



---

# **Implementing the National Voter Registration Act of 1993: Requirements, Issues, Approaches, and Examples**

---

**Prepared by:  
The National Clearinghouse on Election Administration  
Federal Election Commission  
Washington, D.C.  
January 1, 1994**



# CONTENTS

---

**PREFACE**

PURPOSES OF THIS DOCUMENT ..... P-1  
 OTHER SOURCES OF INFORMATION ..... P-2

**INTRODUCTION**

OVERALL PURPOSES OF THE NATIONAL  
 VOTER REGISTRATION ACT ..... I-1  
 HISTORY OF THE NATIONAL VOTER REGISTRATION ACT ..... I-3  
 KEY DEFINITIONS ..... I-4

**CHAPTER 1 - GENERAL PROVISIONS**

THE NONAPPLICABILITY OF THIS LAW TO CERTAIN STATES ..... 1-2  
 THE EFFECTIVE DATES OF THE NVRA ..... 1-2  
 THE RELATIONSHIP OF THE NVRA TO THE  
 VOTING RIGHTS ACT ..... 1-2  
 THE ROLE OF FEDERAL AGENCIES ..... 1-3  
 THE DESIGNATION AND ROLE OF A STATE OFFICER TO  
 COORDINATE RESPONSIBILITIES UNDER THE LAW ..... 1-5  
 THE ROLE OF THE LOCAL REGISTRATION OFFICIAL ..... 1-6  
 THE COMPUTERIZATION OF VOTER REGISTRATION FILES ..... 1-7  
 THE DESIGN OF ALL REQUISITE FORMS IN LIGHT  
 OF THE NEEDS OF CERTAIN SPECIAL POPULATIONS ..... 1-8

**CHAPTER 2 - MOTOR VOTER REGISTRATION PROVISIONS**

IMPORTANT ISSUES IN MOTOR VOTER REGISTRATION ..... 2-1

- The Form to Be Used In the Motor Voter Registration Process ----- 2-2
  - Format of the Form ----- 2-2
  - Data Elements Required ----- 2-3
  - Information and Attestation Items ----- 2-3
- A Declination to Apply For Voter Registration  
 in a Motor Vehicle Office ----- 2-4
- The Form to Be Used In the Driver's License  
 Change of Address Process ----- 2-4

- Format of the Form ----- 2-5
- Data Elements Required ----- 2-5
- A Renewal of a Driver’s License ----- 2-5
- The Transmittal of Motor Voter Registration Applications ----- 2-6
- Administering a Motor Voter Program ----- 2-6
  - Putting Someone in Charge ----- 2-7
  - Training Motor Vehicle Employees ----- 2-7
  - Accountability of Forms ----- 2-7
- APPROACHES TO MOTOR VOTER REGISTRATION PROGRAMS ..... 2-8
- SAMPLE MOTOR VOTER REGISTRATION FORMS ..... 2-11

**CHAPTER 3 - MAIL REGISTRATION PROVISIONS**

- IMPORTANT ISSUES IN MAIL REGISTRATION ..... 3-2
  - The Content and Format of the Mail Registration Form(s) ----- 3-2
    - Data Elements ----- 3-2
    - Information and Attestation Items ----- 3-4
    - Size , Weight, and Color ----- 3-4
    - Needs of Special Populations ----- 3-5
    - Layout ----- 3-5
  - The Transmittal of Mail Registration Applications ----- 3-5
    - In Person By the Registrant ----- 3-6
    - In Person By a Third Party ----- 3-6
    - Through the Postal System ----- 3-6
  - Administering a Mail Registration Program ----- 3-6
    - Accountability of Forms ----- 3-7
    - Postal Markings and Indicia ----- 3-7
    - Distinction Between a Verification Mailing  
and an Acknowledgment Notice ----- 3-7
- SAMPLE MAIL REGISTRATION FORMS ..... 3-9

**CHAPTER 4 - AGENCY REGISTRATION PROVISIONS**

- IMPORTANT ISSUES IN AGENCY REGISTRATION ..... 4-2
  - Selecting Agencies as Voter Registration Sites ----- 4-2
    - Public Assistance Offices ----- 4-2
    - Offices That Operate State-funded Programs Primarily  
Engaged in Providing Services to Persons with Disabilities ----- 4-3
    - Other Offices ----- 4-3
    - Armed Forces Recruitment Offices ----- 4-4
  - The Form To Be Used in Applying for Voter Registration  
in an Agency ----- 4-4

- Format of the Form ----- 4-5
- The Content of the Form ----- 4-5
- Declining to Apply for Voter Registration in an Agency ----- 4-6
  - The Content of the Declination ----- 4-6
  - The Format of the Declination ----- 4-7
  - The Confidentiality of the Declination ----- 4-7
- The Transmittal of Agency Registration Applications ----- 4-8
- Administering an Agency Registration Program ----- 4-9
  - Putting Someone in Charge ----- 4-9
  - Training Agency Employees ----- 4-9
  - Accountability of Forms ----- 4-9

**CHAPTER 5 - VOTER REGISTRATION LIST MAINTENANCE PROVISIONS**

**IMPORTANT ISSUES IN VOTER REGISTRATION LIST MAINTENANCE ..... 5-3**

- The Date by Which Valid Voter Registration Applications  
Must Be Accepted ----- 5-4
- The Rules for Removing Names from the Voter Registration List ----- 5-4
  - No Removal for Failure to Vote ----- 5-5
  - No Removal for Change of Address within the  
Registrar’s Jurisdiction ----- 5-5
  - Removal by Request of the Registrant ----- 5-5
  - Removal for Mental Incapacity ----- 5-6
  - Removal for Criminal Conviction ----- 5-6
  - Removal by Reason of Death ----- 5-7
  - Removal by Reason of a Written Confirmation of a  
Change of Address Outside the Registrar’s Jurisdiction ----- 5-7
  - Removal for Failure to Respond to Certain Confirmation  
Mailings and Failure to Offer to Vote in Any Election  
within Two Subsequent General Federal Elections ----- 5-8
- The Rule for Changing a Registrant’s Address Information ----- 5-9
- Administering the File Maintenance Program ----- 5-10
  - Ensuring Uniformity and Compliance with the  
Voting Rights Act ----- 5-11
  - Addressing Confirmation Notices ----- 5-12
  - Monitoring “Inactive” Voters ----- 5-12
  - Identifying Duplicate Registrations ----- 5-14
  - The Deadline for Completing List Maintenance Activities ----- 5-15
  - The Accountability of List Maintenance Activities ----- 5-15
  - Putting Someone in Charge ----- 5-16
  - Training Local Registration Officials ----- 5-16

**APPROACHES TO DESIGNING A PROGRAM FOR MAINTAINING AN ACCURATE AND CURRENT VOTER REGISTRATION LIST**..... 5-16

- Making Individual or “Spot” Changes to the Voter Registration List ---5-17
- Mass Confirmation Mailings -----5-19
  - The National Change of Address (NCOA) Program-----5-19
  - A First Class Mailing to All Registrants -----5-21
- Targeted Confirmation Mailings -----5-22
- Door-to-Door Canvass-----5-23

**FORMS NEEDED FOR VOTER REGISTRATION LIST MAINTENANCE**..... 5-24

- The Format and Content of the Acknowledgment Notice to All Applicants -----5-24
  - The Format of the Acknowledgement Notice -----5-24
  - The Content of the Acknowledgement Notice-----5-26
- The Format and Content of the Outgoing Confirmation Mailing(s) -----5-27
  - The Format of the Outgoing Confirmation Mailing -----5-27
  - The Content of the Outgoing Confirmation Mailing -----5-27
- The Format and Content of Confirmation Return Notices -----5-30
  - The Format of the Confirmation Return Notice-----5-30
  - The Content of the Confirmation Return Notice -----5-31
- The Format and Content of the Final Notice of Removal -----5-32
  - The Format of the Final Notice of Removal -----5-32
  - The Content of the Final Notice of Removal -----5-33

**SAMPLE FORMS USED IN LIST MAINTENANCE**..... 5-35

**CHAPTER 6 - FAIL-SAFE VOTING PROVISIONS**

**IMPORTANT ISSUES IN FAIL-SAFE VOTING** ..... 6-1

- Who Is Entitled to Vote Under the Fail-Safe Voting Provisions ----- 6-1
  - Those Who Have Failed to Respond to a Confirmation Mailing Triggered by Information Indicating that They May No Longer Reside within the Registrar’s Jurisdiction but Who Continue to Reside in the Jurisdiction ----- 6-2
  - Those Who Have Failed to Respond to a Confirmation Mailing Triggered by Information Indicating that They Moved within the Registrar’s Jurisdiction ----- 6-2
  - Those Who Have Not Been Sent a Confirmation Mailing but Have Moved within the Same Precinct ----- 6-3
  - Those Who Have Not Been Sent a Confirmation Mailing but Have Moved from One Precinct to Another within the Same Registrar’s Jurisdiction ----- 6-3

- Those Who Have Not Been Sent a Confirmation Mailing and Have Not Moved but the Registration Records Say They Have ----- 6-3
- Where They Are Entitled to Vote ----- 6-3
  - Designating the Old Polling Place ----- 6-5
  - Designating the New Polling Place ----- 6-5
  - Voters Who Go to the Wrong Polling Place ----- 6-6
- How They May Cast Their Ballots ----- 6-7
  - Affirmation Versus Confirmation ----- 6-7
  - A Provisional Ballot Versus a Regular Ballot ----- 6-7
  - A Limited Ballot Versus a Full Ballot ----- 6-8
- Recording and Transmitting Election Day Changes to the Central Voter Registration List ----- 6-9
- Administering Fail-Safe Voting Procedures ----- 6-10
  - Procedures for Determining the Eligibility of Fail-Safe Voters ----- 6-10
  - An Effective Public Information Program ----- 6-11
  - Training Poll Workers ----- 6-11
- SAMPLE FORMS FOR USE IN FAIL-SAFE VOTING ..... 6-13

**CHAPTER 7 - RECORD KEEPING AND REPORTING REQUIREMENTS**

- RECORD KEEPING REQUIREMENTS SPECIFIED IN THE LAW ..... 7-1
- RECORD KEEPING IMPLIED BY THE REPORTING REQUIREMENTS ..... 7-2
- OTHER RECORDS THAT ELECTION OFFICIALS MAY WISH TO KEEP ..... 7-4
- IMPORTANT ISSUES IN RECORD KEEPING ..... 7-5

**APPENDICES:**

- A THE NATIONAL VOTER REGISTRATION ACT OF 1993
- B THE HOUSE COMMITTEE REPORT ON THE ACT
- C THE SENATE COMMITTEE REPORT ON THE ACT
- D THE JOINT CONFERENCE COMMITTEE REPORT ON THE ACT
- E DIRECTORY OF FEDERAL AGENCIES
- F EXPEDITING OFFICIAL ELECTION MAILINGS
- G OTHER PUBLICATIONS AVAILABLE
- H A DIRECTORY OF STATE ELECTION OFFICIALS, DRIVER'S LICENSE OFFICIALS, WELFARE OFFICIALS, AND NATIONAL DISABILITY SERVICE ORGANIZATIONS







## PREFACE

---

This document was prepared by the Federal Election Commission (FEC) pursuant to 2 U.S.C. 438(a)(10) which requires the Commission to “serve as a national clearinghouse for the compilation of information and review of procedures with respect to the administration of Federal elections.” In addition, the National Voter Registration Act of 1993 (NVRA) mandates that the FEC “provide information to the States with respect to the responsibilities of the States under this Act” [Section 9(a)(4)] while Section 9 of the Joint Conference Committee Report on the NVRA states that “the conferees expect the Commission to play an advisory role to the States and to facilitate the exchange of information among the States.”

The purposes of this document are:

- to describe the requirements of the National Voter Registration Act (NVRA) of 1993 [Public Law 103-31, 42 U.S.C 1973gg et seq.]
- to identify the important issues relating to State implementation strategies and conforming State legislation, and
- to offer examples, where appropriate and available, of forms and procedures that have proved successful in jurisdictions around the nation.

It is very important to note, however, that the Federal Election Commission does *not* have legal authority either to interpret the Act or to determine whether this or that procedure meets the requirements of the Act. Indeed, the civil enforcement of the Act is specifically assigned to the Department of Justice.

**THIS DOCUMENT, THEN, IS INTENDED ONLY AS A GENERAL REFERENCE TOOL. ANY SUGGESTIONS CONTAINED IN THIS DOCUMENT ARE PURELY HEURISTIC AND ARE OFFERED WITHOUT FORCE OF LAW, REGULATION, OR ADVISORY OPINION. NO DECISION REGARDING THE IMPLEMENTATION OF ANY FORMS, PROCEDURES, OR CONFORMING STATE LEGISLATION SHOULD BE MADE ON THE BASIS OF THIS DOCUMENT ALONE. SUCH DECISIONS SHOULD BE MADE ONLY AFTER CONSULTATION WITH YOUR STATE LEGAL AUTHORITY.**

---

## **OTHER SOURCES OF INFORMATION**

---

In addition to this document, there are a number of other publications available on various provisions of the National Voter Registration Act. A list of these appears in Appendix G.

By the same token, certain State election, driver's license, welfare and disability offices may prove to be valuable resources. A list of these officials, who are occasionally referred to in the text, appears in Appendix H.

A directory of federal agencies related to the requirements of the Act is provided in Appendix E.



## INTRODUCTION

---

The overall objectives of the National Voter Registration Act of 1993 (NVRA) are:

- to establish procedures that will increase the number of eligible citizens who register to vote in elections for Federal office
- to protect the integrity of the electoral process by ensuring that accurate and current voter registration rolls are maintained, and
- to enhance the participation of eligible citizens as voters in elections for Federal office [Section 2(b)].

The Act pursues these objectives by:

- expanding the number of locations and opportunities whereby eligible citizens may apply to register to vote
- requiring voter registration file maintenance procedures that, in a uniform and nondiscriminatory manner, identify and remove the names of only those individuals who are no longer eligible to vote, and
- providing certain “fail-safe” voting procedures to ensure that an individual’s right to vote prevails over current bureaucratic or legal technicalities.

### **Expanding the Number of Locations and Opportunities Whereby Eligible Citizens May Apply to Register to Vote**

The locations and opportunities for eligible citizens to apply for voter registration have heretofore varied widely throughout the States. Based on two decades of State experimentation, however, evidence suggests that expanding the number of locations and opportunities for voter registration results in increased registration.

Accordingly, the Act requires that individuals be given an opportunity to apply for voter registration in elections for federal offices when they are applying for or renewing a driver’s license, when they are applying at certain other public offices, and by mail. The reasoning behind these provisions can be found in the legislative history of the Act.

Driver’s license offices were selected on the basis of statistics from the Department of Transportation indicating that approximately 87% of persons eighteen years and older have driver’s licenses while an additional three or four percent have, in lieu of

a driver's license, an identification card issued by the State motor vehicle agency. Moreover, several States have already adopted a version of this "motor voter" approach [Hse. Rpt., page 4].

Public assistance and other public agencies were selected in order to ensure that "the poor and persons with disabilities who do not have driver's licenses" will "not be excluded from those for whom registration will be convenient and readily available" [Conf. Stat., page 19].

And finally, "[s]ince registration by mail was already in place in approximately half the states, and there was substantial evidence that this procedure not only increased registration but successfully reached out to those groups most under-represented on the registration rolls, this method of registration was considered appropriate as a national standard" [Hse. Rpt., page 4].

"By combining the driver's license application approach with mail and agency-based registration, the Committee felt that any eligible citizen who wished to register would have ready access to an application" [Hse. Rpt., page 5].

**Requiring Voter Registration File Maintenance Procedures That, in a Uniform and Nondiscriminatory Manner, Identify and Remove the Names of Only Those Individuals Who Are No Longer Eligible to Vote**

While expanding voter registration opportunities, the House Committee "felt strongly that no legislative provision should be considered that did not at least maintain the current level of fraud prevention" [Hse. Rpt., page 5]. But at the same time, one of the purposes of the Act is "to ensure that once a citizen is registered to vote, he or she should remain on the list so long as he or she remains eligible to vote in that jurisdiction" [Sen. Rpt., page 17].

Accordingly, the Act requires States to "conduct a program to maintain the integrity of the rolls" [Sen. Rpt., page 18]. Any such program, however, "may not remove the name of a voter from the list of eligible voters by reason of a person's failure to vote. States are permitted to remove the names of eligible voters from the rolls at the request of the voter or as provided by State law by reason of mental incapacity or criminal conviction. In addition, States are required to conduct a general program that makes a reasonable effort to remove the names of ineligible voters from the official lists by reason of death or change of residence" [Sen. Rpt., page 18].

Mindful that list cleaning can sometimes be abused, however, the Act requires that any such program be "uniform, nondiscriminatory, and in compliance with the Voting Rights Act of 1965..."[Section 8(b)(1)]. "The purpose of this requirement is to prohibit selective or discriminatory purge programs."

"The term 'uniform' is intended to mean that any purge program or activity must be applied to an entire jurisdiction. The term 'nondiscriminatory' means that the procedure complies with the requirements of the Voting Rights Act of 1965" [Hse. Rpt., page 15].

## **Providing Certain “Fail-Safe” Voting Procedures in Order to Ensure That an Individual’s Right to Vote Prevails over Current Bureaucratic or Legal Technicalities**

Heretofore, registrants were sometimes denied the right to vote on election day either because of some oversight on their part or even because of some clerical error by the election office. Registrants who changed residence within the registrar’s jurisdiction, for example, often mistakenly assumed they were still entitled to vote — only to discover on election day that their failure to re-register from their new address disenfranchised them. Similarly, registrants who may have failed to receive or return certain election office mailings were often purged from the lists. Even clerical errors, such as an erroneous change of address in the registration files, often resulted either in the loss of the right to vote or else in an elaborate and daunting bureaucratic ordeal.

In order to solve such problems, the Act permits certain classes of registrants to vote despite bureaucratic or legal technicalities. The Congress incorporated these “fail-safe” provisions based on the principle that “once registered, a voter should remain on the list of voters so long as the individual remains eligible to vote in that jurisdiction” [Hse. Rpt., Section 8, page 18].

## **THE HISTORY OF THE NATIONAL VOTER REGISTRATION ACT**

---

The history of the National Voter Registration Act began in the 1970’s when some of its key provisions — motor voter registration, agency registration, and mail registration — were first separately introduced in Congress. Its current comprehensive form, however, dates back to 1989 when Representative Al Swift of Washington introduced H.R.2190 in the House of Representatives and Senator Wendell Ford of Kentucky introduced a companion bill S.874 in the Senate. Although H.R.2190 passed the House in 1990, the Senate took no action on either H.R.2190 or S.874.

In 1991, Senators Ford and Hatfield introduced S.250 which closely resembled the previous S.874. Although S.250 passed both the Senate and the House a year after its introduction, President Bush vetoed the legislation. Lacking a veto-overriding majority in both the Senate and the House, the legislation died.

S.250 was resurrected, however, on January 5, 1993 as H.R.2, introduced by Representative Al Swift and others. In virtually every respect, H.R.2 and its Senate companion, S.460, introduced by Senator Wendell Ford were identical to S.250.

The House of Representatives passed H.R.2 on February 4, 1993 by a vote of 259 to 160. The Senate passed H.R.2 with some amendments on March 17, 1993 by a vote of 62 to 37. The Joint Conference Committee version of H.R.2, retaining some but

not all of the Senate amendments, passed the House on May 5, 1993 by a vote of 259 to 164 and the Senate on May 11, 1993 by a vote of 62 to 36. On May 20, 1993, President Bill Clinton signed the National Voter Registration Act of 1993 into law [Public Law 103-31, 42 U.S.C. 1973gg et seq.].

A copy of the law is provided in Appendix A and is frequently referenced throughout this document.

In trying to understand the requirements of the law, it is immensely helpful to understand the Congressional intent behind each provision. We have therefore appended to this document copies of the House Committee Report (Appendix B, cited in our text as "Hse Rpt"), the Senate Committee Report (Appendix C, cited as "Sen Rpt"), and the Joint Conference Committee Statement (Appendix D, cited as "Conf Stat").

These documents may be useful in determining the Congressional intent behind specific sections of the law. It should be noted, however, that the language in the House and Senate reports is not controlling if the provisions discussed were amended prior to final passage. It is wisest to first consult the Conference Statement which discusses amendments proposed subsequent to the reports.

In determining the intent of the Congress, readers may also want to consult the floor debates in the Congressional Record which, for reasons of space, this report does not provide.

## KEY DEFINITIONS

---

Different usages in different States suggest the need to define the terms used in this document. Accordingly:

### Terms Defined in the Act

**election** - Section 3(1) of the Act gives the term the same meaning as that stated in section 301(1) of the Federal Election Campaign Act of 1971 (2 U.S.C. 431(1)).

"Election", therefore, means:

- a general, special, primary, or run-off election;
- a conventions or caucus of a political party which has authority to nominate a candidate;
- a primary election held for the selection of delegates to a national nominating convention of a political party; and
- a primary election held for the expression of a preference for the nomination of individuals for election to the office of President.



**Federal office** - Section 3(2) of the NVRA gives the term the same meaning as that stated in Section 301(3) of the Federal Election Campaign Act of 1971 (2 U.S.C. 431(3)). "Federal office", therefore means "the office of President or Vice President, or of Senator or Representative in, or Delegate or Resident Commissioner to, the Congress".

**motor vehicle driver's license** - Section 3(3) of the Act defines this term to include "any personal identification document issued by a State motor vehicle authority".

**registrar's jurisdiction** - Section 8(j) of the Act defines this term to mean "(1) an incorporated city, town, borough, or other form of municipality; (2) if voter registration is maintained by a county, parish, or other unit of government that governs a larger geographic area than a municipality, the geographic area governed by that unit of government; or (3) if voter registration is maintained on a consolidated basis for more than one municipality or other unit of government by an office that performs all of the functions of a voting registrar, the geographic area of the consolidated municipalities or other geographic units."

**State** - Section 3(4) of the Act defines this term to mean "a State of the United States and the District of Columbia".

**voter registration agency** - Section 3(5) of the Act defines this term to mean "an office designated under [the provisions of the Act] to perform voter registration activities".

### **Terms Defined in the Congressional Reports**

**nondiscriminatory** - procedures complying with the Voting Rights Act of 1965. [Hse. Rpt., page 15 and Sen. Rpt., page 31].

**request of the registrant** - Section 8(a)(3) of the NVRA provides that, among other reasons, the name of a registrant can be removed from the official list of eligible voters upon the "request of the registrant". The term "request of the registrant" is defined in the House and Senate Reports to include "actions that result in the registrant being registered at a new address, such as registering in another jurisdiction or providing a change-of-address notice through the driver's license process that updates the voter registration." [Hse. Rpt., pages 14-15 and Sen. Rpt., page 33].

**State election officials & appropriate State election official** - these terms refer to "whatever election official under State law has the appropriate responsibility for the administration of voter registrations and elections. In some cases, this may be a local election official." [Hse. Rpt., page 8 and Sen. Rpt., page 24].

**uniform** - the term "uniform" is "intended to mean that any purge program or activity must be applied to an entire jurisdiction" [Hse. Rpt., page 15 and Sen. Rpt., page 31].

**Terms Defined Solely by the Federal Election Commission  
for the Purpose of This Publication**

**acknowledgment notice** - this term describes the product of Section 8(a)(2) of the NVRA, which requires the registration official “to send notice to each applicant of the disposition of the [voter registration] application.”

**affirmation** - an assertion or formal declaration not under oath and not requiring corroboration or verification.

**confirmation** - an attestation, possibly under oath, that requires some form of corroboration or verification.

**confirmation mailing** - this term describes the outgoing mailing, sent by forwardable mail in accordance with the provisions of Sections 8(c)(1)(B) and 8(d)(1) & (2) of the Act, to registrants who may have changed their address, and which includes a postage pre-paid and pre-addressed return card by which the registrant may verify or correct the address, or confirm that he or she has moved outside of the jurisdiction.

**precinct** - for the purposes of this document, this term refers to the area covered by a polling place. (It is understood that a single physical facility — such as a school, a courthouse, a stadium, or the like — may serve more than one precinct. In such cases, however, the same facility also typically contains separate polling places — eg. separate rooms or tables — at which people from the different precincts vote. By this definition, such separate rooms or tables constitute different polling places even though they are within the same facility. Thus, it is the area served by the *polling place* that counts, not the area served by the physical facility. It is therefore possible that the new polling place for registrants who have moved from one precinct to another might simply be a different room in the same physical facility as their old polling place.)

**verification mailing** - this term refers to mailings, neither specifically prohibited nor specifically required by the NVRA, sent out in some jurisdictions to confirm the eligibility of a voter registration applicant *before* the applicant's name is added to the list of registered voters.



## **CHAPTER 1**

# **GENERAL PROVISIONS OF THE NVRA**

---

The National Voter Registration Act of 1993 requires that individuals be given an opportunity to apply for voter registration (or to update their voter registration data) in elections for federal office

- when applying for or renewing a driver's license
- when applying for (or receiving) certain types of public assistance and other services
- by mail, using either an appropriate State form or else a national form, and
- at military recruiting offices.

It also eliminates purging voters' names from the voter registration list solely for failure to vote and requires a program for positively confirming the accuracy and currency of the registration list.

Finally, it provides certain fail-safe mechanisms to ensure that the right to vote prevails over current bureaucratic or legal technicalities.

Although the following chapters below examine these specific requirements of the law in some detail, there are five general provisions of the law that warrant brief mention at the outset:

- the nonapplicability of this law to certain States
- the effective dates of the law
- the relationship of this law to the Voting Rights Act of 1965, as amended
- the role of federal agencies, and
- the designation and role of a State officer or employee as the chief election official to be responsible for coordination of State responsibilities under the law.

In addition, the provisions of the NVRA have certain implications regarding:

- the role of local registration officials
- the computerization of voter registration files
- the design of all requisite forms in light of the needs of certain special populations.

---

## **THE NONAPPLICABILITY OF THIS LAW TO CERTAIN STATES**

---

The NVRA specifically exempts any State in which voter registration for federal elections is not required — provided that such a law was in effect on and after March 11, 1993 [Section 4(b)(1)]. It further exempts any State that permits, in federal elections, election day registration at the polls — provided that such a law was continuously in effect after March 11, 1993 or else came into effect upon the enactment of the NVRA [Section 4(b)(2)].

Although the Federal Election Commission does not have the legal authority to determine whether or not any State is exempt from the provisions of the NVRA, it is our current understanding that: North Dakota considers itself exempt inasmuch as they do not require voter registration; Minnesota and Wisconsin consider themselves exempt inasmuch as they have election day registration at the polls predating March 11, 1993; Wyoming considers itself exempt because they enacted legislation prior to March 11, 1993 authorizing election day registration at the polls upon the enactment of the NVRA; and Maine does not consider itself exempt inasmuch as election day registration at the polls is not universal throughout the State.

---

## **THE EFFECTIVE DATES OF THE NVRA**

---

In most States, the effective date of the NVRA will be January 1, 1995 [Section 13(2)]. But some States may have to amend their State constitutions in order to pass conforming State legislation. In these States, the effective date is extended to either January 1, 1996 or else to 120 days after the date by which a constitutional amendment would have been legally possible without having to hold a special election (whichever of these two dates is the later) [Section 13(1)]. The reason for the complex language in the law is that in some States a constitutional amendment requires passage in two successive legislative sessions separated by a general election.

Again, the Federal Election Commission has no legal authority to determine which States require constitutional amendments. States must decide that for themselves based on the particular nature of their conforming legislation.

---

## **THE RELATIONSHIP OF THE NVRA TO THE VOTING RIGHTS ACT**

---

The National Voter Registration Act of 1993 is specifically intended to complement rather than contradict the Voting Rights Act of 1965. Section 11(d)(1) reads in part “neither the rights and remedies established by this section nor any other provision of this Act shall supersede, restrict, or limit the application of the Voting Rights Act

of 1965 (42 U.S.C. 1973 et seq.).” Section 11(d)(2) reads “Nothing in this Act authorizes or requires conduct that is prohibited by the Voting Rights Act of 1965 (42 U.S.C. 1973 et seq.).”

A spokesperson from of the Civil Rights Division of the Department of Justice emphasized three important consequences of these provisions at the Federal Election Commission’s conference on the National Voter Registration Act in June of 1993.

First, Section 2 of the Voting Rights Act prohibits any State or political subdivision from imposing or applying election laws or procedures which discriminate against individuals on account of race, color, or language minority status [42 U.S.C. 1973]. It follows, then, that any laws or procedures that States may adopt pursuant to the requirements of the NVRA must be nondiscriminatory in both intent and effect.

Second, the Voting Rights Act requires certain covered jurisdictions to provide registration and voting materials and oral assistance in the language of qualified language minority groups as well as in English [42 U.S.C. 1973aa-1a and 1973b(f)(4)]. It follows, then, that jurisdictions covered by this provision must extend such services through appropriate motor vehicle offices and public assistance agencies that will be providing voter registration under the terms of the NVRA. These language minority requirements also extend to the voter registration forms and, indeed, to all other requisite forms and voter registration activities in the covered jurisdictions.

Third, the Voting Rights Act prohibits certain States and political subdivisions from using new election laws and procedures without preclearance from the U.S. Attorney General or from the U.S. District Court for the District of Columbia [42 U.S.C 1973c]. The purpose of this requirement, commonly referred to as Section 5, is to prevent the implementation of voting changes that have the purpose or will have the effect of denying or abridging the right to vote on account of race, color, or membership in a language minority group. Jurisdictions covered by this provision will therefore have to preclear any changes in their election laws and procedures even though those changes are made in order to comply with the NVRA.

## **THE ROLE OF FEDERAL AGENCIES**

---

The Act directly involves four federal agencies and indirectly involves at least two others (the appropriate offices within these agencies are listed in Appendix E).

The *Department of Justice* (DOJ) is involved with the Act in that:

- It is responsible for the civil enforcement of the Act in that “The Attorney General may bring a civil action in an appropriate district court for such declaratory or injunctive relief as is necessary to carry out this Act” [Section 10(a)]. It is likely

that this responsibility will be undertaken by the Voting Section of the DOJ's Civil Rights Division.

- the Act prescribes certain criminal penalties whose enforcement, we understand, falls within the domain of the Election Crimes Branch of the DOJ's Criminal Division [Section 12].
- the Act requires U.S. Attorneys to provide certain information regarding felony convictions to the chief election officials of the States.

The *Federal Election Commission* (FEC) is required by the Act to:

- “provide information to the States with regard to the responsibilities of the States under this Act” [Section 9(a)(4)]
- develop, in consultation with the chief election officers of the States, “a mail voter registration application form for elections for Federal office” [Section 9(a)(2)]
- submit biennial reports to the Congress “assessing the impact of this Act on the administration of elections for Federal office during the preceding 2-year period and including recommendations for improvements in Federal and State procedures, forms, and other matters affected by this Act” [Section 9(a)(3)]
- “prescribe, in consultation with the chief election officers of the States, such regulations as are necessary to carry out [the development of the form and the reporting to the Congress described immediately above]” [Section 9(a)(1)].

But again, it is very important to note that although the FEC can provide information through its National Clearinghouse on Election Administration, it does *not* have legal authority either to interpret the Act or to determine whether this or that form or procedure meets the requirements of the Act. Such determinations must be made by the States in consultation with the State Attorney General.

The *U.S. Postal Service* is involved with the Act in two respects:

- the Act specifically encourages States to use the National Change of Address (NCOA) files (made available through licensees by the Postal Service) for the purpose of identifying registrants who have changed address [Section 8(c)(1)(A)]. The NCOA program manager and the licensees are identified in Appendix E.
- the Act also provides for special postal rates for certain required mailings. Local election officials might also want to anticipate the need to coordinate mailings through their local postmasters.

The Act specifically requires that each State and the *Secretary of Defense* jointly develop voter registration application procedures at Armed Forces recruitment offices. It is our understanding that this responsibility will be undertaken by the Federal Voting Assistance Program in the Department of Defense whose address and telephone number are provided in Appendix E.

In addition to the four federal agencies directly involved, the Act tangentially involves the *Department of Health and Human Services* as well as the *Department of Agriculture* inasmuch as these departments administer many of the public assistance agencies that must provide voter registration services in accordance with Section 7 of the Act (see Chapter 4). The appropriate national offices are identified in Appendix E.

Finally, it should be noted that the Act specifically requires “all departments, agencies, and other entities of the executive branch of the Federal Government” to cooperate with the States in carrying out the agency registration provisions contained in Section 7(a).

## **THE DESIGNATION AND ROLE OF A STATE OFFICER TO COORDINATE STATE RESPONSIBILITIES UNDER THE LAW**

---

The Act requires each State to “designate a State officer or employee as the chief State election official to be responsible for coordination of State responsibilities under this Act” [Section 10]. It does not, however, specify how or even when this designation is to be made. Most States are likely to designate a responsible State official in their conforming legislation. (In the interim, the Federal Election Commission will continue working with the chief election officials or chief registration officials of the States unless some other State officer is designated).

The Act further assigns the chief State election official the duty of making national and State mail registration forms “available for distribution through governmental and private entities, with particular emphasis on making them available for organized voter registration programs” [Section 6(b)].

Finally, the Act designates the chief State election official as the recipient of notices from the United States attorneys regarding felony convictions in federal courts of any persons who claim residence in the State [Section 8(g)(1)]. And should such a conviction have a bearing on the person’s eligibility to be a registered voter in that State, the Act requires the chief State election official to notify the voter registration official of the local jurisdiction in which the offender resides [Section 8(g)(5)].



As a practical matter, although not addressed in the Act, States might also want to consider assigning the chief State election official related responsibilities including but not limited to:

- receiving and forwarding notices from State courts regarding felony convictions (if appropriate) as well as declarations of disqualifying mental incapacity
- receiving and forwarding notices from State bureaus of vital statistics regarding deaths
- receiving and forwarding some or all voter registration applications from motor vehicle offices, public assistance agencies, and by mail (especially national mail registration applications)
- receiving and forwarding notices from local jurisdictions regarding the cancellation of a new registrant's prior registration
- designing all forms and procedures requisite under the NVRA
- training all local election officials regarding the forms and procedures,
- receiving and compiling reports from the local election officials pursuant to the FEC's reporting regulations and, in turn, forwarding the compilations to the FEC.

## **THE ROLE OF THE LOCAL REGISTRATION OFFICIAL**

---

A principal objective of the National Voter Registration Act is to expand the number and range of locations where citizens may obtain and complete a voter registration application. The House Report makes it quite clear, however, that although completing a voter registration application may be *simultaneous* with other transactions, such an application does not constitute *automatic* registration. Indeed, "[o]nly the election officials designated and authorized under State law are charged with the responsibility to enroll eligible voters on the list of voters. This bill should not be interpreted in any way to supplant that authority. The Committee is particularly interested in ensuring that election officials continue to make determinations as to applicant's eligibility, such as citizenship, as are made under current law and practice" [Hse Rpt Section 5, page 8].

In other words, an application received by the local voter registration official is *only* an application and may be subject to whatever verification procedures are currently applied to all applications. By the same token, any subsequent challenge to the eligibility of a registrant would appear to fall within the domain of the local registration official in accordance with current State laws and practices.

## **THE COMPUTERIZATION OF VOTER REGISTRATION FILES**

---

Although the National Voter Registration Act does not require the computerization of voter registration files, computerization would greatly facilitate the carrying out of many of its provisions — especially those related to using the Postal Service National Change of Address files, confirmation mailings, record keeping, and the transmittal of information from State to local election offices.

Local jurisdictions that have not yet computerized their voter registration files might therefore want to take this opportunity to do so. Indeed, the Federal Election Commission has been advised that small to medium sized jurisdictions could obtain the requisite computer hardware for as low as \$2,500.

By the same token, States that do not currently operate a statewide computerized voter registration file might want to begin considering one.

State and local jurisdictions that are already computerized may want to pay particular attention to the following issues:

- the compatibility of your current system, programs, data elements, and protocols (for names, addresses, etc.) with current motor vehicle, agency, and NCOA systems
- the ability of your current system and programs to flag and track registrants designated as “Inactive” until they either return a confirmation card, vote within the specified timeframe, or otherwise provide evidence of continued residence within the jurisdiction
- the ability of your current system to maintain records of outgoing confirmations mailings, return cards, and purge actions
- the ability of your current system either to generate forms or else to complete predesigned forms
- the ability of your current system to designate the origin of the registration application (whether motor vehicle, agency, by mail, or whatever)
- the ability of your current system to print voter registration lists without printing confidential information (such as origin of application or perhaps social security number)
- the ability of your current system to interface with other systems at the State or local levels.

---

## **THE DESIGN OF ALL REQUISITE FORMS IN LIGHT OF THE NEEDS OF CERTAIN SPECIAL POPULATIONS**

---

Several forms are specifically required by the Act while others may be necessary depending on the circumstances in each State.

In designing these forms (and the procedures surrounding their use) States should consider the needs of certain special populations. Of particular concern are:

- the need for those jurisdictions covered by the language minority requirements of the Voting Rights Act to provide forms and services in the appropriate languages.
- the need to meet the type size requirements for the visually impaired (as suggested by the Americans with Disabilities Act), and
- the desirability of meeting the needs of the marginally literate by simplifying both the language and format of the forms.

# VOTER REGISTRATION INTAKE OPTIONS UNDER THE NVRA

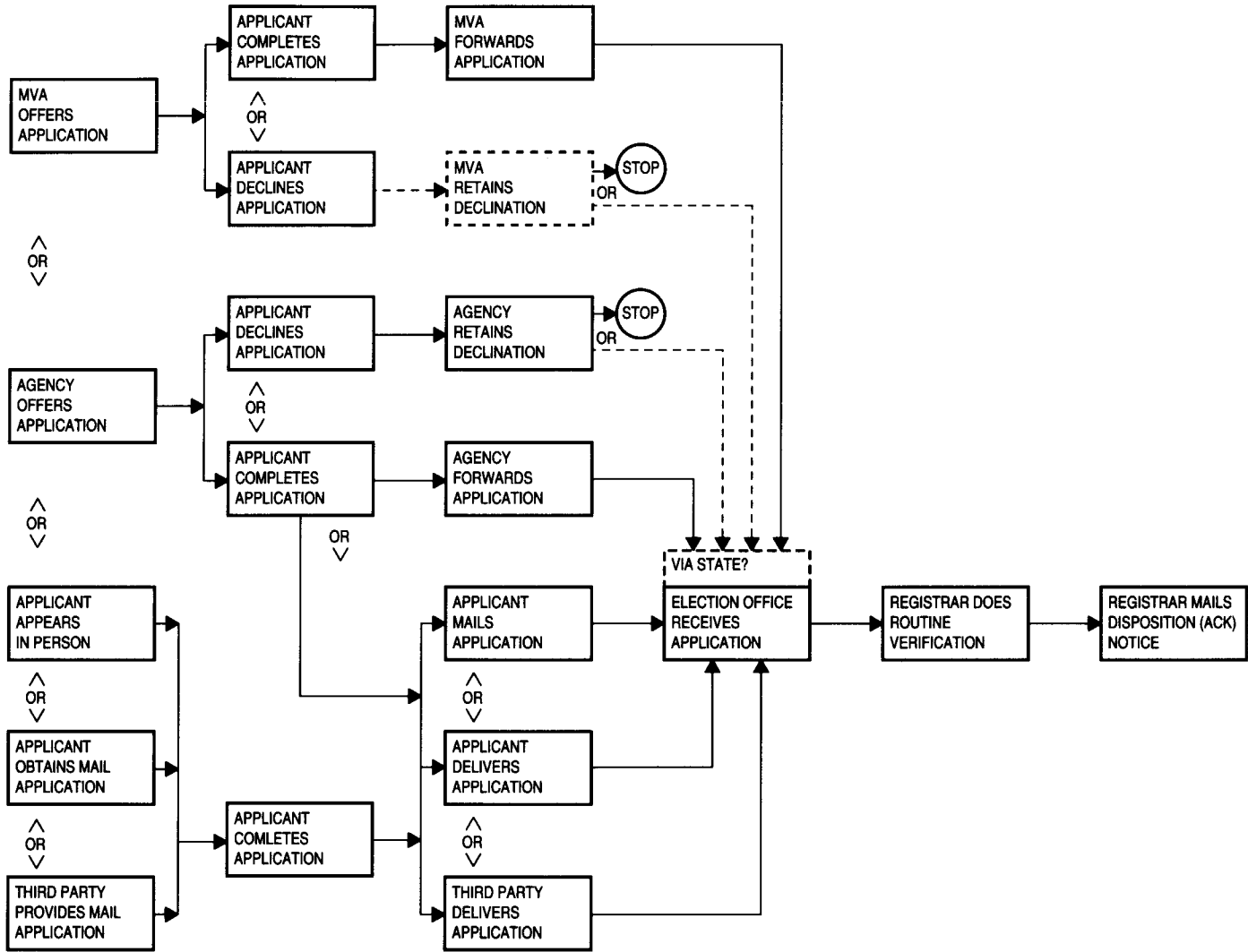





## **CHAPTER 2**

# **MOTOR VOTER REGISTRATION PROVISIONS**

---

The National Voter Registration Act requires that individuals be given an opportunity to register to vote (or to change their voter registration data) in elections for federal office when applying for or renewing a driver's license or other personal identification document issued by a State motor vehicle authority [Section 5(a) with Section 3(3)].

Such individuals may decline the opportunity simply by failing to sign the voter registration application [Section 5(a)(1)]. Information regarding an individual's failure to sign the voter registration application cannot be used for any purposes other than voter registration [Sections 5(b) and 5(c)(2)(D)(ii)].

Similarly, information on the particular motor vehicle *office* where a person registered must remain confidential and be used only for voter registration purposes [Section 5(c)(2)(D)(iii)].

Finally, any change of address submitted for a motor vehicle driver's license shall also serve as a notice of change of address for voter registration purposes unless the individual states on the application that the change of address is not for voter registration purposes [Section 5 (d)].

### **IMPORTANT ISSUES IN MOTOR VOTER REGISTRATION**

---

States should consider the following issues while designing motor voter forms and procedures:

- the form to be used in the motor voter registration process
- a declination to apply for voter registration in a motor vehicle office
- the form to be used in the driver's license change of address process
- the renewal of a driver's license
- the transmittal of voter registration applications from motor vehicle offices to the appropriate election official, and
- administering a motor voter program.

## **The Form to Be Used in the Motor Voter Registration Process**

There are several important aspects to the content and format of the form to be used in the motor voter registration process, including:

- the *format* of the form
- the *data elements* required
- the *information and attestation items*

### ***The Format of the Motor Voter Form***

Section 5(c)(1) of the Act requires that a voter registration application be “part of an application” for a State motor vehicle driver’s license. The House Committee Report amplifies the meaning of this phrase by noting that “the application for voter registration is [to be] simultaneous with an application for a driver’s license [Hse. Rpt., Section 5, page 8]. The House Committee Report further notes that:

Although the Committee would encourage States to adopt a single form for a voter registration application and a motor vehicle driver’s license in order to expedite the process, to minimize the duplication of information, and to establish a truly simultaneous application process, it recognizes that administrative and funding considerations may pose problems for some States. Thus Section 5(c) is so drafted to describe an application process that permits the use of two forms, one for the motor vehicle driver’s license application and one for the voting registration application, thereby avoiding any cost associated with revamping current procedures or computer programs.

The Committee believes that a single combined form will be both more effective and more cost-efficient over the long term, and encourages responsible officials to use such a combined form.

However, where two forms are used, it is expected and intended that such forms will be used simultaneously as part of a single, integrated application process. All applicants appearing at the motor vehicle office must be given an application that includes both forms [Hse. Rpt., Section 5, page 9].

And finally, the House Committee Report recognizes that “in some jurisdictions, the application process is fully computerized. In such cases, any form signed by an applicant during the process shall contain an attestation to the questions on the application...” [Hse. Rpt., Section 5, page 7]. Accordingly, the Act permits voter registration applications to be forwarded from the motor vehicle authority to the appropriate election authority “in machine readable or other format” [Section 5(c)(2)(E)].

The Act appears, then, to afford the States considerable latitude in designing the format of the voter registration application — provided that the opportunity to



register to vote is an integral part of the application for a driver's license. Indeed, according to the House Committee Report:

It is the intent of the Committee that the application procedure should require the affirmative act of an applicant but only after the applicant has received a complete application that includes both the drivers license and voter registration application forms. States are afforded latitude in this section to develop an application which meets the needs of the particular jurisdiction [Hse Rpt, Section 5, page 7].

***The Data Elements Required in a Motor Voter Application***

The law limits the data elements that can be required on a voter registration application in motor vehicle offices to those that are necessary to "prevent duplicate registrations" and (as with State and national mail registration forms) to those that are necessary to "enable State election officials to assess the eligibility of the applicant and to administer voter registration and other parts of the election process [Sections 5(c)(2)(B) and 9(b)(1)].

Moreover, in the case of a combined (or computer generated) motor voter registration form, the voter registration portion "may not require any information that duplicates information required in the driver's license portion of the form (other than a second signature or other information necessary under subparagraph (C))" [Section 5(c)(2)(A)]. (The subparagraph (C) referred to in the quote contains the attestations described immediately below).

As a practical matter (in order to ensure that their motor voter registration forms match their State mail registration forms which, in turn, are constrained by what data elements are requested on the national mail registration form [Section 6(a)(2)]), States that must design or redesign their motor voter registration forms may want to await the promulgation by the Federal Election Commission of what data elements will be required on the national mail registration form (see Chapter 3).

By the same token, States not currently operating a motor voter registration program may want to re-examine the data elements requested in their driver's license application process in light of the information requirements of their voter registration process.

***The Information and Attestation Items to Be Included in a Motor Voter Application***

In addition to the "necessary" data elements discussed immediately above, the law requires certain information and attestation items to appear on motor voter registration forms [Sections 5(c)(2)(C) and 5(c)(2)(D)]. These include:

- each eligibility requirement of the State (including citizenship)
- an attestation that the applicant meets each of these requirements, and
- the signature of the applicant, under penalty of perjury.

Moreover, the voter registration application must also include, in print identical to that used in the attestation portion of the form:

- the penalties provided by law for submitting a false voter registration application
- a statement that if the applicant declines to register to vote, that this decision will remain confidential and be used only for voter registration purposes, and
- a statement that if the applicant does register to vote, information regarding the office to which the application was submitted will remain confidential, again to be used only for voter registration purposes.

States that currently operate entirely computerized, paperless driver's license systems will nevertheless need to develop a document in order to capture the applicant's signature as well as to incorporate the above information either directly or by reference.

### **A Declination to Apply for Voter Registration in a Motor Vehicle Office**

Readers should note that the original House version of the Act required driver's license applicants to decline in writing if they did not wish to register to vote. A Senate amendment, however, provided that the failure of the applicant to sign the voter registration application would suffice as a declination to apply to register.

Because the House accepted the Senate amendment in Conference, all references in the House Committee Report to a "declination in writing" in a motor vehicle office should be ignored since they were superseded by the Conference Committee [Conf. Stat., Section 5, page 17].

It is possible, though, that some motor voter programs might still elicit a declination from applicants (especially programs that are computer based or that have combined forms). In such cases, States will want to decide who should maintain the records of declinations — whether the motor vehicle office or the election office. Nothing in the law requires that information regarding declinations be forwarded to the election office. And as a practical matter, in order to minimize the paper flow and the transmittal burden on motor vehicle agencies, such information might be kept by the motor vehicle agency — provided that it is held confidential pursuant to Sections 5(b) and 5(c)(2)(D)(ii) of the Act.

### **The Form to Be Used in the Driver's License Change of Address Process**

Many States permit licensed drivers to change their address either in person, by mail, or using the same form as an original application without having to re-apply for a license. In such cases, the Act requires that this change of address notification serve as a change of address for voter registration purposes "unless the registrant states on the form that the change of address is not for voter registration purposes" [Section 5(d)]. (Although not required by the Act, States might also want to include motor vehicle change-of-name notifications as a change of name for voter registration purposes).

This provision has ramifications on:

- the *format* of any such change of address form
- the *data elements* required in any such change of address form

***The Format of Any Driver's License Change of Address Form***

Because election officials generally require original signatures on any change to a voter registration record, the format of the driver's license change of address forms should accommodate this need either by forwarding the original form from the motor vehicle office to the election official, by the addition of a perforated separate notice to the election official, or by some sort of multi-ply (carbon or NCR type) form of which the election official would get the original.

***The Data Elements Required on Any Driver's License Change of Address Form***

The provisions of the law combined with the practical requirements of administering voter registration suggest the need for at least the following data elements on any driver's license change of address form:

- a question about whether the change of address is also for voter registration purposes
- name of the registrant
- former residential address
- former mailing address (if different from the former residential address)
- new residential address
- new mailing address (if different from the new residential address)
- signature of registrant
- date of signature

**A Renewal of a Driver's License**

States vary considerably in their manner of renewing driver's licenses. Those States that permit renewals by mail will want to include in their outgoing mailings a voter registration application. Those States employing a renewal process that incorporates a mailing, but requires the individual to appear in person at a motor vehicle office to complete the process (to enable a new license photograph to be taken, etc.) could provide a voter registration application in the outgoing mailing, and/or provide an opportunity for the individual to register to vote at the renewal office itself. Finally, those States that permit renewals by telephone will want to devise procedures that offer applicants an opportunity to receive a voter registration application.

## **Transmittal of Motor Voter Registration Applications to the Appropriate Election Official**

The Act requires that State motor vehicle authorities transmit completed voter registration applications to the appropriate election official within ten (10) days after acceptance, or, if accepted within five (5) days before the close of registration, within five (5) days of acceptance [Section 5(e)]. The Act appears, however, to permit election officials to assume a more active role in the distribution and collection process.

Indeed, in States where motor vehicle jurisdictions are coterminous with election jurisdictions (for example, when they are both administered by county), local election officials might prefer to send a weekly courier to collect all the forms completed in the previous week and, where appropriate, to resupply the agency's stock.

States where motor vehicle jurisdictions are *not* coterminous with election jurisdictions (or where individuals may apply for a driver's license at any motor vehicle office in the State) face a different challenge.

In some cases, States may prefer to have the motor vehicle offices sort completed voter registration forms by election jurisdictions — using postage paid envelopes or pouches that are then forwarded to the appropriate local election officials in those jurisdictions.

In other cases, States may prefer to have some or all voter registration applications forwarded to a central State election authority for sorting and re-routing to the appropriate local election officials.

Nothing in the Act prohibits any of these procedures provided that such voter registration applications are received by the local election official within the ten or five day period prescribed by the Act or else are still accepted by the local election official even though they were received, by virtue of the State's procedure, after the ten or five day period prescribed by the Act.

## **Administering a Motor Voter Program**

With regard to administering a successful motor voter registration program, the Federal Election Commission has available free of charge a publication entitled *Innovations in Election Administration 6: Motor Voter Registration Programs* summarizing the experiences of States that operated such programs prior to the enactment of the NVRA — how they work, problems encountered, recommended practices, and the like.

Three important aspects of administering a motor voter program that warrant consideration here are:

- the need to appoint someone in each motor vehicle driver's license office to be in charge of and responsible for voter registration activities

- the need to train all motor vehicle employees involved with voter registration, and
- the accountability of motor vehicle voter registration forms

### ***Putting Someone in Charge***

Research suggests that one of the principal ingredients of a successful motor voter program is to appoint someone in each motor vehicle office to be in charge of, responsible for, and enthusiastic about all voter registration activities — ensuring an adequate supply of forms (where appropriate), monitoring voter registration activities, training new employees, resolving coordination issues between State or local election officials, and the like. Such a task need not be full time, but it must be continuous.

### ***Training Motor Vehicle Employees***

A second ingredient to a successful motor voter program is the adequate training of all motor vehicle employees involved with voter registration — how to ensure that voter registration forms are completed and signed correctly, how to offer and provide assistance to registrants. After initial training of current employees, the training of new employees can be assumed by the motor vehicle person appointed to be in charge of the program.

### ***The Accountability of Motor Voter Registration Forms***

In monitoring the effectiveness of motor voter programs, many jurisdictions find it useful to account for the number of registration applications that are received from motor vehicle offices. And such a procedure gains importance in light of the record keeping and reporting requirements pursuant to the Act (see Chapter 7 below).

The manner in which motor voter registration applications can be monitored depends on how the application is taken in motor vehicle offices (see APPROACHES below). If the voter registration application is on a distinctive paper form (such as a combined form or a computer generated form), then monitoring incoming applications from motor vehicle offices is fairly simple. Similarly, purely electronic voter registration applications can be counted electronically.

When motor vehicle offices employ the State mail registration form as their application, maintaining accountability becomes a bit more complex. In such cases, election officials should consider printing or subsequently stamping their mail registration forms with sequential numbers. Sequentially numbering mail registration forms and distributing them in numbered batches to motor vehicle offices provides a basis for monitoring the process without divulging to the public the specific office in which any particular applicant registered. (See also the discussion of the accountability of mail registration forms under Chapter 3 and the accountability of agency registration forms under Chapter 4).

## APPROACHES TO MOTOR VOTER REGISTRATION

---

Our examination of States currently operating motor voter registration programs suggests that there are three general models that have been developed in response to particular State needs and resources.

The first general model arises from jurisdictions that, for budgetary or other reasons, choose to implement an entirely paper based system. In this model an individual applying for or renewing a driver's license either

- is given a combined, multi-part driver's license and voter registration form (see SAMPLES below), or else
- is provided by the motor vehicle clerk with a voter registration form as determined by State law (presumably either the State mail registration form or else a special motor voter form designed for the purpose).

The individual then completes the voter registration application (with assistance from the motor vehicle clerk if requested), and then returns it to the clerk for transmittal to the appropriate election official. (In principle, this model also applies to States where driver's license applications or renewals are handled by mail except, of course, that the combined or separate forms are provided to the applicant who returns them both to the motor vehicle office).

Examples of, or variants on, this first general model may be found in Colorado, Minnesota, and the District of Columbia.

The second general model arises from jurisdictions that are fully automated in *both* their election and motor vehicle offices. In this virtually paperless model, the individual appears before a motor vehicle clerk who is first prompted by a computer program to ask if the applicant wishes to register to vote. If not, it is so noted in the computer and the program proceeds to ask only driver's license questions. If so, it is so noted in the computer which then proceeds to ask both driver's license and voter registration questions.

At the end of the interview, the applicant who wishes to register to vote provides a signature which is optically scanned onto an electronic record. The voter registration application, along with the recorded signature, are then transmitted electronically to the appropriate election official. (In principle — and if original signatures are required by law — the applicant's signature could be retained by the motor vehicle office or else forwarded separately to the appropriate election official.

An example of this second general model may be found in the State of Washington.

The third general model arises from jurisdictions in which the computer capabilities of the motor vehicle offices far exceed those of the election offices. (And this probably describes most jurisdictions). In this hybrid model, as in the fully computerized

model above, the individual appears before a motor vehicle clerk who is first prompted by a computer program to ask if the applicant wishes to register to vote. The response, whether positive or negative, is noted in the computer which proceeds to ask driver's license questions.

The difference between this hybrid model and the fully computerized model is that at the end of the interview, for those who responded positively to the voter registration question, the motor vehicle computer completes a pre-printed voter registration application which already contains all duplicative information. The applicant need only complete any blank items on the voter application form, sign it, and return it to the clerk for transmittal to the appropriate election official. (In principle, the computer could be programmed to ask all items required on both forms if the applicant answers positively to the voter registration question).

Examples of, or variants on, this third general model may be found in Montana, Oregon, and Texas.





**SAMPLE MOTOR VOTER REGISTRATION FORMS**

---

<b>ORIGINAL REGISTER OF VOTER</b>		
1. RESIDENCE ADDRESS FOR VOTING PURPOSES		CITY OR TOWN
2. MAILING ADDRESS		CITY OR TOWN
3. DESCRIBE LOCATION OF RESIDENCE IF ADDRESS IS ROUTE OR BOX		4. TRANSFERS WITHIN COUNTY (YES) <input type="checkbox"/>
		5. FORMER RESIDENCE ADDRESS
		CITY OR TOWN
		ZIP CODE
<p>"I declare that the facts relating to my qualifications as a voter recorded on this voter registration form are true. I am a citizen of the United States, I am not presently denied my civil rights as a result of being convicted of an infamous crime, I will have lived in this state, county, and precinct for thirty days immediately preceding the next election at which I offer to vote, and I will be at least eighteen years of age at the time of voting."</p>		
6. _____		7. SIGN HERE X
PLEASE PRINT YOUR FULL NAME		SIGNATURE OF VOTER - PLEASE SIGN WITHIN SHADED AREA
FOR OFFICE USE ONLY	REGISTRATION NUMBER	DATE OF REGISTRATION
	PRECINCT CODE	PRECINCT NAME
		DISTRICT/LEVY CODE
		Record Signing of Petitions Here (In Pencil)
<b>WARNING</b>		
Knowingly providing false information on this voter registration form or knowingly making a false declaration about your qualifications for registration is a class C felony that is punishable by imprisonment for up to five years, or by a fine not to exceed ten thousand dollars, or by both such imprisonment and fine. (RCW 29.07.070)		
LAST NAME (Print)		FIRST NAME
REGISTRATION NUMBER		SIGN HERE X
COUNTY	SIGNATURE OF VOTER	
VOTER - PLEASE PRINT NAME HERE FOR POSITIVE IDENTIFICATION		
STREET AND NUMBER OR RURAL ROUTE		REGISTRATION DATE
CITY	ZIP CODE	
RECORD SIGNING OF PETITIONS HERE (In Pencil)		
		
Secretary of State Form VR - 5/91		

DR 2751 (6/95)

<input type="checkbox"/> <b>CDL</b>		<b>APPLICATION FOR VOTER REGISTRATION and:</b>							
<b>MOTOR VEHICLE USE ONLY</b>		<input type="checkbox"/> Drivers License		<input type="checkbox"/> Identification card		<input type="checkbox"/> Duplicate		<input type="checkbox"/> Change Address	
		<input type="checkbox"/> Name Change/DOB		<input type="checkbox"/> SSN		<input type="checkbox"/> other (see remarks)			
Age Group		First Name		Middle Name		Last Name (Jr. Sr. etc.)		<b>COUNTY CLERK USE ONLY</b>	
Class		Endorsement		Restr.		Residence Address (street and number, apartment no., space no., etc.)		VOTER I.D. NUMBER	
Photo		No Photo		Fee		City/Town		PRECINCT NUMBER	
Driver License		T.I.P.		Mc Endorsement		Zip Code		COUNTY	
Duplicate License		Date of Birth		Change DOB From		Sex		Weight	
Type		Current License Number		Restrictions		Social Security Number		Donor	
Current License Number		Previous License Number		Expires		Post Office Mailing Address (street and number, apartment no., space no., etc.)		City/Town	
						Zip Code		Telephone (optional)	
						U.S. Citizen by:		Party Affiliation	
						<input type="checkbox"/> Birth		<input type="checkbox"/> Republican	
						<input type="checkbox"/> Naturalization		<input type="checkbox"/> Democrat	
						<input type="checkbox"/> Political Organization		<input type="checkbox"/> Unaffiliated	
						- COLORADO ONLY -		TRANSFER AFFILIATION	
						<input type="checkbox"/> YES		<input type="checkbox"/> NO	
Current I.D. Number		Former Name - First		Middle Name		Last Name (Jr., Sr., etc.)		REMARKS	
Previous I.D. Number		Former Residence Address		City/Town		State		Zip Code	
Expires		Drive		No Drive		Oath Administered By		Date	
		T.I.P.		Office No.		Voter Registration Applicant Signature		Date	
						WARNING: It is a Class 1 misdemeanor crime to swear or affirm falsely as to your qualifications to register to vote. .			
						I, _____, do solemnly swear (or affirm) that I am a citizen of the United States and that on the date of the next ensuing election I shall have attained the age of eighteen years and shall have resided in the state of Colorado at least twenty-five days and in my precinct at least twenty-five days before the election. I further swear (or affirm) that the present address I listed herein is my sole legal place of residence and that I claim no other place as my legal residence.			



Government of the District of Columbia — Department of Public Works — Bureau of Motor Vehicle Services  
**APPLICATION FOR: D.C. MOTOR VEHICLE OPERATOR'S PERMIT / VOTER REGISTRATION**



<b>SECTION 1. (Check the proper box for YOUR application)</b>						<b>FOR BMVS USE ONLY</b>							
OPERATOR'S PERMIT		LEARNER'S PERMIT		NON-DRIVER IDENTIFICATION		APPROVAL	DATE	EXAMINER					
New	<input type="checkbox"/>	New	<input type="checkbox"/>	New	<input type="checkbox"/>	Written							
Renewal	<input type="checkbox"/>	Renewal	<input type="checkbox"/>	Renewal	<input type="checkbox"/>	Vision							
Duplicate	<input type="checkbox"/>	Duplicate	<input type="checkbox"/>	Duplicate	<input type="checkbox"/>	Reaction							
<b>SECTION 2. (Fill in completely) <input type="checkbox"/> Check if change of address</b>						Birth Certificate							
<b>PRINT IN INK</b>	Full Name of Applicant (Last Name)		(First Name)		(Middle Name)	Out-of-State License							
	Current Residence (Street Address)				Apt. No.	SS No.							
	City and State				ZIP Code	Restrictions							
	DATE OF BIRTH	SEX	WEIGHT	HEIGHT	COLOR OF EYES	SOCIAL SECURITY NO.	Classification						
Mo.	Day	Yr.	Ft.	Ins.		I wish to be an Organ/Tissue Donor							
						YES	<input type="checkbox"/>	NO <input type="checkbox"/>					
<b>SECTION 3. (Change of Name Applicants ONLY)</b>													
<b>PRINT</b>	Previously Recorded Name of Applicant (Last Name)					(First Name)	(Middle Name)	Court Record Number (If Applicable)					
	<b>SECTION 4. (Check YES or NO for the following questions)</b>												
1. Has your permit or privilege to drive EVER been suspended, revoked, or refused in the District of Columbia or elsewhere? . . . . .				YES <input type="checkbox"/>	NO <input type="checkbox"/>	If YES, where? _____							
2. Has it been restored? . . . . .				<input type="checkbox"/>	<input type="checkbox"/>	If YES, give date of restoration _____							
3. Do you have in your possession a valid operator's permit? . . . . .				<input type="checkbox"/>	<input type="checkbox"/>	If YES, where was it issued? _____							
4. Do you have good natural eyesight for driving? . . . . .				<input type="checkbox"/>	<input type="checkbox"/>	If NO, do you wear glasses <input type="checkbox"/> or contact lenses <input type="checkbox"/>							
<b>SECTION 5. (Check YES or NO for the following Questions)</b>													
						Have you ever had, or been treated for, any of the following:							
STROKE OR PARALYSIS		YES <input type="checkbox"/>	NO <input type="checkbox"/>	MENTAL DISORDER		YES <input type="checkbox"/>	NO <input type="checkbox"/>	DIABETES	YES <input type="checkbox"/>	NO <input type="checkbox"/>	ANY HEART DISORDER	YES <input type="checkbox"/>	NO <input type="checkbox"/>
LOSS OF FUNCTION IN AN EXTREMITY		<input type="checkbox"/>	<input type="checkbox"/>	ANY BRAIN DISORDER		<input type="checkbox"/>	<input type="checkbox"/>	GLAUCOMA, CATARACTS, or OTHER EYE DISEASE	<input type="checkbox"/>	<input type="checkbox"/>	SEIZURE DISORDER OR FAINTING SPELLS	<input type="checkbox"/>	<input type="checkbox"/>
ALCOHOLISM OR OTHER DRUG ABUSE		<input type="checkbox"/>	<input type="checkbox"/>								POOR MUSCLE CONTROL or DIZZY SPELLS	<input type="checkbox"/>	<input type="checkbox"/>
Have you any physical defects not mentioned above, either temporary or permanent? . . . . . <input type="checkbox"/>													
If YES, explain briefly: _____													
<b>PHYSICIAN'S CERTIFICATE (Required for applicants 70 years of age and above)</b>													
I have examined this applicant and find him/her physically and mentally competent to operate a motor vehicle safely.													
(Signature of Physician)				(Address, Including ZIP Code)				(Telephone Number)		(Date)			
<b>SECTION 6. APPLICANT'S CERTIFICATE</b>													
I certify by my signature, under penalties of perjury, that the information given in this application is true to the best of my knowledge and belief.													
								(Signature of Applicant)		(Date)			
<b>TO REGISTER TO VOTE IN THE DISTRICT OF COLUMBIA, COMPLETE AND SIGN FORM BELOW</b>													



Government of the District of Columbia -- Department of Public Works -- Bureau of Motor Vehicle Services  
**APPLICATION FOR: D.C. MOTOR VEHICLE OPERATOR'S PERMIT / VOTER REGISTRATION**



<b>SECTION 1. (Check the proper box for YOUR application)</b>						<b>FOR BMVS USE ONLY</b>		
OPERATOR'S PERMIT		LEARNER'S PERMIT		NON-DRIVER IDENTIFICATION		APPROVAL	DATE	EXAMINER
New	<input type="checkbox"/>	New	<input type="checkbox"/>	New	<input type="checkbox"/>	Written		
Renewal	<input type="checkbox"/>	Renewal	<input type="checkbox"/>	Renewal	<input type="checkbox"/>	Vision		
Duplicate	<input type="checkbox"/>	Duplicate	<input type="checkbox"/>	Duplicate	<input type="checkbox"/>	Reaction		
<b>SECTION 2. (Fill in completely)</b> <input type="checkbox"/> Check if change of address						Birth Certificate		
<b>PRINT IN INK</b>	Full Name of Applicant (Last Name) (First Name) (Middle Name)		Current Residence (Street Address)		Apt. No.	Out-of-State License		
	City and State		ZIP Code			SS No.		
	DATE OF BIRTH	SEX	WEIGHT	HEIGHT	COLOR OF EYES	SOCIAL SECURITY NO.	Restrictions	
	Mo. Day Yr.			Ft. Ins.			Classification	
						I wish to be an Organ/Tissue Donor YES <input type="checkbox"/> NO <input type="checkbox"/>		

<b>SECTION 3. (Change of Name Applicants ONLY)</b>								
<b>PRINT</b>	Previously Recorded Name of Applicant (Last Name) (First Name) (Middle Name)		Court Record Number (If Applicable)					



**SECTION 6. APPLICANT'S CERTIFICATE**  
 I certify by my signature, under penalties of perjury, that the information given in this application is true to the best of my knowledge and belief.

\_\_\_\_\_  
 (Signature of Applicant) (Date)

**TO REGISTER TO VOTE IN THE DISTRICT OF COLUMBIA, COMPLETE AND SIGN FORM BELOW**

Registering to vote will NOT add to your time here today – your Voter ID Card will be mailed to your home.	You may also use form below to file a CHANGE of name, address, or party with the Board of Elections.	<b>FOR BOEE USE ONLY</b> Registration No. _____ Date of Registration _____ Clerk _____
--	--	--

**SECTION 7. CHOOSING YOUR PARTY** (Check ONE box)

DEMOCRATIC PARTY  
 REPUBLICAN PARTY  
 D.C. STATEHOOD PARTY  
 NO PARTY (independent)  
 OTHER PARTY (write name below) \_\_\_\_\_

**PLEASE NOTE:**

To vote in a PRIMARY election in the District of Columbia, you must be registered with either the Democratic, Republican, or D.C. Statehood Party.

**SECTION 9. VOTER DECLARATION** – Read and Sign Below.

I swear or affirm that:

- I am a U.S. citizen
- I live in the District of Columbia at the address above
- I will be at least 18 years old on or before the next election
- I am not in jail on a felony conviction
- I have not been judged "mentally incompetent" in a court of law
- I do not claim the right to vote anywhere outside D.C.

Signature \_\_\_\_\_ Date \_\_\_\_\_

Daytime Telephone No.: \_\_\_\_\_

**WARNING:** If you sign this statement even though you know it is untrue, you can be convicted and fined up to \$10,000 and/or jailed for up to five years.

**SECTION 8. NAME AND ADDRESS ON LAST VOTER REGISTRATION**

Name \_\_\_\_\_

Address \_\_\_\_\_

(If outside D.C., include county and state)

FORWARD TO BOEE

IF YOUR NAME HAS CHANGED, COMPLETE THE FOLLOWING (ENTER ALL INFORMATION AS SHOWN ON PRESENT LICENSE)

NAME \_\_\_\_\_ LICENSE NUMBER \_\_\_\_\_

STREET ADDRESS \_\_\_\_\_ STATE \_\_\_\_\_ ZIP CODE \_\_\_\_\_

DO YOU WANT YOUR LICENSE TO INDICATE YOU ARE AN ANATOMICAL DONOR?  YES  NO

DO YOU WANT TO REGISTER OR REREGISTER TO VOTE TODAY?  YES  NO If you answered "YES," complete the voter registration card below and return it to a DMV representative before you leave.

DMV WILL USE THE MEDICAL INFORMATION IN THE FOLLOWING TWO QUESTIONS ONLY FOR THE PURPOSE OF DETERMINING YOUR ELIGIBILITY TO DRIVE. THE ANSWERS TO THE QUESTIONS WILL BE KEPT CONFIDENTIAL.

HAVE YOU HAD A LOSS OF CONSCIOUSNESS OR PHYSICAL CONTROL, OR HAS YOUR ABILITY TO DRIVE BEEN IMPAIRED WITHIN THE LAST TWO YEARS?  
 YES  NO IF YOU MARKED "YES," TO WHICH OF THE FOLLOWING CONDITION(S) WAS IT RELATED? --- YOU MUST MARK AT LEAST ONE BOX.  
 EPILEPSY/SEIZURES  INSULIN TREATED DIABETES  HEART CONDITION  STROKE  DRUG USE  MENTAL ILLNESS  A PROBLEM WITH ALCOHOL  
 OTHER (EXPLAIN) \_\_\_\_\_

HAVE YOU HAD A PROBLEM INVOLVING YOUR USE OF ALCOHOL OR DRUGS WITHIN THE LAST FOUR YEARS?  YES  NO

HAVE YOU HAD A CHANGE OF VISION, A LOSS OF LIMB OR ANY OTHER PHYSICAL CHANGE WITHIN THE LAST FOUR YEARS THAT MIGHT AFFECT YOUR DRIVING ABILITY? YOU MUST MARK EITHER "YES" OR "NO." IF YOU MARK "YES," DESCRIBE THE CHANGE.  YES  NO

I UNDERSTAND IT IS AGAINST THE LAW TO MAKE ANY FALSE STATEMENT OR SHOW FALSE EVIDENCE OF AGE AND/OR IDENTITY ON THIS APPLICATION. IF I DO, MY PERMIT OR LICENSE WILL BE IMMEDIATELY CANCELED. IF I AM CONVICTED OF SUCH ACT(S), I FURTHER UNDERSTAND I CAN BE FINED OR SENTENCED TO JAIL, OR BOTH, ACCORDING TO OREGON LAW.

**MY SIGNATURE BELOW CERTIFIES THAT ALL INFORMATION GIVEN ON THIS APPLICATION IS TRUE AND CORRECT TO THE BEST OF MY KNOWLEDGE.**

NUMBER	DATE OF BIRTH	CLASS
RESTRICTIONS	ENDORSEMENTS	
EXPIRES	HEIGHT	WEIGHT
ISSUE DATE	ORIGINAL DATE	SEX

**x SAMPLE**

5-6673 (10-91)

337306

**WARNING:** Any person who supplies any information knowing it to be false, is subject upon conviction to imprisonment for not more than five years or to a fine of not more than \$100,000, or both.

**YOU MAY REGISTER TO VOTE IF:**

1. YOU ARE A CITIZEN OF THE UNITED STATES;
2. YOU WILL BE 18 OR OLDER ON ELECTION DAY; AND
3. YOU ARE A RESIDENT OF OREGON

**YOU MUST RE-REGISTER IF:**

1. YOUR RESIDENCE OR MAILING ADDRESS CHANGES;
2. YOUR NAME CHANGES; OR
3. YOU WISH TO CHANGE POLITICAL AFFILIATION

A qualified person must complete this form, sign it, certification and return this card to a Motor Vehicle Division representative. The date of registration is the date on which the legible, accurate and complete registration card is received. To be eligible to vote, you must register by 5 p.m. on the 21st day before the election at which you intend to vote.

**INSTRUCTIONS --**

1. COMPLETELY FILL OUT AND SIGN THE CARD.
2. PLEASE USE BALL POINT PEN.
3. RETURN THIS CARD TO A MOTOR VEHICLES DIVISION REPRESENTATIVE.

**YOUR VOTER REGISTRATION IS IMPORTANT. FOLLOW INSTRUCTIONS CAREFULLY. ERRORS OR MISSING INFORMATION WILL RESULT IN YOUR REGISTRATION BEING REJECTED.**

OFFICE USE ONLY

3. COUNTY \_\_\_\_\_

4. RESIDENCE ADDRESS ( IF DIFFERENT FROM ABOVE): \_\_\_\_\_

5. PHONE (OPTIONAL) \_\_\_\_\_

6. DATE OF BIRTH \_\_\_\_\_

7. PARTY AFFILIATION (SELECT ONE):  
 ← DEMOCRAT  
 ← LIBERTARIAN  ← NOT AFFILIATED WITH ANY POLITICAL PARTY  
 ← REPUBLICAN  ← OTHER PARTY \_\_\_\_\_ (PRINT OTHER PARTY NAME)

8. PLACE OF BIRTH \_\_\_\_\_

9. SPOUSE'S NAME \_\_\_\_\_

10. FATHER'S NAME \_\_\_\_\_

11. MOTHER'S MAIDEN NAME \_\_\_\_\_

12. IF PREVIOUSLY REGISTERED TO VOTE IN OREGON, COMPLETE THIS SECTION:

COUNTY \_\_\_\_\_ NAME ON PREVIOUS REGISTRATION \_\_\_\_\_ PREVIOUS ADDRESS (if known) \_\_\_\_\_

14. SIGNATURE - Sign on line below.

UNDER PENALTY OF LAW: By signing this card, I certify that I am a citizen of the United States and that I shall have been a resident of Oregon for 20 days before the next election at which I vote; that I shall be at least 18 years of age on or before the date of the next election at which I vote; and that all information I have supplied is true to the best of my knowledge.



## CHAPTER 3

# MAIL REGISTRATION PROVISIONS

---

The National Voter Registration Act requires States to accept and use what amounts to a national voter registration form as a means of applying for voter registration or updating voter registration data [Section 6(a)(1)]. This form is to be prescribed by the Federal Election Commission in consultation with chief State election officials [Section 9(a)(2)].

In addition, States are permitted to use their own State mail registration form provided that it meets the criteria described in Section 9(b) — the same criteria as pertain to the contents of the national form [Section 6(a)(2)] and to the contents of the form used at motor vehicle offices [Section 5(c)(2)(B)(ii)].

Such forms are to be made available by the *chief* State election official through governmental and private entities with particular emphasis on organized voter registration programs [Section 6(b)].

It is important to recognize that mail registration forms may well be used by participating public service agencies as explained in Chapter 4 (see also Section 7(a)(6)(A) of the law). And, as noted in Chapter 2, they might also be used in some motor-voter programs (see also Hse. Rpt under Section 5 on page 9).

Finally, Section 6 of the law permits (but does not require) two possible security mechanisms.

The first of these is that States may require first time voters, who have registered by mail, to vote in person (presumably at the next subsequent election in which they offer to vote) unless their right to vote absentee is protected under the Uniformed and Overseas Citizens Absentee Voting Act, the Voting Accessibility for the Elderly and Handicapped Act, or under any other federal law [Section 6(c)].

The second possible security mechanism is that if the acknowledgment notice in response to a mail registration application is returned as undeliverable, the registrar may initiate the confirmation procedure discussed in Chapter 5 below [Section 6(d)].



---

## IMPORTANT ISSUES IN MAIL REGISTRATION

---

Although the mail registration provisions of the law seem simple and straightforward, there are three important issues that must be considered. These are:

- the content and format of the form
- the transmittal of mail registration applications to the appropriate election official, and
- administering a mail registration program.

### **The Content and Format of the Mail Registration Form(s)**

There are several important aspects to the content and format of the mail registration form(s), including:

- the *data elements* requested on the form(s)
- the *information and attestation items* that must appear on the form(s)
- the *physical size, paper weight, and color* of the form(s)
- the *needs of certain special populations*, and
- the *layout* of the national form.

### ***Data Elements Required on Mail Registration Forms***

The law limits the data elements that can be required on mail (and motor vehicle) voter registration forms to those that are “necessary to enable the appropriate State election official to assess the eligibility of the applicant and to administer voter registration and other parts of the election process” [Sections 9(b)(1) and 5(c)(2)(B)(ii)].

Although the Federal Election Commission is currently in the midst of research and rulemaking proceedings in order to determine what data elements the chief State election officials deem to be necessary in practice, our preliminary view is that the following data elements are likely to be requested:

- New registration vs. change of address vs. other change
- Name of applicant (incl any suffix)
- Address where you live (incl apt or unit no.)
- Address where you get your mail (if different from above)
- Date of birth

- Telephone number (optional)
- Political party preference (where appropriate)
- Identification number required or requested by your State
- Signature with oath
- Date signed
- Person who assisted (if any)
- Previous address
- Previous name (if appropriate)
- Map area for rural residence (if appropriate)

By the same token, our preliminary view is that the following items will not be requested:

- Race
- Gender
- Place of birth
- Occupation
- Naturalization information
- Information regarding criminal conviction
- Information regarding mental incapacity
- Height
- Weight
- Hair color
- Eye color
- Marital status
- Misc. (maiden name, mother's maiden name, etc.)

We anticipate that the definitive list of data elements to be included on the national voter registration form will be promulgated during the second quarter of 1994. In the interim, it is crucial for State officials to recognize that even though State mail

and motor vehicle voter registration forms must meet the same criteria as apply to the national mail registration form, **THERE IS NO NEED FOR STATES TO DELAY THEIR IMPLEMENTATION OF THE NVRA UNTIL THE FINAL NATIONAL MAIL REGISTRATION FORM IS AVAILABLE. RATHER, STATES SHOULD PROCEED ON THE BASIS OF THE DATA ELEMENTS RELEASED BY THE FEC.**

***Information and Attestation Items to Appear on Mail Registration Forms***

In addition to the “necessary” data elements, the law requires certain information and attestation items to appear on mail registration forms [Sections 9(b)(2) and (4) and Section 8(a)(5)(B)]. These include statements that:

- specify each eligibility requirement of the State (including citizenship)
- contain an attestation that the applicant meets each such requirement
- specify the penalties provided by law for submitting a false voter registration
- require the signature of the applicant, under penalty of perjury and, in print that is identical to that used in the attestation portion of the application, (presumably for when the application is being completed in a public agency)
- a statement that, if an applicant declines to register to vote, the fact that the applicant has declined to register will remain confidential and will be used only for voter registration purposes, and
- a statement that if an applicant does register to vote, the office at which the applicant submits a voter registration application will remain confidential and will be used only for voter registration purposes.

The law also prohibits any requirement for notarization or other formal authentication on mail registration forms [Section 9(b)(3)].

***Size, Weight, and Color***

Important aspects of the *national* mail registration form (although State mail registration forms may vary in this regard) are physical size, paper stock weight, and color. Ideally, the final national form will be of a size and weight convenient for filing. By the same token, all mail registration forms should be of dimensions, weight, and color contrast (between the ink and the paper stock) that fall within the Postal Service specifications for mailed items (see Appendix F).

Federal Election Commission currently anticipates that the national voter registration form will end up being a 5"x8" card (even though accompanying instructions and information may require the form to be contained within a booklet, as explained under “Layout” below). As a purely practical matter (especially for filing purposes), States may want to consider a 5"x 8" standard size.

### ***The Needs of Certain Special Populations***

In designing or redesigning their mail registration forms, States will want to pay particular attention to the needs of certain special populations identified in Chapter 1.

### ***Layout***

The final important aspect of the *national* mail registration form is layout. This is especially true since, pursuant to the information and attestation requirements cited above, the national form must contain information regarding the voter qualifications of each State. In addition, the Federal Election Commission is concerned about:

- the fact that Section 6(a)(2) of the law requires that the form be usable as a change-of-address form as well as an original registration
- the need to accommodate electronic imaging of either the whole document or, at least, of the signature portion
- the need to provide clear instructions to the applicant for completing each item on the form
- the potential need for providing additional information (such as where to mail the form, the voting accessibility rights of the disabled, and possibly other information of general and practical interest).

The Federal Election Commission is currently inclined to the view that one practicable way of accommodating all the aspects of the national mail registration form described above is through a national voter registration booklet containing one or more tear-out forms that applicants may complete and forward to their appropriate voter registration official. But at this time, the question of format remains a matter of rule making in which alternative views and ideas are welcome. Again, however, **STATES NEED NOT DELAY THEIR IMPLEMENTATION OF THE NVRA UNTIL THE FINAL FORMAT OF THE NATIONAL VOTER REGISTRATION FORM IS DECIDED. RATHER, STATES SHOULD PROCEED ON THE BASIS OF THE DATA ELEMENTS TO BE CONTAINED ON THE FORM AS RELEASED BY THE FEC.**

### **The Transmittal of Mail Registration Applications to the Appropriate Election Official**

There are three ways in which mail registration applications might be transmitted:

- delivery in person by the registrant
- delivery in person by a third party, or
- delivery through the postal system.

***Delivery in Person by the Registrant***

Nothing in the Act prohibits a registrant from delivering a mail registration application in person to the election office. And any such prohibition in State law would appear contrary to the purposes of the Act inasmuch as it requires States to “accept and use” mail registration forms “for the registration of voters in elections for Federal office” [Section 6(a)(1)].

***Delivery in Person by a Third Party***

Similarly, nothing in the Act prohibits a third party from delivering mail registration forms in person to the election office. And again, any such prohibition in State law would appear contrary to the purposes of the Act for the same reason as cited above. Moreover, the Act clearly intends the mail registration form to be employed by third parties when it instructs chief State election officials to make such forms available “with particular emphasis on making them available for organized voter registration programs.

***Delivery through the Postal System***

The Act requires election offices to accept and process mailed voter registration applications that are postmarked not later than 30 days before the election or some lesser time provided by State law [Section 8(a)(1)(B)].

In other words, the Act applies the voter registration deadline to when the form was mailed by the applicant rather than to when it is received by the election office.

As a practical matter, however, postmarks are not always applied by the Postal Service. And even when they are, they are not always readable. States may therefore want to consider accepting “any voter registration application that is postmarked not later than the deadline for voter registration or, if the post mark is missing or unclear, is received in the mail not later than five days after the deadline for voter registration” — this on the presumption that any item arriving within five days after the deadline without a clear postmark was nevertheless probably mailed before the deadline. The practical advantage of this five day period is that it conforms to the five day period granted to motor voter and agency transmittals of registration applications. Such an arrangement yields a single deadline for receiving *all* registration applications except those that are clearly postmarked before the close of registration but seriously delayed in the mails.

**Administering a Mail Registration Program**

With regard to administering a successful mail registration program, the Federal Election Commission will be distributing in 1994 a report summarizing the experiences of the States that currently have mail registration — how they work, problems they have encountered, recommended practices, and the like.

In the interim, there are three important aspects of administering a mail registration program that warrant consideration:

- the accountability of mail registration forms
- the appropriate postal markings and indicia to be used on the front of the mail registration document, and
- the distinction between a verification mailing and an acknowledgment notice.

#### ***The Accountability of Mail Registration Forms***

Many jurisdictions have found it useful to print or to subsequently stamp mail registration forms with sequential numbers.

The traditional purpose of this practice is to monitor the accuracy and efficiency of private registration drives. Private organizations are provided with mail registration forms by number batches. An excessive number of cards from any one batch that return improperly completed may indicate that further training is needed for the members of whatever group was issued that block of numbers.

The same principle gathers importance in light of the record keeping and reporting requirements of the law discussed in Chapter 7 below. Sequentially numbering State mail registration forms (and perhaps even shrink wrapping them in numbered batches) might facilitate the monitoring of participating public assistance agencies without divulging to the public the specific agency in which any particular applicant registered.

As a final note on accounting for mail registration forms, States that opt to require first time voters who have registered by mail to vote in person (in the next subsequent election in which they vote) will want to devise a coding or record keeping system to enable such a procedure to work — perhaps an “M” in the field normally used to designate an absentee voter.

#### ***Appropriate Postal Markings and Indicia***

In order to facilitate the processing of State mail registration forms through the Postal Service, States may wish to design the front of their forms (as well as the fronts of the other mailed items required by the law) in accordance with the specifications set out in an article entitled “Expediting Official Election Mailings” which appeared in Volume 14, Spring 1987 of the *FEC Journal of Election Administration* and is reprinted below in Appendix F.

#### ***The Distinction between a Verification Mailing and an Acknowledgment Notice***

The NVRA requires the registration official “to send notice to each applicant of the disposition of the application” [Section 8(a)(2)]. In order to avoid confusion with the other notices which the Act entails, we at the FEC refer to this notice as the “acknowledgment notice” (see definitions in the Introduction).

As noted previously in this Chapter, if such an acknowledgment notice in response to a mail registration application is returned as undeliverable, the registrar may initiate the confirmation procedure described in Chapter 5 below [Section 6(d) of the law].

Some jurisdictions, however, routinely send out a verification mailing to each applicant in order to confirm the applicant's address *before* adding the applicant to voter registration list. We at the FEC refer to this procedure as a "verification mailing" (again, see definitions in the Introduction).

The crucial distinction is that the NVRA neither requires nor prohibits a verification mailing *before* adding an applicant's name to the voter registry. Indeed, such a verification mailing would seem to fall into the category of making "determinations as to the applicant's eligibility, such as citizenship, as are made under current law and practice" and would appear permissible [Hse. Rpt., Section 5, page 8].

The significance of this distinction is that if a *verification* mailing is returned as undeliverable, the law does not prohibit the registrar from refusing the application — provided that such a refusal is followed by an acknowledgment notice to that effect in accordance with Section 8(a)(2) of the law. If, on the other hand, the applicant's name is first added to the registration list and is then sent an *acknowledgment* notice which is returned as undeliverable, then Section 6(d) of the law limits the registrar to following a confirmation procedure (described in Chapter 5 below) whereby the applicant is sent a confirmation mailing and must, if not respond to, be maintained on the voter registration list for two subsequent federal elections in accordance with Section 8(d) of the law.

There is, then, an important distinction between a verification mailing and an acknowledgment notice as we have defined them.

**SAMPLE MAIL REGISTRATION FORMS**

---



**RURAL VOTERS**

PLEASE COMPLETE THIS SECTION ONLY IF YOU LIVE OUTSIDE THE CITY LIMITS OF ANY CITY, AND YOU DO NOT KNOW THE TOWNSHIP AND SECTION NUMBER IN WHICH YOU LIVE.

Please do not attempt to provide directions to get to the location, but instead describe where it is.

I live \_\_\_\_\_ miles \_\_\_\_\_  
 number N,S,E or W  
 and \_\_\_\_\_ miles \_\_\_\_\_ of  
 number N,S,E or W  
 \_\_\_\_\_  
 landmark or highway junction

PLACE  
STAMP  
HERE

**MORE INFORMATION**

- To register to vote, you must be a citizen of the United States, at least 17½ years old, and declare Iowa as your voting residence. (You must be at least 18 years old to vote.)
- This form must be received by your County Auditor by the 10th day preceding a primary or general election, or by the 11th day preceding any other election, or postmarked by the 15th day preceding any election to be valid for that election.
- You should receive a receipt of this registration within 10 days. If you do not, please contact your County Auditor. Be prepared to state when and where you filled out the form, and to whom it was given or sent if you did not personally mail or take it to the Auditor.
- There are other ways to register. Contact your County Auditor if you need assistance.

County Auditor — Commissioner of Elections

Courthouse

\_\_\_\_\_ City (County Seat)

IOWA \_\_\_\_\_ Zip Code

**INSTRUCTIONS**

- Use this form to register to vote, or to report a change of name, address, telephone number or party affiliation. Please check the appropriate box(es) at the top right. If you are not certain you are presently registered in the county in which you live, check the "new registration" box.
- The following information is required:
  - Your full name.
  - Your birth date.
  - Your complete address, including apartment and box numbers.
  - Your gender.
  - The name of the county in which you live.
  - Where you were last registered to vote.
  - Your signature
- The following information is requested:
  - Your social security number. Solicited pursuant to Iowa Code Section 48.5, this number is used to avoid multiple registrations for a single individual.
  - The name of the city and school district in which you live. If you do not live inside a city, list the name of the township and section number in which you live. If you do not know your township and section number, complete the "RURAL ROUTES" section on the reverse side of the form.
  - Your telephone number, including area code.
- Detach this stub before mailing the form.

ALTERNATE REGISTRATION FORM  
Please see instructions at left.

**PLEASE PRINT**

CHECK ALL THAT APPLY:

This is a new registration in this county.  
 This is a change of  Name  Address  Telephone  Party

_____ Soc. Sec. No. (If available)	_____ Month _____ Day _____ Year _____ Birth Date	Female <input type="checkbox"/> Male <input type="checkbox"/> _____ Gender	( ) _____ Telephone	Democratic <input type="checkbox"/> Republican <input type="checkbox"/> _____ Party
------------------------------------	--	--	---------------------	---

NAME: \_\_\_\_\_  
 Last First and Middle

ADDRESS: \_\_\_\_\_  
 House number & street (or rural route) plus apartment & box number

\_\_\_\_\_ City, State, and Zip Code

PREVIOUS REGISTRATION INFORMATION: I was previously registered to vote in \_\_\_\_\_  
 (City, State, Zip Code, County if known.)

My name then was \_\_\_\_\_

I certify that I am a citizen of the United States, that I am or will be an eligible elector at any election at which I attempt to vote and that all of the information I have given upon this voter registration form is true. I authorize cancellation of any prior registration to vote in this or any other jurisdiction and my eligibility to vote in any jurisdiction where voter registration is not required. I am aware that fraudulently registering, or attempting to do so, is an aggravated misdemeanor under Iowa law.

Signature \_\_\_\_\_ Date \_\_\_\_\_

**COMPLETE ALL YOU KNOW**

COUNTY NAME: \_\_\_\_\_

SCHOOL DISTRICT: \_\_\_\_\_

CITY ( If inside limits): \_\_\_\_\_

TOWNSHIP (If outside city) \_\_\_\_\_

SECTION NUMBER (If outside city) \_\_\_\_\_

**FOR OFFICE USE ONLY**

Registration date: \_\_\_\_\_

Codes: \_\_\_\_\_

Form 2E (Rev. 88) CFN-337-5005 CPF-66929

# Mail-In Voter Registration Form

★ ★ ★ District of Columbia  
Board of Elections and Ethics

**You can use this form to:**

- register to vote in the District of Columbia
- let us know that your name or address has changed
- register with a party or change parties

**To register to vote in D.C., you must:**

- be a U.S. citizen
- be a D.C. resident
- be at least 18 years old on or before the next election
- not be in jail for a felony conviction
- not have been judged "mentally incompetent" by a court of law
- not claim the right to vote anywhere outside D.C.

**Questions? Call 727-2525**

*Hearing-impaired people with TDD, call 639-8916*

**Información en español:** Si le interesa obtener este formulario en español, llame al 727-2525.

**Important!**

**Keep your voter record up-to-date!** If we do not have your current name or address, you might not be on the voter roll. If you are not on the voter roll, you will not be able to vote in the next election.

Use this form to send in your name or address change. If you are not sure if we have your current name or address, use this form, too. Or call 727-2525.

**To vote in a primary election, you must be registered with a party that holds a primary election—either the Democratic, Republican or D.C. Statehood Party.**

If you register with any other party, or with no party, you may vote only in general or special elections. Use this form if you want to register with a party or change parties (see box 8).

0-0976

Use pen—please print clearly

1	Check one: <input type="checkbox"/> new registration <input type="checkbox"/> address change <input type="checkbox"/> party change <input type="checkbox"/> name change				Clerk	Registration No.
					Reg. Date	<b>AB 0532788</b>
2	Mr. Mrs. Miss Ms.	Last Name	First Name	Middle Name	Suffix Jr. Sr. II III IV	
3	Address Where You Live			Circle One NE NW SE SW	Apartment Number	Zip Code
4	Address Where You Get Your Mail (if different from #3)					Zip Code
5	Date of Birth	6	Daytime Telephone Number(s)	7	Social Security Number (optional)	
8	Party Registration—check one box			10	Voter Declaration—read and sign below	
	<input type="checkbox"/> Democratic Party <input type="checkbox"/> Republican Party <input type="checkbox"/> D.C. Statehood Party <input type="checkbox"/> No Party (independent) <input type="checkbox"/> Other Party (write name below)				I swear or affirm that: • I am a U.S. citizen • I live in the District of Columbia at the address (#3) above • I will be at least 18 years old on or before the next election • I am not in jail on a felony conviction • I have not been judged "mentally incompetent" in a court of law • I do not claim the right to vote anywhere outside D.C.	
9	Name and Address on Last Voter Registration			Signature _____ Date _____		
	Name _____ Address _____ (If outside D.C., include county and state)			<b>WARNING: If you sign this statement even though you know it is untrue, you can be convicted and fined up to \$10,000 and/or jailed for up to five years.</b>		

Fold on dotted lines, peel off tape, seal and mail



WASHINGTON, D.C. 20077-1219  
ROOM 4, DISTRICT BUILDING  
BOARD OF ELECTIONS & ETHICS  
DISTRICT OF COLUMBIA

POSTAGE WILL BE PAID BY ADDRESSEE

FIRST CLASS PERMIT NO. 10976 WASHINGTON, D.C.  
**BUSINESS REPLY MAIL**



NO POSTAGE  
NECESSARY  
IF MAILED  
IN THE  
UNITED STATES



**Did you remember to:**

1. Write your full name, address and date of birth (in boxes 2, 3 and 5).
2. Sign and date the form (in box 10).

**Deadline:**

The voter registration deadline is 30 days before the next election. If you mail this form, it must be postmarked by that date. If you miss the deadline, you will not be registered in time to vote.

*If you are qualified and the information on your form is complete, we will add your name to the District's voter roll. We will then mail you a voter card. This card will tell you where to vote.*

**Questions? Call 727-2525**

*Hearing-impaired people with TDD, call 639-8916*



District of Columbia Board of Elections and Ethics



**By Mail** **UTAH ELECTION REGISTRATION FORM**

1. **FULL NAME** (PRINT LEGIBLE) \_\_\_\_\_  
Last First Middle

2. **STREET ADDRESS** \_\_\_\_\_  
of Principle Place of Residence House Number Direction (N,S,E,W) Street Name Type (St. Dr. Ln. Av. etc.) Apt #

**CITY** \_\_\_\_\_ **UTAH, ZIP** \_\_\_\_\_

3. **MAILING ADDRESS** \_\_\_\_\_  
If Different (Include post office box, city, town or other designation for receiving your mail)

4. **DATE OF BIRTH** \_\_\_\_\_  
MO DAY YR

5. **PLACE OF BIRTH** \_\_\_\_\_  
State or Foreign Country

6. **TELEPHONE NUMBER** \_\_\_\_\_  
(Home) (Unless Unlisted) (Work)

7. **DISABLED OR HANDICAPPED** Yes \_\_\_\_\_ No \_\_\_\_\_

8. **U.S. CITIZEN** Yes \_\_\_\_\_ No \_\_\_\_\_

9. Previous record of Voter Registration:  NEVER REGISTERED TO VOTE

MY NAME WAS LISTED AS \_\_\_\_\_  
Maiden or former name used

LAST FORMER ADDRESS LISTED ON VOTER RECORDS: \_\_\_\_\_

CITY \_\_\_\_\_ COUNTY \_\_\_\_\_ STATE \_\_\_\_\_ ZIP CODE \_\_\_\_\_

VOTING DISTRICT OR PRECINCT (if known) \_\_\_\_\_

*I do swear (or affirm), subject to penalty of law or false statements, that the information contained in this form is true, and that I am a citizen of the United States and a resident of the State of Utah, residing at the above address. I will be at least 18 years old and will have resided in Utah for 30 days immediately preceding the next election to be held \_\_\_\_\_ 19 \_\_\_\_\_*

10. **TODAY'S DATE** \_\_\_\_\_  
MO DAY YR

11. **SIGNED & SWORN** \_\_\_\_\_  
Voter Applicant's Signature

**NOTICE:** In order to vote, your name must appear in the Official Register Book.

REGISTRATION AGENT'S USE ONLY

VOTING DISTRICT NUMBER \_\_\_\_\_





## **CHAPTER 4**

### **AGENCY REGISTRATION PROVISIONS**

---

The National Voter Registration Act requires that individuals be given the opportunity to register to vote (or to change their voter registration address) in elections for federal office when applying for (or receiving) services or assistance:

- at any office in the State that provides public assistance [Section 7(a)(2)(A)]
- at or through any office in the State that provides State-funded programs primarily engaged in providing services to persons with disabilities [Section 7(a)(2)(B) with Section 7(a)(4)(B)]
- at certain other offices designated by the State [Section 7(a)(3)(A)], and
- at Armed Forces recruitment offices [Section 7(c)(1)].

Individuals must be provided this opportunity not only at the time of their original application for services, but also when filing any recertification, renewal, or change of address relating to such services [Section 7(a)(6)(A)].

Those who decline to register to vote must do so in writing or by not checking a box on a form that contains wording specified in the Act [Section 7(a)(6)(A) and (B)]. No information regarding a person's declination to register may be used for any purpose other than voter registration [Section 7(a)(7)].

Similarly, if an individual does register to vote, the particular agency at which the applicant submits a voter registration application may not be publicly disclosed [Sections 8(a)(6) and 8(i)(1)].

Agencies providing voter registration services must offer the same degree of assistance, including bilingual assistance where necessary, to individuals in completing a voter registration form as they offer to individuals in completing the agency's own forms, unless the applicant refuses such assistance [Sections 7(a)(4)(A)(ii) and 7(a)(6)(C)].

Moreover, the person who provides such services in the agency is prohibited from:

- seeking to influence an applicant's party preference or party registration
- displaying any such political preference or party allegiance
- making any statement or taking any action whose purpose or effect is to discourage the applicant from registering to vote, or

- making any statement or taking any action whose purpose or effect is to lead the applicant to believe that a decision whether or not to register has any bearing on the availability of services or benefits [Section 7(a)(5)].

## **IMPORTANT ISSUES IN AGENCY REGISTRATION**

---

There are several important issues States will want to consider in designing their agency registration forms and procedures:

- selecting agencies to serve as voter registration sites
- the format and content of the form to be used in applying for voter registration in an agency
- the format and content of the declination form, or portion of the form, to be used for declining to apply for voter registration in an agency
- the transmittal of voter registration applications from agency offices to the appropriate election official, and
- administering a voter registration program.

### **Selecting Agencies as Voter Registration Sites**

The Act mandates four types of offices to be designated as voter registration sites:

- all public assistance offices
- offices that operate State-funded programs primarily engaged in providing services to persons with disabilities
- other designated offices, and
- Armed Forces recruitment offices.

#### ***Public Assistance Offices***

The Act requires that “all offices in the State that provide public assistance” be designated as voter registration agencies [Section 7(a)(2)(A)].

There were some differences between the House and the Senate regarding this issue in general, and specifically which agencies would be considered mandatory. The Conference Committee therefore delineated the minimum of agencies it concluded were to be encompassed. “By public assistance agencies, we intend to include those State agencies in each State that administer or provide services under”:



- the food stamp program
- the Medicaid program
- the Special Supplemental Food Program for Women, Infants, and Children Program (WIC)
- the Aid to Families With Dependent Children Program (AFDC) [Conf Stat, Section 7, page 19].

States must decide for themselves what other of their offices meet the definition of “public assistance offices.”

***Offices that Operate State-funded Programs Primarily Engaged in Providing Services to Persons with Disabilities***

In addition to the above programs, the Act mandates the inclusion of “all offices in the State that provide State-funded programs primarily engaged in providing services to persons with disabilities” [Section 7(a)(2)(B)]. This section of the Act is intended to encompass not only those with physical disabilities, but also people with cognitive disabilities, and people with mental illness or mental disabilities — State law permitting.

It is impossible to delineate which agencies those might include since States vary widely in how they provide such services. “While it would include vocational rehabilitation offices, it would also extend to many other agencies that have contact...with persons with disabilities, such as, but not limited to those agencies which provide transportation, job training, education counseling, rehabilitation or independent living services” [Hse. Rpt., Section 7, page 12]. But each State will have to identify for itself the specific public or private agencies within their own State that fit the definition. (For assistance, States might want to contact their Governor’s designee on the Americans with Disabilities Act, State Developmental Disabilities Council, Governor’s Committee on Disabilities, State Independent Living Council or Section 504 Coordinator).

It is very important to note, however, that the Act requires that if such an agency “provides services to a person with a disability at the person’s home, the agency shall provide [voter registration services] at the person’s home” [Section 7(a)(4)(B)].

***Other Offices***

The Act further requires States to “designate other offices within the State as voter registration agencies” [Section 7(a)(3)(A)]. Although required to designate at least some other agencies, States are given considerable latitude in deciding which agencies those might be. The Act merely says that they *may* include:

- public libraries
- public schools

- offices of city and county clerks (including marriage license bureaus)
- hunting and fishing license bureaus
- government revenue offices
- unemployment compensation offices
- other offices that provide services to those with disabilities, and
- federal and nongovernmental offices, with the agreement of those offices [Section 7(a)(3)(B)].

Nothing in the Act, however, prohibits States from designating still other agencies according to their own needs and preferences.

Should any of these “designated” agencies provide public assistance, they, like those agencies referred to in Section 7(a)(2)(A), must provide the applicant with a means for executing a written declination and must also provide help in filling out the voter registration application to those individuals requesting such help [Section 7(a)(6)(A&B)].

(NOTE: The Act requires all departments, agencies, and other entities of the executive branch of the federal government to cooperate with the States in carrying out agency registration to the greatest extent practicable [Section 7(b)]. States, however, bear the responsibility of negotiating any such arrangements directly with the appropriate federal agency.)

#### ***Armed Forces Recruitment Offices***

Finally, the Act requires each State and the Secretary of Defense to jointly “develop and implement procedures for persons to apply to register to vote at recruitment offices of the Armed Services of the United States” [Section 7(c)].

The Federal Voting Assistance Program, acting as the designee of the Secretary of Defense, will work with the States in implementing this section of the Act. The address and telephone number of the Federal Voting Assistance Program are provided in Appendix E.

#### **The Form to Be Used in Applying for Voter Registration in an Agency**

The Act requires that designated agencies distribute to each applicant a mail registration form that is either the national mail registration form, or “the office’s own form if it is equivalent to” the national mail registration form, unless the applicant declines in writing to register to vote [Section 7(a)(4)(a)(i) with Section 7(a)(6)(A)].

Two important aspects of the form to be used in agency registration are the format of the form, and the content of the form.

***The Format of the Agency Registration Form***

With regard to prescribing their agency registration form, States would appear to have one of three options:

- the national mail registration form
- the State mail registration form (which could, arguably, be declared the “office’s own form”), or
- the agency’s own unique mail registration form if it meets the criteria set out for the national mail registration form.

One available option is using the *national mail registration form* in agency registration programs. The national form, as explained in Chapter 3, however, is likely to contain data elements that do not pertain to all States — such as political party preference. Moreover, the national form is likely to be a booklet in order to accommodate, among other things, the different State qualifications for voting and different mailing addresses for the form. For these reasons, States may not find this option to be the most efficient or effective.

A second option for an agency registration program is the *State mail registration form* which, as noted in Chapter 3, must be equivalent to the national form in terms of content — except that it can be State specific with regard to required data elements and voter qualifications. An additional advantage to the State form is that it can be pre-addressed to the appropriate State or local election official.

A third option is the *agency’s own unique mail voter registration form* which would, presumably, be nearly identical to the State mail registration form. The principal advantage of this choice is that such a form could become a perforated or pressure sensitive part of the agency’s own form(s), thus facilitating the process for both applicants and agency clerks alike. It is important, however, that any such form not clearly identify the particular agency or office in which the applicant registered (for further discussion, see pages 4-12, and 7-3). This is significant because in most States voter registration forms are public documents whereas, under the terms of this Act, the particular agency at which an applicant submits a voter registration application may not be publicly disclosed [Section 8(i)(1)].

***The Content of the Agency Registration Form***

The content of whatever mail registration form is used in the agency registration program must meet the same requirements as the national mail registration form [Section 7(a)(6)(A)(ii)]. See Chapter 3 for a full discussion of these aspects of the national mail registration form. It is also true, however, that State mail registration forms must be “equivalent” to the national mail registration form [Section 6(a)(2)] except that State mail registration forms can be more specific — containing only those items required in that State. (Hence, the advantage of using the State mail registration form or a combined agency form in State agencies).

## **Declining to Apply for Voter Registration in an Agency**

The Act requires that participating agencies provide mail voter registration forms to applicants “unless the applicant, in writing, declines to register to vote” [Section 7(a)(6)(A)]. Indeed, the Act specifies some of the language that must appear as part of the declination form [Section 7(a)(6)(B)]. Further, the Act declares that “No information relating to a declination to register to vote in connection with an application made at an [agency] office...may be used for any purpose other than voter registration” [Section 7(a)(7)].

There are three important aspects to be considered regarding a declination to apply for voter registration in an agency:

- the *content* of the declination
- the *format* of the declination, and
- the *confidentiality* of the declination.

### ***The Content of the Declination***

The Act specifically requires the following elements as part of the declination.

- “If you are not registered to vote where you live now, would you like to apply to register to vote here today?”

(and if the agency provides public assistance)

- “Applying to register or declining to register to vote will not affect the amount of assistance that you will be provided by this agency.”
- “IF YOU DO NOT CHECK EITHER BOX, YOU WILL BE CONSIDERED TO HAVE DECIDED NOT TO REGISTER TO VOTE AT THIS TIME.” (with “yes” and “no” boxes being provided)
- “If you would like help filling out the voter registration application form, we will help you. The decision whether to seek or accept help is yours. You may fill out the application form in private.”, and
- “If you believe that someone has interfered with your right to register or to decline to register to vote, your right to privacy in deciding whether to register or in applying to register to vote, or your right to choose your own political party or other political preference, you may file a complaint with \_\_\_\_\_ (the blank being filled by the name, address, and phone number of the appropriate official to whom such a complaint should be addressed).

If the declination is contained on a separate form, States are required to add two others — parallel to those required on the motor voter registration application:

- a statement that if the applicant declines to register to vote, that this decision will remain confidential and be used only for voter registration purposes, and
- a statement that if the applicant does register to vote, information regarding the office to which the application was submitted will remain confidential, again to be used only for voter registration purposes.

And finally, States will no doubt want to obtain, for record keeping purposes:

- the name of the applicant
- the signature of the applicant (or declinee), and
- the date.

### ***The Format of the Declination***

By its nature, this affirmation or declination opportunity is the first voter registration question that applicants will be presented when they are applying for other services in public or private agencies. This declination lends itself, then, to being included in the other forms being completed by applicants — as an integral part of the agency's own form(s), or as a separate form.

As a practical matter, States should consider designating the chief State election official as the person to whom applicants should address any complaints — including, where possible, a toll free telephone number for the purpose.

States should also consider, as a thoughtful courtesy, perforating the bottom portion of the declination so that applicants can remove and retain the procedures for filing a complaint.

### ***The Confidentiality of the Declination***

Although the Act does not specifically require that the declination be retained, States may nevertheless want to do so in order to maintain an audit trail, to ensure evidence should allegations of wrongdoing arise, and for the benefit of the agencies themselves.

States will want to decide who should maintain the records of agency declinations to register — whether the agency office or the election office. Nothing in the law prohibits or requires that information regarding declinations be forwarded to the election office. In order to minimize the transmittal burden on agency offices, such information might well be kept by the participating agencies — provided that it is held confidential and for two years pursuant to Sections 7(a)(7) and 8(i)(1) of the Act, and also provided that proper consideration be given to maintaining the confidentiality of individual health records in those agencies where such information is protected by law.

These confidentiality provisions are an essential component of agency voter registration procedures given the potential chilling effect public disclosure would have

for people registering to vote in, for example, a local Community Mental Health Center or in the office of the local provider of services for people with AIDS.

### **The Transmittal of Voter Registration Applications from Agency Offices to the Appropriate Election Official**

There are two ways in which agency voter registration applications can be transmitted to the appropriate election official, either:

- by the agency itself, or else
- directly by the applicant.

“An applicant may, if he or she chooses, mail the voter registration application directly to the appropriate State election official rather than returning it to the agency for transmittal. The agency providing voter registration services is prohibited from requiring a registrant to mail the form, and must accept it and forward it to the appropriate registration official if turned in by the applicant. The agency must provide regular, visible means for collecting registration application forms” [Hse. Rpt., Section 7, page 13].

If applicants submit voter registration applications to the agency, then the Act requires that agency authorities transmit them to the appropriate election official within ten (10) days after acceptance, or, if accepted within five (5) days before the close of registration, within five (5) days of acceptance [Section 7(d)].

The Act appears, however, to permit election officials to assume an active role in the forms distribution and collection process. (When the various agencies use separate voter registration forms). Some local election officials, in fact, might prefer to send a weekly courier to collect all the forms completed in the previous week and to resupply the agency's stock.

States where social service agency jurisdictions are not coterminous with election jurisdictions (or where individuals may apply for benefits or services at any agency office in the State) face a different challenge.

In some cases, States may prefer to have the agency offices sort completed voter registration forms by election jurisdictions — using postage paid envelopes or pouches that are then forwarded to the appropriate local election officials in those jurisdictions.

In other cases, States may prefer to have some or all voter registration applications forwarded to a central State election authority for sorting and re-routing to the appropriate local election officials.

Nothing in the Act would appear to prohibit any of these procedures provided that such voter registration applications are received by the local election official within the ten or five day period prescribed by the Act or else are still accepted by the local

election official even though they were received, by virtue of the State's procedure, after the ten or five day period prescribed by the Act.

### **Administering an Agency Voter Registration Program**

With regard to administering a successful agency voter registration program, the Federal Election Commission has available a free publication entitled *Innovations in Election Administration 5: Agency Voter Registration Programs* summarizing the experiences of States that operated some type of agency registration program prior to the passage of the NVRA — how they work, problems they have encountered, recommended practices, and the like.

Three important aspects of administering an agency voter registration program that warrant consideration here are:

- the need to appoint someone in each agency office to be in charge of and responsible for voter registration activities
- the need to train all agency employees involved with voter registration, and
- the accountability of agency voter registration forms.

#### ***Putting Someone in Charge***

Research suggests that a principal ingredient of a successful agency registration program is the appointment of someone in each agency office to be in charge of, responsible for, and enthusiastic about all voter registration activities — ensuring an adequate supply of forms, monitoring voter registration activities, training new employees, resolving questions and problems that arise in coordination with State or local election officials, and the like. Such a task need not be full time, but it must be on going.

#### ***Training Agency Employees***

A second ingredient to a successful agency registration program is the adequate training of all agency employees involved with voter registration — how to ensure that voter registration forms are completed and signed correctly, how to offer and provide assistance to registrants, and the like. After an initial training of all current employees, the training of new employees can be assumed by the agency person appointed to be in charge of the program.

#### ***The Accountability of Agency Registration Forms***

To monitor the effectiveness of agency registration programs, many jurisdictions have found it useful to account for the number of registration applications that are received from the various agency offices. And such a procedure gathers importance in light of the record keeping and reporting requirements of the Act (see Chapter 7 below).

The monitoring of applications depends largely on what form the agency uses.

If agencies use the State mail registration form as their application, then election officials might consider printing or subsequently stamping mail registration forms with sequential numbers. Sequentially numbering mail registration forms and distributing them in numbered batches to agency offices provides a basis for monitoring the process without divulging to the public the specific agency in which any particular applicant registered. (See also the discussion of the accountability of mail registration forms under Chapter 3 and the accountability of motor voter registration forms under Chapter 2).

If the voter registration application is on a *distinctive* agency form (such as a combined form or a computer generated form), then the task of monitoring incoming applications from various agency offices is greatly simplified. However, if original voter registration documents are a matter of public record, then there might be confidentiality problems in light of the Act's prohibition on publicly disclosing "the identity of a voter registration agency through which any particular voter is registered" [Section 8(i)(1)].

Challenges also arise if agencies use either the national mail registration form or the agency's own version of the State mail registration form even if it is identical to the State form (since sequentially numbering these might prove difficult).

Although it may prove possible to code the types of forms described in the previous two paragraphs (using either numbers or symbols), election officials would want to be sure to keep the codes confidential and perhaps even to mask the code with ink after it has been received, counted, and processed.

Failing the use of either sequential numbers or codes, election officials might have to count batches of applications as they are received from each participating agency.





**VOTER REGISTRATION LIST MAINTENANCE OPTIONS UNDER THE NVRA**

5-1

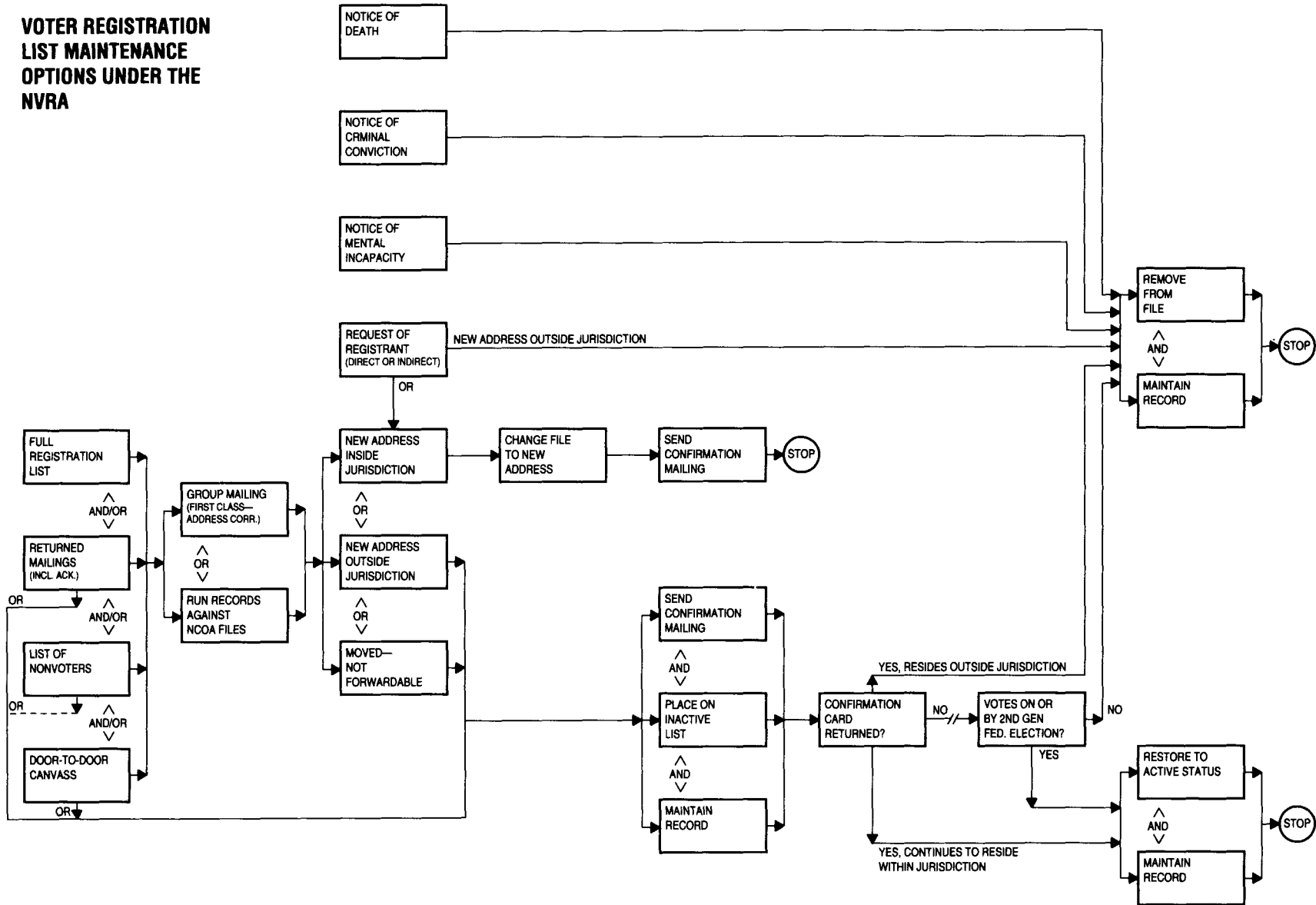



## **CHAPTER 5 - VOTER REGISTRATION LIST MAINTENANCE PROVISIONS**

---

The National Voter Registration Act contains several features that will fundamentally alter the way voter registration lists are maintained in most jurisdictions. These features include:

- a slight change in the date by which valid voter registration applications must be accepted by the registrar [Section 8(a)(1)]
- a requirement that registrars “send notice to each applicant of the disposition of the application” [Section 8(a)(2)]
- a change (for most jurisdictions) in the rules for removing individual names from the voter registration list [Sections 8(a)(3) and (4), Section 8(b)(2), and Sections 8(c) and 8(d)]
- a change (for most jurisdictions) in the rules for changing a registrant’s address information [Sections 8(c), 8(d), and 8(f)], and
- a requirement that States “conduct a general program” the purpose of which is “to protect the integrity of the electoral process by ensuring the maintenance of an accurate and current voter registration roll for elections for Federal office” [Sections 8(a)(4) and 8(b)].

### **IMPORTANT ISSUES IN VOTER REGISTRATION LIST MAINTENANCE**

---

The voter registration list maintenance requirements of the Act are fairly complex but permit the States considerable latitude in designing appropriate procedures. In doing so, there are important issues to consider:

- the date by which valid voter registration applications must be accepted
- the rules for removing names from the voter registration list
- the rule for changing a registrant’s address information, and
- the administration of the file maintenance program.

### **The Date By Which Valid Voter Registration Applications Must Be Accepted**

Most election offices currently accept and process voter registration applications up until their registration deadline. A few, as in California, accept mail registration applications for a few days after the deadline. States will need to revise these practices because the Act effectively applies the State's voter registration deadline (or the Act's 30 days before the election deadline, whichever is later) to when the form was submitted by the applicant rather than to when it is received by the election office.

The Act permits motor vehicle and agency offices up to five days to transmit to the election office any applications they receive on the last day of voter registration. (See the "Transmittal of Forms" portion of Chapters 2 and 4). Therefore, election offices must accept and process motor voter and agency voter registration applications up until at least five (5) days *past* the deadline for registration [Sections 8(a)(1)(A) and (C) along with Sections 5(e), and 7(d)].

The Act also requires election offices to accept and process mailed voter registration applications that are postmarked not later than the State's voter registration deadline (or the Act's 30 days before the election deadline, whichever is later) [Section 8(a)(1)(B)]. (See the "Transmittal of Forms" portion of Chapter 3 above).

As a practical matter, however, postmarks are not always applied by the Postal Service. And even when they are, they are not always readable. States may therefore want to consider accepting "any voter registration application that is postmarked not later than the deadline for voter registration or else is received in the mail not later than five days after the deadline for voter registration." Such an arrangement yields a single deadline for receiving *all* registration applications except those that are clearly postmarked before the close of registration but seriously delayed in the mails.

States might also want to establish rules and procedures to be followed in the event that motor voter or agency applications are, for some reason, *not* transmitted to the appropriate election official within the legal time frame.

### **The Rules for Removing Names from the Voter Registration List**

The NVRA *prohibits* removing the names of any individuals from the voter registration list solely for:

- **failure to vote** [Section 8(b)(2)], or
- **change of address** to another location **within the registrar's jurisdiction** (even if they fail to notify the registrar of the move) [Section 8(f)].

The Act *permits*, however, removing the names of individuals:

- upon **the request of the registrant** [Section 8(a)(3)(A)]
- for **mental incapacity** (as provided in State law) [Section 8(a)(3)(B)], or
- upon **criminal conviction** (as provided in State law) [Section 8(a)(3)(B)]

The Act also *requires* States to conduct a general program that makes a reasonable effort to remove the names of ineligible voters:

- upon their **death** [Section 8(a)(4)(A)]
- upon their **written confirmation of a change of address** to a location **outside the registrar's jurisdiction** [Sections 8(a)(4)(B) and 8(d)(1)(A)], and
- upon their **failure to respond to certain confirmation mailings and their failure to offer to vote in any election within two subsequent general federal elections** [Sections 8(a)(4)(B) and 8(d)(1)(B)].

#### *No Removal for Failure to Vote*

Although most jurisdictions currently remove the names of individuals from the voter registration list after their failure to vote within a specified time frame, the NVRA prohibits this practice [Section 8(b)(2)]. It does so in accordance with “an underlying purpose of the Act; that once registered, a voter should remain on the list of voters so long as the individual remains eligible to vote in that jurisdiction” [Hse. Rpt., Section 8, page 18].

#### *No Removal for Change of Address within the Registrar's Jurisdiction*

For exactly the same reason as quoted above, the Act prohibits removing names of individuals from the voter registration list simply because they changed residences *within* the registrar's jurisdiction [Section 8(f)]. If such a change of address comes to the attention of the registrar, the registrar may proceed in accordance with the “rules for changing a registrant's address” described below in this Chapter. If such a change of address does not come to the attention of the registrar, then the place and manner in which the individual votes is described in Chapter 6 on fail-safe voting procedures.

#### *Removal by Request of the Registrant*

Individuals may request that their names be removed from the voter registration list. The Act permits States to honor such requests [Section 8(a)(3)(A)]. It is also important to note that “A ‘request’ by a registrant would include actions that result in the registrant being registered at a new address, such as registering in another jurisdiction or providing a change-of-address notice through the driver's license process that updates the voter registration” [Hse. Rpt., Section 8, page 14]. (See also The Format and Content of the Form to be Used in the Driver's License Change of Address Process in Chapter 2.)

***Removal for Mental Incapacity***

Although the Act permits removing the names of individuals from the voter registration list by reason of mental incapacity, it does not define “mental incapacity.” Nor does it describe the process through which the registrar is to be informed of such a development. Instead it defers to State law [Section 8(a)(3)(B)]. States that have such provisions may want to take this opportunity to establish procedures whereby registrars are systematically informed of any declarations of mental incapacity — either directly or, perhaps more practicably, through the chief State election official. Research suggests that States with the most effective programs require the agencies responsible for maintaining records of declarations of incompetence (e.g.; clerks of court, district courts, etc.) to report on a scheduled basis (usually monthly) rather than an “as occurs” basis. The reports are made to both the local registration official and the State election official. The State election official, in turn, disseminates the information to the local jurisdiction for review and cross check against reports received from local agencies. State officials may either identify incompetency declarations by address and notify the appropriate official or send the entire report to all local jurisdictions. (See also that portion of Chapter 1 regarding the role of the chief State election official).

***Removal for Criminal Conviction***

The Act permits removing names of individuals from the voter registration list for reason of criminal conviction, but once again defers to State law [Section 8(a)(3)(B)].

To assist States that have such provisions, the Act requires U.S. Attorneys to give written notice of a felony conviction in federal court to the chief election official of the person’s State of residence including:

- the name of the offender
- the offender’s age and address
- the date of entry of the judgment
- a description of the relevant offense(s)
- the sentence imposed by the court

and, upon the request of the chief State or local election official, any additional information the attorney may have regarding the offender or the offense. The U.S. Attorney is required to notify the chief State election official in writing if any such conviction is overturned. Finally, the Act requires the chief State election official to convey any such information to the local registrar of the offender’s jurisdiction of residence [Section 8(g)].

The Act does not require State or local courts to provide the chief State election official with information regarding disqualifying criminal convictions; however, States that disenfranchise for certain crimes may want to consider such a provision.

Research suggests the States that require such notification be provided to the State election official on a regularly scheduled basis (e.g.; monthly) have more effective programs because reporting at the local level tends to be sporadic. The State, in turn disseminates the information to local jurisdictions either by notifying those local election officials appropriate to the addresses on the list, or by sending the entire report to all local jurisdictions.

#### ***Removal by Reason of Death***

The Act requires that States make a reasonable effort to “remove the names of ineligible voters from the official lists of eligible voters by reason of the death of the registrant...” [Section 8(a)(4)(A)]. It does not, however, specify the procedures for doing so. Because obtaining information about deaths of registrants has proved so difficult in the past, States might want to develop a more systematic approach.

One such approach might be requiring the State office in charge of vital statistics (e.g.; Bureau of Vital Statistics, Department of Health, or Division of Human Resources) to inform the chief State election official of all deaths of State residents on a monthly basis (in parallel to notices of court convictions). States may also want to establish what other sources of information about registrants who may have died are permitted and how to verify them, when necessary. These other sources may prove especially important for border jurisdictions whose registrants may seek medical attention from nearby hospitals in another State. These “unofficial” sources might include newspaper obituaries, contact with the deceased’s relatives, or personal knowledge of an employee in the office charged with administering voter registration.

#### ***Removal by Reason of a Written Confirmation of a Change of Address outside the Registrar’s Jurisdiction***

The Act prohibits removing the name of a registrant from the list of eligible voters “on the ground that the registrant has changed residence unless the registrant confirms in writing that the registrant has changed residence to a place outside the registrar’s jurisdiction in which the registrant is registered...” [Section 8(d)(1)(A)].

There are three ways in which a registrar might receive such written confirmation from the registrant.

First, the registrant may spontaneously send a notice informing the registrar of their change of address outside the jurisdiction (although this is an extremely rare practice). Still, should it happen, registrars need obtain no further confirmation.

The second way includes any actions by the registrant “that result in the registrant being registered at a new address, such as registering in another jurisdiction or providing a change-of-address notice through the driver’s license [or agency] process that updates the voter registration” [Hse. Rpt., Section 8, page 14]. This suggests that cancellation notices received from voter registrars in other jurisdictions would be sufficient for removing a registrant’s name. And by the same token, notices received from motor vehicle departments and agencies regarding a registrant’s



change of address for voting purposes to a location outside the registrar's jurisdiction would appear sufficient for removing a registrant's name. The reasoning here appears to be that registrars need obtain no further confirmation in these instances because the registrants initiate such actions or notices and, unless they specifically declare to the contrary, are indicating that the change applies to voter registration. Registrars might want to have, or at least have access to, the registrant's original signature on such notices.

The third way in which registrars might obtain written confirmation of a registrant's change of address to a location outside the registrar's jurisdiction is in response to the "confirmation" mailing described later in this chapter and in Section 8(d)(2) of the Act.

Briefly (though it is described in greater detail below), the confirmation process permits registrars to initiate a mailing to any registrant whom the registrar has legitimate reason to believe has changed address. These reasons must be uniformly applied to all registrants but may include any change-of-address information supplied by the Postal Service either through their National Change of Address files or else through their return of any election mailing (such as the acknowledgment notice described above, sample ballots, or the like) [Hse. Rpt., Section 8, pages 15 and 16]. Reasons may also include information from the courts regarding returned jury duty notices or information on driver's licenses surrendered in other states.

The reasoning here appears to be that because this kind of change-of-address information is second hand, rather than originating from the registrant, the election official must seek to confirm it directly with the registrant. This is done by sending a forwardable mailing to registrants that contains a postage prepaid and pre-addressed return notice on which registrants state their current address. If registrants return the notice confirming an address outside the registrar's jurisdiction, their names can then be removed from the voter registration file. (It should also be noted that a record of such transactions must be maintained as explained in Chapter 7). If registrants do not return the notice, then registrars must follow the procedure described immediately below.

***Removal for Failure to Respond to Certain Confirmation Mailings and Failure to Offer to Vote in Any Election within Two Subsequent General Federal Elections***

The Act provides for two types of confirmation notices. The content and format of both types of notices are addressed in more detail at the end of this chapter. The first type is sent when the Postal Service provides information that the registrant may have moved *within* the jurisdiction [Section 8(c)(1)(B)(i)]. This notice is discussed further in the next section of this chapter.

The second type of notice is sent when there is an indication that the registrant may no longer live in the registrar's jurisdiction [Section 8(d)(2)]. The Act provides that names of registrants may be removed from the voter registration list if they:

- fail to respond to the *second* type of notice (i.e.; sent because there was an indication that the registrant no longer resides in the registrar's jurisdiction); *and*
- have not voted or appeared to vote "in an election during the period beginning on the date of the notice and ending on the day after the date of the second general election for Federal office that occurs after the date of the notice" [Section 8(d)(1)(B)].

*Both* conditions (failure to respond to the second type of notice and failure to appear to vote) are required for removal.

(NOTE: If registrants fail to respond to such a confirmation mailing, they may be placed in an "Inactive" status as explained in Administering the File Maintenance Program at the end of this chapter. Moreover, records of all confirmation mailings and responses must be maintained as explained in Chapter 7.)

This procedure allows for the possibility that the change-of-address information received second hand was in error, the possibility that the registrant did not receive (or take notice of) the confirmation mailing, and the possibility that the registrant may be one of those "presidential voters" who vote only once every four years. Even if all three possibilities pertain, the registrant's right to vote is still preserved.

### **The Rule for Changing a Registrant's Address Information**

The rule for changing a registrant's address information pertains, of course, only to changes of address *within* the registrar's jurisdiction (since if they are changes of address outside the registrar's jurisdiction, registrants will be removed from the voter registration list according to one of the two procedures outlined immediately above).

The Act provides that "In case of a change of address, for voting purposes, of a registrant to another address within the same registrar's jurisdiction, the registrar shall correct the voting registration list accordingly, and the registrant's name may not be removed from the official list of eligible voters except [when the individual confirms in writing that he or she no longer resides in the jurisdiction, or fails to respond to a Section 8(d)(2) notice and fails to vote or appear to vote in an election within a period up to the second general federal election after that notice] [Section 8(f)].

There are at least five ways in which a registrar might receive information about a registrant's change of address within the jurisdiction.

First, the registrant may spontaneously send a note (or a mail registration form) informing the registrar of their move. Should that happen, the registrar need not seek further confirmation before changing the registrant's address in the voter registration file. And although the law does not specifically require it, it would seem appropriate to inform the registrant of this action as well as of the location of the registrant's polling place.

The second way is if the registrant files a change-of-address notice with the motor vehicle office or through an agency designated to register voters under the Act, unless the registrant declares that the change of address is not for voting purposes. Because these notices are also initiated by the registrant, the registrar need not seek further confirmation before changing the registrant's address on the voter registration list (and, presumably, sending an appropriate notice to the registrant).

The third way in which registrars may learn of a registrant's change of address within their jurisdiction is through information provided by the Postal Service either through the National Change of Address program or else upon return of any election mailing.

"[I]f it appears from information provided by the Postal Service that a registrant has moved to a different residence address in the same registrar's jurisdiction in which the registrant is currently registered, the registrar changes the registration records to show the new address and sends the registrant a notice of the change by forwardable mail and a postage prepaid pre-addressed return form by which the registrant may verify or correct the address information" [Section 8(c)(1)(B)(i)].

(NOTE: Even if registrants who have moved within the jurisdiction fail to respond to this type of confirmation mailing, they should *not* be designated as inactive and cannot be removed from the registration list. Moreover, records of all confirmation mailings and responses must be maintained as explained in Chapter 7.)

The reasoning behind this procedure appears to be that because Postal Service change-of-address information is second hand, rather than originating from the registrant, the election official must seek direct, first-hand confirmation.

The fourth way in which registrars might obtain written confirmation of a registrant's change of address to a location within the registrar's jurisdiction is through responses to one of the two confirmation notices described earlier in this chapter and in Sections 8(c)(1)(B)(i) and 8(d)(2) of the Act.

The fifth way in which registrars may learn of a change of address within the jurisdiction is through changes of address made by registrants at the polls on election day. (See Fail-Safe Voting Provisions in Chapter 6.)

### **Administering the File Maintenance Program**

Important aspects of administering a voter registration list maintenance program include:

- the need to ensure uniformity and compliance with the Voting Rights Act of 1965, as amended
- addressing confirmation notices

- monitoring “inactive” voters
- identifying duplicate registrations
- the deadline for completing list maintenance activities
- the accountability of list maintenance activities
- the need to appoint someone to be in charge of list maintenance activities, and
- the need to train local registration officials.

***Ensuring Uniformity and Compliance with the Voting Rights Act***

The Act specifies that “Any State program or activity to protect the integrity of the electoral process by ensuring the maintenance of an accurate and current voter registration role ... shall be uniform, nondiscriminatory, and in compliance with the Voting Rights Act of 1965 (42 U.S.C. 1973 et seq.)” [Section 8(b)(1)].

According to the House, “This requirement may not be avoided by a registrar conducting a purge program or activity based on lists provided by other parties where such lists were compiled as the result of a selective non-uniform, or discriminatory program or activity.” Also, the requirement effects “any activity that is used to start, or has the effect of starting a purge of the voter rolls, without regard to how it is described or to whether it also may have some other purpose. For example, the mailing of sample ballots is clearly a program that has another purpose but might provide the basis for a remove of voter rolls.” [Hse. Rpt., page 15].

The Senate expanded on this concern by noting that list maintenance programs “must be scrutinized to prevent poor and illiterate voters from being caught in a purge system which will require them to needlessly reregister. Such processes must be structured to prevent abuse which has a disparate impact on minority communities” [Sen. Rpt., page 18].

The National Voter Registration Act of 1993 is specifically intended to be complementary to rather than contradictory to the Voting Rights Act of 1965. Section 11(d)(1) states, in part, that “neither the rights and remedies established by this section nor any other provision of this Act shall supersede, restrict, or limit the application of the Voting Rights Act of 1965 (42 U.S.C. 1973 et seq.)”. Section 11(d)(2) states “Nothing in this Act authorizes or requires conduct that is prohibited by the Voting Rights Act of 1965 (42 U.S.C. 1973 et seq.)”. The Senate notes that “Merely because a program was conducted under the National Voter Registration Act would not be a defense to any claim which might be asserted under the Voting Rights Act ... The States must comply with the National Voter Registration Act in a manner which does not violate the Voting Rights Act” [Sen. Rpt., page 18].

States should note that Section 2 of the Voting Rights Act applies to all States and prohibits any State or political subdivision from imposing or applying election laws

or procedures which discriminate against individuals on account of race, color, or language minority status [42 U.S.C. 1973]. It follows, then, that whatever list maintenance procedures that States adopt, they must be nondiscriminatory in both intent and effect.

Furthermore, those jurisdictions that are subject to the preclearance or bilingual requirements of the Voting Rights Act must continue to adhere to these provisions when implementing the NVRA voter list maintenance provisions.

Finally, the removal of the names of registrants who were registered by federal examiners under the U.S. Office of Personnel Management (OPM), in accordance with 42 U.S.C. 1973d, would be subject to the same restrictions as established prior to the NVRA (i.e.; approval must be obtained from OPM before such names can be deleted from the rolls).

#### ***Addressing Confirmation Notices***

Although the Act requires that confirmation mailings be sent to registrants “by forwardable mail” [Sections 8(c)(1)(B)(i) and 8(d)(2)], it does not specify to which address these mailings should be sent. In some cases (such as when a mailing to a registrant has been returned as undeliverable with no forwarding address), the registrar will have only one address. In other cases, however, (such as when notified by the Postal Service of a change of address), the registrar will have a choice of mailing to the old address on file, to the new address provided by the Postal Service, or to both.

When faced with a choice, the advantage in mailing to the old address is that those registrants who have *not* permanently changed address may receive it at the old address and have an opportunity to respond accordingly (whereas they would not receive the mailing if it were sent to the new address). A disadvantage to using the old address is that if the registrant has moved, the notice may not be received through postal forwarding — since most local post offices retain change-of-address records for only 12 or 18 months.

The advantages and disadvantages of mailing to the new address are almost the reverse. If the registrant has moved, the notice will probably be received. If the new address is in error, the registrant would never receive it.

These problems can be overcome if notices are mailed to both addresses, but at the cost of increased printing and postage for the production and mailing of additional mailings plus the potential of voter confusion at receiving both mailings.

States may want to consider establishing a consistent statewide procedure for addressing confirmation mailings.

#### ***Monitoring “Inactive” Voters***

The Act does not prohibit designating as “inactive” those voters who have not responded to a confirmation mailing that was sent in accordance with Section 8(d)(2)

to confirm whether or not the registrant continues to reside in the jurisdiction. (Note: This appears to exclude notices mailed in accordance with Section 8(c)(1)(B)(i) for the purpose of confirming information provided by the Postal Service concerning a change of address *within* the jurisdiction.)

Indeed, the House specifically notes that “Within the official list of eligible voters, notations (such as an asterisk or “I” for inactive status) may be made of those eligible voters who have failed to respond to a notice under Section 8(d)(2).” Such a procedure “permits the State to decline to use these names in performing the type of routine, administrative responsibilities that do not impair the right of such voters to vote as set forth in the Act, and as protected by the Voting Rights Act. For example, those who have failed to respond to a Section 8(d)(2) notice need not be included for administrative purposes in determining the number of signatures that may be required under State law for ballot access, the number of precincts that may be needed to service voters, or the number of ballots or voting machines that may be required in the administration of the voting process” [Hse. Rpt., Section 8, pages 16 and 17]. States should consider carefully the full impact of including or ignoring “inactive” voters for each of these purposes.

States will have to decide *when* to designate recipients of such confirmation mailings as “Inactive.” There appear to be at least three possibilities:

- upon the date of the outgoing confirmation mailing — to be restored to active status (or removed as appropriate) upon receipt of a response to the confirmation notice,
- at some arbitrary date (such as thirty days) after the outgoing confirmation notice if no response has been received — again to be restored to active status (or removed as appropriate) upon receipt of a response to the confirmation return notice, or
- after the closing date for receiving voter registration applications before the next election.

It should be noted that none of these possibilities has any practical consequence on the registrant who either will or will not respond.

States must also decide whether to send the names of “inactive” voters to the polling places. Not sending them, as a cost saving strategy, might complicate and delay the fail-safe voting procedures described in Chapter 6. If they are sent, States then must decide whether they should be on a separate list or should be combined with the “active” voters using an asterisk or “I” as a designation. The decisions here are likely to be driven by the technology available to local jurisdictions.

Election officials at either the State or local level will need to consider how to track the names of individuals who have failed to respond to an 8(d)(2) confirmation

notice during the intervening period prior to removal from the list. During this tracking period, jurisdictions must be alert to:

- any appearance to vote;
- any changes of address subsequently received from the registrant either directly or through the Department of Motor Vehicles or another agency, or from another jurisdiction in which the individual re-registered; and
- any attempt to reregister in the same jurisdiction.

States may want to consider whether or not the signature of an “inactive” registrant on a petition for a candidate or ballot issue would be sufficient to return the individual to active status, provided the registrant continues to reside in the same registrar’s jurisdiction. States may also want to consider the costs and benefits of sending a final notice of removal (which is not required under the Act, but may result in less voter confusion) upon the expiration of the “inactive” period. Some States have found it helpful to publish in area newspapers a list of names scheduled to be deleted.

#### ***Identifying Duplicate Registrations***

Duplicate registrations (as opposed to registrations submitted to report changes of name, address, or political party affiliation) can threaten the integrity of the election process and increase the cost of administering elections. Therefore, although not specifically mentioned in the Act, States may want to require the establishment of programs to identify and remove duplicate registrations.

Research suggests that States with the most effective programs for identifying duplicate registrations require the State as well as local jurisdictions play a part in the process. The local jurisdictions check for duplicates within their jurisdiction and the State checks for duplicates across jurisdictional boundaries within the State. Such State involvement is only possible, however, where registries have been computerized within the State and the State election official has access to these records on electronic media.

Approaches to identifying duplicate registrations include:

- manual review of hard copy files either on a regularly scheduled basis or, if workload permits, as applications are received;
- review of computer files as applications are received and being logged into the system, as workload permits;
- regularly scheduled review of computer-generated lists of possible duplicate registrations; or
- a combination of these methods.

States might want to require that a notice be sent when duplicates are identified, explaining that the applicant need not continue to reregister. When duplicates are identified upon receipt of the application, this notice could be incorporated in the acknowledgment notice. When duplicates are identified after they have been added to the voter registry, a separate notice would have to be sent. In the case of duplicate registrations across jurisdictional boundaries, the notice should explain which registration is scheduled to be deleted and why. (An example of a notice based on duplicate registration across jurisdictional boundaries is provided in Figure 5D.)

States should consider requiring local jurisdictions to maintain records of duplicate registrations, regardless of whether the duplicates are discovered upon receipt of the application or after being added to the list of voters. (See the discussion of recordkeeping and reporting requirements in Chapter 7.)

#### ***The Deadline for Completing List Maintenance Activities***

The Act requires States to “complete, not later than 90 days prior to the date of a primary or general election for Federal office, any program the purpose of which is to systematically remove the names of ineligible voters from the lists of eligible voters” [Section 8(c)(2)(A)]. This would apply to confirmation notices mailed on the basis of the NCOA or other list maintenance programs. And according to the House, this requirement also applies to any “State outreach activity such as a mailing or a door to door canvas and requires that such activity be completed by the 90-day deadline” [Hse. Rpt., page 16].

The Act does *not*, however, apply this 90-day deadline to removing names from the voter registration list at the request of the registrant, by reason of criminal conviction or mental incapacity (as provided by State law), or by reason of the registrant’s death [Section 8(c)(2)(B)(i)]. Nor does the Act apply the deadline to changing the address information of a registrant who has changed voting residence within the registrar’s jurisdiction [Section 8(c)(2)(B)(ii)]. The Act also would not prohibit verifying incoming voter registration applications within the 90-day period before the election.

Finally, the Act does not appear to prohibit using routine mailings sent out within 90 days before a federal election (sample ballots, voter pamphlets, etc.) and returned undeliverable to the election office as a trigger for sending out a confirmation mailing *provided* that the confirmation mailing is sent out (and any subsequent removal of a name is performed) *after* the election and not within the 90 days prior to it. But States contemplating such a strategy might first want to obtain the opinion of their Attorney General.

#### ***The Accountability of List Maintenance Activities***

The Act requires voter registration officials to maintain and to make available for public inspection (and, where available, for photocopying at a reasonable cost), “all records concerning the implementation of programs and activities conducted for the purpose of ensuring the accuracy and currency of official lists of eligible voters” *for*



at least 2 years [Section 8(i)(1)]. And according to Section 8(i)(2), these records are to include:

- lists of the names and addresses of all persons to whom confirmation mailings were sent, and
- information concerning whether or not each such person responded to the mailing as of the date that the records are inspected.

As a matter of prudence, though not as a requirement of the Act, States might also want to retain for the same time period all records of removals from the voter registration list — the date and the reason. (See the reporting requirements outlined in Chapter 7.)

Similarly, States might want to consider retaining the information provided to them by the NCOA (either on tape or printout copies) in order to demonstrate, if challenged, the source of change-of-address information.

#### *Putting Someone in Charge*

Experience suggests that tasks are better accomplished when carried out under the authority and control of a single person. This is especially true for the complex task of voter registration list maintenance and record keeping.

Election offices might want to consider designating one individual to be in charge of and responsible for all list maintenance activities. Such a designation might facilitate meeting the reporting requirements discussed in Chapter 7.

#### *Training Local Registration Officials*

Because this portion of the Act will fundamentally alter the way in which most jurisdictions maintain their voter registration lists, States may want to consider developing a training program for local registration officials — including job aids or procedures manuals for daily reference. These may prove crucial during the first few years of implementation.

## **APPROACHES TO DESIGNING A PROGRAM FOR MAINTAINING AN ACCURATE AND CURRENT VOTER REGISTRATION LIST**

---

The Act requires States to “conduct a general program that makes a reasonable effort to remove that names of ineligible voters from the official lists of eligible voters...” [Section 8(a)(4)].

It further requires that such a program “shall be uniform, nondiscriminatory, and in compliance with the Voting Rights Act of 1965 (42 U.S.C. 1973 et seq.)” [Section 8(b)(1)]. “This requirement may not be avoided by a registrar conducting a purge program or activity based on lists provided by other parties where such lists were compiled as the result of a selective, non-uniform, or discriminatory program or activity” [Hse. Rpt., Section 8, page 15.]

And finally, it requires that States “complete not later than 90 days prior to the date of a primary or general election for Federal office, any program the purpose of which is to systematically remove the names of ineligible voters from the official lists of eligible voters” [Section 8(c)(2)(A)]. This 90-day deadline does not, however, apply to the removal of names from the voter registration list at the request of registrants, by reason of criminal conviction or mental incapacity (as provided for in State law), or by reason of a registrant’s death [Section 8(c)(2)(B)(i)]. Nor does the 90-day deadline apply to changing a registrant’s address information [Section 8(c)(2)(B)(ii)].

Except for establishing this deadline, the Act does not specify either how or when list maintenance activities are to be undertaken. These decisions are left to the States.

In designing a program for maintaining an accurate and current voter registration list, States may want to review the costs and benefits of the following approaches:

- making individual or “spot” changes to the voter registration list
- conducting mass confirmation mailings
- conducting targeted confirmation mailings
- conducting a door-to-door canvass.

For several reasons, States may want to consider adopting a combination of the first three approaches.

### **Making Individual or “Spot” Changes to the Voter Registration List**

One approach to maintaining a voter registration list is to rely solely on incoming information whenever it arrives, as a basis for making changes to the voter registry. Such sporadic incoming information would include:

- direct requests from registrants to be removed from the list
- change-of-address notices from driver’s license or other designated agency offices
- information on driver’s licenses surrendered in other states (followed by a confirmation mailing)
- mailings returned to the election office (followed by a confirmation mailing)

- declarations of mental incapacity (depending on State law)
- notices of criminal conviction (depending on State law)
- death notices
- information from courts regarding returned jury duty notices (followed by a confirmation mailing)
- notices of cancellation of registration from other jurisdictions, and
- election day changes

NOTE: Caution is advised when considering the use of lists provided by candidates, political parties, or certain other persons as sources of information for updating the registry. There have been incidents in which such lists were compiled on a selective, non-uniform, or discriminatory basis.

Although this approach captures some important information, there are problems with relying solely on it.

It may not meet the requirements of the Act to “conduct a general program that makes a reasonable effort to remove the names of ineligible voters” [Section 8(a)(4)]. It will not, for example, capture information on registrants who have moved without filing a change-of-address with the Postal Service. And it may not even capture information on those who have filed a change of address (since local post offices do not maintain records of these changes longer than 12 to 18 months, and most election mailings are not first class and are thus not entitled to “return if undeliverable — address correction requested” services from the Post Office).

Moreover, notices of death, criminal conviction, or mental incapacity tend to be irregular and are seldom timely. And, as a practical matter, few jurisdictions send notices of cancellation of registration to the new registrant’s former jurisdiction.

For these reasons, States would be well advised to combine this “spot changes” approach with a more active mass confirmation approach. And States or local jurisdictions that do not already do so may want to adopt the practice of routinely notifying the registrant’s former jurisdiction (both within and outside the State) of new registrations. This can be accomplished by either mailing a photocopy of the new registration (if it contains information on the former address) or sending a cancellation notice to the State election official or local registrar in the jurisdiction of former residence. (See an example of a cancellation notice that may be used when an individual registers in person in Figure 5A.)

States may also want to consider establishing a statewide computerized voter registry to help account for intrastate re-registrations and cancellations of prior registrations.

## Mass Confirmation Mailings

The idea behind mass confirmation mailings is to identify all persons who have changed address with the Postal Service and then to send each such person one of the confirmation notices described previously in this chapter. There are two ways to identify those persons who have filed a change of address with the Postal Service:

- by using the Postal Service's National Change of Address files (NCOA), or
- by a direct, non-forwardable, first class, "return if undeliverable — address correction requested" mailing to all registrants.

### *The National Change of Address (NCOA) Program*

The Postal Service's National Change of Address (NCOA) program is specifically permitted by the Act as a means of updating the voter registry [Section 8(c)(1)(A)].

Using the NCOA files, however, presupposes a computerized voter registry and a list of no less than 100 names. States should consider giving local jurisdictions the option of using NCOA when some, but not all local jurisdictions, have computerized registries. As an alternative, States might require all local jurisdictions to computerize their registries and employ the NCOA program. As another alternative, States might choose to develop a statewide computerized voter registration list and regularly compare this list against NCOA files.

Under the NCOA program, all changes of address submitted by Postal customers are telecommunicated daily to the U.S. Postal Service National Customer Support Center (NCSC) in Memphis, Tennessee. The NCSC consolidates and standardizes the information. The resulting NCOA master file is provided to 24 private companies operating under a licensing agreement with the U.S. Postal Service. These licensees receive master file updates from the NCSC every two weeks. Prices of the service and the formats required vary by licensee. Jurisdictions would do well to obtain format information and price quotes from many vendors before choosing one.

The objectives of the NCOA program are: to reduce the volume of undeliverable mail, improve address quality on mail, encourage timely and accurate address list updates, and provide cost avoidance for the U.S. Postal Service and its customers. The program features the following:

- All change-of-address actions are maintained on the computer files for *three years* rather than for the twelve to eighteen months normally available from the local postmaster's records.
- All addresses submitted for matching are standardized and ZIP+4 coded.
- Change-of-address information is provided whenever a match is made between addresses submitted and addresses maintained on the NCOA files.

- Address lists may be submitted in virtually any electronic medium (disk, tape, etc.) and virtually any format, depending on the licensee.
- A uniform method for delivering address lists is provided.

Jurisdictions that have employed the NCOA program (such as the Kentucky, Louisiana, and several local jurisdictions in California) found it helpful in maintaining clean, up-to-date voter lists because the program:

- is less expensive than a mass mailing to all registrants;
- permits voter registration files to be updated by computer rather than by hand for changes of address within the jurisdiction;
- provides new addresses for many voters who have moved outside the jurisdiction which can then be used when sending the required Section 8(d)(2) confirmation mailing; and
- provides a standardized, ZIP+4 mailing list that can be used for informational mailings to all eligible voters in the jurisdiction.

Jurisdictions using the NCOA program should, however, understand the logic that the program uses to match names. There are rigid standards for what is considered a match when the names and addresses in the registry are compared against the NCOA file. Even small variations in name or address can result in a failure to match. Some NCOA vendors have a secondary NIXIE file of possible matches which applies looser standards, but this file may also result in many that are not true matches. (Sacramento County ran a test of a NIXIE file and sampled 100 matches. None of them were true matches.)

Jurisdictions should also bear in mind that the NCOA data file will be flawed because:

- the data provided by the public may not correctly note whether just one individual or whether the whole family moved;
- the data provided by the public may not correctly note whether the move is temporary or permanent;
- occasionally errors in entering data from the change of address forms can occur; and
- the date of the change of address (which can be as old as 36 months) may pre-date the latest transaction on the voter registration file.

States or local jurisdictions employing the NCOA program will need their own software to translate the input from the NCOA licensee. This software should provide for the automatic updating of addresses for registrants who have moved within

the jurisdiction. States or local jurisdictions should be sure that this software compares the date of the NCOA address change with the last address transaction date on the voter registry and that it defaults to the later date.

Confirmation notices to both those who have changed address within the jurisdiction and those who appear to have moved outside the jurisdiction should be sent soon after the lists have been compared since the information can quickly become outdated.

States or local jurisdictions should consider providing a telephone number (preferably toll-free) or an address on the confirmation mailing so that registrants can contact the election office to discuss any errors.

Finally, it should be said that the NCOA program is not useful in identifying those who have died, those who have moved without filing a change of address, or those who may be ineligible because of criminal conviction or mental incapacity.

For further information on the NCOA program, refer to *Innovations in Elections 4: Using NCOA Files for Verifying Voter Registration Lists*, authored by Charlotte G. Mullins for the Federal Election Commission's National Clearinghouse on Election Administration. This publication is available by contacting the FEC Clearinghouse. Also contact the Postal Service's National Address Information Center in Memphis, Tennessee on 1-800-238-3150 or 1-800-331-5746.

#### ***A First Class Mailing to All Registrants***

There is an alternative to using the NCOA files for identifying persons who have filed a change of address with the postal service. The procedure is to send a direct, non-forwardable, first class, "return if undeliverable — address correction requested" mailing to all registrants. As a practical matter, however, such a mailing should be sent well before the 90 day deadline. This allows sufficient time for a confirmation mailing to those whose first mailing was returned. (The FEC has been advised by the Postal Service that, because of the relatively low volume of mail in January and February, these would be ideal months to mail.)

Instead of a preliminary non-forwardable mailing, some States have considered sending just the forwardable Section 8(d)(2) confirmation notice to all registrants. The problem with such an approach is that many are not likely to respond in writing. As a consequence, many people will be designated as inactive even though they have not changed their address. And this, in turn, could create serious problems at the polls on election day when they avail themselves of the fail-safe voting procedures described in Chapter 6. Moreover, those who do not attempt to vote over an extended time period will be removed from the registry, even when they continue to reside in the jurisdiction. Such a procedure would run afoul of the provisions of the Act, and might also violate Section 2 of the Voting Rights Act. States might therefore want to ponder the practical and legal consequences of such a strategy.

There are several disadvantages to using the first class mailing approach:

- Although the cost of this process might be somewhat alleviated by combining the initial mailing with some sort of informational mailing, a direct first class mailing is still likely to be considerably more expensive than the NCOA program — not only in terms of printing and mailing costs, but also in terms of staff time and record keeping.
- The Postal Service is likely to deliver mail marked “nonforwardable” to bona fide addresses even though the individual no longer lives there, unless the individual filed a change of address with the post office within the past year or so. To account for this practice, States might want to consider requiring a check box on the front of the initial mailing encouraging the current resident to return the card to the registrar when the addressee either has passed away or otherwise no longer lives there. (An example of such a notice is provided in Figure 5B.)
- Post offices usually maintain records of address changes for only twelve to eighteen months (compared to the 36 months under NCOA). Thus, mass mailings would have to be conducted at least annually.

Finally, it should be noted that a mass mailing would not identify those who have moved but not filed a change of address with the post office, those who have died, or those who are ineligible due to criminal conviction or mental incapacity.

### **Targeted Confirmation Mailings**

Neither the passive approach nor the mass confirmation approach identify those who have moved without filing a change of address with the post office. Nor, as a practical matter, are the death notices obtained in the passive approach likely to be complete and timely. As a result, “deadwood” in the voter registration list is bound to accumulate over time.

For this reason, some States have considered targeting confirmation efforts on individuals who have failed to vote over an extended period of time — either by:

- Sending the list of non-voters a nonforwardable notice, followed by the appropriate forwardable confirmation notice to those who appear to have moved from their address of record;
- Running the list of non-voters against the NCOA files, followed by the appropriate confirmation notices to those who appear to have moved from their address of record; or
- Sending the forwardable confirmation notice provided for in Section 8(d)(2) based on the assumption that failure to vote over an extended period of time may indicate that the registrant no longer lives in the jurisdiction.

States should note that the last of these three options is considered by some advocates to violate the provisions of the Act because the ultimate effect of the action would be to remove people for failure to vote, including those who may still reside in the same jurisdiction. And the second of the above options is not useful in identifying registrants who have failed to file a change of address or have died.

The use of the non-voters list also would not identify those who are ineligible by reason of criminal conviction or mental incapacity. It will not assist in the removal of names of those who have died if another person continues to vote in the name of the deceased. Furthermore, targeting those who have failed to vote may disproportionately affect minority groups, the poor, and illiterate. Thus if States rely solely on “failure to vote” as the trigger for confirmation mailings, they may run afoul of the non-discriminatory provisions of the National Voter Registration Act as well as of Section 2 of the Voting Rights Act.

States that permit such targeted confirmation mailings may therefore want to consider combining it with the other methods of confirming the voter registry described above. States permitting this approach should consider establishing a period of time for non-voting (i.e. within four years, eight years, or the like) before any notice to the registrant is triggered. And States might want to determine whether or not other indicia of activity (e.g.; changes of address within the jurisdiction received from the motor vehicle department or designated agencies, changes in name or party affiliation submitted by the registrant, signatures on petitions, attempts to reregister) occurring during this time period are valid reasons not to follow-up on non-voters.

### **Door-to-Door Canvass**

Some jurisdictions prefer to rely on a door-to-door canvass to confirm the voter registration list. In doing so, they hope to account for those who may no longer reside at a listed address and for those who may have died.

Door-to-door canvassing may be helpful to some jurisdictions; however, the approach does not yield accurate results if canvassers are not thorough, persistent, and non-partisan (or at least bipartisan). In addition, door-to-door canvassing does not identify registrants who are ineligible to vote due to criminal conviction or declaration of mental incompetence, and it may not reliably account for deaths.

Furthermore, because the information on those who may no longer reside in the jurisdiction is received “second hand”, it appears that registrars would have to verify reported deaths and follow up with a forwardable confirmation notice to registrants who appear to have moved. Most jurisdictions will therefore find this approach to be both costly and impractical.



## **FORMS NEEDED FOR VOTER REGISTRATION LIST MAINTENANCE**

---

The Act requires that States employ at least three forms in the list maintenance process: the acknowledgment notice reporting the disposition of each application, the outgoing confirmation notices, and the return notice for responding to confirmation mailings. In addition, although not required by the Act, States may want to require a final notice of removal for those whose names have been deleted from the registry.

In developing these forms, States should consider the following:

- the format and content of the acknowledgment notice to all applicants;
- the format and content of the outgoing confirmation mailing(s);
- the format and content of the confirmation return notices; and
- the format and content of the final notice of removal.

States will also want to be sure to take into account the needs of certain special populations noted in Chapter 1 when designing these notices.

### **The Format and Content of the Acknowledgment Notice to All Applicants**

The Act requires voter registration officials to “send notice to each applicant of the disposition of the application” [Section 8(a)(2)]. As noted in the definitions portion of the Introduction and in Chapter 3 above, we at the FEC have come to call this notice the “acknowledgment notice” even though in some cases it may inform the applicant that the application is incomplete or, for some reason, denied. Please also note in Chapter 3 the important distinction between what we term a “verification mailing” and the acknowledgment notice — a distinction that hinges on whether the applicant is added to the voter registration list before or after the item is mailed.

The following are important aspects of the acknowledgment notice:

- the *format* of the notice, and
- the *content* of the notice.

#### ***The Format of the Acknowledgment Notice***

The Act does not specify the format of the acknowledgment notice — leaving this to the discretion of the States. But as a practical matter, States might want to consider a standard, preprinted, first class, “return if undeliverable - address correction requested”, 12 x 6 inch with a fold crease four inches from the top, a perforation eight inches from the top, and perhaps a fold-over sealing flap at the top. (See postal

specifications in Appendix F below). This would provide a 6 x 8 inch field for the message to the registrant, as well as a 6 x 4 inch detachable pre-addressed response card, if needed.

This approach would permit registrants to use the response card to indicate the following:

- their need for information on the accessibility of their polling place
- their need for voting assistance
- their need for materials in a language other than English
- their willingness to work as a poll worker

All this valuable information (and possibly more) could thus be gathered on an acknowledgment return card without burdening the registration form.

States should consider allowing the chief State election official to design the form. Local offices could then print the form, adding their own return addresses and telephone numbers to a camera-ready copy. Alternatively, States may want to permit local jurisdictions to use simple postcards or letters for the acknowledgment notice.

***The Content of the Acknowledgment Notice***

The Act does not specify the content of the acknowledgment form except to state that it should advise the applicant of the "disposition" of their application. But as a practical matter, States might want to consider pre-printing messages that the local registration official can check off as appropriate. Perhaps something like:

.....

\_\_\_ Your application to register to vote has been received and accepted.  
Your polling place is located at:

\_\_\_\_\_  
\_\_\_\_\_  
\_\_\_\_\_

\_\_\_ Your application to register to vote has been received incomplete.  
Please contact our office at the telephone number or address listed below.

\_\_\_ Your application to register to vote has been rejected because  
(and list here the standard reasons why applications are rejected)

\_\_\_\_\_  
\_\_\_\_\_

\_\_\_ Other \_\_\_\_\_

If you have any questions about this notice, please contact (*local election official's title and phone number*).

.....

Alternatively, local jurisdictions could program their computers to provide acknowledgment notices with responses appropriate to the individual applicant. This information could occupy the top two thirds of the card.

At a minimum, the form should provide the telephone number and address of the election office so recipients can contact the office in the event that either the second or third items above are checked. The form could also provide additional information regarding, for example, the political districts the person is eligible to vote in, the availability of services to persons with disabilities, how to request an absentee ballot, or the like.

## **The Format and Content of the Outgoing Confirmation Mailing(s)**

If a registrant notifies the registrar of a change of voting residence either directly, or else indirectly through the Department of Motor Vehicles or other designated agency, the Act permits the registrar to take appropriate action without further confirmation (whether removing the registrant's name from the voter registration list or changing the registrant's address information) [Sections 8(a)(3)(A) and 8(f)].

If, on the other hand, the registrar only has reason to believe (either through information supplied by the Postal Service or because of some other uniformly applied measure) that the registrant *may* have changed address, then the Act requires the registrar to seek, *by forwardable mail*, address confirmation in writing from the registrant [Sections 8(c) and 8(d)].

Remember, the Act requires registrars to maintain for two years a record of all outgoing confirmation mailings [Section 8(i)(2)]. (See Chapter 7 for further record keeping requirements.)

The following are important elements of these outgoing confirmation mailings:

- the *format* of the mailing, and
- the *content* of the mailing.

### ***The Format of the Outgoing Confirmation Mailing***

The format of the outgoing confirmation mailing is left to the discretion of the States. But States might want to consider using a standard, preprinted, first class, forwardable, 12 x 6 inch format with a fold crease four inches from the top, a perforation eight inches from the top, and perhaps a fold-over sealing flap at the top. (See postal specifications in Appendix F below).

Such a format would accommodate enclosing the confirmation return notice (as a 4 x 6 inch postcard constituting the perforated bottom third of the mailing that could be folded up into the outgoing mailing). It would also provide a 6 x 8 inch field for the message to the registrant.

States should consider allowing the chief State election official to design the form. Local offices could then print the form, adding their own return addresses and telephone numbers to a camera-ready copy.

### ***The Content of the Outgoing Confirmation Mailing***

The content of the outgoing confirmation mailing may vary depending on the reason for the mailing. There are two scenarios:

- the registrar has received information from the Postal Service indicating that a registrant has moved to a different residence address within the same registrar's jurisdiction.

- the registrar questions whether or not the registrant continues to reside in the same jurisdiction (i.e.; either the Postal Service has disclosed that the registrant has moved outside of the jurisdiction or the registrant's continued residence within the jurisdiction otherwise needs to be confirmed).

When the Postal Service provides information indicating that the registrant has moved *within* the same jurisdiction, the Act requires the registrar to send a "form by which the registrant may verify or correct the address information" [Section 8(c)(B)(i)]. The Act does not specify the content of this outgoing mailing.

The Act, however, does require that the confirmation mailing to those whose continued residence within the jurisdiction is in question contain words to the effect that:

- if the registrant has *not* changed address or changed address within the jurisdiction, then they should return the response card not later than the close of registration (See Date by Which Valid Voter Registration Applications Must Be Accepted at the beginning of this chapter).
- if the card is not returned, then affirmation or confirmation of the registrant's address may be required before the registrant is permitted to vote in any subsequent federal election up to the second general federal election after the confirmation mailing
- if the card is not returned and the registrant does not offer to vote by the second general federal election, then the registrant's name will be removed from the voter registration list
- if the registrant has changed address to a location outside the voter registrar's jurisdiction, information on how the registrant may register in their new jurisdiction [all above in Section 8(d)(2), also referenced in Section 8(c)(B)(ii)].

As a practical matter, in accordance with Section 8(f), States also may want to consider adding:

- a note that if the registrant has changed address within the registrar's jurisdiction, that change will be made in the voter registration list and (if it is the courteous practice of the registration office) the registrant will be informed of their new polling place.

In order to satisfy both categories of registrants who will be receiving confirmation mailings, States might want to consider adopting a single, all-purpose confirmation form such as:

.....

\_\_\_ IF, IN THE PAST \_\_\_ YEAR(S), YOU HAVE PERMANENTLY CHANGED THE ADDRESS WHERE YOU LIVE TO A LOCATION **WITHIN** (*jurisdiction*)

- Please detach, complete, and return the postcard at the bottom not later than \_\_\_\_\_ **even if this notice was mailed to your correct current address.** This change will be recorded in the voter registration list and you will be informed by mail of your correct polling place.
- If this card is not returned, affirmation or confirmation of your current address may be required at the polls on election day.
- If this card is not returned and you do not vote by the (*month and year*) general election, then your name may be removed from the voter registration list.

\_\_\_ IF YOU HAVE PERMANENTLY MOVED TO AN ADDRESS **OUTSIDE** (*jurisdiction*) WITHIN THE PAST \_\_\_ YEAR(S)

- Please detach, complete, and return the postcard at the bottom **even if this notice was mailed to your correct current address.**
- Please note that in order to vote, you will have to register with the voter registration office in your new location (Consult your telephone directory).

\_\_\_ IF YOU HAVE **NOT** PERMANENTLY MOVED TO A NEW ADDRESS WITHIN THE PAST \_\_\_ YEAR(S)

- Please detach, complete, and return the postcard at the bottom no later than \_\_\_\_\_.
- If this card is not returned, affirmation or confirmation of your current address may be required at the polls on election day.
- If this card is not returned and you do not vote by the (*month and year*) general election, then your name may be removed from the voter registration list.

If you have any questions about this notice, please contact (*local election official's title and phone number*).

.....

Such an all-purpose approach would reduce costs. Election office records, however, would have to differentiate between notices sent to registrants who appear to have moved within the jurisdiction versus those sent to persons whose continued residence within the jurisdiction is questioned and whose name will be removed from the registry if they neither respond nor vote within the time period specified by the Act.

Alternatively, States may choose to develop two different notices to reflect the two different purposes for the confirmation mailing.

### **The Format and Content of Confirmation Return Notices**

The Act requires that the confirmation mailings discussed above contain a *postage prepaid pre-addressed return form* [Sections 8(c)(B) and 8(d)(2)].

It should also be noted that the Act requires registrars to maintain for two years a record of all responses to confirmation mailings [Section 8(i)(2)]. (See Chapter 7 for further record keeping requirements).

Important aspects of the confirmation return notice include:

- the *format* of the card, and
- the *content* of the card.

#### ***The Format of the Confirmation Return Notice***

Other than requiring that the confirmation return notice be a postage paid, pre-addressed card, the Act does not specify the format of the notice. Yet if States opt for something resembling the format of the confirmation mailing as described immediately above, then the confirmation return notice would take the form of a standard 4 x 6 inch postcard that, as a practical matter, seems the least expensive and most easily filed option. Its front side should, of course, be within postal specifications (See Appendix F).

***The Content of the Confirmation Return Notice***

Although the reasons for the confirmation mailing may vary according to the two scenarios described above, the content of the confirmation return notice could be standardized to satisfy both purposes. States may therefore want to consider adopting a single, all-purpose confirmation return notice containing something like the following:

.....

FULL NAME \_\_\_\_\_  
DATE OF BIRTH \_\_\_\_\_  
IDENTIFICATION NUMBER (optional) \_\_\_\_\_  
TELEPHONE NUMBER (optional) \_\_\_\_\_

THE ADDRESS WHERE I LIVE IS:

\_\_\_\_\_  
\_\_\_\_\_  
\_\_\_\_\_  
\_\_\_\_\_

THE ADDRESS WHERE I RECEIVE MY MAIL IS (only needed if different from address where you live)

\_\_\_\_\_  
\_\_\_\_\_  
\_\_\_\_\_

\_\_\_\_\_  
(Signature)  
\_\_\_\_\_  
(Date)

.....

The receiving registrar could then use this information according to either purpose of the confirmation mailing.

States might also include a reminder of the penalties for providing false voter registration information.



## **The Format and Content of the Final Notice of Removal**

Although not required by the Act, States may want to require a final notice of removal from the voter registry:

- upon expiration of the “inactive” period;
- when information is received from the motor vehicle department or designated agencies that a person has moved from the registrar’s jurisdiction;
- when information is received from another election official that a registrant has subsequently registered in another jurisdiction;
- when information is received from a program to identify duplicate registrations that cross local jurisdictional boundaries; and
- upon request from the voter.

Such a notice may help avoid voter confusion on election day. This is so especially when an individual is removed based on change of address information obtained through the motor vehicle department or designated agency because the registrant may not know that they have crossed jurisdictional boundaries and must reregister.

As with other notices, important aspects of the final notice of removal include:

- the format of the notice, and
- the content of the notice.

### ***The Format of the Final Notice of Removal***

Jurisdictions that provide a final notice of removal have used either a standard preprinted or computer-generated letter, foldover mailer, or postcard format. Many jurisdictions courteously provide a means by which a registrant may respond to the notice in cases of error. This response section may be a detachable section of the letter or a pre-addressed response card or, at the very least, the telephone number of the local election official. (Examples of final notices are provided in Figures 5C and 5D.)

***The Content of the Final Notice of Removal***

The content of the notice of removal may vary depending upon the reason for the mailing. Alternatively, States may want to consider preprinting messages that the local registration official can check off as appropriate. Possibly something like:

.....

This is to let you know that your name has been removed from the list of voters who may vote in (*jurisdiction*) because:

- \_\_\_\_\_ You have requested that we remove your name from the list. If you continue to live in (*jurisdiction*) and wish to vote in future elections, you must reregister. Contact (*local election official*.)
- \_\_\_\_\_ We have received information from the (*motor vehicle department or agency*) that you have moved from (*jurisdiction*). If this is in error and you continue to live in (*jurisdiction*), please contact (*local election official*).
- \_\_\_\_\_ You have registered to vote in another jurisdiction. If this is in error and you continue to live in (*jurisdiction*), please contact (*local election official*).
- \_\_\_\_\_ You have not responded to our notice asking you if you still live in (*jurisdiction*) and you have not voted since we sent you that letter. If you continue to live in (*jurisdiction*) and wish to vote in future elections, you must reregister. Contact (*local election official*.) If you have moved from (*jurisdiction*) and wish to vote in future elections, you must register with the registration office where you live. (Look for the number in your telephone directory.)

If you have any questions, please contact (*local election official's title and phone number*).

.....

And perhaps also in a perforated response section:

.....

Dear (*Title of Local Registration Official*)

Please replace my name on the voting list of (*jurisdiction*) for the following reason:

---



---

I swear that the reason stated above is true.

Signature \_\_\_\_\_

Address \_\_\_\_\_

.....



**SAMPLE FORMS USED IN LIST MAINTENANCE**

---

### FIGURE 5A SAMPLE NOTICE TO CANCEL REGISTRATION IN FORMER JURISDICTION

This notice provides for a carbon copy. The original is sent to the former jurisdiction. The copy is retained by the new jurisdiction and attached to the registration card.

THE ORIGINAL & CARBON COPY OF THIS FORM MUST BE SENT TO THE  
GRANVILLE COUNTY BOARD OF ELECTIONS BY THE REGISTRATION OFFICIAL

#### CANCELLATION OF PREVIOUS REGISTRATION

I am now registered as an elector in Granville County, North Carolina and herby authorize the cancellation of my previous registration in the City of \_\_\_\_\_ Date \_\_\_\_\_

State of \_\_\_\_\_, my last registration address therein being \_\_\_\_\_  
 \_\_\_\_\_  
 \_\_\_\_\_

Date of Birth \_\_\_\_\_ Present Address of Voter \_\_\_\_\_

Signature of Voter \_\_\_\_\_ Registration Official \_\_\_\_\_

Printed Name of Voter \_\_\_\_\_

**FIGURE 5B**  
**SAMPLE NONFORWARDABLE NOTICE TO CONFIRM**  
**CONTINUED RESIDENCE WITHIN THE JURISDICTION**

This notice includes check boxes on the front to encourage current residents to return cards mailed to registrants no longer living at that address.

*Front*

<p>★ ★ ★ ██████ District of Columbia ██████ <b>Board of Elections and Ethics</b></p>	<p>PRESORTED FIRST CLASS MAIL US POSTAGE PAID WASHINGTON, DC Permit No. 8577</p>
<p>P.O. Box 731, Washington, DC 20044-0731</p>	
<p><b>Do Not Forward</b> <b>Address Correction Requested</b></p>	
<hr/> <p><b><i>D.C. Voter: Do We Have Your Correct Address?</i></b></p> <hr/>	
<p><b>Important!</b> ⇨ If this person does not live at the address shown, please check: <input type="checkbox"/> <i>does not live here</i> <input type="checkbox"/> <i>has passed away</i> <b>Drop this card back in the mail. Thank you!</b></p>	

*Back*

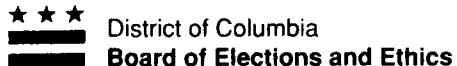

## **Do We Have Your Correct Address?**

In order for you to vote, your voter registration must show the address where you now live. This is D.C. law. We are sending you this post card to check that we have your correct address.

- If your name and address are correct on this card, you do not need to do anything. Your voter registration is OK.
- If you have moved and this card was sent on to you, you need to send us your new address, in writing. By sending us your new address, you will bring your voter registration up to date and assure your right to vote in future elections.
- Use the form below to send us your new address.
- If the person this card was sent to does not live at the address shown, please check the correct box on the front of this card and drop it in the mail. Thank you!

**Questions? Call 727-2525**

En español: 727-2525

TDD: 639-8916

-----  
 **Address Change Form**

\_\_\_\_\_  
 Name Date of Birth

\_\_\_\_\_  
 New Address

\_\_\_\_\_  
 Date Signature Telephone

**Put in envelope and mail to:** D.C. Board of Elections and Ethics,  
 P.O. Box 731, Washington, DC 20044-0731

**FIGURE 5C**  
**SAMPLE OF A LETTER OF FINAL REMOVAL FROM VOTER REGISTRY**

This is an example of a letter listing the specific reason the registrant is being removed from the registry and providing a means for the addressee to request that his or her name be replaced on the voting list.

**TOWN OF GORHAM**

270 Main Street  
Gorham, Maine 04038

Tel. 207-839-5037

April 1, 1993

This is to advise you that your name has been removed from the voting list of the Town of Gorham for the following reason:

You no longer reside at the address shown above and have not notified us of a new address within the Town of Gorham

Your failure to reply within thirty (30) days will be deemed to indicate your agreement with this action.

**BOARD OF VOTER REGISTRATION**  
Gorham, Maine

-----

Dear Board of Voter Registration

I respectfully request that my name be replaced on the voting list of the Town of Gorham for the following reason:

\_\_\_\_\_

\_\_\_\_\_.

I swear that the reason stated above is true.

Signature \_\_\_\_\_

Address \_\_\_\_\_

\_\_\_\_\_



**FIGURE 5D**  
**SAMPLE OF A LETTER OF FINAL REMOVAL**  
**FROM THE VOTER REGISTRY**

This is an example of a letter sent based on a computer-generated list of possible duplicate registrations within the state, prepared by the State election official. The review by the local jurisdiction indicated that the registrant probably registered in a new jurisdiction without canceling the registration in the former jurisdiction.

Helen Purcell  
Recorder  
Cherie Pennington  
Chief Deputy Recorder



Office of The  
Maricopa County Recorder

TO:

FROM: HELEN PURCELL, MARICOPA COUNTY RECORDER

SUBJECT: VOTER REGISTRATION

DATE: JANUARY 07, 1993

In an effort to better serve the public and maintain accurate voter registration rolls, Arizona law provides a voter registration matching system to reveal duplicates.

Arizona Revised Statute §16-168.I. states that the Secretary of State shall prepare a list of all duplicate registrations throughout the State. If a person is registered in more than one County, the County Recorder shall cancel the person's earlier registration and allow the most current registration to remain valid.

A search of the voter registration files indicates that you were registered in Maricopa County on 05-05-89. Further, the files indicate that you are additionally registered in COCHISE County as of 06-19-92.

For the reasons indicated above, your voter registration has been cancelled in Maricopa County. If you have changed residence since you registered in COCHISE County, you must re-register. If you have any questions, please call the COCHISE COUNTY RECORDER at (602) 432-9270.





## **CHAPTER 6**

### **FAIL-SAFE VOTING PROVISIONS**

---

The National Voter Registration Act permits certain classes of registrants to vote that were heretofore unable to do so because of bureaucratic or legal technicalities. The Congress incorporated these “fail-safe” provisions following the principle that “once registered, a voter should remain on the list of voters so long as the individual remains eligible to vote in that jurisdiction” [Hse. Rpt., Section 8, page 18].

#### **IMPORTANT ISSUES IN FAIL-SAFE VOTING**

---

States should consider the following important issues in designing fail-safe voting procedures:

- who is entitled to vote under the fail-safe provisions
- where they are entitled to vote
- how they may cast their ballots
- recording and transmitting election day changes to the central voter registration list
- administering fail-safe voting procedures.

#### **Who Is Entitled To Vote Under the Fail-Safe Provisions**

The Act permits the following types of registrants to employ fail-safe voting provisions:

- Those who have failed to respond to a confirmation mailing that was triggered by information indicating that they may no longer reside in the registrar’s jurisdiction but who do still reside in the jurisdiction [Section 8(d)(1)(B), 8(d)(2)(A), and 8(e)];
- Those who have failed to respond to a confirmation mailing that was triggered by information indicating that they have moved within the registrar’s jurisdiction [Sections 8(c)(1)(B)(i), 8(e), and 8(f)]; and

- Those who have *not* been sent such a confirmation mailing but who:
  - have moved within the same precinct [Sections 8(e)(1) and 8(f)];
  - have moved from one precinct to another within the same registrar's jurisdiction [Sections 8(e)(2) and 8(f)]; or
  - have *not* moved, but the voter registration records incorrectly show that they have [Section 8(e)(3)].

***Those Who Have Failed to Respond to a Confirmation Mailing Triggered by Information Indicating That They May No Longer Reside within the Registrar's Jurisdiction but Who Continue to Reside in the Jurisdiction***

Registrars may send confirmation notices in accordance with Section 8(d)(2) to registrants whose continued residence within the jurisdiction is questioned. Chapter 5 lists some of the reasons such mailings may be sent (e.g.; election mailings returned undeliverable, postal service information indicating that the person may have moved outside of the jurisdiction, etc.). Yet such individuals may still reside in the registrar's jurisdiction. They may have either not moved at all, moved within the jurisdiction without filing a change of address, or the local post office may no longer have the change of address on file. Even if such recipients of confirmation mailings fail to return the confirmation response card and may have been designated "Inactive", they must be permitted to vote in any federal election on or before the second general federal election after the confirmation mailing was sent [Section 8(d)(1)(B), 8(d)(2)(A), and 8(e)].

The Act permits States to require such persons to make either "an affirmation or confirmation of the registrant's address ... before being permitted to vote ..." [Section 8(d)(2)(A)]. But for reasons that are explained below under "How They May Cast Their Ballots", States may require confirmation only under extremely rare circumstances. (The difference between "affirmation" and "confirmation" lies in whether the registrant has to provide some acceptable verification as noted in the definitions in the Introduction).

***Those Who Have Failed to Respond to a Confirmation Mailing Triggered by Information Indicating That They Moved within the Registrar's Jurisdiction***

Registrants whose registration records have been changed based on address information received from the postal service, and who were then sent a confirmation mailing to verify the change, should not be designated "Inactive" and must be permitted to vote in any federal election regardless of whether or not they respond to the notice [Sections 8(c)(1)(B)(i), 8(e) and 8(f)]. Moreover, it appears that these individuals may not be required to affirm or confirm their address when voting unless, of course, the change-of-address information was in error and the registrant offers to vote at the old polling place, or they have subsequently moved to an address not provided by the Postal Service.

***Those Who Have Not Been Sent a Confirmation Mailing but Have Moved within the Same Precinct***

The FEC defines “precinct” to mean “an area covered by a polling place” — although a few States employ different terminology. In any event, the Act is very clear in saying “A registrant who has moved from an address in the area covered by a polling place to an address in the same area shall, notwithstanding failure to notify the registrar of the change of address prior to the date of an election, be permitted to vote at that polling place upon oral or written affirmation by the registrant of the change of address before an election official at that polling place” [Section 8(e)(1)].

Note that this class of registrants is required to provide only “oral or written affirmation.”

***Those Who Have Not Been Sent a Confirmation Mailing but Have Moved from One Precinct to Another within the Same Registrar’s Jurisdiction***

The Act requires that “A registrant who has moved from an address in an area covered by one polling place to an address in an area covered by a second polling place within the same registrar’s jurisdiction and the same congressional district and who has failed to notify the registrar of the change of address prior to the date of an election” must be permitted to correct the voting records and vote [Section 8(e)(2)(A)]. Oral or written affirmation or confirmation may be required of such persons depending on where they vote (see “Where They Are Entitled to Vote” below).

Section 8(f) of the Act implies, however, that such persons also be permitted to vote if they moved within the registrar’s jurisdiction but to a different congressional district. The expression “and the same congressional district” in Section 8(e)(2)(A) does not, then, control whether a person who has moved within the registrar’s jurisdiction is *entitled* to use the fail-safe voting. Rather, it controls *where* such persons may vote.

***Those Who Have Not Been Sent a Confirmation Mailing and Have Not Moved but the Registration Records Say They Have***

Mistakes happen. And to ensure that registrants do not lose their right to vote because of an error in the voter registration list, the Act requires that “If the registration records indicate that a registrant has moved from an address in the area covered by a polling place, the registrant shall, upon oral or written affirmation by the registrant before an election official at that polling place that the registrant continues to reside at the address previously made known to the registrar, be permitted to vote at that polling place” [Section 8(e)(3)].

Note again the requirement for only “oral or written affirmation.”

***Where They Are Entitled to Vote***

The issue of where registrants may vote under the fail-safe provisions applies only to those who have moved from one precinct to another within the registrar’s jurisdiction — since the other categories of who is eligible describe registrants who remain in their original precinct.

The Act permits the States to decide where all registrants who have moved from one precinct to another within their jurisdiction *and the same congressional district* are to correct the records and vote — either at their old polling place or at their new one — provided that the State require only oral or written affirmation by the registrant of their new address [Section 8(e)(2)(B)]. The Act does *not* permit the States to designate only a central location for this purpose.

If the State does *not* designate either the old polling place or the new polling place, then the decision defaults to the registrant who, if they have moved from one precinct to another within the registrar's jurisdiction *and the same congressional district*, may choose either:

- to change the records and vote at their old polling place
- to change the records and vote at a central location, or else
- to change the records for future elections and, if permitted by State law, to vote in the present election upon confirmation by the registrant of his or her new address [Section 8(e)(2)(A)].

The Act does not specifically address where those registrants who have moved within the registrar's jurisdiction, but outside their former congressional district, should correct the record and vote. States may want to consider applying the same rules to these individuals as to those moving within the congressional district in order to avoid administrative problems and voter confusion.

States that consider allowing the voter to choose should weigh the following:

- Voters can choose the location that is most convenient, whether that is the old or central location or, if the State permits, the new location;
- Voters may not know the location of the central office or the new polling place;
- When voters choose the central location, the election official can easily determine the voters' eligibility, determine which full ballot they are entitled to vote, and sort the voted ballots into appropriate precincts for tabulation with other ballots;
- Election officials may have difficulty determining how many staff and ballots and/or voting machines to maintain at the central office and at each polling place;
- The opportunity to choose may either please the voters or add to their confusion; and
- When voters choose to vote at the old polling place or, if permitted by State law, the new polling place, there would be the same advantages and disadvantages as listed below for these sites.

There are benefits to States deciding where registrants are to vote including: simplifying instructions to voters; minimizing election day confusion; reducing the burden on poll workers; and simplifying record keeping. There are, however, advantages and disadvantages to designating either:

- the old polling place, or
- the new polling place.

At the same time there is the question of what to do about:

- registrants who go to the wrong polling place.

#### ***Designating the Old Polling Place***

States that decide to designate the old polling place will gain the following advantages:

- Voters often will know where their old polling place is located, and
- Polling place officials will likely have the voters' names on the poll list (or accompanying inactive list) along with any notations of which ballot they are entitled to vote.

The disadvantages to designating the old polling place are that:

- Voters may be required to travel long distances between their new residence and their old polling place;
- Voters whose addresses have already been corrected will be listed in the poll books of their new polling place; and
- Unless they are given a limited ballot (containing only those offices and issues for which they are entitled to vote in their new precinct), voters may be voting in contests for which they are not, by residence, entitled. (See "How They May Cast a Ballot" below).

#### ***Designating the New Polling Place***

States that decide to designate the new polling place will gain the following advantages:

- The polling place will likely be closer to the voter's residence than the old one, and
- The voters are likely to vote only in the contests to which they are, by residence, entitled (in which case, it would not seem to matter if the registrant moved into a different congressional district within the registrar's jurisdiction).

The disadvantages of designating the new polling place are that:

- Voters may not know the location of their new polling place;
- Polling place officials may not know if the voter is a valid registrant or if the voter's residence is within the precinct's boundaries;
- Polling place officials may have difficulty determining which primary ballot the voter is eligible to vote in closed primaries because records of party affiliation may not be available;
- Polling place officials may have difficulty determining which ballot style the voter should have in the case of split precincts because they may not know the boundaries of each election jurisdiction; and
- Election officials may have difficulty determining how many ballots and/or voting machines to supply each polling place.

***Voters Who Go to the Wrong Polling Place***

Whatever decision the State makes regarding where registrants may vote under the fail-safe voting provisions, they may want to consider what to do about registrants who go to the wrong polling place. The following options have been used by States, alone or in some combination, to address this situation:

- Requiring the poll worker to provide the voter with a card containing the phone number of the local election office and leaving it up to the voter to call and request the correct polling place.
- Requiring the poll worker to call the local election office to ascertain the correct polling place.
- Providing maps of the local jurisdiction at each polling place that display the streets, neighborhoods, precinct boundaries and polling place locations to assist the voter and poll worker in determining where the correct polling place might be located.
- Providing street indices at each polling place that assist in identifying which polling place corresponds to a given street address.
- Requiring the completion of an affidavit at the old polling place when the voter erroneously appears to vote there which the voter, in turn, gives to a poll worker at the new polling place (see sample affidavit in Figure 6A).



## **How They May Cast Their Ballots**

The Act permits the States considerable latitude in prescribing how registrants voting under the fail-safe provisions may cast their ballots. Issues to consider include:

- affirmation versus confirmation
- a provisional ballot versus a regular ballot, and
- a limited ballot versus a full ballot.

### ***Affirmation Versus Confirmation***

The distinction between “affirmation” and “confirmation” appears to hinge on whether registrants may simply assert their current address or whether they must provide some acceptable verification.

As noted previously, States may opt to require registrants that have changed address from one precinct to another within the registrar’s jurisdiction to vote either at their old polling place or else at their new one. If they do so, however, they may require from the registrant only oral or written affirmation of the new address [Section 8(e)(2)(B)].

The only circumstances in which States may require confirmation (as distinct from affirmation) from the registrant are when:

- (1) the State has chosen not to designate either the old or the new polling place as the fail-safe voting location,
- 2) the State nevertheless permits registrants who have moved from one precinct to another within the registrar’s jurisdiction and the same congressional district to *vote* at their new polling place, *and*
- (3) such a registrant chooses to vote at the new polling place from the three options available to him — old, central location, or new — as a result of the State’s failure to decide the matter.

As a practical matter, such circumstances are likely to be extremely rare.

### ***A Provisional Ballot Versus a Regular Ballot***

The Act is silent on the question of whether registrants voting under the fail-safe provisions may be required to vote a provisional ballot (one that is subject to subsequent verification before it is counted). The House Committee report, however, notes that “Under certain circumstances it would be appropriate, and in compliance with the requirements of this Act, to require that such a person vote by some form of provisional ballot” [Hse. Rpt., Section 8, page 18].

Although it is neither required nor prohibited by the Act, then, for reasons of record keeping, fraud prevention, and for any subsequent legal inquiries, States may want to consider employing some form of provisional ballot procedure whereby fail-safe voters:

- cast their ballots
- place them in a blank sealed envelope, and
- place that envelope in a cover envelope which contains on the outside the written affirmation.

Examples of provisional ballot envelopes are provided at the end of this chapter in Figures 6B, 6C, and 6D.

A provisional ballot process may entail some additional costs. There is, for example, the cost of producing the secrecy envelopes and separately processing the voted ballots. And too, jurisdictions that do not currently vote on paper ballot stock would have to pay the costs of producing and providing paper ballots to serve as provisional ballots.

Moreover, if the voter registry is not up to date, there could be a large number of provisional ballots which, in turn could delay final election results. A large number of provisional ballots could also change the outcome of an election from what it appeared to be in the preliminary, unofficial results.

Finally, the provisional ballot process has been used, either deliberately or inadvertently, to discriminate against minorities in some jurisdictions. To combat such abuse in the future, States may want to document uniform procedures to be followed by all local jurisdictions administering the process.

#### ***A Limited Ballot Versus a Full Ballot***

The question of whether registrants casting a ballot under the fail-safe voting provisions should cast a limited ballot or a full ballot depends both on where the State decides that such registrants should vote; on the sensitivity the State attaches to voters voting in contests to which they are not, by residence, entitled; and on the State's procedures for verifying and counting voted provisional ballots. (This question does not arise, of course, in cases where registrants entitled to use the fail-safe procedures have been declared inactive but have not changed their address.)

If the State decides that registrants voting under the fail-safe provisions should do so at their new polling place, then, as noted previously, such voters would in most instances be voting in only the contests to which they are, by residence, entitled. (There is, of course, the problem of determining which ballot the voter should receive in split precincts as noted in "Determining Eligibility" below.)

If, on the other hand, the State decides that such registrants should vote at their old polling place, then the problem arises that certain contests (especially local ones) appearing on the ballot in the old precinct may not be the same as those in the precinct where the voter now resides.

In such instances, States might want to consider issuing such voters a ballot limited to contests in common among all precincts in the jurisdiction. This would require jurisdictions to bear the expense of producing limited ballots for the jurisdiction, or possibly lock out contests on direct electronic recording systems and void contests on paper ballots, potentially violating ballot secrecy.

An alternative strategy is to permit the voter to vote a full but provisional ballot — but subsequently count only those votes cast for contests which the voter is entitled to vote. This strategy also raises ballot secrecy problems in addition to time and cost issues.

Finally, the alternative of issuing a ballot containing only federal or federal, state-wide, and county-wide offices might prove expensive, provoke voter indignation, and may even be challenged as discriminatory.

### **Recording and Transmitting Election Day Changes to the Central Voter Registration List**

States should consider how best to record and transmit election day corrections from registrants voting under the fail-safe provisions. Depending on State law and the voter's situation, these updates may be recorded:

- at the old polling place where records of the voter may or may not exist;
- at the new polling place where records of the registrant are least likely to exist;  
or
- at a central location where records of the registrant most certainly should exist and may or may not be readily accessible in the rush of election day activities.

There are at least four ways that such voter registration list changes can be recorded and transmitted to the central voter registration list.

The first and easiest of these is to employ the outer envelopes containing the provisional ballots cast by registrants voting under the fail-safe provisions. The advantage of this approach, apart from leaving a paper trail with the registrant's signature, is that only validated changes would be made to the central voter registry. That is to say, if the voter was not a registrant or used an invalid or false address, the ballot would presumably not be counted and no change would have to be made to the central voter registration list. (Examples of provisional ballot envelopes are provided in Figures 6B, 6C, and 6D.)

A second alternative, in States that opt not to employ a provisional ballot procedure, is that poll workers could note such changes in the poll books so the changes could be recorded on the central voter registration list when voter histories are updated subsequent to the election.

A third alternative is to use an affidavit form to collect the corrected voter information at the polling place and convey it to the central office. (See an example of such an affidavit in Figure 6A.)

A fourth alternative is the use of a voter authority card which, among several other purposes, serves to record changes to the voter registration list captured at the polls on election day. Those interested in the voting authority card approach are urged to consult *Innovations in Election Administration 1: The Voting Authority Card* authored by Marie Garber and available free of charge from the FEC's National Clearinghouse on Election Administration.

### **Administering Fail-Safe Voting Procedures**

Whatever fail-safe voting procedures States adopt, there can be no doubt that their successful operation will depend on:

- the procedures for determining the eligibility of fail-safe voters;
- an effective public information program; and
- the careful training of poll workers (along with job aids or procedures manuals).

#### ***Procedures for Determining the Eligibility of Fail-Safe Voters***

The problem of determining the eligibility of fail-safe voters applies to:

- registrants who have moved within their precinct;
- registrants who have moved from one precinct to another; and
- registrants who have not moved but the registration records say they have.

With regard to registrants who have moved within their precinct, the problem is for election workers either at the polling place or at a central location to (1) determine if the registrant's new address is indeed within the precinct boundaries and (2) in the case of split precincts, which ballot style the registrant is eligible to vote.

With regard to registrants who have moved from one precinct to another, States may designate where such persons are to vote. But regardless of whether the State designates the registrant's old polling place or new polling place as the location for fail-safe voting, there must be procedures for determining the eligibility of these individuals. In the case of designating the new polling place, for example, persons may mistakenly show up at the wrong polling place. Poll workers will need to know where to direct them. In the case of designating the old polling place (if the State has decided to allow such voters to vote only a limited ballot), poll workers will need to know the ballot style appropriate to the voter's new precinct (a problem further complicated if there are split precincts). And in either case, poll workers may need to determine if the person offering to vote is a registered voter rather than an unregistered person attempting to vote.

Eligibility issues also may arise with regard to registrants who have *not* moved but the registration records show they have. If, for example, the registration records erroneously list their address in another precinct within the jurisdiction, then their proper polling place will have no record of them. Poll workers will need to determine if such persons are in fact registrants rather than unregistered voters attempting to vote. Even if the erroneous address is within the same precinct, poll workers in split precincts will need to determine which ballot their genuine address entitles them to vote.

All of these possible problems suggest the need to ensure communications between polling places and the central office on election day. It also suggests the need for a dedicated phone bank to handle such calls. And finally, it suggests the desirability of computerized geo-coded registration files for quick information retrieval, street address indices containing information on the precinct appropriate to a range of addresses, and maps showing the location and boundaries of polling places in the community.

#### ***An Effective Public Information Program***

States will want to devise an aggressive public information program to inform registrants who have moved from one precinct to another within the same election jurisdiction of where to vote on election day. Acknowledgment notices, confirmation notices, and other pre-election mailings; speeches to community groups; and public service announcements may serve as a vehicle for this information. (See *Voter Information and Education Programs 1: Designing Effective Voter Information Programs*, prepared by Kalba Bowen Associates, Inc. for the Federal Election Commission's National Clearinghouse on Election Administration.)

States might want to consider requiring local jurisdictions to establish a temporary phone bank to answer questions and give polling place locations through election day. Other possibilities include making maps of the community showing polling place locations and boundaries or lists of polling places (and the addresses covered by each) available to political parties, candidates, get-out-the-vote drives, and satellite locations (such as public libraries or agencies that were designated to register voters).

#### ***Training Poll Workers***

No one knows how many fail-safe voters will appear on election day. If not properly managed, fail-safe voting procedures can lead to confusion at the polling place. States and local jurisdictions will need to consider what training and election day job aids should be provided so that poll workers can efficiently process these voters. These aids might include procedures manuals, trouble-shooting guides, and pre-printed notices to be given to provisional ballot voters. (Samples of preprinted notices for provisional ballot voters are provided in Figures 6E and 6F.) Also helpful to the poll worker are important phone numbers for verifying a prospective voter's registration, a precinct-specific street index listing street numbers and names covered by the precinct, and precinct maps (which can be used by the voter to show the poll worker where they live in the precinct).



**SAMPLE FORMS FOR USE IN FAIL-SAFE VOTING**

---

FIGURE 6A
EXAMPLE OF AN AFFIDAVIT AND ACCOMPANYING
POLL WORKER INSTRUCTIONS USED IN FAIL-SAFE VOTING

This affidavit is printed on colored paper and is completed by the poll worker and signed by the poll worker and the voter. The affidavit is used to capture changes of registrants' information made at the polls. It is also used when a registrant has moved within the county but failed to notify the local election official. When the voter erroneously appears to vote at the polling place for their former residence, the poll worker verifies that the registrant is still on the list of registered voters at that polling place and directs the registrant to go the correct polling place and submit the completed affidavit to the poll worker there. The poll worker at the new polling place, then, does not need to confirm that the voter is indeed registered.

THIS FORM CANNOT BE USED FOR NEW REGISTRATIONS, PARTY CHANGES OR TRANSFERS FROM OTHER COUNTIES OR STATES.
AFFIDAVIT
PRECINCT NO. NEW PRECINCT NO.
REGISTRATION NO. ADDRESS OF NEW PRECINCT
DATE OF BIRTH STAPLE (If Voter is being sent to another precinct)
TELEPHONE NO. VOTER'S IDENTIFICATION CARD
PARTY AFFILIATION: HERE
STATE OF FLORIDA
COUNTY OF BROWARD
I do solemnly swear (or affirm) that my present name is (print name of voter)
Current Address City Zip Code
CHECK APPROPRIATE TRANSACTION BELOW
1. CHANGE OF ADDRESS - F.S. 97.091 (2)
2. REQUEST FOR REINSTATEMENT - F.S. 98.081
3. CHANGE OF NAME - F.S. 97.091 (2B)
PRINT NEW NAME OF VOTER
PREVIOUS NAME (Please Print)
SIGNATURE OF CLERK SIGNATURE OF VOTER



**CLERKS MUST FOLLOW THE STEPS OUTLINED  
BELOW WHEN USING THE PINK AFFIDAVIT.**

When a voter presents himself to vote and his name cannot be found on either the Precinct Register or Supplemental List, you must call your Special Operator to determine if the individual is a registered voter. If the voter is registered then:

1. Ask the voter if he has changed his address and take down all information.
2. Call assigned office number to determine in what precinct the voter should be voting.
3. If our office directs you to allow the voter to vote in your precinct, complete a Pink Affidavit checking #1, "Change of Address."
4. If the voter should be voting in another precinct (you will be given the correct precinct number), fill out the Pink Affidavit indicating correct precinct and give it to the voter to take with him to the correct polling precinct. Write the address of correct precinct on top right of Pink Affidavit. You will have a list of all polling places in your Clerk's envelope.

**IMPORTANT**

**When a voter comes to your precinct with a completed Pink Affidavit you should not have to make another phone call. The voter has already been approved to vote by our office.**

1. Verify all general voter information with the individual.
2. Check top right section of Pink Affidavit to make sure voter is in correct voting precinct.
3. Make sure that the voter has signed Pink Affidavit.
4. Take affidavit and place in your affidavit envelope and allow voter to vote.
5. If he has a voter I.D. card, take it and staple it to affidavit as usual.

**FIGURE 6B  
SAMPLE ENVELOPE USED FOR PROVISIONAL BALLOTS**

This envelope is used in San Diego County, California. Note that it includes instructions to the poll worker and requires them to check the reason for the envelope's use. It also provides space for office use that permits notation of the acceptance or rejection of the ballot without looking at the voted ballot.

*Front*

<p><b>INSTRUCTIONS TO PRECINCT OFFICER:</b></p> <p>1. Check one. This voter is:</p> <p><input type="checkbox"/> A. enclosing voted absentee ballot because absentee ID envelope issued by Registrar of Voters' office is not available. (If A is checked, complete step 2 below only.)</p> <p><input type="checkbox"/> B. an Absentee Voter listed on the Roster who wants to vote at polls, but is unable to surrender ballot issued by Registrar of Voters' office.</p> <p><input type="checkbox"/> C. a voter whose name is not on ANY of the following lists: Roster Cancelled Voter List Certification List</p> <p><input type="checkbox"/> D. voting a party ballot different than party designation on the roster.</p> <p><input type="checkbox"/> E. OTHER: WRITE EXPLANATION HERE _____</p> <p>If B, C, D, or E above has been checked, complete steps 2 through 6 below.</p> <p>2. Have voter print name, address and sign declaration on reverse side of this envelope.</p> <p>3. Have voter sign name and residence address on the green provisional roster page.</p> <p>4. Precinct Officer instruct voter to vote, remove stub and seal this envelope.</p> <p>5. Precinct Officer deposit this sealed ballot in ballot box.</p> <p>6. Upon close of polls, remove these green envelopes from ballot box and place them into Provisional Ballots/Voted Absentee Ballots Envelope. <b>DO NOT OPEN THESE GREEN ENVELOPES FOR ANY REASON.</b></p>	<p><b>Use this space for explanation:</b></p> <p>_____</p> <p>_____</p> <p>_____</p> <p>_____</p> <p>_____</p> <p>_____</p> <p>_____</p>
<p><b>PROVISIONAL BALLOT</b> TO BE ADJUDICATED BY THE REGISTRAR OF VOTERS</p>	

Back

**INSTRUCTIONS TO VOTER:**

- After voting:
1. Remove short stub from top of ballot card.
  2. Fold ballot card in half at perforation.
  3. Enclose voted ballot in this envelope.
  4. Seal this envelope.
  5. Check that you have completed and signed the oath below.

(Print Name)

I am a registered voter and I resided at the address below on the 29th day prior to this election. Voting twice constitutes a crime, and I have not voted previously in this election either by absentee ballot or at any other polling place. I declare under penalty of perjury that the above declarations are true and correct to the best of my knowledge and belief.

Signature (Required) Do Not Print

Date

Residence Address (Required)

Zip Code

Day Phone

**TO BE OPENED ONLY BY CANVASSING BOARD AT THE REGISTRAR OF VOTERS**

**OFFICE USE ONLY**

Precinct \_\_\_\_\_

Political Party \_\_\_\_\_

Aff. No. \_\_\_\_\_

Microfilm No. \_\_\_\_\_

AV Eligible: Yes \_\_\_\_\_  
 No \_\_\_\_\_ Reason \_\_\_\_\_

Precinct Eligible: Yes \_\_\_\_\_  
 No \_\_\_\_\_ Reason \_\_\_\_\_

No Ballot Enclosed: \_\_\_\_\_

Note: \_\_\_\_\_

## FIGURE 6C SAMPLE ENVELOPE USED FOR PROVISIONAL BALLOTS

This envelope is used in the District of Columbia. Note the simplified language and format.

**NOTE:** The Act will permit States to require that the voter provide identification showing current address only under very limited circumstances when the voter changes their address at the polls.

*Front*

District of Columbia Board of Elections and Ethics  
**SPECIAL BALLOT ENVELOPE**  
(PLEASE PRINT)

<i>(Last Name)</i>	<i>(First Name)</i>	<i>(Middle Name)</i>	<i>(Suffix - Jr., Sr., etc.)</i>
--------------------	---------------------	----------------------	----------------------------------

Address where you live:

Circle One NE NW SE SW	Apartment No.	ZIP Code:
---------------------------	---------------	-----------

Old Address (for Address Change):

Telephone No:	Date of Birth:	Party Affiliation:
---------------	----------------	--------------------

Under penalty of perjury, I swear or affirm that to the best of my knowledge I am a registered voter in the District of Columbia, and if not, that I meet the qualifications for voter registration; that my current address is shown above; and that, where applicable, I have presented identification showing my current residence address is within this precinct.

\_\_\_\_\_  
(Date)

\_\_\_\_\_  
(Signature of Voter)

Voter MUST SIGN or ballot cannot be counted; signature insures appeal rights.

---

POLLWORKER MUST CHECK THE APPROPRIATE BOXES BELOW TO SHOW THE REASON FOR THE SPECIAL BALLOT BEING VOTED.

IDENTIFICATION, SHOWING CURRENT ADDRESS, REQUIRED FOR:  
ADDRESS CHANGE - REINSTATEMENT - CHALLENGE

Voter request for Change of Address or Reinstatement

Voter challenged by Watcher or Captain

Type of Identification Presented by Voter:

Driver's License/Non-Driver's I.D.

Lease/Rental Agreement showing name and address

Utility or Other Bills showing name and address

Bank Statement, printed deposit slip, or check showing name and address

Other \_\_\_\_\_  
(Must substantiate identity and address)

NO I.D. PRESENTED

IDENTIFICATION NOT REQUIRED FOR:

Different Party Claimed by Voter (See Reverse)

Different ANC/SMD Claimed by Voter (See Reverse)

Absentee Ballot not received

Elderly/Handicapped or Election Worker

.....

**POLLWORKER CERTIFICATION:**  
I certify that the voter has cast the Special Ballot for the REASON indicated above and has provided, where required, the IDENTIFICATION indicated to show his/her current address in this precinct.

Precinct No. _____	_____ (Signature of Pollworker)
--------------------	------------------------------------

**FOR PRIMARY ELECTIONS ONLY:**  
Pollworker must circle one of the following boxes to show the type of ballot issued:

DEM	REP	STD
-----	-----	-----

FOR OFFICIAL USE ONLY:		
Approve	Reject	Clerk

*Back*

**REASON FOR VOTING BY SPECIAL BALLOT**

- Voter's Address on Master Index has changed
- Voter is not listed on the Master Index
- Voter is listed as Absentee Voter

\_\_\_\_\_  
Signature of Master Index Clerk

**For PRIMARY Elections ONLY:**

**DIFFERENT PARTY AFFILIATION CLAIMED BY VOTER**

Party affiliation on MASTER INDEX (Circle One)

DEM REP STD OTH N-P

\_\_\_\_\_  
(Registration No. from Master Index)

Voter claims correct party affiliation is: (Circle one)

DEM REP STD OTH N-P

\_\_\_\_\_  
Signature of Master Index Clerk

**For ANC/SMD Elections ONLY:**

**DIFFERENT ANC/SMD CLAIMED BY VOTER**

ANC/SMD on MASTER INDEX

\_\_\_\_\_  
(Registration No. from Master Index)

Voter claims correct ANC/SMD is:

\_\_\_\_\_  
Signature of Master Index Clerk

### FIGURE 6D SAMPLE ENVELOPES USED FOR PROVISIONAL BALLOTS

These envelopes are used in Thurston County, Washington. In the State of Washington, voters are permitted to vote a “questioned” ballot when their name is not on the list for that polling place. The voter’s eligibility to vote in each contest is later determined at a central location. The outer envelope permits the central office to note on the back what contests the individual is eligible to vote. The envelope with the ballot still inside is grouped with like provisional ballots. Election workers can open the outer envelopes by group, open the inner envelopes, and tabulate the votes that can be counted without associating the name of the voter with a given ballot.

*Front of Outer Envelope*

<p style="text-align: center;"><b>VOTER INFORMATION</b></p> <p>X</p> <p>SIGNATURE OF VOTER _____</p> <p>PRINTED NAME OF VOTER _____</p> <p>DATE OF BIRTH _____</p> <p>ADDRESS _____</p> <p>DAYTIME PHONE _____</p>	<p style="text-align: center;"><b>THURSTON COUNTY</b></p> <p><input type="checkbox"/> CHALLENGED BALLOT of _____</p> <p><input checked="" type="checkbox"/> QUESTIONED BALLOT ( <small>Indicate Which</small> )</p> <p style="text-align: center;"><b>REASON FOR CHALLENGE OR QUESTION</b></p> <p>_____</p> <p>_____</p> <p>Inspector: _____ Precinct Number: _____</p> <p><small>The Inspector or one of the Judges must return the challenged ballot to the County Auditor in this envelope.</small></p>
--	--

*Front of Inner Envelope*

Questioned/Challenge Ballot  
Inner Envelope

Place voted ballot in this envelope and seal. Then place this envelope into the Questioned/Challenge outer envelope with identifying information.

DO NOT MAKE ANY MARK OF IDENTIFICATION ON THIS ENVELOPE.

*Back of Outer Envelope*

Reg. In _____		Dist. _____	Code _____
Voted In _____		(Cor./Incor.) _____	
<input type="checkbox"/> Trans. Needed	<input type="checkbox"/> Letter Needed	<input type="checkbox"/> No Letter	
<input type="checkbox"/> Trans. Made	<input type="checkbox"/> Name Change	<input type="checkbox"/> Letter Sent	
			ID # _____
			Credited _____

OFFICE USE ONLY

The back of the inner envelop is blank.

## FIGURE 6E SAMPLE PROVISIONAL BALLOT VOTER INFORMATION

This single-sided notice is provided by poll workers in San Diego County, California to voters voting provisional ballots.

### PROVISIONAL BALLOT INFORMATION

You have been asked to vote a provisional ballot today due to one of the following reasons:

1. **Your name is not on the official voter roster at this precinct.** Therefore, your voting eligibility cannot be verified by the polls officer today. The Registrar of Voters will check the records, and if you are eligible to vote, this provisional ballot will be counted.
2. **Registrar of Voters records indicate that you have requested an absentee/mail ballot, which you cannot surrender to the polls officer.** The Registrar of Voters will check the records and if you did not cast an absentee/mail ballot, this provisional ballot will be counted.

#### *For Primary Election Only:*

Registrar of Voters records show your registration with a different political party than you now claim. The Registrar of Voters will check your original affidavit of voter registration to verify your party affiliation. If an error has been made, we will correct our records and this provisional ballot will be counted.

ROV/FSPOP801 9/93

Source: San Diego County ROV, September 1993



## FIGURE 6F SAMPLE PROVISIONAL BALLOT VOTER INFORMATION

This notice is provided by poll workers in the District of Columbia to voters voting provisional ballots. The reverse side of the notice explains what will happen to the ballot and the voter's right to appeal.

NOTE: The Act will permit States to require that the voter provide identification showing current address only under very limited circumstances when the voter changes their address at the polls.

*Front*

**NOTICE TO SPECIAL BALLOT VOTERS**

You must vote by Special Ballot for one or more of the reasons checked below. If either of the first two categories is checked, you will be asked to show identification showing that you live in this precinct.

**REASONS FOR VOTING BY SPECIAL BALLOT:**

*(Identification Showing Current Address Required)*

You are requesting a change of address or reinstatement.

Your eligibility to vote has been "Challenged" by the Precinct Captain or an Authorized Watcher.

*(Identification Not Required)*

You claim a different party registration than is listed for you on the Master Index. *Note: This category applies to Primary Elections only.*

You claim a different ANC/SMD than is listed for you on the Master Index. *Note: This category applies any time there is an ANC/SMD office on the ballot.*

You claim your mailed Absentee Ballot was not received.

You are voting in this precinct because your age, disability, or health prevents you from voting in your assigned precinct. Or you are a poll worker assigned outside of the precinct where you are registered.

**HOW TO VOTE BY SPECIAL BALLOT**

1. **Fill out the top portion of the Special Ballot Envelope.**  
*Note: The Precinct Captain or Special Ballot Clerk will assist you.*
2. **Sign the Special Ballot Envelope.**
3. **Vote the ballot(s) marked "SPECIAL".**
4. **Place the ballot(s) in the envelope.**
5. **Seal the envelope and put it in the ballot box.**

- O V E R -

*Back*

**IMPORTANT!!! PLEASE READ IMPORTANT!!!**

**REVIEW OF YOUR SPECIAL BALLOT**

Your Special Ballot will be sent, **unopened**, to the Board of Elections and Ethics. After Election Day, the Board will review the voter registration records to determine whether or not to count your Special Ballot. If the Board's records show that you are properly registered, your Special Ballot will be counted.

If the Board decides **NOT** to count your Special Ballot, your name will be published in a list of voters whose Special Ballots have been rejected. This list will appear in the "Legal Notice" section of *The Washington Post* on the **second Wednesday after Election Day**. Check the list to see if your name appears. You will not receive any other notice that the Board has decided not to count your ballot.

**YOUR RIGHT TO APPEAL**

If your name appears on the list described above, you have the right to appeal the Board's decision not to count your Special Ballot. The Board will hold hearings on the **second Thursday and Friday after Election Day, 9:00 a.m. to 4:45 p.m., at 441- 4th Street, N.W., Suite 270**. If you decide that you want to appeal, call **727-2194** or **727-2525** to set a time for your appeal.

You may bring a lawyer to the hearing or you may represent yourself. You should bring evidence to show that your ballot should be counted.

If you do not win your appeal, you have three (3) days to appeal the Board's decision to the Superior Court of the District of Columbia.



## **CHAPTER 7 - RECORD KEEPING AND REPORTING REQUIREMENTS**

---

This chapter addresses the record keeping and reporting requirements of the National Voter Registration Act and related confidentiality issues. There are three types of record keeping requirements:

- those specifically cited in the law
- those implied by the reporting requirements, and
- those that local election officials may wish to adopt for their own purposes

### **RECORD KEEPING REQUIREMENTS SPECIFIED IN THE LAW**

---

The Act requires voter registration officials to maintain for at least 2 years and to make available for public inspection (and, where available, for photocopying at a reasonable cost), “all records concerning the implementation of programs and activities conducted for the purpose of ensuring the accuracy and currency of official lists of eligible voters, except to the extent that such records relate to a declination to register to vote or to the identity of a voter registration agency through which any particular voter is registered” [Section 8(i)(1)]. And according to Section 8(i)(2), these records are to include:

- lists of the names and addresses of all persons to whom confirmation mailings were sent (see Chapter 5 above), and
- information concerning whether or not each such person responded to the mailing as of the date that the records are inspected.

As a matter of prudence, though not as a requirement of the Act, States might also want to retain for the same period of time all records of removals from the voter registration list — the date and the reason.

The purposes of such record keeping are two-fold. First, such records enable the registrar to maintain an accurate “inactive” file as described in Chapter 5. Second, they enable interested private and public agencies to ensure that “list cleaning” activities are nondiscriminatory and otherwise in accordance with the NVRA.

Finally, although the Act does not specifically require that declinations be retained, States may nevertheless want to do so in order to maintain an audit trail, to ensure evidence should there be allegations of wrongdoing, and for the benefit of the agencies themselves.

## **RECORD KEEPING IMPLIED BY THE REPORTING REQUIREMENTS**

---

The law requires the Federal Election Commission to report to the Congress each two years on the impact of the NVRA on the administration of elections for federal office [Section 9(a)3] and grants the FEC regulatory authority to this end [Section 9(a)(1)].

The FEC views this task as similar to the reporting procedures adopted pursuant to the Voting Accessibility for the Elderly and Act of 1984. That is to say, we envision a three-tier reporting pyramid with local election officials providing reports to the State, State election officials providing summary reports to the FEC, and the FEC preparing a report to the Congress.

We are unable, at this early date, to specify exactly what information the FEC might require of State and local election offices for the purpose of reporting to the Congress. This issue will require considerable consultation with the States. The FEC's objective is to be thorough but not burdensome.

Although the FEC is currently in the midst of research and rulemaking proceedings in order to determine what data are important yet practicable, our preliminary view is that the following data are likely to be requested:

1. State Voting Age Population (to be obtained by the FEC from the Bureau of Census)
2. The number of voters registered in the federal general election two years previous to the most recent federal general election (from previous records at the FEC)
3. The number of voters registered in the most recent federal general election
4. The total number of new registrations received between the past two federal general elections
5. The total number of voter registration applications received from (or generated by) motor vehicle offices between the past two federal general elections, as well as the total number of these that were duplicates.
6. The total number of voter registration applications received by mail between the past two federal general elections, as well as the total number of these that were duplicates.
7. The total number of voter registration applications received from (or generated by) all public assistance agencies (except agencies primarily serving the disabled) between the past two federal general elections, as well as the total number of these that were duplicates.
8. The total number of voter registration applications received from (or generated by) all agencies primarily serving the disabled between the past two federal general elections, as well as the total number of these that were duplicates.

9. The total number of voter registration applications received from (or generated by) Armed Forces recruitment offices between the past two federal general elections, as well as the total number of these that were duplicates.
10. The total number of voter registration applications received from (or generated by) all other designated or discretionary agencies between the past two federal general elections, as well as the total number of these that were duplicates.
11. The total number of voter registration applications received by all other means (in-person, deputy registrars, organized voter registration drives, etc.) between the past two federal general elections, as well as the total number of these that were duplicates.
12. The number of confirmations mailed out between the past two federal general elections in accordance with the NVRA
13. The number of responses to these confirmations mailings returned between the past two federal general elections
14. The total number of names that were, for whatever reason, deleted from the voter registration list between the past two federal general elections
15. The postal costs incurred between the past two federal general elections for all mailings requisite under the NVRA
16. In the first report, a general description of the State's implementation of the NVRA (with emphasis on which options were taken); and in subsequent reports, any changes made to the program
17. Problems encountered

By the same token, our preliminary view is that the following data will *not* be requested:

- The number of persons registered between the past two federal general elections *who voted in the past federal general election* (either totally or by registration intake method).
- Any registration numbers or other information regarding *specific* participating offices or agencies.
- The number of declinations filed at agencies or offices.
- The number of persons voting under the "fail-safe" provisions of the NVRA.
- The general or operating costs of implementing the NVRA.

We anticipate that the definitive list of data items required to be reported to the FEC will be promulgated in the second quarter of 1994.

## **OTHER RECORDS THAT ELECTION OFFICIALS MAY WISH TO KEEP**

---

In addition to retaining the documents and records required either by the NVRA or by the Federal Election Commission, there are two other types of documents that election officials may want to have retained for their own purposes:

- the declination statements completed by applicants for public assistance, and
- any written affirmations required of fail-safe voters.

Ideally, the declination statement completed by each applicant for public assistance — whether it indicates that the applicant wishes to register to vote or declines to do so — would contain the name of the applicant and the date the statement was completed. This could be accomplished preferably by having the applicant sign and date the completed statement or else by having the service agent note the name and date on the statement.

If the name and date are affixed to the declination statement, it could then be removed from the applicant's case file and retained separately by the agency under secure and confidential conditions.

There are several reasons why such a procedure recommends itself. First, it would provide an audit trail of all such transactions should there be subsequent official or legal enquiries. (Indeed, the Election Crimes Branch of the Department of Justice has indicated that declination statements may fall under the 22-month document retention requirements of 42 U.S.C. 1974 *et seq.*). Second, in the event that there are subsequent official or legal enquiries, such a procedure would facilitate an investigation while ensuring the confidentiality of the public assistance case files. And third, should the agency be reimbursed for its voter registration activities through federal matching funds, such a procedure would provide clear evidence of all such activity.

For many of the same reasons, election officials may want to securely retain any written affirmations that State law may require of fail-safe voters on election day (although whether or not to require written affirmations from such voters is optional under the NVRA). Again, such records would provide an audit trail for any subsequent legal enquiry and in any event would clearly fall under the 22-month document retention requirements of 42 U.S.C. 1974 *et seq.*

## IMPORTANT ISSUES IN RECORD KEEPING

---

The most significant issue regarding record keeping is confidentiality. The law specifically prohibits the public disclosure of information regarding any individual's declination to register or regarding the specific public assistance agency or motor vehicle *office* through which any particular individual registered [Sections 5(b), 5(c)(2)(D)(iii), 8(i)(1), and 7(a)(7)].

Yet information regarding the total *number and rate* of persons registered by each social service agency might prove valuable to local election officials and public interest groups even if such detailed information is not requested by the FEC.

The problem is that voter registration documents and records are generally considered public documents and, indeed, are often used for other purposes such as verifying petitions. Thus, in order to prevent divulging the public assistance agency or motor vehicle office through which any particular applicant registered, procedures must be created to obtain aggregate numbers by agency without identifying the agency in any decipherable way on the original voter registration document. (See also the discussions of accounting for motor voter registration forms in Chapter 2, accounting for mail registration forms in Chapter 3, and accounting for agency registration forms in Chapter 4).

Another confidentiality issue is the public disclosure of a registrant's social security number. States that request or require social security number on their voter registration form may want to explore this issue — especially in light of the case of *Greidinger v. Davis*, 988 F.2d 1344 (4th Cir. 1993). Ultimately, all States might want to consider maintaining the confidentiality of all *original* voter registration documents while providing public access to computerized lists of registered voters minus the confidential information.

Alternately, States might want to consider requesting only the last four digits of an applicant's social security number — thereby providing a sorting number while not compromising the confidentiality of the applicants whole number.

Finally, States might want to review their own confidentiality laws regarding the voter registration records of certain protected individuals such as law enforcement officers, abused spouses, stalker victims, public personalities, and the like. This issue is especially important in light of the Act's public disclosure requirements [Section 8(i)(2)].







# APPENDIX A

## THE NATIONAL VOTER REGISTRATION ACT OF 1993

PUBLIC LAW 103-31—MAY 20, 1993

107 STAT. 77

Public Law 103-31  
103d Congress

### An Act

To establish national voter registration procedures for Federal elections, and for other purposes.

May 20, 1993  
[H.R. 2]

*Be it enacted by the Senate and House of Representatives of the United States of America in Congress assembled,*

**SECTION 1. SHORT TITLE.**

This Act may be cited as the “National Voter Registration Act of 1993”.

**SEC. 2. FINDINGS AND PURPOSES.**

(a) **FINDINGS.**—The Congress finds that—

- (1) the right of citizens of the United States to vote is a fundamental right;
- (2) it is the duty of the Federal, State, and local governments to promote the exercise of that right; and
- (3) discriminatory and unfair registration laws and procedures can have a direct and damaging effect on voter participation in elections for Federal office and disproportionately harm voter participation by various groups, including racial minorities.

(b) **PURPOSES.**—The purposes of this Act are—

- (1) to establish procedures that will increase the number of eligible citizens who register to vote in elections for Federal office;
- (2) to make it possible for Federal, State, and local governments to implement this Act in a manner that enhances the participation of eligible citizens as voters in elections for Federal office;
- (3) to protect the integrity of the electoral process; and
- (4) to ensure that accurate and current voter registration rolls are maintained.

**SEC. 3. DEFINITIONS.**

As used in this Act—

- (1) the term “election” has the meaning stated in section 301(1) of the Federal Election Campaign Act of 1971 (2 U.S.C. 431(1));
- (2) the term “Federal office” has the meaning stated in section 301(3) of the Federal Election Campaign Act of 1971 (2 U.S.C. 431(3));
- (3) the term “motor vehicle driver’s license” includes any personal identification document issued by a State motor vehicle authority;

National Voter Registration Act of 1993. Inter-governmental relations. 42 USC 1973gg note. 42 USC 1973gg.

42 USC 1973gg-1.

107 STAT. 78

PUBLIC LAW 103-31—MAY 20, 1993

(4) the term "State" means a State of the United States and the District of Columbia; and

(5) the term "voter registration agency" means an office designated under section 7(a)(1) to perform voter registration activities.

42 USC 1973gg-2. **SEC. 4. NATIONAL PROCEDURES FOR VOTER REGISTRATION FOR ELECTIONS FOR FEDERAL OFFICE.**

(a) **IN GENERAL.**—Except as provided in subsection (b), notwithstanding any other Federal or State law, in addition to any other method of voter registration provided for under State law, each State shall establish procedures to register to vote in elections for Federal office—

(1) by application made simultaneously with an application for a motor vehicle driver's license pursuant to section 5;

(2) by mail application pursuant to section 6; and

(3) by application in person—

(A) at the appropriate registration site designated with respect to the residence of the applicant in accordance with State law; and

(B) at a Federal, State, or nongovernmental office designated under section 7.

(b) **NONAPPLICABILITY TO CERTAIN STATES.**—This Act does not apply to a State described in either or both of the following paragraphs:

(1) A State in which, under law that is in effect continuously on and after March 11, 1993, there is no voter registration requirement for any voter in the State with respect to an election for Federal office.

(2) A State in which, under law that is in effect continuously on and after March 11, 1993, or that was enacted on or prior to March 11, 1993, and by its terms is to come into effect upon the enactment of this Act, so long as that law remains in effect, all voters in the State may register to vote at the polling place at the time of voting in a general election for Federal office.

42 USC 1973gg-3. **SEC. 5. SIMULTANEOUS APPLICATION FOR VOTER REGISTRATION AND APPLICATION FOR MOTOR VEHICLE DRIVER'S LICENSE.**

(a) **IN GENERAL.**—(1) Each State motor vehicle driver's license application (including any renewal application) submitted to the appropriate State motor vehicle authority under State law shall serve as an application for voter registration with respect to elections for Federal office unless the applicant fails to sign the voter registration application.

(2) An application for voter registration submitted under paragraph (1) shall be considered as updating any previous voter registration by the applicant.

(b) **LIMITATION ON USE OF INFORMATION.**—No information relating to the failure of an applicant for a State motor vehicle driver's license to sign a voter registration application may be used for any purpose other than voter registration.

(c) **FORMS AND PROCEDURES.**—(1) Each State shall include a voter registration application form for elections for Federal office as part of an application for a State motor vehicle driver's license.

(2) The voter registration application portion of an application for a State motor vehicle driver's license—

## PUBLIC LAW 103-31—MAY 20, 1993

107 STAT. 79

(A) may not require any information that duplicates information required in the driver's license portion of the form (other than a second signature or other information necessary under subparagraph (C));

(B) may require only the minimum amount of information necessary to—

(i) prevent duplicate voter registrations; and

(ii) enable State election officials to assess the eligibility of the applicant and to administer voter registration and other parts of the election process;

(C) shall include a statement that—

(i) states each eligibility requirement (including citizenship);

(ii) contains an attestation that the applicant meets each such requirement; and

(iii) requires the signature of the applicant, under penalty of perjury;

(D) shall include, in print that is identical to that used in the attestation portion of the application—

(i) the information required in section 8(a)(5) (A) and (B);

(ii) a statement that, if an applicant declines to register to vote, the fact that the applicant has declined to register will remain confidential and will be used only for voter registration purposes; and

(iii) a statement that if an applicant does register to vote, the office at which the applicant submits a voter registration application will remain confidential and will be used only for voter registration purposes; and

(E) shall be made available (as submitted by the applicant, or in machine readable or other format) to the appropriate State election official as provided by State law.

(d) CHANGE OF ADDRESS.—Any change of address form submitted in accordance with State law for purposes of a State motor vehicle driver's license shall serve as notification of change of address for voter registration with respect to elections for Federal office for the registrant involved unless the registrant states on the form that the change of address is not for voter registration purposes.

(e) TRANSMITTAL DEADLINE.—(1) Subject to paragraph (2), a completed voter registration portion of an application for a State motor vehicle driver's license accepted at a State motor vehicle authority shall be transmitted to the appropriate State election official not later than 10 days after the date of acceptance.

(2) If a registration application is accepted within 5 days before the last day for registration to vote in an election, the application shall be transmitted to the appropriate State election official not later than 5 days after the date of acceptance.

**SEC. 8. MAIL REGISTRATION.**

42 USC 1973gg-4.

(a) FORM.—(1) Each State shall accept and use the mail voter registration application form prescribed by the Federal Election Commission pursuant to section 9(a)(2) for the registration of voters in elections for Federal office.

(2) In addition to accepting and using the form described in paragraph (1), a State may develop and use a mail voter registration

107 STAT. 80

PUBLIC LAW 103-31—MAY 20, 1993

form that meets all of the criteria stated in section 9(b) for the registration of voters in elections for Federal office.

(3) A form described in paragraph (1) or (2) shall be accepted and used for notification of a registrant's change of address.

(b) AVAILABILITY OF FORMS.—The chief State election official of a State shall make the forms described in subsection (a) available for distribution through governmental and private entities, with particular emphasis on making them available for organized voter registration programs.

(c) FIRST-TIME VOTERS.—(1) Subject to paragraph (2), a State may by law require a person to vote in person if—

(A) the person was registered to vote in a jurisdiction by mail; and

(B) the person has not previously voted in that jurisdiction.

(2) Paragraph (1) does not apply in the case of a person—

(A) who is entitled to vote by absentee ballot under the Uniformed and Overseas Citizens Absentee Voting Act (42 U.S.C. 1973ff-1 et seq.);

(B) who is provided the right to vote otherwise than in person under section 3(b)(2)(B)(ii) of the Voting Accessibility for the Elderly and Handicapped Act (42 U.S.C. 1973ee-1(b)(2)(B)(ii)); or

(C) who is entitled to vote otherwise than in person under any other Federal law.

(d) UNDELIVERED NOTICES.—If a notice of the disposition of a mail voter registration application under section 8(a)(2) is sent by nonforwardable mail and is returned undelivered, the registrar may proceed in accordance with section 8(d).

42 USC 1973gg-5. **SEC. 7. VOTER REGISTRATION AGENCIES.**

(a) DESIGNATION.—(1) Each State shall designate agencies for the registration of voters in elections for Federal office.

(2) Each State shall designate as voter registration agencies—

(A) all offices in the State that provide public assistance; and

(B) all offices in the State that provide State-funded programs primarily engaged in providing services to persons with disabilities.

(3)(A) In addition to voter registration agencies designated under paragraph (2), each State shall designate other offices within the State as voter registration agencies.

(B) Voter registration agencies designated under subparagraph

(A) may include—

(i) State or local government offices such as public libraries, public schools, offices of city and county clerks (including marriage license bureaus), fishing and hunting license bureaus, government revenue offices, unemployment compensation offices, and offices not described in paragraph (2)(B) that provide services to persons with disabilities; and

(ii) Federal and nongovernmental offices, with the agreement of such offices.

(4)(A) At each voter registration agency, the following services shall be made available:

(i) Distribution of mail voter registration application forms in accordance with paragraph (6).

(ii) Assistance to applicants in completing voter registration application forms, unless the applicant refuses such assistance.

## PUBLIC LAW 103-31—MAY 20, 1993

107 STAT. 81

(iii) Acceptance of completed voter registration application forms for transmittal to the appropriate State election official.

(B) If a voter registration agency designated under paragraph (2)(B) provides services to a person with a disability at the person's home, the agency shall provide the services described in subparagraph (A) at the person's home.

(5) A person who provides service described in paragraph (4) shall not—

(A) seek to influence an applicant's political preference or party registration;

(B) display any such political preference or party allegiance;

(C) make any statement to an applicant or take any action the purpose or effect of which is to discourage the applicant from registering to vote; or

(D) make any statement to an applicant or take any action the purpose or effect of which is to lead the applicant to believe that a decision to register or not to register has any bearing on the availability of services or benefits.

(6) A voter registration agency that is an office that provides service or assistance in addition to conducting voter registration shall—

(A) distribute with each application for such service or assistance, and with each recertification, renewal, or change of address form relating to such service or assistance—

(i) the mail voter registration application form described in section 9(a)(2), including a statement that—

(I) specifies each eligibility requirement (including citizenship);

(II) contains an attestation that the applicant meets each such requirement; and

(III) requires the signature of the applicant, under penalty of perjury; or

(ii) the office's own form if it is equivalent to the form described in section 9(a)(2), unless the applicant, in writing, declines to register to vote;

(B) provide a form that includes—

(i) the question, "If you are not registered to vote where you live now, would you like to apply to register to vote here today?";

(ii) if the agency provides public assistance, the statement, "Applying to register or declining to register to vote will not affect the amount of assistance that you will be provided by this agency.";

(iii) boxes for the applicant to check to indicate whether the applicant would like to register or declines to register to vote (failure to check either box being deemed to constitute a declination to register for purposes of subparagraph (C)), together with the statement (in close proximity to the boxes and in prominent type), "IF YOU DO NOT CHECK EITHER BOX, YOU WILL BE CONSIDERED TO HAVE DECIDED NOT TO REGISTER TO VOTE AT THIS TIME.";

(iv) the statement, "If you would like help in filling out the voter registration application form, we will help you. The decision whether to seek or accept help is yours. You may fill out the application form in private."; and

107 STAT. 82

PUBLIC LAW 103-31—MAY 20, 1993

(v) the statement, "If you believe that someone has interfered with your right to register or to decline to register to vote, your right to privacy in deciding whether to register or in applying to register to vote, or your right to choose your own political party or other political preference, you may file a complaint with \_\_\_\_\_"; the blank being filled by the name, address, and telephone number of the appropriate official to whom such a complaint should be addressed; and

(C) provide to each applicant who does not decline to register to vote the same degree of assistance with regard to the completion of the registration application form as is provided by the office with regard to the completion of its own forms, unless the applicant refuses such assistance.

(7) No information relating to a declination to register to vote in connection with an application made at an office described in paragraph (6) may be used for any purpose other than voter registration.

(b) **FEDERAL GOVERNMENT AND PRIVATE SECTOR COOPERATION.**—All departments, agencies, and other entities of the executive branch of the Federal Government shall, to the greatest extent practicable, cooperate with the States in carrying out subsection (a), and all nongovernmental entities are encouraged to do so.

(c) **ARMED FORCES RECRUITMENT OFFICES.**—(1) Each State and the Secretary of Defense shall jointly develop and implement procedures for persons to apply to register to vote at recruitment offices of the Armed Forces of the United States.

(2) A recruitment office of the Armed Forces of the United States shall be considered to be a voter registration agency designated under subsection (a)(2) for all purposes of this Act.

(d) **TRANSMITTAL DEADLINE.**—(1) Subject to paragraph (2), a completed registration application accepted at a voter registration agency shall be transmitted to the appropriate State election official not later than 10 days after the date of acceptance.

(2) If a registration application is accepted within 5 days before the last day for registration to vote in an election, the application shall be transmitted to the appropriate State election official not later than 5 days after the date of acceptance.

42 USC 1973gg-6. **SEC. 8. REQUIREMENTS WITH RESPECT TO ADMINISTRATION OF VOTER REGISTRATION.**

(a) **IN GENERAL.**—In the administration of voter registration for elections for Federal office, each State shall—

(1) ensure that any eligible applicant is registered to vote in an election—

(A) in the case of registration with a motor vehicle application under section 5, if the valid voter registration form of the applicant is submitted to the appropriate State motor vehicle authority not later than the lesser of 30 days, or the period provided by State law, before the date of the election;

(B) in the case of registration by mail under section 6, if the valid voter registration form of the applicant is postmarked not later than the lesser of 30 days, or the period provided by State law, before the date of the election;



## PUBLIC LAW 103-31—MAY 20, 1993

107 STAT. 83

(C) in the case of registration at a voter registration agency, if the valid voter registration form of the applicant is accepted at the voter registration agency not later than the lesser of 30 days, or the period provided by State law, before the date of the election; and

(D) in any other case, if the valid voter registration form of the applicant is received by the appropriate State election official not later than the lesser of 30 days, or the period provided by State law, before the date of the election;

(2) require the appropriate State election official to send notice to each applicant of the disposition of the application;

(3) provide that the name of a registrant may not be removed from the official list of eligible voters except—

(A) at the request of the registrant;

(B) as provided by State law, by reason of criminal conviction or mental incapacity; or

(C) as provided under paragraph (4);

(4) conduct a general program that makes a reasonable effort to remove the names of ineligible voters from the official lists of eligible voters by reason of—

(A) the death of the registrant; or

(B) a change in the residence of the registrant, in accordance with subsections (b), (c), and (d);

(5) inform applicants under sections 5, 6, and 7 of—

(A) voter eligibility requirements; and

(B) penalties provided by law for submission of a false voter registration application; and

(6) ensure that the identity of the voter registration agency through which any particular voter is registered is not disclosed to the public.

(b) CONFIRMATION OF VOTER REGISTRATION.—Any State program or activity to protect the integrity of the electoral process by ensuring the maintenance of an accurate and current voter registration roll for elections for Federal office—

(1) shall be uniform, nondiscriminatory, and in compliance with the Voting Rights Act of 1965 (42 U.S.C. 1973 et seq.); and

(2) shall not result in the removal of the name of any person from the official list of voters registered to vote in an election for Federal office by reason of the person's failure to vote.

(c) VOTER REMOVAL PROGRAMS.—(1) A State may meet the requirement of subsection (a)(4) by establishing a program under which—

(A) change-of-address information supplied by the Postal Service through its licensees is used to identify registrants whose addresses may have changed; and

(B) if it appears from information provided by the Postal Service that—

(i) a registrant has moved to a different residence address in the same registrar's jurisdiction in which the registrant is currently registered, the registrar changes the registration records to show the new address and sends the registrant a notice of the change by forwardable mail and a postage prepaid pre-addressed return form by which

107 STAT. 84

PUBLIC LAW 103-31—MAY 20, 1993

the registrant may verify or correct the address information; or

(ii) the registrant has moved to a different residence address not in the same registrar's jurisdiction, the registrar uses the notice procedure described in subsection (d)(2) to confirm the change of address.

(2)(A) A State shall complete, not later than 90 days prior to the date of a primary or general election for Federal office, any program the purpose of which is to systematically remove the names of ineligible voters from the official lists of eligible voters.

(B) Subparagraph (A) shall not be construed to preclude—  
(i) the removal of names from official lists of voters on a basis described in paragraph (3) (A) or (B) or (4)(A) of subsection (a); or

(ii) correction of registration records pursuant to this Act.

(d) REMOVAL OF NAMES FROM VOTING ROLLS.—(1) A State shall not remove the name of a registrant from the official list of eligible voters in elections for Federal office on the ground that the registrant has changed residence unless the registrant—

(A) confirms in writing that the registrant has changed residence to a place outside the registrar's jurisdiction in which the registrant is registered; or

(B)(i) has failed to respond to a notice described in paragraph (2); and

(ii) has not voted or appeared to vote (and, if necessary, correct the registrar's record of the registrant's address) in an election during the period beginning on the date of the notice and ending on the day after the date of the second general election for Federal office that occurs after the date of the notice.

(2) A notice is described in this paragraph if it is a postage prepaid and pre-addressed return card, sent by forwardable mail, on which the registrant may state his or her current address, together with a notice to the following effect:

(A) If the registrant did not change his or her residence, or changed residence but remained in the registrar's jurisdiction, the registrant should return the card not later than the time provided for mail registration under subsection (a)(1)(B). If the card is not returned, affirmation or confirmation of the registrant's address may be required before the registrant is permitted to vote in a Federal election during the period beginning on the date of the notice and ending on the day after the date of the second general election for Federal office that occurs after the date of the notice, and if the registrant does not vote in an election during that period the registrant's name will be removed from the list of eligible voters.

(B) If the registrant has changed residence to a place outside the registrar's jurisdiction in which the registrant is registered, information concerning how the registrant can continue to be eligible to vote.

(3) A voting registrar shall correct an official list of eligible voters in elections for Federal office in accordance with change of residence information obtained in conformance with this subsection.

(e) PROCEDURE FOR VOTING FOLLOWING FAILURE TO RETURN CARD.—(1) A registrant who has moved from an address in the

## PUBLIC LAW 103-31—MAY 20, 1993

107 STAT. 85

area covered by a polling place to an address in the same area shall, notwithstanding failure to notify the registrar of the change of address prior to the date of an election, be permitted to vote at that polling place upon oral or written affirmation by the registrant of the change of address before an election official at that polling place.

(2)(A) A registrant who has moved from an address in the area covered by one polling place to an address in an area covered by a second polling place within the same registrar's jurisdiction and the same congressional district and who has failed to notify the registrar of the change of address prior to the date of an election, at the option of the registrant—

(i) shall be permitted to correct the voting records and vote at the registrant's former polling place, upon oral or written affirmation by the registrant of the new address before an election official at that polling place; or

(ii)(I) shall be permitted to correct the voting records and vote at a central location within the same registrar's jurisdiction designated by the registrar where a list of eligible voters is maintained, upon written affirmation by the registrant of the new address on a standard form provided by the registrar at the central location; or

(II) shall be permitted to correct the voting records for purposes of voting in future elections at the appropriate polling place for the current address and, if permitted by State law, shall be permitted to vote in the present election, upon confirmation by the registrant of the new address by such means as are required by law.

(B) If State law permits the registrant to vote in the current election upon oral or written affirmation by the registrant of the new address at a polling place described in subparagraph (A)(i) or (A)(ii)(II), voting at the other locations described in subparagraph (A) need not be provided as options.

(3) If the registration records indicate that a registrant has moved from an address in the area covered by a polling place, the registrant shall, upon oral or written affirmation by the registrant before an election official at that polling place that the registrant continues to reside at the address previously made known to the registrar, be permitted to vote at that polling place.

(f) CHANGE OF VOTING ADDRESS WITHIN A JURISDICTION.—In the case of a change of address, for voting purposes, of a registrant to another address within the same registrar's jurisdiction, the registrar shall correct the voting registration list accordingly, and the registrant's name may not be removed from the official list of eligible voters by reason of such a change of address except as provided in subsection (d).

(g) CONVICTION IN FEDERAL COURT.—(1) On the conviction of a person of a felony in a district court of the United States, the United States attorney shall give written notice of the conviction to the chief State election official designated under section 10 of the State of the person's residence.

(2) A notice given pursuant to paragraph (1) shall include—

(A) the name of the offender;

(B) the offender's age and residence address;

(C) the date of entry of the judgment;

(D) a description of the offenses of which the offender was convicted; and

107 STAT. 86

PUBLIC LAW 103-31—MAY 20, 1993

(E) the sentence imposed by the court.

(3) On request of the chief State election official of a State or other State official with responsibility for determining the effect that a conviction may have on an offender's qualification to vote, the United States attorney shall provide such additional information as the United States attorney may have concerning the offender and the offense of which the offender was convicted.

(4) If a conviction of which notice was given pursuant to paragraph (1) is overturned, the United States attorney shall give the official to whom the notice was given written notice of the vacation of the judgment.

(5) The chief State election official shall notify the voter registration officials of the local jurisdiction in which an offender resides of the information received under this subsection.

(h) **REDUCED POSTAL RATES.**—(1) Subchapter II of chapter 36 of title 39, United States Code, is amended by adding at the end the following:

**“§ 3629. Reduced rates for voter registration purposes**

“The Postal Service shall make available to a State or local voting registration official the rate for any class of mail that is available to a qualified nonprofit organization under section 3626 for the purpose of making a mailing that the official certifies is required or authorized by the National Voter Registration Act of 1993.”

(2) The first sentence of section 2401(c) of title 39, United States Code, is amended by striking out “and 3626(a)–(h) and (j)–(k) of this title,” and inserting in lieu thereof “3626(a)–(h), 3626(j)–(k), and 3629 of this title”.

(3) Section 3627 of title 39, United States Code, is amended by striking out “or 3626 of this title,” and inserting in lieu thereof “3626, or 3629 of this title”.

(4) The table of sections for chapter 36 of title 39, United States Code, is amended by inserting after the item relating to section 3628 the following new item:

“3629. Reduced rates for voter registration purposes.”

Records.

(i) **PUBLIC DISCLOSURE OF VOTER REGISTRATION ACTIVITIES.**—

(1) Each State shall maintain for at least 2 years and shall make available for public inspection and, where available, photocopying at a reasonable cost, all records concerning the implementation of programs and activities conducted for the purpose of ensuring the accuracy and currency of official lists of eligible voters, except to the extent that such records relate to a declination to register to vote or to the identity of a voter registration agency through which any particular voter is registered.

(2) The records maintained pursuant to paragraph (1) shall include lists of the names and addresses of all persons to whom notices described in subsection (d)(2) are sent, and information concerning whether or not each such person has responded to the notice as of the date that inspection of the records is made.

(j) **DEFINITION.**—For the purposes of this section, the term “registrar’s jurisdiction” means—

(1) an incorporated city, town, borough, or other form of municipality;

(2) if voter registration is maintained by a county, parish, or other unit of government that governs a larger geographic

## PUBLIC LAW 103-31—MAY 20, 1993

107 STAT. 87

area than a municipality, the geographic area governed by that unit of government; or

(3) if voter registration is maintained on a consolidated basis for more than one municipality or other unit of government by an office that performs all of the functions of a voting registrar, the geographic area of the consolidated municipalities or other geographic units.

**SEC. 9. FEDERAL COORDINATION AND REGULATIONS.**

42 USC 1973gg-7.

(a) **IN GENERAL.**—The Federal Election Commission—

(1) in consultation with the chief election officers of the States, shall prescribe such regulations as are necessary to carry out paragraphs (2) and (3);

(2) in consultation with the chief election officers of the States, shall develop a mail voter registration application form for elections for Federal office;

(3) not later than June 30 of each odd-numbered year, shall submit to the Congress a report assessing the impact of this Act on the administration of elections for Federal office during the preceding 2-year period and including recommendations for improvements in Federal and State procedures, forms, and other matters affected by this Act; and

(4) shall provide information to the States with respect to the responsibilities of the States under this Act.

Reports.

(b) **CONTENTS OF MAIL VOTER REGISTRATION FORM.**—The mail voter registration form developed under subsection (a)(2)—

(1) may require only such identifying information (including the signature of the applicant) and other information (including data relating to previous registration by the applicant), as is necessary to enable the appropriate State election official to assess the eligibility of the applicant and to administer voter registration and other parts of the election process;

(2) shall include a statement that—

(A) specifies each eligibility requirement (including citizenship);

(B) contains an attestation that the applicant meets each such requirement; and

(C) requires the signature of the applicant, under penalty of perjury;

(3) may not include any requirement for notarization or other formal authentication; and

(4) shall include, in print that is identical to that used in the attestation portion of the application—

(i) the information required in section 8(a)(5) (A) and (B);

(ii) a statement that, if an applicant declines to register to vote, the fact that the applicant has declined to register will remain confidential and will be used only for voter registration purposes; and

(iii) a statement that if an applicant does register to vote, the office at which the applicant submits a voter registration application will remain confidential and will be used only for voter registration purposes.

**SEC. 10. DESIGNATION OF CHIEF STATE ELECTION OFFICIAL.**

42 USC 1973gg-8.

Each State shall designate a State officer or employee as the chief State election official to be responsible for coordination of State responsibilities under this Act.

107 STAT. 88

PUBLIC LAW 103-31—MAY 20, 1993

42 USC 1973gg-9. **SEC. 11. CIVIL ENFORCEMENT AND PRIVATE RIGHT OF ACTION.**

(a) **ATTORNEY GENERAL.**—The Attorney General may bring a civil action in an appropriate district court for such declaratory or injunctive relief as is necessary to carry out this Act.

(b) **PRIVATE RIGHT OF ACTION.**—(1) A person who is aggrieved by a violation of this Act may provide written notice of the violation to the chief election official of the State involved.

(2) If the violation is not corrected within 90 days after receipt of a notice under paragraph (1), or within 20 days after receipt of the notice if the violation occurred within 120 days before the date of an election for Federal office, the aggrieved person may bring a civil action in an appropriate district court for declaratory or injunctive relief with respect to the violation.

(3) If the violation occurred within 30 days before the date of an election for Federal office, the aggrieved person need not provide notice to the chief election official of the State under paragraph (1) before bringing a civil action under paragraph (2).

(c) **ATTORNEY'S FEES.**—In a civil action under this section, the court may allow the prevailing party (other than the United States) reasonable attorney fees, including litigation expenses, and costs.

(d) **RELATION TO OTHER LAWS.**—(1) The rights and remedies established by this section are in addition to all other rights and remedies provided by law, and neither the rights and remedies established by this section nor any other provision of this Act shall supersede, restrict, or limit the application of the Voting Rights Act of 1965 (42 U.S.C. 1973 et seq.).

(2) Nothing in this Act authorizes or requires conduct that is prohibited by the Voting Rights Act of 1965 (42 U.S.C. 1973 et seq.).

42 USC  
1973gg-10.**SEC. 12. CRIMINAL PENALTIES.**

A person, including an election official, who in any election for Federal office—

(1) knowingly and willfully intimidates, threatens, or coerces, or attempts to intimidate, threaten, or coerce, any person for—

(A) registering to vote, or voting, or attempting to register or vote;

(B) urging or aiding any person to register to vote, to vote, or to attempt to register or vote; or

(C) exercising any right under this Act; or

(2) knowingly and willfully deprives, defrauds, or attempts to deprive or defraud the residents of a State of a fair and impartially conducted election process, by—

(A) the procurement or submission of voter registration applications that are known by the person to be materially false, fictitious, or fraudulent under the laws of the State in which the election is held; or

(B) the procurement, casting, or tabulation of ballots that are known by the person to be materially false, fictitious, or fraudulent under the laws of the State in which the election is held,

shall be fined in accordance with title 18, United States Code (which fines shall be paid into the general fund of the Treasury, miscellaneous receipts (pursuant to section 3302 of title 31, United

## PUBLIC LAW 103-31—MAY 20, 1993

107 STAT. 89

States Code), notwithstanding any other law), or imprisoned not more than 5 years, or both.

**SEC. 13. EFFECTIVE DATE.**

42 USC 1973gg note.

This Act shall take effect—

(1) with respect to a State that on the date of enactment of this Act has a provision in the constitution of the State that would preclude compliance with this Act unless the State maintained separate Federal and State official lists of eligible voters, on the later of—

(A) January 1, 1996; or

(B) the date that is 120 days after the date by which, under the constitution of the State as in effect on the date of enactment of this Act, it would be legally possible to adopt and place into effect any amendments to the constitution of the State that are necessary to permit such compliance with this Act without requiring a special election; and

(2) with respect to any State not described in paragraph (1), on January 1, 1995.

Approved May 20, 1993.

**LEGISLATIVE HISTORY—H.R. 2 (S. 460):**

**HOUSE REPORTS:** Nos. 103-9 (Comm. on House Administration) and 103-66 (Comm. of Conference).

**SENATE REPORTS:** No. 103-6 accompanying S. 460 (Comm. on Rules and Administration).

**CONGRESSIONAL RECORD, Vol. 139 (1993):**

Feb. 4, considered and passed House.

Mar. 10, 11, 15-17, S. 460 considered in Senate; H.R. 2, amended, passed in lieu.

May 5, House agreed to conference report.

May 6-8, Senate considered and agreed to conference report.

**WEEKLY COMPILATION OF PRESIDENTIAL DOCUMENTS, Vol. 29 (1993):**

May 20, Presidential remarks.









# APPENDIX B

## THE HOUSE COMMITTEE REPORT ON THE ACT

103 <sup>d</sup> Congress 1st Session	<b>HOUSE OF REPRESENTATIVES</b>	Report 108-9
<p><b>NATIONAL VOTER REGISTRATION ACT OF 1993</b></p> <p>FEBRUARY 2, 1993.—Committed to the Committee of the Whole House on the State of the Union and ordered to be printed</p> <p>Mr. SWIFT, from the Committee on House Administration, submitted the following</p> <p style="text-align: center;"><b>R E P O R T</b></p> <p style="text-align: center;">together with</p> <p style="text-align: center;"><b>MINORITY VIEWS</b></p> <p style="text-align: center;">[To accompany H.R. 2]</p> <p style="text-align: center;">[Including cost estimate of the Congressional Budget Office]</p> <p>The Committee on House Administration, to whom was referred the bill (H.R. 2) to establish national voter registration procedures for Federal elections, and for other purposes, having considered the same, report favorably thereon with amendments and recommend that the bill as amended do pass.</p> <p>The amendments (stated in terms of the page and line numbers of the introduced bill) are as follows:</p> <p>Page 11, beginning on line 5, strike out "substantially".</p> <p>Page 22, strike out line 16 and all that follows through line 21 and insert in lieu thereof the following:</p> <p>(2) The first sentence of section 2401(c) of title 39, United States Code, is amended by striking out "and 3626(a)-(h) and (j)-(k) of this title," and inserting in lieu thereof "3626(a)-(h), 3626(j)-(k), and 3629 of this title".</p> <p>(3) Section 3627 of title 39, United States Code, is amended by striking out "or 3626 of this title," and inserting in lieu thereof "3626, or 3629 of this title".</p> <p style="text-align: center;"><b>PURPOSE</b></p> <p>The purpose of H.R. 2 is to establish national voter registration procedures for Federal elections.</p>		

68-579

## SUBCOMMITTEE ACTION

The Subcommittee on Elections held a hearing on H.R. 2 on January 26. Testimony on the bill was heard from the Honorable Ralph Munro, Washington Secretary of State; David D. Orr, Clerk, Cook County, Illinois; Becky Cain, President, League of Women Voters of the United States; Edward A. Hailes, Counsel, NAACP; James C. Dickson, Disabled AND Able to Vote; Tony Bernhard, Clerk-Recorder, Yolo County, California; Jackie Winchester, Supervisor of Elections, West Palm Beach, Florida; Ronald A. Rasmus, Clerk and Recorder, Ford County, Illinois; Richard Leibovitz, Clerk, Rock Island County, Illinois; and Emmett H. Fremaux, Jr., Executive Director, Board of Elections and Ethics, Washington, D.C.

The Subcommittee held a markup on H.R. 2 on January 26, 1993 and, by voice vote, ordered it reported favorably to the full Committee on House Administration without amendment.

## COMMITTEE ACTION

On January 27, 1993, a quorum being present, the Committee on House Administration held an open markup on H.R. 2. During the markup, Representative Swift offered an amendment to an amendment by Representative Thomas, to strike the word "substantially". After a discussion of the amendment, the Committee agreed to the amendment by Mr. Swift by voice vote.

No other amendments (other than one technical amendment) were agreed to. After further discussion, the Committee ordered H.R. 2, as amended, favorably reported to the House by a roll call vote of 9 "ayes" and 3 "nays".

## FINDINGS

Restrictive registration laws and administrative procedures were introduced in the United States in the late nineteenth and early twentieth centuries to keep certain groups of citizens from voting; in the North, the wave of immigrants pouring into the industrial cities; in the South, blacks and the rural poor. The poll tax, literacy tests, residency requirements, selective purges, elaborate administrative procedures and annual reregistration requirements were some of the techniques developed to discourage participation. These restrictions, along with a weakening of political party competition, were so effective that between 1896 and 1924, the voter turnout for Presidential elections dropped from 79 percent to 49 percent. In the South, the turnout went from 57 percent to 19 percent, with the black vote dropping from 44 percent to essentially zero percent.

The depression, the emergence of the New Deal and a revitalization of the political parties stimulated political activity in the period before World War II, and the national Presidential voter turnout jumped to 62 percent in 1940, although in the South the turnout was only 29 percent. While the more flagrant and discriminatory impediments, such as the poll tax and literacy tests, were gradually going out of existence in the North, they remained very much in place in the South until the Civil Rights movement of the 1950's. In 1940, only 4.5 percent of blacks were registered in the

South. This figure slowly moved up to 12.5 percent in 1947, 20.7 percent in 1952, 29.1 percent in 1960 and 35.5 percent in 1965, just before passage of the Voting Rights Act.

Enactment of the Voting Rights Act of 1965 eliminated the more obvious impediments to registration, but left a complicated maze of local laws and procedures, in some cases as restrictive as the outlawed practices, through which eligible citizens had to navigate in order to exercise their right to vote. The unfinished business of registration reform is to reduce these obstacles to voting to the absolute minimum while maintaining the integrity of the electoral process.

While the steady decline in citizen participation in Federal elections over the past thirty years was reversed in 1992, apparently as many as 44 percent of the eligible electorate failed to vote in last year's Presidential election. There are many factors involved in the lack of public participation, factors largely beyond the control of Congress. However, the difficulties encountered by eligible citizens in becoming registered to vote is an issue which can be directly addressed through the legislative process.

Public opinion polls, along with individual testimony received by the Committee, indicate that failure to become registered is the primary reason given by eligible citizens for not voting. It is generally accepted that over 80 percent of those citizens who are registered vote in Presidential elections. However, according to figures provided by the Congressional Research Service, only slightly over 60 percent of the eligible voters are registered. Thus, even a relatively good turnout of registered voters, such as occurred in 1992, will only produce an overall participation rate in the low 50's percentile. Expanding the rolls of the eligible citizens who are registered is no guarantee that the total number of voters will increase, but it is one positive action Congress can take to give the greatest number of people an opportunity to participate. The Committee believes that Congress should assist in reducing barriers, particularly government-imposed barriers, to applying for registration wherever possible.

The Committee found that:

- (1) the right of citizens of the United States to vote in Federal elections is a fundamental Constitutional right;
- (2) it is the responsibility of each citizen to exercise the right to vote, and it is the duty of the Federal, state and local governments to promote the exercise of that right;
- (3) discriminatory and unfair registration laws and procedures can have a direct and damaging effect on voter participation in elections for Federal office, and disproportionately harm voter participation by various groups, including the disabled and racial minorities.
- (4) Congress has a Constitutionally based authority to enact national registration standards for elections for Federal office;
- (5) while Congress may not be able to directly affect voter turnout in Federal elections through the enactment of legislation, Congress does have the authority and responsibility to make the registration process for Federal elections as accessible as possible while maintaining the integrity of the electoral process;

(6) low voter turnout in Federal elections poses potential serious problems in our democratic society.

In the 101st Congress, in extensive hearings on very similar legislation, the Committee heard a variety of witnesses testify that registration procedures in the United States were not uniform, were not nondiscriminatory and, in some cases, were interpreted in such a manner as to deny eligible citizens their right to vote.

As a result of these hearings, the Committee, in the 101st Congress, reported out favorably H.R. 2190, a bill subsequently passed by the House of Representatives on February 6, 1990. No action was taken on this legislation by the other body.

In developing legislative language for H.R. 2190, the Committee considered a variety of proposals to make the registration process more accessible. Since registration by mail was already in place in approximately half the states, and there was substantial evidence that this procedure not only increased registration but successfully reached out to those groups most under-represented on the registration rolls, this method of registration was considered appropriate for a national standard.

A number of states had already extended the availability of mail registration forms to public agencies, so the Committee adopted this procedure for a national standard, specifically mentioning certain public and private outlets where registration forms would be available.

The most controversial method of registration considered by the Committee in its deliberation on H.R. 2190 was registration on the day of election. Advocates argued that the extensive cut-off period between registration and election day (most states mandating between 25 and 30 days) was a major cause of low registration. They contended that most people don't become interested in elections until the last weeks of a campaign, and then discover it is too late to register. Maine, Minnesota and Wisconsin allow a form of "same day" registration, and they rank among the top states in the percent of eligible voters registered. Strong opposition to "same day" registration was expressed by a number of state and local election officials who argued that such a procedure would be very difficult to administer and could result in fraud. With some 35 percent of the eligible voters not registered, the potential for an overwhelming number of people to show up on election day was a matter of deep concern. The Committee concluded that while the concept of "same day" registration might be desirable it would not be feasible to mandate such a procedure as a national standard until the number of unregistered citizens had been substantially reduced and procedures for verification and vote tabulation clarified.

The Committee felt that the broadest, most effective and cost-efficient method of registration would be the simultaneous application procedure suggested by Washington State Secretary of State Ralph Munro, i.e. a driver's license application serving as an application for registration. A version of this approach was already in place in several states. Statistics from the Department of Transportation indicated that approximately 87 percent of the population eighteen years and older had driver's licenses. It was determined that another three or four percent had, in lieu of a driver's license, an identification card issued by the state motor vehicle agency.

Many of those applying for identification cards fell into the demographic categories of those least likely to be registered.

The Committee felt that many processing systems in place to handle driver's license application data lent themselves naturally to processing a voter registration application.

By combining the driver's license application approach with mail and agency-based registration, the Committee felt that any eligible citizen who wished to register would have ready access to an application.

Ensuring that expanding the opportunities to register would in no way weaken the validity of the registration rolls was a priority for the Committee. The Committee felt strongly that no legislative provision should be considered that did not at least maintain the current level of fraud prevention. Consequently, the Committee concluded that language on list verification procedures was appropriate, specifically prohibiting any registered voter from being removed from the rolls for failure to vote. The Committee agreed on language which mandated that any list cleaning procedure must be uniform and nondiscriminatory and in compliance with the Voting Rights Act of 1965. The Committee also urged adoption of the United States Postal Services' National Change of Address Program as the most efficient and cost-effective method of keeping registration lists up-to-date.

In the 102nd Congress, the Senate passed and sent to the House S. 250, a bill very similar to H.R. 2190. The House considered and passed S. 250 on June 16, 1992. President Bush vetoed S. 250 on July 2, 1992.

With the exception of the effective date and the short title, H.R. 2 is identical to S. 250. It contains all the basic registration procedures of H.R. 2190 and includes a section on verification mandating that States have a program to clean voter registration lists and requiring that any list cleaning program be uniform, nondiscriminatory and in compliance with the Voting Rights Act of 1965. The Committee feels that H.R. 2 addresses all the issues and qualifications of H.R. 2190 and fills the legislative initiatives which prompted H.R. 2190.

#### DESCRIPTION AND DISCUSSION OF BILL

##### SECTION 1. SHORT TITLE

This section provides that the legislation may be cited as the "National Voter Registration Act of 1993".

##### SECTION 2. FINDINGS AND PURPOSES

Section (a) sets forth the findings of the Congress that the right to vote is a fundamental right of citizens; that it is the duty of Federal, state and local governments to promote the exercise of that right; and that discriminatory and unfair registration laws and procedures have a direct and damaging effect on voter participation in elections for Federal office and disproportionately harm voter participation by various groups, including racial minorities.

Section (b) sets forth the purposes of this Act, which are to increase the registration of voters, to make it possible for Federal,

state and local governments to implement the Act in a manner that enhances the participation of eligible citizens, to protect the integrity of the electoral process and guarantee accurate and current voter registration rolls.

#### SECTION 3. DEFINITIONS

Section 3 defines the term "motor vehicle driver's license" to include any personal identification document issued by a State motor vehicle authority, and applies the definitions of Section 301 of the Federal Election Campaign Act of 1971 to election terms used in this Act. "State" is defined to be a State of the United States or the District of Columbia. A "voter registration agency" is any office designated under this Act's agency-based registration provisions to perform registration functions which include distributing registration forms simultaneously with applications for services or benefits, providing assistance to applicants similar to that provided in the completion of the office's own forms, and receipt and transmittal of such forms to the appropriate voter registrar.

#### SECTION 4. NATIONAL PROCEDURES FOR VOTER REGISTRATION FOR ELECTIONS FOR FEDERAL OFFICE

Section 4(a) requires that the States, in addition to any other methods for voter registration provided for under State law, establish procedures to permit voter registration in elections for Federal office: simultaneously with an application for a driver's license; by mail application; by application in person, either at an appropriate registration office, or at a Federal, State or private sector location ("agency registration").

Section 4(b) provides that this Act is not applicable to a State where either or both of the following apply: a State in which there is no voter registration requirement for any voter in the State with respect to a Federal election; or, a State in which all voters may register to vote at the polling place at the time of voting in a Federal general election.

The language of this section is specific as it relates to the exceptions. It is the intent of the Committee that these exceptions are narrowly drawn to assure that only those States in which any voter may vote either without registration or by registering at the polling place on election day would be exempt. A State would be exempt from the requirements of the bill if it meets either or both of these requirements. The Committee believes that states which have implemented one or both of these exceptions have lessened the impediments to registration which goes significantly beyond the requirements of the bill. A State would not be exempt if it merely granted local jurisdictions the option of providing for election day registration or no registration if local jurisdictions also had the option of requiring any other form of registration. The Committee does not believe such an option results in a significant reduction in registration barriers.

#### SECTION 5. SIMULTANEOUS APPLICATION FOR VOTER REGISTRATION AND APPLICATION FOR MOTOR VEHICLE DRIVER'S LICENSE

Subsections (a) and (b) require that each State motor vehicle driver's license application, including a renewal application, shall also serve as an application for voter registration for Federal elections. In addition, such an application will also serve as updating any previous voter registration by the applicant. An applicant for a motor vehicle driver's license may decline to register to vote and such information may not be used for any purpose other than voter registration.

Although the declination to register must be in writing, no particular format is required so long as a record of the declination is created and retained.

The Committee recognizes that in some jurisdictions the application process is fully computerized. In such cases, any form signed by an applicant during the process shall contain an attestation to the questions on the application, including any declination question.

It is the intent of the Committee that the application procedure should require the affirmative act of an applicant but only after the applicant has received a complete application that includes both the drivers license and voter registration application forms. States are afforded latitude in this section to develop an application which will meet the needs of the particular jurisdiction. In some instances, a State may determine that the application should include a box in either form for a registrant to check if he or she declines to register. In other instances, where the application for the driver's license and voting registration are combined into a single form, the failure of an applicant to sign the voting registration application portion could serve as a declination to register, if the drivers license portion contains a notice to the applicant that the failure to complete and sign the voter registration application portion of that form is a declination to register.

This requirement that there be a written declination to register serves two purposes: first, to prevent unnecessary paperwork where a person is already properly registered; and, two, to prevent the registration of ineligible persons. It is not the intent of this bill to generate needless paperwork for either the registry of motor vehicles or the voter registrar. The Committee would expect the registry of motor vehicles staff to instruct applicants who are already properly registered to vote to decline to register. Such instructions should also be included in any written materials provided to applicants as well as in any instructions posted in motor vehicle agency offices.

Some have noted that the requirements for obtaining a driver's license are not the same as those for eligibility to vote, specifically, age and citizenship. The Committee would expect that any driver's license applicant who does not meet the requirements for eligibility to vote would decline to do so. It is important, therefore, that each applicant be advised of the voting requirements and the need to decline to register if he or she does not meet the requirements. The bill provides that all registration requirements be set forth in the application to register to vote so that they will be readily available

for each applicant to review during the application process. The applicant should be advised that there is no obligation to specify the particular reason for choosing to decline to register.

Since some of the reasons for declining to register to vote may involve matters of personal privacy, such as ineligibility under State law due to mental incompetence or a criminal conviction, an individual who declines to register to vote shall not be questioned as to the reasons for such action. If an individual reveals such information, it must be treated as confidential and may not be used for any other purpose. As discussed later, the Act contains a general prohibition against a State or entity from revealing any information relating to a declination to register or to the particular location or agency where a person registered.

Subsection (c) requires that each State shall include a voter registration application form as part of an application for a State motor vehicle driver's license. The voter registration application form may not require any information that duplicates information required in the driver's license portion of the form, other than a second signature and the minimum amount of information necessary to prevent duplicate voter registration and enable State election officials to assess the eligibility of the applicant for voter registration and other parts of the election process, and must include a means by which an applicant may decline to register to vote. The voter registration application form must include a statement that states each eligibility requirement, including citizenship, an attestation that the applicant meets each such requirement, and the signature of the applicant under penalty of perjury. In addition, where appropriate, such forms should include information requesting the applicant's mail address if it differs from the applicant's residence. Each completed voter registration application form must be made available to the appropriate State election official as provided by State law.

The terms "State election officials" and "appropriate State election official" refer to whatever election official under State law has the appropriate responsibility. In some cases, this may be a local election official.

Although the application for voting registration is simultaneous with an application for a driver's license, it is not the intent of the bill to supplant the traditional role of voting registrars over the registration procedure. The bill makes it very clear that the motor vehicle agency is responsible for forwarding voting registration applications to the appropriate State election official. It should be made very clear to any applicant in a driver's license bureau that the application for voter registration is an application which must be reviewed by the appropriate election officials. Only the election officials designated and authorized under State law are charged with the responsibility to enroll eligible voters on the list of voters. This bill should not be interpreted in any way to supplant that authority. The Committee is particularly interested in ensuring that election officials continue to make determinations as to applicant's eligibility, such as citizenship, as are made under current law and practice. Applications should be sent to the appropriate election official for the applicant's address in accordance with the regulations and laws of each State.

Although the Committee would encourage States to adopt a single form for a voter registration application and a motor vehicle driver's license application in order to expedite the process, to minimize the duplication of information, and to establish a truly simultaneous application process, it recognizes that administrative and funding considerations may pose problems for some States. Thus, Section 5(c) is so drafted to describe an application process that permits the use of two forms, one for the motor vehicle driver's license application and one for the voting registration application, thereby avoiding any cost associated with revamping current procedures or computer programs.

The committee believes that a single combined form will be both more effective and more cost-efficient over the long term, and encourages responsible officials to use such a combined form.

However, where two forms are used, it is expected and intended that such forms will be used simultaneously as part of a single, integrated application process. All applicants appearing at the motor vehicle office must be given an application that includes both forms. If such an applicant does not wish to register to vote and so indicates by declining in writing to do so, such an applicant need not complete the voter registration portion of the application.

Subsection (d) provides that any change of address form submitted in accordance with State law for purposes of a State motor vehicle driver's license shall serve as notification of a change of address for voter registration unless the registrant states on the form that the change of address is not for voter registration purposes. The requirements of residency pertaining to driver's licenses may vary from those pertaining to voting; therefore, this provision will permit a person to indicate that a change of address notification to the motor vehicle agency is not intended to effect a change in the address for voting purposes and should not be forwarded to the voting registrar.

#### SECTION 6. MAIL REGISTRATION

Subsection (a) requires that all States accept and use the mail voter registration form prescribed by the Federal Election Commission. In addition, States are permitted to develop and use their own mail registration form, provided it meets the requirements of this Act. Mail registration forms may also be used for voter registration change of address.

The Federal Election Commission, in consultation with the chief election officials of the States, is required pursuant to Section 9 to promulgate a mail registration application form. That form shall include a statement that specifies each eligibility requirement for voting, contain an attestation that the applicant meets each such requirement, including citizenship, and require the signature of the applicant, under penalty of perjury. Where appropriate, the application form should include information requesting the applicant's mail address if it differs from the applicant's residence. The form may not include any requirement for notarization or other formal authentication, such as witnessing. If a State chooses to develop and use its own form, that form must comply with the same crite-

ria that applies to the Federal form promulgated by the Federal Election Commission.

The requirements that States use a uniform mail registration application form serves to augment the extensive outreach features of the "motor-voter" and agency-based registration procedures. Uniform mail forms will permit voter registration drives through a regional or national mailing, or for more than one State at a central location, such as a city where persons from a number of neighboring States work, shop or attend events. By permitting States to develop and use their own forms as well, the bill provides flexibility for the States. In those States that develop their own mail voter registration applications, an applicant may use, and the State must accept, either the national form developed by the FEC or the State's own form.

Subsection (b) requires the chief State election official to make the mail registration forms available for distribution through governmental and private entities, with a particular emphasis on making such forms available to organized voter registration programs. Broad dissemination of mail application forms, when coupled with the other procedures of this bill, should reach most persons eligible to register to vote, and is, therefore, a key element of the voter outreach feature of this bill. Such forms may also be disseminated to agencies designated under the agency-based registration procedures for use by those agencies in their registration programs.

States that use mail registration application procedures generally employ a number of means to prevent fraud, such as including on the form a statement of voter qualification requirements or penalties for fraud, or a follow-up mailing. The form to be developed by the FEC is to include a statement setting forth the requirements to vote (including age and citizenship) and an attestation to be signed by the applicant under penalty of perjury. The Committee intends for forms developed by States to contain the same statement and attestation. The bill requires notice to each applicant of the disposition of his or her application. This requirement could be met by a follow-up mailing by any State that wishes to employ that procedure as a means of protecting against possible fraud in the mail registration process.

The Committee believes that these provisions are sufficient to deter fraudulent registrations. Nevertheless, the bill includes an additional provision relating to first time voters which has been added to address the concerns that this process may be subject to misuse. Subsection (c) provides that a State may require by law that a person who registers to vote by mail and has not previously voted in that jurisdiction, vote in person. This requirement would not be applicable to any person who is entitled to vote by absentee ballot under the Uniformed and Overseas Citizens Absentee Voting Act, or who is provided the right to vote otherwise than in person by the Voting Accessibility for the Elderly and Handicapped Act, or who is entitled to vote otherwise than in person by any other Federal law. States are permitted to employ any other fraud protection procedures which are not inconsistent with this bill.

#### SECTION 7. VOTER REGISTRATION AGENCIES

Subsection (a) requires that each State establish an agency-based registration program by designating various public and private agencies or offices for the registration of voters for Federal elections. The Act requires that certain agencies must be included in such a program. Thus, each State must designate all public offices in the State of those agencies that provide public assistance, unemployment compensation, or related services and all agencies and offices in the State that provide State-funded programs primarily engaged in providing services to persons with disabilities. In addition the State must designate additional Federal, State or local governmental agencies as well as private sector offices as registration agencies, but each State is given discretion as which agencies and what offices of those agencies to include. The Act provides that such discretionary agency programs may include public libraries, public schools, offices of city and county clerks (including marriage license bureaus), fishing and hunting license bureaus, government revenue offices, and any agency or office that provides services to persons with disabilities that is not included in the mandatory agency-based voter registration program. Federal, State and private sector offices could also be included in this program.

A voter registration agency that provides service or assistance in addition to conducting voter registration shall distribute simultaneously with each application for service or assistance, and with each recertification, renewal, or change of address, a mail voter registration application form promulgated by the Federal Election Commission as provided for in the Act or its own form, if the agency has devised its own form in compliance with the requirements of this Act. The offices should to the greatest extent practicable, incorporate in application forms and other forms used for purposes other than voter registration, a means by which an applicant may decline in writing to register to vote. If an applicant does not decline to register, the office is to provide the same type and degree of assistance in completing the registration application as it usually provides its applicants with regard to the completion of the office's own forms. Costs for registration application assistance for these offices should be considered matchable under the current Federal match rate for these programs.

A person who provides these voter registration services at an agency voter registration office shall not influence an applicant's political preference or party registration, display any political preference or party affiliation, or make any statement to an applicant the purpose or effect of which is to discourage the applicant from registering to vote.

While concerns have been raised that applicants will feel pressured to affiliate with a particular political party, the Committee believes that these provisions, coupled with the new criminal provisions, will alleviate such pressure. In addition, the Committee found no evidence of such pressure in the States which have implemented an agency registration application program.

The mandatory portion of the agency-based registration application program, which includes offices providing public assistance, unemployment compensation or related services and services pri-

marily to persons with disabilities, is intended to supplement the motor-voter provisions of the bill by reaching out to those citizens who are likely not to benefit from the State motor-voter registration application provisions. These agencies are included in the mandatory agency registration program because they are considered most likely to serve persons of voting age who may not have driver licenses and therefore are not served by the motor-voter provisions. The Committee strongly believes that the mandatory portion provides a necessary balance to the motor-voter portion, without unduly burdening State resources.

The second portion of a State's agency-based registration program includes other agencies and offices which the State may designate to extend its outreach to as many citizens of voting age as possible. While the States are required to have a discretionary agency registration program in addition to the mandatory one, the State is given latitude to determine which agencies, as well as which of their offices, should be included.

Each agency voter registration office is required to provide the following services: simultaneous distribution of mail voter registration application forms (or the agency's own form), assistance to applicants in completing voter registration application forms, and acceptance of completed voter registration application forms for transmittal to the appropriate State election official. The term "appropriate State election official" shall be interpreted in accordance with State law or practice and is intended to mean that official who is authorized under State law to register voters in the jurisdiction where the registrant resides.

The original bill included in the mandatory agency registration program offices that provide vocational rehabilitation services in an attempt to assure that persons with disabilities would be reached by some part of the State's registration programs. Representatives of programs that serve persons with disabilities made it clear that vocational rehabilitation offices would not have extensive contact with such persons and that a broader designation of offices would be necessary if a State's agency program was to include a sufficient number of persons with disabilities. The Act now includes a definition that is intended to have more extensive outreach to persons with disabilities. While it would include vocational rehabilitation offices, it would also extend to many other agencies that have contact on a with persons with disabilities, such as, but not limited to those agencies which provide transportation, job training, education counseling, rehabilitation or independent living services.

The Committee also recognizes that many persons with disabilities are less likely to visit offices in order to obtain services or benefits. As a result, the bill requires that if a voter registration agency designated by the State provides services to a person with a disability at the person's home, the agency shall provide the voter registration services at the person's home, as well. The Committee notes that the provisions referring to persons with disabilities are not intended to reach any persons otherwise ineligible to register, such as by reason of judicially determined mental incapacity.

Since the requirements for services or assistance at agency offices may differ significantly from those voting registration pur-

poses, the Committee would expect that any applicant for services or assistance from such an agency who does not meet the requirements for eligibility to register to vote would decline to do so. It is important, therefore, that each applicant be advised of the voting requirements and the need to decline to register if he or she does not meet the requirements. The bill provides that all registration requirements should be set forth in the application to register to vote so that they will be readily available for each applicant to review during the application process. These requirements must include a statement of citizenship, an attestation that the applicant meets each such requirement, and the signature of the applicant under penalty of perjury. The applicant should be advised there is no obligation to specify the particular reasons for choosing to decline to register.

Since some of the reasons for declining to register to vote may involve matters of personal privacy, such as ineligibility under State law due to mental incompetence or a criminal conviction, an individual who declines to register to vote shall not be questioned as to the reasons for such action. If an individual reveals such information, it must be treated as confidential and may not be used for any purpose other than voter registration. As discussed later, the Act contains a general prohibition against a State or other entity, including an agency designated under this provision, from revealing any information relating to a declination to register or to the identification of the agency where a person registered.

Subsection (b) requires all entities of the Federal government to cooperate as much as possible with the States in carrying out this program by participating as designated voter registration agencies. This participation requirement is subject to the Federal agency agreeing to participate pursuant to subsection (a). No specific Federal agencies are designated in this bill to participate, it being left to the States to negotiate such arrangements with the appropriate Federal agencies. It is the Committee's intention that any agency or organization providing assistance under the terms of this Act would negotiate a mutually satisfactory arrangement, which could include, where appropriate or required, reimbursement for services provided.

Subsection (c) requires that a completed registration application shall be transmitted to the appropriate State election official no later than 10 days after the date of acceptance. If a registration application is accepted within 5 days before the last day for registration to vote in an election, the application must be transmitted to the appropriate State election official no later than 5 days after the date of acceptance. An applicant may, if he or she chooses, mail the voter registration application directly to the appropriate State election official rather than returning it to the agency for transmittal. The agency providing voter registration services is prohibited from requiring a registrant to mail the form, and must accept it and forward it to the appropriate registration official if turned in by the applicant. The agency must provide regular, visible means for collecting registration application forms.



SECTION 8. REQUIREMENTS WITH RESPECT TO ADMINISTRATION OF  
VOTER REGISTRATION

Subsection (a) provides that any person registered to vote not later than 30 days, or a lesser period as provided by State law, before a Federal election shall be permitted to vote. For these purposes, registration is complete upon submitting the form to the voting registrar, motor vehicle office, designated agency or office, or on date of postmark, if mailed. While the Act is clear with regard to the motor-voter and agency-based registration deadline requirement, the mail situation may be in need of some clarification. The reference, "or a lesser period as provided by State law" means, with regard to mailed registration application, that the shorter State period would apply only if it is referenced to "date of postmark". If the shorter period provided by State law refers to the date of receipt in the registrar's office, the thirty day period provided for here would apply. It is not intended here to penalize a registration applicant; thus, if the application is postmarked after thirty days, but is received before the deadline specified by State law, it should be accepted. Also, one postmarked before thirty days but received after the deadline under State law, should also be accepted as timely.

Each State election official is required to give notice to each applicant regarding the disposition of his or her voter registration application. The means of notifying each applicant is not specified, so that each State may continue to use whatever means is required or permitted by State law or regulation. States may adopt whichever procedure they deem best suited to provide notice to the applicant and to provide the registrar with verification of the accuracy of the information provided by the applicant. The Committee recognizes that such notices are sent by most States as a means of detecting the possibility of fraud in voting registration and intends to give each State discretion to adopt a means of notification best suited to accomplish that purpose as well as providing a means for notifying an applicant, who has not had direct contact with the voter registrar's office, of the appropriate voting place for his or her residence. The Committee believes that accurate and current voter registration lists are essential to the integrity of the election process and for the protection of the individual.

This section also provides that the name of a registered voter may not be removed from the official list of eligible voters except: at the request of the registrant; as provided by State law, by reason of criminal conviction or mental incapacity; or, in accordance with the requirements of the Act, by reason of the death or a change in the residence of the registrant. Recognizing the essential need to maintain the integrity of the voter registration lists, the bill requires that States conduct a general program that makes a reasonable effort to remove the names of ineligible voters from the official lists of eligible voters by reason of death or by a change of residence.

A "request" by a registrant would include actions that result in the registrant being registered at a new address, such as registering in another jurisdiction or providing a change-of-address notice

through the driver's license process that updates the voter registration.

States are required to inform applicants of voter eligibility requirements, the penalties provided by law for the submission of a false voter registration application, and ensure that the identity of the voter registration agency through which any particular voter is registered is not publicly disclosed.

Subsection (b) sets forth the standards for the confirmation of voter registration. Any State program or activity to protect the integrity of the electoral process by ensuring the maintenance of an accurate and current registration roll for Federal elections shall be (1) uniform, nondiscriminatory, and in compliance with the Voting Rights Act of 1965; and (2) shall not result in the removal of the name of any person from the official list because of a failure to vote.

The purpose of this requirement is to prohibit selective or discriminatory purge programs. This requirement may not be avoided by a registrar conducting a purge program or activity based on lists provided by other parties where such lists were compiled as the result of a selective, non-uniform, or discriminatory program or activity. The term "nondiscriminatory" is intended to mean that the procedure complies with the requirements of the Voting Rights Act of 1965.

The term "uniform" is intended to mean that any purge program or activity must be applied to an entire jurisdiction.

It is the intent of this section to impose the uniform, nondiscriminatory and conforming with the Voting Rights Act standards on any activity that is used to start, or has the effect of starting, a purge of the voter rolls, without regard to how it is described or to whether it also may have some other purpose. For example, the mailing of sample ballots is clearly a program that has another purpose but might provide the basis for a purge of voter rolls. If it is to be used for that purpose and the registrar uses it to serve as his or her reason to send notices under subsection (d), that sample ballot mailing program must meet the standards of this section.

The Committee is mindful of the need to keep accurate and current voter rolls. The Committee is concerned that such programs can be abused and may result in the elimination of names of voters from the rolls solely due to their failure to respond to a mailing. Abuses may be found in the design of a program as well as in its implementation. In order to provide some guidance to the States, subsection (c) provides that a State may meet the requirements of conducting a general program that makes a reasonable effort to keep voting lists clean by establishing a program which uses the National Change of Address ("NCOA") program of the U.S. Postal Service. Use of the NCOA program by a State or any of its registration jurisdictions could be deemed to be in compliance with the requirements that the program be uniform, nondiscriminatory and in compliance with the Voting Rights Act of 1965.

By using the NCOA, a State may use change of address information to identify registrants whose addresses may have changed. If it appears from the information provided that a registrant has moved to a different address within the jurisdiction of the same voting registrar, the registrar is required to make the address change

automatically and send the registrant a notice by forwardable mail and a postage prepaid pre-addressed return form by which the registrant may verify or correct the address information. If the registrant appears to have moved to an address outside of the jurisdiction of the registrar, the registrar may not remove the name of the voter until the registrar has sent a notice to the registrant as provided in subsection (d).

The section requires that a State complete any program the purpose of which is to systematically remove the names of ineligible voters from the official lists of eligible voters at least 90 days before a primary or general election for Federal office. This requirement applies to the State outreach activity such as a mailing or a door to door canvas and requires that such activity be completed by the 90-day deadline. This section does not prohibit a State during that 90-day pre-election day period from removing names from the official list of eligible voters on the basis of the request of the registrant, as provided by State law for criminal conviction or mental incapacity, death, or any other correction of registration records pursuant to the Act.

Subsection (d) prohibits a State from removing the name of a registered voter by reason of a change in residence, unless the registered voter confirms in writing that he or she has changed residence outside the jurisdiction in which registered; or has failed to respond to a notice sent by the State and has not voted or appeared to vote within two general elections for Federal office since the date of the notice.

If a State determines that a registrant may have changed residence, the State may send by forwardable mail a postage prepaid return card on which the registrant may state his or her current address, together with a notice which states that: if the registrant has not changed residence or has changed residence within the same jurisdiction, the registrant should return the card before the time for closing registrations for the next Federal election, *i.e.* 30 days before an election, or such lesser period as may be provided by State law. If the card is not returned, affirmation or confirmation of the registrant's address may be required before the registrant would be permitted to vote in a Federal election during the period beginning on the date of the notice and ending on the day after the second general Federal election that occurs after the date of the notice. If the registrant has not appeared to vote in an election during that period, the registrant's name will be removed from the list. If the registrant has moved to a residence outside the jurisdiction, the notice on the mailing must include information concerning how the registrant may continue to be eligible to vote.

Within the official list of eligible voters, notations (such as an asterisk or "I" for inactive status) may be made of those eligible voters who have failed to respond to a notice under Section 8(d)(2). The requirement that names with notations be maintained on the official list of eligible voters permits the State to decline to use these names in performing the type of routine, administrative responsibilities that do not impair the right of such voters to vote as set forth in the Act, and as protected by the Voting Rights Act. For example, those who have failed to respond to a Section 8(d)(2) notice need not be included for administrative purposes in deter-

mining the number of signatures that may be required under State law for ballot access, the number of precincts that may be needed to service voters, or the number of ballots or voting machines that may be required in the administration of the voting process.

The term "registrar's jurisdiction", as used in connection with the NCOA program and with regard to the "affirmation" or "confirmation" requirements, is a term of art for the purpose of this Act and is not intended to dictate to the States their actual administrative structure for the purpose of registering voters. The Committee intends that a "registrar's jurisdiction" for the purposes of the Act be no smaller than a county, parish, city or town. This conforms to current practice. A State would be free, for example, to divide a very large county or city into 2 or more administrative units for registering voters as long as the county continued to be treated as the "registrar's jurisdiction" for those purposes of the Act hereinafter specified. First, that provision pertaining to a person who returns the postcard described in section 8(d) indicating that the registrant has moved to another residence within the jurisdiction of the same voter registrar must have his or her registration corrected to reflect the new address. Second, the provision that requires that a person who has not sent in the card is entitled to vote after affirming or confirming that his or her new residence is within the same congressional district and the same registrar's jurisdiction as that of his or her former residence. And third, the provision that use of the national change of address program could be considered to be in compliance with the requirements of the Act that pertain to list maintenance programs could protect the State if used Statewide or a registrar if used within the registrar's jurisdiction. As long as these protections are maintained a State would be free to alter its administrative structure and jurisdiction for the purpose of registering voters for Federal elections.

Subsection (e) establishes the procedures for voting in a Federal election where the registrant fails to return the card in accordance with the procedures outlined in subsection (d). If a registrant has moved from one residence to another within the jurisdiction of the same polling place, the person shall be permitted to vote at that polling place upon oral or written affirmation of the registrant's change of address, before an election official at the polling place. If a registrant has moved from a residence in one polling place to a residence in another polling place within the jurisdiction of the same voting registrar, the registrant shall be permitted to vote, in one of the following ways, at the option of the voter: (1) at the registrant's former polling place upon written or oral affirmation of the new address; or (2) at a central location, upon written affirmation of the new address; or (3), shall be permitted to correct the voting records at the appropriate polling place for the current address, and, if permitted by State law, shall be permitted to vote upon confirmation of the registrant's new address by such means as required by law. However, if a State permits the registrant to vote at the new polling place by oral or written affirmation of the current address, it need not provide the alternatives of the former polling place or a central location.

If the registration records incorrectly indicate that a registrant has changed his or her residence, the registrant shall be permitted

to vote upon oral or written affirmation that the registrant continues to reside at the same address.

This section of the bill attempts to incorporate an underlying purpose of the Act; that once registered, a voter should remain on the list of voters so long as the individual remains eligible to vote in that jurisdiction. This section ensures that if a registered voter moves within the jurisdiction of the same registrar, he or she should be permitted to vote. However, while this section sets out where an individual may vote, it is silent as to how that individual may be permitted to vote. Under certain circumstances it would be appropriate, and in compliance with the requirements of this Act, to require that such a person vote by some form of provisional ballot. It is not the intent of this provision to pre-empt any State requirement that a person whose eligibility to vote is challenged may be required to vote by a special ballot that is subject to post election rejection, where the challenge is sustained.

Subsection (f) provides that in the case of change of residence within the jurisdiction, the registrar shall correct the voting registration list accordingly, and the registrant's name may not be removed from the official list of eligible voters, nor may a registrant be required to re-register as a result of such a change of residence. The obligation of the registrar to change the rolls to reflect the new residence is triggered by notice to the registrar of such change, not the date of such change. The intent of this requirement is that it is the responsibility of a registrar, upon notification of a change of residence by a voter to another residence within the registrar's jurisdiction, to make the necessary correction of the records. A registrar may not impose requirements, such as re-registration, upon such a voter. Although such notice of change of address might be made by the voter through the use of the motor-voter or agency-based registration process, the registrar's responsibility to make the correction is not dependent on the voter giving such notice; such notice may come through the Postal Service change of address program or other means conducted in conformance with the requirements of the Act, subject to verification by the voter.

Some State election officials expressed concern to the Committee that they had experienced difficulty in obtaining information regarding convictions for Federal offenses from the Federal courts which is needed to remove the names of persons convicted of certain offenses from the voter rolls under State law. Subsection (g) requires a United States Attorney to inform the appropriate State election official of the felony conviction of any person. Such notice must give the name, age, and address of the offender; the entry date of judgment; a description of the offenses on which the person was convicted; and the sentence imposed. Additional information may be provided at the request of the election official if necessary to determine whether a conviction affects the person's eligibility to vote. If such a conviction is overturned, the United States Attorney shall give notice to the appropriate election official.

Subsection (h) provides lower postal rates to a State or local voting registration official for any mailing which is certified to be required or authorized by the Act. This lower postal rate is the rate for any class of mail which is made available to a qualified non-profit organization.

Subsection (i) provides that each State shall maintain for two years all records concerning the implementation of programs and activities conducted for the purpose of ensuring the accuracy and currency of addresses on the official list of eligible voters. The records must be made available for public inspection and, where available, photocopying at reasonable costs. The records shall include lists of names and addresses of all persons to whom notices were sent and information concerning whether or not each person has responded to the notice as of the date of inspection.

Provisions of this Act pertaining to voter registration programs require that information regarding a person's declination to register not be used for any purpose other than registration. There was also concern that information not be made public as to what voters registered at a particular agency, such as a welfare or unemployment office. Therefore, these records may not contain any information relating to a declination to register or the identity of a voter registration agency through which any particular voter is registered, or a list of those persons registered through a particular agency.

#### SECTION 9. FEDERAL COORDINATION AND REGULATIONS

Subsection (a) provides that the Federal Election Commission shall prescribe appropriate regulations necessary to carry out this Act, consult with chief election officers of the States to develop a mail voter registration application form for Federal elections, and submit by June 30 of each odd-numbered year, a report to the Congress assessing the impact of the Act on the administration of elections for Federal office and recommendations for improvements in Federal and State procedures, forms, and other matters, and provide information to the States with respect to the responsibilities of the States under this Act. It is the Committee's intent that the Commission carefully determine which regulations are necessary and appropriate.

Nothing in the Act prohibits the Federal Election Commission from gathering the appropriate statistics necessary to meet its reporting requirements.

Subsection (b) sets forth the requirements of the mail registration form to be developed by the FEC. This form may only require such identifying information (including the signature of the applicant) and other information (including data relating to previous registrations) as is necessary to enable the appropriate State election official to assess the applicant's eligibility. The form must also include a statement that specifies each eligibility requirement (including citizenship); contain an attestation that the applicant meets such requirements, and require the signature of the applicant under penalty of perjury. This form may not include any requirement for notarization or other formal authentication.

#### SECTION 10. DESIGNATION OF CHIEF STATE ELECTION OFFICIAL

Each State shall designate a State officer or employee as the chief State election official to be responsible for the coordination of State responsibilities under this Act. Various provisions of this Act assign to this official certain responsibilities regarding the promul-

gation of regulations, the design of the Federal mail registration form, the receipt of notice of civil suits, and the distribution of mail registration forms.

#### SECTION 11. CIVIL ENFORCEMENT AND PRIVATE RIGHT OF ACTION

Subsection (a) provides that the Attorney General may bring a civil action for declaratory or injunctive relief as is necessary to carry out this Act.

Subsection (b) provides a private right of action to any person who is aggrieved by a violation of this Act by providing written notice of the violation to the chief State election official. If the violation is not corrected within 90 days after receipt of the notice, or within 20 days of when the violation occurs, within 120 days before the date of an election for Federal office the aggrieved person may bring a civil action in Federal court for declaratory or injunctive relief. If the violation occurred within 30 days before the date of an election for Federal office, the aggrieved person may proceed to file a civil suit without notice to the chief State election official.

Subsection (c) permits a prevailing party (other than the United States) in a civil action to seek reasonable attorney fees, including litigation costs and expenses.

The Committee has heard concerns that this section authorizes the award of monetary damages. It does not. Corrective action in the form of declaratory and injunctive relief, plus reasonable attorney fees are the available civil remedies. The Committee does not believe that reasonable attorney fees will result in excessive awards in civil actions brought under this Act.

Subsection (d) provides that the rights and remedies established by this Act are in addition to all other rights and remedies provided by law, and neither the rights and remedies established by this section nor any other provision of this Act shall supersede, restrict, or limit the application of the Voting Rights Act of 1965. Nothing in this Act authorizes or requires conduct that is prohibited by the Voting Rights Act of 1965.

#### SECTION 12. CRIMINAL PENALTIES

This section would make a new Federal offense, punishable by a fine and/or imprisonment for not more than 5 years, for any person, including an election official, who in any election for Federal office: (1) knowingly and willfully intimidates, threatens, or coerces any person for registering to vote, or voting, or attempting to register or vote; urging or aiding any person to register to vote, to vote, or to attempt to register or vote; or exercising any right under this Act; or (2) knowingly and willfully deprives, defrauds, or attempts to deprive or defraud the residents of a State of a fair and impartially conducted election process by the procurement or submission of voter registrations that are known by the person to be materially false, fictitious, or fraudulent under the laws of the State in which the election is held; or the procurement, casting, or tabulation of ballots that are materially false, fictitious, or fraudulent under the laws of the State in which the election is held.

Concern has been expressed that these criminal provisions may be used to impede lawful political activities, such as distributing

campaign literature, poll watching, and registration drives. Careful attention has been given to these concerns and this section has been specifically written to refer to acts which are "knowing and willful" and does not refer to inadvertent omissions or inaccuracies on voter registration forms or absentee ballots.

The Committee has also heard concerns expressed as to the availability of criminal penalties under State law. This section addresses the Federal criminal code only.

#### SECTION 13. EFFECTIVE DATE

The Act will take effect on January 1, 1995. While this Act applies only to Federal elections and States are free to apply other regulations to State elections, many States will prefer to have the same requirements for both Federal and State elections. To accommodate those States that have constitutional obstacles to conforming State requirements to the Act, the effective date for such States will be January 1, 1996.

#### COMMITTEE ACTION

On January 27, 1993, by rollcall vote (9-3), a quorum being present, the Commission agreed to a motion to report the bill favorably to the House, as amended.

#### COMMITTEE OVERSIGHT FINDINGS

In compliance with clause 2(1)(3)(A) of rule XI of the Rules of the House of Representatives, the Committee states that the findings and recommendations of the Committee, based on oversight activities under clause 2(b)(1) of rule X of the Rules of the House of Representatives, are incorporated in the descriptive portions of this report.

#### STATEMENT OF BUDGET AUTHORITY AND RELATED ITEMS

The statement required by clause 2(1)(3)(B) of rule XI of the Rules of the House of Representatives and section 308(a)(1) of the Congressional Budget Act of 1974 is contained in the cost estimate and comparison prepared by the Director of the Congressional Budget Office and included in this report.

#### CONGRESSIONAL BUDGET OFFICE COST ESTIMATE

In compliance with clause 2(1)(3)(C) of rule XI of the Rules of the House of Representatives, the Committee sets forth, with respect to the bill, H.R. 2, the following estimate and comparison prepared by the Director of the Congressional Budget Office under section 403 of the Congressional Budget Act of 1974:

U.S. CONGRESS,  
CONGRESSIONAL BUDGET OFFICE,  
Washington, DC, February 1, 1993.

Hon. CHARLIE ROSE,  
Chairman, Committee on House Administration,  
House of Representatives, Washington, DC.

DEAR MR. CHAIRMAN: The Congressional Budget Office has prepared the attached cost estimate for H.R. 2, the National Voter Registration Act of 1993. Because enactment of H.R. 2 could affect receipts and direct spending, pay-as-you-go procedures would apply to the bill.

If you wish further details on this estimate, we will be pleased to provide them.

Sincerely,

JAMES L. BLUM  
(For Robert D. Reischauer).

CONGRESSIONAL BUDGET OFFICE COST ESTIMATE

1. Bill number: H.R. 2.
2. Bill title: National Voter Registration Act of 1993.
3. Bill status: As ordered reported by the Committee on House Administration on January 27, 1993.
4. Bill purpose: H.R. 2 would create a national system of voter registration procedures for elections for federal office. Responsibility for implementing the system would fall largely to the states, with the federal government responsible for enforcement, as well as some financial and technical assistance.

*Requirements for States*

Under the national system of voter registration, most states (except those with election day registration and those with no registration requirement at all) would be required to provide the following methods of registration:

**Motor/Voter.**—When someone applies for a driver's license (new, renewal, or change of address) at the state motor vehicle authority, the application procedure would have to include the opportunity to register to vote. An individual would have to decline in writing on an application form to avoid registering by this means, or would have to sign an attestation, under penalty of perjury, that the individual is eligible to register to vote.

**Mail Registration.**—Each state would make available through various sources a form, prescribed by the Federal Election Commission (FEC), that applicants could complete and mail to the election official to register for federal elections.

**Agency Registration.**—Each state would have to designate some state and federal offices as well as private sector locations (such as public libraries, unemployment offices, banks, fishing and hunting license bureaus, or post offices) to distribute and collect applications for voter registration. Such locations would then forward the applications to the appropriate election official.

Currently, the federal government has little involvement with voter registration. Each state has its own laws governing registration, and in practice, registration practices vary widely even among

local election jurisdictions within a state. H.R. 2 would mandate that states provide the specified registration methods consistently in all jurisdictions.

In addition, H.R. 2 would mandate that any state programs used to update voter registration lists shall be uniform and nondiscriminatory and may not remove someone from the list for not voting. The bill would permit a state, if it determines a voter has moved, to remove the voter from the list only after spending a forwardable notice with a return card that would allow the voter to confirm the correct address.

Finally, each state would have to designate a chief state official responsible for implementing the state's functions under H.R. 2.

*Requirements for the Federal Government*

H.R. 2 would require the U.S. Postal Service to provide election officials with a postal rate subsidy for any mailings that the bill requires the officials to conduct, such as the registration confirmation notice and the registration update notice. The bill authorizes the appropriation of funds sufficient to reimburse the Postal Service for its losses in providing the subsidy. If the Congress does not appropriate the necessary amounts, then the Postal Service would no longer offer the subsidy.

The bill would require the FEC to provide information to the states regarding their responsibilities and to report to the Congress once every two years on the impact of the registration procedures required by the bill. The FEC also would have to develop a uniform application form to be used by states for mail registration.

In addition, H.R. 2 would authorize the Attorney General to bring civil actions in court to enforce the provisions of the bill. Individuals also would be allowed to ask the court for relief from any violations of the bill's provisions.

Finally, the bill would establish criminal penalties for persons who, in any election for federal office, interfere or seek to interfere with voting or voter registration, falsify voter registration applications, or knowingly cast or tabulate false or fraudulent ballots.

5. Estimated cost to the Federal Government:

(By fiscal year, in millions of dollars)

	1994	1995	1996	1997	1998
Spending Requiring Appropriation Action					
Payment to the Postal Service for revenue forgone:					
Estimated authorization level .....		3.4	4.5	4.5	4.5
Estimated outlays .....		3.4	4.5	4.5	4.5
Federal Election Commission:					
Estimated authorization level .....	0.2	0.2	0.2	0.2	0.2
Estimated outlays .....	0.2	0.2	0.2	0.2	0.2
Bill total:					
Estimated authorization level .....	0.2	3.6	4.7	4.7	4.7
Estimated outlays .....	0.2	3.6	4.7	4.7	4.7
Revenues					
Estimated receipts from fines .....		(1)	(1)	(1)	(1)

(By fiscal year, in millions of dollars)

	1994	1995	1996	1997	1998
Direct Spending					
Crime victims fund					
Estimated budget authority			( <sup>1</sup> )	( <sup>1</sup> )	( <sup>1</sup> )
Estimated outlays			( <sup>1</sup> )	( <sup>1</sup> )	( <sup>1</sup> )

<sup>1</sup> CBO cannot estimate these amounts.

The costs of this bill fall within budget functions 370 and 800.

Basis of estimate: The subsidized postal rates would be used primarily to update voter registration files and to confirm the receipt of voter registration applications. Based on the total number of change-of-address actions filed with the Postal Service, CBO expects that the postal subsidy would amount to no more than \$3 million annually—probably in the vicinity of \$2 million—to cover a portion of the cost of mailing registration update notices. In addition, CBO estimates that officials would mail about 25 million voter confirmation notices, based on election officials' reports that the number of registration applications typically amounts to 20 percent of the total number of registered voters in the jurisdiction. (There are about 130 million registered voters nationwide.) Assuming an average subsidy of 7.3 cents per piece of mail, subsidizing the mailing of these confirmation notices would cost about \$2 million annually at current rates. The postal subsidy would first be available in January 1995, a year in which CBO assumes that an increase in postal rates will occur. Assuming rates will rise about 15 percent, CBO estimates that the total postal subsidy would be about \$4.5 million annually. The subsidy for fiscal year 1995 would be less because the subsidized rates would become available three months into the fiscal year.

Based on information from the FEC, CBO estimates that the additional staff and associated expenses necessary to develop a mail registration form and to provide assistance to the states would cost approximately \$200,000 annually, beginning in 1994. The requirements imposed on states and localities would become effective beginning January 1, 1995, unless provisions in a state's constitution conflict with implementing H.R. 2. In such cases, a state would not have to comply with H.R. 2 until January 1, 1996.

The imposition of criminal penalties could cause governmental receipts to increase through increased penalty collections, but CBO cannot estimate the amount of such an increase. Such fines are deposited in the Crime Victims Fund and are spent in the following year. Thus, direct spending from the fund would match the increase in revenues with a one-year lag.

6. Pay-as-you-go considerations: The Budget Enforcement Act of 1990 sets up pay-as-you-go procedures for legislation affecting direct spending or receipts through 1995. Enactment of H.R. 2 could affect both receipts and direct spending as the result of increased penalty collections. CBO cannot estimate the amount of any such increases, but the changes in spending and receipts would net out over time.

7. Estimated cost to State and local governments: H.R. 2 would require most states to provide three types of voter registration for federal elections beginning in 1995: motor/voter, mail-in, and agency registration. The bill also would mandate that states use a uniform and nondiscriminatory program for maintaining accurate lists of eligible voters.

Consistent with CBO's usual procedures for estimating the cost effects of legislation, this estimate compares the cost of states of complying with the bill's provisions to the cost of their current practices under existing law. Few states and local governments currently employ all the methods required by the bill for registering and maintaining voters on the rolls. In addition, without H.R. 2, states and localities are unlikely to replace their existing practices with those outlined in the bill. Therefore, the costs states would incur in changing their registration procedures would be directly attributable to enactment of the bill.

#### Summary of costs

*Direct Costs.*—If the bill is enacted, state and local governments would have to pay for the cost of complying with the bill's registration provisions. For the additional staff, postage, and printing expenses associated with the expected increase in registrations, especially through motor/voter, CBO estimates that it would cost states and localities an average of about \$20 million a year for the first five years of the program. Added costs would be somewhat lower than the average in federal election years, and above the average in other years, since the procedures required by the bill would have the effect of smoothing the current election-year peaks in registration costs. Some of these expenses would begin in 1994, the year before the bill's provisions take effect, as the states prepare to offer the new registration methods.

Although the bill would not directly require it, some states may decide to acquire, expand, or upgrade computer systems to facilitate implementation of the bill. To the extent that state and local governments make such changes in computer technology, their costs could increase further. For example, we estimate that one-time costs to computerize the registration lists of all the jurisdictions that currently do not have computers would amount to less than \$25 million. We cannot predict how many jurisdictions would do so, or how many that now have computers would choose to change their system.

Another provision that would require most states to make a change from current practices affects the polling place where a registrant may be permitted to vote. Under H.R. 2, if a registrant has changed addresses within a jurisdiction without notifying the registrar, but the new and old addresses have different polling places, then the registrant would have the option of voting at the old or new polling place, or some other polling place that has a list of registered voters. Election officials have indicated that this requirement would be quite difficult to implement without a computerized registration list. Without such a capability, it might not be possible to fully meet this requirement, so the cost to election officials of this provision cannot be estimated at this time.

*Offsets to Costs.*—Because H.R. 2 would authorize the Postal Service to provide a rate subsidy to election officials for mailings required by the bill, state and local governments would be able to shift some of the costs they incur now to the federal government. H.R. 2 would require officials to notify registrants as to the outcome of their application and to contact those whom the officials plan to drop from the rolls because of a change in address. (Most officials already take both of these actions.) CBO estimates that the postal subsidy for these mailings would total about \$4 million annually. Thus, upon enactment of H.R. 2, state and local election officials would save approximately \$4 million annually in postage costs.

*Other Costs.*—To the extent that H.R. 2 is successful in increasing the number of registered voters in all jurisdictions, state and local governments likely would face other costs that are not directly associated with implementing the bill's provisions. For example, if more people are registered, then presumably voter turnout during elections would increase. Because election officials try to maintain a certain ratio of voters per polling place, officials might have to add new polling places, voting machines, and poll workers. However, these officials would take similar steps because of growth or migration patterns, and it would be difficult to separate the bill's effect on increased turnout from other contributing factors.

Certain states with specialized election laws would encounter some secondary effects of the bill. California law, for example, requires state and local officials to mail all voters on the registration list a sample ballot and an explanation of all ballot initiative issues before each election. If enactment of H.R. 2 results in more people registered, then the cost of such special mailings will be greater. On the other hand, the bill's provisions that encourage improved list-cleaning would result in more accurate voter registration lists, and election officials would save money by not having to mail voting materials to or prepare polling places for people who no longer would be on the lists. We have not estimated the total costs or savings from such effects in the various states, which would depend in part on how successful this legislation would be accomplishing its goals. California, which has some of the most extensive requirements relating to communications with registered voters, has estimated that it costs between \$4 and \$5 per registered voter to print ballots, print labels, mail sample ballots, and provide polling places. Most other states have lower costs, because they do not have all these requirements mandated by law.

Because H.R. 2 would allow individuals to sue for relief from violation of the bill's provisions, state and local governments and officials are potentially liable to pay fines and court and attorney fees if they lose a lawsuit. Such costs would not result directly from the bill, but rather from court cases that CBO cannot predict.

#### *Current law*

Under current law, each state sets its own rules or guidelines for registering to vote in federal elections, and many states allow a wide range in practice among decentralized, local election jurisdictions (usually counties or cities and towns). About thirty states already have mail-in registration, and about one-half of the states

have some form of motor/voter registration. States and local jurisdictions pay the costs of registering voters, and the federal government does not currently assist them with these costs.

#### *Data collection*

Because voting registration practices vary so widely, the incremental cost of implementing new procedures in the nation's 18,000 election jurisdictions is difficult to determine. In preparing this estimate, CBO assumed that local jurisdictions within a state generally follow registration guidelines set out by the state (even though there are some variations). We then compared the states' current guidelines with the requirements in the bill. (CBO relied on state-by-state summaries of registration practices prepared by various election information clearinghouses.)

In so doing, CBO surveyed the election officials in just over half of the states (as well as about two dozen counties of varying sizes). We collected cost information from some states that already provide one or more of the registration procedures mandated in the bill. In addition, some states provided CBO with the fiscal notes prepared for their state legislatures when they were considering one of these options. We also contacted about half of the 12 states that currently do not offer any of the bill's registration methods for their assessment of the bill's likely impact.

#### *Assumptions*

Based on this information about the general registration practices in each state and the steps each state would have to take under H.R. 2, CBO makes the following assumptions regarding implementation that could affect the costs to state and local governments:

In most states, motor/voter would become the primary method of registering voters. Because most people have a driver's license and are required to renew it periodically, a motor/voter system eventually would provide most people with a convenient opportunity to register, especially after a change of address.

Although completing a driver's license application at the state department of motor vehicles (DMV) would be the most common way people would apply for registration, local election officials would remain largely responsible for maintaining accurate voter lists.

The several states with constitutional provisions that would conflict with the bill, such as requiring voters to sign an oath in person in front of a registrar, would change their laws to be consistent with H.R. 2. Otherwise, those states would have to maintain separate registration rolls and conduct federal elections separate from other elections. This estimate does not include any cost for such separate elections.

#### *Costs of registration provisions*

*Motor/Voter: DMV Costs.*—H.R. 2 would require states to include a voter registration application form as part of an application for a state driver's license. The bill language suggests that states use a consolidated form, but also allows them the flexibility of using two forms. CBO assumes that states could use two forms if they desire.

because the committee's report language emphatically declares the committee's intent to allow this option to states. Thus, states that already have a two-form motor/voter process would not have to change, and states that would have to decide how to set up a motor/voter process could have a choice.

Based on the experience of the states that already have motor/voter, it appears that the additional cost to states of implementing motor/voter registration would result mainly from hiring additional staff to handle the extra paperwork. For example, state DMVs would need more employees at high traffic locations to continue to process applicants in the same amount of time as they currently do. For the 25 states that do not now have some form of motor/voter, the cost of such additional employees and related expenses would probably be about \$20 million annually during the first five years of implementation. Since most states require renewal of a driver's license every four years, costs would decrease in later years, because most people would have had an opportunity to register and only those who move would have to update their registration.

*Motor/Voter: Election Official Costs.*—Once the DMV receives an application, it probably would forward a copy to the local election official to process the registration, as is current practice in the states that now have motor/voter. While CBO expects that officials in sparsely populated jurisdictions would be able to absorb small increases in the number of applications, others would face increased costs. In especially populous jurisdictions, election officials would have to hire more staff to handle the likely increase in applications and to check for duplicate registrations (although some states with motor/voter report these are less than they had originally anticipated). Counties we contacted report that the number of registration applications they handle annually amounts to about 20 percent of the number of registered voters in the county (there are about 130 million registered voters nationwide). Based on information from counties in states that currently have motor/voter, it appears that the workload could increase by 20 percent because of people registering who otherwise would not have registered, duplicate registrations, and ineligible applications.

Assuming the incremental cost for a county election office of handling an additional application is \$1.50, then local jurisdictions, in aggregate, would have to pay an additional \$5 million to \$10 million annually. Some of these costs would only be incurred during the first few years. Once most people are on the rolls and the number of unregistered voters decreases, use of the motor/voter system would decrease as voters would only register if they have moved.

Such costs, however, would be somewhat offset by a reduction in the cost of part-time employees hired to handle the increased workload around each registration deadline. Officials in some states with motor/voter, such as Colorado and Michigan, report that receiving forms from the DMV evenly over the year rather than in a last-minute pre-election rush has allowed them to reduce their part-time hires and use their full-time staff more efficiently. Based on information from several localities that hire part-time staff during election years, we expect local officials nationwide could

save about \$10 million in a presidential election year and about \$7 million in non-presidential election years by reducing part-time hires. (There would be no savings in non-election years because no part-time help is necessary.)

The total costs that election officials would face would be offset further by the postal rate subsidy authorized by H.R. 2. While the bill requires election officials to notify applicants of the outcome of their registration application, it also would provide a discount of about 43 percent for notices mailed by third class. Because most states already mail such notices to applicants, the notification requirement would not result in additional costs, but the subsidy would shift about \$2 million of postage costs currently incurred by election officials to the federal government.

*Motor/Voter: Computer Costs.*—Rather than forwarding an application from the DMV to a county registrar, a possible alternative, untested thus far, would be to transmit the voter information electronically. The cost of adding registrants to a jurisdiction's list would be lower if the voter data were transferred to computer by tape or other device rather than entered by hand. Some states have indicated that they would probably implement the motor/voter requirement by switching their record-keeping from paper to computers, and arranging for electronic transfer of data from the DMV system to the voter registration system. Some state officials have suggested that record-keeping would be improved if election officials used signature digitizers to store voters' signatures on computer, but this would cost extra. Although the bill would not mandate states to computerize, in some instances states or counties might decide computerization would be the best action, even though it would require a significant one-time investment in equipment.

CBO has no information on which to base an estimate of how many counties would computerize or how many more states would create a statewide registration system. (Currently, 21 states have one.) Based on data from Election Data Services, it appears that jurisdictions already use computers to maintain lists for at least 70 percent to 80 percent of the registered voters in the country. Aside from jurisdictions that might wish to change their existing computer systems, jurisdictions could potentially purchase new equipment to computerize the remaining one-fourth of the nation's voters.

We have examined the costs of existing registration and election systems and have determined that it costs less than one dollar per voter record for a computer system. Therefore, computerizing the registration lists for the 25 million to 35 million people in jurisdictions currently without computers would probably cost less than \$25 million.

*Mail-In and Agency Registration.*—Because most voters (we assume 80 percent to 90 percent) eventually would register through the motor/voter system, mail-in and agency registration would serve as alternate means for those few remaining voters who do not have a driver's license. In those states that currently provide one or both of these methods, the number of registrations received from these sources would decrease over time as voters register instead through the DMV, and would, after the first few years, eventually generate from \$5 million to \$10 million in annual savings,



which would partially offset increased costs of motor/voter. If the states that currently do not have mail-in registration were to implement it along with the other two methods, it would cost them \$1 million to \$2 million annually because they would not use mail-in registration as much as states that currently have mail-in registration do.

Almost all states report that they have some form of agency or satellite registration, which in some states means a voter has to swear an oath in front of a deputy registrar at one of several county offices. H.R. 2 envisions a somewhat expanded type of agency registration in which forms are available at a variety of locations where voters can complete and submit them (or else take them home and mail them in). Again, this would not be a major source of registering voters, and the costs are not expected to be significant in aggregate, although some additional training costs might be necessary to expand the pool of people able to assist voters in completing the forms. Only these states that currently have just a deputy registrar system would have to print extra forms to be available throughout the jurisdiction, but these costs probably would be offset by the reduced amount of work for the registrars and clerks who would not have to register as many voters in person.

#### *Costs of voter confirmation provisions*

Because voters usually do not notify election officials of address changes, the names and addresses of outdated registrants often accumulate on the rolls. Election officials revise registration lists to clean out those who have moved, died, or are otherwise ineligible to vote in that jurisdiction. H.R. 2 would prescribe that whatever method a state uses to maintain accurate registration rolls, it should be uniform and nondiscriminatory. Further, the bill would prohibit states from removing registrants from the list simply for not voting.

*Current Law.*—Almost all states now employ some procedure for updating lists at least once every two years, though practices may vary somewhat from county to county. About one-fifth of the states canvass all voters on the list. The rest of the states do not contact all voters, but instead target only those who did not vote in the most recent election (using not voting as an indication that an individual might have moved). Of these, only a handful of states simply drop the non-voters from the list without notice. These states could not continue this practice under H.R. 2.

Whether states canvass all those on the list or just the non-voters, most send a notice to assess whether the person has moved. In a majority of states, election officials also provide voters with a way to update or prevent removal from the registration list.

*National Change of Address System.*—H.R. 2 suggests, but does not require, an approach election officials can use to make sure that their list cleaning method is uniform and nondiscriminatory. Instead of using non-voting as an indication that a voter has changed addresses, an election official could contact only those who have actually moved, and at their new addresses. By using the National Change of Address (NCOA) system of the U.S. Postal Service, election officials could directly identify those who have moved and

would send those people a forwardable notice with a pre-addressed, postage paid card that outlines the registration options available and allows people to respond to the officials. While an elections jurisdiction would have to pay a vendor licensed by the Postal Service to do a computer match of the registration list and the NCOA list (costing from \$2 to \$8 per 1,000 address matched), these costs probably would be offset by reducing the postage and printing costs that officials currently pay for less-focused canvassing. Several pilot studies of this system in California and Oregon, sometimes called Project MAIL, report that counties would save money by significantly reducing the number of notices sent out.

*Postal Rate Subsidy.*—Whether election officials decide to use this NCOA approach or choose their current or other method for list clearing (as long as it is uniform, nondiscriminatory, and does not drop for nonvoting), their postal costs associated with this process would decrease if H.R. 2 is enacted. The bill authorizes a postal rate subsidy for mailings associated with the list cleaning requirement, thereby shifting costs from the states to the federal government. The ultimate amount of this shift would depend on the number of notice mailed. We have no data on that amount of mail election officials currently send out to update their lists. However, if most states adopt the NCOA approach, the number of changes of address, about 40 million annually, would represent the maximum possible number of matches between the registration rolls and the NCOA list. With an average third class subsidy of about 7.3 cents per piece of mail at current rates, the cost of this subsidy is unlikely to exceed \$3 million annually. In fact, it is likely to be less—probably in the vicinity of \$2 million—because not everyone on the NCOA list will be on a registration list, some changes of address are temporary only, and officials will update their lists through other methods such as motor/voter. When voters move within a state and get a new driver's license, they also would be updating their voting registration, thereby reducing the number of voters that officials will have to contact to determine whether they are recorded on the rolls accurately.

8. Estimate comparison: None.

9. Previous CBO estimate: None.

10 Estimate prepared by: James Hearn, Mickey Buhl, and John Stell.

11. Estimate approved by: C.G. Nuckols, Assistant Director for Budget Analysis.

#### OVERSIGHT FINDINGS OF COMMITTEE ON GOVERNMENT OPERATIONS

The Committee states, with respect to clause 2(1)(3)(D) of rule XI of the Rules of the House of Representatives, that the Committee on Government Operations did not submit findings or recommendations based on investigations under clause 4(c)(2) of rule X of the Rules of the House of Representatives.

#### INFLATIONARY IMPACT STATEMENT

In compliance with clause 2(1)(4) of rule XI of the Rules of the House of Representatives, the Committee states that the bill will

have no inflationary impact on prices and costs in the operation of the national economy.

CHANGES IN EXISTING LAW MADE BY THE BILL, AS REPORTED

In compliance with clause 3 of rule XIII of the Rules of the House of Representatives, changes in existing law made by the bill, as reported, are shown as follows (existing law proposed to be omitted is enclosed in black brackets, new matter is printed in italic, existing law in which no change is proposed is shown in roman):

TITLE 39, UNITED STATES CODE

\* \* \* \* \*

PART III—MODERNIZATION AND FISCAL ADMINISTRATION

\* \* \* \* \*

CHAPTER 24—APPROPRIATIONS AND ANNUAL REPORT

\* \* \* \* \*

§ 2401. Appropriations

(a) \* \* \*

\* \* \* \* \*

(c) There are authorized to be appropriated to the Postal Service each year a sum determined by the Postal Service to be equal to the difference between the revenues the Postal Service would have received if sections 3217, 3403-3406, [and 3626(a)-(h) and (j)-(k) of this title,] 3626(a)-(h), 3626(j)-(k), and 3629 of this title, had not been enacted and the estimated revenues to be received on mail carried under such sections and Acts. In requesting an appropriation under this subsection for a fiscal year, the Postal Service shall (i) include an amount to reconcile sums authorized to be appropriated for prior fiscal years on the basis of estimated mail volume with sums which would have been authorized to be appropriated if based on the final audited mail volume; and (ii) calculate the sums requested in respect of mail under former sections 4452(b) and 4452(c) of this title as though all such mail consisted of letter shaped pieces, as such pieces are defined in the then effective classification and rate schedules.

\* \* \* \* \*

PART IV—MAIL MATTER

CHAPTER 36—POSTAL RATES, CLASSES, AND SERVICES

\* \* \* \* \*

SUBCHAPTER II—PERMANENT RATES AND CLASSES OF MAIL

3621. Authority to fix rates and classes.

\* \* \* \* \*

3629. Reduced rates for voter registration purposes.

\* \* \* \* \*

§ 3627. Adjusting free and reduced rates

If Congress fails to appropriate an amount authorized under section 2401(c) of this title for any class of mail sent at a free or reduced rate under section 3217, 3403-3406, [or 3626 of this title,] 3626 or 3629 of this title, the rate for that class may be adjusted in accordance with the provisions of this subchapter so that the increased revenues received from the users of such class will equal the amount for that class that the Congress was to appropriate.

\* \* \* \* \*

§ 3629. Reduced rates for voter registration purposes

The Postal Service shall make available to a State or local voting registration official the rate for any class of mail that is available to a qualified nonprofit organization under section 3626 for the purpose of making a mailing that the official certifies is required or authorized by the National Voter Registration Act of 1993.

\* \* \* \* \*

## MINORITY VIEWS ON H.R. 2

We support the goal of increasing participation in the electoral process. However, H.R. 2 is a partisan bill containing serious flaws, and almost every attempt to improve it was defeated by Committee Democrats. This bill would rewrite the election laws of virtually all states, unless they adopt same day registration or have no voter registration requirement at all. It would require the states to employ three methods of registering voters for Federal elections, and specify in considerable detail what the states would have to do to implement each one. No funds are authorized to compensate for this expensive new Federal mandate on the states.

H.R. 2 seriously impedes states' ability to combat fraud in order to increase voter turnout, but election results in 1992 showed an increase in voter turnout to the highest level since 1972 without the costs and risks associated with this unnecessary and partisan legislation (See, Chart 1).

CHART 1.—VOTER TURNOUT PRESIDENTIAL ELECTIONS, 1972-92

Year:	Number of persons voting	Percent of eligible voters
1972	77,718,554	55.21
1976	81,555,789	53.55
1980	86,515,221	52.56
1984	92,652,680	53.10
1988	91,594,693	50.15
1992	104,552,736	55.90

Source: Federal Election Commission Data

H.R. 2 is virtually identical to S. 250 (102nd Congress), a bill that was vetoed by President Bush as a partisan sham. During debate on S. 250 last year, several Members of the Majority asserted that the bill was substantially the same as H.R. 2190 (101st Congress). It was not, and neither is the instant bill. H.R. 2190 was a bipartisan compromise which passed the House with a significant number of Republican as well as Democrat votes. It troubles us that an endeavor which began as a cooperative effort in the 101st Congress, which actually produced a bill that was supported by many Republicans, has been supplanted by this bogus facsimile.

Unlike H.R. 2, H.R. 2190 would have required specific uniform and nondiscriminatory programs to assure that official voter registration lists are accurate. It required systematic review of residence addresses on voter registration lists by means of first class mailings or a Post Office change of address system. H.R. 2 on the other hand requires only that each state "conduct a general program that makes a reasonable effort to remove the names of ineligible voters from the official lists . . ." by reason of death, or change

(34)

in residence. Use of the Post Office change of address system is optional.

H.R. 2190 would have required states to designate a wide spectrum of voter registration locations including public libraries, public schools, clerks' offices, marriage license bureaus, fishing and hunting license bureaus, revenue offices, post offices, and offices providing public assistance, unemployment compensation, and related services. H.R. 2 requires states to designate as voter registration agencies all public assistance (welfare) offices, unemployment compensation offices, and offices engaged in providing disability services. Other state or local government agencies are optional.

H.R. 2190 would have applied to every state with a voter registration requirement for elections to federal office. H.R. 2 does not apply to states in which there is no voter registration requirement, or to states in which voters may register to vote at the polling place on election day. This bill is designed to encourage fraud prone election day registration.

H.R. 2190 would have retained under state law the authority to establish special procedures to verify the registration status of an individual at the polls, and to administer voter registration laws in general. H.R. 2 requires the FEC to impose regulations on the states, and to develop a uniform mail voter registration form to be used by the states.

H.R. 2190 would have authorized a \$50,000,000 appropriation for the FEC to provide support, through chief state election officials, for programs for assuring accurate and current official voter registration lists. H.R. 2 provides a reduced rate mail subsidy for registration purposes and no funds are authorized for either the postal subsidy or the increased FEC administrative costs.

We oppose H.R. 2 in its current form because: (1) no sufficient justification has been demonstrated for imposing extensive procedural requirements and significant related costs on the states, and (2) the bill would substantially increase the risk of voter fraud.

States have used a variety of procedures to guard against fraud and maintain the integrity of the electoral process. This flexibility has allowed the states to tailor procedures to local conditions that may make some practices more effective than others or may call for special measures to avoid fraud or for avoiding certain practices entirely. This bill would prevent states from implementing procedures that are responsive to local conditions.

H.R. 2 would increase the potential for corruption and vote fraud. The bill limits the state's ability to confirm independently the information contained in voter registration applications and severely restrict the state's ability to remove ineligible voters from the rolls. This problem would be compounded by the inadequate penalties in current Federal criminal law for electoral crimes and other forms of public corruption. By contrast, the Chairman of the Subcommittee on Elections, Ms. Swift, lauded H.R. 2190 on the Floor of the House because it ". . . provides for the maintenance of accurate and up-to-date registration lists. Inaccurate registration lists are the bane of every election official, can lead to fraud and

are extremely costly to the states, political parties, candidates and others who depend on them for effective voter contact."<sup>1</sup>

Of special concern is the possibility that illegal aliens seeking to apply for a driver's license may complete the entire form, including the citizenship attestation and not check the "decline to register" box so as not to draw attention to themselves. These illegal aliens will end up on the voter rolls.

By mandating compliance with the provisions of this bill, the Congress would be imposing enormous costs on states, many of which are already facing financial crises. During the Subcommittee on Elections hearing on this bill, the costs imposed on California alone were estimated at over \$26 million per year. The estimate nationwide was between \$200 million and \$250 million per year.<sup>2</sup>

The 1991 Congressional Budget Office analysis of S. 250, virtually identical to H.R. 2, estimated annual costs of \$20-25 million to state and local governments for the first five years. But this estimate excluded any costs of computerization that could well be required by the bill. It also excluded any cost due to an increase in the number of voters on the rolls, whether or not those voters are current residents of the voting precincts in which they are registered. Further, it excluded any costs to agencies for their new responsibilities for assistance to those seeking their other services. The real costs of this bill are not yet determined, but they are substantially higher than the \$20-25 million cited by CBO.

During the Committee on House Administration's mark-up of H.R. 2, the Minority Members of the Committee offered various amendments, which were rejected by members of the Majority. These amendments would have improved the bill by:

- (1) Replacing the Agency Registration section of the bill that emphasizes welfare agencies with the broad based agency provisions of H.R. 2190, or in the alternative, striking that section altogether;
- (2) Restoring the mandatory voter address correction provisions of H.R. 2190 in place of the vague section in this bill;
- (3) Striking the section that requires the states to provide voter registration by mail;
- (4) Striking the provision that exempts states from complying with the Act if the states allow all voters to register at the polling place at the time of voting;
- (5) Striking the provision of the bill that requires voter registration agencies to provide the same degree of assistance to voter registration applicants that they provide to the applicants for their own services;
- (6) Changing the procedure for registering to vote while applying for motor vehicle driver's license to require an affirmative action in order to register;
- (7) Allowing the states to remove the name of a person from the official list of registered voters if the person has not voted for at least 4, 10, or even 100 years;

<sup>1</sup> Statement of Mr. Swift, Chairman of the Subcommittee on Elections, Congressional Record, February 6, 1990, p. H 255.

<sup>2</sup> Testimony of Tony Bernhard, Yolo County Clerk and Co-Chair of the California County Clerks' Election Legislation Committee, before the Subcommittee on Elections, January 26, 1993.

(8) Providing that mandates in the bill that are subject to pre-clearance for the nine southern states as required by the Voting Rights Act of 1965 be applied to all 50 states, or in the alternative eliminating the pre-clearance requirements of the Voting Rights Act for any new mandates required by the bill;

(9) Making all provisions of the bill voluntary for states until funds are appropriated to pay for the additional costs imposed by the bill;

(10) Preserving state fraud provisions that are stronger than the federal provisions of the bill;

(11) Requiring that only U.S. citizens can be registered under the bill; and

(12) Clarifying that the mandatory designation as voter registration agencies all offices engaged in providing services to persons with disabilities applied to those offices serving *physically* disabled persons.

In fact, the only amendment Republican Members of the Committee were able to secure involved extending the requirement that mail voter registration forms include a statement that specifies each eligibility requirement (including citizenship), contain an attestation that the applicant meets each such requirement, and require the signature of the applicant under penalty of perjury, to forms distributed by any agency that provides services or assistance in addition to voter registration.

H.R. 2 as recommended by the Committee on House Administration amounts to a partisan exercise which increases the potential for fraud and imposes expensive and unfunded mandates on the states. In considering this resolution, the House must measure the attempt to compel voter registration against the countervailing concerns of accuracy and integrity of the election process. Increased voter participation is a goal shared by all Members of the Committee. However, we fear that passage of the bill as written will substantially impair the ability of the states to maintain the accurate and verifiable voter registration lists needed to administer valid elections, and impose upon them untold costs which many are currently unable to accommodate.

BILL THOMAS.  
 NEWT GINGRICH.  
 PAT ROBERTS.  
 BOB LIVINGSTON.  
 BILL BARRETT.  
 JOHN BOEHNER.

○





# APPENDIX C

## THE SENATE COMMITTEE REPORT ON THE ACT

103 <sup>rd</sup> CONGRESS <i>1st Session</i>	<b>Calendar No. 8</b>	SENATE	REPORT 103-6
--	-----------------------	--------	-----------------

**ESTABLISHING NATIONAL VOTER REGISTRATION PROCEDURES FOR FEDERAL ELECTIONS, AND FOR OTHER PURPOSES**

FEBRUARY 25 (legislative day, JANUARY 5), 1993.—Ordered to be printed

Mr. Ford, from the Committee on Rules and Administration, submitted the following

**REPORT**

together with

**MINORITY AND ADDITIONAL VIEWS**

[To accompany S. 460]

The Committee on Rules and Administration, having considered S. 460, an original bill to establish national voter registration procedures for Federal elections, and for other purposes, reports favorably thereon and recommends that the bill do pass.

**PURPOSES**

The purposes of the bill are to establish procedures which will increase registration of eligible citizens in elections for Federal office; to make it possible for Federal, State, and local governments to implement the Act in a manner that enhances the participation of eligible citizens as voters in elections for Federal office; to protect the integrity of the political process; and to assure an accurate and current voter registration roll.

To increase registration of eligible citizens, this bill would require States that require registration to vote in elections for Federal office, to permit voter registration by the following means, in addition to any other method provided by State law: (a) by application simultaneous with an application for a motor vehicle driver's license—so-called "motor-voter" registration; (b) by use of a uniform mail application; and (c) by application in person at an

(1)

agency designated to process registration applications in each State.

The bill would provide procedures and standards regarding the maintenance and confirmation of voter rolls to assure that voters' names are maintained on the rolls so long as they remain eligible to vote in their current jurisdiction and to assure that voters are not required to re-register except upon a change of voting address to one outside their current registration jurisdiction. The bill would not require a specific mandatory procedure for verifying or confirming voter rolls, but would establish standards for any such procedure a State might employ.

#### BACKGROUND

The declining numbers of voters who participate in Federal elections (only about half of the voting age population went to the polls in the 1988 Presidential election) spurred the Committee's search for possible remedies to this situation. It was noted that the national voter turnout in the 1990 Congressional elections was only 36 percent. Members were encouraged by the fact that the 1992 Presidential election turnout increased 4 percentage points over the 1988 election. Nevertheless, there are almost 70 million eligible citizens who did not participate in the election because they were not registered to vote. The Members are aware that there are multiple and complex factors that contribute to the decline in voter participation in Federal elections. While most contributing factors may not be affected by legislation, one—difficulties encountered by some who desire to register to vote—is susceptible to correction by legislation.

The Committee found that:

- (1) The right of citizens of the United States to vote is a fundamental right;
- (2) It is the duty of the Federal, State, and local governments to promote the exercise of that right; and
- (3) Discriminatory and unfair registration laws and procedures can have a direct and damaging effect on voter participation in elections for Federal office and disproportionately harm voter participation by various groups, including racial minorities.

While there may be no conclusive proof that an increase in the voter rolls will automatically or necessarily result in an increase in voter turnout, it is indisputable that it will increase the number of persons eligible to vote. There are also significant indications that most of those who are eligible to vote, do so. The most common excuse given by individuals for not voting is that they are not registered. The Congressional Research Service has indicated that only approximately 61 percent of those eligible to vote are registered, so that even with an enthusiastic electorate the participation rate by eligible voters would be unimpressive. It has been found, however, that over three-quarters of those who do register, do actually vote, at least in Presidential elections. The Bureau of the Census puts the figure for voter turnout of registered voters in Presidential elections at between 85 percent and 90 percent.

Several witnesses at the Committee's hearings in the 102d Congress testified that registration procedures in the United States are not uniform and that discriminatory and restrictive practices that deter potential voters are employed by some States. Throughout the history of this country there have been attempts to keep certain groups of citizens from registering to vote—which groups specifically depending on the decade and the locale. Among the techniques developed in the various localities to inhibit or exclude potential voters were annual registration, selective purging of the voter rolls, literacy tests and poll taxes. The Voting Rights Act of 1965 made most of these restrictive practices illegal, yet discriminatory and unfair practices still exist and deprive some citizens of their right to vote. This legislation will provide uniform national voter registration procedures for Federal elections and thereby further the procedural reform intended by the Voting Rights Act.

Some restrictive practices in the voting process arise from the attempts of States to respond to the legitimate administrative concerns of election officials, such as the detection and prevention of fraud, the maintenance of accurate and up-to-date voter rolls, and the removal of the names of ineligible persons from the rolls. These tasks are made particularly difficult by the mobility of our population.

In fashioning this bill, the Committee has been concerned with the impact of a regulation or practice on the exercise of the right to vote and not with the question of whether its impact was intentional or inadvertent. It must be remembered that the purpose of our election process is not to test the fortitude and determination of the voter, but to discern the will of the majority. Every effort has been made to produce a bill that balances the legitimate administrative concerns of the election administrators and the objectives of this legislation.

The Committee was also aware that some have questioned the Congress' constitutional authority to enact a measure on voter registration. This Act seeks to remove the barriers to voter registration and participation under Congress' power to enforce the equal protection guarantees of the 14th Amendment to the Constitution. Nevertheless, these critics argue that traditionally, it has been the role of the States to regulate the manner in which elections are conducted. Contrary to this view, the States do not have exclusive authority over elections. Article I, Section 4, clause 1 of the United States Constitution states:

The Times, Places and Manner of holding elections for Senators and Representatives, shall be prescribed in each State by the Legislature thereof; but the Congress may at any time by Law make or alter such Regulations, except as to the Places of choosing Senators.

In *United States v. Classic*, 313 U.S. 299 (1941), the Supreme Court clearly held that the right of the people to choose representatives in Congress is "a right established and guaranteed by the Constitution." *Id.* at 314. It is a right derived from the States, only in the sense that the Constitution authorizes States to legislate on the subject under Article I, Section 2. The Court said, however, that this power of the States only exists to the extent that Con-



gress has not restricted State action by exercising its authority to regulate elections. Id. at 315. Moreover, in *Oregon v. Mitchell*, 400 U.S. 112 (1970), the Court supported the constitutional authority of Congress to enact election laws regulating Federal elections. In this case, the Court upheld the constitutionality of a Federal statute barring a State from denying the right to vote in any election because of a literacy test and of a Federal statute banning durational residency requirements. Justice Stewart wrote: "These cases and others establish that Congress brings to the protection and facilitation of the exercise of privileges of United States citizenship all of its powers under the Necessary and Proper Clause." Id. at 286. Justice Stewart concluded that the Constitution permits Congress to enact statutes protecting the fundamental right to vote.

Congress has the power to regulate Federal elections, including the establishment of national voter registration procedures for Presidential and congressional elections. Congress' power has been clearly established under the Times, Places and Manner Clause and the Necessary and Proper Clause of the Constitution. These provisions, as interpreted by the Supreme court, belie assertions by those who argue that the States have exclusive authority to regulate the manner in which Federal elections are conducted.

#### COMMITTEE ACTION

On January 21, 1993, Senator Ford and Senator Hatfield introduced S. 2, the National Voter Registration Act of 1993. S. 2 was referred to the Committee on Rules and Administration. On February 17, 1993, H.R. 2, the companion bill in the House of Representatives, was received in the Senate and referred to the Committee. H.R. 2 passed the House of Representatives on February 4, 1993.

The substance of both S. 2 and H.R. 2 is based on S. 250, which passed both houses of Congress in the 102nd Congress and which was subsequently vetoed. In the 102nd Congress, the Committee held hearings on the measure and heard from several witnesses representing State and local governments, civic and civil rights organizations, and the U.S. Postal Service. Because the text of both S. 2 and H.R. 2 were identical to a similar measure on which there was substantial Committee hearing record, the Committee proceeded to consider this legislation without further hearings. Consequently, references to testimony in this report correspond to the Committee's hearings from the 102nd Congress.

On February 18, 1993, the Committee considered these bills at a mark-up session of pending legislation. During the consideration of these measures, the Chairman noted that both S. 2 and H.R. 2 presented procedural considerations relating to possible point of order. After consideration of the measures and the procedural circumstances, the Chairman proposed for himself and for Senator Hatfield, that the Committee report an original bill.

After a brief discussion, the roll was called on the motion to approve and report the original bill. That motion was passed by a record vote of 7-5 and the bill was ordered reported favorably by the Committee. Senator Stevens requested that the report include minority views.

## NATIONAL VOTER REGISTRATION PROCEDURES FOR ELECTIONS FOR FEDERAL OFFICE

### I. "MOTOR-VOTER" REGISTRATION

Two points made in testimony before the Committee are central to the Committee's consideration of this legislation, and to the "motor-voter" provisions in particular. First, voter turnout of registered voters in Presidential elections since 1968 has been quite high. Census Bureau figures indicate a range from a high of 91.2 percent in 1968 to a low of 86.2 percent in 1988. While figures from election officials put the totals somewhat lower (from a high in 1968 of 82.5 percent to a low in 1988 of 70.6 percent) they are not adjusted for ineligible and duplicate names on the registration rolls. In any case it is clear that more than three quarters of those who are registered to vote do vote, at least in Presidential elections. And in all but a few States, a person must be registered before election day in order to vote.

Second, between 85 percent and 90 percent of people of voting age nationwide have driver's licenses or identification cards issued by State motor vehicle offices. A voter registration system tied to the application for or the renewal of a motor vehicle driver's license would be an ideal way to register most people of voting age throughout the country.

The driver's license procedure appears to be ideally suited to the purpose of registering voters. A procedure for licensing motor vehicle drivers is in place in every State. The States have developed exacting procedures to assure proper and correct identification of all licensees and to assure that a person has but a single license. Driver license applications require most of the information needed to determine the eligibility of a voting registration applicant, and include the additional protection of a photograph. This provision for simultaneous motor-voter applications permits the voter registrars to piggy-back on the identification techniques developed to assure accuracy in the licensing process.

Washington Secretary of State Ralph Munro, one of the first proponents of the motor voter concept, observed during his testimony before the Committee that incorporating voter registration into the drivers licensing process provides a secure and convenient method for registering voters; an effective means of reaching groups of individuals generally considered hard-to-reach for voting purposes, such as the youngest voting age population who generally have drivers licenses; and a procedure for keeping rolls current through contact with licensees who change addresses, both within a State and from one State to another, and are required to report such changes to the motor vehicles department.

Also, most States already have moved into centralized record keeping, with their driver's license application as the key document. This provision of the bill affords the States the opportunity to build on that process and to include the registration of voters. Although the bill does provide a procedure for registration that is ideally suited for automation in conjunction with the drivers license records, it does, however, permit each State some discretion as to how to administer this process and how to integrate it with

its drivers license process. That discretion would range from a fully integrated, automated process, a single application form for use by both agencies requiring minimal duplication of information, or separate application forms to be completed as part of a single, simultaneous application process at the driver's license agency.

While the bill permits some discretion to States as to how the two systems may be related, ideally the system should be so designed as to include the voter registration application as a simultaneous, automatic part of the overall process with the duplication of information requested and forms to be completed held to an absolute minimum. The system now in place in the District of Columbia accomplishes this goal by use of a single application format in which information entered on that portion of the form dealing with licensing information prints through to the voting registration form so that only a few questions pertaining to voting eligibility and the person's signature remain to be inserted after completion of the license portion.

It would not be sufficient under the terms of this legislation for a State motor vehicles office merely to make a voter registration application available upon request to a license applicant or to simply put some forms on a table in the agency. Likewise, it would not be sufficient to provide a voter registration application separate from the license application. Although this bill permits separate forms, it stresses that there must be a single application process and that requires the simultaneous delivery of the entire application, consisting of both forms, to an applicant. After receipt of the entire application, the applicant may choose not to register to vote by so indicating in writing and by not completing the voter registration portion of the application. Where a single combined form is used, an applicant's failure to sign the portion of the form containing the oath or attestation of eligibility to vote, shall be interpreted as an applicant's decision to decline the opportunity to vote.

To assure that the voter registration process is incorporated into the licensing application process so as to make it simultaneous and as automatic as possible, it is the Committee's intent that all applicants for motor vehicle drivers licenses or renewal thereof receive an application that includes both forms, and that all applicants complete the voter registration application form as part of the application procedure, unless they decline in writing to register to vote. For each license application processed by the motor vehicle registry, that office should receive either a completed voter registration application form to forward to the voting registrar or a written declination to register. Other than the requirement that it be in writing, the bill does not specify any particular form for this declination. So long as it produces a written record of the declination, any format would be sufficient, such as a check-off box on the license application form or a separate form signed by the applicant.

The Committee recognizes that in some jurisdictions, the application process is fully computerized. In such cases, any form signed by an applicant during the process shall contain an attestation to the questions on the application, including any declination question. It will be sufficient for purposes of the requirement of a written declination if the signature of the applicant on the final document produced during the transaction incorporates by reference all

questions which are asked of the applicant, including any declination question.

The Committee is aware that some concern has been expressed that this provision of the bill transfers voting registration authority from State voting registrars to State drivers licensing officers. That is not the intent of this bill and a close reading of its provisions should make that very clear. Under this bill, the role of the motor vehicle registrar is to provide forms to applicants and receive completed voter applications for transmittal to the appropriate State voting registration official. It is that official who determines whether or not to accept the application and place the name on the voting roll for the appropriate voting jurisdiction. The bill requires that the appropriate voting registration official notify each applicant of the disposition of his or her application. Nowhere does the bill suggest that that determination be made by anyone other than the appropriate voting registrar under State law. Also this bill does not give any authority to the motor vehicle agency with regard to the design of the voting registration application form. Although some cooperation would be required to integrate the two application forms to be processed by the motor vehicles agency, the bill leaves it to State law as to the officer who is responsible for the design, layout and contents of the voting registration application form, subject to the requirements of this bill.

Twenty-seven States and the District of Columbia now have a system of registration through the State's Department of Motor Vehicles. In some States, the voter registration process is done on the same form as the application for a drivers license. In other States, employees of the motor vehicle bureau are deputized to register voters. And in some states, the Department of Motor Vehicles will accept the mail registration application and forward the form on to the appropriate election official. Many of the motor-voter programs are part of a larger State agency-based system whereby voter registration applications are available at a State agency, and the agency will accept the completed forms and forward them to the appropriate election official. The type and degree of assistance given or required to complete and process the forms does vary.

States in which the Department of Motor Vehicles accepts applications for voter registration (either directly or through deputy registrars employed by the DMV office) and a brief description of their programs are as follows:

*Alaska.* Although the program was not formalized until 1989, informally Alaska's Department of Motor Vehicles (DMV) has been accepting voter registration applications since 1983. A separate voter registration form is available at the State's DMV offices and must be filled out in front of and witnessed by DMV personnel. DMV will then forward the form to the State Election Office.

*Arizona.* The motor-voter program was established in 1982. A separate form is available in each DMV office and is accepted by a deputy registrar associated with the DMV office.

*Colorado.* The motor-voter program was first established in 1984. The single application form for both voter registration and driver's license was developed by April 1985.

*Idaho.* Legislation has recently been passed that as of July 1, 1991, DMV offices in buildings not adjacent to county clerks' offices will accept voter registration applications and forward them to the appropriate county clerk. This affects approximately 6 counties in the State.

*Illinois.* As of September 1990, at least one employee in each DMV office is designated to become a deputy voter registrar. As such, the employee can register voters and witness applications within the DMV offices. However, it is a separate application process.

*Iowa.* The motor-voter program was established in 1987. At that time, voters were allowed to register through the State's DMV using a separate form for voter registration. As of 1989, Iowa has developed a single unified form for both registering to vote and applying for a driver's license.

*Louisiana.* In 1989, the State legislature authorized a pilot project that would allow employees of the State's DMV office to volunteer to become deputy registrars and register persons to vote from within the DMV offices. However, few persons have volunteered for the program. In January 1991, the pilot project became law.

*Maine.* As of April 1990, Maine's DMV will accept applications for voter registration and forward them to the Secretary of State's office for further distribution. DMV employees are encouraged to ask all applicants for drivers licenses if they are registered to vote and direct them to the deputy registrar in the DMV if they wish to register. The program also covers drivers license renewals and changes of address.

*Michigan.* The motor-voter program was established in 1975. Voter registration requires completion of a separate form. DMV employees are trained to assist in voter registration and accept changes of address for purposes of voter registration.

*Minnesota.* The motor-voter program was established in 1987. While a separate form is required for voter registration, that form and the driver's license application are joined together. DMV personnel need only separate the two forms at a perforated line before sending the voter registration form to the appropriate voter registrar.

*Montana.* As of October 1, 1991, the State's DMV office began accepting voter registration applications and forwarding them to the appropriate election officials. In the future, a single combined drivers license/voter registration application form is planned.

*Nevada.* The motor-voter program was established in 1987. Persons desiring to register to vote must complete a separate form from that required to apply for a driver's license. DMV personnel will accept the voter registration application and forward it to the appropriate county registrar.

*New Jersey.* Motor-voter was established in 1989 by executive order. Employees of the State's DMV offices and other State agencies accept and forward on voter registration applications to the appropriate election officials. In 1991, legislation passed to implement parts of the executive order. Employees of the Department of Motor Vehicles and of Human Services of the

New Jersey Transit Corporation, and the Office of Disabilities, are required under the legislation to accept and forward applications for voter registration to appropriate election officials. In addition, other State agencies, originally covered by the executive order, are still required because of that executive order, to process voter registration applications.

*New Mexico.* As of June 1991, the State's DMV offices will have at least one deputy registrar available to register persons to vote when they come in to apply for a drivers license. The program covers new drivers license applicants as well as renewals and changes of address.

*North Carolina.* The motor-voter program was established in 1983. Persons desiring to register to vote must complete a separate form. DMV personnel will accept the voter registration application and forward it to the State Board of Elections, which will then forward it to the appropriate county registrar.

*Ohio.* The motor-voter program was established in 1977, but not implemented until 1982 when a statewide voter registration form was authorized and developed. Persons desiring to register to vote must complete a separate form. DMV personnel will accept the voter registration application and forward it to the appropriate county registrar.

*Oregon.* In 1989, the State legislature enacted motor-voter provisions into law, conditional on the passage of Federal legislation. However, in 1991, it was decided to proceed and implement a motor-voter registration system. Persons who are applying for a drivers license are asked if they are registered to vote and if they wish to be registered to vote. If they respond "yes", a combined form is printed, part for the DMV application and part for the voter registration application. The forms are accepted by the DMV and picked up by the appropriate election officials at regular intervals.

*Rhode Island.* In January 1990, the legislature established a pilot project in the DMV to have a table occupied by a deputy registrar to register persons to vote. In 1991, this program was made permanent in the DMV where certain employees of the DMV were made deputy registrars. In 1992, the program was extended to several other State agencies. In all cases, selected employees of the agency are trained as deputy voter registrars, a separate voter registration form is used by the agency and the deputy registrar takes a sworn statement relating to the veracity of the information provided on the form.

*Texas.* In 1991, the State legislature passed a bill to implement a motor-voter registration program. The program automatically produces two forms if persons applying for a drivers license wish to be registered to vote. Both forms will be signed and the DMV will forward the voter registration forms to the appropriate election official.

*Vermont.* The motor-voter program was established in 1986. Persons desiring to register to vote must complete a separate form from the required to apply for a drivers license. DMV personnel will then administer an oath to the registrant, accept the voter registration application and forward it to the appropriate county registrar.

*Washington.* In January 1992, motor-voter registration became official in the State. DMV employees will accept voter registration applications.

*West Virginia.* As of July 1, 1991, employees of the State's DMV office will ask all applicants and persons renewing their drivers licenses if they would like to register to vote. If the person wishes to register, they will be sent to the DMV's deputy voter registrar who will accept the voter registration application and administer the oath.

*District of Columbia.* The motor-voter program was established in 1989. A single combined form is used to both register voters and apply for a driver's license. The section of the form containing information required for both processes has a carbon attached; that part of the form containing only information required by the Department of Elections has no carbon. A license applicant who wishes to register to vote must complete and sign both application sections of the form.

It has been reported that in the first month of operation of the motor-voter registration program in the District of Columbia, voter registrations were four times the usual monthly rate and that increase was achieved with one-half of the license applicants declining to register to vote. According to Emmett H. Fremaux, Executive Director of the D.C. Board of Elections and Ethics, who administers the program, during the first 20 months the program has been in operation, 32,000 persons have been registered to vote through the motor-voter program. That program accounted for 45 percent of all voter registrations during that period. Mr. Fremaux concluded, based on the experience in the District of Columbia, that "motor voter is so immediately and dramatically productive in putting new registrants on the roll that implementing this program nationally will produce a quantum leap in the level of voter registration in this country in a surprisingly short period of time. \* \* \* [I]t would mean adding more than 20 million persons to the national voter rolls from one presidential election to the next."

In addition to the States that accept or plan to accept voter registration applications and forward them to the appropriate election officials, a number of the States with mail registration make the forms available within the offices of public agencies, including the DMV office, and some (New York and Pennsylvania) specifically direct the persons visiting the office to where the forms are located. However, citizens still have to fill the forms out and mail them in themselves.

Although not the direct purpose of this bill, a side effect of its motor-voter and agency provisions will likely be to even out the work of voter registration offices throughout the year. Pre-election rushes of registrations caused by registration drives associated with an upcoming election will be minimized. The continuous flow of drivers license applications throughout the year will result in a similar pattern of activity in the voting registration offices. Also, the voter rolls will be updated continuously throughout the year from renewals of licenses, notices of change of address and new applications by persons who move into the State and are required to obtain a State license within a prescribed period of time. All of these activities by the motor vehicle agency to comply with motor

vehicle drivers license requirements and assure accurate and current information on drivers licenses and identification cards will result in the transfer of information to the voting registrar to help keep the voting rolls current and correct, as well.

Some concern has been expressed concerning the issue of fraud in the application process as a result of it being tied to the drivers license application process. This concern centers on the possibility of the registration of license applicants who are under age or not citizens since the requirements for a drivers license are not the same as for voting registration. Two things should be noted in this regard. First, most drivers license agencies require proof of the applicant's date of birth in order to apply for a license. Therefore, although the age requirements may differ, that information will be readily available to the clerk processing the application. Second, the bill requires that the application include a statement as to voting eligibility requirements, including age and citizenship, which must be attested to by the applicant upon signing the application. Thus, the processing of voting registration applications at the motor vehicles agency would lessen the likelihood of such fraud and certainly would not make it greater than it is now. As noted during the Committee's hearings in the 102nd Congress by Ralph Munro, Secretary of State of Washington, if the same scrutiny of driver's license applications is applied to voting registrations, the likelihood of registering ineligible people is severely diminished.

In addition to these safeguards, the bill provides for Federal criminal penalties for knowing and willful offenses, including the submission of voter registration applications containing materially false information. This is a broader provision than current law. Under the "false information" provision of the Voting Rights Act, the false information must relate to one of three items that are listed in the statute; that is, the name, address, and/or period of residence in the voting district. Under the provisions of this bill, prosecution for false information would be expanded beyond these three items.

With regard to the registration of noncitizens, current law at 18 U.S.C. § 911 prohibits the knowing and false assertion of United States citizenship by an alien. Under the provisions of this bill, every application for voter registration must include a statement that sets forth all the requirements for eligibility, including citizenship, and requires that the applicant sign an attestation clause, under penalty of perjury, that the applicant meets those requirements. Together with the criminal penalties section of the bill, the Committee is confident that this Act provides sufficient safeguards to prevent noncitizens from registering to vote.

## II. UNIFORM MAIL REGISTRATION

The second approach of the bill is the development of uniform mail registration. Under the provisions of the bill, the Federal Election Commission, in conjunction with the chief election officials of the 50 States, will develop a universal mail registration form. The form may only require such identifying information (including the signature of the applicant) as is necessary for election officials to determine the eligibility of the applicant. The form

must include a statement that specifies each eligibility requirement (including citizenship); contain an attestation that the applicant meets each such requirement; and require the signature of the applicant under penalty of perjury. The form may not include any requirement for notarization or other formal means of authentication, i.e. a witness requirement.

The bill provides flexibility by permitting States to develop and use their own mail registration form, as long as it meets the requirements of the Act. A registrant is permitted to use either the Federal form or the appropriate State form and the States would be required to accept either form.

Texas was one of the first States to institute a system of registration by mail—the person desiring to register mailed a card containing all pertinent information to a voter registrar.<sup>1</sup> Now, twenty-seven States and the District of Columbia have some form of mail registration program. Mail registration is an effective means for increasing the voter rolls because it relieves the voter of the need to appear in person at one central registration office during prescribed hours and it permits organizations to go to the voter with organized registration drives. Mail registration is convenient for the voter, for registration drive organizers and for voter registrars as well.

Some have expressed concern that mail registration would increase the potential for fraud. This concern was expressed by the Department of Justice in a letter to the Chairman of the Committee, in the 102nd Congress.<sup>2</sup> The letter states, in part, "because some of the registration techniques mandated by the bill are fraught with the potential for fraud if adequate verification methods are not used in light of local conditions, \* \* \* the bill would present a serious potential for increased voting fraud and electoral corruption." In an accompanying memorandum, the Justice Department states that "[r]egistration by mail is much more susceptible to misuse because a would-be registrant never has to appear in person before a registrar for verification of identity and eligibility."

A study by the Congressional Research Service of States having mail registration procedures in 1984, found that "voter registration officials in all eighteen States for which data are available reported they have had little or no fraud with post card registration. Several said they have had no more fraud with post card registration than with in-person registration." In fact, Governor Barbara Roberts of Oregon testified that her State instituted mail registration in 1975, and that despite the fact that Oregon does not have a notarization or witness requirement, Oregon has not experienced any cases of fraud or fraudulent voting with mail registration. Governor Roberts stated that there was "Literally no abuse of the system."

<sup>1</sup> The procedure adopted by Texas was limited to military personnel. The first State to adopt such a procedure universally and as a principal method of registering voters was Alaska.

<sup>2</sup> During the Committee's consideration of similar legislation in the 102nd Congress, the Committee received a letter dated April 17, 1991 to the Chairman and signed by W. Lee Rawls, Assistant Attorney General, Office of Legislative Affairs, U.S. Department of Justice. Throughout this report, there are a number of references to this letter and the Committee's response. Because this letter serves as the basis for much of the arguments made by opponents to this legislation, the Committee was inclined to include references of the letter in this report, as well as the Committee's response. However, it should be noted, that the views expressed in the April 17, 1991 letter may not accurately reflect the views of the current Department of Justice.

The Governor stated that when Oregon adopted mail registration, opponents raised the issue of fraud. As a result, the mail registration form includes detailed information to the registrant in red lettering that abuse of the registration process is punishable by a substantial fine and prison sentence. Moreover, despite Oregon's large migrant worker population, there has not been any indication of non-citizens registering in the State.

In addition to Oregon, it is significant to note that the States with a mail registration procedure include the most populous ones of California, New York, Texas, Ohio, New Jersey and Pennsylvania. Less than half of those States that have mail registration require a witness to the applicant's signature and, of the more populous States, only New Jersey requires a witness. The most commonly used methods of confirming information on mail registration applications are a non-forwardable or forwardable mailing to the applicant after receipt of the application, and warnings of penalties for fraud on the application form. This bill requires a notice to each applicant as to the disposition of his or her application. Thus, it permits a State to use either a forwardable or non-forwardable mailing to confirm a registration. With regard to this notice requirement, States should be aware that such a notice should be drafted with regard to the purge provisions of this bill.

To address these concerns regarding fraud, the bill includes a provision which would permit the States to require by law that a first time voter who registered to vote by mail, and was not previously registered in that jurisdiction, make a personal appearance to vote.<sup>3</sup> This section of the bill again demonstrates the concern of the Committee that each State should develop mechanisms to ensure the integrity of the voting rolls. States may determine, based on their own circumstances, that a personal appearance for mail registrants is necessary to ensure the integrity of the voting rolls. Other States, based on their own experiences may determine that such a requirement is not necessary. Oregon is one such State which has mail registration and does not require a personal appearance to vote.

In addition, this bill requires that mail applications include a statement of voting qualifications and an attestation, which must be signed by the applicant under penalty of perjury, that the applicant meets all those requirements. All applicants must be informed of the penalties provided by law for submission of a false voter registration application and in the case of mail applications such notice would be on the form itself.

Mail registration provides a convenient method for reaching out to eligible voters. But while it makes registration convenient, the bill also provides that there will be sufficient safeguards to prevent an abuse of the system with fraudulent registrations.

<sup>3</sup> The bill provides certain exemptions from the personal appearance to vote, including those who are entitled to vote through other means as provided by the Uniformed and Overseas Citizens Absentee Voting Act, or those who are provided a right to vote otherwise than in person under the Voting Accessibility for the Elderly and Handicapped Act; or as provided by any other Federal law.

### III. AGENCY REGISTRATION

Agency-based voter registration provides a useful supplement to motor-voter registration systems, enables more low income and minority citizens to become registered, and is cost effective. Under the provisions of the bill, States will be required to designate agencies to serve as voter registration offices. The program of registering voters at various agency locations mirrors the registration program of the "motor-voter" provisions of the bill, but does not require the same integration of the voter registration application form with the agency forms. The agency-based registration program is designed to reach out to those sectors of the population which are not likely to have driver's licenses or other identification cards issued by a motor vehicle agency.

The agency-based program of the Act is a two tiered program. In the first tier, the States are required to designate all offices in the State which provide public assistance, unemployment compensation and related services, and all offices which provide State-funded programs primarily engaged in providing services to persons with disabilities. Such programs would include vocational rehabilitation but would also include other programs which provide assistance or services to physically challenged persons. The second tier of the agency-based registration program compliments the first and although each State must have such a program, a State is given discretion in determining which agencies will be included, as well as at which agency's local offices registration will be made available. This second tier may be comprised of Federal, State, local government offices or private sector agencies in the State. Such offices and agencies may include public libraries, schools, offices of city and county clerks (including marriage license bureaus), fishing and hunting license bureaus, government revenue offices, and any office that provides services to persons with disabilities which are not included in the mandatory agency-based program. Within this second tier, a State has discretion to designate some or all of these offices, whichever is in the judgment of the State will serve the purposes of ensuring widespread voter registration opportunities.

Many persons will visit a public office or facility—a public assistance office, an unemployment office, a tax office, a library—in the course of a year. Agency-based voter registration provides a method whereby citizens may easily register to vote and fulfill the requirement that government should do all it can to make registration widely and easily available. Agency-based voter registration means that registration services—forms and assistance in completing such forms—will be available routinely and year round in many government and private sector offices.

As noted during the Committee's hearings last Congress, one of the advantages of the agency-based program is that it is an interactive registration. That is, there are individuals to assist registrants in completing the information on the registration application. Birgit Seifert of the Mexican American Legal Defense Fund noted that "mail registration is important, but perhaps more important are the agency registration procedures because [it is] . . . an interactive form of registration. If you have a stack of mail registration

cards available, that does not necessarily mean that people are going to pick them up and send them in."

While mail registration procedures make registration convenient, in communities where resources are limited, it has been demonstrated to be ineffective in registering those who have historically been left out of the registration process. Thus, in some instances, mail registration is inferior to agency-based registration. As Ms. Seifert noted in her testimony:

If you couple placing the burden on community leaders to register people, and then you have the State affirmatively purging people, you have got them putting all their resources into getting something that is not getting them very far. They are having to marshal all their resources just to maintain the status quo . . . [I]n a country which prides itself on a representative form of government, it is crucial that the government task affirmative steps to register its citizenry and that the burden not fall on communities, especially communities . . . which lack resources.

The experience in many States with registration at schools, at libraries, or in motor vehicle offices provided the precedents for agency voter registration programs. Five States (Alaska, Iowa, Minnesota, New Jersey, and Ohio) have, either through executive order or law, established some form of public agency voter registration system other than motor-voter registration procedures, often as an adjunct to other voter registration procedures. In addition, nine States either make voter registration forms available within offices of State agencies or have added language to agency application forms asking if the applicant would like to register to vote. In these States, an applicant is given a mail voter registration form or is directed to the appropriate office for registration.

An agency registration program may also include private offices and locations throughout a State. An agency program that includes private places at which persons may register to vote may be organized through cooperative arrangements and agreements between the sponsoring agency and appropriate local or State election officials. A comprehensive agency-based program should include private locations and offices, as well as public agencies, in order to make registration available on as broad a basis as possible in a State and to make registration readily available in areas that experience low registration.

To make the agency-based program as comprehensive as possible, the bill requires all entities and agencies of the Federal government to cooperate as much as practicable with the States in carrying out this program by participating as designated voter registration agencies. No specific Federal agencies are designated in this bill to participate; rather, it is left to the States to negotiate such arrangements with appropriate Federal agencies.

A Department of Transportation study noted that almost 50 percent of those persons who do not have a driver's license have annual incomes of less than \$10,000. As a result, motor-voter registration programs may not adequately reach low income citizens and minorities. Active public and private agency-based voter registration programs available through such public agencies as State

public assistance offices, State unemployment offices, or programs primarily engaged in providing services to person with disabilities, as well as at private offices and locations in areas of low registration, are more likely to reach these eligible citizens, who are likely to have contact with a number of these agencies. Currently, most registration systems make it difficult for the low income citizen to qualify to participate in our nation's elections. Agency voter registration programs provide an institutional solution to the problem of unequal access to the voting booth.

Agency-based registration on a year-round basis may also indirectly minimize the necessity for periodic, large scale purges of voter registration lists by election registrars. With an effective agency-based registration system, voters would have the opportunity not only to register, but also to update their registrations each time they sought services at the government agency. Persons who receive social services—welfare, unemployment checks—must keep their addresses up-to-date in order to receive the benefit. Similarly, public housing recipients must keep their address information up-to-date. Like the motor-voter program, any application for renewal, recertification, or change of address would serve as an update for that person's registration to vote unless the applicant declines in writing.

The bill has a broad scope with regard to agency-based registration for persons with disabilities. As noted by a number of organizations representing the disabled community, particularly Disabled AND Able to Vote, there is no one agency which provides services to all, or even a large percentage of the disabled population. Vocational rehabilitation services, for example, reach no more than one disabled person out of 15 at any one time during their entire life. Independent living centers are overwhelmingly located in large cities and do not serve those persons with disabilities who live in suburbs, small towns, or rural areas. Thirty-seven percent of all persons with disabilities acquire the disability after the age of 55. As a result, employment, education and training programs rarely provide services to these individuals. In order to access this isolated population, it is essential that as many locations as possible which provide services to disabled Americans offer voter registration services: by making forms available, providing assistance with filling out the forms, and collecting and forwarding the registration forms to the appropriate election official.

Because many of these services may be offered by home visitations, the bill includes a provision which requires that any agency which provides services to persons with disabilities at the person's home must provide the same degree of assistance for voter registration in the home as an agency provides in the office.

Concerns have also been expressed that the agency-based registration programs risk various forms of intimidation of the public. However, this bill explicitly prohibits those engaged in registering voters from seeking to influence an applicant's political preference or party registration, displaying any political preference or party affiliation, or making any statement to an applicant the purpose of which is to discourage the applicant from voting. Agency personnel are also prohibited from intimidating a person to register who does not want to register, for fear of not receiving benefits. Moreover,

under the criminal penalties section of the bill, it is a Federal offense to intimidate any person who attempts to register to vote. The Committee believes that these provisions are a sufficient deterrent to any person who would seek to intimidate any person who is entitled to register through the agency-based registration program, or any other registration program established by this bill or any other law.

Like the motor-voter provisions of the bill, the Committee is aware that some concern has been expressed that this provision of the bill transfers voting registration authority from State voting registrars to agencies. That is not the intent of this bill. This bill provides only that the role of the agency-based registration program is to provide forms to applicants and receive completed voter applications for transmittal to the appropriate State voting registration official. It is the voter registration official who determines whether or not to accept the application and place the name on the voting roll for the appropriate voting jurisdiction. The bill requires that the appropriate voting registration office notify each applicant of the disposition of the application. There is no provision in this bill which would require or suggest that determination be made by anyone other than the appropriate voting registrar under State law.

In addition, this bill does not give any authority to the agencies with regard to the design of the voting registration application form. In fact, the bill encourages agencies to incorporate their forms to provide one form for the applicant, as an application for services and voter registration. Ideally, the agency-based program would work efficiently if one form were created. In that instance, some cooperation would be required to integrate the two application forms to be processed by the agencies. The bill leaves it to State law as to the officer who is responsible for the design, layout and contents of the voting registration application form, subject to the requirements of this bill.

#### IV. VOTING LIST CONFIRMATION PROCEDURES AND STANDARDS

One of the purposes of this bill is to ensure that once a citizen is registered to vote, he or she should remain on the voting list so long as he or she remains eligible to vote in that jurisdiction. The Committee recognizes that while voting is a right, people have an equal right not to vote, for whatever reason. However, many States continue to penalize such non-voters by removing their names from the voter registration rolls merely because they have failed to cast a ballot in a recent election. Such citizens may not have moved or died or committed a felony. Their only "crime" was not to have voted in a recent election. As the Reverend Jesse Jackson stated during the House hearings on voter registration reform in the 101st Congress: "No other rights guaranteed to citizens are bound by the constant exercise of that right. We do not lose our right to free speech because we do not speak out on every issue."

While most States use the procedure of removal for non-voting merely as an inexpensive method for eliminating persons believed to have moved or died, many persons may be removed from the election rolls merely for exercising their right not to vote, a prac-

tice which some believe tends to disproportionately affect persons of low incomes, and blacks and other minorities.

Such purging for non-voting tends to be highly inefficient and costly. It not only requires eligible citizens to re-register when they have chosen not to exercise their vote, but it also unnecessarily places additional burdens on the registration system because persons who are legitimately registered must be processed all over again.

Although purge systems may be inefficient and costly, the Committee and other participants are well aware of the need for the States to maintain accurate voting rolls. An important goal of this bill, to open the registration process, must be balanced with the need to maintain the integrity of the election process by updating the voting rolls on a continual basis. The maintenance of accurate and up-to-date voter registration lists is the hallmark of a national system seeking to prevent voter fraud. These processes, however, must be scrutinized to prevent poor and illiterate voters from being caught in a purge system which will require them to needlessly re-register. Such processes must be structured to prevent abuse which has a disparate impact on minority communities. Unfortunately, there is a long history of such list cleaning mechanisms which have been used to violate the basic rights of citizens.

One of the advantages of the bill is the fact that the motor-voter and agency-based programs are ongoing and that applications and renewals may serve as updating the addresses of registered voters. Thus, the need for large scale purges and list cleaning systems becomes superfluous. Nevertheless, the bill requires States to conduct a program to maintain the integrity of the rolls. The Act requires that any program or activity to protect the integrity of the electoral process by ensuring the maintenance of an accurate and current voter registration roll must be uniform, nondiscriminatory, and in compliance with the Voting Rights Act of 1965. Merely because a program was conducted under the National Voter Registration Act would not be a defense to any claim which might be asserted under the Voting Rights Act. The requirements of the two acts are distinct and complementary. The States must comply with the National Voter Registration Act in a manner which does not violate the Voting Rights Act.

These programs may not remove the name of a voter from the list of eligible voters by reason of a person's failure to vote. States are permitted to remove the names of eligible voters from the rolls at the request of the voter or as provided by State law by reason of mental incapacity or criminal conviction.<sup>4</sup>

In addition, States are required to conduct a general program that makes a reasonable effort to remove the names of ineligible voters from the official lists by reason of death or a change in residence. Any program which the States undertake to verify addresses must be completed not later than 90 days before a primary or general election. It is intended by this requirement that the State out-

<sup>4</sup> The bill also includes a provision which requires the U.S. Attorney to give notice to the chief State election official information regarding the criminal convictions of any person. This notice requirement will permit States to make a determination if such criminal conviction is reason for the removal of the person's name from the list of eligible voters.

reach activity, such as the mailing of list verification notices or conducting a canvas, must be concluded not later than 90 days before an election, however, this would not prevent a State from making the appropriate changes to the official lists pursuant to the Act during the 90 day pre-election period.

A State or local subdivision may satisfy this requirement by using the National Change of Address program available through licensees of the U.S. Postal Service. The Committee strongly encourages all States to implement the NCOA program, which is efficient, is cost-effective once the start-up computerization expenses are absorbed, and properly implemented, is uniform and objective. Jurisdictions which choose not to use the NCOA program should implement another reasonable program which is designed to meet the requirements of the bill, *i.e.* that it be uniform, non-discriminatory and in conformance with the Voting Rights Act of 1965.

If in the course of using the NCOA program, it is determined that a voter has changed addresses within the jurisdiction of the same voting registrar, the registrar is directed to make the change on the official list of eligible voters and notify the voter of the change by sending a notice of the change by forwardable mail with a postage pre-paid return card for the registrant to verify or correct the information.

The Act allows the removal of a person's name from the official list by reason of a change of residence outside the jurisdiction of the registrar, only if the voter notifies the registrar of such a change or has failed to respond to a notice sent by the registrar and has failed to vote or appear to vote in two Federal general elections following date of the notice.<sup>5</sup> Under this notice requirement, the notice must be sent by forwardable mail, with a return postage prepaid and preaddressed card, on which the registrant may state his or her current address. This mailing must include a notice to the registrant that if he or she has not changed residence, or changed residence within the jurisdiction of the registrar, that the card should be returned no later than the time period provided for registration by mail. Further, if the card is not returned, confirmation or attestation may be required before the registrant is permitted to vote in the Federal election during the period between the date of the notice and ending after the second general election for Federal office that occurs after the date of the notice. If the registrant does not vote or appear to vote, his or her name will be removed from the list of eligible voters. This mailing must also give information to the registrant concerning how the registrant can continue to vote if he or she has moved outside the jurisdiction of the registrar. A voting registrar shall correct the roll based on information obtained through this program.

As previously noted, one of the guiding principles of this legislation to ensure that once registered, a voter remains on the rolls so long as he or she is eligible to vote in that jurisdiction. Thus, when a registrant fails to return a card to the voting registrar, the voter must be permitted to vote if he or she appears at the polls within

<sup>5</sup> A "request" by a registrant would include actions that result in the registrant being registered at a new address, such as registering in another jurisdiction or providing a change of address notice through the drivers license process that updates the voter registration.



two general Federal elections after the date of the notice. While the bill secures the right of the voter to vote, it does not dictate the way in which the person is to vote. The State may establish its own requirements regarding the means of voting.

In response to the concerns of various witnesses representing civil rights organizations, these requirements of the bill were added to prevent the discriminatory nature of periodic voter purges, which they assert appear to affect blacks and minorities more than others. It should be noted that the bill does not mandate any specific time periods for when such list cleaning mechanisms must be used. While these provisions have been included to insure that voting rolls will be free from "deadwood", there will be less need for these mailing because the programs of voter registration include provisions for automatic updating of addresses. Thus, the process of updating registration rolls is an ongoing and continuous process.

#### V. ENFORCEMENT AND REGULATION

##### A. The Federal Election Commission

The Federal Election Commission (FEC) was created to oversee the campaign finance law authorized under the Federal Election Campaign Act and its amendments. The FEC officially became operative in 1975. Although known mostly for its regulatory activities in the area of Federal election campaign finance, the FEC is the only Federal agency uniquely set up to deal with Federal elections. Due to the politically sensitive nature of its role, the FEC was organized as an independent agency with members appointed with consideration of their political affiliations, but under restrictions designed to assure that no single political party would control its deliberations. Further, through its National Clearinghouse on Election Administration, the FEC has maintained an advisory role in election administration and has developed model election administration programs and information to assist States in conducting their elections. Given its composition and independent status, its experience in developing rules and regulations in the area of campaign finance, its unique position within the Federal government as the principal agency dealing with election administration, and its experience in developing model procedures for States, the Federal regulation of any national voter registration could best be administered from the FEC.

##### B. Enforcement

Many State and local election administrators expressed concern about the potential for an increase in voter fraud as a possible result of voter registration reform, and especially that registration by mail would make it easier for persons to vote fraudulently. This bill not only attempts to make voter registration convenient, but is also designed to prevent fraud and abuse of the electoral process.

The Committee is aware of the concerns regarding the potential for fraud in registrations. Throughout the bill, each registration program has been developed to assure the integrity of the voting rolls. One of the principle concerns expressed by critics of this bill is the use of mail registration. Based on the Congressional Re-

search Service's study, however, the experience of the States with mail registration appears to be that voter fraud is no more prevalent under a mail registration system than under other types of voter registration systems. Moreover, where States have investigated fraudulent registration and voting, there has never been a recommendation to repeal mail registration.<sup>6</sup> As previously noted elsewhere in this report, the provisions relating to mail registration permit the States to require by law that a person make a personal appearance to vote if that person registered by mail and had not previously voted in that jurisdiction.

Nevertheless, a uniform national voter registration system should make it a Federal offense to fraudulently register to vote. Voter fraud is a crime against the legitimate electoral process. On the other hand, others expressed concern that legitimate voters should be able to go to the polls without fear of intimidation or threat by either officials or other citizens. As much as it is a crime to attempt to fraudulently cast a ballot, it is equally a crime to try to prevent an eligible citizen from casting a ballot in an election. Any national voter registration measure should discourage equally both of these activities. Language was added to the criminal penalties section to make clear that the person charged must have actual knowledge that the registration forms contain materially false information and were submitted with the specific intent to fraudulently affect the outcome of an election.

In addition to criminal enforcement, an effective national voter registration program must also include private civil enforcement. Such private initiative can encourage action to assure that a reasonable effort is undertaken to achieve its objectives in all States and, indeed, it may be essential to the success of such a program in some areas. Private civil enforcement should be designed to assure and to encourage, to the fullest extent possible, the cooperation of local and State election officials responsible for implementation of the voter registration programs. An essential element of an effective civil enforcement program is a requirement for notice of any complaint regarding its implementation to the appropriate election officials together with a process for its administrative resolution before legal action may be commenced.

#### SECTION-BY-SECTION DESCRIPTION AND DISCUSSION

##### SECTION 1. SHORT TITLE

This Act may be cited as the "National Voter Registration Act of 1993."

<sup>6</sup> Opponents to the legislation have often referred to a footnote reference in the April 17, 1991 Justice Department letter, which refers to an Illinois Grand Jury investigation of voter fraud. However, it should be noted that the Grand Jury never recommended that mail registration should be repealed. In addition, a Grand Jury investigation in Kings County, New York which found substantial incidents of voting fraud never recommended a repeal of New York's mail registration system. The Grand Jury did not conclude that mail registration was the cause or a significant contributing cause to the specific incidence of fraud it investigated. It should be further noted that during the Committee's consideration of S. 250 in the last Congress, the New York State Assembly passed legislation revising its registration laws. Part of this legislation was to maintain and expand the mail registration system. Clearly, if the State of New York believed that the mail registration system resulted in fraudulent registrations, it would have sought to limit or abandon mail registration.

### SECTION 2. FINDINGS AND PURPOSES

Section (a) sets forth the findings of the Congress that the right to vote is a fundamental right of citizens; that it is the duty of Federal, State, and local governments to promote the exercise of that right; and that discriminatory and unfair registration laws and procedures have a direct and damaging effect on voter participation in elections for Federal office and disproportionately harm voter participation by various groups, including racial minorities.

Section (b) sets forth the purposes of this Act, which are to increase the registration of voters, to make it possible for Federal, State, and local governments to implement the Act in a manner that enhances the participation of eligible citizens, to protect the integrity of the electoral process, and guarantee accurate and current voter registration rolls

### SECTION 3. DEFINITIONS

Section 3 defines the term "motor vehicle driver's license" to include any personal identification document issued by a State motor vehicle authority, and applies the definitions of Section 301 of the Federal Election Campaign Act of 1971 to election terms used in this Act. "State" is defined to be a State of the United States or the District of Columbia. A "voter registration agency" is any office designated under this Act's agency-based registration provisions to perform registration functions which include distributing registration forms simultaneously with applications for services or benefits, providing assistance to applicants similar to that provided in the completion of the office's own forms, and receipt and transmittal of such forms to the appropriate voter registrar.

### SECTION 4. NATIONAL PROCEDURES FOR VOTER REGISTRATION FOR ELECTIONS FOR FEDERAL OFFICE

Section 4(a) requires that the States, in addition to any other methods for voter registration provided for under State law, establish procedures to permit voter registration in elections for Federal office: simultaneously with an application for a driver's license; by mail application; by application in person, either at an appropriate registration office, or at a Federal, State or private sector location ("agency registration").

Section 4(b) provides that this Act is not applicable to a State where either or both of the following apply: a State in which there is no voter registration requirement for any voter in the State with respect to a Federal election; or, a State in which all voters may register to vote at the polling place at the time of voting in a Federal general election.

The language of this section is specific as it relates to the exceptions. It is the intent of the Committee that these exceptions are narrowly drawn to assure that only those States in which any voter may vote either without registration or by registering at the polling place on election day would be exempt. A State would be exempt from the requirements of the bill if it meets either or both of these requirements. It is not the intent of this legislation to encourage the adoption of election day registration. Rather, the Committee believes that States which have implemented one or both of

these exceptions have lessened the impediments to registration which goes significantly beyond the requirements of the bill. A State would not be exempt if it merely granted local jurisdictions the option of providing for election day registration or no registration if local jurisdictions also had the option of requiring any other form of registration. The Committee does not believe such an option results in a significant reduction in registration barriers.

### SECTION 5. SIMULTANEOUS APPLICATION FOR VOTER REGISTRATION AND APPLICATION FOR MOTOR VEHICLE DRIVER'S LICENSE

Subsections (a) and (b) require that each State motor vehicle driver's license application, including a renewal application, shall also serve as an application for voter registration for Federal elections. In addition, such an application will also serve as updating any previous voter registration by the applicant. An applicant for a motor vehicle driver's license may decline to register to vote and such information may not be used for any purpose other than voter registration.

Although the declination to register must be in writing, no particular format is required so long as a record of the declination is created and retained. The Committee recognizes that in some jurisdictions, the application process is fully computerized. In such cases, it would be sufficient to satisfy the requirement of a written declination if the form signed by an applicant at the conclusion of the process contains an attestation to all questions in the application, including any declination question. It is the intent of the Committee that the application procedure should require the affirmative act of an applicant but only after the applicant has received a complete application that includes both the drivers license and voter registration application forms. States are afforded latitude in this section to develop an application which will meet the needs of the particular jurisdiction. In some instances, a State may determine that the application should include a box in either form for a registrant to check if he or she declines to register. In other instances where the application for the driver's license and voting registration are combined into a single form, the failure of an applicant to sign the voting registration application portion could serve as a declination to register, if the drivers license portion contains a notice to the applicant that the failure to complete and sign the voter registration application portion of that form is a declination to register.

This requirement that there be a written declination to register serves two purposes: first, to prevent unnecessary paperwork where a person is already properly registered; and, two, to prevent the registration of ineligible persons. It is not the intent of this bill to generate needless paperwork for either the registry of motor vehicles or the voter registrar. The Committee would expect the registry of motor vehicles staff to instruct applicants who are already properly registered or those who are otherwise ineligible to vote decline to register. Such instructions should also be included in any written materials provided to applicants as well as in any instructions posted in motor vehicle agency offices. Some have claimed that the failure to decline to register will result in the automatic

registrations of such individuals. This is simply not true. This bill provides for simultaneous applications procedures, but still requires the intervening act of a review of the registration applications by the appropriate State or local election official.

Some have noted that the requirements for obtaining a driver's license are not the same as those for eligibility to vote, specifically, age and citizenship. The Committee would expect that any driver's license applicant who does not meet the requirements for eligibility to vote would decline to do so. It is important, therefore, that such applicant be advised of the voting requirements and the need to decline to register if he or she does not meet the requirements. The bill provides that all registration requirements should be set forth in the application to register to vote so that they will be readily available for each applicant to review during the application process. The applicant should be advised that there is no obligation to specify the particular reason for choosing to decline to register.

Since some of the reasons for declining to register to vote may involve matters of personal privacy, such as ineligibility under State law due to mental incompetence or a criminal conviction, an individual who declines to register to vote shall not be questioned as to the reasons for such action. If an individual reveals such information, it must be treated as confidential and may not be used for any other purpose. As discussed later, the Act contains a general prohibition against a State or entity from revealing any information relating to a declination to register or to the particular location or agency where a person registered.

Subsection (c) requires that each State shall include a voter registration application form as part of an application for a State motor vehicle driver's license. The voter registration application form may not require any information that duplicates information required in the driver's license portion of the form, other than a second signature and the minimum amount of information necessary to prevent duplicate voter registration and enable State election officials to assess the eligibility of the applicant for voter registration and other parts of the election process, and must include a means by which an applicant may decline to register to vote. The voter registration application form must include a statement that states each eligibility requirement, including citizenship, and attestation that the applicant meets each such requirement, and the signature of the applicant under penalty of perjury. In addition, where appropriate, such forms should include information requesting the applicant's mail address if it differs from the applicant's residence. Each completed voter registration application form must be made available to the appropriate State election official as provided by State law.

The terms "State election officials" and "appropriate State election official" refer to whatever election official under State law has the appropriate responsibility for the administration of voter registrations and elections. In some cases, this may be a local election official.

Although the application for voting registration is simultaneous with an application for a driver's license, it is not the intent of the bill to supplant the traditional role of voting registrars over the registration procedure. The bill makes it very clear that the motor

vehicle agency is responsible for forwarding voting registration applications to the appropriate State election official. It should be made very clear to any applicant in a driver's license bureau that the application for voter registration is an application which must be reviewed by the appropriate election officials. Only the election officials designated and authorized under State law are charged with the responsibility to enroll eligible voters on the list of voters. This bill should not be interpreted in any way to supplant that authority. Election officials should continue to make determinations as to an applicants eligibility, such as citizenship, as are made under current law and practice. Applications should be sent to the appropriate election official for the applicant's address in accordance with the regulations and laws of each State.

Although the Committee would encourage States to adopt a single form for a voter registration application and a motor vehicle driver's license application in order to expedite the process, to minimize the duplication of information, and to establish a truly simultaneous application process, it recognizes that administrative and funding considerations pose serious problems for some States. Thus, Section 5(c) is so drafted to describe an application process that permits the use of two forms, one for the motor vehicle driver's license application and one for the voting registration application, thereby avoiding any cost associated with revamping current procedures of computer programs. Where two forms are used, it is expected and intended that such forms will be used simultaneously as part of a single, integrated application process. All applicants appearing at the motor vehicle office must be given an application that includes both forms. If such an applicant does not wish to register to vote and so indicates by declining in writing to do so, such an applicant should not complete the voter registration portion of the application.

Subsection (d) provides that any change of address form submitted in accordance with State law for purposes of a State motor vehicle driver's license shall serve as notification of a change of address for voter registration unless the registrant states on the form that the change of address is not for voter registration purposes. The requirements of residency pertaining to driver's licenses may vary from those pertaining to voting; therefore, this provision will permit a person to indicate that a change of address notification to the motor vehicle agency is not intended to effect a change in the address for voting purposes and should not be forwarded to the voting registrar.

#### SECTION 6. MAIL REGISTRATION

Subsection (a) requires that all States accept and use the mail voter registration form prescribed by the Federal Election Commission. In addition, States are permitted to develop and use their own mail registration form, provided it meets the requirements of this Act. Mail registration forms may also be used for voter registration change of address.

The Federal Election Commission, in consultation with the chief election officials of the States, is required pursuant to Section 9 to promulgate a mail registration application form. That form shall

include a statement that specifies each eligibility requirement for voting, contain an attestation that the applicant meets each such requirement, including citizenship, and require the signature of the applicant, under penalty of perjury. Where appropriate, the application form should include information requesting the applicant's mail address if it differs from the applicant's residence. The form may not include any requirement for notarization or other formal authentication, such as witnessing. If a State chooses to develop and use its own form, that form must comply with the same criteria that applies to the Federal form promulgated by the Federal Election Commission.

The requirements that States use a uniform mail registration application form serves to augment the extensive outreach features of the "motor-voter" and agency-based registration procedures. Uniform mail forms will permit voter registration drives through a regional or national mailing, or for more than one State at a central location, such as a city where persons from a number of neighboring States work, shop or attend events. By permitting States to develop and use their own forms as well, the bill provides flexibility for the States. In those States that develop their own mail voter registration application, an applicant may use, and the State must accept, either the national form developed by the FEC or the State's own form.

Subsection (b) requires the chief State election official to make the mail registration forms available for distribution through governmental and private entities, with a particular emphasis on making such forms available to organized voter registration programs. Broad dissemination of mail application forms, when coupled with the other procedures of this bill, should reach most persons eligible to register to vote, and is, therefore, a key element of the voter outreach feature of the bill. Such forms may also be disseminated to agencies designated under the agency-based registration procedures for use by those agencies in their registration programs.

States that use mail registration application procedures generally employ a number of means to prevent fraud, such as including on the form a statement of voter qualification requirements or penalties for fraud, or a follow-up mailing. The form to be developed by the FEC is to include a statement setting forth the requirements to vote (including age and citizenship) and an attestation to be signed by the applicant under penalty of perjury. Mail registration forms developed by the State should contain the same statement and attestation.

The bill requires notice to each applicant of the disposition of his or her application. This requirement could be met by a follow-up mailing by any State that wishes to employ that procedure as a means of protecting against possible fraud in the mail registration process. With regard to this notice requirement, States should be aware that such a notice should be drafted with regard to the purge provisions of this bill.

The Committee believes that these provisions are sufficient to deter fraudulent registrations. Nevertheless, the bill includes an additional provision relating to first time voters which has been added to address the concerns that this process may be subject to

misuse. Subsection (c) provides that a State may require by law that a person who registers to vote by mail and has not previously voted in that jurisdiction, vote in person. This requirement would not be applicable to any person who is entitled to vote by absentee ballot under the Uniformed and Overseas Citizens Absentee Voting Act, or who is provided the right to vote otherwise than in person by the Voting Accessibility for the Elderly and Handicapped Act, or who is entitled to vote otherwise than in person by any other Federal law. States are permitted to employ any other fraud protection procedures which are not inconsistent with this bill.

#### SECTION 7. VOTER REGISTRATION AGENCIES

Subsection (a) requires that each State establish an agency-based registration program by designating various public private agencies or offices for the registration of voters for Federal elections. The Act requires that certain agencies must be included in such a program. Thus, each State must designate all public offices in the State of those agencies that provide public assistance, unemployment compensation, or related services and all agencies and offices in the State that provide State-funded programs primarily engaged in providing services to persons with disabilities. In addition the State must designate additional Federal, State or local governmental agencies as well as private sector offices as registration agencies, but each State is given discretion as which agencies and what offices of those agencies to include. The Act provides that such discretionary agency programs may include public libraries, public schools, offices of city and county clerks (including marriage license bureaus), fishing and hunting license bureaus, government revenue offices, and any agency or office that provides services to persons with disabilities that is not included in the mandatory agency-based voter registration program. Federal, State and private sector offices could also be included in this program.

A voter registration agency that provides service or assistance in addition to conducting voter registration shall distribute simultaneously with each application for service or assistance, and with each recertification, renewal, or change of address, a mail voter registration application form promulgated by the Federal Election Commission as provided for in the Act or its own form, if the agency has devised its own form in compliance with the requirements of this Act. The offices should to the greatest extent practicable, incorporate in application forms and other forms used for purposes other than voter registration, a means by which an applicant may decline in writing to register to vote. With this "incorporation to the greatest extent practicable in the agency's own forms," the bill attempts to provide flexibility to the agencies to develop a program that best fits the type of program. For example, in the case of a program such as unemployment compensation, where eligibility must be recertified on a frequent (i.e., weekly or biweekly) basis, the Committee intends that the agency be required to provide voter registration materials and assistance at the time of initial application, upon any change in the address or eligibility status of the applicant, and upon any extension in the eligibility for benefits. If an applicant does not decline to register, the office is

to provide the same type and degree of assistance in completing the registration application as it usually provides its applicants with regard to the completion of the offices own forms. Costs for registration application assistance for these offices should be considered matchable under the current Federal match rate for these programs.

A person who provides these voter registration services at an agency voter registration office shall not influence an applicant's political preference or party registration, display any political preference or party affiliation, or make any segment to an applicant the purpose or effect of which is to discourage the applicant from registering to vote.

While concerns have been raised that applicants will be coerced to affiliate with a particular political party or that the receipt of benefits is contingent upon the act of registering to vote, the Committee believes that these provisions, together with the criminal penalties provisions of the bill, are sufficient to deter any such activities. Moreover, no evidence has been presented that such abuses have occurred in a State which has implemented an agency-based registration program.

The mandatory portion of the agency-based registration program, which includes offices providing public assistance, unemployment compensation or related services and services primarily to persons with disabilities, is intended to supplement the motor-voter provisions of the bill by reaching out to those citizens who are likely not to benefit from the State motor-voter registration program. These agencies are included in the mandatory agency registration program because they are considered most likely to serve persons of voting age who may not have drivers licenses and therefore are not served by the motor-voter provisions. This mandatory portion provides a necessary balance to the motor-voter program, without unduly burdening State resources.

The second portion of a State's agency-based registration program includes other agencies and offices which the State may designate to extend its outreach to as many citizens of voting age as possible. While the States are required to have a discretionary agency registration program in addition to the mandatory one, the State is given latitude to determine which agencies, as well as which of their offices, should be included.

Each agency voter registration office is required to provide the following services: distribution of mail voter registration application forms (or the agency's own form), assistance to applicants in completing voter registration application forms, acceptance of completed voter registration application forms for transmittal to the appropriate State election official. The term "appropriate State election official" shall be interpreted in accordance with State law or practice and is intended to mean that official who is authorized under State law to register voters in the jurisdiction where the registrant resides.

Previous versions of this legislation included in the mandatory agency registration program offices that provide vocational rehabilitation services in an attempt to assure that persons with disabilities would be reached by some part of the State's registration programs. Representatives of programs that serve persons with dis-

abilities made it clear that vocational rehabilitation offices would not have extensive contact with such persons and that a broader designation of offices would be necessary if a State's agency program was to include a sufficient number of persons with disabilities. The Act now includes a definition that is intended to have more extensive out-reach to persons with disabilities. While it would include vocational rehabilitation offices, it would also extend to many other agencies that have more contact on a regular basis with persons with disabilities, such as, but not limited to, those agencies which provide transportation, job training, education counseling, rehabilitation or independent living services.

The Committee also recognizes that many persons with disabilities are less likely to visit offices in order to obtain services or benefits. As a result, the bill requires that if a voter registration agency designated by the State provides services to a person with a disability at the person's home, the agency shall provide the voter registration services at the person's home, as well. The Committee notes that the provisions referring to persons with disabilities are not intended to reach any person otherwise ineligible to register, such as by reason of a current judicial determination of mental incapacity to vote.

Since the requirements for services or assistance at agency offices may differ significantly from those for voting registration purposes, the Committee would expect that any applicant for services or assistance from such an agency who does not meet the requirements for eligibility to register to vote would decline to do so. It is important, therefore, that each applicant be advised of the voting requirements and the need to decline to register if he or she does not meet the requirements. The bill provides that all registration requirements should be set forth in the application to register to vote so that they will be readily available for each applicant to review during the application process. These requirements must include a statement of citizenship, an attestation that the applicant meets each such requirement, and the signature of the applicant under penalty of perjury. The applicant should be advised that there is no obligation to specify the particular reason for choosing to decline to register.

Since some of the reasons for declining to register to vote may involve matters of personal privacy, such as ineligibility under State law due to mental incompetence or a criminal conviction, an individual who declines to register to vote shall not be questioned as to the reasons for such action. If an individual reveals such information, it must be treated as confidential and may not be used for any purpose other than voter registration. As discussed later, the Act contains a general prohibition against a State or other entity, including an agency designated under this provision, from revealing any information relating to a declination to register or to the identification of the agency where a person registered.

Subsection (b) requires all entities of the Federal government to cooperate as much as possible with the States in carrying out this program by participating as designated voter registration agencies. This participation requirement is subject to the Federal agency agreeing to participate pursuant to subsection (a). No specific Federal agencies are designated in this bill to participate, it being left

to the States to negotiate such arrangements with the appropriate Federal agencies. It is the Committee's intention that any agency or organization providing assistance under the terms of this Act would negotiate a mutually satisfactory arrangement, which could include, where appropriate or required, reimbursement for services provided.

Subsection (c) requires that a completed registration application shall be transmitted to the appropriate State election official no later than 10 days after the date of acceptance. If a registration application is accepted within 5 days before the last day for registration to vote in an election, the application must be transmitted to the appropriate State election official no later than 5 days after the date of acceptance. An applicant may, if he or she chooses, mail the voter registration application directly to the appropriate State election official rather than returning it to the agency for transmittal. The agency providing voter registration services is prohibited from requiring a registrant to mail the form, and must accept it and forward it to the appropriate registration official if turned in by the applicant. Thus, the agency has an affirmative obligation to actively collect completed registration applications.

**SECTION 8. REQUIREMENTS WITH RESPECT TO ADMINISTRATION OF  
VOTER REGISTRATION**

Subsection (a) provides that any person registered to vote not later than 30 days, or a lesser period as provided by State law, before a Federal election shall be permitted to vote. For these purposes, registration is complete upon submitting the form to the voting registrar, motor vehicle office, designated agency or office, or on date of postmark, if mailed. While the Act is clear with regard to the motor-voter and agency-based registration deadline requirement, the mail situation may be in need of some clarification. The reference, "or a lesser period as provided by State law" means, with regard to a mailed registration application, that the shorter State period would apply only if it is referenced to "date of postmark". If the shorter period provided by State law refers to the date of receipt in the registrar's office, the thirty day period provided for here would apply. It is not intended here to penalize a registration applicant; thus, if the application is postmarked after thirty days, but is received before the deadline specified by State law, it should be accepted. Also, one postmarked before thirty days but received after the deadline under State law, should also be accepted as timely.

Each State election official is required to give notice to each applicant regarding the disposition of his or her voter registration application. The means of notifying each applicant is not specified, so that each State may continue to use whatever means is required or permitted by State law or regulation. States should be aware that such notices should be drafted with regard to the purge provisions of the bill. States may adopt whichever procedure they deem best suited to provide notice to the applicant and to provide the registrar with verification of the accuracy of the information provided by the applicant. The Committee recognizes that such notices are sent by most States as a means of detecting the possibility of fraud

in voting registration and intends to give each State discretion to adopt a means of notification best suited to accomplish that purpose as well as providing a means for notifying an applicant, who has not had direct contact with the voter registrar's office, of the appropriate voting place for his or her residence. The Committee believes that accurate and current voter registration lists are essential to the integrity of the election process and for the protection of the individual.

This section also provides that the name of a registered voter may not be removed from the official list of eligible voters except: at the request of the registrant; as provided by State law, by reason of criminal conviction or mental incapacity; or, in accordance with the requirements of the Act, by reason of the death or a change in the residence of the registrant. Recognizing the essential need to maintain the integrity of the voter registration lists, the bill requires that States conduct a general program that makes a reasonable effort to remove the names of ineligible voters from the official lists of eligible voters by reason of death or by a change of residence.

A "request" by a registrant would include actions that result in the registrant being registered at a new address, such as registering in another jurisdiction or providing a change-of-address notice through the drivers license process that updates the voter registration.

States are required to inform applicants of voter eligibility requirements, the penalties provided by law for the submission of a false voter registration application, and ensure that the identity of the voter registration agency through which any particular voter is registered is not publicly disclosed.

Subsection (b) sets forth the standards for the confirmation of voter registration. Any State program or activity to protect the integrity of the electoral process by ensuring the maintenance of an accurate and current registration roll for Federal elections shall be (1) uniform, nondiscriminatory, and in compliance with the Voting Rights Act of 1965; and (2) shall not result in the removal of the name of any person from the official list because of a failure to vote.

The purpose of this requirement is to prohibit selective or discriminatory purge programs. This requirement may not be avoided by a registrar conducting a purge program or activity based on lists provided by other parties where such lists were compiled as the result of a selective, non-uniform, or discriminatory program or activity. The term "non-discriminatory" is intended to mean that the procedure complies with the requirements of the Voting Right Act of 1965.

The term "uniform" is intended to mean that any purge program or activity must be applied to an entire jurisdiction.

It is the intent of this section to impose the uniform, nondiscriminatory and conforming with the Voting Rights Act standards on any activity that is used to start, or has the effect of starting, a purge of the voter rolls, without regard to how it is described or to whether it also may have some other purpose. For example, the mailing of sample ballots is clearly a program that has another purpose but might provide the basis for a purge of voter rolls. It it

is to be used for that purpose and the registrar uses it to serve as his or her reason to send notices under subsection (d), that sample ballot mailing program must meet the standards of this section.

The Committee is mindful of the need to keep accurate and current voter rolls. The Committee is concerned that such programs can be abused and may result in the elimination of names of voters from the rolls solely due to their failure to respond to a mailing. Abuses may be found in the design of a program as well as in its implementation. In order to provide some guidance to the States, subsection (c) provides that a State may meet the requirements of conducting a general and comprehensive program that makes a reasonable effort to keep voting lists clean by establishing a program which uses the National Change of Address ("NCOA") program of the U.S. Postal Service. Use of the NCOA program by a State or any of its registration jurisdictions could be deemed to be in compliance with the requirements that the program be uniform, nondiscriminatory and in compliance with the Voting Rights Act of 1965.

By using the NCOA, a State may use change of address information to identify registrants whose addresses may have changed. If it appears from the information provided that a registrant has moved to a different address within the jurisdiction of the same voting registrar, the registrar is required to make the address change automatically and send the registrant a notice by forwardable mail and a postage prepaid pre-addressed return form by which the registrant may verify or correct the address information. If the registrant appears to have moved to an address outside of the jurisdiction of the registrar, the registrar may not remove the name of the voter until the registrar has sent a notice to the registrant as provided in subsection (d).

The section requires that a State complete any program the purpose of which is to systematically remove the names of ineligible voters from the official lists of eligible voters at least 90 days before a primary or general election for Federal office. This requirement applies to the State outreach activity such as a mailing or a door to door canvas and requires that such activity be completed by the 90-day deadline. This section does not prohibit a State during that 90-day pre-election day period from removing names from the official list of eligible voters on the basis of the request of the registrant, as provided by State law for criminal conviction or mental incapacity, death, or any other correction of registration records pursuant to the Act.

Subsection (d) prohibits a State from removing the name of a registered voter by reason of a change in residence, unless the registered voter confirms in writing that he or she has changed residence outside the jurisdiction in which registered; or has failed to respond to a notice sent by the State and has not voted or appeared to vote within two general elections for Federal office since the date of the notice.

If a State determines that a registrant may have changed residence, the State may send by forwardable mail a postage prepaid return card on which the registrant may state his or her current address, together with a notice which states that: if the registrant has not changed residence or has changed residence within the

same jurisdiction, the registrant should return the card before the time for closing registrations for the next Federal election, *i.e.* 30 days before an election, or such lesser period as may be provided by State law. If the card is not returned, affirmation or confirmation of the registrant's address may be required before the registrant would be permitted to vote in a Federal election during the period beginning on the date of the notice and ending on the day after the second general Federal election that occurs after the date of the notice. If the registrant has not voted in an election during that period, the registrant's name will be removed from the list. If the registrant has moved to a residence outside the jurisdiction, the notice on the mailing must include information concerning how the registrant may continue to be eligible to vote.

Within the official list of eligible voters, notations (such as an asterisk or "I" for inactive status) may be made of those eligible voters who have failed to respond to a notice under Section 8(d)(2). The requirement that names with notations be maintained on the official list of eligible voters permits the State to decline to use these names in performing the type of routine, administrative responsibilities that do not impair the right of such voters to vote as set forth in the Act and as protected by the Voting Rights Act. For example, those who have failed to respond to a Section 8(d)(2) notice need not be included for administrative purposes in determining the number of signatures that may be required under State law for ballot access, the number of precincts that may be needed to service voters, or the number of ballots or voting machines that may be required in the administration of the voting process.

The term "registrar's jurisdiction", as used in connection with the NCOA program and with regard to the "affirmation" or "confirmation" requirements, is a term of art for the purpose of this Act and is not intended to dictate to the States their actual administrative structure for the purpose of registering voters. The Committee intends that a "registrar's jurisdiction" for the purposes of the Act be no smaller than a county, parish, city or town. This conforms to current practice. A State would be free, for example, to divide a very large county or city into 2 or more administrative units for registering voters as long as the county continued to be treated as the "registrar's jurisdiction" for those purposes of the Act hereinafter specified. First, that provision pertaining to a person who returns the postcard described in section 8(d) indicating that the registrant has moved to another residence within the jurisdiction of the same voter registrar must have his or her registration corrected to reflect the new address. Second, the provision that requires that a person who has not sent in the card is entitled to vote after affirming or confirming that his or her new residence is within the same congressional district and the same registrar's jurisdiction as that of his or her former residence. And third, the provision that use of the national change of address program could be considered to be in compliance with the requirements of the Act that pertain to list maintenance programs could protect the State if used State-wide or a registrar if used within the registrar's jurisdiction. As long as these protections are maintained a State would be free to alter its administrative structure and jurisdiction for the purpose of registering voters for Federal elections.

Subsection (e) establishes the procedures for voting in a Federal election where the registrant fails to return the card in accordance with the procedures outlined in subsection (d). If a registrant has moved from one residence to another within the jurisdiction of the same polling place, the person shall be permitted to vote at that polling place upon oral or written affirmation of the registrant's change of address, before an election official at the polling place. If a registrant has moved from a residence in one polling place to a residence in another polling place within the jurisdiction of the same voting registrar and the same congressional district, the registrant is provided three options. The registrant shall: (1) be permitted to correct the voting records and vote at the registrant's former polling place upon oral or written affirmation of the new address; or (2) be permitted to correct the voting records and vote at a central location within the same registrar's jurisdiction where a list of eligible voters is maintained upon written affirmation of the new address; or (3) be permitted to correct the voting records for purposes of voting in future elections at the appropriate polling place for the current address, and, if permitted by State law, shall be permitted to vote in the present election, upon confirmation of the new address by such means as are required by State law. If State law permits the registrant to vote in the current election upon oral or written affirmation of the new address at the appropriate polling place for the new address, voting at the old polling place and the central location do not have to be provided as alternative options.

If the registration records incorrectly indicate that a registrant has changed his or her residence, the registrant shall be permitted to vote upon oral or written affirmation that the registrant continues to reside at the same address.

This section of the bill attempts to incorporate an underlying purpose of the Act; that once registered, a voter should remain on the list of voters so long as the individual remains eligible to vote in that jurisdiction. This section ensures that if a registered voter moves within the jurisdiction of the same registrar, he or she should be permitted to vote. However, while this section sets out where an individual may vote, it is silent as to how that individual may be permitted to vote. Under certain circumstances it would be appropriate, and in compliance with the requirements of this Act, to require that such a person vote by some form of challenge ballot. It is not the intent of this provision to pre-empt any State requirement that a person whose eligibility to vote is challenged may be required to vote by a special ballot that is subject to post election rejection, where the challenge is sustained.

Subsection (f) provides that in the case of change of residence within the jurisdiction, the registrar shall correct the voting registration list accordingly, and the registrant's name may not be removed from the official list of eligible voters, nor may a registrant be required to re-register as a result of such a change of residence. The obligation of the registrar to change the rolls to reflect the new residence is triggered by notice to the registrar of such change, not the date of such change. The intent of this requirement is that it is the responsibility of a registrar, upon notification of a change of residence by a voter to another residence within the registrar's

jurisdiction, to make the necessary correction of the records. A registrar may not impose requirements, such as re-registration, upon such a voter. Although such notice of change of address might be made by the voter through the use of the motor-voter or agency-based registration process, the registrar's responsibility to make the correction is not dependent on the voter giving such notice; such notice may come through the Postal Service change of address program or other means conducted in conformance with the requirements of the Act, subject to verification by the voter.

Some State election officials expressed concern to the Committee that they had experienced difficulty in obtaining information regarding convictions for Federal offenses from the Federal courts which is needed to remove the names of persons convicted of certain offenses from the voter rolls under State law. Subsection (g) requires a United States Attorney to inform the appropriate State election official of the felony conviction of any person. Such notice must give the name, age, and address of the offender; the entry date of judgment; a description of the offenses on which the person was convicted; and the sentence imposed. Additional information may be provided at the request of the election official if necessary to determine whether a conviction affects the person's eligibility to vote. If such a conviction is overturned, the United States Attorney shall give notice to the appropriate election official.

Subsection (h) provides lower postal rates to a State or local voting registration official for any mailing which is certified to be required or authorized by the Act. This lower postal rate is the rate for any class of mail which is made available to a qualified non-profit organization.

Subsection (i) provides that each State shall maintain for two years all records concerning the implementation of programs and activities conducted for the purpose of ensuring the accuracy and currency of addresses on the official list of eligible voters. The records must be made available for public inspection and, where available, photocopying at reasonable costs. The records shall include lists of names and addresses of all persons to whom notices were sent and information concerning whether or not each person has responded to the notice as of the date of inspection.

Provisions of this Act pertaining to voter registration programs require that information regarding a person's declination to register not be used for any purpose other than registration. There was also concern that information not be made public as to what voters registered at a particularly agency, such as a welfare or unemployment office. Therefore, these records may not contain any information relating to a declination to register or the identity of a voter registration agency through which any particular voter is registered, or a list of those persons registered through a particular agency.

#### SECTION 9. FEDERAL COORDINATION AND REGULATIONS

Subsection (a) provides that the Federal Election Commission shall prescribe appropriate regulations necessary to carry out this Act, consult with chief election officers of the States to develop a mail voter registration application form for Federal elections, and



submit by June 30 of each odd-numbered year, a report to the Congress assessing the impact of the Act on the administration of elections for Federal office and recommendations for improvements in Federal and State procedures, forms, and other matters, and provide information to the States with respect to the responsibilities of the States under this Act.

It is the Committee's intent that the Commission should carefully determine which regulations are necessary and appropriate. In addition, nothing in the Act prohibits the Federal Election Commission from fathering the appropriate statistics necessary to meet its reporting requirements under the Act.

Subsection (b) sets forth the requirements of the mail registration form to be developed by the FEC. This form may only require such identifying information (including the signature of the applicant) and other information (including data relating to previous registrations) as is necessary to enable the appropriate State election official to assess the applicant's eligibility. The form must also include a statement that specifies each eligibility requirement (including citizenship); contain an attestation that the applicant meets such requirements, and require the signature of the applicant under penalty of perjury. This form may not include any requirement for notarization or other formal authentication, *i.e.*, a witness requirement.

#### SECTION 10. DESIGNATION OF CHIEF STATE ELECTION OFFICIAL

Each State shall designate a State officer or employee as the chief State election official to be responsible for the coordination of State responsibilities under this Act. Various provisions of this Act assign to this official certain responsibilities regarding the promulgation of regulations, the design of the Federal mail registration form, the receipt of notice of civil suits, and the distribution of mail registration forms.

#### SECTION 11. CIVIL ENFORCEMENT AND PRIVATE RIGHT OF ACTION

Subsection (a) provides that the Attorney General may bring a civil action for declaratory or injunctive relief as is necessary to carry out this Act.

Subsection (b) provides a private right of action to any person who is aggrieved by a violation of this Act by providing written notice of the violation to the chief State election official. If the violation is not corrected within 90 days after receipt of the notice, or within 20 days if the violation occurs within 120 days before the date of an election for Federal office, the aggrieved individual may bring a civil action in Federal court for declaratory or injunctive relief. If the violation occurred within 30 days before the date of an election for Federal office, the aggrieved individual may proceed to file a civil suit without notice to the chief State election official.

Section (c) permits a prevailing party (other than the United States) in a civil action to seek reasonable attorney fees, including litigation costs and expenses.

It should be noted that this section does not authorize the award of monetary damages. Rather, the civil remedies that are authorized are corrective action in the form of declaratory and injunctive

relief, plus reasonable attorney fees. The Committee does not believe that reasonable attorney fees will result in excessive awards in civil actions brought under this Act.

Subsection (d) provides that the right and remedies established by this Act are in addition to all other rights and remedies established by this section nor any other provision of this Act shall supersede, restrict, or limit the application of the Voting Rights Act of 1965. Nothing in this Act authorizes or requires conduct that is prohibited by the Voting Rights Act of 1965.

#### SECTION 12. CRIMINAL PENALTIES

This section would make a Federal offense, punishable by a fine and/or imprisonment for not more than 5 years, for any person, including an election official, who in any election for Federal office: (1) knowingly and willfully intimidates, threatens, or coerces, any person for registering to vote, or voting, or attempting to register or vote; urging or aiding any person to register to vote, to vote, or to attempt to register or vote; or exercising any right under this Act; or (2) knowingly and willfully deprives, defrauds, or attempts to deprive or defraud the residents of a State of a fair and impartially conducted election process by the procurement or submission of voter registrations that are known by the person to be materially false, fictitious, or fraudulent under the laws of the State in which the election is held; or the procurement, casting, or tabulation of ballots that are materially false, fictitious, or fraudulent under the laws of the State in which the election is held.

Concern has been expressed that these criminal provisions may be used to impede lawful political activities, such as distributing campaign literature, poll watching, and registration drives. Careful attention has been given to these concerns and this section has been specifically written to refer to acts which are "knowing and willful" and does not refer to inadvertent omissions or inaccuracies on voter registration forms or absentee ballots.

The second addresses the Federal criminal code only, and would not limit or restrict the availability of criminal penalties under State law.

#### SECTION 13. EFFECTIVE DATE

That Act will take effect on January 1, 1995. While this Act applies only to Federal elections and States are free to apply other regulations to State elections, many States will prefer to have the same requirements for both Federal and State elections. To accommodate those States that have constitutional obstacles to conforming State requirements to the Act, the effective date for such States will be January 1, 1996.

#### COST ESTIMATE

In compliance with paragraph 11(a) of rule XXVI of the Standing Rules of the Senate, the estimate of costs of this measure prepared by the Congressional Budget Office pursuant to section 403 of the Congressional Budget Act, is as follows:

U.S. CONGRESS,  
CONGRESSIONAL BUDGET OFFICE,  
Washington, DC, February 25, 1993.

Hon. WENDELL H. FORD,  
Chairman, Committee on Rules and Administration,  
U.S. Senate, Washington, DC.

DEAR MR. CHAIRMAN: The Congressional Budget Office has prepared the attached cost estimate for the National Voter Registration Act of 1993. Because enactment of the legislation could affect revenues, pay-as-you-go procedures would apply to the bill.

If you wish further details on this estimate, we will be pleased to provide them.

Sincerely,

ROBERT D. REISCHAUER,  
Director.

CONGRESSIONAL BUDGET OFFICE COST ESTIMATE

1. Bill number: Not yet assigned.
2. Bill title: National Voter Registration Act of 1993.
3. Bill status: As ordered reported by the Senate Committee on Rules and Administration on February 18, 1993.
4. Bill purpose: The bill would create a national system of voter registration procedures for elections for federal office. Responsibility for implementing the system would fall largely to the states, with the federal government responsible for enforcement, as well as some financial and technical assistance.

REQUIREMENTS FOR STATES

Under the national system of voter registration, most states (except those with election day registration and those with no registration requirement at all) would be required to provide the following methods of registration:

**Motor/voter.**—When someone applies for a driver's license (new, renewal, or change of address) at the state motor vehicle authority, the application procedure would have to include the opportunity to register to vote. An individual would have to decline in writing on an application form to avoid registering by this means, or would have to sign an attestation, under penalty of perjury, that the individual is eligible to register to vote.

**Mail registration.**—Each state would make available through various sources a form, prescribed by the Federal Election Commission (FEC), that applicants could complete and mail to the election official to register for federal elections.

**Agency registration.**—Each state would have to designate some state and federal offices as well as private sector locations (such as public libraries, unemployment offices, banks, fishing and hunting license bureaus, or post offices) to distribute and collect applications for voter registration. Such locations would then forward the applications to the appropriate election official.

Currently, the federal government has little involvement with voter registration. Each state has its own laws governing registration, and in practice, registration practices vary widely even among

local election jurisdictions within a state. The bill would mandate that states provide the specific registration methods consistently in all jurisdictions.

In addition, the bill would mandate that any state programs used to update voter registration lists shall be uniform and nondiscriminatory and may not remove someone from the list for not voting. The bill would permit a state, if it determines a voter has moved, to remove the voter from the list only after sending a forwardable notice with a return card that would allow the voter to confirm the correct address.

Finally, each state would have to designate a chief state official responsible for implementing the state's functions under the bill.

REQUIREMENTS FOR THE FEDERAL GOVERNMENT

The legislation would require the U.S. Postal Service to provide election officials with a postal rate subsidy for any mailings that it requires the officials to conduct, such as the registration confirmation notice and the registration update notice. The bill authorizes the appropriation of funds sufficient to reimburse the Postal Service for its losses in providing the subsidy. If the Congress does not appropriate the necessary amounts, then the Postal Service would no longer offer the subsidy.

The bill would require the FEC to provide information to the states regarding their responsibilities and to report to the Congress once every two years on the impact of the registration procedures required by the bill. The FEC also would have to develop a uniform application form to be used by states for mail registration.

In addition, the bill would authorize the Attorney General to bring civil actions in court to enforce its provisions. Individuals also would be allowed to ask the court for relief from any violations of the bill's provisions.

Finally, the bill would establish criminal penalties for persons who, in any election for federal office, interfere or seek to interfere with voting or voter registration, falsify voter registration applications, or knowingly cast or tabulate false or fraudulent ballots.

5. Estimated cost to the Federal Government:

[By fiscal year, in millions of dollars]

	1994	1995	1996	1997	1998
Spending requiring appropriation action					
Payment to the Postal Service for revenue forgone:					
Estimated authorization level .....		3.4	4.5	4.5	4.5
Estimated outlays .....		3.4	4.5	4.5	4.5
Federal Election Commission:					
Estimated authorization level .....	0.2	0.2	0.2	0.2	0.2
Estimated outlays .....	0.2	0.2	0.2	0.2	0.2
Bill total:					
Estimated authorization level .....	0.2	3.6	4.7	4.7	4.7
Estimated outlays .....	0.2	3.6	4.7	4.7	4.7
Revenues					
Estimated receipts from fines .....		( <sup>1</sup> )	( <sup>1</sup> )	( <sup>1</sup> )	( <sup>1</sup> )

(<sup>1</sup>) CBO cannot estimate these amounts.

The costs of this bill fall within budget functions 370 and 800.

Basis of estimate: The subsidized postal rates would be used primarily to update voter registration files and to confirm the receipt of voter registration applications. Based on the total number of change-of-address actions filed with the Postal Service, CBO expects that the postal subsidy would amount to no more than \$3 million annually—probably in the vicinity of \$2 million—to cover a portion of the cost of mailing registration update notices. In addition, CBO estimates that officials would mail about 25 million voter confirmation notices, based on election officials' reports that the number of registration applications typically amounts to 20 percent of the total number of registered voters in the jurisdiction. (There are about 130 million registered voters nationwide.) Assuming an average subsidy of 7.3 cents per piece of mail, subsidizing the mailing of these confirmation notices would cost about \$2 million annually at current rates. The postal subsidy would first be available in January 1995, a year in which CBO assumes that an increase in postal rates will occur. Assuming rates will rise about 15 percent, CBO estimates that the total postal subsidy would be about \$4.5 million annually. The subsidy for fiscal year 1995 would be less because the subsidized rates would become available three months into the fiscal year.

Based on information from the FEC, CBO estimates that the additional staff and associated expenses necessary to develop a mail registration form and to provide assistance to the states would cost approximately \$200,000 annually, beginning in 1994. The requirements imposed on states and localities would become effective beginning January 1, 1995, unless provisions in a state's constitution conflict with implementing the bill. In such cases, a state would not have to comply with the bill until January 1, 1996.

The imposition of criminal penalties could cause an increase in governmental receipts from penalty collections, but CBO cannot estimate the amount of such an increase. Such fines would be deposited into the general fund of the Treasury.

6. Pay-as-you-go considerations: The Budget Enforcement Act of 1990 sets up pay-as-you-go procedures for legislation affecting direct spending or receipts through 1995. Enactment of the bill could result in greater receipts from penalty collections, but CBO cannot estimate the amount of any such increase.

7. Estimated cost to State and local governments: The bill would require most states to provide three types of voter registration for federal elections beginning in 1995: motor/voter, mail-in, and agency registration. The bill also would mandate that states use a uniform and nondiscriminatory program for maintaining accurate lists of eligible voters.

Consistent with CBO's usual procedures for estimating the cost effects of legislation, this estimate compares the cost to states of complying with the bill's provisions to the cost of their current practices under existing law. Few state and local governments currently employ all the methods required by the bill for registering and maintaining voters on the rolls. In addition, without the bill, states and localities are unlikely to replace their existing practices with those outlined in the legislation. Therefore, the costs states

would incur in changing their registration procedures would be directly attributable to enactment of the bill.

#### SUMMARY OF COSTS

*Direct costs.*—If the bill is enacted, state and local governments would have to pay for the cost of complying with the bill's registration provisions. For the additional staff, postage, and printing expenses associated with the expected increase in registrations, especially through motor/voter, CBO estimates that it would cost states and localities an average of about \$20 million a year for the first five years of the program. Added costs would be somewhat lower than the average in federal election years, and above the average in other years, since the procedures required by the bill would have the effect of smoothing the current election-year peaks in registration costs. Some of these expenses would begin in 1994, the year before the bill's provisions take effect, as the states prepare to offer the new registration methods.

Although the bill would not directly require it, some states may decide to acquire, expand, or upgrade computer systems to facilitate implementation of the bill. To the extent that state and local governments make such changes in computer technology, their costs could increase further. For example, we estimate that one-time costs to computerize the registration lists of all the jurisdictions that currently do not have computers would amount to less than \$25 million. We cannot predict how many jurisdictions would do so, or how many that now have computers would choose to change their system.

Another provision that would require most states to make a change from current practices affects the polling place where a registrant may be permitted to vote. Under the bill, if a registrant has changed addresses within a jurisdiction without notifying the registrar, but the new and old addresses have different polling places, then the registrant would have the option of voting at the old or new polling place, or some other polling place that has a list of registered voters. Election officials have indicated that this requirement would be quite difficult to implement without a computerized registration list. Without such a capability, it might not be possible to fully meet this requirement, so the cost to election officials of this provision cannot be estimated at this time.

*Offsets to costs.*—Because the bill would authorize the Postal Service to provide a rate subsidy to election officials for mailings it requires, state and local governments would be able to shift some of the costs they incur now to the federal government. The bill would require officials to notify registrants as to the outcome of their application and to contact those whom the officials plan to drop from the rolls because of a change in address. (Most officials already take both of these actions.) CBO estimates that the postal subsidy for these mailings would total about \$4 million annually. Thus, upon enactment of the bill, state and local election officials would save approximately \$4 million annually in postage costs.

*Other costs.*—To the extent that the legislation is successful in increasing the number of registered voters in all jurisdictions, state and local governments likely would face other costs that are not di-

rectly associated with implementing the bill's provisions. For example, if more people are registered, then presumably voter turnout during elections would increase. Because election officials try to maintain a certain ratio of voters per polling place, officials might have to add new polling places, voting machines, and poll workers. However, these officials would take similar steps because of growth or migration patterns, and it would be difficult to separate the bill's effect on increased turnout from other contributing factors.

Certain states with specialized election laws would encounter some secondary effects of the bill. California law, for example, requires state and local officials to mail all voters on the registration list a sample ballot and an explanation of all ballot initiative issues before each election. If enactment of the bill results in more people registered, then the cost of such special mailings will be greater. On the other hand, the bill's provisions that encourage improved list-cleaning would result in more accurate voter registration lists, and election officials would save money by not having to mail voting materials to or prepare polling places for people who no longer would be on the lists. We have not estimated the total costs or savings from such effects in the various states, which would depend in part on how successful this legislation would be in accomplishing its goals. California, which has some of the most extensive requirements relating to communications with registered voters, has estimated that it costs between \$4 and \$5 per registered voter to print ballots, print labels, mail sample ballots, and provide polling places. Most other states have lower costs, because they do not have all these requirements mandated by law.

Because the legislation would allow individuals to sue for relief from violation of the bill's provisions, state and local governments and officials are potentially liable to pay fines and court and attorney fees if they lose a lawsuit. Such costs would not result directly from the bill, but rather from court cases that CBO cannot predict.

#### CURRENT LAW

Under current law, each state sets its own rules or guidelines for registering to vote in federal elections, and many states allow a wide range in practice among decentralized, local election jurisdictions (usually counties or cities and towns). About thirty states already have mail-in registration and about one-half of the states have some form of motor/voter registration. States and local jurisdictions pay the costs of registering voters, and the federal government does not currently assist them with these costs.

#### DATA COLLECTION

Because voting registration practices vary so widely, the incremental cost of implementing new procedures in the nation's 18,000 election jurisdictions is difficult to determine. In preparing this estimate, CBO assumed that local jurisdictions within a state generally follow registration guidelines set out by the state (even though there are some variations). We then compared the states' current guidelines with the requirements in the bill. (CBO relied on state-by-state summaries of registration practices prepared by various election information clearinghouses.)

In so doing, CBO surveyed the election officials in just over half of the states (as well as about two dozen counties of varying sizes). We collected cost information from some states that already provide one or more of the registration procedures mandated in the bill. In addition, some states provided CBO with the fiscal notes prepared for their state legislatures when they were considering one of these options. We also contacted about half of the 12 states that currently do not offer any of the bill's registration methods for their assessment of the bill's likely impact.

#### ASSUMPTIONS

Based on this information about the general registration practices in each state and the steps each state would have to take under the bill, CBO makes the following assumptions regarding implementation that could affect the costs to state and local governments:

In most states, motor/voter would become the primary method of registering voters. Because most people have a driver's license and are required to renew it periodically, a motor/voter system eventually would provide most people with a convenient opportunity to register, especially after a change of address.

Although completing a driver's license application at the state department of motor vehicles (DMV) would be the most common way people would apply for registration, local election officials would remain largely responsible for maintaining accurate voter lists.

The several states with constitutional provisions that would conflict with the bill such as requiring voters to sign an oath in person in front of a registrar, would change their laws to be consistent with the bill. Otherwise, those states would have to maintain separate registration rolls and conduct federal elections separately from other elections. This estimate does not include any cost for such separate elections.

#### COSTS OF REGISTRATION PROVISIONS

*Motor/voter: DMV costs.*—The bill would require states to include a voter registration application form as part of an application for a state driver's license. The bill language suggests that states use a consolidated form, but also allows them the flexibility of using two forms. CBO assumes that states could use two forms if they desire, because the committee's report language indicates the committee's intent to allow this option to states. Thus, states that already have a two-form motor/voter process would not have to change, and states that would have to decide how to set up a motor/voter process could have a choice.

Based on the experience of the states that already have motor/voter, it appears that the additional cost to states of implementing motor/voter registration would result mainly from hiring additional staff to handle the extra paperwork. For example, state DMVs would need more employees at high traffic locations to continue to process applicants in the same amount of time as they currently do. For the 25 states that do not now have some form of motor/

voter, the cost of such additional employees and related expenses would probably be about \$20 million annually during the first five years of implementation. Since most states require renewal of a driver's license every four years, costs would decrease in later years, because most people would have had an opportunity to register and only those who move would have to update their registration.

*Motor/voter: Election official costs.*—Once the DMV receives an application, it probably would forward a copy to the local election official to process the registration, as is current practice in the states that now have motor/voter. While CBO expects that officials in sparsely populated jurisdictions would be able to absorb small increases in the number of applications, others would face increased costs. In especially populous jurisdictions, election officials would have to hire more staff to handle the likely increase in applications and to check for duplicate registrations (although some states with motor/voter report these are less than they had originally anticipated). Counties we contacted report that the number of registration applications they handle annually amounts to about 20 percent of the number of registered voters in the county (there are about 130 million registered voters nationwide). Based on information from counties in states that currently have motor/voter, it appears that the workload could increase by 20 percent because of people registering who otherwise would not have registered, duplicate registrations, and ineligible applications.

Assuming the incremental cost for a county election office of handling an additional application is \$1.50, then local jurisdictions, in aggregate, would have to pay an additional \$5 million to \$10 million annually. Some of these costs would only be incurred during the first few years. Once most people are on the rolls and the number of unregistered voters decreases, use of the motor/voter system would decrease as voters would only register if they have moved.

Such costs, however, would be somewhat offset by a reduction in the cost of part-time employees hired to handle the increased workload around each registration deadline. Officials in some states with motor/voter, such as Colorado and Michigan, report that receiving forms from the DMV evenly over the year rather than in a last-minute pre-election rush has allowed them to reduce their part-time hires and use their full-time staff more efficiently. Based on information from several localities that hire part-time staff during election years, we expect local officials nationwide could save about \$10 million in a presidential election year and about \$7 million in non-presidential election years by reducing part-time hires. (There would be no savings in non-election years because no part-time help is necessary.)

The total costs that election officials would face would be offset further by the postal rate subsidy authorized by the bill. While the legislation requires election officials to notify applicants of the outcome of their registration application, it also would provide a discount of about 43 percent for notices mailed by third class. Because most states already mail such notices to applicants, the notification requirement would not result in additional costs, but the subsidy

would shift about \$2 million of postage costs currently incurred by election officials to the federal government.

*Motor/voter: Computer costs.*—Rather than forwarding an application from the DMV to a county registrar, a possible alternative, untested thus far, would be to transmit the voter information electronically. The cost of adding registrants to a jurisdiction's list would be lower if the voter data were transferred to computer by tape or other device rather than entered by hand. Some states have indicated that they would probably implement the motor/voter requirement by switching their record-keeping from paper to computers, and arranging for electronic transfer of data from the DMV system to the voter registration system. Some state officials have suggested that record-keeping would be improved if election officials used signature digitizers to store voters' signatures on computer, but this would cost extra. Although the bill would not mandate states to computerize, in some instances states or counties might decide computerization would be the best action, even though it would require a significant one-time investment in equipment.

CBO has no information on which to base an estimate of how many counties would computerize or how many more states would create a statewide registration system. (Currently, 21 states have one.) Based on data from Election Data Services, it appears that jurisdictions already use computers to maintain lists for at least 70 percent to 80 percent of the registered voters in the country. Aside from jurisdictions that might wish to change their existing computer systems, jurisdictions could potentially purchase new equipment to computerize the remaining one-fourth of the nation's voters.

We have examined the costs of existing registration and election systems and have determined that it costs less than one dollar per voter record for a computer system. Therefore, computerizing the registration lists for the 25 million to 35 million people in jurisdictions currently without computers would probably cost less than \$25 million.

*Mail in an agency registration.*—Because most voters (we assume 80 percent to 90 percent) eventually would register through the motor/voter system, mail-in and agency registration would serve as alternate means for those few remaining voters who do not have a driver's license. In those states that currently provide one or both of these methods, the number of registrations received from these sources would decrease over time as voters register instead through the DMV, and would, after the first few years, eventually generate from \$5 million to \$10 million in annual savings, which would partially offset increased costs of motor/voter. If all states that currently do not have mail-in registration were to implement it along with the other two methods it would cost them \$1 million to \$2 million annually because they would not use mail-in registration as much as states that currently have mail-in registration do.

Almost all states report that they have some form of agency or satellite registration, which in some states means a voter has to swear an oath in front of a deputy registrar at one of several county offices. The bill envisions a somewhat expanded type of agency registration in which forms are available at a variety of locations where voters can complete and submit them (or else take

them home and mail them in). Again, this would not be a major source of registering voters, and the costs are not expected to be significant in aggregate, although some additional training costs might be necessary to expand the pool of people able to assist voters in completing the forms. Only those states that currently have just a deputy registrar system would have to print extra forms to be available throughout the jurisdiction, but these costs probably would be offset by the reduced amount of work for the registrars and clerks who would not have to register as many voters in persons.

#### COSTS OF VOTER CONFIRMATION PROVISIONS

Because voters usually do not notify election officials of address changes, the names and addresses of outdated registrants often accumulate on the rolls. Election officials revise registration lists to clean out those who have moved, died, or are otherwise ineligible to vote in that jurisdiction. The bill would prescribe that whatever method a state uses to maintain accurate registration rolls, it should be uniform and nondiscriminatory. Further, the bill would prohibit states from removing registrants from the list simply for not voting.

*Current law.*—Almost all states now employ some procedure for updating lists at least once every two years, though practices may vary somewhat from county to county. About one-fifth of the states canvass all voters on the list. The rest of the states do not contact all voters, but instead target only those who did not vote in the most recent election (using not voting as an indication that an individual might have moved). Of these, only a handful of states simply drop the non-voters from the list without notice. These states could not continue this practice under the bill.

Whether states canvass all those on the list or just the non-voters, most send a notice to assess whether the person has moved. In a majority of states, election officials also provide voters with a way to update or prevent removal from the registration list.

*National change of address system.*—The bill suggests, but does not require, an approach election officials can use to make sure that their list cleaning method is uniform and nondiscriminatory. Instead of using non-voting as an indication that a voter has changed addresses, an election official could contact only those who have actually moved, and at their new addresses. But using the National Change of Address (NCOA) system of the U.S. Postal Service, election officials could directly identify those who have moved and would send those people a forwardable notice with a pre-addressed, postage paid card that outlines the registration options available and allows people to respond to the officials. While an elections jurisdiction would have to pay a vendor licensed by the Postal Service to do a computer match of the registration list and the NCOA list (costing from \$2 to \$8 per 1,000 addresses matched), these costs probably would be offset by reducing the postage and printing costs that officials currently pay for less-focused canvassing. Several pilot studies of this system in California and Oregon, sometimes called Project MAIL, report that counties would save money by significantly reducing the number of notices sent out.

*Postal rate subsidy.*—Whether election officials decide to use this NCOA approach or choose their current or other method for list cleaning (as long as it is uniform, nondiscriminatory, and does not drop for nonvoting), their postal costs associated with this process would decrease if the legislation is enacted. The bill authorizes a postal rate subsidy for mailings associated with the list cleaning requirement, thereby shifting costs from the states to the federal government. The ultimate amount of this shift would depend on the number of notices mailed. We have no data on the amount of mail election officials currently send out to update their lists. However, if most states adopt the NCOA approach, the number of changes of address, about 40 million annually, would represent the maximum possible number of matches between the registration rolls and the NCOA list. With an average third class subsidy of about 7.3 cents per piece of mail at current rates, the cost of this subsidy is unlikely to exceed \$3 million annually. In fact, it is likely to be less—probably in the vicinity of \$2 million—because not everyone on the NCOA list will be on a registration list, some changes of address are temporary only, and officials will update their lists through other methods such as motor/voter. When voters move within a state and get a new driver's license, they also would be updating their voting registration, thereby reducing the number of voters that officials will have to contact to determine whether they are recorded on the rolls accurately.

8. Estimate comparison: None.

9. Previous CBO estimate: On February 1, 1993, CBO prepared an estimate for H.R. 2, the National Voter Registration Act of 1993, as ordered reported by the Committee on House Administration on January 27, 1993. That estimate showed direct spending from the Crime Victims Fund because fines mandated by the bill would result in greater deposits into the fund. The estimate for this bill does not include any direct spending because income from fines would go into the general fund of the Treasury. The cost estimates for the two bills are otherwise identical.

10. Estimate prepared by: James Hearn, Mickey Buhl, and John Stell.

11. Estimate approved by: C.G. Nuckols, Assistant Director for Budget Analysis.

#### REGULATORY IMPACT

Pursuant to paragraph 11(b) of rule XXVI of the Standing Rules of the Senate, the Committee received the following information from the Federal Election Commission as to the regulatory impact of the bill, as reported by the Committee:

FEDERAL ELECTION COMMISSION,  
Washington, DC, February 25, 1993.

HON. WENDELL H. FORD,  
Chairman, Committee on Rules and Administration,  
U.S. Senate, Washington, DC.

DEAR MR. CHAIRMAN: This letter responds to your inquiry of February 22, 1993, regarding the probable impact of regulatory and reporting responsibilities assigned to the Federal Election Commis-

sion (FEC) under the terms of the National Voter Registration Act of 1993, as reported out of Committee.

At this time, we anticipate that the regulations will be limited to specifying the contents of the national mail voter registration form and the data to be collected and reported by State and local election authorities, pursuant to the reporting requirements set out in Section 9.

In response to the individual items you specified:

1. An estimate of the numbers and classes of individuals and groups who would be regulated.—The Commission estimates that its regulations and reporting requirements would, like other provisions of the bill itself, have a direct impact on approximately 8,000 State and local election officials throughout the nation who are responsible for conducting voter registration for federal elections. Tangentially affected would be the 189,000,000 persons of voting age in the United States who might come in contact with the registration process.

2. The economic impact of the regulations.—We foresee regulations pertaining only to the contents of the mail registration forms and State reporting required by the bill. The latter would have associated costs beyond that inherent in the bill itself. This is addressed under item 4 below.

3. The impact on the personal privacy of the individuals involved.—The Commission's regulations would have no impact on the personal privacy of the election officials themselves. However, certain items that might have to appear on the proposed national mail registration application form could be perceived by some members of the public as an invasion of personal privacy. Three such items are questions regarding Social Security number (required by 13 States, optional in 14 States), political party preference (required by the 26 States that conduct closed primaries) and race (required by some States in carrying out the purposes of the Voting Rights Act). These questions could be viewed as especially intrusive in States that do not require this information for voter registration purposes.

4. An estimate of the time, additional paperwork, and financial costs of recordkeeping requirements.—The Commission anticipates that minimum reporting requirements may necessitate the collection of the following data from State and local election authorities:

The number, method, source, and disposition of registration applications received;

The method, frequency, and consequences of confirming the voter registration lists;

The number and reasons for other deletions from the voter registration lists;

The number of persons of voting age and the percentage of those that are registered;

The number and types of the various mailings required under the bill; and

Costs of implementing the legislation, to include producing registration forms and other necessary materials, training, and maintaining records.

Although several jurisdictions, notably the large ones, routinely collect some or all of the data, a universal mandate to do so would

unquestionably placed some additional burden or many election offices. This burden would fall unevenly on local jurisdictions dependent on both the size of their populations and the extent of their computerization. We can estimate costs of such a reporting mechanism based on the model devised for the Voting Accessibility for the Elderly and Handicapped Act wherein local jurisdictions report to the State, States to the FEC, and the FEC to the Congress.

Our assumption is that such reporting would require one-half (0.5) a staff month (on average) per local jurisdiction and two staff months per State. At \$24,000 salary per person, the approximately 350 staff years would cost about \$8,400,000 per year, to be borne by State and local governments. This figure would likely decrease over time with increased computerization. Furthermore, such data would prove useful to the State and local offices as well as to political parties, the Postal Service, and the Department of Justice.

Should you or your staff require any further information regarding these or other related matters, please do not hesitate to contact me.

Sincerely,

SCOTT E. THOMAS, *Chairman.*

#### COMMITTEE ROLLCALL VOTE

In compliance with paragraph 7 (b) and (c) of rule XXVI of the Standing Rules of the Senate, the record of the rollcall vote in the Committee on Rules and Administration during its consideration of the original bill, to report it favorably, was:

Yeas—7

Mr. Pell  
Mr. Byrd  
Mr. Moynihan  
Mr. Dodd  
Mrs. Feinstein  
Mr. Mathews  
Mr. Ford

Nays—5

Mr. Stevens  
Mr. Helms  
Mr. Warner  
Mr. McConnell  
Mr. Cochran

Senator Stevens presented the proxy of Senator Hatfield in favor of the bill.

**MINORITY VIEWS OF SENATORS STEVENS, HELMS, WARNER, DOLE, MCCONNELL, AND COCHRAN ON THE NATIONAL VOTER REGISTRATION ACT OF 1993**

Since this issue was last debated before the full Senate, two significant developments have occurred: (1) in the 1992 general election, voter turnout increased 5 percent over 1988; and (2) the financial condition of the Federal and State governments has worsened.

The first point clearly indicates that the National Voter Registration Act is not necessary to increase voter turnout. The key to increasing turnout is an electorate that feels they have something at stake and that there is a compelling reason to vote. Those elements were present in 1992.

On the second point, States, the vast majority of whom must balance their budgets, have their backs against the financial wall. The unfunded mandates established by this bill will exacerbate the situation and force many States to resort to offsets in the form of program cuts or tax increases. For them, deficit spending is not an option.

If, as the majority report contends, the costs of this bill are relatively modest, then it should not be difficult for the bill's proponents to provide funding to implement its provisions. Regardless of whose cost estimates are the most accurate, Congress should not impose this bill on the states as the latest in a long line of unfunded Federal mandates.

The National Voter Registration Act of 1993 would require State and local governments to register voters in three ways: (a) by simultaneous applications when applying for motor vehicle drivers' licenses; (b) by applications received through the mail; and (c) by applications through all public assistance, unemployment and vocational rehabilitation offices.

No hearings were held on this bill in the 103d Congress, but the Rules Committee hearings held in 1991 afforded an opportunity for both the proponents and opponents of this legislation to be heard.

The enthusiasm of the bill's supporters for registering people to vote when applying for a driver's license is shared at the state level. In fact, fully 27 States plus the District of Columbia now provide citizens who want to register to vote while visiting a Department of Motor Vehicles office an opportunity to do so. In 1991, legislation was introduced in the statehouses of an additional 17 States to establish some form of motor voter or agency based systems.<sup>1</sup>

While the enthusiasm for such programs at the State level continues to grow, it has not translated into enthusiasm for the strictures of this legislation. This reluctance is partly because States

<sup>1</sup> 100 percent Vote, A Project of Human Serve, Memorandum, May 1, 1991.

are experiencing severe fiscal pressure and simply cannot afford the expensive and unnecessary costs this bill imposes.

State after State has insisted that the costs of motor voter will be substantial and they will have to curtail other programs such as education or child nutrition to come up with the funds needed to meet the unfunded mandates in the bill.

In fact, officials in 13 States with over 36 percent of the Nation's population are so concerned about the financial impact of this proposal they have taken the time to inform the committee of their objections to it. Ten of these States prepared cost estimates of the bill for their jurisdictions.

**STATE ESTIMATES OF THE COSTS OF THE PROGRAMS MANDATED BY THE NATIONAL VOTER REGISTRATION ACT**

(In millions of dollars)

States:		
Alaska	.....	0.4
California	.....	20.0
	(Independent estimate Los Angeles County, CA—4.5)	
Florida	.....	6.4
Illinois	.....	30.4
	(Independent estimate Dupage County, IL—15)	
Kansas	.....	.5
New York	.....	.045
New Jersey	.....	20.3
Oklahoma	.....	1.3
South Carolina	.....	2.8
Virginia	.....	5.0
Total	.....	87.55

Alabama, Minnesota, Missouri and South Dakota also expressed concern over the impact of the requirements contained in motor voter.

Furthermore, the following organizations have criticized the National Voter Registration Act for the unfunded mandates it would impose on state and local governments:

- American Association of Motor Vehicle Administrators National Association of Counties.
- National Governors Association.
- National Association of Secretaries of State.
- National Association of Towns and Townships.
- National League of Cities.

Imposing these additional costs on state and local governments is particularly hard to justify when one considers that any causal link between the registration programs required by the bill and increased voter turnout is tenuous. The Congressional Research Service studied motor voter programs in states that have adopted them and produced the following findings.



## PERCENTAGE OF THE VOTING AGE POPULATION THAT TURNED OUT FOR RESIDENTIAL ELECTIONS

(Before and After the Adoption of Motor Voter Programs: 1972-88<sup>1</sup>)

Turnout of voting age population	Before motor voter	After motor voter
Arizona <sup>2</sup> .....	47.20	46.29
Colorado <sup>2</sup> .....	58.53	56.90
Iowa.....	63.25	60.00
Michigan <sup>2</sup> .....	59.39	58.76
Minnesota <sup>2</sup> .....	70.62	67.23
Nevada <sup>2</sup> .....	46.45	45.42
North Carolina.....	43.08	45.34
Ohio.....	57.23	57.99
Vermont.....	59.60	65.57
Washington.....	61.19	58.01

<sup>1</sup> Nancy Cracher, "Voter Registration and Turnout in States with Mail and Motor Voter Registration Systems", Congressional Research Service Report, February 23, 1990, The Library of Congress.

<sup>2</sup> Active motor voter states.

Note that voter turnout dropped after the adoption of motor voter programs in 7 of these 10 states. Collectively, voter turnout declined in states that adopted motor voter programs by 2.68 percent. For the states that practice the active form of motor voter (similar to the requirements of this bill, turnout went down 6.21 percent in Presidential elections. For non-Presidential elections, turnout increased by just over half of one percent.

Given its lackluster effect at the state level, motor voter is a surprising prescription for arresting the decline in voter turnout nationally.

It should also be noted that this bill provides states with a way to escape the expenses and rigors of the bill: adoption of election day registration. The Department of Justice has said that election day registration "... would greatly impair the ability of the Department and the states to combat voting and election fraud. . . . [and] would totally preclude meaningful verification of voter eligibility, and thus allow easy corruption of the election process by the unscrupulous."<sup>2</sup>

Permitting registration on the day of the vote eliminates the ability of election officials to confirm the identity, address and eligibility of a prospective voter. Congress should be reluctant to provide economic incentives to states to adopt a procedure that undermines the very basis of democracy.

For the first time, this bill would subject voter registration systems to the regulatory control of the Federal Elections Commission—an entity many have criticized for being unable to satisfactorily carry out its current federally mandated duties.

## MAIL REGISTRATION

The National Voter Registration Act mandates unsupervised registration by mail for all states and forbids precautions states may take to reduce the chance of the unscrupulous taking advantage of the system. The Department of Justice wrote in 1991:

<sup>1</sup> W. Lee Rawls, Assistant Attorney General, U.S. Department of Justice, Letter to the Honorable Wendell H. Ford, Chairman, U.S. Senate Committee on Rules and Administration, April 17, 1991, p. 10-11.

[This proposal] would impose a sweeping requirement to allow mail-in registration while simultaneously limiting significantly the ability of the states to use a variety of techniques to verify the applicant's identity and eligibility. For this reason [the bill's] provision for registration by mail would entail a substantial and perhaps prohibitive risk of enhancing the opportunities for fraudulent registration and voting.<sup>3</sup>

Section 9(b)(3) of the bill states that a mail registration form "may not include any requirement or other formal authentication." Alaska requires registration applications received through the mail to be authenticated by the signatures of two adults. Other states require notarization of these applications. All of these precautions would be prohibited under the bill.

Mail registration also prohibits a requirement that registration applications be made in-person. By implication, states would be prohibited from asking applicants to supply identification to determine that persons registering are who they claim to be or live where they say they do. Currently, Connecticut requires a birth certificate, driver's license, or Social Security card to be shown at the time of registration. New Hampshire officials have the authority to require similar identification from applicants who are naturalized citizens.

In 1982, a New York Grand Jury reviewed widespread vote fraud charges in Kings County from 1968 to 1982. It observed:

The advent of mail-in registration in 1976 made the creation of bogus registration cards even easier and less subject to detection. . . . According to testimony, mail-in registration has become the principal means of perpetrating election fraud and has apparently resulted in the abandonment of the pre-1976 election fraud methods.<sup>4</sup>

As a District Attorney in New York, Elizabeth Holtzman wrote the New York Times lamenting "how easy it is to vote illegally" there and called for implementation of the recommendations contained in this Grand Jury Report. Under motor voter New York would be prevented from ending what the Grand Jury said had now become "the principal means of perpetrating election fraud."

The Justice Department pointed out that verification of mail registration applications in states that now have it may be inadequate. Many states rely upon the mailing of non-forwardable letters to mail registration applicants when the application is received by the election office. The assumption is that the Postal Service will return notices if an individual does not actually live at the address.

This assumption is false. The Federal Election Commission's Advisory Committee on Election Administration pointed out that such non-forwardable notices are only returned to the sender if the addressee files a change of address with the Postal Service. The Postal Service never inquires whether an addressee actually lives

<sup>3</sup> Ibid., p. 6.

<sup>4</sup> Supreme Court of the State of New York, County of Kings: Criminal Term, "In the Matter of Confidential Investigation R84-11", pp. 11-12.

at an address. If no change of address form has been filed with the Post Office, the mail is delivered no matter who lives at an address.

The Department of Justice pointed out that because of this underlying assumption for verifying the authenticity of a mail registration application is false ". . . there may in fact be a great deal of fraudulent registration by mail that simply has gone undetected." Nevertheless, this bill mandates this suspect system of registration for all states while forbidding even modest verification procedures for it.

In an effort to reduce the fraud associated with mail registration, the bill has been changed to permit states to require that new voters who have registered by mail must vote in person the first time they vote. States could ask for identification at that time. However, the effectiveness of this requirement is greatly undermined by an exception in the bill that voids the provision if it conflicts with another law. Most states now have absentee balloting. Laying mail registration on top of absentee balloting would result in a complete mailbox voting system particularly susceptible to fraud.

The State of Illinois requires signatures on voter registration applications to be made in front of a registrar. On election day, the signature on the registration form is compared with the signature of the person seeking to vote under that registration form to guard against "ghost voting."

By implication, this bill would prohibit this verification procedure. The Chairman of the Illinois Board of Elections told the Committee that a mail registration program would prevent verification of the original voter application and "would destroy the signature verification process—a key factor in the prevention of vote fraud."<sup>5</sup>

This verification system helped a Grand Jury examining voter fraud in the 1982 Chicago election secure sixty-two indictments resulting in at least fifty-six convictions.<sup>6</sup> Much of the evidence in this case was based on the work of FBI handwriting experts who compared the signatures on authenticated voter registration cards with signatures made at the polling booths. Such detection would have been impossible if mail registration, as mandated by this bill, were in place.

With mail registration, the perpetrators could have easily escaped detection by simply sending in bogus registration forms, and on polling day, having the same person sign to cast a fraudulent ballot. The signatures would then have been identical.

Even with Chicago's signature verification system, a U.S. attorney has estimated that up to one hundred thousand fraudulent ballots were cast in each of the Chicago elections of 1982 and 1986.<sup>7</sup> It is difficult to imagine what the extent of the vote fraud problem in that city would be if its signature verification procedures were prohibited by this bill.

<sup>5</sup> Theresa M. Petrone, Chairman, State Board of Elections, State of Illinois: Testimony to Senate Committee on Rules and Administration; May, 1989, p.3.

<sup>6</sup> U.S. District Court, Northern District of Illinois, Eastern Division: "Report of the Special January 1982 Grand Jury", pp. 3-5.

<sup>7</sup> Mark Eisman, "Massive Fraud Found in Mayoral Primary", Chicago Tribune, March 8, 1986, p. 1, Section 1.

In California, mail registration led to fraudulent filings with a phenomenon called "creative writing." This state experienced fake and duplicate registrations because of registration drives in which registrations were filed, often without knowledge of the "applicant," simply to fill a quota. The problem led this state to hire an investigator to guard against this kind of fraud.

Nationwide mail registration, as proposed by this bill, raises the very real specter of adding to America's illegal immigration problems. Illegal aliens have used easy availability of voter registration cards as a means to gain entry into the United States. Voter registration cards have also been used to gain access to federal and state benefits and even to obtain jobs with the federal government.

The Grand Jury sitting in Chicago reported:

Another pool of potential votes for the unscrupulous precinct captain was that of aliens who were illegally registered. Many aliens register to vote so that they can obtain documents identifying them as U.S. citizens; however, the number of aliens who actually voted is undocumented. We have learned that these aliens used their voters' cards to obtain a myriad of benefits, from Social Security to jobs with the Defense Department.<sup>8</sup>

Although this Grand Jury did not document aliens actually voting, a survey<sup>9</sup> by the Immigration and Naturalization Service of ballots cast in a 1989 U.S. House of Representatives special election in Florida did. In that election, it was confirmed that fully 11 percent of all ballots of foreign born voters sampled were cast by non-citizens. Furthermore, the Immigration and Naturalization Service reported that there is reason to believe that in this federal election, the incidence of illegal alien voting among all ballots examined was as high as 24 percent.

This fraud might be combated by requiring proof of citizenship at the time of registration. However, mail registration under this bill would preclude such corrective action.

This bill would mandate that voter registration cards be accepted by states through the mail from any location in the U.S. (and even around the world for that matter). Therefore, there is the potential for citizens of one state to use mail registration to gain access to another state's benefits.

Alaska, in addition to witnessed signatures, requires all out-of-state mail registration applicants to provide "identification or other documentation that supports . . . a claim to Alaska residency."<sup>10</sup> This precaution would be prohibited under this legislation.

The bill would require all mail registration applications to be processed if postmarked up to thirty days before an election. The Alaska Division of Elections has reviewed absentee mail ballots and found that almost thirty percent of them had illegible postmarks. This would be a problem around the nation and could unintentionally disenfranchise many voters.

<sup>8</sup> "Report of the Special January 1982 Grand Jury", op. cit., p. 8-9.

<sup>9</sup> Richard Wallace, "INS: Noncitizens Voted in 1989 Election, State Doesn't Require Proof of Citizenship to Register to Vote", Miami Herald, March 9, 1991, p. 1B, Section Local.

<sup>10</sup> Alaska Administrative Code 25.027 (c).

Election fraud disenfranchises voters. It erodes confidence in our democratic traditions. Unfortunately, it is not a problem confined to the past and, in some areas of the nation, it will continue to be a problem in the future. The mail registration provisions of this bill would strip the states of their ability to deal with these election fraud problems.

#### AGENCY BASED REGISTRATION

This bill would require all public assistance, unemployment, and vocational rehabilitation offices to register those who receive benefits from those offices.

In its letter to the Committee, the Department of justice wrote in 1991:

The Department's experience demonstrates that public officials sometimes use their power to dispense or withhold benefits in order to pressure citizens into voting a particular way or registering for a particular party. This bill would increase substantially the opportunities for such intimidation and coercion of the public.<sup>11</sup>

The Justice Department was not engaging in mere speculation. The St. Louis Post-Dispatch reported on an investigation into allegations that public assistance employees were routinely registering public assistance applicants, "suggesting" who they should vote for and taking them to the polls.<sup>12</sup>

Such exploitation of vulnerable public assistance recipients is not a new phenomena and continues today. This bill would require public assistance employees across the nation to become actively involved in the administration of elections and we think the results will mean more political manipulation and abuse of public recipients.

The threat of public employee misconduct is not the sole objection to the agency registration provisions of this bill. Even the appearance that a person's public assistance benefits are linked to registering to vote violates the American tradition of voluntary participation in the political system. It should not be required by the federal government.

#### CONCLUSION

Although greater voter participation is a goal shared by all Members of the Committee, state experience with motor voter programs demonstrate that such programs do not increase voter turnout. What will increase are the costs to state and local governments and opportunities for election fraud.

The lion's share of any new registration under this bill is expected to be done at Departments of Motor Vehicles. The supporters of the bill assume that both mail registration and agency based registration under this bill will account for only a small portion of the new registrations. The bill as written, therefore, risks significant

<sup>11</sup> Rawls, op. cit., 7-8.

<sup>12</sup> St. Louis Post-Dispatch, "State Investigating Centerville Township", August 29, 1990, p. 5a.

new opportunities for vote fraud and improprieties by governmental agencies for no significant increase in voter participation.

Rather than assisting state efforts to implement innovative voter registration program, this legislation will impose obligations that are impractical, ineffective and an expensive burden for states.

TED STEVENS.  
JESSE HELMS.  
JOHN WARNER.  
BOB DOLE.  
MITCH McCONNELL.  
THAD COCHRAN.

ADDITIONAL VIEWS OF SENATOR HATFIELD

The bill we report today is substantially similar to S. 250 of the 102nd Congress, the National Voter Registration Act. I supported this legislation last year after the Committee Chairman and I worked to improve its provisions related to protection of the electoral process from registration fraud.

During consideration of the bill last year, the Chairman and I worked to mandate an address verification system which makes a "reasonable" attempt to clean the voting rolls, as well as provisions to allow states to require mail registrants to vote in person the first time.

The goal embodied in this legislation, to improve accessibility to the voting process, deserves our careful consideration at the federal level. The National Voter Registration Act sets a national standard through a national system to provide equal access to the process for all Americans.

My own state's experience with "motor-voter" legislation attests to the merits of a national standard. Oregon enacted its own law in 1991 and from all accounts, its effects on voting habits are quite positive. The number of registered voters in Oregon jumped by 15 percent between the 1990 and 1992 general election. Of all the transactions that have occurred at offices of the Oregon Motor Vehicles Division (DMV) across the state since the "motor-voter" law took effect in October of 1991, 24 percent involved some sort of voter registration activity.

I have remaining concerns about the cost which may be borne by the states in implementing this legislation. The bill now includes a postal rate reduction for state registrars which will be a helpful tool for offsetting the cost to the states of mail registration. My state reports that from the onset of Oregon's law in late 1991 to January 1 of this year, the DMV has spent \$86,135 on voter registration activities. The Division's 1991-1993 biennial budget for "motor-voter" services is \$122,593. These are not exorbitant expenditures, because my state has actively sought methods to cut costs. For example, county clerks in several Oregon counties save postage by going to the local DMV offices in person to pick up the new registration cards. Clearly, the postal rate reduction will be a supportive addition, but it does not compensate for the total additional costs of "motor-voter" procedures. This tradeoff suggests the value we in the federal government place on opening access to the electoral process.

I support the National Voter Registration Act and encourage its swift passage by the Senate.

MARK O. HATFIELD.

CHANGES IN EXISTING LAW

In compliance with paragraph 12 of rule XXVI of the Standing rules of the senate, changes in existing law made by the bill, as reported by the Committee on Rules and Administration, are shown as follows (existing law proposed to be omitted is enclosed in [bold brackets], new matter is printed in *italic*, and existing law in which no change is proposed is shown in roman):

TITLE 39, UNITED STATES CODE
POSTAL SERVICE
PART I—GENERAL

CHAPTER 1—POSTAL POLICY AND DEFINITIONS

. . . . .

CHAPTER 24—APPROPRIATIONS AND ANNUAL REPORT

Sec.
2401. Appropriations.
2402. Annual report.

§ 2401. Appropriations

(a) There are appropriated to the Postal Service all revenues received by the Postal Service.

. . . . .

(c) There are authorized to be appropriated to the Postal Service each year a sum determined by the Postal Service to be equal to the difference between the revenues the Postal Service would have received if sections 3217, 3403-3406, [and 3626(a)-(h) and (j)-(k) of this title,] 3626(a)-(h), 3626(j)-(k), and 3629 of this title had not been enacted and the estimated revenues to be received on mail carried under such sections and Acts. In requesting an appropriation under this subsection for a fiscal year, the Postal Service shall (i) include an amount to reconcile sums authorized to be appropriated for prior fiscal years on the basis of estimated mail volume with sums which would have been authorized to be appropriated if based on the final audited mail volume; and (ii) calculate the sums requested in respect of mail under former sections 4452(b) and 4452(c) of this title as though all such mail consisted of letter shaped pieces, as such pieces are defined in the then effective classification and rate schedules.

. . . . .

**CHAPTER 36—POSTAL RATES, CLASSES, AND SERVICES**

**SUBCHAPTER I—POSTAL RATE COMMISSION**

Sec.

- 3601. Establishment.
- 3602. Terms of office.
- 3603. Rules; regulations; procedures.
- 3604. Administration.

**SUBCHAPTER II—PERMANENT RATES AND CLASSES OF MAIL**

- 3621. Authority to fix rates and classes.
- 3622. Rates and fees.
- 3623. Mail classification.
- 3624. Recommended decisions of Commission.
- 3625. Action of the Governors.
- 3626. Reduced rates.
- 3627. Adjusting free and reduced rates.
- 3628. Appellate review.
- 3629. *Reduced rates for voter registration purposes.*

**§ 3627. Adjusting free and reduced rates**

If Congress fails to appropriate an amount authorized under section 2401(c) of this title for any class of mail sent at a free or reduced rate under section 3217, 3403-3406, [or 3626 of this title,] 3626, or 3629 of this title, the rate for that class may be adjusted in accordance with the provisions of this subchapter so that the increased revenues received from the users of such class will equal the amount for that class that the Congress was to appropriate.

**§ 3629. *Reduced rates for voter registration purposes***

*The Postal Service shall make available to a State or local voting registration official the rate for any class of mail that is available to a qualified nonprofit organization under section 3626 for the purpose of making a mailing that the official certifies is required or authorized by the National Voter Registration Act of 1993.*



C-31





## APPENDIX D - THE JOINT CONFERENCE COMMITTEE REPORT ON THE ACT

### JOINT EXPLANATORY STATEMENT OF THE COMMITTEE OF CONFERENCE

The managers on the part of the House and the Senate at the conference on the disagreeing votes of the two Houses on the amendments of the Senate to the bill (H. R. 2), to establish national voter registration procedures for Federal elections submit the following joint statement to the House and to the Senate in explanation of the effect of the action agreed upon by the managers and recommended in the accompanying conference report:

The Senate amendment struck out all of the House bill after the enacting clause and inserted a substitute text, and the House disagreed to the Senate amendment.

The Committee of Conference recommends that the House recede from its disagreement to the amendment of the Senate to the text of the bill, with an amendment which is a substitute for both the text of the House bill and the Senate amendment to the text of the House bill.

The differences between the text of the House bill, the Senate amendment thereto, and the substitute agreed to in conference are noted below, except for clerical corrections, conforming changes made necessary by reason of agreements reached by the conferees, and minor drafting and clarifying changes.

#### SECTION 1. SHORT TITLE

The House bill (H. R. 2), the Senate amendment, and the conference agreement provide that this legislation may be cited as the "National Voter Registration Act of 1993".

#### SECTION 2. FINDINGS AND PURPOSES

The House bill, the Senate amendment, and the conference agreement set forth identical findings of the Congress and purposes of the Act.

#### SECTION 3. DEFINITIONS

The House bill, the Senate amendment, and the conference agreement set forth identical definitions for the terms "election", "Federal office", "motor vehicle driver's license", "State", and "voter registration agency".

#### SECTION 4. NATIONAL PROCEDURES FOR VOTER REGISTRATION FOR ELECTIONS FOR FEDERAL OFFICE

##### *House bill*

Section 4 requires that each State establish procedures to register to vote in elections for Federal office by application made simultaneously with an application for a motor vehicle driver's license (motor voter), by mail application, and by application at a

(15)



designated Federal, State or nongovernmental office (agency based registration). The bill would exempt any State that has no registration requirement to vote in a Federal election or any State that permits registration at the polling place at the time of voting in a Federal election.

*Senate amendment*

The amendment includes the same requirements for registration as the House bill, but limits the exemption to States that had enacted such a provision on or prior to March 11, 1993 and in effect continuously on and after that date. It also extends that exemption to any State that had enacted such legislation on or prior to that date, but provided that it would go into effect only upon enactment of this Act. To qualify, a State must provide such registration procedures for Federal elections in the year of the Presidential election.

*Conference substitute*

The Conferees agreed to the Senate amendment with the modification that such State provision must apply to Federal elections generally, not just to those in Presidential election years. This modification retains the provisions and requirements of the Senate amendment regarding the effective date and enactment date of such State laws, and the provision of the House bill that such State laws must apply to all Federal elections, not just those occurring in the same year of a Presidential election. There was concern that the State amendment might be interpreted to exempt a State that permitted election day registration, or that had no registration requirement, for voting for Presidential electors only, which is not the intent of the conferees.

SECTION 5. SIMULTANEOUS APPLICATION FOR VOTER REGISTRATION  
AND APPLICATION FOR MOTOR VEHICLE DRIVER'S LICENSE

*House bill*

Section 5 provides that an application for State driver's license or the renewal of a driver's license shall serve as an application for voter registration. It provides that an applicant for a license may decline in writing to be registered by means of that application. It further requires that the application form include a means by which the applicant may decline to register.

It requires that the voter registration application shall be part of the driver's license application; shall not require information which duplicates the license portion of the form except such information as shall be required to prevent duplicate registration and to make an assessment of eligibility; shall include a statement that specifies each eligibility requirement, contains an attestation clause that applicant meets each requirement and requires signature of applicant under penalty of perjury; and shall be transmitted to the appropriate state election officials. There is no provision pertaining to a transmittal deadline.

*Senate amendment*

The Senate amendment is similar to the House bill with the following modifications:

1. The Senate amendment does not include the provisions of the House bill pertaining to declination. Rather, it provides that the failure of the applicant to sign the voter registration portion of the application serves as a declination to apply to register.

2. The voter registration application form must, in addition to the requirements set forth in the bill, include in print that is identical to the attestation statement, a statement of the voter eligibility requirements, penalties for submitting a false application, and that the fact of declining to register and place of registration are confidential and will be used only for registration purposes. A similar change was made for the mail registration application.

3. The Senate amendment contains a transmittal provision identical to that contained in the agency section of the House bill. The voter registration portion of a driver's license application must be transmitted to the appropriate State election official no later than 10 days after it has been accepted, or not later than 5 days after the date of acceptance, if the application has been accepted within 5 days of the deadline for registering.

*Conference substitute*

Same as Senate amendment. Under the House bill, the failure of the applicant to sign the voter registration portion of the application is not addressed, and the conferees agree that the Senate amendment clarifies the outcome of a failure to sign, so that the applicant would be considered to have declined.

## SECTION 6. MAIL REGISTRATION

*House bill*

Provides that each State shall accept and use a mail voter registration application form promulgated by the FEC. In addition, a State may develop and use its own form which meets the criteria of the FEC form. Notarization or other formal authentication is not allowed. Forms shall be readily available for public and private distribution, and especially for organized registration programs.

A State may, by law, require a personal appearance to vote if the person was registered to vote in a local jurisdiction by mail and the person has not previously voted in that jurisdiction. Individuals who are entitled to vote by absentee ballot under the Uniformed and Overseas Citizens Absentee Voting Act and those provided the right to vote other than in person by the Voting Accessibility for the Elderly and Handicapped Act, or any other Federal law, are exempt. There is no provision pertaining to undelivered notices.

*Senate amendment*

The Senate amendment is similar to the House bill but with an additional provision pertaining to undelivered notices. It provides that for applications made by mail, if a State sends a notice of the disposition of the application by non-forwardable mail and, if the notice is returned undelivered, the registrar may remove the

name of the applicant in accordance with the procedures contained in the purge section of the Act.

*Conference substitute*

The substitute is the same as the Senate amendment, with a modification in the language to make clear that this provision applies only to notices sent pursuant to Section 8(a)(2) in response to applications by mail. In addition, the technical modification clarifies that a State may not simply remove the name of the applicant from its list, but, rather must follow the regular process set forth in section 8(d).

SECTION 7. VOTER REGISTRATION AGENCIES

*House bill*

State, Federal and private sector locations shall be designated for the distribution and processing of voter registration applications. States shall designate all offices providing public assistance, unemployment compensation, and related services, and all offices which provide State-funded programs primarily engaged in providing services to persons with disabilities as registration agencies. Such designated offices, shall provide the same assistance in completion of registration application as is provided with regard to that agency's forms. States shall designate other agencies, which may include libraries, schools, fishing/hunting license bureaus, marriage license offices, and any offices that provide services to persons with disabilities to provide forms, assistance and processing of voter registration applications. The Federal Government shall cooperate in this program.

An applicant for services may decline in writing to be registered to vote and no information relating to a declination may be used for any other purpose. If a voter registration office designated by a State provides services to a person with disabilities at the person's home, the office shall provide the voting registration services at the person's home.

*Senate amendment*

The Senate amendment is similar to the House bill, but includes three significant changes. The agency program at offices that provide public assistance, unemployment compensation and related services is made discretionary with the States. The Senate amendment also provides that assistance is to be provided to an applicant unless the applicant refuses assistance.

The Senate amendment mandates that recruitment offices of the Armed Forces be designated voter registration agencies for the purposes of the Act. The provision requires the Secretary of Defense to work with each State to develop and implement procedures for persons to apply to register at recruitment offices.

*Conference substitute*

This provision is similar to the Senate amendment, but it makes two changes. First, agency-based registration at public assistance agencies and at agencies providing services to disabled persons is made mandatory as it was in the House bill. Unemploy-

ment compensation offices are included in the discretionary program as in the Senate amendment. The provision of the Senate amendment regarding assistance to applicants by such agencies is retained.

The conference is concerned that the Senate amendment would permit States to restrict their agency program and defeat a principal purpose of this Act—to increase the number of eligible citizens who register to vote. If a State does not include either public assistance, agencies serving persons with disabilities, or unemployment compensation offices in its agency program, it will exclude a segment of its population from those for whom registration will be convenient and readily available—the poor and persons with disabilities who do not have driver's licenses and will not come into contact with the other principle place to register under this Act. It is important that no State be permitted to so restrict its agency registration program. To eliminate the mandatory agency program altogether will not accomplish the objectives of this Act, since the States are already free to establish agency registration. The only way to assure that no State can create an agency registration program that discriminates against a distinct portion of its population is to require that the agencies designated in each State include an agency that has regular contact with those who do not have driver's licenses.

Of those agencies included in the mandatory program in the House bill, it appears to the conferees that those agencies most likely to have such contact and complement the motor vehicle agency registration program are those agencies that provide public assistance and services to persons with disabilities. By public assistance agencies, we intend to include those State agencies in each State that administer or provide services under the food stamp, medicaid, the Women, Infants and Children (WIC), and the Aid to Families With Dependent Children (AFDC) programs. If the States are required to include these programs, as well as those that provide assistance to persons with disabilities, we will be assured that almost all of our citizens will come into contact with an office at which they may apply to register to vote with the same convenience as will be available to most other people under the motor voter program of this Act.

The second change is intended to deal with concerns raised about the inclusion of certain agencies in an agency-based registration program and the possibility of intimidation or coercion. Concern was expressed that in agencies that provide benefits, staff might suggest that registering to vote could have some bearing on the availability of services or benefits provided by that agency. In addition to the provisions in the House bill relating to coercion and intimidation, the conference substitute includes specific provisions to address that situation.

One provision (Section 7(a)(5)(D)) would prohibit a person providing services at an agency from making any statement to an applicant or taking any action that could lead the applicant to believe that his or her decisions regarding registering to vote had any bearing on the availability of services or benefits.

Another provision (Section 7(a)(6)(B)) would require an agency to include on a form the question "If you are not registered to vote

where you live now, would you like to apply to register to vote here today?" In response to that question, the form would include a box for the applicant to accept or decline to apply to register to vote. Failure to check either would be deemed a declination for purposes of this provision. In addition to that question, these forms would include a statement to the effect that if the applicant would like assistance in completing the application, the agency staff is available to provide that assistance; and that such a decision is left to the individual with a further statement that the applicant may complete the voter registration application in private. Such form would also include the statement: "Applying to register or declining to register to vote will not affect the amount of assistance you are provided by this agency."

The form would also include a statement advising the applicant that he or she may file a complaint with the appropriate State official should that applicant believe that someone has interfered with his or her right to register, or to privacy, or to choose his or her own political party or preference. The appropriate official's name, address and telephone number would be included with that statement.

To insure effective voter registration programs without coercion and intimidation the conferees have looked to ongoing agency-based registration programs. Some States, such as Pennsylvania and Minnesota, which have already developed an agency-based registration program in agencies that provide benefits have incorporated into their agency forms similar statements and questions to applicants informing them of their rights.

The conferees believe that based on the experience of these States, the inclusion of such questions and statements on the agency forms in an agency-based program would serve to deter coercion and intimidation in such a program.

#### SECTION 8. REQUIREMENTS WITH RESPECT TO ADMINISTRATION OF VOTER REGISTRATION

##### *House bill*

This section includes a number of administrative requirements. It provides that the registration cutoff may be no more than 30 days before election or such lesser period as State may provide. It requires that the State election officials notify each applicant of the disposition of his or her registration application. The bill provides that a voter's name may be removed from voter rolls only: (1) at the request of the voter; or (2) as provided by State law, by reason of criminal conviction or mental incapacity. The States shall conduct a general program that makes a reasonable effort to remove the names of ineligible voters by reason of (1) death; or (2) by reason of a change of residence of the voter. A voter's name may not be removed for non-voting. Any State program or activity designed to ensure the maintenance of an accurate and current voter registration roll shall be uniform, nondiscriminatory, and in compliance with the Voting Rights Act of 1965. It does not permit a State to conduct a systematic procedure to confirm voting lists within 90 days before a Federal election. A State may use the National Change of Address (NCOA) program and may make the change of

address on the registration rolls with a notification to the voter of such change.

No State may remove the name of a voter from the rolls due to possible change of address unless the registrant confirms in writing to have moved out of voting jurisdiction, or the voter fails to respond to a notice and does not appear to vote and correct the record during period between date of notice and second general election for Federal office. Where the change of address is to an address covered by the same polling place, the voter shall be permitted to vote upon oral or written affirmation of the change of address. If a registrant has moved to a residence in a new polling place within the jurisdiction of the same voting registrar and the same congressional district, the registrant shall be permitted to vote in one of the following manners, at the option of the registrant: (1) with oral or written affirmation of the new address at the old polling place or, (2) upon written affirmation of the change of address at a designated central location where a list of eligible voters is maintained. Such a registrant may also appear at the appropriate polling place for the new address for the purposes of correcting the registration record, and shall vote, if permitted by State law. If State law permits voting at the new polling place, by oral or written affirmation of the current address, voting at the other locations need not be provided as options. If registration records indicate that a registrant has moved, and in fact has not, the registrant may vote upon oral or written affirmation that he or she continues to reside at the same address.

The bill also provides that State and local voting registration officials would be able to receive reduced postal rates for the purpose of making any mailing which is required or authorized by the Act. This reduced rate would be funded through a revenue foregone appropriation.

Each State is required to maintain and make available for public inspection and copying upon payment of reasonable costs, all records concerning the implementation of programs and activities designed to ensure the accuracy of the voting rolls. These records shall include lists of the names and addresses of those individuals sent notices and information regarding whether or not these individuals have responded. The identity of the voter registration agency through which any particular voter is registered shall not be disclosed to the public.

#### *Senate amendment*

The amendment is the same as the bill with the exception of the location at which a voter may vote upon written or oral affirmation after moving from one location to another within the same registrar's jurisdiction and same Congressional district. That provision is modified to provide that if State law permits voting at either the old polling place, a central location, or the new polling place, by oral or written affirmation of the current address, voting at the other locations need not be provided as options.

#### *Conference substitute*

This section is the same as the Senate amendment with a further modification of the provision regarding the polling place at

which a person may vote who has moved to another address within the jurisdiction of the same registrar and the same Congressional district. It provides that if State law permits voting, under such circumstances, at either the old polling place or the new polling place, by oral or written affirmation, voting at the other locations (old polling place or central location) need not be provided as options to the registrant.

There was concern that permitting a State to require a person to go to a central location to change his or her address and vote could result in hardship to voters in areas where travel to a central location might be difficult due to distance or the lack of convenient means of transportation. Such problems could discourage, or even effectively prevent, some persons from voting. The effect of the amendment is to give each State the option of designating either the polling place for the old address or for the new address. If a State does not provide for voting under those circumstances at either of those locations, the Act would require that the registrant have the option of voting at the polling place for his or her old address or at a central location.

#### SECTION 9. FEDERAL COORDINATION AND REGULATION

##### *House bill*

The House bill provides the Federal Election Commission the general authority to promulgate appropriate regulations necessary to carry out the Act. In addition, the Commission is to consult with chief election officers of the States to develop a mail voter registration application form for Federal elections and to submit to Congress, by June 30 of each odd-numbered year, a report assessing the impact of the Act on the administration of elections for Federal office and recommendations for improvements in procedures, forms or other matters.

##### *Senate amendment*

The Senate amendment is identical to the House bill, except that it limits the Commission's regulatory authority to prescribing only those regulations necessary to carry out its specific responsibilities in designing the mail registration application form and in reporting to the Congress.

##### *Conference substitute*

Adopts the Senate amendment. Although the Senate amendment narrows the provision contained in the House bill, the conferees expect the Commission to play an advisory role to the States and to facilitate the exchange of information among the States.

#### SECTION 10. DESIGNATION OF CHIEF STATE ELECTION OFFICIAL

The House bill, Senate amendment and Conference substitute are identical and require that each State designate an official to coordinate State responsibilities under the Act.

## SECTION 11. CIVIL ENFORCEMENT AND PRIVATE RIGHT OF ACTION

*House bill*

The bill provides that civil enforcement through injunction or declaratory relief may be brought by the U.S. Attorney General, or a person with notice to the chief election official of the State. The rights and remedies established by the Act are in addition to any other rights and remedies provided by law and no provision shall supersede, restrict, or limit the application of the Voting Rights Act of 1965. Nothing in this Act authorizes or requires conduct that is prohibited by the Voting Rights Act of 1965.

*Senate amendment*

Same as House bill.

*Conference substitute*

Same as House bill.

## SECTION 12. CRIMINAL PENALTIES

*House bill*

Federal criminal penalties will apply for registration offenses which are knowing and willful and fines are to be disposed of in accordance with Title 18 of the United States Code.

*Senate amendment*

The amendment is identical to the House bill except for the disposition of fines, which are paid into the general fund of the Treasury. This modification was necessary to avoid a Budget Act point of order.

*Conference substitute*

Same as Senate amendment.

## SECTION 13. RULE OF CONSTRUCTION

*House bill*

No provision.

*Senate amendment*

Provides that nothing in this Act shall prevent a State from requiring presentation of documentation relating to citizenship of an applicant for voter registration.

*Conference substitute*

The conferees agree with the House bill and do not include this provision from the Senate amendment. It is not necessary or consistent with the purposes of this Act. Furthermore, there is concern that it could be interpreted by States to permit registration requirements that could effectively eliminate, or seriously interfere with, the mail registration program of the Act. It could also adversely affect the administration of the other registration programs as well. In addition, it creates confusion with regard to the relationship of this Act to the Voting Rights Act. Except for this provision, this Act has been carefully drafted to assure that it would not



supersede, restrict or limit the application of the Voting Rights Act. These concerns lead the conferees to conclude that this section should be deleted.

SECTION 14. EFFECTIVE DATE

*House bill*

The bill provides that the Act will take effect January 1, 1995 in all States except those with constitutional provisions that would require a separate State and Federal voter roll. In order to give those States sufficient time to amend their constitutions to permit compliance without dual voter rolls, an effective date of January 1, 1996 is set.

*Senate amendment*

The amendment includes the same provisions as the bill and adds a further extension for any State that cannot amend its constitution before the 1996 effective date without a special election. For any such State, the effective date would be the date that is 120 days after the date by which it would be legally possible to amend the State constitution without a special election.

*Conference substitute*

Same as Senate amendment.

CHARLIE ROSE,  
AL SWIFT,  
MARTIN FROST,  
STENY H. HOYER,  
GERALD D. KLECZKA,  
JOHN CONYERS, Jr.,

*Managers on the Part of the House.*

WENDELL FORD,  
CLAIBORNE PELL,  
DANIEL K. INOUE,

*Managers on the Part of the Senate.*

○



## APPENDIX E

### FEDERAL DIRECTORY

---

#### ELECTION COMMITTEES IN CONGRESS

---

##### SENATE COMMITTEE ON RULES AND ADMINISTRATION

305 Senate Russell Office Building  
Washington, DC 20510-6325

Contact:

John L. Sousa  
Chief Counsel  
(202) 224-5648

or

Thomas E. Zoeller,  
Counsel  
(202) 224-0279

##### COMMITTEE ON HOUSE ADMINISTRATION

H-326 Capitol  
Washington, DC 20515-6157

Contact:

Eric F. Kleinfeld  
General Counsel  
(202) 225-2061

##### SUBCOMMITTEE ON ELECTIONS

802 O'Neill House Office Building  
Washington, DC 20515-6162

Contact:

Herbert S. Stone  
Staff Director  
(202) 226-7616

#### DIRECTORY OF FEDERAL AGENCIES

---

##### FEDERAL ELECTION COMMISSION

999 E Street, N.W.  
Washington, DC 20463

Contact:

Susan Propper  
Assistant General Counsel,  
Regulations  
(202) 219-3690

or

Penelope Bonsall,  
Director, National Clearinghouse  
on Election Administration  
(202) 219-3670

##### DEPARTMENT OF JUSTICE

*Civil Rights Division*

P.O. Box 66128  
Washington, DC 20035

Contact:

Barry Weinberg  
Deputy Chief, Voting Section  
(202) 307-3266

*Election Crimes Branch*

Bond Building, 12th Fl.  
1400 New York Avenue, N.W.  
Washington, DC 20005

Contact:

Craig C. Donsanto  
Director  
(202) 514-1421

##### DEPARTMENT OF DEFENSE

*Federal Voting Assistance Program*

Pentagon Rm. 1B-457  
Washington, DC 20301

Contact:

Phyllis Taylor  
Director  
(703) 693-6500

**DEPARTMENT OF HEALTH  
AND HUMAN SERVICES***Office of Family Assistance*

370 L'Enfant Promenade, S.W.

Washington, DC 20447

Contact:

Larry Carnes

Aid to Families with Dependent Children

(AFDC) Program

(202) 401-5782

*Health Care Financing Administration**(Medicaid)*

200 Independence Avenue, S.W.

Washington, DC 20201

Contact:

Carla Bodagli

(202) 690-5636

**DEPARTMENT OF AGRICULTURE***Food and Nutrition Service*

Alexandria, VA 22302

Contact:

Clara L. French

Special Supplemental Food Program

for Women, Infants, and Children (WIC)

(703) 305-2730

or

Dwight Moritz

Food Stamp Program

(703) 305-2520

**U.S. POSTAL SERVICE***Customer Service Support Department**Business Mail Acceptance*

475 L'Enfant Plaza, S.W.

Room 8530

Washington, DC 20260-6808

Contact:

Anita Bizzoto

Manager

(202) 268-5174

*National Address Information Center*

(NCOA)

6060 Primacy Parkway, Ste. 101

Memphis, TN 38188-0001

Contact:

Bernard M. Spiegel

Project Manager

(901) 331-5746

# NCOA VENDORS - MARKETING CONTACTS

<p>* ATTENTION: MIKE FORD ACXIOM CORP 301 INDUSTRIAL BLVD CONWAY AR 72032-7168 (501) 336-1442</p>	<p>ATTENTION: KATHY HASSELKUS GLOBE LIFE AND ACCIDENT INS CO GLOBE LIFE CENTER OKLAHOMA CITY OK 73184-0001 (405) 749-7413</p>	<p>ATTENTION: BETH RAIOLA NEODATA SERVICES 6707 WINCHESTER CIR BOULDER CO 80301-3513 (303) 530-0606</p>
<p>* ATTENTION: PAUL STORCH ANCHOR COMPUTER 1900 NEW HWY FARMINGDALE NY 11735-1537 (516) 293-6100</p>	<p>* ATTENTION: HENRY PONDER GRIZZARD ADVERTISING INC 1002 TEXAS PKY STAFFORD TX 77477-6482 (713) 499-0417</p>	<p>* ATTENTION: MELVIN FOX PSA 8800 EDGEWORTH DR CAPITOL HEIGHTS MD 20743-3711 (301) 350-5600</p>
<p>* ATTENTION: GEOFF WATTERS CREATIVE AUTOMATION CO 3050 S CALHOUN RD NEW BERLIN WI 53151-3549 (708) 449-2800</p>	<p>* ATTENTION: CRAIG COMBEST HARTE HANKS DATA TECHNOLOGIES 1329 ARLINGTON ST CINCINNATI OH 45225-1380 (513) 853-7701</p>	<p>* ATTENTION: LEO YOCHIM PRINTRONIC CORP OF AMERICA 17 BATTERY PL 13TH FL NEW YORK NY 10004-1298 (212) 480-4000</p>
<p>* ATTENTION: JOE BALABAN DATABASE AMERICA INFO SYS INC 100 PARAGON DR MONTVALE NJ 07645-1745 (201) 476-2000</p>	<p>* ATTENTION: MARTY GAMBLE LCS INDUSTRIES INC 120 BRIGHTON RD CLIFTON NJ 07012-1694 (201) 614-3421</p>	<p>* ATTENTION: LYNNE CURRIN R L POLK AND COMPANY 6400 MONROE BLVD TAYLOR MI 48180-1884 (313) 292-3200 ext 5210</p>
<p>ATTENTION: DANIEL J MINNICK DIRECT MARKETING TECH INC 955 AMERICAN LN SCHAUMBURG IL 60173-4998 (708) 517-5683</p>	<p>* ATTENTION: LINDA MCCLOSKEY LIST MAINTENANCE CORP 111 BUSINESS PARK DR ARMONK NY 10504-1737 (914) 273-6380</p>	<p>* ATTENTION: ROBERT J O'BRIEN TIME CUSTOMER SERVICE INC 1 N DALE MABRY TAMPA FL 33609-2700 (813) 878-6903</p>
<p>* ATTENTION: WILLIAM WEISSHAAR DONNELLEY MARKETING 1235 N AVE NEVADA IA 50201-5000 (515) 382-8202</p>	<p>* ATTENTION: GEORGE CAVALENES MAY AND SPEH 1501 OPUS PL DOWNERS GROVE IL 60515-5727 (708) 964-1501</p>	<p>* ATTENTION: MAYLENE SCARLETTE TRIPLEX DIRECT MARKETING CORP 20 LEVERONI CT NOVATO CA 94949-5756 (415) 382-7109</p>
<p>ATTENTION: MARTY MCHALE EQUIFAX INFORMATION TECH INC 11011 RICHMOND AVE STE 100 HOUSTON TX 77042-4773 (713) 954-6400</p>	<p>ATTENTION: STAN BRAUNSTEIN MBS/MULTIMODE INC 7 NORDEN LN HUNTINGTON STA NY 11746-2139 (516) 673-5600</p>	<p>* ATTENTION: MARK TINUCCI TRW TARGET MARKETING SERVICES 901 N INTERNATIONAL PKY STE 191 RICHARDSON TX 75081-2885 (214) 699-1271</p>
<p>* ATTENTION: MIKE TALBOTT **FDC INC 600 HWY 169 S STE 500 MINNEAPOLIS MN 55426-1209 (612) 541-6500</p>	<p>* ATTENTION: BETSY CONLIN METROMAIL CORPORATION 360 E 22ND ST LOMBARD IL 60148-4989 (708) 620-3300</p>	<p>* ATTENTION: JOHN SAWICKI WATS MARKETING OF AMERICA INC 2301 N 117TH AVE OMAHA NE 68164-3682 (402) 498-7662</p>

\* - LICENSEE PROVIDES NIXIE ELIMINATION.

\*\* - LICENSEE PROVIDES DISKETTE PROCESSING.





## APENDIX F

# EXPEDITING OFFICIAL ELECTION MAILINGS

Election officials around the country are coming to depend more and more on the U.S. Postal Service. One reason for this greater dependency is the growing number of different items—registration forms, confirmation/verification cards, impending purge notices, cancellation notices, sample ballot materials, and absentee voting materials—which are now being sent through the mails. Another reason is the ever increasing volume of these mailings (and especially of absentee voting materials) as the voting population increases.

The Postal Service, in order to expedite these and other mailings, is implementing a program of automation which promises more efficient and accurate mail processing, improved consistency of delivery, and lower postal operating costs which will, in turn, keep rates as low as possible for as long as possible.

For your election office to benefit from this postal automation, it is essential that your outgoing and return envelopes and postcards conform to Postal Service Guidelines. Following these guidelines, though voluntary, will ensure that official election materials mailed from and returned to your office can be machine processed rather than being delayed by manual sorting. Major features of the postal guidelines are identified below along with certain other measures you can take to gain the most from the Postal service.

### THE APPLICATION OF THESE GUIDELINES AND FORMATS

In order to properly employ the Postal Service guidelines, it is important to recognize that your election office deals with four distinct types of preprinted mail each of which will require a different format.

- outgoing domestic civilian items
- returning domestic civilian items

- outgoing military and overseas items, and
- returning military and overseas items.

The formats recommended in this article pertain *only to your preprinted outgoing and returning domestic civilian items*. The formats for preprinted mail to and from all military voters and citizens residing overseas are slightly different since these items contain federally prepaid postage. You may obtain the appropriate formats for military and overseas mail from the Federal Voting Assistance Office at the end of this article.

If your State election office provides you with your preprinted envelopes and post cards, you will want to work closely with them to ensure that your return envelopes contain the proper ZIP+4 and bar code as explained below.

### OVERALL GUIDELINES FOR AUTOMATED MAILINGS

These overall guidelines for automated mailings pertain to the size, material, construction, and printing of all your first class outgoing and return envelopes and postcards.

#### Guidelines for Envelopes

Table 1 defines the dimensional standards for letter-size mail. The minimum sizes apply to all mail except pieces which are more than 1/4 inch thick. Anything which does not conform to these minimum size standards is non-mailable. The maximum sizes apply to First-Class Mail weighing one ounce or less and single rate

**Table 1**

Standard Dimensions	Minimum Size	Maximum Size
Height	3 1/2"	6 1/8"
Length	5"	11 1/2"
Thickness (uncompressed)	.007"	0.25"
Aspect Ratio (Length/Height)		
Between 1.3:1 and 2.5:1		



Third-Class Mail weighing one ounce or less. Mail which exceeds these dimensions or falls outside the range of acceptable ratios of length to height will be surcharged. First-Class Mail which exceeds the maximum sizes shown on Table 1 cannot be processed on the new automated equipment and must be sorted by less efficient methods.

The *aspect ratio* (length to height) of letter-size mail requires mail pieces to be rectangular within prescribed limits. The aspect ratio can be checked by dividing the length of a mailing piece by its height. If the result is between 1.3:1 and 2.5:1 inclusive, the piece has a standard size aspect ratio. If not within this range, the mail piece will be considered non-standard and will be subject to the same surcharge as the over-sized mail.

Paper envelopes should have a minimum basis weight of 20 pounds. Envelopes made from material other than paper should be submitted to the Postal Service for testing. At present, bar codes do not print clearly on materials such as spun olefin and certain recycled paper. Envelopes made of these materials cannot be processed on automated postal equipment. Glossy coated paper and other smooth paper stock which is used to manufacture envelopes and post cards is not a problem. A white background, however, is preferred.

#### **Guidelines for Post Cards**

All cards used for mailing must meet the minimum size requirements for First-Class letter mail (see minimum sizes in Table 1 above). Cards which do not meet these minimum sizes are non-mailable.

The special post card rate applies to cards up to 4 1/2 inches in height by 6 inches in length. Cards which exceed this size must pay the same rate as regular First-Class letter mail. The normal surcharge rules will apply to cards exceeding 6 1/8 inches by 11 1/2 inches and falling outside the standard limits of aspect ratio identified in Table 1 above.

Double or multiple-fold post cards should be spot sealed on all three of the open edges after the card is folded. Avoid using staples or clasps since such protrusions often catch on the edges of other mail pieces and cause jams or damage.

#### **Guidelines for Printing**

The new postal automation system relies, as you might suspect, on optical scanning devices. And as any election official who uses optical scan ballot counters will tell you, these devices require an adequate contrast between the background and the items to be read.

In order to achieve a proper contrast against the 20 pound white paper stock recommended above, both outgoing and return envelopes should be printed in fairly dark ink. We recommend using Pantone 193U (a color code that any commercial printer will recognize on both your envelopes and postcards. This is the traditional dark red ink which, in addition to being machine readable, has come to be recognized by postal workers as signifying official election materials.

### **KEY FEATURES OF THE RECOMMENDED FORMATS**

In addition to requiring high contrast printing, the postal optical scan devices are designed to read certain specific items, described below, which appear in otherwise clear fields on the face of the mail piece. These fields and their dimensions are designated by the shaded areas in Figure A. Since each item tells the machine an important bit of information, it is essential that all key items fall within the specifications defined here and in the accompanying figures.

#### **The Address Area, Font, and Format**

Addressing mail properly for automation may require changing some old habits and formats.

The entire address, both on outgoing and on pre-printed reply mail, should be contained within the imaginary rectangle designated in Figure A. The sides of the rectangle are one inch from the left and right edges of the mail piece. The bottom of the rectangle is 5/8 of an inch from the bottom edge; and the top of the rectangle is 2 1/4 inches from the bottom edge (below the identifier ribbon in the examples). Since nothing but the address should appear in this rectangle, it is important to ensure that the identifier ribbon is at least 2 1/4 inches above the bottom edge.

All addresses must be typewritten, machine printed, or preprinted. The font or typeface of

**Figure A – Postal Service Dimensional Requirements for Address, FIM, and Bar Code Areas on First Class Envelopes and Post Cards**

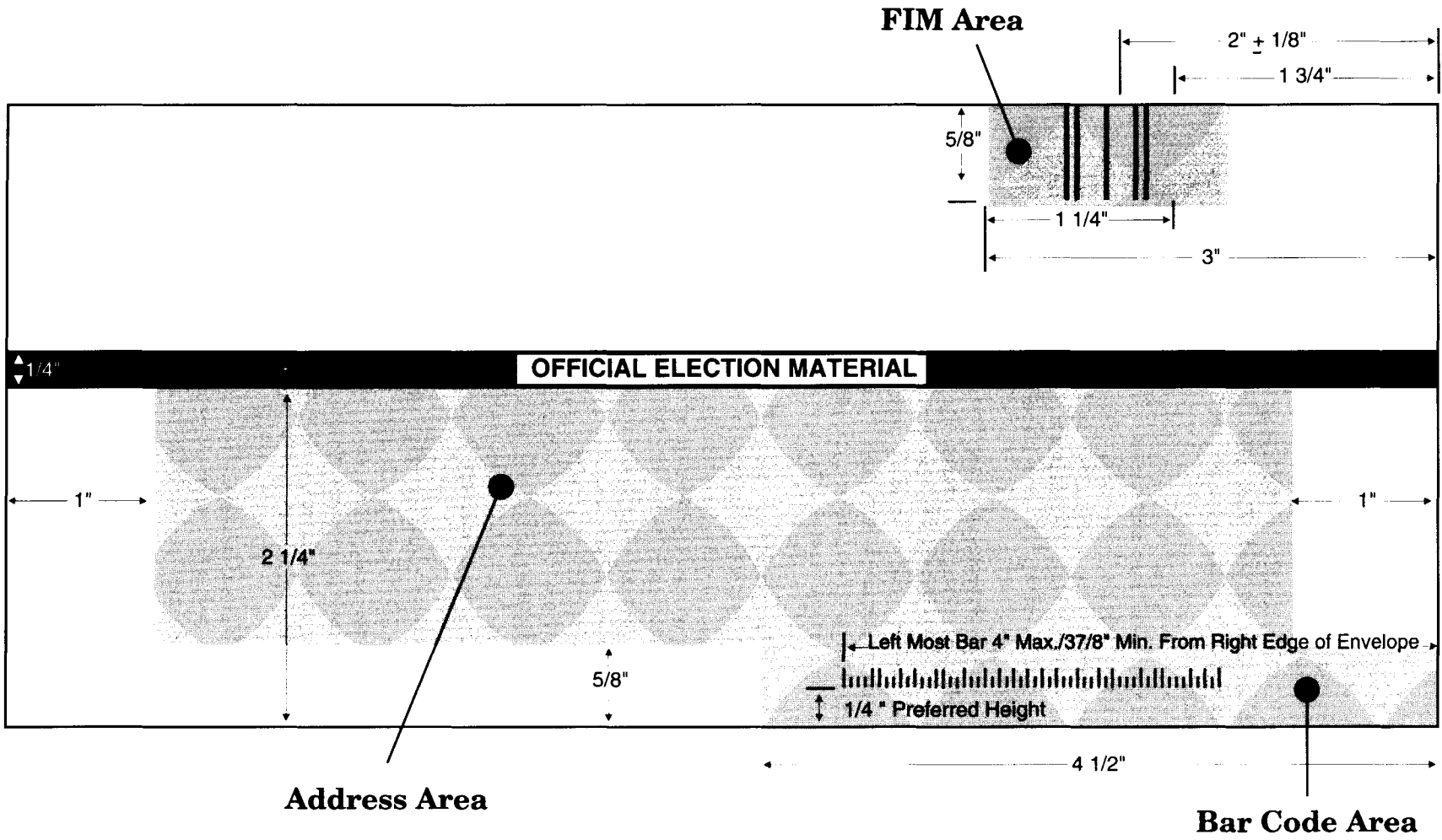

F-3

the address should be simple sans-serif. Stalic, artistic, cyrillic, and script-like fonts cannot be machine read. In general, matrix fonts with touching dots or matrix elements are more readable than those with widely separated elements. **ALL UPPER CASE CHARACTERS ARE PREFERRED** especially in the last line which should contain the post office (city), state, and ZIP code. Punctuation is not required and may be omitted.

Provided that they meet font and format specifications, mailing labels are acceptable. They must, however be applied entirely *within the address area and within +/- 5 degrees of parallel to the bottom edge of the mail piece.*

Ideally, addresses should be no more than five lines long and should be in a block format with a uniform left margin. Non-address data such as attention lines, pre-sort codes, or voter ID numbers should, if used, be entered immediately above the name of the recipient. Two lines are provided for the name and/or title of the recipient.

The next to the last line should contain the street address or box number along with any apartment, suite, room, or other unit number. (When the length of the street address precludes adding the unit number, then it should be placed in the line immediately above the street name.) In identifying the street address, be sure to use numbers rather than spelling them out (e.g., 191 MAPLE AVE. rather than NINE-ONE-NINE MAPLE AVENUE). By the same token, avoid using intersections (MAPLE AND MAIN) unless this is the authorized delivery address.

The last line of the address, containing the post office (city), state, and ZIP code, is particularly important. The two-letter state abbreviation, for example, is preferred over spelling out the state name. Only one or two spaces should be allowed between the state abbreviation and the ZIP code.

ZIP+4 codes should be used whenever possible and should certainly be used on your preprinted reply mail. You can obtain your own ZIP+4 code from your local post office along with the ZIP+4 codes for every address in your jurisdiction. In addition to speeding the mails, using ZIP+4 may entitle you to certain discounts in your mailings. Again, contact your local post office for details. The ZIP+4 code must always be

printed as the five digit ZIP code, a hyphen, and the four digit add on.

### The Bar Code and Area

The bar code is that long line of little hash marks which you see increasingly in the lower right area of envelopes and post cards. The bars are simply a binary encryption of the ZIP+4 code which permits high speed automated sorting.

Bar codes should appear on *all* your preprinted reply mail. The Postal Service will provide you with your correct bar code image on photographic film for use by your printer. It is also possible to obtain equipment, now being used in some election offices, which automatically applies an appropriate bar code to outgoing mail.

The bar code must appear within the otherwise clear read area designated in Figure A. The read area extends 5/8 inch from the bottom and at least 4 1/2 inches from the right edge of the mail piece.

Within the bar code area, the left-most bar must be located between 3 7/8 and 4 inches from the right edge of the mail piece while the bottom of the bar code must be between 3/16 and 1/4 inch from the bottom edge. Because the height of the bars is the critical element for the reader, it is important that the bar code films provided to you by the Postal Service not be enlarged or reduced in the printing. High quality resolution and printing are also crucial.

### FIM Types and Area

You may also have wondered, from time to time, about the meaning and purpose of those larger hash marks which often appear at the top and just to the left of the postage area. These markings are called the FIM (Facing Identification Marks), and their purpose, basically, is to tell the machine what kind of mail it is handling. Each of the following three FIM patterns give the machine a different message so that the mail can be properly sorted in subsequent automated steps.



**FIM A**



**FIM B**



**FIM C**

**Figure B – Recommended Format for Outgoing Domestic Civilian First Class Envelopes and Post Cards**

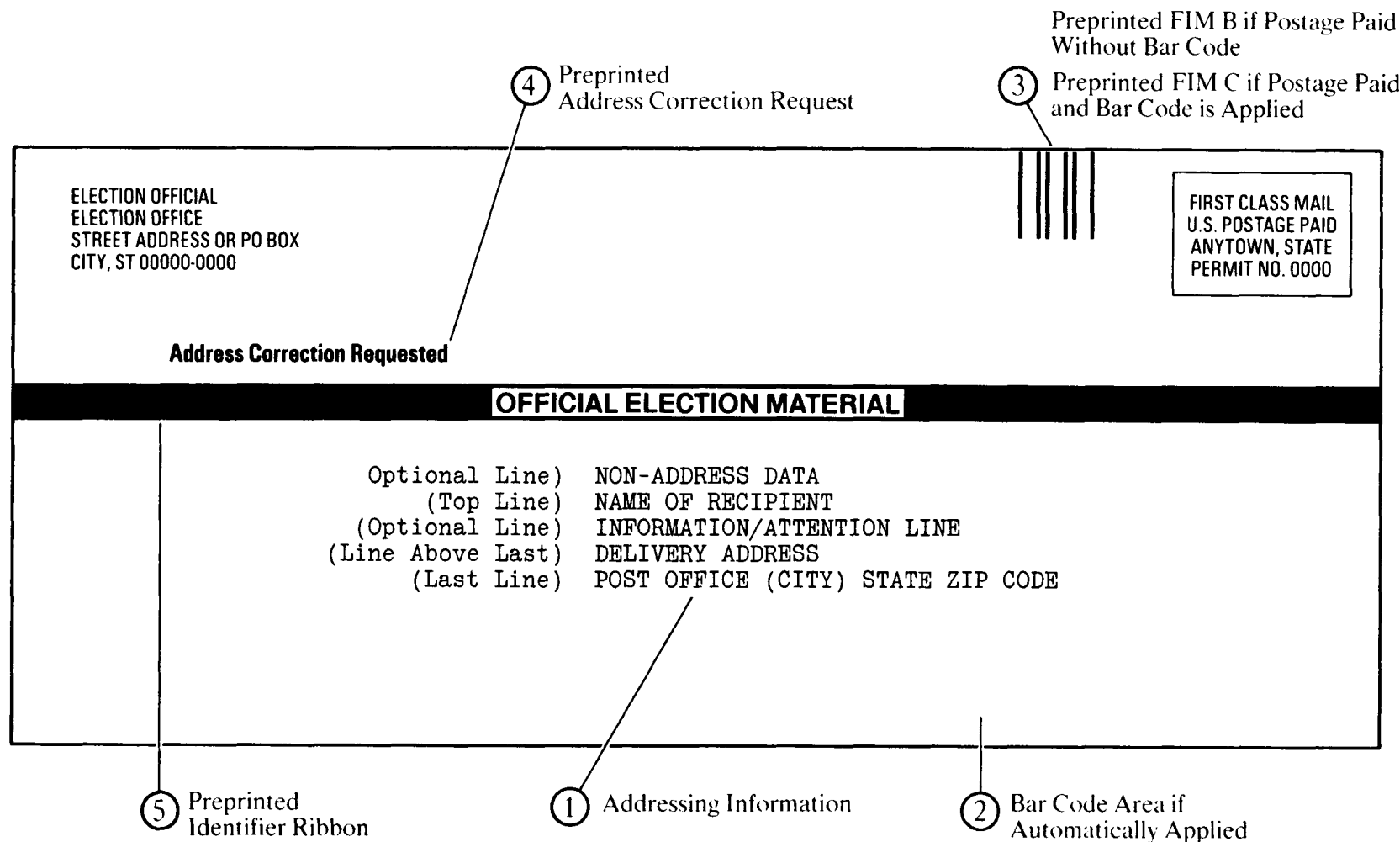

F-5

FIM A tells the machine that it is handling pre-printed reply mail which contains a bar code and to which the sender has affixed the postage. If you do not pay return postage under a permit, this is the FIM you will want to use on all your preprinted barcoded reply mail including domestic civilian absentee ballot return envelopes (See Figure C).

FIM B tells the machine that is processing a piece of postage paid permit mail which does *not* contain a bar code. Unless you have a machine which automatically prints the bar code, this is the FIM you will want to use on your franked outgoing mail including outgoing domestic civilian absentee ballots (See Figure B).

FIM C tells the machine that the item coming through is both bar coded *and* postage paid permit mail. This is the FIM you should use on domestic civilian reply mail if you *do* pay the return postage (see Figure D) and the one you should use on outgoing franked mail if you *do* have a machine that automatically prints your bar code.

These FIMs, which you should obtain from the Postal Service, must appear within the otherwise clear area designated in Figure A. The right boundary of this area must be 1 3/4 inches from the right edge of the mail piece. The left boundary must be 3 inches from the right edge. The area is 5/8 inch deep as measured from the top edge. The top of the bars must be no lower than 1/8 inch from the top edge of the mail piece but may touch the top edge. The right most bar must be 2 inches (+/- 1/8 inch) from the right edge of the mail piece.

### **The Identifier Ribbon**

The identifier ribbon running across the envelope face in each of our samples is optional and is by no means a postal service requirement. It may, however, serve three very useful purposes.

The first purpose of the identifier ribbon is to alert postal carriers and handlers that the mail item contains official election materials and therefore warrants special attention. Since many election offices have used such identifier ribbons in the past, this slightly new format (a single ribbon rather than a double one so as not to intrude on the address area) will continue an established tradition.

A second advantage to the identifier ribbon is that it will enable you to distinguish quickly between your domestic civilian mail and your military and overseas mail. This is because the recommended format for military and overseas envelopes does *not* contain an identifier ribbon. The importance to you of being able to make this distinction is twofold. First, military and overseas mail is postage paid under Federal law which domestic civilian mail is not. Second, such a distinction will help you better manage the new federal blank ballot which will be explained in future editions of this *Journal*.

Finally the identifier ribbon will improve the chances that the intended recipients of your official election mailings will be able to distinguish them from among the campaign mailings, contest entries, and commercial mailings which they also receive.

The identifier ribbon, if used, should appear at least 2 1/4 inches above the bottom edge of the mail piece so that it will not interfere with the address area. The ribbon in the examples is 1/4 inch wide with the words "OFFICIAL ELECTION MATERIAL" enclosed in bold type.

### **The Address Correction Request**

The Postal Service suggests that your outgoing first class mailings contain the words ADDRESS CORRECTION REQUESTED" just above the identifier ribbon and just below and inset from the return address (see Figure B). If these words appear, the Postal Service will make every effort to affix the correct address on undeliverable mail before returning the item to you. This service will, in turn, help you maintain accurate files as well as audit trails on absentee ballots.

### **The Business Reply Mail Box**

The "BUSINESS REPLY MAIL" box is appropriate *only on prepaid permit response mail*. If your office does not pay return postage on domestic civilian mail, then you should not use it on such items (although it will appear on military and overseas reply mail since these are federally prepaid). If your office *does* pay return postage on domestic civilian mail, then the box should appear as indicated in Figure D with the words "NO POSTAGE NECESSARY IF MAILED IN THE UNITED STATES" appearing in the postage area.

**Figure C – Recommended Format for Preprinted Domestic Civilian First Class Reply Mail to Which sender Must Affix Postage**

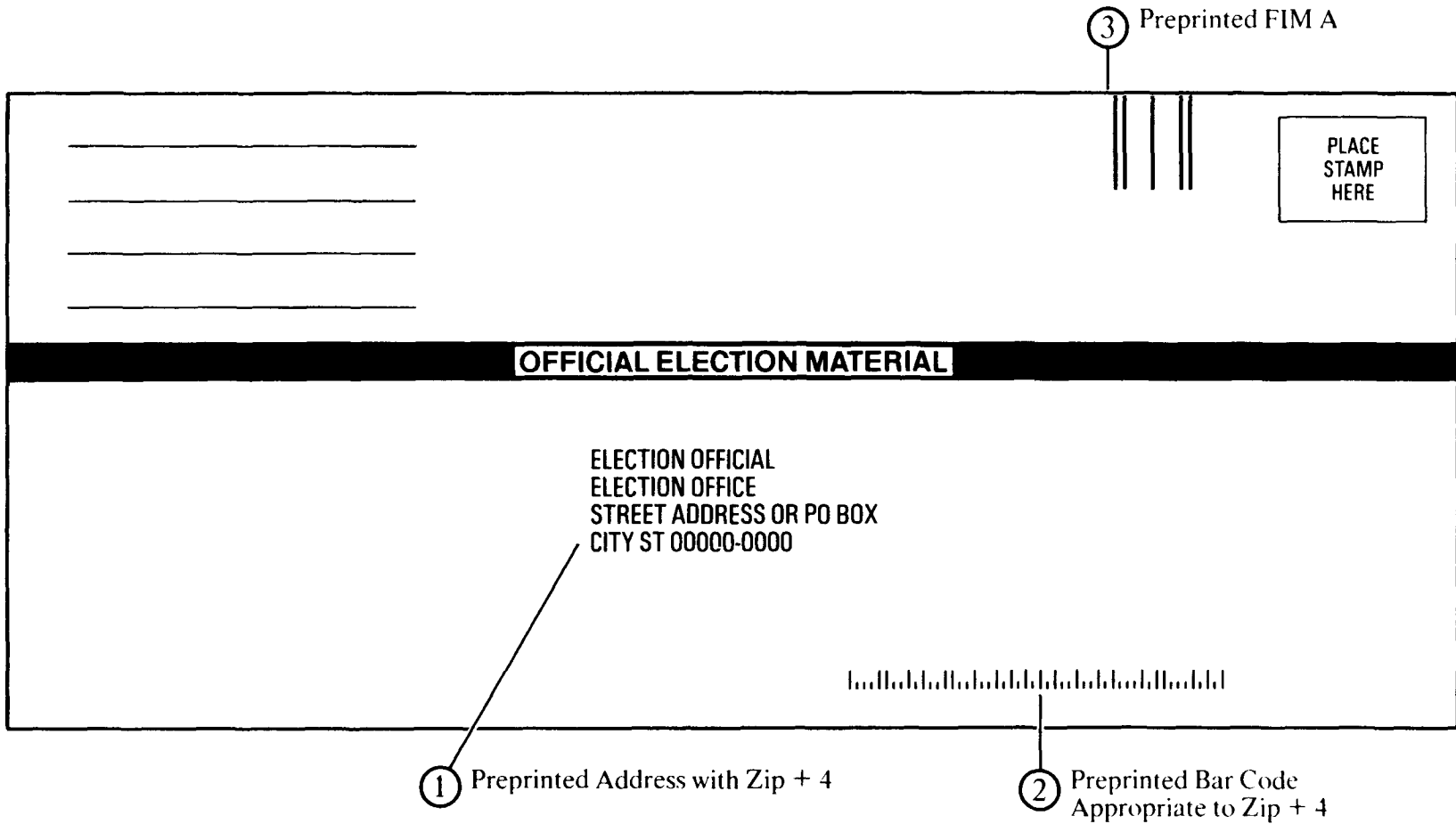

R-7

**Figure D – Recommended Format for Preprinted Domestic Civilian First Class Reply Mail with Postage Paid by the Addressee**

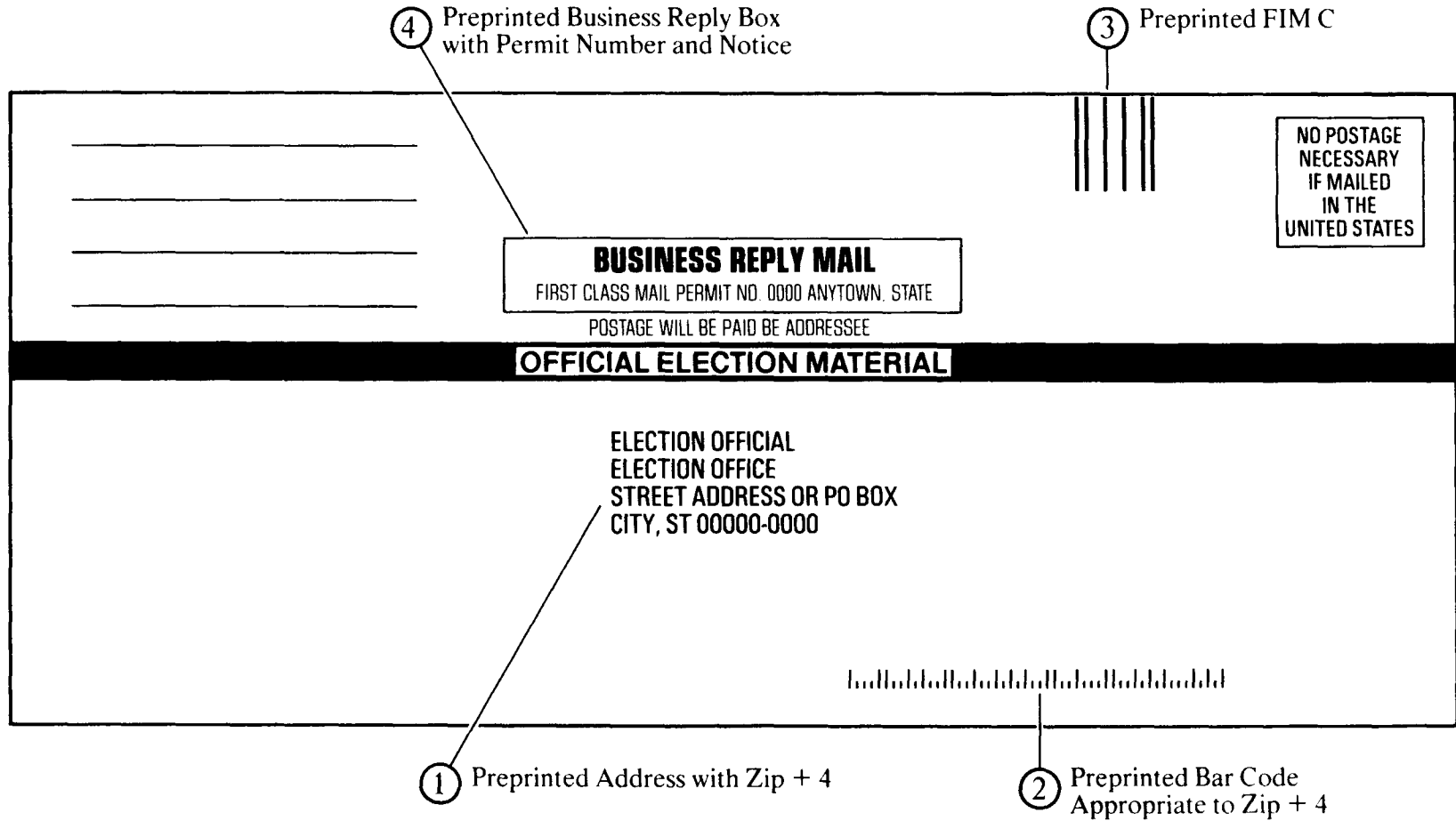

Within the BUSINESS REPLY MAIL box, and right below that legend, the words "FIRST CLASS MAIL PERMIT NO. XXXX" and the name of the issuing post office (city and state) must be shown in capital letters. Immediately below the box but above the identifier ribbon or address area must appear the legend "Postage Will Be Paid by Addressee."

### **FOR FURTHER GUIDANCE AND ASSISTANCE**

It is important to keep in mind that the formats suggested in this article pertain only to your pre-printed outgoing and returning *domestic civilian* mail. You may obtain the recommended formats for outgoing and returning *military and overseas* mail by contacting:

Henry Valentino, Director  
Federal Voting Assistance Program  
Office of the Secretary of Defense  
The Pentagon, RM 1B-457  
Washington, DC 20301  
Tele: 202/659-9330

Additional information on preparing your mail for postal automation can be obtained from three pamphlets published by the Postal Service:

- A Guide to Business Mail Preparation (Publication 25 dated December 1985)
- Addressing for Automation (Notice 221 dated May 1985), and
- Preparing Business and Courtesy Reply Mail (Publication 12, dated March 1986)

Remember that your ZIP+4 number, along with those for all addresses in your jurisdiction, can be obtained from your local postmaster. Your postmaster can also put you in contact with the nearest Postal Service Director of Marketing and Communication who can provide you or your State election office with camera ready copies of the bar code and FIMs appropriate to your needs.







## APPENDIX G

### OTHER PUBLICATIONS AVAILABLE

---

#### **Federal publications include:**

---

*Innovations in Election Administration 4: Using NCOA Files for Verifying Voter Registration Lists* by Charlotte Mullins, published by the National Clearinghouse on Election Administration.

*Innovations in Election Administration 5: Agency Voter Registration Programs* by Margaret Rosenfield, published by the National Clearinghouse on Election Administration.

*Innovations in Election Administration 6: Motor Voter Registration Programs* by Robert Montjoy, published by the National Clearinghouse on Election Administration.

*Innovations in Election Administration 7: Mail Registration Programs* by Robert Montjoy, to be published by the National Clearinghouse on Election Administration.

*Innovations in Election Administration 8: Election Document Retention in an Age of High Technology* by Marie Garber, to be published by the National Clearinghouse on Election Administration.

The above documents, along with additional copies of this one, are available free of charge from:

The National Clearinghouse  
on Election Administration  
Federal Election Commission  
999 E Street, N.W.  
Washington, D.C. 20463  
Direct tele: 202/219-3670  
Toll Free: 800/424-9530  
FAX: 202/219-8500

(NOTE: The last two *Innovations* studies identified above will not be available until late November of 1993.)

#### **State and local publications include:**

---

*Motor Voter Task Force Report* prepared by the Elections Division of the Office of the Secretary of State of Massachusetts. Available free of charge from:

Director of Elections  
Election Division Rm 1705  
Office of the Secretary of State  
One Ashburton Place  
Boston, Massachusetts 02108  
Tele: 617/727-2828  
FAX: 617/742-3238

#### **Private publications include:**

---

*The National Voter Registration Act of 1993: Implementation Manual* prepared by Human SERVE. Available for \$20.00 per copy from:

Campaign for Universal Voter Registration  
Human SERVE  
622 W. 113 Street, Rm 410  
New York, New York 10025  
Tele: 212/854-4053





## APPENDIX H

# DIRECTORY OF STATE ELECTION OFFICIALS, STATE DRIVER'S LICENSE OFFICIALS, WELFARE OFFICES, AND NATIONAL DISABILITY SERVICES ORGANIZATIONS

---

### State Election Officials

---

#### Alabama

Jerry Henderson  
Administrator of Elections  
P.O. Box 5616  
Montgomery, AL 36103-5616

#### Alaska

Joe Swanson  
Director of Elections  
Division of Elections  
P.O. Box 110017  
Juneau, AK 99811-0017

#### Arizona

Margaret Stears  
State Election Officer  
Capitol West Wing  
1700 W. Washington  
Phoenix, AZ 85007-2808

#### Arkansas

Rhonda Langster  
Supervisor of Elections  
Election Services  
State Capitol Bldg., Rm. 026  
Little Rock, AR 72201

#### California

John Mott-Smith  
Chief  
Elections and Political Reform  
1230 J Street, Rm. 232  
Sacramento, CA 95814

#### Colorado

Donetta Davidson  
Elections Officer  
Dept. of State  
1560 Broadway, Ste. 200  
Denver, CO 80202

#### Connecticut

Joanne Chrisoulis  
Manager, Election Services  
30 Trinity Street  
Hartford, CT 06106

#### Delaware

Richard B. Harper  
State Election Commissioner  
32 Loockerman Square, Ste. 203  
Dover, DE 19901

#### District of Columbia

Emmett H. Fremaux, Jr.  
Executive Director  
Board of Elections and Ethics  
1 Judiciary Square, Ste. 250  
441 4th Street, N.W.  
Washington, DC 20001

#### Florida

Dorothy W. Joyce  
Director  
Division of Elections  
Dept. of State  
The Capitol, Rm. 1801  
Tallahassee, FL 32399-0250

#### Georgia

H. Jeff Lanier  
Director, Elections Division  
Office of the Secretary of State  
State Capitol, Rm. 110  
Atlanta, GA 30334

#### Hawaii

Dwayne Yoshina  
Deputy Executive Officer  
Election Division  
Office of the Lieutenant Governor  
State Capitol, 5th Fl.  
Honolulu, HI 96813

**Idaho**

Ben Ysursa  
Chief Deputy Secretary of State  
for Elections  
203 State House  
Boise, ID 83720

**Illinois**

Dr. Ronald Michaelson  
Executive Director  
State Board of Elections  
1020 S. Spring Street  
P.O. Box 4187  
Springfield, IL 62708

**Indiana**

David Maidenburg  
Executive Director  
State Board of Elections  
302 W. Washington  
Indianapolis, IN 46204

**Iowa**

Sandy Steinbach  
Director of Elections  
Office of Secretary of State  
Hoover State Office Bldg.  
Des Moines, IA 50319

**Kansas**

Brad Bryant  
Deputy Assistant for Elections  
and Legislative Matters  
Capitol Bldg.  
Topeka, KS 66612

**Kentucky**

George Russell  
Executive Director  
State Board of Elections  
140 Walnut Street  
Frankfort, KY 40601

**Louisiana**

Jerry Fowler  
Commissioner of Elections  
4888 Constitution Avenue  
P.O. Box 14179  
Baton Rouge, LA 70809-4179

**Maine**

Rebecca Wyke  
Director of Elections  
State House, Sta. 101  
Augusta, ME 04333

**Maryland**

Gene M. Raynor  
Administrator  
State Administrative Board  
of Election Laws  
P.O. Box 231  
Annapolis, MD 21404-0231

**Massachusetts**

John Cloonan  
Director of Elections  
Election Division, Rm.1705  
Office of the Secretary  
of the Commonwealth  
One Ashburton Place  
Boston, MA 02108

**Michigan**

Christopher M. Thomas  
Director of Elections  
Department of State  
Mutual Building, 4th Fl.  
208 N. Capitol Ave.  
Lansing, MI 48901

**Mississippi**

Constance Slaughter-Harvey  
Assistant Secretary of State  
P.O. Box 136  
Jackson, MS 39205

**Missouri**

Joe Carroll  
Deputy Secretary of State  
for Election Services  
MO State Information Center  
600 West Main Street  
Jefferson City, MO 65101

**Montana**

Joe Kerwin  
Election Bureau Chief  
Office of Secretary of State  
State Capitol, Rm. 225  
Helena, MT 59620

**Nebraska**

Ralph Englert  
Deputy Secretary of State  
and Director of Elections  
Office of Secretary of State  
State Capitol, Ste. 2300  
Lincoln, NE 68509

**Nevada**

Alfredo Alonso  
Deputy Secretary of State for Elections  
Capitol Complex  
Carson City, NV 89710

**New Hampshire**

Karen H. Ladd  
Assistant Secretary of State  
State House, Rm. 204  
Concord, NH 03301

**New Jersey**

Kayla Burgeron, Director  
Election Division  
Dept. of State  
315 W. State Street  
Trenton, NJ 08625-0304

**New Mexico**

Hoyt Clifton  
Director  
Bureau of Elections  
State Capitol Bldg., 4th Fl.  
Santa Fe, NM 87503

**New York**

Thomas Wilkey  
Executive Director  
State Board of Elections  
One Commerce Plaza  
P.O. Box Four  
Albany, NY 12260

**North Carolina**

Gary O. Bartlett  
Executive Director  
State Board of Elections  
P.O. Box 1166  
Raleigh, NC 27602

**Ohio**

Donna Harter  
Elections Administrator  
Office of Secretary of State  
30 E. Broad Street, 14th Fl.  
Columbus, OH 43266-0418

**Oklahoma**

Lance D. Ward  
Secretary  
State Election Board  
3-B State Capitol  
P.O. Box 53156  
Oklahoma City, OK 73152

**Oregon**

Colleen Sealock  
Director of Elections  
Office of Secretary of State  
141 State Capitol  
Salem, OR 97310

**Pennsylvania**

William P. Boehm  
Commissioner of Elections  
305 North Office Bldg.  
Harrisburg, PA 17120

**Rhode Island**

Joseph DiStefano  
Chairman  
State Board of Elections  
50 Branch Ave.  
Providence, RI 02904

**South Carolina**

James Hendrix  
Executive Director  
State Election Commission  
P.O. Box 5987  
Columbia, SC 29250

**South Dakota**

Chris Nelson  
Supervisor of Elections  
State Capitol Bldg., 2nd Fl.  
500 E. Capitol  
Pierre, SD 57501-5070

**Tennessee**

Will Burns  
Coordinator of Elections  
James K. Polk Bldg., Ste. 500  
Nashville, TN 37243-0309

**Texas**

Tom Harrison  
Special Assistant for Elections  
Office of Secretary of State  
P.O. Box 12060  
Austin, TX 78711

**Utah**

Kelleen Leishman  
Assistant for Elections  
State Capitol Bldg., Rm. 203  
Salt Lake City, UT 84114



**Vermont**

Ellen Tofferi  
 Director of Elections  
 Office of Secretary of State  
 Redstone Bldg.  
 26 Terrace Street  
 Montpelier, VT 05609-1102

**Virginia**

Audrey Piatt  
 Deputy Director  
 State Board of Elections  
 200 N. 9th Street, Rm. 101  
 Richmond, VA 23219-3497

**Washington**

Gary McIntosh  
 Election Director  
 Elections Division  
 Office of Secretary of State  
 Legislative Bldg., AS-22  
 Olympia, WA 98504-0422

**West Virginia**

William H. Harrington  
 Chief of Staff  
 State Capitol, Rm. 157-K  
 1900 Kanawha Blvd., East  
 Charleston, WV 25305

## State Driver's Licensing Officials

---

**National:**

American Association  
 of Motor Vehicle Administrators (AAMVA)  
 4200 Wilson Blvd., Ste. 1100  
 Arlington, VA 22203  
 Contact:  
 David H. Hugel  
 Director, Government Affairs  
 (703) 522-4200

**State: (Courtesy of AAMVA)****Alabama**

Col. Ned W. McHenry  
 Director  
 Department of Public Safety  
 P.O. Box 1511  
 Montgomery, AL 36102-1511

**Alaska**

Jay N. Dulany  
 Director  
 Division of Motor Vehicles  
 5700 E. Tudor Road  
 Anchorage, AK 99507

**Arizona**

Don Miles, Administrator  
 Driver Licensing  
 Motor Vehicle Division  
 1801 Jefferson Street  
 Phoenix, AZ 85007

**Arkansas**

Mike Munns  
 Administrator  
 Office of Driver Services  
 P.O. Box 1272  
 Little Rock, AR 72203

**California**

Frank S. Zolin, Director  
 or  
 Carol Bedwell, Chief  
 Program/Policy Analysis Div.  
 Department of Motor Vehicles  
 2415 First Avenue  
 Sacramento, CA 95818

**Colorado**

Dee E. Hartman  
 Director  
 Motor Vehicle Division  
 140 West 6th Avenue  
 Denver, CO 80204

**Connecticut**

John L. O'Connell  
 Director, Vehicle Services  
 Department of Motor Vehicles  
 60 State Street  
 Wethersfield, CT 06109

**Delaware**

Michael D. Shahan  
 Director  
 Division of Motor Vehicles  
 P.O. Box 698  
 Highway Administration Building  
 Dover, DE 19903

**District of Columbia**

James E. Nance  
Chief  
Bureau of Motor Vehicle Services  
301 C Street, N.W.  
Washington, DC 20001

**Florida**

James H. Cox  
Director  
Division of Driver Licenses  
Neil Kirkman Building  
Tallahassee, FL 32399

**Georgia**

Capt. C.D. Mason  
Director  
Driver Services Division  
959 E. Confederate Avenue  
Atlanta, GA 30371

**Hawaii**

Lawrence K. Hao  
Administrator  
Motor Vehicle Safety Office  
79 S. Nimitz Highway  
Honolulu, HI 96813

**Idaho**

Douglas L. Kramer  
Chief  
Motor Vehicles  
P.O. Box 7129  
Boise, ID 83707

**Illinois**

Greg O'Connor  
Director  
Driver Services Department  
2701 S. Dirksen Parkway  
Springfield, IL 62723

**Indiana**

Tim Gornall  
Bureau of Motor Vehicles  
State Office Building  
100 North Senate Avenue  
Indianapolis, IN 46204

**Iowa**

Terry Dillinger  
Director  
Office of Driver Services  
Park Fair Mall  
100 Euclid Avenue  
Des Moines, IA 50306

**Kansas**

Joe Dick  
Director  
Division of Vehicles  
Robert B. Docking Office Building  
1st Floor  
Topeka, KS 66626

**Kentucky**

Bill Wilhoite  
Director  
Driver Licensing  
Department of Vehicle Regulation  
State Office Building  
Room 1001  
Frankfort, KY 40622

**Louisiana**

John J. Politz  
Assistant Secretary  
Office of Motor Vehicles  
P.O. Box 64886  
Baton Rouge, LA 70896

**Maine**

Gregory Hanscom  
Deputy Secretary of State  
Motor Vehicle Division  
Child Street, station 29  
Augusta, ME 04333

**Maryland**

W. Marshall Rickert  
Administrator  
Motor Vehicle Administration  
6601 Ritchie Highway  
Glen Burnie, MD 21062

**Massachusetts**

Herbert C. Osgood  
Director  
Driver Control  
Registry of Motor Vehicles  
100 Nashua Street  
Boston, MA 02114

**Michigan**

Joseph Pawlowski  
Deputy Secretary of State  
Motor Vehicle Administration  
Secondary Complex  
7064 Crowner Drive  
Lansing, MI 48918

**Mississippi**

Col. David R. Huggins  
Director  
MS Highway Safety Patrol  
P.O. Box 958  
Jackson, MS 39205

**Missouri**

John A. Lucks  
Divisional Director  
Motor Vehicle/Driver Licensing Division  
Harry S. Truman State Office Building  
301 W. High Street  
Jefferson City, MO 65105

**Montana**

Dean Roberts  
Administrator  
Motor Vehicle Division  
303 N. Roberts  
Helena, MT 59620

**Nebraska**

Jack C. Conrad  
Director  
Department of Motor Vehicles  
301 Centennial Mall South  
Lincoln, NE 68509

**Nevada**

James Weller  
Director  
Department of Motor Vehicles  
555 Wright Way  
Carson City, NV 89711

**New Hampshire**

Richard M. Flynn  
Commissioner  
Department of Safety  
James H. Hayes Safety Building  
10 Hazen Drive  
Concord, NH 03305

**New Jersey**

Straton "Skip" Lee  
Acting Director  
Division of Motor Vehicles  
25 South Montgomery Street  
Trenton, NJ 08666

**New Mexico**

Tim Salazar, III  
Director  
Motor Vehicle Division  
P.O. Box 1028  
Joseph Montoya Building  
Santa Fe, NM 87504

**New York**

Thomas J. Seery, Director  
Office of Field Operations  
Department of Motor Vehicles  
Empire State Plaza  
Albany, NY 12228

**North Carolina**

Robert F. Hodges  
Commissioner  
Division of Motor Vehicles  
1100 New Bern Avenue  
Raleigh, NC 27697

**Ohio**

Cassandra Hicks  
Chief Legal Counsel  
Department of Highway Safety  
240 Parsons Avenue  
Columbus, OH 43266

**Oklahoma**

Maj. Tom Tennery  
Special Services Commander  
Department of Public Safety  
P.O. Box 11415  
Oklahoma City, OK 73136

**Oregon**

Jane Hardy Cease  
Administrator  
Motor Vehicles Division  
1905 Lana Avenue, N.E.  
Salem, OR 97314

**Pennsylvania**

Donald Thomas  
Driver License Division Manager  
Bureau of Driver Licensing  
Transportation/Safety Building  
Harrisburg, PA 17120

**Rhod Island**

Thomas M. Harrington  
 Administrator  
 Division of Motor Vehicles  
 State Office Building  
 Providence, RI 02903

**South Carolina**

T.R. Rusty Easler  
 Administrator, Driver Services  
 Motor Vehicle Division  
 P.O. Box 1498  
 Columbia, SC 29216

**South Dakota**

Pam Ice  
 Chief Examiner  
 Com. Ins/Regulation Division  
 118 W. Capitol Avenue  
 Pierre, SD 57501-2080

**Tennessee**

Tom Hutton  
 Director  
 Driver Control Division  
 1150 Foster Avenue  
 Nashville, TN 37210

**Texas**

Michael Anderson, Chief  
 Driver/Vehicle Records Department  
 Department of Public Safety  
 5805 N. Lamar Blvd.  
 Austin, TX 78773

**Utah**

David Beach  
 Director  
 Driver License Division  
 P.O. Box 30560  
 Salt Lake City, UT 84130

**Vermont**

Michael D. Griffes  
 Commissioner  
 Department of Motor Vehicles  
 120 State Street  
 Montpelier, VT 05603

**Virginia**

Donald E. Williams  
 Commissioner  
 Department of Motor Vehicles  
 2300 west Broad Street  
 Richmond, VA 23269

**Washington**

Mary Riveland  
 Director  
 Department of Licensing  
 Highways-Licensing Bldg.  
 Olympia, WA 98504

**West Virginia**

Jane Cline  
 Commissioner  
 Department of Motor Vehicles  
 1800 Washington Street, East  
 Charleston, WV 25317

**Public Welfare Organizations****National:**

*The American Public Welfare  
 Association (APWA)*  
 810 First Street, N.E., Ste. 500  
 Washington, DC 20002-4267  
 Contact:  
 Rick Ferreira  
 or  
 Elaine Ryan  
 (202) 682-0100

**State: (Courtesy of APWA)****Alabama**

*Alabama Department of Human Resources*  
 Gordon Persons Bldg.  
 50 Ripley Street  
 Montgomery, AL 36130-1801  
 (205) 242-1160

**Alaska**

*Alaska Department of Health  
 and Social Services*  
 P.O. Box 110601  
 Juneau, AK 99811-0601  
 (907) 465-3030

**Arizona**

*Arizona Department of Economic Security*  
 1717 W. Jefferson Street  
 P.O. Box 6123  
 Phoenix, AZ 85005

**Arkansas**

*Arkansas Department of Human Services*  
300 Donaghey Bldg.  
7TH & Main Streets  
P.O. Box 1437  
Little Rock, AR 72203-1437  
(501) 682-8650

**California**

*California Health and Welfare Agency*  
1600 9th Street  
Room 460  
Sacramento, CA 95814  
(916) 654-3454

*California Department of Social Services*  
744 P Street  
M.S. 17-11  
Sacramento, CA 95814  
(916) 657-2598

*California Department of Health Services*  
714 P Street  
Room 1253  
Sacramento, CA 95814  
(916) 657-1425

**Colorado**

*Colorado Department of Social Services*  
1575 Sherman Street  
Denver, CO 80203-1714

**Connecticut**

*Connecticut Department  
of Income Maintenance*  
110 Bartholomew Avenue  
Hartford, CT 06106  
(203) 566-2530

*Connecticut Department  
of Human Resources*  
1049 Asylem Avenue  
Hartford, CT 06105-2431  
(203) 566-3318

*Connecticut Department of Children  
and Youth Services*  
170 Sigourney Street  
Hartford, CT 06105  
(203) 566-3536

**Delaware**

*Delaware Department of Health  
and Social Services*  
1901 N. DuPont Highway  
New Castle, DE 19720  
(302) 577-4500

*Delaware Department of Services  
for Children, Youth, and Their Families*  
1825 Faulkland Road  
Wilmington, DE 19805-1195  
(302) 633-2500

**District of Columbia**

*District of Columbia Department  
of Human Services*  
801 N. Capitol St., N.E.  
Ste. 700  
Washington, DC 20002  
(202) 727-0310

**Florida**

*Florida Department of Health  
and Rehabilitative Services*  
1317 Winewood Blvd.  
Tallahassee, FL 32399-0700  
(904) 488-7721

**Georgia**

*Georgia department of Human Resources*  
State Office Bldg.  
47 Trinity Ave., S.W.  
Atlanta, GA 30334  
(404) 656-5680

*Georgia Dept. of Human Resources / Division  
of Family & Children Services*  
878 Peachtree Street, N.E.  
Atlanta, GA 30309  
(404) 894-6368

*Georgia Department of Medical Assistance*  
Floyd Veterans Memorial Bldg.  
West Tower 1220  
2 M.L. King Jr., Drive, S.E.  
Atlanta, GA 30334  
(404) 656-4479

**Hawaii**

*Hawaii Department of Human Services*  
1390 Miller St.  
Honolulu, HI 96813  
(808) 586-4996

**Idaho**

*Idaho Department of Health and Welfare*  
450 W. State St.- Statehouse Mail  
Boise, ID 83720  
(208) 334-5500

**Illinois**

*Illinois Department of Public Aid*  
Jesse B. Harris Bldg.  
100 S. Grand Ave., E.  
Springfield, IL 62762  
(217) 782-6716

*Illinois Department of Children  
and Family Services*

406 East Monroe Street  
Springfield, IL 62701  
(217) 785-2509

**Indiana**

*Indiana Family and Social Services  
Administration*  
Government Center South  
402 W. Washington Street  
Indianapolis, IN 46204

**Iowa**

*Iowa Department of Human Services*  
Hoover Bldg.  
Des Moines, IA 50319  
(515) 281-4597

**Kansas**

*Kansas Department of Social  
and Rehabilitation Services*  
Docking State Office Bldg., 6th Fl.  
915 Harrison Ave.  
Topeka, KS 66612-1570  
(913) 296-3271

**Kentucky**

*Kentucky Cabinet for Human Resources*  
275 E. Main Street  
Frankfort, KY 40621  
(502) 564-7573

**Louisiana**

*Louisiana Department of Social Services*  
P.O. Box 3776  
Baton Rouge, LA 70821  
(504) 342-0286

**Maine**

*Maine Department of Human Services*  
State House Station #11  
Augusta, ME 04333  
(207) 287-3707

**Maryland**

*Maryland Department of Human Resources*  
Saratoga State Center  
311 W. Saratoga Street  
Baltimore, MD 21201  
(410) 333-0001

**Massachusetts**

*Massachusetts Executive Office  
of Human Services*  
1 Ashburton Pl., Rm. 1109  
Boston, MA 02108  
(617) 727-7600

*Massachusetts Department of Public Welfare*  
600 Washington Street  
Boston, MA 02111  
(617) 348-5970

*Massachusetts Department of Social Services*  
24 Farnsworth Street  
Boston, MA 02210  
(617) 727-0900

**Michigan**

*Michigan Department of Social Services*  
235 S. Grand Avenue  
P.O. Box 30037  
Lansing, MI 48909  
(517) 373-2035

**Mississippi**

*Mississippi Department of Human Services*  
421 W. Pascagoula Street  
Jackson, MS 39203  
(601) 960-4250

**Missouri**

*Missouri Department of Social Services*  
Broadway State Office Bldg.  
221 W. High Street  
P.O. Box 1527  
Jefferson City, MO 65102  
(314) 751-4815

**Montana**

*Montana Department of Social  
and Rehabilitation Services*  
P.O. Box 4210  
Helena, MT 59604  
(406) 444-5622

*Montana Department of Family Services*  
P.O. Box 8005  
Helena, MT 59604  
(406) 444-5902

**Nebraska**

*Nebraska Department of Social Services*  
301 Centennial Mall, South, 5th Fl.  
P.O. Box 95026  
Lincoln, NE 68509-5026  
(402) 471-3121

**Nevada**

*Nevada Department of Human Resources*  
Capitol Complex  
505 E. King Street  
Carson City, NV 89710  
(702) 687-4400

**New Hampshire**

*New Hampshire Department of Health  
and Human Services*  
6 Hazen Drive  
Concord, NH 03301-6505  
(603) 224-5500

**New Jersey**

*New Jersey Department of Human Services*  
Capital Place One  
222 S. Warren Street, 5th Fl.  
CN 700  
Trenton, NJ 08652-0700  
(609) 292-5325

**New Mexico**

*New Mexico Human Services Department*  
P.O. Box 2348  
Santa Fe, NM 87504-2348  
(505) 827-4065

**New York**

*New York State Department of Social Services*  
40 N. Pearl Street  
Albany, NY 12243  
(518) 474-9003

**North Carolina**

*North Carolina Department  
of Human Resources*  
101 Adams Bldg.  
Raleigh, NC 27603  
(919) 733-4534

**North Dakota**

*North Dakota Department of Human Services*  
State Capitol - Judicial Wing  
600 East Blvd.  
Bismarck, ND 58505  
(701) 224-2310

**Ohio**

*Ohio Department of Human Services*  
30 E. Broad Street, 32nd Fl.  
Columbus, OH 43266-0423  
(614) 466-1504

**Oklahoma**

*Oklahoma Department of Human Services*  
P.O. Box 25352  
Oklahoma City, OK 73125

**Oregon**

*Oregon Department of Human Resources*  
Public Service Bldg.  
Salem, OR 97310  
(503) 378-3034

**Pennsylvania**

*Pennsylvania Department of Public Welfare*  
7th and Foster Streets  
P.O. Box 2675  
Harrisburg, PA 17105-2675  
(717) 787-2600

**Rhode Island**

*Rhode Island Department  
of Human Services*  
Aime J. Forand Bldg.  
600 New London Ave.  
Cranston, RI 02920  
(401) 464-1000

*Rhode Island Department  
of Children, Youth & Families*  
610 Mt. Pleasant Avenue  
Providence, RI 02908  
(401) 457-4750

**South Carolina**

*South Carolina Department of Social Services*  
1531 Confederate Avenue  
P.O. Box 1520  
Columbia, SC 29202-1520  
(803) 734-6169

**South Dakota**

*South Dakota Department of Social Services*  
700 Governors Drive  
Pierre, SD 57501

**Tennessee**

*Tennessee Department of Human Services*  
Citizens Plaza  
400 Deaderick Street  
Nashville, TN 37248-0001  
(615) 741-4165

**Texas**

*Texas Department of Human Services*  
701 W. 51st street  
P.O. Box 149030  
Austin, TX 78714-9030  
(512) 450-3011

**Utah**

*Utah Department of Human Services*  
120 N. 200 West  
P.O. Box 45500  
Salt Lake City, UT 84145-0500  
(801) 538-4001

**Vermont**

*Vermont Agency of Human Services*  
103 S. Main Street  
Waterbury, VT 05676  
(802) 241-2220

**Virginia**

*Virginia Department of Social Services*  
8007 Discovery Drive  
Richmond, VA 23229-8699  
(804) 662-7022

*Virginia Department for the Visually  
Handicapped*  
397 Azalea Avenue  
Richmond, VA 23227  
(804) 371-3145

**Washington**

*Washington Department of Social and Health  
Services*  
State Office Bldg.  
P.O. Box 45010  
Olympia, WA 98504-5010  
(206) 753-7039

**West Virginia**

*West Virginia Department of Health and  
Human Resources*  
Bldg. 6, State Capitol Complex  
Charleston, WV 25305  
(304) 558-240

## **Disability Services Organizations**

---

**National Council on Independent Living**

Troy Atrium  
4th Street & Broadway  
Troy, NY 12180  
(518) 274-1979

**The Council of State Administrators  
of Vocational Rehabilitation**

P.O. Box 3776  
Washington, DC 20007  
(202) 638-4634

**The National Council of State Agencies  
for the Blind**

1213 29th Street, NW  
Washington, DC 20007  
(202) 298-8468

**American Council of the Blind**

1155 15th Street, N.W.  
Washington, DC 20005  
(202) 467-5081

**National Federation of the Blind**

1800 Johnson Street  
Baltimore, MD 21230  
(410) 659-9314

**National Association of the Deaf**

814 Thayer Avenue  
Silver Spring, MD 20910  
(301) 587-1788



**National Association of Developmental  
Disabilities Councils**

1234 Massachusetts Avenue, N.W.  
Ste. 103  
Washington, DC 20005  
(202) 347-1234

**Community Transportation Association  
of America**

725 15th Street, N.W.  
Washington, DC 20005  
(202) 628-1480