

Estimating historical range and variation of landscape patch dynamics: limitations of the simulation approach[☆]

Robert E. Keane^{a,*}, Russell A. Parsons^a, Paul F. Hessburg^b

^a USDA Forest Service, Rocky Mountain Research Station, Fire Sciences Laboratory, P.O. Box 8089 Missoula, MT 59807, USA

^b USDA Forest Service, Pacific Northwest Research Station, Forestry Sciences Laboratory, Wenatchee, WA 98801, USA

Received 6 March 2001; received in revised form 25 September 2001; accepted 18 October 2001

Abstract

Landscape patterns in the northwestern United States are mostly shaped by the interaction of fire and succession, and conversely, vegetation patterns influence fire dynamics and plant colonization processes. Historical landscape pattern dynamics can be used by resource managers to assess current landscape conditions and develop target spatial characteristics for management activities. The historical range and variability (HRV) of landscape pattern can be quantified from simulated chronosequences of landscape vegetation maps and can be used to (1) describe temporal variation in patch statistics, (2) develop limits of acceptable change, and (3) design landscape treatment guidelines for ecosystem management. Although this simulation approach has many advantages, the limitations of this method have not been explored in detail. To demonstrate the advantages and disadvantages of this approach, we performed several simulation experiments using the spatially explicit, multiple pathway model a LANDscape Succession Model (LANDSUM) to quantify the range and variability in six class and landscape pattern metrics for four landscapes in the northwestern United States. First, we applied the model to spatially nested landscapes to evaluate the effect of landscape size on the HRV pattern metrics. Next, we averaged the HRV pattern metrics across maps generated from simulation time spans of 100, 500, and 1000 years and intervals 5, 10, 25 and 50 years to assess optimal output generation parameters. We then altered the elevation data layer to evaluate effect of topography on pattern metrics, and cut various shapes (circle, rectangle, square) from a landscape to examine landscape shape and orientation influences. Then, we altered the input vegetation maps to assess the influence of initial conditions on landscape metrics output. Finally, a sensitivity analysis of input fire probabilities and transition times was performed. Results indicate landscapes should be quite large to realistically simulation fire pattern. Landscape shape, and orientation are critically important to quantifying patch metrics. Simulation output need only be stored every 20–50 years but landscapes should be simulated for long time periods (≥ 1000 years). All landscapes are unique so conclusions generated here may not be entirely applicable to all western US landscapes. © 2002 Elsevier Science B.V. All rights reserved.

Keywords: Landscape pattern; Historical range and variation; Landscape fire succession modeling; Landscape pattern metrics

[☆] The use of trade or firm names in this paper is for reader information and does not imply endorsement by the U.S. Department of Agriculture of any product or service. This paper was written and prepared by U.S. Government employees on official time, and therefore is in the public domain and not subject to copyright.

* Corresponding author. Tel.: +1-406-329-4846; fax: +1-406-329-4877.

E-mail address: rkeane@fs.fed.us (R.E. Keane).

1. Introduction

Vegetation pattern often reflects the cumulative and interactive effects of disturbance regimes, biophysical environments, and successional processes (Baker, 1989; Bormann and Likens, 1979; Crutzen and Goldammer, 1993; Pickett and White, 1985; Wright, 1974). Landscapes of the northwestern United States are primarily shaped by wildland fire and vegetation succession, and conversely, these patterns will invariably influence future fire patterns, regeneration and colonization processes, and plant development (Hessburg et al., 1999a; Keane et al., 1998; Turner et al., 1994; Veblen et al., 1994). It follows, then, that some general properties of disturbance regimes may be described from spatio-temporal patch dynamics (Hessburg et al., 1999b; Forman, 1995; Swanson et al., 1990). For example, large patches may indicate a fire regime dominated by large, severe fires (Baker, 1989; Baker et al., 1991; Keane et al., 1999). Using this inference, patch and landscape characteristics can be used to assess, design, and plan ecosystem management activities (Baker et al., 1991; Keane et al., 2000). For example, the range of patch sizes on a landscape over time can be used to design the size of a prescribed fire (Cissel et al., 1999; Swetnam et al., 1999; Mladenoff et al., 1993). Current landscape conditions can also be compared with summarized historical landscape conditions to detect ecologically significant change, such as that brought on by fire exclusion and timber harvesting (Baker, 1992, 1995; Cissel et al., 1999; Hessburg et al., 1999b; Landres et al., 1999).

Landscape structure and composition are usually characterized from the spatial distribution of patches—a term synonymous with stands or polygons (McGarigal and Marks, 1995). Many types of spatial statistics, often called class and landscape metrics, are used to quantitatively describe patch dynamics of landscapes (Turner and Gardner, 1991; McGarigal and Marks, 1995). They are calculated by importing spatial thematic data layers, usually from a Geographic Information System (GIS), into any of the many landscape metrics programs available (e.g. FRAGSTATS, McGarigal and Marks, 1995, R.L.E,

Baker and Cai, 1990). Landscape metrics statistically portray distributions of patch shape, size, and adjacency by patch class (i.e. label or category) across many scales (e.g. individual patch, class, and landscape; Cain et al., 1997; Hargis et al., 1998). These metrics are important, because, they allow a consistent, comprehensive, and objective comparison among and across landscapes, even though it is difficult to test these metrics for statistical significance as yet (Turner and Gardner, 1991).

The historical range and variability (HRV) of landscape pattern characteristics provides a useful concept for planning and designing landscape treatments (Parsons et al., 1999; Landres et al., 1999). In this paper, we define HRV as the quantification of temporal fluctuations in ecological processes and characteristics prior to European settlement (i.e. before 1900). Naturally, HRV is highly scale-dependent and inherently unstable. For instance, the variability of ponderosa pine cover across a landscape greatly depends on the range of years used to compute HRV statistics. Despite its drawbacks, the HRV concept has the potential to be indispensable to ecosystem management, because, it can be used to define limits of acceptable change (Swetnam et al., 1999) for assessing stand or landscape condition to prioritize for restoration treatments (Hessburg et al., 1999a). Since HRV estimates do not integrate future trends in climate change and human activities, we feel that HRV is not the final answer to spatial considerations in land management, but it does provide a good reference point for planning future management projects.

The range and variation of historical patch dynamics can be quantified from three main sources. The best source is a chronosequence (i.e. a sequence of maps of one landscape from many time periods), which can be input to landscape pattern analysis programs to compute HRV pattern results. Unfortunately, temporally deep chronosequences of historical landscape conditions are absent for many western landscapes, because, aerial photography or satellite imagery are rare or non-existent prior to 1930. Second, vegetation maps from many similar, unmanaged landscapes, taken from one or more time periods,

can be gathered across a geographic region and input to spatial analysis programs (Hessburg et al., 1999a). This spatial series essentially substitutes space for time (Hessburg et al., 1999c; Pickett, 1989) and assumes that because all landscapes in the series display highly similar environmental, disturbance, topographical, and biological conditions. Since aerial photographs are absent prior to 1930, historical spatial series must be created from comparable remote, unsettled watersheds mapped with the earliest imagery possible (Hessburg et al., 1999a). A big limitation of this approach source is that subtle differences in landform, relief, soils, and climate make each landscape unique. However, landscapes can be grouped according to the processes that govern vegetation, such as climate, disturbance, and species succession (Hessburg et al., 2000).

The third method of quantifying HRV involves simulating a landscape to produce a chronosequence of simulated maps to compute landscape metrics. This approach assumes that succession and disturbance processes are simulated accurately in space and time, and that the spatial properties of the disturbance simulation are reflected in the patch dynamics (Keane et al., 1999). Many spatially explicit ecosystem simulation models are available for quantifying HRV patch dynamics (see Mladenoff and Baker, 1999), but most are computationally intensive, difficult to parameterize and initialize, and complex in design, thereby making them difficult to use in everyday management applications. On the other hand, those models designed for management planning tend to oversimplify successional development and disturbance initiation, spread and effects (Chew, 1997; Beukema and Kurtz, 1995; Keane et al., 1996, 1997).

Regardless of model complexity and detail, there are still other considerations associated with the simulation approach for quantifying HRV. For example, the size, shape, orientation, topographic complexity, initial conditions, and reporting interval can influence spatial pattern dynamics and associated estimates of HRV. This paper explores the advantages and limitations of using the simulation approach to quantify the HRV of landscape pattern dynamics. The LANDSUM

model (Keane et al., 1996) was used to spatially simulate historical succession and disturbance processes on four very different landscapes in the Pacific Northwest over 1000 years. Summary statistics of selected class and landscape metrics were reported for each simulated landscape. Then, results from a series of simulation experiments are presented to demonstrate some limitations of the simulation approach and to provide important information for interpreting these pattern statistics. Results from this effort can be used to plan and implement landscape-scale ecosystem management activities.

2. Methods

2.1. *The model*

The LANDscape Succession Model (LANDSUM) is a spatially explicit vegetation dynamics simulation C++ program wherein succession is treated as a deterministic process and disturbances (e.g. fire, insects, and disease) are treated as a stochastic processes (Keane et al., 1997). LANDSUM simulates succession within a patch (adjacent similar pixels) or polygon using the multiple pathway fire succession modeling approach presented by Kessell and Fischer (1981). This approach assumes all pathways of successional development will eventually converge to a stable or climax plant community called a potential vegetation type (PVT; Fig. 1). A PVT identifies a distinct biophysical setting that supports a unique and stable climax plant community under a constant climate regime. There is a single set of successional pathways for each PVT present on a given landscape (Arno et al., 1985). Successional development within a patch is simulated as a change in structural stage and cover type (together called a succession class) simulated at an annual time step. The length of time a patch remains in a succession class (transition time, years) is an input parameter that is held constant throughout the simulation. Disturbances disrupt succession and can delay or advance the time spent in a succession class, or cause an abrupt change to another succession class. Occurrences

of human-caused and natural disturbances are stochastically modeled from probabilities based on historical frequencies. All disturbances were simulated at a patch-scale, except for wildland fire, which is discussed next.

The simulation of fire behavior and effects presented a special challenge, because of LANDSUM's simplistic structure. Some spatial models assume a random or patch-to-patch fire spread (Beukema and Kurtz, 1995; Chew, 1997), which maintains map integrity but misrepresents the dynamics of fire growth (Keane et al., 2000). Wildland fires tend to split patches along topographic, fuel, moisture, or wind gradients and rarely follow patch boundaries (Finney, 1999). Inclusion of a detailed mechanistic fire growth model, such as FARSITE (Finney, 1998), into LANDSUM was not possible, because, the addition of required fuels and weather input data would create an overly complex model that would find little use in management. We decided to create a new version of LANDSUM (version 2.0) that simulated spatial fire dynamics and its effect on landscape

pattern and composition using an approach that balanced simplicity and applicability with realism.

In general, the simulation of fire can be represented by three phases, initiation; spread; and effects. Ignition in LANDSUM is stochastically simulated from the fire probabilities assigned to each initial polygon based on its PVT, cover type, and structural stage. The following three-parameter Weibull hazard function was employed to account for fuel buildup (i.e. years since burn—YSB, years) and a no-burn period directly after a fire (REBURN, years).

$$P_f = \left(\frac{\beta}{\text{FRI}} \right) \left[\frac{\text{YSB} - \text{REBURN}}{\text{FRI}} \right]^{\beta - 1} \quad (1)$$

where, β is the shape parameter (parameterized at 2.0 for this study), FRI is the fire return interval or the inverse of fire probability (years), and P_f is the probability of fire. We estimated REBURN at 3.0 years in this study. The probability P_f was then adjusted to account for the size of the polygon and then compared with a random number. If the random number was lower than P_f , a

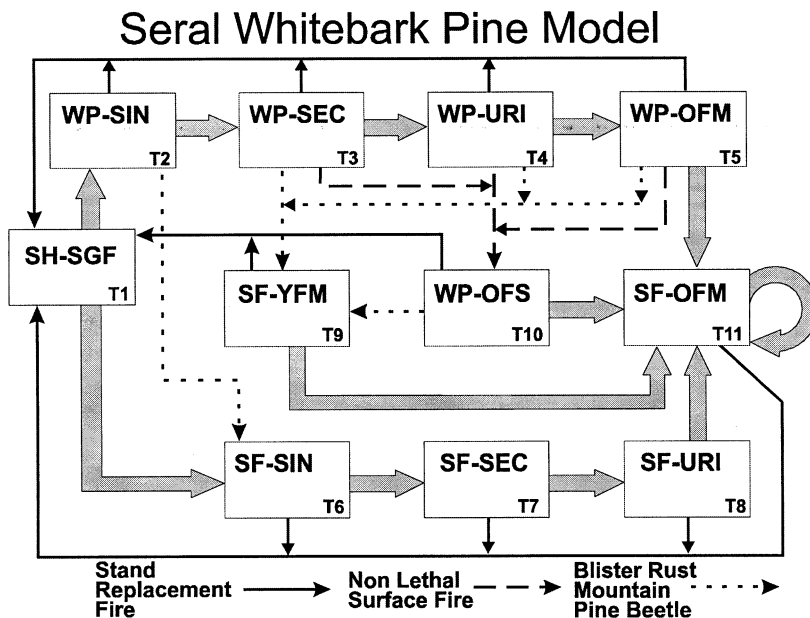

Fig. 1. An example of the multiple successional pathway approach used to simulated succession in LANDSUM for the high elevation subalpine fir PVT (Keane et al., 2000). Cover types are SH, shrub/herb; WP, whitebark pine; LP, lodgepole pine; SF, subalpine fir. Structural stages are SGF, shrub/grass/forb; SIN, stand initiation; SEC, stem exclusion closed; SEO, stem exclusion open; URI, understory reinitiation; OFM, old forest multistrata; OFS, old forest single strata.

fire was started on a randomly selected pixel within that polygon.

Fire was spread across the landscape at a pixel-level using directional vectors of wind and slope. Wind direction (degrees azimuth) is an initial input to the model but then it is randomly modified within 45 ° of the input direction for each simulated fire. Wind speed (m s⁻¹) is also an input parameter that is randomly adjusted within 0.5 times of a user-specified input value for each fire. Slope (%) is calculated from a digital elevation model (DEM), which is a required input map in LANDSUM. The number of pixels to spread the fire in eight possible directions (N, NE, E, SE, S, SW, W, NW) is calculated from the following relationship, which we modified from Rothermel (1991).

$$\text{spix} = (\text{wind}_f)(\text{slope}_f) \quad (2)$$

where spix is the number of pixels to spread in a direction, wind_f and slope_f are wind and slope factors that are computed from the following equations.

$$\text{wind}_f = (1 + 0.125\varpi)(\cos(\text{abs}(\theta_s - \theta_w)))^{\varpi^{0.6}} \quad (3)$$

$$\text{slope}_f = \frac{4}{(1 + 3.5 e^{10\Delta})} \quad (4)$$

where ϖ is wind speed (mph), abs is absolute value, θ_s the spread direction, θ_w the wind direction, and Δ is slope (rise over run; Rothermel, 1991). The slope factor applies to only positive slope values (upslope spread). Downslope spread is computed as:

$$\text{slope}_f = e^{3\Delta^2} \quad (5)$$

These equations were solved for each pixel ignited by the fire, originating from a randomly selected fire start pixel mentioned above. Only those pixels of patches having assigned fire return intervals less than the simulation time period were allowed to burn, except for those patches where P_f was zero, such as in a recently burned patch. Rounding of the computed spix to the nearest pixel (30 m in this study) was stochastically determined from a uniform random number generator. Initially, we let fires burn until they hit the landscape boundary or an unburnable patch, but we

found that too much land that was burning on the simulated landscapes. We then limited fire spread by stochastically calculating a maximum fire size (FIRESIZE, ha) for each fire from the following equation:

$$\text{FIRESIZE} = \alpha \ln(\text{RN})^\beta \quad (6)$$

where α is the magnitude parameter that approximated the average fire size (ha) estimated to be approximately 10–50 ha in this study from the NIFMID data base (Schmidt et al., 2002), RN is a random number from a uniform probability distribution, and β is a shape parameter estimated as 3.0 for this study.

Fire effects were stochastically determined within each burned stand. Probabilities of three fire severities (stand-replacement, mixed severity, and non-lethal surface fires) were assigned to each mapped polygon (i.e. patch) based on PVT, cover type, and structural stage (Keane et al., 1996). The inverse of the sum of these probabilities was used as FRI in Eq. (1), but in calculating fire effects, these probabilities were relativized (scaled from 0.0 to 1.0) and a random number was compared with the cumulative relativized probability distribution to select the severity of the fire to simulate. We also included a slight chance (0.05 probability) that the polygon would not burn at all. The selected fire severity would then determine the appropriate successional pathway (see Fig. 1).

2.2. The landscapes

Four very different landscapes were used in this simulation exercise (Fig. 2). The 516 917 ha Selway landscape in central Idaho represents the largest simulation area with a wide diversity of vegetation and biophysical settings (see Habeck, 1972). The Dahlenega watershed in east-central Idaho on the Salmon-Challis national forest is a large landscape (22 338 ha) that contains relatively simple succession and fire processes on a homogeneous landscape. The Flathead and Grande Ronde watersheds are small landscapes (< 20 000 ha) composed of a wide variety of PVT's that contain complex successional pathways and fire dynamics. Fire has played a critical role in shaping all four

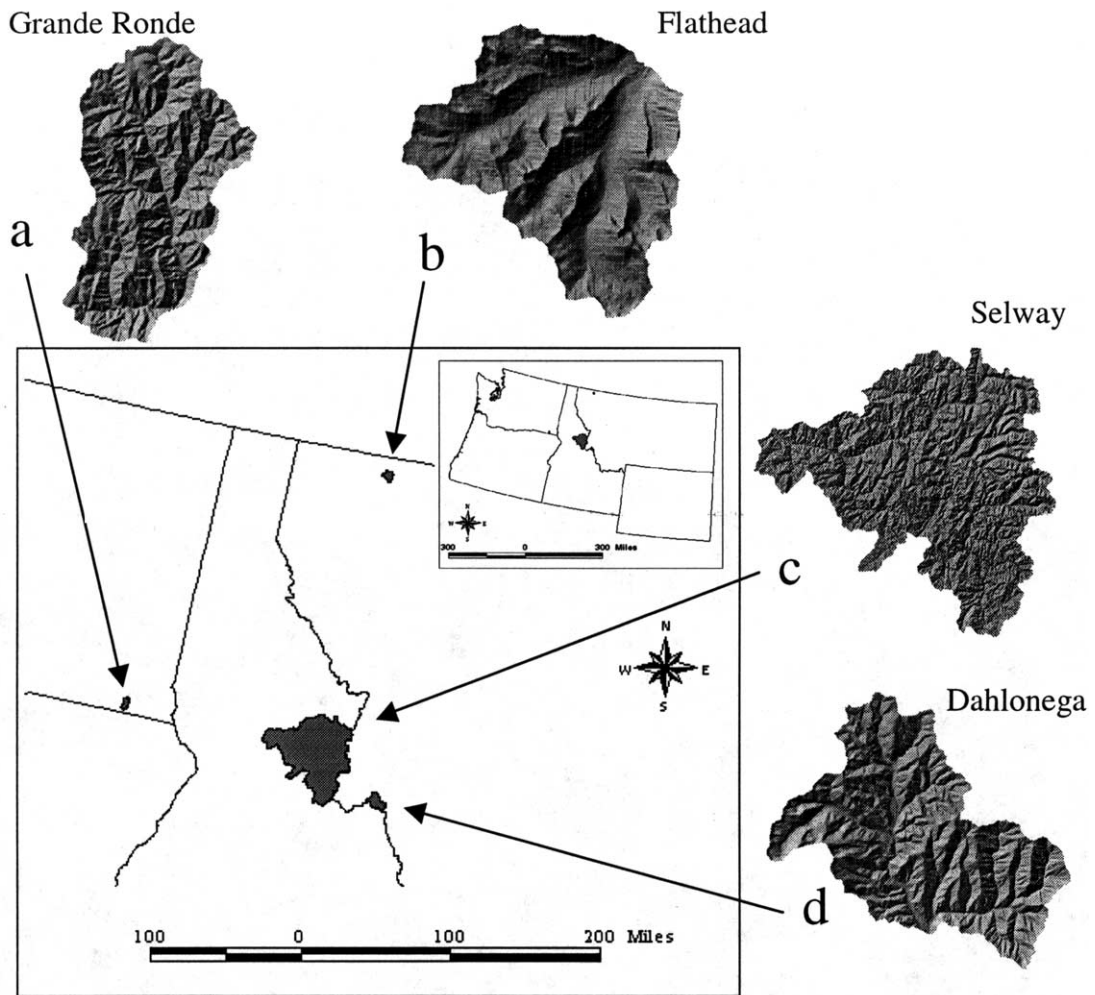

Fig. 2. The suite of simulation landscapes used in this simulation study. The sizes of the landscapes are (a) Grande Rhonde 7460 ha; (b) Flathead 8945 ha; (c) Selway 516 917 ha; and (d) Dahlongega 22 338 ha.

of the selected landscapes. Four landscapes were selected to evaluate applicability of results across diverse settings.

Initial input maps for each landscape were created by delineating and digitizing polygons from historical aerial photography (circa 1930s) by highly trained personnel (Hessburg et al., 1999b). PVT, cover type, and structural stage were classified for each mapped polygon from vegetation attributes interpreted from aerial photographs. Landscapes were defined by watershed boundaries using the US Geological Survey (1987) hydrological unit code classification. Most succes-

sion pathway and patch-level disturbance parameters were taken from a previous modeling effort and then modified to represent local conditions (Keane et al., 1996). All fire parameters were estimated from local fire atlases, previous fire history studies and modeling efforts, and the spatially summarized NIFMID database (Keane et al., 1996; Schmidt et al., 2002).

2.3. The simulation experiments

We evaluated the effects of landscape size on pattern metrics using nested simulation land-

scapes within the large Selway watershed (516 917 ha; Fig. 2). We selected a small 2500 ha² study area near the center of the Selway landscape that served as the context landscape for comparison. We then progressively created three larger landscapes that totally encompassed this smaller landscape but were still smaller than the entire Selway, resulting in the creation of five nested landscapes with similar distributions of PVT, cover types and structural stages (Fig. 3a). We ran LANDSUM on these five landscapes for 1000 years, but only exported raster output maps for the small context landscape (2500 ha) at 50-year intervals for landscape metric analysis. This experiment was designed to evaluate the importance of fires that originate outside, and then spread into the context area, on overall landscape pattern dynamics.

We used the Dahlenega watershed to explore effects of landscape shape, topographic complex-

ity, and reporting interval on landscape metrics. Effects of reporting interval were determined by simulating historical fire and succession processes for 100, 500, and 1000 years and exporting output maps every 5 years. Pattern metrics were summarized across 5, 10, 20, 50, and 100-year intervals. Topography effects were evaluated by creating five new Dahlenega DEM's by multiplying the original DEM by the factors of 0.0 (flat), 0.2 (hilly), 0.5 (half relief), 1.0 (normal relief) and 2.0 (high relief), and simulating LANDSUM with new DEM's for 1000 years exporting maps every 50 years. Effect of landscape shape was evaluated by creating new landscapes from Dahlenega using the following shapes of roughly the same area, narrow vertical rectangle; narrow horizontal rectangle; wide rectangle; square; and circle, and executing LANDSUM for 1000 years with maps output every 50 years (see Fig. 3b). Preliminary

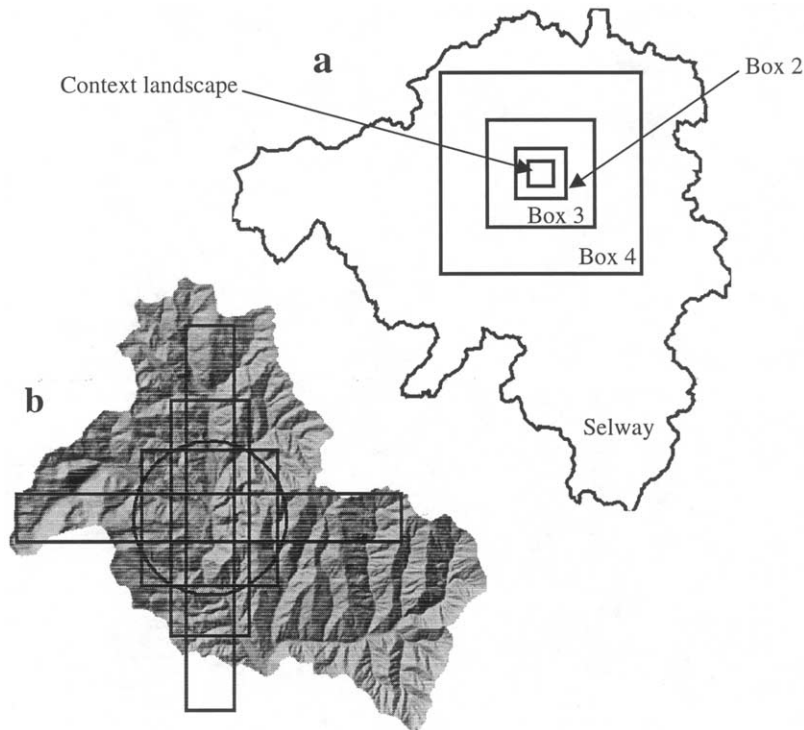

Fig. 3. (a) The set of spatially nested Selway landscapes used to evaluate effect of landscape size on pattern metrics (sizes progress from context landscape = 2500 ha, box 2 = 10 743 ha, box 3 = 45 753 ha, box 4 = 159 920 ha, Selway = 519 917 ha). (b) The five landscape shapes created as subsets of the Dahlenega watershed to determine shape effects on patch dynamics (vertical rectangle, horizontal rectangle, fat rectangle, square, and circle).

analyses revealed subtle, but potentially complicating, differences in landscape composition, topography and underlying PVT distribution between the different shapes, so we ran the final analyses of this experiment with both neutral topography (no topography) and only a single PVT for the whole landscape.

The Grande Ronde landscape was selected to evaluate the influence of initial conditions on patch metric variability, because of its diversity of vegetation types. We created four initial landscape composition maps of varying complexity by modifying the original Grande Ronde vegetation layers. The first initial input map (named Top 1) represented the coarsest approach, where we assigned only one successional class (the most dominant class in the original map) to all polygons within a PVT. A second landscape map (Top 3) was created by randomly assigning the three most dominant succession classes to all polygons in each PVT. The third initial map had the five most dominant types (Top 5). In the last initial landscape map (Random), we randomly assigned every possible successional class to all the polygons across the landscape. Using each of the four initial conditions, we executed LANDSUM for 1000 years with 50-year output intervals.

A focused sensitivity analysis was performed on the Flathead landscape. We adjusted all fire probabilities by multiplying them by 0.5, 1.5, and 2.0 and ran LANDSUM for 1000 years with a 50-year reporting interval. We also multiplied the transition times between successional classes by the same three factors and executed LANDSUM under the same simulation constraints. We used the same random number sequence for all simulation experiments to minimize the effects of stochasticity on our results.

2.4. *Spatial pattern analysis*

Simulated chronosequences were imported into the FRAGSTATS spatial pattern analysis program to compute characterize patterns at two levels (McGarigal and Marks, 1995). At the class level, metrics were summarized by patch

type (cover type, structural stage) to provide consistent detail and context for interpreting landscape level results (Forman, 1995; Chen et al., 1996; Hargis et al., 1998). At the landscape-level, metrics were summarized for the entire landscape without patch type stratification. We selected the cover type and structural stage maps for pattern analysis, because, we were interested in patch dynamics of composition and structure.

We selected a limited number of spatial metrics for comparing classes and landscapes. Hargis et al. (1998) found that only a small set of indices was needed, because of the redundancy and dependency among metrics (also see Turner and Gardner, 1991). It was also important to match the landscape metric with the biological processes that influence landscape structure (Chen et al., 1996). We selected patch density (PD, patches per 100 ha), mean patch size (MPS, ha), and landscape patch index (LPI) to represent the direct effect of disturbance processes on patch size. LPI is maximum percent of the landscape occupied by one patch selected, because, it represents the upward bounds of patch or burn size. We selected relative patch richness (RPR), because, it reflects richness relative to maximum possible richness on a scale of 0–100 (100 = all patch types possible). The Modified Simpson's evenness index (MSIEI), expressed as computed level of diversity divided by the maximum possible diversity for a given patch richness, was selected, because, it describes the degree to which the landscape is composed of one patch class. Lastly, contagion (CONTAG), a number between 0 and 100, measures the interspersion and dispersion of patches across a landscape. Four statistics were used to describe each of the six metrics. The average across the simulated chronosequence was used as the target or reference metric. The standard error was used to describe the variability in a metric. The maximum and minimum values established the range of observations. Results from simulation experiments were tested for statistical significance using multivariate analysis of variance (MANOVA) in the SAS software package (SAS, 1990).

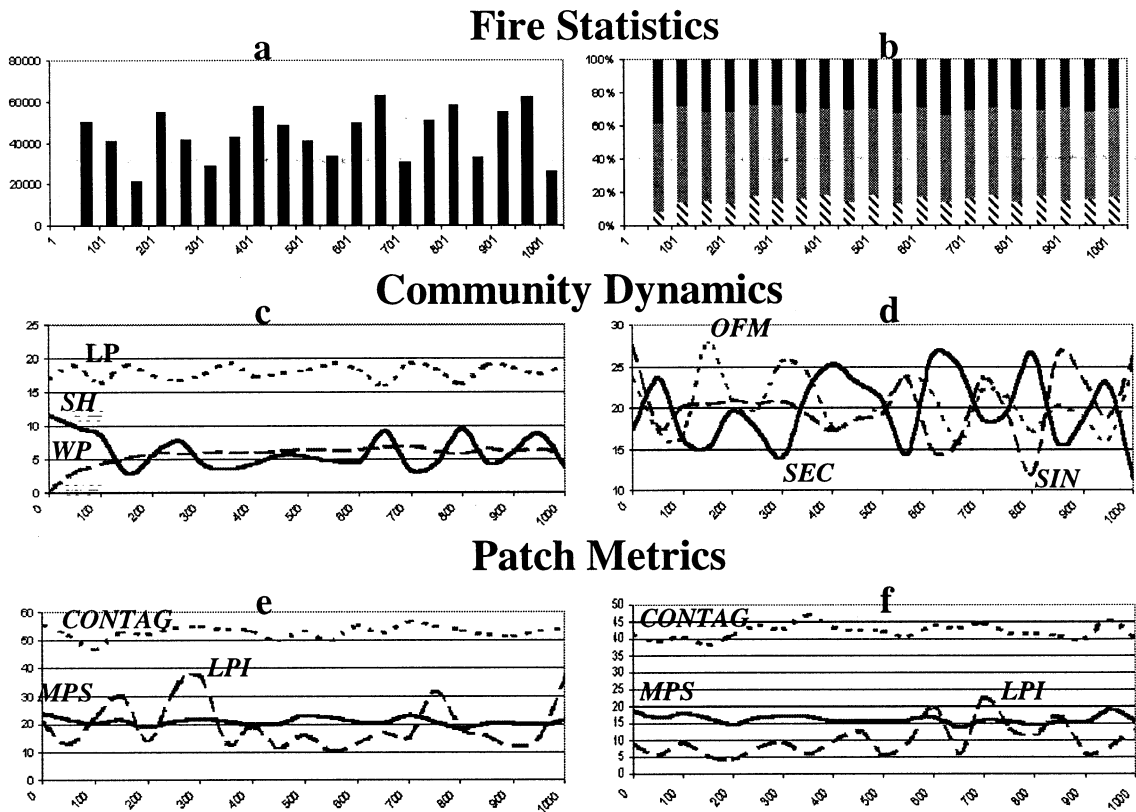

Fig. 4. Results from FRAGSTATS analysis of simulated Selway landscapes from LANDSUM over 1000 year span. These results provide an illustration of the simulated landscape dynamics of various patch characteristics over simulation time. Fire statistics include area burned over time (a), and percent of that area burned by severity class (b). Community dynamics shown are percent of area occupied by the three dominant cover type classes (c), and structural stages (d). Selected patch metrics over time are shown for cover type (e), and for structural stage (f).

3. Results

The set of graphs in Fig. 4 illustrates the diversity of LANDSUM output generated for a portion of the Selway landscape. The temporal distribution of burned area (Fig. 4a) and fire severity (Fig. 4b) influenced the composition of cover types (Fig. 4c) and structural stages (Fig. 4d) on the landscape, and those simulated fires created unique patch characteristics that vary across time and differ for cover type (Fig. 4e) and structural stage (Fig. 4f).

Results from the simulation experiments generated some interesting trends (Tables 1 and 2). Effects of landscape size on patch dynamics in the smallest 2500 ha context area were significant

($P < 0.0001$) for both cover type and structural stage class and landscape metrics (Table 2). For the most part, these significant differences occurred between two groups: the smaller two landscapes (2500 and 10 000 ha), and the larger three landscapes (45 000, 159 920, and 516 917 ha, respectively). No significant differences within those groups were found ($P > 0.05$). Interpretation of trends was more difficult, complicated by substantial differences in trends between cover type and structure maps. For example, variability in several patch metrics (MPS, PD, CONTAG) increased with increasing simulation landscape size for cover type maps (Table 1), but variability decreased or had indeterminate trends for those metrics for structural stage maps. A clear trend of

Table 1
Experiment results for the landscape size, shape topography, initial conditions, fire probabilities and successional transition times experiments for cover type

Experiment	Scenario	MPS (ha)		PD (100 ha ⁻¹)		LPI (%)		CONTAG (%)		RPR (%)		MSIEI (no units)	
		Mean	S.D.	Mean	S.D.	Mean	S.D.	Mean	S.D.	Mean	S.D.	Mean	S.D.
Landscape size	Context box (2500 ha)	21.36	1.82	4.71	0.39	16.84	6.11	51.09	1.94	71.77	5.29	0.64	0.04
	Box 2 (10000 ha)	20.92	2.06	4.82	0.46	12.94	4.55	51.21	3.15	71.43	5.53	0.64	0.07
	Box 3 (45753 ha)	22.30	2.16	4.52	0.42	23.43	10.32	54.06	3.13	71.77	6.18	0.56	0.06
	Box 4 (159917 ha)	22.18	2.70	4.57	0.59	18.91	8.87	55.05	3.52	76.87	9.01	0.55	0.07
	Selway (519917 ha)	20.86	2.60	4.86	0.56	16.46	6.31	53.10	4.20	75.85	8.29	0.59	0.08
Landscape shape	Circle	57.89	14.64	1.84	0.50	54.44	6.83	61.15	4.28	28.25	2.91	0.53	0.06
	Square	51.17	8.59	2.01	0.35	49.02	5.94	51.63	7.00	22.54	3.93	0.68	0.11
	Vertical rectangle	63.89	22.59	1.80	0.73	66.30	15.38	59.05	6.85	17.72	2.24	0.48	0.11
	Horizontal rectangle	53.40	11.07	1.96	0.44	25.99	4.62	55.22	2.69	27.82	2.95	0.65	0.05
Landscape topography	Wide rectangle	58.07	14.41	1.83	0.50	66.34	9.67	57.88	6.69	17.20	2.99	0.51	0.09
	Neutral topography	52.55	2.50	1.91	0.09	21.86	2.88	56.77	1.88	44.44	4.65	0.60	0.05
	Flat (dem × 0.2)	53.30	2.48	1.88	0.09	22.19	2.26	57.30	2.18	45.77	5.53	0.58	0.05
	Rolling relief (dem × 0.5)	53.11	2.83	1.89	0.10	20.96	3.76	57.95	1.55	46.83	3.76	0.58	0.04
	N normal relief (dem × 1)	53.21	3.26	1.89	0.11	21.37	3.52	56.99	2.13	44.71	5.11	0.59	0.05
	Increased relief (dem × 1.5)	53.09	3.97	1.89	0.15	21.84	6.26	57.98	1.80	48.15	4.76	0.57	0.04
	Original	25.01	13.42	4.57	1.23	9.88	7.97	47.74	3.47	74.92	2.91	0.74	0.07
	Top 1	35.88	49.73	4.31	1.57	13.07	17.72	48.74	7.04	71.43	10.36	0.72	0.13
	Top 3	26.12	17.94	4.58	1.34	8.57	5.51	47.49	4.58	74.92	2.91	0.75	0.07
	Top 5	23.75	13.83	4.83	1.25	8.95	8.17	47.16	3.50	75.24	3.74	0.75	0.06
Fire probabilities ^a	Random	26.84	11.78	4.21	1.23	9.03	12.35	48.09	4.75	75.24	3.09	0.74	0.10
	Probabilities × 1	115.74	24.41	0.89	0.15	25.39	11.65	58.60	4.95	97.35	4.85	0.61	0.10
	Probabilities × 0.5	117.24	21.49	0.88	0.15	19.9	10.59	58.90	3.69	98.41	3.98	0.60	0.07
	Probabilities × 1.5	110.74	23.21	0.94	0.18	25.01	17.29	58.83	5.07	98.94	3.34	0.61	0.11
	Probabilities × 2.0	117.60	64.34	0.97	0.27	27.09	24.81	60.31	8.57	98.94	3.34	0.57	0.10
Transition times	Transition × 1	115.74	24.41	0.89	0.15	25.39	11.65	58.60	4.95	97.35	4.85	0.61	0.10
	Transition × 0.5	103.20	21.84	1.00	0.17	18.42	6.00	56.90	2.55	99.44	2.42	0.65	0.06
	Transition × 1.5	106.16	26.10	0.99	0.20	20.38	11.73	57.95	4.28	97.88	5.69	0.61	0.07
	Transition × 2.0	113.15	21.83	0.91	0.16	21.86	10.89	58.79	3.55	97.33	4.85	0.61	0.07

Boldface print indicates overall significant differences (MANOVA, $P < 0.05$) by experiment, with further bold face for variables significantly different at $P > 0.05$, within the table.
^a Overall MANOVA for fire probabilities experiment for cover type maps was significant at $P < 0.0029$, however, significance of individual variables is clouded by multicollinearity within the variable set; for this reason, individual P -values for the patch metric variables are not significant at $P < 0.05$. Only cover type map statistics are shown due to space considerations.

Table 2
Results for the reporting interval experiment for cover type maps

Map attribute: cover type		MPS (ha)		PD (100 ha ⁻¹)		LPI (%)		Contagion (%)		RPR (%)		MSIEI (no units)		
Experiment	Interval	Period	Mean	S.D.	Mean	S.D.	Mean	S.D.	Mean	S.D.	Mean	S.D.	Mean	S.D.
Reporting interval	5	100	51.24	2.25	1.95	0.08	24.53	12.37	59.10	1.93	48.14	4.76	0.50	0.04
	10	100	51.04	2.12	1.96	0.08	24.68	13.54	58.89	1.79	47.98	4.49	0.50	0.04
	20	100	50.93	2.27	1.97	0.09	24.10	13.39	59.53	1.65	49.07	5.46	0.49	0.03
	50	100	50.78	2.08	1.97	0.08	18.08	7.10	60.25	2.20	51.85	6.42	0.48	0.05
	5	500	51.74	2.32	1.94	0.09	20.49	6.77	57.21	2.11	45.32	4.83	0.57	0.05
	10	500	51.89	1.99	1.93	0.07	20.72	7.16	57.00	2.02	44.55	4.34	0.57	0.05
	20	500	51.84	2.04	1.93	0.08	20.65	7.05	56.94	2.14	44.23	4.58	0.58	0.06
	50	500	51.97	2.29	1.93	0.09	19.94	4.46	57.28	2.37	44.94	5.80	0.57	0.06
	100	500	51.92	2.67	1.93	0.10	18.69	5.93	57.86	2.94	46.30	7.59	0.56	0.07
	5	1000	53.45	3.38	1.88	0.12	21.77	4.97	56.66	2.27	43.86	4.89	0.60	0.05
	10	1000	53.47	3.11	1.88	0.11	21.87	5.20	56.66	2.18	43.73	4.56	0.59	0.05
	20	1000	53.32	3.10	1.88	0.11	21.81	5.13	56.72	2.21	44.01	4.56	0.59	0.05
	50	1000	53.21	3.26	1.89	0.11	21.37	3.52	56.99	2.13	44.71	5.11	0.59	0.05
	100	1000	52.41	2.57	1.91	0.09	20.60	4.75	57.69	2.19	46.97	5.75	0.57	0.06

This experiment evaluated the effects of different output temporal resolution (interval), and length of simulation period (period). Boldface indicates significant overall effect ($P < 0.0001$); further boldface indicates differences significant (at $P < 0.05$ or better) for a given patch metric. Significant effects were observed for length of simulation period, but not for reporting interval. Only cover type map statistics are shown due to space considerations.

decreasing MPS and increasing PD was observed within the context area as the simulation landscape size was increased for structural stage maps, but that trend was less apparent for cover type maps (Table 1).

The shape of the landscape also had a significant influence on class and landscape metrics over the 1000-year simulation span (Table 1). Landscape metrics for both cover type and structural stage Dahlonge maps were significantly different ($P < 0.0001$) for horizontal and vertical rectangles (see Fig. 3b) than for all other shapes. Principal differences were in PD and LPI, with substantially lower LPI and higher PD for the horizontal rectangle than in the other shapes, as well as other differences.

Topography had very little effect on either class or landscape metrics for the five Dahlonge simulation scenarios (Table 1); there was very little difference between simulated patch metrics for the five topographic scenarios ($P < 0.48$). We ran this entire experiment using only one PVT for the entire landscape, because of concern in differences of fire frequency by PVT, and again found no significant differences between the five DEM inputs.

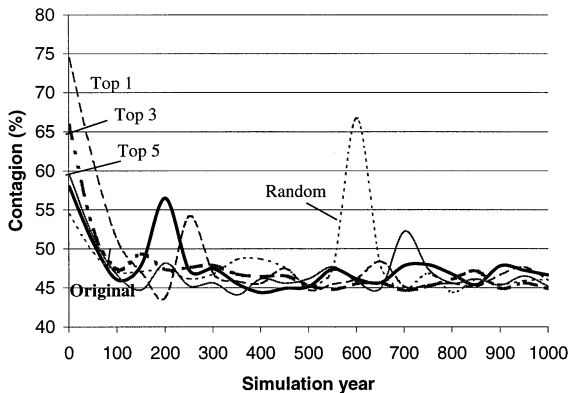

Fig. 5. Effect of initial landscape complexity on landscape patch metrics of cover type maps over 1000 year simulations, shown here for the contagion metric. Occasional peaks are the result of very large fires. Initial conditions were modified to produce a series of initial input maps varying in complexity, by assigning all polygons within a PVT to the single dominant succession class (Top1), top three dominant classes (Top 3), top five dominant classes (Top 5) or randomly assigned from all possible combinations (Random).

It appears that initial conditions ($P < 0.576$) do not have a significant influence on summarized class and landscape metrics over the 1000-year time span (Table 1). It was inconsequential whether the initial Grande Ronde landscape was totally homogeneous (one cover type and one structural stage) or highly heterogeneous (random assignment of all combinations of cover type and structural stages) at the start of simulation, because by approximately year 100, and certainly by year 200, the simulated landscapes were quite similar in cover type and structural stage patch distributions (Fig. 5).

The reporting interval experiment on the Dahlonge landscape produced interesting results. Pattern metrics for both cover type and structural stage were not significantly different when summarized at 5-, 10-, 20- or 50-year intervals ($P < 0.98$), but substantial differences were found when metrics were summarized at 100-year intervals (Table 2). Landscape and class metrics computed over simulation time spans of 100 years were significantly different to those computed over a 500- or 1000-year period ($P < 0.0001$, Table 2 and Fig. 6). It appears likely, then, that a 100-year time span is too short for generating useful landscape metrics summary statistics, regardless of the reporting interval.

Sensitivity analysis of the fire probabilities showed the importance of these parameters in generating realistic landscape patterns (Table 1). Pattern statistics were significantly different for both cover type ($P < 0.0029$) and structural stage ($P < 0.0001$) maps for each set of fire multipliers. For the structural stage maps, the set of simulation runs were clearly separated into two statistically significant groups; those simulations where multipliers were less than or equal to 1 and simulations with multipliers > 1 . Separation was not so clear for the cover type maps, with variable grouping and differences by patch metric. Structural stage metrics show a distinct tendency toward patch aggregation as fire frequencies increase, and cover type metrics became more highly variable with increasing fire frequency.

Results for transition time sensitivity analysis were similar to those of the fire probabilities experiment. Landscape patch metrics for struc-

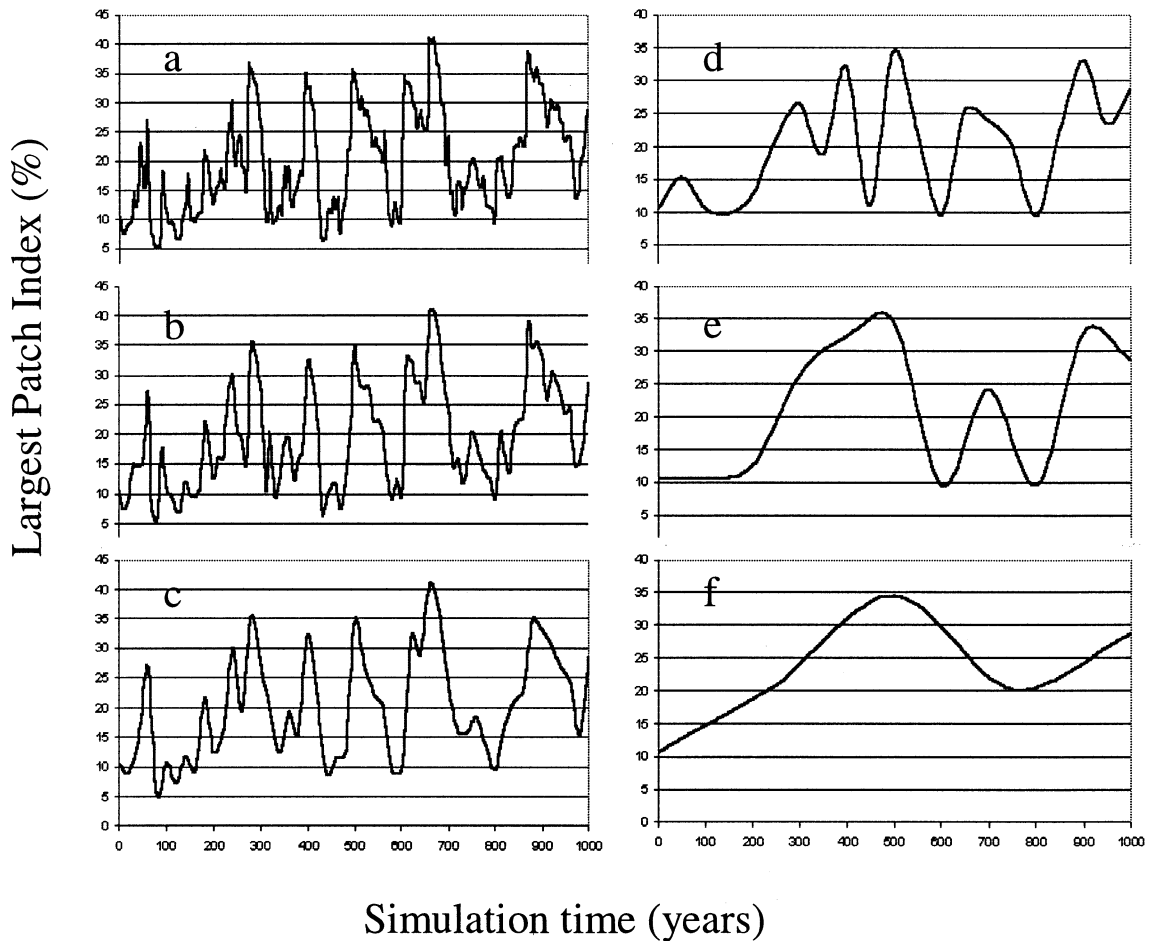

Fig. 6. Line graphs of largest patch index for structural stage by simulation year for six reporting intervals, (a) 5 years; (b) 10 years; (c) 20 years; (d) 50 years; (e) 100 years; and (f) 250 years.

tural stage were significantly different ($P < 0.0013$), and separated into the same two multiplier groups seen in the fire probabilities experiment. Differences in patch metric statistics for cover type maps were not as significant ($P < 0.0529$) and were difficult to interpret.

4. Discussion

These LANDSUM simulation experiments illustrate some of limitations of using simulation modeling to describe the range and variation of historical landscape patch dynamics. First, the

size of the simulation landscape significantly influences fire spread and patch dynamics. Small landscapes did not experience the immigration of simulated fires from outside the study area. As a result, the landscape fire rotation within small landscapes was often overestimated. This was especially evident on simulated landscapes with the propensity for large fires. Judging from our limited results, it appears that the influence of size of the simulation landscape tends to stabilize at around eight to ten times the size of the analysis landscape for those areas similar to the Selway landscape (Table 1 and Fig. 7). However, this factor may be quite different for other landscapes,

such as Yellowstone National Park (Gardner et al., 1997) and Wisconsin, USA (He and Mladenoff, 1999). Those biomes that experience large fires, such as boreal forests, may need much larger simulation areas to realistically simulate landscape patch dynamics (Amiro et al., 2000). Wimberly et al. (2000) also found that smaller simulation areas increased variation across model runs for landscape composition metrics in the Oregon Coast range where large fires are common.

Another important spatial characteristic that influences patch dynamics was simulation landscape shape, and, related to shape, landscape orientation. Simulations on narrow, linear landscapes will tend to underestimate fire spread and burned area (Table 1), because of the lack of fire immigration as mentioned above, and also, because, fires that originate in these elongated landscapes tend to reach the landscape edge well before reaching their full size. This effect was accentuated when the narrow portion of the landscape was perpendicular to predominant wind direction; fires were quickly blown out of landscape before they reached significant sizes. There was very little difference between the square and circular landscapes, because, there was no short

axis to allow the orientation bias. Fire spread simulations on landscapes with elongated shapes created smaller patches, particularly in structural stage maps (Table 1), because of the decreased potential spread area and the interaction with landscape edge. Our results agree with Camp et al. (1997) who also found that orientation of the topography governs fire spread dynamics. Those landscapes having ridge systems that were aligned perpendicular to the wind flow and near landscape edges had underestimated burned area, because, both slope and wind reduce the width of the headfire (Finney, 1999). It appears landscapes defined by watershed boundaries, especially those less than 50 000 ha, may make poor simulation areas, because of the tendency of watersheds to be elongated along river systems with the center of the landscape always the lowest in elevation thereby biasing fire ignition and spread.

To evaluate the effects of between-run variability on patch metric HRV, we conducted a Monte Carlo simulation, with 20 runs of 1000 years for the Grande Rhonde landscape (Fig. 8). Although there was substantial variability in the number, size and timing of fires, and corresponding community dynamics, patch metric statistics remained quite stable, with no significant differences in

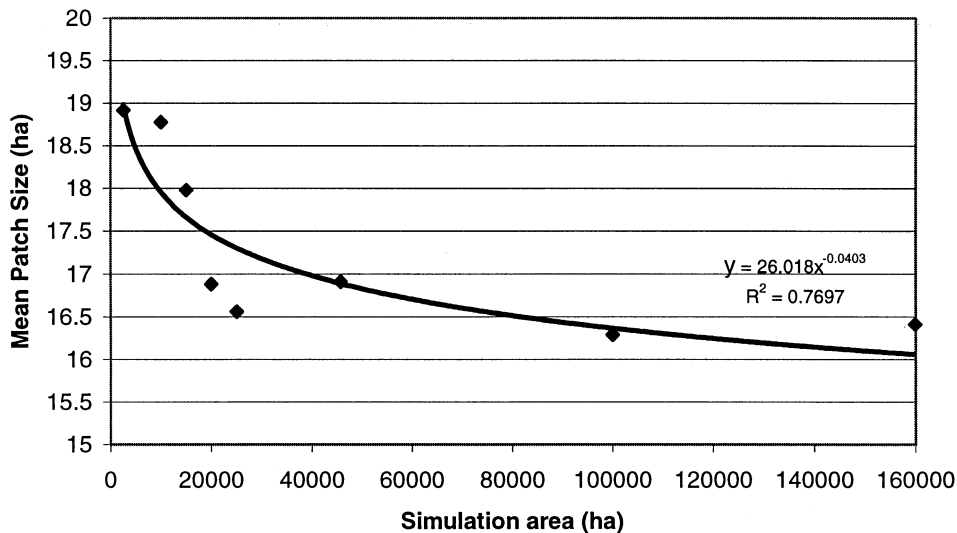

Fig. 7. Effect of landscape size on MPS within 2500 ha context area in the Selway landscape. MPS within the context landscape is affected by the size of the surrounding area; this influence appears to stabilize when size of the surrounding area is roughly eight to ten times the size of the context landscape.

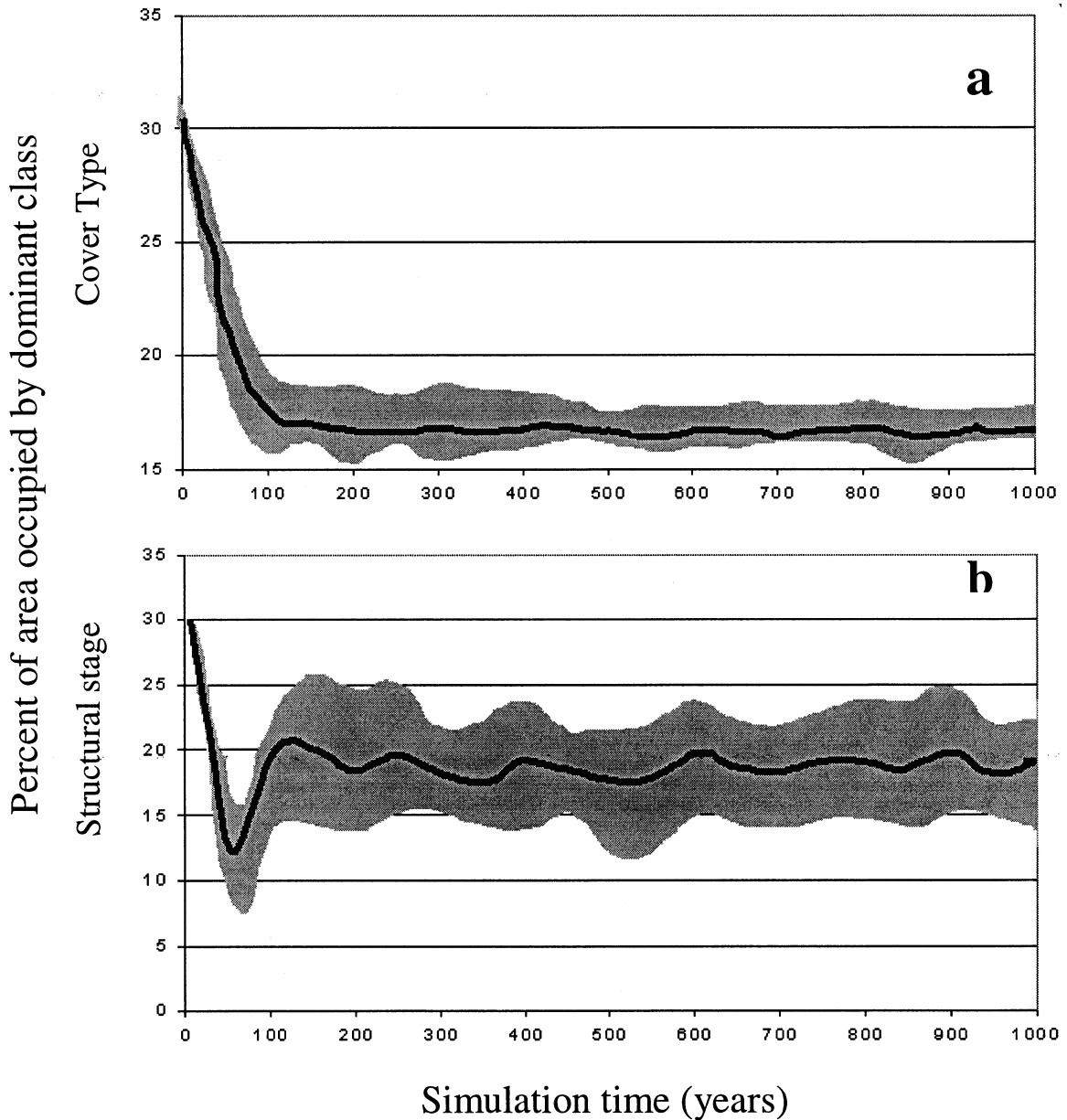

Fig. 8. Range of results for 20 LANDSUM model runs of the same Grand Ronde landscape showing the inherent stochastic variation in predictions of percent landscape for the dominant cover type (a) (ponderosa pine) and structural stage (b) (stem exclusion structure). Both cover type and structure show substantial changes between initial values and mean; this difference suggests that initial values fall outside the simulated range of variability.

patch metric statistics for either cover type ($P < 0.27$) or for structural stage ($P < 0.99$). This could indicate that between-run variability is low and adequate landscape patch metric HRV dynamics

can be quantified from very few simulation runs.

It was somewhat surprising that the initial conditions of the simulation landscape did not seem to affect long-term patch dynamics. This is proba-

bly because, the simplistic succession and fire simulation approach implemented in LANDSUM constrained potential landscape trajectories and caused most landscapes to eventually converge to a single equilibrium condition (Fig. 5). This simplistic approach usually generates landscape metric predictions with low variability (Fig. 8). More complex landscape models tend to be highly sensitive to initial conditions and often predict different landscape trajectories with relatively minor changes in initial landscape composition and structure making predictions more highly variable (Keane et al., 1999; He and Mladenoff, 1999). The simplistic approach also resulted in questionable fire perimeters, which in turn affected the realism of resulting vegetation patterns. For example, Camp et al. (1997) found late-successional forest stands tended to be located within a fairly restricted range of environmental conditions that are somewhat predictable. To simulate accurate fire patterns, complex fire models requiring extensive daily weather (wind, temperature, humidity, precipitation) and fuel moisture input data are needed, but these parameters are difficult to obtain across an entire landscape (Finney, 1999).

Two important criteria must be decided upon before a simulation approach can be adapted to quantify HRV of landscape conditions. First, an adequate simulation time span must be selected that matches model application objectives with computing resources. We found that shorter simulation periods (e.g. 100 years or less) may result in inadequate landscape patch metric statistics (Table 2). A likely reason for this difference is that the 100-year simulation did not have the temporal depth to include effects of fires in PVTs with long fire return intervals (Lertzman et al., 1998). We suggest that the simulation time span be at least ten times the longest fire return interval on those sites that occupy at least 10% of the landscape, but these thresholds will vary by landscape. Second, the temporal density of chronosequences (i.e. reporting interval) must be chosen as a compromise between available analysis resources, management objectives, and temporal autocorrelation (Baker et al., 1991). We found that short reporting intervals (5, 10, and 25 years) did not result in more accurate pattern descriptions

when compared with those computed from maps generated at 50-year intervals (Table 2). However, longer intervals of 100 and 250 years generated significantly different results from the shorter interval chronosequences, because of vast differences in the variance, maximum, and minimum values (Fig. 6). It appears that a 50-year reporting interval is sufficient for LANDSUM applications.

The relative sensitivity of the fire probability and insensitivity of succession transition time input parameters were unexpected results in the LANDSUM simulation experiments. Less frequent fires (probabilities multiplied by 0.5) did not influence long-term patch dynamics when compared with the reference probability set (multiplication factor of one), presumably, because, the full range of seral and climax cover type and structural stage types remained on the landscape. However, when fire return intervals were short (multiplication factors of 1.5 and 2.0), the structural stage and cover type patches became larger as more of the landscape moved into the single story, old growth structural stage and seral, fire-dependent ponderosa pine and larch cover types that are created by low severity fire (Keane et al., 1996). These results may indicate that fire probabilities, although important, need not be estimated with a high degree of accuracy, but they must be consistently applied.

Differences in transition time sensitivity analyses were mostly evident at the extremes (multiplication factors of 0.5 and 2.0) and only for structural stage maps and a small set of pattern metrics (Table 1). The lack of significant differences across metrics, particularly in cover type maps, was due to the dominant effects of simulated fires; high frequency fire on the Flathead landscape overwhelmed any effect of altered transition times on patch size and density. However, transition times were very important for Flathead PVTs with long fire return intervals, because, succession moved patches toward climax cover types and structural stages before fires occurred, thereby reducing evenness and increasing contagion. This dynamic was especially important for structural stage maps, because, there are only two old growth structural stage categories while there can be many old growth cover type categories,

which may explain why structural stage maps were more sensitive to both fire probabilities and transition times than cover type maps. Our results agree with He and Mladenoff (1999) who found that advancing succession results in larger and more severe fires and coarse-grained patterns with the LANDIS model.

The limitations of using a simulation approach to determine range and variation in pattern statistics as presented here may not apply to all landscape fire succession models, because of differences in model assumptions and design. For instance, topography did not influence fire pattern in the LANDSUM experiments, because of the overwhelming effect of the wind and, because of the way fire was simulated on the landscape. LANDSUM simulated fire spread until the fire reached a size computed from a negative exponential probability distribution (see Section 2). This resulted in realistic landscape fire rotation predictions but questionable simulated fire perimeters,

because, a few fires stopped halfway up steep mountain slopes. For comparison purposes, we allowed fires to burn in LANDSUM until they reached unburnable polygons (e.g. rock, water, recent burns) or the landscape boundary, but the result was about two to three times more burned area over 1000 years than would have normally occurred under native fire regimes. This is because, the termination of fire spread is a complex process that depends not only on vegetation and fuels, as modeled in LANDSUM, but also on daily weather, fuel loading, fuel moistures, fuel continuity, and vegetation structure (Agee et al., 2000), which are highly complex and difficult to simulate in a spatial environment. Other fire spread models terminate spread along topographic controls to generate realistic fire regimes, but the generated patterns may not match those observed on actual landscapes (Andrews, 1990). Land managers must select the appropriate fire and succession modeling scheme for their application.

There are other drawbacks of the simulation method for the estimation and interpretation of HRV landscape metrics that were not evaluated in this study. First, map integrity is often compromised, because, spatial simulations of fire spread will dissect stands to create many smaller polygons over long simulation times, especially in portions of the landscape where fires are common. This results in sustained increases in PD and decreases in patch size throughout the simulation (Fig. 9). Still more confounding is that, in parts of the landscape that have long fire return intervals, patch boundaries often remain relatively unchanged from the initial conditions (Keane et al., 2000). Including the initial polygon layer and early simulated layers with later simulated chronosequences for computation of HRV patch statistics is probably inappropriate, because of these differences in mapping resolution. Simulated fires are mapped at 30-m pixel resolution whereas initial polygons are created using much broader mapping criteria (e.g. minimum map units of 4 ha). We aggregated the small polygons to minimum map units of 4 ha using standard GIS techniques to make all maps consistent (Fig. 9), but detail in fire simulations was lost. This is a

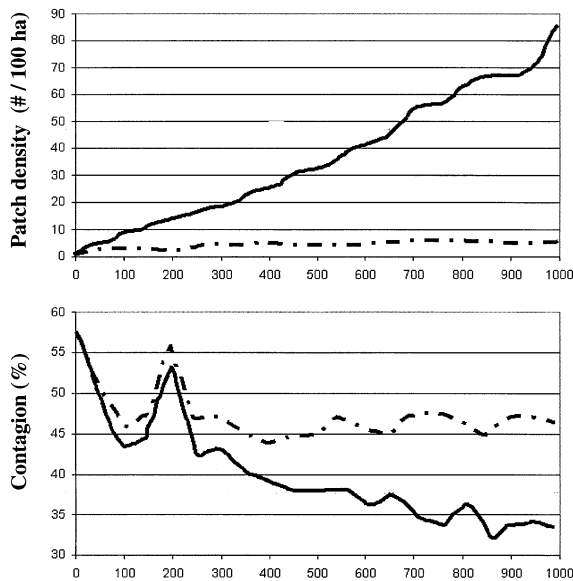

Fig. 9. Effect of the fine scale simulation of fires on landscape patch metrics. Fine scale simulation of fires tends to increasingly fragment stand polygons over time, resulting in increasing PD (top, solid line) and decreasing contagion (bottom, solid line). To mitigate this effect, map chronosequences were aggregated to 2 ha minimum map units using standard GIS techniques. Effect of the aggregation is shown for PD (top, dashed line) and for contagion (bottom, dashed line).

problem for most landscape fire succession models where fire spread is simulated as an independent disturbance process.

The classification resolution of modeled landscape elements also affects HRV metrics (Wickham et al., 1997). Map elements were constrained to the states or successional classes represented in the multiple pathway model, no matter how broadly or narrowly they were defined. Landscape formations and features with unique species assemblages, such as seeps, riparian bottoms, and frost pockets, which can directly contribute to patch composition and structure, were missing from this analysis, because, they were not explicitly included in the pathway model. Inclusion of additional PVTs on the landscape does not always increase classification resolution because many of the same cover types and structural stages may occur across several PVTs.

It is extremely difficult to validate or assess accuracy of landscape fire succession models, because, temporally deep spatial data sets of fire and vegetation are rare. Instead, we compared landscape metrics of Selway fire perimeters compiled by Rollins et al. (2002) with those fire perimeters simulated by LANDSUM for the Selway (Fig. 10). LANDSUM fires compared well with the Selway fires in area (Fig. 10c) and shape (Fig. 10a), but differed in fractal dimension. This is a result of scale and mapping resolutions rather than simulation inaccuracies. Selway fire perimeters were coarsely drawn on low resolution maps (1:100 000 mapscale) and then digitized into a GIS, whereas the LANDSUM fires are simulated on a fine scale, 30-m pixel raster layer. Consequently, scale inconsistencies overwhelm the simulated-to-reference comparison and cause differences to appear in the metrics. This will be a problem for any spatial validation dataset.

5. Summary and conclusions

This paper demonstrates how the HRV of landscape composition and structure can be described from class and landscape metrics com-

puted from simulated chronosequences. HRV statistics can be used to assess, prioritize, compare, and design landscapes for possible restoration treatments. However, simulated chronosequences rely on inexact computer models that are based on oversimplifications of disturbance and succession processes that result in major limitations. These limitations are model- and landscape-specific so it is difficult to generalize on techniques to mitigate the potential simulation shortcomings. But, using the LANDSUM model as an example, we found the following limitations of using simulation modeling to assess range and variation of landscape patch dynamics.

1. Simulation landscape size, shape, and orientation can affect patch dynamics by excluding large fires immigrating from outside the analysis landscape and by limiting fire spread, because of biases in wind direction, topography, and landscape boundaries.
2. Input parameters need not be highly accurate but they should be consistently applied and within at least 30% of the actual value.
3. Simulation periods should be at least ten times the longest fire return interval on the landscape to ensure the effects of all fires are reflected in landscape patch statistics.
4. Output reporting interval need not be frequent. We suggest a 50-year interval is a good compromise between analysis capacity and patch metric characterization.

Since long-term chronosequences of actual landscapes are essentially unavailable, the simulation approach may be the only means available for quantifying pattern HRV. We believe landscape fire succession models are not yet the perfect tools to quantify patch dynamics, but they provide an alternative evaluation resource.

Acknowledgements

We thank Matt Rollins and Don Long of USDA Forest Service, Rocky Mountain Research Station for technical reviews, and Brion Salter, USDA Forest Service, Pacific Northwest Research Station for assistance in spatial pattern

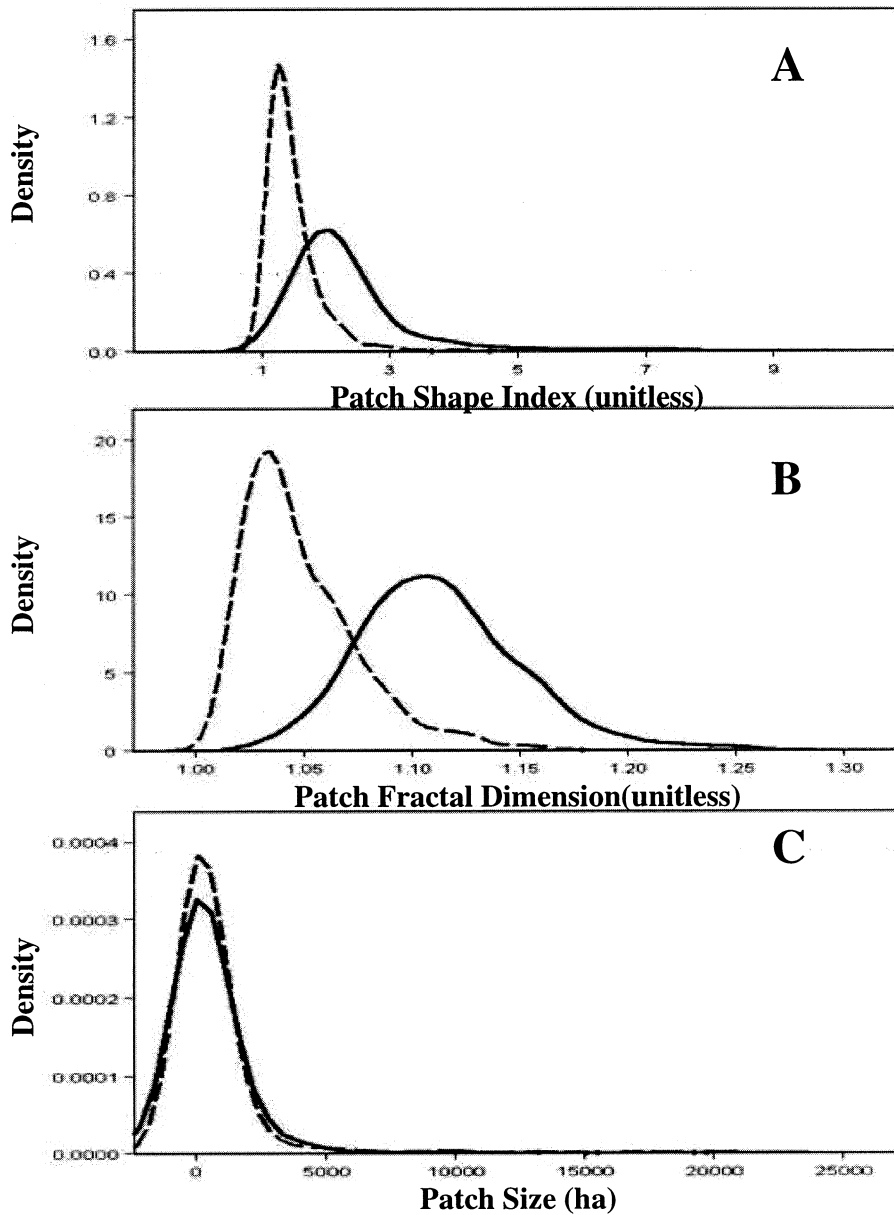

Fig. 10. Validation of the spatial characteristics of the LANDSUM fire boundaries (dashed lines) compared with fire atlas perimeters compiled by Rollins et al. (2002) (solid lines). All three metrics were computed using FRAGSTATS and the indices are defined in McGarigal and Marks (1995).

analysis. This work was partially funded by a grant (NS-7327) from NASA's Earth Science Applications Division as part of the Food and Fiber

Applications of Remote Sensing (FFARS) program managed by the John C. Stennis Space Center.

References

- Agee, J.K., Bahro, B., Finney, M.A., Omi, P.N., Sapsis, D.B., Skinner, C.N., van Wagtenonk, J.W., Weatherspoon, C.P., 2000. The use of shaded fuelbreaks in landscape fire management. *Forest Ecology and Management* 127, 55–66.
- Amiro, B.D., Chen, J.M., Liu, J., 2000. Net primary productivity following fire for Canadian ecoregions. *Canadian Journal of Forest Research* 30, 939–947.
- Andrews, P.L., 1990. Application of fire growth simulation models in fire management. In: *Proceedings of the Tenth Conference on Fire and Forest Meteorology*, April 17–21, Ottawa, Canada. Society of American Foresters, Washington, DC, pp. 317–321.
- Arno, S.F., Simmerman, D.G., Keane, R.E., 1985. Forest succession on four habitat types in western Montana. General Technical Report INT-177. US Department of Agriculture, Forest Service, Intermountain Forest and Range Experiment Station, Ogden, UT, p. 74.
- Baker, W.L., 1989. Effect of scale and spatial heterogeneity on fire-interval distributions. *Canadian Journal of Forest Research* 19, 700–706.
- Baker, W.L., 1992. Effect of settlement and fire suppression on landscape structure. *Ecology* 73 (5), 1879–1887.
- Baker, W.L., 1995. Long-term response of disturbance landscapes to human intervention and global change. *Landscape Ecology* 10 (3), 143–159.
- Baker, W.L., Cai, Y., 1990. The R.LE programs for multi-scale analysis of landscape structure using the GRASS geographical information system. *Landscape Ecology* 7, 291–302.
- Baker, W.L., Egbert, S.L., Frazier, G.F., 1991. A spatial model for studying the effects of climatic change on the structure of landscapes subject to large disturbances. *Ecological Modelling* 56, 109–125.
- Beukema, S.J., Kurtz, W.A., 1995. *Vegetation Dynamics Development Tool User's Guide*. ESSA Technologies, Vancouver, BC, Canada, p. 51.
- Bormann, F.H., Likens, G.E., 1979. *Pattern and Process in a Forested Ecosystem*. Springer, New York, p. 253.
- Cain, D.H., Tiitters, K., Orvis, K., 1997. A multi-scale analysis of landscape statistics. *Landscape Ecology* 12, 199–212.
- Camp, A.E., Oliver, C.D., Hessburg, P.F., Everett, R.L., 1997. Predicting late-successional fire refugia from physiography and topography. *Forest Ecology and Management* 95, 63–77.
- Chen, J., Franklin, J.F., Lowe, J.S., 1996. Comparison of abiotic and structurally defined patch patterns in a hypothetical forest landscape. *Conservation Biology* 10 (3), 854–862.
- Chew, J., 1997. Simulating landscape patterns and processes at landscape scales. In: *Proceedings of the 11th Annual Symposium on Geographic Information Systems*. GIS World Publications, Fort Collins, Vancouver, BC, pp. 287–291.
- Cissel, J.H., Swanson, F.J., Weisberg, P.J., 1999. Landscape management using historical fire regimes: Blue River, Oregon. *Ecological Applications* 9 (4), 1217–1232.
- Crutzen, P.J., Goldammer, J.G., 1993. *Fire in the Environment: The ecological, Atmospheric and Climatic Importance of Vegetation Fires*. Wiley, New York, p. 456.
- Finney, M.A., 1998. FARSITE: Fire Area Simulator Model development and evaluation. USDA Forest Service General Technical Report RMRS-GTR-4, p. 47.
- Finney, M.A., 1999. Mechanistic modeling of fire shape patterns. In: Mladenoff, D.J., Baker, W.L. (Eds.), *Spatial Modeling of Forest Landscape Change*. Cambridge University Press, Cambridge, UK, pp. 186–209.
- Forman, R.T.T., 1995. *Landscape Mosaics—The Ecology of Landscapes and Regions*. Cambridge University Press, UK, p. 632.
- Gardner, R.H., Hargrove, W.W., Turner, M.G., Romme, W.H., 1997. Climate change, disturbances and landscape dynamics. In: Walker, B.H., Steffen, W.L. (Eds.), *Global Change and Terrestrial Ecosystems*, IGBP Book Series Number 2. Cambridge University Press, Cambridge, UK, pp. 149–172.
- Habeck, J.R., 1972. Fire ecology investigations in Selway-Bitterroot wilderness—historical considerations and current observations. University of Montana Publication No. R1-72-001.
- Hargis, C.D., Bissonette, J.A., David, J.L., 1998. The behavior of landscape metrics commonly used in the study of habitat fragmentation. *Landscape Ecology* 13, 167–186.
- Hessburg, P.F., Smith, B.G., Kreiter, S.G., et al., 1999a. Historical and current forest and range landscapes in the Interior Columbia River Basin and portions of the Klamath and Great Basins. Part I: linking vegetation patterns and landscape vulnerability to potential insect and pathogen disturbances. General Technical Report PNW-GTR-458. Pacific Northwest Research Station, Portland, OR, 356 p.
- Hessburg, P.F., Smith, B.G., Salter, R.B., 1999b. Detecting change in forest spatial patterns from reference conditions. *Ecological Applications* 9 (4), 1232–1253.
- Hessburg, P.F., Smith, B.G., Salter, R.B., 1999c. Using natural variation estimates to detect ecologically important change in forest spatial patterns: a case study of the eastern Washington Cascades. USDA Forest Service Research Paper PNW-RP-514, p. 64.
- He, H.S., Mladenoff, D.J., 1999. Spatially explicit and stochastic simulation of forest landscape fire disturbance and succession. *Ecology* 80 (1), 81–99.
- Keane, R.E., Menakis, J.P., Long, D., Hann, W.J., Bevins, C., 1996. Simulating coarse scale vegetation dynamics using the Columbia River Basin Succession Model—CRBSUM. General Technical Report INT-GTR-340. US Department of Agriculture, Forest Service, Intermountain Forest and Range Experiment Station, Ogden, UT, p. 50.
- Keane, R.E., Long, D.G., Basford, D., Levesque, B.A., 1997. Simulating vegetation dynamics across multiple scales to assess alternative management strategies. In: *Conference Proceedings-GIS 97, 11th Annual Symposium on Geographic Information Systems—Integrating spatial information technologies for tomorrow*, February 17–20, 1997,

- Vancouver, British Columbia, Canada. GIS World, Inc., pp. 310–315.
- Keane, R.E., Ryan, K., Mark, F., 1998. Simulating the consequences of fire and climate regimes on a complex landscape in Glacier National Park, USA. *Tall Timbers* 20, 310–324.
- Keane, R.E., Morgan, P., White, J.D., 1999. Temporal pattern of ecosystem processes on simulated landscapes of Glacier National Park, USA. *Landscape Ecology* 14 (3), 311–329.
- Keane, R.E., Garner, J., Teske, C., Stewart, C., Hessburg, P., 2000. Range and variation in landscape patch dynamics: implications for ecosystem management. In: *Proceedings of the 1999 National Silviculture Workshop*. Society of American Foresters, Bethesda, MD, pp. 23–33.
- Kessell, S.R., Fischer, W.C., 1981. Predicting postfire plant succession for fire management planning. General Technical Report INT-94. US Department of Agriculture Forest Service, Intermountain Research Station, p. 19.
- Landres, P.B., Morgan, P., Swanson, F.J., 1999. Overview and the use of natural variability concepts in managing ecological systems. *Ecological Applications* 9 (4), 1179–1189.
- Lertzman, K., Fall, J., Dorner, B., 1998. Three kinds of heterogeneity in fire regimes: at the crossroads of fire history and landscape ecology. *Northwest Science* 72, 4–23.
- Mladenoff, D.J., Baker, W.L., 1999. *Spatial Modeling of Forest Landscape Change: Approaches and Applications*. Cambridge University Press, Cambridge, UK, p. 352.
- Mladenoff, D.J., White, M.A., Pastor, J., Crow, T.R., 1993. Comparing spatial pattern in unaltered old-growth and disturbed forest landscapes. *Ecological Applications* 3 (2), 294–306.
- McGarigal, K., Marks, B.J., 1995. FRAGSTATS: spatial pattern analysis program for quantifying landscape structure. General Technical Report PNW-GTR-351. US Department of Agriculture, Forest Service, Intermountain Forest and Range Experiment Station, Portland, OR, p. 122.
- Parsons, D.J., Swetnam, T.W., Christensen, N.L., 1999. Uses and limitations of historical variability concepts in managing ecosystems. *Ecological Applications* 9 (4), 1177–1179.
- Pickett, S.T.A., 1989. Space for time substitution as an alternative to long term studies. In: Likens, G.E. (Ed.), *Long Term Studies in Ecology: Approaches and Alternatives*. Springer, New York, USA.
- Pickett, S.T.A., White, P.S., 1985. *The Ecology of Natural Disturbance and Patch Dynamics*. Academic Press, San Diego, CA, p. 432.
- Rollins, M.G., Swetnam, T.W., Morgan, P., 2002. Evaluating a century of fire patterns in two Rocky mountain wilderness areas using digital fire atlases. *Canadian Journal of Forest Research*, 31, 2107–2123.
- Rothermel, R.C., 1991. Predicting behavior and size of crown fires in the Northern Rocky Mountains. USDA Forest Service Research Paper INT-438, p. 46.
- SAS Procedures Guide Version 6, third ed. (1990). SAS Institute, SAS Campus Drive, Cary, NC, p. 555.
- Schmidt, K.M., Menakis, J.P., Hardy, C.C., Bunnell, D.L., Sampson, N., 2002. Development of coarse-scale spatial data for wildland fire and fuel management. General Technical Report RMRS-GTR-CD-000. US Department of Agriculture, Forest Service, Rocky Mountain Research Station, Ogden, UT, XX pp., in press.
- Swanson, F.J., Franklin, J.F., Sedell, J.R., 1990. Landscape patterns, disturbance, and management in the Pacific Northwest, USA. In: Zonnneveld, I.S., Forman, R.T.T. (Eds.), *Changing Landscapes: An Ecological Perspective*. Springer, New York, NY, pp. 191–213.
- Swetnam, T.W., Allen, C.D., Betancourt, J.L., 1999. Applied historical ecology: using the past to manage for the future. *Ecological Applications* 9 (4), 1189–1206.
- Turner, M.G., Gardner, R.H. (Eds.), 1991. *Quantitative Methods in Landscape Ecology*. Springer, New York, p. 536.
- Turner, M.G., Hargrove, W.W., Gardner, R.H., Romme, W.H., 1994. Effects of fire on landscape heterogeneity in Yellowstone National Park, Wyoming. *Journal of Vegetation Science* 5, 731–742.
- US Geological Survey, 1987. *Digital Elevation Models Data Users Guide*. Department of the Interior, p. 38.
- Veblen, T.T., Hadley, K.S., Nel, E.M., Kitzberger, T., Reid, M., Villalba, R., 1994. Disturbance regime and disturbance interactions in a Rocky Mountain subalpine forest. *Journal of Ecology* 82, 125–135.
- Wickham, J.D., O'Neill, R.V., Riitters, K.H., Wade, T.G., Jones, K.B., 1997. Sensitivity of selected landscape pattern metrics to land-cover misclassification and differences in land-cover composition. *Photogrammetric Engineering and Remote Sensing* 63 (4), 397–402.
- Wimberly, M.C., Spies, T.A., Long, C.J., Whitlock, C., 2000. Simulating historical variability in the amount of old forests in the Oregon Coast Range. *Conservation Biology* 14 (1), 167–180.
- Wright, H.E., 1974. Landscape development, forest fires and wilderness management. *Science* 186 (4163), 487–495.