

# Small Business Guide for Ethylene Oxide

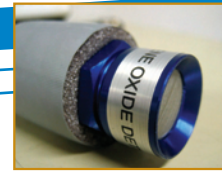

**OSHA**<sup>®</sup> **Occupational Safety  
and Health Administration**  
U.S. Department of Labor  
[www.osha.gov](http://www.osha.gov)



### **Occupational Safety and Health Act of 1970**

“To assure safe and healthful working conditions for working men and women; by authorizing enforcement of the standards developed under the Act; by assisting and encouraging the States in their efforts to assure safe and healthful working conditions; by providing for research, information, education, and training in the field of occupational safety and health.”

This guidance document is not a standard or regulation, and it creates no new legal obligations. The guidance document is advisory in nature, is informational in content, and is intended to assist employers in providing a safe and healthy workplace. The *Occupational Safety and Health Act* requires employers to comply with safety and health standards promulgated by OSHA or by a State with an OSHA-approved state plan. However, the Ethylene Oxide standard (29 CFR 1910.1047) is mandatory for employers and to the extent that this guidance document restates the standard, those restatements are mandatory. In addition, pursuant to Section 5(a)(1), the General Duty Clause of the Act, employers must provide their employees with a workplace free from recognized hazards likely to cause death or serious physical harm. Citations can only be based on standards, regulations, and the General Duty Clause.

# Small Business Guide for Ethylene Oxide

U.S. Department of Labor

Occupational Safety and Health Administration

OSHA 3359-04  
2009





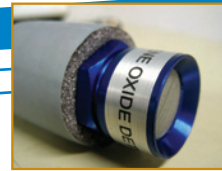

# Contents

- 1. Overview ..... 3**
- 2. Exposure Monitoring ..... 4**
  - A. Understanding OSHA's EtO Exposure Monitoring Requirements..... 4
    - i. Different Types of Exposure Monitoring ..... 4
    - ii. OSHA Requirement for Air Monitoring..... 4
      - a. Personal Monitoring ..... 5
      - b. Area Monitoring ..... 6
      - c. Leak Detection ..... 6
    - iii. OSHA Exposure Levels..... 7
      - a. Permissible Exposure Limits ..... 7
  - B. Monitoring Requirements ..... 8
    - i. Initial Monitoring ..... 9
    - ii. Periodic Monitoring..... 12
  - C. Actions Triggered by Air Sample Results ..... 14
  - D. How to Get Help with Air Monitoring..... 17
- 3. Exposure Reduction/Prevention..... 18**
  - A. Methods of Detecting Emergency EtO Releases ..... 18
    - i. Emergency Situations ..... 18
    - ii. Emergency Plan for EtO ..... 18
    - iii. Emergency Alert Provision..... 19
  - B. Develop a Compliance Program ..... 21
  - C. Reduce Exposures with Engineering Controls or Other Methods ..... 22
  - D. Provide Respiratory Protection ..... 23
- 4. Other Requirements..... 24**
  - A. Employee Information and Training ..... 24
    - i. Hazard Communication..... 24
    - ii. Establish Regulated Areas..... 25
    - iii. Ensure that Cautionary Labels are Fixed to Containers ..... 26
    - iv. MSDS ..... 27
  - B. Medical Surveillance..... 27

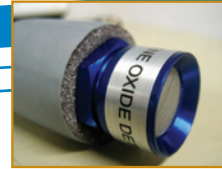

<b>5. Additional Compliance Details and Helpful Information .....</b>	<b>31</b>
A. Retain the Required Exposure Monitoring Records .....	31
B. Accuracy of Sampling and Analytical Methods .....	32
C. Exemptions from Initial Monitoring .....	33
D. Work Shifts of Other Than 8 Hours .....	34
E. How to Obtain Further Assistance.....	35
i. Work with Industry and Supplier Representatives.....	35
ii. Locate an Industrial Hygiene Consultant .....	35
iii. Find an Analytical Laboratory .....	36
F. How to Find a Healthcare Provider for Your Medical Surveillance Program .....	37
G. What a Medical Exam Must Include.....	38
H. Accessing OSHA Standards on the Internet.....	39
I. Other Names for Ethylene Oxide.....	40
J. Breathing Zone.....	41
K. Passive Diffusion Dosimeter (or Monitor) .....	42
L. Air Sampling Pump and Sorbent Tube .....	47
M. Comparison of Passive Dosimeters and Traditional Air Sampling Methods Using a Pump and Sorbent Tube.....	59
<b>6. Related OSHA Standards and Other Helpful Resources .....</b>	<b>61</b>
A. Ethylene Oxide - General .....	61
B. Conducting Personal Monitoring.....	62
C. Respiratory Protection and Personal Protective Equipment .....	68
D. Exposure Control .....	69
E. Hazard Communication .....	70
F. Work Practices .....	72
G. Medical Monitoring.....	73
H. Emergency Planning and Alert Systems .....	74
I. General Occupational Safety and Health Management for Small Businesses.....	76
<b>7. References .....</b>	<b>77</b>
<b>8. OSHA Assistance .....</b>	<b>78</b>
<b>9. OSHA Regional Offices .....</b>	<b>81</b>

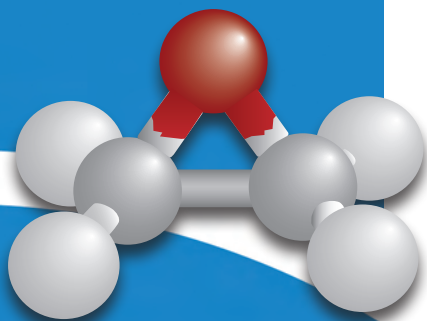

## 1. Overview

**E**thylene oxide (EtO) is used extensively by hospitals and other industries as a sterilizing agent. EtO is a colorless, odorless gas, which is both flammable and highly reactive. Most importantly, you cannot smell EtO until it reaches levels that can cause serious harm to human health (NIOSH, 1989). Human and animal studies consistently show that EtO can be hazardous to human health. Short-term exposures to EtO can cause respiratory irritation and lung injury, shortness of breath, headache, nausea, vomiting, and diarrhea. Long-term exposure over many years may cause cancer, reproductive effects, genetic changes, and damage to the nervous system (LaMontagne et al., 1990).

The purpose of this guidance document is to help employers understand the EtO standard, with particular emphasis on how to monitor the quality of the air in workplaces where EtO is processed, used, or handled. Air monitoring is an important activity that can help alert employers when unsafe levels of EtO are present in the air so they can take steps to reduce employee exposure. EtO can be used more safely if appropriate precautions are taken and if equipment is adequately designed and maintained. This document:

- Clarifies the different types of EtO exposure monitoring.
- Reviews the exposure monitoring requirements in OSHA's EtO standard.
- Lists and explains the exposure levels used by OSHA.
- Provides an overview of actions required when monitoring shows that employees are exposed to EtO at levels exceeding the allowable limits.
- Outlines the monitoring decisions you need to make when employees work in areas where EtO is present.

All of the required actions presented in this document are based on **OSHA's EtO standard (29 CFR 1910.1047)**.

This guidance document provides helpful suggestions for complying with the EtO standard. You will find other general sources of information on EtO listed in Section 6 - Related OSHA Standards and Other Helpful Resources. To see a list of other terms sometimes used for EtO, see Section 5.1 - Other Names for Ethylene Oxide.

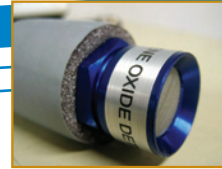

## 2. Exposure Monitoring

### A. Understanding OSHA's EtO Exposure Monitoring Requirements

#### i. Different Types of Exposure Monitoring

There are three types of EtO monitoring available for determining levels of EtO in a workplace: 1) personal monitoring, 2) area monitoring, and 3) leak detection (a special type of area monitoring). However, personal monitoring is required to determine if there is compliance with the exposure limits of the standard.

#### ii. OSHA Requirement for Air Monitoring

 The OSHA EtO standard requires employers who have EtO present in their workplace to conduct personal monitoring unless they are specifically **exempt from the requirement**. This guidance document is intended to help employers understand the difference between personal monitoring, area monitoring, and leak detection, and why area monitoring is complementary to personal monitoring, but can never be used instead of it.



Indicates link to more information elsewhere in this document.





## Passive Dosimeter for personal exposure monitoring



Employee wearing a passive diffusion monitor (or dosimeter).

For more information, see [Section 5.K - Passive Diffusion Dosimeter](#).



Employee wearing an air sampling pump and sorbent tube.

For more information, see [Section 5.L – Air Sampling Pump and Sorbent Tube](#).

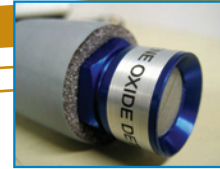

### a. Personal Monitoring

Personal monitoring involves measuring a person's exposure to EtO by testing the air that the person (an employee) would breathe regardless of where the person moves in the workplace. To test airborne EtO concentrations, a sampling device is attached to the shirt collar or as close as practical to the nose and mouth of the employee. This is considered the employee's "breathing zone."

 [See Section 5.J - Breathing Zone.](#)

The device is worn for a specified period of time. During personal monitoring for EtO, the sample is collected for 15 minutes to test for short-term exposures (the excursion limit) or for the length of a whole work shift (typically 8 hours) to test for average exposures over the course of a workday (time weighted average or TWA). These air samples will be referred to here as 15-minute samples and 8-hour samples.

Equipment used for personal monitoring typically includes a passive diffusion monitor (a type of clip-on tag that collects EtO) or, alternatively, a small air pump worn on the employee's belt that pulls a sample of air through a glass tube (called a sorbent tube) filled with a substance that captures EtO. These samples typically must be sent to a laboratory for analysis. Care must be used in collecting the sample and monitoring it to ensure an accurate measurement.

 [See Section 5.M - Comparison of Passive Dosimeters and Traditional Air Sampling Methods Using a Pump and Sorbent Tube.](#)

Within 15 days after receiving the results of the monitoring from the laboratory, the employer must notify each affected employee of these results. This may be done by posting the results in an appropriate location, accessible to the employee (social security numbers should not be posted), or by providing the results to the employee individually and in writing. If an employer uses representative sampling (see section 2.B.i), then each employee represented by the sample should be notified of the result.

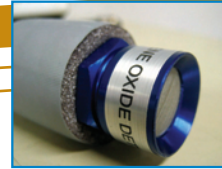

InterScan Corp

A remote display of an EtO monitoring system.



Portable EtO gas-detection meters are available to check for leaks around equipment such as sterilizers, tanks, fittings and pipes that contain EtO. Leak testing is generally performed using hand-held EtO detection meters (a type of portable direct-reading instrument). See the related [Section 3.A.iii - Emergency Alert Provision](#).

### b. Area Monitoring

Area monitoring is used to show the levels of EtO throughout the general work area and to identify problems and priorities, but this kind of monitoring is not required by the EtO standard. Area samples should be taken close to a source of emission in order to evaluate concentrations or the effectiveness of steps being taken to control exposure. Alternatively, area samples can be collected at various places in the work area to assess how far EtO might have spread.

Instruments used for area monitoring are often mounted on the wall or placed directly on equipment. The monitoring instrumentation can be similar to that used for personal monitoring, or it can be of the “direct-reading” type, which gives an immediate reading of the EtO level. When an employer uses direct reading instruments, nothing needs to be sent to a laboratory, but the equipment must be calibrated periodically to ensure accuracy. A wall-mounted emergency alert system used for area monitoring is one example of a direct-reading area monitoring instrument.

### c. Leak Detection

Employers who are required to create a written compliance program because their employees’ exposures are over the permissible exposure limit must also produce a schedule for routine leak detection surveys.

Some businesses that use EtO find it helpful to test equipment such as sterilizers, pipes, tanks, and fittings at least every two weeks to confirm that there are no leaks.

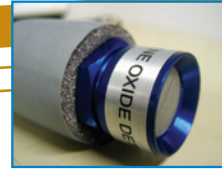

### iii. OSHA Exposure Levels

The Federal OSHA EtO standard establishes certain allowable exposure levels. This section will explain the terms, units, and exposure levels that require action.

**Units of Measure:** Exposure levels are reported as concentrations — the volume of EtO per volume of air. This is typically expressed as “parts per million” (also called “ppm”). One part per million means that there is one part of EtO in every million parts of air sampled. Alternatively, the concentration of EtO can also be reported using weight of EtO per volume of air — milligrams of EtO per cubic meter of air ( $\text{mg}/\text{m}^3$ ). It is important to compare only exposure values that have the same units of measure. For example, only compare exposure results reported in the units’ ppm to the OSHA levels for EtO provided in ppm.

#### a. Permissible Exposure Limits

**Action Level:** The “action level” is the 8-hour exposure level that triggers certain actions under OSHA’s EtO standard. If an employee’s 8-hour sample result is equal to or greater than the action level, the employer must start certain required activities such as exposure monitoring and medical surveillance. The action level for EtO is 0.5 ppm (which equals  $0.9 \text{ mg}/\text{m}^3$ ).

Actions an employer must take if the personal monitoring test result is greater than,  or equal to, the “action level” are outlined in **Section 2.C - Actions Triggered by Air Sample Results.**

**Permissible Exposure Limit (PEL):** This is the exposure level of EtO above which no employees may be exposed under normal workplace conditions. You should become familiar with two EtO PELs, one for 8-hour samples and one for 15-minute samples.

The action level for EtO is 0.5 ppm (which equals  $0.9 \text{ mg}/\text{m}^3$ )

The 8-hour PEL for EtO is 1 ppm (which equals 1.8 mg/m<sup>3</sup>)

The 15-minute excursion limit for EtO is 5 ppm (equal to 9 mg/m<sup>3</sup>)

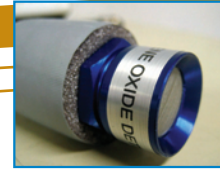

- Eight-Hour Time-Weighted Average (8-hour TWA) —This is an 8-hour (or full work shift) sample that represents the maximum average EtO level to which an employee may be exposed. The 8-hour PEL for EtO is 1 ppm (which equals 1.8 mg/m<sup>3</sup>).
- Excursion Limit (15-minute) — This is a 15-minute (short-term) sample that represents the maximum EtO exposure level to which an employee may be exposed to for a short period of time. The 15-minute excursion limit for EtO is 5 ppm (equal to 9 mg/m<sup>3</sup>).

Rotating employees to different workstations so that they are not exposed to higher EtO levels is not an acceptable way of meeting the 8-hour TWA or the Excursion Limit requirement.

Both types of samples are important because, taken together, they help employers protect employees over the range of exposure conditions that employees are likely to experience. Actions an employer must take if these PELs are exceeded are



outlined in **Section 2.C - Actions Triggered by Air Sample Results**.

#### What if the work shift is not exactly 8 hours?



If the shift is more or less than 8 hours, **see Section 5.D - Work Shifts of Not**



**Exactly 8 Hours**

## B. Monitoring Requirements

The OSHA EtO standard requires that each employer with EtO present, whose workplace does not meet the “exemption” clause (1910.1047(a)(2)), to perform personal monitoring to show whether EtO exposures are exceeding the 8-hour and/or the 15-minute PEL. The OSHA standard requires that these samples be “representative” of EtO exposures under the typical workplace conditions. There are two types of monitoring requirements: initial and periodic.

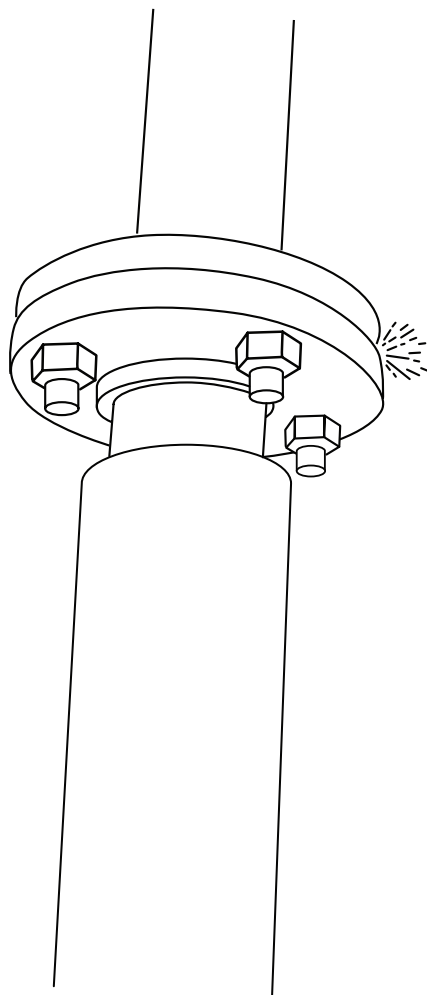

Ethylene oxide pipe leak in joint.

## i. Initial Monitoring

### Do I need to collect initial EtO samples?

Yes. If you have EtO present in the workplace you are required to conduct personal EtO monitoring of employees who might be exposed to EtO to accurately measure the airborne concentrations of EtO. Most employers should assume that they must conduct exposure monitoring: 1) if their business involves processing, using, or handling products containing EtO, 2) if they are not exempt as described in **Section 5.C - Exemptions from Initial Monitoring**, and 3) if they have never conducted personal monitoring.

This level of caution is important because accidental releases of EtO may occur from several sources, including leaking cartridges, sterilizer discharge lines, and leaks or routine changing of EtO supply cylinders. A relatively small quantity of EtO released into an average-sized office space can result in concentrations that are many times the action level or PEL (NIOSH, 1989; LaMontagne and Kelsey 1998). If there are special circumstances that would suggest monitoring is not required for your workplace and you need further clarification, we encourage you to contact your local area OSHA office by calling 1-800-321-OSHA or visiting [www.osha.gov/html/RAmap.html](http://www.osha.gov/html/RAmap.html).

When carrying out initial monitoring, you must collect both 8-hour samples (full work shift) and 15-minute samples (short-term). At least one sample of each type is required for:

- Each work shift,
- Each job classification, and
- Each work area of the workplace.

## Daily Staffing

### Day Shift

Supply Technician (Level 1)  
Supply Technician (Level 2)  
Janitor  
Housekeeper  
Maintenance Operator  
Receiving Dock Manager

### Evening Shift

Supply Technician (Level 1)  
Supply Technician (Level 2)  
Janitor

### Night Shift

Supply Technician (Level 2)  
Housekeeper

**Question:** At your workplace, do all supply technicians have the same level of EtO exposure? What about janitors?

**Answer:** The employees' exposure to EtO will not be the same if their tasks are different or if they work with EtO for a different length of time than other employees.

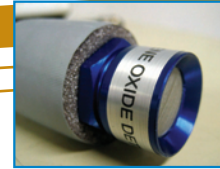

### Do I need to collect initial personal monitoring samples for every employee, on every work shift?

No. But you do need to determine the exposure level of every employee. If you have only one employee, or just a few *who all do different jobs*, you need to collect personal samples for each employee. If you have two or more employees *who do the same job*, however, you may be able to collect personal samples for one of these employees and use the results to document exposure levels for all of these employees. This is known as representative sampling. To decide whether the results for one employee will represent the EtO exposure of other employees in the group, you must evaluate certain criteria:

#### Criteria for Using Results from Similar Work Conditions

- Do the employees do the same work?
- Are their working conditions similar (e.g., do the employees use similar equipment and EtO products)?
- Do the employees have similar work practices, with similar EtO control measures?
- Do they work in the same area or in areas with similar air movement patterns?
- Do the employees use the same EtO product for the same amount of time during their shifts?
- Do the employees work the same distance from possible sources of EtO?

If the answer is “no” to any of the questions above, you may not use one person’s results to represent the EtO exposure of other employees. Instead you need to identify a smaller group of employees that have all of these criteria in common. Alternatively, you can conduct individual personal monitoring for each employee.

If the answer to all of the above questions is “yes,” you may use the results from one or more employee(s) to represent the exposure of other employees in the group. You must, however, select the employee who is likely to have the highest EtO exposure (due to slight variations in work area, work practices, or experience) as the employee whose EtO exposure will represent that of the other employees in the group.

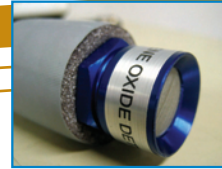

## Today's Schedule

### Day Shift

- 7:00 Sign in
- 7:05 Attend training
- 7:45 Change sterilizer gas cylinder
- 8:05 Paperwork
- 9:30 Break
- 9:45 Meet with Jose M.
- 10:15 Delivery due/inventory
- 11:30 Lunch
- 12:00 Remove batch from sterilizer #3
- 12:15 Paperwork
- 12:30 Sterilizer duty
- 2:00 Break
- 2:15 Sterilizer duty
- 3:30 Sign out

**Question:** When should 15-minute samples be collected?

**Answer:** Collect a 15-minute sample for 15 of the 20 minutes between 7:45 and 8:05. Another sample should be collected at 12:00. It might also be necessary to collect an additional 15-minute sample during the afternoon sterilizer duty, for example when the employee is pumping EtO out of the equipment.

You must also keep a record stating your reasons for selecting an employee from one work shift to represent employees on another shift. One way to document the similarity of shifts is by sampling employees on each shift one time to show that the employee exposures are the same on each shift. If the exposures are the same, you can conduct required periodic sampling in the future on a single shift and consider it representative of all shifts. You may use this option with 8-hour samples and with 15-minute samples.

### **Am I permitted to use results of air samples collected at another time or at a different location from my initial monitoring results?**

Yes, but the work conditions must have been similar on the two dates, or at the two locations. The criteria listed above for using results from similar work conditions also applies in this situation. Again, if the answer is “no” to one or more of these questions, it is likely that you must conduct initial monitoring. If the answer to all of these questions is “yes,” then OSHA allows you to meet the initial monitoring requirements by using personal monitoring results collected for other employees at an earlier date or different location in the workplace. Be sure to keep a document explaining why it was appropriate to use those results to meet your initial monitoring requirements.

### **Which 15-minute period should I monitor?**

You must collect a 15-minute air sample during the portion of the work shift when you have reason to believe that the employee’s EtO exposure will be the highest. You may need to collect several 15-minute samples during the same shift (see text box “Why Is It So Important to Collect 15-Minute Samples?” on the next page).

## Why Is It So Important to Collect 15-Minute Samples?

Research suggests that EtO exposures above the 15-minute OSHA PEL continue to occur in workplaces that are involved in processing, using, or handling products containing EtO. Recent studies have also shown that personal monitoring activities often fail to detect accidental exposures during EtO leaks and spills (LaMontagne et al., 2004; LaMontagne and Kelsey 1998). Therefore, it is important to carefully consider the types of activities for which 15-minute monitoring is most useful. The following examples should help provide some guidance:

- A common situation in which accidental exposures to EtO may occur involves changing EtO supply cylinders. Consider collecting 15-minute personal samples while the employees being sampled are replacing EtO cylinders.
- Employees who work directly with, or in close proximity to, EtO sterilizers or similar equipment should be monitored frequently for short-term (i.e., 15-minute) exposures to EtO at the times when they are most likely to experience exposure (such as when the employee opens the door at the end of the cycle, or while EtO is being pumped in or out of the equipment).

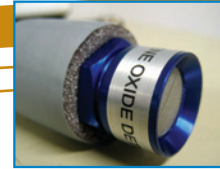

## ii. Periodic Monitoring

### Do I need to repeat the EtO personal monitoring and, if so, what is the monitoring schedule?

Whether you need to repeat EtO personal monitoring depends on the results of your initial personal monitoring. Under certain situations, a long-term schedule for personal monitoring for EtO must be established. Tables 1 and 2 provide the “periodic monitoring” schedule required by the EtO standard. The personal monitoring results may also trigger other requirements, which are listed in Tables 3 and 4 later in this guidance document.

**Table 1 – Schedule for OSHA Exposure Monitoring**

If your initial employee monitoring results...	Then...
...show that employee exposure is below the 8-hour action level...	...discontinue monitoring for only those employees whose exposures are represented by the initial monitoring.
...are between the 8-hour action level (0.5 ppm) and the 8-hour permissible exposure limit (PEL) of 1 ppm (including the value 0.5 ppm)...	...conduct additional 8-hour personal exposure monitoring at least every 6 months.
...are above the 8-hour PEL of 1 ppm or above the 15-minute PEL of 5 ppm...	...conduct additional personal exposure monitoring (either 8-hour or 15-minute, depending on the sample type that initially exceeded the limit) at least every 3 months. Where the 15 minute PEL is exceeded, frequent monitoring may be needed to evaluate the employee’s short-term exposures.



See Table 3 - Actions Triggered by Air Sample Results.





### When would I be allowed to reduce the frequency of air monitoring?

You may reduce the frequency of periodic air monitoring for an employee or group of employees only if two consecutive air test results for that employee (or group) meet the criteria listed in Table 2. To qualify as “consecutive” tests, the tests must be conducted one after the other, at least a week apart, but not more than 3 months apart. The results for the tests must both be below the 8-hour action level or they must both be below the 15-minute PEL. Table 2 also lists the requirements for discontinuing periodic tests.

#### Example of 15-minute Air Monitoring Results for Employees Emptying Sterilizer #3

Test Date	Exposure Level	Action to Take
Feb. 6	7.53 ppm	Use PPE to protect employees. Repair ventilation system power switch. Monitor 15-minute exposure level every 3 months (next test due by May 6).
May 2	8.79 ppm	Fix exhaust ventilation fan (by May 4).
May 6	5.22 ppm	Adjust ventilation suction angle at machine door (by May 6 evening).
May 10	2.18 ppm	Retest air...wait at least 7 days (but not more than 3 months) to do test.
May 25	2.01 ppm	Two test results are less than the 15-minute PEL of 5 ppm and the tests are more than 7 days apart. We may discontinue monitoring!

**Table 2 – Requirements for Reducing or Discontinuing Monitoring**

If your periodic employee monitoring results had been above the PEL (either the 8-hour TWA or the 15-minute excursion limit)* and...	Then...
... are currently between the 8-hour action level (0.5 ppm) and the 8-hour PEL of 1 ppm (including the value 0.5 ppm) for two consecutive tests (these samples must be collected at least 7 days apart, but no more than 3 months apart)...	...you can decrease the 8-hour personal monitoring frequency from every 3 months to every 6 months. Note: If 15-minute exposures exceed the excursion limit of 5 ppm, you will still need to conduct the 15-minute (excursion limit) monitoring at least every 3 months, or more often as necessary to evaluate short-term exposure.
...are currently less than the 8-hour action level (0.5 ppm) for two consecutive tests (the samples must be collected at least 7 days apart, but no more than 3 months apart)...	...you are no longer required to conduct periodic personal monitoring unless a change in the workplace makes additional monitoring necessary.
...currently indicate that employee exposures are at or below the 15-minute PEL of 5 ppm (the excursion limit) for two consecutive tests (the samples must be collected at least 7 days apart, but no more than 3 months apart)...	...you may discontinue 15-minute (excursion limit) monitoring for those employees whose exposures are represented by the monitoring.

\* See Section 2.A.iii for definitions of OSHA Exposure Levels.

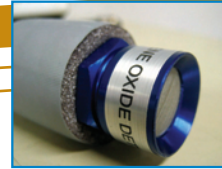

### When must I resume air monitoring?

You must start monitoring again whenever there is a change that could result in new or additional exposures to EtO. Examples of changes that would trigger EtO sampling include:

- Changing EtO process equipment or increasing the volume of EtO used.
- Modifying the exhaust ventilation system.
- Hiring new or inexperienced employees.
- Changing work practices.

You also must resume sampling any time that you have a reason to suspect that a change could result in new or additional exposures.

### C. Actions Triggered by Air Sample Results

Tables 3 and 4 provide the lists of actions you need to take if your EtO monitoring results exceed specific levels. Your need to take these actions is based on how your results compare to the OSHA action level and/or PELs (8-hour and/or 15-minute samples).

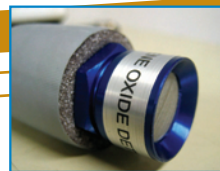

**Table 3 – Actions Triggered by Air Sample Results**

Result Interpretation:	8-Hour Sample Is equal to or above Action Level but equal to or below PEL	8-Hour Sample Is above Permissible Exposure Limit	15-Minute Sample Is above Excursion Limit	Other OSHA Standards That Apply	For More Information, See Section:
Action Triggered by Monitoring Results:					
Develop and put into action a written compliance program for reducing exposure and establishing a schedule for periodic leak detection	Not required	Yes	Yes		3.A and .B
Take steps to reduce exposure levels with engineering controls or other methods	Not required	Yes	Yes		3.C
Provide respirators*	Not required	Yes	Yes	<b>1910.134</b>	3.D
Provide information and training	Yes	Yes	Yes	<b>1910.1200</b>	4.A.i
Establish a regulated area	Not required	Yes	Yes, also if expected to exceed this level		4.A.ii
Ensure that caution labels are fixed to containers (also when container contents are capable of causing or can be reasonably expected to cause these exposure levels)	Yes	Yes	Yes	<b>1910.1200</b>	4.A.iii
Provide medical surveillance (if employee's exposure is more than 30 days per year)**	Yes	Yes	Not required	<b>1910.1020</b>	4.B
Establish periodic air monitoring programs	Yes, at least every 6 months	Yes, at least every 3 months	Yes, at least every 3 months		Table 1

\* Respirators are required for those correcting an emergency condition, regardless of air concentrations during normal operations.

\*\* Medical examinations are also required if there is an exposure related to an emergency situation.

View the provided standard number to see other OSHA standards that apply.

Review section numbers in this document to see a summary of the additional action(s) required when exposure levels are elevated. These sections are not intended to be all-encompassing instructions for compliance; instead, they expand on the limited information in Table 3 by offering you an overview of the general requirements triggered by air sampling results.

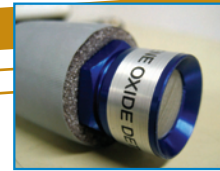

You must keep records of any air monitoring that you perform. For more details on which records must be kept (and for how long), **see Section 5.A – Retain the Required Exposure Monitoring Records.**

**Table 4 – Actions Triggered by the Air Sampling Process**

Other Actions Triggered by Air Monitoring	When to Take Action	Other OSHA Standards That Apply
Post monitoring results within 15 days of receiving them, or give employees the written results individually within 15 days. Mention steps being taken to reduce exposures.	Any time that samples are collected – regardless of the results	
Maintain records of monitoring for 30 years.	Any time that samples are collected – regardless of the results	<b>1910.1020</b>
Allow employees or their representatives to observe air monitoring. The observer must wear PPE and follow safety procedures provided by the employer.	Any time that samples are collected	
View the provided standard number to see other OSHA standards that apply.		



## D. How to Get Help with Air Monitoring

If you need help with air monitoring, contact the OSHA On-Site Consultation Service office for your area. This service is free of charge to employers. Alternatively, you can hire an industrial hygiene consultant who specializes in workplace air monitoring. For more information on how to locate these services in your area,



**See Section 5.E - How to Obtain Further Assistance.**

Laboratories provide analytical services and sometimes advise employers on selecting air sampling equipment and test media. Some laboratories provide the media or loan the equipment as part of the analysis package. Laboratories that analyze workplace air samples are typically listed in the Yellow Pages (under environmental – analysis) and also on the American Industrial Hygiene Association (AIHA) website. When selecting a laboratory, one important question to ask is “Does your laboratory meet the accuracy requirements of OSHA’s EtO standard?”



**See Section 5.B - Accuracy of Sampling and Analytical Methods.**

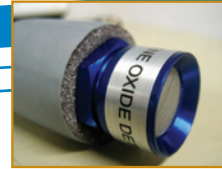

### 3. Exposure Reduction/Prevention

#### A. Methods of Detecting Emergency EtO Releases

There are a number of options available to monitor and test for emergency leaks of EtO. These methods may be appropriate in addition to, but not instead of, personal air monitoring. They cannot be used as a substitute for personal monitoring to satisfy OSHA personal air monitoring requirements.

##### i. Emergency Situations

The OSHA EtO standard requires that each workplace have a written plan for emergency situations.

##### ii. Emergency Plan for EtO

The following are some simple steps to ensure that your workplace meets the emergency plan requirements in OSHA's EtO standard:

- For employers with more than 10 employees, the emergency plan must be in writing and available to employees. If you have 10 or fewer employees, the plan may be communicated verbally to employees.
- The plan must contain procedures for emergency evacuation, including the type of evacuation and exit route assignments (refer to OSHA's standard for Emergency Action Plans [29 CFR 1910.38](#)). Although not specifically required, you can be proactive in emergency planning preparations by conducting employee evacuation drills for potential EtO emergencies.
- You must have a system for alerting employees to emergency EtO exposures. You do have the flexibility to choose any effective method of alerting employees to potential EtO releases that could result in harmful exposures.
- The plan must specifically provide that employees engaged in correcting emer-



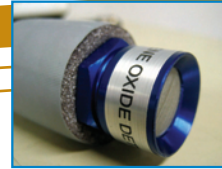

## Monitoring Systems

Alarm systems basically function as a monitor to test the surrounding air for EtO levels.

To monitor EtO levels near sterilizers, some employers find it convenient to install a wall-mounted or equipment-mounted system.

Commercially available alarms that monitor EtO levels and use both visual and sound alarms can alert employees in noisy or crowded areas when the level of EtO is higher than it should be.

Personal alarm systems, worn by an employee, are useful when employees handle portable components of EtO sterilization equipment. The EtO sensors used in personal alarm systems can detect emergency release levels of EtO and sound an alarm. When they include data-recording (“logging”) ability, the instruments can calculate an average exposure level that may be read directly from the instrument screen. These instruments, however, typically do not provide accurate results at concentrations at the PEL or lower and, thus, are not the best choice for measuring 8-hour TWA employee exposures.

gency conditions be equipped with respiratory protection as required by **29 CFR 1910.1047(g)** until the emergency is abated and must be implemented in accordance with **29 CFR 1910.134**, Respiratory Protection.

- The plan must include the elements contained in **29 CFR 1910.38** and **29 CFR 1910.39**, OSHA’s standards on Emergency Action Plans and Fire Prevention Plans.

### iii. Emergency Alert Provision

The emergency alert provision of OSHA’s EtO standard allows employers to choose the most effective method of alerting employees. As part of the emergency plan, you must develop a system for alerting your employees. The precise type of alert system is not specified in the OSHA EtO standard.

OSHA considers the following alert methods acceptable for an EtO monitoring system:

- **A bell or other alarm system:** A bell or alarm system must have a distinctive signal to alert employees to an EtO leak (refer to **29 CFR 1910.165** Employee Alarm Systems).
- **A voice-activated system:** Like other alarm types, this system must have a distinctive signal to alert employees to an EtO leak.
- **Voice communications:** For those employers with 10 or fewer employees in a particular workplace, the requirements under OSHA’s Employee Alarm Systems standard state that direct voice communication is an acceptable method of alerting employees, providing that all employees at their respective workstations can hear the alarm given in this manner. For workplaces with more than 10 employees, simple voice communication is not acceptable.

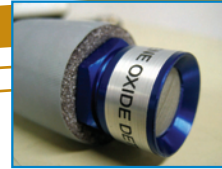

### Is there a specific EtO level that I should use to trigger an alert?

OSHA has not established an “alert” level; you should choose an alert trigger level that is appropriate for your workplace. When evaluating alarms, it is important to remember that the alarm’s purpose is to alert employees to unintended and hazardous EtO releases, rather than to average EtO concentrations measured over an 8-hour work shift. It is not necessary to base the EtO alarm trigger specifically on the OSHA action level (0.5 ppm) or permissible exposure limits for 8 hours (1 ppm) or 15 minutes (5 ppm).

You should also be aware that there is a wide range in the cost and sensitivity of commercially available monitors. Some systems alert employees to EtO levels greater than 20 ppm, while other highly sensitive monitoring devices can trigger an alarm at much lower levels, such as 1 ppm or even lower (NIOSH, 1989).

 **See Section 6.H - Emergency Planning and Alert Systems.**

 **Return to Section 2.A.ii.C - Leak Detection.**



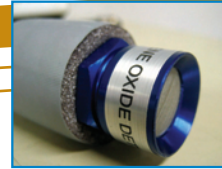

## Personal Protective Equipment

OSHA's general PPE requirements (29 CFR 1910.132, Personal Protective Equipment) mandate that employers conduct a hazard assessment of their workplaces to determine what hazards are present that require the use of PPE, provide employees with appropriate PPE, and require them to use it. Employers must also maintain the PPE in a sanitary and reliable condition. Under OSHA's EtO standard, employees who could have eye or skin contact with EtO or EtO solutions must be provided appropriate protective clothing and equipment, at no cost to the employee, and the employer must ensure that the employees use it. Besides spectacles and goggles, PPE such as special shields, spectacles with side shields, and face shields can protect employees from the hazards of splashes or mists. Employees exposed to EtO through skin absorption can be protected by hand protection, in appropriate cases. In some cases, employees must shield most or all of their bodies against EtO exposure in the workplace.

You can find more information about PPE, including the full text of OSHA's standards, on OSHA's website at [www.osha.gov](http://www.osha.gov). In addition, publications explaining the subject of PPE in greater detail are available from OSHA. *Personal Protective Equipment* (OSHA 3151) and *Assessing the Need for Personal Protective Equipment: A Guide for Small Business Employers* (OSHA 3151) are available on OSHA's website.

## B. Develop a Compliance Program

If your exposure monitoring results are at a level that requires you to develop and put into action a written compliance program, write a memorandum or summary report that outlines the steps you need to take at your facility to comply with the EtO standard. This document will serve as your written compliance program. Include some background information, such as which employees or job categories may be exposed to EtO and the known or suspected sources of exposure. Then describe what methods are being or will be taken to control exposures and include a schedule of leak-detection surveys, a list of personal protective equipment (PPE) employees will wear to protect their eyes and skin from possible contact with EtO or EtO solutions (using PPE selected by methods required in [29 CFR 1910.132, OSHA's Personal Protective Equipment standard](#)), and a written emergency plan. Outline how you will implement the required actions triggered by the air sampling results obtained in your facility. You may wish to include an action plan worksheet, such as the one available as [Appendix A in OSHA's Small Business Handbook](#).

Be sure to follow this plan and take the necessary steps that will put the plan into action. You are required by the EtO standard to review the plan at least every 12 months. If your planned actions change, be sure to update the written compliance program to match your plan. Remember that rotating employees between different workstations does NOT constitute an acceptable compliance program.

 [Return to Table 3 - Actions Triggered by Air Sample Results.](#)

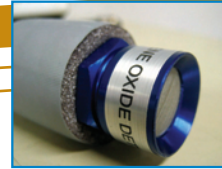

### C. Reduce Exposures with Engineering Controls or Other Methods

If your exposure monitoring results are at a level that requires you to take steps to reduce exposures with engineering controls or other methods, investigate options for modifying or enclosing your EtO equipment. Also consider options for improving ventilation to capture and remove EtO before employees are exposed. Train employees to use work practices that will help lower exposure levels. One example of such a practice is waiting a pre-determined time before opening the sterilizer door when the equipment finishes its cycle. Also, employers may wish to upgrade their equipment with improved sterilizers that have built-in exposure control features (e.g., built-in aerators).

Employers can often obtain helpful information on exposure reduction methods from the sterilization equipment manufacturer, trade associations, OSHA Consultation

 Program offices, and private consultants that specialize in industrial ventilation or industrial hygiene (see [Section 5.E - How to Obtain Further Assistance](#)).

 [Return to Table 3 - Actions Triggered by Air Sample Results.](#)

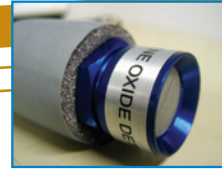

Photos courtesy of NIOSH

A positive-pressure supplied-air respirator might be required. To protect the eyes, use a respirator with a full-facepiece (above) or hood.

## D. Provide Respiratory Protection

If your exposure monitoring results are at a level that requires you to provide respirators, a written respiratory protection program must describe how the respirators are selected, stored, cleaned, and maintained at your facility. A written program is also necessary when employees use respirators for certain tasks, as required by the EtO standard (e.g., maintenance and vessel cleaning activities for which controls are not feasible, operations for which controls are not yet sufficient to reduce exposures, and for controlling emergency releases of EtO).

The written respiratory protection program must state how employees are trained, medically qualified, and fit tested for respirator use. As part of your program, you must try to reduce employee exposures by installing engineering controls and modifying work practices so that respirators will not be necessary. For more information, including information on selecting respirators, review the respiratory protection requirements of OSHA's EtO standard in section [29 CFR 1910.1047\(g\)](#). For assistance with respiratory protection program requirements, review OSHA's Respiratory Protection standard ([29 CFR 1910.134](#)) and the documents listed in [Section 6.C](#) –

 [Respiratory Protection and Personal Protective Equipment.](#)

 [Return to Table 3 - Actions Triggered by Air Sample Results.](#)

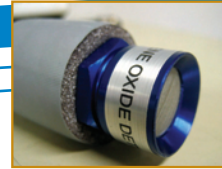

## 4. Other Requirements

### A. Employee Information and Training

#### i. Hazard Communication

If your exposure monitoring results are at a level that requires you to provide information and training, you must arrange a training class for all employees who are potentially exposed to EtO at or above the action level or the 15-minute excursion limit. New employees must be trained before they are assigned to an area where exposure might occur. You must also provide annual (repeated every year) training to



all potentially exposed employees. **See Section 5.E - How to Obtain Further Assistance** for information on locating sources of help with employee training.

The training must cover the following topics:

- The OSHA EtO standard, including an explanation of the requirements of the standard and its Appendices A and B. Employees must also be informed (1) that a copy of the standard is available to them and (2) where they can find a copy. The copy of the standard may be a paper copy stored in an area open to employees. Alternatively, the copy may be in an electronic format (accessible from a computer), but only if every potentially exposed employee can access a workplace computer and knows how to locate the electronic copy.
- Any operations in the employees' work area where EtO is present or may be used.
- The medical surveillance program for employees exposed to EtO and an explanation of the information contained in Appendix C of the OSHA EtO standard.
- The ways EtO is detected and monitored at your facility (for example, by personal exposure monitoring, continuous air monitoring devices, or other methods).
- The physical and health hazards associated with EtO use and potential exposures.





- The steps employees can take to protect themselves from the hazards of EtO, including the procedures used in your workplace to protect employees (e.g., work practices, emergency procedures, and personal protective equipment).
- Details of the workplace hazard communication program, the corresponding labeling system, and how employees can find and use hazard information.
- Having access to and being familiar with the material safety data sheet (MSDS).

For additional information on employee hazard communication and training see **Section 6.E - Hazard Communication**.



Return to **Table 3 - Actions Triggered by Air Sample Results**



#### Mandatory Sign for Regulated Area

**DANGER**

**ETHYLENE OXIDE  
CANCER AND REPRODUCTIVE HAZARD  
AUTHORIZED PERSONNEL ONLY  
RESPIRATORS AND PROTECTIVE CLOTHING  
MAY BE REQUIRED  
TO BE WORN IN THIS AREA**

#### ii. Establish Regulated Areas

If your exposure monitoring results are at a level that requires you to establish regulated areas in your facility, you must identify, mark, and make employees aware of the regulated areas in their workplaces.

- Identify regulated areas by determining where EtO levels may exceed the permissible exposure levels (PELs) in your facility. Also include areas where the EtO levels can reasonably be expected to exceed the excursion limit. These two types of areas will be your regulated areas. You must only allow authorized persons to enter regulated areas.
- Mark the boundary of these regulated areas by posting required signs and using any other methods you decide are needed to prevent unauthorized people from entering the areas. The goal is to limit the number of people in regulated areas to the minimum number needed to do the work. If the regulated area is a portion of a larger space, you must use signs to mark each point where an employee might enter the regulated area. See box at left for what the signs must state.



- Consider using a combination of methods to mark the area and restrict entry. In addition to posting signs, you might also lock the doors to keep unauthorized employees from entering a room that is a regulated area.
- Other methods of alerting people to the potential hazard include changing the floor color, adding physical barriers such as gates, fences, or partitions, or taking other steps to mark the boarder of the regulated area. Regardless of the methods used, it is important that you make sure that unauthorized employees are able to recognize the regulated areas and know to stay out. For example, if you use special floor markings to indicate the regulated area, you must also train employees so that they know what that floor marking means.

 **Return to Table 3 - Actions Triggered by Air Sample Results.**

### iii. Ensure that Cautionary Labels are Fixed to Containers

All containers of EtO, the contents of which are capable of causing employee exposure at or above the action level or may reasonably be foreseen to cause exposure above the 15-minute excursion limit, must be properly labeled. Be sure that employees understand that the labels on containers must not be removed or covered. Check incoming chemical and gas containers to be sure that the labels are readable and firmly attached when they are delivered to your facility.

EPA regulates EtO as a pesticide under the *Federal Insecticide, Fungicide and Rodenticide Act* (FIFRA) when it is used as a fumigant or sterilant for medical items. As a part of this regulation, EPA has specific requirements for labels for EtO containers. In 1996, EPA modified its FIFRA labels to include statements mandating that all users of EtO-containing sterilants and fumigants observe the requirements of 29 CFR 1910.1047.

The label must also include a warning against breathing air contaminated with EtO. One example of a suitable label at bottom left.

#### A Container Label Statement Warning Against Breathing Contaminated Air is Mandatory

USE ONLY WITH ADEQUATE  
VENTILATION  
OR RESPIRATORY PROTECTION<sup>1</sup>

<sup>1</sup> This is the statement suggested by the California Code of Regulations, Title 8, Subchapter 7 - General Industry Safety Orders, Section 5520 - Ethylene Oxide < <http://www.dir.ca.gov/title8/5520.html>>



If the label on a container in your facility is damaged, you may copy the information to a new label and attach it to the container, or you may contact the product manufacturer to see if you can obtain a replacement label.

#### iv. MSDS

Hazard Communication standard requires that you maintain an MSDS, which the manufacturers or distributors are required to provide to you. It must be kept in an area that is accessible to employees exposed to EtO.

**Return to Table 3 - Actions Triggered by Air Sample Results.**

## B. Medical Surveillance

If your exposure monitoring results are at a level that requires you to enroll employees in a medical surveillance program, you must develop a medical surveillance program that provides required medical exams for employees who meet certain criteria. Specifically, the OSHA EtO standard requires medical exams for all employees who are exposed to EtO at or above the action level (0.5 ppm) for at least 30 days per year or if any employees are exposed to EtO during an emergency event. Emergency means any occurrence such as, but not limited to, equipment failure, rupture of container, or failure of control equipment that is likely to or does result in an unexpected significant release of EtO. Important points to remember when determining whether an employee meets the criteria for the medical surveillance program:

- Recognize that the 30 days of exposure might be scattered throughout the year. Therefore, if the number of days of exposure for one employee adds up to a total of 30 or more days in one year, that employee must be included in the medical surveillance program.
- Count each day when the employee has 8-hour EtO exposure at or above the action level (0.5 ppm), even if the employee is wearing a respirator.
- Include in the program any newly hired employee who is taking a job that involves this amount of exposure.

If an employee wears a respirator, OSHA's Respiratory Protection standard, 29 CFR 1910.134, requires that the employee receive a medical evaluation for respirator use, even if the employee is not included in the EtO Medical Surveillance Program.

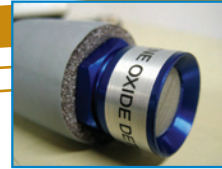

- If you are certain that an employee will be exposed to the EtO action level for less than 30 days per year (for example: exposed only once per month, or 12 times per year), then you do not need to include that employee in the medical surveillance program.
- Enroll an employee in the medical surveillance program as soon as you realize that he or she meets the program criteria. If working conditions change so that an employee who was not included in the program will now be exposed at or above the action level for 30 or more days in the year, enter that employee in the program as soon as you know of the change.

The OSHA EtO standard requires that employers provide their employees who are in the medical surveillance program an opportunity to have medical exams at the employer's expense. This means that the employer must pay for the exams.

 **See Section 5.F - How to Find a Healthcare Provider for Your Medical Surveillance Program.**

Each employee who is enrolled in the medical surveillance program must be offered several different types of exams: an initial exam, an annual (repeat) exam each year, and a final exam. Additional evaluations might also be required under certain circumstances. Although OSHA's EtO standard provides minimum requirements, it is up to the healthcare provider to determine what specific medical tests to include in the exam.

 **See Section 5.G - What a Medical Exam Must Include.**

1. The initial exam must be performed before the employee is assigned to work in an area where his or her exposure may be at or above the action level for 30 or more days per year.
2. The employer must continue to offer an annual (repeat) medical exam each year as long as the employee is exposed to EtO above the action level on at least 30 days per year.



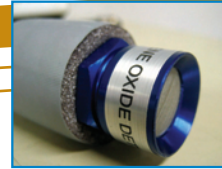

UNITED STATES DEPARTMENT OF LABOR  
OCCUPATIONAL SAFETY & HEALTH ADMINISTRATION

www.OSHA.gov A-Z Index: A B C D E F G H I J K L M N O P Q R S T U V W X Y Z Search OSHA

Regulations (Standards - 29 CFR)  
Ethylene oxide - 1910.1047

Regulations (Standards - 29 CFR) - Table of Contents

• Part Number:	1910
• Part Title:	Occupational Safety and Health Standards
• Subpart:	Z
• Subpart Title:	Toxic and Hazardous Substances
• Standard Number:	1910.1047
• Title:	Ethylene oxide.
• Appendix:	A, B, C, D

1910.1047(a)  
"Scope and application."

1910.1047(a)(1)  
This section applies to all occupational exposures to ethylene oxide (EtO), Chemical Abstracts Service Registry No. 75-21-8, except as provided in paragraph (a)(2) of this section.

1910.1047(a)(2)  
This section does not apply to the processing, use, or handling of products containing EtO where objective data are reasonably relied upon that demonstrate that the product is not capable of releasing EtO in airborne concentrations at or above the action level under the expected conditions of processing, use, or handling that will cause the greatest possible release.

1910.1047(a)(3)  
Where products containing EtO are exempted under paragraph (a)(2) of this section, the employer shall maintain records of the objective data supporting that exemption and the basis for the employer's reliance on the data, as provided in paragraph (k)(1) of this section.

## Ethylene oxide standard

- The employee must also be offered a final medical examination:
  - When the employee leaves the place of employment (i.e., retires, quits, or is fired from the job).
  - When the employee transfers to another job with less EtO exposure (i.e., exposure below the criteria for the medical surveillance program).
- Additional medical evaluations must be provided if:
  - The employee develops symptoms of possible overexposure to EtO.
  - The employee requests medical advice about whether their past or current EtO exposure could affect his or her ability to have a healthy baby.
  - The healthcare provider determines that more frequent exams are necessary.
  - The employee is exposed during an emergency.

The exams must be provided at no cost to the employee, without loss of pay, and at a reasonable time and place. This means scheduling the exam during working hours and allowing the employee to attend the exam on paid time or scheduling it at a reasonable time and place outside working hours and paying the employee for the time and travel expenses incurred in attending the exam.

The employer must provide the healthcare provider with certain information, such as:

- A copy of OSHA's EtO standard and Appendices A, B, C and D (at left).
- A description of the employee's job duties associated with EtO.
- The employee's EtO exposure level (or anticipated exposure level).
- A description of any PPE and/or respiratory equipment used by the employee.
- Any information from previous medical examinations not otherwise available to the healthcare provider (e.g., if the previous exam was conducted by another healthcare provider).

**“Employee medical records. The medical record for each employee shall be preserved and maintained for at least the duration of employment plus thirty (30) years,…”**

**Quote from OSHA’s standard on Access to Employee Exposure and Medical Records, 29 CFR 1910.1020**

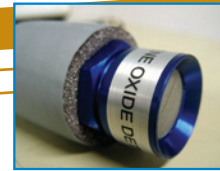

Exams related to OSHA’s EtO standard may be combined with other exams that the employer might need to provide for an employee. For example, if the employee will wear a respirator, any medical exam that the healthcare provider determines is necessary for respirator qualification may be performed during the same visit as the EtO medical surveillance exam.

After each medical exam, the healthcare provider will send to the employer a “physician’s written opinion” that indicates whether the healthcare provider found any condition(s) that would place the employee at increased risk if exposed to EtO. The written opinion must also list any limitations on the employee’s personal protective equipment use, and a statement that the physician has informed the employee of the results of the exam. To help keep medical information private, the employer should instruct the healthcare provider not to reveal in the written opinion given to the employer any specific findings or diagnoses that are unrelated to EtO exposure. The employer must provide the employee with a copy of the written opinion within 15 days of receiving it from the physician.

The employer must keep the written opinion as long as the individual is employed at that workplace and for an additional 30 years beyond the last date that the individual is employed at the workplace. Along with the written opinion, the employer should keep any other information provided by the physician under OSHA’s EtO standard, the employee’s name and social security number, and a record of any EtO-related medical complaints made by the employee. Follow the requirements for maintaining these records and allowing employees to access them established in **29 CFR 1910.1020, OSHA’s standard on Access to Employee Exposure and Medical Records.**



For additional resources, also **see Section 6.G - Medical Monitoring.**



**Return to Table 3 - Actions Triggered by Air Sample Results.**

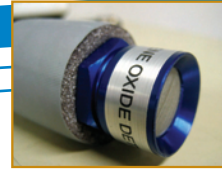

## 5. Additional Compliance Details and Helpful Information

### A. Retain the Required Exposure Monitoring Records

You must maintain documentation of your employees' exposure monitoring. Employee monitoring documentation must include the following:

- The date of measurement.
- The operation involving exposure to EtO that is being monitored.
- Sampling and analytical methods used and evidence of their accuracy  (see **Section 5.B - Accuracy of Sampling and Analytical Methods**).
- Number, duration, and results of samples taken.
- Type of protective devices worn, if any.
- Name, social security number, and exposure levels of the employees whose exposures are represented.

The employer is required to maintain this record for at least 30 years beyond last date of employment (following the requirements of **29 CFR 1910.1020**). Employees must be informed of their personal monitoring results within 15 working days after the employer receives the results.

If you use representative sampling, i.e., results from other employees (or other locations or dates) in place of initial monitoring results, you must document your reasons for considering the working conditions and exposure levels to be similar.

 **Return to Table 3 - Actions Triggered by Air Sample Results.**



## *Instrument Manufacturer's Certificate of Calibration*

For

Ethylene Oxide Detection Meter

Manufacturer:

Model:            Serial #:

Date of calibration:

Next calibration due:

Conditions of testing:

Accuracy:

Authorized signature \_\_\_\_\_

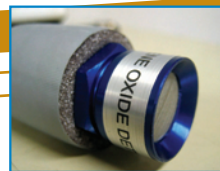

## **B. Accuracy of Sampling and Analytical Methods**

To record the sampling and analytical methods, document the type of equipment you used to obtain the samples (make, model) and the sampling media on which you collected the samples (manufacturer, description, part number).

When conducting sampling required by OSHA's EtO standard, you may only use sampling and analytical methods that meet minimum standards of accuracy which appear in OSHA's EtO standard 29 CFR 1910.1047(d)(6).

- If the EtO exposure level is at the PEL (1 ppm) you may only use methods that provide a confidence level of 95 percent  $\pm$ 25 percent.
- If the EtO level is at the action level (0.5 ppm) your method must be able to achieve a confidence level of 95 percent  $\pm$ 35 percent.
- Monitoring shall be accurate to a confidence level of 95 percent  $\pm$  35 percent for the excursion limits.

The laboratory that analyzes your samples can confirm that the method will meet this level of accuracy. For your records, ask the laboratory to provide the name of the analytical method and evidence that the analysis meets OSHA's accuracy requirements for EtO.

If a direct-reading instrument is used to obtain samples, keep a copy of the most recent calibration documentation and of the instrument manufacturer's specifications for the accuracy of the instrument. At this time, most direct-reading instruments are intended to alert the user to very high levels of EtO caused by an emergency release. These instruments typically do not meet the accuracy requirements for personal monitoring at the level of the PEL or action level.

 [Return to Section 2.D - How to Get Help with Air Monitoring.](#)



## C. Exemptions from Initial Monitoring

Initial monitoring is not always required. Employers are exempt from initial monitoring for a specific job or task if “objective data” show that airborne releases associated with the processing, use, or handling of products containing EtO are not capable of resulting in concentrations at or above the OSHA action level (0.5 ppm).

These objective data might include specific information from chemical manufacturers, industry studies, or trade associations that documents why your facility’s processing, use, or handling of EtO would not result in workplace concentrations exceeding the action level.

To show that a job or task is exempt, you will need the following supporting information (see 29 CFR 1910-1047(k)(i)):

- The name (make, model, or product name) of the equipment or product that qualifies for an exemption (e.g., a manufacturer might have shown that a specific type of sterilizer or a certain sterilant solution qualifies for an exemption as long as it is used as instructed by the manufacturer).
- The source of the objective data (where you obtained the information).
- The testing protocol, results, and/or analysis of data.
- The operation (job or task) at your facility that is exempt and an explanation of why the operation is exempt. Specifically describe how the objective data apply to your situation and how the data support your exemption. Any other data relevant to the operations, materials, processes, or employee exposures covered by the exemption.
- Any other data relevant to the operations, materials, processes, or employee exposures covered by the exemption.

Objective data records must be kept as long as the employer relies on the data to show that monitoring is not required. Depending on the type of jobs performed at the facility and the objective data that are available, the data might show that all of the operations in the facility are exempt. Alternatively, the data might show that only one job is exempt, while other jobs in the facility require initial monitoring.



[Return to Section 2.A.ii - OSHA Requirement for Air Monitoring.](#)



[Return to Section 2.B.i - Initial Monitoring.](#)

**Try to sample the employee's entire 8-hour work shift.**

**If the work shift is more than 8 hours, consult an industrial hygienist for assistance with your air sampling plan (see the next section on How to Obtain Further Assistance).**



## D. Work Shifts of Other Than 8 Hours

When you collect an 8-hour sample, OSHA expects you to collect the sample for the length of the whole work shift, no matter how long it is. The shift might be more or less than 8 hours. Although not every sample will have a duration of exactly 8 hours, any sample to determine exposure to the OSHA action level or 8-hour permissible exposure limit must be compared to an 8-hour sample result.

To avoid confusion caused by samples collected for more or less time, OSHA allows you to use a simple equation that converts any full-shift sample result to an 8-hour equivalent result (also called an 8-hour time-weighted average or an 8-hour TWA result).

### Equation:

$$C_8 = [ C_A (T_A) ] / T_8$$

$C_8$  = The 8-hour equivalent result for your sample (in ppm)

$C_A$  = The actual result (concentration) for your sample (in ppm)

$T_A$  = The actual time during which your sample was collected (in minutes)

$T_8$  = 480 minutes (this is the number of minutes in 8 hours)

Fortunately, most analytical laboratories will do the calculation for you. Ask the laboratory to “Report the full-shift results as 8-hour time weighted averages (or 8-hour TWAs).” You do not need to make this arrangement for 15-minute samples, which should always be collected for exactly 15 minutes.

When exposure levels are high, it may be necessary to collect a series of mid-length samples (e.g., 1 to 2 hours each) instead of a single 8-hour sample for an employee. In this case, ask the laboratory to combine all of the results from one employee to create a single 8-hour TWA result.

 [Return to Section 2.A.iii.a - Permissible Exposure Limits.](#)

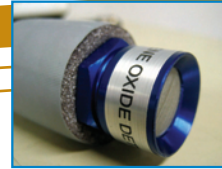

## E. How to Obtain Further Assistance

### i. Work with Industry and Supplier Representatives

Talk to the manufacturer of the sterilization equipment used in your facility. The company may have helpful recommendations for adjusting your equipment and implementing engineering controls to minimize employee exposure.

Contact the manufacturer of the EtO product that you use (gas or solution). As a benefit to customers, several manufacturers offer materials and services that can help you with training and other OSHA compliance activities.

Inquire about assistance offered through industry trade associations and employees' union health and safety programs.

Check with your workers' compensation insurance carrier. Some insurance carriers will provide or recommend professionals who can assist you.

### ii. Locate an Industrial Hygiene Consultant

You can obtain the services of a health and safety professional, called an industrial hygienist, who has expertise in employee training, exposure monitoring, engineering controls, respiratory protection, compliance program development, and other related areas. This type of professional assistance is offered through several sources:

- OSHA offers free health and safety consultation services through offices in each state. For more information, visit [www.osha.gov/dcsp/smallbusiness/consult.html](http://www.osha.gov/dcsp/smallbusiness/consult.html).
- Alternatively, you might wish to contract with a private industrial hygiene consultant. To find a private consultant in your area, ask for recommendations from other employers whose employees handle chemicals. You can also look in the Yellow Pages under a heading such as "Environmental Services."

The screenshot shows the OSHA On-Site Consultation program website. The header includes the United States Department of Labor logo and the text 'UNITED STATES DEPARTMENT OF LABOR OCCUPATIONAL SAFETY & HEALTH ADMINISTRATION'. Below the header is a navigation menu with tabs for 'Small Business', 'Consultation', 'SHARP', 'Tools', and 'Hispanic Safety'. The main content area features a map of the United States with a call to action: 'Click on the map to find the local OSHA office in your state.' Below the map is a section titled 'OSHA On-Site Consultation' which describes the service as free and confidential advice for small and medium-sized businesses. A 'SHARP' logo is also visible, representing the Safety and Health Achievement Recognition Program. The page includes various links and a search bar.

Consultation Program

## Sources of Assistance

Industry and supplier representatives

OSHA (or State-OSHA) Consultation Programs

Industrial hygiene consultants

Laboratories specializing in environmental analysis



- Another way to locate a private consultant is through the **American Industrial Hygiene Association (AIHA) Consultants Listing** on the Internet. To use the AIHA consultants listing, go to the AIHA website ([www.aiha.org](http://www.aiha.org)) and click on “Consultants Listing,” then choose “Consumer.” You can enter your city/state and choose a consultant specialty for your search. Depending on the type of assistance needed, many employers concerned about EtO might be most interested in a consultant with a specialty in one or more of the following categories:
  - Ventilation/engineering
  - Exposure assessment
  - Respiratory protection/PPE
  - Communication/training

### iii. Find an Analytical Laboratory

You can locate an industrial hygiene laboratory that will analyze EtO exposure monitoring samples by using the same sources listed above for locating an industrial hygienist. If you obtain the services of an industrial hygiene consultant, that individual will also be able to coordinate laboratory services, if necessary.

 **Return to Section 2.D - How to Get Help with Air Monitoring.**

 **Return to Section 3.C - Reduce Exposures with Engineering Controls or Other Methods.**

 **Return to Section 3.D - Provide Respiratory Protection.**

 **Return to Section 4.A.i - Hazard Communication.**



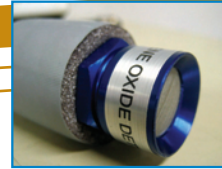

## F. How to Find a Healthcare Provider for Your Medical Surveillance Program

Medical exams must be performed by, or under the supervision of, a licensed physician. Many employers locate a healthcare provider who performs occupational medical surveillance services (also called “medical monitoring”) by asking other local employers for recommendations. Some hospitals and clinics offer medical surveillance services or can recommend a medical office that does. The following questions might help you determine whether a healthcare provider is knowledgeable about general OSHA requirements:

- Are you familiar with OSHA’s recordkeeping requirements?
- Do you provide medical evaluations of employees required to wear respirators?
- Do you have a process for maintaining employee medical records according to **29 CFR 1910.1020**?

A healthcare provider who regularly conducts occupational medical evaluations, is likely to answer “yes” to each of these questions. The provider should also be able to offer a reasonable description of how these processes are accomplished at the medical office.

You must provide the healthcare provider with a copy of the EtO standard, or mention that he or she must get the standard at OSHA’s web site. In **29 CFR 1910.1047(i)**, the standard provides information on the patient medical history and tests that the healthcare provider must include in the medical exam for EtO. Appendix C of the standard offers additional details for healthcare providers and individuals who are interested in more information.

 **Return to Section 4.B - Medical Surveillance.**

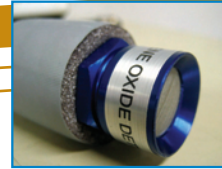

## G. What a Medical Exam Must Include

The healthcare provider must include the following elements in the routine medical exam:

- Medical and work histories with special emphasis directed to symptoms related to the pulmonary, hematological, neurological, and reproductive systems and to the eyes and skin.
- Physical examination with particular emphasis given to the pulmonary, hematological, neurological, and reproductive systems and to the eyes and skin.
- Complete blood count to include at a minimum a white cell count (including differential cell count), red cell count, hematocrit, and hemoglobin.
- Any laboratory or other test that the examining physician deems necessary based on sound medical practice. OSHA's EtO standard allows the healthcare provider to decide whether other tests are necessary.

If requested by the employee, the medical examinations shall also include pregnancy testing or a laboratory evaluation of fertility if considered appropriate by the physician.

 [Return to Section 4.B - Medical Surveillance.](#)



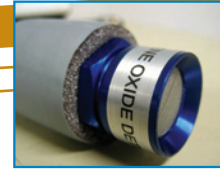

## H. Accessing OSHA Standards on the Internet

OSHA's website contains a complete listing of all OSHA standards. To see the complete text of any standard listed in this document, you may go to [www.osha.gov](http://www.osha.gov). Once at OSHA's website, select the "Regulations" tab at the top. Then click the tab for "General Industry." You can also access standards by selecting "Laws & Regulations" at OSHA's website.

All general industry standards start with "1910.," followed by another number (for example, the Ethylene Oxide standard is number 1910.1047). Scroll down the list of standards to the number of the standard that you want to view.



[www.osha.gov](http://www.osha.gov)

No matter what it is called, if a substance is ethylene oxide the CAS number listed on the material safety data sheet (MSDS) for the substance will be CAS Number 75-21-8.



## I. Other Names for Ethylene Oxide

The term ethylene oxide is often shortened to:

- EtO
- EO
- E.O.

The National Institute for Occupational Safety and Health (NIOSH) also lists the following other terms (synonyms) that are sometimes used for ethylene oxide (NIOSH 2006):

- 1,2 - Epoxy ethane
- 1,2 - Epoxyethane
- Amprolene
- Anprolene
- Anproline
- CAS #: 75-21-8
- Dihydrooxirene
- Dimethylene oxide
- ENT - 26263
- Epoxyethane
- Ethene oxide
- Ethox
- FEMA No. 2433
- Merpol
- NCI - C50088
- Oxacyclopropane
- Oxane
- Oxidoethane
- Oxiran
- Oxirane
- Oxirene, dihydro -
- Oxyfume
- Oxyfume 12
- RCRA waste number U115
- Sterilizing gas ethylene oxide 100%
- T - Gas
- alpha,beta - Oxidoethane



[Return to Section 1 - Overview.](#)

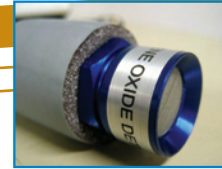

## J. Breathing Zone

 [Return to Section 2.A.ii.a - Personal Monitoring.](#)

Personal air samples should represent the air the employee breathes. Position the sample media (air intake point) in the breathing zone, the hemisphere forward of the shoulders with a radius of approximately six to nine inches and centered on the employee's nose.

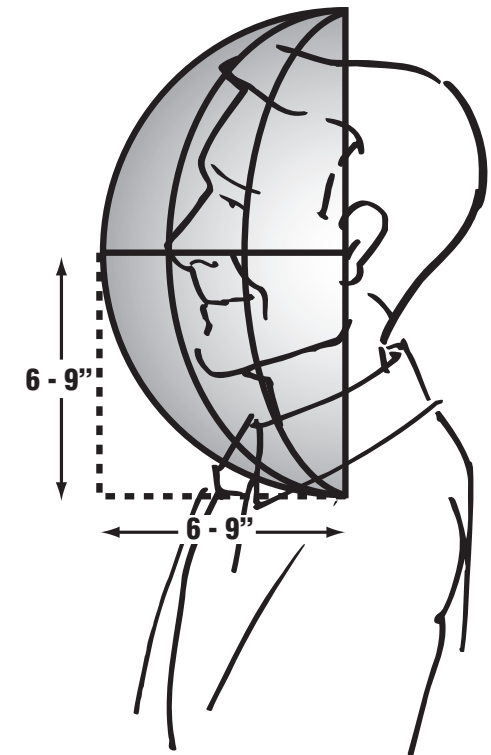
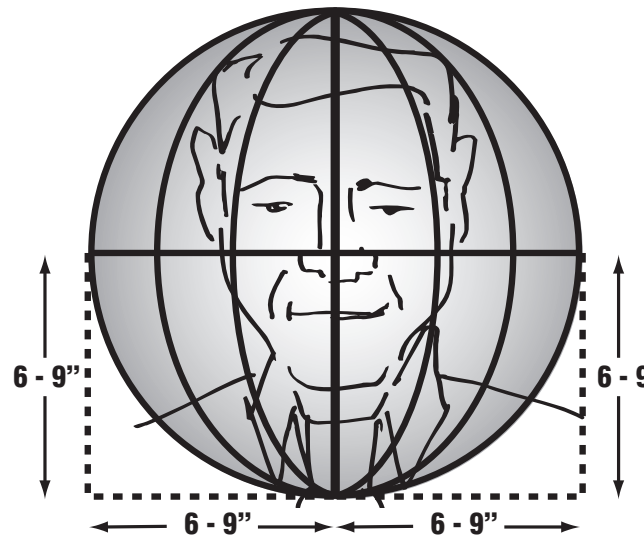

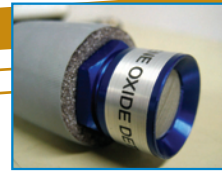

## K. Passive Diffusion Dosimeter (or Monitor)

### *Before using a passive dosimeter*

When planning air monitoring, first decide which jobs and which employees will be monitored. Then determine whether passive dosimeters are the right monitoring method for the expected situations (i.e., does the monitoring session involve a routine 8-hour period with exposure levels similar to the PEL or lower, or a 15-minute period with exposure in the range of the excursion level?). If the work shift will be shorter or longer than 8 hours, discuss this possibility with the laboratory or an industrial hygienist before you start the test. Some passive dosimeters become less accurate if used for too short or too long a period of time. If your work shifts vary greatly, you might need to use a different sampling method. The same is true if you think that your EtO levels are likely to exceed OSHA's PEL, which might overload the dosimeter. Another possible problem is interference from other chemical substances in the air. If other chemicals will also be used, you will need to determine whether they could affect the results.

You may need professional advice to make these decisions. In such cases, consult the laboratory, an industrial hygienist, or your Consultation Service to get help planning a sampling procedure that will work well in your workplace. Professional advice may save you time and effort. It can also increase your confidence that the resources you expend on sampling and analysis will provide you with valid results and are not wasted on inappropriate monitoring methods.

 **See Section 5.E - How to Obtain Further Assistance.**

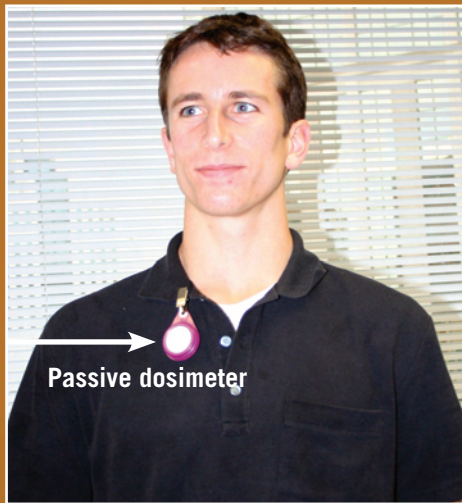

Front



Back

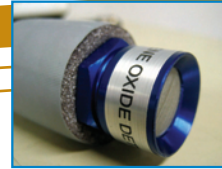

Package of sampling supplies.



Do not open the sealed container or pouch until it is time to begin collecting the sample.

### ***If you decide to use a passive dosimeter***

Tell your laboratory or dosimeter supplier what type of sampling you are planning. This information will help ensure that you order the correct type and number of dosimeters. Be sure to inquire about the need for “blank samples” used for quality assurance purposes. When you call the laboratory, you should be able to answer the following questions:

- What air contaminant will you be monitoring (e.g., ethylene oxide)?
- What will be the sample durations (i.e., 15-minute or 8-hour/full-shift)?
- How many samples of each type do you plan to collect? (This will also affect how many blank quality assurance samples you will need to submit to the lab.)
- When do you plan to monitor employee exposure?
- How soon do you need your results? (rush analysis is typically available, but at a premium cost).

Each passive dosimeter will arrive from the supplier or laboratory in an airtight package (a canister or pouch). The dosimeter typically comes with instructions. Before you begin sampling, carefully read the instructions and be sure that you understand them. If necessary, contact your dosimeter supplier for clarification.

The sampling period begins when you expose the passive dosimeter to air. Do not open the airtight container until you are ready to begin monitoring!

Before you begin sampling, talk to employees so that they understand the process. Provide adequate advance notice to afford employees (including those who work in the area but will not be monitored) or their representatives an opportunity to observe the monitoring if they wish.



Open the container, remove the dosimeter, and label it.



Document the sample.



Personal monitoring.

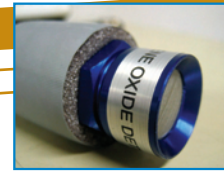

### ***Beginning a sampling period***

Start 8-hour, full-shift samples at the beginning of the work shift so that you can monitor the whole shift. Start 15-minute samples so that the period of highest exposure is included in the 15 minutes.

Once you are ready to begin air monitoring, open the container or pouch, remove the dosimeter, and label it with the date and time the sampling period is started, the sample number, and the name of the employee or area.

For each sample, record on a sampling form or in a log book the same information that you wrote on the dosimeter label, plus any additional details that may be useful or relevant. Useful details include the temperature and relative humidity in the work area, a description of the employee's activities, the products and equipment used by the employee, the name of the person performing the sampling, the instruments used to conduct the monitoring, and information about other chemicals also used in the work area during the shift.

For personal monitoring, place the dosimeter on the employee's lapel (within the breathing zone, as described in the previous section).



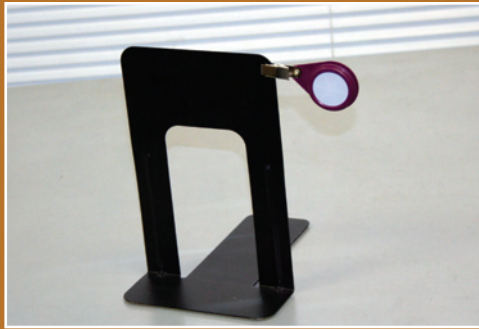

Area monitoring.



Snap-on cap.



Complete the label.

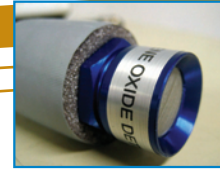

For a general area sample, place the dosimeter in an open space, away from walls and closed spaces that might have poor air circulation. Results could be inaccurate if air movement across the face of the dosimeter is not adequate. Clip the dosimeter to a clean object that will help keep the dosimeter suspended well away from surfaces.

Handle blank samples (quality assurance samples) in the same way as your other samples, except do not expose the dosimeter to air for the sampling period. Instead, open the dosimeter and then immediately seal it according to the instructions that came with the dosimeters. Issue the blank sample a number as if it were an air sample; however, instead of noting the sample start and stop time, write "BLANK" on the sample form.

### ***Ending the sampling period***

At the end of the sampling period, enter on the sampling form or log book the time that the sampling period ended, then remove the passive dosimeter from the employee or work area. Immediately seal the dosimeter using the same process that you used for the blank sample (following the instructions that came with the dosimeter). The model of dosimeter shown here included a plastic cover that snaps in place to seal the dosimeter. Small holes in the cover, to be used by the laboratory during analysis, must be covered with the attached caps. This dosimeter can now be packaged and shipped to the laboratory along with a copy of the sampling form.

### ***Sending samples to the laboratory for analysis***

The procedure for sealing and shipping will be different for each model of passive dosimeter. Consult the instructions that come with your dosimeter. **Section 6.B -  Conducting Personal Monitoring** contains links to Web-based instructions for several models and brands of dosimeters.

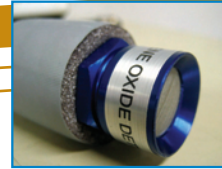

Follow the laboratory's shipping instructions.

Many samples, including most ethylene oxide samples, can be wrapped in padding and shipped to the laboratory in a rigid (crushproof) box. Some types of samples, however, require refrigeration or require you to avoid some packaging materials that might contaminate the sample. To be certain, ask the analytical laboratory whether your sample needs any special handling.

If the laboratory directs you to ship a sample “on ice” or under refrigeration, you can put the sample in a rigid, compact ice chest and add a freezer pack to ship the sample using an overnight express service. Use care in packing the sample to prevent it from being battered by the freezer pack if the ice chest receives rough handling in transit.

 For more information on exposure monitoring for employees, see **Section 6.B - Conducting Personal Monitoring.**

 **Return to Section 2.A.ii.a - Personal Monitoring.**

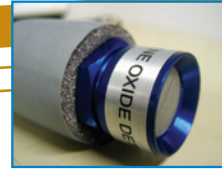

Plastic tube from pump on hip.

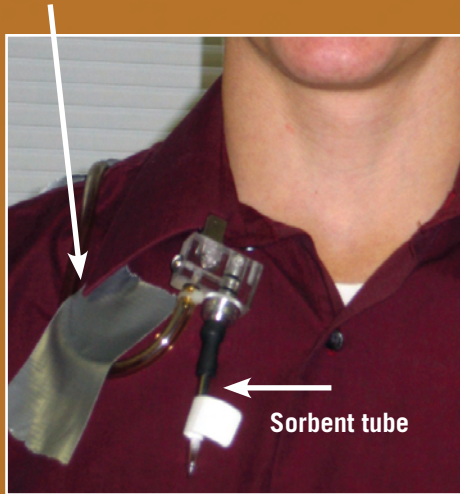

## L. Air Sampling Pump and Sorbent Tube

### *Before using an air sampling pump and sorbent tube*

Several important factors must be considered before you use a pump and sorbent tube. First, do you have the expertise and equipment needed to perform the task? If you have access to appropriate equipment, do you also have the knowledge to determine an appropriate sampling procedure that will provide useful (and valid) results?

If you are not sure, you should consider obtaining professional assistance from an industrial hygienist or your on-site Consultation Service. The following information will help you understand what is involved in the sampling process.

### *Overview*

To conduct this type of monitoring, you will need to:

- Obtain sample media (sorbent tubes of an appropriate type), a personal air sampling pump that provides a suitable air flow rate, and an air flow meter to calibrate the pump.
- Ensure that the pump battery is adequately charged.
- Calibrate the pump before and after the sampling period.
- Correctly place the pump and sorbent tube on the employee (see information in the subsection on preparing the equipment and collecting samples presented later in this section).
- Monitor the pump performance during the air sampling period.
- Change the media (sorbent tube) at appropriate intervals.
- Maintain accurate records for use by you and the analytical laboratory.



A typical sorbent tube.

### ***About sorbent tubes***

A sorbent tube consists of a slim glass tube containing a material (sorbent) that traps certain air contaminants. One example of a sorbent material is specially treated charcoal, to which many air contaminants adhere. Different air contaminants require different types of sorbent tubes and sampling procedures. The sorbent tube supplier will help ensure that you obtain the correct tube for your intended purpose.

These tubes are easily overloaded with air contaminant if the sampling period is long or if the concentration of air contaminant is high. Results from an overloaded tube may be invalid. To avoid this problem, it may be necessary to use several sorbent tubes, one after the other, to sample an entire shift.

It is also important to sample a large enough volume of air on each sorbent tube, so that the contaminant can be detected at the concentration of interest (for EtO, this level is usually the OSHA 15-minute PEL or the 8-hour action level). This means that in order to obtain a valid result, each tube must be attached to the pump for no less than a minimum amount of time, but no more than a maximum time. Unfortunately, the minimum and maximum times vary depending on the model of tube used, the specific air contaminant being measured, the anticipated concentration of contaminant in the air, the air flow rate through the pump, and factors associated with the analytical laboratory methods. An industrial hygiene professional will use available workplace and laboratory information to estimate how often tubes must be changed.

Another possible problem is interference from other chemical substances in the air. If other chemicals will also be used, it is necessary to determine whether they could affect the results. Historically, substances such as isopropyl alcohol, Freon 12, and certain other oxides have interfered with some ethylene oxide analytical methods. Note other possible chemical substances that could be present in your workplace and discuss them with the laboratory that will analyze your samples. This step will



help to determine whether an interference could exist and to identify an appropriate sampling strategy.

You may wish to obtain professional advice to address these issues. Consult an industrial hygienist to get help planning a sampling procedure that is suitable for your workplace. Professional advice may save you time and effort. It can also increase your confidence that the resources you expend on sampling and analysis will provide you with valid results. **See Section 5.E - How to Obtain Further Assistance.**



### ***Preparing the equipment and collecting samples***

#### **Excerpt: OSHA's Sampling and Analytical Method 50**

OSHA's Sampling and Analytical Method 50 – Ethylene Oxide, Sections 2.1 and 2.3, [www.osha.gov/dts/sltc/methods/organic/org050/org050.html](http://www.osha.gov/dts/sltc/methods/organic/org050/org050.html) provide the following instructions for using an air sampling pump and sorbent tube (Figures 1 through 12 on the next pages illustrate key points):

#### **2.1. Apparatus**

2.1.1. A constant flow personal sampling pump is used which can be calibrated to within  $\pm 5\%$  of the recommended 0.1 L/min flow rate while the sampling train is in line. See Figures 1-6.

#### **2.3. Technique**

2.3.1. Properly label the sampling tube before sampling. See Figure 7.

2.3.2. Attach the sampling tube to the pump using a section of flexible, plastic tubing such that the large, front section of the sample tube is exposed directly to the atmosphere. Do not place any tubing in front of the sampling tube. The sampling tube should be attached in the worker's breathing zone vertically such that it does not impede work performance. See Figures 8 and 9.

2.3.3. After sampling for the appropriate time, remove the sampling tube from the pump, replace the plastic caps and seal the tube with an official seal. See Figure 10.

2.3.4. Include at least one blank for each sampling set. The blank should be handled in the same manner as the samples with the exception that air is not drawn through it. See Figure 11.

2.3.5. List any potential interferences on the sample data sheet. See Figure 12.

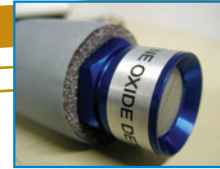

Figure 1: Select a personal air sampling pump that provides a suitable range of air flow rates. The pump shown here requires a special added low-flow valve to adjust the air flow rate to the correct level for sampling EtO, which is 100 milliliters of air per minute (ml/min) or the equivalent of 0.100 liters per minute (l/min).

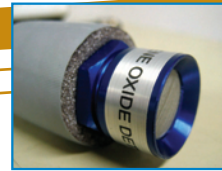

Figure 2: Communicate with the analytical laboratory to select an appropriate sorbent tube for the situation to be monitored. Sorbent tubes come in several sizes, which may appear similar to, but not necessarily identical to the tube shown here.



Figure 3: Tubes usually arrive in an envelope, along with caps for sealing the tube after air sampling is completed.

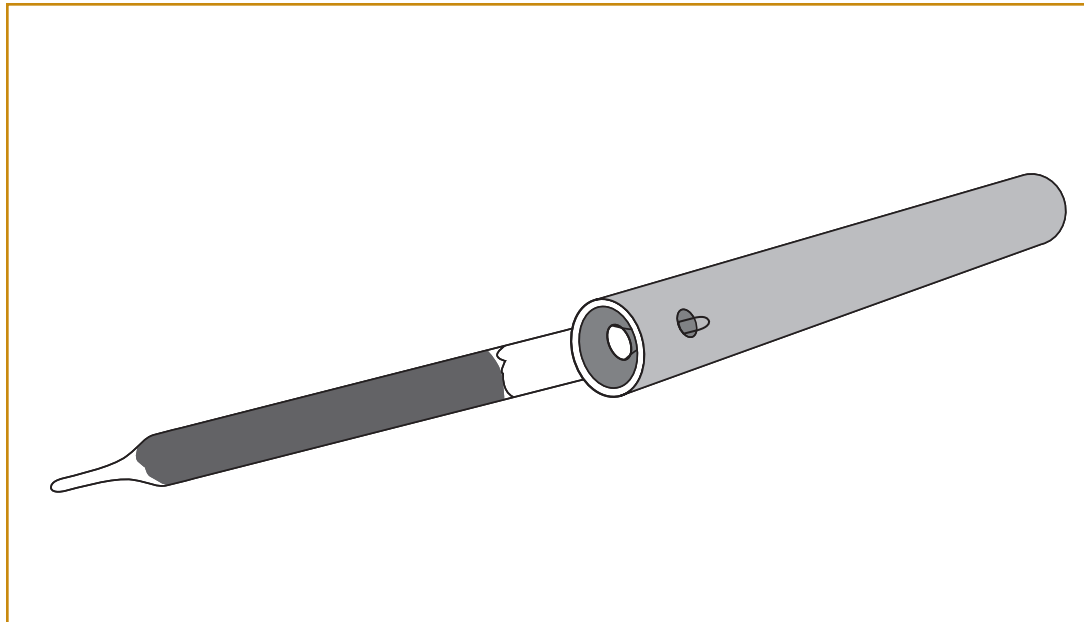
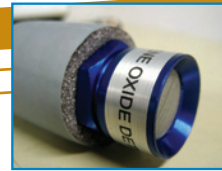

Figure 4: Just before using a tube, use a commercially available “tube breaker” (left) or pliers (right) to gently break the glass tip off each end of the tube so that air can flow through it. As a rule of thumb, break the tip at a point that will make an opening about half the diameter of the tube body. Check that both ends of the tube are open – improperly opened tubes will cause the air sampling effort to fail.



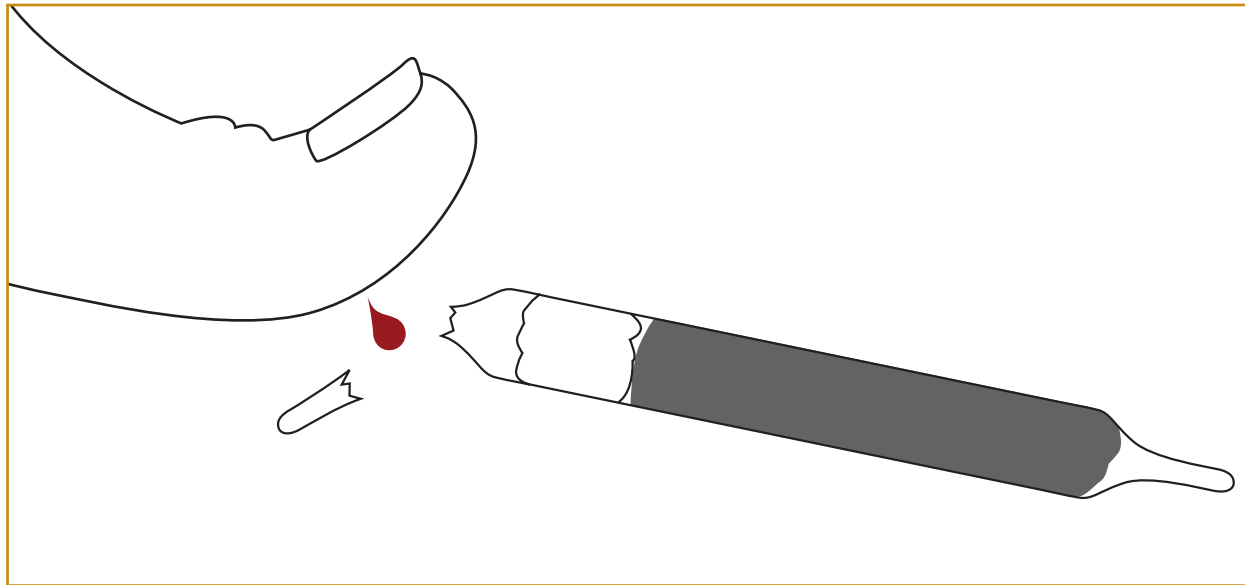
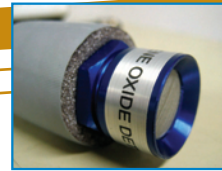

Figure 5: While breaking the glass, wear safety glasses and hold the tube in a box or trash receptacle. Handle the tube with care to avoid injury. The broken glass tips can be sharp.

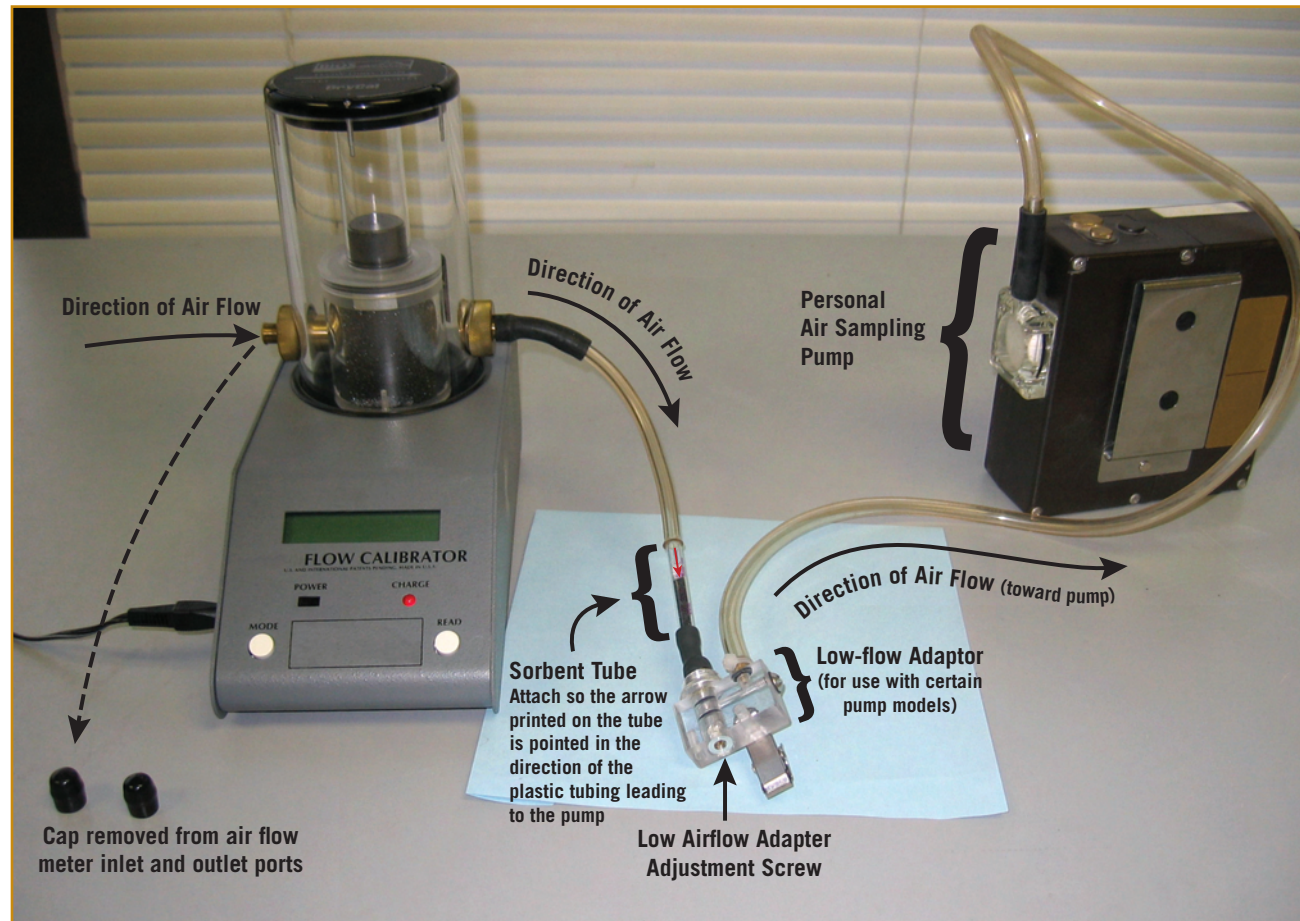
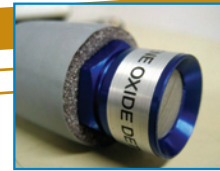

Figure 6: The pump must be calibrated to adjust the air flow to the correct flow rate. A wide variety of flow meters are commercially available and one should be used to confirm the rate of air flow before and after each sampling session. During calibration, air flow through older pump models is adjusted using a set screw, while some recent models may be programmed electronically. These calibration tests must always be performed with a sorbent tube, of the same model as that used for sampling, placed in-line between the pump and the flow meter. Hint: Order an extra sorbent tube to use for pump calibration. This calibration tube is never sent to the laboratory for analysis.

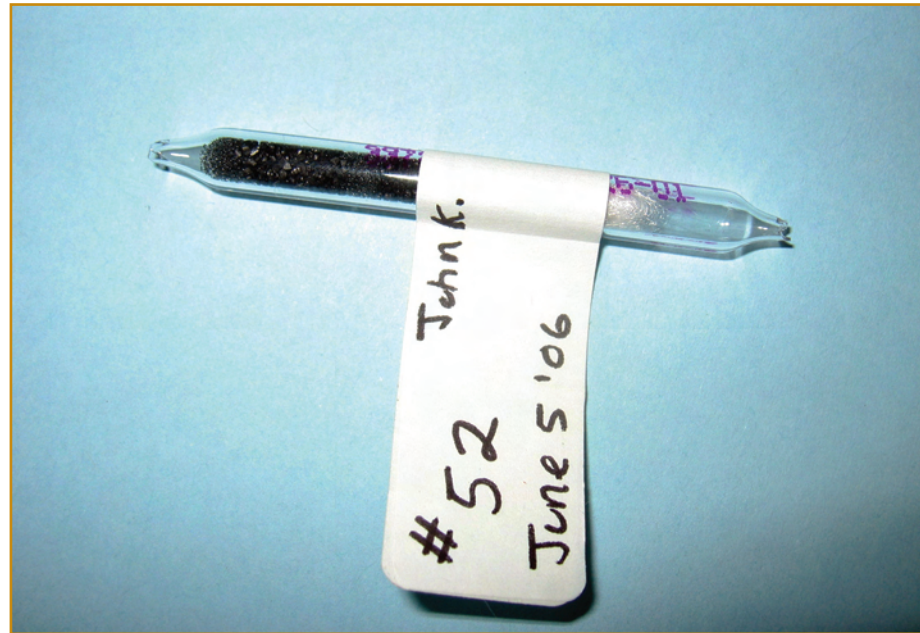
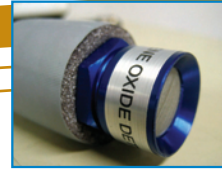

Figure 7: Wrap a strip label around the tube and print the sample number on the label. Include any additional information needed to track the sample. Enter this number and relevant information about the sample on a sampling form and a log book (date, work location, employee name, job title/activities, contaminant being sampled, name of person performing the sampling).

Before you begin sampling, talk to employees so that they understand the process. Provide adequate advance notice to allow employees or their representatives to observe the monitoring if they wish.



Figure 8: Attach the pump to a belt at the employee's hip. Insert the sorbent tube in a commercially available tube holder or similar device and clip it in the area of the employee's lapel, with the sorbent tube hanging down.



Figure 9: Air sampling professionals often use duct tape to hold excess plastic tubing in place so that it will not get in the employee's way. Provide adequate slack in the plastic tubing to allow the employee to reach and bend. For each sorbent tube used, enter on the sampling form the time that sampling starts with that tube. Turn the pump ON and check periodically to be sure that it is running smoothly. Use a fully charged pump battery to ensure that the pump will run for the full sampling period.

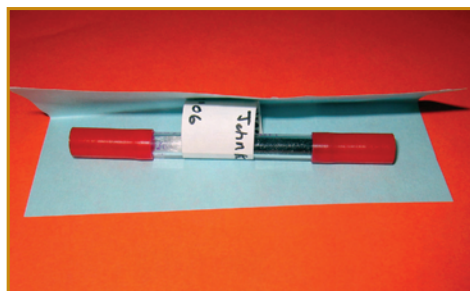
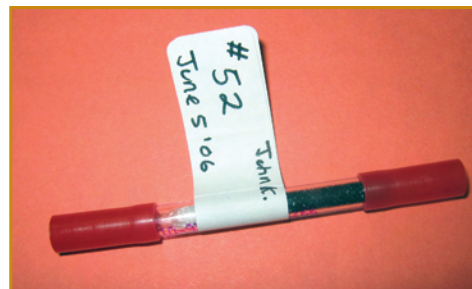

Figure 10: When it is time to remove a sorbent tube from the pump, mark the sample form with the time that sampling with that tube stopped (if sampling continues with another tube, also mark the start time for the new tube). Next, place a cap on either end of the sorbent tube to make it airtight. Then, if desired, fold the tube and its label in a strip of paper (blue in the photo series above) and seal the edges of the paper with tape to create a tamper-resistant seal. Mark the outside of the sealed sorbent tube with its original label number and other identifying information requested by the laboratory (e.g., company name, date, security seal and signature).

Many samples, including most ethylene oxide samples, can be placed in a plastic zip bag, wrapped in padding, and shipped to the laboratory in a rigid (crush-proof) box. Some types of samples, however, require refrigeration or require you to avoid some packaging materials that might contaminate the sample. To be certain, ask the analytical laboratory whether your sample needs any special handling.

Sample Number	Pump Number	Flow (lpm on)
52	15	0.100
53	4	0.100
54	Blank	

Figure 11: For quality control purposes, the laboratory will request at least one “blank” sample per group of sorbent tubes submitted for analysis. A blank sample is a sorbent tube of the same lot number as the tubes used to conduct the air monitoring. The blank tube should be opened (tube tips broken off), but no air should be drawn through it (do not connect the blank sorbent tube to a pump). Label and seal the blank sorbent tube in the same manner as the other samples. Issue the blank sample a number as if it were an air sample; however, instead of noting the pump flow rate and sample time, write “BLANK” on the sample form.



Figure 12: Record sample information and notes to the laboratory on the sample data sheet.

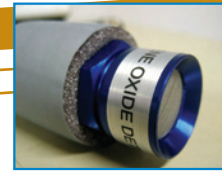

For more information on exposure monitoring for employees,  
 see [Section 6.B - Conducting Personal Monitoring](#).

 [Return to Section 2.A.ii.a - Personal Monitoring](#).

If the laboratory directs you to ship a sample “on ice” or under refrigeration, you can put the sample in a rigid, compact ice chest (as shown) and add a freezer pack to ship the sample using an overnight express service. Use care in packing the sample to prevent it from being battered by the freezer pack if the ice chest receives rough handling in transit.



## M. Comparison of Passive Dosimeters and Traditional Air Sampling Methods Using a Pump and Sorbent Tube

Consideration	Passive dosimeter	Personal air sampling pump and sorbent tube
Alternate names	Passive Dosimeter Passive Diffusion Monitor Personal Monitoring Badge Passive (Diffusive or Diffusion) Sampler	Sorbent Tube Charcoal Tube Coated/treated Charcoal Tube
Ease of use	Easy to use under routine conditions, including 8-hour sampling sessions with exposures in the range of the PEL or lower, or 15-minute sessions of exposure in the range of the excursion limit or lower. Under other circumstances, special calculations may be required to determine whether and how passive dosimeters should be used.	Requires some training and experience to obtain reliable results. Additionally, a sample plan should be developed in advance to evaluate task and shift duration, anticipated exposure levels, and sorbent tube capacity. These factors determine whether and how often tubes need to be changed during the sampling session.
Accuracy of results	Natural air currents might not be adequate to ensure reliable sampling. Results might be affected if the dosimeter is placed in an area with poor air circulation (such as in a corner or next to a wall).  When routine sampling is conducted correctly and analysis is performed by a qualified laboratory, results typically meet OSHA accuracy requirements.	An air sampling pump allows more control over the sampling process, and, therefore, produces more reliable results under a wider range of conditions (e.g., during irregular work shifts, short sampling periods, periods of high exposure levels, and locations with poor air circulation). Under these conditions, results obtained with a pump may be more accurate and precise than results obtained using a passive dosimeter.  When sampling is conducted correctly and analysis is performed by a qualified laboratory, results typically meet OSHA accuracy requirements.



Consideration	Passive dosimeter	Personal air sampling pump and sorbent tube
Cost of sampling media (not including analysis).	Cost more than sorbent tubes (in the range of \$20 to \$25 per passive dosimeter).	Cost less than passive dosimeters (usually less than \$5 per sorbent tube).
Cost of analysis (may include sampling media and other options).	Variable depending on how quickly results are needed. Cost of analysis is similar for these two types of media (passive dosimeter and sorbent tube).	
Cost of additional equipment.	No additional equipment required.	An air sampling pump and pump calibration equipment are required and can cost hundreds of dollars each. However, pump rental or loan is sometimes included in the cost of the sampling and analysis. Check with an industrial hygienist or analytical laboratory.
Chemicals that can be monitored.	Passive dosimeter models are commercially available for a limited but growing number of airborne vapors. Check with your analytical laboratory.	Manufacturers offer a selection of sorbent tubes appropriate for monitoring a wide range of airborne vapors. Check with your analytical laboratory.
Interferences	Can be affected by temperature, humidity, and the presence of other chemical substances. Discuss your situation with the analytical laboratory.	Can be affected by temperature, humidity, and the presence of other chemical substances. Discuss your situation with the analytical laboratory.

 [Return to Section 2.A.ii.a - Personal Monitoring.](#)

 [See Section 6 - Related OSHA Standards and Other Helpful Resources.](#)



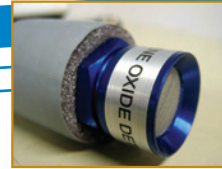

## 6. Related OSHA Standards and Other Helpful Resources

### A. Ethylene Oxide - General

#### **OSHA Standard – Ethylene Oxide: 29 CFR 1910.1047**

This is the standard that lists the OSHA requirements for ethylene oxide in the workplace. This website also includes direct links to the appendices associated with OSHA's EtO standard.

[www.osha.gov/pls/oshaweb/owadisp.show\\_document?p\\_table=STANDARDS&p\\_id=10070](http://www.osha.gov/pls/oshaweb/owadisp.show_document?p_table=STANDARDS&p_id=10070)

#### **NIOSH Health and Safety Topic Page for Ethylene Oxide**

This website provides links to several NIOSH publications on topics related to employee exposure to ethylene oxide (e.g., laboratory analytical methods, NIOSH Alerts, employee notification information). Some of these documents are quite technical, while others are intended for employees and their supervisors.

[www.cdc.gov/niosh/topics/ethyleneoxide](http://www.cdc.gov/niosh/topics/ethyleneoxide)

#### **Example of an Ethylene Oxide Management Plan**

The Medical University of South Carolina Ethylene Oxide Management Plan is one example of an EtO management plan. The plan outlines how the university complies with the requirements of OSHA's EtO standard and lists the work practices used by employees at the university to help keep exposures below the action level.

[www.musc.edu/fanda/risk/osh/safetymanual2005/ethylene.pdf#search=%22Ethylene%20oxide%20Safety%20plan%22](http://www.musc.edu/fanda/risk/osh/safetymanual2005/ethylene.pdf#search=%22Ethylene%20oxide%20Safety%20plan%22)





### **State of Washington Ethylene Oxide Standard (Chapter 296-855, WAC, January 2006)**

This document presents Washington State's EtO standard. Because Washington is an OSHA State Plan State, this standard is at least as protective as Federal OSHA's EtO standard and many of the provisions are identical, although the Washington State standard may also include additional provisions not found in the federal standard. The Washington EtO standard applies only in Washington; however, even if employers do not have facilities in Washington, some may find the user-friendly presentation style of the Washington State standard helpful.

[www.lni.wa.gov/WISHA/Rules/ethylene/PDFs/296-855Complete.pdf](http://www.lni.wa.gov/WISHA/Rules/ethylene/PDFs/296-855Complete.pdf)

 [Return to Section 1 - Overview.](#)

## **B. Conducting Personal Monitoring**

### ***OSHA Technical Manual – Personal Sampling for Air Contaminants (Section II, Chapter 1)***

This chapter of the manual for OSHA personnel provides basic instructions on performing personal air monitoring. It covers general procedures, sample media, instrument preparation and calibration, and a discussion of sampling and analytical error. Although the manual is intended for OSHA personnel and lists forms and sample shipping instructions specific to OSHA, the chapter provides a good overview of the air sampling process. Anyone planning to conduct air sampling should contact their analytical laboratory of choice before any monitoring is performed. This step is important to coordinate the choice of methods and sampling media.

[http://www.osha.gov/dts/osta/otm/otm\\_ii/otm\\_ii\\_1.html](http://www.osha.gov/dts/osta/otm/otm_ii/otm_ii_1.html)



### ***3M Air Monitoring Systems (Document 4026)***

Simple illustrations on the first page of this 2-page document show how to attach a passive dosimeter to the collar in the employee's breathing zone. The guide also lists dosimeter accuracy information. Dosimeter placement information contained in this guide applies to all types of passive dosimeters. Employers conducting air sampling, however, should ensure that they obtain accuracy information from the supplier for the specific brand of dosimeters they use. The accuracy must meet OSHA's minimum requirements of 95 percent  $\pm$  25 percent (for 1 ppm samples) or  $\pm$  35 percent (for 0.5 ppm or for 15-minute excursion samples) as discussed in Section 5.B.

<http://multimedia.mmm.com/mws/mediawebserver.dyn?6666660Zjcf6IVs6EVs6667MCC0rrrrQ->

### ***3M Technical Data Bulletin #1028 – Organic Vapor Monitor Sampling and Analysis Guide***

This 11-page technical publication provides general background information on the use of passive dosimeters for sampling under a variety of circumstances. Although not specific to ethylene oxide, it introduces relevant topics such as homogeneous exposure groups (HEG), monitor capacity, laboratory analysis procedure, recovery coefficients, and work shifts that are not 8 hours.

<http://multimedia.mmm.com/mws/mediawebserver.dyn?6666660Zjcf6IVs6EVs666CswC0rrrrQ->



### ***3M Air Monitoring Guide (for passive dosimeters including models 3550/3551 for ethylene oxide)***

This guide provides detailed illustrated instructions for using passive dosimeters for personal and area monitoring. The monitoring instructions apply to all passive dosimeters, but the dosimeter preparation instructions apply specifically to 3M monitors (including those for ethylene oxide). Although the examples in this guide refer to specific models of 3M equipment, you may substitute other equivalent equipment made by other manufacturers; however, you should consult with your supplier for dosimeter preparation instructions for the specific model you use.

<http://multimedia.mmm.com/mws/mediawebserver.dyn?6666660Zjcf6IVs6EVs666MFPC0rrrrQ->

### ***SKC Passive (Diffusive) Samples***

A cross-sectional view inside a passive dosimeter and illustrated instructions for using passive dosimeters for personal monitoring. Although the examples in this guide refer to specific models of SKC equipment, you may substitute other equivalent equipment made by other manufacturers; however, you should consult with your supplier for dosimeter preparation instructions for the specific model you use.

[www.skcinc.com/prod/575-001.asp](http://www.skcinc.com/prod/575-001.asp)

### ***SKC Application Guide: Sampling Train - Sorbent Sampling Tubes***

This document describes the process for collecting personal exposure samples using an air sampling pump and sorbent tubes (one of the ways to conduct personal monitoring). The instructions illustrate how to connect the sorbent tube to the pump and where to attach both of these items to the employee. Special note: although the examples in this guide refer to specific models of equipment, you may substitute other equivalent equipment made by other manufacturers.

[www.skcinc.com/instructions/1168.pdf](http://www.skcinc.com/instructions/1168.pdf)



### **Ethylene Oxide – OSHA 50 (SKC chemical fact file)**

This document includes air flow rate, sample time, and air volume for collecting a personal monitoring sample for ethylene oxide using a sorbent tube and personal air sampling pump. It also outlines the steps for handling a sorbent tube and pump. This specifically targeted 1-page fact sheet is adapted from the 21-page OSHA Method 50 for laboratory analysis of ethylene oxide samples. Although the examples in this guide refer to specific models of equipment, you may substitute other equivalent equipment made by other manufacturers.

[www.skcinc.com/cff/1014.pdf](http://www.skcinc.com/cff/1014.pdf)

### ***OSHA Sampling and Analytical Method 50 (sorbent tube method)***

This highly technical 21-page document contains detailed information on laboratory analysis of ethylene oxide. It contains instructions for using a sorbent tube and air sampling pump; however, most small business employers might prefer to get the same information in summary form by requesting instructions from their analytical laboratory of choice.

[www.osha.gov/dts/sltc/methods/organic/org050/org050.html](http://www.osha.gov/dts/sltc/methods/organic/org050/org050.html)

### ***SKC Application Guide: Calibrating a Pump Using an Electronic Calibrator (Pub 1014 rev 208)***

This 2-page guide provides detailed illustrated instructions for using an electronic flow meter to calibrate a personal air sampling pump fitted with a sorbent tube. Although the examples in this guide refer to specific models of equipment, you may substitute other comparable equipment made by other manufacturers.

[www.skcinc.com/instructions/1366.pdf](http://www.skcinc.com/instructions/1366.pdf)

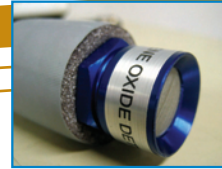

### ***OSHA Sampling and Analytical Method 49 (passive dosimeter method)***

This highly technical 16-page document contains detailed information on laboratory analysis of ethylene oxide monitors. It contains instructions for using a passive dosimeter; however, most small business employers might prefer to get the same information in summary form by requesting instructions from their analytical laboratory of choice.

[www.osha.gov/dts/sltc/methods/organic/org049/org049.html](http://www.osha.gov/dts/sltc/methods/organic/org049/org049.html)

 [Return to Section 5.K - Passive Diffusion Dosimeter.](#)



**The mention of any instrument provider, product, or process in this publication does not constitute or imply endorsement by the Occupational Safety and Health Administration. This list is not meant or able to be comprehensive, as there may be other suppliers that have not been brought to our attention.**

**Suppliers of passive diffusion dosimeters/monitors for ethylene oxide monitoring**

**Assay Technology**, Pleasanton, CA. Tel: 800-833-1281.

**SKC Inc.**, Eighty Four, PA. Tel: 800-752-8472.

[www.skcinc.com](http://www.skcinc.com)

**3M**, St. Paul, MN. Tel: 800-869-4223.

[www.3M.com/occsafety](http://www.3M.com/occsafety)

**Suppliers of sorbent tubes suitable for ethylene oxide monitoring**

**Assay Technology**, Pleasanton, CA. Tel: 800-833-1281.

**SKC Inc.**, Eighty Four, PA. Tel: 800-752-8472.

[www.skcinc.com](http://www.skcinc.com)

**Supelco (Sigma-Aldrich Group)** St. Louis, MO. Tel: 800-247-6628. [www.sigmaaldrich.com](http://www.sigmaaldrich.com)

**Suppliers of low-flow personal air sampling pumps suitable for ethylene oxide monitoring (100 ml/minute flow rate)**

**A.P. Buck Inc.** Orlando, FL. Tel: 800-330-2825.

[www.apbuck.com](http://www.apbuck.com)

**Sensidyne (Gillian pumps)**, Clearwater, FL. Tel: 800-451-9444. [www.sensidyne.com](http://www.sensidyne.com)

**SKC Inc.**, Eighty Four, PA. Tel: 800-752-8472.

[www.skcinc.com](http://www.skcinc.com)

**TSI Inc.** Shoreview, MN. Tel: 800-874-2811.

[www.tsi.com](http://www.tsi.com)

Other sources of sampling instruments and media: Some analytical laboratories will loan pumps and provide sample media as part of the analytical fee. Alternatively, you may rent or lease air sampling pumps and gas detection equipment from laboratories and technical equipment rental agencies (for example, conduct an Internet search for “rent – personal air sampling pump”). If you use an industrial hygiene consultant, that professional will likely arrange to have all the necessary equipment and supplies available.

 [Return to Section 5.K - Passive Diffusion Dosimeter \(or Monitor\).](#)

 [Return to Section 5.L - Air Sampling Pump and Sorbent Tube.](#)



## C. Respiratory Protection and Personal Protective Equipment

### **OSHA Standard – Respiratory Protection: 29 CFR 1910.134**

This is the standard that lists the OSHA requirements for respiratory protection.

[www.osha.gov/pls/oshaweb/owadisp.show\\_document?p\\_table=STANDARDS&p\\_id=12716](http://www.osha.gov/pls/oshaweb/owadisp.show_document?p_table=STANDARDS&p_id=12716)

### **OSHA Booklet – *Small Entity Compliance Guide for the Revised Respiratory Protection Standard (OSHA 9071), 1998***

This document provides general information about respiratory protection in the workplace and OSHA's Respiratory Protection standard. The guide is intended to assist small business employers to set up a respiratory protection program.

[www.osha.gov/Publications/secgrev-current.pdf](http://www.osha.gov/Publications/secgrev-current.pdf)

### **OSHA's Respiratory Protection eTool**

The purpose of this eTool is to help you comply with the OSHA Respiratory Protection standard. It provides instruction on the proper selection of respiratory protection.

[www.osha.gov/SLTC/etools/respiratory/index.html](http://www.osha.gov/SLTC/etools/respiratory/index.html)

### **OSHA Standard – Personal Protective Equipment General Requirements: 29 CFR 1910.132**

This is the standard that requires employers to perform a hazard assessment to determine what PPE employees need. It also requires that employees be trained to use the PPE and that the PPE fits the employee.

[http://www.osha.gov/pls/oshaweb/owadisp.show\\_document?p\\_table=STANDARDS&p\\_id=9777](http://www.osha.gov/pls/oshaweb/owadisp.show_document?p_table=STANDARDS&p_id=9777)





### **OSHA Booklet – *Personal Protective Equipment (OSHA 3151), 2003***

This OSHA guide reviews procedures for determining what PPE is required to protect employees and discusses OSHA requirements for training employees to use the PPE correctly. To help employers evaluate the need for PPE, the guide includes select questions to ask about the jobs employees perform.

<http://www.osha.gov/Publications/osha3151.pdf>

### **OSHA Letter of Interpretation – Requirements under the Ethylene Oxide Standard**

This is the letter OSHA provided in response to a question about whether EtO-equipment service personnel must be issued PPE and respirators if they visit workplaces where ethylene oxide is used.

 [http://www.osha.gov/pls/oshaweb/owadisp.show\\_document?p\\_table=INTERPRETATIONS&p\\_id=21749](http://www.osha.gov/pls/oshaweb/owadisp.show_document?p_table=INTERPRETATIONS&p_id=21749)

**Return to Section 3.D - Provide Respiratory Protection.**

## **D. Exposure Control**

### ***Ethylene Oxide Sterilizers in Health Care Facilities: Engineering Controls and Work Practices***

This link provides information on accessing NIOSH Current Intelligence Bulletin-52 (1989, July 13), 15 pages, which describes exposure control methods for sterilizers.

[http://www.cdc.gov/niosh/89115\\_52.html](http://www.cdc.gov/niosh/89115_52.html)



### **OSHA Letter of Interpretation – Procedures for Ethylene Oxide (EtO) Spills and Ethylene Oxide Disposal**

This is the letter OSHA provided in response to a question about the procedures for handling material during EtO spill cleanup.

[http://www.osha.gov/pls/oshaweb/owadisp.show\\_document?p\\_table=INTERPRETATIONS&p\\_id=19343](http://www.osha.gov/pls/oshaweb/owadisp.show_document?p_table=INTERPRETATIONS&p_id=19343)



**Return to Section 3.C - Reduce Exposures with Engineering Controls or Other Methods.**

## **E. Hazard Communication**

### **OSHA Standard – Hazard Communication: 29 CFR 1910.1200**

This is OSHA's regulation on providing information to employees who might be exposed to hazardous substances (not just EtO) in the workplace.

[http://www.osha.gov/pls/oshaweb/owadisp.show\\_document?p\\_table=STANDARDS&p\\_id=10099](http://www.osha.gov/pls/oshaweb/owadisp.show_document?p_table=STANDARDS&p_id=10099)

### **OSHA Safety and Health Topics – Hazard Communication**

This website provides links to resources that are useful for employers developing or updating a hazard communication program. Among the listings at this site, you will find downloadable software developed for the Mine Safety and Health Administration and intended to help those responsible for writing an OSHA hazard communication program; a self-inspection checklist; and a sample online HazCom training program developed by the state of Oregon.

<http://www.osha.gov/SLTC/hazardcommunications/solutions.html>



### **Ethylene Oxide Training Program**

This editable training program from the Washington State Department of Labor and Industries is available at no charge in PDF or PowerPoint formats for use in employee education. The website also includes a script. Both the presentation and script may be downloaded and customized to reflect the situation in the area where employees work.

<http://www.lni.wa.gov/Safety/TrainTools/Trainer/Kits/EthyleneOxide/default.asp>

### **Sample Hazard Communication Program**

This is a program from the Division of Safety, Florida Department of Labor and Employment Security. Employers may customize this model hazard communication program to create a program for their own worksites.

<http://www.cdc.gov/elcosh/docs/d0300/d000384/d000384.html>

### **Ethylene Oxide (EtO) Fact Sheet**

From the California Department of Public Health, this 6-page fact sheet (updated 1999) includes information that could be used as part of an employee communication and training program.

[http://www.dhs.ca.gov/ohb/HESIS/eto.htm#TESTS\\_FOR\\_EXPOSURE\\_AND\\_MEDICAL\\_TESTS](http://www.dhs.ca.gov/ohb/HESIS/eto.htm#TESTS_FOR_EXPOSURE_AND_MEDICAL_TESTS)



***NIOSH Worker Notification on Sterilization of Medical Instruments and Treatment of Spices (Ethylene Oxide). April 2004***

This summary report describes the results of a study of employees who were exposed to EtO while working at sterilization plants. The study was conducted to determine if exposure to EtO is associated with cancer and other diseases.

<http://www.cdc.gov/niosh/pgms/worknotify/EthyleneOxide.html>

 [Return to Section 4.A.i. - Hazard Communication.](#)

## **F. Work Practices**

***Preventing Worker Injuries and Death from Explosions in Industrial Ethylene Oxide Sterilization Facilities – NIOSH Alert, NIOSH Pub: 2007-164, Revised Edition. (August 2007)***

This document describes several accidents at sterilization facilities and suggests work practices and controls to improve safety.

<http://www.cdc.gov/niosh/docs/2007-164>

***Ethylene Oxide Handling***

This guide describes safe handling practices for unloading, handling, and storing EtO drums.

<http://www.balchem.com/images/pdfs/EOHandlingGuide.pdf>

 [Return to Section 3.C - Reduce Exposures with Engineering Controls or Other Methods.](#)



## G. Medical Monitoring

### **OSHA Standard – Access to Employee Exposure and Medical Records: 29 CFR 1910.1020**

This is OSHA's standard describing what medical and exposure records you must keep and how long you must keep them. It also lists requirements for keeping employee medical records confidential and for providing copies of these records to employees and individuals designated to represent them.

[http://www.osha.gov/pls/oshaweb/owadisp.show\\_document?p\\_table=STANDARDS&p\\_id=10027](http://www.osha.gov/pls/oshaweb/owadisp.show_document?p_table=STANDARDS&p_id=10027)

### **OSHA Booklet – *Access to Medical and Exposure Records* (OSHA 3110), 2001**

This is an easy-to-read summary of the OSHA standard on the same topic. It is intended for employers and their employees.

<http://www.osha.gov/Publications/OSHA3110.pdf>

### **OSHA Letter of Interpretation – The Interpretation of the Medical Examinations and Consultations for Employees Who are Hired for Areas That Have Ethylene Oxide. August 7, 1995.**

This is the letter OSHA provided in response to a question about what testing is required for medical surveillance examinations and how initial and yearly exams differ from exams conducted in response to an exposure.

[http://www.osha.gov/pls/oshaweb/owadisp.show\\_document?p\\_table=INTERPRETATIONS&p\\_id=21877](http://www.osha.gov/pls/oshaweb/owadisp.show_document?p_table=INTERPRETATIONS&p_id=21877)



**Return to Section 4.B - Medical Surveillance.**



## H. Emergency Planning and Alert Systems

### **OSHA Standard – Emergency Action Plans: 29 CFR 1910.38**

This OSHA standard lists the minimum requirements for an employer's emergency action plan.

[http://www.osha.gov/pls/oshaweb/owadisp.show\\_document?p\\_table=STANDARDS&p\\_id=9726](http://www.osha.gov/pls/oshaweb/owadisp.show_document?p_table=STANDARDS&p_id=9726)

### **OSHA Standard – Fire Prevention Plans: 29 CFR 1910.39**

This OSHA standard describes the minimum elements that must appear in an employer's fire prevention plan.

[http://www.osha.gov/pls/oshaweb/owadisp.show\\_document?p\\_table=STANDARDS&p\\_id=12887](http://www.osha.gov/pls/oshaweb/owadisp.show_document?p_table=STANDARDS&p_id=12887)

### ***Emergency Response Guide (ERG) 119 – Ethylene Oxide (Applicable to ethylene oxide)***

This entry from the U.S. Department of Transportation (U.S. DOT) provides basic information on responding to a large release of EtO (e.g., hazards, evacuation, spill and leak control procedures). Most information is also applicable to smaller releases.

<http://hazmat.dot.gov/pubs/erg/g119.pdf>

### ***Ethylene Oxide Sterilizer Alarm Systems***

This section, from the *U.S. Joint Services Pollution Opportunity Handbook* (updated 2003) discusses characteristics of commercially available ethylene oxide alarm systems and provides information from two manufacturers.

[http://p2sustainabilitylibrary.mil/P2\\_Opportunity\\_Handbook/3\\_VII\\_2.html](http://p2sustainabilitylibrary.mil/P2_Opportunity_Handbook/3_VII_2.html)



**The mention of any instrument provider, product, or process in this publication does not constitute or imply endorsement by the Occupational Safety and Health Administration. This list is not intended or able to be comprehensive, as there may be suppliers who have not been brought to our attention.**

**Suppliers of handheld and/or fixed position leak detectors and alarm systems for EtO**

**American Gas & Chemical Co., Ltd.**, Northvale, NJ. Tel. 1-800-288-3647

**Anderson Products**, Haw River, NC. Tel. 800-523-1276

**Dräger Safety, Inc.**, Pittsburgh, PA. Tel: 1-800-858-1737

**BW Technologies**, Arlington, TX. Tel: 888-749-8878

**Interscan Corporation**, Chatsworth, CA. Tel: 800-458-6153

**Sierra Monitor Corporation**, Milpitas, CA. Tel: 408-262-6611

**U.S. Industrial Products**, Cyprus, CA. Tel: 714-220-1829



**Return to Section 3.A.iii - Emergency Alert Provision.**



## I. General Occupational Safety and Health Management for Small Businesses

### **OSHA Booklet – *Small Business Handbook* (OSHA 2209), 2005**

This document includes a brief description of employers' responsibilities for workplace safety and health. The document includes checklists to help employers conduct a self-inspection.

<http://www.osha.gov/publications/smallbusiness/small-business.pdf>

### **OSHA Hospital eTool – Central Supply Module**

The eTool offers background information on various hazards (including EtO) that employees might encounter in the area of a hospital where instruments are sterilized - typically the central supply department.

<http://www.osha.gov/SLTC/etools/hospital/central/central.html>

### **OSHA Consultation Program**

This program offers free and confidential advice to small and medium-sized businesses in all states, with priority given to high-hazard worksites. Employers can find out about potential hazards at their worksites and improve their occupational safety and health management systems.

<http://www.osha.gov/dcsp/smallbusiness/consult.html>



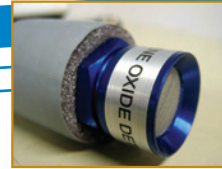

## 7. References

LaMontagne, AD, et al. 1990. Ethylene Oxide Health & Safety Manual: Training and Reference Materials on the Safe Use of Ethylene Oxide in Sterilizing Equipment. Second Edition. (OSHA Docket H200C, exhibit 2-9-L).

LaMontagne, AD, and Kelsey, MD. 1998. OSHA's Renewed Mandate for Regulatory Flexibility: In Support of the 1984 Ethylene Oxide Standard. American Journal of Industrial Medicine. 34: 95-104.

LaMontagne, AD, Oakes, JM, and Lopez, RN. 2004. Long-Term Ethylene Oxide Exposure Trends in U.S. Hospitals: Relationship with OSHA Regulatory and Enforcement Actions. American Journal of Public Health. 94: (9), 1614-1619.

NIOSH. 1989. Technical Report: Control Technology for Ethylene Oxide Sterilization in Hospitals. Report No. 89-120. National Institute for Occupational Safety and Health. 89-120.pdf (179 pages). (Accessed September 17, 2005.)

<http://www.cdc.gov/niosh/pdfs/89-120.pdf>

NIOSH. 2006. Ethylene Oxide - Registry of Toxic Effects of Chemical Substances (RTECS). National Institute for Occupational Safety and Health (NIOSH). (Accessed September 21, 2006.)

<http://www.cdc.gov/niosh/rtecs/kx256250.html#L>



## 8. OSHA Assistance

OSHA can provide extensive help through a variety of programs, including technical assistance about effective safety and health programs, state plans, workplace consultations, and training and education.

### **Safety and Health Management System Guidelines**

Effective management of worker safety and health protection is a decisive factor in reducing the extent and severity of work-related injuries and illnesses and their related costs. In fact, an effective safety and health management system forms the basis of good worker protection, can save time and money, increase productivity and reduce employee injuries, illnesses and related workers' compensation costs.

To assist employers and workers in developing effective safety and health management system, OSHA published recommended Safety and Health Program Management Guidelines (54 Federal Register (16): 3904-3916, January 26, 1989). These voluntary guidelines can be applied to all places of employment covered by OSHA.

The guidelines identify four general elements critical to the development of a successful safety and health management system:

- Management leadership and employee involvement,
- Worksite analysis,
- Hazard prevention and control, and
- Safety and health training.

The guidelines recommend specific actions, under each of these general elements, to achieve an effective safety and health management system. The Federal Register notice is available online at [www.osha.gov](http://www.osha.gov).

### **State Programs**

*The Occupational Safety and Health Act of 1970* (OSH Act) encourages states to develop and operate their own job safety and health plans. OSHA approves and monitors these plans. Twenty-four states, Puerto Rico and the Virgin Islands currently operate approved state plans: 22 cover both private and public (state and local government) employment; Connecticut, New Jersey, New York and the Virgin Islands cover the public sector only. States and territories with their own OSHA-approved occupational safety and health plans must adopt standards identical to, or at least as effective as, the Federal OSHA standards.

### **Consultation Services**

Consultation assistance is available on request to employers who want help in establishing and maintaining a safe and healthful workplace. Largely funded by OSHA, the service is provided at no cost to the employer. Primarily developed for smaller employers with more hazardous operations, the consultation service is delivered by state governments employing professional safety and health consultants. Comprehensive assistance includes an appraisal of all mechanical systems, work practices, and occupational safety and health hazards of the workplace and all aspects of the employer's present job safety and health program. In addition, the service offers assistance to employers in developing and imple-

menting an effective safety and health program. No penalties are proposed or citations issued for hazards identified by the consultant. OSHA provides consultation assistance to the employer with the assurance that his or her name and firm and any information about the workplace will not be routinely reported to OSHA enforcement staff. For more information concerning consultation assistance, see OSHA's website at [www.osha.gov](http://www.osha.gov).

### **Strategic Partnership Program**

OSHA's Strategic Partnership Program helps encourage, assist and recognize the efforts of partners to eliminate serious workplace hazards and achieve a high level of worker safety and health. Most strategic partnerships seek to have a broad impact by building cooperative relationships with groups of employers and workers. These partnerships are voluntary relationships between OSHA, employers, worker representatives, and others (e.g., trade unions, trade and professional associations, universities, and other government agencies).

For more information on this and other agency programs, contact your nearest OSHA office, or visit OSHA's website at [www.osha.gov](http://www.osha.gov).

### **OSHA Training and Education**

OSHA area offices offer a variety of information services, such as technical advice, publications, audiovisual aids and speakers for special engagements. OSHA's Training Institute in Arlington Heights, IL, provides basic and advanced courses in safety and health for Federal and state compliance

officers, state consultants, Federal agency personnel, and private sector employers, workers and their representatives.

The OSHA Training Institute also has established OSHA Training Institute Education Centers to address the increased demand for its courses from the private sector and from other federal agencies. These centers are colleges, universities, and nonprofit organizations that have been selected after a competition for participation in the program.

OSHA also provides funds to nonprofit organizations, through grants, to conduct workplace training and education in subjects where OSHA believes there is a lack of workplace training. Grants are awarded annually.

For more information on grants, training and education, contact the OSHA Training Institute, Directorate of Training and Education, 2020 South Arlington Heights Road, Arlington Heights, IL 60005, (847) 297-4810, or see Training on OSHA's website at [www.osha.gov](http://www.osha.gov). For further information on any OSHA program, contact your nearest OSHA regional office listed at the end of this publication.

### **Information Available Electronically**

OSHA has a variety of materials and tools available on its website at [www.osha.gov](http://www.osha.gov). These include electronic tools, such as Safety and Health Topics, eTools, Expert Advisors; regulations, directives and publications; videos and other information for employers and workers. OSHA's software programs and eTools walk you through challenging safety and health issues and common problems to find the best solutions for your workplace.

## **OSHA Publications**

OSHA has an extensive publications program. For a listing of free items, visit OSHA's website at [www.osha.gov](http://www.osha.gov) or contact the OSHA Publications Office, U.S. Department of Labor, 200 Constitution Avenue, NW, N-3101, Washington, DC 20210; telephone (202) 693-1888 or fax to (202) 693-2498.

## **Contacting OSHA**

To report an emergency, file a complaint, or seek OSHA advice, assistance, or products, call (800) 321-OSHA or contact your nearest OSHA Regional office listed at the end of this publication. The teletypewriter (TTY) number is (877) 889-5627.

Written correspondence can be mailed to the nearest OSHA Regional or Area Office listed at the end of this publication or to OSHA's national office at: U.S. Department of Labor, Occupational Safety and Health Administration, 200 Constitution Avenue, N.W., Washington, DC 20210.

By visiting OSHA's website at [www.osha.gov](http://www.osha.gov), you can also:

- File a complaint online,
- Submit general inquiries about workplace safety and health electronically, and
- Find more information about OSHA and occupational safety and health.

## 9. OSHA Regional Offices

### Region I

(CT,\* ME, MA, NH, RI, VT\*)  
JFK Federal Building, Room E340  
Boston, MA 02203  
(617) 565-9860

### Region II

(NJ,\* NY,\* PR,\* VI\*)  
201 Varick Street, Room 670  
New York, NY 10014  
(212) 337-2378

### Region III

(DE, DC, MD,\* PA, VA,\* WV)  
The Curtis Center  
170 S. Independence Mall West  
Suite 740 West  
Philadelphia, PA 19106-3309  
(215) 861-4900

### Region IV

(AL, FL, GA, KY,\* MS, NC,\* SC,\* TN\*)  
61 Forsyth Street, SW, Room 6T50  
Atlanta, GA 30303  
(404) 562-2300

### Region V

(IL, IN,\* MI,\* MN,\* OH, WI)  
230 South Dearborn Street  
Room 3244  
Chicago, IL 60604  
(312) 353-2220

### Region VI

(AR, LA, NM,\* OK, TX)  
525 Griffin Street, Room 602  
Dallas, TX 75202  
(972) 850-4145

### Region VII

(IA,\* KS, MO, NE)  
Two Pershing Square  
2300 Main Street, Suite 1010  
Kansas City, MO 64108-2416  
(816) 283-8745

### Region VIII

(CO, MT, NO, SO, UT,\* WY\*)  
1999 Broadway, Suite 1690  
PO Box 46550  
Denver, CO 80202-5716  
(720) 264-6550

### Region IX

(AZ,\* CA,\* HI,\* NV,\* and American  
Samoa, Guam and the Northern  
Mariana Islands)  
90 7th Street, Suite 18-100  
San Francisco, CA 94103  
(415) 625-2547

### Region X

(AK,\* ID, OR,\* WA\*)  
1111 Third Avenue, Suite 715  
Seattle, WA 98101-3212  
(206) 553-5930

\* These states and territories operate their own OSHA-approved job safety and health programs and cover state and local government employees as well as private sector employees. The Connecticut, New Jersey, New York and Virgin Islands plans cover public employees only. States with approved programs must have standards that are identical to, or at least as effective as, the Federal OSHA standards.

Note: To get contact information for OSHA Area Offices, OSHA-approved State Plans and OSHA Consultation Projects, please visit us online at [www.osha.gov](http://www.osha.gov) or call us at 1-800-321-OSHA.







**Occupational Safety  
and Health Administration**

U.S. Department of Labor

[www.osha.gov](http://www.osha.gov)