

# Forest Health Technology Enterprise Team

TECHNOLOGY  
TRANSFER

*Biological  
Control*

## BIOLOGY AND BIOLOGICAL CONTROL OF YELLOW STARHISTLE



LINDA M. WILSON, CYNTHIA JETTE, JOHN CONNETT,  
JOSEPH McCAFFREY

**T**he Forest Health Technology Enterprise Team (FHTET) was created in 1995 by the Deputy Chief for State and Private Forestry, USDA, Forest Service, to develop and deliver technologies to protect and improve the health of American forests. This book was published by FHTET as part of the technology transfer series.

<http://www.fs.fed.us/foresthealth/technology/>

The U.S. Department of Agriculture (USDA) prohibits discrimination in all its programs and activities on the basis of race, color, national origin, sex, religion, age, disability, political beliefs, sexual orientation, or marital or family status. (Not all prohibited bases apply to all programs.) Persons with disabilities who require alternative means for communication of program information (Braille, large print, audiotape, etc.) should contact USDA's TARGET Center at 202-720-2600 (voice and TDD).

To file a complaint of discrimination, write USDA, Director, Office of Civil Rights, Room 326-W, Whitten Building, 1400 Independence Avenue, SW, Washington, D.C. 20250-9410 or call 202-720-5964 (voice and TDD). USDA is an equal opportunity provider and employer.

The use of trade, firm, or corporation names in this publication is for information only and does not constitute an endorsement by the U.S. Department of Agriculture.



Federal Recycling Program  
Printed on recycled paper.

# Biology and Biological Control of Yellow Starthistle

Linda M. Wilson<sup>1</sup>, Cynthia Jette<sup>1</sup>  
John Connett<sup>1</sup>, and Joseph P. McCaffrey<sup>1</sup>

*in cooperation with*

Carol Bell Randall<sup>2</sup>, Christina Kuykendall<sup>3</sup>, Leonard Lake<sup>4</sup>

<sup>1</sup> Department of Plant, Soil and Entomological Sciences, University of Idaho,  
P.O. Box 442339, Moscow, ID 83844-2339

<sup>2</sup> Forest Health Protection, USDA Forest Service, 3815 Schreiber Way, Coeur d'Alene, ID 83815-8363

<sup>3</sup> Nez Perce Biocontrol Center, P.O. Box 365, Lapwai, ID 83540

<sup>4</sup> USDA Forest Service, Nez Perce National Forest, Route 2, Grangeville, ID 83530

---

**For additional copies of this publication, contact:**

**Carol Bell Randall**  
USDA Forest Service  
Coeur d'Alene  
Idaho  
(208) 765-7343  
crandall@fs.fed.us

**Richard Reardon**  
FHTET, USDA Forest Service  
Morgantown  
West Virginia  
(304) 285-1566  
rreardon@fs.fed.us

---

## ACKNOWLEDGMENTS

We thank Christina Kuykendall, Leonard Lake, and Carol Bell Randall for their contributions to this manual; Cindy Roché for contributing photographs and drawings; and Mark Riffe and Chuck Benedict of INTECS/Forest Health Technology Enterprise Team, USDA Forest Service, Fort Collins, Colorado, for editing, layout and graphics. We would also like to thank Richard Reardon of the Forest Health Technology Enterprise Team, USDA Forest Service, Morgantown, West Virginia, for providing the funds needed to complete and publish this manual.

All photographs used in this publication can be accessed and viewed on line. You'll find reference codes (UGA0000000) in the captions for the figures in this publication. Point your browser at <http://www.forestryimages.org>, and enter the reference code at the search prompt.

## Sources of Figures

Cover	J. Connett, C. Roché, L. Wilson
Figures 2b, 3, 5a-l, 38	C. Roché
Figures 2a, 10, 29, 31, 33, 35-37, 40	University of Idaho
Figure 6	Biocontrol of Weeds in the West
Figures 12, 27	E. Coombs, Oregon Department of Agriculture
Fig 1, 11, 13-16, 19, 20, 39	J. Connett, University of Idaho
Figure 24	G. Piper, Washington State University
Figures 17, 18, Table 4	J. Johnson, University of Idaho
Figures 4, 7-9, 21, 26, 28, 41	L. Wilson, University of Idaho
Figure 22	L. Lake, US Forest Service
Figure 23, 25	D. Schotzko, University of Idaho
Figure 30, 32a, 34	K. Loeffelman, University of Idaho
Figure 32b	BioQuip Catalog
Table 2	California Department of Food and Agriculture

# Contents

<b>INTRODUCTION .....</b>	<b>1</b>
Overview .....	1
Biological Control of Weeds .....	2
About This Manual .....	3
<b>CHAPTER 1: GETTING TO KNOW YELLOW STARThISTLE .....</b>	<b>5</b>
Yellow starthistle, <i>Centaurea solstitialis</i> L. ....	6
<b>CHAPTER 2: BIOLOGY OF YELLOW STARThISTLE BIOCONTROL AGENTS .....</b>	<b>11</b>
Overview .....	11
Basic Insect Biology .....	11
What is This Insect? .....	12
Yellow Starthistle Weevils .....	14
<i>Bangasternus orientalis</i> .....	16
<i>Eustenopus villosus</i> .....	18
<i>Larinus curtus</i> .....	20
Yellow Starthistle Flies .....	21
<i>Chaetorellia australis</i> and <i>C. succinea</i> .....	23
<i>Urophora siruneseva</i> .....	25
<b>CHAPTER 3: ELEMENTS OF A YELLOW STARThISTLE BIOLOGICAL CONTROL</b>	
<b>PROGRAM .....</b>	<b>27</b>
1. Selecting and Preparing Release Sites .....	28
2. Collecting Biocontrol Agents .....	30
3. Handling Biocontrol Agents .....	36
4. Releasing Biocontrol Agents .....	38
5. Monitoring .....	41
6. Establishing Photo Points .....	47
<b>GLOSSARY .....</b>	<b>49</b>
<b>SELECTED REFERENCES .....</b>	<b>53</b>
General: Biological Control .....	53
Yellow starthistle ( <i>Centaurea solstitialis</i> L.) .....	54
<i>Bangasternus orientalis</i> .....	57
<i>Chaetorellia australis</i> .....	58
<i>Chaetorellia succinea</i> .....	58
<i>Eustenopus villosus</i> .....	59

<i>Larinus curtus</i> .....	59
<i>Urophora sirunaseva</i> .....	60
Vegetation Monitoring .....	60

## APPENDICES

Appendix A: Troubleshooting Guide: When Things go Wrong
Appendix B: Biological Control Agent Release Form
Appendix C: Monitoring Plan Questionnaire
Appendix D: Biocontrol Monitoring Report
Appendix E: Qualitative Monitoring Form
Appendix F: Quadrat Density and Cover Data Form
Appendix G: Macroplot Design for Measuring Density

## FIGURES

Figure 1. Flowering yellow starthistle near Peck, Idaho. ....	1
Figure 2. Yellow starthistle plant. ....	6
Figure 3. Yellow starthistle seeds. ....	7
Figure 4. Map of yellow starthistle distribution in the United States. ....	7
Figure 5. Yellow starthistle growth stages. ....	9
Figure 6. Diagram of insect body parts. ....	12
Figure 7. Example of insect life cycle showing complete metamorphosis. ....	13
Figure 8. Key for identification of fly and weevil larvae. ....	13
Figure 9. Key for identification of fly and weevil pupae. ....	13
Figure 10. <i>Bangasternus orientalis</i> adult. ....	16
Figure 11. <i>Bangasternus orientalis</i> egg. ....	16
Figure 12. <i>Bangasternus orientalis</i> pupal chamber. ....	17
Figure 13. <i>Eustenopus villosus</i> adult. ....	18
Figure 14. Adult <i>Eustenopus villosus</i> feeding on BU-1 bud. ....	18
Figure 15. <i>Eustenopus villosus</i> oviposition hole. ....	18
Figure 16. <i>Eustenopus villosus</i> egg. ....	18
Figure 17. <i>Eustenopus villosus</i> larva. ....	19
Figure 18. <i>Eustenopus villosus</i> pupa. ....	19
Figure 19. <i>Eustenopus villosus</i> exit hole. ....	19
Figure 20. Dead and bent yellow starthistle head from feeding <i>Eustenopus villosus</i> . ....	19
Figure 21. Adult <i>Larinus curtus</i> . ....	20
Figure 22. Adult <i>Larinus curtus</i> face down in starthistle flower head. ....	20
Figure 23. Adult <i>Chaetorellia australis</i> . ....	23
Figure 24. <i>Chaetorellia australis</i> larva. ....	23
Figure 25. Adult <i>Urophora sirunaseva</i> . ....	25
Figure 26. <i>Urophora sirunaseva</i> woody gall. ....	25
Figure 27. Emergence hole of <i>Urophora sirunaseva</i> . ....	26

Figure 28. Yellow starthistle plant. ....	27
Figure 29. An example of a yellow starthistle infestation suitable for a biocontrol program	29
Figure 30. Sweep net. ....	33
Figure 31. Sweeping for insects .....	33
Figure 32. Aspirators used to collect yellow starthistle biocontrol agents. ....	34
Figure 33. Collecting yellow starthistle biocontrol agents. ....	34
Figure 34. Insect rearing cage, also called a sleeve box. ....	36
Figure 35. Paper-towel lined carton containing bioagents .....	36
Figure 36. Shipping box containing agents and cartons , styrofoam to prevent shifting, and blue ice packs. ....	37
Figure 37. Screen cage in which to release yellow starthistle biocontrol agents. ....	39
Figure 38. Milk jug release cage for yellow starthistle biocontrol agents. ....	39
Figure 39. Monitoring yellow starthistle biocontrol agents. ....	41
Figure 40. Measuring plant height at a quantitative monitoring site. ....	45
Figure 41. Monitoring a yellow starthistle infestation.. ....	46

## TABLES AND CHARTS

Table 1. List of yellow starthistle biocontrol agents. ....	12
Table 2. Comparison of adult yellow starthistle weevils. ....	14
Table 3. Comparison of weevil lifecycles by yellow starthistle growth stages. ....	15
Table 4. Comparison of adult yellow starthistle flies. ....	21
Table 5. Comparison of fly lifecycles by yellow starthistle growth stages .....	22
Table 6. Collection methods for yellow starthistle biocontrol agents. ....	35
Table 7. Release methods for yellow starthistle biocontrol agents. ....	35
Table 8. Suggested timing for monitoring yellow starthistle weevils. ....	42
Table 9. Suggested timing for monitoring yellow starthistle flies. ....	43
Table 10. Identification of yellow starthistle biocontrol agent larvae and pupae. ....	44
Chart 1. Phenology of yellow starthistle and its biocontrol agents. ....	31





## INTRODUCTION

### Overview

Yellow starthistle (*Centaurea solstitialis* L.) is an invasive weed introduced from the Mediterranean region. It predominantly infests rangelands in the western United States. This second edition manual on the biological control of yellow starthistle is intended to give weed and land managers guidelines to develop and successfully establish a starthistle biocontrol program (Fig. 1).

In the United States, approximately 18 million acres are infested with yellow starthistle. A highly competitive and invasive weed, yellow starthistle has adapted to a wide range of habitats and environmental conditions, mostly in California, Oregon, Washington and Idaho (see Fig. 4, page 7).

A large amount of information is available giving land managers useful tools to manage yellow starthistle by a variety of strategic methods. Chemical, cultural and mechanical methods used to control weeds all apply when managing yellow starthistle. However, most people recognize that yellow starthistle management on a large scale over the landscape requires well-planned, integrated programs that maximize the effective use of all weed management strategies in combination.

Among the myriad of weed control approaches to manage yellow starthistle is biological control, a well known and long-established tool in the United States and Canada. There is a lot of readily available information describing certain aspects of yellow starthistle biological control. This manual provides a practical reference for field workers and resource managers that provides information on starthistle and its biocontrol agents, combined with a how-to, on-the-job reference that outlines, step-



**Figure 1.** Flowering yellow starthistle near Peck, Idaho (UGA1350002).

by-step, the process of establishing a biocontrol program, including selecting a release site, collecting and releasing agents, evaluating past releases, and monitoring agents and vegetation after the release. The guidelines and suggested timetables outlined in this manual are based on research and practical field experience, and can be used to maximize the success of your yellow starthistle biological control program.

## Biological Control of Weeds

Biological control of weeds is the deliberate use of naturally occurring organisms to limit the distribution and abundance of a target weed. These organisms are the ‘natural enemies’ of the weed in its native range (i.e., the Mediterranean) and include such organisms as insects, mites, nematodes, and pathogens. Natural enemies are also referred to as biocontrol agents, bioagents, biological control organisms and weed herbivores. Insects and other organisms can be very damaging to a host plant. They might control the weed by killing it directly, by weakening the ability of the weed to compete, by destroying seeds, roots, or stems thus limiting reproduction in the weed, or by enabling secondary infection from pathogens to invade feeding lesions.

There are a number of advantages to biological control of weeds. Biocontrol with carefully selected agents is not damaging to the environment; it is directed to a specific weeds or closely related group of weeds, thus it is highly selective, it provides long-term impacts on the target plant, it has limited side effects, it has nonrecurring costs, and biocontrol agents are self-perpetuating. Also, once an agent is introduced, it reproduces without additional cost to the land manager.

Historically, biological control has worked best on large infestations of a single weed species. It has been most successfully used on weeds that have been introduced into areas where their specialized natural enemies do not occur. For example, most of our rangeland weeds are not native; they arrived with immigrants and commerce from Europe and elsewhere, sometimes brought intentionally to adorn future gardens in the New World or sometimes as ship ballast or as stowaways stuck to clothing and goods. These plants, destined to become major pests in their new home, were free of their complex of natural enemies from the old country, and thus enjoyed unrestrained expansion.

In a system known as *Classical Biological Control*, natural enemies are identified in the weeds native range, and rigorously tested to determine what plants they eat (their *host range*). These areas need to be climatically similar to the area where the weed is to be controlled. Ecological and genetic studies are conducted to ensure that the biology and lifecycle of the insect is closely synchronized with the host plant. Biocontrol agents selected for study undergo 5 to 10 years of rigorous testing to ensure that they have a very narrow range of suitable host plants. In order to qualify as a biocontrol agent, an insect is only allowed to eat and develop on yellow starthistle and in some cases on a few very closely related plant species. The most important precondition for an insect to be used as a biocontrol agent is that it will die without yellow starthistle.

These preliminary studies are important in order to:

- Have the best fit between bioagents and yellow starthistle
- Preclude introduction of unapproved organisms
- Protect non-target plant species
- Influence future assessments of risk
- Affect future evaluation processes

The USDA Animal and Plant Health Inspection Service (APHIS) is the governing agency responsible for authorizing the importation of an insect and other organisms for biological control of weeds. Laws and regulations are in place to minimize risks associated with introducing foreign organisms. Biocontrol researchers work closely with APHIS to maximize safety in biocontrol programs.

Although biocontrol is an effective and important weed management tool, it is not a panacea; it doesn't "*fix*" the problem of yellow starthistle. The goal of biological control is not to eradicate starthistle but to reduce its competitive ability so that yellow starthistle-infested sites can be colonized by desirable plant species. In the most effective programs, biological control is used along with other methods of weed control. In fact, many land managers, ranchers, and farmers use integrated weed management systems, which combine more than one method to control weeds while keeping the plant community intact. The article listed under the Selected References chapter, entitled "Biological Control of Weeds", by R. McFadyen, provides a review, examples, and a discussion about advantages and disadvantages of different approaches used to control weeds using biological methods.

## About This Manual

This manual provides background information on yellow starthistle and each of the six yellow starthistle biological control insects, and provides guidelines to establish and manage a starthistle biocontrol program. The chapters are:

**Chapter 1** provides detailed description of yellow starthistle, including scientific name, description of the leaves, stems, flowers, seeds, and habitat and occurrence in the United States. Photographs, drawings, and distribution maps are also provided.

**Chapter 2** features the six starthistle biocontrol agents; three species of flies and three species of beetles. Included is information on their biology, identification and lifecycle. This chapter is particularly useful for identifying each biocontrol agents in the field.

**Chapter 3** includes detailed elements of a starthistle biocontrol program (planning, implementing, and evaluating). It encompasses techniques for all the agents. Included are guidelines for:

- Developing work schedules for field activities
- Selecting and preparing a release or nursery site
- Collecting, handling release, transporting and shipping biocontrol agents
- Monitoring agents and vegetation at the release site

**Glossary** defines technical terms essential in using and communicating about biological control effectively.

**Selected References** provides critical references from the comprehensive body of literature on yellow starthistle biology, ecology, and biological control.

**Appendices A-G** contains various insect release and monitoring forms, checklists, vegetation monitoring forms, and a troubleshooting guide.

**Appendix A:** Troubleshooting Guide: When Things Go Wrong

**Appendix B:** Sample Biocontrol Agent Release Form

**Appendix C:** Monitoring Plan Questionnaire

**Appendix D:** Biocontrol Monitoring Report

**Appendix E:** Qualitative Monitoring Form

**Appendix F:** Quadrat Density and Cover Data Form

**Appendix G:** Macroplot Design for Measuring Density

## CHAPTER 1: GETTING TO KNOW YELLOW STARHISTLE

Yellow starthistle is an annual rangeland weed originating from the Mediterranean region. It became established in North America in the mid-1800s in contaminated alfalfa or other crop seeds. Yellow starthistle seeds were found in adobe brick in California beginning in the early 1800's. First reports of yellow starthistle in the Pacific Northwest include an alfalfa field near Walla Walla, Washington at the beginning of the 1900s.

Yellow starthistle primarily infests annual and perennial grasslands, pastures, shrub steppe, open woodlands, and disturbed habitats such as hayfields, orchards, vineyards, roadsides and abandoned areas. Starthistle is present in 23 states, having the largest, contiguous infestations in California (about 15 million acres), Idaho (about 3 million acres), Oregon and Washington (about 150,000 acres each). It is estimated to spread at the rate of about 6 percent per year.

The thorny spines that surround the flower heads of starthistle interfere with grazing by livestock, recreation, and wildlife management. It is toxic to horses, causing a chronic and potentially fatal neurological disorder known as "chewing disease". It reduces biodiversity by displacing native vegetation in grasslands and woodlands.

Long-term strategies for management of yellow starthistle includes a combination of cultivation, hand pulling and mowing, herbicides, burning, managed grazing, biological control and other practices that suppress starthistle and enhance competition by desirable vegetation. Well-adapted, perennial grasses can limit yellow starthistle invasion and curtail its expansion.

Yellow starthistle is a winter annual. Seeds germinate in the fall and grow into overwintering rosettes. Under favorable conditions of temperature and moisture, germination can continue through the winter and early spring. Once established, fall germi-

nated seedlings monopolize soil moisture and are highly competitive for soil nutrients and space. In the spring, plants bolt, producing a few to several branched, erect stems, each with a terminal flower head.

Yellow starthistle is renowned for its variable growth habits. This wide response, or *plasticity*, enables the plant to respond rapidly to wet or dry conditions, producing large plants with abundant seed during moist years, and small plants with few heads and seeds in dry years. For example, in a dry years, starthistle plants can be 6 inches tall with 1 to 2 flower heads, in contrast to moist years, when starthistle plants at the same site can be 2 to 4 feet tall with one to several hundred flower heads.

Like all members of the sunflower family, the starthistle seedhead, or *capitulum*, is an aggregation of 20 to 50 small, individual flowers. The individual flowers, or florets, are tightly clustered and anchored to a concave base, called the *receptacle*. The receptacle and florets are surrounded by an envelope of modified leaves, or *bracts*. Bracts of starthistle have a long, stiff spine at the tip, often 2 to 3 times the width of the head.

### Yellow starthistle, *Centaurea solstitialis* L.

Other common names: Barnaby thistle, Golden thistle, Cotton-tip thistle.

Family: Sunflower family (Asteraceae or Compositae)

Description: A winter-hardy annual that reproduces by seeds (Fig. 2).

**Height:** Widely variable year to year depending on site conditions. The average rangeland size is 1 to 3 feet (0.3 to 1m), 4 to 6 feet (1.2 to 1.8 m) tall in shady, wet areas, or as short as 6 inches (15 cm) in dry, warm areas.

**Leaves:** Basal leaves form a rosette beginning in the fall and continuing through the winter. Each leaf is divided into lobes with the end lobe larger and rounder than the side lobes, the stalk shorter than the leaf blade. Stem leaves attach directly to the stem by a wing that runs down the side of the stem; they are up to 4 inches (10 cm) long and 0.25 inch (6 mm) wide, linear or tapered at both ends with the broadest part below the middle.

**Heads:** Each flower bud appears as a small, egg-shaped swelling up to 0.75 inch (1.9 cm) long and enclosed by shingle-like layers of bud scales called bracts. A

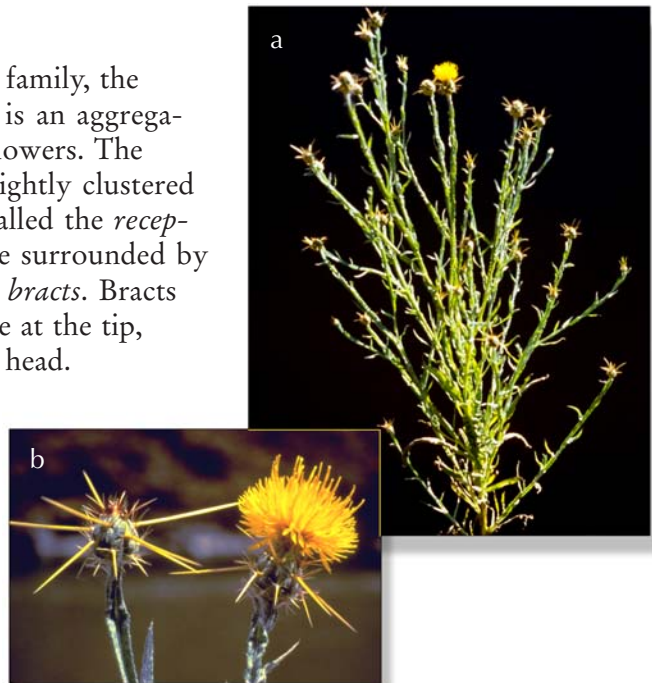

**Figure 2.** Yellow starthistle plant. a. (UGA1350003), b. (UGA1350004).



sharp, yellow-green spine appears at the tip of each bract can be 0.25 to 2 inches (0.6 to 5 cm) long after the flowers fully open. Buds are solitary at the ends of the branches. The base of the head is pubescent.

**Stems:** The stems are upright, stiff, winged and branched. Small plants can have an unbranched stem and one flower head; large plants have a stem with multiple branches and can have over one to several hundred heads.

**Flowers:** Bright yellow flowers, about 5/8 inch (1.6 cm) in diameter.

**Seeds:** Two types of seeds are produced: plumed and plumeless. Seeds are tan to black and about 1/8 inch (0.3 cm) long. Plumed seeds, located at the center of the seedhead, have a ring of fine, white bristles (called a *pappus*), 1/8 inch long and are easily dislodged from the seedhead by wind or other disturbances.

Though not readily airborne, they disperse when they become lodged in hair, fur and feathers or are carried by water, vehicles or rodents. Most unplumed seeds fall to the ground near the mother plant. The black, unplumed seeds surround the periphery of each head are smaller (Fig. 3). Starthistle produces 20 to 50 seeds per head that have about 95 percent viability. Seeds can remain dormant in the soil for up to 10 years.



**Figure 3.** Yellow starthistle seeds (UGA1350005).

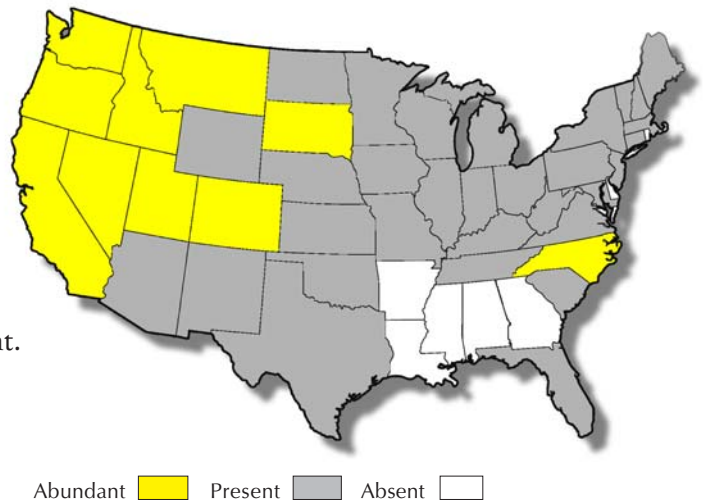

**Figure 4.** Map of yellow starthistle distribution in the United States.

**Distribution:** Figure 4 depicts the distribution of yellow starthistle in North America.

**Timeline of Attack:** The relationship between biocontrol insect activity and starthistle growth stage is very important in starthistle biological control. Each of the insects' lifecycle is closely tied to, or *synchronized* with, specific plant growth stages. Nine primary growth stages of yellow starthistle (see Fig. 5, page 9) are commonly used.

1. Seedling stage (Fig. 5a). Germination begins in the fall and continues through spring and is followed by the emergence of two oblong cotyledons or seed leaves. The plants then produce 5 or more basal leaves and 2 to 4 deeply lobed leaves.
2. Rosette stage (Fig. 5b). In the spring, 7 or 8 lobed leaves emerge to form a rosette as the plant grows in height and diameter ending with 20 or more leaves in the rosette. During this spring growth period, dense infestations of yellow starthistle can be identified from a distance by their characteristic blue-green color.
3. Bolting stage (Fig. 5c). The plant begins to bolt in late spring, sending up a rigid, winged flower stalk with a blue-green, cottony pubescence and tipped with a firm flower bud. The flower stalk can be simple in small plants, or branched in larger plants.
4. Floral bud stage. Learning to recognize the four floral bud stages is important for biological control planning.
  - BU-1 (Fig. 5d) Small buds with yellow-green spines begin to be visible at the top.
  - BU-2 (Fig. 5e) Spines protrude more than half of the bud length.
  - BU-3 (Fig. 5f) Spines are equal to or greater than 45° angle from stem
  - BU-4 (Fig. 5g) Spines are straw-colored and equal to or greater than 90° angle from stem.
5. Flowering stage (Fig. 5h). Bright yellow flowers appear in the summer.
6. Seed formation stage (Fig. 5i). There is a progressive loss of color in mid-summer, but the bud still retains some green.
7. Mature stage (Fig. 5j). By late summer, the leaves wither and dry, the bright yellow flowers fade, the plants take on a straw-colored appearance.
8. Seed dissemination stage (Fig. 5k). From late summer to early fall, the flower head dries to a tan color, the bracts dry and release the plumed seeds which are dispersed either by wind, water or by clinging to clothing, fur or feathers.
9. Senescence stage (Fig. 5l). The final stage begins in the fall and continues through the following spring when the plants continue to dry and lose their leaves, becoming silver-gray skeletons with heads that look like white, cottony tufts by December or January. The flower heads have lost most of their spines and the plumeless seeds by this time. Eventually the head disintegrates and plumed seeds are shed.



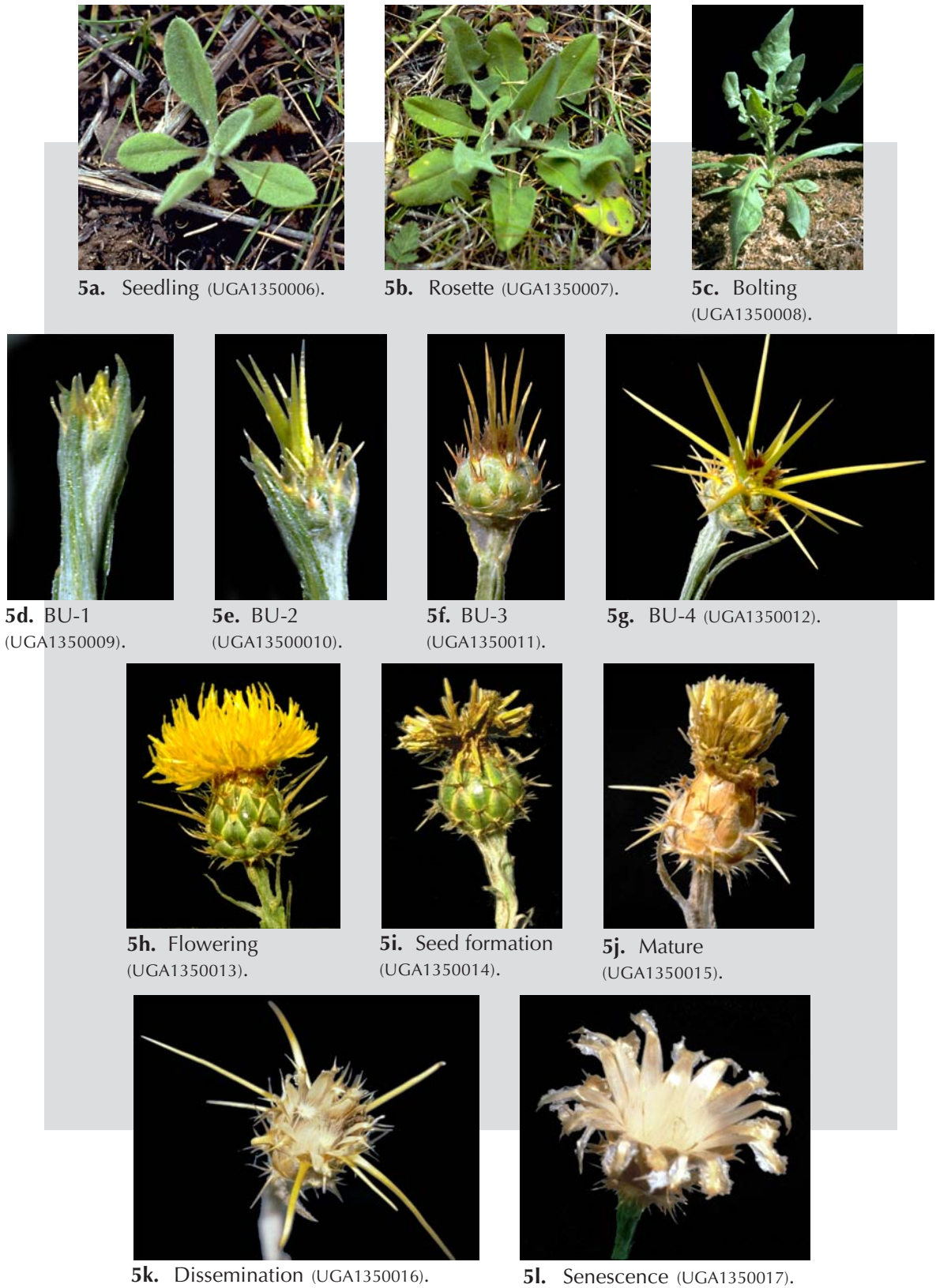

Figure 5. Yellow starthistle growth stages.



## CHAPTER 2: BIOLOGY OF YELLOW STARHISTLE BIOCONTROL AGENTS

### Overview

Biological control of yellow starthistle began in North America in 1985. Since then, six biocontrol insects have been released: three beetles and three flies. All are seed feeding. All the beetles are weevils and include the bud weevil, *Bangasternus orientalis*, the hairy weevil, *Eustenopus villosus*, and the flower weevil, *Larinus curtus*. All of the flies are fruit flies and include the peacock fly, *Chaetorellia australis*, the closely-related false-peacock fly, *C. succinea*, and the banded fly, *Urophora sirunaseva* (Table 1, page 12).

All of the agents are widely distributed in starthistle-infested areas of the western United States, particularly California, Oregon, Washington and Idaho. Though the degree to which each is prevalent may differ, most areas have one or more species well established.

This section describes, in detail, the life history, biology and impact of each of the agents and is organized into two subsections: seed-feeding weevils and seed-feeding flies.

### Basic Insect Biology

Insects are a very large, diverse, complicated group of animals. In order to optimize using insects in a biocontrol program, it is useful to know something about insects. Basic knowledge of their anatomy and lifecycle will help a great deal in understanding and recognizing insects in the field. Adult insects share several characteristics,

**Table 1.** List of yellow starthistle biocontrol agents.

Type	Scientific Name	Common Name
Beetle	<i>Bangasternus orientalis</i> (Capiomont)	Yellow starthistle bud weevil
Beetle	<i>Eustenopus villosus</i> (Boheman)	Yellow starthistle hairy weevil
Beetle	<i>Larinus curtus</i> (Hochhut)	Yellow starthistle flower weevil
Fly	<i>Chaetorellia australis</i> (Hering)	Yellow starthistle peacock fly
Fly	<i>Chaetorellia succinea</i> (Hering)	Yellow starthistle false peacock fly
Fly	<i>Urophora sirunaseva</i> (Hering)	Banded yellow starthistle fly

including: an exoskeleton; a segmented body in three parts, the head, thorax and abdomen; and three pairs of legs (Fig. 6).

Insects grow and develop through a series of molts. The transformation from juvenile to adult stage is called *metamorphosis*. This process can be incomplete or complete. Insects used in biocontrol of yellow starthistle all undergo complete metamorphosis, meaning they have an egg stage, a larva stage (of which there can be three or more *instars*), a pupal stage, and an adult stage (Fig. 7).

**Insect Body Parts**

- A Head
- B Antenna
- C Thorax
- D Abdomen
- E Wing

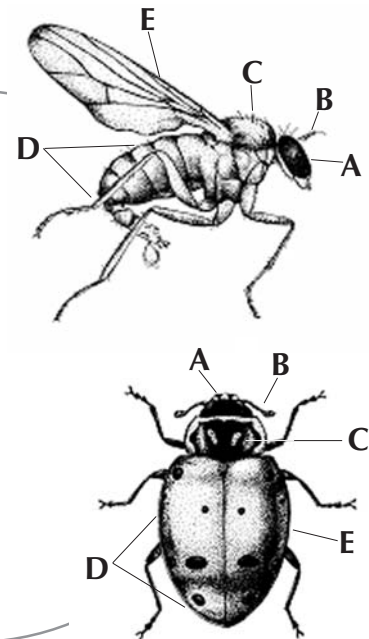

**Figure 6.** Diagram of insect body parts.

**What is This Insect?**

An important part of any successful biocontrol program is to be able to identify the insects in the field. As adults, the insects are relatively easy to identify, with their variable size, form, color, and habits. The larvae are more challenging than the adults – and yet are probably more important to know as this is the stage that 1) does the damage, 2) is monitored in the field, and 3) provides the best evidence that the insects are established in the field.

Using the key in Figure 8, you can tell in three easy steps if you are looking at a starthistle fly or a beetle larva. Beetle larvae are as variable as adult beetles are, but weevil larvae are distinctly white, C-shaped grubs with a brown head capsule and lacking *prolegs*. Fly larvae have no head capsule. They are sometimes confused with other larvae because they appear to have a broad, dark head. However, this is actually a dark, hardened anal plate that is used to anchor the larva to its host.

Using the key in Figure 9, you can tell weevil pupae from fly pupae that are located inside the starthistle head. Beetle pupae have well-developed appendages that are obviously not fused to the body. Fly pupae are contained inside a *puparium*.

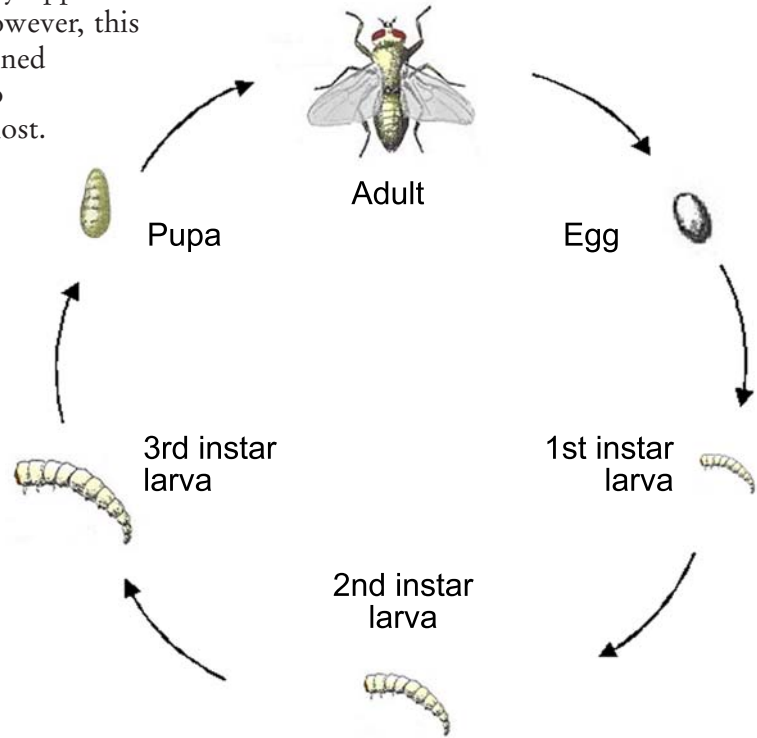

Figure 7. Example of an insect lifecycle and complete metamorphosis.

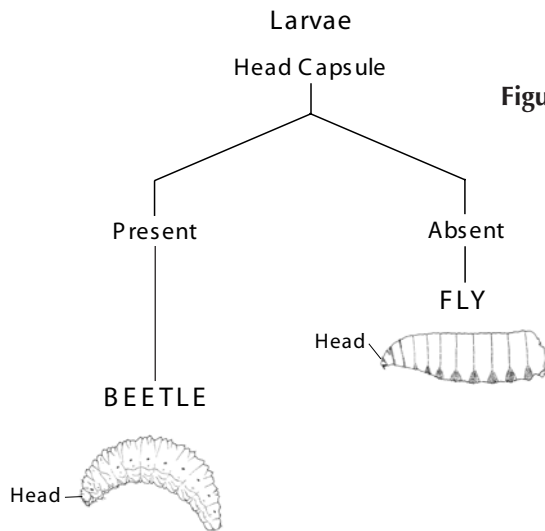

Figure 8. Key to identification of fly and weevil larvae.

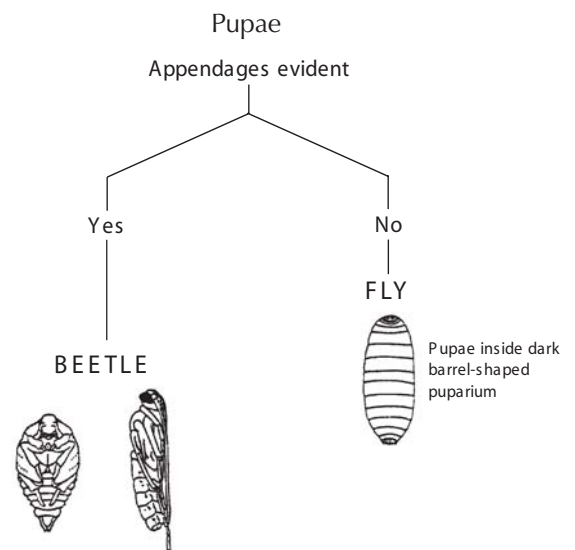

Figure 9. Key to identification of fly and weevil pupae.



## Yellow Starthistle Weevils

Weevils are *phytophagous* (plant-eating) beetles that generally have long, well-developed snouts with chewing mouthparts at the tip. They use the snout to chew deep into a host plant. Antennae are elbowed and attached to the snout about half-way along its length. Weevils are hard-bodied insects with tough, thick exoskeletons. They possess two pairs of wings; the front pair is thickened to form a hard covering called *elytra*. When weevils are not flying, the elytra are held over the back to form a protective covering. The membranous hind wings are used for flight and fold under the elytra when not in use.

Starthistle weevils are *univoltine*, meaning they complete one generation per year. The adult overwinters in protected areas on the ground and become active the following spring. Thus, the first weevils seen in the spring are from the overwintering generation and the new weevils that emerge mid- to late summer are from the new generation. As adults, weevils generally cause little damage to the plant. They may do some feeding of the foliage, but the amount is usually negligible. The exception is the hairy weevil (*E. villosus*) which feeds on starthistle buds, often killing the bud. For most of the insects, however, it is the internally-feeding juvenile stage, or larva, that causes damage. Larvae undergo three molts (or *instars*) during their development inside the starthistle head.

Table 2 provides details on three weevils available for starthistle biocontrol. Table 3 compares lifecycles of each of the weevils.

**Table 2.** Comparison of adult yellow starthistle weevils.

<i>Bangasternus orientalis</i>	<i>Eustenopus villosus</i>	<i>Larinus curtus</i>
		
Emerges 1st (bolting)	Emerges 2nd (BU-I)	Emerges 3rd (BU-1)
Cylindrical body shape	Cylindrical-oblong body shape	Oblong body shape
0.16-0.24 inches	0.16-0.24 inches	0.2-0.24 inches
Brown with yellow/white hairs	Brown with gray/white hairs	Brown
Mottled appearance	Striped	Yellow, spotted
Non-hairy looking	Hairy-looking	Pollen-covered
Short snout	Long, slender snout	Medium-sized snout
Release at BU-1 to BU-3 stages	Release at BU-3 to BU-4 stages	Release at flowering stage

**Table 3.** Comparison of weevil lifecycles by yellow starthistle growth stages.

YST Stage	<i>Bangasternus orientalis</i>	<i>Eustenopus villosus</i>	<i>Larinus curtus</i>
Seedling	Adult overwinters in the ground litter.	Adult overwinters in the ground litter.	Adult overwinters in the ground litter.
Rosette			
Bolting			
BU-1	Female oviposits; black egg cases visible.	Adults emerge, feed on buds; visible on plant.	Adults emerge; visible on plant.
BU-2			
BU-3			
BU-4	Larvae develop; find in seedhead.	Female oviposits. Feeding damage visible.	Female oviposits.
Flowering		Larvae develop; find in seedhead.	
Seed formation			
Mature	Larvae pupate.	Larvae pupate.	Larvae pupate.
Dissemination	Adults emerge; visible on plant.	Adults emerge; visible on plant.	Adults emerge; visible on plant.
Senescence	Adult overwinters in ground litter.	Adult overwinters in ground litter.	Adult overwinters in ground litter.



## *Bangasternus orientalis*

Insect Order: Coleoptera  
 Insect Family: Curculionidae  
 Common Name: Yellow starthistle bud weevil

Description: Adults are 0.2 to 0.3 inch (4 to 6 mm) long. The weevil is dark reddish brown with pale colored hairs giving it a mottled appearance, and has a somewhat flattened, cylinder-shaped body and a short snout (Fig. 10). It has one generation per year.

Adults emerge from overwintering sites early in the yellow starthistle bolting stage to mate and lay eggs.

The adults are especially active during warm periods of the day. Although adults feed on foliage, they do not significantly damage the plant.

Oviposition begins within 1 or 2 weeks of emergence and continues for 4 to 8 weeks. Eggs are laid singly on terminal leaflets, on or at the bases of young flower buds and on or near BU-1 and BU-2 buds. They are covered with a dark mucilage to protect them from predators and desiccation (Fig. 11). At high weevil densities, dark-covered eggs can be seen on most plants. Presence and density of these conspicuous eggs are a good indicator of *B. orientalis* presence at the site.



Figure 10. *Bangasternus orientalis* adult (UGA1350018).



Figure 11. *Bangasternus orientalis* egg (UGA1350019).

Eggs hatch within 1 week after oviposition and the larva tunnels superficially through the plant tissue, until it reaches the bud. Inside the bud, the larva develops and feeds on the receptacle tissue and developing seeds. Usually only one larva develops per bud. It will pupate in the flower head in a brown, thin-walled chamber (Fig. 12).

The new generation adult emerges from pupation chamber in late summer to feed on foliage then overwinter in ground litter. A small percentage of weevils may overwinter in the head.



**Impact:**

Larval feeding in the head can reduce the number of seeds by 40 to 60 percent.

**Comments:**

*Bangasternus orientalis* was introduced in 1985. It is now widely established in California, Oregon, Washington and Idaho and is abundantly available for collection and redistribution. Purple starthistle (*C. calcitrapa*) are also a host for this weevil.

This is the first of the three weevil species to appear in the spring. *B. orientalis* is a good flier and disperses well. It is difficult to establish at sites where *E. villosus* is already established due to the predatory nature of *E. villosus*.



**Figure 12.** *Bangasternus orientalis* pupal chamber (UGA1350020).

## *Eustenopus villosus*

Insect Order: Coleoptera  
 Insect Family: Curculionidae  
 Common Name: Yellow starthistle hairy weevil



**Figure 13.** *Eustenopus villosus* adult (UGA1350021).

Description: Adult *E. villosus* is an oblong, cylindrical weevil 0.2 to 0.3 inch (4 to 6 mm) long with a long, slender snout. They are to, brown with gray to whitish longitudinal stripes and have long hairs on the back. (Fig. 13).

Adults emerge from overwintering sites in the soil litter during the starthistle BU-2 bud stage. Males typically emerge 1 to 2

weeks before females. Adults feed extensively on young buds, by chewing holes into the bud. Adults continue to feed and mate for about a month (Fig. 14).



**Figure 14.** Adult *Eustenopus villosus* feeding on BU-1 bud (UGA1350022).



**Figure 15.** *Eustenopus villosus* oviposition hole (UGA1350023).

Unlike other weevils, *E. villosus* eggs are laid inside the seedhead. A females chews a hole at the base of a bract in a BU-4 bud and lays a single egg in the hole that she then plugs with frass (Figs. 15 and 16). The egg hatches within 3 to 4 days.

Weevil larvae develop and feed on the receptacle tissue and developing seeds for 16 to 19 days. (Fig. 17). Pupation occurs within the head in a chamber and lasts 8 to 13 days (Fig. 18).

New generation adult weevils emerge during the seed dissemination stage and overwinter outside the seedhead in the ground litter (although a small percentage overwinter in the seedhead) (Fig. 19).



**Figure 16.** *Eustenopus villosus* egg (UGA1350024).

**Impact:**

*Eustenopus villosus* has excellent biocontrol potential because of the dual impacts of adult and larval feeding. Adult feeding and oviposition can destroy young buds, which appear as brown, dry and tilted heads (Fig. 20 and see also, Fig. 11, page 16). Larval feeding in the head can reduce the number of seeds by 90 to 100 percent. *Eustenopus villosus* is slower to disperse than *B. orientalis*.



**Figure 18.** *Eustenopus villosus* pupa (UGA1350026).

**Comments:**

*Eustenopus villosus* was introduced in 1990. It is now widely established in California, Oregon, Washington and Idaho and is abundantly available for collection and redistribution.

External indicators of the presence of *E. villosus* are oviposition scars that look like brown scabs on the side of the bud or at the base of a spiny bract.

The hairs on *E. villosus* tend to rub off late in the season, making the weevil look like *L. curtus*.



**Figure 17.** *Eustenopus villosus* larva (UGA1350025).



**Figure 19.** *Eustenopus villosus* exit hole (UGA1350027).



**Figure 20.** Dead and bent yellow starthistle head from feeding *Eustenopus villosus* (UGA1350028).

## *Larinus curtus*

Insect Order: Coleoptera

Insect Family: Curculionidae

Common Name: Yellow starthistle flower weevil



**Figure 21.** Adult *Larinus curtus* (UGA1350029).

Description: *L. curtus* weevils are medium-brown, oval-shaped with a medium-sized snout and is 0.2 to 0.3 inch (5 to 6 mm) long (Fig. 21). They are often pollen-covered, giving them a yellow, spotted appearance.

Adult weevils appear from overwintering during the BU-3 bud stage. Adults feed and mate on open flower heads and are often seen face down into an open flower head (Fig. 22).

The female weevils must feed on yellow starthistle pollen to develop ovaries. Females prepare an opening among the florets and oviposits a single egg a few millimeters above the receptacle. Eggs hatch in about 4 days. The long oviposition period extends through the entire flowering period.

The weevil larva develops during the seed formation stage and feeds within the capitula on the receptacle and developing seeds. Larval development lasts from 17 to 20 days. Pupation occurs in a chamber within the mature head and takes 4 to 5 days to complete.

The new generation of adults begins to appear during the seed dissemination stage to overwinter outside the seedhead in the ground litter.

### Impact:

Adult feeding on pollen and flowers does little to damage the plant. Seed reduction of 75 to 100 percent is common.

### Comments:

*Larinus curtus* was introduced in 1992. It is now established in California, Oregon, Washington and Idaho. *L. curtus* is the last of the three starthistle weevils to emerge during the summer.

Though not as widely distributed as the other weevils, *L. curtus* is a strong flier and is expected to disperse well on its own. The weevil is parasitized by a protozoan (called *Nosema*) that kills larvae and can decimate some weevil populations.



**Figure 22.** Adult *Larinus curtus* face down in starthistle flower head (UGA1350030).



## Yellow Starthistle Flies



Flies used for starthistle biocontrol are fruit flies; larvae of the flies eat the developing starthistle seeds (fruit). They are small, light to dark bodied, with short antennae and patterned wings.

Adult flies are found on yellow starthistle plants and other flowers where they obtain nectar.

Flies, like weevils, undergo complete metamorphosis: egg, larva, pupa and adult. Yellow starthistle flies usually have two generations per year, although *C. australis* may have three generations per year if the site has a long growing season.

The overwintering generation emerges in the spring from old seedheads during the starthistle bolting stage to feed, mate, and lay eggs. The summer generation adults emerge from a seedhead during the BU-3 stage and feed, mate and oviposit. The larvae from this generation overwinter in the seedhead to finish development and emerge the following spring.

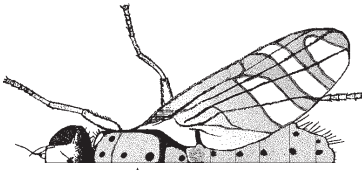
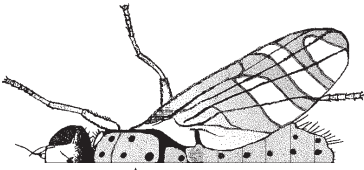
**Table 4.** Comparison of adult yellow starthistle flies.

<i>Chaetorellia australis</i>	<i>Chaetorellia succinea</i>	<i>Urophora sirunaseva</i>
		
4 spots, two per side	6 spots, three per side	yellow spot
Straw-colored body	Straw-colored body	Black body
4 black spots on thorax	6 black spots on thorax	Yellow spot on thorax
Straw-colored wing bands	Straw-colored wing bands	Black wing bands
2-3 generations per year	2-3 generations per year	2 generations per year
Female oviposits inner side lateral bracts	Female oviposits inner side lateral bracts	Female oviposits on top of buds
Release at BU-3 bud stage	Release at BU-3 bud stage	Release at BU-2 thru BU-3 bud stage

**Table 5.** Comparison of fly lifecycles by yellow starthistle growth stages.

YST Stage	<i>Chaetorellia australis</i> and <i>C. succinea</i>	<i>Urophora sirunaseva</i>
Seedling	Larvae in old seedheads.	Larvae within gall.
Rosette	Pupae in seedhead.	Dissect seedheads for galls.
Bolting	Adults emerge.	Adults emerge; find on plants.
BU-1	Females oviposit eggs.	
BU-2	Larvae develop, feed on seeds. Pupate.	Females oviposit eggs. Eggs hatch in 2-4 days. New larvae tunnel, develop, feed on seeds. Larvae pupate. Find adults on plants.
BU-3	New generation adults emerge, oviposit.	New generation adult emerges, oviposits. Eggs hatch in 2-4 days. Larvae develop, feed on seeds.
BU-4	Eggs hatch in 2-4 days. Larvae tunnel, feed on developing seeds. Find adults on plants.	Larvae develop, feed on seeds.
Flowering	Larvae develop, feed on seeds.	
Seed formation		
Mature		
Dissemination	Larvae found in seedheads.	
Senescence		Larvae overwinter. Dissect seedheads for woody galls.

Female flies lay up to 250 eggs that hatch within 8 to 12 days. Fly eggs are generally elongated, white or pale yellow and are deposited on a yellow starthistle bud or in a flower head. The fly larva is white, turning yellowish with maturity, legless, cone-shaped without a head capsule, slightly thicker at one end, and about 0.13 inch (3 mm) in length. Larvae feed and develop through 3 instars inside the yellow starthistle seedhead.

Flies pupate inside the seedhead concealed within a barrel-shaped *puparium*, which is pale yellow with dark ends. Pupae are about 0.14 inch (3.5 mm long). The pupal stage lasts about 2 to 3 weeks.

Table 4 (page 21) compares the three yellow starthistle adult flies for use in identification. Table 5 compares the fly lifecycles at each growth stage of yellow starthistle for use in field activities.

## *Chaetorellia australis* and *C. succinea*

Insect Order: Diptera

Insect Family: Tephritidae

Common Name: Yellow starthistle peacock fly and the false peacock fly

Two small fruit flies introduced from Greece in 1988. These flies can have 2 or 3 generations depending on the length of the growing season.

*Chaetorellia* flies are straw-colored with several black spots on the thorax and light brown wing bands (Fig. 23). They are about 0.12 to 0.24 inch (3 to 5 mm) long; females are typically longer than the males and have an ovipositor. *C. australis* can be distinguished from *C. succinea* by the number of black spots in the thorax.

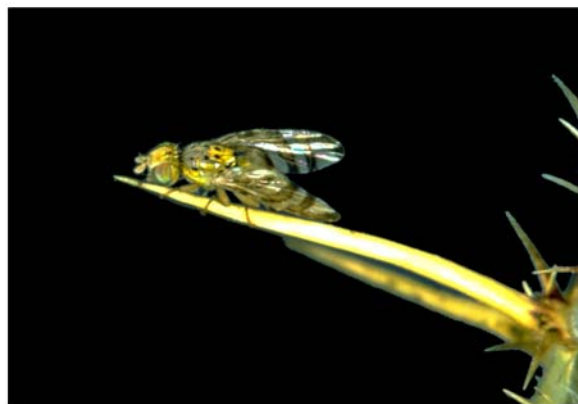

**Figure 23.** Adult *Chaetorellia australis* (UGA1350031).

*Chaetorellia* overwinters in yellow starthistle seedheads as a mature larva and pupates when yellow starthistle is in the rosette stage. The new generation adults emerge in the spring during the yellow starthistle bolting stage and feed on plant nectar.



**Figure 24.** *Chaetorellia australis* larva (UGA1350032).

First generation adults develop on bachelor's button (*C. cyanus*). Summer generation adults generally emerge at the BU-3 stage. Female flies oviposit during the BU-3 or BU-4 bud stage. Eggs are laid singly at the lateral walls of the closed capitulas beneath an bract of a flower head. The eggs are white, spindle-shaped and have a long characteristic filament thickened at the distal end, which can extend beyond the margins of the bract. Eggs hatch within 2 to 4 days. The development from egg to adult takes about 4 weeks.

The fly larvae tunnel into the center of the head, where they feed on the ovaries and developing seeds during the BU-4 through flowering stages (Fig. 24).

**Impact:**

Internal larval feeding reduces the number of developing seeds in the bud by 80 to 100 percent. This agent disperses very well, thus it is widespread in most areas it was established.

**Comments:**

Bachelor's button was thought to be necessary for optimum establishment of *C. australis*. Although the fly is established at most sites without bachelor's button, it is possible that preference for bachelor's button at emergence could be a limiting factor at some sites.

*Chaetorellia succinea* is very similar to *C. australis*. With experience, however, it can be distinguished from *C. australis* by two extra dots on the thorax. *Chaetorellia succinea* has six dots (three per side) on the thorax, *C. australis* has four dots (two per side) on the thorax (see Table 4). *Chaetorellia succinea* was unintentionally introduced into the United States. In Idaho, it was first released in 1997 and has since spread over 100 miles away.



## *Urophora siruneseva*

Insect Order: Diptera

Insect Family: Tephritidae

Common Name: Banded yellow starthistle gall fly



**Figure 25.** Adult *Urophora siruneseva* (UGA1350034).

Adult flies are black with a yellow triangle on the back of the thorax. Wings are marked with dark crossbands. The adults are approximately 0.2 to 0.24 inch (3 to 5 mm) long. The female is typically longer than the male and has an obvious ovipositor (Fig. 25).

*Urophora siruneseva* overwinters in galls in the yellow starthistle seedhead as a mature larva and pupates inside the gall in the spring; pupation lasts 4 to 5 weeks.

First generation adult flies emerge from galls in the spring, about 2 to 4 weeks after *C. australis*, and begin mating within 3 to 4 days. Females then begin oviposition. Eggs are laid on the top of BU-2 or BU-3 buds where the points of the smaller bracts emerge. The eggs are white and spindle-shaped, and about 0.006 inch (0.15 mm) long, and hatch within 9 or 10 days.

After hatching, the larvae eat through the florets in the head, and can be found on and between the florets. When the larvae reach the receptacle, the gall begins to form. Tissues begin to grow and change consistency, forming a hard gall around the larva. There is one larva per gall and up to four galls per seed head. Galls of the summer generation larvae are thin and delicate compared with the thicker galls formed by the overwintering generation.

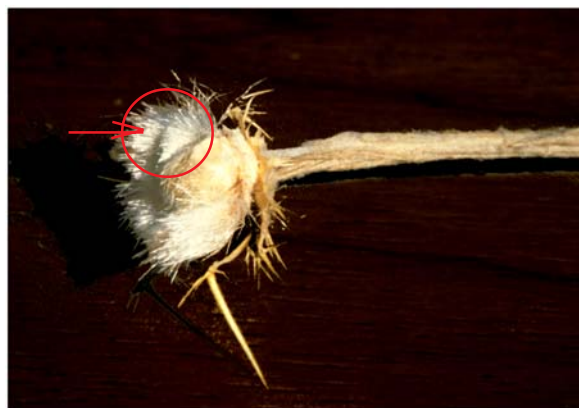

**Figure 26.** *Urophora siruneseva* woody gall (UGA1350035).

Larva and pupa can be found by dissecting the seedhead. Presence of a woody gall within a seedhead is an indication of presence of the agent (Fig. 26).

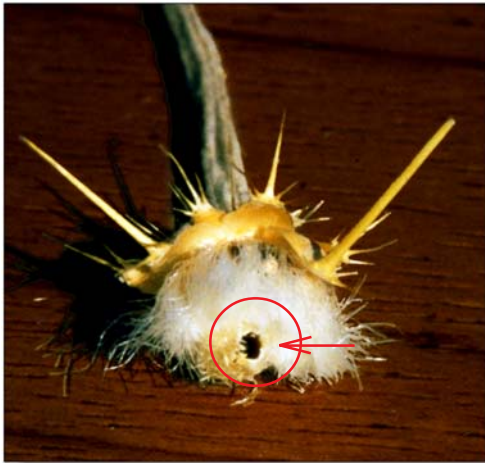

**Figure 27.** Emergence hole of *Urophora sirunaseva* (UGA1350036).

Pupation lasts about 2 to 3 weeks inside the gall. The summer generation adults emerge in late June and early July and begin oviposition within 3 days. An emergence hole in the gall can be detected (Fig. 27).

Larvae of this generation feed and develop for about 3 weeks. Once the larvae reach maturity, they enter diapause and overwinter in the gall formed in the yellow starthistle seedhead for approximately 7 months.

**Impact:**

Internal larval feeding reduces the number of developing seeds in the head by approximately 50 percent. Heads infested with this gall fly produce fewer seeds than heads infested with *Chaetorellia* flies.

**Comments:**

The presence of high densities of *U. sirunaseva* at a site does not appear to interfere with the survival of other seedhead infesting agents. The seedhead fly, *U. quadrifasciata*, is sometimes found in yellow starthistle seedheads.

## CHAPTER 3: ELEMENTS OF A YELLOW STARHISTLE BIOLOGICAL CONTROL PROGRAM

This chapter discusses the elements necessary to successfully establish and operate a yellow starthistle biological control program. Successful biological control programs require careful planning and implementation and a commitment to evaluation and monitoring. This chapter provides detailed information and guidelines to make your yellow starthistle biocontrol program a success.

1. **Background information.** Read the information contained in this manual and become familiar with: 1) general knowledge of biological control of weeds, 2) yellow starthistle biology, and 3) its biocontrol agents (also referred to as bioagents, flies, and beetles). It is essential to be able to identify yellow starthistle (Fig. 28) by growth stage, each of the biocontrol agents, and to recognize how they impact the weed.



**Figure 28.** Yellow starthistle plant (UGA1350037).

2. **Select the release site.** Make note of the bioagents already present at the selected site (see “Selecting a Site”).
3. **Schedule field activities.** Timing of the collection and release is crucial for the success of a biocontrol program; thus, pay close attention to scheduling of field activities. For optimum results, follow the timetables suggested in this chapter as closely as possible.
4. **Obtain bioagents.** Collect, handle, transport and release the bioagents at the selected site.
5. **Monitor bioagents and vegetation.**

A systematic process to establish a yellow starthistle biological control program consists of the following elements:

1. Selecting and preparing study sites
2. Collecting biocontrol agents
3. Transporting biocontrol agents
4. Releasing biocontrol agents
5. Monitoring
  - a) Biocontrol agents
  - b) Vegetation (quantitative and qualitative)
6. Establishing photo points

Methods for carrying out each of these processes are discussed in separate sections in this chapter.

(For solutions to common problems encountered when establishing a starthistle biocontrol program, see Appendix A.)

## 1. Selecting and Preparing Release Sites

There are three types of biocontrol sites: study, nursery, and field release.

**Study site.** A study site is a release site where the damage and impact is evaluated. Study sites can be used as demonstration areas for educational and training purposes, and can be monitored intensively to determine the effects of bioagents on starthistle over time. However, demonstration and monitoring activities at the study site should be planned carefully because frequent site visits can damage the site through disturbance and trampling of vegetation.

**Nursery site.** A nursery site, or field insectary, is used to grow large quantities of surplus bioagents for redistribution to other starthistle infested areas where bioagents have not been previously released or are of low density. Nursery sites should be left undisturbed for 3 to 5 years to allow the bioagent populations to increase. Careful monitoring will determine when the bioagent population is

large enough to enable collection for redistribution. It is essential that nursery sites receive minimal disturbance.

**Field Release.** A field release site is simply an open site for general control purposes. Monitoring or redistribution efforts are not planned for these sites.



**Figure 29.** Example of yellow starthistle infestation suitable for a biological control program (UGA1350038).

### Selecting the Site

The type of site you select will depend on the objectives of your biocontrol program. Visit prospective field sites. Use the following guidelines and criteria to select a site (study, nursery, or field release).

**Location.** Consider accessibility, slope and cover (avoid shaded, forested sites).

**Size of site.** An area with at least 2 acres of starthistle infestation is minimal. However, a larger area of infestation is more desirable (Fig. 29).

**Presence of bioagents.** If bioagents you want to release are already present at the

prospective site, move on and choose a different location.

**Density of infestation.** Choose a moderately dense area of infestation, an area containing three or more starthistle plants per square yard.

**Landuse and disturbance factors.** Select sites that are not cultivated, away from land development, and where no livestock are grazed.

**Pesticides.** Select sites which are pesticide-free (no herbicides and insecticides have been or will be applied to the area).

**Landowner consent.** The landowner/manager must be willing to have the release site available for visitations and monitoring over several to many years. Consent is particularly important when planning a study or nursery site. When getting permission to use a site, be sure to secure the following:

1. Written permission from the landowner or land manager allowing use of the area as a release site.
2. Written agreement by the landowner allowing access to the site for monitoring and collection for a period of at least 6 years (3 years for establishment and buildup and at least 3 years for collections).
3. Permission to put a permanent location marker at the site.



## Preparing the Site

Preparing the release site involves the following activities:

- Determine the need. Look for presence of bioagents before the release is made. Some yellow starthistle bioagents are so common and widespread that it is no longer necessary to redistribute them. For example, the weevil *Bangasternus orientalis* is the most widespread agent and will likely already be present at the site. If so, it will not be necessary to release this weevil at the site.
- Establish a permanent location marker. After selecting a site, choose a dense, uniform patch of yellow starthistle in which to place a marker. Use white-colored markers (wood or metal stake) to mark the exact location of the release. The stake must be tall (about 4 feet [1.2 m]) and clearly visible so that it can be easily found during future visits.
- Set up a photo point. A photo point (see page 47) is used to photographically record changes in yellow starthistle infestation (decline or increase) over time following release of bioagents at a site. Use a permanent feature in the background as a reference point.
- Draw a map. A map and written directions to study and nursery sites are essential for other people to locate the site. Note permanent roads, creeks, rivers, mile markers, etc. Include the legal description or latitude and longitude global positioning system (GPS) coordinates so that the site can be easily re-located.
- Monitor baseline vegetation. In study sites where vegetation will be monitored, baseline data are used for comparing yellow starthistle infestation measurements before and after releasing bioagents in the area. It is always useful to collect baseline vegetation data even at nursery or field release sites (see page 44).

## 2. Collecting Biocontrol Agents

Planning and timing of the collection is critical (Chart 1). The type of bioagent will dictate the best time in the season and method of collection. Ensure that all necessary collection supplies are on hand. Also, accurate identification the bioagents is important. Whether collecting larvae or adults, follow these general guidelines.

### General Collection Guidelines

**Quantity.** The minimum needed to optimize establishment is 200 bioagents per site, but more is better.

**Containers.** Use “breathable” containers at all times. Breathable containers allow air flow to the insects and will not form condensation. One of the best containers to use is a pint-sized, non-waxed ice cream carton. These are sturdy and breathable. Paper bags can work as temporary containers if care is taken to keep the bag from getting wet or squashed. Do not use plastic bags as containers

Chart 1. Phenology of yellow starthistle and its biocontrol agents.

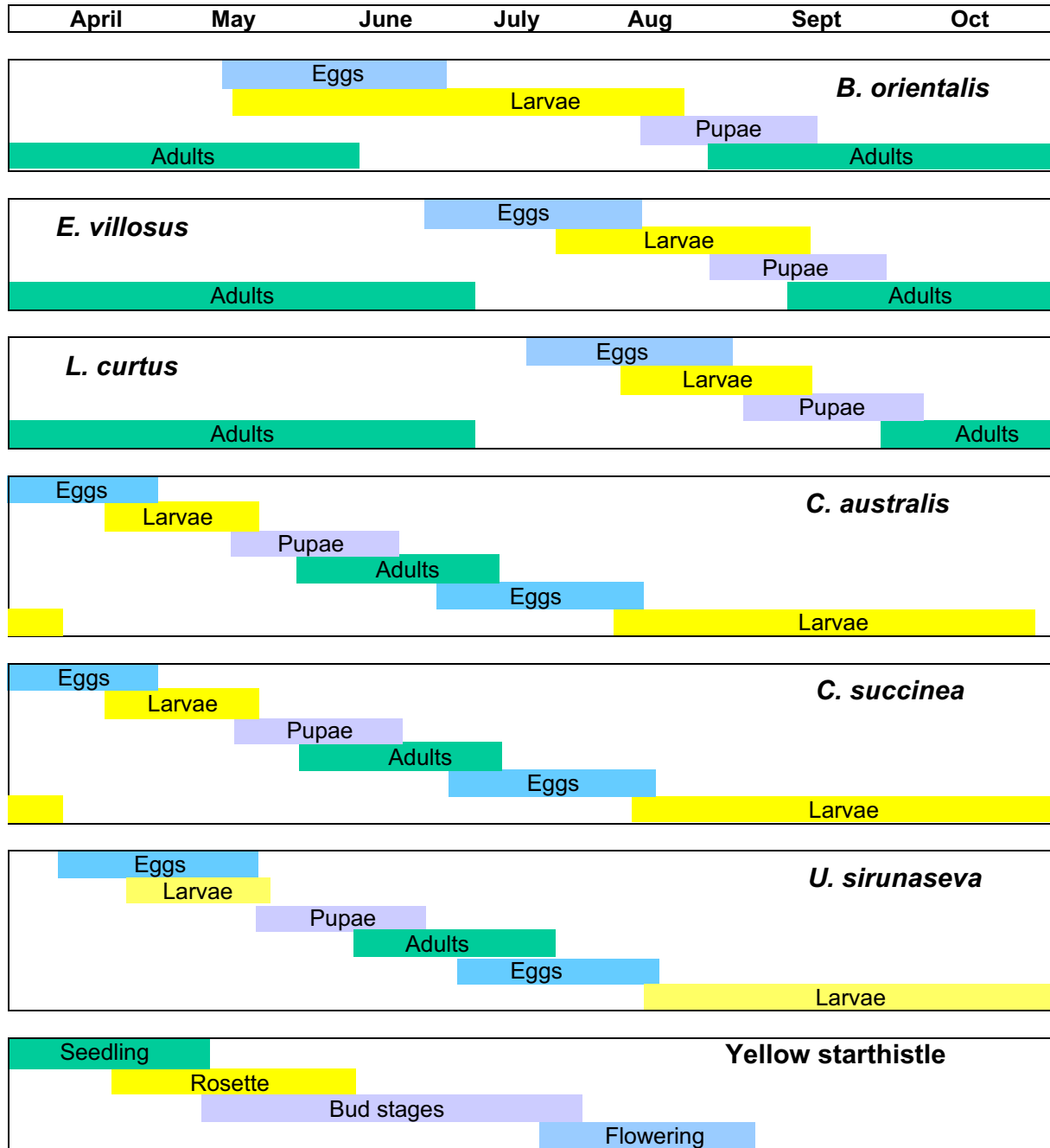

because they are airtight and will not release moisture. Put a small wad of toilet tissue in the container to absorb moisture and to give the insects a crawling surface.

**DO NOT USE PLASTIC BAGS AS CONTAINERS**

**Cooling.** Keep bioagents shaded and cool at all times while collecting, sorting, counting and transporting. Bring a cooler with pre-frozen blue ice packs to the field. Secure an ice pack to the interior side of the cooler so that it does not roll around and crush the bioagents.

**Sorting.** Sorting is done after collecting to separate the insects from other organisms and debris, such as weed seeds, collected along with the insects. Empty the contents of the sweep net onto a tray and aspirate or hand-pick the insects out of the debris. For fast moving insects, keep them in the net and grip the top of the net at the rim. Slowly loosen your grip to open the top of the net and collect the insects as they attempt to escape (insects will always move toward the light). If the collected material is first chilled, the insects (especially weevils) move slower and are easier to collect.

**Care.** Exercise care in handling bioagents (see “Handling Biocontrol Agents”). Difficulties that may be encountered when collecting bioagents are identified in Appendix A: Troubleshooting Guide: When Things Go Wrong.

**Supplies Needed**

- Breathable container
- Masking tape
- Paper towel or styrofoam (for transporting)
- Cooler
- Blue ice pack
- Cardboard box (for shipping)

**KEEP INSECTS COOL AND SHADED WHILE COLLECTING SORTING, COUNTING OR TRANSPORTING THEM**

**Planning and Timing**

Planning and timing of bioagent collection is critical. It involves knowing where, when, how and what to collect.

**Where to collect**

Collect from nursery sites or open field sites that have an abundance of insects. You may wish to consult with your county extension educator, university or state entomologist, or county weed superintendent for an appropriate site.



**When to collect:**

- Collect insects at their peak emergence time, when they are mating and their density is highest.
- When sweeping for insects, the best time to collect is during the heat of the day (between 1:00 and 6:00 p.m.) because bioagents are more active at that time.
- Wait for a good day. Do not collect in the rain. Flying insects will not be active during a rain; crawling beetles will hide in protected niches and become more difficult to find. Excess moisture from bioagents collected wet can result in drowning and mold problems.

**Common Mistakes**

- **Excess heat.** Do not expose biogents to direct sunlight
- **Excess moisture.** Remove spilled or excess water in the container
- **Lack of air.** Provide adequate ventilation; use only breathable containers.

**How to collect**

Choose a collection method suggested in Table 6 (page 35). The best collection method is the one that i) produces the greatest number of insects in the least amount of time and effort, ii) produces insects in the best condition, and iii) requires to least handling and sorting (clean collection). The six typical collection methods are as follows: sweep net, aspirator, handpicking, tapping (stick and bucket), black light, and seedhead collecting.

- Sweep net: A sweep net is made of cotton or muslin on a 10"-15" hoop attached to a 3' (0.9 m) long handle (Fig. 30).



**Figure 31.** Sweeping for insects (UGA1350070).

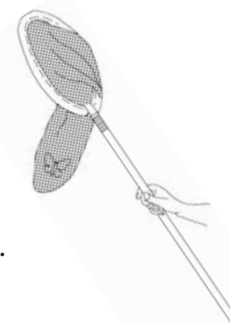

**Figure 30.** Sweep net.

As its name implies, it is used to “sweep” weevils off the yellow starthistle. The sweep net method is relatively easy and efficient and is recommended for collecting adult weevils. It is best to sweep no more 25 times and then aspirate the insects out of the net, alternating between sweeping and aspirating (Fig. 31). This reduces the harm that could result from knocking the bioagents around with debris or other insects inside the net.

- **Aspirator:** Use an aspirator (Fig. 32) to suck the weevils from the plant or out of a sweep net. When using an aspirator, little unwanted or unknown material is inadvertently collected and the quantity of the agent being collected is easier to record. Transfer the weevils from the aspirator to a collection container. Seal and label the carton with the species, number of bioagents, collection site and date.

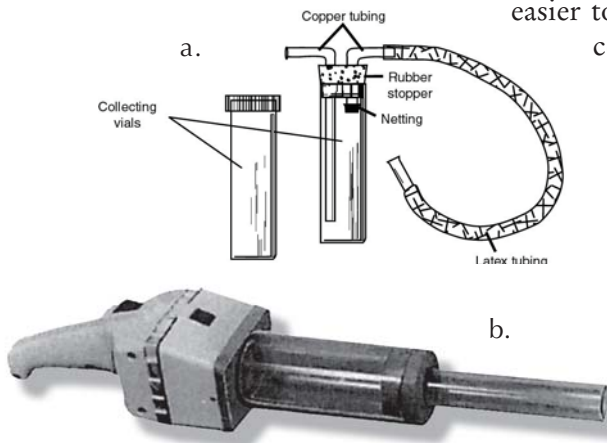

**Figure 32.** Aspirators for collecting biocontrol agents. a. Manual. b. Hand held vacuum, gasoline or battery powered.

- **Tapping:** If a sweep net is not available, tapping is the easiest collection method to use for collecting weevils. Using a stick, gently tap the yellow starthistle stems to knock the weevils into a bucket or onto a plastic tray. Separate the weevils further from unwanted plant material that dislodges during tapping, then place them in a breathable container.

**What to collect**

For starthistle biocontrol agents, weevils are collected as adults and flies are collected as larvae or pupae. See Table 6 for the appropriate life stage in which to collect bioagents.

**Collecting weevils.** Weevils are best collected as adults. The ideal weather for collecting weevils is a sunny, warm day with a slight breeze. It is best to collect weevils when they are mating to ensure you are collecting both males and females and that eggs will be laid at the new site (Fig. 33). Adult weevils can be collected easily by sweep-netting. Hand-picking is possible but it is slow. Weevils will usually jump away or fall to the ground when they see you coming. Determine the collection and release date(s) using the recommended timetable (Tables 6 and 7) to plan your collection.

**Collecting flies.** Flies are best collected as larvae or pupae. Sweeping adult flies is not recommended because they are fragile and can be damaged during collection, transportation and release. Rather, collect fly-infested heads in late winter or early spring (mid-February to mid-March). Flies are overwintering as larvae or pupae in the heads at this time. Heads



**Figure 33.** Collecting yellow starthistle biocontrol agents (UGA1350039).

**Table 6.** Collection methods for yellow starthistle biocontrol agents.

Agent	Method
<i>Bangasternus orientalis</i>	The adults are inactive and difficult to see during the cool morning hours, however, sweeping at any time during the day will be successful if the weevils are present. The tap method is an efficient and productive collection method for collecting weevils, although sweep netting is preferable.
<i>Eustenopus villosus</i>	Sweep netting is the recommended method. The tap method is also effective.
<i>Larinus curtus</i>	Sweep method or tap method works well.
<i>Chaetorellia australis</i> , <i>C. succinea</i> and <i>Urophora sirunaseva</i>	Adult flies can be collected by sweeping, but it is difficult and the flies can be damaged. The seedhead collection method is the easiest.

**Table 7.** Release methods for yellow starthistle biocontrol agents.

Agent	Method
<i>Bangasternus orientalis</i>	Release mating weevils during the BU-1 through BU-3 bud.
<i>Eustenopus villosus</i>	Release mating weevils during the BU-3 and BU-4 bud stages. <i>E. villosus</i> tends to disperse more readily uphill than downhill. Releasing the agents at the bottom of the hill encourages the agents to follow the phenological stages of the yellow starthistle uphill, which may increase the rate of spread.
<i>Larinus curtus</i>	Release mating weevils during the flower stage.
<i>Chaetorellia australis</i> and <i>C. succinea</i>	Transferring fly-infested heads in early spring is the best method, however, if releasing adults, collect and release adults during the BU-3 bud stage..
<i>Urophora sirunaseva</i>	Transferring fly-infested heads in early spring is the best method; however, if releasing adults, collect and release adults during the BU-3 bud stages.

can be taken indoors to rear out adults, or taken to the new site and left to emerge as adults under natural conditions.

### Rearing flies indoors

Collect several hundred dry seedheads from last year's plants and put them in labeled paper bags. Once indoors, adults will likely emerge in a few weeks, so time the collection of heads carefully. You do not want adults to emerge too early and be out

of synchrony with the starthistle plants, so collect heads a few weeks before flies would normally emerge outdoors. Empty infested seedheads from bag into a clear, breathable container such as a covered terrarium or in a rearing cage (Fig. 34). Leave the heads at room temperature. In 2 to 3 weeks, adult flies will begin to emerge from the seedheads. Collect the adults that emerge, package and release them at the new site, or ship them to a cooperator.

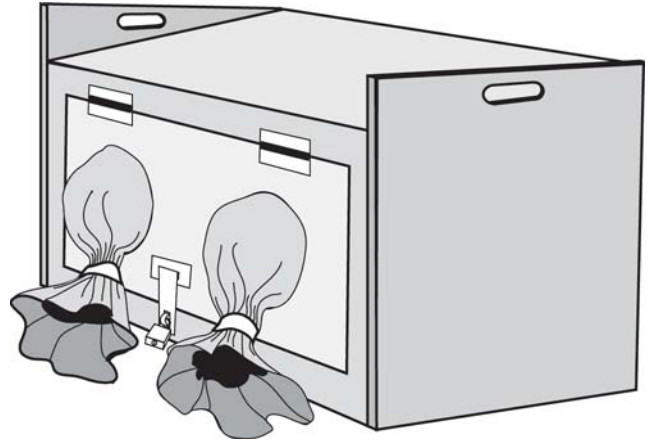

**Figure 34.** Insect rearing cage, also called a sleeve box.

### 3. Handling Biocontrol Agents

How the bioagents are handled after collection and transported to the release site can affect whether the bioagents will survive and multiply at the new site. This section contains guidelines for transporting and shipping the bioagents.



**Figure 35.** Paper-towel lined carton containing bioagents (UGA1350071).

#### Transporting Bioagents

How the bioagents are handled and transported can greatly impact whether they become established. It is best to redistribute the bioagents immediately after they are collected to prevent injury to the specimens, within 24 hours if possible.

- For immediate redistribution. Transport the insects in a breathable container with crumpled tissue (Fig. 35).
- For later redistribution. Store the weevils in a refrigerator. Weevils can last up to 3 days in a refrigerator; however, only 1 day of refrigerated storage is recommended. For storage longer than 1 day, bring them out of the refrigerator for an hour each day.
- Seal and label the container. Seal with tape and label the container with the name of the bioagent, the quantity collected, and collection date. Tape a blue ice pack to the bottom of the cooler to avoid physical damage. Put a barrier (e.g., newspaper) between the ice pack and the bioagents to protect the bioagents from excess moisture or cold.

#### Shipping Bioagents

To ship bioagents over a long distance, plan the route and timing of shipments to prevent undue delays and stress on the bioagents. Ship the agents by overnight courier and notify your cooperator when they are being shipped, when they can expect to receive them and to release the insects immediately. Try to collect on the Sunday or



Monday, and ship Tuesday or Wednesday, so releases can be made before the week-end. Avoid shipping late in the week, and be aware of holidays etc, that can delay shipping. Overall, observe the following guidelines:

**Know the regulations.** Observe appropriate rules, restrictions and regulations pertaining to shipping bioagents to a cooperator or moving bioagents out of the county or state. For the current regulations, contact your local weed district, cooperative extension agent, the state Department of Agriculture, or the USDA Animal and Plant Health Inspection Service (APHIS).

**Prepare the bioagents.** Sort the bioagents from all other unwanted material to avoid contamination at the receiving site.

**Shipping containers.** Put bioagents in containers with enough space to allow the insects to move about within the container. Line the container with a crawling surface for the insects (such as wadded tissue or paper towel). Do not put food or water in the container. Tape lids on the containers and make sure that the bioagents do not get caught on the sticky part of the tape. Pack the shipping container with care. Tape the blue ice packs to the inner side of the chest and pack with a layer of paper to absorb condensation (Fig. 36). Keep the bioagents cool until they are shipped.



**Figure 36.** Shipping box containing agents and cartons, styrofoam to prevent shifting, and blue ice packs (UGA 1350072).

### Summary: Care of Bioagents

- Provide the bioagents with a crawling surface, such as crumpled tissue or paper towel.
- Avoid physical damage to the bioagent by taping down potentially harmful objects, such as blue ice packs.
- Ensure that predators (i.e. spiders and ants) are not trapped with the bioagent in the container by sorting bioagents before packaging them.
- Do not expose bioagents to heat above 80°F. Keep shipping containers cool (in a cooler) and out of direct sunlight.
- If release or shipping is not immediate, store the bioagents in refrigerators no colder than 40° to 50° F (4°C) for a no longer than 2 days or keep them in an ice chest until the bioagents are ready to be shipped or transported. Longer storage decreases the bioagents' chance for survival at the new site.
- Provide container with adequate ventilation. If necessary, punch holes in the lid with a pin.

## 4. Releasing Biocontrol Agents

Timing the bioagent release is critical (see Table 7, page 35). It will determine whether the bioagents survive and flourish at the new site. Follow these steps for releasing bioagents:

1. Place the permanent location marker. Release the insects at the location marker. This location will be later used in monitoring activities.
2. Make the release. Consult Table 7 to determine the appropriate method to use for releasing each insect.
3. Take pictures. Take a series of photographs to record the release. A photo point will record the change in the site over time. (For further information, see page 47).
4. Collect baseline vegetation data. Choose a monitoring method (see Tables 8 and 9). Establish baseline data at the time of the release. Use the same monitoring method every year.
5. Fill out and submit a release form. Complete the Biocontrol Agent Release Form (see Appendix B). Submit the form to your county extension educator, university or state department of agriculture. Keep a copy for your records.

### Timing the Release

Release bioagents at the appropriate growth stage of the yellow starthistle (review “Selecting and Preparing a Study Site”) or check with your county extension agent or county weed supervisor. If most yellow starthistle buds are beyond the recommended stage, it is too late to release at that site.

Do not wait for good weather. If you must release in the rain, provide shelter for the bioagents until they can disperse on their own. One way to do this is to place a cardboard box on its side, place the container in the box and open the lid. The bioagents will disperse when weather conditions improve.

The three methods of releasing bioagents are as follows:

- Direct placement of the fly-infested heads: The easiest method for releasing flies is to place bouquets of infested plants at the new site. Collect last year’s plants in late winter, tie them into bouquets, take them to the new site and secure the bouquets to fence post or stake. Adults will emerge later in the spring as usual and establish at the new site. Retain 50 heads from the bouquet, put them in a labeled paper bag or dry container and allow the insects to emerge indoors. This allows you to be certain which species you released at the new site. You can also estimate the number of flies released based on how many adults emerge from the seedheads.



- Open-field release. When releasing adult weevils or flies, place the bioagents on the ground within a radius of 3 feet of the permanent location marker under yellow starthistle plants where they can continue to mate and disperse on their own.
- Caged release. An alternative to open-field release is to put the insects in a release cage or tent (Fig. 37). The bottomless tent, placed over a patch of yellow starthistle, is very useful in keeping flying insects together while giving them “natural” conditions. Another simpler release cage is constructed from plastic milk jugs (Fig. 38) used for seedhead flies. The cover over the jug keeps the seedheads dry; newly emerged adults can escape through the hole under the handle, and seeds are not released into the environment (the jug, with seeds, can be removed later).



**Figure 37.** Screen cage in which to release yellow starthistle biocontrol agents (UGA1350041).

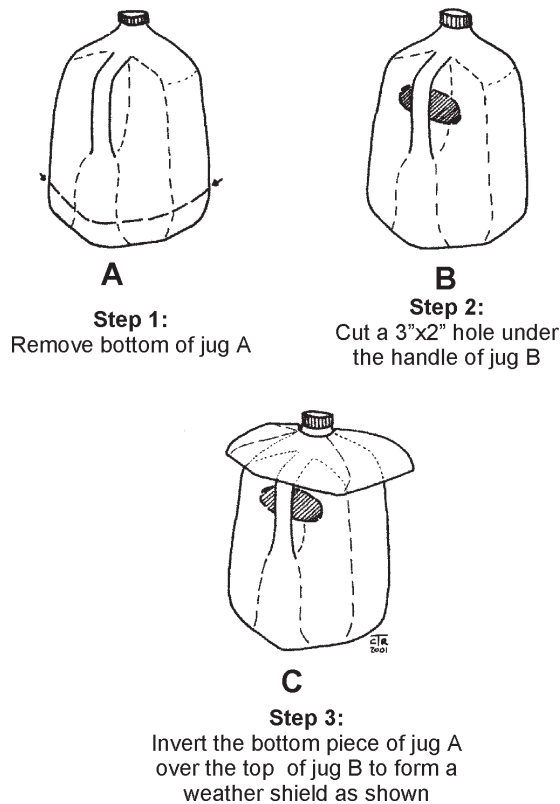

**Figure 38.** Milk jug release cage for yellow starthistle bioagents.

### Retaining Voucher Specimens

Retain 5 to 10 bioagents (dead or alive). Put the bioagents in a small vial with 70 percent ethyl alcohol (ethanol) or rubbing alcohol for a voucher specimen. On a piece of white paper, in pencil (always use a pencil because alcohol will dissolve and bleed ink from pens and markers), write the name of the bioagent, source of the bioagent, the date of release, person or agency releasing, and release site. Put inside the vial. This identifies the bioagents released for future reference. Save several specimens for in-house records. Send the voucher specimens to your county extension educator or weed biocontrol expert.

### Frequency of Release

Generally, if done correctly a single release will be sufficient to establish a bioagent population. More

## Questions to Ask

---

- Are the bioagents already present at the site?
- Did the bioagents successfully establish following release?
- Are the bioagents found in high enough density to be collected and distributed?
- How far have bioagents dispersed from the initial release sites?
- Are the bioagents causing visible damage to the target weed?
- Are changes occurring within the plant community?

*Answers to these questions will allow land managers to do the following:*

- Determine the success of biological control efforts for target weed populations.
- Determine if a supplemental release is needed.
- Establish that biocontrol agents are impacting the target weed.
- Document changes in the plant community.

than one release might be needed if a prior release fails. It might take 2 years to determine if the release was successful.

### Releasing Multiple Bioagents

It is expected that bioagent populations will overlap and eventually sort themselves out naturally depending on the habitat, population density, and weed levels. As a rule, however, separate the species by at least 110 yards (100 m) to allow your insect to establish without being impeded by another species.

### Suggestions for Optimal Establishment

- A release of 200 bioagents is minimal.
- Releasing in the early morning hours between 6 and 10 a.m. or in the cooler evening hours between 7 and 8 p.m. is recommended. Bioagents are less likely to fly away immediately when released in cool temperatures.
- Avoid releasing weevils during rainy or very hot weather for optimal establishment. However, sometimes it may be necessary to release in the rain.
- Releasing weevils at the bottom of a hill may encourage them to follow the phenological stages of the yellow starthistle uphill, which may possibly increase the rate of spread.
- Common sense and care is a major factor in the survival and establishment of the insects.

## 5. Monitoring

Monitoring is an activity that follows changes in the weed population that you are observing or measuring. In biocontrol, it involves monitoring insects and vegetation at the study site. Monitoring is conducted to: 1) ensure that the bioagents have established, 2) determine if the bioagents have spread from the release site, and 3) assess the impact of the bioagents on the target yellow starthistle. Monitoring provides useful information. Consider the *Questions to Ask* box above to determine your monitoring objectives. Outline your monitoring objectives before you begin monitoring (see Appendix C).

### A. Monitoring Biocontrol Agents

#### When to Begin Monitoring

Some bioagents may be detected as early as 1 year following release. Most bioagents take 2 to 4 years to be detectable. Thus, if no bioagents are detected a year after the release, it does not mean that the insects failed to establish. Revisit the site for 4 years. If no evidence of insects is seen, either choose another site or make additional releases (see Appendix A for reasons on why agents fail to establish.) Consult with your county extension educator or local biocontrol of weeds expert. See Tables 8 and 9 (pages 42 - 43) to determine how and when to monitor starthistle bioagents.

#### Monitoring Methods

The monitoring method you choose depends on the life stage of the insect, amount of time available, expertise of the observer, availability of equipment, and your monitoring objective.



**Figure 39.** Monitoring yellow starthistle biocontrol agents (UGA1350042).

For example, to merely determine if bioagents are established at the release site, observing any life stage is adequate. To determine the density of insects at the release site (i.e., number of insects per square yard), more detailed and intensive monitoring is needed. Likewise, if you want to know how far the bioagents have spread from the release site, a more systematic monitoring method is needed.

It is usually necessary to collect bioagents in order to monitor their population and activity. The collection methods described in “Collecting Biocontrol Agents” work just as well in monitoring starthistle

biocontrol agents. An additional monitoring method is visual counting adults (Fig. 39). This is an easy and fast way to monitor starthistle insects. Using six to ten, 60-foot (20 m) long transects radiating away from the permanent location marker at the

**Table 8.** Suggested timing for monitoring yellow starthistle weevils.

YST Stage	Monitor for	Activity
<i>Bangasternus orientalis</i>		
Bolting - seed dissemination	Presence, absence or establishment	Look or sweep for adults.
Bolting	Overwintering generation adult emergence	Look or sweep for adults.
BU-1 thru BU-3	Determine collection and release date	Look for mating adults. Look for black, tear-shaped egg cases on or near the heads.
Seed dissemination	New generation emergence	Look or sweep for adults.
<i>Eustenopus villosus</i>		
BU-1 thru seed dissemination	Presence, absence or establishment	Look or sweep for adults. Look for adult feeding damage: wilted heads, dead buds, buds bent at an angle.
BU-1BU-2	Overwintering generation adult emergence	Look or sweep for adults. Look for adult feeding damage.
BU-3 thru BU-4	Determine collection and release date	Collect when weevils are mating.
BU-4 thru seed dissemination	Presence, absence or establishment	Look or sweep for adults. Look for adult feeding damage. Look for oviposition scars.
Seed dissemination	New generation emergence	Make a visual count of emergence holes. Record number of exit holes seen during 15-minute time period. Record distance from permanent location marker.
Seed dissemination thru senescence	Presence, absence or establishment	Look for oviposition damage as darkened area among pappus hairs.
<i>Larinus curtus</i>		
BU-1 thru seed dissemination	Presence, absence or establishment	Look or sweep for adults.
BU-1 thru BU-4	Overwintering generation adult emergence	Look or sweep for adults.
Flowering	Determine collection and release date	Look for mating adults. Look for adult chewing damage in center of flower, and adults face down in an open flower head.
Seed dissemination	New generation emergence	Look or sweep for adults.

**Table 9.** Suggested timing for monitoring yellow starthistle flies.

YST Stage	Monitor for	Activity
<i>Chaetorellia australis</i>		
Bolting - BU-4	Presence, absence or establishment	Look or sweep for adults
Bolting	Overwintering generation adult emergence	Look or sweep for adults
BU-3	Determine collection and release date	Collect when flies are active
Seed dissemination	New generation emergence	Look or sweep for adults. Find larvae inside heads
<i>Chaetorellia succinea</i>		
Bolting - BU-4	Presence, absence or establishment	Look or sweep for adults
Bolting	Overwintering generation adult emergence	Look or sweep for adults.
BU-3	Determine collection and release date	Collect when flies are active
Seed dissemination	New generation emergence	Look or sweep for adults. Find larvae inside heads
<i>Urophora sirunaseva</i>		
Bolting - flowering	Presence, absence or establishment	Look or sweep for adults
Bolting	Overwintering generation adult emergence	Look or sweep for adults
BU-2 - BU-3	Determine collection and release date	Look for mating adults. Collect when present and active
BU-3	New generation emergence	Look or sweep for adults. Look for emergence hole. Look for evidence of gall

release site, count the number of adult insects you see on or near the plants in a 3-5 foot (0.9-1.6 m) circle every 20 feet (6.6 m) along the transect.

In order to evaluate larval feeding damage inside the starthistle head, follow this quick method of collecting plants to evaluate larval feeding damage. Collect 10 plants along each of four lines (transects) in four cardinal directions (N, S, E, W) from the permanent location marker, for a total of 24 plants. Clip all of the heads and place them in a paper bag. Label collection bags with site name, date and transect. Heads can be dissected indoors to see if they contain bioagent larvae or pupae. Dissect each bud carefully to determine what larva, pupae and adults is/are in the head (Table 10, page 44). Record the species of insect and the number of larvae present. More than one

species can be present in the same head. Be sure to count and record the total number of buds and seedheads collected from each plant.

Fill out the “Biocontrol Monitoring Report” (Appendix D).

**Table 10.** Identification of yellow starthistle biocontrol agent larvae and pupae.

Agent	Description
<i>Bangasternus orientalis</i>	Larva C-shaped, cream-colored with light brown head capsule. Feeds on receptacle and developing seeds. Forms pupal chamber from frass. Larval damage to seeds 40% to 60%.
<i>Eustenopus villosus</i>	Larva C-shaped, cream-colored with light brown head capsule. Leaves a mass of chewed-up debris in the bottom of the receptacle. Forms chamber from debris and glue-like substance. Larvae predatory. Larval damage to seeds 75% to 100%.
<i>Larinus curtus</i>	Larva C-shaped, cream-colored with light brown head capsule. Leaves a mass of chewed-up debris in the bottom of the receptacle. Larval damage to seeds 75% to 100%.
<i>Chaetorellia flies</i>	Larva flattened and dirty lemon-colored; found at base of the receptacle and encased in sticky mass of matted pappus hairs. Seed is found partially chewed. Multiple larva per seed head. Pupate in head. Larval damage to seeds 80% to 100%.
<i>Urophora sirunaseva</i>	Larva cream-colored with dark brown anal plate. Forms a woody, one-chambered gall in which it pupates. Larvae damage seeds 50%.

## B. Monitoring Vegetation

Vegetation monitoring is conducted to describe and measure changes in the yellow starthistle population following the release of bioagents. It consists of taking multiple measurements of a variable, such as plant height, density or number of seedheads. Analysis is performed to determine if changes in the weed infestation have occurred. The type of vegetation monitoring to use depends on the type of site (e.g., study or nursery site), availability of resources, and your monitoring objective.

Monitoring can be as simple as before-and-after photos, or counting seeds left in seedheads, or as intensive as conducting field studies for accurate and detailed assessment over time. The level of intensity used in monitoring should be dictated by the questions you want to address and the level of precision you need in the answer. In general, the simpler the monitoring method, the greater the likelihood of obtaining consistent and useful information. Develop a plan for collecting data based on the monitoring objectives. Use the “Monitoring Plan Questionnaire” (see Appendix C) to determine the objective or purpose of monitoring.

Two types of monitoring are *qualitative* and *quantitative*.



### Qualitative monitoring

Qualitative monitoring uses descriptive elements about yellow starthistle at the management site. It includes such general recording of presence or absence of bioagents, estimates of density, age and distribution classes, infestation mapping, and permanent photo points. Qualitative monitoring tends to be quick and inexpensive, and provides some insight into the status or change of the starthistle population. Its descriptive nature does not allow for detailed statistical analysis. Data obtained in qualitative monitoring may trigger more intensive monitoring later on. In addition, interpretations derived from this type of monitoring are often subjective.

### Quantitative monitoring

The purpose of quantitative monitoring is to record and measure changes in the yellow starthistle population after release of the bioagents. Quantitative monitoring can be as simple as counting the number of flowering starthistle plants in an area, or as detailed as measuring plant height (Fig. 40), seed production, rosette diameter and density, biomass, or plant community diversity. The data can be statistically analyzed and generally give precise information on population or community changes. In quantitative monitoring, sampling is more detailed than in qualitative monitoring (e.g., plant height, rosette diameter, number and size of seedheads, percent cover, species diversity). Quantitative monitoring takes more time to plan and implement, making it more expensive. It may also require specialized skills and training.



**Figure 40.** Measuring plant height at a quantitative monitoring site (UGA1350076).

A suggested format for qualitative and quantitative monitoring:

- **Choose location to monitor.** Begin monitoring where the bioagents were first released since this is where the highest density agents is likely to occur and therefore where changes to the yellow starthistle are more likely to be detected.
- **Schedule monitoring activities.** Schedule monitoring activities at the same time each year to be consistent and compare year-to-year variation.
- **Determine a photo point.** Establish a permanent photo point in the monitoring area. The photo point is an area where estimated cover and/or density classes of the yellow starthistle can be recorded. Be sure to label the photo point. Create a photo record beginning at the time of bioagent release and at 2-year intervals thereafter (called before-and-after photos). Trends and changes in the starthistle infestation and the plant community over time can be visually assessed with photographs.

- **Plan.** This step involves knowing what and how much data to collect before starting. Consult an experienced field technician, researcher or statistician for guidance on the design of your monitoring plan. The types of variables usually measured are one or more of the following:
  - **Visual estimates** (*qualitative*). Record visual estimates of canopy cover. Determine the density and distribution classes of starthistles at the release site at 1- or 2-year intervals (distribution classes are seedlings, rosettes, bolted and mature). Fill out a qualitative monitoring report (see Appendix E). Personnel may have to be trained in estimating general vegetation attributes.
  - **Counts** (*quantitative*). Count the number of seedlings, rosettes, seedheads, flowering starthistle plants within the quadrat (Fig. 41). Seeds can be counted from a sub-sample of heads (about 30 heads) within the quadrat.
  - **Measurements** (*quantitative*). Measure plant height, stem diameter, plant circumference, etc.



**Figure 41.** Monitoring a yellow starthistle infestation (UGA1350043).

- **Choose a monitoring method.** Choice of a monitoring method depends on the amount of time available to conduct the work and the monitoring objectives. Two methods of quantitative monitoring are *transects* and *macroplots*.

- **Transect.** A transect is a straight line measured on the ground along which vegetation is sampled. Transect lines can be as long as 300 feet (100 m) or as short as 30 feet (10 m). Vegetation along the transect is sampled or measured using a quadrat placed at regular intervals along the transect (i.e., every 10 feet (3.2 m). While transects are a more systematic method of sampling vegetation, the location of the transect can be random.

Transects are faster and easier to set up and use than macroplots (see Appendix F).

- **Macroplot.** The purpose of the macroplot is to define a large area (e.g., 4 acres [1.6 hectares]) within which randomly placed small quadrats (1 sq. yd or 1 sq. m) are used to sample vegetation (see Appendix G). Although the macroplot is very useful and allows for sampling over a large area, it can cause considerable trampling by people at the site during sampling.

## 6. Establishing Photo Points

Photographs of the release site are a valuable assessment tool. Visual evidence of vegetation change over time is derived from comparing pictures of the same site taken from the same location, at the same time of year, with the same horizon, over a period of years. Records consisting of photographs are a qualitative form of monitoring and can be used in conjunction with more intensive quantitative monitoring techniques (see page 45).

- Take baseline photographs at the time of the release. Choose the time of year to take the first set of pictures; flowering stages are ideal because of the contrasts with the surrounding vegetation. Once a year is sufficient but it is good practice to frequently take pictures of the site.
- Locate a photo point. The location of the photo point is determined at the time of establishing the release site. Note and document the location of the photo point marker in case of need to relocate it later. When photographing the site, point your camera so as to include the permanent marker location in the scene.
- Take close-up pictures. Close-up pictures are useful to show the amount of ground covered by vegetation and litter. A square frame measuring 3 feet x 3 feet is recommended. Frames can be made of PVC pipe, steel rods, rebar, etc. Drive brightly painted angle iron stakes into the corners to permanently establish the plot. Repaint the stakes each time photos are taken. Put a plot identification label on the ground next to the frame. The camera point should be on the north side of the photo, so that pictures can be taken at any time of the day without a shadow.
- Take general view pictures. General view pictures give a broad view of the release site and the surrounding landscape.
- Establish the point approximately 100 feet from the permanent location marker.
- Choose an angle that will best show changes in the yellow starthistle infestation over time.

### Supplies Needed

- Camera (35 mm or digital)
- Color film (if 35 mm)
- Notebook and forms
- Metal or wooden stake for camera point
- Bright spray paint
- Previous year's photo



## GLOSSARY

achene	A small, one-seeded fruit that does not split at maturity.
alternate	Leaves that are arranged singly along a stem; one leaf or bud at each node on alternate sides of the stem.
aspirator	An apparatus used to suck insects into a container. Can be as simple as in a mouth-aspirator, or mechanical as in a gasoline- or battery-powered vacuum aspirator.
basal	At the base of a plant or plant part.
biennial	A plant which lives two years.
biological control	The intentional use of a weed's natural enemies for control purposes. Also referred to as biocontrol.
bolting	Plant stage at which the flower stalk begins to grow.
bract	A small, leaf-like structure below a flower.
capitulum (pl. capitula)	Seedhead of plants in the sunflower family.
coordinate	Any of a set of numbers used to specify a point on a line, or an intersection of 2 lines.
cotyledon	First leaf-like structures that appear after germination; seed leaves.
density	Number of individuals per unit area.
diapause	Period of dormancy in insects.
dissemination	Dispersal. Can be applied to seeds or insects.
duff	Partly decayed organic matter on the forest floor.
entire	Leaf margins that are not cut or toothed.
elytron (pl. elytra)	Hardened front wings of a beetle.
emergence	Act of adult insect leaving the pupal exoskeleton, or from winter dormancy.
exoskeleton	External skeleton of the body of an insect.
floret	One of the small, closely clustered flowers forming the head of a composite flower in the sunflower family.

frass	Plant fragments, usually mixed with excrement, deposited by feeding insects.
gall	An abnormal growth on a plant, usually induced by an insect that lives in the gall.
grub	A soft, thick-bodied, C-shaped beetle larva.
head	A group of flowers borne tightly together.
host specificity	The highly-evolved, often obligatory association between an insect and its host: (i.e., weed).
inflorescence	The flowering arrangement of a plant, as in panicle or raceme.
instar	The phase of an insect's development between molts.
involucre	A circle of bracts under an inflorescence.
larva (pl. larvae)	Immature insect stage between the egg and pupa.
lobed:	A leaf with deeply or shallowly-rounded segments, as in a starthistle rosette leaf.
metabolic sink	Site of the plant that receives photosynthate (food) produced by the plant, diverting the resource from the plant's normal use.
metamorphosis	In insects, a change in form during development.
molting	Process of insect development that involves shedding its exoskeleton and producing a new exoskeleton for the life stage.
mottled	Surface having colored spots or blotches.
multivoltine	Two or more generations per year, as in starthistle flies.
oviposit	To lay or deposit eggs.
pappus	A tuft of hairs, scales or bristles at one end of a seed, as in a thistle plume, used to aid seed dispersal.
phytophagous	Plant eating.
proleg	A fleshy, unsegmented, abdominal walking appendage of some insect larvae.



pubescence	Hairs or bristles covering a leaf, stem, or flower.
pupa (pl. pupae) (v. pupate)	Non-feeding, inactive stage between the larva and adult in insects.
quadrat	A specific area used for sampling (e.g., 1 square meter).
qualitative	Measurement of descriptive elements (e.g., age class, distribution)
quantitative	Measurement of quantity - number or amount (e.g., number of seeds per plant, number of larvae per seedhead).
receptacle	Part of the capitulum to which flowers are attached.
rosette	A round, compact, normally basal cluster of leaves in a juvenile plant.
senescence	Final stage in a plant's lifecycle.
snout	'Nose' of a weevil. The elongate head of a weevil with mouth parts at the apex (tip).
spine	A stiff, pointed plant part.
synchrony	Occurring at the same time, i.e. flowering and insect oviposition.
thorax	Body region of an insect between the head and abdomen, bearing the legs and wings.
transect	A straight line of varying length along which plants are sampled individually or in quadrats.
univoltine	One generation per year, as in starthistle weevils.
variable	A quantity that can have more than one of a set of values (e.g., plant height).
weevil	A type of plant-eating beetle; the adult has a long snout and the larva is a C-shaped grubs (a.k.a. snout beetle).
x-axis	Horizontal axis or line in a coordinate system.
y-axis	Vertical axis or line in a coordinate system.



## SELECTED REFERENCES

The following references were selected to provide the reader with a good overview of the literature relevant to the biology and biological control of yellow starthistle.

### General: Biological Control

- DeBach, P. and D. Rosen, eds. 1991. Biological control by natural enemies. 2nd ed. Cambridge Univ. Press, Cambridge and New York.
- Harley, K.L.S. and I.W. Forno, eds. 1992. Biological control of weeds: a handbook for practitioners and students. Inkata Press, Melbourne and Sydney.
- James, L.F., J.O. Evans, M.H. Ralphs and R.D. Child, eds. 1991. Noxious range weeds. Westview Press, Boulder Co.
- Maddox, D., R. Sobhian, D.B. Joley, A. Mayfield and D. Supkoff. 1986. New biological control for yellow starthistle. Calif. Agric. 40 (11 and 12):4-5.
- McFadyen, R.E.C. 1998. Biological Control of Weeds. Annu. Rev. Entomol. 43: 369-393.
- Randall, J.M. 1996. Weed control for the preservation of biological diversity. Weed Technol. 10: 370-383.
- Rees, N.E., P.C. Quimby, Jr., G.L. Piper, E. Coombs, C.E. Turner, N.R. Spencer and L.V. Knutson, eds. 1996. Biological control of weeds in the west. Western Society of Weed Science.
- Sheley, R.L., T.J. Svejcar and B.D. Maxwell. 1996. A theoretical framework for developing successional weed management strategies on rangeland. Weed Technol. 1 a: 766-773.
- Shishkoff, N.; Bruckart, W.L. 1996. Water stress and damage caused by *Puccinia jaceae* on two *Centaurea* species. Biological control : theory and applications in pest management, v. 6 (1), p. 57-63.
- Smith, L.; Balciunas, J.; Pitcairn, M.J. 2001. Biological control of yellow starthistle. Proceedings: Annual California Weed Science Society, v. 53, p. 105-106.
- Stelljes, K.B. 1999. Weevil gets upper hand with unruly weed. Agricultural research, v. 47 (2), p. 22.

- Valenzuela-Valenzuela, J.M.; Lownds, N.K.; Sterling, T.M. 2001. Clopyralid uptake, translocation, metabolism, and ethylene induction in picloram-resistant yellow starthistle (*Centaurea solstitialis* L.). Pesticide biochemistry and physiology v. 71 (1), p. 11-19.
- Van den Bosch, R., P.S. Messenger and A.P. Gutierrez. 1982. An introduction to biological control. Plenum Press, N.Y.
- Van Driesche, R.G. and T.S. Bellows, Jr. 1996. Biological Control. Chapman and Hall, N.Y.
- Whitson, T.D., L.C. Burrill, S.A. Dewey, D.W. Cudney, B.E. Nelson, R.D. Lee and R.C. Parker, eds. 1991. Weeds of the west. Western Society of Weed Science, Laramie, WY.

### **Yellow starthistle (*Centaurea solstitialis* L.)**

- Benefield, C.B.; DiTomaso, J.M.; Kyser, G.B. 1998. Impacts of yellow starthistle density on the soil moisture profile and rangeland management. Proceedings of the Western Society of Weed Science, v. 51, p. 66-67.
- Benefield, C.B.; DiTomaso, J.M.; Kyser, G.B.; A. Tschohl. 2001. Reproductive biology of yellow starthistle: maximizing late-season control. Weed science, v. 49 (1), p. 83-90.
- Bruckart, W.L.; Eskandari, F. 2002. Factors affecting germination of *Puccinia jaceae* var. *solstitialis* teliospores from yellow starthistle. Phytopathology, v. 92 (4), p. 355-360.
- Callihan, R.H., T.S. Prather, and F. E. Northam. 1993. Longevity of yellow starthistle (*Centaurea solstitialis*) achenes in soil. Weed Technol 7: 33-35.
- Callihan, R.H., F.E. Northam, J.B. Johnson, E.L. Michalson and T.S. Prather. 1989. Yellow starthistle: biology and management in pasture and rangeland. Univ. Idaho College of Agric. Coop. Ext. Serv. Curr. Info. Ser., No.634.
- Carrithers, V.F.; Gaiser, D.R.; Duncan, C.; Horton, D. 1997. Seed germination of yellow starthistle and spotted knapweed after treatment with picloram or clopyralid. Proceedings of the Western Society of Weed Science, v. 50, p. 39-40.
- Clement, S. L. 1990. Insect natural enemies of yellow starthistle in southern Europe and the selection of candidate biological control agents. Environ. Entomol. 19:1882-88.
- Cordy, D.R. 1978. *Centaurea* species and equine nigropallial encephalomalacia. In: Effects of poisonous plants on livestock. Keeler, R.F. (Eds: van Kampen, K.R. and L.F. James)(eds.) Academic Press, New York, 327-336.

- DiTomaso, J.M.; Kyser, G.B.; Hastings, M.S. 1999. Prescribed burning for control of yellow starthistle (*Centaurea solstitialis*) and enhanced native plant diversity. *Weed science*, v. 47 (2), p. 233-242.
- DiTomaso, J.M.; Orloff, S.B.; Kyser, G.B.; Nader, G.A. 1998. Influence of timing and chemical control on yellow starthistle. *Proceedings: Annual California Weed Science Society*, v. 50, p. 190-193.
- Enloe, S.F.; DiTomaso, J.M. 2001. Ecological deception: pulling the trigger on yellow starthistle seed germination. *Proceedings: Annual California Weed Science Society*, v. 53, p. 32-33.
- Enloe, S.; DiTomaso, J.; Orloff, S.; Drake, D. 1999. Integrated management of Yellow starthistle on California rangelands. *Proceedings: Annual California Weed Science Society*, v. 51, p. 24-27.
- Enloe, S.; DiTomaso, J.M.; Orloff, S.; Drake, D. 1999. Selective yellow starthistle management and revegetation strategies for annual rangelands. *Proceedings: Annual Forest Vegetation Management Conference*, (20th), p. 29-32.
- Fuerst, E.P.; Sterling, T.M.; Norman, M.A.; Prather, T.S.; Irzyk, G.P.; Wu, Y.; Lownds, N.K.; Callihan, R.H. 1996. Physiological characterization of picloram resistance in yellow starthistle. *Pesticide biochemistry and physiology*, v. 56 (2), p. 149-161.
- Gaiser, D.R.; Carrithers, V.F.; Duncan, C. 1997. Efficacy of picloram or clopyralid applications at three timings on spotted knapweed or yellow starthistle. *Proceedings of the Western Society of Weed Science*, v. 50, p. 42-44.
- Jette, C.; Connett, J.; McCaffrey, J.P.; Bell-Randall, C.; Kuykendall, C.; Lake, L. 1999. Biology and biological control agents of yellow starthistle. Morgantown, WV : U.S. Dept. of Agriculture, Forest Service, Forest Health Technology Enterprise Team.
- Joley, D.B., D.M. Maddox, D.M. Supkoff and A. Mayfield. 1992. Dynamics of yellow starthistle (*Centaurea solstitialis*) achenes in field and laboratory. *Weed Sci.* 40: 190-194.
- Lanini, W.T., C. Thomsen, T.S. Prather, C.E. Turner, M.J. Smith, C.L. Elmore, M. Vayssieres and W.A. Williams. 1994. Yellow starthistle. *Univ. Calif. Div. Agric. Nat. Res., Pest Notes* No.3.
- Larson, L.; Kiemnec, G. 1997. Differential germination by dimorphic achenes of yellow starthistle (*Centaurea solstitialis* L.) under water stress. *Journal of arid environments*, v. 37 (1), p. 107-114.

- Lass, L.W.; Shafii, B.; Price, W.J.; Thill, D.C. 2000. Assessing agreement in multi-spectral images of yellow starthistle (*Centaurea solstitialis*) with ground truth data using a bayesian methodology. *Weed technology : a journal of the Weed Science Society of America*, v. 14 (3), p. 539-544.
- Maddox, D.M. 1981. Introduction, phenology, and density of yellow starthistle in coastal, intercoastal, and central valley situations in California. USDA-ARS ARR-W-20.
- Miller, T.W.; Shinn, S.L.; Callihan, R.H.; Lass, L.W.; Thill, D.C. 1998. Livestock trampling of grass seedings for enhanced establishment on yellow starthistle-infested rangelands. *Proceedings of the Western Society of Weed Science*, v. 51, p. 114-116.
- Roche, B.F., Jr. 1992. Achene dispersal in yellow starthistle (*Centaurea solstitialis* L.) Northwest. *Sci.* 66: 62-65.
- Roche, C.T., D.C. Thill. 2001. Biology of common crupina and yellow starthistle, two Mediterranean winter annual invaders in western North America. *Weed science*, v. 49 (4), p. 439-447.
- Roche, C.T., D.C. Thill.; B. Shafii. 1997. Reproductive phenology in yellow starthistle (*Centaurea solstitialis*). *Weed science*, v. 45 (6), p. 763-770.
- Roche, C. T., G. R. White. 2000. Managing yellow starthistle in southwestern Oregon. Oregon State University. Extension Service. Corvallis, Or.
- Sabba, R.P.; Sterling, T.M.; Lownds, N.K. 1998. Effect of picloram on resistant and susceptible yellow starthistle (*Centaurea solstitialis*): the role of ethylene. *Weed science*, v. 46 (3), p. 297-300.
- Schoenig, S.; Queheillalt, A.; Shields, L. 2000. Cooperative Sierra yellow starthistle mapping and assessment project. *Proceedings: Annual California Weed Science Society*, (52nd), p. 180.
- Sheley, R.L.; L.L. Larson, 1994. Observation: comparative live-history of cheatgrass and yellow starthistle. *Journal of range management*, Nov v. 47 (6), p. 450-456.
- Sheley, R.L., L.L. Larson. 1997. Cheatgrass and yellow starthistle growth at 3 soil depths. *Journal of range management*, v. 50 (2), p. 146-150.
- Shinn, S.L.; Thill, D.C. 2002. The response of yellow starthistle (*Centaurea solstitialis*), annual grasses, and smooth brome (*Bromus inermis*) to imazapic and picloram. *Weed technology : a journal of the Weed Science Society of America*, v. 16 (2), p. 366-370.



- Sterling, T.M.; Lownds, N.K.; Murray, L.W. 2001. Picloram-resistant and -susceptible yellow starthistle accessions have similar competitive ability. *Weed science*, v. 49 (1), p. 42-47.
- Sun, M. 1997. Population genetic structure of yellow starthistle (*Centaurea solstitialis*), a colonizing weed in the western United States. *Canadian journal of botany (Journal canadien de botanique)*, v. 75 (9), p. 1470-1478.
- Sun, M.; Ritland, K. 1998. Mating system of yellow starthistle (*Centaurea solstitialis*), a successful colonizer in North America. *Heredity : an international journal of genetics*, v. 80 (pt.2), p. 225-232.
- Thomsen, C.D., W.A. Williams, W. Olkowski; D.W. Pratt. 1996. Grazing, mowing and clover plantings control yellow starthistle. *The IPM practitioner : the newsletter of integrated pest management*, v. 18 (2), p. 1-4.
- Thomsen, C. D., W. A. Williams, M. P. Vayssieres, C. E. Turner and W. T. Lanini. 1996. Yellow starthistle biology and control. University of California. Publication 21541. Woods, D. M., (ed.) 1997. Biological Control Program Annual Summary, 1996. California Department of Food and Agriculture, Division of Plant Industry, Sacramento, California.
- Turner, C.E., J.B. Johnson and J.P. McCaffrey. 1994. Yellow starthistle *Centaurea solstitialis* L. (Asteraceae). In: *Biological Control in the United States; Western Region: Accomplishments and Benefits of Regional Research Project W-84 (1964-1989)*. University of California, Division of Agriculture and Natural Resources.
- Woo, I.; Swiadon, L.; Drlik, T.; Quarles, W. 1999. Integrated management of yellow starthistle. *The IPM practitioner : the newsletter of integrated pest management*, v. 21 (7), p. 1-10.
- Zimmerman, John R.; Johnson, Wayne S.; Eiswerth, Mark E. 2001. Yellow starthistle control in Nevada. Nevada Cooperative Extension. Reno, Nev.

### ***Bangasternus orientalis***

- Clement, S. l. 1990. Insect natural enemies of yellow starthistle in southern Europe and the selection of candidate biological control agents. *Environ. Entomol.* 19:1882-88.
- Campobasso, G.; Sobhian, R.; Knutson, L.; Terragitti, G. 1998. Host specificity of *Bangasternus orientalis* Capiomont (Coleoptera: Curculionidae) introduced into the United States for biological control of yellow starthistle (*Centaurea solstitialis* L., Asteraceae: Carduae). *Environmental entomology*, v. 27 (6), p. 1525-1530.

- Maddox, D.M. 1985. A petition for the importation into quarantine and subsequent release in the United States, of the weevil *Bangasternus orientalis* Capiomont (Coleoptera: Curculionidae), a candidate natural enemy for the biological control of yellow starthistle (*Centaurea solstitialis* L.).
- Maddox, D.M., D.B. Joley, A. Mayfield and B.E. Mackey. 1991. Impact of *Bangasternus orientalis* (Coleoptera: Curculionidae) on achene production of *Centaurea solstitialis* (Asterales: Asteraceae) at a low and high elevation site in California. Environ. Entomol. 20: 335-337.
- Maddox, D. M., and R. Sobhian. 1987. Field experiment to determine host specificity and oviposition behavior of *Bangasternus orientalis* and *Bangasternus fausti* (Coleoptera: Curculionidae), biological control candidates for yellow starthistle and diffuse yellow starthistle. Environ. Entomol. 16: 645-648.
- Maddox, D.M., R. Sobhian, D.B. Joley, A. Mayfield and D. Supkoff. 1986. New Biocontrol for yellow starthistle. Calif. Agric. 40(1 &2):4-6.
- Sobhian, R., and H. Zwolfer. 1985. Phytophagous insect species associated with flower heads of yellow starthistle (*Centaurea solstitialis* L.). Z. Angew. Entomol. 99:301-321
- Sobhian, R. G. Campobasso and P.H. Dunn. 1992. Contribution to the biology of *Bangasternus orientalis* Capiomont (Col., Curculionidae). J. Appl. Entomol. 113:93-102.

### ***Chaetorellia australis***

- Maddox, D.M.; A. Mayfield and C.E. Turner. 1990. Host specificity of *Chaetorellia australis* (Diptera, Tephritidae) for biological control of yellow starthistle (*Centaurea solstitialis*, Asteraceae). In: Proceedings of the Entomological Society of Washington. 92: 426-430.
- Pittara, I. and B. I. Katsoyannos. 1990. Evidence for a host-marking pheromone in *Chaetorellia australis*. Entomol. Exp. Appl. 54: 287-295.
- Pittara, I. and B.I. Katsoyannos. 1991. Oviposition behavior, longevity, fecundity and fertility of *Chaetorellia australis* Hering (Diptera, Tephritidae). Bulletin De La Societe Entomologique Suisse 64: 59-66.
- Turner, C.E., G.L. Piper and E.M. Coombs. 1996. *Chaetorellia australis* (Diptera: Tephritidae) for biological control of yellow starthistle, *Centaurea solstitialis* (Compositae), in the western USA: establishment and seed destruction. Bull. Entomol. Res. 86: 1 77-182.

***Chaetorellia succinea***

Balciunas, J.K.; Villegas, B. 2001. Unintentionally released *Chaetorellia succinea* (Diptera: Tephritidae): is this natural enemy of yellow starthistle a threat to safflower growers? *Environmental entomology*, v. 30 (5), p. 953-963.

***Eustenopus villosus***

Clement, S.L. and R. Sobhian. 1991. Host-use patterns of capitulum-feeding insects of yellow starthistle: results from a garden plot in Greece. *Environ. Entomol.* 20(2):724-30.

Connett, J. F. 1997. *Eustenopus villosus*: Its phenological synchrony with *Centaurea solstitialis* and its feeding and oviposition behavior. M.S. Thesis, University of Idaho.

Connett, J.F.; Wilson, L.M.; McCaffrey, J.P.; Harmon, B.L. 2001. Phenological synchrony of *Eustenopus villosus* (Coleoptera: Curculionidae) with *Centaurea solstitialis* in Idaho. *Environmental entomology*, v. 30 (2), p. 439-442.

Fornasari, L., C.E. Turner and L.A. Andres. 1991. *Eustenopus villosus* (Coleoptera: Curculionidae) for biological control of yellow starthistle (Asteraceae: Cardueae) in North America. *Environ. Entomol.* 20(4):1189-94.

Fornasari, L., and R. Sobhain. 1993. Life history of *Eustenopus villosus* (Coleoptera: Curculionidae), a promising biological control agent for yellow starthistle. *Environ. Entomol.* 22: 684-692.

Roche, C.T.; Harmon, B.L.; Wilson, L.M.; McCaffrey, J.P. 2001. *Eustenopus villosus* (Coleoptera: Curculionidae) feeding of herbicide-resistant yellow starthistle (*Centaurea solstitialis* L.). *Biological control : theory and applications in pest management*, v. 20 (3), p. 279-286.

Turner, C.E. and L. Fornasari. 1992. Biological control of yellow starthistle (*Centaurea solstitialis* L.) in North America. In: *Proceedings of the Eighth International Symposium on Biological Control of Weeds*. Delfosse, E.S. and R.R. Scott, eds. 2-7 February 1992, Lincoln University, Canterbury, New Zealand.

***Larinus curtus***

Clement, S. L. 1990. Insect natural enemies of yellow starthistle in southern Europe and the selection of candidate biological control agents. *Environ. Entomol.* 19:1882-88.

- Fornasari, L. and C.E. Turner. 1992. Host specificity of the Palearctic weevil *Larinus curtus* Hochhut (Coleoptera: Curculionidae), a natural enemy of *Centaurea solstitialis* L. (Asteraceae: Cardueae). In: Proceedings of the Eighth International Symposium on Biological Control of Weeds. 2-7 February 1992. Lincoln University, Canterbury, New Zealand, 385-391.
- Sobhian, R.; Fornasari, L. 1994. Biology of *Larinus curtus* Hochhut (Coleoptera: Curculionidae), a European weevil for biological control of yellow starthistle, *Centaurea solstitialis* L. (Asteraceae), in the United States. Biological control: theory and applications in pest management, v. 4 (4), p. 328-335.

### ***Urophora sirunaseva***

- Clement, L. 1990. Insect natural enemies of yellow starthistle in southern Europe and the selection of candidate biological control agents. Environ. Entomol. 19:1882-88.
- Sobhian, R. 1993. Life history and host specificity of *Urophora sirunaseva* (Hering)(Dipt., Tephritidae), an agent for biological control of yellow starthistle, with remarks on the host plant. J. Appl. Entomol. 116: 381-390.
- Turner, C. E. 1994. Host specificity and oviposition of *Urophora sirunaseva* (Hering) (Diptera: Tephritidae), a natural enemy of yellow starthistle, pp. 31-36. Proceedings of the Entomological Society of Washington. 96(1 ): 31-36.
- Turner, C. E., R. Sobhian, D. B. Joley, E. M. Coombs and G. L. Piper. 1994. Establishment of *Urophora sirunaseva* (Hering) (Diptera: Tephritidae) for biological control of yellow starthistle in the western United States. Pan. Pac. Entomol. 70: 206-211.
- White, I.M. and S.L. Clement. 1987. Systematic notes on *Urophora* (Diptera, Tephritidae) species associated with *Centaurea solstitialis* (Asteraceae, Cardueae) and other palaeartic weeds adventive in North America, pp. 571-580. In: Proceedings of the Entomological Society of Washington.

### **Vegetation Monitoring**

- BLM: National Applied Resource Sciences Center, Ed. 1996. Sampling vegetation attributes. Cooperative Extension Service, USDA Forest Service, Natural Resource Conservation Service, Grazing land Technology Institute and USDI Bureau of land Management. BLM/RS/ST-96/002+1730.
- Hironaka, M. 1985. Frequency approaches to monitor rangeland vegetation. Proceedings 38th Society Range Management Conference at Salt Lake City, Utah, February 11-15: 84-86.

## APPENDICES

Appendix A: Troubleshooting Guide: When Things Go Wrong

Appendix B. Sample Biocontrol Agent Release Form

Appendix C: Monitoring Plan Questionnaire

Appendix D: Biocontrol Monitoring Report

Appendix E: Qualitative Monitoring Form

Appendix F: Quadrat Density and Cover Data Form

Appendix G: Macroplot Design for Measuring Density

**Note:** *Please make photocopies of these appendices and use them as worksheets.*

## Appendix A: Troubleshooting Guide—When Things Go Wrong

This guide is intended to assist those who encounter problems when establishing a biological control program. It identifies the probable cause of a typical problem and offers solutions.

<b>Problem</b>	<b>Probable Cause</b>	<b>Solution</b>
Bioagents unhealthy	Physical damage to agents	Prevent containers from colliding; use crush-proof containers.
	Drowning	Do not put water in containers. Prevent accumulation of excess moisture in the collection containers.
	Excess or prolonged heat or cold	Keep containers cool at all times; use coolers and blue ice packs; avoid exposure to direct sunlight while in transit.
	Starvation	Put yellow starthistle foliage (no flowers, seeds, or roots) in containers.
	Redistribution time	Transport or ship agents immediately after collection.  Release agents at new site immediately upon arrival or receipt of agent.
	Parasitism and/or disease	Check source of agents. Ensure the insect population is disease-free when collecting or receiving shipment.
Number of eggs low	Agents past reproductive stage	Collect at times of peak activity (i.e., insects are mating).
	Sex ratio: not enough males or females	Observe mating among bioagents before collecting; males often emerge earlier than females.
	Synchrony	Agents not synchronized with the yellow starthistle growth stage; bioagents require starthistle to be at a specific growth stage for optimal oviposition.



## Appendix A: Troubleshooting Guide (*continued*)

<b>Problem</b>	<b>Probable Cause</b>	<b>Solution</b>
Few bioagents collected	Wrong method used	Refer to Table 6 for recommended collection time and technique.
	Collection done at wrong time	Refer to Tables 11 and 12 for recommended collection time and technique.
	Collection technique	Bioagents can be killed during sweeping or aspirating.  Use vacuum aspirator if aspirating by mouth is not working.  Practice sweeping.
	Conditions at time of collection wrong	Refer to "Collecting Biocontrol Agents" and "Monitoring Biocontrol Agents" for guidelines on desirable weather conditions.
Agents not found after release	Site is unsuitable	Refer to "Collecting Biocontrol Agents."
	Site too small	Select a larger site with a dense, uniform stand of yellow starthistle.
	Pesticide used in area	Select pesticide-free site.
Cannot locate release site	Permanent location marker not obvious	Use bright-colored wooden, metal, or plastic stake.
	Map poorly or incorrectly drawn	Check map; redraw with more detail or add landmarks.

# Appendix B: Biological Control Agent Release Form

## AGENT RELEASE

Released By: \_\_\_\_\_ Release Date: \_\_\_/\_\_\_/\_\_\_ County: \_\_\_\_\_ State: \_\_\_\_\_  
(mm dd yy)

Agent: \_\_\_\_\_ # Released: \_\_\_\_\_ Target Weed: \_\_\_\_\_

Source of Agents: \_\_\_\_\_ Date Collected: \_\_\_/\_\_\_/\_\_\_  
(mm dd yy)

Life Stage (circle): Larvae Pupa e Adults Eggs Other (specify) \_\_\_\_\_

Land Ownership (circle): Private County State USFS BLM COE BOR BIA/Tribe TNC Other (specify) \_\_\_\_\_

Legal: T \_\_\_ R \_\_\_ Sec \_\_\_ Q \_\_\_ QQ \_\_\_ **(OR)** Lat: Deg \_\_\_ Min \_\_\_ Sec \_\_\_ Long: Deg \_\_\_ Min \_\_\_ Sec \_\_\_

## ENVIRONMENT

Temperature (°F): \_\_\_\_\_ Wind: Calm, Light, Moderate, Strong, Gusty Wind Direction: N S E W

Weather (circle): Clear, Ptl y Cloudy, Cloudy, Rain, Snow Release Time (military): \_\_\_\_\_

Site Aspect (circle): N, NE, E, SE, S, SW, W, NW Elevation: \_\_\_\_\_

Site Slope: Flat (0-10%) \_\_\_\_\_ Gentle (10-30%) \_\_\_\_\_ Moderate (30-60%) \_\_\_\_\_ Steep (>60%) \_\_\_\_\_

Topographic Position (circle): Valley Bottom Terrace Lower Slope Mid/Upper Slope Crest

Disturbance: (check all that apply, circle most prevalent) Cultivation \_\_\_ Fire \_\_\_ Flood \_\_\_ Grazing \_\_\_ Logging \_\_\_  
 Roads \_\_\_ Mining \_\_\_ Recreation \_\_\_

Directions to Site (include a map to the site on the back of this form): \_\_\_\_\_

## SITE CHARACTERISTICS

Site Name: \_\_\_\_\_ Size of Infestation (acres): \_\_\_\_\_ Weed Cover %: \_\_\_\_\_

Weed Height: \_\_\_\_\_ Weed Density (# per meter sq.): \_\_\_\_\_ Dominant Plant: \_\_\_\_\_

Distribution of Weed: Isolated \_\_\_ Scattered \_\_\_ Sc-Patchy \_\_\_ Patchy \_\_\_ Continuous \_\_\_ Linear \_\_\_

Phenology: Seedling % \_\_\_ Rosette % \_\_\_ Bolt % \_\_\_ Bud % \_\_\_ Flowering % \_\_\_ Seed % \_\_\_ Dormant % \_\_\_

### Vegetation Type (check):

- Annual Grassland
- Perennial Grassland
- Shrubland/Steppe
- Dry Conifer
- Mixed Conifer
- Dry Meadow
- Moist Meadow

### Estimate % Cover:

- Tree \_\_\_\_\_
- Shrub \_\_\_\_\_
- Forb \_\_\_\_\_
- Grass \_\_\_\_\_
- Litter \_\_\_\_\_
- Bare Ground \_\_\_\_\_
- Rock \_\_\_\_\_

Soil Texture: (check) Sand \_\_\_ Silt \_\_\_ Clay \_\_\_ Gravel \_\_\_ Loam \_\_\_

Comments (continue on reverse if necessary)

## Appendix C: Monitoring Plan Questionnaire

The following is a list of questions to be answered and documented prior to collecting data. Use the questionnaire to outline a monitoring plan.

What is the management objective of the biocontrol release site? \_\_\_\_\_

---

---

---

What is the monitoring objective of the biocontrol release site? \_\_\_\_\_

---

---

---

What will be measured? \_\_\_\_\_

---

---

---

What equipment and supplies are needed? \_\_\_\_\_

---

---

---

What training is needed? \_\_\_\_\_

---

---

---

What is the cost of monitoring? \_\_\_\_\_

---

---

---

What is the time interval between monitoring? \_\_\_\_\_

---

---



# Appendix E: Qualitative Monitoring Form

Name: \_\_\_\_\_ Date: \_\_\_\_\_ Time: \_\_\_\_\_ am/pm \_\_\_\_\_

Location: \_\_\_\_\_ Site #: \_\_\_\_\_

Insect: \_\_\_\_\_ Year of release: \_\_\_\_\_

Cover Class by Plant Type						
	0%	1-5%	6-20%	21-50%	51-75%	76-100%
Starthistle						
Annual Grasses						
Perennial Grasses						
Forbs						
Shrubs						
Trees						

<b>Dominant Plants on Site:</b>
<b>Other Noxious Weeds:</b>

Yellow starthistle density class (check one)			
Flowering plants/meter sq)		Starthistle distribution	
0		Isolated	
1-25		Scattered	
26-50		Scattered-Patchy	
51-75		Patchy	
>75		Continuous	

Phenology class at time of monitoring	
Starthistle stage	Estimated percent
Seedling	
Rosette	
Bolting	
Flowering	
Senescent	

**Comments/Observations** \_\_\_\_\_

\_\_\_\_\_

\_\_\_\_\_

\_\_\_\_\_

\_\_\_\_\_

\_\_\_\_\_

\_\_\_\_\_





# Appendix G: Macroplot Design for Measuring Density

Designed for a 1 x 2 ft. quadrat in a 22 x 22 ft. macroplot  
 The X-axis is in 2 ft. increments; the Y-axis is in 1 ft. increments.

22											XX9	
21							XX5					
20												
19			XX2									
18												
17												
16												
15				XX3								
14												
13												
12	XX1									XX8		
11						XX4						
10												
9									XX7			
8												
7												
6												
5												
4								XX6				
3												
2												
1												XX10
	1	2	3	4	5	6	7	8	9	10	11	12
	0	2 ft	4 ft	6 ft	8 ft	10 ft	12 ft	14 ft	16 ft	18 ft	20 ft	22 ft

----- X-axis -----

Each square (cell) is a quadrat measuring 2 ft x 1 ft.

Vertical and horizontal numbers are the coordinates of the Y and X axes respectively

xx = randomly selected quadrat to be sampled

Examples: XX1 = coordinate (1,12); XX2 = coordinate (3,19); XX3 = coordinate (4,15);  
 XX4 = coordinate (6,11); XX5 = coordinate (7,21); XX6 = coordinate (8,4);  
 XX7 = coordinate (9,9); XX8 = coordinate (10,12); XX9 = coordinate (11,22);  
 XX10 = coordinate (12,1)

# Macroplot Instructions

**Size:** The sides of the macroplot need to be multiples of the sides of the quadrat. For example, a macroplot of 25 ft by 50 ft could be designed for a 1 x 2 ft quadrat.

A total of 500 (1X2 ft) non-overlapping quadrats could be placed within the macroplot.

**Quadrats:** Quadrats are small, measured areas that are used to sample vegetation. Rather than measure all of the vegetation in a large plot area (e.g., 0.5 acre plot), a smaller plot (e.g., 10 X 20 inch rectangle) is used. Placement of the quadrat can be completely random (e.g., close your eyes and throw it), can be placed along a measured transect (straight line), or can be precisely located within the macroplot by a set of randomly selected XYcoordinates. The random coordinates are generated from a random numbers table.

- Design the macroplot.
- Determine the quadrat shape and size.
- Randomly select the coordinates.
- Mark the selected quadrat on a macroplot layout to help locating the quadrats in the field.
- If a pair of coordinates repeats, drop the second set of coordinates, and select another set.
- Outline the macroplot at the field site. Place the Y-axis measuring tape perpendicular to the slope and upslope from the 0,0-ft mark. This is the Y-axis. Carefully mark the beginning and ending of the Y-axis. Place a second measuring tape along the slope perpendicular to the Y-axis. This is the X-axis. Where the two lines meet is the origin with a coordinate of 0,0. Other coordinates are measured from this point. The two numbers of a coordinate refer to X position then the Y position. For example, a coordinate of (15,8) means 15 feet across the X-axis and 8 feet up the Y-axis.
- Position the quadrat so that the long side is parallel to the X-axis, and placed adjacent and above the tape (upslope side of the tape) with the lower-left hand corner corresponding to the set of coordinates.
- Sample from 20 to 30 quadrats.

Sample Coordinate:

