

In the Matter of
Certain Ammonium Octamolybdate Isomers

Investigation No. 337-TA-477

Publication 3668

January 2004

U.S. International Trade Commission

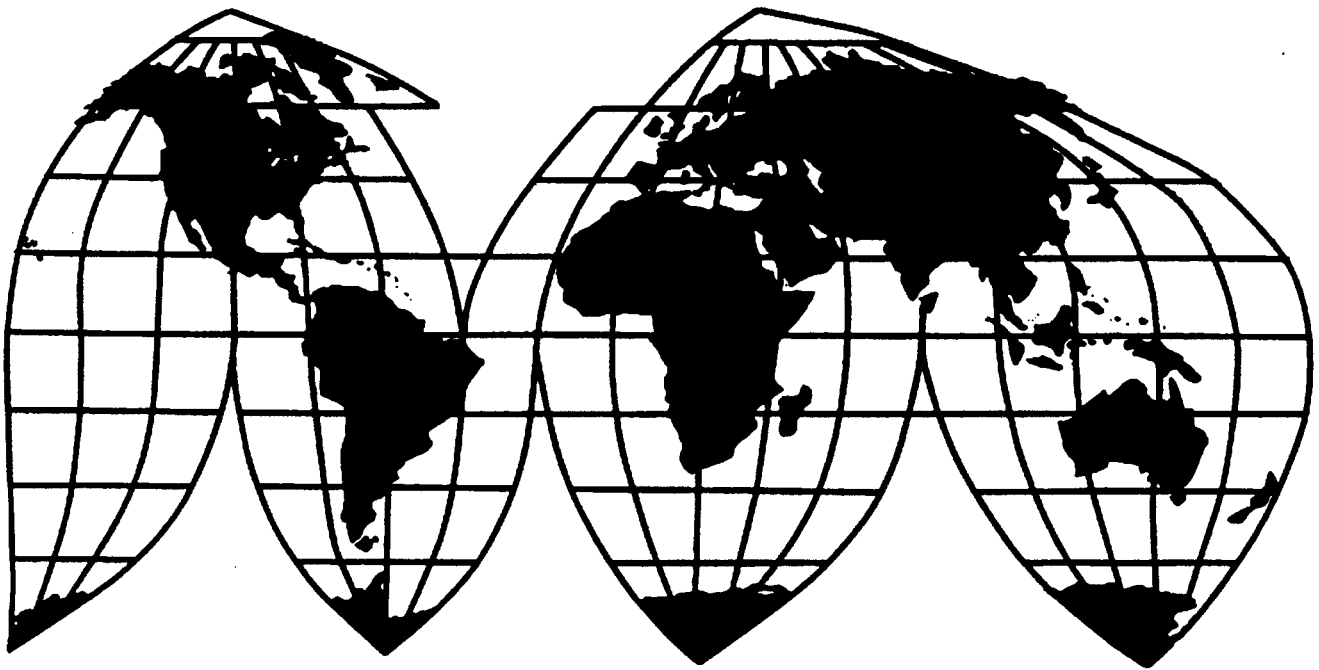

Washington, DC 20436

U.S. International Trade Commission

COMMISSIONERS

Deanna Tanner Okun, Chairman
Jennifer A. Hillman, Vice Chairman
Marcia E. Miller
Stephen Koplan
Charlotte R. Lane
Daniel R. Pearson

**Address all communications to
Secretary to the Commission
United States International Trade Commission
Washington, DC 20436**

U.S. International Trade Commission

Washington, DC 20436

www.usitc.gov

In the Matter of **Certain Ammonium Octamolybdate Isomers**

Investigation No. 337-TA-477



Publication 3668

January 2004

UNITED STATES INTERNATIONAL TRADE COMMISSION
Washington, D.C. 20436

In the Matter of)
)
CERTAIN AMMONIUM)
OCTAMOLYBDATE ISOMERS)
_____) Inv. No. 337-TA-477

NOTICE OF COMMISSION DETERMINATION
OF NO VIOLATION OF SECTION 337;
TERMINATION OF INVESTIGATION

AGENCY: U.S. International Trade Commission.

ACTION: Notice.

SUMMARY: Notice is hereby given that the U.S. International Trade Commission has determined to terminate the above-captioned investigation with a finding of no violation of section 337 of the Tariff Act of 1930, 19 U.S.C. §1337.

FOR FURTHER INFORMATION CONTACT: Wayne Herrington, Esq., Office of the General Counsel, U.S. International Trade Commission, 500 E Street, S.W., Washington, D.C. 20436, telephone (202) 205-3090. Copies of the Commission order, the public version of the forthcoming Commission opinion in support thereof, the public version of the administrative law judge's (ALJ's) final initial determination (ID), and all other nonconfidential documents filed in connection with this investigation are or will be available for inspection during official business hours (8:45 a.m. to 5:15 p.m.) in the Office of the Secretary, U.S. International Trade Commission, 500 E Street, S.W., Washington, D.C. 20436, telephone 202-205-2000. General information concerning the Commission may also be obtained by accessing its Internet server (<http://www.usitc.gov>). The public record for this investigation may be viewed on the Commission's electronic docket (EDIS) at <http://edis.usitc.gov>. Hearing-impaired persons are advised that information on this matter can be obtained by contacting the Commission's TDD terminal on 202-205-1810.

SUPPLEMENTARY INFORMATION: The Commission instituted this investigation on August 20, 2002, based on a complaint filed by Climax Molybdenum Company (Climax) against one respondent, Molychem LLC. (Molychem). 67 *Fed. Reg.* 53966. In that complaint, as supplemented, Climax alleged violations of section 337 in the importation into the United States, sale for importation, and/or sale within the United States after importation of certain ammonium octamolybdate isomers by reason of infringement of claim 1 of Climax's U.S. Patent No. 5,985,236. Subsequently, the complaint and notice of investigation were amended to add four additional respondents to the investigation: Anhui Wonder Trade Co., Ltd.; Pudong Trans USA, Inc.; John S. Conner, Inc. (Conner); and Chem-Met International, Inc. One of these respondents, Conner, was eventually terminated from the investigation as the result of a settlement agreement.

On May 15, 2003, the ALJ issued his final ID on violation and his recommended determination on remedy and bonding. The ALJ found no violation of section 337 because he concluded that claim 1 of the '236 patent was invalid on the basis of an on-sale bar under 35 U.S.C. § 102(b). Complainant Climax filed a petition for review of the ID on May 27, 2003. On May 30 and June 3, 2003, respectively, respondent Molychem and the Commission investigative attorney each filed a response to the petition for review. On June 10, 2003, Climax filed a motion for leave to file a reply to the response of the Commission investigative attorney, including its proposed reply. On June 11, 2003, Molychem filed a motion to strike Climax's motion for leave.

On June 30, 2003, the Commission issued notice of its determination to review the ID in its entirety, and set a schedule for the receipt of written submissions on the question of violation of section 337 and on the issues of remedy, public interest, and bonding. The Commission denied Climax's request for oral argument. The Commission also denied Climax's motion for leave to file a reply and Molychem's motion to strike, without prejudice to Climax or Molychem renewing their arguments in their written submissions on review.

Having examined the record in this investigation, including the ALJ's final ID, the written submissions on review, and the responses thereto, the Commission determined to terminate this investigation with a finding of no violation of section 337 for the following reasons:

1. Claim 1 of the '236 patent is invalid under 35 U.S.C. §102(b) as anticipated by the Tytko article and by the Huggins patent.
2. Claim 1 of the '236 patent is invalid under 35 U.S.C. §102(b) because of an on-sale bar.
3. The '236 patent is unenforceable because of inequitable conduct during the prosecution of its underlying application at the U.S. Patent and Trademark Office.

The Commission also determined to deny Molychem's request for oral argument during the review proceeding.

The authority for the Commission's determination is contained in section 337 of the Tariff Act of 1930, as amended (19 U.S.C. §1337), and in section 210.45 of the Commission's Rules of Practice and Procedure (19 C.F.R. §210.45).

By order of the Commission.

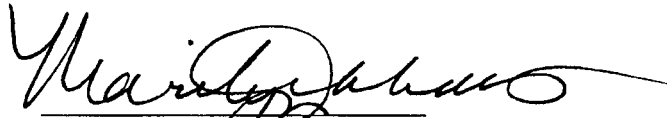
A handwritten signature in black ink, appearing to read "Marilyn R. Abbott", written over a horizontal line.

Marilyn R. Abbott
Secretary

Issued: August 20, 2003

UNITED STATES INTERNATIONAL TRADE COMMISSION
Washington, D.C.

In the Matter of

**CERTAIN AMMONIUM
OCTAMOLYBDATE ISOMERS**

Inv. No. 337-TA-477

ORDER

The Commission instituted this investigation on August 20, 2002, based on a complaint filed by Climax Molybdenum Company (Climax) against one respondent, Molychem LLC. (Molychem). *67 Fed. Reg.* 53966 (August 20, 2002). In that complaint, as supplemented, Climax alleged violations of section 337 of the Tariff Act of 1930 (19 U.S.C. §1337) in the importation into the United States, sale for importation, and/or sale within the United States after importation of certain ammonium octamolybdate isomers by reason of infringement of claim 1 of Climax's U.S. Patent No. 5,985,236. Subsequently, the complaint and notice of investigation were amended to add four additional respondents to the investigation: Anhui Wonder Trade Co., Ltd.; Pudong Trans USA, Inc.; John S. Conner, Inc. (Conner); and Chem-Met International, Inc. One of these respondents, Conner, was eventually terminated from the investigation as the result of a settlement agreement.

On May 15, 2003, the administrative law judge (ALJ) issued his final initial determination (ID) on violation and his recommended determination on remedy and bonding. The ALJ found no violation of section 337 because he concluded that claim 1 of the '236 patent was invalid on the basis of an on-sale bar under 35 U.S.C. §102(b). Complainant Climax filed a petition for review of the ID on May 27, 2003. On May 30 and June 3, 2003, respectively, respondent

Molychem and the Commission investigative attorney each filed a response to the petition for review. On June 10, 2003, Climax filed a motion for leave to file a reply to the response of the Commission investigative attorney, including its proposed reply. On June 11, 2003, Molychem filed a motion to strike Climax's motion for leave.

On June 30, 2003, the Commission issued notice of its determination to review the ID in its entirety, and set a schedule for the receipt of written submissions on the the question of violation of section 337 and on the issues of remedy, public interest, and bonding. The Commission denied Climax's request for oral argument. The Commission also denied Climax's leave to file a reply and Molychem's motion to strike, without prejudice to Climax or Molychem renewing their arguments in their written submissions on review.

Having examined the record in this investigation, including the ALJ's final ID, the written submissions on review, and the responses thereto, the Commission has determined to terminate this investigation with a finding of no violation of section 337 for the following reasons:

1. Claim 1 of the '236 patent is invalid under 35 U.S.C. §102(b) as anticipated by the Tytko article and by the Huggins patent.
2. Claim 1 of the '236 patent is invalid under 35 U.S.C. §102(b) because of an on-sale bar.
3. The '236 patent is unenforceable because of inequitable conduct during the prosecution of its underlying application at the U.S. Patent and Trademark Office.

The Commission has also determined to deny Molychem's request for oral argument during the review proceeding.

Accordingly, it is hereby **ORDERED THAT:**

1. Molychem's motion for oral argument is denied;
2. The investigation is terminated with a finding of no violation of section 337 of the Tariff Act of 1930 (19 U.S.C. §1337); and
3. The Secretary shall serve a copy of this Order upon each party to the investigation and publish notice thereof in the *Federal Register*.

By order of the Commission.



Marilyn R. Abbott
Secretary

Issued: August 20, 2003

CERTIFICATE OF SERVICE

I Marilyn R. Abbott, hereby certify that the attached NOTICE OF COMMISSION DETERMINATION OF NO VIOLATION OF SECTION 337; TERMINATION OF INVESTIGATION, was served upon the following parties, via first class mail and air mail where necessary, on August 21, 2003.

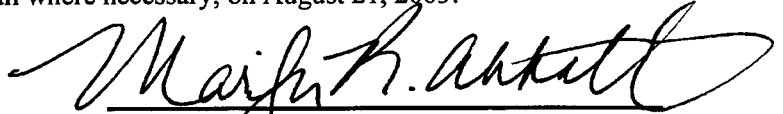

Marilyn R. Abbott, Secretary
U.S. International Trade Commission
500 E Street, SW - Room 112
Washington, DC 20436

**ON BEHALF OF COMPLAINANT
CLIMAX MOLYBDENUM COMPANY:**

Timothy B. Scull, Esq.
Merchant and Gould
1400 Independence Plaza
1050 Seventeenth Street
Denver, CO 80265-0100

Bruce E. Dahl, Esq.
Dahl and Osterloth, LLP
555 Seventeenth Street
Suite 3405
Denver, CO 80202-3937

**ON BEHALF OF MOLYCHEM, LLC AND
CHEM-MET INTERNATIONAL, INC.:**

Ramon L. Pizarro, Esq.
Hart and Trinen, LLP
3515 S. Tamarac Drive
Suite 200
Denver, CO 80237

Donald t. Trinen, Esq.
Hart and Trinen, LLP
1624 Washington Street
Denver, CO 80203

RESPONDENTS

Anhui Wonder Trade Co., Ltd.
No. 872 Yuxi Road
Hefei, Anhui, Peoples Republic of China
230011

Pudong Trans USA, Inc.
9960 Flair Drive, Suite 218
El Monte, CA 91731

PUBLIC MAILING LIST

Donna Wirt
LEXIS - NEXIS
1150 18th Street, NW
Suite 600
Washington, D.C. 20036

Ronita Green
West Services, Inc.
901 Fifteenth Street, NW
Suite 1010
Washington, D.C. 20005

PUBLIC VERSION

UNITED STATES INTERNATIONAL TRADE COMMISSION
Washington, D.C. 20436

In the Matter of)

CERTAIN AMMONIUM)
OCTAMOLYBDATE ISOMERS)
_____)

Inv. No. 337-TA-477

04 JAN -5 112:18

RECEIVED
U.S. ITC
337-TA-477

COMMISSION OPINION

On August 20, 2003, the Commission issued notice that it had concluded the above-captioned investigation, conducted pursuant to section 337 of the Tariff Act of 1930, as amended (19 U.S.C. §1337), with a final determination of no violation of section 337. The unfair act alleged in this investigation was infringement of claim 1 of U.S. Patent No. 5,985,236 (“the ‘236 patent”). The Commission found that claim 1 of the ‘236 patent is invalid under 35 U.S.C. §102(b) for anticipation and because of an on-sale bar. The Commission also found that the ‘236 patent was unenforceable because of inequitable conduct during its prosecution before the United States Patent and Trademark Office. The following opinion sets out the reasons for the Commission’s final determination and the conclusions on which it is based.

I. BACKGROUND

A. Procedural History

The Commission instituted this patent-based section 337 investigation on August 20, 2002, based on a complaint filed by Climax Molybdenum Company (“Climax”) against one respondent, Molychem LLC (“Molychem”). 67 Fed. Reg. 53966 (Aug. 20, 2002). Climax’s

PUBLIC VERSION

complaint alleged a violation of section 337 of the Tariff Act of 1930 in the importation into the United States, the sale for importation, and the sale within the United States after importation of certain ammonium octamolybdate isomers by reason of infringement of claim 1 of U.S. Patent No. 5,985,236 (“the ‘236 patent”).¹ The investigation was assigned to administrative law judge (“ALJ”) Charles E. Bullock.

A few weeks after institution, the complaint and notice of investigation were amended to add four additional respondents: Anhui Wonder Trade Co., Ltd. (“Anhui”); Pudong Trans USA, Inc. (“Pudong”); John S. Conner, Inc. (“Conner”); and Chem-Met International, Inc. (“Chem-Met”). Respondent Conner was subsequently terminated from the investigation on the basis of a settlement agreement. Of the remaining respondents, Molychem has actively participated in the investigation. Respondent Chem-Met filed a response to the amended complaint and notice of investigation. Respondents Anhui and Pudong made no appearance in the investigation, nor did they respond to the amended complaint and notice of investigation. Both failed to respond to an order to show cause by February 21, 2003, why they should not be found in default. However, neither was formally declared to be in default.

The ALJ held an evidentiary hearing from February 10-14 and 24, 2003. After the completion of post-hearing briefing, the parties presented closing arguments on April 2, 2003.

On May 15, 2003, the ALJ issued his final initial determination (“ID”), including his recommended determination on remedy and bonding. In his ID, the ALJ found no violation of section 337 based on his conclusion that claim 1 of the ‘236 patent is invalid under 35 U.S.C.

¹ A copy of the ‘236 patent is attached to this opinion.

PUBLIC VERSION

§102(b) because the claimed invention was on sale in the United States more than one year prior to the U.S. filing date of the application for the '236 patent. The ALJ rejected arguments by respondent Molychem that the '236 patent was invalid as anticipated by an article by Tytko *et al.* ("the Tytko article") and by U.S. Patent No. 4,762,700 to Huggins ("the Huggins patent"). He also rejected arguments by Molychem that the '236 patent was unenforceable because of inequitable conduct before the U.S. Patent and Trademark Office ("PTO"). He found that, if the '236 patent were valid, it would be infringed by respondents' products and that Climax had established the existence of a domestic industry based on the '236 patent. In the event the Commission disagreed with him and found a violation of section 337, the ALJ also recommended issuance of a limited exclusion order and cease and desist orders, and that the amount of the bond during the Presidential review period be set at 25 percent of entered value. The ALJ noted that the '236 patent is currently the subject of reissue proceedings in the PTO.

On May 27, 2003, Climax filed a petition for review of the final ID, specifically the ALJ's conclusion that claim 1 was invalid under 35 U.S.C. §102(b) because of an on-sale bar. Molychem and the Commission investigative attorney ("IA") did not file petitions for review, but both opposed Climax's petition for review. On June 10, 2003, Climax filed a motion for leave to file a reply to the response of the IA, including its proposed reply. On June 11, 2003, Molychem filed a motion to strike Climax's motion for leave.

On June 30, 2003, the Commission issued a notice that it had determined to review the ALJ's final ID in its entirety and set a schedule for written submissions on the issues under review and on the questions of remedy, the public interest, and bonding. The Commission's

PUBLIC VERSION

notice was subsequently published in the *Federal Register*. 68 *Fed. Reg.* 40293 (July 7, 2003).

In its notice, the Commission indicated that, while it had determined to review the ID in its entirety, it was particularly interested in briefing on the issues of personal jurisdiction over respondent Pudong, claim construction, invalidity of claim 1 of the '236 patent for anticipation by the Tytko article, and unenforceability of the '236 patent for inequitable conduct. The Commission also requested the parties to respond to three questions relating to certain of the issues under review, specifically:

1. What is the meaning of the term "octamolybdate" in claim 1 of the '236 patent? In particular, the Commission wishes the parties to address whether the term refers to a single polyanion containing eight molybdenum and twenty-six oxygen atoms.
2. Whether (a) the Raman spectrum shown in Figure 1(f) of the Tytko article (second from the top) falls within the Raman spectrum set out in Claim 1 of the '236 patent, and (b) whether the Tytko article contains sufficient enabling disclosure with respect to the composition represented by that spectrum so as to be available as prior art.
3. The legal foundation and record support for the existence or non-existence of the specific offer for sale or sale found by the ALJ in his final ID in connection with his finding of the existence of an on-sale bar.

The Commission also ordered complainant Climax to file and serve with its main brief on review a copy of the file for the reissue application for the '236 patent which is currently pending in the PTO, as well as the files of any other proceedings in the PTO relating to the '236 patent, the reissue application, or the original application for the '236 patent. The Commission also ordered Climax to file and serve any additions to such files as they were made in the PTO.

The Commission denied Climax's request for oral argument in the review proceeding. In addition, the Commission denied Climax's motion for leave to file a reply to the IA's opposition

PUBLIC VERSION

to its petition for review, and also denied Molychem's motion to strike, without prejudice to Climax and Molychem renewing any pertinent arguments in their written submissions on review.

On July 14, 2003, Climax, Molychem, and the IA filed their written submissions on review. Climax also filed several other papers with its written submission, which it stated constituted "a copy of the reissue application file for the '236 patent and the files of other proceedings in the PTO relating to the '236 patent, the reissue application, or the original application for the '236 patent." Climax Brief ("Climax Br."), p. 2. On July 21, 2003, Climax, Molychem, and the IA filed their respective reply briefs. In addition, Molychem filed a motion for oral argument in connection with Commission review of the ID. On August 4, 2003, the IA filed an opposition to Molychem's motion.

On August 20, 2003, the Commission issued notice of its final determination of no violation of section 337. The Commission found that claim 1 of the '236 patent is invalid under 35 U.S.C. §102(b) because of (1) anticipation by the Tytko article and by the Huggins patent, and (2) the existence of an on-sale bar. The Commission also found that the '236 patent was unenforceable because of inequitable conduct during its prosecution before the PTO. The Commission denied Molychem's request for oral argument.

B. The Product at Issue

The product at issue is ammonium octamolybdate, also known as AOM, an inorganic chemical compound which, according to the '236 patent, has the formula $(\text{NH}_4)_4\text{Mo}_8\text{O}_{26}$, where NH_4 is ammonium, Mo is molybdenum, and O is oxygen. AOM exists in multiple forms or "isomers" which include alpha-AOM, beta-AOM, gamma-AOM, and delta-AOM. Alpha-AOM

PUBLIC VERSION

and, secondarily, beta-AOM, are commercially useful as smoke suppressants in many different compositions, including plastic materials used for coating electrical wiring and fiber-optic elements. The '236 patent claims what it says is a fifth isomer of AOM, referred to as X-AOM in the specification, which is also commercially useful as a smoke suppressant. It is X-AOM which is the subject of this investigation.

C. The '236 Patent

1. In General

The '236 patent is entitled "Ammonium Octamolybdate Composition And Method For Producing The Same." CX-1. It issued on November 16, 1999, based on Application Serial No. 09/094,194, filed June 9, 1998. The inventors named on the face of the patent are: Mohamed H. Khan, James A. Cole, Timothy G. Bruhl, Wendell S. Elder, Gary S. Glasgow, and Vijaykumar M. Wagh. As issued, the patent was assigned to Cyprus Amax Minerals Company. CX-1; CX-3. It was subsequently assigned to complainant Climax Molybdenum Company. CX-4.

Claim 1 is the only claim in the '236 patent. It claims "[a]n ammonium octamolybdate isomer having Raman spectra² peaks at wavelength values of about 953-955 cm⁻¹, about 946-948 cm⁻¹, and about 796-798 cm⁻¹." As noted above, the specification of the '236 patent identifies this compound as a novel ammonium octamolybdate isomer and refers to it as X-AOM.

² Raman spectra are based on the so-called Raman scattering of monochromatic light (usually provided by a laser) by chemical substances. Most light scattered by a substance has the same frequency as the incident light. However, a small portion of the incident light will interact with the substance and be scattered at a different frequency. This type of scattering is known as Raman scattering and it is this frequency-shifted light which is used to produce a Raman spectrum. Raman spectra are powerful tools in chemical analysis and are used to identify chemical substances.

PUBLIC VERSION

2. Development of the Claimed Invention

The claimed invention is said to be the result of a research and development program begun by Climax in 1995. At that time, Climax was producing AOM (specifically alpha-AOM) at its Fort Madison, Iowa facility using a thermal decomposition process, the so-called “dry process.” Cole, Tr. 89:24-90:11; King, Tr. 549:4-8. Beginning in 1994, Climax began to receive numerous complaints about the quality of its dry process AOM from [[

]] Corporation. Cole, Tr. 89:24-94:4; CX-138C; CX-152C. By the end of 1995, Climax began experimenting, *inter alia*, with the so-called “wet process” for making AOM described in the Huggins patent, and by [[]] had determined that that process produced the best preliminary results. Cole, Tr. 89:2-95:9; CX-138C. By March, 1996, Climax began producing samples made in its chemical plant by what Cole described as a process somewhat different from the Huggins process. Cole, Tr. 110:22-114:15. A memorandum dated November, 1996 indicates that by that date samples of the material produced by a wet chemical process had been sent to [[]] and [[]], Climax’s two largest customers, both of which tested the samples and found them “superior to any product evaluated.” RX-31C. Based on this positive feedback, Climax constructed [[]] at its Fort Madison facility, which was completed by [[]]. Cole, Tr. 321:13-322:9, 386:9-387:7. Climax began production using [[]]. Cole, Tr. 321:13-322:9.

In conjunction with its research and development effort, Climax contracted with [[]] to have [[]] assist it in [[]] and [[]]. Cole, Tr.

PUBLIC VERSION

119:14-25; CX-24C; CX-105C; CX-168C. [[]] efforts resulted in a series of reports regarding the results of his tests and experiments. ID 49-50. By August 1997, [[]] had concluded that the AOM being produced by the wet process was not alpha-, beta-, or gamma-octamolybdate but rather a “new polyisomolybdate,” which he termed “X-AOM.” CX-106C at 2, 8.

In his [[]], progress report, [[]] reported on (among other things) the preparation of AOM by use of the prior art Huggins method [[]] thereof. CX-157C, RX-4C. Raman spectra were taken from samples at different time intervals in these processes. These Raman spectra were reproduced in the report as [[]

]]; the wavenumbers of the peaks of these Raman spectra are identified in these figures, which also include handwritten notes as to which peak is associated with what product (alpha-AOM, beta-AOM, X-AOM, or MoO₃). In his report, [[]] concluded that the Huggins process does not produce pure alpha-AOM, but rather a mixture of alpha-AOM and X-AOM, with alpha-AOM as the dominant phase. CX-157C at 4-5.

In that same report, [[]] also concluded that the product referred to as X-AOM was “an unknown isopolymolybdate phase” and, [[]

]] Subsequently, in order to definitively characterize X-AOM, [[]] attempted to obtain [[]] In his [[]],

PUBLIC VERSION

progress report, he indicated that he had not been able [[

]]

3. The Original Application for the '236 Patent; Prosecution Before the PTO

As originally filed, the application for the '236 patent contained 19 claims. CX-2, pp. 149-205. Application claim 1 claimed “[a]n ammonium octamolybdate isomer having Raman spectra peaks at wavelength values of about 953-955 cm^{-1} , about 946-948 cm^{-1} , and about 796-798 cm^{-1} .” Application claims 2-19 claimed, in various ways, a “method for producing an ammonium octamolybdate isomer,” *i.e.*, the ammonium octamolybdate isomer of application claim 1.

On March 1, 1999, the PTO examiner issued a first office action on the merits, rejecting all the claims in the application. CX-2, pp. 233-39. Claims 2-19 were rejected under 35 U.S.C. §112, second paragraph, as indefinite. Claims 1-19 were rejected for obviousness under 35 U.S.C. §103 over U.S. Patent No. 4,762,700 to Huggins in view of U.S. Patent No. 4,079,116 to Ronzio *et al.* With respect to application claim 1, the examiner stated:

Regarding claim 1, while Huggins does not specifically recite the Raman spectra peaks at a [sic] specific wavelengths, as recited by applicants, for his isomers, it would be expected that the isomers of Huggins would be the same, because the product was made in the same manner.

CX-2, p. 238.

On July 6, 1999, Climax filed an amendment responding to the examiner’s first office action. CX-2, pp. 243-62. In that amendment, Climax cancelled application claims 2-19. Climax maintained application claim 1 in its original form and submitted a declaration by one of

PUBLIC VERSION

the named inventors, James A. Cole, which it argued showed that the ammonium octamolybdate produced according to the Huggins patent is not the ammonium octamolybdate of application claim 1, specifically stating that:

as demonstrated in the attached Rule 132 declaration of Mr. James A. Cole, the AOM [ammonium octamolybdate] produced by the method according to the Huggins patent **does not** produce the X-AOM isomer as specifically defined by currently pending claim 1. That is, the AOM produced according to the Huggins method does not produce spectral peaks at wavenumber ranges of about 953-955 cm^{-1} , 946-948 cm^{-1} , and 796-798 cm^{-1} .

CX-2, pp. 244-45. [Emphasis in original.]

Climax stated further that the Cole Declaration:

presents the Raman spectral data gathered from AOM produced by the method disclosed in the Huggins reference as well as Raman spectral data from AOM produced according to the method of the present invention.

CX-2, p. 245.

After discussing the data, Climax argued as follows:

Significantly, the Raman spectral data of the Huggins AOM presented in Exhibit A do not show formation of the X-AOM phase. That is, none of the Raman spectra include peaks having wavenumbers in the ranges of about 953-955 cm^{-1} , 946-948 cm^{-1} , and 796-798 cm^{-1} , which are the peaks specifically set forth in currently pending claim 1. While the Raman spectral data gathered on the Huggins AOM do show the existence of a small spectral peak at about wavenumbers 797-798 cm^{-1} at time $t = 170$ minutes and again at $t = 230$ minutes, the Raman spectral data do not show the existence of any spectral peaks at the other claimed wavenumber values, i.e., 953-955 cm^{-1} and 946-948 cm^{-1} . Consequently, there is no way that the AOM produced according to the process disclosed in the Huggins patent can be said to contain the claimed X-AOM isomer.

CX-2, pp. 245-46.

After discussing Exhibit B to the Cole Declaration, which related to Raman spectra for material produced by the process disclosed (but no longer claimed) in the application, Climax stated:

PUBLIC VERSION

To summarize, the Raman spectral data contained in the Rule 132 declaration [the Cole Declaration] make clear that the process disclosed in the Huggins patent does not result in the formation of the X-AOM isomer having the spectral peaks set forth in currently pending claim 1. Consequently, claim 1 cannot be said to be anticipated or made obvious by the prior art.

CX-2, p. 246.

The foregoing statements in Climax's amendment reflect statements made by Cole in his declaration which was attached thereto, especially paragraphs 6-14 and 19 of that declaration, which are reproduced in relevant part below:

6. I [*i.e.*, Cole] instructed the Iowa State University to perform a series of tests in order to determine the Raman spectra associated with ammonium octamolybdate ("AOM") produced by the process disclosed in the Huggins patent, U.S. Patent No. 4,762,700.

7. As will be discussed in greater detail below, the tests conducted by the Iowa State University confirm that the AOM isomers produced by the process disclosed in the Huggins patent **do not include** the novel X form ("X-AOM") having the characteristic spectral peaks as set forth in currently pending claim 1. [Emphasis in original.]

8. The AOM samples tested by the Iowa State University were produced by the Iowa State University in accordance with the process disclosed in the Huggins patent (*i.e.*, U.S. Patent No. 4,762,700). More specifically, the AOM samples were produced and analyzed as follows:

I instructed Dr. Robert McCarley at the Iowa State University to prepare an amount of AOM according to the process disclosed in the Huggins patent. In order to assist Dr. McCarley in this matter, I provided him with a copy of the Huggins patent and specifically discussed the procedure outlined therein. Dr. McCarley has confirmed with me that the AOM samples were, indeed, produced according to the process disclosed in the Huggins patent.

The AOM produced by the Iowa State University according to the Huggins patent was thereafter analyzed with a Raman spectrometer. Raman spectroscopy is an established analytical technique that provides highly accurate and definitive results. The Raman spectral analysis of the Huggins AOM is presented in Exhibit A which is attached hereto and forms a part of

PUBLIC VERSION

this declaration.

9. Exhibit A contains a plurality of spectra taken from the AOM material after the material had been at a temperature of 95°C for the times indicated on the right-hand portion of the spectra. For example, Exhibit A includes spectra of the Huggins AOM material taken after being maintained at about 95°C for the following times:

- t = 8.5 minutes;
- t = 20.5 minutes;
- t = 25 minutes;
- t = 30 minutes;
- t = 45 minutes;
- t = 65 minutes;
- t = 170 minutes; and
- t = 230 minutes.

10. With reference to Exhibit A, MoO₃ was clearly noted in the initial sample (i.e., t = 8.5 minutes) at 996, 820, and 667 cm⁻¹. A weak second phase (i.e., the β-AOM phase) was also detected at 977, 957, and 913 cm⁻¹.

11. After 20.5 minutes, the amount of MoO₃ was drastically reduced, as evidenced by the reduction in the peaks at 996, 820, and 667 cm⁻¹. The intermediate β-AOM phase was also more clearly observed by peaks at 978, 951, 941, 912, 902, and 841 cm⁻¹. Also, the first indications of the α-AOM phase were observed as indicated by the spectral peak at 966 cm⁻¹.

12. Within 5 more minutes (i.e., at t = 25 minutes), the α-AOM phase begins to dominate, and by t = 30 minutes, the intermediate β-AOM phase has completely disappeared. The spectra remain essentially unchanged for the remainder of the times (i.e., t = 45 min. through t = 230 min.).

13. The Raman spectral data of the AOM produced according to the Huggins process **do not** show the formation of the X-AOM phase. That is, none of the Raman spectra include peaks having wavenumbers in the ranges of about 953-955 cm⁻¹, 946-948 cm⁻¹, and 796-798 cm⁻¹, which are the peaks specifically set forth in currently pending claim 1. [Emphasis in original.]

14. While the Raman spectral data gathered on the Huggins AOM show the existence of a small spectral peak at about wavenumbers 797-798 cm⁻¹ at time t = 170 minutes and again at t = 230 minutes, the Raman spectral data do not show the existence of any spectral peaks at the other claimed wavenumber values, i.e., 953-955 cm⁻¹ and 946-948 cm⁻¹.

PUBLIC VERSION

* * *

19. Several salient facts and conclusions are supported by the Raman spectral data attached hereto and described above:

a). First, the AOM produced according to the method disclosed in the Huggins patent **does not** produce the X-AOM isomer as specifically defined by currently pending claim 1. That is, the AOM produced according to the Huggins method does not produce spectral peaks at wavenumber ranges of about 953-955 cm^{-1} , 946-948 cm^{-1} , and 796-798 cm^{-1} . See Exhibit A. [Emphasis in original.]

b). While the Raman spectral data gathered on the Huggins AOM show the existence of a small spectral peak at 797-798 cm^{-1} at times $t = 170$ minutes and $t = 230$ minutes, the Raman spectral data do not show the existence of any spectral peaks at the other claimed wavenumber values, i.e., 953-955 cm^{-1} and 946-948 cm^{-1} . Since the other two spectral peaks are not present, the AOM produced according to the Huggins method cannot be said to include the claimed X-AOM isomer.

* * *

CX-2, pp. 248-53.

The language of paragraphs 10 and 11, as well as the first sentence of paragraph 12, of the Cole Declaration closely tracks the language of Dr. McCarley's [[]], report on his evaluation of the Huggins process. However, the declaration nowhere discloses Dr. McCarley's [[]]. Further, the handwritten notations on [[]] of Dr. McCarley's report, indicating the production of X-AOM by the Huggins process, do not appear in the copies of those figures attached to the Cole Declaration as Exhibit A.

On July 22, 1999, the PTO examiner issued a notice of allowability, including an examiner's amendment and reasons for allowance. The notice was expressly issued in response to Climax's July 6, 1999, amendment. In her reasons for allowance, the examiner stated that:

PUBLIC VERSION

ammonium octamolybdate is known to the art, but the particular ammonium octamolybdate having specific raman spectra wavelength as recited in claim 1 distinguishes over the prior art.

CX-2, p. 264; RX-8, p. CM000261.

On November 16, 1999, the application issued as the '236 patent. It contains only one claim, claim 1, which is identical to application claim 1.

4. The Pending Reissue Application

As noted in the ID, the '236 patent is the subject of a reissue application filed by Climax in the PTO in November of 2001, which is still pending. As noted above, the Commission ordered Climax to produce the file of the reissue proceeding and the files of any other proceedings at the PTO related to the reissue application, the '236 patent, or the original application. Climax filed papers related to the reissue proceeding with its main review brief on July 14, 2003. These papers were not certified by the PTO (*i.e.*, Climax did not file a certified copy of the file of the reissue proceeding), but appear to be copies of papers in the possession of Climax or its counsel. They are not identified by any index and it is apparent that they are incomplete.

It appears from the reissue proceeding papers submitted by Climax that the reissue application contains 12 claims. Claim 1 of the reissue application is identical to claim 1 of the '236 patent. Claims 2-12 constitute an attempt by Climax to define the claimed invention in terms of additional or different Raman peaks than those in claim 1. Molychem filed protest papers in the reissue proceeding, but one of those papers is missing from the papers filed with the Commission by Climax. From the papers provided by Climax, it appears that Molychem's

PUBLIC VERSION

protest was based entirely on alleged anticipation by the Huggins patent.

In an office action mailed March 12, 2003, the reissue examiner (who also examined the original application) objected to the reissue specification as including prohibited new matter because of the addition thereto of material referring to an additional Raman peak. The reissue examiner rejected claims 2-12 as drawn to the objected-to new matter and also under 35 U.S.C. §112, first paragraph, because the claims were “not commensurate with the scope of the original disclosure.” The examiner responded to Molychem’s protest by stating that there is at least one difference between the process disclosed in the ‘236 patent and the process of the Huggins patent (“the gradual, non-instantaneous addition of the ADM [ammonium dimolybdate] and the molybdenum trioxide (or MoO₃)”) and noting the apparent presence in the ‘236 patent of another difference (related to heating) which was said to result in the preferential production of X-AOM and the avoidance of other AOM isomers such as alpha-AOM. Because the examiner found that the production of alpha-AOM is not desired in the ‘236 patent, she concluded that “the product of Khan et al. [the ‘236 patent] cannot be the same as the Huggins’ product.”³

II. DISCUSSION

A. Subject Matter Jurisdiction

The Commission’s subject matter jurisdiction is invoked where the alleged unfair practice occurs in the importation of articles into the United States, in their sale for importation, or in

³ As discussed *infra*, we have found claim 1 of the ‘236 patent invalid for anticipation by the Huggins patent. In our view, the question is not whether the process of the ‘236 patent produces alpha-AOM, but whether the process of the Huggins patent produces X-AOM, whether or not it also produces alpha-AOM.

PUBLIC VERSION

their sale in the United States after importation. *Enercon GmbH v. International Trade Commission*, 151 F.3d 1376, 1380-83 (Fed. Cir. 1998). Climax has made such allegations in this case. The ALJ found that Molychem imports the subject product into the United States. ID 9. This finding is supported by the record and is not disputed.

B. The '236 Patent: Claim Construction

1. Applicable Law

Claim construction is a question of law. *Markman v. Westview Instruments, Inc.*, 517 U.S. 370, 384-91 (1996); *Texas Digital Systems, Inc. v. Telegenix, Inc.*, 308 F.3d 1193, 1201 (Fed. Cir. 2002). The analytical focus of claim construction begins, and remains, on the language of the claims themselves. *Texas Digital*, 308 F.3d 1193, 1201-02. Claim terms are presumptively construed to have the ordinary meaning that would be attributed to them by persons skilled in the relevant art. *Texas Digital*, 308 F.3d 1193, 1202. Dictionaries, encyclopedias, and treatises which were publicly available at the time a patent is issued are permissible and particularly useful resources to assist a tribunal in determining the ordinary and customary meaning of claim terms. *Texas Digital*, 308 F.3d 1193, 1202-03. After examining the claim language to determine the possible meanings that would have been attributed to the claim terms by those skilled in the art, the intrinsic record (*i.e.*, the specification and prosecution history) must be consulted to determine which of these possible meanings is most consistent with the use of the words by the inventor and to determine whether the presumption of ordinary meaning is rebutted (*e.g.*, by the inventor acting as his own lexicographer). *Texas Digital*, 308 F.3d 1193, 1203-05.

PUBLIC VERSION

2. Claim Terms in Issue

Before the ALJ, the parties addressed the claim terms "octamolybdate" and "about."

In its review notice, the Commission asked the parties to address the meaning of "octamolybdate" and specifically whether the term refers to "a single polyanion containing eight molybdenum and twenty-six oxygen atoms." In their review briefs, all parties agreed with this definition and we adopt it here.

The ALJ construed the term "about" as used in claim 1 of the '236 patent to mean "a Raman spectra wavelength that is within +/- 2-4 cm⁻¹ of the specified ranges." ID 18. He stated that both private parties, by their experts, had agreed that "it is reasonable to interpret the term 'about' when used in reference to Raman spectra, to include a range that is plus or minus two to four cm⁻¹ of the ranges claimed in claim 1 of the Khan '236 patent," and that the IA also agreed with this construction. No party sought review of this definition and we adopt it here.

C. Claim 1 of the '236 Patent is Invalid for Anticipation by the Tytko Article and by the Huggins Patent

1. Applicable Law

A patent is presumed valid. 35 U.S.C. § 282; *Richardson-Vicks Inc. v. The Upjohn Co.*, 122 F.3d 1476, 1480 (Fed.Cir. 1997). The party challenging a patent's validity has the burden of overcoming this presumption by clear and convincing evidence. *Uniroyal, Inc. v. Rudkin-Wiley Corp.*, 837 F.2d 1044, 1050 (Fed.Cir.), *cert. denied*, 488 U.S. 825 (1988).

Molychem argues that claim 1 of the '236 patent is invalid for anticipation under 35 U.S.C. §102(b), which provides that:

A person shall be entitled to a patent unless --

PUBLIC VERSION

* * *

(b) the invention was patented or described in a printed publication in this or a foreign country or in public use or on sale in this country, more than one year prior to the date of the application for patent in the United States.

Specifically, Molychem argues that claim 1 of the '236 patent is invalid under 35 U.S.C. §102(b) for anticipation by the Tytko article and by the Huggins patent.

A claim is anticipated, and therefore invalid, if a single prior art reference discloses each and every limitation of the claim. *Celeritas Technologies, Ltd. v. Rockwell Int'l*, 150 F.3d 1354, 1361 (Fed. Cir. 1998). The disclosure of the prior art reference need not be express, but may anticipate by inherency. *Celeritas*, 150 F.3d 1354, 1361; *Schering Corp. v. Geneva Pharmaceuticals, Inc. et al.* Appeal Nos. 02-1540 *et al.* (Fed. Cir., August 1, 2003).

In order for a printed publication which discloses the claimed invention to be available as prior art, it must contain a sufficient disclosure to enable those of ordinary skill in the art to make that invention without undue experimentation. *Helifix Ltd. v. Blok-Lok, Ltd.*, 208 F.3d 1339, 1346-1349 (Fed. Cir. 2000), citing, *inter alia*, *In re Donohue*, 766 F.2d 531 (Fed. Cir. 1985). Evidence of such enablement is not limited to the anticipating patent or printed publication; it may be shown by other evidence, including other patents and printed publications. *Donohue*, 766 F.2d 531, 534.

Anticipation is a question of fact. *Glaxo Inc. v. Novopharm Ltd.*, 52 F.3d 1043, 1047, 34 USPQ2d 1565, 1567 (Fed. Cir.), *cert. denied*, 516 U.S. 988 (1995). It must be established by clear and convincing evidence. According to the the Federal Circuit:

Clear and convincing evidence has been described as evidence which proves in the mind of the trier of fact "an abiding conviction that the truth of [the] factual contentions are [sic] 'highly probable.'"

PUBLIC VERSION

Intel Corp. v. U.S. International Trade Commission, 946 F.2d 821, 830 (Fed. Cir. 1991).

2. Claim 1 of the '236 Patent is Invalid Under 35 U.S.C. §102(b) for Anticipation by the Tytko Article

The Tytko article is a German language article entitled "Über Isopolymolybdatfeststoffe und deren Beziehung zu Isopolymolybdaten in wässriger Lösung" (translated into English as "Concerning Solid Isopolymolybdates and their Relation to Isopolymolybdate Ions in Aqueous Solution"). CX-118 (with translation), RX-14, RX-14.1 (partial translation). It was authored by Karl-Heinz Tytko and Bernd Schonfeld of the Inorganic Chemistry Institute of the University of Göttingen. The Tytko article was published in 1975 in the German scientific journal "Zeitschrift für Naturforschung." It is prior art as a printed publication under 35 U.S.C. §102(b), but was not among the prior art references that were considered by the PTO examiner during the prosecution of the '236 patent.⁴

As its title indicates, the Tytko article concerns an investigation of isopolymolybdates as a group and it is clear from the article that there are many different kinds of isopolymolybdates. Figure 1(f) of the Tytko article (second from the top)⁵ shows the Raman spectrum for a substance identified as $(\text{NH}_4)_2\text{O}\cdot 4\text{MoO}_3$. CX-118, p. CM0002376 (German version). This substance is one of several substances discussed under the head "Polymolybdates $\text{A}_2\text{O}\cdot 4\text{MoO}_3\cdot x\text{H}_2\text{O}$ ($Z+ = 1.50$) [(1:4)-molybdates, metamolybdates]." CX-118, pp. CM0002377-78. Molychem argues that the Raman spectrum of this substance, shown in Figure 1(f) of the Tytko article, is the same

⁴ The Tytko article has apparently been cited in the reissue proceedings.

⁵ For convenience, this figure will simply be referred to as Figure 1(f) or Figure 1(f) of the Tytko article.

PUBLIC VERSION

as the Raman spectrum for X-AOM, shown in Figure 2 of the '236 patent, and thus that claim 1 of the '236 patent is anticipated by the Tytko article.

An understanding of the chemical nomenclature used in much of the Tytko article is essential to understanding what the Tytko article says and, just as importantly, what it does not say. It is especially important in understanding that the Tytko article does not identify or state that the substance relied on by Molychem is a *tetramolybdate* (as opposed to an *octamolybdate*). As noted above, the substance relied upon by Molychem is identified in the Tytko article as $(\text{NH}_4)_2\text{O}\cdot 4\text{MoO}_3$. It is one of several substances discussed under the more general heading $\text{A}_2\text{O}\cdot 4\text{MoO}_3\cdot x\text{H}_2\text{O}$. As used in the Tytko article, the term A_2O is a generic term for a “basic oxide,” specifically Na_2O , K_2O , and $(\text{NH}_4)_2\text{O}$. *See*, CX-118, p. CM0002375. MoO_3 is molybdenum trioxide and H_2O is water. Na_2O , K_2O , $(\text{NH}_4)_2\text{O}$, MoO_3 , and H_2O are distinct compounds; they are not cations or anions. This type of formula system is not the same as that used in the '236 patent, which describes ammonium octamolybdate using a formula system which identifies its specific cation (four NH_4^+ (ammonium) cations) and its specific anion ($\text{Mo}_8\text{O}_{26}^{-4}$, the octamolybdate polyanion).⁶

Molychem argues that the record clearly shows that the Raman spectrum in Figure 1(f) of the Tytko article is the same as that shown in Figure 2 of the '236 patent, which is identified in

⁶ The difference in the two formula systems is made plain in the Tytko article itself when it refers to “ $(\text{NH}_4)_2\text{O}\cdot 4\text{MoO}_3\cdot 2.5\text{H}_2\text{O}$ or $\cdot 2\text{H}_2\text{O}$ ” to describe one of the (1:4)-molybdates and then, after stating that the structure of that compound is known, uses the cation/anion system: “There are discrete $\text{Mo}_8\text{O}_{26}^{-4}$ ions present, built up of MoO_6 octahedrons.” CX-118, p. CM0002377. The “dot-type” formula system used in the Tytko article describes a class of compounds or specific compound as a ratio of basic oxide to MoO_3 (and water, if present) present in the class or specific compound.

PUBLIC VERSION

that patent as showing the Raman spectrum of X-AOM, and thus the two spectra are of the same material. Molychem Brief (“Molychem Br.”), p. 13. To support its argument, Molychem relies on the testimony of Dr. Uy, its expert, who compared the two spectra. Molychem Br., pp. 7-15. Molychem also argues that the Tytko article contains an enabling disclosure. Molychem Br. 15-17.

Climax argues that there is no identity of invention between the disclosure of the Tytko article and claim 1 of the ‘236 patent because the spectrum of Figure 1(f) of the Tytko article does not fall within the Raman spectrum of claim 1 and because that spectrum is of a “tetramolybdate,” not an octamolybdate, relying on the testimony of its expert, Dr. Martin, and also that of Dr. Uy. Climax Br., pp. 6-15. Climax also argues that the Tytko article is not enabling.

We agree with Molychem. The evidence is clear and convincing that (1) the spectrum in Figure 1(f) of the Tytko article is the same as that of Figure 2 in the ‘236 patent and thus that they are spectra of the same substance, and (2) the Tytko article contains sufficient information to permit those of ordinary skill in the art to make the substance of Figure 1(f) without undue experimentation, *i.e.*, the Tytko article contains an enabling disclosure.

As to the first point, there is clear and convincing evidence that the spectrum in Figure 1(f) of the Tytko article is the same as that of Figure 2 in the ‘236 patent and thus that they are spectra of the same substance. This was the testimony of Dr. Uy, testimony which is consistent with visual inspection and comparison of the two spectra. Uy, Tr. 843:21-849:7, 853:22-854:21; RX-54.2. Climax did not object to Dr. Uy’s testimony and, when asked by the ALJ, specifically

PUBLIC VERSION

did not object to the admissibility of CX-54.2. Climax refers to testimony by its expert, Dr. Martin, that the spectrum in Figure 1(f) is not usable because it is “highly compressed,” but Dr. Martin offered no explanation of what he meant by “highly compressed” or why the Tytko spectrum was not usable. Climax also refers to testimony by Dr. Martin referring to “inherent inaccuracies” in Molychem’s enlargement of Figure 1(f) in RX-54.2, about which Dr. Uy testified. Again, however, neither Climax nor Dr. Martin offered any explanation of what these so-called inaccuracies are, nor are they evident from inspection of the exhibit. Dr. Martin’s testimony, relied on by Climax, that he was not able to discern the claimed peaks in the spectrum of Figure 1(f) is not credible, as the ALJ himself appears to have noted.⁷

Climax argues that even if the two spectra are “similar” (the most that Climax and Dr. Martin will concede), this does not mean that they are the same substance.⁸ This argument begs the question. Dr. Uy did not simply testify that the spectra in Figure 1(f) of the Tytko article and Figure 2 of the ‘236 patent were similar; he testified that they were identical and that they were

⁷ The ALJ noted that Dr. Martin testified that he could not tell if the two figures matched (particularly the so-called doublet feature), but on examining the figures himself, the ALJ found that “when looking at the figure in the original publication, the undersigned clearly sees a doublet peak and it appears that the Figure 1(f) and Figure 2 of the Khan ‘236 patent are very similar.” ID 53-54.

⁸ For this argument, Climax relies on Dr. Martin’s testimony concerning what he regarded as the similarity of spectra in Figures 1(c), 1(e) and 1(h) of the Tytko article. None of these spectra are similar to the spectrum in Figure 2 of the ‘236 patent, nor are they argued to be. Climax has not pointed to any spectrum which is “similar” to Figure 2 of the ‘236 patent which is not X-AOM.

PUBLIC VERSION

therefore spectra of the same substance.⁹ Further, as noted, Climax has not pointed to any spectrum which is “similar” to Figure 2 of the ‘236 patent which is not X-AOM.

Climax also argues that Tytko identified the substance of Figure 1(f) as a tetramolybdate, and did not identify it as an octamolybdate. This argument begs the question, since if the spectrum of Figure 1(f) is the same as that of Figure 2 of the ‘236 patent, they are spectra of the same substance, the substance which Climax has identified in the ‘236 patent as ammonium octamolybdate. In any event, Climax’s argument is the result of a misreading of the Tytko article. Tytko did not identify the substance of Figure 1(f) as a tetramolybdate. The use of the term “tetramolybdate” by the authors of the Tytko article does not refer to 4MoO_3 (*i.e.*, four moles of molybdenum trioxide), as Climax argues. This is evident from inspection of page CM0002375 of Tytko, which refers to “ammonium polytetramolybdate” as “ $\text{NH}_4\text{[Mo}_4\text{O}_{14}]_n$.” In contrast, in the portion of Tytko which specifically discusses the substance of Figure 1(f), $(\text{NH}_4)_2 \cdot 4\text{MoO}_3$, it is referred to as a member of the class of compounds referred to as (1:4)-molybdates, but it is not referred to as a tetramolybdate. CX-118, pp. CM0002377-78. While Tytko does state that the 1:4 molybdates are “also referred to in the literature as ‘tetramolybdates’ or metamolybdates,” the use of quotation marks indicates that the authors of the Tytko article were not following the nomenclature practice of this other literature, but were simply quoting

⁹ Climax argues that on cross-examination Dr. Uy was not able to “pinpoint” the location of the peaks in Figure 1(f) in the manner called for by claim 1, referring to his testimony at Tr. 951:10-13. Climax Br., pp. 8-9. Climax’s argument ignores Dr. Uy’s testimony that the two spectra are identical and is in any event incorrect. Climax’s argument is also inconsistent with its argument on infringement, which relied on Dr. Martin’s testimony of 801 cm^{-1} for the accused products as being sufficient to meet the claim limitation of “about 798 cm^{-1} .”

PUBLIC VERSION

that literature, as they make clear in footnote 22 of the Tytko article. Indeed, Tytko sets out the formula for one of the (1:4)-molybdates as $(\text{NH}_4)_4\text{Mo}_8\text{O}_{26} \cdot 5(4)\text{H}_2\text{O}$, a clear indication that it is an octamolybdate.¹⁰ CX-118, p. CM0002378.¹¹

Molychem argues, as it did before the ALJ, that the Tytko article is an enabling disclosure, referring to the testimony of its expert, Dr. Uy, and noting that the Tytko article states that the material of Figure 1(f) was commercially available as of at least 1975. Molychem Br. 15-17. Climax and the IA argue that the Tytko is not enabling. Climax relies on testimony from Dr. Martin and also testimony of Dr. Uy, which Climax argues constitutes a concession by Dr. Uy that the Tytko article is not specific and would require additional information outside the four corners of the article itself to permit a person of ordinary skill in the art to make the material of Figure 1(f). Climax Br. 12-15. The IA's argument on this point is similar to that of Climax. IA Br., pp. 11-12.

We agree with Molychem. There is ample evidence of enablement in this case. Dr. Uy testified that in 1975, a chemist using the Tytko article and his or her "ordinary knowledge" would have been able to make the substance of Figure 1(f). Uy, Tr. 970:7-18. The Tytko article identifies numerous methods for making isopolymetalates. One, which the authors refer to as the "classic method of producing isopolymetalates" consists of "acidifying an aqueous solution of

¹⁰ The authors also state that "other (1:4)-molybdates are also more frequently being called octamolybdates, although this has in no sense been clarified experimentally." CX-118, p. CM0002378.

¹¹ While both Dr. Martin and Dr. Uy referred to $(\text{NH}_4)_2\text{O} \cdot 4\text{MoO}_3$ as ammonium tetramolybdate, that testimony is inconsistent with the Tytko article.

PUBLIC VERSION

the normal metalate, such as Na_2MoO_4 , with mineral acid and bringing it to crystallization.” CX-118, pp. CM0002374-75.¹² It was this “classic method” that the authors of the Tytko article used to make the polymolybdates for their study, *i.e.*, they produced the polymolybdates of their study “from acidified aqueous molybdate solutions.” CX-118, p. CM0002375. Their investigation focused on the systems $\text{Na}_2\text{O}-\text{MoO}_3-\text{H}_2\text{O}$, $\text{K}_2\text{O}-\text{MoO}_3-\text{H}_2\text{O}$, and $(\text{NH}_4)_2\text{O}-\text{MoO}_3-\text{H}_2\text{O}$. In order to obtain all of the possible solid products of these systems, the authors systematically varied “the concentration of molybdate (added), the level of acidification, the temperature and the crystallization time.” CX-118, p. CM0002375.

The Tytko article also states: “The concentration of molybdate used in the case of sodium

¹² The full paragraph from which this quote is taken reads as follows:

The classic method of producing isopolymetalates consists in acidifying an aqueous solution of the normal metalate, such as Na_2MoO_4 , with mineral acid and bringing it to crystallization. Variants of this method are the use of the corresponding “metallic acids,” for example “molybdenum acid,” in place of the mineral acid, precipitation of polymetalate ions as low-solubility salts by adding a suitable cation, or the use of a polymetalate ion as the source species. The literature, especially the older literature [footnote omitted], contains descriptions of a great many isopolymolybdate solids produced according to this method. However, as a rule they were formerly characterized by analyzing and describing the crystal habit, so that many of the proposed species are probably the result of inadequate options for characterization, the ambiguity of the analytical values and the presence of mixtures of substances. In recent years additional methods of production have been found: controlled hydrolysis of metal acid esters in organic solvents in the presence of organic bases or salts [footnotes omitted]; reaction of the metal oxides or metal oxide hydrates with liquid organic bases or such bases dissolved in organic solvents or in water [footnotes omitted]; conversion of polymetalate salts with organic cations to form ones with inorganic cations [footnote omitted] (the references in each case are to the literature pertaining to polymolybdates).

CX-118, pp. CM0002374-75. (Emphasis supplied.)

PUBLIC VERSION

salts was about 1 mole l⁻¹, in the case of the potassium and ammonium salts 0.1-0.2 mole l⁻¹.”

CX-118, p. CM0002375.

In specifically discussing the preparation of 1:4 molybdates, the authors state:

The polymolybdates which are obtainable from solutions with $Z \approx 1.5$ (pH ≈ 2.5) require several days to form (at room temperature). This time can be shortened by raising the temperature. Already from their external nature one suspects the presence of various types of polymolybdates.

* * *

Two different products are obtained from the ammonium salt solutions: a finely crystalline precipitation with the composition $(\text{NH}_4)_2\text{O} \cdot 4\text{MoO}_3$ (without H_2O) [footnote omitted] (according to [footnote omitted] this substance is formed only from heated solutions), and large crystals of the formula $(\text{NH}_4)_2\text{O} \cdot 4\text{MoO}_3 \cdot 2.5\text{H}_2\text{O}$ or $\cdot 2\text{H}_2\text{O}$ [footnote omitted] ($Z+ = 12/8$). The structure of the latter product is known [footnotes omitted]: There are discrete $\text{Mo}_8\text{O}_{26}^{4-}$ ions present, built up of MoO_6 octahedrons. The two products normally accumulate side-by-side. As a rule, the finely crystalline product precipitates first, and the large crystals of the octamolybdate then appear later. From the mother liquor and in the attempt to recrystallize the octamolybdate, we always obtained only $(\text{NH}_4)_2\text{O} \cdot 4\text{MoO}_3$ [footnote omitted]. Both salts are poorly soluble.

* * *

CX-118, pp. CM0002377-78.

Also relevant are two footnotes in this section of Tytko. The first of these footnotes supports the statement that $(\text{NH}_4)_2\text{O} \cdot 4\text{MoO}_3$ is “formed only from heated solutions” and refers to *Gmelins Handbuch der Anorganischen Chemie (Gmelins Handbook of Inorganic Chemistry)*, 8th ed., “Molybdenum” (System No. 53), Berlin, 1935. CX-118, n. 16. The second footnote supports a reference to $(\text{NH}_4)_2\text{O} \cdot 4\text{MoO}_3$. It states: “The product sold by the company E. Merck, Darmstadt, as ‘molybdic acid, normal commercial quality’ (Item No. 400) is identical to this

PUBLIC VERSION

substance.” CX-118, n. 47.¹³ This statement indicates that the ammonium octamolybdate of claim 1 of the ‘236 patent has been known since at least 1935, that persons of ordinary skill in the art have known how to make it since that time, and that it has been commercially manufactured since at least 1975.

To be enabling, a reference must provide such disclosure as would permit a person of ordinary skill in the art to practice the claimed invention disclosed therein without undue experimentation. *Helifix Ltd. v. Blok-Lok, Ltd.*, 208 F.3d 1339, 1346-1349 (Fed. Cir. 2000), citing, *inter alia*, *In re Donohue*, 766 F.2d 531 (Fed. Cir. 1985). The evidence clearly shows that the Tytko article is sufficient to enable one of ordinary skill in the art to make the substance of Figure 1(f). Indeed, the article clearly indicates that those of ordinary skill in the art were actually making (and selling) that substance for many years prior to the date of the Tytko article and certainly prior to the critical date here. Given the identity of disclosure in Tytko, we determine that claim 1 of the ‘236 patent is invalid for anticipation by the Tytko article under 35 U.S.C. §102(b).

3. Claim 1 of the ‘236 Patent Is Invalid Under 35 U.S.C. §102(b) for Anticipation by the Huggins Patent

Molychem argues that claim 1 of the ‘236 patent is invalid under 35 U.S.C. §102(b) as

¹³ Molychem relied on this footnote before the ALJ, as it does now. The ALJ rejected this argument because he found that Tytko “focuses on tetramolybdates, not octamolybdates” and that “[w]hether tetramolybdates were described or commercially available as early as 1975 does not have a bearing on the Khan ‘236 patent, which is a patent on ammonium octamolybdate.” ID 56. However, as noted above, Tytko does not refer to the substance of Figure 1(f) as a tetramolybdate.

PUBLIC VERSION

anticipated by U.S. Patent No. 4,762,700 (“the Huggins patent”). The Huggins patent issued on August 9, 1988, *i.e.*, more than one year prior to June 9, 1998, the date of the application for the ‘236 patent in the United States. RX-58.

As explained by the ALJ, the Huggins patent, which has six claims, describes and claims an aqueous or “wet” process for making alpha-AOM. The Huggins patent does not expressly refer to the X-AOM isomer. Molychem argues that the Huggins process anticipates by application of the doctrine of inherency because practice of that process invariably produces the X-AOM isomer. The Huggins process is described in the specification of the patent and includes a specific example. The specification summarizes the invention at RX-58, col. 1, line 66 - col. 2, line 5. It states that the process involves adding molybdic oxide to a solution of ammonium molybdate to form a slurry. The slurry is heated while being stirred to form a thicker slurry of very fine particles of alpha-AOM. There is a detailed description of the invention beginning at RX-58, col. 2, line 6 and a specific example beginning at RX-58, col. 2, line 63.

Molychem’s argument is similar to that considered by the Federal Circuit in *Glaxo, Inc. v. Novopharm, Ltd.*, 52 F.3d 1043 (Fed. Cir. 1995), where the defendant argued that a claim to a pharmaceutical was anticipated by a prior art reference disclosing a process asserted to inherently produce the claimed pharmaceutical. Further, in *Schering Corp. v. Geneva Pharmaceuticals, Inc., et al, supra*, the Federal Circuit held that the doctrine of inherency could be the basis of a finding of anticipation even when the entire structure of the claimed subject matter is inherent in the prior art. In *Schering*, the court upheld a summary judgment of invalidity for anticipation where a claimed compound was necessarily produced as a metabolite when a prior art compound

PUBLIC VERSION

was ingested by humans (as specified by the prior art reference). The court also held that an anticipatory reference need only enable subject matter that falls within the claims at issue, and that in the case before it, the anticipating reference did not need to describe the claimed metabolite in its isolated form because the claim was for the metabolite *per se*. Because numerous clinical tests had shown that the claimed metabolite was always produced on ingestion by humans, and because there were no conflicting tests involving humans, the court found that there was no genuine issue of material fact on this point, rejecting expert testimony concerning a proposed metabolic scheme and animal data that questioned whether ingestion of the prior art compound always produced the claimed metabolite.

In this case, an important question for purposes of the inherency inquiry is: what is the Huggins process? Molychem argues that it is any process disclosed by the Huggins patent, including any process covered by the claims of the Huggins patent. Climax argues that, for purposes of inherency, the Huggins process must be limited to the process of the specific example in the Huggins patent. The ALJ selected a middle ground and held that the Huggins process was that which fell within the “general parameters” of the claims. ID 45-46. He excluded “any experiment that varies significantly from the example or the claims.” ID 46. This approach is similar (but not identical) to the approach the Federal Circuit took in *Glaxo*, where the accused infringer argued that the process of Example 32 of a prior art patent inherently produced the claimed product of the asserted patent. The patentee, however, argued that both one of the inventors and its expert had performed the process of Example 32 and had only produced a different product. The accused infringer argued that the district court erred in

PUBLIC VERSION

considering this evidence because the inventor and the expert had “employed procedures that sometimes departed from the strict letter of Example 32.” The Federal Circuit found that the district court did not err in finding that “one skilled in the art would understand that these procedures were consistent with the teaching of Example 32.” *Glaxo*, 52 F.3d 1043, 1047 n. 4.

The ALJ discounted the experiments of Molychem’s expert, Dr. Uy, which purported to follow the Huggins process (and variants) and which purported to show that the Huggins process never produces alpha-AOM and always produces X-AOM. ID 46. The ALJ discounted these experiments because he accepted the testimony of Climax’s expert, Dr. Macalady, that in Huggins the starting materials for the chemical reaction are mixed at room temperature, while Dr. Uy heated the starting materials. ID 46-48. The ALJ noted that one of Climax’s experts, Dr. Martin, testified that the X-ray diffraction data from the Huggins patent revealed only alpha-AOM and not X-AOM. ID 49. However, the ALJ also noted that Dr. McCarley testified that X-ray diffraction is not sensitive enough to reveal small amounts of X-AOM in a mixture. ID 49.

The ALJ also discounted experiments performed by Dr. McCarley and set out in his [[]], progress report, experiments in which preparations were purportedly made by the Huggins process [[]]. Climax argues that only one of those experiments followed the Huggins process and that it does not show the production of X-AOM. The ALJ discounted Dr. McCarley’s experiment because it did not follow the exact procedure in the example of Huggins (*i.e.*, the sample of interest, sample 16, was taken at 170 minutes, not at “exactly 180 minutes”) and because the experiment was not performed at least ten times, as Climax had argued in opposing Dr. Uy’s experiments. ID 51. The ALJ thus found Dr.

PUBLIC VERSION

McCarley's study no more persuasive than Dr. Uy's and that, in any event, the former did not clearly and convincingly show that X-AOM is produced by the Huggins procedure. ID 51.

The ALJ ultimately concluded that MolyChem had failed to meet its burden of proof to show by clear and convincing evidence that the Huggins patent anticipates claim 1 of the '236 patent. ID 52. We disagree. We find that the record shows that it is "highly probable" that the Huggins process will always produce at least some X-AOM.¹⁴

As noted above, Climax takes the position that the Huggins process is defined exclusively by the single example therein. We do not find that the law supports such a limited view of what the Huggins process is; rather, we find that the Huggins process includes what is actually described in and enabled by the specification of the Huggins patent. However, under either definition of the Huggins process, we find anticipation, as discussed below.

Climax does not dispute that Dr. McCarley, the expert hired by Climax in 1997 to conduct research for it on AOM, performed the Huggins process in the course of that work¹⁵ and that he stated in his [[]], report to Climax that the Huggins process produced X-AOM. Dr. McCarley confirmed his opinion in his subsequent deposition testimony. CX-167C, McCarley Dep. Tr. 176:9-177:19, 178:14-179:3, 184:15-187:10, 200:13-25. He further stated that it would be "very difficult" *not* to make X-AOM in performing the Huggins process. CX-

¹⁴ As mentioned above, the Federal Circuit has described clear and convincing evidence as evidence which proves in the mind of the trier of fact "an abiding conviction that the truth of [the] factual contentions are [sic] 'highly probable.'" *See* pp. 18-19, *supra*.

¹⁵ Indeed, Climax represented to the PTO in the Cole Declaration that Dr. McCarley performed the Huggins process.

PUBLIC VERSION

167C, McCarley Dep. Tr. 195:3-22, 202:25-203:22. One of Climax's experts, Dr. Macalady, testified that because of the nature of isopolymolybdate chemistry, both alpha-AOM and beta-AOM are metastable and less energetically favored than X-AOM, which is the stable phase, and thus alpha-AOM and beta-AOM require precise reaction conditions for their formation. Macalady, Tr. 1158:13-1161:22, 1204:23-1206:17, 1214:9-15. He testified that if the reaction conditions of the example in Huggins were not carefully followed, the tendency of the reaction would be in the direction of producing X-AOM. Macalady, Tr. 1204:23-1206:17. Indeed, he testified that Dr. McCarley's experiments with variations of the Huggins recipe which produced X-AOM "confirms that that's what happens." Macalady, Tr. 1181:22-1182:3. In our opinion, this is sufficient evidence that it is highly probable that the Huggins process will always produce at least some X-AOM, whether that process is defined to include what is disclosed in the specification or is limited to the specific example therein.

The ALJ's rejection of Dr. McCarley's experiment replicating the Huggins process on the ground that sample 16 in that experiment was not taken at exactly 180 minutes appears to contradict the ALJ's own approach in permitting variations from the exact conditions of the example and fails to take into account that Climax admitted that this experiment conformed to the Huggins process. In any event, the Raman spectrum of the next sample, taken at 230 minutes, also shows a peak at 798 cm^{-1} , a peak that is even higher, indicating not only the presence of X-AOM, but also that the amount of X-AOM was increasing through the three-hour time specified in the example.

Climax argues that Dr. McCarley did not produce X-AOM in his experiment. These

PUBLIC VERSION

arguments have no merit, as we discuss *infra* in the section of this opinion on inequitable conduct. Climax also argues that Dr. McCarley testified that ten or twenty experiments would have to be performed before it could be concluded that the Huggins process always produces X-AOM. A review of that testimony, however, shows that Dr. McCarley was not testifying about whether the Huggins process produced X-AOM, but rather about performing confirmatory experiments preparatory to submitting an article for scientific publication on the polyisomolybdate chemistry work he had done (and hoped to do) at Climax, a circumstance where, as he testified, “you’ve got to be certain of the absolute reproducibility of what you’re doing.” CX-167C, McCarley Dep. Tr. 166:10-169:24. In our view, this standard of “certainty” is higher than the “highly probable” standard for clear and convincing evidence applicable here. It also appears that at least part of Dr. McCarley’s testimony had to do with optimizing production of X-AOM. And it was after this testimony that Dr. McCarley testified that he had produced X-AOM using the Huggins process and that it would be very difficult not to make X-AOM when performing the Huggins process. Finally, we believe it is telling that neither Climax nor its experts attempted to replicate the Huggins process, though it appears they could easily have done so.

D. Claim 1 of the ‘236 Patent is Invalid Under 35 U.S.C. § 102(b) Because of an On-Sale Bar

1. Applicable Law

Under 35 U.S.C. §102(b), a person will be barred from obtaining a patent if certain events have occurred “more than one year prior to the date of the application for patent in the United States.” One of these events is referred to as the “on-sale bar.” Such a bar to patentability arises

PUBLIC VERSION

if “the invention was ... on sale in this country” more than one year prior to the date of the application for patent in the United States. 35 U.S.C. §102(b). The date of the application for the ‘236 patent was June 9, 1998. Thus, for the bar to apply in this case, the invention must be “on sale” in this country prior to the critical date of June 9, 1997.

The U.S. Supreme Court has held that in order for the on-sale bar to apply, two criteria must be satisfied. *Pfaff v. Wells Electronics, Inc.*, 525 U.S. 55 (1998). First, “the product must be the subject of a commercial offer for sale.” *Pfaff*, 525 U.S. at 67. Second, “the invention must be ready for patenting.” *Id.* An invention may be shown to have been “ready for patenting” in two ways: (1) “by proof of reduction to practice before the critical date,” or (2) “by proof that prior to the critical date the inventor had prepared drawings or other descriptions of the invention that were sufficiently specific to enable a person skilled in the art to practice the invention.” *Id.* The Federal Circuit has had several opportunities to elaborate on the Supreme Court’s holding in *Pfaff* and from those decisions the following general principles are clear.

A determination that a product was placed on sale prior to the critical date is a conclusion of law based on underlying findings of fact. *Minnesota Mining and Manufacturing Company v. Chemque, Inc.*, 303 F.3d 1294, 1301 (Fed. Cir. 2002). Only an offer which rises to the level of a commercial offer for sale, one which the other party could make into a binding contract by simple acceptance, assuming consideration, constitutes an offer for sale. *Lacks Industries, Inc. v. McKechnie Vehicle Components USA, Inc.*, 322 F.3d 1335, 1347 (Fed. Cir. 2003), citing *Group One, Limited v. Hallmark Cards*, 254 F.3d 1041 (Fed. Cir. 2001). Whether such an offer has been made is a matter of Federal Circuit law, not state contract law. *Id.* To that end, the Federal

PUBLIC VERSION

Circuit has looked to the Uniform Commercial Code. *Id.* The court has also referred favorably to the *Restatement (Second) of Contracts* and learned treatises on contracts. *See, Group One, Ltd. v. Hallmark Cards, Inc.*, 254 F.3d 1041, 1048 (Fed. Cir. 2001). A party challenging a patent on the basis of an on-sale bar must demonstrate by clear and convincing evidence that there was a definite sale or offer to sell more than one year before the application for the patent, and that the product sold or offered for sale anticipated the claimed invention or rendered it obvious. *Id.* As noted above, clear and convincing evidence is that which establishes in the mind of the trier of fact an abiding conviction that the truth of a factual contention is highly probable.

For purposes of the on-sale bar, it is irrelevant that the sale was made by third parties either innocently or fraudulently, and it is not necessary that the parties know precisely the nature of the subject matter with which they are dealing. Thus, in *Abbott Laboratories v. Geneva Pharmaceuticals, Inc.*, 182 F.3d 1315 (Fed. Cir. 1999), the Federal Circuit found an on-sale bar where commercial sales before the critical date had been made by third parties and those parties were unaware that their product contained the particular crystalline form of the pharmaceutical which was the subject of the involved patent.

A non-commercial offer for sale or sale, *i.e.*, an offer or sale for experimental purposes, does not come within the on-sale bar. The assessment of whether there has been a commercial sale or offer to sell also involves an assessment of whether the circumstances surrounding the transaction show that the transaction was not primarily for purposes of experimentation. *Allen*

PUBLIC VERSION

Engineering Corp. v. Bartell Industries, Inc., 299 F.3d 1336, 1352-53 (Fed. Cir. 2002).¹⁶ The question is not whether the invention was under development, subject to testing, or otherwise still in its experimental stage at the time of the asserted sale. Instead, the question is whether the primary purpose of the inventor at the time of the sale, as determined from an objective evaluation of the facts surrounding the transaction, was to conduct experimentation. *Allen Engineering*, 299 F.3d 1336, 1354. Once the invention is reduced to practice, however, there can be no experimental use negation of the on-sale bar. *Zacharin v. United States*, 213 F.3d 1366, 1369 (Fed. Cir. 2000). Experimentation conducted to determine whether the claimed invention would suit a particular customer's purposes does not fall within the experimental use exception. *Allen Engineering*, 299 F.3d 1336, 1355.

As to the question of when an invention is ready for patenting, as noted above, this may

¹⁶ In assessing experimentation, the court has considered a number of factors, not all of which may apply in any particular case. These factors are:

1. The necessity for public testing;
2. The amount of control over the experiment retained by the inventor;
3. The nature of the invention;
4. The length of the test period;
5. Whether payment was made;
6. Whether there was a secrecy obligation;
7. Whether records of the experiment were kept;
8. Who conducted the experiment;
9. The degree of commercial exploitation during testing;
10. Whether the invention reasonably requires evaluation under actual conditions of use;
11. Whether testing was systematically performed;
12. Whether the inventor continually monitored the invention during testing; and
13. The nature of contacts made with potential customers.

Allen Engineering, 299 F.3d 1336, 1353.

PUBLIC VERSION

be shown in two ways: (1) “by proof of reduction to practice before the critical date,” or (2) “by proof that prior to the critical date the inventor had prepared drawings or other descriptions of the invention that were sufficiently specific to enable a person skilled in the art to practice the invention.” The necessity for fine tuning does not undermine the conclusion that an invention is ready for patenting. *STX, LLC v. Brine, Inc.*, 211 F.3d 588, 591 (Fed. Cir. 2000). With regard to the second criterion, even though the inventor may conceive the claimed invention before verifying that his idea will work, when development and verification are needed in order to prepare a patent application that complies with the statutory enablement requirement, the invention is not ready for patenting. *Space Systems/Loral, Inc. v. Lockheed Martin Corp.*, 271 F.3d 1076, 1080 (Fed. Cir. 2001). It is not necessary, however, that the inventor have complete confidence that his invention will work for its intended purpose. *Robotic Vision Systems, Inc. v. View Engineering, Inc.*, 249 F.3d 1307, 1312 (Fed. Cir. 2001).

2. Claim 1 of the ‘236 Patent is Invalid Because of an On-Sale Bar

The ALJ found that claim 1 of the ‘236 patent was invalid “as anticipated under 35 U.S.C. §102 due to the on-sale bar provision.” ID 77. We agree that an on-sale bar exists.

As discussed above and in the ID, in the mid-1990s Climax was producing alpha-AOM using a thermal decomposition process, known as the “dry process.” Beginning in 1994, Climax began receiving numerous complaints about the quality of that AOM material, [[

]] Cole, Tr. 89:24-94:4;

CX-138C; CX-152C. Most of these complaints came from [[]], Climax’s [[]]

customer, which used AOM as one of several materials it blended with [[]]

PUBLIC VERSION

to make [[

]] Cole, Tr. 96:9-97:10;

CX-152C. So severe were the quality problems that [[]] threatened Climax with litigation for “shutting them down” by failing to supply the same quality of material it had previously supplied. Cole, Tr. 414: 12-25; RX-30C. A 1996 e-mail from co-inventor Cole states that until further notice, preshipment samples would have to be sent to AlphaGary. RX-61C.

In late [[]], Climax began experimenting with the wet process for making AOM described in the Huggins patent, a patent owned by Climax. Laboratory experiments with the wet process were successful and by [[]] Climax began producing samples made in its chemical plant by what Cole described as a process somewhat different from the Huggins process. Cole, Tr. 110:22-114:15. A memorandum dated November, 1996 indicates that by that date samples of the material produced by a wet chemical process had been sent to [[

]], Climax’s two largest customers, both of which tested the samples and found them “superior to any product evaluated.” RX-31C.

Climax then invested [[]] to construct a new wet process AOM pilot plant at its Fort Madison, Iowa, facility. Cole, Tr. 321:13-322:9, 386:9-387:7. Climax completed the pilot plant by [[]] and began making X-AOM there that same month. Cole, Tr. 321:13-322:9. Samples of X-AOM made at the pilot plant were sent to customers, [[]] for testing, with positive results. See, e.g., CX-120C, CX-121C, CX-122C, King, Tr. 582:7-583:20; RX-34C.

PUBLIC VERSION

On April 24, 1997, Climax took an order from [[]] of AOM as reflected in CX-130C (RX-33C), a form entitled [[]] which calls for the entry of specified information. In CX-130C, this information was entered by hand by the sales assistant taking the order. The information entered on CX-130C included the [[]] purchase order number, which was [[]], and also a Climax order number, given as [[]], a number which not only constituted an order number, [[]] for that order. When [[]] placed its order, it specified a sequence of at least [[]] and apparently [[]] deliveries. King, Tr. 595:12-596:24, 624:18-627:10; CX-142C. On entry by the Climax sales assistant taking the order, a Climax order number [[]] would be generated which would [[

]]

King, Tr. 595:12-596:24.

For Climax order no. [[]], documents of record reflecting Climax shipments of AOM to [[]] show the following shipment dates: [[

]] CX-142C. The [[]] shipment (Climax order no. [[]]) consisted of [[]] pounds of dry process AOM and [[]] of wet process AOM (*i.e.*, the claimed invention). CX-142C.

Order no. [[]] is the subject of CX-130C. Handwritten entries on CX-130C indicate that the order was to be shipped, [[]] for delivery on [[]] that the price was [[]] per pound, and that the contact at [[]] was [[

PUBLIC VERSION

]] the buyer at [[]] at the time. CX-130C; King, Tr. 604:25-605:3. Other handwritten entries appear to indicate that the order was for [[]] pounds of (dry process) AOM and further handwritten entries indicate that the order was subsequently changed by a Climax sales assistant to [[]] pounds of dry process AOM plus [[]] pounds of wet process AOM, the latter taken from lot no. [[]] all at the original price of [[]] per pound, with the date "June 10" appearing on the document. Jack King (Climax's manager of chemical sales for North and South America) testified that the original [[]] pound order was for dry process AOM and that [[]] pounds was a full truckload order of product. King, Tr. 600:8-16; 601:10-20. While King stated he did not have a clear recollection, he testified that the document indicated that he had given the sales assistant the lot number and price on June 10. King, Tr. 602:14-603:19. This price, which applied to both the dry process AOM and wet process AOM, was the same price that Climax was charging [[]] for dry process AOM in June, 1997. King, Tr. 606:23-607:13. The document also has an entry that the order was "released" on June 10, which King testified reflected the approval of Climax's credit department that the order could be shipped. King, Tr. 605:8-606:2. A Climax [[]] bearing the notation "Printed: 10-JUN-97" contains similar information. CX-141C, King, Tr. 619:18-620:16. Climax shipping documents indicate that order no. [[]] was shipped to [[]] and that it consisted of [[]] pounds of wet process AOM from lot [[]] and [[]] pounds of dry process AOM. CX-142C; King, Tr. 624:18-626:18.

In May 1997, there were discussions regarding the possibility of Climax supplying [[]] with more than trial samples of wet AOM. An internal Climax memorandum from

PUBLIC VERSION

King, dated May 1, 1997, refers to a conversation that King had with [[]] and lists several “key points”:

[[

]]

CX-135C; RX-34C (emphasis supplied).

The reference in item 1 of the May 1 memorandum to wet chemical lots [[]] is a reference to the samples sent to [[]] in April of 1997 noted above. King, Tr. 584:12-20.

The reference to T/L in item 2 of the May 1 memorandum is to truckloads. King, Tr. 586:11-16.

On May 22, 1997, King, accompanied by his eastern regional sales manager, visited [[]] and “probably” discussed the question, referred to in item 6 of the May 1 memorandum, of the kind of bag Climax would use to supply wet process AOM to [[]].

PUBLIC VERSION

King, Tr. 588:19-590:16; CX-136C. A letter from King to [[]] dated June 3, 1997, confirms those discussions, stating that “our standard package for wet chemical AOM shall be 25 pounds net of AOM in the normal paper sack.” *Id.* The normal paper sack held 50 pounds of dry process AOM, but Climax was only able to get 25 pounds of wet process AOM into that normal sack. King, Tr. 590:17-591:2.

A set of facsimiles and a Federal Express receipt indicate that on June 2, 1997, [[]] a sample of wet chemical AOM from lot [[]] and that the sample was delivered to [[]] on June 3, 1997. CX-123C; CX-124C; RX-35C; RX-36C; RX-56. An [[]] log book contains an entry for that sample, indicating that it was tested on that date, and there is evidence of record that this testing indicated that the sample was “acceptable.” RX-56.

The record includes a Climax internal e-mail from co-inventor Cole dated June 4, 1997, indicating that personnel at [[]] had earlier “expressed a concern that the [[]] we ship be properly identified.” CX-127C; RX-38C. The e-mail indicates that Cole had had a conversation with [[]] that same day in which Cole told [[]] that “(a) the wet AOM [[]] and (b) each bag is identified as containing [[]] each.” CX-127C; RX-38C. The e-mail also states that to “further safeguard inadvertent use of this sample,” [[]] had requested that “a label be placed on each side of each pallet stating ‘EVAL’” and that Cole had already made up the label master and would provide the labels “[a]s soon as we get approval on the pre-shipment sample.” CX-127C; RX-38C. According to Cole, the purpose of the “EVAL” label was so that the X-AOM would be

PUBLIC VERSION

used in [[]] product lines that were not as “critical” or products that did not require large concentrations of X-AOM. Cole, Tr. 214:6-16, 496:24-498:10.

At some time before delivery, the April 24, 1997, order [[]] for [[]] pounds of dry AOM was changed to substitute [[]] pounds of wet process AOM for [[]] pounds of the dry process AOM. The record includes a copy of that order with additional handwritten entries reflecting this change. CX-130C; RX-33C. The original reference to [[]] pounds is changed to [[]] pounds and in a space titled “other” there is added a reference to “[[]] wet chem,” “Lot [[]],” “all @[[]],” and some other writing which is difficult to read, but which includes the entry “6/10.” There is a stamp in the upper right hand corner of the order indicating that order was “released” on “6/10.”

The record includes a letter dated June 10, 1997, from Cole to [[]] indicating that order [[]] “is scheduled to ship June 11” and that the order includes [[]]

CX-128C; CX-176C; RX-39C; RX-57C. One of the copies of the letter in the record appears to bear a handwritten notation from [[]]: “R&D to coordinate this evaluation.” CX-176C; RX-57C.

Climax shipped the amended order on June 11, 1997. CX-142C.

Molychem and the IA argue that the June 2, 1997, sample constitutes a commercial offer to sell Climax’s patented X-AOM to [[]] prior to the critical date of June 9, 1997, and

PUBLIC VERSION

that claim 1 of the '236 patent is thus invalid under 35 U.S.C. §102(b). Indeed, Molychem argues that such an offer existed by May of 1997, but does not elaborate on that argument. Both Molychem and the IA rely on the definition of an offer for sale in the *Restatement (Second) of Contracts* § 24:

An offer is the manifestation of willingness to enter into a bargain, so made as to justify another person in understanding that his assent to that bargain is invited and will conclude it.

It is clear from the facts recited above that on April 24, 1997, [[]] had submitted a purchase order to Climax for AOM requiring [[]] separate deliveries. It is also clear that Climax entered [[]] purchase order on its books and began delivery pursuant to that order on April 28, 1997, and that it made [[]] other deliveries under that purchase order prior to its June 11, 1997 delivery (and eventually made all [[]] deliveries).

The record also shows that:

- (1) Since 1996, [[]] required preshipment samples of AOM from Climax prior to delivery;
- (2) By 1996 and at least by May, 1997, Climax and [[]] specifically contemplated that Climax would supply [[]] with X-AOM;
- (3) Climax submitted a sample, which it described as a "preshipment sample," of X-AOM to [[]] on June 2, 1997; [[]] tested the sample on June 3, 1997, and found it acceptable;
- (4) At least as of June 4, 1997, Climax specifically contemplated shipping [[]] pounds of X-AOM to [[]] if the preshipment sample was acceptable;

PUBLIC VERSION

(5) At least by June 10, 1997, that part of [[]] order dealing with the [[]] delivery thereunder (of [[]] of dry AOM) was changed to substitute [[]] of X-AOM for [[]] of dry process AOM;

(6) The [[]] of X-AOM was to be (and eventually was) from the same lot as the preshipment sample;

(7) Climax charged [[]] for the [[]] of X-AOM and the price was the [[]] as for dry process AOM; and

(8) Climax shipped the entire [[]] on June 11, 1997.

In view of the foregoing circumstances, we believe it is highly probable that the June 2, 1997, preshipment sample constituted a commercial offer for sale.

Climax argues that the evidence does not show a commercial offer for sale such that [[]] could create a binding contract through simple acceptance. However, Climax ignores the fact that it supplied AOM to [[]] for many years and that at the time it provided the June 2, 1997, sample, it was in the midst of performing its agreement to provide [[]] with [[]] deliveries of AOM. Climax itself identified the sample as a preshipment sample, a term and practice used in connection with its commercial sales of AOM to [[]]. The only matters the record shows were discussed between Climax and [[]] as to the [[

]] of X-AOM to be shipped had to do with the bags the material would be shipped in and the marking of the pallets containing those bags, both of which issues were resolved by June 4, 1997, with the parties simply awaiting approval of the preshipment sample before immediate

PUBLIC VERSION

shipment from the same lot as the sample. The absence of any evidence of other discussions concerning the details of this shipment is an indication that the parties were otherwise following their existing course of dealing with regard to it.¹⁷ Indeed, the record shows they followed that practice to its ultimate conclusion, simply substituting the [[] of X-AOM (from the same lot as the sample) for [[] of dry process AOM in the context of a preexisting agreement. We believe that it is highly probable that the June 2, 1997, preshipment sample was an offer to sell X-AOM on the same terms as the parties had previously agreed to with regard to other shipments of AOM, that acceptance of that offer was invited by way of acceptance of the preshipment sample, and that such acceptance would obligate Climax to perform, which it did by delivering the [[] of X-AOM as part of its June 11 shipment.

Climax's argument that the shipment was primarily for experimental use cannot be accepted because the claimed invention was reduced to practice long before it provided the June 2, 1997, preshipment sample to [[]]. As noted above, the Federal Circuit has held that a reduction to practice precludes a finding of experimental use. *Zacharin*, 213 F.3d 1366, 1369. In a recent case involving an on-sale bar, the court relied on Supreme Court authority stating that a chemical composition is reduced to practice when it is made. *Abbott*, 182 F.3d.1315, 1318. As noted above, the claimed X-AOM was made as early as 1996 and certainly prior to June 2, 1997, the date the preshipment sample was sent to [[]]. There is every indication that it was

¹⁷ [[

]]

PUBLIC VERSION

satisfactory for its intended purpose of acting as a smoke suppressant by that time. See, *e.g.*, CX-135C; RX-31C; RX-34C. That Climax may not have realized that X-AOM was a new isomer of AOM until after June 9, 1997, is not relevant. The Federal Circuit has held that the bar applies even if the person selling the claimed chemical composition is not fully aware of what it is. *Abbott*, 182 F.3d 1315, 1318-19 (finding an on-sale bar because of sales by third parties who were unaware that pharmaceutical composition sold was the the particular polymorph of the claimed invention).

Since the claimed invention was reduced to practice prior to the critical date, it is not necessary to address Climax's arguments (Climax Br. 31-44) regarding experimental use, which presuppose that there was no actual reduction to practice prior to the critical date. In any event, we do not regard these arguments as sufficient to establish experimental use by the inventors or Climax. At best, they simply indicate that [[]] was testing the material to determine its suitability for its own production facility.

Since Climax's X-AOM was reduced to practice prior to the critical date, it was also "ready for patenting" prior to the critical date. *Pfaff*, 525 U.S. 55, 67-68. It is therefore unnecessary to address Climax's arguments (Climax Br. 45) concerning the second way an invention may be found "ready for patenting," an argument which presupposes the absence of an actual reduction to practice prior to the critical date.

We find that there is clear and convincing evidence that Climax made a commercial offer to sell the patented X-AOM prior to the critical date and that the claimed invention was "ready for patenting" prior to the critical date. Claim 1 of the '236 patent is therefore invalid because of

PUBLIC VERSION

an on-sale bar under 35 U.S.C. §102(b).

E. The ‘236 Patent is Unenforceable for Inequitable Conduct

1. Applicable Law

A patent is unenforceable on grounds of “inequitable conduct” if it is shown by clear and convincing evidence that during prosecution of the patent application at the PTO the patentee made affirmative misrepresentations of a material fact, failed to disclose material information, or submitted false material information, coupled with an intent to deceive. *GFI, Inc. v. Franklin Corp.*, 265 F.3d 1268, 1273 (Fed. Cir. 2001); *Purdue Pharma L.P. v. Boehringer Ingelheim GmbH*, 237 F.3d 1359, 1366 (Fed. Cir. 2001); *Labounty Manufacturing, Inc. v. U.S. Int’l. Trade Comm.*, 958 F.2d 1066, 1070 (Fed. Cir. 1992). Both materiality and intent are questions of fact. *Purdue Pharma*, 237 F.3d 1359, 1366.

Once threshold levels of materiality and intent have been established, the tribunal weighs materiality and intent in light of all the circumstances to determine whether the applicant’s conduct is so culpable that the patent should be held unenforceable. *GFI*, 265 F.3d 1268, 1273; *Critikon, Inc. v. Becton Dickinson Vascular Access, Inc.*, 120 F.3d 1253, 1256 (Fed. Cir. 1997). Generally, when withheld information is highly material, a lower showing of deceptive intent will be sufficient to establish inequitable conduct. *Id.* Moreover, “[d]irect evidence of intent or proof of deliberate scheming is rarely available in instances of inequitable conduct, but intent may be inferred from the surrounding circumstances.” *Critikon*, 120 F.3d 1253, 1256. See also, *LaBounty*, 958 F.2d 1066, 1076.

2. The ‘236 Patent is Unenforceable for Inequitable Conduct

The principal allegation of misconduct in this case stems from the Cole Declaration,

PUBLIC VERSION

which, as discussed above, was filed with the PTO during the prosecution of the application for the '236 patent. As noted above, in her first office action, the examiner rejected claim 1 over the Huggins patent in view of another patent to Ronzio *et al.*, specifically stating that the isomers of Huggins would be expected to be same as those covered by the pending claim, since the processes to make them were the same. In his [[]], report to Climax, [[]] had expressly stated that he had performed the Huggins process and that it produced X-AOM, in addition to the major product, alpha-AOM, a conclusion which is also indicated in handwritten notes in Figures 8-10 of his report. In responding to the office action, Climax argued that it had had the Huggins process performed by Dr. McCarley and that it did not produce X-AOM, submitting the Cole Declaration, which referred specifically to the experiments performed by Dr. McCarley which were the subject of his [[]], report. The language of paragraphs 10 and 11, as well as the first sentence of paragraph 12, of the Cole Declaration closely tracks the language of Dr. McCarley's [[]], report on his evaluation of the Huggins process. However, the declaration nowhere discloses Dr. McCarley's conclusion that the Huggins process produces both alpha-AOM and X-AOM. Further, the handwritten notations on Figures 8-9 of Dr. McCarley's report, indicating the production of X-AOM by the Huggins process, do not appear in the copies of those figures attached to the Cole Declaration as Exhibit A. Cole testified that he and Climax removed these notations from Figures 8 and 9 before submitting them as part of his declaration. Cole, Tr. 180:14-182:14.

Climax's conduct constitutes a deliberate withholding of material information of the

PUBLIC VERSION

highest order, no matter how materiality is defined.¹⁸ Indeed, it could well be characterized as a deliberate misrepresentation. The information withheld specifically supported the examiner's position that the Huggins process produced X-AOM. It was not cumulative of any information before the examiner and it was obviously inconsistent with the position being taken by Climax.

The ALJ found that the withheld information was material. ID 85. Nevertheless, he did not conclude that the '236 patent is unenforceable because he found that Molychem had failed to show the requisite intent to deceive. He accepted Climax's argument that it had a good faith belief that Dr. McCarley's data did not indicate the presence of X-AOM because not all three peaks called for by claim 1 were present. ID 85-86. The ALJ also stated that, since Climax had noted the existence of a spectral peak at 797-798 cm⁻¹ in paragraphs 14 and 19(b) of the Cole Declaration, "the PTO examiner could have raised it as an issue but chose not to." ID 86.

In its briefs on review, Climax does not dispute that it did not inform the PTO examiner of the conclusions reached by Dr. McCarley and that it removed the handwritten notations in the figures of that report which indicate the presence of X-AOM, but attempts to justify its actions as the consequence of a good faith disagreement with Dr. McCarley which, Climax argues, the ALJ found to be credible.

To support its argument, Climax refers to deposition testimony of Dr. McCarley in which

¹⁸ The withheld information is certainly that which a reasonable examiner would substantially likely consider important in deciding whether to allow an application to issue as a patent. This standard, long employed by the Federal Circuit, is based in part on 37 C.F.R. §1.56(a)(1991). *Dayco Products, Inc. v. Total Containment, Inc.*, 329 F.3d 1358, 1363 (Fed. Cir. 2003). The withheld information also meets the standard of materiality set out in the 1992 amendment to that rule in that it is not cumulative of information of record and it refutes and is clearly inconsistent with Climax's argument for patentability over the examiner's rejection.

PUBLIC VERSION

he allegedly testified that it was reasonable to interpret his data as indicating that the alpha, not the X, isomer of AOM was produced when he practiced the Huggins process. Climax Br. 57, citing CX-167C, McCarley Dep. Tr. 180:1-6. However, this is a mischaracterization of Dr. McCarley's testimony, in which he reiterated his position that his Raman and other data showed that when he practiced the Huggins process, he produced X-AOM. Dr. McCarley testified that *experts* could reasonably disagree with his conclusion, and that Cole should have consulted an expert before he reached his (opposite) conclusion. CX-167C, McCarley Dep. Tr. 179:12-180:6. Cole is not an expert on Raman spectroscopy; he testified that he had no previous exposure or experience with such spectroscopy until Dr. McCarley mentioned it to him. Cole, Tr. 128:23-129:13. Elsewhere (Climax Br. 58), Climax states that Dr. McCarley "now admits" that his own data did not support his conclusion, without any supporting record citation.¹⁹

Climax argues that if X-AOM had actually been present "all three peaks would have been clearly distinguishable" in the spectrum in Dr. McCarley's report. Climax Br. 58. This argument misses the point, which is that Cole was aware that Dr. McCarley had concluded that the Huggins process produced X-AOM, yet Cole hid this information from the PTO. In any event,

¹⁹ Climax may be referring to certain McCarley deposition testimony which Climax argues indicates that 10 to 20 experiments would have been necessary before a conclusion could have been reached that the Huggins process produces the X-isomer. Climax Br. 57-58, citing CX-167C, McCarley Dep. Tr. 169:14-24. The testimony does not specifically refer to Dr. McCarley's performance of the Huggins process; it has to do with "experiments to confirm those conditions that lead to the production of X-AOM every time you do it," by which Dr. McCarley was apparently referring to "the best conditions" for producing X-AOM. CX-167C, McCarley Dep. 169:2-24. This is of little help to Climax, even if it supported Climax's conclusion, because Cole represented that the data showed that Huggins did not produce X-AOM, when he knew McCarley had stated that the data showed that it did.

PUBLIC VERSION

Dr. McCarley testified that all three peaks were present, but because of their low intensity and the presence of an intense peak for alpha-AOM at 966 cm^{-1} , the doublet at 953 and 946 cm^{-1} appeared as a shoulder instead of being resolved as two peaks. CX-167C, McCarley Dep. Tr. 176:9-177:19, 178:14-179:3, 184:15-187:10, 200:13-25. Furthermore, the peak at 798 cm^{-1} (the strongest peak for X-AOM) is admittedly present and would have been the first to appear.²⁰

To counter Dr. McCarley's testimony, Climax relies on testimony from Dr. Martin that he had tested mixtures of alpha-AOM and X-AOM and that he could distinguish all three peaks of X-AOM, proportionately reduced, even when the amount of X-AOM was only one or two percent of the mixture. This testimony is impossible to assess since the record does not appear to include these Raman spectra.²¹ Climax also relies on testimony of Dr. Macalady, another of Climax's experts, that the peak at 798 cm^{-1} could be due to impurities and that it could not be concluded that it was due to X-AOM. However, Dr. Macalady did not testify that the peak at 798 cm^{-1} was not due to X-AOM, nor did he attribute it to any other specific material. We also note that, while Dr. Macalady was permitted to testify as an expert and testified that he could read a Raman spectrum, he also testified that he has little experience in either molybdenum chemistry or Raman spectroscopy.

Climax also argues that the ALJ's conclusion of lack of intent was based on a

²⁰ We note that in the Cole Declaration, Climax relied on a single peak to show the presence of alpha-AOM. CX-2, p. 250, para. 11.

²¹ We note that two days prior to giving this testimony, Dr. Martin testified that he had not taken the Raman spectrum of a sample that contained predominately alpha-AOM and a small amount of X-AOM (Martin, Tr. 753:11-21) and that he had only performed Raman spectroscopy on X-AOM (Martin, Tr. 755:3-22).

PUBLIC VERSION

determination that Cole and Dahl (the patent attorney who prosecuted the application) were credible witnesses, but no specific credibility determinations appear in the ID. In any event, all the circumstances of their conduct must be examined, and given the high degree of materiality here, they may not simply rely on assertions of lack of intent to mislead. *FMC Corp. v. Manitowoc Co.*, 835 F.2d 1411, 1416 (Fed. Cir. 1987). Most importantly, the law is clear that even in close cases disclosure is the rule. *LaBounty Mfg. Inc. v. U. S. International Trade Commission*, 958 F.2d 1066, 1076 (Fed. Cir. 1992).

This is not a close case. The information withheld was highly material and should have been supplied to the PTO examiner; it was directly relevant to the examiner's rejection and supported that rejection. It was inconsistent with Climax's position. Cole, a non-expert in Raman spectroscopy, was in no position to have a "good faith" disagreement with Dr. McCarley's assessment, and even if he was, he was still under an obligation to disclose Dr. McCarley's assessment to the PTO, and this is true even if Cole did disclose the 798 cm^{-1} peak. Balancing the high materiality of the information withheld and the lack of any reasonable grounds for so doing, we are of the opinion that Cole and Climax committed inequitable conduct at the PTO and that the '236 patent is therefore unenforceable.

F. If Valid and Enforceable, Claim 1 of the '236 Patent Is Infringed

1. Applicable Law

To determine infringement, one must compare the (properly construed) claim with the accused article to determine whether that article is within the scope of the claim, *i.e.*, whether the device infringes the claim. Infringement may be either literal or by the doctrine of equivalents.

PUBLIC VERSION

To infringe a claim literally, the accused article must contain every element of the claimed invention, as properly interpreted. To prove infringement under the doctrine of equivalents, the patentee must show that the accused article contains elements identical or equivalent to each claimed element of the patented invention. *Warner-Jenkinson Co., Inc. v. Hilton Davis Chemical Co.*, 520 U.S. 17, 40 (1997).

2. Infringement by the Accused Products

The ALJ concluded that respondents infringed claim 1 of the '236 patent. He found that Climax had provided testimony and documentary evidence demonstrating that the products Molychem imports into the United States have the Raman spectra of claim 1 of the '236 patent and, indeed, that Molychem had admitted that the products it imports have Raman spectra peaks that fall within claim 1 of the '236 patent. ID 26-30. The ALJ found “not persuasive” Molychem’s argument that its product is not an octamolydate. He found that the “numerous Molychem business records introduced by Climax as exhibits show that MolyChem has, at least, imported AOM into the United States.” ID 29, citing CX-38, CX-40C through CX-61C. He also found that the “additional testing done by Climax shows that, not only was the imported chemical AOM, but that the chemical contained the X-AOM isomer.” ID 29, citing Cole Tr. 82-83 and Martin, Tr. 723-725. Having found literal infringement, the ALJ did not reach the issue of infringement under the doctrine of equivalents. ID 30.

If claim 1 of the '236 patent is valid and that patent is enforceable, we would affirm the ALJ’s infringement determination. In doing so, we rely specifically on the the Raman spectra data for the accused products provided by Climax.

PUBLIC VERSION

G. If Claim 1 of the '236 Patent is Valid and Enforceable, There is a Domestic Industry

1. Applicable Law

As a prerequisite to finding a violation of section 337, complainant Climax must establish that “an industry in the United States, relating to the articles protected by the patent ... concerned, exists or is in the process of being established.” 19 U.S.C. § 1337(a)(2). Typically, the domestic industry requirement of section 337 is viewed as consisting of two prongs: the economic prong and the technical prong. *Certain Variable Speed Wind Turbines and Components Thereof*, Inv. No. 337-TA-376, Comm’n Opinion at 14-17 (1996). The economic prong concerns the activities of or investment in a domestic industry, while the technical prong involves whether complainant (or its licensees) practices its own patents. In order to satisfy the technical prong of the domestic industry requirement, it is sufficient to show that the domestic industry practices any claim of that patent, not necessarily an asserted claim of that patent. *Certain Microsphere Adhesives*, Inv. No. 337-TA-366, Commission Opinion at 7-16. To satisfy the economic prong, the domestic industry must involve: (1) significant investment in plant and equipment; (2) significant employment of labor or capital; or (3) substantial investment in its exploitation, including engineering, research and development, or licensing. 19 U.S.C. § 1337(a)(3).

The economic prong relates to whether the domestic investments are “significant” or “substantial.” Satisfaction of the economic criteria of the domestic industry requirement under section 337 is not determined by a rigid formula.

2. There is a Domestic Industry

The ALJ found that the evidence submitted by Climax showed that its ammonium

PUBLIC VERSION

octamolybdate product literally meets the limitations of claim 1 of the '236 patent and that Molychem does not dispute, and indeed admitted, that Climax's product literally meets the limitations of claim 1. ID 33-34. He therefore found that the technical prong of the domestic industry requirement is literally satisfied and that it was not necessary to reach the issue of whether Climax practices the claimed invention under the doctrine of equivalents. ID 34.

As to the economic prong, the ALJ found that Climax produces its X-AOM in the United States at its Fort Madison, Iowa facility, obtaining its raw molybdenum material from its Henderson Mine in Colorado. ID 34-35. He found that Climax has made significant investments in plant and equipment and employs significant labor or capital in its production of X-AOM. ID 34-36. He also found that Climax has made a substantial investment in the exploitation of the '236 patent, including investment in research and development. ID 36-37. Thus, the ALJ found that Climax had met each of three independent criteria for demonstrating a domestic industry. He noted that Climax had not alleged or provided any evidence to show that it was in the process of establishing a domestic industry, but found the issue moot, since Climax had established the existence of a domestic industry.

If claim 1 of the '236 patent is valid and enforceable, we would affirm the ALJ's conclusion that there is a domestic industry at least under section 337(a)(3)(A)-(B), which was based on Climax's production of X-AOM at its Fort Madison, Iowa, facility. In doing so, we specifically rely on the Raman data provided by Climax for its product and on the admission of Molychem.

PUBLIC VERSION

III. CONCLUSION

This investigation is terminated with a finding of no violation of Section 337. We therefore do not reach the issues of remedy, public interest, and bonding.²² To the extent the ALJ's findings of fact on the issues we have addressed are consistent with the Commission's final determination and this opinion, they are adopted.

²² We therefore do not reach the question of whether the Commission has personal jurisdiction over respondent Pudong, since that question arose in the context of the issue of remedy, i.e., whether the Commission may issue a cease and desist order to Pudong (an *in personam* order), if it found that Pudong was in violation of section 337.



US005985236A

United States Patent [19]

Khan et al.

[11] Patent Number: 5,985,236

[45] Date of Patent: Nov. 16, 1999

[54] AMMONIUM OCTAMOLYBDATE COMPOSITION AND METHOD FOR PRODUCING THE SAME

[75] Inventors: Mohamed H. Khan; James A. Cole, both of Ft. Madison; Timothy G. Bruhl, Wever; Wendell S. Elder, Keokuk; Gary A. Glasgow, Ft. Madison; Vijaykumar M. Wagh, Donnellson, all of Iowa

[73] Assignee: Cyprus Amax Minerals Company, Englewood, Colo.

[21] Appl. No.: 09/094,194

[22] Filed: Jun. 9, 1998

[51] Int. Cl.⁶ C01B 13/14; C01G 13/14; C01G 39/00; B01J 23/00

[52] U.S. Cl. 423/592; 423/606; 423/593; 502/300; 502/305

[58] Field of Search 423/592, 593, 423/600, 606; 502/300, 305

[56] References Cited

U.S. PATENT DOCUMENTS

- 1,838,767 12/1931 Iredell .
- 3,656,888 4/1972 Barry et al. .
- 3,714,325 1/1973 Bloom et al. .
- 3,834,894 9/1974 Spedden et al. .
- 3,848,049 11/1974 Ronzio et al. .
- 3,899,284 8/1975 Stanley .
- 3,963,823 6/1976 Kulkarni .
- 4,046,852 9/1977 Vertes et al. .
- 4,079,116 3/1978 Ronzio et al. .
- 4,207,296 6/1980 Nauta et al. .
- 4,379,127 4/1983 Bauer et al. .
- 4,382,069 5/1983 Heytmeijer .

- 4,512,958 4/1985 Bauer et al. .
- 4,552,749 11/1985 McHugh et al. .
- 4,612,172 9/1986 Brunelli et al. .
- 4,724,128 2/1988 Cheresnowsky et al. .
- 4,762,700 8/1988 Huggins .
- 5,534,997 7/1996 Schrader .

FOREIGN PATENT DOCUMENTS

1268595 12/1961 France .

OTHER PUBLICATIONS

Morrison, R. T., et al., *Organic Chemistry*, Allyn and Bacon, Inc., Boston, 3rd ed., p. 37 (1973).
U. S. application No. 08/790, 702 filed Jan. 29, 1997 for Method for the Production of a Purified MoO₃ Composition.

Primary Examiner—Gary P. Straub

Assistant Examiner—Cam N. Nguyen

Attorney, Agent, or Firm—Bruce E. Dahl, Esq.; Dahl & Osterloth LLP

[57] ABSTRACT

A novel isomer of ammonium octamolybdate ("AOM") and method for producing the same. A new AOM isomer ("X-AOM") is described which is characterized by a distinctive Raman spectral profile compared with other AOM isomers including α and β -AOM. To produce the novel isomer, ammonium dimolybdate ("ADM") is combined with molybdenum trioxide (MoO₃) and water to yield a mixture. When mixing these materials, optimum results are achieved if at least one of the foregoing molybdenum-containing reagents is added in a gradual, non-instantaneous manner so that the selected reagent is not added to the mixture in a single large mass. This gradual delivery procedure, along with a carefully controlled prolonged heating stage (e.g. in excess of 3 hours) contributes to a maximum yield of high purity X-AOM.

1 Claim, 2 Drawing Sheets

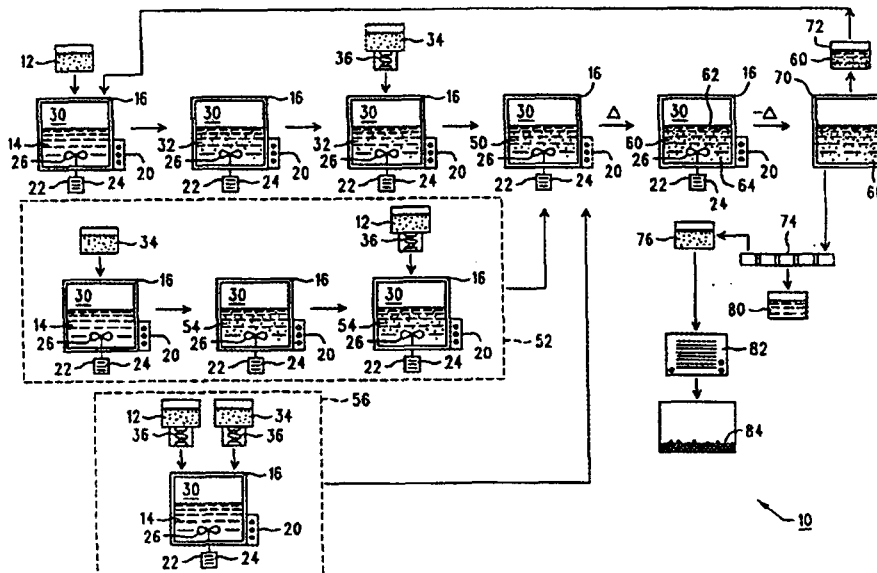

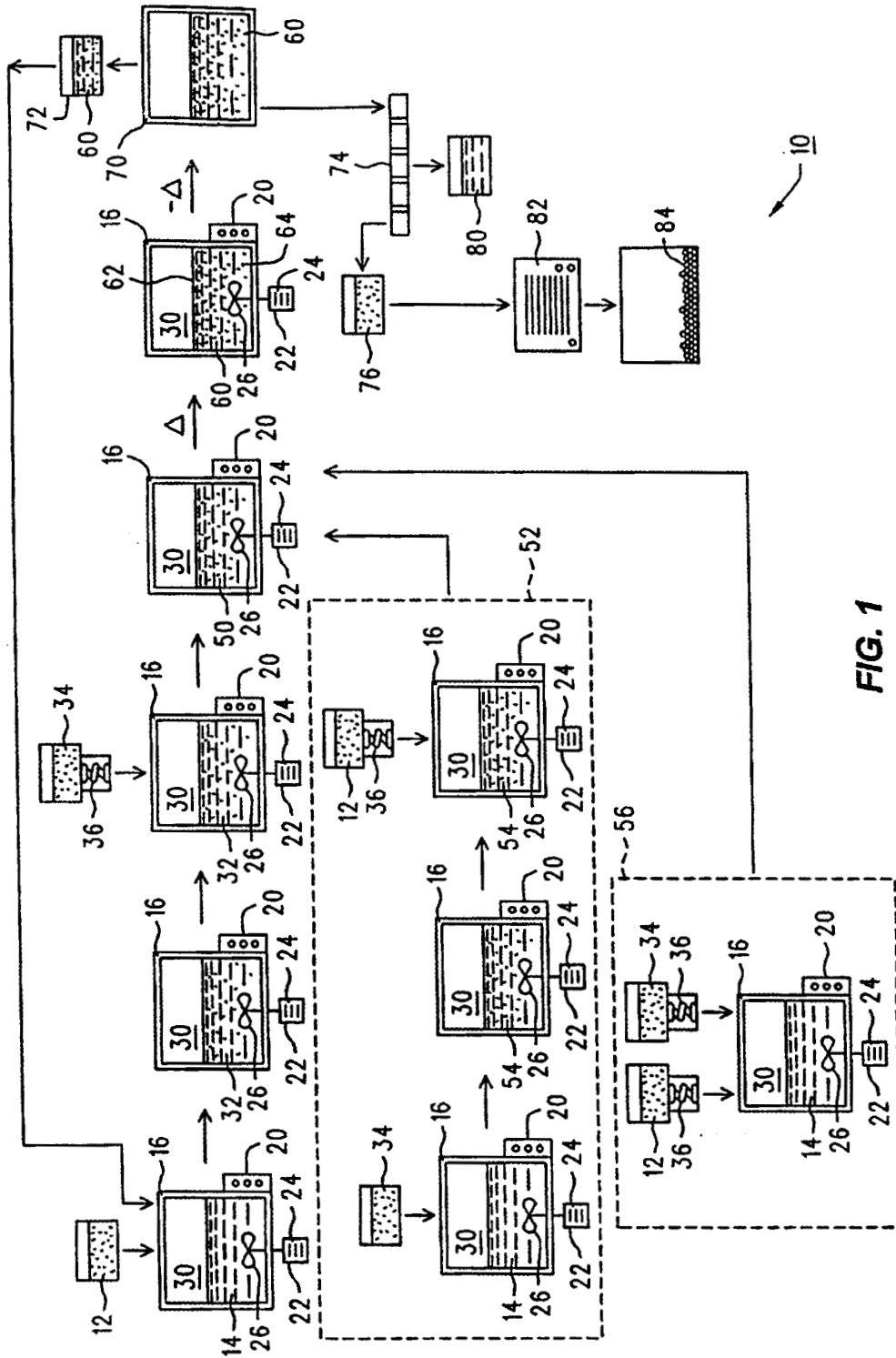

FIG. 1

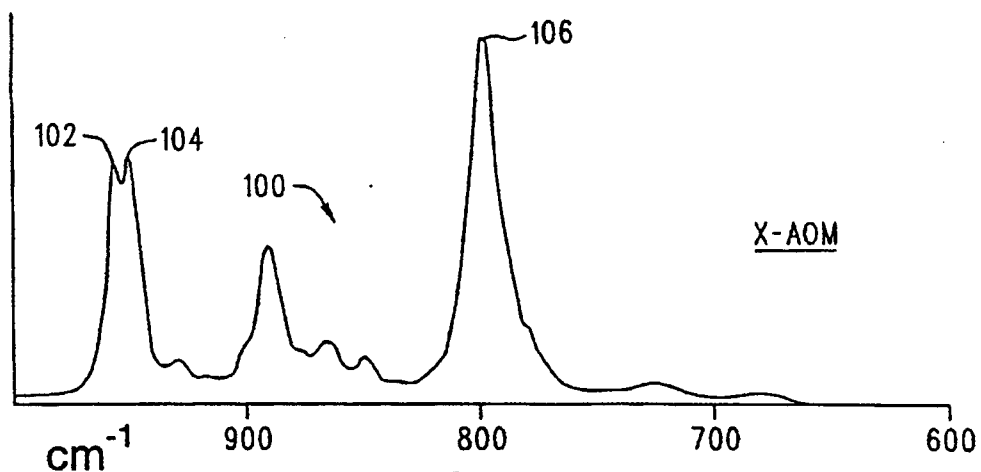

FIG. 2

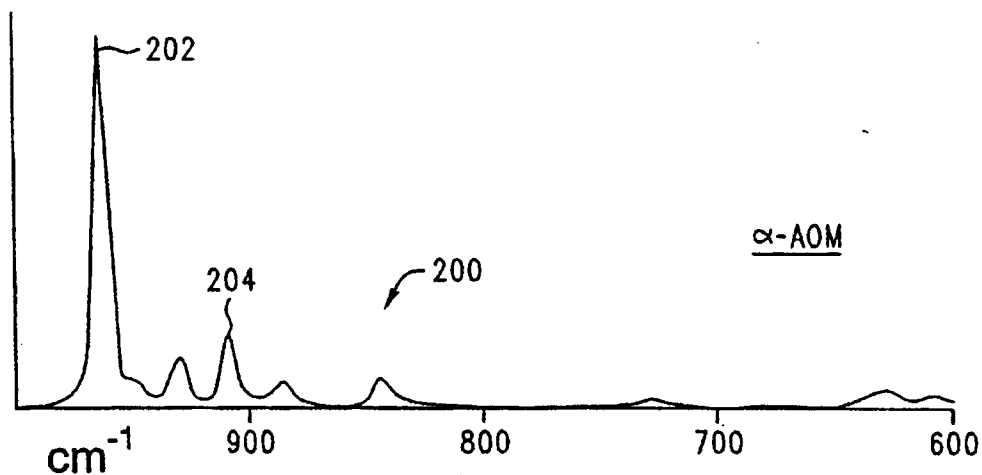

FIG. 3

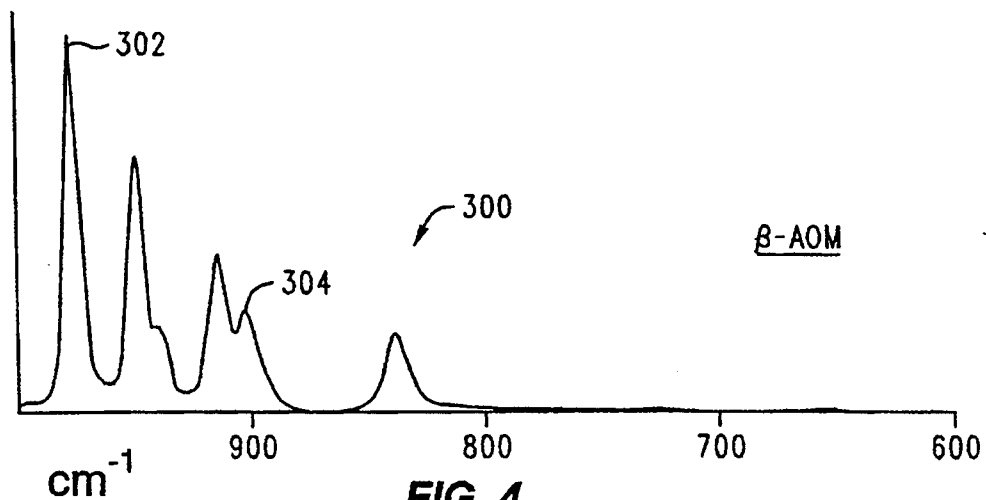

FIG. 4

AMMONIUM OCTAMOLYBDATE COMPOSITION AND METHOD FOR PRODUCING THE SAME

BACKGROUND OF THE INVENTION

The present invention generally relates to the production of an ammonium octamolybdate composition, and more particularly to the manufacture of a novel and unique ammonium octamolybdate isomer having a number of beneficial characteristics.

Ammonium octamolybdate (hereinafter designated as "(NH₄)₈Mo₈O₂₆" or "AOM") is a commercially-useful molybdenum composition which is available in multiple forms or "isomers". Each isomer is characterized by its ability to differentially rotate and otherwise reflect light passing therethrough. In particular, two main isomers of AOM have been isolated and used commercially, namely, (1) the α form ("α-AOM"); and (2) the β form ("β-AOM"). Other isomers also exist including the γ form ("γ-AOM") and the δ form ("δ-AOM"). However, little information is available regarding the γ and δ materials which are mostly generated in very small quantities as by-products and are predominantly theoretical/experimental in nature. Of particular interest from a commercial standpoint is the manufacture of α-AOM which is used as a smoke suppressant in many different compositions including polymeric plastic coating materials for electrical wiring and fiber-optic elements. Representative plastic materials suitable for combination with α-AOM include rigid polyvinyl chloride ("PVC"). The β-AOM isomer is likewise secondarily useful for this purpose although α-AOM is preferred.

In general, α-AOM is traditionally produced by the thermal decomposition of ammonium dimolybdate which shall be designated hereinafter as "(NH₄)₂Mo₂O₇" or "ADM". This process occurs in accordance with the following basic chemical reaction:



However, as noted in U.S. Pat. No. 4,762,700 (which is incorporated herein by reference), the foregoing process is characterized by numerous disadvantages including the generation of α-AOM having too large a particle size. As a result, the α-AOM product generated from reaction (1) listed above had to be physically size-reduced using conventional material-handling procedures which resulted in additional production costs and increased manufacturing time.

Another disadvantage associated with the conventional thermal generation of α-AOM involved the production of undesired by-products if the chemical reactants were improperly heated (e.g. over-heated or insufficiently heated according to U.S. Pat. No. 4,762,700). When this situation occurred, the following undesired by-products were generated: (1) ammonium trimolybdate (which is also characterized as "(NH₄)₂Mo₃O₁₀" or "ATM") and (2) molybdenum trioxide (also designated herein as "molybdic oxide" or "MoO₃"). Since neither of these materials have the important and beneficial smoke-suppressive characteristics of α-AOM as discussed herein, they are undesired in the α-AOM production process. For this reason, the thermal decomposition method outlined above must be very carefully monitored, which again results in greater labor costs, more extensive processing equipment, and increased margins of error.

To overcome these disadvantages, an "aqueous" or "wet" reaction process was developed which is extensively dis-

cussed in U.S. Pat. No. 4,762,700 (again incorporated herein by reference). This process basically involves the initial combination of ammonium dimolybdate ("ADM" as previously noted) with water to yield a slurry-type mixture. In a preferred embodiment, about 50-350 grams of ADM are used per liter of water to form the desired mixture. Thereafter, particulate molybdenum trioxide is combined with the ADM-containing slurry, with the molybdenum trioxide having a preferred particle size of about 10-300 microns and a high purity level (e.g. not more than about 0.5% by weight (total) of iron (Fe), potassium (K), copper (Cu), lead (Pb), calcium (Ca), and other impurities.) It is further stated in U.S. Pat. No. 4,762,700 that both of these materials are specifically combined in the stoichiometric proportions set forth in the following basic formula:



The initial ADM-containing slurry product used in the reaction listed above may be manufactured in many different ways including but not limited to a combination of water, ammonium hydroxide ("NH₄OH"), and molybdenum trioxide. The ADM-containing slurry product can be also derived from "ADM crystallizer mother liquor". Finally, commercially-available, pre-manufactured ADM can be directly combined with water to yield the slurry. Regardless of which process is employed for this purpose, U.S. Pat. No. 4,762,700 states that the molar ratio of ammonia to molybdenum (e.g. [NH₃]/[Mo]) in the ADM-containing slurry should be adjusted to a value of 1.00 prior to addition of the particulate molybdenum trioxide so that the resulting α-AOM product is substantially free from undesired impurities including β-AOM, ammonium heptamolybdate, and other non α-AOM compounds.

Regarding β-AOM, this material is again generated as a side product in traditional thermal decomposition methods. While β-AOM also has smoke suppressant properties, α-AOM is generally recognized as being superior for these purposes. Accordingly, β-AOM has only secondary commercial value compared with α-AOM as previously noted.

Further information, data, and other important parameters regarding α-AOM and β-AOM will be presented below from a comparative standpoint in order to illustrate the novelty of the present invention which involves a new AOM isomer. This unique isomer (designated herein as "X-AOM") differs considerably from all other forms/isomers of AOM including but not limited to α-AOM and β-AOM (as well as the γ and δ forms of AOM). As discussed in greater detail below, X-AOM is different from the other listed isomers both structurally and functionally.

In accordance with the information provided herein, α-AOM is traditionally used as a smoke control agent in plastic materials and other related compositions. However, the X-AOM isomer offers a number of benefits compared with traditional α-AOM including more efficient smoke suppression per unit volume and greater stability/uniformity. Furthermore, as confirmed by sophisticated chemical identification techniques (including a process known as "Raman spectral analysis" which will be summarized in further detail below), the claimed X-AOM product is likewise characterized by a novel isomeric structure which differs considerably from the structure of α-AOM and β-AOM. The use of Raman spectral analysis enables the X-AOM product to be clearly identified and distinguished from other isomers of AOM. In addition, X-AOM is produced using a unique manufacturing process which facilitates the generation of this material in a highly-effective and preferential manner on production-scale levels.

For these and other reasons discussed in the Detailed Description of Preferred Embodiments section, the present invention represents a considerable advance in the art of ammonium octamolybdate production. The claimed invention specifically involves (1) the generation of a structurally novel isomeric AOM product which provides many important functional capabilities; and (2) the creation of a specialized manufacturing method which enables the X-AOM product to be produced in high yields with a considerable degree of purity. Accordingly, the present invention is novel, unique, and highly beneficial in many ways as outlined in greater detail below.

SUMMARY OF THE INVENTION

The following summary is provided as a brief overview of the claimed product and process. It shall not limit the invention in any respect, with a detailed and fully-enabling disclosure being set forth in the Detailed Description of Preferred Embodiments section. Likewise, the invention shall not be restricted to any numerical parameters, processing equipment, chemical reagents, operational conditions, and other variables unless otherwise stated herein.

It is an object of the present invention to provide a novel isomer of ammonium octamolybdate ("AOM") and method for producing the same.

It is another object of the invention to provide a novel AOM isomer and method for producing the same in which the isomer is characterized by a unique Raman spectrum (and arrangement of intensity peaks associated therewith) which is entirely distinguishable from other AOM isomers including but not limited to the α and β forms of this material.

It is another object of the invention to provide a novel AOM isomer and method for producing the same in which the claimed method is able to generate large quantities of the desired isomer (designated herein as "X-AOM") with a maximum degree of purity and efficiency.

It is another object of the invention to provide a novel AOM isomer and method for producing the same in which the method of interest employs readily-available materials and a minimal number of processing steps.

It is another object of the invention to provide a novel AOM isomer and method for producing the same in which the claimed method facilitates production of the desired isomer in a rapid, operationally-efficient manner with minimal labor requirements.

It is a further object of the invention to provide a novel AOM isomer and method for producing the same in which the claimed method avoids the manufacture of other AOM isomers, thereby resulting in a highly pure X-AOM product.

It is a still further object of the invention to provide a novel AOM isomer and method for producing the same in which the claimed method is further characterized by the use of minimal reagent quantities in order to provide a cost-efficient, highly-effective X-AOM production system.

It is an even further object of the invention to provide a novel AOM isomer and method for producing the same in which the claimed product and method result in a unique composition (X-AOM) which provides improved smoke suppression capacity per unit volume and greater uniformity/purity levels compared with other AOM products (including α -AOM).

The claimed invention involves a unique, novel, and previously-unknown isomer of ammonium octamolybdate [(NH₄)₄Mo₈O₂₆] which, for the purposes of identification,

shall be characterized herein as "X-AOM". Isomers traditionally involve compounds which are different yet have the same molecular formula as discussed in Morrison, R. T., et al., *Organic Chemistry*, Allyn and Bacon, Inc., Boston, 3rd ed., p. 37 (1973). From a structural standpoint, individual isomers have a different arrangement and orientation of atoms relative to each other. These dissimilarities typically lead to substantial differences in chemical properties from one isomer to another. Ammonium octamolybdate isomers (particularly the α isomer which is conventionally designated herein as " α -AOM") have been employed as smoke suppressants in various materials including electrical and fiber-optic cables produced from polymeric plastics. Upon combustion, plastic materials which employ α -AOM therein will generate less smoke compared with compositions which lack any α -AOM. The novel isomer claimed herein ("X-AOM") provides superior smoke suppressive behavior per unit volume compared with conventional AOM isomers (including α -AOM). The X-AOM isomer therefore offers a considerable degree of utility in many important applications.

The following discussion again constitutes a brief overview of the present invention and its various features (including the unique distinguishing characteristics of X-AOM compared with other AOM isomers). Unless otherwise stated herein, the claimed process shall not be restricted to any numerical production parameters, processing equipment, and reagents used to generate the X-AOM product. The invention in its broadest sense shall therefore be defined in accordance with the claims presented below.

To produce X-AOM in a preferred embodiment, a number of process steps and reagents are employed. However, before a summary of these items is provided, an overview of the distinguishing characteristics of X-AOM relative to the other isomers of ammonium octamolybdate ("AOM") is in order. The X-AOM product is readily characterized (and clearly distinguished from all other forms of AOM) using its unique Raman spectral profile which includes a number of distinctive peaks that are not present in the Raman spectral profiles of other AOM isomers. As outlined in further detail below, Raman spectral analysis basically involves a collection of spectral intensity values which are produced when light obtained from a high-energy source (e.g. a quartz-mercury lamp or argon-ion laser unit) is passed through a substance. Raman spectroscopy is an established analytical technique that provides highly accurate and definitive results. In accordance with the present invention, Raman spectral analysis of the novel X-AOM product yields a unique spectral profile having three (3) main intensity peaks which are distinctive and not present in the spectral profiles of other AOM isomers. These main peaks involve the following values: Peak #1—about 953–955 cm⁻¹; Peak #2—about 946–948 cm⁻¹; and Peak #3—about 796–798 cm⁻¹. The foregoing values are completely distinguishable and absent from the Raman spectral profiles associated with the other main AOM isomers listed above including (1) α -AOM [two main peaks]: Peak #1—about 964–965 cm⁻¹; and Peak #2—about 910–911 cm⁻¹; and (2) β -AOM [two main peaks]: Peak #1—about 977–978 cm⁻¹; and Peak #2—about 900–901 cm⁻¹. Regarding the term "main peaks" as used above, this term shall encompass peaks for any given AOM isomer which are not present in the Raman spectral profiles of other AOM isomers. In accordance with this information (which clearly distinguishes X-AOM from the other AOM isomers listed above), the creation of X-AOM represents a new, unique, and significant development in the art of molybdenum technology.

The use of Raman spectral analysis involves the most feasible and practical way of identifying X-AOM, with this method being accurate, repeatable, and subject to minimal error. It is therefore entirely sufficient, enabling, and definitive for the claimed X-AOM isomer to be characterized (e.g. identified) spectrally, particularly using Raman spectral profile techniques. Additional information, along with a detailed overview of the Raman spectral data associated with X-AOM (and other AOM isomers) will be provided below in the Brief Description of the Drawings and Detailed Description of Preferred Embodiments sections.

To manufacture X-AOM with acceptable purity values (e.g. +95% by weight pure) while avoiding the production of other AOM isomers (particularly α -AOM), a unique and specialized procedure for accomplishing this goal will now be summarized. While the specific molecular basis for the preferential production of X-AOM using the claimed process is not entirely understood at this time, a number of process steps are considered to be of primary importance as identified herein.

The first step in producing X-AOM involves initially providing (A) a supply of ammonium dimolybdate (e.g. "(NH₄)₂Mo₂O₇" or "ADM"); (B) a supply of molybdenum trioxide (e.g. "molybdic oxide" or "MoO₃"); and (C) a supply of water (which, in all of the embodiments set forth herein, should be deionized). The molybdenum compositions listed above are commercially available from numerous sources including but not limited to the Climax Molybdenum Company of Ft. Madison, Iowa (USA). However, as indicated in U.S. Pat. No. 4,762,700 (incorporated herein by reference), ADM may be conventionally manufactured in accordance with the following formula:

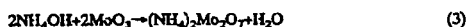

In the formula listed above (and in the other formulae presented herein), "NH₄OH"=ammonium hydroxide. Molybdenum trioxide may also be produced using many alternative processing techniques including the roasting of molybdenum sulfide ("MoS₂") to form molybdenum trioxide as indicated in U.S. Pat. No. 4,046,852 or the use of a multi-slurry oxidation process as described in co-owned pending U.S. patent application Ser. No. 08/790,702 filed on Jan. 29, 1997, both of which are incorporated herein by reference. However, this invention shall not be restricted to any particular methods for producing ADM, molybdenum trioxide (or any other reagents set forth herein), with the specific procedures listed in this summary and the Detailed Description of Preferred Embodiments section being provided for example purposes only. Likewise, the term "providing" as used in connection with any given reagent shall encompass (1) adding the reagent in pre-manufactured form obtained from, for example, a commercial supplier; or (2) generating the desired reagent in situ during the production process by combining the necessary ingredients to generate the reagent on-demand, with both methods being considered equivalent.

The compositions listed above are then combined with a supply of water to produce an aqueous chemical mixture. However, three different methods may be employed to generate the aqueous chemical mixture. The first and second methods are related and basically involve initially selecting one of the ammonium dimolybdate ("ADM") and molybdenum trioxide supplies for use as a "first reagent", and thereafter selecting another of the ADM and molybdenum trioxide supplies for use as a "second reagent". Normally, when the material to be used as the first reagent (either ADM

or molybdenum trioxide) is initially chosen, selection of the second reagent will involve the material which is "left over" and not used as the first reagent. In a first embodiment of the invention, the first reagent will involve ADM, with the second reagent consisting of molybdenum trioxide. In the second embodiment, molybdenum trioxide will be used as the first reagent, with the second reagent consisting of ADM. The only difference between the first and second embodiments involves the particular materials that are used as the first and second reagents, with the first reagent being added into the system before the second reagent as discussed below.

Once a selection is made as to which compositions will be employed as the first and second reagents, both embodiments are substantially the same. Specifically, the first reagent (either ADM in embodiment number (1) or molybdenum trioxide in embodiment number (2)) is initially combined with the supply of water to yield an aqueous intermediate product. The second reagent (either molybdenum trioxide in embodiment number (1) or ADM in embodiment number (2)) is then added to the intermediate product in a controlled, gradual, and non-instantaneous manner over time to yield the aqueous chemical mixture.

A third embodiment of the claimed process involves a situation in which the ADM and molybdenum trioxide are combined with the supply of water simultaneously (e.g. both at the same time). The delivery of both materials shall be undertaken in a controlled, gradual, and non-instantaneous manner over time to yield the aqueous chemical mixture. In this particular embodiment, an intermediate product is not generated since all of the reactants are added into the system simultaneously.

It should also be noted that any terminology in the present description which indicates that ADM or molybdenum trioxide is "added", "combined", or otherwise delivered into the system shall again involve the use of these materials in a pre-manufactured form, or the addition of "precursor" compounds which, when combined, react in situ to form the desired reagent(s)/ingredients. Likewise, when the term "combining" is used herein to generally involve mixing of all the listed ingredients to produce the aqueous chemical mixture, this term shall encompass the addition of such materials in any order (and in any manner either gradually or non-gradually) if the order or delivery mode is not specifically designated in the claim or example under consideration.

In accordance with currently available information, a novel feature of the claimed process which, in a preferred embodiment, is currently believed to at least partially contribute (in most cases) to the preferential production of X-AOM over other AOM isomers is the use of a technique which involves "gradual, non-instantaneous" addition of the selected reagent(s) as previously noted. This phrase shall signify a technique in which the composition of interest is not added to the water (or aqueous intermediate product depending on which embodiment is involved) all at once, but is instead delivered in a gradual and progressive manner at a pre-determined rate (e.g. a specific quantity over a designated time period). Controlled and gradual addition may involve (A) continuous delivery of the desired material (s) at a constant and uniform rate over the selected time period; or (B) delivery of the desired material(s) in discrete amounts (e.g. allotments) at periodic intervals over the chosen time period. This particular technique (regardless of which variant is employed) is designed to avoid delivering all of the selected material(s) into the system at one time in a single large mass. Accordingly, when a particular compo-

sition (e.g. ADM, molybdenum trioxide, or both) is selected for delivery in a "gradual, non-instantaneous manner", this phrase shall again encompass any procedure in which the composition is not added into the system all at once, but is instead accomplished over time. While not entirely understood, it is believed that this delivery method creates a complex kinetic environment which promotes the formation of X-AOM in most cases.

The claimed process shall not be restricted to any particular addition rates in connection with chemical compositions that are delivered in a "gradual, non-instantaneous manner". However, to provide optimum results, the "gradual, non-instantaneous" addition of ADM and molybdenum trioxide typically involves a delivery rate of (1) about 75-150 kilograms per minute for ADM; and (2) about 65-130 kilograms per minute for molybdenum trioxide. These rates (which may be varied as needed in accordance with preliminary pilot studies) are applicable to all of the embodiments set forth herein as outlined below.

The invention shall also not be limited to any particular numerical quantities in connection with the supplies of ADM and molybdenum trioxide. It is nonetheless preferred that such materials be employed in the approximate stoichiometric proportions provided by the following chemical reaction:



However, to achieve optimum results, it has been determined that the use of molybdenum trioxide in a slight excess of stoichiometric requirements (e.g. about 1-5% by weight excess molybdenum trioxide) is preferred.

After formation of the aqueous chemical mixture using any of the techniques listed above, the mixture is thereafter heated to generate a completed reaction product having the X-AOM isomer therein (in solid form). While the claimed method shall not be restricted to any particular heating parameters in connection with the aqueous chemical mixture, it is preferred that the mixture be heated to a temperature of about 85-90° C. over a time period which should exceed 3 hours (e.g. about 3.5-5 hours). Likewise, optimum results are achieved if the aqueous chemical mixture is constantly agitated (e.g. stirred) during the heating process to ensure a maximum yield of X-AOM with high purity values. It is also believed that heating of the aqueous chemical mixture in accordance with the numerical parameters listed above (especially over a time period which exceeds 3 hours) contributes to the preferential generation of X-AOM over other AOM isomers including α -AOM when used with or without the gradual, non-instantaneous addition procedures listed above. However, a combination of both techniques (e.g. gradual, non-instantaneous addition and the time/temperature parameters listed above) provides best results.

After heating as previously noted, the reaction product is optionally (but preferably) cooled to a temperature of about 60-70° C. which is designed to provide additional ease of handling and the further promotion of X-AOM crystal growth. The cooled reaction product is thereafter processed to physically remove the solid X-AOM therefrom. This may be accomplished in many different ways, without restriction to any particular isolation methods. For example, in a preferred and non-limiting embodiment, the X-AOM-containing reaction product can be passed through a selected filtration system one or more times as needed and desired (with or without the use of one or more water-washing steps). The resulting X-AOM product is thereafter dried and collected to complete the reaction process. The final

X-AOM composition is characterized by a high degree of purity (+95% by weight X-AOM) and a distinctive Raman spectral profile as outlined below in the Detailed Description of Preferred Embodiments section.

In a still further alternative embodiment of the invention which is designed to produce an X-AOM product with a fine, easily-handled consistency, a supply of previously manufactured X-AOM (e.g. X-AOM generated from the previous production run) is retained and combined with the water, ADM, and molybdenum trioxide at the initial stages of the process. Preferably, a portion of the aqueous chemical mixture discussed above (which contains X-AOM therein) is used for this purpose which provides the foregoing benefits, along with a "seed" function that provides improved X-AOM yield and handleability characteristics by increasing the overall density of the X-AOM. The resulting mixture is then heated as discussed above (e.g. using the above-listed parameters) to yield a reaction product containing additional amounts of X-AOM therein. This particular development is applicable to all of the embodiments set forth herein regardless of whether gradual or non-gradual component addition is employed, and is not limited to any other reaction conditions.

While the claimed method shall not be restricted to any numerical or other parameters (including those listed above unless otherwise stated herein), an exemplary procedure which yields optimum results involves the following steps: (1) providing a supply of ammonium dimolybdate ("ADM"), a supply of molybdenum trioxide, and a supply of water; (2) combining the ADM with the water to produce an intermediate product, with about 283 grams of ADM being used per liter of water; (3) combining the molybdenum trioxide with the intermediate product generated in accordance with step (2) to yield an aqueous chemical mixture, with about 0.87 grams of molybdenum trioxide being used per gram of ADM, wherein this step involves adding the molybdenum trioxide to the aqueous intermediate product in a gradual, non-instantaneous manner (defined above) at a rate of about 110 kilograms of molybdenum trioxide per minute in order to avoid delivering the molybdenum trioxide to the intermediate product all at once; (4) heating the aqueous chemical mixture at a temperature of about 88° C. for a time period of about 4.5 hours to generate a completed reaction product containing the desired ammonium octamolybdate isomer therein (e.g. X-AOM); (5) cooling the X-AOM-containing reaction product to a temperature of about 66° C. after it has been heated in accordance with step [4]; and (6) removing the solid X-AOM composition from the liquid fractions of the reaction product after it has been cooled pursuant to step (5) (e.g. using filtration or other equivalent techniques). Implementation of this procedure results in the highly effective manufacture of X-AOM at purity levels of +95% by weight X-AOM. This purity level reflects the substantial absence of non-X-AOM isomers therein.

In conclusion, the claimed product and process collectively represent an important development in molybdenum technology. The X-AOM composition described above is not only characterized by a unique isomeric structure (which is different from other AOM isomers as demonstrated by Raman spectroscopy), but likewise has improved smoke suppression qualities. The distinctive X-AOM composition is likewise produced in a manner which enables large quantities of X-AOM to be generated with high purity and uniformity levels. These and other objects, features, and advantages of the invention shall be presented below in the following Detailed Description of Preferred Embodiments.

BRIEF DESCRIPTION OF THE DRAWINGS

FIG. 1 is a schematic representation of the basic process steps which are employed in a preferred embodiment of the present invention to yield a new and unique isomer of ammonium octamolybdate (e.g. "X-AOM").

FIG. 2 is a Raman spectral profile of the novel X-AOM isomer claimed herein.

FIG. 3 is a Raman spectral profile of conventional α -AOM which is significantly different from the Raman spectral profile of X-AOM presented in FIG. 2.

FIG. 4 is a Raman spectral profile of conventional β -AOM which is significantly different from the Raman spectral profile of X-AOM presented in FIG. 2.

DETAILED DESCRIPTION OF PREFERRED EMBODIMENTS

In accordance with the claimed invention, a novel isomer of ammonium octamolybdate ("AOM") is disclosed which is different in structure and function compared with all other ammonium octamolybdate isomers (including the α , β , γ , and δ forms of this material). The "isomers" of a compound traditionally involve compositions which are different in structural configuration yet have the same molecular formula as discussed in Morrison, R. T., et al., *Organic Chemistry*, Allyn and Bacon, Inc., Boston, 3rd ed., p. 37 (1973). Specifically, individual isomers have a different arrangement and orientation of atoms relative to each other. These dissimilarities can lead to substantial differences in chemical properties from one isomer to another. In the present invention, ammonium octamolybdate has the following basic molecular formula: " $(\text{NH}_4)_4\text{Mo}_8\text{O}_{26}$ " which is also known as simply "AOM". The novel isomer associated with the present invention (characterized herein as "X-AOM") involves a different structural configuration compared with all previously-known isomers of AOM including the α and β forms of this material as discussed below and clearly shown in the Raman spectral profiles of FIGS. 2-4. The structural dissimilarities between X-AOM and the other isomers of AOM (α -AOM and β -AOM) are reflected in a number of beneficial attributes associated with X-AOM including improved smoke suppression capacity/performance when the X-AOM composition is employed within, for example, polymer plastic-based electrical and/or fiber optic cable materials (e.g. made of rigid PVC) as previously noted. In particular, it has been determined in certain applications that effective smoke suppression will occur using reduced amounts of X-AOM as an additive within, for example, polymer plastics compared with conventional α -AOM. Likewise, X-AOM is characterized by significant levels of stability and uniformity. Regarding the structural dissimilarities between X-AOM and other AOM isomers, these differences can again be shown in a definitive manner by Raman spectrographic techniques in accordance with specific information provided below.

As a preliminary point of information, the claimed process shall again not be restricted to any particular operational parameters including reagent quantities, the order of reagent addition, reaction conditions, and other numerical values unless otherwise indicated. Specific reaction parameters and other operational factors may be optimized in a given situation (taking into account environmental factors, production-scale requirements, and the like) using routine preliminary pilot testing. The discussion provided below involves one or more preferred embodiments which are designed to provide optimum results and shall not be considered limiting or restrictive.

A. The X-AOM PRODUCTION METHOD

With reference to FIG. 1, an exemplary and schematic overview of a process designed to produce the novel X-AOM isomer of the present invention is provided. This process may again be varied as needed based on routine preliminary testing unless otherwise noted. As shown in FIG. 1, the entire processing system is generally represented at reference number 10. Within system 10, a supply of ammonium dimolybdate 12 (also known as " $(\text{NH}_4)_2\text{Mo}_2\text{O}_7$ " or "ADM") is initially provided. This composition is commercially available from numerous sources including but not limited to the Climax Molybdenum Company of Ft. Madison, Iowa (USA). However, as discussed in U.S. Pat. No. 4,762,700 (incorporated herein by reference), ADM may be conventionally manufactured in accordance with the following formula:

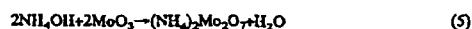

In the formula listed above (and in other formulae presented herein), NH_4OH =ammonium hydroxide and MoO_3 =molybdenum trioxide. However, the present invention shall not be restricted to any particular methods for producing ADM (or the other reagents set forth herein). As discussed in U.S. Pat. No. 4,762,700, an aqueous solution of ADM which is suitable for use in the claimed process at this stage could likewise be derived from other sources including "ADM crystallizer mother liquor" obtained from commercial ADM manufacturing processes.

In the present embodiment, the supply of ADM 12 shall be designated herein and selected for use as a "first reagent" (e.g. the reagent that is initially added into the system 10). The materials which can be employed in connection with the first reagent may be different in the other embodiments of the claimed process as discussed further below. While all embodiments of the invention shall not be restricted to the use of ADM materials having a particular particle size, it is preferred that a particle size value of about 22-26 microns be employed in connection with the supply of ADM 12 to facilitate proper mixing and dissolution of this material.

With continued reference to FIG. 1, the supply of ADM 12 (again characterized as the first reagent in this embodiment) is then combined with (e.g. added to) a supply of water 14 (optimally deionized) which is retained within a containment vessel 16 produced from a number of possible materials including but not limited to stainless steel, inert plastic (e.g. polyethylene), and the like. It should be noted at this point that any production-scale may be employed in connection with the claimed process. However, in a representative and exemplary embodiment designed for mass-production purposes, the containment vessel 16 will have an optimum capacity of about 20,000-25,000 liters although smaller or larger vessels may be used as desired. All of the remaining process steps associated with the claimed method which are used to produce the desired aqueous X-AOM-containing chemical mixture (discussed below) in each of the embodiments set forth herein can be implemented within the containment vessel 16. However, to ensure rapid processing on a large scale, the multi-vessel configuration specifically shown in FIG. 1 is preferred.

While not required, the supply of water 14 inside the containment vessel 16 may be pre-heated to facilitate immediate dissolution of the ADM 12 (and other materials) in the water 14 during subsequent stages of the reaction process. To accomplish pre-heating, the vessel 16 will include a heating unit 20 associated therewith which may involve many known systems including steam-based, water-flow,

electrical-resistance, or hot-water immersion units which are suitable for this purpose. While the process discussed herein shall not be limited to a single pre-heating temperature, optimum results are achieved if the water 14 is pre-heated to about 85–90° C. and maintained at this temperature up to and during the remaining stages of the reaction process as indicated below.

Addition of ADM 12 to the water 14 within the vessel 16 (whether pre-heated or not) is thereafter initiated. The manner in which the supply of ADM 12 is added to the water 14 (e.g. either all at once or in a gradual, non-instantaneous fashion (defined further below) is not critical at this stage, provided that the ADM 12 (e.g. the first reagent) is ultimately dissolved in a substantially complete manner within the water 14. To accomplish this goal, it is preferable to add the supply of ADM 12 to the water 14 in a gradual, non-instantaneous manner to ensure rapid and complete dissolution. A representative, non-limiting addition rate will involve about 75–150 kilograms of ADM 12 per minute. However, as outlined in greater detail below, it is even more important for the second reagent (e.g. molybdenum trioxide in the present embodiment) to be added to the water 14 in a gradual, non-instantaneous manner. It is currently believed that this technique, while not completely understood, beneficially contributes in most cases to the preferential generation of X-AOM over other forms of ammonium octamolybdate (including α -AOM).

The phrase "gradual, non-instantaneous addition" as employed herein (relative to all of the listed embodiments) shall signify a technique in which the composition of interest is not added to the water 14 (or any intermediate products depending on which embodiment is involved) all at once, but is instead delivered in a gradual and progressive manner at a pre-determined rate (e.g. a specific quantity over a selected time period). This type of controlled, gradual addition may involve (A) continuous delivery of the desired material(s) at a constant and uniform rate over the designated time period; or (B) delivery of the desired material(s) in discrete amounts (e.g. allotments) at periodic intervals over the chosen time period. The gradual addition of reagents as defined above is designed to avoid delivering all of the selected materials(s) into the system 10 at one time in a single large mass. Accordingly, when a particular material is indicated to be delivered in a "gradual, non-instantaneous manner", this phrase shall encompass any procedure in which the selected reagent is not added into the system 10 all at once, but is instead accomplished over time. While not entirely understood, it is again believed that this gradual addition technique creates a complex and unique kinetic environment which promotes the preferential formation of X-AOM.

It is preferred in all embodiments of the claimed process that the containment vessel 16 be designed to include a stirring system 22 therein (e.g. in the form of a motor 24 operatively connected to a mixing blade 26 positioned within the interior region 30 of the containment vessel 16 and entirely beneath the surface of the water 14 as shown). The stirring system 22 is used to agitate the supply of water 14 and materials added thereto so that complete dissolution of the delivered materials will occur in an efficient manner to produce maximum X-AOM yields.

After addition of the ADM 12 (e.g. the first reagent in this embodiment) to the supply of water 14 within the containment vessel 16, the ADM 12 will rapidly dissolve (especially if agitated as noted above) to yield an ADM-containing solution designated herein as an "aqueous intermediate product" 32. At this point, further information is relevant

regarding the amount of the ADM 12 to be employed in producing the aqueous intermediate product 32. While the claimed invention shall not be restricted to any given amounts of added ADM 12 as the first reagent in this embodiment, optimum results will be achieved if about 275–290 grams of ADM 12 are used per liter of water 14. This value may be varied as needed in accordance with preliminary pilot studies involving numerous factors including the desired operating scale of the system 10.

After formation of the intermediate product 32 (e.g. the supply of water 14 having the ADM 12 dissolved therein), a supply of molybdenum trioxide 34 (also known as "molybdic oxide" or " MoO_3 ") is provided. In the present embodiment, the supply of molybdenum trioxide shall be designated herein and selected for use as the "second reagent". The material to be employed in connection with the second reagent may be different in the other embodiments of the claimed process as discussed further below. The supply of molybdenum trioxide 34 can be obtained from many different commercial sources including but not limited to the Climax Molybdenum Company of Ft. Madison, Iowa (USA). Likewise, all of the embodiments described herein shall not be limited to any particular types of molybdenum trioxide (or methods of production). However, best results are achieved if the molybdenum trioxide 34 is of sufficiently high purity to contain not more than about 0.5% by weight (total) of non-molybdenum trioxide materials including iron (Fe), potassium (K), copper (Cu), lead (Pb), calcium (Ca), or other comparable materials in both elemental and compound form. Likewise, in a representative embodiment, the molybdenum trioxide 34 employed at this stage of the manufacturing process will have an exemplary particle size of about 10–400 microns although this value may be varied if needed and desired. Representative production methods which can be employed in connection with the supply of molybdenum trioxide 34 range from the roasting of molybdenum sulfide (" MOS_2 ") to form molybdenum trioxide as discussed in U.S. Pat. No. 4,046,852 to the use of a multi-slurry oxidation process as indicated in co-owned pending U.S. application Ser. No. 08/790,702 filed on Jan. 29, 1997, with both of these documents being incorporated herein by reference.

It should also be noted that any terminology in the present description which indicates that the ADM 12 or molybdenum trioxide 34 is "added", "combined", "provided", or otherwise delivered into the system 10 shall involve the use of these compositions in a pre-manufactured form or the delivery of "precursor" materials which, when added, react in situ to form the desired reagent(s).

While the precise reaction kinetics and molecular interactions associated with the formation of X-AOM over other AOM isomers within system 10 are not entirely understood, it is currently believed that the manner in which the molybdenum trioxide 34 (e.g. the second reagent) is delivered into the system 10 in the current embodiment assists in promoting the preferential formation of X-AOM in most cases. The molybdenum trioxide 34 is preferably added to the aqueous intermediate product 32 in a gradual, non-instantaneous manner in accordance with the definition of this phrase provided above. This technique is again employed in order to avoid delivering the supply of molybdenum trioxide 34 to the intermediate product 32 in a single large quantity (e.g. all at once). To accomplish this goal, the molybdenum trioxide 34 may be delivered in a continuous, progressive, and uniform manner over time or in discrete allotments added at periodic intervals. However, in a preferred and non-limiting embodiment, continuous, progressive, and uniform addition of the molybdenum trioxide 34 over a selected time period

is employed in order to ensure maximum yields of high-purity X-AOM.

The gradual, non-instantaneous addition of the molybdenum trioxide 34 can be physically accomplished through the use of a standard controlled-delivery conveyor apparatus 36 which may involve a conventional screw-type transfer system or other functionally-equivalent material handling device known in the art for continuous or interval-based material transfer. It should also be noted that the apparatus 36 can be employed for delivering the ADM 12 into the supply of water 14 (if gradual delivery is desired). Likewise, the apparatus 36 may be used to deliver any other reagent into the system 10 in a gradual, non-instantaneous manner when this type of delivery technique is needed and desired.

While the claimed method shall not be restricted to any particular rate at which gradual, non-instantaneous delivery of the molybdenum trioxide 34 may be achieved, it is preferred that such delivery be undertaken at an overall rate of about 65-130 kilograms of molybdenum trioxide 34 per minute. In any given situation, the precise delivery rate associated with the molybdenum trioxide 34 (or any other materials to be transferred in a gradual, non-instantaneous manner as discussed herein) shall again be determined in accordance with routine pre-production testing taking into account the desired production-scale and other related factors. The method described herein (including all embodiments) shall also not be limited to any particular numerical quantities in connection with the supply of molybdenum trioxide 34 (and supply of ADM 12). It is nonetheless preferred that such materials be employed in the approximate stoichiometric proportions provided by the following basic chemical reaction:



However, to achieve optimum results, tests have demonstrated that the use of molybdenum trioxide 34 in a slight excess of stoichiometric requirements (e.g. about 1-5% by weight excess molybdenum trioxide 34) is preferred. Translated into numerical terms, optimum results are achieved if about 0.85-0.89 grams of molybdenum trioxide 34 are used per gram of ADM 12. Notwithstanding the information provided above, specific reagent quantities to be employed in a given situation are again best determined through routine preliminary testing.

In accordance with the steps provided above in which the water 14, ADM 12, and molybdenum trioxide 34 are all combined, a reaction product is generated which shall be designated herein as an "aqueous chemical mixture" 50. Further treatment of this mixture 50 to obtain X-AOM and other important related information will be provided below.

As previously noted, the aqueous chemical mixture 50 in the present embodiment is produced by (1) combining the supply of water 14 with the ADM 12 which is used as the first reagent to yield the aqueous intermediate product 32; and (2) adding the molybdenum trioxide 34 (as the second reagent) to the intermediate product 32 in a gradual, non-instantaneous manner (defined above) to yield the aqueous chemical mixture 50. While this method is generally preferred and provides highly effective results with minimal labor, other comparable procedures can be employed for producing the aqueous chemical mixture 50. These alternative methods each involve a different order in which the various reagents (e.g. ADM 12 and molybdenum trioxide 34) are delivered into the system 10.

A second embodiment of the invention is shown within dashed box 52 in FIG. 1. As a preliminary note, all of the basic procedures, equipment, operational parameters, and

other factors discussed above in connection with the first embodiment (including pre-heating of the water 14 to the previously-listed temperature, agitation of the liquid components in the system 10, and the like) are substantially identical to those used in the second embodiment. The applicability of this information to the second embodiment is confirmed and represented by the use of common reference numbers in both embodiments for the various components of the system 10 including the heating unit 20, the stirring system 22 (consisting of the motor 24 and the mixing blade 26), and the like. Thus, all of the information, data, and techniques discussed above in connection with the first embodiment are incorporated by reference relative to the second embodiment unless otherwise indicated herein. The only substantial difference between both embodiments involves the order in which the supplies of ADM 12 and molybdenum trioxide 34 are added into the system 10 which will now be discussed.

With continued reference to the dashed box 52 in FIG. 1, the supply of molybdenum trioxide 34 is initially combined with the supply of water 14. In the previous embodiment, the ADM 12 was initially added to the water 14, followed by the molybdenum trioxide 34. Thus, the order of component addition associated with the second embodiment is reversed compared with the first embodiment. As a result, the supply of molybdenum trioxide 34 is selected for use as the "first reagent" in this embodiment (since it is being added first), with the supply of ADM 12 being designated for use as the "second reagent". Addition of the molybdenum trioxide 34 to the water 14 may be accomplished either instantaneously (e.g. all at once) or in a gradual, non-instantaneous manner (defined above) at a representative rate of about 65-130 kilograms of molybdenum trioxide 34 per minute. While the particular addition technique used in connection with the supply of molybdenum trioxide 34 as the first reagent shall not be considered critical, gradual, non-instantaneous addition of this material as defined above is preferred in order to ensure rapid and complete dissolution of the molybdenum trioxide 34 within the supply of water 14. In this manner, an aqueous intermediate product 54 is generated (FIG. 1) which involves the supply of water 14 having the molybdenum trioxide 34 dissolved therein. Regarding the amount of the molybdenum trioxide 34 which is used to form the intermediate product 54, the present invention shall again not be restricted any particular quantity values which may be determined by preliminary pilot testing. However, it is preferred that about 240-252 grams of molybdenum trioxide 34 be used per liter of water 14 to achieve maximum X-AOM yields and purity values. Likewise, it should be noted that the intermediate product 54 has been given a different reference number compared with intermediate product 32 in the first embodiment since both products 32, 54 have a different chemical character. Specifically, intermediate product 32 in the first embodiment involves a solution containing dissolved ADM therein, while intermediate product 54 consists of a solution made from dissolved molybdenum trioxide. Regardless of the chemical content of the intermediate products 32, 54, they will both effectively produce the aqueous chemical mixture 50 (although the method of the first embodiment is again preferred for technical, ease-of-use, and solubility reasons).

After formation of the aqueous intermediate product 54 (which contains the supply of water 14 and dissolved molybdenum trioxide 34 therein), the supply of ADM 12 is preferably added to the intermediate product 54 in a gradual, non-instantaneous manner as defined above in order to avoid delivery of the entire supply of ADM 12 to the intermediate

product 54 at the same time (e.g. in one large mass). To accomplish this goal, the ADM 12 may be delivered in a continuous, progressive, and uniform manner over time or in discrete allotments added at periodic intervals. In a preferred and non-limiting embodiment, continuous, progressive, and uniform addition of the ADM 12 over a selected time period is employed in order to ensure maximum yields of high-purity X-AOM. The benefits provided by a gradual, non-instantaneous addition of this material are discussed above in connection with the first embodiment and are equally applicable to the second embodiment.

The gradual, non-instantaneous addition of the ADM 12 can be achieved by using controlled-delivery conveyor apparatus 36 discussed above which may again involve a conventional screw-type transfer system or other functionally-equivalent material handling device known in the art for continuous or interval-based material transfer. It should also be noted that the apparatus 36 can be employed for initially delivering the molybdenum trioxide 34 into the supply of water 14 in this embodiment (if gradual delivery is desired). Likewise, the apparatus 36 may be used to deliver any other reagent into the system 10 in a gradual, non-instantaneous manner when this type of delivery technique is needed and desired as indicated above.

While this embodiment of the claimed process shall not be restricted to any particular rate at which gradual, non-instantaneous delivery of the ADM 12 (e.g. the second reagent in the current embodiment) may be accomplished, it is preferred that such delivery be undertaken at an overall rate of about 75-150 kilograms of ADM 12 per minute. In any given situation, the precise delivery rate associated with the supply of ADM 12 (or any other materials to be transferred in a gradual, non-instantaneous manner) shall again be determined in accordance with routine pre-production testing taking into account the desired production-scale and other related factors. The method described herein (including all embodiments) shall also not be restricted to any particular numerical quantities in connection with the supply of molybdenum trioxide 34 (and supply of ADM 12). It is nonetheless preferred that such materials again be employed in the approximate stoichiometric proportions provided by the following basic chemical reaction which was discussed above in connection with the first embodiment and is equally applicable to the second embodiment:



However, to achieve optimum results, tests have demonstrated that the use of molybdenum trioxide 34 in a slight excess of stoichiometric requirements (e.g. about 1-5% by weight excess molybdenum trioxide 34) is preferred. Translated into numerical terms, optimum results are achieved if about 0.85-0.89 grams of the molybdenum trioxide 34 are used per gram of ADM 12 in all of the embodiments described herein.

In accordance with the procedure discussed above and shown schematically in dashed box 52, the aqueous chemical mixture 50 is again generated. The chemical mixture 50 in both of the foregoing embodiments is substantially the same in content, form, and other parameters. The only substantial difference between both embodiments again involves the order in which the supplies of ADM 12 and molybdenum trioxide 34 are added. At this stage in the claimed process, the aqueous chemical mixture 50 produced in accordance with the second embodiment (if used) is further processed in a manner which is common to all of the embodiments provided herein (discussed in greater detail below).

In addition to the first and second embodiments listed above, a still further embodiment (e.g. a third embodiment) may be employed to produce the aqueous chemical mixture 50. The third embodiment is illustrated schematically in dashed box 56 (FIG. 1). It should again be noted that all of the basic procedures, equipment, operational parameters, and other factors discussed above in connection with the first embodiment (including pre-heating of the water 14 to the previously-listed temperature, agitation of the liquid components in the system 10, and the like) are substantially identical to those associated with the third embodiment unless otherwise indicated herein. The applicability of this information to the third embodiment is confirmed and represented by the use of common reference numbers in both embodiments for the various components of the system 10 including the heating unit 20, the stirring system 22 (consisting of the motor 24 and the mixing blade 26), and the like. Thus, all of the information, data, and techniques discussed above in connection with the first embodiment are incorporated by reference relative to the third embodiment. The only difference of consequence between the first, second, and third embodiments again involves the order in which the supplies of ADM 12 and molybdenum trioxide 34 are added into the system 10 as will now be discussed.

The third embodiment shown in dashed box 56 specifically involves a situation in which the supplies of ADM 12 and molybdenum trioxide 34 are both added to the water 14 at the same time, but in a gradual, non-instantaneous manner as defined above. Since the ADM 12 and molybdenum trioxide 34 are both combined with the water 14 in a simultaneous fashion, there are no specific materials designated as first and second reagents in this embodiment. Likewise, no aqueous intermediate products are generated as discussed below. The gradual, non-instantaneous, and simultaneous delivery of ADM 12 and molybdenum trioxide 34 shown in FIG. 1 (dashed box 56) is designed to avoid delivery of the entire supplies of ADM 12 and molybdenum trioxide 34 to the water 14 at the same time (e.g. in one large mass associated with each composition). To accomplish this goal, the supplies of ADM 12 and molybdenum trioxide 34 may be delivered in a continuous, progressive, and uniform manner over time or in discrete allotments added at periodic intervals. In a preferred and non-limiting embodiment, continuous, progressive, and uniform addition of the ADM 12 and molybdenum trioxide 34 over a selected time period is employed to ensure maximum yields of high-purity X-AOM. The benefits provided by the gradual, non-instantaneous addition of these materials are discussed above in connection with the previous two embodiments and are equally applicable to the third embodiment. Likewise, in the third embodiment, the delivery process associated with the supplies of ADM 12 and molybdenum trioxide 34 will both ideally begin at substantially the same time. However, the term "simultaneously" as used in this embodiment shall involve a process in which at least part of the above-listed materials (e.g. ADM 12 and molybdenum trioxide 34) enter the water 14 at the same time, regardless of whether the delivery of one material is started before the other material.

The gradual, non-instantaneous addition of the ADM 12 and molybdenum trioxide 34 in this embodiment can be achieved by using the controlled-delivery conveyor apparatus 36 discussed above which may again involve a conventional screw-type transfer system or other functionally-equivalent material handling device known in the art for continuous or interval-based material transfer. A separate apparatus 36 can be employed for the supply of ADM 12 and the supply of molybdenum trioxide 34 as shown in dashed

box 56 of FIG. 1. However, in the alternative, both of these ingredients (the ADM 12 and molybdenum trioxide 34) can be delivered into the water 14 within the containment vessel 16 using a single conveyor apparatus 36 in which such materials are effectively "mixed" during delivery.

While this embodiment of the claimed process shall not be restricted to any particular rate at which gradual, non-instantaneous, and simultaneous delivery of the ADM 12 and molybdenum trioxide 34 may be accomplished, it is preferred that such delivery be undertaken at the following rates: (1) the ADM 12—about 75–150 kilograms per minute; and (2) the molybdenum trioxide 34—about 65–130 kilograms per minute. If a single conveyor apparatus 36 is used to simultaneously deliver both of the above materials, it is preferred that a single delivery rate which falls within both of the above-listed ranges be selected to deliver the combined ADM 12 and molybdenum trioxide 34. However, the precise delivery rate associated with the supplies of ADM 12, molybdenum trioxide 34, or any other materials to be delivered in a gradual, non-instantaneous manner as discussed herein shall again be determined in accordance with routine pre-production testing taking into account the desired production-scale and other related factors. The claimed method (including all embodiments) shall also not be restricted to any particular numerical quantities in connection with the supplies of ADM 12 and molybdenum trioxide 34. It is nonetheless preferred that such materials again be employed in the approximate stoichiometric proportions provided by the following basic chemical reaction which was discussed above in connection with the previous two embodiments and is equally applicable to the third embodiment:



However, to achieve optimum results, tests have demonstrated that the use of molybdenum trioxide 34 in a slight excess of stoichiometric requirements (e.g. about 1–5% by weight excess molybdenum trioxide 34) is preferred. Translated into numerical terms, optimum results are achieved if about 275–290 grams of ADM 12 are used per liter of water 14, with about 0.85–0.89 grams of molybdenum trioxide 34 being used per gram of ADM 12.

In accordance with the procedure discussed above and shown schematically in dashed box 56, the aqueous chemical mixture 50 is again generated, with the subsequent treatment thereof being outlined further below. However, in this embodiment, the combined, simultaneous addition of the supplies of ADM 12 and molybdenum trioxide 34 to the water 14 avoids the generation of any intermediate products and instead directly produces the aqueous chemical mixture 50 as illustrated in FIG. 1. The aqueous chemical mixture 50 in all of the foregoing embodiments is substantially the same in content, form, and other parameters. The only difference of consequence between all of the embodiments again involves the order in which the supplies of ADM 12 and molybdenum trioxide 34 are added into the system 10.

Regardless of which embodiment is employed to produce the aqueous chemical mixture 50, it is believed that the gradual delivery process discussed above contributes to the overall efficiency of the system 10 in generating high yields of the X-AOM isomer in an effective manner. This gradual delivery procedure apparently results in a series of complex kinetic interactions which are not yet entirely understood but enable the X-AOM isomer to be preferably generated (in most situations) over other AOM isomers (including α -AOM). As previously noted, the claimed invention shall not be restricted to any given order in which the ADM 12

and molybdenum trioxide 34 are combined with the water 14, and which of these materials should be added in a gradual, non-instantaneous manner. However, in a process which does not involve adding the ADM 12 and molybdenum trioxide 34 simultaneously as defined above, the composition that is added to the intermediate product 32 or 54 (e.g. the "second reagent") should optimally be delivered in a gradual, non-instantaneous manner to achieve maximum, high-purity yields of X-AOM. Likewise, if the ADM 12 and molybdenum trioxide 34 are delivered to the supply of water 14 simultaneously as discussed above, they should both be added in a gradual, non-instantaneous fashion to obtain best results. Again, it is currently believed that this process maximizes the yield and purity levels of the resulting X-AOM product in most cases.

With continued reference to FIG. 1, the aqueous chemical mixture 50 (regardless of the manner in which it is generated) is thereafter processed to obtain a purified X-AOM product. To accomplish this goal, the aqueous chemical mixture 50 is heated within the containment vessel 16 to further promote maximum X-AOM formation. This particular step can take place within the containment vessel 16 as illustrated in FIG. 1 or, in the alternative, may be undertaken in a separate vessel (not shown) of the same type, size, and construction material as the vessel 16 (depending on the desired scale of the system 10 and other related factors).

The heating process associated with the aqueous chemical mixture 50 in the containment vessel 16 preferably involves heating the mixture 50 to a temperature of about 85–90° C. which is maintained over a time period that preferably exceeds 3 hours (e.g. optimally about 3.5–5 hours). Heating is accomplished in the embodiment of FIG. 1 using the heating unit 20 discussed above. Likewise, optimum results will be achieved if the chemical mixture 50 is constantly agitated (e.g. stirred) during the heating process to ensure maximum yields of X-AOM with high purity values. Agitation may be undertaken using the stirring system 22 which again includes a motor 24 operatively connected to a rotatable mixing blade 26 positioned within the interior region 30 of the vessel 16 (and entirely beneath the surface of the aqueous chemical mixture 50).

It is also believed that, regardless of whether or not gradual, non-instantaneous delivery techniques are employed, heating in accordance with the particular operational parameters recited herein (especially in excess of 3 hours) contributes to the preferential generation of X-AOM while avoiding the production of other AOM isomers including α -AOM. Again, while the exact isomerization reactions which promote the formation of X-AOM over other AOM isomers are not entirely understood, the specific heating process discussed above (and numerical parameters associated therewith including the heating time exceeding 3 hours) apparently creates a unique chemical environment which promotes X-AOM formation. Optimum results will be achieved if the above-described heating process is used in combination with gradual, non-instantaneous delivery techniques as described herein.

As a result of the heating process, the aqueous chemical mixture 50 is basically converted into a thickened slurry-type composition having solid X-AOM suspended therein which shall be characterized as a "reaction product" 60 schematically illustrated in FIG. 1. The reaction product 60 basically includes (1) a liquid fraction 62 consisting primarily of water derived from the original supply of water 14 along with very small amounts of residual dissolved ADM and/or molybdenum trioxide; and (2) a suspended solid

fraction 64 that consists essentially of the desired X-AOM product, the unique characteristics of which will be summarized below. After the heating process is completed, the reaction product 60 is preferably cooled in an optional cooling stage. Cooling in the embodiment of FIG. 1 again optimally occurs within the containment vessel 16 although a separate vessel (not shown) of the same type, size, and construction material as the vessel 16 can be employed for this purpose, depending on the desired scale of the system 10 and other related factors.

Cooling of the reaction product 60 at this stage provides a number of advantages including the promotion of X-AOM crystal formation and growth (which leads to improved handleability characteristics). Cooling of the reaction product 60 inside the containment vessel 16 may occur via the deactivation of heating unit 20 and the natural dissipation of heat over time without the use of external cooling aids or systems. While the claimed invention shall again not be specifically limited to any particular cooling temperatures, optimum results are achieved if the reaction product is cooled to about 60–70° C. which is designed to provide additional ease of handling, further X-AOM crystal growth, and the like. Alternatively (and in a preferred embodiment), the cooling process may be accelerated through the use of an optional cooling unit (not shown) of conventional design associated with the containment vessel 16 and positioned on the inside or outside thereof. Representative systems suitable for use as the cooling unit may include but are not limited to standard chiller coil/refrigeration systems or water cooling devices that are known in the art for the large-scale cooling of industrial fluids. Likewise, if the heating unit 20 is of a type which employs circulating hot water or steam therein to increase the temperature of the containment vessel 16 and its contents, cold water may likewise be routed through the unit 20 for cooling purposes if desired.

After cooling of the reaction product 60 (if desired), the product 60 is optionally transferred out of the containment vessel 16 in the embodiment of FIG. 1 and routed into a temporary storage vessel 70. In a preferred embodiment, the storage vessel 70 is of the same type, size, and construction material as the vessel 16 or otherwise configured as needed. The next step (which is also optional but beneficial in character) involves a procedure in which a portion 72 of the reaction product 60 is routed (e.g. recycled) from the storage vessel 70 back into the initial containment vessel 16 at the beginning of the system 10 as illustrated in FIG. 1. This portion 72 of the reaction product 60 will again include a supply of X-AOM therein from the previous (e.g. prior) processing sequence discussed above. The portion 72 of the reaction product 60 that is transferred back to the vessel 16 functions as a "seed" composition that promotes favorable reaction kinetics within the vessel 16 which lead to improved X-AOM yield characteristics and a more easily handled product with beneficial physical characteristics (e.g. a greater overall density). While the claimed process shall not be restricted to any particular quantity in connection with the recycled portion 72, it is preferred that about 5–15% by weight of the reaction product 60 be used as the portion 72. In systems which do not employ a separate storage vessel 70 as shown in FIG. 1, the "seeding" process outlined above may be accomplished by simply leaving about 5–15% by weight (or other selected amount as needed and desired) of the reaction product 60 within the containment vessel 16 after the majority of the product 60 is removed for subsequent treatment (e.g. by filtration and the like as indicated below). Thus, this aspect of the present invention in its broadest sense involves combining a supply of previously-

produced X-AOM (derived from the portion 72) with the ADM 12, water 14, and molybdenum trioxide 34 (regardless of the order and manner of addition [e.g. gradual or non-gradual]) to yield additional supplies of X-AOM having the beneficial physical characteristics listed above. It should nonetheless be emphasized that this "seeding"/recycling stage is optional, with the use thereof being employed in accordance with preliminary routine testing, taking into consideration the particular reaction conditions and production-scale of interest.

Next, the reaction product 60 within the storage vessel 70 is treated to remove/recover the X-AOM-containing solid fraction 64 from the liquid fraction 62. This may be achieved in many different ways, with the present invention not being limited to any particular isolation methods. For example, in a preferred and non-limiting embodiment illustrated schematically in FIG. 1, the slurry-type reaction product 60 containing the liquid and solid fractions 62, 64 is passed through a selected filtration system 74. Many different components and materials can be employed in connection with the filtration system 74. However, representative and non-limiting examples of filtration devices which can be used in connection with the filtration system 74 include but are not limited to vacuum and/or pressure-type filters as discussed further below in the Example section. Other removal devices may also be employed for separating the X-AOM-containing solid fraction 64 from the liquid fraction 62 in the reaction product 60 include conventional centrifuge systems, settling units, cyclones, and the like.

In accordance with the recovery/filtration process shown in FIG. 1 and discussed above, a retentate 76 and a permeate 80 are generated. The retentate 76 involves the isolated solid fraction 64, namely, an X-AOM crystalline product having a representative purity level of about +95% by weight X-AOM. The retentate 76 may optionally be washed one or more times with water if needed and desired. The permeate 80 consists of the liquid fraction 62 which again comprises mostly water and residual dissolved quantities of the various molybdenum-based chemical species used in the system 10. These species include relatively insignificant amounts of dissolved ADM and dissolved molybdenum trioxide. The permeate 80 can either be discarded or further treated to recover molybdenum therefrom. While the recovery/filtration step discussed above is shown only once in FIG. 1, multiple, successive recovery stages can be used if necessary.

The retentate 76 consisting primarily of crystalline X-AOM can then be air dried or preferably dried one or more times (e.g. in single or multiple drying stages) using a conventional oven apparatus 82 illustrated schematically in FIG. 1. While the claimed method shall not be restricted to any given heating systems in connection with the oven apparatus 82, exemplary devices which may be used in connection with the oven apparatus 82 include but are not limited to steam or gas-heated rotary dryer units, spray dryer systems, and combinations thereof. Likewise, the present invention shall not be limited to any specific parameters in connection with the drying process discussed above. However, in an exemplary embodiment, drying of the X-AOM-containing retentate 76 will typically occur at a temperature of about 145–150° C. for a time period of about 60–90 minutes (in a single drying stage). An example of a multiple drying process which may be employed in order to achieve more gradual and controlled drying will be discussed below in the Example section.

The resulting dried composition obtained from the oven apparatus 82 will consist of the final X-AOM product 84

shown in FIG. 1. If needed for particular applications, the X-AOM product 84 may be ground or otherwise size-reduced using conventional grinding systems (not shown). It is desired in most cases for the final X-AOM product 84 to have an average particle size of about 16 microns or less. The X-AOM product 84 (which, again, is typically about +95% by weight X-AOM) may thereafter be stored for future use or otherwise immediately utilized in a variety of important applications including incorporation within various polymeric plastic materials (e.g. electrical or fiber-optic cable coverings made of rigid PVC) as a highly effective smoke suppressant with increased thermal stability. As previously noted, the X-AOM product 84 is able to provide superior smoke suppressant (and flame retardant) characteristics compared with other AOM isomers (including α -AOM). For example, tests have shown that X-AOM can offer a greater degree of smoke-suppression per unit volume compared with other AOM isomers such as α -AOM. The process discussed above and the resulting X-AOM product 84 therefore represent a considerable advance in the art of molybdenum technology.

In order to provide further information regarding a preferred and enabling process which may be used to yield substantial amounts of X-AOM at high purity levels (e.g. +95% by weight X-AOM), the following Example is provided. It shall be understood that the Example presented below is representative only and is not intended to limit the invention in any respect.

EXAMPLE

In this Example, about 8025 liters of deionized water were initially provided and placed in a containment vessel of the type discussed above having a capacity of about 22,700 liters. Also combined with the water was about 2270 liters of the X-AOM-containing aqueous chemical mixture (defined above) obtained from the previous production run. This material again functions as a "seed" composition as previously noted. A supply of ADM having a particle size of about 22-26 microns was added to the water (and "seed" material) to produce an aqueous intermediate product. Addition of the ADM to the water was undertaken in a gradual, non-instantaneous manner as defined above. Addition of the ADM was accomplished using a screw conveyor apparatus of conventional design. In this Example, about 283 grams of ADM were used per liter of water. This resulted in the use of a grand total of about 2268 kilograms of ADM which were delivered into the water at a rate of about 110 kilograms of ADM per minute.

Thereafter, a supply of molybdenum trioxide having a particle size of about 380 microns was added to the aqueous intermediate product in a gradual, non-instantaneous manner (discussed above) at a rate of about 95 kilograms of molybdenum trioxide per minute. The total amount of molybdenum trioxide used in this Example was about 1973 kilograms (e.g. about 0.87 grams of molybdenum trioxide per gram of ADM). Addition of the molybdenum trioxide was also achieved using a conventional screw conveyor apparatus. As a result of these steps, an aqueous chemical mixture was produced from the water, ADM, and molybdenum trioxide.

Next, while maintaining the aqueous chemical mixture within the containment vessel, it was heated for about 4.5 hours at a temperature of about 88° C. (with agitation as discussed above) to produce a slurry-type reaction product. Thereafter, the reaction product was cooled to about 66° C. within the containment vessel. Cooling was accomplished through the use of a conventional water-based cooling coil

system associated with the containment vessel and in physical contact therewith in which cooling water (at a temperature of about 23° C.) was transferred therethrough. Cooling occurred over a time period of about 60 minutes. The cooled reaction product which contained the solid X-AOM composition of interest therein was then routed into a separate pre-filtration storage vessel.

After transfer of the cooled reaction product to the storage vessel, about 10% by weight of the cooled reaction product was sent back into the initial containment vessel to act as a "seed" formulation for the enhanced production, generation, and growth of X-AOM crystals in subsequent production runs which will again improve the handleability of the X-AOM product by increasing its overall density. Next, the cooled product was routed into a filtration system which, in this Example, involved a pressure-based filter unit of a type obtainable from numerous suppliers including the Larox Corporation of Patuxent Woods Drive, Columbia Md. (USA). Filtration occurred over a time period of about 24 hours (to process the complete amount of material which was recovered/filtered in individual batches).

The resulting filtered product (consisting of X-AOM) was then directed into a conventional continuously-operating rotary primary drying apparatus heated by natural gas (or steam) to a temperature of about 140° C. over a time period of about 1 hour (making certain that the temperature did not exceed about 230-250° C. which can result in thermal decomposition of the desired materials.) Thereafter, the dried X-AOM was reduced to a particle size of about 150 microns or less using a material handling apparatus suitable for this purpose (e.g. a hammermill), followed by transfer of the size-reduced X-AOM into a secondary drying apparatus (e.g. of a conventional vertical type which is obtainable from many different sources including the Wyssmont Co., Inc. of Fort Lee, N.J. (USA) under the trademark "TURBO-DRYER".) Within the secondary drying apparatus, the X-AOM was heated to a temperature of about 110° C. over a time period of about 1 hour. The dried X-AOM was then subjected to additional grinding/size reduction in a primary grinding unit (e.g. a mill/grinding system of a type obtainable from many sources including Hosokawa Micron Powder Systems of Summit, N.J. [USA] under the trademark "Mikro-ACM") so that the X-AOM product was further size-reduced to a particle size not exceeding about 30 microns.

Finally, after treatment in the primary grinding unit, the particulate X-AOM was further dried in a tertiary drying apparatus (e.g. of the same type as employed in connection with the secondary drying apparatus listed above) at about 110° C. for a time period of about 3 hours to yield the final X-AOM product. This product was further size-reduced in a secondary grinding unit of the same type as the primary grinding unit listed above to a particle size of about 16 microns or less.

Again, the claimed method shall not be restricted to the parameters, equipment, processing sequences, and other information set forth in this Example which are provided for informational purposes.

B. CHARACTERISTICS OF THE COMPLETED X-AOM PRODUCT

As previously noted, the X-AOM composition of the present invention has a unique isomeric configuration which differs substantially from that of other AOM isomers including α -AOM and β -AOM (as well as the γ and δ forms of AOM). The X-AOM product is readily characterized (and

clearly distinguished from other forms of AOM) using its unique Raman spectral profile. Raman spectroscopy basically involves the collection of spectral intensity values which result when light obtained from a high-energy source (e.g. a quartz-mercury lamp or argon-ion laser unit) is passed through a substance. Raman spectroscopy is an established analytical technique that provides highly accurate and definitive results. In accordance with the present invention, Raman spectral analysis of the novel X-AOM product results in a distinctive spectral profile which is entirely different from the spectral profiles of other AOM isomers. Raman spectroscopy specifically provides detailed covalent chemical bonding information, and likewise graphically illustrates medium and long range order modes in connection with the compounds being analyzed. Further general information concerning Raman spectroscopy is provided in U.S. Pat. No. 5,534,997 which is incorporated herein by reference. The use of Raman spectral analysis represents the most feasible and practical way that is currently known for the identification of X-AOM, with this method being accurate, repeatable, and subject to minimal error. It is therefore entirely sufficient, enabling, and definitive for the novel X-AOM isomer to be claimed and characterized (e.g. identified) spectrally, particularly using Raman spectral analysis. Basically, the presence of intensity peaks in one spectral profile which do not appear in other spectral profiles supports the existence of a different and distinctive compound (X-AOM in this case).

To confirm the distinctive character of X-AOM, its Raman spectral profile was compared with the Raman spectral profiles obtained from α -AOM and β -AOM. Many different Raman spectral analyzers may be used with consistent results. Accordingly, analysis of the X-AOM product using Raman spectroscopy shall not be restricted to any particular analyzing equipment. For example, Raman spectral analysis services suitable for use in identifying X-AOM are available from many commercial enterprises including Namar Scientific, Inc. of McKeesport, Pa. (USA) which employs a Model 1000 Raman Spectrometer produced by the Renishaw Company of Schaumburg, Ill. (USA). This particular system uses a 514.5 nm (2 mW) argon-ion laser excitation source, with a 1800 groove/mm grating that allows a 1.5 cm^{-1} spectral resolution. A spectral region of 100-4000 cm^{-1} is utilized, with detection/analysis being accomplished using a -70° C. Peltier-cooled CCD detector. A microscope having 10x, 20x, and 50x objectives is ultimately employed to collect scattered radiation obtained from the laser-illuminated samples, with the scattered radiation thereafter being directed into the Raman spectrometer described above. Notwithstanding the availability of this particular system for testing purposes involving X-AOM, the claimed invention shall not be restricted to any particular Raman-type analytical equipment, with many different systems and configurations providing equivalent results.

With reference to FIG. 2, a Raman spectral profile 100 of the X-AOM product is provided. At the outset, it is important to note that the various peaks which are not identified or otherwise discussed in connection with the profiles of FIGS. 2-4 involve other species, phases, and/or by-product molybdates (e.g. trace impurities) which constitute non-AOM contaminants. The peaks to be discussed below involve those which are unique to the products being analyzed and can be used to distinguish one product from another. The profile 100 of X-AOM was generated at Iowa State University in Ames, Iowa (USA) using the following type of Raman spectral analyzer: Spex Triplemate Model 1877 produced by Instruments, SA of Edison, N.J. (USA). As

illustrated in FIG. 2, the spectral profile of X-AOM includes three main peaks as follows (with the term "main peaks" denoting peaks for a given AOM isomer which are not present in the Raman spectral profiles of other AOM isomers): (1) Peak #1 shown at reference number 102=953-955 cm^{-1} ; (2) Peak #2 shown at reference number 104=946-948 cm^{-1} ; and (3) Peak #3 shown at reference number 106=796-798 cm^{-1} . These values are expressed in ranges to account for a minor degree of experimental variation which exists between individual Raman spectral analyzers (e.g. from one type or brand to another). The Raman spectral profile 100 of FIG. 2 is entirely distinctive compared with the Raman data obtained from the α -AOM and β -AOM isomers (discussed below), with peaks 102, 104, and 106 being absent from the profiles described below. Thus, X-AOM represents a new and distinctive compound which is structurally different from other AOM isomers.

FIG. 3 involves a Raman spectral profile 200 of α -AOM. The spectral profile 200 was generated using the same equipment and parameters that were employed in producing the spectral profile 100 of FIG. 2. As illustrated in FIG. 3, the spectral profile 200 of α -AOM includes only two main peaks as follows: (1) Peak #1 shown at reference number 202=964-965 cm^{-1} ; and (2) Peak #2 shown at reference number 204=910-911 cm^{-1} . Comparing FIGS. 2 and 3, the number of peaks and the magnitudes/locations of the peaks are significantly different. Also, peaks 202, 204 are not present in FIG. 2. In accordance with the sensitive and accurate nature of Raman spectroscopy, the significant differences between X-AOM and α -AOM are clearly demonstrated using the information presented above which supports the novelty of X-AOM.

Finally, in FIG. 4, a Raman spectral profile 300 of β -AOM is provided. The spectral profile 300 was generated using the same equipment and parameters that were employed in producing the spectral profile 100 of FIG. 2. As illustrated in FIG. 4, the spectral profile 300 of β -AOM includes only two main peaks as follows: (1) Peak #1 shown at reference number 302=977-978 cm^{-1} ; and (2) Peak #2 shown at reference number 304=900-901 cm^{-1} . Comparing FIGS. 2 and 4, the number of peaks and the magnitudes/locations of the peaks are significantly different. Also, peaks 302, 304 are not present in FIG. 2. In accordance with the sensitive and accurate nature of Raman spectroscopy, the significant differences between X-AOM and β -AOM are likewise demonstrated using the information presented above which again supports the novelty of X-AOM.

It is readily apparent that the process discussed herein creates a new, unique, and distinctive form of ammonium octamolybdate which likewise has improved functional capabilities. This is especially true in connection with the superior smoke suppressant capacity of X-AOM compared with other AOM isomers including α -AOM. It has again been determined in various applications that effective smoke suppression will occur using reduced amounts of X-AOM as an additive to, for example, polymer plastics, compared with conventional α -AOM and β -AOM. The X-AOM product is also characterized by high levels of uniformity and purity. Thus, X-AOM has a greater degree of functional efficiency in accordance with the different structural characteristics of this material relative to other AOM isomers.

In conclusion, the claimed product and process collectively represent an important development in molybdenum technology. The X-AOM composition described above not only includes a unique isomeric structure (which is different from all other AOM isomers), but likewise has improved smoke suppression qualities. The product and process dis-

cussed above are novel, distinctive, and highly beneficial from a technical and utilitarian standpoint. Having herein set forth preferred embodiments of the present invention, it is anticipated that suitable modifications can be made thereto which will nonetheless remain within the scope of the invention. For example, the claimed process shall not be restricted to any particular operational parameters, processing equipment, and the like unless otherwise noted herein.

The invention shall therefore only be construed in accordance with the following claims:

The invention that is claimed is:

1. An ammonium octamolybdate isomer having Raman spectra peaks at wavelength values of about $953-955\text{ cm}^{-1}$, about $946-948\text{ cm}^{-1}$, and about $796-798\text{ cm}^{-1}$.

* * * * *

CERTIFICATE OF SERVICE

I Marilyn R. Abbott, hereby certify that the attached **COMMISSION OPINION**, was served upon the following parties, via first class mail and air mail where necessary, on January 5, 2004.



Marilyn R. Abbott, Secretary
U.S. International Trade Commission
500 E Street, SW - Room 112
Washington, DC 20436

**ON BEHALF OF COMPLAINANT
CLIMAX MOLYBDENUM COMPANY:**

Timothy B. Scull, Esq.
Merchant and Gould
1400 Independence Plaza
1050 Seventeenth Street
Denver, CO 80265-0100

Bruce E. Dahl, Esq.
Dahl and Osterloth, LLP
555 Seventeenth Street
Suite 3405
Denver, CO 80202-3937

**ON BEHALF OF MOLYCHEM, LLC AND
CHEM-MET INTERNATIONAL, INC.:**

Ramon L. Pizarro, Esq.
Hart and Trinen, LLP
3515 S. Tamarac Drive
Suite 200
Denver, CO 80237

Donald T. Trinen, Esq.
Hart and Trinen, LLP
1624 Washington Street
Denver, CO 80203

RESPONDENTS

Anhui Wonder Trade Co., Ltd.
No. 872 Yuxi Road
Hefei, Anhui, Peoples Republic of China
230011

Pudong Trans USA, Inc.
9960 Flair Drive, Suite 218
El Monte, CA 91731

UNITED STATES INTERNATIONAL TRADE COMMISSION
Washington, D.C. 20436

In the Matter of)

CERTAIN AMMONIUM)
OCTAMOLYBDATE ISOMERS)

Inv. No. 337-TA-477

NOTICE OF COMMISSION DETERMINATION TO REVIEW A
FINAL INITIAL DETERMINATION FINDING NO VIOLATION OF
SECTION 337; SCHEDULE FOR FILING WRITTEN SUBMISSIONS ON
THE ISSUES UNDER REVIEW AND ON REMEDY, THE
PUBLIC INTEREST, AND BONDING

AGENCY: U.S. International Trade Commission.

ACTION: Notice.

SUMMARY: Notice is hereby given that the U.S. International Trade Commission has determined to review in its entirety the final initial determination (ID) issued by the presiding administrative law judge (ALJ) on May 15, 2003, finding no violation of section 337 of the Tariff Act of 1930, 19 U.S.C. § 1337, in the above-captioned investigation.

FOR FURTHER INFORMATION CONTACT: Wayne Herrington, Esq., Office of the General Counsel, U.S. International Trade Commission, 500 E Street, S.W., Washington, D.C. 20436, telephone (202) 205-3090. Copies of the ALJ's ID and all other nonconfidential documents filed in connection with this investigation are or will be available for inspection during official business hours (8:45 a.m. to 5:15 p.m.) in the Office of the Secretary, U.S. International Trade Commission, 500 E Street, S.W., Washington, D.C. 20436, telephone 202-205-2000. General information concerning the Commission may also be obtained by accessing its Internet server (<http://www.usitc.gov>). The public record for this investigation may be viewed on the Commission's electronic docket (EDIS) at <http://edis.usitc.gov>. Hearing-impaired persons are advised that information on this matter can be obtained by contacting the Commission's TDD terminal on 202-205-1810.

03 JUN 30 11:14

REC'D
U.S. ITC
JUN 30 2003

SUPPLEMENTARY INFORMATION: The Commission instituted this investigation on August 20, 2002, based on a complaint filed by Climax Molybdenum Company ("Climax") against one respondent, Molychem LLC. (Molychem). *67 Fed. Reg.* 53966. In that complaint, as supplemented, Climax alleged violations of section 337 in the importation into the United States, sale for importation, and/or sale within the United States after importation of certain ammonium octamolybdate isomers by reason of infringement of claim 1 of Climax's U.S. Patent No. 5,985,236. Subsequently, the complaint and notice of investigation were amended to add four additional respondents to the investigation: Anhui Wonder Trade Co., Ltd.; Pudong Trans USA, Inc. (Pudong); John S. Conner, Inc. (Conner); and Chem-Met International, Inc. One of these respondents, Conner, was eventually terminated from the investigation as the result of a settlement agreement.

On May 15, 2003, the ALJ issued his final ID on violation and his recommended determination on remedy and bonding. The ALJ found no violation of section 337 because he concluded that claim 1 of the '236 patent was invalid on the basis of an on-sale bar under 35 U.S.C. § 102(b). In his ID, the ALJ noted that the '236 patent is currently the subject of a reissue proceeding in the United States Patent and Trademark Office (PTO). Complainant Climax filed a petition for review on May 27, 2003. On May 30 and June 3, 2003, respectively, respondent Molychem and the Commission investigative attorney each filed a response to the petition for review. On June 10, 2003, Climax filed a motion for leave to file a reply to the response of the Commission investigative attorney, including its proposed reply. On June 11, 2003, Molychem filed a motion to strike Climax's motion for leave.

Having examined the record in this investigation, including the ALJ's final ID, the petition for review, and the responses thereto, the Commission has determined to review the final ID in its entirety. The Commission has also determined to deny Climax's request for oral argument. In addition, the Commission has determined to deny Climax's motion for leave to file a reply and to deny Molychem's motion to strike without prejudice to renewing any pertinent arguments in their written submissions in the course of the Commission's review of the final ID.

On review, the Commission requests briefing based on the evidentiary record. While the Commission has determined to review the final ID in its entirety, it is particularly interested in briefing on the issues of personal jurisdiction over respondent Pudong, claim construction, invalidity of claim 1 of the '236 patent for anticipation by the Tytko article, and unenforceability of the '236 patent for inequitable conduct, and especially in receiving answers to the following questions:

1. What is the meaning of the term "octamolybdate" in claim 1 of the '236 patent? In particular, the Commission wishes the parties to address whether the term refers to a single polyanion containing eight molybdenum and twenty-six oxygen atoms.

2. Whether (a) the Raman spectrum shown in Figure 1(f) of the Tytko article (second from the top) falls within the Raman spectrum set out in Claim 1 of the '236 patent, and (b) whether the Tytko article contains sufficient enabling disclosure with respect to the composition represented by that spectrum so as to be available as prior art.
3. The legal foundation and record support for the existence or non-existence of the specific offer for sale or sale found by the ALJ in his final ID in connection with his finding of the existence of an on-sale bar.

The Commission has also determined to order complainant Climax to file and serve with its main review brief a copy of the file for the reissue application for the '236 patent which is currently pending in the PTO, as well as the files of any other proceedings in the PTO relating to the '236 patent, the reissue application, or the original application for the '236 patent. Complainant Climax is also ordered to file and serve any additions to such files as they are made in the PTO.

In connection with the final disposition of this investigation, the Commission may (1) issue an order that could result in the exclusion of the subject articles from entry into the United States, and/or (2) issue one or more cease and desist orders that could result in respondents being required to cease and desist from engaging in unfair acts in the importation and sale of such articles. Accordingly, the Commission is interested in receiving written submissions that address the form of remedy, if any, that should be ordered. If a party seeks exclusion of an article from entry into the United States for purposes other than entry for consumption, the party should so indicate and provide information establishing that activities involving other types of entry either are adversely affecting it or likely to do so. For background, see *In the Matter of Certain Devices for Connecting Computers via Telephone Lines*, Inv. No. 337-TA-360, USITC Pub. No. 2843 (December 1994) (Commission Opinion).

If the Commission contemplates some form of remedy, it must consider the effects of that remedy upon the public interest. The factors the Commission will consider include the effect that an exclusion order and/or cease and desist orders would have on (1) the public health and welfare, (2) competitive conditions in the U.S. economy, (3) U.S. production of articles that are like or directly competitive with those that are subject to investigation, and (4) U.S. consumers. The Commission is therefore interested in receiving written submissions that address the aforementioned public interest factors in the context of this investigation.

If the Commission orders some form of remedy, the President has 60 days to approve or disapprove the Commission's action. During this period, the subject articles would be entitled to enter the United States under a bond, in an amount determined by the Commission and prescribed by the Secretary of the Treasury. The Commission is therefore interested in receiving submissions concerning the amount of the bond that should be imposed.

WRITTEN SUBMISSIONS: The parties to the investigation are requested to file written submissions on the issues under review. The submissions should be concise and thoroughly referenced to the record in this investigation. Parties to the investigation, interested government agencies, and any other interested parties are encouraged to file written submissions on the issues of remedy, the public interest, and bonding. Such submissions should address the May 15, 2003, recommended determination by the ALJ on remedy and bonding. Complainant and the Commission investigative attorney are also requested to submit proposed remedial orders for the Commission's consideration. The written submissions and proposed remedial orders must be filed no later than close of business on July 14, 2003. Reply submissions must be filed no later than the close of business on July 21, 2003. No further submissions on these issues will be permitted unless otherwise ordered by the Commission.

Persons filing written submissions must file the original document and 14 true copies thereof on or before the deadlines stated above with the Office of the Secretary. Any person desiring to submit a document (or portion thereof) to the Commission in confidence must request confidential treatment unless the information has already been granted such treatment during the proceedings. All such requests should be directed to the Secretary of the Commission and must include a full statement of the reasons why the Commission should grant such treatment. *See* section 201.6 of the Commission's Rules of Practice and Procedure, 19 C.F.R. § 201.6. Documents for which confidential treatment by the Commission is sought will be treated accordingly. All nonconfidential written submissions will be available for public inspection at the Office of the Secretary.

The authority for the Commission's determination is contained in section 337 of the Tariff Act of 1930, as amended (19 U.S.C. § 1337), and in sections 210.43-.44 of the Commission's Rules of Practice and Procedure (19 C.F.R. §§ 210.43-.44).

By order of the Commission.

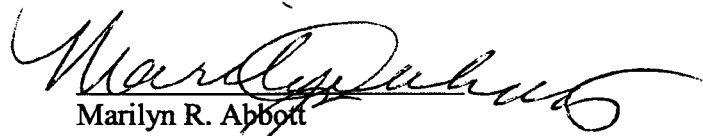
Marilyn R. Abbott
Secretary to the Commission

Issued: June 30, 2003

CERTIFICATE OF SERVICE

I Marilyn R. Abbott, hereby certify that the attached NOTICE OF DECISION TO REVIEW A FINAL INITIAL DETERMINATION FINDING NO VIOLATION OF SECTION 337; SCHEDULE FOR FILING WRITTEN SUBMISSIONS ON THE ISSUES UNDER REVIEW AND ON REMEDY, THE PUBLIC INTEREST AND BONDING, was served upon the following parties, via first class mail and air mail where necessary, on June 30, 2003.

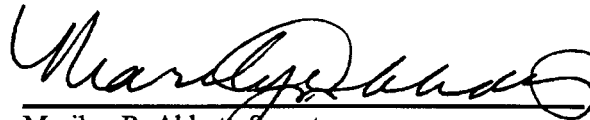

Marilyn R. Abbott, Secretary
U.S. International Trade Commission
500 E Street, SW - Room 112
Washington, DC 20436

**ON BEHALF OF COMPLAINANT
CLIMAX MOLYBDENUM COMPANY:**

Timothy B. Scull, Esq.
Merchant and Gould
1400 Independence Plaza
1050 Seventeenth Street
Denver, CO 80265-0100

Bruce E. Dahl, Esq.
Dahl and Osterloth, LLP
555 Seventeenth Street
Suite 3405
Denver, CO 80202-3937

**ON BEHALF OF MOLYCHEM, LLC AND
CHEM-MET INTERNATIONAL, INC.:**

Ramon L. Pizarro, Esq.
Hart and Trinen, LLP
3515 S. Tamarac Drive
Suite 200
Denver, CO 80237

Donald t. Trinen, Esq.
Hart and Trinen, LLP
1624 Washington Street
Denver, CO 80203

RESPONDENTS

Anhui Wonder Trade Co., Ltd.
No. 872 Yuxi Road
Hefie, Anhur, Peoples Republic of China
230011

Pudong Trans USA, Inc.
9960 Flair Drive, Suite 218
El Monte, CA 91731

PUBLIC VERSION

UNITED STATES INTERNATIONAL TRADE COMMISSION

Washington, D.C.

In the Matter of

**CERTAIN AMMONIUM
OCTAMOLYBDATE ISOMERS**

Investigation No. 337-TA-477

**INITIAL DETERMINATION ON VIOLATION OF SECTION 337
AND RECOMMENDED DETERMINATION ON REMEDY AND BOND**

Administrative Law Judge Charles E. Bullock

(May 15, 2003)

Appearances:

For the Complainant Climax Molybdenum Company:

Albert L. Underhill, Esq.; Gregg I. Anderson, Esq.; Timothy B. Scull, Esq.; of Merchant & Gould P.C., Denver, Colorado

Susan E. Chetlin, Esq.; of Dahl & Osterloth, L.L.P., Denver, Colorado

For the Respondent Molychem LLC and Chem-Met International, Inc.:

Ramon L. Pizarro, Esq., Denver, Colorado

Donald T. Trinen, Esq., of Hart & Trinen, LLP, Denver, Colorado

For the Commission Investigative Staff:

Lynn I. Levine, Esq., Director; T. Spence Chubb, Esq., Supervising Attorney; James B. Coughlan, Investigative Attorney; of the Office of Unfair Import Investigations, U.S. International Trade Commission, of Washington, D.C.

RECEIVED
OFC OF THE SEC. GEN.
US INT. TRADE COM.
03 JUN 26 PM 3:00

TABLE OF CONTENTS

I.	Introduction	2
II.	Jurisdiction/Importation	7
III.	Claim Construction	11
IV.	Infringement	21
V.	Domestic Industry	30
VI.	Invalidity	37
VII.	Unenforceability	78
	FINDINGS OF FACT	89
	CONCLUSIONS OF LAW	115
VIII.	Order	116
IX.	Remedy and Bonding	117
	APPENDIX OF EXHIBIT LISTS	121

LIST OF ABBREVIATIONS

FF:	Administrative Law Judge's Findings of Fact
Tr.:	Transcript
Dep.:	Deposition
CX:	Complainants' exhibit
RX:	Respondents' exhibit
CDX:	Complainants' demonstrative exhibit
RDX:	Respondents' demonstrative exhibit
RPX:	Respondents' physical exhibit
CIB:	Complainants' initial post-hearing brief
CRRB:	Complainants' reply post-hearing brief to respondents
CRSB:	Complainants' reply post-hearing brief to Staff
RIB:	Respondents' initial post-hearing brief
RRB:	Respondents' reply post-hearing brief
SIB:	Staff's initial post-hearing brief
SRB:	Staff's reply post-hearing brief

PUBLIC VERSION

UNITED STATES INTERNATIONAL TRADE COMMISSION

Washington, D.C.

In the Matter of

**CERTAIN AMMONIUM
OCTAMOLYBDATE ISOMERS**

Investigation No. 337-TA-477

**INITIAL DETERMINATION ON VIOLATION OF SECTION 337
AND RECOMMENDED DETERMINATION ON REMEDY AND BOND**

Administrative Law Judge Charles E. Bullock

(May 15, 2003)

Pursuant to the Notice of Investigation, 67 Fed. Reg. 53,966 (August 20, 2002), and Rule 210.42(a) of the Rules of Practice and Procedure of the United States International Trade Commission, 19 C.F.R. § 210.42(a), this is the Administrative Law Judge's Initial Determination in the Matter of Certain Ammonium Octamolybdate Isomers, Investigation No. 337-TA-477.

The Administrative Law Judge hereby determines that no violation of Section 337 of the Tariff Act of 1930, as amended, has been found in the importation into the United States, the sale for importation, or the sale within the United States after importation of certain ammonium octamolybdate isomers in connection with claim 1 of U.S. Letters Patent No. 5,985,236 and that a domestic industry in the United States exists that practices U.S. Letters Patent No. 5,985,236. The Administrative Law Judge also determines that no domestic industry as to any patent at issue is "in the process of being established" as set forth in Section 337.

DISCUSSION

I. Introduction

A. Procedural History

On July 18, 2002, complainant Climax Molybdenum Company of Phoenix, Arizona (“Climax” or “Complainant”) filed a complaint with the Commission pursuant to Section 337 of the Tariff Act of 1930, as amended, 19 U.S.C. § 1337, against Molychem LLC (“Molychem”). On August 15, 2002, the Commission issued a notice of investigation that was subsequently published in the Federal Register on August 20, 2002.¹ Molychem served its response to the complaint and notice of investigation on September 10, 2002.

On October 3, 2002, Climax moved to amend its complaint to add four additional respondents to the investigation, pursuant to § 210.14(b) of the Commission’s Rules of Practice and Procedure.² The additional respondents were Anhui Wonder Trade Co. Ltd. (“Anhui”); Pudong Trans USA, Inc. (“Pudong”); John S. Conner, Inc. (“Conner”) and Chem-Met International, Inc. (“Chem-Met”). Climax’s motion was granted on October 22, 2002 by Initial Determination.³ The Commission issued a notice of decision not to review the Initial Determination on November 18, 2002. Conner served its response to the complaint on November 5, 2002. Chem-Met served its response to the complaint and notice of investigation on November 27, 2002.

The complaint, as amended, asserts unfair methods of competition and unfair acts in violation of Section 337 by respondents Molychem, Chem-Met, Anhui, Pudong and Conner in connection

¹ See Notice of Investigation, 67 Fed. Reg. 53,966 (August 20, 2002).

² 19 C.F.R. § 210.14(b).

³ See Order No. 5.

with the importation, sale for importation, and sale within the United States after importation of certain ammonium octamolybdate isomers (“AOM”). The complaint accuses the respondents products of infringing claim 1 of U.S. Letters Patent No. 5,985,236 (“the Khan ‘236 patent”). The complaint further alleges that there exists a domestic industry with respect to the patent at issue.

On December 30, 2002, Climax moved to terminate the investigation as to respondent Conner, pursuant to § 210.21 of the Commission’s Rules of Practice and Procedure.⁴ The motion was based on a Settlement Agreement between Climax and Conner. Climax filed a supplement to its motion on January 8, 2003. Climax’s motion was granted on January 16, 2003 by Initial Determination.⁵ The Commission issued a notice of decision not to review the Initial Determination on February 6, 2003.

Anhui and Pudong have made no appearance in this Investigation, nor have they responded to the amended complaint. On December 21, 2002, Climax filed a motion, pursuant to Rule 210.16 of the Commission’s Rules of Practice and Procedure, for issuance of an order to show cause why respondents Anhui and Pudong should not be found in default. Climax’s motion was granted on February 4, 2003, which ordered Anhui and Pudong to show cause why they should not be found in default by February 21, 2003.⁶ No responses were received from Anhui or Pudong.

An evidentiary hearing before the Administrative Law Judge was conducted in this investigation from February 10-14 and 24, 2003. After the hearing, post-hearing briefs and reply briefs, together with proposed findings of fact, conclusions of law and rebuttals to the same, were

⁴ 19 C.F.R. § 210.21.

⁵ See Order No. 19.

⁶ See Order No. 20.

filed on March 5, 2003 and March 13, 2003, respectively. Closing arguments were conducted on April 2, 2003.

B. The Parties

1. Complainant

Complainant Climax Molybdenum Company (“Climax”) is Delaware corporation. Climax is a subsidiary of the Phelps Dodge Corporation, which has its principal place of business located at One North Central Avenue, Phoenix, Arizona. Climax is the current owner by assignment of the Khan ‘236 patent. Climax manufactures and sells AOM. Climax produces AOM at a facility in Fort Madison, Iowa.

2. Respondents

Respondent Molychem LLC (“Molychem”) is a limited liability company formed under the laws of the state of Illinois with its principal place of business located at 2625 Sewell Street, Rockford, Illinois. Molychem imports AOM products into the United States.

Respondent Chem-Met International, Inc. (“Chem-Met”) is a U.S. corporation with its principal place of business located at 6419 Yochelson Place, Clinton, Maryland. Chem-Met imports AOM products into the United States.

Respondent Anhui Wonder Trade Co. Ltd. (“Anhui”) is a Chinese company with its principal place of business at No. 872 Yuxi Road, Hefei, Anhui, Peoples Republic of China. Anhui manufactures AOM products and imports them into the United States.

Respondent Pudong Trans USA, Inc. (“Pudong”) is a U.S. corporation with its principal place of business at 9960 Flair Drive, Suite 218, El Monte, California. Pudong imports AOM products into the United States.

C. Overview of the Technology

At issue in this investigation is the X-isomer of AOM. AOM has the following chemical formula:



An isomer is a molecule that has the same number and kind of atoms as another molecule, but the spatial arrangement or configuration of the atoms in the molecule differs. The known isomers of AOM include α -AOM, β -AOM, γ -AOM, δ -AOM, and X-AOM. The α -AOM, β -AOM, and X-AOM isomers are useful as smoke suppressants. See CX-1, RX-53, col. 1:11-32. The structure of AOM depends on the specific isomer. It is possible to distinguish between the different isomers of AOM by methods such as X-Ray Diffraction (“XRD”) or Raman spectroscopy.

XRD is the diffraction of x-rays off of a material, whereas Raman spectroscopy is an absorption process. In XRD, the light coming off the sample has exactly the same wavelength and frequency as the laser or the x-ray hitting the sample. The “signature” for a particular material is based on the wavelengths, which are on the order of the atomic distances that show up on a spectra, or more particularly, a diffractogram. See Martin, Tr. 714-719.

Raman spectroscopy involves directing a beam of light from a source, such as a laser, at a test sample in order to identify the substances and materials in that test sample. Some of the light from the test sample bounces off the test sample inelastically and is scattered. The wavelengths of this inelastically scattered light are altered by the molecular vibrations of the test sample. Some of the scattered light is captured, and the shifts in its wavelengths are measured and plotted on a graph to create a Raman spectra. Because every substance has unique atomic vibration frequencies, the scattered light produces a unique Raman spectrum with peaks at different locations on the spectrum.

It is common practice in Raman spectroscopy to measure atomic frequency in “wavenumber” units. The wavenumber is usually calculated as 1 divided by the wavelength of the vibration, when wavelength is expressed in centimeters. Therefore, the unit of the wavenumber is in inverse centimeters, denoted as cm^{-1} . *See* Martin, Tr. 705-714.

It possible to determine the composition of an unknown test sample by comparing the Raman spectrum with that of known substances, similar to a “fingerprint.” Martin, Tr. 712. If two or more substances are combined in a given test sample and Raman spectroscopy is performed, the resulting graph will be a combination of the Raman spectra graphs of each of the individual substances. And if the substances in the mixture are not present in equal portions, the spectra graph of the substance that is present in the lesser proportion may have peaks that are much shorter than expected. *See* Martin, Tr. 750-751.

AOM can be produced by a “dry” process where ammonium dimolybdate is heated to the point where it thermally decomposes and produces ammonium octamolybdate. AOM can also be produced by a “wet” process, which involves combining ammonium dimolybdate (“ADM”) and molybdenum trioxide in water to produce an aqueous chemical mixture which is then heated, filtered, dried and subjected to particle reduction steps. *See* CX-1, RX-53.

D. The Patent at Issue

The Khan ‘236 patent is entitled “Ammonium Octamolybdate Composition and Method for Producing the Same,” which was issued on November 16, 1999, based on an application (Application Serial No. 09/094,194) filed on June 9, 1998. CX-1; RX-53; FF 1. The named inventors are Mohammed H. Khan, James A. Cole, Timothy G. Bruhl, Wendell S. Elder, Gary A. Glasgow and Vijaykuman M. Wagh. CX-1; RX-53; FF 2. Climax owns the Khan ‘236 patent by

assignment. CX-3; CX-4; FF 3. The Khan '236 patent only has one claim. CX-1; RX-53; FF 4.

In November 2001, Climax filed a reissue application with the U.S. Patent and Trademark Office ("PTO") in connection with the Khan '236 patent in order to obtain additional claims, which is still pending. Amended Complaint, ¶ 11. Molychem filed a protest with the PTO against the Khan '236 patent in May-June 2002, which is also pending.

E. The Products at Issue

1. Complainant's Products

AOM is a well known chemical compound which is generally used as a fire retardant and smoke suppressant additive for plastics. Climax has produced various AOM isomers via both the "dry" and "wet" processes. Climax asserts that the wet process used to form AOM is a complicated chemical reaction and system and that several metastable phases characterize the system. As such, Climax asserts that the wet process is very sensitive to variable reaction conditions which can affect the end result, or even the isomer produced by the reaction. Such variable conditions include the particle size of the starting materials and the time and temperature of the reaction.

2. Respondents' Products

Molychem imports AOM into the United States from its Chinese manufacturer, Anhui. A sales contract between Anhui and Molychem shows that Molychem has purchased AOM from Anhui with the formula $(\text{NH}_4)_4 \text{Mo}_8 \text{O}_{26}$, bulk density of 0.45-0.50 g/cm³, solubility in water of 5.6 g/l @ 25°C, loss on ignition @ 450°C of 8.29%, 61% molybdenum, and a particle size of 0.95-1.2 µm. CX-38 at 14.

II. Jurisdiction/Importation

Section 337 confers subject matter jurisdiction on the International Trade Commission to

investigate, and if appropriate, to provide a remedy for, unfair acts and unfair methods of competition in the importation of articles into the United States, or in their sale by the owner, importer, consignee or agent of either, which have the effect or tendency to destroy or substantially injure an industry, efficiently and economically operated, in the United States.⁷ In order to have the power to decide a case, a court or agency must have both subject matter jurisdiction, and jurisdiction over either the parties or the property involved.⁸

The power of the Commission to issue a remedy in a Section 337 investigation is based on its *in rem* jurisdiction over the property involved. Thus, the remedy operates against property, not against parties.⁹ As a result, it is not necessary for the Commission to have *in personam* jurisdiction over a party to name them as a respondent or to adversely affect their interest in the property under dispute.¹⁰

Although the Commission may act on the strength of its *in rem* jurisdiction in the absence of *in personam* jurisdiction, due process requires that it provide notice to persons with an interest in property reasonably calculated to inform them of the pendency of an action affecting that property so that they may have the opportunity to appear and defend their interests.¹¹ Thus, service of the

⁷ 19 U.S.C. § 1337. See *Certain Steel Rod Treating Apparatus and Components Thereof*, Inv. No. 337-TA-97, Commission Memorandum Opinion, 215 U.S.P.Q. 229, 231 (1981) (“*Steel Rod*”).

⁸ *Id.*

⁹ *Sealed Air Corp. v. U.S. Int’l Trade Comm’n*, 209 U.S.P.Q. 469 (C.C.P.A. 1981) (“*Sealed Air*”).

¹⁰ *Steel Rod*, 215 U.S.P.Q. at 232; see also *In re Orion*, 21 U.S.P.Q. 563, 571 (C.C.P.A. 1934) (“*Orion*”).

¹¹ *Mullane v. Central Hanover Bank & Trust Co.*, 339 U.S. 306 (1950) (“*Mullane*”).

complaint and notice of investigation by the Commission on a named foreign respondent may not necessarily be an assertion of personal jurisdiction over that party, but will satisfy the due process requirement of reasonable notice to support *in rem* jurisdiction.¹²

A. Subject Matter Jurisdiction

The complaint alleges that Molychem has violated Subsection 337(a)(1)(A) and (B) in the importation and sale of products that infringe the Khan '236 patent. Molychem has admitted that it imports AOM into the United States. *See Response to Complaint and Notice of Investigation*, ¶ 16; FF 5. Accordingly, the Commission has subject matter jurisdiction in this investigation.¹³

B. Personal Jurisdiction

Respondents Molychem and Chem-Met have responded to the complaint and notice of investigation, participated in the investigation, including participating in discovery, and made an appearance at the hearing, thereby submitting to the personal jurisdiction of the Commission.¹⁴ Respondents Anhui and Pudong have not made an appearance in this investigation, nor have they responded to the complaint or notice of investigation. Anhui is a foreign respondent, while Pudong is a U.S. respondent.

A finding of personal jurisdiction over a foreign respondent who does not participate in a Section 337 proceeding may be based on evidence that the respondent has minimum contacts with

¹² *Steel Rod*, 215 U.S.P.Q. at 231.

¹³ *See Amgen, Inc. v. U.S. Int'l Trade Comm.*, 902 F.2d 1532, 1536 (Fed. Cir. 1990) (“Amgen”).

¹⁴ *See Certain Miniature Hacksaws*, Inv. No. 337-TA-237, U.S.I.T.C. Pub. No. 1948, Initial Determination (unreviewed by Commission in relevant part) at 4, 1986 WL 379287 (U.S.I.T.C., October 15, 1986) (“*Miniature Hacksaws*”).

the United States and that the respondent had adequate notice of the Commission's proceeding. As to minimum contacts, Climax offered evidence that Anhui has exported to the United States the accused AOM after the issuance of the Khan '236 patent. *See* CX-38. Evidence was received into the record which supports a finding that Anhui has minimum contacts with the United States. No party, however, offered into evidence proof of adequate notice to Anhui, nor did any party specifically seek to establish personal jurisdiction over Anhui by sanction, as enumerated in Commission Rule 210.33(b)¹⁵ and permitted under the standard enumerated by the Supreme Court in *International Shoe Co. v. Washington*.¹⁶

In this investigation, the Commission Secretary served the complaint and notice of investigation on all respondents, and there is sufficient proof on this record to establish that all respondents received notice of this investigation. With respect to respondents Anhui and Pudong, although the Commission did not receive a return receipt or a written response to the complaint, the complaint and notice that were served by mail were not returned to the Commission. In view of the fact that Pudong is a domestic company and that the notice of investigation was published in the Federal Register, the undersigned finds that Pudong, at a minimum, received constructive notice of this investigation. On the basis of the facts of record, the undersigned finds that the Commission has personal jurisdiction over all domestic respondents named in the investigation.

It has not been established that Anhui, the foreign respondent, directly engages in business in the United States, although its products are exported to the United States. Therefore, there is no basis for determining whether or not the Commission may have personal jurisdiction over this

¹⁵ *See* 19 C.F.R. § 210.33(b).

¹⁶ *Int'l Shoe Co. v. Washington*, 326 U.S. 310 (1945).

respondent. The *in rem* nature of this proceeding, however, makes such an inquiry unnecessary.¹⁷ The record indicates that the foreign respondent Pudong received actual notice of this investigation. Thus, adequate notice has been provided to support the Commission's assertion of *in rem* jurisdiction in this matter. For the foregoing reasons, the undersigned finds that the Commission has jurisdiction over the subject matter of this investigation, *in rem* jurisdiction over the product at issue, and personal jurisdiction over the domestic respondents named in this investigation.

III. Claim Construction

A. Relevant Law

Analyzing whether a patent is infringed “entails two steps. The first step is determining the meaning and scope of the patent claims asserted to be infringed. The second step is comparing the properly construed claims to the device or process accused of infringing.”¹⁸ The first step is a question of law, whereas the second step is a factual determination.¹⁹ To prevail, the patentee must establish by a preponderance of the evidence that the accused device infringes one or more claims of the patent either literally or under the doctrine of equivalents.²⁰

Concerning the first step of claim construction, “[i]t is well-settled that, in interpreting an asserted claim, the court should look first to the intrinsic evidence of record, *i.e.*, the patent itself,

¹⁷ *Steel Rod*, 215 U.S.P.Q. at 229.

¹⁸ *Dow Chem. Co. v. United States*, 226 F.3d 1334, 1338 (Fed. Cir. 2000) (“*Dow Chemical*”), citing *Markman v. Westview Instruments, Inc.*, 52 F.3d 967, 976 (Fed. Cir. 1995) (*en banc*), *aff’d*, 517 U.S. 370 (1996) (“*Markman*”).

¹⁹ *Markman*, *supra*.

²⁰ *Bayer AG v. Elan Pharm. Research Corp.*, 212 F.3d 1241, 1247 (Fed. Cir.), *cert. denied*, 531 U.S. 993 (2000) (“*Bayer*”).

including the claims, the specification and, if in evidence, the prosecution history Such intrinsic evidence is the most significant source of the legally operative meaning of disputed claim language.”²¹

“In construing claims, the analytical focus must begin and remain centered on the language of the claims themselves, for it is that language that the patentee chose to use to ‘particularly point [] out and distinctly claim [] the subject matter which the patentee regards as his invention.’”²² Thereafter, if the claim language is not clear on its face, “[t]hen we look to the rest of the intrinsic evidence, beginning with the specification and concluding with the prosecution history, if in evidence” for the purpose of “resolving, if possible, the lack of clarity.”²³

The specification is considered “always highly relevant” to claim construction and “[u]sually, it is dispositive; it is the single best guide to the meaning of a disputed term.”²⁴ The prosecution history is also examined for a claim’s scope and meaning “to determine whether the patentee has relinquished a potential claim construction in an amendment to the claim or in an argument to overcome or distinguish a reference.”²⁵

There is a “heavy presumption” that claim terms are to be given “their ordinary and accustomed meaning as understood by one of ordinary skill in the art,” and in aid of this

²¹ *Bell Atlantic Network Serv., Inc. v. Covad Communications Group, Inc.*, 262 F.3d 1258, 1267 (Fed. Cir. 2001) (“*Bell Atlantic*”).

²² *Interactive Gift Express, Inc. v. Compuserve Inc.*, 256 F.3d 1323, 1331 (Fed. Cir. 2001) (“*Interactive Gift Express*”), citing 35 U.S.C. § 112, ¶ 2.

²³ *Id.*

²⁴ *Bell Atlantic*, 262 F.3d at 1268.

²⁵ *Id.*

interpretation, “[d]ictionaries and technical treatises, which are extrinsic evidence, hold a ‘special place’ and may sometimes be considered along with the intrinsic evidence when determining the ordinary meaning of claim terms.”²⁶ Caution must be used, however, when referring to non-scientific dictionaries “lest dictionary definitions . . . be converted into technical terms of art having legal, not linguistic significance.”²⁷

The presumption in favor of according a claim term its ordinary meaning is overcome “(1) where the patentee has chosen to be his own lexicographer, or (2) where a claim term deprives the claim of clarity such that there is ‘no means by which the scope of the claim may be ascertained from the language used.’”²⁸ In this regard, “[t]he specification acts as a dictionary ‘when it expressly defines terms used in the claims or when it defines terms by implication.’”²⁹

“[I]f the meaning of the claim limitation is apparent from the intrinsic evidence alone, it is improper to rely on extrinsic evidence other than that used to ascertain the ordinary meaning of the claim limitation. [citation omitted] However, in the rare circumstance that the court is unable to determine the meaning of the asserted claims after assessing the intrinsic evidence, it may look to additional evidence that is extrinsic to the complete document record to help resolve any lack of clarity.”³⁰ “Extrinsic evidence consists of all evidence external to the patent and prosecution history

²⁶ *Id.* at 1267-68.

²⁷ *Id.* at 1267 (internal quotation marks omitted).

²⁸ *Id.* at 1268.

²⁹ *Id.*

³⁰ *Id.* at 1268-69.

....”³¹ It includes “such evidence as expert testimony, articles, and inventor testimony.”³² But, “[i]f the intrinsic evidence resolves any ambiguity in a disputed claim, extrinsic evidence cannot be used to contradict the established meaning of the claim language.”³³ “What is disapproved of is an attempt to use extrinsic evidence to arrive at a claim construction that is clearly at odds with the claim construction mandated by the claims themselves, the written description, and the prosecution history, in other words, with the written record of the patent.”³⁴

In interpreting particular limitations within each claim, “adding limitations to claims not required by the claim terms themselves, or unambiguously required by the specification or prosecution history, is impermissible.”³⁵ Further, a patent is not limited to its preferred embodiments in the face of evidence of broader coverage by the claims.³⁶ “[T]here is sometimes ‘a fine line between reading a claim in light of the specification, and reading a limitation into the claim from the specification.’”³⁷ On the other hand, a claim construction that excludes the preferred embodiment

³¹ *Markman*, 52 F.3d at 980.

³² *Bell Atlantic*, 262 F.3d at 1269.

³³ *DeMarini Sports, Inc. v. Worth, Inc.*, 239 F.3d 1314, 1322-23 (Fed. Cir. 2001) (“*DeMarini*”).

³⁴ *Markman*, 52 F.3d at 979.

³⁵ *Dayco Prod., Inc. v. Total Containment, Inc.*, 258 F.3d 1317, 1327 (Fed. Cir. 2001) (“*Dayco Products*”), citing *Laitram Corp. v. NEC Corp.*, 163 F.3d 1342, 1347 (Fed. Cir. 1998) (“*Laitram*”) (“a court may not import limitations from the written description into the claims”).

³⁶ *Acromed Corp. v. Sofamor Danek Group, Inc.*, 253 F.3d 1371, 1382-83 (Fed. Cir. 2001) (“*Acromed*”); *Electro Med. Sys. S.A. v. Cooper Life Sci., Inc.*, 34 F.3d 1048, 1054 (Fed. Cir. 1994) (“*Electro Med.*”) (“[P]articular embodiments appearing in a specification will not be read into the claims when the claim language is broader than such embodiments.”).

³⁷ *Bell Atlantic*, 262 F.3d at 1270.

in the specification of a patent is “rarely, if ever, correct.”³⁸

A patent claim limitation that is written in “means plus function” format is treated differently, however. Such a limitation identifies a function without reciting definite structure in support of that function, and as such is subject to the requirements of 35 U.S.C. § 112, ¶ 6 in discerning its meaning.³⁹ “Literal infringement of a claim containing a means clause requires that the accused device perform the identical function as that identified in the means clause and do so with structure which is the same as or equivalent to that disclosed in the specification.”⁴⁰ Thus, in distinct contrast to the general rule that particular embodiments in the specification are not read into claim limitations, “means plus function” claim limitations are construed according to “[d]isclosed structure . . . which is described in a patent specification, including any alternative structures identified.”⁴¹ In other words, correctly construed “means plus function” limitations of claims cover “equivalents of the described embodiments.”⁴²

Claims amenable to more than one construction should, when it is reasonably possible to do so, be construed to preserve their validity.⁴³ A claim cannot, however, be construed contrary to its

³⁸ See *Vitronics Corp. v. Conceptronic, Inc.*, 90 F.3d 1576, 1583-34 (Fed. Cir. 1996) (“*Vitronics*”).

³⁹ *Serrano v. Telular Corp.*, 111 F.3d 1578, 1582 (Fed. Cir. 1997) (“*Serrano*”).

⁴⁰ *Id.*

⁴¹ *Id.* at 1583.

⁴² *Texas Instruments, Inc. v. U.S. Int’l. Trade Comm’n*, 805 F.2d 1558, 1562 (Fed. Cir. 1986) (“*Texas Instruments*”).

⁴³ *Karsten Mfg. Corp. v. Cleveland Golf Co.*, 242 F.3d 1376, 1384 (Fed. Cir. 2001) (“*Karsten*”).

plain language.⁴⁴ Claims cannot be judicially rewritten in order to fulfill the axiom of preserving their validity; “if the only claim construction that is consistent with the claim’s language and the written description renders the claim invalid, then the axiom does not apply and the claim is simply invalid.”⁴⁵

B. Claim 1 of the Khan ‘236 Patent

The Khan ‘236 patent only has one claim, which read as follows:

An ammonium **octamolybdate** isomer having Raman spectra peaks at wavelength values of **about 953-955 cm⁻¹, about 946-948 cm⁻¹, and about 796-798 cm⁻¹.**

CX-1; RX-53 (emphasis added). Figure 2 of the Khan ‘236 patent shows the Raman spectra for the X-AOM isomer, which has the wavelength values as stated in claim 1:

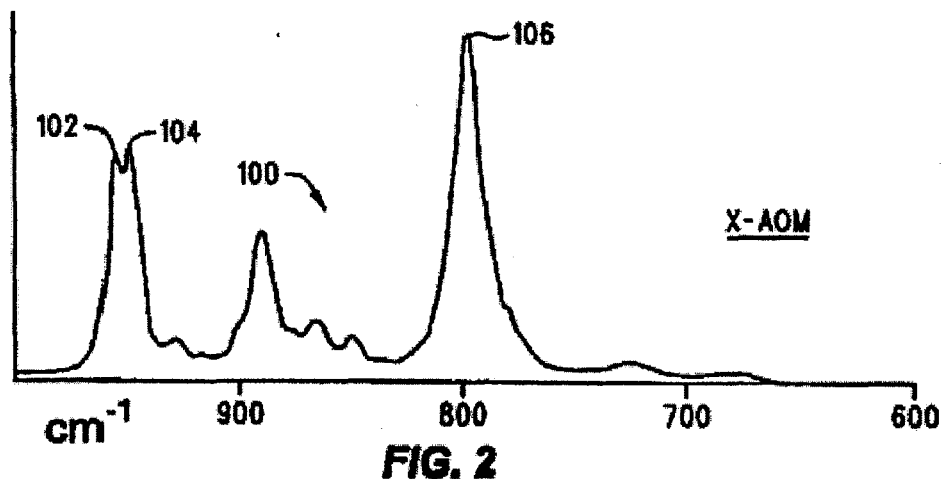

CX-1, RX-53, Figure 2. Figures 3 and 4 show the Raman spectra for alpha-AOM and beta-AOM, respectively.

⁴⁴ See *Rhine v. Casio, Inc.*, 183 F.3d 1342, 1345 (Fed. Cir. 1999) (“*Rhine*”).

⁴⁵ *Id.*

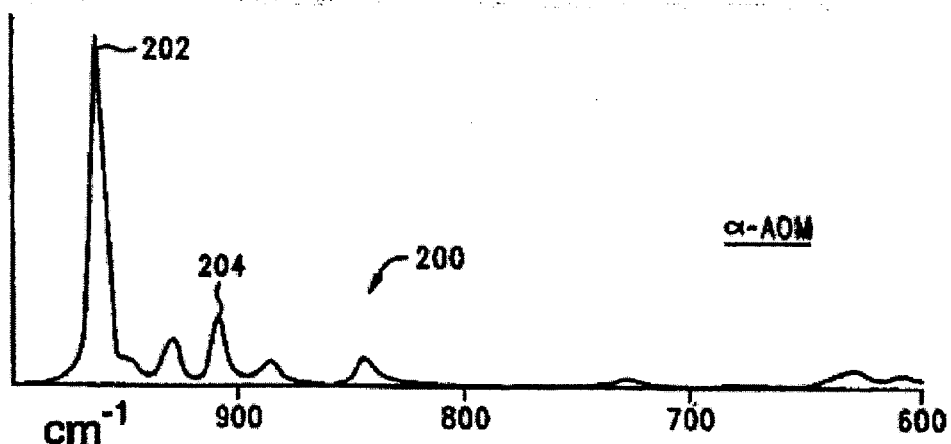

FIG. 3

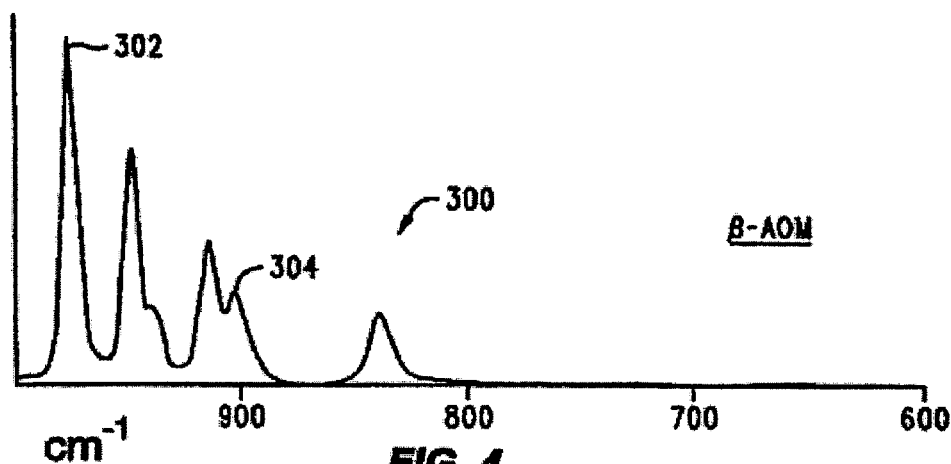

FIG. 4

CX-1, RX-53, Figures 3-4. As can be seen from the figures, each isomer of AOM has a distinctive Raman spectra “fingerprint.” A characteristic of the X-AOM isomer is a “doublet” peak, which is shown in Figure 2 above at peak 102 (about 953-955 cm^{-1}) and 104 (about 946-948 cm^{-1}).

1. “About”

The term “about” is used to describe a range of Raman spectra peak values within claim 1 of the Khan ‘236 patent. Climax had two experts testify regarding the Khan ‘236 patent and Molychem had one expert testify regarding the Khan ‘236 patent.

Climax's two experts were Dr. Steve Martin and Dr. Donald Macalady. Dr. Martin is a professor in material science engineering at the Iowa State University. Martin, Tr. 690. Dr. Martin received his bachelor's degree in chemistry from Capital University and his Ph.D. in physical chemistry from Perdue University in 1986. Martin, Tr. 691; CX-178C, Martin Dec. at ¶¶ 1-2. Dr. Macalady is a professor of chemistry and geochemistry at the Colorado School of Mines. Macalady, Tr. 1149. Dr. Macalady received his bachelor's degree in chemical engineering from Pennsylvania State University and his Ph.D. in physical chemistry from the University of Wisconsin. Macalady, Tr. 1150.

Molychem's expert was Dr. Manuel Uy, who is a professor at Johns Hopkins University. Uy, Tr. 781. Dr. Uy received his bachelors in chemistry from LaSalle College in Manila, the Philippines, was a Fulbright Scholar, and has a Ph.D. in physical chemistry from the Case Institute of Technology. Uy, Tr. 780.

Both parties, by their experts, agree that it is reasonable to interpret the term "about" when used in reference to Raman spectra, to include a range that is plus or minus two to four cm^{-1} of the ranges claimed in claim 1 of the Khan '236 patent. RIB 4; CX-178C, ¶ 12. The Staff also agrees with this construction of the term "about." SIB 7.

Accordingly, the term "about" as used in claim 1 of the Khan '236 patent, is construed to mean a Raman spectra wavelength that is within $\pm 2-4 \text{ cm}^{-1}$ of the specified ranges.

2. "Octamolybdate"

The parties dispute the use of the term "octamolybdate." Climax and the Staff assert that the meaning is unambiguous and clear on its face. CIB 6; CRRB 2-4; SIB 7; SRB 2. Molychem, however, asserts that a polymolybdate, such as tetramolybdate, can also be considered an

octamolybdate.⁴⁶ RIB 4.

Molychem bases its assertion on a German prior art article entitled “Concerning Solid Isopolymolybdates and Their Relation to Isopolymolybdate Ions in Aqueous Solution” by Karl-Heinz Tytko and Bernd Schönfeld (“the Tytko article”). See RX-14, RX-14.1 and CX-118. Specifically, Molychem appears to be referring to a portion of the Tytko article, which has been translated as follows:

The (1:4)-molybdates are also referred to in the literature as “tetramolybdates” or metamolybdates. Unfortunately, since the structure of $(\text{NH}_4)_4 \text{Mo}_8\text{O}_{26} \cdot 5(4) \text{H}_2\text{O}$ came to be known, other (1:4)-molybdates are also more frequently being called octamolybdates, although this has in no sense been clarified experimentally.

See CX-118.⁴⁷

In interpreting the term “octamolybdate,” three sources must be considered: the claim, the specification and the prosecution history of the Khan ‘236 patent.⁴⁸ “In construing claims, the analytical focus must begin and remain centered on the language of the claims themselves, for it is that language that the patentee choose to use to ‘particularly point [] out and distinctly claim [] the

⁴⁶ Climax argues that Molychem did not raise this issue in its pre-trial brief and that the issue is therefore waived under Ground Rule 8.2. CRRB 2. Upon a review of Molychem’s pre-trial brief, although there is no detailed discussion regarding the specific definition of an octamolybdate in the claim construction section, the undersigned finds that the reference to having to prove whether a product is an octamolybdate sufficiently preserves the issue. See Molychem’s [Pre] Trial Brief at 3 (January 29, 2003).

⁴⁷ Similarly, RX-14.1 has the following translation:

In the literature, the (1:4)-molybdates are also referred to as “tetramolybdates” or metamolybdates. Ever since the structure of $(\text{NH}_4)_4 \text{Mo}_8\text{O}_{26} \cdot 5(4) \text{H}_2\text{O}$ has become known, unfortunately, other (1:4)-molybdates are increasingly being called octamolybdates in spite of the fact that this has not been confirmed experimentally.

⁴⁸ See *CCS Fitness, Inc. v. Brunswick Corp.*, 288 F.3d 1359, 1366 (Fed. Cir. 2002) (“*CCS Fitness*”).