



# **ARLINGTON FIRE DEPARTMENT**

## **DEVELOPER AND CONSTRUCTION INFORMATION**

**2003 EDITION  
INTERNATIONAL FIRE CODE**

**Compiled by:**

*Arlington Fire Department  
Development Services*

## Table of Contents

Permit Fees and Application Process.....	3
Certificate of Occupancy Inspection.....	9
Fire Code Board of Appeals.....	10
Fire Lane Requirements.....	11
Fire Hydrant Requirements.....	14
Fire Sprinkler Systems.....	18
Fire Alarm Systems.....	19
Access Control/Special Locking Systems.....	20
Spray Booth Requirements.....	21
Inside Flammable Liquids Storage Requirements.....	22
Underground Flammable and Combustible Liquids Tank and Line Installations.....	23
Aboveground Outside Waste Oil, Gasoline or Diesel Storage Tanks.....	26
Extension Cords.....	28
Outdoor Burning.....	29
Fireworks.....	30
Explosive Materials.....	30
Flammable and Combustible Decorations.....	31
Christmas Trees.....	32
Haunted House Guidelines.....	33
Key Box and Locks.....	35
Inspection and Maintenance of Portable Fire Extinguishers.....	36
Tents and Canopies.....	38
Outdoor Carnivals and Fairs.....	40
Temporary Concession Stands/Trailers.....	41
Addresses, Street Names and Signs.....	43
Kitchen Fire Extinguishing Systems.....	44
High-Piled Combustible Storage.....	45



**PERMIT REQUIRED AND FEES  
(2003 International Fire Code)**

A permit shall be obtained from the Fire Marshals Office prior to engaging in any of the listed activities, operations or functions. Fees for specific permits shall comply with the following schedule:

1. Installation of grass pavers for use in a fire lane.
  - \* - \$100 for the first two hundred feet (200') or portion thereof.
  - \* - \$200 for every additional four hundred feet (400').
2. All permits required by Section 3301.2 for explosive materials - \$100.00.
3. To conduct authorized burning operations - \$1,000.00.
4. Direction of fireworks displays - \$100.00 per display date. The Chief or authorized representative may waive this fee for civic or nonprofit organizations.
- 4A. Pyrotechnic Special or Theatrical Effects - \$50.00. per event. (An annual permit may be issued in the amount of \$500.00).
- 4B. Flame Effects - \$50 per event. (An annual permit may be issued in the amount of \$500). Only required if not used in conjunction with either fireworks display or pyrotechnic permit.
5. Installation or testing of underground flammable liquid storage tank systems - \$300.00 per location. Testing of lines only - \$100.00 per location. Installation of miscellaneous systems or equipment - \$100.00.
  - 5A1. Aboveground Waste Oil Tank - \$50.00.
  - 5C1. Aboveground Protected Tank - \$100.00.
  - 5C2. Aboveground Inside Waste Oil Tank - \$50.00.
  - 5C3. Airport Refueling Units- \$200.00 per year.
  - 5C4. Mobile Fueling - \$200.00 per year per site.
6. Removal of underground flammable liquid storage tanks - \$50.00 per tank.
- 6A. Abandonment of Underground Tanks/Lines - \$200.00 per tank.
7. Installation of, dry chemical, wet agent, carbon dioxide or other fire extinguishing systems or standpipe systems and the testing thereof to include underground piping - \$75.00 per system.

- 8. Installation of fire alarm systems -
 

1 – 10 devices	\$50
11 – 25 devices	\$75
26 - 100 devices	\$150
101 - 200 devices	\$200
201 – 500 devices	\$400

An additional \$1.00 per device for each device over five hundred (500).

- 8A. Installation of Special Locking System - \$200.00.
- 9. Installation of any LP gas container larger than one hundred-twenty (120) gallons water capacity - \$75.00 per container.
- 12. Installation of automatic sprinkler systems and the testing thereof:
  - 12A. Underground - \$100.
  - 12B. Aboveground, 1 – 19 heads - \$50.00.  
 Aboveground, 20 – 100 heads - \$75.00.  
 Aboveground, 101 – 300 heads - \$150.00.  
 Aboveground, 301 – 1000 heads - \$300.00.  
 An additional \$1.00 per head for each head over one thousand (1000).  
 Fire Pump – additional \$100.00
- 13. Residential (Group R-3 Occupancies) Automatic Sprinkler System - \$50.00.
- 14. Installation of a smoke control system - \$100.00 per system.
- 16. Installation of the underground piping and private fire hydrants.
  - \* - \$100.00 for first two hundred feet (200') or portion thereof, including any fire hydrants.
  - \* - \$200.00 for every additional four hundred feet (400') or portion thereof, including fire hydrants.

**PENALTIES**

***Fees of permits shall be Tripled if a contractor has begun work without a permit. For the second and subsequent occurrence by the same contractor within two (2) years, the permit fees shall be Quadrupled.***

**ARLINGTON FIRE DEPARTMENT  
DEVELOPMENT SERVICES  
817-459-5536 or 817-459-5542**

**FIRE PERMIT APPLICATION PROCESS**

Effective Monday, April 17, 2006, the City of Arlington launched a new system, to provide our customers new online services for permitting, inspections, registration, and electronic payments.

This new system is the product of “One Start Center,” a citywide commitment to allow contractors to conduct business with different departments with the City of Arlington at one location. As a result, fire plans and permits related to construction will be processed at City Hall, 101 W. Abram St. 2nd Floor, Building Inspections (BI) counter. Please contact a permit tech at 817-277-5561 for help with a permit application or registration.

Permits for Fireworks Displays, Pyrotechnic and Theatrical Effects, Flame Effects, Trench Burning, Blasting, Mobile Refueling Units and Airport Refueling Units will be processed at the Fire Prevention Office, 405 W. Main St., Arlington, Texas 76010. You may contact the Fire Prevention Office at 817-459-5539 with any questions.

To begin using the new permitting system, please register as a first time user at [www.ArlingtonPermits.com](http://www.ArlingtonPermits.com).

(See First-Time Web User or Online Quick Start Guide:

<http://www.ci.arlington.tx.us/build/pdf/permits/QuickstartBrochure.pdf>).

In addition to registering as a first-time user, you will need to register your business, if you are applying for any of the following permit types. The business registration must be completed by the primary person (i.e. owner, president, general manager) in the company or organization. The primary person will need to give the City of Arlington permission to allow employees to apply for permits under his/her Business Registration. (See Web Contractor Registration Instructions and Agent Form.)

<b>Required Registration</b>	<b>Type of Permit</b>	
Blasting Contractor	2 – Blasting Permit	Not Available Online
Pyrotechnic Contractor	4 - Fireworks Displays	
	4A – Pyrotechnic Special / Theatrical Effects	
	4B – Flame Effects	
UST Contractor	5 – Installation or Testing of Underground Flammable Liquid Storage Tank	Available Online
	6 – Removal of Underground Flammable Liquid Storage Tank	
	6A – Abandonment of Underground Tanks/Lines	
Fire Extinguishing Contractor	7 – Miscellaneous Extinguishing Systems	
Fire Alarm Contractor	8 –Fire Alarm System Installation	
	8A – Special Locking System (when connected to a Fire Alarm System)	
LP Gas Contractor	9 –LPG Container Installation	
Fire Sprinkler Contractor	12A – Underground Fire Protection System	
	12B – Above ground Fire Sprinkler System	
	13 – Residential (Group R-3) Automatic Sprinkler System	
	16 – Installation of Underground Fire Line w/Hydrants	
Mechanical HVAC Contractor	14 – Installation of Smoke Control System	



ArlingtonPermits.com  
THE ONE START CENTER

**ArlingtonPermits.com**  
**Agent Form -**  
**Adding and Removing Agents**

This form may only be completed by the owner or principal of the registered contractor in order to add or remove agents. The authorized agents will then be able to apply for permits, check the status of permit applications, request and cancel inspections, check inspection results and pay fees on-line.

This form must be completed and submitted any time an agent is added or removed. The agents listed herein must first be a registered web user of **ArlingtonPermits.com**. The names of the agents must appear identically to the name of the registered web user.

Please type or print clearly (First Name, Middle Initial, Last Name):

- 1.  Add  Remove: \_\_\_\_\_
- 2.  Add  Remove: \_\_\_\_\_
- 3.  Add  Remove: \_\_\_\_\_
- 4.  Add  Remove: \_\_\_\_\_
- 5.  Add  Remove: \_\_\_\_\_
- 6.  Add  Remove: \_\_\_\_\_
- 7.  Add  Remove: \_\_\_\_\_
- 8.  Add  Remove: \_\_\_\_\_

**CRIMINAL PENALTIES FOR MAKING FALSE STATEMENTS**

Any person convicted of making false statements shall be fined not more than \$1,000 or imprisoned for not more than 180 days, or both. A person commits the offense of making false statements if that person willfully makes a false statement that is in fact material, in writing, directly or indirectly, to any instrumentality of the City of Arlington government, under circumstances in which the statement could reasonably be expected to be relied upon as true.

I certify that all information provided is true and correct as of the date of this statement, that I have not knowingly withheld disclosure of any information requested; and that supplemental statements will be promptly submitted to the City of Arlington, Texas, as changes occur.

Registered Contractor's Business Name: \_\_\_\_\_

Principal or Owner's Name: \_\_\_\_\_

\_\_\_\_\_  
Signature of Principal or Owner

\_\_\_\_\_  
Date



# ***ArlingtonPermits.com***

## **First Time Web Registration Instructions**

ArlingtonPermits.com offers the user the ability to apply for permits, check plan review status, schedule and cancel inspections and pay fees online.

Homeowners, contractors, architects and engineers wanting to take advantage of these services must first become a registered web user. Follow the step by step instructions to become a registered web user of ArlingtonPermits.com.

1. First log on to [www.ArlingtonPermits.com](http://www.ArlingtonPermits.com) and click on On-line Permit Applications, Inspections and Contractor Registration. Then click on Registration for first time users and enter your email address twice to ensure that it is entered correctly. Click on Continue.
2. You will then receive a reply email. The email will contain a message and a link. The message will direct you to click on the link in order to continue your web registration process.
3. When you click on the link, the message will ask you to enter your first name, last name and PIN Number. At this stage in the web registration process, you will not have a PIN number. Leave this blank and click on Submit. You will see a web application form to complete with your name, address, phone number, etc. After you enter the required information, click on Submit. You will be contacted by staff for instructions to complete the web registration process.
4. The permit tech will update our records and then provide you with your PIN Number via email communication.
5. You may now log on again, follow the instructions beginning with #1 above. You will now have a PIN Number when you get to step #5.

After you have registered as an ArlingtonPermits.com web user, you may also register as a contractor. To view the instructions for this contractor registration process, please see **WEB CONTRACTOR REGISTRATION INSTRUCTIONS**.



# ***ArlingtonPermits.com***

## Web Contractor Registration Instructions

***ArlingtonPermits.com*** offers contractors the ability to apply for permits, check the status of permit applications, request and cancel inspections, check inspection results and pay fees on-line. Contractors wanting to take advantage of these services must be a registered contractor with at least one registered web user. Additional employees may be added as agents of the contractor and take advantage of the same services. To register your contracting business, follow these simple instructions:

1. The owner or principal for the company must first be a registered web user. See **WEB USER REGISTRATION** for instructions to become a web user.
2. After the owner or authorized agent for the company becomes a registered web user, log on to ***ArlingtonPermits.com***.
3. Click on **On-line permit applications, inspections and Contractor Registration**. Then click on **Apply for a permit**. Then log on by entering your email address and password and click "Login."
4. Click on the type of contracting business that you are registering. For a list of the types of contractors, see **Types of Contractors**. To see the required information for registration, click on the specific type of contractor
5. You will also need to provide copies of certain information such as: driver's license, trade license, certificate of insurance, etc, as needed. Originals and/or copies of this information will be scanned and attached to your business registration.
  - a. Certificates of Insurance must be originals, if delivered in person; may be faxed directly from the insurance carrier with a cover sheet; or may be emailed directly from the insurance carrier.
  - b. For the original registration, all trade licenses must be presented in original form for copying. Copies of trade licenses will be accepted for only registration renewal.
  - c. For the original registration, all drivers' licenses must be presented in original form for copying.
6. After you have completed the online registration application, paid any required fees and provided the necessary items in #5, the permit tech will provide you with a PIN Number to complete the web contractor registration process. You may then log on to ***ArlingtonPermits.com*** and apply for permits, check the status of permit applications, request and cancel inspections, check inspection results and pay fees on-line.

April 17, 2006



**April 17, 2006 ARLINGTON FIRE DEPARTMENT  
DEVELOPMENT SERVICES  
817-459-5549 or 817-459-5536**



## **CERTIFICATE OF OCCUPANCY INSPECTION**

An application for the Certificate of Occupancy should be filled out before you are ready to move into a commercial space. The application is available at the Building Inspections counter on the second floor of City Hall (101 W. Abram St.). The Fire, Building and Health Departments should all be contacted to inspect your building or space. Call 817-459-5542 to schedule a Fire Department inspection. The Fire Department requires that someone be present at the time of inspection.

The Fire Department will also complete courtesy inspections. When the Fire Department receives a call from a potential business owner with plans to locate or relocate, we recommend a courtesy inspection before the building is bought or leased. At this inspection we can point out any problems with the Code. This will, in many cases, save time and money if the building is incompatible for your intended use.

All Fire Department Certificate of Occupancy Inspections will be completed and called into the Building Department by two thirty (2:30) P.M. on the day received from the Building Inspections Department. Building Inspections calls the electric company at 10 A.M. each day with releases.

**ARLINGTON FIRE DEPARTMENT  
DEVELOPMENT SERVICES  
817-459-5549 or 817-459-5536**

**FIRE CODE BOARD OF APPEALS**

In order to determine the suitability of alternate materials and types of construction and to provide for reasonable interpretations of the provisions of the Uniform Fire Code, the Building Code Board of Appeals, as created and organized under the "Construction" Chapter of the Code of the City of Arlington, sitting as Fire Prevention Board of Appeals shall pass upon all pertinent matters.

To appeal a case the following steps should be taken:

1. Fill out appeals form located at Development Services Desk, 2nd floor of City Hall.
2. Pay \$50.00 appeal fee.
3. Board of Appeals meet 2nd and 4th Monday of each month as needed.

**ARLINGTON FIRE DEPARTMENT  
DEVELOPMENT SERVICES  
817-459-5549 or 817-459-5536**

**FIRE LANE REQUIREMENTS  
(Section 503, 2003 International Fire Code)**

To provide adequate emergency vehicle access, (Fire, Police, Ambulance), and to give the Citizens of Arlington the best possible emergency response time, it is necessary that all required Fire Lanes be installed and accepted before any construction goes above the slab.

**General.** Fire Lanes are required to be installed and maintained in accordance with the Fire Code. All fire lanes shall be approved by the Fire Department and plans shall be submitted for approval prior to starting construction of any building where fire lanes are required. *No one shall mark, post, or otherwise identify a non-fire lane street, whether public or private, as a fire lane.*

**Where Required.** All buildings or structures shall be constructed in such a way that all ground level, exterior sides of the building are within one hundred fifty feet (150') of the dedicated street or fire lane, measured by the route necessary to extend firefighting hose lines around the building. If the one hundred fifty feet (150') cannot be reached from a public street, a fire lane will be required on site.

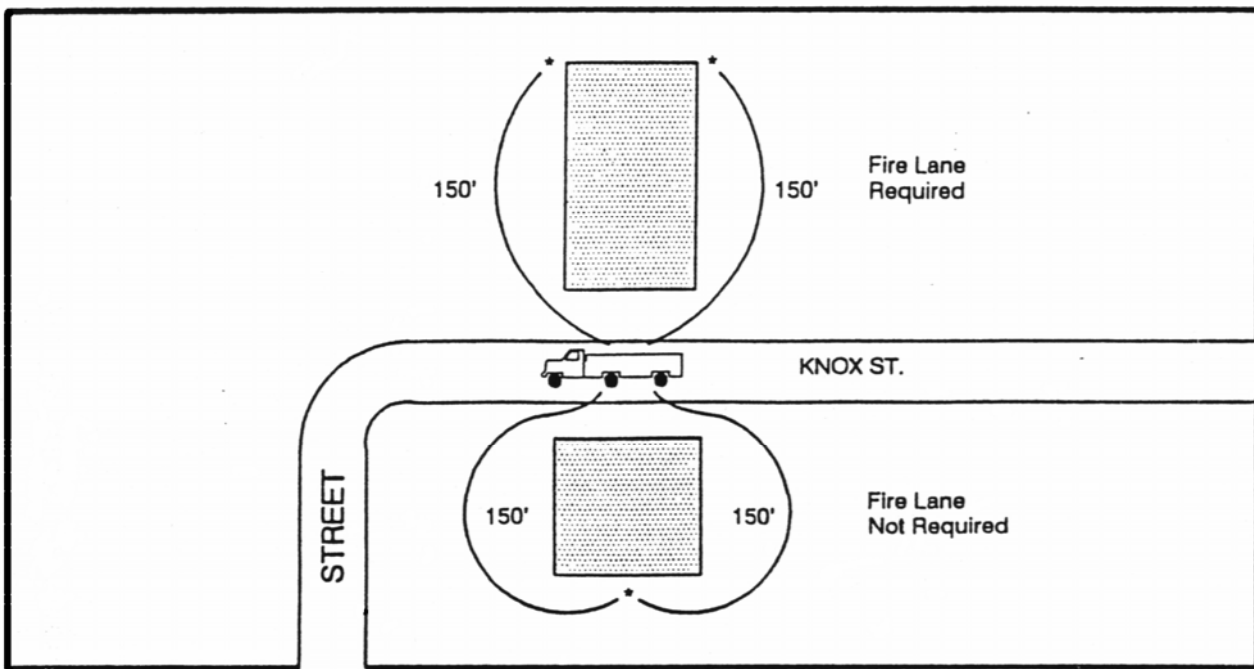

**Exceptions:** The Fire Code Official is authorized to increase the dimension of 150 feet where:

1. The building is equipped throughout with an approved automatic sprinkler system.
2. Fire lanes cannot be installed due to topography, waterways, non-negotiable grades or other similar conditions, and an approved alternative means of fire protection is provided.
3. There are not more than two (2) Group R-3 or Group U occupancies.
4. When a building is provided with a complete automatic fire sprinkler system and the building exceeds one hundred fifty feet (150') in length or width on any side, a fire lane or dedicated street shall be within one hundred fifty feet (150') of the entire length of one of the longest sides of the building.

**Surface.** Fire lanes shall be provided with a concrete or asphalt surface to provide all-weather driving capabilities and shall be constructed to support the imposed weight of a 60,000 pound vehicle.

**Vertical Clearance.** All fire lanes shall have a vertical clearance of not less than fourteen feet (14'). This height is required for a fire truck to pass under.

**Width.** The minimum unobstructed width of a fire lane shall be not less than twenty-four feet (24'). This is required for two fire trucks to pass in case of an emergency.

**Turning Radius.** All fire lanes shall have at least a thirty foot (30') inside turning radius and at least a fifty-four foot (54') outside turning radius.

**Grade.** The gradient for a fire lane serving a building not protected throughout by a complete automatic sprinkler system shall not exceed eight percent (8%).

**Bridges and elevated surfaces.** Where a bridge or an elevated surface is part of a fire apparatus access road, the bridge shall be constructed and maintained in accordance with AASHTO Standard Specification for Highway Bridges.

**Gates.** All gates across streets or fire lane access must meet the approval of the Fire Department and Transportation Department. Plans should be submitted to the Fire Department and approved prior to a permit being taken out with the Building Inspections Department. Security gates shall be maintained and an approved means of emergency operation shall be provided and maintained. An Opticom receiver is required at all new installations of security gates across streets or fire lanes at apartments, subdivisions, and other locations as required by the Fire Code Official.

**Turn-Around Areas.** When it is not possible to connect a fire lane at both ends to a dedicated street, an approved turn-around shall be provided. Dead-end fire lanes shall not exceed one hundred fifty feet (150') in length. Illustrations of approved turn-around arrangements are as follows:

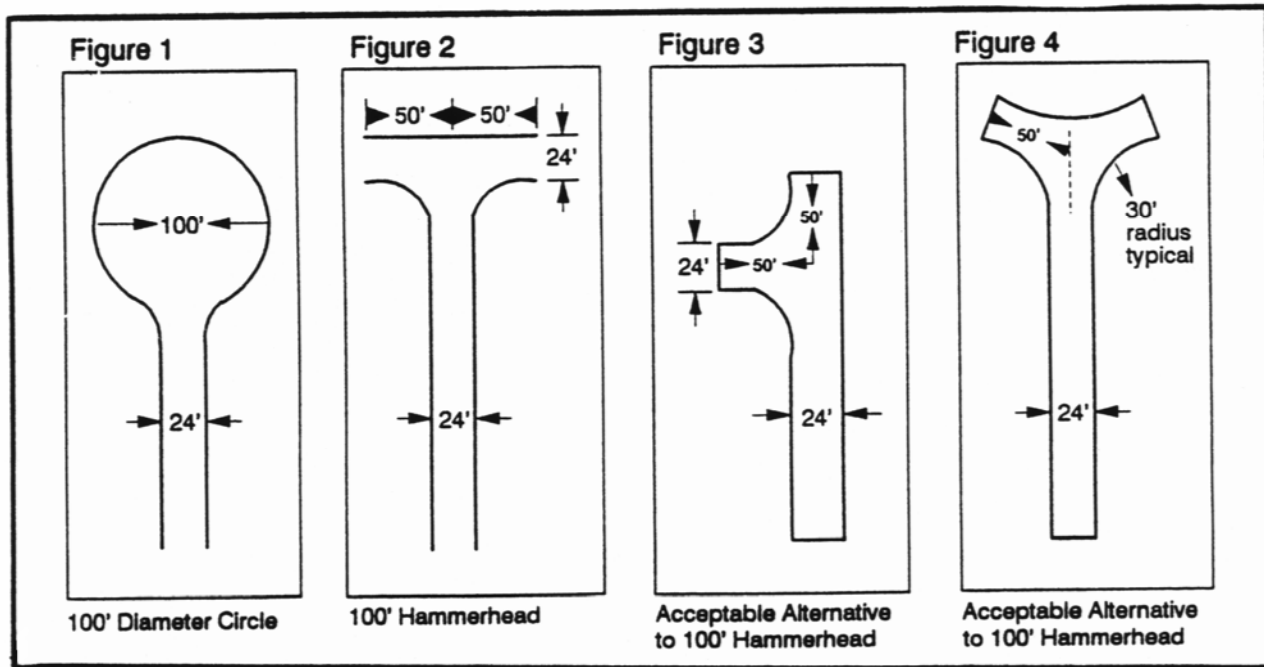

**Obstruction.** The required fire lane width shall not be obstructed by the parking of vehicles, or in any other manner. Speedbumps or other similar obstacles that have the effect of slowing or impeding the response of fire apparatus shall be approved by the Fire Department prior to installation. The following is an example of an acceptable speed bump



**Signs.** If the Chief or authorized representative determines that other means of notice are ineffective to designate a fire lane, signs may be required by written notice to the property owner.

**Striping.** All required fire lanes shall be provided and maintained with fire lane striping that consists of a six inch (6") wide red background stripe with four inch (4") high white letters stating "No Parking, Fire Lane" to be painted upon the red stripe every fifteen feet (15') along the entire length of the fire lane showing the exact boundary of the fire lane. Fire lane markings shall be upon the vertical surface of the curb, unless otherwise approved by the Chief or authorized representative. Illustration of approved fire lane markings is as follows:

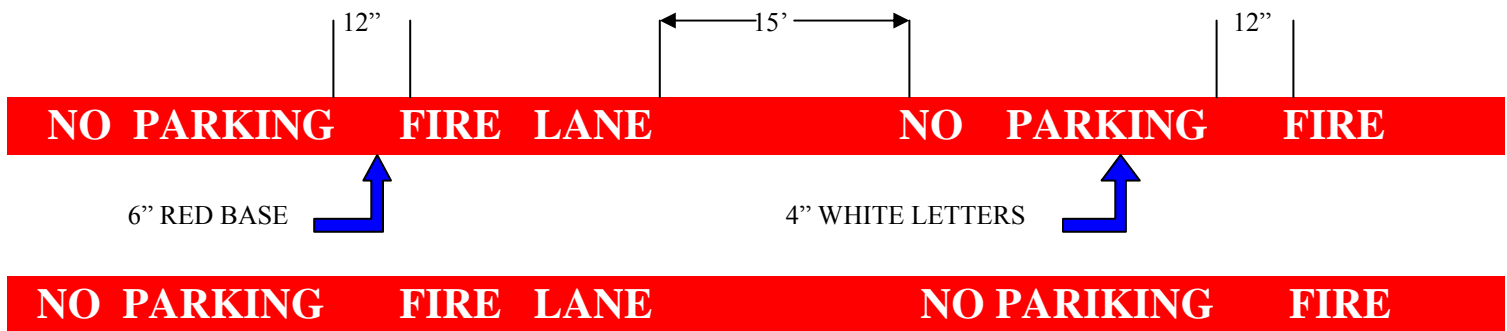

1. **NO PARKING FIRE LANE** TO BE PAINTED ENTIRE LENGTH OF DEDICATED FIRE LANE.
2. FIRE LANE MARKINGS SHALL BE PLACED UPON THE VERTICAL SURFACE OF CURBS.
3. WHERE THE ABOVE FIRE LANE MARKINGS ARE DETERMINED TO BE INADEQUATE IN CONTROLLING TRAFFIC, THE PROPERTY OWNER WILL BE REQUIRED TO POST FIRE LANE SIGNS IN ADDITION TO OTHER MARKINGS.
4. WHEN RESTRIPING, ADDITIONS TO THE EXISTING FIRE LANES ARE NOT ALLOWED WITHOUT PRIOR APPROVAL OF THE FIRE DEPARTMENT.

**Maintenance.** All designated fire lanes shall be maintained and kept in a state of good repair at all times by the owner or person in control of the premises.

**Modifications.** Fire lanes for high-pile combustible storage shall comply with Section 2306.6, 2003 International Fire Code. **[High-piled combustible storage - is combustible materials in closely packed piles or combustible materials on pallets or in racks more than twelve feet (12') in height. For certain special-hazard commodities such as rubber tires, plastics, some flammable liquids, idle pallets, etc., the critical pile height may be as low as six feet (6')].**



**FIRE HYDRANT REQUIREMENTS  
(Section 508, 2003 International Fire Code)**

**Water Supply.** An approved water supply capable of supplying required fire flow for fire protection shall be provided to all premises upon which buildings or portions of buildings are constructed, as set forth in Appendix B of the 2003 International Fire Code. Total Fire Flow requirements depend upon the type of construction and number of square feet.

Fire flow for one- and two-family dwellings which do not exceed 3,600 square feet shall be 1,000 gallons per minute. Fire flow and flow duration for dwellings having a fire area in excess of 3,600 square feet shall not be less than that specified in Appendix B of the 2003 International Fire Code.

An additional fire hydrant will be required for every 2,000 Gallons per Minute (GPM), or portion of fire flow required. (Example: Fire flow of 3,100 g.p.m. is required. Two fire hydrants will be required to supply this amount).

Fire Hydrants shall be required on the same side of the street that the building is being built upon, when the street is designated as a minor arterial or larger. All streets with median strips, regardless of size, shall have required fire hydrants on the same side of the street as the construction.

All fire hydrants required by Code are required to be in place and accepted before any construction continues above the slab. (For Fire Hydrant Specifications see, "Standard Specifications for Water and Sewer Construction" of the City of Arlington Design Manual.

A three foot (3') clear space shall be maintained around the circumference of all fire hydrants.

The location, number and type of fire hydrants connected to a water supply capable of delivering the required fire flow shall be provided as follows:

1. For all one- and two-family residences, excluding townhouses and apartments, fire hydrants shall be installed when any portion of the building protected is in excess of six hundred feet (600'), as measured by the laying distance for fire apparatus hose lines along public street and right-of-way, from the nearest water supply on a public street.

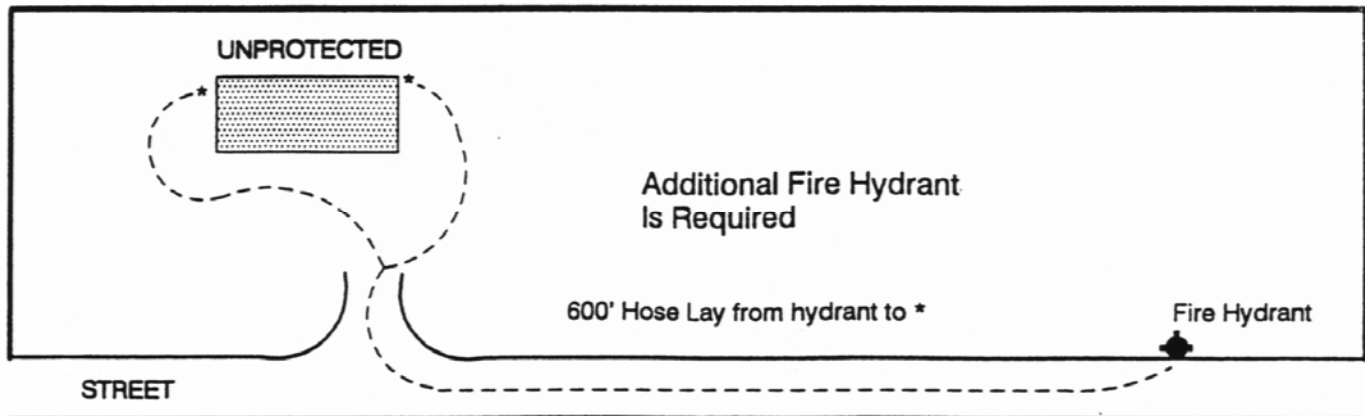

2. For all other land uses except one- and two-family residences, including townhouses and apartments, fire hydrants shall be installed when any portion of the building protected is in excess of five hundred feet (500'), as measured by the laying distance for fire apparatus hose lines along public streets and right-of-way, from the nearest water supply on a public street.

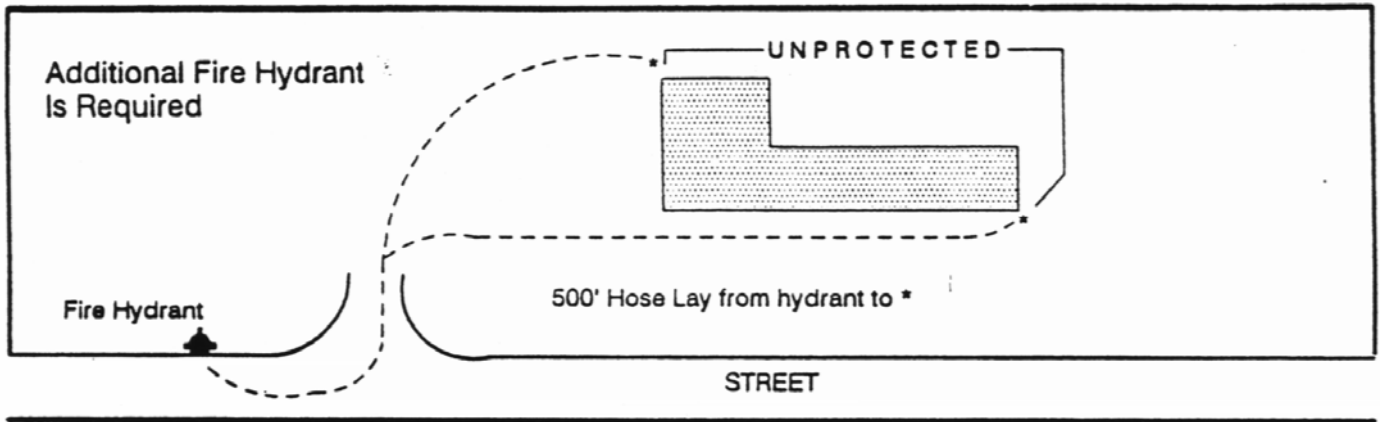

3. A fire hydrant shall be installed no more than two hundred feet (200') from the Fire Department connection for a standpipe or automatic sprinkler system. The Fire Department Connection (FDC) shall be within fifty feet (50') of a firelane or street.

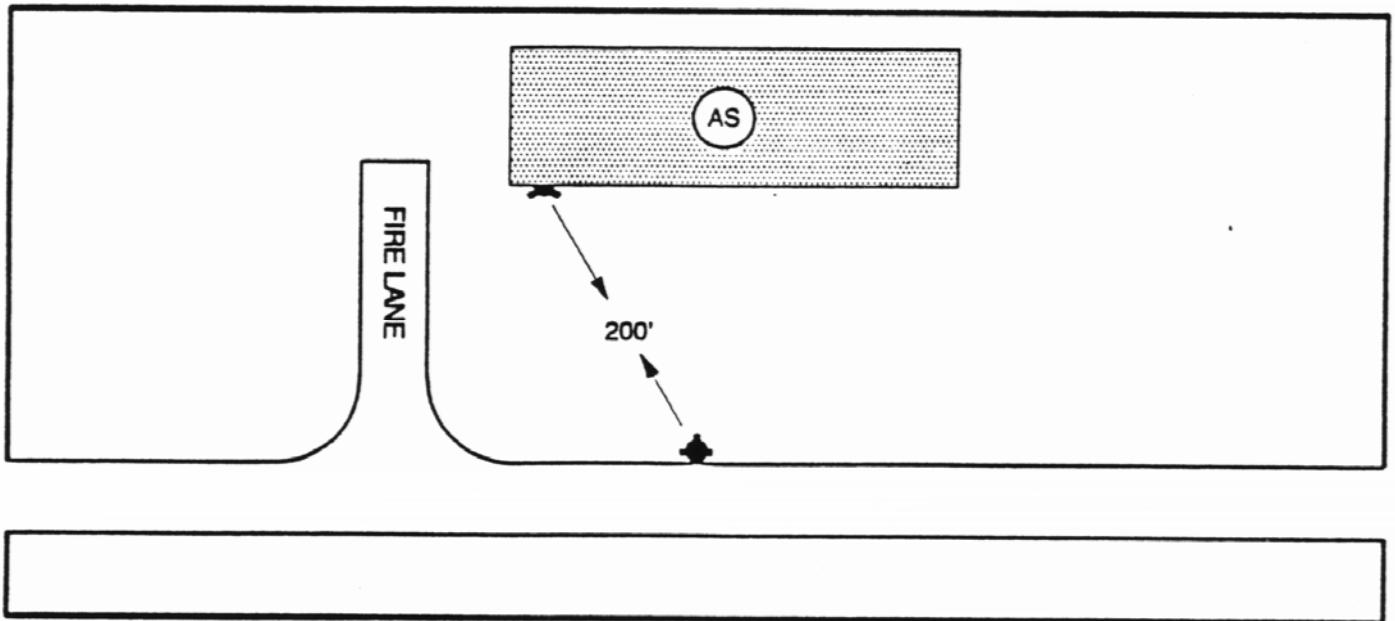



## Water Lines

### Plans

1. Plans for all underground fire protection water lines shall be submitted to the Fire Department for approval and permit. Plans for the tap and the detector check shall be submitted to the City of Arlington Utilities Department.
2. All underground piping, beginning at the point where water is used exclusively for sprinklers, shall be installed by a State certified fire sprinkler firm.
2. All plans shall have the registration number of a State certified firm and RME number with original signature.

### Looped Water Lines

For insurance and reliability, the City prefers and encourages looped water systems for fire hydrant supply lines. Minimum pipe sizing for private looped water lines shall be determined by the City Fire Marshal's office.

### Dead-end Water Lines

As an acceptable alternative to looped fire supply lines, dead-end water lines shall meet the following requirements for minimum pipe sizes:

- a. one hydrant, max. 150 ft. - 6 in.
- b. one hydrant, max. 500 ft. - 8 in.
- c. one hydrant and fire sprinkler supply, max. 150 ft. -8 in.
- d. one hydrant and fire sprinkler supply, max. 500 ft.- 10 in.
- e. two hydrants, maximum 500 feet - 10 inch
- f. three hydrants or two hydrants and fire sprinkler supply - not permitted on dead-end line

## Quantity of Water and Pressure Available

In all cases, it is the responsibility of the property owner or developer to provide adequate water line piping capacity in order to provide the minimum water flow required by the Fire Marshal's Office.

All Fire Hydrants required by code shall be in place and accepted before any construction continues above the slab. (See Standard Specifications for Water & Sewer Construction, Arlington Design Manual)



### **Embedment**

- ◆ Pipe burial depth shall be 42 inches minimum and 60 inches maximum to top of pipe unless otherwise specifically approved.
- ◆ In all cases, clean granular (sand) backfill shall be provided a minimum of six inches (6") below, around and above pipe. In rock, tamped backfill shall be used six inches under and around the pipe and at least two feet above the pipe, per NFPA No. 24.
- ◆ Standard thrust blocks shall be provided at each change in direction and at all tees, plugs, caps, and bends, per NFPA No. 24.
- ◆ All underground mains shall be located with a minimum of two feet (2') clearance between the water line and any other utility or obstruction.

### **Fire Department Connection**

All fire department connections in the City of Arlington shall be 4" Storz connections. The permanent Storz adapter shall be constructed of high strength, light weight, corrosion resistant aluminum alloy capable of being securely attached to standpipe/sprinkler outlets designed for fire department Storz connections. The Storz lug connection shall conform to industry standards. The hose sealing surface shall consist of a machined metal seat to eliminate rubber gaskets, coated to protect against long term exposure to the environment. The Storz connection shall connect to the pipe outlet using National Standard Thread. The connection shall be placed between 30 and 48 inches off grade and angled downward at a 30° angle. A semi-permanent ¼" mesh screen shall be provided inside the Storz adapter, constructed of corrosion resistant metal.

A Knox locking 4" Storz aluminum cap with chain or cable shall be provided for the fire department connection.

For each additional 1500 G.P.M. or fraction thereof required for the fire sprinkler system, an additional 4" Storz connection is required.

### **Wall Hydrants**

**Scope.** Wall hydrants are to be used only where fire lane access is not possible, or where otherwise required by the policy for fire lanes. Wall hydrants are not allowable as an alternative to fire hydrants when fire hydrants are required to be installed. (Contact the Fire Prevention office at 817-459-5536 for further information.)

## **FIRE SPRINKLER SYSTEMS**

Installation and/or changes to fire sprinkler systems require that plans be submitted by a State-licensed fire protection contractor and a permit obtained prior to starting work. Penalties for non-compliance with this requirement will entail triple or quadruple permitting fees. Normal plan review time is 7-10 working days. Make sure you plan ahead and get your plans in early.

The Arlington Fire Department amendments to the 2003 International Fire Code are available on the City of Arlington web site [www.ci.arlington.tx.us/fire](http://www.ci.arlington.tx.us/fire). Some of the local requirements regarding fire sprinkler systems are outlined below:

- 1. All fire sprinkler systems shall be designed with a 10 psi safety factor.**
2. Automatic fire sprinkler systems shall be installed throughout all self-service storage facilities.  
Exception: One-story self-service storage facilities that have no interior corridors, with a one-hour fire barrier separation wall installed between every storage compartment.
3. Automatic fire sprinkler systems shall be installed throughout all buildings over 2 stories.
4. Any building exceeding 12,000 sq. ft. that has a clear height in excess of 12 feet, making it possible to be used for storage in excess of 12 feet, shall be considered to be high-piled storage and shall comply with Chapter 23 of the 2003 International Fire Code, including a fire sprinkler system. When a specific product cannot be identified, a fire protection system shall be installed as for Class IV commodities, to the maximum pile height.
5. Automatic fire sprinkler systems in Group R occupancies of four stories or less may be hydraulically calculated within the dwelling units in accordance with NFPA 13R and as amended by this code. **Sprinkler protection shall be provided throughout, including the means of egress, patios, bathrooms, closets, balconies and attics.**
6. Fire Department connections shall be 4" Storz connections as outlined in amended section 903.3.7.
7. All sprinkler systems consisting of more than 20 heads shall be monitored by a UL Listed Central Station.
8. Sprinkler and Standpipe system water-flow detectors shall be provided for each floor tap to the sprinkler system and shall cause an alarm upon detection of water flow.

**ARLINGTON FIRE DEPARTMENT  
DEVELOPMENT SERVICES  
817-459-5549 OR 817-459-5536**

**FIRE ALARM SYSTEMS**

Installation and/or changes to fire alarm systems require that plans be submitted by a State-licensed fire protection contractor and a permit obtained prior to starting work. Penalties for non-compliance with this requirement will entail triple or quadruple permitting fees. Normal plan review time is 7-10 working days. Make sure you plan ahead and get your plans in early.

The Arlington Fire Department amendments to the 2003 International Fire Code are available on the City of Arlington web site [www.ci.arlington.tx.us/fire](http://www.ci.arlington.tx.us/fire). Some of the local requirements regarding fire alarm systems are outlined below:

1. All fire alarm systems shall be wired Class "A" for all initiating devices with a minimum of six feet separation between supply and return loops. Notification devices may be wired Class "B".
2. The fire alarm control panel shall be installed in an approved location adjacent to the main entrance to the building unless otherwise approved by the Fire Code Official. Annunciators are **not** an acceptable substitute for this requirement.
3. Fire alarm control panel functions such as silence and reset shall be operable without the use of a key or code. The panel cover may be locked, but the function keys cannot require a key or code.
4. All alarm systems new or replacement serving 50 or more alarm initiating devices shall be addressable fire detection systems. Alarm systems serving more than 75 smoke detectors or more than 200 total fire alarm devices shall be analog intelligent addressable fire detection systems.
5. Existing systems shall be brought up to present code when the total system and/or building remodel or expansion initiated after October 1998 exceeds 30% of the building or system. When cumulative building and/or system remodel or expansion exceeds 50%, the building must comply within 18 months of permit application.
6. In hotels and motels, carbon monoxide detectors shall be provided in all locations where there is gas-fired equipment, such as, but not limited to, dryers, HVAC, hot water heaters and fireplaces.
7. Manual pull stations are prohibited in apartment buildings less than 4 stories in height.

**ARLINGTON FIRE DEPARTMENT  
DEVELOPMENT SERVICES  
817-459-5549 OR 817-459-5536**

**ACCESS CONTROL/SPECIAL LOCKING SYSTEMS**

The 2003 International Fire Code as adopted by the City of Arlington states, “**Egress doors shall be readily openable from the egress side without the use of a key or special knowledge or effort.**” This requirement has been in the Uniform Fire and Building Codes since 1973.

**Starting in 1994, the Fire Department has required a permit for the installation of any and all access control/special locking systems/magnetic locks/electric strikes/delayed egress systems. Plans shall be submitted and a permit obtained prior to the installation of any such systems. An acceptance test is required prior to putting the locks in service.**

- Push buttons are not allowed for exiting purposes.
- Motion detectors are only listed as “request to exit,” which means they can only be utilized with an approved UL listed exit device. The exit device must open the door without the use of the motion detector.
- If the door having locks installed is a required rated door, it shall have a latching device.
- The only approved exit device for magnetic locks is panic hardware, touch bar or similar device without the use of any type of push button.
- It can require only one motion (pushing or turning a knob) to exit any door.
- All systems shall be fail safe or else fail secure with a key provided in a Knox box located at the main entrance. If power is lost or for any reason the system fails, it must fail in the unlocked position from the inside.
- Anyone wanting to exit shall be able to do so without any delay. EXCEPTION: Approved, listed delayed egress locks shall be permitted to be installed on doors serving any occupancy except Group A, E and H occupancies in buildings which are equipped throughout with an automatic fire sprinkler system and an approved automatic smoke or heat detection system and which meet all the requirements of the International Fire Code Section 1008.1.8.6 as amended and adopted by the City of Arlington.
- A Knox box is required for Fire Department access.

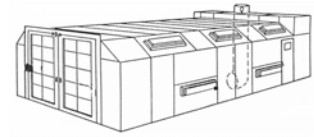

## **SPRAY BOOTH REQUIREMENTS**

### **2003 International Fire Code, Chapter 15 - Application of Flammable Finishes**

- An approved automatic fire extinguishing system shall be provided with fire sprinkler heads or nozzles installed to cover the duct, spray area, and behind the filters. Plans shall be submitted to the Fire Department for review and approval prior to starting work.
- **"NO SMOKING"** signs shall be posted in the spraying area.
- Conspicuous signs with the following warning shall be posted in the vicinity of spraying areas, dipping operations and paint storage rooms:

**NO WELDING.  
THE USE OF WELDING OR CUTTING  
EQUIPMENT IN OR NEAR THIS AREA  
IS DANGEROUS BECAUSE OF FIRE AND  
EXPLOSION HAZARDS.  
WELDING AND CUTTING SHALL BE DONE  
ONLY UNDER THE SUPERVISION OF THE  
PERSON IN CHARGE.**

- Only manufactured booths of steel not less than 0.0478 inch (18 gage) in thickness are acceptable.
- Any paint booth having a floor area of 200 sq. ft. or more shall be served by at least two exits. The area of a paint spray booth shall not exceed 1,500 sq. ft. and shall not exceed 10 percent of the basic area permitted for the major use of the building.
- The interior surfaces must be smooth, without edges, for cleaning purposes.
- No storage is allowed within three (3') feet and no welding within twenty (20') feet of the booth.
- All lights must be behind heat treated or hammered wire glass. (NO PORTABLE LIGHTS.)
- Wiring and electrical fixtures inside the booth must be designed and utilize devices UL Listed for Class 1, Division 1 locations.
- Air velocity through the booth during spraying operation shall be not less than one hundred (100) linear feet per minute.
- Approved UL Listed filters shall be used.
- Space heaters or hot surfaces are prohibited inside spray booths.
- No electrical equipment is allowed in booth unless it is Listed by UL for Class 1, Division 1 locations and located to avoid deposits of combustible residues.

- All metal parts of the spray booth, exhaust ducts, or flammable liquid piping system shall be properly electrically grounded.
- Electrical equipment shall be interlocked with the ventilation equipment so that the equipment cannot be operated unless the vent fans are on.
- Each spray booth shall have an exhaust duct discharging to the building exterior (through the roof is preferred, through the wall is acceptable, if not a fire hazard or a nuisance to neighbors).
- Exhaust fan motors shall not be placed inside booths or ducts. Fan blades shall be nonferrous or non-sparking or the casing shall be lined with such material. Fan motor shall be UL Listed for Class 1, Division 1 locations.
- Fan belts and pulleys within the duct or booth shall be tightly enclosed.
- The discharge point for exhaust ducts shall be at least 30 feet from the property line; 10 feet from openings into the building; 6 feet from exterior walls and roofs; 30 feet from combustible walls or openings into the building which are in the direction of the exhaust discharge; and 10 feet above adjoining grade.
- Exhausted air shall not be re-circulated.
- The exhaust air intake ducts shall be extended to pick up flammable vapors within six inches (6") of the floor.

All of the above requirements must be approved by the Fire Prevention Division prior to and after construction.

**PLANS SHALL BE SUBMITTED TO THE BUILDING INSPECTIONS DEPARTMENT TO INSTALL THE BOOTH. WHEN THE FIRE DEPARTMENT HAS REVIEWED THE BUILDING PERMIT, PLANS FOR THE FIRE EXTINGUISHING SYSTEM MAY THEN BE SUBMITTED TO THE FIRE PLANS REVIEW SECTION FOR THE FIRE EXTINGUISHING SYSTEM PERMIT.**

### **INSIDE FLAMMABLE LIQUIDS STORAGE REQUIREMENTS 2003 International Fire Code, Chapter 34**

- No storage near exits.
- Empty containers are considered to be full.
- Where the quantity of flammable liquids in five gallon and smaller containers (other than original sealed containers) **exceeds a total of ten (10) gallons**, it shall be stored in an Underwriters Laboratories Listed/Factory Mutual approved Flammable Liquids Storage Cabinet. Quantities greater than those listed in 2003 IFC Table 2703.1.1(1) shall be stored inside a storage and mixing room designed in accordance with the International Building Code and the International Fire Code.

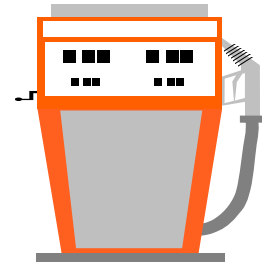

**REQUIREMENTS FOR NEW UNDERGROUND FLAMMABLE AND COMBUSTIBLE LIQUIDS TANK AND LINE INSTALLATIONS**

1. Texas Commission on Environmental Quality (TCEQ) shall be provided with 30 days advance notice. Their phone number is 817-588-5800.
2. Installation plans and specifications shall be approved by Fire Department and a permit issued.
3. Tanks must be more than three feet (3') from a building or property line with more than one foot (1') shell to shell.
4. Air test, 3-5 psi for 30 minutes prior to tank being placed in pit and witnessed by the Fire Department.
5. Soap bubble test of entire tank witnessed.
6. Locations subject to flooding, locations with flood plain and holes where a high water table is present: tank(s) shall be properly anchored.
7. Clean backfill must be available; pit will be free of rocks, trash, and debris.
8. Tank serial numbers and UL Listing number is required from each tank.
9. Approved sampling tubes of a minimum 6 inches in diameter shall be installed in the backfill material of each underground flammable or combustible liquid storage tank. The tubes shall extend from a point 12 inches below the average grade of the excavation to ground level and shall be provided with suitable surface access caps. Each tank site shall provide a sampling sump at the corners of the excavation with a minimum of 4 sumps. Sampling tubes shall be placed in the product line excavation within 10 feet of the tank excavation and one every 50 feet routed along product lines towards the dispensers, a minimum of two are required. (Sampling tubes shall be well screen with bottom and top cap).
10. Backfill placed (all openings and fittings remain exposed), per manufactures recommendations.
11. Air test of all tanks, including waste oil tanks of 3-5 psi for 30 minutes with all fittings soap bubble tested.
12. All piping, valves are UL Listed or of an approved type.
13. Approved UL Listed flex joints are installed:
  - where piping leaves the tank;
  - where piping leaves the dispensing island;
  - other locations where subject to thermal expansion or differential movements.
14. Piping is supported and separated to prevent damage from vibration.
15. Pressure test of lines, including oil tank lines and vent piping, witnessed for ten minutes, all joints and fittings are soap bubble tested. **Tanks are not under pressure from lines.**

16. All metallic pipes must be properly wrapped (with 50% overlay), properly coated, and cathodically protected to prevent corrosion or galvanic action.
17. Tanks will have a minimum cover of: two feet (2') of earth, or one foot (1') of earth plus four inches (4") of reinforced concrete, or if subject to vehicular traffic, three feet (3') of earth, or eighteen inches (18") of well tamped earth plus four inches of reinforced concrete, or eight inches (8") of asphaltic concrete, which in all cases extends one foot (1') beyond the outline of the tanks.
18. Location of emergency pump shut off(s) must be outside of building and within 100 feet but not less than 20 feet from any dispenser.
19. Dispenser(s) shall be protected against physical damage from vehicles by mounting on a concrete island a minimum of six inches (6") in height or by other approved methods.
20. All dispensers shall be located at least ten feet (10') from a property line. The nozzle shall be at least five feet (5') from any building opening with the hose line extended.
21. All dispensers shall be visible from the attendant's location.
22. Provisions shall be made to prevent fuel spills from traveling into buildings (driveway, slope, curbs, etc.).
23. Emergency Pump shut off shall be located outside of building within 100 feet of, but not less than 20 feet from, dispensers.
24. Required signage:
  - "NO SMOKING/STOP ENGINE/NO FILLING OF UNAPPROVED CONTAINERS", conspicuously posted within sight of each customer.
  - The manually operated pump master switch is clearly labeled, "EMERGENCY PUMP SHUT OFF".
  - Building address is posted to be plainly visible and legible from the street with numerals in contrast to their background (minimum of six inches (6") in height).
  - Emergency telephone number (911) of the Fire Department posted.
25. All dispensers are properly secured to islands in an approved manner independent of the piping and conduit. Approved emergency shut off valves (impact valves) incorporating a fusible link designed to close automatically in the event of fire or impact are properly installed with the shear section of the valve mounted flush with the surface of the concrete island for each dispenser (plus or minus 1/4 inch).
26. Approved leak detectors are installed to provide an indication if the piping and dispensers are not essentially liquid tight.
27. Vent piping terminates outside building at least twelve feet (12') above grade and at least five feet (5') from any building opening or property line. UL Listed flame arresters installed at top of each vent line.
28. Management of station is required to maintain (available for Fire Department review):
  - Accurate daily inventory records (log) reconciled each day;
  - A record of annual leak testing device test;
  - Report all leaks or spills immediately to the Fire Department.
29. Fire extinguishers with a minimum rating of 4A40BC shall be properly mounted where they will be readily visible and immediately available, in the event of fire, within seventy-five feet (75') of every dispenser and tank fill pipe opening.





**PERMIT REQUIREMENTS  
(FLAMMABLE STORAGE TANKS/LINES)**

1. Three sets of plans showing location of tanks and/or lines with distance to building and property line and extent of work.
2. If pulling tank, copy of letter from Texas Commission on Environmental Quality.
3. Copy of Texas Commission on Environmental Quality license.
4. Permit fee is \$300.00 per location to install or test a tank system. \$100.00 for lines only or installation of a single waste oil tank.
5. Permit fee for pulling a tank is \$100.00 per tank.

Test conducted on new tank/line installations (which have never contained petroleum products) shall be as follows: tanks will be pneumatically tested at five psi for thirty minutes before and after the tank is installed. Lines will be tested pneumatically at 1.1 times the normal working pressure or hydrostatically tested at 1.5 times the normal working pressure. A soap bubble test of all fittings will also be conducted at this time. These tests shall be witnessed by a representative of the Fire Marshal's office.

Tests conducted on existing tank/line installations shall be an approved precision type test. A permit is required prior to conducting the test. The test may be performed using the product in the tank. If the test indicates the tank is leaking, the product must be immediately removed. The Chief may require that the test be conducted in his or his representative presence. When possible the Fire Marshal's office must be notified twenty four (24) hours prior to testing existing installations and a copy of the field test results should be left at the site upon completion of the test. The Fire Department should be advised of the test results (phone 817-543-5903, after 5:00 p.m.) with written results to be provided within ten (10) days.

**Concerning all new and existing underground storage tank installations for flammable or combustible liquids, including waste oil storage tanks and lines, it is the owner or operator's responsibility to insure that an approved test is conducted at least once every five years (this test shall be conducted by an approved competent contractor and a permit is required), and the Fire Marshal's office shall be contacted twenty- four (24) hours prior to the test in order to arrange for an inspector to witness the test.**

A copy of the test results, with an indication that the tank and lines are either tight or leaking, shall be provided to the Fire Marshal's office within ten (10) days of the test. An inconclusive test will be considered as an unsatisfactory test and the test must be repeated or all product removed from the tanks.

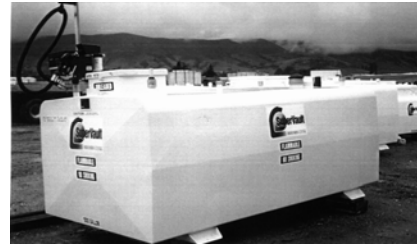

## **ABOVEGROUND OUTSIDE WASTE OIL, GASOLINE OR DIESEL STORAGE TANKS**

The City of Arlington may allow aboveground storage tanks for flammable or combustible waste oil in a listed special enclosure in accordance with Chapter 34 of the 2003 International Fire Code.

1. Each tank location shall be approved by the Fire Marshal's Office.
2. **Plans shall be submitted for review and approval prior to installing any equipment and a permit shall be obtained from the Fire Marshals Office prior to starting work. Phone 817-459-5549 or 817-459-5536 for additional information.**
3. The installation plans shall include the design, details, and specifications of the following:
  - 3.1 Quantities and types of liquids to be stored;
  - 3.2 Distances from tanks and dispensers to property lines and buildings;
  - 3.3 Vehicle access;
  - 3.4 Fire appliances;
  - 3.5 Vehicle impact protection;
  - 3.6 Protected aboveground tanks and their supports;
  - 3.7 Method of storage and dispensing;
  - 3.8 Overfill prevention, spill containment, vents, vapor recovery, dispensers, and other equipment and accessories;
  - 3.9 Seismic design in accordance with the Building Code;
  - 3.10 Secondary containment;
  - 3.11 Venting;
  - 3.12 Piping;
  - 3.13 Electrical systems; and
  - 3.14 Emergency controls.
4. Each tank shall rest on a concrete foundation of sufficient design and construction to minimize the possibility of uneven settling of the tank.
6. Provide probe tube in secondary containment to allow for leak detection monitoring.
7. Leak detection devices and equipment shall be tested annually.

8. Provide either a system of piping with a Listed Pneumatic pump or a minimum five gallon capacity container with a removable steel debris screen at fill opening. In lieu of the above, a check valve may be installed at the fill opening to prevent vapors from escaping or entering the building via the piping system.
9. Tanks to be a minimum of three feet (5') from building.
10. Tank shall be within 500' hoselay of a fire hydrant.
11. When required, fencing shall be provided for protection from vandals as well as screening for flammable and combustible liquids (installation must not be in conflict with landscape ordinance).
12. Each tank shall have a factory installed liquid level indicating gauge and emergency pressure relief vent.
13. A minimum 1¼-inch diameter vent line shall terminate twelve feet (12') above grade.
14. All tanks shall be properly labeled as to their contents and standard "NO SMOKING/STOP ENGINE and NO FILLING OF UNAPPROVED CONTAINERS" signage shall be provided.
15. A portable fire extinguisher with a minimum rating of 4A60BC shall be properly mounted adjacent to the tank.
16. Each tank shall be provided with an automatic fill shut-off device capable of stopping further filling when the level in the tank reaches 90 percent of tank capacity.
17. Vehicular protection shall be provided when tank is subject to vehicular damage. For automobiles, minimum four inch (4") concrete filled steel ballads, at least four foot (4') on center, three feet (3') high with two foot (2') burial will be adequate. Where truck traffic is present, ballads shall be of six inch (6") diameter.
18. A five (5)-psi/30 minute air test shall be witnessed by the Fire Department prior to placing any product in the tank.
19. Maximum tank size shall be limited to 12,000 gallons individual or 48,000 gallons aggregate capacity.

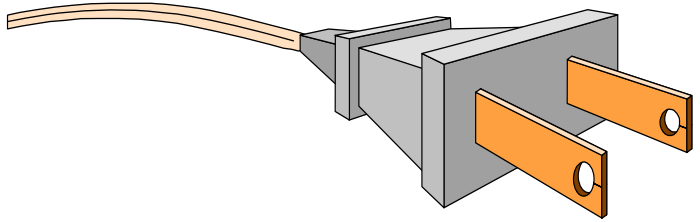

## **EXTENSION CORDS** **(Section 605, 2003 International Fire Code)**

The National Electrical Code allows for a maximum cord length of eight feet (8') on an appliance/fixture (**this does not include an extension cord**). The appliance/fixture cord should plug directly into an approved receptacle (wall, floor, or ceiling outlet). Extension cords shall be listed by an approved testing laboratory. (Underwriters, Factory Mutual, etc.)

**The International Fire Code allows for the use of a properly sized extension cord when it is used with a portable appliance/fixture (such as a vacuum cleaner, portable radio, calculator, etc.).** Only one appliance/fixture should be plugged into each extension cord. An extension cord that has a multi-plug end may be approved providing that it is not likely to be overloaded. The extension cord must be of the grounded type when serving grounded appliances/fixtures. Extension cords shall not be affixed to the structure with staples, nails, wire, tape, ties, etc., extended through walls (hole through wall so the cord can be plugged into an outlet on the other side of the wall), ceiling (run up into the space above lay-in ceilings, etc.), floors, under doors, mats, floor coverings (except rubber or plastic thresholds designed for this purpose), or not be subjected to environmental damage or physical impact. Extension cords with splices shall not be permitted.

Cords should be visible or accessible along their entire length so that any damage or deterioration can be easily detected (except where protected along the floor by a rubber or plastic threshold designed for this purpose).

While it is intended to allow the use of some extension cords on a limited basis, extension cords shall not be used as a substitute for the structure's permanent wiring (wall, floor, or ceiling outlets).

The International Fire Code defines a multi-plug adapter as "any device that plugs into a receptacle and allows that receptacle to supply power to more appliances or fixtures than that for which it was originally designed, such as cube adapters, strip plugs, and multi-plug extension cords." **Only Underwriters Laboratories Listed adapters may be used.**

**UL listed Multi-plug adapters are available that incorporate their own 15 amp circuit breaker or fuse. These adapters may be approved for continuous use (except that more than one appliance may be serviced by one adapter). These "approved" multi-plug adapters shall plug directly into the structure's wiring. Multi-plug adapters shall not be serviced by an extension cord or by other multi-plug adapters.**



**OUTDOOR BURNING  
(Section 307, 2003 International Fire Code)**

Outdoor burning within Arlington City limits is restricted. The following should help clarify the requirements when outside burning is permitted.

**TRENCH BURNING ONLY IS PERMITTED**

How to obtain a burn permit:

1. Submit a plan of the burn site to the Fire Prevention Division along with a letter of approval from the Texas Commission on Environmental Quality. Specify location for burn trenches with "X" on the plan provided.
2. An on-site inspection will be made by a Fire Prevention Inspector.
3. When all criteria listed are met satisfactorily a permit may then be issued. *Permit fee \$1,000.00.*

**BURN PERMIT REQUIREMENTS**

- \* Location of burning must be approved by the Arlington Fire Department and be 1,000 feet from any structure or public way.
- \* A clear buffer zone of 50 feet must be maintained around all burn areas of which a portion may be required to be graded earth at the discretion of the Chief.
- \* Wind speed must be between 5 mph and 16 mph inclusive.
- \* Local relative humidity must be greater than 35%.
- \* All burning must be done in daylight hours. Burning may be started after dawn and **must be extinguished one half hour before dark.**
- \* Notification and approval from the Texas Commission on Environmental Quality must be accomplished. Their phone number is 817-588-5800.
- \* Burning is not allowed on OZONE ALERT days or on days when there is a burning ban issued by Tarrant County. Call the Arlington Fire Prevention Division at 817-459-5542 to determine if it is an Ozone Alert day.
- \* Arlington Fire Department Dispatcher shall be called and notified before burning is started and after burning is extinguished at the end of the day. (817-543-5903)
- \* **The Chief reserves the right to halt burning at any time he deems necessary to prevent danger or nuisance to any person or property. (If three complaints are received burning will be halted.)**
- \*\* *The current local meteorological data is to be obtained from the TV weather channel in Arlington, Texas.*



## **FIREWORKS**

**It shall be unlawful for any person to manufacture, possess, store, to offer for sale, expose for sale, sell at retail or wholesale, or use or explode any fireworks within the city limits of Arlington.**

EXCEPTION: Properly permitted supervised public displays of fireworks by an approved pyrotechnic operator.

The 2003 International Fire Code defines fireworks as: Any composition or device for the purpose of producing a visible or an audible effect for entertainment purposes by combustion, deflagration, or detonation that meets the definition of 1.4G fireworks or 1.3G fireworks as set forth herein.

**Fireworks, 1.4G.** (Formerly known as Class C, Common Fireworks.) Small fireworks devices containing restricted amounts of pyrotechnic composition designed primarily to produce visible or audible effects by combustion.

**Fireworks, 1.3G.** (Formerly Class B, Special Fireworks.) Large fireworks devices, which are explosive materials, intended for use in fireworks displays and designed to produce audible or visible effects by combustion, deflagration, or detonation. Such 1.3 G fireworks include, but are not limited to, firecrackers containing more than 130 milligrams (2 grains) of explosive composition, aerial shells containing more than 40 grams of pyrotechnic composition and other display pieces which exceed the limits for classification as 1.4G fireworks.

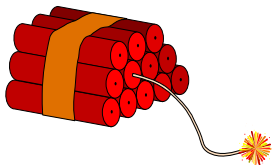

## **EXPLOSIVE MATERIALS (Chapter 33, 2003 International Fire Code)**

A permit is required and will be issued upon proof of no less than a \$1,000,000.00 security bond or liability insurance of same amount for purpose of payment of all damages to persons or property resulting from loading or firing of any explosive materials.

The location(s) shall be approved by the Chief prior to transporting, use, or handling of explosive materials within city limits. The company handling these materials shall apply to the Fire Prevention Division for a permit to use explosive materials. A permit will be issued for a maximum of 30 days.

Explosive materials shall not be left on-site overnight. Nor shall there be any detonations between the hours of sunset and sunrise.

Storage of explosives on-site either in a magazine or truck shall be placarded with the appropriate classification (i.e., explosive A, B, or C). No permit will be issued to keep or store any explosives at any place of habitation or within 100 feet of any place of habitation.

The Chief may require that any operations permitted be supervised at any or all times by employees of the Fire Department to ensure all safety and fire regulations are observed.

The transporting vehicle shall have a fire extinguisher with a rating of no less than 2A10BC, be placarded, be clean, and be free of grease and oil; the driver shall not smoke, carry matches or any other flame producing device, or any firearm, nor shall he drive, load, or unload in a careless or reckless manner.



### **FLAMMABLE AND COMBUSTIBLE DECORATIONS**

The 2003 International Fire Code, Section 805.1 require all drapes, hangings, curtains, drops, , cotton batting, either natural, artificial or manufactured, straw dry vines, leaves, trees, or other highly flammable materials shall not be used for decorative purposes in show windows or other parts of commercial, industrial, or institutional occupancies unless made flame retardant. Exit doors, exit lights, fire alarm pull stations, standpipe hose cabinets, and fire extinguisher locations shall not be concealed or obstructed by any decorative material.



**CHRISTMAS TREES  
(Section 804, 2003 International Fire Code)**

In occupancies where resin-bearing cut Christmas trees are used, the following guidelines shall be followed: **(Shall not be allowed in Group A, E, M, or R-1 Occupancies that are not sprinkled. Not allowed in R-2 Occupancies.)**

- Must be placed in a supportive stand
- The base of the tree trunk should be provided with a fresh angle cut before being placed in water.
- The tree is required to be flame-retarded.
- The tree shall bear a tag stating date of placement in the public building, type of flame-retardant treatment used, name of the person who applied the flame retardant and the name of the person affixing the tag.
- The tree shall always be in water and removed if needles begin falling due to dryness.
- The tree shall not obstruct any fire extinguisher or fire alarm system manual pull station.
- The tree shall not be placed adjacent to exits or where an exit could be obstructed by a burning tree.
- No open flames or candles shall be used on or near the tree.
- A UL Listed multi-outlet device with a built-in circuit breaker should be used to provide power for the lights if use of an extension cord is necessary. The portable outlet shall be plugged directly into a wall or floor receptacle.
- Only UL Listed light sets will be allowed on Christmas trees.

**\*\*The use of live trees, even if treated to be fire retardant, is not recommended in buildings that are not protected by automatic sprinkler systems.**





### **HAUNTED HOUSE GUIDELINES (2003 IFC)**

In order to obtain a temporary (30 days or less) haunted house Certificate of Occupancy (C.O.), the following requirements must be met prior to Fire Department approval and issuance of the Certificate of Occupancy.

**All haunted houses must also be approved by Building Inspections. All new electrical, plumbing, or air conditioning work performed must meet the current codes as adopted by the City of Arlington. Wiring shall be installed by a licensed electrician. Permits and inspections are required and can be obtained by contacting Building Inspections.**

1. Three complete sets of floor plans shall be submitted to the Fire Marshal's office for review **not less than five (5) working days prior** to the time that the haunted house is to open. These plans shall consist of:
  - A. A complete floor plan showing the route of the haunted house tour;
  - B. The exit routes from within the rooms, passage ways, etc., to a place of safe discharge on a public way;
  - C. An emergency exit must be provided approximately every 100 feet in all temporary passages or corridors and must be provided with illuminated exit lights.
  - D. Location of fire extinguishers (2A10BC)

Note: If the Haunted house is inside of a tent then tent guidelines must be followed.

2. During the hours of operation, required exits may not be locked and each door shall be operable from the interior of the structure without the use of a key or any special knowledge or effort; all exits must open in the direction of egress or be locked in an open position during the hours of operation.
  - A. Exit signs must function properly and be visible from all areas.
  - B. All exits, hallways, and aisles leading from buildings are to be kept clear and unobstructed at all times.
  - C. There shall be no obstruction blocking exit doors from the outside of any building, such as autos parked in doorways or barricades across sidewalks.
  - D. No curtains, drapes, or decorations shall be hung in such a manner as to cover any exit signs.
3. A Certificate of Occupancy will be required; phone 817-459-5528 or 817-459-5542 for information.
4. Approved fire extinguishers (minimum size 2A10BC) one per each 3,000 gross square feet of floor area, are required to be placed within 75 feet travel distance from any point.
5. No open flames will be allowed, such as candles or torches.
6. Actuation of any smoke detection device shall sound an alarm and cause illumination to increase to that required by the Building Code.

7. Require one UL Listed smoke detector for every 900 square feet or fraction thereof - a minimum of two smoke detectors is required. Installation shall be in accordance with the manufacturer's installation instructions and NFPA No. 72 (1996), Standard on Automatic Fire Detectors.
8. All curtains, walls, tunnels, sawdust, shavings, table skirts, drapes, and decorations must be constructed of fire retardant material or treated with an approved flame retardant solution, per NFPA No. 701 (1989). **Treatment shall be renewed as often as may be necessary to maintain the flame retardant effect. Plastic sheeting is not allowed.** Flame retardant solutions may be obtained by contacting local decoration contractors and flame-proofing companies listed in the yellow pages. Approval by the Fire Marshal's office will be required.

**NOTE: Materials such as (man-made fibers) polyesters, rayon, and nylon are difficult to treat to obtain fire retardancy.**

9. "NO SMOKING - BY ORDER OF FIRE MARSHAL" signs are required. Provide sand filled bucket or container for use as ashtray.
10. All employees shall be schooled in:
  - A. Emergency exiting procedures, including location of light switches.
  - B. Locations and operation of the manual shut off for the air conditioning units.
  - C. Require extra flashlights at entrance/exit in case power goes out to lights (**unless Emergency Lighting is in place**).
11. Truck trailers or other similar types of containers that would create a vault like atmosphere when subjected to fire, smoke, or toxic fumes may not be used for haunted houses.
12. Each tour shall be limited to 20 persons and have a guide. Each guide must have an operable flashlight.
13. If conditions are created which present a hazard to life, a standby fire watch will be required at your expense.
14. Ceiling level must be at least seven feet (7') including all areas where the public will walk.
15. Exit signs are required at all exits and emergency exits. Exit signs do not have to be internally lit but must be illuminated.
16. No dead-end corridors 25' or more.

Final approval will be subject to conducting an inspection of the completed work, prior to occupancy. For additional information, phone 817-459-5528.



## **KEY BOX AND LOCKS**

**Scope** - Key boxes are required for all buildings with fire sprinkler systems and/or fire alarm systems and may be required when access to or within a structure or area is unduly difficult because of secured openings or where immediate access is necessary for life saving or firefighting purposes. Boxes may also be installed on a voluntary basis.

**Box Construction** - All boxes must be manufactured by the Knox Company. Any style of Knox Box offered by the Knox Company shall be acceptable, provided it is of heavy duty or extra heavy duty construction. No other types of key boxes or additional keys will be acceptable. "Recessed Mount" style boxes are recommended.

- Boxes shall be installed on all new construction with a fire sprinkler or fire alarm system.
- It is recommended, but not required, that on existing buildings with a fire sprinkler or fire alarm system, a Knox Box be installed.
- Opticom receivers, boxes, padlocks, or key operated switches shall be installed on chains, gates, or any type access control to the fire lanes and all such access control devices shall be approved by the Fire Marshal's Office.
- A fire department alert decal shall be mounted on or adjacent to each building entry door.

**Supervision** - It is recommended that all key boxes be supervised by an electronic security system to detect possible unauthorized entry. All of the acceptable models of Knox Boxes are available with alarm tamper switches.

**Entry Keys** - Keys necessary for building entry shall be placed inside the key box and shall be adequately labeled. Keys shall be limited to one set and shall be attached to a substantially constructed key ring.

**Liability** - The City of Arlington accepts no liability for security breeches in the use of this key box system. This system appears to be the best system available to address the complicated problem of building access.

**Purchasing** - All devices shall be purchased, installed, and maintained by the building owner. Complete purchase information can be obtained by contacting the Fire Prevention Division.

**Securing The Box** - After the Knox device is installed, contact the Fire Prevention Office (817-459-5539) to make arrangements to lock the Knox Box, padlock, or key switch.

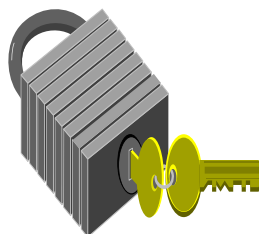



**INSPECTION AND MAINTENANCE OF PORTABLE FIRE  
EXTINGUISHERS, NUMBER OF EXTINGUISHERS  
REQUIRED AND MOUNTING  
(NFPA 10)**

**Responsibility**

The owner or occupant of a property in which extinguishers are located shall be responsible for ensuring that the inspection, maintenance, and recharging of these extinguishers is accomplished as required.

**Inspection**

Inspection is a "quick check" that an extinguisher is available and will operate. It is intended to give reasonable assurance that the extinguisher is fully charged and operable. This is done by seeing that it is in its designated place, that it has not been actuated or tampered with, and that there is no obvious physical damage or condition to prevent operating. If present, the pressure gauge reading or indicator should be in the operable range or position.

Extinguishers shall be inspected when initially placed in-service and thereafter at approximately 30 day intervals. Extinguishers shall be inspected at more frequent intervals when circumstances require.

The owner or occupant of the property where the extinguishers are located may conduct his own extinguisher inspections at the approximate 30 day interval.

The Fire Department Inspector shall accomplish an inspection or "quick check" of each extinguisher required at the property during the initial inspection visit of each recurring fire inspection he conducts at the property. This extinguisher inspection will also verify for the Fire Department Inspector that the required annual maintenance was accomplished and documents with an appropriate tag. (See **MAINTENANCE** below)

**Maintenance**

Maintenance is a "thorough check" of the extinguisher. It is intended to give maximum assurance that an extinguisher will operate effectively and safely. It includes a thorough examination and any necessary repair or replacement. It will normally reveal the need for hydrostatic testing. The thorough examination covers the three basic elements of an extinguisher:

1. mechanical parts
2. extinguishing agent
3. expelling means

**The required annual maintenance of portable fire extinguishers must be performed by trained extinguisher service technicians** having available the appropriate servicing manual(s), the proper types of tools, recharge materials, lubricants, and manufacturer's recommended replacement parts. These extinguisher service technicians shall be licensed by the State Fire Marshal's office and upon request, a copy of the license shall be provided for the Arlington Fire Department.

## NUMBER OF FIRE EXTINGUISHERS REQUIRED

The number and type of portable fire extinguishers used shall be approved by the Fire Department. Extinguishers shall be Underwriters Laboratories Listed.

Occupancy Type	Minimum Size	Maximum Area Per Extinguisher/Travel Distance
office, church classroom, etc.	2A10BC	3,000 sq. ft. /75 ft.
High-rise Office Buildings	2A10BC	*mounted in common corridors and exitways with maximum travel distance in corridor of 75 ft.
retail non-combustible storage, etc.	2A10BC	3,000 sq. ft./75 ft.
service stations	4A40BC	3,000 sq. ft. /50 ft.
warehouses with combustible storage	4A40BC	3,000 sq. ft. /75 ft.
storage or processes utilizing flammable/ combustible liquids	4A40BC	1,000 sq. ft. /30 ft.
restaurant kitchens	“K”	1,000 sq. ft. /30 ft.

\*normally extinguishers mounted in the corridors adjacent to exits will be adequate in sprinkled office buildings.

## EXTINGUISHER MOUNTING

Extinguishers shall be conspicuously located where they will be readily accessible and immediately available in the event of fire. Preferably they shall be located along normal paths of travel, including exits from an area.

Extinguishers shall be properly mounted at least four inches (4") from the floor and not more than five feet (5') above the floor.

In areas where aesthetics is a concern, extinguishers may be located in an approved fire extinguisher cabinet. The cabinet must be marked and readily identifiable as a fire extinguisher cabinet. Where locked cabinets are permitted (with Fire Marshal's Office approval obtained in advance) an approved tool shall be attached to the cabinet for access.

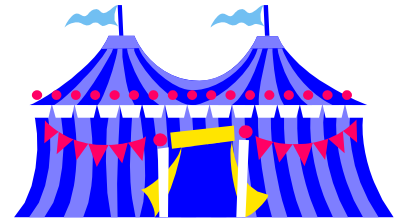

**TENTS & CANOPIES  
(ARTICLE 24, 2003 INTERNATIONAL FIRE CODE)**

Tents having an area in excess of 200 square feet and canopies in excess of 400 square feet shall comply with the following requirements:

1. An Outdoor Festival permit will be required from Building Inspections.
2. The tent or canopy shall be of flame-retardant material or shall be made fire retardant.
3. A flame-retardant certificate shall accompany the application for permit, and one copy must be retained on the premises indicating the following:
  - a. Identification of tent, canopy or temporary membrane structure, size and fabric type.
  - b. Date that tent, canopy or temporary membrane structure and other flammable materials were last treated with flame-retardant solution.
  - c. Trade name and type of solution utilized in flame-retardant treatment.
  - d. Name of persons and firm treating materials.
4. Site Plan showing location of tent in regard to fire lane.

**Sources of Ignition**

Smoking shall not be permitted in tents, canopies and temporary membrane structures or in adjacent areas where hay, straw, sawdust or any other combustible materials are stored or used.

Fireworks, open flames, and devices emitting flames or fire or creating a glow capable of igniting combustible materials shall not be used in or adjacent to a tent, canopy or temporary membrane structure.

**Heating and Cooking Equipment**

Heating and cooking equipment must be in accordance with the Mechanical Code. Location of equipment must not be located within 10 feet of exits, aisles, passageways or combustible materials.

Gas-, solid- and liquid-fuel-burning cooking equipment located outside of a tent, canopy or temporary membrane structure shall not be located within 30 feet of the structure.

Gas, solid and liquid-fuel-burning equipment shall be vented to the outside air by means of a flue or vent approved for use with type of equipment used and such a manner that no portion of the tent, canopy or temporary membrane structure is within 12 inches of the flue or vent. Vents shall be equipped with spark arrestors having openings no larger than 1/4 inch wire mesh.

## **Portable Fire Extinguishers**

Fire extinguishers and other fire protection appliances shall be provided in every tent, canopy and temporary membrane structure as follows:

Minimum fire-extinguisher coverage shall be provided in every tent, canopy and temporary membrane structures as follows:

1. 200 to 500 square feet of floor area: One 2A10BC extinguisher;
2. 501 to 1,000 square feet of floor area: Two 2A10BC extinguishers;
3. Each additional 2,000 square feet of floor area or fraction thereof: One 2A10BC extinguisher.

## **Access and Parking**

Location of tents, canopies, temporary membrane structures, fire access roadways and parking of automobiles or other internal combustion engines shall be in accordance with Section 2403 of the 2003 International Fire Code.

## **Exits**

Exits shall be spaced at approximately equal intervals around the perimeter of the tent, canopy or temporary membrane structure and shall be so located that no point is more than 100 feet from an exit. Number of exits shall comply with Table 2403.12.2 of the 2003 International Fire Code.

## **Hazardous Gases**

Balloons and other similar devices that are filled with toxic, explosive or flammable gases shall not be permitted in or adjacent to a tent, canopy or temporary membrane structure.

Flammable or combustible liquids and LP-gas shall not be stored in a tent or temporary membrane structure or less than 50 feet from such structures.

## **Standby Personnel**

Qualified persons necessary to safeguard the premises may be required by the Fire Department to safeguard the premises.

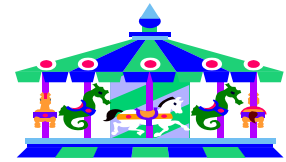

## **OUTDOOR CARNIVALS AND FAIRS (Section 2407 I.F.C.)**

The grounds of carnivals and fairs, including concession booths, shall provide the following:

1. Fire Lanes will be required.
2. Fire Extinguishers will be required for the entire midway.
  - ◆ Maximum travel distance to a portable fire extinguisher (minimum size 2A10BC) shall not exceed 75 feet.

### **Concessions Stands**

Concessions stands utilized for cooking shall have a minimum of ten feet of clearance on two sides and shall not be located within ten feet of amusement rides or devices.

A minimum of one (1) 2A10BC fire extinguisher is required for all locations performing cooking operations. A 40BC rated dry chemical or a K fire extinguisher shall be provided where deep-fat fryers are used.

### **Power Sources**

Internal combustion power sources, including motor vehicles, generators and similar equipment, shall comply with the following:

1. Fuel tanks shall be of adequate capacity to permit uninterrupted operation during normal operating hours. Refueling shall be conducted only when the ride is not in use.
2. Internal combustion power sources shall be isolated from contact with the public by either physical guards, fencing or enclosure.
3. A minimum of one fire extinguisher with a rating of not less than 2A10BC shall be provided.

### **Mobile Amusement Rides**

Texas Department of Insurance defines mobile amusement rides as any mechanical, gravity, or water device or devices that carry or convey passengers along, around, or over a fixed or restricted route or course or within a defined area for the purpose of giving its passengers amusement, pleasure, or excitement, but such term does not include: coin-operated or non-mechanized playground equipment.

All mobile amusement rides are required to have their own current Texas Department of Insurance State Inspection sticker posted at the ride.



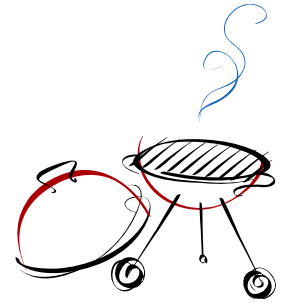

## **TEMPORARY CONCESSION STANDS/TRAILERS**

1. A minimum 24' fire lane/fire department access shall be within one hundred fifty feet (150') of stand/trailer/tent.
2. There must be a minimum of 10 feet separation between all concession stands/trailers/tents.
3. A minimum of one (1) 2A10BC fire extinguisher is required.
4. Cooking and heating equipment shall not be located within 10 feet of combustible materials and comply with Section 307 of the 2003 International Fire Code.
5. Tents, canopies and/or temporary membrane structures shall be of flame-retardant material or shall be made fire retardant in an approved manner. Floor coverings, buntings, flammable decorations or effects, including sawdust when used on floors, shall be made fire retardant in an approved manner.
6. An approved Fire Retardant certification shall be posted on premises indicating the following:
  - Identification of tent, canopy or temporary membrane structure, size and fabric type,
  - Date that tent, canopy or temporary membrane structure and other flammable materials were last treated with flame-retardant solution,
  - Trade name and type of solution utilized in flame-retardant treatment,
  - Name of persons and firm treating materials.
7. Flammable material storage such as, hay, straw, trash and other flammable material shall not be stored within twenty (20') feet outside of structures.
8. The floor surface inside, and the grounds adjacent to or within twenty (20') feet outside of temporary structures, shall be kept free and clear of combustible waste. Such waste shall be stored in approved containers until removed from the premises.
9. **No Smoking Signs shall be posted.** Smoking shall not be permitted in tents, canopies or temporary structures or in adjacent areas where LP-gas containers, hay, straw, sawdust or other combustible materials are stored or used.
10. Heating and cooking equipment shall be in accordance with the Mechanical Code.
11. Flammable or combustible liquids and/or LP-gas containers shall not be stored or located in a temporary structure.

12. All appurtenances and equipment placed in LP-gas service shall be listed by a nationally recognized testing laboratory.
13. Hose used with LPG shall be continuously marked in clearly legible letters and figures with the manufacturer's name or other identification, and the wording "LP-gas" or "LPG."
14. All connections shall be checked for leaks with soapy water prior to use of LPG.
15. When LP-gas is used for cooking the LP-gas containers, regulators and piping shall be protected from damage.
16. **When flammable liquids are used, a minimum of one "K" type fire extinguisher shall be provided. i.e.: (Deep Frying)**  
  
*When a deep fat fryer is present, one (1) fire extinguisher meeting the requirements of UL 300 should be present.*  
  
*Have available a lid or cover for deep fat fryer to cover cooker in case of fire or rain.*
19. Weeds, grass, brush, trash and other combustible materials shall be kept not less than ten feet (10') from LP-gas tanks or containers.
20. LP-gas containers shall also be located with respect to special hazards such as aboveground flammable or combustible liquid tanks, oxygen or gaseous containers and electric power lines.
21. **LPG containers used for temporary service shall be placed on concrete pads, paved surfaces or firm level earth for such temporary service.**
22. **Inspection of all Concession Stands/Trailers/tents is REQUIRED prior to opening for business.**

**MOST FIRES CAN BE PREVENTED IF YOU FOLLOW A FEW BASIC FIRE SAFETY TIPS.**

**CALL 9-1-1 FOR FIRE, MEDICAL OR POLICE EMERGENCIES.**

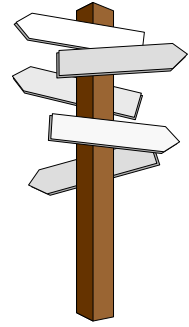

### **ADDRESSES, STREET NAMES AND SIGNS**

- Address numbers shall be placed on all new and existing buildings, structures, and mobile homes in such a position as to be plainly visible and legible from the street fronting the property. Address numbers may be posted upon approved ground signs, if permitted by the Sign Chapter of the Zoning Ordinance, with address numbers being a minimum of twenty-four inches above grade. Numbers shall be a minimum of four inches tall and contrast with their background.
- In mall tenant spaces, numbers should be four inches high,  $\frac{1}{2}$  inch stroke; suite numbers in office and hotel occupancies should be two inches high and  $\frac{1}{4}$  inch stroke.
- If access to a premises is provided by a private drive or easement, or if a structure or portion of a structure is obscured by another structure or other feature, either man-made or natural, or a premises is located on the interior of a lot or block, the numeric address in addition to being posted on the building, shall be posted in a permanent manner at a location in the nearby vicinity of the intersection of the private driveway with a public street.

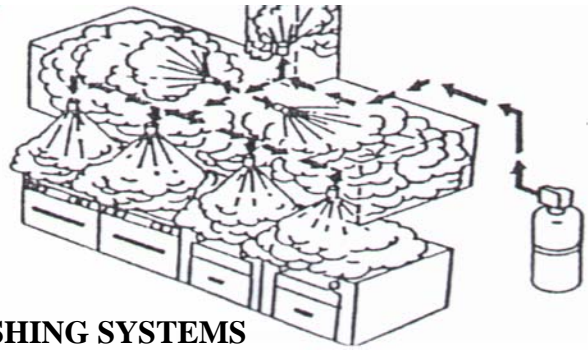

### **KITCHEN FIRE EXTINGUISHING SYSTEMS**

Cooking hood extinguishing systems provided for protection of kitchen grease hoods and ducts will be reviewed at the time of permit application. For a complete review to take place the following information shall be provided:

1. A minimum of two sets of drawings are required to be submitted to the Arlington Fire Department Development Services Section at 405 West Main Street.
2. Description of extinguishing system type (automatic sprinkler, carbon dioxide, dry chemical or liquid agent).
3. Type of system design – Either an engineered system or a pre-engineered system.
4. Engineered and pre-engineered systems shall contain full details of system design.
5. Design shall specifically note interconnection of fuel supply shutoff, ventilation control, damper control, associated ducting system, alarm retransmission, etc.
6. Cooking hood extinguishing systems shall be designed in accordance with the latest locally adopted editions of NFPA 13 and/or 17, International Fire Code, International Building Code, International Mechanical Code, and any applicable local amendments and rules.
7. Alarm Retransmission – If a kitchen fire extinguishing system is installed in a building with an existing fire alarm, that system is required to be interfaced with the fire alarm control panel through a dedicated zone. This should be indicated on the plans. Alarm retransmission will be verified by the field inspector.
8. Manufacturer's cut sheets should be submitted with plans.

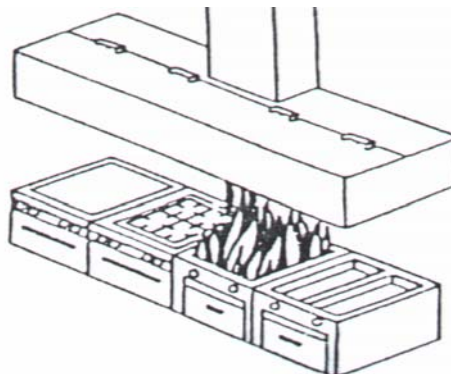

**HIGH-PILED COMBUSTIBLE STORAGE  
(Chapter 23, 2003 International Fire Code)**

High-piled combustible storage is combustible materials in closely packed piles more than 12 feet in height or combustible materials on pallets or in racks more than 12 feet in height. For certain special hazards commodities such as rubber tires, plastics, some flammable liquids, idle pallets, etc., the critical pile height may be as low as 6 feet.

If your company is planning for any type of storage such as this, we highly recommend you contact the Arlington Fire Department Development Services Section in the initial stages of planning and design. Special considerations, as well as numerous options, may be available for each application of this complicated article of the International Fire Code. Design engineers may be needed to properly assist you with all applicable details of this article.

It also may be necessary to provide details of several special aspects of design criteria critical to Chapter 23 requirements. These areas may include:

- Specially designed sprinkler systems
- Specially designed fire alarm systems
- Smoke and heat removal systems
- Curtain boards

Please contact the Arlington Fire Department Community Development Section for assistance on this and any other questions regarding this article. Special forms and/or submittals

