

INLAND FISHERIES ANNUAL REPORT 2006

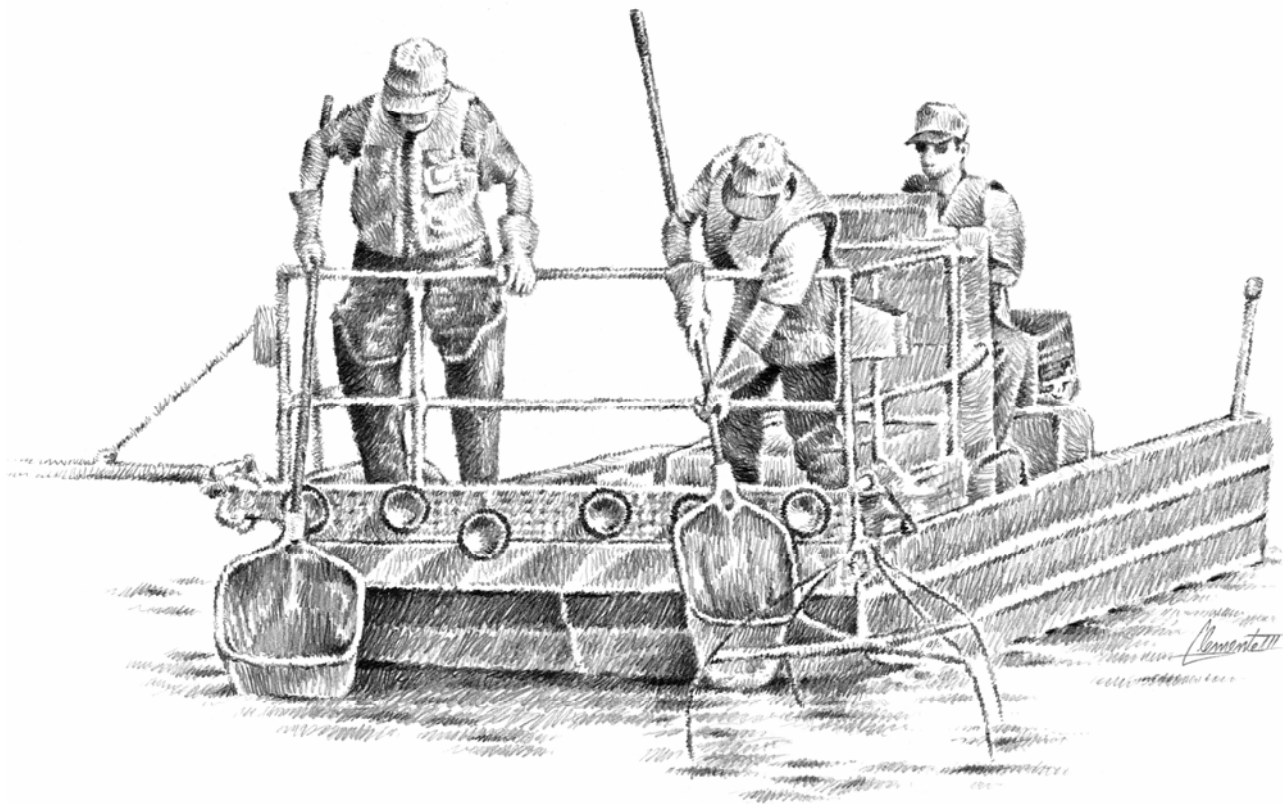

IMPROVING THE QUALITY OF FISHING

Robert L. Cook
Executive Director



Philip P. Durocher
Director, Inland Fisheries



INLAND FISHERIES ANNUAL REPORT 2006



TEXAS PARKS AND WILDLIFE DEPARTMENT

Commissioners

Joseph B.C. Fitzsimons
Chairman, San Antonio

Donato D. Ramos
Vice-Chair, Laredo

Mark E. Bivins
Amarillo

J. Robert Brown
El Paso

T. Dan Friedkin
Houston

Ned S. Holmes
Houston

Peter M. Holt
San Antonio

Philip Montgomery
Dallas

John D. Parker
Lufkin

Lee M. Bass
Chairman-Emeritus
Ft. Worth

The policy of Texas Parks and Wildlife is to fully comply with the intent of Title VI of the Civil Rights Act of 1964. Title VI provides that no person in the United States shall, on grounds of race, color, or national origin, be excluded from participating in, denied the benefits of, or subjected to discrimination under any program or activity receiving federal financial assistance.

TABLE OF CONTENTS

1 INLAND FISHERIES OVERVIEW

- Mission
- Scope
- Responsibilities
- Staff
- Funding and Allocation

3 ADMINISTRATION

- Goal
- Rationale
- Offices
 - Administrative Addresses*
 - Facility Locations Map*
- Program Costs
- Organization

5 RESOURCE MANAGEMENT – FISHERIES AND HABITAT MANAGEMENT

- Goal
- Rationale
- Responsibilities
- Methodology
 - General Survey Reservoirs*
 - Small Reservoirs*
 - Rivers and Streams*
- Program Costs
- Accomplishments
 - Regulation Changes*
 - Fish Stocking*
 - Fish Monitoring*
 - Habitat Enhancement*
 - Outreach Events*
 - General Activities*
 - Special Projects*
- Organization

21 RESOURCE MANAGEMENT – FISHERIES RESEARCH

- Goal
- Rationale
- Facility
 - Heart of the Hills Fisheries Science Center*
- Responsibilities
- Program Costs
- Accomplishments
 - State-Supported Research Studies*
 - Sport Fish Restoration Federal Aid-Supported Studies*
 - Land Owner Incentive Program (LIP) Study*
 - State Wildlife Grant (SWG) Study*
 - Publications*
 - Reports*
 - Articles*
 - Presentations*
 - Special Projects – Fisheries and Habitat Management*
 - Special Projects – Education and Outreach*
 - Special Projects – Fish Hatcheries and Analytical Services*
- Organization

47 ECOSYSTEM/HABITAT ASSESSMENT

- Goal
- Rationale
- Facilities
 - Texas Rivers Center*
 - A.E Wood Fish Hatchery*
 - Fountain Park Plaza*
- Responsibilities
- Methodology
- Program Costs
- Accomplishments
 - State-Supported Studies*
 - Federal Aid-Supported Studies*
 - General Activities*
- Organization

57 EDUCATION AND OUTREACH

- Goal
- Rationale
- Facility
 - Texas Freshwater Fisheries Center*
- Responsibilities
 - Visitor Center*
 - Hatchery*
- Program Costs
- Accomplishments
 - Visitor Center*
 - Hatchery*
- Special Projects
- Organization

61 FISH HATCHERIES

- Goal
- Rationale
- Facilities
 - Dundee Fish Hatchery*
 - Possum Kingdom Fish Hatchery*
 - A.E. Wood Fish Hatchery*
 - Jasper Fish Hatchery*
 - Texas Freshwater Fisheries Center (TFFC)*
- Responsibilities
- Program Costs
- Accomplishments
 - Species Stocked in Public Waters*
 - Special Project Activities*
 - Other Activities*
- Organization

64 APPENDIX

- Organization Charts
- Division Personnel Directory
- Inland Fisheries IFS Project Cost Codes
- Stocking Reports

INLAND FISHERIES OVERVIEW

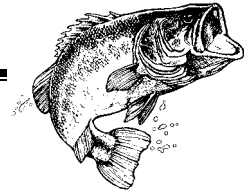

Mission

To provide the best possible fishing in Texas while protecting and enhancing its freshwater aquatic resources.

Scope

The Inland Fisheries Division is responsible for managing the fishery resources in approximately 800 public impoundments and about 191,000 miles of rivers and streams together totaling 1.7 million acres. Over 2 million anglers, whose fishing activities result in at least \$2 billion in trip and equipment expenditures, use these resources.

Responsibilities

To assess annually the status, utilization and value of freshwater fishery resources in all public waters in order to develop and evaluate management strategies to prevent resource depletion and to optimize yield.

To maintain or enhance existing fish stocks and species diversity by regulating means and methods of capture and harvest regulation of sport fishes, and by stocking public waters with hatchery-produced fishes.

To inform the Legislature, Commission, resource agencies and resource users of the status of the resource by publishing and presenting results of management and research assessments and the best scientific information available.

To conduct studies and assessments for the enhancement, protection and conservation of aquatic resources.

To conduct investigations and assessments on fish kills and pollution events to protect, mitigate, and restore impacted natural resources and habitats.

To provide recommendations to local, state and federal resource and regulatory agencies to protect and conserve aquatic resources and habitats.

To enhance annually the amount of quality aquatic habitat available to fish, and to anglers, by managing overabundant aquatic vegetation or increasing the habitat where deficiencies exist.

To increase outreach efforts and establish urban fishing programs to increase fishing opportunities for children, the elderly, and the physically or mentally challenged.

To expand fishing and other recreational opportunities in public waters.

To optimize the State's fishing opportunities in State parks and other state-owned facilities.

To restore and protect stocks of endangered or threatened native species.

To increase the State's fish production efficiency by maintaining and renovating existing hatcheries.

Staff

Inland Fisheries has 223 permanent positions assigned to management, hatchery, research, outreach and administrative branches.

Funding and Allocation

In FY 06, \$12,957,459 (not including fringe benefits, worker's compensation, or capital construction) was budgeted for Inland Fisheries. Federal Aid grants are expected to reimburse the Department \$7,497,000 on eligible Inland Fisheries activities. The allocation of Federal Aid monies was \$2,359,319 for Fish Hatchery and Research Facilities, \$884,931 for Research, \$4,318,604 for Management, and \$65,854 for Education and Outreach.

The budget is allocated for personnel, operation, and capital costs to implement three goals from the Department's Strategic Plan "Natural Agenda: A Strategic Plan for Texas Parks and Wildlife 2007 – 2011."

Acquire, improve, or access additional public fisheries and wildlife and their habitat. [Agency Goal #1, Objective #1, and Strategy #1.] \$3,281,732

Design and implement outreach programs to expand fishing, hunting and wildlife-viewing opportunities for targeted user groups. [Agency Goal #2, Objective #2, and Strategy #1.] \$350,188.

Protect and manage Texas fish and wildlife resources by determining the status and condition of their habitats, monitoring and assessing their populations, and by undertaking scientific research to address ecosystem- and species-level issues. [Agency Goal #3, Objective #3, and Strategy #1.] \$9,325,539

ADMINISTRATION

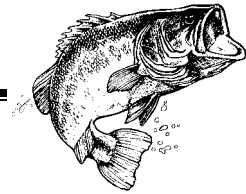

Goal

To direct all Inland Fisheries Division activities within Commission policy and budget, based on the results of Inland Fisheries monitoring and research programs, and to recommend management, operating, and funding strategies to the Executive Director, Texas Parks and Wildlife Commission and Legislature.

Rationale

The Inland Fisheries administrative staff is responsible for providing program direction to achieve the mission and goals of the Department as expressed in the Texas Parks and Wildlife Department "Natural Agenda: A Strategic Plan for Texas Parks and Wildlife 2007 – 2011." The administrative staff, in concert with field units, guides the collection and interpretation of all information from fisheries survey, research, and evaluation efforts.

Offices

Administrative Addresses

Headquarters
4200 Smith School Road
Austin, Texas 78744
Phone: (512) 389-4864

Region I Management
3407-B S. Chadbourne
San Angelo, Texas 76903
Phone: (325) 651-4846

Region II Management
1601 E. Crest Dr.
Waco, Texas 76705
Phone: (254) 867-7874

Region III Management
11810 FM 848
Tyler, Texas 75707
Phone: (903) 566-1615

Research
5103 Junction Hwy.
Ingram, Texas 78025
Phone: (830) 866-3356

Region I Hatcheries
(A. E. Wood & Jasper)
507 Staples Road
San Marcos, Texas 78666
Phone: (512) 353-0572

Region II Hatcheries
600 S. HWY 16
Grayford, Texas 76449
Phone: (940) 779-2301

Education & Outreach
5550 FM 2495
Athens, Texas 75752
Phone: (903) 670-2224

Facility Locations Map

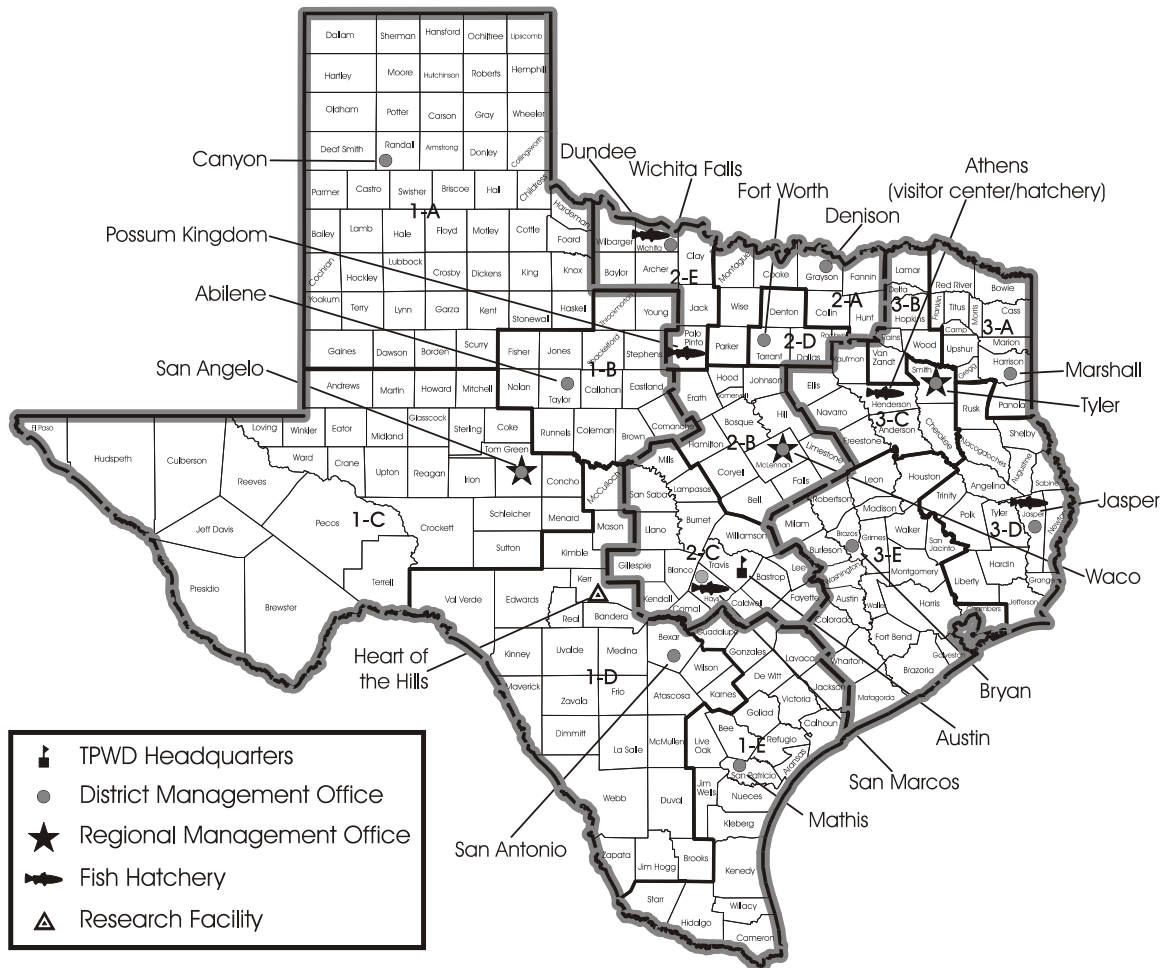

Program Costs

Total administrative cost for FY 06 was \$1,940,142.

Organization

Administration organizational flow chart is located in *Appendix, Organization Charts*, page 66.

RESOURCE MANAGEMENT – FISHERIES AND HABITAT MANAGEMENT

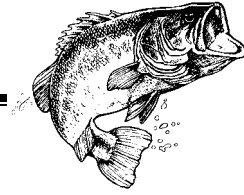

Goal

To develop plans and conduct applied management activities for all freshwater impoundments, rivers, and streams.

Rationale

Effective management of the freshwater resource depends on knowledge of the habitat available, the dynamics and structure of populations and their utilization. Standardized monitoring based on scientifically accepted techniques and survey procedures was begun in 1975 and is updated periodically whenever new procedures to improve the timeliness and precision of estimates are found. Data obtained from these surveys are used to monitor fish populations, habitat, and angler use of fisheries. They provide the foundation for the development of management plans/strategies aimed at improving and protecting recreational fisheries. Statewide management activities supported and evaluated through monitoring data include development of fish stocking plans, fish harvest regulations, and habitat improvement and mitigation. Public support of management activities is obtained through a variety of outreach activities that are designed to educate and inform the public about on-going management programs and fishing opportunities.

Responsibilities

Monitor public freshwater fisheries resources, including habitat.

Monitor the activities of freshwater fishery users.

Recommend, implement, and evaluate fisheries management plans to protect, increase, or make better use of the fisheries resources.

Formulate and propose regulation for the means and methods of take and bag limits of sport fishes designed to maintain or enhance existing fish stocks.

Recommend, implement, and evaluate activities that enhance the amount of quality habitat available to fish and anglers.

Report on significant findings and results.

Educate and inform the public about Division programs and activities.

Coordinate and/or conduct fishing clinics, rodeos, etc., for young people, as well as for people not usually involved in fishing.

Methodology

Standardized procedures are detailed in the Inland Fisheries Assessment and Aquatic Enhancement procedure manuals. These manuals provide staff with specific sampling procedures and minimum survey requirements for reservoirs, rivers, and streams. Current staffing does not allow for annual monitoring of all state fresh waters. All major public reservoirs are surveyed at least once every four years. Small reservoirs, rivers, and streams are surveyed on an "as needed" basis and on a schedule determined by local biologists. Listed below are the categories of water bodies sampled and their basic sampling requirements:

General Survey Reservoirs

- Includes all major public reservoirs that are greater than 500 acres in size and are sampled on a four-year rotation basis.
- Sampling activities: Gill netting (spring), structural habitat and aquatic vegetation surveys (summer), electrofishing and trap netting (fall), access survey (year-round), and creel survey (optional).

Small Reservoirs

- Includes all public reservoirs that are less than 500 acres in size. Reservoirs in this category include designated "Community Fishing Lakes" and most state park lakes.
- Sampling activities: Sampling methods typically follow general survey reservoir guidelines; however, choice of sampling methods is determined by local biologists.

Rivers and Streams

- Includes all unimpounded segments of rivers and streams.
- Sampling activities: boat, backpack, and low-pulse DC electrofishing, seining, habitat survey, hoop netting, gill netting, access surveys and creel surveys. Choice of sampling methods is determined by local biologists.

Program Costs

The total cost for the Management Program for FY06 was \$4,000,899.

Accomplishments

Regulation Changes

The following changes in fishing harvest regulations recommended by staff were adopted by the TPW Commission to improve angling quality, optimize angling opportunity, and protect fisheries resources.

- **Marine Creek Reservoir (Tarrant County)** - Harvest regulations for largemouth bass were changed to an 18-inch minimum length limit from a 14-inch minimum length limit. The five fish daily bag will be retained.
- **Statewide baitfish exceptions** - Kinney County was added to the list of counties with bait fish exceptions. "In Brewster, Crane, Crockett, Culberson, Ector, El Paso, Jeff Davis, Hudspeth, *Kinney*, Loving, Pecos, Presidio, Reeves, Terrell, Upton, Val Verde, Ward, and Winkler counties, the only fishes that may be used or possessed for bait while fishing are common carp, fathead minnows, gizzard and threadfin shad, golden shiners, goldfish, Mexican tetra, Rio Grande cichlid, silversides (Atherinidae family), and sunfish (*Lepomis*)."
- **Allow harvest of catfish by use of lawful archery equipment** - Blue, channel, and flathead catfish are now legal to harvest using lawful archery equipment (longbow, recurved bow, compound bow, and crossbow).

Fish Stocking

A total of 20,439,186 fish were stocked at management's recommendation into 359 locations from January 1, 2006 through December 31, 2006 (see **Appendix, Stocking Reports**, page 107).

Fish Monitoring

General Survey Texas Reservoirs

Reservoir	Size	Creel	Angler Access	Electrofish	Gill Net	Habitat Survey	Veg Survey	Seine	Water Quality	Trap Net
Toledo Bend	162,476	X		X	X		X			
Sam Rayburn	111,422	X	X	X		X	X			X
Falcon	83,654	X			X					
Texoma	74,686				X				X	
Amistad	63,680			X	X					
Richland-Chambers	41,356	X		X			X			X
Tawakoni	37,879			X		X	X			X
Cedar Creek Reservoir	32,623				X					
Lewisville	29,592				X					
Caddo	27,472				X		X			X
Lake Fork	27,264	X		X	X	X	X			X
Choke Canyon Reservoir	25,989	X		X	X		X			X
Palestine	23,434	X			X					X
Buchanan	22,211				X					
Whitney	22,180				X					
Ray Hubbard	21,671			X						
Lavon	21,400			X						X
Wright Patman	20,143			X			X			
Conroe	20,118	X		X	X		X			
Travis	19,161			X						
O. H. Ivie	19,149	X	X	X	X		X			
Cooper Reservoir	19,018				X					
Lake Corpus Christi	18,256		X	X		X	X			X
Meredith	16,411	X	X	X	X					X
Lake O' the Pines	16,269			X			X			X
Possum Kingdom	15,588	X	X	X	X	X			X	X
Kemp (Baylor County)	15,104				X					
Arrowhead	14,969									X
E. V. Spence	14,640				X				X	
Belton (Bell County)	12,385			X						X
Bridgeport	11,954			X	X					
Limestone	11,785						X			
Somerville	11,456				X		X			
Red Bluff	11,193								X	
Houston	10,459	X		X		X	X			
Texana	9,727		X	X		X	X			X
Bob Sandlin	9,116				X					X
Twin Buttes	9,080								X	
Granbury	8,310				X	X				
Canyon	8,308				X					
Waco	7,173			X	X					
Grapevine	6,684			X						

General Survey Texas Reservoirs – January 2006 thru December 2006

Reservoir	Size	Creel	Angler Access	Electrofish	Gill Net	Habitat Survey	Veg Survey	Seine	Water Quality	Trap Net
Brownwood	6,509			X						
Joe Pool	6,469			X	X		X			
Lyndon B. Johnson	6,449			X			X			
Stillhouse Hollow	6,429				X		X			
Kickapoo	6,028	X			X					
O. C. Fisher	5,440			X	X					
Stamford (Haskell County)	5,124		X	X						X
Martin Creek Reservoir	4,981	X			X					
Proctor	4,474		X	X						X
Granger	4,009									X
Benbrook	3,635			X	X					
Worth	3,489		X	X		X				X
Cypress Springs	3,461	X		X		X	X			X
Murvaul	3,397			X			X			
Bardwell	3,138	X		X			X			X
Diversion (Baylor County)	3,133									X
Calaveras	3,110				X					
Coleto Creek Reservoir	3,100	X			X		X			X
Alan Henry	2,884		X	X	X	X				
Palo Duro Reservoir	2,413		X	X						
Palo Pinto	2,399				X					
Graham	2,396			X	X					X
Fayette County	2,394	X		X			X			
Oak Creek	2,375			X					X	X
Delta	2,371			X	X					X
Aquila	2,366	X		X			X			X
Tyler East	2,276						X			
Tyler West	2,224						X			
Nacogdoches	2,212						X			
Fairfield	2,034			X						
Greenbelt	2,025	X			X					
Brady Creek Reservoir	2,021		X	X		X	X			X
Gibbons Creek Reservoir	2,110			X		X	X			X
Monticello	2,001	X		X						
Coleman City (Coleman County)	2,000			X						
Arlington	1,939		X	X		X				X
Striker Reservoir	1,920						X			
Athens	1,799				X					
Millers Creek	1,794				X					
Tradinghouse Creek	1,793					X	X			
Colorado City	1,612			X					X	
Austin	1,599			X			X			
Leon	1,590		X	X						X
Buffalo Creek	1,576		X	X					X	X

General Survey Texas Reservoirs – January 2006 thru December 2006

Reservoir	Size	Creel	Angler Access	Electrofishing	Gill Net	Habitat Survey	Veg Survey	Seine	Water Quality	Trap Net
Champion Creek	1,560			X						X
Amon G. Carter	1,540	X								
Lone Star	1,397	X		X		X	X			X
Sulphur Springs	1,478				X					
White River Reservoir	1,418			X		X				
Nasworthy	1,380			X						X
Houston County	1,330	X					X			
Victor Braunig	1,298			X	X					
Lake Georgetown	1,297				X					
Walter E. Long Reservoir	1,269			X			X			
Sheldon	1,230			X			X			
Wichita	1,224									X
Jacksonville	1,208			X			X			
Moss	1,140		X	X		X	X	X	X	X
White Rock Lake	1,088	X		X						
Casa Blanca	1,055		X	X		X	X			X
Crook	1,043		X	X		X	X			X
Bonham City	1,020			X						
Gilmer Reservoir	1,010	X					X			
Bastrop	865			X			X			
Mackenzie	896			X	X					
Winnsboro	797		X	X		X	X			X
Quitman	799				X		X			
Inks	768				X					
Kirby	740	X			X					X
Lake Bryan	737			X	X		X			
Kurth	726		X			X	X			X
Fort Parker State Park	725			X						X
Coffee Mill	650				X					
Holbrook	650			X			X			
Hawkins	634			X			X			
Baylor Creek	610									
Abilene	595				X					
Marble Falls	573				X					
Balmorhea	573		X	X	X			X		
Waxahachie	553				X					
Big Creek Lake	520			X						
Hords Creek	510				X					
New Ballinger	500			X	X					
Gladewater City	481				X		X			X
Mineral Wells	440		X	X						X
Alvarado Park	437				X	X				
Dunlap	410				X					
McQueeney	396				X					

General Survey Texas Reservoirs – January 2006 thru December 2006

Reservoir	Size	Creel	Angler Access	Electrofishing	Gill Net	Habitat Survey	Veg Survey	Seine	Water Quality	Trap Net
Lost Creek	385		X	X		X			X	X
Davy Crockett	355			X	X					
McClellan	339		X							
Raven	204			X	X		X			
San Augustine City	200		X	X		X	X			X
Totals	1,342,996	27	25	79	61	25	52	0	11	48

Small Texas Reservoirs

Reservoir	Size	Creel	Angler Access	Electrofishing	Gill Net	Habitat Survey	Veg Survey	Seine	Water Quality	Trap Net
Town Lake	469			X			X			
Clyde	449			X						
Pinkston	447			X			X			
Purtis Creek State Park	349			X			X			
Marine Creek (Ft. Worth)	250	X		X		X				X
Buffalo Springs	241			X						
Mill Creek Lake	237			X						
Timpson	223						X			
Bringle	199			X			X			
Placid	198			X						X
Averhoff	174			X						
Bellwood	160			X			X			X
Moss Creek City	160				X				X	
Bachman Lake (Dallas)	132			X		X				X
TXU Contract Lake #1	110			X						
Cleburne State Park	107			X						
Center City	89						X			
Fryer	86			X						
Tyler State Park	65			X			X			
Meadow Lake (Round Rock)	59			X						
Coleman (Hopkins County)	56			X						
Mt. Vernon City	42		X	X						
Upper Kaufman	40			X						
Petrolia City (Old)	36			X						
Buescher State Park	25								X	
Bright Lake	18			X						
Meredith Stilling Basin	15			X						
Rusk City	9			X						
Faulkner Park Lake (Tyler)	7			X			X			
Medical Center South	7	X							X	
Bastrop State Park	6								X	
Gillam-Howell South Lake	5			X						
Lobo	5			X						
Mary Joe Peckham Park	5	X								
Wilson-Ledbetter Park Pond	5			X						
Breshears	3			X						
Canyon Southeast Park Lake	3			X						
Lakeside Park (Duncanville)	3			X						
Central Park Pond #1	2	X								
Lamesa 9th Street Park Lake	2			X						
Tyler Nature Center Pond	2						X			
Beal Park Lake	1								X	
C. J. Kelly Park Pond	1								X	

Small Texas Reservoirs – January 2006 thru December 2006

Reservoir	Size	Creel	Angler Access	Electrofishing	Gill Net	Habitat Survey	Veg Survey	Seine	Water Quality	Trap Net
Comanche Trails Park (Odessa)	1								X	
Gillam-Howell North Lake	1			X						
Greenbelt Stilling Basin #2	1			X						
Greenbelt Stilling Basin #3	1			X						
Palo Duro Stilling Basin	0			X						
Totals	4,506	4	1	36	1	2	10	0	7	4

Texas Stream Surveys

River	Miles	Creel	Angler Access	Electrofish	Gill Net	Habitat Survey	Veg. Survey	Seine	Water Quality	Hoop Net	Trap Net
Canyon Tailrace	11	X				X					
Wichita River	6								X		
Livingston Tailrace	1			X							
Totals	18	1	0	1	0	1	0	0	1	0	0

Habitat Enhancement

Vegetation Planting

	<u>District</u>	<u>Acres (47)</u>
Bellwood	3C	22
Pflugerville	2C	1
Sikes	2E	1
TXU #1	3C	23

Brush Shelter Installation

	<u>District</u>	<u>Acres (12.5)</u>
Benbrook	2D	1
Canyon	2C	1
Kirby	1B	1
Lake Bryan	3E	5
Martin Creek	3D	1
McDonald Lake	1A	1
Texoma	2A	0.5
Welsh	3A	1
Wichita	2E	1

Lake Fertilization

	<u>District</u>	<u>Acres (207)</u>
Cleburne State Park	2B	107
Meridian State Park	2B	50
TXU #1	3C	50

Shoreline Improvements

	<u>District</u>	<u>Acres (5.2)</u>
Tyler Nature Center Pond	3C	1.2
Wichita Barrow Pit	2E	4

Vegetation Control (Mechanical)

	<u>District</u>	<u>Acres (.5)</u>
Athens	3C	0.5

Vegetation Control (Biological)

	<u>District</u>	<u>Acres (22,337.8)</u>
Conroe	3E	21,000
Jacksonville	3C	1,208
Raven	3E	25
Sikes	2E	4
Toledo Bend	3F	100
Tyler Nature Center Pond	3C	0.8

<u>Vegetation Control (Chemical)</u>	<u>District</u>	<u>Acres (624.85)</u>
75 Acre Lake	1E	3
Armand Bayou	3F	10
Caddo	3F	372.1
Center City	3F	32
Choke Canyon	1E	26.5
Fairfield	3F	2
Lake Fork	3F	5
Quitman	3F	0.25
Raven	3E	10
Sheldon	3E	16
Steinhagen	3F	7.5
Tawakoni	3F	4
Toledo Bend	3F	136.5

Outreach Events

Inland Fisheries staff members were event leaders at 298 outreach events for targeted user groups (youth under 17, minorities, women, and physically challenged) in which 28,816 individuals participated.

Events Summary:

	Youth 17 & under	Adults	Total
Males (1)	8,767	6,655	15,423
Females (2)	7,884	5,509	13,393
Minorities	5,878	878	6,756
Phys. Challenged	644	397	1,041
Total (1+2)	16,652	12,164	28,816

General Activities

- Angler Recognition Program staff updated record application, rules brochure and website to reflect addition of new category
- Management and habitat staff conducted 393 surveys on 183 reservoirs covering 1,343,042 surface acres of water. Staff conducted 4 additional surveys on 3 rivers and streams (18 miles).
- Management and Habitat Staff conducted habitat improvement activities that impacted 23,234 surface acres on 32 public reservoirs.
- Recommendations from management staff resulted in the stocking of 20,439,186 fish of 18 different species in 359 different water bodies
- Inland Fisheries staff investigated 172 fish kills statewide during this year.
- Management staff issued 300 news releases and published 55 popular articles dealing with TPWD management programs and activities.

- Management and hatchery staff continued participation in an on-going nationwide effort to study the largemouth bass virus (LMBV). We collaborated with other state/federal governmental agencies, universities, and laboratories on various research projects. We organized and sponsored a LMBV Workshop to exchange information on this subject. This workshop was held in conjunction with the SDAFS meeting in San Antonio, February 2006.
- Management staff continued work with the Lake Fork Sportsman's Association and the Lake Fork Chamber of Commerce to monitor trophy bass catches at Lake Fork Reservoir. Over the past four years (March 2003 – February 2007), anglers from 46 different states have reported catching 6,682 trophy-size largemouth bass (>7 lbs). Over 16% of these fish were larger than 10 lbs and 32% were longer than the current size limit (24 inches).
- Management staff implemented a new and improved our standardized Federal Aid Project F-30-R Performance Report format (annual DJ Management Report). Updates included the addition of various statistical measures in response to recommendations coming from our Division's Science Review and automated generation of figures, and population indices, directly from the FMF database.
- Extensive training was provided to fisheries management staff on GIS technology in fisheries management and habitat related work.
- Management staff organized and participated in a "Biologist, Angler, and Industry Interaction Workshop" sponsored by TPW Inland Fisheries Division, the Texas Chapter of the American Fisheries, the Southern Division of the American Fisheries Society (SDAFS), and the Bass Angler Sportsman's Society. This workshop was held in conjunction with the SDAFS spring meeting in San Antonio, February 2006.
- Management and Habitat staff worked with the Texas Chapter of the American Fisheries Society, the USACOE, and San Antonio Water Systems to host an Aquatic Plant Establishment Workshop. This workshop was held in conjunction with the SDAFS spring meeting in San Antonio, February 2006.
- Inland Fisheries staff worked with Gulf States Toyota, the Professional Anglers Association, the Sabine River Authority, and TPW Commissioners to plan and organize a benefit bass tournament at Lake Fork. The 1st Annual "Toyota Texas Bass Classic" will showcase a new "conservation-minded" tournament format, promote department programs and fisheries management activities, and raise funds to support our agencies mission.
- Inland Fisheries staff worked members of the Texas Chapter of the American Fisheries Society and Southern Division of the American Fisheries Society (SDAFS) to host a successful SDAFS Spring Meeting in San Antonio, TX in February 2006. Over 530 fisheries professionals and students attended the meeting from across the United States. This meeting supported 19 technical symposia, 6 workshops, and 8 AFS committee meetings. A total of 191 oral and 19 poster presentations were given during the meeting program. Twenty-two presentations were given by Inland Fisheries staff members.
- Inland Fisheries staff met with Oklahoma Department of Wildlife and Conservation fisheries and law enforcement staffs to discuss fisheries management and regulations for Lake Texoma.
- Management staff initiated or implemented integrated aquatic vegetation management plans at lakes Conroe, Tyler, Jacksonville, Austin, Hawkins, Purtis Creek, and Cypress Springs. Plans are being carried out in cooperation with local controlling authorities, property owners, angling groups, media, political representatives, and the general public.
- Management and habitat staff continued intensive work on Sheldon Reservoir in cooperation with the Lake Sheldon Environmental Learning Center Project and TPW Commissioner Alvin Henry.
- Management and habitat staff controlled 624 acres of nuisance aquatic vegetation on 13 public water bodies statewide. Giant salvinia, water hyacinth and hydrilla remain a significant threat to public water bodies statewide. Inland Fisheries continued cooperative work in this area with the State of Louisiana, river controlling authorities, local government entities and public organizations.

- Region 3 management staff continued work with the East Texas Woods and Waters Foundation to raise funds for and do cooperative projects at the Tyler Nature Center. The Tyler Nature Center serves as a major focal point for fisheries-related outreach in the NE Texas area.
- Management staff continued active involvement with Houston Outreach Initiative. Staff took a leadership role in a "Best Practices Evaluation" for fisheries improvement projects in the Houston MSA.
- Management staff continued participation in a statewide fish tissue monitoring program; a cooperative program conducted by Texas Parks and Wildlife Department, Texas Commission on Environmental Quality, and Texas Department of Health. This 3-year project is aimed at collecting data on fish tissue contaminants from 81 reservoir and river sites throughout the state.
- Management, research, and hatchery staff continued work to examine performance of offspring produced from selectively bred Sharelunker largemouth bass (13 lb or larger). Advanced-size fingerling bass were stocked into three additional public reservoirs (6 total) to examine the growth and trophy characteristics of these unique fish. This project is an evaluation component of our Division's "Operation World Record Program".
- Management staff worked in cooperation with the City Public Service Board of San Antonio to obtain \$20,000 for the purchase of advanced fingerling largemouth bass to stock in Lake Braunig and initiated a special study to evaluate the impacts of the stocking.
- Management staff assisted the Corps of Engineers and the United States Department of Agriculture with the collection and monitoring of water hyacinth weevil, hydrilla fillies and giant salvinia weevils in several South Texas reservoirs.
- Management staff continued a long term golden algae monitoring program at numerous West Texas reservoirs that have experienced catastrophic kills.
- Management staff co-sponsored a Mini-Expo in El Paso and provided a fishing tank and channel catfish.
- Management staff organized one state-wide staff meeting to review regulation proposals and other topics.
- Management staff organized two meetings of the Freshwater Fisheries Advisory Board to receive constituent input on various fisheries issues.
- Management staff initiated a project to investigate the promotion of carp fishing as an alternative species including economic impact studies and attitude and opinion studies.
- Management staff initiated a Tackle Loaner Program in Amarillo in cooperation with the Amarillo Discovery Museum that will serve as a pilot program for other Texas Urban Fishing sites.
- Management staff initiated a project in cooperation with the National Park Service to determine the effects various tournament release procedures at Lake Amistad.
- Management staff initiated an intensive evaluation of the largemouth bass fishery at Lake Amistad including the effects of bass tournaments on the overall fishery and the economic impacts of the bass fishery on the local economy.
- Management staff initiated a project to evaluate the use of tandem trap nets as a part of an overall evaluation of trap net procedures.
- Management staff continued work on creating bathymetric maps of small reservoirs in the Abilene area utilizing GIS technology to aid anglers on water bodies where no commercial maps were available.

- Inland Fisheries Kills and Spills staff along with management staff continued long term monitoring of Golden Alga on 9 Central and West Texas reservoirs and rivers.
- Management staff continued to coordinate and partner with the Oklahoma Department of Wildlife Conservation and the Oklahoma University Biological Station to sample the fisheries and monitor Golden Alga blooms on Lake Texoma.
- Management staff from the Lake Texoma fisheries station worked with the 6 Old Geezers group who donated \$9,157.00 for use in purchasing a new boat, motor and trailer for the district.
- Management staff assisted Game Warden Dale Moses with the identification, quarantine and cleaning of zebra mussels from a boat brought to High Port Marina
- Management staff partnered with Bastrop State Park staff to apply 27 tons of bentonite clay to the face of the dam in an effort to seal off the leaks. Fish kill mitigation funds in the amount of \$2,900.00 were used to purchase the clay.
- Management, research and hatchery staff all worked together on the continued development of the Texas Urban Fishing program.
- Management staff continued partnering with the Guadalupe River Chapter of Trout Unlimited to stock rainbow trout as well as secure access for anglers.
- Management staff partnered with the Lake Buchanan Conservation Corporation and Burnet County to stock 500,000 Sunshine bass fry into Lake Buchanan.
- Inland Fisheries staff led 298 outreach events to provide fishing opportunities and education to targeted user groups and reached 28,816 individuals.
- Angler Recognition Program staff added a new State Catch and Release Record category, based on length rather than weight, in January 2006.
- Angler Recognition Program staff updated record application, rules brochure and website to reflect addition of new category
- Programming staff brought new record tracking system online on internal data server
- On TPWD website, launched new web application with searchable records in August 2006. Records on web are now updated approximately once/month
- Agency launched GovDelivery e-mail subscription system in August, allowing staff to send e-mail updates on more than 100 topics. From August through December, Inland Fisheries staff sent 36,500 update bulletins on freshwater topics.
- Web & Communications staff worked with IF district offices and marketing staff to provide updated content for urban-area Take Me Fishing brochures and companion website showing urban families where they can fish without boats. (Originally produced with RBFF funding)
- Web & Communications staff updated Bass Fishing in Central Texas fact sheet with District 3C and placed on website.
- Web & Communications staff expanded Heart of the Hills section of website.
- Web & Communications staff Continued work on long-term project to complete Texas Public Water Access guide and bring it into compliance with current web standards. Completed new template for access-point pages. Data entry and interactive features still in progress.

- Weekly Fishing Reports and the Texas Lake Finder were the 6th and 7th most visited pages on the TPWD website in 2006.
- Wetlands Conservation staff coordinated with the Corps of Engineers, U.S Fish and Wildlife Service and other resource agencies on over 159 projects reviewed for various permits, planning or grants to assess the impacts to State fishery resources, including Corps 404 permits, FEMA Hazard Mitigation grants and Department permits and grants.
- Wetlands Conservation staff coordinated with Wildlife Division on updating a Memorandum of Understanding with Texas Department of Transportation covering advance review of transportation projects and the commitment to mitigate for highway impacts to both regulated and unregulated habitats.
- Wetlands Conservation staff participated in an interagency workshop hosted by the Federal Highways Works Administration and the Texas Department of Transportation to seek opportunities to streamline the processes for satisfying the requirements of the National Environmental Policy Act for construction and maintenance of transportation projects.
- Wetlands Conservation staff coordinated with federal, State, and local authorities and planners on developing plans for:
 - Lake Ralph Hall, a proposed 7000-acre reservoir on the North Sulphur River, which would affect a part of the Ladonia Unit of the National Grassland.
 - Fastrill Reservoir, a proposed 14,000-acre reservoir on the Upper Neches River, would overlap a major portion of the proposed Upper Neches National Wildlife Refuge. It is proposed as a part of the future water supply plan for the Dallas-Fort Worth area.
 - Hearts Bluff Mitigation Bank, a proposed 1387-acre mitigation area within the flood plain of the Sulphur River in Titus County within the footprint of a future proposed Marvin Nichols Reservoir
 - Bunker Sands Mitigation Bank, a proposed 3500-acre bank lying along, and cycling water from the Trinity River just southeast of Dallas. This project would restore overbank flooding and riparian vegetation to an area converted to agriculture in the 1920s.
 - Castle Drive Mitigation Bank would establish a small, 75-acre bank within the City of Garland, to enhance the riparian aquatic functions to an area previously mined for aggregates.
 - The Middle Neches Mitigation Bank (Pineywoods Mitigation Bank) would establish a bank on 33,000 acres adjacent to and including the Neches River between two national forests to compensate for loss of wetland functions due to construction of a new Interstate Highway 69 through the Pineywoods Ecoregion in East Texas. As a partner with Texas Department of Transportation, Department staff have performed a major part of the field work for this effort.
 - A proposed expansion of the KLAMM Wetland Mitigation Bank that would add 152 acres of Sabine River bottomland hardwood wetlands to an existing mitigation bank.
 - A proposed 315-acre addition to the existing Trinity River Mitigation Bank. The new acreage is a wetland/small lake complex separated from the Trinity River by a deteriorating levee.
- Wetlands Conservation staff coordinated with the Corps of Engineers and other agencies on ongoing, multi-year River Basin Studies for Flood Damage Reduction and Ecological Restoration in the Nueces River basin (including several tributary rivers in the Hill Country and the Nueces Estuary), the Colorado River basin in Austin and Wharton, San Antonio River basin in San Antonio, the Cibolo Creek basin in central Texas, the Olmos Creek basin in San Antonio, and the Trinity River basin at Dallas.

- Wetlands Conservation staff assisted with siting studies and the preparation of permit application documents for the proposed East Texas Fish hatchery near Jasper.
- Wetlands Conservation staff assisted with the planning, contracting, permitting, and supervision of the Frio River Restoration project at Garner State Park, including critical design features for true riparian habitat restoration coupled with the protection of a National Historic Site threatened by flood-caused erosion of the site.
- Wetlands Conservation staff participated in stakeholders workshops hosted by the Lower Colorado River Authority to develop new LCRA regulations governing quarries within impacting distances of tributaries of the Colorado River.
- Wetlands Conservation staff participated in the interagency review board for the issuance of FEMA/Department of Public Safety grants for the "Hazard Mitigation Grant Program" funneling over \$ 150 million in FEMA grants to local governments to reduce or repair damages from natural disasters, such as hurricanes, floods, and wildfires. Staff focuses its efforts on trying to assure that such grants are not implemented in ways that are unsound and cause ecological damage.
- Wetlands Conservation staff coordinated, edited and published the Wetlands Newsletter, distributed twice a year to over 800 readers, featuring articles on conservation efforts, wetlands research, and wetland-related learning opportunities.
- Wetlands Conservation Staff performed field investigations and made recommendations relative to the issuance of Department "Sand and Gravel" permits for disturbance or taking of substrate materials in the Nueces, Frio, Sabinal, Guadalupe, San Marcos, Blanco, Llano, Colorado, Brazos, Sabine, Paluxy and North Sulphur Rivers; Camp Wood Creek, Onion Creek, and other smaller streams to assure that the activity would not harm the fishery.
- Wetlands Conservation Staff collaborated with USACE and TCEQ staff to work with Stephen F. Austin State University and Temple-Inland personnel to develop a regional Hydrogeomorphic Assessment Method that would be used to determine the functional capacity of an East Texas Riverine Wetland.
- Wetland Conservation Staff participated in interagency planning efforts on the Colorado River Corridor Project. Project goals include conservation, restoration, and study of a reach of the Colorado River in a fast-developing region of central Texas.
- Wetlands Conservation Staff received training to improve their habitat assessment skills -- this training included: Natural Stream Channel Assessment, ArcGIS training, and Proper Functioning Condition for Riparian Areas.

Special Projects

Special projects are included in the **Fisheries Research** section on page 38. These activities are research oriented and are coordinated through fisheries research biologists.

Organization

Fisheries Management flow charts are located in Appendix, Organization Charts, pages 67-70.

RESOURCE MANAGEMENT – FISHERIES RESEARCH

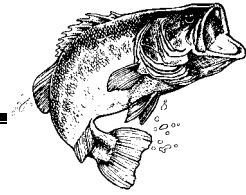

Goal

To provide scientifically sound information leading to the understanding and management of aquatic resources, their production, improvement and utilization.

Rationale

The scope of fisheries research includes statewide investigations ranging from short-term studies for the purpose of immediate decisions to long-term studies for better understanding of fisheries resources and evaluation of management programs. Communication of basic study findings through publications, press releases and special presentations, as well as providing technical assistance to other functions within Inland Fisheries is the product of this function. Fisheries research is a cooperative function maintaining close liaison with private and governmental entities for information needed to solve common problems of fisheries management programs.

Facility

Description of Heart of the Hills Fisheries Science Center

- Location – Heart of the Hills Fisheries Science Center is located on an old state fish hatchery approximately 17 miles northwest of Kerrville, Texas on State Highway 27.
- Construction Date – Original construction was completed in 1925. Following subsequent land acquisitions in 1927 and 1942 and additional pond construction, the facility contained 44 hatchery ponds and associated buildings on approximately 56 acres of land.
- Renovation History – A major renovation effort occurred beginning in 1969 when the existing fish hatchery was converted into the current fisheries research station. The 44 hatchery ponds were consolidated to form 25 research ponds ranging in size from approximately 0.5 to 2.0 acres. In 1970, a combination office building and wet laboratory was constructed. Also at that time, an existing 4,800-ft² storage building was converted into a wet laboratory. In 1978, a pole barn was constructed to house various field equipment. In 1980, a vehicle maintenance building was constructed, and in 1982 a metal shop building was constructed. An artificial stream system was installed in 1998 and enlarged in 2001. A 30' x 60' metal shop building was constructed in 2004.

Responsibilities

Conduct special investigations on unique problems identified through management surveys.

Develop new techniques to enhance fisheries resources.

Evaluate new techniques and procedures to monitor resources and resource users.

Provide assistance to other functions regarding literature searches and statistical data analyses.

Evaluate biological means of eradication of harmful or potentially harmful exotic plants and management of indigenous plants.

Aid in identification and management of exotic fish, shellfish and aquatic plants.

Program Costs

The total cost for the Research Program for FY06 was \$946,931.

Accomplishments

State-Supported Research Studies

Work was conducted on the following State-supported research studies:

Title: **Inland Fisheries Creel Procedures Workshop**

Principal Investigators: Warren Schlechte, John Taylor, Randy Myers and Fred Janssen

Objective: To provide training on technical aspects of current creel procedures to assist all Inland Fisheries personnel with efficient use of the creel tools.

Completion Date: 2006.

Title: **Statewide Freshwater Mussel Status Evaluation**

Principal Investigator: Robert Howells

Objective: To document reports about the status of Texas freshwater mussel resources, perform occasional field surveys on an approved case-by-case basis, prepare annual summaries of these data, and provide mussel-related information as requested.

Completion Date: 2006.

Title: **Channeled Applesnail Status Survey**

Principal Investigator: Robert Howells

Objectives: 1) To assist the U.S. Department of Agriculture's Mollusk Action Plan Working Group in developing a plan to address problems related to these harmful exotic snails; and 2) To assist ongoing academic research on these snails at two Texas universities.

Completion Date: 2006.

Title: **Exotic Species Identification and Evaluation**

Principal Investigator: Robert Howells

Objective: To provide species identification, technical information, and regulation advice to the public, biologists, and law enforcement personnel concerning exotic species that may be harmful or potentially harmful to Texas natural resources.

Completion Date: 2006.

Title: **Effects of Barley Straw and Liquid Live Micro-Organisms (LLMO) on Density and Ichthyotoxicity of *Prymnesium parvum*.**

Principal Investigator: Aaron Barkoh

Objective: To determine if barley straw or LLMO can control *Prymnesium parvum* and its ichthyotoxicity. Completion Date: 2006.

Title: Determining Sample Size Requirements for Age Estimation

Principal Investigators: David Buckmeier and Warren Schlechte

Objective: To determine sample size requirements for calculating growth, age structure and mortality.

Completion Date: 2007.

Title: Effects of Liquid Live Micro-Organisms (LLMO) System on Sediments and Turbidity in Koi Carp Production Ponds.

Principal Investigator: Aaron Barkoh

Objective: To determine if LLMO can reduce turbidity and sediments and improve fish production in Koi carp production ponds.

Completion Date: 2007.

Title: Bow-fishing Evaluation

Principal Investigators: Dave Buckmeier, John Taylor, and Jeremy Leitz

Objective: To collect information about bow anglers, what they harvest, where they fish, and future catfish management plans in Texas.

Completion Date: 2007.

Title: Survey of Fish age estimation by State and Provincial Natural Resource agencies

Principal Investigator: Dave Buckmeier

Objective: To assess status of aging freshwater fish in North America.

Completion Date: 2007.

Title: Mortality, Predation, and Tag Retention of fish marked with Visible Implant Elastomer Tags

Principal Investigators: Kerry Reeves, Dave Buckmeier

Objective: Assess the effectiveness of visible implant elastomer tags to mark fish.

Completion Date: 2007.

Title: Ammonia Tolerance by Striped Bass Fry and Fingerlings in Hard Water.

Principal Investigators: Aaron Barkoh and Thomas Wyatt

Objective: To determine 24-h, 48-h, 72-h and 96-h ammonia tolerance of different age (4-, 10-, 20-, 30-, 38-day) striped bass.

Completion Date: 2008.

Title: Over-winter Survival of Young-of-the-Year Fish

Principal Investigator: Kerry Reeves

Objective: Determine if survival of young-of-the-year fish in streams is size dependent.

Completion Date: 2008.

Title: Golden Alga Taskforce

Principal Investigators: Aaron Barkoh and numerous members of Inland Fisheries

Objective: To explore ways of management and control of golden alga in Texas.

Completion Date: Ongoing.

Title: Texas Urban Fishing Program

Principal Investigators: Bob Betsill, Rafe Brock, David Buckmeier, Jason Henegar, Jeff Henson, Mark Howell, Tom Hungerford, John Tibbs, Mandy Scott, and Brian Van Zee

Objective: To develop and evaluate a program that provides fishing opportunities in all urban areas and emphasizes youth participation.

Completion Date: Ongoing.

Title: Establishment of Reservoir Nutrient Criteria for Texas

Principal Investigators: Research biological staff, along with Water Quality staff

Objective: To draft a proposed approach for monitoring and evaluating nutrient levels in Texas reservoirs that will maintain current water quality and prevent further degradation.

Completion Date: Ongoing.

Title: Fishes of Texas Book

Principal Investigator: Gary Garrett

Objective: Produce a comprehensive listing of the fishes of Texas, their biology and distribution.

Completion Date: Ongoing.

Title: Life History Requirements of the Devils River Minnow

Principal Investigator: Gary Garrett

Objective: Determine life history requirements of Devils River minnow in order to aid in implementation of the Devils River Minnow Conservation Agreement.

Completion Date: 2008.

Title: Guadalupe Bass Restoration Project

Principal Investigator: Gary Garrett

Objective: Restore hybridized populations of Guadalupe bass to genetic purity.

Completion Date: Ongoing.

Sport Fish Restoration Federal Aid-Supported Studies

Work was conducted on the following Federal Aid-supported (Sport Fish Restoration) studies:

Title: Contribution of Stocked Northern Largemouth Bass in Selected Texas Reservoirs Composed Largely of Florida Largemouth Bass.

Principal Investigators: John Prentice and Gary Garrett

Objective: To determine if stocking 10,000 fingerling NLMB every 2 km of a 6-km length of shoreline in a reservoir containing a resident population \leq 1% NLMB genotype can increase the proportion of NLMB to 10% with 1, 2 or 3 years of consecutive stocking.

Completion Date: 2006.

Title: Efficacy of Mass Fluorescent-chemical Double Marking in Largemouth Bass

Principal Investigators: John Prentice, Warren Schlechte, and Bob Betsill

Objective: To determine mass marking efficacy, relative survival and mark retention beyond one year when applying double marks with oxytetracycline and calcein to largemouth bass.

Completion Date: 2006.

Title: **Catfish Gear Selectivity Evaluation**

Principal Investigator: David Buckmeier

Objective: To determine a preliminary evaluation of the effectiveness and bias of gears used to sample catfishes with the intent of developing a formal evaluation in future years.

Completion Date: 2007.

Land Owner Incentive Program (LIP) Study

Work was conducted on the following Federal Aid-supported (Landowner Incentive Program) study:

Title: **Restoration of Pecos Pupfish Habitat**

Principal Investigator: Gary Garrett

Objective: Restore existing habitat and create new habitat for Pecos pupfish as called for in the Pecos Pupfish Conservation Agreement.

Completion Date: Ongoing.

State Wildlife Grant (SWG) Study

Work was conducted on the following Federal Aid-supported (State Wildlife Grant) studies:

Title: **Freshwater Mussel Survey**

Principal Investigator: Robert Howells

Objective: To direct field surveys conducted by two academic institutions in Texas to examine the status of freshwater mussel populations (1) in the Webb County area of the Rio Grande and (2) at other selected sites statewide where mussel assemblages were known to occur.

Completion Date: 2006

Publications

Edwards, R. J. and G. P. Garrett. 2006. Aspects of the life history of the San Felipe gambusia, *Gambusia clarkhubbsi*: Habitat utilization patterns. Pages 40-46 in: Studies of North American Desert Fishes in Honor of E. P. (Phil) Pister, Conservationist (M.L. Lozano-Vilano and A.J. Contreras-Balderas, eds.), Universidad Autónoma de Nuevo León.

Henson, J. C. 2004. Use of regulatory catch-and-release to improve a trophy largemouth bass fishery at Gibbons Creek Reservoir, Texas. Texas Chapter, American Fisheries Society Annual Proceedings 26: 14-19.

Kurten, G. L., A. Barkoh, L. T. Fries, and D. Begley. 2006. Combined Nitrogen and Phosphorus Fertilization for Controlling the Toxigenic Alga *Prymnesium parvum*. North American Journal of Aquaculture (accepted Sept 1, 2006).

Littrell, B. M., D. J. Lutz – Carrillo, T. H. Bonner, and L. T. Fries. 2006. Status of an introgressed Guadalupe bass population in a central Texas stream. North American Journal of Fisheries Management (accepted).

- Lutz – Carrillo, D. J., C. C. Nice, T. H. Bonner, M. R. J. Forstner, and L. T. Fries. 2006. Admixture analysis of Florida largemouth bass and northern largemouth bass using microsatellite loci. *Transactions of the American Fisheries Society* 135:779-791.
- Matthews, W. J., K. B. Gido, G. P. Garrett, F. P. Gelwick, J. G. Stewart and J. Schaefer. 2006. Modular Experimental Riffle–Pool Stream System. *Transactions of the American Fisheries Society* 135:1559–1566.
- Moczygemba, J. H., B. T. Hysmith, and J. W. Schlechte. 2005. Comparison of Guided and Unguided Fishing Trips from Two Texas Reservoirs. *Texas Chapter of the American Fisheries Society Proceedings* 27:17-30.
- Schlechte, J. W., and D. L. Buckmeier. 2006. A pond evaluation of habituation as a means to reduce initial mortality associated with poststocking predation of hatchery-reared largemouth bass. *North American Journal of Fisheries Management* 26:119-123.
- Wagner T., A.K. Jubar, and M.T. Bremigan 2006. Can habitat alteration and spring angling explain largemouth bass nest success? *Transactions of the American Fisheries Society* 135:843-852

Reports

- Bradle, T.A., S. J. Magnelia and J.B. Taylor. 2006. Trout angler utilization, opinions, and economic impact at the Canyon Reservoir Tailrace – Final report. White Paper. Texas Parks and Wildlife Department, Inland Fisheries Division, Austin, Texas. 41 pp.
- Brazos River Authority, Texas Commission on Environmental Quality, Texas Parks and Wildlife Department, and Texas Water Development Board. 2006. Biological data collection: Brazos River study area. Report submitted for TWDB Research and Planning Fund Contract No. 2005-483-561, Waco, TX.
- Buckmeier, D. L. 2006. Catfish gear selectivity evaluation. Texas Parks and Wildlife Department. Federal Aid in Sportfish Restoration. Grant F-159-R. Interim Performance Report. Austin, Texas.
- Garrett, G. P. 2006. Contribution of stocked northern largemouth bass in selected Texas reservoirs composed largely of Florida largemouth bass. Texas Parks and Wildlife. Federal Aid in Sportfish Restoration. Grant F-145-R. Final Report. Austin, Texas.
- Houston, F., H. Elder, and E. Chilton. 2006. Nuisance Aquatic Vegetation Control in 2004. Management Data Series No. 239. Texas Parks and Wildlife Department, Austin.
- Howells, R. G. 2006. Statewide freshwater mussel survey. Texas Parks and Wildlife Department. State Wildlife Grant T-15-P. Final Report. Austin, Texas.
- Lyon, D. D., A. Barkoh, and J. W. Schlechte. 2006. Comparison of day versus night feeding on production of advanced imperial-strain channel catfish *Ictalurus punctatus* in indoor raceways. Management Data Series Number 238. Texas Parks and Wildlife Department, Austin.

- Lyon, D. D., A. Barkoh, D. Smith, and D. Begley. 2006. Guidelines for the culture of striped bass and palmetto bass. Management Data Series Number 243. Texas Parks and Wildlife Department, Austin.
- Martinez, J. G., T. Wyatt, and G. Kurten. 2006. Effect of inoculation and supplemental feeding of zooplankton on Florida largemouth bass (*Micropterus salmoides floridanus*) fingerling production in plastic-lined ponds. Management Data Series Number 237. Texas Parks and Wildlife Department, Austin.
- Sabine River Authority, Texas Commission on Environmental Quality, Texas Parks and Wildlife Department, and Texas Water Development Board. 2006. Baseline fish collections: lower Sabine River priority instream flow study. Report submitted for TWDB Research and Planning Fund Contract No. 0604830567, Orange, Texas.
- Saunders, K. 2005. First record of *Nymphoides indica* (Menyanthaceae) in Texas. SIDA 21(4): 2441-2443.
- Schlechte, J. W., and J. P. Prentice. 2006. Efficacy of mass fluorescent-chemical double marking in largemouth bass. Texas Parks and Wildlife Department. Federal Aid in Sportfish Restoration. Grant F-146-R. Final Report. Austin, Texas.

Articles

- Ashe, D.E. 2006. Conditions in Toledo Bend and potential impacts on largemouth Bass. Lakecaster Vol. 16 No. 1.
- Ashe, D.E. 2006. Largemouth bass spawning and factors for success. Lakecaster Vol. 16 No. 4.
- Ashe, D. 2006. Channel catfish. Lakecaster Vol. 16 No. 6.
- Ashe, D.E. 2006. Why does TPWD ask so many creel questions. Lakecaster Vol. 16 No. 8.
- Ashe, D.A. 2006. Toledo Bend Reservoir fishing report for the past year. Lakecaster Vol. 16 No. 10.
- Ashe, D. 2006. Double Crested Comorants in Texas. Lakecaster Vol. 16 No. 11.
- Benson, L. 2006. Big country lakes heating up. Abilene Reporter News, Sports page. March 13.
- Cole R. 2006. Area lakes are getting 'topo mapped'. Abilene Reporter News, Sports page. April 7.
- Cole R. 2006. Crappie doing well at area lakes. Part 1. Abilene Reporter News, Sports page. December 28.
- Cortez, D.F. 2006. Scouts Get Hooked. Texas Parks & Wildlife 64(6):13.
- Cortez, D.F. 2006. Life in a Puddle. Texas Parks & Wildlife 64(7):86.

- Cortez, D.F. 2006. Hunting Tamales. Texas Parks & Wildlife 64(12):42.
- Driscoll, M.T. 2006. Rainbow trout stocked in area lakes. Lakecaster Vol. 17 No. 1.
- Driscoll, M.T. 2006. Anglers pay, anglers benefit. Lakecaster Vol. 16 No. 11.
- Driscoll, M.T. 2006. Aquatic vegetation diverse at Sam Rayburn and Toledo Bend reservoirs. Lakecaster Vol. 16 No. 9.
- Driscoll, M.T. 2006. Fish parasites and infections increase during summer. Lakecaster Vol. 16 No. 7.
- Driscoll, M.T. 2006. Livewell-held bass require special care during summer months. Lakecaster Vol. 16 No. 5.
- Driscoll, M.T. 2006. Impact of tournaments on the largemouth bass population at Sam Rayburn Reservoir. Lakecaster Vol. 16 No. 3.
- Dumont S. 2006. Brownwood and Coleman bass keep on keepin' on. Abilene Reporter News, Sports page. November 16.
- Dumont S. 2006. Rainbows coming to Abilene. Abilene Reporter News, Sports page. November 30.
- Dumont S. 2006. Growth of fish species vary in Big Country. Abilene Reporter News, Sports page. September 10.
- Dumont S. 2006. Celebrate family fishing at Abilene State Park. Abilene Reporter News, Sports page. September 21.
- Dumont S. 2006. Lake levels continue dropping fast. Abilene Reporter News, Sports page. August 8.
- Dumont S. 2006. The Blue Jewell is on fire. Abilene Reporter News, Sports page. August 24.
- Dumont S. 2006. Bass in Abilene and Clyde recovering fast. Abilene Reporter News, Sports page. July 2.
- Dumont S. 2006. Lake Abilene catfish on rebound. Abilene Reporter News, Sports page. May 4.
- Dumont S. 2006. Kirby has the blues. Abilene Reporter News, Sports page. May 29.
- Dumont S. 2006. Public hearings on regulation changes to begin next week. Abilene Reporter News, Sports page. February 16.
- Dumont S. 2006. Contour maps of area lakes available. Abilene Reporter News, Sports page. January 19.
- Elder, Howard. 2006. Giant salvinia Remains a threat to east Texas reservoirs. The Lakecaster. Vol.6. Number 7.

- Farooqi, M. 2006. Biologists hope to produce some world record size bass in Texas. Abilene Reporter News, Sports page. December 14.
- Farooqi, M. 2006. Activity-filled Austin event returns. Abilene Reporter News, Sports page. October 5.
- Farooqi, M. 2006. Bass-release tube study being done at Amistad Reservoir. Abilene Reporter News, Sports page. October 19.
- Farooqi, M. 2006. Fishing for saugeye picks up. Abilene Reporter News, Sports page. July 21.
- Farooqi, M. 2006. Big Country offers variety of catfish angling opportunities. Abilene Reporter News, Sports page. June 8.
- Farooqi, M. 2006. Angler gets \$250,000 for catching a common carp. Abilene Reporter News, Sports page. April 20.
- Farooqi, M. 2006. The world according to carp. Texas Parks and Wildlife Magazine. March 2006.
- Farooqi, M. 2006. Wintertime crappie fishing can have rewards. Abilene Reporter News, Sports page. January 7.
- Farooqi, M. 2006. Fish stocking can be plus or minus. Abilene Reporter News, Sports page. February 2.
- Henson, Jeff. 2006. Electrofishing survey at Lake Conroe provides biologists with vital fish population data. The Dockline Magazine. November-December Issue.
- Henson, Jeff. 2006. Upcoming creel survey will help biologists' manage Lake Conroe. The Dockline Magazine. June-July Issue.
- Houston, Flynt. 2006. Giant salvinia on the Move. Lakecaster. Volume 16. Number 11.
- Houston, Flynt. 2006. Duckweeds and your pond. The Lakecaster. Vol 16. No .5.
- Hodge, L. D. 2006. Prince of Bass. Texas Parks & Wildlife 64(1):34.
- Hodge, L. D. 2006. Bass Under the Microscope. Texas Parks & Wildlife 64(2):38.
- Hodge, L. D. 2006. Texas Freshwater Fisheries Center. Athens, Texas, Chamber of Commerce n.d.:14.
- Hodge, L. D. 2006. Lone Star State Fishing Calendar. Texas Sportsman 2006(2):24.
- Hodge, L. D. 2006. Catch and Release: Have We Gone Too Far? Texas Wildlife 21(11):36.
- Hodge, L. D. 2006. Hatching a Revolution. Texas Parks & Wildlife 64(4):38.
- Hodge, L. D. 2006. Seeing Red. Texas Parks & Wildlife 64(4):44.
- Hodge, L. D. 2006. Crappie Days Are Here Again. Texas Parks & Wildlife 64(5):50.

- Hodge, L. D. 2006. Stocking Up. Texas Parks & Wildlife 64(5):54.
- Hodge, L. D. 2006. Hungry Hordes to the Rescue. Texas Parks & Wildlife 64(5):18.
- Hodge, L. D. 2006. Fishing Hotspots in State Parks. Texas Parks & Wildlife 64(6):46.
- Hodge, L. D. 2006. Growing Fish Food. Texas Parks & Wildlife 64(6):14.
- Hodge, L. D. 2006. Snaring the Red Drum. Texas Parks & Wildlife 64(8):28.
- Hodge, L. D. 2006. Don't Dump That Aquarium. Texas Parks & Wildlife 64(8):10.
- Hodge, L. D. 2006. H.O.T. Cats. Catfish Now. 1(8):54.
- Hodge, L. D. 2006. Dog Days and Cat Nights of Summer. Lone Star Outdoor News 2(24):1.
- Hodge, L. D. 2006. City Fish. Texas Parks & Wildlife 64(9):14.
- Hodge, L. D. 2006. Triple Play. Texas Parks & Wildlife 64(10):52.
- Hodge, L. D. 2006. Fly-Fishing the Red River. Texas Fish & Game 22(6):70.
- Hodge, L. D. 2006. Top Spots for Fall Bass. Texas Sportsman 2006(10):24.
- Hodge, L. D. 2006. A Buffet for Bass. The Fishing & Hunting Journal (Port Alfred, South Africa) 9(4):16.
- Hodge, L. D. 2006. Bass Fishing Heaven. The Fishing & Hunting Journal (Port Alfred, South Africa) 9(5):3.
- Hodge, L. D. 2006. Night Cats on the Prowl. Catfish Now (1)11:40.
- Howell, M. 2006. Plum Lake benefiting from TUF. Wichita Falls Times-Record News, Sports Page, December 7.
- Howell, M. 2006. TPWD fisheries division programs targeting kids. Wichita Falls Times-Record News, Sports Page, July 13.
- Lenderman, Ray. 2006. Annual fishing event brings in biggest crowd. The Jasper Newsboy. January 18.
- Magnelia, S.J. 2006. Some words about access. Fishers of Men Tournament Trail Newsletter. November Issue.
- Magnelia, S.J. 2006. Deflating swim bladders of bass caught in deep water. Fishers of Men Tournament Trail Newsletter. June Issue.
- Magnelia, S.J. 2006. Find the shad in the post-spawn. Fishers of Men Tournament Trail Newsletter, May Issue.

- Magnelia, S.J. 2006. The importance of forage in bass fishing. Fishers of Men Tournament Trail Newsletter. March Issue.
- Magnelia, S.J. 2006. Keeping tournament caught bass alive. Fishers of Men Tournament Trail Newsletter. February Issue.
- Magnelia, S.J. 2006. Dispersal of tournament-caught bass. Fishers of Men Tournament Trail Newsletter. January Issue.
- Mauk, R. 2006. Fisheries surveys good news for area lakes. Wichita Falls Times-Record News, Sports Page, December 21.
- Mauk, R. 2006. Angler recognition program beneficial to fisheries biologists. Wichita Falls Times-Record News, Sports Page, July 6.
- Mauk, R. 2006. Gill net survey's produce good numbers on area lakes. Wichita Falls Times Record News, Sports Page, May 25.
- Singhurst, L. 2006. Golden alga kills fish. Reel Lines. 20:10. Texas Parks and Wildlife Department. Texas Angler Education Program. July 2006.
- Tibbs, J. and M. Baird. 2007. Fishing forecast 2007. Lake Whitney Views. Volume 55, Number 11.
- Webb, Mark A. and Earl Chilton. 2006. Grass carp stocking in Lake Conroe. The Dockline Magazine. March-April Issue.
- Webb, Mark A. and Earl Chilton. 2006. Hydrilla management continues at Lake Conroe. The Dockline Magazine. September-October Issue.

Presentations

- Aziz, K. and D. Mosier. 2006. Texas Instream Flow Program: Reconnaissance efforts. Presented at the Annual Meeting of the Southern Division of the American Fisheries Society, San Antonio, Texas, February 11.
- Barkoh, A., J. Paret, D. D. Lyon, and J. W. Schlechte. 2006. Effects of the probiotic, Liquid Live Micro-Organisms System, on sludge, water quality, and koi carp production in hatchery ponds. Presented at the Annual Meeting of the Southern Division of the American Fisheries Society, San Antonio, Texas, February 11.
- Barkoh, A., J. Paret, J. W. Schlechte, D. D. Lyon, S. Hamby. 2006. Can barley straw and the probiotic, Liquid Live Micro-Organisms System, control *Prymnesium parvum* and improve water quality for fish production? Presented at the Annual Meeting of the Southern Division of the American Fisheries Society, San Antonio, Texas, February 11.

- Barkoh, A., J. W. Schlechte, J. Paret, and D. D. Lyon. 2006. Can the probiotic, liquid live microorganisms system, reduce sediments and improve water quality and koi carp production in hatchery ponds? Presented at the Annual Conference of the Southeastern Association of Fish and Wildlife Agencies, Norfolk, Virginia, November 7.
- Betsill, R. K. 2006. Texas urban fishing programs. Presented at the Annual Meeting of the Southern Division of the American Fisheries Society, San Antonio, Texas, February 11.
- Bister, T. J., R. A. Myers, M. T. Driscoll, and D. R. Terre. 2006. Largemouth bass population trends in two Texas reservoirs with LMBV-related die-offs. Presented at the Annual Conference of the Southeastern Association of Fish and Wildlife Agencies, Norfolk, Virginia, November 6.
- Bister, T. J., R. A. Myers, M. T. Driscoll, and D. R. Terre. 2006. Largemouth bass population trends in two Texas reservoirs with LMBV-attributed die-offs. Presented at the Annual Meeting of the Southern Division of the American Fisheries Society, Largemouth Bass Virus Update and Workshop, San Antonio, Texas, February 9.
- Bonds, C. and J. Warren Schlechte. 2006. Can biotelemetry information improve trap-net catch rates of adult white crappie? Presented at the Annual Conference of the Southeastern Association of Fish and Wildlife Agencies, Norfolk, Virginia, November 7.
- Bonds, C. C., and J. W. Schlechte. 2006. Testing if knowing white crappie locations can improve trap net sampling. Presented at the Annual Meeting of the Southern Division of the American Fisheries Society, San Antonio, Texas, February 11.
- Bonner, T. and K. Saunders. 2006. Biological condition gradient concept applied to a Texas river. Presented at the Annual Meeting of the Southern Division of the American Fisheries Society, San Antonio, Texas, February 12.
- Bradle, T.A., Magnelia, S.J. and J.B. Taylor. 2006. Angler attitudes and opinions and economic impact of trout anglers on the Canyon Reservoir Tailrace. Presented at the Annual Meeting of the Southern Division of the American Fisheries Society, San Antonio, Texas, February 11.
- Buckmeier, D. L. 2006. Largemouth bass stocking in Texas. Presented at the Missouri Natural Resource Conference Stocking Symposium, Tan-Tar-A Resort, Missouri, February 11.
- Chilton, E. W., II 2006. Results of radio tracking study of movement and range of white amur within the Lake Conroe system. Presented at the Annual Meeting of the Texas Aquatic Plant Management Society, Jasper Texas, September 12
- Chilton, E. W., II 2006. Aquatic vegetation management. Presented at the Annual Meeting of the Southern Division of the American Fisheries Society, Biologist, Angler, and Fishing Industry Workshop, San Antonio, Texas, February 10.
- Chilton, E. W., II. 2006. Ecological impacts of *Arundo donax*. Presented at the *Arundo donax* conference sponsored by USDA, October.

- Chilton, E. W., II. 2006. Aquatic vegetation and herbicide use in Texas. Presented at the Annual meeting of the Texas Vegetation Management Association, October.
- Chilton, E. W., II. 2006. Integrated management of aquatic invasive plants to improve flows and water quality in the Rio Grande, Texas. Presented at the 54th Annual Meeting of the North American Benthological Society, June.
- Chumchal, M. M., R. W. Drenner, B. Fry, D. J. Lutz-Carrillo, K. D. Hambright, W. C. McClain, and L. Newland. 2006. Mercury contamination in fish from Caddo Lake, Texas. Presented at the Annual Meeting of the Southern Division of the American Fisheries Society, San Antonio, Texas, February 11.
- Chumchal, M. M., R. W. Drenner, B. Fry, D. J. Lutz-Carrillo, K. D. Hambright, W. C. McClain, and L. Newland. 2006. Mercury contamination in fish from Caddo Lake, Texas. Presented at the International Conference on Mercury as a Global Pollutant, Madison, Wisconsin, August 6.
- Dennis, J. A., T. Bradle, F. Janssen, R. A. Myers, and J. W. Schlechte. 2006. Annual expenditures of black bass tournament and non-tournament anglers at O.H. Ivie Reservoir, Texas. Presented at the Annual Conference of the Southeastern Association of Fish and Wildlife Agencies, Norfolk, Virginia, November 7.
- Driscoll, M.T., J.L. Smith, and R.A. Myers. 2006. Impacts of tournaments on the largemouth bass population at Sam Rayburn Reservoir, Texas. Presented at the Annual Meeting of the Southern Division of the American Fisheries Society, San Antonio, Texas, February 11.
- Dumont, S. 2006. Using GIS for reservoir creel surveys and mapping. Presented at the Annual Meeting of the Southern Division of the American Fisheries Society, San Antonio, Texas, February 11.
- Elder, H. 2006. Prohibited aquatic plants in Texas. Surface Water Quality Monitoring Annual Meeting. Texas Commission on Environmental Quality. November, 2006. Galveston, Texas.
- Elder, H. 2006. Giant salvinia (*Salvinia molesta*) control efforts on Toledo Bend Reservoir, Texas 2005-2006. Presented at the Annual Meeting of the Texas Aquatic Plant Management Society, Jasper, Texas, September 12.
- Elder, H. 2006. The Expansion of giant salvinia (*Salvinia molesta*) on Toledo Bend Reservoir, Texas. Presented at the Annual Meeting of the Southern Division of the American Fisheries Society, San Antonio, Texas, February 11.
- Farooqi, M.A., J. Leitz, and J.B. Taylor. 2006. The socio-economic characteristics of anglers participating in a common carp (*Cyprinus carpio*) fishing tournament in Austin, Texas. Presented at the Annual Conference of the Southeastern Association of Fish and Wildlife Agencies, Norfolk, Virginia, November 7.

- Farquhar, B. 2006. Comparison of relative contribution, growth, and vulnerability to angling of triploid Florida largemouth bass and diploid northern largemouth bass stocked in a newly renovated reservoir. Presented at the Annual Conference of the Southeastern Association of Fish and Wildlife Agencies, Norfolk, Virginia, November 6.
- Forshage, A. and L. Fries. 2006. ShareLunker program. Presented at the Annual Meeting of the Southern Division of the American Fisheries Society, San Antonio, Texas, February 11.
- Forshage, A. 2006. Texas Freshwater Fisheries Center a valuable production and outreach tool. Presented at the Annual Conference of the Southeastern Association of Fish and Wildlife Agencies, Norfolk, Virginia, November 7.
- Fries, L. T., D. J. Lutz-Carrillo, and G. L. Kurten. 2006. Striped bass brood stock management in Texas: Planning for the future. Presented at the Annual Conference of the Southeastern Association of Fish and Wildlife Agencies, Norfolk, Virginia, November 6.
- Garrett, G. P. 2006. Management and conservation of native Texas fishes. Presented as part of Crate Lecture Series, Schreiner University, Kerrville, Texas, November 2.
- Garrett, G. P. 2006. Innovative approaches to resource conservation. Presented at the Annual Conference of the Southeastern Association of Fish and Wildlife Agencies, Norfolk, Virginia, November 6.
- Garrett, G. P. 2006. Desert fishes research and management – 2006. Presented at the Annual Meeting of the Desert Fishes Council, Death Valley, California, November 16.
- Garrett, G. P. and R. J. Edwards. 2006. Aquifer-dependent fishes of central and western Texas. Presented at the Annual Meeting of the Southern Division of the American Fisheries Society, San Antonio, Texas, February 11.
- Glass, J. 2006. Golden alga fish kills in the Brazos River Basin. Presented at the Annual Meeting of the Southern Division of the American Fisheries Society, San Antonio, Texas, February 11.
- Gordon, W., K. Mayes, J. Klumpp, K. Aziz, and M. Wentzel. 2006. Application of GIS to Texas Instream Flow Program. Poster presented at American Water Resources Association - GIS in Water Resources Conference, Houston, Texas, May 18-19.
- Houston, Flynt. 2006. Field identification of exotic aquatic plants found in Texas. Surface Water Quality Monitoring Annual Meeting. Texas Commission on Environmental Quality. November, 2006. Galveston, Texas.
- Hodge, L. D. and A. Forshage. 2006. The development of largemouth bass fishing and management in Texas. Presented at the Annual Conference of the Southeastern Association of Fish and Wildlife Agencies, Norfolk, Virginia, November 7.
- Janssen, F. W. and C. Scofield, 2006. A grid-based approach to mapping habitat in Texas reservoirs. Presented at the Annual Meeting of the Southern Division of the American Fisheries Society, San Antonio, Texas, February 11.

- Jubar, A. and K. Storey. 2006. Using a voluntary survey to improve knowledge of trophy largemouth bass catches in Lake Fork Reservoir, Texas. Presented at the Annual Meeting of the Southern Division of the American Fisheries Society, San Antonio, Texas, February 11.
- Jubar, A. and K. Storey. 2006. Using a voluntary survey to improve knowledge of trophy largemouth bass catches in Lake Fork Reservoir, Texas. Poster presented at the Annual Conference of the Southeastern Association of Fish and Wildlife Agencies, Norfolk, Virginia, November 6.
- Jurgensen, T. 2006. Collecting fish for baseline information in planning instream flow studies in Texas. Presented at the Annual Conference of the Texas River and Reservoir Management Society, Austin, Texas, May 19.
- Kurten, G. 2006. Freshwater harmful and nuisance algal blooms. Presented at the Annual Meeting of the Texas Aquaculture Society, Bay City, Texas, January 27.
- Kurten, G., A. Barkoh, L. T. Fries, and D. Begley. 2006. Combined nitrogen and phosphorus fertilization for controlling *Prymnesium parvum* in fish culture ponds. Presented at the Annual Meeting of the Southern Division of the American Fisheries Society, San Antonio, Texas, February 11.
- Littrell, B. M., D. J. Lutz-Carrillo, T. H. Bonner, and L. T. Fries. 2006. Status of an introgressed Guadalupe bass population in a central Texas stream. Presented at the Annual Meeting of the Southern Division of the American Fisheries Society, San Antonio, Texas, February 11.
- Lutz-Carrillo, D. J. 2006. Admixture and ancestry of trophy bass. Presented at the Annual Meeting of the Southern Division of the American Fisheries Society, San Antonio, Texas, February 11.
- Lutz-Carrillo, D. J., B. M. Littrell, G. P. Garrett, T. H. Bonner, and L. T. Fries. 2006. Guadalupe Bass: Introgressive hybridization and restoration. Presented at the Annual Meeting of the American Fisheries Society, Lake Placid, New York, September 7.
- Matthews, J. 2006. ShareLunker Program. Presented at the Annual Conference of the Southeastern Association of Fish and Wildlife Agencies, Norfolk, Virginia, November 7.
- Mauk, R. J. 2006. Efficacy of oxytetracycline marking fingerling palmetto bass in hard water. Presented at the Annual Meeting of the Southern Division of the American Fisheries Society, San Antonio, Texas, February 12.
- Mayes, K. 2006. An ecosystem template for conducting instream flow studies. Presented at the Annual Meeting of the Southern Division of the American Fisheries Society, San Antonio, Texas, February 11.
- Mayes, K. 2006. Texas Instream Flow Program: biology. Presented for Texas Instream Flow Program stakeholder and technical workshop, San Antonio, Texas, June 15.
- Mayes, K. 2006. Texas Instream Flow Program: integration. Presented for Texas Instream Flow Program stakeholder and technical workshop, San Antonio, Texas, June 15.

- Mayes, K. 2006. Texas Instream Flow Program: biology. Presented for Texas Instream Flow Program stakeholder and technical workshop, Dallas, Texas, July 12.
- Mayes, K. 2006. Texas Instream Flow Program: integration. Presented for Texas Instream Flow Program stakeholder and technical workshop, Dallas, Texas, July 12.
- Mayes, K. 2006. Texas Instream Flow Program: reconnaissance and fish sampling. Presented at Region G Water Planning Group meeting, Waco, Texas, August 9.
- Mayes, K. and K. Aziz. 2006. Texas Instream Flow Program: Overview. Presented at the Biennial Meeting of the Instream Flow Council, Vancouver Island, Canada, April 11.
- Mosier, D. 2006. Texas Instream Flow Program: Opportunities for stakeholder participation. Presented for Texas Instream Flow Program stakeholder and technical workshop, San Antonio, Texas, June 15.
- Mosier, D. 2006. Texas Instream Flow Program: Opportunities for stakeholder participation. Presented for Texas Instream Flow Program stakeholder and technical workshop, Dallas, Texas, July 12.
- Myers, R. and M. Allen. 2006. Factors related to angler catch of trophy largemouth bass in Texas reservoirs. Presented at the Annual Meeting of the Southern Division of the American Fisheries Society, San Antonio, Texas, February 11.
- Ott, R. and T. J. Bister. 2006. Largemouth bass population recovery following hydrilla control in Lake Bellwood, Texas. Poster presented at the Annual Conference of the Southeastern Association of Fish and Wildlife Agencies, Norfolk, Virginia, November 6.
- Ott, R. 2006. Evaluation of methods for establishing native aquatic vegetation in seven Texas reservoirs. Presented at the Annual Meeting of the Southern Division of the American Fisheries Society, Aquatic Plant Establishment Workshop, San Antonio, Texas, February 10.
- Parker, M. 2006. Paddling Trails: Navigating the process. Presented at the Texas Recreation and Parks Society (TRAPS) Conference, Ft. Worth, Texas, March 10.
- Prentice, J. A. and J. Warren Schlechte, and R. K. Betsill. 2006. Longevity of oxytetracycline and calcein in double-marking batches of fry and fingerlings largemouth bass. Presented at the Annual Conference of the Southeastern Association of Fish and Wildlife Agencies, Norfolk, Virginia, November 7.
- Sager, D., L. Singhurst, J. Glass, J. Ralph, L. Fries, G. Southard, G. Kurten, and D. Buzan. 2006. The growing national threat of the toxic golden alga and how Texas is addressing it. Presented at the Annual Meeting of the Southern Division of the American Fisheries Society, San Antonio, Texas, February 11.
- Scott, M. and D. Magoullick. 2006. Swimming performance of five warmwater stream fish species. Presented at the Annual Meeting of the Southern Division of the American Fisheries Society, San Antonio, Texas, February 11.

- Singhurst, L., J. Glass, J. Ralph, and D. Sager. 2006. *Prymnesium parvum* fish kills in the Colorado River basin, Texas (October 2001 to February 2002). Presented at the Annual Conference of the Texas River and Reservoir Management Society, Austin, Texas, May 19.
- Smith, J.L., M.T. Driscoll, and R.A. Myers. 2006. Components of fishing mortality for largemouth bass at Sam Rayburn Reservoir with implications for alternative length limits. Poster presented at the Annual Meeting of the Southern Division of the American Fisheries Society, San Antonio, Texas, February 11.
- Southard, G. M. 2006. Texas LMBV update. Presented at the Annual Meeting of the Southern Division of the American Fisheries Society, Largemouth Bass Virus Update and Workshop, San Antonio, Texas, February 9.
- Southard, G. M., L. T. Fries, and D. Terre. 2006. Texas response to largemouth bass virus (LMBV): Five years of monitoring freshwater hatcheries and fisheries. Presented at the Annual Conference of the Southeastern Association of Fish and Wildlife Agencies, Norfolk, Virginia, November 7.
- Terre, D. R. 2006. Introduction and workshop purpose. Presented at the Annual Meeting of the Southern Division of the American Fisheries Society, Biologist, Angler, and Fishing Industry Workshop, San Antonio, Texas, February 10.
- Webb, M. 2006. Limited reintroduction of white amur as a part of Integrated Pest Management (IPM) of hydrilla on Lake Conroe, Texas. Presented at the Annual Meeting of the Texas Aquatic Plant Management Society, Jasper, Texas, September 12.
- Webb, M. 2006. Native vegetation establishment. Presented at the Annual Meeting of the Southern Division of the American Fisheries Society, Biologist, Angler, and Fishing Industry Workshop, San Antonio, Texas, February 10.

Special Projects – Fisheries and Habitat Management

Region 1

Bobby Farquhar

Title: Investigations in the Use of Triploid Florida Largemouth Bass in a Newly Renovated Reservoir

Objectives: 1) To compare the relative contribution of stocked triploid Florida largemouth bass and northern largemouth bass to each year class in a newly renovated reservoir; 2) To compare the growth of stocked triploid Florida largemouth bass to northern largemouth bass in a newly renovated reservoir; 3) To compare the relative vulnerability of triploid Florida largemouth bass to northern largemouth bass to angling in a newly renovated reservoir. Approval Date: 2/18/01. Completion date: 2006 (*in press*)

Charles Munger

Title: Evaluation of a Regulation Allowing Harvest of 2 Walleye under 16 inches

Objectives: To evaluate the effects of a walleye regulation of 5 fish per day bag limit with no more than 2 fish under 16 inches imposed in September 1999. The evaluation will include determination of changes of walleye relative abundance, population size structure, growth and condition, and angler catch and harvest rates. Approval Date: 2/14/01. Completion Date: 2007

Spencer Dumont

Title: Assessment of population genetic composition of Age-0 versus adult largemouth bass

Objectives: Determine if genetic composition from samples of age-0 largemouth bass is an accurate and precise representation of genetic composition of adult largemouth bass. Approval Date: 11/07/06. Completion Date: 2008

Craig Bonds

Title: Investigation of Adult White Crappie Movement in Two Texas Reservoirs with Implications for Improving Frame Net Sampling Efficiency

Objectives: 1) Monitor seasonal and diel crappie movement in two Texas reservoirs; 2) estimate adult white crappie home range as a function of season, sex, and size; and 3) test whether new information can improve frame net catch rates of adult white crappie. Approval Date: 2/14/01. Completion Date: 2006 (*in press*)

John Dennis

Title: Expenditures, Economic Impact, Economic Surplus, Attitudes and Management Preferences of Black Bass Tournament and Non-Tournament Anglers at O. H. Ivie Reservoir, Texas

Objectives: 1) Estimate the number of "Open" type bass tournaments and "Club" type bass tournaments conducted at O.H. Ivie and the number of participants during 1 year; 2) estimate the direct expenditures, economic impact and recreational value of bass tournaments to the local counties surrounding O.H. Ivie Reservoir and to the state of Texas during 1 year; 3) estimate the direct expenditures, economic impact and recreational value of non-tournament anglers to the local counties surrounding O.H. Ivie and to the state of Texas; 4) measure the attitudes, management preferences and socio-demographics of tournament and non-tournament anglers at O.H. Ivie

Reservoir; and 5) estimate contribution to total number of angler days and total fishing expenditures by "Club" tournament anglers, "Open" tournament anglers, and non-tournament anglers at O.H. Ivie Reservoir for 1 year. Approval Date: 6/8/01. Completion Date: 2006 (*in press*)

John Dennis

Title: Stocking sub-adult northern largemouth bass in a power plant reservoir

Objectives: 1) determine 72-h post-stocking mortality of the stocked fish, 2) determine the contribution of the stocked fish to the reservoir's largemouth bass population at 8, 20, and 32 months following each stocking, 3) determine the effect of each stocking on largemouth bass abundance, size structure, and genetic composition, and 4) determine the effect of each stocking on the reservoir's fishery. Approval Date: 5/15/06. Completion Date: 2011

Region 2

Brian Van Zee

Title: Saugeye Stocking Evaluation

Objective: To determine, in selected reservoirs, if stocking saugeye will create an additional sport fishery, increase total fishing pressure, and/or increase the abundance of crappie \geq 10 inches.

Approval Date: 1/15/93. Completion Date: 2007

Brian Van Zee

Title: Evaluation of the Gizzard Shad Standard Weight Equation and Development of a Redbreast Sunfish Standard Weight Equation

Objectives: 1) To develop a new standard weight (Ws) equation for gizzard shad using the regression-line-percentile (RLP) technique and data sets that represent the entire geographical range of the species; 2) to use the new gizzard shad Ws equation to evaluate the current gizzard shad Ws equation for length-related biases and based upon the results recommend use of the proper equation by fisheries managers in calculating relative weight (Wr); and 3) to develop a Ws equation for redbreast sunfish using RLP technique and data sets from the entire geographical range of the species. Approval Date: 5/1/98. Completion Date: 2007

Bruce Hysmith

Title: Evaluation and Genetic Identification of Striped Bass in Lake Texoma and the Red River, Texas-Oklahoma Objective: 1) To determine if inbreeding is occurring in striped bass in Lake Texoma and the Red River below Denison Dam; and 2) to identify possible subpopulations of striped bass in Lake Texoma.

Approval Date: 3/3/00. Completion Date: 2007

John Tibbs

Title: Factors Related to the Fishing Quality and Trophy Potential of Largemouth Bass Fisheries in Texas Reservoirs Objectives: 1) Determine the relationships among selected biotic and abiotic factors and selected indicators of quality and trophy bass fisheries; and 2) evaluate criteria for stocking Florida largemouth bass. Approval Date: 9/1/98. Completion Date: 2007

Michael Baird

Title: Stress-Induced Post Stocking Mortality of Red Drum, *Sciaenops ocellatus*, and Effects of Acclimation Time and Stocking Season on Survivorship

Objective: Test the effects of two different acclimation times, and stocking season on red drum post-stocking mortality using current hatchery rearing and hauling procedures. Approval Date: 8/5/02. Completion Date: 2007

Steve Magnelia

Title: Survival and Growth of Rainbow Trout Fingerlings Stocked into the Special Regulation Zone of the Canyon Reservoir Tailrace

Objectives: 1) Evaluate survival for micro-tagged rainbow trout fingerlings stocked in the special regulation area of the Canyon Reservoir Tailrace. 2) Evaluate growth for micro-tagged rainbow trout fingerlings stocked in the special regulation area of the Canyon Reservoir Tailrace. Approval Date: 6/06/05. Completion Date: 2007

Rafe Brock

Title: Selection of Potential Texas Urban Fishing Sites

Objective: To develop a set of criteria and a ranking system to help select future TUF sites. Approval Date: 04/01/05. Completion Date: 2007

Mark Howell

Title: Wichita River Monitoring Plan in Response to Microfiltration/Reverse Osmosis Plant Discharge

Objectives: 1) Determine if there are changes in fish and benthic assemblages in a segment of the Wichita River in response to point source discharge of reject water from the City of Wichita Falls new microfiltration/reverse osmosis treatment plant; 2) Determine if there are changes in Wichita River water chemistry that could affect fish and other aquatic resources during the study period; and 3) Determine if there is any enhancement of golden alga risks in the study area as a result of potential changes in water chemistry. Approval Date: 02/2005. Completion Date: 2008

Robert Mauk

Title: Examination of Fingerling Hybrid Striped Bass *Morone saxatilis* x *M. chrysops* 24-h Boat Stocking Mortality and OTC Marking

Objectives: 1) Determine if boat stocking increases 24-h hybrid striped bass mortality because of extra handling and hauling stress; and 2) evaluate mark effectiveness in terms of mortality and marking success/retention for hybrid striped bass fingerlings marked with oxytetracycline hydrochloride (OTC) immersion at 500 and 700 ppm. Approval Date: 04/04/2003. Completion Date: 2007

Region 3

Tim Bister

Title: Largemouth Bass Population Trends in Two Texas reservoirs with LMBV-attributed die-offs

Objective: Determine if largemouth bass relative abundance, growth, relative weight, and angling success changed in Lake Fork and Sam Rayburn Reservoirs after the occurrence of largemouth bass virus associated die-offs. Approval Date: 10/27/04. Completion Date: 2006 (*in press*)

Mike Brice

Title: Florida Bass Introgression Following Annual Supplemental Stockings. Objective: To determine changes in genetic composition of a largemouth bass population following annual supplemental stockings of Florida largemouth bass at Caddo Lake, TX. Approval Date: 10/16/97. Completion Date: 2007.

Kevin Storey

Title: The Lake Fork Trophy Bass Survey

Objectives: 1) To annually monitor angler catches of trophy-size largemouth bass (\geq 7 pounds and/or 24 inches) at Lake Fork Reservoir through a volunteer angler reporting program held in cooperation with the Lake Fork Sportsman's Association and Lake Fork Chamber of Commerce; 2) Foster cooperative work relationships between sponsoring organizations, area businesses, local fishing guides, and Lake Fork anglers; 3) Use angler catch data to help publicize, promote, and educate anglers about trophy bass fishing opportunities at Lake Fork Reservoir; and 4) Use angler catch data, in conjunction with results of standardized population and creel surveys, to monitor trends in Lake Forks Largemouth bass fishery and to help evaluate management programs.

Approval Date: 11/13/02. Completion Date: 2007

Richard Ott

Title: Use of Native Macrophytes to Reduce Growth of Radial Spread of Hydrilla verticillata in Pond-scale Mesocosms

Objective: Determine if established colonies of 3 native macrophyte species resist growth (measured as radial expansion) of hydrilla for a 2-year period following introduction of hydrilla to the colonies and, if so, is there is any difference among the 3 native species in the ability to resist hydrilla growth. Approval Date: 5/2/02. Completion Date: 2007

Todd Driscoll

Title: Annual Exploitation of Largemouth Bass at Sam Rayburn Reservoir: Incorporating the Tournament-Related Mortality Component

Objectives: 1) Determine largemouth bass exploitation adjusted for delayed tournament mortality at Sam Rayburn Reservoir; and 2) Evaluate the effect of delayed tournament mortality on exploitation at Sam Rayburn Reservoir. Approval Date: 7/28/03. Completion Date: 2006 (*in press*)

Todd Driscoll

Title: Use of a Largemouth Bass Tournament Monitoring Program at Sam Rayburn Reservoir

Objectives: 1) Supplement largemouth bass population information currently collected from standardized electrofishing and creel surveys at Sam Rayburn Reservoir with tournament results via an annual tournament monitoring program; 2) Evaluate utility of program by comparing associated costs/man-hours of obtaining information to similar data from electrofishing and creel surveys; and 3) Utilize program to characterize bass tournaments at Sam Rayburn Reservoir (i.e., frequency, type, participation level, and seasonality of tournaments). Approval Date: 3/14/03.

Completion Date: 2007

Mark Webb

Title: Texas Parks and Wildlife Habitat Establishment Initiative

Objectives: 1) Determine aquatic plant species suitable for habitat enhancement efforts in Texas reservoirs; 2) develop techniques for establishing founder colonies in Texas reservoirs; and 3) monitor survival, growth and spread of founder colonies. Approval Date: 4/24/98. Completion Date: 2007

Statewide

Michael Baird, Tim Bister, Mukhtar Farooqi, Tom Hungerford

Title: An Evaluation of Growth of Selectively Bred Largemouth Bass in Six Texas Reservoirs.

Objective: Compare mean length and weight of age 4 ShareLunker and resident largemouth bass in six Texas reservoirs. Approval Date: 10/31/05. Completion Date: 2017

Austin Headquarters

Fred Janssen

Title: A Comparison of Population Indices for Fishes Collected from Subjectively and Randomly Selected Sampling Sites at Twelve Texas Reservoirs

Objectives: 1) To compare catch rates and structural indices for target species captured at subjectively and randomly selected sampling sites; and 2) to compare effort (man-hours) required to conduct three survey techniques (frame nets, gill nets and electrofishing) at subjectively and randomly selected sampling sites. Approval Date: 9/22/94. Completion Date: 2007

Special Projects – Education and Outreach

Texas Freshwater Fisheries Center

Jim Matthews and Tony Owens

Title: Refinement of Alkalinity Adjustment Strategies for a Recirculating Raceway System.

Objective: To determine the amount of sodium bicarbonate required to optimize nitrification in a recirculating system at the Texas Freshwater Fisheries Center. Approval Date: 9/06/01. Completion Date: 2007.

Deborah Wade

Title: The Effect of Ozone on Largemouth Bass Fry Production in a Re-circulating System.

Objective: To determine if ozone treatment of incubation water for largemouth bass eggs improves fry production. Approval Date: 2/11/04. Completion Date: 2007.

Juan Martinez and Tony Owens

Title: Efficacy of Pond Inoculation and Supplemental Feeding with Zooplankton to Increase Growth and Survival of Florida Largemouth Bass Fingerlings. Objective: To increase production of Florida largemouth bass fingerlings. Approval Date: 11/05. Completion Date: 2008.

Special Projects – Fish Hatcheries and Analytical Services

Analytical Services

Lorraine T. Fries, Greg Southard, and Dijar J. Lutz-Carrillo

Title: Statewide Survey of Texas for Golden Alga *Prymnesium parvum*" Objectives: To collect baseline statewide prevalence, environmental, and genetics data for *P. parvum*. Approval Date: 9/2003. Completion Date: 12/2007.

Travis Glenn et al. (including Dijar Lutz-Carrillo)

Title: Identification, development and optimization of novel microsatellites for largemouth bass. Objectives: Develop a microsatellite library, design primers and screen for polymorphic markers. These markers are to be used for a variety of issues, among them: parentage analyses, hatchery versus wild origins of collected specimens, species and population discrimination, as well as evaluations of genetic diversity within hatchery populations. Approval Date: 6/2006. Completion Date: 12/2008.

Dijar Lutz-Carrillo

Title: Evaluation of the CytB (cytochrome B) gene: species and subspecies specific mtDNA PCR-RFLP (polymerase chain reaction – restriction fragment length polymorphisms). Objectives: Use DNA sequence variation to identify conserved species specific endonuclease restriction sites in relevant micropterid and moronid species. Approval Date: 11/2006. Completion Date: 12/2007.

Dijar Lutz-Carrillo

Title: Operation World Record: resolution of OWR progeny (this includes OWR progeny in Raven, Meridian, and Mill Creek as well as the TXU contract lake, and Spring Lake). Objectives: Resolve OWR progeny from wild fishes using microsatellite loci. Approval Date: 11/2005. Completion Date: Ongoing.

Dijar Lutz-Carrillo

Title: Operation World Record: genetic gender determination. Objectives: Identify gender specific markers for largemouth bass based on multiple AFLP assays. Approval Date: 11/2006. Completion Date: 12/2008.

Dijar Lutz-Carrillo

Title: Species Specific Microsatellites for the Resolution of Striped Bass and White Bass. Objectives: Identify species specific microsatellite markers and develop multilocus assays for the discrimination of striped bass from white bass and their associated hybrids. Approval Date: 11/2006. Completion Date: 12/2008.

Dijar Lutz-Carrillo

Title: Evaluation of novel microsatellites for striped bass. Objectives: Screen and optimize publicly available primer pairs for variation at microsatellites in the Livingston/Trinity population of striped bass. These markers may then be used to evaluate changes in genetic diversity over time and assess parentage and thus, hatchery vs wild origin, of collected specimens. Approval Date: 10/2006. Completion Date: 12/2007.

Gregory M. Southard, Loraine T. Fries, and Dave R. Terre

Title: The Texas Largemouth Bass Virus (LMBV) Statewide Survey. Approval Date: 5/ 2000.

Completion Date: 12/2007.

A. E. Wood Hatchery

Hugh Glenewinkel

Title: Effects of Two Stocking Densities on Advanced Catfish Production and Water Quality in Earthen Rearing Ponds. Objectives: 1) To compare growth, harvest length, feed conversion, condition (W_r), and percent return of advanced catfish fingerlings reared at two stocking densities in earthen ponds; and 2) Compare select water quality variables between the two stocking densities. Approval Date: 7/3/01. Completion Date: 2006.

Hugh Glenewinkel, Tony Owens, Lee Hall and John Paret

Title: Black Bass Culture Manual. Objective: Document standard procedures for the culture of black basses. Approval Date: 1/05. Completion Date: 2007.

Jake Isaac, Jr.

Title: Production Performance of Wild Stock and Imperial Stock Channel Catfish Fingerlings in Hatchery Ponds. Objective: Determine differences in growth rate, feed conversion and survival between wild stock and imperial stock channel catfish for the 75-225-mm production period. Approval Date: 07/28/98. Completion Date: 2007.

Chris Thibodeaux

Title: Intensive Spawning and Mass Production of Koi Carp Fry. Objective: To document the techniques developed at the A. E. Wood Hatchery for mass production of koi carp fry. Approval Date: 11/98. Completion Date: 2007.

Chris Thibodeaux, Ted Engelhardt, Glen Alexander and Deborah Wade

Title: Forage Culture Manual. Objective: Document standard procedures for the culture of forage fish. Approval Date: 1/05. Completion Date: 2007.

Jasper Fish Hatchery

Reese Sparrow

Title: Smallmouth Bass Culture in Texas. Objective: Document the techniques developed at the Dundee State Fish Hatchery for the smallmouth bass program. Approval Date: 11/98. Completion Date: 2007.

Possum Kingdom Hatchery

Aaron Barkoh, John Paret, Dale Lyon and Steve Hamby

Title: Effects of Barley Straw and Liquid Live Micro-Organisms (LLMO) on Density and Ichthyotoxicity of *Prymnesium parvum* in Hatchery Ponds. Objectives: 1) Determine if decomposing barley straw inhibits *P. parvum* population growth and ichthyotoxicity; 2) Determine if the LLMO system inhibits *P. parvum* density and ichthyotoxicity; 3) Determine effects of decomposing barley straw on water quality, nutrient levels, phytoplankton community structure, zooplankton community structure and fish production; and 4) Determine effects of the LLMO system on water quality, nutrient levels, phytoplankton community structure, zooplankton community structure and fish production. Approval Date: 6/2/04. Completion Date: 2006.

Aaron Barkoh, John Paret and Dale Lyon

Title: Effects of the Liquid Live Micro-Organisms (LLMO) System on Sludge, Water Quality and Koi Carp Production in Hatchery Ponds. Objectives: 1) Determine if the LLMO System reduces sludge; and 2) Determine if LLMO improves water quality and Koi carp production in hatchery ponds. Approval Date: 6/1/04. Completion Date: 2007.

Dale Lyon

Title: Effect of Pine Straw on pH. Objective: Determine if decomposing pine straw can reduce pH in hard water. Approval Date: 11/2006. Completion Date: 12/2007.

Dale Lyon and Aaron Barkoh

Title: Enumeration of Florida Largemouth Bass Fry: an Index for Gravimetric Estimation of Numbers. Objectives: 1) Evaluate the accuracy of the Jensorter fry counter for Florida largemouth bass fry enumeration; 2) Develop an index (fry/g) for estimation of numbers of Florida largemouth bass fry and determine influence of water temperature, fish age and fish length on estimation of fry numbers by weight; and 3) Compare the index from this study with the index (275 fry/g) developed several years ago. Approval Date: 03/24/00. Completion Date: 2007.

Dale Lyon, Lee Hall and Steve Hamby

Title: Effects of Water Hardness on Egg Hatch Rate of Florida Largemouth Bass. Objective: Determine if egg hatch rate increases with increasing water hardness. Approval Date: 2/20/04. Completion Date: 2007.

Dundee Hatchery

Aaron Barkoh, Drew Begley and Dennis Smith

Title: Effects of Barley Straw on Density and Ichthyotoxicity of *Prymnesium parvum* and Water Quality in Hatchery Ponds. Objectives: 1) Determine if decomposing barley straw inhibits *P. parvum* population growth and ichthyotoxicity; and 2) Determine effects of decomposing barley straw on water quality. Approval Date: 12/13/04. Completion Date: 2006.

Aaron Barkoh, Thomas Wyatt and Dennis Smith

Title: Ammonia Tolerance by Striped Bass Fry and Fingerlings in Hard Water. Objectives: 1) Determine the maximum concentrations of un-ionized ammonia that striped bass (*Morone saxatilis*) fry and fingerlings can tolerate for 96 h at selected pH and temperature; 2) Estimate the 96-h LC₅₀ (median lethal concentration that will kill 50%) of un-ionized ammonia for striped bass fry and fingerlings; and 3) Estimate the no-effect-level of un-ionized ammonia nitrogen to striped bass fry and fingerlings. Approval Date: 4/6/2005. Completion Date: 2008.

Gerald Kurten, Aaron Barkoh, Loraine Fries and Drew Begley

Title: Combined Nitrogen and Phosphorus Fertilization for Controlling *Prymnesium parvum* Toxicity in Fish Culture Ponds. Objective: To determine efficacy of two fertilization regimes of nitrogen and phosphorus (300 N: 40 P and 300 N: 60 P, three times weekly). Approval Date: 8/4/05. Completion Date: 2007

Tom Wyatt, Reese Sparrow and Juan Martinez

Title: Channel Catfish and Blue Catfish Culture Manual. Objective: Document standard procedures for the culture of channel and blue catfish. Approval Date: 1/05. Completion Date: 2007.

Organization

Fisheries Research Organization flow chart is located in **Appendix, Organization Charts**, page 71.

ECOSYSTEM/HABITAT ASSESSMENT

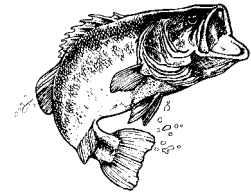

Goal

To conduct ecological risk and injury assessments; to determine water quality and quantity requirements to maintain, protect, and enhance state aquatic ecosystems; and to restore habitats to mitigate injuries to ecosystems.

Rationale

To protect and enhance aquatic ecosystems it is necessary to understand the basic requirements of the ecosystems and to take actions to see that these requirements are provided and if possible improved. Various research studies and environmental assessments are undertaken using scientifically accepted methods to gain this knowledge with an emphasis on water quality and quantity requirements for the various eco-regions and watersheds of the state. These efforts include in-stream flow assessments, water quality and contaminant impact assessments, ecological risk assessments, natural resource damage assessments, fish kill investigations, and harmful algal bloom evaluations. Fish and wildlife kill and pollution investigations are coordinated statewide to assess impacts and seek compensation from responsible parties for injuries to state natural resources under state and federal laws. Coordination and cooperation with state, federal, and local agencies is critical for addressing possible adverse impacts to aquatic ecosystems. Information and recommendations are provided to applicable stakeholders (especially regulatory agencies) to help protect and enhance aquatic ecosystems. Where possible habitat restoration projects, or other suitable environmental projects, are undertaken with other stakeholders to restore and protect the resources impacted.

Facilities

Texas Rivers Center

- Location – The Texas Rivers Center is located on the Texas State University - San Marcos campus. The facility is located on the Aquarena Center complex at the spring flow headwaters of the San Marcos River.
- Renovation History – A major renovation effort was completed in 2006 that converted a historic inn into the current Texas Rivers Center. The Center houses offices of the Inland Fisheries Freshwater Resources Program and Contaminants Assessment Team, the University's Rivers Institute, and the National Park Service. Conference and exhibit space provides educational presentations on spring and rivers systems of Texas.

A.E Wood Fish Hatchery

- Offices, laboratory, and shop facilities are provided at the state fish hatchery in San Marcos. Staff of the Freshwater Resources Program and Kills and Spills Team are housed at this facility.

Fountain Park Plaza

- Offices are provided at the Fountain Park Plaza office complex in Austin for staff of the Kills and Spills Team, Trustee Team, and branch administration.

Responsibilities

Conduct instream flow assessments for permitting, water planning, river management, etc. to determine the water quantity and quality needed to support aquatic ecosystems.

Conduct water quality assessments for permitting, water quality standards, and planning to determine water quality needed to support aquatic ecosystems.

Determine the cause, extent of injury, and value of losses resulting from kills and pollution incidents that affect state fish and wildlife resources and their habitats.

Pursue compensation for injuries to natural resources that result from oil discharges and hazardous materials releases through the Natural Resource Damage Assessment (NRDA) process under federal and state statutes and rules.

Seek compensation or restoration for injured fish and wildlife resources through state civil restitution actions and by the design, implementation, and oversight of habitat and resource restoration projects through state and federal laws.

Participate in the Ecological Risk Assessment process under the TCEQ Texas Risk Reduction Program for the cleanup of waste sites to ensure that cleanup goals are protective of fish and wildlife resources.

Design and implement contaminant and toxicological studies of aquatic ecosystems to evaluate impacts and provide information regarding conditions to maintain healthy communities.

Review and comment on regulatory agency assessments for permits, rules, and regulations to insure appropriate protection of state fish and wildlife resources.

Represent the agency in interagency committees such as for SB1 (regional water planning), SB2 (State Instream Flow Program), SB818 (clean rivers) to promote actions to protect state fish and wildlife resources, and the Interagency Toxic Substances Coordinating Committee and sub-committees.

Coordinate the department's Golden Alga Task Force to develop critical information through research and monitoring for developing management options for this toxic alga; coordinate developing guidance and information exchange internally, with other agencies, and stakeholders; and overseeing the review of proposals, approval of projects, and contracting for research funded by the department with dedicated funds to address issues related to this alga.

Methodology

Standardized procedures are employed for all investigations, assessments, and studies. The methods used are determined by the task being undertaken and the goals of this effort. The procedures are detailed in the Kills and Spills Team (KAST) Standard Operating Procedures Manual, the interagency Texas

Instream Flow Program (TIFP) Technical Overview Document, and the Texas Commission on Environmental Quality's Surface Water Quality Monitoring Procedures Manual. The manuals noted provide specific sampling procedures and requirements for instream flow, water quality, pollution, and fish kill assessments to provide data acceptable within the state regulatory processes that is legally defensible for court and/or regulatory hearings. The procedures used for actions as a federal natural resource trustee for the State of Texas exist under the rules, regulations, and guidelines established under federal law for conducting natural resource injury and damage assessments and restoration projects.

Program Costs

The total cost for the Ecosystem/Habitat Assessment Branch for FY06 was \$869,972.

Accomplishments

State-Supported Studies

Work was conducted on the following state-supported studies:

Title: State Instream Flow Study.

Principal Investigators: Kevin Mayes, Gordon Linam, Tim Jurgensen, Doyle Mosier, Leroy Kleinsasser, Kenny Saunders, Karim Aziz, Praveen Kokkanti, and staff from the Texas Water Development Board, Texas Commission on Environmental Quality, Brazos River Authority, Sabine River Authority, and San Antonio River Authority

Objective: To determine instream flows necessary to maintain a sound ecological environment in Texas rivers and streams initially focusing on the Brazos, San Antonio, and Sabine rivers.

Completion Date: 2010

Title: Wichita River Reverse Osmosis Water Treatment Plant Discharge Study.

Principal Investigators: Mark Howell, Leroy Kleinsasser, Kevin Mayes, and Joan Glass

Objective: To determine potential adverse effects of the plant discharge on the aquatic ecosystem of the Wichita River.

Completion Date: 2008

Title: Wichita River Reverse Osmosis Water Treatment Plant Discharge Contaminants Study.

Principal Investigators: Roxie Mills and Mark Luedke

Objective: To determine potential uptake of contaminants associated with the plant discharge into the aquatic food-web of the Wichita River and its potential ramifications.

Completion Date: 2008

Title: Interagency Statewide Fish Tissue Contaminants Survey.

Principal Investigators: David Klein, Ken Kurzawski and David Sager plus staff from the Texas Commission on Environmental Quality and the Department of State Health Services.

Objective: To determine contaminant concentrations in selected fish species of reservoirs and rivers across Texas to address potential problems for fish health (and human health by the other agencies) and the environment.

Completion Date: 2008

Title: Mercury concentrations in East Texas finfish.

Principal Investigators: Roxie Mills and Mark Luedke

Objective: To determine mercury uptake and concentrations into East Texas finfish of selected rivers and reservoirs with potential fish health and control issues examined.

Completion Date: 2007

Title: Trace element concentration in aquatic resources of minimally impacted streams.

Principal Investigators: Mark Luedke and Roxie Mills

Objective: To determine trace element concentrations in aquatic resources that can serve as reference levels expected in Texas aquatic ecosystems for future comparison with data from impacted sites and remediation planning.

Completion Date: 2007

Federal Aid-Supported Studies

Work was conducted on the following Federal Aid-supported studies:

Sportfish Restoration Funding

Title: Freshwater Game Fish Environmental Assistance and Technical Guidance. F-139-T

Principle Investigators: David Sager, Doyle Mosier, Cindy Loeffler, Patricia Radloff

Objective: To perform studies and field assessments which identify the extent of man's impact upon water and sport fish in freshwater and to provide technical advice and recommendations to private entities and local, state, and federal regulatory agencies.

Completion Date: Ongoing

State Wildlife Grant Funding

Title: Toxic Golden Alga. T-14-P

Principle Investigators: David Sager, Loraine Fries, Gerald Kurten

Objectives: The Golden Alga (*Prymnesium parvum*) State Wildlife Grant is composed of several projects addressing issues related to golden alga management and assessments in Texas. The projects objectives are:

Project A (Historical Data Assessment of Golden Alga (*P. parvum*) Fish Kills): Gather and assess available data related to past documented fish kill events caused by golden alga blooms to determine possible underlying conditions or parameters promoting the occurrence of these events.

Project B (Statewide Survey of *P. parvum* Distribution): Determine the level and breadth of *P. parvum* distribution in Texas and collect environmental data and *P. parvum* nucleic acids from representative Texas water bodies.

Project C (Molecular Investigations of the Golden Alga): 1) Construct and characterize a *P. parvum* cDNA library to develop species-specific tests for the organism, 2) Develop a real-time PCR assay to accurately detect and quantify *P. parvum* in raw water samples, and 3) Make the information gained available to the public and researchers using publicly accessed databases.

Project D (Scientific Workshop and Meetings to Coordinate Management Efforts): Conduct a scientific workshop to examine existing information on the golden alga and potential areas for management of the alga and also conduct coordination and information sharing with other stakeholders, researchers, and regulators.

Project E (Nutrient and Oxidative Compound Affects on the Golden Alga): Conduct studies to determine the affects of nutrient manipulations and oxidative compound treatments on the golden alga as potential management options.

Project F (Develop Toxin Standards): Conduct laboratory efforts to isolate and purify standards of the prymnesin toxins released by the toxic golden alga.

Completion Date: Ongoing

Title: **Toxic Golden Alga Research. T-23-P**

Principle Investigator: David Sager

Objective: To fund research and information development to address specific topics identified by the department, through the TPWD Golden Alga Task Force and planning efforts being undertaken for the toxic golden alga, as critical for developing treatments and management strategies for the toxic alga.

Completion Date: Ongoing

Title: **Geomorphic Monitoring of the Upper San Marcos River.**

Principal Investigators: Roy Kleinsasser

Objectives: The five-year project involves continued monitoring of the geomorphology of the upper San Marcos River in the area where dredging is occurring and adjacent river reaches. Baseline data was collected prior to the dredging project and further work is anticipated during and after disturbance to evaluate changes in the channel form.

Completion Date: 2010

General Activities

Many activities have been undertaken during the year. Numerous publications, reports, and presentations have been made and are listed in the **Resource Management – Fisheries Research** section of the report, pages 21 - 46. Additionally, several stream assessments were conducted and are listed in the next table followed by a listing of selected activities for the year.

Texas Stream Surveys - January, 2006 thru December, 2006

<u>River</u>	<u>Miles</u>	<u>Electrofishing</u>	<u>Gill Net</u>	<u>Habitat</u>	<u>Seine</u>	<u>Other</u>	<u>Paddling Tr</u>
Sabine River	147	X	X	X	X	X	
Big Cow Creek	15	X		X	X		
Bayou Anacoco	4	X		X	X	X	
Brazos River	323	X	X	X	X		
Navasota River	122	X		X	X		
Little River	103	X		X	X		
Colorado River	12					X	X
San Saba River	8					X	X
San Marcos River	20.5					X	X
San Antonio River	214	X		X	X	X	X
Cibolo Creek	80	X		X	X		

Other selected activities

- Includes all unimpounded segments of rivers and streams.
- Kills and Spills Team (KAST) investigated 172 fish kill (64%) and pollution (36%) complaints. Drought conditions in 2006 exacerbated losses within stressed habitats; however, the greatest losses (4.1 million fishes) were again attributed to toxic blooms of the golden alga, *Pyrmnesium parvum*, primarily during winter in the Brazos River basin reservoirs.
- The environmental projects were completed for the KAST negotiated a settlement with the San Antonio Water System for a 2004 fish kill caused by a illegal discharge of about 20 million gallons of raw sewage into Salado Creek. A final report was provided documenting completion of projects to plug open wells along the creek, clean up creek side trash dumps, and sponsoring the Wetlands Restoration Workshop at the American Fisheries Society Southern Division Mid-year Meeting that included planting aquatic vegetation along a section of the San Antonio River.
- KAST reached settlement on two fish kill civil restitution cases during the year with a total of \$10,032 for environmental projects. One environmental project had funds allocated to repair and refurbish a pond on the Gus Engeling Wildlife Management Area as an educational centerpiece for Kid Fishing and Outdoor Woman activities.
- KAST staff were the regional point of contact for IF representation/coordination at the Clean Rivers Coordinated Monitoring meetings.
- Staff participated in watershed planning efforts funded by U.S. Environmental Protection Agency through the Texas State Soil and Water Conservation Board and other groups including for the San Antonio River, Plum Creek, and Caddo Lake.

- Staff coordinated the TPWD Golden Alga Task Force activities for research efforts and funding on the toxic golden alga.
- Staff revised the golden alga web pages to meet new department web site guidelines.
- Staff participated in the interagency Harmful Algal Bloom Committee to share information and coordinate efforts on harmful algae.
- Freshwater Resources staff led TPWD efforts in the interagency Texas Instream Flow Program including revision of the Technical Overview Document based on suggestions from the National Academy of Science program review. A draft revision was completed in May for review.
- Freshwater Resources staff worked with the interagency Texas Instream Flow Program to develop and conduct two public technical workshops (one in San Antonio in June and one in Dallas in July) on the instream flow program and revisions to the Technical Overview Document. According to workshop evaluation forms submitted, the attendees appeared satisfied with the workshops and had their expectations met. Feedback on the draft stakeholder chapter is ongoing and a finalized Technical Overview is expected in 2007.
- Freshwater Resources moved into the renovated Texas Rivers Center on the Texas State University-San Marcos campus (at the old Aquarena Springs). Staff participated in the Texas Rivers Center official opening in April.
- Freshwater Resources staff collaborated with Texas State University-San Marcos on various outreach and educational events and exhibits for the Texas Rivers Center (TRC). Staff also serve on the Texas River Center's Master Planning Committee and the River Systems Institute Steering Committee.
- Freshwater Resources staff led efforts in the interdepartmental Texas Paddling Trail (TPT) program. The first Inland TPT was launched on the San Marcos River at Luling. Trails that are being developed and are scheduled to open in near future include: Columbus Paddling Trail (Colorado River), Webberville Paddling Trail (Colorado River), Goliad Paddling Trail (San Antonio River), Waco Paddling Trail (Brazos and Bosque Rivers), Bastrop Paddling Trail (Colorado River), Comal County/WORD Paddling Trail (Guadalupe River), and the Victoria- Riverside Park Paddling Trail (Guadalupe River). An additional seven trails are in the early application phase.
- Freshwater Resources staff responded to public inquiries concerning local river access plans under Chapter 90 (restrictions on motorized vehicles in navigable streambeds).
- Natural Resource Trustee staff continued serving as the Lead Administrative Trustee for the oversight of restoration action undertaken as part of the Alcoa Lavaca Bay superfund site damage assessment case. Construction was completed for projects that would enhance recreational access to Lavaca Bay including fishing piers constructed at Point Comfort Park, 6-Mile Park and Port Lavaca Bayfront Peninsula as well as boat ramp improvements at 6-Mile Park, Port Lavaca Lighthouse Beach and Magnolia Beach. Sites will continue to be monitored for utilization. The construction and planting of a 70 acre intertidal marsh adjacent to Powderhorn Lake has also been completed and monitoring of the wetlands vegetation had been initiated.

- Natural Resource Trustee staff, with other trustees, initiated a Natural Resource Damage Assessment associated with a former Kerr-McGee Chemical LLC wood treatment plant in Bowie County concerning creosote, and other chemical, releases to Days, Waggoner, and Howard Creeks and downstream areas. Staff are also involved in the Ecological Risk Assessment for this site and will provide input into site remediation decision making.
- Natural Resource Trustee staff and other state and federal trustees reached a settlement for natural resource damages for the Old Gulf Refinery in Port Arthur. Staff is the Lead Administrative Trustee for restoration, overseeing the about \$4.6 million of restoration projects on the Lower Neches and JD Murphree WMAs including the construction of about 120 acres of wetlands and water control structures to enhance management of about 600 acres of waterfowl habitat.
- Natural Resource Trustee staff continued serving as the Lead Administrative Trustee for the Tex-Tin superfund site damage assessment case and are responsible for the implementing the construction of wetlands within Swan Lake adjacent to West Bay. Approximately 430,000 yds³ of sediment has been removed from a US Corps of Engineers dredge materials management unit and placed in adjacent Swan Lake. Completion of the contouring of the placed sediments to elevations that will support emergent and high marsh was delayed due to weather conditions. Trustees anticipate the final size of the constructed marsh will total 80 acres.
- Natural Resource Trustee staff and other state and federal trustees continued work on the restoration projects agreed to in the settlement for natural resource damages by the Brio superfund site adjacent to Clear Creek for the preservation of about 200 acres of riparian habitat and construction of 6 acres of wetlands worth about \$500,000.
- Natural Resource Trustee staff is implementing a Natural Resource Damage Assessment with other trustees for an oil spill into an unnamed tributary of the Sulphur River in Titus County.
- Natural Resource Trustee staff initiated new natural resource damage assessment cases for three waste sites. Assessment were initiate for the Encycle/Asarco smelter site adjacent to Nueces Bay and Corpus Christi Harbor in Nueces County, Tronox wood treating facility adjacent to Days Creek in Bowie County and the Malone hazardous materials disposal site adjacent to Swan Lake in Galveston County.
- Natural Resource Trustee staff continue to monitor the construction of 85 acres of riparian habitat adjacent to the Colorado River in Mitchell County under terms of a settlement for natural resource damages associated with the former Col-Tex Refinery.
- Natural Resource Trustee staff serve as the Lead Administrative Trustee for state and federal trustees with the Nature Conservancy of Texas to complete habitat restoration projects for wetlands, riparian and native prairie habitats to compensate for injuries to Sayle Creek.
- Natural Resource Trustee staff continued to provide technical review of ecological risk assessments under the Texas Commission on Environmental Quality's (TCEQ) Texas Risk Reduction Program.
- Management, laboratory, and E/HA staff participated in the interagency Statewide Fish Contaminants Monitoring Study with TCEQ and the Department of State Health Services (DSHS). Contaminants Assessment Team members actively participated with regional fisheries crews in the collection of fish tissue samples for analysis.

- Contaminants Assessment staff continued studies on mercury concentrations in fish of east Texas waters.
- Contaminants Assessment Team staff initiated an evaluation trace metals and persistent organic compounds within tissues of fish collected from the lower Sabine River as part of the interagency evaluation of the biological communities being conducted by the Texas Parks and Wildlife Department, Sabine River Authority of Texas, Texas Water Development Board, and Texas Commission on Environmental Quality.
- In response to the results of contaminants analyses of striped bass from Canyon Reservoir that indicated elevated mercury concentrations, Contaminants Assessment Team staff initiated the sampling of striped bass and largemouth bass from Possum Kingdom, Buffalo Springs, Livingston, Lavon, Buchanan, Amistad, Tawakoni, Whitney, Travis, and Texoma reservoirs.
- Contaminants Assessment staff evaluated study results for contaminants in fish from 8 urban impoundments designated as community fishing lakes under management programs. Contaminants did not exceed human health screening values established by the DSHS for the interagency statewide monitoring program.
- Staff participated in the interagency Toxic Substances Coordinating Committee and its Finfish Sampling Subcommittee and Harmful Algal Bloom Subcommittee.
- Freshwater Resources staff participated in department assessments of major proposed water rights permits such as the Brazos River Authority basin-wide permit and the Lower Colorado River Authority proposed transfer of water to San Antonio.
- Freshwater Resources and branch administration staff assisted in the department's support efforts for the legislative Environmental Flows Advisory Committee.
- Freshwater Resources staff coordinated with the Sabine, San Antonio, and Brazos river authorities for baseline fish sampling and report preparation for the Brazos, Sabine, and San Antonio river basins to update biological information and spatial and temporal information gaps to support developing instream flow study plans for subbasins in these rivers. Habitat and fish assemblage data from 2006 will be analyzed to evaluate correlations between physical habitat variables and species occurrence.
- Staff participated in an IF special study on the impact of a Microfiltration/Reverse Osmosis plant discharge on the Wichita River.
- Freshwater Resources staff continued participation in the Tiered Aquatic Life Use Development for Texas effort involving the U.S. Environmental Protection Agency, TCEQ, universities, and river authorities.
- Freshwater Resources staff continued working with TCEQ to develop guidance for biological and habitat sampling protocols and quality assurance. Work continued on examining the variability in bioassessment data and to develop and refine a regional habitat quality index for use in relating biological data with physical habitat.
- Freshwater Resources staff prepared a curriculum for the Goliad State Park cooperative grant project.

- Staff coordinated and hosted a workshop of the Golden Alga Task Force to revise and update the task force's mission statement and list of priority research topics to gain the needed information to develop management options for this toxic alga.
- Continued development of division-wide database for golden alga data and interactive web Kills and Spills reporting tool with GIS Lab and Inland Fisheries division staff.
- Staff with other members of the Golden Alga Task Force prepared a presentation and manuscript with Arizona Game and Fish Department staff on knowledge on and management of the toxic golden alga in reservoirs for the 2007 American Fisheries Society Reservoir Symposium. The presentation was accepted for the meeting.
- Staff continued to coordinate with Oklahoma state agencies to monitor Lake Texoma and to exchange information about the golden alga.
- Staff assisted monitoring of Lake Whitney during spring golden alga research project.
- Staff communicated information on golden alga to public through news releases, appearance on local morning news show, 1-800 phone information line, and web updates on golden alga blooms and fish kills.
- Staff participated in the departmental Bacterial Total Maximum Daily Load Committee to develop a consistent department position on bacterial TMDLs related to wildlife loadings and especially new bacterial source tracking techniques.
- Staff conducted educational outreach presentations at several schools, State Parks, and community learning centers.
- Staff once again participated in the TPWD Wildlife EXPO in Austin with several educational and public participation exhibits on aquatic ecosystems relating to water quality and quantity issues.

Organization

The Ecosystem/Habitat Assessment flow chart is located in **Appendix, Organization Charts**, pages 72.

EDUCATION AND OUTREACH

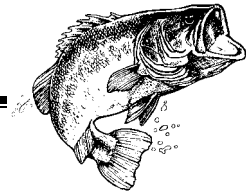

Goal

Dedicated to the understanding, celebration and conservation of freshwater sport fishing in Texas through excellence in education, aquaculture, interpretive exhibits, and community relations.

Rationale

Provide individuals with an informative and exciting opportunity to observe and better understand aquatic life and its management in Texas. Exposure is provided to fisheries management surveys and inventories, fish hatchery operations, scientific research, applied fishery management, fishes and aquatic habitats, and the support anglers and boaters provide to conservation. The educational messages are designed to encourage sport fishing as a recreational activity with “hands-on” angling opportunities provided.

Facility

Texas Freshwater Fisheries Center

- Location – Texas Freshwater Fisheries Center (TFFC) is located in Henderson County, 4 miles east of Athens, Texas, on 106 acres of land close to Lake Athens.
- Construction Date – The 26,000 ft² Visitor Center, with 300,000 gallons of outside aquariums, 1.5-acre fishing pond, 3,000 ft² Anglers Pavilion, 150-seat theater with a 25,000-gallon aquarium, 24,656 ft² intensive culture building, water quality lab, genetic lab, and 2,788 ft² maintenance building, was completed on November 19, 1996. The extensive culture facilities, which include 45 lined ponds with a combined area of 37.3 acres, were completed on August 31, 1998. The Richard M. Hart & Johnny Morris Conservation Center was completed April 14, 2007. This 12,994 ft² building has a large meeting room with seating for up to 300, a class room, four administrative offices, small conference room, a library, game warden museum, and three game warden offices.
- Renovation History – A 0.7 mile wetlands trail was completed in 2002. The project features an all-weather, ADA-compliant trail with interpretive stations about the plants and animals of Texas wetlands. The trail includes an observation beehive, an interactive nature communications center, duck blind, timber-framed pavilions, streams, ponds, pitcher plant bog, wildflower area, hunter education features and a fly fishing area. A restroom was added to the upper trail in 2005. In 2006 a second ticket booth was added to the rear entrance to the facility. In 2007 a new amphitheater and hunter skills trail, including a air rifle range, was completed.

Responsibilities

Visitor Center

Perform a vital public relations and education function through visitor center tours, hatchery tours, school visitation, public lectures, educational workshops, fishing pond experiences, and ShareLunker Program.

Increase public knowledge of Inland Fisheries Management, Research and Hatcheries.

Provide partners/sponsors with successful avenues to promote their conservation ethic.

Involve the public in the conservation and enhancement of trophy bass fishing in Texas through the ShareLunker Program.

Enhance community relations through hosting public events such as Halloween at the Hatchery, Fly Fish Texas, Outdoors Fools Day, Cinco de Mayo, and fireworks at the fishery.

Provide a venue for professional and business meetings and seminars.

Culture 42 different species of fish, reptiles, birds, and mammals for educational displays.

Manage project income and grants to help support the Visitor Center.

Maintain a volunteer program to assist with the daily operations of the Visitor Center.

Actively market and promote TFFC to increase visitation.

Maintain facilities and equipment for peak operation.

Hatchery

Culture three different species of fish and stock into public waters.

- Florida largemouth bass (including ShareLunker offspring)
- Channel catfish
- Rainbow trout

Conduct aquaculture research designed to increase hatchery productivity and efficiency.

Maintain facilities and equipment for peak operation and appearance.

Program Costs

The total cost for the Education and Outreach and Hatchery Programs for FY06 was \$730,230.

Accomplishments

Visitor Center

- Open to the public for 284 days. The visitor center was closed the entire month of December 2005 for major repairs.
- Visitation to TFFC during FY06 was 50,655 of which 19,404 were youth. Visitor surveys indicated the most liked activity at the center was fishing. Visitor satisfaction has been rated excellent.
- Generated \$255,277 in project income.
- Hatchery Tram Tours – The extensive hatchery tram tour provided 20,064 visitors with information about freshwater fish production in the 45 production ponds.
- Fishing Pond Activity - Adjacent to the Visitor Center is a 1.5-acre casting pond and Anglers Pavilion, which serves as a classroom and staging area for fishing. School age children receive instruction on basic fishing skills, equipment, angler ethics, catch-and-release conservation, and safety. Here, instructors also take the opportunity to reinforce the Visitor Center information on the Sport Fish Restoration Program and its importance to future anglers. Stocked with rainbow trout in winter and channel catfish during summer, the casting pond offers visitors an interactive opportunity to put their newly acquired knowledge to work and catch fish. Over 27,316 visitors fished in the casting pond. More than 581 children received a certificate for catching their first fish at the casting pond.
- Fly Fish Texas - Hosted by TFFC and Texas fly fishing clubs, Fly Fish Texas provided an interactive educational experience featuring seminars, demonstrations and hands-on experience. Most of the 1,022 attendees were new to the sport and desired inexpensive hands-on training and information.
- Three flyfishing classes were conducted with approximately 50 adults attending.
- Two pre-service teacher groups were trained at TFFC through Stephen F. Austin State University.
- Six summer teacher training workshops were conducted with approximately 153 teachers attending.
- A teacher survey was distributed to youth group leaders in order to receive feedback about the TFFC educational experience. Of 224 distributed surveys, 87 were returned (39%). The three most-enjoyed items were fishing, dive show, and exhibits/fish feeding.
- Staff at the Center spoke before a variety of clubs and organizations during the year. Additional educational outreach included exhibiting at the TPWD's Wildlife Expo in Austin, the state Conference for the Advancement of Science Teaching (CAST) in Houston, and the regional MiniCAST in Tyler, and two fishing and or youth oriented tradeshow.
- Three Boy Scout Fishing Merit Badge Programs were provided to 44 scouts. A TFFC staff person or volunteer was available for teaching or assisting the individual scouts in completing each of the activities. These activities included identifying fishing equipment and tackle along with demonstrating their individual uses, tying knots, identifying safety concerns, understanding fishing laws, catching fish, releasing and processing fish, and practicing good sportsmanship behavior.

- Digital photography workshop conducted by Canon, Inc, and Texas State Photographer Wyman Meinzer trained 34 professional and amateur photographers in the basics of digital photography.
- Forty volunteers donated 3,500 hours to the center's educational programs.

Hatchery

- Had a successful ShareLunker year with 32 fish donated.
- Held and stocked 71,071 rainbow trout.
- Reared and stocked 55,169 channel catfish.
- Produced, reared, and stocked 2,257,836 Florida largemouth bass.

Special Projects

Special projects are included in the **Fisheries Research** section on page 42. These activities are research oriented and are coordinated through fisheries research biologists.

Organization

The organizational flow chart for Texas Freshwater Fisheries Center, Athens, can be found on page 76 of Appendix, Organization Charts.

FISH HATCHERIES

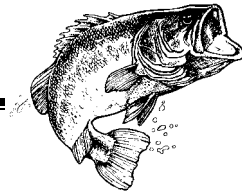

Goal

To meet the stocking needs for Texas public waters as determined by Inland Fisheries resource management teams.

Rationale

Freshwater fish hatcheries are an important component of Inland Fisheries resource management. Hatchery-reared fish are used to establish new fish populations, enhance existing populations, support research efforts, and maintain put-and-take or put-grow-and-take fisheries in small urban reservoirs where natural production will not meet angling needs.

Facilities

Dundee Fish Hatchery

- Location – The Dundee Fish Hatchery is located directly below Lake Diversion approximately 23 miles southwest of Wichita Falls, Texas in Archer County.
- Construction Date – Original construction in 1927 included 44 earthen ponds totaling 32.9 acres. Water for the facility is acquired by gravity flow through 14- and 30-inch pipelines from Lake Diversion.
- Renovation History – Hatchery ponds were renovated in 1958 and expanded to 91 earthen ponds totaling 78.31 acres in 1977. In 1993, seventy-five percent of the production ponds received complete renovation including plastic liners and state-of-the-art harvest basins. Plastic liners were replaced in 2006.

Possum Kingdom Fish Hatchery

- Location – The Possum Kingdom Fish Hatchery is located below Possum Kingdom Reservoir Dam 10 miles north of Brad, Texas in Palo Pinto County.
- Construction Date – The original 44 earthen ponds totaling 28.98 acres were constructed in 1950.
- Renovation History – In 1993 an intensive incubation and rearing building (60'x 90') was constructed. Additionally, pond liners were installed in 75 percent of the production ponds in 1994. Repair of the hatchery water distribution and drain lines as well as the construction of an effluent screening and water re-use system was completed in 2002. Phase two of planned renovations including construction of an intensive rearing facility and a new administrative and laboratory building was completed in July 2005. Renovation and relocation of the facility effluent screening facility was completed in June 2006.

A.E. Wood Fish Hatchery

- Location – The A. E. Wood Fish Hatchery is a state-of-the-art fish production facility located on the San Marcos River in San Marcos, Texas in Hays County.

- Construction Date – Original construction was completed in 1949 and consisted of 92 earthen ponds totaling 61.02 acres of water.
- Renovation History – The hatchery was completely renovated in 1989 to include 50 plastic lined ponds totaling 46.25 acres and a 33,000 square foot production building at a cost of \$14 million. Housed in the culture building are 8 concrete raceways (80'x8'x3') for intensive production and spawning, 22 fiberglass holding troughs (20'x2.5'x2'), a state-of-the-art incubation facility and laboratory. The culture building also houses a 19,000 square foot basement used as mechanical and storage areas. Additionally an effluent treatment and water re-use facility was constructed in 1999 at a cost of \$3,000,000. Pond liners and the facility intake screens were replaced in 2005 and the facility storage reservoir was renovated and relined in 2006

Jasper Fish Hatchery

- Location – The Jasper Fish Hatchery is located 10 miles northwest of Jasper, Texas in Jasper County.
- Construction Date – The original 33 earthen ponds totaling 42.44 acres were constructed in 1932.
- Renovation History – Thirty additional earthen ponds totaling 21.5 acres were constructed in 1947. In 1993 an intensive incubation and rearing building (60'x 90') was constructed. Planning and design of the East Texas Fish Hatchery located in Jasper County below Sam Rayburn Reservoir and being constructed to replace the Jasper facility continues.

Texas Freshwater Fisheries Center (TFFC)

See Education and Outreach, page 57.

Responsibilities

Support resource management needs by:

- Providing requested species for stocking through established production programs at Inland Fisheries' hatchery facilities or through contracts with commercial producers.
- Conducting aquaculture research designed to increase productivity and efficiency.
- Ensuring general health and genetic integrity of stocked species.
- Performing vital public affairs and education functions through hatchery tours, public lectures and school visitations.
- Maintaining facilities and equipment for peak operation.

Program Costs

The total operating and salary cost for the TPWD freshwater fish hatcheries for FY06 (including culture operations at TFFC) was \$4,469,285.

Accomplishments

Species Stocked in Public Waters

There were 20,439,186 fishes stocked in State waters during 2006. These stockings are presented in the *Appendix* (page 86), 2006 Stocking Records. Largemouth bass (29%), striped bass (19%) and palmetto bass (35%) represent the majority of the fish stocked.

Blooms of golden algae (*P. parvum*) continue to significantly impacted culture activities at Dundee and Possum Kingdom Fish Hatcheries. Hatchery and research staff continue to conduct applicable research and revise management plans to control or mitigate the toxic effects of the algae in hatchery production ponds. Current plans call for incorporation of ozone disinfection to the incomes water supply at Possum Kingdom and Dundee to assist in controlling the algae and its' toxins.

Special Project Activities

Special projects are included in the **Fisheries Research** section on page 43. These activities are research in nature and are a by-product of routine hatchery operations. Study designs are coordinated through Fisheries Research biologists.

Other Activities

A site below Sam Rayburn Reservoir in Jasper County was selected from 7 potential sites as the preferred location for a new fish hatchery in East Texas to replace the Jasper Facility in 2004. A Design and Engineering firm was selected and programming and design of the new facility has begun. Design of phase one of the project should be complete early spring of 2007. Construction is anticipated to take 12-18 months. Phase two of the project will follow as funds from the Freshwater Fishing Stamp are made available.

Organization

Inland Fisheries Hatcheries organizational flow charts are located on pages 77 - 79 of *Appendix, Organization Charts*.

Appendix

Organization Charts

INLAND FISHERIES DIVISION

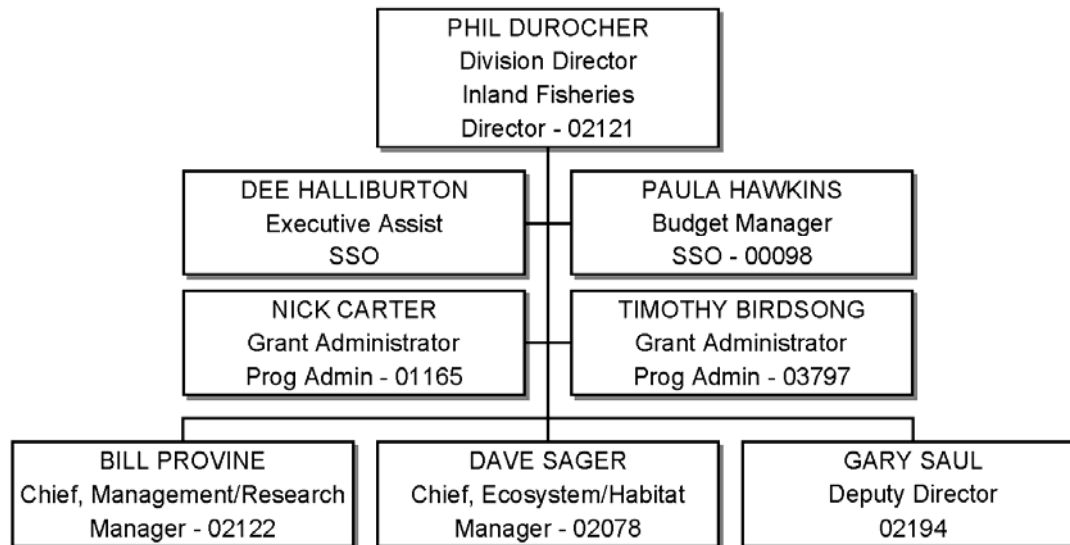

MANAGEMENT AND RESEARCH

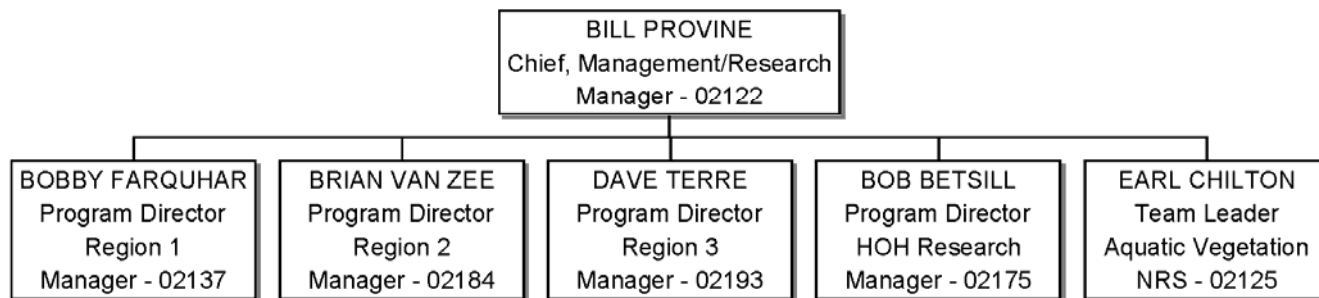

MANAGEMENT REGION 1 - SAN ANGELO

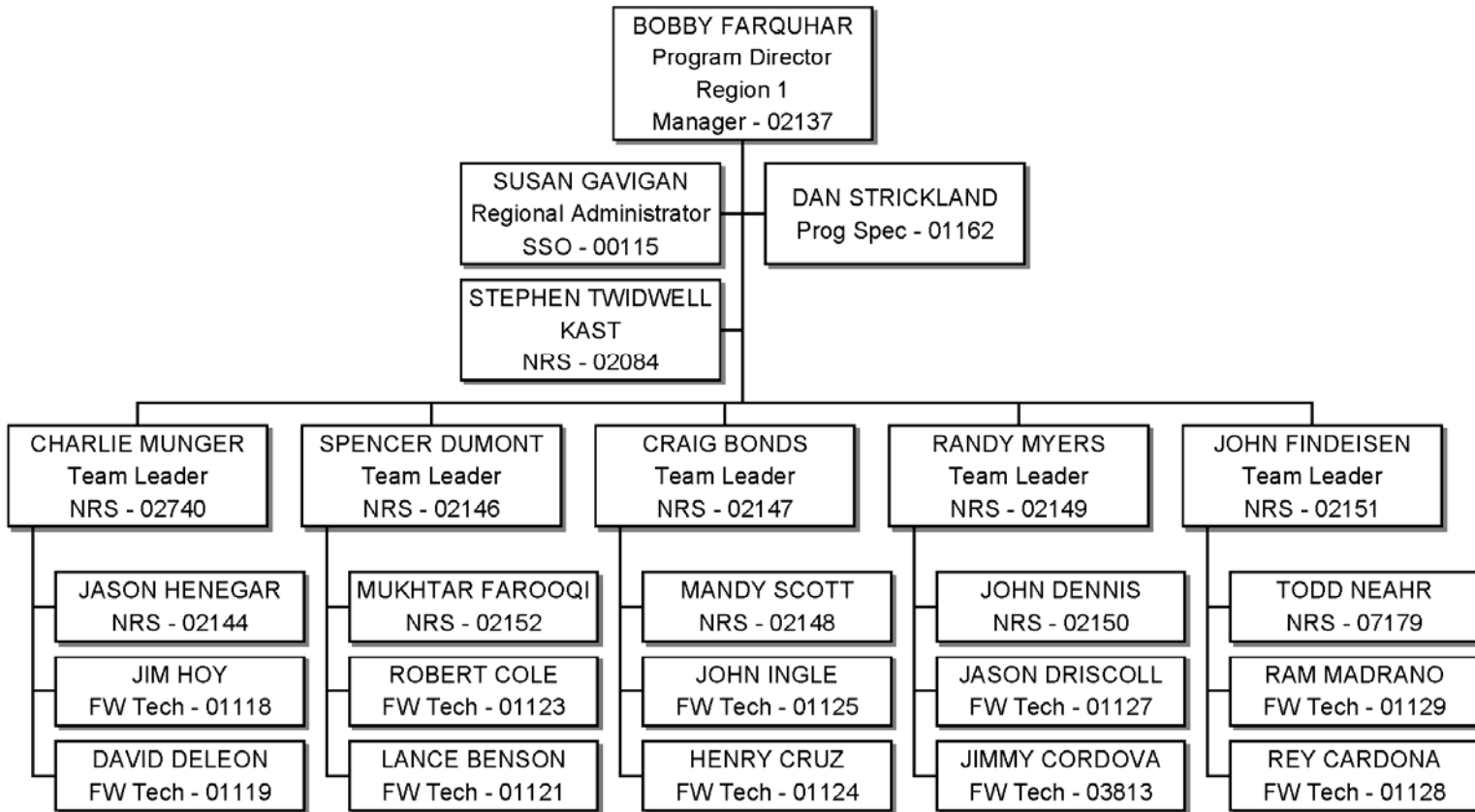

MANAGEMENT REGION II - WACO

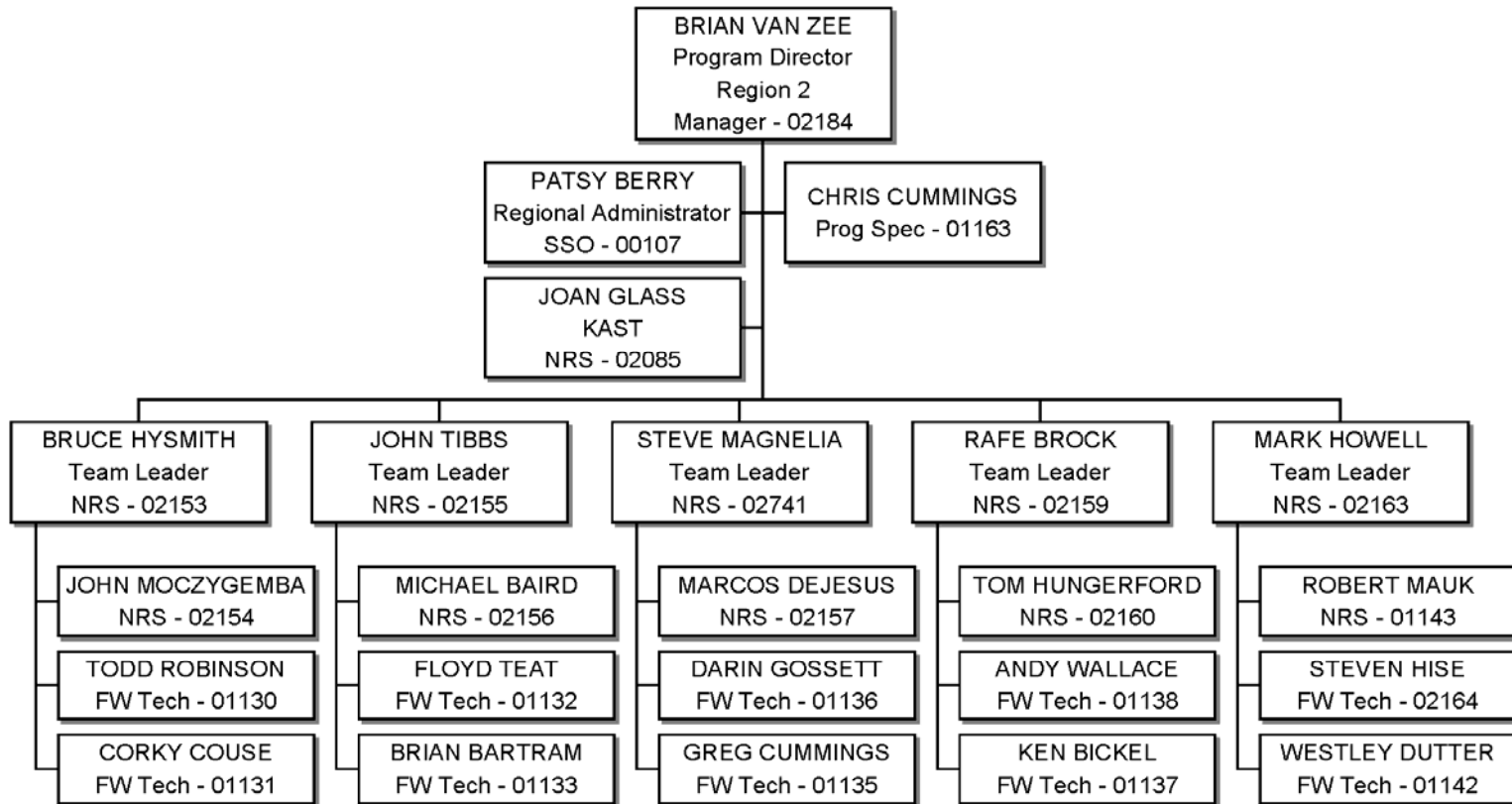

MANAGEMENT REGION III - TYLER

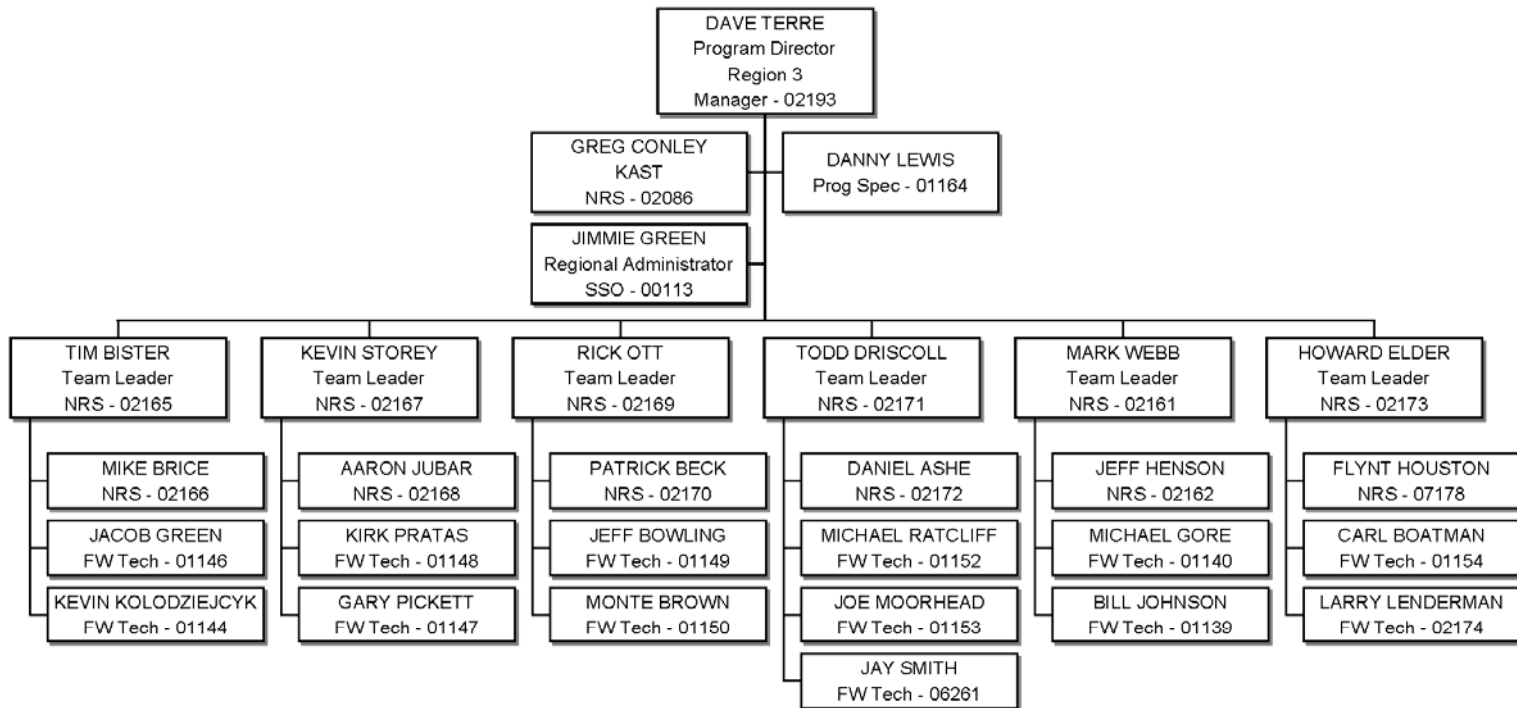

FISHERIES RESEARCH - HEART OF THE HILLS

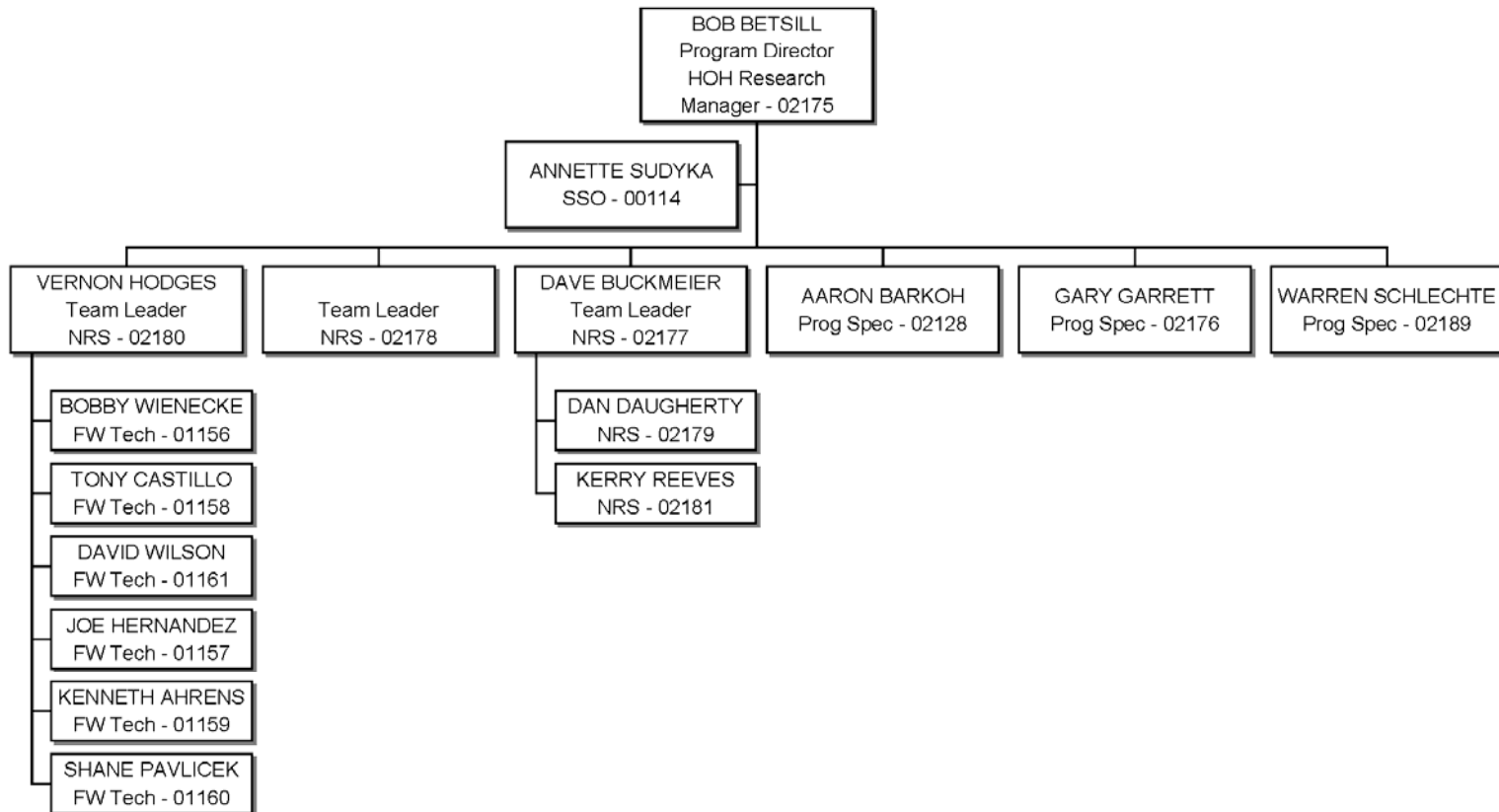

ECOSYSTEM / HABITAT

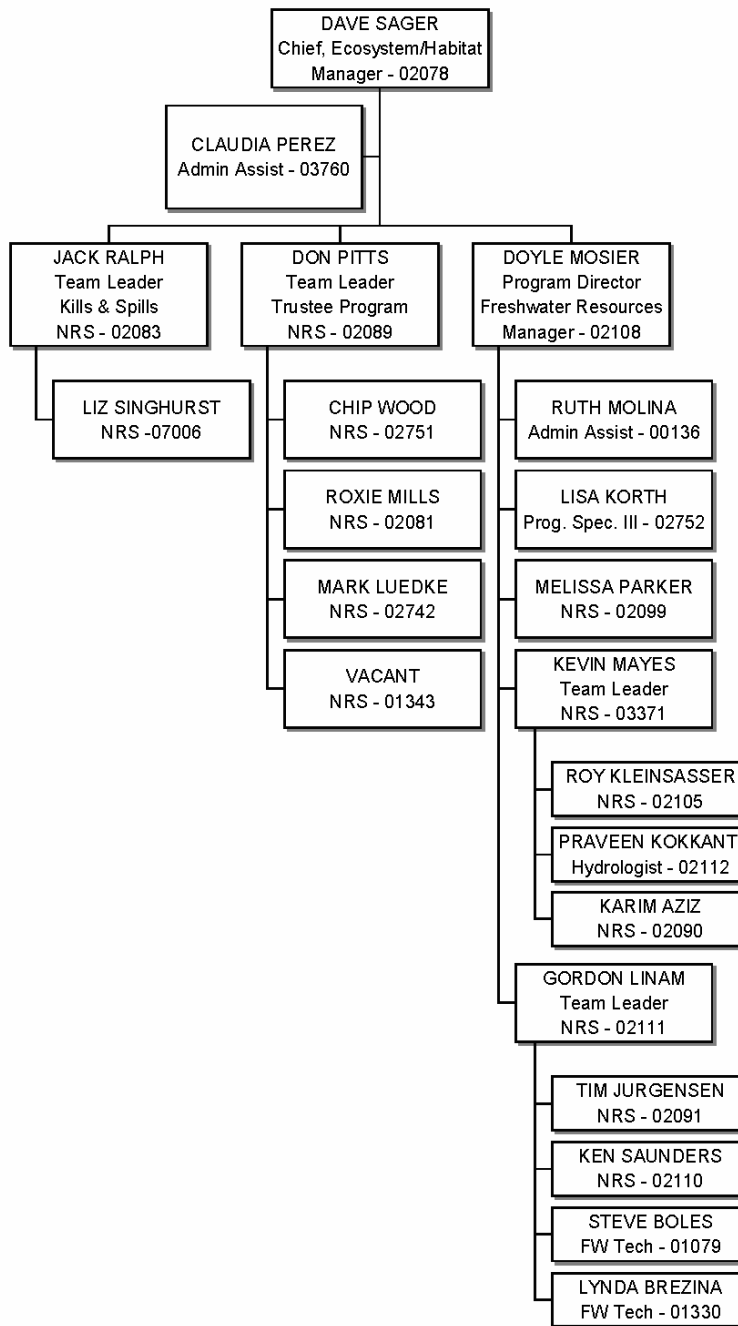

SUPPORT SERVICES

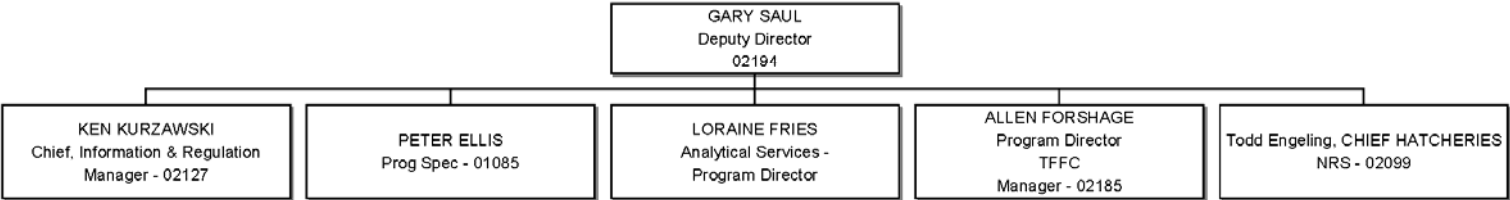

INFORMATION AND REGULATION

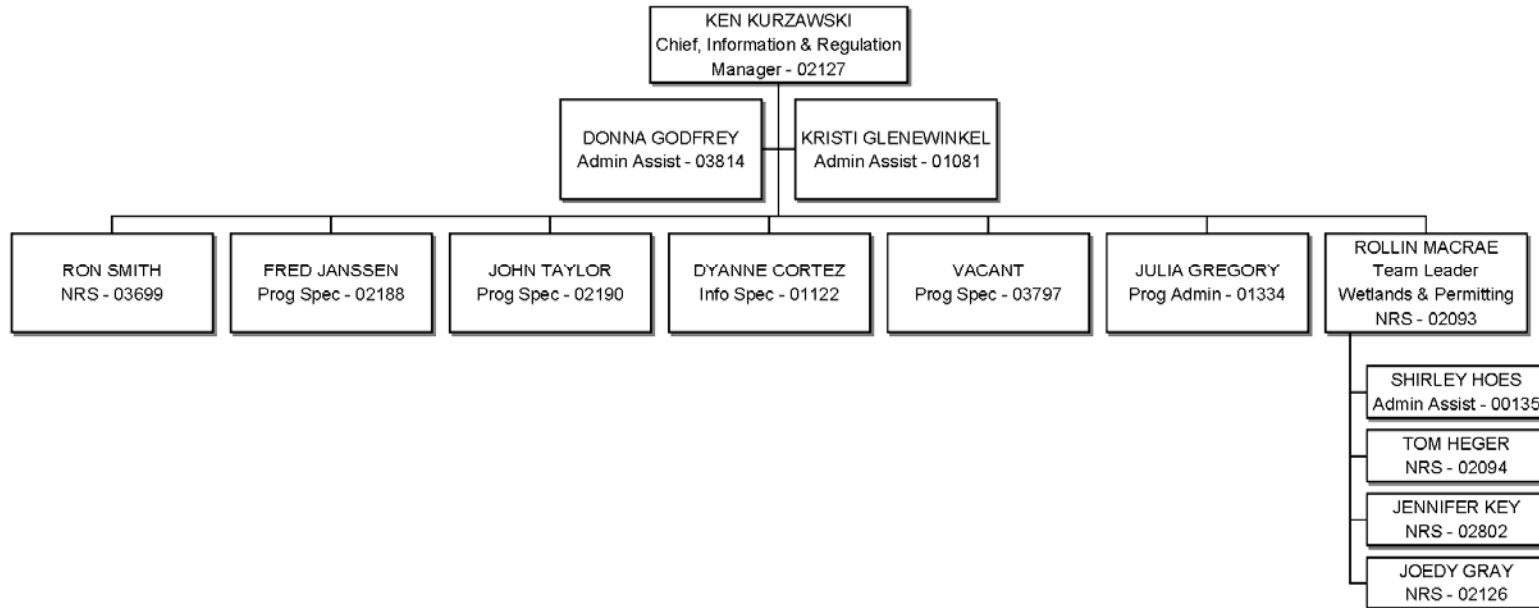

ANALYTICAL SERVICES

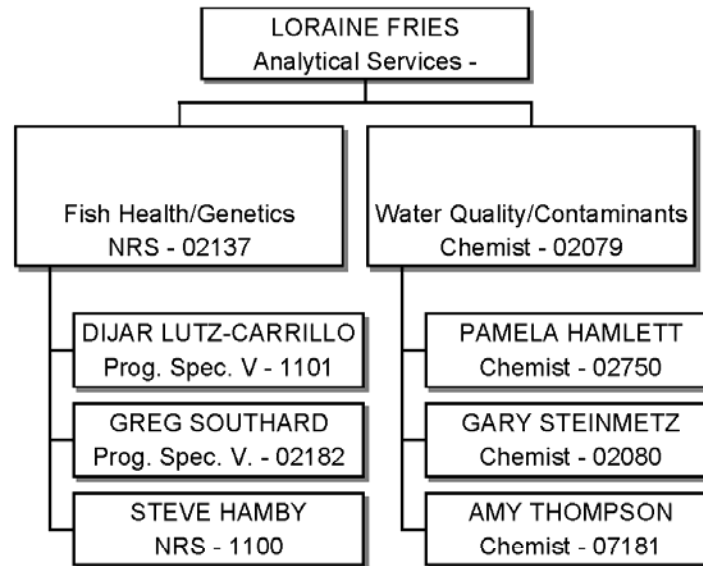

TEXAS FRESHWATER FISHERIES CENTER

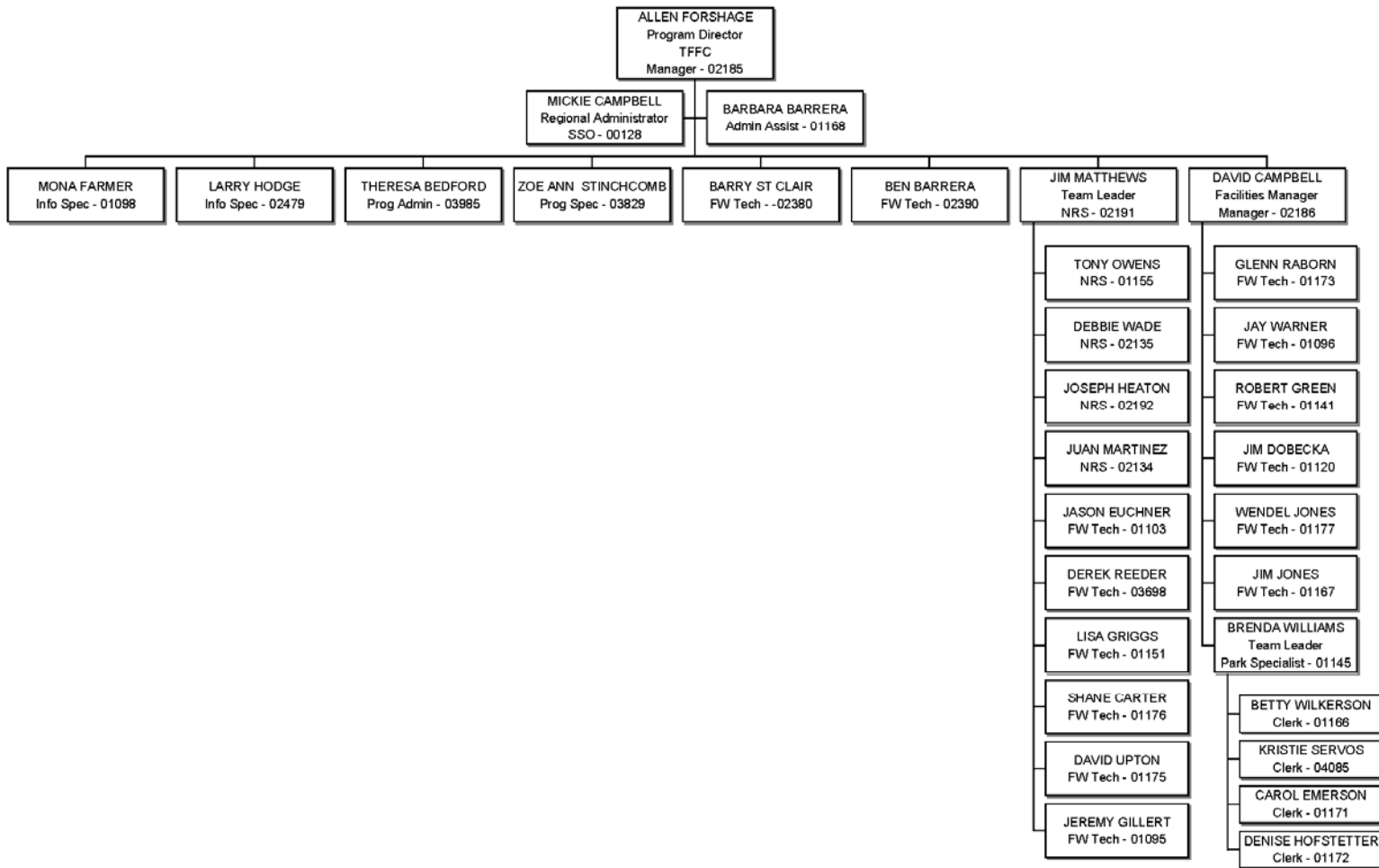

HATCHERIES

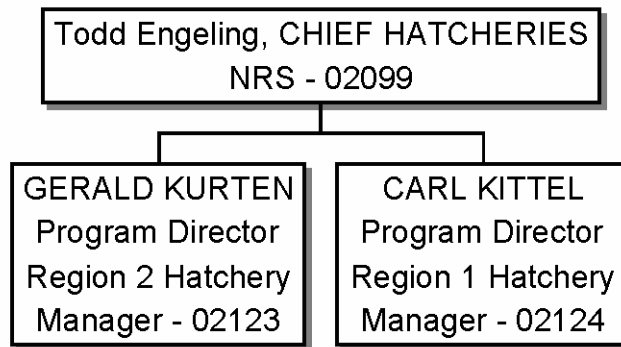

Hatcheries - Region I

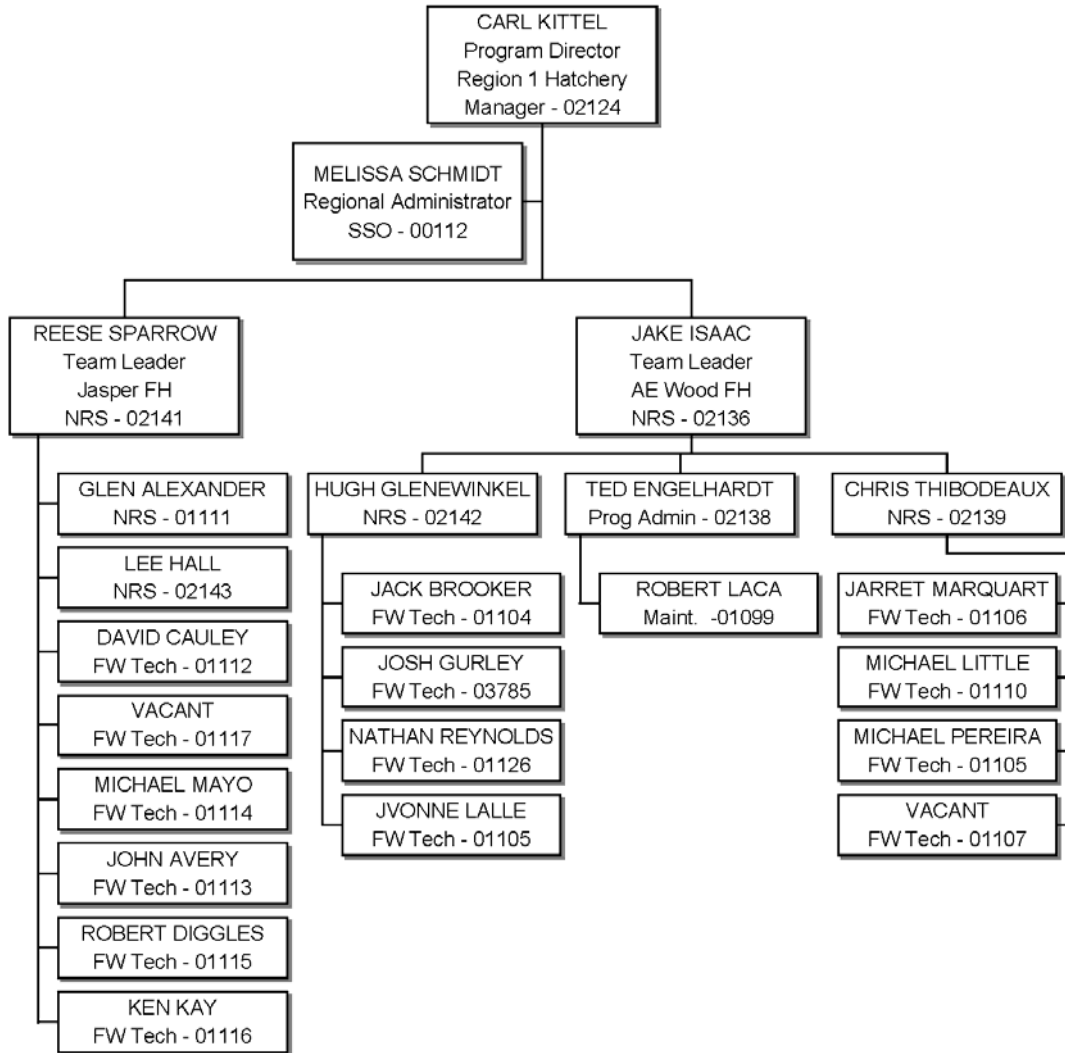

Hatchery - Region II

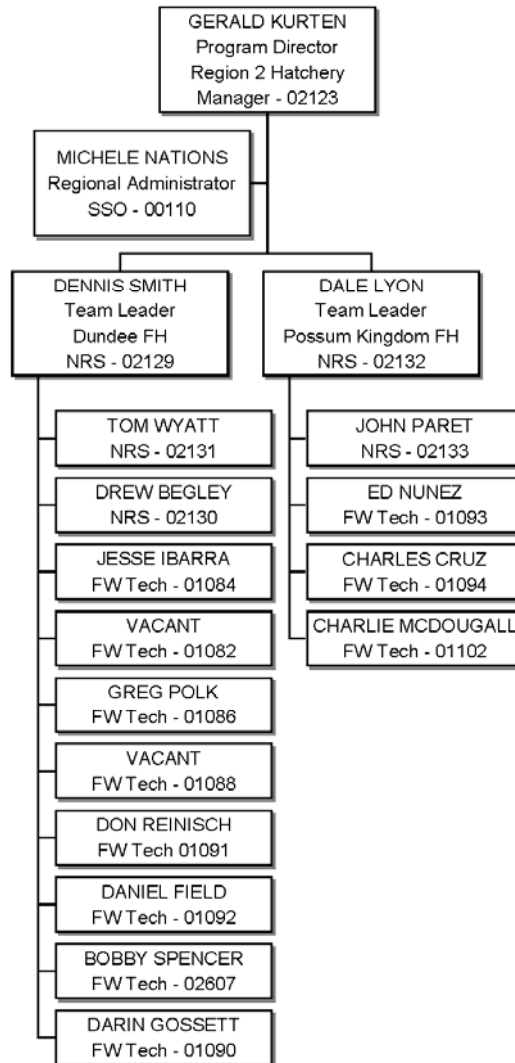

Division Personnel Directory

Inland Fisheries Division Directory

B3221000102	Durocher, Philip P. 4200 Smith School Rd. Austin, TX 78744	Austin Headquarters	Division Director III	Division Director	phil.durocher@tpwd.state.tx.us	Work: 512/389-4643 Fax: 512/389-4394
B3221000102	Birdsong, Timothy 4200 Smith School Rd. Austin, TX 78744	Austin Headquarters	Prog. Spec. VI	Fed. Aid Coord.	timothy.birdsong@tpwd.state.tx.us	Work: 512/389-4744 Fax: 512/389-4043
B3221000102	Carter, Neil 4200 Smith School Rd. Austin, TX 78744	Austin Headquarters	Prog. Admn. V	Fed. Aid Coord.	nick.carter@tpwd.state.tx.us	Work: 512/389-4641 Fax: 512/389-4043
B3221000102	Chilton, II, Earl W. 4200 Smith School Rd. Austin, TX 78744	Austin Headquarters	NRS VI	Staff Sup. Spec.	earl.chilton@tpwd.state.tx.us	Work: 512/389-4652 Fax: 512/389-4405
B3221000704	Cortez, Dyanne Fry 4200 Smith School Rd Austin, TX 78744	Austin Headquarters	Web Administrator II		dyanne.cortez@tpwd.state.tx.us	Work: 512 389-8055 Fax: 512 389-4405
B3221000102	Engeling, Todd 4200 Smith School Rd Austin, TX 78744	Austin Headquarters	Manager V	Chief, Inland Hatcheries	todd.engeling@tpwd.state.tx.us	Work: 512 389-4826 Fax: 512 389-4405
B3221000704	Glenewinkel, Kristi 4200 Smith School Rd Austin, TX 78744	Austin Headquarters	Admn. Tech. III	Admn. Assistant	Kristi.Glenewinkel@tpwd.state.tx.us	Work: 512 389-4444 Fax: 512 389-4405
B3221000704	Godfrey, Donna 4200 Smith School Rd Austin, Tx 78744	Austin Headquarters	Admn. Tech III	Admn. Assistant	donna.godfrey@tpwd.state.tx.us	Work: 512 389-4551 Fax: 512 389-4405
B3221000029	Gray, Joedy D. 4200 Smith School Rd. Austin, TX 78744	Austin Headquarters	Manager IV	Program Admn.	joedy.gray@tpwd.state.tx.us	Work: 512/389-8037 Fax: 512/389-4405
B3221000704	Gregory, Julia 4200 Smith School Rd. Austin, Texas 78744	Austin Headquarters	Web Administrator I		julia.gregory@tpwd.state.tx.us	Work: 512-389-4973
B3221000102	Halliburton, Dee 4200 Smith School Rd Austin, TX 78744	Austin Headquarters	Exec. Assistant		Dee.Halliburton@tpwd.state.tx.us	Work: 512 389-4864 Fax: 512 389-4394
B3221000102	Hawkins, Paula 4200 Smith School Rd. Austin, TX 78744	Austin Headquarters	Staff Serv. Officer II	Budget Manager	paula.hawkins@tpwd.state.tx.us	Work: 512/389-4859 Fax: 512/389-4405
B3221000029	Heger, Thomas G. 4200 Smith School Rd. Austin, TX 78744	Austin Headquarters	NRS V	Wetlands Cons. Coord.	tom.heger@tpwd.state.tx.us	Work: 512/389-4583 Fax: 512/389-8059

Inland Fisheries Division Personnel Directory

B3221000029	Hoes, Shirley A. 4200 Smith School Rd. Austin, TX 78744	Austin Headquarters	Admn. Tech III	Admn. Assistant	shirley.hoes@tpwd.state.tx.us	Work: 512/389-4592 Fax: 512/389-8059
B3221000704	Janssen, Fred 4200 Smith School Road Austin, TX 78744	Austin Headquarters	Prog Spec V	Data Analyst	fjanssen@tpwd.State.tx.us	Work: 512/389-4655 Fax: 512/389-4405
B3221000029	Key, Jennifer 4200 Smith School Rd. Austin, TX 78744	Austin Headquarters	NRS IV	Conser. Ecologist	jennifer.key@tpwd.state.tx.us	Work: 512/389-8521 Fax: 512/389-8059
B3221000704	Kurzawski, Ken 4200 Smith School Rd. Austin, TX 78744	Austin Headquarters	Manager V	Regulation/Info. Program Director	ken.kurzawski@tpwd.state.tx.us	Work: 512/389-4591 Fax: 512/389-4405
B3221000029	MacRae, J. Rollin 4200 Smith School Rd. Austin, TX 78744	Austin Headquarters	NRS VI	Wetlands Cons. Prog. Leader	rollin.macrae@tpwd.state.tx.us	Work: 512/389-4639 Fax: 512/389-8059
B3221000102	Provine, Bill 4200 Smith School Rd. Austin, TX 78744	Austin Headquarters	Manager V	Chief, Management & Research	bill.provine@tpwd.state.tx.us	Work: 512/389-4855 Fax: 512/389-4388
B3221000102	Saul, Gary 4200 Smith School Rd. Austin, TX 78744	Austin Headquarters	Director I	Deputy Director	gary.saul@tpwd.state.tx.us	Work: 512/389-8082 Fax: 512/389-4388
B3221000704	Smith, Ron 4200 Smith School Rd Austin, TX 78744	Austin Headquarters	Program Specialist V		ron.smith@tpwd.state.tx.us	Work: 512-389-8302 Fax: 512-389-4405
B3221000704	Taylor, John Barry 4200 Smith School Road Austin, TX 78744	Austin Headquarters	Prog Spec V	Data Analyst	john.taylor@tpwd.state.tx.us	Work: 512/389-4338 Fax: 512/389-4405
B3220000102	David Sager 3000 S. IH-35, Suite 375 Austin, TX 78704	Fountain Park Plaza	Manager V	Chief, Ecosystem/Habitat Assessment	david.sager@tpwd.state.tx.us	Work: 512-912-7150 Fax: 512-912-7160
B3220000102	Claudia Perez 3000 S. IH-35, Suite 375 Austin, TX 78704	Fountain Park Plaza	Admn. Asst. IV	Admn. Assistant	claudia.perez@tpwd.state.tx.us	Work: 512-912-7156 Fax: 512-912-7160
B3220000102	Jack Ralph 3000 S. IH-35, Suite 375 Austin, TX 78704	Fountain Park Plaza	NRS VI	KAST Leader	jack.ralph@tpwd.state.tx.us	Work: 512-912-7153 Fax: 512-912-7160
B3220000102	Elizabeth Singhurst 3000 S. IH-35, Suite 375 Austin, TX 78704	Fountain Park Plaza	NRS III	Golden Alga Coordinator	liz.singhurst@tpwd.state.tx.us	Work: 512-912-7144 Fax: 512-912-7160

Inland Fisheries Division Personnel Directory

B3223000479	Don Pitts 3000 S. IH-35, Suite 375 Austin, TX 78704	Fountain Park Plaza	NRS VI	Trustee Team Leader	don.pitts@tpwd.state.tx.us	Work: 512-912-7154 Fax: 512-912-7160
B3223000479	Charles "Chip" Wood 3000 S. IH-35, Suite 375 Austin, TX 78704	Fountain Park Plaza	PS V	Assessment Biologist	charles.wood@tpwd.state.tx.us	Work: 512-912-7155 Fax: 512-912-7160
B3223000479	Johanna Gregory 3000 S. IH-35, Suite 375 Austin, TX 78704	Fountain Park Plaza	NRS III	Assessment Biologist	johanna.gregory@tpwd.state.tx.us	Work: 512-912-7103 Fax: 512-912-7160
B3223000479	Roxie Mills TPWD, P.O. Box 1685, San Marcos, TX 78667	Texas Rivers Center	NRS VI	Contaminants Biologist	roxie.mills@tpwd.state.tx.us	Work: 512-754-6844 Fax: 512-353-3484
B3223000479	Mark Luedke TPWD, P.O. Box 1685, San Marcos, TX 78667	Texas Rivers Center	NRS V	Contaminants Biologist	mark.luedke@tpwd.state.tx.us	Work: 512-754-6844 Fax: 512-353-3484
B3223000355	Doyle Mosier TPWD, P.O. Box 1685, San Marcos, TX 78667	Texas Rivers Center	Manager V	Freshwater Resources Director	doyle.mosier@tpwd.state.tx.us	Work: 512-754-6844 Fax: 512-353-3484
B3223000355	Ruth Molina TPWD, P.O. Box 1685, San Marcos, TX 78667	Texas Rivers Center	Admn. Assist. IV	Adm. Assistant	ruth.molina@tpwd.state.tx.us	Work: 512-754-6844 Fax: 512-353-3484
B3223000355	Kevin Mayes TPWD, P.O. Box 1685, San Marcos, TX 78667	Texas Rivers Center	NRS VI	River Team Leader	kevin.mayes@tpwd.state.tx.us	Work: 512-754-6844 Fax: 512-353-3484
B3223000355	Roy Kleinsasser TPWD, P.O. Box 1685, San Marcos, TX 78667	Texas Rivers Center	NRS VI	Senior Aquatic Biologist	leroy.kleinsasser@tpwd.state.tx.us	Work: 512-754-6844 Fax: 512-353-3484
B3223000355	Karim Aziz TPWD, P.O. Box 1685, San Marcos, TX 78667	Texas Rivers Center	NRS V	Cartographer	karim.aziz@tpwd.state.tx.us	Work: 512-754-6844 Fax: 512-353-3484
B3223000355	Praveen Kokkanti TPWD, P.O. Box 1685, San Marcos, TX 78667	Texas Rivers Center	Hydrologist V	Hydrologist	praveen.kokkanti@tpwd.state.tx.us	Work: 512-754-6844 Fax: 512-353-3484
B3223000355	Melissa Parker TPWD, P.O. Box 1685, San Marcos, TX 78667	Texas Rivers Center	NRS VI	Riparian Ecologist	melissa.parker@tpwd.state.tx.us	Work: 512-754-6844 Fax: 512-353-3484
B3223000355	Lisa Korth TPWD, P.O. Box 1685, San Marcos, TX 78667	Texas Rivers Center	PS II	Conservation Education Coordinator	lisa.korth@tpwd.state.tx.us	Work: 512-754-6844 Fax: 512-353-3484

Inland Fisheries Division Personnel Directory

B3223000355	Gordon Linam 505 Staples Rd. San Marcos, TX 78666	A.E. Wood Fish Hatchery	NRS VI	Stream Team Leader	gordon.linam@tpwd.state.tx.us	Work: 512-353-3480 Fax: 512-353-7329
B3223000355	Tim Jurgensen 505 Staples Rd. San Marcos, TX 78666	A.E. Wood Fish Hatchery	NRS V	Aquatic Biologist	tim.jurgensen@tpwd.state.tx.us	Work: 512-353-3480 Fax: 512-353-7329
B3223000355	Ken Saunders 505 Staples Rd. San Marcos, TX 78666	A.E. Wood Fish Hatchery	NRS V	Aquatic Biologist	ken.saunders@tpwd.state.tx.us	Work: 512-353-3480 Fax: 512-353-7329
B3223000355	Steve Boles 505 Staples Rd. San Marcos, TX 78666	A.E. Wood Fish Hatchery	F&W Tech IV		steve.boles@tpwd.state.tx.us	Work: 512-353-3480 Fax: 512-353-7329
B3223000355	Kevin Kolodziejcyk 505 Staples Rd. San Marcos, TX 78666	A.E. Wood Fish Hatchery	F&W Tech III		kevin.kolodziejcyk@tpwd.state.tx.us	Work: 512-353-3480 Fax: 512-353-7329
B3221100009	Farquhar, Bobby 3407 B South Chadbourne St. San Angelo, TX 76904	Region I Office San Angelo	Manager V	Regional Director	bobby.farquhar@tpwd.state.tx.us	Work: 325/651-4846 Fax: 325/651-4752
B3221100009	Gavigan, Susan 3407 B South Chadbourne St. San Angelo, TX 76904	Region I Office San Angelo	SSO I	Admn. Assistant	susan.gavigan@tpwd.state.tx.us	Work: 325/651-4846 Fax: 325/651-4752
B3221100009	Strickland, Dan 3407 B South Chadbourne St. San Angelo, TX 76904	Region I Office San Angelo	Program Spec. III		dan.strickland@tpwd.state.tx.us	Work: 325/651-4846 Fax: 325/651-4752
B3221100103	Munger, Charles R. P.O. Box 835 Canyon, TX 79015	District I - A Canyon	NRS VI	District Team Leader	charlie.munger@tpwd.state.tx.us	Work: 806/655-4341 Fax: 806/655-8104
B3221100103	Deleon, David J. P.O. Box 835 Canyon, TX 79015	District I - A Canyon	F&W Tech V		david.deleon@tpwd.state.tx.us	Work: 806/655-4341 Fax: 806/655-8104
B3221100103	Hoy, James T. P.O. Box 835 Canyon, TX 79015	District I - A Canyon	F&W Tech IV		jim.hoy@tpwd.state.tx.us	Work: 806/655-4341 Fax: 806/655-8104
B3221100103	Jason Henegar P O Box 835 Canyon, TX 79015	District I - A Canyon	NRS II	Mgmt. Biologist	jason.henegar@tpwd.state.tx.us	Work: 806/655-4341 Fax: 806/655-8104
B3221100155	Dumont, Spencer 5325 N. 3rd St. Abilene, TX 79603	District I - B Abilene	NRS VI	District Team Leader	spencer.dumont@tpwd.state.tx.us	Work: 325/692-0921 Fax: 325/698-3528

Inland Fisheries Division Personnel Directory

B3221100155	Benson, Lance M 5325 N 3 rd Abilene, TX 79603	District I - B Abilene	F W Tech IV		lance.benson@tpwd.state.tx.us	Work: 325/692-0921 Fax: 325/698-3528
B3221100155	Cole, Robert L. 5325 N. 3 rd St. Abilene, TX 79603	District I - B Abilene	F&W Tech V		robert.cole@tpwd.state.tx.us	Work: 325/692-0921 Fax: 325/698-3528
B3221100155	Farooqi, Mukhtar 5325 N. 3 rd St. Abilene, TX 79603	District I - B Abilene	NRS IV	Mgmt. Biologist	mukhtar.farooqi@tpwd.state.tx.us	Work: 325/692-0921 Fax: 325/698-3528
B3221100271	Bonds, Craig 3407 A South Chadbourne St. San Angelo, TX 76904	District I - C San Angelo	NRS VI	District Team Leader	craig.bonds@tpwd.state.tx.us	Work: 325/651-5556 Fax: 325/651-5569
B3221100271	Cruz, Henry L. 3407 A South Chadbourne St. San Angelo, TX 76904	District I - C San Angelo	F&W Tech V		henry.cruz@tpwd.state.tx.us	Work: 325/651-5556 Fax: 325/651-5569
B3221100271	Mandy Scott 3407 A South Chadbourne St. San Angelo, TX 76904	District I - C San Angelo	NRS II	Mgmt. Biologist	Mandy.scott@tpwd.state.tx.us	Work: 325/651-5556 Fax: 325/651-5569
B3221100271	Ingle, John R. 3407 A South Chadbourne St. San Angelo, TX 76904	District I - C San Angelo	F&W Tech. IV		john.ingle@tpwd.state.tx.us	Work: 325/651-5556 Fax: 325/651-5569
B3221100493	Myers, Randy 134 Braniff Dr. San Antonio, TX 78216-3301	District I - D San Antonio	NRS VI	District Team Leader	Randy.myers@tpwd.state.tx.us	Work: 210/348-6355 Fax: 210/366-2319
B3221100493	Cordova, Jimmy S. 134 Braniff Dr San Antonio, TX 78216-3301	District I - D San Antonio	F&W Tech IV		jimmy.cordova@tpwd.state.tx.us	Work: 210/348-6355 Fax: 210/366-2319
B3221100493	Driscoll, Jason 134 Braniff Dr San Antonio, TX 78216-3301	District I - D San Antonio	F&W Tech IV		jason.driscoll@tpwd.state.tx.us	Work: 210/348-6355 Fax: 210/366/2319
B3221100493	Dennis, John A. 134 Braniff Dr San Antonio, Tx 78216-3301	District I - D San Antonio	NRS IV	Mgmt. Biologist	john.dennis@tpwd.state.tx.us	Work: 210/348-6355 Fax: 210/366-2319
B3221100622	Findeisen, John P.O. Box 116 Mathis, TX 78368-0166	District I - E Mathis	Manager II	District Team Leader	john.findeisen@tpwd.state.tx.us	Work: 361/547-9712 Fax: 361/547-7225
B3221100622	Cardona, Rey P.O. Box 116 Mathis, TX 78368-0166	District I - E Mathis	F&W Tech IV		rey.cardona@tpwd.state.tx.us	Work: 361 /547-9712 Fax: 361/547-7225

Inland Fisheries Division Personnel Directory

B3221100622	Todd Neahr P O Box 116 Mathis, Texas 78368-0116	District I - E Mathis		Mgmt. Biologist	todd.neahr@tpwd.state.tx.us	Work: 361/547-9712 Fax: 361/547-7225
B3221100622	Medrano, Ramiro P.O. Box 116 Mathis, TX 78368-0166	District I - E Mathis	F&W Tech. III		ram.medrano@tpwd.state.tx.us	Work: 361/547-9712 Fax: 361/547-7225
B3221200006	Van Zee, Brian 1601 E. Crest Dr. Waco, TX 76705-1555	Region II Office-Waco	Manager V	Regional Director	brian.vanzee@tpwd.state.tx.us	Work: 254/867-7974 Fax: 254/867-6839
B3221200006	Berry, Patsy 1601 E. Crest Dr Waco, TX 76705	Region II Office-Waco	SSO I	Admn. Assistant	patsy.berry@tpwd.state.tx.us	Work: 254/867-7973 Fax: 254/867-6839
B3221200006	Cummings, William Chris 1601 E. Crest Dr. Waco, TX 76705-1555	Region II Office-Waco	Program Specialist III		chris.cummings@tpwd.state.tx.us	Work: 254/867-7975 Fax: 254/867-6839
B3221200006	Glass, Joan 1601 E. Crest Dr. Waco, TX 76705-1555	Region II Office-Waco	NRS V		Joan.glass@tpwd.state.tx.us	Work: 254/867-7956 Fax: 254/867-6839
B3221200019	Hysmith, Bruce P O Box 1446 Pottsboro, TX 75076-1446	District II - A Pottsboro	NRS VI	District Supervisor	bruce.hysmith@tpwd.state.tx.us	Work: 903/786-2389 Fax: 903/786-9871
B3221200019	Moczygemba, John H. P O Box 1446 Pottsboro, TX 75076-1446	District II - A Pottsboro	NRS V	Mgmt. Biologist	john.moczygemba@tpwd.state.tx.us	Work: 903/786-2389 Fax: 903/786-9871
B3221200019	Robinson, Todd P O Box 1446 Pottsboro, TX 75076-1446	District II - A Pottsboro	F&W Tech. IV		todd.robinson@tpwd.state.tx.us	Work: 903/786-2389 Fax: 903/786-9871
B3221200019	Clouse, Corey P O Box 1446 Pottsboro, TX 75076-1446	District II - A Pottsboro	F&W Tech. II		corey.clouse@tpwd.state.tx.us	Work: 903/786-2389 Fax: 903/786-9871
B3221200020	Tibbs, John 8684 LaVillage Ave. Waco, TX 76712	District II - B Waco	NRS VI	District Supervisor	john.tibbs@tpwd.state.tx.us	Work: 254 666-5190 Fax: 254 666-4297
B3221200020	Baird, Michael S 8684 La Village Ave Waco, TX 76712	District II -B Waco	NRS IV	Mgmt Biologist	michael.baird@tpwd.state.tx.us	Work: 254 666-5190 Fax: 254 666-4297
B3221200020	Teat, William Floyd 8684 La Village Ave. Waco, TX 76712-8618	District II - B Waco	F&W Tech. V I		floyd.teat@tpwd.state.tx.us	Work: 254/666-5190 Fax: 254/ 666-4297

Inland Fisheries Division Personnel Directory

B3221200020	Bartram, Brian 8684 La Village Ave. Waco, TX 76712-8618	District II – B Waco	F&W Tech. II		brian.bartram@tpwd.state.tx.us	Work: 254/666-5190 Fax: 254/ 666-4297
B3221200049	Magnelia, Steve 505 Staples Road San Marcos, TX 78666	District II - C San Marcos	NRS VI	District Supervisor	stephan.magnelia@tpwd.state.tx.us	Work: 512/353-0072 Fax: 512/353-7304
B3221300049	DeJesus, Marcos 505 Staples Rd San Marcos, TX 78666	District II - C San Marcos	NRS IV	Mgmt Biologist	marcos.dejesus@tpwd.state.tx.us	Work: 512 353-0072 Fax: 512 353-7304
B3221200049	Duty, Joshua L. 505 Staples Road San Marcos, TX 78666	District II - C San Marcos	F&W Tech. III		joshua.duty@tpwd.state.tx.us	Work: 512/353-0072 Fax: 512/353-7304
B3221200049	Greg Cummings 505 Staples Rd San Marcos, TX 78666	District II - C San Marcos	FW Tech III		greg.cummings@tpwd.state.tx.us	Work: 512 353-0072 Fax: 512-353-7304
B3221200193	Brock, Raphael 6200 Hatchery Rd. Fort Worth, TX 76114-2413	District II - D Ft. Worth	NRS VI	District Supervisor	raphael.brock@tpwd.state.tx.us	Work: 817/732-0761 Fax: 817/377-4569
B3221200193	Hungerford, Thomas 6200 Hatchery Rd. Fort Worth, TX 76114-2413	District II - D Ft. Worth	NRS III	Mgmt Biologist	thomas.hungerford@tpwd.state.tx.us	Work: 817/732-0761 Fax: 817/377-4569
B3221200193	Bickel, Kenneth 6200 Hatchery Rd. Fort Worth, TX 78667-0947	District II - D Ft. Worth	F&W Tech IV		kenneth.bickel@tpwd.state.tx.us	Work: 817/732-0761 Fax: 817/377-4569
B3221200193	Wallace, Andrew 6200 Hatchery Rd. Fort Worth, TX 76114-2413	District II - D Ft. Worth	F&W Tech. III		andrew.wallace@tpwd.state.tx.us	Work: 817/732-0761 Fax: 817/377-4569
B3221200267	Howell, Mark H. 409 Chester Ave. Wichita Falls, TX 76301-5304	District II - E -Wichita Falls	NRS VI	District Supervisor	mark.howell@tpwd.state.tx.us	Work: 940/766-2383 Fax: 940/766-1496
B3221200267	Mauk, Robert 409 Chester Ave Wichita Falls, TX 76301-5304	District II - E -Wichita Falls	NRS IV		robert.mauk@tpwd.state.tx.us	Work:940 766-2383 Fax: 940 766-1496
B3221200267	Dutter, Wes 409 Chester Dr Wichita Falls, TX 76301-5304	District II - E -Wichita Falls	F&W Tech IV		wes.dutter@tpwd.state.tx.us	Work: 940 766-2383 Fax: 940 766-1496
B3221200267	Hise, Steven 409 Chester Avenue Wichita Falls, TX 76301-5304	District II - E -Wichita Falls	F&W Tech III		steven.hise@tpwd.state.tx.us	Work: 940/766-2383 Fax: 940/766-1496

Inland Fisheries Division Personnel Directory

B3221300037	Terre, David 11810 FM 848 Tyler, TX 75707	Region III Office-Tyler	Manager V	Regional Director	dave.terre@tpwd.state.tx.us	Work: 903/566-1615 Ext. 202 Fax:903/566-1546
B3221300037	Green, Jimmie 11810 FM 848 Tyler, TX 75707	Region III Office-Tyler	SSO I	Admn. Assistant	jimmie.green@tpwd.state.tx.us	Work: 903 566-1615 Ext. 200 Fax: 903 566-1546
B3221300037	Lewis, Danny 11810 FM 848 Tyler, TX 75707	Region III Office-Tyler	Programmer III		danny.lewis@tpwd.state.tx.us	Work: 903/566-1615 Ext. 201 Fax: 903 566-1546
B3221300062	Bister, Timothy 3802 E. End Blvd. S. Marshall, TX 75672-9705	District III - A Marshall	NRS VI	Team Leader	timothy.bister@tpwd.state.tx.us	Work: 903/938-1007 Fax: 903/938-8652
B3221300062	Brice, Michael 3802 E. End Blvd. S. Marshall, TX 75672-9705	District III - A Marshall	NRS IV	Mgmt. Biologist	michael.brice@tpwd.state.tx.us	Work: 903/938-1007 Fax: 903/938-8652
B3221300062	Green, Thomas Jacob 3802 East End Blvd., So Marshall, TX 75672	District III-A Marshall	FW Tech IV		jacob.green@tpwd.state.tx.us	Work: 903 938-1007 Fax: 903 938-8652
B3111300062	Kay, Kenneth A 3802 East End Blvd St Marshall, TX 75672	District III-A Marshall	F&W Tech III		kenneth.kay@tpwd.state.tx.us	Work: 903/938-1007 Fax: 903/938-8652
B3221300115	Storey, Kevin Winston 2122 Henderson Hwy. Tyler, TX 75702-6400	District III - B Tyler	NRS VI	Team Leader	kevin.storey@tpwd.state.tx.us	Work: 903/593-5077 Fax: 903/531-0109
B3221300115	Jubar, Aaron 2122 Old Henderson Hwy Tyler, TX 75702	District III - B Tyler	NRS IV	Mgmt. Biologist	aaron.jubar@tpwd.state.tx.us	Work: 903 593-5077 Fax: 903 531-0109
B3221300115	Brown, Monte 2122 Old Henderson Hwy. Tyler, TX 75702-6400	District III - B Tyler	F&W Tech. IV		monte.brown@tpwd.state.tx.us	Work: 903/593-5077 Fax: 903/531-0109
B3221300115	Pratas, Kirk S. 2122 Old Henderson Hwy. Tyler, TX 75702-6400	District III - B Tyler	F&W Tech. V		kirk.pratas@tpwd.state.tx.us	Work: 903/593-5077 Fax: 903/531-0109
B3221300128	Ott, Jr., Richard 11810 FM 848 Tyler, TX 75707-5234	District III - C Tyler	NRS VI	Team Leader	richard.ott@tpwd.state.tx.us	Work: 903/566-2161 Fax: 903/566-3542 903 566-1546
B3221300128	Beck, Patrick 11810 FM 848 Tyler, TX 75707	District III - C Tyler	NRS IV	Mgmt. Biologist	pat.beck@tpwd.state.tx.us	Work: 903 566-2161 Fax: 903 566-3542

Inland Fisheries Division Personnel Directory

B3221300128	Bowling, Jeffrey 11810 FM 848 Tyler, TX 75707	Region III - C Tyler	F&W Tech. V		jeffrey.bowling@tpwd.state.tx.us	Work: 903 566-2161 Fax: 903 566-3542
B3221300128	Hughes, William J 11942 FM 848 Tyler, TX 75707-5234	District III - C Tyler	F&W Tech. II		william.hughes@tpwd.state.tx.us	Work: 903/566-2161 Fax: 903/566-3542
1B3221300179	Driscoll, Michael Todd Rt 2, Box 535 Jasper, TX 75951	District III - D Jasper	NRS VI	Team Leader	todd.driscoll@tpwd.state.tx.us	Work: 409 384-9572 Fax: 409 384-4984
B3221300179	Moorhead, Joe Rt 2, Box 535 Jasper, TX 75951	District III - D Jasper	FW Tech IV		joe.moorhead@tpwd.state.tx.us	Work: 409 384-9572 Fax: 409 384-4984
B3221300179	Ashe, Dan Rt 2, Box 535 Jasper, TX 75951-9685	District III - D Jasper	NRS IV	Mgmt. Biologist	dan.ashe@tpwd.state.tx.us	Work: 409/384-9572 Fax: 409/384-4984
B3221300179	Ratcliff, Michael J. Rt 2, Box 535 Jasper, TX 75951-9685	District III - D Jasper	F&W Tech V		michael.ratcliff@tpwd.state.tx.us	Work: 409 384-9572 Fax: 409 384-4984
B3222200250	Smith, Jules L Rt 2 Box 535 Jasper, Texas 75951	District III - D Jasper	F W Tech IV		jay.smith2@tpwd.state.tx.us	Work: 409 384-9572 Fax: 409 384-4984
B3221300317	Webb, Mark 1004 E. 26th Street Bryan, TX 77803-7800	District III - E Bryan	NRS VI	Team Leader	mark.webb@tpwd.state.tx.us	Work: 979/822-5067 Fax: 979/823-5860
B3221300317	Gore, Michael Scott 1004 E. 26 th St Bryan, TX 77803	District III - E Bryan	F W Tech V		mike.gore@tpwd.state.tx.us	Work: 979 822-5067 Fax: 979/823-5860
B3221300317	Henson, Jeffrey 1004 E. 26th St. Bryan, TX 77803-7800	District III - E Bryan	NRS V	Mgmt. Biologist	jeff.henson@tpwd.state.tx.us	Work: 979/822-5067 Fax: 979/823-5860
B3221300317	Johnson, Bill 1004 E. 26th St. Bryan, TX 77803-7800	District III - E Bryan	F&W Tech V		william.johnson@tpwd.state.tx.us	Work: 979/822-5067 Fax: 979/823-5860
B3221000141	Elder, Howard Rt 2, Box 535 Jasper, TX 75951-9202	District III - Aquatic Vegetation Control - Jasper	Manager II	Habitat Enhanc. Superv.	howard.elder@tpwd.state.tx.us	Work: 409/384-9965 Fax: 409/384-4984
B3221000102	Boatman, Carl E. Rt 2, Box 535 Jasper, TX 75951-9202	District III - Aquatic Vegetation Control - Jasper	F&W Tech V		carl.boatman@tpwd.state.tx.us	Work: 409/384-9965 Fax: 409/384-4984

Inland Fisheries Division Personnel Directory

B3221000102	Lenderman, Larry R Rt 2, Box 535 Jasper, TX 75951-9202	District III - Aquatic Vegetation Control – Jasper	FW Tech IV		larry.lenderman@tpwd.state.tx.us	Work: 409/384-9965 Fax: 409/384-4984
B3223000129	Robert K. Betsill 5103 Junction Hwy. Ingram, TX 78025	Heart of the Hills Fisheries Science Center	Manager V	Program Director	bob.betsill@tpwd.state.tx.us	Work: 830/866-3356 Fax: 830/866-3549
B3223000129	Ahrens, Kenneth R. 5103 Junction Hwy. Ingram, TX 78025	Heart of the Hills Fisheries Science Center	F&W Tech IV	Research Technician	kenneth.ahrens@tpwd.state.tx.us	Work: 830/866-3356 Fax: 830/866-3549
B3223000129	Barkoh, Aaron 5103 Junction Hwy. Ingram, TX 78025	Heart of the Hills Fisheries Science Center	Prog Spec V	Research Biologist	aaron.barkoh@tpwd.state.tx.us	Work: 830/866-3356 Fax: 830/866-
B3223000129	Buckmeier, David L. 5103 Junction Hwy. Ingram, TX 78025	Heart of the Hills Fisheries Science Center	NRS VI	Research Biologist	david.buckmeier@tpwd.state.tx.us	Work: 830/866-3356 Fax: 830/866-3549
B3223000129	Castillo, Antonio J. 5103 Junction Hwy. Ingram, TX 78025	Heart of the Hills Fisheries Science Center	F&W Tech IV	Research Technician	tony.castillo@tpwd.state.tx.us	Work: 830/866-3356 Fax: 830/866-3549
B3223000129	Pavlicek, Shane L. 5103 Junction Hwy. Ingram, TX 78025	Heart of the Hills Fisheries Science Center	F&W Tech III	Research Technician	shane.pavlicek@tpwd.state.tx.us	Work: 830 866-3356 Fax: 830 866-3549
B3223000129	Garrett, Gary P. 5103 Junction Hwy. Ingram, TX 78025	Heart of the Hills Fisheries Science Center	Prog Spec V	Research Biologist	gary.garrett@tpwd.state.tx.us	Work: 830/866-3356 Fax: 830/866-3549
B3223000129	Hernandez, Joe L. 5103 Junction Hwy. Ingram, TX 78025	Heart of the Hills Fisheries Science Center	F&W Tech IV	Research Technician	joe.hernandez@tpwd.state.tx.us	Work: 830/866-3356 Fax: 830/866-3549
B3223000129	Hodges, Vernon L. 5103 Junction Hwy. Ingram, TX 78025	Heart of the Hills Fisheries Science Center	NRS V	Research Biologist	vernon.hodges@tpwd.state.tx.us	Work: 830/866-3356 Fax: 830/866-3549
B3223000129	Daugherty, Dan J. 5103 Junction Hwy. Ingram, TX 78025	Heart of the Hills Fisheries Science Center	NRS II	Research Biologist	dan.daugherty@tpwd.state.tx.us	Work: 830/866-3356 Fax: 830/866-3549
B3223000129	Reeves, Kerry S. 5103 Junction Hwy. Ingram, TX 78025	Heart of the Hills Fisheries Science Center	NRS II	Research Biologist	kerry.reeves@tpwd.state.tx.us	Work: 830/866-3356 Fax: 830/866-3549
B3223000129	Schlechte, J. Warren 5103 Junction Hwy. Ingram, TX 78025	Heart of the Hills Fisheries Science Center	Prog Spec V	Biometrician	warren.schlechte@tpwd.state.tx.us	Work: 830 866-3356 Fax: 830 866-

Inland Fisheries Division Personnel Directory

B3223000129	Sudyka, Annette M. 5103 Junction Hwy. Ingram, TX 78025	Heart of the Hills Fisheries Science Center	SSO I	Admn Assistant	annette.sudyka@tpwd.state.tx.us	Work: 830/866-3356 Fax: 830/866-3549
B3223000129	Wienecke, Robert W. 5103 Junction Hwy. Ingram, TX 78025	Heart of the Hills Fisheries Science Center	F&W Tech IV	Research Technician	robert.wienecke@tpwd.state.tx.us	Work: 830/866-3356 Fax: 830/866-3549
B3223000129	Wilson, David C. 5103 Junction Hwy. Ingram, TX 78025	Heart of the Hills Fisheries Science Center	F&W Tech III	Research Technician	david.wilson@tpwd.state.tx.us	Work: 830/866-3356 Fax: 830/866-3549
B3222300030	Forshage, Allen 5550 FM 2495 Athens, TX 75752-6381	TFFC-Athens	Manager V	TFFC Director	allen.forshage@tpwd.state.tx.us	Work: 903/676-2277 ext. 224 Fax: 903/676-3474 Direct line: 903 670-2224
B3222300705	Matthews, James Hardy 5550 FM 2495 Athens, TX 75752-6381	TFFC-Athens	Mgr II	Hatchery Mgr.	jim.matthews@tpwd.state.tx.us	Work: 903/676-2277 ext. 337 Fax: 903/676-3474 Direct line: 903 670-2237
B3222300030	Barrera, Barbara 5550 FM 2495 Athens, TX 75752-6381	TFFC-Athens	Ad Tech III	Reservations/ Secretary	barbara.barrera@tpwd.state.tx.us	Work: 903/676-2277 Fax: 903/676-3474
B3222300030	Barrera, Ben 5550 FM 2495 Athens, TX 75752-6381	TFFC-Athens	F&W Tech. III	Education		Work: 906/676-2277 Fax: 903/677-2694
B3222300705	Campbell, David 5550 FM 2495 Athens, TX 75752-6381	TFFC-Athens	Program Specialist VI	Facility Manager/ ShareLunker Director	david.campbell@tpwd.state.tx.us	Work: 903/676-2277 ext. 230 Fax: 903/676-3474 Direct line: 903 670-2226
B3222300030	Campbell, Mickie 5550 FM 2495 Athens, TX 75752-6381	TFFC-Athens	SSO I	Admn. Assistant	mickie.campbell@tpwd.state.tx.us	Work: 903/676-2277 ext. 226 Fax: 903/676-3474 Direct line: 903 670-2226
B3222300705	Carter, Stephen (Shane) 5550 FM 2495 Athens, TX 75752-6381	TFFC-Athens	F&W Tech. III	Hatchery/Exhibits	stephen.carter@tpwd.state.tx.us	Work: 903/676-2277 ext. 332 Fax: 903/676-3474
B3222300705	Eucher, Jason M 5550 FM 2495 Athens, TX 75752-6381	TFFC-Athens	F&W Tech. III	Hatchery/Exhibits		Work: 903/676-2277 Fax: 903/676-3474
B3222300705	Dobecka, James 5550 FM 2495 Athens, TX 75752-6381	TFFC-Athens	F&W Tech. III	Maintenance	jim.dobeka@tpwd.state.tx.us	Work: 903/676-2277 Fax: 903/676-3474

Inland Fisheries Division Personnel Directory

B3222300030	Farmer, Mona A. 5550 FM 2495 Athens, TX 75752-6381	TFFC-Athens	Info. Spec. IV	Marketing	mona.farmer@tpwd.state.tx.us	Work: 903/676-2277 ext. 228 Fax: 903/676-3474 Direct line: 903 670-2228
B3222300705	Gillert, Jeremy 5550 FM 2495 Athens, TX 75752-6381	TFFC –Athens	F&W Tech II	Hatchery	Jeremy.gillert@tpwd.state.tx.us	Work: 903/676-2277 Fax 903/676-3474
B3222300030	Green, Robert 5550 FM 2495 Athens, TX 75752-6381	TFFC Athens	F&W Tech III	Maintenance	bob.green@tpwd.state.tx.us	Work: 903 676-2277 Fax: 903 676-3474
B3222300705	Griggs, Lisa M. 5550 FM 2495 Athens, TX 75752-6381	TFFC-Athens	F&W Tech. IV	Hatchery/Exhibits	lisa.griggs@tpwd.state.tx.us	Work: 903/676-2277 ext. 336 Fax: 903/676-3474
B3222300030	Heaton, Joseph (Wayne) 5550 FM 2495. Athens, TX 75752-6381	TFFC-Athens	NRS I	Exhibits Curator	Wayne.heaton@tpwd.state.tx.us	Work: 903/676-2277 ext. 339 Fax: 903/676-2694 Direct Line: 903/670-2239
B3222300030	Hodge, Larry 5550 FM 2495. Athens, TX 75752-6381	TFFC-Athens	F&W Tech III	Marketing	Larry.hodge@tpwd.state.tx.us	Work: 903/676-2277 ext. 255 Fax: 903/676-2694 Direct Line: 903/670-2255
B3222300030	Hofstetter, Denise 5550 FM 2495 Athens, TX 75752-6381	TFFC-Athens	Clerk IV	Visitors Services		Work: 903 676-2277 Fax: 903 676-3474
B3222300705	Jones, Jim	TFFC-Athens	F& W Tech III	Maintenance	Jim.jones@tpwd.state.tx.us	Work: 903/676-2277 x442 Fax: 903/676-3474
B3222300705	Jones, Wendel Wayne 5550 FM 2495 Athens, TX 75752-6381	TFFC-Athens	F&W Tech. IV	Maintenance	Wendel.jones@tpwd.state.tx.us	Work: 903/676-2277 ext. 443 Fax: 903/676-3474
B3222300705	Martinez, Juan 5550 FM 2495 Athens, TX 75752-6381	TFFC Athens	NRS I	Intensive Culture	Juan.martinez@tpwd.state.tx.us	Work: 903 670-2277 Fax: 903 677-2694 Direct line 678 2285
B3222200705	Owens, Tony 5550 FM 2495 Athens, TX 75752-6381	TFFC-Athens	NRS III-A	ExtensiveCulture	tony.owens@tpwd.state.tx.us	Work: 903/676-2277 Fax: 903/676-3474 Direct line: 903 670-2236
B3222300030	Raborn, Glenn 5550 FM 2495 Athens, TX 75752-6381	TFFC-Athens	F&W Tech. IV	Maintenance	Glenn.raborn@tpwd.state.tx.us	Work: 903/676-2277 Fax: 903/676-3474

Inland Fisheries Division Personnel Directory

B3222300705	Reeder, Derek 5550 FM 2495 Athens, TX 75702-6381	TFFC-Athens	FW Tech II	Hatchery/Exhibits		Work: 903 676-2277 Fax: 903 676-3474
B3222300030	Servos, Kristie Renee 5550 FM 2495 Athens, Texas 75752-6381	TFFC-Athens	Clerk IV	Visitor Services		Work: 903 676-2277 Fax: 903 676-3474
B3222300030	St. Clair, Barry 5550 FM 2495 Athens, TX 75752-6381	TFFC-Athens	F&W Tech. III	Marketing/ Education	barry.stclair@tpwd.state.tx.us	Work: 903/676-2277 Fax: 903/677-2694 Direct Line: 903/676-2222
B3222300030	Stinchcomb, Zoe Ann 5550 FM 2495 Athens, TX 75752-6381	TFFC-Athens	Program Specialist IV	Education Specialist	Zoeann.stinchcomb@tpwd.state.tx.us	Work: 903/676-2277 x338 Direct line: 903/670-2238 Fax: 903/677-2694
B3222200705	Wade, Deborah 5550 FM 2495 Athens, TX 75751-6381	TFFC-Athens	NRS V	Lab	deborah.wade@tpwd.state.tx.us	Work: 903 670-2234 903 676-2277 Fax: 903/676-3474
B322300030	Warner, Alonzo (Jay) 5550 FM Athens, TX 75751-6381	TFFC-Athens	FW Tech III	Maintenance/ Custodian		Work: 903/676-2277 Fax: 903/676-3474
B3222300030	Wilkerson, Betty S 5550 FM 2495 Athens, TX 75751-6381	TFFC-Athens	Clerk IV	Visitor Services		Work: 903 676-2277 Fax: 903 676-3474
B3222300030	Williams, Brenda 5550 FM 2495 Athens, TX 75751-6381	TFFC-Athens	Staff Serv. Officer II	Visitor Service Director	brenda.williams@tpwd.state.tx.us	Work: 903/676-2277 ext. 232 Fax: 903/676-3474 Direct line: 903 670-2232
B3221000102	Gerald Kurten 600 S. Hwy 16 Graford, TX 76449	Possum Kingdom Fish Hatchery	Manager V	Program Director	Gerald.kurten@tpwd.state.tx.us	Work: 940/779-2301
B3222100036	Dennis Smith. RR 1, Box 123-A Electra, TX 76360-9502	Dundee Hatchery-Electra	Manager III	Hatchery Manager	Dennis.smith@tpwd.state.tx.us	Work: 940/586-1203 Fax: 940/586-1540
B3222200036	Begley, Drew C Rt I, Box 123Aa Electra, TX 76360	Dundee Hatchery-Electra	NRS I	Hatchery Biologist	drew.begley@tpwd.state.tx.us	Work: 940/586-1203 Fax: 940-586-1540
B3222200036	Field, Daniel Wayne Rt I, Box123A Electra, TX 76360	Dundee Hatchery-Electra	F W Tech III		daniel.field@tpwd.state.tx.us	Work: 940 586-1203 Fax: 940 586-0089
B3222100036	Ibarra, Jr., Jesse RR 1, Box 123-A Electra, TX 76360-9502	Dundee Hatchery-Electra-	F&W Tech. III		ibarra.jesus@tpwd.state.tx.us	Work: 940/586-1203 Fax: 940/586-1540

Inland Fisheries Division Personnel Directory

B3222100036	Nations, Michele A. 5550 FM 2495 Athens, TX 75751-6381	Possum Kingdom Fish Hatchery	SSO I	Admn. Assistant	michele.nations@tpwd.state.tx.us	Work: 940/779-2301
B3222100036	Polk, Gregory L. Rt 1, Box 123-A Electra, TX 76360-9502	Dundee Hatchery-Electra	F&W Tech. IV		greg.polk@tpwd.state.tx.us	Work: 940/586-1203 Fax: 940/586-1540
B3222100036	Reinisch, Donald Rt 1, Box 123-A Electra, TX 76360-9502	Dundee Hatchery-Electra	F&W Tech III		don.reinisch@tpwd.state.tx.us	Work: 940 586-1203 ext 25 Fax: 940 586-1540
B3222200036	Wyatt, Tom Rt 1, Box 123-A Electra, TX 76360	Dundee Hatchery-Electra	NRS III	Hatchery Biologist	tom.wyatt@tpwd.state.tx.us	Work: 940 586-1203 Fax: 940 586-1540
B3222100036	Spencer, Bobby Rt 1, Box 123-A Electra, TX 76360-9502	Dundee Hatchery-Electra	F&W Tech. II		Bobby.spencer@tpwd.state.tx.us	Work: 940/586-1203 Fax: 940/586-0089
B3222100036	Gosset, Darin Rt 1, Box 123-A Electra, TX 76360-9502	Dundee Hatchery-Electra	F&W Tech. II		Bobby.spencer@tpwd.state.tx.us	Work: 940/586-1203 Fax: 940/586-0089
B3222100208	Dale Lyon 600 Hwy 16 South Graford, TX 76449	Possum Kingdom-Graford	Manager III	Hatchery Manager	dale.lyon@tpwd.state.tx.us	Work: 940/779-2301 Fax: 940/779-2670
B3221300208	Cruz, Charles 600 Hwy 16 South Graford, TX 76449	Possum Kingdom-Graford	F W Tech III			Work: 940 779-2301 Fax. 940 779-2670
B3222200208	McDougall, Charles Eugene 600 Hwy 16 South Graford, TX 76449	Possum Kingdom -Graford	F W Tech III			Work: 940 779-2301 Fax: 940 779-2670
B3222100208	Nunez, Eduardo 600 Hwy 16 South Graford, TX 76449	Possum Kingdom-Graford	F W Tech IV		eduardo.nunez@tpwd.state.tx.us	Work: 940/779-2301 Fax: 940/779-2670
B3221300208	John Paret 600 Hwy 16 South Graford, TX 76449	Possum Kingdom-Graford	NRS V	Hatchery Biologist	John.paret@tpwd.state.tx.us	Work: 940 779-2301 Fax. 940 779-2670
B3222100250	Gelen Alexander RR2, Box 535 Jasper, TX 75951-9685	Jasper Hatchery	NRS V	Hatchery Biologist	glen.alexander@tpwd.state.tx.us	Work: 409 384-2221 Fax: 409 384-4984
B3222200250	Avery, John RR 2, Box 535 Jasper, TX 75951-9685	Jasper Hatchery	F&W Tech. III			Work: 409/384-2221 Fax: 409/384-4984

Inland Fisheries Division Personnel Directory

B3222200250	Cauley, David RR 2, Box 535 Jasper, TX 75951-9685	Jasper Hatchery	F&W Tech. IV			Work: 409/384-2221 Fax: 409/384-4984
B3222200250	Diggles, Robert RR 2, Box 535 Jasper, TX 75951-9685	Jasper Hatchery	F&W Tech. III			Work: 409/384-2221 Fax: 409/384-4984
B3222200250	Hall, Belva Lee RR 2, Box 535 Jasper, TX 75951-9685	Jasper Hatchery	NRS IV	Hatchery Biologist	lee.hall@tpwd.state.tx.us	Work: 409/384-2221 Fax: 409/384-4984
B3222100250	Kay, Kenneth A. RR 2, Box 535 Jasper, TX 75951-9685	Jasper Hatchery	FW Tech II			Work: 409/384-2221 Fax: 409/384-2221
B3222200250	Mayo, Michael C. RR 2, Box 535 Jasper, TX 75951-9685	Jasper Hatchery	F&W Tech. III			Work: 409/384-2221 Fax: 409/384-4984
B3222100250	Sparrow, Reese RR 2, Box 535 Jasper, TX 75951-9685	Jasper Hatchery	Manger II	Hatchery Manager	reese.sparrow@tpwd.state.tx.us	Work: 409 384-2221 Fax: 409 384-4984
B3221000366	Carl Kittel 507 Staples Road San Marcos, Texas 78666	A.E. Wood Fish Hatchery	Manager V	Program Director	Carl.kittel@tpwd.state.tx.us	Work: 512/7353-0313 Fax: 512/353-0629
B32221000568	Jake Isaac 507 Staples Road San Marcos, Texas 78666	A.E. Wood Fish Hatchery	Manager III	Hatchery Manger	Jake.Isaac@tpwd.state.tx.us	Work: 512/7353-0572 Fax: 512/353-0629
B32221000568	Hugh Glenewinkel 507 Staples Road San Marcos, Texas 78666	A.E. Wood Fish Hatchery	NRS VI	Hatchery Biologist	Hugh.glenewinkel@tpwd.state.tx.us	Work: 512/7353-0572 Fax: 512/353-0629
B32221000568	Chris Thibodeaux 507 Staples Road San Marcos, Texas 78666	A.E. Wood Fish Hatchery	NRS VI	Hatchery Biologist	Chris.thibodeaux@tpwd.state.tx.us	Work: 512/7353-0572 Fax: 512/353-0629
B32221000568	Ted Engelhardt 507 Staples Road San Marcos, Texas 78666	A.E. Wood Fish Hatchery	Program Specialist III	Facility Manager	ted.engelhardt@tpwd.state.tx.us	Work: 512/7353-0572 Fax: 512/353-0629
B32221000366	Melissa Schmidt 507 Staples Road San Marcos, Texas 78666	A.E. Wood Fish Hatchery	SSO I	Admn. Assistant	Melissa.schmidt@tpwd.state.tx.us	Work: 512/7353-0572 Fax: 512/353-0629
B32221000568	Marquart, Jarret 507 Staples Road San Marcos, Texas 78666	A.E. Wood Fish Hatchery	F&W Tech. IV		Jarret.marquart@tpwd.state.tx.us	Work: 512/7353-0572 Fax: 512/353-0629

Inland Fisheries Division Personnel Directory

B32221000568	Laca, Robert 507 Staples Road San Marcos, Texas 78666	A.E. Wood Fish Hatchery	Maintenance Tech IV		bob.laca@tpwd.state.tx.us	Work: 512/7353-0572 Fax: 512/353-0629
B32221000568	Brooker, Jack 507 Staples Road San Marcos, Texas 78666	A.E. Wood Fish Hatchery	F&W Tech. IV		Jack.brooker@tpwd.state.tx.us	Work: 512/7353-0572 Fax: 512/353-0629
B32221000568	Reynolds, Nathan 507 Staples Road San Marcos, Texas 78666	A.E. Wood Fish Hatchery	F&W Tech. III		nathan.reynolds@tpwd.state.tx.us	Work: 512/7353-0572 Fax: 512/353-0629
B32221000568	Pereira, Mike 507 Staples Road San Marcos, Texas 78666	A.E. Wood Fish Hatchery	F&W Tech. III		mike.pereira@tpwd.state.tx.us	Work: 512/7353-0572 Fax: 512/353-0629
B32221000568	Little, Mike 507 Staples Road San Marcos, Texas 78666	A.E. Wood Fish Hatchery	F&W Tech. IV		Mike.little@tpwd.state.tx.us	Work: 512/7353-0572 Fax: 512/353-0629
B32221000568	Lalla, Jovonne 507 Staples Road San Marcos, Texas 78666	A.E. Wood Fish Hatchery	Maintenance Tech IV		Jovonne.lalla@tpwd.state.tx.us	Work: 512/7353-0572 Fax: 512/353-0629
B32221000568	Gurley, Josh 507 Staples Road San Marcos, Texas 78666	A.E. Wood Fish Hatchery	F&W Tech. IV		Josh.Gurley@tpwd.state.tx.us	Work: 512/7353-0572 Fax: 512/353-0629

**INLAND FISHERIES
IFS PROJECT COST CODES**

INLAND FISHERIES IFS PROJECT CODES

PROJECT	DESCRIPTION	TASK	DESCRIPTION	GRANT
FAAIF	General Administration - Inland Fisheries	XX	Unspecified	STATE
		HA	Hatchery General Administration	STATE
FRMIF	Inland Fisheries Resource Management	XX	Unspecified	STATE
		TT	Training	STATE
		CO	Computer Programming	STATE
		SY	Accident Prevention/Safety Training	STATE
		BB	Angler Awareness/Education	STATE
		FW	Applied Management Activities	STATE
		NN	Angler Recognition	STATE
		PA	Public Assistance / Presentations	STATE
		SES	Statewide Economic Study	STATE
		RBFF	Recreational Boating & Fishing Foundation	STATE
XRM	Risk Management	TT	Training	STATE
		XX	Unspecified	STATE
ACE	Security - Austin HQ Security	XX	Unspecified	STATE
XDR	Disaster Recovery	XX	Unspecified	STATE
XDS	Department Safety Program	TT	Training	STATE
		XX	Unspecified	STATE
XEM	Energy Management	XX	Unspecified	STATE
LEMA	Emergency Management Program Administration		Enter County Code	STATE
RSEN1	Senate Bill 1	XX	Unspecified	STATE
FAA22	General Administration – F22D	XX	Unspecified	F22D
FFD22	Heart-of-the-Hills Fisheries Research Station	NF	New Facilities Development	F22D
		HX	General Operations/Maintenance	F22D
		RF	Renovation of Facilities	F22D
FAS	Artificial Streams	XX	Unspecified	STATE
FAA30	General Administration – F30R	XX	Unspecified	F30R

INLAND FISHERIES IFS PROJECT CODES

PROJECT	DESCRIPTION	TASK	DESCRIPTION	GRANT
FAM30	Office Maintenance	XX	Rent, utilities, telecommunications, any other expenses incurred at facility site	F133M
		HX	Maintenance	F133M
FRM30	Freshwater Fisheries Monitoring and Management	XX	Unspecified	F30R
		HX	Maintenance	F30R
		SM	Scoping Meetings	F30R
		DM	Data Management	F30R
		ES	Electrofishing	F30R
		FG	Gill Netting	F30R
		FJ	Frame Netting	F30R
		HM	Harvest Monitoring	F30R
		RA	Other Monitoring	F30R
		PL	General Planning	F30R
		SR	Survey	F30R
		FW	Applied Management Activities	F30R
		BC	Braunig-Calaeras Project	F30R
		SRES	Sam Rayburn Economic Study	F30R
		TBES	Toledo Bend Economic Study	F30R
		CT	Crappie Telemetry Project	F30R
		OHES	O H Ivie Economic Study	F30R
		SRFP	Sam Rayburn Fish Population	F30R
NVR30	Native Vegetation Restoration	XX	Unspecified	F30R
FRC30	River Recreation	XX	Unspecified	F30R
FAA31	General Administration - F31R	XX	Unspecified	F31R
IR066	Florida Largemouth Bass Growout Study	XX	Unspecified	F31R
IR094	Florida LMB Introgression	XX	Unspecified	F31R
IR095	FLMB Performance Comparison	XX	Unspecified	F31R
IR096	Short Term Mortality of Stocked FLMB	XX	Unspecified	F31R
IR097	Contribution of Stocked Northern LMB	XX	Unspecified	F145R

INLAND FISHERIES IFS PROJECT CODES

PROJECT	DESCRIPTION	TASK	DESCRIPTION	GRANT
IR098	Efficacy of Mass Fluorescent-Chemical Double Marking in LMB	XX	Unspecified	F146R
FAA101	General Administration - F101D	XX	Unspecified	F101D
FFD101	A E Wood FH	NF	New Facilities Development	F101D
		HX	General Operations/Maintenance	F101D
		RF	Renovation of Facilities	F101D
FGB101	Guadalupe Bass - F101D	XX	Unspecified	F101D
FNC101	Florida Bass - F101D	XX	Unspecified	F101D
FNE101	Smallmouth Bass - F101D	XX	Unspecified	F101D
FNG101	Coppernose Bluegill - F101D	XX	Unspecified	F101D
FNL101	Trout - F101D	XX	Unspecified	F101D
FNM101	Walleye - F101D	XX	Unspecified	F101D
FNN101	Striped Bass - F101D	XX	Unspecified	F101D
FNO101	White X Striped Hybrid F101D	XX	Unspecified	F101D
FNQ101	White Crappie - F101D	XX	Unspecified	F101D
FNT101	Other Hybrids - F101D	XX	Unspecified	F101D
FOB101	Northern Largemouth Bass - F101D	XX	Unspecified	F101D
FOC101	Channel Catfish - F101D	XX	Unspecified	F101D
FOD101	Blue Catfish - F101D	XX	Unspecified	F101D
FOF101	Flathead Catfish - F101D	XX	Unspecified	F101D
FOR101	Forage - F101D	XX	Unspecified	F101D
FOS101	Native Sunfish - F101D	XX	Unspecified	F101D
PPF101	Paddle Fish - F101D	XX	Unspecified	F101D
FTR101	Trout – State	XX	Unspecified	STATE
FUR101	Red Drum - F101D	XX	Unspecified	F101D
FWB101	White Bass - F101D	XX	Unspecified	F101D
FNV101	Other Species - F101D	XX	Unspecified	F101D
FFCIF	Texas Freshwater Fisheries Center	MG	Gift Shop	STATE
		MA	Admissions	STATE
		MK	Marketing	STATE
		SL	Sharelunker program	STATE
		XX	Unspecified	STATE
FAA90	General Administration - F90D	XX	Unspecified	F90D
FFD90	Texas Freshwater Fisheries Center	NF	New Facilities Development	F90D
		HX	General Operations/Maintenance	F90D
		RF	Renovation of Facilities	F90D

INLAND FISHERIES IFS PROJECT CODES

PROJECT	DESCRIPTION	TASK	DESCRIPTION	GRANT
		EX	Exhibits	F90D
FGB90	Guadalupe Bass - F90D	XX	Unspecified	F90D
FNC90	Florida Bass - F90D	XX	Unspecified	F90D
		SL	Sharelunker	F90D
FNE90	Smallmouth Bass - F90D	XX	Unspecified	F90D
FNG90	coppernose Bluegill - F90D	XX	Unspecified	F90D
FNL90	Trout - F90D	XX	Unspecified	F90D
FNM90	Walleye - F90D	XX	Unspecified	F90D
FNN90	Striped Bass - F90D	XX	Unspecified	F90D
FNO90	White X Striped Hybrid F90D	XX	Unspecified	F90D
FNQ90	White Crappie - F90D	XX	Unspecified	F90D
FNT90	Other Hybrids - F90D	XX	Unspecified	F90D
FOB90	Northern Largemouth Bass - F90D	XX	Unspecified	F90D
FOC90	Channel Catfish - F90D	XX	Unspecified	F90D
FOD90	Blue Catfish - F90D	XX	Unspecified	F90D
FOF90	Flathead Catfish - F90D	XX	Unspecified	F90D
FOR90	Forage - F90D	XX	Unspecified	F90D
FOS90	Native Sunfish - F90D	XX	Unspecified	F90D
FPF90	Paddle Fish - F90D	XX	Unspecified	F90D
FTR90	Trout – State	XX	Unspecified	STATE
FUR90	Red Drum - F90D	XX	Unspecified	F90D
FWB90	White Bass - F90D	XX	Unspecified	F90D
FNV90	Other Species - F90D	XX	Unspecified	F90D
FED125	Education Programs	XX	Unspecified	F125E
		VFT	Virtual Field Trip	F125E
FOM125	Facility Operating & Maintenance / Visitor Center	XX	Unspecified	F125E
		MK	Marketing	F125E
FCO125	Construction	XX	Unspecified	F125E
FAA95	General Administration - F95D	XX	Unspecified	F95D
FFD95	Dundee FH	NF	New Facilities Development	F95D
		HX	General Operations/Maintenance	F95D
		RF	Renovation of Facilities	F95D
		PARVM	Parvum / Golden Algae	F95D
FGB95	Guadalupe Bass - F95D	XX	Unspecified	F95D
FNC95	Florida Bass - F95D	XX	Unspecified	F95D
FNE95	Smallmouth Bass - F95D	XX	Unspecified	F95D
FNG95	coppernose Bluegill - F95D	XX	Unspecified	F95D
FNL95	Trout - F95D	XX	Unspecified	F95D
FNM95	Walleye - F95D	XX	Unspecified	F95D

INLAND FISHERIES IFS PROJECT CODES

PROJECT	DESCRIPTION	TASK	DESCRIPTION	GRANT
FNN95	Striped Bass - F95D	XX	Unspecified	F95D
FNO95	White X Striped Hybrid F95D	XX	Unspecified	F95D
FNQ95	White Crappie - F95D	XX	Unspecified	F95D
FNT95	Other Hybrids - F95D	XX	Unspecified	F95D
FOB95	Northern Largemouth Bass - F95D	XX	Unspecified	F95D
FOC95	Channel Catfish - F95D	XX	Unspecified	F95D
FOD95	Blue Catfish - F95D	XX	Unspecified	F95D
FOF95	Flathead Catfish - F95D	XX	Unspecified	F95D
FOR95	Forage - F95D	XX	Unspecified	F95D
FOS95	Native Sunfish - F95D	XX	Unspecified	F95D
FPF95	Paddle Fish - F95D	XX	Unspecified	F95D
FTR95	Trout – STATE	XX	Unspecified	STATE
FUR95	Red Drum - F95D	XX	Unspecified	F95D
FWB95	White Bass - F95D	XX	Unspecified	F95D
FNV95	Other Species - F95D	XX	Unspecified	F95D
FAA96	General Administration - F96D	XX	Unspecified	F96D
FFD96	Possum Kingdom FH	NF	New Facilities Development	F96D
		HX	General Operations/Maintenance	F96D
		RF	Renovation of Facilities	F96D
FGB96	Guadalupe Bass - F96D	XX	Unspecified	F96D
FNC96	Florida Bass - F96D	XX	Unspecified	F96D
FNE96	Smallmouth Bass - F96D	XX	Unspecified	F96D
FNG96	coppernose Bluegill - F96D	XX	Unspecified	F96D
FNL96	Trout - F96D	XX	Unspecified	F96D
FNM96	Walleye - F96D	XX	Unspecified	F96D
FNN96	Striped Bass - F96D	XX	Unspecified	F96D
FNO96	White X Striped Hybrid F96D	XX	Unspecified	F96D
FNQ96	White Crappie - F96D	XX	Unspecified	F96D
FNT96	Other Hybrids - F96D	XX	Unspecified	F96D
FOB96	Northern Largemouth Bass - F96D	XX	Unspecified	F96D
FOC96	Channel Catfish - F96D	XX	Unspecified	F96D
FOD96	Blue Catfish - F96D	XX	Unspecified	F96D
FOF96	Flathead Catfish - F96D	XX	Unspecified	F96D
FOR96	Forage - F96D	XX	Unspecified	F96D
FOS96	Native Sunfish - F96D	XX	Unspecified	F96D
FPF96	Paddle Fish - F96D	XX	Unspecified	F96D
FTR96	Trout – STATE	XX	Unspecified	STATE
FUR96	Red Drum - F96D	XX	Unspecified	F96D
FWB96	White Bass - F96D	XX	Unspecified	F96D

INLAND FISHERIES IFS PROJECT CODES

PROJECT	DESCRIPTION	TASK	DESCRIPTION	GRANT
FNV96	Other Species - F96D	XX	Unspecified	F96D
FAA98	General Administration - F98D	XX	Unspecified	F98D
FFD98	Jasper FH	NF	New Facilities Development	F98D
		HX	General Operations/Maintenance	F98D
		RF	Renovation of Facilities	F98D
FGB98	Guadalupe Bass - F98D	XX	Unspecified	F98D
FNC98	Florida Bass - F98D	XX	Unspecified	F98D
FNE98	Smallmouth Bass - F98D	XX	Unspecified	F98D
FNG98	coppernose Bluegill - F98D	XX	Unspecified	F98D
FNL98	Trout - F98D	XX	Unspecified	F98D
FNM98	Walleye - F98D	XX	Unspecified	F98D
FNN98	Striped Bass - F98D	XX	Unspecified	F98D
FNO98	White X Striped Hybrid F98D	XX	Unspecified	F98D
FNQ98	White Crappie - F98D	XX	Unspecified	F98D
FNT98	Other Hybrids - F98D	XX	Unspecified	F98D
FOB98	Northern Largemouth Bass - F98D	XX	Unspecified	F98D
FOC98	Channel Catfish - F98D	XX	Unspecified	F98D
FOD98	Blue Catfish - F98D	XX	Unspecified	F98D
FOF98	Flathead Catfish - F98D	XX	Unspecified	F98D
FOR98	Forage - F98D	XX	Unspecified	F98D
FOS98	Native Sunfish - F98D	XX	Unspecified	F98D
FPF98	Paddle Fish - F98D	XX	Unspecified	F98D
FTR98	Trout – STATE	XX	Unspecified	STATE
FUR98	Red Drum - F98D	XX	Unspecified	F98D
FWB98	White Bass - F98D	XX	Unspecified	F98D
FNV98	Other Species - F98D	XX	Unspecified	F98D
FGC	Grass Carp	XX	Unspecified	STATE
		IS	Grass Carp Inspection	STATE
		GR	Guadalupe River Study	STATE
RGGC	Rio Grande Grass Carp Project	XX	Unspecified	RGGC-1
FNH01	Hydrilla - Galveston Corps	XX	Unspecified	G
		VB	Aquatic Veg - Survey	G
		VC	Aquatic Veg - Chemical Treatment	G
		VE	Aquatic Veg - Biological Treatment	G

INLAND FISHERIES IFS PROJECT CODES

PROJECT	DESCRIPTION	TASK	DESCRIPTION	GRANT
		VM	Aquatic Veg - Mechanical Treatment	G
FNH02	Hydrilla – Other	XX	Unspecified	STATE
		VB	Aquatic Veg - Survey	STATE
		VC	Aquatic Veg - Chemical Treatment	STATE
		VE	Aquatic Veg - Biological Treatment	STATE
		VM	Aquatic Veg - Mechanical Treatment	STATE
FNW01	Water Hyacinth - Galveston Corps	XX	Unspecified	G
		VB	Aquatic Veg - Survey	G
		VC	Aquatic Veg - Chemical Treatment	G
		VE	Aquatic Veg - Biological Treatment	G
		VM	Aquatic Veg - Mechanical Treatment	G
FNW02	Water Hyacinth – Other	XX	Unspecified	STATE
		VB	Aquatic Veg - Survey	STATE
		VC	Aquatic Veg - Chemical Treatment	STATE
		VE	Aquatic Veg - Biological Treatment	STATE
		VM	Aquatic Veg - Mechanical Treatment	STATE
FSV02	Salvinia – Other	XX	Unspecified	STATE
		VB	Aquatic Veg - Survey	STATE
		VC	Aquatic Veg - Chemical Treatment	STATE
		VE	Aquatic Veg - Biological Treatment	STATE
FSV03	Hydrilla - BOR - Rio Grande River	XX	Unspecified	SAV01-1
		VB	Aquatic Veg - Survey	SAV01-1
		VC	Aquatic Veg - Chemical Treatment	SAV01-1
		VE	Aquatic Veg - Biological Treatment	SAV01-1
		VM	Aquatic Veg - Mechanical Treatment	SAV01-1
FSV04	Salvinia - F&W Service (\$40K)	XX	Unspecified	SAV02-1
		VB	Aquatic Veg - Survey	SAV02-1
		VC	Aquatic Veg - Chemical Treatment	SAV02-1
		VE	Aquatic Veg - Biological Treatment	SAV02-1
		VM	Aquatic Veg - Mechanical Treatment	SAV02-1
FOV01	Other Vegetation - Galveston Corps	XX	Unspecified	G
		VB	Aquatic Veg - Survey	G
		VC	Aquatic Veg - Chemical Treatment	G
		VE	Aquatic Veg - Biological Treatment	G
		VM	Aquatic Veg - Mechanical Treatment	G
FOV02	Other Vegetation – Other	XX	Unspecified	STATE
		VB	Aquatic Veg - Survey	STATE
		VC	Aquatic Veg - Chemical Treatment	STATE
		VE	Aquatic Veg - Biological Treatment	STATE

INLAND FISHERIES IFS PROJECT CODES

PROJECT	DESCRIPTION	TASK	DESCRIPTION	GRANT
FMI01	Watermilfoil - Galveston Corps	XX	Unspecified	G
		VB	Aquatic Veg - Survey	G
		VC	Aquatic Veg - Chemical Treatment	G
		VE	Aquatic Veg - Biological Treatment	G
FMI02	Watermilfoil – Other	XX	Unspecified	STATE
		VB	Aquatic Veg - Survey	STATE
		VC	Aquatic Veg - Chemical Treatment	STATE
		VE	Aquatic Veg - Biological Treatment	STATE
FNA01	Alligator Weed - Galveston Corps	XX	Unspecified	G
		VB	Aquatic Veg - Survey	G
		VC	Aquatic Veg - Chemical Treatment	G
		VE	Aquatic Veg - Biological Treatment	G
FNA02	Alligator Weed – Other	XX	Unspecified	STATE
		VB	Aquatic Veg - Survey	STATE
		VC	Aquatic Veg - Chemical Treatment	STATE
		VE	Aquatic Veg - Biological Treatment	STATE
RWDA	Water Data Access	XX		STATE

INLAND FISHERIES IFS PROJECT CODES

CODE	DESCRIPTION	FED AID GRANT	Contract	State	Agency
FRMIF/FAAIF	General Administration-State			X	
RRA01F	Administration-Fed Aid	F139T			
FRAS	Freshwater Invest/Respon/Assess/Pollution/Wet Pol (State)			X	
RFTM	Fish Tissue Monitoring		TCEQ		
RSEF	Freshwater COE Permits	F139T			
RCA01F	Freshwater Invest/Respon/Assess/Pollution/Wet Pol (Fed Aid)	F139T			
RSEN1F	Freshwater Planning and Strategy (SB1)	F139T			
RSNF	Freshwater Quality Permits and Standards	F139T			
RSW01F	Freshwater Rights Permits-Fed	F139T			
RGA	Golden Algae (Research SWG)	SWG			
RGBR01	Guad/Blanco River Instream Flow	F139T			
RSV04	REMAP-State			X	
RSV01	River/Stream Evaluation and Studies	F139T			
RSV02	River/Stream Evaluation and Studies		REMAP		
RSV03	River/Stream Evaluation and Studies			X	
XDS	Safety Training			X	
RRG	Sand, Shell and Gravel Permits			X	
RSWG4	SWG-Golden Algae *	SWG	USFWS		
RSWG5	SWG-River Planning	SWG	USFWS		
WEX	Wildlife Expo			X	
XXPALP	Administrative Leave				X
XXPNLP	Annual Leave				X
XXPWEP	Educational Leave				X
XXPELP	Emergency Leave				X
XXPWXP	Executive Leave				X
XXPHOP	Holiday Leave				X
XXPWJP	Jury Duty				X
XXPABP	Leave Without Pay				X
XXPWMP	Military Leave				X
XXPWNP	Non-Premium Comp Time Earned				X
XXPWCP	Non-Premium Comp Time Taken				X
XXPWPP	Premium Comp Time Earned				X
XXPWTP	Premium Comp Time Taken				X
XXPSLP	Sick Leave				X

*** RSWG4 Task Codes:**

AHDA = Project A = Historic Data Assessment of Golden Alga Kills
 BSPP = Project B = Survey of P. parvum
 DSWM = Project C = Scientific Workshop and Meetings to Coordinate Management Efforts

Stocking Reports

Stocking Reports – January 2006 thru December 2006

Waterbody	Blue catfish	Bluegill	Channel catfish	Florida Largemouth bass	Grass carp	Guadalupe bass	Largemouth bass	Palmetto Bass	Rainbow trout	Red drum	ShoreLunker Largemouth Bass	Smallmouth bass	Striped bass	Sunshine Bass	Threadfin shad	Walleye	Walleye X Sauger	White crappie	Grand Total
29th Street			741																741
Abernathy Community Lake			877																877
Adams Bayou				50,092															50,092
Alan Henry											7,184								7,184
American Legion Park Pond			736						2,006										2,742
Amistad											4,519		120,085						124,604
Amsler Park			400						757										1,157
Arrowhead				360,109															360,109
Ascarate			1,650						7,012										8,662
Atlanta City Park Lake			490																490
Bachman Lake (Dallas)			600																600
Baird				14,586															14,586
Balmorea	14,570		58,114															650	73,334
Bandera City Park Lake			684						2,004										2,688
Bane Park Lake									2,000										2,000
Bates Allen Park Pond 1			491						900										1,391
Beal Park Lake			403						1,756										2,159
Bear Creek Park (Keller)			552						1,752										2,304
Bell Street			1,119																1,119
Belton (Bell County)											123,337								123,337
Benbrook											36,336								36,336
Bentsen State Park			888																888
Bethany Park Pond C									3,151										3,151
Bethany Ridge Pond			456																456
Bevis Skinner Park Pond			490																490
Birch Creek #1			400																400
Bishop City Lake			600																600

Stocking Reports – January 2006 thru December 2006

Waterbody	Blue catfish	Bluegill	Channel catfish	Florida Largemouth bass	Grass carp	Guadalupe bass	Largemouth bass	Palmetto Bass	Rainbow trout	Red drum	ShoreLunker Largemouth Bass	Smallmouth bass	Striped bass	Sunshine Bass	Threadfin shad	Walleye	Walleye X Sauger	White crappie	Grand Total
Black Creek Lake			1,127																1,127
Blanco State Park #3			756																756
Blanco State Park #4			736						4,979										5,715
Blue Hole Park Lake			552						2,318										2,870
Blue Ridge Park Pond			552						900										1,452
Bob Sandlin				385,675															385,675
Bob Sandlin State Park									2,407										2,407
Boerne City			599																599
Bonham State Park Lake			1,625																1,625
Borden City Lake			707																707
Brackenridge Park			780						1,255										2,035
Bradfield Pond 2			640																640
Brazos Lake			19,609																19,609
Breckenridge Park Lake			784																784
Breshears			555																555
Bright Lake			936																936
Brothers Pond			400																400
Brownwood			300																300
Buchanan													1,341,040	500,000					1,841,040
Buck Lake			400																400
Buena Vista Park Lake			1,923						1,909										3,832
Buescher State Park			1,025						1,506										2,531
Buffalo Creek							48,070												48,070
Buffalo Springs													11,619						11,619
Bullfrog Pond			418																418
Burke-Crenshaw Lake			780						3,000										3,780
Burroughs Park Pond			707						2,000										2,707
Byers City			830																830

Stocking Reports – January 2006 thru December 2006

Waterbody	Blue catfish	Bluegill	Channel catfish	Florida Largemouth bass	Grass carp	Guadalupe bass	Largemouth bass	Palmetto Bass	Rainbow trout	Red drum	ShoreLunker Largemouth Bass	Smallmouth bass	Striped bass	Sunshine Bass	Threadfin shad	Walleye	Walleye X Sauger	White crappie	Grand Total
C. J. Kelly Park Pond			406						2,080										2,486
Caddo				500,582															500,582
Calaveras								46,997		693,892									740,889
Canton City			1,250						2,523										3,773
Canyon													42,980						42,980
Canyon Lake Project #1			932																932
Canyon Lake Project #2			982																982
Canyon Southeast Park Lake			611						1,843										2,454
Canyon Tailrace									33,249										33,249
Carl Barton Jr. Park Pond			586						2,508										3,094
Carver Park Lake			401																401
Casa Blanca											4,517								4,517
Casey Park			640																640
Cedar Creek Reservoir								132,664											132,664
Centennial Park Lake (Friendswood)			552						1,000										1,552
Center Municipal Park Lake			600																600
Central High			483																483
Central Park Pond #1			3,946						1,799										5,745
Challenger 7 Pond			683																683
Claiborne West Park			640																640
Clear Fork Trinity River									1,609										1,609
Cleburne State Park			2,673																2,673
Cleburne-Hulen Park									1,655										1,655
Cliff Park (Dallas)			828																828
Clifford Andrews Park			885																885
Coleman (Hopkins County)			1,400																1,400
Colleyville Nature Center Pond 4			400						925										1,325
Colorado								4,600,439											4,600,439

Stocking Reports – January 2006 thru December 2006

Waterbody	Blue catfish	Bluegill	Channel catfish	Florida Largemouth bass	Grass carp	Guadalupe bass	Largemouth bass	Palmetto Bass	Rainbow trout	Red drum	ShoreLunker Largemouth Bass	Smallmouth bass	Striped bass	Sunshine Bass	Threadfin shad	Walleye	Walleye X Sauger	White crappie	Grand Total
Colorado City		140,191	142,404																282,595
Comanche Trails (Big Spring)			1,148																1,148
Comanche Trails Park (Odessa)			406						7,618										8,024
Conroe					130			132,429			4,592								137,151
Cooper Reservoir								142,178											142,178
Copperas Cove City			406																406
Cuero Park			828																828
Cy Miller Pond			400																400
Davy Crockett			3,559																3,559
Diboll City Park			520																520
Dimmitt City Lake			640																640
Doombos									543										543
Dupree Park			803																803
E. V. Spence		239,789	233,974																473,763
Eagle Mountain				425,660															425,660
Eagle Pass City			950																950
Earl Scott Pond			514																514
Edinburg City Park Lake			758																758
Eisenhower Park Pond			1,116						1,501										2,617
Elder Lake			780						2,928										3,708
Eldridge Park Pond			200						1,950										2,150
Elkins Lake (Dalworthington Gardens)			743																743
Ellen Trout Zoo			1,162																1,162
Elm Creek Buffalo Wallow									1,376										1,376
Engeling WMA #1			501																501
Engeling WMA #2			403																403
Fairfield										2,439									2,439

Stocking Reports – January 2006 thru December 2006

Waterbody	Blue catfish	Bluegill	Channel catfish	Florida Largemouth bass	Grass carp	Guadalupe bass	Largemouth bass	Palmetto Bass	Rainbow trout	Red drum	ShoreLunker Largemouth Bass	Smallmouth bass	Striped bass	Sunshine Bass	Threadfin shad	Walleye	Walleye X Sauger	White crappie	Grand Total
Falcon			334																334
Fannin Lake			1,125																1,125
Faulkner Park Lake (Tyler)									2,422										2,422
First Capitol Park Pond			493						1,750										2,243
Fish Trap Lake (Dallas)			787																787
Flower Mound Rheudasil			672						2,301										2,973
Forest Park			938																938
Fort Boggy State Park									1,000										1,000
Fort Brown Resaca			1,524																1,524
Fort Phantom Hill								65,346											65,346
Fort Richardson State Park			683						2,506										3,189
Frio County Regional Park Lake			950																950
Frisco Commons Pond			603				400		3,676										4,679
Fryer									3,500										3,500
Gabbards Park Pond			400																400
Galveston State Park Pond #1			1,487																1,487
Garner State Park									932										932
Giddings State School			830																830
Gordon																	1,766		1,766
Graham								12,000											12,000
Graham Park Pond			672				330												1,002
Granbury													127,280						127,280
Green Valley Community Park Pond A (North Richland Hills)			368						2,051										2,419
Greenbelt																41,200			41,200
Greenbelt Stilling Basin			1,057																1,057
Greenbriar Park (Fort Worth)			552						1,659										2,211
Guadalupe River						67,552													67,552

Stocking Reports – January 2006 thru December 2006

Waterbody	Blue catfish	Bluegill	Channel catfish	Florida Largemouth bass	Grass carp	Guadalupe bass	Largemouth bass	Palmetto Bass	Rainbow trout	Red drum	ShoreLunker Largemouth Bass	Smallmouth bass	Striped bass	Sunshine Bass	Threadfin shad	Walleye	Walleye X Sauger	White crappie	Grand Total
Guy Park Lake			657																657
Hale			850																850
Hamilton Creek Park Lake (Burnet)			400						503										903
Harlingen City Lake			1,125																1,125
Harlingen Sports Complex			401						1,005										1,406
Hearne Eastside Park Pond			490						387										877
Hemphill City Lake			552																552
Henderson City Lake			828																828
Hereford City Lake			957																957
Heritage Park Lake			552																552
Herman Brown Park Pond			380						1,400										1,780
Higginbotham Park			700						1,300										2,000
Hi-Lions			780																780
Hoell			486																486
Hords Creek				52,712															52,712
Hubbard City			825																825
Hubbard City #2			568																568
Hubbard City #3			836																836
Hubbard City #4			954																954
Hubbard City #5			640																640
Huneke Park Lake			640																640
Hurst Chisholm Park			5,612						1,906										7,518
Independence Retention Pond			552																552
Inks			111																111
Iowa Park							32,765												32,765
Irving Street			360																360
J. L. Lake			4,330																4,330
Jacksonville				86,081															86,081

Stocking Reports – January 2006 thru December 2006

Waterbody	Blue catfish	Bluegill	Channel catfish	Florida Largemouth bass	Grass carp	Guadalupe bass	Largemouth bass	Palmetto Bass	Rainbow trout	Red drum	ShoreLunker Largemouth Bass	Smallmouth bass	Striped bass	Sunshine Bass	Threadfin shad	Walleye	Walleye X Sauger	White crappie	Grand Total
Jasper City Park Pond			972				32		1,800										2,804
Jasper Hatchery Fishing Canal							15												15
Jennings			600																600
Joe Pool				325,681															325,681
Johnson Creek						14,094													14,094
Joseph Garcia Municipal Park Pond			553																553
Keneteso Pond									2,699										2,699
Kennedale City Park			552						1,006										1,558
Kidd Springs Park (Dallas)			490						4,354										4,844
Kingfisher Lake			552																552
Kirby																	12,134		12,134
Kitty Hollow Lake			780						1,500										2,280
Knierim			552																552
L.B.J. State Park			552																552
Lady Bird			1,216																1,216
Lake Corpus Christi									1,509										1,509
Lake Fork				501,313							4,800								506,113
Lake Georgetown								6,487				11,764							18,251
Lake Grady T. Wallace			707																707
Lake Independence			1,290																1,290
Lake Pflugerville		18,415	4,500	83,490														206	106,611
Lake Zebco			2,013						6,512										8,525
Lakeside Park (Duncanville)			5,600						1,904										7,504
Lakeview Park Pond			400																400
Lakeview Park Pond (Nacogdoches)			410						771										1,181
Lamesa 9th Street Park Lake			564						3,000										3,564
Landmark Inn State Park			520						1,006										1,526
Lavon													216,086						216,086

Stocking Reports – January 2006 thru December 2006

Waterbody	Blue catfish	Bluegill	Channel catfish	Florida Largemouth bass	Grass carp	Guadalupe bass	Largemouth bass	Palmetto Bass	Rainbow trout	Red drum	ShoreLunker Largemouth Bass	Smallmouth bass	Striped bass	Sunshine Bass	Threadfin shad	Walleye	Walleye X Sauger	White crappie	Grand Total
League City (Pool)									400										400
Leftwich Park			810																810
Lewisville				507,625				1,241,318			3,585								1,752,528
Liberty Municipal Park Pond			400																400
Little Chocolate Bayou Park Pond #1			600																600
Little Chocolate Bayou Park Pond #2			320																320
Live Oak City			4,835				3,568												8,403
Livingston				201,694									746,278						947,972
Llano City			1,750																1,750
Llano River (Grenwelge Park)									1,205										1,205
LNVA Barrier Pond			817						4,760										5,577
Lobo			641																641
Lockhart City #1			400																400
Lockhart Maple Street Pond		83					100												183
Lost Creek			4,000																4,000
Louise Hayes Park									2,811										2,811
Lower Kaufman			1,276																1,276
Lower Overton									1,126										1,126
Loy Lake			1,177																1,177
Lufkin State School Pond			404																404
Mahon Park			408																408
Marine Creek (Ft. Worth)											6,290								6,290
Mark Holtz Lake (Arlington)			828						3,008										3,836
Martin Road			936																936
Marvin			6,702																6,702
Marvin Finn Pond-Sammon's Park #2			406																406
Mary Joe Peckham Park			10,291						3,176										13,467
Matthews Lake			9,676																9,676

Stocking Reports – January 2006 thru December 2006

Waterbody	Blue catfish	Bluegill	Channel catfish	Florida Largemouth bass	Grass carp	Guadalupe bass	Largemouth bass	Palmetto Bass	Rainbow trout	Red drum	ShoreLunker Largemouth Bass	Smallmouth bass	Striped bass	Sunshine Bass	Threadfin shad	Walleye	Walleye X Sauger	White crappie	Grand Total
McCullough			602						1,524										2,126
McDonald Lake		130	2,117																2,247
McGovern Lake			672																672
Meadow Lake (Round Rock)															900				900
Medical Center North			552																552
Medical Center South			12,937						5,006										17,943
Meredith Stilling Basin									2,787										2,787
Meridian State Park			1,440						2,204										3,644
Meyer Park Pond			552																552
Mill Creek Park			619																619
Miller Park			639																639
Miller Park Pond (Temple)			400						1,305										1,705
Millers Creek								19,000											19,000
Miller's Pond			672																672
Missouri City C. P. L			552																552
Monahans Perch Pond			640						3,191										3,831
Morris Park Lake (Elgin)			405																405
Moss Creek City		17,940	20,311																38,251
Nassau			1,153																1,153
Nasworthy								6,775											6,775
Nelson Park									600										600
New Ballinger																15,206			15,206
New Horseshoe			736																736
Nolan Creek									1,937										1,937
North Anson				33,055															33,055
North Concho Park			741																741
Northwest Park			226																226
Northwest Park Pond (Irving)			640						2,797										3,437

Stocking Reports – January 2006 thru December 2006

Waterbody	Blue catfish	Bluegill	Channel catfish	Florida Largemouth bass	Grass carp	Guadalupe bass	Largemouth bass	Palmetto Bass	Rainbow trout	Red drum	ShoreLunker Largemouth Bass	Smallmouth bass	Striped bass	Sunshine Bass	Threadfin shad	Walleye	Walleye X Sauger	White crappie	Grand Total
O. C. Fisher	112,596		120,619																233,215
Oakes Street			7,753						2,999										10,752
Old Winters	16,561																		16,561
Onion Creek			504																504
On-Site Private Water Delivery			91						901										992
Optimist Pond			400																400
Pair-a-Trees Pond			200						502										702
Palmetto State Park			640						575										1,215
Palo Duro Stilling Basin			205																205
Palo Pinto								12,084											12,084
Pampa City			731						2,001										2,732
Paris Sports Complex Pond			368																368
Petrolia City (Old)			1,219																1,219
Pickens Lake									4,640										4,640
Pine Island Bayou				100,042															100,042
Pinkston											11,150								11,150
Pittsburg City Lake			392						3,014										3,406
Plum Lake			9,192						4,350										13,542
Possum Kingdom													629,786						629,786
Possum Kingdom Tailrace									12,204										12,204
Post City			779																779
Private Lake		849	315								3,372								4,536
Proctor								66,925											66,925
Purtis Creek State Park			4,604								8,734								13,338
Ratcliff											3,337								3,337
Raven			2,930																2,930
Ray Hubbard				542,236															542,236
Reeves Lake			467																467

Stocking Reports – January 2006 thru December 2006

Waterbody	Blue catfish	Bluegill	Channel catfish	Florida Largemouth bass	Grass carp	Guadalupe bass	Largemouth bass	Palmetto Bass	Rainbow trout	Red drum	ShoreLunker Largemouth Bass	Smallmouth bass	Striped bass	Sunshine Bass	Threadfin shad	Walleye	Walleye X Sauger	White crappie	Grand Total
Resaca De La Guerra			1,160																1,160
Resaca De La Palma			1,235																1,235
Resoft Park Lake			604						1,009										1,613
Richards Park-Upper									934										934
Richland-Chambers				420,129				150,753											570,882
Rita Blanca Kids Fishing Pond									4,008										4,008
River Park Clear Fork of the Trinity River (Fort Worth)									1,606										1,606
Robinson City Park			1,400																1,400
Rose Park (Mansfield)			400						1,279										1,679
Round Rock City			885																885
Rusk State Park			991						1,650										2,641
Rustic Oaks Park			552																552
Sam Rayburn				499,858															499,858
Sammon's Park			1,092																1,092
Samuell Farm Pond #4 (Mesquite)									1,872										1,872
San Antonio River									1,250										1,250
San Augustine City											4,592								4,592
San Gabriel Park			912																912
Saxet Park Lake			1,328																1,328
Seabourne Creek Park			600						1,950										2,550
Searight Park Lake #1			885																885
Seymour Golf Course		188	315																503
Sheldon State Park Children's #1			400																400
Sheldon State Park Children's #2			400																400
Shirley McDonald Park Pond			400																400
Sikes Lake			2,324				1,955												4,279
Somerville								58,085											58,085

Stocking Reports – January 2006 thru December 2006

Waterbody	Blue catfish	Bluegill	Channel catfish	Florida Largemouth bass	Grass carp	Guadalupe bass	Largemouth bass	Palmetto Bass	Rainbow trout	Red drum	ShoreLunker Largemouth Bass	Smallmouth bass	Striped bass	Sunshine Bass	Threadfin shad	Walleye	Walleye X Sauger	White crappie	Grand Total
South Lakes Park Pond (Denton)			400						1,003										1,403
South Lakes Park Pond North (Denton)			490						1,000										1,490
South Llano River State Park			771						2,608										3,379
Southeast Metropolitan Park Pond 1			360																360
Southeast Metropolitan Park Pond 2			320																320
Southeast Metropolitan Park Pond 3			360																360
Southeast Metropolitan Park Pond 4			360																360
Southwood Hallowan Pool (College Station)									2,016										2,016
Spring Creek (Tom Green)			844																844
Spring Lake Park			614						2,689										3,303
Spring Lake Park Pool (Texarkana)									1,580										1,580
Springfield			506						1,005										1,511
Stevens Park			490																490
Tadpole Pond			226																226
Tawakoni								188,206					156,865						345,071
Taylor Bayou				50,008															50,008
Taylor City			490																490
Taylor City #2			600																600
Taylor City #4			552																552
Teague Park (Gregg County)			416						2,682										3,098
Temple Lion's Park Lake									835										835
Temple V.A. Center			642																642
Tennessee				150,508															150,508
Texana				489,326															489,326
Theo (Caprock Canyon)			1,751																1,751
Thompson Park			985																985

Stocking Reports – January 2006 thru December 2006

Waterbody	Blue catfish	Bluegill	Channel catfish	Florida Largemouth bass	Grass carp	Guadalupe bass	Largemouth bass	Palmetto Bass	Rainbow trout	Red drum	ShoreLunker Largemouth Bass	Smallmouth bass	Striped bass	Sunshine Bass	Threadfin shad	Walleye	Walleye X Sauger	White crappie	Grand Total
Toledo Bend											4,592								4,592
Tom Bass III			885						5,505										6,390
Town Resaca			1,027																1,027
Towne Lake									2,368										2,368
Tradinghouse Creek										146,597									146,597
Travis													98,842						98,842
TXU Contract Lake #1											741								741
TXU HR-10											749								749
Tyler Nature Center Pond									412										412
Tyler State Park			1,693						4,313										6,006
Tyler Water Department Rearing Pond			7,562																7,562
Tyler West			4,450																4,450
Univerisities			150																150
Upper Overton			903																903
Victor Braunig							11,997	21,572		311,971									345,540
W. M. Brook Park Lake			736																736
Waco Optimist (HOT Fairgrounds)									2,005										2,005
Waldron Park			491						998										1,489
Walter E. Long Reservoir								6,070											6,070
Waterloo Lake			1,321																1,321
Waterloo Park Pond			121						5,727										5,848
West Guth Park Pond (Corpus Christi)			403																403
White Oak (Old Lake)									2,099										2,099
Whitney													322,532						322,532
Wichita							63,078												63,078
Wichita Borrow Pit			828																828

Stocking Reports – January 2006 thru December 2006

Waterbody	Blue catfish	Bluegill	Channel catfish	Florida Largemouth bass	Grass carp	Guadalupe bass	Largemouth bass	Palmetto Bass	Rainbow trout	Red drum	ShoreLunker Largemouth Bass	Smallmouth bass	Striped bass	Sunshine Bass	Threadfin shad	Walleye	Walleye X Sauger	White crappie	Grand Total
Wilson-Ledbetter Park Pond			504																504
Windmill Lake			1,088																1,088
Woldert Park Pond									1,459										1,459
Woodlawn			1,147																1,147
Grand Total	143,727	417,585	873,490	5,780,462	130	81,646	162,310	7,069,001	285,963	1,154,899	72,754	11,764	3,813,393	500,000	900	56,406	13,900	856	20,439,186



4200 Smith School Road • Austin, Texas 78744

www.tpwd.state.tx.us

Dispersal of this publication conforms with Texas State Documents Depository Law, and it is available at Texas State Publications Clearinghouse and/or Texas Depository Libraries.

© 2007 TPWD PWD RP T3200-909 (9/07)