

Desalination for Texas Water Supply

Part A: Membrane Technologies and Costs

**Part B: Economic Importance of Siting Factors
for Seawater Desalination**

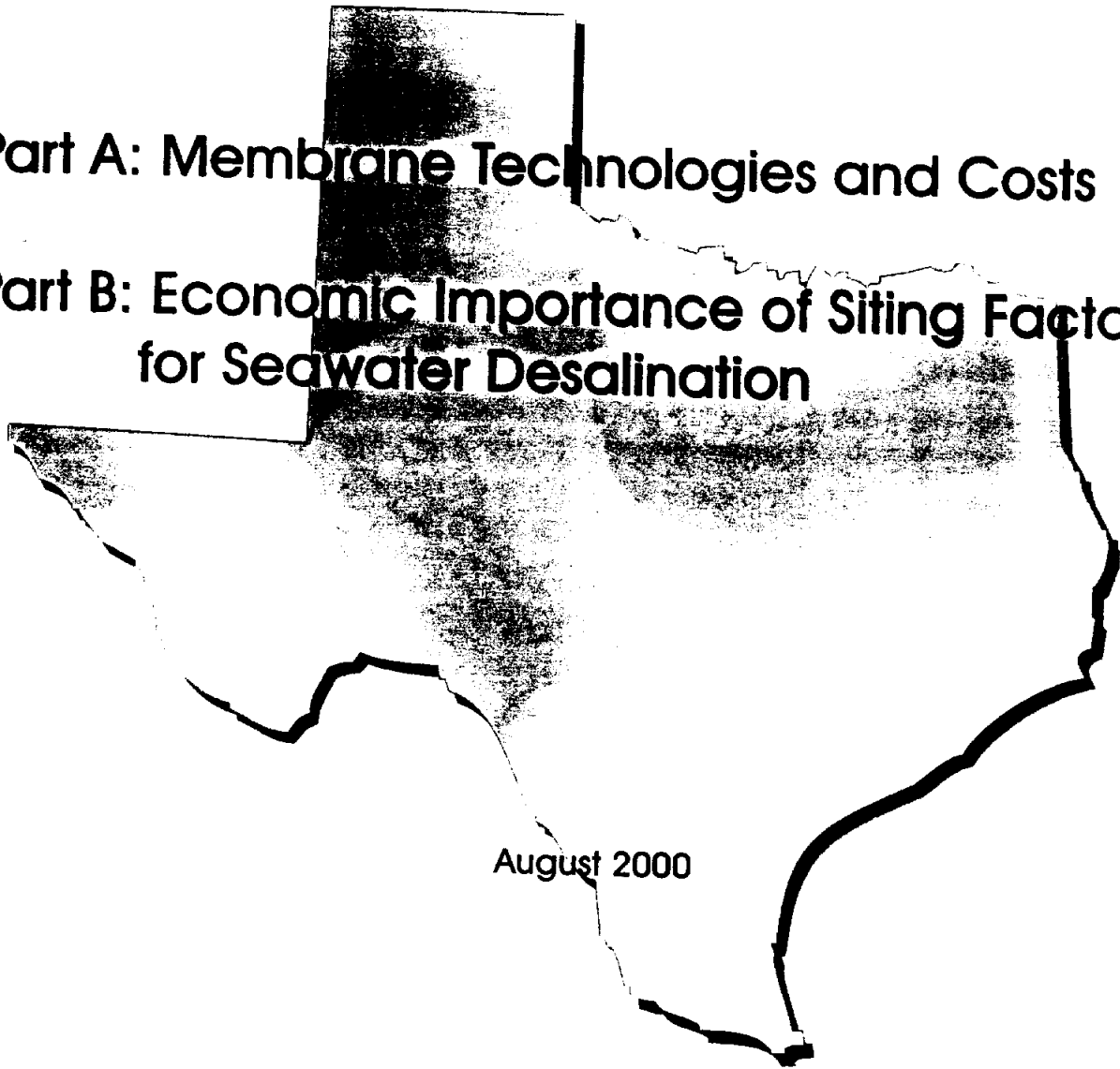

August 2000

Prepared for:

Texas Water Development Board
Nueces River Authority
Central Power & Light Company
City of Corpus Christi
San Patricio Municipal Water District

Prepared by:

HDR
HDR Engineering, Inc.

In association with:
Water Resources Associates
Malcolm Pirnie, Inc.
PB Water

Desalination for Texas Water Supply

Part A: Membrane Technologies and Costs

Part B: Economic Importance of Siting Factors for Seawater Desalination

RECEIVED

AUG 18 2000

TWDB R&PF
GRANTS MANAGEMENT

Prepared for

**Texas Water Development Board
Nueces River Authority
Central Power & Light Company
City of Corpus Christi
San Patricio Municipal Water District**

Prepared by

HDR
HDR Engineering, Inc.

in association with
**Water Resources Associates
Malcolm Pirnie, Inc.
PB Water**

August 2000

Signature Sheet

This report is released under the authority of Bryan Black, P.E. #83647, on August 3, 2000.

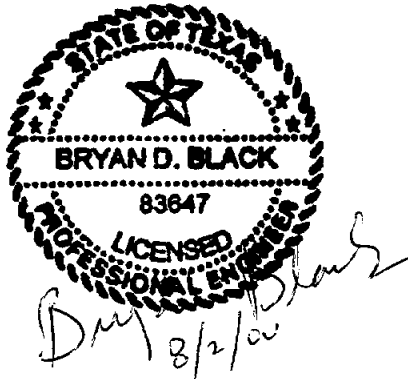

Bryan Black, P.E.
TX# 83647

Mark Graves, EIT
AL# 10120

Contents Summary

Section

Part A Membrane Technologies and Cost

- 1 Introduction
- 2 Basic Concepts
- 3 Design Concepts
- 4 Operations and Maintenance
- 5 Concentrate Production and Disposal
- 6 Costs of Water Desalination Using Membranes
- 7 Process Performance and Selection
- 8 Trends

Part B Economic Importance of Siting Factors for Seawater Desalination

- 1 Introduction
- 2 Tampa Bay Water Desalination Project
- 3 Siting Issues Assessment
- 4 Desalination Cost Impacts Identified
- 5 Siting Conditions on the Texas Coast
- 6 Example Sites on the Texas Coast
- 7 Data Needs to Reduce Siting Uncertainty

Appendices

Appendix A — Glossary

Appendix B — Example Cost Estimate

Appendix C — Example Questionnaire

Appendix D — Texas Coastal Water Quality Data

Appendix E — Flood Insurance Rate Maps (FIRM)

Appendix F — Estimating Model Files

Appendix G — Reply to Executive Administrator's Review Comments

Acknowledgments

This report results from the contributions of many individuals. Their participation greatly improved the study and final report.

<u>Individual</u>	<u>Organization</u>	<u>Contribution</u>
Mark Graves	HDR Engineering, Inc. Austin, Texas	Primary Author of Report Part B
James Dodson	Nueces River Authority Corpus Christi, Texas	Project Conception, Motivation, and Coordination
Mark Farrell	Water Resources Associates Tampa, Florida	Concentrate Production and Disposal
Jim Vickers	Malcolm Pirnie, Inc. Carlsbad, California	Portions of Design Concepts and Process Selection
Jim Jensen	PB Water Tampa, Florida	Tampa Experience Information, Report Part B Review
J.B. Neethling	HDR Engineering, Inc. Sacramento, California	RO Cost-estimating Method

Steering Committee Members:

James Dodson	Nueces River Authority Corpus Christi, Texas
Greg Carter	Central Power & Light Corpus Christi, Texas
Ed Garaña	City of Corpus Christi, Texas
Don Roach	San Patricio MWD Ingleside, Texas
J. D. Beffort	Texas Water Development Board Austin, Texas
William R. Hartley	BHP Engineering & Construction Corpus Christi, Texas

HDR internal review was provided by Bud Benjes, Ken Choffel, and Roger Noack. Kathy Abrams and Jennifer Regan prepared the graphics and manuscript.

Executive Summary

Many factors are resulting in increased consideration of using membranes for water treatment. The costs of membrane systems are declining, finished water regulatory requirements are becoming more stringent, and population growth continues in areas with limited freshwater resources. Membrane technologies and costs for water desalination are reviewed in this report, along with an analysis of siting factors for seawater desalination along the Texas coast.

Reverse osmosis and electro dialysis reversal systems are the primary membrane treatment options to desalinate brackish water. Reverse osmosis is the only viable membrane treatment option to desalinate seawater. Process selection includes the consideration of water quality, treatment objectives, and costs. Reverse osmosis offers several advantages over electro dialysis reversal, including control of dissolved organic constituents and pathogenic microorganisms. Electro dialysis reversal has a treatment niche for waters not requiring the removal of these constituents and for waters that require removal of less than 3,000 mg/L total dissolved solids.

Cost components of reverse osmosis systems include pretreatment, feedwater pumping, membrane process, membrane cleaning system, and concentrate disposal. Pretreatment costs vary based on source water characteristics, with ground waters typically requiring minimal pretreatment and surface waters requiring pretreatment by full conventional filtration. The costs of reverse osmosis systems can be estimated using the methodology presented in this document.

Table ES1 presents costs for treating brackish water that needs minimal pre-treatment. Water needing minimal pre-treatment includes some groundwaters and surface water that has already been treated by conventional filtration. Many items, such as source water development and concentrate disposal, are site-specific and are not included in Table ES1 costs. The costs for these items should be estimated separately for site specific conditions using standard engineering approaches.

A survey of operating desalination plants in Texas, Florida, and California, indicates that the majority of membrane desalination plants are reverse osmosis systems treating brackish groundwater. However, both reverse osmosis and electro dialysis reversal systems are currently being used to treat inland brackish surface water in Texas. Total treated water costs for groundwater ranged from \$1.50/Kgal to \$2.75/Kgal while surface water ranged from \$1.00/Kgal

**Table ES-1.
Brackish Water Treatment Costs
for Water Needing Minimal Pre-Treatment**

Item	Estimated Costs 0.1 MGD	Estimated Costs 0.5 MGD	Estimated Costs 1 MGD	Estimated Costs 3 MGD	Estimated Costs 5 MGD	Estimated Costs 10 MGD
Water Treatment Plant	\$478,000	\$1,077,000	\$1,823,000	\$3,946,000	\$5,718,000	\$9,097,000
Engineering, Legal Costs and Contingencies (35%)	167,000	377,000	638,000	1,381,000	2,001,000	3,184,000
Interest During Construction (1 years)	<u>29,000</u>	<u>65,000</u>	<u>109,000</u>	<u>237,000</u>	<u>343,000</u>	<u>546,000</u>
Total Project Cost	\$674,000	\$1,519,000	\$2,570,000	\$5,564,000	\$8,062,000	\$12,827,000
Annual Costs						
Debt Service (6 percent for 30 years)	\$49,000	\$110,000	\$187,000	\$404,000	\$586,000	\$932,000
O&M - Water Treatment Plant	<u>37,544</u>	<u>112,103</u>	<u>209,522</u>	<u>541,840</u>	<u>864,519</u>	<u>1,647,977</u>
Total Annual Cost	\$86,544	\$222,103	\$396,522	\$945,840	\$1,450,519	\$2,579,977
Available Project Yield (acft/yr)	112	560	1,120	3,360	5,601	11,202
Annual Cost of Water (\$ per acft)	\$773	\$397	\$354	\$281	\$259	\$230
Annual Cost of Water (\$ per 1,000 gallons)	\$2.37	\$1.22	\$1.09	\$0.86	\$0.79	\$0.71

Notes:

TDS range from 1,000 mg/L to 3,000 mg/L, Feedwater pressure 300 psi, Recovery Rate 80%, Power cost \$0.06 per kWh.
Costs Not Included: Source Water Development, Concentrate Disposal, Finished Water Storage and Pumping, Distribution, Environmental/Archaeology, Land Acquisition, and Surveying

to \$1.20/Kgal. Operation and maintenance cost data showed significant economies of scale. The survey also suggests that few seawater desalination facilities are currently operating in the US. Fortunately, the project under development by Tampa Bay Water provides an excellent case study for evaluating costs for seawater desalination along the Texas coast.

The Tampa Bay Water project has shown that seawater desalination can be a feasible large-scale potable water supply option provided that siting conditions are suitable. There were numerous advantages for the Tampa Bay Water project. A couple of the major advantages included co-siting with an existing power plant and adequate flushing in the bay for discharge of the concentrate. The potential exists to duplicate some but probably not all of these advantages for a seawater desalination facility on the Texas coast.

Several siting factors were evaluated for the Texas Coast to determine their impact on costs and ability to permit a seawater desalination facility. The cost of desalting water with the reverse osmosis process is sensitive to water quality parameters such as salinity, fouling potential, and temperature.

The ability to permit a facility is dependent on observed or perceived impact of the raw water intake and concentrate disposal system. Tampa Bay Water had an ideal situation for these facilities with an existing power plant providing sufficient raw water without drawing additional water from the bay and a cooling water flow rate of 1,350 MGD to dilute the discharged concentrate. Also, several studies by Tampa Bay Water and Florida regulatory authorities indicate that the concentrate can be discharged through the existing power plant outfall without harmful environmental effects. These findings are largely dependent on the high degree of mixing and flushing observed in the discharge bay. In contrast, the preliminary findings of this report indicate that the majority of the bays on the Texas coast have comparably low mixing and flushing capabilities.

Without existing co-sited facilities, building and operating separate raw water intake and concentrate disposal facilities can considerably increase the total cost of desalted water. Costs for concentrate disposal are highly site specific and will depend on the proximity of a facility to a disposal location that meets all regulatory requirements.

The cost for a 25 MGD desalted water supply operating at 100 percent utilization at two sites on the Texas coast were estimated to be around \$2.85 per thousand gallons of product water. More realistic utilization rates (e.g., 85 percent) will cause the unit costs of water to be

higher. The unit costs are about 35 percent higher than the lowest proposal of \$2.08 received by Tampa Bay Water. The increased cost of these example Texas facilities are primarily due to higher salinity and added costs for concentrate disposal.

Foreword

Water desalination is becoming an increasingly attractive option to produce potable water in many areas of Texas. Technological advances in desalination, shifting market conditions, and increasingly stringent drinking water treatment regulations are making desalination more cost-competitive with conventional drinking water treatment. Texas leads the nation in population growth and the 2000 Census will likely show that Texas has more than 20 million people. Although this rate of population growth is benefiting the Texas economy, it is also straining the water resources of the state. Recognizing this condition, the Texas Legislature enacted Senate Bill 1 (SB1) to support water supply and drought contingency planning within the state. This document, *Desalination for Texas Water Supply*, supports the SB1 process and general water supply and drought contingency planning in Texas. Development of this document describing membrane technologies, costs and siting factors for water desalination provides a resource for municipalities or regions considering water desalination. The report is composed of two parts: Part A: Membrane Technologies and Costs and Part B: Economic Importance of Siting Factors for Seawater Desalination.

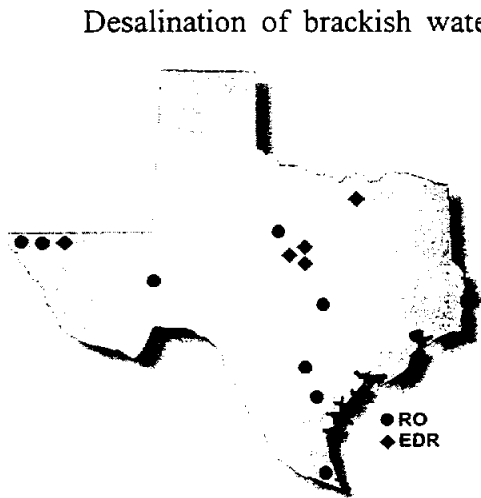

Figure 1. Municipal Desalination Plants

Desalination of brackish water or seawater in Texas has the potential to expand the resources available for producing potable water. Large amounts of brackish ground and surface water and a virtually limitless supply of seawater are not suitable for drinking due to excess salinity, unless treated. Figure 1 illustrates the locations of existing municipal water desalination facilities operating in Texas. As shown in the figure, desalination is not simply a coastal issue but a statewide issue due to the natural salt contamination in many of Texas' major rivers and aquifers.

It is increasingly difficult to develop freshwater storage projects, particularly large on-channel reservoirs. Additionally, the value of interbasin water rights transfers was diminished by SB1. Population growth continues throughout the State in areas vulnerable to drought where

freshwater is limited. These factors are driving water utilities and industry to consider desalinating brackish or saline waters in Texas.

State and federal regulatory agencies require that drinking water meet primary drinking water standards. The voluntary secondary drinking water standards limit constituents in water that affect the aesthetic quality of drinking water, such as taste, odor, color, mineral content and appearance, that may deter the public acceptance of drinking water. Membrane desalination technologies can demineralize water so that secondary standards are met, producing water with a pleasing aesthetic quality. Reverse osmosis membrane filtration produces superior water that can meet even the most stringent primary drinking water regulations. As shown in Figure 2, the use of reverse osmosis for water treatment is rapidly expanding.

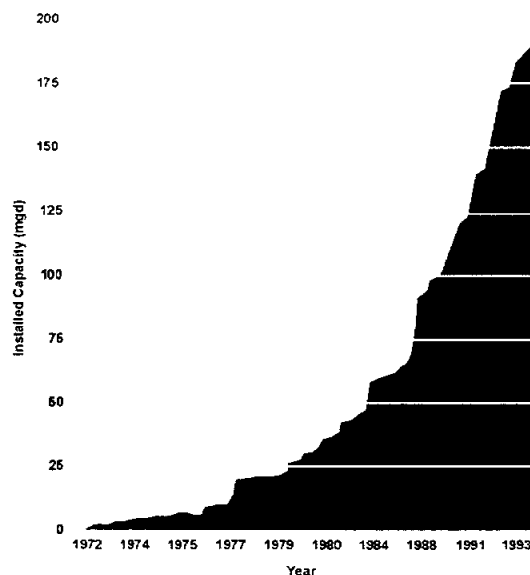

Figure 2. Reverse Osmosis Capacity in U.S.

Desalination provides economic benefits and enables wastewater reuse. Due to perceived health impacts or taste preferences, customers may treat mineralized water with home treatment units or use bottled drinking water. Industry may be forced to install point of entry treatment for pure process water. Providing centralized desalination treatment eliminates the need for site specific treatment. A mineralized water supply produces a mineralized wastewater, restricting the reuse of wastewater for agricultural irrigation. Therefore, desalinating water using membranes in a central facility can reduce costs to the homeowner or industry and provide wastewater effluent that is more suitable for reuse. These important considerations drive the need to evaluate current technologies, costs, and siting considerations for water desalination in Texas for use in water supply planning and development.

Although broad in scope, this document is intended for use primarily at the planning level. For greater detail on design and operation and maintenance of membrane desalination treatment systems, the reader is referred to additional sources of information provided in Table 1.

Table 1.
Sources of Additional Information on Water Desalination

Organization	Website	References
American Water Works Association	www.awwa.org	AWWA M46: <i>Reverse Osmosis and Nanofiltration</i> AWWA M38: <i>Electrodialysis and Electrodialysis Reversal</i>
AWWA Research Foundation	www.awwarf.com	Report: <i>Membrane Concentrate Disposal</i> Book: <i>Water Treatment, Membrane Processes</i>
American Desalting Association	www.desalting-ada.org	Conferences and Publications
US Bureau of Reclamation	www.usbr.gov	Report: <i>The Desalting and Water Treatment Membrane Manual: A Guide to Membranes for Municipal Water Treatment (2nd Ed.)</i> Cost Estimating Software
Tampa Bay Water	www.tampabaywater.org/NewTBW/MWP/Projects/Desal/Desal.htm	Seawater desalination project website

Part A
Membrane Technologies and Costs

Prepared for

**Texas Water Development Board
Nueces River Authority
Central Power & Light Company
City of Corpus Christi
San Patricio Municipal Water District**

Prepared by



HDR Engineering, Inc.

**in association with
Water Resources Associates
Malcolm Pirnie, Inc.**

August 2000

Table of Contents

<u>Section</u>		<u>Page</u>
1	Introduction.....	A.1-1
2	Basic Concepts.....	A.2-1
	2.1 Membrane System Types.....	A.2-1
	2.2 Definition of Terms.....	A.2-1
	2.3 Theory.....	A.2-2
	2.3.1 Reverse Osmosis.....	A.2-2
	2.3.2 Electrodialysis Reversal.....	A.2-4
	2.4 Operating Principles.....	A.2-5
	2.4.1 Reverse Osmosis.....	A.2-5
	2.4.2 Electrodialysis.....	A.2-7
3	Design Concepts.....	A.3-1
	3.1 Reverse Osmosis Introduction.....	A.3-1
	3.1.1 Membrane Materials.....	A.3-1
	3.1.2 Reverse Osmosis Configurations.....	A.3-2
	3.1.3 Reverse Osmosis Components and Design Considerations.....	A.3-6
	3.2 Electrodialysis and Electrodialysis Reversal.....	A.3-8
	3.2.1 Introduction.....	A.3-8
	3.2.2 Materials.....	A.3-8
	3.2.3 Configurations.....	A.3-9
	3.2.4 Components and Design Considerations.....	A.3-10
	3.3 Source Water Quality.....	A.3-15
	3.4 Pretreatment.....	A.3-17
	3.5 Post-Treatment.....	A.3-18
	3.6 Concentrate Disposal.....	A.3-18
	3.7 Instrumentation/SCADA.....	A.3-19

**Table of Contents
(continued)**

<u>Section</u>		<u>Page</u>
6.3	Costs of Concentrate Disposal.....	A.6-39
6.3.1	Surface Water Discharge Major Cost Considerations	A.6-39
6.3.2	Discharge into Municipal Wastewater System Major Cost Considerations.....	A.6-39
6.3.3	Deep Well Injection Major Cost Considerations.....	A.6-40
6.3.4	Land Application Major Cost Considerations.....	A.6-40
7	Process Performance and Selection	A.7-1
7.1	Process Selection	A.7-1
7.2	Impact of Operation of Performance	A.7-4
8	Trends	A.8-1
8.1	New Products	A.8-1
8.1.1	Modules/Elements.....	A.8-1
8.1.2	Pressure Vessels.....	A.8-2
8.1.3	Reduced Costs.....	A.8-3
8.2	Integrated Membrane Systems.....	A.8-4
8.3	Safe Drinking Water Act Requirements	A.8-4

(This page intentionally left blank.)

List of Figures

<u>Figure</u>		<u>Page</u>
2-1	Schematic of Membrane Desalination System	A.2-2
2-2	Normal Osmosis Process	A.2-3
2-3	Reverse Osmosis Process.....	A.2-4
2-4	Simplified Diagram of an EDR Cell.....	A.2-5
3-1	Spiral-Wound Membrane Construction.....	A.3-2
3-2	Schematic of Single Stage Pressure Vessel	A.3-3
3-3	Schematic of Parallel Staging Pressure Vessel.....	A.3-3
3-4	Schematic of Reject Staging Pressure Vessel.....	A.3-4
3-5	Schematic of Product Staging Pressure Vessel.....	A.3-5
3-6	Schematic of Bypassing and Blending Pressure Vessel	A.3-5
3-7	Reverse Osmosis Flow Schematic	A.3-7
3-8	Electrical Ion Transfer Cell.....	A.3-9
3-9	Electrodialysis Membrane Stack.....	A.3-11
3-10	Typical EDR Flow Schematic	A.3-13
5-1	Typical Injection System (Groundwater Containment Remediation Technology).....	A.5-32
6-1	Layout of Reverse Osmosis Pretreatment Facilities	A.6-2
6-2	Reverse Osmosis Pretreatment — Construction.....	A.6-5
6-3	Reverse Osmosis Pretreatment — O&M.....	A.6-6
6-4	Reverse Osmosis Pretreatment — Building Area.....	A.6-7
6-5	Layout of Membrane Feed Pumping Facilities.....	A.6-8
6-6	Reverse Osmosis Feed Pumping — Construction.....	A.6-9

**List of Figures
(continued)**

<u>Figure</u>		<u>Page</u>
6-7a	Membrane Feed Pumping (Low Pressure, 300 psi) — O&M	A.6-10
6-7b	Membrane Feed Pumping (Medium Pressure, 500 psi) — O&M	A.6-11
6-7c	Membrane Feed Pumping (High Pressure, 700 psi) — O&M	A.6-12
6-7d	Membrane Feed Pumping (Seawater Pressure, 900 psi) — O&M	A.6-13
6-8	Membrane Feed Pumping — Building Area	A.6-14
6-9	Layout of Reverse Osmosis Trains	A.6-15
6-10	Reverse Osmosis Process System — Construction	A.6-18
6-11a	Reverse Osmosis Process System (Low Pressure) — O&M	A.6-19
6-11b	Reverse Osmosis Process System (Medium Pressure) — O&M	A.6-20
6-11c	Reverse Osmosis Process System (High Pressure) — O&M	A.6-21
6-11d	Reverse Osmosis Process System (Seawater) — O&M	A.6-22
6-12	Reverse Osmosis Process System — Building Area	A.6-23
6-13	Layout of Reverse Osmosis Cleaning System	A.6-24
6-14	Reverse Osmosis Cleaning System — Construction	A.6-26
6-15a	Reverse Osmosis Cleaning System (2 wk) — O&M	A.6-27
6-15b	Reverse Osmosis Cleaning System (1 mo) — O&M	A.6-28
6-15c	Reverse Osmosis Cleaning System (6 mo) — O&M	A.6-29
6-15d	Reverse Osmosis Cleaning System (12 mo) — O&M	A.6-30
6-16	Reverse Osmosis Process System — Building Area	A.6-31
6-17	Typical Groundwater Desalination Schematic	A.6-34
6-18	Groundwater Desalination Capital Costs	A.6-35

**List of Figures
(continued)**

<u>Figure</u>		<u>Page</u>
6-19	Typical Surface Water Desalination Schematic	A.6-35
6-20	Groundwater Desalination O&M Costs.....	A.6-36
6-21	Distribution of O&M Costs for Groundwater Desalination	A.6-37
6-22	Distribution of O&M Costs for Surface Water Desalination.....	A.6-68
6-23	Total Treated Water Cost for Groundwater Desalination.....	A.6-38
7-1	General Membrane Process Selection Chart.....	A.7-2
8-1	Increased Salt Removal Efficiency by RO Membranes	A.8-1
8-2	Reduced Reverse Osmosis Membrane Operating Pressures (Brackish Water).....	A.8-2
8-3	Reduced Element Costs	A.8-3

(This page intentionally left blank.)

List of Tables

<u>Table</u>		<u>Page</u>
5-1	Dunedin, Florida Membrane Softening Plant	A.5-3
5-2	City of Fort Meyers, Florida Membrane Softening Plant	A.5-3
5-3	Brackish Reverse Osmosis Process Comparison	A.5-4
5-4	Sarasota County, Florida Carlton EDR Water Treatment Facility	A.5-5
5-5	Comparison of Reverse Osmosis and EDR Concentrate	A.5-6
5-6	Seawater and Concentrate Water Chemistry Analysis – Antigua, West Indies	A.5-7
5-7	Concentrate Disposal Options Summary	A.5-36
6-1	Allowances for RO System Components	A.6-1
6-2	Distribution of Survey Responses	A.6-32
7-1	Reverse Osmosis Typical Operational Parameters	A.7-3

Section 1 Introduction

Reverse osmosis (RO) and electrodialysis reversal (EDR) are the primary membrane treatment processes that remove dissolved salts from water. Nanofiltration membrane filtration is used primarily for water softening. RO and EDR receive primary emphasis in this report, with EDR not being considered for desalination of waters with greater than 3,000 mg/L TDS. The processes are generally more expensive than conventional water treatment but the costs are decreasing due to a more competitive market and technological innovation.

Desalting has two principal steps: water-concentrate separation and concentrate disposal. The RO and EDR desalting processes have several characteristics in common:

- Both processes require some form of pre-treatment. At a minimum, pre-treatment will include cartridge filtration and chemical conditioning. Chemical treatment may include chlorination, pH adjustment and scale control.
- Both processes produce concentrate that requires disposal. The objective is to optimize the system recovery to minimize the total cost including concentrate disposal.
- Both processes use significantly more electricity than conventional water treatment processes.
- The membranes used in RO and EDR systems require careful monitoring and routine maintenance, including cleaning. All membranes have a finite useful life and must be periodically replaced.

RO desalting systems are capable of removing high percentages of all dissolved salts. All RO systems employ a semi-permeable membrane to retain salt from the feedwater on the concentrate side while permitting pure or nearly pure water to pass through. RO is a pressure based membrane filtration system while EDR is electrically driven.

EDR desalting systems are also capable of removing high percentages of the dissolved salts. However, they differ from RO systems in that their performance and cost are more directly related to feed water quality and the salt removals desired. EDR systems employ membranes made from ion exchange resin materials supported by open weave cloth cast in the resin for physical strength. When a membrane is subjected to electrical current, the solution on one side of the membrane becomes partially desalted while the solution on the other side becomes more concentrated.

This project evaluates the technologies and costs for water desalination using membranes—both RO and EDR processes. A literature review and summary was performed to gather information on trends in membrane desalination, membrane suppliers, and operating membrane desalination plants. This literature review gathered information from sources such as the American Water Works Association and Research Foundation, the American Desalting Association, and the Electric Power Research Institute. Membrane manufacturers and suppliers were interviewed to gather cost, performance, operating, and equipment data for their membrane products.

A survey of drinking water utilities currently practicing desalination was performed to identify trends in the costs associated with construction, operation and maintenance, and concentrate disposal. The facilities contacted focused on Texas, but also included some in Florida and California. The contact list was developed from a telephone survey of membrane vendors, the inventory of desalting plants prepared by the American Desalting Association, literature review, and the knowledge of the engineering consultants performing this project. A questionnaire was developed to gather cost and performance data from existing plants. The information obtained included plant capacity, operating, and cost data.

Costs developed from survey information are presented in curves representing capital, operation and maintenance, and total treatment costs. The cost curves were developed by statistical regression using the cost data points developed from the survey. O&M costs generally include labor, chemicals, power, membrane replacement, and other costs. Of these items, labor and power are generally the items of greatest cost. Capital and O&M costs are aggregated into one cost curve representing total treated water unit cost for membrane desalination.

Considerations in membrane process selection include: water supply quality, desired finished water quality, costs, reliability, operational requirements, flexibility, and disposal requirements. Guidance on process selection and configuration under various conditions has been developed based on the literature review, conversations with suppliers, and the survey. Considerations include the need to control particles and scaling potential of the feedwater as well as post treatment requirements. One consideration in selection is that RO provides a barrier to pathogenic microorganisms while EDR does not.

The key to an economical desalting application is inexpensive disposal or recovery of concentrate. Applicable state and federal concentrate disposal regulations are summarized.

Considerations for concentrate disposal depend on geography and results from the survey will assist utilities in understanding the most common methods and their costs. Many municipal desalting plants in the U.S. dispose of concentrate to an ocean, stream or lake. When concentrate disposal to open bodies of water is not viable, options include solar evaporation ponds, deep well injection, or mechanical evaporation followed by solar ponds or mechanical dryer.

Section 2 **Basic Concepts**

This section describes some basic terms and concepts about theory and operation membrane water treatment systems for desalination. The section begins with a discussion of membrane system types and a definition of terms. Theory and operating principles are reviewed to support discussions in the remainder of this document.

2.1 Membrane System Types

There are currently several different types of membrane systems that may be used for water treatment and fall within the general membrane categories of microfiltration, ultrafiltration, nanofiltration, reverse osmosis, and EDR processes. However, not all of these membrane types are suitable for water desalination.

Microfiltration and ultrafiltration are low-pressure membranes systems used to remove suspended particles from the feedwater. The pore sizes of these membrane types are too large to removed dissolved ions responsible for TDS. Micro- and ultrafiltration are being used increasingly as pretreatment for reverse osmosis systems—an application called integrated membrane systems.

Although both nanofiltration and reverse osmosis are high-pressure membrane systems used to remove dissolved minerals, nanofiltration systems are more typically used as a softening process (removing calcium and magnesium) rather than for desalination applications (removing chloride and sodium). Electrodialysis reversal (EDR) is an electrically driven, rather than pressure driven, membrane process for water desalination.

This report focuses on using reverse osmosis and EDR to desalinate water. For a more detailed description of these two types of membranes, including types of materials and configurations, see Section 3 on design concepts.

2.2 Definition of Terms

To better understand how a membrane desalination system operates, it is helpful to be familiar with some general terminology that is common to both reverses osmosis and EDR systems. Appendix A contains a glossary of selected terms commonly used in the desalination process. Figure 2-1 displays a schematic diagram of a membrane treatment system.

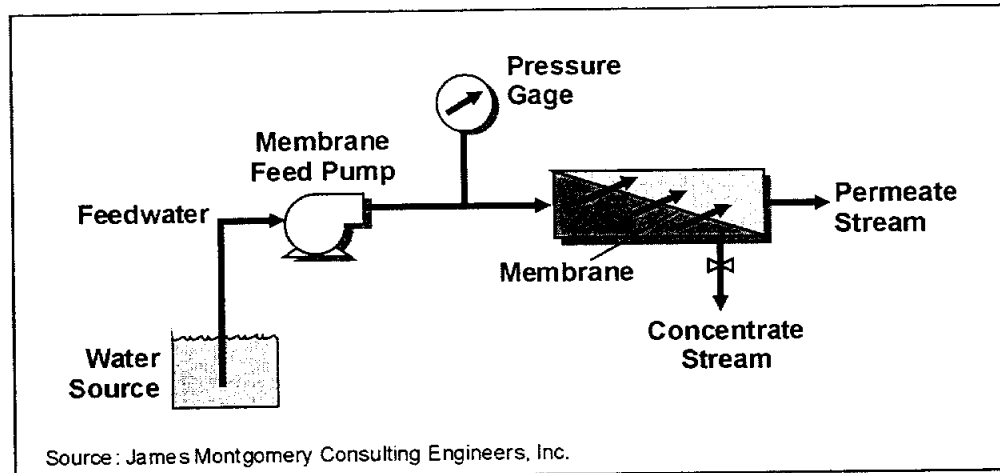

Figure 2-1. Schematic of Membrane Desalination System

The influent water to the membranes is called the *feedwater* (Figure 2-1). The feedwater is the source of water for the selected membrane process. A *membrane* can be defined as a thin film separating two phases and acting as a selective barrier to the transport of matter (Figure 2-1). Although membranes may be characterized by their structure, their performance also depends on the nature of the elements contained in the two phases and on the applied driving force.

The feedwater is separated into two streams at the membrane: permeate and concentrate. The *permeate stream* has passed through the membrane and is the demineralized product water. The *concentrate (or brine) stream* contains the total dissolved solids removed from the permeate by the membranes. The TDS concentration of the concentrate stream is much greater than the permeate stream. *Water recovery* is the percent of feedwater recovered as product water. *Salt rejection* quantifies the reduction in TDS concentration from the feedwater to the product water.

2.3 Theory

2.3.1 Reverse Osmosis

If a semi-permeable membrane separates aqueous solutions with different concentrations of dissolved minerals, the liquid tends to flow through the membrane from dilute to the concentrated side until the concentrations on both sides of the membrane are equal.¹ In

¹ James Montgomery Consulting Engineers, Inc., Op. Cit., 1985.

Figure 2-2, the chambers initially contain a dilute and a concentrated solution, separated by a semi-permeable membrane that will allow water to pass through it but not dissolved ions. The liquid flows through the semi-permeable membrane, causing the level of liquid in the chamber with the initial higher concentration to rise. The liquid in the chamber will continue to rise until the hydrostatic head of the water column in the chamber is just adequate to prevent further flow through the semi-permeable membrane. At this point, the osmotic pressure (seen in Figure 2-2 as the pressure created by the difference in water levels) will counter the diffusion process exactly, and equilibrium will be achieved.

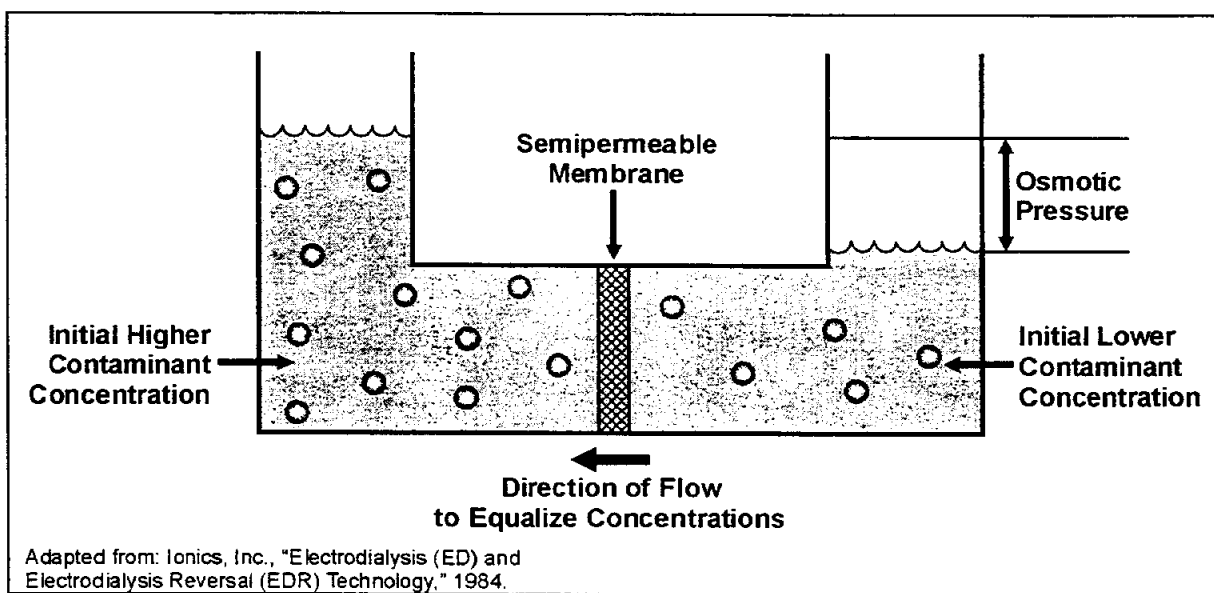

Figure 2-2. Normal Osmosis Process

If this process is repeated but hydrostatic pressure in excess of the osmotic pressure is applied to the concentrated solution, the direction of liquid flow is reversed. Water flows from the concentrated solution to the dilute solution. Higher water pressure on the source side is used to “reverse” the natural osmotic process, with the semi-permeable membrane still permitting the passage of water while rejecting most of the other contaminants (Figure 2-3). This phenomenon, whereby the liquid flows from the concentrated solution to the dilute solution across a semi-permeable membrane by the application of an external pressure or driving force is known as reverse osmosis.

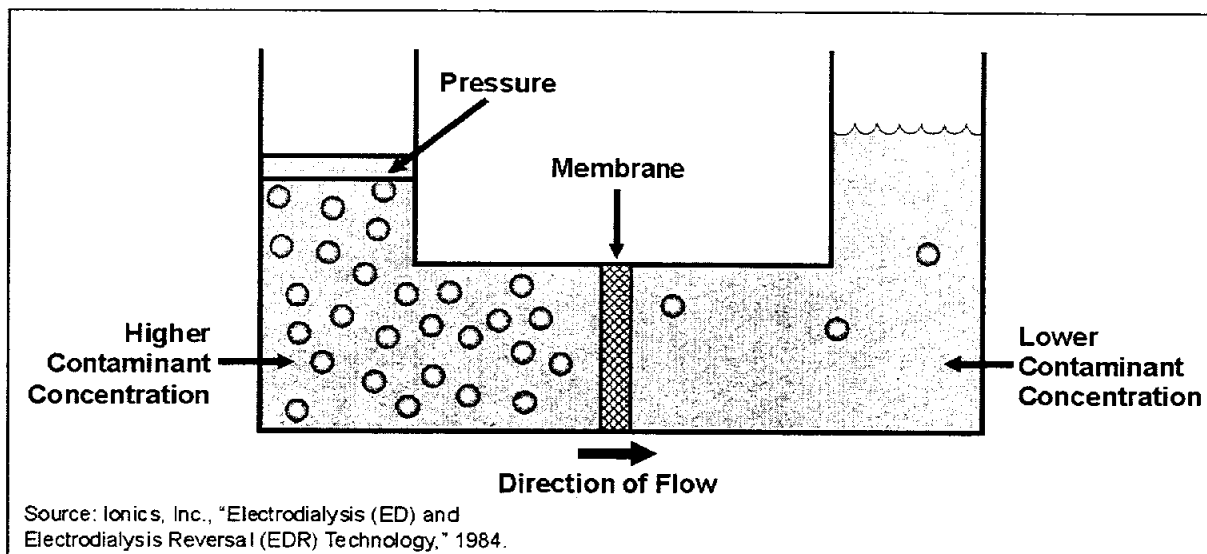

Figure 2-3. Reverse Osmosis Process

2.3.2 Electrodialysis Reversal

The basic EDR cell consists of alternating anion-permeable and cation-permeable membranes, which provide a basis for separation of ions under DC voltage. A simplified diagram of a complete cell for sodium chloride removal is shown in Figure 2-4. As the water flows across the membrane surfaces, ions are electrically transferred through the membranes from the demineralized stream to the concentrate stream. Sodium ions are allowed to pass through the cation-transfer membrane, while chloride ions are allowed to pass through the anion-transfer membrane.² The sodium and chloride ions then become trapped in the concentrate channel by the alternating ion exchange membranes. The alternating ion exchange membranes produce a demineralized product, or permeate, and a concentrate stream (Figure 2-4).³ The EDR process differs from pressure-driven processes such as reverse osmosis because ions, not water, travels through an electrically charged membrane.

² Ionics, Inc, Op. Cit., 1984.

³ AWWA, Op. Cit., 5th Edition.

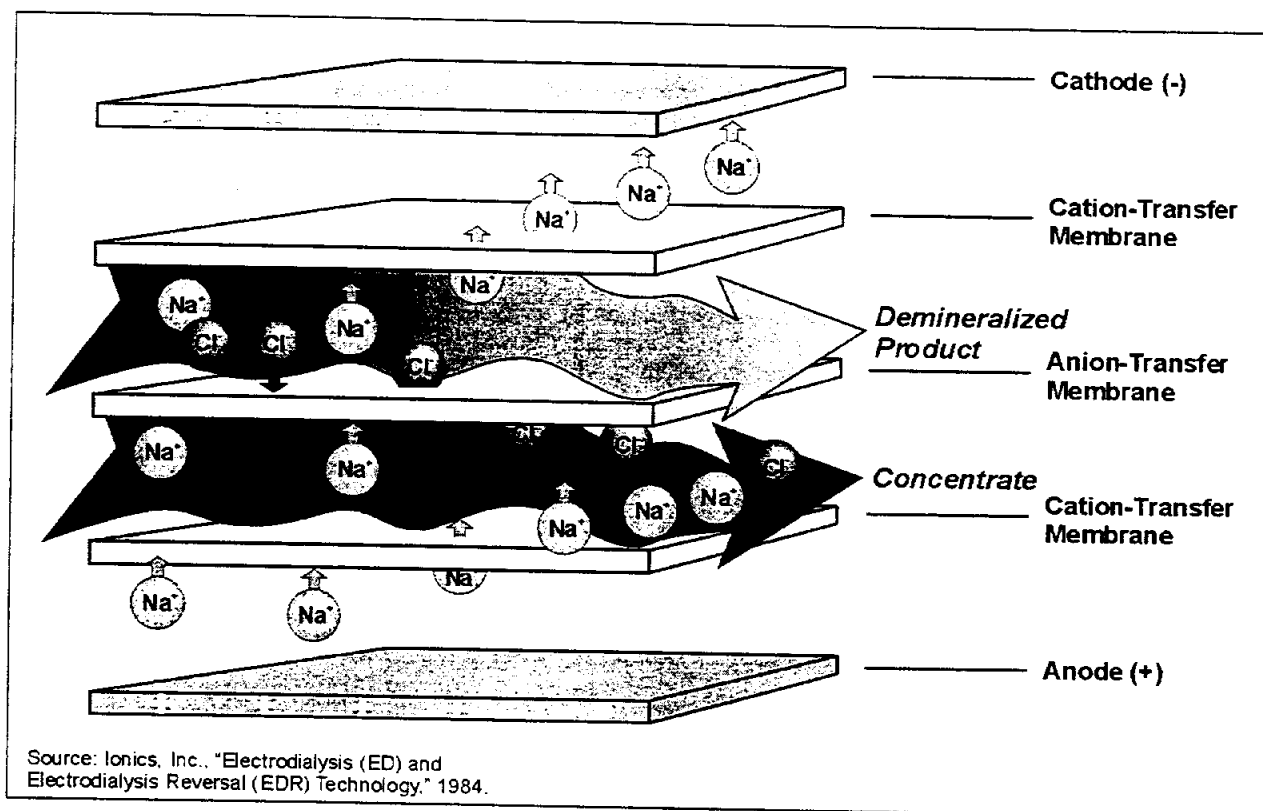

Figure 2-4. Simplified Diagram of an EDR Cell

2.4 Operating Principles

For the desalination of brackish or seawater there two membrane processes – reverse osmosis and electro dialysis. Reverse osmosis is a pressure driven membrane process and electro dialysis is an electrically driven membrane process. Both will demineralize the water with different operating principles and driving forces.

2.4.1 Reverse Osmosis

Reverse osmosis is a membrane process for desalting brackish water or seawater by the application of pressure to drive the feedwater through a semi-permeable membrane. Reverse osmosis membranes generally allow the passage of water but retains many other contaminants, such as salts, on the feedwater side of the membrane.⁴ Water moving through the membrane, known as product water or permeate, is relatively pure and emerges at near

⁴ James Montgomery Consulting Engineers, Inc., Op. Cit., 1985.

atmospheric pressure. A continuous waste stream, known as concentrate, emerges from the membrane pressure vessel at slightly lower pressure than the feedwater.⁵ In the reverse osmosis process, the permeate loses its salt content to the concentrate, that contains a much greater level of dissolved ions.

During the reverse osmosis process, the feedwater is pumped to raise the pressure of the water against a membrane in a closed pressure vessel. The driving force pressure must be higher than the osmotic pressure of the water and membrane resistance to move water through the membrane. The dissolved minerals, salts, and organic matter move through the membrane at a much slower rate than water, so the remaining solution becomes more and more concentrated. The concentrate stream exits the vessel through a controlled valve and discharge piping. The pure water, or permeate, which has passed through the membrane, is collected separately for use.

The passage of water and dissolved contaminants is determined by the membrane characteristic in terms of two fundamental equations for water flux (equation RO-1) and solute flux (equation RO-2):

$$F_w = K_w(\Delta P - \Delta\pi) \quad (\text{RO-1})$$

$$F_s = K_s(C_m - C_p) \quad (\text{RO-2})$$

Where:

F_w = Water flux, gpd/sf or gfd

K_w = Water mass transfer coefficient or flux per pressure, gfd/psi

ΔP = Transmembrane pressure differential, psi

$\Delta\pi$ = Transmembrane osmotic pressure differential, psi

F_s = Solute flux, lb/sf/d

K_s = Solute mass transfer coefficient, ft/d

C_m = Concentration on feed side of membrane surface (inside), mg/L

C_p = Concentration on product side of membrane surface (outside), mg/L

Both water and dissolved ions move through the membrane. The mass transfer coefficients are determined by the membrane material characteristics. The flow of water through the membrane depends on the pressure gradient across the membrane while the flow of salt

⁵ James Montgomery Consulting Engineers, Inc, Op. Cit., 1985.

across the membrane depends on the concentration gradient across the membrane. As the feedwater pressure increases, the water flow increases but the salt flow does not, improving the quality of the product water.

2.4.2 Electrodialysis

During Electrodialysis (ED) water is desalted or concentrated using an electrical driving force. Salts in water dissociate into positively and negatively charged ions. The keys to the ED process are semi-permeable membranes that allows passage of either positively charged ions (cations) or negatively charged ions (anions), while excluding passage of oppositely charged ions. These semi-permeable membranes are commonly known as ion-exchange, ion-selective, or electrodialysis membranes.⁶

Depending on the quality of the water supply, salts can form on the surface of the membranes, causing membrane scaling or fouling. To counteract this process, the polarity of the electrodes can be automatically reversed periodically, typically about every 15 to 20 minutes, reversing the direction of flow of the ions. The process of reversing the polarity of the electrodes is an enhancement of the normal electrodialysis process and is called electrodialysis reversal (EDR). Reversal causes the permeate stream to become the concentrate stream and vice versa. Each time the polarity of the terminals is reversed, the concentrate compartment is flushed out which helps to reduce or eliminate the build up of dissolved minerals on the concentrate side of the membrane.⁷

The feedwater characteristics, design parameters, and equipment selection control the rate of ion removal during EDR. The water quality and temperature of the feedwater determine the system recovery and rate of mass transfer. Ion removal increases as temperature and ionic charge increase. System recovery is typically limited by the precipitation of the least soluble salt.⁸

⁶ Ionics, Inc., "Electrodialysis (ED) and Electrodialysis Reversal (EDR) Technology," Floyd H. Meller, editor, 1984.

⁷ des Eaux, Lyonnaise, Op. Cit., 1996.

⁸ AWWA, "Water Quality and Treatment: A Handbook of Community Water Supplies," New York, 5th Edition.

Section 3 Design Concepts

3.1 Reverse Osmosis Introduction

Reverse osmosis (RO) was the first commercially available membrane treatment process and was developed for desalination of seawater. RO membranes were developed to reduce seawater from 35,000 mg/L TDS to less than 500 mg/L TDS so that the water produced would be acceptable for drinking. RO membranes have very high salt rejection characteristics with sodium chloride rejection in excess of 99.4 percent.

3.1.1 Membrane Materials

The first RO membrane materials were made from cellulose acetate (CA). Cellulose acetate membranes offer reasonably high flux and salt rejection characteristics while remaining inexpensive and easy to manufacture. Cellulosic membranes can tolerate chlorine at a continuous dosage of less than 1.0 mg/L, or periodic shock dosages. Operational limitations associated with the hydrolysis of cellulose membranes limit the operating temperature to 30°C and pH to a range of 3.0 to 6.0. Cellulose membranes are subject to microbial degradation, but this can be controlled by adding chlorine to the feedwater.

Polymeric membranes have become available more recently; common materials include polyamide, polysulfone, polyhydrazide, and polyurea. These membranes are generally not tolerant of chlorine or other oxidants, but also are not subject to biodegradation. These materials offer wider ranges of operating temperatures and pH, thus providing more flexibility in their use.

Most polymeric membranes use a very thin active membrane layer supported on a porous substrate media consisting of either the same or a different polymer material. The “thin film composite” (TFC) method of membrane construction decreases the thickness of the membrane, thereby lowering required driving pressures.¹

¹ Malcolm Pirnie, Inc., “Manual on Membrane Processes for Drinking Water Treatment,” Technical Publication, October 1996 (a).

3.1.2 Reverse Osmosis Configurations

RO membrane elements are either spiral-wound or hollow fine fiber membranes.² For hollow fine fibers, the flow direction is outside-in, with feedwater on the outside of the fibers and permeate within the fibers' central bore (lumen). Hollow fine fiber membranes are more commonly used for seawater desalting. Spiral-wound membranes are assembled from a flat sheet material where two sheets are separated by a permeate carrier and are connected to a central permeate collector tube. A feedwater channel spacer is used to separate the membrane media. Figure 3-1 shows the construction of a spiral-wound membrane.

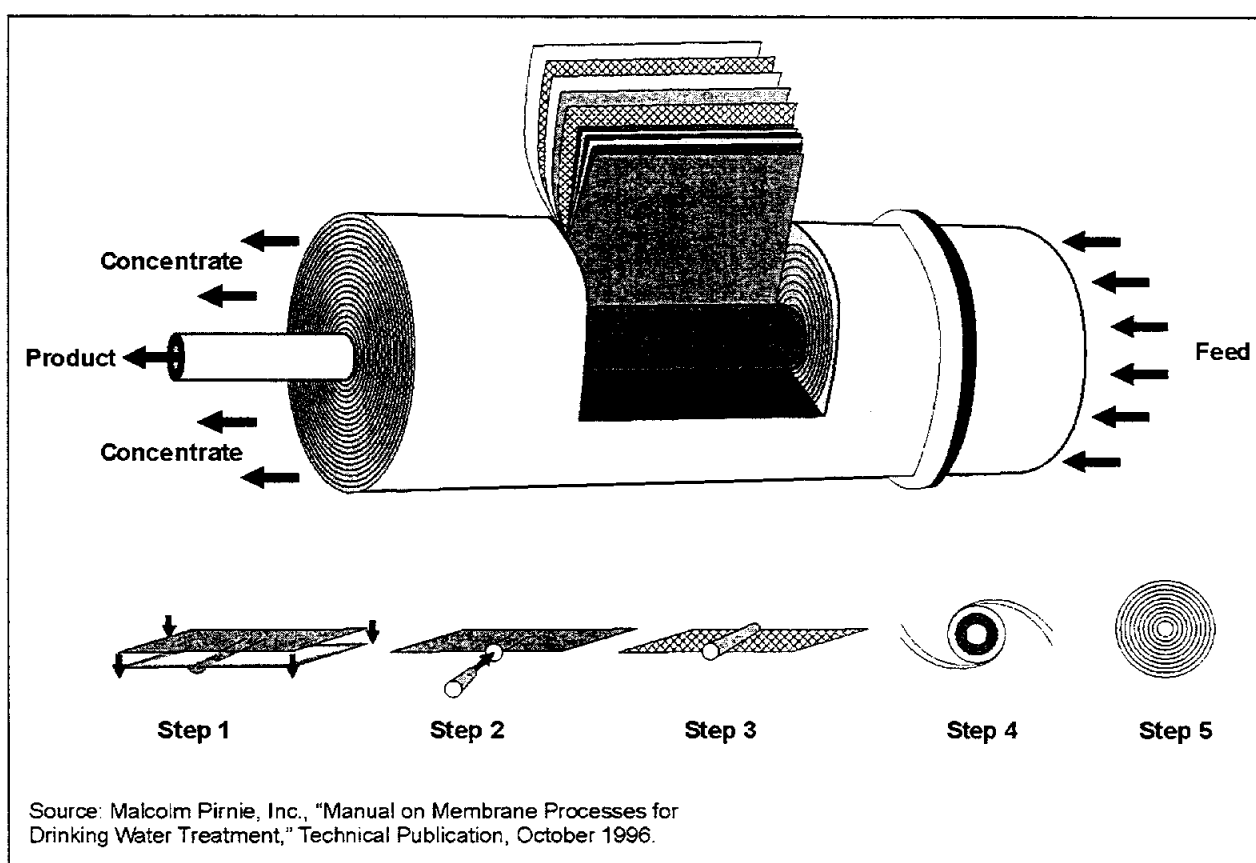

Figure 3-1 Spiral-Wound Membrane Construction

² James Montgomery Consulting Engineers, Inc., "Water Treatment Principles and Design," New York, 1985.

3.1.2.3 Reject Staging

Reject staging is used to increase product recovery by using the concentrate stream from the first stage as feedwater into a second, then using the concentrate from the second stage into a third stage, etc. (Figure 3-4). This process is also referred to as multiple-stage, cascade, pyramidal, or tapered array configuration. Additional pumping is generally not required between stages because of the high concentrate pressure. However, inner stage booster pumps can be used to increase the pressure of the concentrate feed to the second stage to increase permeate production. The number of stages is limited by the raw water characteristics to prevent precipitation of inorganic compounds and deterioration of product water quality. The advantages of reject staging include higher recoveries and lower pumping costs per unit of product. However, the combined product water quality may be slightly lower.

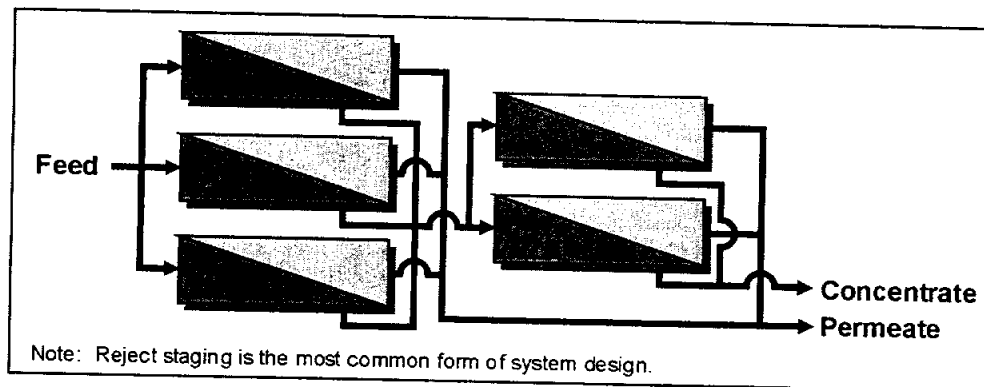

Figure 3-4. Schematic of Reject Staging Pressure Vessel

3.1.2.4 Product Staging

This configuration is typically used for high TDS feedwater, especially seawater, to provide a high quality product at higher recoveries than are possible with the earlier discussed configurations. Product staging is actually two separate membrane processes, with the product water from the first stage being used as feedwater to the second stage. The first stage is designed to produce moderately brackish feedwater to the second stage, allowing the use of low-pressure membranes. Very little pretreatment is necessary because the first stage removes most of the limiting elements allowing high recoveries in the second stage. Concentrate from the second stage may be mixed in with the raw water feed to the first stage to further increase system recovery. Product water from the second stage normally produces a very low TDS permeate

One or more spiral-wound elements are placed inside each pressure vessel in a series arrangement. Pressure vessels typically contain from one to seven membranes and are configured to reduce operational and capital costs while producing the needed volume of product water. Five process configurations for membrane desalination are discussed and schematically presented below:

3.1.2.1 Single Stage

A single pressure vessel is loaded with up to seven 40-inch-long membrane elements. This is the simplest configuration but is limited in production by the capacity of the available membrane assemblies (Figure 3-2).

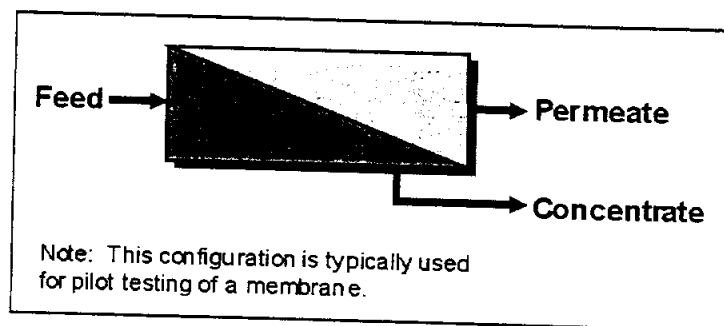

Figure 3-2. Schematic of Single Stage Pressure Vessel

3.1.2.2 Parallel Staging

This configuration will increase overall water production capabilities by increasing the number of pressure vessels. However, water recovery or salt rejection will not change from the single pressure vessel configuration (Figure 3-3).

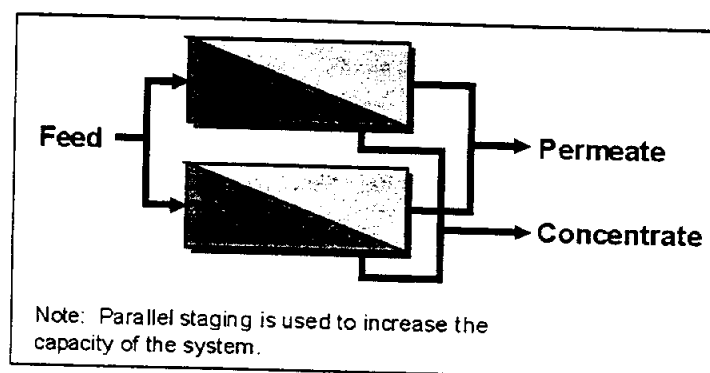

Figure 3-3. Schematic of Parallel Staging Pressure Vessel

which may be blended with the bypassed permeate from the first stage to produce the desired product water TDS levels. Membrane elements are inserted into pressure vessels that are arranged to provide the product water quantity and quality required (Figure 3-5).

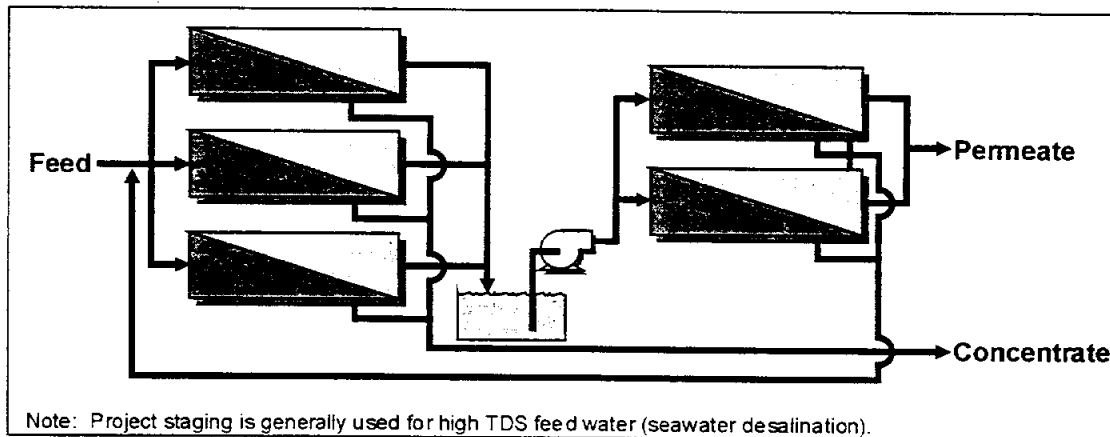

Figure 3-5. Schematic of Product Staging Pressure Vessel

3.1.2.5 Bypassing and Blending

RO is a very effective process for removing TDS from a feedwater. In some circumstances, the product water is of higher quality than is needed by the user. In the treatment of relatively low TOC brackish groundwater, a portion of the feedwater may be bypassed around the membrane process and blended with the permeate stream to create a product water blend of the desired quality. The primary benefit of the bypass and blend arrangement is that it reduces the required size of the membrane system as well as lowering the overall cost of water production. Post-treatment conditioning requirements may be reduced as natural alkalinity and other characteristics of the feedwater buffers the membrane permeate (Figure 3-6).

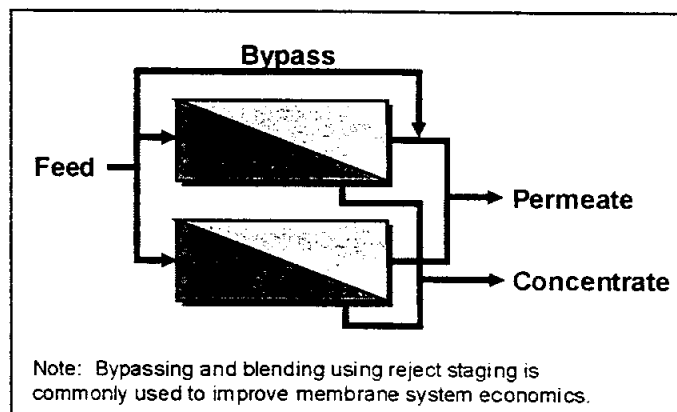

Figure 3-6. Schematic of Bypassing and Blending Pressure Vessel

3.1.2.6 Expansion Capability

Because membrane systems are modular in nature, additional membrane capacity can be easily and economically added to increase treatment capacity once the design criteria is established. Note that the plant infrastructure for the membrane treatment facilities needs to be adequately planned and engineered in the initial installation for the future expansion(s).

3.1.3 Reverse Osmosis Components and Design Considerations

3.1.3.1 Groundwater

The majority of drinking water RO systems operating in the US use groundwater as their source water. However, many RO systems around the world use brackish surface water or seawater. Groundwater sources generally have low turbidity and the primary treatment objective is the removal of TDS. Therefore, typically the only pretreatment required is acid and scale inhibitor addition as well as cartridge filtration.

3.1.3.2 Surface Water

Surface waters require more stringent monitoring than groundwaters because of the variables that can influence pretreatment. Surface waters require more pretreatment due to seasonal variations, which can produce significant levels of suspended solids and biological matter in the source water. For low turbidity surface water sources, in addition to the acid and scale inhibitor addition and cartridge filtration required for pretreatment at the membranes, coagulant addition ahead of media filtration may also be required. In cases where the surface water source has a high turbidity, full conventional treatment (coagulation/flocculation, sedimentation, media filtration) are required before the chemical addition and cartridge filtration.³ Treatment of brackish surface water may be more expensive than treatment of groundwater due to the extensive pretreatment requirements.

3.1.3.3 Components

Figure 3-7 presents a typical RO schematic. RO systems primarily include pretreatment, feedwater pumping, membrane units, post treatment, and a membrane cleaning system.

³ Malcolm Pirnie, Inc., Op. Cit., October 1996 (a).

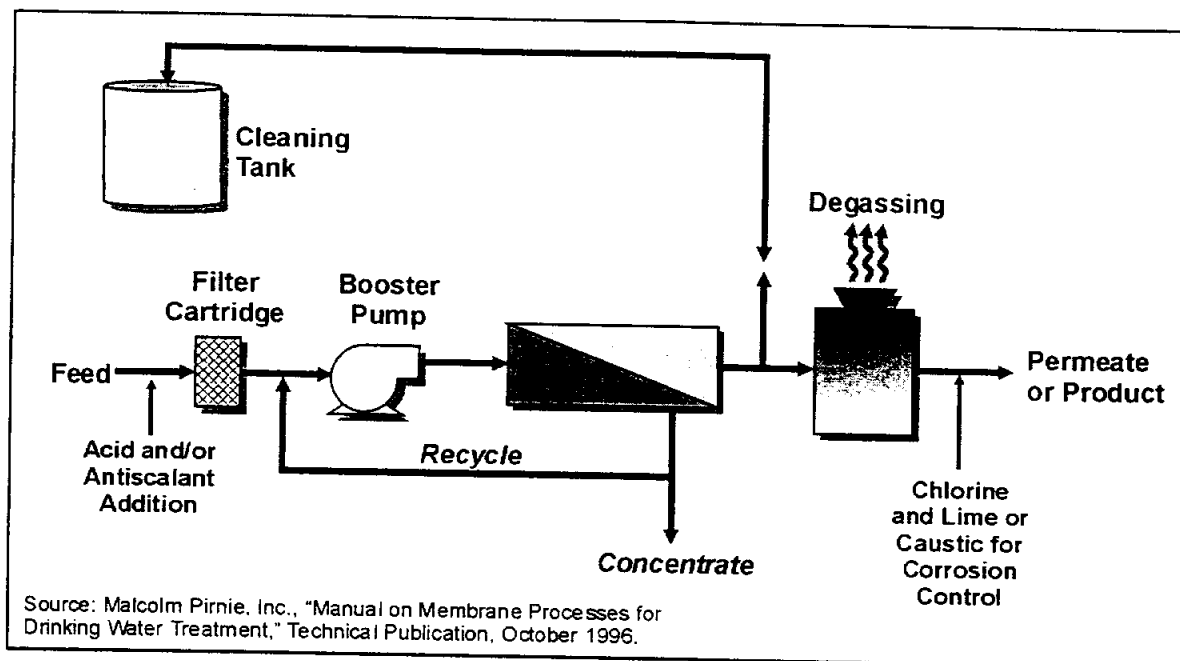

Figure 3-7. Reverse Osmosis Flow Schematic

3.1.3.4 Membrane Treatment Units

The materials required for the non-membrane RO components include: stainless steel piping for the high-pressure feed systems, fiberglass pressure vessels hold the membrane elements, and PVC piping is used for permeate and chemical feed systems.

Membrane elements are inserted into pressure vessels arranged to provide the product water quantity and quality required. The pressure vessel is typically 8 inches in diameter by 24 to 28 feet in length. Feedwater is commonly fed tangentially to the membrane surface with reject staging used to increase product recovery.

During membrane staging, the system needs to be hydraulically and ionically balanced to prevent damage to the membrane elements. Proper design of the hydraulic staging ensures sufficient feedwater flow from the last element of each pressure vessel. The next stage contains fewer (typically half as many) pressure vessels; thereby, returning the feed flow velocity back to acceptable levels. The number of membrane elements in each pressure vessel and stage is controlled by the amount of water lost from the feed flow through permeation (product flow) and desired system recovery. Computer modeling is used to determine the hydraulic staging requirements for a membrane system.

In preparation for the design of RO systems, the following must be considered:

- Source water quality;
- Pretreatment and post-treatment requirements;
- Concentrate residuals disposal;
- Instrumentation/SCADA requirements; and
- Capital and operations and maintenance (O&M) costs.

Each of these design considerations will be discussed in Section 3.3, with the exception of costs, that are discussed in Section 6.

3.2 Electrodialysis and Electrodialysis Reversal

3.2.1 Introduction

Electrodialysis (ED) is an electrochemical separation process in which ions are transferred through anion and cation selective membranes from a less concentrated to a more concentrated solution by application of direct electric current (DC). Electrodialysis reversal (EDR) is an ED process in which the polarity of the electrodes is reversed on a prescribed time cycle (15 to 30 minutes), thus reversing the direction of ion movement in a membrane stack. The purification of water with ED/EDR takes place by the removal of the undesirable ions through the membrane, whereas the purification of water with RO occurs through the selective transport of water through the membrane that rejects the solute (salt). The key to the ED/EDR process is a semi-permeable membrane barrier that allows passage of oppositely charged ions while excluding the passage of ions of the same charge and the passage of water. The semi-permeable barriers are commonly known as ion-exchange or ion-selective membranes.⁴

3.2.2 Materials

An ion-exchange membrane allows the passage or transfer of only certain ions in solution based on ionic charge. The mechanism of operation of an ion-exchange membrane under the influence of an electrical potential is shown in Figure 3-8. The anion-exchange membrane is charged positively and is permeable to negatively charged anions such as chloride, sulfate, etc.

⁴ Ionics, Inc., "Electrodialysis (ED) and Electrodialysis Reversal (EDR) Technology," Floyd H. Meller, ed., 1984.

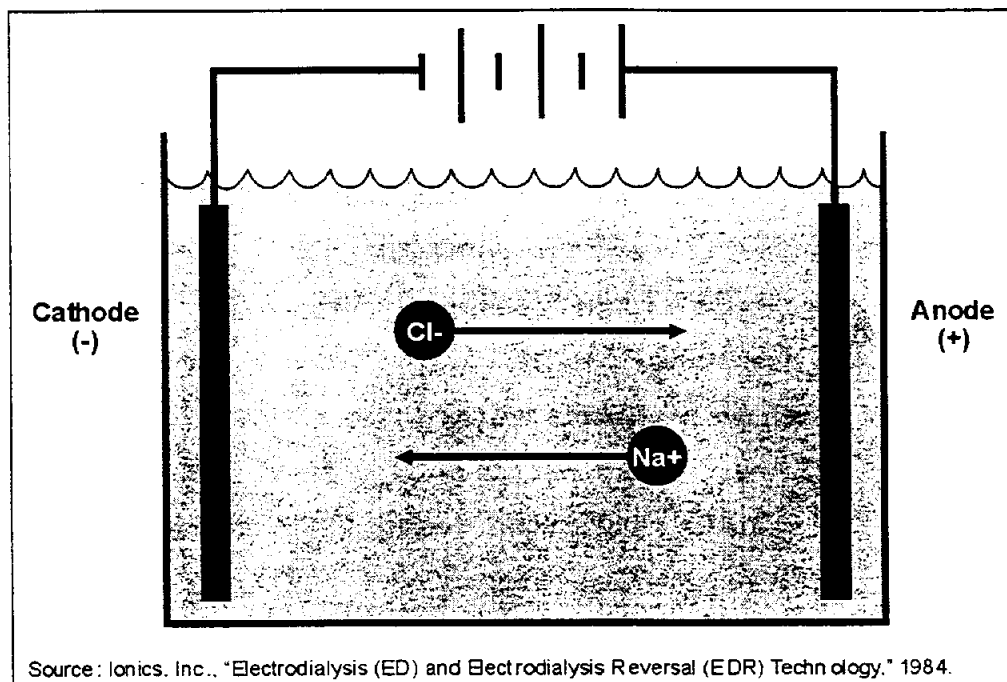

Figure 3-8. Electrical Ion Transfer Cell

The converse is true of a cation-exchange membrane. This selectivity encountered in ion-exchange membranes forms the basis of the ED/EDR process.⁵

3.2.3 Configurations

In the EDR process, the polarity of the electrodes is automatically reversed about three to four times per hour. By means of motor-operated valves, the "product water" or "dilute stream" and "concentrate" outlets from the membrane stack are interchanged. The ions are thus transferred in opposite directions across the membranes. Reversing the direction in which the ions travel aids in breaking up and flushing out scale, slime, and other deposits from the cells. The product water emerging from the previous concentrate cells is usually discharged to waste for a period of 30 seconds to 1 minute, or until the desired water quality is restored.

ED/EDR utilizes a percentage removal basis of operation. Membranes are assembled into "stacks" containing alternating layers of anion and cation exchange membranes. The manner in which the membrane stack array is arranged is called staging. The purpose of staging is to provide sufficient membrane area and retention time to remove a specified fraction of salt

⁵ Ibid.

from the demineralized stream. As a general rule of thumb, 40 to 60 percent of the total dissolved solids are removed per stage. Two types of staging are used, hydraulic staging and electrical staging.

In a stack with one hydraulic and one electrical stage, each increment of water upon entering the stack makes one pass across the membrane surface between one pair of electrodes and exits. It should be noted that in a typical ED/EDR membrane stack, water flows in multiple parallel paths across the membrane surfaces and that a single pass consists of flowing through one water flow spacer between two membranes and exiting through the outlet manifold.

In a sheet flow stack, water enters at one end of the stack and flows as a sheet across the membrane to exit at the other end in a single pass. Therefore, additional hydraulic stages must be incorporated to increase the amount of salt removed in an ED/EDR system.

Electrical staging is accomplished by inserting additional electrode pairs into a membrane stack. This gives flexibility in system design and provides maximum salt removal rates while avoiding polarization (breaking down the water molecule into the hydrogen and hydroxyl ion) and hydraulic pressure limitation. An example of electrical and hydraulic staging is shown in Figure 3-9.

3.2.3.1 Expansion Capability

As discussed with RO, the ED/EDR processes are modular in nature. Therefore, additional capacity can be easily and economically added to increase treatment capacity once the design criteria are established and if infrastructure for the treatment facilities are adequately planned and engineered in the initial installation.

3.2.4 Components and Design Considerations

The principal applications of ED/EDR are in the separation of ionic species from neutral species (water) and the concentration and removal of minerals. The TDS concentration affects the relative economics of ED/EDR more than any other factor. As the TDS increases, more electrical power is required; conversely, as the TDS decreases, less electrical power is required.⁶ Not surprisingly, ED/EDR has been widely used for desalination of brackish water with less than 3,000 mg/L TDS.

⁶ Ibid.

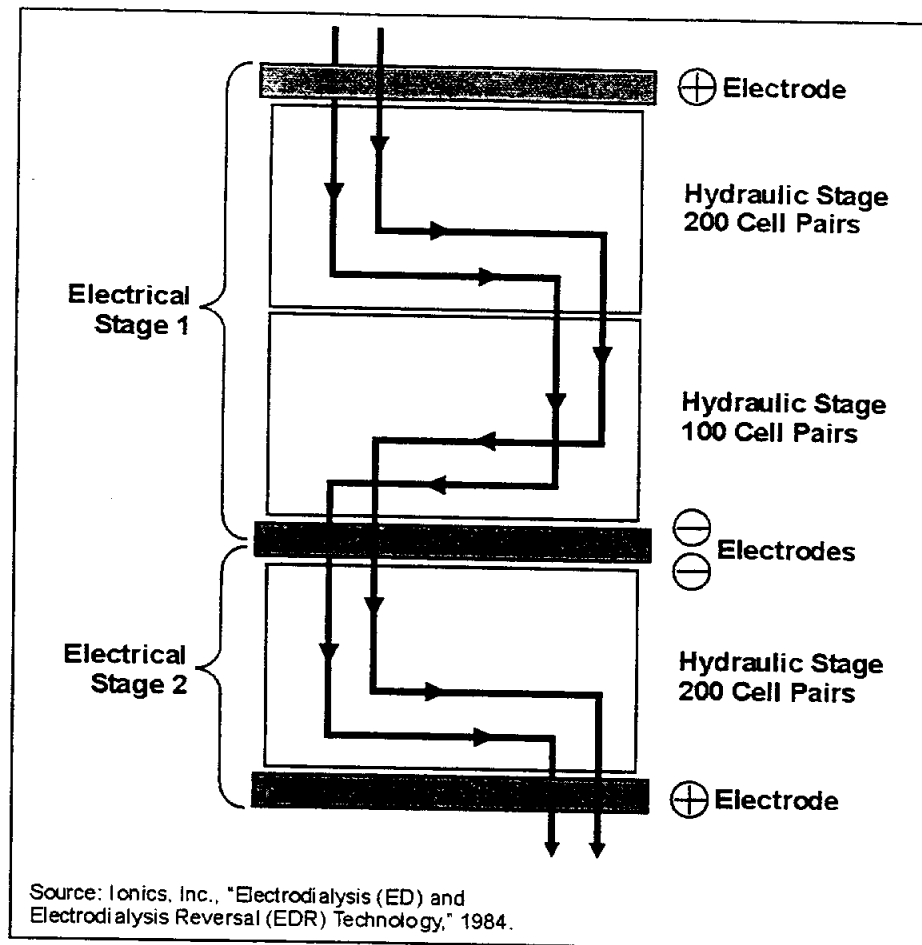

Figure 3-9. Electrodeionization Membrane Stack

In preparation for the design of ED/EDR systems, the following must be considered:

- Source water quality;
- Pretreatment and post treatment requirements;
- Concentrate residuals disposal;
- Instrumentation/SCADA requirements; and
- Capital and O&M costs.

ED/EDR is specifically designed for each application. Factors influencing the design are the quantity and quality of product water desired. The quantity determines the size of the ED/EDR unit, pumps, piping and stack size. The quantity of salt to be removed determines the stack

array.⁷ These design considerations will be discussed in Section 3.3, with the exception of costs, that are discussed in Section 6.

3.2.4.1 Groundwater

The majority of drinking water ED/EDR systems presently in operation utilize groundwater as their source water. Groundwater sources generally have low turbidity and the primary treatment objective is the removal of TDS. Therefore, typically the only pretreatment required is cartridge filtration.

3.2.4.2 Surface Water

Surface waters require more stringent monitoring than groundwaters because of the variables that can influence pretreatment. Surface waters require more pretreatment due to seasonal variations, which can produce significant levels of suspended solids and biological matter in the source water. For low turbidity surface water sources, in addition to cartridge filtration, coagulant addition ahead of media filtration may also be required. In cases where the surface water source has a high turbidity, full conventional treatment (coagulation/flocculation, sedimentation, media filtration) are required before the chemical addition and cartridge filtration.

3.2.4.3 Components

Operation of the ED/EDR process has the same flow limitations as RO. ED/EDR is also set up as a constant flow operation. For groundwater sources, normally a well water pump is designed to provide a flooded suction to a variable speed pump to obtain a feedwater pressure of 70 to 80 psi to transport the water through a 10 μm cartridge filter and through the membrane stacks.^{8,9} Unlike RO membranes, ED/EDR product water does not pass through the membrane, therefore provisions must be made in the pretreatment system to remove unwanted colloids, organics, or microbial pathogens that could be present in the feedwater. A typical ED/EDR treatment system is shown in Figure 3-10.

⁷ Ibid.

⁸ American Water Works Association (AWWA) "Water Quality and Treatment: A Handbook of Community Water Supplies," New York, 4th Edition.

⁹ AWWA and American Society of Civil Engineers, "Water Treatment Plant Design," New York, 3rd Edition.

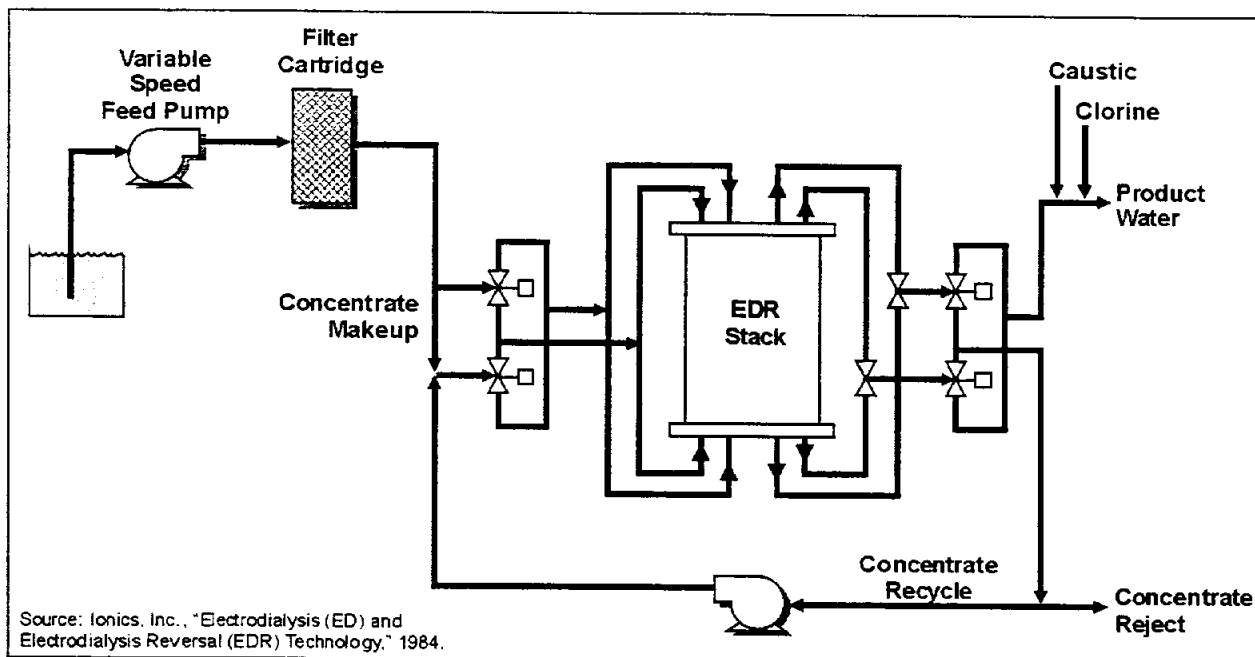

Figure 3-10. Typical EDR Flow Schematic

The EDR pretreatment system is site-specific depending on the feedwater quality. Cartridge filtration is used to protect the membrane system from contaminants that may be present in the feedwater. An ED/EDR system requires periodic chemical cleaning in order to remove foulants that have accumulated on the membrane surface. In some cases disassembly of the membrane stack and scrubbing of the membranes is necessary to remove certain contaminants. Three methods of removing scale and other surface-fouling matter are used in the ED/EDR process: polarity reverse flow, clean-in-place (CIP), and stack disassembly. ED/EDR systems periodically flush an acid solution across the electrodes to prevent scale from depositing on the electrode surface.

ED/EDR is carried out in modules with vertically oriented membranes separated from one another by flow spacers. The module, or cell stack, consists of cell pairs (up to 600) comprising a cation selective membrane, a diluent flow spacer, an anion-selective membrane, and a concentrate flow spacer. In addition to the cell pairs, each stack contains two electrodes and electrode compartments, plumbing necessary to transport water to and from the stack, and hardware necessary to hold the stack together.

The membranes are flat sheets, usually made of a plastic film formed on a fabric backing of dynel, acrylic, or other similar materials to provide strength. Ion transfer sites are added to the membranes with the site charge differing between the anion- and cation-permeable membranes to give each type the characteristics to selectively pass either anions or cations.

The thickness of the membrane sheets is dependent on the application and its selection is a balance between membrane properties. Thicker membranes usually have greater strength, increased erosion resistance, and longer life cycles. Thinner membranes have lower electrical resistance and hence reduced energy requirements.¹⁰

Spacers separate the membranes and provide a pathway in the cell for the water flow. Sheet flow and tortuous path flow are two of the most commonly used designs. Cells are made up of two membranes with a spacer in between. Cells are stacked with alternating concentrate and dilute cells to form a stage. In each stage, the feedwater is exposed only to the electromotive force for the distance of the pathway in one cell (the hydraulic stage). Using the spacer arrangement, more than one hydraulic stage can be placed between a set of electrodes. The number of stacks, stages, and electrodes is determined at the time of design based on site-specific information.

One pair of electrodes is required for each electrical stage. Normally, no more than two electrical stages are present in a single membrane stack whereas a pair of electrodes is needed for each electrical stage. The electrodes are generally constructed of titanium with platinum coating.¹¹

3.2.4.4 Water Recovery

ED/EDR normally achieves a high water recovery by recycling some of the concentrate stream back to the feedwater; thus, resulting in the conservation of water. The volume of concentrate recycled depends on water temperature and chemistry (i.e., the percentage and type of scaling salts in the feedwater). Normally, water recoveries of 80 percent or higher can be obtained without chemical addition to the concentrate stream. Up to 90 percent and higher product water recoveries can be obtained by the addition of antiscalant chemicals to the concentrate stream.

¹⁰ Ionics, Inc., Op. Cit., 1984.

¹¹ Ibid.

3.3 Source Water Quality

The source water quality is an important component of the information required for the RO and ED/EDR design process. Constituents in the source water can cause precipitation, fouling, and scaling of or on the membranes. Following is a list of recommended source water analyses that may be performed before the design of a RO or ED/EDR system:¹²

- Temperature
- pH
- Alkalinity
- Hardness
- Turbidity
- Total Dissolved Solids (TDS)
- Total Suspended Solids (TSS)
- Conductivity
- Silt Density Index (SDI)
- Silica
- Hydrogen Sulfide
- Calcium
- Sodium
- Magnesium
- Potassium
- Strontium
- Ammonium
- Barium
- Iron
- Manganese
- Chloride
- Fluoride
- Sulfate
- Nitrate
- Phosphate
- Carbonate
- Bicarbonate

Based on the components of the source water, the following generalizations about the applicability of RO, specifically with respect to solute rejection of the source water, are:¹³

- Multivalent ions have higher rejection than monovalent ions (e.g., calcium ion is better rejected than the sodium ion).
- Undissociated or poorly dissociated substances have lower rejection (e.g., silica).
- Acids and bases are rejected to a lesser extent than their corresponding salts.
- Co-ions affect the rejection of a particular ion (e.g., sodium is better rejected as sodium sulfate than as sodium chloride).
- Generally, low molecular weight organic acids are poorly rejected.
- Undissociated low molecular weight organic acids are poorly rejected and their salts are well rejected.
- Trace quantities of monovalent ions are generally poorly rejected.
- The membrane process does not remove dissolved gasses (carbon dioxide and hydrogen sulfide).

¹² AWWA, Op. Cit., 4th Edition.

¹³ James Montgomery Consulting Engineers, Inc., Op. Cit., 1985.

During normal operation over a period of time, RO membrane elements are subject to fouling by suspended or sparingly soluble materials that may be present in the source water. Common examples of such foulants are calcium carbonate scale, calcium sulfate scale, metal oxides scale, silica coating, and organic or biological deposits.

For ED/EDR processes, the following generalizations can be made regarding the quality of the source water:¹⁴

- Each hydraulic stage is capable of removing approximately 50 percent of the dissolved solids. Therefore, when specific constituents (e.g., silica, nitrate, or fluoride) are present in groundwater and require removal ED/EDR is an ideal application;
- ED/EDR does not remove organic carbon from a source water; and
- ED/EDR is not a microbial barrier to viruses or other pathogenic microorganisms.

The indicators of saturation levels of sparingly soluble salts in the concentrate stream for both RO and ED/EDR processes are the Langelier Saturation Index (LSI) and the saturation ratios. The LSI provides an indication of the calcium carbonate saturation. Negative values of LSI indicate that the water is undersaturated and that it will have a tendency to dissolve calcium carbonate. Positive values of LSI indicate the possibility of calcium carbonate precipitation. Langelier originally developed the LSI for low-salinity potable water. For high-salinity water encountered in RO applications, the LSI is an approximate indicator only.

The saturation ratio is the ratio of the product of the actual concentration of the ions in the concentrate stream to the theoretical solubilities of the salts at given conditions of temperature and ionic strength. These ratios are applicable mainly to sparingly soluble sulfates of calcium, barium, and strontium.

For RO membrane systems, silica could be also a potential scale forming constituent. A silica coating not associated with either metal hydroxides or organic matter will usually respond only to very specialized cleaning methods.¹⁵

Related to source water quality, groundwater hydrogeology is an essential aspect to investigate when groundwater is the water source. In locating wells, especially in coastal areas, it is important to place them at depths whereas to avoid saltwater intrusion into the brackish water region of the groundwater due to well field withdrawals. For an RO or ED/EDR system

¹⁴ Malcolm Pirnie, Inc., Op. Cit., October 1996 (a).

¹⁵ Hydranautics, Hydranautics RO Projection Program.

with a groundwater source that has infiltration of highly saline water into the brackish water zone, productivity of the system is decreased due to the increased TDS concentrations.

3.4 Pretreatment

After an analysis of feedwater quality and selection of the membrane type and design criteria, the most applicable pretreatment technique(s) can be applied. Adequate pretreatment is an important component of RO and ED/EDR processes; lack of pretreatment can lead to reduced productivity and fouling of the membranes. Pretreatment is used to prevent the membranes from plugging, fouling, and scaling, maximize the cleaning interval, and prolong the life of the membranes.

Iron and manganese can be problematic for some systems. If elevated levels of iron or manganese are present in the groundwater, greensand filtration can be used to remove these contaminants. However, the design and operation of these facilities is more complex because of the use of oxidants prior to the membrane system.¹⁶

Acid, if required to reduce the feedwater pH, and a scale inhibitor are commonly added to feedwater as it enters the membrane system. Both processes serve to increase the solubility of feedwater constituents and increase system recovery. Cartridge filters are used to remove particles greater than 10 microns in size that may foul the feedwater channels of the membrane module. The pressure drop across a clean cartridge is 3 to 5 psi, and the pressure drop across a soiled cartridge is 15 to 30 psi. Residual pressure from the cartridge filter should be monitored prior to the high-pressure pump.

Low-pressure membranes (i.e., microfiltration and/or ultrafiltration) have become increasing popular for the pretreatment of water prior to reverse osmosis membranes, in integrated membrane systems. The primary advantage of this treatment approach is the low-pressure membrane process removes contaminants that may pass through conventional treatment processes and then foul RO membrane processes. This is particularly true of conventional treatment processes that historically have used alum as a coagulant. Alum (aluminum) has been identified as a constituent that can degrade RO membranes. The use of integrated membrane systems is prevalent in advanced wastewater treatment applications. Low-pressure membranes

¹⁶ O'Connell, Jack and Savas Danos, "An Innovative Combination of Ozonation and Ultrafiltration," Proceedings from the 1997 AWWA Membrane Technology Conference, 1997.

have recently been used to replace the lime softening process historically used in the treatment of wastewater for indirect potable reuse.

3.5 Post Treatment

For RO systems, addition of an acid to the feedwater increases the concentration of carbon dioxide as alkalinity is converted. After treatment, the permeate may contain excessive carbon dioxide, resulting in a low pH water. Degasification may be needed to remove the excess carbon dioxide, thereby increasing the pH and stabilizing the water. Degasification is also used to remove hydrogen sulfide that is present in many groundwaters. Degasification is accomplished using tray aerators, air-strippers, or packed towers. Caustic, limestone, or lime can be added to further elevate the pH and buffer the water. Chlorine, for disinfection, and corrosion inhibitor are generally added after the RO and ED/EDR systems.¹⁷

3.6 Concentrate Disposal

The method of concentrate disposal has become one of the defining factors in the decision to implement a RO or ED/EDR system. It is important to remember that the concentrate stream is typically 10 to 25 percent of the feedwater flow for brackish waters and greater for seawater desalination. Therefore, a significant volume of concentrate requires disposal.

The classification of concentrate streams as industrial wastewaters and existing toxicity standards have created severe problems in the permitting of surface water discharges of the concentrate. Often, the concentrate streams require point source discharge permits under Federal regulations (NPDES) and are also subject to State and/or local regulations.

There are various innovative methods of disposing of the concentrate stream (e.g., combining concentrate with wastewater effluent and then using as spray irrigation for a golf course), yet the most common practices for concentrate disposal include:

- Discharging to a wastewater treatment plant (WWTP);
- Discharging with stormwater;
- Discharging to a saline surface water (e.g., ocean outfall);
- Evaporation by either thermal or solar application;
- Spray irrigation; and

¹⁷ AWWA, Op. Cit., 4th Edition.

Section 4

Operations and Maintenance

Water treatment processes for desalination, RO and ED/EDR, have special operation, monitoring, and maintenance requirements that differ from procedures used in conventional water treatment. In this chapter, general guidelines and common procedures are presented. Note that this information should not be used as a substitute for specific manufacturer's instructions.

The most common problems with membrane systems is fouling by suspended particles or microorganisms in the water and scaling. Both fouling and scaling reduces water flow through a given area of the membranes. Fouling is typically caused by particles on or embedded in the membrane or feed channel spaces that increases the resistance to the flow of water. The particles could be either biological (bacteria) or nonbiological (colloids, silt, or clay) that adhere to or become embedded in the membrane. Scaling is caused by the concentration of an inorganic salt or dissolved mineral to a level higher than its saturation point. When the inorganic salt dissolved mineral concentration is higher than its saturation point, it will precipitate and deposit in or on the membrane or flow channels. As the membranes foul or scale, permeate flow is reduced, permeate quality may be affected adversely, and the pressure drop across the membranes (or pressure vessel) increases. Therefore, it is very important to monitor the operation of a membrane system to determine when it should be cleaned or maintained to produce the most and best quality permeate flow possible.

4.1 System Monitoring

It is essential to monitor all the processes within the treatment facility to prevent the fouling and scaling of the membranes and, if they begin to foul, identify the problem early when it can be easily reversed and/or fixed. Treating the feedwater to reduce the suspended particles will protect the membranes to reduce fouling and scaling. The feedwater fouling potential is measured by the turbidity and silt density of the water. The conductivity and temperature of the water and the saturation levels of specific scaling compounds provides an indication of the scaling potential of the feedwater. In addition, the membrane material may have some specific tolerances for oxidants (i.e., chlorine or ozone) that can be present in the feedwater. Therefore, the turbidity, conductivity, temperature, and oxidation reduction potential of the feedwater to the membranes should be monitored on a continuous for membrane protection. On a daily basis, the

silt density, alkalinity, pH, and concentration of various dissolved ions, such as barium, calcium, and sulfates, should be determined to check the on-line instrumentation and verify the fouling and scaling potentials of the feedwater.

As the feedwater is monitored to provide the best quality possible to the membranes, the membrane system needs to be monitored also to determine that it is operating efficiently and producing high quality permeate. All membrane systems are designed to produce a specific permeate flow so that the salts in the concentrate do not reach saturation or scale forming levels. Based on the design parameters of the membrane, flowmeters should be installed on the feedwater, permeate, and concentrate streams to determine the recovery of the system. Likewise, there are two pressures to monitor that are critical to the operation of the membrane system – feedwater and permeate. With these pressures, the transmembrane pressure can be determined. An increase in the transmembrane pressure is an indication of fouling or scaling of the membranes.

Since the ED/EDR process is driven by an electrical gradient, not a pressure gradient, there are different techniques required to monitor the membranes. Typically, the voltage difference over a set distance (usually one inch) is measured over the entire height of the membrane stack. If the voltage difference is higher in one area than another, it indicates potential problems with membrane stack fouling or scaling. If a substantial area is fouled or scaled, then the stacks should be cleaned.

By monitoring the membrane system, membrane performance can be determined on a regular basis – daily, weekly, or monthly. Typically, there are three performance parameters that should be calculated to determine when the membranes should be cleaned. These three parameters are percent salt rejection, normalized permeate flow, and pressure drop. If one of these parameters falls outside acceptable limits, then the membranes should be cleaned.

4.2 Cleaning Systems

If the membranes become fouled or scaled, they must be cleaned to remove the fouling material to return the system to proper operating condition. The chemicals used in cleaning must be compatible with the membranes and the materials of construction for the pressure vessels, piping, valves, etc. The membrane manufacturer should recommend the cleaning solutions and methods to be used with their particular membranes. RO membranes are not removed from the

pressure vessels that they are housed in, but are cleaned in place. Thus the name for the cleaning cycle, "Clean-in-Place" or "CIP." However, it may be necessary to remove EDR membranes for cleaning.

Since there are different causes for fouling and scaling, the membranes may require different types of cleanings. Generally, detergents and surfactants are used to remove particles and dissolved organic matter from and within the membranes. An acid solution with a chelator is used to remove the scale formed in the membrane system. Due to the nature of the cleaning solutions, the cleaning of the membranes is typically performed in two separate steps or processes.

Cleaning systems usually consist of a non-corrosive material (e.g., stainless steel or fiberglass) pump, a fiberglass or polypropylene mixing tank, a 1.0 to 5.0 micron cartridge filter, non-corrosive piping, valves, hoses, and controls.¹ Periodically, (every 3 months to 2 years, with an average of 6 months) chemical cleaning (with an acid/base detergent) of the membrane system is needed to remove contaminants that can accumulate and foul the membrane surface. Cleaning more than once a month suggests inadequate pretreatment, a poorly designed system, or a changing feedwater quality. The chemical solution is circulated through the membrane system for a period of time (1 to 4 hours) in order to dissolve contaminants present.² After circulation, the membranes can be soaked in the solution for 1 to 12 hours. After soaking, the circulation of the cleaning solution is resumed to remove all contaminants from the membrane system. Once the membranes are cleaned, the system is flushed with feedwater for some time, possibly up to an hour. During this time, both permeate and concentrate are discharged to waste, because the permeate is not of acceptable quality. After cleaning the membranes, the cleaning solution should be checked to determine whether it is still acceptable. If not, the cleaning solution is properly disposed of and replaced for the next cleaning cycle.

4.3 Module Integrity

Although reverse osmosis membranes were originally developed for the removal of dissolved salts and minerals, they will also remove pathogenic microorganisms found in most

¹ American Water Works Association (AWWA), "Water Quality and Treatment: A Handbook of Community Water Supplies," New York, 4th Edition.

² Malcolm Pirnie, Inc., "Manual on Membrane Processes for Drinking Water Treatment," Technical Publication, October 1996 (a).

water supplies. However, various operational events can occur (e.g., O-ring leaks) that can compromise the integrity of the membrane system. Therefore, tests are performed on a periodic basis to ensure the integrity of the membrane and the system as a whole. Continuous online measurement of permeate conductivity, in conjunction with vessel probing (checking the performance of each element in a pressure vessel), has historically been used as the indicator for membrane module and system integrity.

From a historical perspective, disinfecting the permeate of the membranes has provided the requisite level of microbial inactivation needed for the production of drinking water. Thus, the microbial removal efficiency of a membrane system was not an appropriate concern. Recent work conducted on wastewater has provided insight to the removal efficiency of RO membranes on waterborne pathogens including *Giardia*, *Cryptosporidium*, Coliform bacteria and viruses.³ Research has indicated that RO membranes can attain complete removal of *Giardia* and *Cryptosporidium* at challenge levels in excess of 6-log, and virus removal of greater than 4-log. Recent research has provided a method of viably enumerating bacteriophages to be used in testing membrane integrity.⁴

Vacuum integrity testing, TOC monitoring⁵ and particle counting⁶ have also been investigated and proposed as methodologies to assess membrane system integrity through higher levels of detection, although these methods are generally not used in the evaluation of membrane systems for drinking water production.

As stated earlier, ED/EDR systems do not act as microbial barriers because the feed water does not pass through the membrane. Therefore, "module integrity" is not a significant concern for the ED/EDR process.

³ Gagliardo, Paul, Samer Adham, and Rhodes Trussel, "Water Repurification Using Reverse Osmosis: Thin Film Composite vs. Cellulose Acetate Membranes," Proceedings from 1997 AWWA Membrane Technology Conference, 1997.

⁴ Gagliardo, Paul, Samer Adham, and Yelidiz Chambers, "Development of an Innovative Method to Monitor the Integrity of a Membrane Water Repurification System," Proceedings from 1999 AWWA Membrane Technology Conference, 1999.

⁵ Kruithof, Joop, et al., "Disinfection by Integrated Membrane Systems for Surface Water Treatment," Proceedings from 1999 AWWA Membrane Technology Conference, 1999.

⁶ Gagliardo, Paul, Samer Adham, and Rhodes Trussel, Op. Cit., 1997.

Section 5

Concentrate Production and Disposal

In the production of desalinated water from brackish or seawater sources there is a byproduct produced known as concentrate (more often referred to as brine). The term concentrate is a much clearer depiction of the discharge, since the process of desalination separates the purer product water from the source water constituents and concentrates the separated materials in the discharge. The chemical composition of concentrate generated by a desalination process will vary widely according to the quality of the source water and the desalination process employed to produce the product water. In any case, the concentrate discharge will require an environmentally acceptable disposal method that will meet the regulatory requirements from several regulatory agencies, depending upon the concentrate disposal method employed. This section will discuss the nature of desalination concentrate, federal and state regulatory requirements to permit a discharge, and available disposal options.

5.1 Concentrate Prediction

In the design of a desalination facility, the ability to estimate the quality and quantity of the projected process concentrate stream is key to the selection of the preferred disposal process and subsequent regulatory permitting. Understanding the parameters that will be found in the concentrate discharge will allow the plant designer to predict the ability for the plant's discharge to meet state and federal discharge requirements. The disposal process selected, based in part upon the characteristics of the concentrate, will be a major element for the overall cost of the desalination process.

The most accurate method of predicting the quality of the discharge is to perform pilot tests with the actual source water and the chosen desalination process. This is often accomplished with assistance from the manufacturer that can provide bench scale or skid-mounted desalination process units for the pilot plant process. In most cases, RO membrane manufacturers will provide information for the prediction of concentrate quality and quantity under given flow scenarios, but this information is subjective and should not be relied upon for regulatory permitting purposes.

Desalination processes will yield a different quality concentrate due to the nature of each process that is designed to accomplish a specific task in terms of water treatment. The

desalination processes that are most likely to be employed in Texas include membrane softening, RO, or EDR. A process such as EDR is designed to be ion-specific in the removal process and therefore will create a concentrate unlike an RO process for the same feedwater.

For comparison of predicted concentrate quality to actual plant data, there is an abundance of information for brackish RO and EDR facilities, but seawater concentrate data are very limited. This is mainly due the fact that most seawater systems are located outside of the United States, where regulatory recordkeeping is generally not required. In addition, plant operators outside the United States generally do not monitor concentrate water quality—only quantity—to determine rejects ratios and plant efficiency.

In review of some recorded concentrate data, a general comparison can be made between the expected quality of concentrate by process. However, as previously stated, concentrate composition—even between like processes—are not directly comparable due to a series of variables, including raw water quality, system yield, pretreatment procedures, and process components (e.g., membranes). The following information is offered to show the general relationship between raw water quality and the resulting concentrate quality by a variety of desalination processes.

5.1.1 Membrane Softening

Membrane softening plants tend to operate at recoveries that exceed 80 percent, due to the low TDS composition of the raw water. Considering that the purpose of such a plant is to reduce the alkalinity associated with low TDS source water, the observed predominant ion species in the concentrate will be calcium, bicarbonate, and sulfate. The prediction of concentrate quality from a membrane softening plant is so unique to the source water and selected membrane that the best estimation process involves a modeling prediction by the membrane manufacturer and the specific source water and product water goals. Tables 5-1 and 5-2 provide concentrate quality information for two full-scale membrane softening plants.

5.1.2 Brackish Water Reverse Osmosis

The overwhelming majority of desalination facilities in the United States are brackish RO facilities. With the development of scale inhibitors and more efficient membrane designs, the overall recovery of the RO process has increased and therefore the characteristics of the

Table 5-1.
Dunedin, Florida
Membrane Softening Plant

Component	Raw (mg/L)	Concentrate (mg/L)
Iron	0.50	0.41
Sulfate	26	1,200
Chloride	120	220
Fluoride	0.15	0.17
TDS	460	2,140

Table 5-2.
City of Fort Meyers, Florida
Membrane Softening Plant

Component	Raw (mg/L)	Feed (mg/L)	Concentrate (mg/L)
Calcium	80	80	618
Magnesium	12	12	93
Sodium	50	50	153
Potassium	4	4	10
Strontium	0.50	0.50	3.90
Barium	0.05	0.05	0.40
Bicarbonate	244	111	548
Sulfate	20	125	1,092
Chloride	70	70	211
Fluoride	0.00	0.00	0.00
Silica	5	5	10
TDS	364	402	2,466

Source: Watson, Ian C., "Characterization of Desalting Concentrates," Seminar: Disposal of Concentrate from Brackish Water Desalting Plants, Palm Beach Gardens, Florida, November 18, 1988.

concentrate have also changed. More efficient membranes have resulted in rejection rates that produce a concentrate consisting of higher levels of ions and carbonates. The data in Table 5-3 illustrates the relationship between RO concentrate characteristics and salt rejection efficiency.

**Table 5-3.
Brackish Reverse Osmosis Process Comparison**

Component	Raw (mg/L)	Case 1 (mg/L)	Case 2 (mg/L)	Case 3 (mg/L)	Case 4 (mg/L)
Calcium	60	237.3	393.2	238.6	396.5
Magnesium	76	300.6	498.1	302.2	502.2
Sodium	314	1,112.6	1,755.5	1,181.6	1,916.3
Potassium	11	37.6	58.4	40.7	65.4
Strontium	10	39.5	65.5	39.8	66.1
Barium	0.02	0.08	0.11	0.08	0.11
Bicarbonate	109.9	421.2	688.6	430.2	709.9
Sulfate	338.2	1,348.6	2,243.4	1,350.3	2,248.3
Chloride	543	1,945.4	3,086	2,055	3,340.4
Fluoride	2	6.7	10.2	7.3	11.7
Silica	19	60.4	90.7	67.7	107.2
TDS	1483.1	5,509.8	8,889.7	5,713.6	9,364.2
Case 1: Yield = 75 percent, Salt Rejection = 96 percent Case 2: Yield = 85 percent, Salt Rejection = 96 percent Case 3: Yield = 75 percent, Salt Rejection = 98 percent Case 4: Yield = 85 percent, Salt Rejection = 98 percent					

From the data presented in Table 5-3, it is evident that an increase in salt rejection will result in an increase in concentrate chloride and TDS concentrations.

- General Formula for Reverse Osmosis Concentrate Prediction:
 - The concentration factor for RO systems is based on a 100 percent salt rejection factor to yield a conservative result for prediction purposes.

$$\text{Concentration Factor (CF)} = 1/(1-Y)$$

Example: RO System Projected Recovery = 85 percent
 CF = 1/(1-0.85)
 CF = 6.67

<u>Ex. - Raw Water</u>	<u>CF</u>	<u>Ex. - Predicted Concentrate</u>
70 mg/L Ca	X 6.67	467 mg/L Ca
500 mg/L Cl	X 6.67	3,335 mg/L Cl

Ion to ion, this equation provides a very conservative result since no membrane has 100 percent salt rejection and there are variations in rejection.¹

5.1.3 Electrodialysis Reversal

The EDR process is designed to have a higher product water recovery than RO, which is an economic tradeoff to the higher operating cost. It is also a characteristic that monovalent ions are separated more efficiently than divalent, so that the concentrate from an EDR system will tend to be somewhat higher proportionally in sodium chloride than that from an equivalent RO system.²

There is no method to accurately predict the concentration of an EDR process concentrate other than through actual system design by the engineer. Each EDR system is designed to produce a specific water quality depending upon factors such as raw water quality, customer quality requirements, and cost limitations. Presented in Table 5-4 is data from an EDR system that was designed to treat a raw water source containing high levels of sulfate and calcium.

Table 5-4.
Sarasota County, Florida
Carlton EDR Water Treatment Facility¹

Component	Raw (mg/L)	Concentrate (mg/L)
Calcium	492	761
Sulfate	817	3,142
Chloride	84	434
TDS	1,607	5,032
¹ Plant operating at 85 percent yield.		

The comparison of a RO concentrate to an EDR concentrate at equivalent yields illustrates the generally uniform ratio of removal by the RO process and ion specific removal emphasis by the EDR process (Table 5-5).

¹ Watson, Ian C., "Characterization of Desalting Concentrates," Seminar: Disposal of Concentrate from Brackish Water Desalting Plants, Palm Beach Gardens, Florida, November 18, 1988.

² Ibid.

Table 5-5.
Comparison of Reverse Osmosis and EDR Concentrate

Component	Raw (mg/L)	Case 1 (mg/L)	Case 2 (mg/L)	Case 3 (mg/L)
Calcium	60	389	4,630	1,406
Magnesium	76	493	526	1,704
Sodium	314	1,868	2,014	6,399
Potassium	11	64	75	244
Strontium	10	64.90	68	223
Barium	0.02	0.13	0.12	4
Bicarbonate	227	729	1,227	3,707
Sulfate	246	2,180	1,735	5,647
Chloride	543	3,258	3,767	12,220
Fluoride	2	13	10.20	27
Silica	19	91	19	19
TDS	1,508	8,785	9,851	31,570
Case 1: RO at 85 percent Y, acidified feed				
Case 2: EDR at 85 percent Y, no chemical addition				
Case 3: EDR at max. Y, scale inhibitor added				

Source: Watson, Ian C., "Characterization of Desalting Concentrates," Seminar: Disposal of Concentrate from Brackish Water Desalting Plants, Palm Beach Gardens, Florida, November 18, 1988.

5.1.4 Seawater Reverse Osmosis

The process of desalinating seawater to potable water involves the production of a characteristically different concentrate than produced in the brackish water RO process. In addition to the obvious difference of raw water salinity concentration, the process of seawater desalination will produce a lower product yield and may require a pretreatment chemical additive(s) to effectively treat the raw water. All of these differences will result in a concentrate that is more difficult to dispose than a brackish RO concentrate.

There is very little published data available to evaluate the concentrate composition for an operating seawater desalination facility. Most seawater desalination facilities in the world do not have a regulated discharge and therefore data is not maintained or not published.

The requirement for high salt rejection and the higher than normal osmotic pressure limit seawater RO systems to 35 to 50 percent recoveries. Therefore, the chemical concentrations in the concentrate are generally 50 to 100 percent greater than the chemical concentrations in the

raw water. The formula for the Concentration Factor, previously mentioned for brackish RO systems, would apply for seawater RO as well.

- General Formula for Reverse Osmosis Concentrate Prediction:
 - The concentration factor for RO systems is based on a 100 percent salt rejection factor to yield a conservative result for prediction purposes.

$$\text{Concentration Factor (CF)} = 1/(1-Y)$$

Example: Seawater RO System Projected Recovery = 50 percent
 CF = 1/(1-0.50)
 CF = 2.00

<u>Ex. - Raw Water</u>	<u>CF</u>	<u>Ex. - Predicted Concentrate</u>
400 mg/L Ca	X 2.00	800 mg/L Ca
32,000 mg/L Cl	X 2.00	64,000 mg/L Cl

Since no membrane has 100 percent salt rejection, and there is a variation in rejection rates, ion to ion, this provides a conservative result. Table 5-6 provides raw water and concentrate quality information for an active seawater RO desalination plant in Antigua, West Indies. More information on this facility and its concentrate discharge is provided in Section 5.3.2.

Table 5-6.
Seawater and Concentrate Water Chemistry Analysis
Antigua, West Indies

Component	Seawater (mg/L)	Concentrate (mg/L)
Calcium	377	712
Magnesium	1,324	2,270
Sodium	11,110	19,460
Potassium	417	733
Bicarbonate	1,324	2,270
Sulfate	2,852	5,195
Chloride	20,140	35,800
Fluoride	0.729	0.855
Silica	<0.1	<0.1
Recovery 45 to 50 percent		
Production capacity 1.32 MGD		

Source: Southwest Florida Water Management District, "Effects of the Disposal of Seawater Desalination Discharges on Near Shore Benthic Communities," Draft Document, 5-123 pp., 1998.

5.2 State and Federal Requirements

It should be noted that large-scale desalination facilities do not currently exist in the State of Texas. Therefore, codified standards geared specifically towards concentrate disposal from a desalination facility have not been developed. With no large-scale industrial desalination facilities currently disposing of concentrate within Texas, and, in turn, no defined standards for concentrate disposal, potential state and federal requirements can only be inferred. This section describes the potential state and federal regulatory issues that may be involved in the disposal of concentrate from a desalination facility in the State of Texas. Emphasis will be placed on the required permits, codified rules, and the regulatory considerations that may be involved in the disposal of concentrate by means of surface water discharge, land application, and deep well injection.

5.2.1 Surface Water Discharge

Compliance with all federal and state regulations involving industrial wastewater disposal of concentrate into waters within the State of Texas can be accomplished through the acquisition of a Texas Pollution Discharge Elimination System (TPDES) permit. The TPDES program is the state program for issuing, amending, terminating, monitoring, and enforcing permits for point and non-point (e.g., storm water) source discharges into waters of Texas.

In essence, this 5-year permit translates the general requirements of the Clean Water Act, Code of Federal Regulations, Texas Water Code, and Texas Administrative Code into specific provisions tailored to the operations of each facility discharging pollutants.

5.2.1.1 Federal and State Agencies Involved in Permitting

Under previous permitting systems, the U.S. Environmental Protection Agency (EPA) authorized discharges of pollutants into waters of the U.S. under Section 402 the federal Clean Water Act. Likewise, the TNRCC authorized discharges of pollutants specifically into waters of Texas under Chapter 26 of the Texas Water Code (TWC). Until September 1998, all such discharges into waters in the State of Texas required separate permits from both the EPA and TNRCC.

The National Pollutant Discharge Elimination System (NPDES) is the federal program used to control the point source discharge of pollutants into waters of the United States. On

September 14, 1998, EPA authorized TNRCC to implement the TPDES program, the state program now used to carry out the federal NPDES program within Texas. The Wastewater Permits Section of the Water Quality Division within TNRCC has received the responsibility to administer, issue, and enforce pending and future industrial wastewater disposal permits and applications.

Involvement of EPA with the TPDES permitting program is now limited to administrative oversight responsibilities within the permitting process. A copy of the application and draft permit may be sent to EPA Region 6 for a 45-day comment period. If no comments are received and an additional 45-day extension is not requested, the permitting process continues. The decision to review a permit application or drafted permit is determined on a case-by-case basis. A decision on whether or not to review a permit for concentrate discharge would be based on factors including geographic area, raw water quality, pretreatment procedures, process components, and predicted concentrate quality. If it was determined that any of these parameters posed an environmental and/or health risk, the EPA would review the draft permit.

Aside from the primary oversight of EPA, various other federal, state, and local agencies may review a draft permit by request. The following organizations may be sent permit applications and draft permits for surface water discharge of concentrate depending on the nature and geographic location of the discharge:

- U.S. Fish and Wildlife Service;
- U.S. Army Corps of Engineers;
- Texas Water Development Board;
- Texas Coastal Coordination Council;
- Texas Parks and Wildlife Department;
- Association of State Drinking Water Administrators;
- River Authorities;
- Rio Grande Assessment of Water Quality;
- Water Control and Improvement District;
- Office of Compliance and Enforcement;
- Public Interest Council;
- Corpus Christi Bay National Estuary Program;
- Galveston Bay Estuary Program;
- Galveston County Pollution Control Department;
- Texas Environmental Awareness Network; and
- City and County Planning Commissions, City Councils, and Boards of Supervisors.

Although these organizations have no permitting authority, any agency can request a hearing to argue technical and/or administrative reasons for opposing a permit. Their input may have significant influence over the decision of TNRCC to issue a permit.

5.2.1.2 Rules Commonly Considered in TPDES Permitting

This section shows a breakdown of the federal and state rules typically incorporated into a TPDES permit.

- **Title 40 Code of Federal Regulations (CFR)**

- Part: 125 - Technology-based Standards

- 129 - Toxic Pollutants Standards

- 130 - Water Quality Management Plans

- 131 - Water Quality Based Standards

- 136 - Test Procedures for Analysis of Pollutants

- **Title 30 Texas Administrative Code (TAC)**

- Procedural Issues

- Chapter: 7 - Memoranda of Understanding

- 39 - Public Notice

- 50 - Action on Application

- 55 - Request for Contested Case Hearings

- 281 - Applications Processing

- 305 - Consolidated Permits

- Technical Issues

- Chapter: 213 - Edwards Aquifer

- 307 - Texas Surface Water Quality Standards

- 308 - Criteria and Standards for NPDES

- 311 - Watershed Protection

- 314 - Toxic Pollutant Effluent Standards

- 315 - General Pretreatment Regulations

- 319 - General Regulations Incorporated into Permits

- Additional Federal and State Regulatory Considerations
 - EPA Toxic criteria documents
 - EPA *Permit Writer's Guide to Water Quality Based Permitting*
 - State of Texas Water Quality Inventory (305b Report)
 - EPA *Technical Support Document for Water Quality-Based Toxins Control*

5.2.1.3 Chapter 307, Texas Surface Water Quality Standards: Specific Regulatory Issues

The most pertinent regulatory tool for guiding regulators through the technical aspects of the industrial wastewater permitting process is Chapter 307, Texas Surface Water Quality Standards (TSWQS). This section examines the specific regulatory issues and requirements described in the TSWQS that are commonly considered in permitting.

- **General Criteria**

The general surface water criteria described in the TSWQS apply to all surface waters in the State of Texas unless otherwise exempted by site-specific water quality standards. The general parameters regulated in the TSWQS that are considered in a TPDES permit could include aesthetics, temperature, salinity, and toxicity.

It is required by TNRCC that all surface waters of Texas be maintained in an “aesthetically attractive” condition. This means that concentrate discharged into a water body must not interfere with the taste and odor of the receiving water along with the food fish and shellfish living in the water. Concentrate discharge must not cause persistent foaming or frothing, or alter ambient conditions of turbidity or color within the receiving water. Finally, a concentrate discharge must not result in the existence of suspended solids that may adversely effect aquatic life or settleable solids that may in any way alter the flow of receiving waters.

TNRCC requires that temperatures in all waters of the state be maintained “so as not to interfere with the reasonable use of such waters”. This means that concentrate discharges from a desalination plant must not alter the receiving water temperature in excess of established maximum temperature differentials. In gulf waters, bays, and tidal river reaches, this maximum differential has been set at 4 degrees Fahrenheit for the fall, winter, and spring. However, a more stringent maximum differential of 1.5 degrees Fahrenheit is required for the summer months of June, July, and August. (30 TAC, Section 307.4)

Although proper salinity gradient maintenance is required to ensure healthy marine life populations, estuarine salinity criteria have yet to be established for surface waters of Texas. However, an absence of numerical salinity criteria does not necessarily mean lax regulation. Careful regulatory consideration will be given to all activities that may significantly effect coastal salinity levels and estuarine salinity

gradients. Therefore, an applicant discharging desalination concentrate should expect the salt concentration of the discharge to be a defining issue in the permitting process.

- **Total Toxicity**

Total toxicity, also referred to as whole-effluent toxicity, will be a key consideration in the permitting of a surface water concentrate discharge. An applicant must prove that the effluent from a proposed facility will be controlled so that acute and chronic toxicity indicated by the Texas Surface Water Quality Standards is not exceeded. The specific effluent tests and testing procedures to determine total toxicity are discussed in Section 5.2.1.5.

Total toxicity must be shown to fall below acute toxicity limits in receiving waters with the exception of small zones of initial dilution (ZID's) at points of discharge. Acute criteria may be exceeded in a ZID as long as the predicted effluent toxicity levels are not lethal to any aquatic organisms that may move through a ZID. A ZID may not extend more than 60 feet downstream and 20 feet upstream from a discharge point in a river. A ZID may not exceed a volume equal to a 50-foot radius in all directions from the discharge point in a bay, tidal river, or estuary. (30 TAC, Section 307.4) ZID sizes for ocean disposal of concentrate are not specified and would be considered on a case specific basis by TNRCC.

Total toxicity must be shown to fall below chronic toxicity levels in receiving waters with the exception of mixing zones. Mixing zones encompass a larger area, and are subject to more stringent standards than ZID's. These zones are usually designated by TNRCC on a case-by-case basis. Factors considered in permitting mixing zones and determining mixing zone size limits include concentrate quality and receiving water characteristics.

The toxicity of some substances is defined as a function of pH and hardness. Appropriate pH or hardness standards are listed in the Texas Surface Water Quality Standards for each individual river basin. An applicant must show that these standards can be met unless data is available to derive site-specific pH and hardness criteria for the waters receiving the concentrate discharge.

Additional requirements must be met if effluent tests indicate that a proposed concentrate discharge will exceed toxicity levels established in the Texas Surface Water Quality Standards. If toxicity levels are exceeded, an applicant should expect to conduct a toxicity identification evaluation and a toxicity reduction evaluation. After assessing these evaluations, TNRCC may include additional conditions within the permit to ensure compliance with water quality standards. These conditions could include chemical specific limits and best management practices designed to reduce total toxicity levels.

- **Antidegradation Policy**

Degradation is defined by TNRCC as a lowering of water quality to the extent that an existing use is impaired. Water quality must be maintained to a level that ensures the protection of existing uses. The baseline condition for determining degradation is defined as the highest water quality sustained since November 28, 1975. (30 TAC, Section 307.5)

The antidegradation policy of TNRCC is strictly enforced. However, a discharge of concentrate that causes degradation may be allowed if an applicant can show that the lowering of water quality is necessary for vital economic or social development. TNRCC deals with exemptions from the antidegradation policy on a case-by-case basis and requires significant evidence that degradation is necessary.

5.2.1.4 Required Reports Considered in TPDES Permitting

When applying for a TPDES permit for surface water disposal of concentrate, an applicant must complete both an *Administrative Report for Permit Application* and an *Industrial Wastewater Permit Application Technical Report*. The decision of TNRCC to issue an industrial wastewater permit depends heavily on the information submitted within these reports. The following is a breakdown of the general filing requirements, and regulatory issues considered within each report.

The information required to be submitted in the *Administrative Report* deals with general facility operations, disposal methods, ownership issues, and site characteristics. More specifically, these items include a description of the proposed project site and vicinity information adequate to determine whether the project complies with all relevant policies. Maps and photographs of the site area, disposal fallout points, and adjacent land and water bodies are required, as well as structural and schematic drawings for the proposed facility. The description of the development should also include any mitigation measures available that would substantially lessen any significant adverse impacts the development may have on the environment. Legal easements or lease agreements are required for proof of land ownership and land use authorization. Finally, extensive information involving adjacent landowners whose property may be adversely effected is an essential aspect of the *Administrative Report*.

After the *Administrative Report* is declared administratively complete, the *Technical Report* becomes open to a rigorous technical review process. The *Technical Report* deals with specific, technology-based information discussed in more detail in Section 5.2.1.5. It is encouraged that technical reports be prepared by either a Texas Registered Professional

Engineer, or by a qualified person who is competent and experienced in the field of desalination and concentrate disposal. TNRCC will then review the report and administer various simulated tests that will be used to develop appropriate permit limits and ensure that the proposed project will be in compliance with all relevant regulations. In essence, the decision of TNRCC to issue a permit is based primarily on the information submitted in the *Technical Report*.

5.2.1.5 Information Required for Regulatory Consideration in the Technical Report

- **Influent and Effluent Characterization**

A list of all raw materials, major intermediates, maintenance chemicals, and products handled at the facility is to be submitted. Trade names for chemical compounds should be avoided. Proposed duration of discharge flow (hrs/day) is required along with the predicted daily average and maximum flows (MGD). All chemical constituents predicted to be present in the facilities discharge are to be indicated in the report. Average and maximum influent and effluent concentrations (mg/L) of indicated pollutants must be predicted and listed along with estimated pH levels. Note: It is required that all methods used for testing be sensitive enough to detect the constituents at the Minimum Analytical Levels (MAL) specified in the report.

- **Toxicity Testing**

Since concentrated effluent may exert toxicity in receiving waters, a permittee should expect to perform whole effluent toxicity (WET) tests. Two types of toxicity tests using effluent produced from bench-scale or skid mounted pilot plant processes are required. Also known as biomonitoring, these tests include 100 percent end-of-pipe acute toxicity tests, and whole effluent tests based upon receiving water dilution. Permittees should consult the Water Quality Assessment Team of the Water Quality Division to for assistance regarding the characteristics of the proposed receiving water and the suitability of the marine test species. The following are examples of the whole effluent tests based upon receiving water dilution that are required:

- An acute 24-hour static toxicity test using Mysidopsis bahia. It is required that a minimum of five (5) replicates with eight (8) organisms per each replicate be used.
- An additional acute 24-hour static toxicity test must be done also using a minimum of five (5) replicates with eight (8) organisms per each replicate. However, the second test should be carried out using Inland Silverside minnows (Menidia beryllina).

For both tests five effluent concentrations should be used including 6, 13, 25, 50, and 100 percent. An additional sample of 0 percent concentration must be used for a control. Each effluent sample should consist of a 24-hour composite sample. A 24-hour composite sample consists of a sample continuously collected proportional to flow over a 24-hour period, or at least twelve (12) effluent portions collected at equal

time intervals and combined proportional to flow (30 TAC, Section 307.4). The dilution water used in the toxicity tests should consist of synthetic seawater.

When all tests are completed the applicant is required to submit a complete toxicity test report that includes the 24-hour LC50 and mean survival for each species at all effluent dilutions. The report should be prepared according to "Methods for Measuring the Acute Toxicity of Effluents and Receiving Waters to Freshwater and Marine Organisms, Fourth Edition" (EPA 600/4-90/027F), Section 12, Report Preparation.

An applicant should note that a new study by the Florida Department of Environmental Protection has indicated that concentrate toxicity may result from conditions other than increased levels of one of more of the specific chemical constituents. During a study to determine the potential sources of toxicity, FDEP found that in some cases toxicity might be caused solely by the proportional imbalance of major seawater ions as opposed to elevated concentrations of certain individual elements.³ Since an imbalance of major seawater ions would be corrected differently than an increased concentration of one or more individual ions, an applicant should take measures to determine the exact source of toxicity. Determining the exact source of toxicity is key in planning the most effected means to reduce toxicity and comply with state and federal requirements.

- **Receiving Water Characterization**

The applicant must submit an in-depth, physical description of the receiving waters indicating the following characteristics:

- Approximate surface area (acres);
- Average depth (feet);
- Approximate depth within a 500 foot radius (feet);
- Stream channel modifications (e.g., dammed, concrete lined, etc.);
- Basis of flow assessment;
- Uses of water bodies (e.g., navigation, recreation, etc.);
- Upstream influences to discharge areas (e.g., agricultural or urban runoff, septic tanks, upstream discharges, etc.); and
- Aesthetic characterization (e.g., wilderness, natural area, common setting, or offensive).

Original USGS quadrangle maps must also be submitted showing the location of the facility and proposed discharge points. Additional USGS quadrangle maps should be included showing the discharge paths three (3) miles from these discharge points. The applicant must indicate the existence of any domestic drinking water supplies

³ Florida Department of Environmental Protection. "Major-Seawater-Ion Toxicity in Membrane-Technology Water-Treatment Concentrate." 16 pp., 1995.

and/or oyster beds downstream of the proposed discharge points. Approximate distances from each concentrate outfall must be indicated for any oyster bed, while any drinking water supplies must be located on a USGS 7.5-minute topographic map.

- **Pollution Prevention Issues**

Along with the many technical issues considered in the report, the TNRCC also evaluates an applicant's proposed efforts toward pollution prevention. Facilities are encouraged to implement new and existing pollution prevention programs that will help to minimize the environmental impacts of a concentrate discharge. Within the *Technical Report* is a section intended to gather information pertaining to any initiated pollution prevention efforts of the applicant.

5.2.1.6 Determination of Appropriate Permit Limits

Technology based limits for EPA classified categorical industries must be at least as stringent as Best Practical Control Technology, Best Available Technology Economically Achievable, and Best Conventional Pollutant Control Technology. However, the EPA has not yet designated desalination as a categorical industry and so it is still considered a "New Source". Effluent limits for surface water discharge of concentrate from a desalination facility will therefore be subject to separate guidelines. These guidelines, referred to as New Source Performance Standards, will be much more stringent than the traditional technology based permit limits and will be set on a case-by-case basis.

Once the *Industrial Wastewater Permit Application Technical Report* is reviewed and declared complete the information is used to determine appropriate effluent limitations. The *Technical Report* is sent to the Toxicity Evaluation Team of Standards and Assessments Section where each proposed outfall will be plotted on maps to identify critical low flow conditions. Predicted effluent concentrations are evaluated along with critical low flow conditions to determine appropriate permit limits and monitoring requirements.

The *Technical Report* is then transferred to the Water Quality Standards Team where the receiving waters are evaluated to determine the use category. Uses are determined through a Receiving Water Assessment (RWA) consisting of measurements and observations at the discharge site. Habitat characteristics, flow characteristics, and aquatic species composition and abundance are key in designating uses.

This information is then sent to the Water Quality Modeling Team that will run water quality models. The purpose of these models will be to predict discharge impacts on the

receiving waters and determine effluent limits that will secure protection of the designated uses. These limits will ensure compliance with the antidegradation policies described in the Texas Surface Water Quality Standards.

The application consisting of the complete *Administrative Report for Permit Application, Industrial Wastewater Permit Application Technical Report*, and all recommended effluent limitations are forwarded to a permit writer for the development of a draft permit.

5.2.1.7 Monitoring Requirements

Once appropriate limits are determined and a permit is issued, all holders of a TPDES permit are required to periodically report the status of their compliance with all relevant state and federal statutes. Based on recommendations from various permitting divisions involved in the technical evaluation, TNRCC determines what parameters must be monitored. These parameters are determined on a case-by-case basis and are designated in the TPDES permit. Also indicated in the permit are requirements for sampling points, testing methods, and minimum frequencies for each parameter at which tests must be made.

5.2.2 Land Application Disposal

A discharger in the State of Texas must obtain a Texas Land Application Permit (TLAP) when planning to dispose of concentrate by means of irrigation or evaporation ponds. Although the TLAP regulates a form of concentrate disposal very different from surface water discharge, many of the filing requirements and regulatory considerations either remain the same, or are very similar to those of the TPDES permit.

As part of a hybrid application system, an individual applying for a TLAP must complete the same application used for TPDES permits. An applicant is subject to the same administrative filing requirements and must also complete the same reports required for a TPDES application. The main differences between the two permitting processes involve the extent of federal involvement, the Texas Administrative Code rules considered in permitting, and the information required in the administrative and technical reports.

Since regulatory processes are so similar between the TLAP and TPDES permits this section will emphasize the regulatory aspects unique to the TLAP. Key regulatory issues that are also part of the TPDES permitting process will be only mentioned briefly.

5.2.3.1 Required Applicants

The owner of a proposed desalination facility must apply for a TLAP when proposing to discharge concentrate onto land adjacent to waters of the state. Unlike the TPDES permit, the entity responsible for the overall operation of the facility need not apply as a co-permittee if different from the owner.

In most cases, land application disposal of concentrate will involve geologic structures such as evaporation ponds. With part of the facility so annexed to the realty, a plant would typically be considered a fixture of the land. Special considerations must be made if a proposed facility is classified as a fixture of the land and the plant owner differs from the landowner. The property owner must either provide a copy of a deed recorded easement giving the plant owner sufficient property rights to utilize the land for the life of the facility, or apply with the owner as a co-permittee.

5.2.2.2 State Agencies Involved in TLAP Permitting

One of the most significant differences between the TLAP and TPDES permit is the extent of federal involvement. Designated by the Texas Water Code, TNRCC has sole regulatory authority over the disposal of waste adjacent to waters in the state. Since the TLAP program is exclusively state run, permit applications and draft permits need not be sent to federal agencies for review. Furthermore, an applicant should expect less permit review by state agencies involved with surface water management, and more reviews from agencies involved with groundwater and land management.

The following organizations may request permit applications and draft permits for disposal of concentrate by means of land application:

- Texas Department of Agriculture;
- Texas General Land Office;
- Texas Park and Wildlife Department;
- Texas Soil and Water Conservation Board;
- Association of State Drinking Water Administrators;
- Texas Alliance of Groundwater Districts;
- Texas Groundwater Protection Committee;
- Office of Compliance and Enforcement;
- Public Interest Council;

- Texas Environmental Awareness Network; and
- City and County Planning Commissions, City Councils, and Boards of Supervisors.

5.2.2.3 Rules Commonly Considered in TLAP Permitting

This section lists the codified regulations incorporated into a Texas Land Application Permit.

- **Title 30 Texas Administrative Code (TAC)**
 - Procedural Issues
 - Chapter: 7 Memoranda of Understanding
 - 39 - Public Notice
 - 50 - Action on Application
 - 55 - Request for Contested Case Hearings
 - 281 - Applications Processing
 - 305 - Consolidated Permits
 - Technical Issues
 - Chapter: 213 - Edwards Aquifer
 - 309 - Effluent Standards
 - 311 - Watershed Protection
 - 314 - Toxic Pollutant Effluent Standards
 - 315 - General Pretreatment Regulations
 - 319 - General Regulations Incorporated into Permits

5.2.2.4 Required Reports Considered in TLAP Permitting

As with the TPDES permit application, both the *Administrative Report for Permit Application* and an *Industrial Wastewater Permit Application Technical Report* must be completed for a TLAP permit. The decision of TNRCC to issue a TLAP depends heavily on the information submitted within these reports.

Within the TLAP *Administrative Report* an applicant must submit information dealing with facility operations, site characteristics, disposal methods, ownership issues, and adjacent property information. The report requires a written description that traces the flow of effluent to its final disposition including transportation and any temporary storage points. An applicant must also include a representation of the proposed project site incorporating maps and

photographs of the disposal areas and property boundaries of the facility site. A legal easement or lease agreement must be submitted to demonstrate land ownership and land use authorization. An applicant planning to dispose of concentrate effluent via irrigation is required to clearly delineate the boundaries of the proposed irrigation site on an area map. Property boundaries of all landowners surrounding the proposed irrigation site must also be delineated. An applicant planning to dispose of effluent into evaporation/holding ponds must simply plot their approximate location on a map. Finally, extensive information involving adjacent landowners whose property may be adversely effected is an essential aspect of the *Administrative Report*.

Once the *Administrative Report* is declared administratively complete the *Industrial Wastewater Permit Application Technical Report* is subjected to a rigorous technical review. The specific technical information required in the *Technical Report* is discussed in detail throughout the following section.

5.2.2.5 Information Required for Regulatory Consideration in the TLAP Technical Report

- **Effluent Characterization for Evaporation Ponds and Irrigation**

A list of all raw materials, major intermediates, maintenance chemicals, and products handled at the facility is to be submitted. Trade names for chemical compounds should be avoided. Proposed duration of discharge flow (hrs/day) is required along with the predicted daily average and maximum flows (MGD). All chemical constituents predicted to be present in the facilities discharge are to be indicated in the report.

- **Evaporation Pond Information**

The following information is considered by the TNRCC during the TLAP permitting process if an applicant is proposing the use of evaporation ponds as a means of concentrate disposal.

1. Impoundment Parameters

- Length (feet);
- Width (feet);
- Surface area (acres);
- Depth from water surface (feet);
- Depth form below natural ground level (feet);
- Capacity of impoundment (gallons and acft); and
- Daily average effluent flow into pond (gal/day).

2. Pond Liner Information

An applicant must submit as much available data as possible on the pond liners that will be used at the facility. This information could include liner thickness, permeability, compatibility with concentrate waste, and results from any tests performed on the liners. The use of some soil-based liners may require soils boring information and procedures for soil compaction. The use of some plastic or rubber liners may require information describing leak detection systems used for each pond and any ground water monitoring well data available. The following is a breakdown of the specific requirements for the most common liners used in evaporation ponds.

If a facility will be using a Compacted Clay Liner it must be constructed to achieve a permeability of at most $1E^{-7}$ cm/sec. To comply with permeability requirements the liner must be at least 3 feet thick and constructed of clay-rich soil compacted to 95 percent standard proctor density at optimum moisture content in lifts less than 9 inches.

If a facility will be using an In-Situ Clay Liner it must also be constructed to achieve a permeability of at most $1E^{-7}$ cm/sec. The soil liner must then be at least 3 feet thick and consist of clay rich soil of which more than 30 percent must be passing a 200-mesh sieve. The soil must also have a liquid limit of at least 30 percent and a plasticity index greater than or equal to 15.

If a facility will be using a plastic or rubber liner it must be made to completely cover the sides and bottom of the pond and be at least 30 mils thick. A liner cannot be used that may be subject to chemical degradation from the concentrate it will receive. Furthermore, a 6-inch protective layer of soil will be required to cover any liner that may be subject to ultraviolet or ozone depletion. Plastic or rubber liners will also require a leak detection system.

3. Regional Flood Level Information

Migration of wastes outside the boundaries of an impoundment may cause significant environmental damage to surrounding areas. Therefore, TNRCC takes into consideration the possibility of waste migration due to floodwaters. An applicant must determine if any proposed impoundment sites lie within the 100-year flood frequency levels. If any proposed disposal ponds do lie within the flood frequency level an applicant must prove to TNRCC that inundation can be avoided. A description of any tailwater control facilities and operations that will be used to protect the impoundments from inundation must be submitted.

- **Irrigation Information**

An applicant electing to dispose of concentrate by means of irrigation is required to submit detailed information describing an annual cropping plan and the proposed waste application methods.

The annual cropping plan should indicate the acreage to be irrigated and the growing seasons for each crop. Crop characteristics including watering, nutrient, and fertilizer requirements should also be indicated. Salt tolerances for each crop are considered in the permitting process and must be determined when applying concentrate. Key information involving the waste application conditions are considered in permitting. An applicant must indicate the proposed method, equipment, frequency, and rate used in the irrigation process. Furthermore, an applicant should predict the irrigation efficiency based on the methods and equipment proposed.

An applicant is required to conduct soil analysis tests in any proposed irrigation site for the following chemical parameters:

- pH;
 - Sodium absorption ration (SAR);
 - Nitrogen;
 - Nitrate;
 - Potassium;
 - Phosphorous;
 - Calcium;
 - Magnesium;
 - Sulfur; and
 - Sodium.
- **Pollution Prevention Issues**

As with the TPDES, any facility planning to dispose of waste via land application is encouraged to implement new and existing pollution prevention programs that will help to minimize the environmental impacts. Within the "Technical Report" is a section intended to gather information pertaining to any initiated pollution prevention efforts of the applicant.

5.2.2.6 Determination of Appropriate Permit Limits and Monitoring Requirements

TLAP applications are subject to much less regulatory consideration than TPDES applications because land application methods usually have no direct affect on the quality of water in the state. Since Texas Surface Water Quality Standards are not an issue, there are no standard effluent limits applied to all Texas Land Application Permits. Instead, limits are set on a case-by-case basis depending primarily on recommendations from those individuals who review the technical aspects of the permit application.

Monitoring requirements for land application facilities are specified by TNRCC in the approved TLAP permit. Although frequent monitoring is required, land application disposal facilities are exempt from reporting the analysis to TNRCC on a set basis. However, TNRCC can view this information whenever a facility's compliance is in question.

5.2.3 Deep Well Injection

A Class I Injection Well Permit must be obtained in order to comply with all state regulations involving the disposal of concentrate by means of deep well injection. The primary goal of a Class I Injection Well Permit is to ensure that various waste injection conditions are met in order to prevent the movement of fluids into or between EPA classified Underground Sources of Drinking Water (USDWs). Incorporated into the permit are various procedural and technical regulations that can be found in Chapter 27 of the Texas Water Code, Chapter 361 of the Texas Health and Safety Code, and various chapters of the Texas Administrative Code.

5.2.3.1 Federal and State Agencies Involved in Permitting

Class I Injection Well Permits for the construction, operation, and abandonment of Class I injection wells in the state of Texas are administered, issued, and enforced by the Underground Injection Control & Radioactive Waste Section of TNRCC. In rare cases the EPA may take on various administrative and technical oversight responsibilities if a proposed deep well injection site may involve increased elements of risk to any surrounding USDWs.

For a Class I Injection Well Permit to be issued, a letter must be submitted to TNRCC by the Railroad Commission of Texas (RCT) stating that drilling the proposed well and injecting it with concentrate will not endanger any known gas or oil resources. The Railroad Commission will make these determinations based on information submitted by the applicant. This information should include general data from the application form, a discussion of the local geology and hydrogeology, local oil and gas production data, and any other information necessary for the RCT to make a determination.

The primary environmental risk of concentrate disposal by deep well injection is the possible migration of contaminants into USDWs. Therefore, an applicant should expect draft permit and application reviews by agencies involved with subsurface geologic surveying and groundwater protection. The following organizations may have influence on TNRCC's decision to issue a Class I Injection Well Permit:

- U.S. Environmental Protection Agency;
- U.S. Geologic Survey;
- U.S. Army Corps of Engineers;
- American Society for Testing Materials;
- Railroad Commission of Texas;
- Texas Groundwater Protection Committee;
- Texas Alliance of Groundwater Districts;
- Texas Soil and Water Conservation Board;
- Texas Department of Health;
- Edwards Aquifer Authority;
- Office of Compliance and Enforcement;
- Tribal Governments; and
- City and County Planning Commissions, City Councils, and Boards of Supervisors.

5.2.3.2 Rules Commonly Considered in Permitting

For information on the procedural and technical regulations incorporated into a Class I Injection Well Permit an applicant should refer to the following codified state rules.

- **Title 30 Texas Administrative Code (TAC)**
 - Procedural Issues
 - Chapter: 7 - Memoranda of Understanding
 - 39 - Public Notice
 - 50 - Action on Application
 - 55 - Request for Contested Case Hearings
 - 281 - Applications Processing
 - 305 - Consolidated Permits
 - Technical Issues
 - Chapter: 213 - Edwards Aquifer
 - 331 - Underground Injection Control

5.2.3.3 Chapter 331, Underground Injection Control: Specific Regulatory Issues

The most pertinent regulatory tool for guiding regulators through the technical aspects of the Class I injection well permitting process is Chapter 331, Underground Injection Control.

This section examines the specific regulatory issues and requirements described in Chapter 331 that are commonly considered in Class I injection well permitting.

- **Area of Review**

A typical area of review should extend no less than 2.5 miles from the proposed wellbore site or 0.25 miles from any other existing or proposed injection wells. (30 TAC, Section 331.42) The local hydrogeology along the population of the region and its dependence on ground water along are key factors when delineating an area of review.

- **Mechanical Integrity Standards**

An injection well is considered by TNRCC to have mechanical integrity only if there is no migration of wastes through the casing, tubing, or packer. Furthermore, wastes must not be allowed to migrate through the vertical channels adjacent to the wellbore. Either of these occurrences could result in the movement of injection wastes into surrounding USDWs.

- **Corrective Action Standards**

An applicant may be responsible for preventing the migration of wastes into USDWs due to other inadequately constructed, completed, plugged, or abandoned wells within the area of review. Corrective action plans must be submitted outlining the steps or modifications necessary to prevent such pollution from other existing wells. Factors considered when reviewing the adequacy of a proposed corrective action plan may include the history of injection operations in the area; completion and plugging records for existing wells; and/or abandonment procedures in effect at the time other wells were abandoned.

- **Approval for Construction**

In order for TNRCC to consider approving the construction of an injection well various well data must be objectively reviewed for compliance with all standards and criteria listed in Chapter 331 of the Texas Administrative Code. An applicant must demonstrate that the construction design will ensure mechanical integrity based on the maximum proposed pressure and flow rate along with the waste compatibility. TNRCC will also review the calculated area of review and cone of influence to ensure that any corrective action plans for existing wells within these areas are adequate.

- **Construction Standards**

All Class I injection wells must be designed with the purpose of preventing the movement of waste into surrounding USDWs. Well design must permit the use of testing devices for the continuous monitoring of the injection tubing, long string casing, and annulus. All materials should be designed to resist physical and chemical degradation from the injected waste. Surface casing must reach a minimum depth

that extends past the confining bed below the lowest USDW. At least one string casing should extend all the way to the injection interval. Specific casing and cementing criteria will be set by TNRCC based on the proposed injection conditions and the local hydrogeology.

A Class I Injection Well should be drilled in a way that minimizes problems that could compromise closure activities such as deviated holes and washouts. An injection hole should be drilled under laminar flow conditions with adequate fluid loss control so that hole washouts are minimized.

Using the pump and plug method, cementing may be accomplished by staging. The volume of cement pumped should equal 120 percent of the combined volume between the hole and casing and between the casing strings and surface of the ground. Deviation checks should be made at frequent intervals to ensure that no migration of waste will occur. Surface casing must be pressure tested at 1,000 psig while long string casing must be tested at 1,500 psig. (30 TAC, Section 331.6) Both casings should be tested for at least thirty minutes. Core samples must be taken to determine porosity, bulk density, and permeability.

In accordance with the Texas Engineering Practice Act, a licensed professional engineer skilled in well construction operations must supervise all phases of well construction.

- **Operating Requirements**

All chemical and physical characteristics must be maintained below permit limits to ensure protection of the injection well materials. To ensure that there is no migration of fluids into USDWs, monthly instantaneous rates and volumes of injected waste must fall within permit limits set by TNRCC.

- **Monitoring and Testing Requirements**

An operator must develop and follow a waste analysis plan that illustrates the procedures used to carry out a chemical and physical analysis of the injected waste. The plan must include specified parameters for which the waste will be analyzed. Test methods and sampling procedures should be indicated along with the monitoring frequency for each parameter. Waste monitoring plans require approval from TNRCC.

5.2.3.4 Information Required for Regulatory Consideration in the Class I Injection Well Technical Report

Once the *Administrative Report* is reviewed members of the Underground Injection Control Section permitting team will examine the *Technical Report*. The team will verify that all proposed construction, operation, and closure conditions comply with the criteria for underground injection listed in Chapter 331 of the Texas Administrative Code. TNRCC will

decide to issue a Class I Injection Well Permit if all proposed injection conditions are found to comply with the underground injection control criteria. The specific geologic and hydrogeologic information required in the Technical Report is discussed in this section.

An applicant must submit stratigraphy and hydrostratigraphy that depicts any major aquifers, USDWs, and/or fault lines that may exist as part of the local geology. A Class I Injection Well Permit cannot be issued unless it is demonstrated to TNRCC that each fault within a 2.5 mile radius of the well is not vertically or horizontally transmissive to an extent that contaminants may migrate from the injection zone. The confining zone, injection zone, injection interval, and lower confining strata must all be defined using structure and isopach maps. TNRCC also requires a thorough description of the regional groundwater flow including its direction and discharge measurements.

An applicant must describe the configuration of the lowest USDW in terms of its base. The methods of this determination should be included. It must be demonstrated that the proposed confining zone is separated from the base of the lower most USDW by at least one other confining unit. Furthermore, it must be demonstrated that the potentiometric surface of the injection zone is less than the potentiometric surface of the lowermost USDW prior to injection.

5.2.3.5 Determination of Appropriate Permit Limits and Monitoring Requirements

Permit conditions such as effluent limitations, operational standards and monitoring requirements involving deep well injection are impossible to generalize as permitting is carried out strictly on a case-by-case basis. However, there are specific core requirements for all injection wells that applicants should consider when planning to dispose of concentrate by means of deep well injection.

Contrary to the effluent-based permit limitations of a surface water discharge, permit limits and monitoring requirements for deep well injection are established by TNRCC based on site-specific geologic and hydrogeology characteristics. Permit conditions are also heavily based on the engineering design, construction materials, and operating conditions of the injection well.

The primary goal of a Class I Injection Well Permit is to ensure that various waste injection conditions are met in order to prevent the movement of fluids into or between overlying USDWs. An applicant should site a well in an area where geologic and hydrogeologic conditions will best prevent any migration of concentrate from the injection reservoir into or

between sources of drinking water. Furthermore, an applicant should use engineering design methods, materials, and operational conditions that will best prevent the leakage of concentrate. A proposed Class I injection well sited and designed with the above recommendations in mind will most likely be subject to a less time consuming permitting process while limitations and monitoring requirements will be less stringent.

5.3 Disposal Methods

This section will discuss the various options available for concentrate disposal that can be considered by an operator. As in most cases, disposal options are limited for effluents classified by the regulatory agencies as an industrial waste. The disposal method should be carefully evaluated prior to selection due the potentially significant impact the chosen method can have on the ability of the facility to meet regulatory requirements for operation and the associated cost of plant capital and operations.

In the case of concentrate disposal, there are various disposal options available to plant operators that depend on a series of factors. Key factors for consideration include the chemical composition and daily volume of the concentrate produced. Options may also be influenced by plant location. Operators must consider the proximity of a facility to suitable receiving water bodies, dilution sources, and/or to geologically suitable disposal sites.

5.3.1 Brackish Water Concentrate

This section will discuss the available disposal options for brackish water desalination facilities. Across the United States, brackish facilities are generally located within 20 miles of a coastline and utilize a mix of disposal options including surface water discharge, deep well injection and discharge to a municipal wastewater system. This section will discuss all three options and the criteria that should be consider when selecting each disposal option for a facility.

5.3.1.1 Surface Water Discharge

The ability to discharge to a surface water body, fresh or saltwater, is limited by the regulatory constraints for the receiving water body and the cost of the discharge system infrastructure.

In most states the concentrate discharge is classified as an industrial waste and must conform to applicable waste load allocations for the receiving stream. In the case of brackish

concentrate, waste load allocations and bioaccumulation of pollutants are not issues of concern since the desalination processes do not normally introduce new metal ions or toxins into the waste stream. There will be a concentration of the chemical constituents found in the raw water source, but this will generally not impact the waste load allocation for the receiving stream. The concern for surface discharge will be toxicity, as defined in Chapter 307 of the Texas Administrative Code, to the receiving stream biota prior to dilution. Further discussion of the toxicity standards and testing can be found under Section 5.2.1.5.

A direct surface water discharge may be available without a dilution option dependant upon the quality and quantity of the concentrate discharge and the characteristics of the receiving water body. These parameters must be determined in advance while required testing is completed in order to determine if additional regulatory conditions must be met prior to permitting an acceptable discharge.

Identification of the receiving water regulatory designation is necessary to determine if any site-specific regulatory protection has been afforded to the receiving water body. Site-specific regulatory constraints can dramatically impact the feasibility for a desalination concentrate discharge.

In order to comply with TPDES regulations for toxicity, both acute and chronic, dilution of the concentrate may be necessary. Dilution ratios will vary by the quality of the concentrate and the quality of the mixing water. Dilution can be accomplished by defining a regulatory mixing zone in the receiving water body or premixing the concentrate with an acceptable dilution source prior to discharge.

- **Regulatory Mixing Zones**

The use of regulatory mixing zones is the most efficient and cost effective method of disposing a concentrate. The US EPA defines a regulatory mixing zone as an "allocated impact zone" within which the water quality limits may be exceeded for the non-toxic category pollutants; e.g., conventional, non-conventional and heat. The regulatory mixing zone can be thought as a limited distance, area, or volume where the initial dilution of the discharge occurs. The water quality limits apply at the boundary of the mixing zone and not within the mixing zone it. Assuming there are no site-specific regulatory prohibitions to a discharge-mixing zone, the historic flow rates for the receiving stream must be modeled to determine the size and location of an acceptable mixing zone. These zones are permitted on a surface area basis, dependent upon stream flows and dilution required to meet standards for discharge.

The efficiency of direct discharge mixing can be improved through the use of a pipe manifold and diffuser design that will increase the dilution capacity of the receiving water body. It must be noted that desalination concentrate is negatively buoyant and therefore will need adequate depth and/or horizontal velocity in the receiving water body to mix prior to accumulation on the floor of the receiving water body.

- **Pre-Discharge Mixing**

Pre-discharge mixing can be accomplished in a piping configuration that combines concentrate with raw water taken from a higher quality water source. The dilution water source can be obtained from a ground or surface water source that contains lower salinity concentrations than the concentrate. The fresher the dilutant, the lower mixing ratios that will be required to meet regulatory standards. Testing must be conducted to determine adequate ratios of concentrate to dilutant in order to meet Texas Administrative Code regulations for pre-mixing discharge.

The pre-discharge mixing can also be accomplished in a manmade canal system that mixes the concentrate prior to discharge into the regulated receiving water body. Such manmade canals are sometimes found associated with existing discharge or drainage systems operated by municipalities or industry.

5.3.1.2 Discharge into Municipal Wastewater System

Another option for a brackish desalination concentrate would be discharge into a municipal wastewater system. This option can be very cost effective if a desalination facility is located within close proximity of a wastewater treatment plant of an existing collection system which handles the discharge flow.

The discharge to a municipal wastewater system can be handled in several ways dependant upon the overall objectives of the treatment facility. For a facility that is used solely for wastewater treatment and disposal, the concentrate can be combined at the discharge point of the treatment plant effluent stream for mixing. This option is best suited for a desalination facility that is co-located with a waste treatment facility in order to minimize the cost of piping the concentrate to the treatment plant.

In the case where the desalination facility is not co-located with a wastewater treatment facility, the concentrate can be delivered through the municipal collection system. Analysis must be performed to determine impacts to the wastewater treatment process due to the concentrate influent. Typical biological waste treatment systems have a significant tolerance to high chloride levels and can readily accept concentrate. Pilot studies to address concentrate parameters such as

pH and dilution effects to biological treatment systems should be performed to address potential impacts to the wastewater treatments system.

An additional benefit of a combined concentrate – wastewater discharge is the ability of the combined discharge to provide a more neutrally buoyant effluent that will remain in the water column for a longer period to provide greater mixing. Concentrate, negatively buoyant, combined with wastewater, positively buoyant, will provide an effluent that more approximates the buoyancy found in ambient receiving water.

The addition of a concentrate flow to a treatment plant used to produce irrigation water would provide additional product water for these irrigation purposes. In this case the main limiting agent is the required chloride limits that must be maintained to adequately protect grass and ornamentals. Experience in the State of Florida, where this disposal method is common, reveals reclaimed water with chlorides not in excess of 400 mg/L is generally acceptable for irrigation purposes. Note, this experienced acceptability level is native to Florida and will vary by the type of vegetation irrigated and the climatic conditions present where applied.

5.3.1.3 Deep Well Injection

Deep well injection disposal is most commonly found in inland desalination facilities. In many cases, due to lack of any surface water body within a reasonable distance, deep well injection is the only disposal option for plants of size (greater than one MGD). This process of disposal has been routinely used as a disposal method for industrial waste and wastewater for decades. This principal is to dispose of the concentrate in a geologic zone that contains lower quality water and is separated from potential potable water aquifers by a series of low permeability zones. Obviously, this disposal method is very site specific and geological investigations discussed further in Section 5.2.3.4 will be required to determine feasibility for a specific location.

Typically, the wells are multi-cased, with the final casing set to the top of the selected injection zone. Figure 5-1 illustrates the construction of a typical injection well where this method is commonly employed by desalination facilities. A typical injection well consists of concentric pipes that extend several thousand feet down from the surface level into highly saline, permeable

casing either through perforations in the well casing or in the open hole below the bottom of the long inner casing string. The annulus between the well casing and the injection tube is filled with an inert, pressurized fluid, and is sealed at the top of the injection zone by a removable packer preventing injected concentrate from backing up into the annulus.

Injection wells used to dispose of concentrate from RO plants require additional corrosion protection. Various types of materials such as fiberglass, plastic (ABS), stainless steel or extra thick steel pipe have been used for the construction of the inner liner of this type of injection well.

Factors that may limit the applicability and effectiveness of a deep injection well include:

- Potential seismic activity in the area;
- Compatibility of the concentrate with the mechanical components of the injection well system and the injection reservoir fluids;
- Plugging of the injection interval due to high concentrations of suspended solids (typically >2 ppm);
- Fouling resulting from high iron concentrations when conditions alter valence states and convert soluble to insoluble species;
- Costly geologic and hydrogeologic site assessments required to determine the suitability of a site; and
- Chemical reaction with host rock plugging injection interval.

5.3.1.4 Land Disposal

The disposal of concentrate to a land surface evaporation pond is an option for available under very restricted conditions. The requirements for effective disposal through land application include:

- Sufficient land availability;
- High evaporation rates;
- Low precipitation rates;
- Low concentrate discharge volumes; and
- Adequate pond liner material.

Typically this method is used for low discharge volumes (<.01 MGD) associated with facilities found in industrial uses. Public water supply facilities are usually too large and require an excessive amount of land for effective evaporation. Siting land application facilities is

difficult due to the requirement for ideal climatic conditions of high evaporation and low precipitation.

5.3.2 Seawater Desalination Concentrate

The quality of the concentrate from a seawater desalination facility presents a more difficult problem for disposal than a brackish water source. A typical seawater desalination facility will yield 40 to 50 percent product water. This recovery rate results in a concentrate that contains approximately two times the concentration of the raw water chemical parameters. This poses a greater concern for the regulatory constraints of acute toxicity and therefore greater attention must be paid to the dilution of the concentrate prior to final discharge.

Research performed by the Southwest Florida Water Management District (SWFWMD), Brooksville, Florida in conjunction with the Electric Power Research Institute (EPRI), has produced results which indicate the concentrate from a seawater desalination facility, specifically RO, can be safely disposed in an open ocean outfall if proper dilution is available. This research conducted by SWFWMD is considered the most advanced work performed to date regarding the potential short and long term effects from a seawater RO desalination concentrate discharge.

Laboratory tests on prepared concentrate were used to determine the acute and chronic toxicity responses using EPA approved methods. The acute definitive bioassays consisted of a seawater control, 100 percent effluent concentrate, 50, 25, 12.5, 6.25 and 3.125 percent effluent concentrations. The 96-hour LC concentrations showed acceptable levels of species survival at all concentrations. The State of Florida requires a three fold safety factor over EPA standards and therefore a concentrate diluted to 45,000 ppm TDS would be required to meet acceptable acute toxicity levels in Florida.

The chronic toxicity bioassays were conducted for seven days per EPA approved methods. The same dilutions were tested as in the acute tests. There was some degree of toxicity in the chronic tests, however 68 percent of the values were at 100 percent No Observable Effect Concentrations (NOEC) for the concentrate. The levels of the chronic toxicity observed would also be eliminated by the dilution ratio necessary to meet Florida standards.⁴

⁴ Southwest Florida Water Management District (SWFWMD), "An Investigation of Concentrate Disposal by Means of a Coastal Ocean Outfall, 1-10pp., 1995.

SWFWMD followed up the lab testing with field testing and monitoring for an active seawater RO desalination plant in Antigua, West Indies. The Culligan Enerserve Antigua Ltd. had been operating at a discharge capacity of 1.47 MGD with a discharge salinity of 57,000 ppm since 1993. Large areas of sea grasses, coral heads, and common tropical reef invertebrates and fish surrounded the study area selected at the facility's discharge point. The Antigua plant was chosen because the surrounding ecology, model verifications, and logistics were all considered ideal to adequately determine the effects of a concentrate discharge on near shore benthic communities.

Six radial transects extending ten meters from the discharge point were spaced at 60-degree intervals. Sampling stations were placed along each transect at 2, 4, 6, 8, and 10 meters where changes in the surrounding chemical, physical and biological parameters were measured over a 6-month period. The study focused on the effects of increased salt concentrations on seagrass, microalgae, foraminifera, and macrofauna communities within the study area.

Throughout the study period seasonal variance caused the fluctuation of rainfall amounts, water temperature, pH, salinity and turbidity. Furthermore, twice-a-day tidal changes contributed to erratic fluctuations in salinity within the study area. However, at no time during the study period did any of the species in question exhibit any detectable acute or chronic effects directly linked to increased salinity caused by the concentrate discharge.⁵

In order to meet the disposal requirement for the TPDES permit, samples of source seawater should be concentrated and tested to determine acute and chronic toxicity levels. If dilution is necessary, dilution sources can be designed using one of the following three methods:

1. Combining concentrate discharge with an existing discharge such as a power plant cooling water discharge or a municipal wastewater discharge. Any existing discharge, which contains a lower TDS and salinity level than the concentrate, will provide a suitable source for a discharge dilution flow. Power plants that utilize seawater for cooling purposes are ideal location for a combined discharge because of the very large amount of flow available for discharge, typically several hundred million gallons per day. The most important regulatory concern for a power plant discharge is thermal pollution, which is not affected by a discharge from a RO facility that does not elevate the temperature of the process water. Other sources for a combined discharge are wastewater or industrial water discharge facilities. Although

⁵ SWFWMD, "Effects of the Disposal of Seawater Desalination Discharges on Near Shore Benthic Communities," Draft Document, 5-123pp., 1998.

these sources are more abundant, they can be limiting in the amount of flow available for dilution while extensive monitoring requirements are typically required. In the case of a domestic wastewater discharge, the addition of a desalination concentrate improves open water body mixing due the negatively buoyant concentrate mixing with the positively buoyant wastewater. The resulting discharge is a more neutrally buoyant discharge and therefore stays in the water column longer for improved mixing in the receiving body.

2. Designing and permitting a regulatory mixing zone in the receiving water body. The TPDES program allows a mixing zone for discharges, which would require some degree of ambient water dilution prior to meeting standards. The availability and design of mixing zones are very site specific and dependant upon a number of factors. These may include the quality and quantify of the effluent, the quality and flow rate of the receiving body in which the mixing zone is sought, and existing mixing zones in the area of the proposed discharge. The application for a mixing zone will require significant hydrologic analysis and water quality testing.
3. Designing and constructing an intake system to provide a dilution mixing stream for the concentrate prior to open ocean discharge. In the design of the desalination facility design, the intake structure could be sized to provide additional raw water for a post treatment mixing stream.

**Table 5-7.
Concentrate Disposal Options Summary**

<i>Disposal Option</i>	<i>Advantages</i>	<i>Constraints</i>
Brackish Desalination		
1. Direct surface water discharge	<ul style="list-style-type: none"> • Low cost up front 	<ul style="list-style-type: none"> • Requires available receiving water body • Future regulations may restrict • Monitoring program
2. Pre-discharge mixing	<ul style="list-style-type: none"> • Low to medium cost up front 	<ul style="list-style-type: none"> • Requires adequate mixing source • Monitoring program
3. Municipal wastewater system	<ul style="list-style-type: none"> • Low cost (if co-located) • Additional source for reclaimed water 	<ul style="list-style-type: none"> • Higher wastewater treatment costs • Impacts to treatment process
4. Deep well injection	<ul style="list-style-type: none"> • Can handle large volume • May be available to inland plants 	<ul style="list-style-type: none"> • Difficult permitting, high up front cost
5. Land Application	<ul style="list-style-type: none"> • Best suited for small facilities 	<ul style="list-style-type: none"> • Difficult to site
Seawater Desalination		
1. Open ocean outfall	<ul style="list-style-type: none"> • Can handle large volume 	<ul style="list-style-type: none"> • Requires adequate depth and circulation
2. Co-located discharge	<ul style="list-style-type: none"> • Low cost 	<ul style="list-style-type: none"> • Requires large co-located discharge

Section 6

Costs of Water Desalination Using Membranes

This report section presents information about the cost of desalinating water using membrane treatment systems. Section 6.1 provides a detailed cost estimating methodology for reverse osmosis treatment systems. The cost-estimating methodology is illustrated in an example contained in Appendix B and is used to develop the economic impacts of siting factors for seawater desalination in Part B of this document. Section 6.2 describes a survey of operating municipal water desalination facilities using membrane technologies.

6.1 Detailed Cost Estimating Methodology for Reverse Osmosis

This report section presents a detailed methodology for estimating the costs of building and operating reverse osmosis water treatment systems. The cost estimating method is suitable for detailed planning purposes and is illustrated by an example cost estimate provided in Appendix B. The cost curves presented in this section are used in Part B of this document to examine the economic impacts of siting factors for seawater desalination. Reverse osmosis system components include the following unit processes: Pretreatment (cartridge filters, pH control, and antiscalant); Feedwater pumping; Membrane process system; and Chemical cleaning system.

The cost estimates include major equipment components, as described below, process mechanical, interconnecting piping, and allowances for equipment installation (Table 6-1). The process mechanical costs are assumed to be 35 percent of the total process equipment costs due to the requirement for corrosion resistant materials. The process mechanical allowance also includes power and control wiring and mechanical installation. The allowance is applied to the total equipment cost for each component. A slab-on-grade floor is provided for the membranes and the area determined to house the units. The cost calculations do not include housing over the units. Housing costs would be added separately based on the style of housing required.

Table 6-1.
Allowances for RO System Components

<i>Item</i>	<i>Allowance</i>
Process Mechanical	35%
Interconnecting Piping	7.5%
Installation	30%

6.1.1 Reverse Osmosis Pretreatment

As noted in Section 3, surface waters can require extensive pretreatment by either direct or conventional filtration. That degree of pretreatment is not considered here and costs would have to be estimated separately using standard engineering methods. Sludge generated during pretreatment would be handled in a manner similar to conventional water treatment plants. To be disposed of in a landfill, sludge would have to be de-watered sufficiently to pass a paint filter test and pass the Toxicity Characteristic Leaching Procedure (TCLP) test.

RO systems require pretreatment using a cartridge filter and chemical conditioning of the feedwater. The chemical dosages and chemical types vary based on the specific application. The high salt recovery for RO systems results in significant scaling potential that must be controlled. Pretreatment antiscalants and pH control is used to reduce the potential for scaling of the RO system. An example layout of a pretreatment system is provided in Figure 6-1.

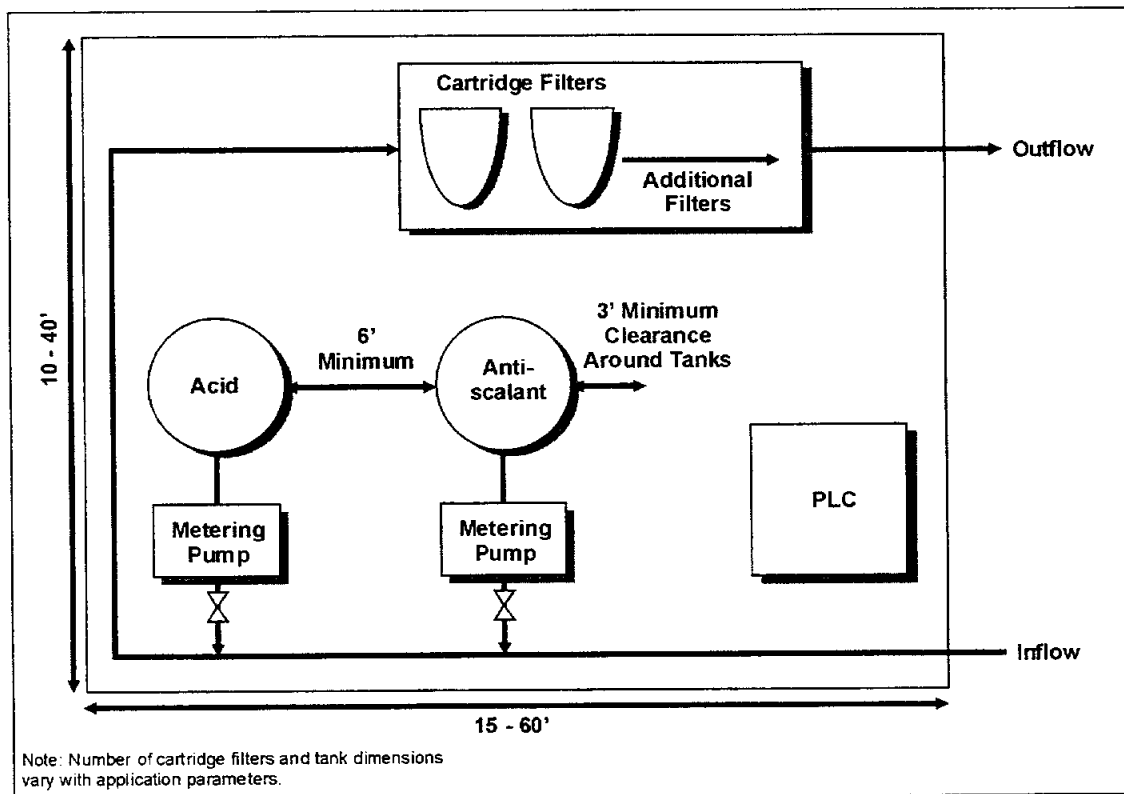

Figure 6-1. Layout of Reverse Osmosis Pretreatment Facilities

6.1.1.1 Construction

Cartridge filters are installed upstream of the membrane units, between the feedwater pumps and the membrane units. Cartridge filters are used to remove any particles that may prematurely foul, clog, or damage the membrane. Most cartridge filters specified are designed for a nominal rating of 5 microns. For planning purposes, one filter is assumed for every 5 MGD of plant design flow. One standby cartridge filter is added for plant design flows up to 50 MGD and two standby units for every 50 MGD for higher flows. Unit capital costs for cartridge filters are based on manufacturer's quotes. Cost per filter ranges from \$42,000 to \$60,000, with the discounted rate applying to bulk discount.

Chemical conditioning of the feedwater includes pH reduction with acid addition, and adding antiscalant chemicals to prevent precipitation. The acid dose is determined by the volume of chemical required to reduce the pH from existing pH to a level that sufficiently decreases the scaling tendency of the water being treated and is compatible with the membranes used (generally pH around 5.5 to 6.5). Antiscalant chemical consumption depends on feedwater quality and water chemical composition. Acid and antiscalant dose is determined through bench or pilot studies, consultation with membrane manufacturers, and water analysis.

Equipment required for both the acid and antiscalant chemical systems consists of:

- Fiberglass tank (one per chemical, upright, cylindrical);
- Metering pump, 2 (one duty and one standby per chemical);
- Acid and antiscalant feed system; and
- Control panel.

Small systems (below 1 MGD) are sometimes designed without chemical feed and operated at lower recoveries. This style design simplifies the system operation but increases the capital cost requirements.

Chemical tanks are sized to hold approximately 30 days of chemical flow with a maximum tank volume of 12,500 gallons.

6.1.1.2 Operation and Maintenance

Annual O&M for general equipment maintenance are assumed to be 5 percent of the capital equipment costs. Labor requirements are estimated at 24 hr/chemical feed system/year plus 12 hr/filter/year. Addition of sulfuric acid (93 percent) is assumed to be the method of pH control. The chemical costs for acid addition is based on a dosage of 20 mg/L and unit chemical cost of \$0.39/lb. The chemical cost for antiscalant addition is based on a dose of 3 mg/L and a

unit chemical cost of \$1.25/lb. Cartridge filters are assumed to be replaced every 3 months. These costs can be adjusted for site-specific conditions, as shown in the example calculation included in Appendix A.

Figures 6-2 through 6-4 show the construction cost, operation and maintenance costs, and housing area, respectively, for RO pretreatment systems.

6.1.2 Pumping Facilities

This section contains cost curves for feedwater pumping for reverse osmosis water treatment systems. Figure 6-5 shows the schematic layout of membrane feed pumping facilities.

6.1.2.1 Construction Cost

Feedwater pumping assumes that horizontal split case pumps with variable frequency drives are used.¹ All designs assume that the feedwater piping system uses a raw water header so that any raw water pump can supply any membrane train.² However, each train will essentially have a dedicated feedwater pump. The bank of feedwater pumps includes one pump per train plus one standby pump. Costs are estimated for a range of discharge pressures between 300 and 900 psi. The pump pressure is selected based on application and engineering design requirements. The typical application for these pumps are envisioned as:

- Low-pressure RO (300 psi);
- Medium-pressure RO (500 psi);
- High-pressure RO (700 psi); and
- Seawater RO (900 psi).

Costs for horizontal split case pumps were obtained from engineering experience with similar projects, and scaled to the specific design requirements. The feedwater pumps should be sized based on the product water flow required, plus the concentrate (or reject) lost. Therefore, the feedwater flow rate is the product water flow divided by the recovery rate. The recovery rate for a system is a function of process configuration and water characteristics and can range from 50 to 90 percent for RO.

¹ American Water Works Association (AWWA), "Water Quality and Treatment: A Handbook of Community Water Supplies," New York, 4th Edition.

² Ibid.

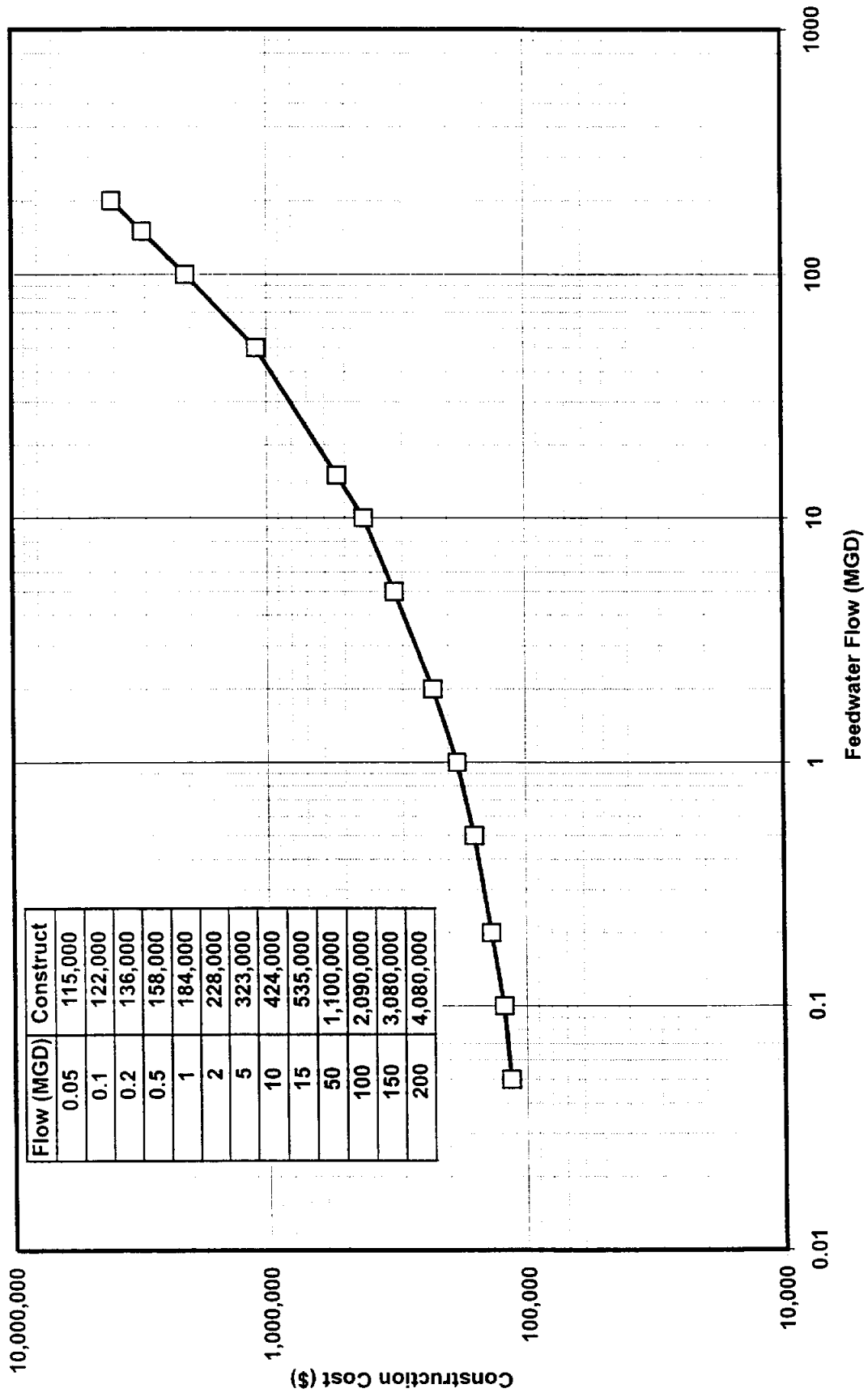

Figure 6-2. Reverse Osmosis Pretreatment — Construction

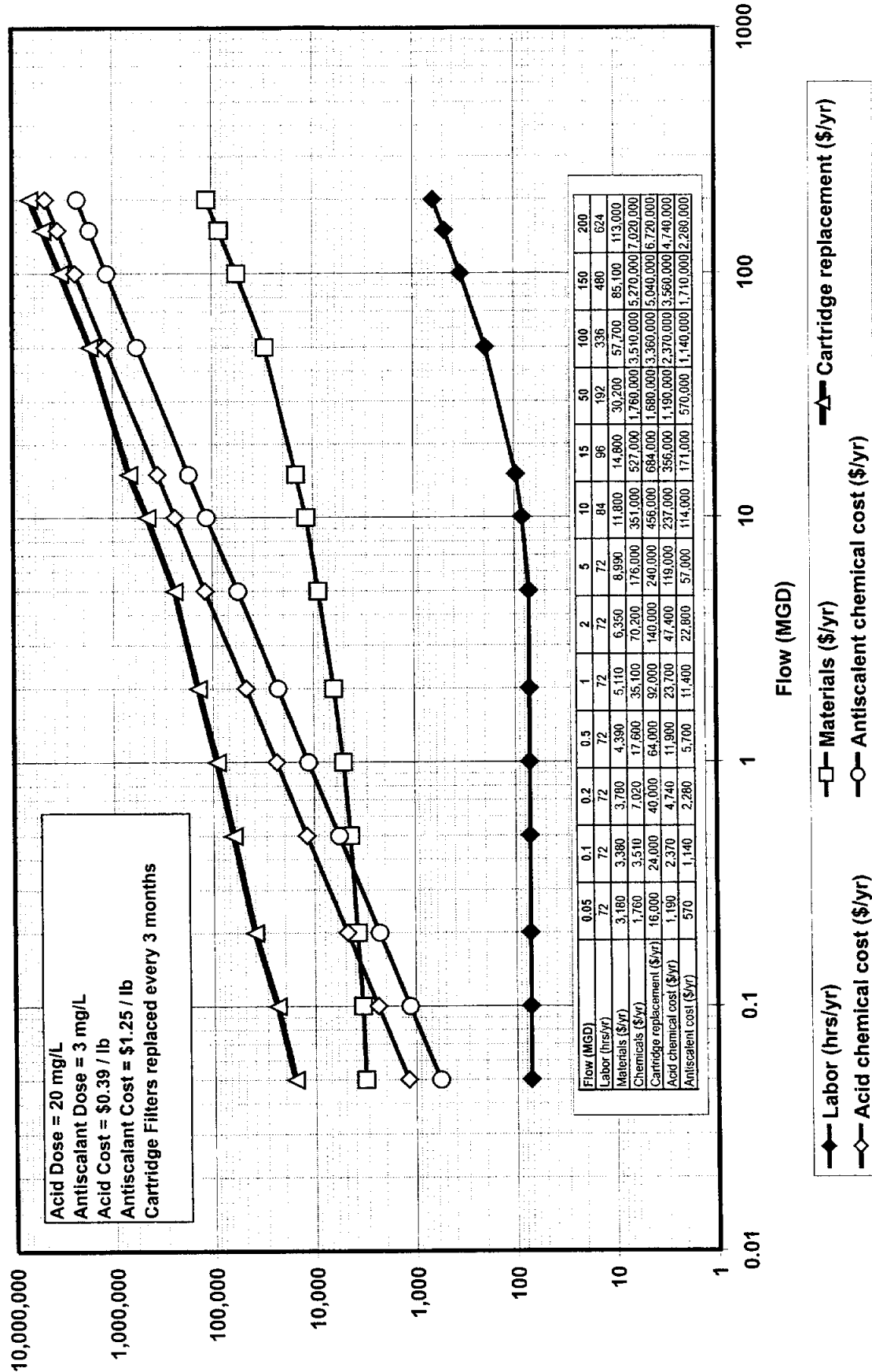

Figure 6-3. Reverse Osmosis Pretreatment — O&M

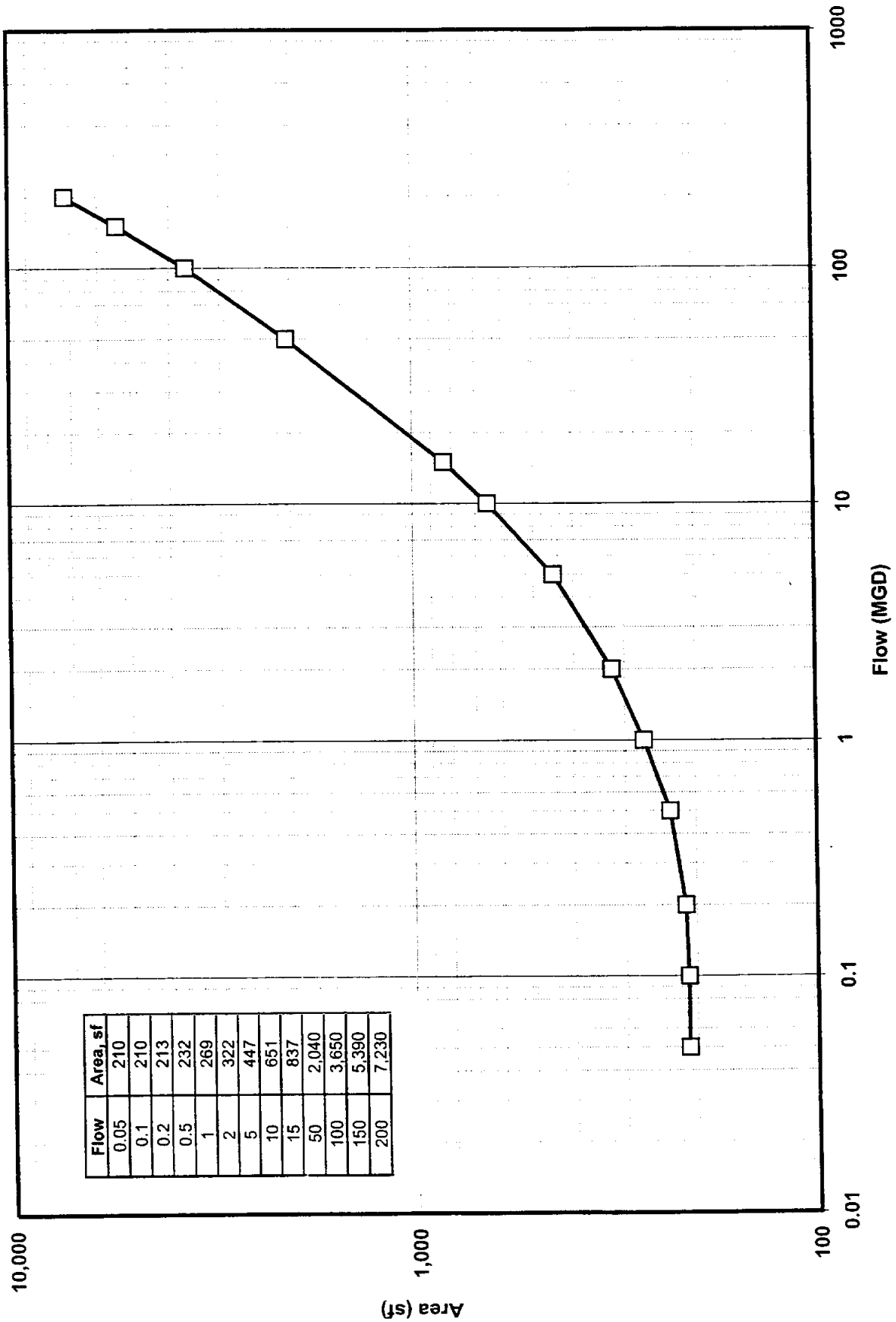

Figure 6-4. Reverse Osmosis Pretreatment — Building Area

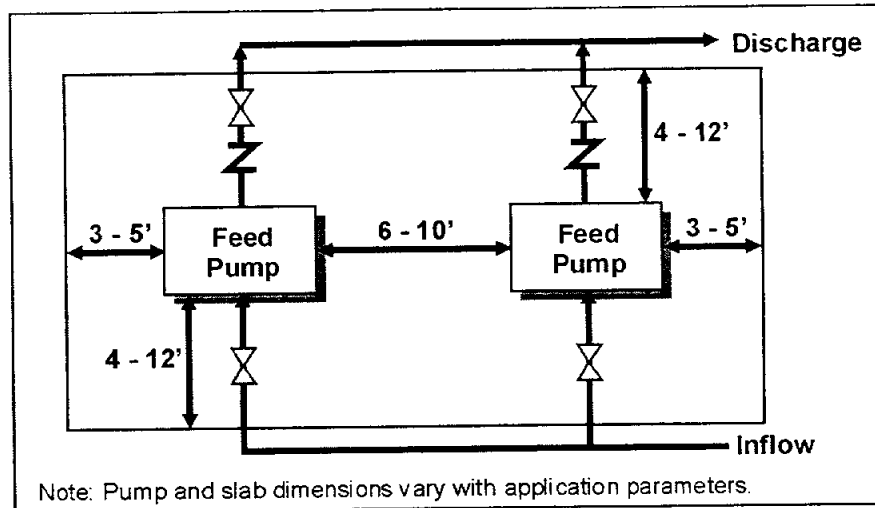

Figure 6-5. Layout of Membrane Feed Pumping Facilities

6.1.2.2 Operations and Maintenance

Feedwater pumping is assumed to be in continuous operation—24 hours per day, 365 days per year. Due to the variability of electric power rates throughout the United States, annual power requirements in megawatt-hours (MWh) were calculated. The pump efficiency of 75 percent and the design pump head were used in energy calculations. General equipment maintenance materials are assumed to be 5 percent of the process equipment capital cost. Labor is estimated at 1 hr/pump/week with a 156 hr/yr (3 hr/pump/wk) minimum. Labor requirements are also increased as a function of pump flow.

Figures 6-6 through 6-8 show the construction cost, operation and maintenance costs, and housing area, respectively, for RO pumping systems as a function of the pumped water flow rate, and for the four different pressure ratings between 300 and 900 psi.

6.1.3 RO Membrane Process Trains

6.1.3.1 Construction

Reverse osmosis facilities include pressure vessels that house the RO elements arranged in a sequence to provide the desired product water recovery. The desired recovery, feedwater composition, target removal efficiencies, membrane characteristics, and operating pressure all play a role in selecting the proper design. A 4-2-1 arrangement is often used to achieve target removal efficiency. Figure 6-9 shows the layout for the RO trains.

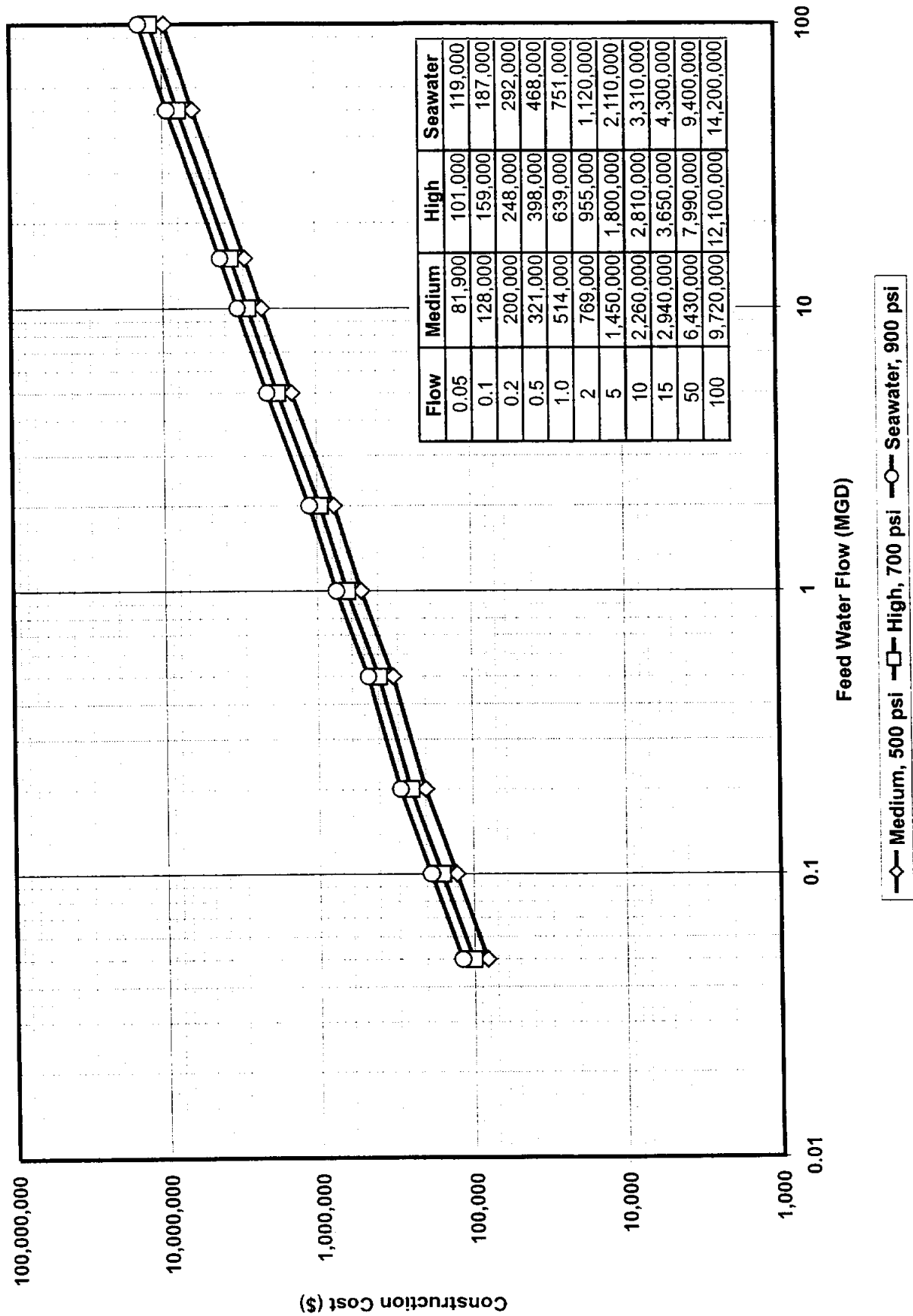

Figure 6-6. Reverse Osmosis Feed Pumping — Construction

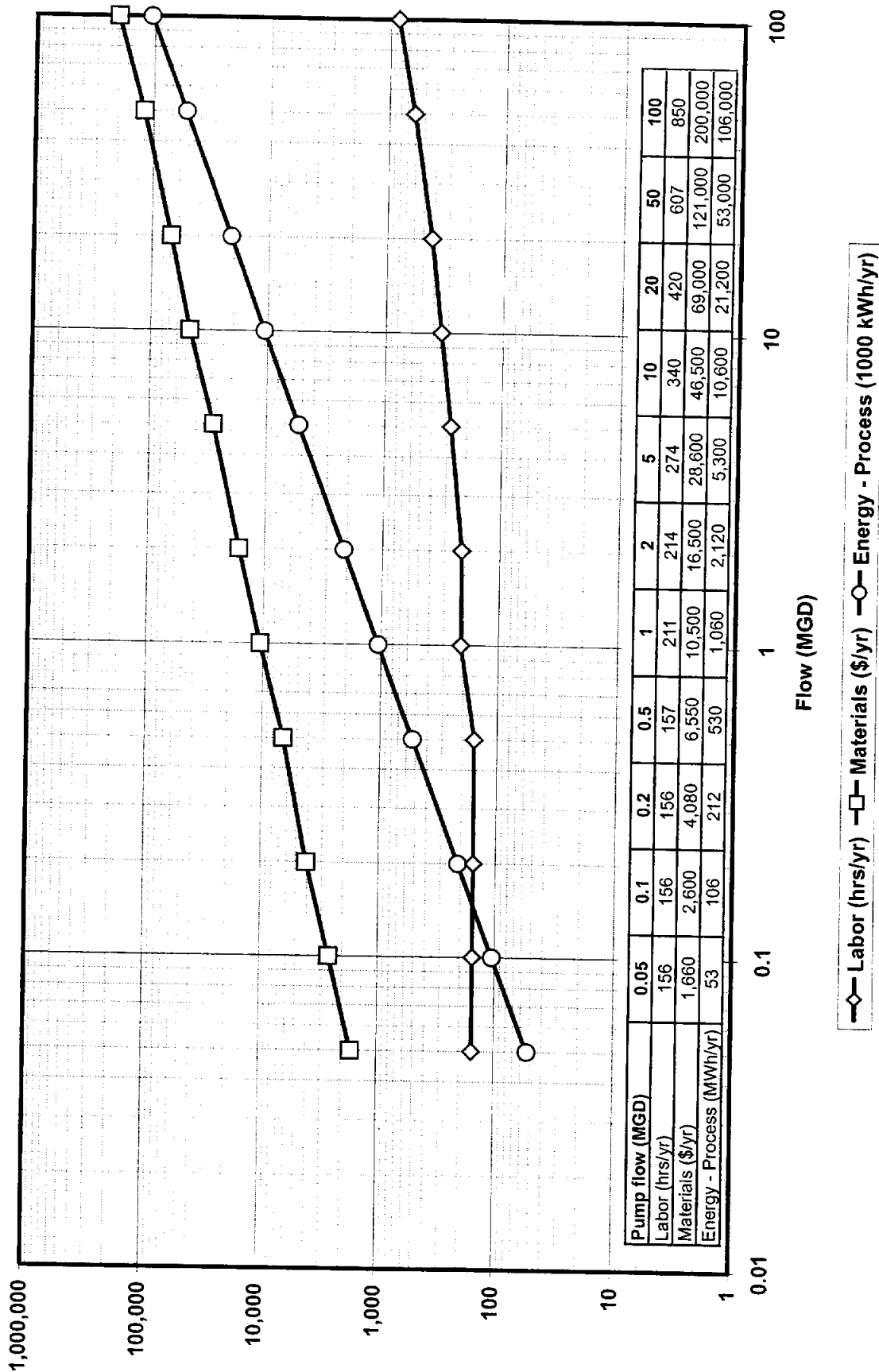

Figure 6-7a. Membrane Feed Pumping (Low Pressure, 300 psi) — O&M

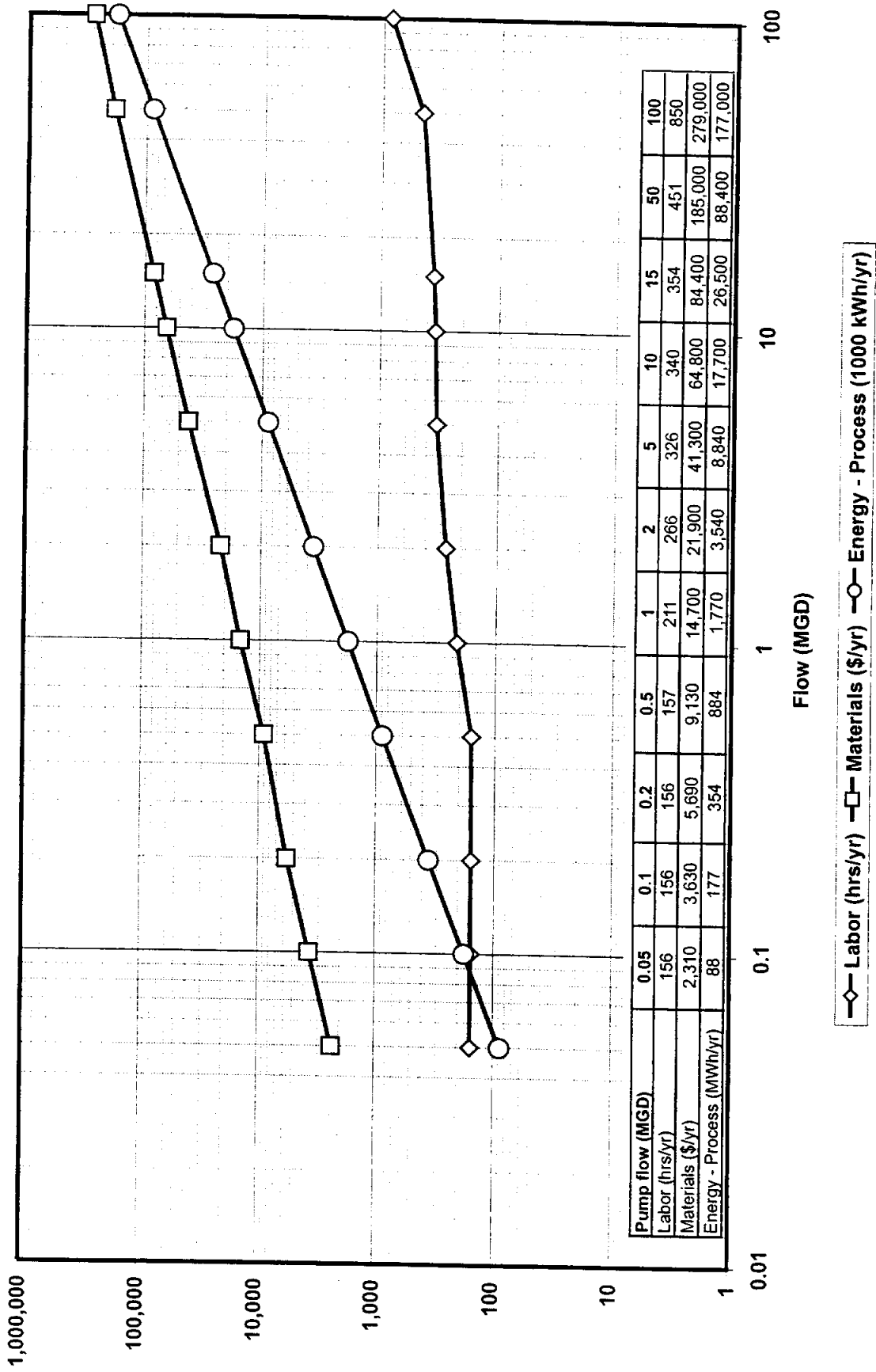

Figure 6-7b. Membrane Feed Pumping (Medium Pressure, 500 psi) — O&M

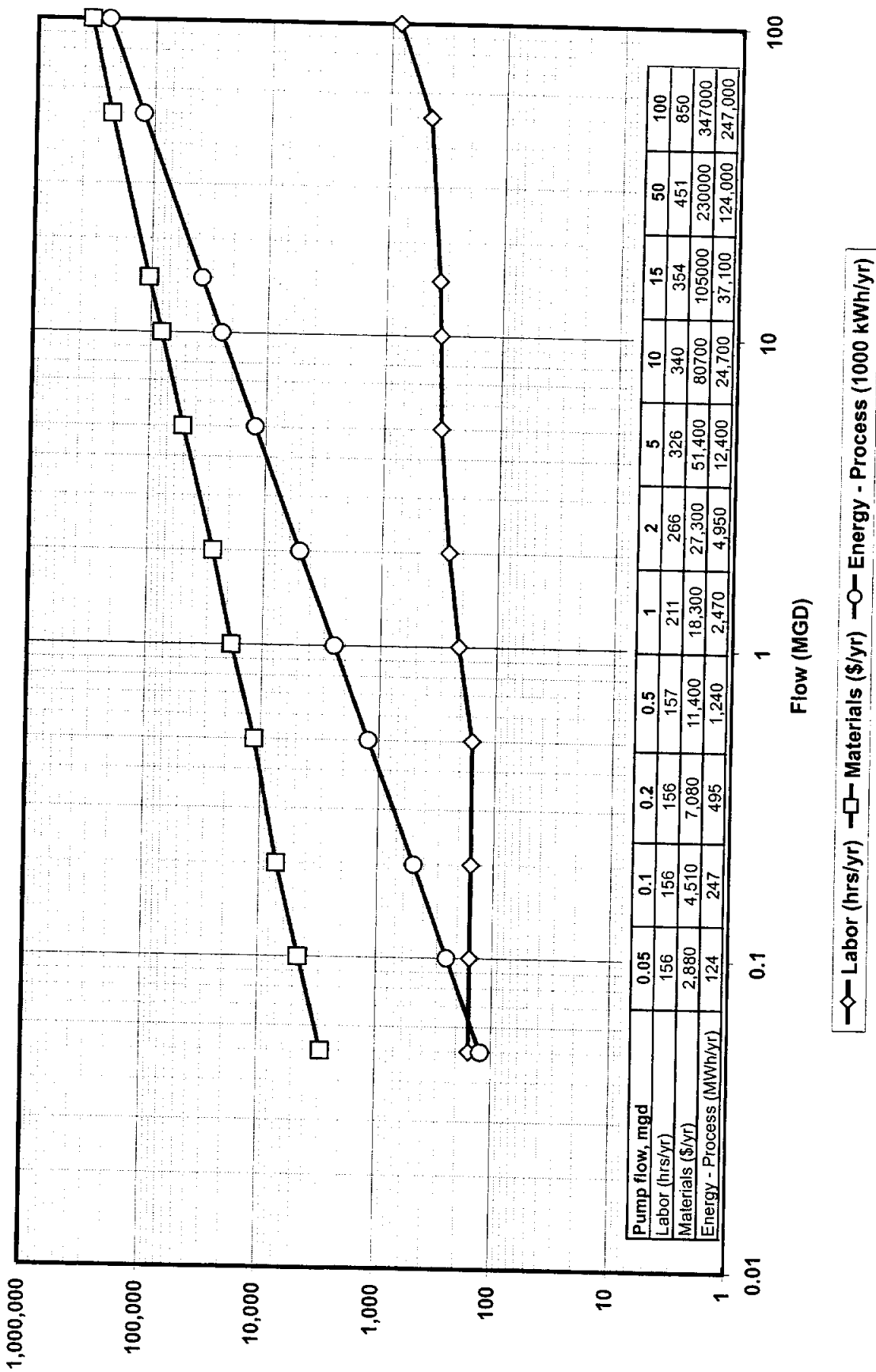

Figure 6-7c. Membrane Feed Pumping (High Pressure, 700 psi) — O&M

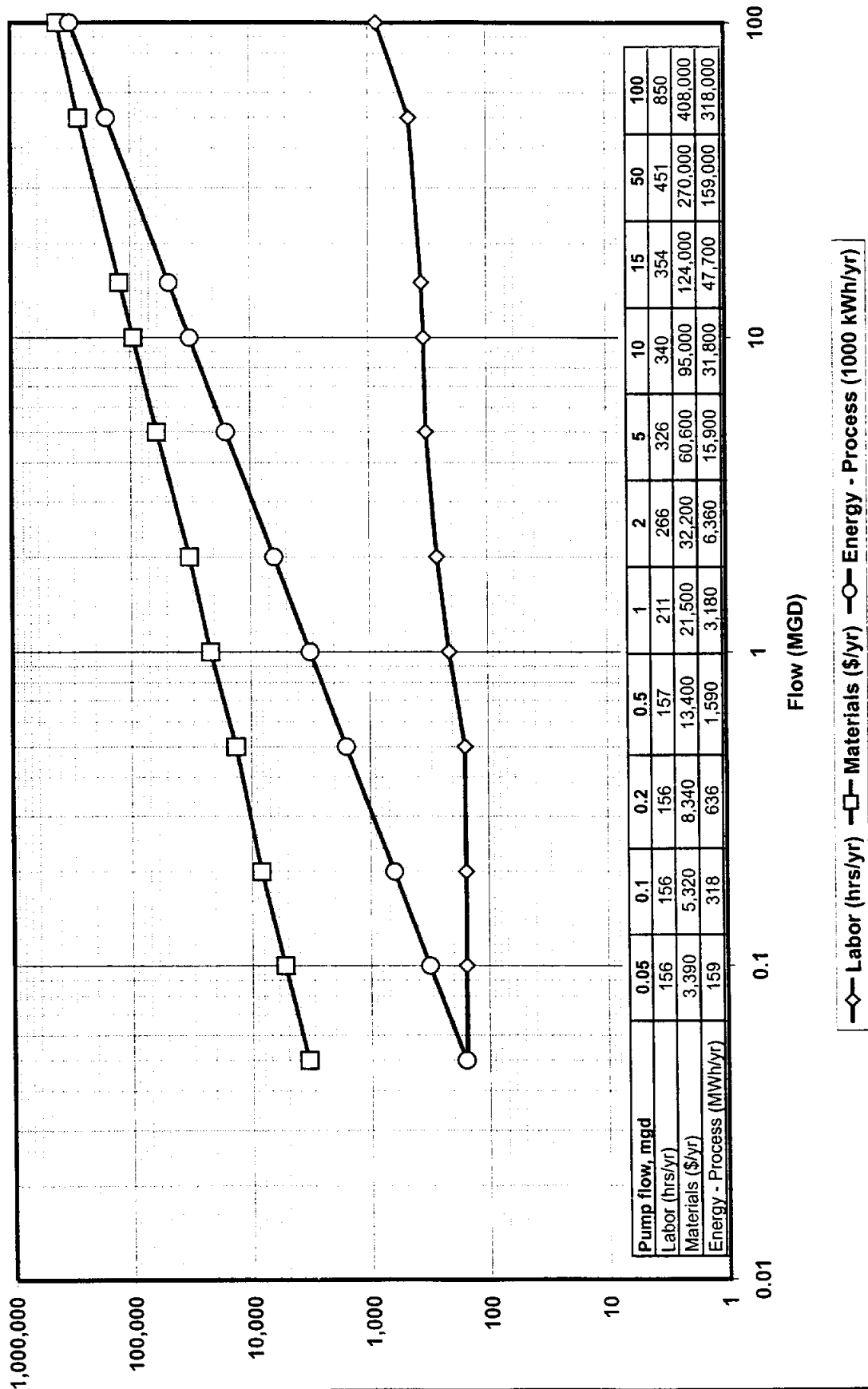

Figure 6-7d. Membrane Feed Pumping (Seawater Pressure, 900 psi) — O&M

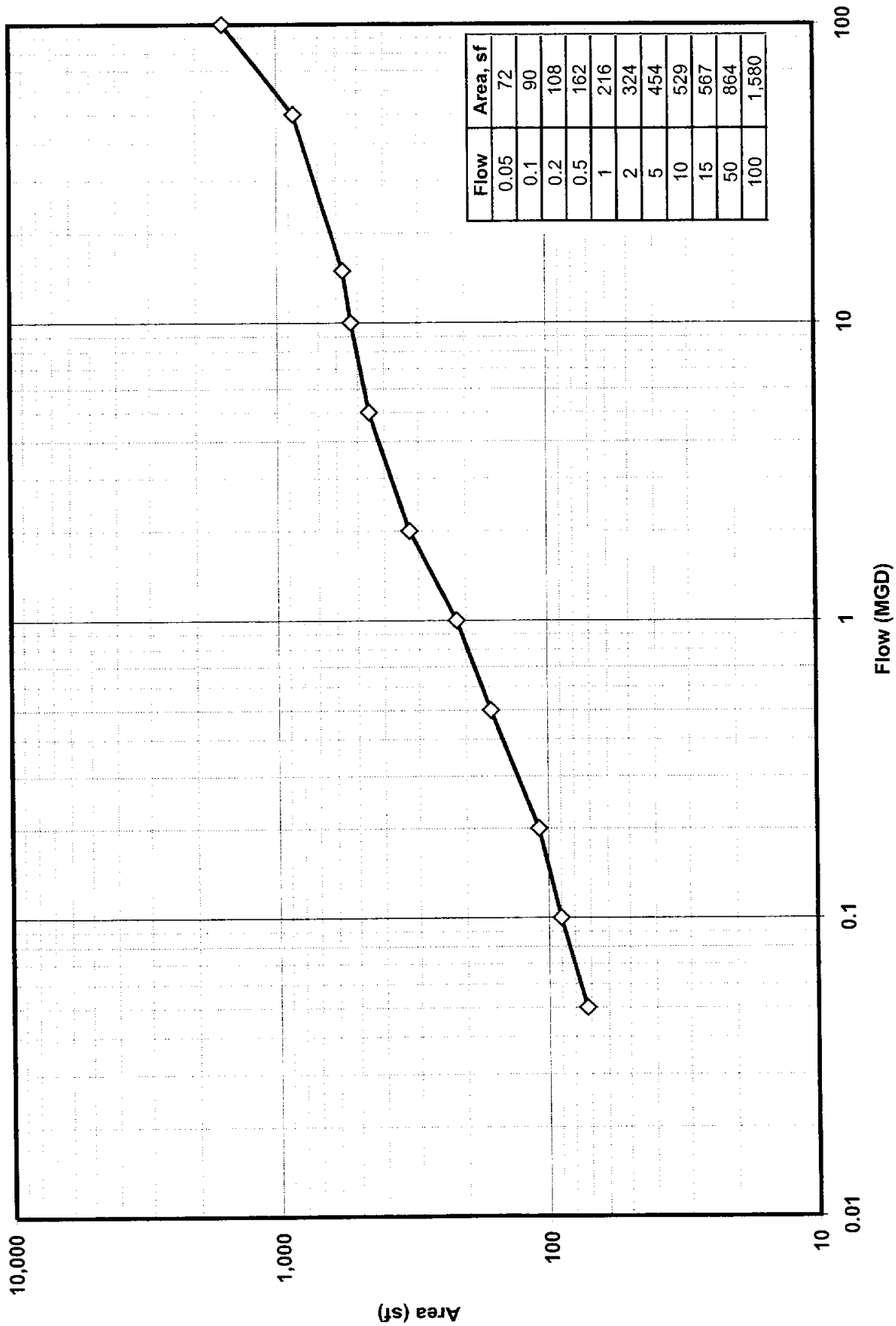

Figure 6-8. Membrane Feed Pumping — Building Area

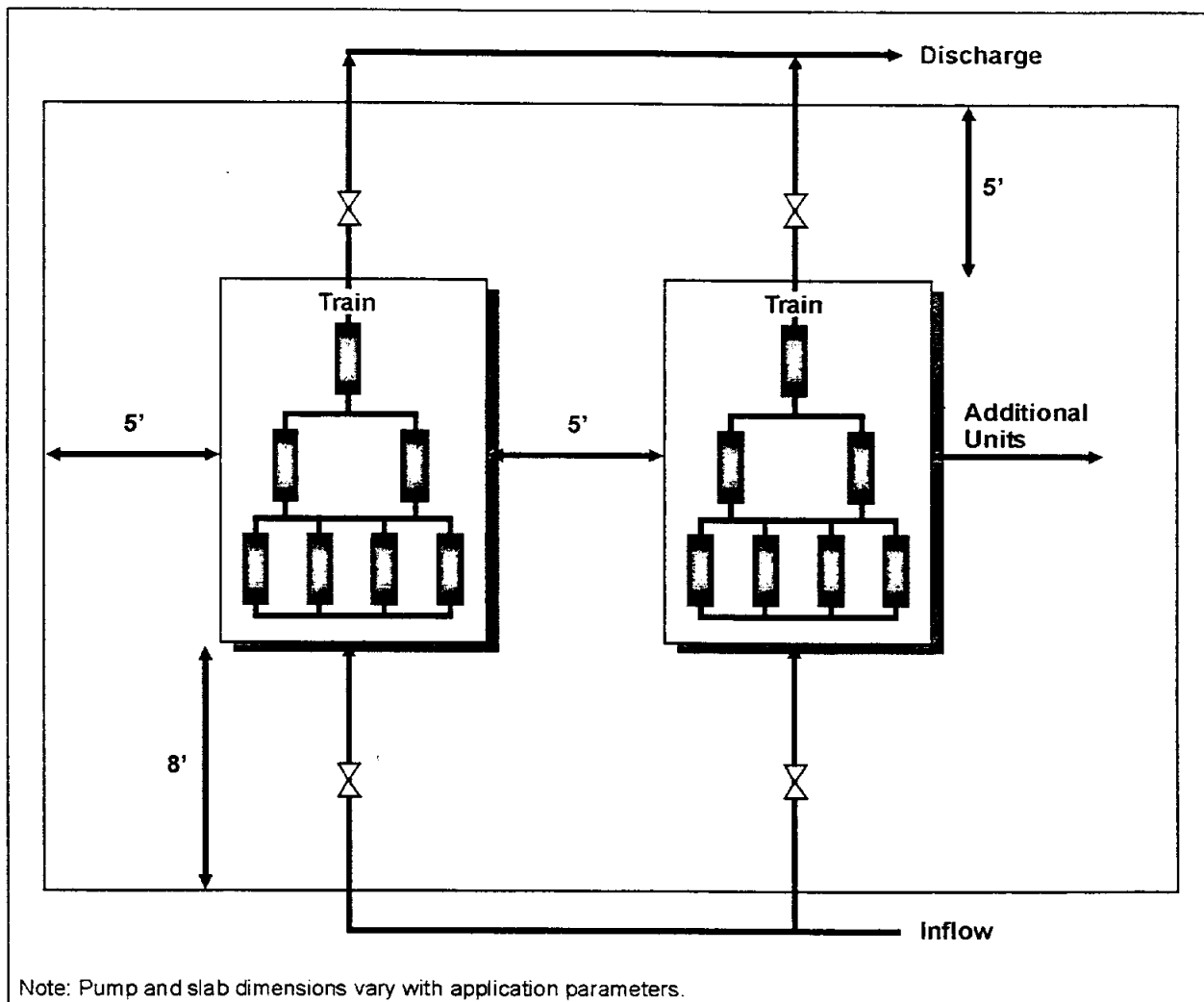

Figure 6-9. Layout of Reverse Osmosis Trains

There are two essential components to the RO design: the membrane elements and the pressure vessels. RO elements are the actual filtration membranes that need to be placed in housings or pressure vessels. The pressure vessels are, in turn, mounted in trains. The process recovery rate has little effect on the number of elements required; however, it can effect the number and arrangement of the pressure vessels.

The plant design flow and permeate flux will determine the number of elements (and thus trains) required. Each RO membrane element is assumed to have a filtration area of 400 sf (37.1 m²).^{3,4} The number of elements required can be calculated as shown in Equation RO1:

$$\text{Number of Elements} = \frac{Q \times 10^6}{A_m \times J} \times (1 + \text{SF}) \quad (\text{RO1})$$

Where:

- Q = Plant Design flow (MGD), product water;
- A_m = Module Unit Area (sf);
- J = Permeate flux (gal/sf-d); and
- SF = Safety Factor (typically 10 percent).

The flux and safety factor in the design is determined by the engineer, based on the available information and reliability required. Flux rates are determined by the water quality, removal efficiencies, operating pressure, and temperature as discussed above. The flux rate also has a significant impact on the pretreatment and cleaning frequency during operation.

Reverse osmosis manufacturers were contacted to obtain quotes for element costs. Quotes were obtained for membranes capable of operating at four pressures: Low RO (300 psi), Medium RO (500 psi), High RO (700 psi), Saltwater RO (900 psi). Element costs as quoted by these manufacturers were found to approximately fit power law functions. The average cost for each operating pressure is used in the estimate.

- Low RO – Cost per element (Average used) = \$989 (Number of elements)^{-0.065}
- Medium RO - Cost per element (Average used) = \$650 (Number of elements)^{-0.065}
- High RO - Cost per element (Average used) = \$750 (Number of elements)^{-0.065}
- Seawater RO -Cost per element (Average used) = \$850 (Number of elements)^{-0.065}

Reverse osmosis pressure vessel manufacturers provided costs. Pressure vessel price generally increases as the design pressure increases. The costs of seven element pressure vessels were found to follow the following relationship:

- Low RO – 7 element pressure vessel = \$1,902 (number of pressure vessels)^{-0.047}
- Medium RO - 7 element pressure vessel = \$2,800 (number of pressure vessels)^{-0.047}
- High RO - 7 element pressure vessel = \$3,400 (number of pressure vessels)^{-0.047}
- Seawater RO -7 element pressure vessel = \$3,800 (number of pressure vessels)^{-0.047}

³ AWWA, Op. Cit., 4th Edition.

⁴ AWWA/American Society of Civil Engineers, "Water Treatment Plant Design," New York, 3rd Edition.

6.1.3.2 Operation and Maintenance

Labor requirements were based on engineering and operational experience, and are assumed to be 3.3 hours per train per week plus 0.1 hours per element per year. Maintenance materials are estimated at 1 percent of the process system equipment cost. In addition, RO elements must be replaced periodically due to excessive wear. Cost per RO element for replacement is assumed to be the same as the original element cost calculated for construction. The cost calculations assume a 5-year life for the RO element.

Figures 6-10 through 6-12 show the construction cost, operation and maintenance costs, and housing area, respectively, for RO trains presented as a function of the number elements.

6.1.4 RO Chemical Cleaning System

6.1.4.1 Construction

Chemical cleaning for RO systems generally consists of several cycles of an acid wash followed by several cycles of caustic wash. For this analysis the entire cleaning cycle is assumed to last two days, one day per complete chemical wash. A typical chemical cleaning system can wash a maximum of 100 pressure vessels per cleaning cycle. The number of cleaning systems required is determined by the following expression, rounded up to the next number of cleaning systems:

$$\text{No. Cleaning Systems} = \left[\frac{\text{PV}}{100 \frac{\text{Cleaning interval}}{2}} \right] \tag{5}$$

Where:

No. Cleaning System = The number of chemical cleaning systems (acid and caustic) required

PV = Number of pressure vessels

100 = Maximum pressure vessels cleaning capacity

Cleaning interval = Days between cleanings

2 = Days per complete cleaning cycle

Chemical cleaning equipment required for both the acid and caustic chemical systems consists of the following (Figure 6-13):

- Fiberglass tank (one per chemical, upright, cylindrical)
- Flushing pumps, two each for caustic and acid
- Chemical fill station (larger systems only)
- Metering pump control panel (larger systems only)

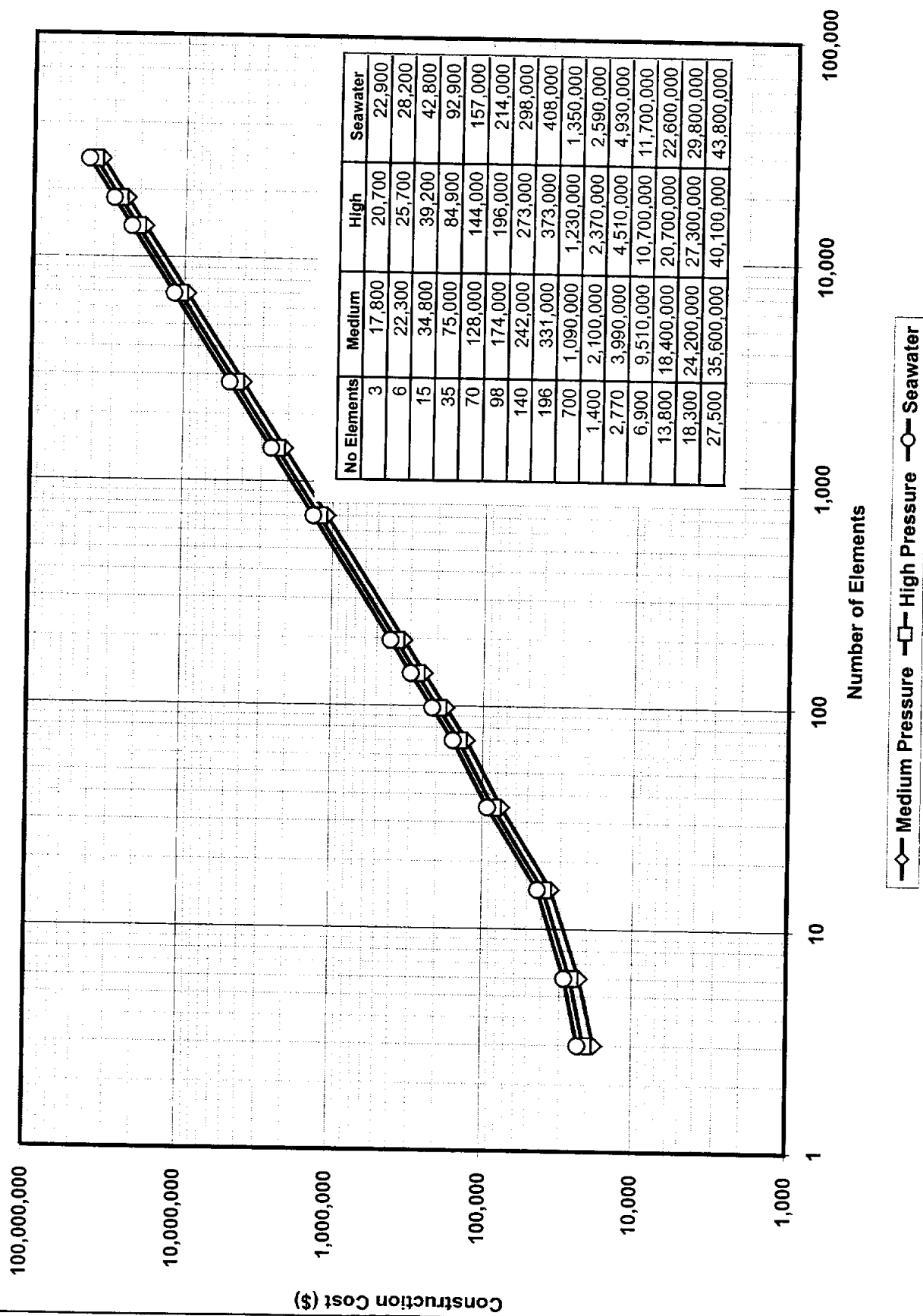

Figure 6-10. Reverse Osmosis Process System — Construction

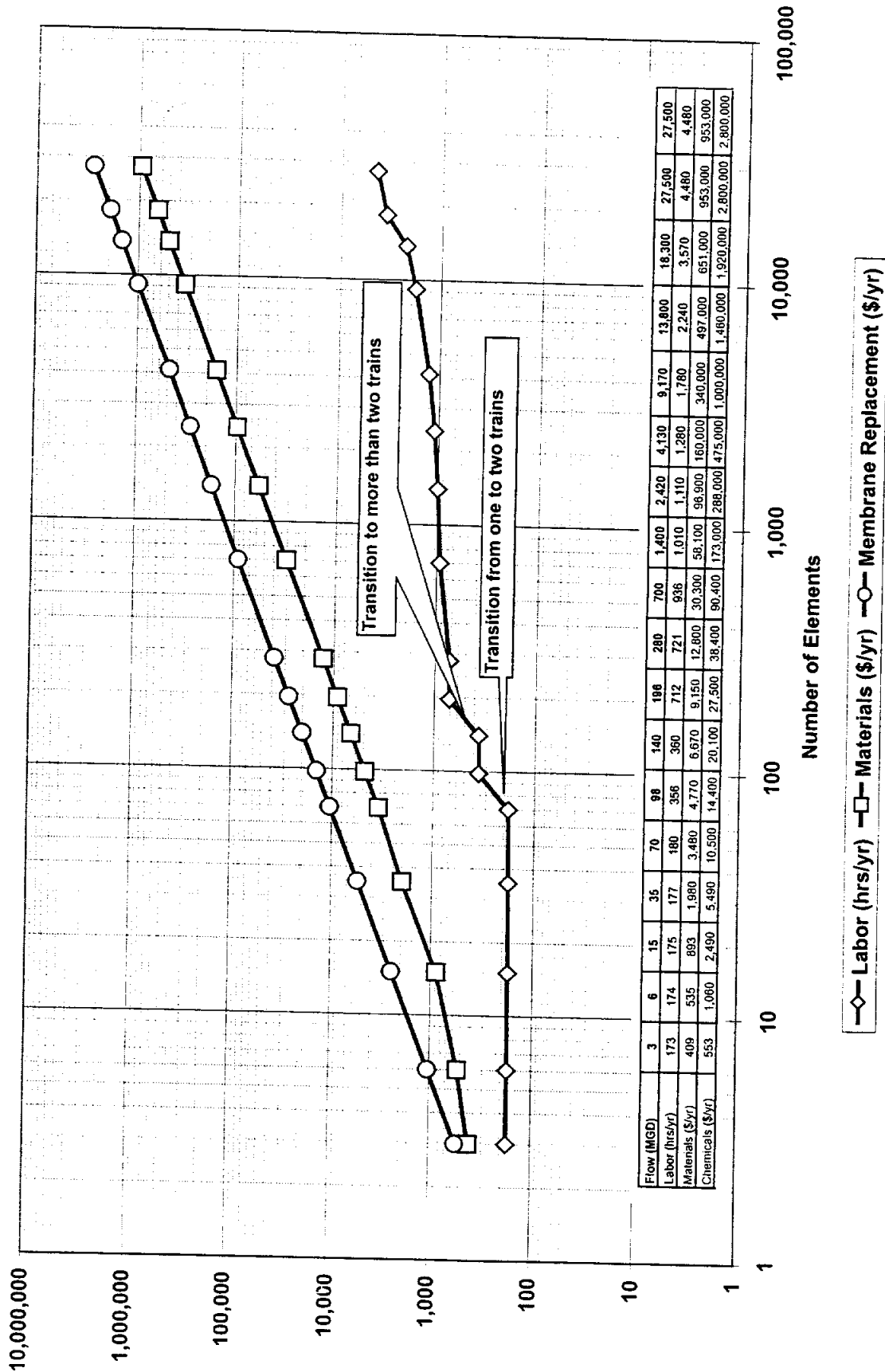

Figure 6-11a. Reverse Osmosis Process System (Low Pressure) — O&M

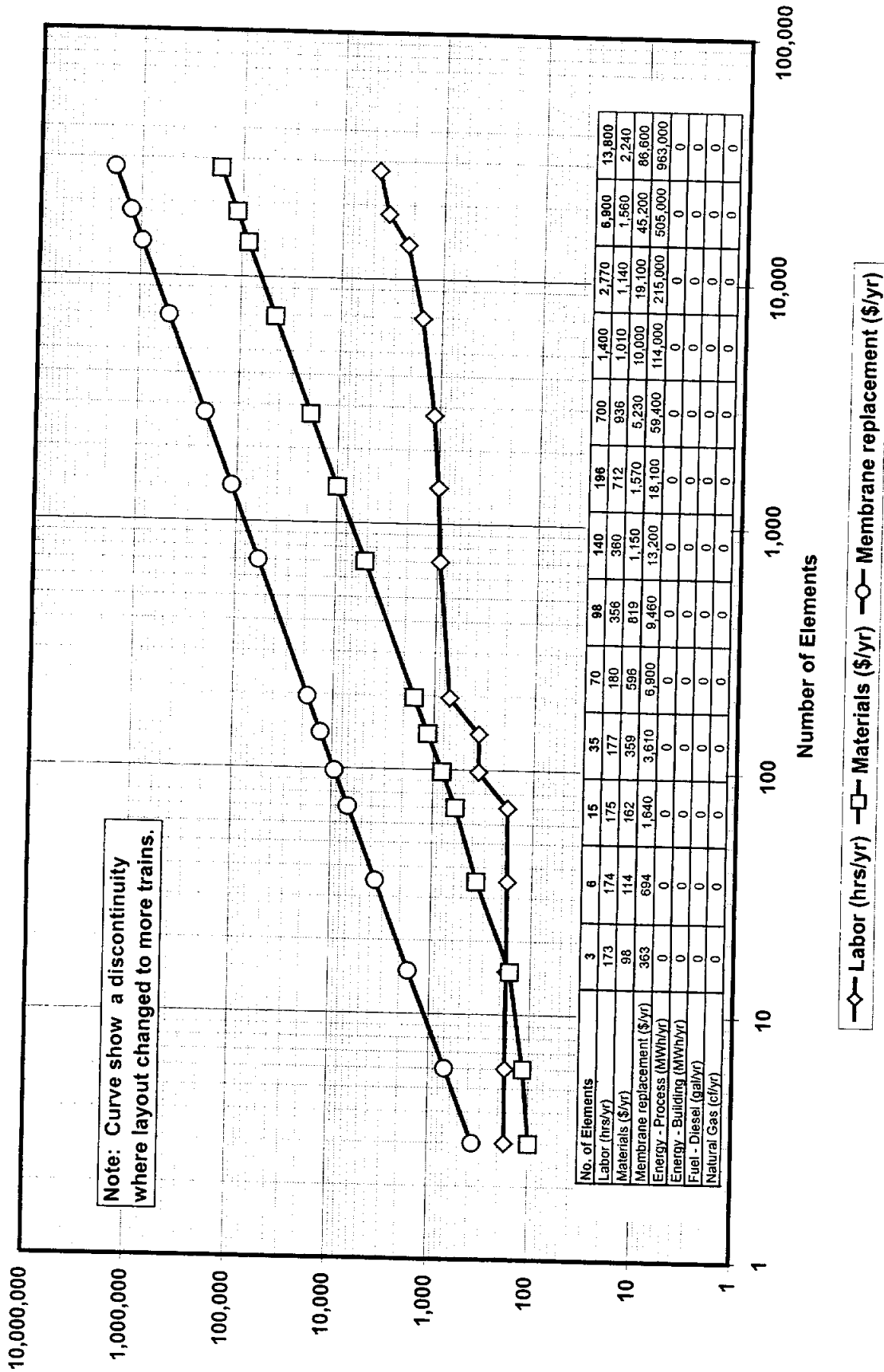

Figure 6-11b. Reverse Osmosis Process System (Medium Pressure) — O&M

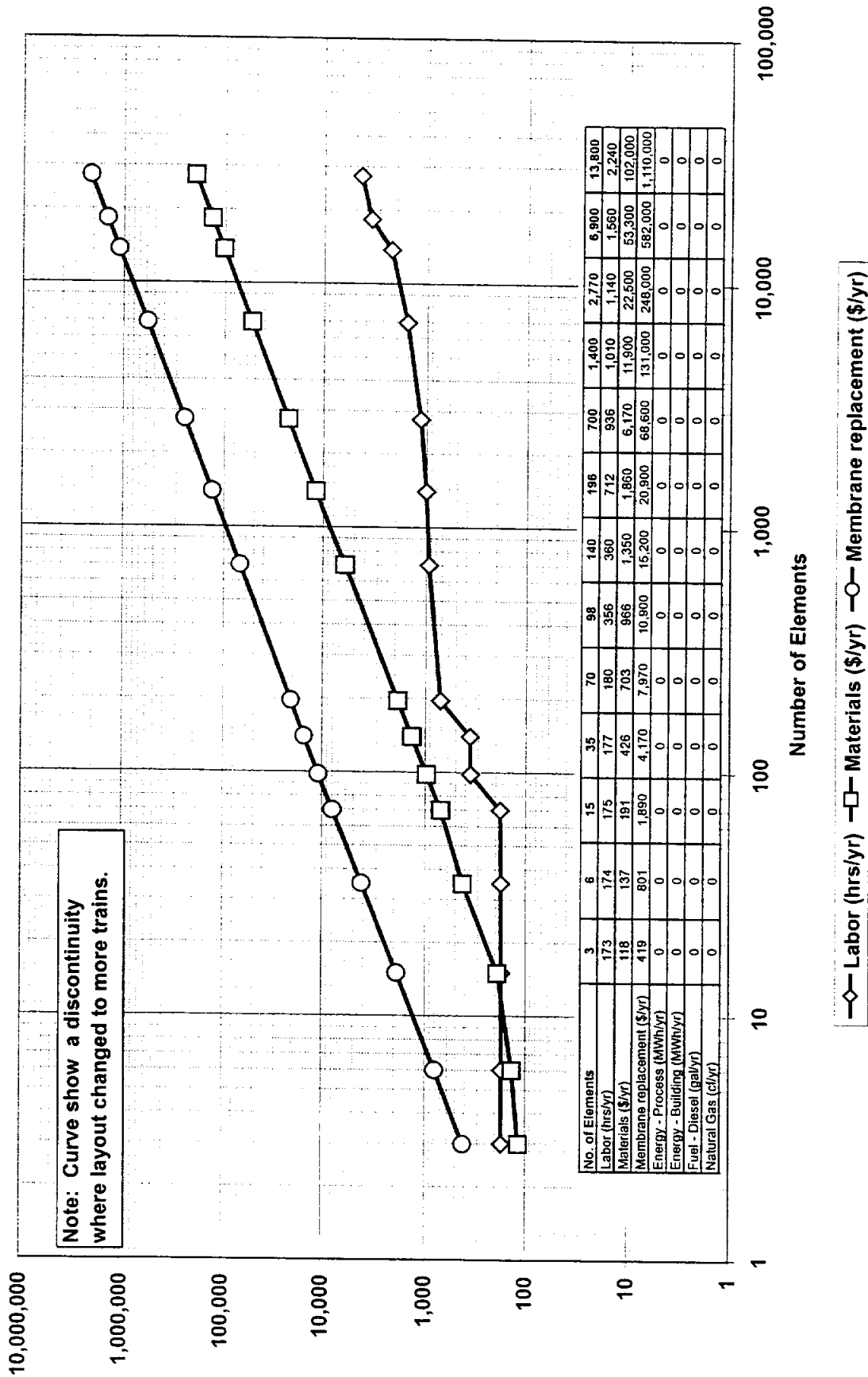

Figure 6-11c. Reverse Osmosis Process System (High Pressure) — O&M

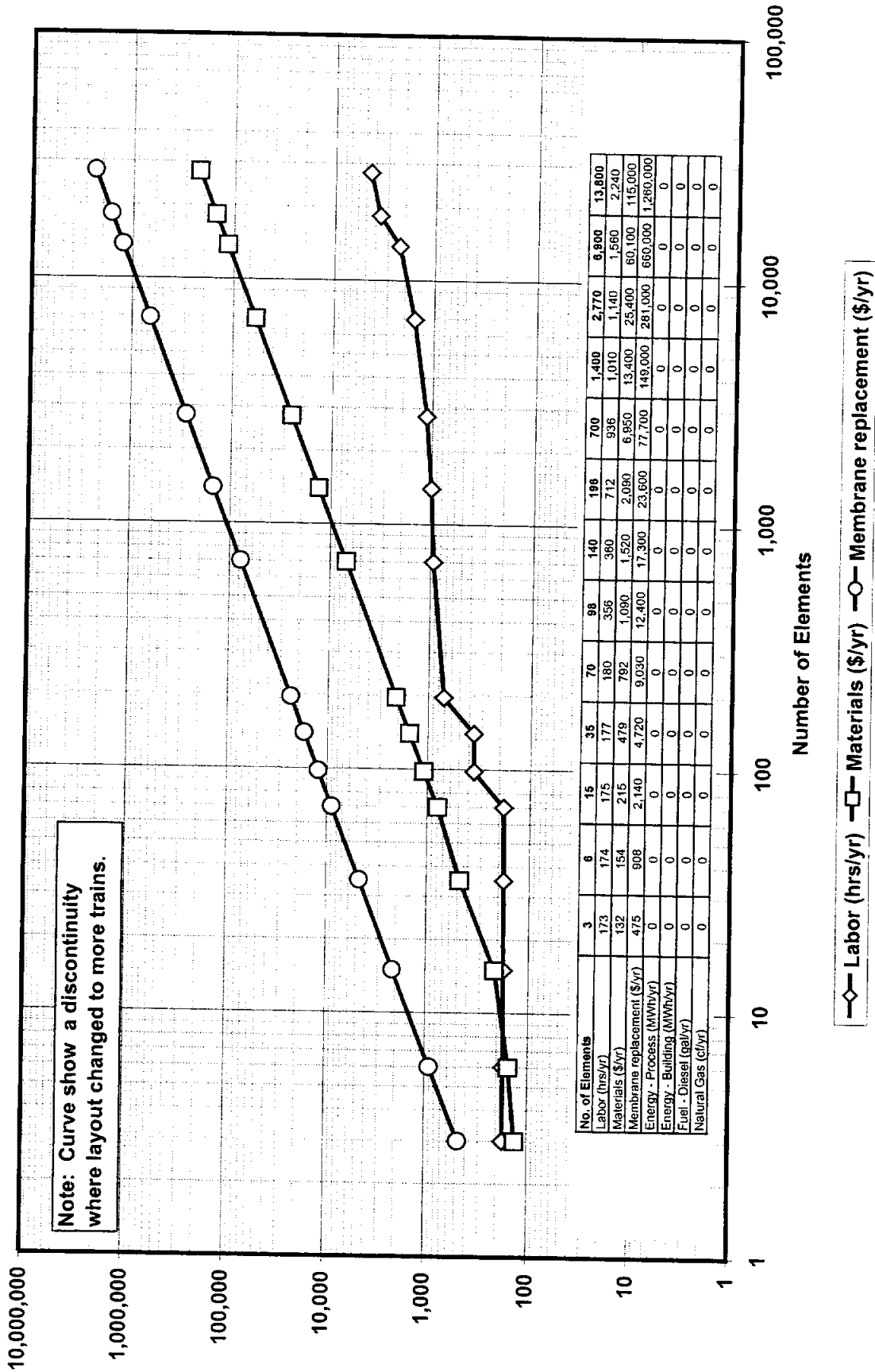

Figure 6-11d. Reverse Osmosis Process System (Seawater) — O&M

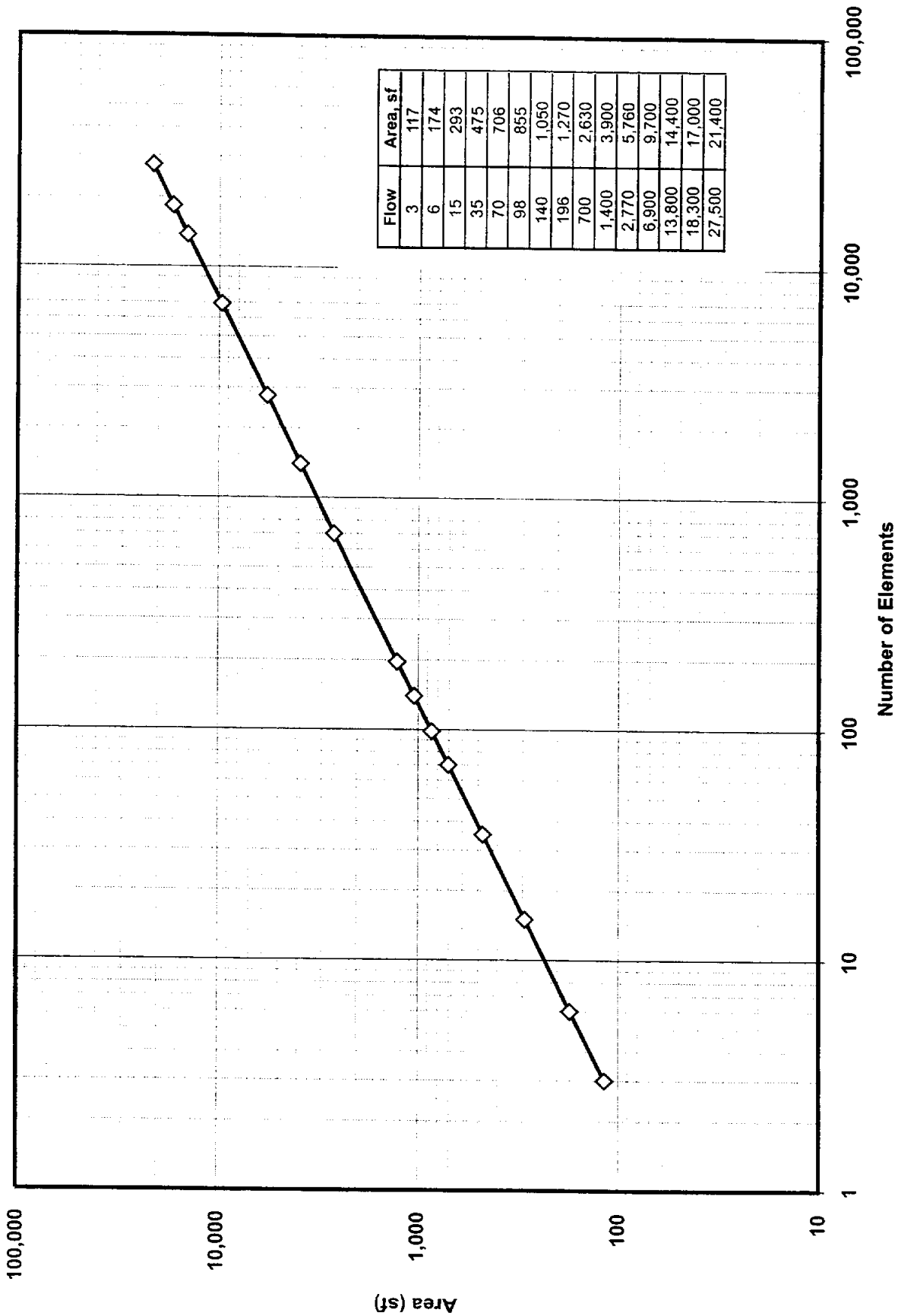

Figure 6-12. Reverse Osmosis Process System — Building Area

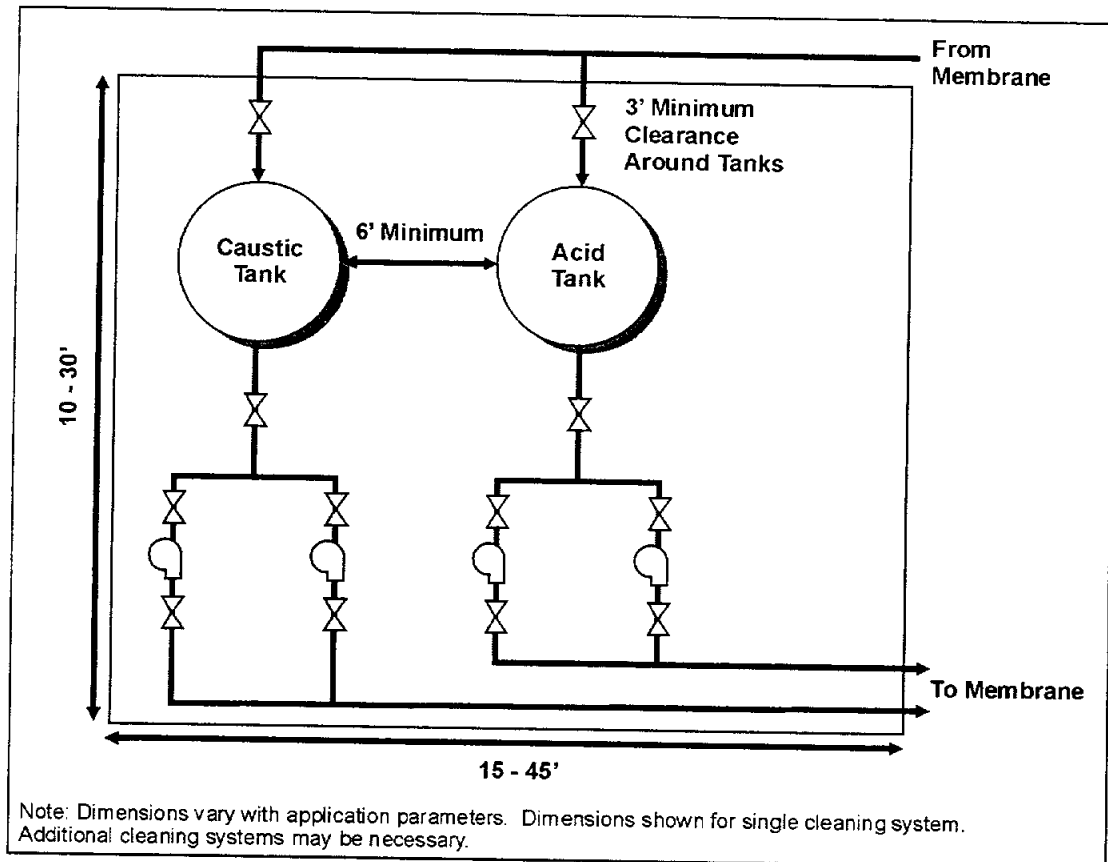

Figure 6-13. Layout of Reverse Osmosis Cleaning System

The volume of the chemical tank is estimated by multiplying the total volume of the pressure vessels by 3. The chemical flushing pump design flow is based on a flow of 40 gpm per pressure vessel, with a maximum of 100 pressure vessels per cleaning. The flushing pumps TDH is assumed to be 150 psi (345 feet). One pump per chemical service plus one standby per cleaning system is assumed. Larger facilities having lower chemical storage capacity are assumed to require a separate outdoor chemical filling station for both acid and caustic due to the frequent chemical delivery. Smaller facilities do not require a filling station due to their lower chemical consumption. A control panel for the flushing pumps is assumed to be included in the package system for the larger facilities and not included for the smaller facilities.

Standard chemical cleaning system configurations for RO were developed using the assumptions and criteria above. The cost per element for the cleaning systems were then plotted and standard equations were developed for the relationship between number of elements and cleaning cost per element.

Figure 6-14 shows the construction cost for the chemical cleaning system presented as a function of the number elements cleaned per year. The cost curves show the following:

- As expected, for a given annual cleaning cycle requirement, the capital cost is lowest if the cleaning is completed frequently. This requires smaller facilities to clean the same number of elements on an annual basis.
- The cost reaches a plateau that corresponds to the point where the cleaning system becomes used to capacity.
- Once the capacity of a single cleaning system is exceeded, more than one unit is required to provide the cleaning capacity and construction cost rise again.

6.1.4.2 Operation and Maintenance

Labor requirements are assumed to be 16 hours per cleaning system run. The labor requirement is reduced as the annual cleaning requirements increase.

Chemical consumption rates were obtained from equipment manufacturers and scaled to specific design requirements for each plant design flow. Chemical consumption requirements for acid and caustic are based on changing the pH of the cleaning solutions from 7.5 to 2.0 and 12.0, respectively. Cleaning chemicals are shipped in concentrated form and diluted with product water. General equipment maintenance requirements are assumed to be 5 percent of the cleaning equipment capital costs.

Even though the costs are presented in terms of the number of elements cleaned per year, the costs increases when the cleaning frequency is high. Therefore, O&M chemical consumption costs are presented for cleaning at bimonthly, monthly, semi-annual, and annual intervals to capture the incremental cost for large numbers of systems. The more frequent cleanings require additional chemicals as well as increased equipment cost.

Flushing pumps are assumed to be in operation 48 hours per day per cleaning run (24 hours each for the acid and caustic pump). Due to the variability of electric power rates throughout the United States, annual power requirements in MWh were calculated. The pump efficiency of 75 percent and pump head of 150 psi were used in energy calculations.

Figures 6-14 through 6-16 show the construction cost, operation and maintenance costs, and housing area, respectively, for the reverse osmosis chemical cleaning system presented as a function of the number elements cleaned per year.

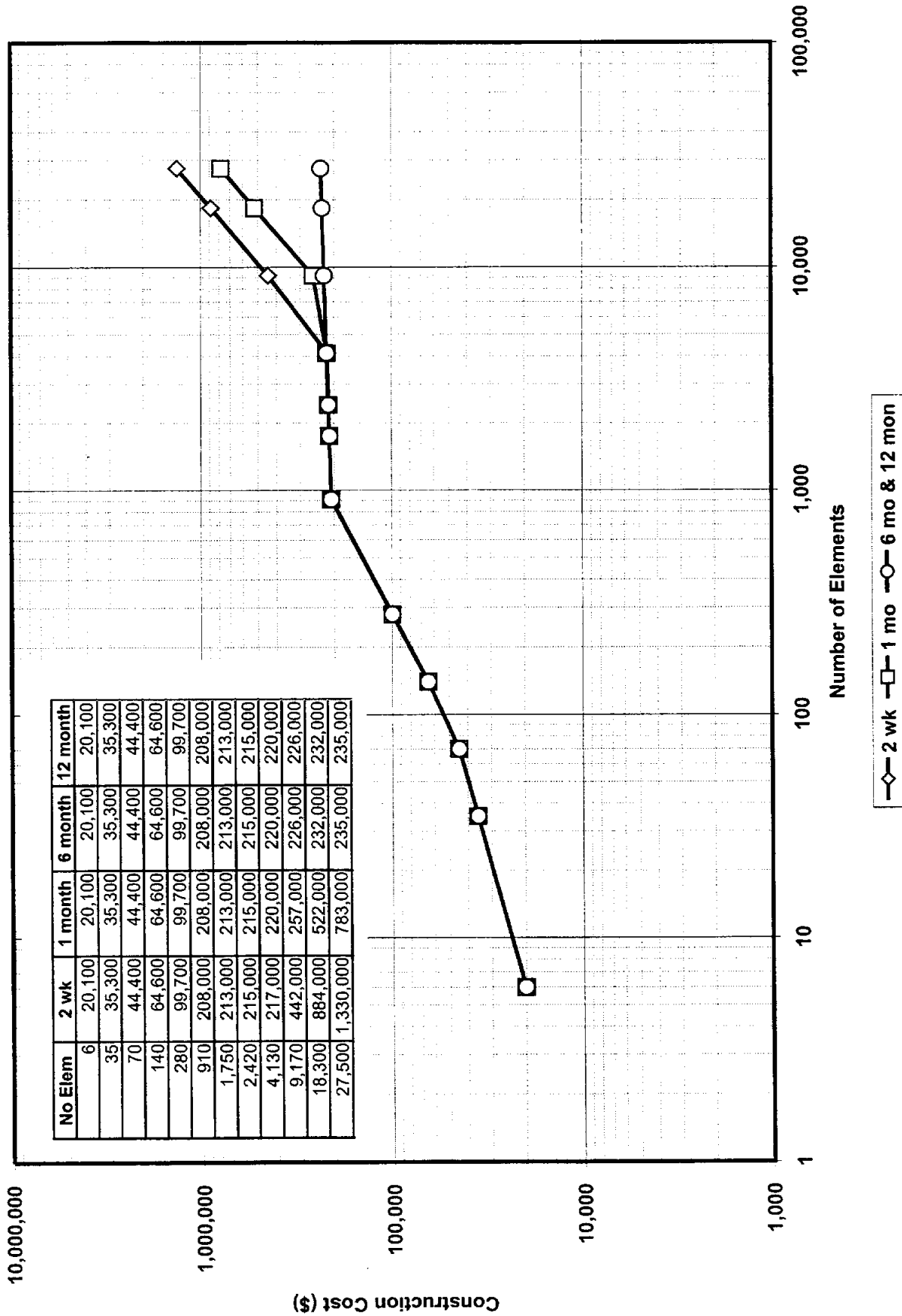

Figure 6-14. Reverse Osmosis Cleaning System — Construction

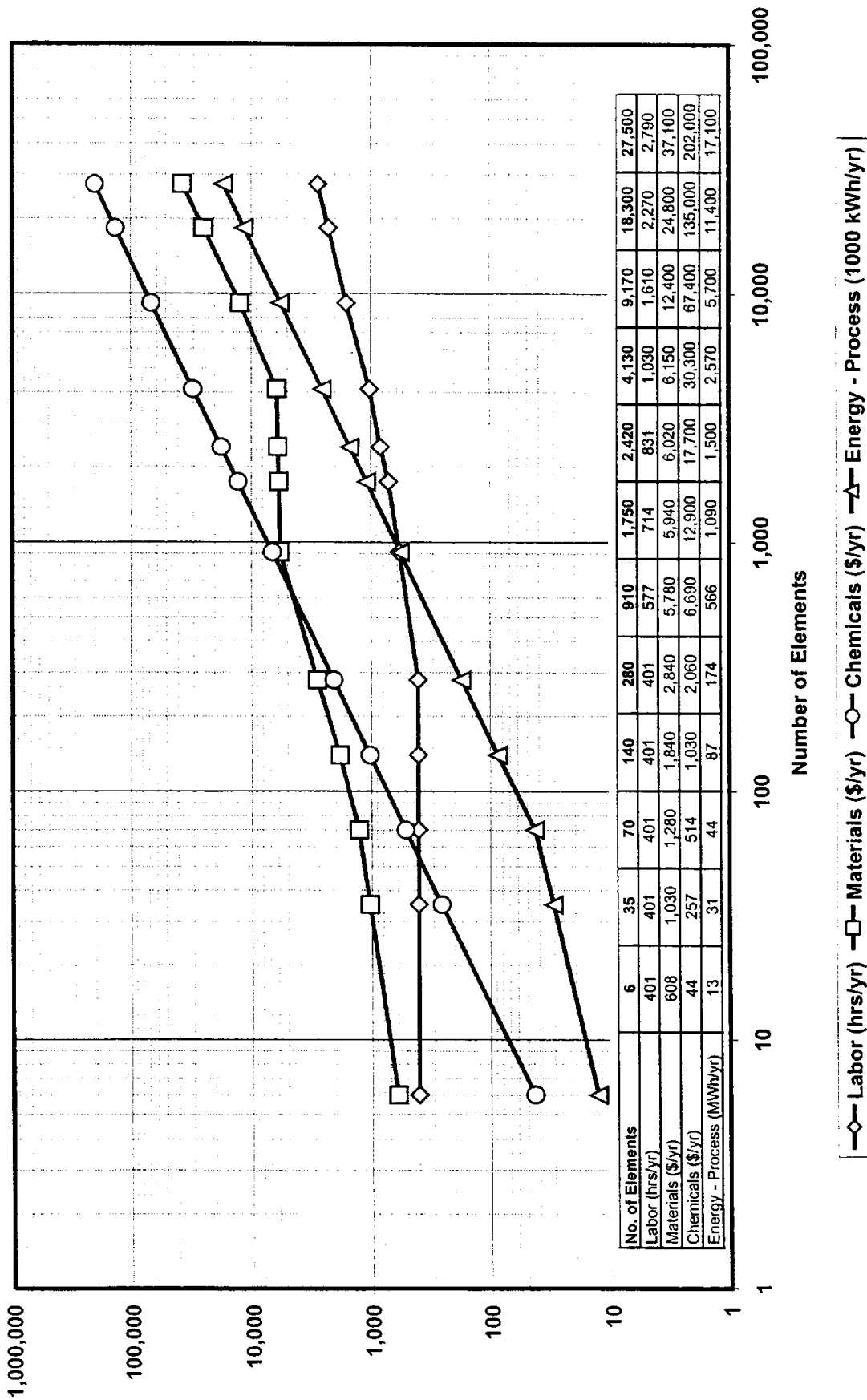

Figure 6-15a. Reverse Osmosis Cleaning System (2 wk) — O&M

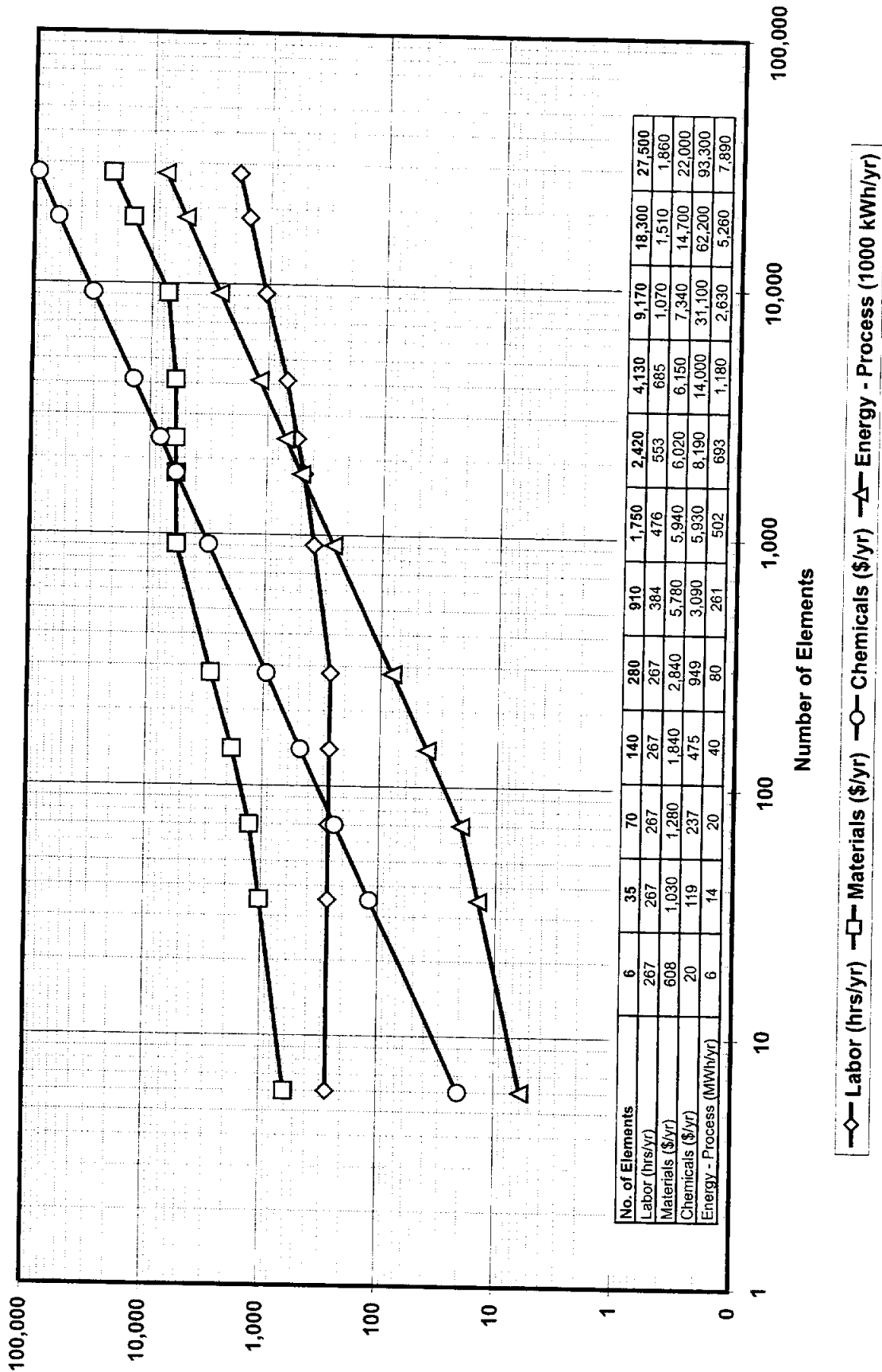

Figure 6-15b. Reverse Osmosis Cleaning System (1 mo) — O&M

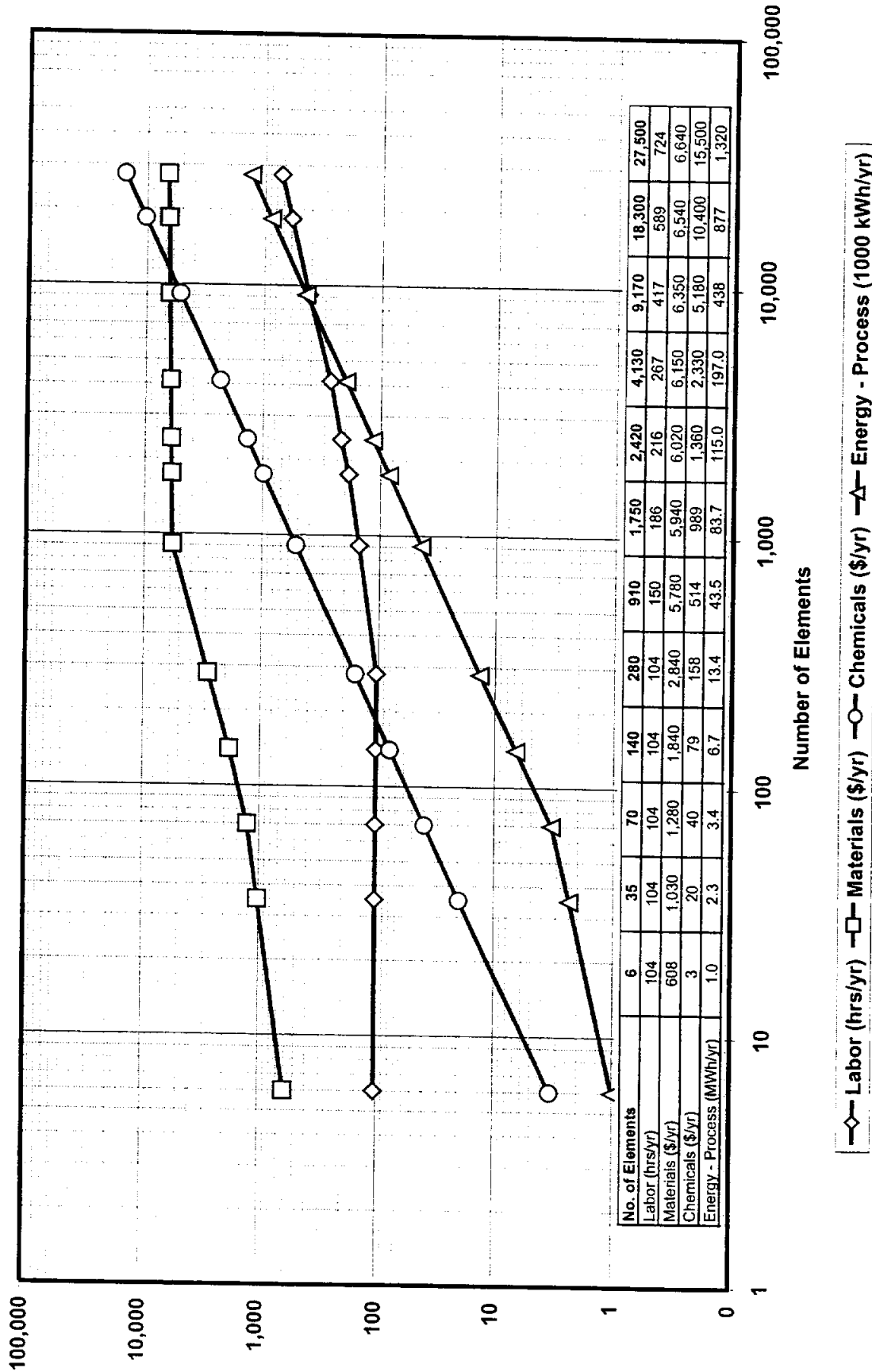

Figure 6-15c. Reverse Osmosis Cleaning System (6 mo) — O&M

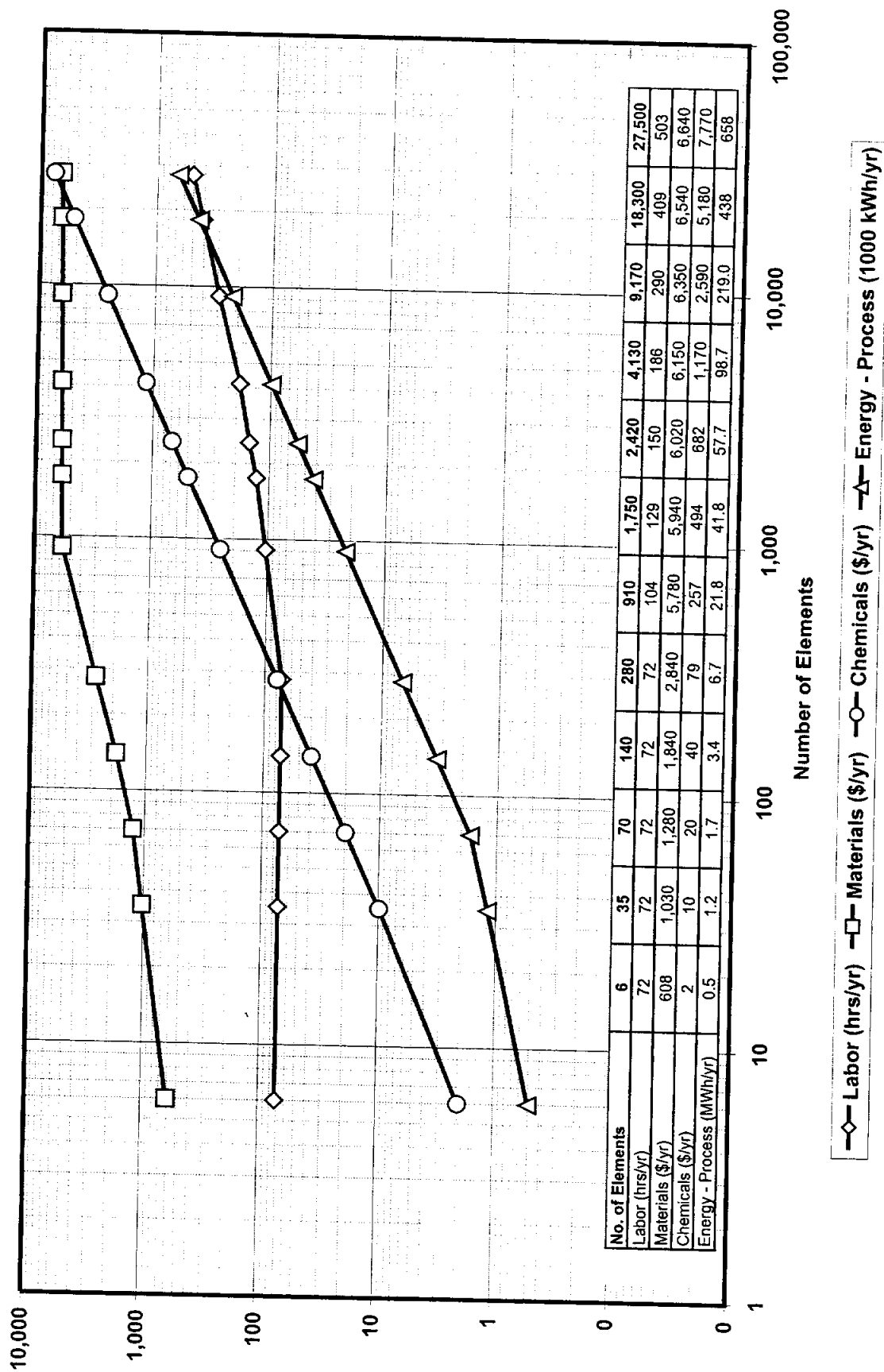

Figure 6-15d. Reverse Osmosis Cleaning System (12 mo) — O&M

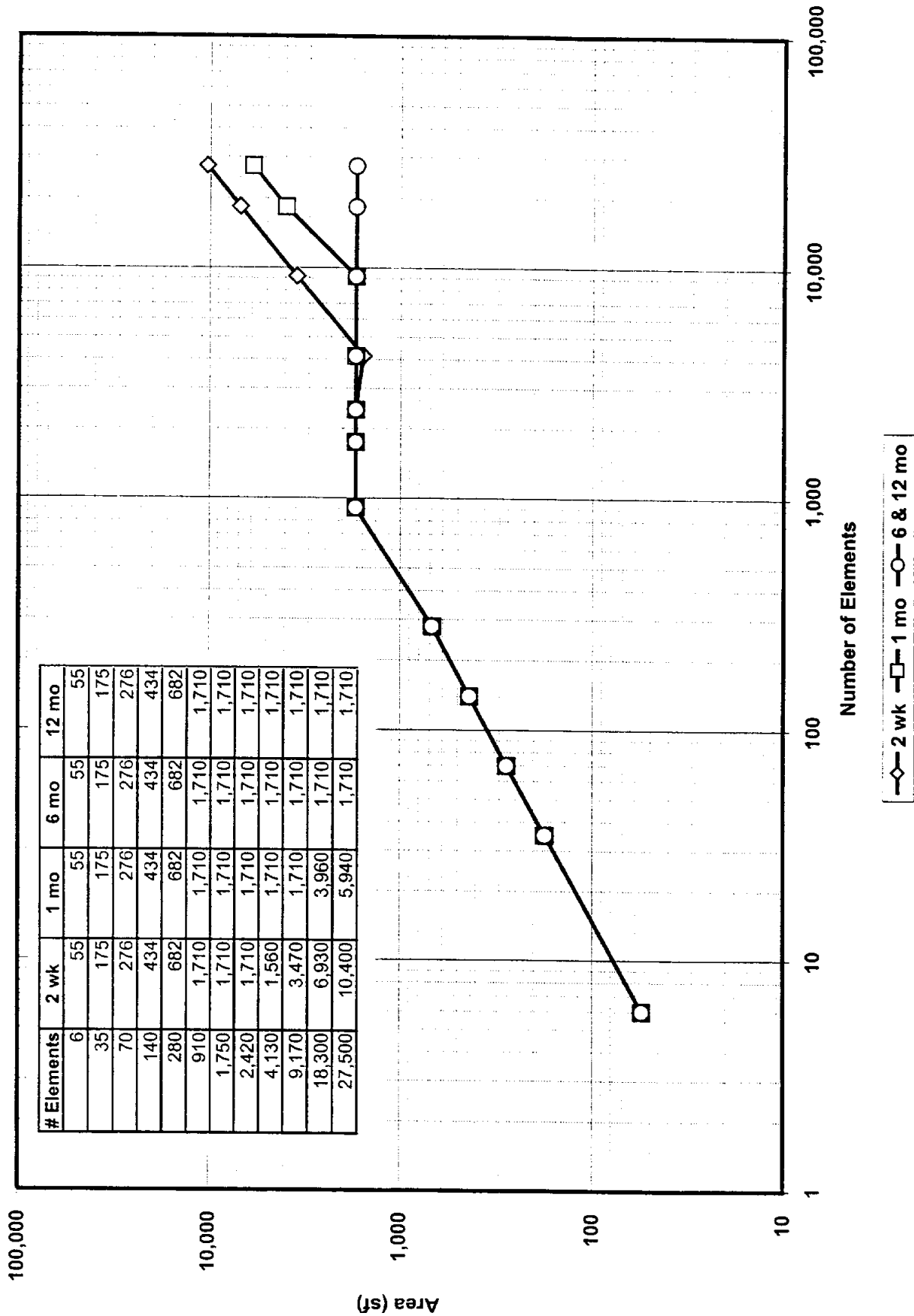

Figure 6-16. Reverse Osmosis Cleaning System — Building Area

6.2 Survey of Desalination Costs

A survey of drinking water utilities currently practicing desalination was performed to identify the types of membrane applications and quantify the costs associated with construction, operation and maintenance, and concentrate disposal. The facilities contacted focused on Texas, but also included some in Florida and California. The contact list was developed from a telephone surveys of membrane vendors, the inventory of desalting plants prepared by the American Desalting Association, literature review, and the knowledge of the engineering consultants performing this project. A questionnaire was developed to gather cost and performance data from existing plants. The information requested included plant capacity, operating, and cost data. A copy of the questionnaire is included as C.

Surveys were mailed to 117 public water systems thought to operate some form of desalination water treatment using membranes. Of the surveys mailed, 17 responses were obtained. The distribution of responses illustrated in Table 6-2, segregated by membrane and source water type.

Table 6-2.
Distribution of Survey Responses

Source Water	Membrane Type		Total
	RO	EDR	
Ground	10	1	11
Surface	0	3	3
Seawater	3	0	3
Total	13	4	17

More responses were received from utilities desalinating ground water, than surface or seawater. Of the groundwater utilities responding, the majority used reverse osmosis over EDR. Three utilities desalinating surface water responded to the survey, all in Texas. Texas is unique in that brackish surface waters occur inland, due to natural salt contamination in some major rivers (Brazos, Colorado, and others). Of the surface water utilities that responded, all use EDR for desalination. Three seawater desalination facilities responded, but none of these facilities are currently operating.

At the start of the survey, about 17.6 MGD of desalination capacity in Texas was identified. Of this capacity, 14.9 MGD, or 85 percent, is represented by response to the survey. Reasons identified for building membrane plants included TDS (11), TDS and hardness (3), TDS and arsenic (1), sulfate and radionuclides (1). Concentrate disposal methods include ocean outfall (5), surface water discharge (3), groundwater injection (1), discharge to sanitary sewer (3), and percolation plus evaporation (4).

6.2.1 Cost Curve Development and Use

Costs developed from survey information are presented in curves representing capital, operation and maintenance, and total treatment costs. Factors influencing capital and operating costs are described in Section 6.1. Capital and O&M costs are aggregated into one cost curve representing total treated water unit cost for membrane desalination.

Capital costs of initial construction and later expansions were requested by the questionnaire. The construction costs provided were adjusted to the present using *Engineering News Record* cost indices from the time of construction. Present day costs for initial construction and expansions were summed to yield the total capital costs associated with the water desalination facilities. The total capital cost was divided by the present plant capacity to yield the unit cost for plant construction in dollars per gallon per day (\$/gpd).

Operation and maintenance costs were requested by the questionnaire in the following categories: personnel, chemical, electrical, replacement membranes / parts, concentrate disposal, and other costs. Some O&M costs are fixed (do not vary with plant flow rate) and some are variable (vary with plant flow rate). Personnel and membrane replacement costs were considered fixed, while chemical, electrical, concentrate disposal and other costs were assumed to vary in proportion to plant flow rate. All O&M costs are reported as if the plant was treating 100 percent of its design capacity. Variable costs were increased by a ratio of the design capacity to the average flow treated to represent O&M costs for full plant utilization.

Total treated water cost curves are computed as the sum of the amortized capital costs and the operation and maintenance costs. Annual debt service was computed using 8 percent interest over a 20-year period.

6.2.2 Capital Costs

Figure 6-17 illustrates a typical groundwater schematic diagram returned by the survey. Groundwater systems typically have minimal pretreatment and have degasification and disinfection for post-treatment.

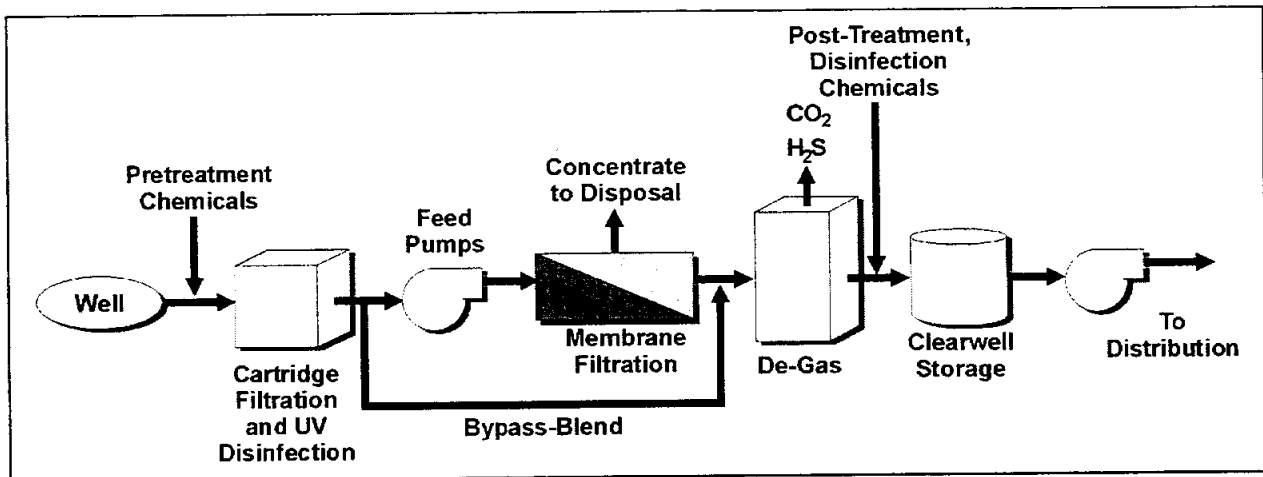

Figure 6-17. Typical Groundwater Desalination Schematic

Figure 6-18 presents capital cost curves for groundwater desalination reported in the survey. The unit costs (\$/gpd) are highly variable, probably reflecting the coarse nature of this survey. The survey does not account for differences in source water quality, except by water source type. Groundwater desalination capital costs range from \$2/gpd to \$4/gpd and may exhibit slight economies of scale.

Desalination of surface waters typically requires extensive pretreatment to control fouling. Figure 6-19 illustrates a typical surface water desalination schematic that includes pretreatment by a conventional water treatment plant. Post-treatment includes water stabilization and disinfection.

There are a few plants treating brackish surface water. The two plants responding to this survey both used EDR to desalinate surface water with conventional pretreatment. The total capital costs returned by the survey were \$2.05/gpd and \$1.15/gpd for plants in the range of 7 MGD design capacity.

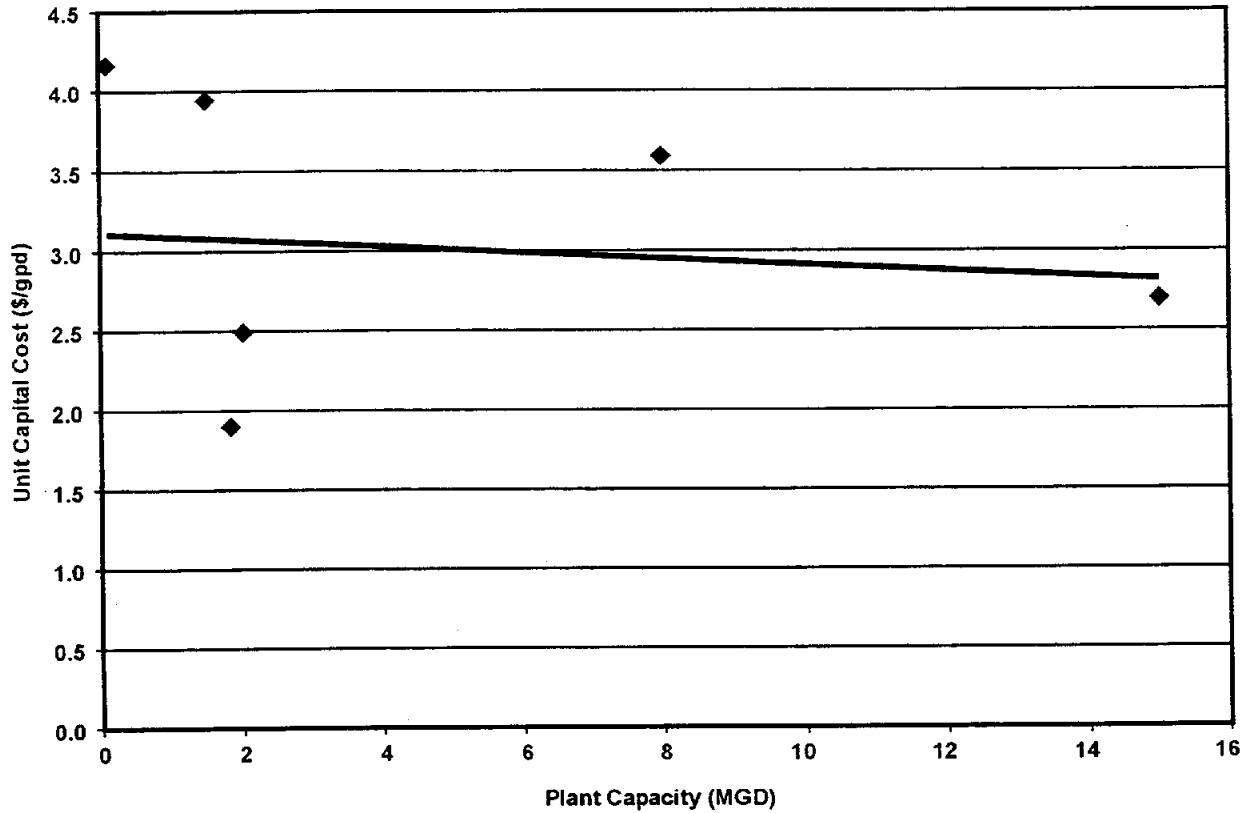

Figure 6-18. Groundwater Desalination Capital Costs

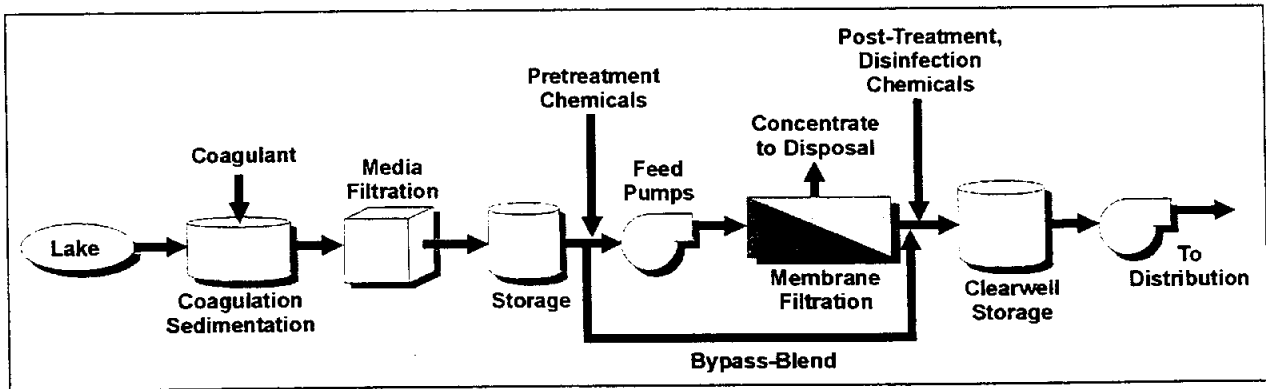

Figure 6-19. Typical Surface Water Desalination Schematic

6.2.3 Operation and Maintenance Costs

Operation and maintenance costs for desalination of groundwater are presented in Figure 6-20. The O&M costs are based on full plant utilization (the variable costs have been escalated by the ratio of plant capacity to average flow). Groundwater O&M costs range from

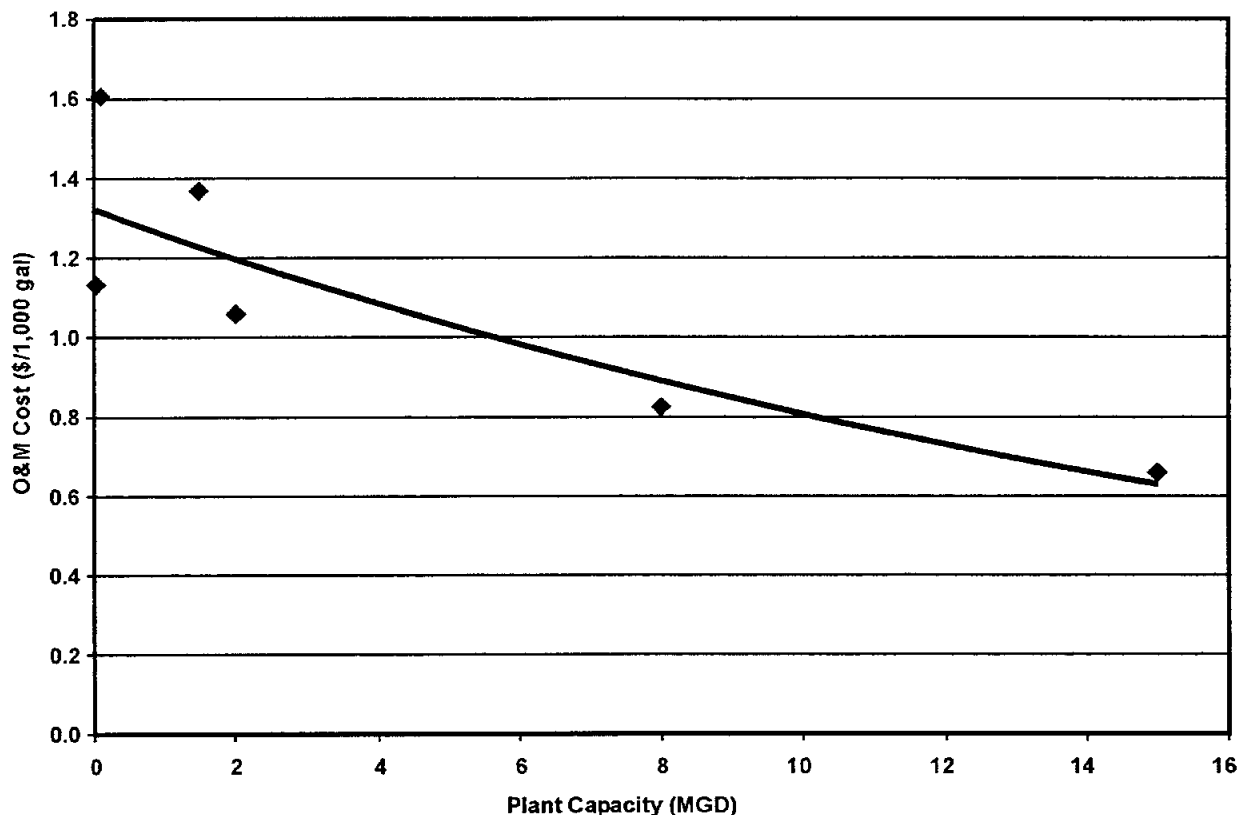

Figure 6-20. Groundwater Desalination O&M Costs

\$0.60/kgal to \$1.60/kgal. Economies of scale are evident in the decreasing unit O&M costs with plant capacity. Variation at a given plant capacity may reflect differences in source water quality (e.g., TDS concentration).

The distribution of O&M costs for groundwater desalination is illustrated in Figure 6-21. Labor and power are the most significant cost categories. Chemical costs were reported to be 9 percent of total O&M. Other references have estimated that 70 percent of annual O&M cost attributed to chemicals is from pretreatment with sulfuric acid and scale inhibitor and post treatment with sodium hydroxide. The remainder of the annual chemical costs is for cleaning chemicals. Membrane replacement is probably under-reported. Utilities may not budget for membrane replacement adequately in each budget year, since it is a cost that may only occur every 5 to 8 years.

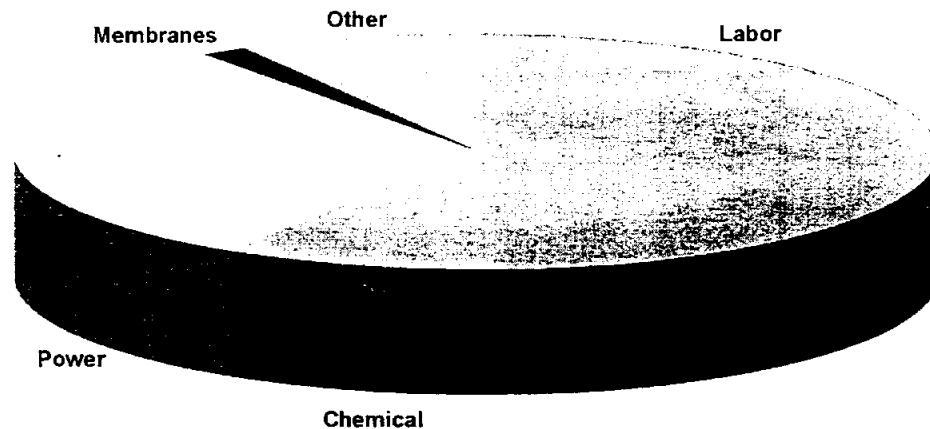

Figure 6-21. Distribution of O&M Costs for Groundwater Desalination

Operation and maintenance costs for surface water generally includes both the O&M for conventional pretreatment and the membrane system. The two facilities desalinating brackish surface water with an EDR process that responded to this survey had operation and maintenance costs of \$0.62/kgal and \$0.66/kgal for plant sizes in the range of 7 MGD. An economy of scale is expected with surface water treatment O&M costs, similar to that observed for groundwater.

The distribution of O&M costs for surface water desalination reported by the survey is presented in Figure 6-22. The significant cost items reported are labor, power, and other. Other costs were noted to be related to the conventional pretreatment systems. Membrane replacement costs appear to be more accurately portrayed in the annual budget here than for groundwater systems.

6.2.4 Total Treated Water Costs

Total treated water costs are the sum of the amortized capital costs and the operation and maintenance costs. Capital is amortized over 20 years at 8 percent interest.

Figure 6-23 shows the total treated water cost for groundwater desalination as reported by the survey. Total treated water costs range from \$1.50/Kgal to \$2.75/Kgal and exhibit economies of scale. Total treated water costs for surface water desalination were reported to be \$1.00/Kgal and \$1.20/Kgal for the two EDR plants responding to the survey.

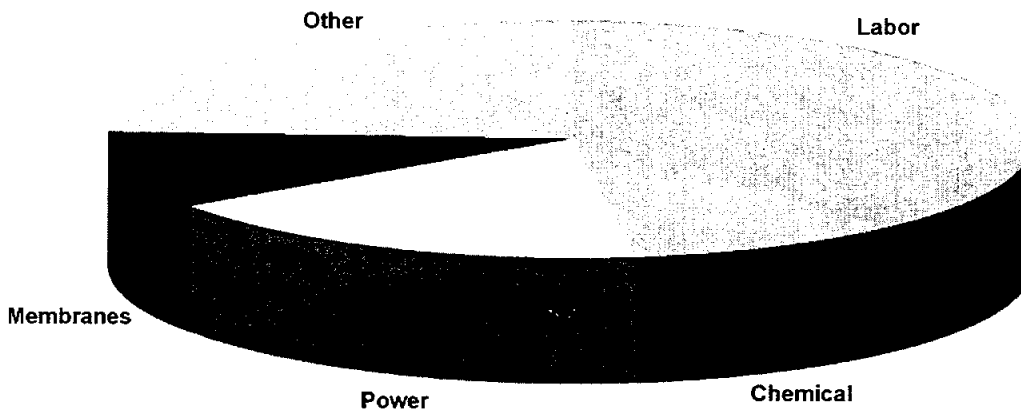

Figure 6-22. Distribution of O&M Costs for Surface Water Desalination

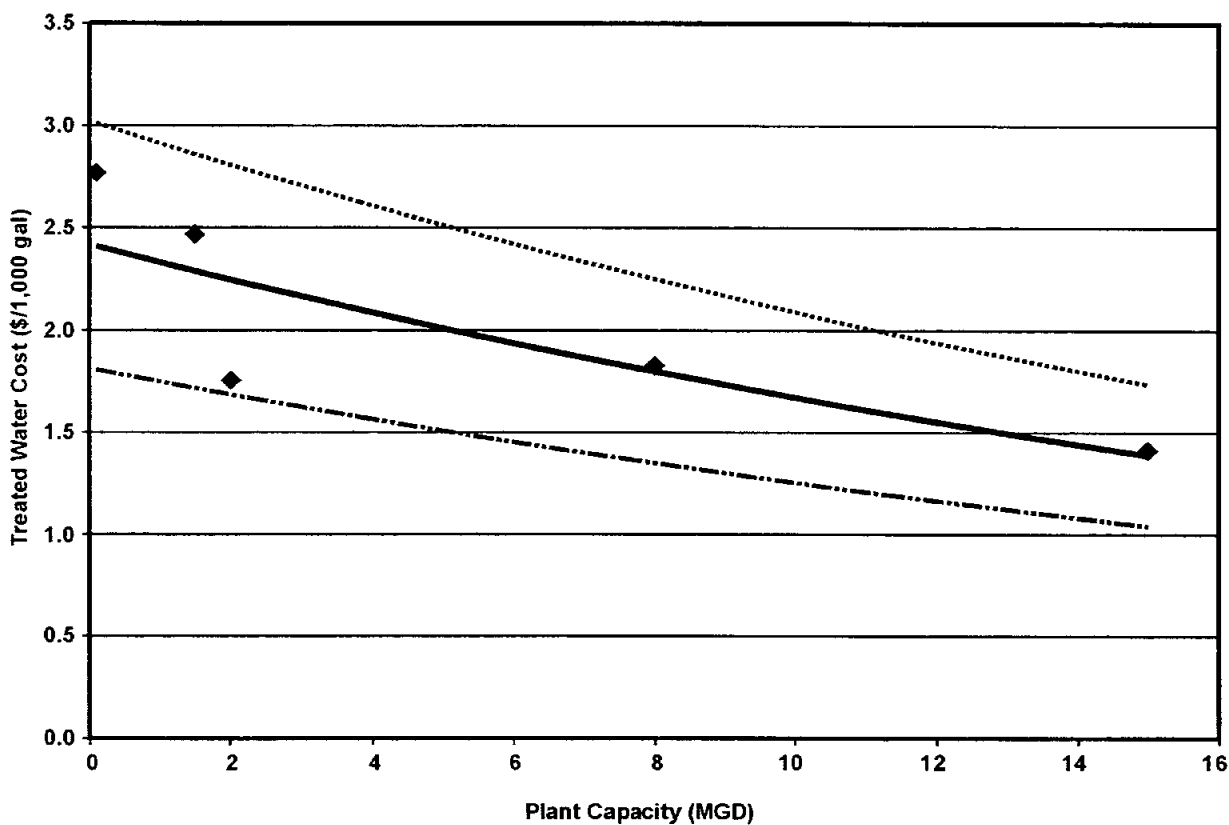

Figure 6-23. Total Treated Water Cost for Groundwater Desalination

6.3 Costs of Concentrate Disposal

The cost to effectively dispose of a desalination process concentrate will vary greatly according to a host of factors. Such costs can best be summarized by identifying the factors that will have a direct and material impact on the total capital and operating cost for a properly designed and permitted concentrate disposal system. The following are a list of the major factors impacting cost:

- Distance from plant facility to discharge point;
- Quantity of concentrate discharge;
- Quality of concentrate discharge;
- Method of disposal;
- Permitting requirements; and
- Monitoring requirements.

Specific to the various types of disposal most likely to be employed in Texas, the following is an identification of the cost items that will have the most impact upon a chosen disposal method.

6.3.1 Surface Water Discharge Major Cost Considerations

A. Capital Costs:

- Concentrate transmission pipe to discharge point;
- Discharge pump(s);
- Pre-discharge mixing piping and pumps (if required);
- Pre-discharge chemical treatment system; and
- Permitting and design.

B. O&M Costs:

- Compliance monitoring; and
- Pre-discharge treatment chemicals.

6.3.2 Discharge into Municipal Wastewater System Major Cost Considerations

A. Capital Costs:

- Concentrate transmission pipe to wastewater plant intake;
- Discharge pump(s); and
- Permitting and design.

B. O&M Costs:

- Compliance monitoring; and
- Utility charges or additional treatment plant costs.

6.3.3 Deep Well Injection Major Cost Considerations

A. Capital Costs:

- Concentrate transmission pipe to deep well;
- Discharge pump(s);
- Permitting, testing, and design;
- Pre-discharge treatment; and
- Deep well infrastructure.

B. O&M Costs:

- Compliance monitoring;
- Energy Costs for pumps; and
- Chemical costs.

6.3.4 Land Application Major Cost Considerations

A. Capital Costs:

- Concentrate transmission pipe to evaporation pond;
- Discharge pump(s);
- Permitting, testing, and design;
- Pre-discharge treatment; and
- Pond liner system.

B. O&M Costs:

- Compliance monitoring;
- Energy costs for pumps; and
- Chemical costs.

Section 7

Process Performance and Selection

The use of membranes has significantly increased over time, due to the need for additional water supply, increasing regulatory requirements, and the demand for better quality drinking water. As more public water systems investigate the possible use of membranes, there are a number of considerations that will impact selection of the most appropriate treatment process.

7.1 Process Selection

Establishing the finished water quality goals is the first step in process selection. State and federal regulations provide a starting point for many of the quality parameters that must be set for the desired finished water quality. However, local considerations may require a higher level of quality than that required by regulations. The allowable TDS concentration by Texas state regulation (secondary drinking water standards) is 1,000 mg/L. Once the finished water quality goals have been established, capabilities of treatment options can be compared.

One of the primary factors in determining whether RO or ED/EDR is a suitable treatment process for a particular water supply is the quality of the source water. Groundwater sources are generally preferred due to the stability or consistency of the raw water. Surface water sources usually require additional pretreatment due to the suspended solids, organics, and biological substances in the water. Therefore, for surface water sources, conventional surface water treatment or its equivalent is often required to treat the water to meet the feedwater quality needs of the membrane system. The source and finished water quality determines the degree and type of pretreatment, the membrane configuration, and the post-treatment requirements.

The method of disposal for the RO and/or ED/EDR concentrate is another important consideration in the selection process. The concentrate is considered an industrial waste, so a permit is required for discharge off-site to a local receiving body of water or an injection well (see Section 5). If the plant is not located in a coastal area for an ocean outfall discharge or a dry climate where evaporation rates are high, concentrate disposal can be a complicated and expensive obstacle for desalination.

Figure 7-1 presents a process selection chart for membrane water treatment systems. The goal of the chart and process selection is to choose the most cost-effective treatment technology

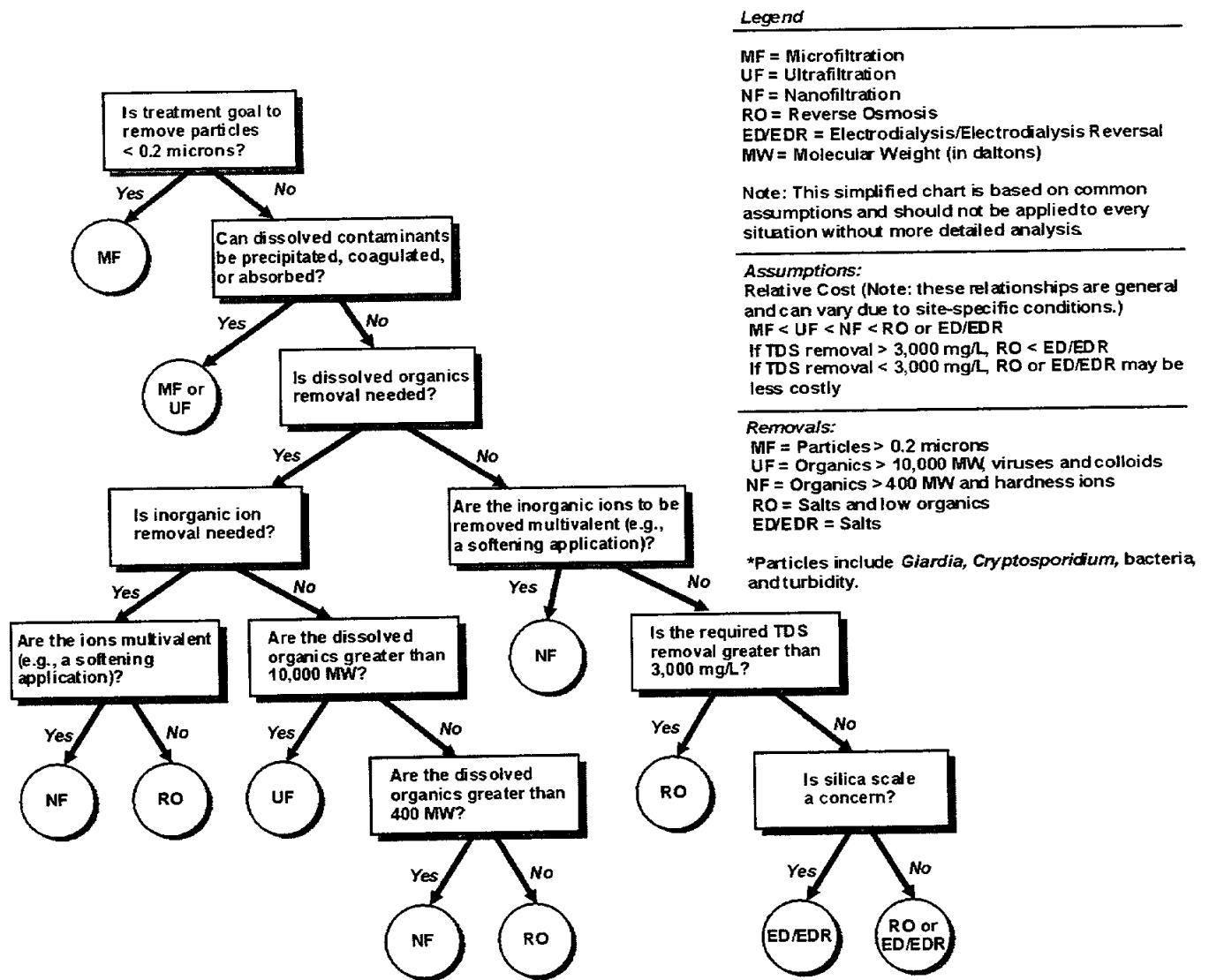

(Source: American Water Works Association, 1999)

Figure 7-1. General Membrane Process Selection Chart

that reliably meets treatment objectives. The major advantages of Reverse Osmosis over EDR are control of dissolved organics and providing a barrier to pathogenic microorganisms. *Cryptosporidium*, a pathogenic microorganism resistant to chemical disinfection, is effectively removed by RO but not impacted by EDR. For applications requiring greater than 3,000 mg/L TDS removal, RO is more cost-effective than EDR. Therefore, EDR has potential applications

for brackish waters that do not require further control of microbiological or dissolved organic constituents and for waters that pose scaling problems for RO systems.

When deciding on the type RO system for an application, the operational characteristics outlined in Table 7-1 can be used.

Table 7-1.
Reverse Osmosis Typical Operational Parameters

System	System Pressure (psi)	Feedwater TDS (mg/L)	System Recovery Rate (percentage)
Ultra Low-pressure (TFC)	80 to 200	500 to 3,500	50 to 85
Low-pressure (TFC)	200 to 300	500 to 3,500	50 to 85
Standard Pressure (CA)	400 to 650	3,500 to 10,000	50 to 85
Seawater	800 to 1,500	10,000 to 50,000	25 to 55

Source: American Water Works Association, "Water Quality and Treatment: A Handbook of Community Water Supplies," New York, 4th Edition.

When deciding whether ED/EDR is a viable option, the following operational parameters can be used to estimate the performance of such a system:¹

- Electric energy consumption of feedwater pumping equipment will be approximately 2.5 kWh per 1,000 gallons for pumping at normal system pressures of 70 to 90 psi or 2.0 kWh per 1,000 gallons per 1,000 mg/L of salts removed.

The cost of ED/EDR is primarily affected by the volume of water treated, the TDS of the raw water, and the percentage of contaminants removed. As a general statement, because of the limited capacity of a single membrane stack, the capital cost of EDR increases more linearly with design capacity than with RO. This aspect makes EDR more likely to be selected for locations that have lower volumetric requirements and lower percentage removal requirements. EDR is generally more appropriate for specific contaminant removal, such as fluoride or nitrate or if high concentrations of silica, barium, or strontium are present in the raw water. One particular advantage of the EDR process is that the chemical consumption is minimal as pH changes through the process are minimal. Blending options are also applicable for EDR; however, these

¹ American Water Works Association (AWWA), "Water Quality and Treatment: A Handbook of Community Water Supplies," New York, 4th Edition.

are not usually employed because of the ability to control the percentage removal required for the contaminants.

7.2 Impact of Operation on Performance

The principal determinant that can affect RO or ED/EDR system performance is a change in the source water quality. The feedwater is monitored continuously for conductivity and periodically checked for changes in water quality (e.g., both chemical and biological parameters should be collected, organized, and analyzed on a regular basis). Without monitoring these changes in the water quality, the necessary modifications to the pretreatment process cannot be made in order to maximize the life of the membranes.

Another operational issue that can affect the performance of RO and ED/EDR systems is system maintenance. A membrane system is highly automated and the instrumentation and control (I&C) systems require regularly scheduled maintenance and calibration. System instruments must be operational at all times, especially those associated with fail-safe or shutdown conditions; therefore, spare parts should always be available.

Mechanical components of the system, including bulk storage tanks, feeders, heaters, and injection lines, should be regularly checked, calibrated, and cleaned. Degassing systems for RO systems require cleaning, due to the accumulation of slime. High-service pumps also require routine maintenance for surface water systems with extensive pretreatment; there are added components, including intake screens and filters, that also require maintenance. A failure to maintain any of these systems could result in a decreased lifetime of the membranes due to plugging, scaling, and fouling.²

² American Water Works Association and the American Society of Civil Engineers, "Water Treatment Plant Design," New York, 3rd Edition.

Section 8 Trends

Trends related to the use of membrane systems, include:

- Membrane improvements have decreased element costs, improved performance, and lengthened membrane life;
- Use of integrated membrane systems (IMSS);
- Regulatory Requirements.

These trends are discussed further below.

8.1 New Products

8.1.1 Modules/Elements

The membranes that are being produced today provide higher salt rejection, operate with lower pressures, and last longer. Figures 8-1 and 8-2 illustrate the improved characteristics of membranes over the past three decades. As shown in the figures, the removal efficiency for all membranes has increased, approaching 100 percent. Operating pressures for brackish water membranes have decreased from 500 psi to below 200 psi. Due to improved manufacturing techniques, membrane life is extended and membrane replacement costs are decreased.

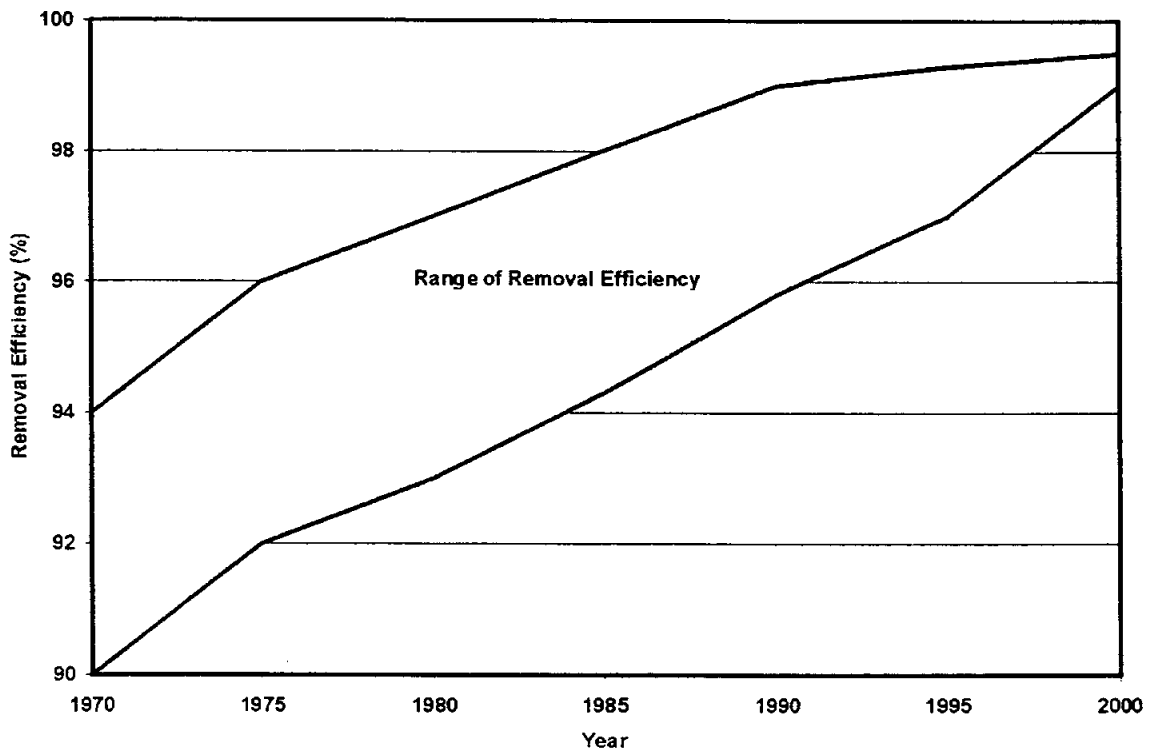

Figure 8-1. Increased Salt Removal Efficiency by RO Membranes

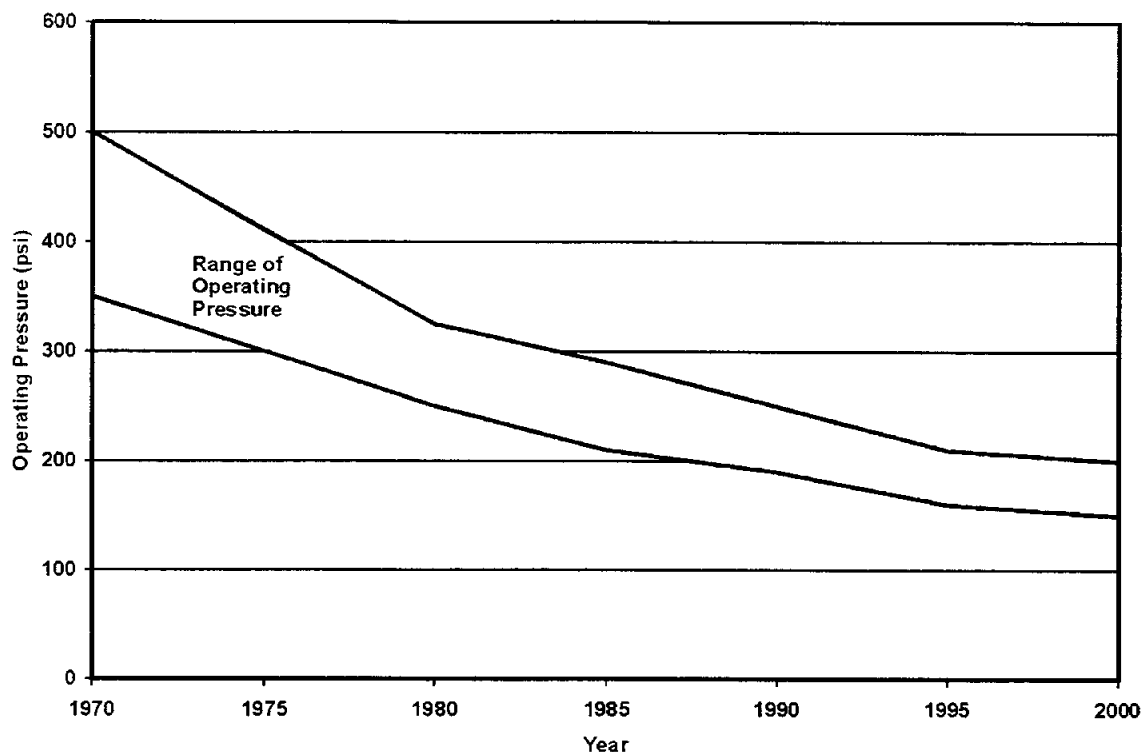

Figure 8-2. Reduced Reverse Osmosis Membrane Operating Pressures (Brackish Water)

8.1.2 Pressure Vessels

The design of the membrane pressure vessel is another improvement in the membrane systems being produced today. Historically, an RO pressure vessel was designed so that the feed and permeate connection were located at the end-cap of the pressure vessel. In order to remove a membrane module, the feed and permeate piping was disconnected and removed to allow access to the end-cap. The introduction of a side entry pressure vessel has eliminated the high-pressure connection and simplified the disassembly of the piping system.

Another improvement to the pressure vessels is the seal in the end-cap of the vessel. In the past, the pressure vessel end-cap was sealed into the pressure vessel using a snap-ring. A snap-ring is designed so that it will expand into a retaining groove that is cut into the pressure vessel. To remove the snap-ring, a special set of pliers is used to compress the ring and reduce its diameter. Large diameter snap rings are very difficult to compress and remove and a source of frustration to anyone who has ever attempted to remove one. An alternative to the snap-rings is the segmented rings that are bolted into place using cap screws. Although segmented rings

can be more cumbersome than snap-rings, maintenance personnel generally prefer the segmented rings.

The recent introduction of a spiral-wound lock ring has greatly simplified the process by which end-caps are removed and replaced. A spiral-wound lock ring is similar to a “Slinky” in design. Once the end-cap is in position, the lock ring is positioned and spiraled into place. Removal consists of twisting a tab on the lock ring to disengage the ring from the retaining groove.

8.1.3 Reduced Costs

Due to these advances in membrane technology, total system costs are reduced. For example, the reduction in pressure requirements for membranes lowers plant annual operation costs. In addition, more traditional materials can be used, which results in decreased costs for equipment purchases. Figure 8-3 depicts the relative decline in cost for membrane elements from \$1,600 per element in 1970 to \$400 per element in the late 1990s.

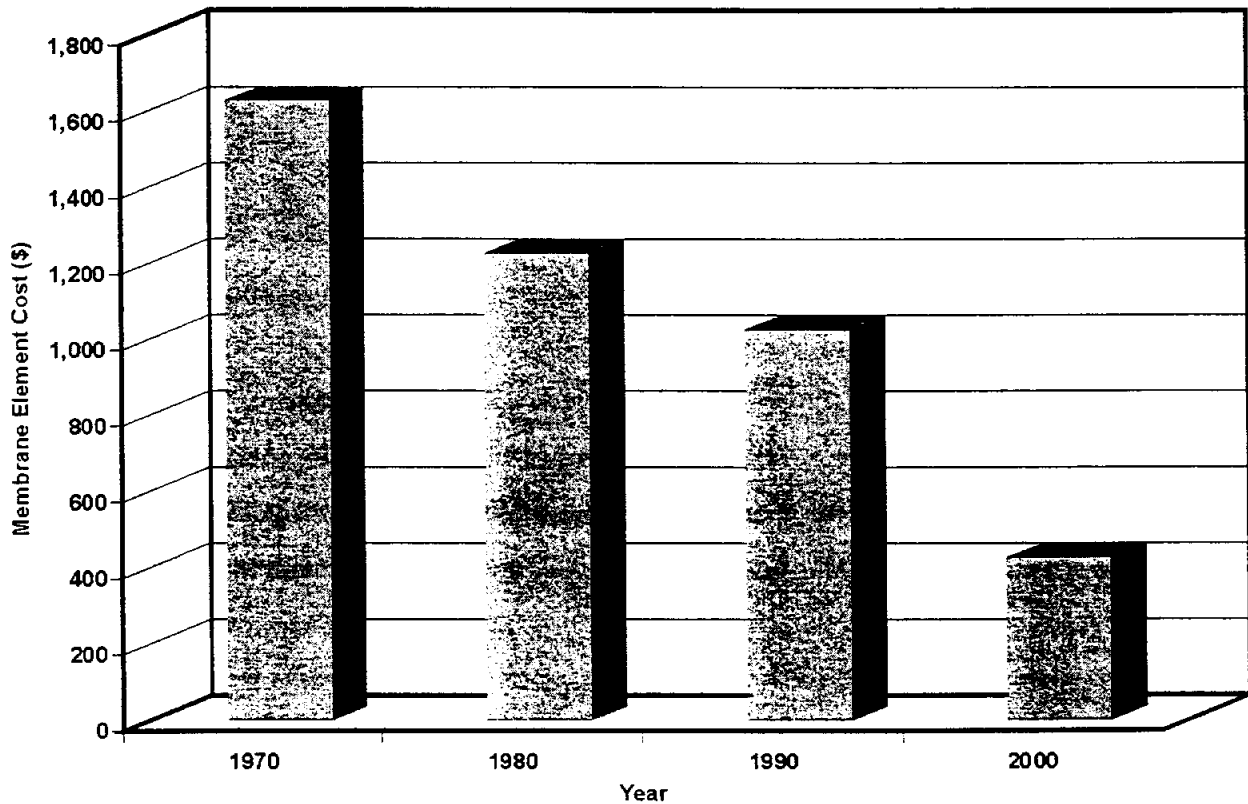

Figure 8-3. Reduced Element Costs

8.2 Integrated Membrane Systems

Integrated Membrane Systems (IMSS) include the combination of the microfiltration/ultrafiltration (MF/UF) and nanofiltration/reverse osmosis (NF/RO) membrane systems, in conjunction with advanced and/or conventional treatment processes. IMSS are most often used to obtain enhanced finished water quality objectives. For groundwater, the objectives usually include disinfection byproduct (DBP) control and hardness removal. Customarily, there are multi-contaminant (e.g., TDS, pathogens, turbidity, nitrates, pesticides, and taste and odor compounds) removal goals for IMSS with regard to surface water sources. The limiting factor for surface water sources with RO and ED/EDR treatment is the potential for fouling of the membranes and the need for increased cleaning to restore the productivity of the membranes. Also, with more stringent water quality regulations for surface waters, membrane treatment receives more consideration. There are various processes that are used (alone or in combination) with the MF/UF-NF/RO systems to make up an IMS. The following is a list of processes that could be placed upstream of RO:

- Coagulation/flocculation, sedimentation, filtration;
- Ozonation;
- Biological Activated Carbon Filtration;
- Powdered Activated Carbon (PAC); and
- Dissolved Air Flotation (DAF).

There are increasing numbers of IMSS being developed, primarily for surface water sources.

8.3 Safe Drinking Water Act Requirements

The Safe Drinking Water Act (SDWA) Amendments of 1996 contained a significant number of new provisions. With these new provisions, water treatment goals have become, or will become, increasingly more stringent. RO, as well as MF, UF, and NF membranes are tools that can be used to meet a variety of objectives, such as *Cryptosporidium* removal (or disinfection), taste and odor and DBP control.

Reverse osmosis membrane processes are capable of effectively removing bacteria, viruses, and protozoa. They act as an absolute barrier against the larger microorganisms, thus reducing the amount of chemical disinfectant necessary to achieve adequate disinfection. *Cryptosporidium*, a pathogenic microorganisms resistant to chemical disinfection, can be

effectively removed by all membrane processes, except EDR. In addition, organic matter is rejected by NF and RO membranes, which helps control DBP concentrations in finished water.

For raw water supplies that contain bromide, brominated DBPs are likely to be formed after the addition of any oxidant used for taste and odor control or disinfection. It is not possible to reduce bromide levels with conventional treatment processes. In contrast, RO can control the level of bromide and decrease disinfection byproduct formation.

RO is also highly effective at removing arsenic. Therefore, water supplies with elevated levels of arsenic, most often groundwater sources in the southwestern United States, could implement RO to reduce arsenic. The TNRCC maintains a secondary constituent level of 1,000 mg/L TDS, yet the national secondary maximum contaminant level (SMCL) for TDS is 500 mg/L. RO can achieve TDS levels of 500 mg/L or lower. Membrane processes, RO specifically, should play an important role in future water treatment systems, as product water quality becomes a more critical determining factor in water process development.

Part B
***Economic Importance of Siting Factors for
Seawater Desalination in Texas***

Prepared for

**Texas Water Development Board
Nueces River Authority
Central Power & Light Company
City of Corpus Christi
San Patricio Municipal Water District**

Prepared by



**in association with
Water Resources Associates
Malcolm Pirnie, Inc.**

August 2000

Table of Contents

<u>Section</u>		<u>Page</u>
1	Introduction.....	B.1-1
2	Tampa Bay Water Desalination Project.....	B.2-1
	2.1 Tampa Bay Water Project History.....	B.2-1
	2.1.1 Environmental Studies.....	B.2-4
	2.1.2 Best and Final Offer Process.....	B.2-5
	2.1.3 Final Award Process.....	B.2-6
	2.1.4 Post Award Schedule.....	B.2-10
	2.2 Tampa Bay Water Low Cost Factors.....	B.2-10
	2.2.1 Design-Build-Operate.....	B.2-11
	2.2.2 Power Plant Co-Location.....	B.2-11
	2.2.3 Source Water Quality.....	B.2-13
	2.2.4 Proximity to Product Water Demand Center.....	B.2-13
	2.2.5 Environmental Conditions, Permits, and Mitigation Requirements.....	B.2-14
3	Siting Issues Assessment.....	B.3-1
	3.1 Capital and Operation & Maintenance Cost Models.....	B.3-1
	3.2 GIS Mapping.....	B.3-2
	3.3 Regulatory Considerations.....	B.3-2
4	Desalination Cost Impacts Identified.....	B.4-1
	4.1 Source Water Salinity.....	B.4-2
	4.2 Source Water Fouling Potential.....	B.4-4
	4.3 Proximity to Product Water Demand Center.....	B.4-5
	4.4 Concentrate Disposal.....	B.4-8
	4.4.1 Concentrate Disposal Costs.....	B.4-10
	4.4.2 Example Concentrate Disposal Costs.....	B.4-11
	4.5 Raw Water Intake.....	B.4-14
	4.6 Power Cost.....	B.4-14
	4.7 Co-location with Power Plant.....	B.4-15
	4.8 Proximity to Sensitive Environmental Features.....	B.4-16

Table of Contents
(continued)

<u>Section</u>	<u>Page</u>
4.9	Surge/Flood Zones B.4-16
4.9.1	Example Precautions..... B.4-16
4.9.2	Surge/Flood Zones Cost Impact..... B.4-17
4.10	Additional Impacts..... B.4-17
4.11	Total Reverse Osmosis Seawater Desalination Costs..... B.4-18
5	Siting Conditions on the Texas Coast..... B.5-1
5.1	Water Quality..... B.5-1
5.2	Coastal Power Plants..... B.5-7
5.3	Power Cost..... B.5-7
5.3.1	Current Electricity Market B.5-8
5.3.2	Current and Projected Electric Rates B.5-12
5.4	Regulatory Impacts B.5-13
5.4.1	Concentrate Disposal B.5-13
5.4.2	Raw Water Supply B.5-15
5.5	Coastal Flooding Risk..... B.5-16
5.5.1	Understanding FEMA Maps and Studies B.5-18
5.5.2	Desalination Site Examples B.5-19
5.6	Environmental Constraints..... B.5-21
6	Example Sites on the Texas Coast..... B.6-1
6.1	Example 1: Corpus Christi..... B.6-1
6.2	Example 2: Brownsville/Port Isabel B.6-4
7	Data Needs to Reduce Siting Uncertainty..... B.7-1

List of Figures

<u>Figure</u>		<u>Page</u>
2-1	Proposed Tampa Bay Seawater Desalination Plant Locations	B.2-3
4-1	Reverse Osmosis Specific Electrical Consumption versus Feedwater TDS	B.4-3
4-2	Reverse Osmosis Water Production Cost versus Feedwater TDS.....	B.4-3
4-3	Energy Recovery Turbine Schematic	B.4-4
4-4	Reverse Osmosis Water Production Cost versus Source Water Fouling Potential	B.4-6
4-5	Reverse Osmosis Water Production Cost versus Flux Rate	B.4-6
4-6	Distance to Demand Center Cost Impact.....	B.4-7
4-7	Offshore Concentrate Disposal Cost Impact.....	B.4-11
4-8	Reverse Osmosis Power Cost Impact	B.4-15
4-9	Product Water Flow Cost Impact.....	B.4-19
5-1	Texas Coastal Area	B.5-3
5-2	Seagrass and Depth Contours	B.5-22
5-3	Protected Coastal Boundaries	B.5-23
5-4	State and National Parks and Vegetation.....	B.5-24
5-5	Localized Environmental Constraints.....	B.5-25
6-1	Example 1: Corpus Christi.....	B.6-2
6-2	Example 2: Port Isabel/Brownsville	B.6-2

(This page intentionally left blank.)

List of Tables

<u>Table</u>		<u>Page</u>
2-1	1997 Tampa Bay Water Proposal Water Costs.....	B.2-4
2-2	Best and Final Offer In-the-Box Proposals.....	B.2-6
2-3	Best and Final Offer Out-of-the-Box Proposals	B.2-7
2-4	Nominal Costs for In-the-Box Water Quality – Option 1 Tax Exempt Stabilized Water	B.2-7
2-5	Nominal Costs for In-the-Box Water Quality – Option 2 Tax Exempt Stabilized Water	B.2-8
2-6	In-the-Box Comparative Present Value Unit Cost.....	B.2-9
2-7	Water Quality Option 1 Net Present Value Breakdown Analysis	B.2-9
2-8	Best and Final Ratings for Water Quality Options 1 and 2	B.2-10
2-9	Tampa Bay Power Plant Co-location Cost Savings.....	B.2-12
4-1	Base Assumptions for Estimates.....	B.4-2
4-2	Distance to Demand Center Cost Estimate Summary	B.4-8
4-3	Concentrate Production.....	B.4-9
4-4	Offshore Concentrate Disposal Cost Estimate Summary	B.4-12
4-5	Total Reverse Osmosis Seawater Desalination Cost Range.....	B.4-19
5-1	Texas Coastal Water Salinity Summary	B.5-5
5-2	Texas Coastal Residence Time Summary.....	B.5-6
5-3	Texas Coastal Power Plants	B.5-8
5-4	Energy Cost Projections – End-Use Price Projections for Industrial Users within the Electric Reliability Council of Texas Region.....	B.5-12

**List of Tables
(continued)**

<u>Table</u>		<u>Page</u>
6-1	Seawater Desalination at Barney M Davis Power Station Engineering Assumptions	B.6-3
6-2	Seawater Desalination at Barney M Davis Power Station Cost Estimate Summary.....	B.6-5
6-3	Seawater Desalination at Port Isabel – Engineering Assumptions	B.6-6
6-4	Seawater Desalination at Port Isabel – Cost Estimate Summary.....	B.6-8

Section 1 Introduction

The costs and feasibility of providing water through seawater desalination are highly dependent on several siting factors that can vary considerably. This part of the report identifies these factors and reviews their relative impact on seawater desalination for the Texas Coast. The Tampa Regional Water Supply project in Florida recently received water purchase contract offers for a large capacity seawater reverse osmosis system that were lower by a factor of 2 to 3 times than those previously observed for other seawater desalination facilities. These low costs resulted from not only technological improvements, but also from siting and macroeconomic factors. This report describes the Tampa case study in detail and captures the factors leading to this major advance in seawater desalination. The potential application of these factors along the Texas Coast is also reviewed as discussed below.

The quality of source water and quantity of water to be treated both impact costs. This report describes the relation between Texas coastal geography, hydraulics and salinity and provides data on bay water flushing and salinity. The variability of water quality at different areas of the coast and over time is also evaluated. A quantitative relation is developed to describe the impacts of source water salinity and other water quality parameters on capital and operation and maintenance costs. Estimates for the production of concentrate and finished water are provided using typical recovery rates over a range of conditions. Issues regarding water rights permits required for diversion of state waters are also addressed.

Water production and delivery impact the unit cost of water. This report describes product water delivery issues and solutions, including post-treatment, water chemistry and blending. The impacts of siting on the costs of intake and outfall structures are addressed as well as the benefits of co-location with power stations. Flooding and storm surge issues are described as they impact potential sites and water production costs. Power supply, energy recovery, power costs, and probable trends are described including projections of the impact of electric utility deregulation on desalination power costs.

Concentrate disposal is a key issue for seawater desalination. The impact of concentrate disposal issues on site selection is evaluated. Available literature is reviewed on environmental

impacts of concentrate discharges in coastal and marine waters including toxicity, hydraulics, and mass balance models.

The siting factors described above are incorporated into a general siting framework that is demonstrated by application to several case study sites on the Texas coast. The framework incorporates the siting factors considered in detail above. Environmental considerations are addressed and prominent environmental features are illustrated in maps. Compliance with other local, state and federal regulations is also briefly addressed.

Additional data collection and evaluation will be needed to implement seawater desalination on a large scale. This report identifies data needs to reduce siting uncertainties and describes general planning measures for data acquisition. Topics addressed include source water quality, toxicity testing, receiving water hydraulics, and mass balance modeling for concentrate discharge.

Section 2

Tampa Bay Water Desalination Project

Desalination of seawater has been implemented to produce potable water in energy-rich but water-poor areas, such as portions of the Middle East, for many years. However, seawater desalination in most areas with other water supply options has not been economically viable until recently. Advances in reverse osmosis membrane technology and desalination process systems are decreasing costs to a point where production of potable water from seawater on a large scale is becoming a reasonable alternative for some areas.

Two recent contracts highlight the potential for low-cost seawater desalination. In July 1999, Tampa Bay Water entered into a water purchase agreement with a development team led by Stone & Webster to fund, design, build, operate, and, at some point, transfer a seawater desalination plant. The plant is to have an installed capacity of 29 million gallons per day (MGD), producing an average of 25 MGD of potable water at an average cost over 30 years of \$2.08 per 1,000 gallons. This cost is two to three times lower than costs previously observed for large-scale seawater desalination facilities. Also, in late 1999, the Water and Sewerage Authority of Trinidad and Tobago contracted with an Ionics, Inc. joint venture to design, build, and operate a seawater desalination plant. This plant is to produce 28.8 MGD of potable water at an average cost over 23 years of \$2.67 per 1,000 gallons.¹ The history and low-cost factors for the Tampa Bay Water project are evaluated in this report section to provide background for the remaining report sections that consider application of these siting factors in Texas.

2.1 Tampa Bay Water Project History

In 1993, Tampa Bay Water (formerly the West Coast Regional Water Supply Authority) began an integrated resource planning process that resulted in the Resource Development Plan. In addition to determining water supply needs, the plan determined potential new sources of supply and supply alternatives. Following a series of public workshops and meetings, the original Master Water Plan was approved in December 1995. The plan proposes several new supply elements, as well as pipeline interconnections, to improve water transfer capabilities within the system. Seawater desalination was identified as an alternative to meet

¹ Membrane & Separation Technology News, October 1999.

the area's growing water needs. A management advisory committee recommended that the Request for Proposals (RFP) process begin for seawater desalination prior to the overall proposal evaluation stage. The management advisory committee was set up by Tampa Bay Water's General Manager and was comprised of an area regulator, public utilities, and Tampa Bay Water personnel. In a co-operative effort, the Southwest Florida Water Management District (SFWMD) funded 50 percent of the RFQ/RFP process.

On August 19, 1996, Tampa Bay Water selected PB Water (a division of Parsons Brinckerhoff Quade & Douglas, Inc.) to provide professional services to develop an RFP for the procurement of a seawater desalination water supply. The PB Water project team was supplemented by Dr. Philip Roberts, an expert in ocean outfalls, and the Blackmon Roberts Group, assisting with the public information and involvement program. The primary goal of the project was to assist in the development of a feasible and cost-effective method, or methods, to acquire seawater as a new alternative potable water supply source. This included preparation of an RFP for a desalination water supply of 20 to 50 MGD, and the subsequent evaluation of the most advantageous process to procure the desalinated water.

On December 3, 1997, as a result of the RFP, proposals for a desalination water supply of 20 to 50 MGD were received from five pre-qualified developers. Proposals were for the financing, developing, designing, supplying, procuring, constructing, erecting, completing, testing, commissioning, and operating and maintaining of a seawater desalination plant providing a firm base supply of 20 MGD with options to increase to 35 MGD and 50 MGD. Also included was the delivery of the desalinated water, of an agreed quality, via a pipeline(s) to the Tampa Bay Water distribution system. The anticipated contract provisions included a 30-year term with an option to renew. The proposed site(s) for the desalination plant(s) was selected by the Developer. Between the five Developers there were three proposed plant locations: Big Bend Power Station, Anclote Power Station, and Higgins Power Station. Locations of the proposed sites are shown in Figure 2-1.

The five developer proposals were evaluated based on the desalination facility's economic feasibility, design, operation, and delivered water costs. The lifecycle water costs were calculated using Net Present Value (NPV) of the water supply contract based on total water sales over the 30-year contract. The NPV analysis focused on the 20-MGD capacity plant for purposes of comparing each submission. Economies of plant size were also considered by

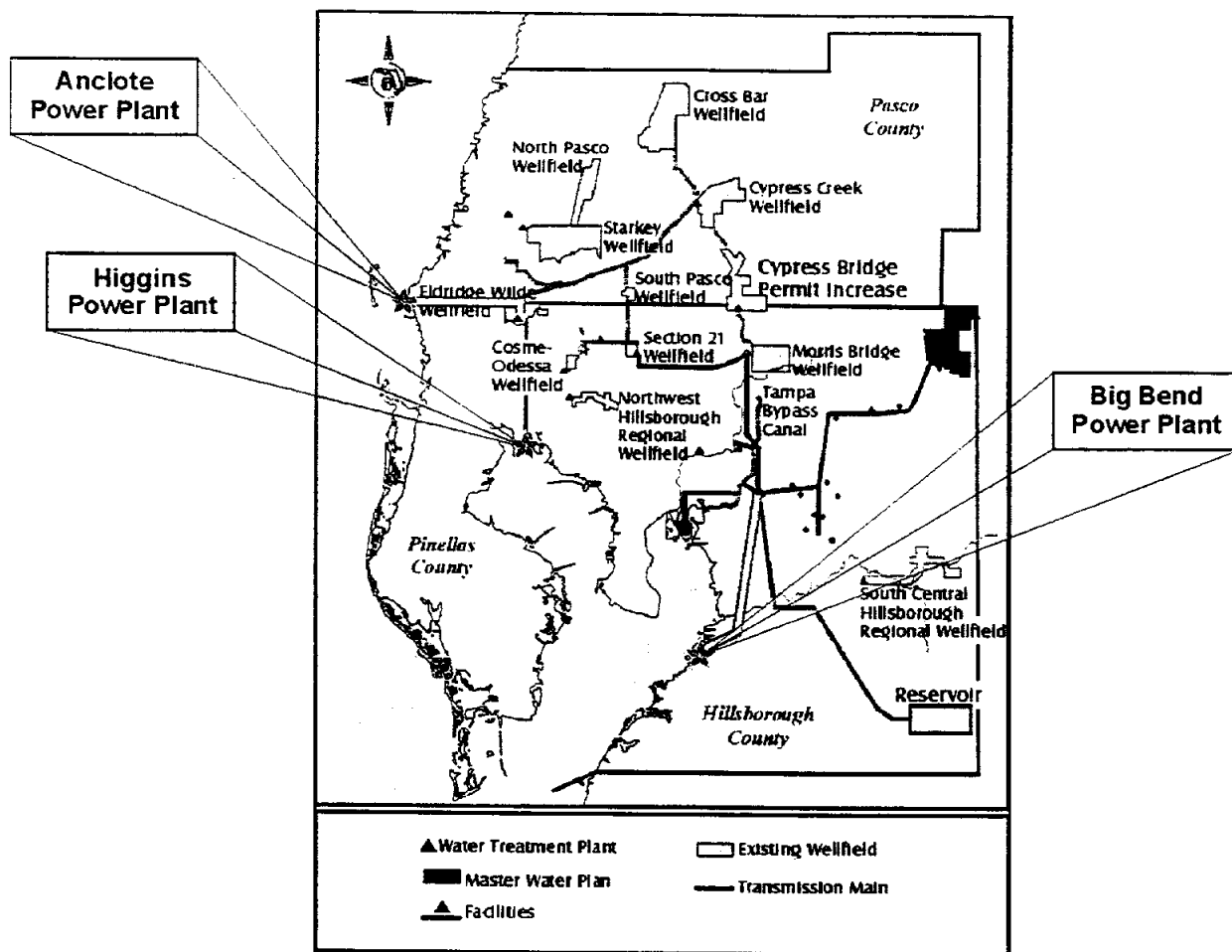

Figure 2-1. Proposed Tampa Bay Seawater Desalination Plant Locations

evaluating proposal costs as water price per 1,000 gallons as a function of plant capacity. The results of the PB Water proposal evaluations are shown in Table 2-1. Developers were allowed to propose multiple options. The NPV of the proposal by Florida Progress Energy Corporation/Ionics Partnership (PECIP) at Higgins Power Plant Station was significantly lower than for other development proposals. However, the Higgins site was subsequently removed from consideration based on the final assessment of the proposals because there were environmental permitting concerns regarding the adequacy of flushing action in the upper portion of Old Tampa Bay to prevent salinity build up. The Enova/SSI proposal was also dropped from consideration based on the recommendation in the preliminary proposal evaluation and ranking. In the Final Proposal Assessment by PB Water (June 1998) the PECIP at Anclote proposal was ranked as the top proposal.

Table 2.1.
1997 Tampa Bay Water Proposal Water Costs
(all costs in 1997 dollars)

<i>Option</i>	<i>20 MGD Total NPV¹ (millions)</i>	<i>20 MGD (per 1,000 gallons)</i>	<i>35 MGD (per 1,000 gallons)</i>	<i>50 MGD (per 1,000 gallons)</i>
PECIP at Higgins	\$332.5	\$2.29	\$2.15	\$2.06
PECIP at Anclote	\$361.1	\$2.49	\$2.35 ²	\$3.00
Florida Water Partners	\$449.2	\$3.20	\$3.40	\$2.30
Stone & Webster	\$417.6	\$2.76	N/A	N/A
Florida Seawater Desalination Co.	\$409.3	\$2.80 ³	N/A	\$2.30 ³
Enova/SSI	\$639.0	N/A	N/A	N/A

¹ 3 percent discount rate.
² First year (2000) water price, as reported in the Florida Seawater Desalination Company proposal submission.
³ Estimated.

2.1.1 Environmental Studies

In late 1997, because of environmental concerns about the implementation of the proposed Master Water Plan projects, Tampa Bay Water authorized a cumulative impact study of Tampa Bay.² The study included a fatal flaw analysis of the affects on Tampa Bay of withdrawal water from the Alafia River, Hillsborough River, and the Tampa Bypass Canal during high flow periods with storage at a proposed reservoir, operation of the Brandon Dispersed Wellfield and Cone Ranch Wellfield, the Hillsborough Bay Resource Exchange Project (since deleted from consideration), and a 20 MGD seawater desalination project at the Big Bend Power Station. The analyses included predicting potential impacts from individual projects, and the cumulative impact that may result from implementing a number of the Master Water Plan projects. Methods that were employed included regression analyses, the use of a mechanistic model, and a box model for a water and salinity mass balance. Based on all the projects in operation simultaneously, the results indicate a potential increase in salinity of 4 to 6 percent within various segments of the Bay. This is within the range of long-term variability of salinity in the respective segments of the Bay.

² Coastal Environmental/PBS&J, Inc., "Fatal Flaw Cumulative Impact Analysis for Master Water Plan Projects," Tampa Bay Water, April 30, 1998.

On June 22, 1998, Tampa Bay Water authorized PBS&J, Inc. to conduct an assessment of the potential environmental impacts of constructing and operating a proposed seawater desalination plant located at the Anclote Power Plant site. The objectives of this work were to characterize existing conditions, and to quantify potential impacts to water quality and living resources resulting from the operation of a desalination facility at the Anclote site. This analysis was conducted at a screening level of detail and it was anticipated that a more detailed examination of manageable impacts would be required during the project planning and permitting process. To meet this requirement a box model was developed and calibrated to assess the salt and water mass balance for the lower Anclote River and nearby Gulf of Mexico. The study concluded that no major environmental impacts to water quality and living resources would occur for either a 20 or 50 MGD seawater desalination facility at the Anclote Power Plant site.

2.1.2 Best and Final Offer Process

On July 31, 1998, the Developers were requested to submit Binding Offers for 10-, 20-, 35-, and 50-MGD capacity desalination facilities and for three product water qualities. Binding Offers were received from all four Developer teams on the due date of August 28, 1998. Based on assessment of the Binding Offers, the Board declared that all the Developers were equally qualified. Simultaneous negotiations were scheduled for all four Developers.

Based on the simultaneous negotiations with the Developer teams over several months and comments from Tampa Bay Water staff, member government staff, and Tampa Bay Water Board, a Draft Agreement for the Construction and Operation of a Seawater Desalination Plant and Water Purchase Agreement (hereafter referred to as the "Water Purchase Agreement") and instructions were developed as the basis for the Best and Final Offer. At the January 25, 1999 meeting, Tampa Bay Water's Board authorized staff to request Best and Final Offer proposals from the four Developers for the development of a 20 to 25 MGD seawater desalination water supply with expansion capability to 35 MGD.

Each Developer was required to submit the following general information:

- Offers for two different water quality options:
 - Water quality Option 1 chloride concentration ≤ 35 mg/L;
 - Water quality Option 2 chloride concentration ≤ 100 mg/L;

- For each water quality option the Developers were required to submit information for stabilized and unstabilized product water;³ and
- For each water quality and stabilization option, the Developers were required to submit costs using tax-exempt (private activity bonds) and taxable financing.

Developers were also permitted to submit alternatives that did not meet the requirements of the instructions. These were referred to as an “out-of-the-box” offer.

2.1.3 Final Award Process

All four qualified developers submitted Best and Final Offers. The evaluation criteria previously adopted by the Tampa Bay Water Board remained the same. The assessment categories were as follows:

- Plant siting & design;
- Environmental effects;
- Ability to acquire permits;
- Product water quality & delivery; and
- Schedule, water purchase agreement terms & financial factors (including present value analysis and impact on rate stability).

The offers for water quality Options 1 and 2 submitted “in-the-box” (Table 2-2) by the Developers were assessed. This included stabilized and unstabilized product water and tax-exempt and taxable financing.

**Table 2-2.
Best and Final Offer
In-the-Box Proposals**

<i>Developer</i>	<i>Plant Capacity</i>	<i>Location</i>
Florida Seawater Desalination Co.	23.3 MGD	Near Anclote Power Station
Florida Water Partners	25 MGD	At Big Bend Power Station
PECIP	25 MGD	At Anclote Power Station
Stone & Webster	25 MGD	At Big Bend Power Station

³ Stabilized product water requires some post-treatment in addition to disinfection after the RO membrane process. There is no additional treatment included for unstabilized product water. Methods of water stabilization proposed by the developers included lime dosing and addition of corrosion inhibitor.

There was only a cursory evaluation of the out-of-the-box proposals (Table 2-3) due to time constraints. The request for Best and Final Offers allowed Tampa Bay Water to evaluate or consider for selection an out-of-the-box proposal solely at their option.

**Table 2-3.
Best and Final Offer
Out-of-the-Box Offers**

<i>Developer</i>	<i>Technological</i>	<i>Financial</i>
Florida Seawater Desalination Co.	Not proposed	Letter of credit in lieu of 10 percent cash contribution.
Florida Water Partners	Ultra-filtration pretreatment	Not proposed.
PECIP	Not proposed	Modified 63-20 Corporation with parent guarantees in lieu of prescribed surety bonds.
Stone & Webster	Ultra-filtration pretreatment based on demonstration study	Alternate project financial security and insurance and surety bonds.

Each of the Developers received the same rating for both water quality Options 1 and 2. The only significant differences between the offers for Options 1 and 2 were the level of membrane treatment. This difference did affect the capital and the operations and maintenance costs but did not change the relative order of present value unit costs between the Developers.

The 30-year average nominal costs for in-the-box stabilized water with tax exempt financing are provided in Tables 2-4 and 2-5. The first year costs for in-the-box stabilized water with tax-exempt financing are also provided for information purposes only.

**Table 2-4.
Nominal Costs for In-the-Box Water Quality – Option 1 (Chloride Conc. \leq 35 mg/L)
Tax Exempt Stabilized Water**

<i>Developer</i>	<i>First Year Cost (\$/1,000 Gal)</i>	<i>30-Year Average Cost (\$/1,000 Gal)</i>
Florida Seawater Desalination Co.	2.26	2.71
Florida Water Partners	2.12	2.41
PECIP	2.15	2.58
Stone & Webster	1.86	2.30

Table 2.5.
Nominal Costs for In-the-Box Water Quality – Option 2 (Chloride Conc. \leq 100 mg/L)
Tax Exempt Stabilized Water

<i>Developer</i>	<i>First Year Cost (\$/1,000 Gal)</i>	<i>30-Year Average Cost (\$/1,000 Gal)</i>
Florida Seawater Desalination Co.	2.04	2.45
Florida Water Partners	1.99	2.27
PECIP	2.11	2.53
Stone & Webster	1.71	2.08

Table 2-6 shows a present value cost summary for in-the-box Options 1 and 2 proposals. Because the plants did not all have the same capacity, it was necessary to calculate a net present value of the 30-year cost series for each plant, and then divide this by the volume of water delivered to Tampa Bay Water over the 30 years of the contract. This calculation yields a present value unit cost of water for each plant in present value dollars per 1,000 gallons of product water from facilities of differing capacities. The use of present value calculation is also an equitable way to compare lifetime costs of facilities with differing cost escalation rates during the contract lifetime. The present value calculation was performed using a 7 percent discount rate, as specified in the instructions to Developers. Because the present value discount rate was higher than any of the prescribed inflation index values in the instructions to Developers, it has the effect of yielding a lower apparent lifetime cost of water than the average nominal cost presented in Tables 2-4 and 2-5.

A breakdown of the major components of the net present value calculation for water quality Option 1 stabilized product water with tax-exempt financing is presented in Table 2-7.

Distribution of lifecycle costs among fixed cost items, chemicals, electric power, and other escalating costs are not very divergent. Consequently, rankings were not likely to change at various alternative rates of inflation, or inflation assumptions.

Florida Water Partners and Stone & Webster avoid entrainment, impingement, and mortality of additional marine organisms in the water intake system by taking the feed water from the cooling water discharged from the power station prior to it entering the discharge canal. Florida Water Partners and Stone & Webster discharge their concentrate into the existing cooling water discharge system for the power plant. By mixing the water prior to discharge to the canal, disturbance of the canal to construct an additional discharge structure or diffuser is avoided.

Table 2-6.
In-the-Box Comparative Present Value Unit Cost
(all costs in present value dollars per 1,000 gallons)

<i>Financing</i>	<i>Product Water Stabilization</i>	<i>FSDC</i>	<i>FWP</i>	<i>S&W</i>	<i>PECIP¹</i>
Water Quality Option 1					
Tax Exempt	Stabilized	1.05	0.95	0.90	1.01
Tax Exempt	Unstabilized	NP	0.94	0.86	1.00
Taxable	Stabilized	NP	NC	0.91	1.13
Taxable	Unstabilized	NP	NC	0.91	1.12
Water Quality Option 2					
Tax Exempt	Stabilized	0.95	0.90	0.81	0.99
Tax Exempt	Unstabilized	NP	0.88	0.81	0.97
Taxable	Stabilized	NP	NC	0.85	1.11
Taxable	Unstabilized	NP	NC	0.85	1.09
¹ There is an arithmetic error in Progress Energy Corporation/Ionics Partnership's calculation. ² NP = Not Presented. Insufficient information was provided ³ NC = Not Calculated. Information provided was sufficient to permit calculation.					

Table 2-7.
Water Quality Option 1 Net Present Value Breakdown Analysis

<i>Developer</i>	<i>Net Present Value (million dollars)</i>	<i>Percent Fixed</i>	<i>Percent Power</i>	<i>Percent Chemicals</i>	<i>Percent Other</i>
Florida Seawater Desalination Co.	\$269.0	43.6	27.5	3.1	25.7
Florida Water Partners	\$260.8	53.2	26.0	7.9	12.7
PECIP	\$275.5	48.2	24.1	7.1	20.7
Stone & Webster	\$245.1	48.1	31.9	5.0	15.0

Florida Water Partners and Stone & Webster appear to avoid the need for intake structure permits and dredge and fill permits by taking their feedwater from and discharging the concentrate into the condenser cooling water discharge lines prior to the power plant discharge canal. Florida Seawater Desalination Company and PECIP would need permits for their intake structures and dredge and fill permits to install submerged diffuser in the discharge canal at the Anclote Power Station.

The ratings for each category (Table 2-8) are relative based upon the best or most desirable proposal response to each category receiving an “A”. The Stone & Webster team received the best cumulative ranking and was awarded the contract.

**Table 2-8.
Best and Final Ratings for
Water Quality Options 1 and 2**

<i>Developer</i>	<i>Plant Capacity</i>	<i>Location</i>	<i>Plant Siting and Design</i>	<i>Environmental Effects</i>	<i>Permitability</i>	<i>Product Water Quality and Delivery</i>	<i>Schedule, Agreement Terms, and Financial Factors</i>
FSDC	23.3 MGD	Near Anclote Power Station	D	B	B	A	D
FWP	25 MGD	Big Bend Power Station	A	A	A	A	B
PECIP	25 MGD	Anclote Power Station	A	B	B	A	C
S&W	25 MGD	Big Bend Power Station	A	A	A	A	A

2.1.4 Post Award Schedule

- December 1999 — Stone & Webster submitted Permit applications to Florida Department of Environmental Protection.
- January through March 2000 — Development of environmental monitoring plan.
- August 2000 — Permitting completed.
- May 2001 — Start construction.
- August 2002 — Complete construction.
- October 2002 — Obtain final operating permits.
- October 2002 — Begin plant testing.
- November 2002 — Complete plant testing.
- November 2002 — Begin operations.
- December 31, 2002 — Completion deadline date.

2.2 Tampa Bay Water Low Cost Factors

The factors that led to the costs and viability of the Tampa Bay Water desalination project are numerous and varied. Some of the factors were intrinsic to the specific case, time, and location and are difficult to quantify. Some of these intrinsic factors include the procurement and financial arrangements used, the regulatory climate, public attitudes toward the project, and market conditions swaying developers. There are other factors that do lend

themselves to some evaluation by quantified costs or by a discussion of their general impacts. Where practical specific cost impacts are estimated.

2.2.1 Design-Build-Operate

The design-build-operate project delivery option offers many advantages for seawater desalination contracts. Seawater desalination facilities must be customized to treat source waters with variable water qualities to deliver product water that meets client/customer specifications. In most cases process parameters cannot be determined without extensive pilot testing and then process parameters may need to be modified once full-scale operation begins. These types of projects lend themselves to the performance based contract process where the water quality, quantity, delivery schedule, etc. are specified but the plant design is left to the developer. Performance based specifications allow the developer to propose the best and most cost-effective technology that they are familiar with. It also allows for the project to take advantage of innovations in desalination technology, which also generally lowers the cost of desalination. Design-build-operate also transfers more of the project risk to the developer in that the developer specifies the plant design and yet must meet the performance specifications.

2.2.2 Power Plant Co-Location

The Tampa Bay Water desalination plant will avoid substantial capital costs by sharing the intake and outfall canals with the Tampa Electric Company power station. The feed water for the desalination plant will flow through the trash grates and screens of the power plant. Underwater construction is avoided in that the intake and discharge pipeline from the desalination plant tie on land into the power plant cooling water discharge pipeline. The elevated temperature of the discharged cooling water (approximately 15° F above ambient Bay water temperature) will increase the amount of product water produced by the membranes in the desalination plant.

The power plant cooling water flow is approximately 1,350 MGD providing dilution for the 16.7 MGD concentrate discharge flow. Due to the high rate of dilution the salinity in the power plant effluent is expected to rise by less than 2 percent. Without this large cooling water flow it may not be possible to discharge the concentrate into the bay without additional mixing facilities.

The data and modeling that was required for the Tampa Electric Company NPDES permit by the Department of Environmental Protection and ongoing monitoring will reduce the amount of new studies required to obtain the NPDES permit for the desalination plant. The Tampa desalination plant does not plan to share power plant personnel for the operations. The exception is that large motor/pump repair technicians from the power plant will be contracted to service and repair the desalination plant high-pressure pumps and associated motors. It is estimated that \$15 to \$130 million dollars in cost avoidance was realized due to co-locating the desalination plant with the power plant. Table 2-9 summarizes approximate cost savings for co-location with the power plant.

**Table 2-9.
Tampa Bay Power Plant Co-location Cost Savings**

	Low Estimate			High Estimate		
	Capital Cost	O&M Cost	Cost per 1,000 gallons	Capital Cost	O&M Cost	Cost per 1,000 gallons
Intake Canal	\$5,000,000	\$1,000,000	\$0.15	\$40,000,000	\$2,000,000	\$0.54
Outfall Canal	5,000,000	1,000,000	0.15	40,000,000	2,000,000	0.54
Trash Gates and Screens	300,000	30,000	0.01	500,000	300,000	0.04
Elevated Temperature ¹	4,000,000	250,000	0.06	7,563,492	334,106	0.10
Data and Modeling for Permits	1,000,000	100,000	0.02	2,000,000	100,000	0.03
Ongoing Monitoring	0	100,000	0.01	0	300,000	0.03
Total	15,300,000	2,480,000	\$0.39	130,063,492	5,034,106	\$1.59

¹ Water flux increases by 2 percent per degree Fahrenheit temperature increase. Cost savings for temperature increase based on 15 degree Fahrenheit increase resulting in flux rate increasing from 6.46 gal/sfd to 8.4 gal/sfd for 25 MGD product water flow rate with 168 x 8 element array (1,344 elements). The average Bay temperature is 77° F and the average boiler condenser discharge used for feedwater is 92° F.
Assumptions: Interest Rate = 6.0 percent; Financing Period = 30 years; Average Product Flow = 25 MGD.

The Big Bend power plant will receive some benefits for co-siting with the seawater desalination facility. The desalination plant is to pay the power plant \$0.022 per 1,000 gallons of intake water for the use of the power plant intake facilities. With an intake rate of approximately 41.7 MGD, the yearly payment to the power plant will be approximately \$335,000. As long as the power plant is using the intake and outfall for its own cooling water, there are no additional costs incurred by the power plant due to the desalination facilities. If the power plant stops pumping cooling water for its own purposes, then an agreement will have to be negotiated

between the two facilities to pay for the intake of the water needed by the desalination facilities. About 8.5 acres of land for the desalination facilities will be leased from the power plant. The greatest benefit for the power plant is probably the addition of the desalination facilities as a customer with a large, almost constant demand for power.

2.2.3 Source Water Quality

Favorable water quality (lower Total Dissolved Solids [TDS]) of the raw water from the bay will contribute to decreased operating costs (principally, lower electric power requirements). Analysis indicated that TDS ranged from 10,000 to 33,000 mg/L, with an average annual salinity of about 26,000 mg/L. This is considerably lower than the typical open ocean TDS of approximately 35,000 mg/L. However, because of the fluctuating TDS concentration, variable frequency drives (VFDs) are required for the high-pressure pumps at an additional capital cost.

The surface water source for the desalination plant has a relatively high fouling potential due to biological activity in the bay and erosion runoff (sediment) into the bay. Nitrogen and phosphorus loading in the bay, plus the relatively warm temperature, encourages algae and other biological growth. Rivers and streams contribute sediment and organics to the bay, especially during periods of high flow. Storms can also stir up sediments in the relatively shallow portions of the bay. However, the Big Bend intake canal is approximately 3,460 feet long, 200 feet wide, and 20 feet deep, with a water flow velocity of about 0.5 feet per second. Therefore, even with high TSS loading in the bay, the intake channel will act as a settling basin to allow the majority of sand and silt to settle out. The algae and other biological matter have significant fouling potential requiring a high capacity pretreatment system to protect the reverse osmosis membranes. A budget of approximately \$13,318,000 was set aside for the feedwater pretreatment system for the desalination plant.

2.2.4 Proximity to Product Water Demand Center

The Big Bend power station site is approximately 14 miles from the delivery point for the stabilized desalinated water at a new Tampa Bay Water regional water treatment plant. The desalinated water will be transported through a 42-inch diameter pipeline that will follow Tampa Electric Company right-of-way easements most of the distance. The pipeline will have one major river crossing, one railroad crossing, and a number of road crossings. The desalinated water will be blended with groundwater and surface water at the water treatment plant for

delivery through the Tampa Bay Water distribution pipeline network to its wholesale customers. The cost for the pipeline and the right-of-way is part of the desalination project cost and is estimated to be about \$13,400,000. The cost of 12,500,000 gallons of desalinated water storage capacity is approximately \$3,000,000.

2.2.5 Environmental Conditions, Permits, and Mitigation Requirements

Extensive agency review is anticipated due to a lack of precedence in permitting in the United States a desalination facility of the size and configuration of the Tampa Bay project. However, the effort required by the developer to fully meet all environmental data acquisition and modeling requirements will be diminished at the selected site due to previous permits and studies required for the existing power plant. Additional savings for the developer will be realized due to studies conducted in the Bay for other purposes and studies conducted on behalf of Tampa Bay Water during the desalination proposal selection process. A budget of \$1,300,000 has been established by the developer for obtaining the required permits for the desalination plant and pipeline.

Another advantage of the Tampa Bay location is the large amount of flushing that occurs in the Lower Hillsborough Bay where the Big Bend Power Station cooling water discharges. A study by the U.S. Geological Survey concluded that with each tide reversal, more than 25 times as much water enters or leaves Hillsborough Bay than is circulated through the power station.⁴ The overall residence time for Tampa Bay is approximately 145 days.⁵ However, the Big Bend Power Station discharges to the lower portion of Tampa Bay near the interface with the open Gulf, and therefore the overall residence time for all of Tampa Bay may not be representative of flushing that occurs near the Big Bend Power Station. Without adequate flushing it would not be possible to discharge the concentrate into the bay due to the risk of salinity buildup causing ecological damage.

⁴ Levesque, Victor A., and K.M. Hammett, "Water Transport in Lower Hillsborough Bay, Florida, 1995-96," U.S. Geological Survey Open-File Report 97-416, Tallahassee, Florida, 1997.

⁵ Bianchi, Pennock, and Twilley, "Biogeochemistry of Gulf of Mexico Estuaries, John Wiley & Sons Inc., 1999.

Section 3

Siting Issues Assessment

Siting information is presented in four interdependent categories for evaluation. First, cost models are developed to quantify the effects of major source water, siting, and macroeconomic parameters on product water costs. Second, Geographic Information System (GIS) figures and data tables are used to summarize environmental features and siting conditions along the Texas coast. Third, regulatory and permitting issues relevant to siting a seawater desalination facility along the Texas coast are discussed. Finally, all of the information gathered on cost impacts, siting conditions, and regulatory considerations is used to assess the costs and viability of siting a seawater desalination facility at two example sites on the Texas coast.

3.1 Capital and Operation & Maintenance Cost Models

In addition to example costs obtained from the Tampa Bay Water project and other desalination projects, two separately developed cost models are used to analyze desalination costs. The use of cost models allows the flexibility to test cost sensitivities for varying process parameters and site specific conditions. The two models are used in conjunction to estimate different portions of the cost analysis and also as a check against each other. Additional costs not covered by either of the cost models are estimated using a combination of engineering calculations, historical costs, and information from manufacturers.

The American Desalting Association (ADA) and U.S. Bureau of Reclamation distribute a model developed in Microsoft Excel that is titled Water Treatment Estimation Routine (WaTER). WaTER is based primarily on the EPA report, "Estimating Water Treatment Costs, Vol. 2, Cost Curves Applicable to 200-MGD Treatment Plants" (EPA-600/2-79-1626, August 1979). EPA is working on an update to the cost study and hopes to incorporate the new cost curves and parameters into the updated WaTER program. This is a detailed cost model that can be used to calculate desalination system costs using several different treatment processes, including reverse osmosis, nanofiltration, ion exchange, and electro dialysis. Included are costs for other pretreatment and post treatment processes relevant to desalination, such as gravity filtration and lime feed. Model input is specific water quality parameters, such as TDS concentration, pH, and alkalinity, along with general input such as flow and recovery rate. From this input the model calculates the cost of a treatment process for particular source waters. The

model does not include means to estimate costs for energy recovery turbines, source water intake, concentrate disposal, or delivery to the point of distribution.

The second model used is based on a document currently being developed for EPA entitled "Manual of Cost Estimates for Selected Water Treatment Technologies." Portions of this cost estimating document have been included in Part A, Section 6 of this report. Cost information from the EPA document was developed into a model based on standard desalination costs using reverse osmosis. This model includes standard reverse osmosis water production costs for feedwater pumping, pretreatment (acid and antiscalant addition and cartridge filters), reverse osmosis membranes and process system, and membrane cleaning system. The model does not include costs for energy recovery turbines, source water intake, additional pretreatment (such as chlorination or media filtration), post treatment, concentrate disposal, or delivery to the point of distribution.

3.2 GIS Mapping

GIS coverages available for download on the Internet were used to evaluate and present environmental and geographic information relevant for siting a desalination facility along the Texas coast. Several government agencies supply GIS information on their web sites for general use. Some of the agency web sites where information was obtained include the Texas General Land Office, Texas Natural Resource Information System, and Texas Parks and Wildlife Department. Additional information on the GIS mapping can be found in Appendix B.

3.3 Regulatory Considerations

To better understand the regulatory considerations for siting a seawater desalination facility on the Texas coast, sources of information on desalination regulations and previous projects or studies were reviewed. Information sources included:

- Published regulations and guidelines from national, state, and local regulatory organizations;
- Correspondence with regulatory officials familiar with desalination permitting issues;
- Published studies or reports on past desalination or concentrate disposal projects; and
- Correspondence with participants in previous desalination projects and/or concentrated brine disposal projects.

Section 4

Desalination Cost Impacts Identified

The cost impacts of different siting parameters are estimated using developed cost models, engineering calculations, and example projects. Both initial capital expenditures and annual O&M costs are included in the cost impact analyses. Some siting parameters have a general impact on the entire desalination process and are quantified by estimating the impact on water production costs. Alternatively, other siting parameters only impact a particular portion of the desalination process and are quantified by their impact on those individual components of the water system. The term “water production costs” will be used throughout this report to refer to the core desalination process without the other ancillary components of a complete water supply system. Water production costs include standard water treatment components common to all seawater reverse osmosis (RO) systems. Water production costs include feedwater pumps with energy recovery turbines, standard pretreatment (acid and antiscalant addition and cartridge filters), RO membranes and process system, and membrane cleaning system. Since the cost models do not include energy recovery turbines, these were estimated using engineering calculations and historical costs. Water production costs do not include other costs that are more site-specific, such as costs for source water intake, additional pretreatment (e.g., chlorination or media filtration), post treatment, concentrate disposal, or delivery to the point of distribution. These excluded items may have significant cost implications and are considered separately.

Parameters of the Tampa Bay Water desalination project were used as the base assumptions in most of the estimated example costs. The base assumptions used in the cost estimates are given in Table 4-1. These are the base assumptions used for all the variables in the estimates except where noted in the individual cost impact estimates. Additional assumptions and estimating methodology can be found in Part A, Section 6 of this report.

Section 4 is organized so that the impact of individual process parameters and site conditions can be assessed. Sections 4.1 through 4.9 highlight some of the cost impacts and show the relative costs for varying situations. Also, the total cumulative cost range for RO seawater desalination facilities with all typical components included are shown in Section 4.10.

Table 4-1.
Base Assumptions for Estimates

Parameter	Assumption	Description
Labor, including Benefits	\$25 per hour	
Energy Cost	\$0.04 per kWh	Interruptible Power
Interest Rate	6 percent	
Financing Period	30 years	
Recovery Rate	60 percent	Percent of feedwater recovered as product
Flux	8.4 gfd	Rate product water passes through membrane
Pumping Head	900 psi	Pressure for seawater
Cleaning Frequency	6 months	Membranes cleaned once every 6 months
Membrane Life	5 years	Membrane elements replaced every 5 years

4.1 Source Water Salinity

Source water salinity affects almost every aspect of the RO process. Required driving pressure across the membrane is dictated by the osmotic pressure caused by the difference in salinity concentrations between the feed and product waters. Increased feedwater salinity increases the osmotic pressure, requiring higher driving pressure. Higher operating pressures necessitate the use of stronger membrane pressure vessels and RO elements designed to handle higher operating pressures.

Recovery rate and process configurations are also affected by source water salinity. Higher salinity generally decreases the recovery rate of a single stage process configuration. Depending on the source water salinity and required product water TDS concentration, different levels of reject staging, product staging, or bypassing/blending staging may be necessary. High TDS source water will produce higher TDS reverse osmosis concentrate that may be more difficult to dispose of due to permitting issues.

Specific electrical consumption and water production costs versus feedwater TDS are shown in Figures 4-1 and 4-2, respectively. These costs are based on increasing feedwater pressure with increasing TDS concentration. Feedwater pressures vary from 400 to 900 psi as the TDS concentrations increase from 10,000 to 35,000 mg/L, with the pressure increasing by 100 psi for each 5,000 mg/L increase in TDS. The costs are based on constant flux rate of

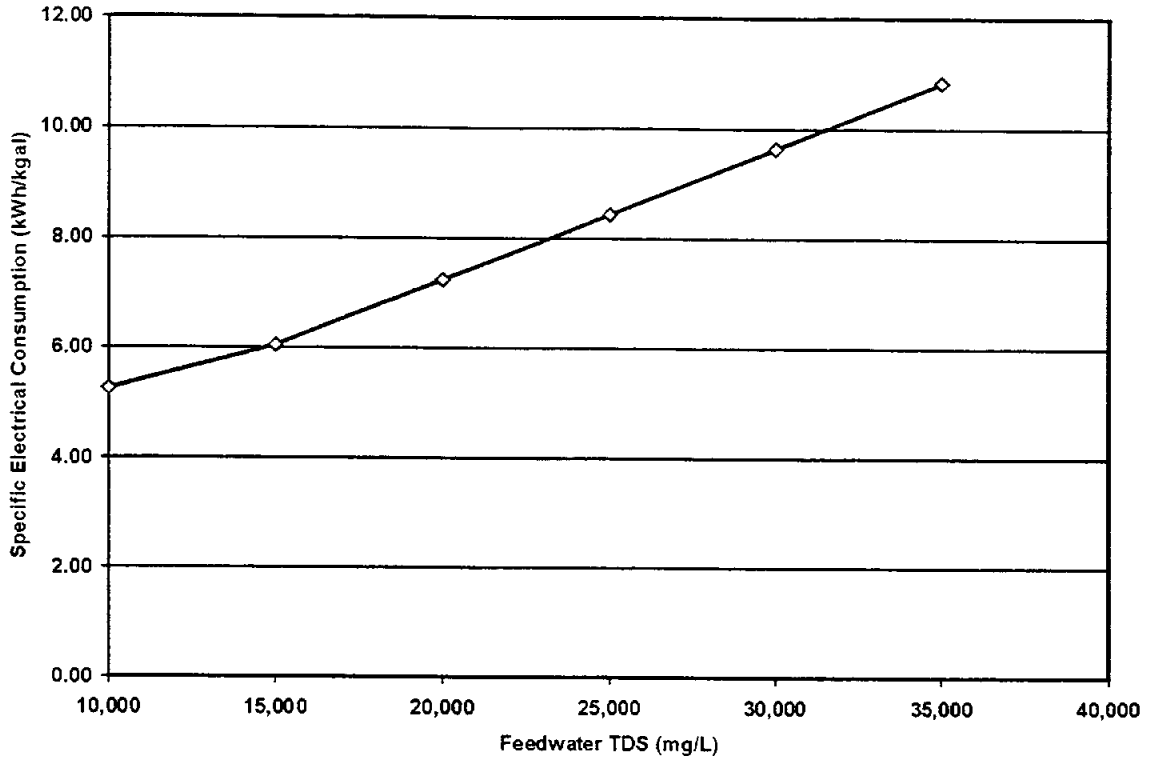

Figure 4-1. Reverse Osmosis Specific Electrical Consumption Versus Feedwater TDS

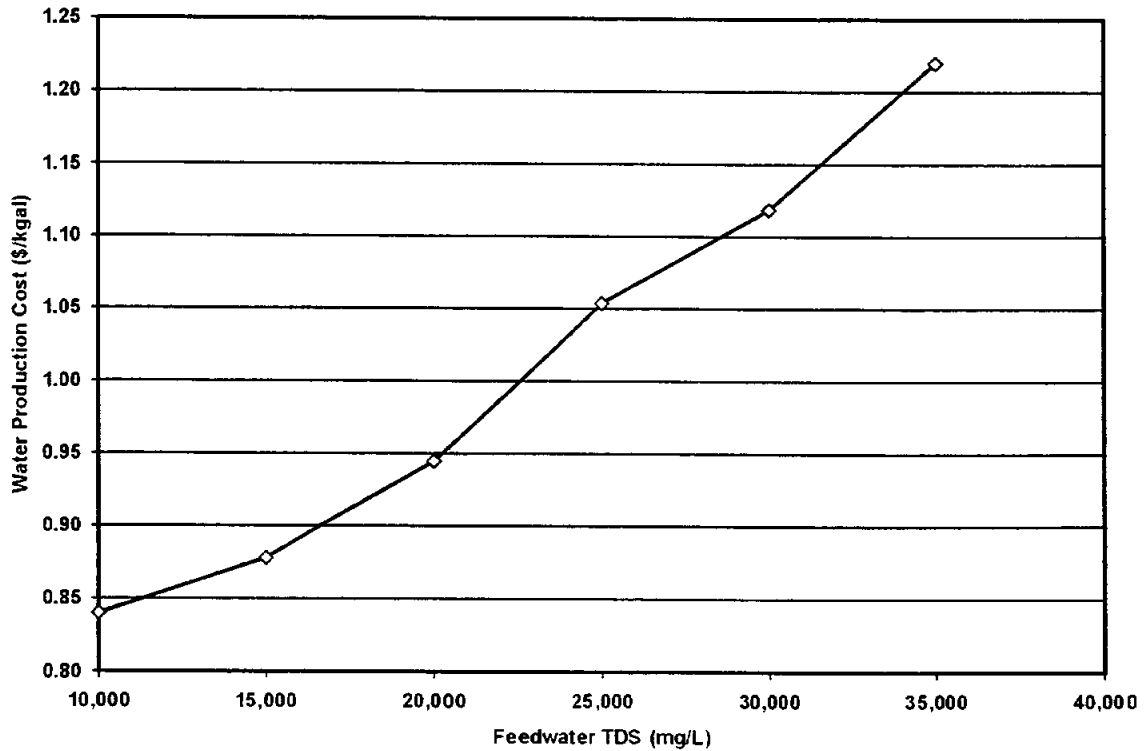

Figure 4-2. Reverse Osmosis Water Production Cost Versus Feedwater TDS

8.4 gfd and recovery rate at 60 percent regardless of TDS concentration. Curves could be significantly steeper if process configuration and/or product water quality requirements cause a decrease in flux rate and/or recovery rate in response to higher TDS concentrations.

Feedwater pump capital costs and energy consumption assume the use of energy recovery turbines to recover some of the energy in the concentrate. Capital costs of the energy recovery turbines are assumed to be 50 percent of the feedwater pumps capital cost. It is assumed that 65 percent of the energy in the concentrate is recovered. Therefore, energy recovered is a function of the recovery rate and feedwater pump energy. Figure 4-3 shows a schematic of the energy recovery turbine system.

$$\text{Energy recovered} = \text{Feedwater pump energy} * (1 - \text{recovery rate}) * 65\%$$

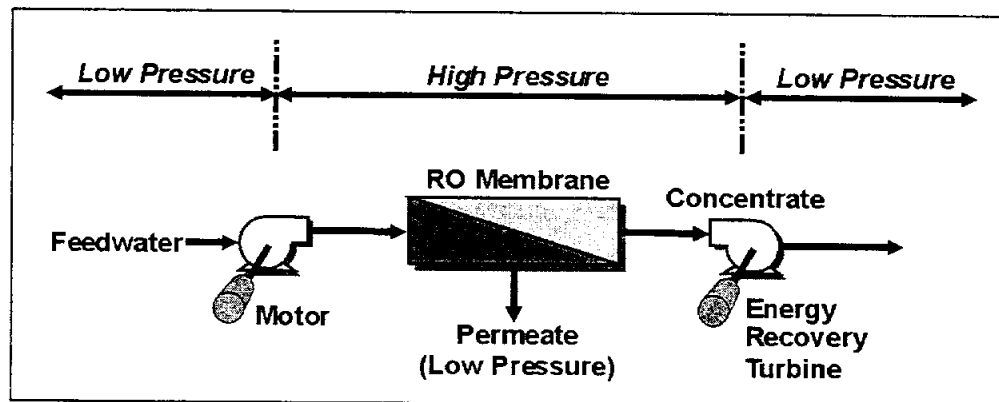

Figure 4-3. Energy Recovery Turbine Schematic

4.2 Source Water Fouling Potential

Reverse osmosis membrane elements are susceptible to fouling that can decrease the flux rate through the membrane thereby decreasing the treatment capacity per element or requiring higher operating pressures to maintain production. Sources of fouling include suspended solids, organic matter, microbial growth, and inorganic scale deposits.

Source waters with a higher fouling potential can also increase desalination costs by requiring higher levels of pretreatment and/or membrane cleaning. Pretreatment may include chlorination, acid addition, antiscalant, and cartridge filters. Poor source water quality can also require additional pretreatment, such as chemical coagulation, media filtration, and/or ultrafiltration (low-pressure membrane filtration). The required frequency of membrane

cleanings may increase with higher fouling potential. Also, some fouling agents are difficult, if not impossible, to remove by current cleaning methods, thereby shortening the effective life of the membranes requiring more frequent membrane replacement.

Feedwater characteristics used to predict fouling potential include pH, alkalinity, temperature, and concentrations of several constituents. The pH affects alkaline scale formation, membrane stability, and salt rejection optimization. Lowering pH by acid addition to about 5.5 to 6.0 so the Langlier index is negative can reduce the scaling potential due to calcium carbonate. Temperature affects flux rates, membrane life, and scaling. Elevated levels of water constituents, such as strontium, barium, iron, hydrogen sulfide, and silica, can impair performance of RO membranes.

Figure 4-4 shows a semi-quantitative relationship between RO water production cost and source water fouling potential. Cost projections are determined by increasing the pretreatment required with increasing fouling potential. Pretreatment includes acid and antiscalant addition and cartridge filters. As the fouling potential increases, acid addition increases from 10 to 30 mg/L of sulfuric acid (93 percent) and antiscalant addition increase from 1 to 5 mg/L. The cartridge filter replacement interval is held constant at 3 months. For the highest fouling potentials, such as for surface water intake systems, sludge handling and gravity filtration through anthracite and sand beds 1.75 feet deep was added. The included sludge handling consists of mechanical sludge dewatering and disposal to an off-site nonhazardous waste landfill.

The fouling potential of source water can also affect the flux rate achieved across the RO membrane elements. Lower flux rates require that more membrane elements be used to produce the same quantity of product water. Figure 4-5 shows the inverse relationship between flux rate and water production costs. The figure assumes that membrane cleaning frequency does not increase significantly with increasing flux.

4.3 Proximity to Product Water Demand Center

The ultimate cost of desalted seawater is affected by the costs of delivering the product water to customers. While it may be economically desirable to locate a seawater desalination facility in close proximity to a dense population center, several factors, including a suitable seawater source, political issues, available land, environmental considerations, and geography, may require a facility to be located far from the user.

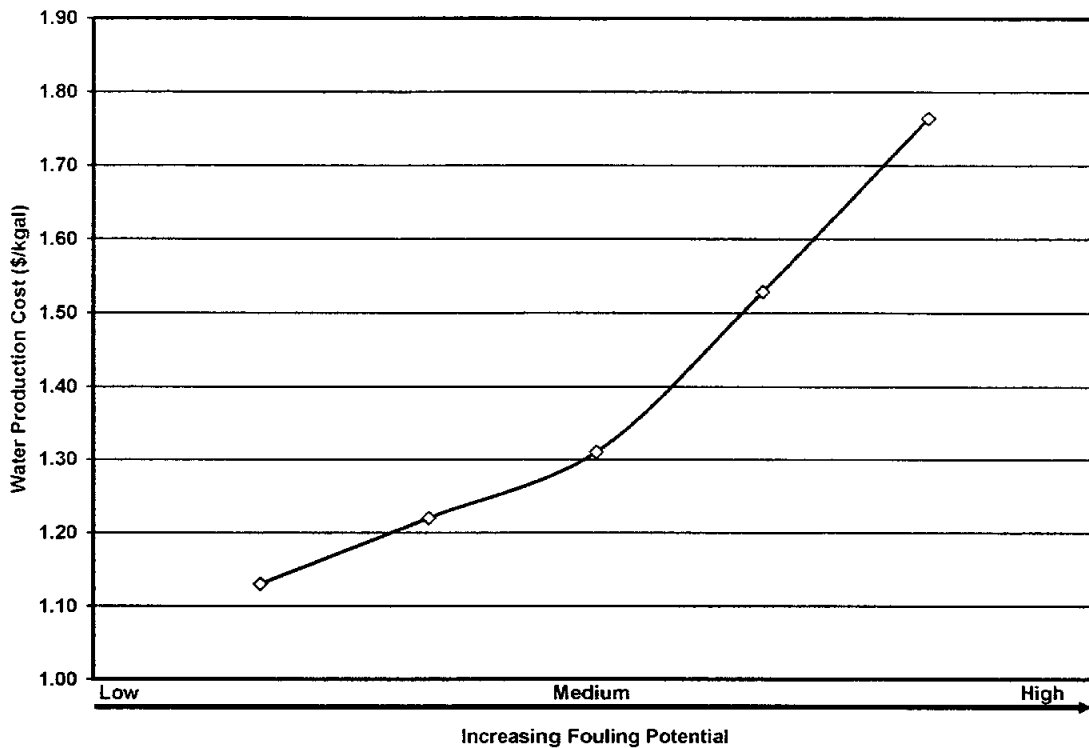

Figure 4-4. Reverse Osmosis Water Production Cost Versus Source Water Fouling Potential

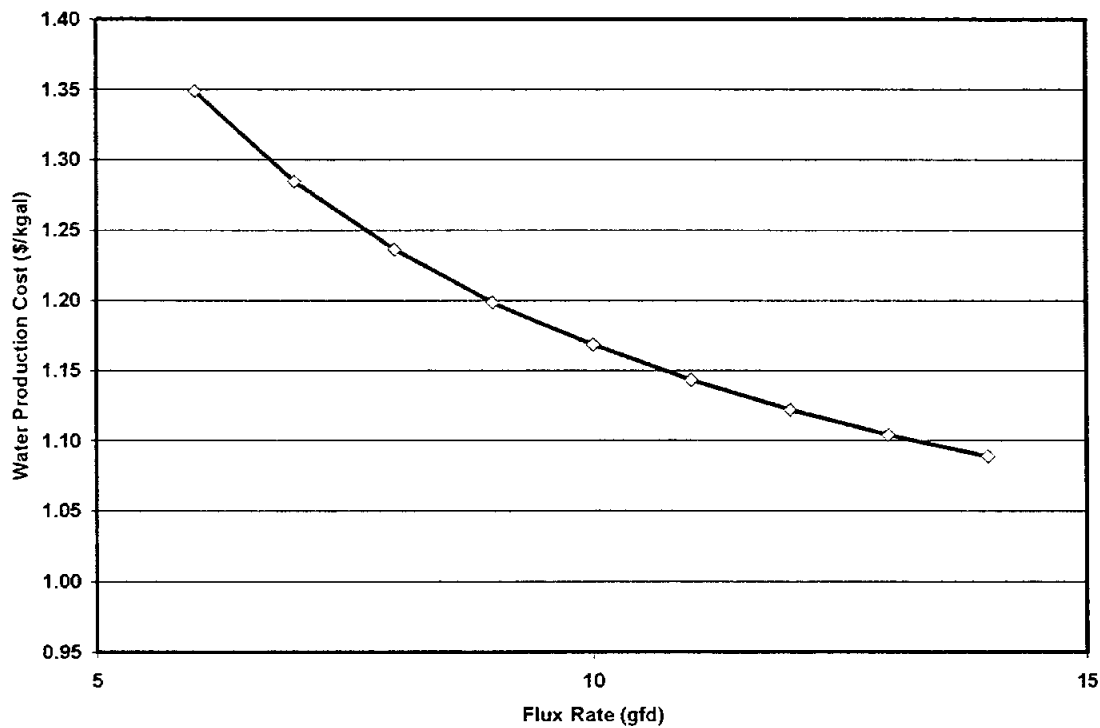

Figure 4-5. Reverse Osmosis Water Production Cost Versus Flux Rate

As with any water delivery system, pumping and piping costs increase as the delivery distance and elevation difference between points increases. Significant elevation differences may need to be overcome for demand centers that lie far inland. Demand centers near the coast will typically not be at significantly different elevation from the desalination facility.

Estimated costs for delivery to the demand center for increasing distance are shown in Figure 4-6 and Table 4-2. Costs are for delivery of 25 MGD of product water and are expressed as cost per 1,000 gallons of product water. The costs include required pumps, a 42-inch pipeline, and a 13 million-gallon storage tank.

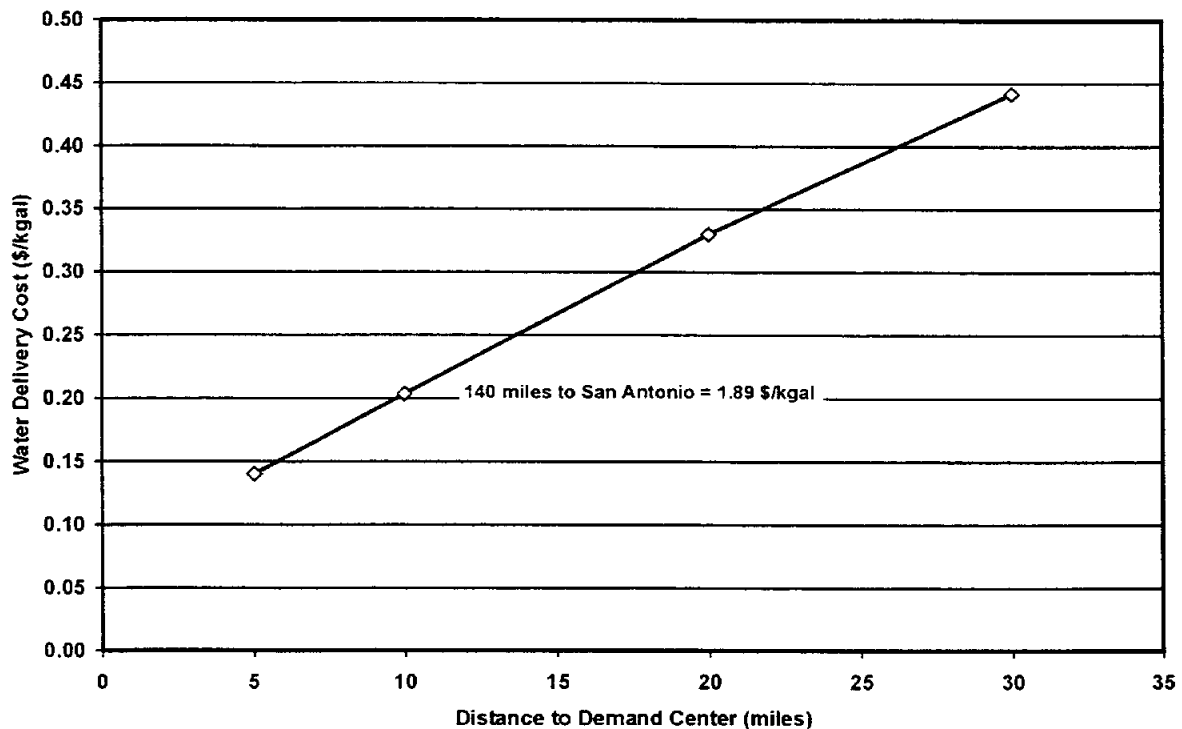

Figure 4-6. Distance to Demand Center Cost Impact

Estimated cost to deliver desalinated water 140 miles to San Antonio is included. A 140-mile route generally along the route of the San Antonio River from San Antonio Bay to the center of Bexar County was assumed. The pumping requirements assumed are 17,300 gpm (25 MGD) for the intake and each booster pumping station. The energy requirements estimated were based on total dynamic heads of 100 feet for the intake and 335 feet for each of the three booster pumping stations to pump treated water to the urban demand center. Water delivery costs are significantly reduced as larger volumes of water are transferred.

Table 4-2.
Distance to Demand Center Cost Estimate Summary

<i>Item</i>	<i>Estimated Costs (5 miles)</i>	<i>Estimated Costs (10 miles)</i>	<i>Estimated Costs (15 miles)</i>	<i>Estimated Costs (30 miles)</i>	<i>Estimated Costs (140 miles)</i>
Capital Costs					
Intake Pump Station	\$850,000	\$1,252,000	2,056,000	\$2,677,000	\$1,154,000
Transmission Pipeline	3,142,000	6,283,000	12,566,000	18,850,000	101,891,000
Transmission Pump Stations	0	0	0	0	6,925,000
Highway and Stream Crossings	128,000	255,000	510,000	765,000	2,969,000
Rail Crossings	51,000	102,000	204,000	306,000	593,000
Storage Tanks	<u>4,550,000</u>	<u>4,550,000</u>	<u>4,550,000</u>	<u>4,550,000</u>	<u>4,550,000</u>
Total Capital Cost	\$8,721,000	\$12,442,000	\$19,886,000	\$27,148,000	\$118,082,000
Engineering, Legal Costs and Contingencies	\$3,052,000	\$4,355,000	\$6,960,000	\$9,502,000	\$41,329,000
Environmental & Archaeology Studies and Mitigation	318,000	582,000	1,110,000	819,000	3,814,000
Land Acquisition and Surveying	350,000	641,000	1,195,000	1,802,000	8,228,000
Interest During Construction (4 years)	<u>1,245,000</u>	<u>1,803,000</u>	<u>2,918,000</u>	<u>3,928,000</u>	<u>17,162,000</u>
Total Project Cost	\$13,686,000	\$19,823,000	\$32,069,000	\$43,199,000	\$188,615,000
Annual Costs					
Debt Service (6 percent for 30 years)	\$994,000	\$1,440,000	\$2,332,000	\$3,138,000	\$13,715,000
Operation and Maintenance:					
Pipeline and Storage Tank	77,000	108,000	171,000	234,000	1,064,000
Intake and Pump Station	30,000	44,000	72,000	94,000	283,000
Pumping Energy Costs (\$0.04 per kWh)	<u>180,000</u>	<u>265,000</u>	<u>436,000</u>	<u>567,000</u>	<u>2,200,000</u>
Total Annual Cost	\$1,281,000	\$1,857,000	\$3,011,000	\$4,033,000	\$17,262,000
Available Project Yield (acft/yr)	28,000	28,000	28,000	28,000	28,000
Annual Cost of Water (\$ per acft)	\$46	\$66	\$108	\$144	\$617
Annual Cost of Water (\$ per 1,000 gallons)	\$0.14	\$0.20	\$0.33	\$0.44	\$1.89

4.4 Concentrate Disposal

One of the most contentious siting factors for a large-scale desalination facility is determining an acceptable location to discharge the concentrate. Potential concentrate disposal methods include discharge to a bay or open ocean, deep well injection, solar ponds, thermal evaporation, and discharge to sewer system. With seawater desalination recovery rates ranging from 40 to 60 percent there can be a tremendous volume of concentrate generated. Example

concentrate production quantities and qualities with varying recovery rates are shown in Table 4-3. For large seawater desalination facilities the only practical option for concentrate disposal may be discharge to a bay or open ocean. Other options may be feasible for smaller plants (less than 5 MGD) where the volume of concentrate is less prohibitive for other disposal options.

**Table 4-3.
Concentrate Production**

Recovery Rate	40 percent	50 percent	60 percent	70 percent
Feedwater Flow (MGD)	62.50	50.00	41.67	35.71
Concentrate Flow (MGD)	37.50	25.00	16.67	10.71
TDS of Concentrate (mg/L)	50,000	60,000	75,000	100,000
Source Water TDS = 30,000 mg/L		Product Water Flow = 25 MGD		

A study¹ for the Tampa Bay Water desalination plant indicated that an increase in salinity of less than 6 percent above baseline in the receiving surface water is most likely not detrimental to native biota. Current EPA regulations allow for an increase of no greater than 10 percent in background salinity concentration. Additional studies by the Florida Department of Environmental Protection (FDEP) and others have also shown that, with sufficient dilution, desalination concentrate can be discharged to marine waters with negligible impact to the surrounding environs.² However, site-specific studies are necessary to characterize existing conditions and to quantify potential impacts to water quality and living resources resulting from a desalination facility at sites along the Texas coast.

Typical concentrate production values are shown in Table 4-3. The volume of concentrate decreases as the recovery rate increases. However, when concentrate volume is reduced, dissolved solids in the concentrate are even more highly concentrated. Depending on disposal method and regulatory considerations it may be more or less advantageous to have a greater volume with lower concentration. For highly concentrated discharge, allowance for a mixing zone may allow surface discharge of the concentrate. However, disposal of highly concentrated discharge may be limited by bioassay test requirements. Where there are

¹ PBS&J, Inc., "Impact Analysis of the Anclote Desalination Water Supply Project," prepared for Tampa Bay Water, November 1998.

² Response to Best & Final Offer Seawater Desalination Water Supply Project, Stone & Webster, 1999

allowances for a mixing zone, the maximum concentration within the mixing zone is dependent on the acute toxicity concentration. The concentrate at higher recoveries may exceed the allowable toxicity concentration.³

4.4.1 Concentrate Disposal Costs

Concentrate disposal costs can vary widely depending on regulatory requirements and disposal method utilized. Disposing of concentrate through a co-sited outfall, such as the power plant outfall proposed in Tampa Bay, can dramatically decrease concentrate disposal costs. However, concentrate disposal costs can be a large portion of the total desalination cost if more costly options such as offshore discharge are required.

Estimated offshore concentrate disposal costs are shown in Figure 4-7 and Table 4-4. Costs are based on disposing of 16.7 MGD of concentrate, which is the concentrate from a seawater desalination plant producing 25 MGD of product water with a recovery rate of 60 percent. The offshore disposal system consists of concentrate pumps, 42-inch pipeline laid on the ocean floor in a 6-foot deep trench and covered, and a diffuser array at the end of the pipeline. The pipeline and diffusers are assumed to be of the same configuration and construction as those used in the Bryan Mound concentrate disposal project discussed in Section 4.4.2. Pumps are sized to provide a residual pressure of 100 psi at the end of the pipeline to allow sufficient concentrate exit velocity from the diffuser nozzles for mixing. Sea grass mitigation costs are included assuming that 50 percent of the disposal line will be laid in sea grass areas. Mitigation is assumed to consist of replacing five times the sea grass area disturbed. From previous project experience, mitigation cost is estimated to be \$200,000 per acre of sea grass area disturbed. An additional 10 percent of the construction cost is added to account for potential environmental studies and reports. Costs are shown as dollars per 1,000 gallons of product water (25 MGD or 28,000 acft/yr).

³ Mickley, M., et al., "Membrane Concentrate Disposal," AWWA Research Foundation and American Water Works Association, 1993.

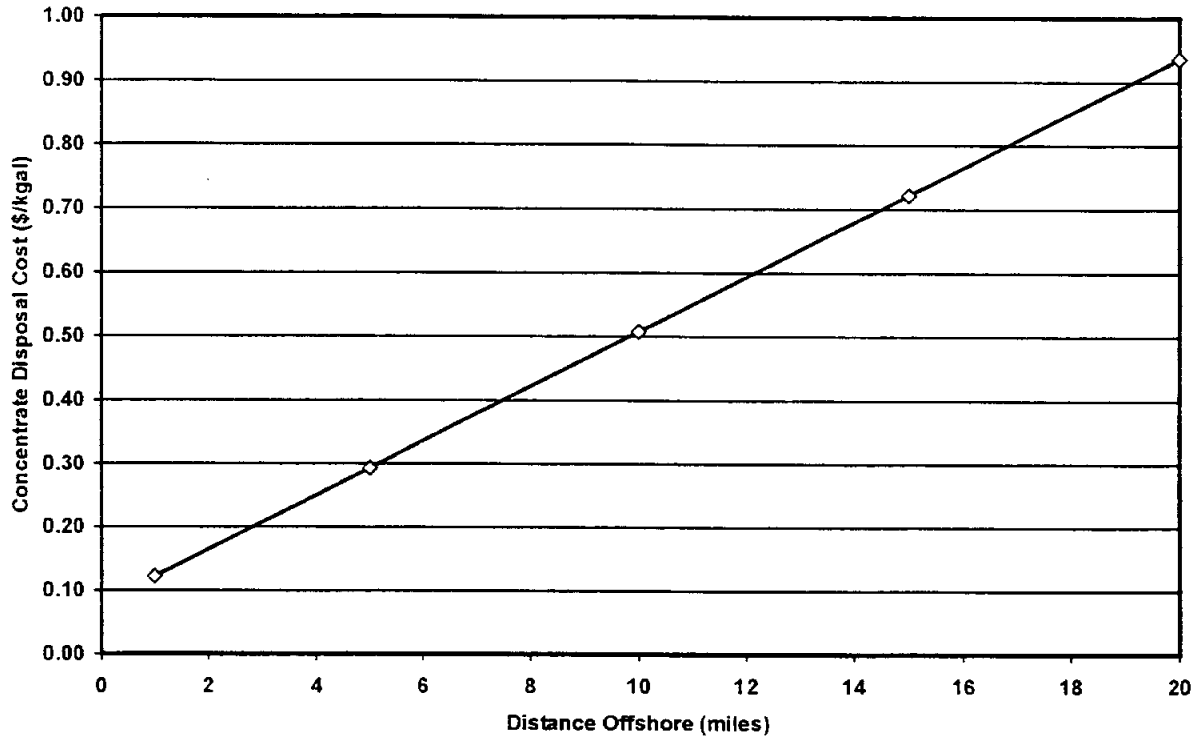

Figure 4-7. Offshore Concentrate Disposal Cost Impact

4.4.2 Example Concentrate Disposal Costs

4.4.2.1 Bryan Mound Strategic Petroleum Reserves Brine Disposal

The storage facility at the Bryan Mound Salt Dome is part of the Strategic Petroleum Reserve (SPR) Program that started in 1975 and is implemented by the Department of Energy (DOE). The Bryan Mound SPR site is located in Brazoria County near Freeport, Texas. The Bryan Mound project consisted of storing petroleum reserves in underground caverns previously filled primarily with salt. The salt from the caverns was leached out with water diverted from the Brazos River.

A pipeline and diffuser was built to dispose of the concentrated brine in the open Gulf of Mexico. Brine flow rate at its maximum was 46.2 MGD and the average TDS concentration was 268,000 mg/L. The disposal pipeline was 36 inches in diameter and extended 12.5 miles offshore. The pipeline was laid using a barge-mounted system in a trench on the ocean floor 12 feet deep and covered. The pipeline had a working pressure of 720 psi with a wall thickness

**Table 4-4.
Offshore Concentrate Disposal Cost Estimate Summary**

<i>Item</i>	<i>Estimated Costs (1 mile)</i>	<i>Estimated Costs (5 miles)</i>	<i>Estimated Costs (10 miles)</i>	<i>Estimated Costs (15 miles)</i>	<i>Estimated Costs (20 miles)</i>
Capital Costs					
Outfall Pump Station	\$1,215,000	\$1,270,000	\$1,339,000	\$1,408,000	\$1,477,000
Outfall Pipeline (42-inch)	2,877,600	14,388,000	28,776,000	43,164,000	57,552,000
Outfall Diffuser	<u>1,845,000</u>	<u>1,845,000</u>	<u>1,845,000</u>	<u>1,845,000</u>	<u>1,845,000</u>
Total Capital Cost	\$5,937,600	\$17,503,000	\$31,960,000	\$46,417,000	\$60,874,000
Engineering, Legal Costs and Contingencies	\$2,078,000	\$6,126,000	\$11,186,000	\$16,246,000	\$21,306,000
Environmental & Archaeology Studies and Mitigation	836,000	2,962,000	5,620,000	8,278,000	10,936,000
Surveying	119,000	350,000	639,000	928,000	1,217,000
Interest During Construction (4 years)	<u>898,000</u>	<u>2,695,000</u>	<u>4,941,000</u>	<u>7,187,000</u>	<u>9,434,000</u>
Total Project Cost	\$9,868,000	\$29,636,000	\$54,346,000	\$79,056,000	\$103,767,000
Annual Costs					
Debt Service (6 percent for 30 years)	\$717,000	\$2,153,000	\$3,948,000	\$5,743,000	\$7,539,000
Operation and Maintenance:					
Pipeline	29,000	144,000	288,000	432,000	576,000
Pump Station	107,000	109,000	111,000	114,000	116,000
Pumping Energy Costs (\$0.04 per kWh)	<u>257,000</u>	<u>269,000</u>	<u>284,000</u>	<u>298,000</u>	<u>313,000</u>
Total Annual Cost	\$1,110,000	\$2,675,000	\$4,631,000	\$6,587,000	\$8,544,000
Available Project Yield (acft/yr)	28,000	28,000	28,000	28,000	28,000
Annual Cost of Water (\$ per acft)	\$40	\$96	\$165	\$235	\$305
Annual Cost of Water (\$ per 1,000 gallons)	\$0.12	\$0.29	\$0.51	\$0.72	\$0.94

of 0.5 inches. The diffuser array was attached to the pipeline 12.5 miles offshore at a depth of 72 feet of water. The diffuser consisted of a pipeline running parallel to the shore and perpendicular to the attached pipeline. The diffuser pipeline was 3,060 feet long and had 52 diffuser ports spaced 60 feet apart. The diffuser ports were constructed of flexible 3-inch diameter nozzles that extended about 4 feet above the plane of the ocean floor. The diffusers

were designed to provide brine exit velocities between 20 and 30 fps so that the seawater and exiting brine would be highly mixed.⁴

Construction costs for the 36-inch pipeline and diffuser only with costs updated to March 2000 were approximately \$2,500,000 per mile (Ramen, 2000) for a construction cost of \$31,250,000 for the 12.5-mile pipeline. This cost does not include construction costs for pumping and other miscellaneous costs for the project, such as design and permitting. Some of the permitting considerations for open ocean discharge are discussed in Section 5.3.

4.4.2.2 Draft Report, Tampa Bay Water Phase I Brackish Groundwater Desalination Study, September 21, 1999, Missimer International, Inc.

The following estimated construction costs are for separate concentrate disposal options for proposed brackish water facilities to be constructed in Pinellas County, Florida. The site used for the estimated cost options below is the proposed Clearwater Airpark site. The costs for a disposal system for a seawater desalination facility would be similar.

4.4.2.2.1 Option: Class I Injection Disposal Wells

Disposal of 1.25 MGD of concentrate by a Class I deep well system to be constructed at the desalination plant. The system would consist of two, 8-inch diameter, 1,100-foot deep injection wells (1 active and 1 backup) each equipped with a tubing and packer system, wellhead with annulus tank, one dual-zone monitor well, and a concentrate pump station consisting of two (one standby) 868 gpm (1.25 MGD) injection pumps.

Two injection wells	\$3,800,000
Dual zone monitoring well	\$220,000
Two annulus tanks and wellheads	\$200,000
Two tubing and packer systems	\$560,000
Pump station with two 900 gpm injection pumps	\$90,000
Total Costs	\$4,870,000

4.4.2.2.2 Option: Disposal with Wastewater Treatment Plant Outfall

A surface water discharge would consist of constructing a duplex 1.25 MGD concentrate pump station at the RO plant site and installing an 8-inch diameter HDPE pipe from the pump

⁴ Department of Energy, 1981.

station to a wastewater treatment plant, a distance of approximately 4 miles. It has been assumed that the concentrate will share the existing Tampa Bay outfall and will be mixed with the wastewater treatment plant effluent. Aeration and other treatment of the concentrate may be required prior to discharge but are not included in the capital cost of \$980,000.

4.4.2.2.3 Option: Submerged Outfall to Gulf of Mexico

The estimated capital cost for a submerged outfall to the Gulf of Mexico is provided. It is anticipated that a duplex 1.25-MGD concentrate pump station at the RO plant site and an 8-inch diameter HDPE pipeline would be required. The pipeline would be on land in public rights-of-way or suspended beneath bridges for a distance of approximately 5.5 miles. The distance that the pipeline would need to be extended out into the Gulf is not stated but is probably at least a mile to a diffuser system. The cost for Gulf disposal system reported is \$6,460,000

4.5 Raw Water Intake

The cost of seawater intake can vary considerably depending on regulatory requirements, specific site conditions, and whether the desalination plant is co-sited with another facility with an intake. The construction for seawater wells, galleries or collector wells will be similar whether for fresh, brackish, or seawater feedwater. The use of corrosion resistant materials will increase the costs somewhat for a seawater system.

4.6 Power Cost

Seawater desalination is a power-intensive treatment process, so desalination costs are highly sensitive to the price of power. Power costs are generally about 30 percent of total seawater desalination costs. Electrical consumption for state-of-the-art RO seawater desalination with energy recovery can range from about 11 to 19 kWh per 1,000 gallons of product water. Use of energy recovery turbines can significantly reduce power requirements by recovering up to 85 percent of the energy remaining in the concentrate. Stone & Webster's Tampa Bay proposal indicates that for their desalination facility the energy recovery turbines will recover about 26 percent of the total power used by the feedwater high pressure pumps (HPRO pumps = 13.3 kWh/kgal, ERT = - 3.5 kWh/kgal). Because the RO process can be easily started and stopped, interruptible power can typically be used provided adequate on-site water storage facilities are provided.

The relative impact of power cost on the RO water production cost is shown in Figure 4-8. All the base assumptions shown in Table 4-1 are used to determine the relative impact of power cost. The feedwater pumps consume the majority of power. Energy required is dependant on several factors including the salinity and related feedwater pressure and also the recovery rate that affects the amount of feedwater that must be pumped. The impact of recovery rate on the quantity of power required is somewhat mitigated with the use of efficient energy recovery turbines. The costs assume that energy recovery turbines that recover 65 percent of the energy in the rejected concentrate are used.

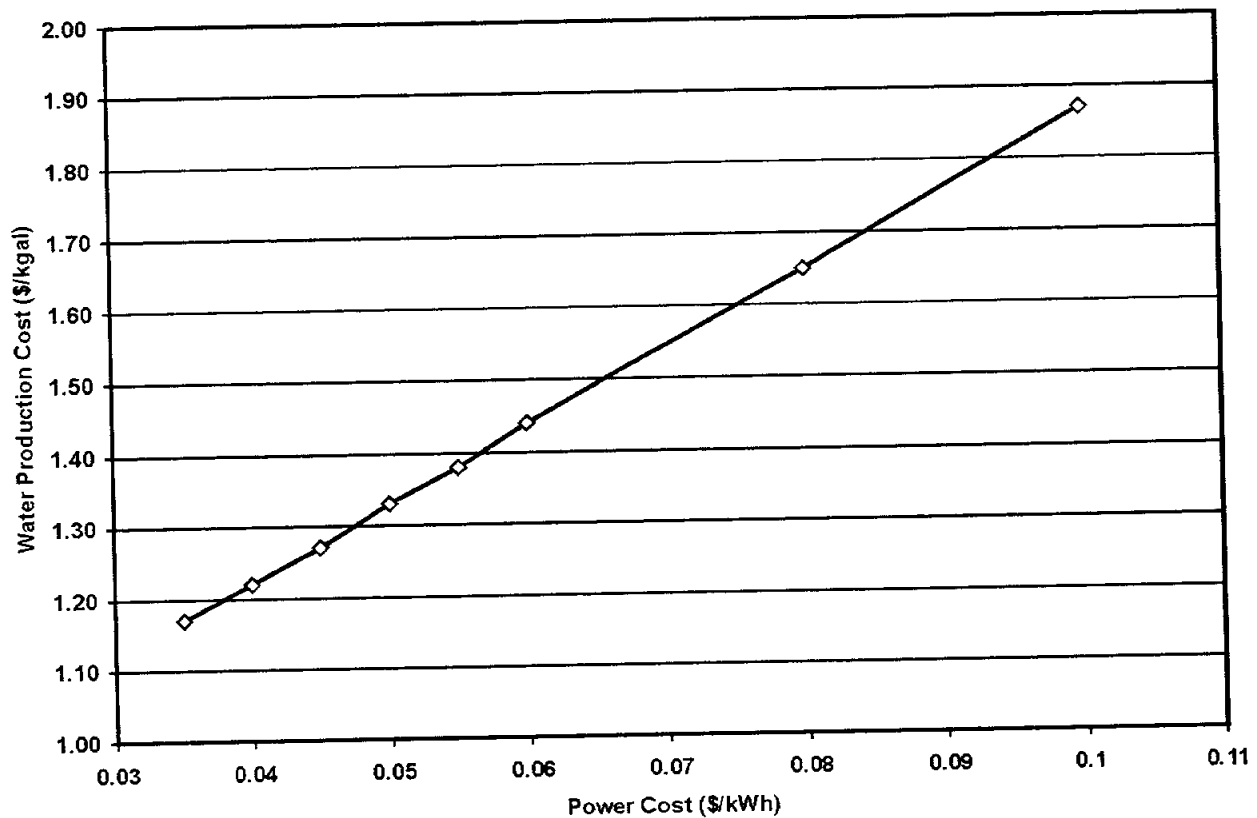

Figure 4-8. Reverse Osmosis Power Cost Impact

4.7 Co-location with Power Plant

Several areas of cost savings can potentially be realized from siting a RO desalination plant with an existing or proposed power plant. For a once-through cooling water power plant,

the intake and outfall can be shared, resulting in significant savings in infrastructure capital, O&M, and permitting costs. Using power plant effluent with increased temperature as the desalination feedwater can decrease treatment costs due to increased RO membrane flux rate with increased temperature. In a deregulated power environment there may also be some savings in power costs due to decreased power distribution costs. Some of the estimated cost savings for co-locating a 25-MGD seawater desalination plant with a power plant are given in Section 2.1.2.

Typically, the temperature of once-through cooling water from a power plant is raised by 15 to 20° F. The RO flux rate increases by about 2 percent per degree Fahrenheit. The impact on water production cost due to increasing the flux rate can be seen in Figure 4-5. There is a maximum benefit that can be realized from increasing temperature due to operating limitations of RO membranes. The maximum feed temperature for RO membranes is around 115° F.

4.8 Proximity to Sensitive Environmental Features

Reverse osmosis desalination feedwater intake, treatment plant, concentrate disposal, and product distribution pipeline can all have environmental impacts that may prohibit the siting or increase the cost of these facilities in sensitive areas. Sensitive environmental features include dunes, wetlands, coastal preserves, state parks, oyster reefs, nursery and juvenile fish areas, and commercial fishing areas. Opposition by commercial and recreational fishermen and environmental groups can cause substantial delay through legal challenges that add costs to the project and may even make a good project politically untenable.

4.9 Surge/Flood Zones

To reduce water transmission costs, seawater desalination facilities will most likely be constructed near the coast. Therefore, the effects of surge/flood zones on siting decisions and costs should be evaluated. The potential for surge and/or flood events at a facility site can affect costs by requiring increased capital improvements in anticipation of an event, higher insurance costs, and, if an event does occur, then costs for repair and lost revenue.

4.9.1 Example Precautions

Beginning in 1998, the Florida Keys Aqueduct Authority began upgrading a 3-MGD seawater RO facility originally built in 1981 on Stock Island. The original facility was built in a 100-foot by 50-foot single-story metal building. Rehabilitation included construction of a new

concrete building and moving water-sensitive equipment off of the first floor for protection from potential flood damage. The facility was designed to remain operational during a hurricane event. A three-level building was proposed for the Stock Island RO plant with the following layout:

- Ground level: cartridge filters, RO feed pumps, RO process trains, and membrane cleaning system with electrical equipment relocated to be above flood elevation, and maintenance and storage space;
- Second level: chemical storage and feed systems, control room, lab, offices, and shower/locker rooms; and
- Third level: Engine and right angle drives, generator, air supply system, electrical room, mechanical room, kitchen, and an emergency operations center.⁵

4.9.2 Surge/Flood Zones Cost Impact

The potential cost impacts of siting a facility in a surge/flood zone can be estimated by determining the probability of an event and calculating associated costs. For a facility located in the 100-year flood zone, the estimated additional costs due to surge/flood concerns are approximately \$20.00 per square foot of building area for capital costs plus 0.3 percent of total construction cost per year for O&M considerations. The cost per square foot of building area is the approximate cost to make the facility two stories and locate the water sensitive equipment off of the ground floor including costs for additional wiring and piping. The added O&M cost is for increased insurance premiums, extra maintenance and operations costs associated with additional floors, and an annualized cost for repairs and lost revenues in the event that a flood does occur.

For a seawater desalination facility producing 25 MGD of product water with the base assumptions in Table 4-1, the added cost for a facility located in a surge/flood zone is approximately:

- Capital cost = \$206,000;
- O&M cost = \$129,000 per year; and
- Total = \$0.02 per 1000 gallons of product water.

4.10 Additional Impacts

Other considerations when evaluating possible seawater desalination sites and costs include water chemistry and blending issues. Desalinated water will have substantially different characteristics than currently distributed water, including lower buffer capacity, lower overall

⁵ Florida Keys Aqueduct Authority, 1998.

hardness, and potentially lower chloride and sulfate levels. Blending this water with currently distributed waters can substantially change the corrosion character of the water in contact with the distribution system. This has the potential to generate several problems relative to corrosion, metal release, taste and odor, and DBP production. If studies indicate that blending is a concern then several approaches such as pH/alkalinity adjustment, calcium adjustment, and/or inhibitor addition can be considered to alter the desalinated water so that it is more compatible with the distribution system. For the Tampa Bay Water project, the cost of stabilization was in the range of \$0.01 to \$0.02 per 1,000 gallons of product water. Additional costs to address blending issues may include studies and distribution system upgrades.

Another consideration is the adequacy and proximity of roads and other transportation. Roads that can handle normal truck traffic are likely sufficient to supply a desalination plant with the chemicals and other materials necessary for operation. Rail or barges can in some instances be used to bring in materials for construction of the plant at costs that are generally lower than by truck.

The quantity of water to be treated also has an impact on total water costs. Significant savings can be realized from efficiencies present in facilities producing larger quantities. Figure 4-9 shows the relative impact of product water flow versus water production cost for flows from 1 to 50 MGD. Energy recovery turbines are included for product water flows of 5 MGD and greater. They are not included for the 1 MGD flow because the capital cost of the turbine outweighs the power savings for flows less than 5 MGD.

4.11 Total Reverse Osmosis Seawater Desalination Costs

To compare the cumulative impact of some of the desalination process parameters and siting factors, a range of total costs for RO seawater desalination facilities are shown in Table 4-5. These costs are for an example facility treating seawater with an average salinity of 30,000 mg/L TDS that produces an average of 25 MGD of desalinated water. Most of the typical assumptions shown in Table 4-1 are used. Some of the parameters are modified to account for varying source water quality. The parameters from Table 4-1 that fluctuate are the recovery rate that ranges from 40 to 60 percent, flux rate that ranges from 6 to 10 gfd, and cleaning frequency that ranges from once every 2 weeks to once every year. Other modifications

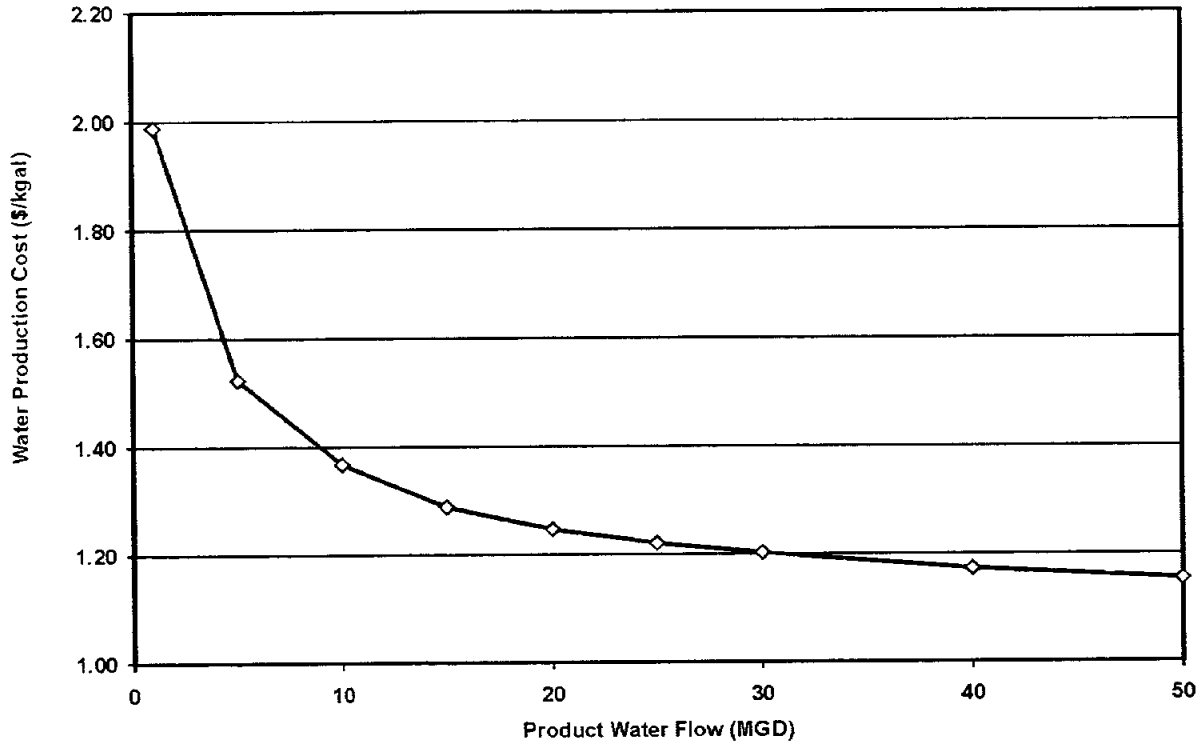

Figure 4-9. Product Water Flow Cost Impact

Table 4-5. Total Reverse Osmosis Seawater Desalination Cost Range

	Low Estimate			High Estimate		
	Capital Cost	O&M Cost	\$/kgal	Capital Cost	O&M Cost	\$/kgal
Raw Water Supply	\$1,100,000	\$200,000	0.03	\$40,000,000	\$2,000,000	0.54
Desalination Process	51,000,000	6,200,000	1.09	105,000,000	15,000,000	2.48
Concentrate Disposal	6,900,000	370,000	0.10	112,583,000	977,000	1.00
Delivery to Demand Center	<u>17,382,000</u>	<u>300,000</u>	<u>0.17</u>	<u>205,336,000</u>	<u>2,840,000</u>	<u>1.95</u>
Total	\$76,382,000	\$7,070,000	1.38 ¹	\$445,919,000	\$17,817,000	5.97

Notes:

- Cost is expressed in dollars per 1,000 gallons of product water.
- Costs are for plants producing an average of 25 MGD of desalinated water.
- Costs are for reverse osmosis desalination of seawater with average salinity of 30,000 mg/L TDS.
- Each case is site-specific and costs can vary beyond these ranges.

¹ The total low estimate represents an idealized condition that could not actually occur on any single site.

are specific to individual portions of the desalination process and are explained below. The financial assumptions in Table 4-1 are used for all portions of the estimates.

Raw water supply includes the necessary intake structure, pumps, and piping to deliver seawater to the RO treatment plant. Raw water supply facilities on the low end include only minimal pumps and piping for a desalination plant that is co-sited with a power plant that has an adequate intake structure for use by the desalination plant. Raw water supply facilities on the high end include a large intake structure with precautions to prevent impingement, an intake canal several thousand feet long, pumps, and piping.

Desalination process includes all necessary pretreatment, feedwater pumping, RO membrane process system, and cleaning system. The desalination process on the low end is for the treatment of an ideal source water that requires minimal pretreatment, allows the membranes to operate at around the maximum design flux rate and recovery rate, and does not require frequent cleaning of the membranes. The desalination process on the high end is for poor source water that requires extensive pretreatment including coagulation and filtration, prevents the membranes from operating at a high design flux rate and recovery rate, and requires frequent cleaning of the membranes.

Concentrate disposal includes the necessary outfall, pumps, and piping to dispose of the RO concentrate to surface water. Concentrate disposal facilities on the low end include only minimal pumps and piping for a desalination plant that is co-sited with a power plant that has an adequate outfall for use by the desalination plant. Concentrate disposal facilities on the high end include pumps, piping, and diffuser for an open ocean discharge into waters a minimum of 30 feet deep.

Delivery to demand center includes the necessary pumps, piping, and water storage tanks for supply of the desalinated water to the distribution system. Delivery to demand center on the low end includes a 13-MGD storage tank with pumps and pipes for delivery 1 mile to the distribution system. Delivery to demand center on the high end includes a 13-MGD storage tank with pumps and pipes for delivery 140 miles to San Antonio.

Section 5

Siting Conditions on the Texas Coast

5.1 Water Quality

The shallow estuaries along the Texas Gulf of Mexico coastline are complex systems, affected by numerous factors, such as freshwater inflows, tidal forcing from the Gulf of Mexico (diurnal, lunar, and storm tides), and prevailing and seasonal meteorological patterns. Water quality within an estuary varies both spatially and temporally. The water quality at a specific location within an estuary will be affected by the relative proximity to freshwater inflow sources and interfaces with the Gulf of Mexico and the overall geomorphology of an estuary. At locations proximate to river mouths, water quality characteristics can be expected to more frequently approach those of the freshwater inflows. At locations proximate to tidal inlets where water is exchanged with the Gulf of Mexico, the water quality can be expected to be closer to that of seawater. The geomorphology of the estuary directly affects circulation patterns within the estuary and controls much of the mixing of the freshwater and seawater inflows. Sandbars, islands, and navigation channels within the estuary can isolate specific areas and cause zones of stagnation where minimal mixing occurs with adjacent zones. These spatial variations can vary temporally with diurnal tidal cycles, and seasonal weather patterns. Storm surges from the Gulf of Mexico and flood flows from the rivers and streams also vary the spatial distribution of water quality within an estuary. Substantial quantities of water are exchanged frequently between estuaries and the Gulf of Mexico at tidal inlets, but these exchanges frequently have little effect in the "interiors" of the estuaries because of estuary geomorphology that inhibits circulation.

Water quality data collected at 19 estuary locations along the Texas coastline were summarized and evaluated in order to provide a general characterization of the spatial and temporal variation of the quality of water available for desalinization along the Texas coastline. Note that the data summarized herein are site-specific; the spatial variability of water quality constituents within an estuary preclude using these data as anything more than indicators of conditions at other locations. Specific detailed studies should be performed for specific intake and brine disposal sites.

Figure 5-1 shows the locations where the TWDB and others have operated continuous water quality monitors. These monitors generally record temperature, pH, and salinity on an

hourly, or more frequent, basis. Data for these sites were downloaded from the web site maintained by TWDB and are available for different locations during different years, with the most recent data for each site ranging from 1989 through 1999. Generally, the site data from the most recent representative year was analyzed and summarized. For some sites data for multiple years was analyzed. Table 5-1 presents summary statistics for the individual salinity measurements recorded at each site. Additional summary statistics for the sites delineated in Figure 5-1 are included in Appendix D.

Along the Texas coast, salinity concentrations can range between 0.0 mg/L to more than 40,000 mg/L. The salinity of seawater is generally assumed to be 25,000 to 33,000 mg/L, indicating that many locations along the Texas coast exhibit salinity concentrations in excess of that of seawater. Solis and Powell¹ note that the Laguna Madre, a large estuary system that extends from near Corpus Christi to near Brownsville, is one of only four estuaries in the world that regularly exhibit hypersalinity (greater than 33,000 mg/L). This hypersalinity can occur when the quantity of water evaporated from the water body exceeds inflows from freshwater and Gulf of Mexico sources. The Laguna Madre system has relatively few locations where significant quantities of seawater are exchanged with the Gulf of Mexico, and freshwater inflows are frequently small due to the semi-arid nature of the south Texas watersheds that drain to the estuary. In addition, evaporation rates frequently exceed the total precipitation over the water body, concentrating dissolved solids over much of the estuary.

Siting for the intake and brine disposal locations for a desalination plant should be governed by the expected water quality of the source water, and the opportunity for efficient disposal of the brine concentrate without adversely increasing localized and overall estuarine salinity concentrations. Intake sites located away from freshwater inflows would expect to experience higher salinity concentrations and, if located in areas that experience frequent stagnation, might be expected to deal with hypersalinity frequently. Intake sites located near freshwater sources would expect to experience wide ranges in salinity concentrations (i.e., very low salinities during times of high freshwater inflows, but increased salinities during times of low flow).

¹ Solis, Ruben S. and Gary L. Powell, "Hydrography, Mixing Characteristics, and Residence Times of Gulf of Mexico Estuaries," Chapter 2 of *Biogeochemistry of Gulf of Mexico Estuaries*, edited by Thomas Bianchi, Jonathan Pennock, and Rober Twilley, John Wiley and Sons, Inc., New York, 1999.

Table 5-1.
Texas Coastal Water Salinity Summary

Bay/Estuary	Year(s) of Analysis	Salinity (ppt)		
		Min.	Max.	Median
Arroyo (deep)	1997	0.0	41.1	32.0
Arroyo (shallow)	1997	0.0	33.3	17.0
Laguna Madre (Isabel)	1991	21.5	37.2	30.8
Baffin Bay	1998	19.7	46.0	34.6
Upper Baffin Bay	1999	0.2	36.5	23.9
Laguna Madre (JFK)	1997 - 1999	0.8	46.4	31.1
Oso Bay	1997	1.1	42.1	32.3
Corpus Christi Bay	1987 - 1989	8.6	40.0	32.7
Nueces Bay	1989	32.2	43.1	36.8
Copano Bay	1989	24.8	34.5	29.3
Mission-Aransas Estuary	1999	6.1	32.5	19.7
Mesquite Bay	1999	3.3	29.9	19.1
San Antonio Bay	1996	1.8	34.3	25.8
Lavaca Bay	1997 - 1999	0.0	27.3	12.6
Matagorda Bay	1987 - 1989	9.3	36.6	29.8
Trinity-San Jacinto Estuary	1999	0.3	24.8	7.2
Galveston Bay (Dollar Point)	1999	1.1	29.7	17.7
Galveston Bay (Redbluff-upper)	1998	0.8	20.8	12.2
Sabine-Neches Estuary (upper)	1999	0.0	17.6	3.4

Source: TWDB's ambient water quality monitoring program for bays and estuaries. Data obtained from TWDB's internet site.

Table 5-2 presents calculated residence times for several Texas estuaries,² which can be utilized to infer flushing characteristics of a given water body. For comparison the residence time for Tampa Bay has also been included. Numerous definitions and means of estimating estuary residence times are available. The residence times presented in the table are defined as "the average amount of time required to replace the equivalent fresh water in the estuary by fresh-water inputs."³ Estuaries along the Texas coastline have relatively high residence times,

² Solis, Ruben, telephone conversation, April 10, 2000.

³ Solis and Powell, Op. Cit., 1999.

Table 5-1.
Texas Coastal Water Salinity Summary

Bay/Estuary	Year(s) of Analysis	Salinity (ppt)		
		Min.	Max.	Median
Arroyo (deep)	1997	0.0	41.1	32.0
Arroyo (shallow)	1997	0.0	33.3	17.0
Laguna Madre (Isabel)	1991	21.5	37.2	30.8
Baffin Bay	1998	19.7	46.0	34.6
Upper Baffin Bay	1999	0.2	36.5	23.9
Laguna Madre (JFK)	1997 - 1999	0.8	46.4	31.1
Oso Bay	1997	1.1	42.1	32.3
Corpus Christi Bay	1987 - 1989	8.6	40.0	32.7
Nueces Bay	1989	32.2	43.1	36.8
Copano Bay	1989	24.8	34.5	29.3
Mission-Aransas Estuary	1999	6.1	32.5	19.7
Mesquite Bay	1999	3.3	29.9	19.1
San Antonio Bay	1996	1.8	34.3	25.8
Lavaca Bay	1997 - 1999	0.0	27.3	12.6
Matagorda Bay	1987 - 1989	9.3	36.6	29.8
Trinity-San Jacinto Estuary	1999	0.3	24.8	7.2
Galveston Bay (Dollar Point)	1999	1.1	29.7	17.7
Galveston Bay (Redbluff-upper)	1998	0.8	20.8	12.2
Sabine-Neches Estuary (upper)	1999	0.0	17.6	3.4

Source: TWDB's ambient water quality monitoring program for bays and estuaries. Data obtained from TWDB's internet site.

Table 5-2 presents calculated residence times for several Texas estuaries,² which can be utilized to infer flushing characteristics of a given water body. For comparison the residence time for Tampa Bay has also been included. Numerous definitions and means of estimating estuary residence times are available. The residence times presented in the table are defined as "the average amount of time required to replace the equivalent fresh water in the estuary by fresh-water inputs."³ Estuaries along the Texas coastline have relatively high residence times,

² Solis, Ruben, telephone conversation, April 10, 2000.

³ Solis and Powell, Op. Cit., 1999.

Table 5-2.
Texas Coastal Residence Time Summary

<i>Bay/Estuary</i>	<i>Residence Time (days)¹</i>
Corpus Christi Bay	355
Mission-Aransas Estuary	360
San Antonio Bay	40
Matagorda Bay	67
Galveston Bay (Dollar Point)	40
Galveston Bay (Redbluff-upper)	40
Sabine-Neches Estuary (upper)	9
Tampa Bay	145
¹ Residence times are approximate and are intended for comparison purposes only. The values presented are not to be considered as absolute values.	

Source: Bianchi, Pennock, and Twilley, "Biogeochemistry of Gulf of Mexico Estuaries, John Wiley & Sons Inc., 1999.

exceeding 355 days in places. Brine disposal sites located in interior areas of most Texas estuaries would be expected to increase localized salinity/dissolved solids concentrations because of the low circulation exhibited by most Texas estuaries. Brine disposal sites located near freshwater inflows would be expected to have little effect on local salinity during times of high freshwater inflows, but possibly significant effects when freshwater inflows are small. Ideally, brine disposal should be sited near tidal inlets where frequent direct exchanges of water occur with the Gulf of Mexico. These locations provide the least potential for increasing local salinity concentrations.

The potential for harm to fragile estuarine ecosystems is great and careful study and analysis of the potential effects of a treatment plant's intake and concentrated brine disposal should be undertaken during the preliminary engineering/feasibility study for a proposed desalination plant. The siting of the intake and brine disposal for a desalination plant should be undertaken considering the hydrodynamics of the source and receiving water bodies. The TWDB has developed numerical hydrodynamic models of each of the Texas Gulf of Mexico estuary water bodies that can compute circulation patterns and salinity concentrations throughout a water body under a defined set of boundary conditions. These models can be used to assist in

the siting of intake and disposal by indicating the relative circulation patterns near potential sites. In some areas confidence in the models is high, and the effects of a particular intake and brine disposal outfall on local salinity concentrations can be quantified.

5.2 Coastal Power Plants

There are several power plants along the Texas coast with the potential for co-siting with a seawater desalination plant. Figure 5-1 shows the locations of identified Texas Coastal Power Plants. Table 5-3 shows some of the once-through cooling water power plants along the Texas coast with the maximum cooling water diversion rate from the TNRCC permits. In some cases the actual power plant once-through cooling water flow rate is considerably lower than the permitted rate. To get an indication of the true dilution capacity of a plant, utility officials were contacted and the maximum installed diversion capacity reported are included. This capacity is the sum of circulating water flows and the salt water flows. The reported capacity is the maximum circulating water rate if all units at the power plant are running at the same time. Under normal operating conditions not all units at a power plant will be running all of the time. Therefore, this maximum capacity is somewhat higher than the actual firm dilution capacity because the circulating water and saltwater pumps on units that are off line will be shut down. For the Tampa Bay Water co-sited desalination plant, the concentrate disposal flow rate was less than 2 percent of the total cooling water flow rate of 1,350 MGD.

5.3 Power Cost

The single greatest operating expense for RO seawater desalination is power cost. Current and potential future industrial electricity rates considering deregulation are examined to determine cost impacts on RO seawater desalination. Three major power utilities currently serve the majority of the Texas Coastal Bend area; therefore there is little geographic difference in the current power costs in the study area. Cost impacts of using interruptible versus non-interruptible power are also examined.

Table 5-3.
Texas Coastal Power Plants

Power Plant	Permitted Diversion Rate (MGD)	Maximum Installed Diversion Capacity (MGD)	Basin	
			Diverted from	Returned to
Central Power and Light Plants				
Barney M Davis	646	467	Laguna Madre	Oso Bay
Nueces Bay	604	487	Corpus Ship Channel	Nueces Bay
E S Joslin	768	210	Lavaca Bay	Cox's Bay
Relient-HL&P Plants				
Sam R. Bertron	277	740	Houston Ship Channel	Houston Ship Channel
Cedar Bayou	917	1,454	Cedar Bayou	Trinity Bay
Deepwater	1,975	125	Houston Ship Channel	Vince Bayou
P.H. Robinson	1,314	1,680	Dickinson Bay	Galveston Bay
Webster	185	530	Clear Creek	Clear Creek
Entergy-Gulf States Plants				
Sabine	N/A	1,264	Sabine Lake	Sabine Lake

5.3.1 Current Electricity Market

Historically, market forces have not set electricity prices in Texas. Consumers' electricity supply choices have been limited to the utilities franchised to serve their areas. Similarly, electricity suppliers have not been free to pursue customers outside their designated service territories. Generally, utilities have built generation, transmission, and distribution capacity only to serve the needs of the customers in their service territories, and the price of electricity has been set, based on the average cost of producing and delivering power to customers.

In Texas, as well as the vast majority of states, there has been an increasing interest in expanding competition in electric markets to the retail sector. In fact, a number of states have determined that retail competition is in the public interest and have passed legislation to that effect. In addition, retail access has begun to receive increased attention at the federal level, evidenced by the amount of proposed legislation introduced in the 105th U.S. Congress addressing the subject of electric industry restructuring.

Currently, the legal structure of the electric industry in Texas consists of a regulated retail market and a partially competitive wholesale electric market. That is, sales for resale are open to competition from electricity suppliers other than traditional utilities, but ultimate sales to end-use retail customers are still limited exclusively to electric utilities legally certified to provide electric service in a specific geographic area. However, the structure of the electric industry in Texas is set to change with the passage of Senate Bill 7 in June of 1999.

5.3.1.1 Senate Bill 7

In June 1999, electric utility deregulation legislation, Senate Bill 7, was enacted to restructure the Texas electric industry allowing retail competition. The bill requires retail competition to begin by January 2002. Current customers of investor-owned utilities and those served by public utilities that decide to compete will be allowed to choose between a number of competing companies for service. However, customers now served by a city, cooperative, or other power generator that opts not to compete will not have a choice. For electric utilities that participate in the deregulation, electric rates will be frozen for three years, and then a six-percent reduction will be required for residential and small commercial consumers. This will remain the "price to beat" for 5 years or until utilities lose 40 percent of the consumers to competition. Participating electric utilities must unbundle, using separate companies or affiliate companies, into three separate categories including generation, distribution and transmission, and retail electric.

5.3.1.2 Pilot Programs Enacted Under Senate Bill 7

Senate Bill 7 directs utilities to implement pilot programs amounting to 5 percent of the utility's load, beginning June 1, 2001. The pilot programs will allow the Public Utility Commission of Texas to evaluate the ability of each power region and utility to implement direct access.

Texas-New Mexico Power Company (TNMP) named two communities, Gatesville and Olney City, in which to initiate its pilot program for retail access to generation suppliers of choice. TNMP's pilot programs in Gatesville and Olney City began November 1, 1999 when customers began receiving power from Bryan Texas Utilities. Prices are between seven and 10.5 percent lower than other TNMP customers.

5.3.1.2.1 Electricity Rates in a Non-competitive Market

In a vertically integrated utility, the total cost of generating, transmitting, and distributing electricity is borne by the utility and recouped directly through cost-based rates charged to customers. As an example, the largest percentage of costs for a utility are due to generation, which typically accounts for 72 percent of the cost of a kilowatt-hour. Transmission of the power may require 7 percent of costs, and distribution can account for the remaining 21 percent.⁴ The actual cost allocation for specific utilities may differ.

Under the present system, electric providers serve all customers in their service areas with a few exceptions. Generally, electric customers are classified into five categories:

1. Residential, which consists of homeowners and tenants;
2. Commercial, including small businesses, small industrial plants, retail stores, and office buildings;
3. Industrial, which includes large manufacturing plants and accounts for the great bulk of sales in some areas of the state;
4. Municipal, which uses power for city facilities and services such as street lights, but also for resale to end user customers; and
5. Other public utilities such as co-ops, other wholesalers, or retailers.

Each type of customer is charged a different rate, according to the cost of delivering the power and the way that customer uses the power. Residential customers' usage fluctuates, with the highest usage during the daytime, particularly when the heat of the summer months makes air conditioners work harder. Demand lessens at night when temperatures cool and electrical appliances are not in use. The same holds true for commercial customers that use more power when employees are at work during the day. Large industrial plants that manufacture other goods have different demands. Manufacturing has a steady need for large amounts of electricity, 24 hours a day, 7 days a week. Industrial users typically have the lowest rates of all customers since their demand is constant and easy to forecast. The more consistent load patterns of industrial users means that the lower price of off-peak power is averaged into their rates, thereby decreasing industrial rates overall relative to residential rates.

Industrial customers can also receive lower rates from some utilities by agreeing to become interruptible customers, meaning that the utilities can interrupt or temporarily cut off the

⁴ Public Utility Commission of Texas, "The Scope of Competition in the Electric Industry in Texas: A Detailed Analysis," *Report to the 75th Legislature, Volume II*, January 1997, p. ES-6 through ES-7.

flow of electricity at peak demand times. The most common example is during the hottest part of summer when electric demand is at its highest. In order to continue to provide service to customers who pay higher rates for guaranteed power, a utility may temporarily halt the flow of power to an interruptible customer until demand lessens or additional power is made available by increased generation output from the utility or another wholesale provider.

5.3.1.3 Pricing Electricity in a Competitive Environment

While many issues related to the structure and regulation of competitive electricity markets remain to be resolved, the trend toward increased competition is clear. As this trend continues, especially in the generation market, the relationship between the cost of producing electricity and the price charged for it will change fundamentally. If fully competitive electricity market develops, prices will not be set to average costs as they have been in the past. Rather, the various services provided will be available and priced separately. For the most part, the prices for transmission and distribution services are expected to continue to be set administratively on the basis of the average cost of service. In contrast, competitive market forces will set generation prices. Buyers and sellers of power will work together, through power pools or one-on-one negotiations, to set the price of electricity.

Although many analysts expect electricity prices to fall as the generation market becomes more competitive, there are situations in which prices could be higher. Moving from regulated cost of service pricing to competitive pricing does not, in and of itself, guarantee that prices will fall for everyone. Also, the movement from average embedded cost pricing in regulated markets to marginal costs pricing in competitive markets has a number of implications for both consumers and suppliers. Competitive prices are likely to be more volatile than historical average prices. With average cost pricing, most consumers are unaware of the variation in operating costs across seasons and times of day. With competitive pricing, consumers may see more price volatility in the form of time-of-use prices, which will vary with the costs of producing power.

5.3.2 Current and Projected Electric Rates

In 1999, the reported state average for industrial electric rates was approximately \$0.044/kWh; however, the industrial electric rate varied from utility to utility.⁵ For example, Central Power & Light Company, which serves the City of Corpus Christi and surrounding areas as well as several areas around the City of Brownsville, reported an average industrial rate of \$0.041/kWh as did the Houston Lighting & Power Company, which serves the City of Houston and surrounding areas.⁶ The San Antonio Public Service Board, which serves most of Bexar County, reported an average electric rate for industrial users of \$0.045.⁷

Although projections of industrial electric rates are not available for individual utilities, the Energy Information Administration has made projections of industrial electric rates for the region served by the Electric Reliability Council of Texas (ERCOT), which includes approximately 85 percent of Texas and most of the Gulf Coast Region (Entergy – Gulf States is in the Southwest Power Pool). These projections are for non-interruptible power and range between \$0.038/kWh to \$0.041/kWh.⁸ Table 5-4 shows the average end-use price projection for industrial users for 5-year periods from 2000 to 2019.

Table 5-4.
Energy Cost Projections
End-Use Price Projections for Industrial Users
Within the Electric Reliability Council of Texas Region
(1998 cents per kilowatt-hour)

Reported Average in 1998	Projected Averages			
	2000 to 2004	2005 to 2009	2010 to 2014	2015 to 2019
4.0	3.9	4.0	3.8	3.9

Source: Energy Information Administration, AEO2000 National Energy Modeling System run AEO2K.D100199A.

Current Texas power industry projections do not indicate any significant change in the cost of power for large industrial users over the next 20 years. Although these projections do consider power industry deregulation, the actual changes that may occur to impact power costs

⁵ Energy Information Administration, Monthly Electric Utility Sales/Revenue data (EIA-826 data file).

⁶ Ibid.

⁷ Ibid.

⁸ Energy Information Administration, AEO2000 National Energy Modeling System run AEO2K.D100199A.

over the next several years will be influenced by several factors and are difficult to project in a changing industry.

5.4 Regulatory Impacts

Evaluation of permitting requirements for disposal of RO concentrate is key to bringing a seawater desalination plant to fruition. Regulatory considerations and economic factors for siting a seawater desalination facility on the Texas coast are discussed here.

5.4.1 Concentrate Disposal

5.4.1.1 Coastal Bay Outfall

A coastal bay outfall requires sufficient flushing of the bay to prevent salinity buildup with time and adequate mixing or dilution at the outfall to prevent localized toxicity. Mixing the concentrate with a power plant once-through cooling water outfall could provide dilution to maintain salinity concentrations below 10 percent of background in the receiving water. Without the benefit of dilution before discharge, concentrate would need to be discharged in waters at least 30 feet deep and diffusers would be required. To determine the risk of salinity buildup, extensive modeling and monitoring of flow patterns and flushing characteristics within the bay would be required. Current data on the Texas coastal bays indicates that in general the Texas coastal bays may not have adequate flushing frequency to prevent salinity buildup from large volumes of concentrate discharge (desalination plants producing over 5 MGD of product water).

5.4.1.2 Open Gulf Outfall

Due to the apparent lack of flushing in the Texas coastal bays, discharge to the open Gulf of Mexico may be necessary for concentrate disposal. For some coastal areas this would entail building a pipeline from the mainland across the bay and barrier island and out a sufficient distance in the open Gulf to meet regulatory requirements. In Tampa Bay and for several Strategic Petroleum Reserves brine discharge projects, EPA has requested that concentrate be discharged in waters a minimum of 30 feet deep. Diffusers would be required at the end of the pipeline to help prevent concentrate buildup. There are no examples in Texas of what would be required to build such a pipeline out to the open ocean for disposal of seawater desalination concentrate. However, there are several strategic petroleum reserve projects that have been built

since the late 1970s for the Department of Energy that did use open ocean outfalls to discharge concentrated brines.

Permitting for the Bryan Mound Strategic Petroleum Reserves concentrate outfall required extensive cooperation between regulatory agencies, significant public participation, and detailed analysis of potential impacts. Additional details and some of the costs associated with the Bryan Mound project are discussed in Section 4.4. The proposed brine diffusion system was relocated from a site 5 miles offshore to the ultimate location 12.5 miles offshore because the site at 5 miles was believed to be a shrimp spawning ground.⁹ Data collection included frequent surveys of the biological communities in the diffuser area. Analyses of the monitoring data collected for 6 months after the start of brine discharge indicated no no measurable adverse impacts on the marine community due to brine discharge.

Significant permitting and mitigation costs may be incurred for a pipeline and diffuser. A pipeline through sea grass beds would require mitigation consisting of, at a minimum, replacing any damaged sea grass. An environmental impact assessment would most likely be required to evaluate potential impacts at a specific proposed site. Assessment should include concentrate plume modeling and biological community surveys and sensitivity evaluations.

The Texas Coastal Management Program has established guidelines for submerged pipelines. Guidelines for submerged pipelines of interest for potential offshore concentrate disposal include:

- Crossings should be aligned along the least environmentally damaging route. Environmentally critical habitats such as submerged aquatic vegetation, oyster reefs, emergent marsh, bird rookeries, sand and mud flats, and endangered species habitats, should be avoided.
- Directional drilling, a technique that allows horizontal, sub-surface, placement of pipelines is recommended for crossing sensitive wetland habitats, beaches, dunes or navigational channels.
- Following backfilling of the trench, planting of the disturbed area may be required in those areas previously supporting marsh or sea grass vegetation. Additional off site mitigative actions may be required to offset unavoidable project impacts.
- Pipelines and submerged cables should be buried and maintained below the water bottom. The Corp of Engineers requires a minimum burial depth of 5 feet in shallow draft channels and 15 feet in deep draft channels.
- If sea grasses or oyster reefs occur at or near the project site, silt curtains or other type barriers should be used to reduce turbidity and sedimentation. These silt barriers

⁹ Department of Energy, 1981

should extend at least 100 feet beyond the limits of the sea grass beds or oyster reef. If sea grasses or oyster reefs can not be avoided, pre- and post-construction surveys should be completed to determine project impacts and mitigation needs.

Beach/Dune rules have been established in 31 Texas Administrative Code (TAC) Chapter 15 that apply to beachfront construction permits. Facilities and pipelines crossing beach/dune areas are required to follow all applicable rules. Restrictions include that non-exempt pipelines shall not be permitted within critical dune areas or seaward of a dune protection line unless there is no practicable alternative (31 TAC 15.4).

5.4.2 Raw Water Supply

5.4.2.1 Raw Water Intake

The Texas Coastal Management Program has established guidelines for intake and outfalls for projects sited in the coastal zone that utilize estuarine and marine waters. Guidelines for raw water intake include:

- Once-through cooling systems should not be designed for areas such as estuaries, inlets, or small coastal embayments.
- Intakes should be designed to minimize impingement of fishery resources. Intake velocities that do not exceed 0.5 fps across intake screens are recommended.

5.4.2.2 Texas Water Rights

The State of Texas owns the surface water within the state watercourses, including bays and estuaries, and is responsible for the appropriation of these waters. Surface water is currently allocated by the TNRCC for the use and benefit of all people of the state through a water rights system. The water right grants a certain quantity of water to be diverted or stored. Section 11.134 of the Water Code provides that the TNRCC may grant an application for a new appropriation of water only if (1) the application meets all necessary requirements, (2) unappropriated water is available in the source of supply, (3) the water will be beneficially used, (4) the use will not impair an existing water right or vested riparian right, (5) the use will not be detrimental to the public welfare, and (6) the applicant provides evidence that reasonable diligence will be used to avoid waste and achieve water conservation.

A desalination plant located along the Texas Gulf Coast would require a water rights permit to divert water from a bay or estuary to be used in the production of water for municipal and industrial uses. In order to obtain a water rights permit, the applicant must submit an

application to the TNRCC. As part of the water rights permit application process there is generally a pre-application meeting between the applicant and TNRCC to obtain a better understanding of the requirements associated with a particular application. After the initial pre-application meeting, the applicant then submits a completed water rights permit application to the TNRCC. If the application is found to be administratively complete, TNRCC will begin the technical review process for the application, however, if the application is not found to be administratively complete, the applicant has a chance to resubmit the application.

The technical review process will consider water availability, beneficial use, non-impairment of existing water rights, public welfare, waste prevention and water conservation, environmental assessments, areas of origin protection, and long-term water supply options. If the TNRCC finds that the proposed permit would meet all of the technical criteria, a draft permit is prepared and a notice of application is published.

A public hearing on the proposed water rights permit may or may not be required. If the proposed permit is contested and a request for a hearing is filed, a hearing will be conducted by a hearing examiner who acts as an administrative law judge. After the hearing is completed, the Commissioners of the TNRCC will decide to either deny or approve the application, or remand the matter back to the examiner for further evidence on a particular issue. However, if a permit application is uncontested, the permit will go to the Executive Director of the TNRCC for his signature to grant the permit.

5.5 Coastal Flooding Risk

Coastal areas frequently encounter both riverine and coastal flooding. Riverine flooding is the result of heavy rain of localized storms. Coastal flooding is caused by both tropical storms and hurricanes. These storms bring not only large quantities of rain and runoff, but also storm surge and wave action.

Along the Texas Gulf Coast, hurricanes and tropical storms are common. The effects of the storm are felt long before the storm hits the shore as Gulf of Mexico and other coastal bodies of water rise creating a storm surge. This storm or tidal surge results from a rise in coastal waters at the storm moves inland. A surge not only raises the water levels at the shore, but also along stream, bays, canals, and drainage systems connected to the Gulf. A tidal surge may also include wave action. Wave action is created by the wind and air pressure acting on the surge depths.

The Gulf Coast has been subject to wave action in previous hurricanes where it has caused severe damage. FEMA designates areas that are potential subject to wave action with a special zone, Zone V.

The recurrence of storm events including hurricanes and tropical storms and the consequent flooding associated with those events are estimated with probability and statistics. Flood events are classified by the magnitude of the flooding determined by hydrology and hydraulics of an area and any known historical events in the area. The resulting flood events are designated with a 10-, 25-, 50-, 100-, or 500-year recurrence interval. The recurrence interval is an statistical estimate of the frequency of the flood event.

A 100-year flood event is an event that is estimated to occur once every 100 years. The probability of a 100-year flood occurring in a given year is 1/100 or 0.01. Each year there is a 1 percent chance that a 100-year flood event will occur. As with all statistics, each year the event has the same probability of occurring. In other words, a 100-year flood event can occur more than once in a given 100-year period. For example, if a flood event that occurred 5 years ago is determined have been a 100-year event, this does not mean that a 100-year event will not occur for another 95 years. There is a 1 percent chance that a 100-year event will occur each year.

More generally, probability of a particular flooding event occurring is one divided by the recurrence interval, T or 1/T. The risk (\bar{R}) of the flood event occurring in the design lifetime of a plant is:

$$\bar{R} = 1 - \left(1 - \frac{1}{T}\right)^n$$

where T is the recurrence interval of the flood event and n is the years in the design period of the plant¹⁰.

The Risk_Cost over the lifetime of the plant is the \bar{R} * Cost or

$$Risk_Cost = \bar{R} * Cost$$

¹⁰ Chow, Vente; David R Maidment, Larry W Mays. Applied Hydrology. McGraw-Hill, 1998.

The annual cost of the flooding risk is Risk_Cost divided by the number of years in the design period or

$$\text{Annual Risk_Cost} = \frac{\text{Risk_Cost}}{n}$$

For example, if a plant was designed with a 30 year lifetime and is in the 100-year floodplain (T=100 and n=30), then \bar{R} is 0.26 or 26 percent. For a cost of \$1,000,000, the Risk_Cost is \$260,000 over 30 years. The Annual Risk_Cost of the plant would be about \$8,667.

5.5.1 Understanding FEMA Maps and Studies

The Federal Emergency Management Agency (FEMA) publishes maps and studies of communities and regions that participate in the National Flood Insurance Program (NFIP). This program was established to provide flood insurance for property owners and offers protection against property losses as a result of flooding. To determine the potential risk of flooding in a region, studies are conducted to estimate the frequency and likelihood of flooding in the area. FEMA published the resulting maps and reports from these studies. FEMA maps are known as FIRM or Federal Insurance Rate Maps. These maps can be obtained from the a community's local Floodplain Administrator. If the area is within city limits, the local Floodplain Administrator at the city can provide the FEMA FIRM and FIS. Otherwise, the FIRMs can be found at the county office or by contacting Texas Natural Resources Information System (TNRIS).

The FIRM shows both general and detailed flooding zones. If a Flood Insurance Study (FIS) has been completed for the area, detailed information about the depth of flooding will be included. In areas not near the coast, the detailed study areas are indicated by base flood elevation marks on the stream segments. A detailed study of coastal areas will indicate the flood hazard factors that are used by insurance companies to determine the value of flooding risk.

A typical FIRM from an area along the coast will have zones V, A, B, and C. Zone V are the coastal areas that are exposed to direct wave action. The depth of flooding in these areas are a result of rainfall, storm surge, and wave action. The 100-year floodplain is indicated by the Zone A designations.

Zone V	Areas of 100-year coastal flooding with velocity (wave action)
Zone A	100-year Floodplain
Zone B	Areas between the limits of the 100-year to 500-year floodplain
Zone C	Areas of minimal flooding

The FIS is a good resource for information about historical storm events and the flooding conditions in the site area. In coastal areas, most FIS reports will include major storm events that caused flooding in the region of interest and may include recorded storm surge elevations from those storms. For any project in a coastal area, this portion of the FIS should be examined. The historical data presented in the FIS is usually incorporated into the floodplain analysis.

When a project site is located in a Zone C area, the site will experience minimal flooding and likewise the risk for flooding is minimum. Zone V sites are located in the wave action of the storm and should be avoided. None of the example sites in this study are located in Zone V.

The Zone A designation is divided into separated subzones that indicate the flood hazard factor for the zone. As mentioned above, these flood hazard factors are used to determine the risk of flooding in insurance terms. Sites located in Zone A are within the 100-year floodplain. To determine the potential depth of floodwater during a 100-year flood event, find the elevation marked on the map near the Zone A marking in the site area. The elevation is written as "(EL 11)" for an elevation of 11 feet above mean sea level. The flood depth in this area is the elevation (11 feet msl) minus the ground elevation.

Zone B designates the 500-year floodplain. The flood elevation of Zone B can be determined by comparing the FIRM to a topographical map. Determine the location of the 500-year floodplain boundary and from the topographical map determine the floodplain elevation. This elevation is the flood elevation for the 500-year flood event. The flood depth at the site is calculated by subtracting the ground elevation at the site from the floodplain elevation.

5.5.2 Desalination Site Examples (FIRM maps for each of these sites are attached)

5.5.2.1 Site 1 – City of Point Comfort, Calhoun County (Joslin Power Station)

The topography of Calhoun County is generally flat with elevations ranging from sea level to 50 feet mean sea level. The county experienced six hurricanes between 1942 and 1971. In 1961, Hurricane Carla hit the Matagorda Bay area creating tide elevation ranging from 17 to 22 feet msl in the Port Lavaca area. A hurricane hit the Port Lavaca area in 1942 producing a

maximum tide elevation of 14.8 feet msl. Major flooding occurred in Calhoun County during the 1919 Storm, 1967 (Beulah), 1970 (Celia) and 1971 (Fern).

The proposed site near Point Comfort is located adjacent to the Joslin Power Station. Site 1 is about 600 feet from the shoreline of Cox Bay and is located in Zone C on the Calhoun County FIRM. Zone C areas are defined as areas of minimal flooding. This site is 350 feet from the 500-year floodplain Zone B and 400 feet from the 100-year floodplain or Zone A15. The Zone C designation indicates that there is less than a 0.2 percent probability that flooding will occur in this area each year. Since the probability of flooding in this area is minimal, the risk associated with this probability is also minimal. No calculations for potential costs incurred from flooding are necessary. Flood insurance is always recommended at a site such as this one.

5.5.2.2 Site 2 – City of Corpus Christi, Nueces County (Barney Davis Power Station)

The City of Corpus Christi in Nueces County is located on the southern side of Corpus Christi Bay. The Upper Laguna Madre borders Corpus Christi on the east. The topography is very flat in most areas, with steep bluffs along Nueces Bay, Corpus Christi Bay, and Oso Creek. Ground elevations ranges from 75 feet msl in the northwest area of the city to sea level. Both coastal and riverine flooding have occurred in the area. Riverine flooding is usually localized and coastal flooding is more widespread due to the storm surges accompanying large storms.

Previous storms in the Corpus Christi area include the 1919 storm, the 1945 Storm, Hurricane Carla in 1961, and Hurricane Celia in 1970. Hurricane Carla caused surge elevations of 11 feet msl on the coastline. Hurricane Celia brought storm surge elevations of about 4 to 6 feet msl.

Site 2 is located adjacent to the Barney Davis Power Station. It is located in an area of Corpus Christi between Laguna Madre on the east and Oso Bay on the west. The site is at an approximate elevation of 16 feet msl and is located about 4,000 feet from Laguna Madre. The proposed site is located in Zone C (see attached FIRM) indicating that only minimal flooding is expected in this area.

Although Site 2 is outside the 500-year floodplain, it is close enough to the 500-year floodplain that facilities could possibly be located in the 500-year floodplain (Zone B). The probability of a 500-year flood event occurring in a given year is 0.2 percent. Over a 30 year lifetime of a facility, the risk of such a flood occurring is 0.058 or 5.8 percent. Comparing the

flood elevation of about 13 feet msl to the local topography, the flood depth in the 500-year floodplain is up to 2 feet.

5.5.2.3 Site 3 – City of Port Isabel, Cameron County

The City of Port Isabel in Cameron County is bordered on the north by the Laguna Madre and by South Bay to the southeast. Looking at the Cameron County FIRM, it is evident that the majority of this region is in the 100-year floodplain (Zone A) and that many areas are also subject to flooding due to wave action (Zone V).

Historical storms in the Cameron County area include Hurricane Beulah in 1967, Hurricane Allen in 1980, Hurricane Gilbert in 1988. Additional hurricanes and storms causing severe flooding in 1857, 1867, 1919, 1933, 1945, 1961, and 1970. The City of Port Isabel has a historical high-water mark of 11 feet from a storm that occurred on September 4, 1933. A storm such as this 1933 storm would have resulted in up to 4 feet of flood depth at the proposed plant location. The return intervals for historical storms are not typically provided in the FIS. Severe past storm events are considered in the floodplain analysis and hence are incorporated into the FIRM.

At this particular site, the property is at an elevation of approximately 7 feet msl and is located at about 1,900 feet from the Port Isabel Channel to the east. Site 3 is within the Zone B designation (see attached FIRM). Zone B indicates that the site is within the 500-year floodplain. This means that in any 1 year the probability of a flooding event of this magnitude 0.2 percent. For a 30 year design lifetime, the risk of a 500-year flood occurring in those 30 years is 0.058 or 5.8 percent. Comparing the flood elevation of about 10 feet msl to the local topography, the flood depth in the 500-year floodplain is about 3 feet.

5.6 Environmental Constraints

There are numerous environmental features and protected areas along the Texas coast that may prevent the siting or increase the cost of a seawater desalination facility and its ancillary pieces such as the source water intake and concentrate disposal. Figures 5-2 through 5-5 show some of the identified constraints along the Texas Coast.

Figure 5-2 shows the locations of seagrass beds along the coast as identified by a General Land Office (GLO) map and depth of water contours. These two coastal features are important considerations for a concentrate discharge pipeline. A concentrate discharge pipeline through

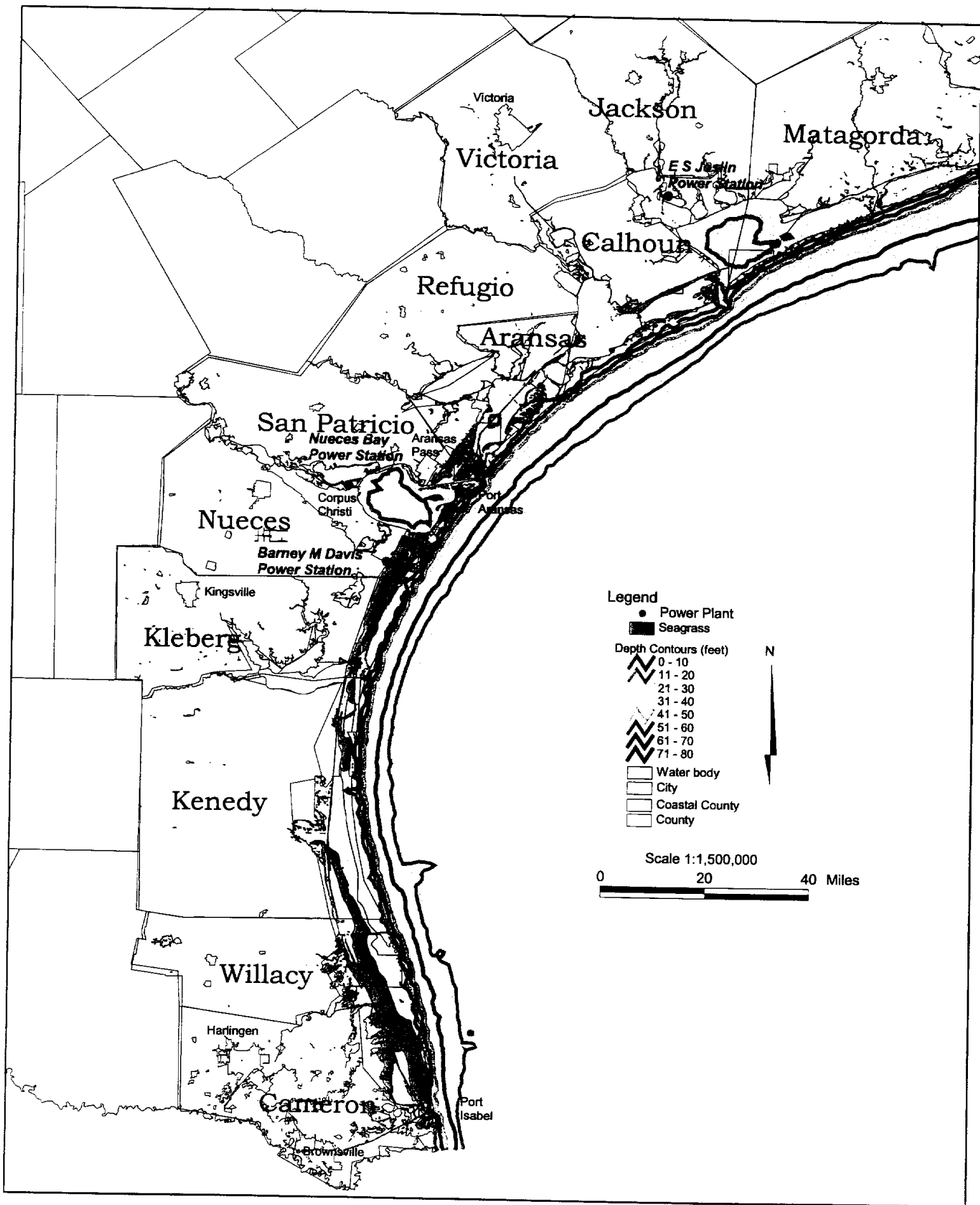

Figure 5-2 Seagrass and Depth Contours

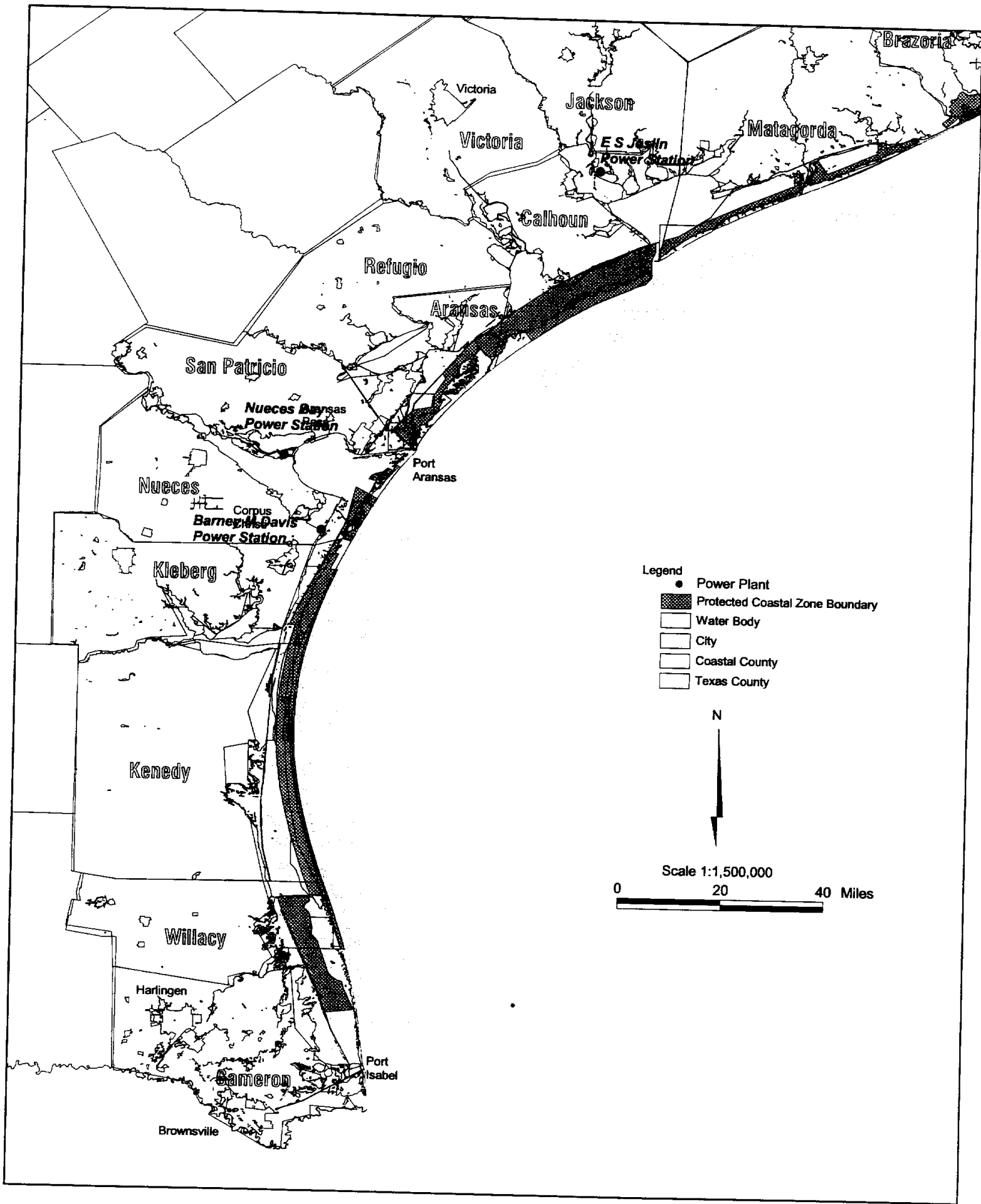

Figure 5-3 Protected Coastal Boundaries

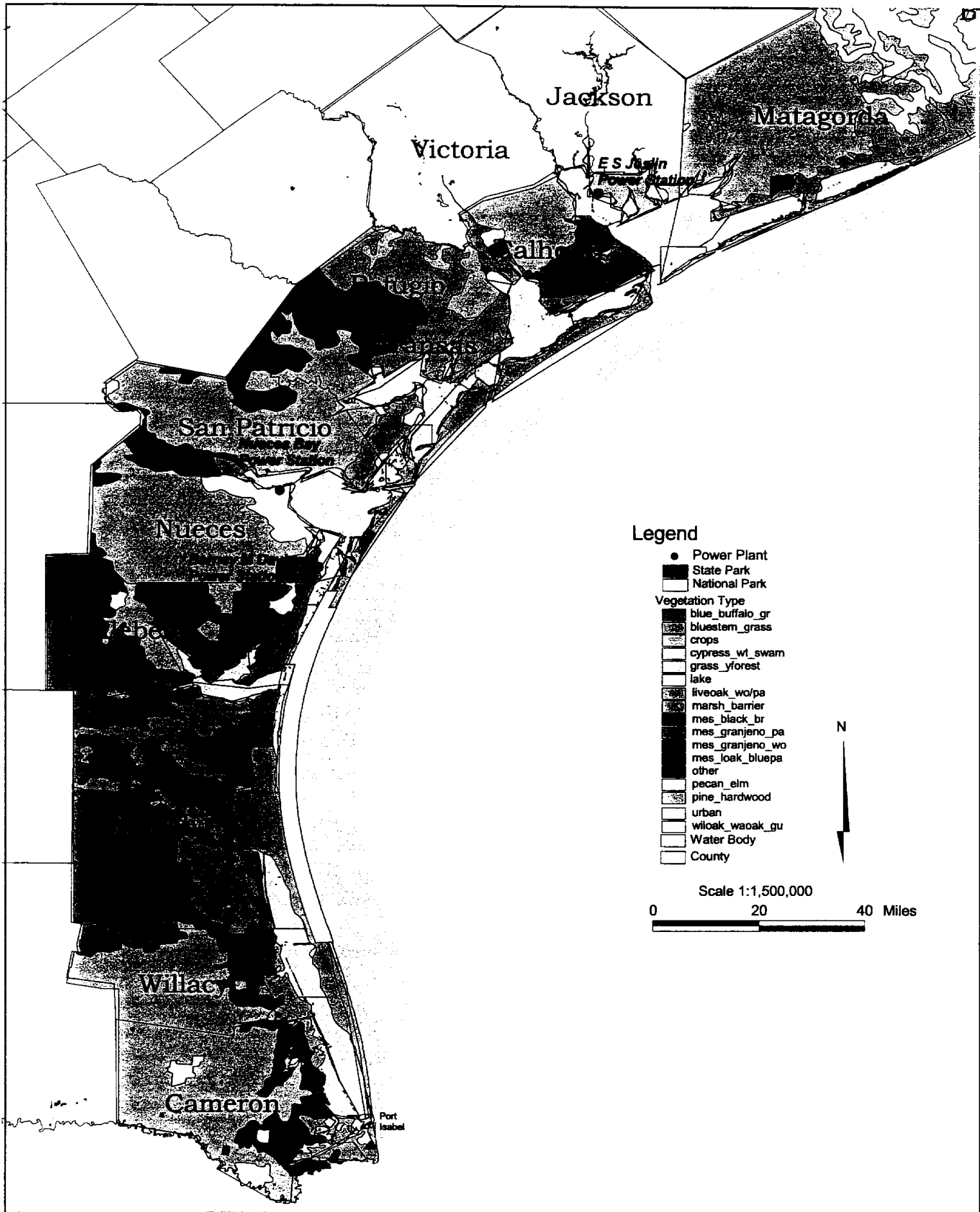

Figure 5-4 State and National Parks and Vegetation

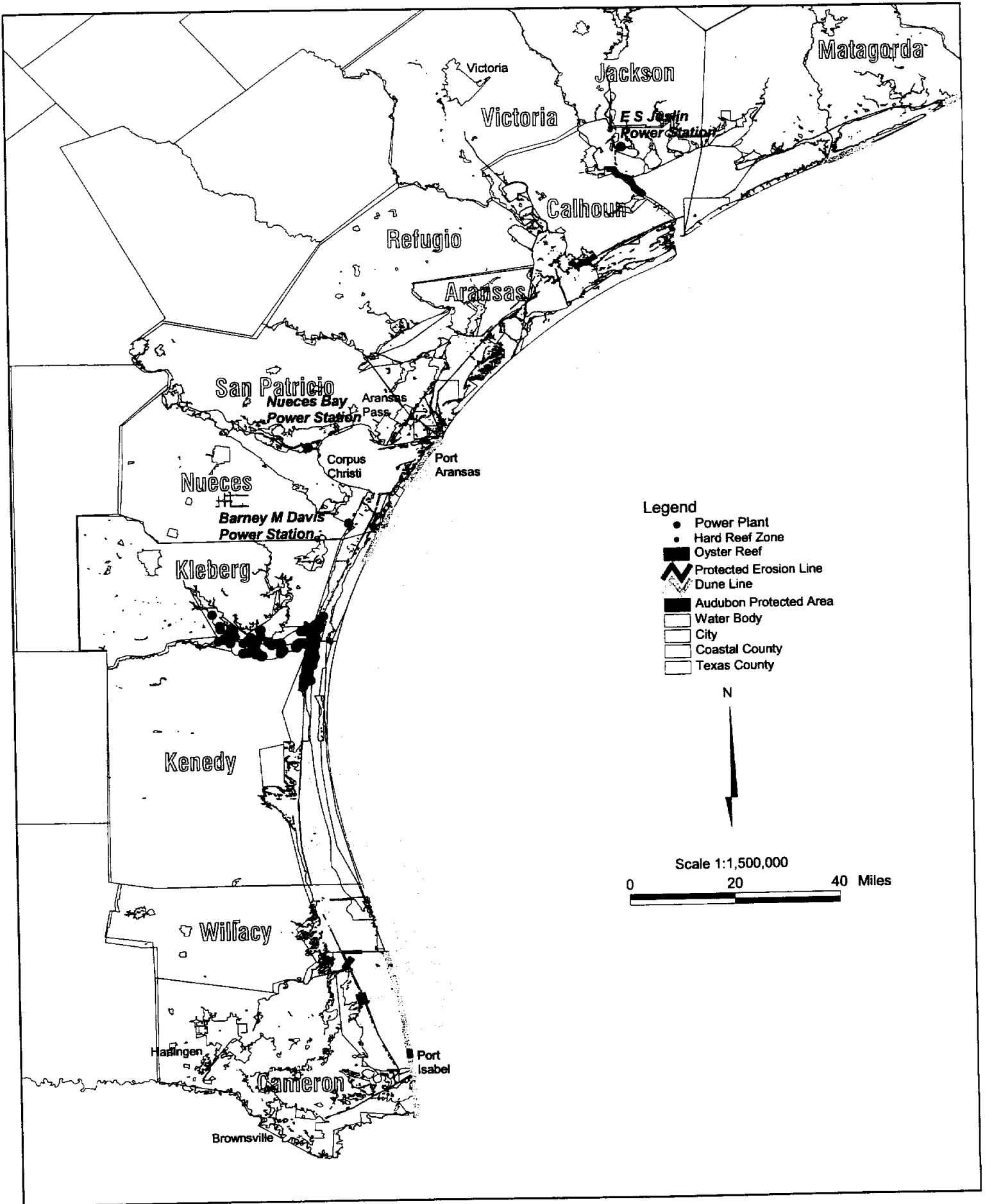

Figure 5-5 Localized Environmental Constraints

seagrass beds may be considerably more difficult to permit and will increase costs due to mitigation requirements. In the past the EPA has required that concentrate be discharged in waters at least 30 feet deep. Therefore, the distance offshore to reach 30 feet of water may dictate the minimum concentrate discharge pipeline length.

The remaining figures identify areas where it is unlikely that a desalination plant, source water intake, or concentrate disposal facilities could be located. Figure 5-3 shows the protected coastal zone boundaries as identified by GLO. These areas are a composite of several constraints. Figure 5-4 shows the locations of State and National Parks and the distribution of vegetation types. Figure 5-5 shows several additional localized environmental constraints such as oyster reefs, protected erosion lines, dune lines, and Audubon protected areas.

Section 6

Example Sites on the Texas Coast

Two sites were chosen to present example costs for a complete seawater desalination water supply on the Texas coast. Both facilities were assumed to supply 25 MGD of desalted water. One is a co-sited facility at Barney M. Davis Power station in Corpus Christi while the other is a separate facility near Port Isabel on the southern tip of Texas. Financial and other assumptions given in Table 4-1 were used except where stated in each example. Site-specific water quality and physical conditions for each location were used to the extent possible.

6.1 Example 1: Corpus Christi

The seawater desalination facility for Corpus Christi was assumed to be located next to the Barney M. Davis Power station between Laguna Madre Bay and Oso Bay in south Corpus Christi. Figure 6-1 shows the location for this example. Davis is a once-through cooling water power plant with an existing reported cooling water flow of 467 MGD. Cooling water is diverted from Laguna Madre Bay and returned to Oso Bay. Engineering assumptions for the Davis seawater desalination example are shown in Table 6-1.

The estimate assumes that the power plant seawater intake is utilized to obtain the RO treatment plant feedwater using pumps and 1,000 feet of intake pipeline to transfer the feedwater from the discharge canal to the desalination plant. Drawing the source water from the power plant discharge eliminates the need to draw additional flow from the bay for cooling water and supplies feedwater with an increased temperature that is beneficial for the RO process.

Preliminary data indicates that there may be insufficient flushing in Oso Bay and the other surrounding bays for discharge of the RO concentrate. Therefore, for this estimate a separate RO concentrate disposal outfall is included to pipe the RO concentrate to the open Gulf. The outfall crosses Laguna Madre Bay and Padre Island and extends into the Gulf to be diffused in water over 30 feet deep. Figure 5-3 shows that seagrass covers the bay between the mainland and the barrier island. The assumptions from Section 4.4 are applied including the assumption that half of the concentrate pipeline will be located through sea grass beds and appropriate mitigation will be required.

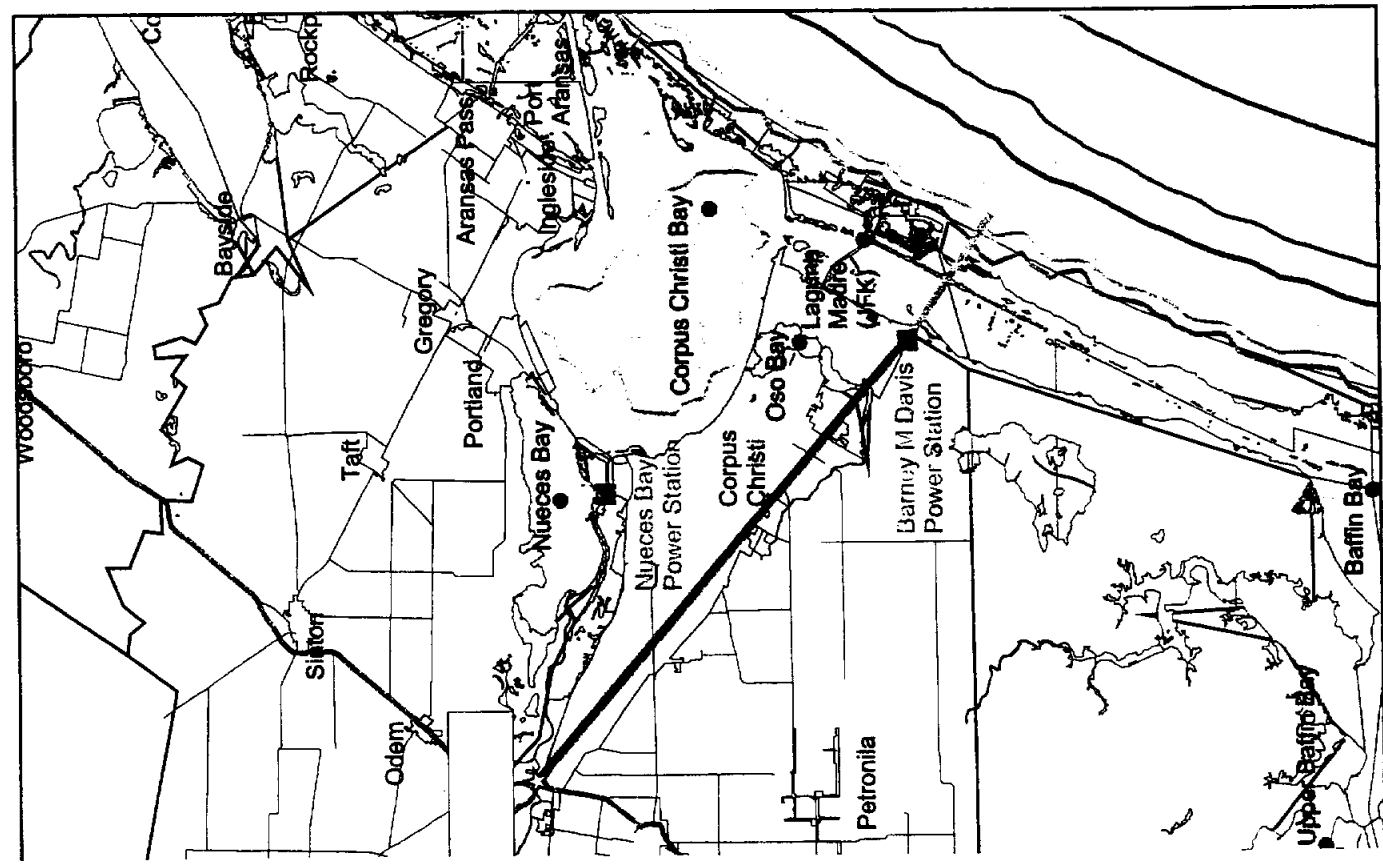

Figure 6-1. Example 1: Corpus Christi

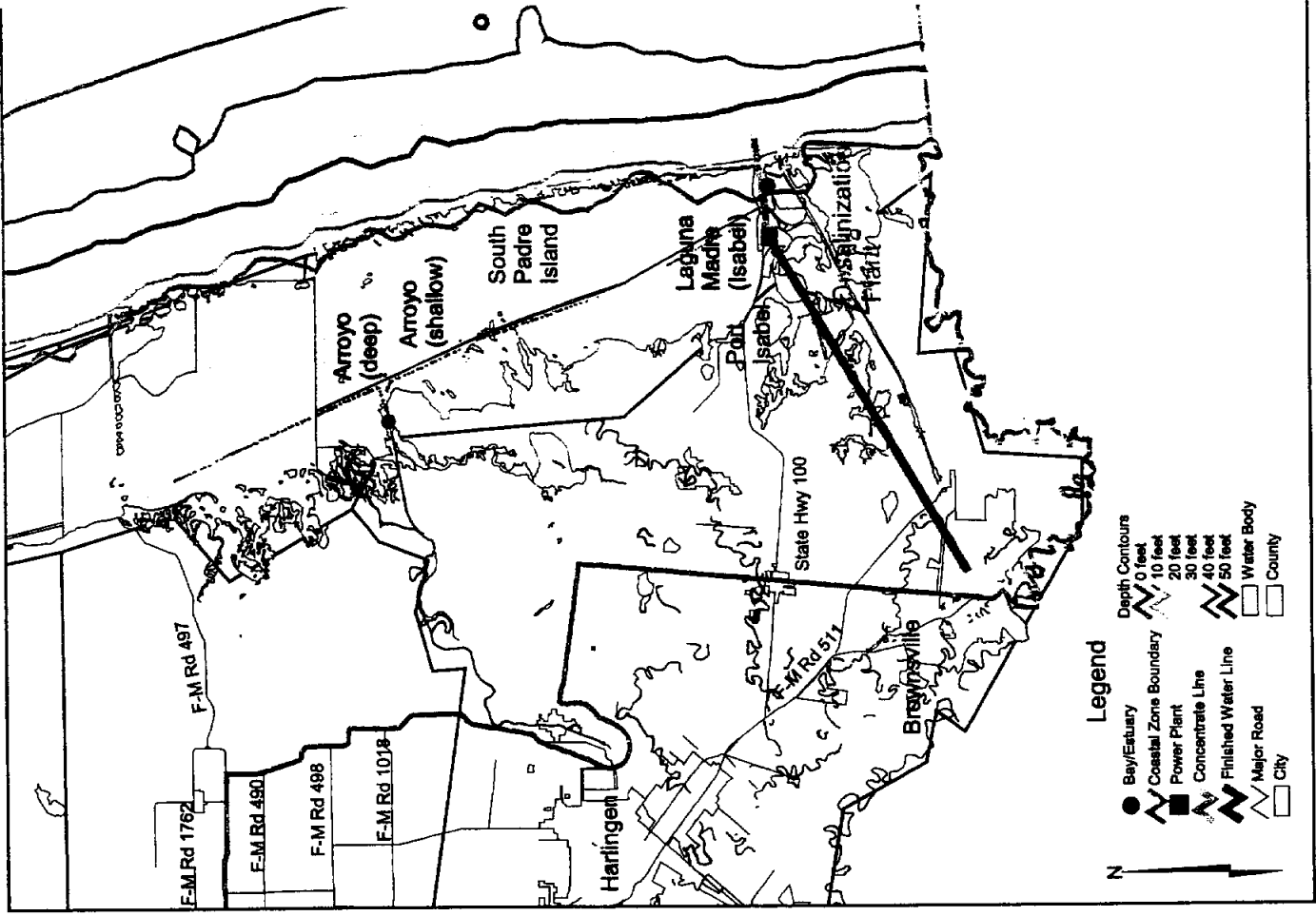

Figure 6-2. Example 2: Port Isabel/Brownsville

Table 6-1.
Seawater Desalination at Barney M Davis Power Station
Engineering Assumptions

<i>Parameter</i>	<i>Assumption</i>	<i>Description</i>
Raw Water Salinity	33,000 mg/L	Intake from power plant at Laguna Madre Bay
Raw Water Total Suspended Solids	40 mg/L	
Finished Water Chlorides	100 mg/L	Existing median at Stevens Plant is about 120 mg/L
Product Water Flow	25 MGD	
Concentrate Pipeline Length	10 miles	Diffused in open gulf in over 30 feet of water
Treated Water Pipeline Length	20 miles	Distance to Stevens Plant or port industries
Feedwater Pumping Head	900 psi	
Pretreatment	High	Coagulation, media filtration, and chemical addition
Post-treatment	Stabilization & disinfection	Lime and chlorination
Recovery Rate	50 percent	
Flux	8 gfd	Rate product water passes through membrane
Cleaning Frequency	6 months	Membranes cleaned once every 6 months
Membrane Life	5 years	Membrane elements replaced every 5 years

Water treatment parameters are estimated based on available water quality data for Laguna Madre Bay near the power plant intake. Coagulation and media filtration is included along with the other standard pretreatment components (cartridge filtration, antiscalant and acid addition). Included sludge handling consists of mechanical sludge dewatering and disposal to a nonhazardous waste landfill. A product water recovery rate of 50 percent was used for this example. This is a lower recovery rate than the 60 percent reported for the Tampa Bay Water project. The lower recovery rate is anticipated due to the higher average salinity of the Laguna Madre Bay at 33,000 mg/L TDS as compared to the water source for the Tampa Bay Water project at 26,000 mg/L TDS.

Land acquisition includes 20 acres for the desalination plant and 97 acres for the desalted water storage tank and transmission pipeline. No land acquisition is included for the concentrate disposal pipeline but surveying costs are included.

A 13 million gallon water storage tank and water transmission pumps and pipeline are included to transport the product water 20 miles to either the Stevens plant to blend into the city system or to distribution lines supplying industries along the ship channel. Assumptions and

costs from Section 4.3 are used for delivery of the product water. Post treatment stabilization and disinfection are included.

Table 6-2 shows the cost estimate summary for seawater desalination at Barney M Davis Power Station. The estimated total cost at 100 percent utilization of \$3.08 per 1,000 gallons of product water is about 45 percent higher than the lowest proposal received for the Tampa Bay Water desalination project. The estimated increased costs for this project are primarily the result of higher source water salinity and additional costs for the concentrate disposal pipeline and diffuser system. The total product water cost at 85 percent utilization is estimated at \$3.40 per 1,000 gallons.

Permitting of this facility will require extensive coordination with all applicable regulatory entities. Use of the existing power plant intake should facilitate permitting for the source water because no additional water is to be drawn from the bay. However, permitting the construction of the concentrate pipeline across Laguna Madre and Padre Island and construction of the ocean outfall will be major project issues.

6.2 Example 2: Brownsville/Port Isabel

The seawater desalination facility is assumed to be located in Port Isabel close to the Lower Laguna Madre Bay. Figure 6-2 shows the location for example 2. For this example the desalination facility is not co-sited with a power plant and therefore several of the cost advantages included in the Corpus Christi example are not available. Otherwise, the water quality and other parameters are similar to the Corpus Christi example. Engineering assumptions for the Port Isabel seawater desalination example are shown in Table 6-3.

A seawater intake is included along with pumps and 1,000 feet of intake pipeline to transfer the feedwater from the intake to the desalination plant. The seawater intake is designed with an intake velocity less than 0.5 fps and precautions included to prevent organism entrainment and minimize suspended solids in the feedwater.

Preliminary data acquisition indicates that there may be insufficient flushing in Laguna Madre Bay for discharge of the RO concentrate. Therefore, for this estimate a separate RO concentrate disposal outfall is included to pipe the RO concentrate to the open Gulf. The outfall crosses Laguna Madre Bay and Padre Island and extends into the Gulf to be diffused in water over 30 feet deep. The concentrate disposal system assumptions from Section 4.4 are applied.

Table 6-2.
Seawater Desalination at Barney M Davis Power Station
Cost Estimate Summary

<i>Item</i>	<i>Estimated Costs (100% Utilization)</i>	<i>Estimated Costs (85% Utilization)</i>
Capital Costs		
Source Water Supply	\$800,000	\$800,000
Water Treatment Plant	72,000,000	72,000,000
Concentrate Disposal	32,000,000	32,000,000
Finished Water Transmission	<u>20,000,000</u>	<u>20,000,000</u>
Total Capital Cost	\$124,800,000	\$124,800,000
Engineering, Legal Costs and Contingencies (35%)	\$43,680,000	\$43,680,000
Land Acquisition and Surveying	2,100,000	2,100,000
Environmental & Archaeology Studies and Mitigation	6,900,000	6,900,000
Interest During Construction (6 percent for 2.5 years)	<u>18,720,000</u>	<u>18,720,000</u>
Total Project Cost	\$196,200,000	\$196,200,000
Annual Costs		
Debt Service (6 percent for 30 years)	\$14,254,000	\$14,254,000
Operation and Maintenance:		
Source Water Supply	200,000	200,000
Water Treatment Plant (Except Energy)	8,000,000	6,900,000
Water Treatment Plant Energy Cost	4,300,000	3,700,000
Concentrate Disposal	700,000	650,000
Distribution	<u>700,000</u>	<u>650,000</u>
Total Annual Cost	\$28,154,000	\$26,354,000
Available Project Yield (acft/yr)	28,004	23,803
Annual Cost of Water (\$ per acft)	\$1,005	\$1,107
Annual Cost of Water (\$ per 1,000 gallons)	\$3.08	\$3.40

**Table 6-3.
Seawater Desalination at Port Isabel
Engineering Assumptions**

<i>Parameter</i>	<i>Assumption</i>	<i>Description</i>
Raw Water Salinity	32,000 mg/L	Intake from Lower Laguna Madre Bay
Raw Water Total Suspended Solids	50 mg/L	
Finished Water Chlorides	100 mg/L	
Product Water Flow	25 MGD	
Concentrate Pipeline Length	5 miles	Diffused in open gulf in over 30 feet of water
Treated Water Pipeline Length	20 miles	Distance to Brownsville
Feedwater Pumping Head	900 psi	
Pretreatment	High	Coagulation, media filtration, and chemical addition
Post-treatment	Stabilization & disinfection	Lime and chlorination
Recovery Rate	50 percent	
Flux	7 gfd	Rate product water passes through membrane
Cleaning Frequency	6 months	Membranes cleaned once every 6 months
Membrane Life	5 years	Membrane elements replaced every 5 years

Water treatment parameters are estimated based on available water quality data for Laguna Madre Bay near Port Isabel. Coagulation and media filtration are included along with the other standard pretreatment components (cartridge filtration, antiscalant and acid addition). It is assumed that the separate raw water intake for this desalination plant is not as effective at removing suspended solids as the co-sited intake at the power plant for the Corpus Christi example. Therefore, more extensive coagulation and media filtration are included for this estimate. Included sludge handling consists of mechanical sludge dewatering and disposal to a nonhazardous waste landfill. For the reverse osmosis system, a product water recovery rate of 50 percent was used.

Land acquisition includes 20 acres for the desalination plant and 97 acres for the desalted water storage tank and transmission pipeline. No land acquisition is included for the concentrate disposal pipeline but surveying costs are included.

A 13 million gallon water storage tank and water transmission pumps and pipeline are included to transport the product water 20 miles to Brownsville. Assumptions and costs from

Section 4.3 are used for delivery of the product water. Post treatment stabilization and disinfection are included.

Table 6-4 shows the cost estimate summary for seawater desalination at Port Isabel. The estimated total cost at 100 percent utilization of \$3.24 per 1,000 gallons of product water is about 5 percent higher than the estimated cost for the Corpus Christi example. Offsetting conditions at the two example sites yielded similar total product water costs. The Port Isabel costs were higher for the raw water intake and water treatment plant because the facility was not co-sited with a power plant. Offsetting these cost increases is the lower estimated concentrate disposal cost for the Port Isabel site because a shorter pipeline is needed to reach 30 feet of water in the open Gulf. The total product water cost at 85 percent utilization is estimated at \$3.57 per 1,000 gallons.

Permitting of this facility will require extensive coordination with all applicable regulatory entities. Permitting the raw water intake, construction of the concentrate pipeline across Laguna Madre and Padre Island, and construction of the ocean outfall will be major project issues.

**Table 6-4.
Seawater Desalination at Port Isabel
Cost Estimate Summary**

<i>Item</i>	<i>Estimated Costs (100% Utilization)</i>	<i>Estimated Costs (85% Utilization)</i>
Capital Costs		
Source Water Supply	\$10,000,000	\$10,000,000
Water Treatment Plant	81,000,000	81,000,000
Concentrate Disposal	18,000,000	18,000,000
Finished Water Transmission	<u>20,000,000</u>	<u>20,000,000</u>
Total Capital Cost	\$129,000,000	\$129,000,000
Engineering, Legal Costs and Contingencies (35%)	\$45,150,000	\$45,150,000
Land Acquisition and Surveying	1,500,000	1,500,000
Environmental & Archaeology Studies and Mitigation	4,000,000	4,000,000
Interest During Construction (6 percent for 2.5 years)	<u>19,350,000</u>	<u>19,350,000</u>
Total Project Cost	\$199,000,000	\$199,000,000
Annual Costs		
Debt Service (6 percent, 30 years)	\$14,457,000	\$14,457,000
Operation and Maintenance:		
Source Water Supply	600,000	600,000
Water Treatment Plant (Except Energy)	9,000,000	7,800,000
Water Treatment Plant Energy Cost	4,300,000	3,700,000
Concentrate Disposal	500,000	450,000
Distribution	<u>700,000</u>	<u>650,000</u>
Total Annual Cost	\$29,557,000	\$27,657,000
Available Project Yield (acft/yr)	28,004	23,803
Annual Cost of Water (\$ per acft)	\$1,055	\$1,162
Annual Cost of Water (\$ per 1,000 gallons)	\$3.24	\$3.57

Section 7

Data Needs to Reduce Siting Uncertainty

Additional information will be needed once a site has been identified as a potential seawater desalination location. The Tampa Bay Water desalination project provides an example of the kind of information required to reduce uncertainty about the suitability of a particular location for a desalination facility.

Tampa Bay Water obtained several environmental reports and studies that helped establish the feasibility of a desalination plant disposing of concentrate to a Florida bay or the Gulf of Mexico. Reports included an analysis from the U.S. Geologic Survey on the water transport in Lower Hillsborough Bay, Florida. This USGS report helped establish that there is most likely sufficient flushing in the bay to allow discharge of the desalination concentrate without salinity buildup. If concentrate discharge to a Texas bay is pursued, a similar analysis is needed to determine the water transport characteristics of the Texas bay that is being considered as receiving water for concentrate.

Tampa Bay Water also commissioned a report titled "Impact Analysis of the Anclote Desalination Water Supply Project." This report focused on the potential environmental impacts associated with 1) the discharge of desalination plant concentrate to the coastal estuary of the Anclote Sound and 2) the intake of ambient surface waters for potable water production. These are the two primary environmental concerns that will need to be addressed for a Texas coastal desalination facility.

The above mentioned Tampa Bay Water siting evaluations are only the ones performed prior to receiving best and final offers from the developers. Additional detailed studies will be required once a site has been settled upon to ensure that all regulatory requirements are met. The selected Developer for the Tampa Bay Water project was required to perform all additional studies required to obtain permits for the seawater desalination facility.

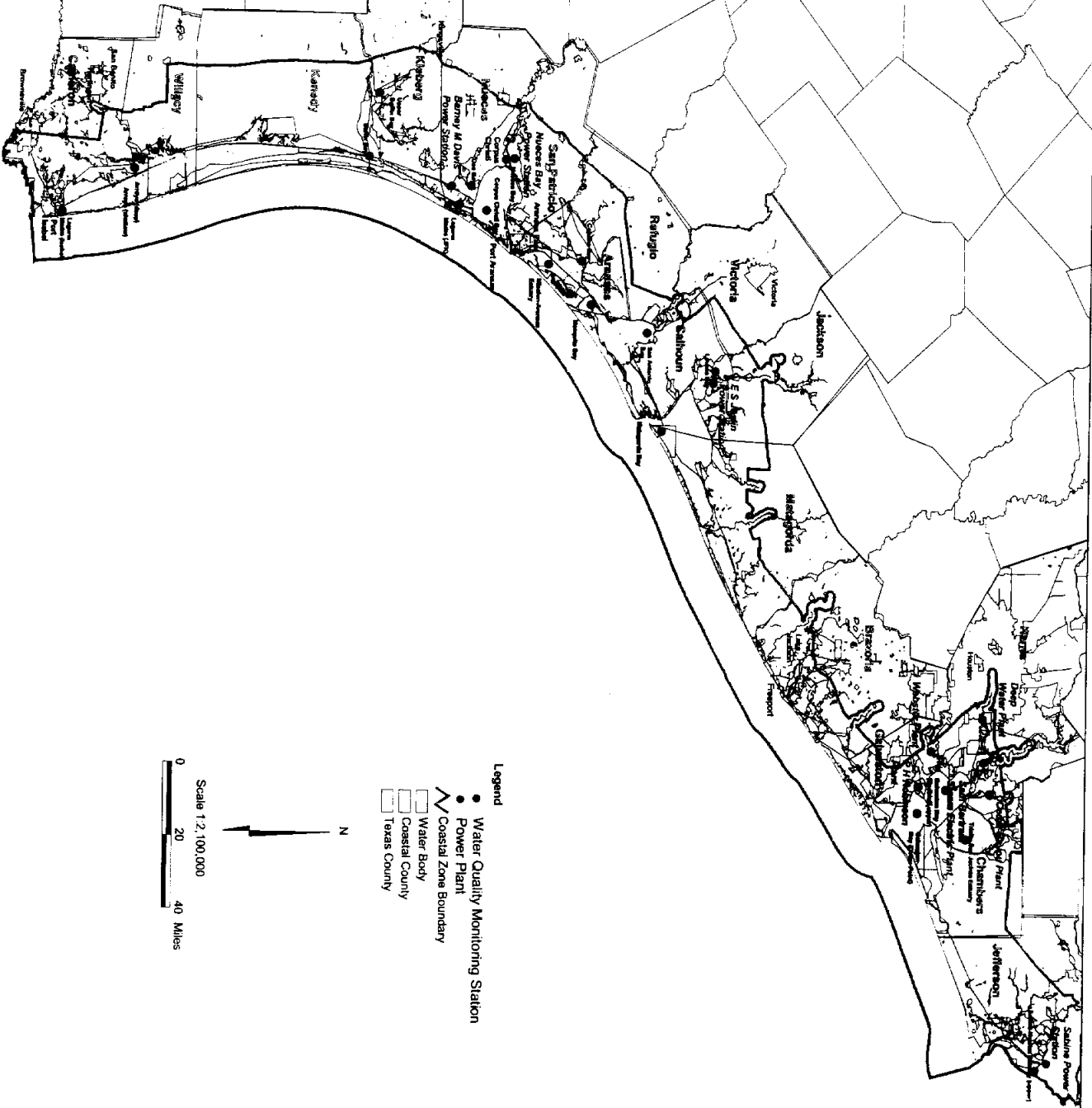

Legend

- Water Quality Monitoring Station
- Power Plant
- ▭ Coastal Zone Boundary
- ▭ Water Body
- ▭ Coastal County
- ▭ Texas County



Scale 1:2,100,000



Appendix A

Glossary

acidic Pertaining to an acid, generally of a solution or environment having an excess of hydrogen ions of pH less than 7.0.

acidity The quantitative capacity of aqueous media to react with hydroxyl ions.

alkaline Pertaining to a base, generally of a solution or environment having an excess of hydroxyl ions of pH greater than 7.0.

alkaline scale Scale that will dissolve under acidic conditions; usually composed of calcium carbonate and magnesium hydroxide.

alkalinity A measure of the ability of a water to neutralize acids; the sum of titratable bases. Bicarbonate, carbonate, and hydroxides in natural or treated water are major contributors to alkalinity.

alum Aluminum sulfate, $\text{Al}_2(\text{SO}_4)_3 \cdot 18\text{H}_2\text{O}$.

ambient temperature The temperature of the surroundings, usually taken as 70°F.

amorphous Non-crystalline; lacking any regular cohesive structure.

angstrom A unit of length equivalent to 10^{-10} meters, 10^{-4} microns, 10^{-8} centimeters, and 4×10^{-9} inches, indicated by the symbol Å, A, or A.U.

anion The ion in an electrolytic solution that migrates to the anode. It carries a negative charge.

anion membrane (anion transfer membrane) A membrane through which only anions will transfer.

anode The positive electrode of an electro dialysis cell.

antiscalant A chemical that inhibits scale formation.

antitelescoping device A plastic cover, resembling a wheel with spokes, attached to the ends of a spiral-wound cartridge to prevent movement of the cartridge leaves in the feed flow direction due to high feed flows.

AOC Assimilable organic carbon.

aquifer A geological formation, group of formations, or part of a formation capable of yielding a significant amount of water to a well or spring.

aramid An aromatic polyamide.

array A series of installed pressure vessels with common feedwater, product, and concentrate lines.

atomic weight A number indicating the relative weight of an element (hydrogen = 1.0).

ATP Adenosine triphosphate.

autopsy The dissection of a membrane element to investigate causes for unsatisfactory performance.

AWWA American Water Works Association.

AWWARF American Water Works Association Research Foundation.

back diffusion Phenomenon due to high concentrate to demineralized stream ratios in which ions will transfer to the demineralized stream from the concentrate stream against the force of the DC potential.

backwash The process of reversing the flow of water either across or through a medium or a membrane.

bacteria Any of a class of microscopic single-celled organisms that reproduce by fission or by spores. Bacteria are characterized by round, rod-like, spiral, or filamentous bodies, often in colonies or moving by means of flagella. They are widely dispersed in soil, water, organic matter, and the bodies of plants and animals. They are often symbiotic in humans, but sometimes pathogenic.

bactericide An agent capable of destroying bacteria.

bacteriostat A substance that inhibits bacterial growth and metabolism.

bank A grouping of modules and a high-pressure pump.

BAT Best available technology for a particular contaminant as defined by the US Environmental Protection Agency.

biological deposits Deposits of organisms or the products of their life processes.

biomass Any material that is or was part of a living organisms.

blinding In-depth and surface filtration, a buildup of particulates on or within the filter, preventing fluid flow through the filter at normal pressures.

boundary layer A very thin layer adhering to a membrane facing the feedwater or concentrate water stream.

brackish water Water having a total dissolved solids concentration ranging from 1,000 to 30,000 mg/L.

brine A concentrate stream containing total dissolved solids at a concentration greater than 36,000 mg/L.

brine seal A rubber lip seal on the outside of a spiral-wound cartridge that prevents feed bypass between the cartridge and the inside pressure vessel wall.

bump An action in the anolyte stream in which gasses are flushed from the anode compartment by allowing water to flow through the electrode compartment for a brief period of time (approximately 30 seconds).

bundle A collection of parallel filaments or fibers.

calcium sulfate (CaSO₄) saturation The point beyond which any further addition of CaSO₄ in a given solution will cause precipitation.

cathode The negative electrode of an electro dialysis cell.

cation A positively charged ion in solution that migrates to the cathode.

cation membrane (cation transfer membrane) A membrane through which only cations will transfer.

cell pair Repetitive section of a membrane stack consisting of a cation membrane, a demineralized water-flow spacer, an anion membrane, and a concentrate water-flow spacer.

cellulose The carbohydrate that is the principal constituent of wood.

cellulose acetate A polymer used to make semi-permeable membranes.

channeling A condition of unequal flow distribution in a desalination bundle or filter bed.

chelating agent A sequestering or completing agent that, in aqueous solution, renders a metallic ion inactive through the formation of an inner ring structure with the ion.

chemical rejuvenation Any of several in-place chemical cleaning methods to remove fouling and scaling or to recondition membranes.

CIP Cleaning in place.

compaction Compression of reverse osmosis membranes due to long-term exposure to pressure resulting in a decreased water flux.

composite membrane A membrane obtained by precipitating a thin desalinating layer on a porous carrier membrane.

concentrate The membrane output stream that contains water rejected by the membrane. It is where feedwater constituents are concentrated. It is also known as reject, retentate, or the residual stream.

concentrate recycle Technique for increasing recovery in which a controlled fraction of the concentrate stream is recycled through the membrane stack(s).

concentrate stream The stream in the membrane stack into which ions are transferred and concentrated.

concentration polarization The phenomenon of increased salt concentration relative to the bulk solution that occurs in a thin boundary layer at a membrane surface on its high-pressure side.

conductivity The ability of a solution to conduct electrical current, commonly expressed in microsiemens/cm (micromhos/cm).

contaminant Any foreign substance present that will adversely affect performance.

control block A group of permeators having a common piping and control system.

cpu Chloroplatinate units (color indicator).

cross leakage Refers to the water leakage between demineralized and concentrate streams in the membrane stack.

D/DBP Rule The Disinfectant/Disinfection Byproduct Rule.

DBP Disinfection byproduct.

decarbonation A process to remove carbon dioxide in the form of CO₂ gas from feedwater.

degasification The process of removing dissolved gases from water.

demineralization The process of removing minerals from water, usually through deionization, reverse osmosis, or distillation.

demineralize To reduce the quantity of minerals or salts in an aqueous solution.

demineralized stream The stream in the membrane stack from which ions are removed.

doc Dissolved organic carbon.

double-pass RO system A reverse osmosis system in which the permeate is further processed by a subsequent reverse osmosis system.

drawback The reverse flow of permeate from the permeate side across the membrane to the feedwater or concentrate side as a result of osmosis.

ED (electrodialysis) Dialysis conducted with the aid of an electromotive force applied to electrodes adjacent to both sides of the membrane.

EDR (electrodialysis reversal) An electrodialysis process in which the polarity of the electrodes is reversed on a prescribed time cycle, thus reversing the direction of ion movement in a membrane stack.

electrical staging The addition of electrode pairs in ED/EDR systems to optimize the DC electrical system within a membrane stack.

electrode A thin metal plate that carries electric current in and out of a membrane stack, normally constructed of platinum-coated titanium alloys.

electrode compartment The water flow compartment containing the metal electrode where oxidation/reduction reactions occur.

electrodialysis See ED.

electrolyte A substance that dissociates into two or more ions when dissolved in water.

electron An elementary unit which is negatively charged and whose flow through a conductor produces electric current.

epm (equivalents per million) A method of expressing ionic concentrations in terms of equivalent electrical charges.

equivalent weight The weight of an ion determined by dividing the ionic weight by its electrical charge (valence).

ESWTR Enhanced Surface Water Treatment Rule.

Faraday A quantity of electricity equal to 96,500 ampere-seconds (coulombs).

feed channel spacer A polypropylene netting between membrane leaves that increases the turbulence of the feed-brine stream.

feed distributor The plastic mesh cylinder found at the core of the fiber bundle that distributes the feed evenly.

feedwater Influent or source water into the membrane process.

fiber bundle The heart of a permeator, consisting of a hollow fiber polymer membrane, epoxy tube sheet, nub, and feed distributor.

filtrate The portion of the feedwater that has passed through a filter.

flat sheet membrane A reverse osmosis membrane coated onto a fabric substrate.

flux of water (F_w) The rate of water flow across the membrane surface area, (Q_p/A), typically express in gallons per day per square foot (commonly abbreviated as gpd/ft²).

fouling A reduction in water mass transfer by materials in the water, typically caused by silts and colloids.

FRP Fiberglass-reinforced plastic.

GAC Granular activated carbon.

gas blanketing The accumulation of electrode reaction gases on the surface of the electrode.

gpd Gallons per day.

gram equivalent weight The equivalent weight of a substance in grams; also the amount of a substance electrically transferred by one faraday.

groundwater Water confined in permeable sand layers between rock or clay; that part of the subsurface water that is in the saturated zone.

HAA Haloacetic acid.

hard scale Deposits of calcium sulfate or other materials that cannot be dissolved by acid.

hardness The concentration in water of polyvalent cations, generally calcium and magnesium.

heavy cation membrane A cation membrane made twice normal thickness (1.0 mm) to withstand greater differential pressures.

HSD Homogenous solution diffusion.

hydraulic staging Multiple passes of a water between electrodes used in ED/EDR systems to achieve further demineralization.

infiltration The movement of water into and through a soil.

IOC Inorganic chemical.

ion An electrified portion of matter of atomic or molecular dimensions.

ion selectivity An ED membrane's ability to either reject or transfer positive or negative ions based on electric charge.

ion strength A measure of the overall electrolytic potential of a solution.

ionic weight The weight of an ion determined by the sum of its component atomic weights.

Langelier Saturation Index A calculated value based on total dissolved solids, calcium concentration, total alkalinity, pH, and solution temperature. This index shows the tendency of a water solution to precipitate or dissolve calcium carbonate.

leaf A combination of a flat sheet membrane, a product channel spacer, and another flat sheet membrane, layered and glued together on three sides.

lime Calcium oxide, CAO.

limestone Either calcite limestone (CaCO_3) or dolomitic limestone (CaCO_3 and MgCO_3).

mass transfer The passage of a given mass of material through a membrane to the permeate side.

mass transfer coefficient (MTC) A coefficient quantifying material passage through a membrane. The MTC of water is called K_w and the solute MTC is K_s .

MCL Maximum contaminant level.

membrane A highly engineered polymer film containing controlled distributions of pores. Membranes serve as a barrier permitting the passage of materials only up to a certain size, shape, or character. Membranes are used as a separation mechanism in water treatment, laboratory, and industrial applications.

membrane compaction See compaction.

membrane configuration The arrangement of individual elements (cartridges) in a membrane treatment process.

membrane element A single membrane unit or cartridge.

membrane system Several membrane trains in parallel.

microfiltration (MF) Filtration designed to remove particles and bacteria in the approximate range of 0.05 to 10 micrometers.

milliequivalents per liter (meq/L) A weight-per-volume measurement obtained by dividing the concentration expressed in milligrams per liter by the equivalent weight of the substance or ion.

milligrams per liter (mg/L) A weight-per-volume measurement that expresses the concentration of a solute. When specific gravity is unity, a milligrams-per-liter value equals the parts per million (ppm) value. When specific gravity is not unity, a milligrams per liter value divided by specific gravity of the solution equals the parts per million value.

module A membrane element combined with the membrane element housing; a pressure vessel containing one or more membrane elements.

NaHMP Sodium hexametaphosphate.

nanofiltration (NF) A crossflow membrane separation process that removes particles in the 300 to 1,000 molecular weight range, selected salts, and most organics.

NOM Natural organic matter.

nonalkaline scale See hard scale.

noncarbonate hardness Hardness caused by chlorides, sulfates, and nitrates of calcium and magnesium. Evaporation of waters containing these ions makes the water highly corrosive.

normality The concentration of a solution expressed in a gram-equivalents per liter.

ntu Nephelometric turbidity unit.

O&M Operations and maintenance.

OEM Original equipment manufacturer.

operating pressure The pressure at which feedwater enters a device.

osmosis The naturally occurring transport of water through a membrane from a solution of low salt content to a solution of high salt content in order to equalize salt concentrations.

osmotic pressure A measurement of the potential energy difference between solutions on either side of a semipermeable membrane. The applied pressure must first overcome the osmotic pressure in the chemical solution for satisfactory reverse osmosis equipment performance.

OSP (off spec product) Product water that does not meet purity specifications.

OSPR Off spec product recycle.

oxidation A chemical reaction occurring at the anode resulting in the loss of electrons.

parts per billion (ppb) A measure of proportion by weight, reflecting the number of unit weights of solute per billion unit weights of solution.

parts per million (ppm) A measure of proportion by weight, reflecting the number of unit weights of solute per million unit weights of solution (approximately equal to milligrams per liter in dilute solutions).

percent recovery The percentage of feed water that becomes product water (the amount of product water produced divided by the total amount of feed water multiplied by 100).

permeability The capacity of a membrane to allow water or solutes to pass through.

permeate channel space See product channel spacer.

permeate stream A membrane output stream that typically contains a desirable quantity of constituents and is to be used as a product.

permeator A reverse osmosis production unit consisting of the membranes and pressure vessel.

phased reversal A technique employed in EDR systems to improve percent recovery by staging electrical polarity reversal.

plant capacity A plant's volume production of permeate per unit time.

polarization The point at which the amount of current per unit area of membrane is high enough to dissociate the water molecule resulting in the formation of OH⁻ and H⁺ ions.

pore An opening in a membrane or filter matrix.

porosity The proportion, usually stated as a percentage, of the total volume of material that consists of pore space or voids.

post-treatment One or more processes that may be used on the product water, such as chlorination or neutralization. Post-treatment of concentrate, such as pH adjustment, may also be required before disposal.

precipitate A substance separated from a solution by chemical or physical change as an insoluble amorphous or crystalline solid.

pressure filtration Filtration aided by imposing a pressure drop across an enclosed filter vessel.

pressure vessel Several membrane elements in series contained in a single tube.

pretreatment The processes such as chlorination, clarification, coagulation, acidification, and degasification that may be used on the feedwater to a membrane system to minimize algae growth, scaling, and corrosion.

product channel spacer The knit fabric through which permeate water flows after it passes through a flat sheet membrane.

product stream See permeate stream.

raw water See source water.

recovery The ratio of the permeate flow to the feed flow, generally expressed as a percentage.

reduction A chemical reaction occurring at the cathode resulting in the gain of electrons.

reverse osmosis (RO) The transport of water from a solution having a high salt concentration to one having a low salt concentration through a membrane by applying pressure to the solution having a high salt concentration. RO removes ionized salts, colloids, and organics down to 150 molecular weight. It may also be called hyperfiltration.

RIB Rapid infiltration basin.

scaling The precipitation of inorganic salts on the feed side of a membrane.

SDI Silt Density index.

SDWA Safe Drinking Water Act.

semipermeable membrane A membrane that is permeable only by certain molecules or ions. For example, reverse osmosis membranes will allow water but not salt to pass.

sequestering agent An agent added to feedwater to extend the limits of saturation of scaling substances. The agent ties up and inactivates certain metal ions.

SHMP Sodium hexametaphosphate.

SMBS Sodium metabisulfite.

SOC Synthetic organic chemical.

soft scale Scale that dissolves under acidic conditions. It is mainly composed of calcium carbonate and magnesium hydroxide.

softener Water treatment equipment that uses a sodium-based ion exchange resin principally to remove calcium and magnesium cations.

solids rejection The percentage of mass removed from the feedwater.

solubility A measure of the maximum amount of a certain substance that can dissolve in a given amount of water at a given temperature.

solute Matter dissolved in a solvent, typically water.

solution A homogenous mixture of substances in which the molecules of the solute are uniformly distributed among the molecules of the solvent.

solvent A liquid medium that carries dissolved substances, or solutes, typically water.

source water Water that has not been treated onsite, including untreated water from wells, surface sources, the sea, or public water supplies.

spiral-wound cartridge The heart of a spiral-wound desalination device, consisting of the product tube, membrane leaves, feed channel spacers, antitelescoping devices, and brine seal.

spiral-wound membrane See flat sheet membrane.

stack shorting A point at which excessive voltage has been applied to a membrane stack whereby electric current will travel through a membrane generating enough heat to damage the membrane

stage Pressure vessels installed in parallel. For example, it is common for a membrane array to have three stages, with four pressure vessels in the first stage, two in the second, and one in the third.

sterilization Destruction or removal of all viable organisms.

supersaturation A state in which the inorganic salts are in solution at a level such that the respective solubility product is exceeded.

TDS See total dissolved solids.

telescoping A movement of the outer layers of a spiral-wound cartridge in the direction of the feed flow, caused by excessive flow through the feed channel spacer.

THM See trihalomethane.

thrust collar A plastic cylinder located between the last spiral-wound cartridge and end plate to support the last cartridge in a pressure vessel. It has the same diameter as the inside diameter of the pressure vessel.

TOC Total organic carbon.

tortuous path A water flow in an Ionics spacer in which turbulence promoters, or crosstraps, are used to produce turbulence in the flow stream.

total dissolved solids The sum of all dissolved solids, volatile and nonvolatile.

TOX Total organic halides.

TOXFP Total organic halide formation potential.

train A membrane arrangement of multiple stages in series where the concentrate is typically used as feed to the subsequent stage.

trihalomethane (THM) Any of several derivatives of methane, CH₄, in which three halogen atoms (chlorine, bromine, or iodine) are substituted for three hydrogen atoms.

turbidity Any undissolved materials in water, such as finely divided particles of sand or clay, reducing the penetration of light and causing the water to appear cloudy.

ultrafiltration (UF) A process using a semipermeable membrane under a hydraulic pressure gradient to separate components in a solution. The membrane pores allow passage of the solvent but will retain nonionic components primarily on the basis of physical size.

USEPA United States Environmental Protection Agency.

valence The number of electrical charges, positive or negative, carried by an ion.

water flow spacer A die-cut sheet of plastic that forms discrete flow paths for the demineralized and concentrate streams within an ED membrane stack.

water transfer Phenomenon in which water molecules are transferred through a membrane along with an ion.

water transport The passage of water through a membrane. Water transport is desirable in reverse osmosis and nonfiltration and undesirable in electro dialysis.

Appendix B

Example Cost Estimate

R 070003 Final FPA Cost Estimate

Computation

Job No. 07003-013-036

Calc. No.

HDR

Project	TWDB Membrane Technologies and Costs for Desalination	Computed	MCG
System	Seawater Desalination - Reverse Osmosis Membrane System	Date	2/1/00
Component	Example Calculation	Reviewed	BB
Task	Design and Cost Estimate	Date	2/15/00

Purpose Setup Design form and basic calculations to estimate the capital and O&M cost of RO facilities.

Problem Statement Determine the construction and O&M costs for RO treatment facilities. Include facilities for feedwater pumping and cleaning as needed.

Design Peak Flow 25 mgd
Average Flow 25 mgd

Legend

- a Assumption
- x Critical Assumption — MUST BE CHECKED.
- i Input value - user defined value
- c Cost curve input to determine capital cost
- o Cost curve input to determine O&M cost
- 1,2,3, ... Note number
- Blue = Input value
- Green Italics = Design Guidance
- Red/other color = changed cell.

Facilities Needed

- Facilities Needed
- Pretreatment
- Feedwater Pumping
- Membrane Process System
- Chemical Cleaning System

Assumptions Global/General Assumptions and constants

Process Design

Assumptions and Calculated Design Parameters				
1	i	Process Capacity	mgd	25
		(Flow - design)	gpm	17,361
2	i	Average Process Flow	mgd	25
		(Flow - operating)	gpm	17,361
3	i	Recovery Rate	%	60%
4	i	Flux	gfd	6
5	i	Area per element	sf/element	400.0
6	i	Pumping head	psi	900
7	i	Safety Factor	%	10%
8	i	Cleaning Frequency	-	6 mon ref number =
9	i	Membrane Life	yr	5 1 (note - 2 wk = 1, 1 mon = 2, 6 mon = 3, 12 mon = 4)
10	i	Pretreatment Dose	-	Medium ref number = 3 (note - low = 1, med = 2, high = 3)
Calculated Estimate Basis Design				
11		Number elements design	No	11,458
12		Feedwater Capacity	mgd	41.7
		(Flow - design)	gpm	28,935
Calculated Estimate Basis Operating				
13		Number elements operating	No	11,458
14		Average Feedwater Flow	mgd	41.7
		(Flow - operating)	gpm	28,935

Guidance

- 1 Facilities are designed for peak flow. Construction costs are based on peak flow.
- 2 Operations costs are based on the average flow.
- 3 Recovery rate is determined through pilot studies, membrane manufacturer, and process configuration. Typically range from 50 to 90%. The recovery rate is the % of feedwater that passes through the membrane system and is recovered as product water. Feedwater flow rate is calculated from recovery rate.
- 4 Design flux is determined through pilot studies and membrane manufacturer. Typically range from 5 to 20 gfd. Feedwater quality affects the flux due to the potential for fouling or scaling on the membrane.
- 5 Element area determined by manufacturer. Standard size at 400 sf. element.
- 6 Operating pressure is determined through pilot studies, membrane manufacturer, and process configuration. For this estimate range from 300 to 900 psi for RO. Total Dissolved Solids (TDS) concentration of feedwater affects the operating pressure. The typical operating pressures roughly correspond to feedwater TDS from 2,000 to 35,000 mg/l.
- 7 A safety factor is included for calculating the number of NF elements required.
- 8 Cleaning frequency depends on water quality. Typical expect 2-weeks to 12 months between main cleanings. Determine by pilot study.
- 9 Membrane life is determined by long term fouling and feed water quality. Default cost curves calculated at 5 yr membrane replacement cycle.
- 10 Pretreatment dose is determined through pilot studies, membrane manufacturer, and water analysis. Three pretreatment doses have been selected to approximate varying levels of pretreatment. Low - 10 mg/l acid and 1 mg/l antiscalant. Medium - 20 mg/l acid and 3 mg/l antiscalant. High - 30 mg/l acid and 5 mg/l antiscalant.
- 11 Number of elements design is the basis for estimating the construction costs of the membrane process system and chemical cleaning system. Calculated from design peak flow.
- 12 Feedwater capacity is the basis for estimating the construction costs of pretreatment and feedwater pumping. Calculated from design peak flow divided by recovery rate.
- 13 Number of elements operating is the basis for estimating the operating costs of the membrane process system and chemical cleaning system. Calculated from average flow.

14 Average feedwater flow is the basis for estimating the operating costs of pretreatment and feedwater pumping. Calculated from average flow divided by recovery rate.

Pretreatment

1	i	Feedwater Capacity	mgd	41.7	copied from assumptions at top
2	i	Average Feedwater Flow	mgd	41.7	copied from assumptions at top
3	i	Pretreatment Dose	-	Medium	copied from assumptions at top

Guidance

- 1 Pretreatment is determined by the peak flow.
- 2 Operating costs for consumables depends on the actual flow treated.
- 3 One of the three pretreatment levels is input.

Cost Curve Adjustments

The cost curves are based on typical operating conditions. Three standard pretreatment levels are given. Interpolate between estimated costs for between levels. No Adjustment for this estimate. Costs obtained from medium curves.

Cost Summary From Curves	4	5	4,6	4,5	4,7,8	4,7	4,7	4,7
Lookup basis	Construction \$	Housing, sf	Labor, hr/yr	Material, \$/yr	Chemical, \$/yr	Energy, MWh/yr	Natural gas, \$/yr	Fuel, gal/yr
Pretreatment costs	973,318	1,669	169	26,880	2,436,620	0	0	0
Pretreatment costs - adjusted	973,318	1,669	169	26,880	2,436,620	0	0	0

Notes:

- Cost basis shows the design parameter value used to estimate cost.
- Costs show the construction and operating costs read from cost curves and tables.
- Adjusted are the costs after adjusting the curve/table values for site specific conditions.

Guidance

- 4 Construction and O&M costs can be interpolated from respective Figures.
- 5 Housing requirements can be interpolated from Figures.
- 6 Routine maintenance is performed on all units available.
- 7 Running costs are associated with average operating conditions.
- 8 Screen replacement is shown as a "chemical" cost - frequent replacement based on the flow treated, not units installed.

Feedwater Pumping

1,4	i	Influent Pumping			
	i	Feedwater Capacity	mgd	41.7	copied from assumptions at top
		(Flow - design)	gpm	28,935	-This flow is used to determine construction cost.
2,4	i	Average Feedwater Flow	mgd	41.7	copied from assumptions at top
		(Flow - operating)	gpm	28,935	-This flow is used to determine O&M cost.
3	i	Pumping head	ft	900	copied from assumptions at top
		(Influent pump head)			

Guidance

- 1 Feed pumping is determined by the peak flow.
- 2 Operations costs for influent pumping are based on the average flow.
- 3 Pump head is determined by the hydraulics of the specific design. Specific membranes require certain transmembrane pressure to achieve desired flux rates. Feedwater pumps cost estimates based on feedwater pumping head.
- 4 No added redundancy is required since influent pumping costs presented in the cost table were determined for a system that includes a redundant pump.

Cost Curve Adjustments

The cost curves are based on typical operating conditions. Adjust these values for the site specific conditions.

Pump head	ft	Cost curve (low)	Cost curve (high)	Specific	Adjustment
		700	900	900	Interpolate

Cost Summary	5	6	7	7	8	8	8	8
Pumping cost basis	Construction \$	Housing, sf	Labor, hr/yr	Material, \$/yr	Chemical, \$/yr	Energy, MWh/yr	Natural gas, \$/yr	Fuel, gal/yr
Pumping - cost (low)	7,691,331	441	428	221,670	0	132,566		
Pumping - cost (high)	7,691,331	441	428	221,670	0	132,566		
Pumping - adjusted	7,691,331	441	428	221,670	0	132,566	0	0

Notes:

- Cost basis shows the design parameter value used to estimate cost.
- Costs show the construction and operating costs read from cost curves and tables.
- Adjusted are the costs after adjusting the curve/table values for site specific conditions.

Guidance

- 5 Interpolate cost from Figures for the total installed pump capacity.
- 6 Interpolate housing cost from Figures for the total installed pump capacity.
- 7 Labor and Material costs driven by installed units.
- 8 Chemical, energy, gas, and fuel consumption driven by units in operation - average condition.

Membrane Process System

1	RO Membrane Reference #	3	Medium pressure (400 to 600 psi) = 1, High pressure (600 to 800 psi) = 2, Seawater pressure (> 800) = 3
---	-------------------------	---	---

Cost Curve Adjustments

The cost curves are based on typical operating conditions. Adjust these values for the site specific conditions.

Membrane life	yr	Cost curve	Specific	Adjustment
		5	5	1.00 -Apply to Chemical O&M cost - used to show membrane replacement cost.

Cost Summary From Figures	2	2	3	3	4	4	4
Membrane Process System Basis	Construction \$	Housing, sf	Labor, hr/yr	Material, \$/yr	Chemical, \$/yr	Energy, MWh/yr	Natural gas, Fuel, gal/yr
	11,460	11,460	11,460	11,460	11,460	11,460	11,460

Membrane Process System	17,000,669	9,304	2,012	484,377	1,059,730			
Membrane Process System Adjusted	17,000,669	9,304	2,012	484,377	1,060,000	0	0	0

Notes:

Cost basis shows the design parameter value used to estimate cost.
 Costs show the construction and operating costs read from cost curves and tables.
 Adjusted are the costs after adjusting the curve/table values for site specific conditions.

Guidance

- 1 Cost of membranes and pressure vessels are dependent on the operating pressure of the process system. Cost estimates based on three levels of components.
- 2 Interpolate cost from Figures for the total installed number units.
- 3 Labor and Material costs driven by installed units.
- 4 Chemical, energy, gas, and fuel consumption driven by units in operation - average condition.

Chemical Cleaning System

1 Cleaning Frequency - 6 mon copied from assumptions at top

Cost Curve Adjustments
 NONE

Cost Summary From Curves

	1	2	4	4	5	5	5	5
	Construction \$	Housing, sf	Labor, hr/yr	Material, \$/yr	Chemical, \$/yr	Energy, MWh/yr	Natural gas, \$/yr	Fuel, gal/yr
Lookup basis	11,460	11,460	11,460	11,460	11,460	11,460	11,460	11,460
Cleaning Facilities	618,398	3,208	1,770	15,469	84,176	7,123	0	0
Cleaning facilities - adjusted	618,398	3,208	1,770	15,469	84,176	7,123	0	0

Notes:

Cost basis shows the design parameter value used to estimate cost.
 Costs show the construction and operating costs read from cost curves and tables.
 Adjusted are the costs after adjusting the curve/table values for site specific conditions.

Guidance

- 1 Cleaning costs based on cleaning frequency and number of elements
- 2 Construction and O&M costs can be interpolated from respective Figures
- 3 Housing requirements can be interpolated from Figure
- 4 Labor and Material costs driven by installed units.
- 5 Chemical, energy, gas, and fuel consumption driven by units in operation - average condition.

Housing

Define housing requirements and unit costs

Select percentage of each unit process to be enclosed and the estimated building cost for the various buildings.

		1	2
	% Coverage	Unit Cost, \$/sf	
Pretreatment	% coverage	100%	125
Feedwater Pumping	% coverage	100%	125
Membrane Process System	% coverage	100%	125
Chemical Cleaning System	% coverage	100%	125

Housing O&M requirements

1 Labor	hr/sf/yr	0.06
4 Material	\$/sf/yr	0.5
5 Energy	kWh/sf/yr	30
6 Natural gas	Therm/sf/yr	1.6

Housing required - Full floor areas were determined above for each unit process.

	1	1	1	2	
	Full cover, sf	% Coverage	Housing, sf	Unit cost	Building \$
Pretreatment	1,669	100%	1,669	125	208,613
Feedwater Pumping	441	100%	441	125	55,089
Membrane Process System	9,304	100%	9,304	125	1,162,981
Chemical Cleaning System	3,208	100%	3,208	125	401,000
Total	14,622		14,622		1,828,000

	Construction	Labor	Chemical	Material	Energy	Natural gas	Fuel
Unit cost values	\$	hr/yr	\$/yr	\$/yr	MWh/yr	Therm/yr	gal/yr
Housing total	1,828,000	880	0	7,300	439	23,400	0

Guidance

- 1 The previous cost estimates determine the housing area required for various process units. The housing costs are determined for the various units based on the design, and applying a typical construction housing cost (\$/sf) basis. Adjust the percent coverage to account for the current scenario for housing requirements.
- 2 The unit cost for various buildings will vary with the construction materials and architectural treatment added. See housing document for help on selecting appropriate housing allowances.
- 3 Building cost typically \$75-130/sf, depending on building style, size, and location.
- 4 Labor for routine maintenance depends on building type. Estimated at 0.060 - 0.065 hrs/sf/yr.
- 5 Material for routine maintenance depends on building type. Estimated at 0.45-0.50 \$/sf/yr.
- 6 Energy for building, including ventilation and lighting ranges from 20 - 100 kWh/sf for hot and cold climates; about 30 kWh/sf typical moderate climate. Heating typically with natural gas.
- 7 Natural gas for building heating ranges from 0.3 to 6.5 therm/sf/yr for hot and cold climate; typically 1.6 therm/sf/yr for a moderate climate.

Summary

	Unit Costs		
1	Labor including benefits	\$/hr	25
2	Energy cost	\$/kWh	0.05
3	Natural Gas	\$/therm	0.60
4	Fuel	\$/gal	1.00

	Construction, \$	Labor, hr/yr	Material, \$/yr	Chemical, \$/yr	Energy, MWh/yr	Natural gas, cf/yr	Fuel, gal/yr
Pretreatment	973,318	169	26,880	2,436,620	0	0	0
Feedwater Pumping	7,691,331	428	221,670	0	132,566	0	0
Membrane Process System	17,000,669	2,012	484,377	1,060,000	0	0	0
Chemical Cleaning System	618,398	1,770	15,469	84,176	7,123	0	0
Housing	1,828,000	880	0	7,300	439	23,400	0
Total	28,111,716	5,259	748,396	3,588,096	140,128	23,400	0

Unit Costs		25			0.05	0.6	1.0
Annual Cost		131,475	748,396	3,588,096	7,000,000	14,000	0
Total O&M, \$/yr		11,482,000					

	Project Base Allowances		
5	Contingency	%	25% of estimated construction
6	Mobilization	%	5% of estimated construction
7	Sitework	%	10% of estimated construction
8	Yard piping	%	5% of estimated construction
9	Geotechnical allowance	%	0% of estimated construction
10	Electrical	%	12% of estimated construction
11	I&C	%	5% of estimated construction
12	Contractor overhead and Profit	%	10% of estimated construction
13	Engineering	%	15% of project bid cost
14	Legal, Fiscal, Administration	%	5% of project bid cost
Economical			
15	Interest Rate	%	6%
16	Financing Period	yr	30

Computation of Project Allowances

Construction estimate above				28,111,716	7,028,000
Contingency	%	25%	of	28,111,716	1,405,600
Mobilization	%	5%	of	28,111,716	2,811,000
Sitework	%	10%	of	28,111,716	1,406,000
Yard piping	%	5%	of	28,111,716	0
Geotechnical allowance	%	0%	of	28,111,716	3,373,400
Electrical	%	12%	of	28,111,716	1,406,000
I&C	%	5%	of	28,111,716	2,811,172
Contractor overhead and Profit	%	10%	of	28,111,716	48,353,000
Construction subtotal				48,353,000	7,253,000
Engineering	%	15%	of	48,353,000	2,418,000
Legal, Fiscal, Administration	%	5%	of	48,353,000	

Total Construction	58,024,000
---------------------------	-------------------

Annualized cost

Construction cost at	6%	over	30	year	4,215,000 \$/yr
Operation and Maintenance cost					11,482,000 \$/yr
Total Annual Cost					15,697,000 \$/yr

Unit costs

Unit construction cost at	25.0 mgd =	2.32 mil \$ / mgd capacity
Unit production cost at	25.0 mgd =	1.72 \$/1000 gal produced

Guidance

- 1 Labor includes benefits and overhead. Load labor with special administrative overhead as needed. Benefits typically 40% of labor cost. Typical labor rates are \$15-45/hr.
- 2 Electric energy cost is an averaged rate. Typically range from 0.02 to 0.08 \$/kWh.
- 3 Natural gas cost is an averaged rate. Typically range from 0.20 to 0.80 \$/therm.
- 4 Fuel cost is typically 0.75 to 1.5 \$/gal.
- 5 Contingencies for entire project allows for units not specifically included in the estimate. Typically, add 15-20% to estimated construction cost.
- 6 Mobilization includes bonds and insurance. Typically 2-5% of estimated construction cost.
- 7 Sitework includes allowance for preparation of level site for construction, roads, parking lots, fencing, landscaping, storm water control, etc. Typically, add 5-15% to estimated construction cost.
- 8 Yard piping provides allowance for interconnecting piping between treatment units. Typically, add 3-7% to estimated construction cost.
- 9 Geotechnical allowance provides for special subsurface conditions requiring special construction techniques such as pile, high groundwater table dewatering, etc. Significant cost and highly site specific. Determine separately. No allowances in this estimate.
- 10 Electrical allowance to provide duct banks, MCCs, relays, lighting, etc. Typically, add 10-15% to estimated construction cost.
- 11 I&C - Instrumentation and Control includes facility SCADA control system, software, etc. Cost depends on degree of automation desired for entire facility. Local control included within unit processes. Typically, add 3-8% to estimated construction cost.
- 12 Contractor Overhead and Profit is included in the cost estimates prepared above. Add percentage for special considerations, such as a remote site or high cost areas.
- 13 Engineering includes study, design, construction supervision, special testing during construction, O&M Manuals, startup, record drawings. Typically, add 10-20% to construction bid cost.
- 14 Legal, Fiscal, Administration is additional project cost and is highly specific to the local agency. To be determine by each utility. Add 5% nominal allowance.
- 15 Interest Rate for financing of project depends on funding source, subsidies, and general economy. Typically between 3 and 10%.
- 16 Financing Period of project is typically 20 years.

Appendix C

Example Questionnaire

SURVEY INSTRUCTIONS AND GUIDANCE

Purposes of the survey.

- identify the major membrane technologies available to desalinate brackish and salt water;
- gather data on the performance, costs, and process issues related to the technologies; and
- identify concentrate disposal methods.

Contact Information. We have the following contact information for your facility. Please verify that the information is correct. If it is not, please write the correct information to the side.

Plant Name: Clayton Regnecy MHP
Your Name: Carl Hickman
Title: President
Organization: Water Systems Technical Service
Mailing Address: P.O. Box 4067
City: Cave Creek
State: AZ
Postal Code: 85327-
Telephone: (602) 488-4644
FAX: _____
e-mail address: _____
Plant ID Number: 2

At the time the plant was built, what were the alternatives for supplying the same quantity of water and what were the costs? Why was the decision made to build the membrane desalination facility? _____

Submission of the survey. The completed survey (2 double sided pages) should be returned using the postage-paid envelope provided. If there is no envelope, please call us for another or send it to the address below.

We request that you **return the survey by April 14, 1999.** Your cooperation is appreciated!

Questions. If you have any questions concerning the survey, please contact the Texas Water Development Board's research contractor:

Bryan Black
HDR Engineering, Inc.
2211 S. IH-35, Suite 300
Austin, TX 78741

Phone: 512/912-5161
FAX: 512/912-5158
e-mail: bblack@hdrinc.com

Design of the Survey. The survey is comprised of three main parts:

- General Information on the contact information, schematic, source water, membrane system, and design parameters for the plant (pages 2 and 3)
- Costs of facilities, including Capital and annual operations and maintenance (page 3)
- Checklist that provides a further description of the facilities and cost components (page 4)

SURVEY INSTRUCTIONS AND GUIDANCE

Terms used in the survey.

- Membrane types: RO (Reverse Osmosis), ED (Electrodialysis), EDR (Electrodialysis Reversal), TFC – Thin Film Composite, CA – Cellulose Acetate
- DBP – Disinfection By-product

Instructions for Page 1 of the Survey

1. Check the appropriate description of source water and membrane type, providing the manufacturer and model of the membranes, if known. Note if multiple manufacturers and types, provide all.
2. Enter the present Design Parameters for your facility and average annual values for the finished water for the fiscal year identified in Operation and Maintenance Costs. In addition, check the original reason(s) for the construction of this facility.
3. Enter the Capital Costs for the initial construction and subsequent expansions of the facility. Do not include costs for land, engineering, site development, or source water development. Costs can be given in total dollars or dollars per gallon of capacity constructed, whichever is more convenient. If costs are given in dollars per gallon, please indicate the flow used for determining the values. If the plant was built with facilities sized for future membrane treatment capacity expansion, please indicate so and identify the facilities.
4. Enter the Operation and Maintenance Costs for the fiscal year that you identify. Costs should be for the desalination facility only. Costs can be given in total dollars or dollars per thousand gallons, whichever is more convenient. If costs are given in dollars per thousand gallons, please indicate the flow used for determining the values. Please list the energy used for the electrical costs given, if known.

Instructions for Page 2 of the Survey

1. Check the appropriate description of the treatment process for the plant. If other components are provided, please list in the space provided.
2. Check the appropriate facilities that were constructed for the various phases of the plant constructed.
3. Check the appropriate descriptions that are included in the categories of Operation and Maintenance Costs provided on page 1. If known, please indicate the number of personnel for the personnel costs provided.

Please draw in the space provided or attach a schematic diagram of the membrane plant showing any pretreatment and post-treatment processes, including locations of chemical addition.

General Information

Source Water: Groundwater Lake River Seawater Other _____
 Membrane: RO ED EDR Other _____
 Manufacturer _____ Model _____

Design Parameters (present)

		Flow MGD or GPM	TDS (mg/l)	TOC (mg/l)	Reason for Building Plant
Design	Feedwater				<input type="checkbox"/> TDS Reduction
	Product				<input type="checkbox"/> Hardness Reduction
	Blend				<input type="checkbox"/> Organic Removal
	Finish				<input type="checkbox"/> Color Removal
	Concentrate				<input type="checkbox"/> DBP Reduction
	Average Annual Finish				<input type="checkbox"/> Disinfection

Facilities sized for future capacity? Please describe: _____

Capital Costs (See description of system at top of following page)

Phase	Year	Total System		Membrane System		Concentrate Disposal	
		\$	Design Flow (MGD)	\$	Design Flow (MGD)	\$	Design Flow (MGD)
Initial Capital							
Expansion 1							
Expansion 2							
Expansion 3							

Operation and Maintenance Costs for Fiscal Year ending _____

Category (See description of Annual Costs at bottom of following page)	Total Dollars	Dollars per 1,000 gallons	If using flow for costs, indicate which flow it is.
Personnel (total)			<input type="checkbox"/> Feed <input type="checkbox"/> Product <input type="checkbox"/> Finish
Operation/Maintenance Personnel			
Administrative Personnel			
Chemical (total)			Annual Energy Use (kWh/year)
Membranes			
Disinfectant			
Other			
Electricity (total)			
Membranes			
Other			
Replacement Membranes / Parts			
Concentrate Disposal			
Other Costs			
Total Annual Cost			

Description of System (Check all that apply)

Pre-treatment

- Rapid Mix
- Flocculation
- Sedimentation
- Media Filtration
- Storage
- Cartridge Filtration
- Microfiltration
- Ultrafiltration
- Chlorine
- Ozone
- Predisinfectant
- Chlorine Dioxide
- Chloramines
- Preoxidant
- Aeration

Membrane System

- Feedwater Pumping
- Anti-scalant
- pH Adjustment (lower)
- Disinfectant Neutralizer
- Membrane Type & Stages
 - TFC 1 Stage
 - CA 2 Stage
 - ED/EDR 3 Stage
- Clean-in-Place
- SCADA (membrane)
- Online Monitoring
 - TDS
 - Particle Count
 - Other
- Building
- Energy Recovery

Post-Treatment

- pH Adjustment (raise)
 - Caustic Soda
 - Soda Ash
 - Lime
 - Degasifier
- Disinfection
 - Cl₂ O₃ UV
 - NH₃Cl ClO₂
- Storage
- High Service Pumping
- Corrosion Inhibitor
- Blend System**
 - Pumping
 - Metering
 - Before/After Storage
 - Storage

Other

- Maintenance Bldg.
- Administration Bldg.
- Combination Maint/Admin
- Plant SCADA
- Concentrate Disposal**
 - Source Water
 - Sea
 - Injection Well
 - Evaporation
 - Sanitary Sewer
 - Irrigation
 - Other Use (re-use)
 - Pump Station
 - Storage
 - Gravity Line

Describe other items not listed above _____

Description of Capital Costs (Check all that were included for each phase of construction)

	<i>Initial</i>	<i>Expansion 1</i>	<i>Expansion 2</i>	<i>Expansion 3</i>
Pre-Treatment				
Membrane System				
Post-Treatment				
Blend System				
Concentrate Disposal				
Other				

Description of Annual Cost (Check all items included in major cost headings)

Operation/Maintenance Personnel

- Operators (# _____)
- Maintenance (# _____)
- Maintenance/Operators (# _____)
- Workers (# _____)
- Benefits

Administrative Personnel

- Superintendent
- Assistant Superintendent
- System Engineer
- Secretary
- Clerks
- Benefits

Membranes

Anticipated life _____ years
 Membrane replacement cost \$ _____

Chemical

Membrane

- CIP Chemicals
- Anti-scalant
- pH Adjustment (lower)
- Disinfectant Neutralization
- pH Adjustment (raise)
- Corrosion Inhibitor

Other

- Coagulant Chemicals
- Adsorbent

Disinfectant

- Chlorine
- Chloramine
- Ozone
- Chlorine Dioxide

Electricity

Membrane

- Feedwater Pumping
- CIP Pumping
- Energy Recovery
- Lighting & Controls (Membrane Bldg.)

Other

- Raw Water Pumping
- Lighting (Plant)
- Lighting (Buildings)
- Pre-Treatment
- High Service Pumping
- Blend Pumping
- Concentrate Pumping
- Other Building Electrical

Describe other items not listed above _____

Appendix D

Texas Coastal Water Quality Data

Data obtained from TWDB's ambient water quality monitoring program for bays and estuaries was used to develop the charts of water quality data in Appendix D. Data obtained from TWDB's internet site.

Maximum Daily Salinity
Laguna Madre (Isabel)

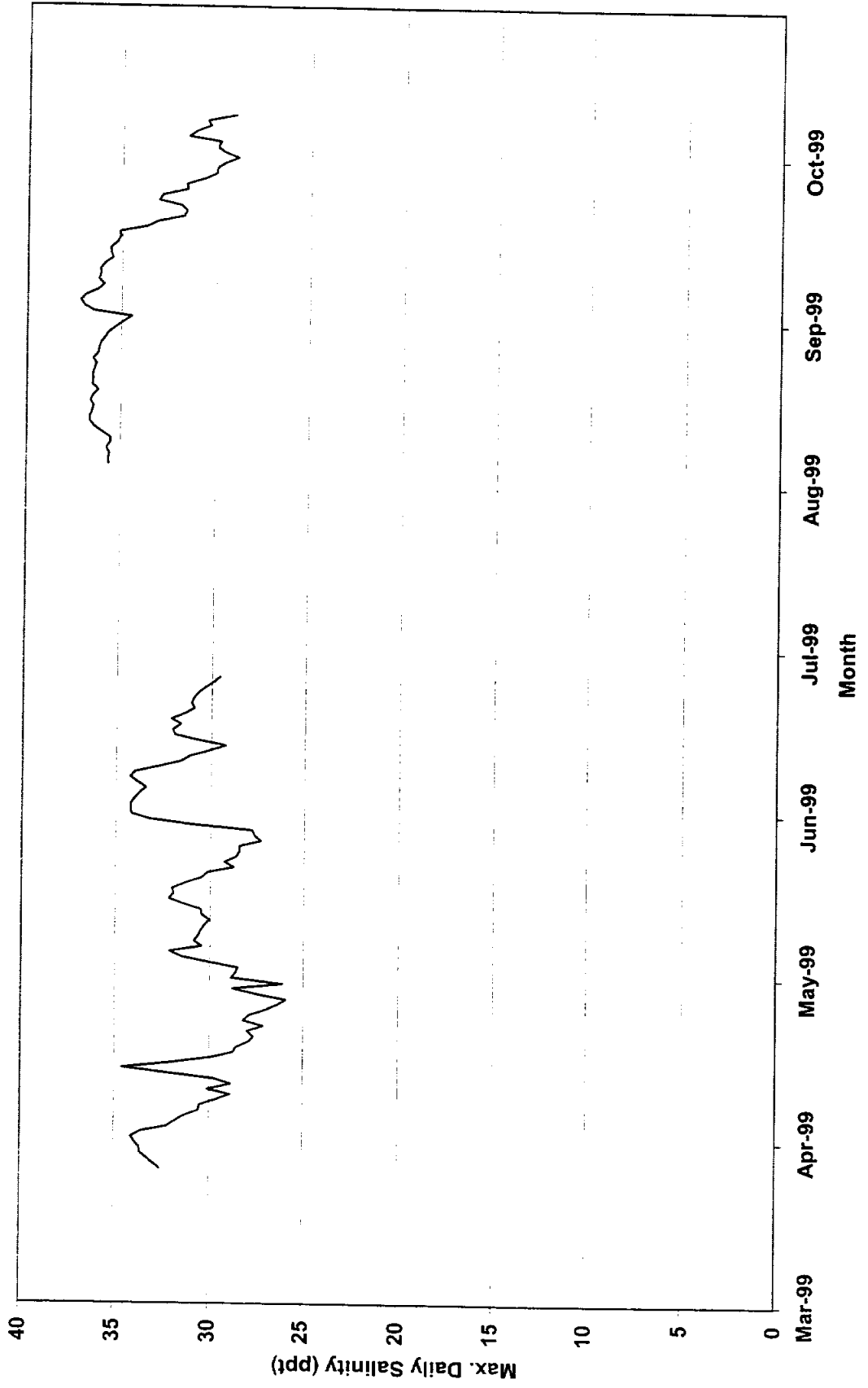

**Temperature Frequency Analysis
Laguna Madre (Isabel)**

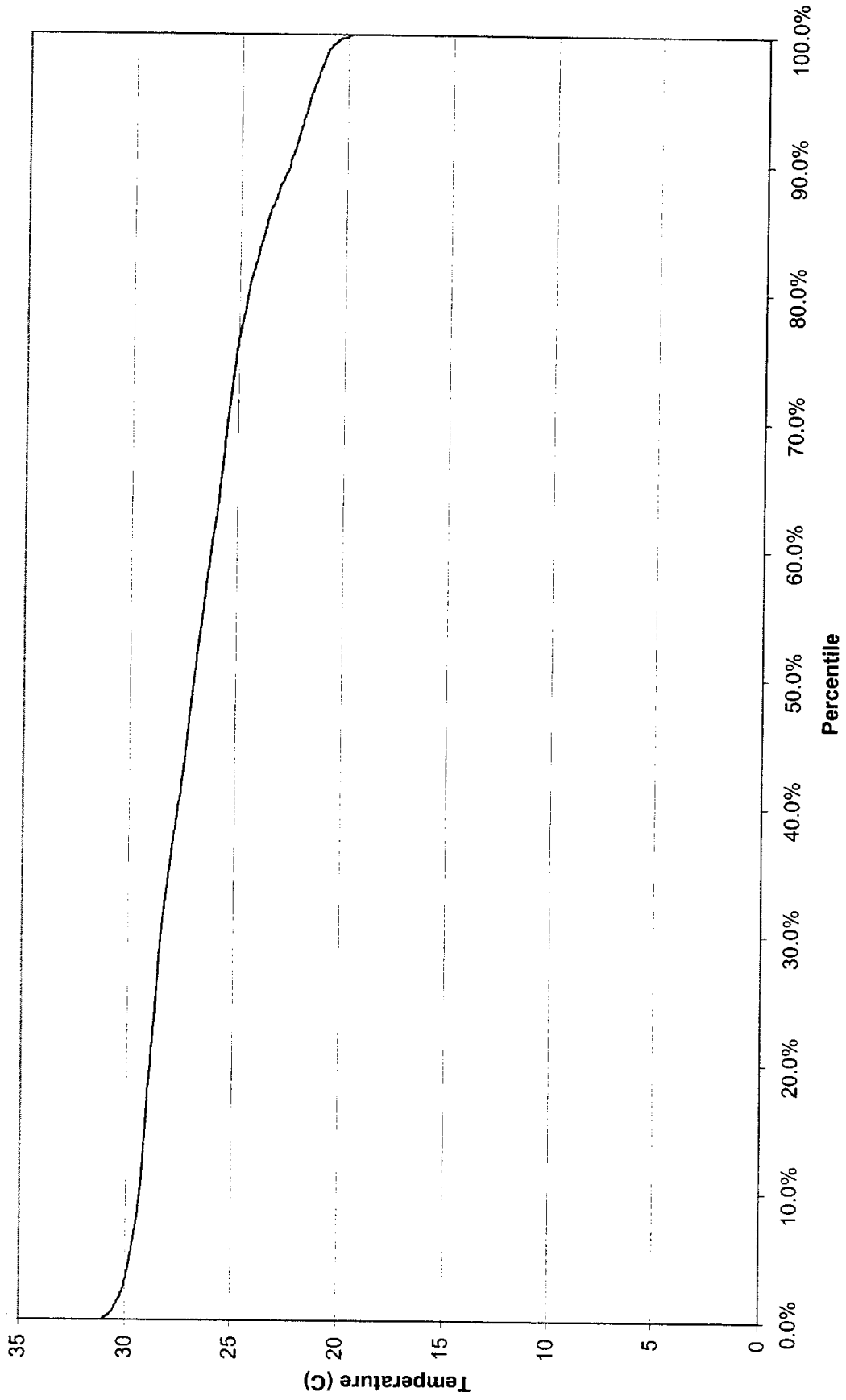

**pH Frequency Analysis
Laguna Madre (Isablel)**

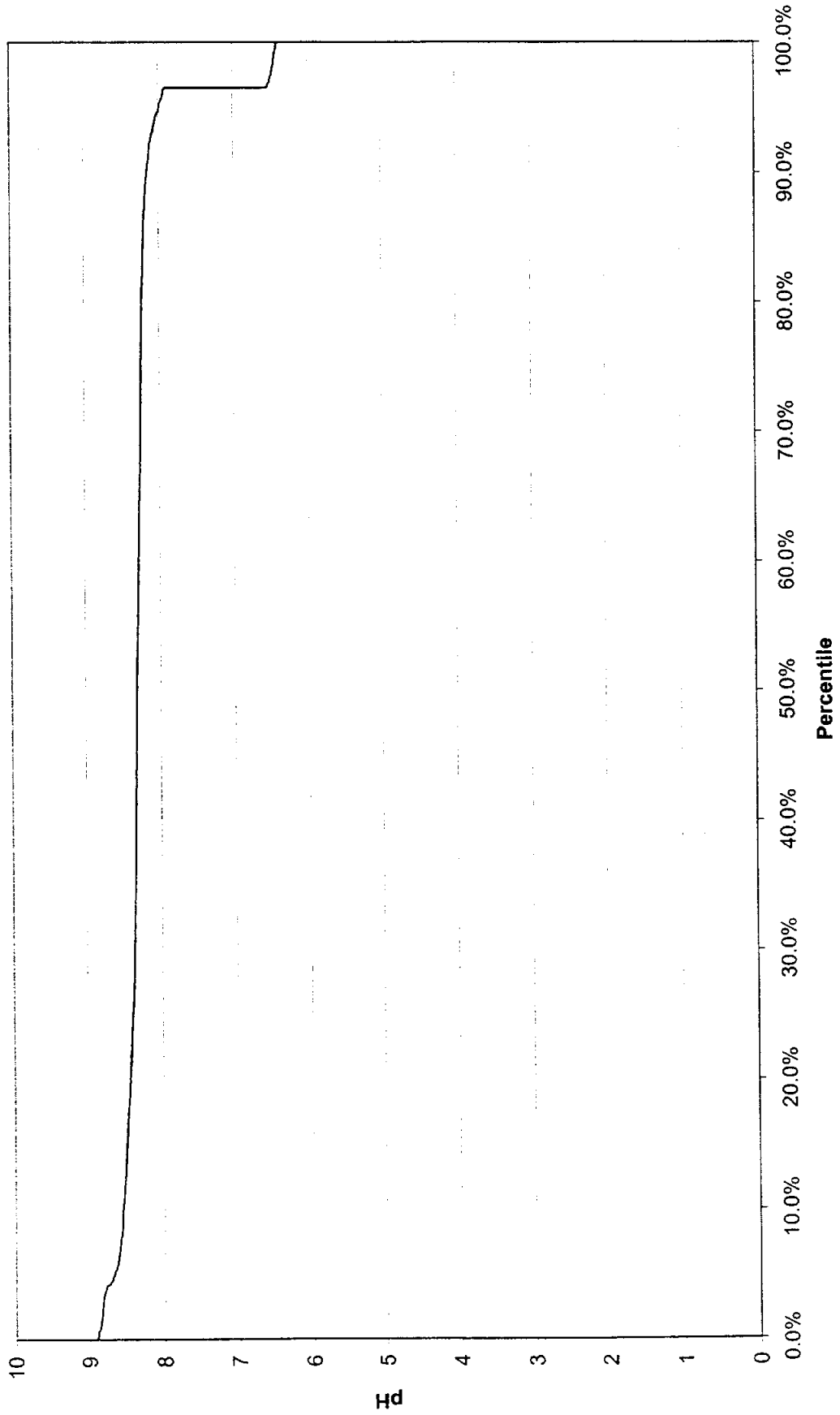

Maximum Daily Salinity Laguna Madre (JFK)

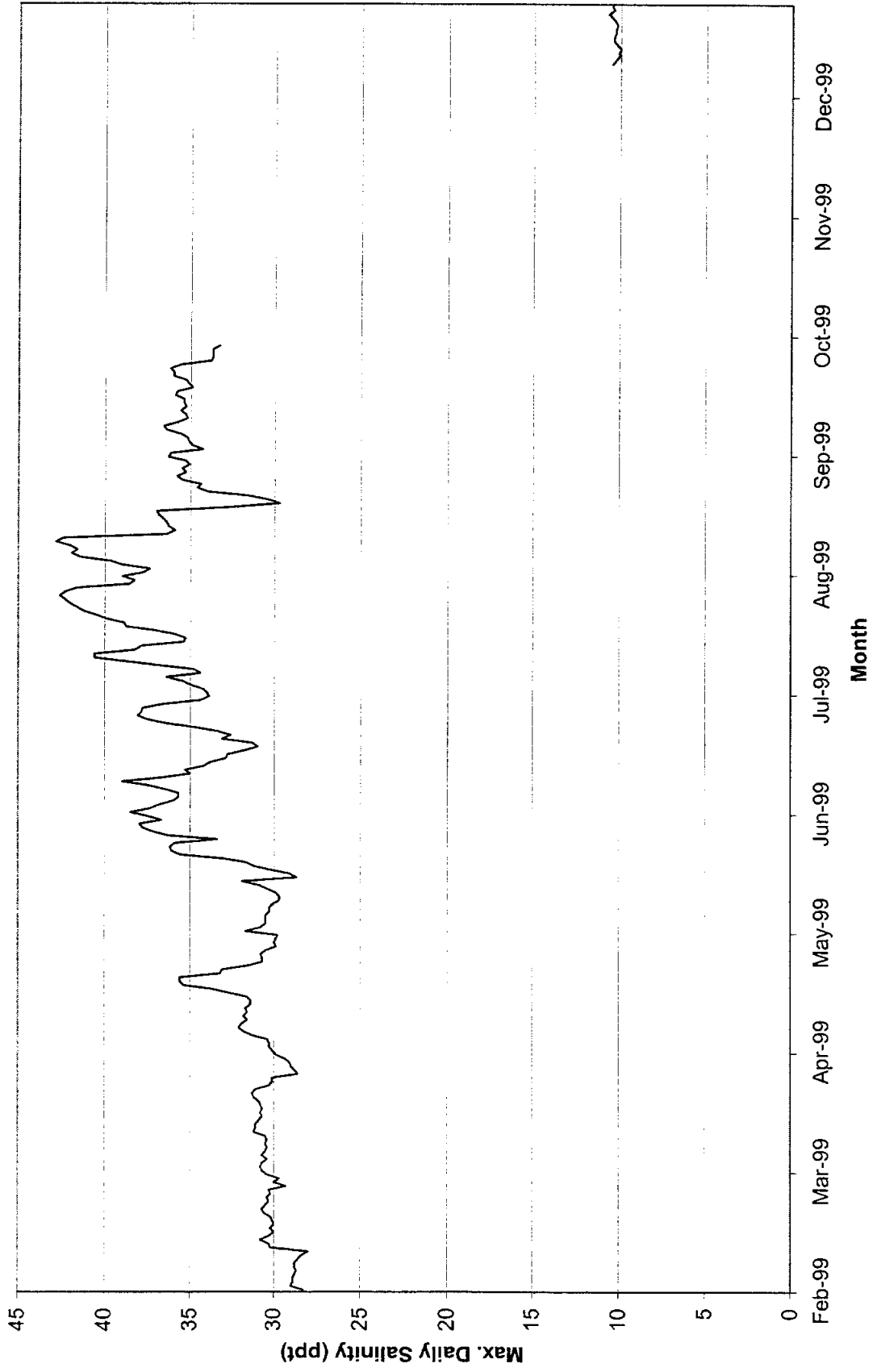

**Temperature Frequency Analysis
Laguna Madre (JFK)**

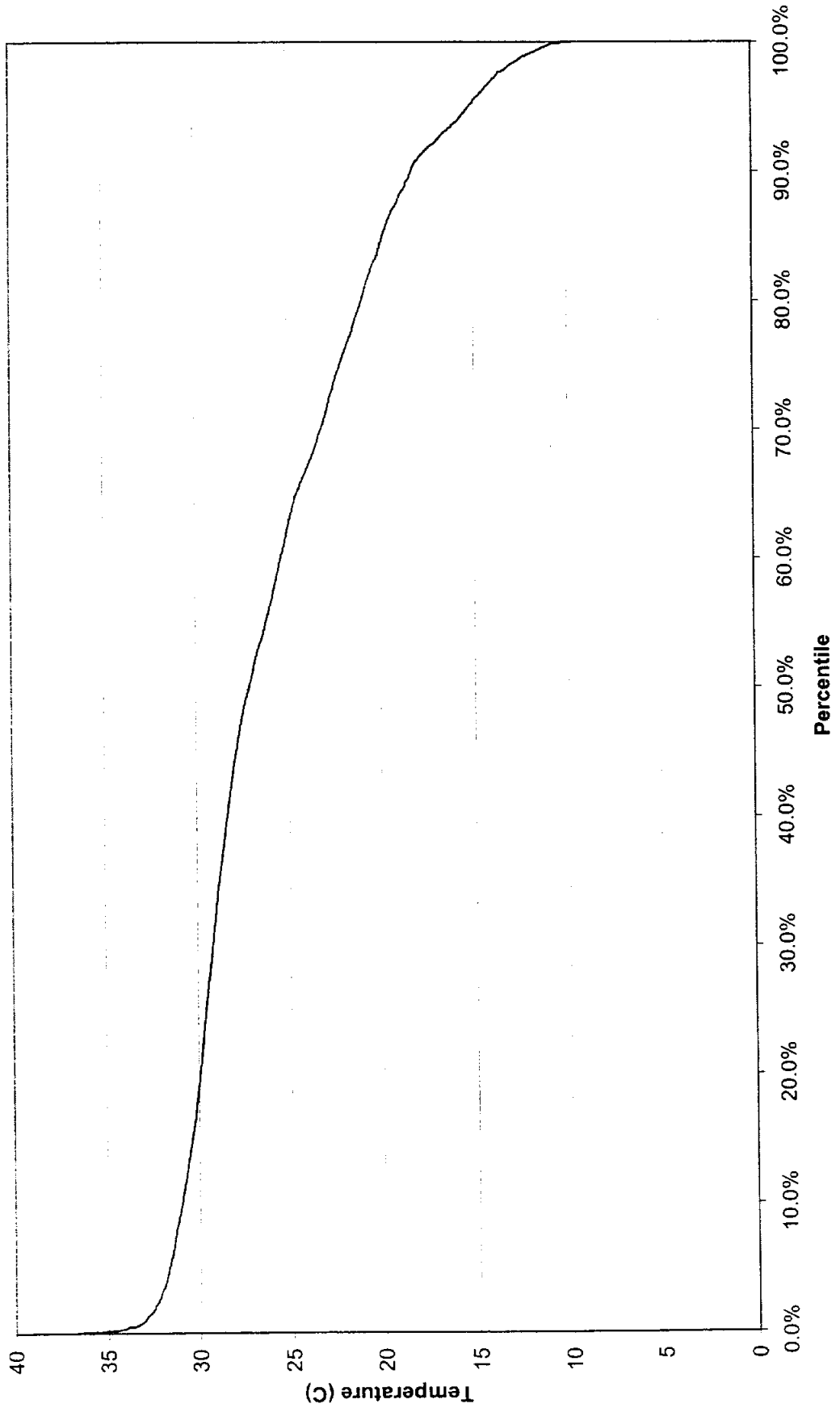

**pH Frequency Analysis
Laguna Madre (JFK)**

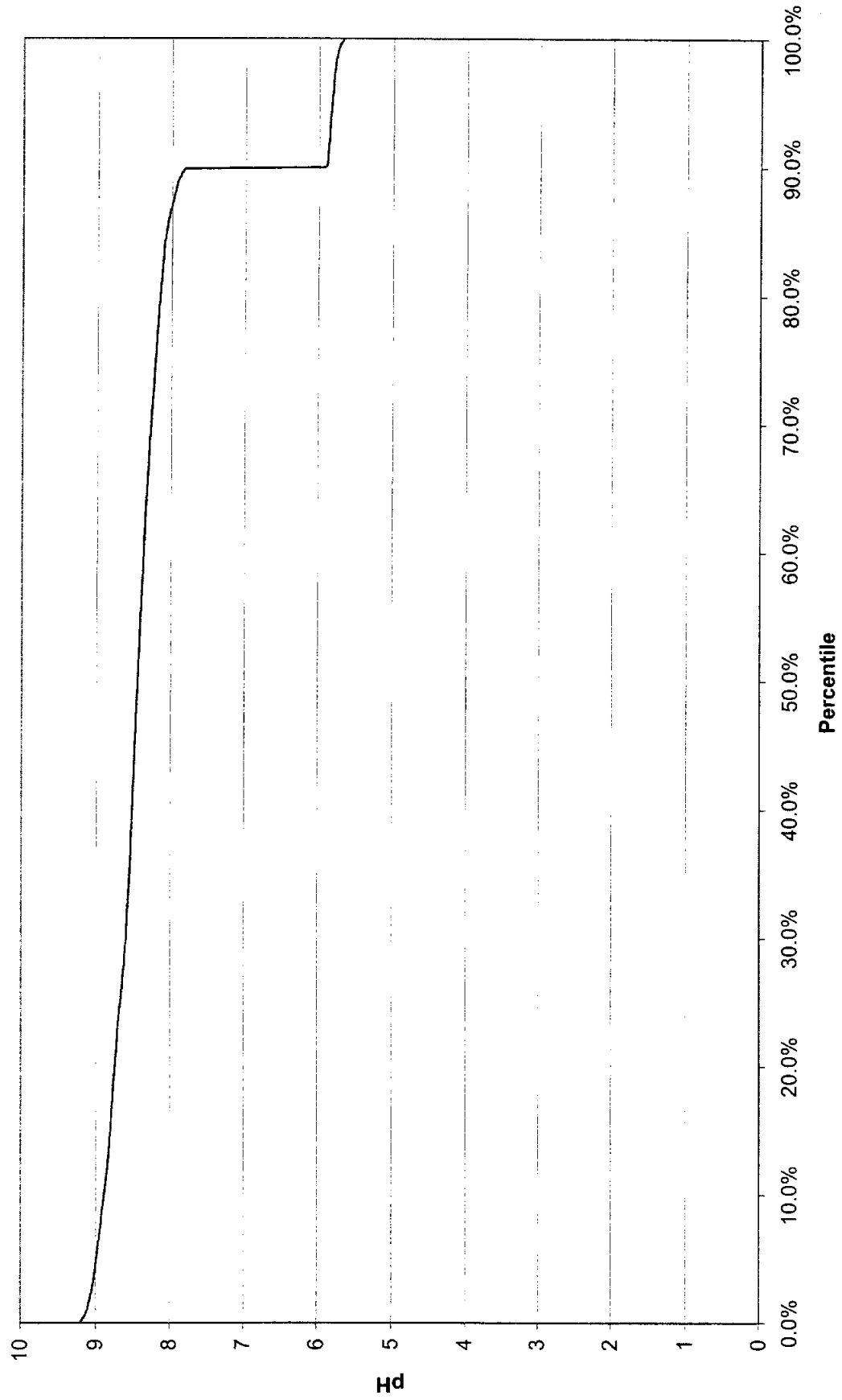

Maximum Daily Salinity
Lavaca Bay

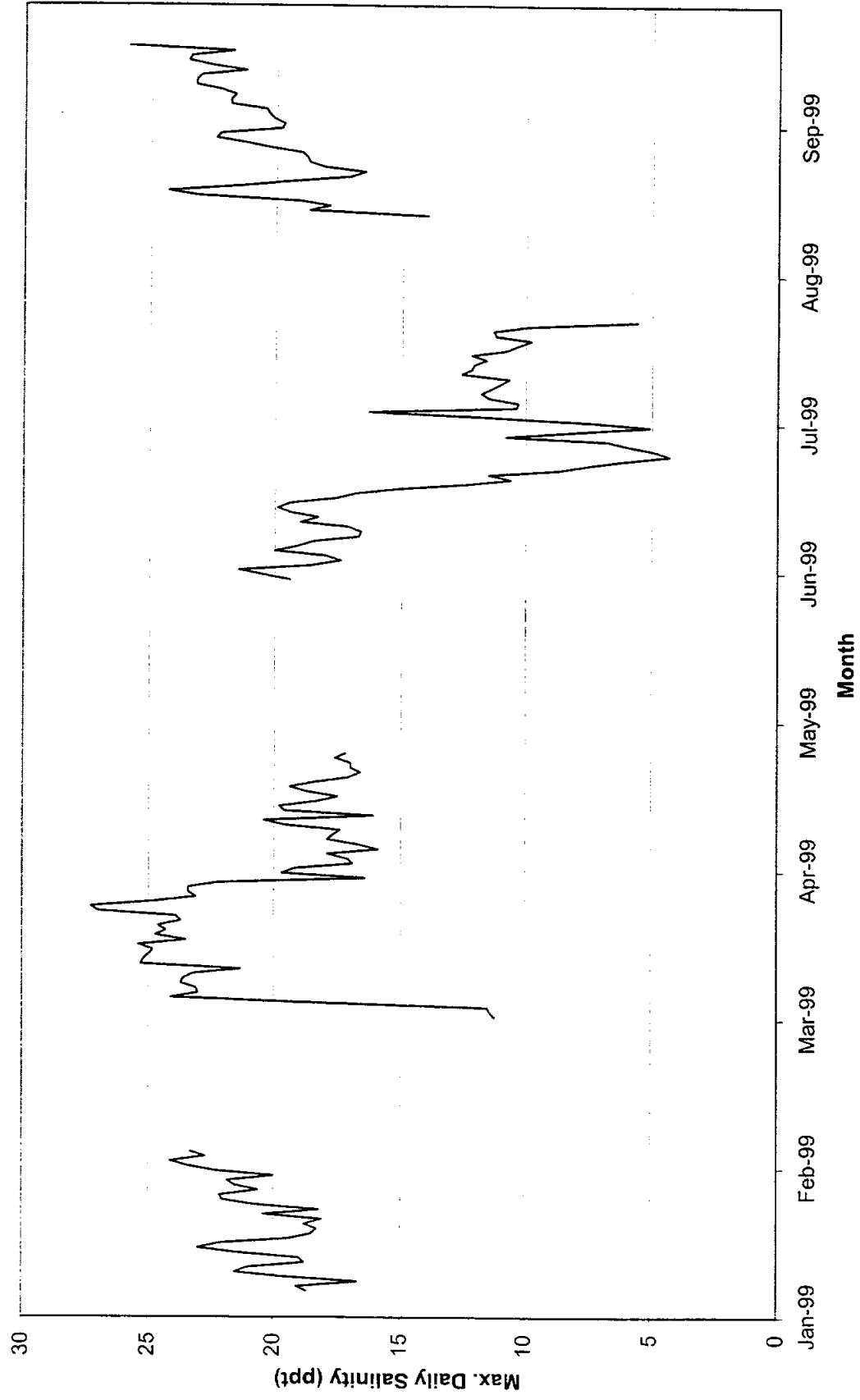

Temperature Frequency Analysis Lavaca Bay

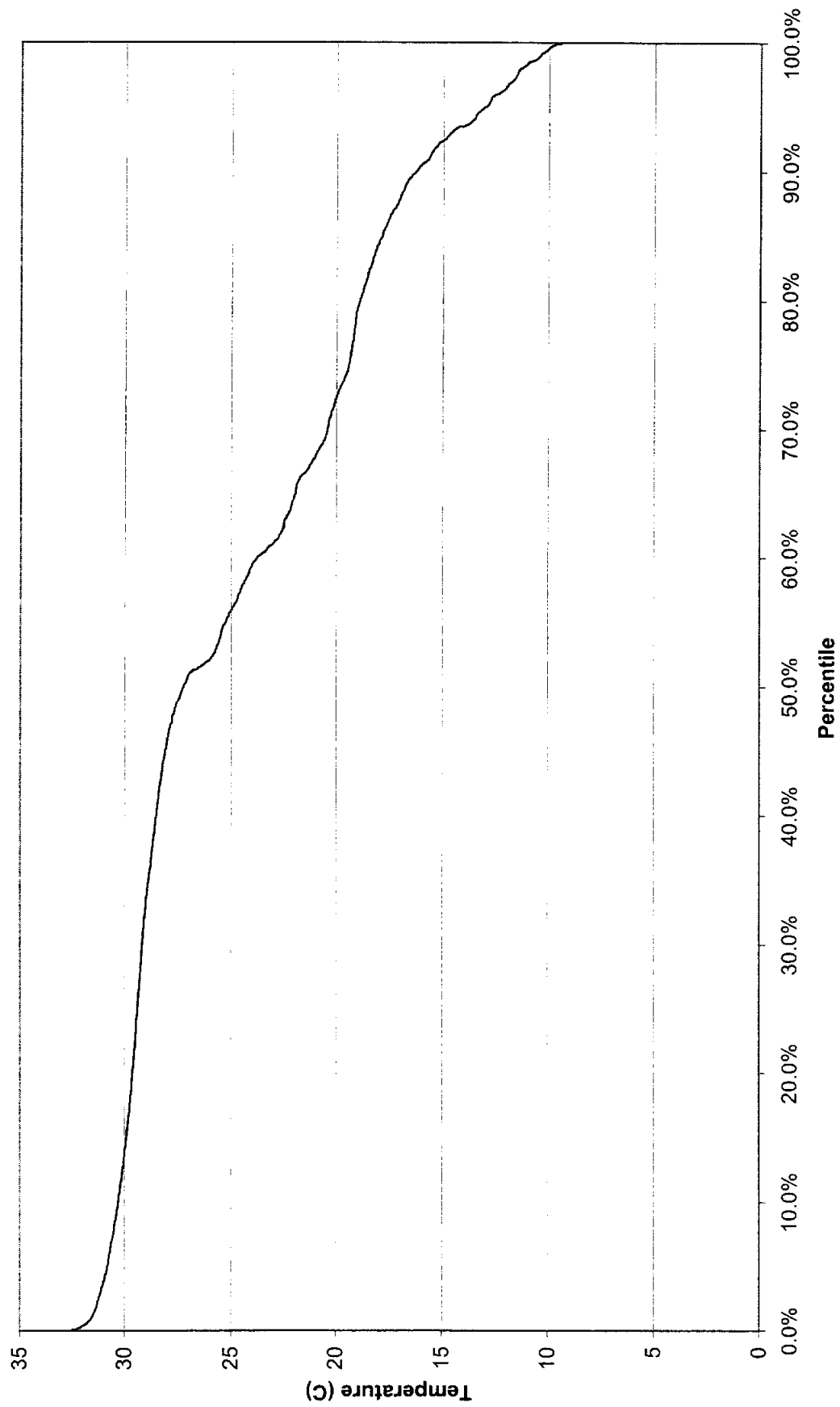

**pH Frequency Analysis
Lavaca Bay**

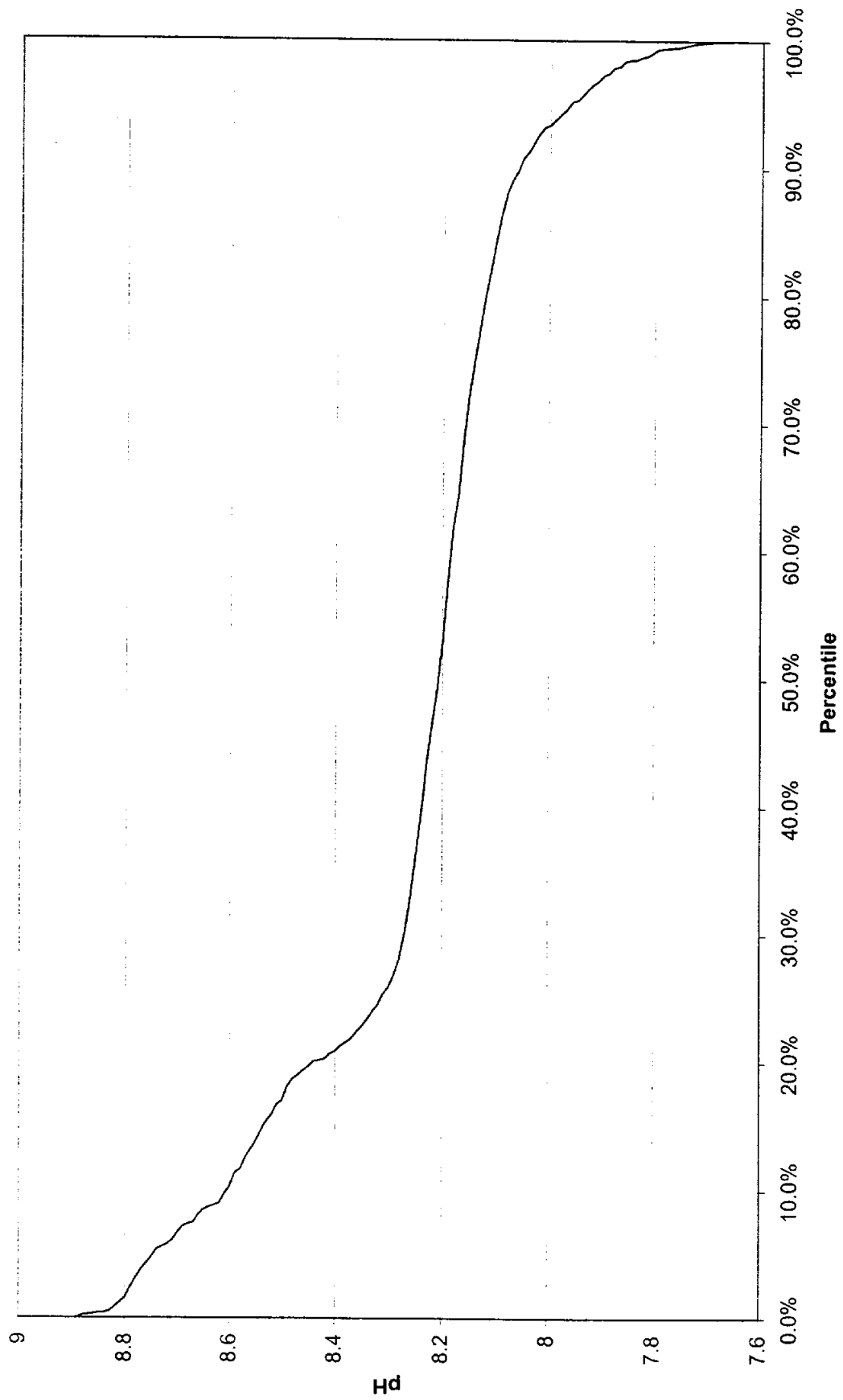

Maximum Daily Salinity Nueces Bay

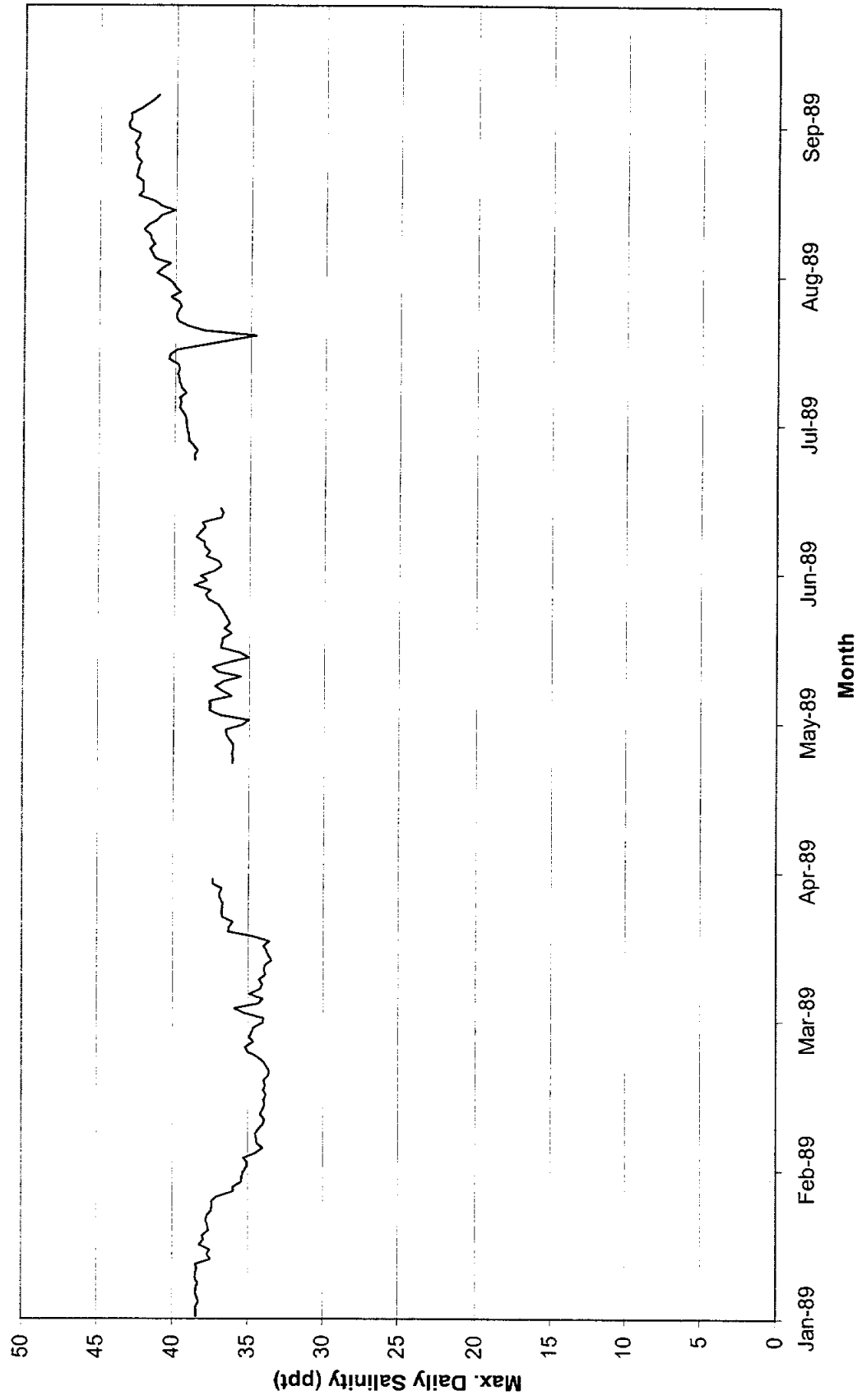

Temperature Frequency Analysis Nueces Bay

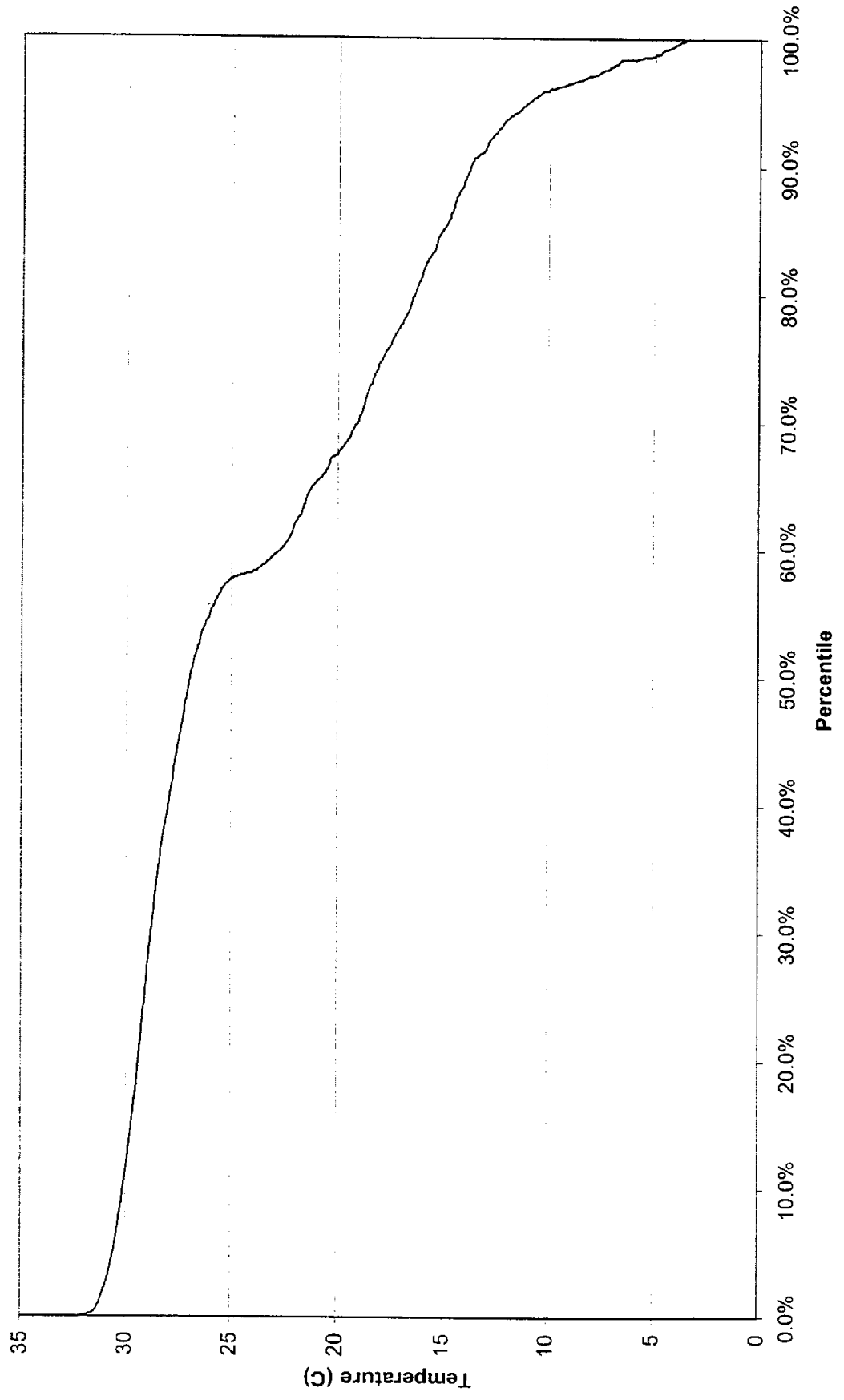

**pH Frequency Analysis
Nueces Bay**

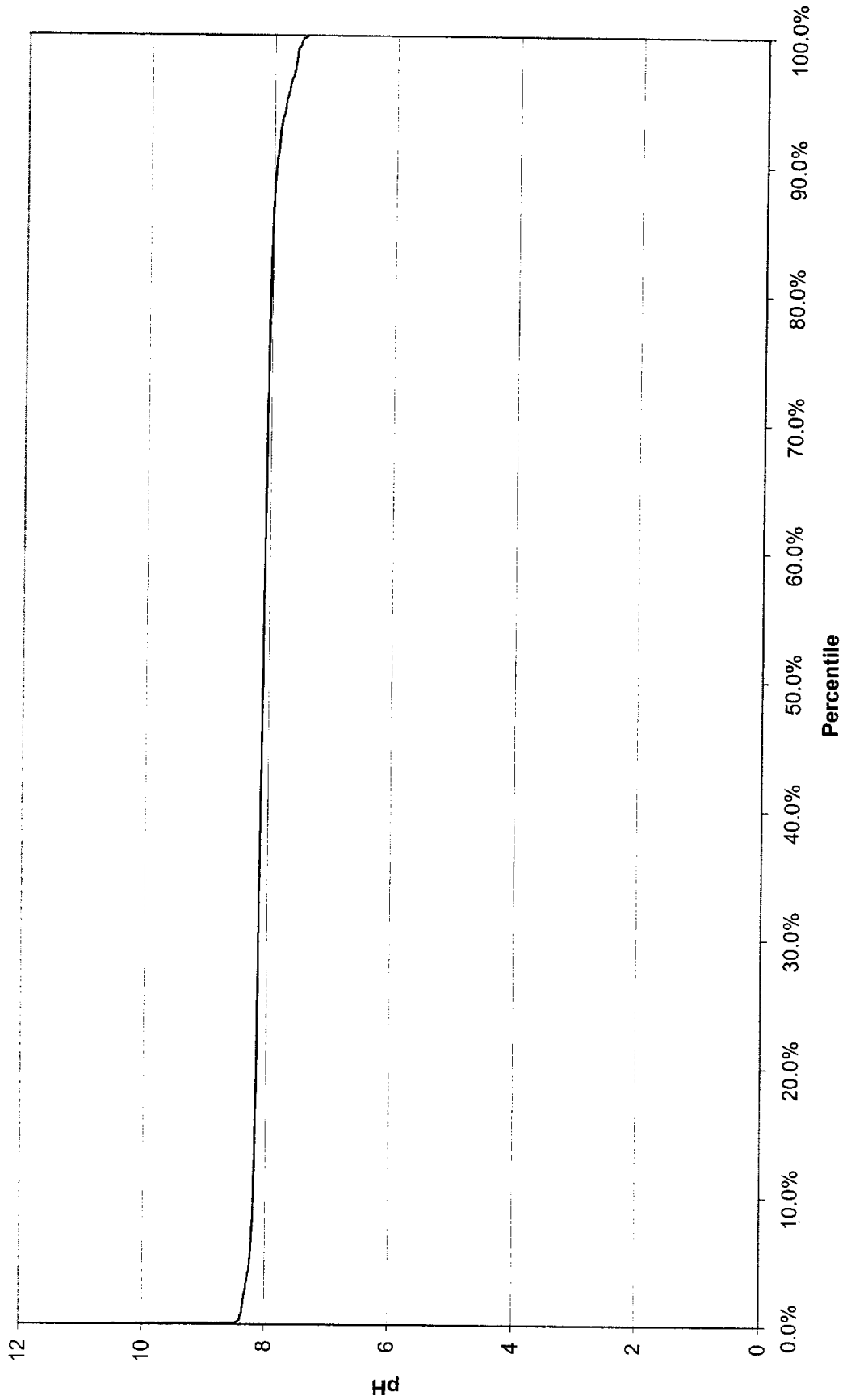

Appendix E

Flood Insurance Rate Maps (FIRM)

Appendix F

Estimating Model Files

Appendix G

***Reply to Executive Administrator's
Review Comments***

Reply to Executive Administrator's Review Comments

TWDB staff comments:

1. The estimated total costs discussed in the narrative on pages B.6-6 and B. 6-9 do not agree with the associated cost figures listed respectively in Table 6-2 and Table 6-4. This should be clarified or corrected.

Reply: Cost figures are correct narrative changed to match figures.

Comments from other commentator (Greg Carter of Central and SouthWest Services):

2. Page B4-8 – Table 4.2 – Using \$0.04 power for the pump station may be too low. It is my understanding that HDR is using \$0.06 power for pump stations in the Region L planning group.
Reply: Power costs of \$0.04 per kWhr are used for the pump station at the desalination plant because for this report it is assumed that the desalination plant receives a discounted power rate due to the large volume of power used. Since it is assumed that the desalination plant gets \$0.04 power then it would be appropriate that the finished water transmission pump station on the plant site would be using the same cost power. Estimates for the Region L planning group do include a more conservative option that uses a cost of \$0.06 power for both the desalination plant and the finished water transmission pump station but those more conservative assumptions were not used for this report.
3. Page B5-3 – Figure 5.1 – The figure does not show Entergy's Sabine plant on Sabine Lake. Please include.
Reply: Plant added to figure.
4. Page B5-7 – Table 5-3 – The maximum possible flow rate for Joslin (231 MGD), Nueces Bay (528 MGD), and Barney Davis (521 MGD) is the sum of the circulation water flows and the salt water flows. Also please title column 3 as Maximum Installed Diversion Capacity. Please note that not all units at a power plant will be running all of the time. The circulation water and salt water pumps on units that are off line will be shut down.
Reply: Changes made as requested.
5. Page B5-8 – Section 5.3 – Please note that there are three major utilities that serve the Texas Gulf Coast (not the Coastal Bend), CPL Houston Lighting and Power – Reliant, and Entergy – Gulf States. A fourth smaller utility, Texas New Mexico Power serves an area along the coast near Lake Jackson.
Reply: Changes made as requested.
6. Page B5-24 – Figure 5-4 – Please add the private, state and national wildlife refuges to the map.

Reply: Wildlife refuge information is not currently available in a GIS format for inclusion in this report. Some colors on Figure 5-4 were changed so that the State and National Park areas are more distinct.

7. Page B6-6 – Section 6-1 – The cost estimates for Barney Davis need to be updated in the written report to agree with Table 6.2.

Reply: Text updated.

8. Page B6-7 – Table 6-2 – The engineering cost contains a typo – too many zeros.

Reply: Corrected.

9. Page B6-9 – The cost estimates for Port Isabel need to be updated in the written part of the report to agree with Table 6.4.

Reply: Text updated.

10. As mentioned in the meeting on 5/11, if an electronic copy of the modeling spreadsheets could be included, it would be beneficial to future users.

Reply: A disk is included with the final report that contains the zipped Excel files used to develop costs.



TEXAS WATER DEVELOPMENT BOARD

William B. Madden, *Chairman*
Jack Hunt, *Member*
Wales H. Madden, Jr., *Member*

Craig D. Pedersen
Executive Administrator

Noé Fernández, *Vice-Chairman*
William W. Meadows, *Member*
Kathleen Hartnett White, *Member*

July 20, 2000

Mr. Con Mims
Executive Director
Nueces River Authority
P.O. Box 349
Uvalde, Texas 78802-0349

Re: Research Grant Contract Between the Nueces River Authority (NRA) and the Texas Water Development Board (Board), Draft Final Report Review "Desalination for Texas Water Supply", Contract No. 99-483-280

Dear Mr. Mims:

Staff members of the Texas Water Development Board have completed a review of the draft report under TWDB Contract No. 99-483-280. As stated in the above referenced contract, NRA will consider incorporating comments from the EXECUTIVE ADMINISTRATOR shown in Attachment 1 and other commentors on the draft final report into a final report. NRA must include a copy of the EXECUTIVE ADMINISTRATOR's comments in the final report.

The Board looks forward to receiving one (1) unbound camera-ready original and nine (9) bound double-sided copies of the Final Report on this research project. Please contact Mr. J.D. Beffort at (512) 463-7989, if you have any questions about the Board's comments.

Sincerely,

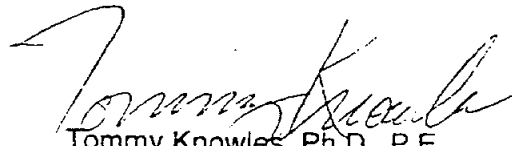
Tommy Knowles, Ph.D., P.E.
Deputy Executive Administrator
Office of Planning

Cc: James A. Dodson, Deputy Executive Director
J.D. Beffort

Our Mission

Provide leadership, technical services and financial assistance to support planning, conservation, and responsible development of water for Texas.

P.O. Box 13231 • 1700 N. Congress Avenue • Austin, Texas 78711-3231
Telephone (512) 463-7847 • Telefax (512) 475-2053 • 1-800- RELAY TX (for the hearing impaired)
URL Address: <http://www.twdb.state.tx.us> • E-Mail Address: info@twdb.state.tx.us

Printed on Recycled Paper

ATTACHMENT 1
TEXAS WATER DEVELOPMENT BOARD
Review of the Draft Final Report: Contract No. 99-483-280
"Desalination for Texas Water Supply"

TWDB staff comments:

1. The estimated total costs discussed in the narrative on pages B. 6-6 and B. 6-9 do not agree with the associated cost figures listed respectively in Table 6-2 and Table 6-4. This should be clarified or corrected.

Comments From Other Commentor (Greg Carter of Central and SouthWest Services):

2. Page B4-8 - Table 4.2 - Using \$0.04 power for the pump station may be too low. It is my understanding that HDR is using \$0.06 power for pump stations in the Region L planning group.
3. Page B5-3 - Figure 5.1 - The figure does not show Entergy's Sabine plant on Sabine Lake. Please include.
4. Page B5-7 - Table 5-3 - The maximum possible flow rate for Joslin (231 MGD), Nueces Bay (528 MGD), and Barney Davis (521 MGD) is the sum of the circulating water flows and the salt water flows. Also please title column 3 as Maximum Installed Diversion Capacity. Please note that not all units at a power plant will be running all of the time. The circulating water and salt water pumps on units that are off line will be shut down.
5. Page B5-8 - Section 5.3 - Please note that there are three major utilities that serve the Texas Gulf Coast (not the Coastal Bend), CPL, Houston Lighting and Power - Reliant, and Entergy - Gulf States. A fourth smaller utility, Texas New Mexico Power, serves an area along the coast near Lake Jackson.
6. Page B5-24 - Figure 5-4 - Please add the private, state and national wildlife refuges to the map.
7. Page B6-6 - Section 6-1 - The cost estimates for Barney Davis need to be updated in the written part of the report to agree with Table 6.2.
8. Page B6-7 - Table 6-2 - The engineering cost contains a typo - too many zeros.
9. Page B6-9 - The cost estimates for Port Isabel need to be updated in the written part of the report to agree with Table 6.4.
10. As mentioned in the meeting on 5/11, if an electronic copy of the modeling spreadsheets could be included, it would be beneficial to future users.

Desalination for Texas Water Supply- #99-483-280 &
#2000-483-328

Part A: Membrane Technologies and Costs

Part B: Economic Importance of Siting Factors
For Seawater Desalination
August 2000

The following maps are not attached to this report. Due to their size, they could not be copied. They are located in the official file and may be copied upon request.

Firm Flood Insurance Rate Map Calhoun County, Texas
Community - Panel Number 480097 0053 C Site 1 Jan. 3, 1985

City of Corpus Christi, Texas Nueces and Kleberg Counties
Community -Panel Number 485464 0356 C, Site 2
Revised July 18, 1985

City of Port Isabel, Texas Cameron County
Community -Panel Number 480109 0001 B
Revised June 1, 1983 Site 3

Please contact Research and Planning Fund Grants Management
Division at (512) 463-7926 for copies.