

April 13

Locks to Fla

28 Mar

Evaluation of Alternate Plans

INTERIM SURVEY REPORT  
LAKE PONTCHARTRAIN, LOUISIANA  
AND VICINITY

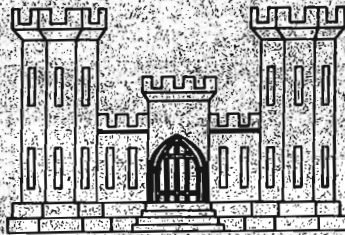

U. S. ARMY ENGINEER DISTRICT, NEW ORLEANS  
CORPS OF ENGINEERS  
NEW ORLEANS, LOUISIANA

21 NOVEMBER 1962

SERIAL NO. 289

HURRICANE STUDY  
INTERIM SURVEY REPORT  
LAKE PONTCHARTRAIN, LOUISIANA AND VICINITY

SYLLABUS

The lowlands in the Lake Pontchartrain tidal basin are subject to tidal overflow. The Greater New Orleans Metropolitan area which lies in this basin will continue its rapid economic development in the near future even though severe damages have resulted from several hurricanes in the recent past. Hurricane damages result from surges entering Lake Pontchartrain from Lake Borgne through natural tidal passes at Rigolets and Chef Menteur Pass and through improved channels of the Mississippi River-Gulf Outlet and Inner Harbor Navigation Canal. The surges are intensified by local wind effects, and the combination of waves and surges causes overtopping of the protective works along the shores of the lake. The eastern portion of the area is also subject to flooding by surges and waves that move directly from Lake Borgne and overtop the existing inadequate protective system seaward of the developed land areas. As a result, residences and industrial and commercial establishments suffer damage, business activities are disrupted, lives endangered, and hazards to health created. Hurricanes much more severe than any of record are possible. In the event of the occurrence of such a severe hurricane, catastrophic property damage and loss of human life would be experienced. Local interests have requested protection against these threats to life and property. Another and related problem exists in the area. The Mississippi River-Gulf Outlet provides a deep, direct route for the inflow of saline currents from the Gulf of Mexico to the area along its channel and to Lake Pontchartrain, with resultant adverse effect on fishery resources in the area. The Gulf Outlet Channel also will produce high velocity currents in the Inner Harbor Navigation Canal, creating a hazard to navigation and causing serious scour and damage, particularly in constricted areas at bridge crossings. These adverse effects can be greatly alleviated by construction of a lock for navigation and salinity control at the lake end of the Inner Harbor Navigation Canal at Seabrook. This lock is properly chargeable as a feature of the Gulf Outlet project. A low level lock to the height of the existing protective works will serve the needs of the Gulf Outlet project. By increasing the grade of the rock dike and the landward gate bay section and gates, this structure will also serve as an essential part of a hurricane barrier plan by preventing the entry of hurricane surges into Lake Pontchartrain through the Gulf Outlet. The incremental cost of raising the lock to serve the dual purpose of excluding hurricane surges is properly a charge to the hurricane plan.

The recommended protection plan for the Lake Pontchartrain basin consists of a barrier at the east end of the lake to exclude hurricane tides, coupled with construction or enlargement of protective works fronting developed or potentially developable areas. The barrier would comprise enlarged embankments along the seaward levee system, new embankment extending to high ground on the north side of the Rigolets with regulating tidal and navigation structures in the Rigolets and Chef Menteur Pass, and a dual purpose navigation lock in the Inner Harbor Navigation Canal at Seabrook for control of hurricane inflows into the lake as

well as to limit objectionable salinity intrusion into the lake and tidal currents in the canal now developing from construction of the Mississippi River-Gulf Outlet. Additional protective works along the shores of the lake consist of new lakeshore levees in St. Charles Parish, Citrus, and New Orleans East, and the enlargement or strengthening of existing protective works in Jefferson and Orleans Parishes, and at Mandeville. Gravity drainage facilities are included as integral parts of all new levees. Costs of these features and distribution of costs between navigation and hurricane protection are given in the pertinent data table.

The plan of protection recommended for the Chalmette area provides for the improvement of the existing levee along the Inner Harbor Navigation Canal and construction of new levees along the south side of the Mississippi River-Gulf Outlet from the Inner Harbor Navigation Canal to Bayou Dupre and thence along the bayou to Violet. Gravity drainage structures are included as an essential part of the plan.

For the Lake Pontchartrain barrier plan and for the Chalmette area, local interests will be required to provide all lands, easements, rights-of-way, and relocations without cost to the United States; to maintain and operate the project and all drainage facilities after completion except as described below; to hold and save the United States free from damages due to the construction works; to contribute 30 percent of the first costs in cash or equivalent work necessary to accomplish approved construction schedules, said 30 percent to include fair market values of lands and relocations, unless they exceed the value of the 30 percent contribution; to acquire adequate easements or other interests in land to prevent encroachment on existing ponding areas unless substitute storage capacity or equivalent pumping capacity is provided promptly without cost to the United States; and to provide all interior drainage and pumping plants required for reclamation and development of the protected areas. Local interests also will provide, at the time of construction of the hurricane protection works, an additional cash contribution equal to the capitalized value of the annual cost for the operation and maintenance of the Rigolets lock and navigation canal, said operation and maintenance to be undertaken by the United States.

Local interests will be required to provide for the Mississippi River-Gulf Outlet lock project at Seabrook all lands, easements, and rights-of-way without cost to the United States, and hold and save the United States free from damages due to the construction works.

Additional protection from hurricane tides can be afforded by local interests to residents of low-lying coastal communities by the establishment of building codes and zoning regulations, provision of adequate havens of refuge, and organization of hurricane preparedness committees to formulate plans for effective preventive measures, evacuation and rescue work, all at no cost to the United States.

Project	First cost	Federal	Non-Federal	Lands & relocations	Annual Oprn. & Maint. Federal	Capitalized Oprn. & Maint.	Av. annual benefits	B/C ratio	
	\$1,000	\$1,000	\$1,000	\$1,000	\$1,000	\$1,000	\$1,000		
Lake Pontchartrain barrier plan	64,703(a)	41,200(b)	23,503(c)	5,027	125	4,092	2,535.6	48,009	18.9 to 1
Chalmette	15,143	10,600	4,543	899	-	-	572.2	5,152	9.0 to 1
Mississippi River-Gulf Outlet (existing project)	104,220(d)	95,490	8,730	8,730	1,627.5	-	4,965.7	9,080	1.8 to 1
Seabrook Lock (proposed)	4,980(e)	4,980	-	-	120.0	-	278.6	-	-
Mississippi River-Gulf Outlet (recommended modification)	109,200	100,470	8,730	8,730	1,747.5	-	5,244.3	9,080	1.7 to 1

- (a) Includes \$400,000 cost for modification of Seabrook dual purpose lock.
- (b) 70 percent of first cost less capitalized operation and maintenance.
- (c) 30 percent of first cost plus capitalized operation and maintenance.
- (d) Approved cost estimate from PB-3 effective 1 July 1962.
- (e) Excludes \$400,000 chargeable to hurricane protection.



INTERIM SURVEY REPORT  
ON  
LAKE PONTCHARTRAIN, LOUISIANA AND VICINITY

TABLE OF CONTENTS

<u>Paragraph</u>	<u>Title</u>	<u>Page</u>
	GLOSSARY	ix
	SYLLABUS	i
	SECTION I - AUTHORIZATION, PURPOSE, AND SCOPE	
1	Authority	1
2	Purpose and extent of investigation	3
3	Prior reports	4
	SECTION II - DESCRIPTION	
4	Description	4
	Location and extent	4
	Topography	4
	Geology	7
	Tides	9
	Flood protection and interior drainage	10
	Maps	12
5	Economic development	13
	Population	13
	Industry	13
	Mineral production	13
	Fisheries and fur animals	14
	Recreation	14
	Agriculture	14
	Foreign trade	14
	Navigation	14
	Transportation	14
	Defense establishments	15
	Trends of growth and development	15
6	Climatology	16
	Climate	16
	Temperature	16
	Rainfall	16
	Wind	16
7	Hurricanes of record	17
	Historical hurricanes	17
	Hurricane frequency	21

TABLE OF CONTENTS (cont'd).

<u>Paragraph</u>	<u>Title</u>	<u>Page</u>
8	Hurricane characteristics	22
	General description	22
	Origins and tracks	22
	Barometric pressures and winds	23
	Surge	23
	Waves	24
	Rainfall	24
9	Standard project hurricane	24
10	Probable maximum hurricane	25
11	Extent and character of flooded area	25
12	Hurricane flood damages	27
	Flood damage surveys	27
	Experienced damages	28
	Estimates of probable future damages	28
	Average annual damages	30
13	Existing Corps of Engineers' projects	30
14	Improvements by other Federal and non-	
	Federal agencies	31
	Federal	31
	Non-Federal	32
SECTION III - PROBLEMS UNDER INVESTIGATION		
15	Improvements desired	32
	Public hearings	32
	Proposals by local interests	32
16	Hurricane flood problems, related problems, and solutions considered	33
	Hurricane flood problems	33
	Related problem	33
	Protective measures considered	33
	Model study	38
SECTION IV - PROPOSED SOLUTIONS AND PROJECT FORMULATION		
17	Plans of protection	38
	General	38
	Design hurricane	39
	Design elevations	39
	Description of the plans	39
	Construction	43
	Operation and maintenance	43
18	Other desirable improvements	44
	Hurricane preparedness plans	44
	Refuge shelters	44
	Zoning regulations and building codes	44

TABLE OF CONTENTS (cont'd)

<u>Paragraph</u>	<u>Title</u>	<u>Page</u>
SECTION V - ECONOMIC ANALYSIS		
19	Estimates of first cost	44
	Mississippi River-Gulf Outlet, Seabrook Lock	45
	Lake Pontchartrain barrier plan Chalmette	45 46
20	Estimates of annual charges	46
	Mississippi River-Gulf Outlet, Seabrook Lock	46
	Lake Pontchartrain barrier plan Chalmette	47 47
21	Estimates of benefits	47
	Mississippi River-Gulf Outlet, Seabrook Lock	47
	Flood damages and flood damages prevented	48
	Enhancement	49
22	Economic justification	50
SECTION VI - COORDINATION AND LOCAL COOPERATION		
23	Proposed local cooperation	51
	Mississippi River-Gulf Outlet, Seabrook Lock	51
	Lake Pontchartrain barrier plan and Chalmette	51
24	Apportionment of costs among interests	53
	Mississippi River-Gulf Outlet, Seabrook Lock	53
	Hurricane protection plans	53
25	Coordination with other agencies	54
	U. S. Department of Commerce	55
	U. S. Department of the Interior	55
	U. S. Coast Guard	56
	U. S. Department of Agriculture	56
	State of Louisiana	57
	Assurances of cooperation	57
SECTION VII - RESULTS OF INVESTIGATION		
26	Discussion and conclusions	57
	Lake Pontchartrain barrier plan Chalmette	58 59
	Effects on other interests	59
	Local measures	59

TABLE OF CONTENTS (cont'd)

<u>Paragraph</u>	<u>Title</u>	<u>Page</u>
SECTION VIII - RECOMMENDATIONS		
27	Recommendations	60
	Lake Pontchartrain barrier plan	60
	Chalmette	62
	Mississippi River-Gulf Outlet, Seabrook Lock	63

FIGURES

<u>Figure</u>	<u>Title</u>	<u>Page</u>
1	New Orleans seawall - 1947	20
2	New Orleans seawall and St. Bernard flooding - 1956	29
3	New Orleans flooding - 1956	34

PLATES

<u>Plate</u>	<u>Title</u>
1	General map
2	Drainage pattern - Orleans and Jefferson Parishes
3	Plans of protection
4	Mississippi River-Gulf Outlet-Navigation Lock- Seabrook
5	Hurricane barriers - Chef Menteur
6	Hurricane barriers - Rigolets
7	Typical sections - Barrier embankments
8	Navigation lock - Rigolets
9	Lake Pontchartrain barrier plan-navigation lock-Seabrook
10	Typical sections - Lakeshore embankments
11	Typical sections - Back and lateral embankments
12	Drainage structure - St. Charles Parish
13	Drainage structure - Bayou Bienvenue and Bayou Dupre

APPENDIXES

<u>Appendix</u>	<u>Title</u>
A	HYDROLOGY AND HYDRAULICS
B	GEOLOGY
C	FLOOD LOSSES AND BENEFITS
D	COST ESTIMATES
E	PROTECTION AND IMPROVEMENT FEATURES
F	REPORT OF U. S. FISH AND WILDLIFE SERVICE
G	VIEWS OF ORLEANS LEVEE DISTRICT
H	PERSONNEL
I	ADDITIONAL CORPS OF ENGINEERS' PROJECTS



TABLE OF CONTENTS (cont'd)

APPENDIXES

<u>Appendix</u>	<u>Title</u>
A	HYDROLOGY AND HYDRAULICS
B	GEOLOGY
C	FLOOD LOSSES AND BENEFITS
D	COST ESTIMATES
E	PROTECTION AND IMPROVEMENT FEATURES
F	REPORT OF U. S. FISH AND WILDLIFE SERVICE
G	VIEWS OF ORLEANS LEVEE DISTRICT
H	PERSONNEL
I	ADDITIONAL CORPS OF ENGINEERS' PROJECTS

ATTACHMENT

Information Called for by Senate Resolution 148,  
85th Congress, Adopted 28 January 1958

SUPPLEMENTS

(published separately)

<u>Supplement</u>	<u>Title</u>
1	"History of Hurricane Occurrences along Coastal Louisiana," 29 Dec. 1961, U. S. Army Engineer District, New Orleans.
2	"Transcript of Public Hearings," 13, 15, and 20 March 1956, U. S. Army Engineer District, New Orleans.
3	"Effects on Lake Pontchartrain, La. of Hurricane Surge Control Structures and Mississippi River-Gulf Outlet Channel," February 1963, U. S. Army Engineer Waterways Experiment Station.
4	"Prototype Data Collection Program for Model Study of Lake Pontchartrain, La. and Vicinity," July 1962, U. S. Army Engineer District, New Orleans.
5	"A Detailed Report on Hurricane Study Area No. 1 Lake Pontchartrain and Vicinity, Louisiana," U. S. Dept. of the Interior, Fish and Wildlife Service.

## GLOSSARY

ASTRONOMICAL TIDE - See PREDICTED NORMAL TIDE.

ATMOSPHERIC PRESSURE ANOMALY - The difference between atmospheric pressure at any point within the hurricane and normal pressure at the periphery of the hurricane.

BUILDUP - The increase, in feet, over that from other causes, of water surface elevation in a body of water resulting from:

1. Convergence in depth or width
2. Construction of a barrier
3. Ponding

CENTRAL PRESSURE - The minimum atmospheric pressure within the hurricane at any specific time.

FETCH - The continuous area of water over which the wind blows in essentially a constant direction. Often used synonymously with FETCH LENGTH.

FETCH LENGTH - The horizontal distance over which the wind from a fixed direction may have unobstructed contact with the water surface.

HURRICANE - A cyclonic storm, usually of tropical origin, containing winds of 75 miles per hour or more.

- a. DESIGN HURRICANE - That hurricane selected by the reporting office as a basis for design of the proposed plan of improvement.
- b. STANDARD PROJECT HURRICANE - A hurricane that may be expected from the most severe combination of meteorological conditions that are considered characteristic of the region involved.
- c. PROBABLE MAXIMUM HURRICANE - The hurricane that may be expected from the most severe combination of meteorological conditions that are reasonably possible in the region.
- d. MODERATE HURRICANE - A hurricane that may be expected from a combination of meteorological conditions that are frequently experienced in the region.
- e. TRANSPOSED HURRICANE - A storm transferred from actually observed location to another location for the purpose of study, with appropriate changes in storm characteristics.

HURRICANE PATH (OR TRACK) - The line connecting successive locations of central pressure of the hurricane.

HURRICANE SPEED - The rate of forward movement.

HURRICANE SURGE - The mass of water causing an increase in elevation of the water surface at the time of a hurricane.

HURRICANE SURGE HEIGHT - The elevation of the still water level at a given point resulting from hurricane surge action. It may be the result of one or more of the following components:

1. Predicted normal tide
2. Pressure setup
3. Wind setup
4. Buildup

In inland lakes, surge height does not include local wind setup.

HURRICANE TIDE - The elevation of the still water level at a given point during a hurricane. In inland lakes it is the sum of hurricane surge height and additional local wind setup, but does not include wave setup.

KNOT - A velocity equal to one nautical mile (6,080 feet) per hour, or about 1.15 statute miles per hour.

LANDFALL - The arrival of a hurricane center at the coastline.

OVERTOPPING - The amount of water passing over the top of a structure as a result of wave runup or surge action.

PONDING - The storage behind a water-retaining structure of water from interior runoff or from overtopping of a structure.

PREDICTED NORMAL TIDE - The predicted still water elevation of the ocean and its tidal arms at a given time and place when unaffected by abnormal phenomena, i.e., resulting only from the gravitational attraction of the moon, sun, and other astronomical bodies acting upon the rotating earth. (This term is preferable to "astronomical," whose other meaning, fabulously large, could be misleading to the uninformed.)

PRESSURE SETUP - The conversion of atmospheric pressure anomaly to equivalent height of water and adjusted for its dynamic effects as a part of the total hurricane surge.

RANGE - A narrow fetch over which the hurricane surge height is computed.

- RUNUP - The vertical elevation above still water level to which water rises on the face of a structure as a result of wave action.
- SETDOWN - The decrease in water surface elevation behind a water-retaining barrier or at a windward shore due to wind action.
- SETUP - Same as WIND SETUP.
- SIGNIFICANT WAVE - A statistical term denoting waves having the average height and period of the highest one-third waves of a given wave train.
- STILL WATER LEVEL - The elevation of the water surface if all wave action were to cease.
- STORM SURGE - Same as HURRICANE SURGE, except that it may be caused by storms not of hurricane characteristics as well as by hurricanes.
- WAVE HEIGHT - The vertical distance between the crest and the preceding trough. (Referenced to significant waves in this report.)
- WAVE SETUP - The superelevation of the water surface above the hurricane tide height due to wave action alone.
- WAVE TRAIN - A series of waves from the same direction.
- WIND SETUP - The vertical rise in the still water level, above that which would occur without wind action, caused by wind stresses on the surface of the water. Wind setup is a component of hurricane surge height, and of hurricane tide in inland lakes.



U. S. ARMY ENGINEER DISTRICT, NEW ORLEANS  
CORPS OF ENGINEERS  
Foot of Prytania Street  
New Orleans, Louisiana

21 November 1962

SUBJECT: Interim Survey Report on Hurricane Study of  
Lake Pontchartrain, Louisiana and Vicinity

THRU: Division Engineer  
U. S. Army Engineer Division  
Lower Mississippi Valley  
Vicksburg, Mississippi

TO: Chief of Engineers  
Department of the Army  
Washington 25, D. C.

SECTION I - AUTHORIZATION, PURPOSE, AND SCOPE

1. AUTHORITY

This report is submitted in response to the following:

a. Public Law 71, 84th Congress, 1st Session, approved 15  
June 1955:

"BE IT ENACTED BY THE SENATE AND HOUSE OF REPRESENTATIVES  
OF THE UNITED STATES OF AMERICA IN CONGRESS ASSEMBLED, That:

"In view of the severe damage to the coastal and tidal areas of the eastern and southern United States from the occurrence of hurricanes, particularly the hurricanes of August 31, 1954, and September 11, 1954, in the New England, New York, and New Jersey coastal and tidal areas, and the hurricane of October 15, 1954 in the coastal and tidal areas extending south to South Carolina, and in view of the damages caused by other hurricanes in the past, the Secretary of the Army, in cooperation with the Secretary of Commerce and other Federal agencies concerned with hurricanes, is hereby authorized and directed to cause an examination and survey to be made of the eastern and southern seaboard of the United States with respect to hurricanes, with particular reference to areas where severe damages have occurred.

1.a.

"Sec. 2. Such survey, to be made under the direction of the Chief of Engineers, shall include the securing of data on the behavior and frequency of hurricanes, and the determination of methods of forecasting their paths and improving warning services, and of possible means of preventing loss of human lives and damages to property, with due consideration of the economics of proposed breakwaters, seawalls, dikes, dams, and other structures, warning services, or other measures which might be required.

"Sec. 3. There are hereby authorized to be appropriated such sums as may be necessary to carry out the provisions of this Act."

b. Provisions of the River and Harbor Act as approved 2 March 1945, which read in part as follows:

"Sec. 6. The Secretary of War is hereby authorized and directed to cause preliminary examinations and surveys to be made at the following-named localities: \* \* \*

"Lake Pontchartrain, Louisiana, \* \* \* with a view to the protection of the shoreline and repairs to the existing protective works on Lake Pontchartrain at Mandeville, Louisiana."

c. A resolution of the United States Senate Committee on Public Works as adopted 28 January 1949, which states:

"RESOLVED BY THE COMMITTEE ON PUBLIC WORKS OF THE UNITED STATES SENATE, That the Board of Engineers for Rivers and Harbors, created under Section 3 of the River and Harbor Act, approved June 13, 1902, be, and is hereby, requested to review existing reports on Lake Pontchartrain, Louisiana, with a view to determining if any modifications of recommendations contained therein are advisable at the present time with respect to flood control, navigation, and beach erosion control in Orleans Parish, Louisiana."

d. A resolution of the United States Senate Committee on Public Works as adopted 4 February 1957, which states:

"RESOLVED BY THE COMMITTEE ON PUBLIC WORKS OF THE UNITED STATES SENATE, That the Chief of Engineers of the United States Army is hereby requested to review the reports published as House Document Numbered 691, Seventy-ninth Congress, Second Session, and subsequent reports on Lake Pontchartrain, Louisiana, with a view to determining the advisability of extending the existing levee on the south shore of Lake Pontchartrain in Jefferson Parish, along the lake shore in St. Charles Parish to tie-in with the south guide levee of the Bonnet Carre Spillway, in view of recent changed physical or economic conditions."

## 2. PURPOSE AND EXTENT OF INVESTIGATION

a. The authorizing legislation cited in paragraph 1.a. prescribes a Hurricane Study for the eastern and southern seaboard of the United States. In order to facilitate the study, the entire Louisiana coast within the limits of the U. S. Army Engineer District, New Orleans, was divided into six independent areas. The study area covered by this interim report, designated "Lake Pontchartrain, Louisiana and Vicinity," is one of these areas and is shown on plate 1. The purpose of this report is to present plans and recommendations for protection of life and property against hurricane flooding. This includes consideration of hurricane protective works at New Orleans and Mandeville. Beach erosion and navigation are discussed in paragraph 26 a. A report in response to the resolution cited in paragraph 1.d. was assigned to the Mississippi River Commission but that report has been combined with the hurricane study.

b. Basic data were available for the study from surveys and studies made in connection with previous reports and existing projects in the area. These data consisted of topographic maps and aerial photographs, topographic and geological surveys, construction drawings, hurricane damage survey reports, census reports, development planning reports and records of hurricane damages from newspapers, periodicals, miscellaneous reports, and U. S. Weather Bureau files. Details and descriptions of experienced hurricane characteristics and damage are given in supplement 1, which is published separately. Additional data required for the study were obtained from field surveys, appraisal studies to determine damages for selected surge heights, and research of technical bulletins, reports, and publications. The U. S. Army Engineer Waterways Experiment Station conducted model studies to determine the effect of proposed plans on the existing circulation patterns and salinity regimen of Lake Pontchartrain.

c. The following agencies and organizations were consulted during the course of the study: U. S. Department of Commerce, Weather Bureau; U. S. Department of Interior, Fish and Wildlife Service and Geological Survey; U. S. Coast Guard; U. S. Department of Agriculture, Soil Conservation Service; U. S. Department of Health, Education and Welfare, Public Health Service; State of Louisiana, Department of Public Works, Department of Wild Life and Fisheries, Department of Highways, Board of Health, Port of New Orleans, Orleans Levee Board, and Chalmette Back Levee District; Sewerage and Water Board of New Orleans; and Jefferson Parish, Department of Sanitation.

d. The District Engineer made a reconnaissance of the area during the preparation of this report.

3.

### 3. PRIOR REPORTS

The prior reports in the area have been concerned with navigation, and with flood control in the Lower Mississippi River and Lake Pontchartrain. Pertinent reports are as follows:

a. House Document No. 90, 70th Congress, 1st Session, submitted 8 December 1927, is the basis of the Flood Control, Mississippi River and Tributaries project adopted by the Flood Control Act of 15 May 1928. The Mississippi River levee system is included in this general plan.

b. House Document No. 215, 76th Congress, 1st Session, submitted 15 March 1939, is the basis of the existing project "Mississippi River, Baton Rouge to the Gulf of Mexico, La.," adopted by the River and Harbor Act of 2 March 1945.

c. House Document No. 96, 79th Congress, 1st Session, submitted 19 May 1942, provides the basis for the existing project on the Gulf Intracoastal Waterway east of New Orleans.

d. House Document No. 245, 82nd Congress, 1st Session, submitted 25 September 1951, recommended the 36- by 500-foot channel for the Mississippi River-Gulf Outlet project.

e. Senate Document No. 139, 81st Congress, 2nd Session, submitted 20 February 1950, provides the basis for the existing Lake Pontchartrain, La. levee project along the Jefferson Parish lake-front.

## SECTION II - DESCRIPTION

### 4. DESCRIPTION

a. Location and extent. The study area, as shown on plate 1, is located in southeastern Louisiana in the vicinity of New Orleans. It comprises the low land and water areas between the Mississippi River alluvial ridge and the Pleistocene escarpment to the north and west. The dominant topographic feature is Lake Pontchartrain, a shallow landlocked tidal basin approximately 640 square miles in area and averaging 12 feet in depth. It connects with lesser Lake Maurepas to the west and through Lake Borgne and Mississippi Sound to the Gulf of Mexico to the east. The lake drains approximately 4,700 square miles of tributary area.

b. Topography.

(1) South shore. The south shore area from the Bonnet Carre Spillway to Lake Borgne, comprising part of the Parishes of St. Charles, Jefferson, Orleans, and St. Bernard, is essentially



uniform in topography. The land slopes gently downward as shown on plate 2, from an average elevation 12 feet above m.s.l.,\* along the natural banks of the river to approximately sea level near the lake shores. All of this area is protected from Mississippi River overflow by the main line Mississippi River levee system. A ridge at an elevation of approximately 4 feet and about 2 to 3 miles from the lake runs about parallel to the lake shore in eastern Jefferson Parish and throughout Orleans Parish. This ridge, known as the Metairie-Gentilly Ridge, is the remains of the natural levees of an ancient distributary of the Mississippi River. U. S. Highway 90 generally traverses this ridge in the eastern part of Orleans Parish.

(a) St. Charles Parish. The principal topographical feature of the area is the Bonnet Carre Spillway located in the western part of the parish. Artificial guide levees along both sides of the spillway protect the adjacent land from Mississippi River flood waters diverted through the spillway. Most of the area is unprotected from tidal overflows from the lake.

(b) Jefferson Parish. The Jefferson Parish area is partially protected from tidal overflow from the lake by a Federal levee system, as shown on plate 2, and all runoff is pumped into the lake. The operation of drainage systems has caused subsidence of the natural ground elevations. Interior areas remote from the river are as low as 4 feet below mean sea level.

(c) Orleans Parish. The city of New Orleans includes all of the lands within the boundaries of Orleans Parish. In order to facilitate the study, division of the city into five study areas was necessary.

1. New Orleans. The portion of the city between Jefferson Parish and the Inner Harbor Navigation Canal is designated New Orleans. It is protected from moderate lake stages by a step-face concrete seawall along the lakefront and levees along its east and west boundaries. The drainage system, with pumping plants discharging into the lake and in operation for many years, has caused subsidence of natural ground elevations as much as 6 feet below mean sea level.

2. Inner Harbor Navigation Canal. The lands between the levees along both banks of the canal have been raised to an average elevation of about 5 feet with spoil from the canal. No other protection is afforded to this area against flooding from the canal.

\*Mean sea level, the datum to which all elevations in this report are referenced, unless otherwise indicated.

3. Citrus. The section between the Inner Harbor Navigation Canal and the levee along Paris Road and the slip at Michoud, extending from the lake to the Gulf Intracoastal Waterway, is designated Citrus. It is partially protected from tidal overflow. The area south of U. S. Highway 90 (Chef Menteur Highway) is composed generally of low-lying undeveloped swamp, woodland, and marsh, with an average elevation of about 1.5 feet, and is largely undrained. The area north of the highway, drained by pumping for many years, has subsided as much as 7 feet below mean sea level in the low areas. The Gulf Intracoastal Waterway joins the Inner Harbor Navigation Canal in this area.

4. New Orleans East. The remaining area to the east of the Citrus area is known as New Orleans East. It is partially protected from tidal overflow and consists of low-lying undeveloped marshland, with an average elevation of about 1.5 feet. The Mississippi River-Gulf Outlet, a tidewater channel, connects with the Gulf Intracoastal Waterway in this area.

5. The remainder of the area to the east of New Orleans East is unprotected tidal marsh with an elevation of 1.5 feet. Dominant features are the Rigolets, a tidal channel approximately 3,500 feet wide, 28 feet deep, and about 9 miles long, connecting Lake Pontchartrain with Mississippi Sound; and Chef Menteur Pass, a tidal channel approximately 1,000 feet wide, 43 feet deep, and about 7 miles long, connecting Lake Pontchartrain with Lake Borgne, an embayment of brackish water having access to the gulf by way of Mississippi Sound in the north. U. S. Highway 90, which crosses the marsh from the south shore levee system to the north shore escarpment ranges in elevation between 5 and 12 feet.

(d) Chalmette. The sections of St. Bernard and Orleans Parishes, between the Mississippi River and the Mississippi River-Gulf Outlet, extending from the Inner Harbor Navigation Canal to Bayou Dupre, is designated Chalmette. The higher segment along the river (about 35% of the total) is protected from tidal overflow by a locally built back levee. The area west of Paris Road is drained by pumping and the remainder by gravity. The remainder of the area fronting on the Gulf Outlet consists mainly of undeveloped marshland unprotected and undrained with an average elevation of about 1.5 feet.

(2) North shore. The north shore, comprising the area in St. Tammany Parish, is composed of low-lying marsh and swamp at an elevation of about 1.5 feet, and the adjacent higher land comprising the edge of the escarpment. The principal tributaries of the area, which drain directly into Lake Pontchartrain, are the Tchefuncta River and Bayous Lacombe, Liberty, Bonfouca, and Castine.

(3) West shore. The portions of the study area to the west in Tangipahoa, Livingston, Ascension, St. James, and St. John the Baptist Parishes are essentially similar in topography. The major portion of the area is undeveloped low-lying marsh and swamp, having an average elevation of about 1.5 feet. Developed sections, averaging about 10 feet in elevation, are located along the Mississippi River bank. To the west and north of the study area, the land slopes upward from the marsh to higher, developed sections of land. Lake Maurepas, a shallow landlocked tidal basin of approximately 90 square miles, is located in this area. The principal tributaries are the Blind, Amite, Natalbany, and Tickfaw Rivers which drain into Lake Maurepas and the Tangipahoa River which drains into Lake Pontchartrain.

c. Geology.

(1) Physiography. The study area, known as the Pontchartrain Basin, is situated along the northeastern flank of the Mississippi River Deltaic Plain and includes a small portion of the Central Gulf Coastal Plain. The basin is a shallow depression which lies between the alluvial ridge of the Mississippi River and gulfward sloping uplands on the north and west. A low alluvial ridge (Metairie-Gentilly ridge), marking the position of an ancient distributary and subdelta of the river, extends northeastward from New Orleans towards the uplands and subdivides the basin. In addition to the alluvial ridges and the uplands, the region includes large lakes of which Lake Pontchartrain is the most prominent. Except for short stretches along the northern shore of Lake Pontchartrain in the vicinity of Mandeville where the uplands border the lake, and behind the seawall along the south shore at New Orleans where sand fill has been placed, the lakes are surrounded and separated from the uplands and alluvial ridges by marsh and swamp lands. The shorelines of the lakes are smoothly rounded and in many places poorly defined because of encroachment of the lake waters into the marsh and swamp lands, and the absence of well-defined beach ridges. The area is of extremely low relief.

(2) Geologic history. During the later part of the Pleistocene epoch, the Mississippi River built a large delta centered in southwest Louisiana, which extended from approximately the Mississippi State boundary to the Texas State boundary, and far gulfward of the present gulf shoreline. At the end of the Pleistocene epoch, sea level dropped and the Mississippi River and the coastal plain streams became deeply entrenched in the Pleistocene deposits. At that time the Pleistocene surface in the study area remained relatively undissected as a shelf on the northeast side of the deep trench of the Mississippi River, and the soils on this shelf were weathered and desiccated. During the Recent epoch sea level rose to its present position, and sediments carried down by the Mississippi River were deposited and completely filled the river entrenchment and buried the Pleistocene shelf in the study area. As burial

was accomplished, the Mississippi River was confined to the central part of the Deltaic Plain and the Pontchartrain depression area was a shallow arm of the gulf, or a huge bay, marginal to the north-eastern and distal ends of the Deltaic Plain. During this period marine and brackish water sediments were deposited in the Pontchartrain embayment. Approximately 2,500 years ago, the Mississippi River changed its course and began rapidly filling the embayment with alluvial sediments. Concomitantly, the alluvial ridges along the Mississippi River and the Metairie-Gentilly subdelta course were formed, regional subsidence gradually occurred, the swamp and marsh deposits around the lakes accumulated, and the waters in the lakes became less saline. During the filling of the embayment a few fine sand and shell beaches were formed locally. The major known beach thus formed lies buried in the northern part of New Orleans, near the present shoreline of Lake Pontchartrain. The main elements of the history of the area have been the burying of the ancient Pleistocene surface and the filling of the Pontchartrain embayment with Recent sediments that were carried into the area by the Mississippi River, and the accumulating of organic matter, derived from local vegetation, at the surface in the low areas surrounding the lakes. With construction of artificial levees along the river, the basin has been largely deprived of the sediment-laden overflow waters and there is evidence that for the past century the lakes are enlarging.

(3) Surface drainage. Drainage from most of Louisiana east of the Mississippi River and a considerable area in southwestern Mississippi is accomplished by relatively small streams which flow generally southward into the basin from the uplands on the north. At present the only water from the Mississippi River received by the basin is that discharged occasionally into Lake Pontchartrain through Bonnet Carre Spillway. The alluvial ridges drain down-slope into the adjacent marsh or swamp lands which, under natural conditions, are underdrained. In the reclaimed areas of the marsh and swamp lands protection levees have been constructed and drainage is accomplished by large pumps that generally discharge into canals that connect with the lakes.

(4) Subsidence. Progressive subsidence of the region in the vicinity of New Orleans has been recorded by many observers. It has been estimated that the Pleistocene surface has been down-warped towards the south and west from zero at the Pleistocene outcrop north of Lake Pontchartrain, to a maximum of 350 feet near the present gulf shoreline. It has been estimated that the rate of subsidence in the New Orleans area has been about 0.4 foot per century. In addition to the regional subsidence, large settlements of the ground surfaces have occurred in the marsh and swamp land areas that have been reclaimed and drained. These settlements were the results of the shrinking of the highly organic surface soils when they were drained.



(5) Subsurface conditions. Except for the Pleistocene deposit that outcrops along the northern boundary of the basin, the subsurface consists of Recent deposits varying in thickness from zero at the Pleistocene outcrop to about 50 feet at the south shore of Lake Pontchartrain in New Orleans. Generally, the Recent deposits in the marsh and swamp lands consist of a surface stratum of peat and very soft highly organic clay 8 to 14 feet thick, overlying soft and very soft gray clay containing lenses and local zones of loose silt. The Recent deposits lie unconformably upon the Pleistocene. Exceptions to the prevailing deposits in the Recent are the buried sand beach situated near the southern shore of Lake Pontchartrain, relatively firm lean clays and silt comprising the natural levee deposits, the silt and fine sand filling in the ancient distributary stream channel, and zones of predominantly sandy soils in the subsurface at the distal end of the ancient Metairie-Gentilly subdelta. The Pleistocene deposit that underlies the Recent and forms the uplands to the north of the lakes consists predominantly of very stiff to stiff oxidized clays with local zones and strata of firm silt and dense sands.

(6) Ground water conditions. All of the sand and silt deposits in the area are water bearing, and the piezometric head in these deposits is generally equal to sea level.

(7) Foundation problems. From a geologic standpoint no unusual problems are anticipated for the proposed work that is located where the Pleistocene soils outcrop. However, in the Recent deposits which include most of the project, the very low shear strengths and unusually high compressibility of the soft peats and clays, and the perviousness of and the excessive heads in the silts and sands create problems in the design of protective works. The detailed discussion of these problems and their consideration in the design of the various features of the project are included in appendix B.

(8) Mineral deposits. The study area is located in a region where oil and gas are likely to exist in the subsurface. However, exploration and production of petroleum in this area will not be adversely affected by the proposed hurricane protection works.

(9) Source of construction material. Rock is not available in the vicinity of the proposed works and will have to be imported from sources as remote as Texas, Arkansas, or Alabama. Concrete sand and gravel are available from sources within a distance of less than 50 miles from the proposed structures. Clam shells are available in the general vicinity of the proposed work.

d. Tides. Under normal conditions, the tide in both Lakes Pontchartrain and Borgne is diurnal and has a range of approximately one-half foot and 1 foot, respectively. The Rigolets and the Chef Menteur Pass have developed naturally deep and wide channels having

4.d.

adequate capacity for normal tidal flows and for discharge of tributary flow. Fluctuations in the level of Lake Pontchartrain are greatly influenced by wind. This effect is evident in winds as low as 5 miles per hour. Easterly winds cause a rise in Mississippi Sound and Lake Borgne, producing an increase in flow through the passes and a subsequent rise in the lake level. Westerly winds have the reverse effect. Major storms and hurricanes produce significant changes in the lake. Tide gage readings are available at six locations in Lake Pontchartrain. Five of these are of the recording type with periods of record ranging from 4 to 14 years. Three of these previously had staff gages, with additional periods of record ranging from 16 to 18 years. Other gages include one staff in Lake Maurepas (6 years), one in Rigolets (12 years' recording and 18 years' staff), and three recording in Lake Borgne (4 to 13 years). Sixteen high water (crest) pipe indicators are distributed within the study area to obtain data on maximum surge heights. Location and description of gages and their periods of record are shown in table A-6, appendix A. Maps showing areas flooded and maximum water surface elevations of record in the study area are contained in supplement 1 to this report. Observed stages for regular locations are published annually in "Stages and Discharges of the Mississippi River and Tributaries and Other Streams and Waterways in the New Orleans District," by the U. S. Army Engineer District, New Orleans.

e. Flood protection and interior drainage. The Mississippi River levee system affords complete protection from headwater floods on the river. Partial protection from tidal overflow from the lakes is afforded to the south shore area in Jefferson and Orleans Parishes and to the north shore at Mandeville. All of the south shore protected areas, except the New Orleans East area, are drained by pumping into the tidal lakes or waterways.

(1) St. Charles Parish and west. Along the entire western shore of Lake Pontchartrain and along the St. Charles Parish front, there is no effective protective system against flooding from the lake. The embankment of the Illinois Central Railroad offers a limited degree of protection. Some of the developed areas near the river are leveed and pumped. These systems are operated by the Pontchartrain Levee District.

(2) Jefferson Parish. A Federal levee with a 10-foot grade extends along the entire 10.4 miles of Jefferson Parish lakefront. The levee returns along the St. Charles Parish line 4.8 miles with a grade of 7 feet at the terminus. The Metairie Relief outfall canal divides Jefferson and Orleans Parishes. The levee on the Jefferson side has a grade of 10 feet at the lake and 7 feet 2.5 miles inland. The drainage system of Jefferson Parish, operated by the Sanitation Department, consists of a series of collection ditches and canals (shown on plate 2) leading to four pumping stations discharging directly into Lake Pontchartrain. The diesel operated pumps have a

total combined capacity of approximately 4,600 c.f.s. and serve a drainage area of approximately 29,000 acres. The floor of each station is at an elevation of 2.6 feet. The pumps can operate with several feet of flooding over the floor because all of the fuel connections and oil vents are above the floor level.

(3) New Orleans. The New Orleans lakefront protection consists of a seawall backed by a low levee from its western boundary to the Inner Harbor Navigation Canal. The first one-half mile adjacent to Jefferson Parish is a vertical seawall having a crown elevation of 7.5 feet protected by a breakwater at an elevation of 6.0 feet which forms the Municipal Yacht Harbor and backed by a levee with an elevation of 10 feet. To the east of the harbor area a stepped type seawall with a crown elevation of 8.2 to 9.0 feet extends along the lakefront for a distance of 5.2 miles. Several hundred feet landward of the seawall a small levee, with a crown elevation of 9.6 feet, provides secondary protection. The area is protected on the west by a levee on the east bank of the Metairie Relief outfall canal with a controlling grade of 9.5 feet, and on the east by a levee along the Inner Harbor Navigation Canal having an elevation of 9.6 feet. Extending into the interior of this highly developed area are three major channels. The Orleans Avenue Relief outfall canal, 2.5 miles long, and the London Avenue outfall canal, 2.9 miles long, each has levees with net grades of about 10.0 feet terminating at major pumping stations. The third, Bayou St. John, is now closed by a floodgate about one-half mile from the lake with 10-foot levees tying-in to the seawall. The drainage system in New Orleans, operated by the Sewerage and Water Board of New Orleans, comprises a network of collecting ditches, covered and open canals, relay pumping stations, and outfall pumping stations, that ultimately empty into Lake Pontchartrain, as shown on plate 2. The canal system is so designed that normal or light rainfall is discharged into Bayou Bienvenue and heavy rainfall is discharged into the lake. The total nominal capacity of outfall pumps for New Orleans is 20,830 c.f.s. for the drainage of an area that is approximately 27,800 acres, including the 2,000 acres in the Chalmette area. Internal relay pumps have a capacity of 8,340 c.f.s. The design elevation of the floors of the stations is 2.6 feet. The pumps are electrically driven with power from a central generating station. Emergency power is available from the local power company.

(4) Citrus and New Orleans East. The New Orleans Airport is fronted by a vertical seawall with an average elevation of 11.5 feet and a length of 2.3 miles. The embankment of the Southern Railway extends along the remainder of the south shore to the east for approximately 11.5 miles with an average elevation of about 9.3 feet. The embankment is a heterogeneous fill composed largely of cinders, and has been severely damaged on many occasions in the past by relatively minor hurricane tides and waves. This type of embankment will not provide dependable protection against major hurricane tides and waves. The area is protected on the west by a

levee along the Inner Harbor Navigation Canal having a grade of 9.6 feet, on the east by a levee that extends from South Point to the Gulf Intracoastal Waterway with an elevation of 11.6 feet, and on the south by a levee along the Gulf Intracoastal Waterway with elevation 9.6 to 14. The Paris Road-Michoud slip levee separates this area into two segments, Citrus and New Orleans East. The Citrus area drains through a system of open canals with one pumping station at Citrus. This partially developed area of 8,900 acres is drained by a 520-c.f.s. electrically driven plant. An emergency power source is provided. Improvements to this system are being planned. The New Orleans East area has no major drainage system at this time but plans for the development of an adequate system for the area are well advanced. Some small units are in operation.

(5) Chalmette. In the Chalmette area about 10,400 acres of the higher lands along the Mississippi River are protected by a locally built levee with a net grade of 10 to 10.5 feet. Partial protection is afforded the remaining area by a spoil bank with an elevation of approximately 8.0 feet along the south bank of the Mississippi River-Gulf Outlet between the Inner Harbor Navigation Canal and Bayou Dupre. The leveed portion of the Chalmette area in St. Bernard Parish, west of Paris Road, is drained by pumping plants. The capacity of the stations in this area is 666 c.f.s. existing plus 478 c.f.s. being installed for an area of approximately 8,000 acres. East of Paris Road, runoff is conveyed to the marshes by flood gates.

(6) Inner Harbor Navigation Canal. The highly developed industrial areas along the canal between its levees are not protected against flooding from the canal. The area has been raised to about elevation 5 with spoil from the canal.

(7) The area bounded by the Mississippi River-Gulf Outlet, the Gulf Intracoastal Waterway, and Lake Borgne and the area east of U. S. Highway 90 between New Orleans East and Pearl River are unprotected. The area west of U. S. Highway 90 is afforded a limited degree of protection against flooding from Lake Borgne by the highway embankment.

(8) Mandeville. A vertical seawall with a height of 6.0 feet and a length of 1.5 miles protects the town of Mandeville. Plans to expand this structure to provide a height of 9.5 feet are being developed by the town officials. Drainage is by gravity into the lake.

f. Maps. Reference is made to U. S. Geological Survey quadrangles Yscloskey, scale 1:62,500 and Malheureaux Point, Drum Bay, Door Point, Lake Eugenie, Oak Mound Bayou, Mitchell Keys, Lake Eloui, and Morgan Harbor, scale 1:24,000; U. S. Army Corps of Engineers quadrangles Slidell, Covington, Ponchatoula, Springfield, Denham Springs, Donaldsonville, Mt. Airy, Bonnet Carre, Spanish Fort, Chef

Mentour, Rigolets, St. Bernard, New Orleans, and Hahnville, scale 1:62,500; U. S. Coast and Geodetic Survey Charts Nos. 1115 and 1116, scales 1:456,394 and 1:458,596; and the maps attached to this report.

## 5. ECONOMIC DEVELOPMENT

a. Population. The 1960 population of the study area was about 772,000, essentially all urban. The majority of the population is located inside the south shore protected areas and is composed of about 593,000 in the city of New Orleans (Orleans Parish), 133,000 in Jefferson Parish, 27,300 in St. Bernard Parish, and 9,800 in St. Charles Parish. The population of the New Orleans metropolitan area, comprised of Orleans, Jefferson, and St. Bernard Parishes was 868,480 (1960). The population north of Lake Pontchartrain was 8,900 (1960), most of which was in the towns of Mandeville, Slidell, and Madisonville. The rate of growth of the population for the study area and for St. Charles, Jefferson, Orleans, and St. Bernard Parishes is shown in the following tabulation:

<u>Year</u>	<u>Area (Total)</u>	<u>St. Charles Parish</u>	<u>Jefferson Parish</u>	<u>Orleans Parish</u>	<u>St. Bernard Parish</u>
1930	466,000	6,300	13,400	438,000	3,800
1940	506,000	5,300	18,800	473,000	4,300
1950	618,000	6,300	54,000	545,000	7,100
1960	772,000	9,800	133,000	593,000	27,300

b. Industry. Industries in and adjacent to the study area, including those on the west bank of the Mississippi River, consist of the manufacture and processing of food and kindred products, transportation equipment, paper and allied products, ships and boats, stone, clay and glass products, fabricated metal products, printing and publishing, chemical and allied products, apparel and related products, basic chemicals, concrete and plaster, nonmetallic minerals, petroleum and coal products, and structural metal products. These industries accounted for about 95 percent of the value added by manufacture, which was in excess of \$466,000,000 in 1958. The majority of industry is located within the New Orleans metropolitan area. Several small industrial plants are located in Slidell, including clay products, building products, and boat building and repair.

c. Mineral production. The area contains 11 producing oil and gas fields. Three fields are located in Lake Pontchartrain, one in Lake Maurepas, and one in Lake Borgne. The remaining six fields are situated between the lake and the Mississippi River westward of Kenner, Louisiana. Shell deposits at or near the land surface are mined in Lake Pontchartrain and in the bays to the east of the lake.

5.d.

d. Fisheries and fur animals. Lake Pontchartrain, Lake Maurepas, and the extensive marshlands and water bottoms to the east contribute to an important seafood industry and support an important trapping program.

e. Recreation. New Orleans long has been renowned as a recreation and vacation center. The city offers a variety of entertainment, including the historic French Quarter, numerous night clubs, extensive hotel facilities, and French, Spanish, and Italian restaurants. Annual events are the Mardi Gras; and the Mid-Winter Sports Carnival, including the Sugar Bowl Football Game, the horse race season, and the Spring Fiesta. City parks cover 1,800 acres and provide a variety of recreation facilities. Lake Pontchartrain is popular for sailing, motor boating, water skiing and swimming. Sport fishing is popular on Lake Pontchartrain and in the connecting outlets to the Gulf of Mexico, and on streams that enter the lake. The areas north of the lake along the Tchefuncta and Bogue Falaya Rivers, Bayous Lacombe and Liberty, and other streams are popular as sites for summer homes of New Orleans residents.

f. Agriculture. Agriculture holds a relatively unimportant position in the economy of the area. A considerable amount of truck crops is grown in St. Bernard Parish and at scattered locations in the Little Woods section of Orleans Parish and near the western edge of Jefferson Parish. In Jefferson Parish there are several small dairies and small acreages of grazing lands. These lands are decreasing as urban areas are developed and probably will disappear completely within a few years.

g. Foreign trade. The port of New Orleans ranks as the second port of the nation in value of foreign trade. Imports were 5,423,330 and exports were 9,144,075 short tons during 1960.

h. Navigation. In addition to the Mississippi River project, 40-foot depth; the Gulf Intracoastal Waterway, 12-foot depth; and the Mississippi River-Gulf Outlet, 36-foot depth, which is under construction, the area is served by numerous improved waterways, natural streams, and lakes including Lakes Pontchartrain and Maurepas that are navigable by shallow draft vessels. Projects for improved waterways include Amite River and Bayou Manchac; Bayou Bonfouca; Bayou Lacombe; Tchefuncta River and Bogue Falaya; Pass Manchac; Tangipahoa River; Tickfaw, Natalbany, Ponchatoula, and Blood Rivers; and the Inner Harbor Navigation Canal (Industrial Canal) between the Mississippi River and Lake Pontchartrain.

i. Transportation. The area is served by an extensive system of highways and railroads. U. S. Highways 11, 51, and 61 enter from a northerly direction and terminate in New Orleans. U. S. Highway 90 passes through New Orleans in an east-west direction and crosses the Mississippi River. U. S. Highway 190 passes north of Lake Pontchartrain in an east-west direction. The Greater New Orleans

Expressway Bridge (toll) connects U. S. Highways 61, 90, and 190. The proposed Federal Interstate Highway System, under construction, will be located near present U. S. Highways 51, 61, and 11. Eight trunk line railroads that terminate at New Orleans provide through train service to major cities in the nation and direct connections to practically all others. The New Orleans Public Belt Railroad, owned by the city of New Orleans, provides a connection over the Huey P. Long Mississippi River Bridge between rail lines and to industries and wharves. The New Orleans International Airport, Moisant Field, which is located near Kenner, is the center of commercial aviation. Major airlines provide regularly scheduled flights to all parts of the United States and to parts of Central and South America. The New Orleans Airport, located on the southeast shore of Lake Pontchartrain, at present, serves mostly local commercial and private aviation. Extension of a runway to accommodate commercial jet planes is under construction.

j. Defense establishments. New Orleans is a strategic major port on which the defense of the nation will depend to a great extent in any national emergency. As in the past, it is probable that the areas along the Inner Harbor Navigation Canal and the Mississippi River-Gulf Outlet will accommodate extensive defense industries and military operations in the event of war. The National Aeronautics and Space Administration recently has contracted for the manufacture of the Saturn Booster at the Michoud plant on the Gulf Intracoastal Waterway in the Citrus area. This plant was used in the recent past for the manufacture of Army tank motors.

k. Trends of growth and development. The 1960 population of metropolitan New Orleans, which includes Orleans, Jefferson, and St. Bernard Parishes, was 868,480 in 1960. The population was 685,405; 552,244; and 505,306 in the years 1950, 1940, and 1930. These statistics indicate that the population will exceed 2,000,000 by the end of the next 50 years. The major part of the growth will be in Jefferson Parish, the Citrus and New Orleans East areas of Orleans Parish, and in St. Bernard Parish. The section of New Orleans between Jefferson Parish and the Inner Harbor Navigation Canal is largely developed and the remaining vacant areas will likely be developed during the next 15 years. It is probable that the population within the study area on the north shore of Lake Pontchartrain will double during the next 50 years, with a major part of the growth occurring in and around Slidell. It is probable that areas near Slidell that are located outside of tidal overflow limits will grow at a much faster rate. No significant development of the areas to the west of Lake Pontchartrain is indicated. The residential development in St. Charles Parish would probably double during the next 50 years without additional flood protection.



6.

## 6. CLIMATOLOGY

a. Climate. The study area is located in a subtropical latitude having mild winters and hot, humid summers. During the summer, prevailing southerly winds produce conditions favorable for afternoon thundershowers. In the colder seasons, the area is subjected to frontal movements which produce squalls and sudden temperature drops. River fogs are prevalent in the winter and spring when the temperature of the Mississippi River is somewhat colder than the air temperature. Climatological data for the area are contained in monthly and annual publications by the U. S. Department of Commerce, Weather Bureau, titled "Climatological Data for Louisiana," and "Local Climatological Data, New Orleans, La.," and in appendix A.

b. Temperature. The first-order weather station in New Orleans has temperature records extending back to 1871. The mean annual temperature is 70°F. and the recorded extremes range from 7° to 102°. The average temperature in summer is 82.3° and in winter 56.3°. Detailed temperature records are shown in appendix A.

c. Rainfall. Precipitation generally is heavy in two fairly definite rainy periods. Summer showers last from about mid-June to mid-September, and heavy winter rains generally occur from mid-December to mid-March. The drainage area tributary to Lake Pontchartrain is served by 29 precipitation stations of the U. S. Weather Bureau, with periods of record ranging from 5 to 90 years. Average annual precipitation is 60 inches, with annual variations of plus or minus 50 percent. Extreme monthly rainfalls exceeding 12 inches are not uncommon, and as much as 25 inches have been recorded in a single month. Average monthly rainfalls range from 6.9 inches in July to 3.2 inches in October. Several stations have experienced periods in which no rainfall was recorded in a calendar month. Snow occurs infrequently in the area. New Orleans had an 8.2-inch fall on 14-15 February 1895. The last appreciable snowfall occurred on 12 February 1958, when stations reported from 1.3 to 4.0 inches. Pertinent temperature and precipitation data and location of climatological stations are shown in appendix A.

d. Wind. Wind records are available adjacent to and over Lake Pontchartrain for various periods. Periods of record of anemometers are shown in appendix A.

(1) Two over-water recording anemometers were established in 1957 on the Greater New Orleans Expressway Bridge across Lake Pontchartrain, approximately 4 miles from the north and south terminals. Recording anemometers were installed around the perimeter of the lake at West End (New Orleans), Madisonville, Frenier, and Slidell in 1957-59. The installations on the bridge furnish the only valid over-water record of winds. The other locations are influenced by the friction incurred by the winds traversing land masses.

(2) The U. S. Weather Bureau anemometer coverage at the New Orleans International Airport, Moisant Field, since 1949 is the longest record adjacent to the lake. A 10-year summary of winds at Moisant is shown in appendix A. The average wind velocity is 8.8 m.p.h., but winds over 100 m.p.h. are experienced occasionally in hurricanes. The predominant wind directions are S. to SSE. from January through July, and NE. to ENE. from September through November. In applying Moisant wind summaries to Lake Pontchartrain, the factors for comparing over-land to over-water conditions, as described in the U. S. Weather Bureau Hydrometeorological Report No. 32, are considered applicable. It is a matter of record that important changes in lake level reflect changes in the wind patterns. The most serious consequences of high winds occur over the lake during hurricanes.

## 7. HURRICANES OF RECORD

a. Historical hurricanes. This area has experienced many severe hurricanes and lesser storms which caused loss of life and damage to property. Official U. S. Weather Bureau meteorological records are not available prior to 1893 and most accounts had to be obtained from newspapers and historical documents. Because a large portion of the area was relatively uninhabited, most of the flooding went unobserved.

(1) Prior to 1800, New Orleans had little protection from flooding by lake waters entering the city. Bienville's newly established capital city of New Orleans was severely damaged by a hurricane in 1722. The church, crops, stores, and 35 huts were destroyed and the city was reduced to a state of famine. As a result all property owners were ordered to erect palisades within 2 months. The 1723 hurricane caused similar damage. Other storms in 1776, 1779, 1780, 1781, 1793, and 1794 struck the area. Severe crop damage was reported for a few of these storms. The lack of storm reports during the midcentury is thought primarily due to the lack of records rather than the absence of storms.

(2) In 1800, 1811, 1812, and 1821, storms struck the area. A particularly severe storm in 1831 devastated the area near the gulf and caused considerable damage in the study area. Waves swept over the village of Milneburg in New Orleans. Almost all of the boats in both the river and the lake sustained heavy damage, and several vessels were stranded in the marshes around Lake Pontchartrain. Several lives were lost and all of the buildings fronting on the lake in the vicinity of New Orleans were washed away. The hurricane of 1837 inundated the city of New Orleans for a distance of approximately 2 miles from the shoreline of the lake. Several lives were lost and crops suffered heavily once again. All of the boats in the pens near the lake were swamped, and four lake steamers were sunk during this storm. In 1860 another severe hurricane struck the area. Heavy damage was reported in Mandeville, and

storm water was several feet deep over the railroad track between Pass Manchac and Frenier. On the southwestern shore of Lake Pontchartrain about 8 people lost their lives. Several deaths occurred in New Orleans where approximately two-thirds of the city was inundated. Flooding occurred in the city during a storm in 1877 although the storm struck well to the west near Galveston, Texas. In 1887 a storm which had paralleled the entire coast of Texas passed inland near New Orleans. Flooding occurred in the rear of the city as well as in some interior localities through levee breaks along drainage canals. Considerable crop damage was experienced and property near the lakefront was heavily damaged. The next year, 1888, another storm passed inland near Grand Isle. During this storm a maximum wind of 90 m.p.h. was reported at New Orleans.

(3) In October 1893, a hurricane of great violence devastated the coastal region of Louisiana just west of the Mississippi River. The great loss of life, placed at 2,000 persons, and heavy damage in other areas in Louisiana occupied most of the storm records. It was indicated that the lack of any advance warning of the approach of a storm was in part responsible for such a high death toll. It was noted that the rate of forward motion of this storm decreased to nearly zero in the vicinity of the Mississippi River. As a result of this stalling, the winds in the area were of long duration and great volumes of gulf waters were forced from Lake Borgne into Lake Pontchartrain. Winds of 65 m.p.h. were recorded in New Orleans and it is estimated that if wind tides had been recorded they would be in the order of 10 feet along the New Orleans lakefront under present conditions.

(4) The storm of 4-16 August 1901 had a barometric pressure of 28.72 inches and passed just east of New Orleans. The U. S. Weather Bureau was commended for the excellent advanced warnings issued. This storm caused considerable property damage and the loss of 10 lives. It also tended to stall, and although the wind velocity at New Orleans reached only 39 m.p.h., the duration and direction of that wind caused considerable flooding in the area. Approximately 3 square miles of the city were inundated to depths of from 1 to 4 feet. A 2-foot depth of flow was observed over the 9-foot railroad embankment on the southeast shore of Lake Pontchartrain.

(5) The storm of 24-30 September 1905 flooded many low sections of the area. Stages of 6 feet above normal were reported in Lake Pontchartrain at Mandeville. Water was reported to have been 5 feet over the marshes in the vicinity of North Shore. The lakefront area of New Orleans was again flooded.

(6) The hurricane of 10-22 September 1909 caused damage exceeding \$6 million and a loss of 353 lives. The railroad between Frenier and Ruddock was washed out. The stage at New Orleans reached

6.2 feet, and the western portion of the city was flooded to depths of 1 to 2 feet. Stages were 8 feet at the west shore of Lake Pontchartrain, 7 feet on the north shore, and 6 feet in the area near the Rigolets.

(7) Two storms in 1915 caused damage in this area. On 5-24 August, a storm struck west of Galveston, Texas and produced tides of only 3 feet at the south shore of Lake Pontchartrain and the Rigolets, and damage was small. The later storm, 22 September to 2 October, which had a central pressure of 27.87 inches and winds at New Orleans of 75 m.p.h. caused considerable damage. Torrential rains accompanied the storm, causing severe flooding in the southeastern portion of Louisiana. New Orleans reported a total of 8.2 inches of rain with a maximum of 1.59 inches in 1 hour. Maximum stages around Lake Pontchartrain were 13 feet at Frenier, 6.1 feet at West End, New Orleans, 7.2 to 11 feet on the east shore, and 7.7 feet on the north shore. The south shore of Lake Borgne had stages up to 11.6 feet and the marshland had stages of 9.0 feet. In New Orleans 25,000 buildings were destroyed or damaged. The city was flooded to depths of from 1 to 8 feet. Failure of the drainage pumps caused the impounded water to remain for several hours. Total property losses exceeded \$13 million and the death toll was 275.

(8) The hurricane of 21-29 September 1917 approached the coast of Louisiana but curved sharply to the east approximately 50 miles south of Port Eads and moved inland near Pensacola, Florida. Little damage was reported in the inhabited sections.

(9) The hurricane of 2-10 August 1940 followed an unusual path across Florida, moved across the northern gulf, and finally struck the Texas coast near the Louisiana border. Tides of 6.4 feet were recorded at Frenier on the southwest shore of Lake Pontchartrain, 4.4 feet on the north shore, 3 to 4 feet in the vicinity of Violet, and 3.6 to 3.8 in the area between Lakes Pontchartrain and Borgne.

(10) The hurricane of 4-21 September 1947 ranked as one of the greatest of record. It originated near West Africa, crossed the Atlantic Ocean and the Florida Peninsula causing maximum damage, then passed into the Gulf of Mexico. It struck the Louisiana coast just south of Lake Borgne and continued westward just south of Lake Pontchartrain. The path of the storm center in relation to the converging coasts of Mississippi and southeastern Louisiana was conducive to the generation of a very high tidal surge in that zone. Water surface elevations in Lake Pontchartrain were 6.8 feet at Mandeville, and 5.5 feet at New Orleans. Water flowed over the seawall at New Orleans lakefront (see fig. 1) inundating approximately 8.9 square miles of lakefront area, of which 2.7 square miles were covered by sheet flow 2 feet or more in depth. Sheet flow over the low protective embankment along the lakeshore caused

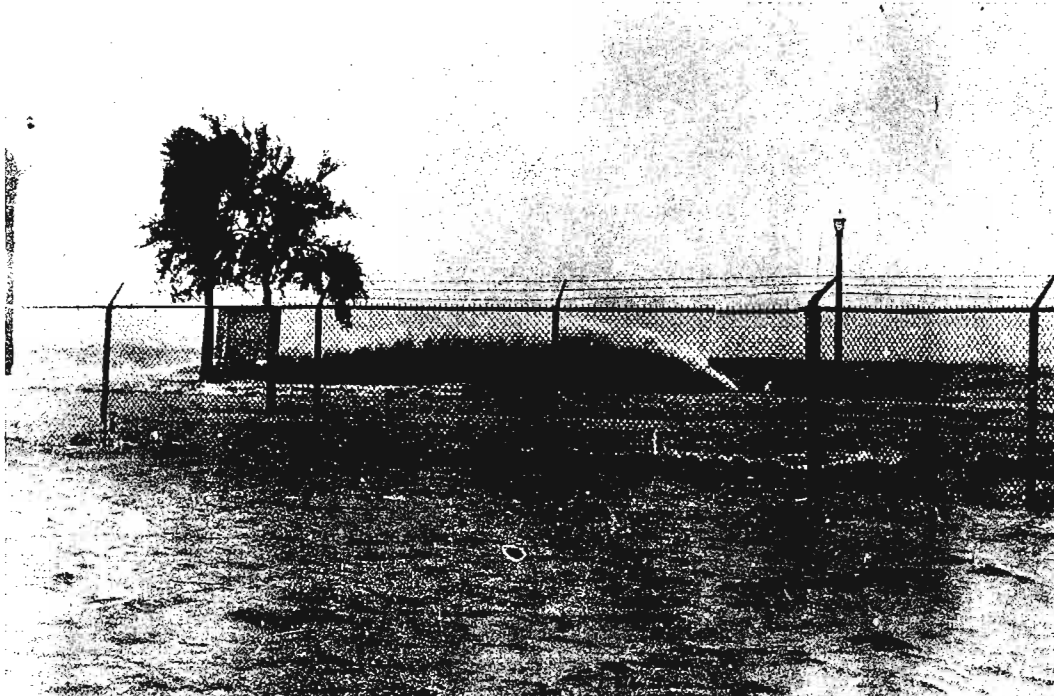

Official U.S. Navy Photograph

Waves breaking over New Orleans Lake Pontchartrain seawall in vicinity of U. S. Naval Air Station near London Ave., September 1947.



Official U. S. Navy Photograph

Sheet flow across Lake Shore Development in New Orleans at Pontchartrain Beach between Inner Harbor Navigation Canal and London Avenue, September 1947.

flooding in Jefferson Parish of approximately 31 square miles, making the drainage pumps inoperative for a considerable period of time. Water stood 6 feet deep in some sections. New Orleans International Airport, Moisant Field, had one-half foot of water on the runways and could not operate. Stages around the lake were 4.2 feet on the west shore, 8 to 10 feet in the Rigolets, and 2.4 to 5 feet in the marsh west of the lake. On the south shore of Lake Borgne the stage was 11.2 feet at the shore and 7.4 to 7.8 feet inland near the Chalmette back levee. Wind was reported as high as 98 m.p.h. with gusts to 112 m.p.h. from the northeast at Moisant Field. The barometer reading at New Orleans was 28.57 inches. Total storm damage was estimated at \$110 million with 51 lives lost, of which 12 were in Louisiana.

(11) During the period 28 August-6 September 1948 a storm passed just east of the city. The highest wind reported at Moisant Field was 78 m.p.h. with gusts to 90 m.p.h. The barometric pressure was 29.21 inches. Tides rose to 4.4 feet along the southwest shore of Lake Pontchartrain and some lakefront flooding occurred.

(12) Hurricane "Flossy," 21-30 September 1956, passed over the mouth of the Mississippi River on a northeasterly track. Heavy rains, varying from 4 to 10 inches, fell along the path of the storm from Florida to Louisiana. Tides were unusually high along the coast from Florida to Grand Isle. Shell Beach, on the south shore of Lake Borgne, had a tide of 10.9 feet. Flooding in the surrounding marshland ranged from 6.4 to 8.6 feet. Lake Pontchartrain had stages of 7.3 feet at Frenier, 7.1 feet at Little Woods, and 5.4 feet at New Orleans. The seawall was overtopped by waves, flooding an area of approximately 2.5 square miles, in the eastern part of the city. Jefferson Parish was protected by the levee built since the 1947 storm. Total deaths reported on the coast were 15 and damage was estimated at \$20 million.

(13) Other storms in 1894, 1923, 1926, 1941, and 1961, caused minor damage and storms in 1886, 1892, 1897, 1900, 1902, 1904, 1906, 1907, 1914, 1919, 1920, July 1936, August 1936, 1943, 1945, 1946, July 1955, August 1955, and 1961 resulted in unassessed damages to the area.

b. Hurricane frequency. Although damaging floods caused by hurricane tides have been experienced throughout the study area on numerous occasions in the past, it was not possible to establish adequate stage-frequency relationships for the entire study area because of the sparse records of observed maximum high water elevations. Observed stages were analyzed and adjustments made where necessary to reflect stages that would have occurred along the south shore of Lake Pontchartrain had existing protective works been in place. It was found that adjustments were required for only the 1893 and 1901 hurricanes, both of which stalled over the

7.b.

area. In addition, a synthetic method for computing stage-frequencies was derived by relating central pressure frequencies and stages that were computed for selected hurricane tracks. After computing hurricane frequencies for the south shore of Lake Pontchartrain by the synthetic frequency procedure, the two relationships were combined, using the synthetic data to establish shape and the observed data to establish placement of the final stage-frequency curve. This procedure, verified in other study areas for which sufficient data were available, was applied to all sections in the Lake Pontchartrain study area. A detailed discussion of methods used in the computation of hurricane stage-frequencies is presented in appendix A.

## 8. HURRICANE CHARACTERISTICS

a. General description. A hurricane is a well-developed cyclonic storm, usually of tropical origin. The term "hurricane" meaning "big wind" is thought to be of Carib Indian origin and it applies to cyclonic storms that have hurricane characteristics and occur in the North Atlantic Ocean, Gulf of Mexico, Caribbean Sea, and Eastern and Southern Pacific Oceans. Storms having similar characteristics but occurring in other locations are named typhoons, baguios or willy-willies. The South Atlantic Ocean is excluded because its generally cool temperatures prevent hurricane formation. Hurricane characteristics are violent winds, tremendous waves and surges, and torrential rainfall. Size and duration vary with each hurricane but generally they extend over thousands of square miles, reach heights of 30,000 feet or more, and last from 9 to 12 days.

b. Origins and tracks. Hurricanes apparently originate exclusively in the shifting zone of equatorial calms called the "doldrums" which lie between the two trade wind systems. However, since all hurricanes cannot be traced to a point of genesis, it is possible that they may originate elsewhere. Cyclonic storms are not likely to develop when the doldrums belt is within  $6^{\circ}$  of the equator because there the deflecting effect of the earth's rotation, which is an important factor in cyclonic formation, is at a minimum. Other conditions necessary for cyclonic formation are light variable winds, warm moist air, an ocean surface temperature in excess of  $80^{\circ}\text{F.}$ , and a moderately low pressure area. However, these conditions may produce a cyclone and yet not increase in severity so as to produce a hurricane. Just what causes the actual formation of a hurricane is not readily apparent. It has been observed that a continuation of stormy weather for 2 to 10 days, a continued lowering of barometric pressure in the storm center, and perhaps well-developed circulation in the upper level of air above the storm may be important steps towards hurricane development. Some of the hurricanes which affect the Atlantic and gulf coasts develop in the eastern North Atlantic Ocean off the coast of Africa near the Cape Verde Islands, while others develop in the western Caribbean Sea when that



body of water is influenced by an extension of the Pacific doldrums. Early in the hurricane season, June and July, there is a tendency for the storms to develop in the western Caribbean but late in the season, September and October, storms are more likely to develop in the Atlantic. While still in the initial stages of development the storms are affected by the trade winds and begin to move toward the west or northwest. In the vicinity of 30° north latitude, they re-curve and begin to move in a northeasterly direction at an accelerated speed. This is only a very general path that hurricanes follow and actually there are many deviations, for hurricanes have been known to circle back and cross over their earlier paths.

c. Barometric pressures and winds. Normal barometric pressures in the tropics are about 30 inches of mercury whereas the pressures recorded in hurricane centers range between about 29 and 27 inches. The pressure system of a hurricane appears on a weather map as a low pressure area encircled by lines called isobars which connect points of equal barometric pressure. The isobars have a circular pattern near the center of the storm but become asymmetric towards the periphery. With the counterclockwise wind direction deflecting about 30° inward towards the center of the storm the wind system of a hurricane also follows a circular pattern. At the storm's outer limits, the winds are light to moderate; at about 30 miles from the center, they reach a maximum velocity of about 100 m.p.h.\* with gusts as high as 150 m.p.h.; and at the center, they are relatively calm. This calm area, called the "eye" of the storm, ranges between 7 and 20 miles in diameter. Here the sky is sometimes unclouded enough to see the sun, while from all sides is heard the roar of the hurricane winds. The point of lowest barometric pressure is located in the vicinity of or within the eye. The lowest recorded barometric pressure for hurricanes occurring along the gulf coast was 26.35 inches.

d. Surge. The hurricane surge which inundates low coastal lands is the most destructive of the hurricane characteristics. It alone accounts for three-fourths of the lives lost from hurricanes. It is the product of meteorological, beach, and shore conditions. In the initial stage of development, it reaches a height of about 3 feet in the open sea from the combined effects of high velocity winds and a lowered barometric pressure. Simultaneously, at shore, the water level slowly begins to rise. As the hurricane approaches and the surge develops under the influence of a gently rising ocean floor and a favorable or indented shore contour, the shoreline water level rises more rapidly. A higher surge will be produced if the hurricane path is perpendicular to shore, the velocity of forward movement is slow, or the storm's diameter is

---

\*Wind velocities represent a 5-minute average, 30 feet above ground level



8.d.

very large. Maximum surge heights experienced along the gulf and Atlantic coasts range between 10 and 16 feet.

e. Waves. The waves generated by hurricane winds cause a great deal of damage to ships and shore structures. At sea the waves are high and turbulent, particularly in the right front quadrant and the eye of the storm. The pyramidal shaped waves in the eye have been observed to reach heights of 45 feet or more. Near shore, wave heights which have diminished some since origin, begin to increase again because of the slowing and therefore building effect of the shallow water. Further, breaking waves can run up and overtop shore structures whose crowns are higher than the wave heights. But the force expended when they break is the most damaging to the shore structures. Some waves which are generated in midocean travel away from the point of origin faster than the storm advances, and arrive at the shore 2 to 3 days ahead of the full fury of the storm.

f. Rainfall. The rainfall accompanying a hurricane usually is heavy and sometimes torrential. However, its distribution during the passage of a hurricane is not uniform. The rain may begin long before the storm's arrival. Prior to the passage of the eye, rainfall generally reaches its maximum rate, and after the eye has passed, it ceases almost entirely. Rainfall is particularly heavy in the right front quadrant. Some hurricanes, however, are accompanied by little or no rainfall over considerable lengths of their paths.

## 9. STANDARD PROJECT HURRICANE

a. A standard project hurricane, SPH, is one that may be expected from the most severe combination of meteorological conditions that are considered reasonably characteristic of the region. The general SPH that is characteristic for the coastal region of Louisiana was developed in cooperation with the Hydrometeorological Section, U. S. Weather Bureau, and corresponds to one having a frequency of once in about 200 years in the study area. The derivation of procedures and frequency computations are described in detail in appendix A. Each of the specific SPH's for the study area has a central pressure index, CPI, of 27.6 inches and a maximum wind velocity of 100 m.p.h. at a radius of 30 nautical miles. These parameters define a hurricane which is similar in intensity to the September 1915 hurricane. Various translation speeds, rates of hurricane forward movement, and paths are necessary to produce SPH effects with maximum winds perpendicular to the shores at different locations in the study area. The occurrence of an SPH for any location in the study area would produce maximum surge heights of 11.2 feet along the south shore of Lake Pontchartrain, 12.5 feet at Mandeville, 11.9 feet in the Chalmette area, 12.5 feet at the Citrus and New Orleans East back levees, and 13 feet in the Rigolets and the Chef Menteur Pass.

b. The SPH critical to the south shore of Lake Pontchartrain has an average translation speed of 6 knots. Over water the speed is about 8 knots, and over land, at the time of recurvature, the speed is 4 knots. This SPH approaches from the south, traverses the coast west of the Mississippi River delta and curves eastward over Lake Borgne. The SPH critical to the north shore of Lake Pontchartrain has a translation speed of 5 knots. This hurricane approaches from the south-southeast, traverses the coast west of the Mississippi River delta, and curves northward passing west of Lake Maurepas. The SPH critical to the Chalmette area, the back levees of Citrus and New Orleans East, and from the Lake Borgne side in the vicinity of the Rigolets and the Chef Menteur Pass has a translation speed of 11 knots. This hurricane approaches from the east, traverses the coast east of the Mississippi River delta and south of Lake Borgne, and curves slightly northward passing to the west of Lake Maurepas.

#### 10. PROBABLE MAXIMUM HURRICANE

The probable maximum hurricane, PMH, is one that may be expected from the most severe combination of critical meteorological conditions that are reasonably possible for the region. It has an infinite recurrence period. The PMH for the study area has a CPI of 26.9 inches with a maximum wind velocity of 115 m.p.h. at a radius of 30 nautical miles. Translation speeds and paths are identical to those for the SPH. The occurrence of a hurricane of PMH characteristics in the study area would produce surge heights of 12.7 feet along the south shore of Lake Pontchartrain, 14.7 feet at Mandeville, 13.8 feet in the Chalmette area, 14.6 feet at the back levees of Citrus and New Orleans East, and 15.2 feet in the Rigolets and the Chef Menteur Pass region.

#### 11. EXTENT AND CHARACTER OF FLOODED AREA

The standard project hurricane would inundate a land area of approximately 700,000 acres to depths of up to 16 feet in the study area. About 240,000 acres of this area are situated eastward of a line extending along U. S. Highway 90 from near Pearl River to Chef Menteur, then along the Gulf Intracoastal Waterway to the Inner Harbor Navigation Canal, around the Inner Harbor Navigation Canal, and thence along the back levee of the Chalmette area in Orleans and St. Bernard Parishes. All of this land is marsh except for the spoil areas along the banks of the improved navigable channels. Improvements include the Gulf Intracoastal Waterway, the Mississippi River-Gulf Outlet which is under construction, the Louisville and Nashville Railroad, fishing camps and residences along U. S. Highway 90 and the L. & N. Railroad, and the numerous industrial plants along the Inner Harbor Navigation Canal. Westward of the above described line approximately 460,000 acres of land are subject to inundation. This area includes a major part of metropolitan New Orleans. The extent and character of the flooded areas within the several subareas are as follows:

11.a.

a. St. Charles Parish. The total area subject to inundation is 29,600 acres comprised of 630 acres of residential development; 740 acres of commercial and industrial development; 1,710 acres of open land; 15,450 acres of swamp and 11,070 acres of marsh. An oil field occupies about 1,000 acres of swamp. The Illinois Central and the Louisiana and Arkansas railroads, and U. S. Highway 61 cross the flood plain. The lack of flood protection from Lake Pontchartrain and inadequate drainage have hindered the development of this area except for the high ground located near the Mississippi River and limited development along U. S. Highway 61.

b. Jefferson Parish. The total area subject to overflow is 21,500 acres comprised of 6,190 acres of residential development; 1,040 acres of commercial and industrial improvements; 1,950 acres of other developments; 7,870 acres of open land; and 4,450 acres of woodland. The overflow area covers about 70 percent of eastern Jefferson Parish. The New Orleans International Airport, Moisant Field, U. S. Highway 61, and the approach to the Greater New Orleans Expressway Bridge are located within the flood plain. This area has experienced a rapid growth since about 1946 and its steady growth will continue.

c. New Orleans. The area subject to inundation, comprising about 65 percent of the land area of this segment of New Orleans, is 16,800 acres including 11,120 acres of residential development; 1,900 acres of commercial and industrial development; and 3,780 acres of other developed areas. Essentially all of the area is developed to the extent of having streets and utilities and about 95 percent of the area available for residences and other improvements is occupied.

d. Citrus. The area subject to flooding, comprising all of the Citrus area, is 14,800 acres, including 1,610 acres of residential development; 1,210 acres of commercial and industrial development; 540 acres of other development; 2,335 acres of open land; and 9,105 acres of swamp, woodland, and marsh. The portion of the area north of U. S. Highway 90 is zoned mainly for residential use, and the area adjoining and south of U. S. Highway 90 is zoned mainly for commercial and industrial use. The residential development in this area began after 1946 and its continued steady growth is anticipated. Substantial industrial and commercial development has taken place and water transportation available on the Gulf Intracoastal Waterway and the Mississippi River-Gulf Outlet will insure continued steady growth.

e. New Orleans East. The entire area of New Orleans East is subject to overflow. Approximately 18,300 acres are in the area, of which 3 acres are presently occupied by residences and about 5 acres are occupied by commercial developments. Plans are being developed for installing drainage, streets, and utilities on the 18,300 acres situated within the levees. Some 7,000 acres will

be residential; 1,200 acres will be commercial; and 4,500 acres will be other development, all located north of the present U. S. Highway 90. Some 5,600 acres south of U. S. Highway 90 are planned for industrial development.

f. Mandeville. About 600 acres within the town of Mandeville are subject to overflow. Approximately 590 acres are covered by residences and the park behind the seawall, and 10 acres are occupied by commercial establishments. The section of the town subject to flooding has been essentially developed for many years and future growth is expected to be moderate.

g. Remaining areas on the shores of Lake Pontchartrain. About 348,000 acres of land outside of the subareas described above are subject to overflow. Of this area, 2,025 acres are residential and 95 acres are commercial development, the major part of which is in and near Slidell, 7,600 acres are open land, and 338,280 acres are marsh and swamp. Open land is used primarily as range pasture. Substantial residential and commercial growth is indicated for the areas around Slidell. About 5,700 acres of marsh situated between the New Orleans East levee, the shore of Lake Pontchartrain, and Chef Menteur Pass is planned for so-called Florida-type development consisting of numerous dredged waterways with the spoil utilized as land fill material. About 2,400 acres will be residential; 1,900 acres of commercial and other development; and 1,400 acres industrial.

h. Chalmette. The total Chalmette area in Orleans and St. Bernard Parishes consists of 29,230 acres. The area within the existing Chalmette back levee, 10,400 acres, includes 3,190 acres residential development, 1,290 acres commercial and industrial, 160 acres other development, 1,810 acres open land, and 3,950 acres woodland. This area has experienced a rapid growth since about 1951 and future steady and increasing growth is indicated. The remaining 18,830 acres of marsh and swamp land outside the Chalmette levee system is undeveloped. The 5,000 acres west of Paris Road is expected to develop rapidly on completion of the Gulf Outlet. Development of the remaining 13,830 acres is more remote.

## 12. HURRICANE FLOOD DAMAGES

a. Flood damage surveys. Flood damage surveys were made of this region following the occurrences of hurricane "Flossy" on 23-24 September 1956 and hurricane "Audrey" on 27 June 1957. Factual data for the hurricane of 19 September 1947 were obtained from the results of surveys conducted by two private firms for local governmental agencies, compilations by individuals and business concerns, and results of surveys by Federal, state, and local governmental agencies.

12.a.(1)

(1) The hurricane of 19 September 1947 caused severe flooding along the south shore of Lake Pontchartrain. In Jefferson Parish, flood waters inundated about 21,000 acres of land and 2,800 residential and commercial buildings. Wave action along the New Orleans seawall resulted in extensive erosion of backfill and collapse of much of the adjoining concrete sidewalk. The lakeshore development area landward of the wall, some 1,725 acres in extent, was subjected to sheet flow to a depth of 2 feet at several places and the water flowed into the lower areas south of original shore line, flooding some 4,000 acres additionally. Breaks in the railroad embankment resulted in the flooding of about 900 acres of partially developed residential area east of the Inner Harbor Navigation Canal. Overtopping of the Chalmette back levee caused flooding of about 4,000 acres of land between the Chalmette and Violet communities. Wave action and tidal flooding destroyed or damaged numerous camps and small business buildings along the shore of the lake, U. S. Highways 90 and 11, and the Louisville and Nashville Railroad. U. S. Highways 90, 11, and 51 were inundated and closed for several days. The track, ballast, and trestles of the Louisville and Nashville Railroad were severely damaged. The Illinois Central Railroad ballast was damaged at several locations. A total of 12 lives was lost.

(2) Hurricane "Flossy" in 1956 caused overtopping of the New Orleans seawall for practically its entire length by waves (see fig. 2), but damage was caused only to about 1,450 acres of residential area between the London Avenue Canal and the Southern Railway. The St. Bernard Parish back levee between Chalmette and Violet was overtopped and crevassed, flooding 4,700 acres (see fig. 2). Damage was sustained by several business establishments along the Inner Harbor Navigation Canal, and by numerous camps and commercial establishments along the lakeshore, and along U. S. Highways 90 and 11. Traffic was stopped on U. S. Highways 11, 90, and 51 for about 2 days and the Louisville and Nashville Railroad lost one day of operation.

(3) Tidal overflow resulting from hurricane "Audrey" in 1957 was confined to the low marsh and swamp areas and caused no damage of consequence in the study area.

b. Experienced damages. The hurricane of 19 September 1947 caused flood damage of about \$6,600,000 in the study area, including \$3,900,000 in eastern Jefferson Parish, \$1,210,000 in New Orleans, \$40,000 in St. Bernard Parish, and \$1,450,000 in areas outside of local protection systems. Flood damage in the study area from "Flossy" in 1956 amounted to \$1,523,000, of which \$261,000 was in New Orleans, \$459,000 in St. Bernard Parish, and \$803,000 in areas outside of the protective works.

c. Estimates of probable future damages. Flood damage data from experienced hurricanes are of little value in estimating future

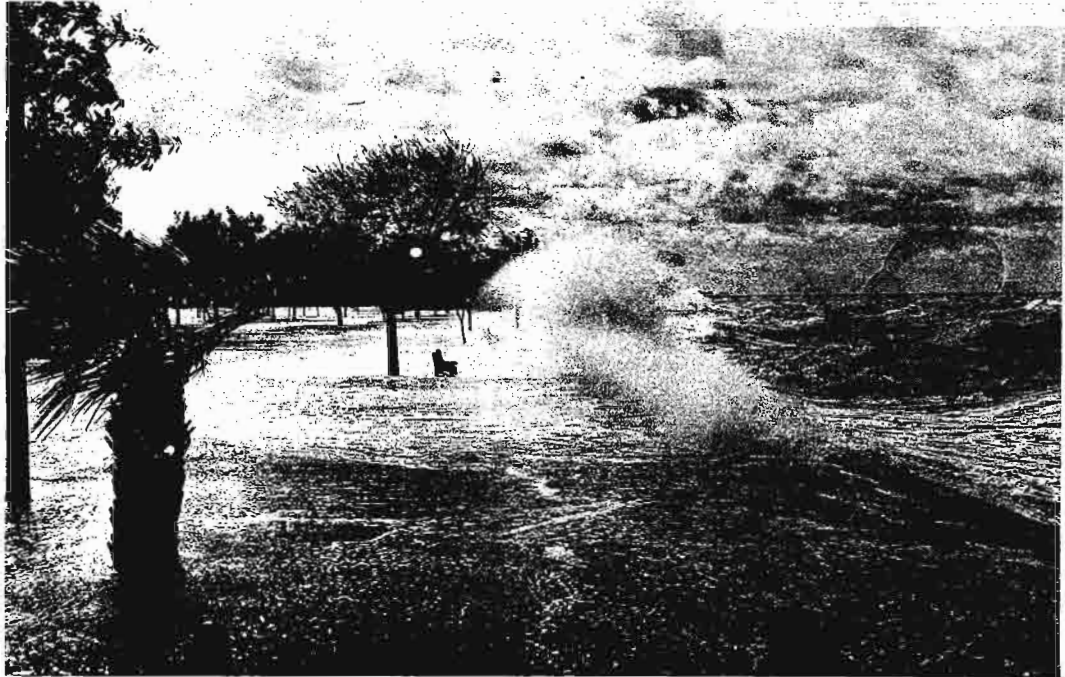

Photo Courtesy of The Times-Picayune

Overtopping of Lake Pontchartrain seawall at New Orleans in vicinity of Inner Harbor Navigation Canal by waves during abating hurricane, 24 Sept 1956.



Typical scene of flooding in St. Bernard Grove Subdivision, located on Louisiana State Highway No. 39, approximately one mile east of Paris Road, 25 Sept 1956.

probable damages from major hurricanes approaching the SPH for several reasons. Rapid development makes obsolete all but the most recent data. Partial protection works are effective against the moderate hurricanes of the past 20 years. Thus, hurricanes of magnitude somewhat larger than those of recent experience and approaching the SPH occurring under present conditions of protection and development would cause damage of catastrophic proportions. The calculated damage within the study area that would result from an occurrence of the standard project hurricane under the present state of development is in excess of \$475,000,000.

d. Average annual damages. Average annual losses from tidal flooding were derived by correlating stage-damage, stage-frequency, and damage-probability relationships. The derivation of stage-frequency curves is described in appendix A. Details on estimates of average annual damages are contained in appendix C. Average annual damage, based on December 1961 price levels and present development, is estimated as follows:

<u>Area</u>	<u>Damage</u>
St. Charles Parish	\$ 9,400
Jefferson Parish	2,256,000
New Orleans	2,741,100
Citrus	4,497,000
New Orleans East	None
Mandeville	62,400
Remaining areas along shores of Lake Pontchartrain	<u>112,100</u>
Subtotal	\$ 9,678,000
Chalmette	\$ 1,212,000
Inner Harbor Navigation Canal	90,000
Unprotected areas adjacent to Lake Borgne	<u>100,000</u>
Study area total	\$11,080,000

### 13. EXISTING CORPS OF ENGINEERS' PROJECTS

The existing projects in the study area are as follows:

a. The Flood Control, Mississippi River and Tributaries project, authorized by the Flood Control Act of 15 May 1928, as amended, includes, among other features, the Mississippi River levee system, the Bonnet Carre Spillway guide levees, and the lakefront levee in Jefferson Parish. The costs of features of work within the study area are not separable from total project costs. Further information on this project is contained in "Report of the Mississippi River Commission" in "Annual Report of the Chief of Engineers, U. S. Army on Civil Works Activities, 1961."

b. The Mississippi River-Gulf Outlet, La., authorized by Public Law 455, 84th Congress, 2d Session, as a modification of the Mississippi River, Baton Rouge to the Gulf of Mexico, La. project (described in appendix I) will provide a tidewater channel 36 feet deep and 500 feet wide, extending from the Inner Harbor Navigation Canal in New Orleans to the Gulf of Mexico. As of 30 June 1961 the project was 20 percent complete and the funds expended for construction were \$18,912,713.

c. The Gulf Intracoastal Waterway project extending from Florida to Brownsville provides a channel 12 feet deep by 125 feet wide through this area, except in the section between Lake Borgne and New Orleans which has a width of 150 feet. The project provides for a 9-foot channel from the Inner Harbor Navigation Canal across Lake Pontchartrain and through the Rigolets. The costs for these improvements are not separable from the total cost of the project within Louisiana. For further details on this project, see the "Annual Report of the Chief of Engineers, U. S. Army, on Civil Works Activities, 1961."

d. The following additional Corps of Engineers' projects within the study area are described in appendix I:

- (1) Mississippi River, Baton Rouge to the Gulf of Mexico, La.
- (2) Pass Manchac, La.
- (3) Bayous La Loutre, St. Malo, and Yscloskey, La.
- (4) Chefuncte River and Bogue Falia, La.
- (5) Tangipahoa River, La.
- (6) Bayou Lacombe, La.
- (7) Bayou Bonfouca, La.
- (8) Amite River and Bayou Manchac, La.
- (9) Amite River and Tributaries, La.
- (10) Tickfaw, Natalbany, Ponchatoula, and Blood Rivers, La.

#### 14. IMPROVEMENTS BY OTHER FEDERAL AND NON-FEDERAL AGENCIES

a. Federal. No other Federal water resource projects exist in the study area.



14.b.

b. Non-Federal. All of the protective works and drainage facilities described in par. 4.e., exclusive of those outlined in par. 13.a., were constructed through the combined efforts of the State of Louisiana, local levee and drainage districts, and parish police juries, and all excepting the Mississippi River and Bonnet Carre levees are being maintained by local interests.

### SECTION III - PROBLEMS UNDER INVESTIGATION

#### 15. IMPROVEMENTS DESIRED

a. Public hearings. Three public hearings were held to obtain data on hurricane problems and the views of local interests relative to their solution. The hearings at New Orleans, Morgan City, and Lake Charles, Louisiana, on 13, 15, and 20 March 1956, respectively, were attended by about 50 representatives of business, transportation, industrial interests, civic organizations, and Federal, state, and local agencies. Reflecting the preponderance of local opinion, local interests and the State of Louisiana, Department of Public Works, requested that maximum consideration be given to the provision of protective works required to safeguard lives and property from hurricane damage and to the development of an adequate warning system, and indicated that they would actively support the studies. A transcript of the public hearings is presented in supplement 2, published separately. Subsequent to the public hearings and hurricane "Flossy" in September 1956, letters requesting studies of protective measures and commenting on proposed plans of improvement were received from local governmental offices, civic associations, sportsmen's organizations, and residents. A number of meetings and conferences were held with representatives of state agencies as the details of the plans were developed.

b. Proposals by local interests. Local interests in New Orleans suggested an offshore breakwater extending the full length of the existing seawall. St. Charles Parish interests proposed the construction of a lakeshore levee between Bonnet Carre Spillway and the Jefferson Parish boundary, coupled with the establishment of a drainage district. Representatives of Jefferson Parish requested a continuance of levee maintenance. Residents and local officials of the north shore of Lake Pontchartrain were concerned with a shore erosion problem which is accelerated during the occurrence of hurricanes. Construction of a seawall was proposed as a possible solution. Interests in Mandeville requested a new seawall. Local interests in Orleans and St. Bernard Parishes requested the construction of a levee along Paris Road, between the Mississippi River-Gulf Outlet and the Chalmette back levee, and along the Gulf Intracoastal Waterway to provide protection to approximately 9 square miles of undeveloped lands west of Paris Road. Interests in St. Bernard Parish also informally requested the construction of levees along the Mississippi River-Gulf Outlet from Paris Road to Bayou Dupre and

thence along the bayou to the Chalmette back levee to provide protection to an additional area of approximately 22 square miles of undeveloped lands.

#### 16. HURRICANE FLOOD PROBLEMS, RELATED PROBLEMS, AND SOLUTIONS CONSIDERED

a. Hurricane flood problems. The area surrounding Lake Pontchartrain is susceptible to flooding from wind-driven hurricane tides from the lake. This condition is aggravated by increases in lake level resulting from the influx of surges from Lake Borgne and the Gulf of Mexico that accompany hurricanes from the southeast, south, and southwest. Historical hurricanes have produced recorded stages up to 13 feet on the southwest shore of the lake, 6.2 feet at the south shore, 7.1 feet at the southeast shore, and 7.7 feet at the north shore. Overtopping of protective works and flooding of developed areas have occurred several times during recent hurricanes. The 1947 hurricane caused extensive flooding in Jefferson Parish when a lakeshore embankment that was in a poor state of repair proved inadequate to prevent overtopping, even though the stage was only about 5 feet. Considerable overtopping of the New Orleans seawall occurred during this storm and about 9 square miles of residential area were flooded. In 1956, the New Orleans seawall was again overtopped, resulting in the flooding of about 2.5 square miles of residential and commercial area in the lakefront area, fig. 3. On the north shore in 1915, the 7.7-foot stage flooded a considerable area of the land. Wave action during moderate to high lake stages has undercut the existing seawall at Mandeville causing the backfill which was subsequently developed into a public park to slump and the seawall to become hazardous as a hurricane protective structure. The 13-foot stage experienced at the southwest shore during the 1915 storm caused extensive flooding in the marsh to the west of Lake Maurepas. On several occasions, the marsh area between Lake Pontchartrain and Lake Borgne has been flooded by stages up to 11 feet. Much of the developed area in New Orleans and Jefferson Parishes is below lake level, some land being as low as 7 feet below mean sea level, with a considerable portion lower than 2 feet below mean sea level. Flooding as deep as 16 feet above ground level could result from severe overtopping. Stages attending a standard project hurricane would cause overtopping of all existing protective works by several feet and ponding in the developed areas. The pumping system on which removal of all flood waters is dependent would be inoperable for an extended period of time. This prolonged inundation would cause enormous damage to private and public property, create serious hazards to life and health, disrupt business and community life, and require immense expenditure of public and private funds for evacuation and subsequent rehabilitation of local residents.

b. Related problem. Prior to the initiation of construction of the Mississippi River-Gulf Outlet the interchange of tidal flow between Lake Pontchartrain and Lake Borgne was through the Rigolets, Chef Menteur Pass, and the Gulf Intracoastal Waterway-Inner Harbor Navigation Canal channel. Salinities of the incoming tides from Lake Borgne were controlled primarily by fresh water flows from the Pearl River basin and brackish water outflows from Lake Pontchartrain.



Photo Courtesy of The Times-Picayune

Aerial view of general inundation in Gentilly Area of New Orleans behind Lakefront, looking west from Peoples Ave., between Inner Harbor Navigation Canal and London Ave., 24 Sept. 1956.



Photo Courtesy of The Times-Picayune

View of typical residential flooding at St. Roch Ave. and Vienna St. in Gentilly Area, 24 Sept 1956.

Upon completion of the Gulf Outlet, tidal flows also will enter Lake Pontchartrain directly through the Inner Harbor Navigation Canal via the enlarged Gulf Outlet channel to Breton Sound and to the Gulf of Mexico without first passing through Lake Borgne. Thus, salinities in the lake will be increased significantly. Current velocities in the Inner Harbor Navigation Canal have increased notably as construction of the Gulf Outlet progresses with a corresponding increase in navigation difficulties and the creation of major scour problems along existing bridges and harbor developments. The restricted section through the Seabrook Bridge has enlarged greatly since the initiation of construction of the Gulf Outlet. These conditions will worsen as the channel approaches completion.

c. Protective measures considered.

(1) General. Preliminary studies indicated that the extensive marsh, swamp areas, and water bottoms experience a minor degree of damage from hurricane tides and that protective works are impracticable and uneconomical. Hence, detailed studies were not made of these areas. These preliminary studies revealed that justification could be established for the highly developed and inhabited portions of the study area on the north and south shores of Lake Pontchartrain and in the vicinity of Chalmette, and that solution of the problems created by the Mississippi River-Gulf Outlet was required.

(2) Protective structures.

(a) The problems of excessive current velocity and scour in the Inner Harbor Navigation Canal and increased salt water intrusion into Lake Pontchartrain caused by the Mississippi River-Gulf Outlet can be solved only by construction of a lock in the system which can also be utilized to regulate salinity intrusion. The logical site for such a structure is at the Lake Pontchartrain end of the Inner Harbor Navigation Canal at Seabrook. This structure, if raised to the required height, will also serve as an essential part of the barrier plan by preventing the entry of hurricane surges from the lake through the Gulf Outlet.

(b) Protection plans for the areas bordering Lake Pontchartrain were of two types. One plan, the high level plan, contemplated raising, strengthening, and extending the existing protective systems to meet design hurricane requirements. The other plan, the barrier-low level plan, involved the control of hurricane stages in Lake Pontchartrain by construction of a barrier along the east shore of the lake together with a lesser modification of protective works fronting the lake. Protective systems facing Lake Borgne, including the levees along the Inner Harbor Navigation Canal, the Gulf Intracoastal Waterway, and the Gulf Outlet were high level, being unaffected by the barrier. The high level plan, estimated to cost approximately \$100 million, was determined to be much more costly than the barrier-low level plan and to require a much longer construction period in view of the

required height of levees and poor foundation conditions. Therefore, detail study was limited to the barrier-low level plan.

(c) An offshore breakwater was considered for the New Orleans reach to alleviate the erosion problem behind the New Orleans seawall. It was found that such a structure, while effectively reducing wave action at the seawall, would not prevent overtopping of the seawall and its appurtenant back levee by major hurricane tides. In the meantime, local interests have repaired the erosion damage in such a manner as to prevent its recurrence, and they now consider that erosion is no longer a major problem and that such a breakwater is unnecessary and undesirable. A letter expressing the views of the Board of Levee Commissioners of the Orleans Levee District is presented in appendix G.

(d) Several plans were studied for the Chalmette area. One contemplated the enlargement of the existing Chalmette back levee. Another envisioned construction of the hurricane protective system along the south bank of the Gulf Outlet, extending from the Inner Harbor Navigation Canal to Bayou Dupre with gravity drainage structures in Bayou Bienvenue and Bayou Dupre. The existing Chalmette back levee and drainage system would remain in effect. An intermediate plan, extending the expanded protective system only to Paris Road, was also studied. The Gulf Outlet levee system protecting the maximum area was found to be most practicable. Its cost was essentially no higher than the lesser protective systems and it offered substantial additional benefits for the future.

(e) Replacement of the existing seawall at Mandeville by a new wall along the present alignment or offshore was found to be excessive in cost. The wall alone would cost about \$850,000. It was found that strengthening the existing wall in conjunction with the Lake Pontchartrain barrier would provide adequate hurricane protection. The addition of a levee landward of the wall to increase the height of protection was not justified.

(f) The provision of an offshore seawall for Citrus in lieu of the levee at this location also was investigated, but excessive construction costs precluded detail study of this proposal.

(g) The erosion problem along unprotected reaches of the north shore of Lake Pontchartrain was found to be primarily one of beach erosion control which can be studied under other existing legislation and which is not within the purview of the hurricane study authority, hence a detailed study was not made. Erosion control studies of these reaches will require appropriate resolution from the Public Works Committee of either the U. S. House of Representatives or Senate as provided by Section 110 of Public Law 87-874. This Act provides for surveys of coastal areas of the United States in the interest of beach erosion control, hurricane protection, and related purposes.

(h) Local interests requested that the barrier levee be located along the Gulf Intracoastal Waterway from the existing levee to and across Chef Menteur Pass, in order to protect a larger

area of land from Lake Borgne stages. Construction of a closure dam together with a combined control structure and navigation gate in the pass between the railroad bridge and the Gulf Intracoastal Waterway presents a number of unusual and complex problems, of seepage, settlement, and structural stability under design conditions. In addition, the navigation gate could not be converted to a lock if later found necessary. Accordingly, a detail study was not made.

(3) Hurricane warning and flood evacuation measures.

(a) Experience in recent past hurricanes along the Louisiana coast indicates that inhabitants of the low areas are not fully responsive to the adequate and timely hurricane warnings of the U. S. Weather Bureau. Some leave promptly, some prefer to remain, and others elect to evacuate after such action is no longer feasible. This last group creates the major problem and usually suffers greatest mortality. Action is necessary at the local or state level to implement the warnings and coordinate timely evacuation while such action is still feasible. The populace of the vulnerable communities must be made fully cognizant of advance hurricane preparedness planning, and advised of the inherent danger of indecision after evacuation warnings have been issued. Local authorities should be informed of the potential hurricane stages along the coastline and the estimated time of arrival, thereby helping to determine the approximate number of hours left before roads become flooded.

(b) Highways traversing the unprotected portions of the problem area adjacent to the east bank of the Mississippi River and the shores of Lake Pontchartrain serve as evacuation routes for the populace prior to the time of occurrence of maximum hurricane tides. These highways have minimum elevations ranging from 4 to 6 feet, and the majority are located some distance inland from open waters. Ample time is available for safe and orderly evacuation to protected areas should the populace of low-lying unprotected areas heed warnings of the authorities.

(4) Zoning regulations and building codes. Public buildings in unprotected areas including schools, churches, auditoriums, and gymnasiums should be designed with upper floor elevations above the height of hurricane surges, and of adequate structural stability to withstand wind and wave forces to be anticipated. Building codes should require sturdy structures in places where buildings and homes are subject to destruction by hurricane surges, and zoning regulations should restrict construction in critical flood areas. Provisions for the future construction of havens of refuge are dependent upon the enactment of legislation by state and local authorities prescribing zoning regulations and building codes.

d. Model study.

(1) The control structures in the Rigolets and Chef Menteur Pass as elements of the barrier plan were early recognized as potentially hazardous to the established salinity and circulation patterns in Lake Pontchartrain. In order to determine the economical proportions and design of these structures and evaluate their effect on the ecology of the lake a model study of the problem was determined to be necessary. The model included Lakes Pontchartrain, Maurepas, and Borgne and a portion of Mississippi Sound, to scales of 1:2000 horizontally and 1:100 vertically. Tests were run to verify the salinity and flow patterns under existing conditions. The model was then altered to include the Mississippi River-Gulf Outlet. Tests were made to determine the severity of any increase in salt water intrusion into Lake Pontchartrain, the extent of change in salinity gradient in the lake, the increase in channel velocities that ultimately will result from construction of the project, and the effect of prolonged closure of any structure upon the salinity of the lakes and the channel areas. Tests were then run with barrier structures of several sizes for representative years of low and high rainfall inflow into the area, and with the Bonnet Carre Spillway in operation during a flood year. Storm effects were excluded as being impracticable of model determination. A description and the results of this model study are presented in supplement 3 to this report, published separately. A description of the program for the collection of prototype data, and the data are presented in supplement 4 to this report, published separately.

## SECTION IV - PROPOSED SOLUTIONS AND PROJECT FORMULATION

## 17. PLANS OF PROTECTION

a. General. The most effective plan to protect the developments and the navigation along the Inner Harbor Navigation Canal from high velocities, and to prevent excessive saltwater intrusion into Lake Pontchartrain involves a lock and dam at Seabrook. This feature is necessary to correct the adverse conditions resulting from construction of the Mississippi River-Gulf Outlet. The most effective plan for the control of hurricane tides along the shores of Lake Pontchartrain involves the construction of a barrier along the eastern boundary of the lake with navigation and hurricane control gates in Chef Menteur Pass and the Rigolets. These protective works, together with the strengthening and extension of existing protective works and the raising of the Seabrook Lock and dam will afford full protection to the south shore from Bonnet Carre Spillway to the eastern limit of the city of New Orleans. Levees along the Gulf Intracoastal Waterway and the Inner Harbor Navigation Canal, and a new back levee for the Chalmette area would complete the protective system. Strengthening of the existing seawall at



Mandeville on the north shore at its present height will insure that future hurricanes will not seriously damage this resort community.

b. Design hurricane. Areas to be protected are highly developed for residential, commercial and industrial use, or have immediate potential for such development. Because of the serious threat to human life and property involved, the design of the protective plan must be based on the standard project hurricane for the region, as described in paragraph 9. Additional details pertinent to the design hurricane are shown in appendix A.

c. Design elevations.

(1) Mississippi River-Gulf Outlet, Seabrook Lock. The lock and dam at Seabrook will be adequate to provide navigation between the Inner Harbor Navigation Canal and Lake Pontchartrain for any combination of tides up to 3 feet and winds up to 25 m.p.h. Navigation by barge traffic is not considered practicable under conditions of higher tides or winds. All components of the lock and dam will have crest elevations of 7.2 feet except the control houses which will have floor elevations of 12.2 feet.

(2) Hurricane protection plan. The elevations of protective structures were established by computing the most critical combination of wind tide level and corresponding significant wave runup for the design hurricane for each reach. With the barriers and connecting levees in place and operating, the occurrence of the design hurricane would produce a mean lake level of approximately 2 feet and maximum wind tide levels between 5.5 and 6.5 feet along the south shore of Lake Pontchartrain, 6.5 feet at Mandeville, 11 feet at the barrier, between 12 and 12.5 feet along the Gulf Intracoastal Waterway and the Mississippi River-Gulf Outlet, and 12 feet along the Inner Harbor Navigation Canal. Levee grades were determined by adding an amount equal to wave runup for the significant wave to these maximum wind tide levels. Runups range between 2 and 4.5 feet, the exact amount dependent upon the types of structures, slopes of structure, water depths, and wave characteristics. The elevation of the barrier has an allowance of approximately 1 foot above design hurricane surge elevation, because in this reach overtopping can be allowed that does not significantly alter the mean lake elevation. Additional details pertaining to the hydraulic design of the structures are presented in appendix A.

d. Description of the plans. The major features of the plans are described in the following paragraphs. Additional details are shown in appendix E.

(1) Mississippi River-Gulf Outlet, Seabrook Lock. The lock and dam at Seabrook will be located lakeward of the existing Southern Railway bridge, as shown on plate 4. The chamber will be



17.d.(1)

84 by 800 feet with sill elevation at -15.8 feet. Gates will be 60-degree radial type. The walls will be composed of 54-inch round prestressed concrete shells 5 inches thick on 5.5-foot centers filled with sand and capped. Reinforced concrete sections comprise the filler wall between piling. Chamber bottom is riprap on a shell blanket. The landward sector gate structure will be connected to the existing seawalls along the shore by a rockfill embankment. Riprap aprons will be provided at both ends.

(2) Lake Pontchartrain barrier plan.

(a) Barrier levee. The barrier levee, which will extend between the New Orleans East levee and the high ground about 2 miles north of the Rigolets, will have a crest elevation of 9 feet and a crown width of 10 feet, as shown on plate 7. It will utilize the embankment of U. S. Highway 90 where its grade is adequate and will require adjacent levee construction east of the highway where the highway grade is inadequate. The total length of this levee enlargement is 5.6 miles.

(b) Chef Menteur Pass. The barrier structure at Chef Menteur Pass will consist of a gated control structure, navigation channel and floodgate, closure dam, and flanking and connecting levees, as shown on plate 5. The concrete control structure with a crest elevation at 14.0 feet, and a sill elevation at -25 feet will consist of 8 bays with vertical lift steel gates, 50 feet on centers, and will be 700 feet in length between abutments. The gates will be operated by a gantry crane. The approach channels will flare at a  $12.5^{\circ}$  angle horizontally and slope downward from the sill on 1 on 10 slopes to natural bottom. Riprap aprons 50 feet wide both upstream and downstream will prevent erosion of the channel bottom adjacent to the structure. The sector-gated navigation floodgate, shown on plate 5, will have a crest elevation at 14 feet, a width of 56 feet, and a sill elevation of -12 feet. The connecting channels will have a bottom width of 100 feet at an elevation of -12 feet. The closure dam, earthfill with riprap slope protection, will have a crest elevation of 14 feet and a crown width of 20 feet, as shown on plate 7. The grade of the levees adjacent to the structures and the closure dam will have a crest elevation of 14 feet for a minimum distance of 100 feet. The high grade will extend continuously between the closure dam and the control structure.

(c) Rigolets. The barrier structure at the Rigolets will be similar to that at Chef Menteur Pass except that a navigation lock will replace the floodgate, and with other exceptions, as noted and as shown on plate 6. The control structure will have a sill elevation at -20 feet and will consist of 23 50-foot bays for an overall length of 1,450 feet. Incorporated into the structure will be a roadway for the relocation of U. S. Highway 90. The lock chamber will be 84 by 800 feet with sill

elevation at -14 feet as shown on plates 6 and 8. Gates will be 60-degree radial type. The chamber walls are composite type with concrete sheet piles to elevation -2 feet mounted by buttress walls and stabilized by concrete batter piles. Chamber bottom is riprap on a shell blanket. The west gate bay along the barrier alignment will have a crest elevation at 14 feet, and the chamber and east gate a crest elevation at 6 feet. Connecting channels will have bottom widths of 100 feet at an elevation of -14 feet. A minor relocation of U. S. Highway 90 is required.

(d) Seabrook. A dual purpose control structure is required to complete the Lake Pontchartrain barrier system and prevent the entry of hurricane tides through the Mississippi River-Gulf Outlet. The Seabrook Lock, required as a feature of the Mississippi River-Gulf Outlet and described in par. 17.d.(1) above, may be utilized for this purpose by increasing the grade of the rock dike and the landward gate bay to an elevation of 13.2 feet, as shown on plate 9.

(e) St. Charles Parish. The plan provides for the construction of a new levee 5.5 miles in length along the St. Charles Parish lakeshore from the Bonnet Carre Spillway to the east St. Charles Parish boundary. The levee, shown on plate 10, will have a crown elevation of 10 feet and a crown width of 20 feet with slope protection on the lakeside extending from 15 feet beyond the toe to elevation 6.5 feet. A lateral return levee will extend 3.8 miles along an existing canal adjacent to the east St. Charles Parish line to the Illinois Central Railroad. The levee grade will be elevation 8 feet and the crown width 15 feet, as shown on plate 11. Interior drainage ditches will be provided along the entire length of both levees, as shown on plate E-1, appendix E. A drainage structure, as shown on plate 12, will be constructed at the lake end of the lateral levee, equipped with flapgates to provide maximum drainage with tidal fluctuations in the lake, and obviate the employment of operating personnel at the inaccessible site. Additional details related to the hydraulic design for interior drainage are shown in appendix A. Alteration of one 16-inch pipeline crossing will be required.

(f) Jefferson Parish. The grade and section of the existing Jefferson Parish levee system are adequate. The existing riprap slope protection along the lakefront will be extended upward to elevation 6.5 feet. Length of the improvement is 9.7 miles. A typical section is shown on plate 10.

(g) New Orleans. The existing low levees landward of the seawall in this 4.1-mile reach will be raised to an elevation of 11.5 feet, as shown on plate 10. The ramping of streets will be required at 12 locations of levee crossings, as shown in appendix E. The levee along 5.8 miles of the Inner Harbor Navigation Canal can be raised only by construction of a

sheet piling wall with concrete cap at elevation 13 feet in the crown of the existing levee. Stoplog structures will be provided at an elevation of 13 feet for crossings of the Southern Railway at Seabrook and Florida Avenue, and of the Louisville and Nashville Railroad. Low bridge crossings over London Avenue at Robert E. Lee Boulevard and Gentilly Boulevard will require minor sandbagging for the occurrence of a design hurricane.

(h) Citrus. A levee 4.5 miles in length will be constructed lakeward of the existing railroad embankment with a crest elevation of 11 feet and a crown width of 20 feet, as shown on plate 10. Riprap slope protection will be provided on the lake-side slope below elevation 6.5 feet. Incorporation of the railroad embankment in the protective levee was impracticable because of the heterogeneous nature of the fill and because of adverse effects on the railroad facilities. Other features include a stoplog structure at the entrance to Lincoln Beach, modification of the existing Citrus pumping station outfall, and the Lincoln Beach protection walls. The Inner Harbor Navigation Canal levee on the east side, 3.1 miles in length, will be raised by sheet pile construction similar to that described for the west side. Stoplog structures also will be required for the three railroad crossings on the east side similar to those previously described for the west side. The Citrus back levee, 7.4 miles along the Gulf Intracoastal Waterway, will be enlarged to an elevation of 13 feet west and 16 feet east of Paris Road, as shown on plate 11. Riprap foreshore protection against erosion by wave wash from shipping will be provided.

(i) New Orleans East. A levee 6.3 miles long will be required lakeward of the railroad embankment. It will have a crest elevation of 10 feet and a crown width of 20 feet, and riprap slope protection on the lakeside below elevation 6.5 feet, as shown on plate 10. Other features include modification of two pipeline crossings and alteration of an existing drainage culvert. The existing levee from South Point to U. S. Highway 90 is adequate. From this point to the Gulf Intracoastal Waterway, and thence along the waterway the levee will require enlargement for a distance of 9.3 miles to a crest elevation of 16 feet with a crown width of 10 feet, as shown on plate 11. Riprap foreshore protection against wave wash from shipping is required. Other features include a stoplog structure for the Louisville and Nashville Railroad crossing and modification of two pipeline crossings.

(j) Mandeville. The existing seawall at Mandeville will be strengthened by the placement of a shell backfill to an elevation of 5 feet and a riprap blanket along the toe in the lake to an elevation of +1 foot along the entire length of the existing wall, and construction of 200 feet of concrete sheet pile wall to an elevation of 6 feet (see plate 10).

(3) Chalmette protection plan. The plan provides for the construction of a new levee 13.5 miles in length along the south

shore of the Mississippi River-Gulf Outlet from the Inner Harbor Navigation Canal to Bayou Dupre, thence along the west bank of the bayou for a distance of 3.8 miles to Violet. The levee, shown on plate 11, will have a crown width of 10 feet and a grade of 13 feet west of Paris Road and 16 feet east of Paris Road. Riprap foreshore protection against erosion by wave wash from shipping will be provided. A sheet piling wall with concrete cap, with crest elevation of 13 feet and similar to that for the New Orleans reach, will be required for a distance of 1 mile along the Inner Harbor Navigation Canal levee. Gravity drainage structures will be required in the levee at Bayou Bienvenue and at Bayou Dupre. These will be of the sector gate type designed to pass small boats and tidal flows. Other features include alteration of five pipeline crossings and the construction of a stoplog structure at the Florida Avenue crossing of the Southern Railway.

e. Construction. The generally adverse foundation conditions and the methods of construction that must be utilized will require that the levees be built in from one to as many as six stages or lifts, with a minimum interval of 2 years between lifts. Levees requiring four lifts or less will be based in one lift and require only the shaping of the fill in place to accomplish the succeeding lifts. Levees requiring five or more lifts will be constructed by multiple castings of fill and shapings. Adequate allowances have been made for shrinkage and settlement during and after construction. Typical sections shown on plates 5, 6, 7, 10, and 11 are representative for the various reaches.

f. Operation and maintenance.

(1) The control structures will be operated to maintain a mean lake level not exceeding 2 feet during periods of hurricane hazard, as defined by advisories and forecasts from the U. S. Weather Bureau. The gates will be kept closed during hurricane periods and until stages return to normal. At all other times the control gates at the Rigolets and at the Chef Menteur Pass will remain open. The lock structures at the Rigolets and at Seabrook will be operated as necessary to permit navigation until the lock chamber walls are overtopped by rising hurricane tides, at which time the higher level gate will be closed and remain closed until tides recede. Under normal tide conditions, the Rigolets Lock can be left open whenever velocities are not excessive. The Seabrook Lock will be operated in cooperation with the U. S. Fish and Wildlife Service to control the salinity in Lake Pontchartrain and in the Mississippi River-Gulf Outlet area provided such operation will not interfere with navigation.

(2) The physical operation and maintenance of all project features, with the exception of the two lock structures

17.f.(2)

and the Rigolets navigation channel, will be the responsibility of local interests. The Seabrook Lock will be maintained and operated by and at the expense of the United States as a feature of the Mississippi River-Gulf Outlet project. The Rigolets lock and channel will be maintained and operated by the United States in the public interest but the costs for operation and maintenance will be contributed by local interests as a feature of local cooperation of the hurricane project.

#### 18. OTHER DESIRABLE IMPROVEMENTS

a. Hurricane preparedness plans. Each coastal community should organize a permanent committee of parish and local officials essentially in accordance with the recommendations outlined in the U. S. Weather Bureau report, National Hurricane Research Project, Report No. 28, March 1959. The committee would establish a preparedness plan; direct a public educational program on the hazards of hurricanes and the need for desirable protective measures; maintain preparations for a hurricane emergency; and direct evacuation when authorized, and rescue work when necessary. The committee would utilize and coordinate the resources and efforts of state and Federal agencies.

b. Refuge shelters. An inventory should be made and plans developed for the use of buildings suitable for shelters of refuge and these should be incorporated in the preparedness plan. The data should be reviewed and revised periodically to insure the availability of all shelters, such as courthouses, schools, churches, and other suitable buildings. All public buildings to be constructed in the future should be designed to withstand anticipated wind and wave forces and with the upper floor grades of sufficient elevation to serve as an emergency shelter in addition to its principal purpose. Agreements with owners of non-public buildings should be incorporated in the preparedness plan in advance of any required emergency use.

c. Zoning regulations and building codes. One of the important functions of the preparedness committee would be to recommend appropriate building codes and zoning regulations for exposed communities, to review codes and regulations in effect, and to recommend desirable revisions.

### SECTION V - ECONOMIC ANALYSIS

#### 19. ESTIMATES OF FIRST COST

The costs of the Mississippi River-Gulf Outlet and the proposed lock at Seabrook, and the costs of the two hurricane

protection plans are summarized below. Prices include contingencies and are of the level of December 1961. Detailed estimates are given in appendix D.

a. Mississippi River-Gulf Outlet, Seabrook lock.

<u>Item</u>	<u>Federal</u>	<u>Non-Federal</u>	<u>Total</u>
Mississippi River-Gulf Outlet (existing project)	\$ 95,490,000	\$ 8,730,000	\$104,220,000*
Seabrook Lock (proposed)			
Lock and dam	4,371,000	-	4,371,000
Engineering and design	250,000	-	250,000
Supervision and administration	359,000	-	359,000
FIRST COST	\$ 4,980,000	\$ -	\$ 4,980,000
Mississippi River-Gulf Outlet (recommended modification)	\$100,470,000	\$ 8,730,000	\$109,200,000

\*Approved cost estimate from PB 3 effective 1 July 1962.

b. Lake Pontchartrain barrier plan.

<u>Item</u>	<u>Federal</u>	<u>Non-Federal</u>	<u>Total</u>
Rigolets barrier structures	\$ 16,488,000	\$ -	\$ 16,488,000
Chef Menteur barrier structures	6,184,000	-	6,184,000
Modification of Miss. River- Gulf Outlet Seabrook Lock	400,000	-	400,000
Levee enlargements and appur- tenant works:			
St. Charles Parish	4,938,000	-	4,938,000
Jefferson Parish	463,000	-	463,000
New Orleans	4,379,000	-	4,379,000
Citrus	9,451,000	-	9,451,000
New Orleans East	10,990,000	-	10,990,000
Barrier levee	214,000	-	214,000
Mandeville	196,000	-	196,000
Land and damages	-	4,479,000	4,479,000
Relocations	-	548,000	548,000
Engineering and design	2,435,000	-	2,435,000
Supervision and administration	3,538,000	-	3,538,000
Subtotal	\$ 59,676,000	\$ 5,027,000	\$ 64,703,000
Cash contribution*	-18,476,000	18,476,000	-
FIRST COST	\$ 41,200,000	\$23,503,000	\$ 64,703,000

(Cost estimates are exclusive of preauthorization costs of \$449,000)

\*See par. 24 and table D-15 of appendix D.

19.c.

c. Chalmette.

<u>Item</u>	<u>Federal</u>	<u>Non-Federal</u>	<u>Total</u>
Levees and appurtenant works	\$ 12,921,000	\$ -	\$ 12,921,000
Lands and damages	-	452,000	452,000
Relocations	-	447,000	447,000
Engineering and design	518,000	-	518,000
Supervision and administration	805,000	-	805,000
Subtotal	\$ 14,244,000	\$ 899,000	\$ 15,143,000
Cash contribution*	-3,644,000	3,644,000	-
FIRST COST	\$ 10,600,000	\$ 4,543,000	\$ 15,143,000

(Cost estimates are exclusive of preauthorization costs of \$26,000)

\*See par. 24 and table D-24 of appendix D.

20. ESTIMATES OF ANNUAL CHARGES

The estimated annual economic costs of the plans of protection are based on an interest rate of 2-7/8 percent on both Federal and non-Federal costs, and on an economic life of 100 years. Details are given in appendix D.

a. Mississippi River-Gulf Outlet, Seabrook Lock.

Mississippi River-Gulf Outlet  
(existing project)

<u>Item</u>	<u>Federal</u>	<u>Non-Federal</u>	<u>Total</u>
Interest	\$ 2,704,000	\$ 337,600	\$ 3,041,600
Amortization	219,400	11,200	230,600
Maintenance and operation	1,627,500	62,000	1,689,500
Replacements	4,000	-	4,000
TOTAL	\$ 4,554,900	\$ 410,800	\$ 4,965,700

Seabrook Lock (proposed)

<u>Item</u>	<u>Federal</u>	<u>Non-Federal</u>	<u>Total</u>
Interest	\$ 149,300	\$ -	\$ 149,300
Amortization	9,300	-	9,300
Maintenance and operation	120,000	-	120,000
TOTAL	\$ 278,600	\$ -	\$ 278,600

Mississippi River-Gulf Outlet  
(recommended modification)

<u>Item</u>	<u>Federal</u>	<u>Non-Federal</u>	<u>Total</u>
Interest	\$ 2,853,300	\$ 337,600	\$ 3,190,900
Amortization	228,700	11,200	239,900
Maintenance and operation	1,747,500	62,000	1,809,500
Replacements	<u>4,000</u>	<u>-</u>	<u>4,000</u>
 TOTAL	 \$ 4,833,500	 \$ 410,800	 \$ 5,244,300

b. Lake Pontchartrain barrier plan.

<u>Item</u>	<u>Federal</u>	<u>Non-Federal</u>	<u>Total</u>
Interest	\$ 1,284,500	\$ 718,600	\$ 2,003,100
Amortization	80,000	44,700	124,700
Economic loss on land	-	79,500	79,500
Maintenance and operation	125,000	96,800	221,800
Replacements	<u>-</u>	<u>106,500</u>	<u>106,500</u>
 TOTAL	 \$ 1,489,500	 \$ 1,046,100	 \$ 2,535,600

c. Chalmette.

<u>Item</u>	<u>Federal</u>	<u>Non-Federal</u>	<u>Total</u>
Interest	\$ 348,600	\$ 149,400	\$ 498,000
Amortization	21,700	9,300	31,000
Economic loss on land	-	2,700	2,700
Maintenance	-	29,000	29,000
Replacements	<u>-</u>	<u>11,500</u>	<u>11,500</u>
 TOTAL	 \$ 370,300	 \$ 201,900	 \$ 572,200

21. ESTIMATES OF BENEFITS

a. Mississippi River-Gulf Outlet, Seabrook Lock. Benefits attributable to the basic low level lock at Seabrook are primarily corrective in nature. The lock will facilitate navigation of an increasing annual tonnage between the Inner Harbor Navigation Canal and Lake Pontchartrain currently estimated at approximately 3,000,000 tons annually. The structure will prevent serious salt water intrusion and adverse effect on fishery values in Lake Pontchartrain which will otherwise result from the Gulf Outlet project. As modified for the hurricane project the lock forms an integral element of the hurricane barrier to exclude hurricane surges from Lake Pontchartrain. Its benefits for this purpose are not separable.



21.b.

b. The areas along the south shore of Lake Pontchartrain, excepting St. Charles Parish; the area within the existing Chalmette levee; and the area at Mandeville have a fair degree of flood protection at this time. Benefits accruing to these areas are predominantly flood damage prevented. Little enhancement will result from the added protection. On the other hand, the unprotected areas in St. Charles Parish and in the Chalmette area outside the present levee system will be enhanced considerably by the protective works proposed. Average annual benefits derived from the prevention of flood damages were computed by determining the difference between annual losses without the projects and the losses remaining after construction of the proposed improvements. These benefits were then adjusted to allow for the development and growth to be expected without the proposed protective works. Population projections indicate that development of essentially all available areas will take place within 50 years. The projects are designed to protect against the standard project hurricane, which has a recurrence frequency of about 200 years. Residual damage with the projects in place would be the annual damages from the less frequent great hurricanes. Depths of flooding from rainfall were assumed to be the same for all hurricane occurrences; since damage from this cause would not be preventable, it was eliminated from all damage calculations.

c. Flood damages and flood damages prevented. The estimated average annual flood damage in the project area under present conditions and under conditions with the proposed projects in place, the average annual damage prevented under the present state of development, and the annual damage prevented as adjusted to reflect future growth are shown in the following tabulation. Damage prevented on future development was based on population projections. It was assumed that improvements constructed in the future, without additional flood protection, would be similar to that in adjoining areas. Stage-damage relationships, based on ultimate development, were constructed and annual values obtained were then discounted on the basis of estimated growth periods indicated for the several reaches. Price levels are December 1961. Detailed estimates of benefits are outlined in appendix C.

<u>Area</u>	<u>Avg. annual damage under present conditions</u>	<u>Avg. annual damage with project</u>	<u>Avg. annual damage prevented</u>	<u>Avg. annual damage prevent- ed as adjusted for future development</u>
<u>Lake Pontchartrain barrier plan</u>				
St. Charles Ph.	\$ 9,400	\$ -	\$ 9,400	\$ 14,200
Jefferson Ph.	2,256,000	12,000	2,244,000	10,214,100
New Orleans	2,741,100	-	2,741,100	3,046,200
Citrus	4,497,000	24,100	4,472,900	22,092,200
New Orleans East	-	-	-	11,536,700
Mandeville	62,400	400	62,000	62,000
Remaining areas along shores of Lake Pontchar- train	<u>112,100</u>	<u>2,500</u>	<u>109,600</u>	<u>693,600</u>
TOTAL	\$9,678,000	\$39,000	\$9,639,000	\$47,659,000
<u>Chalmette</u>	\$1,212,000	\$ 7,000	\$1,205,000	\$ 4,773,000

d. Enhancement.

(1) Lake Pontchartrain barrier plan. Protection will be afforded to an area of 29,600 acres in St. Charles Parish, with a present appraised value of \$16,399,000. The project will make possible the drainage and development of the entire area. Considering the rate of development experienced in adjoining Jefferson Parish, it is probable that sale of these lands to developers would be accomplished within 20 years. The value is estimated to be enhanced during that period to \$25,614,000, exclusive of enhancement that will result from drainage and other improvements by local interests. The annual value of the enhancement based on the increased value of \$9,215,000 at a 5 percent interest rate is \$460,000. The discounted annual value of the enhancement on this basis is \$350,000 ( $\$460,000 \times 0.760$ ).

(2) Chalmette. The portions of Orleans and St. Bernard Parishes inclosed by the proposed Chalmette levee and the existing Chalmette back levee aggregate 18,830 acres, consisting of 12,830 acres of marsh, 5,875 acres of wooded swamp, and 125 acres of open land, which will be protected from tidal overflow. The appraised value is \$3,710,000. It is estimated that these lands after protection will enhance in value to \$13,010,000, exclusive of enhancement that would result from drainage and other improvements by local interests. The annual value of the enhancement based on the increased value of \$9,300,000 at 5 percent is \$465,000. In consideration of the proximity of this area to New Orleans, and the Mississippi River-Gulf Outlet, which is nearing completion, it is

21.d.(2)

probable that sale of these lands to developers will be accomplished within 15 years. The discounted annual value of the enhancement on this basis is \$379,000 ( $\$465,000 \times 0.815$ ).

e. Average annual benefits from the hurricane protection plans are as follows:

	<u>Lake Pontchartrain barrier plan</u>	<u>Chalmette</u>
Flood damage prevented	\$ 47,659,000	\$ 4,773,000
Enhancement	<u>350,000</u>	<u>379,000</u>
TOTAL	\$ 48,009,000	\$ 5,152,000

f. Intangible benefits include the protection of human life, the prevention of hazards to health arising from pollution, and the improvement of sanitary facilities and water supplies in the area.

## 22. ECONOMIC JUSTIFICATION

a. A comparison of the estimated average annual benefits and annual economic costs for the authorized Mississippi River-Gulf Outlet and proposed modification thereof, and for the two plans of hurricane protection investigated are as follows:

<u>Area</u>	<u>Avg.annual benefit</u>	<u>Avg.annual cost</u>	<u>Benefit- cost ratio</u>
Mississippi River-Gulf Outlet (existing project)	\$ 9,080,000	\$4,965,700	1.8 to 1
Mississippi River-Gulf Outlet (recommended modification)	9,080,000	5,244,300	1.7 to 1
Lake Pontchartrain barrier plan	48,009,000	2,535,600	18.9 to 1
Chalmette	5,152,000	572,200	9.0 to 1

b. Modification of the Mississippi River-Gulf Outlet, to include a lock at Seabrook, is remedial construction. It reduces the benefit-cost ratio from 1.8 to 1 for the existing project to 1.7 to 1 for the modified project.

c. The Lake Pontchartrain barrier plan, including the cost for modification of the Seabrook Lock chargeable to the barrier plan, is amply justified as a comprehensive coordinated plan. The several separable protective systems around the lake shore were analyzed incrementally to the barrier system sufficiently to determine that each was justified. Analysis of the Citrus and New

Orleans East lakefront protection, which consists of the embankment of the Southern Railway, indicated that the embankment would fail under severe hurricane conditions and would be overtopped by the less severe storms resulting in annual damages with the barrier in place and under conditions of future development of \$3,637,000 in the Citrus area and \$1,110,000 in the New Orleans East area. Provision of the proposed levee enlargements would reduce these damages to \$176,000 and \$80,000 and result in annual benefits of \$3,461,000 and \$1,030,000, respectively. Annual costs of the Citrus levee are \$127,300 and the annual costs of the New Orleans East levee are \$232,400. The benefit-cost ratios are 27.0 and 4.4 to 1 for these levees incremental to the barrier plan. Flood damage in the St. Charles Parish area will be essentially eliminated by the barrier system. Subsequent construction of the proposed St. Charles Parish area levee will place the lands in a condition whereby local interests can provide pumped drainage and develop the area. It is estimated that the levee will cause these lands to be enhanced by \$350,000 annually. The annual cost of the levee and appurtenances is \$204,000, resulting in a benefit-cost ratio of 1.7 to 1 for this feature. Improvement and strengthening of the protection in Jefferson Parish, New Orleans, and Mandeville, to insure that these protective works do not fail are considered necessary in view of the threat to life and property, and the relatively small costs for these improvements, \$509,000, \$282,000, and \$224,000, respectively, are amply justified.

- d. The Chalmette hurricane protection plan is justified.

## SECTION VI - COORDINATION AND LOCAL COOPERATION

### 23. PROPOSED LOCAL COOPERATION

a. Mississippi River-Gulf Outlet, Seabrook Lock. It is proposed that modification of the existing Mississippi River-Gulf Outlet project to include authorization for the construction of a lock in the vicinity of Seabrook shall be subject to the conditions that prior to initiation of construction local interests give assurances satisfactory to the Secretary of the Army that they will:

(1) Provide without cost to the United States, and upon the request of the Chief of Engineers, all lands, easements, and rights-of-way, including borrow and spoil-disposal areas required for construction, operation, and maintenance of the project; and

(2) Hold and save the United States free from damages due to the construction works.

b. Lake Pontchartrain barrier plan and Chalmette. It is proposed that construction of the barrier plan of protection for the areas around Lake Pontchartrain, and of the plan of protection for Chalmette shall be subject to the conditions that prior to

initiation of construction on each separable independent feature local interests give assurances satisfactory to the Secretary of the Army that they will without cost to the United States:

(1) Provide all lands, easements, and rights-of-way, including borrow and spoil-disposal areas necessary for construction, operation, and maintenance of the project;

(2) Accomplish all necessary alterations and relocations to roads, railroads, pipelines, cables, wharves, drainage structures, and other facilities required by the construction of the project;

(3) Hold and save the United States free from damages due to the construction works;

(4) Bear 30 percent of the first cost, to consist of the fair market value of the items listed in subparagraphs (1) and (2) above and a cash contribution as presently estimated below, to be paid either in a lump sum prior to initiation of construction or in installments at least annually in proportion to the Federal appropriation prior to start of pertinent work items, in accordance with construction schedules as required by the Chief of Engineers, or, as a substitute for any part of the cash contribution, accomplish in accordance with approved construction schedules items of work of equivalent value as determined by the Chief of Engineers, the final apportionment of costs to be made after actual costs and values have been determined:

<u>Project</u>	<u>Total contribution for construction</u>	<u>Lands and relocations</u>	<u>Cash contribution for construction</u>
Lake Pontchartrain barrier plan	\$19,411,000	\$5,027,000	\$14,384,000
Chalmette	4,543,000	899,000	3,644,000

(5) Provide for the Lake Pontchartrain barrier plan an additional cash contribution equivalent to the estimated capitalized value of maintenance and operation of the Rigolets navigation lock and channel to be undertaken by the United States, presently estimated at \$4,092,000, the final determination to be made after construction is complete, said amount to be paid either in a lump sum prior to initiation of construction of the barrier or in installments at least annually in proportion to the Federal appropriation for construction of the barrier;

(6) Provide all interior drainage and pumping plants required for reclamation and development of the protected areas;

(7) Maintain and operate all features of the project in accordance with regulations prescribed by the Secretary of the Army, including levees, floodgates and approach channels, drainage structures, drainage ditches or canals, floodwalls,

seawalls, and stoplog structures, but excluding the Rigolets navigation lock and its appurtenant navigation channels and the modified Seabrook Lock; and

(8) Acquire adequate easements or other interest in land to prevent encroachment on existing ponding areas unless substitute storage capacity or equivalent pumping capacity is provided promptly.

#### 24. APPORTIONMENT OF COSTS AMONG INTERESTS

a. Mississippi River-Gulf Outlet, Seabrook Lock. First costs and annual costs of operation and maintenance for the low level lock at Seabrook will be borne by the United States. The apportionment of costs between Federal and non-Federal agencies for the existing Mississippi River-Gulf Outlet project; for the proposed new lock near Seabrook under the authority of the Mississippi River-Gulf Outlet project; and the modified Mississippi River-Gulf Outlet project are as follows:

<u>Item</u>	<u>First cost</u>	<u>Federal</u>	<u>Non-Federal</u>
Mississippi River-Gulf Outlet (existing project)	\$104,220,000	\$95,490,000	\$8,730,000
Seabrook Lock (proposed)	<u>4,980,000</u>	<u>4,980,000</u>	<u>-</u>
Mississippi River-Gulf Outlet (recommended modification)	\$109,200,000	\$100,470,000	\$8,730,000

b. Hurricane protection plans. The apportionment of costs of the proposed plans for hurricane protection is based on the cost sharing formula adopted in the Flood Control Act of 1958 for the Narragansett Bay, New Bedford, and Texas City projects. This act specifies that first costs, including the costs of lands, easements, rights-of-way, and relocations, but excluding the cost of preauthorization studies, shall be apportioned at least 30 percent to non-Federal interests and not to exceed 70 percent to the Federal government. Land, easements, rights-of-way, and relocations shall be provided by non-Federal interests without cost to the United States and will be credited to the local contribution. Operation and maintenance costs of all levees, structures, and drainage facilities, except the modified Seabrook Lock, shall be the responsibility of non-Federal interests. The Rigolets lock and navigation channel will be operated by the Federal government with funds to be contributed by local interests. The estimated annual cost of operation and maintenance is \$125,000. The local cash contribution is based on the capitalized value of \$125,000 over the life of the project. On this basis, the apportionments of first costs of the proposed plans found to be economically justified are as follows:

24.b.(1)

(1) Lake Pontchartrain barrier plan.

<u>Item</u>	<u>First cost</u>	<u>Federal</u>	<u>Non-Federal</u>
Construction	\$59,676,000	70%	30%
Lands, damages, and re- locations	<u>5,027,000</u>	_____	_____
Total	\$64,703,000	\$45,292,000	\$19,411,000
Less costs of lands, damages, and reloca- tions			<u>-5,027,000</u>
Cash contribution for construction			\$14,384,000
Cash contribution for capitalized annual maintenance and oper- ation		-4,092,000	<u>4,092,000</u>
Total cash contribution			\$18,476,000
Plus costs of lands, damages, and relocations		_____	<u>5,027,000</u>
FIRST COSTS		\$41,200,000	\$23,503,000

(2) Chalmette.

<u>Item</u>	<u>First cost</u>	<u>Federal</u>	<u>Non-Federal</u>
Construction	\$14,244,000	70%	30%
Lands, damages, and relocations	<u>899,000</u>	_____	_____
Total	\$15,143,000	\$10,600,000	\$ 4,543,000
Less costs of lands, damages, and relocations			<u>-899,000</u>
Cash contribution			\$ 3,644,000

25. COORDINATION WITH OTHER AGENCIES

This study has been coordinated with Federal, state, and local agencies that are concerned with hurricane problems, or that are responsible for the protection of public and private property or

fish and wildlife resources. They have been consulted during the course of the study to obtain technical data, pertinent information, or cooperation where mutual responsibilities were involved. The participation of these agencies and a summary of their views are stated below.

a. U. S. Department of Commerce. The Weather Bureau furnished technical information regarding intensity, frequency, and duration of future hurricanes and expanded data related to historic hurricanes which were necessary for verification of procedures. Descriptions of these data are included in appendix A.

b. U. S. Department of the Interior.

(1) The Fish and Wildlife Service was kept fully informed of the plans of protection under consideration throughout the study. Numerous conferences and discussions were held during the development and design phases of the plans of protection. The Service found that construction of the proposed hurricane tide barrier along the east side of Lake Pontchartrain would not significantly affect the existing salinity gradient pattern in the lake, and that improvement of existing levees, or construction of new levees would cause no significant project effects because of the normal metropolitan expansion that the area is presently undergoing. The Service found, however, that the salt water intrusion problem induced by the construction of the Mississippi River-Gulf Outlet would be detrimental to existing conditions in the lake, the navigation channel area, and the contiguous areas, and that proper control should be provided. Reports of the Fish and Wildlife Service are presented in appendix F.

(2) The recommendations presented in the report dated 13 March 1962 are that:

(a) "In the event you recommend the low level plan, your plan include provision for enlarging the structures in the tidal passes should the salinity gradient in Lake Pontchartrain, as established by a cooperative sampling program, be adversely affected.

(b) "The existing salinity gradient in Lake Pontchartrain be maintained insofar as salt water intrusion control requirements in the overall Lake Pontchartrain-Gulf Outlet complex will permit.

(c) "A structure, as necessary for salt water intrusion control, be built as a feature of the Gulf Outlet project in the Gulf Outlet-Industrial Canal connection with Lake Pontchartrain.



25.b.(2)(d)

(d) "The pertinent design-criteria and operational procedure for this structure be developed as a part of the continuing studies on the Gulf Outlet project."

(3) The recommendations presented in the report dated 22 October 1962 are:

(a) "That two floodgates proposed for the Chalmette section of the hurricane protection area be modified as necessary to provide, within feasible limits, for maintenance of the natural salinity regimen of interior waters. Design and operation for this purpose be established during advanced planning for this project.

(b) "Your request for authorization on this project should provide sufficient flexibility in regard to the Seabrook structure that design and operation can be established during advanced planning and in accordance with findings of salinity studies currently in progress."

(4) The above recommendations are acceptable with the exception of that in par. 25.b.(2)(a). The design of the control structures presented in this report is considered adequate for the preservation of the present salinity gradient of Lake Pontchartrain. The design is based upon the most conservative application of engineering principles and results of extensive model tests, with the full cooperation and concurrence of the Service in the plan, and the structures will require no foreseeable enlargement. In addition, the lock at Seabrook will provide control of sufficient flexibility to regulate salinity in the lake within reasonable limits. Any modification later found necessary should be authorized through normal review procedures.

(5) A report, entitled "A Detailed Report on Hurricane Study Area I, Lake Pontchartrain and Vicinity, Louisiana," was published by the U. S. Fish and Wildlife Service in June 1962. This report, supplement 5, provides detailed information supporting the summarized findings presented in the Service's letter report of 13 March 1962.

c. U. S. Coast Guard. The Coast Guard was consulted as to the requirements of aids to navigation and has stated that the proposed improvements will require no changes in the existing aids to navigation nor will additional Coast Guard aids to navigation be required.

d. U. S. Department of Agriculture. The Soil Conservation Service was consulted during the study and requested to furnish views and comments on the plans of protection. The Service feels that agriculture holds a relatively unimportant position in the economy of the area, and that intensively developed agricultural

land is decreasing and will probably be converted to urban development within a few years. It is not expected that the proposed project will adversely affect any potential P.L. 566 project or other Soil Conservation Service activities within the project area.

e. State of Louisiana.

(1) The Department of Public Works was consulted throughout the development phase of the study. The Department concurs in the suitability of the proposed plans of protection.

(2) The Department of Health was requested to furnish views and comments on the proposed plan of protection and stated that public health problems would not result from the plans presented.

(3) The Wild Life and Fisheries Commission was requested to furnish its views and comments relative to the project. The U. S. Fish and Wildlife Service has stated that the Commission concurs with the findings of the Service and has attached to its reports letters of confirmation from that organization, appendix F.

(4) In the early phases of the study, the Department of Highways was consulted relative to the merits of a dual-purpose interstate highway-hurricane barrier embankment, but the plan was abandoned because of the incompatible schedules of the two projects. The minor modifications to U. S. Highway 90 in connection with the barrier plan are acceptable to the Highway Department.

(5) The Board of Levee Commissioners of the Orleans Levee District and the Board of Commissioners of the Port of New Orleans have been consulted during the course of the study and have furnished important data in connection therewith. Representatives of both Boards have reviewed the plans of protection and have expressed general concurrence with the recommendations of this report.

f. Assurances of cooperation. The State of Louisiana, Department of Public Works, the agency designated to act in such matters on behalf of the Governor of the State of Louisiana, has concurred in the suitability of the plans of protection, and has stated that assurances from local interests will be provided when required.

## SECTION VII - RESULTS OF INVESTIGATION

### 26. DISCUSSION AND CONCLUSIONS

a. The Louisiana coastal area, including the shores of Lake Pontchartrain, is subject to flooding by hurricane surges. Much of the

area is tidal marsh remote from any developments and its protection is impracticable and uneconomical. The partially protected areas along the south shore of the lake, including the Greater New Orleans Metropolitan area, along the north shore of Mandeville, and along the Mississippi River at Chalmette, as well as contiguous areas of potential development in St. Charles Parish and in the Chalmette area, are feasible of protection. A related problem exists, in that observations during the construction of the Mississippi River-Gulf Outlet, supplemented by the model studies made in connection with the hurricane study, show that current conditions in the Gulf Outlet and in the Inner Harbor Navigation Canal will be hazardous to navigation and will further and seriously impair the safety of structures along and across these waterways, particularly the existing major traffic bridge across the Inner Harbor Navigation Canal. The Gulf Outlet will, by reason of its direct connection to the Gulf of Mexico, greatly increase the salinity regimen of Lake Pontchartrain and in the area contiguous to the canal. Provision of a low level lock at the lakeward terminus of the Inner Harbor Navigation Canal is necessary to alleviate the adverse effects on navigation and on the ecology of the area affected by the Mississippi River-Gulf Outlet. Benefits of the existing project are sufficient to justify the additional authorization of the proposed lock. The lock required as a corrective measure for navigation can be readily incorporated in a plan for a hurricane barrier to a higher elevation. The incremental cost of raising the lock walls and gates as necessary to complete the barrier and exclude hurricane surges from Lake Pontchartrain is properly a charge to the hurricane plan.

b. Lake Pontchartrain barrier plan. The plan found most suitable for the protection of the shores of Lake Pontchartrain from flooding by hurricane tides is the barrier plan. This plan provides for the construction of a barrier along the east side of Lake Pontchartrain, a levee along the St. Charles Parish lakefront, a new levee along the Citrus and New Orleans East lakeshores, the improvement or enlargement of existing protective works on the south and north shores of the lake, along the Gulf Intracoastal Waterway and the Inner Harbor Navigation Canal including a dual-purpose lock at Seabrook, and necessary modifications to roads, pipelines, pumping stations, and drainage facilities. The project is amply justified.

c. The Gulf Intracoastal Waterway was formerly routed from the Inner Harbor Navigation Canal through Lake Pontchartrain and thence through the Rigolets to connect with the existing route east of the Rigolets. Thus, the Rigolets is a segment of an authorized navigation channel. Increased channel velocities through the Rigolets barrier structure would make navigation hazardous for the heavy commercial traffic that uses the pass. Therefore, a lock is necessary at this location. The proposed lock in the Rigolets is a feature of the hurricane protective plan and its maintenance and operation are properly chargeable to local interests. However, it is deemed appropriate in the public interest that physical operation and maintenance be kept

under the jurisdiction of the United States. Accordingly, a lump sum contribution of \$4,092,000, representing the capitalized annual costs of \$125,000, should be made by local interests during the construction period. At Chef Menteur Pass, the traffic is local in nature and will be adequately served by a floodgate structure with long approach channels. The Chef Menteur structure is designed to permit expansion to a lock should conditions in the future indicate the need for such a facility.

d. Chalmette. The Chalmette area can be afforded adequate protection against hurricane flooding by construction of a new levee along the Mississippi River-Gulf Outlet from the Inner Harbor Navigation Canal to Bayou Dupre, thence along the bayou to Violet and the improvement of existing protective structures along the Inner Harbor Navigation Canal, including necessary modifications to railroads, pipelines, and drainage facilities. Benefits are sufficient to justify authorization of the project.

e. The plans described above for prevention of flooding by hurricane tides, and for corrective action to alleviate the adverse effects of the Mississippi River-Gulf Outlet on navigation and on the ecology of the area are based on thorough and careful analysis of experienced and potential flood situations. Protective works will provide dependable protection to a high degree and will result in major reduction in average annual damage, in damage resulting from flooding by the standard project hurricane, and in damage to navigation and conservation interests.

f. Effects on other interests. The proposed plans will have negligible effect on other interests in the area. The barrier will not modify the salinity regimen or ecology of the Lake Pontchartrain area and fishery values will undergo little or no change. The improvement of existing protective works will not affect wildlife values. The plans will in no way hamper business and industrial operations, or agricultural activities. The plans of protection make adequate provision for preserving existing navigation facilities. The dual purpose Seabrook Lock makes adequate provision for existing and future traffic between the Inner Harbor Navigation Canal and Lake Pontchartrain.

g. Local measures. Further protection of human life and property can be afforded by the more widespread dissemination of information relative to potential hurricane tide elevations and limits of flooding. This can be accomplished through the organization of a hurricane preparedness committee in each community. Such a committee would establish a continual preparedness plan, conduct public educational programs, formulate plans for use of buildings as hurricane shelters, recommend desirable zoning regulations and building codes, and direct evacuation and rescue work when necessary. Zoning regulations and building codes should be established and enforced where not presently in effect. All of these measures will be undertaken by local interests at no cost to the United States.

h. The report is fully responsive to all of the resolutions cited in par. 1. The authorization cited in par. 1.c. requires study with respect to flood control, navigation and beach erosion control in Orleans Parish. Flood control measures desired by local interests were those which would prevent flooding by hurricane tides and waves from Lake Pontchartrain, and were not related to flooding resulting from inadequate interior drainage. Although mentioned in the resolution, navigation is not involved as a basic problem, but only as affected by protective measures to be provided. As discussed in par. 16.c.(2)(c), local interests have solved the erosion problem and no longer consider it of major importance.

i. Additional information on recommended projects outlined in Senate Resolution 148, 85th Congress, adopted 28 January 1958, is shown in the attachment to this report.

#### SECTION VIII - RECOMMENDATIONS

##### 27. RECOMMENDATIONS

###### a. Lake Pontchartrain barrier plan.

(1) It is recommended that the barrier plan for the hurricane protection of the shores of Lake Pontchartrain be authorized for construction to include the following features:

(a) A barrier across the east side of Lake Pontchartrain, to consist of a levee along U. S. Highway 90; a control structure and approach channels, navigation lock and channels, and closure dam at the Rigolets; a control structure, floodgate, navigation channel, and closure dam at Chef Menteur Pass;

(b) A levee along the lakeshore of St. Charles Parish between the Bonnet Carre Spillway and Jefferson Parish; a lateral levee along the St. Charles-Jefferson Parish line; and a drainage structure in the lateral levee near its lakeward extremity; and

(c) Improvement of existing levees along the lakeshores of Jefferson Parish and New Orleans, a new levee along the lakeshore of Citrus and New Orleans East, and improvement of existing protective works between U. S. Highway 90 and the Gulf Intracoastal Waterway in the northeastern section of Orleans Parish, along the Gulf Intracoastal Waterway and the Inner Harbor Navigation Canal in Orleans Parish, including the incremental cost of a dual purpose lock in the Inner Harbor Navigation Canal at Seabrook chargeable to Hurricane Protection, and along the lakeshore at Mandeville, La.

(2) The proposed plan shall be generally in accordance with the plan of improvement described herein and as shown on the accompanying

plates and with such modification thereof as in the discretion of the Chief of Engineers may be advisable, at estimated costs to the United States of \$41,200,000 for new work, and \$125,000 annually for operation and maintenance.

(3) Construction of the project shall be subject to the conditions that prior to initiation of construction on each separable independent feature local interests give assurances satisfactory to the Secretary of the Army that they will without cost to the United States:

(a) Provide all lands, easements, and rights-of-way, including borrow and spoil-disposal areas necessary for construction, operation, and maintenance of the project;

(b) Accomplish all necessary alterations and relocations to roads, railroads, pipelines, cables, wharves, drainage structures, and other facilities required by the construction of the project;

(c) Hold and save the United States free from damages due to the construction works;

(d) Bear 30 percent of the first cost, to consist of the fair market value of the items listed in subparagraphs (a) and (b) above and a cash contribution as presently estimated below, to be paid either in a lump sum prior to initiation of construction or in installments at least annually in proportion to the Federal appropriation prior to start of pertinent work items, in accordance with construction schedules as required by the Chief of Engineers, or, as a substitute for any part of the cash contribution, accomplish in accordance with approved construction schedules' items of work of equivalent value as determined by the Chief of Engineers, the final apportionment of costs to be made after actual costs and values have been determined:

<u>Project</u>	<u>Total contribution for construction</u>	<u>Lands and relocations</u>	<u>Cash contribution for construction</u>
Lake Pontchartrain barrier plan	\$19,411,000	\$5,027,000	\$14,384,000

(e) Provide an additional cash contribution equivalent to the estimated capitalized value of maintenance and operation of the Rigolets navigation lock and channel to be undertaken by the United States, presently estimated at \$4,092,000, the final determination to be made after construction is complete, said amount to be paid either in a lump sum prior to initiation of construction of the barrier or in installments at least annually in proportion to the Federal appropriation for construction of the barrier;

27.a.(3)(f)

(f) Provide all interior drainage and pumping plants required for reclamation and development of the protected areas;

(g) Maintain and operate all features of the project in accordance with regulations prescribed by the Secretary of the Army, including levees, floodgates and approach channels, drainage structures, drainage ditches or canals, floodwalls, seawalls, and stoplog structures, but excluding the Rigolets navigation lock and its appurtenant navigation channels and the modified dual purpose Seabrook Lock; and

(h) Acquire adequate easements or other interest in land to prevent encroachment on existing ponding areas unless substitute storage capacity or equivalent pumping capacity is provided promptly.

b. Chalmette.

(1) It is further recommended that a plan for hurricane protection of the Chalmette area be authorized for construction to provide for a levee along the Mississippi River-Gulf Outlet from the Inner Harbor Navigation Canal to Bayou Dupre, thence along the bayou to Violet, La.; the improvement of the existing levee along the Inner Harbor Navigation Canal; and drainage structures in the levee alignment at Bayous Bienvenue and Dupre.

(2) The proposed plan shall be generally in accordance with the plan of improvement described herein and as shown on the accompanying plates and with such modification thereof as in the discretion of the Chief of Engineers may be advisable, at an estimated cost to the United States of \$10,600,000 for new work.

(3) Construction of the project shall be subject to the conditions that prior to initiation of construction on each separable independent feature local interests give assurances satisfactory to the Secretary of the Army that they will without cost to the United States:

(a) Provide all lands, easements, and rights-of-way, including borrow and spoil-disposal areas necessary for construction, operation, and maintenance of the project;

(b) Accomplish all necessary alterations and relocations to roads, railroads, pipelines, cables, wharves, drainage structures, and other facilities required by the construction of the project;

(c) Hold and save the United States free from damages due to the construction works;

(d) Bear 30 percent of the first cost, to consist of the fair market value of the items listed in subparagraphs (a) and (b) above and a cash contribution as presently estimated below, to be

paid either in a lump sum prior to initiation of construction or in installments at least annually in proportion to the Federal appropriation prior to start of pertinent work items, in accordance with construction schedules as required by the Chief of Engineers, or, as a substitute for any part of the cash contribution, accomplish in accordance with approved construction schedules items of work of equivalent value as determined by the Chief of Engineers, the final apportionment of costs to be made after actual costs and values have been determined:

<u>Project</u>	<u>Total contribution for construction</u>	<u>Lands and relocations</u>	<u>Cash contribution for construction</u>
Chalmette	\$4,543,000	\$ 899,000	\$3,644,000

(e) Provide all interior drainage and pumping plants required for reclamation and development of the protected areas;

(f) Maintain and operate all features of the project in accordance with regulations prescribed by the Secretary of the Army, including levees, floodgates and approach channels, drainage structures, drainage ditches or canals, floodwalls, and stoplog structures;

(g) Acquire adequate easements or other interest in land to prevent encroachment on existing ponding areas unless substitute storage capacity or equivalent pumping capacity is provided promptly.

c. Mississippi River-Gulf Outlet, Seabrook Lock.

(1) It is further recommended that the existing project for the Mississippi River, Baton Rouge to the Gulf of Mexico, La., project, authorized by the River and Harbor Act of 2 March 1945, Public Law No. 14, 79th Congress, 1st Session, and modified by the addition of the Mississippi River-Gulf Outlet, authorized by the River and Harbor Act of 29 March 1956, Public Law No. 455, 84th Congress, 2d Session, be further modified to provide for the construction of a dual purpose lock at the lakeward terminus of the Inner Harbor Navigation Canal in the vicinity of Seabrook, La.

(2) The proposed plan shall be generally in accordance with the plan of improvement described herein and as shown on the accompanying plates and with such modification thereof as in the discretion of the Chief of Engineers may be advisable, at estimated costs to the United States of \$4,980,000 for new work, and \$120,000 annually for operation and maintenance, in addition to that now required for the authorized Mississippi River-Gulf Outlet.



27.c.(3)

(3) Construction of the project shall be subject to the conditions that prior to initiation of construction local interests give assurances satisfactory to the Secretary of the Army that they will:

(a) Provide without cost to the United States and upon the request of the Chief of Engineers, all lands, easements, and rights-of-way, including borrow and spoil-disposal areas required for construction, operation, and maintenance of the project; and

(b) Hold and save the United States free from damages due to the construction works.

Incls  
Plates 1-13  
Appendixes A-I  
Attachment

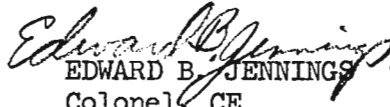
  
EDWARD B. JENNINGS  
Colonel, CE  
District Engineer

R-1/9/63

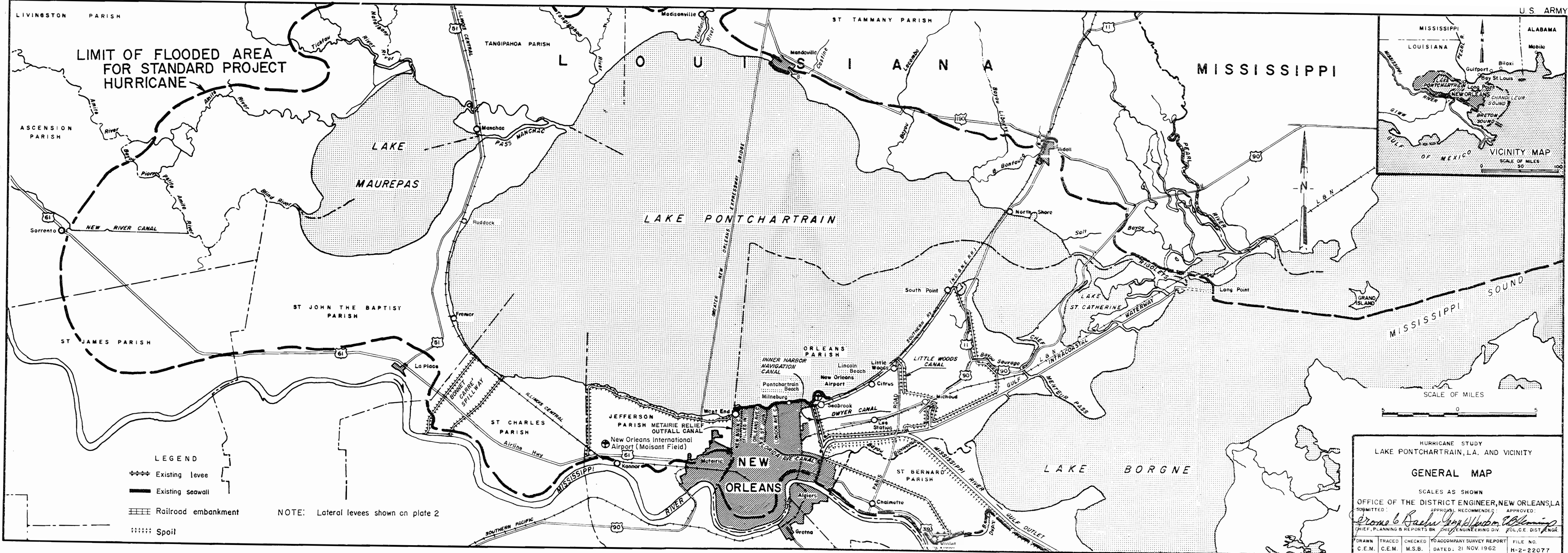

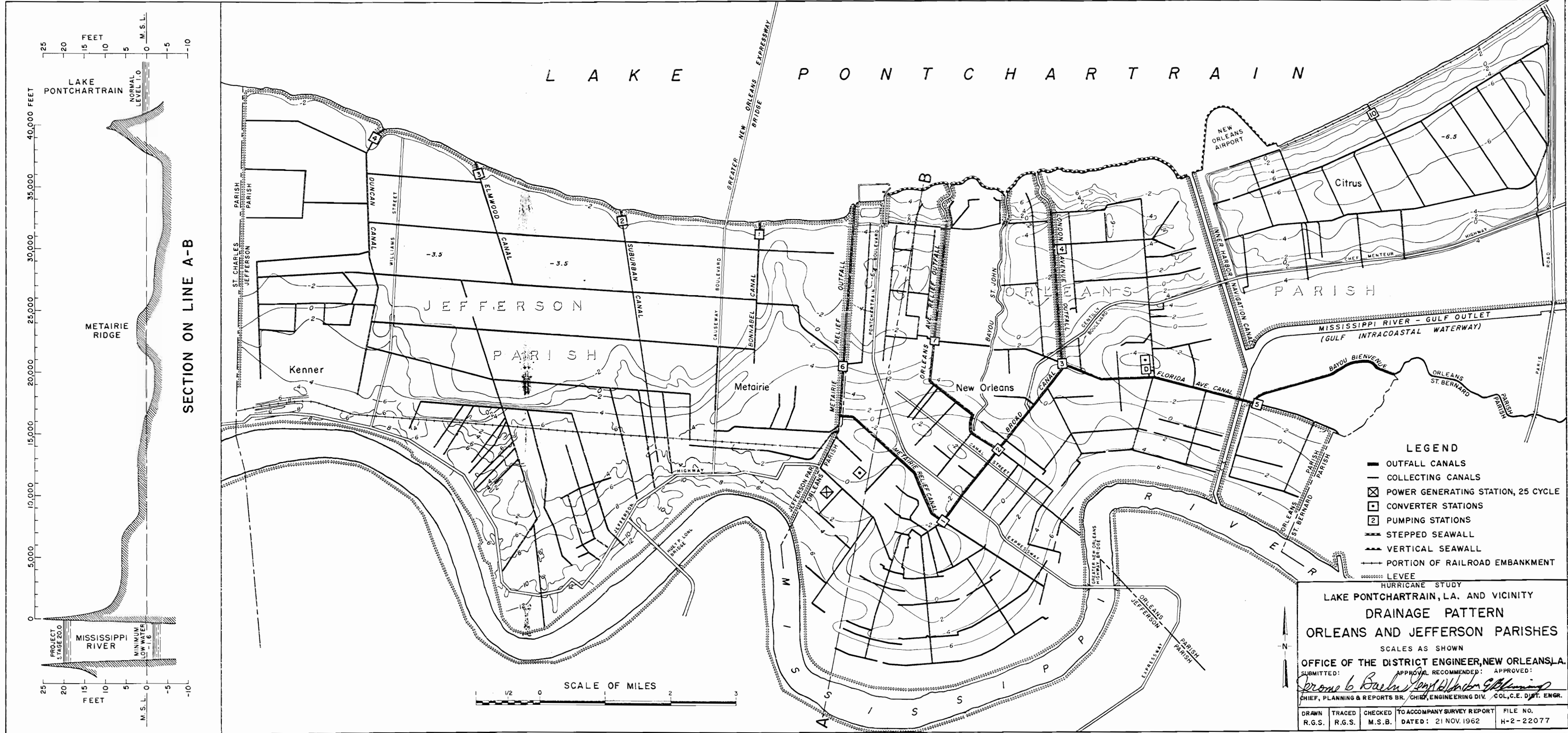



PROTECTIVE WORKS

- |   |       |                         |                        |
|---|-------|-------------------------|------------------------|
| EXISTING                                |       | IMPROVEMENTS CONSIDERED |                        |
| Embankments                             | ----- |                         | Barrier-low level plan |
| Elevation of embankments                | 9.6   |                         | High level plan        |
| Lock                                    |       | 10.5                    | Barrier-low level plan |
| HURRICANE BARRIER STRUCTURE:            |       | 13.5                    | High level plan        |
| Rigolets (See plate 6 & 8)              |       |                         | See plates 4 & 9       |
| Chef Menteur (See plate 5)              |       |                         |                        |
| Drainage Structure (See plates 12 & 13) |       |                         |                        |
| High level or barrier                   |       |                         |                        |

NOTE:  
Elevations are in feet and refer to m.s.l.

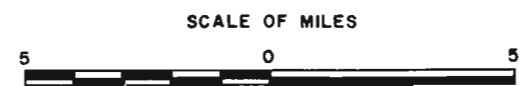
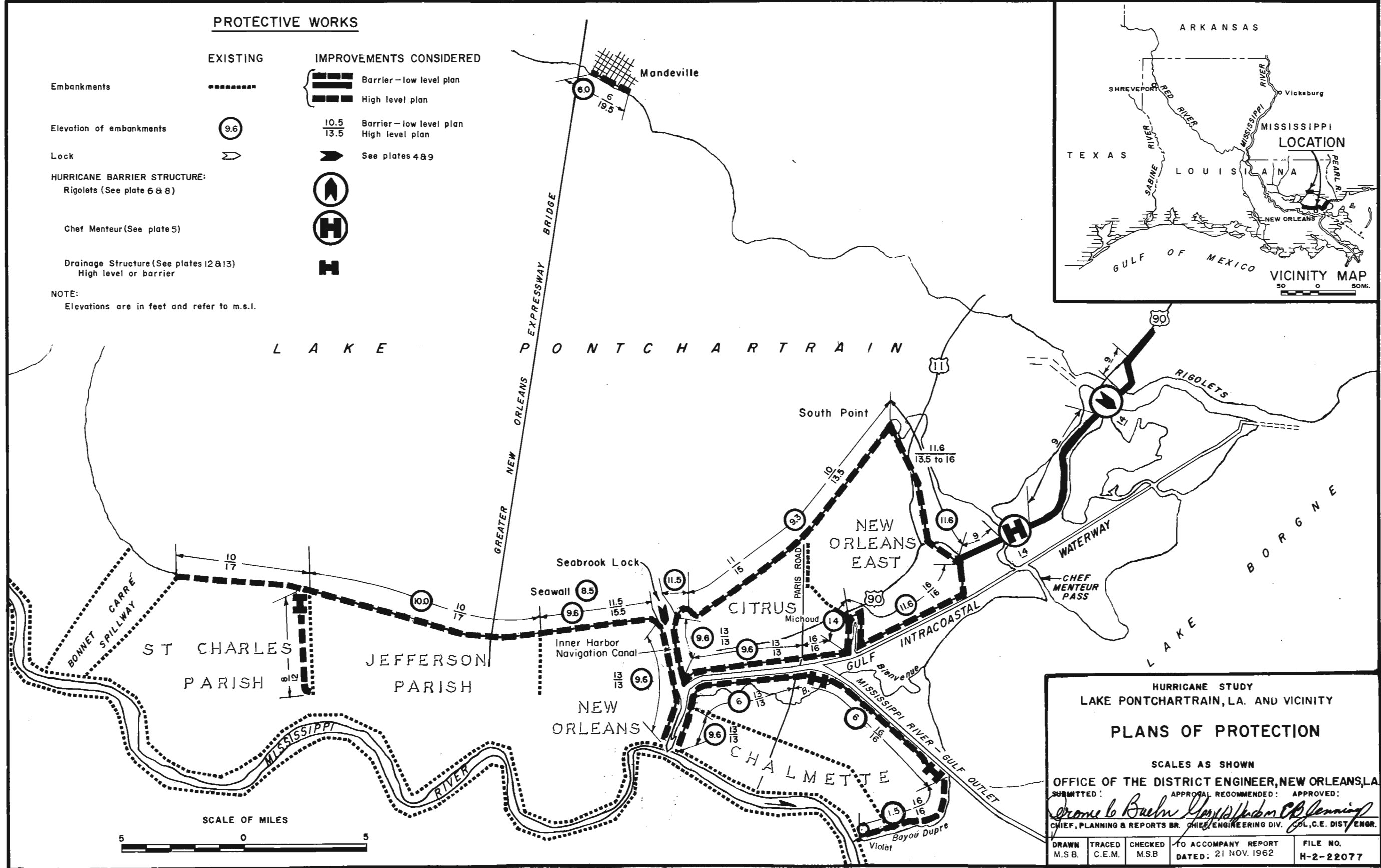
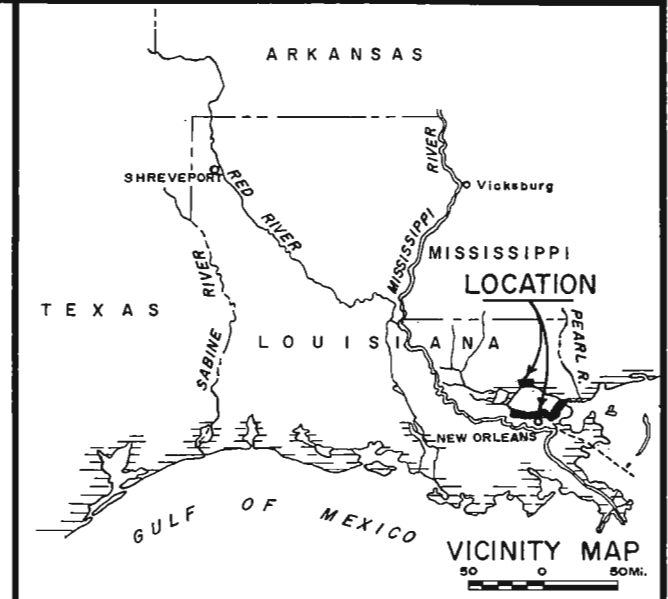

HURRICANE STUDY  
LAKE PONTCHARTRAIN, LA. AND VICINITY

PLANS OF PROTECTION

SCALES AS SHOWN

OFFICE OF THE DISTRICT ENGINEER, NEW ORLEANS, LA.

SUBMITTED: \_\_\_\_\_ APPROVAL RECOMMENDED: \_\_\_\_\_ APPROVED: \_\_\_\_\_

*Ernie L. Buehn* *George J. Jackson* *Col. C.E. Dist. Engr.*

CHIEF, PLANNING & REPORTS BR. CHIEF, ENGINEERING DIV. COL., C.E. DIST. ENGR.

DRAWN M.S.B.	TRACED C.E.M.	CHECKED M.S.B.	TO ACCOMPANY REPORT DATED: 21 NOV. 1962	FILE NO. H-2-22077
-----------------	------------------	-------------------	--	-----------------------

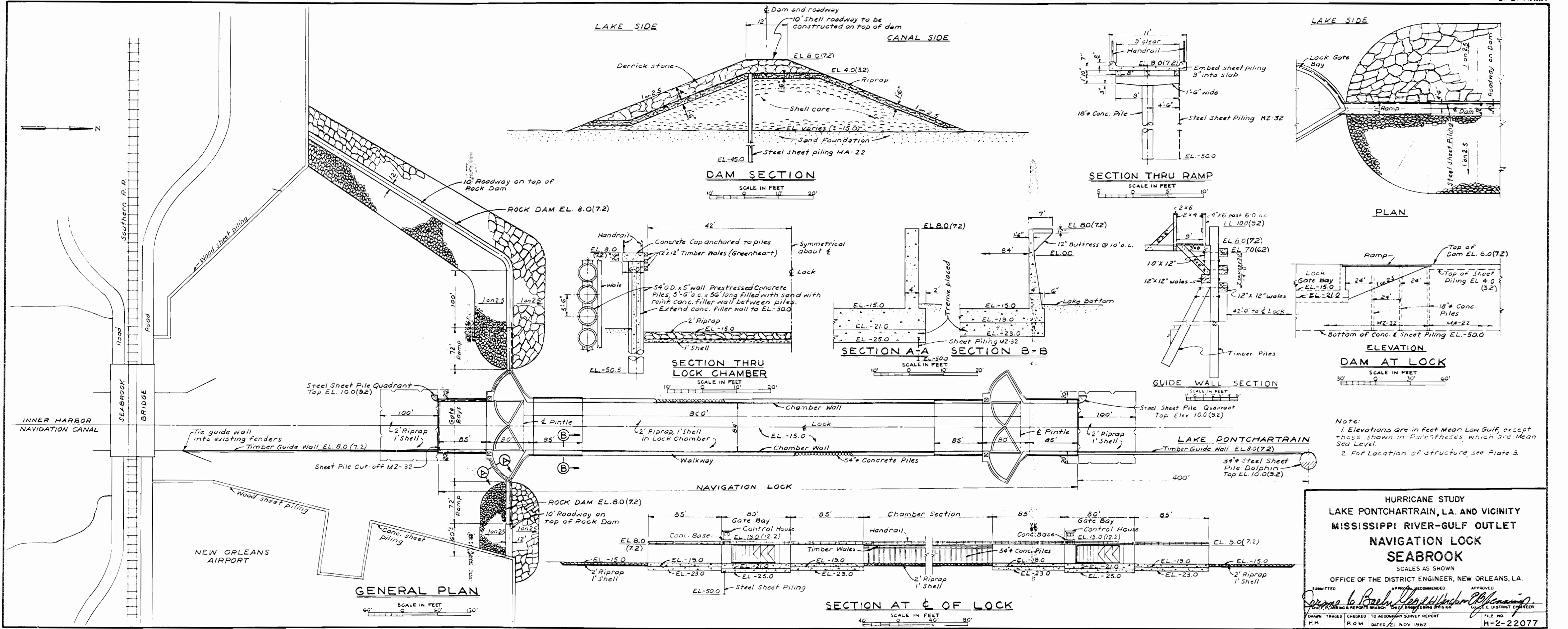

Note:  
 1. Elevations are in Feet Mean Low Gulf, except those shown in Parentheses, which are Mean Sea Level.  
 2. For Location of structure, see Plate 3.

**HURRICANE STUDY  
 LAKE PONTCHARTRAIN, LA. AND VICINITY  
 MISSISSIPPI RIVER-GULF OUTLET  
 NAVIGATION LOCK  
 SEABROOK**

SCALES AS SHOWN  
 OFFICE OF THE DISTRICT ENGINEER, NEW ORLEANS, LA.

SUBMITTED: \_\_\_\_\_ APPROVED: \_\_\_\_\_  
 CHECKED: \_\_\_\_\_  
 F.M. TRAGEDY CHECKED TO ACCOMPANY SURVEY REPORT FILE NO. H-2-22077  
 DATED 21 NOV 1962

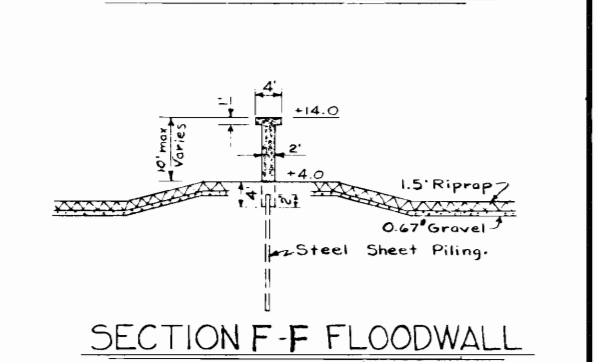
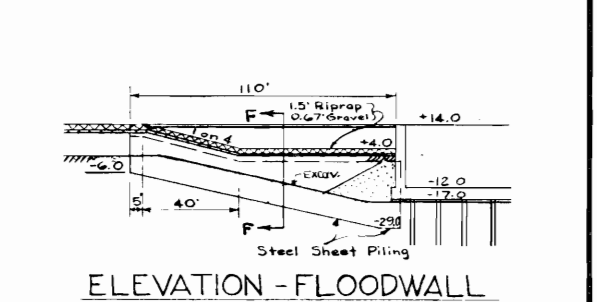
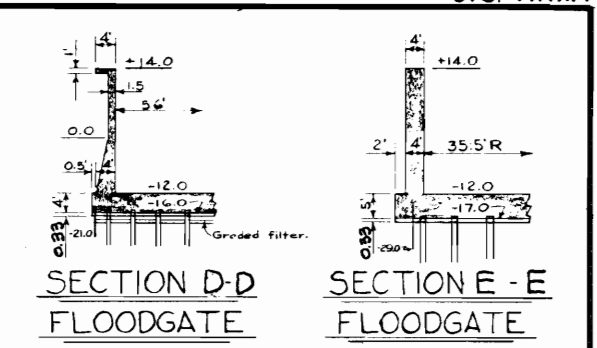
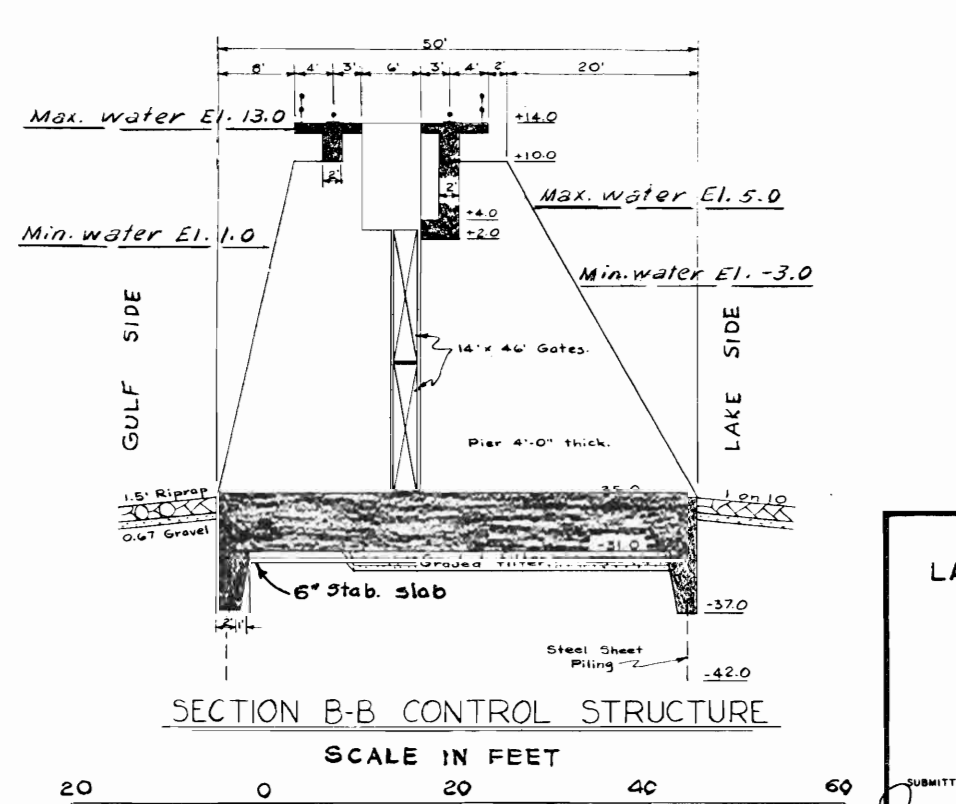
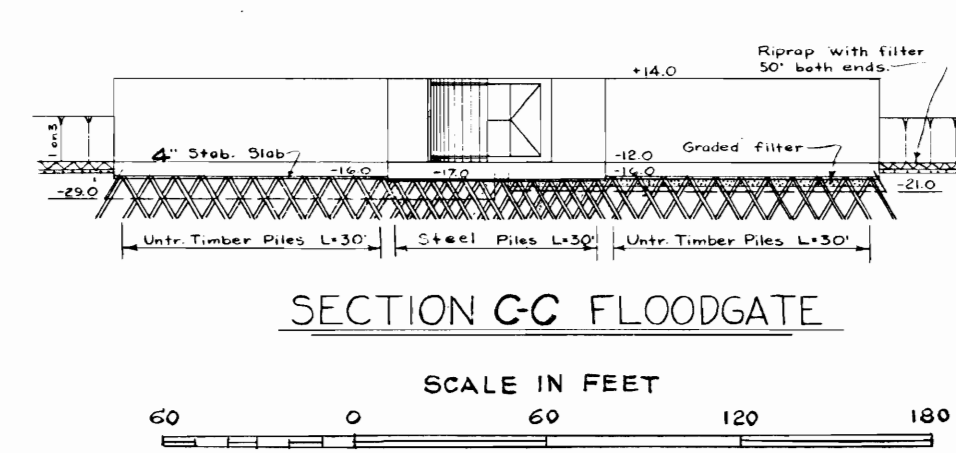
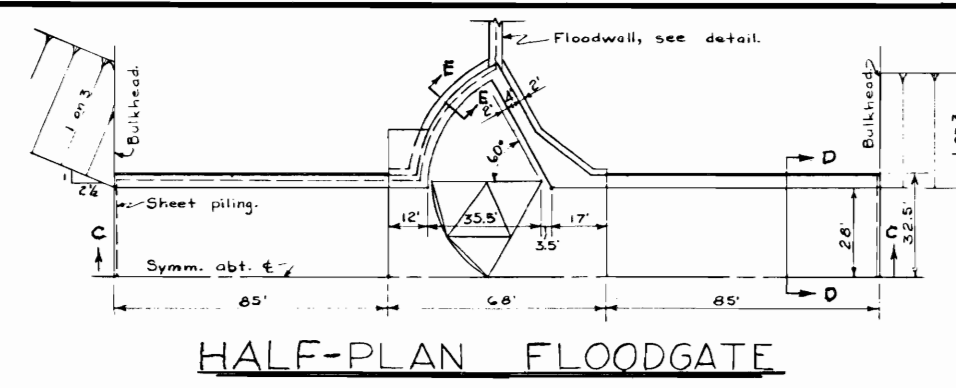
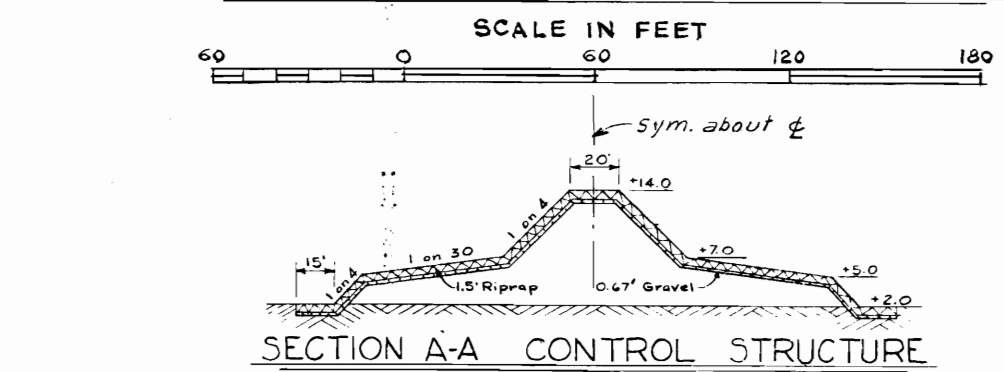
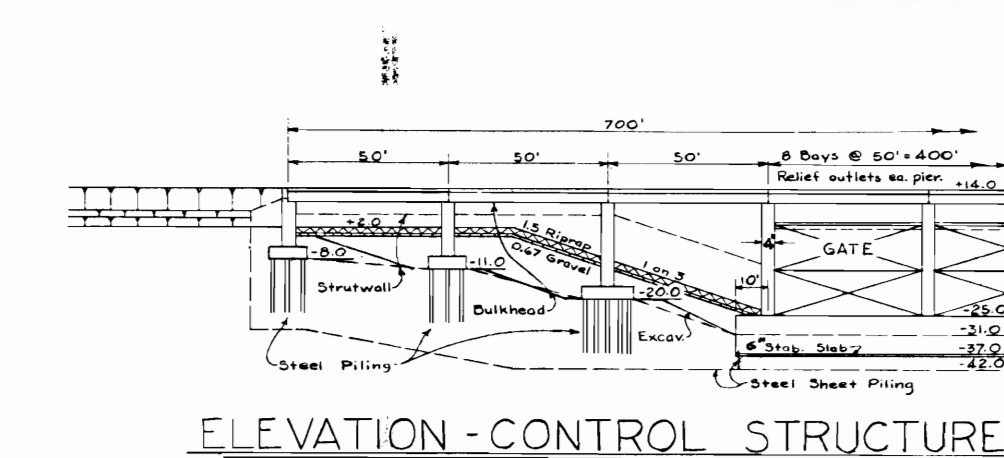
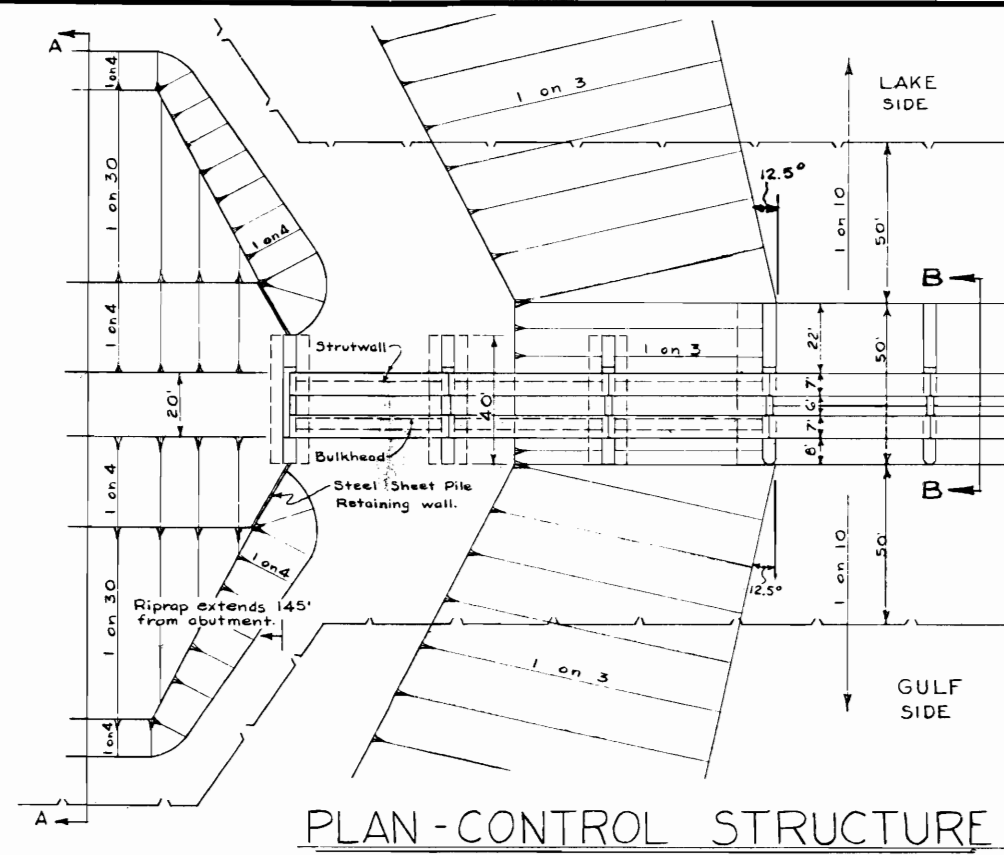
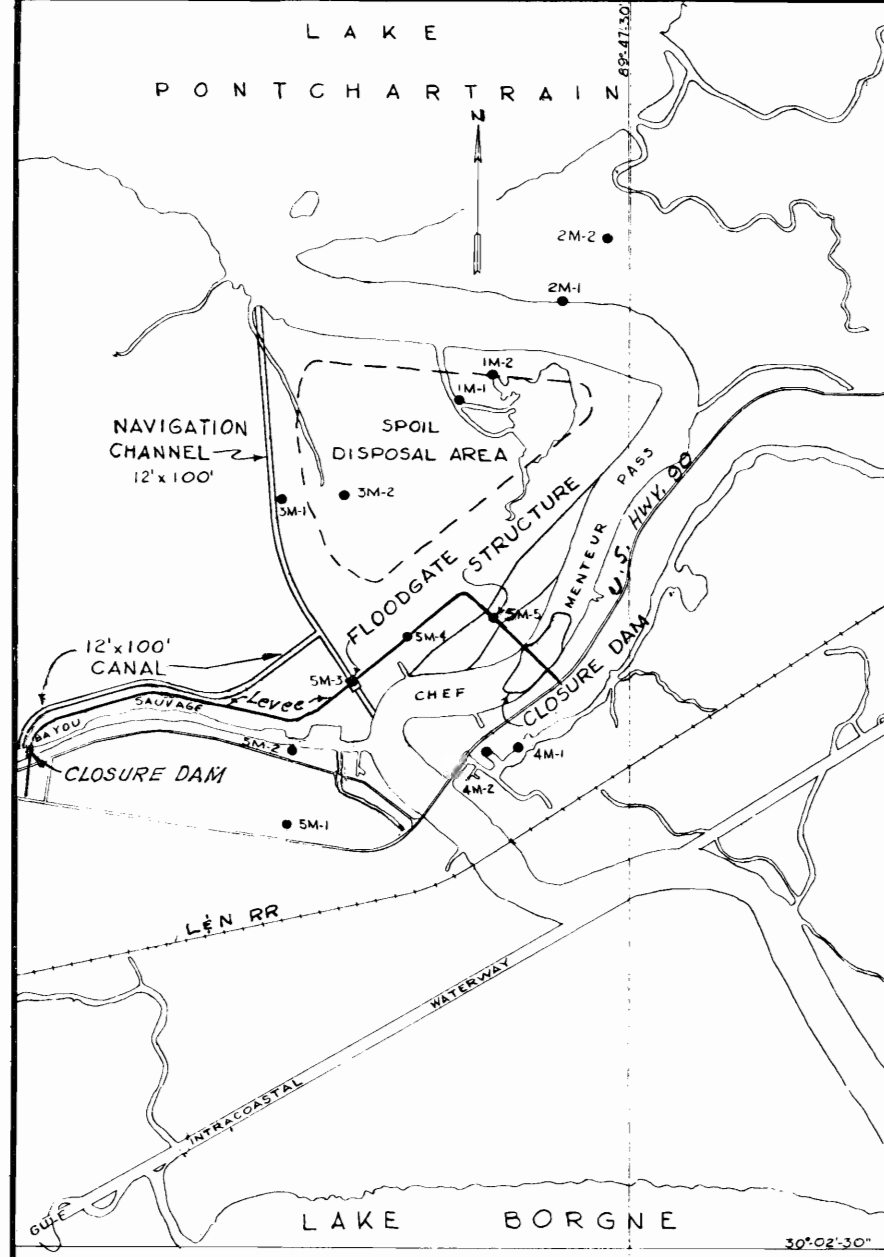

- NOTES:
1. All elevations are in feet referred to M.S.L.
  2. See Plate 7 for levee and closure sections.
  3. ● Denotes location of soil borings.
  4. Sand backfill adjacent to Floodgate walls as shown on Floodwall detail.
  5. See Plate B-3 for soil boring logs.
  6. See Plate 3 for location of structure

HURRICANE STUDY  
LAKE PONTCHARTRAIN, LA. AND VICINITY  
HURRICANE BARRIERS  
CHEF MENTEUR

SCALES AS SHOWN  
OFFICE OF THE DISTRICT ENGINEER, NEW ORLEANS, LA.

SUBMITTED: *Promote Bach* APPROVAL RECOMMENDED: *James H. Vanden* APPROVED: *E. Blanning*

CHIEF, PLANNING & REPORTS BRANCH CHIEF, ENGINEERING DIVISION COL. C.E., DISTRICT ENGINEER

DRAWN: M.R.D. TRACED: R.G.M. CHECKED: TO ACCOMPANY SURVEY REPORT FILE NO. H-2-22077

DATED: 21 NOV. 1962

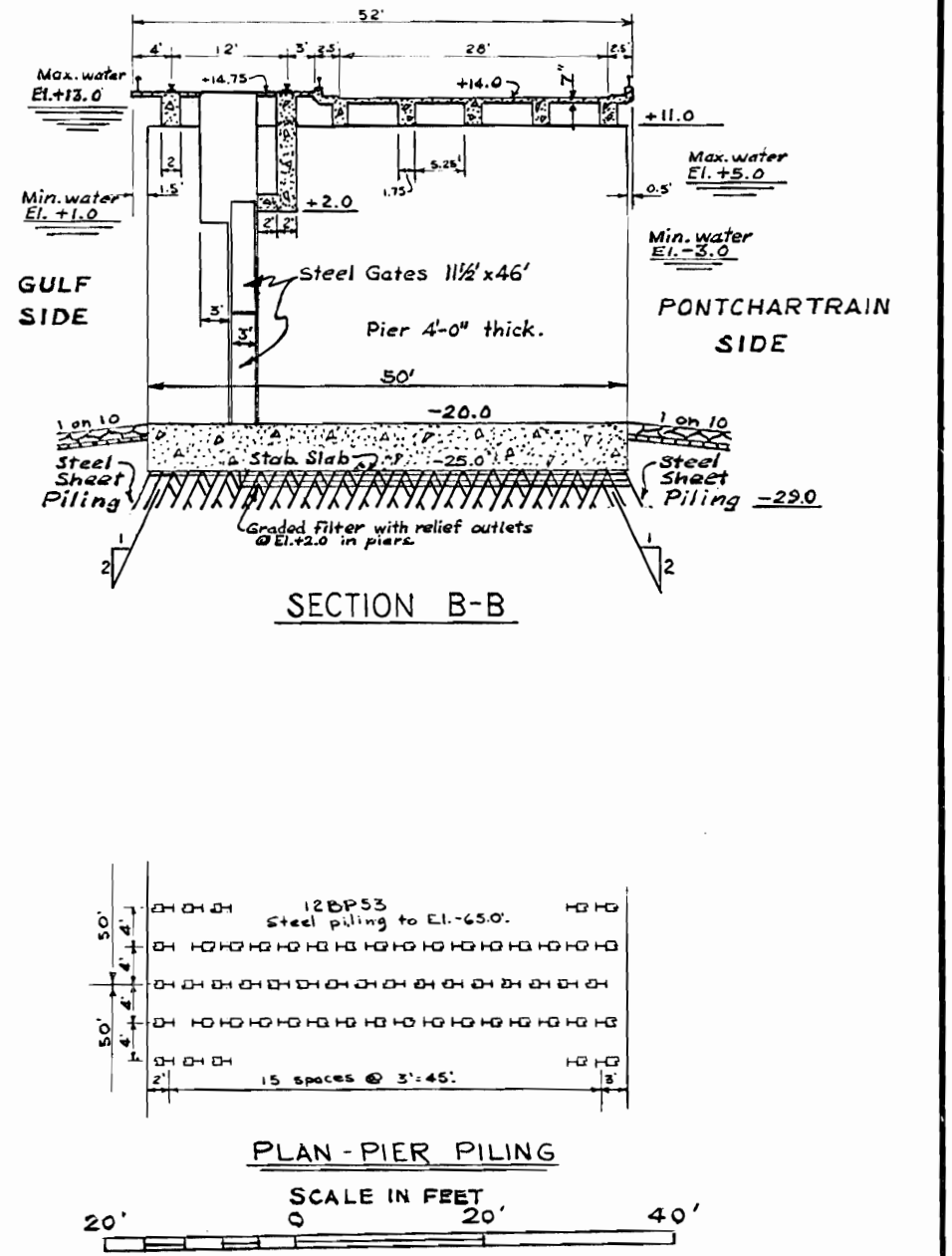
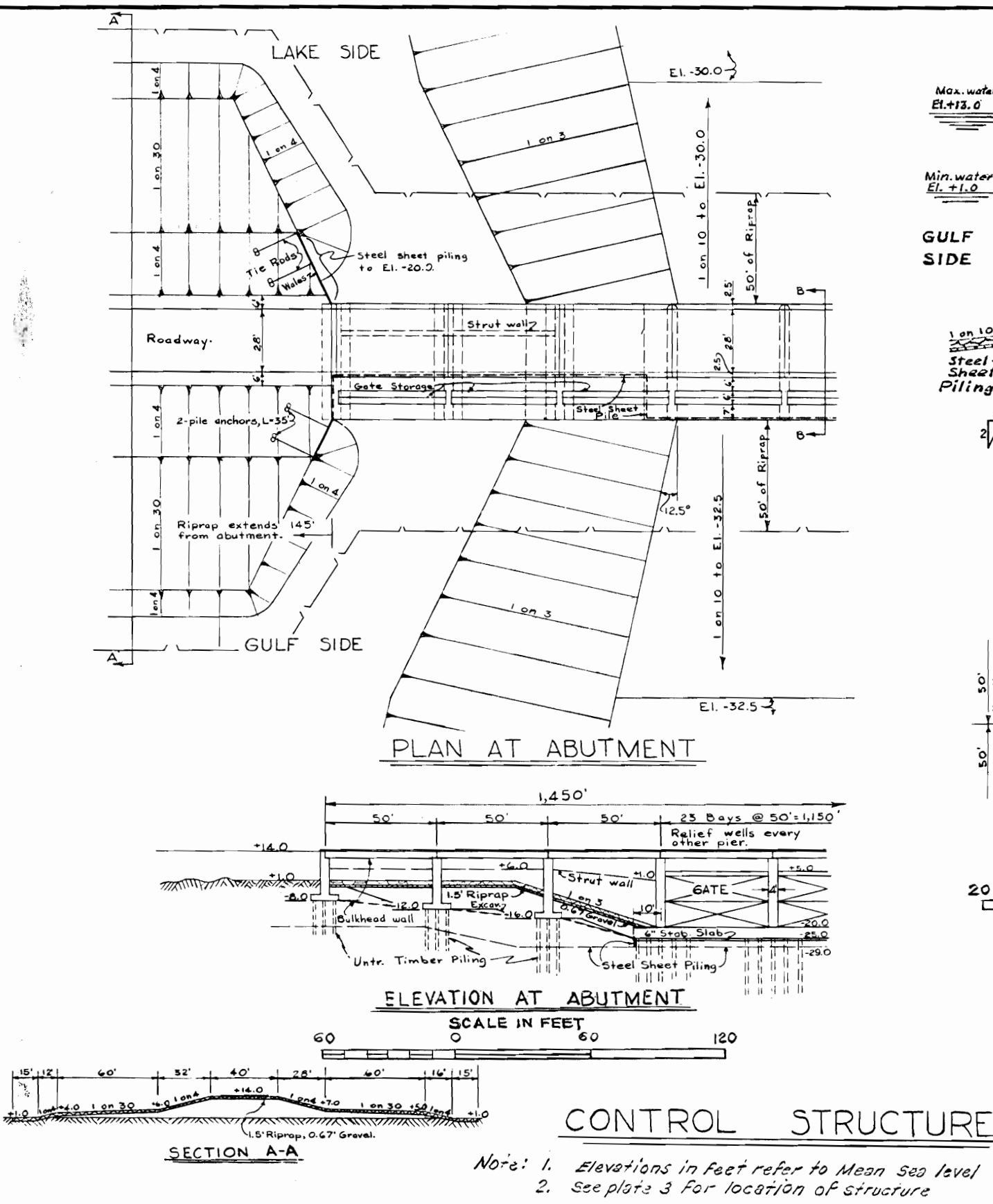
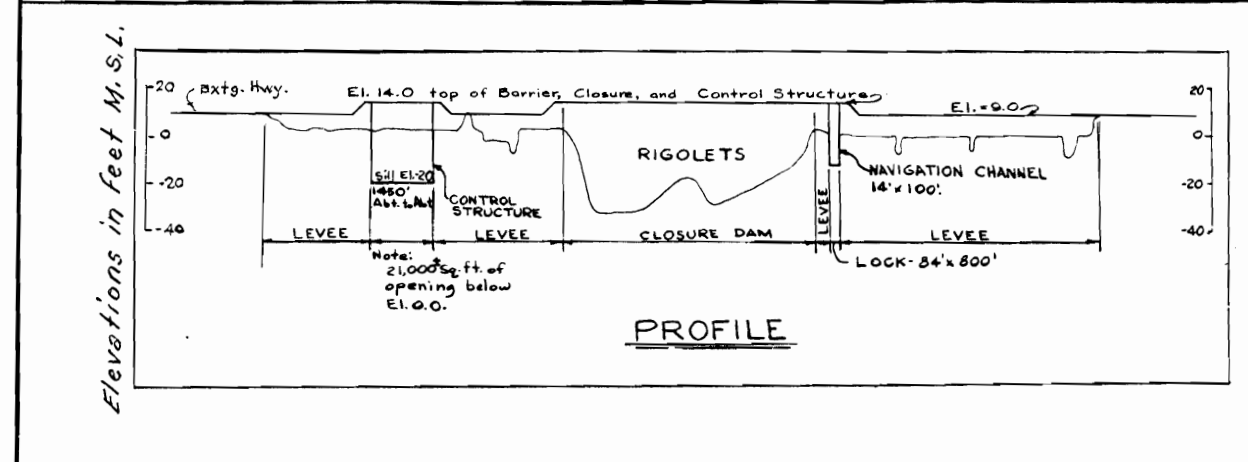
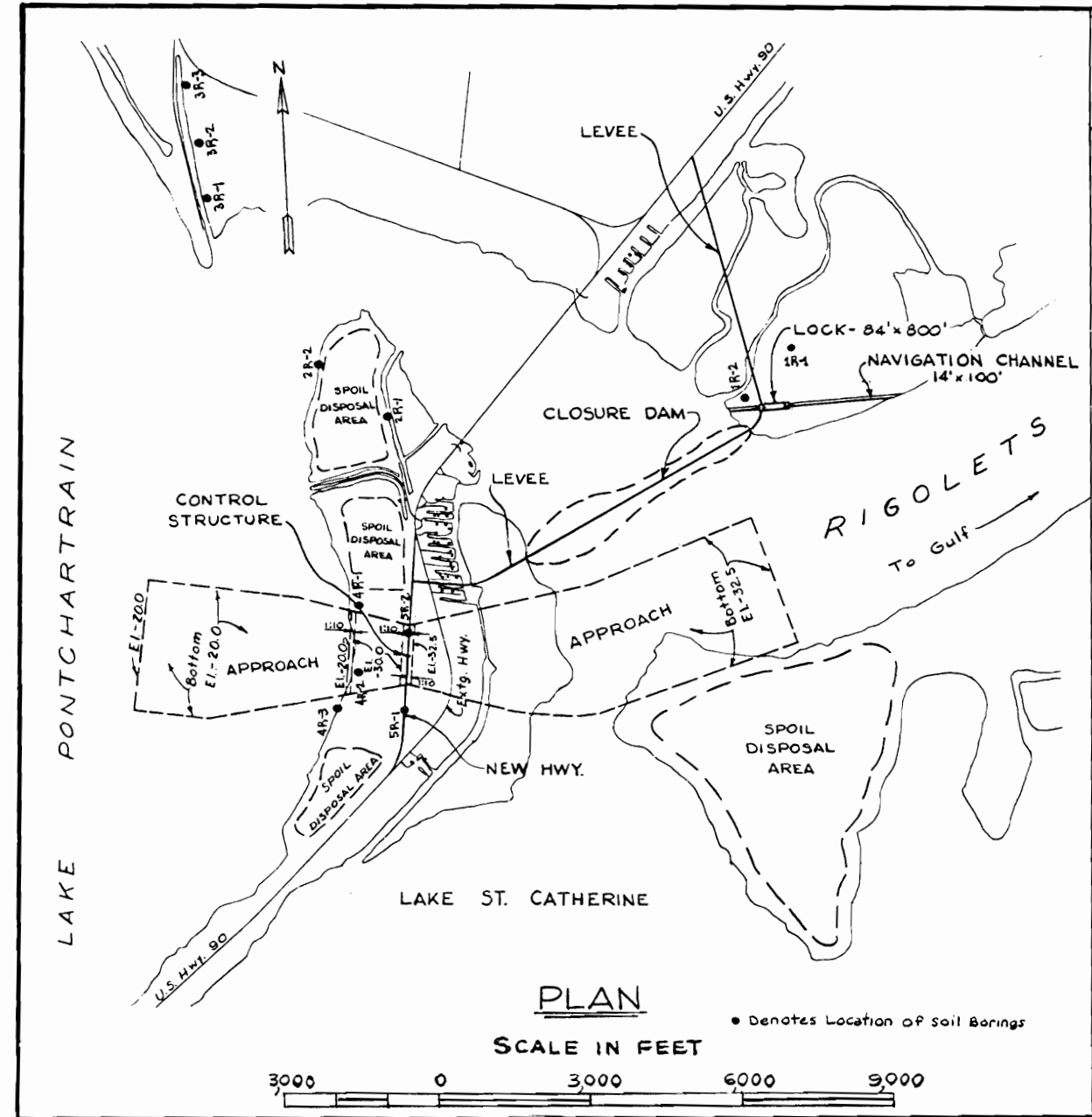

HURRICANE STUDY  
LAKE PONTCHARTRAIN, LA. AND VICINITY  
HURRICANE BARRIERS  
RIGOLETS

SCALES AS SHOWN  
OFFICE OF THE DISTRICT ENGINEER, NEW ORLEANS, LA.

SUBMITTED: *George B. Baehr* CHIEF, PLANNING & REPORTS BRANCH  
APPROVAL RECOMMENDED: *George B. Baehr* CHIEF, ENGINEERING DIVISION  
APPROVED: *George B. Baehr* COL. C.E., DISTRICT ENGINEER

DRAWN TO ACCOMPANY SURVEY REPORT FILE NO. H-2-22077  
H.R.D. R.O.M. DATED: 21 NOV. 1962

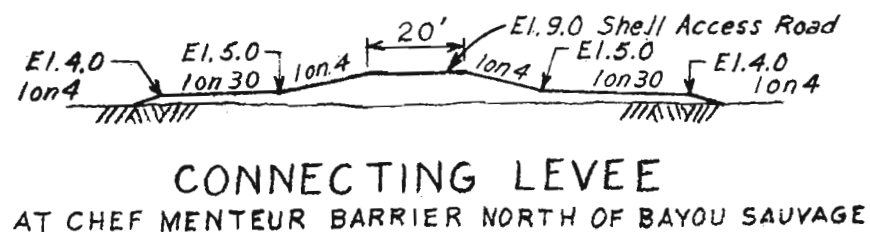
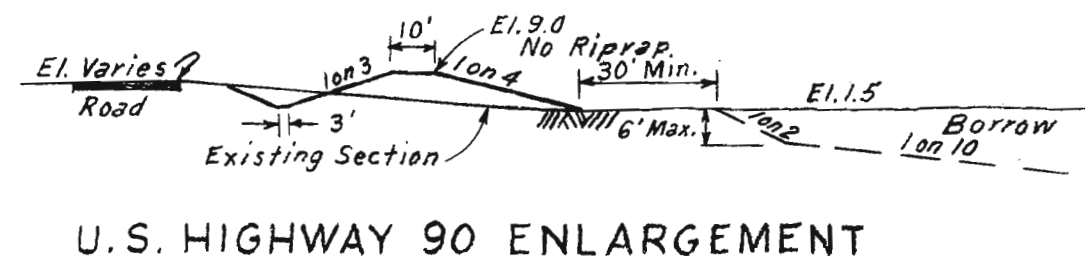
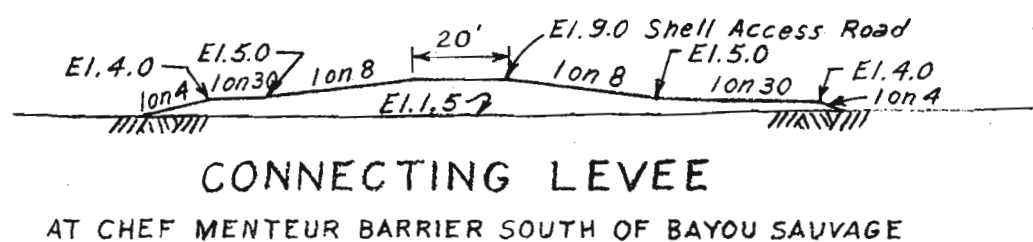
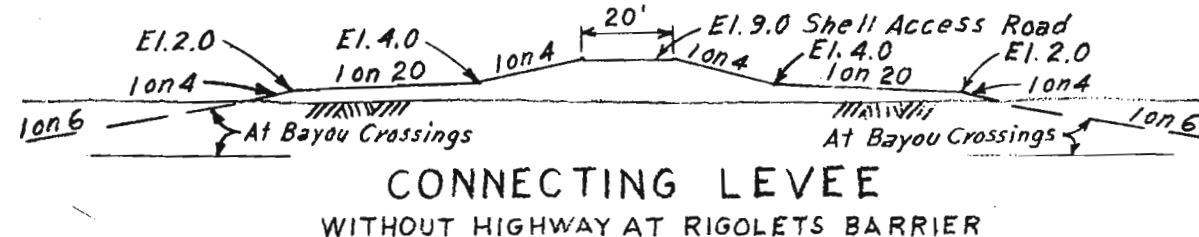
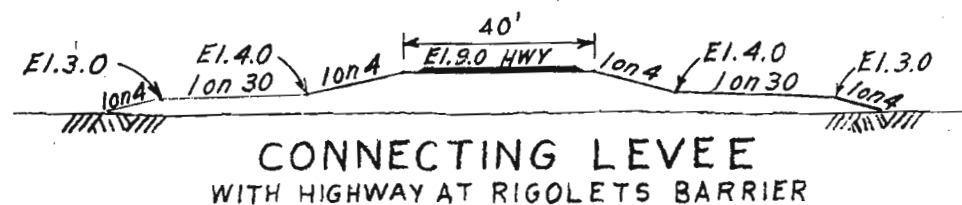
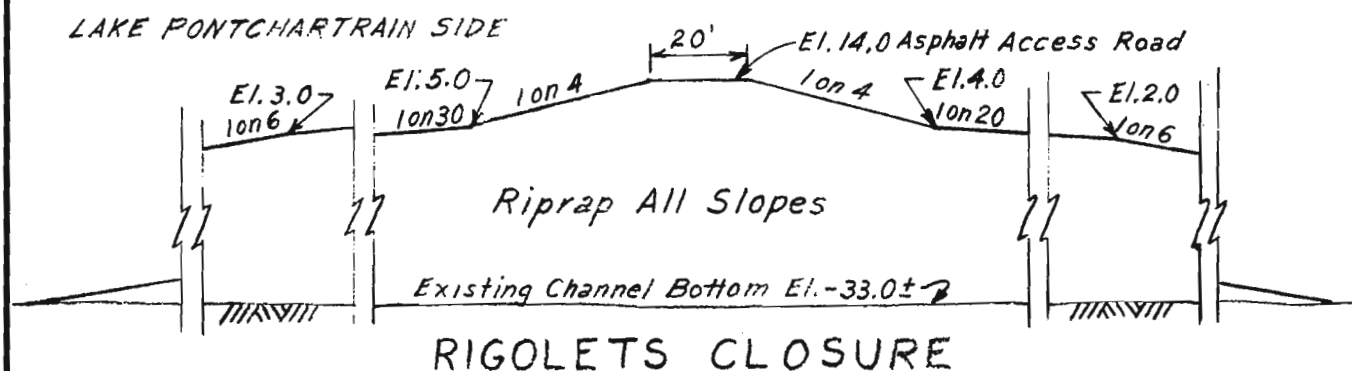
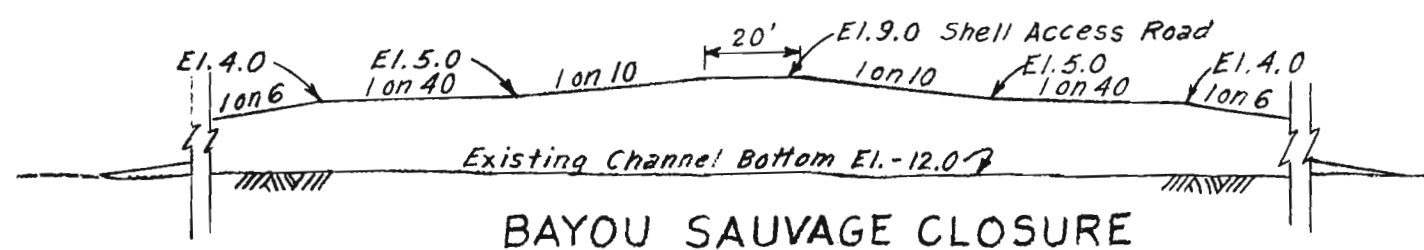
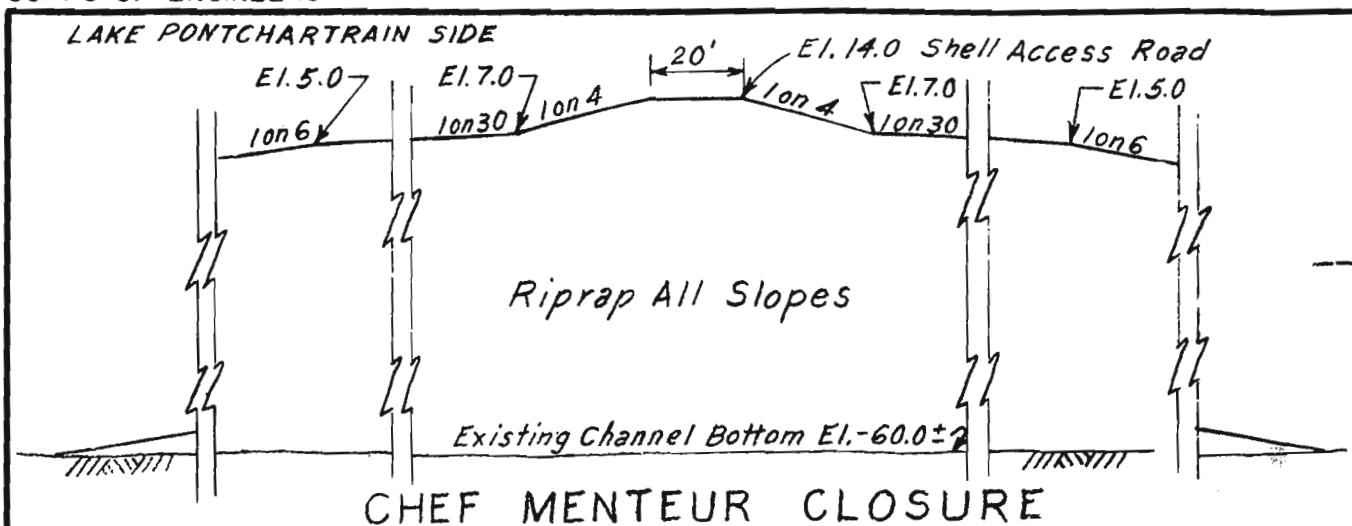

NOTES:  
1. All elevations are in feet and refer to M.S.L.  
2. For location see Plates 5 and 6.

HURRICANE STUDY  
LAKE PONTCHARTRAIN, LA. AND VICINITY  
TYPICAL SECTIONS  
BARRIER EMBANKMENTS  
NOT TO SCALE

OFFICE OF THE DISTRICT ENGINEER, NEW ORLEANS, LA.

SUBMITTED: APPROVAL RECOMMENDED: APPROVED:

*Promo to Baeh...*  
CHIEF, PLANNING & REPORTS BR. CHIEF, ENGINEERING DIV. COL., C.E. DIST. ENGR.

DRAWN R.A.B.	TRACED R.A.B.	CHECKED M.S.B.	TO ACCOMPANY REPORT DATED: 21 NOV. 1962	FILE NO. H-2-22077
-----------------	------------------	-------------------	--	-----------------------



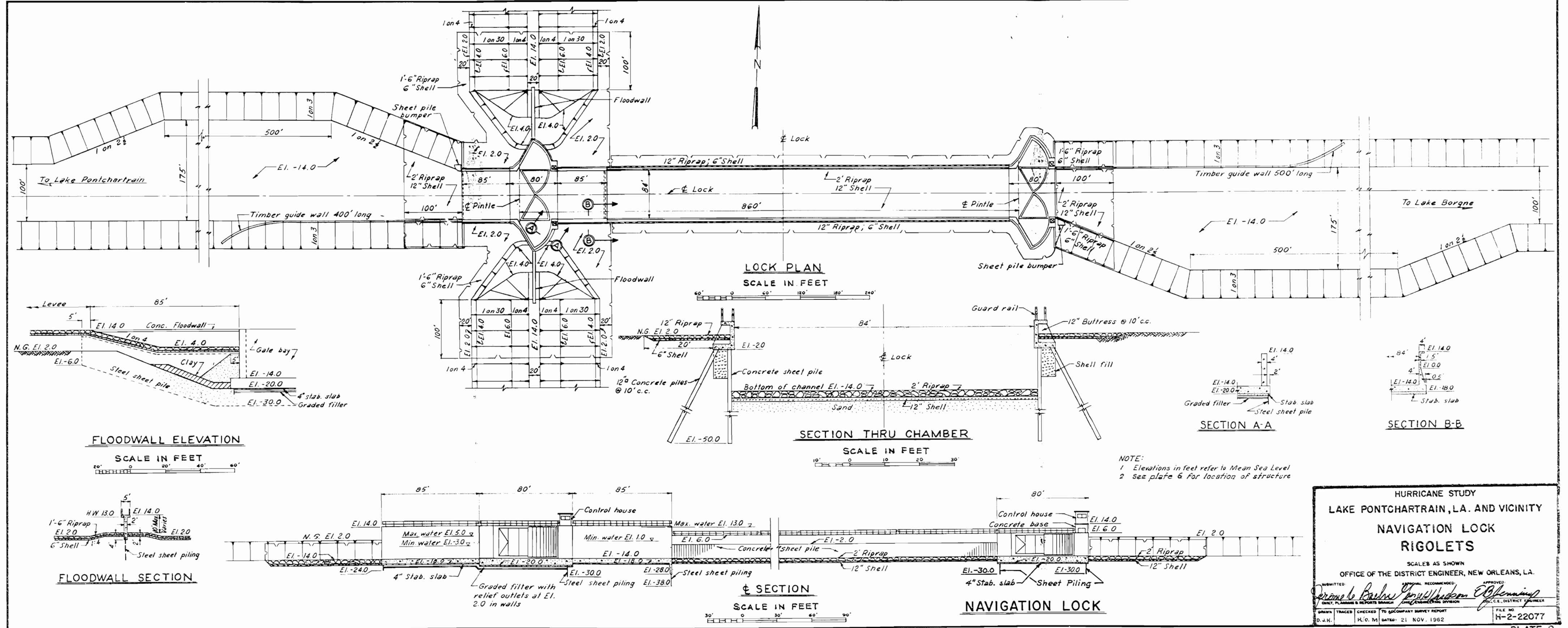

HURRICANE STUDY  
LAKE PONTCHARTRAIN, LA. AND VICINITY  
**NAVIGATION LOCK  
RIGOLETS**  
SCALES AS SHOWN  
OFFICE OF THE DISTRICT ENGINEER, NEW ORLEANS, LA.

SUBMITTED: *Peronnele Basler*  
CHECKED: *John W. Hudson*  
TO ACCOMPANY SURVEY REPORT  
DATE: 21 NOV. 1962

APPROVED: *John W. Hudson*  
DISTRICT ENGINEER

FILE NO. H-2-22077

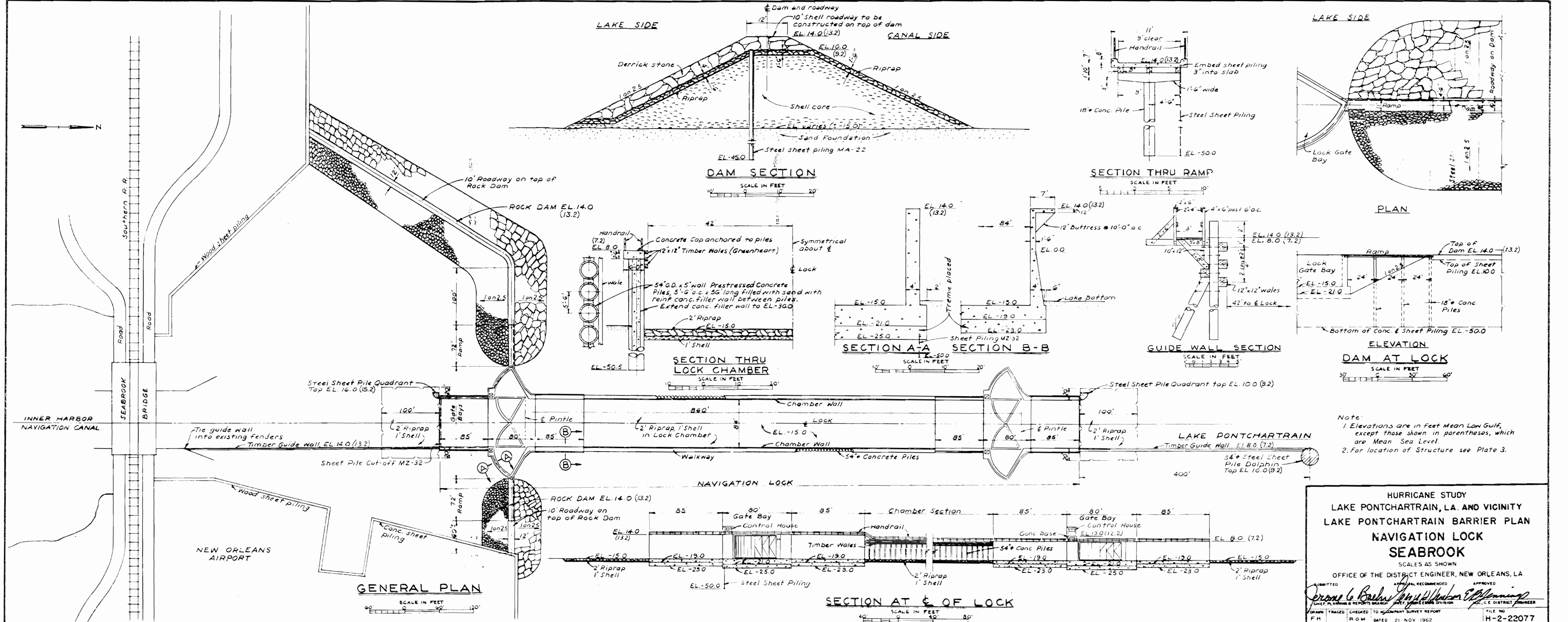

HURRICANE STUDY  
 LAKE PONTCHARTRAIN, LA. AND VICINITY  
 LAKE PONTCHARTRAIN BARRIER PLAN  
 NAVIGATION LOCK  
 SEABROOK  
 SCALES AS SHOWN  
 OFFICE OF THE DISTRICT ENGINEER, NEW ORLEANS, LA.

APPROVED  
*George L. Barber*  
 DISTRICT ENGINEER

APPROVED  
*W. H. ...*  
 DISTRICT ENGINEER

FORW. PLANNING & REPORTS BRANCH  
 CHECKED TO COMPANY SURVEY REPORT  
 F.H. R.O.M. DATED 21 NOV 1962

FILE NO.  
 H-2-22077

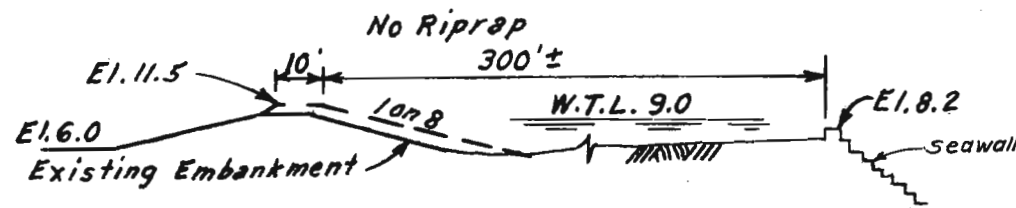
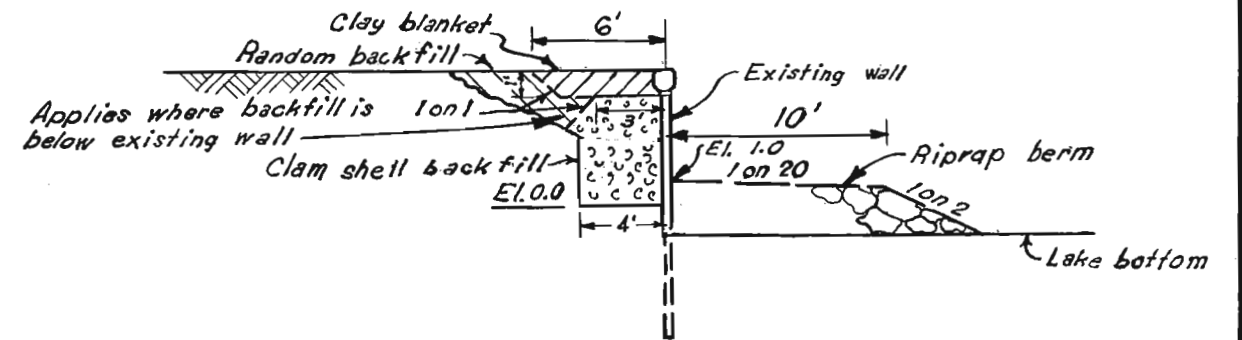
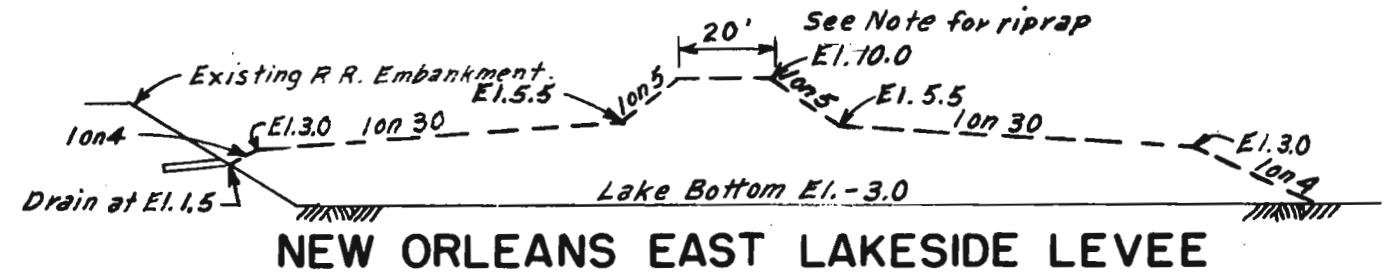
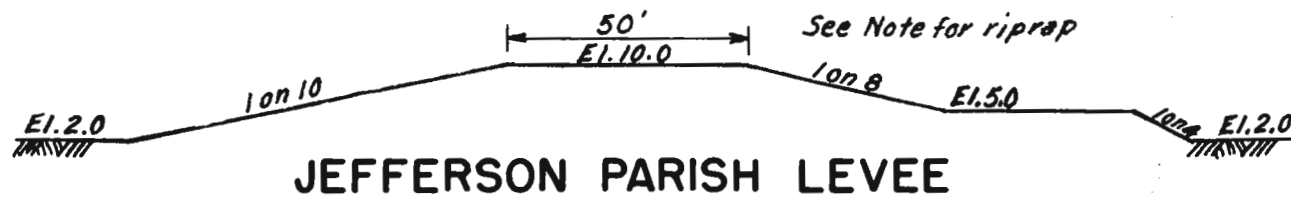
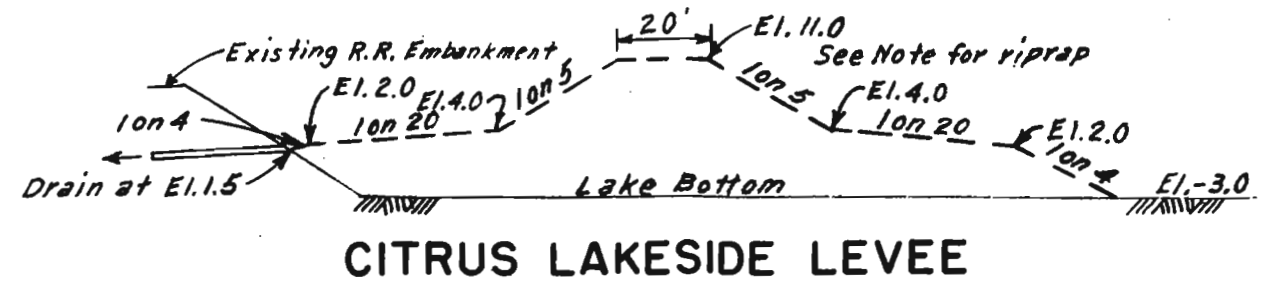
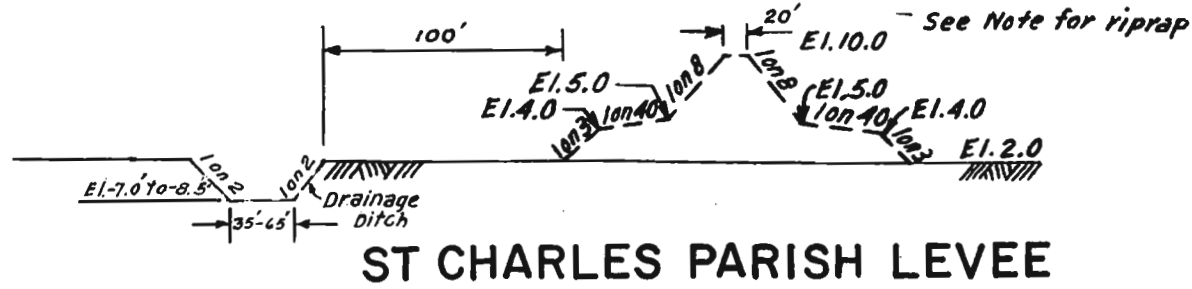

NEW ORLEANS EMBANKMENT

MANDEVILLE SEAWALL

- NOTES:
1. Riprap on lake side extends from elevation 6.5 (except N.O. East, 5.5) to 15' beyond toe unless otherwise noted.
  2. All elevations are in feet and refer to M.S.L.
  3. — Existing
  4. - - Proposed

HURRICANE STUDY  
LAKE PONTCHARTRAIN, L.A. AND VICINITY  
TYPICAL SECTIONS  
LAKESHORE EMBANKMENTS  
NOT TO SCALE

OFFICE OF THE DISTRICT ENGINEER, NEW ORLEANS, LA.

SUBMITTED: *Jerome L. Baehr* APPROVAL RECOMMENDED: *John W. Anderson* APPROVED: *Ed Manning*  
CHIEF, PLANNING & REPORTS BR. CHIEF, ENGINEERING DIV. COL., C.E. DIST. ENGR.

DRAWN R.A.B.	TRACED R.A.B.	CHECKED M.S.B.	TO ACCOMPANY REPORT DATED: 21 NOV. 1962	FILE NO. H-2-22077
-----------------	------------------	-------------------	--	-----------------------

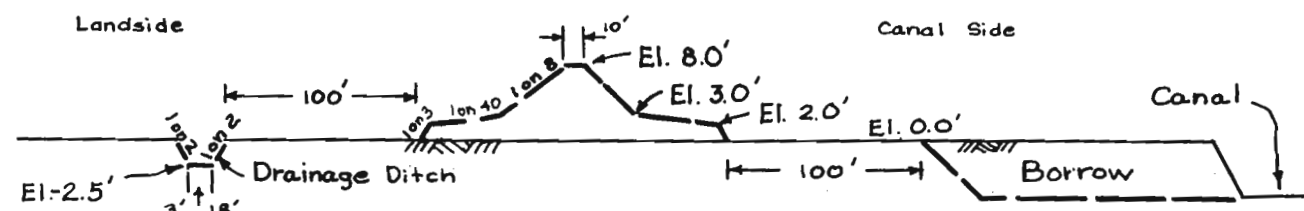

ST. CHARLES LATERAL LEVEE

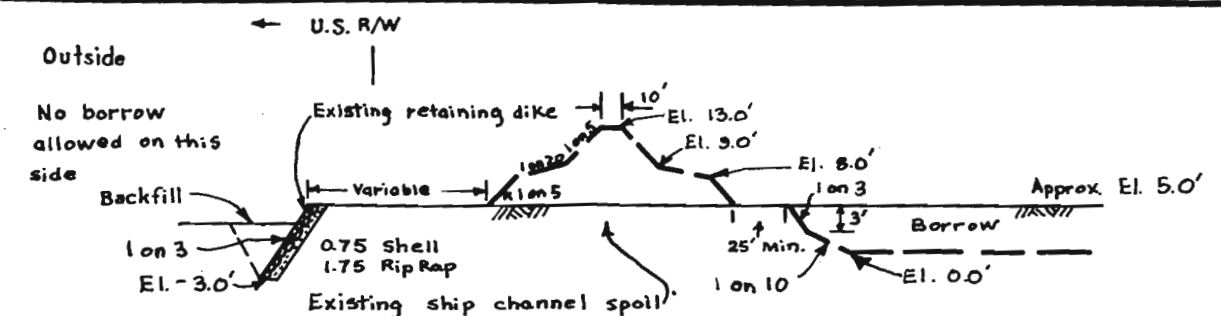

CHALMETTE BACK LEVEE  
(Inner Harbor Navigation Canal to Paris Road)

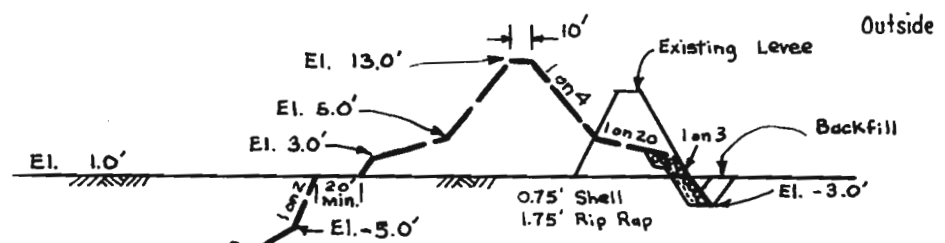

CITRUS BACK LEVEE  
(West of Paris Road)

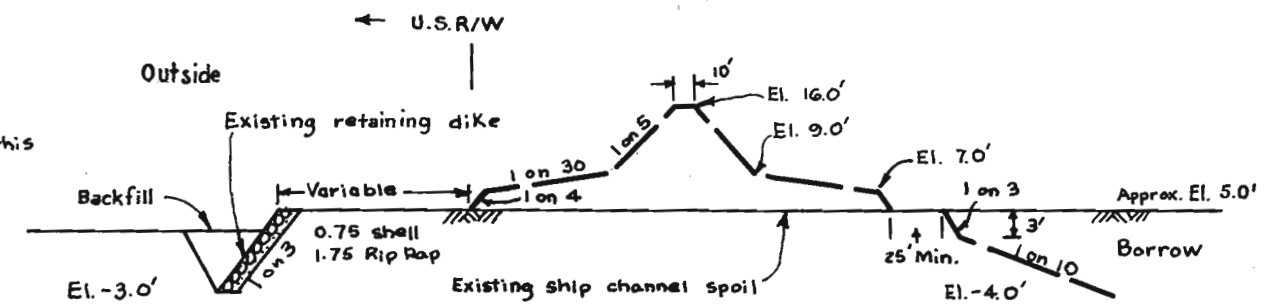

CHALMETTE BACK LEVEE  
(Paris Road to Bayou Dupre)

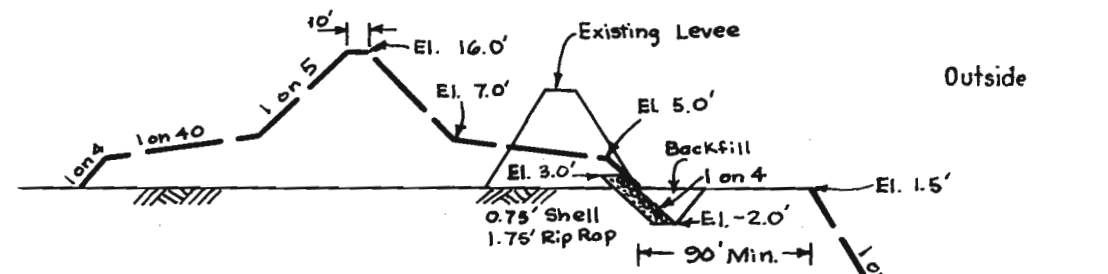

CITRUS AND NEW ORLEANS EAST BACK LEVEE  
(East of Paris Road)

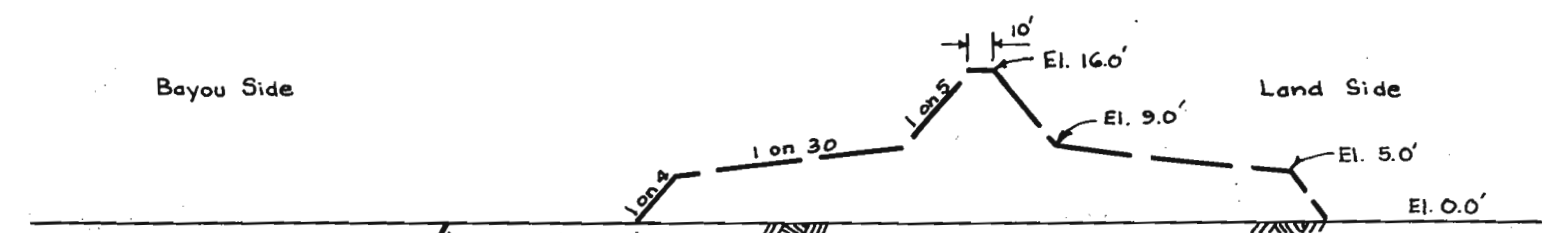

CHALMETTE BACK LEVEE  
(Mississippi River - Gulf Outlet to Violet)

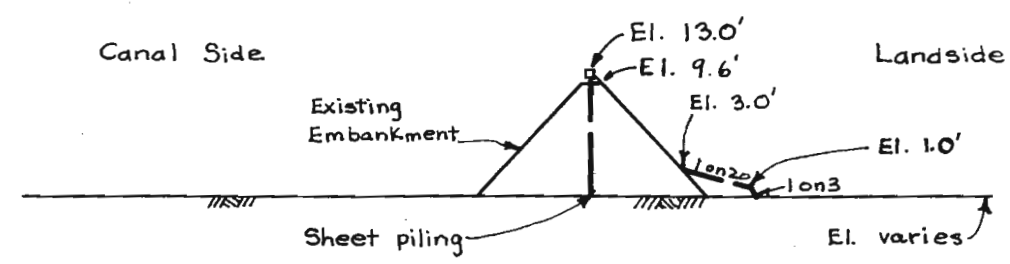

INNER HARBOR NAVIGATION CANAL  
Sheet Piling Enlargement

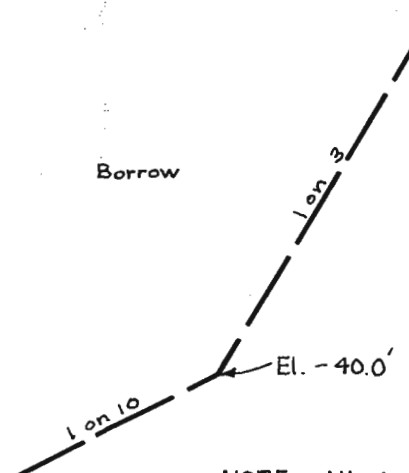

NOTE: All elevations are in feet and refer to M.S.L.

HURRICANE STUDY  
LAKE PONTCHARTRAIN, LA. AND VICINITY  
TYPICAL SECTIONS  
BACK AND LATERAL EMBANKMENTS  
NOT TO SCALE

OFFICE OF THE DISTRICT ENGINEER, NEW ORLEANS, LA.  
SUBMITTED: APPROVAL RECOMMENDED: APPROVED:  
*Perome le Baube* *Joseph Anderson* *William*  
CHIEF, PLANNING & REPORTS BR. CHIEF ENGINEERING DIV. DIST. C.E. DIST. ENGR.

DRAWN M.S.B.	TRACED V.L.A.	CHECKED M.S.B.	TO ACCOMPANY REPORT DATED: 21 NOV. 1962	FILE NO. H-2-22077
-----------------	------------------	-------------------	--	-----------------------





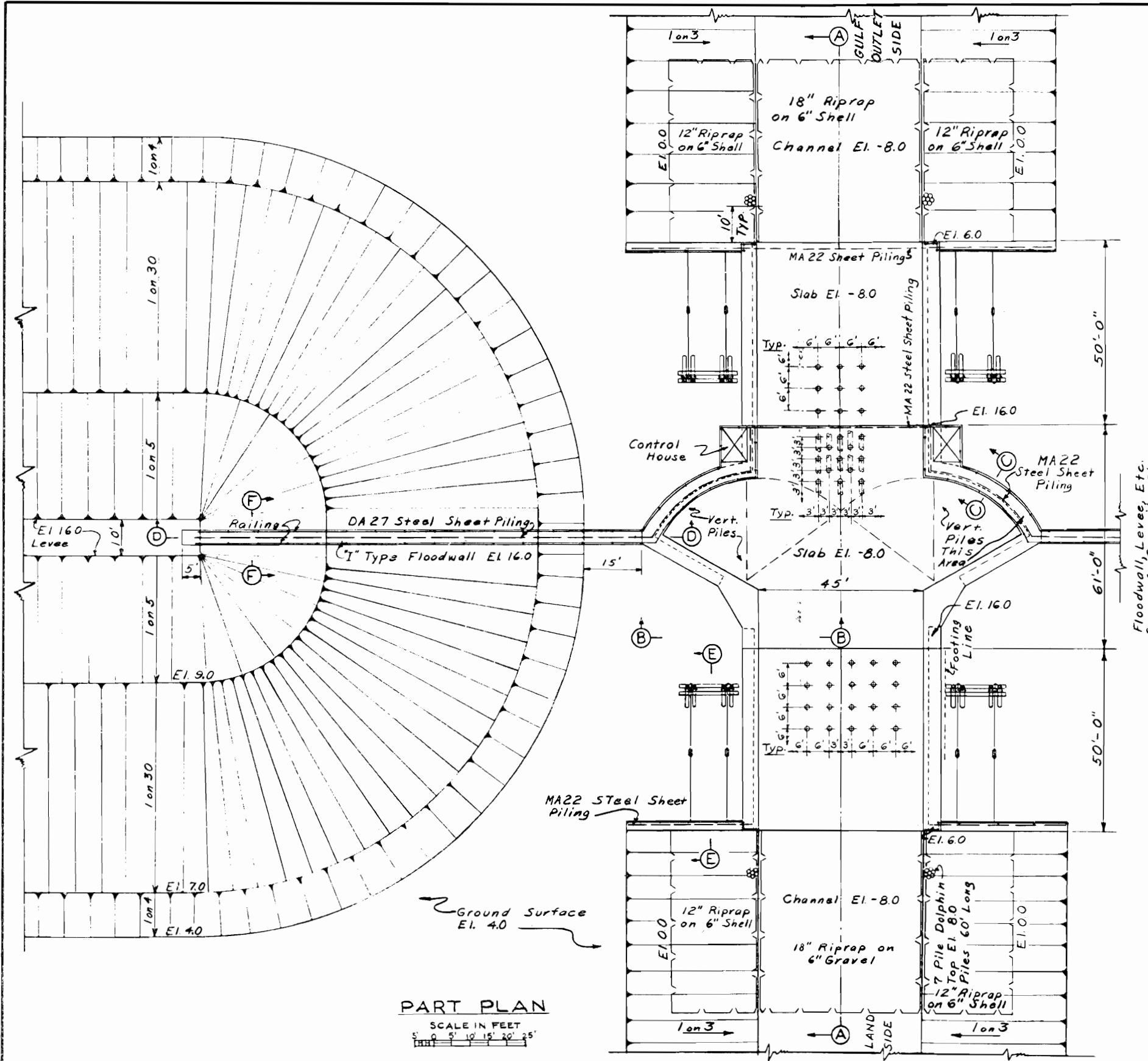

**PART PLAN**  
SCALE IN FEET  
0 5 10 15 20 25

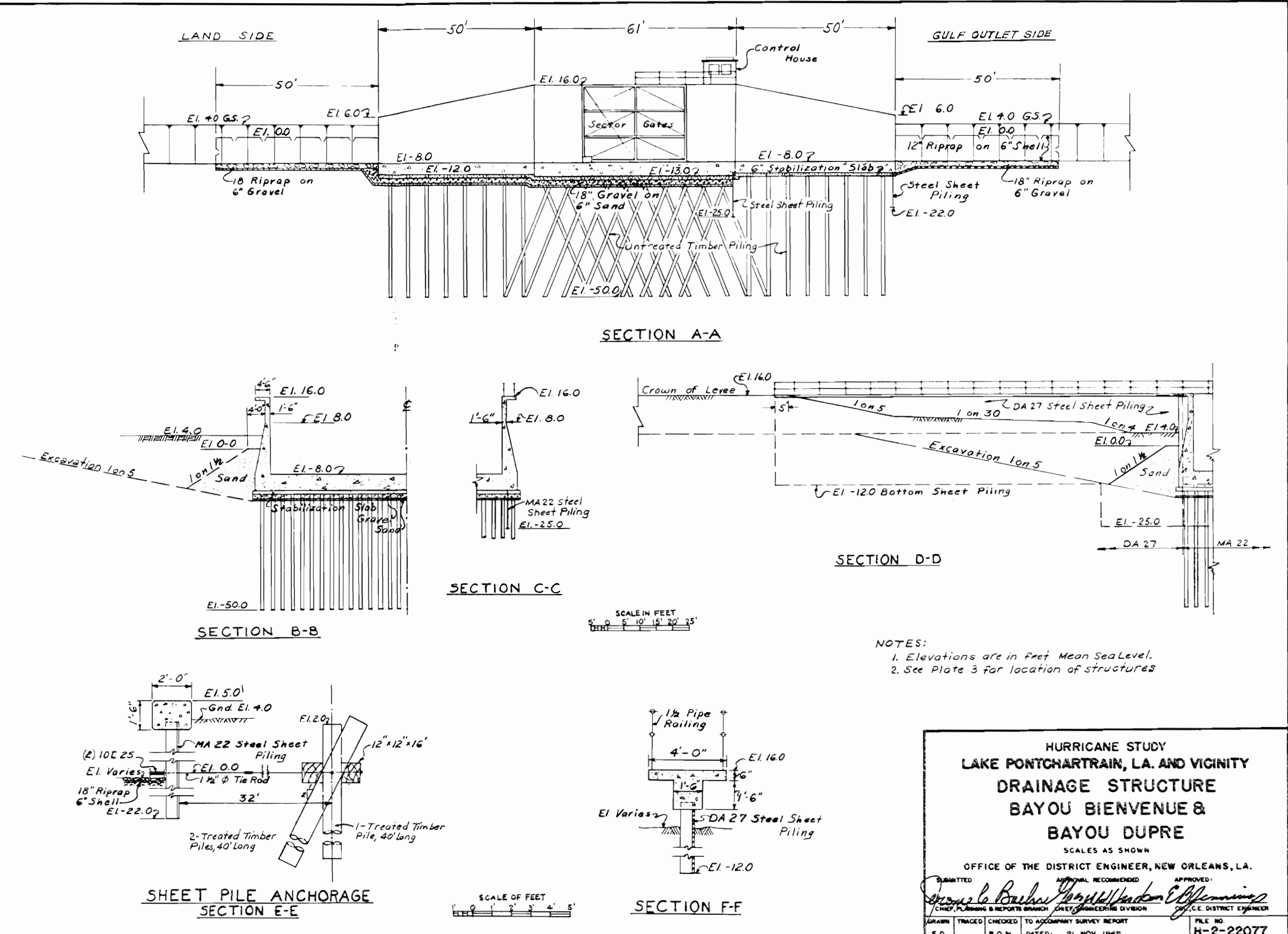

SCALE IN FEET  
0 5 10 15 20 25

SECTION C-C

SECTION B-B

SECTION D-D

SHEET PILE ANCHORAGE  
SECTION E-E

SCALE OF FEET  
0 1 2 3 4 5

SECTION F-F

NOTES:  
1. Elevations are in feet Mean Sea Level.  
2. See Plate 3 for location of structures

HURRICANE STUDY  
LAKE PONTCHARTRAIN, LA. AND VICINITY  
DRAINAGE STRUCTURE  
BAYOU BIENVENUE &  
BAYOU DUPRE  
SCALES AS SHOWN  
OFFICE OF THE DISTRICT ENGINEER, NEW ORLEANS, LA.

APPROVED: [Signature]  
CHIEF, PLANNING & REPORTS BRANCH  
DATE: 21 NOV 1965

FILE NO. H-2-22077

APPENDIX A

HYDROLOGY AND HYDRAULICS

LAKE PONTCHARTRAIN, LA. AND VICINITY

APPENDIX A

HYDROLOGY AND HYDRAULICS

SECTION I - ANALYSES

<u>Paragraph</u>	<u>Title</u>	<u>Page</u>
A-1	Climatology	A-1
A-2	Hydrologic regimen	A-6
	General	A-6
	Runoff and stream flow	A-6
	Stages, salinities, waves, and tides	A-12
A-3	Description and verification of procedures	A-13
	Hurricane memorandums	A-13
	Historical storms used for verification	A-13
	Synthetic storms	A-14
	Surges	A-16
	Routing	A-19
	Wind tides	A-21
	Maximum runup and overflow	A-23
	Residual flooding	A-40
	Rainfall	A-40
	Flooding	A-40
	Sheet flow	A-41
A-4	Frequency estimates	A-41
	Procedure	A-41
	Relationships	A-45
A-5	Design hurricane	A-46
	Selection of the design hurricane	A-46
	Characteristics	A-46
	Normal predicted tides	A-46
	Design rainfall	A-46
	Design tide	A-47
	Design flood levels	A-47
	Stream flow coincident with hurricane flooding	A-47
	SECTION II - HYDRAULIC DESIGN INTERIOR DRAINAGE	
A-6	Hydraulic design interior drainage - St. Charles Parish	A-48
	Description of drainage areas	A-48
	Proposed plan of improvement	A-48
	Design of drainage system	A-48

SECTION III - BIBLIOGRAPHY



TABLES

<u>No.</u>	<u>Title</u>	<u>Page No.</u>
A-1	Monthly temperatures - New Orleans	A-1
A-2	Monthly rainfall - New Orleans	A-2
A-3	Wind summaries, New Orleans International Airport, Moisant Field	A-3
A-4	Meteorologic stations	A-4
A-5	Hydrologic stations on tributary streams	A-7
A-6	Hydrologic stations, Lakes Maurepas, Pontchartrain, and Borgne	A-8
A-7	Pertinent streamflow data for model study	A-11
A-8	Maximum stages - Lake Pontchartrain	A-12
A-9	Wave data	A-13
A-10	Hurricane characteristics	A-16
A-11	Hurricane surge heights	A-17
A-12	Verification of hurricane surge heights	A-18
A-13	Maximum runup - Standard project hurricane	A-23
A-14	Wave and overtopping data	A-27
A-15	Wave data	A-39
A-16	Central pressure index vs. wind tide level Lake Pontchartrain reach-New Orleans	A-43
A-17	Stage-frequency - South shore-Lake Pontchartrain	A-44
A-18	Design hurricane characteristics	A-46

PLATES

<u>Plate</u>	<u>Title</u>
A-1	Meteorologic and hydrologic stations
A-2	Monthly mean elevations and tributary inflow
A-3	Hurricane of 28 September to 1 October 1915 - Isovel patterns
A-4	Hurricane of 19 September 1947 - Isovel patterns
A-5	Standard Project Hurricane tracks and isovel patterns
A-6	Frequency of hurricane central pressures
A-7	Hurricane paths
A-8	Typical tidal cycles
A-9	Bottom and surge profiles - Long Point
A-10	Lake Pontchartrain routing
A-11	Stage hydrographs - Hurricane of 19 September 1947
A-12	Stage hydrographs - Tropical storm of 17-18 September 1957
A-13	Standard Project Hurricane - Stage hydrographs - North shore
A-14	Standard Project Hurricane - Stage hydrographs - South shore
A-15	Wind tide level forecast curves
A-16	Isovels - Setup zones - Wind tide contours
A-17	Maximum surge contours - Probable Maximum Hurricane
A-18	Maximum surge contours - Standard Project Hurricane
A-19	Maximum surge contours - Moderate Hurricane
A-20	Maximum surge contours - Observed
A-21	Wave runup on sloped structures

PLATES (cont'd)

<u>Plate</u>	<u>Title</u>
A-22	Citrus lakefront - SPH wave factors - Existing conditions
A-23	Citrus lakefront - SPH overflow - Existing conditions
A-24	Mass rainfall curves
A-25	Wind tide levels and flooding elevations - St. Charles and Jefferson Parishes
A-26	Wind tide levels and flooding elevations - New Orleans
A-27	Wind tide levels and flooding elevations - Citrus-New Orleans East-Mandeville
A-27a	Wind tide levels and flooding elevations - Chalmette
A-28	Stage-frequency - New Orleans, La.
A-29	Stage-frequency curves

APPENDIX A

HYDROLOGY AND HYDRAULICS

SECTION I - ANALYSES

A-1 CLIMATOLOGY

Data relative to temperatures, rainfall, and winds are given in tables A-1 to A-3 and the locations and periods of record of meteorological stations are shown in table A-4.

TABLE A-1

MONTHLY TEMPERATURES (1871 - 1958)

New Orleans

Month	<u>Degrees Fahrenheit</u>			Month	<u>Degrees Fahrenheit</u>		
	<u>Mean</u>	<u>Maximum</u>	<u>Minimum</u>		<u>Mean</u>	<u>Maximum</u>	<u>Minimum</u>
Jan.	55.2	67.2	<u>43.0</u>	July	82.7	85.2	79.1
Feb.	57.6	67.2	45.0	Aug.	82.8	<u>87.1</u>	79.3
Mar.	63.0	71.4	55.0	Sept.	79.6	84.0	75.6
Apr.	69.2	73.8	65.1	Oct.	71.4	79.5	66.0
May	75.7	79.8	72.2	Nov.	61.9	68.6	56.2
June	81.3	84.8	77.4	Dec.	56.1	64.7	48.1
			Annual		69.7		

Extreme minimum 7° F., 13 February 1899

Extreme maximum 102° F., 30 June 1954 (also other dates)

TABLE A-2

MONTHLY RAINFALL (1870 - 1958)

## New Orleans

<u>Month</u>	<u>Inches</u>			<u>Month</u>	<u>Inches</u>		
	<u>Mean</u>	<u>Maximum</u>	<u>Minimum</u>		<u>Mean</u>	<u>Maximum</u>	<u>Minimum</u>
Jan.	4.54	11.15	0.61	July	6.86	12.93	2.02
Feb.	4.40	13.85	0.04	Aug.	6.03	22.74	0.87
Mar.	5.44	21.09	0.04	Sept.	5.51	16.57	0.25
Apr.	5.30	14.94	0.04	Oct.	3.25	<u>25.11</u> <sup>(1)</sup>	<u>Trace</u> <sup>(2)</sup>
May	4.77	18.68	0.02	Nov.	3.74	14.41	0.10
June	5.76	16.01	0.59	Dec.	4.76	14.43	0.67
			Annual		60.37	85.73 <sup>(3)</sup>	31.07 <sup>(4)</sup>

LEGEND

(1) October 1937

(2) October 1952 (also other dates)

(3) 1875

(4) 1899

TABLE A-3

WIND SUMMARIES, NEW ORLEANS INTERNATIONAL AIRPORT, MOISANT FIELD  
(1949 - 1958)

Wind direction (or velocity)	Percent of time												Annual
	Jan.	Feb.	Mar.	Apr.	May	June	July	Aug.	Sept.	Oct.	Nov.	Dec.	
N	6.41	6.10	5.85	4.72	4.35	3.53	3.00	4.96	5.01	7.02	8.64	6.79	5.53
NNE	5.95	5.98	5.07	4.10	3.31	2.83	2.59	4.30	6.43	7.84	8.07	7.65	5.34
NE	7.47	8.91	7.98	5.58	4.84	4.19	4.65	6.68	13.04	11.59	8.94	8.72	7.71
ENE	6.68	7.43	7.19	6.17	4.78	4.61	4.53	5.77	15.99	13.13	9.42	9.18	7.90
E	5.90	6.64	5.55	5.51	5.15	4.72	5.40	6.12	9.85	9.27	6.60	8.12	6.57
ESE	3.13	3.86	3.87	4.92	4.17	3.40	3.33	2.37	3.82	4.17	3.32	3.87	3.68
SE	5.20	5.29	5.81	7.86	6.47	5.82	5.22	3.00	4.96	4.45	4.85	3.66	5.21
SSE	12.53	8.62	8.63	12.24	10.60	8.03	6.13	4.81	4.83	3.48	7.17	7.30	7.86
S	13.56	11.26	13.90	14.32	16.16	13.54	11.69	7.02	5.24	3.71	8.03	9.03	10.62
SSW	6.96	8.04	8.56	6.29	8.87	13.11	10.39	7.62	2.90	1.92	4.35	5.15	7.01
SW	2.80	4.60	4.05	4.22	5.71	7.22	7.80	6.88	2.28	1.28	2.15	2.49	4.29
WSW	1.77	1.55	2.02	2.21	2.22	3.40	3.71	3.67	1.17	1.03	1.38	1.72	2.16
W	2.00	2.36	1.96	2.42	2.49	3.33	4.14	4.27	1.04	1.21	2.33	2.19	2.48
WNW	2.36	3.07	2.94	2.94	1.83	2.67	3.68	3.36	1.01	2.43	2.86	2.35	2.63
NW	3.40	4.03	3.59	3.24	2.90	3.39	3.47	4.54	1.72	3.66	4.25	4.26	3.54
NNW	6.18	5.66	5.58	4.17	3.90	3.00	3.08	4.52	2.93	5.62	6.69	7.06	4.87
Cal.m	7.67	6.60	7.45	9.09	12.25	13.19	17.19	20.12	17.78	18.20	10.96	10.47	12.63
0-3 m.p.h.	11.87	9.82	10.96	13.04	16.26	16.64	22.03	23.92	20.75	21.16	14.46	14.48	16.33
4-7	23.36	22.59	21.24	23.68	28.90	35.51	36.45	36.02	28.89	25.58	23.89	22.81	27.44
8-12	32.34	32.34	31.32	32.21	33.74	34.57	30.97	30.09	28.39	28.99	29.60	32.61	31.43
13-18	24.26	26.30	26.79	23.79	17.54	12.28	9.46	9.01	17.97	19.27	23.26	22.00	19.27
19-24	6.94	7.55	7.88	5.67	3.14	0.83	0.89	0.81	3.21	4.33	7.32	6.56	4.57
25-31	1.06	1.34	1.65	1.50	0.38	0.14	0.15	0.13	0.53	0.69	1.40	1.49	0.87
32-38	0.15	0.03	0.16	0.08	0.03	0.02	0.03	0	0.18	0.03	0.07	0.05	0.07
39-46	0.03	0.03	0	0.03	0.01	0	0.03	0.01	0.06	0	0	0	0.02
47 and over	0	0	0	0	0	0	0	0	0.01	0	0	0	0+

TABLE A-4

METEOROLOGIC STATIONS

Map index No. (plate A-1)	Station	Length of record in years (as of 1961)	Collecting agency
<u>COMPLETE METEOROLOGICAL STATIONS</u>			
1	New Orleans	90	WB
2	New Orleans International Airport, Moisant Field	15	WB
<u>RECORDING BAROGRAPH STATIONS</u>			
3	Lake Pontchartrain at Frenier	3	NOD
4	Lake Pontchartrain near Madisonville	4	NOD
5	Lake Pontchartrain at West End (New Orleans)	4	NOD
<u>RECORDING RAINFALL STATIONS</u>			
6	New Orleans - Algiers	62	S&WB
7	New Orleans - Dublin Street	68	S&WB
8	New Orleans - Jefferson Ave.	68	S&WB
9	New Orleans - Jourdan Ave.	28	S&WB
10	New Orleans - London Ave.	68	S&WB
<u>NON-RECORDING RAINFALL STATIONS</u>			
11	Metairie	13	WB
12	New Orleans - Pines Village	7	WB
13	Nott Fire Tower near Mandeville (Disc. May 1955)	3	WB
14	Pearl River	55	WB
15	Pearl River, Lock 1	13	WB
16	Violet	6	WB

TABLE A-4 (cont'd)

Map index No. (plate A-1)	Station	Length of record in years (as of 1961)	Collecting agency
---------------------------------	---------	---	----------------------

RAINFALL (NON-RECORDING) AND TEMPERATURE STATIONS

		<u>Rainfall</u>	<u>Temp.</u>	
17	New Orleans Airport (Disc. July 1954)	15	17	WB
18	New Orleans - Audubon Park	72	72	WB
19	Greater New Orleans Expressway Bridge	5	5	WB
20	Reserve	60	60	WB
21	Slidell	5	5	WB

RECORDING ANEMOMETER STATIONS

22	GIWW at Paris Road Bridge (near New Orleans)	1		NOD
3	Lake Pontchartrain at Frenier	3		NOD
19	Greater New Orleans Expressway Bridge near Mandeville	4		WB
23	Greater New Orleans Expressway Bridge near Metairie	4		WB
24	Lake Pontchartrain near north end of U. S. Hwy. 11 Bridge	2		NOD
5	Lake Pontchartrain at West End (New Orleans)	4		NOD
25	Mississippi River at H. P. Long Bridge (U. S. Hwy. No. 90)	23		NOPBRR
4	Mouth of Tchefuncta River, Madisonville	4		NOD

LEGEND

WB = U. S. Weather Bureau  
 NOD = U. S. Army Engineer District, New Orleans  
 S&WB = New Orleans Sewerage and Water Board  
 NOPBRR = New Orleans Public Belt Railroad

## A-2 HYDROLOGIC REGIMEN

a. General. The water level in Lake Pontchartrain is subject to variations from direct rainfall, tributary inflow, wind driven water movements, and translation through the Rigolets, Chef Menteur Pass, Lake Borgne, Mississippi Sound, Inner Harbor Navigation Canal, and Mississippi River-Gulf Outlet by tidal variations originating in the Gulf of Mexico. Infrequently, it is affected by Mississippi River diversions through Bonnet Carre Spillway. The combinations of these factors determine the salinity regimen in the lake. Locations and periods of record of hydrologic stations are shown in tables A-5 and A-6.

b. Runoff and stream flow. Runoff from the 4,700 square miles north and west of Lakes Pontchartrain and Maurepas drains into the lakes via the Amite, Tickfaw, Natalbany, Tangipahoa, and Tchefuncta Rivers; and Bayous Lacombe, Bonfouca, and Liberty. Streamflow records are available at five locations on these streams for the periods of record listed in table A-7. New Orleans and adjacent parishes are drained by outfall canals that discharge directly into Lake Pontchartrain. Yearly fresh water inflow records show considerable variation, as shown in table A-7.



TABLE A-5

HYDROLOGIC STATIONS ON TRIBUTARY STREAMS

Map index No. (plate A-1)	Station	Period of record		Collecting agency
		Type of water level gage	Records available (as of 1961)	
26	Amite River at Port Vincent	Recorder.	Gage heights, Dec. 1954 to date. High water discharge, 7 observations in 1950, 1 in 1953, 2 in 1955, 1 in 1956, and 1 in 1959.	NOD
27	Amite River at French Set- tlement	Recorder. Crest indi- cator.	Gage heights, Dec. 1954 to date. High water discharge, 5 observations in 1950 and 1 in 1956.	NOD
28	Petite Amite River near Sorrento	Recorder. Crest indi- cator.	Gage heights, inter- mittent Mar. 1950 to May 1951 and daily Oct. 1951 to date.	NOD
29	Bayou Pierre near St. Paul	Recorder. Crest indi- cator.	Gage heights, inter- mittent May 1949 to Jan. 1950 and daily Jan. 1950 to Sept. 1959. Discharge ob- servations, 1 in 1955 and 2 in 1956.	NOD
30	Tickfaw River near Springfield	Recorder.	Gage heights, May 1947 to date.	NOD

LEGEND

NOD = U. S. Army Engineer District, New Orleans

TABLE A-6

HYDROLOGIC STATIONS, LAKES MAUREPAS, PONTCHARTRAIN, AND BORGNE

Map index No. (plate A-1)	Station	Period of record		Collecting agency
		Type of water level gage	Records available (as of 1961)	
31	Lake Maurepas at Pass Manchac	Wire-weight. Crest indi- cator.	Gage heights, July 1955 to date. Salinity, Mar. 1951 to date.	NOD
3	Lake Pontchar- train at Frenier	Staff gage prior to Feb. 1950. Record- ing gage from Feb. 1950 to date. Crest indicator.	Gage heights, Sept. 1931 to date. Wave data, Mar. 1958 to date. Salinity, June 1947 to Dec. 1950.	NOD
32	Greater New Orleans (Lake Pont- chartrain) Expressway Bridge near Metairie	Recording wave gage.	Wave data, Aug. 1957 to date. Salinity, Aug. 1957 to date.	NOD
33	Greater New Orleans (Lake Pontchartrain) Expressway Bridge near midlake	Recorder.	Gage heights, Aug. 1957 to date.	NOD
34	Greater New Orleans (Lake Pontchartrain) Expressway Bridge at north shore	Staff, Sept. 1931 to Oct. 1947. Record- er, Oct. 1947 to date. Crest indicator.	Gage heights, Sept. 1931 to date. Wave data, 1957 to date. Salinity, Aug. 1957 to date.	NOD
5	Lake Pontchar- train at West End (New Orleans)	Staff, Sept. 1931 to Jan. 1947. Recor- der, Jan. 1947 to date. Crest indicator.	Gage heights, Sept. 1931 to Dec. 1946 and Mar. 1949 to date. Salinity, Oct. 1945 to Dec. 1946.	NOD

TABLE A-6 (cont'd)

HYDROLOGIC STATIONS, LAKES MAUREPAS, PONTCHARTRAIN, AND BORGNE

Map index No. (plate A-1)	Station	Period of record		Collecting agency
		Type of water level gage	Records available (as of 1961)	
35	Lake Pontchar- train at Little Woods	Staff gage. Crest indi- cator.	Gage heights, Sept. 1931 to date. Salinity, Mar. 1946 to date.	NOD
36	Lake Pontchar- train near south end of U.S. Hwy. 11 Bridge	Recorder. Crest indi- cator.	Gage heights, May 1949 to date.	NOD
24	Lake Pontchar- train near north end of U.S. Hwy. 11 Bridge	Crest indi- cator in- stalled 1956.	Salinity, July 1957 to date.	NOD
37	Rigolets at U.S. Hwy. 90 Bridge	Staff prior to June 1949. Recorder June 1949 to date. Crest indi- cator.	Gage heights, Sept. 1931 to date. Salinity, July 1957 to date.	NOD
38	Chef Menteur U.S. Hwy. 90 Bridge	-	Salinity, Mar. 1957 to date.	NOD
39	Lake Borgne at Rigolets	Recorder.	Gage heights, Dec. 1957 to date.	NOD
40	Lake Borgne at Chef Menteur Pass	Recorder.	Gage heights, July 1957 to date.	NOD
41	Lake Borgne at Shell Beach	Recorder. Crest indi- cator.	Gage heights, July 1948 to date. Salinity, Aug. 1948 to date.	NOD

TABLE A-6 (cont'd)

HYDROLOGIC STATIONS, LAKES MAUREPAS, PONTCHARTRAIN, AND BORGNE

Map index No. (plate A-1)	Station	Period of record		Collecting agency
		Type of water level gage	Records available (as of 1961)	
42	Lake Borgne at Doulluts Canal west of Shell Beach		Salinity, Feb. 1957 to date.	NOD
22	Gulf Intracoast- al Waterway at Paris Road	Staff gage. Crest indi- cator.	Gage heights, Apr. 1948 to date. Salinity, Aug. 1948 to date.	NOD

LEGEND

NOD = U. S. Army Engineer District, New Orleans

## CREST INDICATORS\*

Map index No. (plate A-1)	Location	Year installed
$\frac{56}{1}$ (AR)	Amite River at Clio	1956
$\frac{58}{18}$ (LP)	Lake Pontchartrain near Madisonville	1958
$\frac{57}{17}$ (LP)	Lake Pontchartrain at Pass Manchac	1957
$\frac{58}{19}$ (LP)	Lake Pontchartrain at Ruddock	1958
$\frac{56}{10}$ (LP)	Lake Pontchartrain at Jefferson Parish Pumping Station No. 4	1956
$\frac{57}{15}$ (LP)	Lake Pontchartrain at mouth of Bayou Lacombe	1957

\*This list includes only those indicators not associated with other types of water surface gages.

TABLE A-7  
PERTINENT STREAMFLOW DATA (1938-1960)  
FOR MODEL STUDY

<u>Inflow point</u>	<u>Total drainage area</u> sq. mi.	<u>Gage location*</u>	<u>Gaged area</u> sq. mi.	<u>Period of record</u>	<u>Avg.</u> c.f.s.	<u>Discharge</u>		<u>Minimum Date</u>	
						<u>Maximum Rate</u> c.f.s.	<u>Date</u> c.f.s.		
Amite River	2,373	Amite River near Denham Springs	1,334	9/38 to date	1,962	67,000	5/20/53	271	10/17/56 10/18/56
Tickfaw River	735	Tickfaw River at Holden	242	10/40 to date	375	9,680	3/22/43	75	8/30/57
		Natalbany River at Baptist	80	8/43 to date	116	9,550	5/3/53	2	10/22/52
Tangipahoa River	885	Tangipahoa River at Robert	646	10/38 to date	1,094	50,500	5/3/53	264	Several days in 10/39
Tchefuncta River	459	Tchefuncta River near Folsom	96	1/44 to date	173	18,300	5/3/53	33	8/29/57
Bayous Lacombe and Liberty	211								
Pearl River	8,689	Pearl River at Bogalusa	6,630	10/38 to date	8,899	60,000	1/25/47 to 1/26/47	1,100	9/15/54 thru 9/17/54
Vicinity of New Orleans	213	Bogue Chitto near Bush	1,210	10/37 to date	1,877	51,200	3/23/43	424	10/26/55 thru 10/28/55

\* = U. S. Geological Survey gage stations

c. Stages, salinities, waves, and tides.(1) Lake stages.

(a) The Bonnet Carre Spillway is operated as required during the high water season on the Mississippi River to divert flows through Lake Pontchartrain in order to insure that a stage of 20 feet above mean sea level is not exceeded at New Orleans. Studies indicate that the operations of the spillway resulted in the raising of the lake level about 0.8 foot in 1937, 1.5 feet in 1945, and 1.0 foot in 1950. These variations are small when compared to stage increases produced by hurricanes.

(b) The maximum recorded stage in Lake Pontchartrain of 13.0 feet above mean sea level occurred at Frenier on 29 September 1915. The minimum of minus 2.2 feet occurred at West End (New Orleans) on 26-27 January 1938. The mean lake stage for the period from 1949 through 1958 is 1.0 foot. Plate A-2 shows the monthly mean stages in Lake Pontchartrain from 1941 through 1959.

(c) Maximum stages occur in Lake Pontchartrain during hurricane activity in the vicinity. A list of recorded high stages is presented in table A-8.

TABLE A-8  
MAXIMUM STAGES - LAKE PONTCHARTRAIN

<u>Location</u>	<u>Date</u>	<u>Stage-ft.m.s.l.</u>
Mandeville	20 Sept. 1909	8.0
West End	20 Sept. 1909	6.2
Frenier	29 Sept. 1915	13.0
West End	29 Sept. 1915	6.0
West End	19 Sept. 1947	5.4
Mandeville	19 Sept. 1947	6.8
New Orleans	4 Sept. 1948	4.9
Frenier	24 Sept. 1956	6.8)
Little Woods	24 Sept. 1956	7.0) "Flossy"
West End	24 Sept. 1956	5.3)

(2) Salinities. Diluted saline gulf water enters Lake Pontchartrain from Lake Borgne via the Rigolets and Chef Menteur Pass and the Mississippi River-Gulf Outlet and Inner Harbor Navigation Canal in large quantities and mixes with the freshwater inflow. The resultant salinity in Lake Pontchartrain averages about 1,500 parts per million of chloride ion, ranging seasonally from a low of about 450 in the spring to a high of 5,300 in the late fall. It is subject to considerable variation with respect to location, seasonal trends, and short term fluctuations. More extensive data on salinities, tides, and currents in Lake Pontchartrain and vicinity will be shown in the U. S. Army Engineers Waterways Experiment Station (WES)

report relative to a model study of the Lake Pontchartrain area, which is supplement 3, and published separately to this report.

(3) Waves. In August 1957, two wave gages were installed on the east side of the Greater New Orleans Expressway Bridge, Station Ten at the north end, and Station Four on the south end. Both are approximately one-quarter mile from shore. In 1958, Station Nine was established at Frenier, with the gage on a tower approximately 1,200 feet from shore. Locations are shown on plate A-1. Pertinent observed data are listed in table A-9.

TABLE A-9  
WAVE DATA

<u>Station</u>	<u>Significant Waves</u>	<u>Maximum Waves</u>		
	<u>Range</u> ft.	<u>Wind</u> m.p.h.	<u>Height</u> ft.	<u>Date</u>
4	0.1 to 4.9	30	8.3	9 October 1958
9	0.1 to 4.9	29	7.8	9 October 1958
10	0.1 to 5.3	40	9.0	10 May 1959

(4) Tides. The normal tide has general ranges of one-half foot in Lake Pontchartrain and 1 foot in Lake Borgne, and is diurnal in nature. However, wind effects usually mask the daily ebb and flood variations. Because of the annual volume of freshwater inflow (estimated to average 5 million acre-feet), tides, and storm surges, enormous volumes of water pass in both directions through the Rigolets, Chef Menteur Pass, Lake Borgne, Mississippi Sound, Inner Harbor Navigation Canal, and Mississippi River-Gulf Outlet. With so many variables operating on the several elements of the system, the current patterns are continually changing.

### A-3 DESCRIPTION AND VERIFICATION OF PROCEDURES

a. Hurricane memorandums. The Hydrometeorological Section (HMS), U. S. Weather Bureau, cooperated in the development of hurricane criteria for experienced and potential hurricanes in the study area. The HMS memorandums provided frequency data, isovel and rainfall patterns, pressure profiles, hurricane paths, and other parameters required for the hydraulic computations. Those relative to experienced hurricanes are based on reevaluation of historic meteorologic and hydrologic data. Those relative to potential hurricanes contain generalized estimates of hurricane parameters that are based on the latest research and concept of hurricane theory. Memorandums pertinent to the study area are listed in Section III, Bibliography.

b. Historical storms used for verification. Three observed storms, with known parameters and effects, were used to establish and verify procedures and relationships for determining surge heights, wind tide levels (WTL's), inflow into Lake Pontchartrain, overtopping

flows, and ultimately, flooding elevations that would result from synthetic hurricanes. These three storms occurred in September of 1915, 1947, and 1957. Isovel patterns for the hurricanes of September 1915<sup>(1)\*</sup> and September 1947<sup>(2)</sup> are shown on plates A-3 and A-4.

(1) The hurricane of 29 September 1915 had a central pressure index (CPI) of 27.87 inches, an average forward speed of 10 knots, and a maximum wind speed of 99 m.p.h. at a radius of 29 nautical miles. This hurricane approached the mainland from the south. At the Lake Borgne entrance to the Rigolets, a high water elevation of about 10 feet was experienced and the average elevation in Lake Pontchartrain rose to 6 feet. This storm was not used for verification of levee overtopping because the present lakefront levee system was not in existence in 1915.

(2) The 19 September 1947 hurricane had a CPI of 28.57 inches, an average forward speed of 16 knots, and a maximum windspeed of 72 m.p.h. at a radius of 33 nautical miles. The direction of approach of this hurricane was approximately from the east. In Lake Borgne, at the entrance to the Rigolets, the maximum water surface elevation was 10 feet and in Lake Pontchartrain, the maximum elevation was 5 feet. However, because of the rapid forward speed of this storm, the average water elevation in Lake Pontchartrain did not reach its maximum at the time that the winds were critical to the south shore. The step-type seawall was in place along the New Orleans lakefront during this storm, and a fairly reliable flood line of overtopping flows was available for verification.

(3) Tropical storm Esther occurred on 16 September 1957, and the resultant elevations were accurately registered by stage recording gages at many locations within the study area. These records were available for verification of routing procedures. This storm was not severe enough to cause flooding.

c. Synthetic storms. Computed flood elevations, resulting from synthetic storms, are necessary for frequency and design computations. Parameters for certain synthetic storms and methods for derivation of others were furnished by the U. S. Weather Bureau. The standard project hurricane (SPH) for the entire Louisiana coast was used for all locations in the study area with changes only in path and forward speed. The probable maximum hurricane (PMH) and moderate hurricane (Mod H) for a definite location were derived from the SPH for that location and differ from it only in wind velocities and CPI's.

(1) The SPH for the Louisiana coast was derived by the U. S. Weather Bureau from a study of 42 hurricanes that occurred in the region over a period of 57 years. SPH paths critical to different locations in the study area and isovel patterns at critical hours are shown on plate A-5.

\*Numbers in parentheses indicate references in bibliography.



(a) The SPH for the Louisiana coastal region has a frequency of once in 100 years. The CPI that corresponds to this frequency is 27.6 inches. CPI probabilities are based on the following relationship<sup>(3)</sup>:

$$P = \frac{100 (M-0.5)}{Y}$$

where P = percent chance of occurrence per year  
 M = number of the event (rank)  
 Y = number of years of record

(b) Radius of maximum winds is an index of hurricane size. The average radius of 12 hurricanes occurring in the New Orleans area is 36 nautical miles. From relationships of CPI and radius of maximum winds of gulf coast hurricanes<sup>(3)</sup>, a radius of 30 nautical miles is considered representative for an SPH having a CPI of 27.6 inches.

(c) Different forward speeds are necessary to produce SPH effects at various locations within the study area. In Lake Pontchartrain, the forward speed is a particularly critical factor and may be as important as the track itself. Sufficient time must elapse between the time of maximum elevation at the entrances to Chef Menteur Pass and the Rigolets and the time of maximum critical winds at the Lake Pontchartrain shore in question to allow for maximum inflow into the lake. The SPH for the south shore, patterned after the September 1915 hurricane, has an average forward speed of 6 knots<sup>(4)</sup> and the SPH for the north shore has a forward speed of 5 knots. The average forward speed of 11 knots was used for the SPH along the west shore of Lake Borgne.

(d) Maximum theoretical gradient wind <sup>(3)</sup> is expressed as:

$$V_{gx} = 73 \sqrt{P_n - P_o} - R (0.575 f)$$

where  $V_{gx}$  = maximum gradient wind speed in miles per hour

$P_n$  = asymptotic pressure in inches

$P_o$  = central pressure in inches

R = radius of maximum winds in nautical miles

f = coriolis parameter in units of hour<sup>-1</sup>

The estimated wind speed (30 feet above ground level) ( $V_x$ ) <sup>(5)</sup> in the region of highest speeds is obtained as follows:

$$V_x = 0.885 V_{gx} + 0.5T$$

where T = forward speed in miles per hour.

From these relationships, a wind speed of approximately 100 m.p.h. was obtained.

(2) A CPI of 26.9 inches was recommended for the PMH by the U. S. Weather Bureau<sup>(6)(7)</sup>. A hurricane with this CPI actually occurred at 33° N. latitude. Other synthetic storms of different frequency and CPI are derived from the SPH. With the exception of the PMH, other CPI's for desired frequencies are obtained from the graph shown on plate A-6.  $V_{gx}$ 's corresponding to any other CPI are determined similarly by use of the method described for the SPH. Variations in CPI's of historic storms were accomplished by the same procedure<sup>(3)</sup>. Characteristics of synthetic storms and some historic storms are listed in table A-10.

TABLE A-10  
HURRICANE CHARACTERISTICS

Hurricane*	CPI inches	Radius of	Forward	$V_x$
		max. winds nautical miles	speed knots	m.p.h.
Sept. 1915	27.87	29	10	99
Sept. 1947	28.57	33	16	72
Track A PMH	26.9	30	6	114
Track A SPH	27.6	30	6	100
Track A Mod H	28.3	30	6	83
Track C PMH	26.9	30	5	114
Track C SPH	27.6	30	5	100
Track C Mod H	28.3	30	5	83
Track F PMH	26.9	30	11	114
Track F SPH	27.6	30	11	100
Track F Mod H	28.3	30	11	83

\*Tracks are shown on plate A-7.

d. Surges.

(1) Maximum hurricane surge heights along the western shores of Lake Borgne were obtained from computations made for ranges extending from the shores out to the continental shelf by use of a general wind tide formula that is based on the steady state conception of water super-elevation<sup>(8)(9)(10)</sup>. In order to reach agreement between computed maximum surge heights and observed high water marks, it was necessary to introduce a calibration coefficient or surge adjustment factor into the general equation which, in its modified form, is as follows:

$$S = 1.165 \times 10^{-3.2} \frac{V_F N Z \text{ Cos } \theta}{D}$$

Where S = wind setup in feet

V = windspeed in statute miles per hour  
 F = fetch length in statute miles  
 D = average depth of fetch in feet  
 $\theta$  = angle between direction of wind and the fetch  
 N = planform factor, generally equal to unity  
 Z = surge adjustment factor

(2) Water surface elevations along a range were determined by incremental summation of wind setup above the water elevation at the gulf end of the range. The low strip of marshland between Lake Borgne and the gulf was considered already submerged prior to the time of maximum elevation at shore. Initial elevation at the beginning of each range was determined from the predicted normal tide and the setup due to atmospheric pressure anomaly. Typical tidal cycles for the study area are shown on plate A-8. An adjustment was made at the shoreward end of the range to compensate for the difference in pressure setup between both ends of the range. This procedure for the determination of surge height at the coastline was developed for an area along the Mississippi gulf coast, where reliable data were available at several locations for more than one severe hurricane, and was used for the entire coastal Louisiana region. Due to dissimilar shoreline configurations, different surge adjustment factors were required at each location, but identical factors were used for each storm. The value of the factor is apparently a function of the distance between the shoreline and deep water and varies inversely with this distance. Comparative computed maximum elevations and observed high water elevations for the locations of the 1915 and 1947 hurricanes that were used in the development of the procedure are shown in table A-11.

TABLE A-11  
HURRICANE SURGE HEIGHTS

<u>Location</u>	<u>Surge adjust- ment factor(Z)</u>	<u>1915</u>		<u>1947</u>	
		<u>Observed</u> feet	<u>Computed</u> m.s.l.	<u>Observed</u> feet	<u>Computed</u> m.s.l.
Long Point, La.	0.21	9.8	9.6	10.0	10.1
Bay St. Louis, Miss.	0.46	11.8	11.8	15.2	15.1
Gulfport, Miss.	0.60	10.2*	9.9	14.1	14.3
Biloxi, Miss.	0.65	10.1*	9.8	12.2*	12.6

\*Average of several high water marks.

(3) The incremental step computation was used to check experienced maximum hurricane surge heights at several locations within the area. Verification of these surge heights and the surge adjustment factors used in the computations are shown in table A-12.

TABLE A-12  
VERIFICATION OF HURRICANE SURGE HEIGHTS

Location	Sept. 1915		Sept. 1947		Sept. 1956		Surge adjustment factor (Z)
	Observed feet	Computed m.s.l.	Observed feet	Computed m.s.l.	Observed feet	Computed m.s.l.	
Violet	-	-	7.3	7.9	6.5	7.7	0.30
Michoud	11.0	11.4	-	-	-	-	0.30
Long Point	9.8	9.6	10.0	10.1	-	-	0.21

(4) An example of the setup computation for one increment ( $\Delta F$ ) along a range radiating from Long Point for an SPH along Track A and at 4 hours after landfall of the hurricane is as follows:

- (a) Initial elevation:
- Normal pressure = 30.14 inches of mercury
  - Pressure at beginning of range, 68 miles from center = 29.15 inches of mercury
  - Deviation from normal pressure = 0.99 inches of mercury
  - Pressure setup = 0.99 x 1.14 feet = 1.13 feet of water
  - Normal predicted tide = 0.50 feet above mean low water (m.l.w.)
  - Initial elevation = 1.63 feet m.l.w.

(b) Incremental setup (for setup between adjacent stations on range):

Sta. mile	$\Delta F$ miles	V m.p.h.	$\cos \theta$	$V^2 \cos \theta$	Av. $V^2 \cos \theta$	Depth: Av. D+1.63	$\Delta S/2$	S
1.7	1.7	79	0.326	2040	1670	7	14.22	9.06
0.0		76	0.225	1300		0		9.11

$$S = 1.165 \times 10^{-3} \times \frac{1,670 \times 1.7 \times 1 \times 0.21}{14.22} = 0.05'$$

## (c) Setup for pressure differential:

Normal pressure	= 30.14 inches of mercury
Pressure at end of range, 56 miles from center	= 29.14 inches of mercury
Deviation from normal (1.00 x 1.14 feet)	= 1.00 inches of mercury = 1.14 feet of water
Deviation at beginning	= 1.13 feet of water
Differential setup	= 0.01 foot

## (d) Final surge height:

Normal predicted tide	= 0.50 feet m.l.w.
Setup at beginning of range	= 1.13 feet
Correction m.l.w. to m.s.l.	= -0.50 foot
{ S	= 9.11 feet
Differential setup	= 0.01 foot
Surge height at shore	= 10.25 feet m.s.l.

Bottom and surge profiles for the Mod H, SPH, and PMH for the same range and track described above are shown on plate A-9.

e. Routing. Since the major hurricane damage in the study area results from storm induced effects on Lake Pontchartrain, it was necessary to establish a method to determine the hydraulic regimen in the lake at any time during the hurricane occurrence. This procedure involves the construction of a stage hydrograph for Lake Borgne, and the simultaneous hourly calculations of flows through Lake Pontchartrain's natural inlet and outlet passes, tilt and stage-volume relationships in Lake Pontchartrain and Lake Maurepas, accumulated rainfall, and overflow from the lake to the land areas.

(1) Prerequisite to any routing is the choice of an actual or hypothetical hurricane of known or designated characteristics. It is then possible to develop surge heights for any point in Lake Borgne for the selected storm. For routing purposes, Long Point, which is east of the mouth of the Rigolets, was selected as the critical point for a hydrograph. The hydrograph for Long Point reflects stages at the mouths of both the Rigolets and Chef Menteur Pass. Construction of such a hydrograph of hourly stages at the mouths of the two passes was based on a method developed by R. O. Reid <sup>(11)</sup> that was modified by using the maximum surge elevation computed by the incremental setup method as the peak of the hydrograph for the critical period. A comparison of the rising portion of the hydrograph thus derived, with one obtained by computing surge elevations at hourly intervals, indicated agreement between the two methods. Final stages for the recession portion of the hydrograph could not be computed by the incremental setup method because of the offshore wind directions prevailing after the peak stage. The recession produced by Reid's method, obtained by rotating the

hydrograph about the peak ordinate, indicated stages considerably lower than corresponding stages for the 1947 hurricane surge. The observed stages of the 1957 storm surge also indicated that the recession was somewhat slower at intermediate stages in Lake Borgne. It was therefore necessary to estimate the recession portion of the hydrograph to verify routing procedures. Storm surge hydrographs for Long Point for each storm investigated were determined by identical procedures.

(2) Storm tides flow in and out of Lake Pontchartrain through three major natural passes and an artificial canal. Rating tables, derived by reverse routing of observed storms, were developed for use in routing through the passes and canal. The elevation of Lake Borgne at Long Point was determined from the average of records obtained from automatic tide gage recorders located at the mouths of the passes and at Shell Beach. Elevations of Lake Pontchartrain were determined from records of the automatic tide gages located in Lake Pontchartrain at U. S. Highway 11 and at West End. Although there was a fairly consistent relationship between head and flow, there was no consistency when a parameter of stage was introduced.

(a) The combined rating of the Rigolets, Chef Menteur Pass, flow over U. S. Highway 90 in vicinity of the passes, and Inner Harbor Navigation Canal was based on the period 25 July to 11 August 1957, during which time a minor storm accompanied by moderate stages was experienced. The empirical relationship,  $Q = 560 H^{0.935}$  was derived from plots of the data, and used to compute a rating table.

(b) The empirical relationship of  $Q = 109.3 H^{0.321}$  was derived from plots of observed data for Pass Manchac, and was used in computing the Pass Manchac rating table. This gives only the quantity of flow through the pass itself. During a storm with very high stages, e.g., the PMH, the railroad embankment, which prevented overflow in lesser storms, is overtopped. The flow over the embankment was then calculated by use of the formula  $Q = 2.95 LH^{1.47}$  (12) and was added to the amount going through the pass.

(3) The difference in water surface elevations at U. S. Highway 11 and the entrance to Pass Manchac, obtained from water surface contours derived from wind setup computations for Lake Pontchartrain, is the tilt in the lake. The tilt for Lake Maurepas was assumed to be one-fifth of the tilt used for Lake Pontchartrain since its width is approximately one-fifth of that of Lake Pontchartrain.

(4) Storage tables for the range of stages were made for Lakes Maurepas and Pontchartrain. The storage amounts include the volumes contained in the adjacent marsh areas when the stages exceed the surface elevations of these marshes.

(5) The cumulative amount of rainfall that is coincident with the storm significantly affects the lake elevation and hence

the routing procedure. The amount of this rainfall was calculated by the methods described in U. S. Weather Bureau memorandums<sup>(13)(14)</sup>, using a moderate rainfall that would be coincident with a tropical storm. For routing purposes, rainfall was considered as additional inflow into Lake Pontchartrain. The effect of cumulative rainfall is to raise the lake level.

(6) The stages, wind tide elevations, and waves induce flow over the shore protective structures. Adjustments were made in the routing procedure to account for the quantities that overtopped these structures.

(7) With the above-mentioned items resolved, the routing procedure was reduced to the successive approximation type problem in which the variable factors were manipulated until a condition of balance between flows and storages was obtained for the incremental time intervals. A typical routing computation is illustrated on plate A-10. The 1947 and 1915 hurricanes were routed by this procedure. Routed average stages for Lake Pontchartrain were found to be in reasonable agreement with the observed average stages for the two hurricanes. The degree of agreement between the observed and computed stages that were obtained by use of the routing procedure verifies the methods and rating tables used. Observed and computed average stages for the 1947 and 1957 hurricanes are shown on plates A-11 and A-12. All other hurricanes studied were routed using similar procedures. The resultant stage hydrographs for the SPH's critical to the north and south shores of Lake Pontchartrain under present conditions are shown on plates A-13 and A-14, respectively.

(8) It was necessary for economic studies and levee design purposes to determine the elevation in Lake Pontchartrain during an occurrence of an SPH or PMH with the project in place. Flow over the barrier was computed by methods described in paragraph A-3g.(5). Using the resultant volume, the elevation was obtained from the aforementioned Lake Pontchartrain storage tables.

f. Wind tides.

(1) The storms under consideration are accompanied by strong winds. The effect of strong winds blowing over shallow enclosed bodies of water, such as Lake Pontchartrain and Lake Maurepas, is to drive large quantities of water ahead of the winds. It was necessary for purposes of routing and overflow computations to determine the wind tide levels for Lake Pontchartrain. This was accomplished by dividing the lake into four or five segments that are roughly parallel to the wind directions, and by calculating set-up and setdown for each of the segments. The average windspeed and average depth in each segment were determined from isovel and hydrographic charts for each wind tide computation. The storm isovel patterns were furnished by the U. S. Weather Bureau<sup>(15)(16)(17)</sup>. The computation of wind tides along each zone was based on the

segmental integration method<sup>(10)</sup> and was calculated by use of the step-method formulas<sup>(18)</sup> that were modified as follows:

$$\text{Setup} = d_t \left( \sqrt{\frac{0.00266 u^2 FN}{d_t^2} + 1} - 1 \right)$$

$$\text{Setdown} = d_t \left( 1 - \sqrt{1 - \frac{0.00266 u^2 FN}{d_t^2}} \right)$$

Where: Setup or setdown in feet is measured above or below mean water level (m.w.l.) of the surge in the lake

$d_t$  = av. depth of fetch in feet below m.w.l.

$u$  = windspeed in m.p.h. over fetch

$F$  = fetch length in miles, node to shoreline

$N$  = planform factor, equal generally to unity

(2) Graphs were constructed from the above formulas to determine setup and setdown quickly about any nodal elevation, plate A-15. Volumes of water along the zones, represented by the setup and setdown with respect to a nodal elevation, were determined and the water surface profiles adjusted until the setup and setdown volumes balanced within 5 percent. Water surface contours were then drawn for several even-foot nodal elevations, and the tilt and WTL's were determined from the contour sketch. In the routing of surges, pertinent wind tides and tilts for other nodal elevations were interpolated from the contour sketches for the even-foot nodes. Typical wind tide computations are illustrated on plate A-16.

(3) In areas where wind tides are ponded in shallow areas to depths of 2 feet or less and these ponds are exposed to wave action, a superelevation of the water surface is experienced<sup>(19)</sup>. This additional wave setup was computed by use of a proportional formula which related experienced wave height and setup at another location to computed wave height and setup, and then added to the ponding level that obtained if unaffected by wave action.

(4) Maximum computed and observed setup elevations for the 1947 hurricane, respectively, were 6.7 feet and 6.8 feet at Mandeville, and 4.9 feet and 5.4 feet at West End. Computed stages for the 1915 hurricane compared favorably with observed high water marks. Wind tide levels for all hurricanes studied were computed by applying the same methods and procedures described above. Maximum surge height contours in the Lake Borgne area and maximum WTL contours in the Lake Pontchartrain area were developed for the PMH, SPH, and Mod H. These contours are shown on plates A-17, A-18, and A-19. The



contours represent the maximum elevations that would be experienced for the occurrence of hurricanes in each of these three categories for storm paths most critical for every location. Similar contours that represent simultaneous occurrence of maximum observed surge heights are shown on plate A-20.

g. Maximum runup and overflow.

(1) Hurricanes approaching on paths critical to the shores of Lake Pontchartrain create conditions whereby shore protective structures are overtopped. It was necessary to calculate the magnitude of the heights of wave runup and quantities of this overflow by use of routing procedures to develop improved protective structure designs and to determine damages. This determination was divided into three significant parts for convenience of calculation, namely maximum runup, wave overtopping, and free-flow. Common factors which must be resolved in all three types of calculations are the WTL, and the geometry and crown elevation of the protective structure.

(2) Computation of maximum runup was necessary in order to determine the heights to which existing shore protective structures would have to be raised to prevent all overflow for the significant wave accompanying the SPH. For purposes of this study, wave runup was considered to be the ultimate height to which water in a wave ascended on the proposed slope of a protective structure. This condition occurred when the WTL was at a maximum, and was calculated by the interpolation of model study data developed by Saville (20)(21) (22) which relates runup ( $R/H_0'$ ), wave steepness ( $H_0'/T^2$ ), relative depth ( $d/H_0'$ ), and structure slope, and is shown on plate A-21. In cases of levees with berms, runup was computed by using the depth of water for each berm, and the controlling berm established for the maximum runup. Table A-13 shows examples of maximum runup for the SPH, assuming the upward extension of slopes of existing structures.

TABLE A-13  
MAXIMUM RUNUP - STANDARD PROJECT HURRICANE

<u>Location</u>	<u>Existing</u>	<u>WTL</u>	<u>Runup</u>
	<u>crest</u>		<u>elevation*</u>
	feet m.s.l.	feet m.s.l.	feet m.s.l.
Jefferson Parish, lakefront	10.0	11.1	16.2
New Orleans, lakefront	9.6	11.2	15.5
Citrus, lakefront	9.4	11.2	16.0
New Orleans East, lakefront	9.2	10.3	15.1
New Orleans East, back	11.6	12.5	16.2
Citrus, back	9.6	12.2	15.9
Chalmette, back	1.5-6.0	11.9	15.5
Inner Harbor Navigation Canal	9.6	12.0	-

\*Runup on extended slopes of existing protective works.

(3) In the process of determining wave overtopping amounts, many contributing calculations had to be performed. From prediction curves developed by C. L. Bretschneider<sup>(18)</sup>, significant wave heights and periods for average winds and depths were determined. The deep water wave lengths were obtained from  $L_0 = gT^2/2\pi$ , and the equivalent deep water significant wave heights by use of the appropriate shoaling coefficients. To determine if the deepwater wave could be supported at the base of the structure, the breaking depth was computed, using:

$$d_b = 0.67H_0' \frac{1}{(H_0'/T^2)^{1/3}}, (8).$$

When the depth of the water at the toe of the structure was insufficient to support a wave equivalent to that of the deepwater wave height, this wave height was then recomputed using the actual water depth. For the reaches adjacent to Lake Borgne, the effective depth was taken as the height from the WTL to the top of the marsh grass (23). In the case of levees with berms, runups were computed using the depth of the water for each berm and the depth which gave the maximum runup was used to calculate the overtopping rates. These overtopping rates were determined by interpolating model study data presented by Saville<sup>(21)</sup>. However, these data were based on a train of waves of uniform height. It was then necessary to reduce the overtopping rates in order to obtain rates corresponding to a natural spectrum of waves of varying heights. The spectrum used was presented by Saville<sup>(22)</sup> as follows:

<u>H/H<sub>s</sub></u>	<u>Percent</u>
1.58	2
1.23	8
0.90	23
0.65	17
0.48	25
0.31	13
0.18	12

Overtopping rates were then computed for each increment of wave height and the total volume for the spectrum obtained. Rates determined, using the significant wave height and the spectrum wave heights at the same location and for the same period of time, were then compared. Several such computations were made and an average reduction factor derived for each area involved. These calculations were applied in all subsequent computations of overtopping rates that were based on significant wave heights. The reduction factors varied between the limits of 40 and 50 percent, dependent upon wave and structure characteristics.

(4) The overtopping rates per foot of structure thus computed were applicable for waves whose orthogonals were normal to the structure alignment. However, when wind directions and wave

orthogonals were other than normal to a structure face, the adjustment in overtopping volumes to compensate for the angle of incidence was necessary. The length of equivalent structure in a reach was considered to be its length along an airline alignment between both ends. This length was multiplied by the cosine of the angle between wind direction at any given time and a normal to the equivalent structure in order to obtain the effective length of structure that is parallel to the wave front and is subject to wave overtopping rates. Varying angles of incidence were used from hour to hour as the wind direction shifted with the passage of the hurricane.

(5) Total overflow for the hurricanes considered was computed by using a combination of free-flow and overtopping methods. The application of these methods was as follows:

(a) Case 1. Until the time that the WTL exceeds the elevation of the protective structure, the quantity of flow, Q, over the structure is caused by waves breaking, and running up and over the control works. This amount was calculated as described in paragraph A-3g.(3) and (4), above. The overflow due to wave runup increases as the WTL approaches the crown elevation of the structure, and reaches its maximum when the WTL equals the crown elevation.

(b) Case 2. At the other extreme is when the WTL is at such a high elevation that all wave troughs clear the structure and the flow over the structure is not affected by waves. It was assumed that this condition was in effect when the WTL surpassed an elevation of approximately 3 feet above the crown elevation in order to conform with the average half-wave heights for the storms under analysis. The Q for this case was calculated as free-flow over a weir, using the appropriate weir formulas<sup>(12)(24)</sup>.

(c) Case 3. For WTL's between the structure crest and the elevation that is 3 feet higher, the total overflow was the result of both free-flow and wave overtopping. The rate of free-flow was computed, using the appropriate weir formulas, as in Case 2. The rate of wave overtopping was determined by varying the overtopping rate linearly, using the maximum rate for a WTL at the structure crest (as computed in Case 1), and a zero rate for a WTL at the elevation that is 3 feet higher. The total overflow was the sum of the two rates.

(6) The south shore was divided into segments to facilitate evaluation of variables which had different values in each segment at any given time. Segmental divisions are grouped for differing methods of calculations. These groups are from west to east; St. Charles Parish, Jefferson Parish, New Orleans, Pontchartrain Beach, Citrus, New Orleans East, and Chalmette.

(a) St. Charles Parish. Computation of overflow for

St. Charles Parish was not necessary because there are no existing protective works and all lands below WTL would be inundated.

(b) Jefferson Parish, Pontchartrain Beach, and Chalmette. Overtopping was calculated as described in paragraph A-3g.(5) for overflow conditions at the several structures. Reduction factors varying between 40 and 50 percent were used to adjust overtopping that was derived from significant waves in order to obtain overflow for a natural wave spectrum.

(c) New Orleans. This area is protected from Lake Pontchartrain by a seawall adjacent to the lake and by a levee that is about 2 feet high and is several hundred feet landward of the wall. The lake water surmounts the seawall by either overtopping or free-flow, thereby creating a pool in the area between the seawall and the back levee. In this pool additional setup is induced by waves and shallow depths. This additional setup was calculated as described in paragraph A-3f.(3) and was added to the ponding level or lakeside WTL, whichever is higher, to obtain the WTL at the back levee. Wave overtopping and free-flow were calculated for the back levee by using the adjusted WTL's, method as explained in paragraph A-3g.(5). The wave spectrum reduction factor in this area was 40 percent.

(d) Citrus and New Orleans East. These areas are protected from the lake by a railroad embankment. Due to previous damage to the embankment during relatively minor storms, it is assumed that 50 percent of the embankment will fail and erode to an elevation of 5.5 feet by the time the WTL reaches 5.5 feet. During the early hours of a storm before the WTL reaches 5.5 feet, percentages less than 50 and elevations greater than 5.5 feet but less than existing heights were used depending upon the WTL elevations. Hourly overtopping rates were calculated as described in paragraph A-3g.(b) for existing embankment heights and 5.5 feet. Rates for intermediate heights were interpolated. The back of these areas is protected from Lake Borgne by levees. Flow over these levees was calculated as described in paragraph A-3g.(5). The wave spectrum reduction factor in these areas was 50 percent.

(7) Computed flood heights that were derived from wave overtopping for the 1947 hurricane were in close agreement with the observed values in the New Orleans area. Since no free-flow occurred during this storm, this agreement verifies the above described procedures for evaluating observed wave overtopping. Similar methods were used to determine overflow for all other hurricanes that were studied. Wave and overtopping data for the SPH relative to existing protective works are shown in table A-14 and on plates A-22 and A-23. Maximum hour wave data for the SPH relative to the barrier plan are shown in table A-15.

TABLE A-14

WAVE AND OVERTOPPING DATA (Existing Conditions)-SPH  
Jefferson Parish - West

Hour	Wind m.p.h.	Av. depth feet	Hs feet	T sec.	WTL feet	Q <sub>ff</sub> c.f.s./ft.	Q <sub>ot</sub> * c.f.s./ft.	Q <sub>tot</sub> c.f.s./ft.	L cos θ feet	Acres feet
3	66	21.2	6.9	6.7	7.71	0.00	0.17	0.17	32,500	230.3
4	72	22.6	7.6	7.0	9.09	0.00	2.07	2.07	32,500	3,033.3
5	74	22.8	7.8	7.0	9.25	0.00	2.33	2.33	32,500	5,958.3
6	76	23.8	8.1	7.2	10.29	0.13	3.45	3.58	32,500	8,003.2
7	77	24.3	8.2	7.3	10.80	1.05	3.11	4.16	31,525	10,312.3
8	78	24.5	8.4	7.3	11.04	1.83	2.91	4.72	29,900	11,344.7
9	72	24.1	8.0	7.2	10.61	0.60	2.99	3.59	25,350	9,672.3
10	63	23.2	7.1	6.9	9.73	0.00	3.26	3.26	20,150	6,529.0
11	59	22.2	6.6	6.7	8.72	0.00	1.95	1.95	17,225	4,136.6
12	55	21.4	6.2	6.5	7.95	0.00	1.12	1.12	13,650	2,036.6
										637.0
										Total acre feet = 61,894

$Q_{ff} = 1.67 L H^2 \cdot 0.07$   
 $L = 32,500'$  (airline distance)

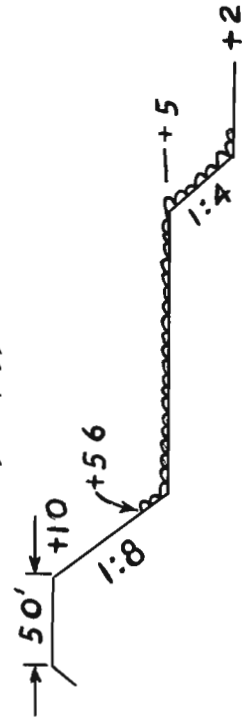

\*Q<sub>ot</sub> is calculated for that portion of wave spectrum producing maximum runup

TABLE A-14 (cont'd)

WAVE AND OVERTOPPING DATA (Existing conditions)-SPH  
Jefferson Parish - East

Hour	Wind m.p.h.	Av. depth feet	H <sub>s</sub> feet	T sec.	WTL feet	Q <sub>ff</sub> c.f.s./ft.	Q <sub>ot*</sub> c.f.s./ft.	Q <sub>tot</sub> c.f.s./ft.	L cos θ feet	Acre feet
3	68	22.3	7.2	6.8	7.70	0.00	0.15	0.15	16,613	103.8
4	74	23.0	7.8	7.1	8.43	0.00	0.94	0.94	15,152	697.3
5	77	23.5	8.1	7.2	8.91	0.00	1.71	1.71	15,336	1,686.2
6	81	24.2	8.6	7.4	9.59	0.00	1.78	1.78	17,279	2,374.3
7	79	24.8	8.5	7.4	10.29	0.13	3.25	3.38	18,500	3,886.9
8	78	25.4	8.6	7.4	10.80	1.05	3.08	4.13	17,390	5,597.9
9	77	25.7	8.6	7.5	11.06	1.88	2.92	4.80	16,909	6,374.3
10	71	25.4	8.1	7.3	10.78	1.00	3.15	4.15	16,188	6,181.0
11	64	24.2	7.4	7.0	9.61	0.00	3.11	3.11	14,763	4,712.3
12	57	23.1	6.6	6.7	8.50	0.00	1.68	1.68	12,585	2,794.0
13	47	22.2	5.8	6.4	7.60	0.00	0.03	0.03	11,396	895.3
										14.3

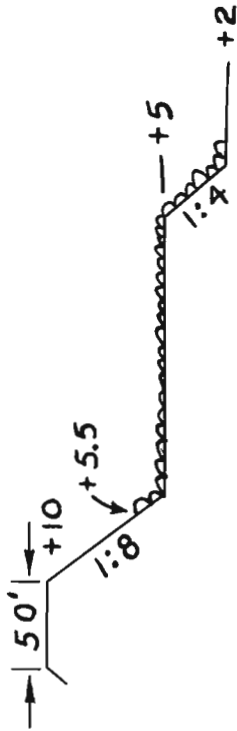

Total acre feet = 35,318

$$Q_{ff} = 1.67LH^2 \cdot 0.07$$

$$L = 18,500' \text{ (airline distance)}$$

\*Q<sub>ot</sub> is calculated for that portion of wave spectrum producing maximum runup.

TABLE A-14 (cont'd)

WAVE AND OVERTOPPING (Existing conditions)-SPH  
New Orleans - Orleans to New Basin Canal

Hour	Wind m.p.h.	Av. depth feet	Hs feet	T sec.	WTL		Q <sub>ff</sub> c.f.s./ ft.	Q <sub>ot</sub> c.f.s./ ft.	Q <sub>tot</sub> c.f.s./ ft.	L cos θ feet	Acre feet
					Seawall feet	Back levee feet					
5	80	23.6	8.2	7.2	8.80	9.60	0.00	0.48	0.48	3,855	77.1
6	76	23.8	8.1	7.2	8.99	9.77	0.21	0.58	0.79	4,330	219.6
7	74	24.6	8.1	7.3	9.83	10.62	3.14	0.59	3.73	4,515	844.2
8	71	25.4	8.2	7.3	10.61	11.40	7.38	0.69	8.07	4,700	2,282.1
9	82	26.0	9.1	7.6	11.16	12.04	11.67	0.37	12.04	4,720	3,948.3
10	75	25.8	8.5	7.4	10.97	11.79	9.91	0.47	10.38	4,740	4,417.9
11	68	24.6	7.7	7.1	9.83	10.51	2.91	0.69	3.60	4,055	2,658.3
12	60	23.6	7.0	6.8	8.78	9.46	0.00	0.53	0.53	3,370	682.7
13	49	22.6	6.0	6.4	7.80	8.78	0.00	0.12	0.12	3,370	91.3
Total acre feet = 15,238											16.8



Q<sub>ff</sub> = 3.0LH<sup>1.49</sup>

L = 4938' (airline distance)

TABLE A-14 (cont'd)

WAVE AND OVERTOPPING DATA (Existing conditions)-SPH  
New Orleans-Orleans Canal to Bayou St. John

Hour	Wind m.p.h.	Av. depth feet	H <sub>s</sub> feet	T sec.	WTL		Q <sub>ff</sub> c.f.s./ ft.	Q <sub>ot</sub> c.f.s./ ft.	Q <sub>tot</sub> c.f.s./ ft.	L cos θ feet	Acre feet
					Seawall feet	Back levee feet					
4	74	22.6	7.7	7.0	7.80	8.99	0.00	0.14	0.14	3,730	21.8
5	80	23.6	8.2	7.2	8.75	9.49	0.00	0.31	0.31	4,045	74.0
6	73	23.5	7.8	7.1	8.72	9.43	0.00	0.26	0.26	4,360	99.5
7	72	24.5	8.0	7.2	9.71	10.42	2.23	0.18	2.41	4,435	492.6
8	69	25.4	8.0	7.2	10.55	11.27	6.67	0.38	7.05	4,510	1,770.2
9	80	26.0	8.9	7.6	11.19	11.19	11.55	0.27	11.82	4,310	3,447.5
10	74	25.8	8.4	7.4	11.03	11.79	10.11	0.30	10.41	4,110	3,905.4
11	67	24.7	7.7	7.1	9.89	10.58	2.96	0.27	3.23	3,310	2,228.2
12	60	23.6	6.8	6.8	8.85	9.46	0.00	0.14	0.14	2,510	460.1
13	50	22.7	6.1	6.4	7.87	8.85	0.00	0.07	0.07	2,510	22.0



Total acre feet = 12,529

$$Q_{ff} = 3.0 IH^{1.49}$$

$$L = 4,541' \text{ (airline distance)}$$



TABLE A-14 (cont'd)

WAVE AND OVERTOPPING DATA (Existing conditions)-SPH  
New Orleans-Bayou St. John to London Ave.

Hour	Wind m.p.h.	Av. depth feet	H <sub>s</sub> feet	T sec.	WTL		Q <sub>ff</sub> c.f.s./ ft.	Q <sub>ot</sub> c.f.s./ ft.	Q <sub>tot</sub> c.f.s./ ft.	L cos θ feet	Acre feet
					Seawall feet	Back levee feet					
6	75	23.7	8.0	7.2	8.46	9.45	0.00	0.22	0.22	1,580	14.5
7	72	24.7	8.1	7.2	9.53	10.29	1.73	0.31	2.04	1,760	164.1
8	69	25.6	8.0	7.3	10.41	11.16	5.99	0.53	6.52	1,940	676.7
9	80	26.4	9.0	7.6	11.22	12.06	11.94	0.31	12.25	2,470	1,787.8
10	78	26.3	8.8	7.6	11.10	11.92	10.92	0.39	11.31	3,000	2,674.5
11	69	25.2	8.0	7.2	9.95	10.69	3.46	0.43	3.89	2,975	1,895.9
12	60	24.1	7.1	6.9	8.93	9.59	0.00	0.17	0.17	2,950	503.2



TABLE A-14 (cont'd)

WAVE AND OVERTOPPING DATA (Existing conditions)-SPH  
New Orleans-London Ave. to Pontchartrain Beach

Hour	Wind m.p.h.	Av. depth feet	H <sub>s</sub> feet	T sec.	WTL		Q <sub>ff</sub> c.f.s./ ft.	Q <sub>ot</sub> c.f.s./ ft.	Q <sub>tot</sub> c.f.s./ ft.	L cos θ feet	Acre feet
					Seawall feet	Back levee feet					
6	75	23.6	8.0	7.2	8.19	9.41	0.00	0.29	0.29	2,650	32.1
7	71	24.8	8.0	7.2	9.44	10.11	1.10	0.24	1.34	2,855	191.5
8	67	25.7	7.9	7.2	10.34	11.00	5.11	0.11	5.22	3,060	825.0
9	78	26.6	8.9	7.6	11.23	11.97	11.52	0.38	11.90	3,340	2,321.7
10	80	26.5	9.0	7.6	11.13	11.88	10.86	0.17	11.03	3,620	3,319.8
11	71	25.4	8.1	7.3	9.99	10.67	3.41	0.10	3.51	3,290	2,144.9
12	62	24.4	7.2	7.0	8.98	9.58	0.00	0.33	0.33	2,960	521.9
13	52	23.4	6.4	6.6	7.97	9.23	0.00	0.16	0.16	2,960	60.5
											19.8

Total acre feet = 9,437  
 $Q_{ff} = 3.0 LH^{1.49}$   
 L = 3,620' (airline distance)

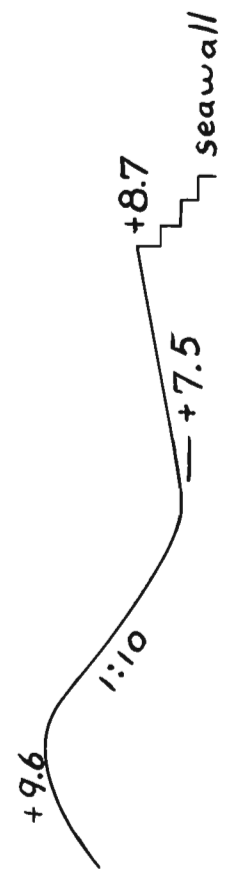

TABLE A-14 (cont'd)

WAVE AND OVERTOPPING DATA (Existing conditions)-SPH  
New Orleans - Franklin Ave. to Inner Harbor Navigation Canal

Hour	Wind m.p.h.	Av. depth feet	H <sub>s</sub> feet	T sec.	WTL		Q <sub>ff</sub> c.f.s./ ft.	Q <sub>ot</sub> c.f.s./ ft.	Q <sub>tot</sub> c.f.s./ ft.	L cos θ feet	Acre feet
					Seawall feet	Back levee feet					
5	81	23.6	8.3	7.2	8.16	9.63	0.02	0.16	0.18	4,180	31.4
6	75	23.2	7.9	7.1	7.82	9.59	0.00	0.20	0.20	4,430	68.3
7	71	24.4	7.9	7.2	8.95	9.74	0.16	0.20	0.36	4,500	104.4
8	67	25.3	7.8	7.2	9.91	10.69	3.46	0.55	4.01	4,570	831.1
9	78	26.5	8.8	7.6	11.14	12.03	11.70	0.34	12.04	4,275	2,908.3
10	80	26.6	9.0	7.6	11.23	12.14	12.54	0.27	12.81	3,980	4,269.0
11	71	25.6	8.2	7.4	10.19	11.01	5.11	0.58	5.69	3,250	2,894.9
12	62	24.6	7.3	7.0	9.25	9.98	0.71	0.37	1.08	2,520	884.0
13	52	23.5	6.4	6.6	8.14	9.44	0.00	0.26	0.26	2,520	140.8
											27.3



Total acre feet = 12,160  
Q<sub>ff</sub> = 3.0 LH<sup>1.49</sup>

L = 4,583' (airline distance)

TABLE A-14 (cont'd)

WAVE AND OVERTOPPING DATA (Existing conditions)-SPH  
Citrus - Lake Side

Hour	Wind m.p.h.	Av. depth ft.	Hs ft.	T sec.	Lo ft.	WTL ft.	L cos $\phi$ feet	% of emb. at eroded height	% of emb.at 9.4'	Embankment at eroded height			Embankment at 9.4 feet			Total hourly overtopping acre-feet	
										Q <sub>ff</sub> cfs/ft.	Q <sub>ot</sub> cfs/ft.	Av.ac.ft. <sup>a</sup>	Q <sub>ff</sub> cfs/ft.	Q <sub>ot</sub> cfs/ft.	Av.ac.ft. <sup>b</sup>		
4	75	19.5	7.1	6.6	225	6.02	11,800	50% at 5.5'	50%	0.93	3.47	1,082	0	1.23	1.23	302	1,384
5	81	20.7	7.7	6.8	238	7.18	13,000	"	"	6.16	2.64	3,465	0	2.30	2.30	926	4,391
6	74	20.7	7.2	6.8	233	7.17	15,300	"	"	6.09	2.28	5,051	0	2.07	2.07	1,282	6,333
7	66	21.6	7.0	6.7	230	8.10	20,800	"	"	12.57	1.03	8,561	0	3.04	3.04	1,977	10,538
8	58	22.4	6.6	6.6	225	8.94	24,900	"	"	15.91	0	14,146	0	3.51	3.51	3,138	17,284
9	72	24.3	8.0	7.2	265	10.78	26,000	"	"	15.91	0	16,871	4.74	2.65	7.39	5,824	22,694
10	78	24.7	8.4	7.4	279	11.19	25,100	"	"	15.91	0	16,938	6.94	2.13	9.07	8,746	25,684
11	76	24.0	8.2	7.2	269	10.54	23,000	"	"	15.91	0	15,943	3.58	3.12	6.70	7,953	23,896
12	64	23.4	7.2	7.0	247	9.95	22,000	"	"	15.91	0	14,916	1.22	3.53	4.75	5,388	20,304
13	54	21.9	6.2	6.5	216	8.40	22,000	"	"	15.00	0.20	14,258	0	2.78	2.78	3,451	17,709
14	44	21.2	5.4	6.2	194	7.70	22,300	"	"	9.52	0.50	11,622	0	1.73	1.73	2,078	13,700
												4,655				804	5,459
																	169,376

$$a_{Q_{ot}} = \frac{Q_{ot} \times L \cos \theta \times 2}{24} \times \%$$

$$b_L = 26,000' \text{ (airline distance)}$$

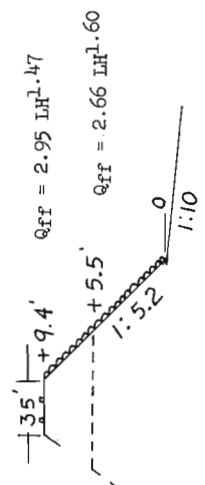



TABLE A-14 (cont'd)

WAVE AND OVERTOPPING DATA (Existing conditions)-SPH  
New Orleans East - Back

Hour	Wind m.p.h.	Av. depth feet	H <sub>s</sub> ft.	T sec.	Lo ft.	WTL ft.	Q <sub>ff</sub> c.f.s./ft.	Q <sub>ot</sub> c.f.s./ft.	Q <sub>tot</sub> c.f.s./ft.	L cos θ feet	Acre feet
-1	90	2.6	2.0	3.1	49.2	8.12	0.00	0.01	0.01	8,110	3
0	85	3.8	2.4	3.5	62.7	9.32	0.00	0.39	0.39	10,847	180
1	80	5.0	2.8	3.9	77.9	10.53	0.00	0.76	0.76	13,821	614
2	76	6.3	3.2	4.2	90.3	11.78	0.23	1.48	1.71	22,100	2,012
3	67	6.3	3.0	4.2	88.2	11.80	0.27	1.35	1.62	23,485	3,160
4	61	6.4	2.9	4.1	86.1	11.90	0.50	1.23	1.73	33,049	3,968
5	60	7.0	3.0	4.2	90.3	12.50	2.57	1.03	3.60	15,781	4,750
6	59	6.4	2.8	4.1	85.3	11.90	0.50	1.18	1.68	18,856	3,687
7	68	7.0	3.2	4.4	96.9	12.50	2.57	1.14	3.71	30,109	5,974
8	75	6.0	3.1	4.2	88.2	11.50	0.00	1.50	1.50	29,838	6,519
9	80	5.3	2.9	4.0	81.9	10.80	0.00	0.96	0.96	30,413	3,081
10	78	3.8	2.3	3.4	60.9	9.30	0.00	0.20	0.20	29,534	1,463
11	77	3.2	2.0	3.2	54.1	8.70	0.00	0.06	0.06	29,534	320
											74

Total acre feet = 35,805

Q<sub>ff</sub> = 3.0 LH<sup>1.49</sup>

L = 33,792' (airline distance)

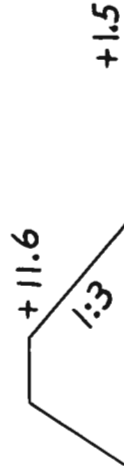

TABLE A-14 (cont'd)

WAVE AND OVERTOPPING DATA (Existing conditions)-SPH  
Citrus - Back

Hour	Wind m.p.h.	Av. depth feet	H <sub>s</sub> ft.	T sec.	Lo ft.	WTL ft.	Q <sub>ff</sub> c.f.s./ft.	Q <sub>ot</sub> c.f.s./ft.	Q <sub>tot</sub> c.f.s./ft.	L cos θ feet	Acres feet
-1	90	2.3	1.8	3.0	46.1	7.82	0.00	0.13	0.13	17,383	94
0	85	3.5	2.3	3.4	59.2	9.02	0.00	1.31	1.31	21,172	1,250
1	80	4.7	2.8	3.8	73.9	10.23	1.51	0.98	2.49	25,235	3,774
2	76	6.0	3.1	4.1	86.1	11.45	7.50	0.54	8.04	35,821	14,618
3	67	6.0	2.8	4.0	84.0	11.45	7.50	0.48	7.98	37,540	24,482
4	61	6.1	2.8	4.0	81.9	11.60	8.43	0.43	8.86	27,813	22,750
5	60	6.7	2.9	4.1	87.4	12.20	12.45	0.19	12.64	10,156	15,616
6	59	6.1	2.7	4.0	79.9	11.60	8.43	0.41	8.84	13,086	10,169
7	68	6.7	3.2	4.2	91.2	12.20	12.45	0.20	12.65	24,610	17,792
8	75	5.7	3.0	4.0	84.0	11.21	6.09	0.63	6.72	24,297	19,775
9	80	5.0	2.8	3.9	77.9	10.50	2.57	0.87	3.44	32,461	11,456
10	78	3.5	2.2	3.4	57.5	9.00	0.00	0.60	0.60	33,477	5,490
11	77	2.9	1.9	3.2	50.8	8.40	0.00	0.34	0.34	33,477	1,311
12	72	1.9	1.6	2.7	37.3	7.40	0.00	0.03	0.03	34,141	517
											43

Total acre feet = 149,137

Q<sub>ff</sub> = 3.0 LH<sup>1.49</sup>

L = 39,063' (airline distance)

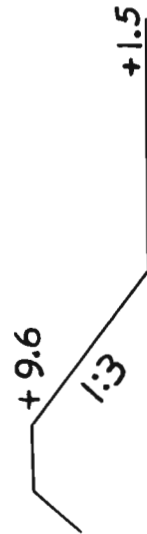

TABLE A-14 (cont'd)

WAVE AND OVERTOPPING DATA (Existing conditions) - SPH  
Chalmette

Hour	Wind m.p.h.	Av. depth feet	H <sub>s</sub> ft.	T sec.	Lo ft.	WTL ft.	Q <sub>ff</sub> c.f.s./ft.	Q <sub>ot</sub> c.f.s./ft.	Q <sub>tot</sub> c.f.s./ft.	L cos θ feet	Acre feet
-3	60	2.6	1.6	2.7	37.3	8.14	0.00	0.07	0.07	47,267	137.9
-2	68	4.0	2.2	3.4	60.9	9.49	0.00	0.61	0.61	49,091	1,385.7
-1	76	4.9	2.8	3.9	76.7	10.42	0.82	0.98	1.80	51,009	5,073.4
0	74	5.9	3.0	4.1	86.9	11.42	5.06	0.70	5.76	55,342	17,107.8
1	72	6.4	3.2	4.2	91.2	11.90	7.80	0.53	8.33	57,381	33,198.1
2	65	5.9	2.8	4.0	81.9	11.42	5.06	0.63	5.69	54,011	32,721.2
3	59	4.9	2.3	3.7	70.1	10.42	0.82	0.78	1.60	50,089	16,144.4
4	37	4.0	1.6	3.0	47.0	9.49	0.00	0.38	0.38	28,475	3,790.1
											450.9

Total acre feet = 110,010

Q<sub>ff</sub> = 3.0 LH<sup>1.49</sup>

L = 63,360' (airline distance)

Legend:

Av. depth = depth + WTL minus (where applicable) marsh grass elev.

H<sub>s</sub> = height of significant wave

T = wave period

Lo = deep water wave length

WTL = wind tide level

Q<sub>ff</sub> = Q resulting from free flow

Q<sub>ot</sub> = Q resulting from wave overtopping

Q<sub>tot</sub> = total Q

L = length of protective work

θ = angle between wind direction and normal to protective works

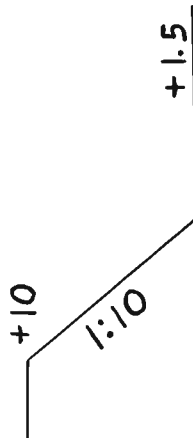



TABLE A-15

## WAVE DATA (Project conditions) (a) Maximum Hour - SPH

Location	H <sub>s</sub> ft.	Av. depth ft.	T sec.	WTIL ft.	Rumup EL. feet	Design EL. ft. m. s. l.
Mandeville	6.0	17.0	6.2	6.40	9.3	10.0
St. Charles	6.0	16.9	6.2	6.48	8.8	10.0
Jefferson Parish	7.6	21.0	6.9	6.30	8.4	10.0
New Orleans-New Basin to Orleans	7.9	21.2	7.0	6.37(b)	10.3(c)	11.5
" " Orleans to Bayou St. John	7.7	21.2	7.0	6.40(b)	10.9(c)	11.5
" " Bayou St. John to London Ave.	7.8	21.6	7.0	6.45(b)	10.5(c)	11.5
" " London Ave. to Pontchartrain Beach	7.8	21.8	7.0	6.40(b)	11.2(c)	11.5
" " Franklin Ave. to Inner Harbor Nav.	8.0	22.1	7.1	6.70(b)	10.5(c)	11.5
Citrus - Lake Side	7.3	20.0	6.8	6.50	11.0	11.0
New Orleans East - Lake Side	6.6	17.9	6.4	5.50	8.0	10.0
" " - Back	3.2	7.0	4.3	12.50	16.2	16.0
Citrus - Back						
Inner Harbor Nav. Canal to Paris Road	-	-	-	12.20	12.2	13.0
Paris Road to slip at Michoud	3.2	6.7	4.2	12.20	15.9	16.0
Chalmette						
Inner Harbor Nav. Canal to Paris Road	-	-	-	11.90	11.9	13.0
Paris Road to Violet	3.2	6.4	4.2	11.90	15.5	16.0

## Legend:

(a) See plates 11 and 12 for typical  
levee sections

(b) On lake side of seawall

(c) On lake side of back levee

H<sub>s</sub> = Height of significant wave  
Av. depth = Depth of WTIL minus (where appli-  
cable) marsh grass elevation

T = Wave period

WTIL = Wind tide level

h. Residual flooding. The procedures described in paragraph A-3g. are used to determine maximum wave runup and wave overtopping for the significant wave that would be experienced during hurricane occurrences. However, 14 percent of the waves in a spectrum are higher than the significant wave and the maximum wave height to be expected is about 1.87 times the significant wave height. Thus a structure designed to prevent all overtopping by a significant wave would be overtopped by that portion of the spectrum that is higher than the significant wave. It was therefore necessary to assure that this residual overtopping would not produce flooding and subsequent damage to the extent that only partial protection was afforded to an area for the design hurricane. A determination of the residual overtopping was made for the Citrus area. This area was chosen because of its higher frontage-area ratio and steeper protective structure slopes. Total overtopping for the design hurricane for the barrier-low level plan of protection is 800 acre-feet. This volume would cause flooding to a depth of 0.3 foot above that to be expected from the average hurricane rainfall. Residual flooding in all of the remaining areas would be experienced to a lesser degree because of the gentler slopes on protective structures and the lower frontage-area ratios. It was therefore concluded that the use of the significant wave runup would result in design grades for protective structures that would permit residual flooding only to a negligible degree.

i. Rainfall. Complete precipitation records, including but not limited to hurricane associated rainfall, indicate maximum 24-hour point depths of 21 inches for a standard project rainfall and 40 inches for the probable maximum rainfall. Based on data available for about 52 gulf region hurricanes, the mean 24-hour maximum point precipitation depth is 9.4 inches. Since hurricanes are usually accompanied by intense rainfalls, it was necessary to estimate cumulative rainfall amounts for critical areas for use in the routing purposes and to establish flooding heights. The methods used for these rainfall estimates are described in HUR memorandums (13)(14). Using a moderate rainfall, the SPH point precipitation depths were 8.5 inches for Jefferson Parish, 8.7 inches for New Orleans, and 9.6 inches for Citrus, and the SPH areal precipitation for Lake Pontchartrain was 7.8 inches. Mass rainfall curves for the four locations are shown on plate A-24. Mass rainfall curves were used to determine cumulative rainfall amounts to any hour for a critical point or area and to resolve the effect on flooding heights and routing. Similar procedures were used to derive rainfall estimates for all storms that were analyzed.

j. Flooding.

(1) Critical to south shore. The amount of overflow into the south shore areas is of such magnitude that it was necessary to determine the elevations to which these areas were flooded. The amounts of rainfall concurrent with overtopping were also sufficient to influence flooding elevations. Therefore, the rainfall amounts

were added to the overflow amounts to give the total inflow that caused flooding. It was assumed that the pumping stations in the affected areas were inoperative during the inflow period. Although the stations are capable of operating continuously during a hurricane, this assumption was made on the basis that inoperative stations could be expected in some locations because of the limitations of the drainage system, hurricane wind damage, and/or lost time due to conversion of fuel systems. Thus, the unadjusted sum of overtopping, free-flow, and rainfall was taken as the inflow into each area. Flooding heights were determined by the routing of the inflows into ponding areas. These resulting heights of flooding are shown on plates A-25, A-26, and A-27. The computed flood line for the 1947 hurricane compared very favorably with that observed. Similar procedures for determining flood heights were used for the other hurricanes that were investigated.

(2) Critical to north shore. Mandeville is the only area on the north shore with existing hurricane protection works. This town is protected from minor storm action on Lake Pontchartrain by a seawall that has a 6-foot elevation. This seawall is so low that it affords only limited protection against even moderate hurricanes. It was assumed that the community would flood to WTL elevations, and over-topping computations were therefore not necessary. Flooding contours are shown on plate A-27.

k. Sheet flow. During hours of maximum overflow in the New Orleans lakeshore development area, the elevation of the flow profile usually exceeded the final flooding heights. This movement of water is designated as sheet flow, and it is this depth that is required to assess damages due to this phenomena, as the flood waters flow across the lakeshore development to the ponding areas. The Manning formula was used as a basis for the computation of the depth of flow. The n factor was computed by assigning a roughness coefficient to each of the various types of surfaces in the area such as lawns, parks, and streets<sup>(23)</sup>. Then the factor for the whole area was computed by weighting the percentages of each of the types of surfaces in the total area. The flow profile was assumed equal to the bottom slopes and velocities and volumes of flow were determined by successive approximations until the computed flow equaled the maximum overtopping flow. Evaluation of depths of sheet flow was required only for segments of the sloping landfill behind the New Orleans lakefront that is protected by a seawall. The computed sheet flow depths for the 1947 hurricane compared favorably with those observed. Similar procedures for determining sheet flow depths were used for other hurricanes that were investigated.

#### A-4 FREQUENCY ESTIMATES

##### a. Procedure.

- (1) The maximum WTL or stage for a specific reach is a

measure of the character of storm that produces it. With the stage and storm established the amount of overflow and limits of flooding were calculated as described in paragraphs A-3g. and A-3j. The frequencies of occurrence and the damages resulting from various flooding limits are required for economic determinations. It was, therefore, necessary to develop maximum WTL-frequency curves for each affected reach within the study area. In order to use data from early hurricanes which caused high wind tides along the south shore of Lake Pontchartrain, it was necessary to analyze meteorologic factors and to adjust the observed data in order to represent stages that would have occurred had presently existing protective works then been in place. It was found that adjustments were required for only the 1893 and 1901 hurricanes, both of which stalled over the area. In the New Orleans reach, determinations of maximum WTL's from the adjusted historical hurricane data form the locus of points through which a representative WTL-frequency curve would pass in the low-stage, high-frequency region. Probabilities for historical data on the curve shown on plate A-28 were calculated by means of the formula:

$$P = \frac{100 (M-0.5)}{Y}$$

The WTL for the PMH, which has an infinite return period, establishes another limit for the frequency curve in the high-stage, low-frequency region. However, because of the lack of historical data for the region of the curve between these two extremes, the synthetic WTL-frequency relationships were developed to show the shape of the curve in this region. In the process of formulating such relationships, it was necessary to correlate the following hurricane parameters: central pressure indexes, paths of approach, wind velocities, radii to maximum winds, and forward speeds of translation.

(2) Prior to 1900, information of record dealt primarily with loss of life and damage in the more densely populated areas, with practically no reference to water surface elevations caused by hurricanes. Only since 1900 has detailed information been available on flooding in coastal Louisiana and adjacent areas. Subsequent to the widely destructive September 1915 hurricane, Charles W. Oakey, Senior Drainage Engineer, Office of Public Roads and Rural Engineering, U. S. Department of Agriculture, made a thorough survey of the coastal areas between Biloxi, Mississippi, and Palacios, Texas, as described in supplement 1 to this report, "History of Hurricane Occurrences along Coastal Louisiana." The 1915 investigation is the only known area-wide study containing reliable stages until the investigation of hurricane "Flossy," September 1956, was completed. The data indicate that there is no locality along the Louisiana coast which is more prone to hurricane attack than other localities.

(3) The first requirement in the development of synthetic frequency relationships for localities within the study area was to select representative critical hurricane paths of approach for

the particular locale in question. For the south shore of Lake Pontchartrain and the Chalmette area, tracks A and F were selected to represent possible hurricane situations that would produce critical conditions. For the north shore of Lake Pontchartrain and the barrier locations, tracks C and F were representative hurricane paths that would produce critical conditions. The above mentioned tracks are shown on plate A-7.

(4) Surge heights and wind tide levels were then developed, as described in paragraphs A-3d. and A-3f., for at least three storms of different CPI values for each track. Each hurricane selected for the representative paths was assumed to have the same radius of maximum winds, the same forward speed of translation, and the same adjustment for any land effects. Conversion of wind fields of hurricanes of different CPI's requisite to computing surge heights and WTL's is covered in paragraphs A-3c. Results of these computations for the New Orleans reach of Lake Pontchartrain are shown in table A-16. Wind tide elevations for storms with other CPI values were obtained graphically by plotting the above data and reading from the resulting curves.

TABLE A-16

CENTRAL PRESSURE INDEX VS. WIND TIDE LEVEL  
LAKE PONTCHARTRAIN REACH - NEW ORLEANS

<u>PATH A</u>		<u>PATH F</u>	
<u>Central pressure index (CPI)</u>	<u>Max. wind tide level</u>	<u>Central pressure index (CPI)</u>	<u>Max. wind tide level</u>
inches	ft.m.s.l.	inches	ft.m.s.l.
26.9	12.7	27.6	7.7
27.6	11.2	27.87	6.6
28.5	8.2	28.57	4.8

(5) Hurricane characteristics of area-representative storms were developed in cooperation with the U. S. Weather Bureau. This agency has made a generalized study of hurricane frequencies for a 400-mile zone along the central gulf coast, Zone B, from Cameron, La., to Pensacola, Fla., and has presented the results in a memorandum<sup>(3)</sup>. Frequencies for hurricane central pressure indexes that were presented in the report, as shown on plate A-6, reflect the probability of hurricane recurrence from any direction in the midgulf coastal area. In order to establish frequencies for the localities under study, it was assumed that a hurricane whose track is perpendicular to the coast will ordinarily cause high tides and inundation for a distance of about 50 miles along the coast. Thus, the number of occurrences in the 50-mile subzone would be 12.5 percent of the number of occurrences in the 400-mile zone, provided

that all hurricanes traveled in a direction normal to the coast. However, the usual hurricane track is oblique to the shoreline as shown in table 2 of the HMS memorandum<sup>(3)</sup>. The average projection along the coast of this 50-mile swath for the azimuths of 42 Zone B hurricanes is 80 miles. Since this is 1.6 times the width of the normal 50-mile strip affected by a hurricane, the probability of occurrence of any hurricane in the 50-mile subzone would be 1.6 times the 12.5 percent, or 20 percent of the probability for the entire midgulf Zone B. Thus, 20 percent of the Zone B frequencies shown on plate A-6 was used to represent the CPI-frequencies in the 50-mile subzone that is critical for each study locality.

(6) The azimuths of tracks observed in the vicinity of landfall were divided into quadrants corresponding to the four cardinal points. In Zone B, 24 tracks were from the south, 14 from the east, 3 from the west, and 1 from the north. Hurricanes with tracks having major components from south or east are more critical relative to WTL's within the study area than hurricanes from other directions. Approximately two-thirds of all experienced hurricanes have come from a southerly direction, whereas about one-third have come from the east. The average azimuth of tracks from the south are 180°. Tracks from the east had an average azimuth of 115°. Approximately these azimuths were used in computing WTL's. Further adjustment of the probability of occurrence was made by using two-thirds of the probability for WTL's computed for hurricanes approaching from the south and one-third of the probability for WTL's computed for hurricanes approaching from the east. The probabilities of equal stages for both groups of tracks were then added arithmetically to develop a curve representing a synthetic probability of recurrence of maximum wind tide levels for hurricanes from all directions. Table A-17 presents these computations and those of the previous paragraph for the New Orleans reach.

TABLE A-17

STAGE-FREQUENCY  
SOUTH SHORE - LAKE PONCHARTRAIN

CPI	Zone B	New Orleans Reach 80-mi. subzone	PATH A		PATH F	
			WTL	Freq.* (67% Col.3)	WTL	Freq. (33% Col.3)
1	2	3	4	5	6	7
in.	occ/100 years		ft.m.s.l.	occ/100 yrs.	ft.m.s.l.	occ/100 yrs.
27.6	1	0.2	11.2	0.13	7.7	0.07
27.8	2	0.4	10.6	0.27	6.8	0.13
28.1	5	1.0	9.6	0.67	5.9	0.33
28.3	10	2.0	8.9	1.34	5.4	0.66
28.6	20	4.0	7.8	2.68	4.7	1.32
29.0	40	8.0	6.3	5.36	4.0	2.64

$$*\text{Freq.} = \frac{100}{\text{Return period years}}$$

(7) Using the shape of the synthetic stage-frequency curve as a guide, it was then possible to complete a final curve for the New Orleans reach between the predetermined limits mentioned in paragraph A-4a.(1).

(8) Lack of historical data prevented the similar development of WTL-frequency relationships for other localities within the study area. For the remaining reaches, PMH and SPH wind tide levels were calculated for different combinations of critical paths and distribution of azimuths of incidence. It followed that an SPH for any locale in the study area would have the same recurrence period since all are within the same subzone. Therefore, the final stage-frequency curves for the remaining reaches were made to pass through their respective SPH WTL's at the frequency observed on the New Orleans curve, limited by their PMH levels, and adhering to the shape of the synthetic curves. The low-WTL, high-frequency portions of the curves for those locales on the south shore of Lake Pontchartrain assume the shape of the New Orleans curve in that region since the values of depths, fetch lengths, wind velocities, and WTL's for identical storms are markedly similar.

(9) In New Orleans, the topography is characterized by depressions separated by areas of higher ground. Storms of different intensities cause different amounts of overflow which pond to different heights in the depressions. The determination of frequency-ponding height relationships for each of the sump areas was an almost insurmountable requirement if all were computed by the lengthy procedures described in paragraph A-3, i.e., random choice of a CPI for a storm, and development of surge, routing, WTL, overflow, and flooding heights. However, proper economic analysis required the establishment of such relationships. Consequently, a shorter method was developed. It was assumed that the stage-overtopping relationship for the SPH was applicable to the maximum stage for storms of lesser intensities, and that total volumes of overtopping varied proportionally to the maximum rates for the two hurricanes. The total volume of overtopping was distributed to the segments of New Orleans by use of similar percentages to those obtained in the distribution of SPH flooding. Flooding heights in the depressions were obtained from storage curves. The above method was also worked in reverse to determine the frequency of the storm that would pond a certain depression to a certain height. This same method was used in the other areas, Jefferson, St. Charles, etc., where similar data were required and an insufficient number of storms had been calculated by the long method to meet the requirements.

b. Relationships. Based on the above described procedures, stage-frequency relationships were established for the north and south shores of Lake Pontchartrain, and for the area affected by Lake Borgne. Stage-frequency curves are shown on plate A-29.

A-5 DESIGN HURRICANE

a. Selection of the design hurricane. The standard project hurricane was selected as the design hurricane (Des H) due to the urban nature of the study area. A design hurricane of lesser intensity which would indicate a lower levee grade and an increased frequency would expose the protected areas to hazards to life and property that would be disastrous in event of the occurrence of a hurricane of the intensity and destructive capability of the standard project hurricane.

b. Characteristics. The characteristics of the Des H's for the proposed plan of protection are identical to the standard project hurricane described in detail in paragraph 9. However, due to transposition of the regional SPH to the smaller study area the design hurricane would have a probability of recurrence of only once in about 200 years in the study area. The paths of the Des H's were located successively to produce maximum hurricane tides along the entire length of the proposed structures. The Des H's are theoretical hurricanes but ones of similar intensity have been experienced in the area. Table A-18 is a summary of the Des H characteristics.

TABLE A-18  
DESIGN HURRICANE CHARACTERISTICS

<u>Location</u>	<u>CPI</u> inches	<u>Max. winds</u> m.p.h.	<u>Radius of max.winds</u> miles	<u>Forward speed</u> knots	<u>Direction of approach</u>	<u>Track</u> (plate A-7)
Lake Pontchartrain						
South shore	27.6	100	30	6	South	A
North shore	27.6	100	30	5	SSE.	C
Lake Borgne						
Rigolets & Chef						
Menteur Pass	27.6	100	30	11	East	F
Chalmette	27.6	100	30	11	East	F

c. Normal predicted tides. The average tidal ranges in Lakes Borgne, Pontchartrain, and Maurepas are 1.0 foot, 0.5 foot, and 0.3 foot, respectively. The average elevation of the three lakes differ very little. Lake Borgne has an average elevation of about 0.9 foot; Lakes Pontchartrain and Maurepas are 1.0 foot and 1.1 feet, respectively. In determining the elevation of design surges and wind tide levels, the mean normal predicted tide was assumed to occur at the critical period.

d. Design rainfall.

(1) Estimates of rainfall amounts were necessary for the computation of hurricane tides and the resultant flood levels. Areal precipitation depths over Lake Pontchartrain were added to the



estimated average lake elevation during routing procedures. Maximum point precipitation volumes, computed separately for the various areas along the south shore, were accounted for in the determination of the flooding depth in each area, both under present conditions and after the project is in place.

(2) The Des H rainfall is equivalent to the rainfall associated with an occurrence of an SPH critical to the south shore under the same conditions. SPH and therefore Des H point and areal precipitation depths and derivation procedures are described in detail in paragraph A-3i. Mass rainfall curves are shown on plate A-24.

e. Design tide. The hurricane tide is the maximum still water surface elevation experienced at a given location during the passage of a hurricane. It reflects the combined effects of the hurricane surge, and, where applicable, the overland flow of the surge, and wind tide. Design hurricane tides were computed for conditions reflecting both existing and proposed protective works or improvements. Under existing conditions, the hurricane tide was computed by use of procedures described in paragraphs A-3d., e., and f. The control structure gate will be operated to maintain an elevation between 1.5 and 2.0 feet in Lake Pontchartrain. With the proposed project in place, the surge will not enter the lake through the Rigolets and Chef Menteur Pass. Instead, flow over U. S. Highway 90 embankment is computed according to the procedures described in paragraph A-3e.(8). It is estimated that the flow over U. S. Highway 90 embankment during an occurrence of the Des H critical to the south shore would raise the lake level about 0.3 foot. The resultant elevations, which are identical to those for an SPH, are shown for both existing and proposed protective works in tables A-14 and A-15, respectively.

f. Design flood levels. Delineation of areas flooded and determination of flood levels that are based upon the combined effects of rainfall and levee overtopping in the low shoreline areas of Lake Pontchartrain were necessary for economic analyses. Flood levels resulting from the Des H, both under existing conditions and after construction of the project, were computed by the methods outlined in paragraphs A-3h. and j. Since the Des H is identical to the SPH, the resulting flood levels for existing conditions would be identical to those shown on plates A-25, A-26, A-27, and A-27a. The combined effects of rainfall and an occurrence of the Des H with the project in place would not cause flooding of any significance in the protected areas within the barrier. The present (1962) drainage facilities along the south shore of Lake Pontchartrain are adequate.

g. Stream flow coincident with hurricane flooding.

(1) The Mississippi River flows through the southern portion of the study area. The amount of flow in the river is determined by the rainfall and runoff in its upper reaches. Because of the high river levees and the low adjacent land, there are no tributaries draining into the river from the study area.

(2) Bonnet Carre Spillway, described in paragraphs 4.b.(1)(a) and 4.e.(1)(a), is not likely to be placed into operation during the hurricane season, its past three openings being between January and May. During its operation, the lake level was increased by about 1 foot.

(3) Stream flow during the hurricane season from the north shore of Lake Pontchartrain is usually very low, and during a Des H occurrence, stream flow would be impeded by the high wind tide levels. Flow from the developed areas on the south shore is through pumps which would be inoperative during an occurrence of the Des H.

(4) The only streams in the Chalmette area are drainage laterals which extend through the area and terminate at the back levee drainage canal.

## SECTION II - HYDRAULIC DESIGN INTERIOR DRAINAGE

### A-6 HYDRAULIC DESIGN INTERIOR DRAINAGE - ST. CHARLES PARISH

a. Description of drainage areas. The problem area, St. Charles Parish, is bounded on the north by Lake Pontchartrain, on the south by the Mississippi River, on the west by the Bonnet Carre Spillway, and on the east by the St. Charles Parish-Jefferson Parish line. The major portion of the area is low-lying marsh and woodland. The improved land in the area is located on and adjacent to the natural levee of the Mississippi River. The problem area is traversed by a number of natural and artificial channels which collect the runoff as it moves, by gravity, away from the natural levee toward the lake.

b. Proposed plan of improvement. The area will be protected from hurricane overflow by constructing levees along the shore of Lake Pontchartrain and along the St. Charles-Jefferson Parish line. Interior drainage intercepted by the levees will be collected by land-side borrow pits and conveyed to a drainage structure consisting of eight 9- by 5-foot flap-gated openings in a vertical wall, located in the north end of the levee along the parish line.

c. Design of drainage system. The drainage system was designed to evacuate 1 inch of runoff from the entire area in 24 hours, with a normal lake stage of 1.2 feet and a total head on the system of 2.0 feet. Channel capacities were computed using the Manning formula with a roughness coefficient of 0.030. Drainage structure losses were based on an entrance loss of 50 percent of the difference in velocity heads with friction loss neglected. The bottom widths for the borrow pit channel along the Lake Pontchartrain levee ranges from 35 to 65 feet with a depth of flow of 10 feet. Bottom widths for the borrow pit channel along the parish line levee are from 7 to 18 feet with a depth of flow of 4 feet. All side slopes are one vertical to two horizontal.

### SECTION III - BIBLIOGRAPHY

- (1) U. S. Weather Bureau, "Revised Wind Fields Vicinity of Lake Pontchartrain, Hurricane of September 29, 1915," Memorandum HUR 7-39, August 16, 1957.
- (2) U. S. Weather Bureau, "Wind Speed and Direction Charts for the Lake Pontchartrain, Chandeleur and Breton Sounds and Mississippi Delta Regions, Hurricane of September 19, 1947," Memorandum HUR 7-37, June 12, 1957.
- (3) U. S. Weather Bureau, "Hurricane Frequency and Correlations of Hurricane Characteristics for the Gulf of Mexico Area, P. L. 71," Memorandum HUR 2-4, August 30, 1957.
- (4) U. S. Weather Bureau, "Curving Hurricane Tracks as Related to Lake Pontchartrain," Memorandum HUR 7-38, July 19, 1957.
- (5) U. S. Weather Bureau, "SPH Parameters and Isovels, Mid-Gulf Coast U. S. Zone B, and SPH Lake Pontchartrain, La.," Memorandum HUR 7-42, October 11, 1957.
- (6) U. S. Weather Bureau, "Relationships Between SPH Isovel Patterns and Probable Maximum Events for the New Orleans Area," Memorandum HUR 7-61, August 21, 1959.
- (7) U. S. Weather Bureau, "Relationships Between SPH Isovel Patterns and Probable Maximum Events for the New Orleans Area, continued," Memorandum HUR 7-61a, November 15, 1961.
- (8) Beach Erosion Board, "Shore Protection Planning and Design," Technical Report No. 4, June 1954.
- (9) Saville, Thorndike, Jr., "Wind Set-Up and Waves in Shallow Water," Beach Erosion Board, Technical Memorandum No. 27, June 1952.
- (10) U. S. Army Engineer District, Jacksonville, "Design Memorandum, Wind Tides Produced by Hurricanes," Partial Definite Project Report, Central and Southern Florida Project, for Flood Control and Other Purposes, Part IV, Supplement 2, Section 3, July 26, 1956.
- (11) Reid, Robert O., "Approximate Response of Water Level on a Sloping Shelf to a Wind Fetch Which Moves Towards Shore," Beach Erosion Board, Technical Memorandum No. 83, June 1956.
- (12) Yarnell, D. L. and Nagler, F. A., "Flow of Flood Water over Railway and Highway Embankments," Public Roads, Vol. II, No. 2, April 1930.

- (13) U. S. Weather Bureau, "Hurricane Rainfall Estimates Applicable to Middle Gulf Standard Project Hurricanes, Tracks A, C, F, D, and B, New Orleans Study, Zone B," Memorandum HUR 3-5, November 30, 1959.
- (14) U. S. Weather Bureau, "Estimates of Moderate Hurricane Rainfall Applicable to Middle Gulf Standard Project Hurricanes," Memorandum HUR 3-5a, December 11, 1959.
- (15) U. S. Weather Bureau, "Louisiana Hurricane of September 29, 1915, Transposed to a Critical Track," Memorandum HUR 7-40, September 6, 1957.
- (16) U. S. Weather Bureau, "SPH Wind Field for Track C with a Rotated SPH Pattern," Memorandum HUR 7-62A, September 28, 1959.
- (17) U. S. Weather Bureau, "SPH Wind Fields for Track F with Forward Speed 5 Knots Critical for Area I," Memorandum HUR 7-63, September 21, 1959.
- (18) Bretschneider, C. L., "Prediction of Wind Waves and Set-Up in Shallow Water, with Special Application to Lake Okeechobee, Florida," Unpublished Paper, Texas A&M College, August 1954.
- (19) Fairchild, J. C., "Model Study of Wave Set-Up Induced by Hurricane Waves at Narragansett Pier, Rhode Island," Annual Bulletin of the Beach Erosion Board, Vol. 12, July 1958.
- (20) Saville, Thorndike, Jr., "Wave Run-Up on Shore Structures," Journal of the Waterways Division of the American Society of Civil Engineers, Vol. 82, No. WW 2, April 1956.
- (21) Saville, Thorndike, Jr., "Laboratory Data on Wave Run-Up and Overtopping on Shore Structures," Beach Erosion Board, Technical Memorandum No. 64, October 1955.
- (22) Saville, Thorndike, Jr., Inclosure to letter from Beach Erosion Board to U. S. Army Engineer District, New Orleans, 1 July 1958.
- (23) University of California, "Effect of Bottom Roughness on Wind Tide in Shallow Water," Beach Erosion Board, Technical Memorandum No. 95, May 1957.
- (24) King, H. W., "Handbook of Hydraulics," McGraw-Hill Book Co., Inc., 1954.



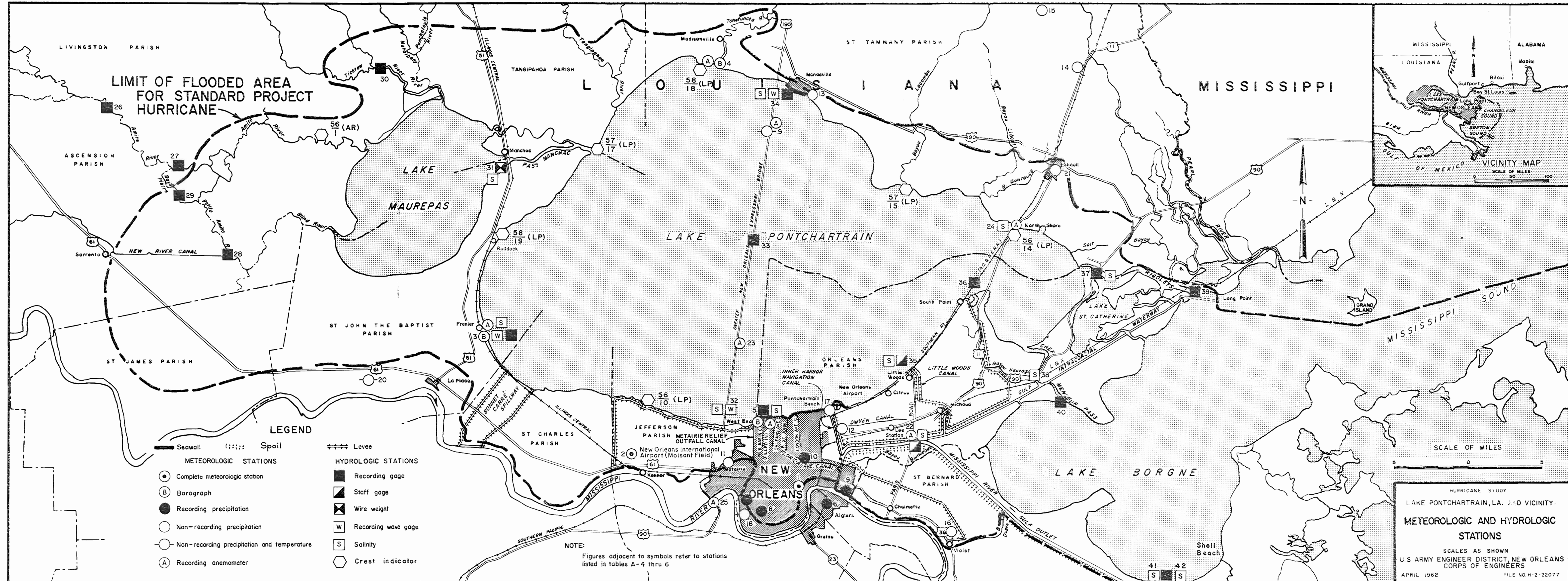

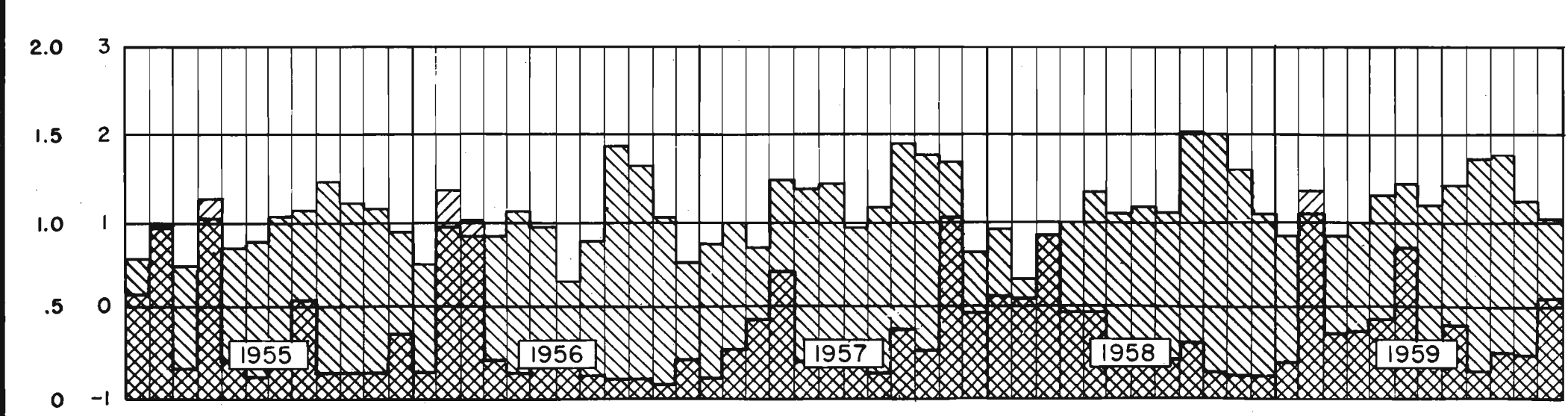
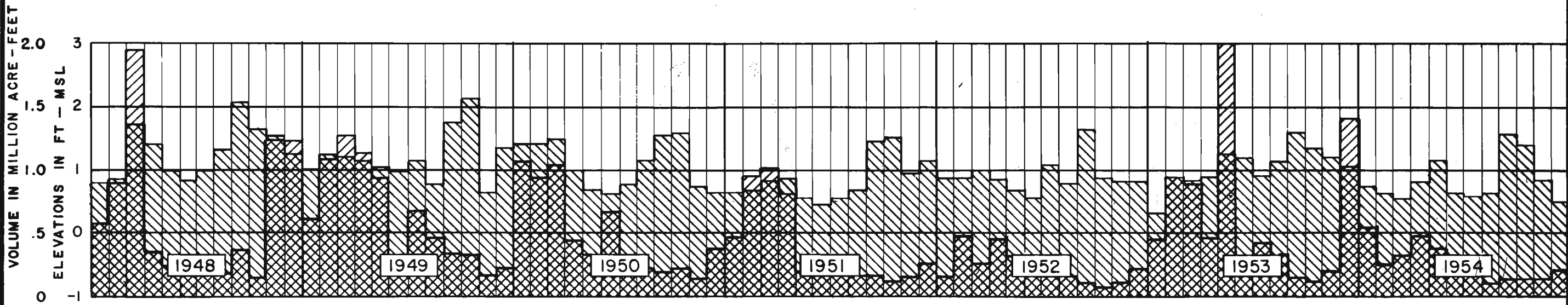
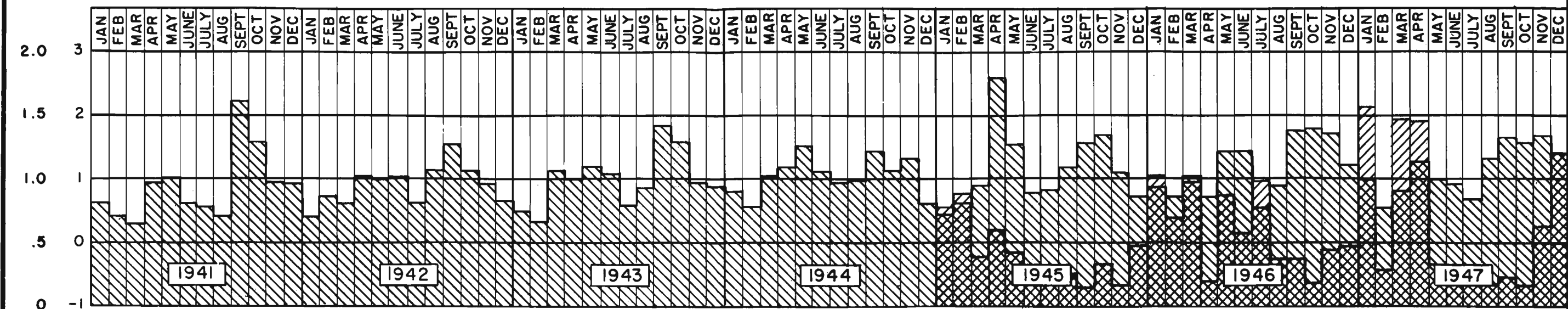

**LEGEND**  
 ▨ Mean Elevations  
 ▩ Tributary Inflow

HURRICANE STUDY  
 LAKE PONTCHARTRAIN, LA. AND VICINITY  
**LAKE PONTCHARTRAIN**  
**MONTHLY MEAN ELEVATIONS**  
**AND TRIBUTARY INFLOW**  
 US ARMY ENGINEER DISTRICT, NEW ORLEANS  
 CORPS OF ENGINEERS  
 APRIL 1962 FILE NO. H-2-22077



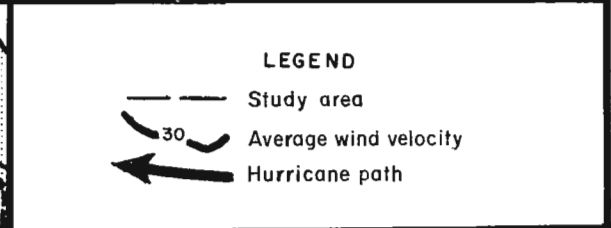
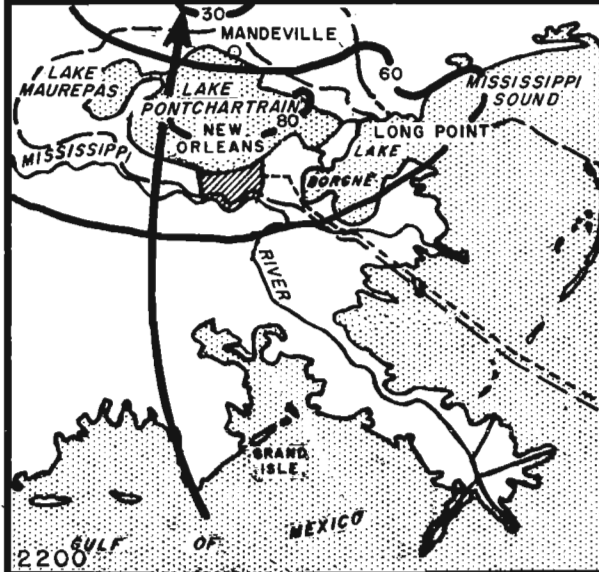
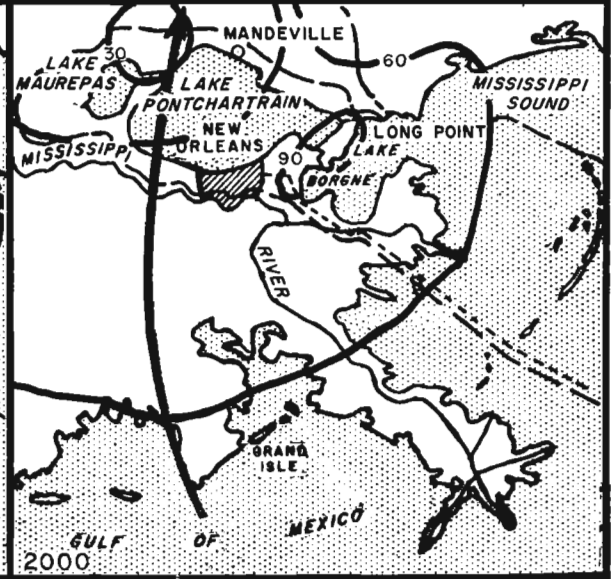
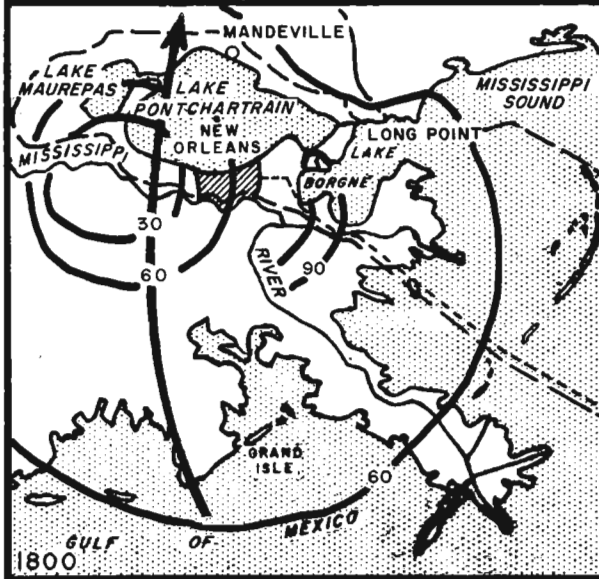
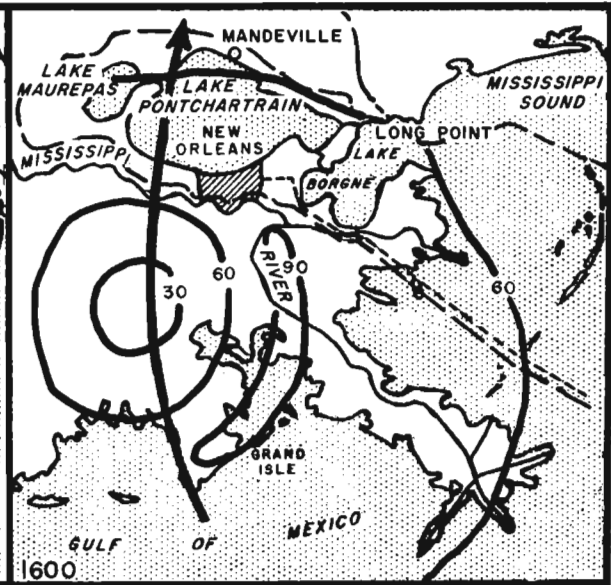
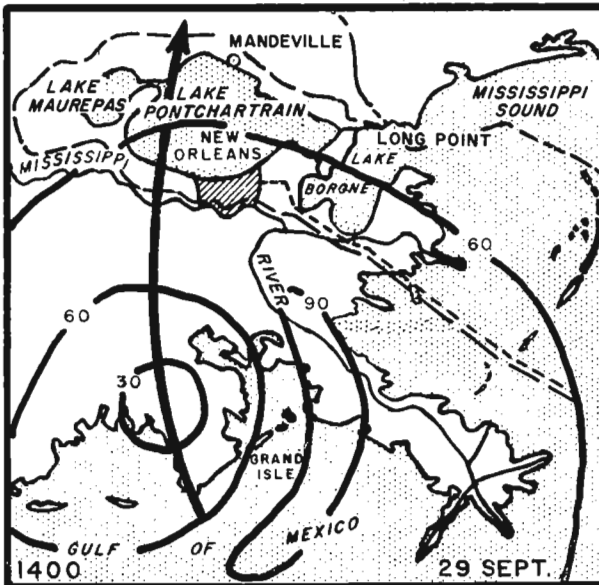

HURRICANE STUDY  
 LAKE PONTCHARTRAIN, LA. AND VICINITY  
 HURRICANE OF  
 28 SEPT. TO 1 OCT. 1915  
 ISOVEL PATTERNS

SCALE OF MILES  
 25 0 25 50

U.S. ARMY ENGINEER DISTRICT, NEW ORLEANS  
 CORPS OF ENGINEERS

APRIL 1962 FILE NO. H-2-22077

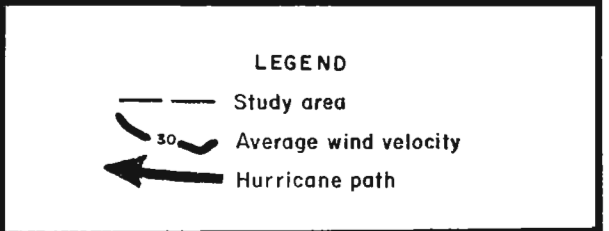
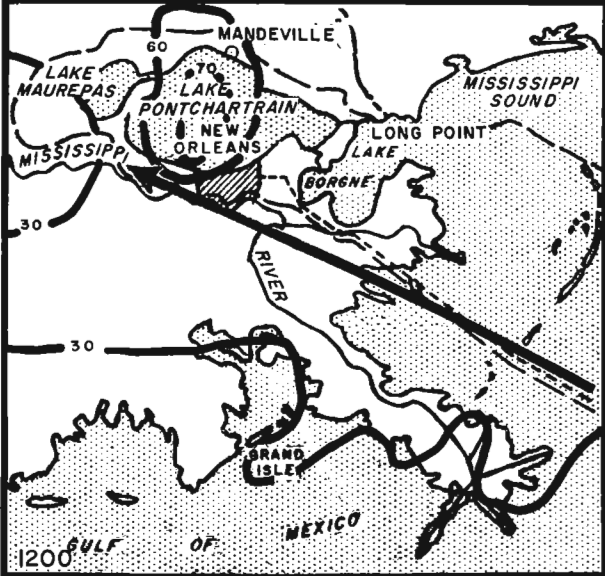
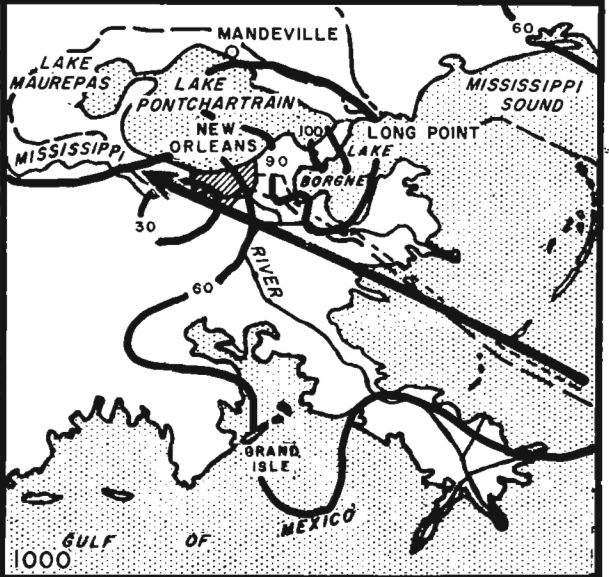
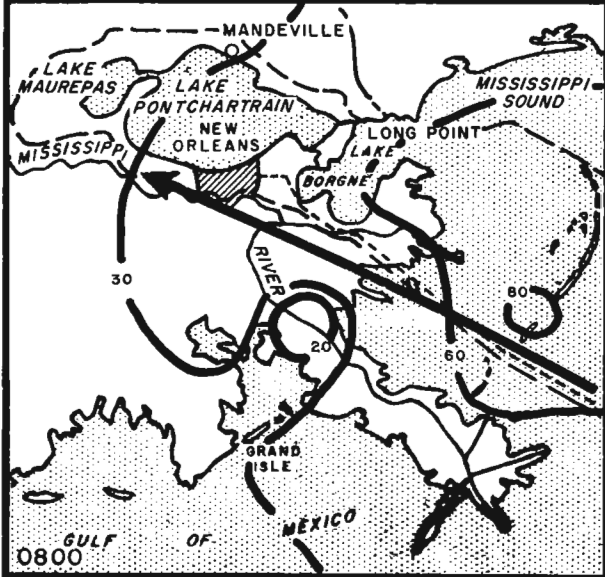
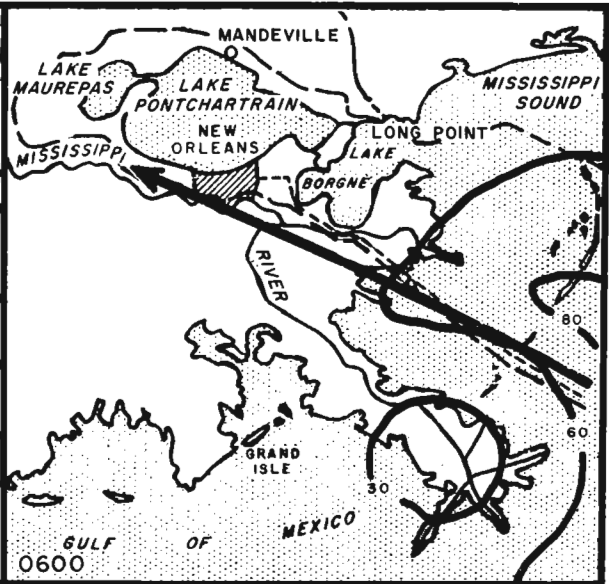
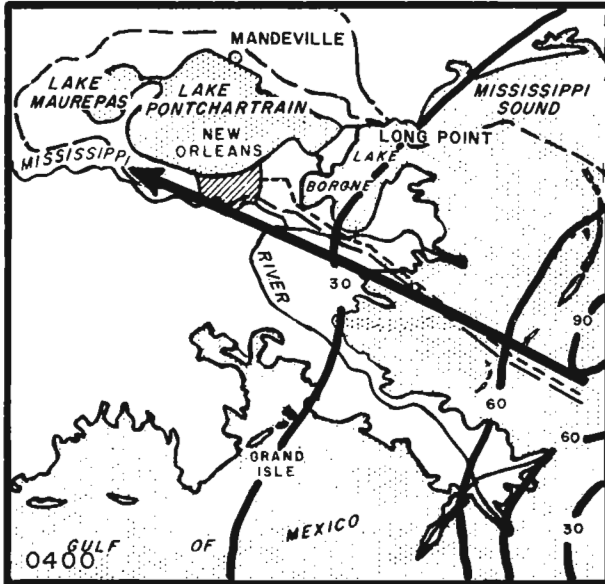

HURRICANE STUDY  
 LAKE PONTCHARTRAIN, LA. AND VICINITY  
**HURRICANE OF 19 SEPT. 1947**  
**ISOVEL PATTERNS**

SCALE OF MILES  
 25 0 25 50

U.S. ARMY ENGINEER DISTRICT, NEW ORLEANS  
 CORPS OF ENGINEERS

APRIL 1962 FILE NO. H-2-22077



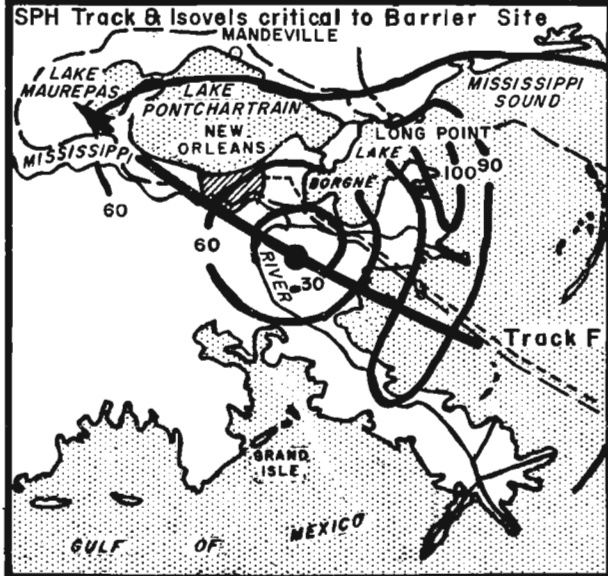
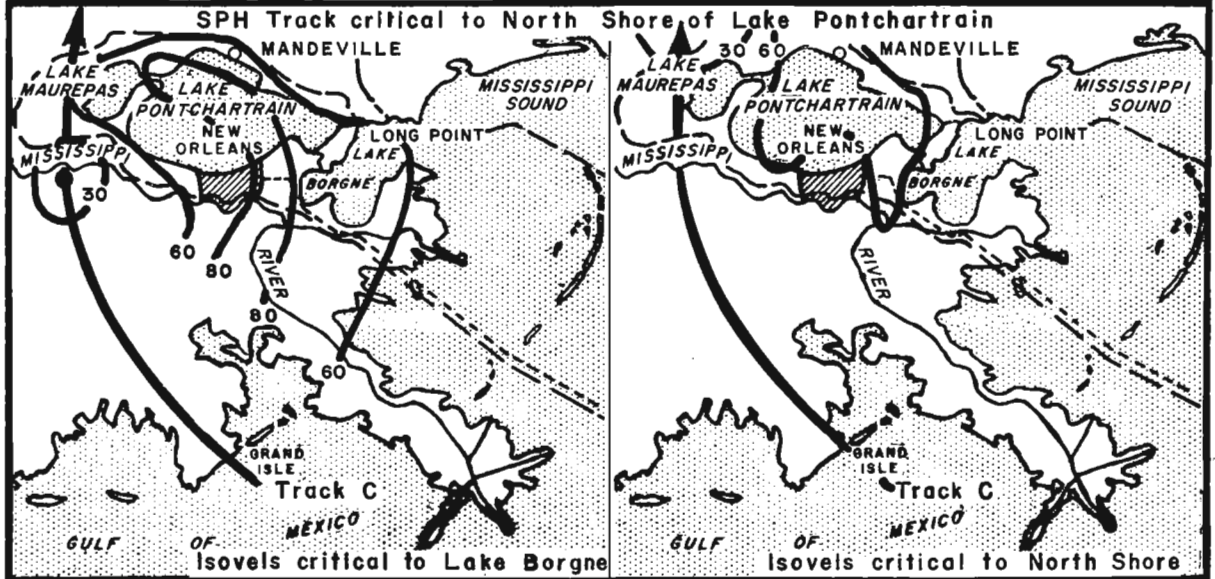
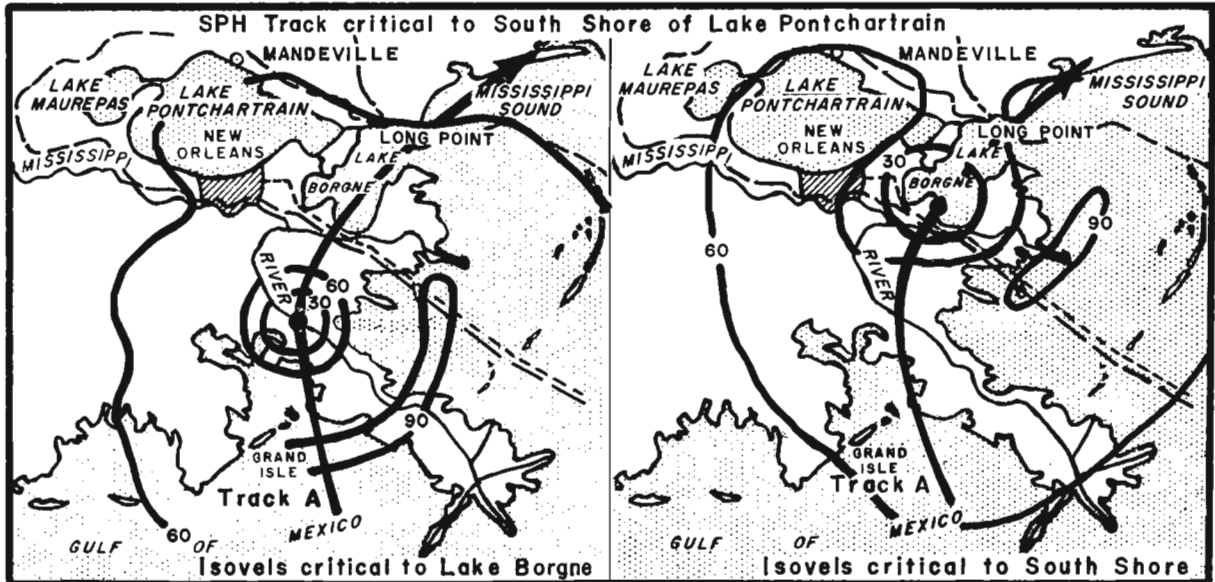

**LEGEND**

- Study area
- 30 Average wind velocity
- ← Hurricane path

**HURRICANE STUDY**

LAKE PONTCHARTRAIN, LA. AND VICINITY

**STANDARD PROJECT HURRICANE TRACKS AND ISOVEL PATTERNS**

SCALE OF MILES

25 0 25 50

U.S. ARMY ENGINEER DISTRICT, NEW ORLEANS  
CORPS OF ENGINEERS

APRIL 1962 FILE NO. H-2-22077

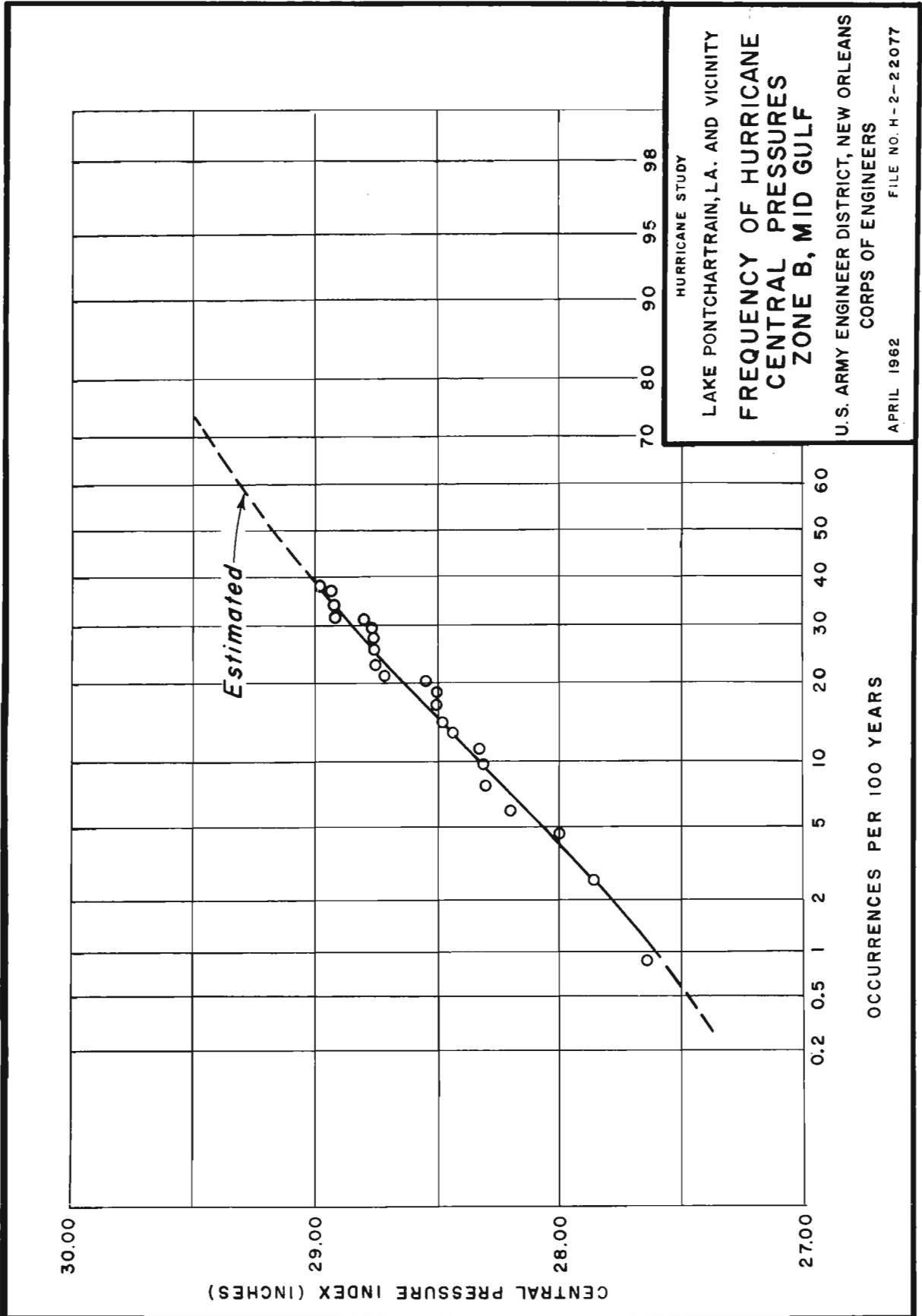
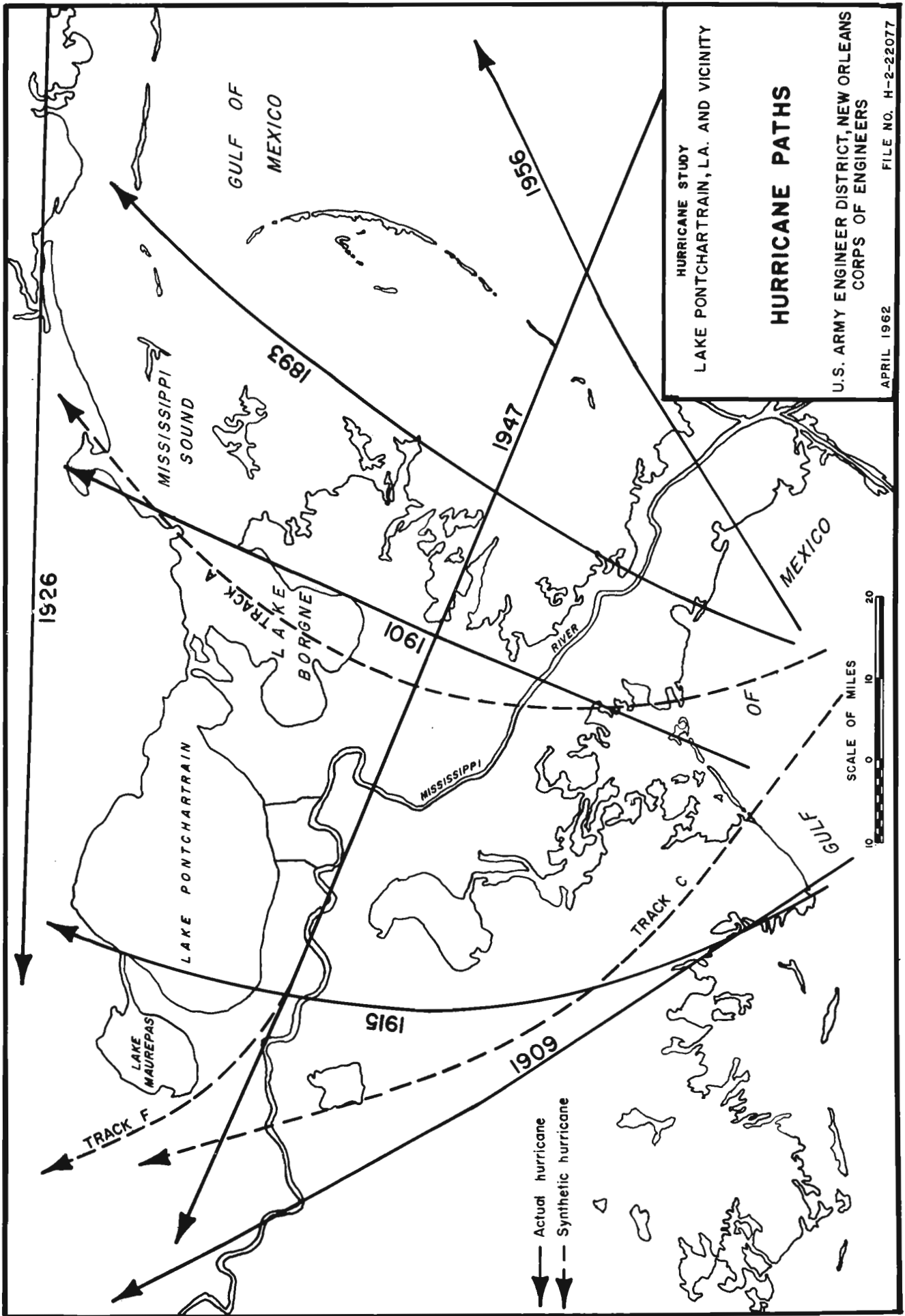
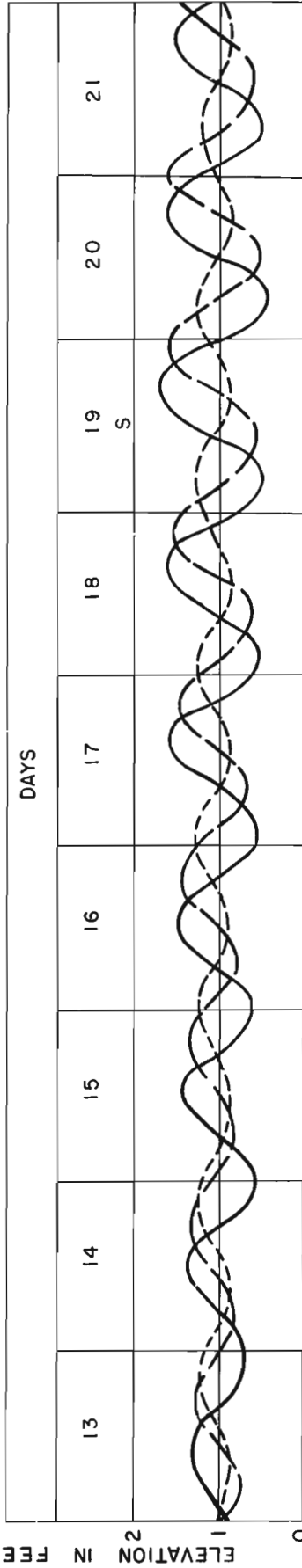
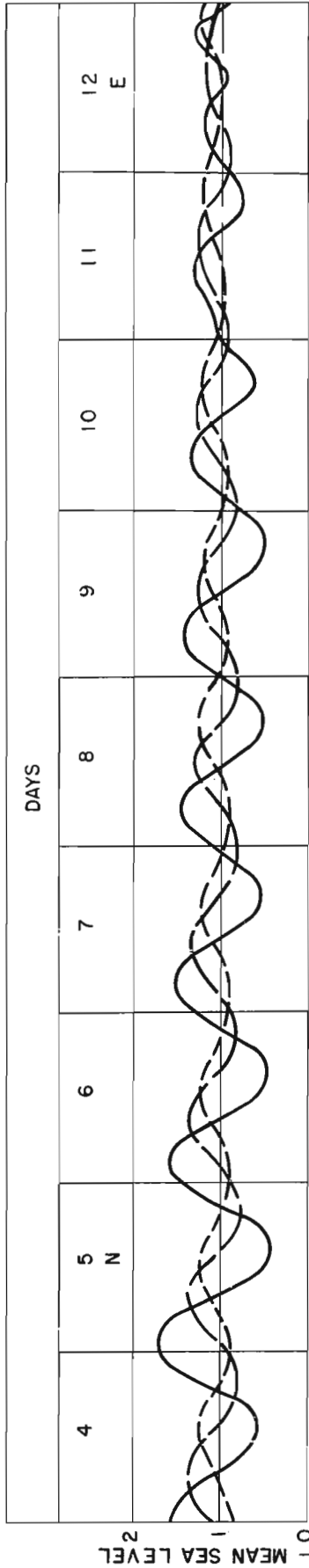

PLATE A-6





LEGEND  
 Lake Borgne  
 Lake Pontchartrain  
 Lake Maurepas  
 E moon on the equator  
 N,S moon in the north or south of the equator

HURRICANE STUDY

LAKE PONTCHARTRAIN, L.A. AND VICINITY

TYPICAL TIDAL CYCLES

U.S. ARMY ENGINEER DISTRICT, NEW ORLEANS  
 CORPS OF ENGINEERS

APRIL 1962 FILE NO. H-2-22077

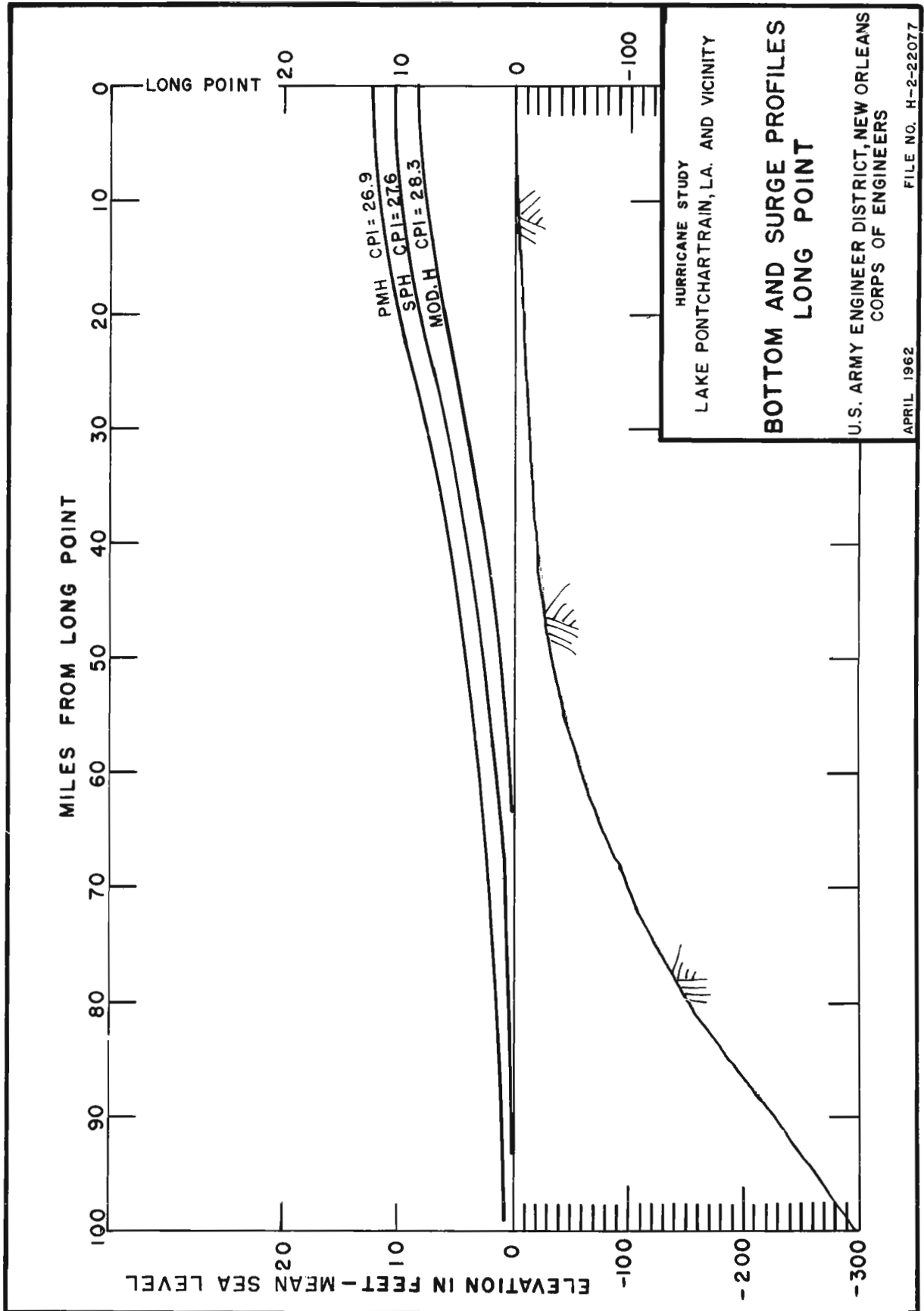

HURRICANE STUDY  
LAKE PONTCHARTRAIN, LA. AND VICINITY

**BOTTOM AND SURGE PROFILES  
LONG POINT**

U.S. ARMY ENGINEER DISTRICT, NEW ORLEANS  
CORPS OF ENGINEERS

APRIL 1962 FILE NO. H-2-22077

**PLATE A-9**

9 - A - 9

HOURS REFERENCED TO LANDFALL	EL. IN LAKE BORGNE		EL. IN LAKE PONTCHARTRAIN			FLOW INTO LAKE PONTCHARTRAIN						L. PONT. STORAGE		OVERFLOW	FLOW INTO L. MAUREPAS	EL. IN LAKE MAUREPAS		STAGES IN PASS MANCHAC						FLOW INTO LAKE MAUREPAS			STAGE IN LAKE MAUREPAS	
	EL. IN L. BORGNE	AV. OF (2)	AV. EL. IN L. PONT.	EL. AT HWY. 11	AV. OF (5)	HEAD BETWEEN L. BORGNE & L. PONT.	FLOW IN-TO L. PONT.	VOLUME OF FLOW FOR 2 HOURS	RAIN IN L. PONT.	VOLUME OF RAIN FOR 2 HOURS	TOTAL IN-FLOW INTO L. PONT.	STORAGE IN L. PONT. FOR EL. IN (4)	Δ STORAGE IN L. PONT.	FLOW OVER L. PONT. LEVEES FOR 2 HOUR	(12)-(14)-(15)	STORAGE IN L. MAUREPAS	AV. EL. IN L. MAUREPAS	EL. IN PASS MANCHAC	AV. OF (19)	TILT IN L. PONT.	TILT IN L. MAUREPAS	EL. IN PASS MANCHAC	AV. OF (23)	HEAD BETWEEN L. PONT. & L. MAUREPAS	FLOW INTO L. MAUREPAS	VOLUME OF FLOW FOR 2 HOURS	STORAGE IN L. MAUREPAS	EL. IN L. MAUREPAS
	FEET M.S.L.	FEET M.S.L.	FEET M.S.L.	FEET M.S.L.	FEET M.S.L.	FEET	1000 C.F.S.	1000 D.S.F.	FEET	1000 D.S.F.	1000 D.S.F.	1000 D.S.F.	1000 D.S.F.	1000 D.S.F.	1000 D.S.F.	1000 D.S.F.	FEET M.S.L.	FEET M.S.L.	FEET	FEET	FEET M.S.L.	FEET M.S.L.	FEET	1000 C.F.S.	1000 D.S.F.	1000 D.S.F.	FEET M.S.L.	
2	9.16	9.86	3.94	2.33	1.21	8.65	4214.0	351.2	0.115	13.7	364.9	1970.6	346.5	2.3	16.1	225.1	1.12	3.54	4.52	1.21	0.24	1.00	0.84	3.66	165.8	13.8	226.2	1.13
4	10.25	9.91	5.26	0.09	1.62	8.29	1043.2	336.9	0.052	42.0	378.9	2317.1	351.7	11.6	15.4	241.2	1.27	5.50	6.02	5.41	1.08	0.73	0.90	5.12	181.6	15.4	240.0	1.24
6	9.56	9.11	6.55	3.14	1.55	4.56	2310.6	192.6	0.155	49.6	242.2	2668.8	202.5	25.8	13.9	256.8	1.41	6.55	6.08	3.41	0.68	1.07	1.32	4.76	180.5	15.0	255.4	1.40
8	8.66	7.43	7.28	5.96	7.13	0.00	0.0	0.0	0.180	21.0	21.0	2871.8	-47.7	54.9	13.8	270.7	1.58	5.61	5.11	-0.35	-0.07	1.57	1.82	3.29	160.2	13.4	270.4	1.53
10	6.19	7.43	7.11	8.90	7.13				0.075			2823.6				284.5	1.45	4.61	5.11	-4.29	-0.86	2.08					283.8	1.44

EXPLANATION:

- COLUMN (2) FROM LAKE BORGNE HYDROGRAPH DERIVED BY THE METHOD DESCRIBED IN PARAGRAPH A-3e(1) AND SHOWN ON PLATE A-14
- (4) ASSUMED
- (5) OBTAINED FROM WATER SURFACE CONTOURS DERIVED FROM WIND SETUP COMPUTATIONS FOR LAKE PONT., SAMPLE SHOWN ON PLATE A-16
- (7) (3) - (6)
- (8) FROM CHEF MENTEUR PASS AND RIGOLETS RATING CURVE SHOWN BELOW
- (10) FROM RAINFALL ESTIMATES DESCRIBED IN PARAGRAPH A-3i AND MASS RAINFALL CURVES SHOWN ON PLATE A-24
- (12) (7) + (11)
- (13) FROM LAKE PONT. STORAGE CURVE SHOWN BELOW FOR THE ELEVATION IN (4)

- COLUMN (14) (13) - (13)
- (15) BY THE PROCEDURES DESCRIBED IN PARAGRAPH A-3g
- (17) (14) + (17)
- (18) CORRESPONDING ELEVATION FOR VOLUME IN (7) FROM LAKE MAUREPAS STORAGE CURVE SHOWN BELOW
- (19) SAME AS EXPLANATION FOR (5)
- (21) (3) - (5)
- (22) 1/5 OF (21), AS DESCRIBED IN PARAGRAPH A-3c(3)
- (23) (18) - (22)
- (25) (23) - (23)
- (26) FROM PASS MANCHAC RATING CURVE SHOWN BELOW
- (28) (27) + (24)
- (29) CORRESPONDING ELEVATION FOR VOLUME IN (26) FROM LAKE MAUREPAS STORAGE CURVE SHOWN BELOW

SAMPLE ROUTING

WATER SURFACE PROFILES

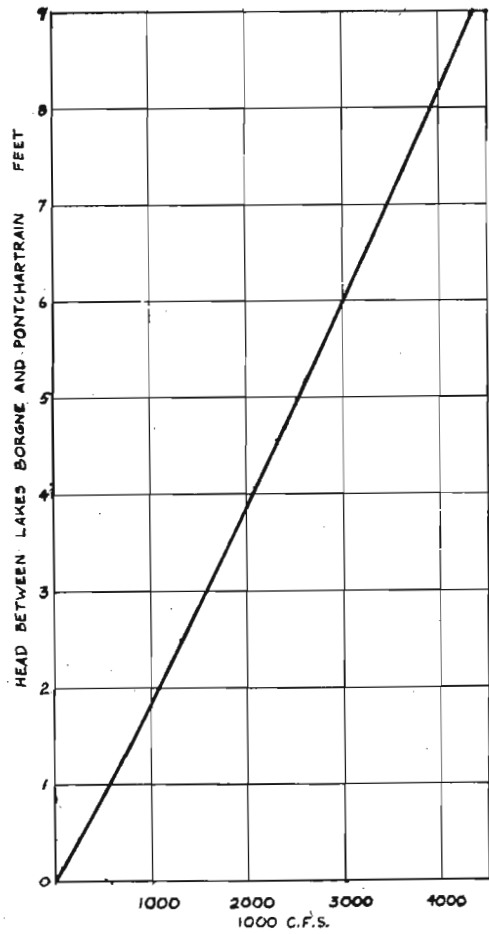
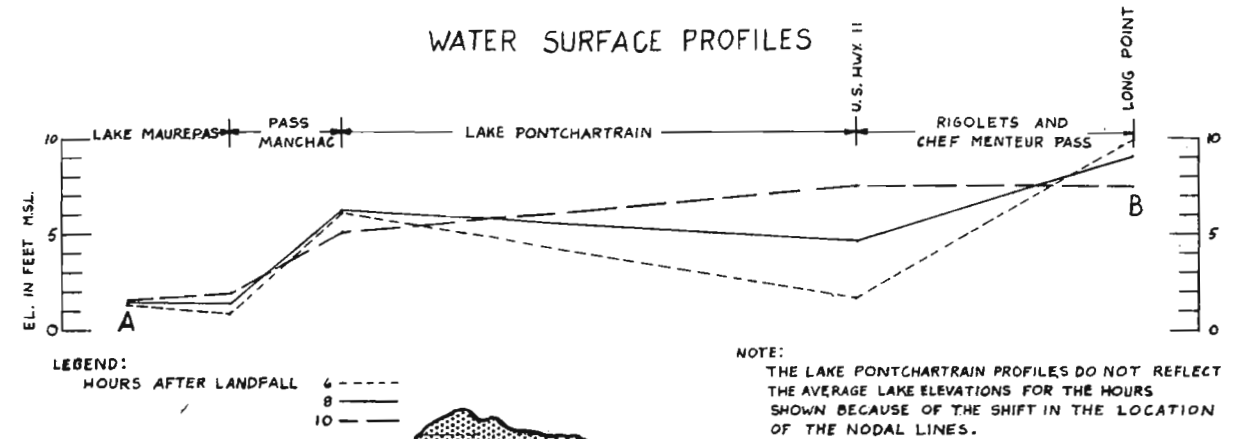

CHEF MENTEUR PASS & RIGOLETS FLOW

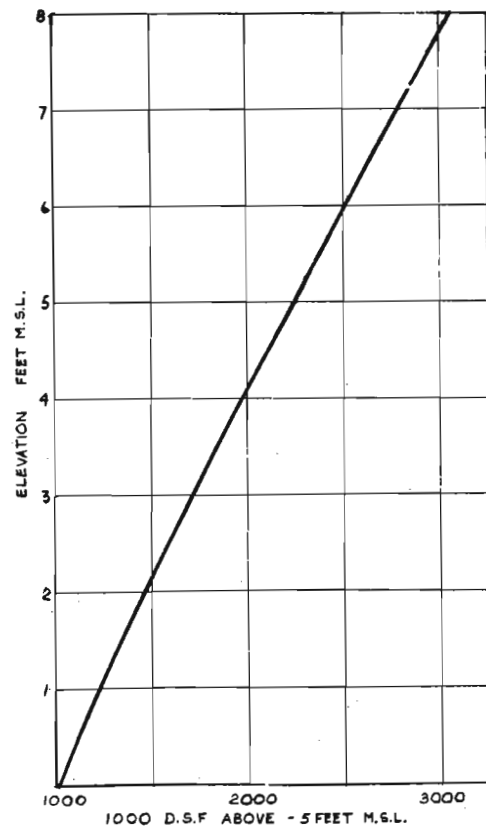

LAKE PONTCHARTRAIN STORAGE

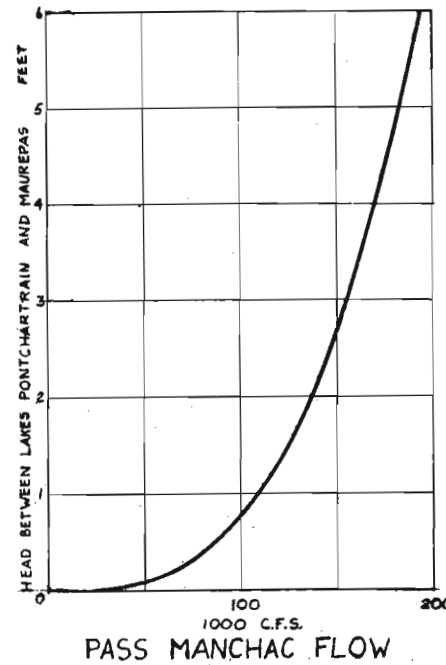

PASS MANCHAC FLOW

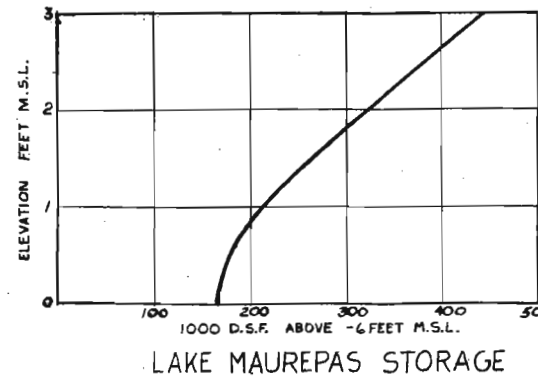

LAKE MAUREPAS STORAGE

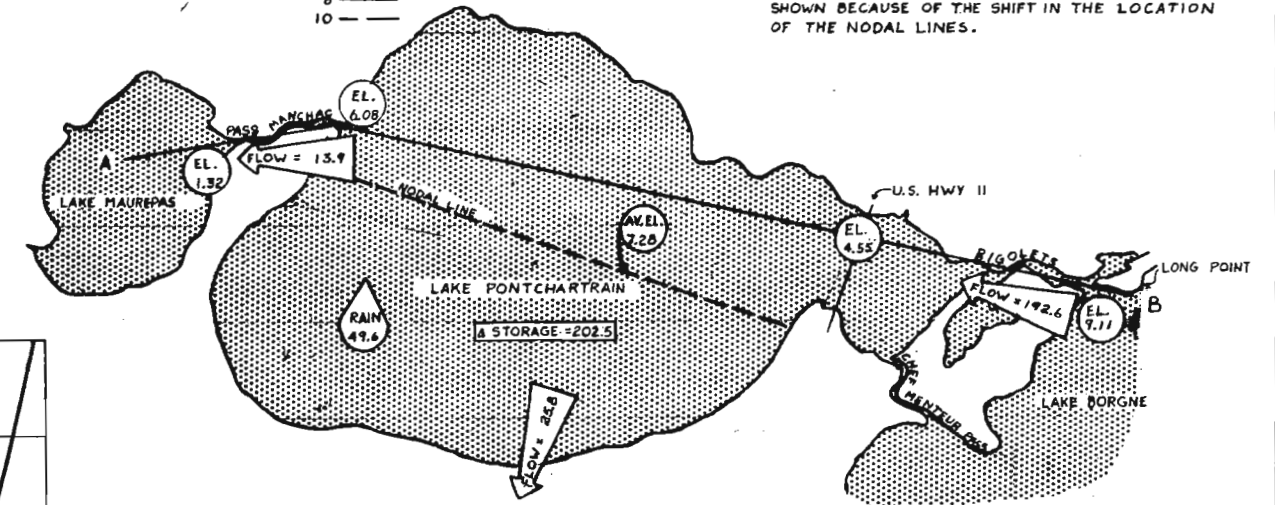

HURRICANE STUDY  
LAKE PONTCHARTRAIN, LA. AND VICINITY

**LAKE PONTCHARTRAIN ROUTING**

SCALE AS SHOWN  
U.S. ARMY ENGINEER DISTRICT, NEW ORLEANS, LA.  
CORPS OF ENGINEERS

DATE: JUNE 1962 FILE NO. H-2-28077

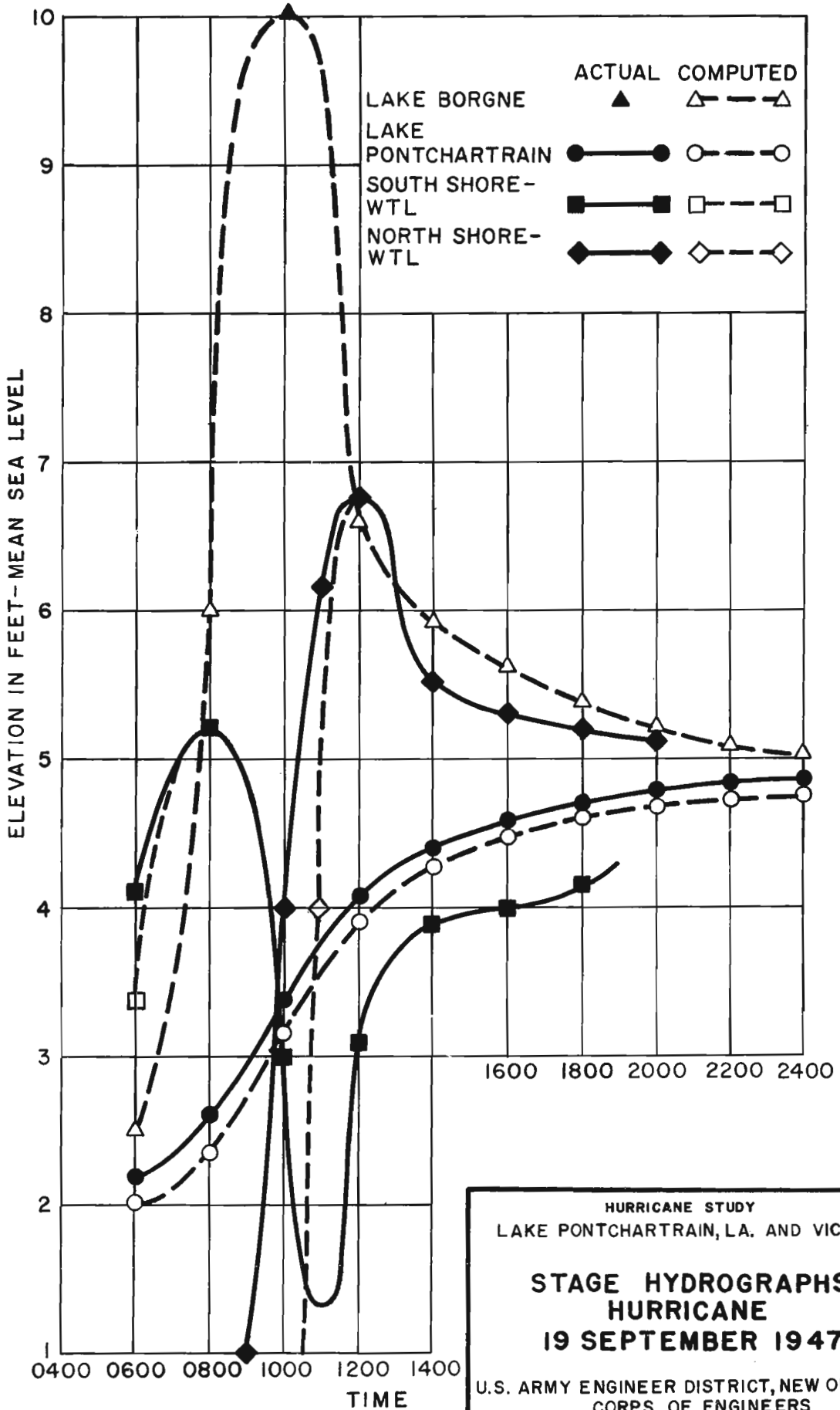

HURRICANE STUDY  
 LAKE PONTCHARTRAIN, LA. AND VICINITY

**STAGE HYDROGRAPHS  
 HURRICANE  
 19 SEPTEMBER 1947**

U.S. ARMY ENGINEER DISTRICT, NEW ORLEANS  
 CORPS OF ENGINEERS

APRIL 1962 FILE NO. H-2-22077

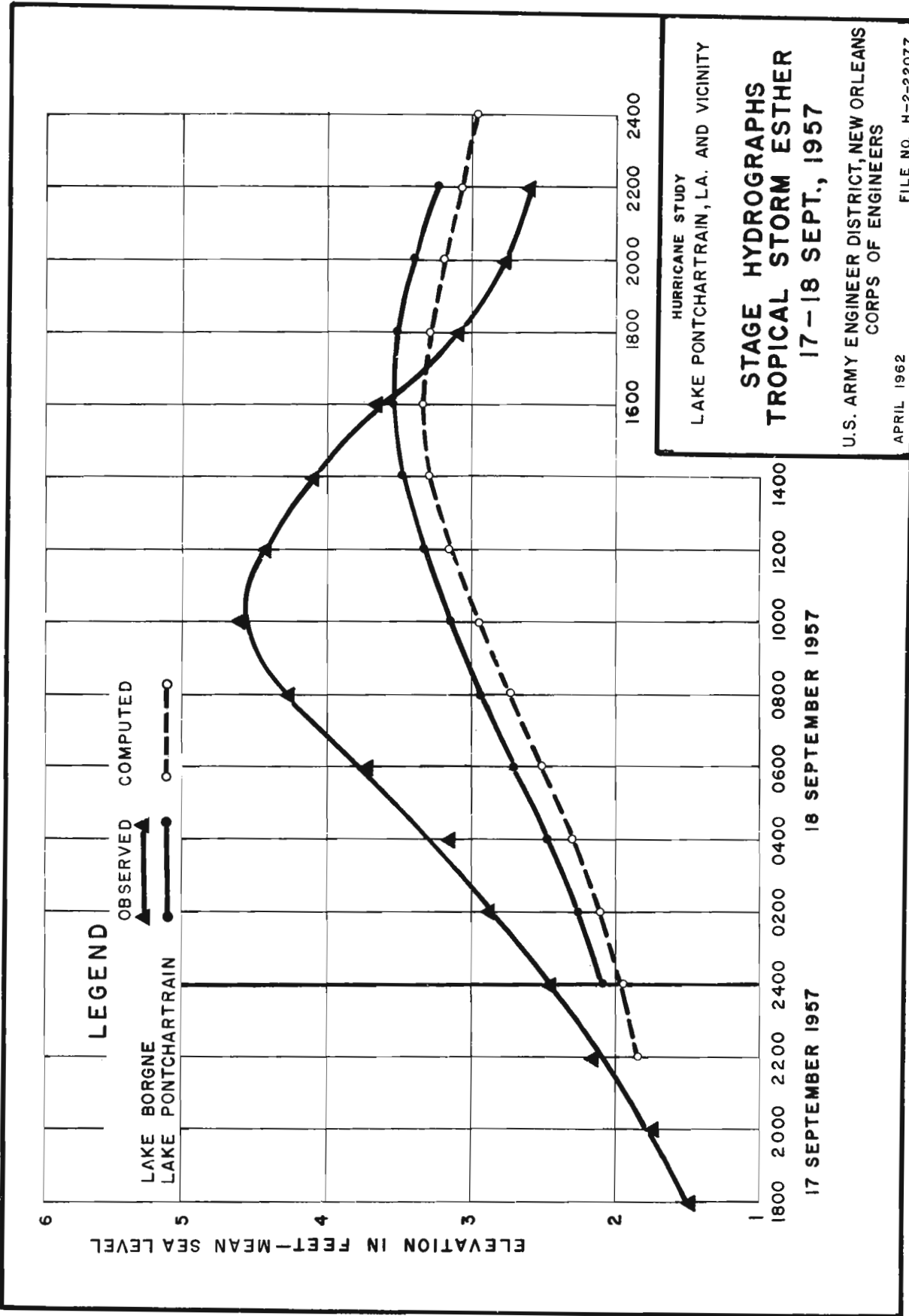

HURRICANE STUDY  
 LAKE PONTCHARTRAIN, LA. AND VICINITY

**STAGE HYDROGRAPHS**  
**TROPICAL STORM ESTHER**  
**17 - 18 SEPT., 1957**

U.S. ARMY ENGINEER DISTRICT, NEW ORLEANS  
 CORPS OF ENGINEERS

APRIL 1962 FILE NO. H-2-22077

**PLATE A-12**

PLATE A-12



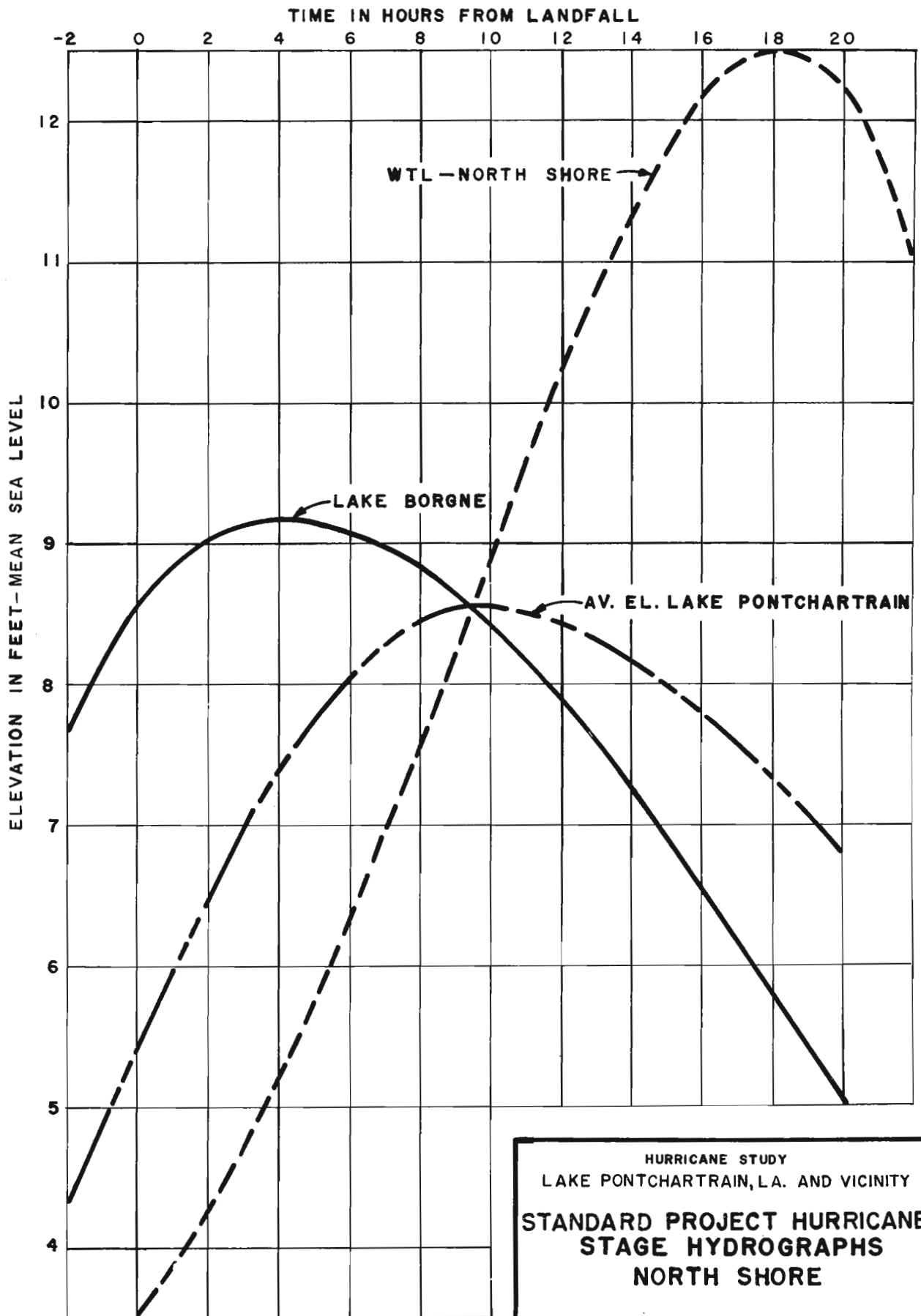

**HURRICANE STUDY**  
**LAKE PONTCHARTRAIN, L.A. AND VICINITY**  
**STANDARD PROJECT HURRICANE**  
**STAGE HYDROGRAPHS**  
**NORTH SHORE**  
 U.S. ARMY ENGINEER DISTRICT, NEW ORLEANS  
 CORPS OF ENGINEERS  
 APRIL 1962 FILE NO. H-2-22077

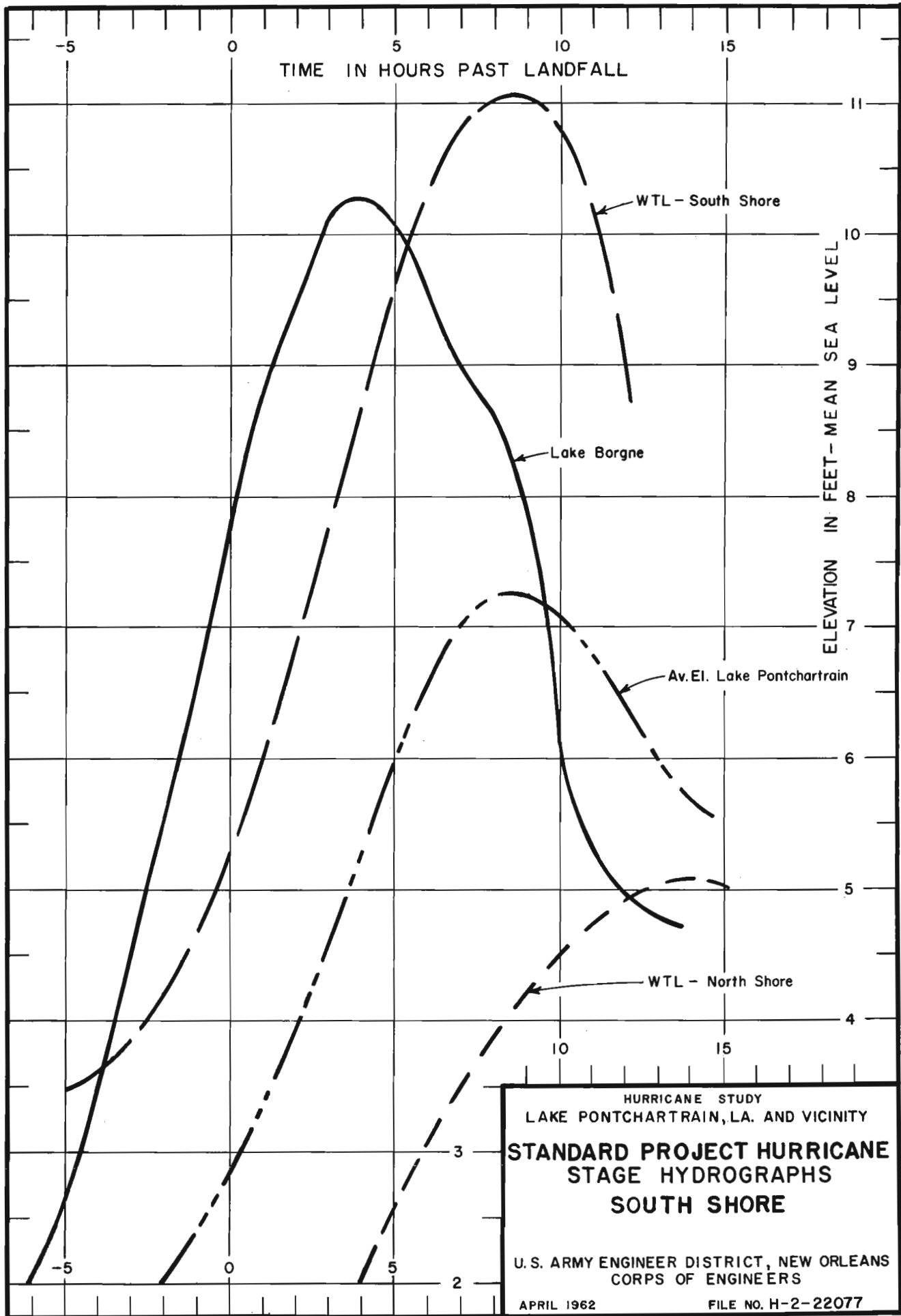

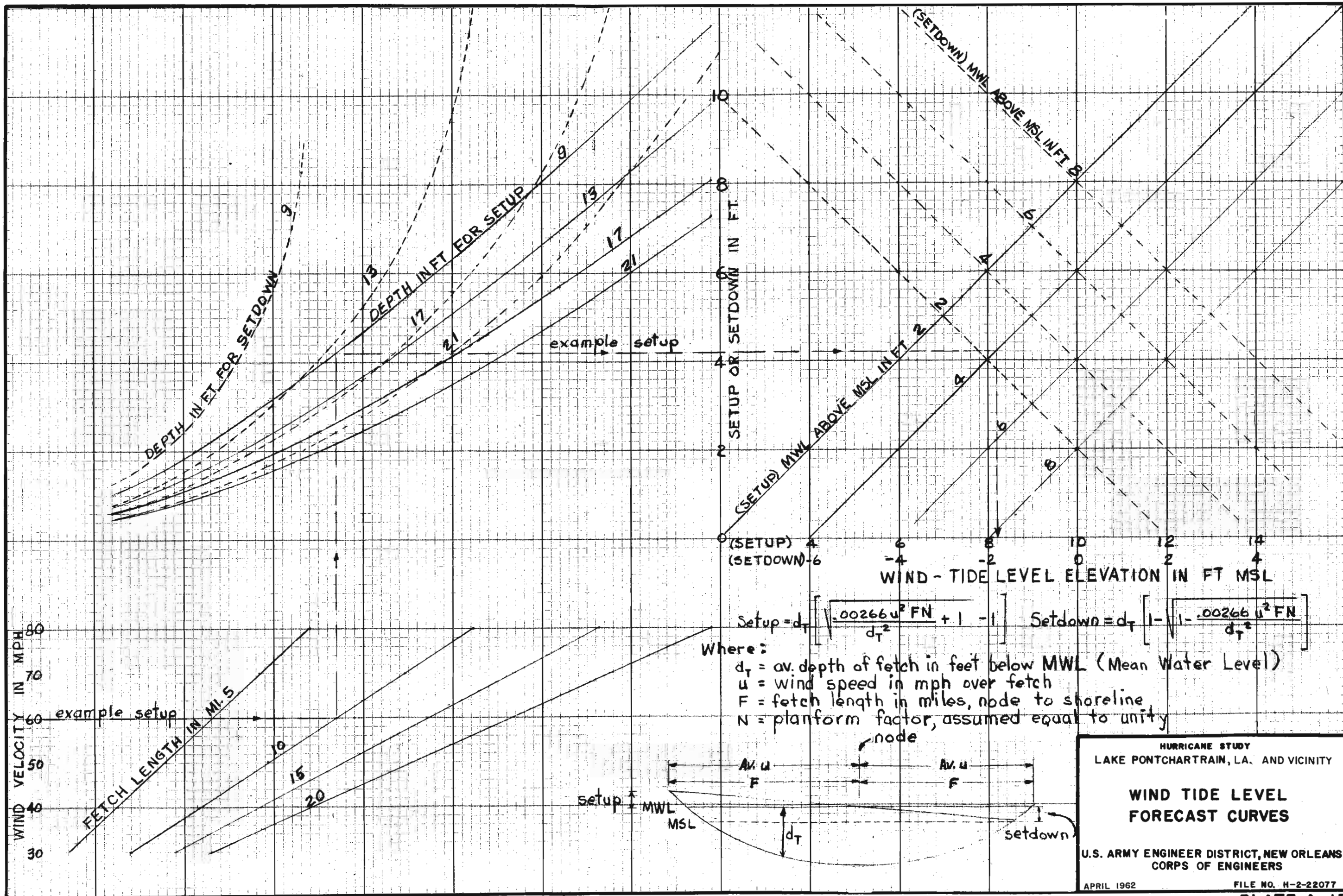

$$\text{Setup} = d_T \left[ \sqrt{\frac{.00266 u^2 F N}{d_T^2} + 1} - 1 \right] \quad \text{Setdown} = d_T \left[ 1 - \sqrt{1 - \frac{.00266 u^2 F N}{d_T^2}} \right]$$

Where:  
 $d_T$  = av. depth of fetch in feet below MWL (Mean Water Level)  
 $u$  = wind speed in mph over fetch  
 $F$  = fetch length in miles, node to shoreline  
 $N$  = planform factor, assumed equal to unity

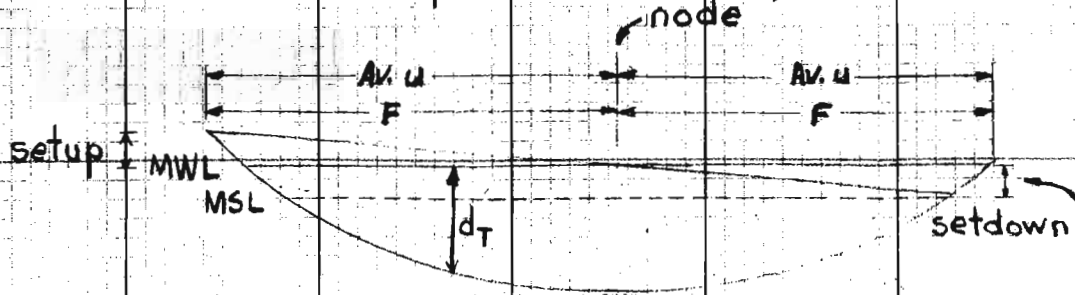

HURRICANE STUDY  
 LAKE PONTCHARTRAIN, LA. AND VICINITY

**WIND TIDE LEVEL  
 FORECAST CURVES**

U.S. ARMY ENGINEER DISTRICT, NEW ORLEANS  
 CORPS OF ENGINEERS

APRIL 1962 FILE NO. H-2-22077

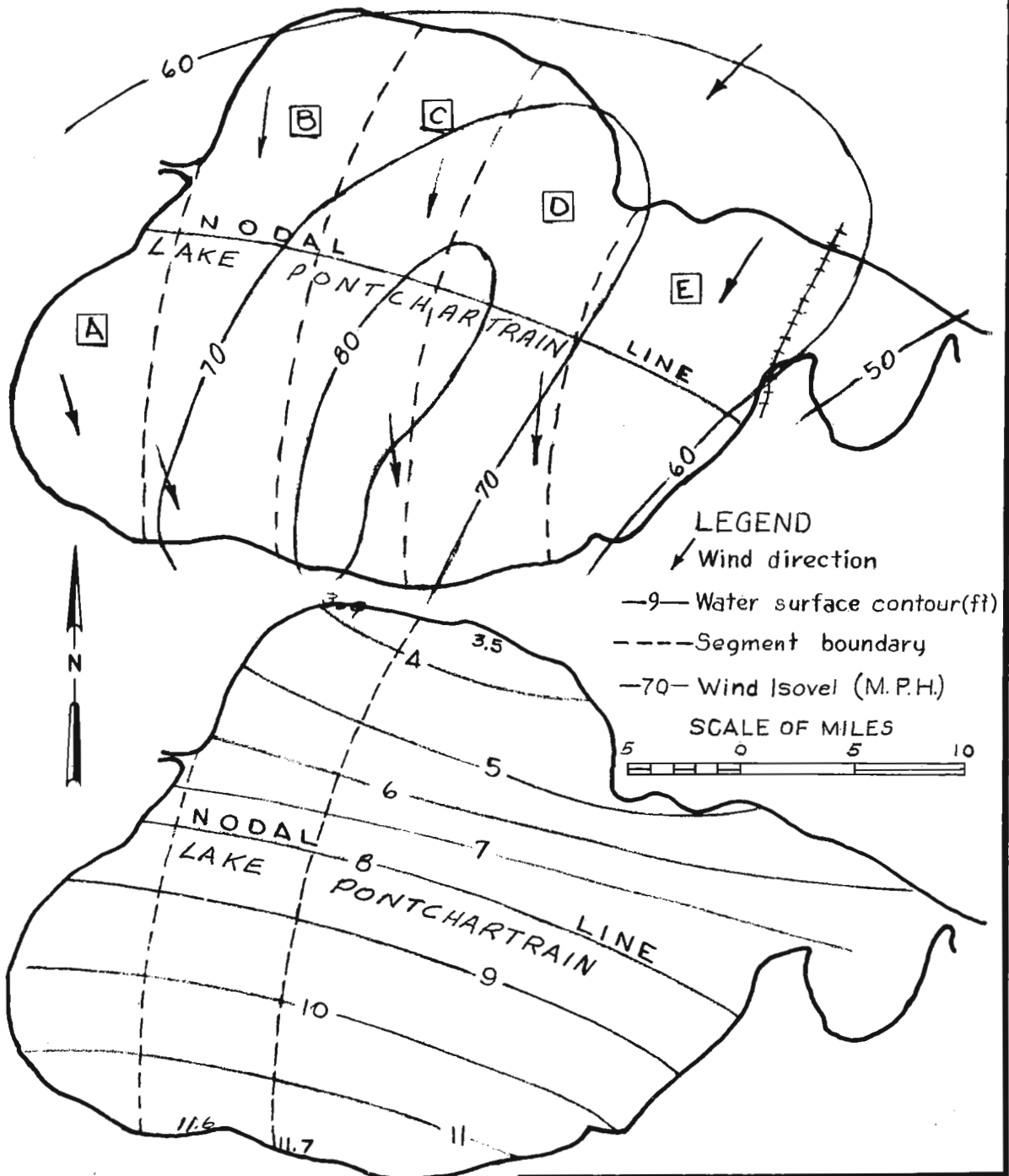

Sample: 8 hours after landfall - Track A - SPH

Setdown:

$$S = 19.2 \left[ \sqrt{1 - \frac{0.00266(66)^2(12.5)(1.0)}{(19.2)^2}} \right] + 8.0 = \text{MWL}$$

$$= -4.1 + 3.9 = \text{WTL}$$

Setup:

$$S = 20.5 \left[ \left( \sqrt{\frac{0.00266(70)^2(12.5)(1.0)}{(20.5)^2} + 1} \right) - 1 \right]$$

$$= +3.6'$$

$$8.0 = \text{MWL}$$

$$+ 11.6 = \text{WTL}$$

Interpolate with data for MWL = 6.0' to obtain WTL's for routed MWL = 7.28'

HURRICANE STUDY  
 LAKE PONTCHARTRAIN, LA. AND VICINITY  
**LAKE PONTCHARTRAIN  
 ISOVELS - SETUP ZONES  
 WIND TIDE CONTOURS**  
 U.S. ARMY ENGINEER DISTRICT, NEW ORLEANS  
 CORPS OF ENGINEERS  
 APRIL 1962 FILE NO. H-2-22077

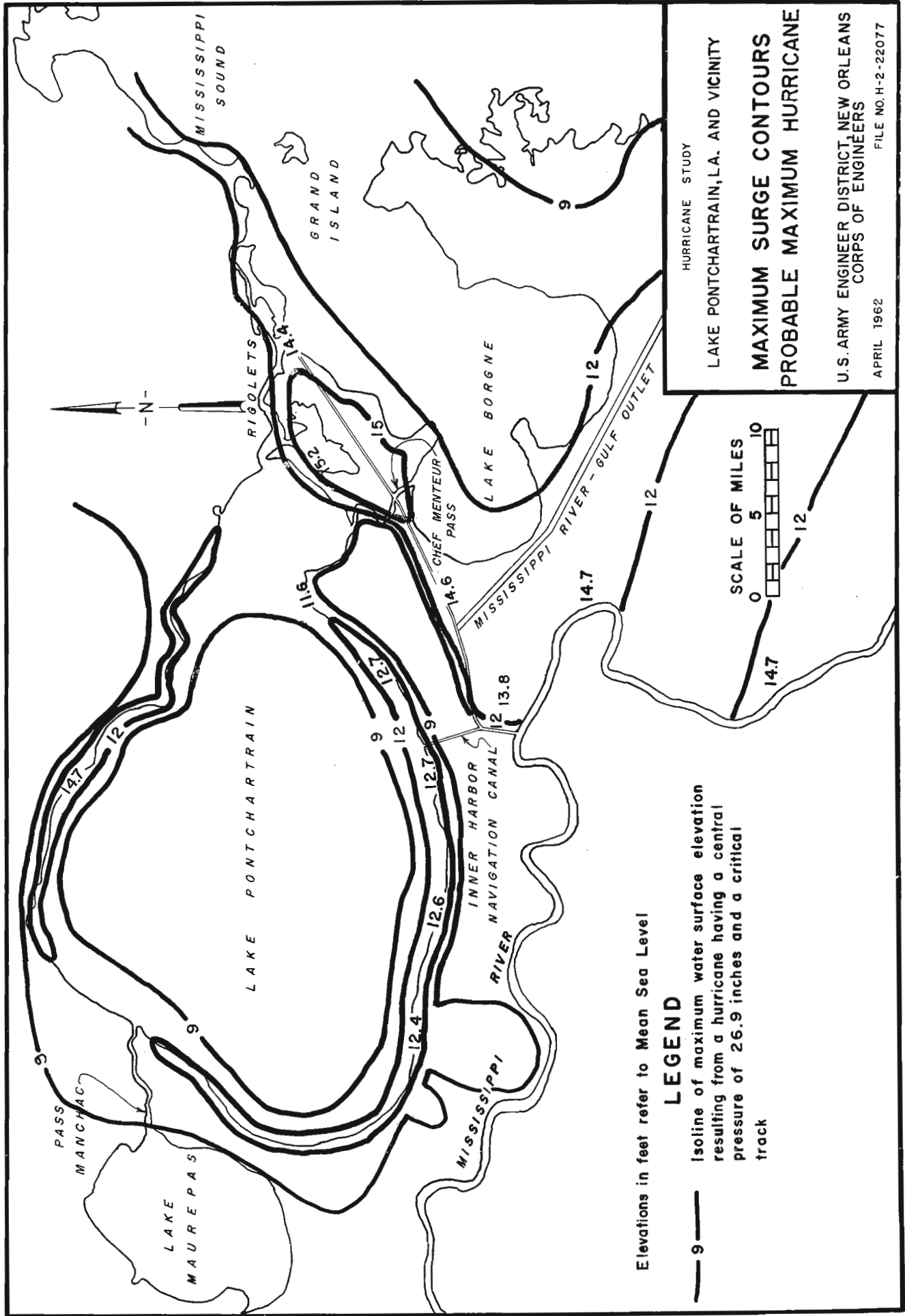

Elevations in feet refer to Mean Sea Level

**LEGEND**

- 9 — Isoline of maximum water surface elevation resulting from a hurricane having a central pressure of 26.9 inches and a critical track



HURRICANE STUDY  
 LAKE PONTCHARTRAIN, LA. AND VICINITY  
**MAXIMUM SURGE CONTOURS**  
**PROBABLE MAXIMUM HURRICANE**  
 U.S. ARMY ENGINEER DISTRICT, NEW ORLEANS  
 CORPS OF ENGINEERS  
 APRIL 1962  
 FILE NO. H-2-22077

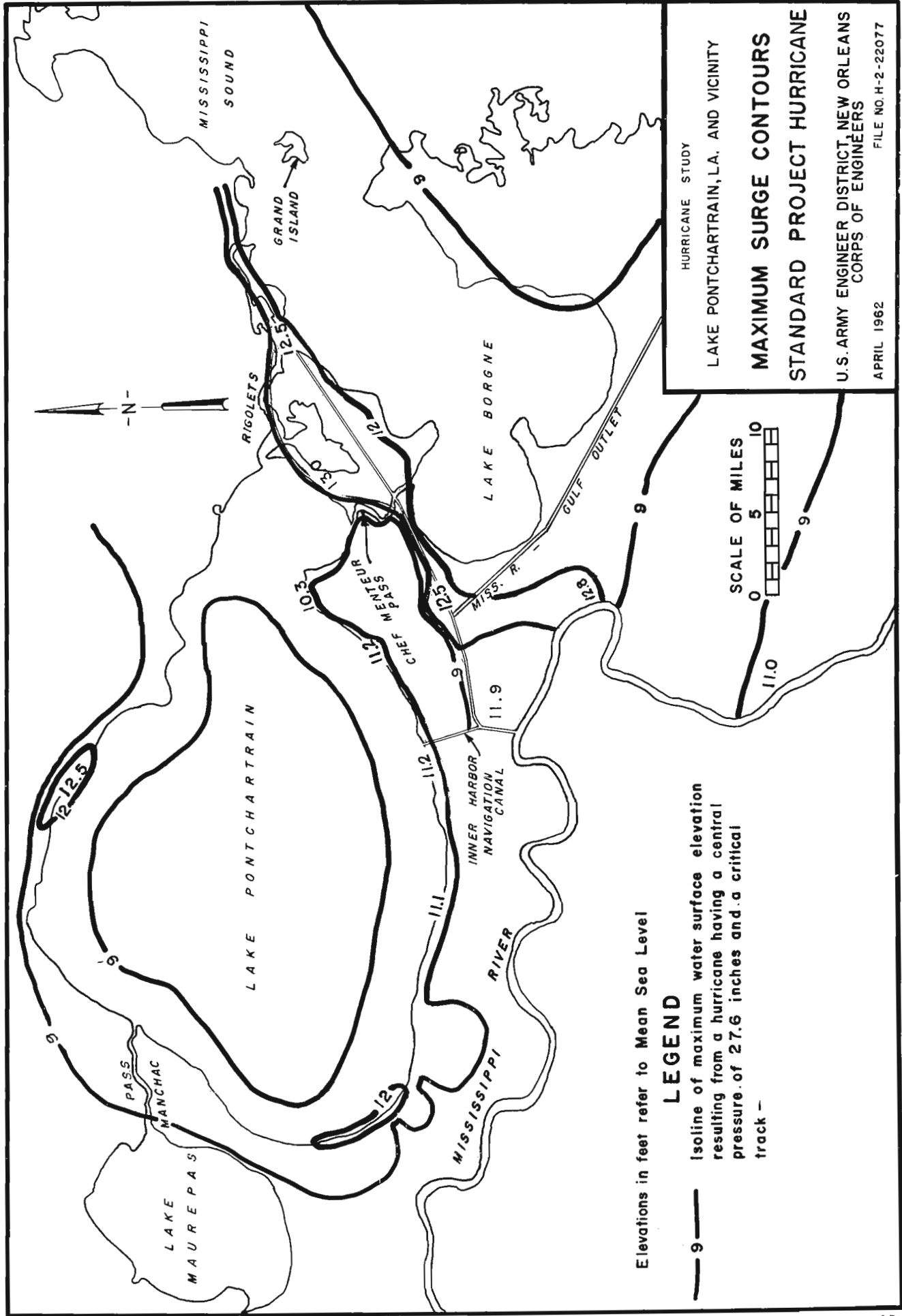

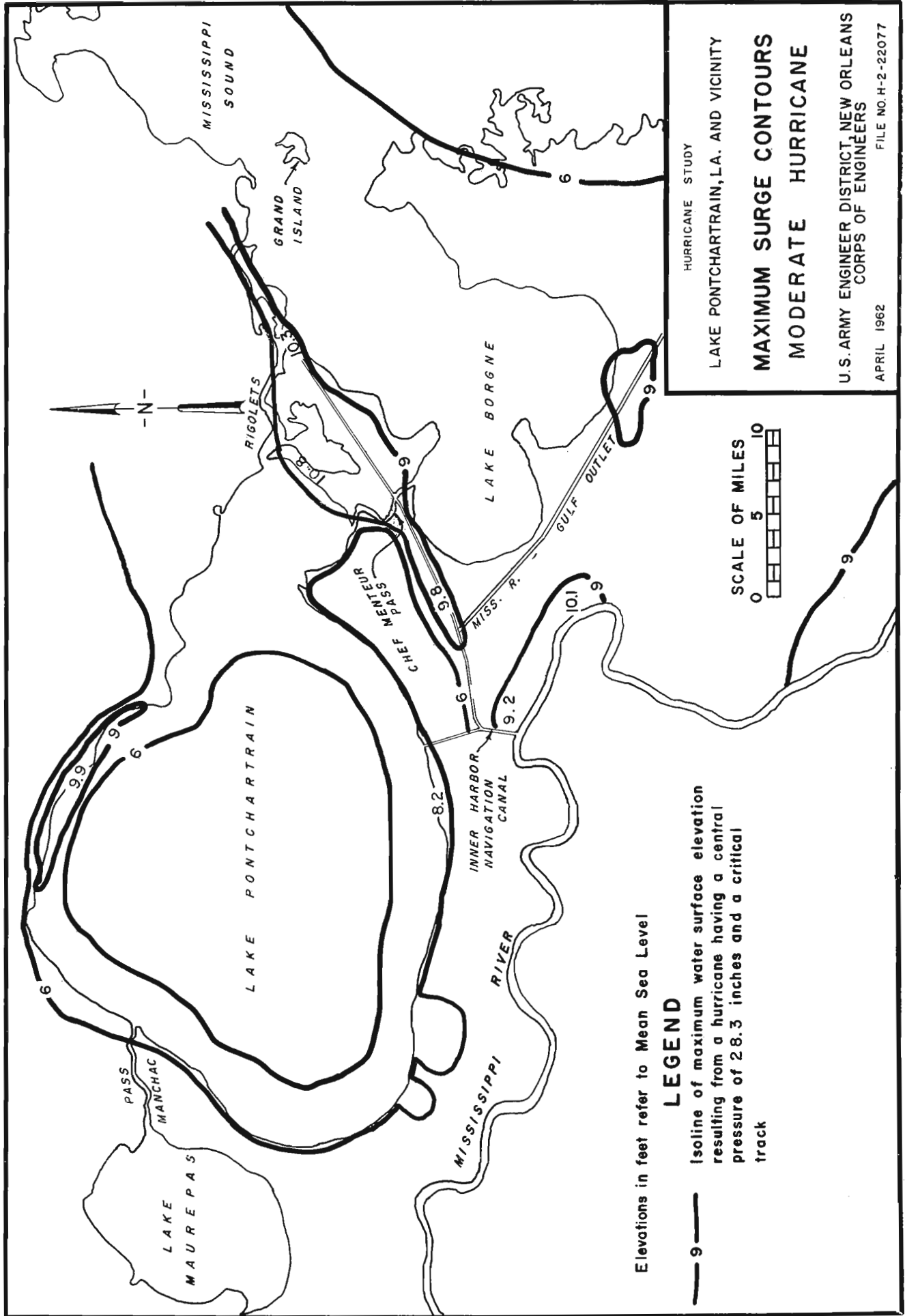

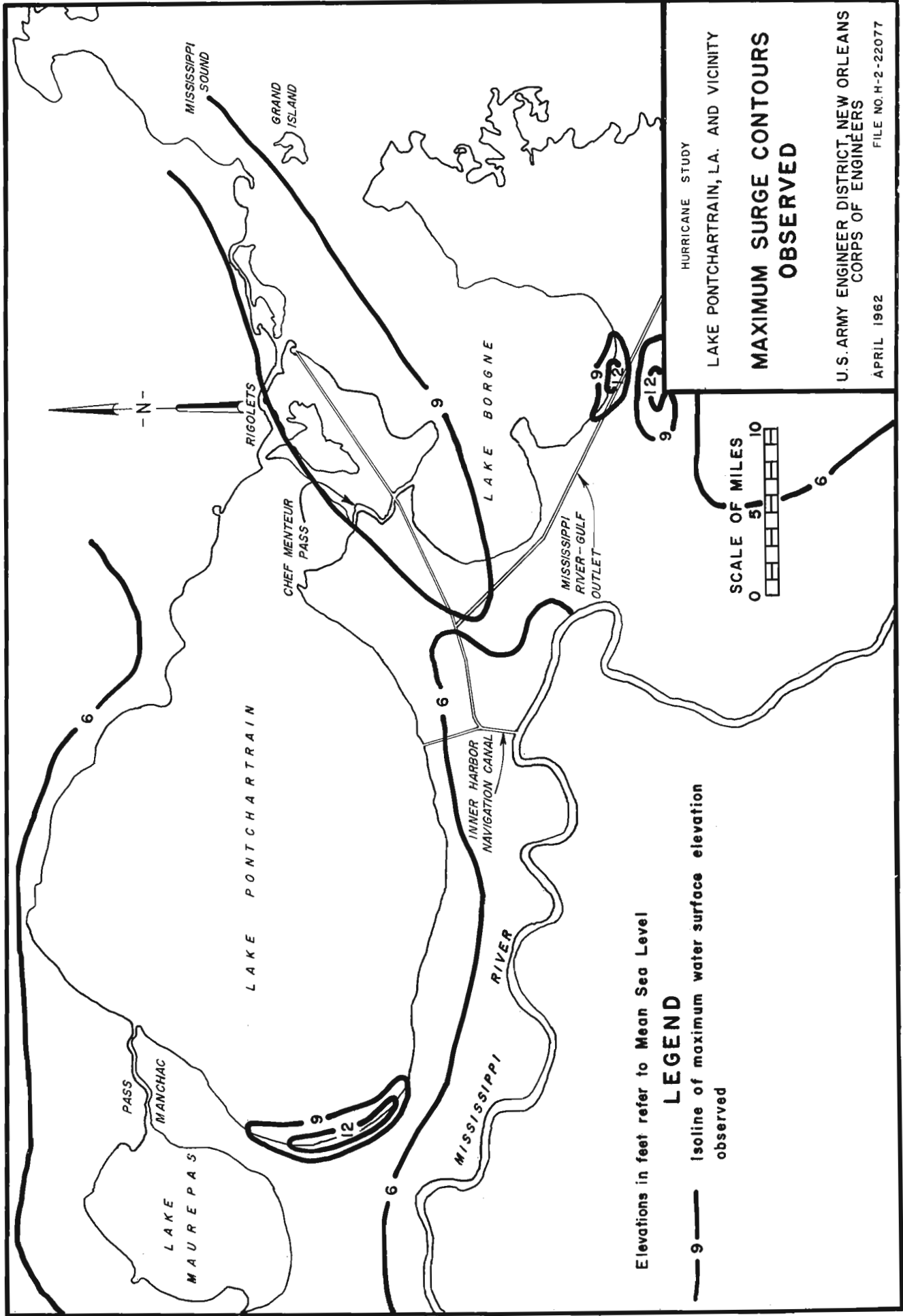

Elevations in feet refer to Mean Sea Level

**LEGEND**

— 9 — Isoline of maximum water surface elevation observed

HURRICANE STUDY

LAKE PONTCHARTRAIN, LA. AND VICINITY

**MAXIMUM SURGE CONTOURS OBSERVED**

U.S. ARMY ENGINEER DISTRICT NEW ORLEANS  
CORPS OF ENGINEERS

APRIL 1962  
FILE NO. H-2-22077



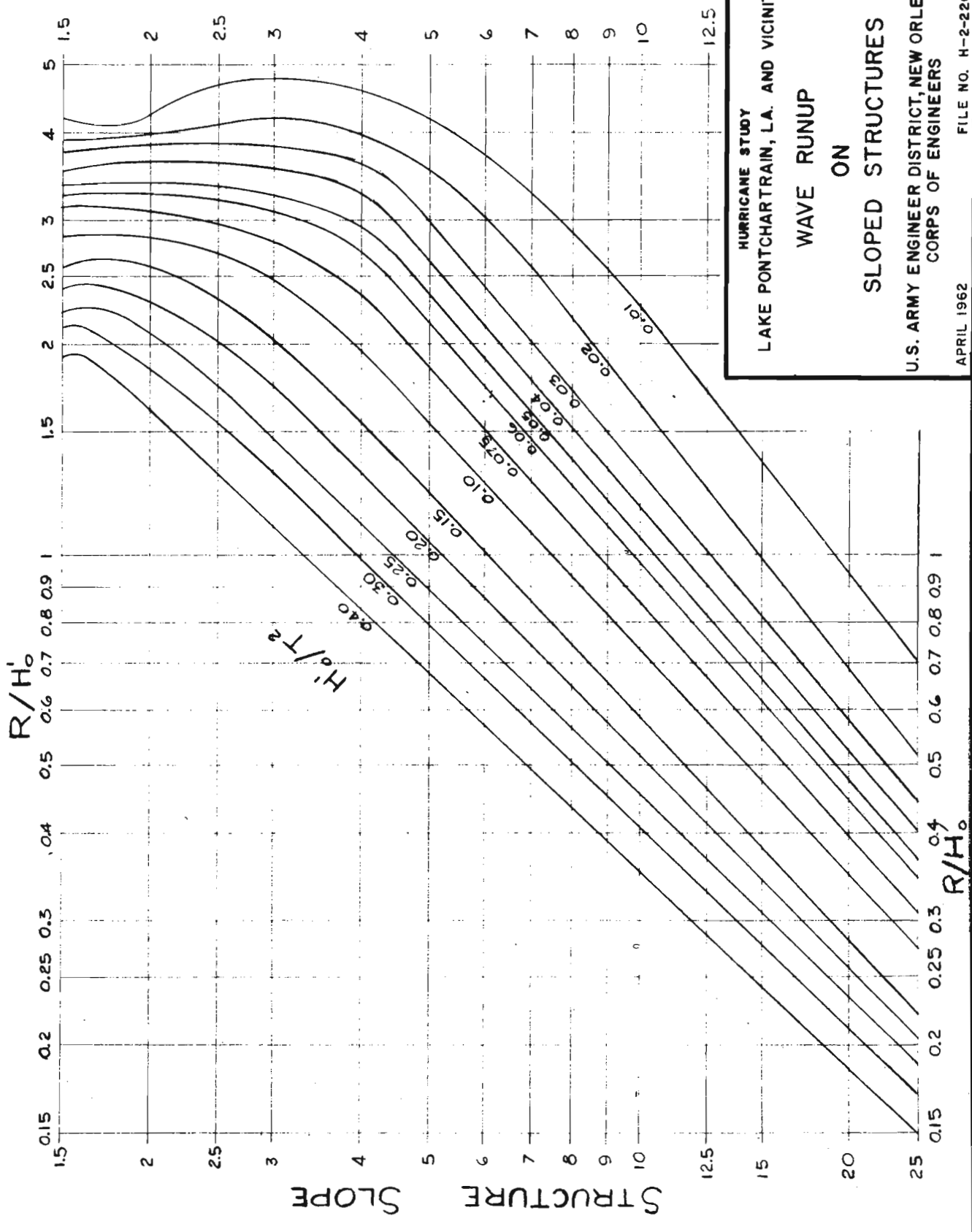

HURRICANE STUDY  
 LAKE PONTCHARTRAIN, L.A. AND VICINITY  
 WAVE RUNUP  
 ON  
 SLOPED STRUCTURES  
 U.S. ARMY ENGINEER DISTRICT, NEW ORLEANS  
 CORPS OF ENGINEERS  
 APRIL 1962  
 FILE NO. H-2-22077

PLATE A-21

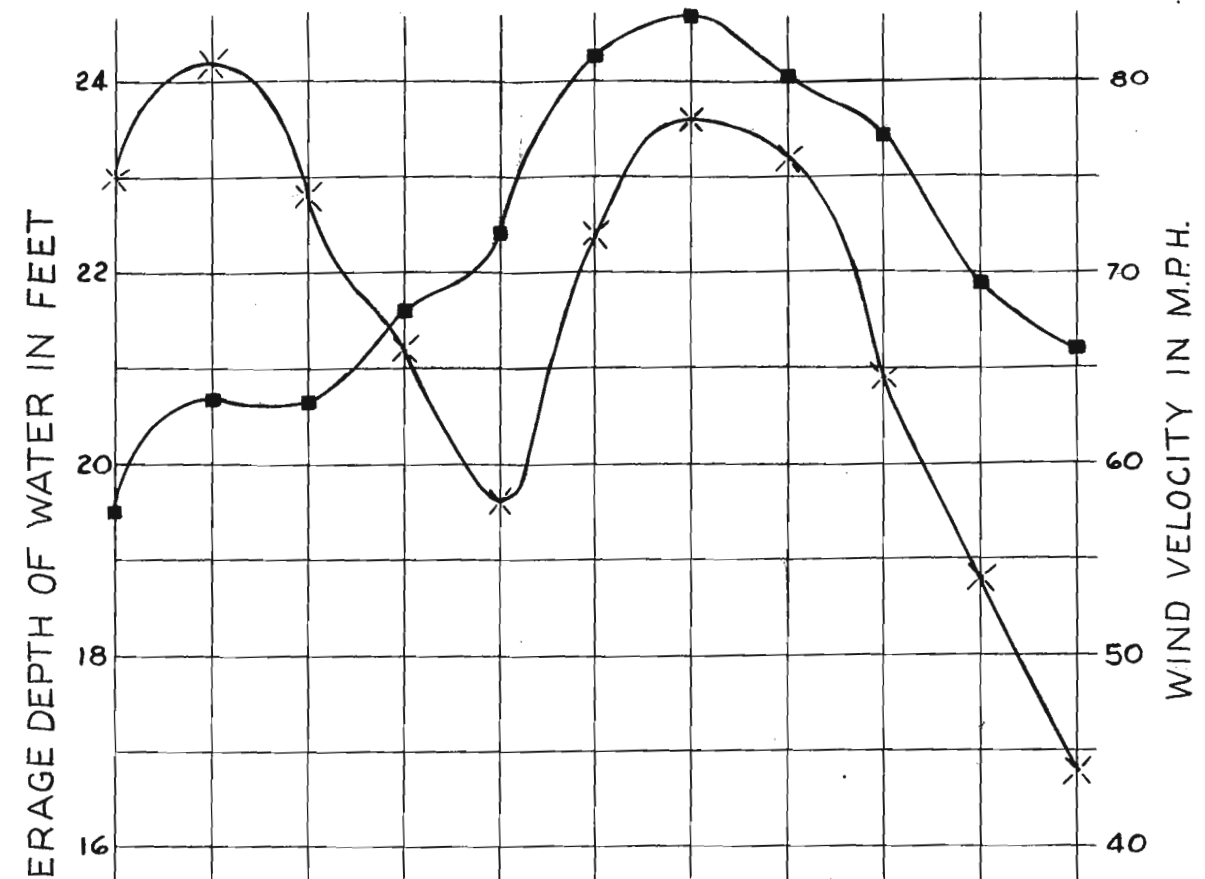

- ✕ = AVERAGE WIND VELOCITY.
- = AVERAGE DEPTH OF WATER (d) ALONG 5 MILE FETCH. Average bottom surface equals -13.5 feet (m.s.l.)
- = WIND TIDE LEVEL.
- ◆ = SIGNIFICANT WAVE ( $H_3$ ) AT TOE OF LEVEE.

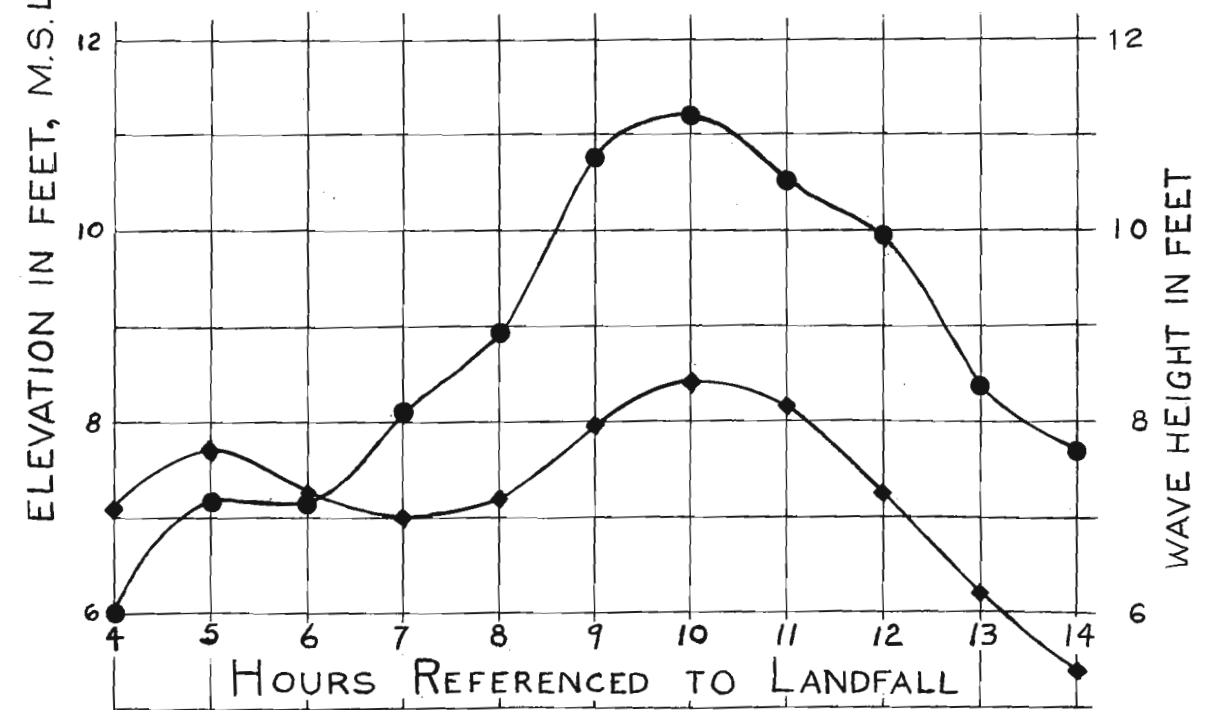
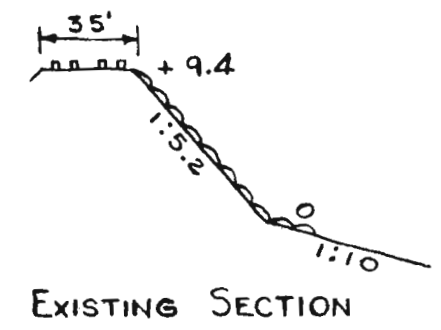

HURRICANE STUDY  
 LAKE PONTCHARTRAIN, LA. AND VICINITY

**CITRUS LAKEFRONT  
 SPH WAVE FACTORS  
 EXISTING CONDITIONS**

U.S. ARMY ENGINEER DISTRICT, NEW ORLEANS  
 CORPS OF ENGINEERS

APRIL 1962 FILE NO. H-2-22077

□ Free-flow - embankment fails at elev. 5.5'  
 ■ Free-flow - embankment holds at elev. 9.4'  
 ○ Wave overtopping - embankment fails at elev. 5.5'  
 ● Wave overtopping - embankment holds at elev. 9.4'  
 Total hourly overflow - acre feet  
 Effective embankment length - 1000 feet

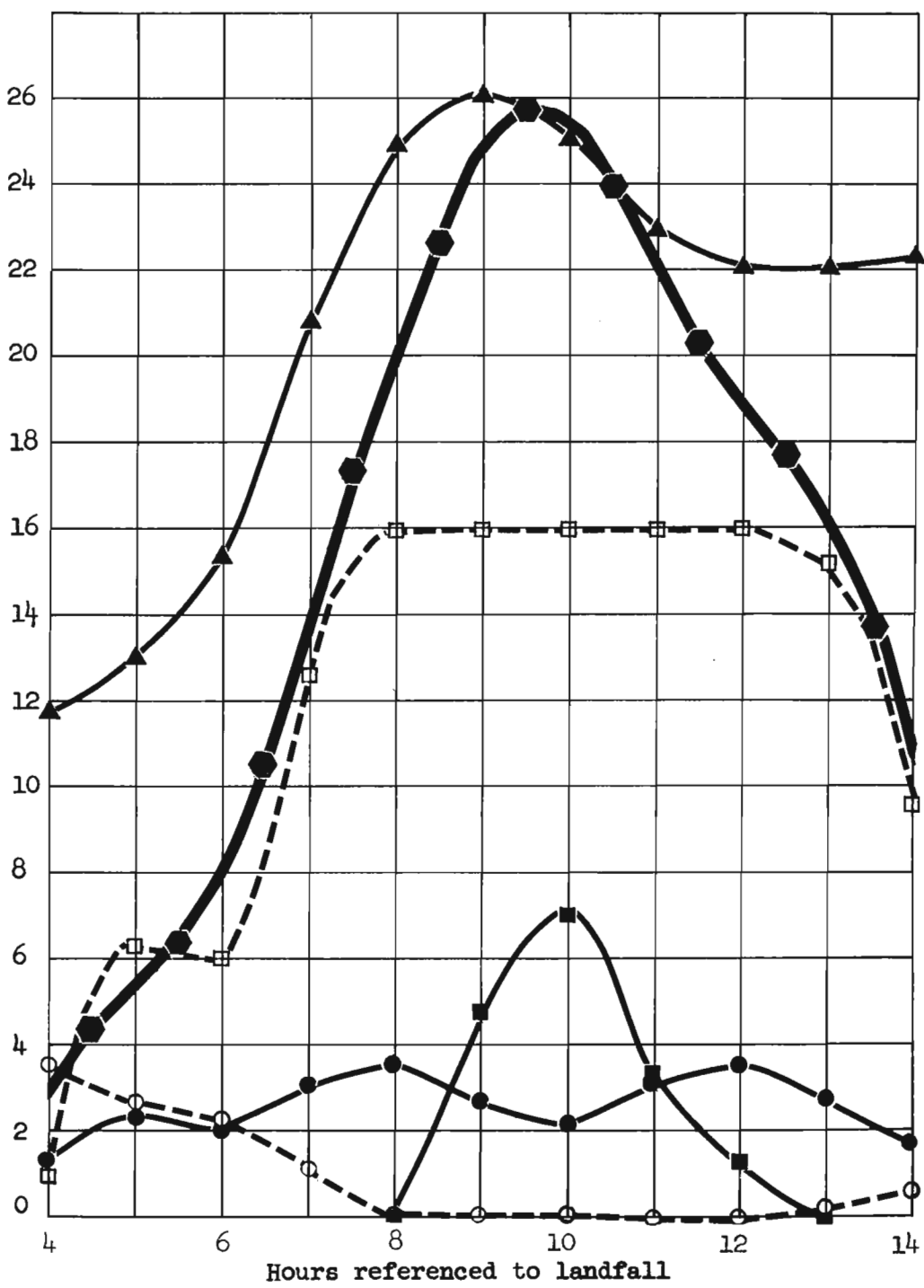

HURRICANE STUDY  
 LAKE PONTCHARTRAIN, LA AND VICINITY  
**CITRUS LAKEFRONT  
 SPH OVERFLOW  
 EXISTING CONDITIONS**  
 U.S. ARMY ENGINEER DISTRICT, NEW ORLEANS  
 CORPS OF ENGINEERS  
 APRIL 1962 FILE NO. H-2-22077

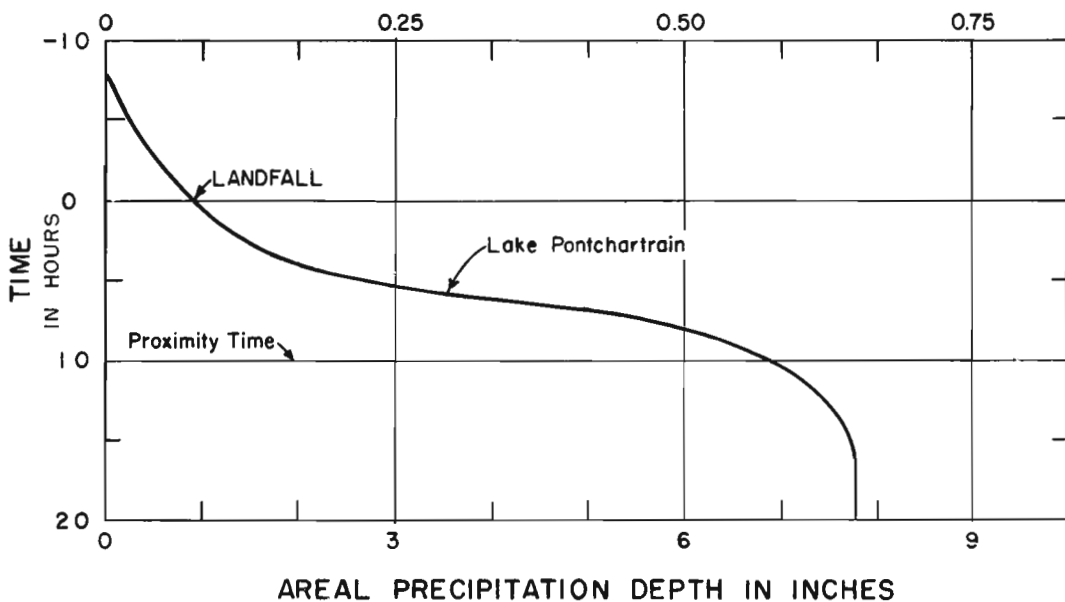
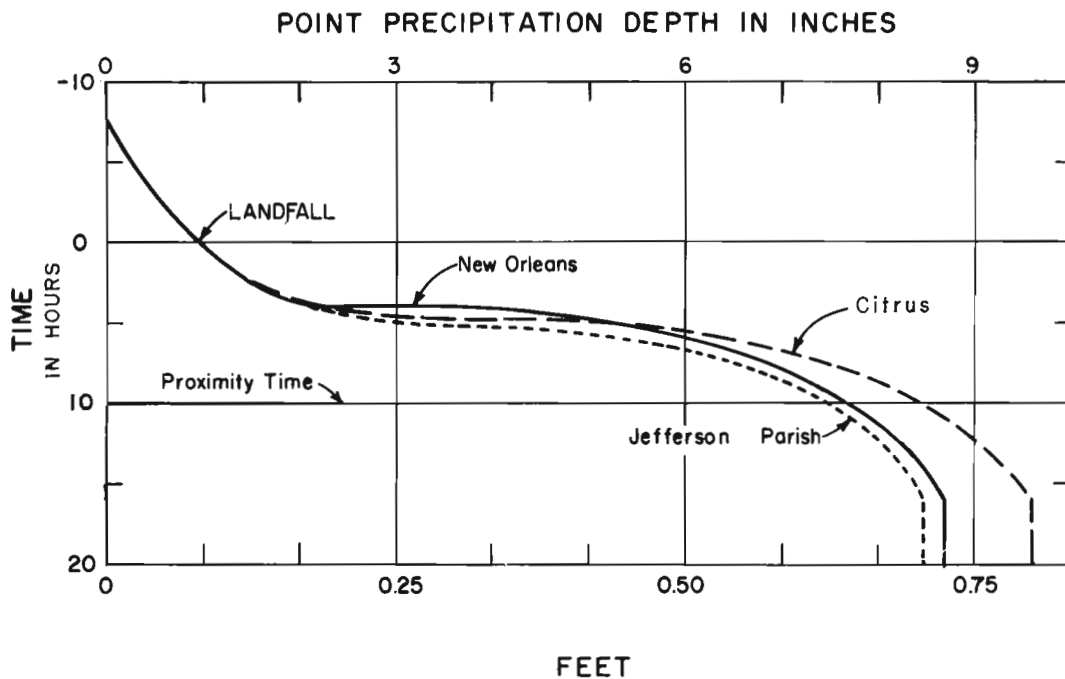

HURRICANE STUDY  
LAKE PONTCHARTRAIN, LA. AND VICINITY

**MASS RAINFALL CURVES**

U.S. ARMY ENGINEER DISTRICT, NEW ORLEANS  
CORPS OF ENGINEERS

APRIL 1962 FILE NO. H-2-22077

Max. SPH WTL=11.0'.  
Max. PMH WTL=12.4'.

Max. SPH WTL=11.1'.  
Max. PMH WTL=12.6'.

ST. CHARLES PARISH

JEFFERSON PARISH

BONNET CARRÉ  
SPILLWAY

AIRLINE  
HIGHWAY

METAIRIE  
ROAD

SPH flooding limits = 8.5'  
PMH flooding limits = 10.0'

SPH flooding limits = 3.7'

PMH flooding limits = 8.1'

M I S S I P P I R I V E R

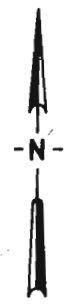

LEGEND

- Probable maximum hurricane flooding
- Standard project hurricane flooding

SCALE OF MILES

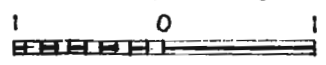

HURRICANE STUDY  
 LAKE PONTCHARTRAIN, LA. AND VICINITY  
 WIND TIDE LEVELS  
 AND FLOODING ELEVATIONS  
 ST. CHARLES AND  
 JEFFERSON PARISHES  
 U.S. ARMY ENGINEER DISTRICT, NEW ORLEANS  
 CORPS OF ENGINEERS  
 APRIL 1962 FILE NO. H-2-22077

LAKE PONTCHARTRAIN

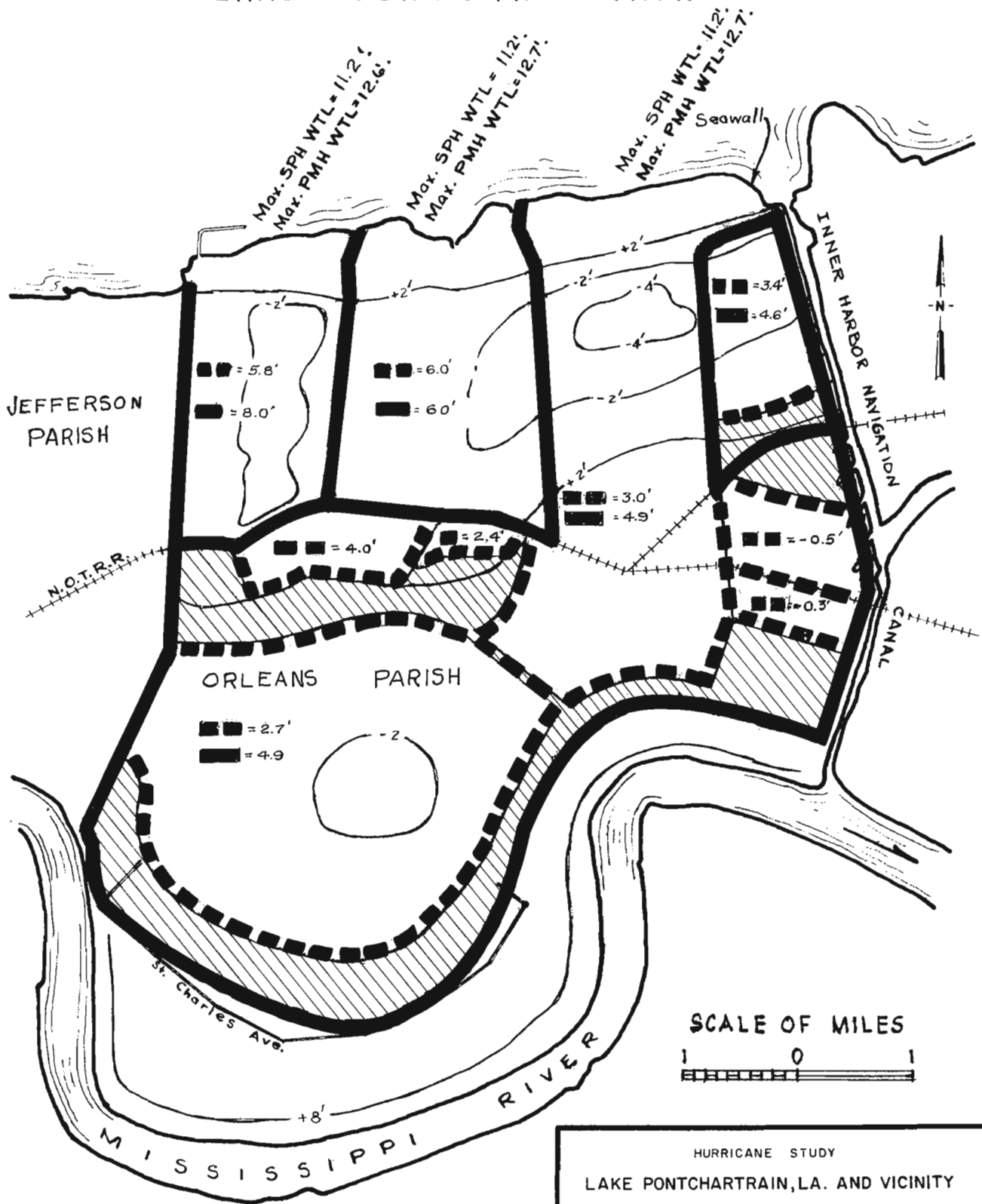

JEFFERSON PARISH

ORLEANS PARISH

N.O.T.R.R.

INNER HARBOR NAVIGATION CANAL

Seawall

St. Charles Ave.

MISSISSIPPI RIVER

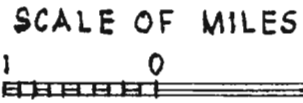

LEGEND

- 3.0' ■■■ Standard project hurricane flooding
- 4.9' - - - Probable maximum hurricane flooding
- //// Not flooded by SPH.

HURRICANE STUDY  
 LAKE PONTCHARTRAIN, LA. AND VICINITY  
**WIND TIDE LEVELS  
 AND FLOODING ELEVATIONS  
 NEW ORLEANS**  
 U.S. ARMY ENGINEER DISTRICT, NEW ORLEANS  
 CORPS OF ENGINEERS  
 APRIL 1962 FILE NO. H-2-22077



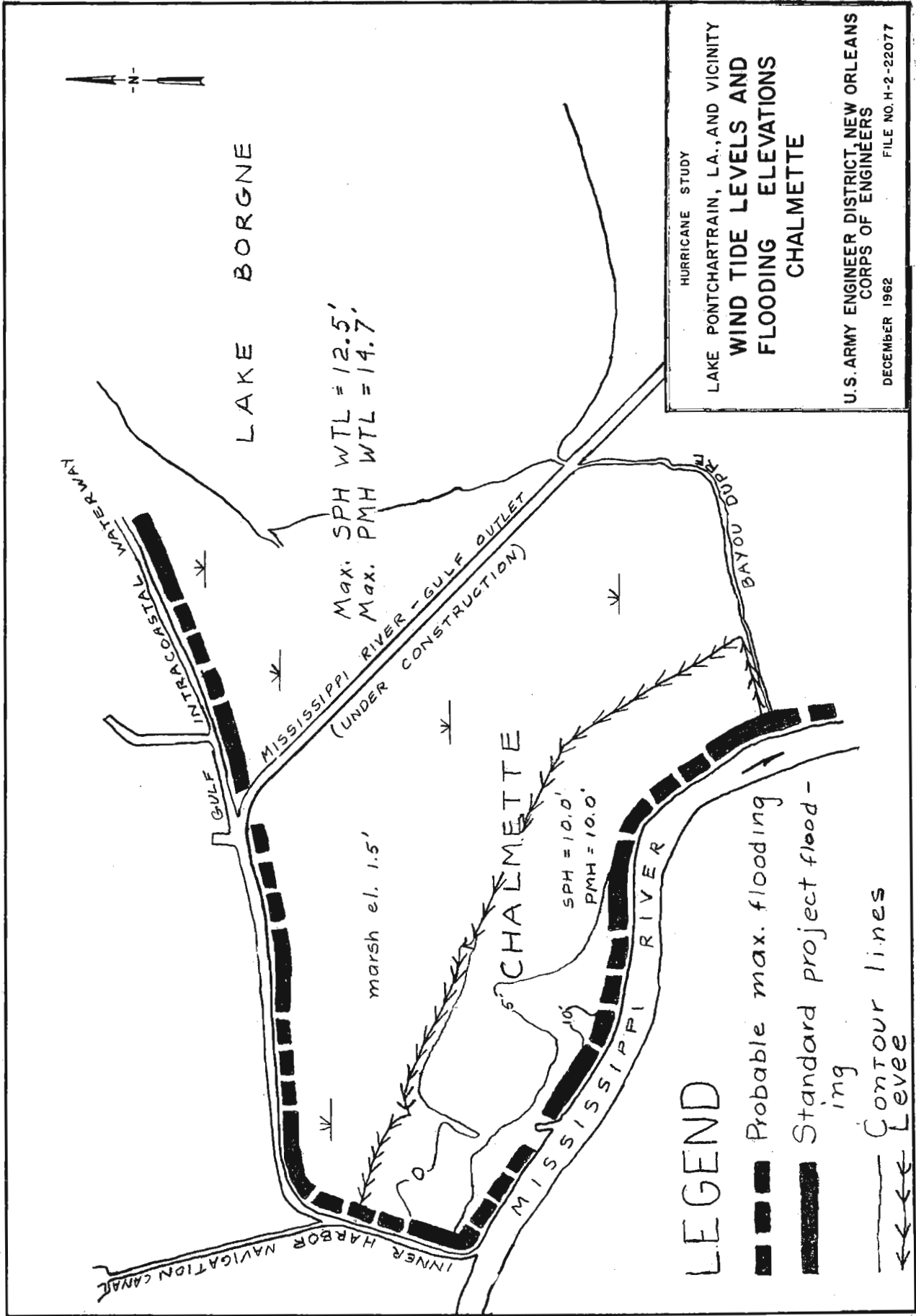



**LEGEND**

- (A) Hurricane tracks from the south
- (B) Hurricane tracks from the east
- (C) Combined hurricane tracks
- (D) Shifted to experienced frequency plot
- ⊙ Experienced stage frequency

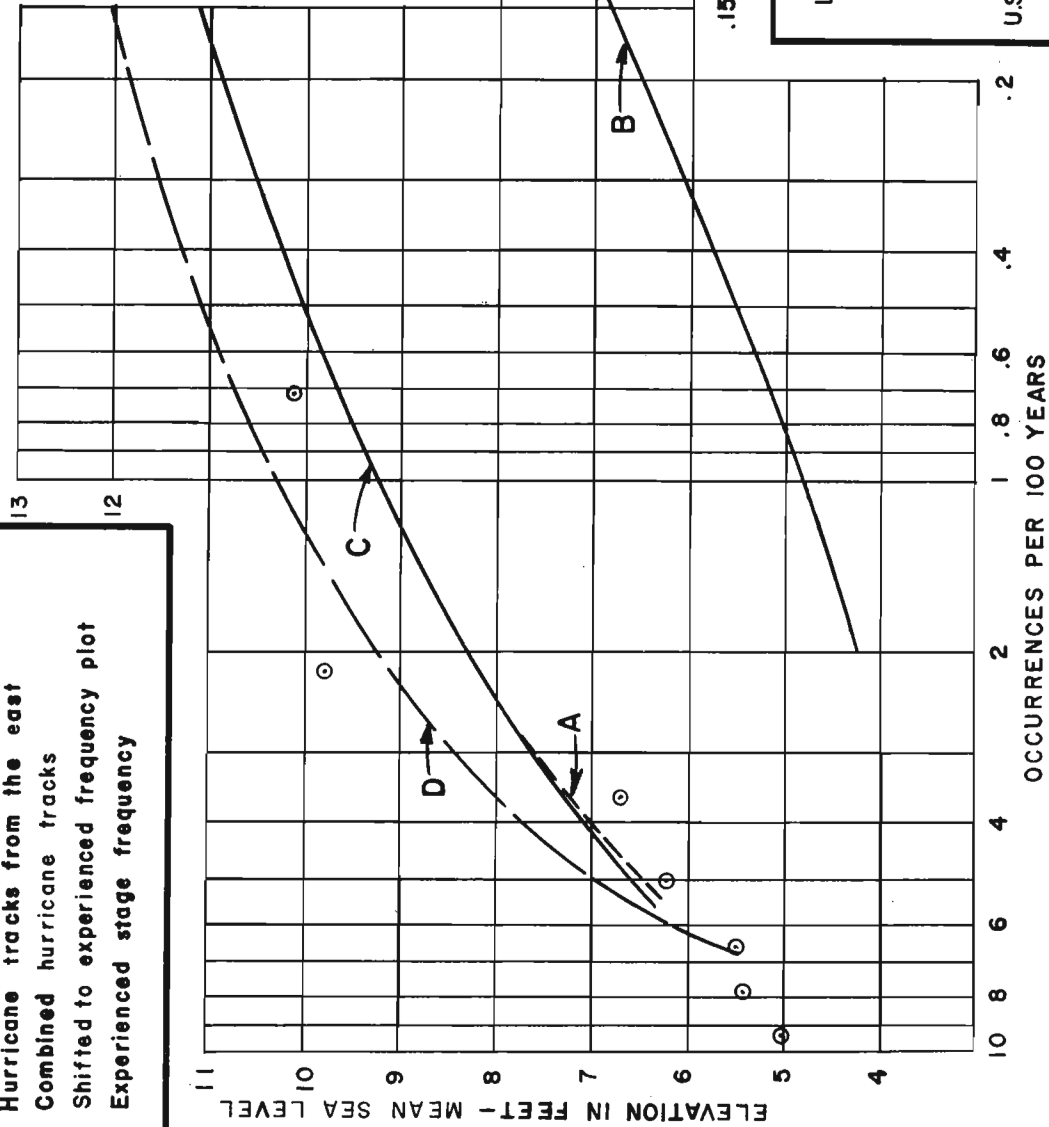

**FREQUENCY ANALYSIS**

M	Years	Wind tide level (ft.)	Probability (1)
1	1901	10.1	.725
2	1893	9.8	2.18
3	1915	6.7	3.62
4	1909	6.2	5.07
5	1947	5.5	6.53
6	1956	5.4	7.98
7	1926	5.0	9.42

(1) Probability  
 $P = \frac{100(M-0.5)}{Y}$  where  
 M = Number of the event (rank)  
 Y = Number of years of record (69)

HURRICANE STUDY  
 LAKE PONTCHARTRAIN, LA. AND VICINITY

**STAGE-FREQUENCY  
 NEW ORLEANS, LA.**

U.S. ARMY ENGINEER DISTRICT, NEW ORLEANS  
 CORPS OF ENGINEERS

APRIL 1962  
 FILE NO. H-2-22077

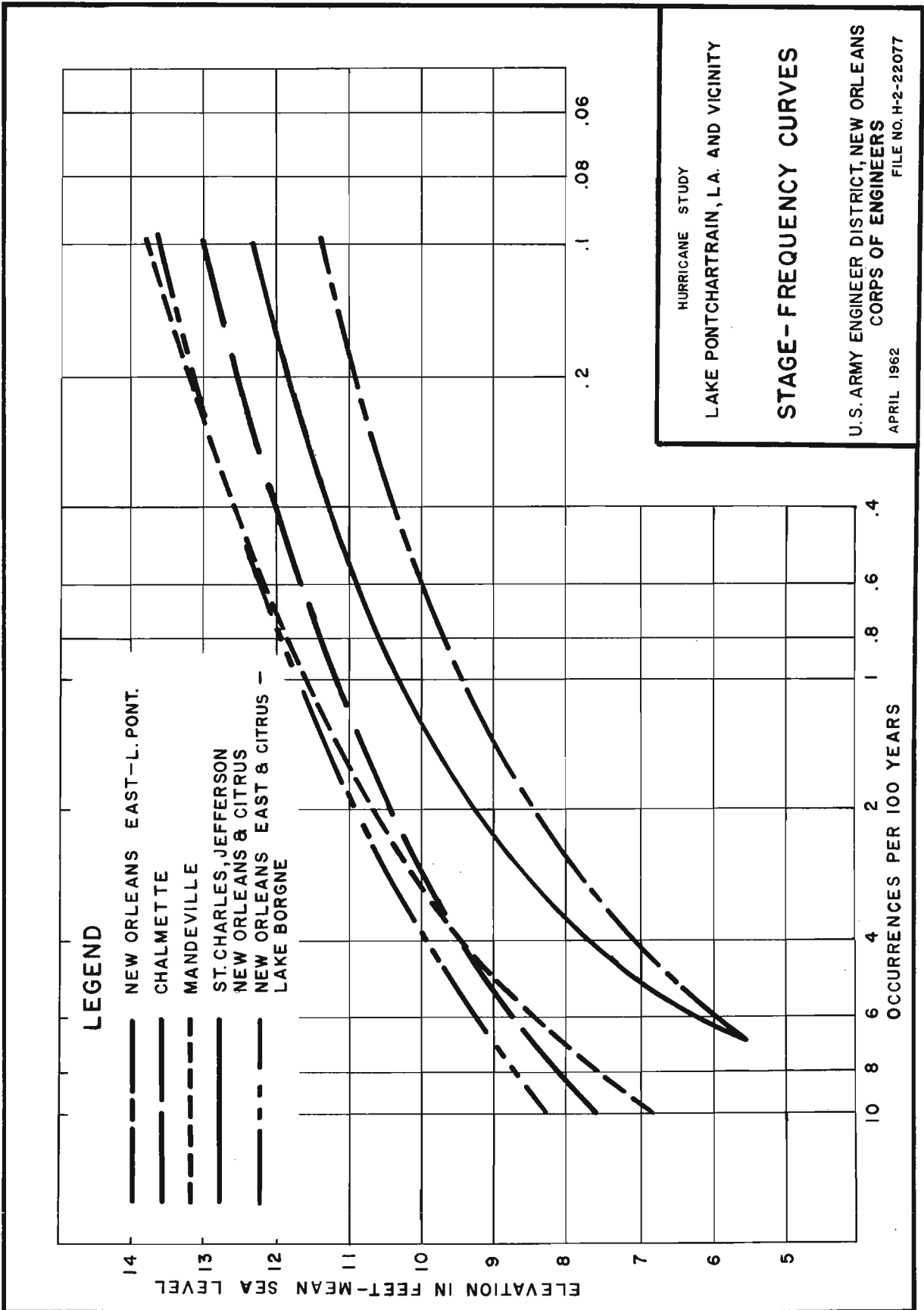

APPENDIX B

GEOLOGY

APPENDIX B

GEOLOGY

<u>Paragraph</u>	<u>Title</u>	<u>Page</u>
B-1	Field exploration	B-1
	North and south shores of Lake Pontchartrain	B-1
	Rigolets barrier site	B-1
	Chef Menteur barrier site	B-1
B-2	Laboratory tests	B-1
	North and south shores of Lake Pontchartrain	B-1
	Rigolets and Chef Menteur barrier sites	B-1
B-3	Soil conditions	B-2
	North shore of Lake Pontchartrain	B-2
	South shore of Lake Pontchartrain	B-2
	Rigolets barrier site	B-2
	Chef Menteur barrier site	B-2
	Chalmette	B-3
B-4	Stability analysis	B-3
B-5	Seepage analysis	B-3
B-6	Settlement analysis	B-4
B-7	Foundation piles	B-4
B-8	Structure excavation dewatering	B-4
	South shore structure	B-4
	Rigolets barrier site	B-4
	Chef Menteur barrier site	B-6
B-9	Permanent pressure relief	B-6
B-10	Steel pile bulkheads and seepage cutoffs	B-6
B-11	Floodwalls	B-6
B-12	Backfill	B-6
B-13	Clay cutoffs	B-7
B-14	Approach channels	B-7
	Rigolets barrier site	B-7
	Chef Menteur barrier site	B-7
B-15	Earthen barriers	B-8
	South shore of Lake Pontchartrain	B-8
	Chalmette	B-9
B-16	Spoil disposal	B-9
B-17	Riprap protection	B-9

PLATES

<u>Plate</u>	<u>Title</u>
B-1	Location map and generalized soil profile of south shore
B-2	Rigolets barrier site - soil profile and boring logs
B-3	Chef Menteur barrier site - soil profile and boring logs

## APPENDIX B

### GEOLOGY

#### B-1 FIELD EXPLORATION

a. North and south shores of Lake Pontchartrain. No additional soil borings were made to investigate the foundation in these areas for the proposed work. Soil boring information from existing projects in the general area was available. A generalized soil profile of the south shore barrier alignment, developed from the available data, is shown on plate B-1.

b. Rigolets barrier site. Ten general type reconnaissance soil borings were made in May 1957 to investigate the foundation. Two additional general type soil borings, numbers 5R-1 and 5R-2, were made in July 1961 to supplement these borings. The soil borings extended to depths of 50 to 60 feet below the ground surface and penetrated to approximate elevation -60 feet m.s.l. Standard split-spoon penetration resistances were obtained in the sands in borings numbered 5R-1 and 5R-2. The locations and logs of the borings are shown on plates 6 and B-2, respectively. A generalized soil profile of the foundation along the proposed barrier alignment is shown on plate B-2.

c. Chef Menteur barrier site. Eight general type reconnaissance soil borings were made in April 1957 to investigate the foundation. Five additional general type soil borings, numbers 5M-1 through 5M-5, were made in July and August 1961 to supplement these borings. The soil borings extended to depths of 50 to 60 feet below the ground surface and penetrated to approximate elevation -60 feet m.s.l. Standard split-spoon penetration resistances were obtained in the sands in borings numbered 5M-1 through 5M-5. The locations and logs of the borings are shown on plates 5 and B-3, respectively. A generalized soil profile of the foundation along the proposed barrier alignment is shown on plate B-3.

#### B-2 LABORATORY TESTS

a. North and south shores of Lake Pontchartrain. Laboratory test data consisting of visual classification, water content, liquid and plastic limits, and shear and consolidation tests were available from the soil borings made for other projects in the general area.

b. Rigolets and Chef Menteur barrier sites. Visual classification and water content determinations were made on all samples obtained from the soil borings. Unconfined compression (UC) shear tests were run on small cores of representative samples of the cohesive soils from the borings. Grain size determinations were made

on representative samples of the silts and sands. The results of these tests are shown on the soil boring logs on plates B-2 and B-3.

### B-3 SOIL CONDITIONS

a. North shore of Lake Pontchartrain. The available geologic and soils data indicate that the subsurface consists of overconsolidated Pleistocene clay soils with silts and sands of Recent origin in the lake bed and stream valleys.

b. South shore of Lake Pontchartrain. The available soil data from other projects in the general area indicate that the soils from the ground surface to approximate elevation -60 feet m.s.l. on the west, and elevation -40 feet m.s.l. on the east are predominantly soft fat clays of Recent origin overlying the overconsolidated clays of the Pleistocene formation. The upper 20 to 30 feet of the Recent deposit consists of very soft highly organic clays and peats of an extremely compressible nature. The lower portion of the stratum contains thin layers of silt and sand with traces of shell. The conformation of the Recent clay stratum is disrupted in the vicinity of the London and Inner Harbor Navigation Canals by an ancient buried sand beach which lies in a southwest to northeasterly direction across the general area.

c. Rigolets barrier site. The soil boring data indicate the subsurface at the Rigolets site consists of a surface layer of very soft fat clay of Recent origin, approximately 10 to 20 feet thick, overlying the overconsolidated clay crust of the Pleistocene formation. On the south, in the vicinity of the proposed barrier control structure site, the Recent clay stratum is approximately 20 feet thick and thins to approximately 10 feet in the vicinity of the proposed lock site on the north. The Pleistocene formation, underlying the Recent clay stratum, consists of strata of clay, silt, and sand topped by a highly overconsolidated fat clay crust. South of the proposed barrier control structure site the Pleistocene formation consists predominantly of layers of clay and silt. In the immediate vicinity of the control structure site, a transition occurs under the thin clay crust of the Pleistocene formation, from clays and silts to fine sand which continues beyond the proposed lock site on the north. This pervious deposit contains a few thin layers of silt and clay and exhibits densities which range from loose at the top to dense at the bottom of the stratum. The Rigolets, in the vicinity of the proposed closure damsite, has cut through the clayey soils and lies entrenched in the fine sands to an approximate depth of 33 feet below ground surface.

d. Chef Menteur barrier site. The soil boring data indicate that the soil foundation along the Chef Menteur barrier site consists of a stratum of Recent soils, 37 to 42 feet thick, overlying overconsolidated clays of the Pleistocene formation. On the west, between the existing highway and Bayou Sauvage, the Recent stratum

extends approximately 40 feet below the ground surface and consists of very soft to soft fat clays containing organic matter in the upper part and thin silt and sand layers in the lower part. Along the remainder of the barrier alignment, which borders the Chef, the Recent overburden consists of a surface layer of fat clay, 10 to 20 feet thick, overlying silts and fine sands which extend to a depth of approximately 37 feet below ground surface. This pervious deposit of Recent silts and sands contains a few thin layers of soft fat clay and exhibits densities which range from loose at the top to dense at the bottom of the stratum. The Pleistocene formation, underlying the Recent soil stratum, consists predominantly of fat clays with some thin layers of silt. The highly oxidized, overconsolidated clay crust is approximately 12 to 15 feet thick but abruptly changes to grey fat clays of medium consistency, indicating that a considerable portion of the original Pleistocene surface has been eroded away during its past history. Chef Menteur Pass, in the vicinity of the proposed closure damsite, has cut through the clays and sands of the Recent stratum and lies entrenched in the overconsolidated clays of the Pleistocene formation to an approximate depth of 50 feet below ground surface.

e. Chalmette. The available soil data from other projects in the general area and geologic information indicate that the soils from the ground surface to approximate elevation -40 feet m.s.l. on the east, and elevation -60 on the west are predominantly fat clays of Recent origin overlying the Pleistocene. The upper 10 to 15 feet at the surface of the Recent deposit consists of very soft highly organic clays and peats of an extremely compressible nature. The remaining portion of the Recent clay stratum consists of soft fat clays with some silt lenses.

#### B-4 STABILITY ANALYSIS

Based on assigned (S) shear strength of  $\phi=23^\circ$  and  $C=0$ , and available (Q) shear test data for the Recent clays; and an assigned shear value of  $\phi=30^\circ$  and  $C=0$  for the sand, stability analyses for the structure excavation slopes, navigation and control structure approach channel slopes, levee and closure dam embankment sections, berm distances and sheet pile bulkheads were determined by the method of planes. Factors of safety of 1.2 and 1.5 were applied in the design of the earthen sections and sheet pile bulkheads, respectively. The design sections used for cost estimates are shown on plates 5 thru 13.

#### B-5 SEEPAGE ANALYSIS

Based on available soils and grain size data, seepage analyses were performed and quantities of seepage estimated by applying a coefficient of permeability value approximated from the  $D_{10}$  grain sizes of the pervious soils. The proposed sheet pile cutoffs were

considered effective in lengthening the seepage path, but ineffectual in reducing potential uplift pressure.

#### B-6 SETTLEMENT ANALYSIS

Based on available soil classification, water content, liquid limit, and consolidation data, generalized settlement analyses were performed to determine the approximate gross yardage required in the earthen barrier sections. Adequate allowances have been made for this settlement and shrinkage during and after construction in the computation for quantities of fill required. Because of the large amount of settlement that will occur on the levees, and the impracticability of providing sufficient fill in one lift to compensate for this settlement, the levees will be constructed in stages as shown in the following tabulation.

#### B-7 FOUNDATION PILES

Based on the available (Q) shear strengths from the boring data and an assigned (S) shear strength of  $\phi=30^{\circ}$  and  $C=0$ , foundation pile lengths were determined with a factor of safety of 2.0 applied to the anticipated design loads. Only the sands and Pleistocene soils were considered to offer resistance to penetration in determining the pile lengths.

#### B-8 STRUCTURE EXCAVATION DEWATERING

a. South shore structure. The Seabrook Lock will be constructed in Lake Pontchartrain at the Inner Harbor Navigation Canal. The lock will consist of an open chamber with cylindrical concrete pile walls between monolithic concrete sector type gate bays. Construction dewatering for the gate bays will consist of pumps for dewatering the sheet pile enclosure and deep 8-inch diameter relief wells on 25-foot spacing penetrating to elevation -40 feet m.s.l. for hydrostatic pressure relief and interception of seepage through the sheet piles. The chambered section will be constructed without dewatering.

b. Rigolets barrier site.

(1) Control structure excavation. A two-stage well point system installed around the lower portion of the excavation will be required to intercept seepage and relieve uplift pressures in the foundation silty sands. Collection ditches, sumps, and pumps will be required to remove surface runoff water from the excavation slopes.

(2) Lock structure excavation. A single-stage well point system installed around the lower portion of the gate excavations will be required to lower the uplift pressure and intercept seepage from the foundation sands. The concrete sheet pile chamber section will be excavated without dewatering.



CONSTRUCTION SCHEDULES

<u>Area</u>	<u>Feature</u>	<u>No. of lifts</u>	<u>Casting</u>	<u>Shaping</u>	<u>Total years</u>
St. Charles	Front	5	2	3	8
	Return	5	2	3	8
	Closure	3	1	2	4
Jefferson	Front	1	1	-	1
New Orleans	Front	1	1	-	1
	Inner Harbor Navigation Canal	1	1	-	1
Citrus	Front	5	2	3	8
	Back	6	3	3	10
	Inner Harbor Navigation Canal	1	1	-	1
New Orleans East	Front	5	2	3	8
	Back	6	3	3	10
Barrier levee	Side	1	1	-	1
Rigolets & Chef Mentour	Structures	1	1	-	1-2
	Levees	3	1	2	4
	Closure	3	1	2	4
Chalmette	Gulf Outlet, West of Paris Road	4	1	3	6
	Gulf Outlet, East of Paris Road	5	1	4	8
	Bayou Dupre	6	3	3	10
	Inner Harbor Navigation Canal	1	1	-	1

c. Chef Menteur barrier site.

(1) Control structure excavation. A two-stage well point system installed around the lower portion of the excavation will be required to intercept seepage from the sandy slopes and relief uplift pressures in the foundation.

(2) Floodgate structure excavation. A single-stage well point system installed around the lower portion of the excavation will be required to relief uplift pressures in the foundation. Collection ditches, sumps, and pumps will be required to remove surface runoff water from the excavation slopes.

B-9 PERMANENT PRESSURE RELIEF

Pressure relief facilities will be required at the Rigolets and Chef Menteur structure sites. Graded filters will be required beneath all of the proposed structures in the barrier alignment. Relief wells in the foundation will be required beneath the control structures at both sites and beneath the floodgate structure at the Chef Menteur site and beneath the Seabrook lock gates. Pressure relief outlets and collectors in the filter blanket will be required at the Rigolets lock gate in the barrier alignment.

B-10 STEEL PILE BULKHEADS AND SEEPAGE CUTOFFS

Steel sheet pile anchored bulkheads will be required at each end of the floodgate at the Chef Menteur site and the lock structure at the Rigolets site to retain the backfill adjacent to the walls. Sheet pile anchored bulkheads will also be required adjacent to each approach abutment at the control structures to retain the earthen embankments. Steel sheet pile cutoffs will be required beneath the structures, floodwalls, and lock gates to provide protection against hazardous seepage.

B-11 FLOODWALLS

Reinforced concrete, I-type floodwalls, with sheet pile cutoffs, will be required adjacent to the floodgate and lock structures tying-in the gate monoliths and the levees.

B-12 BACKFILL

Sand backfill, with a 3-foot clay blanket cover, will be required adjacent to the walls of the floodgates and lock gates at the Chef Menteur and Rigolets sites with random backfill outside of the sand backfill. A 5-foot clay blanket will be required at the Rigolets lock site between the sand backfill and the foundation sands to prevent excessive hydrostatic heads from developing in the sand backfills adjacent to the structure walls. Soils for the construction of the random backfill and clay blankets can be obtained

from the excavation spoils and from partial excavations in the approach channel areas. Sufficient suitable sand will be available from the excavation spoils at the Rigolets and Chef Menteur sites for the required sand backfill at the floodgate structures.

### B-13 CLAY CUTOFFS

Clay cutoffs in the sand backfills, 5 feet thick on each side of the steel sheet piles beneath the floodwalls, will be required at all of the floodgate and lock structures that have backfill and will extend to the foundation clay or clay blanket. Material for the clay backfill can be obtained from the structure excavation spoils.

### B-14 APPROACH CHANNELS

#### a. Rigolets barrier site.

(1) Control structure approach channel. The channel will have a 1,150-foot bottom width at elevation -20 feet m.s.l. at the structure sill and will flare outward from the channel centerline at a  $12\frac{1}{2}^{\circ}$  angle from each side of the structure. On the Rigolets side, the channel bottom will slope downward from the structure along a 1 on 10 slope to elevation -32.5 feet m.s.l. and continue at this elevation toward the Rigolets. On the Lake Pontchartrain side, the channel bottom will slope downward from the structure along a 1 on 10 slope to elevation -30 feet m.s.l. and remain flat for a distance of 100 feet, thence slope upward along a 1 on 10 slope to elevation -20 feet m.s.l. and continue at this elevation to the lake. The channel side slopes will be 1 on 3 from the bottom of the channel to the surface of the ground.

(2) Navigation channel. The navigation channel to the proposed lock will have a 100-foot bottom width at elevation -14 feet m.s.l. with a 2-foot overdepth and 1 on 3 side slopes to the surface of the ground.

#### b. Chef Menteur barrier site.

(1) Control structure approach channel. The channel will have a 400-foot bottom width at elevation -25 feet m.s.l. at the structure sill and will flare outward from the channel centerline at a  $12\frac{1}{2}^{\circ}$  angle from each side of the structure. The channel bottom will slope downward from each side of the structure along a 1 on 10 slope until it intersects the bottom of the existing Chef Menteur channel. The channel side slopes will be 1 on 3 from the bottom of the channel to the surface of the ground.

(2) Navigation channel. The navigation channel to the proposed floodgate will have a 100-foot bottom width at elevation -12 feet m.s.l. with a 2-foot overdepth and 1 on 3 side slopes to the surface of the ground.

## B-15 EARTHEN BARRIERS

a. South shore of Lake Pontchartrain. The proposed barrier levee protection along the lakefront extends from the east levee of the Bonnet Carre Spillway on the west to the south point on the east and encompasses five reaches as shown in plan on plate B-1. In addition to the proposed lakefront protection, some new levee construction and raising of existing levees are necessary along return canals and back levees in the area to be protected. A levee will also be required at the Seabrook Lock tying the south shore levee to the lock structure in Lake Pontchartrain.

(1) St. Charles Parish. A new levee will be required along the lakefront. The proposed levee will be built with Pleistocene material pumped by hydraulic dredge methods from adjacent borrow areas in Lake Pontchartrain. The levee section used for the cost estimate is shown on plate 10.

(2) Jefferson Parish. The existing levee will furnish the necessary protection and no new work is contemplated under this project other than wave wash protection.

(3) Orleans Parish.

(a) Jefferson Parish line to Inner Harbor Navigation Canal. Lakeside enlargement of the existing levee is required along the lakefront. The proposed enlargement will be built with material hauled from either the Mississippi River batture, Bonnet Carre Spillway, or other sources. The levee section used for the cost estimate is shown on plate 10. It will be necessary to furnish additional protection along the Inner Harbor Navigation Canal west side levee as shown on plate 11. A new levee is required at the Seabrook Lock tying the lakefront levee to the lock structure and will consist of a shell core covered with riprap, with derrick stone on the lakeside, as shown on plate 9.

(b) Citrus area. New levee construction will be required along the lakefront on the lakeside of the existing Southern Railway embankment. The proposed levee will be built with Pleistocene material pumped by hydraulic dredge methods from adjacent borrow areas in Lake Pontchartrain. The levee section used for the cost estimate is shown on plate 10. Landside enlargement of the existing back levee is required as shown in section on plate 11. It will be necessary to furnish additional protection along the Inner Harbor Navigation Canal east side levee as shown in section on plate 11.

(c) New Orleans East area. New levee construction will be required along the lakefront on the lakeside of the existing Southern Railway embankment. The proposed levee will be built with Pleistocene material pumped by hydraulic dredge methods from adjacent

borrow areas in Lake Pontchartrain. The levee section used for the cost estimate is shown on plate 10. Landside enlargements of the existing back levees and the return levee are required as shown in section on plate 11.

(d) Rigolets and Chef Menteur barrier sites.

Gulfside levee protection is required on the existing highway embankments at each end of the barrier line at the Rigolets, and on the west of the barrier line at Chef Menteur. The proposed levees will be built with material cast by dragline methods from gulfside borrow areas. The extent of the required protection is shown in plan on plates 5 and 6. Earthen barriers in the form of tie-in levees, closure dams across the Rigolets and Chef Menteur and highway approach embankments to the control structure at the Rigolets are required to complete the barrier lines between the highways at the two sites. The proposed earthen sections will be built with Pleistocene and Recent fill material pumped by hydraulic dredge methods from structure and channel excavations and from adjacent lakeside borrow areas. Sections used for cost estimates at the Rigolets and the Chef are shown on plate 7.

b. Chalmette. Levee protection is required along the southside of the Gulf Intracoastal Waterway from the Inner Harbor Navigation Lock to the junction of the Mississippi River-Gulf Outlet, thence along the southside of the Mississippi River-Gulf Outlet to Bayou Dupre, thence along the eastside of Bayou Dupre to Violet Lock. The proposed levee will be built on the existing spoil banks along the Gulf Intracoastal Waterway and the Mississippi River-Gulf Outlet, and built with material obtained from the existing spoil on the south or widening and deepening the Mississippi River-Gulf Outlet channel. The proposed levee from the Mississippi River-Gulf Outlet to Violet Lock, along the eastside of Bayou Dupre, will be built with material obtained by hydraulic methods from side borrow on the Lake Borgne side of Bayou Dupre. The proposed levee sections are shown on plate 11.

B-16 SPOIL DISPOSAL

Rigolets and Chef Menteur barrier sites. Spoil from the control structure excavations and approach channels will be used in the adjacent earthen embankments and closure dams. Spoil from the floodgate structure excavations will be placed in temporary spoil areas adjacent to the worksites and used later for structure backfill. Material excavated for the navigation channels will be used in the tie-in levees where practicable, or placed in spoil banks adjacent to the channels.

B-17 RIPRAP PROTECTION

The extent of riprap protection required is shown on the drawings.

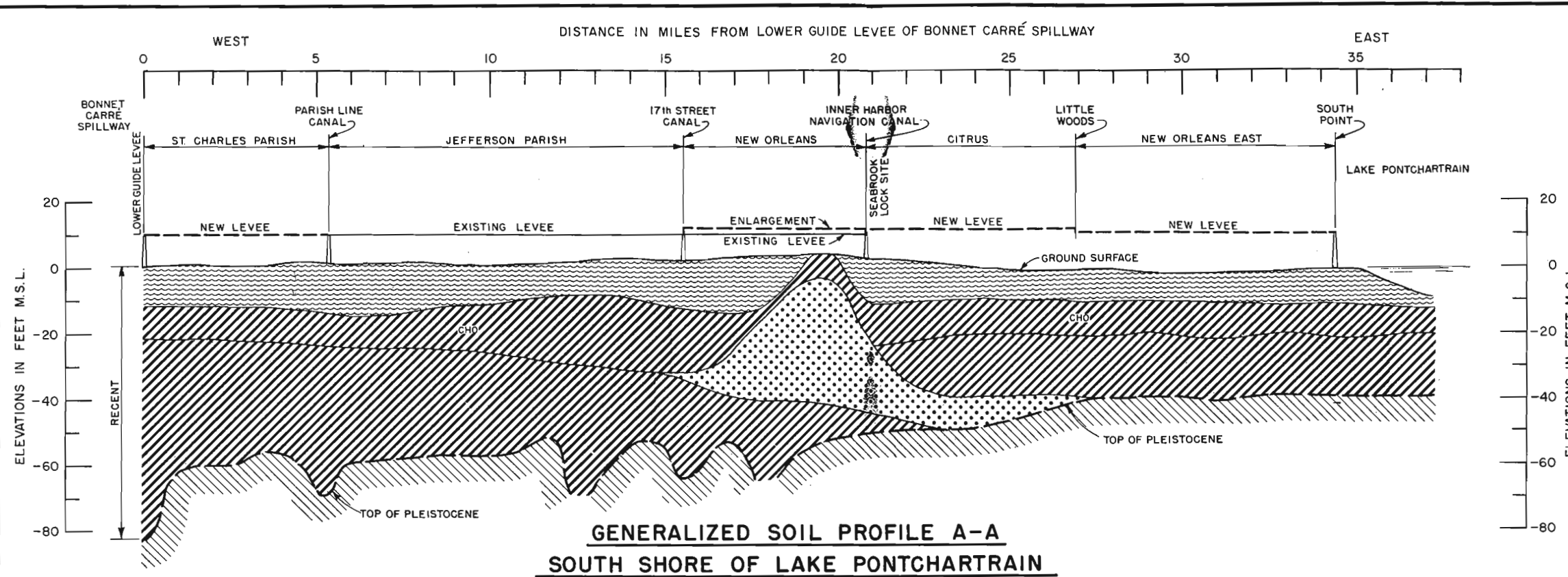

**LEGEND**

	(Pt) PEAT
	(CHO) FAT CLAY, WITH ORGANIC MATTER
	(CH) FAT CLAY
	(SP) SAND, FINE (POORLY GRADED)
	TOP OF PLEISTOCENE

**GENERALIZED SOIL PROFILE A-A  
SOUTH SHORE OF LAKE PONTCHARTRAIN**

**GENERAL NOTES**

For the Rigolets and Chef Menteur soil profiles and soil boring logs see Plates B-2 and B-3.  
 For the Rigolets and Chef Menteur detail plan and profiles of structures and earthen embankments see Plates 5, 6, 7 and 10.  
 For north shore seawall strengthening plan see Plate 10.  
 For south shore structures and earthen embankments see Plates 10, 11 and 12.

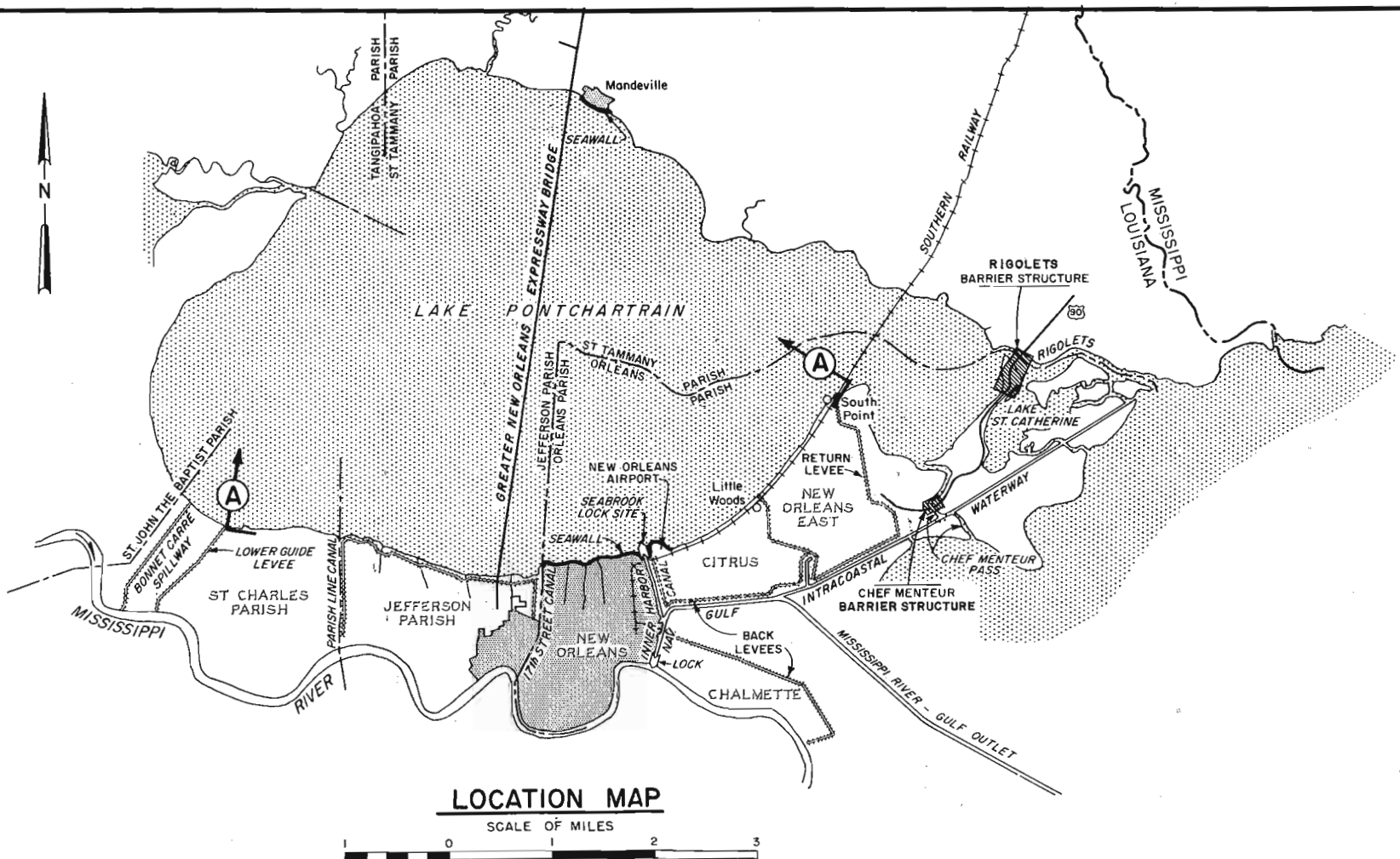

**LOCATION MAP**  
SCALE OF MILES

HURRICANE STUDY  
 LAKE PONTCHARTRAIN, LA. AND VICINITY

**LOCATION MAP  
AND GENERALIZED SOIL PROFILE  
OF SOUTH SHORE**

SCALE AS SHOWN  
 U.S. ARMY ENGINEER DISTRICT, NEW ORLEANS, LA.  
 CORPS OF ENGINEERS

DATE: APRIL 1962 FILE NO. H-2-22077

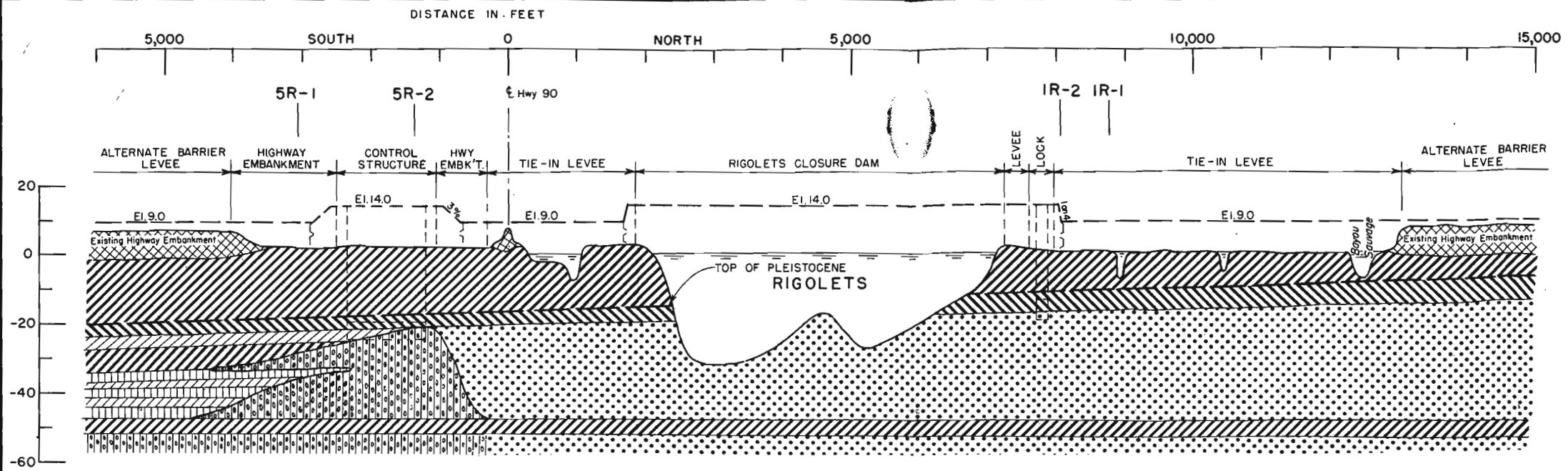

**GENERALIZED SOIL PROFILE**

- LEGEND**
- PEAT (Pt)
  - FAT CLAY (CHO) (with Organic Matter)
  - FAT CLAY (CH)
  - LEAN CLAY (CL)
  - SILTY SAND (SM)
  - SANDY SILT (ML)
  - FINE SAND (SP) (Poorly Graded)
  - TOP OF PLEISTOCENE
  - 47 WATER CONTENT
  - 402 UNIT COHESIVE STRENGTH IN LBS./SQ. FT.
  - (18) STANDARD SPLIT SPOON PENETRATION RESISTANCE IN BLOWS PER FOOT
  - 0.200 D<sub>10</sub> GRAIN SIZE

**GENERAL NOTES**

For location of soil borings, structure, and earthen embankment sections, see plates 6, 7, and 8.  
 For Chef Menteur site soil data see plate B-3.  
 For South Shore of Lake Pontchartrain barrier line soil profile see plate B-1.  
 Soil samples were taken with a 1 7/8" I.D. Core Barrel Sampler in the cohesive soils and a 1 3/8" I.D., 2" O.D. Standard Split Spoon Sampler in sandy soils where penetration resistances are shown.  
 Borings 5R-1 and 5R-2 were taken in July 1961, remainder were taken in May 1957.  
 All elevations are in feet and refer to mean sea level.

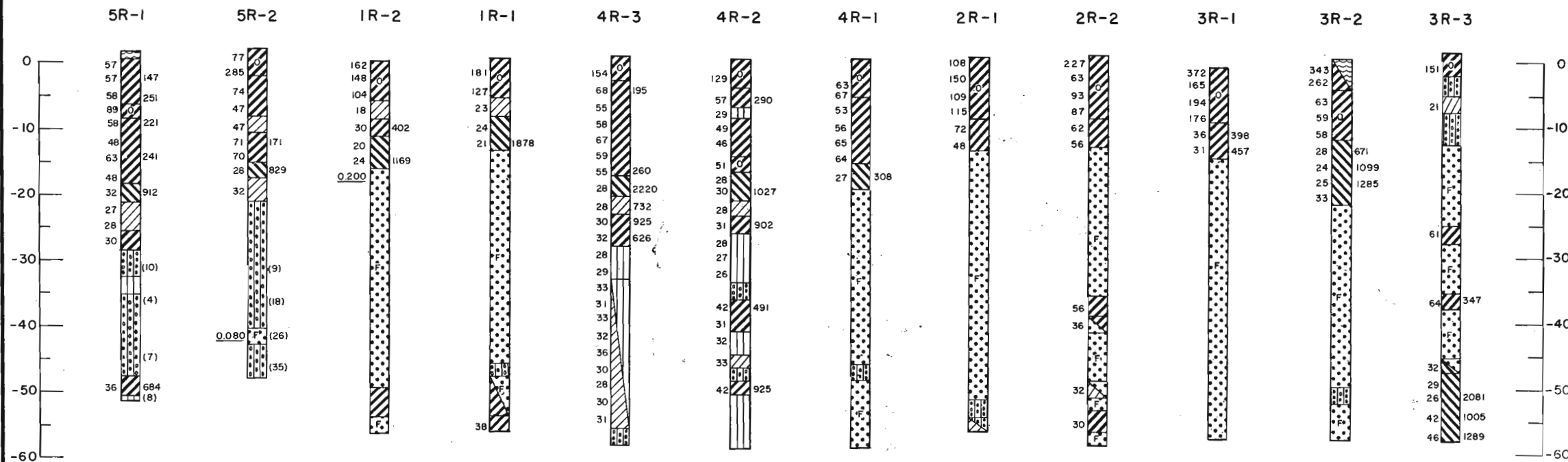

**SOIL BORING LOGS**

HURRICANE STUDY  
 LAKE PONTCHARTRAIN, LA. AND VICINITY  
**RIGOLETS BARRIER SITE  
 SOIL PROFILE AND  
 BORING LOGS**  
 SCALE AS SHOWN  
 U.S. ARMY ENGINEER DISTRICT, NEW ORLEANS, LA.  
 CORPS OF ENGINEERS  
 DATE: APRIL 1962 FILE NO. H-2-22077



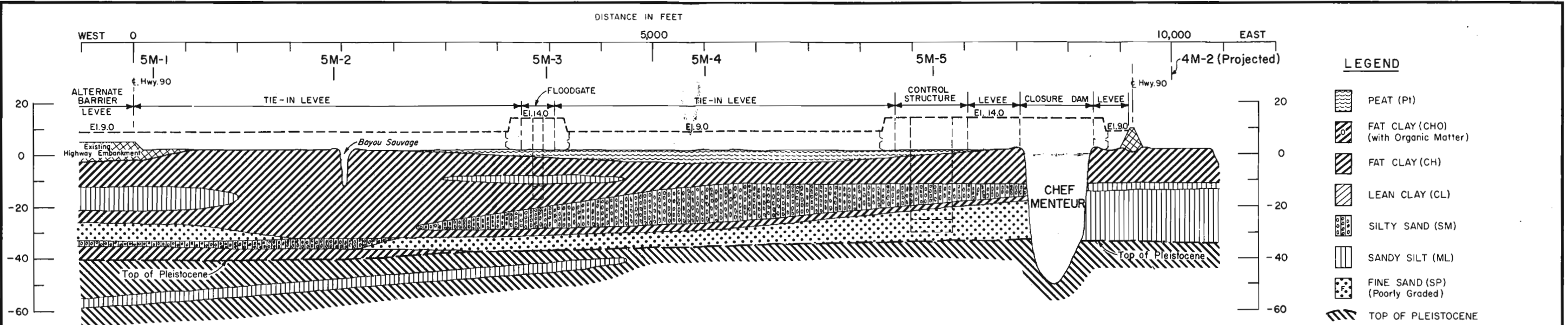

**GENERALIZED SOIL PROFILE**

- LEGEND**
- PEAT (P1)
  - FAT CLAY (CHO) (with Organic Matter)
  - FAT CLAY (CH)
  - LEAN CLAY (CL)
  - SILTY SAND (SM)
  - SANDY SILT (ML)
  - FINE SAND (SP) (Poorly Graded)
  - TOP OF PLEISTOCENE
  - 4.7 WATER CONTENT
  - 402 UNIT COHESIVE STRENGTH IN LBS./SQ. FT.
  - (18) STANDARD SPLIT SPOON PENETRATION RESISTANCE IN BLOWS PER FOOT
  - 0.200 D<sub>10</sub> GRAIN SIZE

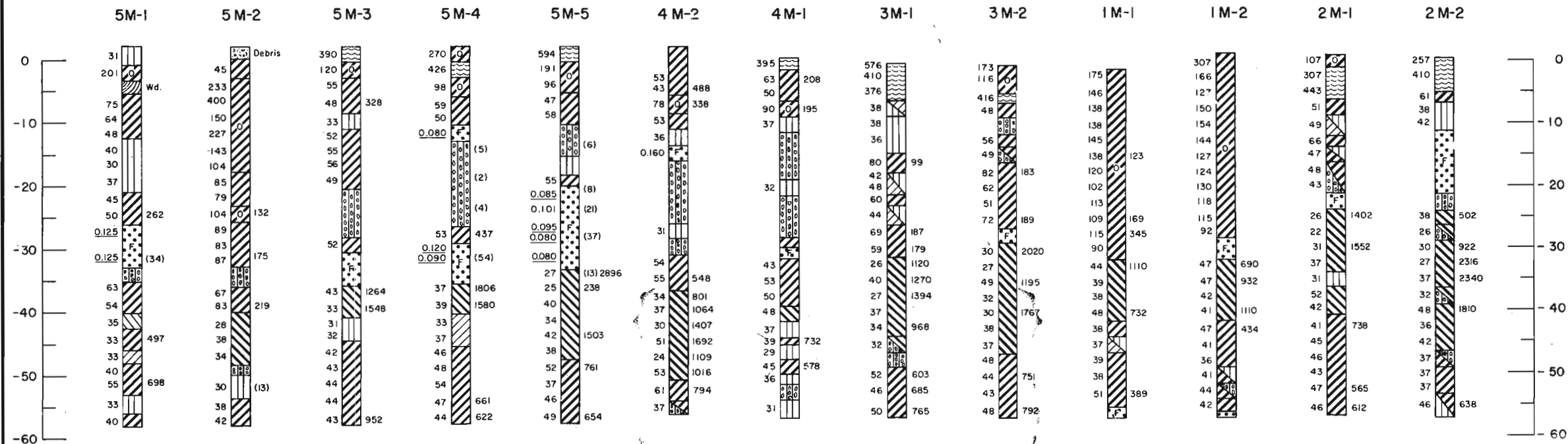

**SOIL BORING LOGS**

- GENERAL NOTES**
- For location of soil borings, structure, and earthen embankment sections, see plates 5 and 7.
  - For Rigolets site soil data see plate B-2.
  - For South Shore of Lake Pontchartrain barrier line soil profile see plate B-1.
  - Soil samples were taken with a 1 7/8" I.D. Core Barrel Sampler in the cohesive soils and a 1 3/8" I.D., 2" O.D. Standard Split Spoon Sampler in sandy soils where penetration resistances are shown.
  - Borings 5M-1 through 5M-5 were taken in July and August 1961, remainder were taken in April 1957.
- ALL ELEVATIONS ARE IN FEET AND REFER TO MEAN SEA LEVEL.

HURRICANE STUDY  
LAKE PONTCHARTRAIN, LA. AND VICINITY

**CHEF MENTEUR SITE  
SOIL PROFILE AND  
BORING LOGS**

SCALE AS SHOWN  
U.S. ARMY ENGINEER DISTRICT, NEW ORLEANS, LA.  
CORPS OF ENGINEERS

DATE: APRIL 1962 FILE NO. H-2-22077



APPENDIX C

FLOOD LOSSES AND BENEFITS

APPENDIX C

FLOOD LOSSES AND BENEFITS

<u>Paragraph</u>	<u>Title</u>	<u>Page</u>
C-1	Measurement of flood damage	C-1
C-2	Annual losses and benefits	C-1
	Average annual flood damages	C-1
	Average annual damage prevention benefits	C-2
	Adjustment of average annual damage prevention benefits to account for future growth	C-3
	Enhancement benefits	C-4

PLATES

<u>Plate</u>	<u>Title</u>
C-1	Reach B - New Orleans - stage frequency
C-2	Reach B - New Orleans - stage damage
C-3	Reach B - New Orleans - damage probability

## APPENDIX C

### FLOOD LOSSES AND BENEFITS

#### C-1 MEASUREMENT AND FLOOD DAMAGE

a. Severe flooding over much of the study area occurred in the hurricanes of September 1947 and September 1956, which furnished important data on extent of damages. However, much of the area has not been inundated in recent times. Therefore, in order to establish hurricane flood tide stage-damage relationships, an appraisal survey was made throughout the area of improvements that are likely to be damaged by flood waters and economic activities that would be affected. Sample residential areas were selected throughout the area that are subject to overflow and tabulations were made that show type of construction, elevation of floors, and estimated replacement value. These samples were expanded to include homogeneous areas. Damage relationships between building values and depth of flooding over floors, established from a large amount of data accumulated in recent damage surveys, provided a basis for estimating physical damages that would result to buildings and furnishings. Damage to retail, wholesale, manufacturing, school, church, and service buildings and furnishings were estimated in a similar manner. Other physical damages considered included the loss of stock on hand in retail and wholesale trade; damage to utilities and automobiles and other vehicles. Non-physical losses that were evaluated included the loss of net profit and salaries in wholesale, retail, and manufacturing, selected services, and miscellaneous services, and the subsistence cost of residents evacuated. The Federal census of retail, wholesale, manufacturing, and selected services provided a basis for estimating the loss of net profit and wages and also provided a basis for estimating the stock on hand that is subject to damage. The utility companies furnished estimates on damages to their facilities.

b. As a basis for the economic analysis, stage-damage curves were constructed for the numerous reaches within the study area. These curves were based on data obtained as described in paragraph C-1 a.

#### C-2 ANNUAL LOSSES AND BENEFITS

a. Average annual flood damages. Average annual damages were obtained by combining stage-damage curves with stage-frequency curves to obtain damage-probability curves. The area under the damage-probability curve represents the average annual damage. Stage-damage, stage-frequency, and damage-probability curves for reach B of the New Orleans area, which are typical of the curves

used in the study, are shown on plates C-1, C-2, and C-3. Reach B includes the section of New Orleans bounded by Pontchartrain Boulevard, Robert E. Lee Boulevard, City Park, and the Southern Railway. The average annual damages, based on present development and December 1961 price levels, are as follows:

<u>Area</u>	<u>Average annual damage</u>
St. Charles Parish	\$ 9,400
Jefferson Parish	2,256,000
New Orleans	2,741,100
Citrus	4,497,000
New Orleans East	None
Mandeville	62,400
Remaining areas along shores of Lake Pontchartrain	<u>112,100</u>
Subtotal	\$9,678,000
Chalmette	1,212,000
Inner Harbor Navigation Canal	90,000
Unprotected areas adjacent to Lake Borgne	<u>100,000</u>
Study area total	\$11,080,000

b. Average annual damage prevention benefits. The average annual benefits from flood damage prevented is the average annual damage without the proposed projects less the average annual damage remaining with the proposed projects in place. The projects are designed to protect against flooding from the standard project hurricane (SPH) which has a frequency of about 200 years. The residual damages consist of damages resulting from hurricane occurrences less frequent than once in about 200 years. Damage resulting from flooding by rainfall would not be preventable and has been eliminated from damage estimates in all cases. Within the section of New Orleans located between Jefferson Parish and the Inner Harbor Navigation Canal there would be no residual damage of consequence from hurricanes less frequent than the SPH. The wind tide level on the lake side of the seawall fronting this area would vary with the hurricane intensity. However, average water levels between the seawall and the back levee paralleling it would be controlled by the crest elevation of the seawall. The combination of structures, seawall and back levee, will provide essentially complete protection from all hurricanes. The average annual flood damage under present conditions, with the proposed projects in place, and the average annual damage prevented, in the several areas are as follows:

<u>Area</u>	<u>Avg.annual damage, pres- ent conditions</u>	<u>Avg.annual damage with proposed projects in place</u>	<u>Avg.annual damage prevented</u>
St. Charles Parish	\$ 9,400	\$ -	\$ 9,400
Jefferson Parish	2,256,000	12,000	2,244,000
New Orleans	2,741,100	-	2,741,100
Citrus	4,497,000	24,100	4,472,900
New Orleans East	-	-	-
Mandeville	62,400	400	62,000
Remaining areas along shore of Lake Pontchartrain	112,100	2,500	109,600
Subtotal	<u>\$9,678,000</u>	<u>\$ 39,000</u>	<u>\$9,639,000</u>
Chalmette	1,212,000	7,000	1,205,000
Inner Harbor Navigation Canal (canal side of existing levee)	90,000	No protection proposed	
Unprotected areas adjacent to Lake Borgne	<u>100,000</u>	No protection proposed	
Study area total	<u>\$11,080,000</u>		

c. Adjustment of average annual damage prevention benefits to account for future growth. Analysis of the growth trend of metropolitan New Orleans indicates a population in excess of 2,000,000 within the next 50 years. This growth indicates that the unoccupied areas within the project area on the south shore of Lake Pontchartrain within Jefferson, Orleans, and St. Bernard Parishes would be completely developed within 50 years. It is indicated that the high land in St. Charles Parish near the Mississippi River levee which drains by gravity and which is flooded only by infrequent great hurricanes would fully develop within 50 years. It is likewise indicated that areas on the shore of Lake Pontchartrain near Slidell would develop within 50 years. This growth is expected to occur without further protection from hurricane flooding. A substantial part of the growth of metropolitan New Orleans, which is composed of Orleans, Jefferson, and St. Bernard Parishes, will occur on the west bank of the Mississippi River since remaining areas available on the east bank could not accommodate the growth indicated for the next 50 years. It is indicated that certain areas presently largely developed would fully develop within 10 to 15 years and others sparsely developed would reach full development in 50 years. It was assumed that future improvements constructed in these areas would be similar to those in adjoining existing developed areas. Stage-damage relationships were

established in the future growth areas and annual damages were estimated on the basis of full development, reduced by annual residual damages and then discounted to annual values based on a project life of 100 years and an interest rate of 2-7/8 percent. The estimated average annual damage prevented on future development and the total average annual damage prevented are outlined in the following tabulation:

<u>Area</u>	<u>Ann.damage prevented on future development (full develop.)</u>	<u>Est.yrs. req'd. for develop.</u>	<u>Discount factor</u>	<u>Discounted ann. damage prevented</u>	<u>Ann.damage prev. on existing develop. (par.C-2b)</u>	<u>Total ann.damage prevented</u>
St. Chas. Ph.	\$ 9,400	50	0.514	\$ 4,800	\$ 9,400	\$ 14,200
Jeff. Ph.	15,506,000	50	0.514	7,970,100	2,244,000	10,214,100
New Orleans	374,400	15	0.815	305,100	2,741,100	3,046,200
Citrus	31,869,000	50	0.514	16,380,700	4,472,900	20,853,600
Citrus	1,415,500	10	0.875	1,238,600	0	1,238,600
New Orleans E.	22,445,000	50	0.514	11,536,700	0	11,536,700
Mandeville	0			0	62,000	62,000
Remaining areas on shores of L.Pontchartrain	1,136,200	50	0.514	584,000	109,600	693,600
Totals				\$38,020,000	\$9,639,000	\$47,659,000
Chalmette	608,600	15	0.815	496,000	492,000	988,000
Chalmette	5,976,700	50	0.514	3,072,000	713,000	3,785,000
Totals				\$ 3,568,000	\$1,205,000	\$ 4,773,000

d. Enhancement benefits.

(1) Within St. Charles Parish there are 29,600 acres of land which will be protected from tidal overflow. Upon completion of the proposed lake front levee, construction of drainage improvements and development of these lands for residential, commercial, and industrial use can be accomplished by local and private interests. The present appraised value of these lands is \$16,399,000. It is estimated that by providing flood protection the lands will have an enhanced value of \$25,614,000. This enhanced value is exclusive of enhancement that would result from drainage and other improvements. The annual value of the enhancement based on the increased value of \$9,215,000 at a 5-percent interest rate is \$460,000. In consideration of the rate of land transactions experienced in adjoining Jefferson Parish, it is probable that sale of these lands to developers would be accomplished within 20 years. The discounted annual value of

enhancement on this basis is \$350,000 ( $\$460,000 \times 0.760$ ). The estimates of present and enhanced land values were based on real estate appraisers' sample inspections of properties in this area and in similar areas situated in flood-free areas and consultation with several real estate firms. The estimated present appraised values of lands in the overflow area and the estimated enhanced values are as follows:

<u>Item</u>	<u>Acres</u>	<u>Present value</u>	<u>Future value</u>	<u>Enhancement</u>
Residential, commercial, and industrial land	1,370	\$6,666,000	\$ 7,376,000	\$ 710,000
Agricultural land	1,710	1,373,000	1,510,000	137,000
Swamp	15,450	5,775,000	11,558,000	5,783,000
Marsh	<u>11,070</u>	<u>2,585,000</u>	<u>5,170,000</u>	<u>2,585,000</u>
Total	29,600	\$16,399,000	\$25,614,000	\$9,215,000

(2) Within Orleans and St. Bernard Parishes, there are 18,830 acres of land, consisting of 12,830 acres of marsh, 5,875 acres of wooded swamp, and 125 acres of open land occupied by radio towers, lying between the existing Chalmette back levee and the embankment of the Southern Railway, and the proposed Chalmette levee along the Mississippi River-Gulf Outlet, which will be protected from tidal overflow. Upon completion of the proposed levee, construction of drainage improvements and development of these lands for residential, commercial, and industrial use can be accomplished by local and private interests. The present appraised value of these lands is \$3,710,000. It is estimated that as the result of providing flood protection these lands will have an enhanced value of \$13,010,000. Real estate appraisers estimated the present value of these lands as ranging from \$50 to \$750 an acre depending on accessibility to presently developed areas and transportation, and enhanced values ranging from \$200 to \$3,000 an acre. The enhanced values are exclusive of enhancement that would result from drainage and other improvements. The annual value of the enhancement based on the increased value of \$9,300,000 and a 5-percent interest rate is \$465,000. Due to the proximity of this area to the city of New Orleans and the Mississippi River-Gulf Outlet it is probable that sale of these lands to developers would be accomplished in 15 years. The discounted annual value of the enhancement on this basis is \$379,000 ( $\$465,000 \times 0.815$ ).

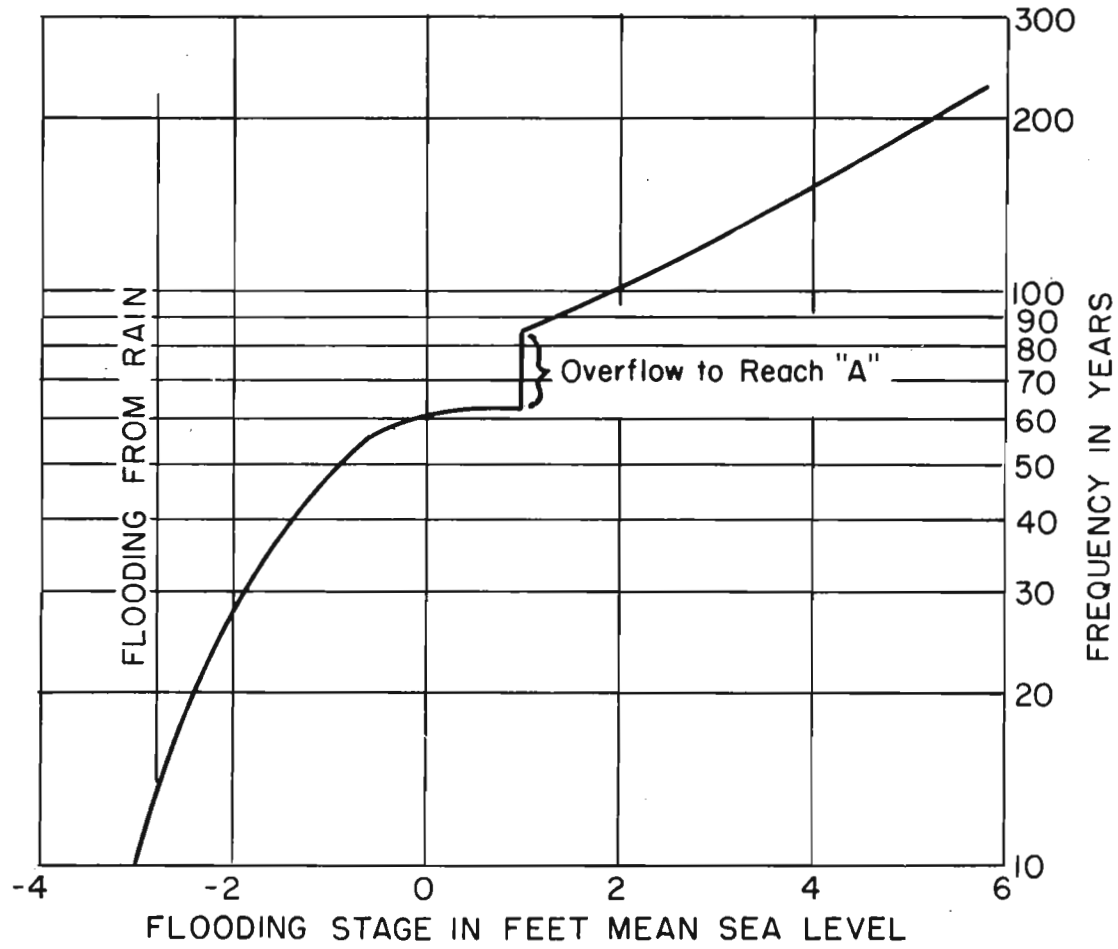

HURRICANE STUDY  
 LAKE PONTCHARTRAIN, LA. AND VICINITY

**REACH B  
 NEW ORLEANS  
 STAGE FREQUENCY**

U.S. ARMY ENGINEER DISTRICT, NEW ORLEANS  
 CORPS OF ENGINEERS

APRIL 1962 FILE NO. H-2-22077



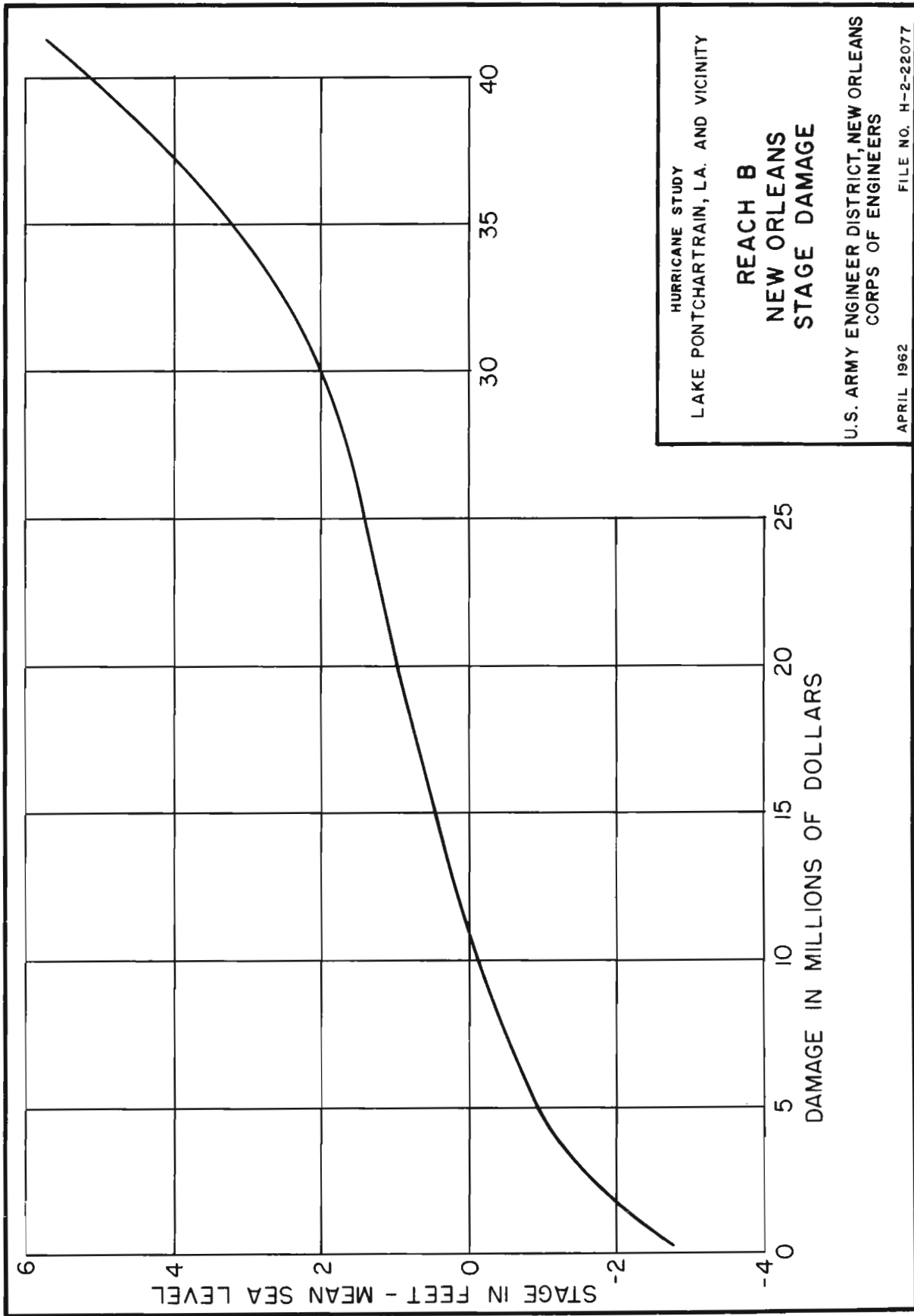

HURRICANE STUDY  
LAKE PONTCHARTRAIN, LA. AND VICINITY

**REACH B  
NEW ORLEANS  
STAGE DAMAGE**

U.S. ARMY ENGINEER DISTRICT, NEW ORLEANS  
CORPS OF ENGINEERS

APRIL 1962

FILE NO. H-2-22077

PLATE C-2

PLATE C-2

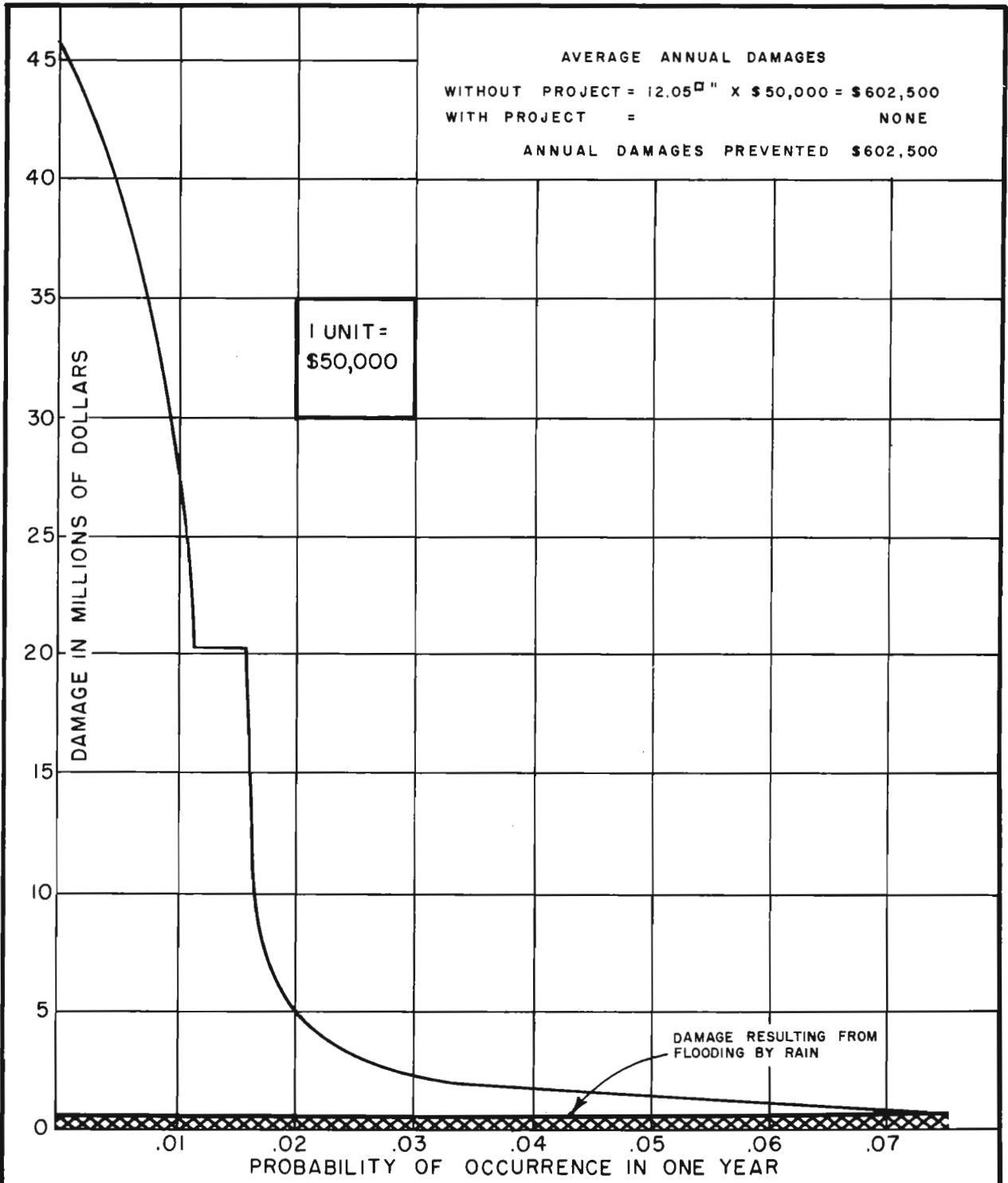

HURRICANE STUDY  
 LAKE PONTCHARTRAIN, LA. AND VICINITY

**REACH B  
 NEW ORLEANS  
 DAMAGE PROBABILITY**

U.S. ARMY ENGINEER DISTRICT, NEW ORLEANS  
 CORPS OF ENGINEERS

APRIL 1962 FILE NO. H-2-22077

APPENDIX D

COST ESTIMATES

LAKE PONTCHARTRAIN, LOUISIANA AND VICINITY

APPENDIX D

COST ESTIMATES

TABLES

<u>Table</u>	<u>Title</u>	<u>Page</u>
MISSISSIPPI RIVER-GULF OUTLET		
D-1	First Cost - Seabrook Lock	D-1
D-2	Estimate of annual economic cost	D-3
LAKE PONTCHARTRAIN BARRIER PLAN		
D-3	First Cost - Rigolets barrier structures	D-5
D-4	First Cost - Chef Menteur barrier structures	D-8
D-5	First Cost - Modified Seabrook Lock	D-11
D-6	First Cost - St. Charles Parish levees	D-13
D-7	First Cost - St. Charles Parish drainage structure	D-14
D-8	First Cost - Jefferson Parish wave wash protection	D-14
D-9	First Cost - New Orleans levees	D-15
D-10	First Cost - Citrus levees	D-16
D-11	First Cost - New Orleans East levees	D-18
D-12	First Cost - Barrier levee	D-20
D-13	First Cost - Mandeville seawall	D-21
D-14	Summary of estimates of first cost	D-22
D-15	Estimate of apportionment of cost between Federal and non-Federal interests	D-23
D-16	Estimate of annual economic cost	D-24
LAKEFRONT LEVEES		
D-17	New Orleans	D-26
D-18	Citrus	D-26
D-19	New Orleans East	D-27
D-20	Estimate of apportionment of costs between Federal and non-Federal interests and annual economic costs	D-28
CHALMETTE LEVEES		
D-21	First Cost - Levees, lands, and relocations	D-32
D-22	First Cost - Floodgates	D-34
D-23	Summary of estimates of first cost	D-35
D-24	Estimate of apportionment of costs between Federal and non-Federal interests	D-35
D-25	Estimate of annual economic cost	D-36

APPENDIX D

COST ESTIMATES  
(Based on December 1961 prices)

TABLE D-1  
MISSISSIPPI RIVER-GULF OUTLET, SEABROOK LOCK

FIRST COST

<u>Item</u>	<u>Quantity</u>	<u>Unit</u>	<u>Unit price</u>	<u>Cost</u>
<u>CONSTRUCTION</u>				
<u>Lock structure</u>				
Dewatering (during constr.)		job		\$ 345,000
Permanent relief wells		job		89,000
Excavation (under water)	23,000	cu.yd.	\$ 4.00	92,000
Concrete (Tremie placed-slab)	7,400	cu.yd.	35.00	259,000
Concrete, gate bay slabs	10,500	cu.yd.	35.00	367,500
Concrete, gate bay walls	3,400	cu.yd.	50.00	170,000
Concrete, approach bridges	60	cu.yd.	80.00	4,800
Cement	28,500	bb1.	6.00	171,000
Reinforcing steel	2,100,000	lb.	0.17	357,000
Steel sheet piling MZ-32	17,100	sq.ft.	4.50	76,950
Steel sheet piling MZ-38	41,500	sq.ft.	4.00	166,000
(drive and pull twice with full salvage value)				
Structural steel, misc. shapes	380,000	lb.	0.25	95,000
Pipe handrail	5,100	lin.ft.	6.00	30,600
Concrete cylinder piles 18"	360	lin.ft.	10.00	3,600
Concrete cylinder piles 54"	12,320	lin.ft.	40.00	492,800
Concrete cap (on cyl.piles)	1,220	lin.ft.	20.00	24,400
Timber wales (12"x12" Greenheart)	45	MFBM	600.00	27,000
Riprap 24"	8,650	ton	8.00	69,200
Shell (filter)	2,800	cu.yd.	3.50	9,800
Timber guide walls	850	lin.ft.	150.00	127,500
Sheet pile bumper (quadrants)	2	each	18,000.00	36,000
Sheet pile dolphin (circ.34' dia.)	1	each		30,000
Sector gates		job		300,000
Sector gate machinery		job		50,000
Electrical system		job		20,000
Control houses	4	each	8,000.00	32,000
Subtotal				\$3,446,150
Contingencies				516,850
Subtotal				\$3,963,000
Engineering and design				238,000
Supervision and administration				327,000
TOTAL (Lock Structure)				\$4,528,000

TABLE D-1 (cont'd)

<u>Item</u>	<u>Quantity</u>	<u>Unit</u>	<u>Unit price</u>	<u>Cost</u>
<u>Rock dam</u>				
Shell	26,200	cu.yd.	\$ 2.50	\$ 65,500
Riprap	6,500	ton	8.00	52,000
Derrick stone	10,500	ton	9.00	94,500
Steel sheet pile, MA-22	35,770	sq.ft.	4.00	143,080
Subtotal				\$ 355,080
Contingencies				52,920
Subtotal				\$ 408,000
Engineering and design				12,000
Supervision and administration				32,000
TOTAL (Rock dam)				\$ 452,000
TOTAL CONSTRUCTION				\$4,980,000

TABLE D-2

ESTIMATE OF ANNUAL ECONOMIC COST

MISSISSIPPI RIVER-GULF OUTLET

(Existing project)

Summary of project costs

	<u>Federal</u>	<u>Non-Federal</u>	<u>Total</u>
First cost	\$ 95,490,000 <sup>(2)</sup>	\$8,730,000	\$104,220,000 <sup>(1)</sup>
Interest during construction (6 yrs.)	<u>7,520,000</u>	<u>917,000</u>	<u>8,437,000</u>
TOTAL PROJECT INVESTMENT	\$103,010,000	\$9,647,000	\$112,657,000

Annual economic costs

Interest (2-5/8%)	\$ 2,704,000	\$ -	\$ 2,704,000
Amortization (2-5/8%- 100 yrs.)	219,400	-	219,400
Interest (3 1/2%)	-	337,600	337,600
Amortization (3 1/2%-100 yrs.)	-	11,200	11,200
Maintenance and operation Replacements	<u>1,627,500</u> <u>4,000<sup>(3)</sup></u>	<u>62,000</u> <u>-</u>	<u>1,689,500</u> <u>4,000</u>
TOTAL	\$ 4,554,900	\$ 410,800	\$ 4,965,700

SEABROOK LOCK (Proposed)

Summary of project costs

	<u>Federal</u>	<u>Non-Federal</u>	<u>Total</u>
First cost	\$ 4,980,000	\$ -	\$ 4,980,000
Interest during construction (3 yrs.)	<u>214,800</u>	<u>-</u>	<u>214,800</u>
TOTAL PROJECT INVESTMENT	\$ 5,194,800		\$ 5,194,800

Annual economic costs

Interest (2-7/8%)	\$ 149,300	\$ -	\$ 149,300
Amortization (2-7/8%-100 yrs.)	9,300	-	9,300
Maintenance and operation	<u>120,000</u>	<u>-</u>	<u>120,000</u>
TOTAL	\$ 278,600		\$ 278,600

TABLE D-2 (cont'd)

MISSISSIPPI RIVER-GULF OUTLET

(Recommended modification)

Summary of project costs

	<u>Federal</u>	<u>Non-Federal</u>	<u>Total</u>
First cost	\$100,470,000	\$8,730,000	\$109,200,000
Interest during construction	<u>7,734,800</u>	<u>917,000</u>	<u>8,651,800</u>
TOTAL PROJECT INVESTMENT	\$108,204,800	\$9,647,000	\$117,851,800

Annual economic costs

Interest <sup>(4)</sup>	\$ 2,853,300	\$ -	\$ 2,853,300
Amortization	228,700	-	228,700
Interest (3½%)	-	337,600	337,600
Amortization (3½%-100 yrs.)	-	11,200	11,200
Maintenance and operation	1,747,500	62,000	1,809,500
Replacements	<u>4,000</u>	<u>-</u>	<u>4,000</u>
TOTAL	\$ 4,833,500	\$ 410,800	\$ 5,244,300

(1) Approved cost estimate from Pb-3 effective 1 July 1962.

(2) Includes \$490,000 for aids to navigation.

(3) Replacement of aids to navigation.

(4) Interest rate 2-5/8% on existing project and 2-7/8% on proposed Seabrook Lock.



LAKE PONTCHARTRAIN BARRIER PLAN

TABLE D-3  
RIGOLETS BARRIER STRUCTURES

FIRST COST  
NAVIGATION LOCK, CONTROL STRUCTURE, HIGHWAY  
EMBANKMENT, LEVEES, CLOSURE DAM, AND LANDS

<u>Item</u>	<u>Quantity</u>	<u>Unit</u>	<u>Unit price</u>	<u>Cost</u>
<u>CONSTRUCTION</u>				
<u>Navigation lock</u>				
Excavation	76,000	cu.yd.	\$ 1.50	\$ 114,000
Backfill	21,000	cu.yd.	1.00	21,000
Dewatering		job		200,000
Concrete-gate bay walls	3,180	cu.yd.	40.00	127,200
Concrete-gate bay slab	8,350	cu.yd.	20.00	167,000
Concrete-chamber walls	1,200	cu.yd.	60.00	72,000
Cement	15,800	bbl.	5.00	79,000
Reinforcing steel	1,898,000	lb.	0.15	284,700
Pipe handrail	2,400	lin.ft.	7.50	18,000
Steel sheet piling, MA-22	5,200	sq.ft.	3.50	18,200
Steel sheet piling, MZ-32	4,650	sq.ft.	5.25	24,412
Concrete sheet piles (2' wide)	35,000	lin.ft.	7.00	245,000
Concrete batter piles (12"x12")	7,000	lin.ft.	7.00	49,000
Steel sheet pile bumper (quadrant) high	-		lump sum	30,000
Steel sheet pile bumper (quadrant) low	-		lump sum	22,000
Timber guide wall	900	lin.ft.	150.00	135,000
Floodwalls	170	lin.ft.	150.00	25,500
Bulkheads, high gate	-		lump sum	32,000
Bulkheads, low gate	-		lump sum	25,000
Sector gates	-		lump sum	303,000
Sector gate machinery	-		lump sum	50,000
Electrical system	-		lump sum	20,000
Misc. struc. steel	17,000	lb.	0.30	5,100
Riprap	12,380	ton	8.00	99,040
Filter (gravel)	840	cu.yd.	8.00	6,720
Filter (shell)	3,500	cu.yd.	3.50	12,250
Control houses	4	each	8,000.00	32,000
Channel excavation	300,000	cu.yd.	0.20	60,000
Subtotal				\$2,277,122
Contingencies				341,878
Subtotal				\$2,619,000

TABLE D-3 (cont'd)

<u>Item</u>	<u>Quantity</u>	<u>Unit</u>	<u>Unit price</u>	<u>Cost</u>
Engineering and design				\$ 156,000
Supervision and administration				207,000
TOTAL (Navigation lock)				<u>\$2,982,000</u>
 <u>Control structure</u>				
Excavation	172,000	cu.yd.	\$ 1.50	\$ 258,000
Backfill	12,000	cu.yd.	0.80	9,600
Dewatering (2 stage well point system)		job		375,000
Filter gravel	2,000	cu.yd.	8.00	16,000
Filter sand	1,000	cu.yd.	8.00	8,000
Riprap (in channel)	13,500	ton	10.00	135,000
Gravel	4,500	cu.yd.	8.00	36,000
Steel sheet piling (MA-22)	24,600	sq.ft.	3.50	86,100
Concrete, Class A (in hwy. and crane br.)	3,521	cu.yd.	75.00	264,075
Concrete, Class A (in piers and curt. walls)	6,944	cu.yd.	30.00	208,320
Concrete, Class A (in floor slab)	10,834	cu.yd.	20.00	216,680
Concrete, Class A (in bents and abutment)	1,206	cu.yd.	40.00	48,240
Concrete, stabilization slab	1,084	cu.yd.	15.00	16,260
Cement	31,500	bbbl.	5.00	157,500
Reinforcing steel	3,400,000	lb.	0.175	595,000
Timber piles, untreated	14,080	lin.ft.	1.50	21,120
Steel piling, 12BP-53#	55,680	lin.ft.	7.00	389,760
Structural steel (gates and miscl.)	3,300,000	lb.	0.45	1,485,000
Water stops	550	lin.ft.	5.00	2,750
Pipe handrail 1½"	4,350	lin.ft.	7.50	32,625
Crane rails	58,000	lb.	0.35	20,300
Gantry crane		job		200,000
Channel excavation	20,500,000	cu.yd.	0.18	3,690,000
Subtotal				<u>\$8,271,330</u>
Contingencies				1,260,670
Subtotal				<u>\$9,532,000</u>
Engineering and design				567,000
Supervision and administration				756,000
TOTAL (Control structure)				<u>\$10,855,000</u>

TABLE D-3 (cont'd)

<u>Item</u>	<u>Quantity</u>	<u>Unit</u>	<u>Unit price</u>	<u>Cost</u>
<u>Highway</u>				
Embankment, pump	220,000	cu.yd.	\$ 0.76	\$ 167,200
First lift, shaping	15,400	cu.yd.	0.40	6,160
Second lift, shaping	6,600	cu.yd.	0.40	2,640
Concrete surface	15,500	sq.yd.	5.50	85,250
Seeding	15	acre	75.00	1,125
Subtotal				\$ 262,375
Contingencies				39,625
Subtotal				\$ 302,000
Engineering and design				12,000
Supervision and administration				18,000
TOTAL (Highway)				\$ 332,000
<u>Levee and closure dam</u>				
Embankment, pump	2,666,000	cu.yd.	\$ 0.76	\$2,026,160
First lift, shaping	186,600	cu.yd.	0.40	74,640
Second lift, shaping	79,980	cu.yd.	0.40	31,992
Seeding	90	acre	75.00	6,750
Shell surfacing	10,000	cu.yd.	3.00	30,000
Riprap	112,000	ton	10.00	1,120,000
Gravel	27,600	cu.yd.	8.00	220,800
Subtotal				\$3,510,342
Contingencies				524,658
Subtotal				\$4,035,000
Engineering and design				162,000
Supervision and administration				242,000
TOTAL (Levee and closure dam)				\$4,439,000
TOTAL CONSTRUCTION				\$18,608,000
<u>LANDS</u>				
Structure R/W	200	acre	variable	\$ 431,050
Levee R/W	35	acre	variable	45,240
Highway R/W	16	acre	variable	1,600
Navigation channel R/W	15	acre	variable	900
Spoil disposal R/W	495	acre	variable	32,500
Nav. channel disp. R/W	33	acre	variable	1,980
Subtotal				\$ 513,270
Contingencies				76,730
Market value				\$ 590,000
Improvements				90,000
Severance				3,600
Acquisition cost				3,400
TOTAL LANDS				\$ 687,000

TABLE D-4  
CHEF MENTEUR BARRIER STRUCTURES

FIRST COST  
NAVIGATION STRUCTURE, CONTROL STRUCTURE,  
LEVEE, CLOSURE DAM, AND LANDS

<u>Item</u>	<u>Quantity</u>	<u>Unit</u>	<u>Unit price</u>	<u>Cost</u>
<u>CONSTRUCTION</u>				
<u>Navigation structure</u>				
Gate bay and approaches:				
Excavation	30,000	cu.yd.	\$ 1.50	\$ 45,000
Backfill	14,100	cu.yd.	0.80	11,280
Sand backfill	4,000	cu.yd.	5.00	20,000
Dewatering		job		155,000
Concrete, Class A in walls	1,654	cu.yd.	40.00	66,160
Concrete, Class A in floor slabs	3,204	cu.yd.	20.00	64,080
Cement	6,800	bb1.	5.00	34,000
Reinforcing steel	680,000	lb.	0.175	119,000
Pipe handrail	1,100	lin.ft.	7.50	8,250
Steel sheet piling, MA-22	6,640	sq.ft.	3.50	23,240
Steel piling 12BP53	7,590	lin.ft.	7.00	53,130
Untreated timber piling Cl."B"	8,580	lin.ft.	1.50	12,870
Filter gravel	285	cu.yd.	8.00	2,280
Filter sand	143	cu.yd.	8.00	1,144
Riprap	1,120	ton	10.00	11,200
Gravel	170	cu.yd.	8.00	1,360
Sand	170	cu.yd.	8.00	1,360
Floodwalls (2):				
Concrete, Class A	165	cu.yd.	40.00	6,600
Cement	230	bb1.	5.00	1,150
Reinforcing steel	16,500	lb.	0.175	2,888
Steel sheet piling, MZ-32	4,940	sq.ft.	5.25	25,935
Bulkheads (4):				
Steel sheet piling, MA-22	4,610	sq.ft.	3.50	16,135
Structural steel (wales, tierods)	35,000	lb.	0.30	10,500
Timber guide walls:				
Treated timber piles	6,000	lin.ft.	2.00	12,000
Treated timber	27	MFBM	500.00	13,500
Excavation nav. channel	729,000	cu.yd.	0.18	131,220
Excavation Bayou Sauvage Canal	243,000	cu.yd.	0.18	43,740
Sector gate:				
Structural steel	220,000	lb.	0.45	99,000
Pipe handrail 1½"	340	lin.ft.	7.50	2,550
Rubber seals	180	lin.ft.	4.50	810

TABLE D-4 (cont'd)

<u>Item</u>	<u>Quantity</u>	<u>Unit</u>	<u>Unit price</u>	<u>Cost</u>
Timber fenders	3	MFBM	\$ 500.00	\$ 1,500
Painting		job		3,000
Cathodic protection		job		15,000
Upper and lower hinges:				
Structural steel	5,000	lb.	0.45	2,250
Cast steel	3,600	lb.	0.50	1,800
Bronze	600	lb.	2.00	1,200
Roller track, seal plates, beams:				
Structural steel	9,000	lb.	0.45	4,050
Corrosion resistant steel	4,500	lb.	1.25	5,625
Needle beam seats, corner prot. plates, ladders:				
Structural steel	10,000	lb.	0.30	3,000
Sector gate machinery			lump sum	18,000
Subtotal				\$1,050,807
Contingencies				156,193
Subtotal				\$1,207,000
Engineering and design				71,000
Supervision and administration				94,000
TOTAL (Navigation structure)				\$1,372,000
<u>Control structure</u>				
Excavation	105,300	cu.yd.	1.50	\$ 157,950
Backfill	15,000	cu.yd.	0.80	12,000
Dewatering		job		340,000
Filter gravel	550	cu.yd.	8.00	4,400
Filter sand	275	cu.yd.	8.00	2,200
Riprap (in channel)	6,548	ton	10.00	65,480
Gravel	2,150	cu.yd.	8.00	17,200
Steel sheet piling, MA-22	12,480	sq.ft.	3.50	43,680
Concrete Class A (in crane girders)	588	cu.yd.	75.00	44,100
Concrete Class A (in piers and curtain walls)	3,175	cu.yd.	30.00	95,250
Concrete Class A (in floor slab)	5,134	cu.yd.	20.00	102,680
Concrete Class A (in bents and abutment)	880	cu.yd.	40.00	35,200
Cement	13,700	bbbl.	5.00	68,500
Reinforcing steel	1,400,000	lb.	0.175	245,000
Steel piling 12B53#	8,190	lin.ft.	7.00	57,330
Structural steel (gates and misc.)	1,300,000	lb.	0.45	585,000
Waterstops	200	lin.ft.	5.00	1,000
Pipe handrails 1½"	1,400	lin.ft.	7.50	10,500
Crane rails	28,000	lb.	0.35	9,800

TABLE D-4 (cont'd)

<u>Item</u>	<u>Quantity</u>	<u>Unit</u>	<u>Unit price</u>	<u>Cost</u>
Gantry crane		job		\$ 200,000
Channel excavation	6,742,000	cu.yd.	\$ 0.18	1,213,560
Subtotal				<u>\$3,310,830</u>
Contingencies				497,170
Subtotal				<u>\$3,808,000</u>
Engineering and design				227,000
Supervision and administration				302,000
TOTAL (Control structure)				<u>\$4,337,000</u>
<u>Levee and closure dam</u>				
Embankment, pump	852,200	cu.yd.	0.76	\$ 647,672
First lift, shaping	59,700	cu.yd.	0.40	23,880
Second lift, shaping	25,600	cu.yd.	0.40	10,240
Seeding	45	acre	75.00	3,375
Shell surfacing	6,000	cu.yd.	3.00	18,000
Riprap	26,100	ton	10.00	261,000
Gravel	6,500	cu.yd.	8.00	52,000
Subtotal				<u>\$1,016,167</u>
Contingencies				152,833
Subtotal				<u>\$1,169,000</u>
Engineering and design				47,000
Supervision and administration				70,000
TOTAL (Levee and closure dam)				<u>\$1,286,000</u>
TOTAL CONSTRUCTION				<u>\$6,995,000</u>
<u>LANDS</u>				
Structure R/W	70	acre	variable	\$ 7,000
Levee R/W	27	acre	variable	43,800
Nav. channel and berm R/W	58	acre	variable	3,150
Nav. channel spoil disposal R/W	105	acre	variable	5,775
Spoil disposal area R/W	375	acre	variable	18,750
Subtotal				<u>\$ 78,475</u>
Contingencies				11,825
Market value				<u>\$ 90,300</u>
Improvements				5,500
Contingencies				800
Subtotal				<u>\$ 6,300</u>
Severance				1,400
Acquisition cost				1,000
TOTAL LANDS				<u>\$ 99,000</u>

TABLE D-5  
LAKE PONTCHARTRAIN BARRIER PLAN  
MODIFIED SEABROOK LOCK

FIRST COST

<u>Item</u>	<u>Quantity</u>	<u>Unit</u>	<u>Unit price</u>	<u>Cost</u>
<u>CONSTRUCTION</u>				
<u>Lock structure</u>				
Dewatering (during constr.)		job		\$ 345,000
Permanent relief wells		job		89,000
Excavation (under water)	23,000	cu.yd.	\$ 4.00	92,000
Concrete (Tremie placed-slab)	7,400	cu.yd.	35.00	259,000
Concrete, gate bay slabs	10,500	cu.yd.	35.00	367,500
Concrete, gate bay walls	4,150	cu.yd.	50.00	207,500
Concrete, approach bridges	60	cu.yd.	80.00	4,800
Cement	31,300	bbl.	6.00	187,800
Reinforcing steel	2,205,000	lb.	0.17	374,850
Steel sheet piling, MZ-32	17,100	sq.ft.	4.50	76,950
Steel sheet piling, MZ-38	41,500	sq.ft.	4.00	166,000
(drive and pull twice with full salvage value)				
Structural steel, misc. shapes	380,000	lb.	0.25	95,000
Pipe handrail	5,100	lin.ft.	6.00	30,600
Concrete cylinder piles 18"	360	lin.ft.	10.00	3,600
Concrete cylinder piles 54"	12,320	lin.ft.	40.00	492,800
Concrete cap (on cylinder piles)	1,220	lin.ft.	20.00	24,400
Timber wales (12"x12" Greenheart)	45	MFBM	600.00	27,000
Riprap	10,400	ton	8.00	83,200
Shell (filter)	1,000	cu.yd.	3.50	3,500
Timber guide walls	850	lin.ft.	125.00	106,250
Sheet pile bumper (quadrants)	2	each	20,000.00	40,000
Sheet pile dolphin (circular 34' dia.)	1	each	30,000.00	30,000
Sector gates			lump sum	353,000
Sector gate machinery			lump sum	50,000
Electrical system			lump sum	20,000
Control houses	4	each	8,000.00	32,000
Subtotal				\$3,561,750
Contingencies				536,250
Subtotal				\$4,098,000
Engineering and design				247,000
Supervision and administration				339,000
TOTAL (Lock structure)				\$4,684,000

TABLE D-5 (cont'd)

<u>Item</u>	<u>Quantity</u>	<u>Unit</u>	<u>Unit price</u>	<u>Cost</u>
<u>Rock dam</u>				
Shell	76,600	cu.yd.	\$ 2.50	\$ 191,500
Riprap	8,520	ton	8.00	68,160
Derrick stone	15,980	ton	9.00	143,820
Steel sheet pile, MA-22	35,770	sq.ft.	4.00	143,080
Subtotal				\$ 546,560
Contingencies				82,440
Subtotal				\$ 629,000
Engineering and design				18,000
Supervision and administration				49,000
TOTAL (Rock dam)				\$ 696,000
TOTAL CONSTRUCTION				\$5,380,000
Less first cost of Mississippi River-Gulf Outlet, Seabrook Lock (Table D-1)				<u>-4,980,000</u>
Cost for modifying Seabrook Lock				\$ 400,000



TABLE D-6  
ST. CHARLES PARISH

FIRST COST  
LEVEES, DRAINAGE STRUCTURE, LANDS, AND RELOCATIONS

<u>Item</u>	<u>Quantity</u>	<u>Unit</u>	<u>Unit price</u>	<u>Cost</u>
<u>CONSTRUCTION</u>				
Front levee (5.5 miles)				
First lift, pump	1,276,125	cu.yd.	\$ 0.76	\$ 969,855
Second lift, pump	425,375	cu.yd.	0.76	323,285
Third lift, shaping	85,075	cu.yd.	0.40	34,030
Fourth lift, shaping	51,045	cu.yd.	0.40	20,418
Fifth lift, shaping	34,030	cu.yd.	0.40	13,612
Riprap	165,000	ton	9.00	1,485,000
Shell	37,000	cu.yd.	3.00	111,000
Seeding	130	acre	75.00	9,750
Return levee, parish line (3.84 miles)				
First lift, pump	854,000	cu.yd.	0.76	649,040
Second lift, pump	283,750	cu.yd.	0.76	215,650
Third lift, shaping	56,250	cu.yd.	0.40	22,500
Fourth lift, shaping	33,750	cu.yd.	0.40	13,500
Fifth lift, shaping	22,500	cu.yd.	0.40	9,000
Parish Line Canal closure				
First lift, haul	2,805	cu.yd.	1.50	4,208
Second lift, haul	330	cu.yd.	1.50	495
Third lift, haul	165	cu.yd.	1.50	247
Seeding	90	acre	75.00	6,750
Landside ditch	676,000	cu.yd.	0.30	202,800
Subtotal				\$4,091,140
Contingencies				613,860
Subtotal				\$4,705,000
Drainage structure*	1	job		206,000
Contingencies				27,000
Subtotal				\$ 233,000
TOTAL				\$4,938,000
Engineering and design				202,000
Supervision and administration				301,000
TOTAL CONSTRUCTION				\$5,441,000
<u>LANDS</u>				
Front levee	143	acre	\$250.00	\$ 35,750
Return levee	370	acre	250.00	92,500
Landside ditch	200	acre	250.00	50,000
Contingencies				17,750
Market value				\$ 196,000
Severance				19,700
Acquisition costs				6,300
TOTAL LANDS				\$ 222,000
<u>RELOCATIONS</u>				
One 16" pipeline	400	lin.ft.	\$ 90.00	\$ 36,000

\*See table D-7 for detailed cost estimate.

TABLE D-7  
ST. CHARLES PARISH

FIRST COST  
DRAINAGE STRUCTURE

<u>Item</u>	<u>Quantity</u>	<u>Unit</u>	<u>Unit price</u>	<u>Cost</u>
<u>CONSTRUCTION</u>				
Stripping	27,900	cu.yd.	\$ 0.50	\$ 13,950
Backfill (river sand)	38,700	cu.yd.	1.50	58,050
Steel sheet piling, DA-27	10,850	sq.ft.	4.50	48,825
Concrete cap	360	lin.ft.	8.00	2,880
Drain 4" clay perf.	145	lin.ft.	1.00	145
Drain 6" clay	160	lin.ft.	1.50	240
Drain flapgates	7	each	50.00	350
Gravel, drain	90	cu.yd.	8.00	720
Sand, drain	30	cu.yd.	8.00	240
Concrete	310	cu.yd.	80.00	24,800
Cement	390	bb1.	5.00	1,950
Reinf. steel	55,100	lb.	0.175	9,642
Cast iron gates (108" x 60" - 20' hd)	8	each	3,400.00	27,200
Timber piles (untreated)	3,780	lin.ft.	2.00	7,560
Riprap	310	ton	10.00	3,100
Shell, filter	100	cu.yd.	3.50	350
Handrail (1½" pipe)	840	lin.ft.	7.50	6,300
Subtotal				\$ 206,302
Contingencies				26,698
<b>TOTAL CONSTRUCTION</b>				<b>\$ 233,000</b>

TABLE D-8  
JEFFERSON PARISH

FIRST COST  
WAVE WASH PROTECTION  
JEFFERSON PARISH FRONT LEVEE

<u>Item</u>	<u>Quantity</u>	<u>Unit</u>	<u>Unit price</u>	<u>Cost</u>
<u>CONSTRUCTION</u>				
Riprap (9.7 miles)	46,100	ton	\$ 8.00	\$ 368,800
Shell	11,300	cu.yd.	3.00	33,900
Subtotal				\$ 402,700
Contingencies				60,300
Subtotal				\$ 463,000
Engineering and design				18,000
Supervision and administration				28,000
<b>TOTAL CONSTRUCTION</b>				<b>\$ 509,000</b>

TABLE D-9  
NEW ORLEANS  
(Jefferson Parish Line to Inner Harbor Navigation Canal)

FIRST COST  
LEVEES, LANDS, AND RELOCATIONS

<u>Item</u>	<u>Quantity</u>	<u>Unit</u>	<u>Unit price</u>	<u>Cost</u>
<u>CONSTRUCTION</u>				
<u>Levees</u>				
Levee enlargement-lakefront, haul	112,355	cu.yd.	\$ 1.50	\$ 168,533
Levee enlargement (Inner Harbor Nav. Canal):				
Embankment, haul	131,850	cu.yd.	1.50	197,775
Steel sheet piling, MA-22	922,071	sq.ft.	3.50	3,227,249
Concrete cap	30,736	lin.ft.	6.00	184,416
Stop log closures	3	job	8,434.00	25,302
Seeding levees	56.6	acre	75.00	4,245
Subtotal				\$3,807,520
Contingencies				571,480
Subtotal				\$4,379,000
Engineering and design				175,000
Supervision and administration				263,000
TOTAL CONSTRUCTION				\$4,817,000
<u>LANDS</u>				
I.H. Nav. Canal levee	17	acre	variable	\$ 658,600
Contingencies				65,400
Market value				\$ 724,000
Improvements				45,000
Contingencies				4,500
Subtotal				\$ 49,500
Severance				48,200
Acquisition cost				9,300
TOTAL LANDS				\$ 831,000*
<u>RELOCATIONS</u>				
Road crossings (12):				
Fill, haul	6,500	cu.yd.	\$ 1.50	\$ 9,750
Concrete surfacing	1,700	cu.yd.	25.00	42,500
Subtotal				\$ 52,250
Contingencies				7,750
Subtotal				\$ 60,000
Engineering and design				2,400
Supervision and administration				3,600
TOTAL RELOCATIONS				\$ 66,000

\*Exclusive of 7.5 acres required for enlargement of lakefront levee.  
There will be no cost to the project for the land occupied by the levee.

TABLE D-10  
CITRUS

FIRST COST  
LEVEES, LANDS, AND RELOCATIONS

<u>Item</u>	<u>Quantity</u>	<u>Unit</u>	<u>Unit price</u>	<u>Cost</u>
<u>CONSTRUCTION</u>				
<u>Levees</u>				
Levee enlargement (front), 4.9 miles				
First lift, pump	1,657,500	cu.yd.	\$ 0.76	\$1,259,700
Second lift, pump	552,500	cu.yd.	0.76	419,900
Third lift, shaping	110,500	cu.yd.	0.40	44,200
Fourth lift, shaping	66,300	cu.yd.	0.40	26,520
Fifth lift, shaping	44,200	cu.yd.	0.40	17,680
18" Drainage pipe thru RR emb.	1,300	lin.ft.	25.00	32,500
Riprap	113,060	ton	8.00	904,480
Shell	41,900	cu.yd.	3.00	125,700
Seeding	120	acre	75.00	9,000
Levee enlargement (I.H.Nav. Canal)				
Embankment, haul	70,425	cu.yd.	1.50	105,640
Steel sheet piling, MA-22	492,500	sq.ft.	3.50	1,723,750
Concrete cap	16,417	lin.ft.	6.00	98,500
Seeding	16.9	acre	75.00	1,270
Levee enlargement (G.I.W.W.) I.H.Nav.Canal to Paris Road				
Embankment, cast	1,240,000	cu.yd.	0.50	620,000
Embankment, rehandle	255,000	cu.yd.	0.50	127,500
Seeding	88	acre	75.00	6,600
Levee enlargement (G.I.W.W.) Paris Road to Michoud				
First lift, pump	1,136,000	cu.yd.	0.76	863,360
Second lift, pump	474,000	cu.yd.	0.76	360,240
Third lift, pump	285,000	cu.yd.	0.76	216,600
Fourth lift, shaping	97,500	cu.yd.	0.40	39,000
Fifth lift, shaping	58,500	cu.yd.	0.40	23,400
Sixth lift, shaping	39,000	cu.yd.	0.40	15,600
Seeding	90	acre	75.00	6,750
Stoplog closures	3	job	-	33,700
Bank stabilization (Miss.River-Gulf Outlet & G.I.W.W.)				
I.H.Nav.Canal to Michoud, 9.2 miles				
Excavation and backfill	179,000	cu.yd.	0.25	44,750
Riprap	119,600	ton	8.00	956,800
Shell	45,000	cu.yd.	3.00	135,000
Subtotal				\$8,218,140
Contingencies				1,232,860
Subtotal				\$9,451,000
Engineering and design				352,000
Supervision and administration				569,000
TOTAL CONSTRUCTION				\$10,372,000

TABLE D-10 (cont'd)

<u>Item</u>	<u>Quantity</u>	<u>Unit</u>	<u>Unit price</u>	<u>Cost</u>
<u>LANDS</u>				
I.H. Nav.Canal levee	9.1	acre	variable	\$ 351,800
Intracoastal W.W. levee	313	acre	variable	782,500*
Subtotal				<u>\$1,134,300</u>
Contingencies				113,700
Market value				<u>\$1,248,000</u>
Improvements				24,000
Contingencies				2,400
Subtotal				<u>\$ 26,400</u>
Severance				178,000
Acquisition cost				6,600
TOTAL LANDS				<u>\$1,459,000</u>

\*Exclusive of 218 acres of Federal lands with an estimated value of \$599,500.

RELOCATIONS

Modification of Citrus pumping plant discharge pipes	1	job		\$ 74,000
---	---	-----	--	-----------

TABLE D-11  
NEW ORLEANS EAST

FIRST COST  
LEVEES, LANDS, AND RELOCATIONS

<u>Item</u>	<u>Quantity</u>	<u>Unit</u>	<u>Unit price</u>	<u>Cost</u>
<u>CONSTRUCTION</u>				
<u>Levees</u>				
Levee enlargement (front) 6.3 miles				
First lift, pump	3,213,750	cu.yd.	\$ 0.76	\$2,442,450
Second lift, pump	1,071,250	cu.yd.	0.76	814,150
Third lift, shaping	214,250	cu.yd.	0.40	85,700
Fourth lift, shaping	128,550	cu.yd.	0.40	51,420
Fifth lift, shaping	85,700	cu.yd.	0.40	34,280
18" drainage pipe thru R.R. emb.	1,700	lin.ft.	25.00	42,500
Riprap	190,000	ton	8.00	1,520,000
Shell	70,187	cu.yd.	3.00	210,561
Seeding	190	acre	75.00	14,250
Levee enlargement (Intracoastal W.W.) 6.4 miles				
First lift, pump	2,808,000	cu.yd.	0.76	2,134,080
Second lift, pump	1,170,000	cu.yd.	0.76	889,200
Third lift, pump	702,000	cu.yd.	0.76	533,520
Fourth lift, shaping	234,000	cu.yd.	0.40	93,600
Fifth lift, shaping	140,000	cu.yd.	0.40	56,000
Sixth lift, shaping	94,000	cu.yd.	0.40	37,600
Seeding	223	acre	75.00	16,725
Stoplog closure I&N R.R.	1	job	-	8,400
Bank stabilization (G.I.W.W.) 6.7 miles				
Excavation and backfill	105,000	cu.yd.	0.25	26,250
Riprap	58,000	ton	8.00	468,000
Shell	26,000	cu.yd.	3.00	78,000
Subtotal				<u>\$9,556,686</u>
Contingencies				1,433,314
Subtotal				<u>\$10,990,000</u>
Engineering and design				426,000
Supervision and administration				659,000
TOTAL CONSTRUCTION				<u>\$12,075,000</u>
<u>LANDS</u>				
Back levee	480	acre	variable	\$ 240,000
Contingencies				24,000
Market value				<u>\$ 264,000</u>
Acquisition cost				1,000
TOTAL LANDS				<u>\$ 265,000</u>

TABLE D-11 (cont'd)

<u>Item</u>	<u>Quantity</u>	<u>Unit</u>	<u>Unit price</u>	<u>Cost</u>
<u>RELOCATIONS</u>				
One 20" pipeline (front levee)	500	lin.ft.	\$110.00	\$ 55,000
One 24" pipeline " "	500	lin.ft.	128.00	64,000
Extend two 42" culv. " "	500	lin.ft.	30.00	15,000
One 20" pipeline (back levee)	1,000	lin.ft.	110.00	110,000
One 24" pipeline " "	1,000	lin.ft.	128.00	128,000
TOTAL RELOCATIONS				\$ 372,000

TABLE D-12  
BARRIER LEVEE

FIRST COST  
LEVEES AND LAND

<u>Item</u>	<u>Quantity</u>	<u>Unit</u>	<u>Unit price</u>	<u>Cost</u>
<u>CONSTRUCTION</u>				
<u>Levees</u>				
West of Chef Menteur levee, cast	103,500	cu.yd.	\$ 0.60	\$ 62,100
Drainage culvert	1	job		3,060
South of Rigolets levee, cast	145,000	cu.yd.	0.60	87,000
Drainage culvert	1	job		4,700
North of Rigolets levee, cast	22,000	cu.yd.	1.00	22,000
Drainage culvert	1	job		2,820
Seeding	55	acre	75.00	4,125
Subtotal				\$ 185,805
Contingencies				28,195
Subtotal				\$ 214,000
Engineering and design				8,000
Supervision and administration				13,000
TOTAL CONSTRUCTION				\$ 235,000
 <u>LANDS</u>				
West of Chef Menteur				
Levee	15	acre	\$15,000.00	\$ 225,000
Berm	6	acre	15,000.00	90,000
Borrow	16	acre	15,000.00	240,000
Contingencies				55,500
Market value				\$ 610,500
Acquisition cost				500
TOTAL (West of Chef Menteur)				\$ 611,000
 South of Rigolets				
Levee	20	acre	\$3,000.00	\$ 60,000
Berm	9	acre	3,000.00	27,000
Borrow	0.5	acre	16,000.00	8,000
Borrow	22.5	acre	3,000.00	67,500
Contingencies				16,500
Market value				\$ 179,000
Improvements				60,000
Severance				26,000
Acquisition cost				1,800
TOTAL (South of Rigolets)				\$ 266,800



TABLE D-12 (cont'd)

<u>Item</u>	<u>Quantity</u>	<u>Unit</u>	<u>Unit price</u>	<u>Cost</u>
North of Rigolets				
Levee	8	acre	\$1,500.00	\$ 12,000
Berm	5	acre	1,500.00	7,500
Borrow	10	acre	1,500.00	15,000
Contingencies				3,500
Market value				\$ 38,000
Acquisition cost				200
TOTAL (North of Rigolets)				\$ 38,200
TOTAL LANDS				\$ 916,000

TABLE D-13

MANDEVILLE SEAWALL  
(Strengthening of existing wall)

FIRST COST

<u>Item</u>	<u>Quantity</u>	<u>Unit</u>	<u>Unit price</u>	<u>Cost</u>
<u>CONSTRUCTION</u>				
Riprap	11,620	ton	\$ 10.00	\$ 116,200
Clam shell backfill	5,580	cu.yd.	5.00	27,900
Clay blanket	1,520	cu.yd.	2.00	3,040
Random backfill	2,300	cu.yd.	1.50	3,450
Excavation	3,364	cu.yd.	1.50	5,046
Concrete sheet pile wall	200	lin.ft.	75.00	15,000
Subtotal				\$ 170,636
Contingencies				25,364
Subtotal				\$ 196,000
Engineering and design				12,000
Supervision and administration				16,000
TOTAL CONSTRUCTION				\$ 224,000

TABLE D-14

LAKE PONTCHARTRAIN  
SUMMARY OF ESTIMATES OF FIRST COST

<u>Item</u>	<u>Cost</u>
Rigolets barrier structures:	
Navigation lock	\$ 2,619,000
Control structure	9,532,000
Highway	302,000
Levee and closure dam	4,035,000
Chef Menteur barrier structures:	
Navigation structure	1,207,000
Control structure	3,808,000
Levee and closure dam	1,169,000
Modification of Miss. River-Gulf Outlet Seabrook Lock <sup>(1)</sup>	400,000
Levee enlargement and appurtenant works:	
St. Charles Parish	4,938,000
Jefferson Parish	463,000
New Orleans	4,379,000
Citrus	9,451,000
New Orleans East	10,990,000
Barrier Levee	214,000
Mandeville	196,000
Subtotal	<u>\$53,703,000*</u>
Engineering and design	2,435,000
Supervision and administration	3,538,000
TOTAL CONSTRUCTION	<u>\$59,676,000</u>
Lands and damages	4,448,900*
Acquisition costs	30,100
Subtotal	<u>\$ 4,479,000</u>
Relocations	<u>548,000*</u>
 FIRST COST	 <u>\$64,703,000</u>

\*Includes contingencies.

(1) Cost for modification of Seabrook Lock (Table D-5)



TABLE D-16

LAKE PONTCHARTRAIN  
ESTIMATE OF ANNUAL ECONOMIC COST

<u>Summary of project costs</u>	<u>Federal</u>	<u>Non-Federal</u>	<u>Total</u>
Construction	\$ 59,676,000	\$ -	\$ 59,676,000
Lands, damages, and relocations	-	5,027,000	5,027,000
Less cash contribution	-18,476,000	18,476,000	
<b>FIRST COST</b>	<u>\$ 41,200,000</u>	<u>\$23,503,000</u>	<u>\$ 64,703,000</u>
Interest during const.(1)	<u>3,478,900</u>	<u>1,491,100</u>	<u>4,970,000</u>
<b>TOTAL PROJECT INVESTMENT</b>	<b>\$ 44,678,900</b>	<b>\$24,994,100</b>	<b>\$ 69,673,000</b>
 <u>Annual economic costs</u>			
Interest (2-7/8%)	\$ 1,284,500	\$ 718,600	\$ 2,003,100
Amortization (2-7/8%-100 yrs.)	80,000	44,700	124,700
Economic loss on land(2)	-	79,500	79,500
Maintenance and operation(3)	125,000	96,800	221,800
Replacements(4)	-	106,500	106,500
<b>TOTAL ANNUAL ECONOMIC COSTS</b>	<b>\$ 1,489,500</b>	<b>\$1,046,100</b>	<b>\$ 2,535,600</b>

		<u>Federal</u>	<u>Non-Federal</u>
(1)Rigolets barrier structures ( 2 yr.)	\$ 388,300	\$ 166,400	
Chef Menteur barrier str. ( 2 yr.)	142,800	61,200	
Modification of Seabrook Lock ( 3 yr.)	12,100	5,200	
St. Charles Parish ( 8 yr.)	458,700	196,700	
Citrus (10 yr.)	1,197,900	513,400	
New Orleans East (10 yr.)	1,279,100	548,200	
<b>Total</b>	<u>\$3,478,900</u>	<u>\$1,491,100</u>	
(2)Rigolets barrier structures Market value	\$ 590,000 @ .02125 =	\$12,500	
Chef Menteur barrier structures	" " 90,300 @ .02125 =	1,900	
New Orleans	" " 724,000 @ .02125 =	15,400	
Citrus	" " 1,248,000 @ .02125 =	26,500	
New Orleans East	" " 264,000 @ .02125 =	5,600	
Barrier levee	" " 827,500 @ .02125 =	17,600	
<b>Total</b>		<u>\$79,500</u>	

TABLE D-16 (cont'd)

	<u>Federal</u>	<u>Non-Federal</u>
(3)Rigolets barrier structures	\$ 125,000(a)	\$ 13,500
Chef Menteur barrier structures	-	52,300
St. Charles Parish	-	9,900
Jefferson Parish	-	700
Citrus	-	8,500
New Orleans East	-	9,800
Barrier levee	-	900
Mandeville	-	<u>1,200</u>
Total	\$ <u>125,000</u>	\$ <u>96,800</u>
(4)New Orleans (Inner Harbor Navigation Canal sheet piling)	\$ 67,000	
Citrus (Inner Harbor Navigation Canal sheet piling)	35,800	
Mandeville (seawall)	<u>3,700</u>	
	\$ <u>106,500</u>	

(a)Includes \$120,000 for lock and \$5,000 for navigation channel.

TABLE D-17  
NEW ORLEANS LAKEFRONT LEVEE

FIRST COST  
LEVEE AND RELOCATIONS

<u>Item</u>	<u>Quantity</u>	<u>Unit</u>	<u>Unit price</u>	<u>Cost</u>
<u>CONSTRUCTION</u>				
Levee enlargement, haul	112,355	cu.yd.	\$ 1.50	\$ 168,533
Seeding	25	acre	75.00	1,875
Subtotal				\$ 170,408
Contingencies				25,592
Subtotal				\$ 196,000
Engineering and design				8,000
Supervision and administration				12,000
TOTAL CONSTRUCTION				\$ 216,000
<u>RELOCATIONS</u>				
Road crossings	12	job	\$5,500.00	\$ 66,000

TABLE D-18  
CITRUS LAKEFRONT LEVEE

FIRST COST  
LEVEE AND RELOCATIONS

<u>Item</u>	<u>Quantity</u>	<u>Unit</u>	<u>Unit price</u>	<u>Cost</u>
<u>CONSTRUCTION</u>				
Levee enlargement (front) 4.9 miles				
Two lifts, pump	2,210,000	cu.yd.	\$ 0.76	\$1,679,600
Three lifts, shaping	221,000	cu.yd.	0.40	88,400
18" drainage pipe thru				
R.R.emb.	1,300	lin.ft.	25.00	32,500
Riprap	113,060	ton	8.00	904,480
Shell	41,900	cu.yd.	3.00	125,700
Seeding	120	acre	75.00	9,000
Stoplog closure	1	job		11,233
Subtotal				\$2,850,913
Contingencies				428,087
Subtotal				\$3,279,000
Engineering and design				131,000
Supervision and administration				197,000
TOTAL CONSTRUCTION				\$3,607,000
<u>RELOCATIONS</u>				
Modification of citrus pumping plant discharge pipes	1	job		\$ 74,000

TABLE D-19  
NEW ORLEANS EAST LAKEFRONT LEVEE

FIRST COST  
LEVEE AND RELOCATIONS

<u>Item</u>	<u>Quantity</u>	<u>Unit</u>	<u>Unit price</u>	<u>Cost</u>
<u>CONSTRUCTION</u>				
Levee enlargement (front) 6.3 miles				
Two lifts, pump	4,285,000	cu. yd.	\$ 0.76	\$3,256,600
Three lifts, shaping	428,500	cu. yd.	0.40	171,400
18" drainage pipe thru				
R.R. emb.	1,700	lin. ft.	25.00	42,500
Riprap	190,000	ton	8.00	1,520,000
Shell	70,187	cu. yd.	3.00	210,561
Seeding	190	acre	75.00	14,250
Subtotal				<u>\$5,215,311</u>
Contingencies				782,689
Subtotal				<u>\$5,998,000</u>
Engineering and design				240,000
Supervision and administration				360,000
TOTAL CONSTRUCTION				<u>\$6,598,000</u>
<u>RELOCATIONS</u>				
One 20" pipeline	500	lin. ft.	\$110.00	\$ 55,000
One 24" pipeline	500	lin. ft.	128.00	64,000
Extend two 42" culv.	500	lin. ft.	30.00	15,000
TOTAL RELOCATIONS				<u>\$ 134,000</u>

TABLE D-20  
LAKE FRONT LEVEES

ESTIMATE OF APPORTIONMENT OF COSTS BETWEEN  
FEDERAL AND NON-FEDERAL INTERESTS  
AND ANNUAL ECONOMIC COSTS

ST. CHARLES PARISH

Construction	\$5,441,000
Lands, damages, and relocations	258,000
TOTAL (See Table D-6)	\$5,699,000

<u>Apportionment of cost</u>	<u>Federal</u>	<u>Non-Federal</u>
	70%	30%
	\$3,989,000	\$1,710,000
Less lands, damages, and relocations		258,000
Cash contribution		\$1,452,000

<u>Summary of project costs</u>	<u>Federal</u>	<u>Non-Federal</u>	<u>Total</u>
Construction	\$5,441,000		\$5,441,000
Lands, damages, and relocations		\$ 258,000	258,000
Less cash contribution	-1,452,000	1,452,000	
FIRST COST	\$3,989,000	\$1,710,000	\$5,699,000
Interest during constr. (8 yr.)	458,700	196,700	655,400
TOTAL INVESTMENT	\$4,447,700	\$1,906,700	\$6,354,400

<u>Annual economic costs</u>	<u>Federal</u>	<u>Non-Federal</u>	<u>Total</u>
Interest (2-7/8%)	\$ 127,900	\$ 54,800	\$ 182,700
Amortization (2-7/8% - 100 yr.)	8,000	3,400	11,400
Maintenance	-	9,900	9,900
TOTAL	\$ 135,900	\$ 68,100	\$ 204,000

JEFFERSON PARISH

Construction	\$ 509,000
Lands, etc.	None

TOTAL (See Table D-8)	\$ 509,000
-----------------------	------------

<u>Apportionment of cost</u>	<u>Federal</u>	<u>Non-Federal</u>
	70%	30%
	\$ 356,000	\$ 153,000



TABLE D-20 (cont'd)

Annual economic costs

	<u>Federal</u>	<u>Non-Federal</u>	<u>Total</u>
Interest (2-7/8%)	\$ 10,200	\$ 4,400	\$ 14,600
Amortization (2-7/8% - 100 yrs.)	700	300	1,000
Maintenance	<u>-</u>	<u>700</u>	<u>700</u>
 TOTAL	\$ 10,900	\$ 5,400	\$ 16,300

NEW ORLEANS

Construction	\$ 216,000
Relocations	66,000
TOTAL (See Table D-17)	\$ <u>282,000</u>

Apportionment of cost

	<u>Federal</u> 70%	<u>Non-Federal</u> 30%
	\$ 197,000	\$ 85,000

Annual economic costs

	<u>Federal</u>	<u>Non-Federal</u>	<u>Total</u>
Interest (2-7/8%)	\$ 5,700	\$ 2,400	\$ 8,100
Amortization (2-7/8% - 100 yr.)	300	200	500
Maintenance	<u>-</u>	<u>-</u>	<u>-</u>
 TOTAL	\$ 6,000	\$ 2,600	\$ 8,600

CITRUS

Construction	\$3,607,000
Relocations	<u>74,000</u>
 TOTAL (See Table D-18)	\$3,681,000

Apportionment of cost

	<u>Federal</u> 70%	<u>Non-Federal</u> 30%
	\$2,577,000	\$1,104,000
Less relocations		<u>74,000</u>
Cash contribution		\$1,030,000

TABLE D-20 (cont'd)

<u>Summary of project costs</u>	<u>Federal</u>	<u>Non-Federal</u>	<u>Total</u>
Construction	\$3,607,000	\$ -	\$3,607,000
Relocations	-	74,000	74,000
Less cash contribution	<u>-1,030,000</u>	<u>1,030,000</u>	<u>                    </u>
FIRST COST	\$2,577,000	\$1,104,000	\$3,681,000
Interest during constr. (8 yr.)	<u>296,400</u>	<u>127,000</u>	<u>423,400</u>
TOTAL INVESTMENT	\$2,873,400	\$1,231,000	\$4,104,400
 <u>Annual economic costs</u>	 <u>Federal</u>	 <u>Non-Federal</u>	 <u>Total</u>
Interest (2-7/8%)	\$ 82,600	\$ 35,400	\$ 118,000
Amortization (2-7/8% - 100 yr.)	5,100	2,200	7,300
Maintenance	<u>-</u>	<u>2,000</u>	<u>2,000</u>
TOTAL	\$ 87,700	\$ 39,600	\$ 127,300
 <u>NEW ORLEANS EAST</u>			
Construction		\$6,598,000	
Relocations		<u>134,000</u>	
TOTAL (See Table D-19)		\$6,732,000	
 <u>Apportionment of cost</u>			
	<u>Federal</u>	<u>Non-Federal</u>	
	70%	30%	
	\$4,712,000	\$2,020,000	
Less relocations		- 134,000	
Cash contribution		<u>\$1,886,000</u>	
 <u>Summary of project costs</u>	 <u>Federal</u>	 <u>Non-Federal</u>	 <u>Total</u>
Construction	\$6,598,000	\$ -	\$6,598,000
Relocations		134,000	134,000
Less cash contribution	<u>-1,886,000</u>	<u>1,886,000</u>	<u>                    </u>
FIRST COST	\$4,712,000	\$2,020,000	\$6,732,000
Interest during constr. (8 yr.)	<u>541,900</u>	<u>232,300</u>	<u>774,200</u>
TOTAL INVESTMENT	\$5,253,900	\$2,252,300	\$7,506,200

TABLE D-20 (cont'd)

<u>Annual economic costs</u>	<u>Federal</u>	<u>Non-Federal</u>	<u>Total</u>
Interest (2-7/8%)	\$ 151,000	\$ 64,800	\$ 215,800
Amortization (2-7/8%- 100 yr.)	9,400	4,000	13,400
Maintenance	<u>          </u>	<u>3,200</u>	<u>3,200</u>
 TOTAL	 \$ 160,400	 \$ 72,000	 \$ 232,400

MANDEVILLE SEAWALL

Construction	\$ 224,000
Lands, etc.	<u>None</u>

TOTAL (See Table D-13) \$ 224,000

Apportionment of cost

	<u>Federal</u>	<u>Non-Federal</u>
	70%	30%
\$ 157,000	\$ 67,000	

<u>Annual economic costs</u>	<u>Federal</u>	<u>Non-Federal</u>	<u>Total</u>
Interest (2-7/8%)	\$ 4,500	\$ 1,900	\$ 6,400
Amortization (2-7/8% - 100 yr.)	300	100	400
Maintenance		1,200	1,200
Replacements	<u>          </u>	<u>3,700</u>	<u>3,700</u>
 TOTAL	 \$ 4,800	 \$ 6,900	 \$ 11,700

TABLE D-21  
CHALMETTE LEVEES

FIRST COST  
LEVEES, LAND, AND RELOCATIONS

<u>Item</u>	<u>Quantity</u>	<u>Unit</u>	<u>Unit price</u>	<u>Cost</u>
<u>CONSTRUCTION</u>				
<u>Levees</u>				
Levee enlargement (Inner Harbor Nav.Canal)				
Embankment, haul	22,725	cu.yd.	\$ 1.50	\$ 34,087
Steel sheet piling, MA-22	158,920	sq.ft.	3.50	556,220
Concrete cap	5,297	lin.ft.	6.00	31,782
Seeding	5.45	acre	75.00	409
Stoplog closure	1	job		8,400
New levee (along Miss.River -Gulf Outlet from Florida Ave. to Paris Road)				
Embankment, cast	920,000	cu.yd.	0.20	184,000
First shapeup	46,000	cu.yd.	0.40	18,400
Second shapeup	28,000	cu.yd.	0.40	11,200
Third shapeup	18,000	cu.yd.	0.40	7,200
Seeding	73	acre	75.00	5,475
New levee (along Miss.River-Gulf Outlet from Paris Road to Bayou Dupre)				
Embankment, cast	4,490,000	cu.yd.	0.25	1,122,500
First shapeup	225,000	cu.yd.	0.40	90,000
Second shapeup	180,000	cu.yd.	0.40	72,000
Third shapeup	135,000	cu.yd.	0.40	54,000
Fourth shapeup	90,000	cu.yd.	0.40	36,000
Seeding	191	acre	75.00	14,325
New levee (along Bayou Dupre from Miss. River-Gulf Outlet to Violet) 3.75 mi.				
First lift, pump	4,512,000	cu.yd.	0.76	3,429,120
Second lift, pump	1,880,000	cu.yd.	0.76	1,428,800
Third lift, pump	1,128,000	cu.yd.	0.76	857,280
First shapeup	376,000	cu.yd.	0.40	150,400
Second shapeup	226,000	cu.yd.	0.40	90,400
Third shapeup	150,000	cu.yd.	0.40	60,000
Seeding	259	acre	75.00	19,425
Stream closures				
First lift, pump	102,000	cu.yd.	0.76	77,520
Second lift, pump	68,000	cu.yd.	0.76	51,680
First shapeup	5,100	cu.yd.	0.40	2,040
Second shapeup	3,100	cu.yd.	0.40	1,240
Third shapeup	2,100	cu.yd.	0.40	840

TABLE D-21 (cont'd)

<u>Item</u>	<u>Quantity</u>	<u>Unit</u>	<u>Unit price</u>	<u>Cost</u>
Bank stabilization (Miss.River-Gulf Outlet) 13.5 miles				
Excavation and backfill	66,000	cu.yd.	\$ 0.25	\$ 16,500
Riprap	155,000	ton	8.00	1,240,000
Shell	56,000	cu.yd.	3.00	168,000
Subtotal				<u>\$9,839,243</u>
Contingencies				1,459,757
Subtotal				<u>\$11,299,000</u>
Floodgate*	2		lump sum	1,410,032
Contingencies				211,968
Subtotal				<u>\$1,622,000</u>
 TOTAL				 \$12,921,000
 Engineering and design				 518,000
Supervision and administration				<u>805,000</u>
 TOTAL CONSTRUCTION				 \$14,244,000

\*See Table D-22 for detailed cost estimate

LANDS

Along Bayou Dupre	581	acre	variable	\$ 229,250
Inner Harbor Nav. Canal	2.9	acre	variable	<u>113,500</u>
Subtotal				\$ 342,750
Contingencies				34,250
Market value				<u>\$ 377,000</u>
Improvements				34,800
Contingencies				3,200
Subtotal				<u>\$ 38,000</u>
Severance				30,000
Acquisition costs				<u>7,000</u>
 TOTAL LANDS				 \$ 452,000

RELOCATIONS

One 16" pipeline	1,000	lin.ft.	\$ 90.00	\$ 90,000
Two 20" pipelines	1,500	lin.ft.	110.00	165,000
Two 24" pipelines	1,500	lin.ft.	128.00	<u>192,000</u>
 TOTAL RELOCATIONS				 \$ 447,000

TABLE D-22  
CHALMETTE LEVEES

FIRST COST  
FLOODGATES

<u>Item</u>	<u>Quantity</u>	<u>Unit</u>	<u>Unit price</u>	<u>Cost</u>
<u>CONSTRUCTION</u>				
Excavation	30,720	cu.yd.	\$ 1.50	\$ 46,080
Dewatering during construction		job		75,000
Backfill	21,800	cu.yd.	0.80	17,440
Sheet piling MA-22	4,040	sq.ft.	3.50	14,140
Riprap 18"	1,000	ton	10.00	10,000
Shell	3,900	cu.yd.	6.00	23,400
Concrete stab. slab	380	cu.yd.	25.00	9,500
Concrete walls and slab	3,100	cu.yd.	50.00	155,000
Cement	3,900	bbl.	5.00	19,500
Reinf. steel	460,000	lb.	0.175	80,500
Timber piling (untreated)	22,000	lin.ft.	2.00	44,000
Pile clusters	4	each	2,250.00	9,000
Headwalls	128	lin.ft.	134.00	17,152
"I" type floodwall	252	lin.ft.	162.00	40,824
Sector gates			lump sum	75,000
Sector gate machinery			lump sum	25,000
Pipe handrail	700	lin.ft.	6.00	4,200
Control houses	2	each	4,000.00	8,000
Electrical work		job		10,000
Headwall anchorages	4	each	1,800.00	7,200
Miscl. steel	24,000	lb.	0.40	9,600
Gravel filter	420	cu.yd.	8.00	3,360
Sand filter	140	cu.yd.	8.00	1,120
Subtotal				\$ 705,016
Contingencies				105,984
Subtotal				\$ 811,000
Engineering and design				49,000
Supervision and administration				63,000
TOTAL CONSTRUCTION (each structure)				\$ 923,000

TABLE D-23  
CHALMETTE LEVEES

SUMMARY OF ESTIMATES OF FIRST COST

<u>Item</u>	<u>Cost</u>
<u>CONSTRUCTION</u>	
<u>Levees and appurtenant works</u>	
New and enlargement	\$12,921,000*
Engineering and design	518,000
Supervision and administration	<u>805,000</u>
 TOTAL CONSTRUCTION	 \$14,244,000
 Lands and damages	 \$ 445,000*
Acquisition costs	7,000
Subtotal	<u>\$ 452,000</u>
Relocations	<u>447,000*</u>
 FIRST COST	 \$15,143,000

\*Includes contingencies.

TABLE D-24  
CHALMETTE LEVEES

ESTIMATE OF APPORTIONMENT OF COSTS BETWEEN  
FEDERAL AND NON-FEDERAL INTERESTS

<u>Project first cost</u>		
Construction		\$14,244,000
Lands, damages, and relocations		<u>899,000</u>
 TOTAL		 \$15,143,000
<u>Apportionment of costs</u>		
	<u>Federal</u>	<u>Non-Federal</u>
	70%	30%
Less lands, damages, and relocations	\$10,600,000	\$ 4,543,000
		<u>899,000</u>
 Cash contribution		 \$ 3,644,000

TABLE D-25  
CHALMETTE LEVEES

ESTIMATE OF ANNUAL ECONOMIC COST

<u>Summary of project costs</u>	<u>Federal</u>	<u>Non-Federal</u>	<u>Total</u>
Construction	\$ 14,244,000	\$ -	\$ 14,244,000
Lands, damages, and relocations	-	899,000	899,000
Less cash contribution	<u>\$ -3,644,000</u>	<u>\$3,644,000</u>	<u>                    </u>
 FIRST COST	 \$ 10,600,000	 \$4,543,000	 \$ 15,143,000
 Interest during construction (10-yr.)	 <u>\$ 1,523,700</u>	 <u>\$ 653,100</u>	 <u>\$ 2,176,800</u>
 TOTAL PROJECT INVESTMENT	 \$ 12,123,700	 \$5,196,100	 \$ 17,319,800
 <u>Annual economic costs</u>			
Interest (2-7/8%)	\$ 348,600	\$ 149,400	\$ 498,000
Amortization (2-7/8%-100 yrs.)	21,700	9,300	31,000
Economic loss on land (Market value \$124,900* @ .02125)	-	2,700	2,700
Maintenance	-	29,000	29,000
Replacements	<u>-</u>	<u>11,500</u>	<u>11,500</u>
 TOTAL ANNUAL ECONOMIC COSTS	 \$ 370,300	 \$ 201,900	 \$ 572,200

\*Rights-of-way on Inner Harbor Navigation Canal



APPENDIX E

PROTECTION AND IMPROVEMENT FEATURES

APPENDIX E

PROTECTION AND IMPROVEMENT FEATURES

PLATES





<u>Plate</u>	<u>Title</u>
E-1	St. Charles and Jefferson Parishes
E-2	New Orleans
E-3	Citrus, New Orleans East, and Chalmette

## APPENDIX E

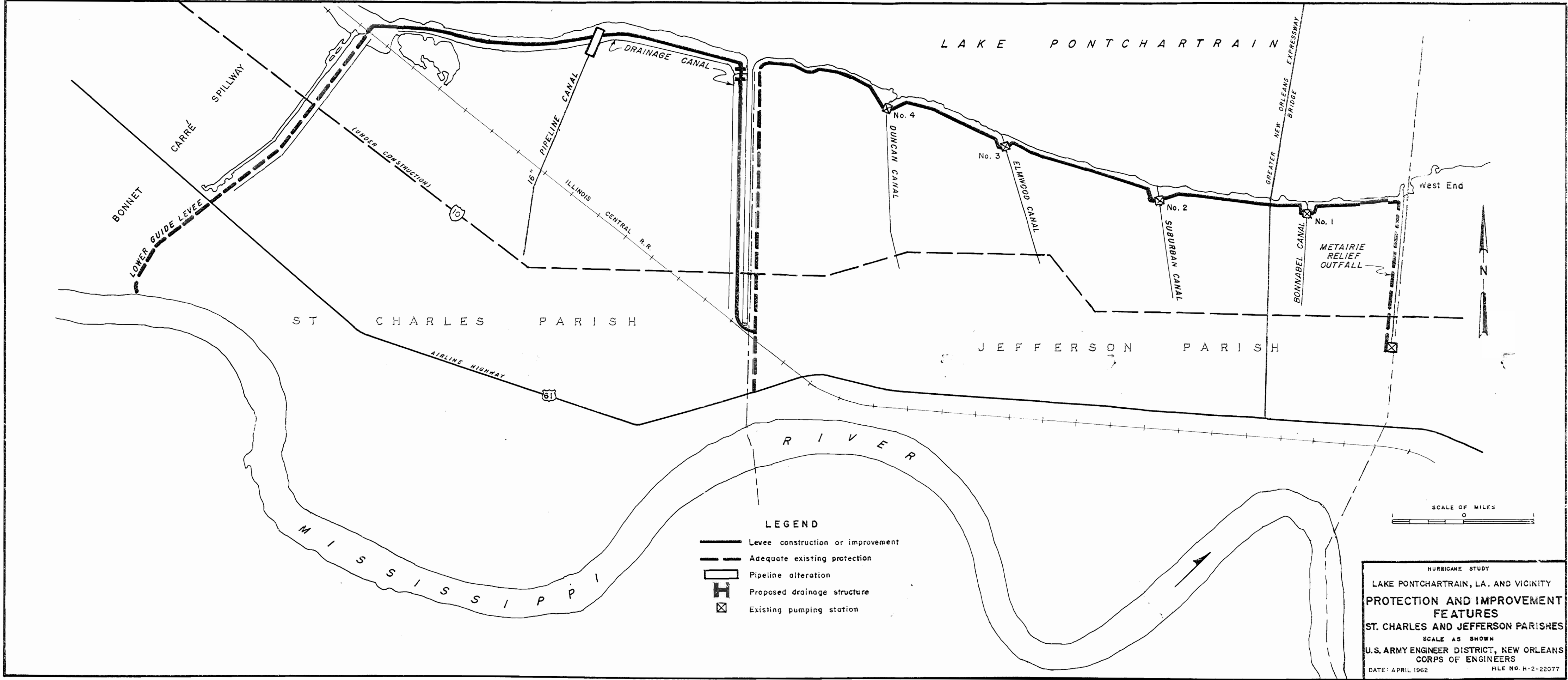
### PROTECTION AND IMPROVEMENT FEATURES

Protection and improvement features shown in detail on plates E-1 through E-3 of this appendix are supplemental to those shown in plan on plate 3 and in detail on plates 4 through 13. Locations and types of improvement features are shown on the following plates: St. Charles and Jefferson Parishes, plate E-1; New Orleans, plate E-2; and Citrus, New Orleans East and Chalmette, plate E-3.



- LEGEND**
-  Levee construction or improvement
  -  Adequate existing protection
  -  Pipeline alteration
  -  Proposed drainage structure
  -  Existing pumping station



HURRICANE STUDY  
 LAKE PONTCHARTRAIN, LA. AND VICINITY  
**PROTECTION AND IMPROVEMENT  
 FEATURES**  
 ST. CHARLES AND JEFFERSON PARISHES  
 SCALE AS SHOWN  
 U.S. ARMY ENGINEER DISTRICT, NEW ORLEANS  
 CORPS OF ENGINEERS  
 DATE: APRIL 1962 FILE NO. H-2-22077

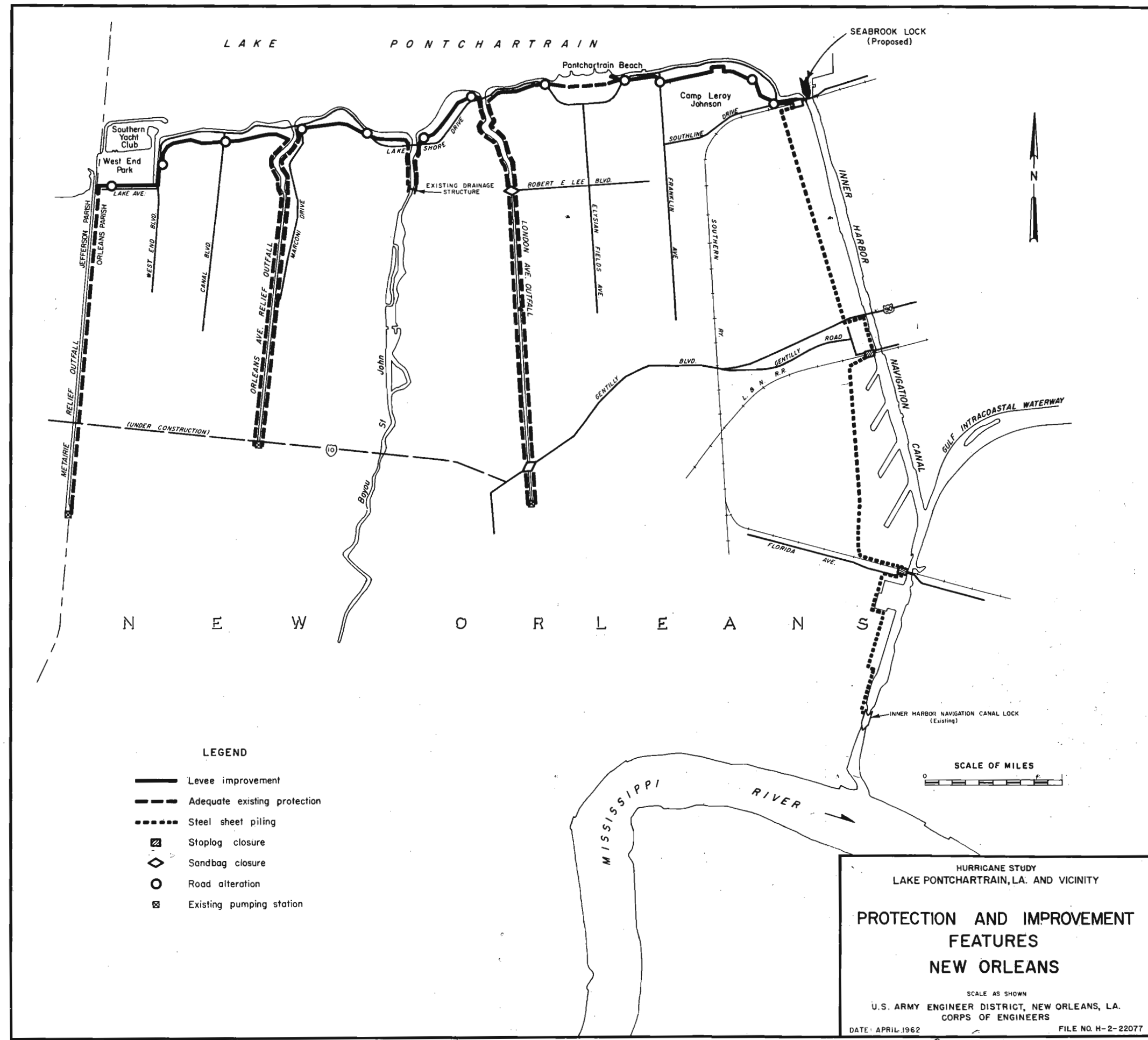

HURRICANE STUDY  
 LAKE PONTCHARTRAIN, LA. AND VICINITY







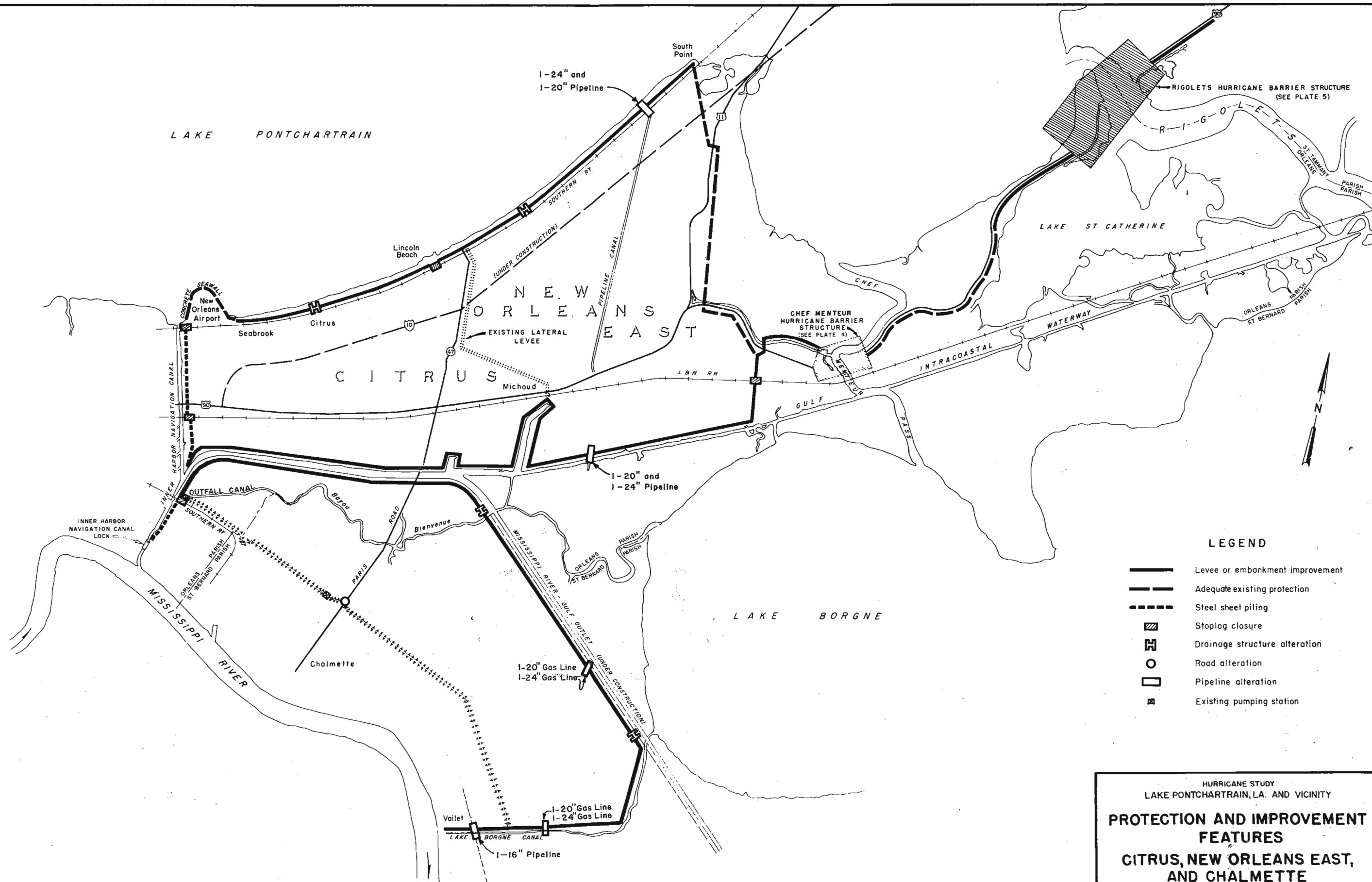

**PROTECTION AND IMPROVEMENT  
 FEATURES  
 NEW ORLEANS**

SCALE AS SHOWN  
 U.S. ARMY ENGINEER DISTRICT, NEW ORLEANS, LA.  
 CORPS OF ENGINEERS

DATE: APRIL 1962 FILE NO. H-2-22077



**LEGEND**

-  Levee or embankment improvement
-  Adequate existing protection
-  Steel sheet piling
-  Stoplog closure
-  Drainage structure alteration
-  Road alteration
-  Pipeline alteration
-  Existing pumping station

HURRICANE STUDY  
 LAKE PONTCHARTRAIN, LA. AND VICINITY  
**PROTECTION AND IMPROVEMENT  
 FEATURES**  
**CITRUS, NEW ORLEANS EAST,  
 AND CHALMETTE**  
 SCALE AS SHOWN  
 U.S. ARMY ENGINEER DISTRICT, NEW ORLEANS, LA.  
 CORPS OF ENGINEERS  
 DATE: APRIL 1962 FILE NO. H-2-22077

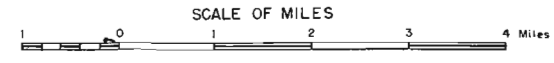

APPENDIX F

REPORT OF U. S. FISH AND WILDLIFE SERVICE

APPENDIX F

REPORTS OF U. S. FISH AND WILDLIFE SERVICE

1. Report dated 13 March 1962.

ENCLOSURES

Plate

Title

- |   |                    |
|---|--------------------|
| 1 | Plan of protection |
|---|--------------------|

Figure

Title

- |   |   |
|---|---|
| 1 | Variations in Lake Pontchartrain salinity   |
| 2 | Effect of hurricane closure operation on surface salinity in Gulf Outlet channel at Bayou La Loutre |
| 3 | Response of Lake Pontchartrain salinity to control of Gulf Outlet capacity flow                     |
| 4 | Response of salinity in Gulf Outlet channel to controlled flow                                      |

LETTER FROM STATE OF LOUISIANA, WILD LIFE  
AND FISHERIES COMMISSION DATED 28 FEBRUARY 1962

2. Report dated 22 October 1962.

ENCLOSURE

LETTER FROM STATE OF LOUISIANA, WILD LIFE  
AND FISHERIES COMMISSION, DATED 16 OCTOBER 1962





UNITED STATES  
DEPARTMENT OF THE INTERIOR  
FISH AND WILDLIFE SERVICE  
BUREAU OF SPORT FISHERIES AND WILDLIFE  
PEACHTREE-SEVENTH BUILDING  
ATLANTA 23, GEORGIA

SOUTHEAST REGION

(REGION 4)

NORTH CAROLINA  
SOUTH CAROLINA  
GEORGIA  
FLORIDA  
KENTUCKY  
TENNESSEE  
ALABAMA  
MISSISSIPPI  
ARKANSAS  
LOUISIANA  
VIRGINIA  
MARYLAND  
PUERTO RICO  
VIRGIN ISLANDS

ADDRESS ONLY THE  
REGIONAL DIRECTOR

March 13, 1962

CE-LM-po (Lake Pont-  
chartrain, Louisiana)

District Engineer  
U. S. Army, Corps of Engineers  
New Orleans, Louisiana

Dear Sir:

Pursuant to the Fish and Wildlife Coordination Act (48 Stat. 401, as amended; 16 U.S.C. 661 et seq.), the U. S. Fish and Wildlife Service, in cooperation with the Louisiana Wild Life and Fisheries Commission, has examined the fish and wildlife aspects of Lake Pontchartrain and vicinity, Louisiana, in relation to proposed plans for hurricane protection under consideration by your agency. This is a letter report of our findings, submitted for inclusion in your survey report.

In addition to presenting the relation of fish and wildlife requirements to your plans for hurricane protection, this report considers the project-associated probability of salt-water intrusion into the lake via the Mississippi River-Gulf Outlet channel, a navigation project currently under construction by your agency.

Report findings are based on intensive fish and wildlife investigations in both the primary project and the Mississippi River-Gulf Outlet project areas. Where appropriate, the resource appraisals were coordinated with model studies conducted by the Waterways Experiment Station, Vicksburg, Mississippi. The model study limitations are recognized, but for reporting purposes, the study data have been used as furnished.

Frequent coordination meetings between this Service, your staff, and the Louisiana Wild Life and Fisheries Commission have been of invaluable assistance in directing the scope and approach of the field investigations as well as use and interpretation of the model study data.

DESCRIPTION OF THE AREA

Lake Pontchartrain is a shallow (14-foot average depth) 640 square-mile tidal basin bordered on its south side by the New Orleans metropolitan locale. It is important to note the lake is only a part of the total interrelated estuarine environmental complex of

this southeastern Louisiana coastal area. Likewise, it must be recognized that changes effected in the lake can result in changes within other segments of the complex. Accordingly, certain major factors that influence the final appreciation of the total fresh and saline contributions to the lake require explanation.

Lake Pontchartrain lies between the relatively salt water conditions of Lake Borgne and Mississippi Sound and the relatively fresh water conditions of Lake Maurepas. Local residents generally consider the lake to be fresh water west of the Lake Pontchartrain Causeway and salt water east of this division line. The upper or westward half of the lake has average annual salinities of about 1-2 p.p.t. in comparison to the  $1\frac{1}{2}$ - $4\frac{1}{2}$  p.p.t. obtained in the lower half of the area. It is, of course, recognized that this division line or salinity gradient varies as the result of influx from either of the contributing systems.

### Saline Waters

The transport of salt water into Lake Pontchartrain is currently accomplished through the Chef Menteur and Rigolets passages by Lunar and wind tides. These are natural passes, having average widths of about 1,000 feet and 3,500 feet, and controlling depths of 25 feet and 20 feet in the Chef Menteur and Rigolets channels, respectively.

The normal flow through the passes results from tidal head differential developed between Lake Pontchartrain and Lake Borgne-Mississippi Sound. Wind affects normal tidal exchange considerably, and at times wind tides are dominant. Easterly winds increase inflow through the passes, and at times, depending on source values, salinity. The salinities of sourcewaters of Lake Borgne and Mississippi Sound are subject to considerable variation caused by discharges from Pearl River.

The Mississippi River-Gulf Outlet navigation channel may have equal or greater importance than the natural passes for transporting saline waters to Lake Pontchartrain. This 36-foot deep, 500-foot bottom width channel, when completed, will afford a more direct connection between Lake Pontchartrain and the Gulf of Mexico. The controlling depth of this system will be the 30-foot deep Industrial Canal. Gulf waters entering the lake through this system would have salinities several times higher than waters entering through the natural passes.

### Fresh Water

The normal fresh water contributions arise from direct rainfall and runoff into both Lake Pontchartrain and Lake Maurepas. An atypical

freshwater source is the Bonnet Carre Floodway, a floodwater outlet designed to bypass certain Mississippi River flood stages through Lake Pontchartrain. Operation of this system has been required only three times in its 27 years of existence.

#### DESCRIPTION OF THE PROJECT

Two basic plans of hurricane protection have been studied (Plate 1).

##### Low Level Plan

The low level plan provides for a system of levees on the south lakeshore adjacent to the New Orleans metropolitan area and a barrier across the east lakeshore with control structures in the two tidal passes. A structure or lock would also be included at the junction of Industrial Canal and Lake Pontchartrain.

Structures would reduce the cross sectional area of each tidal pass 75 percent. Sills would be at the present controlling depth of the passes (minus 25 feet in Chef Menteur and minus 20 feet in the Rigolets) and closure would be accomplished with tainter gates. Navigation locks would pass boat traffic around each structure. Gates would be closed only when a hurricane was approaching the Louisiana coast, and reopened when danger was past. Hurricanes strike the Louisiana coast an average of 1.6 times a year between spring and fall. Model tests of the operation were based on a maximum closure of two weeks.

##### High Level Plan

The high level plan does not include the barrier along the eastern lakeshore which incorporates control structures in the tidal passes or the structure in the Gulf Outlet connection. In most other respects the two plans are similar, except that higher levees would be required along the south lakeshore.

Under either plan drainage facilities would be included in the levee system. Control gates in the drains from the marshes and swamp immediately east of Bonnet Carre spillway would remain open except when closure would be required to prevent hurricane flooding. The levee portion of either plan would not necessarily be provided over the entire project area, but could be adapted as separate units, protecting those parishes giving the required local project assurances and participation.

#### FISH AND WILDLIFE RESOURCES

Lake Pontchartrain, with its salinity gradient, sustains an important fishery resource. Ninety-five percent of the sport fishing

harvest and 90 percent of the commercial fishery production are marine species. Bait sales of live and dead shrimp, live small fish, crabs, and clams to supply fisherman needs in the immediate Lake Pontchartrain area amount to 1/4 million dollars annually. With maintenance of existing salinities a without-the-project use of 800,000 man-days of sport fishing and sport and commercial fishery harvest of 5-1/4 million pounds of fish and shellfish are assignable to the lake.

While all of Lake Pontchartrain is considered a nursery area, the nursery value of the upper lake is of exceptional importance to such species as menhaden and white shrimp. These nursery stocks, in addition to contributing to the harvest elsewhere when they mature, also provide forage (food) for desirable sport and commercial fish species in the lower lake.

Since it is evident that the fishery complex is intimately related to the salinity gradient, it must be emphasized that a major change or shift in the salinity gradient could have significant effect upon the fishery resources both in the lake and adjacent areas. Both the harvest area of the lower lake and the valuable nursery area of the upper lake are related to the existing salinity gradient. Lowering lake salinity could reduce the area of marine fishery harvest. A significant salinity increase could reduce the nursery area value, and, indirectly, the harvest.

Wildlife of significant value is present in the area, primarily waterfowl and fur animals; however, considering the metropolitan expansion without the project, significant project-occasioned losses are not assignable to this resource.

#### EFFECTS OF THE PROJECT

##### Levees

Levee construction included in either plan for hurricane protection is not expected to affect fish and wildlife resources directly. Indirectly, both plans would hasten urbanization and industrialization of valuable marshes by providing basic features for further flood protection and reclamation. This applies especially to the area of marsh and swamp east of Bonnet Carre Spillway that now does not have levee protection.

Since the high level plan consists essentially of levee protection, it is not expected that significant project effects would occur. In contrast, the low level plan contains other features that must be considered; namely, the control structures in the tidal passes and in the Industrial Canal connecting the Gulf Outlet with Lake Pontchartrain.

### Structures in the Tidal Passes

The principal factor considered in project investigations was the possible adverse effect of reducing the tidal volume exchange between Lake Pontchartrain and the brackish waters of Mississippi Sound-Lake Borgne by restricting the tidal passes with control structures. Of particular concern was the relation of tidal volume exchange to salinity, inasmuch as the salinity gradient in Lake Pontchartrain is dependent upon tidal introduction of brackish waters. Effect of project structures in the passes on velocity of flow and as a physical obstruction was also considered but is not believed to be significant to fish and wildlife.

Salinities were not altered significantly in model tests when the respective cross-sectional areas of the tidal passes were reduced by 75 percent. Existing salinities in Lakes Maurepas, Pontchartrain, and Borgne, under the range of inflow or salinity conditions tested, were virtually unaffected. It was also shown that the structures would not alter, to an appreciable degree, salinities which may occur in the lake system with the Gulf Outlet project completed. The model tests indicated that severe salt water intrusion into Lake Pontchartrain would occur as a result of high salinities entering the lake via Gulf Outlet channel (Fig. 1 and 3).

Salinity control was shown to be possible by placement of a structure at the junction of Lake Pontchartrain and Industrial Canal. Operation of this structure accomplished control of salt water intrusion into the lake system of the test models. Structures in the tidal passes did not interfere with this control. Figure 1 summarizes model test results showing effect of control structures in the tidal passes on existing Lake Pontchartrain salinity, effect of salt water intrusion via Gulf Outlet channel, and salt water intrusion control.

Structure closure for a period of two weeks did not alter, significantly, salinities, as modified by the Gulf Outlet channel, in Lakes Maurepas, Pontchartrain, or Borgne. Salinities in the Gulf Outlet channel increased significantly during the closure period, but were reduced upon reopening the structures by evacuation from Lake Pontchartrain of accumulated hurricane rainfall (Figure 2). Prolonged or permanent closure of the structure in the Gulf Outlet connection could have extremely adverse effects upon the Gulf Outlet channel area.

### Other Hydrological Factors

While model studies indicate that structures in the tidal passes would not affect salinity adversely, the structures would increase

velocities locally in the passes. Increased velocities could present a hazard to small boats, and locking around the structures, when required, could delay passage in and out of the lake. This delay may be a problem for boats entering the lake ahead of a hurricane. In addition, while the structures could possibly interfere with movement of fish and shellfish in and out of the lake, it appears that maintenance of the controlling depth of the passes would tend to overcome this problem.

#### DISCUSSION AND CONCLUSIONS

The Service has appraised the two plans you have under consideration for control of hurricane surges in Lake Pontchartrain. The plans consist: one, of a high levee protection for certain areas adjacent to the lake; and two, of a combination of lesser degree of levee protection combined with control structures in Chef Menteur and Rigolets passes and a structure located at the junction of the Industrial Canal and the lake.

The determination of project-occasioned changes under either plan are based primarily on model studies and data obtained from investigations conducted on the Mississippi River-Gulf Outlet Navigation project.

Lake Pontchartrain is a segment of the total estuarine environmental complex of the Southeast Louisiana coastal zone. This particular zone, which includes the total gradient between fresh and Gulf of Mexico saline waters, results from conditions maintained by both the water sources contributing to the complex.

In consequence, alteration of any segment of the complex will result in changes in other areas within the complex.

In model studies existing lake salinities were not altered significantly by control structures in Chef Menteur and Rigolets passes. The structures could result in higher flow velocities through the passes with the associated problems to boats. Also, the probability of delay of boat entry into the lake during the period of an approaching hurricane does require attention.

Model tests also established that intrusion of waters from the Mississippi River-Gulf Outlet channel through the Industrial Canal into Lake Pontchartrain, if not controlled, would result in increased salinity conditions within the lake, as well as higher salinities in the Gulf Outlet channel and adjacent areas. Opportunities to control salt water intrusion in the lake and to some degree reduce the extent of intrusion within the navigation channel appear feasible (Figures 3 and 4). Further Service studies are

being conducted to determine intrusion characteristics and to define design and operational requirements for a control structure. The Service studies will be coordinated with your efforts. In this regard, it appears further model studies or hydrological investigations conducted by your agency merit correlation with our proposed investigations.

The Service concludes that the hurricane protection, essentially by means of levee construction (High Level Plan), would have no significant detrimental effects to the fish and wildlife resources within the area of project influence. Model study findings on the low level plan indicate the two proposed control structures in the natural passes would not significantly alter the salinity gradient in Lake Pontchartrain. The model studies did establish that salt water intrusion problem through the Mississippi River-Gulf Outlet navigation channel would be detrimental to existing conditions both in the lake and in the navigation channel area. Accordingly, the Service finds that with a proper control facility the risk of detrimental effects of the low level plan is within reason.

#### RECOMMENDATIONS

The U. S. Fish and Wildlife Service therefore recommends that:

1. In the event you recommend the low level plan, your plan include provision for enlarging the structures in the tidal passes should the salinity gradient in Lake Pontchartrain, as established by a cooperative sampling program, be adversely affected.
2. The existing salinity gradient in Lake Pontchartrain be maintained insofar as salt water intrusion control requirements in the overall Lake Pontchartrain-Gulf Outlet complex will permit.
3. A structure, as necessary for salt water intrusion control, be built as a feature of the Gulf Outlet project in the Gulf Outlet-Industrial Canal connection with Lake Pontchartrain.
4. The pertinent design criteria and operational procedure for this structure be developed as a part of the continuing studies on the Gulf Outlet project.

The Louisiana Wild Life and Fisheries Commission has reviewed this report and their letter of concurrence is attached.

In the event your plans are modified, we request notification and opportunity to revise fish and wildlife considerations accordingly.

Should either of the alternate plans for hurricane protection be found favorable and authorized for construction, we request opportunity to review and comment on your detailed plans prior to construction.

We are pleased to have had this opportunity to work with you and members of your staff. It is requested that you notify us of your proposed action on our recommendations.

Sincerely yours,



Walter A. Green  
Regional Director, Bureau of  
Sport Fisheries and Wildlife

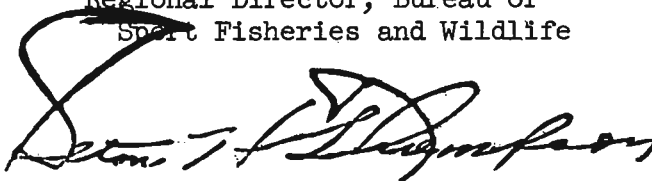

Seton H. Thompson  
Regional Director, Bureau of  
Commercial Fisheries



Enclosures 6

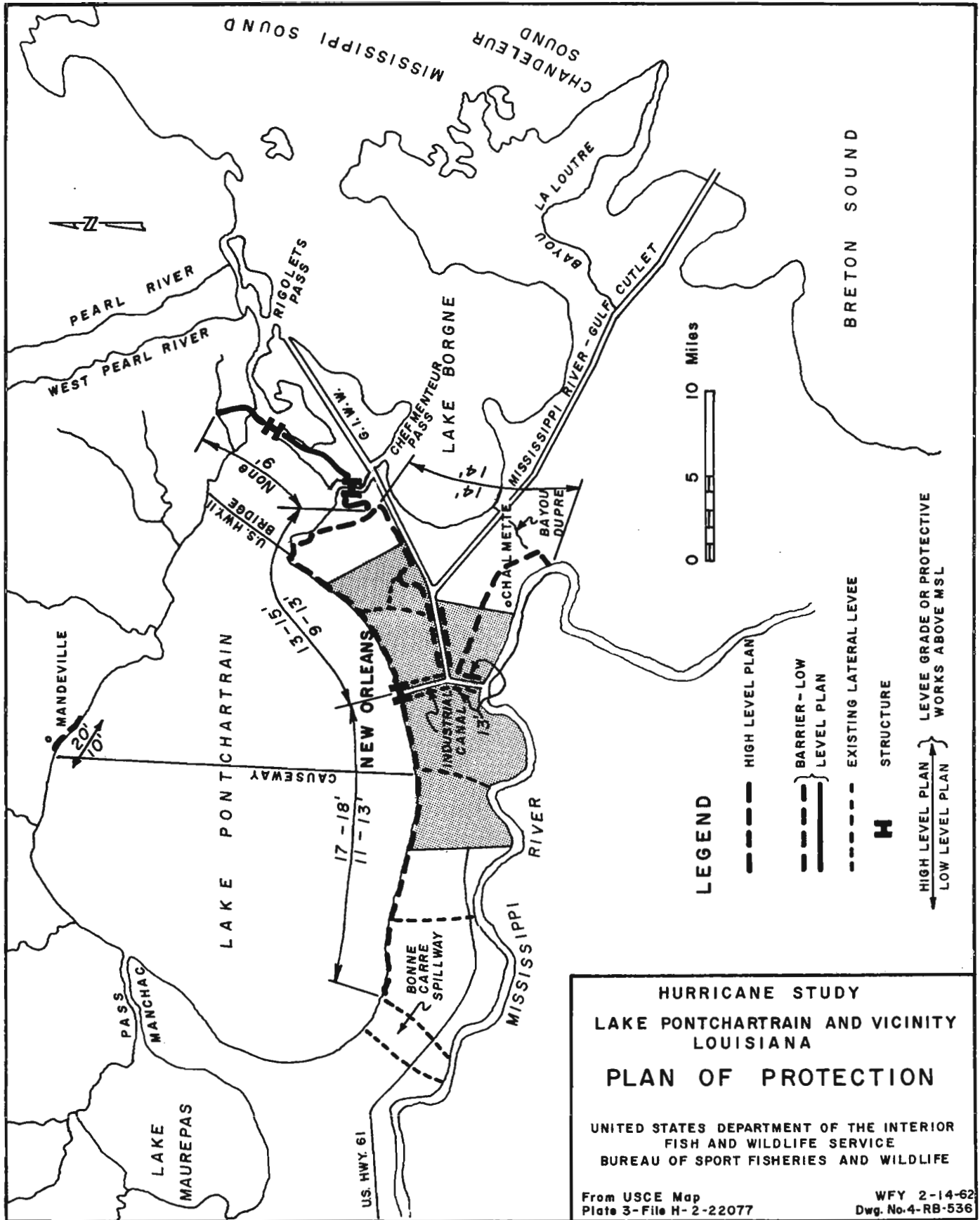

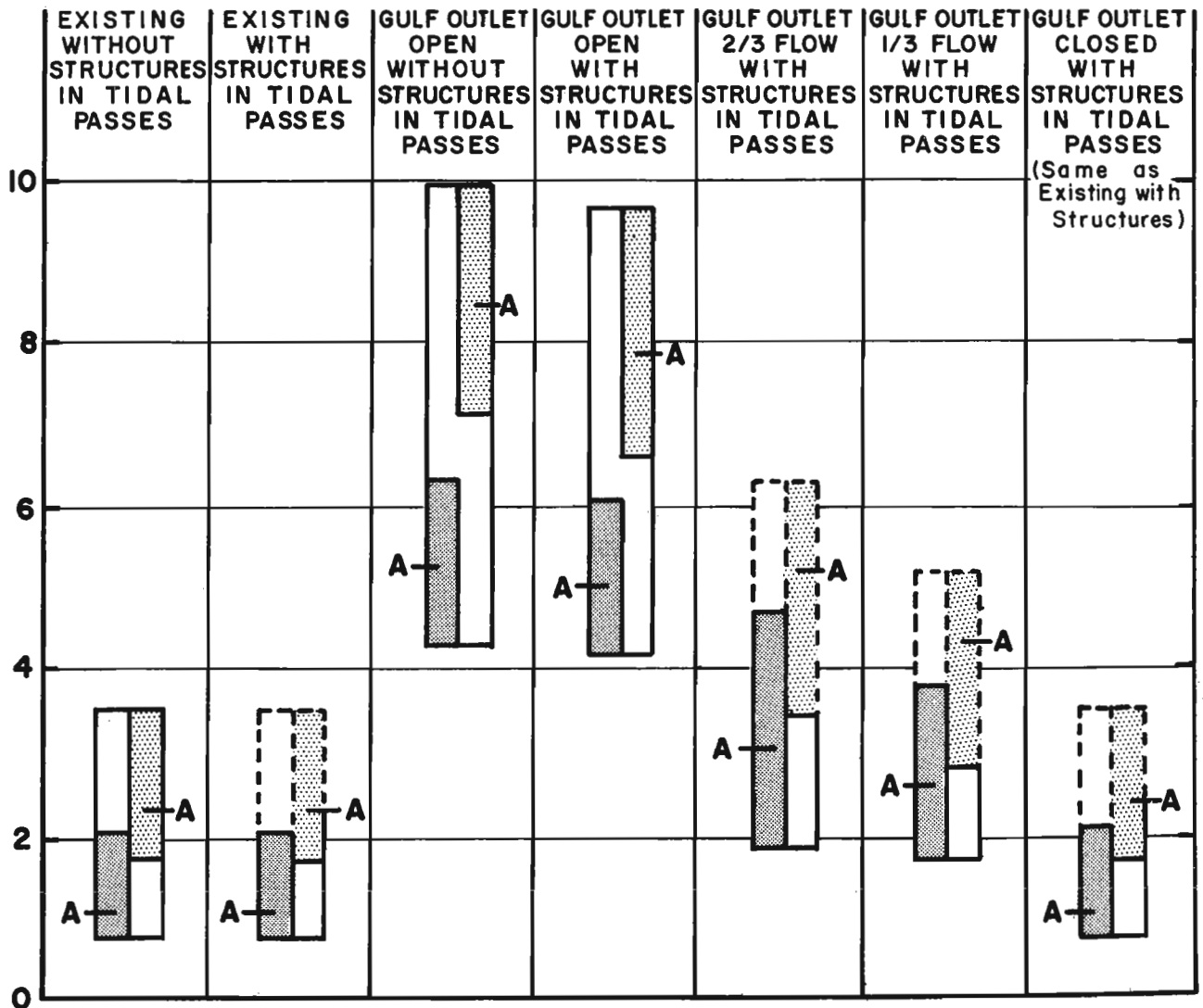

**FIG. I - VARIATIONS IN LAKE PONTCHARTRAIN SALINITY**  
 - FROM MODEL TEST DATA -

HIGH INFLOW YEAR      LOW INFLOW YEAR

 RANGE       RANGE  
**A-** AVERAGE      **A-** AVERAGE  
 -----CALCULATED

**SALINITY  
 PPT.**

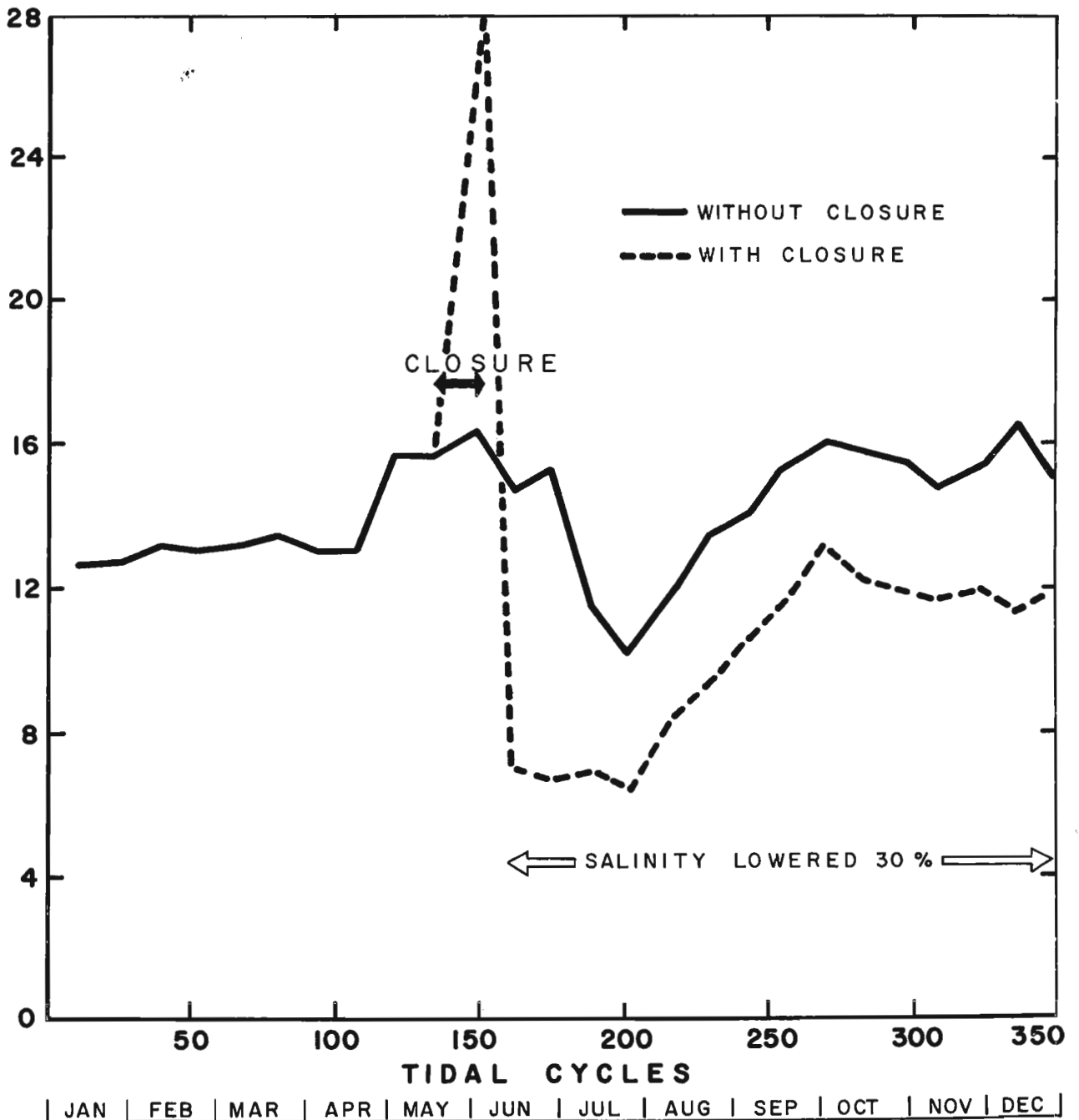

**FIG. 2 - EFFECT OF HURRICANE CLOSURE OPERATION  
ON SURFACE SALINITY IN GULF OUTLET CHANNEL  
AT BAYOU LA LOUTRE**

- FROM MODEL TEST DATA -

**HIGH INFLOW YEAR**

**SALINITY  
PPT.**



**FIG. 3 - RESPONSE OF LAKE PONTCHARTRAIN SALINITY TO CONTROL OF GULF OUTLET CAPACITY FLOW**

- FROM MODEL TEST DATA -

CONTROL POINT AT JCT. INDUSTRIAL CANAL / LAKE

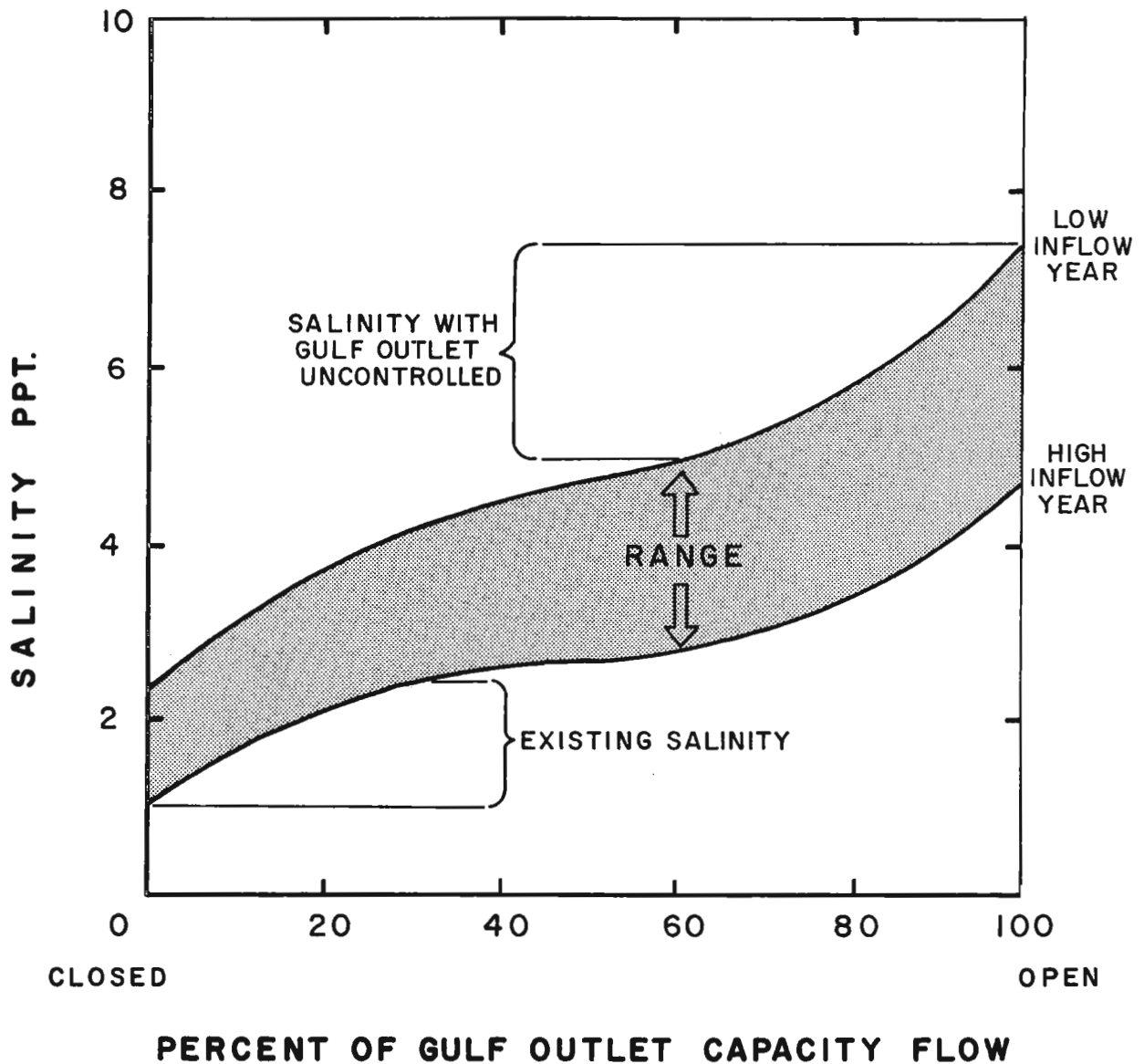

**FIG. 4 - RESPONSE OF SALINITY IN GULF OUTLET CHANNEL TO CONTROLLED FLOW**

-FROM MODEL TEST DATA-

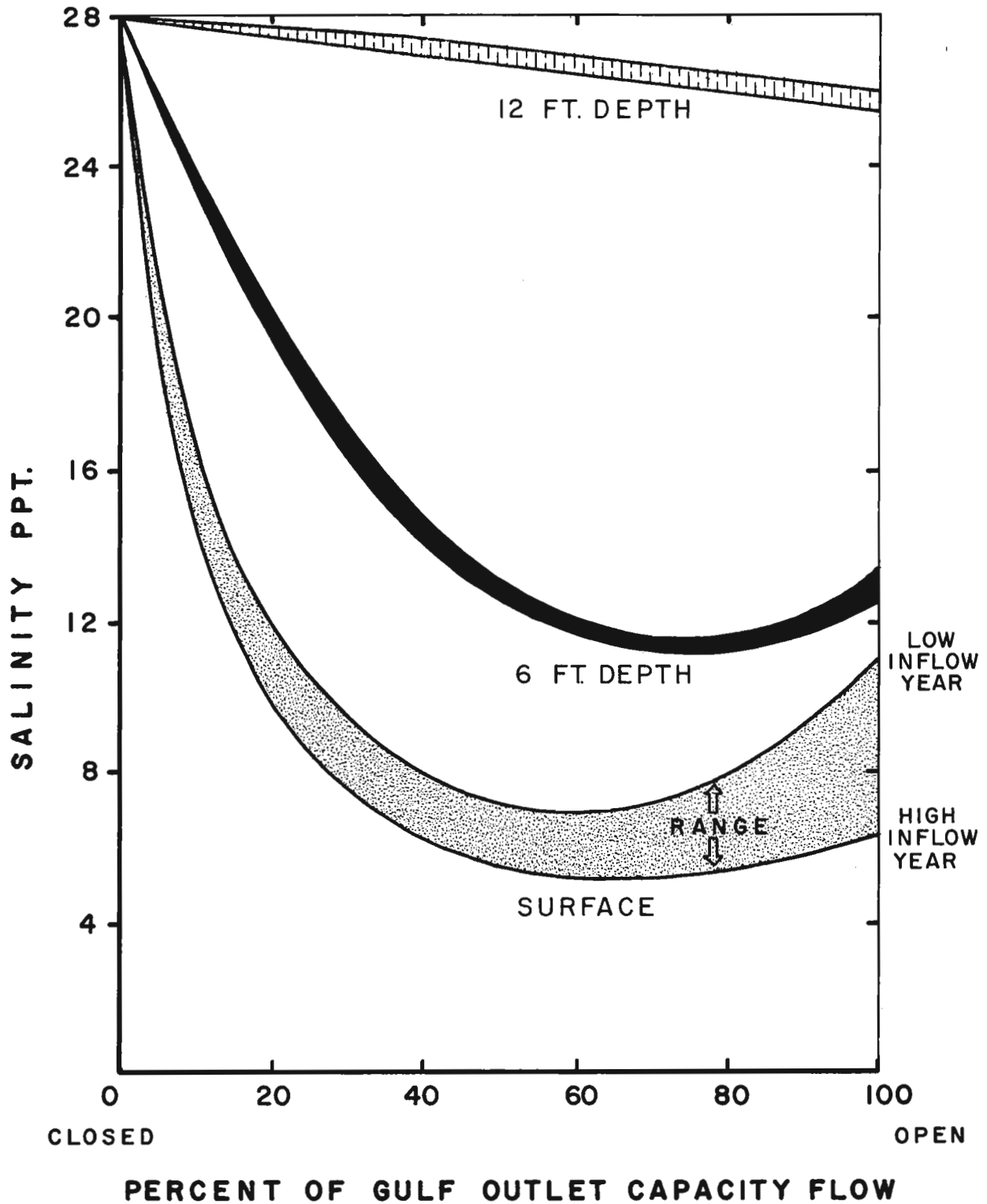

NOTE: LOW INFLOW DATA PARTIALLY CALCULATED

# State of Louisiana



WILD LIFE AND FISHERIES COMMISSION  
400 ROYAL STREET  
NEW ORLEANS 16

L. D. YOUNG, JR.  
DIRECTOR

February 28, 1962

Mr. F. C. Gillett, Acting Regional Director  
U. S. Fish and Wildlife Service  
Bureau of Sport Fisheries and Wildlife  
Peachtree-Seventh Building  
Atlanta 23, Georgia

Dear Mr. Gillett:

This is in reply to your letter of February 16, 1962 concerning the enclosed draft report on the Lake Pontchartrain Hurricane Study.

Various staff members have reviewed and discussed this report in detail and it is as previously decided upon by coordinated efforts between your agency and this Commission.

We do concur in this report and the provisions contained therein and do not have additional comments to make at this time.

We would like to obtain at least twenty-five copies of this report when it is released to the Corps of Engineers.

Thank you for your cooperation, and we appreciate the opportunity to review and comment on this report.

Sincerely,

L. D. Young, Jr.,  
Director

LDY, Jr/sl.



UNITED STATES  
DEPARTMENT OF THE INTERIOR  
FISH AND WILDLIFE SERVICE  
BUREAU OF SPORT FISHERIES AND WILDLIFE  
PEACHTREE-SEVENTH BUILDING  
ATLANTA 23, GEORGIA

October 22, 1962

District Engineer  
U. S. Army, Corps of Engineers  
New Orleans, Louisiana

CE-IM-po

Dear Sir:

Your letter of September 11, 1962, advised that you are considering a modification of the Lake Pontchartrain hurricane protection plan in response to a local interests' request. Comments on this modification, by the U. S. Fish and Wildlife Service, to supplement our report of March 13, 1962, were requested by October 15, 1962.

It is our understanding, on the basis of your September 11 letter and additional information obtained from your office by our field representatives, that the project modification would consist of an extension of the protected area to include additional lands north of Chalmette, Louisiana.

The modified plan would provide for the construction of new levees along the south side of the Gulf Intracoastal Waterway from the Inner Harbor Navigation Canal eastward to Paris Road, thence along the south side of the Mississippi River-Gulf Outlet to Bayou Dupre, thence southward along Bayou Dupre or Lake Borgne Canal (Violet Canal) to Violet, Louisiana. The hurricane levee along the south side of the Mississippi River-Gulf Outlet between Paris Road and Bayou Dupre, constructed on top of the existing spoil bank, would cross and permanently close two openings through the spoil retention area designed to maintain the channels of Bayou Villere and a navigable pipeline canal.

In order to provide for interior drainage and water exchange, two hurricane sector-gated structures would be installed along the Mississippi River-Gulf Outlet levee alignment. One floodgate would be constructed on Bayou Bienvenue; the other would be located on an outlet to Bayou Dupre.

The present back-dike canal, paralleling the landward side of the Mississippi River-Gulf Outlet spoil area, would be maintained or enlarged to connect the two floodgate openings, thereby serving as a collection ditch for interior drainage and providing for an interchange of tidal flow. You propose that the two floodgates remain open except during the occurrence of a hurricane in the vicinity.

The additional area which is to be enclosed by the hurricane protection levee consists principally of marsh, though a considerable area of cypress swamp occurs adjacent to the higher ground along the Mississippi River. This wetland area has appreciable fish and wildlife values which have been described in some detail in our March 1962 report.

Since you have stated that the plan would provide for maintenance of the brackish water circulatory system, it does not appear that the hurricane levees would directly affect fish and wildlife resources to any major degree. However, as we have pointed out in the previous report, levee protection would hasten land reclamation for industrial and other developments, thereby paving the way for reduction in total habitat area.

Installation of hurricane control features of the modified plan may provide opportunity for environmental control within the protected area to lessen damaging effects anticipated from the Mississippi River-Gulf Outlet project, and this possibility should be considered in design and operation of the floodgates. Continuing studies on salinity intrusion via the Mississippi River-Gulf Outlet channel indicate that significant increases in salinity would occur from this source and that adjacent marshes would be detrimentally affected. Attention, therefore, should be given to the feasibility of modifying the structures for purpose of salinity control within the leveed area.

Apart from the change in levee alignment, we note that a lock structure, labeled "Seabrook Lock", is shown on the diagram attached to your September 19 letter. Location of this proposed lock is at the confluence of the Inner Harbor Navigation Canal and Lake Pontchartrain, in the vicinity of the existing Seabrook Bridge. Follow-up communication with your office reveals that this lock structure has been included in your draft report on this project.

Our March 1962 report recommended that a structure be built in the Seabrook location for salt-water intrusion control. It recommended, also, that the pertinent design criteria and operational procedure for this structure be developed as a part of the continuing studies on the Gulf Outlet project.

In view of the fact that the model studies conducted by the Waterways Experiment Station were not sufficiently detailed to establish criteria for the control structure, and that our joint studies of salinity intrusion in this area are still in progress, we do not believe that structure specifications should be finalized at this time.



Salinity control apparently will be a complex problem. This was indicated in a general way in our previous report, and is becoming more evident as additional records of salinity intrusion become available. It will be desirable not only to control saline waters entering the lake from the Gulf Outlet channel, but also to utilize outflowing lake water to depress excessively high saline concentrations in the channel. Since stratification also may be an important factor, accomplishment of these objectives may require vertical control of water flow in addition to directional control. Additional data will need to be accumulated and salinity intrusion patterns ascertained before design and operational requirements of a control structure can be reasonably defined.

It is the opinion of the Service, therefore, that the design specifications for the Seabrook structure as included in your report to higher authority should be sufficiently flexible to permit such modifications as may become advisable following studies now in progress.

In view of events which have transpired since release of the Service's March 1962 report, the Service wishes to make two recommendations additional to those contained in the earlier report.

1. The two floodgates proposed for the Chalmette section of the hurricane protection area be modified as necessary to provide, within feasible limits, for maintenance of the natural salinity regimen of interior waters. Design and operation for this purpose be established during advanced planning for this project.
2. Your request for authorization on this project should provide sufficient flexibility in regard to the Seabrook structure that design and operation can be established during advanced planning and in accordance with findings of salinity studies currently in progress.

This supplement to the Lake Pontchartrain hurricane study report has been reviewed by the Louisiana Wild Life and Fisheries Commission and their letter of concurrence is attached.

We appreciate the opportunity for commenting on the modified

plans and request that you keep us advised of the status of your studies and reporting on this project.

Sincerely yours,

A handwritten signature in cursive script that reads "W. L. Towns".

W. L. Towns  
Acting Regional Director  
Bureau of Sport Fisheries  
and Wildlife

A handwritten signature in cursive script that reads "Seton H. Thompson".

Seton H. Thompson  
Regional Director, Bureau  
of Commercial Fisheries

Enclosure



L. D. YOUNG, JR.  
DIRECTOR

EDWARD E. YANNEY  
ASSISTANT DIRECTOR

STATE OF LOUISIANA  
WILD LIFE AND FISHERIES COMMISSION  
400 ROYAL STREET  
NEW ORLEANS 16

October 16, 1962

E. R. MODNAL  
SHARHAN  
NEWELLTON  
RAY A. WHITLEY  
VIVE-SHARHAN  
ALEXANDRIA  
JOHN PAUL GRAM  
GRAND CHENIER  
JOHN J. OUTRAGE  
MORGAN CITY  
A. J. BUGEY  
IBERIA  
L. RICHARD FLEMING  
BOREVEQUEST  
JAMES A. FRY  
LAFAYETTE

Mr. W. L. Towns, Acting Regional Director  
U. S. Fish and Wildlife Service  
Bureau of Sport Fisheries and Wildlife  
Peachtree-Seventh Building  
Atlanta 23, Georgia

Dear Mr. Towns:

Reference is made to your letter of October 5 and enclosed letter report concerning the modification of the Lake Pontchartrain hurricane protection plan, Chalmette extension.

We were also asked to submit our views directly to the District Engineer concerning this project. Your field office provided us with a draft copy of your proposed comments in order to expedite necessary coordination.

Our views have been prepared and are very similar to the provisions and recommendations contained in your report.

Your report has been reviewed and we concur with its details and recommendations.

Thank you for your early submission of the field draft to us for review. We appreciate the opportunity to review and comment on this report.

Sincerely,

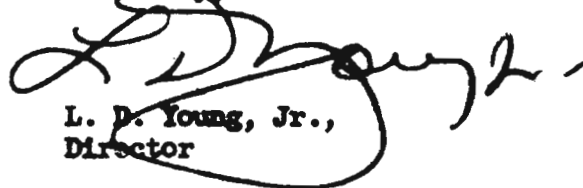

L. D. Young, Jr.,  
Director

LDYJr/sl.

APPENDIX G

VIEWS OF ORLEANS LEVEE DISTRICT

# The Board of Levee Commissioners

OF THE

## Orleans Levee District

WILDLIFE AND FISHERIES BUILDING  
418 ROYAL STREET

New Orleans 16

March 1, 1962



### COMMISSIONERS

GERALD J. GALLINGHOUSE, PRESIDENT  
 CLAUDE W. DUKE, PRO-TEMPORE  
 EDMOND G. MIRANNE  
 DR. NOEL C. GENEVAY, JR.  
 F. L. SCHMITT

### EX-OFFICIO

MAYOR VICTOR H. SCHIRO  
 COUNCILMAN THEODORE M. HICKEY  
 A. L. WILLOZ, CHIEF ENGINEER  
 EARL J. SCHMITT, SECRETARY  
 FRANK LAIS, JR., ADMINISTRATIVE ASSISTANT

District Engineer  
 U. S. Corps of Eng. - N. O. Dist  
 P. O. Box 267  
 New Orleans 9, La.

Attention: Mr. Jerry Baer

Dear Sir:

In the year of 1950, the Orleans Levee Board joined the U. S. Corps of Engineers to make a study of the Lakefront, in the Parish of Orleans, with the view of protecting the City of New Orleans from flood waters of Lake Pontchartrain.

A report made by Bedell & Nelson, Engineers, in October 1950, for the Orleans Levee Board, was submitted to the U. S. Corps of Engineers for their information. This report recommended the installation of a breakwater from the New Basin Canal to the Industrial Canal along the south shore of Lake Pontchartrain, to prevent overtopping of the seawall by wave action caused by hurricane winds.

Since that time the Orleans Levee Board has done considerable work along the seawall and in the Lakeshore Parkway, which makes the need of a breakwater unnecessary and undesirable from an esthetic point of view.

Also, from an esthetic point of view, a breakwater in the lake paralleling the seawall would fence off the view of the lake, besides creating a narrow strip of water with little circulation, which might cause undesirable marine growth and an accumulation of debris.

The Orleans Levee Board has removed the 15 foot concrete sidewalk in the rear of the seawall and placed rip rap in the triangular void under the wall. This has arrested the erosion from seepage through openings in the concrete sheet pile wall at the toe of the seawall expansion joints.

It is estimated that approximately 175,000 tons of rip rap has been placed under and behind the wall. At \$5.00 per ton makes the rip rap cost approximately \$875,000.00. In addition, the erosion back of the seawall has been backfilled with river sand and shells. It is estimated that 30,000 yards of fill have been placed in erosion repair, at a cost of \$40,000.00.

**Board of Levee Commissioners**  
**Orleans Levee District**

District Eng.

Att. Mr. J. Baer - 3/1/62

In order to contain the water spilling over the seawall from the wave action in the lake during storms, the Orleans Levee Board has constructed approximately 200 to 300 feet from the seawall, in the Lakefront Parkway, a levee at an elevation of 2 to 4 feet higher than the top of the seawall. This levee required the placing of approximately 400,000 cubic yards of fill, at an approximate cost of \$420,000.00.

In the 1956 hurricane only that portion of the levee between Bayou St. John and London Avenue Canal was completed, and it proved its effectiveness by not permitting any water from the lake find its way into the built up areas south of the lakefront. In comparison, the remainder of the Lakefront, which was not protected by such a levee, allowed large areas to the south of the lakefront to be flooded.

This letter is written for the purpose of explaining the reason why it is the opinion of the Orleans Levee Board that a breakwater, suggested in 1950, is not now necessary for the protection of the area betweenthe New Basin Canal and the Industrial Canal.

Should additional information on this matter be required, we will be glad to furnish it.

Very truly yours,



**A. L. WILLOZ**  
**CHIEF ENGINEER**

ALW:mgl

cc: Mr. E. J. Schmitt

APPENDIX H

PERSONNEL

## APPENDIX H

### PERSONNEL

U. S. Army Engineer District, New Orleans, personnel directly responsible for this project were:

E. B. Jennings, Colonel, CE, District Engineer  
G. H. Hudson, Chief, Engineering Division  
J. C. Baehr, Chief, Planning and Reports Branch  
W. S. Mask, Chief, Hydrology and Meteorology Section  
P. A. Becnel, Jr., Head, Design (Tidal) Unit, Project Engineer  
A. P. Gautreau, Hydraulic Engineering Technician  
M. S. Boyd, Hydraulic Engineering Technician  
W. B. Seale, Hydraulic Engineer  
H. R. Davis, Hydraulic Engineer  
G. A. Price, Head, Hydrologic Investigations Unit  
R. L. Sylvester, Hydraulic Engineer  
C. A. Peyronnin, Head, Beach Erosion Studies Unit  
J. S. Gentilich, Chief, Hydraulic Design Section  
C. W. Miller, Head, Economic Justification Unit  
W. C. Carey, Chief, Design Branch  
A. F. Jacobi, Chief, General Design Section  
R. O. Mohr, Structural Engineer  
H. A. Huesmann, Chief, Foundations and Materials Branch  
K. J. Cannon, Foundations Structural Engineer  
M. W. Bland, Chief, Survey Branch  
A. M. McNeil, Chief, Service Branch, Drafting  
J. O. Ecuyer, Appraiser, Real Estate



APPENDIX I

ADDITIONAL CORPS OF ENGINEERS' PROJECTS

APPENDIX I

ADDITIONAL CORPS OF ENGINEERS' PROJECTS

<u>Title</u>	<u>Page</u>
Mississippi River, Baton Rouge to the Gulf of Mexico, La.	I-1
Pass Manchac, La.	I-1
Bayous La Loutre, St. Malo, and Yscloskey, La.	I-1
The Chefuncte River and Bogue Falia, La.	I-2
The Tangipahoa River, La.	I-2
The Bayou Lacombe, La.	I-2
The Bayou Bonfouca, La.	I-2
The Amite River and Bayou Manchac, La.	I-3
The Amite River and Tributaries, La.	I-3
The Tickfaw, Natalbany, Ponchatoula, and Blood Rivers, La.	I-3

LAKE PONTCHARTRAIN, LA. AND VICINITY

APPENDIX I

ADDITIONAL CORPS OF ENGINEERS' PROJECTS

Existing Corps of Engineers' projects in the study area, in addition to those described in the report, are as follows:

a. The Mississippi River, Baton Rouge to the Gulf of Mexico, La. project, authorized by the River and Harbor Act of 2 March 1945, combined the then-existing separate projects for the Mississippi River, Baton Rouge to New Orleans, South Pass, and Southwest Pass into a new project extending from Baton Rouge to the Gulf of Mexico with the following channel dimensions, depths in feet below mean low gulf:

Baton Rouge to the Port of New Orleans	35 by 500 feet
Port of New Orleans	35 by 1,500 feet
Port of New Orleans to Head of Passes	40 by 1,000 feet
Southwest Pass	40 by 800 feet
Southwest Pass bar channel	40 by 600 feet
South Pass	30 by 450 feet
South Pass bar channel	30 by 600 feet

This project is complete except for some minor work associated with the deepening of the channel in Southwest Pass and bar channel from 35 feet to 40 feet. Total costs under the existing project to 30 June 1961 were \$76,884,714, of which \$28,357,654 was for new work, and \$48,527,060 was for maintenance. The average annual maintenance cost during the past five years was \$1,991,820. Modification of the project to provide a channel 40 feet deep by 500 feet wide from the lower limit of the port of New Orleans to Baton Rouge has been recommended in Senate Document No. 36, 87th Congress, 1st Session.

b. The Pass Manchac, La. navigation project, authorized by the River and Harbor Act of 25 June 1910, in accordance with House Document No. 882, 60th Congress, 1st Session, provides for the removal of snags, logs, and other obstacles from this pass and the bars at the entrance. This pass is 7 miles long and extends from Lake Maurepas to Lake Pontchartrain with depths ranging from 5 feet over the bars to 19 feet in the pass. Cost of this project was \$1,374 for construction and \$10,039 for maintenance through 30 June 1961. The latest estimate for annual maintenance is \$250.

c. The Bayous La Loutre, St. Malo, and Yscloskey, La. project was adopted by the River and Harbor Act of 26 August 1937, in accordance with House Document No. 275, 75th Congress, 1st Session, and modified by the River and Harbor Act of 2 March 1945,

in accordance with Senate Document No. 116, 77th Congress, 1st Session. This project provides for a channel 5 feet deep and 40 feet wide from deep water in Lake Borgne to the shoreline at the mouth of Bayou Yscloskey; a channel 6 feet deep and 40 feet wide from deep water in Lake Borgne through Bayous St. Malo, la Loutre, and Eloï to deep water in Lake Eloï; and a channel 5 feet deep and 30 feet wide in a portion of Bayou la Loutre, the total length of the improvements being 30 miles. The project is complete. Cost of new work was \$96,916 and maintenance \$179,484 to 30 June 1961, with annual maintenance costs of \$12,000.

d. The Chefuncte (sic) River and Bogue Falia, La. project, authorized by the River and Harbor Act of 10 June 1872, provides for a channel 10 feet deep with a bottom width of 125 feet from that depth in Lake Pontchartrain to mile 3.5 of the Tchefuncta (Chefuncte) River and 8 feet deep to Covington, La. for a total length of approximately 14 miles. The project is complete and to 30 June 1961 has cost \$58,342 for construction and \$77,160 for maintenance. Average annual maintenance during the 5 years prior to 30 June 1961 was \$5,537.

e. The Tangipahoa River, La. project was authorized by the River and Harbor Act of 10 June 1872, in accordance with House Document No. 54, 46th Congress, 2d Session, and modified by the River and Harbor Act of 14 June 1880, to provide improvements without dredging by removing overhanging trees, snags, and obstructions for a distance of 53.5 miles above the mouth. The project is complete and cost \$11,500 for new work and \$15,203 for maintenance to 30 June 1961. The latest, 1950, estimate of annual maintenance is \$1,000.

f. The Bayou Lacombe, La. project was authorized by the River and Harbor Act of 30 August 1953, in accordance with River and Harbors Committee Document No. 53, 72d Congress, 2d Session. It provides for a channel 60 feet wide and 8 feet deep through the entrance bar in Lake Pontchartrain and the removal of snags and overhanging trees from the mouth to a distance of approximately 8.2 miles upstream. The project is complete and cost \$4,716 for new work and \$15,918 for maintenance to 30 June 1961. The latest, 1955, estimate for annual maintenance cost is \$4,000.

g. The Bayou Bonfouca, La. project was authorized by the River and Harbor Act of 21 January 1927, in accordance with House Document No. 474, 68th Congress, 2d Session. It provides for a channel 10 feet deep at mean low water and 60 feet wide on the bottom from Slidell to deep water in Lake Pontchartrain, a distance of about 7-3/4 miles. The project is complete. Total expenditures to 30 June 1961 were \$30,997 for new work and \$58,993 for maintenance. The latest, 1955, approved estimate for annual cost of maintenance is \$7,000.

h. The Amite River and Bayou Manchac, La. project, authorized by the River and Harbor Act of 21 January 1927, in accordance with House Document No. 473, 68th Congress, 2d Session, provides for a channel 60 feet wide and 7 feet deep at mean low water from that depth in Lake Maurepas to Port Vincent, and the removal of snags between that point and the railway bridge across Bayou Manchac. The total length of improvement is 44 miles. The project is complete. Total expenditures to 30 June 1961 were \$28,234 for new work, and \$63,534 for maintenance. The latest, 1950, approved estimate for annual cost of maintenance is \$1,200.

i. The Amite River and Tributaries, La. flood control project was authorized by the Flood Control Act of 9 August 1955, in accordance with House Document No. 419, 84th Congress, 2d Session. The project provides for a flood flow diversion channel from the Amite River at mile 25.3 to Blind River at mile 4.8, with clearing and snagging of Blind River to Lake Maurepas, enlargement and realignment of Amite River from mile 25.3 to mile 35.75 and clearing and snagging from there to mile 54, clearing of Bayou Manchac for 8.4 miles and enlargement of Comite River from mile 0 to mile 10. The project is 80 percent complete and has cost \$2,387,249 to 30 June 1961.

j. The Tickfaw, Natalbany, Ponchatoula, and Blood Rivers, La. project, authorized by the River and Harbor Act of 3 March 1881, in accordance with House Executive Document No. 54, 46th Congress, 2d Session, provides for the removal of obstructions on the Tickfaw River from its mouth to a point 26 miles above, on the Blood River from its mouth to the head of navigation, and on the Natalbany and Ponchatoula Rivers for a distance of 15.5 miles, the total length of improvements being 45.5 miles. The project is complete. Total expenditures to 30 June 1961 were \$8,115 for new work, and \$32,416 for maintenance. The latest, 1950, approved estimate for annual cost of maintenance is \$2,000.

ATTACHMENT

INFORMATION CALLED FOR BY  
SENATE RESOLUTION 148, 85th CONGRESS  
ADOPTED 28 JANUARY 1958

ATTACHMENT

ATTACHMENT

HURRICANE STUDY

LAKE PONTCHARTRAIN, LOUISIANA AND VICINITY

INFORMATION CALLED FOR BY  
SENATE RESOLUTION 148, 85th CONGRESS  
ADOPTED 28 JANUARY 1958

1. PROJECT DESCRIPTION AND ECONOMIC LIFE

a. Description. The plan proposed to eliminate excessive velocities in the Inner Harbor Navigation Canal and excessive salinity in Lake Pontchartrain and the Mississippi River-Gulf Outlet channel area provides for the construction of a lock at the Lake Pontchartrain terminus of the Inner Harbor Navigation Canal. The proposed plans of protection against flooding by hurricane tides in the areas studied provide for construction of new levees; enlargement or improvement of presently existing protective works; construction of control structures, floodgates, and locks; modification of the above proposed Mississippi River-Gulf Outlet Seabrook Lock; necessary construction and alteration of drainage facilities; and alteration of road and oil and gas pipeline crossings as required. New levee construction will provide protection for one area which is presently unprotected.

b. Economic life. The costs and benefits of the above described improvements are based on an economic life of 100 years.

2. PROJECT COSTS

The following tables give the estimated first costs and annual economic costs for the proposed plans of improvement, based on December 1961 prices and an economic life of 100 years.

2.a.

a. First cost (100-year life).

(1) Mississippi River-Gulf Outlet, Seabrook Lock.

<u>Item</u>	<u>Federal</u>	<u>Non-Federal</u>	<u>Total</u>
Mississippi River-Gulf Outlet (existing project)	\$ 95,490,000	\$ 8,730,000	\$104,220,000*
Seabrook Lock (proposed)			
Lock and dam	4,371,000	-	4,371,000
Engineering and design	250,000	-	250,000
Supervision and administration	359,000	-	359,000
<b>FIRST COST</b>	<b>\$ 4,980,000</b>	<b>\$ -</b>	<b>\$ 4,980,000</b>
Mississippi River-Gulf Outlet (recommended modification)	\$100,470,000	\$ 8,730,000	\$109,200,000

\*Approved cost estimate from PB 3 effective 1 July 1962.

(2) Lake Pontchartrain barrier plan.

<u>Item</u>	<u>Federal</u>	<u>Non-Federal</u>	<u>Total</u>
Rigolets barrier structures	\$ 16,488,000	\$ -	\$ 16,488,000
Chef Menteur barrier structures	6,184,000	-	6,184,000
Modification of Mississippi River-Gulf Outlet Seabrook Lock	400,000	-	400,000
Levee enlargements and appurtenant works:			
St. Charles Parish	4,938,000	-	4,938,000
Jefferson Parish	463,000	-	463,000
New Orleans	4,379,000	-	4,379,000
Citrus*	9,451,000	-	9,451,000
New Orleans East	10,990,000	-	10,990,000
Barrier levee	214,000	-	214,000
Mandeville	196,000	-	196,000
Land and damages	-	4,479,000	4,479,000
Relocations	-	548,000	548,000
Engineering and design	2,435,000	-	2,435,000
Supervision and administration	3,538,000	-	3,538,000
<b>Subtotal</b>	<b>\$ 59,676,000</b>	<b>\$ 5,027,000</b>	<b>\$ 64,703,000</b>
Cash contribution*	<u>-18,476,000</u>	<u>18,476,000</u>	
<b>FIRST COST</b>	<b>\$ 41,200,000</b>	<b>\$ 23,503,000</b>	<b>\$ 64,703,000</b>

(Cost estimates are exclusive of preauthorization costs of \$449,000)

\*See Par. 24; and tables D-11 and D-15, appendix D.



(3) Chalmette.

<u>Item</u>	<u>Federal</u>	<u>Non-Federal</u>	<u>Total</u>
Levees and appurtenant works	\$ 12,921,000	\$ -	\$ 12,921,000
Lands and damages	-	452,000	452,000
Relocations	-	447,000	447,000
Engineering and design	518,000	-	518,000
Supervision and administration	805,000	-	805,000
Subtotal	\$ 14,244,000	\$ 899,000	\$ 15,143,000
Cash contribution*	<u>-3,644,000</u>	<u>3,644,000</u>	<u>-</u>
FIRST COST	\$ 10,600,000	\$ 4,543,000	\$ 15,143,000

(Cost estimates are exclusive of preauthorization costs of \$26,000)

\*See Par. 24; and tables D-11 and D-15, appendix D.

b. Annual economic costs (100-year life).(1) Mississippi River-Gulf Outlet, Seabrook Lock.

Mississippi River-Gulf Outlet  
(existing project)

<u>Item</u>	<u>Federal</u>	<u>Non-Federal</u>	<u>Total</u>
Interest	\$ 2,704,000	\$ 337,600	\$ 3,041,600
Amortization	219,400	11,200	230,600
Maintenance and operation	1,627,500	62,000	1,689,500
Replacements	4,000	-	4,000
TOTAL	\$ 4,554,900	\$ 410,800	\$ 4,965,700

Seabrook Lock (proposed)

<u>Item</u>	<u>Federal</u>	<u>Non-Federal</u>	<u>Total</u>
Interest	\$ 149,300	\$ -	\$ 149,300
Amortization	9,300	-	9,300
Maintenance and operation	120,000	-	120,000
TOTAL	\$ 278,600	\$ -	\$ 278,600

Mississippi River-Gulf Outlet  
(recommended modification)

<u>Item</u>	<u>Federal</u>	<u>Non-Federal</u>	<u>Total</u>
Interest	\$ 2,853,300	\$ 337,600	\$ 3,190,900
Amortization	228,700	11,200	239,900
Maintenance and operation	1,747,500	62,000	1,809,500
Replacements	4,000	-	4,000
TOTAL	\$ 4,833,500	\$ 410,800	\$ 5,244,300

2.b.(2)

(2) Lake Pontchartrain barrier plan.

<u>Item</u>	<u>Federal</u>	<u>Non-Federal</u>	<u>Total</u>
Interest	\$ 1,284,500	\$ 718,600	\$ 2,003,100
Amortization	80,000	44,700	124,700
Economic loss on land	-	79,500	79,500
Maintenance and operation	125,000	96,800	221,800
Replacements	-	106,500	106,500
TOTAL	\$ 1,489,500	\$ 1,046,100	\$ 2,535,600

(3) Chalmette levees.

<u>Item</u>	<u>Federal</u>	<u>Non-Federal</u>	<u>Total</u>
Interest	\$ 348,600	\$ 149,400	\$ 498,000
Amortization	21,700	9,300	31,000
Economic loss on land	-	2,700	2,700
Maintenance	-	29,000	29,000
Replacements	-	11,500	11,500
TOTAL	\$ 370,300	\$ 201,900	\$ 572,200

3. BENEFIT-COST RATIOS

a. The tangible benefits which would accrue to the proposed project for the Lake Pontchartrain barrier plan and the Chalmette plan based on a 100-year economic life are estimated to be as follows:

Lake Pontchartrain barrier plan.

Average annual flood damage prevented	\$ 47,659,000
Enhancement	<u>350,000</u>
Total benefits	\$ 48,009,000

Chalmette.

Average annual flood damage prevented	\$ 4,773,000
Enhancement	<u>379,000</u>
Total benefits	\$ 5,152,000

b. The benefit-cost ratios of the proposed improvements for a 100-year economic life are:

	<u>Total project cost</u>	<u>Annual economic cost</u>	<u>Annual benefits</u>	<u>Benefit- cost ratio</u>
Mississippi River- Gulf Outlet (existing project)	\$104,220,000	\$ 4,965,700	\$ 9,080,000	1.8 to 1
Mississippi River- Gulf Outlet (recommended modi- fication)	109,200,000	5,244,300	9,080,000	1.7 to 1
Lake Pontchartrain barrier plan	64,703,000	2,535,600	48,009,000	18.9 to 1
Chalmette	15,143,000	572,200	5,152,000	9.0 to 1

#### 4. INTANGIBLE PROJECT EFFECTS

a. The U. S. Fish and Wildlife Service reports that fish and wildlife losses would be considered minor with the proposed project in place provided that the Seabrook Lock would be used for salinity control of Lake Pontchartrain and the channel area. The views of this agency are given in appendix F of the report.

b. The project will afford some additional benefits which cannot be evaluated in monetary terms. The economic value of the proposed projects was based on the reduction of flood damage and enhancement for the Lake Pontchartrain barrier plan and the Chalmette project. Control of flooding may result in prevention of loss of life, prevention of disease arising from polluted flood waters, elimination of worry among residents concerning unpredictable hurricane flooding and additional time for evacuation which may be gained by the population of the nearby unprotected areas.

#### 5. PHYSICAL FEASIBILITY AND COST OF PROVIDING FOR FUTURE NEEDS

The lock structure at Seabrook will remedy the present adverse effects on navigation of the Mississippi River-Gulf Outlet as well as the foreseeable adverse effects of the project on fishery resources. The proposed levees, structures, and appurtenant works will accommodate the present needs for protection from hurricane flooding in each of the separate project areas, as well as in the foreseeable future.

#### 6. ALLOCATION OF COSTS

Allocation of costs is not involved.

7.

7. APPORTIONMENT OF COSTS

Total first costs and cost of maintenance and operation for the Seabrook Lock project will be borne by the Federal government. First costs, excluding preauthorization study costs, but including costs for modification of the Mississippi River-Gulf Outlet Seabrook Lock, are apportioned at 30 percent to local interests and 70 percent to the Federal government for the Lake Pontchartrain barrier plan and the Chalmette project. An additional cost of \$4,092,000 for maintenance and operation of the Rigolets lock and navigation channel by the Federal government is also chargeable to local interests. Maintenance and operation of the Lake Pontchartrain barrier plan and the Chalmette project will be the responsibility of local interests. The estimated cash contributions required of local interests are \$18,476,000 and \$3,644,000 for the Lake Pontchartrain barrier plan and the Chalmette project, respectively. Details of the computations are contained in appendix D of the report.

8. EXTENT OF INTEREST IN PROJECT

Three public hearings were held in order to obtain information on the problems caused by hurricane flooding. During the hearings, the State of Louisiana, Department of Public Works, requested that maximum consideration be given to the construction or improvement of protective works required to safeguard lives and protect property from damage caused by hurricane tides, and to the development of an adequate warning system. The said Department of Public Works concurs with the suitability of the recommended plans of protection. Two other State of Louisiana agencies, the Board of Levee Commissioners of the Orleans Levee District and the Board of Commissioners of the Port of New Orleans have reviewed the plans of protection and have indicated their concurrence. Findings of the investigations of willingness and ability of local interests to meet the prescribed requirements of local cooperation are discussed in paragraph 25.f. of the report.

9. REPAYMENT SCHEDULES

Repayment schedules are not involved.

10. EFFECT OF PROJECT ON STATE AND LOCAL GOVERNMENTS

a. The increase in the value of lands benefiting from the project will offset the value of lands required for the construction of the improvements. Therefore, no loss in tax revenue will result.

b. There will be some small additional costs over present requirements as a result of some levee enlargements. Only minor changes in nature or extent of required state and local governmental services are anticipated.

c. The non-Federal first costs for construction of the projects, chargeable to local interests, for a 100-year life are as follows:

<u>Project</u>	<u>Lands, damages, and relocations</u>	<u>Cash contribution</u>		<u>Total</u>
		<u>Construction</u>	<u>Maintenance</u>	
Lake Pontchartrain barrier plan	\$ 5,027,000	\$14,384,000	\$ 4,092,000	\$23,503,000
Chalmette	899,000	3,644,000	-	4,543,000

#### 11. ALTERNATE PROJECTS

a. Lake Pontchartrain high level plan. Consideration was given to a high level plan which consisted of enlargement and extension of existing protective works that would prevent flooding without construction of the barrier at the eastern end of Lake Pontchartrain. Because of the extreme height of levees required and generally adverse foundation conditions, it was found that construction would have to be extended over very long periods of time to prevent failure by excessive subsidence. The high level plan was found to be more costly than the recommended barrier plan and, in addition, met strong initial resistance from local interests due to aesthetic reasons.

b. Chalmette. An additional plan considered involved the enlargement and improvement of the existing Chalmette back levee. This plan was not acceptable to local interests because of the advantages of the proposed plan in view of the potentials for residential, industrial, and commercial development of the areas adjacent to the Mississippi River-Gulf Outlet.