

Appendix 11

Analysis of Performance of the Inner Harbor Navigation Canal

Executive Summary

Four breaches occurred on the Inner Harbor Navigation Canal (IHNC) during Hurricane Katrina, on the morning of August 29th. Two of the breaches occurred on the east bank between the Florida Avenue Bridge and the North Claiborne Avenue Bridge adjacent to the 9th Ward, and two on the west bank just north of the intersection of France Road and Florida Avenue (Figure 11-1). Three of the breaches involved failures of floodwalls on levees, and one involved failure of a levee.

All of the IHNC floodwalls and levees were overtopped on August 29th. The peak storm surge elevation in the IHNC was 14.2 ft¹ at 9:00 AM, about 1.7 ft above the tops of the floodwalls and levees. The reaches where the floodwalls and levees did not collapse have therefore survived water loading considerably higher than the design loading.

Water flowing over the I-walls when they were overtopped eroded trenches on the protected side of the walls as it cascaded onto the levee fill. Soil that was providing support for the walls eroded away, making the walls less stable.

Although it is clear that the walls were overtopped, and that their stability was compromised by the erosion that occurred, it is also clear that one of the east side breaches occurred before the wall was overtopped. Eyewitness reports indicate that the water level in the 9th Ward near Florida Avenue was rising as early as 5:00 AM, when the water level in the IHNC was still below the top of the floodwall. Stability analyses indicate that foundation instability would occur before overtopping at the north breach on the east side of the IHNC. This breach location is thus the likely source of the early flooding in the 9th Ward. Stability analyses indicate that the other three breach locations would not have failed before they were overtopped.

The soil immediately beneath the levees and floodwalls at all four breach locations included marsh, beneath which was clay, and beneath the clay, sand. Through most of their lengths, the

¹ All elevations refer to NAVD88(2004.65) datum.

critical circles passed through the marsh and clay. The critical circles did not extend to the sand layer beneath the clay.

Stability analyses of the north breach on the east side resulted in a computed factor of safety equal to 1.0 with a crack or gap on the canal side of the wall and water in the IHNC at elevation 11.2 ft. This is about 1.0 ft higher than the average IHNC water level at the time flood water was observed in the 9th Ward. Considering that the effective water level could have been one foot higher due to wave effects, this result is consistent with the observed IHNC water level when flood water was first reported in the 9th Ward. It thus appears that the north breach occurred before overtopping, and that this breach was the source of the first influx of water into the 9th Ward.

Stability analyses of the south breach on the east side, and the north breach on the west side, resulted in computed factors of safety larger than 1.0 with the water level at the top of the wall and a gap behind the wall, indicating that the walls at those locations would have remained stable if none of the soil supporting the wall had been removed by erosion. Stability analysis of the south breach on the west side, where there was no I-wall, showed that the factor of safety there was also high, and the failure was due to overtopping erosion.

The lower computed factor of safety at the north breach on the east side is attributable to the fact that the ground elevation on the protected side is lower at that location, and as a result there was less soil on the protected side of the wall that was able to provide support for the wall.

The IPET strength model used for the north breach on the east bank, which is based on all of the data available in May 2006, agrees fairly closely with the design strengths reported in the GDM² under the center of the levee. Both the GDM and the IPET strength model assign lower strengths beneath the embankment toe and beyond than beneath the crest of the embankment, but the GDM strengths at this location are higher than the IPET strengths. The GDM strengths are thus reasonably consistent with the currently available data.

The design analyses were performed using the Method of Planes³, without a gap between the wall and the levee fill on the canal side of the wall. For the canal water level at 10.5 ft (the design water level), the factor of safety computed using the Method of Planes was 1.25. The minimum factor of safety calculated for the same conditions using Spencer's method⁴ was 1.45, indicating that the Method of Planes is conservative by about 14% in this case.

In summary, the failure that resulted in the north breach on the east side of the IHNC resulted from two differences between the stability analyses that were used as the basis for design and those described in this report: (1) the ground surface beyond the toe of the levee at the north breach location was lower than the landside ground surface in the design cross section, and

² Design Memorandum No. 3, General Design, Lake Pontchartrain, LA, and Vicinity, Chalmette Area Plan, U.S. Army Engineer District, New Orleans, October 1966.

³ A study of the Method of Planes, undertaken by IPET at the request of the New Orleans District Task Force Guardian, indicates that the Method of Planes gives lower factors of safety than more accurate methods of analysis, such as Spencer's method. The magnitude of the difference between the two varies from case to case.

⁴ Spencer, E. (1967) "A Method of Analysis of the Stability of Embankments Assuming Parallel Inter-Slice Forces," *Geotechnique*, Institution of Civil Engineers, Great Britain, Vol. 17, No. 1, March, pp. 11-26.

(2) the design analyses did not consider the possibility of a gap forming behind the wall, allowing water to run into the gap and increase the load on the wall. The other three breaches on the IHNC were due to overtopping and erosion.

Observations and Possible Modes of Failure

As shown by the hydrograph in Figure 11-2, the water level in the IHNC rose from elevation 1.0 ft. at 12:00 AM on August 28th to 14.2 ft. at 9:00 AM on August 29th. The peak water level was 1.7 ft. above the tops of the floodwalls and levees which were at elevation 12.5 ft. The hydrograph in Figure 11-3 shows that the water level in the 9th Ward was rising at 5:00 AM on August 29th, when the water level in the IHNC was at elevation 10.2 ft., about 2.3 ft. below the tops of the floodwalls and levees. With ground surface elevations approximately -4.0 ft., water at elevation +2.0 ft. indicates that the water was 6.0 ft. deep in the 9th Ward at 5:00 AM on August 29th.

Initial observations after the hurricane revealed that overtopping had eroded at least one section of levee along the west bank and had eroded the soil adjacent to the wall on the protected side along the east and west bank. It appeared that water flowing over the floodwall scoured and eroded the levee on the protected side of the I-wall, exposing the supporting sheet piles and reducing the passive resistance (Figure 11-4). The erosion appeared to be so severe in the breach locations that the sheet piles may have lost all of their foundation support, resulting in failure (Figure 11-5). Perhaps the best evidence of this scour can be seen along the unbreached reaches of the east bank I-walls on the Inner Harbor Navigation Canal where U-shaped scour trenches could be found adjacent to the I-walls. As the scour increased, the I-wall may have moved laterally and leaned to the protected side, causing the scour trench to grow as the water began cascading farther down the slope until sufficient soil resistance was lost and the wall was carried landward.

Other possible modes of failure are sliding instability and piping and erosion from underseepage. Piping and erosion from underseepage is unlikely because the I-walls were founded in a clay levee fill, a marsh layer made up of organics, clay and silt, and a clay layer. Because of the thickness, the low permeabilities of these materials, and the relatively short duration of the storm, this failure mode was considered not likely and was eliminated as a possible mode of failure.

It is necessary to investigate the possibility of sliding instability to determine if the I-walls could breach as a result of shear through the foundation. The foundation conditions are similar to the 17th Street Canal. As shown in Figure 11-6, no significant wall movement was found in the wall sections adjacent the south breach. However, Figure 11-7 shows significant wall movement did occur in the wall sections adjacent to the north breach.

Stratigraphy

IHNC East Bank – Lower 9th Ward

The data available to assess the stratigraphy of the area includes borings from the General Design Memorandum (GDM), borings taken after the failure, and cone penetration tests taken after the failure. The locations of these borings and cone penetration tests are shown in Figure 11-8. Note that all borings taken after the failure were at the levee toe. The GDM contains 10 borings on the levee centerline (2-U, 3, 4, 5, 6-U and 7 in the vicinity of the breach, and four at the levee toe (2-UT, 3T, 4T and 6UT). A centerline profile under the levee is represented in Figure 11-9 and is based on both pre-Katrina and post-Katrina borings. This section shows 60 to 70 ft of predominantly fine-grained Holocene (i.e., less than 10,000 years old) shallow water and terrestrial sediments overlying the Pleistocene surface (i.e., older than 10,000 years). Holocene sediments are separated into various depositional environments in Figure 11-9, based on soil texture, organic content, and other physical and engineering properties. Engineering properties of these layers are described in greater detail below.

The sections of the IHNC east bank where the north and south breaches occurred encompass Stations 54+00 to 56+00 and 22+00 to 31+00, respectively. These breaches occurred between Florida Avenue and North Claiborne Avenue. The strength evaluation focused primarily on these areas.

The GDM borings indicate the levee fill properties for the north and south breach areas are similar, consisting of compacted CL and CH materials. The average moist unit weight of the fill was estimated to be 109 pcf.

Beneath the fill is a marsh unit about 17 ft thick. The marsh layer is composed of organic material from the cypress swamp that occupied the area, together with silt and clay deposited in the marsh. Because the upper 8 to 9 ft of this unit has different material properties than the lower portion, it was divided into two layers, Marsh 1 and Marsh 2. Water contents and saturated unit weights determined from samples of marsh material taken from the toe are shown in Figures 11-10 and 11-11, respectively. These figures clearly depict the differences in the marsh layers.

Water contents, unit weights and undrained shear strengths are shown in Table 11-1, and these properties for the Marsh 2 layer are shown in Table 11-2. These properties are based on samples from post-Katrina borings at the levee toe. The average saturated unit weight of the Marsh 1 layer is about 105 pcf. Water contents of the Marsh 1 layer are as high as 80%. The average water content is approximately 49%. The average saturated unit weight of the Marsh 2 layer is about 80 pcf. Water contents of the marsh 2 layer are as high as 442%. The average water content is approximately 175%. The marsh 1 layer is mostly CH material. The Marsh 2 layer is fibrous at the top, and more amorphous near the bottom, indicating more advanced decomposition of the older organic materials at depth.

Beneath the marsh layers is a layer of interdistributary clay with an average Liquid Limit of about 79% and an average Plastic Limit of 26%. Based on consolidation test results presented in

the GDM, the clay is normally consolidated throughout its depth. The average saturated unit weight of the clay is about 100 pcf, and the average water content is approximately 60%. Water content and unit weights are summarized in Table 11-3.

Beneath the clay is a layer of Beach Sand. This layer is not involved in the observed or calculated mechanisms of instability, and its strength is therefore of little importance in stability analyses, except as a more resistant layer beneath the clay.

The unit weights measured for individual laboratory test specimens and the values used in subsequent analyses are shown in Figure 11-11.

Table 11-1					
Properties of Marsh 1 Layer from Post-Katrina Borings at Toe					
Marsh 1 Layer					
Number of Samples = 16					
	Mean	Standard Deviation	COV	Max	Min
%w	49	17	0.342	80.2	21.9
Saturated Unit Weight (pcf)	104	9	0.081	120.5	92.2
S _u (psf)	550	214	0.389	3195	90.0

Table 11-2					
Properties of Marsh 2 Layer from Post-Katrina Borings at Toe					
Marsh 2 Layer					
Number of Samples = 12					
	Mean	Standard Deviation	COV	Max	Min
%w	175	96	0.549	441.6	90.9
Saturated Unit Weight (pcf)	78.4	7	0.091	87.1	63.4
S _u (psf)	195.3	116	0.595	336	64.6

Table 11-3					
Properties of Interdistributary Clay from Post-Katrina Borings at Toe					
Interdistributary Clay					
Number of Samples = 45					
	Mean	Standard Deviation	COV	Max	Min
%w	60	12	0.208	77.2	25
Saturated Unit Weight (pcf)	101.1	6	0.063	125	93.6

Shear Strength - IHNC – East Bank

The sources of shear strength data include borings from the General Design Memorandum (GDM), and borings, cone penetration tests, and vane shear tests performed as part of the failure investigation. From the available sources, two GDM borings, four cone penetration tests, and three vane shear tests provide information beneath the centerline of levee. From the GDM borings (2-U and 6-U), the results of 11 Q test envelopes and 26 unconfined compression tests

were available. All laboratory tests were performed on specimens trimmed from 5-in diameter undisturbed tube samples.

Beneath the toe of the levee, the GDM contained the results of over 70 unconfined compression tests. In addition, about 100 unconfined compression tests have been conducted on test specimens obtained since Katrina. Tests were performed on 1.4-inch diameter specimens trimmed from 5-in.-diameter tube samples. Statistical analyses have been performed on the data from the post-Katrina tests to compute minimum, maximum, and average values of strength for the levee fill, the marsh layers, and the clay. The results of the statistical analyses are shown in Tables 11-1 through 11-3. Also, one cone penetration test with pore pressure measurements (CPTU) and one series of vane shear tests were performed near the area of the breaches after the failure.

Shown in Figure 11-12 are the available laboratory and vane shear test results for samples obtained beneath the crest of the levee, as well as values of undrained shear strength determined from CPTU-1 using Mayne's method⁵. Figure 11-13 presents the data available for undrained shear strength from the toe of the levee and areas beyond the toe. Plotted with these data are the results from CPTU-1T, which was performed at the toe of the levee.

Only a few strength tests for the levee fill are available from GDM borings in the breach area. The shear strength used for design ($s_u = 500$ psf) was assumed for the levee-fill strength in the IPET strength model. As can be seen in Figure 11-12, a value of $s_u = 500$ psf for the levee fill seems reasonable based on the results of the CPTU tests, vane shear tests, and laboratory tests. However, the strength of the levee is not much involved in the calculated mechanisms of instability and therefore has limited importance in the stability analyses.

The marsh material is stronger beneath the levee crest where it has been compressed under the weight of the levee, and weaker at the toe of the levee and beyond, where it has not been compressed so heavily. CPTU data, vane shear tests, and unconfined compression tests conducted on test specimens trimmed from 5-in. samples were used to measure the Marsh 1 layer strengths at the toe. The measured shear strengths from the unconfined compression tests in the Marsh 1 layer scatter very widely from about 90 psf to over 800 psf, as shown in Figures 11-12 and 11-13. The vane shear test results summarized in Table 11-4 were conducted under the levee; they indicate shear strengths (corrected for strain rate effects and plasticity) ranging from 490 psf to 820 psf. Values of $s_u = 650$ psf beneath the levee crest, and $s_u = 550$ psf beneath the levee toe appear to be reasonably representative of the measured strengths for Marsh 1 layer, and these values are shown by the solid lines on Figures 11-12 and 11-13.

⁵ Mayne, P. W. (2003). "Class 'A' Footing Response Prediction from Seismic Cone Tests," Proceedings, Deformation Characteristics of Geomaterials, Vol. 1, Lyon, France.

Table 11-4 IHNC East Bank - Results of Vane Shear Tests in Marsh 1 Layer, Beneath Levee				
Vane Shear Tests	Elev. ft NAVD88	%w	PI	Corrected Peak Strength (psf)
IHNC-VST-3	-6.3	--	--	732
IHNC-VST-6	-5.8	73	56	489
IHNC-VST-6	-10.8	--	--	566
IHNC-VST-1	-3.3	--	--	818
Average				651

The shear strength characterization of the Marsh 2 layer was difficult because of large scatter in the data. Data obtained from post-Katrina toe borings taken between Florida Avenue and North Claiborne Avenue are presented in Table 11-2. Noting Figures 11-12 and 11-13, which include both pre-Katrina and post-Katrina strength results, the undrained shear strength of the Marsh 2 layer ranges from about 200 to 620 psf under the levee centerline, and from 90 to 500 psf beneath the levee toe. Values of $s_u = 300$ psf beneath the levee crest, and $s_u = 200$ psf beneath the levee toe appear to be reasonably representative of the measured values; these values are shown on Figures 11-12 and 11-13. These strengths are the same as were used in the GDM design analyses.

Interpretation of the undrained shear strength of the interdistributary clays was developed considering the results of all laboratory and field tests. The pore pressure results from the CPTU tests were questionable, and for this reason, less emphasis was placed on determining undrained shear strengths from the cone penetration test results. The CPTU tests did indicate that the clay deposit was normally consolidated, and that the undrained shear strength increased linearly with depth. Figure 11-12 shows the undrained shear strength with depth determined using Mayne's method⁶ for CPTU-1, which was conducted under the centerline of the levee. Figure 11-13 presents the results of CPTU-1T, which was conducted at the toe of the levee.

The straight line shown in Figure 11-12, representing the average undrained shear strength in the clay, has a slope of 8.6 psf per foot of depth. This rate of strength increase with depth appears to compare reasonably well to the laboratory strength test results.

The rate of increase of strength with depth is directly related to the s_u/p' ratio for the clay and its buoyant unit weight as follows:

$$\frac{s_u}{p'} = \frac{\text{rate of increase of } s_u \text{ with depth}}{\text{rate of increase of } p' \text{ with depth}} = \frac{\Delta s_u / \Delta z}{\gamma_{\text{buoyant}}} \quad (11-1)$$

The value of γ_{buoyant} for the clay is $100 \text{ pcf} - 62.4 \text{ pcf} = 37.6 \text{ pcf}$. Thus, the value of s_u/p' is:

⁶ Mayne, P. W. (2003). "Class 'A' Footing Response Prediction from Seismic Cone Tests," Proceedings, Deformation Characteristics of Geomaterials, Vol. 1, Lyon, France.

$$\frac{s_u}{p'} = \frac{8.6 \text{ psf per ft}}{37.6 \text{ pcf}} = 0.23 \quad (11-2)$$

which is a reasonable value for this normally consolidated clay.

These values provide a good basis for establishing undrained strength profiles in the clay. The undrained strength at the top of the clay is equal to 0.23 times the effective overburden pressure at the top of the clay, and the undrained strength increases with depth in the clay at a rate of 8.6 psf per foot.

In the IPET strength model, the undrained shear strength of the clay is equal to 0.23 times the effective overburden pressure. The clay strength thus varies with lateral position, being greatest beneath the levee crest where the effective overburden pressure is greatest, and varying with depth, increasing at a rate of 8.6 psf per foot at all locations. Figure 11-13 shows the calculated undrained shear strength variation in the interdistributary clay at the toe of the levee and beyond. Based on the available test data, the IPET strength model appears to be an adequate, albeit conservative, representation of the strength beneath the toe.

The IPET strength model does not consider details of the stress distribution beneath the levee, which would result in “load spread” effects. These effects would result in rotation of principal stresses beneath the levee, and in the added stress due to the levee load that would decrease with depth. The model described in the previous paragraphs uses a simple stress distribution beneath the levee that satisfies vertical equilibrium. The consequences of this assumption are that the vertical effective stresses in the clay layer beneath the toe, and thus the undrained shear strength distribution, is underestimated. Likewise, the undrained strength distribution in the clay layer beneath the crest is overestimated using the vertical equilibrium assumption. These two effects tend to balance out, and the average shear strength on the failure plane is approximately the same as would be obtained from more complex methods of calculating the vertical effective stress in the clay layer.

It is also important to note that the ground elevation of the toe of the levee is not constant; therefore it is not possible to use the same strength versus elevation relationship for the south breach and the north breach. The decrease in elevation of the toe from the south breach to the north breach is shown in the LIDAR survey of the area in the year 2000, which is plotted in Figure 11-14. The elevation of the protected side levee toe decreases about 4 ft from the south breach to the north breach.

The drained friction angle of the sand beneath the clay was estimated to be 30 degrees for the stability analysis. As noted previously, the sand layer is not involved in observed or computed failure mechanisms, and the value of ϕ' assigned to it, therefore, has no influence on computed factors of safety.

Original Design Strengths - East Bank

The design analyses in the Chalmette Area Plan General Design Memorandum (GDM)⁷ used undrained strengths for the levee fill, the marsh layers, and the clay, and a drained friction angle to characterize the strength of the sand layer beneath the clay, as does the IPET strength model described above. However, there are four marsh layers in the GDM interpretation compared to only two marsh layers for the IPET strength model. The design strengths are comparable to the IPET strengths discussed here and shown in Table 11-5 and Figure 11-15.

The values of strength for the levee fill, the marsh layers, and the clay layer that were used in the design analyses for the IHNC I-wall, Station 16+08.85 to Station 58+12.00, are shown in Table 11-5. This reach includes both breach areas on the east bank, which extends approximately from Stations 54+00 to 56+00 for the north breach and 22+00 to 31+00 for the south breach.

Material	Strengths used for design	IPET strength model
Levee fill	$s_u = 500$ psf, $\phi = 0$	$s_u = 500$ psf, $\phi = 0$
Marsh 1a layer (uppermost marsh layer)	$s_u = 400$ psf, $\phi = 0$ beneath the levee and toe	$s_u = 650$ psf, $\phi = 0$ beneath levee $s_u = 550$ psf, $\phi = 0$ beneath toe
Marsh 1b layer (directly below uppermost marsh layer)	$s_u = 600$ psf, $\phi = 0$ beneath levee $s_u = 500$ psf, $\phi = 0$ beneath toe	
Marsh 2a layer (highly organic layer)	$s_u = 300$ psf, $\phi = 0$ beneath levee $s_u = 200$ psf, $\phi = 0$ beneath toe	$s_u = 300$ psf, $\phi = 0$ beneath levee $s_u = 200$ psf, $\phi = 0$ beneath toe
Marsh 2b layer (directly below marsh 2a layer)	$s_u = 500$ psf, $\phi = 0$ beneath levee $s_u = 300$ psf, $\phi = 0$ beneath toe	
Interdistributary Clay	12.3 psf/ft increase beneath levee (starting at 355 psf) 8 psf/ft increase beneath toe (starting at 300 psf)	$S_u/p' = 0.23$; 8.6 psf/ft increase both beneath levee and toe (starting value depends on depth of overburden)

A comparison between the GDM and IPET strength models is presented in Figures 11-16 and 11-17 for the GDM design cross section. Shown in Figure 11-16 is the shear strength profile under the crest of the levee (horizontal coordinate of 0 ft) used in the original design, and the shear strength profile calculated using the IPET model. The IPET strength model has higher shear strengths in the Marsh 1 layer, and the GDM strength model has higher strengths in the lower portion of the Marsh 2 layer. Both models show a linear increase in undrained shear strength in the interdistributary clay layer, with the rate of increase greater for the GDM model than the IPET model. The difference in the rate of increase can be partially attributed to the difference in unit weights used in each model. The GDM strength model assumes a unit weight of the clay of 102.4 pcf for the upper portion of the clay and 107 pcf for the lower portion of the clay. The IPET model uses a unit weight of 100 pcf for the clay. The higher unit weights used in the GDM strength model would produce a larger increase in undrained shear strength per foot than the IPET model for the same undrained strength ratio. In addition, based on the assumed

⁷ Design Memorandum No. 3, General Design, Lake Pontchartrain, LA, and Vicinity, Chalmette Area Plan, U.S. Army Engineer District, New Orleans, October 1966.

unit weights and the rate of strength increase, the GDM model corresponds to a greater undrained strength ratio, from about 0.28 to 0.31.

The difference between the GDM and IPET strength model is more pronounced for undrained strengths below the toe of the levee. Shown in Figure 11-17 is the shear strength profile under the toe of the levee (horizontal coordinate of 60 ft) used in the original design, and the shear strength profile calculated using the IPET model. The undrained shear strengths are comparable in the marsh layers, but there is about a 200 psf difference in undrained shear strength in the interdistibutary clay. The rate of increase for both models is essentially the same, but the IPET strength model produces a lower shear strength at the marsh/clay interface. As stated earlier, the IPET strength model would tend to underestimate the undrained shear strengths beneath the toe when compared to available test data.

It is interesting to note the similarity of the two strength models, particularly since the GDM strength model was developed about 40 years ago. Both models share the essential characteristics of using different strengths under the levee crest and toe, and a lateral variation of shear strengths between these points.

IHNC East Bank North and South Failures

Eighteen slope stability analyses (Cases 1 through 5, 5a, and 6 through 17 in Table 11-6) were performed for the cross section at Station 55+00 at the north breach. The cross section used for these analyses is shown in Figure 11-18. Also, 17 slope stability analyses (Cases 1 through 17 in Table 11-7) were performed for a cross section developed for Station 26+00 at the south breach. The cross section used for these analyses is shown in Figure 11-19.

In addition, four slope stability analyses (Cases 1 through 4 in Table 11-8) were performed using the cross section and strength profile shown in the GDM, and presented in this report as Figure 11-15.

Average values of saturated unit weight were used in the analyses: $\gamma_{\text{sat}} = 109$ pcf for the levee fill, $\gamma_{\text{sat}} = 105$ pcf for the Marsh 1 layer, $\gamma_{\text{sat}} = 80$ pcf for the Marsh 2 layer, and $\gamma_{\text{sat}} = 100$ pcf for the interdistibutary clay beneath the marsh layers. These values are based on values measured in laboratory tests on undisturbed samples.

The critical slip surfaces found in the analyses did not extend down to the sand beneath the clay, and the sand strength and unit weight therefore did not influence the results of the analyses.

The analyses were performed for undrained conditions in the levee fill, the marsh layer, and the clay beneath the marsh layer. Based on available information, it appears that the values of permeability of all three of these materials were low enough so that dissipation of excess pore pressures during the rise of the water level in the canal would have been negligible, and would have had, at most, a minor influence on stability.

Analyses were performed for two conditions regarding contact between the I-wall and the adjacent soil on the canal side of the wall. These are indicated by “yes” or “no” in the column labeled “Crack” in Tables 11-6, 11-7 and 11-8.

- For the “no crack” analyses, it was assumed that the soil on the canal side of the wall was in intimate contact with the wall. Water pressures were applied to the surface of the levee fill, and to the I-wall where it projected above the crown of the levee, but were not applied to the face of the wall below the crown of the levee.
- For the “crack” analyses, it was assumed that the I-wall was separated from the levee fill on the canal side of the wall as the water level in the canal rose and caused the wall to deflect away from the canal. Full hydrostatic water pressures were applied to the I-wall, from the water level in the canal to the bottom of the wall.

For the north breach, stability analyses were performed for canal water elevations of 10.0, 10.5, 11.2, and 12.5 ft. Analyses were performed with water elevations of 10.0, 10.5, and 12.5 for the south breach. The elevation of the top of the wall is 12.5 ft for both the north and south cross sections.

The analyses described here were performed using the computer program UTEXAS4⁸. Critical circular slip surfaces were located for each case using the search routines available in UTEXAS4. The analyses were verified using the computer program SLIDE⁹. The analyses were performed using Spencer’s method¹⁰, which satisfies all conditions of equilibrium. Methods that satisfy all conditions of equilibrium have been shown to result in values of factor of safety that are not influenced appreciably by the details of the assumptions they involve¹¹.

⁸ Available from Shinoak Software, 3406 Shinoak Drive, Austin, TX 78731

⁹ Available from Rocscience Inc., 31 Balsam Avenue, Toronto, Ontario, Canada M4E 3B5

¹⁰ Spencer, E. (1967) “A Method of Analysis of the Stability of Embankments Assuming Parallel Inter-Slice Forces,” *Geotechnique*, Institution of Civil Engineers, Great Britain, Vol. 17, No. 1, March, pp. 11-26.

¹¹ Duncan, J. M., and Wright, S. G. (2005), *Soil Strength and Slope Stability*, John Wiley and Sons, New York, 293 pp.

**Table 11-6
Results of Slope Stability Analyses for IHNC East Bank, North Breach. Note all Analyses Use Spencer's Method and Circular Slip Surfaces**

Case	Water Elev. ft NAVD88	Strength Model	Crack (Yes or No)	Factor of Safety
1	10.0	IPET	Yes	1.04
2	10.5	IPET	Yes	1.03
3	10.5	IPET	No	1.22
4	11.2	IPET	Yes	1.00
5	12.5	IPET	Yes	0.96
5a	12.5	IPET	No	1.13
6	10.0	Marsh 1 + 25%	Yes	1.12
7	10.0	Marsh 1 – 25%	Yes	0.96
8	10.0	Marsh 2 + 25%	Yes	1.12
9	10.0	Marsh 2 – 25%	Yes	0.95
10	10.0	Interdistributary + 25%	Yes	1.12
11	10.0	Interdistributary – 25%	Yes	0.94
12	12.5	Marsh 1 + 25%	Yes	1.04
13	12.5	Marsh 1 – 25%	Yes	0.88
14	12.5	Marsh 2 + 25%	Yes	1.05
15	12.5	Marsh 2 – 25%	Yes	0.88
16	12.5	Interdistributary + 25%	Yes	1.03
17	12.5	Interdistributary – 25%	Yes	0.88

**Table 11-7
Results of Slope Stability Analyses for IHNC East Bank, South Breach. Note all Analyses Use Spencer's Method and Circular Slip Surfaces**

Case	Water Elev. ft NAVD88	Strength Model	Crack (Yes or No)	Factor of Safety
1	10.0	IPET	Yes	1.20
2	10.5	IPET	Yes	1.18
3	10.5	IPET	No	1.34
4	12.5	IPET	Yes	1.10
5	12.5	IPET	No	1.25
6	10.5	Marsh 1 + 25%	Yes	1.29
7	10.5	Marsh 1 – 25%	Yes	1.07
8	10.5	Marsh 2 + 25%	Yes	1.27
9	10.5	Marsh 2 – 25%	Yes	1.09
10	10.5	Interdistributary + 25%	Yes	1.27
11	10.5	Interdistributary – 25%	Yes	1.07
12	12.5	Marsh 1 + 25%	Yes	1.21
13	12.5	Marsh 1 – 25%	Yes	1.00
14	12.5	Marsh 2 + 25%	Yes	1.18
15	12.5	Marsh 2 – 25%	Yes	1.02
16	12.5	Interdistributary + 25%	Yes	1.18
17	12.5	Interdistributary – 25%	Yes	1.01

Formation of a crack on the canal side of the wall, allowing hydrostatic water pressure acting through the full depth of the crack, causes a very significant reduction in the value of the calculated factor of safety. Evidence that a crack did form behind the wall near the breaches can be seen in Figures 11-6 and 11-7.

For the north breach (Station 55+00), with the canal water level at elevation 12.5 ft (top of the wall), the calculated factor of safety for the cracked condition is 0.96, as compared to 1.13 for the uncracked condition (Cases 5 and 5a). A canal water elevation of 11.2 ft produces a factor of safety of unity for the cracked condition (Case 4). Figures 11-20 through 11-25 show the critical circles from UTEXAS4 analyses for the north breach for Cases 1 through 5 and Case 5a.

For the south breach (Station 26+00), the factor of safety was greater than unity for all canal water elevations analyzed using the IPET strength model. For the most extreme case of the canal water level at elevation 12.5 ft (top of the wall), the calculated factor of safety for the cracked condition is 1.10. The critical circles for the stability analyses performed on the south breach for Cases 1 through 5 are shown in Figures 11-26 through 11-30.

Analysis of GDM Cross section

An analysis of the design cross section was performed using the GDM strength model discussed earlier. This analysis allows a comparison of the Method of Planes, used in the original design, with Spencer's method using circular failure surfaces.

In the original design, a canal water level of 10.5 ft NAVD88 (13.0 ft NGVD29) was used as the design water level load condition. The Method of Planes resulted in a minimum factor of safety of 1.25 for a horizontal failure plane located in the Marsh 2 layer. Using Spencer's method with the GDM strength model, a factor of safety of 1.45 was calculated for the same canal water level. Thus, the Method of Planes is conservative by about 14% in this case.

Three other variations of the design cross section were analyzed. Introducing a crack behind the wall for the design water level decreases the factor of safety to 1.19. For a canal water elevation at the top of the wall (12.5 ft NAVD88), the factor of safety is 1.35 for the uncracked condition and 1.05 for the cracked condition. The results of all analyses performed on the GDM cross section are presented in Table 11-8. Figures 11-31 through 11-34 show the critical circles for the UTEXAS4 analysis.

Probabilities of Failure

Probabilities of failure have been estimated using an approximate technique based on the Taylor Series method. The coefficient of variation of the average clay strength and the average marsh layer strength were estimated to be 25%. The data available is sparse, and the scatter in measured values is influenced significantly by sample quality, as well as variations in properties from one location to another and systematic variations with depth over burden. The estimated values of $COV = 25\%$ is, thus, largely based on judgment. Even so, it is useful to examine what

probabilities of failure would be associated with this level of uncertainty concerning shear strengths.

The Taylor Series numerical method¹², was used to estimate the standard deviation of the factor of safety (σ_F) and the coefficient of variation of the factor of safety (COV_F), using these formulas:

$$\sigma_F = \sqrt{\left(\frac{\Delta F_{clay\ strength}}{2}\right)^2 + \left(\frac{\Delta F_{marsh\ strength}}{2}\right)^2} \quad (11-3)$$

$$COV_F = \frac{\sigma_F}{F_{MLV}} \quad (11-4)$$

where $\Delta F_{clay\ strength}$ = difference between the values of the factor of safety calculated with the clay strength increased by one standard deviation and decreased by one standard deviation from its most likely value. $\Delta F_{marsh\ strength}$ is determined in the same way. F_{MLV} is the “most likely value” of factor of safety, computed using the IPET shear strengths.

Values of F_{MLV} and COV_F have been calculated for Station 55+00 and for Station 26+00. The results are listed in Table 11-9, together with the corresponding values of probability of instability based on an assumed lognormal distribution of factor of safety.

For Station 55+00, the calculated probabilities of instability are 42% for a water level of 10.0 ft, and 64% for the water level at the top of wall (12.5 ft, NAVD 88). For Station 26+00, the calculated probabilities of instability are 15% for the design water level of 10.5 ft, and 27% for a water level of 12.5 ft (top of wall). These values are reasonable, considering that evidence suggest that the north breach occurred before the wall overtopped and the south breach more likely failed due to overtopping.

Table 11-8				
Results of Slope Stability Analyses for IHNC East Bank, Using GDM No. 3, Plate 38.				
Note All Analyses Use Spencer’s Method with Critical Circles				
Case	Water Elev. ft. NAVD88	Strength Model	Crack (Yes or No)	Factor of Safety
1	10.5**	GDM	No	1.45
2	10.5**	GDM	Yes	1.19
3	12.5 – Top of Wall	GDM	No	1.35
4	12.5 – Top of Wall	GDM	Yes	1.05
Note: Design WL is 2.0 ft below top of wall				

¹²Wolff, T. F. (1994). “Evaluating the reliability of existing levees.” Report, Research Project: Reliability of Existing Levees, prepared for the U.S. Army Engineer Waterways Experiment Station, Geotechnical Laboratory, Vicksburg, MS.

Area	Water level (ft) NAVD88	F _{MLV}	COV _F	Probability of instability
North Breach	10.0	1.04	14%	42%
North Breach	12.5	0.96	15%	64%
South Breach	10.5	1.18	15%	15%
South Breach	12.5	1.10	14%	27%

F_{MLV} = most likely value of factor of safety
COV_F = coefficient of variation of factor of safety

West Bank North and South Breaches

Observations

Two breaches occurred on the west bank of the IHNC, as shown in Figure 11-1. Both breaches occurred north of the railroad gate on France Road and just east of the France Road crossing.

The northern breach, between Stations 195+00 and 196+40¹³, occurred after the I-wall at that location was overtopped, and soil supporting the wall was removed by erosion. The water elevation of the top of the wall was 12.5 ft, 1.7 ft lower than the peak elevation reached in the IHNC. A cross section through the levee and the I-wall is shown in Figure 11-35.

The southern breach, between stations 0+80 and 2+80¹⁴, occurred when the levee at that location was overtopped and eroded. There was no I-wall in this levee reach. The elevation of the top of the levee was 12.5 ft. A cross section through the levee is shown in Figure 11-36.

The levees at both locations were founded on about 8 ft to 10 ft of fill. The fill at the north breach was clay. At the south breach the fill consisted partly of silty sand and partly of clay, as shown in Figure 11-36. At both locations the fill was underlain by a layer of marsh material, about 11 to 12 ft thick, and a layer of normally-consolidated interdistributary clay 30 to 35 ft thick.

The shear strengths used in the stability analyses of the breached sections are summarized in Table 11-10. These values are based on data from the GDMs and from post-Katrina investigations.

¹³ Design Memorandum No. 2 – General, Supplement No. 8, Lake Pontchartrain, LA and Vicinity, Lake Pontchartrain Barrier Plan, Inner Harbor Navigation Canal Remaining Levees, Office of the District Engineer, New Orleans District, Corps of Engineers, February, 1968.

¹⁴ Modification of Protected Alignment and Pertinent Design Information, IHNC Remaining Levees, West Levee Vicinity, France Road and Florida Avenue Containerization Complex, Office of the District Engineer, New Orleans District, Corps of Engineers, October, 1971. Note: A different stationing origin was used for the two sections in the GDMs. The location of the south section would correspond to Stations 208+00 to 210+00 in the stationing system used for the north section.

Results of Stability Analyses – West Bank – North Breach

Stability analyses of the north breach section were performed using UTEXAS4⁸ for canal water elevations of 12.0 ft (the design water elevation) and 12.5 ft (the top of the wall). Analyses were performed for the cracked condition and the no-crack condition. For the cracked condition, the water-filled gap extended to the bottom of the sheetpile, elevation -12.5 ft. The factors of safety calculated in these analyses are listed in Table 11-11. It can be noted that the factors of safety for the cracked and the un-cracked conditions are the same. This occurs because, even with the crack, the critical slip circle passes beneath the tip of the sheet pile. If the slip circle is forced to intersect the gap at the bottom of the sheetpile, the calculated factor of safety increases.

These analyses show that the wall would have a considerable margin of safety against instability, even with the water at the top of the wall and a crack at the back of the wall. It thus seems highly likely that wall would have remained stable if none of the supporting soil had been removed by overtopping erosion.

Results of Stability Analyses – West Bank – South Breach

Stability analyses of the south breach section were performed using UTEXAS4⁸ for a canal water elevation of 12.5 ft (the top of the levee). The factor of safety for this condition was found to be 2.08. The concept of a gap does not apply to this section since there is no sheet pile wall on or in the embankment. The high factor of safety indicates that the breach was the result of erosion of the levee.

Summary

Four breaches occurred on the IHNC, two on the east bank, and two on the west bank. Three of the breaches involved failures of floodwalls on levees, and one involved failure of a levee without a floodwall.

The peak storm surge elevation in the IHNC was 14.2 ft at 9:00 AM on August 29, about 1.7 ft above the tops of the floodwalls and levees. Water flowing over the walls when they were overtopped eroded trenches on the protected side of the walls as it cascaded onto the levee fill, and soil that was providing support for the walls was removed by this erosion, making the walls less stable.

It is clear that one of the east side breaches occurred before the wall was overtopped, because eyewitness reports indicate that the water level in the 9th Ward near Florida Avenue was rising when the water level in the IHNC was still below the top of the floodwall. Stability analyses indicate that foundation failure would occur before overtopping at the north breach on the east side of the IHNC. This breach location is thus the likely source of the early flooding in the 9th Ward. Stability analyses indicate that the other three breach locations would not have failed before they were overtopped.

The failure that resulted in the north breach on the east side of the IHNC resulted from two differences between the stability analyses that were used as the basis for design and those described in this report: (1) the ground surface beyond the toe of the levee at the north breach location was lower than the landside ground surface in the design cross section, and (2) the design analyses did not consider the possibility of a crack forming behind the wall, allowing water to run into the gap and increase the load on the wall.

Table 11-10 Shear Strength Parameters Used in Stability Analyses of North and South Breach Locations on the IHNC West Bank		
Unit	Unit Weight (pcf)	Shear Strength
Levee Fill	109	$\phi = 0$ $s_u = 500$ psf
Fill (Clay)	105	$\phi = 0$ $s_u = 500$ psf
Fill (Sand)*	120	$\phi' = 30^\circ$ $c' = 0$
Marsh	80	Toe: $\phi = 0$ $s_u = 200$ psf Crest: $\phi = 0$ $s_u = 300$ psf
Interdistributary Clay	100	Calculated using $s_u/p' = 0.27$
*Only present under south breach		

Table 11-11 Results of Slope Stability Analyses of the IHNC West Bank North Breach				
Case	Water Elev. ft NAVD88	Strength Model	Crack (Yes or No)	Factor of Safety
1	12.0	IPET	Yes	1.75
2	12.0	IPET	No	1.75
3	12.5	IPET	Yes	1.73
4	12.5	IPET	No	1.73
Note – analyses performed using Spencer’s Method with circular slip surfaces.				

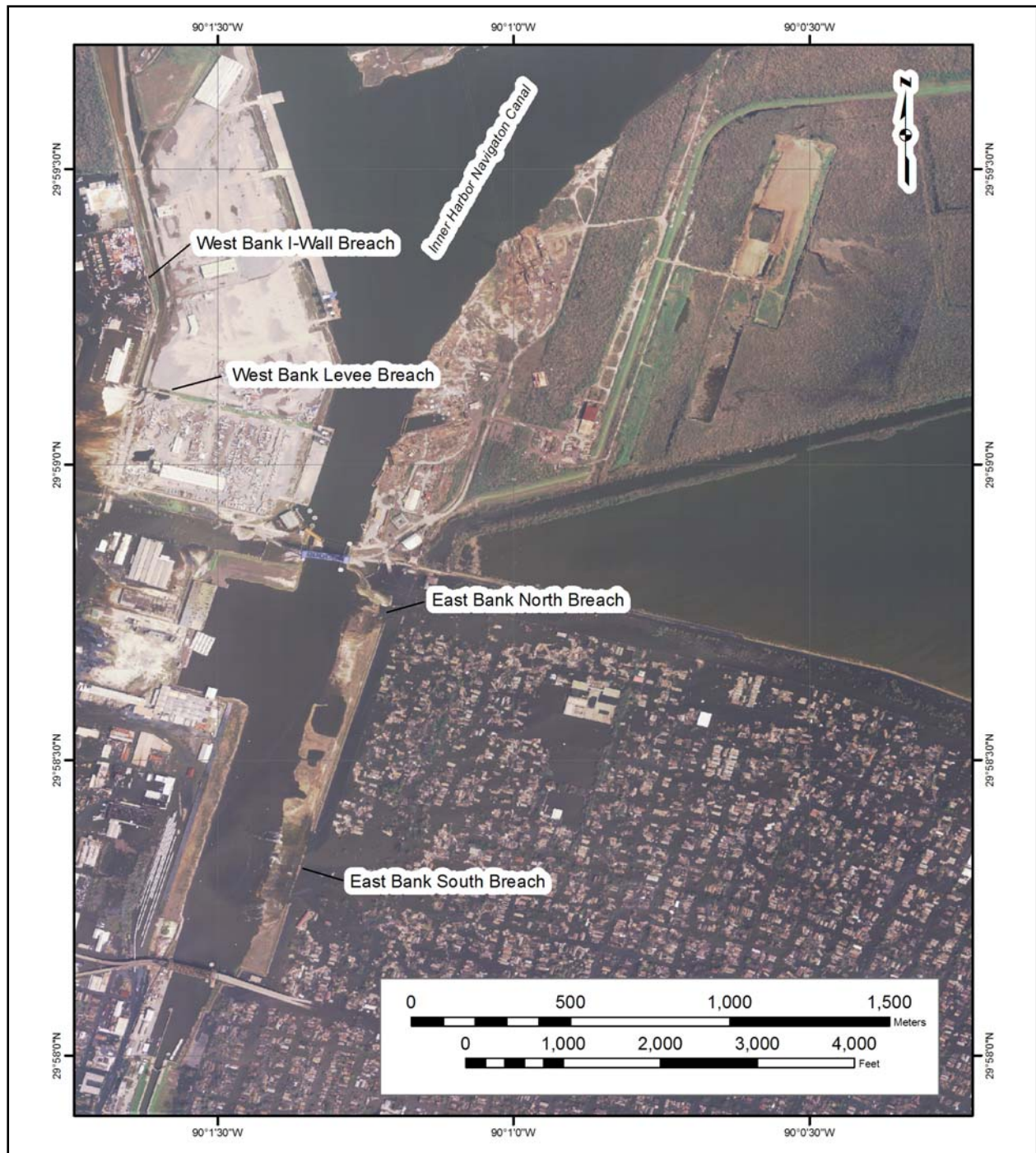

Figure 11-1. Four Breach Locations on the Inner Harbor Navigation Canal

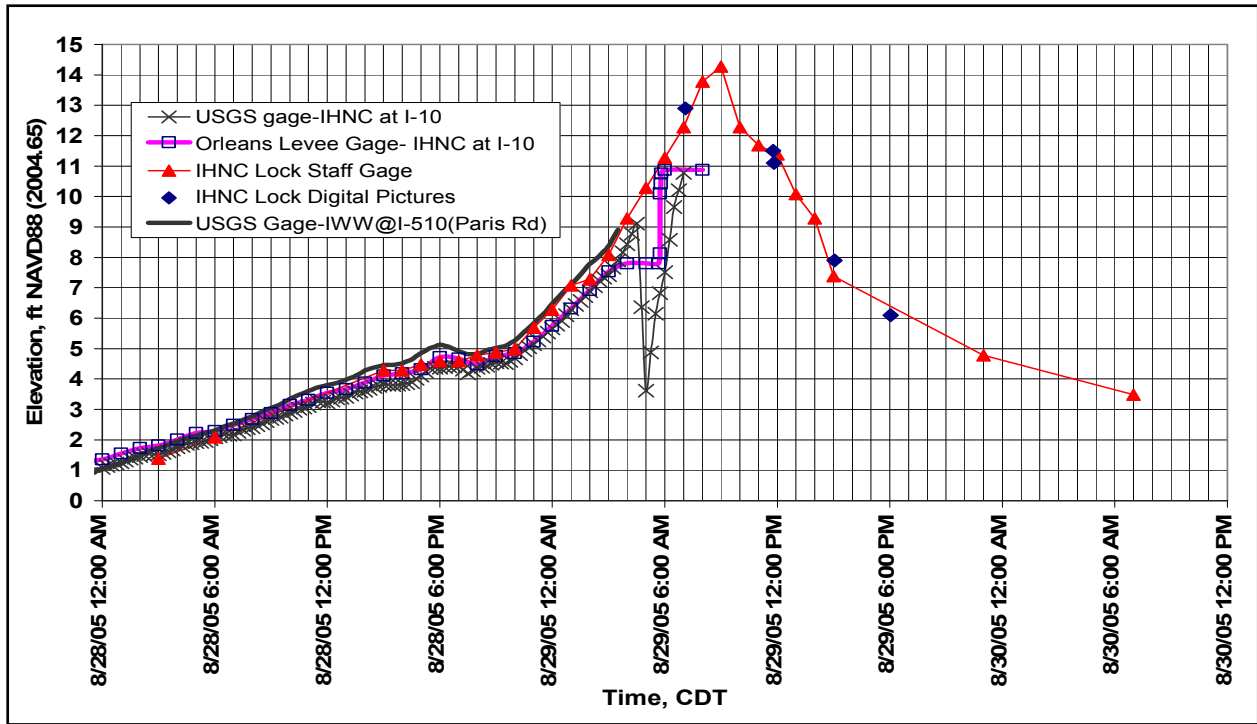

Figure 11-2. Katrina Hydrograph for the Inner Harbor Navigation Canal

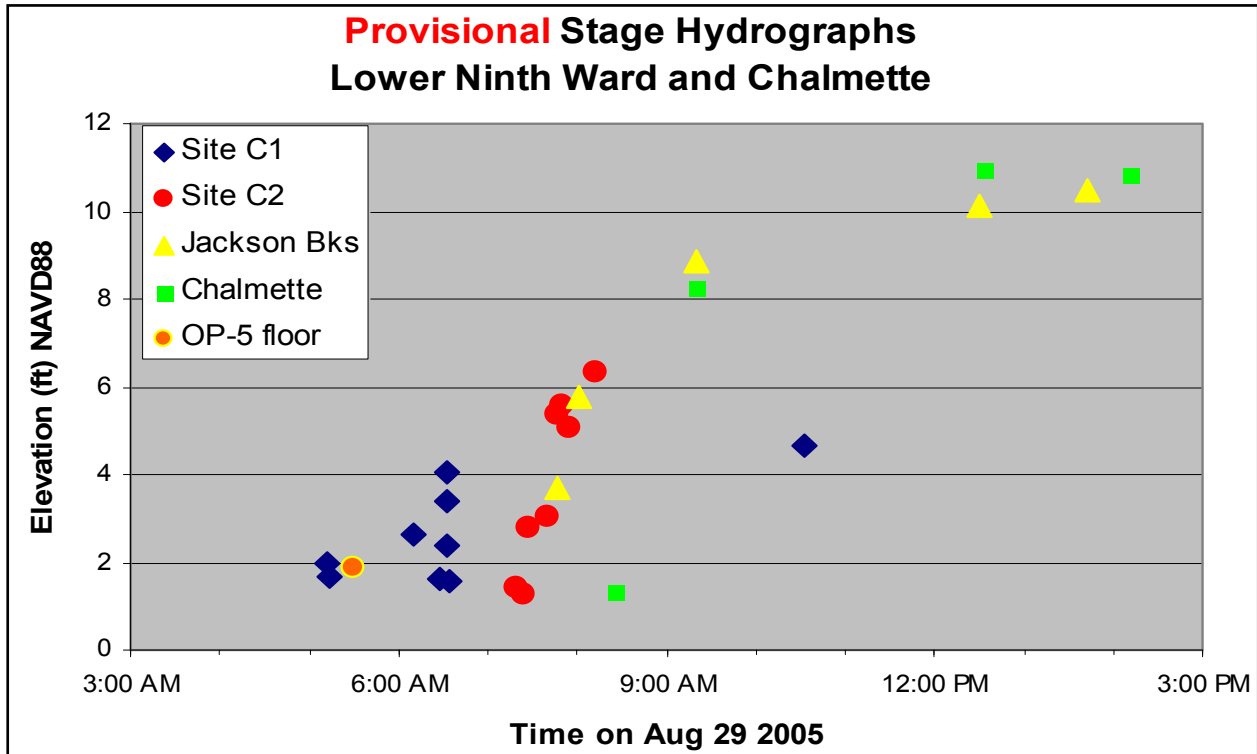

Figure 11-3. Hydrograph for the 9th Ward Inundation



Figure 11-4. Scour and Erosion on the Protected Side of the IHNC Adjacent to the Ninth Ward in the Vicinity of the South Breach



Figure 11-5. Scour and Erosion Leading to the Failure of the I-Wall on the IHNC Adjacent the South Breach (9th Ward)



Figure 11-6. IHNC East Bank – South Breach – Wall Movement



Figure 11-7. IHNC East Bank – North Breach – Wall Movement (View looking south)

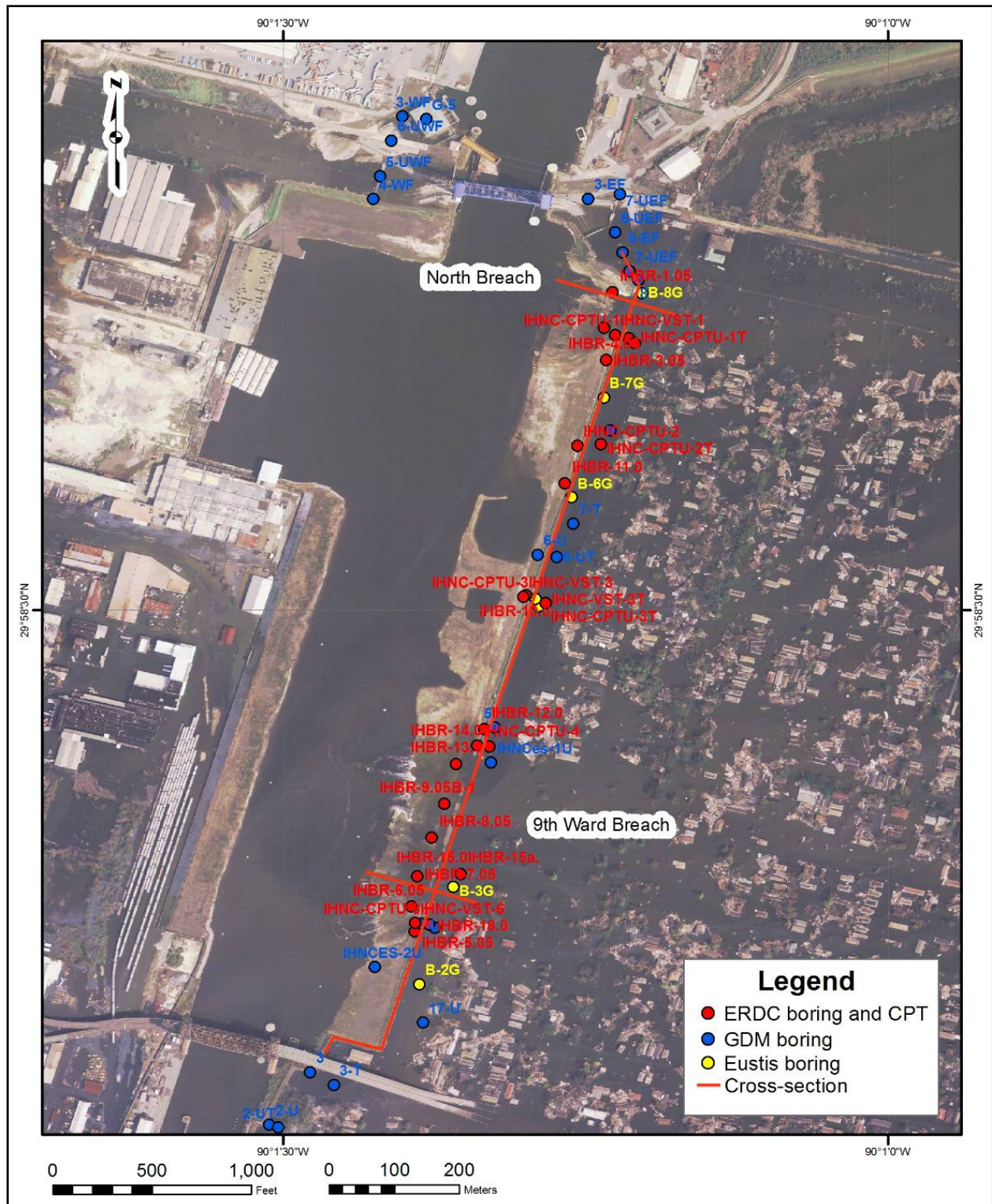

Figure 11-8. IHNC – East Bank (Between Florida Ave. and North Claiborne Ave.), Boring and CPTU Location Map

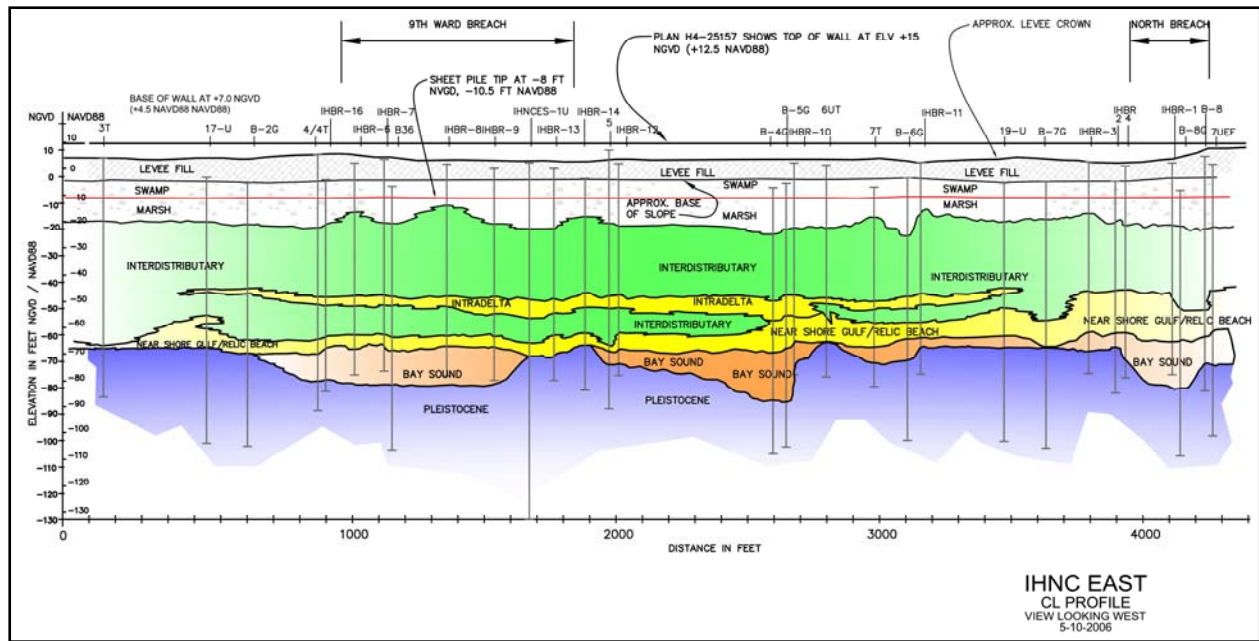

Figure 11-9. IHNC East Bank, Centerline Geologic Section Showing South (9th Ward) and North Breaches

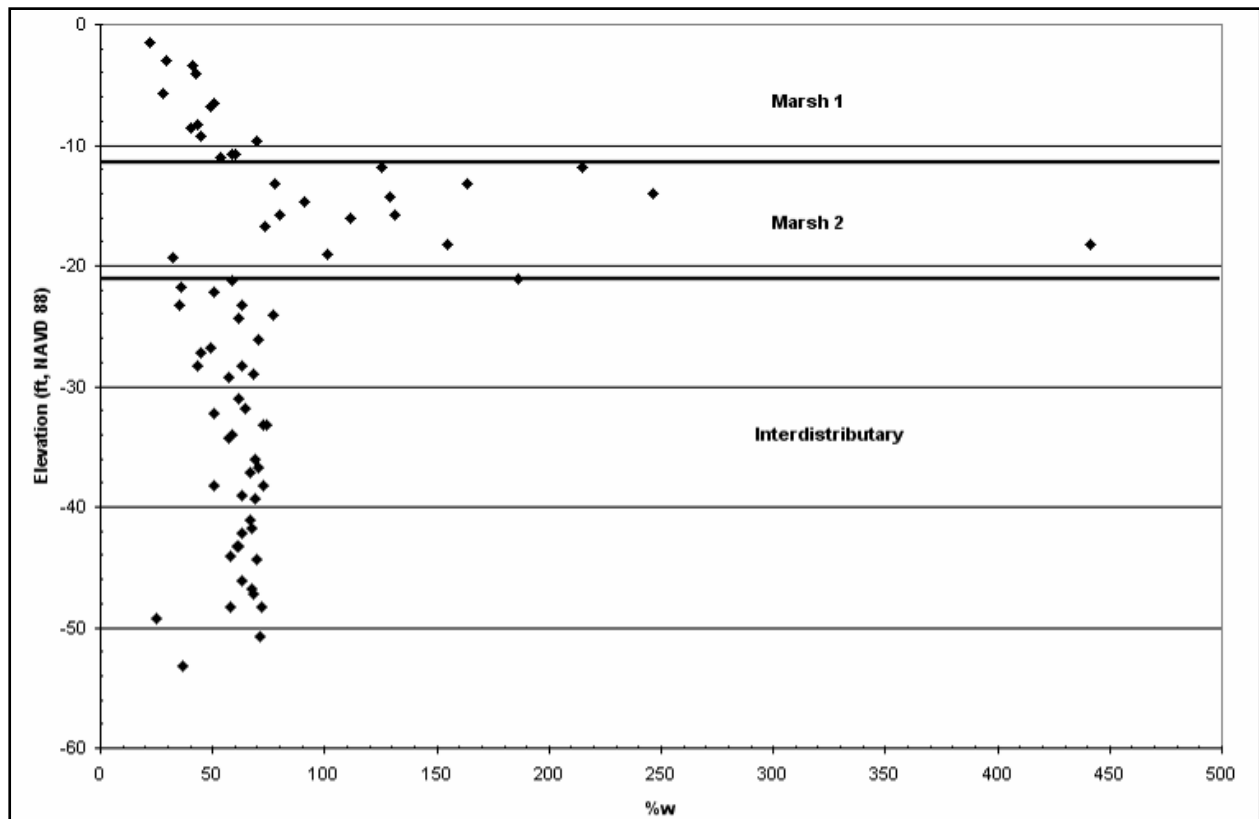

Figure 11-10. IHNC – East Bank (Between Florida Ave. and North Claiborne Ave.), % w Versus Elevation (ft, NAVD 88) from Toe Borings

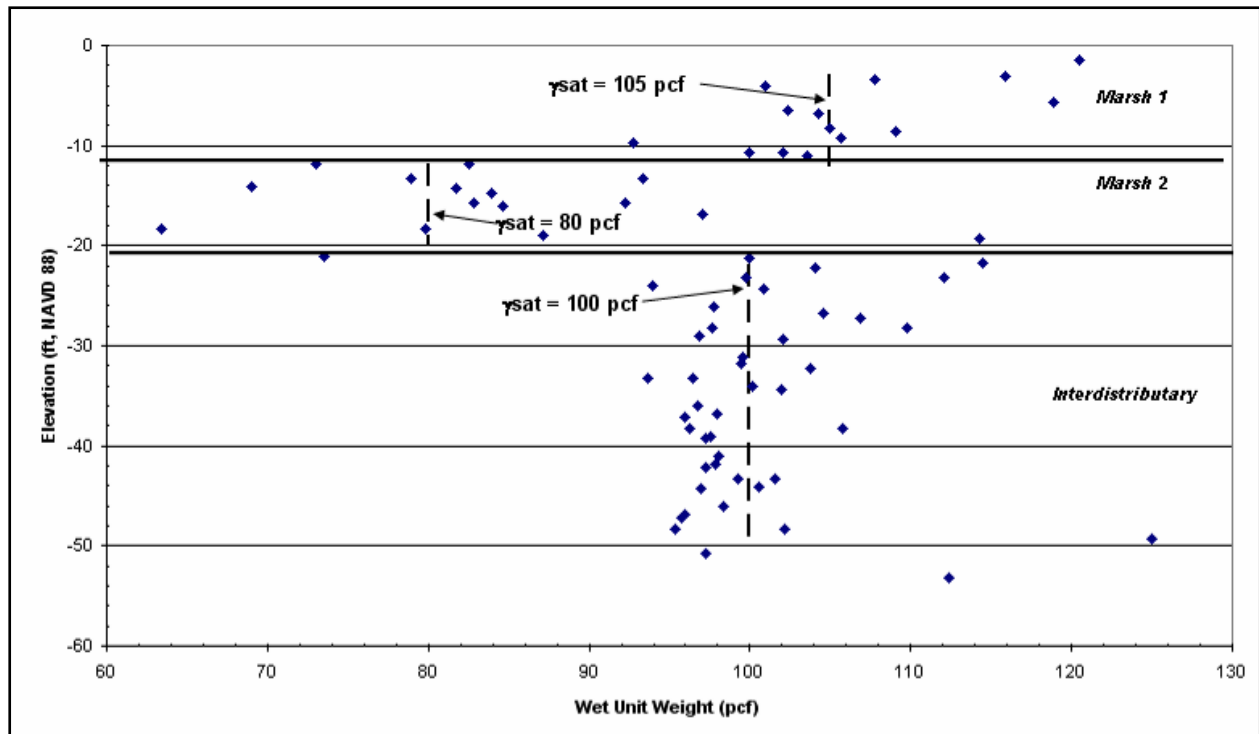

Figure 11-11. IHNC – East Bank (Between Florida Ave. and North Claiborne Ave.), Wet Unit Weight versus Elevation (ft, NAVD 88) from Post-Katrina Borings

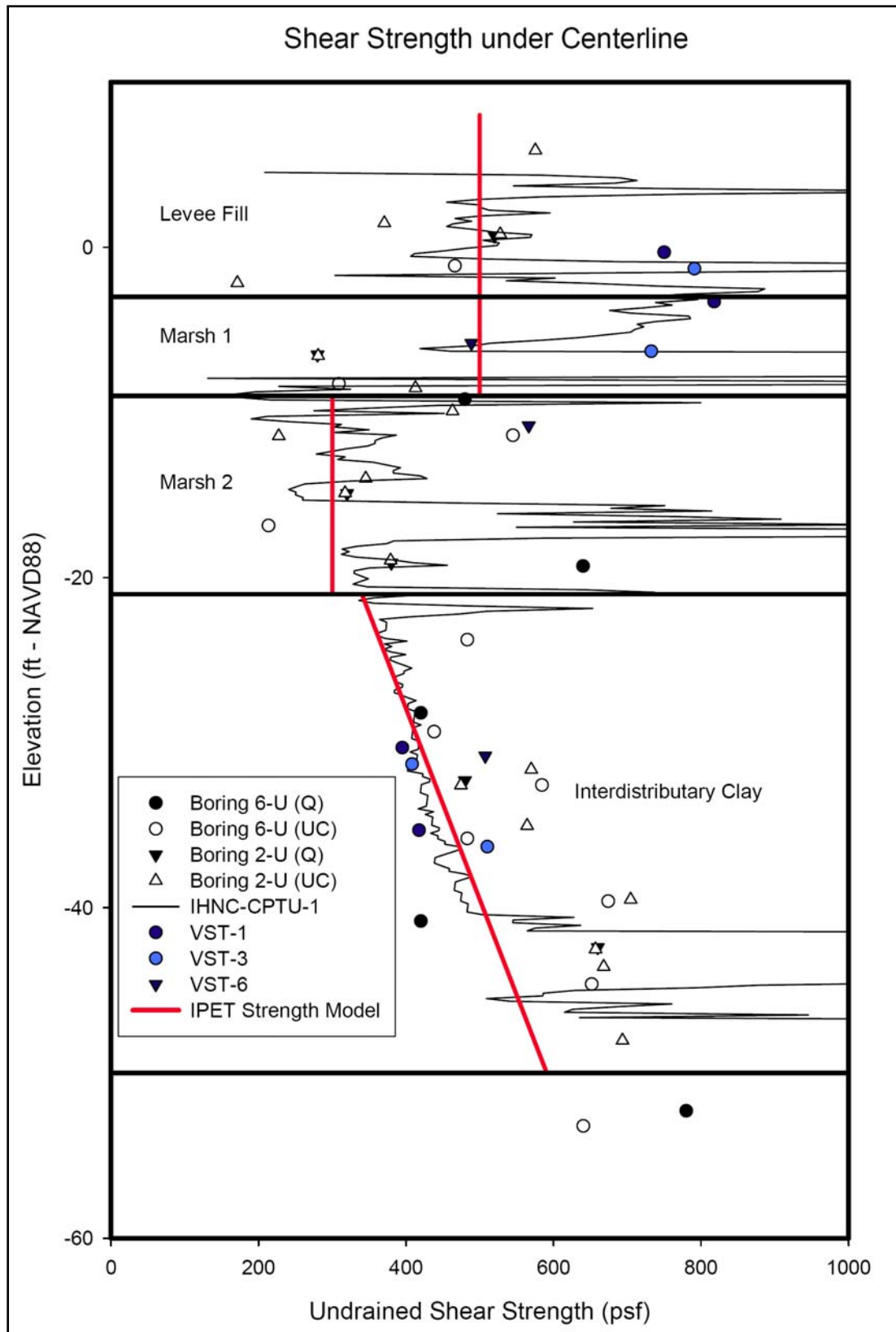

Figure 11-12. IHNC – East Bank Laboratory and Field Shear Strength Results for the Centerline of the Levee

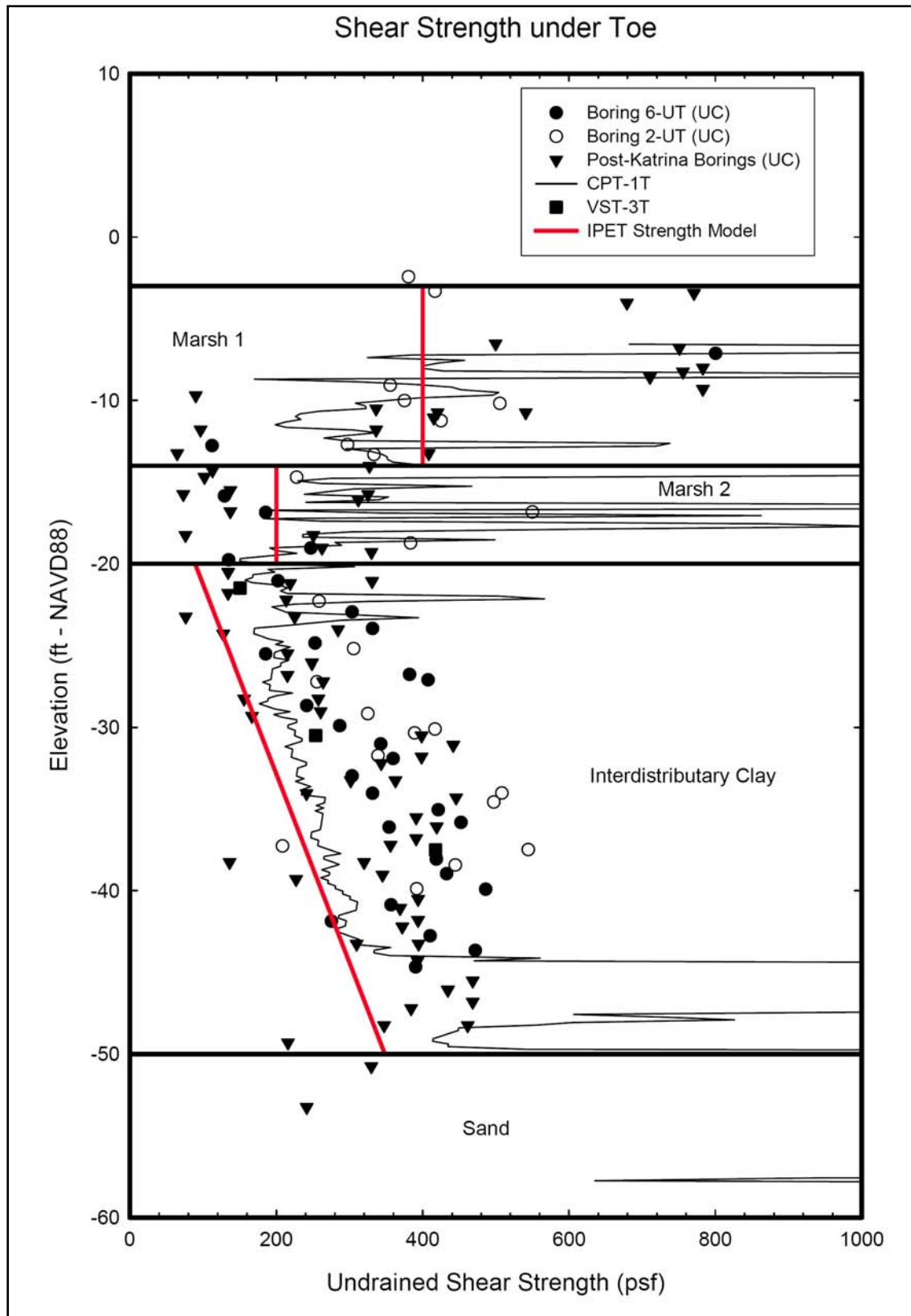

Figure 11-13. IHNC – East Bank Laboratory and Field Shear Strength Results for Toe of Levee and Beyond

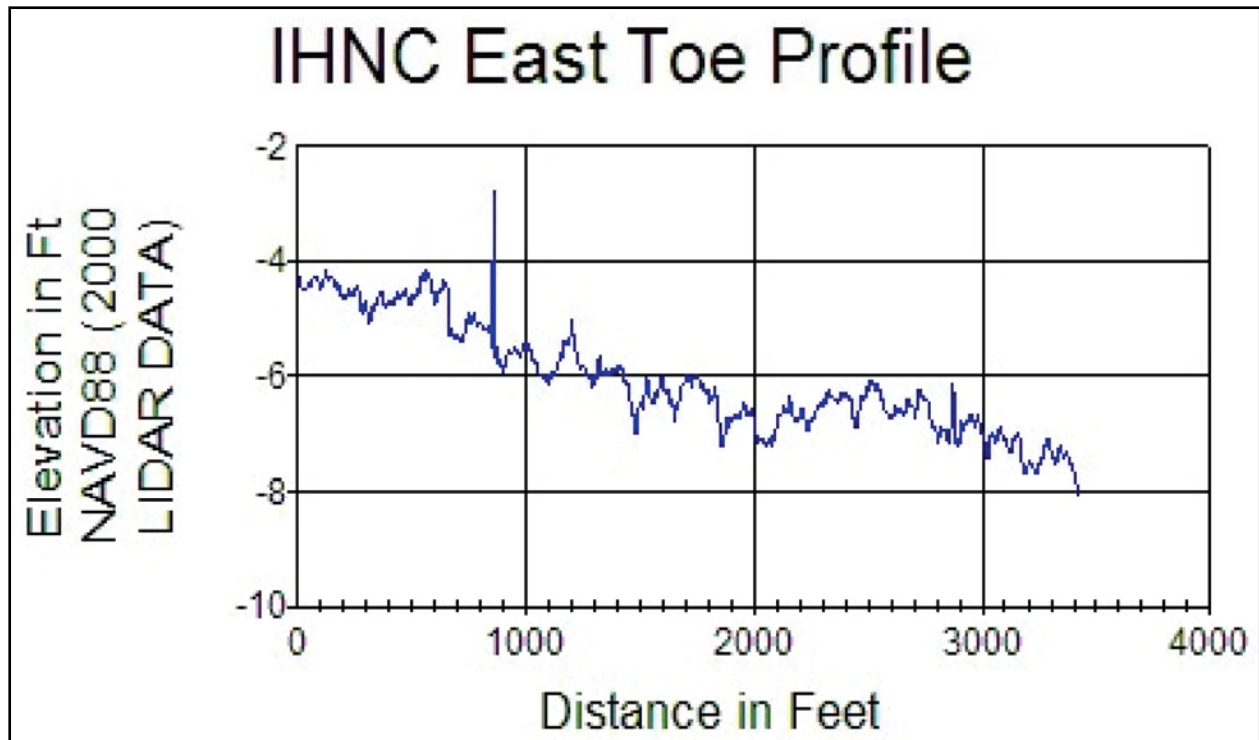

Figure 11-14. LIDAR Data at Toe of Levee

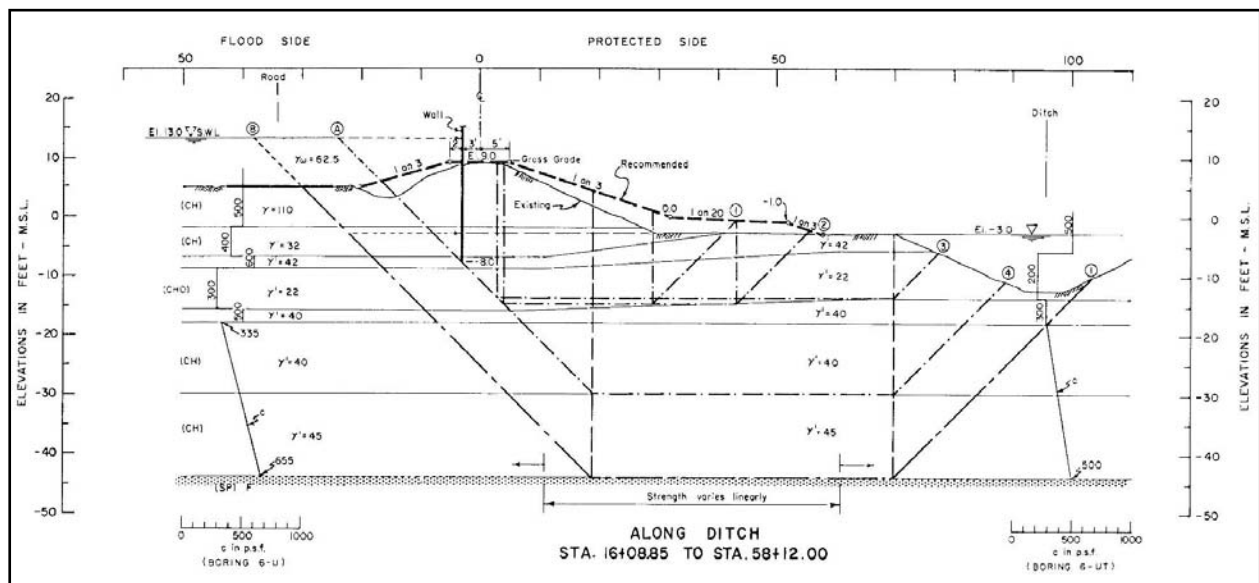

Figure 11-15. Cross Section Used for Design for Stations 16+09 to 58+12. Both East Bank Breaches Occurred Between These Two Stations

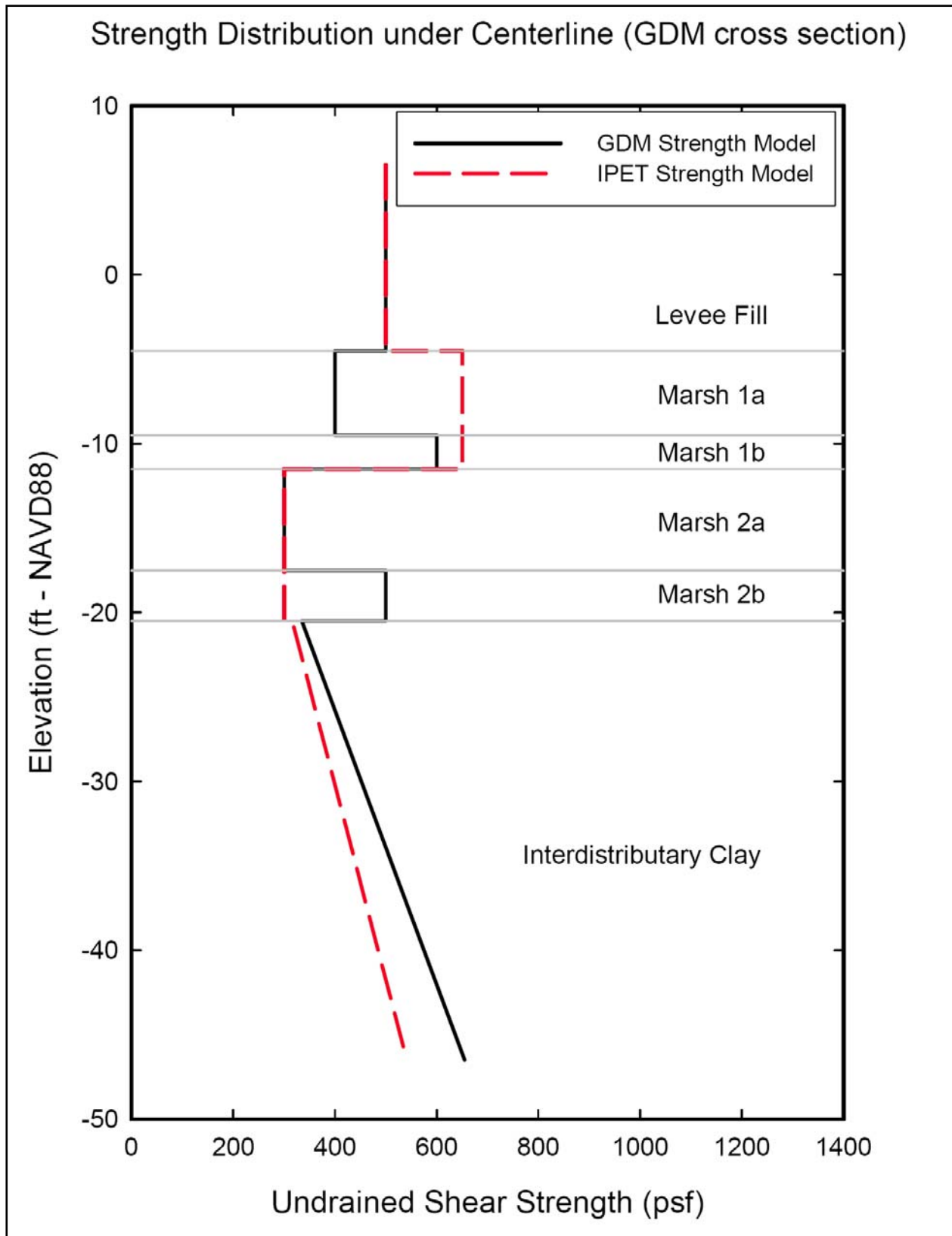

Figure 11-16. Comparison of GDM and IPET Shear Strength Models for GDM Design Cross Section at the Centerline (Horizontal Coordinate of 0 ft in Figure 11-15)

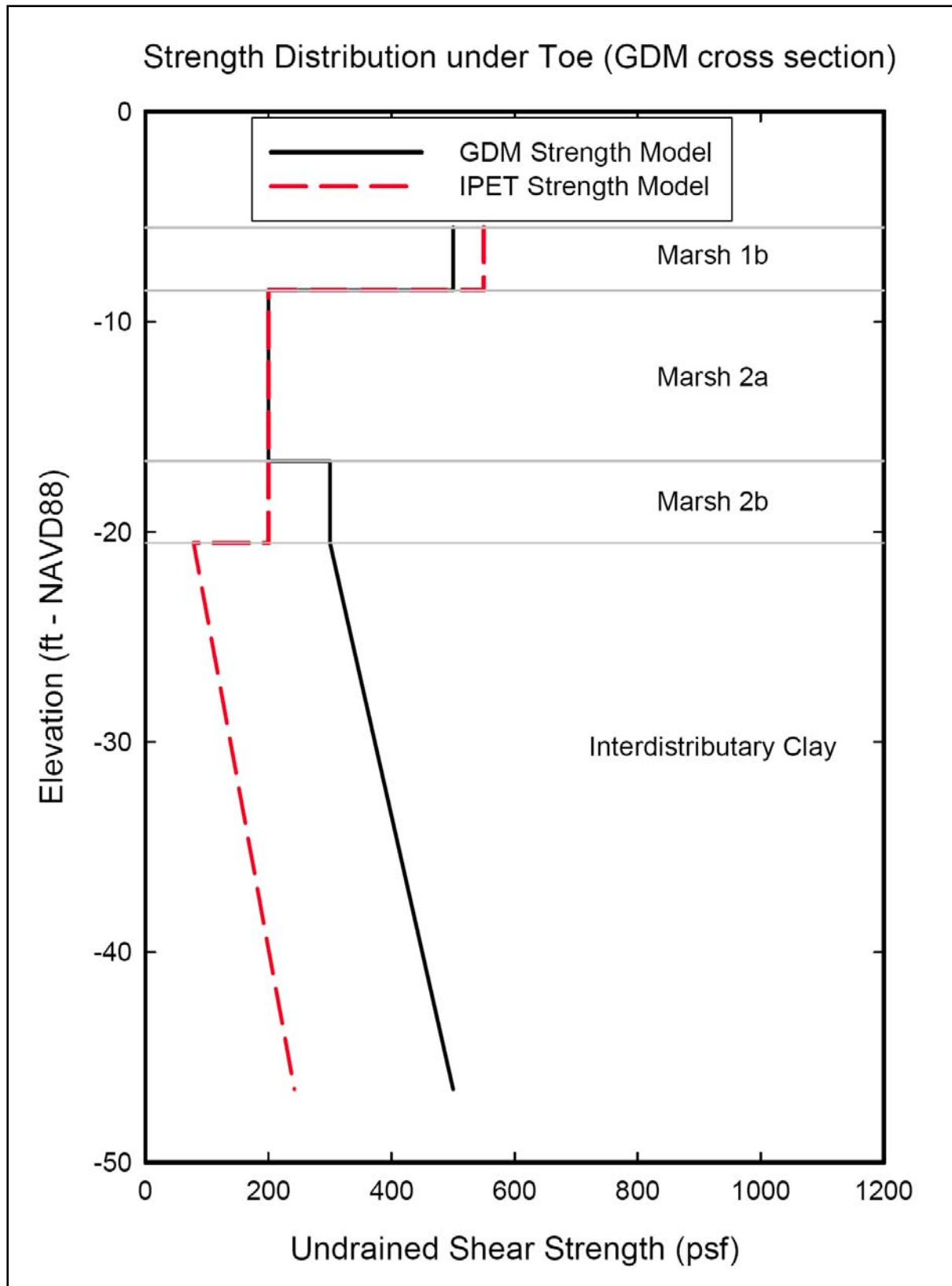

Figure 11-17. Comparison of GDM and IPET Shear Strength Models for GDM Design Cross Section at the Toe (Horizontal Coordinate of 60 ft in Figure 11-15)

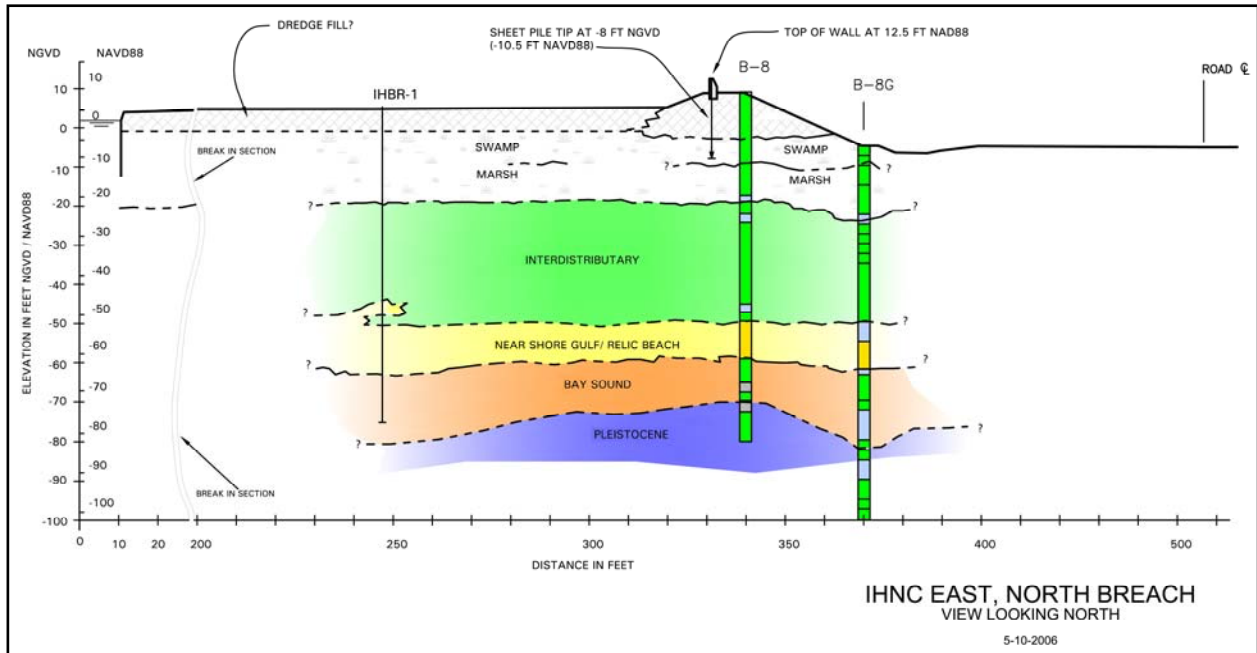

Figure 11-18. Profile of the North Breach at IHNC East bank, View Looking North

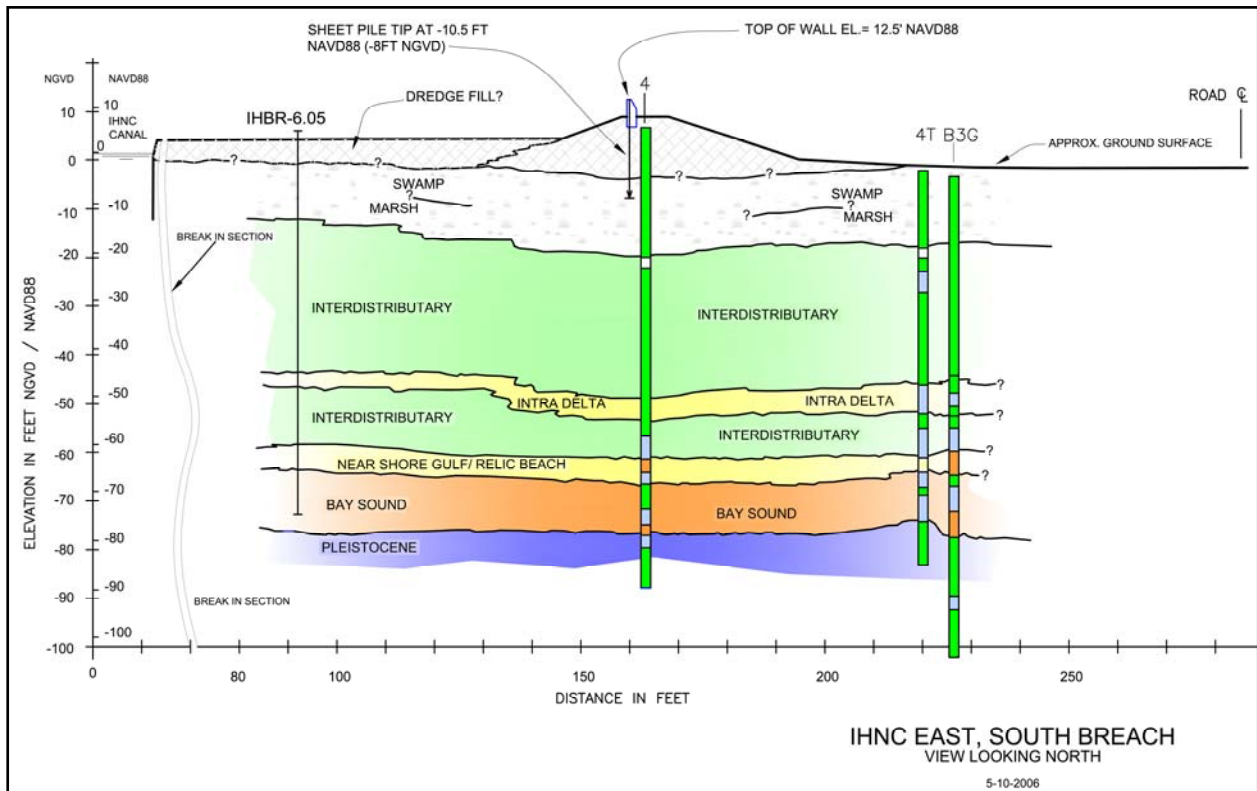

Figure 11-19. Profile of the South (9th Ward) Breach at IHNC East Bank, View Looking North

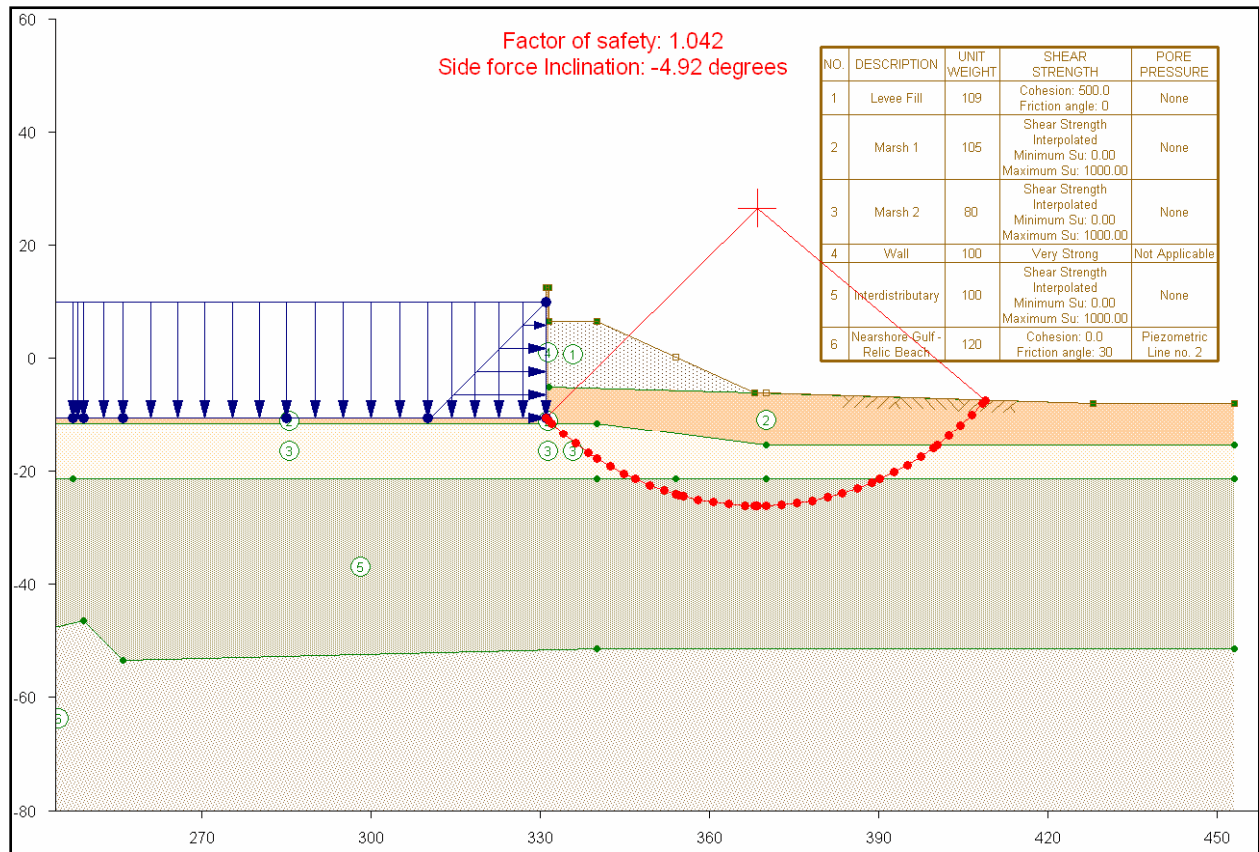

Figure 11-20. IHNC – East Bank (North Breach), Case 1, Canal Water Level = 10.0 ft (NAVD 88), with Crack

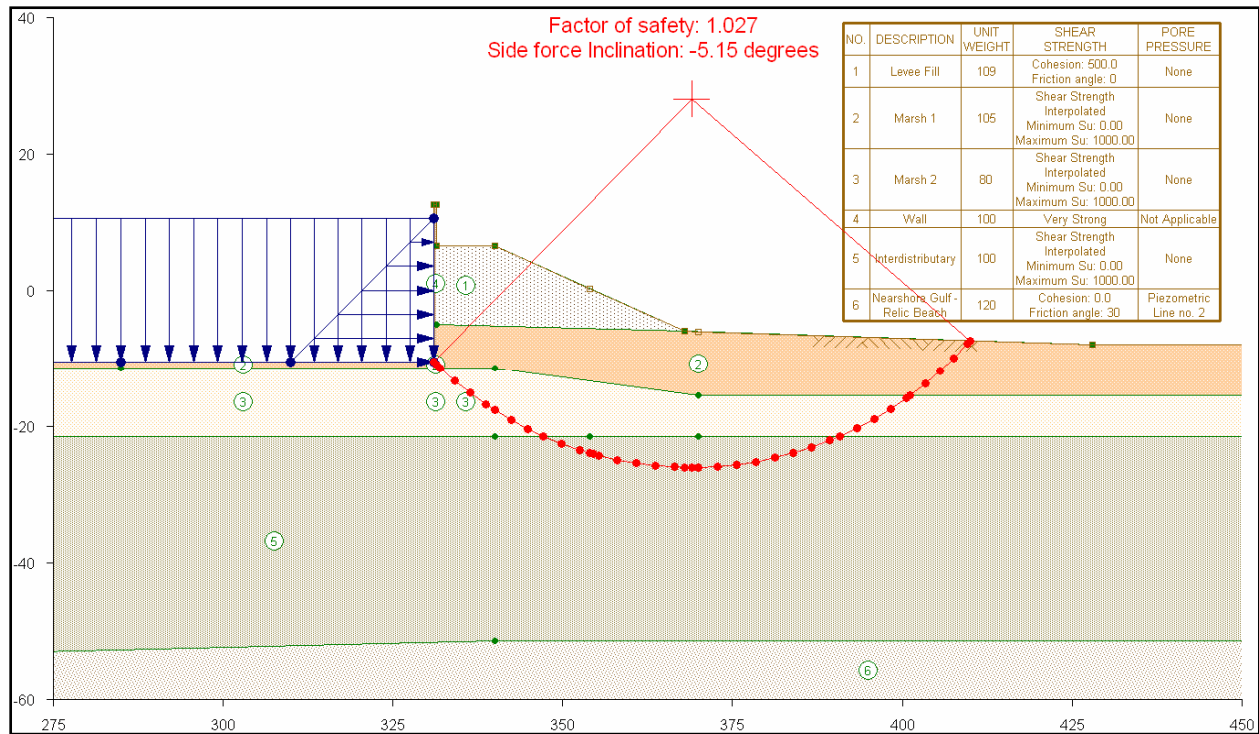

Figure 11-21. IHNC – East Bank (North Breach), Case 2, Design Canal Water Level = 10.5 ft (NAVD 88), with Crack

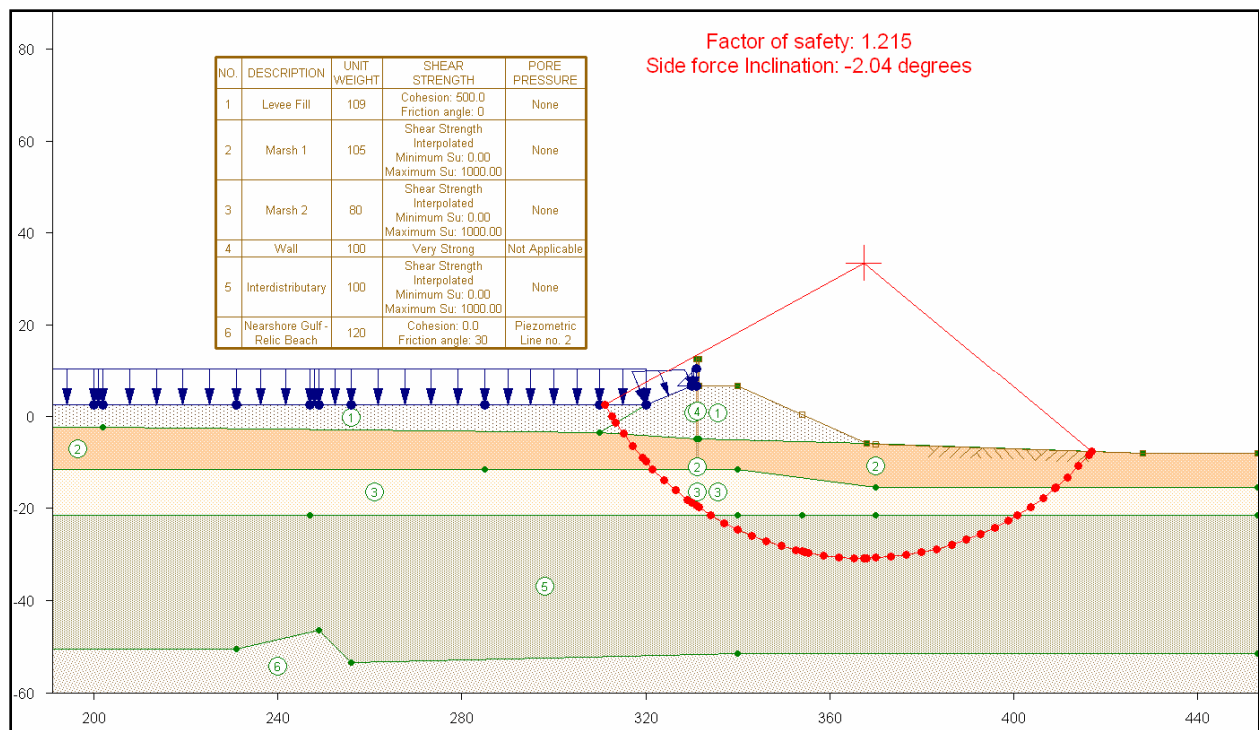

Figure 11-22. IHNC – East Bank (North Breach), Case 3, Design Canal Water Level = 10.5 ft (NAVD 88), without Crack

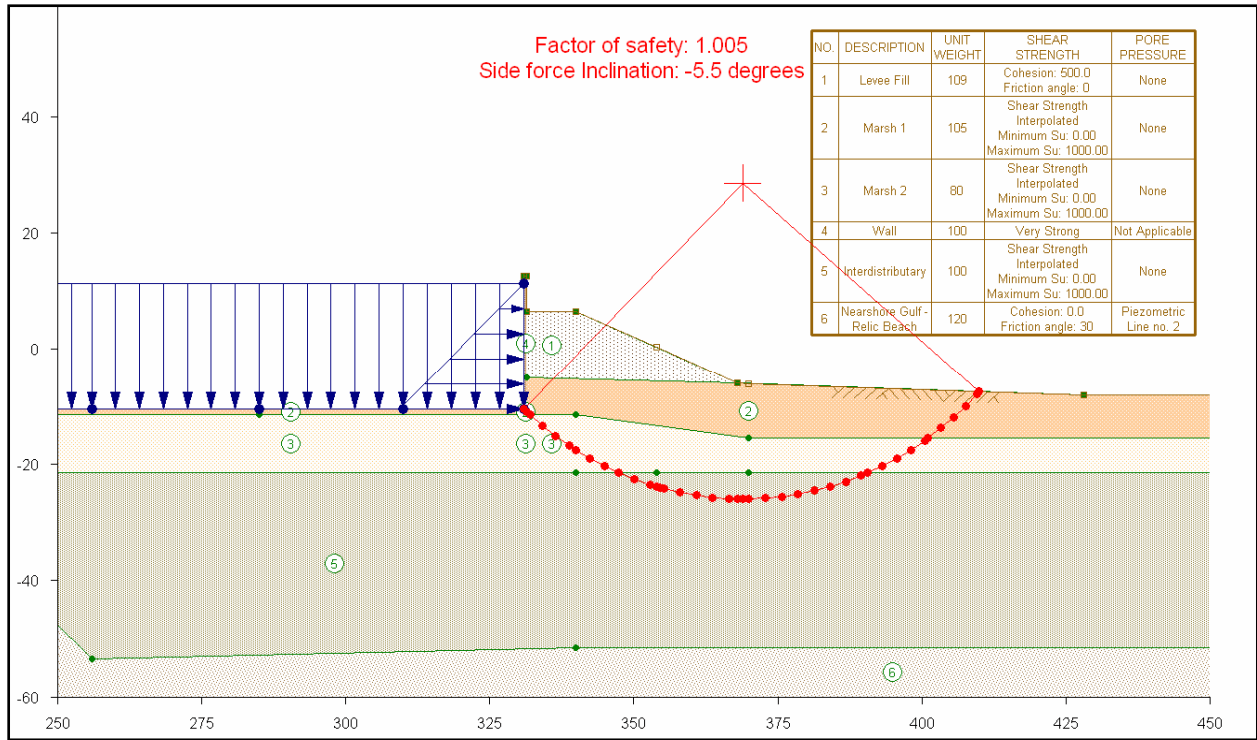

Figure 11-23. IHNC – East Bank (North Breach), Case 4, Canal Water Level = 11.2 ft (NAVD 88), with Crack

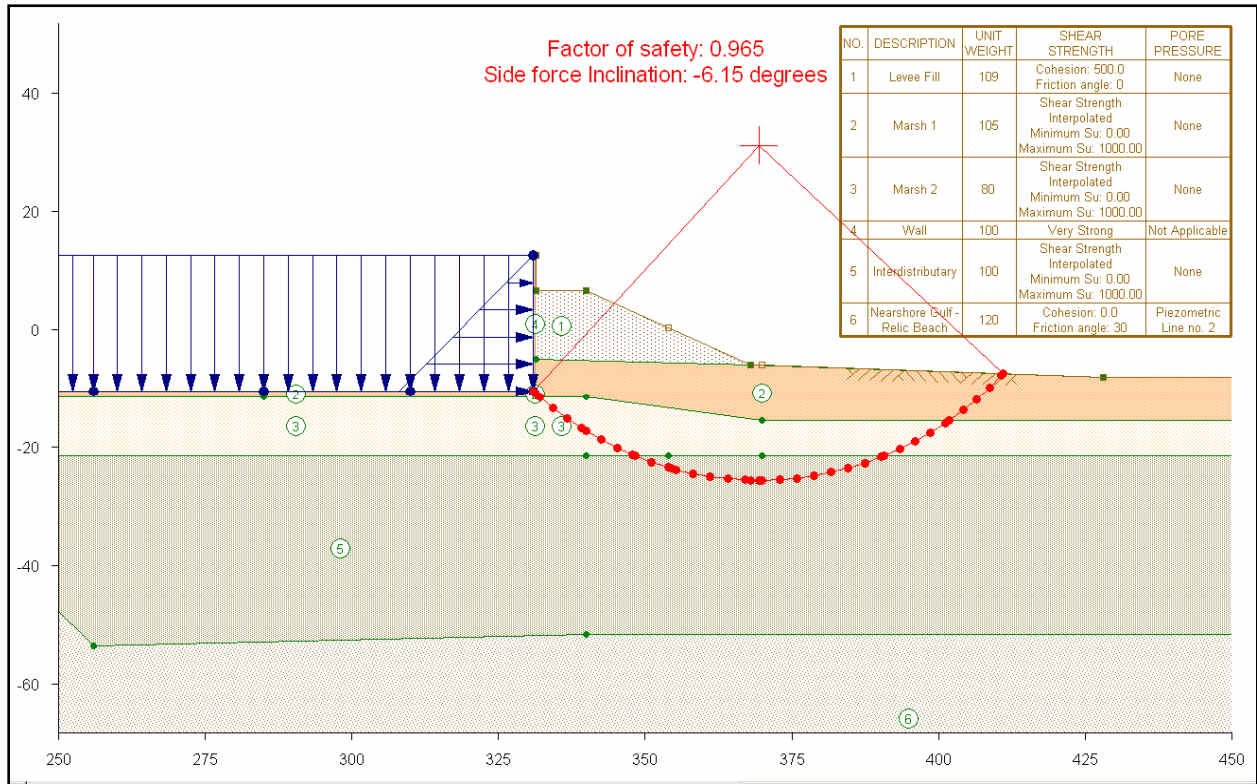

Figure 11-24. IHNC – East Bank (North Breach), Case 5, Canal Water Level = Top of Wall = 12.5 ft (NAVD 88), with Crack

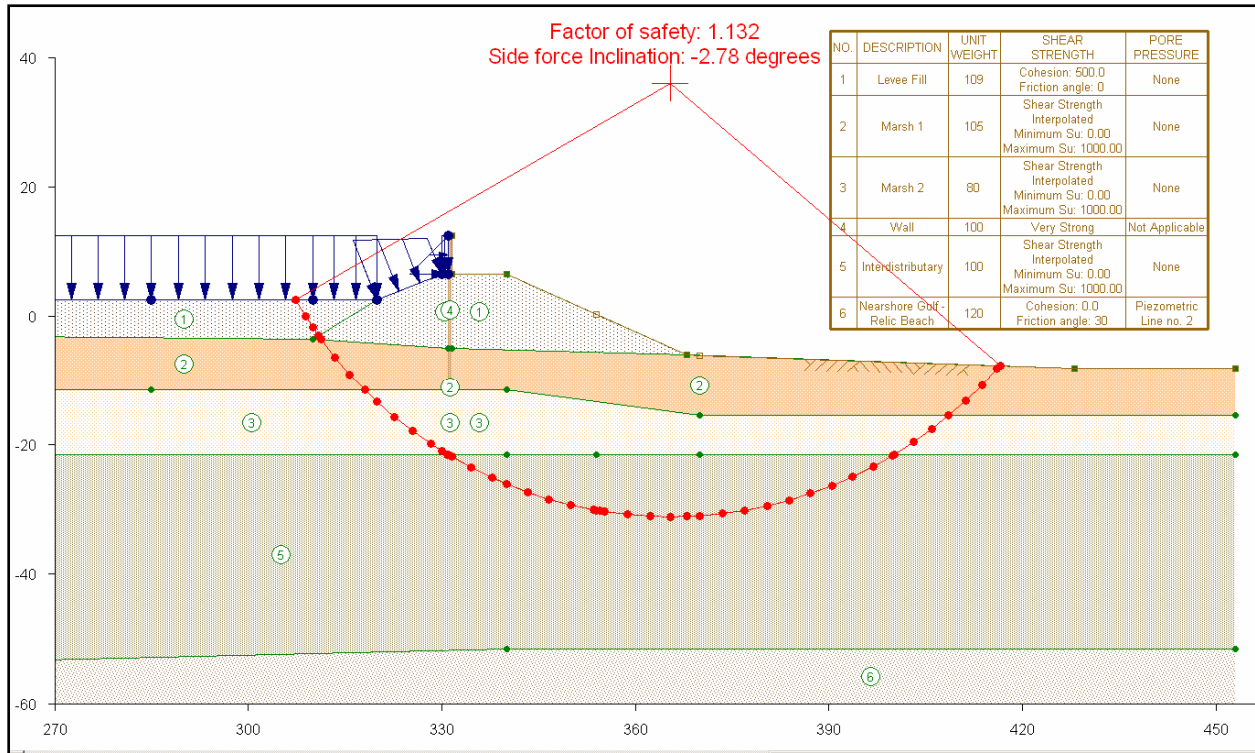

Figure 11-25. IHNC – East Bank (North Breach), Case 5a, Canal Water Level = Top of Wall = 12.5 ft (NAVD 88), without Crack

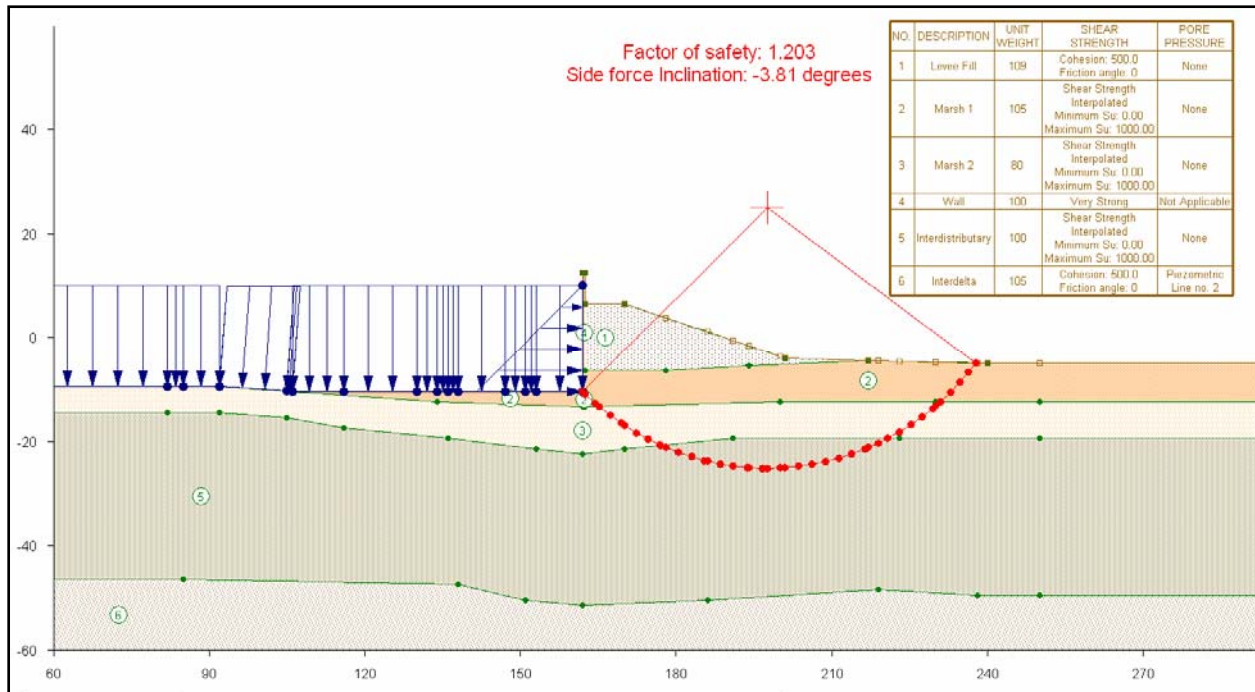

Figure 11-26. IHNC – East Bank (South Breach), Case 1, Canal Water Level = 10.0 ft (NAVD 88), with Crack

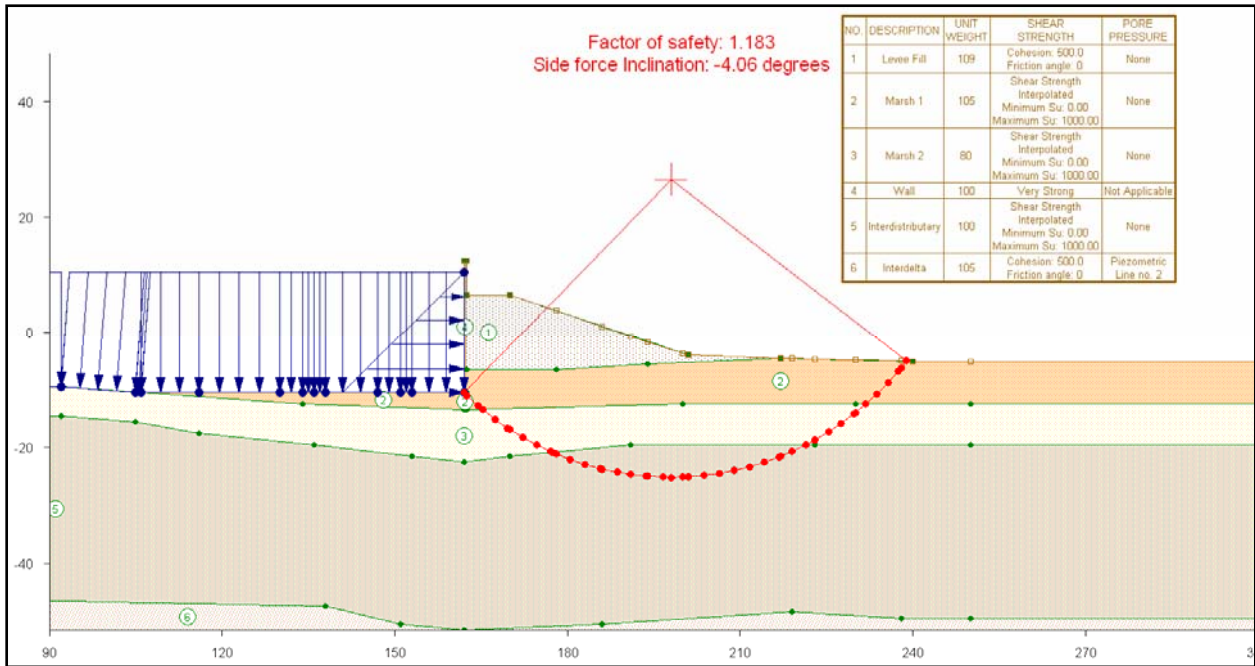

Figure 11-27. IHNC – East Bank (South Breach), Case 2, Design Canal Water Level = 10.5 ft (NAVD 88), with Crack

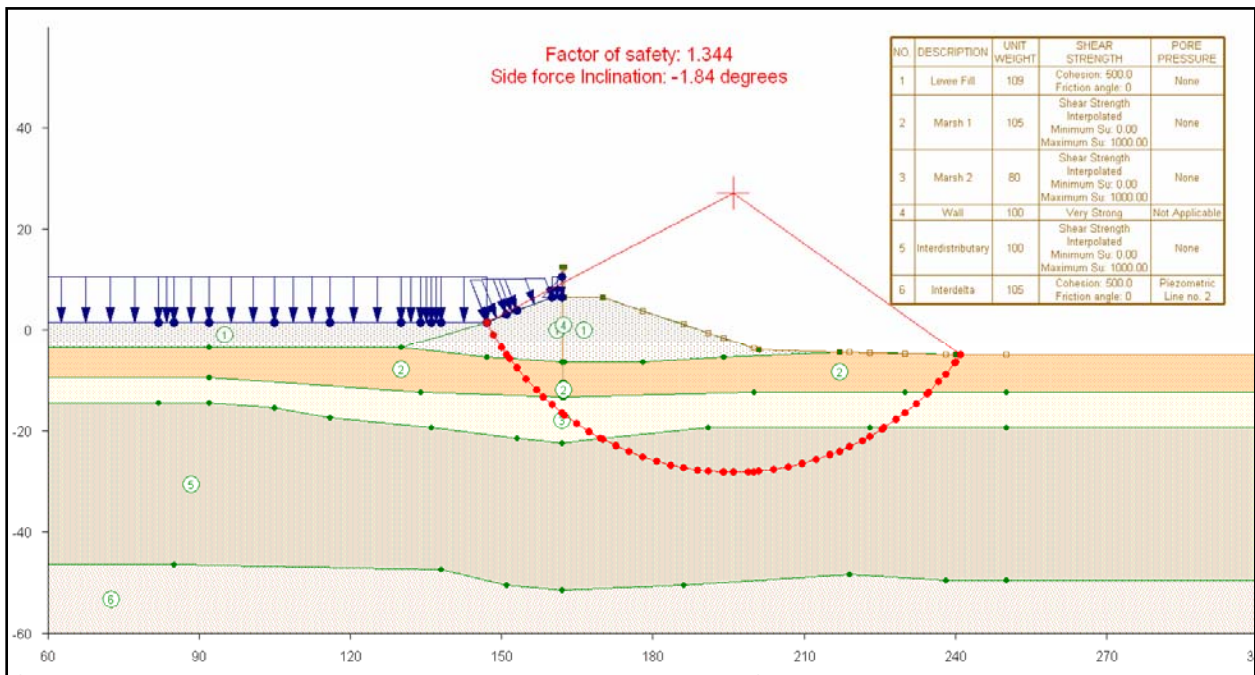

Figure 11-28. IHNC – East Bank (South Breach), Case 3, Design Canal Water Level = 10.5 ft (NAVD 88), without Crack

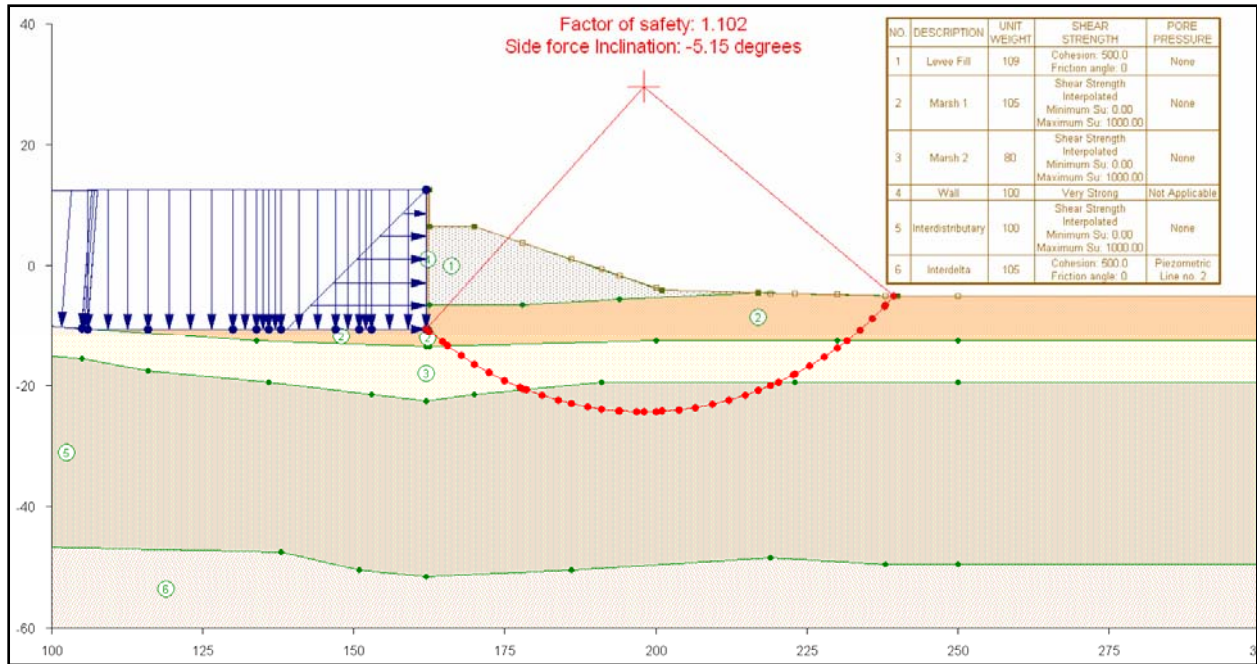

Figure 11-29. IHNC – East Bank (South Breach), Case 4, Canal Water Level = Top of Wall - 12.5 ft (NAVD 88), with Crack

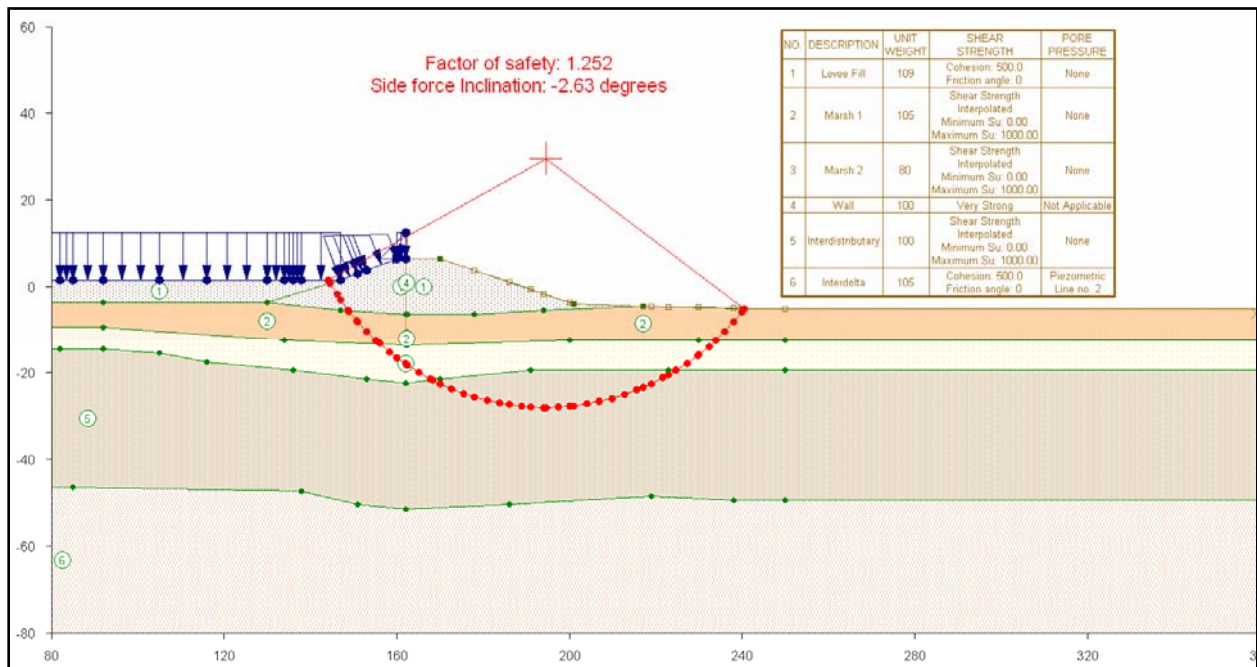

Figure 11-30. IHNC – East Bank (South Breach), Case 5, Canal Water Level = Top of Wall - 12.5 ft (NAVD 88), without Crack

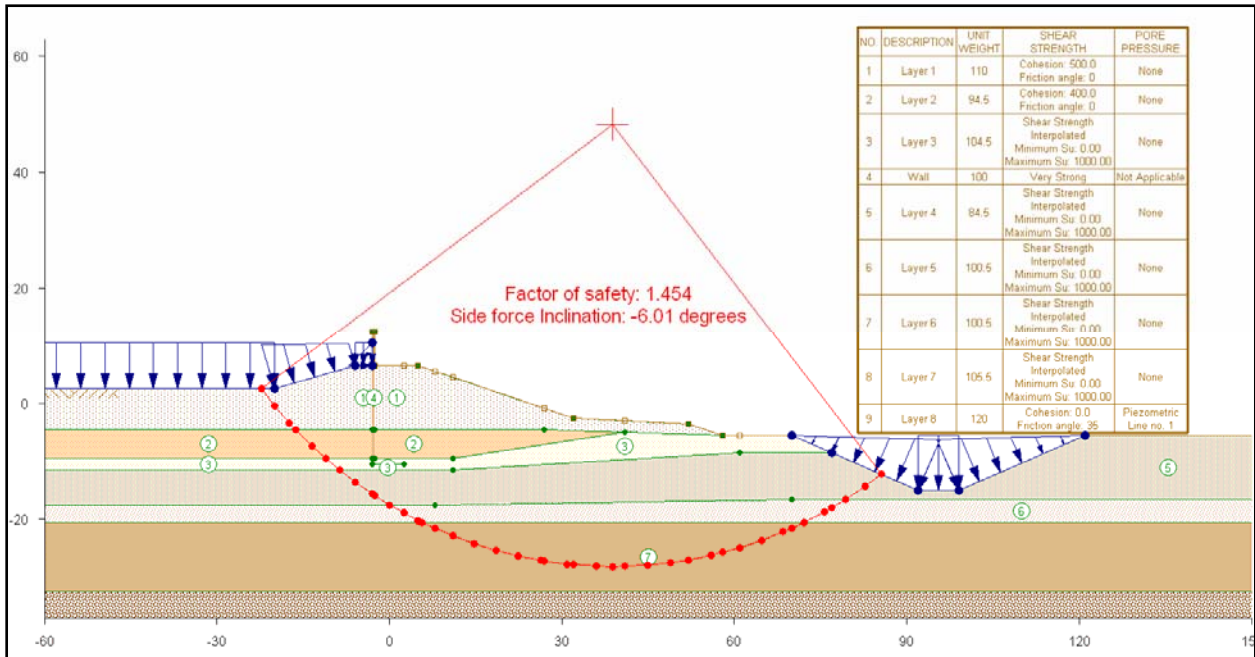

Figure 11-31. IHNC – East Bank (GDM Stability Plate), Case 1, Canal Water Level = Design - 10.5 ft (NAVD 88), without Crack

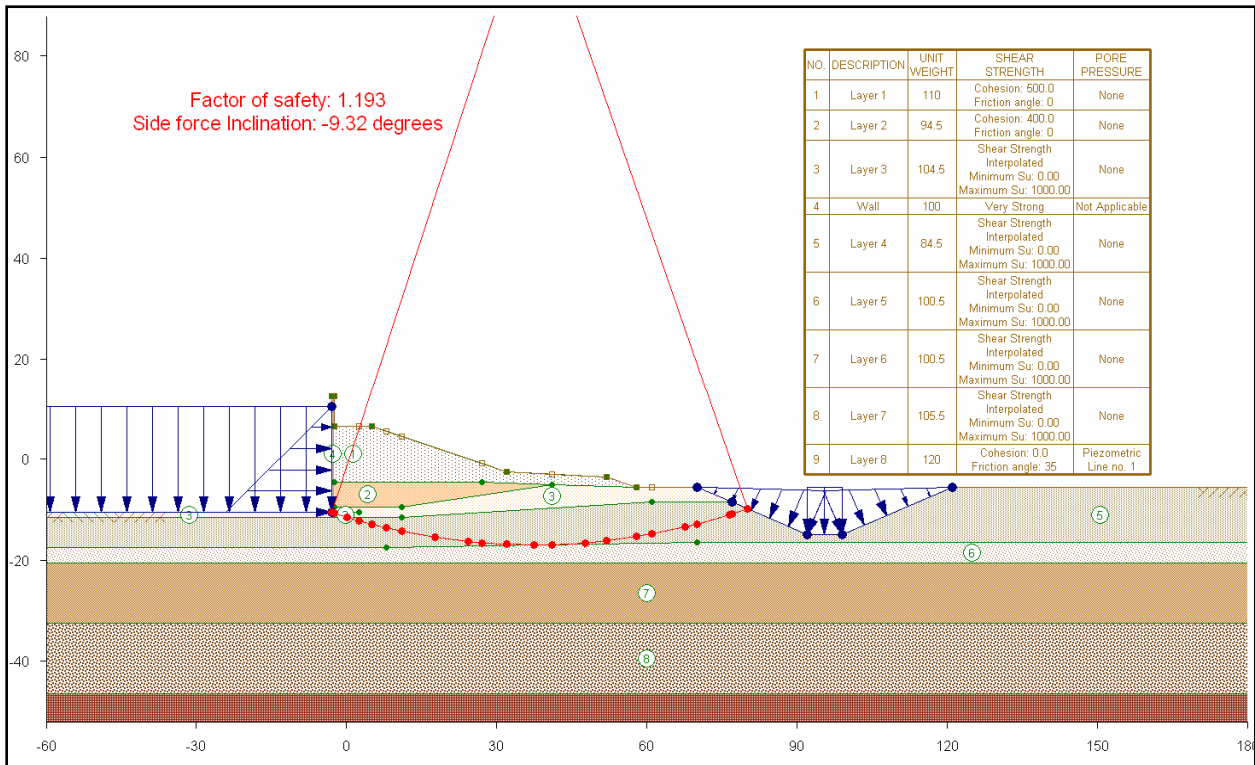

Figure 11-32. IHNC – East Bank (GDM Stability Plate), Case 2, Canal Water Level = Design - 10.5 ft (NAVD 88), with Crack

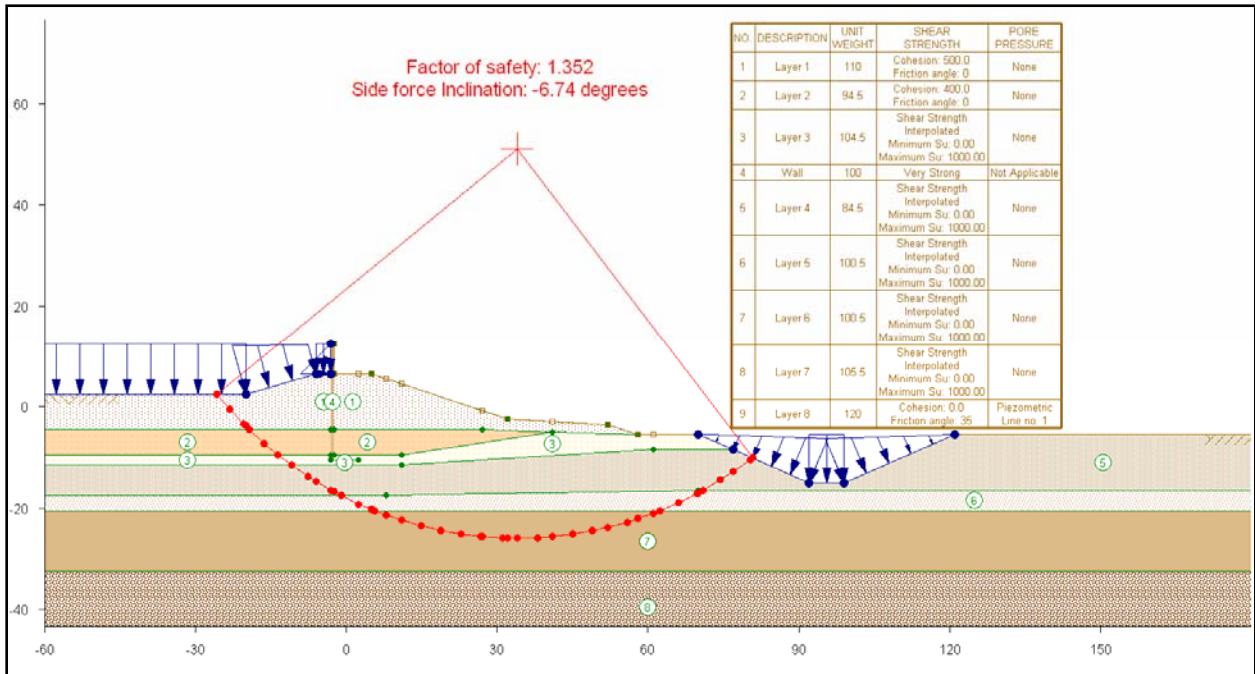

Figure 11-33. IHNC – East Bank (GDM Stability Plate), Case 3, Canal Water Level = Top of Wall - 12.5 ft (NAVD 88), without Crack

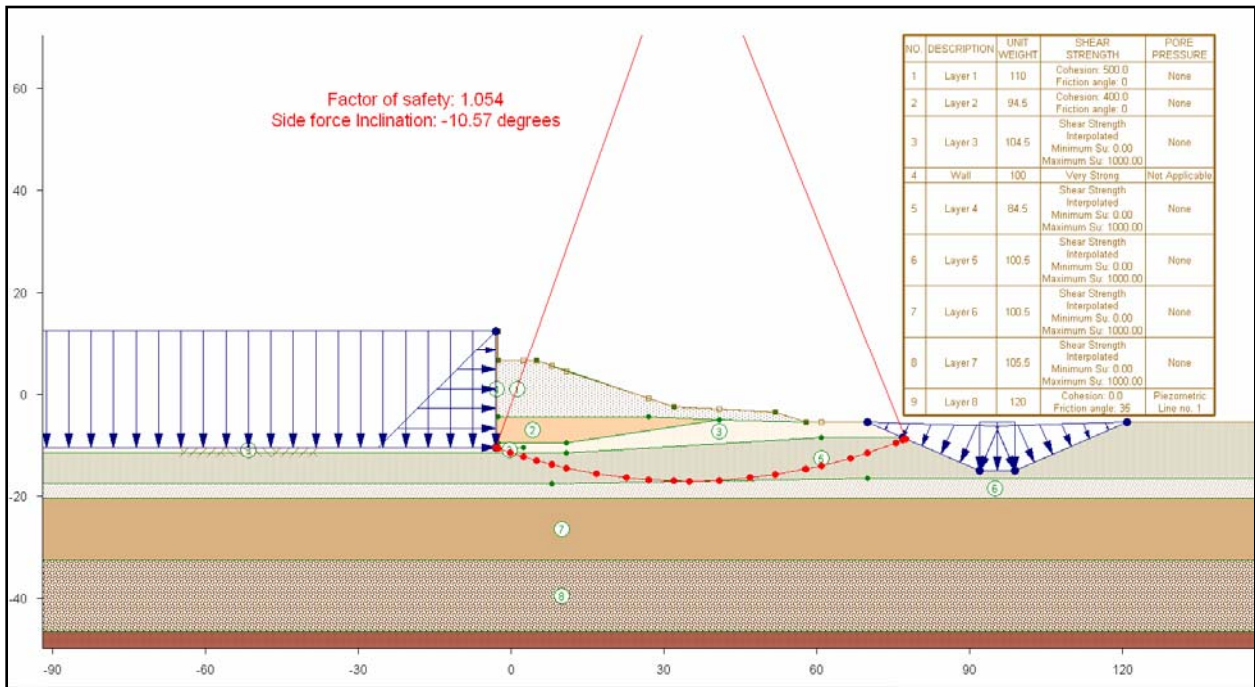

Figure 11-34. IHNC – East Bank (GDM Stability Plate), Case 4, Canal Water Level = Top of Wall - 12.5 ft (NAVD 88), with Crack

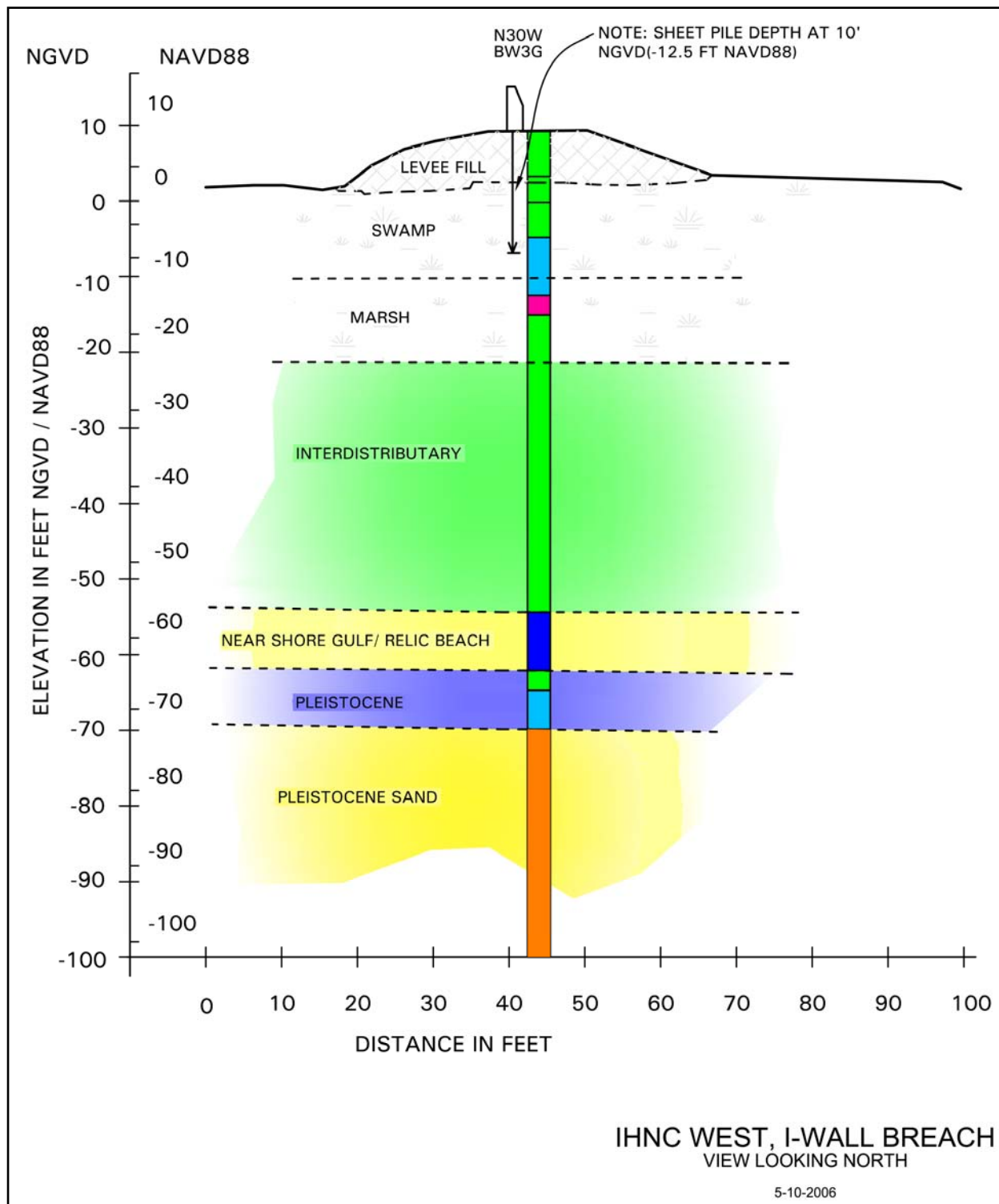

Figure 11-35. IHNC – West Bank – Cross Section of North Breach

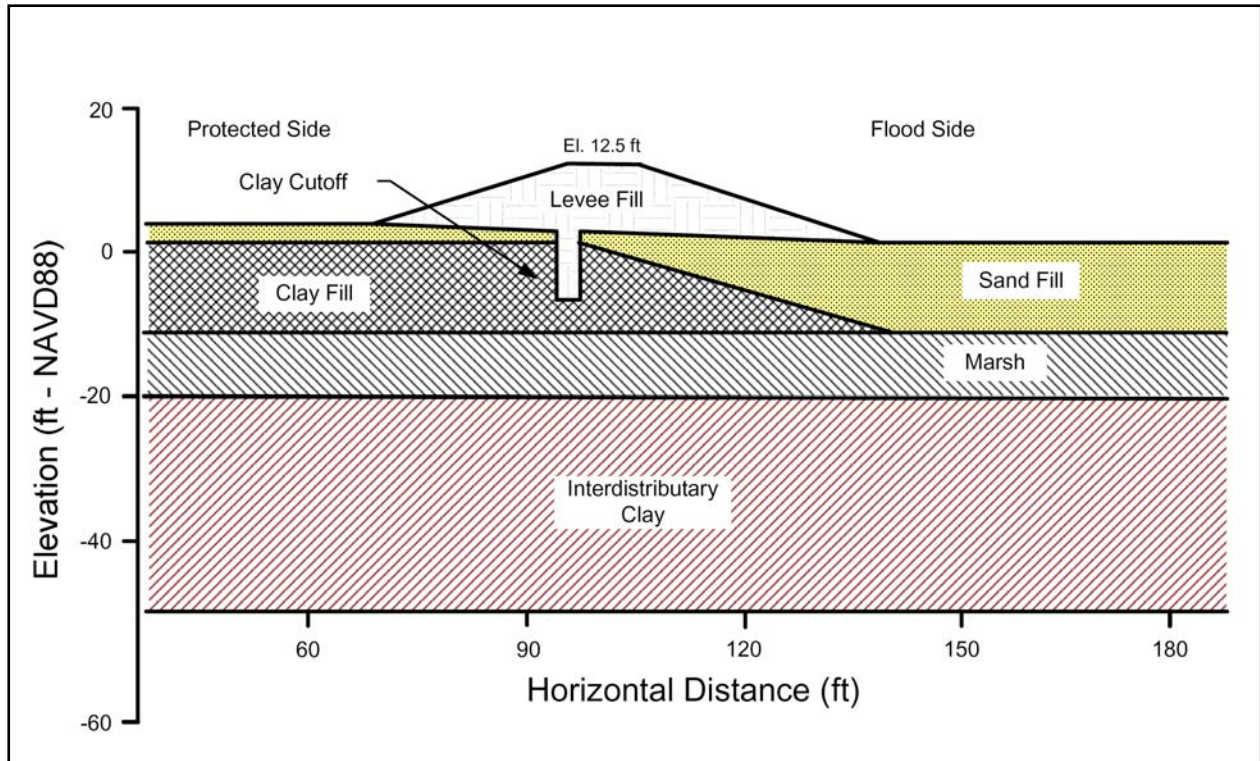

Figure 11-36. IHNC – West Bank – Cross Section of South Breach

Appendix 12

Levee Damage Report — Geotechnical Investigation — New Orleans East (Orleans Parish)

Table of Contents

General Description of the New Orleans East Basin and Hurricane Protection System	6
NOE Basin Components.....	6
Hurricane Protection Features	7
IPET Investigation of Hurricane Protection Project Performance	7
Levee/Floodwall damage categories	7
Current IPET Task 7 Scope.....	8
Summary of Damages from Hurricane Katrina	10
Details of Damages from Hurricane Katrina.....	12
Lakefront Airport Floodwall Scour Repairs.....	13
Lake Pontchartrain Lakefront Levee Scour Repair.....	16
Drainage and Floodgate Structures Scour Repairs From Southpoint to the GIWW	20
CSX Railroad Floodgate	22
Floodwall Repair at Pump Station 15.....	26
East Back Levee Repair from Michoud Canal to CSX RR.....	37
Floodwall Repair near Air Products Hydrogen Plant.....	44
Floodwall Scour Repairs from Michoud Slip to Michoud Canal.....	52
Citrus Back Levee Floodwall Repair	55
Citrus Back Levee, IHNC to Paris Rd.....	69
Attachment A. Data Sources.....	76

Table of Figures

Figure 12-1.	NOE Basin General Components and Top of Levee/Floodwall As-Built Elevations (feet) (source USACE, New Orleans District (Wayne Naquin).....	6
Figure 12-2.	Generalization of Levee and Floodwall Failures in the NOE Basin.....	8
Figure 12-3.	U.S. Army Corps of Engineers, New Orleans District Soil Boring Location Database (2006) New Orleans East Basin	9
Figure 12-4.	NOE - Project Summary Map of Repair Contracts, Project Information Report (TFG 2005)	11
Figure 12-5.	NOE6_A	13
Figure 12-6.	NOE6_B. Scoured Section on Protected Side at Lakefront Airport Floodwall.....	14
Figure 12-7.	NOE6_C Rotated Plan View of Above Picture Defining Scour Extent and Type (from NOE6 Contract Solicitation drawing 4 of 9)	15
Figure 12-8.	NOE6_D Scour Between Sta 19+17 and 19+77 in Above Picture Was 11 ft Wide and About 3 ft Deep (from dwg. sheet 5 of 9).....	15
Figure 12-9.	NOE7_A Project NOE10 Addresses Levee/Wall Repairs Near the Lakefront Airport, at Specific Locations. This project will provide scour aprons and concrete /pavement repair at less than 10 locations.....	16
Figure 12-10.	NOE7_B Typical Crown and Landside Scouring.....	17
Figure 12-11.	NOE7_C Floodwall Landside Scouring on Hayne Blvd. East of Downman Rd.....	18
Figure 12-12.	NOE7_D Above Picture Plan View from NOE10 Reconstruction Solicitation Drawings.....	19
Figure 12-13.	NOE7_E Scoured Areas Near St. Charles Pump Station (B/L Sta 74+00)	19
Figure 12-14.	NOE7_F Pre-Levee Undisturbed Soil Boring at Sta 91+59 (from Plate 30, DM14).....	20
Figure 12-15.	NOE8_A	21
Figure 12-16.	NOE8_B.....	22
Figure 12-17.	NOE5_A. Location 30 deg 03 min 24.03 sec N, 89 deg 49 min 56.76 sec W	23
Figure 12-18.	NOE5_B.....	24
Figure 12-19.	NOE5_C. View of Scour Around T-Wall.....	25
Figure 12-20.	NOE5_C. Filled-In Scour Holes	26
Figure 12-21.	NOE2_A Location of Pumpstation 15	27
Figure 12-22.	NOE2_B Pump Station 15 Coordinates are 30 deg 01 min 45.74 sec N, 89 deg 52 min 03.89 sec W (located at termination of Shell Rd).....	28
Figure 12-23.	NOE2_C Closeup of Sheet Pile Damaged by Scour/Rotation/Sliding Failure.....	29
Figure 12-24.	NOE2_D View from Above	30

Figure 12-25.	NOE2_E PS 15	31
Figure 12-26.	NOE2_F Failed Sheet Pile Section Between Sta 874+40 and T-Wall at Sta 875+60 (Plan view).....	32
Figure 12-27.	NOE2_G Profile View Showing 27' Difference Between Bottom Elevations of Existing (pre-1977) and Newer (1977 construction) Sheet Pile. Sections are from Plate 2 of 16, Mod P00001, Contract DACW29-77-C-0037	33
Figure 12-28.	NOE2_H Newer (1977) Cut and Fill Sections for T-Wall, Same Contract as Above.....	34
Figure 12-29.	NOE2_I Top Elevation Difference of 5.5' Between Sheet Pile and T-Wall (plate 14 of 16 from above contract).....	34
Figure 12-30.	NOE2_J Soil Borings (from page 81 of 238, DM2 Gen Design Supp 4 N.O. East Back Levee (Mar 1971).pdf). Boring logs are shown on pages 88 and 89 of 238 (plates 10 and 11).....	35
Figure 12-31.	NOE2_K Nearest Boring Log (from plate 10 DM2 Sup 4) Showing Thin CL Layer in pre-1977 Levee.....	35
Figure 12-32.	NOE2_L Plan view from Contract Solicitation NOE1 Drawing.....	36
Figure 12-33.	NOE2_M Plan and Post-Damage Scour Profile Immediately West of Pump Station 15 (from Contract Solicitation NOE1 drawing H-8-45594, sheet 3 of 16)	37
Figure 12-34.	NOE1_A	38
Figure 12-35.	NOE1_B Page 79 of 238, DM2 Gen Design Supp 4 N.O. East Back Levee (Mar 1971).pdf.....	39
Figure 12-36.	NOE1_C Complete Breach East of Pump Station 15	40
Figure 12-37.	NOE1_D LIDAR Profiles of Levee East of Pump Sta 15 (from Contract Solicitation NOE1 drawings).....	41
Figure 12-38.	NOE1_E Partial Breach East of Pump Station 15	42
Figure 12-39.	NOE1_F Rebuilding to Initial Elevation 10'	43
Figure 12-40.	NOE1_G Localized Scour Typical of Several Locations	44
Figure 12-41.	NOE3_B.....	45
Figure 12-42.	NOE3_A. Page 80 of 238, DM2 Gen Design Supp 4 N.O. East Back Levee (Mar 1971).pdf.....	46
Figure 12-43.	NOE3_C. Blue Color is Top of Wall Elevation 20 ft.....	46
Figure 12-44.	NOE3_D Sheetpile Wall Failure (near Sta 772+00 B/L New Orleans East Back Levee) (Coordinates 30 deg 01 min 04.30 sec N, 89 deg 53 min 49.36 sec W).....	47
Figure 12-45.	NOE3_E. Page 107 of 238, DM2 Gen Design Supp 4 N.O. East Back Levee (Mar 1971).pdf Showing Add-On to Existing Levees (1965 and interim add-on).....	48
Figure 12-46.	NOE3_F. Post-Damaged Lidar Elevations Show Scour Hole (approx Sta 768+00) Depth was About 8' deep (from Contract Solicitation NOE1 drawing H-8-45594, sheet 2 of 16)	48
Figure 12-47.	NOE3_G. West of Failure Looking East. Drawings from NOE3 Contract Solicitation Show Scour Depth And Outline.....	49

Figure 12-48.	NOE3_H. Boring 5-E from plate 5, DM2 Supp 4 (March 1971) Shows CH Material in Pre-Existing 1965 Levee	50
Figure 12-49.	NOE3_I. Repair Progress.....	51
Figure 12-50.	NOE3_J. Repair Sheetpile View to the West	52
Figure 12-51.	NOE9_A	53
Figure 12-52.	NOE9_B.....	54
Figure 12-53.	NOE9_C. I-Wall Damage Likely Due to Impact.....	55
Figure 12-54.	NOE4_A	56
Figure 12-55.	NOE4_B. Bulk Loading Terminal Facility I-Wall Failed by Rotation with Attendant Scour and Erosion (2000' near Elaine St. at GIWW), near Sta 271+55 B/L (Citrus Back Levee), Immediately Adjacent to the Tool Shed Metal Building.....	57
Figure 12-56.	NOE4_C. Begin I-Wall Rotation at 30 deg 00 min 00.91 sec N, 89 deg 59 min 39.53 sec W. Pre-Existing Wall Elevation was 15 ft and Levee Elevation was 14 ft.....	58
Figure 12-57.	NOE4_D. Bulk Loading Facility on the GIWW. Note Tool Shed Metal Building Location	59
Figure 12-58.	NOE4_E. Post-Katrina Condition.....	59
Figure 12-59.	NOE4_F. Sections are from the Lake Pontchartrain, Louisiana and Vicinity, New Orleans East Area Plan Emergency Restoration, Modifications to Citrus Back Levee Floodwall Sta. 250+17.5 B/L to Sta. 279+44.50 B/L (Sta. 0+02.0 W/L to Sta. 29+41.71 W/L) Construction Contract Solicitation.....	60
Figure 12-60.	NOE4_G. Scour Pattern Along the I-Wall Immediately Adjacent to the Tool Shed Building	60
Figure 12-61.	NOE4_H. Scour Pattern 200' to the East.....	61
Figure 12-62.	NOE4_I. I-Wall Demolition to Replace with New “L” Wall	62
Figure 12-63.	NOE4_J. Pre-Existing Condition, from Plate 2, page 104 of 161, DM2-Gen Design Citrus Back Levee (Aug 1967).pdf.....	63
Figure 12-64.	NOE4_K. Plate 2, Sta 250+ to Sta 279+.....	64
Figure 12-65.	NOE4_L. Nearby Boring 4 Shows Top Layer of CL (from Plate 2 profile section).....	65
Figure 12-66.	NOE4_M. Plate 6 Shows Different Borrow Source Beyond Sta 278+	65
Figure 12-67.	NOE4_N. Plate 26 Shows Sheetpile Elevations	66
Figure 12-68.	NOE4_O. Plate 28 Shows Elevations.....	67
Figure 12-69.	NOE4_P. Plate 35, Geology Profile. Note that Sta 240+ to Sta 300+ of the 1965 levee was approximately 5 ft of CL (lean clay) from top elevation 10' MSL down to 5' MSL. Organic clay fill lies beneath.....	68
Figure 12-70.	NOEX_Q. Amid Pump Station Landside Slope Erosion from Overtopping at Transition	69

Figure 12-71.	NOEX_R. Above Picture Taken Near GIWW/IHNC (coordinates 29 deg 59 min 55.37 sec N, 90 deg 00 min 41.62 sec W)	70
Figure 12-72.	NOEX_S. Plate 2 of DM2-Gen Design Citrus Back Levee (Aug 1967) IHNC to NASA.pdf Shows Original Borings and Profile at Above Picture Location. Note that overtopping scour occurred at the intersection of the dirt road and levee crown as seen in Figure 12-NOEX-Q above	71
Figure 12-73.	NOEX_T. Closeup of Scoured Road at Levee Crown, Amid Pump Station.....	72
Figure 12-74.	NOEX_U. Overtopping Erosion on Flood Side and Land Side	73
Figure 12-75.	NOEX_V. Narrow Localized Breach at Pre-Existing Pipeline Crossing. Coords 30 deg 00 min 10.66 sec N, 89 deg 57 min 49.31 sec W (Approximate Sta 349+00 B/L).....	74
Figure 12-76.	NOEX_W. 600' Reach of Levee with Landside Scouring	75

Hurricane Protection Features

New Orleans East Lakefront includes the Citrus Lakefront Levee and New Orleans East Lakefront Levee consisting of 12.4 miles of earthen levee paralleling the Lakefront from the IHNC to Southpoint. It also includes floodwalls at the Lakefront Airport and Lincoln Beach.

The New Orleans East Levee consists of 8.4 miles of earthen levee from Southpoint to the GIWW along the eastern boundary of the Bayou Sauvage National Wildlife Preserve.

GIWW - The basin includes the Citrus Back Levee and New Orleans East Back Levee which consisting of approximately 17.5 miles of earthen levees and concrete floodwalls along the northern edge of the GIWW.

IHNC - The basin protection includes approximately 2.8 miles of levee and concrete floodwall along the eastern side of the IHNC. The IHNC is described in a separate report.

Pump Stations – Eight pump stations and numerous drainage structures, pipe crossings and culverts also lay on the boundaries

Exterior levee and floodwall (1 wall)	39 miles
Drainage Structures	4
Pump Stations	8
Highway Closure Structures	2
Railroad Closure Structure	1

IPET Investigation of Hurricane Protection Project Performance

Levee/Floodwall damage categories

The goal of Task 7 of the IPET is to characterize the adverse affects of Hurricane Katrina on the levees and floodwalls and to determine why some of these structures failed and others did not. To begin this study the levee behavior was observed from TFG reports and categorized. These categories distinguish catastrophic failure (total breach) to poor performance (scour). The categories are defined below. Figure 12-2 illustrates the spatial distribution of levee and floodwall performance along the basin boundaries. This study is not concerned with the inner levees that are not federally owned.



LEGEND

- LONB = Overtopped levees, no breaching
- WS = Overtopped floodwalls, no breaching (stable)
- LOB = Overtopped levees, breaching
- TF = Transition failure (floodwall to levee transition)
- WF = Overtopped floodwalls, breached (failure)
- WCF = Overtopped floodwalls, no breaching but came close

Figure 12-2. Generalization of Levee and Floodwall Failures in the NOE Basin

Current IPET Task 7 Scope

To determine why some of the levees/floodwalls performed well and others did not, a geotechnical investigation is being conducted. Available soil boring logs and soil tests are being collected for comparison of soil properties to levee performance. All available soil boring logs are held in the NOD boring log database. The NOE boring locations have been plotted on an aerial photo of the study area and are illustrated by Figure 12-3. The top 20 ft or so of these borings represent the levee material and possibly includes the top of the foundation. It is presumed that the soil types will correlate to levee performance. This study will focus on finding soil classification and strength data along with levee design documents.

Original test data and levee physical dimensions will be taken from the design memoranda. Additional soil data will be obtained from current drilling, sampling and cone penetration investigations in the study area. Surface geology maps will also be studied for trends in geologic environment associated with foundation scour, failure or good performance. Levee performance may be categorized as good, moderate, or poor with respect to severity of scour, length of breach, etc. This information is well defined by the TFG Project Information Reports, and other data reports. Floodwall behavior may be correlated to mode of failure or severity (sliding along foundation, rotation, minor separation from levee or embankment).

Because of the large amount of data and limited amount of time to conduct this study, this investigation will concentrate on a portion of the NOE basin; the southern border including the Citrus Back Levee and the NOE Back Levee. The entire basin will be characterized with respect to performance, but only the southern portion will be correlated to soil properties.

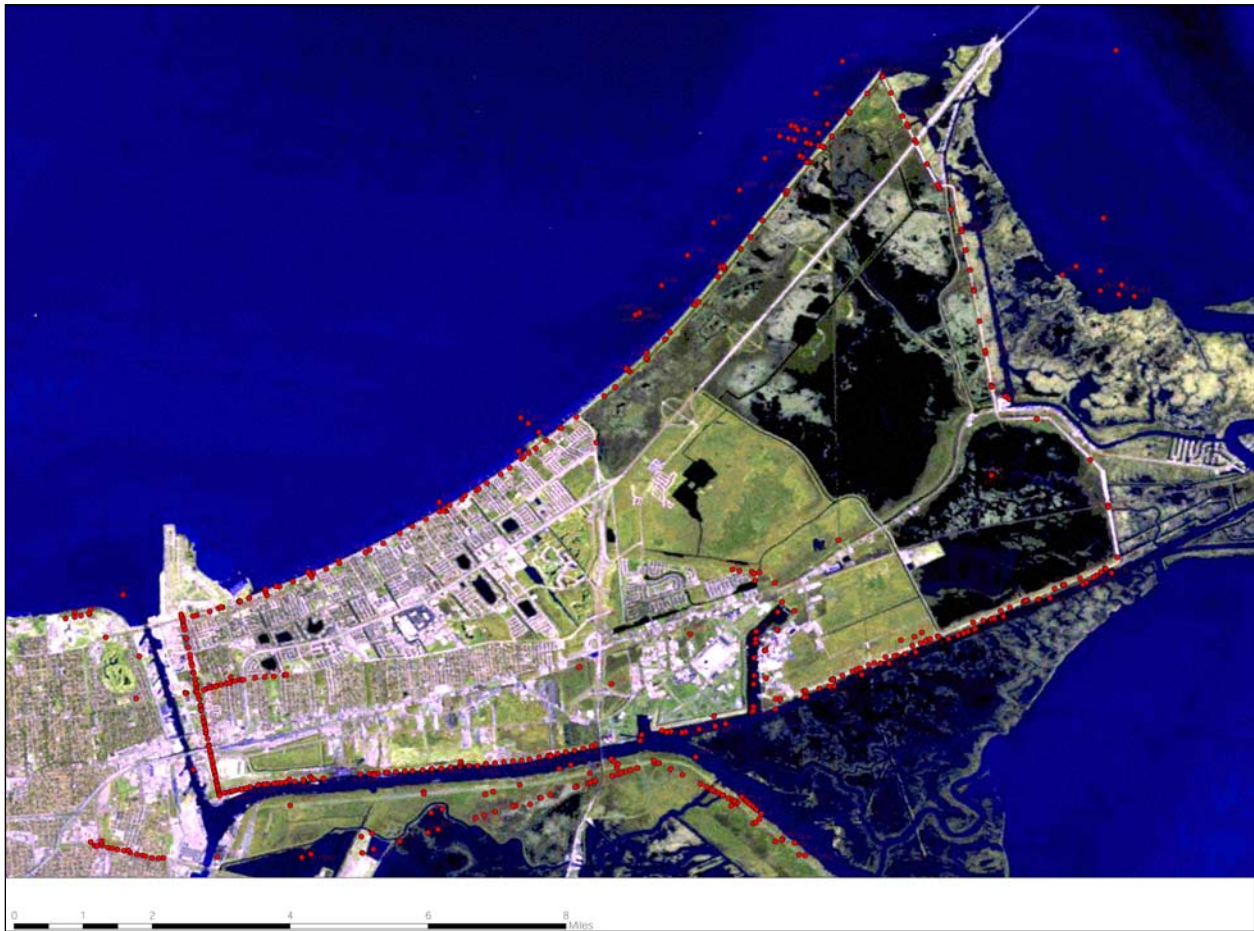

Figure 12-3. U.S. Army Corps of Engineers, New Orleans District Soil Boring Location Database (2006)
New Orleans East Basin

Summary of Damages from Hurricane Katrina

Significant damages occurred mainly along the IHNC, southern end of the NOE Levee, NOE Back Levee and the Citrus Back Levee. The IHNC will be discussed in another report. Levee and floodwall damages have been documented by the Task Force Guardian in their Project Information Reports (2005) and Damage Survey Report (2005) for NOE Basin. The TFG describes the major damages as follows:

- 12,750 ft of levee breach in the NOE Back Levee between Michoud Canal along the GIWW up to the CSX Railroad crossing along the NOE Levee.
- floodwall breaches at Pump Station 15 (800 feet) near the Maxent Levee and at the Air Products Hydrogen Plant near the Michoud Canal (300 feet);
- floodgate, floodwall and adjacent levee damage at the CSX railroad;
- and 2000 feet of floodwall damage in the Citrus Back Levee along the GIWW between the IHNC and Paris Road.
- Levee and floodwall scour along the lakefront and NOE levees
- Damage to all eight pump stations.
- Note: Overtopping was generally associated with varying degrees of scour (surface erosion), generally on the levee landside.

Table 12-2 provides the gross estimated linear feet of missing levee, damaged levee and damaged floodwall.

Table 12-2 NOE Basin - Gross Linear Estimates of Damaged Features (Damage Survey Report, TFG 2005)	
Total length of levee w/o cross section	2,900 ft.
Total length of levee w/reduced cross section	3,800 ft.
Total length of damaged flood wall	24,600 ft
Total	31,300 ft.

Nine separate construction projects have been identified by Project Information Report (TFG 2005) to repair the damaged areas and restore flood protection to pre-hurricane Katrina conditions. These projects represent an estimated \$52.4 M (not including pump stations) in construction costs. Figure 12-4 shows the linear extent of each repair contract. Table 12-3 describes the damage as light, moderate or heavy, in addition to the repair method.

TASK FORCE GUARDIAN

New Orleans East - Project Summary

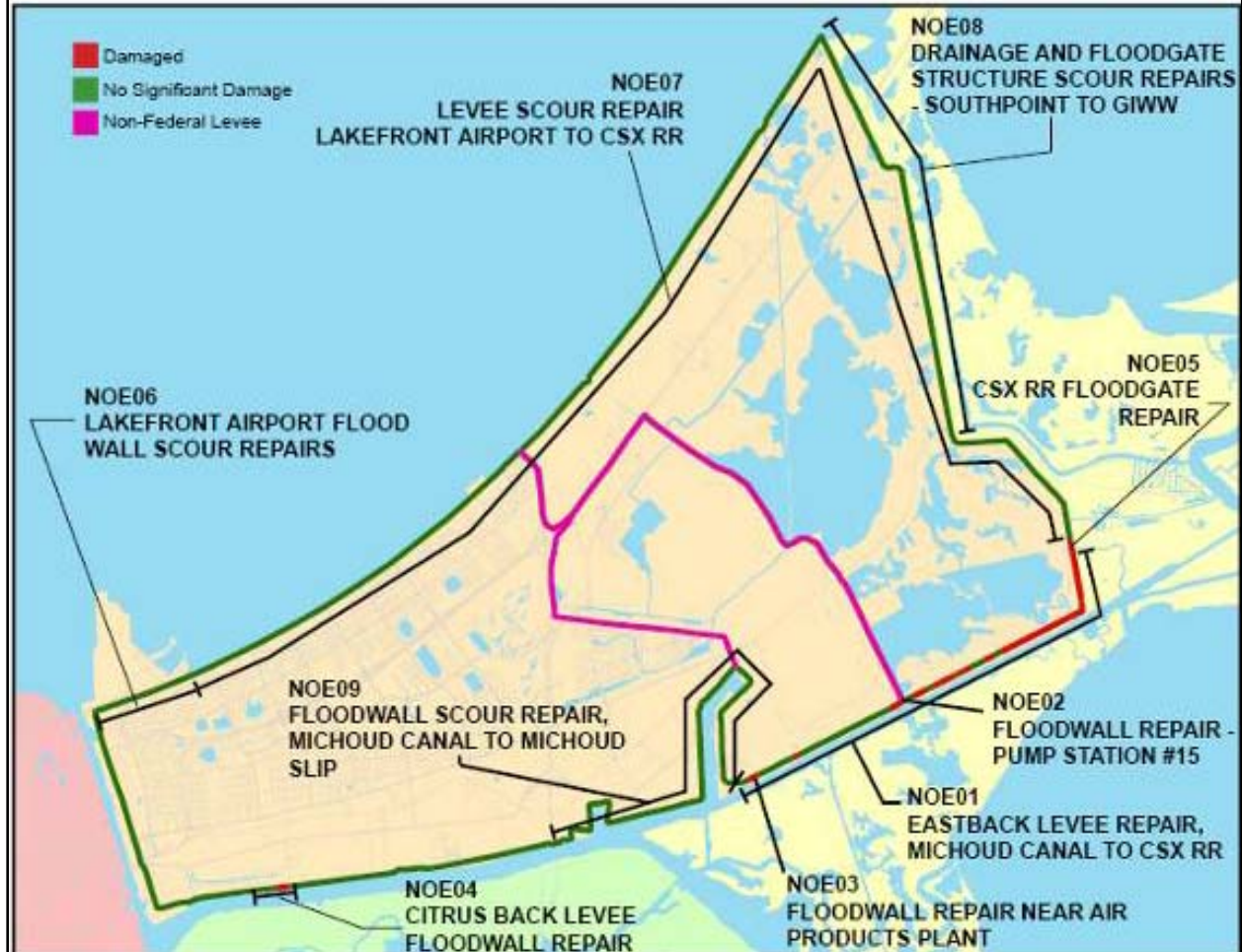

Figure 12-4. NOE - Project Summary Map of Repair Contracts, Project Information Report (TFG 2005)

Table 12-3 NOE Damage Synopsis			
Citrus Lakefront Levee and Floodwall			
Lakefront Airport Floodwall (Capped I-wall)	Moderate scour	the land side of the floodwall	Excavate the scour area, place flowable fill and compacted material, place bedding material and 6"-7" slope pavement
Star & Strips Blvd Floodwall	None noted		
Jancke Pumping Station Floodwall	Light Scour	the land side of the floodwall	Excavate the scour area, place flowable fill and compacted material, place bedding material and 6"-7" slope pavement
Lincoln Beach Floodwall	Light Scour	the land side of the floodwall	Excavate the scour area, place flowable fill and compacted material, place bedding material and 6"-7" slope pavement
New Orleans East Lakefront Levee			
Collins Pipeline	None noted		
South Point to GIWW Levee			
Drainage structure, N19 (400+/- If south of South point)	Moderate scour	the lake side of levee	Excavate the scour area, place compacted material, place bedding material and gabions
Other Drainage structures	Light Scour	the lake side of levee	Excavate the scour area, place compacted material, place bedding material and gabions
Pumping Stations	None noted		
CSX Railroad gate	Heavy Scour	the land side of the floodwall	Raising the flood protection from (NAVD29) 13.5 to '88 datum Elevation 20
New Orleans Back Levee			
OP Pump Station 15	Rotation & Failure of Iwall Tie-In Walls to frontage Twalls	10'-12' Scour holes on both FS & PS of wall	Replace uncapped Iwall w/ pile founded Twalls, Raise protection from (29 datum) 17 to (88 datum) 23.
Iwall West of OPFS 15	Moderate scour	Both FS & PS	Excavate the scour area, place compacted material and graded stone
East Michoud Canal (Air Products Breach)	Rotation & Failure of Iwall Tie-In Walls to levee	10'-20' Scour holes on both FS & PS of wall; 300 lf long	Replace uncapped Iwall w/ new levee section and uncapped Iwall; Raise protection from (29 datum) 17 to (88 datum) 21.
Michoud Slip to Michoud Canal Floodwalls	Light to moderate scour	PS of floodwall	Excavate the scour area, place flowable fill and compacted material, place bedding material and 6"-7" slope pavement
Citrus Lakefront Levee and Floodwall			
IHNC to Paris Road	Light Scour	the land side of the floodwall	Excavate the scour area, place flowable fill and compacted material, place bedding material and 6"-7" slope pavement
Citrus Floodwall at Bulk Loading Facility	Rotation & Failure of Iwall	6'-10' Scour holes on both FS & PS of wall	Replace Iwall w/ new L-type wall; Raise protection from (29 datum) current 13.5 to (88 datum) 15 (as built elevation)

Details of Damages from Hurricane Katrina

This section will describe the damage associated with each of the nine repair projects, and includes all pertinent geotechnical information collected to date on the location. Discussion of NOE levee damage and repair begins at the lakefront and progresses clockwise around the polder; Lakefront, Southpoint to GIWW, Back Levee, Citrus Levee and IHNC.

Lakefront Airport Floodwall Scour Repairs

Project NOE06 consists of filling in and paving over the scour holes next to the concrete wall. It also includes filling in the scour hole and paving the damaged road section with concrete at the interface of the Floodgate L-15 concrete wall and levee. The damage in this reach was primarily scouring along the landside of the floodwall and levee sections at several distinct locations. The severity of the scouring varies from minor to severe. Scouring occurred to some degree at each of the tie-in to the closure structures located within this reach. The total quantity of materials removed by scouring along the entire Lakefront reach is estimated to be less than 5000 cys. January 31, 2006 was scheduled completion date.

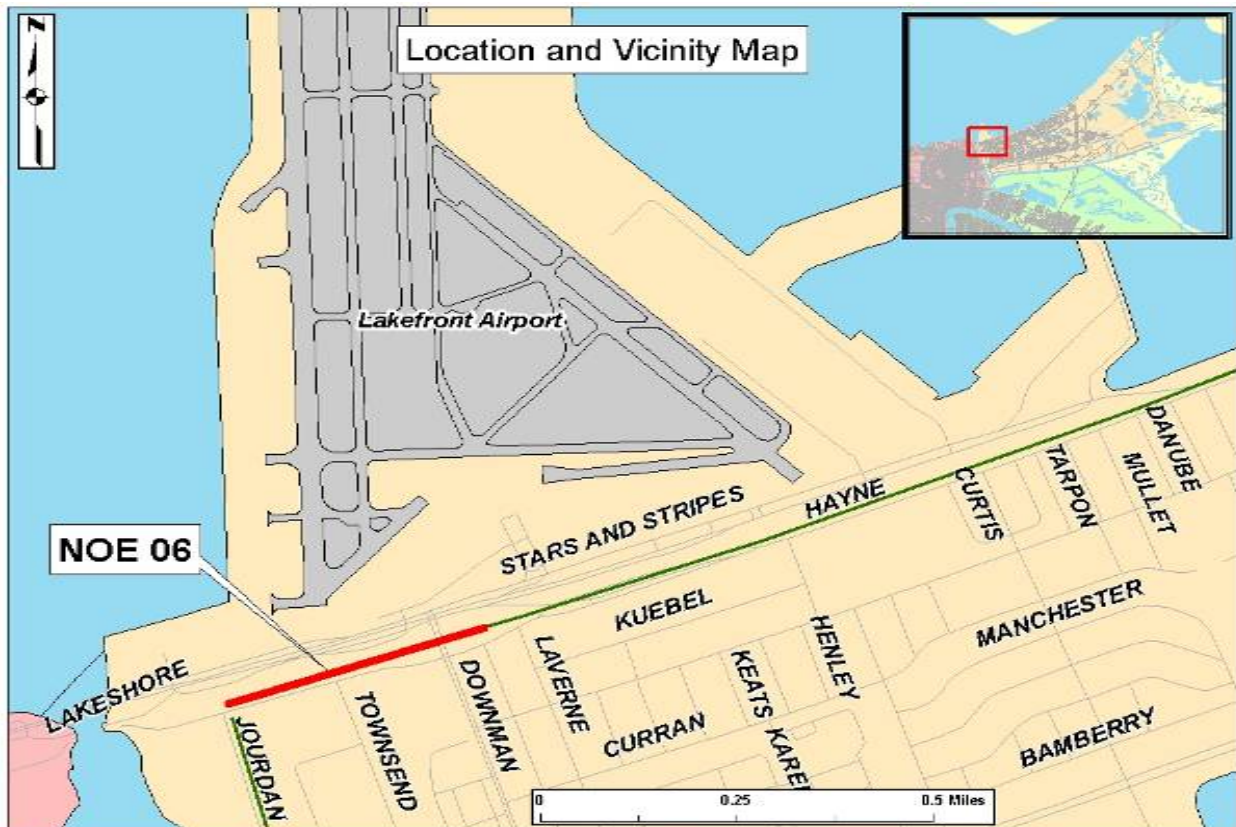

Figure 12-5. NOE6_A



Figure 12-6. NOE6_B. Scoured Section on Protected Side at Lakefront Airport Floodwall

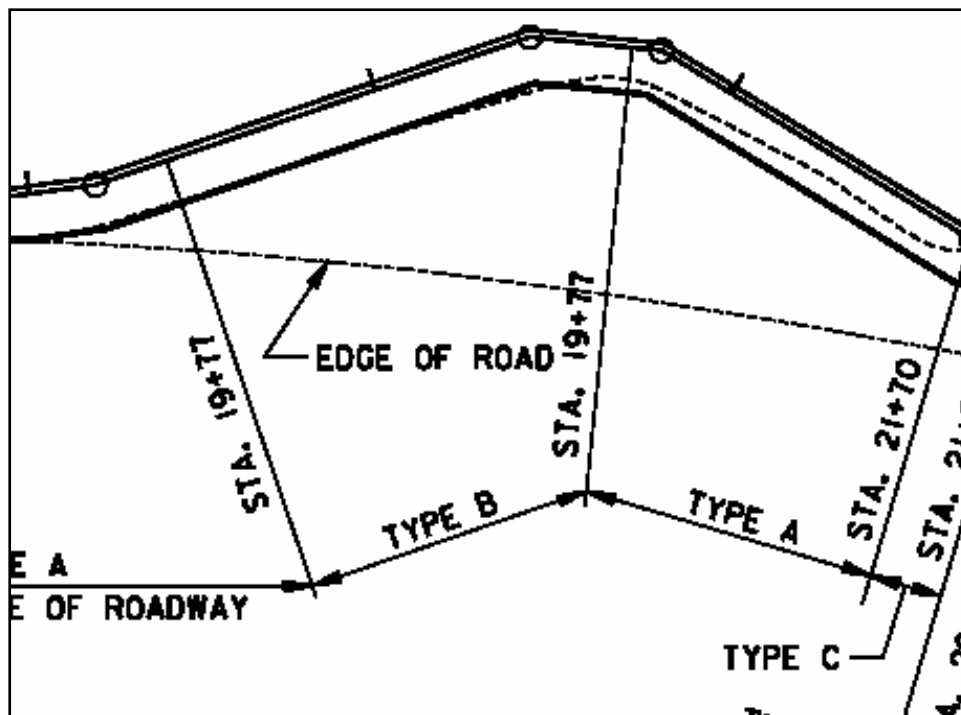

Figure 12-7. NOE6_C Rotated Plan View of Above Picture Defining Scour Extent and Type (from NOE6 Contract Solicitation drawing 4 of 9)

SCOUR DETAIL SCHEDULE				
Scour Detail	Station	Scour Width (feet)	Scour Depth (feet)	Distance (feet)
A	18+16	0	0	
				54
	18+70	7	3	
				47
	19+17	11	2.5	
				60
B	19+77	12	3	
				62
	20+39	14	3	
				17
	20+56	12.5	3	
				18
A	20+74	10	3	
				96
	21+70	3	3	
C	21+70 to 21+89 No Scour			19

Figure 12-8. NOE6_D Scour Between Sta 19+17 and 19+77 in Above Picture Was 11 ft Wide and About 3 ft Deep (from dwg. sheet 5 of 9)

Lake Pontchartrain Lakefront Levee Scour Repair

Project NOE07 includes intermittent scour repair along approximately 19 miles of earthen levee along the Lake Pontchartrain Lakefront and the eastern boundary of the Bayou Sauvage National Wildlife Preserve. The work consists of filling in the scour areas with semi-compacted fill, reshaping where needed, and seeding and fertilizing. January 31, 2006 was scheduled completion date.



Figure 12-9. NOE7_A Project NOE10 Addresses Levee/Wall Repairs Near the Lakefront Airport, at Specific Locations. This project will provide scour aprons and concrete /pavement repair at less than 10 locations



Figure 12-10. NOE7_B Typical Crown and Landside Scouring



Figure 12-11. NOE7_C Floodwall Landside Scouring on Hayne Blvd. East of Downman Rd.

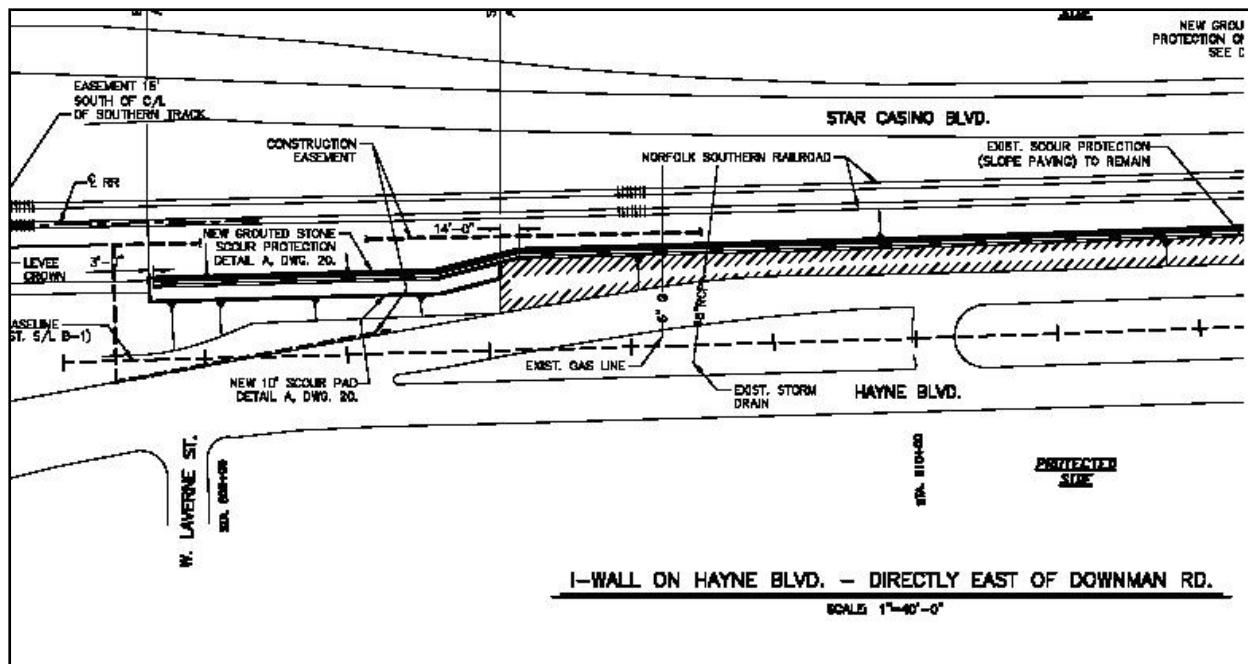

Figure 12-12. NOE7_D Above Picture Plan View from NOE10 Reconstruction Solicitation Drawings

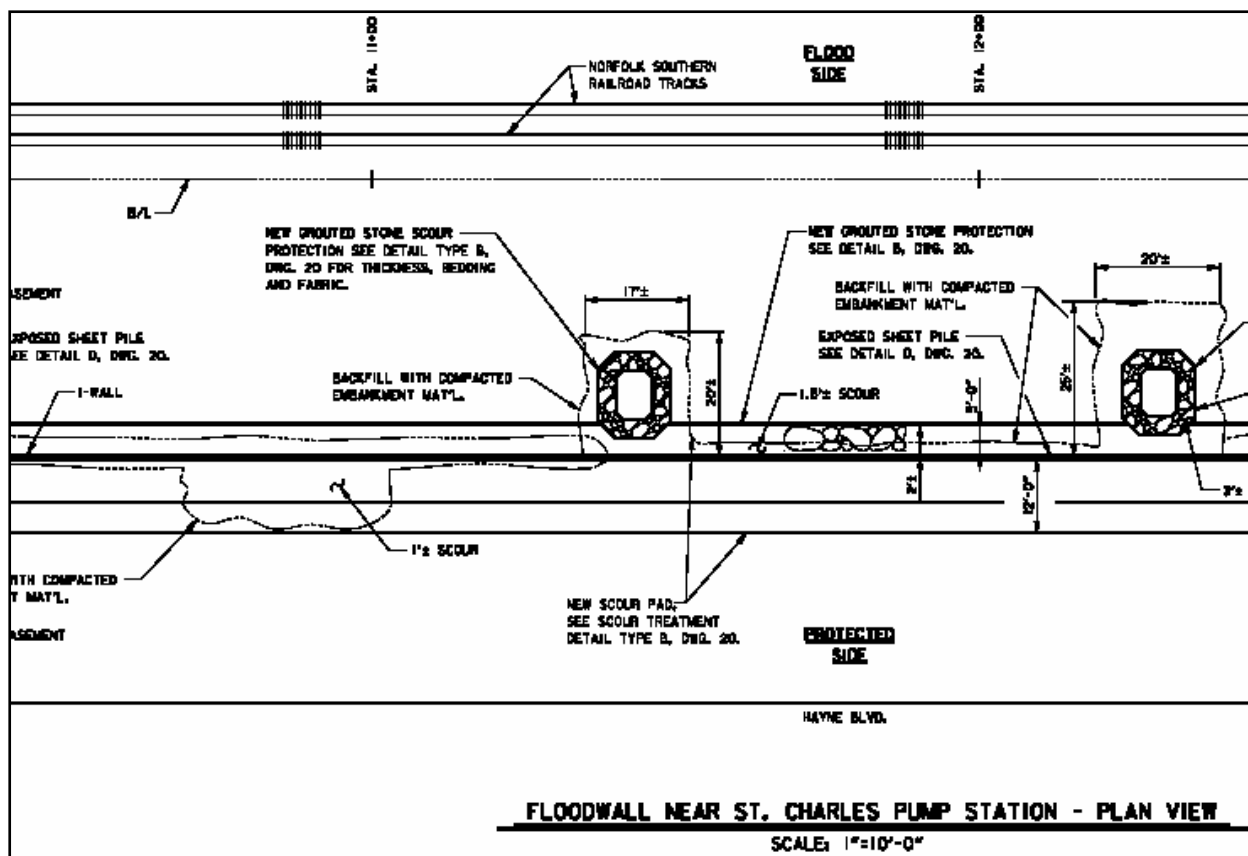

Figure 12-13. NOE7_E Scoured Areas Near St. Charles Pump Station (B/L Sta 74+00)

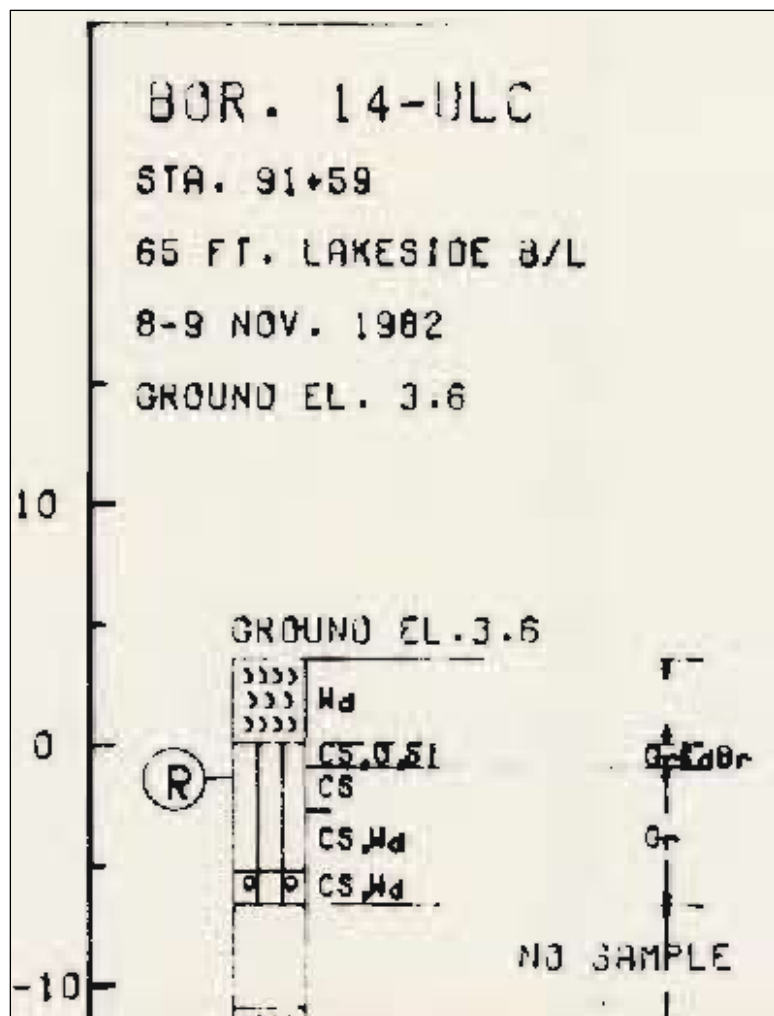

Figure 12-14. NOE7_F Pre-Levee Undisturbed Soil Boring at Sta 91+59 (from Plate 30, DM14)

Drainage and Floodgate Structures Scour Repairs From Southpoint to the GIWW

Project NOE08 includes filling in the scour holes and capping with gabion structures to prevent future erosion. The gabion structures are wire baskets filled with stone interlocked to form a surface erosion barrier. January 31, 2006 was scheduled completion date.

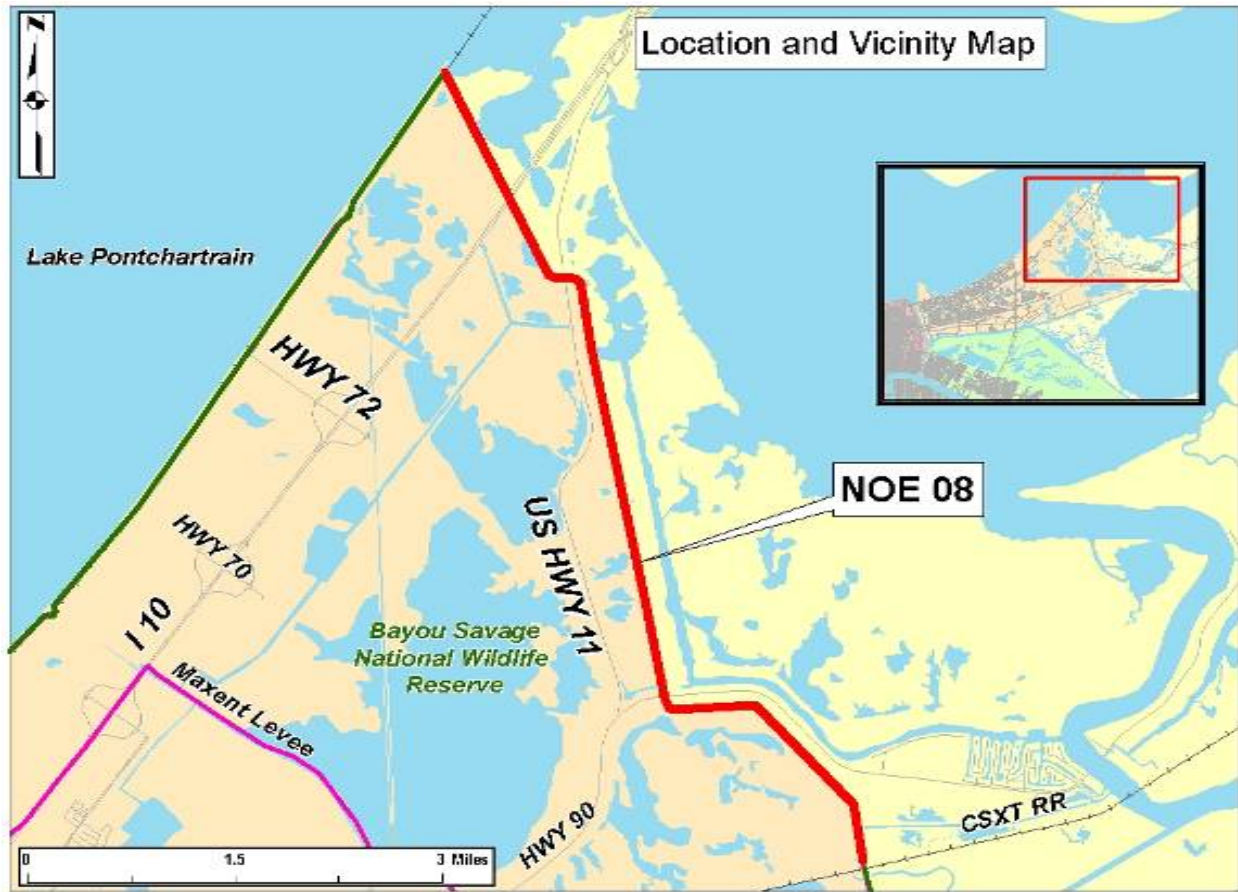

Figure 12-15. NOE8_A



Figure 12-16. NOE8_B

CSX Railroad Floodgate

Project NOE05 includes the removal of the existing concrete wall and railroad closure gate, filling the scoured areas, constructing a new closure gate and new concrete T-walls and I-walls, placement of rip rap, concrete slope paving and concrete roadway. The CSX railroad floodgate and adjacent section of the levee were damaged during the storm event. There was scour of the structural fill material resulting from overtopping of the closure gate and levee. April 1, 2006 is scheduled completion for repairs.

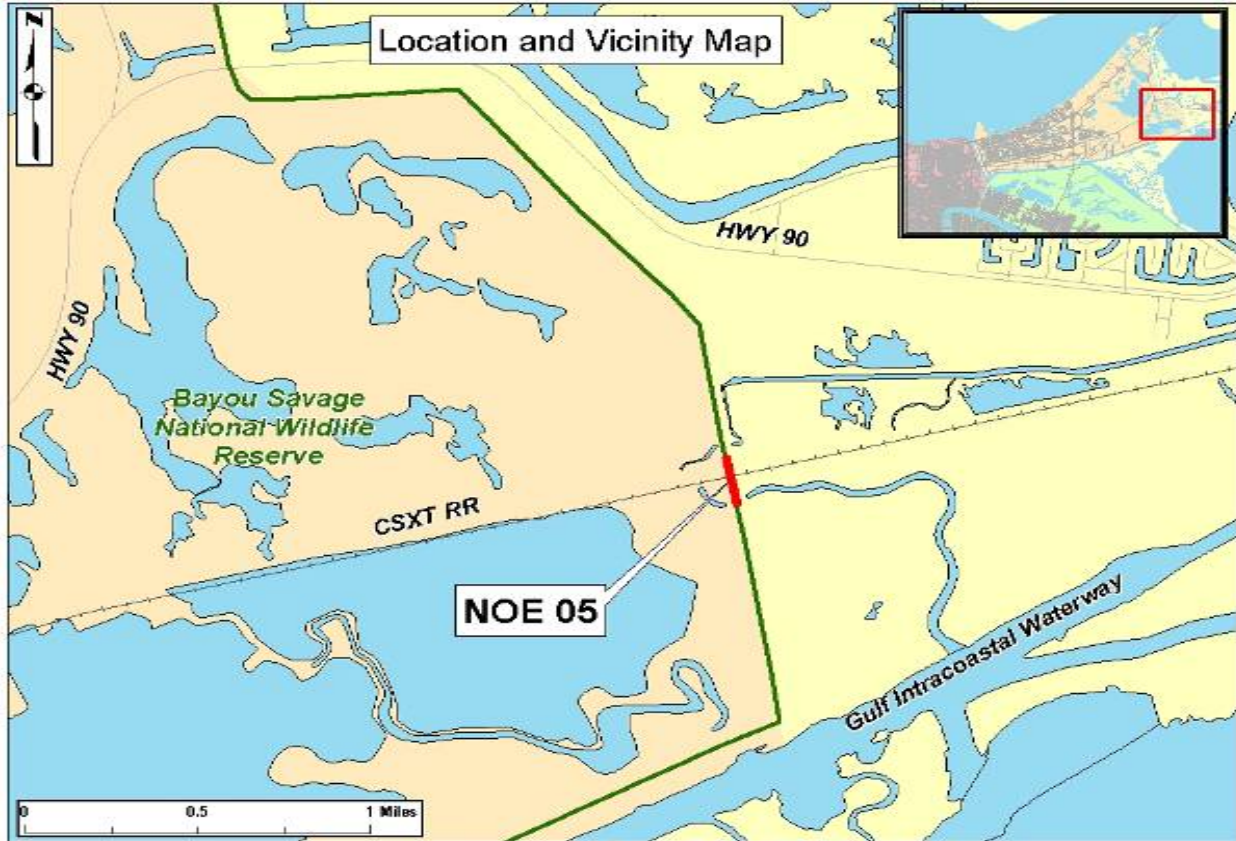

Figure 12-17. NOE5_A. Location 30 deg 03 min 24.03 sec N, 89 deg 49 min 56.76 sec W



Figure 12-18. NOE5_B



Figure 12-19. NOE5_C. View of Scour Around T-Wall



Figure 12-20. NOE5_C. Filled-In Scour Holes

Floodwall Repair at Pump Station 15

Project NOE02 includes removing the damaged steel sheet pile wall, installing a new concrete T-wall, filling in scour holes and bringing the damaged levee back up to pre-hurricane Katrina elevation. Damaged I-wall length is 900 ft (beginning at Sta 876+87 B/L). Approximately 240 ft of sheetpile failed by rotation. April 1, 2005 is scheduled completion date. (see NO East Back Levee Floodwall at Intracoastal Pumping Station.pdf for drawings). Plate 56 in DM2 Gen Design Supp 4 N.O. East Back Levee (Mar 1971).pdf shows original (pre-1977 modification) plan drawings.



Figure 12-21. NOE2_A Location of Pumpstation 15



Figure 12-22. NOE2_B Pump Station 15 Coordinates are 30 deg 01 min 45.74 sec N, 89 deg 52 min 03.89 sec W (located at termination of Shell Rd)



Figure 12-23. NOE2_C Closeup of Sheet Pile Damaged by Scour/Rotation/Sliding Failure



Figure 12-24. NOE2_D View from Above



Figure 12-25. NOE2_E PS 15

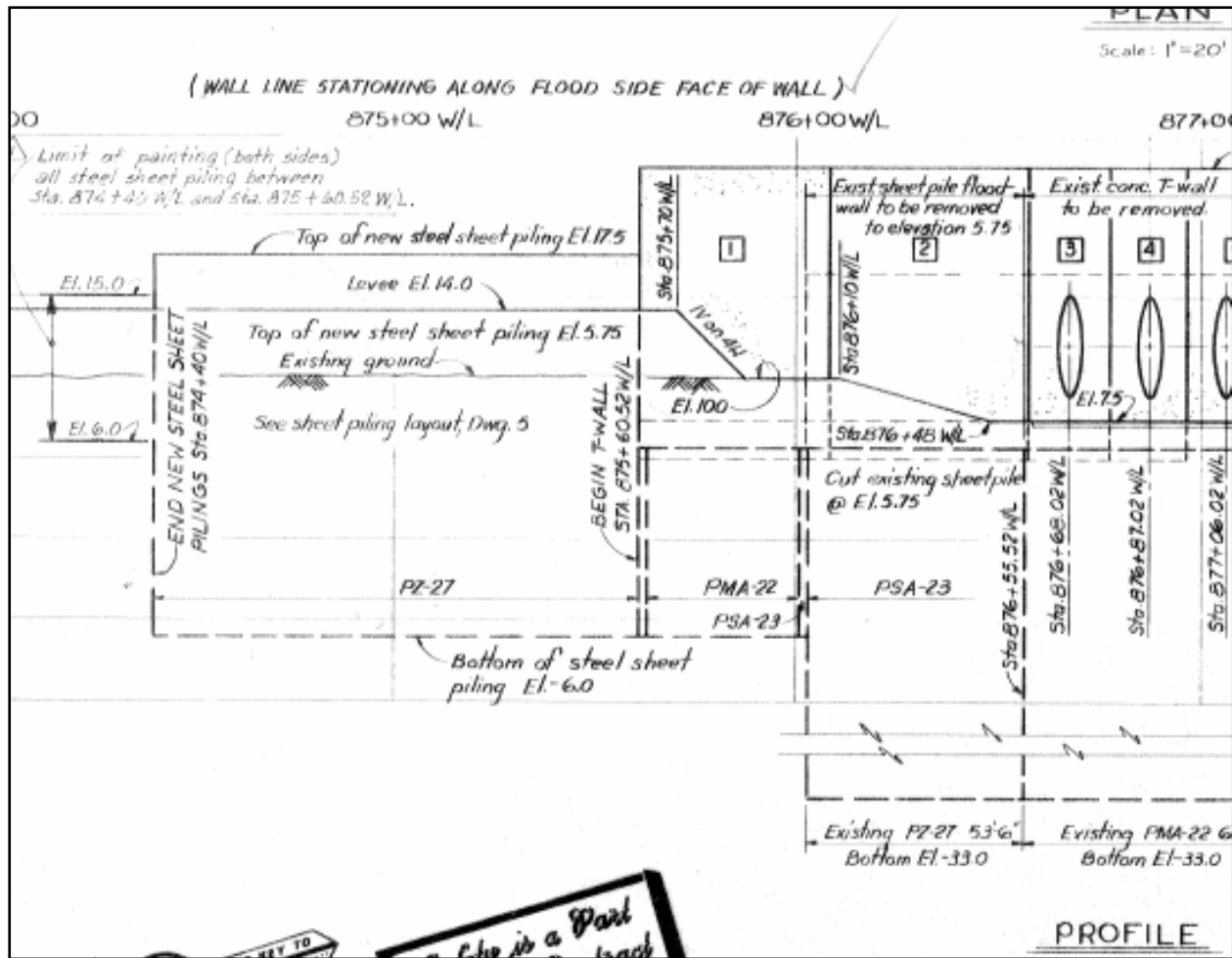

Figure 12-27. NOE2_G Profile View Showing 27' Difference Between Bottom Elevations of Existing (pre-1977) and Newer (1977 construction) Sheet Pile. Sections are from Plate 2 of 16, Mod P0001, Contract DACW29-77-C-0037

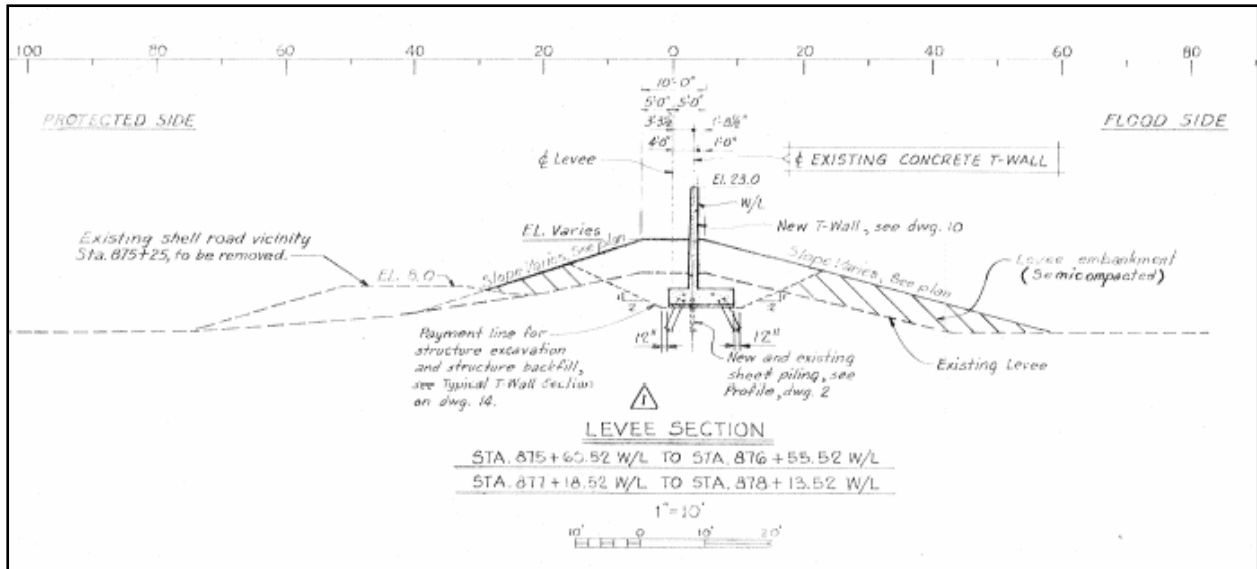

Figure 12-28. NOE2_H Newer (1977) Cut and Fill Sections for T-Wall, Same Contract as Above

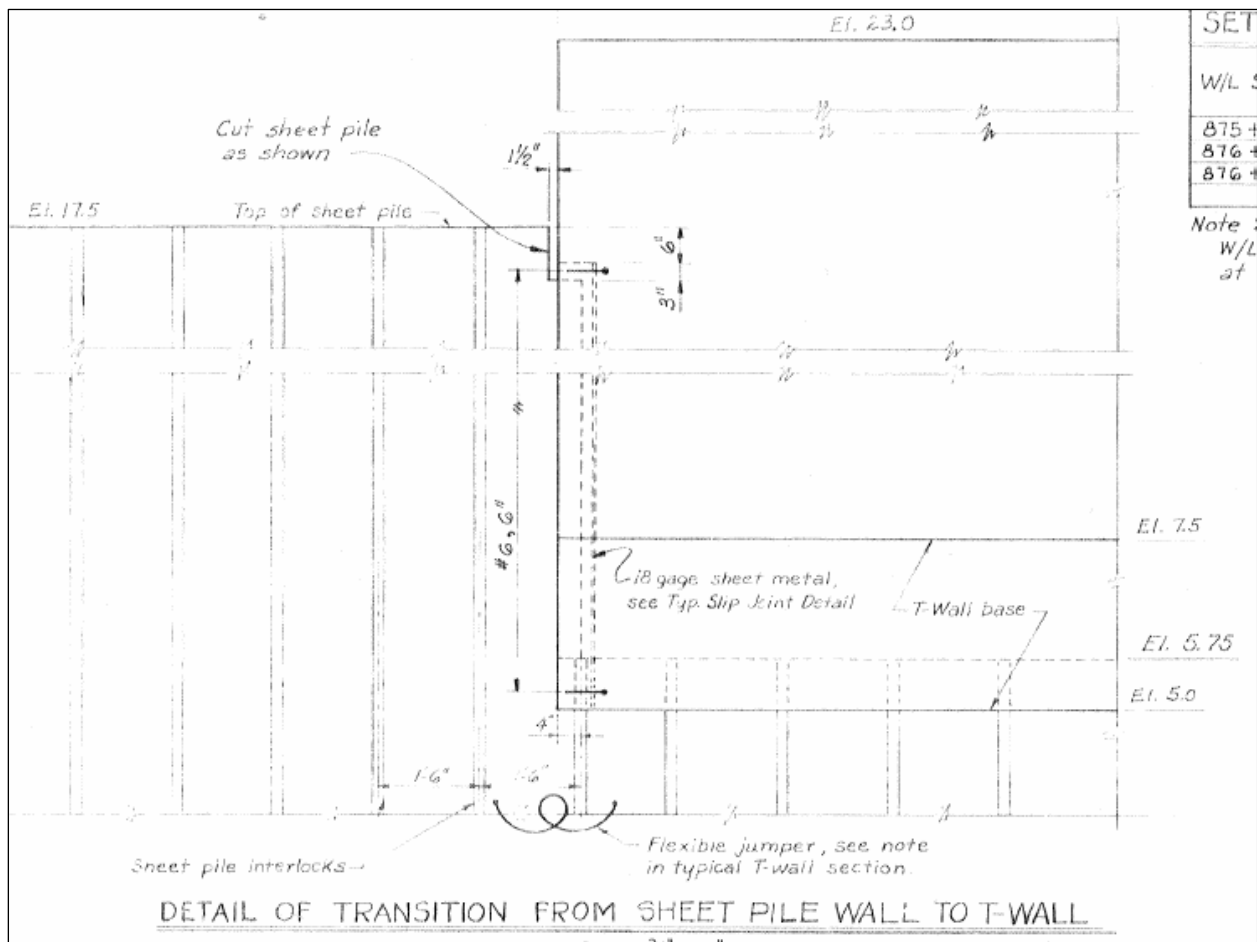

Figure 12-29. NOE2_I Top Elevation Difference of 5.5' Between Sheet Pile and T-Wall (plate 14 of 16 from above contract)

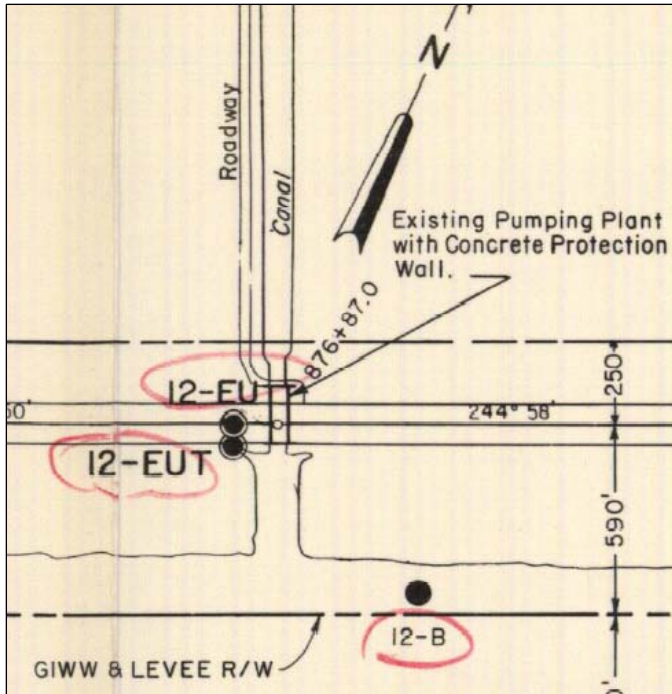

Figure 12-30. NOE2_J Soil Borings (from page 81 of 238, DM2 Gen Design Supp 4 N.O. East Back Levee (Mar 1971).pdf). Boring logs are shown on pages 88 and 89 of 238 (plates 10 and 11)

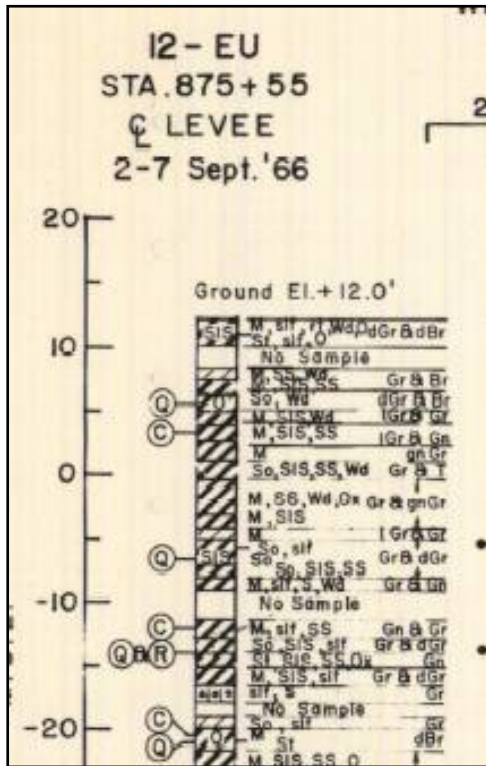

Figure 12-31. NOE2_K Nearest Boring Log (from plate 10 DM2 Sup 4) Showing Thin CL Layer in pre-1977 Levee

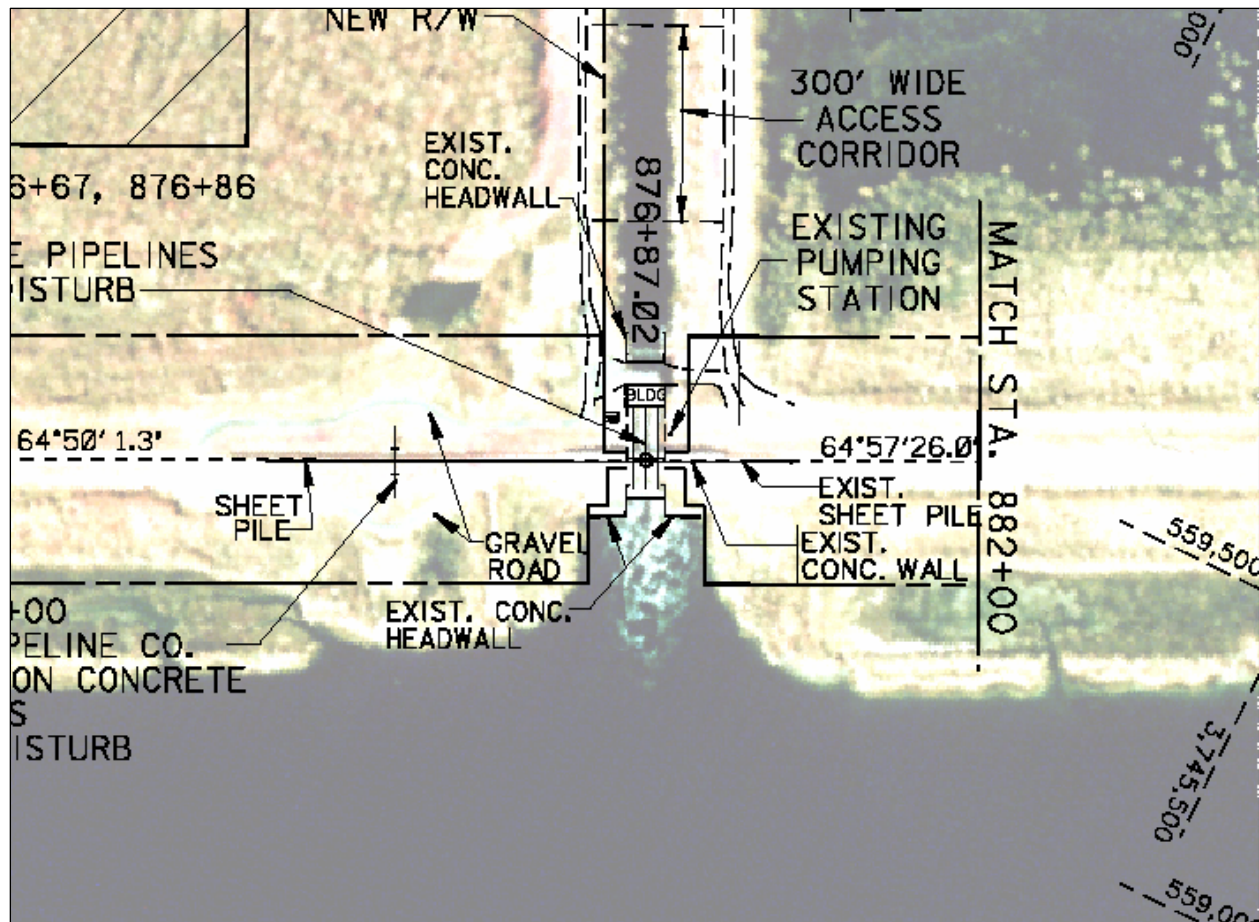

Figure 12-32. NOE2_L Plan view from Contract Solicitation NOE1 Drawing

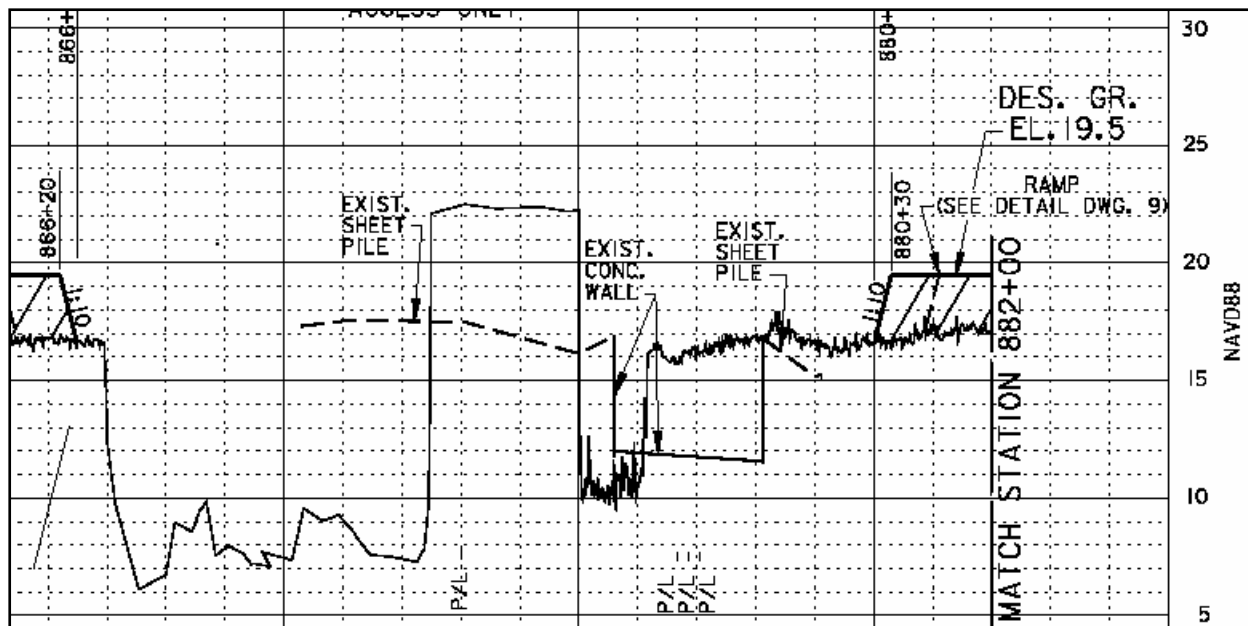

Figure 12-33. NOE2_M Plan and Post-Damage Scour Profile Immediately West of Pump Station 15 (from Contract Solicitation NOE1 drawing H-8-45594, sheet 3 of 16)

East Back Levee Repair from Michoud Canal to CSX RR

Project NOE01 consists of rebuilding approximately 4.3 miles of the existing levee back up to its constructed grade with 680,000 CY of earthen material, then seeding and fertilizing. There is 12,750 feet of levee east of Pump Station #15 that is completely degraded (Station 876+87 B/L to 1101+90 B/L). Plate 4 of DM2 Gen Design Supp 4 N.O. East Back Levee (Mar 1971).pdf shows the original soil borings and profile. The levees in the section 879+27 and 1006+59 were constructed from hydraulic fill in stages over three years (see plates 31 and 32).

West of the pump station, 9,800 feet of levee is completely degraded (approx Sta 778+00 to 876+00). Plate 3 of DM2 Gen Design Supp 4 N.O. East Back Levee (Mar 1971).pdf shows the soil borings and profile. The levees in this section were constructed from hydraulic fill in stages over three years (see plates 30 and 31).

The remaining level of protection was EL 4.0. The entire reach of levee was brought up to an interim level of protection of elevation +10 by November 15, 2005. April 1, 2006 is scheduled completion date.

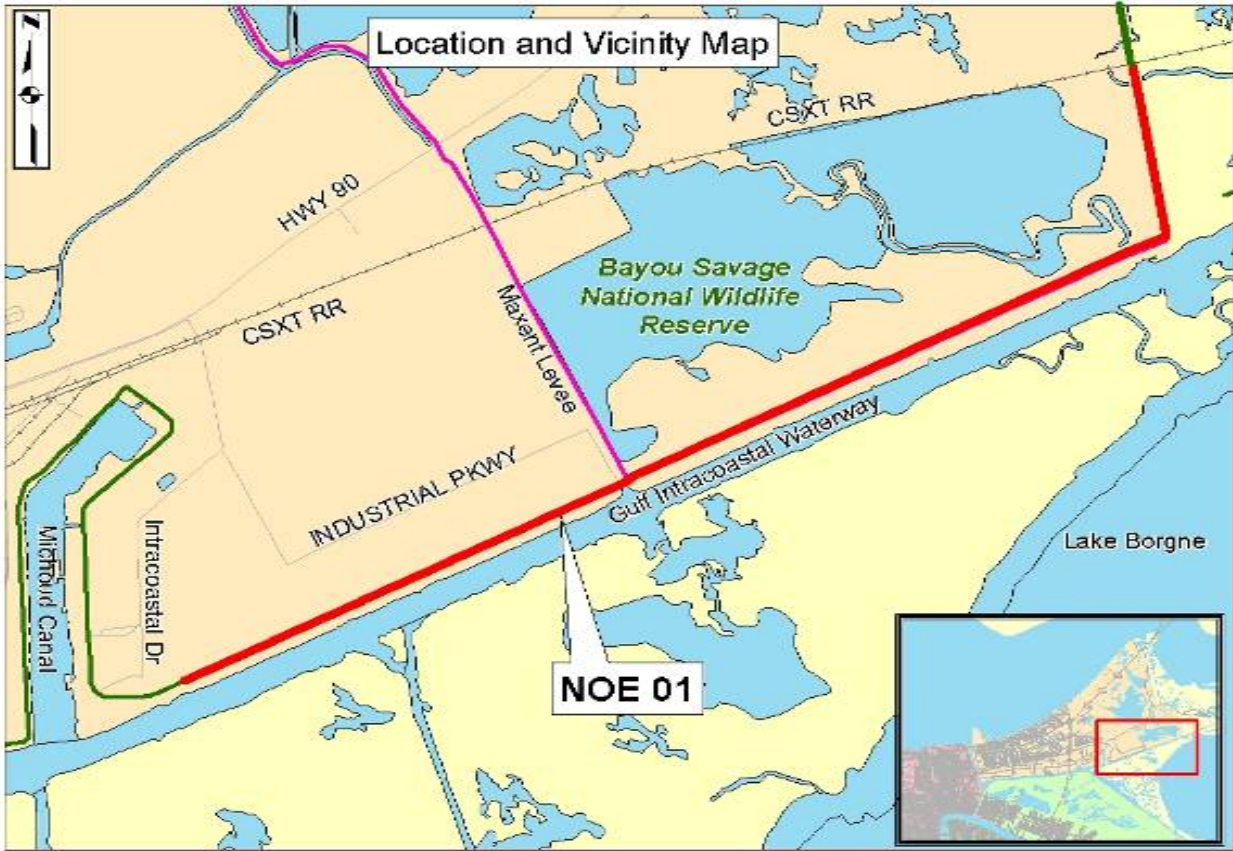

Figure 12-34. NOE1_A

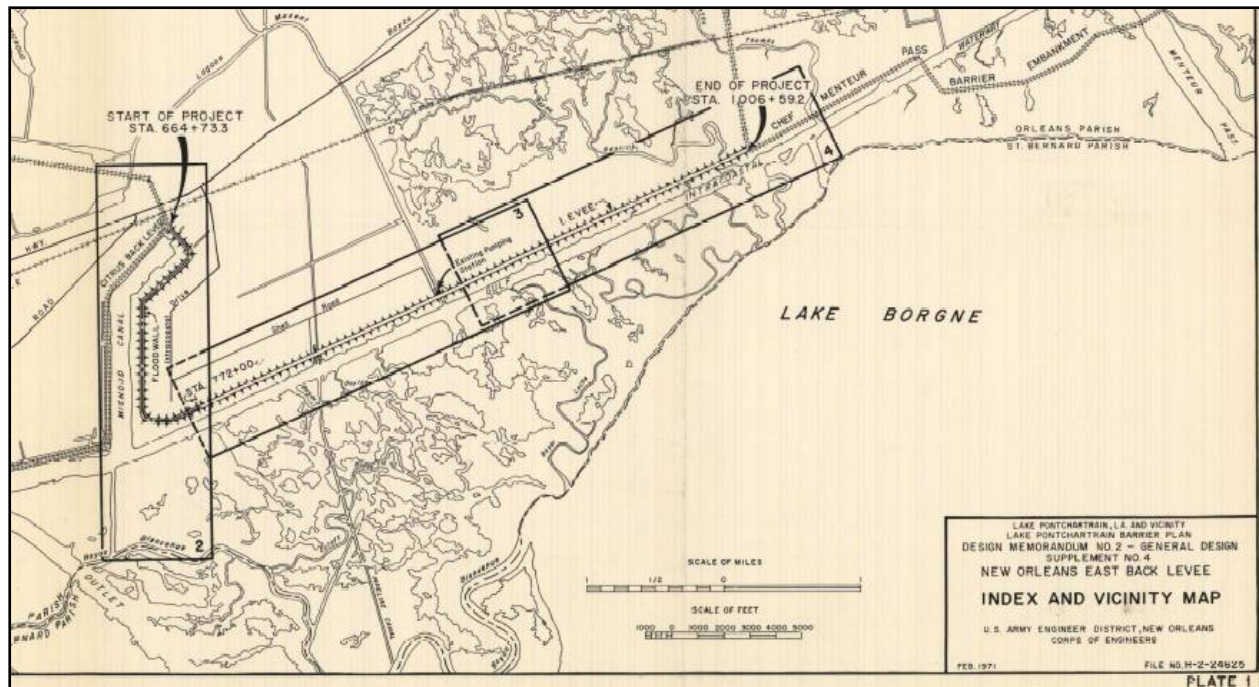

Figure 12-35. NOE1_B Page 79 of 238, DM2 Gen Design Supp 4 N.O. East Back Levee (Mar 1971).pdf



Figure 12-36. NOE1_C Complete Breach East of Pump Station 15

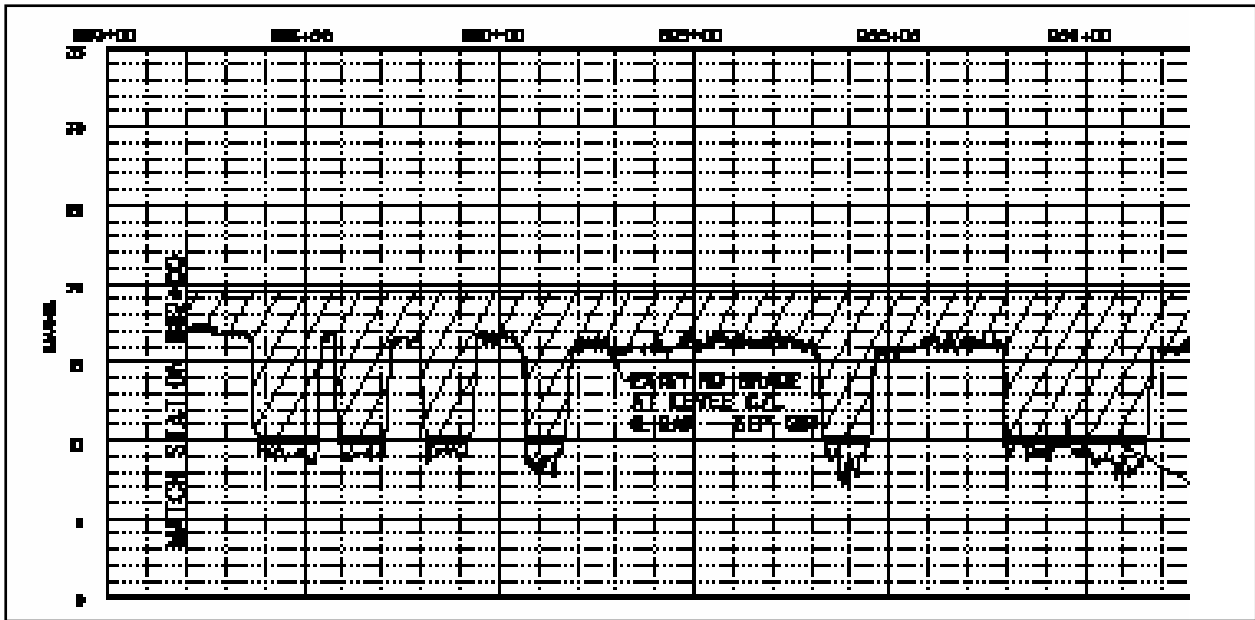

Figure 12-37. NOE1_D LIDAR Profiles of Levee East of Pump Sta 15 (from Contract Solicitation NOE1 drawings)



Figure 12-38. NOE1_E Partial Breach East of Pump Station 15



Figure 12-39. NOE1_F Rebuilding to Initial Elevation 10'



Figure 12-40. NOE1_G Localized Scour Typical of Several Locations

Floodwall Repair near Air Products Hydrogen Plant

Project NOE03 includes removing the damaged concrete I-wall and steel sheet pile wall, filling in scour holes, installing a new concrete I-Wall, and raising the damaged levee to pre-hurricane Katrina elevation and then seeding and fertilizing. The damaged reach was first brought up to an interim level of protection of elevation +10 by November 15, 2005 before final repairs are made. Breach length was 300' at transition between sheet pile and concrete I-wall. April 1, 2006 is scheduled completion date.

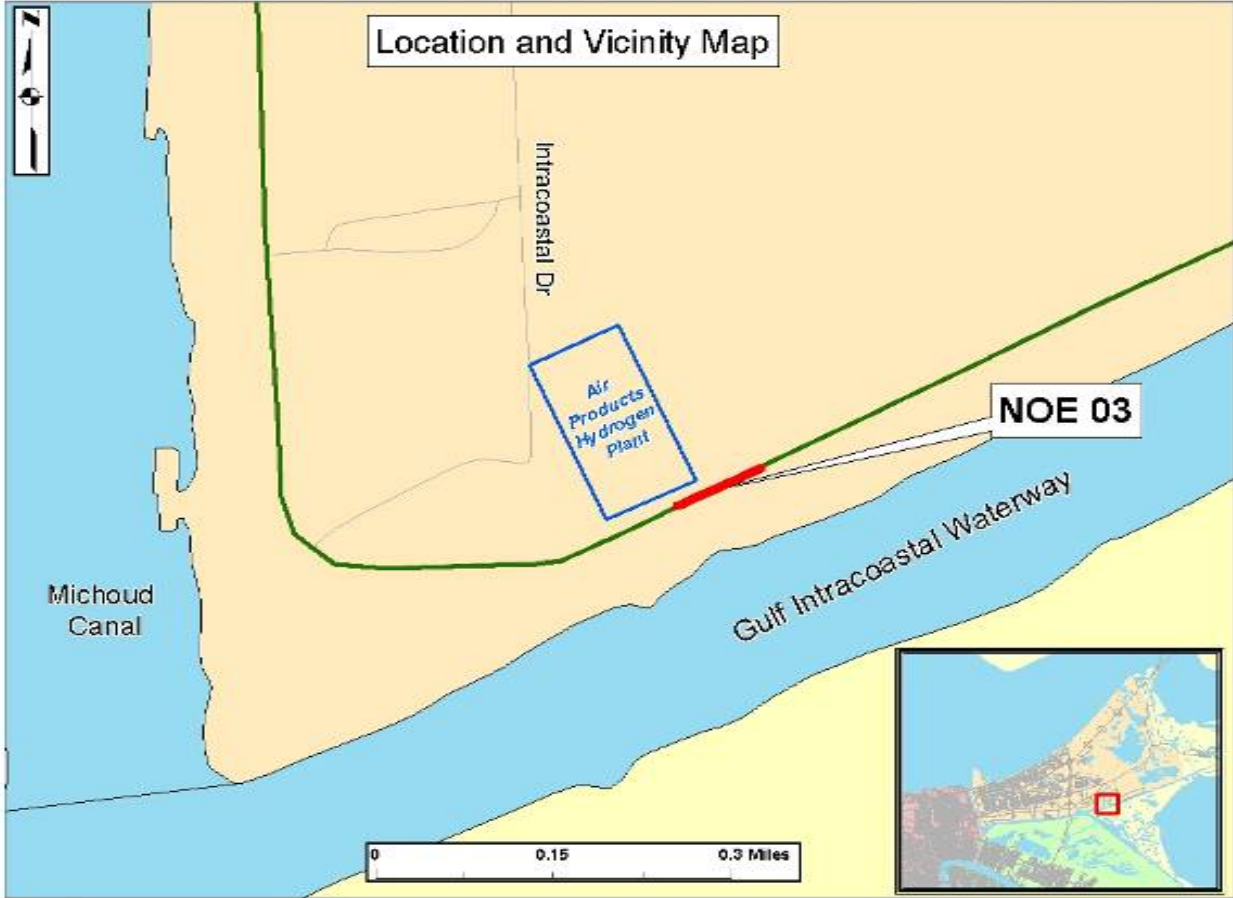

Figure 12-41. NOE3_B

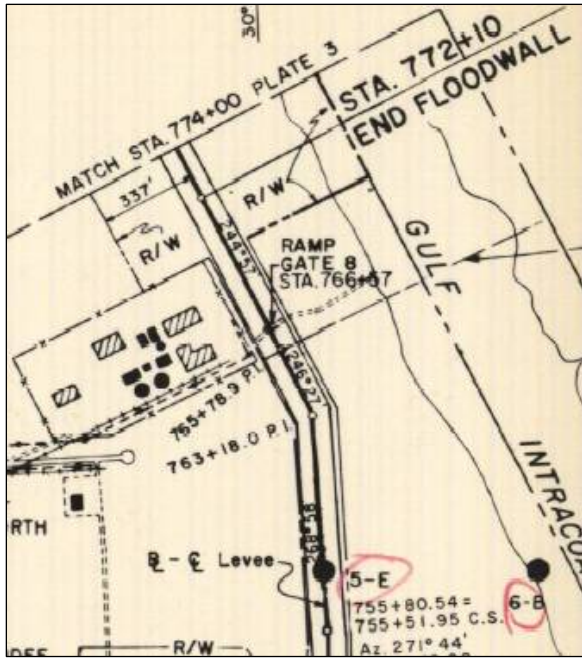

Figure 12-42. NOE3_A. Page 80 of 238, DM2 Gen Design Supp 4 N.O. East Back Levee (Mar 1971).pdf

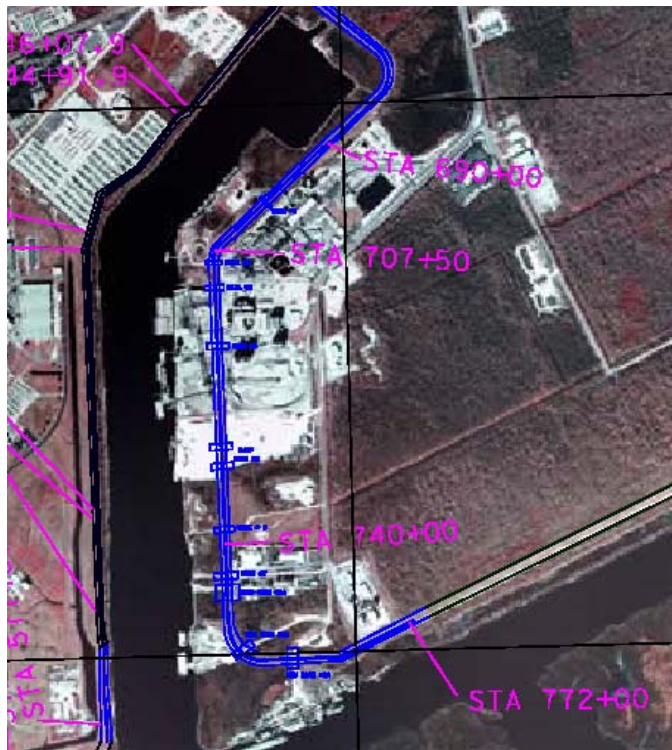

Figure 12-43. NOE3_C. Blue Color is Top of Wall Elevation 20 ft



Figure 12-44. NOE3_D Sheetpile Wall Failure (near Sta 772+00 B/L New Orleans East Back Levee)
(Coordinates 30 deg 01 min 04.30 sec N, 89 deg 53 min 49.36 sec W)

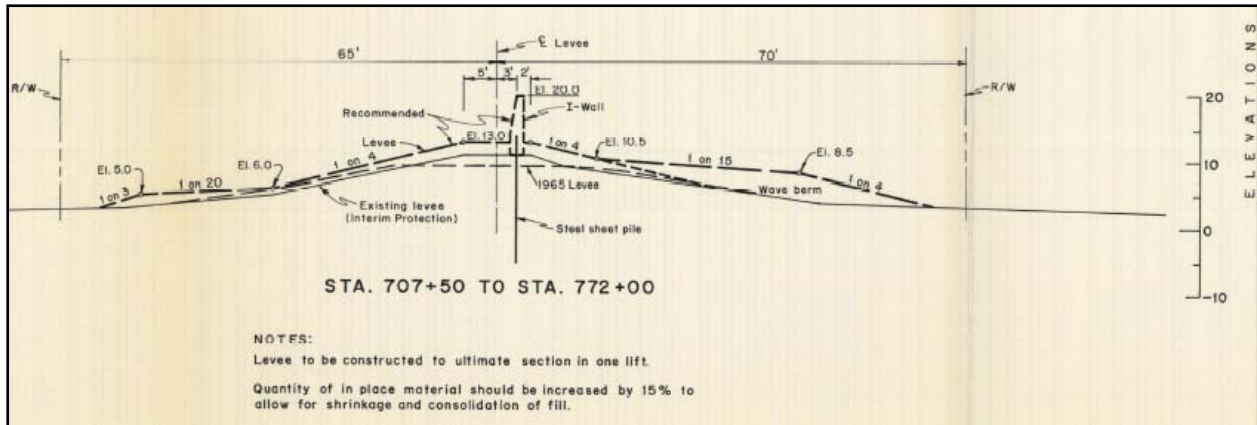

Figure 12-45. NOE3_E. Page 107 of 238, DM2 Gen Design Supp 4 N.O. East Back Levee (Mar 1971).pdf Showing Add-On to Existing Levees (1965 and interim add-on)

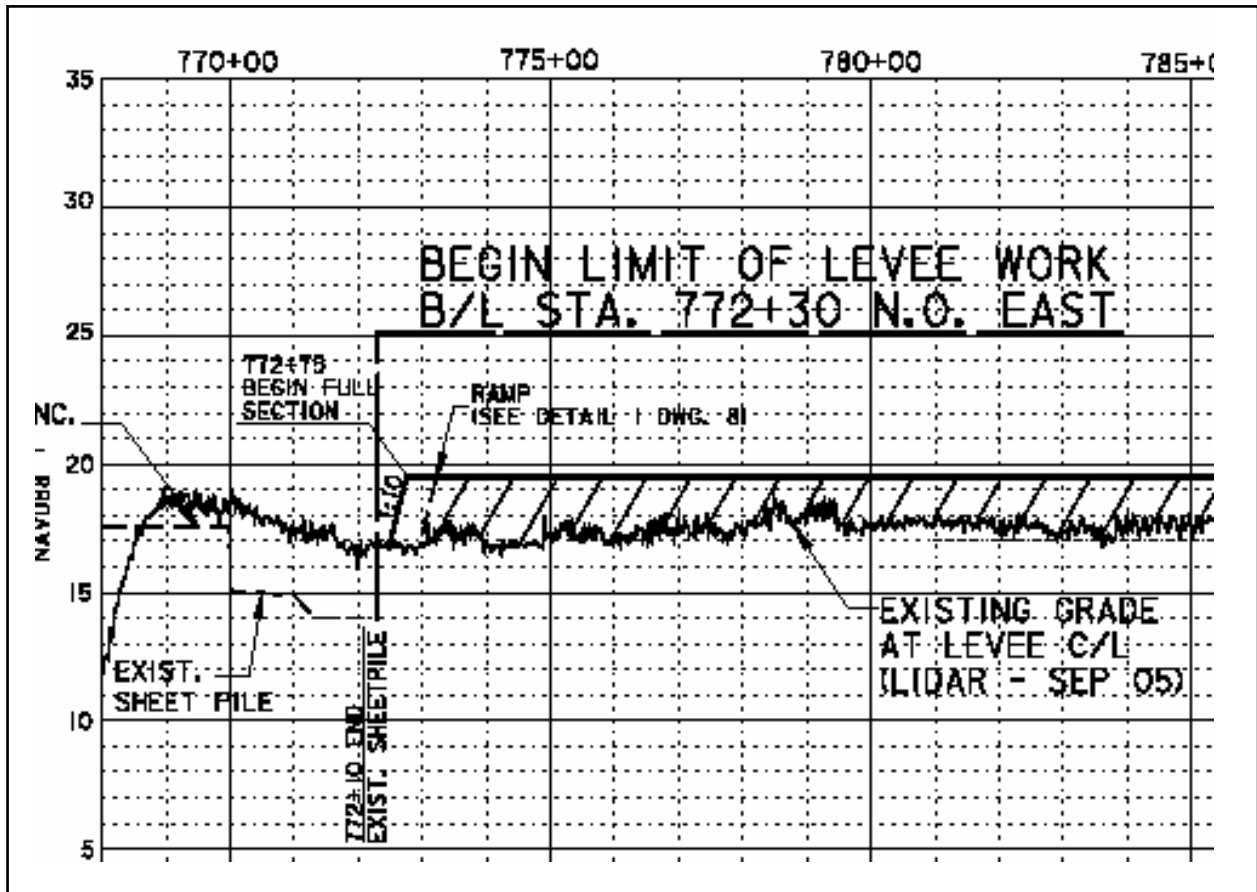

Figure 12-46. NOE3_F. Post-Damaged Lidar Elevations Show Scour Hole (approx Sta 768+00) Depth was About 8' deep (from Contract Solicitation NOE1 drawing H-8-45594, sheet 2 of 16)



Figure 12-47. NOE3_G. West of Failure Looking East. Drawings from NOE3 Contract Solicitation Show Scour Depth And Outline

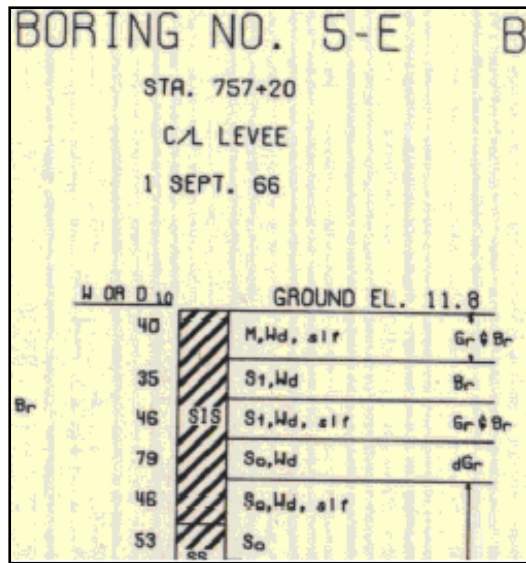

Figure 12-48. NOE3_H. Boring 5-E from plate 5, DM2 Supp 4 (March 1971) Shows CH Material in Pre-Existing 1965 Levee



Figure 12-49. NOE3_I. Repair Progress



Figure 12-50. NOE3_J. Repair Sheetpile View to the West

Floodwall Scour Repairs from Michoud Slip to Michoud Canal

Project NOE09 includes filling in the scour holes next to the wall with embankment material, installing bedding material, and concrete slope paving above the scour to prevent future erosion. Also includes adding an earthen stability berm on both flood and protected sides of the wall. The project also consists of intermittent repairs to damaged concrete and various joints and gates in the walls. April 1, 2006 is scheduled completion date.

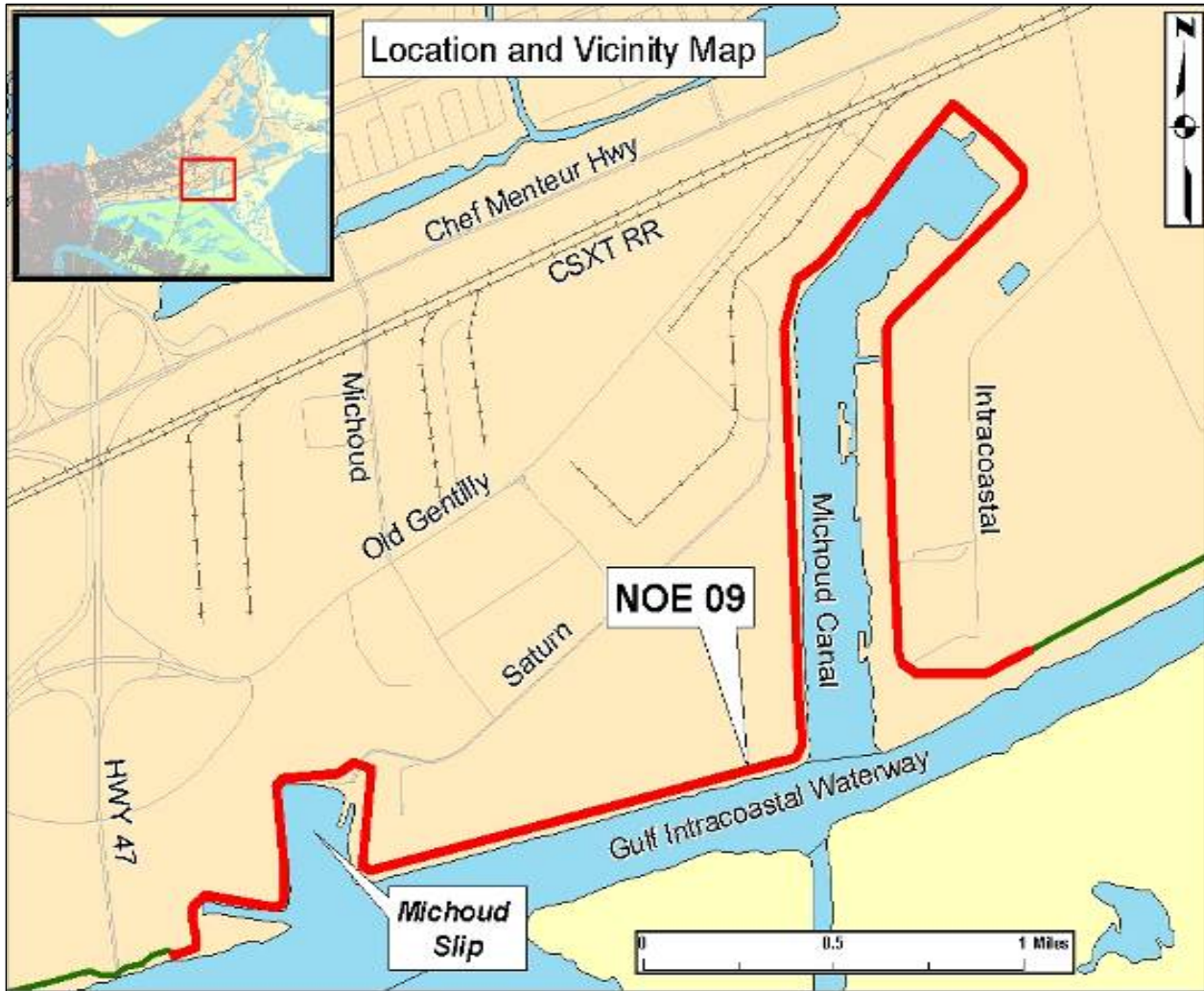

Figure 12-51. NOE9_A



Figure 12-52. NOE9_B



Figure 12-53. NOE9_C. I-Wall Damage Likely Due to Impact

Citrus Back Levee Floodwall Repair

Project NOE04 includes removing the damaged concrete I-wall sections, filling in the scour holes, regrading the damaged levee, constructing new concrete wall, and putting in an earthen stability berm on the landside of the wall. The most severe damage in this reach is a 2000 ft. section of I-wall that failed by rotation, with attendant erosion and scouring. The extend of material below the water surface that has been removed by the scouring is unknown. Localized scouring occurred at several locations along this reach. The total quantity of material removed by scouring within this reach is estimated at 150,000 cys.

The repaired levee section and stability berm will be seeded and fertilized. The damaged reach was first brought up to an interim level of protection of elevation +10 by December 1, 2005 before final repairs are made. Geotechnical analysis has determined an earthen stability berm may be required which will require additional real estate. April 1, 2006 is scheduled completion date.

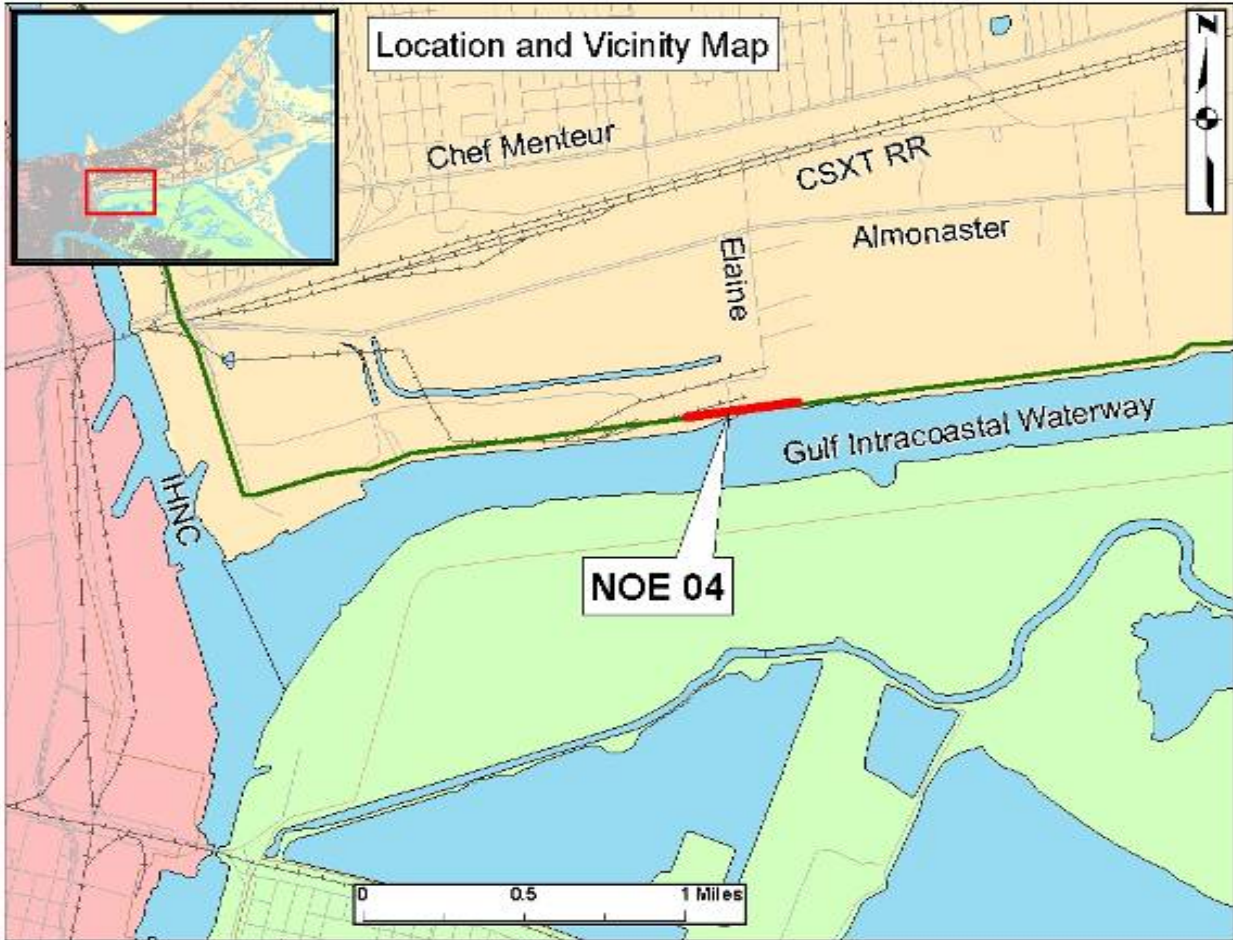

Figure 12-54. NOE4_A



Figure 12-55. NOE4_B. Bulk Loading Terminal Facility I-Wall Failed by Rotation with Attendant Scour and Erosion (2000' near Elaine St. at GIWW), near Sta 271+55 B/L (Citrus Back Levee), Immediately Adjacent to the Tool Shed Metal Building



Figure 12-56. NOE4_C. Begin I-Wall Rotation at 30 deg 00 min 00.91 sec N, 89 deg 59 min 39.53 sec W.
Pre-Existing Wall Elevation was 15 ft and Levee Elevation was 14 ft



Figure 12-57. NOE4_D. Bulk Loading Facility on the GIWW. Note Tool Shed Metal Building Location

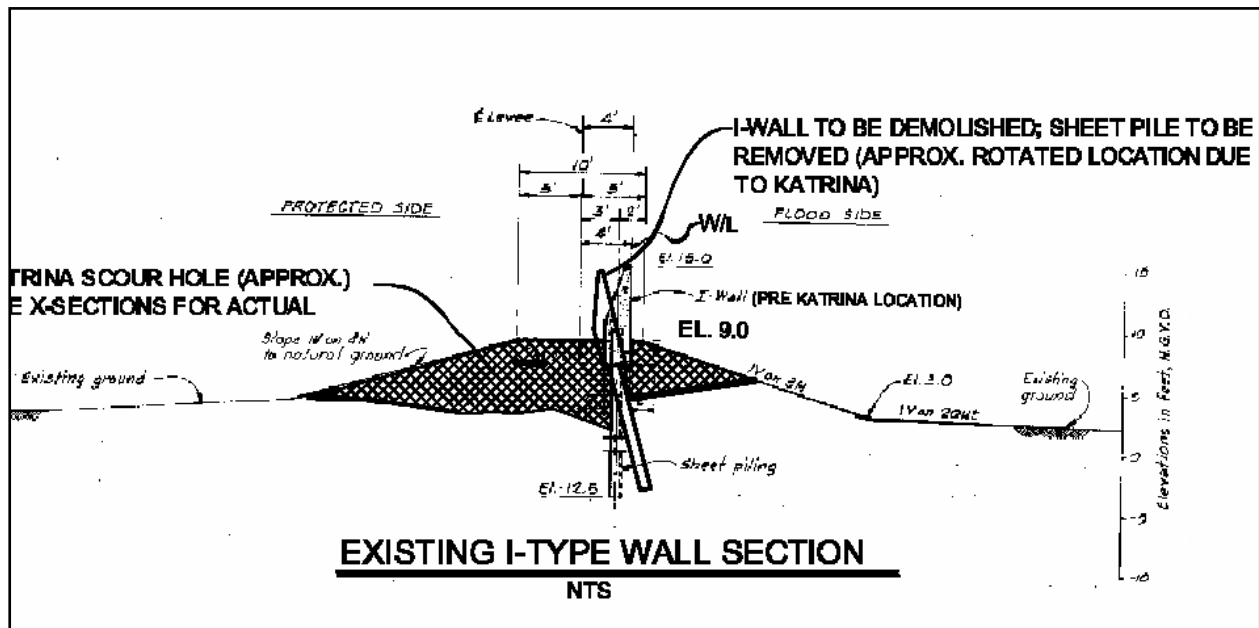

Figure 12-58. NOE4_E. Post-Katrina Condition

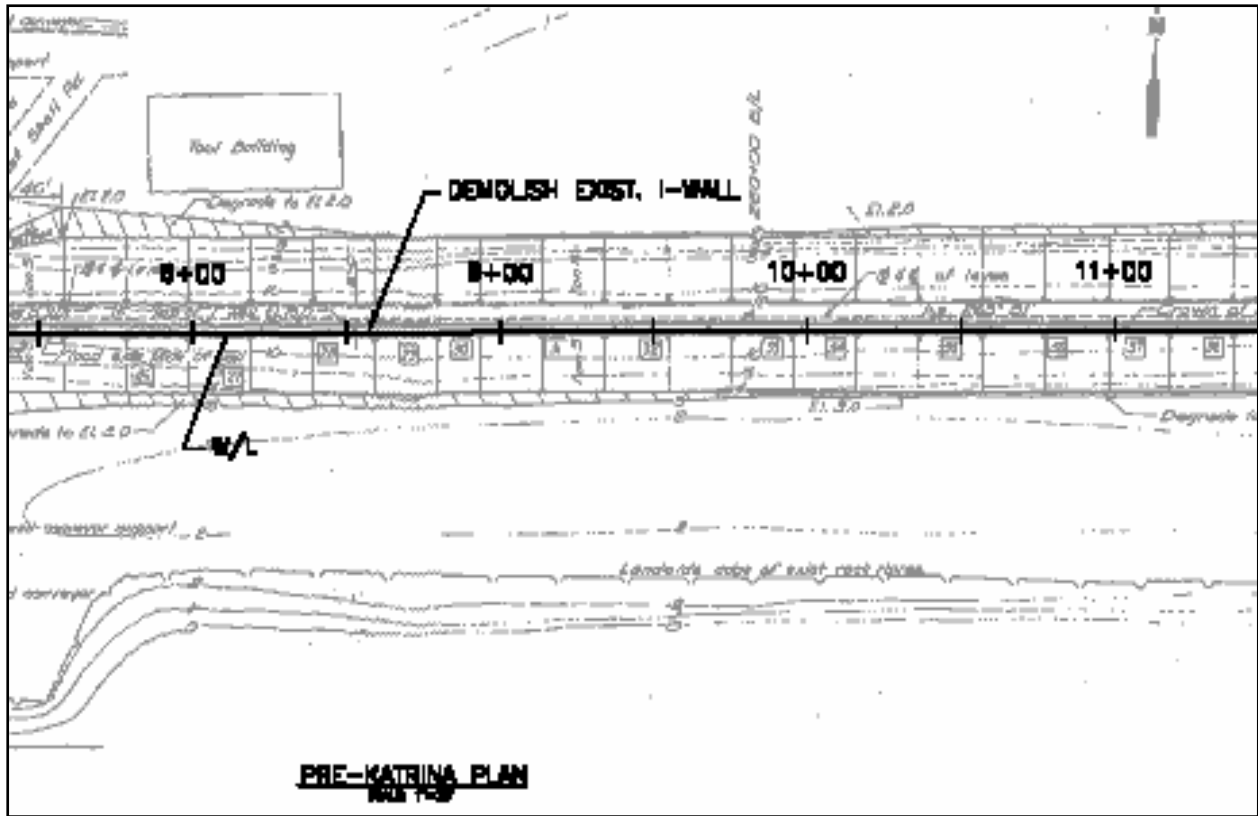

Figure 12-59. NOE4_F. Sections are from the Lake Pontchartrain, Louisiana and Vicinity, New Orleans East Area Plan Emergency Restoration, Modifications to Citrus Back Levee Floodwall Sta. 250+17.5 B/L to Sta. 279+44.50 B/L (Sta. 0+02.0 W/L to Sta. 29+41.71 W/L) Construction Contract Solicitation

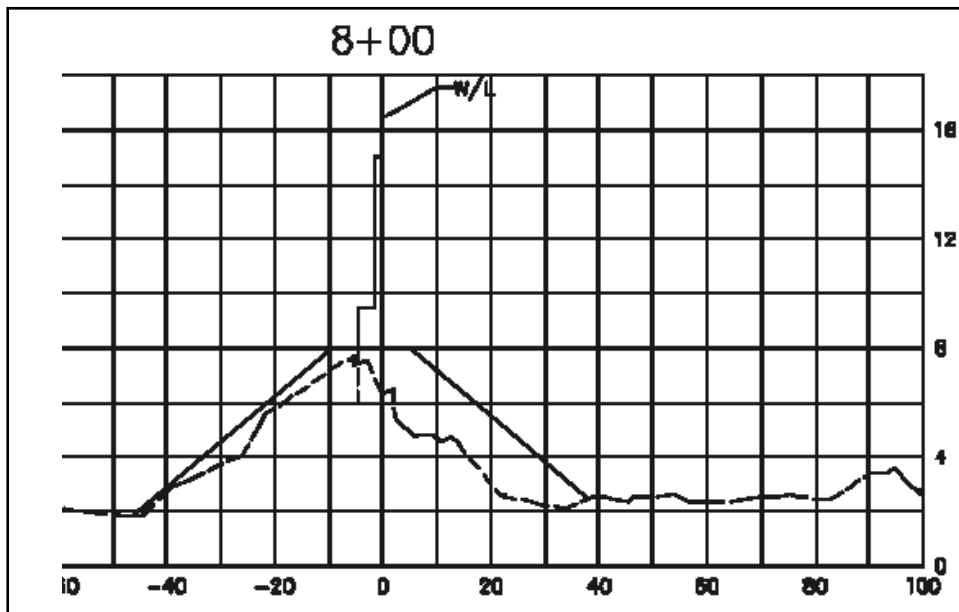

Figure 12-60. NOE4_G. Scour Pattern Along the I-Wall Immediately Adjacent to the Tool Shed Building

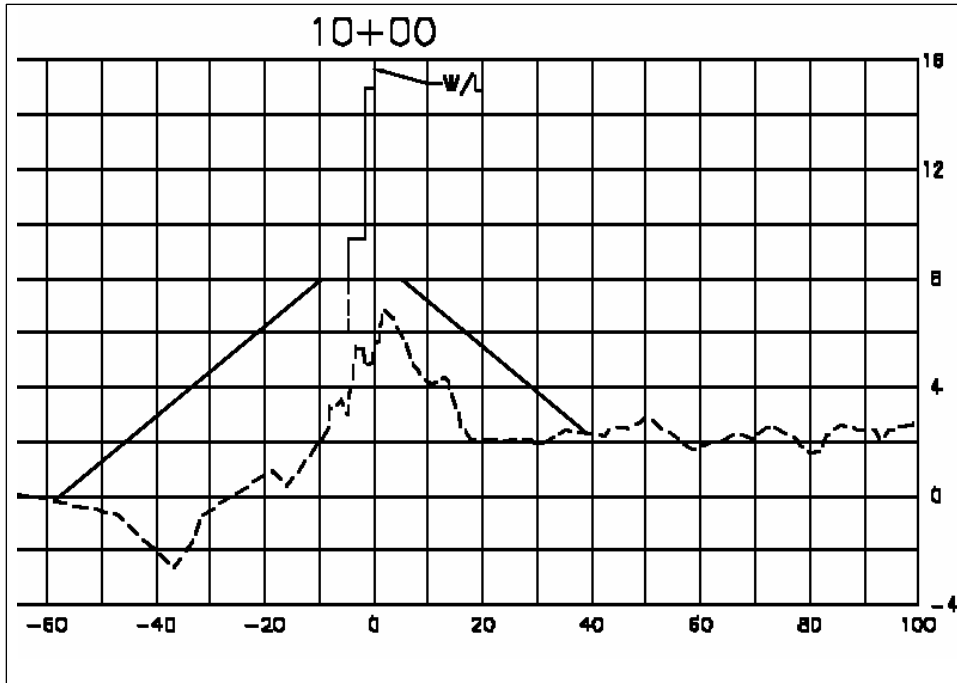

Figure 12-61. NOE4_H. Scour Pattern 200' to the East



Figure 12-62. NOE4_I. I-Wall Demolition to Replace with New “L” Wall

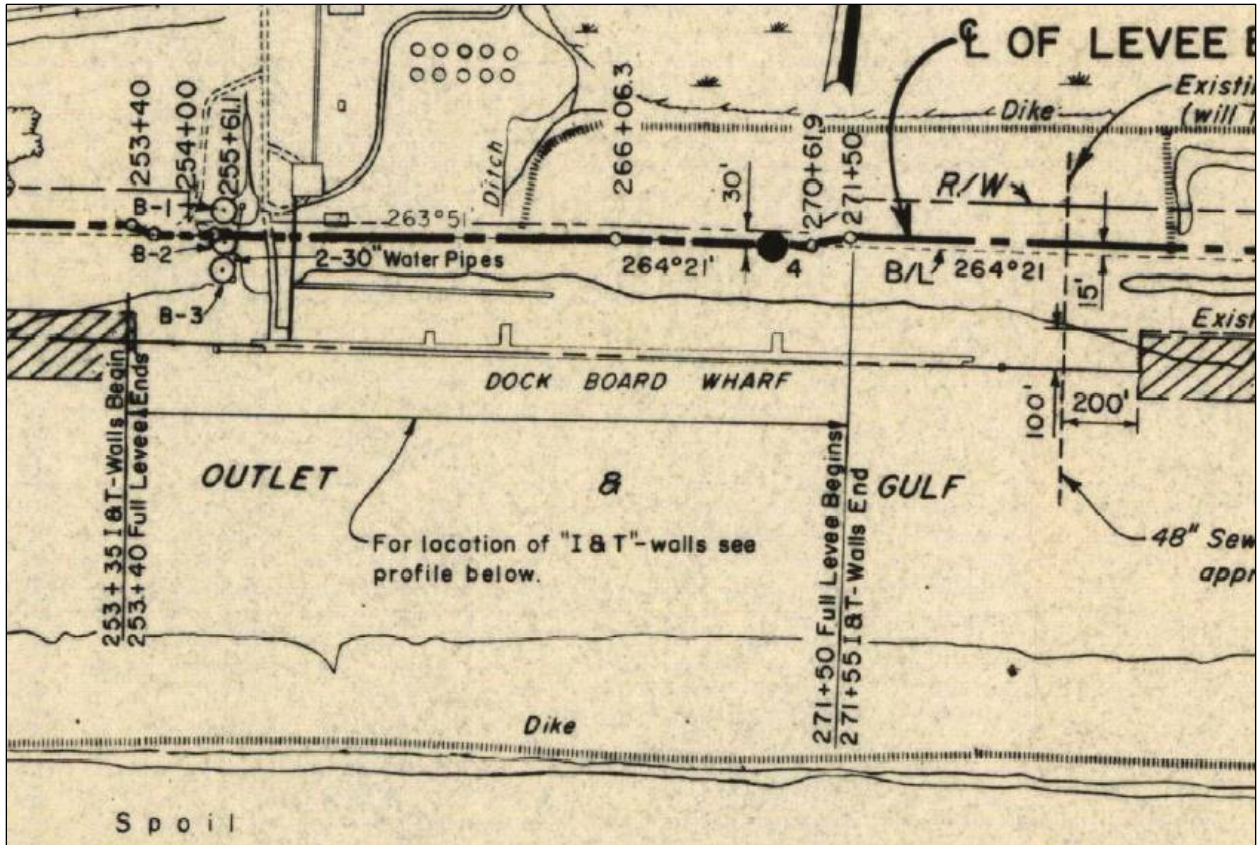

Figure 12-64. NOE4_K. Plate 2, Sta 250+ to Sta 279+

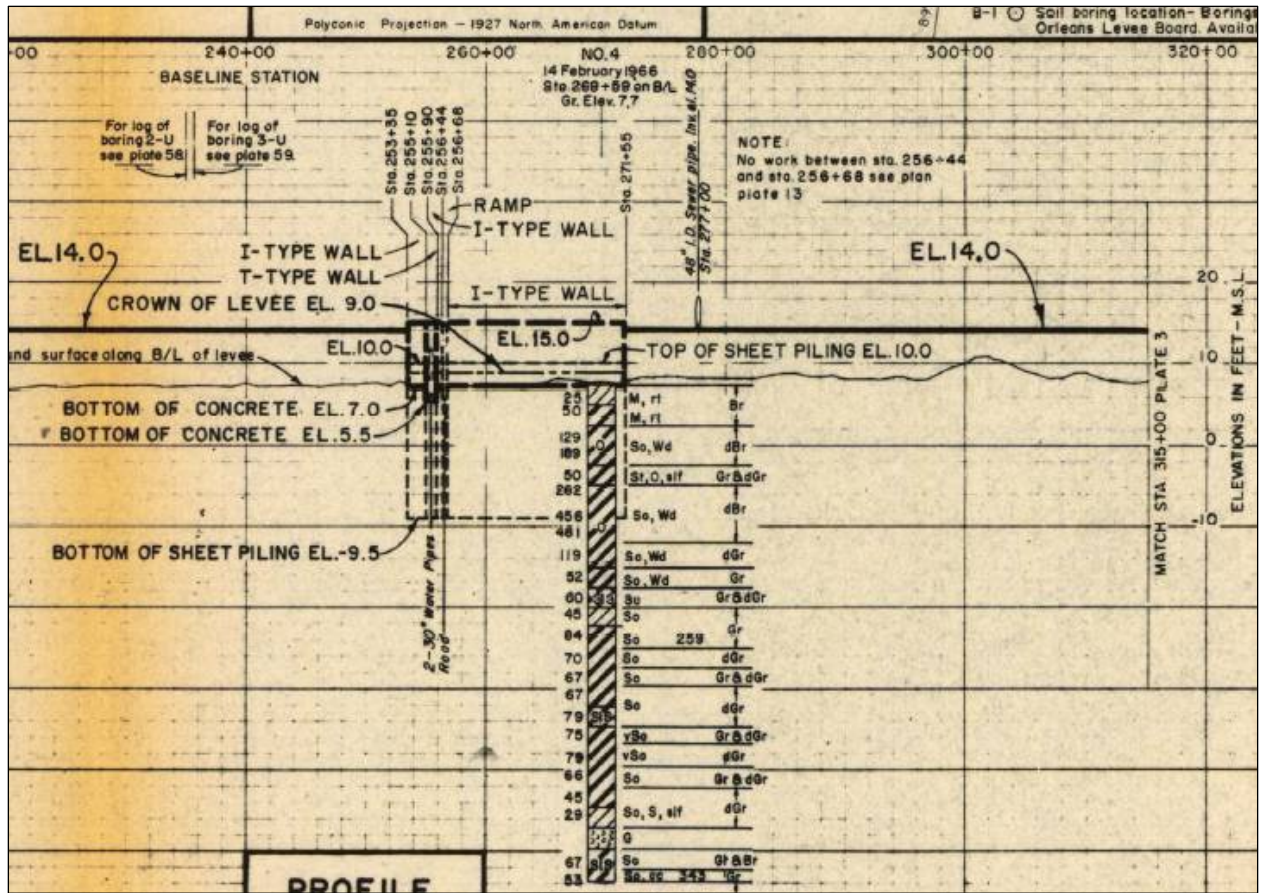

Figure 12-65. NOE4_L. Nearby Boring 4 Shows Top Layer of CL (from Plate 2 profile section)

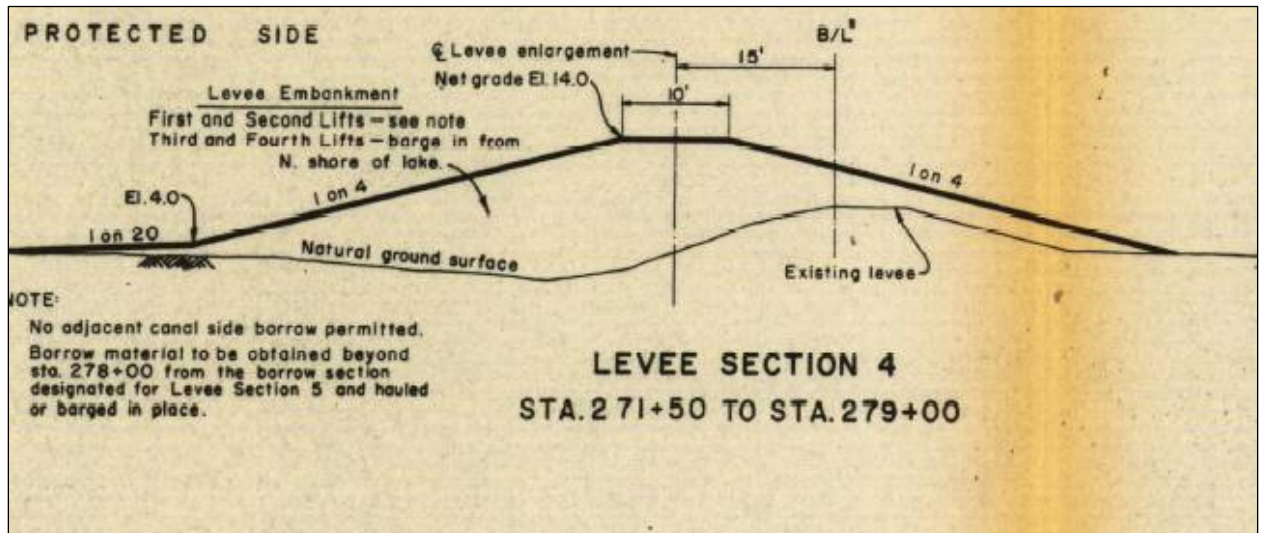

Figure 12-66. NOE4_M. Plate 6 Shows Different Borrow Source Beyond Sta 278+

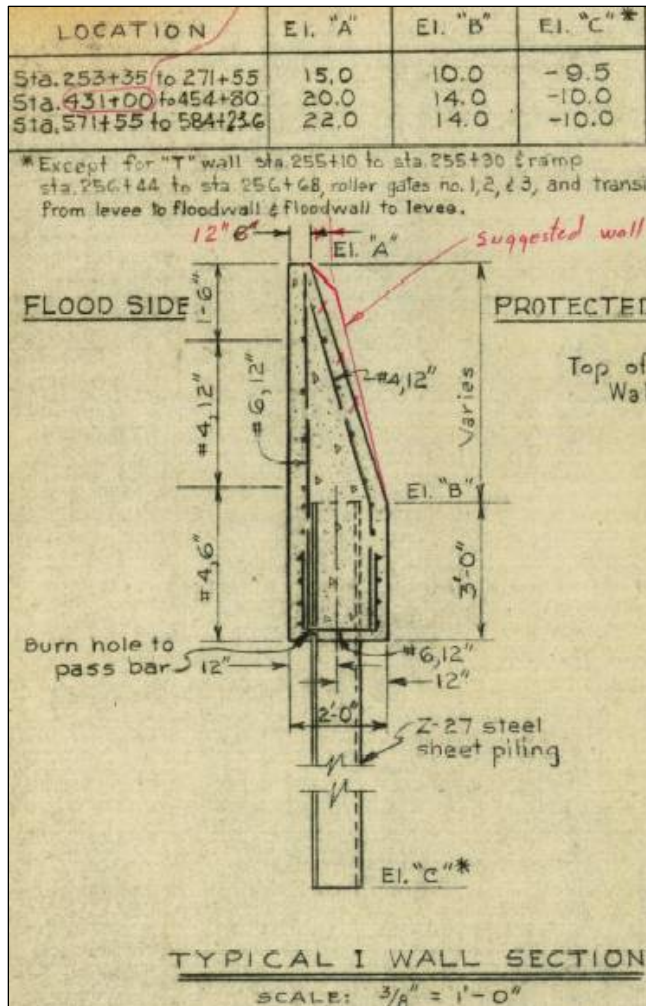

Figure 12-67. NOE4_N. Plate 26 Shows Sheetpile Elevations

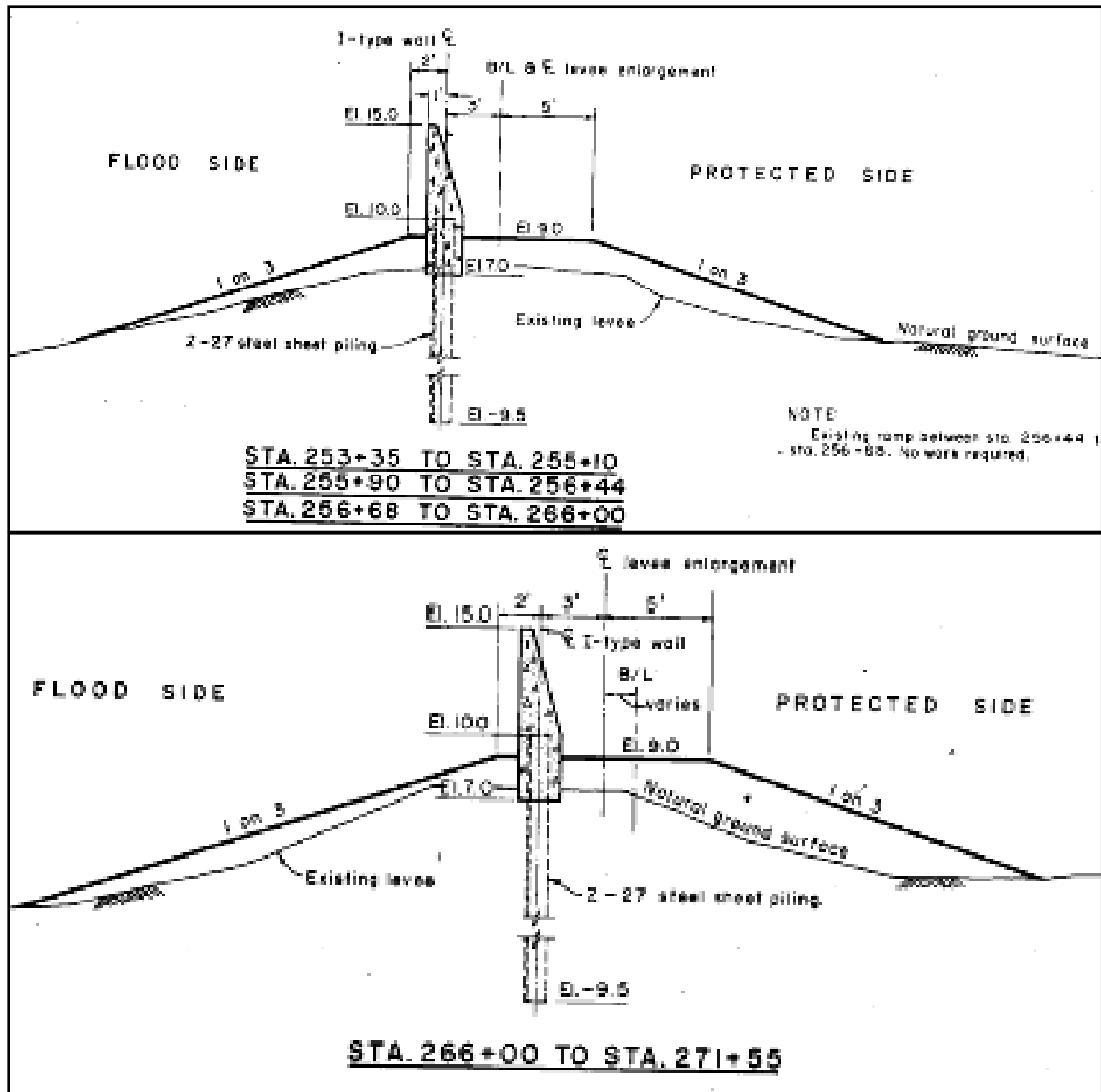

Figure 12-68. NOE4_O. Plate 28 Shows Elevations

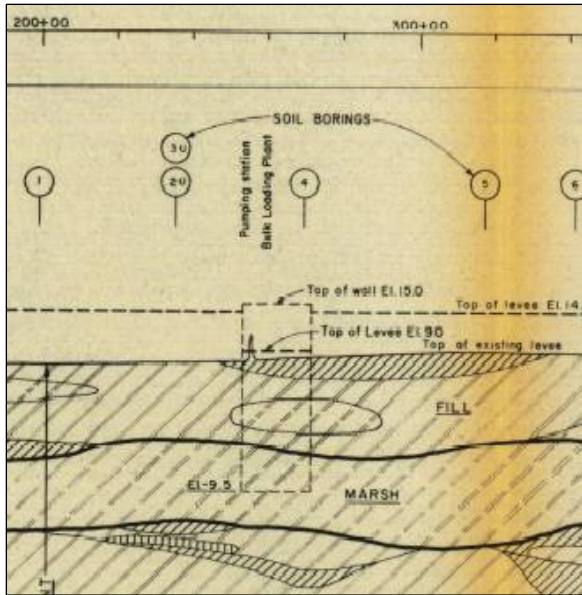

Figure 12-69. NOE4_P. Plate 35, Geology Profile. Note that Sta 240+ to Sta 300+ of the 1965 levee was approximately 5 ft of CL (lean clay) from top elevation 10' MSL down to 5' MSL. Organic clay fill lies beneath.

Citrus Back Levee, IHNC to Paris Rd



Figure 12-70. NOEX_Q. Amid Pump Station Landside Slope Erosion from Overtopping at Transition

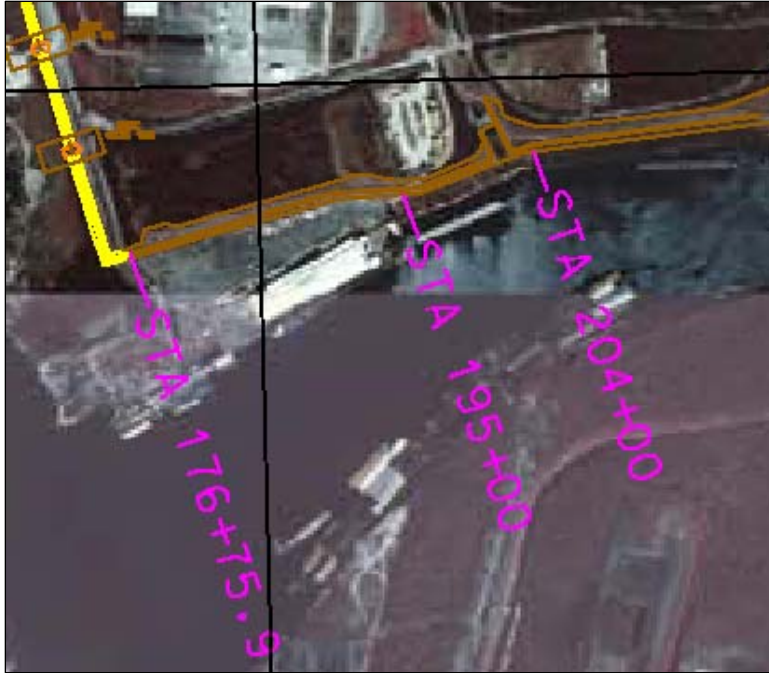

Figure 12-71. NOEX_R. Above Picture Taken Near GIWW/IHNC (coordinates 29 deg 59 min 55.37 sec N, 90 deg 00 min 41.62 sec W)



Figure 12-72. NOEX_S. Plate 2 of DM2-Gen Design Citrus Back Levee (Aug 1967) IHNC to NASA.pdf Shows Original Borings and Profile at Above Picture Location. Note that overtopping scour occurred at the intersection of the dirt road and levee crown as seen in Figure 12-NOEX-Q above



Figure 12-73. NOEX_T. Closeup of Scoured Road at Levee Crown, Amid Pump Station



Figure 12-74. NOEX_U. Overtopping Erosion on Flood Side and Land Side



Figure 12-75. NOEX_V. Narrow Localized Breach at Pre-Existing Pipeline Crossing. Coords
30 deg 00 min 10.66 sec N, 89 deg 57 min 49.31 sec W (Approximate Sta 349+00 B/L)



Figure 12-76. NOEX_W. 600' Reach of Levee with Landside Scouring

Attachment A Data Sources

Pre-existing conditions from Design Memoranda

Design Memoranda related to the NOE Basin are:

- DM 14 Citrus Lakefront Levee
- DM16 Gen Design NO East Levee South Point to GIWW (Sept 1987).pdf
- DM2 Gen Design Supp 4 N.O. East Back Levee (Mar 1971) pdf
- DM2-Gen Design Citrus Back Levee (Aug 1967) pdf

Figures C-1 thru C-4 show the geographical extent of each hurricane protection project.

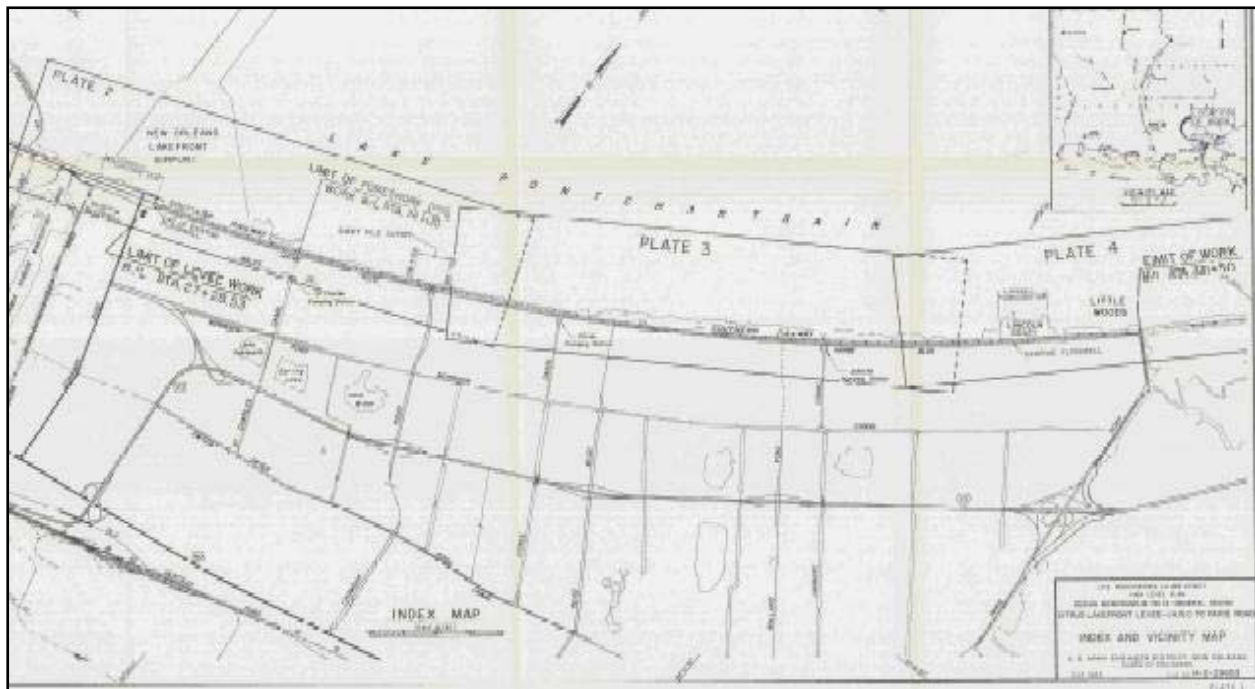

Figure C-1. DM14 CitrusLakefrontLevee.pdf

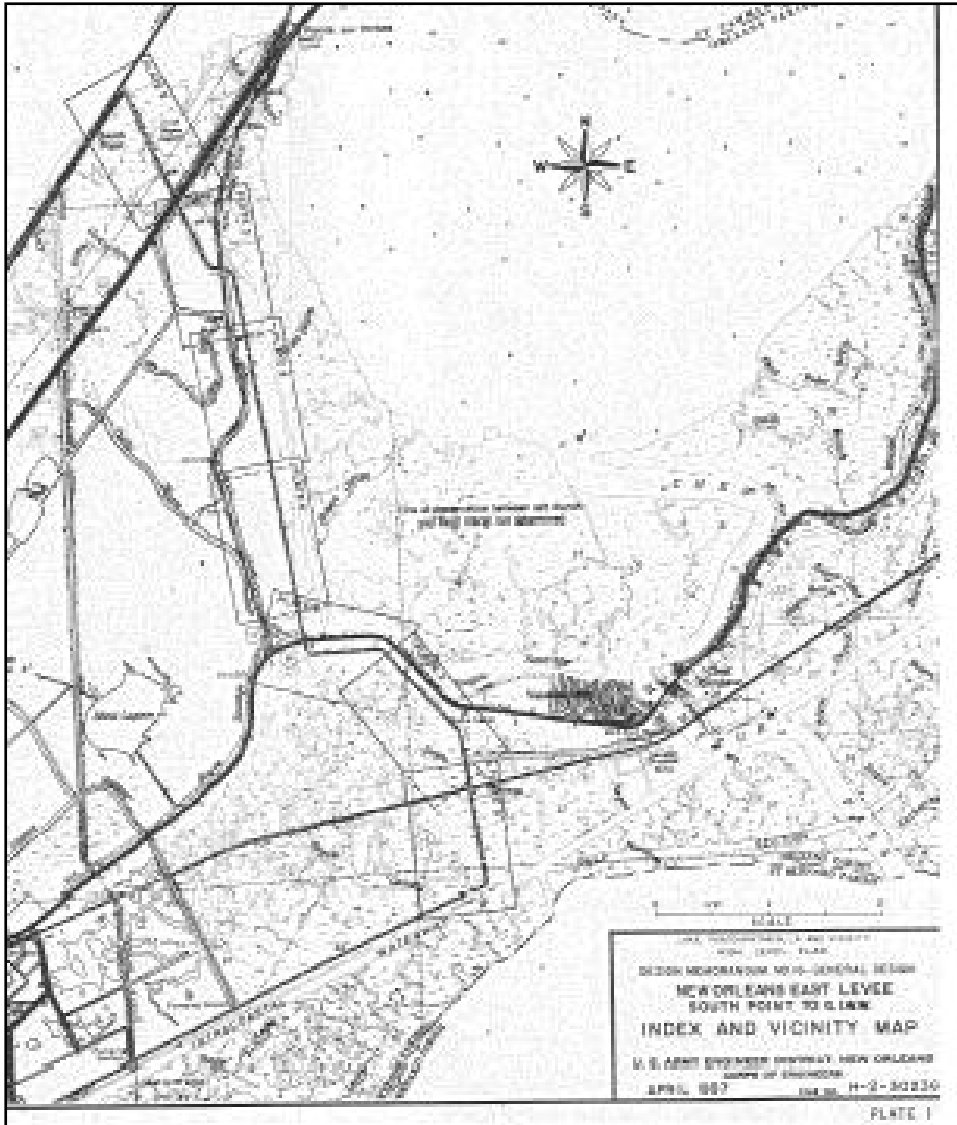

Figure C-2. DM16 Gen Design NO East Levee South Point to GIWW (Sept 1987).pdf

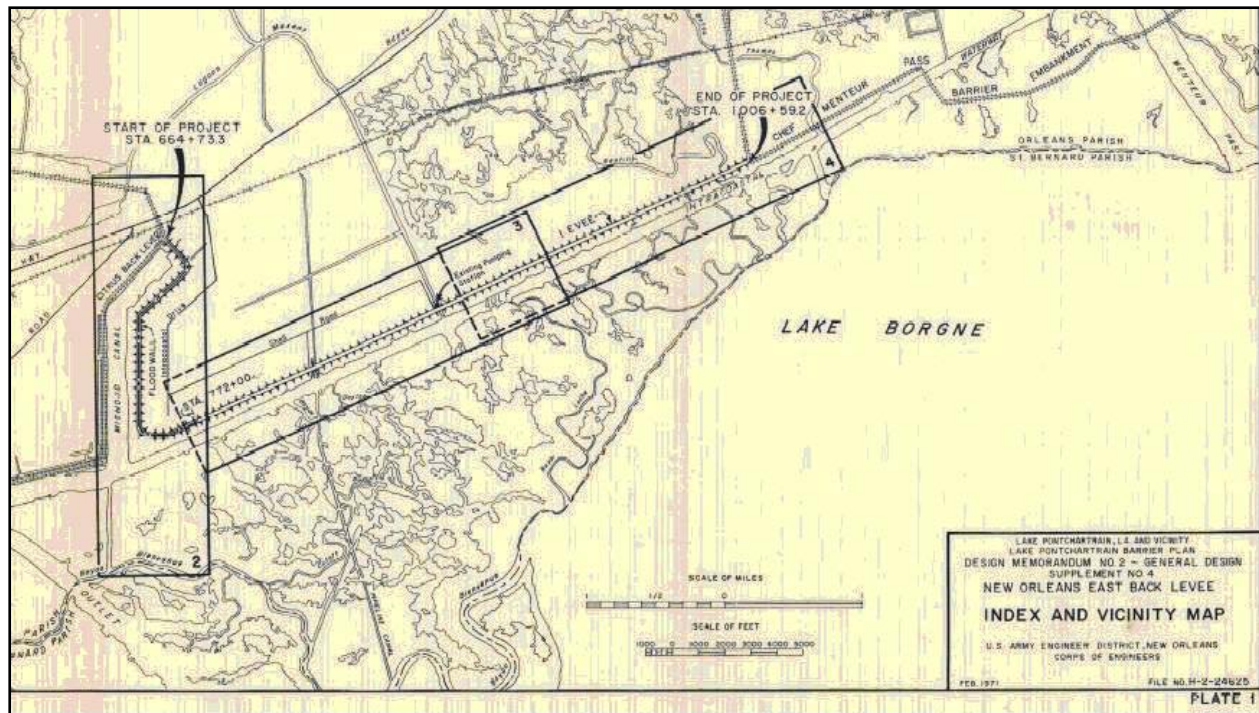

Figure C-3. DM2 Gen Design Supp 4 N.O. East Back Levee (Mar 1971) pdf

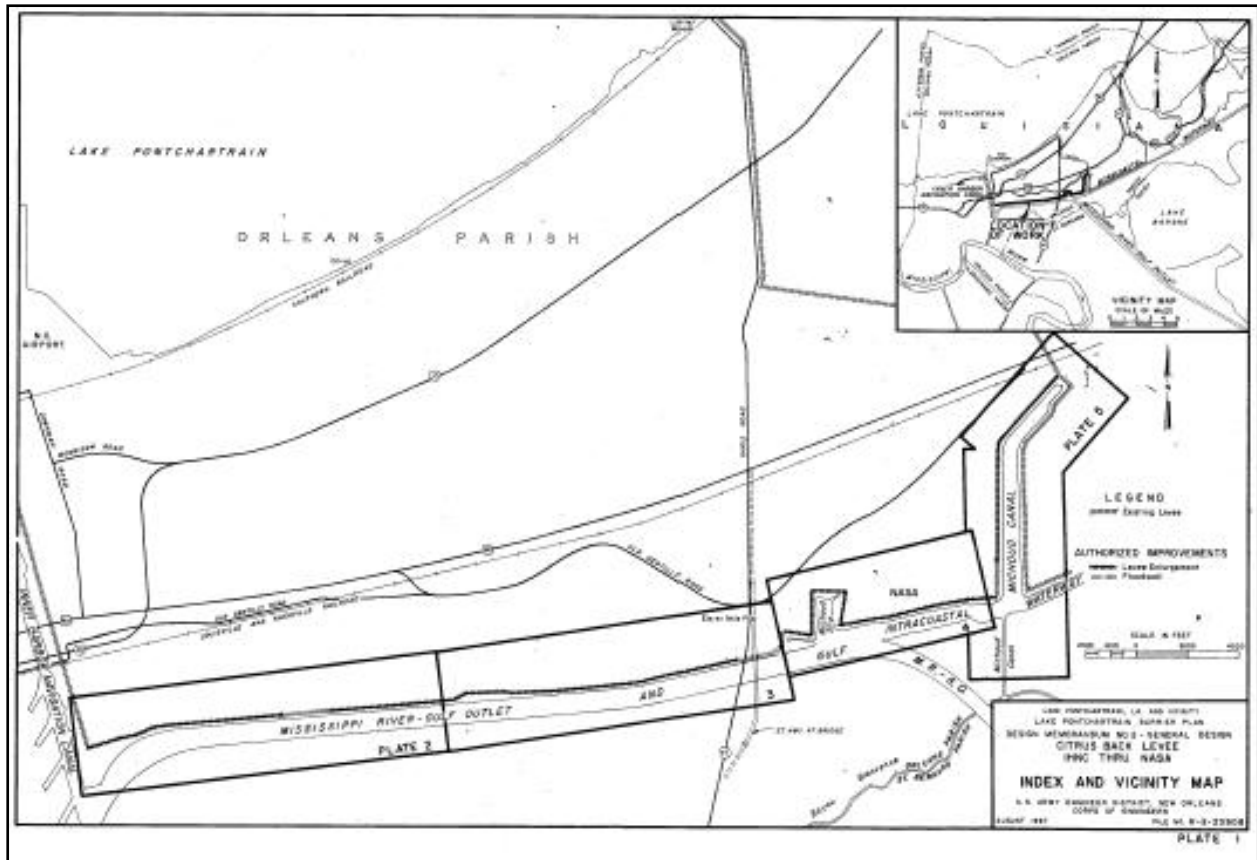

Figure C-4. DM2-Gen Design Citrus Back Levee (Aug 1967) pdf

Appendix 13

Levee and Floodwall Erosion and Scour from Overtopping Storm Surge

Background

Slope stability (sliding failure), underseepage and internal seepage leading to progressive failure are considered to be the primary functional failure modes for levees, and floodwalls. Water overtopping an embankment leading to surface scour and erosion has been considered as a potential failure mode for dams. Hurricane Katrina has highlighted the importance of overtopping initiating surface erosion and progressive erosion leading to breaching of the levees and floodwalls making up hurricane protection system.

The only failure modes absolutely known to have occurred during the Katrina event were overtopping and breaching, based on eyewitness accounts and forensic evidence such as high-water marks and barges resting on top of floodwalls. Lengthy reaches (miles) of earthen levees and capped levees were overtopped. Some reaches showed signs of initial erosion, others showed signs of progressive erosion, and other reaches contained significant breaching. Similar to levees, lengthy reaches of floodwall were overtopped and were left in various stages of damage ranging from minor scour at the wall base to breaches where complete floodwall sections were flattened.

In the New Orleans East, Lakeshore, and St. Bernard Parish basins, approximately 50 miles of earthen levees overtopped but did not breach; approximately 20 miles of earthen levees overtopped and contained significant breaches; approximately 7 miles of floodwall overtopped but did not breach; and approximately 2 miles of floodwall overtopped and had breaches. The majority of levees and floodwalls damaged by overtopping, but did not breach.

In Plaquemines Parish, the Mississippi River mainline levee and the back levee lengths total about 162 miles. There are about 7 miles of floodwall (I-walls and sheetpile). All of the levees in Plaquemines Parish sustained damage, and there was considerable crown and slope scour along the total length, due to overtopping. The mainline levee riverside slope pavement sustained damage from the hundreds of ships and barges that crashed into it. There were also several severe breaches, coinciding with pipeline crossings and with some floodwalls. Five of the 7 miles of floodwall were damaged beyond repair. There were major breaches at sheet pile wing

walls at two pump stations in the back levee. A major breach occurred at the Shell pipeline crossing near Nairn, and the West Pointe a la Hache pipeline crossing was severely damaged.

Post-Katrina evidence also indicated that progressive surface soil erosion and scour due to overtopping may have contributed to breaching. It is well known that any reduction in the cross-sectional area of a physical object will reduce the ultimate strength for which that object is capable. An earthen levee's ability to resist hydrodynamic water loading will be compromised if the cross-section geometry is altered. If water overtops the levee and washes out (erodes) the backside slope, the lateral stress-resisting ability and the underseepage force-resisting ability will be compromised, depending on the degree of erosion. Several stages of erosion and scour progression were noted along numerous levee / floodwall reaches, and although it may be too late to scientifically classify their contribution to breaching probability (due to construction repair), general observations and assumptions may be developed regarding soil erodibility and erosion progression.

Failure Patterns

Very little evidence of frontside (floodside) erosion was noted in the post-Katrina forensic evidence. Backside (landside) erosion patterns were observed along breached and unbreached levee and floodwall in Orleans, St. Bernard, and Plaquemines Parishes. The following overtopping and breaching damage patterns were observed:

- a.* Earthen levee backside erosion caused by: (1) wave overtopping when the surge level was below the levee crest elevation, and (2) continuous water overtopping when the surge level exceeded the levee crest elevation. Progressive erosion of unprotected soil on the protected side (backside) likely contributed to levee breaching.
- b.* Damage to the earthen levee on the backside of vertical floodwalls caused by wave and/or water overtopping impacting the unprotected soil. Loss of lateral soil support and progressive erosion likely contributed to wall and levee breaching.
- c.* Damage to transitions between earthen levees and structures such as flood gates and floodwalls. Erosion of earthen levee material and scour at the transitions was observed, and localized overtopping was most likely due to levee / wall elevation differentials.

The following pictures and descriptions show examples of the damage patterns, and available additional information such as soil borings and pre-Katrina elevations are included to provide possible explanations for scouring erosion. Figure 13-1 is a diagram of the observed general failure progression patterns.

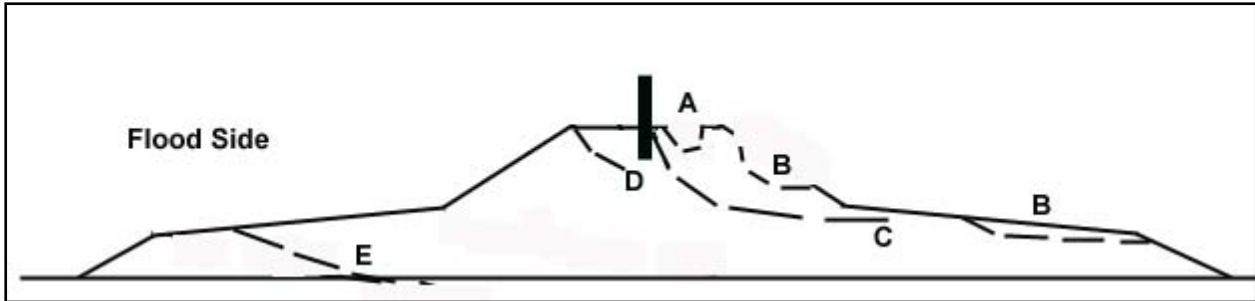

Figure 13-1. Erosion Progression Patterns for Earthen Levees, Floodwalls, and Exposed Sheetpile

Scour pattern “A” indicates scour located on the protected side levee slope (or located immediately adjacent to the floodwall or sheetpile protected side), “B” indicates erosion on the protected slopes including stabilizing transition slopes, “C” indicates erosion progressing to the levee crown and adjacent to the floodwall or sheetpile protected side, “D” indicates scour on both the flood side and the protected side of the levee or floodwall, and “E” indicates the original levee footprint has been significantly altered due to erosion and the original foundation base may have scour holes or washouts.

Concrete and Sheetpile Floodwalls

The majority of floodwalls and exposed sheetpile experienced scour pattern “A” on the backside. Figure 13-2 is a conceptual diagram illustrating the water overtopping plunging velocity and force of impact on the wall backside.

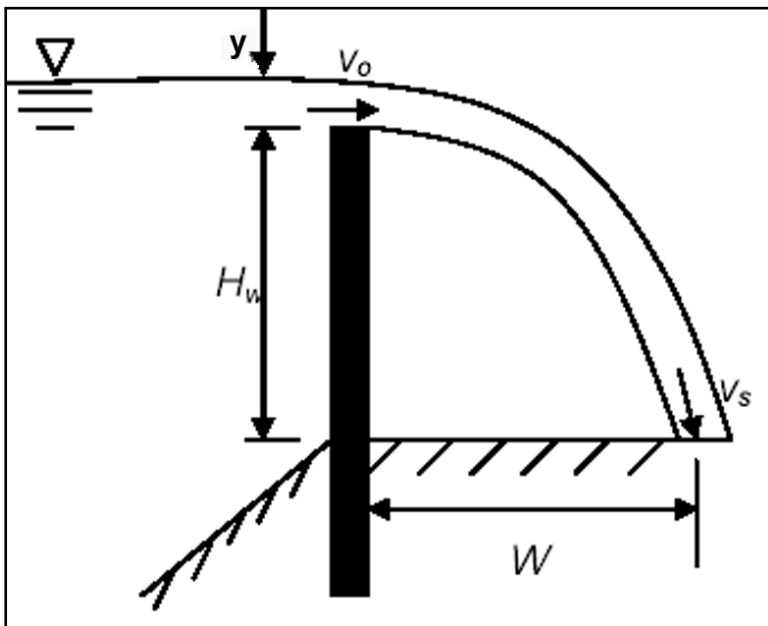

Figure 13-2. Conceptual Diagram of Water Overtopping a Floodwall or Exposed Sheetpile

Hydrodynamic analysis for floodwall overtopping assumes the floodwall acts as a weir, and the overtopping flowrate, velocity, and impact force (per unit length of floodwall) values are

derived accordingly. Figures 13-3 and 13-4 are diagrams of overtopping velocity and impact force impinging on the ground surface on the floodwall backside. These diagrams were developed from hydrodynamic relationships (Hughes 2006).

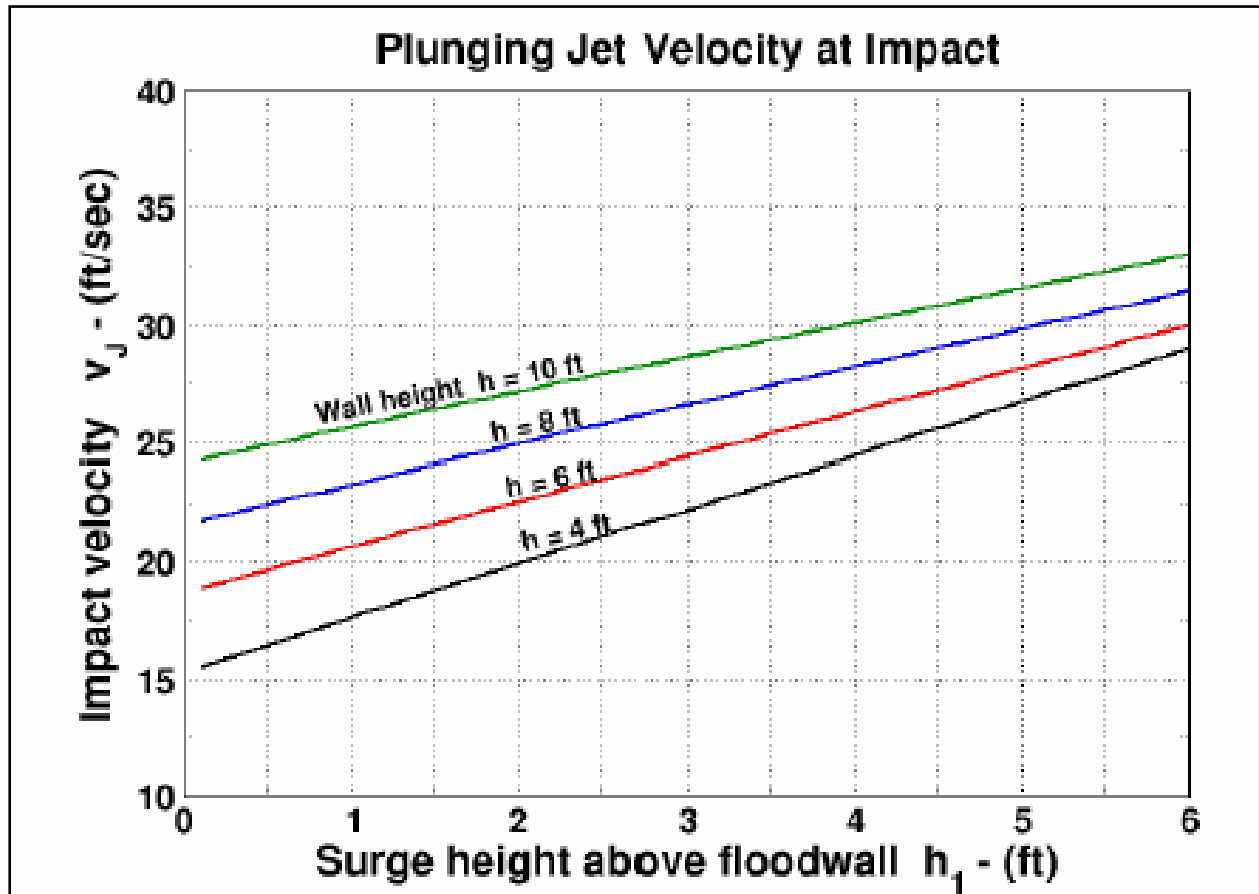

Figure 13-3. Ground Impact Velocity as a Function of Surge Height where $h_1 = y$ in Figure 13-2 (Hughes 2006)

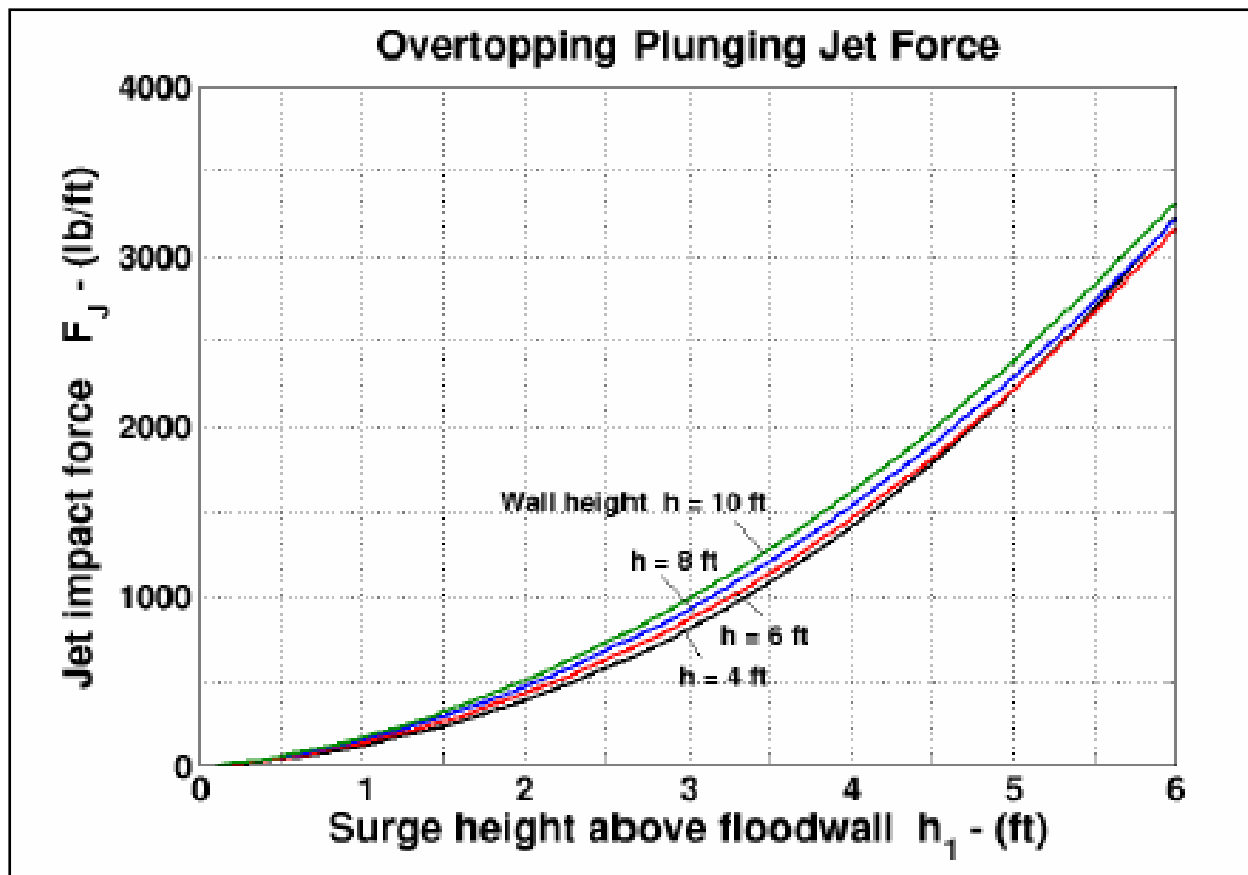

Figure 13-4. Ground Impact Force as a Function of Surge Height (Hughes 2006)

Figure 13-5 shows the I-wall along the east side of the IHNC at approximate B/L Sta 11+00 (DM3 Chalmette Area Plan), looking toward the Claiborne Avenue bridge. Depth of scour was to the bottom of the I-wall concrete cap (2 ft), and scour width was approximately 7 ft. The I-wall elevation was designed to height of 15 ft above mean sea level, the bottom of the concrete cap was elevation 7 ft, and the levee crown was elevation 9 ft. Actual wall height was reported to be 12.5 ft converted to local mean sea level, and the storm surge height was reported to be up to 15 ft. As an approximation of the overtopping water impact, a 2.5 ft crest of water cascaded from a 6-ft height onto the levee crown. Figures 13-3 and 13-4 show the estimated impact velocity was about 23 ft/sec and impact force was about 700 lb/ft. The water impact removed a portion of the levee crown, including all of the structural backfill zone adjacent to the concrete wall.



Figure 13-5. Scour Pattern "A" on East Side IHNC near N. Claiborne Ave. Bridge

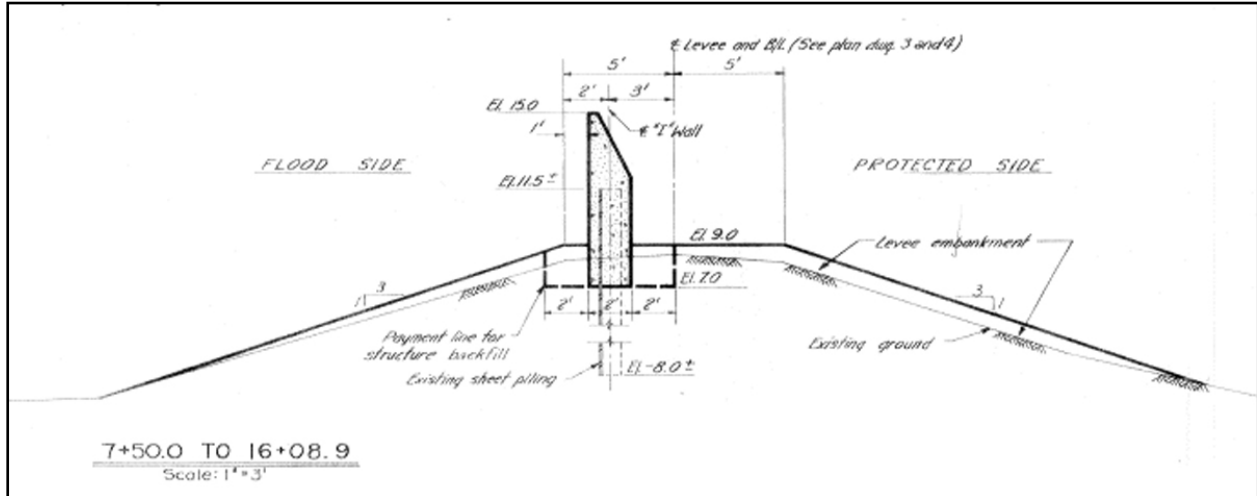

Figure 13-6. Existing Levee and I-Wall Drawing for IHNC East. Note that scoured soil included the "structure backfill" zone (from drawing file H-4-25157, IHNC East Levee from Lock to Florida Ave. Floodwall, sheet 12 of 15)

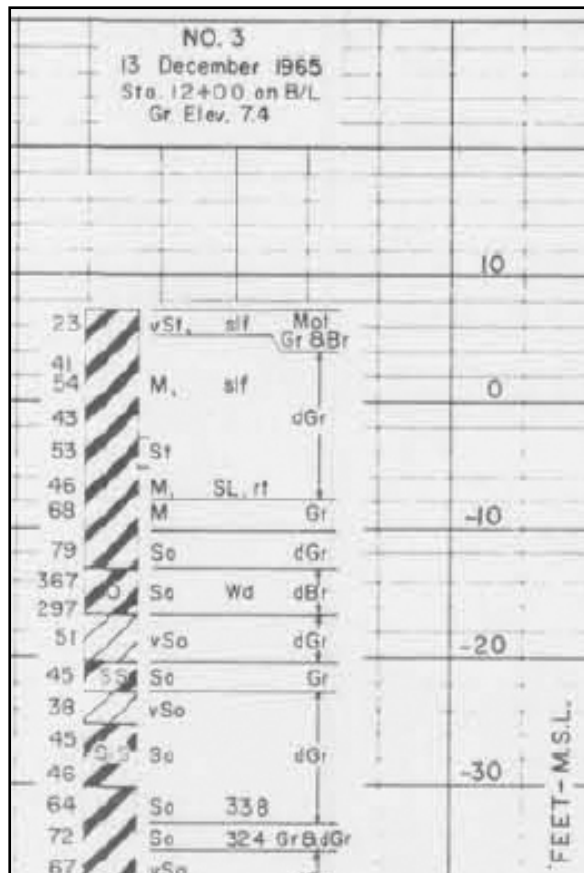

Figure 13-7. Nearest Soil Boring, No. 3, 100 ft Distant, Shows Fat Clay (CH) at Center Line Surface



Figure 13-8. IHNC East, Approximate B/L Sta 7+00 (DM3 Chalmette Area Plan), North of the Claiborne Avenue Bridge. Depth of scour was to the bottom of the I-wall concrete cap. I-wall elevation was designed 15 ft above mean sea level (MSL), bottom of concrete was elevation 7 ft (MSL), and levee crown was elevation 9 ft (MSL). Actual wall height was reported to be 12.5 ft converted to local mean sea level (LMSL), and storm surge height was reported to be up to 15 ft. As an approximation of the overtopping water impact, a 2.5 ft crest of water cascaded from a 6-ft height onto the levee crown. Nearby soil boring 2U (Figure 13-9) indicates the upper 5 ft was fat clay (CH) with sand / silt lenses

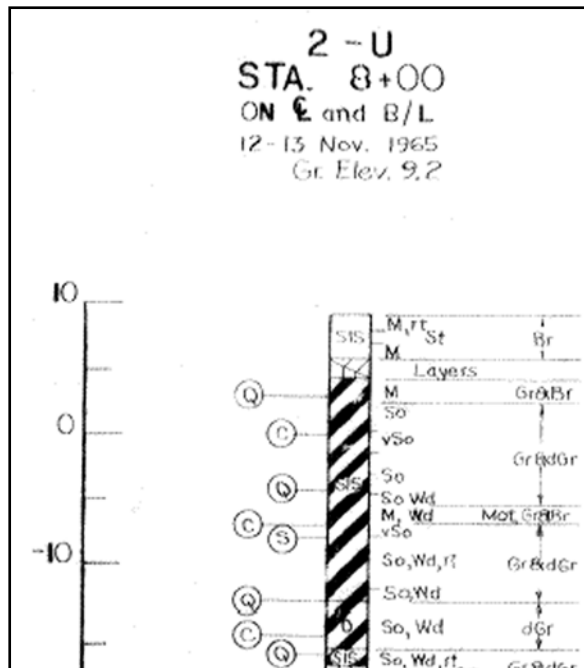

Figure 13-9. Undisturbed Boring 2U Located 100 ft to the North Shows Silt / Sand Lenses in Lean Clay in the Upper 5 ft. Undrained shear strength in the upper 3.2 ft was approximately 500 psf

Soil scour within the structure backfill zone is also evident at other locations such as the T-wall on the north side of Gate 13E on the east side of the IHNC near Lakefront Airport at approximate W/L Sta 61+38 (DM2 Supplement 8 IHNC Remaining Levees). The top of T-wall elevation is 13.25 ft (MSL) and the existing top of ground elevation was 0.1 ft (MSL), from drawing file H-2- 24111, plate IV-20. Scour depth was 30in and width was approximately 8 ft caused by a 13-ft overtopping water impact (Figure 13-10). Figures 13-3 and 13-4 show the estimated impact velocity was about 30 ft/sec and impact force was over 700 lb/ft.



Figure 13-10. T-Wall Base Scour on Backside, East IHNC Near Lakefront Airport

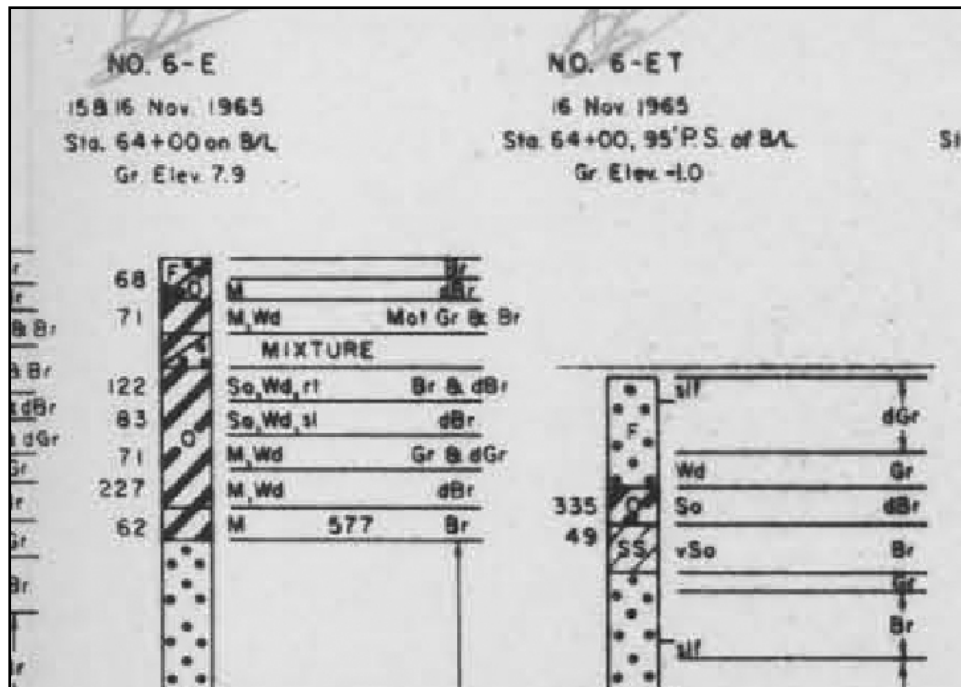

Figure 13-11. Nearest Soil Boring 6-E Shows Built-Up Levee at Elevation 7.9 ft (MSL), but Boring 6-ET, Offset 95 ft to the Protected Side of the B/L, Shows Original Ground Surface Elevation -1.0 ft (MSL) was Approximately a 10-ft Layer of Sandy Material (from drawing file H-2-24111, plate IV-34). The vertical and horizontal scour pattern indicates that the T-wall base structural backfill had lower erosion resistance than the original levee soil



Figure 13-12. Scour Along Lakefront Airport Floodwall Measures 305' (L) x 14' (w) x 48" (d). Existing levee crown appears to be composed of sandy material, based on visual observation. Nearby soil boring 1-C (5/29/1969) at Sta. 8+85, 57 ft right of B/L shows sand, silt, and lean clay lenses to 9-ft depth. Soil boring 4-A (11/3/1970) at Sta 18+00, 200 ft landside of B/L also shows sand, silt, and lean clay lenses to 9-ft depth



Figure 13-13. Lakefront Airport Floodwall. Scour is approximately 11 ft wide by 2 ft deep. Floodwall elevation is approximately 13.5 ft, ground elevation is approximately 6 ft, and wall height is approximately 7.5 ft



Figure 13-14. IHNC East, Approximate B/L Sta 101+00 (from drawing file H-2-24111, plate IV-23, DM2 Supp 8 IHNC Remaining Levees), North of Chef Menteur Hwy Bridge. Top of I-wall is elev 14.75, bottom of concrete is elev 7, and levee crown is elev 9. Nearest B/L boring is Sta 96+00 (No. 9EU), 500 feet distant. Approximate storm surge impact was a 2.5-ft water crest cascading over the 6-ft concrete wall. Note that the scour was deeper than the concrete base, indicating that the structural backfill and the original levee material eroded

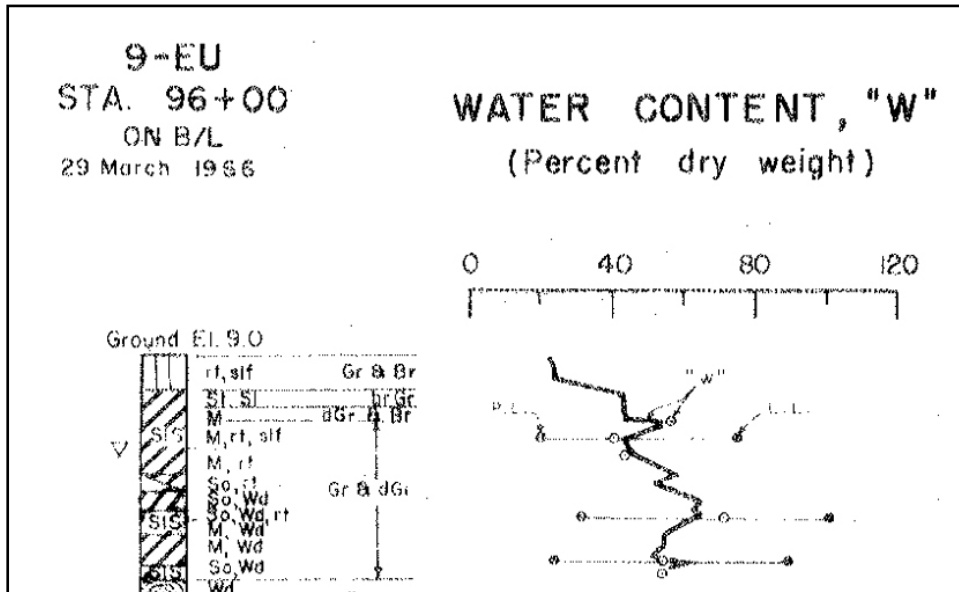

Figure 13-15. Boring 9EU (Sta 96+00 B/L, East Side IHNC) Shows a Top Layer of Silt at Levee Crown Elevation 9 ft, Possibly Explaining the Low Erosion Resistance of the Original Levee Material



Figure 13-16. IHNC West Side Between Chef Menteur Hwy. and Hayne Blvd, Approx 8400 LF. Top of I-wall elevation is 14.75 ft(MSL), bottom of concrete is elevation 7 ft (MSL), and levee crown is elevation 8 ft (MSL). Borings in this reach (B/L Sta 31+06 to Sta 109+00, borings 1W to 14W) show the top 2 ft to 3 ft layer at crown elevation is composed of sandy and/or silty soil instead of fat clay



Figure 13-17. Scour at T-Wall Base of Gate W23, West Side IHNC



Figure 13-18. IHNC West Side, View South from Benefit St. Gate Toward France Rd Ramp. Approximate W/L Sta 5+56 (B/L Sta 205+44). Top of I-wall elevation 15 ft, levee crown 9 ft, bottom of concrete 7 ft, bottom of pre-existing Z-27 sheet pile (installed by the Orleans Levee Board) at -10ft (MSL). From drawing file H-2-24111, plate IV-15. Nearest soil boring (Figure 13-19) is 30W at B/L Sta 203+00. The I-wall rotated and floodside levee deformation occurred, probably as a result of sheetpile rotation opening up a floodside tension crack. This picture represents scour pattern "C" which is a pre-breaching failure mode

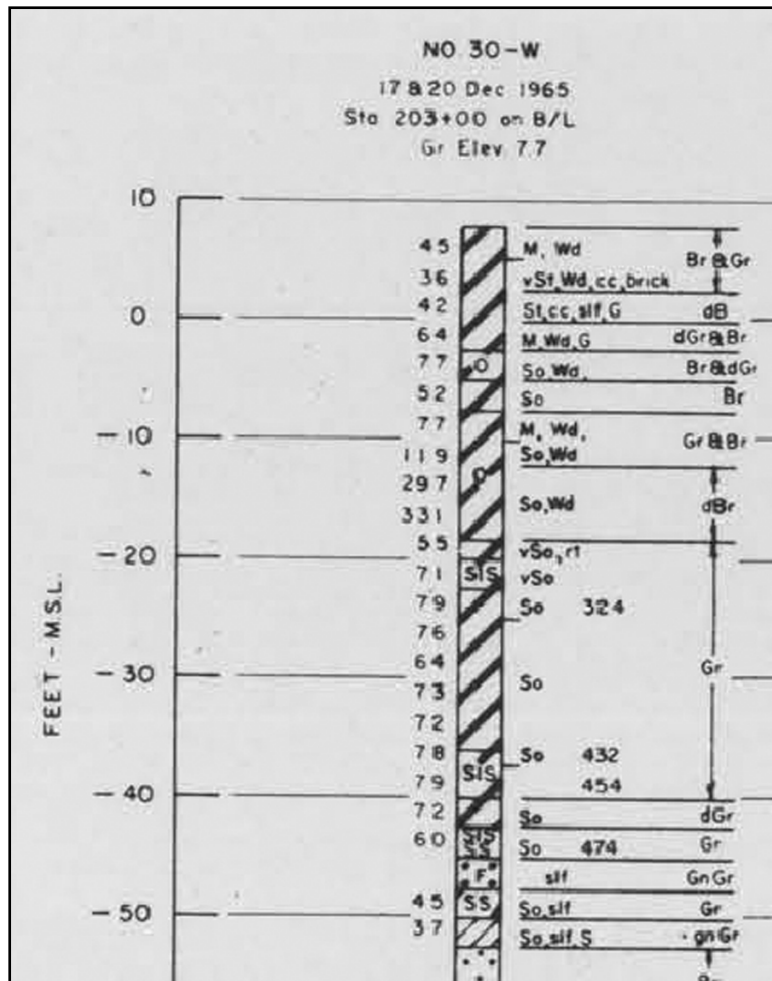

Figure 13-19. Boring 30W About 300 ft from Benefit St Gate Shows Fat Clay Soil Layers in Pre-1965 Levee

Exposed sheetpile reaches along the MRGO in St. Bernard Parish (Chalmette and Chalmette Extension Hurricane Protection Plans) experienced scouring on the backside, and several locations were breached.



Figure 13-20. View Looking Southeast from the Bayou Bienvenue Control Structure Showing Backside Scour Beyond the Structure

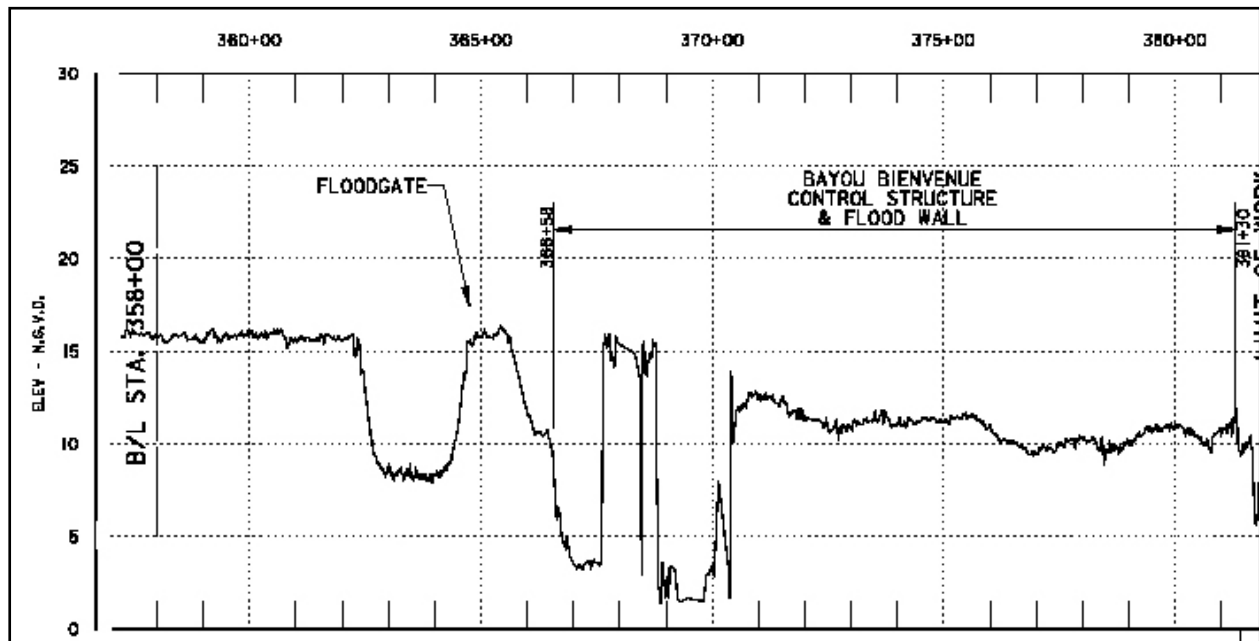

Figure 13-21. Centerline Scour Depths of Floodgate and Control Structure (from dwg 1 of 8, Emergency Restoration B/L 383+00 to 704+00 contract solicitation)

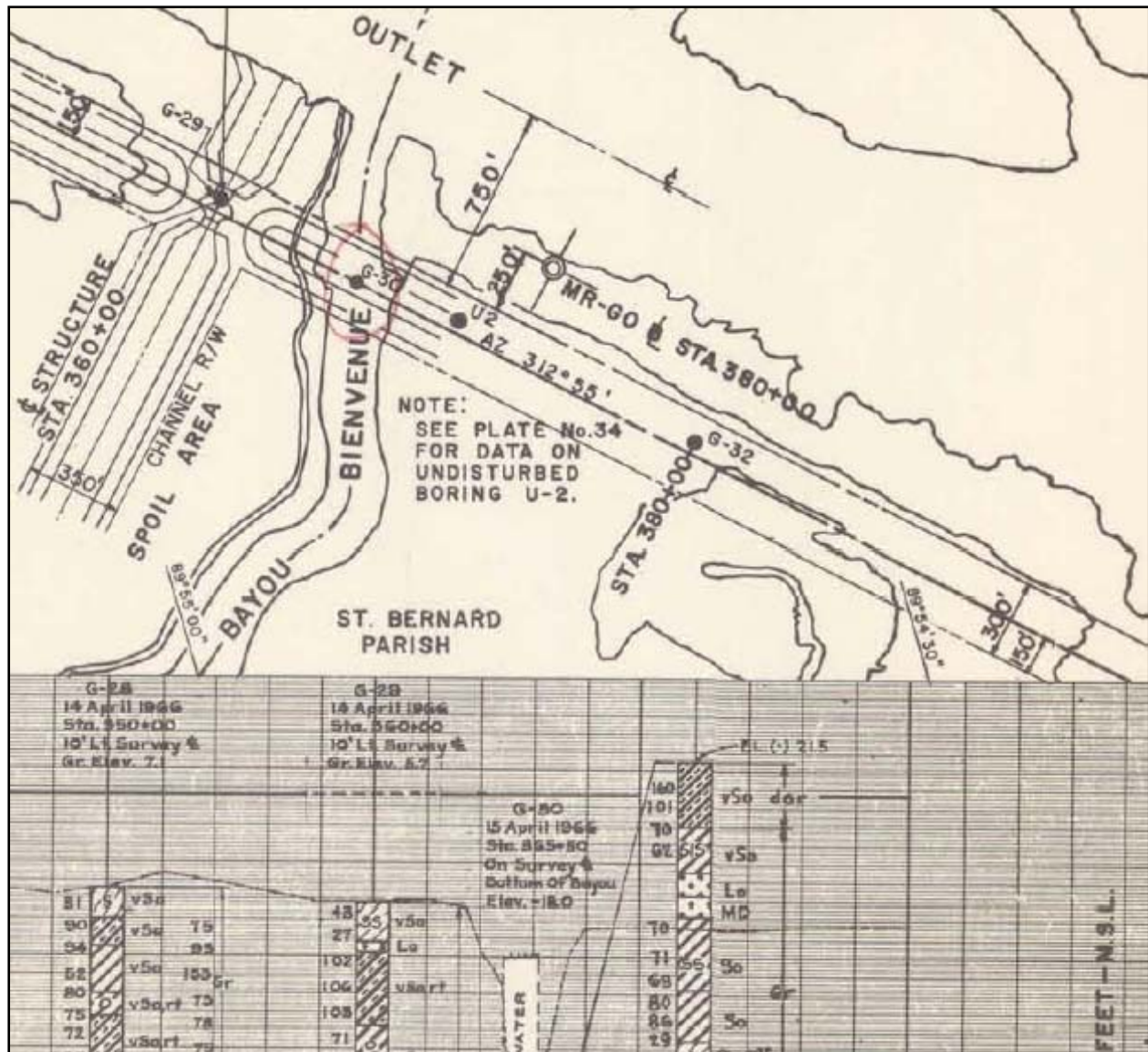

Figure 13-22. Original Ground Surface (1966) Had Sand / Silt Lenses Overlying Very Soft Organic Clay (plate 10, DM3). Note that the sheetpile east of structure (Figure 13-20 above) was driven to cut off the old Bayou channel in addition to reducing loading on the top layer of very soft organic clay seen in boring G-32.

Figure 13-23 shows a section with 4300 ft of exposed sheetpile damage along MRGO between Bayous Bienvenue and Dupre, St. Bernard Parish. The damaged sheetpile section is near utility crossings, with scour on the protected side and levee crown. B/L Sta 590+70 is centerline of the two pipelines.



Figure 13-23. Pattern "A" Scour on the Backside of Exposed Sheetpile Wall Along the MRGO South Bank in St. Bernard Parish

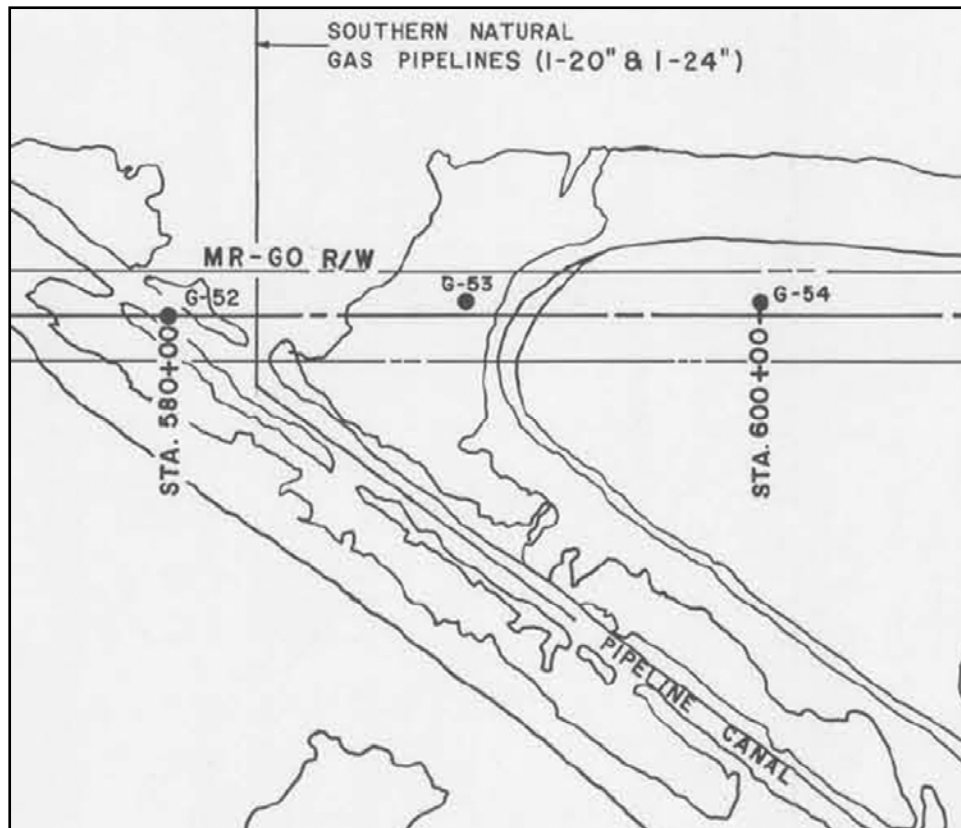

Figure 13-24. Original Pipeline Canal Prior to Backfilling and Sheetpile (from drawing file H-2-23820, plate 13)

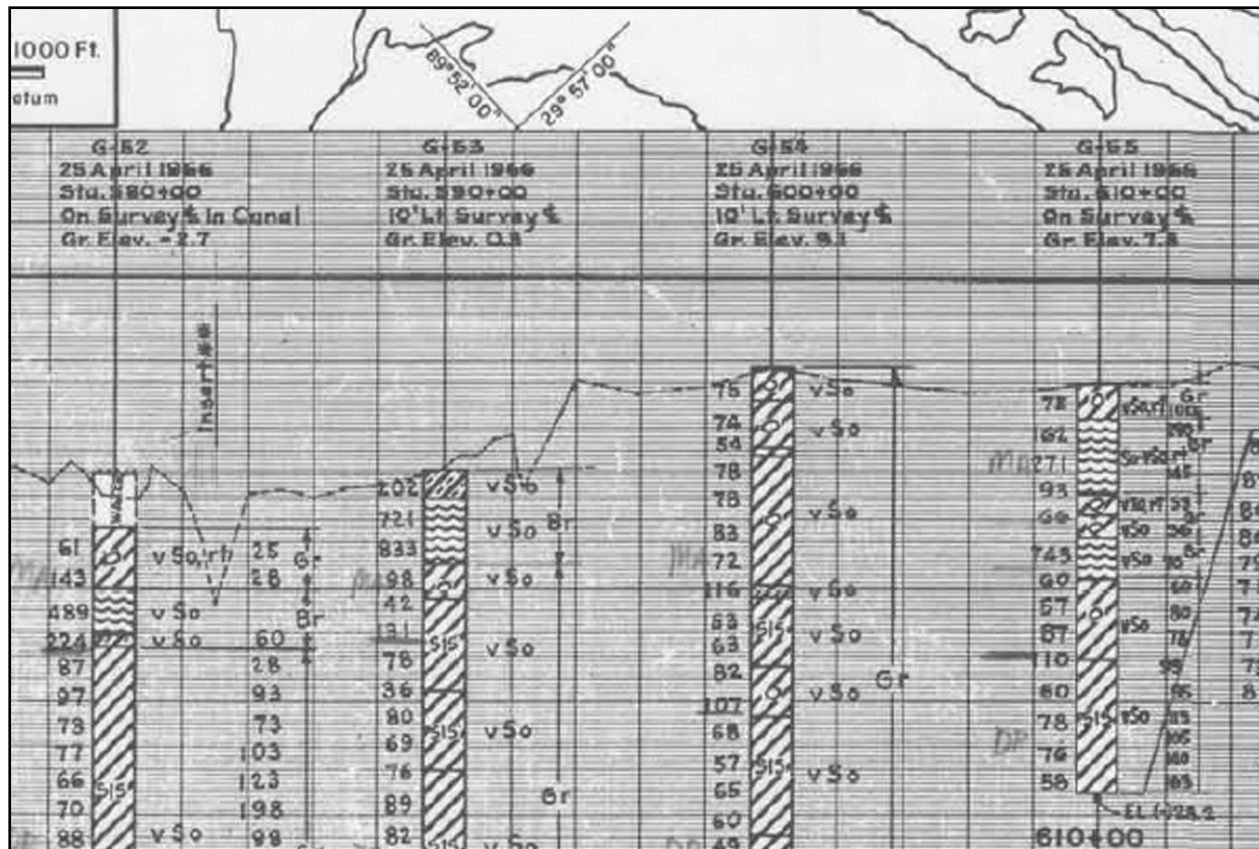

Figure 13-25. Adjacent Borings Show Very Soft Fat Clay and Peat Layer Stratification

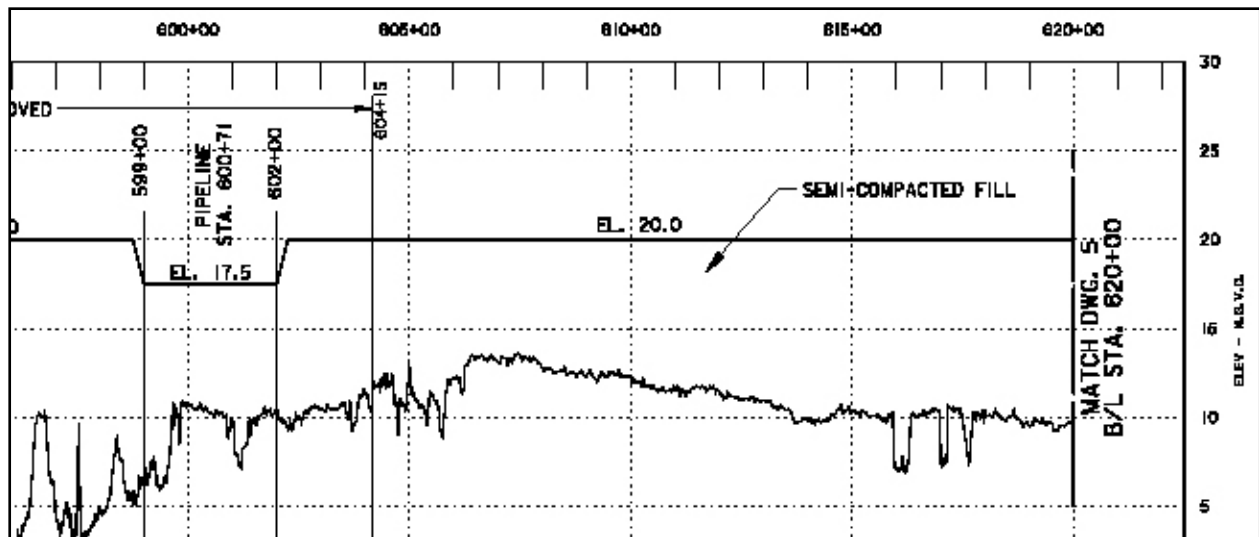

Figure 13-26. Scour Depths and Levee/Sheetpile Elevations Between B/L Sta 600+00 to 620+00 (from SB04 Contract Solicitation W912P8-05-R-0063, B/L 383+00 to 704+00 Emergency Restoration)



Figure 13-27. Closeup of Adjacent Breached Sheetpile with Backside Scour. Note the stratified layers in the soil profile representing existing hydraulic fill historically dredged from the MRGO



Figure 13-28. Sheetpile Between Bienvenue and Dupre Control Structures. Note the sheetpile elevation differences

Soil boring 18-UBD (91-02) from 1991 at B/L Sta 596+00 shows the top 5.8 ft of levee (at elevation 14.4) was composed of sandy silt (SM), with CH layers underneath. At a depth of 12 ft below the crown, a shear Q test indicated cohesion value 396 psf at 27% water content and 95 pcf dry density in a CL layer.



Figure 13-29. Sheetpile Reach Along the MRGO Southeast of Bayou Bienvenue at Approximate B/L Sta 600+00. Top of sheetpile was elevation 17 ft (MSL) and levee crown elevation was approximately 12 ft (MSL), for an exposed sheetpile height of approximately 5 ft. Storm surge on the MRGO was approximately 18 ft, resulting in approximate overtopping velocity of 20 ft per second with approximate 250 lbs/ft impact force. The end of the sheetpile section with transition to the severely eroded levee is approximate B/L Sta 604+15

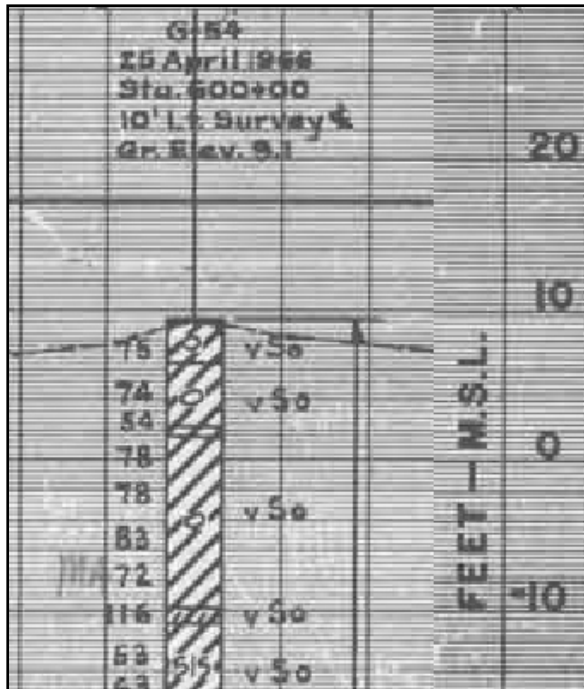

Figure 13-30. Nearest Boring at 10 ft Offset from B/L Sta 600+00 (from drawing file H-2-23820, plate 13) Shows 1966 Hydraulic Fill (dredge spoil) Surface at Elevation 10 ft Was Very Soft Fat Clay

Soil boring 13BU-CHBD (01-16834) taken in 2001 at Sta 614+00 (Martello Castle) shows the top 25 ft of levee (elevation 15.4) was composed of fat clay (CH), with organic clays and peats underneath. At a depth of 5 ft below the crown, a shear Q test indicated cohesion value 632 psf at 29% water content and 92 pcf dry density in the CH layer.



Figure 13-31. Exposed Soil Layer (final eroded surface) on Sheetpile Wall Backside Appears to be In-Situ Fat Clay with Embedded Shell Hash, Possibly an Exposed Estuarine Deposit

Large breaches along sheetpile reaches and scour patterns resembling “C” and “D” (from Figure 13-1) were evident on the north bank of the GIWW, including the Bulk Loading Facility, the Michoud Canal (Air Products plant), and pump station 15.

Figure 13-32 shows the Air Products plant breach near Sta 772+00 B/L (New Orleans East Back Levee). Scour depths were 10 to 12 ft on both floodside and protected side of the sheetpile wall. Nearest borings (Figure 13-29) on either side of the failure, 5-E and 6-E (from plate 5, DM2 Supp 4, March 1971) shows CH material with sand / silt lenses in the pre-existing (1965) levee at crown elevation ~12 ft, prior to construction of the sheetpile wall. The storm surge in the GIWW was approximate elevation 15 to 17 ft, and Figures 13-3 and 13-4 show the estimated impact velocity ranged up to about 23 ft/sec and impact force ranged up to about 700 lb/ft. Note that the breach occurred in the sheetpile reach, not along the adjacent transitions to earthen levee on the east side and connection to the T-wall on the west side.



Figure 13-32. Air Products Sheetpile Breach

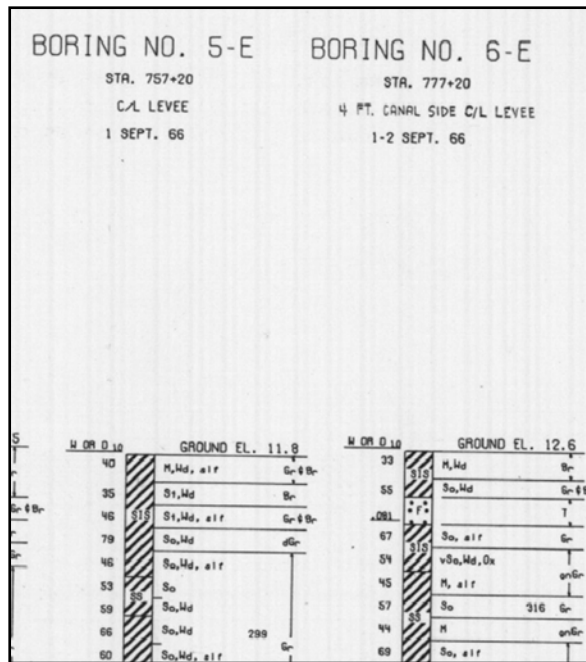

Figure 13-33. Nearest Borings on Either Side of the Breach, 5-E and 6-E (from plate 5, DM2 Supp 4, March 1971) Show CH Material With Sand / Silt Lenses in the Pre-Existing (1965) Levee at Crown Elevation ~12 ft, Prior to Sheetpile Wall. Storm surge in the GIWW was approximately 15 to 17 ft elevation



Figure 13-34. Bulk Loading Facility I-Wall Breach (2000' near Elaine St. at GIWW, near Sta 271+55 B/L, Citrus Back Levee, north bank GIWW). Scour depths were 6 to 10 ft on both floodside and protected side of the I-wall. Pre-existing wall elevation was approximately 15 ft (MSL), and levee elevation was approximately 9 ft (MSL), for an exposed wall height of approximately 6 ft. Storm surge ranged from elevation 15 to 17 ft



Figure 13-36. New Orleans East Basin, Pump Station 15 on the North Bank GIWW. Failed sheetpile between B/L Sta 874+40 and Sta 875+60 (N.O. East Back Levee). Pre-Katrina elevations ranged from 17.5 to 19.5 ft in this reach

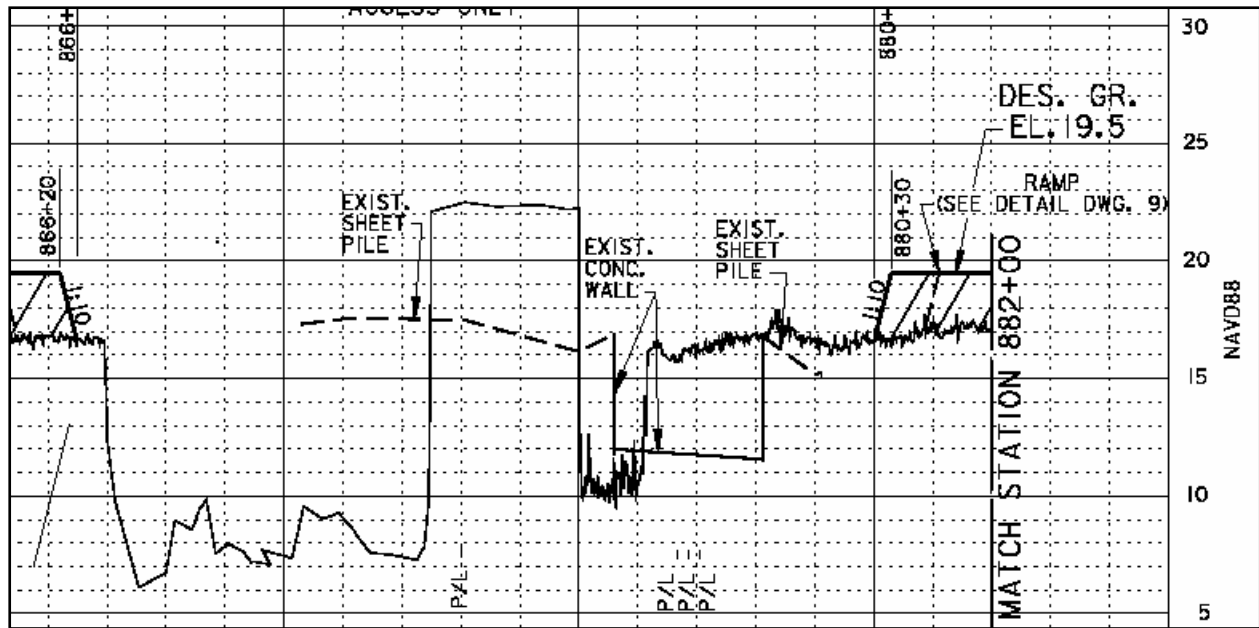

Figure 13-37. Plan and Post-Damage Scour Profile Immediately West of Pump Station 15 (from Contract Solicitation NOE1 drawing H-8-45594, sheet 3 of 16)

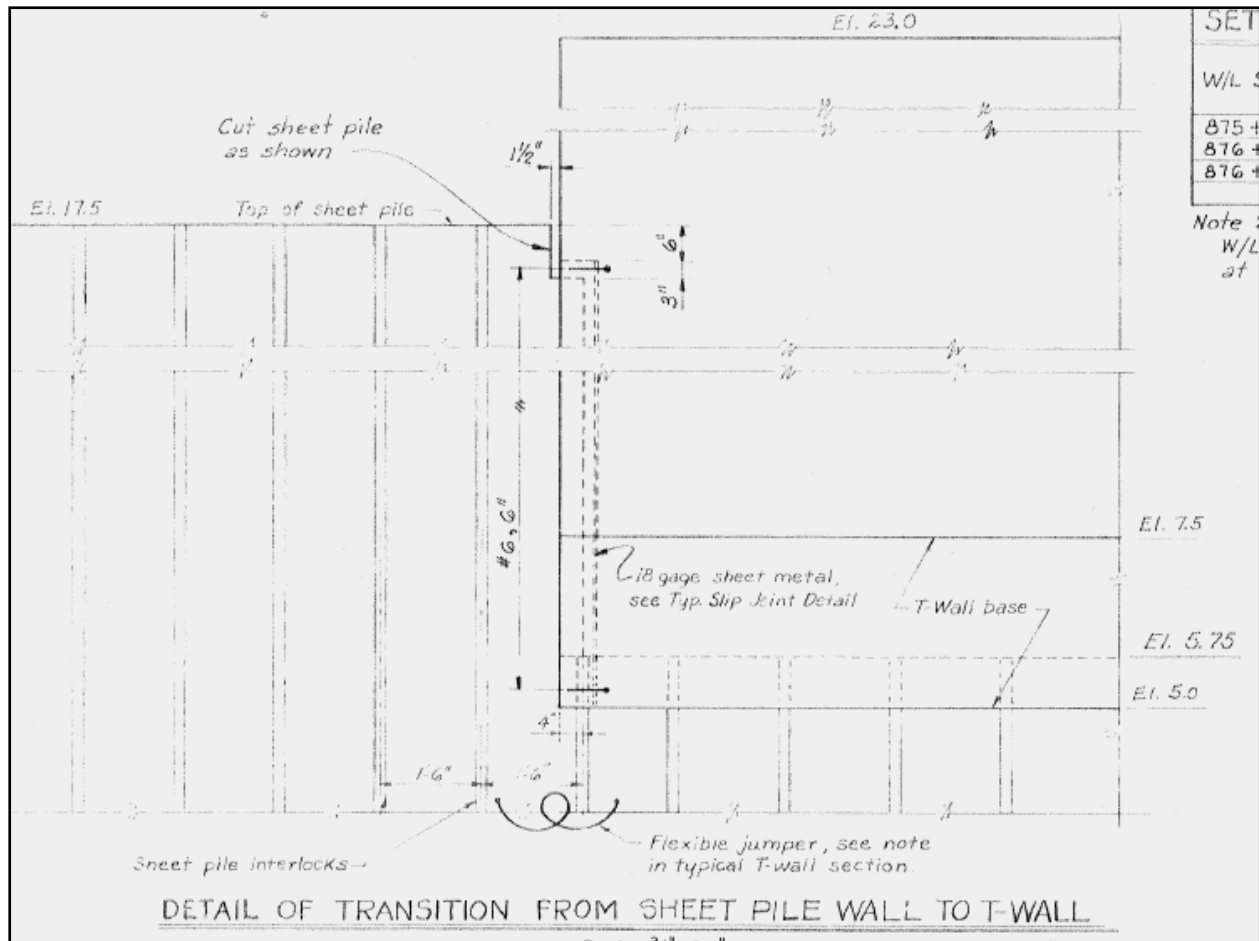

Figure 13-38. Pump Station 15 Top Elevation Difference of 5.5' Between Sheet Pile and T-Wall (plate 14 of 16 from Contract DACW29-77-C-0037, Mod P00001). If pre-Katrina sheetpile elevation was 17.5 ft and storm surge in the MRGO/GIWW was up to 18 ft, then there was minimal overtopping, and the sheetpile breach may have had contributing factors other than overtopping scour

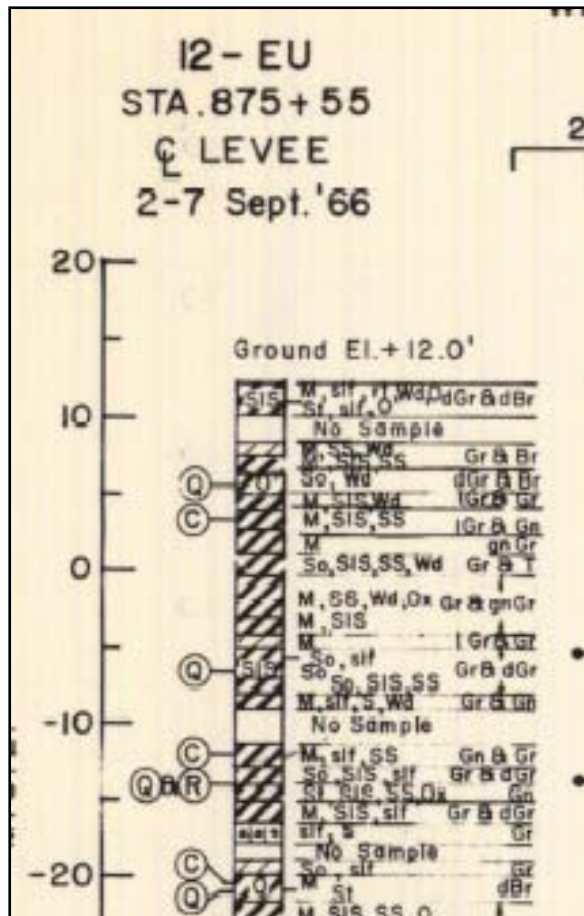

Figure 13-39. Pump Station 15 Nearest Boring 12EU Shows Levee Crown Elevation at 12 ft (MSL) with Fat Clay / Sand / Silt Lenses Overlying Lean Clay (CL) in the Upper 5 ft (from drawing file H-2-24625, plate 3)

Several floodwall (I-wall) reaches were catastrophically breached along the 17th St. and London Ave. canals and the IHNC (east and west sides). It is likely that failure modes other than erosion may have played larger roles at those locations.

Earthen Levees

Soil material properties greatly influence erodibility and erosion progression rate during overtopping. Cohesive (silt and clay) soils erode due to the formation and migration of a headcut perpendicular to the levee axis (i.e. across the levee section from the backside to the floodside). A headcut is a vertical or near-vertical elevation drop, and migrates upstream due to hydraulic stresses at the overfall, base seepage, weathering, and gravity (Hanson et al 2001). Sandy (non-cohesive) soil erosion involves a sediment transport process as the material is removed in layers. Cohesive soil erosion rates are more strongly influenced by soil material properties such as water content, density, erodibility, shear strength, and compaction effort during construction. For example, it was found that only a 5-point (5%) decrease in compaction water content caused a 100-fold increase in the breach widening rate for clay soil (Hanson et al 2003).

Figure 13-40 shows a generalized cross sectional diagram of an overtopped levee (wave dynamics are not illustrated). The water crest height (y) and mean velocity (v) impart a shear stress (τ) on the backside levee surface having a slope gradient (S). The majority of levees have slope gradients of 1V:3H ($S = 0.33$) or 1V:4H ($S = 0.25$).

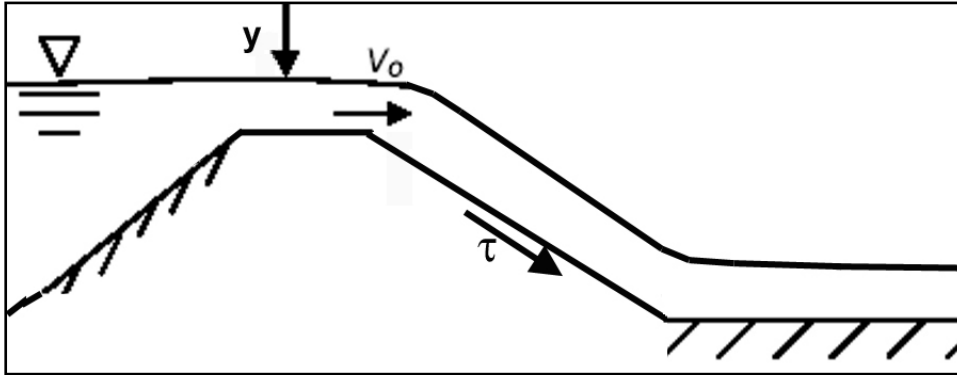

Figure 13-40. Conceptual Diagram of Water Surge (without waves) Overtopping an Earthen Levee

Overflow velocity and soil shear stress values may be estimated by making simple assumptions regarding the flow regime and using the following equations (Vennard and Street 1975). Assuming the Manning coefficient (n) for grassed levees is approximately 0.03, the friction factor (f) may be estimated as

$$f = 258 (0.03 / 1.49 y^{0.16})^2 \text{ where } y = \text{approximate overtopping crest depth, ft}$$

and

$$v = (258 / f)^{1/2} (Sy)^{1/2}, \text{ ft/sec}$$

For example, the approximate friction factor and overtopping velocity on a 1V:3H grassed slope with crest height of 1 ft is:

$$f = 0.1$$

and

$$v = 29 \text{ ft/sec}$$

Soil shear stress (τ) is idealized by the equation

$$\tau = \gamma y S, \text{ where } \gamma = \text{unit weight of water}$$

For example, the idealized shear stress imposed by a water depth of 1 ft on a 1V:3H slope is:

$$\tau = \gamma y S = (63)(1)(0.33) = 21 \text{ psf}$$

These equations are listed only for the purpose of generally estimating the magnitudes of shear stress and overflow velocity for ideal flow. The actual shear stresses and overflow velocities were different due to numerous non-ideal variables (turbulence, non-uniform flow fields, and wave dynamics) present during the hurricane.

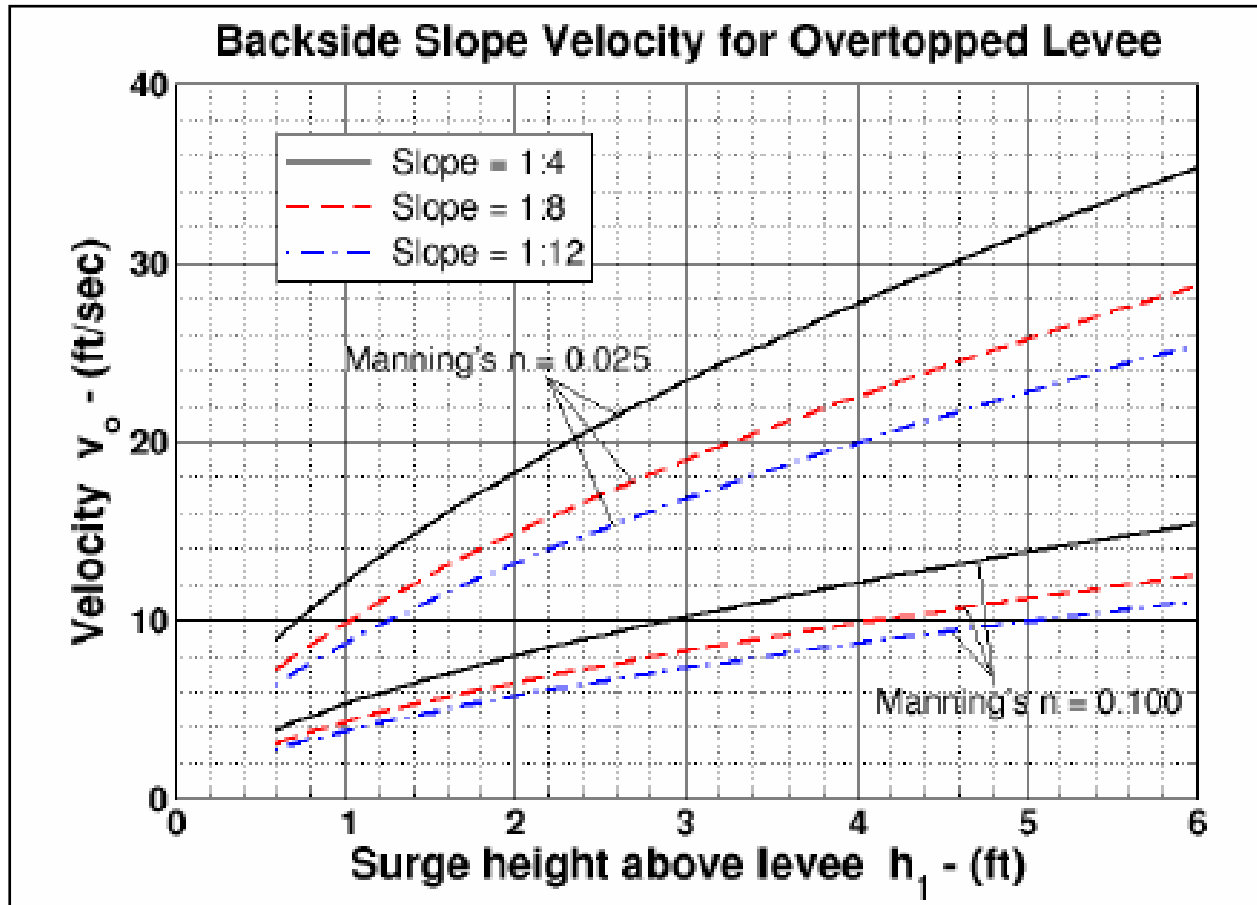

Figure 13-41. Overtopping Velocity as a Function of Surge Height ($h_1 = y$ in above equations) (Hughes 2006)

Erosion pattern “B”

Initial overtopping causes surface sheet and rill erosion which develops into a series of cascading overfalls. The highest forces develop from the backside slope down to the backside toe, and the crown is not initially exposed to these large hydraulic forces. The cascading overfalls develop into one large headcut that migrates from the slope to the crest such that the erosion width approximately matches the overtopping width (Hanson et al 2001).

Figures 13-42 and 13-43 show examples of initial overtopping erosion on the Citrus Back Levee backside along the north bank of the GIWW in New Orleans East. The levee crown was elevation 14 to 15 ft and storm surge was 15 to 17 ft from the GIWW, so the overtopping crest

depth was approximately 1 to 2 ft. Approximate surge velocity down a 1:4 slope was 40 fps with shear stress 30 psf. Soil borings along this reach indicated non-homogeneity in the surficial layers of the levee crest and slopes, and cohesive soils with interbedded layers of silt and/or sand were typical.



Figure 13-42. Backside Levee Erosion Pattern “B” on the Citrus Back Levee, N.O. East



Figure 13-43. 600' Reach of Levee Along the North Bank of the GIWW (Citrus Back Levee, New Orleans East) Between Elaine Pump Station and Paris Road

Figure 13-44 shows a closeup of landside slope scour between the Highway 47 (Paris Rd) overpass and the Elaine Pump Station from the north bank of the GIWW protected side looking east (Citrus Back Levee, New Orleans East). Erosion damage measured 24' (length) x 13' (width) x 8" (depth). Note the headcut that developed up the slope toward the crest.



Figure 13-44. Closeup of Landside Slope Erosion at N 30deg 0 min 2.29sec W 89deg 58min 27.29sec

There is a possibility that the Figure 13-44 erosion was pre-Katrina, as seen in pre-Katrina satellite photo below (Figure 13-45).



Figure 13-45. Possible Pre-Existing Surface Erosion on Levee Slopes Along the North Bank of the GIWW (Citrus Back Levee) at N 30deg 0 min 7 sec W 89deg 58min 31 sec. (pre-Katrina image from GoogleEarth website). Possible erosion is evidenced by vegetation distress and bare spots along the levee

Figure 13-46 shows backside slope erosion and minor erosion on the stabilizing berm slope along the south bank GIWW levee between Sta. 65+008 and STA. 277+20 in St. Bernard Parish. The General Design section for the south bank GIWW indicated that the levee was built to approximate elevation +14 ft. circa 1970, and an additional lift up to elevation 19 was added circa 1985 (Figure 13-47). Post-Katrina LIDAR along the south bank GIWW shows the uneroded levee crown was up to approximate elevation 16 ft (Figures 13-48 and 13-49). Storm surge along the GIWW was approximately 15 to 17 ft, causing an estimated overtopping depth of approximately 1 to 2 ft and an approximate overtopping velocity of 40 fps. Drawing 9 of 19, New Orleans District file H-8-45533, shows several layers of hard lean clay (CL) at centerline top of levee (boring elevation 16.8 ft) from the 5/11/2000 soil boring 5A-CAU, B/L Sta 135+50 (Figure 13-51).



Figure 13-46. Scour on the Backside of the South Bank GIWW Levee Between STA. 65+008 and STA. 277+20, St. Bernard Parish, Minor Scour on the Protected Side Levee Transition Slope. The Paris Rd (I-510) high rise bridge is over approximate B/L Sta 270+00

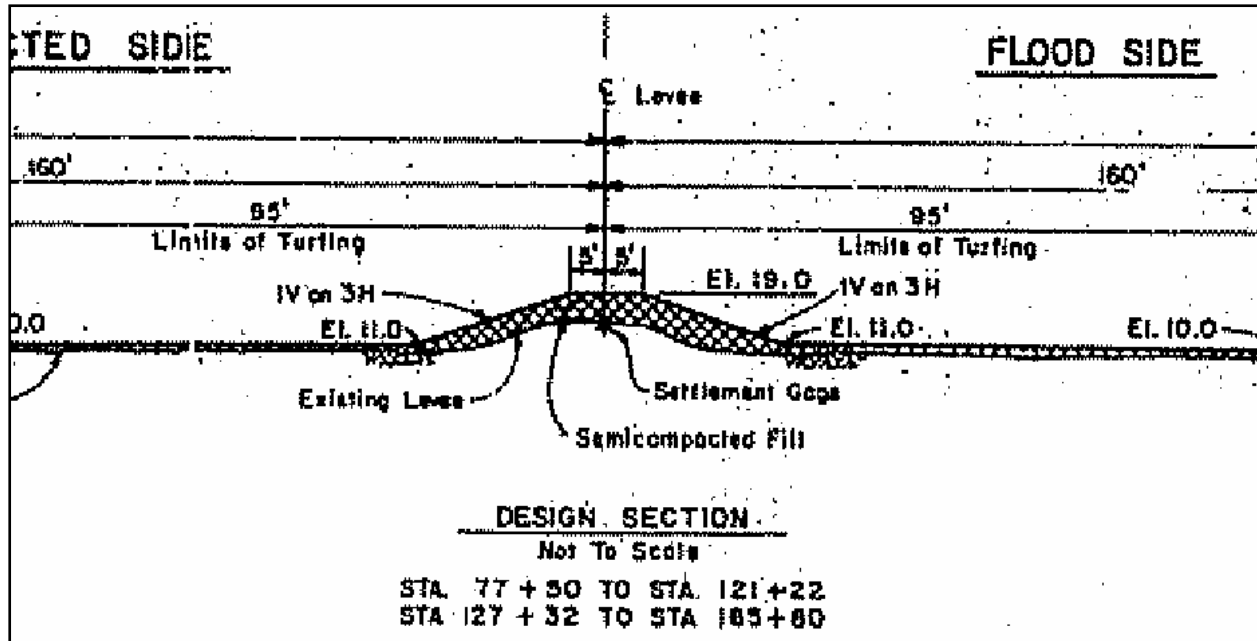

Figure 13-47. Design Section for South Bank GIWW Levee Enlargement in 1985. Levee was built to approximate elevation +14 ft. circa 1970. Additional lift up to elevation 19 was added circa 1985. Post-Katrina LIDAR along the south bank GIWW shows the unscoured levee crown was up to approximate elevation 16 ft. Storm surge along the GIWW was approximately 15 to 17 ft, causing an overtopping crest of 1 to 2 ft

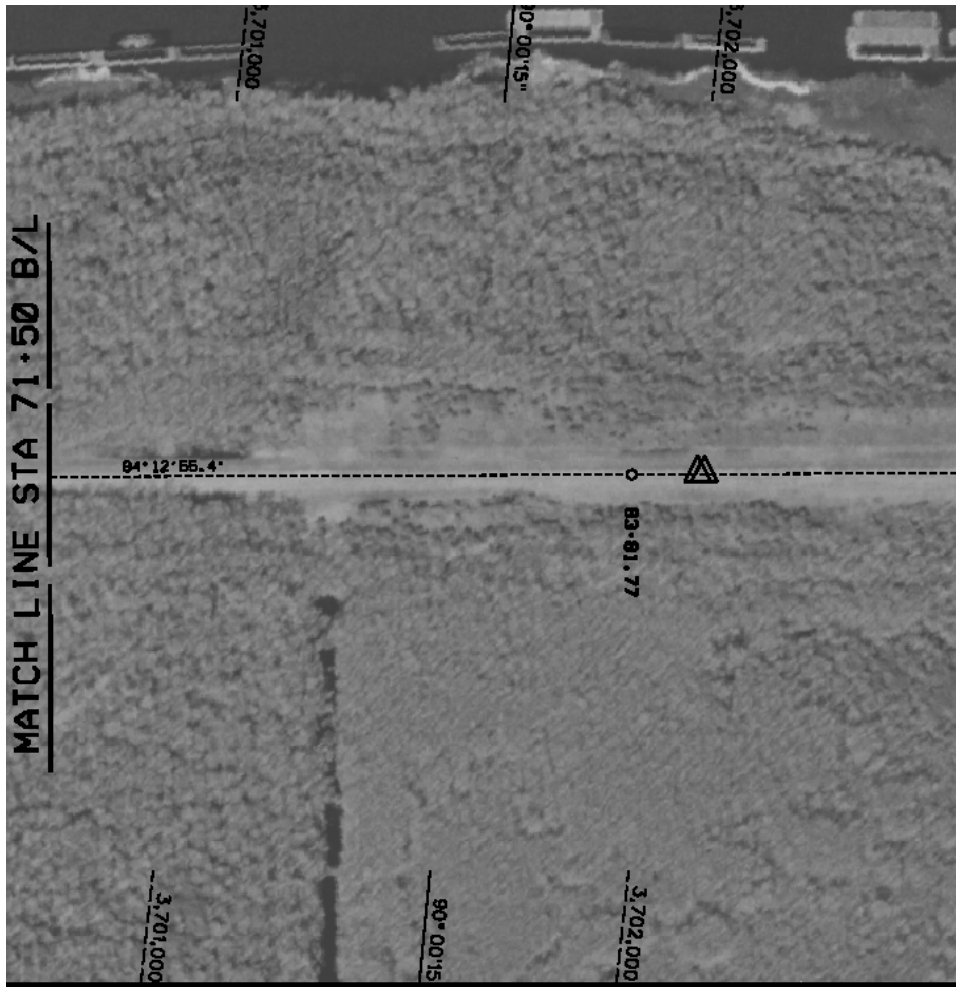

Figure 13-48. Scour Damage (Marked with Triangle) Identified East of B/L Sta 81+50 (from TFG Contract Solicitation W912PB-06-R-0022, drawing 3 of 12)

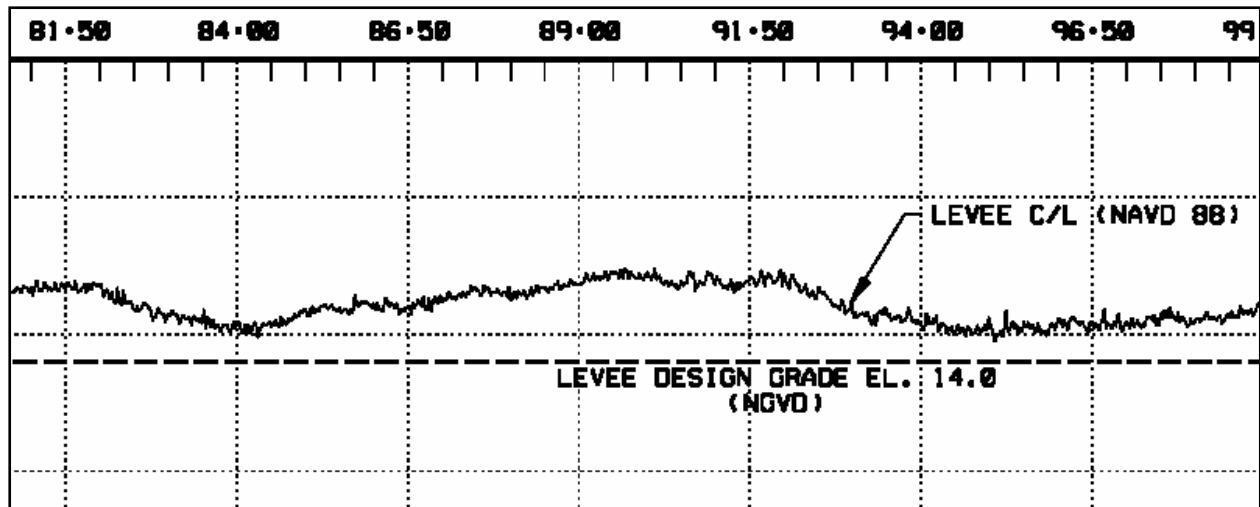

Figure 13-49. Levee Profile East of B/L Sta 81+50 (dwg 3 of 12). Note design grade elev 14 (NGVD) and lidar post-Katrina elev between 14 and 16 (NAVD 88). Also note crown grade change up to 2 ft along this 1750-ft reach

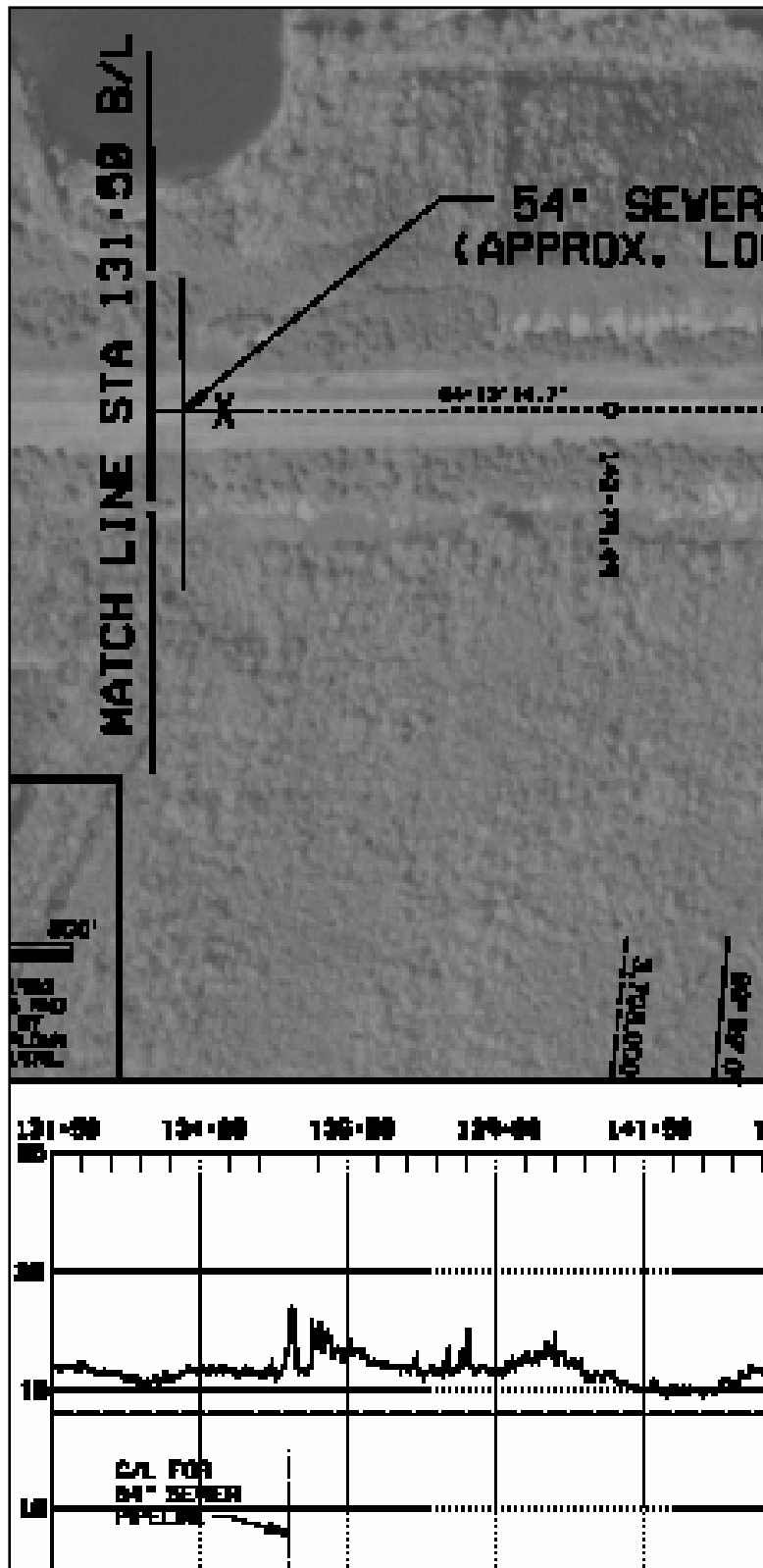

Figure 13-50. A Minor Scour Location on St. Bernard Parish South Bank GIWW Levee (marked with X) at B/L Sta 135+00 (from dwg 4 of 12, Contract Solicitation W912P8-06-R-0022)

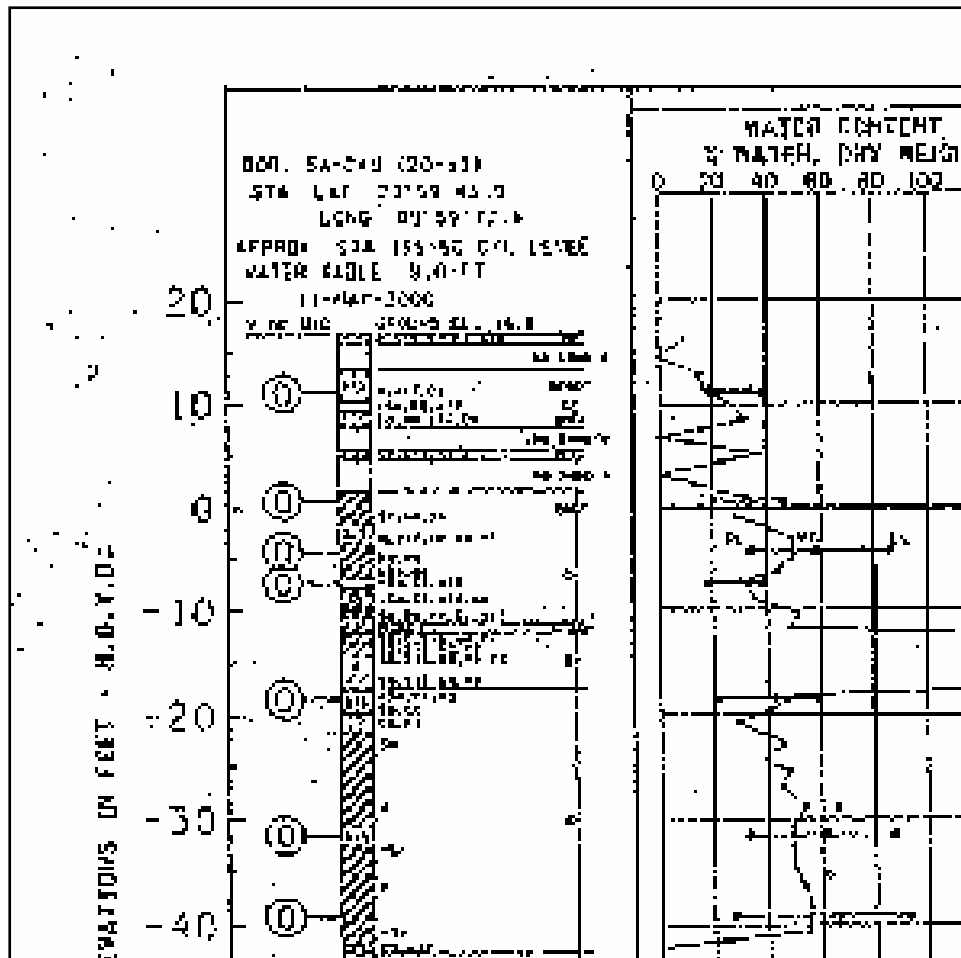

Figure 13-51. Dwg 9 of 19, New Orleans District file H-8-45533 Shows Several Layers of Hard Lean Clay (CL) at Centerline Top of Levee (boring elevation 16.8 ft) from the 5/11/2000 Soil Boring 5A-CAU, B/L Sta 135+50



Figure 13-52. New Orleans East Bank Lake Pontchartrain Floodwall Scour, 20ft long x 10ft wide x 2ft deep. GPS coords N90 deg 05min 17.3 sec, W30deg 01 min 39.3 sec

Erosion pattern “C”. The headcut continues to migrate from the backside crest (crown) to the floodside crest.

Figure 13-53 shows a short levee section with progressive erosion on the west side of the IHNC protecting the container terminal between France Rd. and IHNC. The headcut extends to the top crest elevation, and was beginning to cut through the crown. Although the nearest historical boring pre-dates the levee (Figure 13-54), the unscoured soil surface appears to be a fat clay and the eroded soil visually appears to be a shell hash mixture of clay and oyster shell fragments.



Figure 13-53. Eroded Levee Crown on the IHNC West Side at Container Facility



Figure 13-55. Levee with Eroded Crown Between Bienvenue and Dupre Bayous, View South From Approximate B/L Sta 570+00. MRGO is to the Left of Photo

Soil boring 12BU-CHBD (01-16834) from 2001 at Sta 570+00 (Martello Castle) shows the top 1.4 ft of levee (elevation 16) was composed of lean clay (CL), with CH layers underneath. At a depth of 8.5 ft below the crown, a shear Q test indicated cohesion value 270 psf at 51% water content and 68 pcf dry density in a CH layer. At a depth of 16.8 ft, cohesion was slightly higher (396 psf) at 62% water content and 62 pcf dry density, also in a CH layer.

Erosion pattern “D”. The crest drops as a breach begins to develop.

Figures 13-56 through 13-58 show progressive crown scour along approximate B/L Sta 1203+00 to Sta 1230+00 on the St. Bernard levee between the MRGO and the Mississippi River. Crown elevation was approximately 15 ft, but dropped to about 12 ft for about a mile in this eroded section. The levee along this reach was constructed of Mississippi River hydraulic sand fill, capped with local borrow material fat clay interbedded with silt and/or sand lenses, and shaped to grade with Mississippi River batture soil (truck-hauled fill). Similar to other levee’s construction materials and history, this section contains heterogeneous soil layering probably compacted to different densities over a half-century or so timeframe.



Figure 13-56. Crown Scour Along Approximate B/L Sta 1203+00 to Sta 1230+00, St. Bernard Levee Between MRGO and Miss. River. Crown was Approximate Elevation 15 ft

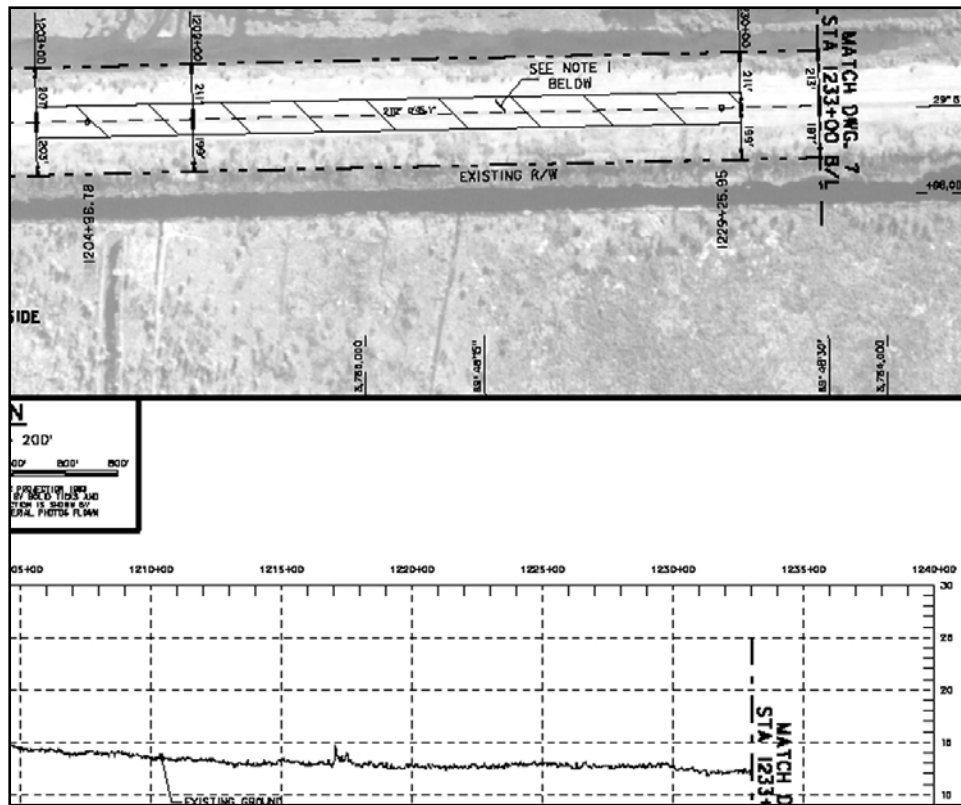

Figure 13-57. Levee Crown Elevation Drops from Elev 15 ft to Elev 12 ft in the Scour Area. Elevation 12 ft remains fairly constant along the reach for about a mile beyond the scour section. From Contract Solicitation STB08 W912P8-06-R-0094, drawing sheet C-06

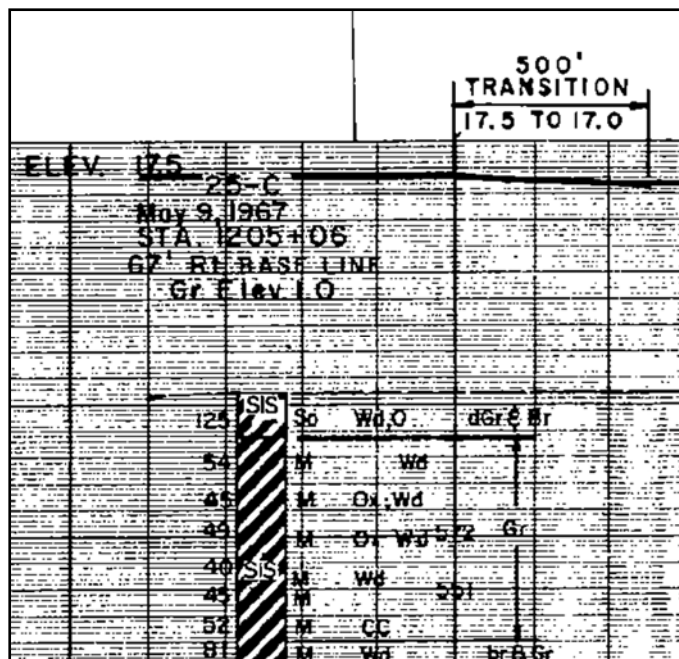

Figure 13-58. Original 1967 Boring at Ground Elevation 1 ft shows Fat Clay With Silt / Sand Lenses (from DM3 Chalmette Extension drawing file H-2- 24306, plate 7). The levee along this reach was constructed of Miss. River hydraulic sand fill, capped with local borrow clay, and shaped to grade with Miss. River batture soil (truck-hauled fill)

Figure 13-59 shows a section of Plaquemines Parish east bank back levee along Reach C (Phoenix to Bohemia, between river miles 59.3 and 44.3). Approximately 3 miles of crown erosion were noted along this 16-mile reach. This levee is approximate elevation 17 ft, and consists of a hydraulic-filled sand core with trucked-in clay blanket cap. Note the erosion has cut through the clay cap, moving clay blocks as erosion progressed downward to the sand layer.



Figure 13-59. Plaquemines Parish East Bank Back Levee Erosion

Erosion pattern “E”. The breach opening erodes out to the toe and the breach widens.



Figure 13-60. East of Pump Station 15 (N.O. East Back Levee), North Bank of GIWW. 12,750 feet of levee east of Pump Station #15 was completely degraded (Station 876+87 B/L to 1101+90 B/L). West of the pump station, 9,800 feet of levee was completely degraded (approx Sta 778+00 to 876+00). The levees in these reaches were constructed from GIWW hydraulic fill in stages over three years

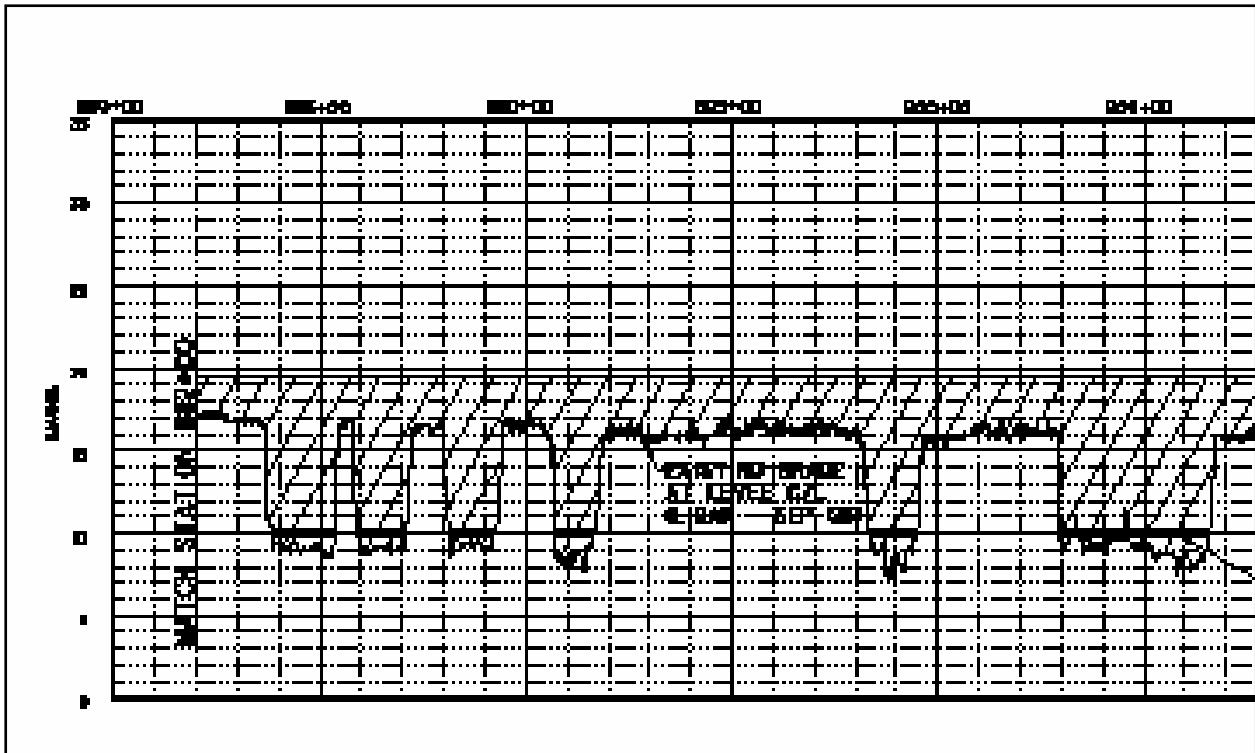

Figure 13-61. LIDAR Profiles of Levee East of Pump Sta 15 (from Contract Solicitation NOE1 drawings)



Figure 13-62. Partial Breach East of Pump Station 15



Figure 13-63. 19,000 ft. of Levee Between Bayou Bienvenue (Sta 383+00) and Bayou Dupre (Sta 704+00) Lost Approximately 12' of Levee Height From Original (design) Height 17.5 ft. Pre-Katrina elevation was approximately 12 ft, and storm surge along the MRGO was approximately 18 ft, causing an overtopping crest of up to 6 ft



Figure 13-64. 2,300 ft. of Levee Between Bayou Bienvenue (Sta 383+00) and Bayou Dupre (Sta 704+00) That Only Lost 50% of Height

Hydraulic fill from the MRGO channel formed the levee between Bienvenue and Dupre. Soil boring 9BU-CHBD (01-16834) from 2001 at Sta 445+00 shows the top 1.5 ft of the levee (elevation 18.1 ft) was composed of lean clay (CL). The underlying layers are mostly fat clay (CH) with interbedded lean clay layers. At a depth of 9.7 ft below the crown, a shear Q test indicated cohesion value 238 psf at 32% water content and 88 pcf dry density in a CH layer.

Soil boring 11BU-CHBD (01-16834) from 2001 at Sta 509+00 shows the top 2 ft of levee (elevation 17.4) was composed of fat clay (CH), but there was a 1-ft thick layer of poorly graded sand (SP) underneath. At a depth of 15.4 ft below the crown, a shear Q test indicated cohesion value 238 psf at 56% water content and 64 pcf dry density in a CH layer.

Soil boring 12BU-CHBD (01-16834) from 2001 at Sta 570+00 (Martello Castle) shows the top 1.4 ft of levee (elevation 16) was composed of lean clay (CL), with CH layers underneath. At a depth of 8.5 ft below the crown, a shear Q test indicated cohesion value 270 psf at 51% water content and 68 pcf dry density in a CH layer. At a depth of 16.8 ft, cohesion was slightly higher (396 psf) at 62% water content and 62 pcf dry density, also in a CH layer.

Soil boring 18-UBD (91-02) from 1991 at B/L Sta 596+00 shows the top 5.8 ft of levee (elevation 14.4) was composed of sandy silt (SM), with CH layers underneath. At a depth of 12 ft below the crown, a shear Q test indicated cohesion value 396 psf at 27% water content and 95 pcf dry density in a CL layer.

Soil boring 13BU-CHBD (01-16834) from 2001 at Sta 614+00 (Martello Castle) shows the top 25 ft of levee (elevation 15.4) was composed of fat clay (CH), with organic clays and peats underneath. At a depth of 5 ft below the crown, a shear Q test indicated cohesion value 632 psf at 29% water content and 92 pcf dry density in the CH layer.

Soil boring 19-UBD (91-02) from 1991 at Sta 640+00 shows the top 3 ft of levee (elevation 18.6) was composed of sandy silt (SM), with fat clay layers underneath. At a depth of 8 ft below the crown, a shear Q test indicated cohesion value 254 psf at 46% water content and 74 pcf dry density in a CH layer.



Figure 13-65. Wall / levee on the Southeast Side of Bayou Dupre Control Structure



Figure 13-66. 8,000 ft. section of the levee immediately southeast of Bayou Dupre (St. Bernard Parish) that was severely damaged and not only lost approximately 12 feet of levee height but also part of the original levee foundation

The storm surge depth overtopping this section of levee (Figure 13-66) was approximately 6 ft. A nearby soil boring through the crown showed the top 3 ft consisted of lean clay (CL), fat clay (CH), silt (ML or MH), and interbedded lenses of silt and/or sand. Any of these soil materials may have contributed to erosion initiation and progression. It is interesting to note in this photo that large scour pools developed on the levee backside which could possibly indicate that slope failure occurred along semi-circular slip planes on the levee backside, and the weaker soil above the slip planes eroded concurrently with the breach erosion. In other words, there may have been a slope instability failure mode in addition to overtopping erosion.

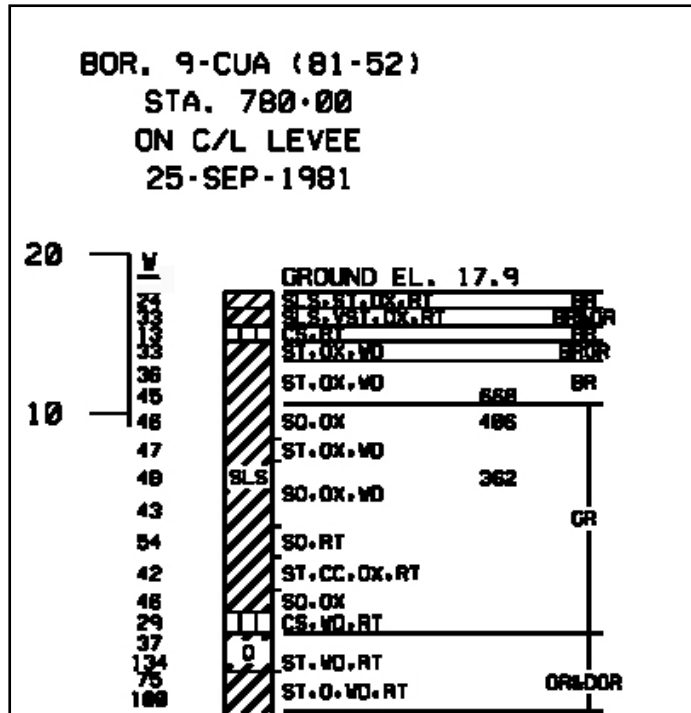

Figure 13-67. 1981 Soil Boring at Sta 780+00 Near Dupre Shows Top Layer of Lean Clay (CL) Underlain By Fat Clay (CH), Silt (ML or MH), and Silt / Sand Lenses (SLS) in the CH Material (from drawing 9 of 10, contract solicitation W912P8-06-R-0002)



Figure 13-68. 2,500 ft. of levee along MRGO from Bayou Dupre to Sta 1007+91 that lost approximately 8' of elevation

Levee and Floodwall Transitions

Numerous transition breaches were observed post-Katrina, and they overtopped due to elevation differences. After overtopping, the soil either scoured on the backside of the vertical structure or eroded the levee. The overtopping erosion / scour followed the progressive stages for the levee and/or the impact scour pattern for the floodwall, both as described above. Figure 13-69 is a diagram of the flow patterns that develop as overtopping occurs. The backside has increased erosion due to local increases in overtopping velocity, especially if the levee crest is lower than the floodwall. As the overtopping height increases above the floodwall height, backside erosion develops along the floodwall.

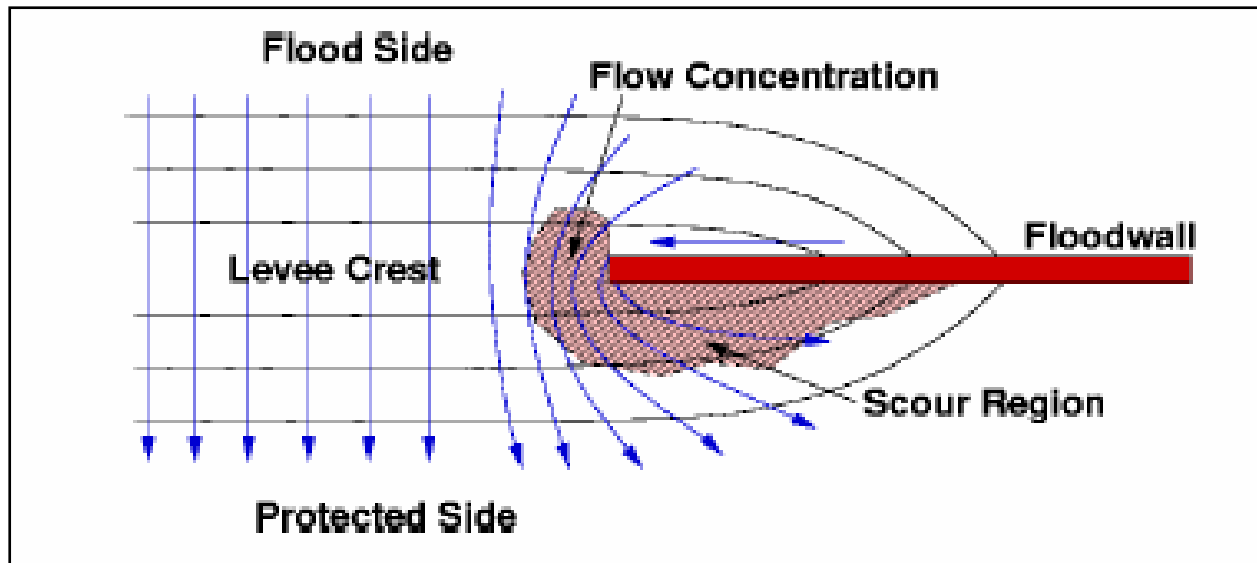

Figure 13-69. Diagram of Overtopping Erosion at Levee - Floodwall Transition (from Hughes 2006)

Figure 13-70 shows non-breaching scour caused by overtopping behind the concrete floodwall at closure gates S2 and S3 on the east side of the IHNC. Although the earthen levee abuts the concrete wall, the majority of scour occurred behind the concrete wall. Figure 13-71 depicts the scour pattern that developed along the levee slope behind the wall instead of the levee slope on the abutting earthen levee.



Figure 13-70. Southern Scrap Facility Gates S2 and S3

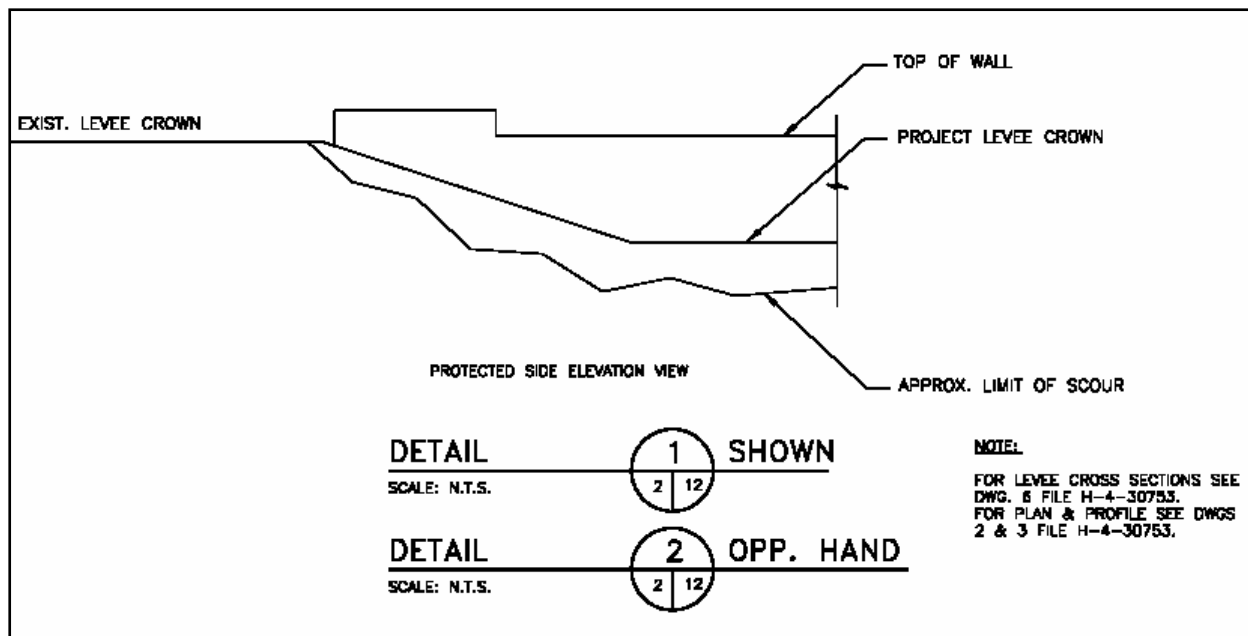

Figure 13-71. S2/S3 Erosion Pattern (From Levee Restoration, Misc. Gates and Floodwall Repairs, IHNC to Bienvenue, Chalmette Area Plan Emergency Restoration solicitation W912P8-06-R-0022, October 2005 contract drawing H-8)

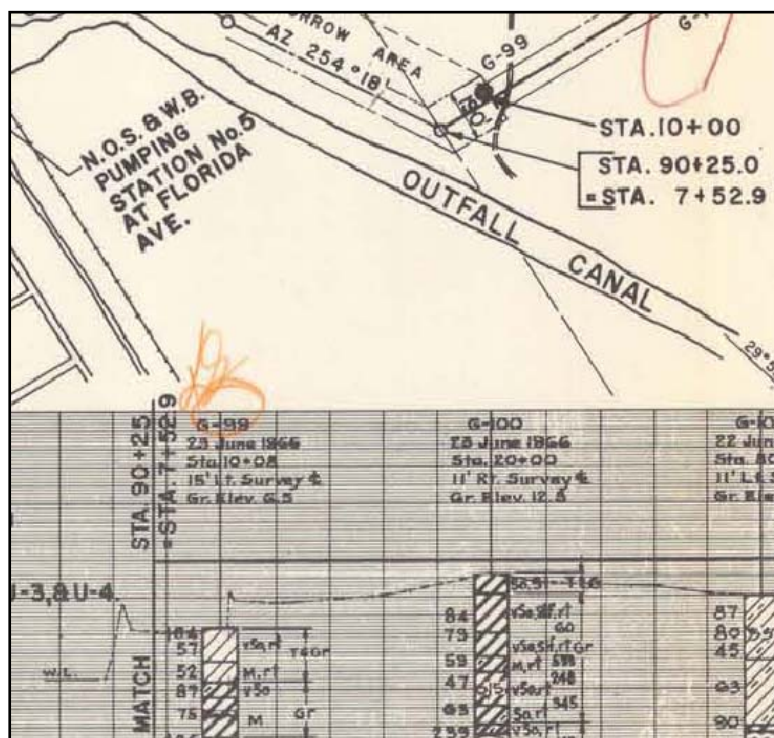

Figure 13-72. Boring G-99 Near Future Gates S2 and S3 Shows Lean Clay (CL) at Existing Ground Surface (Approximately 6' MSL). From plate 7, DM3

Figure 13-73 shows breached levee erosion at east end of floodgate structure S5, located about 100 yards west of the Bayou Bienvenue control structure. Although the levee was higher

than the wall (Figure 13-74) beyond the transition, it appears that the overtopping erosion began at the wall / levee transition where the wall was higher than the soil backfill.



Figure 13-73. Floodgate S5 Near Bienvenue Control Structure

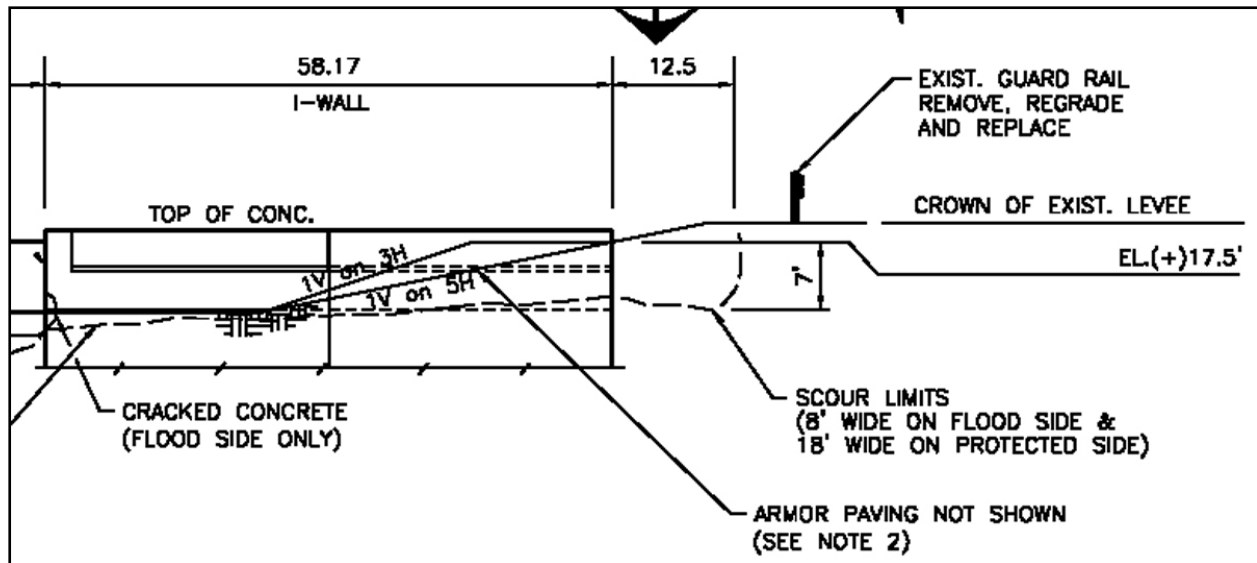

Figure 13-74. Scour pattern (From Levee Restoration, Misc. Gates and Floodwall Repairs, IHNC to Bienvenue, Chalmette Area Plan Emergency Restoration solicitation W912P8-06-R-0022, October 2005 contract drawing H-8)

Figure 13-75 shows an earthen levee breach at east side IHNC floodgate E5 looking south from inside the protected area. Scour damaged 7' (w) x 7' (d) around the adjacent flood wall. Top of wall at gate is approximate elevation 13 ft.



Figure 13-75. IHNC Floodgate E5 Transition to Levee



Figure 13-76. End of Sheetpile Wall at B/L Sta 980+58, along the MRGO (St. Bernard Parish). Note that scour occurred along the sheetpile wall and minimally beyond the levee transition. Approximate sheetpile elevation was 17 ft and levee crown elevation was 13 ft. Beyond the transition, the levee crown elevation was approximately 17 ft. The approximate storm surge overtopping crest was 4 ft over the sheetpile and 1 ft over the transition levee

Pre-Katrina soil boring 10-CUHA (91-02) from 1991 at Sta 976+00 in the sheetpile reach shows the top 4 ft of levee (elevation 13) was composed of lean silt and clay (ML and CL) with CH layers underneath. At a depth of 4.6 ft below the crown, a shear Q test indicated cohesion value 770 psf at 45% water content and 75 pcf dry density in the uppermost CH layer.

**BOR. 10-CUI (85-38)
 STA. 989+00
 C/L LEVEE
 04-DEC-1985**

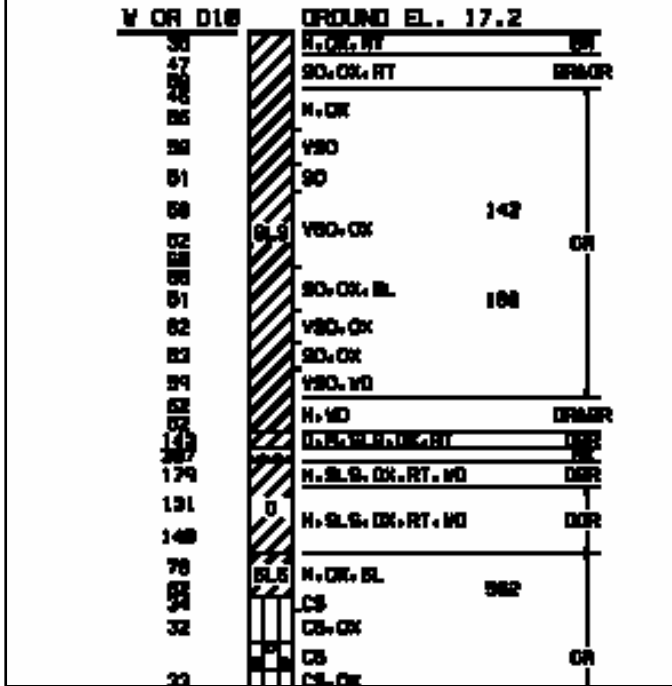

Figure 13-77. Pre-Katrina (1985) Boring at Sta 989+00 (about 800 ft beyond the sheetpile/levee transition) Shows Levee Section With Fat Clay (CH) Cap and Core, With Interbedded Silt Lenses (SLS)

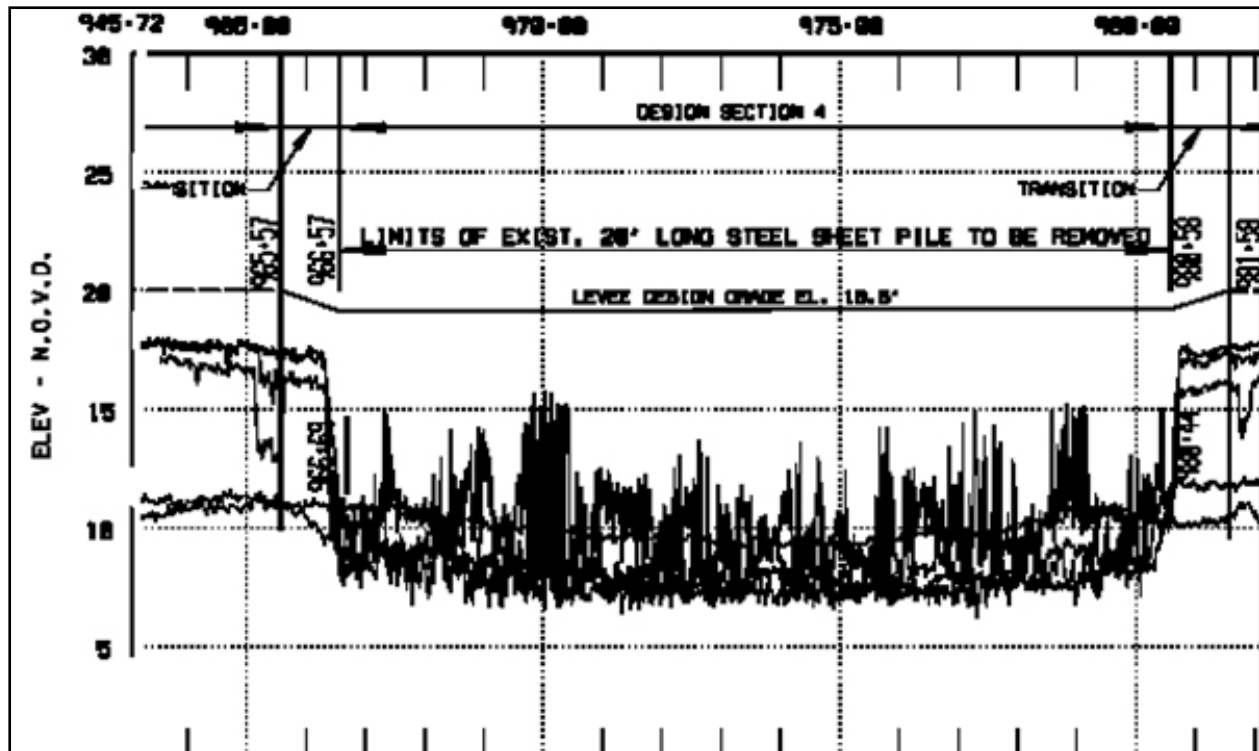

Figure 13-78. Scour Depths Along Sheetpile and at Transition to Levee. Note that scour occurred along the sheetpile reach, not at the sheetpile / levee transition (also seen in Figure 13-76), from drawing 7 of 10, contract solicitation W912P8-06-R-0002

Figure 13-79 shows the I-wall/levee transition on the east side of the IHNC at the IHNC Lock. In this case, the levee crest was about a foot lower than the I-wall top, and overtopping caused erosion and/or a scour hole on the backside. Visual observation indicates a non-cohesive surface soil type.



Figure 13-79. IHNC Lock I-wall transition to levee

Geotechnical Issues

A more erodible embankment will need a higher level of protection than a less erodible embankment to reduce or prevent backside overtopping erosion. Knowing the engineering properties of an existing embankment will help determine erodibility and allow better-informed choices for designing erosion protection. Many of the levee reaches have recently been freshly-capped with cohesive soils and compacted to specification for Katrina repair.

The rate of erosion is proportional to the applied shear stress in excess of a critical shear stress and is also proportional to an erodibility coefficient (Hanson and Simon 2001). Soils with a lower critical shear stress tend to have a higher erodibility coefficient. Levee geometry is important when analyzing erosion probability. A 1:3 side slope is steeper than a 1:4 slope, and a stabilizing berm slope acts as an overtopping energy dissipator. Water cascading down a 1:3 slope impacting a 1:20 berm slope would be more likely to initiate erosion than that on a 1:4 slope, and would also depend on slope distance between the crest and the toe, surface roughness, and water depth.

Assessing soil erodibility is a complex matter, due to spatial (horizontal and vertical) non-homogeneity and uncertainty, difficulty in selecting accurate engineering properties needed to determine erodibility, and temporal effects during erosion progression such as surface roughness changes which in turn affect the hydraulic stress and turbulence conditions. Soil properties affecting erodibility are soil classification (gravel, sand, silt, clay proportions); water content (antecedent moisture); clay mineralogy and proportion; soil structure; Atterberg limits; organic content; pore water chemistry (salinity, hardness, quality, pH); in-situ density; erodibility parameters such as the critical shear stress required to initiate soil particle detachment, hydraulic shear stress, and erodibility coefficient; in-situ shear strength, and compaction effort during construction (optimum moisture content and optimum dry density values both specified and as-built).

Answering the question of why one section of levee eroded compared to another section is difficult to do as the forensic evidence washed away during the hurricane. The pre-Katrina soil boring data (where available) was useful only for observing soil types, stratigraphy, and strength. Forensically assessing the erosion probability using the pre-Katrina soil parameters may be accomplished only in a general fashion. For example, the levees constructed of hydraulic fill along the MRGO seemed to have higher erodibility potential compared to the truck-hauled fill between the MRGO and the Mississippi River. The levees constructed with lower-plasticity (sandy or silty) surface soils instead of fat clay also appeared to have more erosion. Levees with “semicompacted” fill likely fared better than those with hydraulic fill (noncompacted).

Summary

Most erosion appeared to have occurred on the backside (landside or protected side) of both levees and floodwalls. The minor erosion / scour patterns (A and B) were the most geographically widespread. The most serious patterns (D and E) were confined to lengthy levee reaches generally located along the East Back Levee (N.O. East) and the south bank of the MRGO (Bayou Bienvenue to Bayou Dupre and southeast of Bayou Dupre). The most serious floodwall backside erosion (patterns D and E) were confined to specific relatively short reaches along the IHNC (east and west sides) and the north bank of the GIWW (East Back and Citrus Back). Localized scour contributing to failure was observed at several floodwall/levee transitions.

The environmental forcing conditions for erosion initiation (storm surge, wave height, wave period, wind velocity, etc.) are not described in the detail shown in other portions of the IPET tasks. Storm surge crest elevations are approximated for several reaches, and the overtopping waterfall heights are approximated based on available pre-Katrina levee/floodwall elevations presumably referenced to local mean sea level datum. Overtopping crest heights ranged up to about 6 ft along MRGO reaches, and waterfall cascades impacting the soil surface ranged from 1 ft to about 13 ft, depending on exposed floodwall height. The most common cascade height was about 6 ft.

Erosion was initiated on soil surfaces ranging from sandy silts to fat clays, and only a limited amount of pre-Katrina soil borings were available at the eroded locations. In general, the eroded

soil surface contained sand / silt / lean clay layers, which are known to be more erodible than compacted fat clay generally specified as a levee “cap”. Many of the end-of-erosion (post-Katrina) pictures showed an exposed layer of fat clay mixed with oyster shells, which is presumed to be less erodible than the missing soil.

References

- Hanson, G.J., K.R. Cook, W. Hahn, and S.L. Britton. 2003. “Evaluating erosion widening and headcut migration rates for embankment overtopping tests,” American Society of Agricultural Engineers Paper no. 032067.
- Hanson, G.J. and A. Simon. 2001. “Erodibility of cohesive streambeds in the loess area of the midwestern USA,” *Hydrological Processes*, Vol 15, pp 23 - 38.
- Hanson, G.J., K.M. Robinson, and K.R. Cook. 2001. “Prediction of headcut migration using a deterministic approach,” *Transactions of the American Society of Agricultural Engineers*, Vol 44(3), pp 525 - 531.
- Hughes, S.A. 2006. “Protection for backside levee slopes,” draft report to the New Orleans District Corps of Engineers.
- Hunt, S.L., G.J. Hanson, K.R. Cook, and K.C. Kadavy. 2005. “Breach widening observations from earthen embankment tests,” *Transactions of the American Society of Agricultural Engineers*, Vol 48(3), pp 1115 - 1120.
- Venard, J.K. and R.L. Street. 1975. *Elementary fluid mechanics*, 5th Ed., John Wiley and Sons, New York.

Scour Damage Tabulations (from TFG Damage Reports and Restoration Contract Drawings)

Inner Harbor Navigation Canal - West Levee															
Summary of Damages															
DSR ID.#	Type of Structure	Start/End	GPS Coordinates					Scour Dimensions (Feet)				Scour Damage Class	Condition of Floodwall		
			Degrees (N)	°	'	Degrees (W)	°	'	Length	Depth	Width		Cu-yd to fill	Type	Description
Lock to Florida Avenue (West side)															
W-1	Levee with I-wall (capped)	Start/End	29	57	59.3	90	1	37.2	20				II	I-Wall	Scour adjacent to wall
W-2	Gates W2, W3 (T-wall monoliths)	Start	29	58	65.3	90	1	37.5	500	3	15	833	I	T-Wall	Scour adjacent to wall
		End	29	58	8.9	90	1	36.1							
W-3	Gates W4, W5 (T-wall monoliths)	Start	29	58	8.9	90	1	36.1	700	3	15	1,167	I	Gate monolith	Scour adjacent to wall
		End	29	58	13.6	90	1	36.2							
W-4	Wall btwn Gates W5, W6 (T-wall monoliths)	Start	29	58	13.6	90	1	36.2	1,460	3	15	2,433	I	Gate monolith	Scour adjacent to wall
		End	29	58	27.9	90	1	31.8							
W-5	Wall between Gate W6 and Namasco Bldg to Gate W13 (T-wall, I-wall monoliths)	Start	29	58	27.9	90	1	31.8	1,330	3	5	739	I	Gate monoliths, T-wall I-wall	Scour adjacent to wall
		End	29	58	38.6	90	1	34.8							
W-6	Wall btwn Gate W14 and Gate W15 (T-wall and I-wall monoliths)	Start	29	58	40.7	90	1	33.8	300	2	5	111	I	Gate monoliths, I-wall	Scour adjacent to wall
		End	29	58	43.4	90	1	33.1							
W-7	Gate W17	Start/End	29	58	48.6	90	1	32.7	30	1	3	3	I	Gate monoliths	Scour adjacent to wall
W-8	Gate W18 to Gate W19	Start	29	58	48.6	90	1	32.3	600	2	5	222	I	I-wall	Scour adjacent to wall
		End	29	58	49.0	90	1	31.2							
W-9	Gate W19 to Gate W20	Start	29	58	49.0	90	1	31.2	200	4	5	148	I	I-wall	Scour adjacent to wall
		End	29	58	50.7	90	1	25.4							
W-10	Gate W20 to Gate W22 (adjacent to PS#19)	Start	29	58	50.7	90	1	25.4	200	2	5	74	I	I-wall	Scour adjacent to wall
		End	29	58	53.0	90	1	22.8							
Florida Avenue to Hwy 90 (West side)															
W-11	Gate W23	Start/End	29	58	56.2	90	1	27.9	30	4	15	67	II	T-wall	Scour adjacent to wall
W-12	Gate W2 to W3	Start	29	58	56.5	90	1	22.5	300	3	5	167	I	I-wall	Scour adjacent to wall
		End	29	59	4.0	90	1	19.9							
W-13	Levee	Start	29	59	4.7	90	1	23.4	150	Scour repaired			II		Scour repaired w/ aggregate
		End	29	59	4.8	90	1	25							
W-14	Gate W25B to Gate W26	Start	29	59	4.7	90	1	23.4	800	Scour repaired			III		Scour around gate W25B and on P/S of Gate W26
		End	29	59	8.0	90	1	38.2							Some scour backfilled by RR
W-15	Gate W26 to Gate W28	Start	29	59	8.0	90	1	38.2	500	5	10	926	I	I-wall	
		End	29	59	14.3	90	1	36.7							
W-16	Levee with I-wall (capped)	Start	29	59	18.7	90	1	37	200	Breach repaired			III	I-wall	I-wall rotated, breached, and scoured
		End	30	0	9.0	90	1	45.9							
W-17	Gate W29	Start	30	0	10.1	90	1	42.1	240	2	6	107	I	I-wall	Scour adjacent to wall
		End	30	0	12.3	90	1	41							
W-18	Levee with I-wall (capped)	Start	30	0	18.7	90	1	38.1	90	2	3	20	I	I-wall	Scour adjacent to wall
		End	30	0	19.6	90	1	38.3							
W-19	Gate W32 to Gate W34	Start	30	0	20.7	90	1	38.6	220	1	2	16	I	I-wall	Scour adjacent to wall
		End	30	0	26.1	90	1	40.4							

(Definition - Structural Damage is the rotation and or collapse of a floodwall or other structure.)

Floodwall/Levee	Scour type	Where	Repair methodology
Citrus Lakefront Levee and Floodwall			
Lakefront Airport Floodwall (Capped I-wall)	Moderate scour	the land side of the floodwall	Excavate the scour area, place flowable fill and compacted material, place bedding material and 6"-7" slope pavement
Star & Strips Blvd Floodwall	None noted		
Jancke Pumping Station Floodwall	Light Scour	the land side of the floodwall	Excavate the scour area, place flowable fill and compacted material, place bedding material and 6"-7" slope pavement
Lincoln Beach Floodwall	Light Scour	the land side of the floodwall	Excavate the scour area, place flowable fill and compacted material, place bedding material and 6"-7" slope pavement
New Orleans East Lakefront Levee			
Collins Pipeline	None noted		
South Point to GIWW Levee			
Drainage structure, N19 (400+/- If south of South point)	Moderate scour	the lake side of levee	Excavate the scour area, place compacted material, place bedding material and gabions
Other Drainage structures	Light Scour	the lake side of levee	Excavate the scour area, place compacted material, place bedding material and gabions
Pumping Stations	None noted		
CSX Railroad gate	Heavy Scour	the land side of the floodwall	Raising the flood protection from (NAVD29) 13.5 to '88 datum Elevation 20
New Orleans Back Levee			
OP Pump Station 15	Rotation & Failure of Iwall Tie-In Walls to frontage Twalls	10'-12' Scour holes on both FS & PS of wall	Replace uncapped Iwall w/ pile founded Twalls, Raise protection from (29 datum) 17 to (88 datum) 23.
Iwall West of OPPS 15	Moderate scour	Both FS & PS	Excavate the scour area, place compacted material and graded stone
East Michoud Canal (Air Products Breach)	Rotation & Failure of Iwall Tie-In Walls to levee	10'-20' Scour holes on both FS & PS of wall; 300 lf long	Replace uncapped Iwall w/ new levee section and uncapped Iwall; Raise protection from (29 datum) 17 to (88 datum) 21.
Michoud Slip to Michoud Canal Floodwalls	Light to moderate scour	PS of floodwall	Excavate the scour area, place flowable fill and compacted material, place bedding material and 6"-7" slope pavement
Citrus Lakefront Levee and Floodwall			
IHNC to Paris Road	Light Scour	the land side of the floodwall	Excavate the scour area, place flowable fill and compacted material, place bedding material and 6"-7" slope pavement
Citrus Floodwall at Bulk Loading Facility	Rotation & Failure of Iwall	6'-10' Scour holes on both FS & PS of wall	Replace Iwall w/ new L-type wall Raise protection from (29 datum) current 13.5 to (88 datum) 15 (as built elevation)

Table J-1

Orleans East Bank Lakefront - Summary of Damages

ID #	Location (GPS Coordinates)						Dimensions (feet)			Cu-yd to fill	Description
	Degrees <i>N</i>	'	"	Degrees <i>W</i>	'	"	Length	Width	Depth		
L 46	90	05	17.3	30	01	39.3	20	10	2	15	Eroded levee under I-wall
L 50	90	05	10.4	30	01	36.1	10	20	1	7	Scour
L 51	90	05	7.9	30	01	35.6	20	3	1	2	Scour
L 52	90	05	7.5	30	01	35.5	10	3	1	1	Scour
L 59	90	04	59.1	30	01	33.6	20	20	3	44	Scour under bridge
L 60	90	04	59.0	30	01	34.1	20	20	1.5	22	Scour under bridge
L 67	90	04	55.4	30	01	31.1					Floodwall damage
L 72	90	04	55.3	30	01	33.7	30	20	2	44	Scour under bridge
L 73	90	04	55.4	30	01	34.6	30	20	3	67	Scour under bridge
L 83	90	03	52.6	30	01	57.2	6	4	2	2	Erosion
L 88	90	03	49.5	30	01	57.3	30	15	0.5	8	Shallow erosion
L 90	90	03	43.6	30	01	57.3					Floodwall damage
L 104	90	03	28.9	30	01	56.8	30	15	0.5	8	Degraded fill material at base of wall
L 119	90	02	15.9	30	01	52.1	10	2	2	1	Scour
L 120	90	02	15.4	30	01	52.2	10	2	2	1	Scour
L 124	90	02	19.2	30	01	53.8	20	6	2	9	Scour

(total backfill 231 cubic yards)

Scour details for levee/floodwall between Lakefront Airport and Gate L-15 along Lake Pontchartrain (New Orleans East), from dwg 5 of 9, contract solicitation NOE06W912P8-06-R-0043

Station	Scour Width (feet)	Scour Depth (feet)	Distance (feet)
18+16	0	0	
			54
18+70	7	3	
			47
19+17	11	2.5	
			60
19+77	12	3	
			62
20+39	14	3	
			17
20+56	12.5	3	
			18
20+74	10	3	
			96
21+70	3	3	
21+70 to 21+89 No Scour			19
21+89	12	2.5	
			17
22+06	12	2.5	

22+06 to 22+34 No Scour			28
22+34	11	3	
			45
22+79	11	2.5	
			21
23+00	11	2.5	
23+00 to 23+33 No Scour			33
23+33	10	3	
			37
23+70	10	3.5	
			55
24+25	7	2.5	
			22
24+47	15	5	
			60
25+07	14	2	
			46
25+53	15.5	5	

			120
26+73	16	4.5	
			104
27+77	16	4.5	
			50
28+27	13	4.5	
			32
28+59	11	4.5	
			36
28+95	10	3	
28+95 to 29+26 Floodgate L-14			31
29+26	10	3.5	
			46
29+72	6	3	
			44
30+16	11.5	3	
			61
30+77	14	4.5	
			7

30+84	10	3	
			72
31+56	2	2	
31+56 to 32+00 Floodgate L-15			44
32+00	See Plan	0	
			250
32+50	See Plan	6	
SEVERE SCOUR DETAILS			
Location	Area (sq ft)	Depth (ft)	
I	2680	6	
II	3050	6	
	1400	4	
III	3600	5	

**S1, S2 & S3 - FLOOD GATES/WALL (IHNC
[0 - 2+20.00'] TO STA. 23 + 04.00 W/L)**

STATION	Df	Dp	Wf	Wp
0 - 220.00'	0.0	5.0	0.0	15.0
0 - 185.00'	0.0	4.0	0.0	15.0
0 - 185.00' TO 0 - 160.00'	0.0	0.0	0.0	0.0
0 - 160.00' TO 0 - 50.00'	0.0	5.0	0.0	10.0
0 - 50.00'	0.0	3.0	0.0	8.0
0 + 00.00	0.0	3.0	0.0	5.0
0 + 00.00 TO 0 + 73.00	0.0	7.0	0.0	15.0
1 + 23.00	0.0	5.0	0.0	15.0
1 + 23.00 TO 2 + 01.00	0.0	6.0	0.0	15.0
2 + 01.00	2.0	6.0	2.0	15.0
9 + 59.67 TO 11 + 20.56	1.0	6.0	2.0	15.0
20 + 00.00	0.0	3.5	0.0	10.0
20 + 43.00	0.0	5.5	0.0	9.0
21 + 15.00	0.0	2.0	0.0	9.0
21 + 80.00	1.0	2.0	6.0	9.0
21 + 84.00	0.0	4.0	0.0	10.0
22 + 61.06 TO 23 + 04.00	0.0	2.0	0.0	7.0

STATIONS INDICATED PER REFERENCE
DWG: FILE NO. H-4-27147 "FLOODWALL
AND LEVEE I.H.N.C. EAST - NORTH OF
FLORIDA AVENUE"

Scour Stationing and Extent (feet), from Chalmette Area Plan Emergency Restoration contract drawings, October 2005:

- Df = scour depth on flood side
- Dp = scour depth on protected side
- Wf = scour width on flood side
- Wp = scour width on protected side

S4 - PARIS ROAD FLOOD GATE/WALL (STA. 267 + 00.00 C/L TO STA. 277+24.50 C/L)

STATION	Df	Dp	Wf	Wp
0 + 00.00 W/L (267 + 00.00 W/L)	0.0	8.0	0.0	8.5
0 + 50.00	0.0	3.0	0.0	25.0
0 + 83.00	0.0	10.0	0.0	35.0
1 + 29.00	0.0	4.0	0.0	40.0
1 + 29.00 TO 1 + 89.00	0.0	3.0	0.0	40.0
1 + 90.00	0.0	4.5	0.0	11.5
10 + 24.74	0.0	3.0	0.0	11.5

STATIONS INDICATED PER REFERENCE DWG:
FILE NO. H-4-29216 "PARIS ROAD FLOODWALL"

S5 - FLOOD GATE/WALL WEST OF BAYOU BIENVENUE (STA. 354 + 00 B/L TO STA. 357+00 B/L)

STATION	Df	Dp	Wf	Wp
354 + 24.83	8.0	8.0	7.0	11.0
354 + 40.00	2.0	4.0	5.0	15.0
354 + 83.00	0.5	2.0	2.0	15.0
354 + 83.00 TO 355 + 90.00	0.0	4.5	0.0	15.0
355 + 90.00	0.5	2.0	2.0	15.0
356 + 40.00	4.0	5.0	6.0	15.0
356 + 48.00	8.0	8.0	8.0	18.0

STATIONS INDICATED PER REFERENCE DWG:
FILE NO. H-8-29720 "STA. 277 + 20 TO 359 + 33
(PARIS ROAD TO BAYOU BIENVENUE) 2ND LIFT"

Scour Stationing and Extent (feet), from Chalmette Area Plan Emergency Restoration contract drawings, October 2005:

- Df = scour depth on flood side
- Dp = scour depth on protected side
- Wf = scour width on flood side
- Wp = scour width on protected side

Appendix 14

General Description of New Orleans’ Basins and Damage from Hurricane Katrina

General Description of Lake Pontchartrain, LA and Vicinity and NOV, Hurricane Protection Projects Basins

The Lake Pontchartrain, LA and Vicinity Hurricane Protection Project (HPP) covers St. Bernard, Orleans, Jefferson and St. Charles Parishes in southeast Louisiana, generally in the vicinity of the city of New Orleans, and between the Mississippi River and Lake Pontchartrain. The Orleans East Bank portion of the project includes the east bank of the Mississippi River between the 17th Street Canal and Inner Harbor Navigational Canal (IHNC). Figure 14-1 is an index map showing the individual polders within the Lake Pontchartrain, LA and Vicinity HPP.

Plaquemines Parish Basin includes long, narrow strips of protected land on both sides of the Mississippi River between New Orleans and the Gulf of Mexico. The Mississippi River Levees (MRL) protect the Parish from floods coming down the river. Protection from hurricane induced tidal surges is achieved by the New Orleans to Venice (NOV) HPP. The NOV HPP is a system of levees on the gulf side of the protected lands and additional berms and floodwall on top of the MRL along the river. The NOV extends from Phoenix, LA to Venice, LA. A HPP map is not available for NOV however.

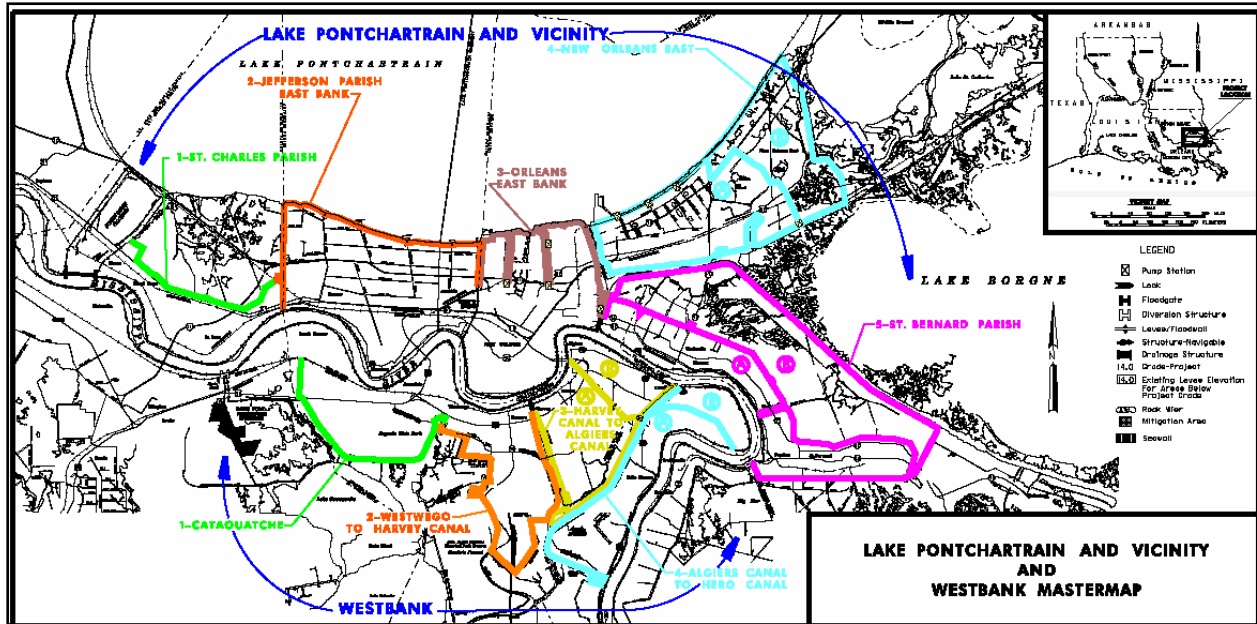

Figure 14-1. Index Map to Lake Pontchartrain, LA and Vicinity Hurricane Protection Project



Figure 14-2. Extent of NOV Hurricane Protection in Plaquemines Parish. The NOV consists of five distinct reaches; Reach C, Reach St. Jude to City Price, Reach A, Reach B-1 and Reach B-2

Orleans East Bank – HPP Features

This portion of the project that protects the city of New Orleans was designed to protect 28,300 acres of urban and industrial lands and is illustrated in detail by Figure 14-3. A series of diagrams like Figure 14-3 were developed by the New Orleans District for planning and design purposes for each of the basins and show as-built levee and floodwall elevations.

The levee portion of the New Orleans East Bank HPP is constructed with a 10-foot crown width with side slopes of 1 on 3. Along Lake Pontchartrain Lakefront the top elevation of the earthen levees range between elevation +13 and +18 ft National Geodetic Vertical Datum (NGVD). Floodwalls were designed to provide lines of protection on the east side of the 17th Street Canal, both sides of Orleans Avenue Canal and London Avenue Canal, and the west

side of the IHNC. Floodwalls consist of reinforced concrete T-wall floodwalls and reinforced concrete I-wall floodwalls constructed on the top of sheet-pile, and sheet piling without a concrete section. Top elevations of the floodwalls vary between elevation +13 and +15 ft.

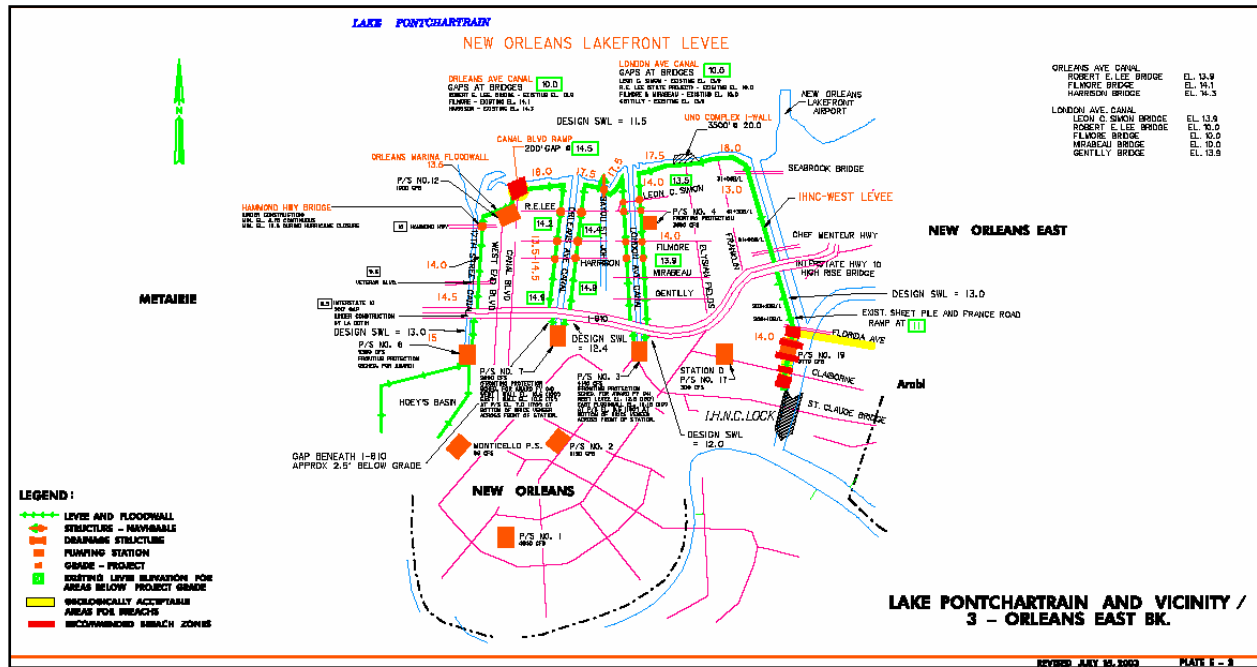

Figure 14-3. HPP features – New Orleans East Bank

Orleans East Bank Lakefront. A levee segment located in southeastern Louisiana in New Orleans and roughly parallels the shoreline of Lake Pontchartrain between the IHNC on the east and 17th Street Canal on the west. This levee segment is located in Orleans Parish.

IHNC Canal (West Bank). The Inner Harbor Navigation Canal is located in the east portion of Orleans Parish and is described in the IHNC section of this report.

17th Street Outfall Canal (Metairie Relief). The 17th Street Outfall Canal lies in Jefferson Parish immediately west of the Orleans Parish boundary line. The canal extends approximately three miles from Pump Station No. 6 near Interstate Highway 10 to its confluence with Lake Pontchartrain.

London Avenue Outfall Canal. The London Avenue Outfall Canal is located on the south side of Lake Pontchartrain in Orleans Parish. The London Avenue Outfall Canal lies to the east of 17th Street Canal and Orleans Avenue Canal.

Orleans Avenue Canal. The Orleans Avenue Canal extends about 2.4 miles from Pumping Station No.7 in the vicinity of I-610 to its mouth at Lake Pontchartrain.

Table 14-1 New Orleans East Bank Hurricane Protection System	
19.2 miles	levee and floodwall
13	pump stations
15	roadway floodgates

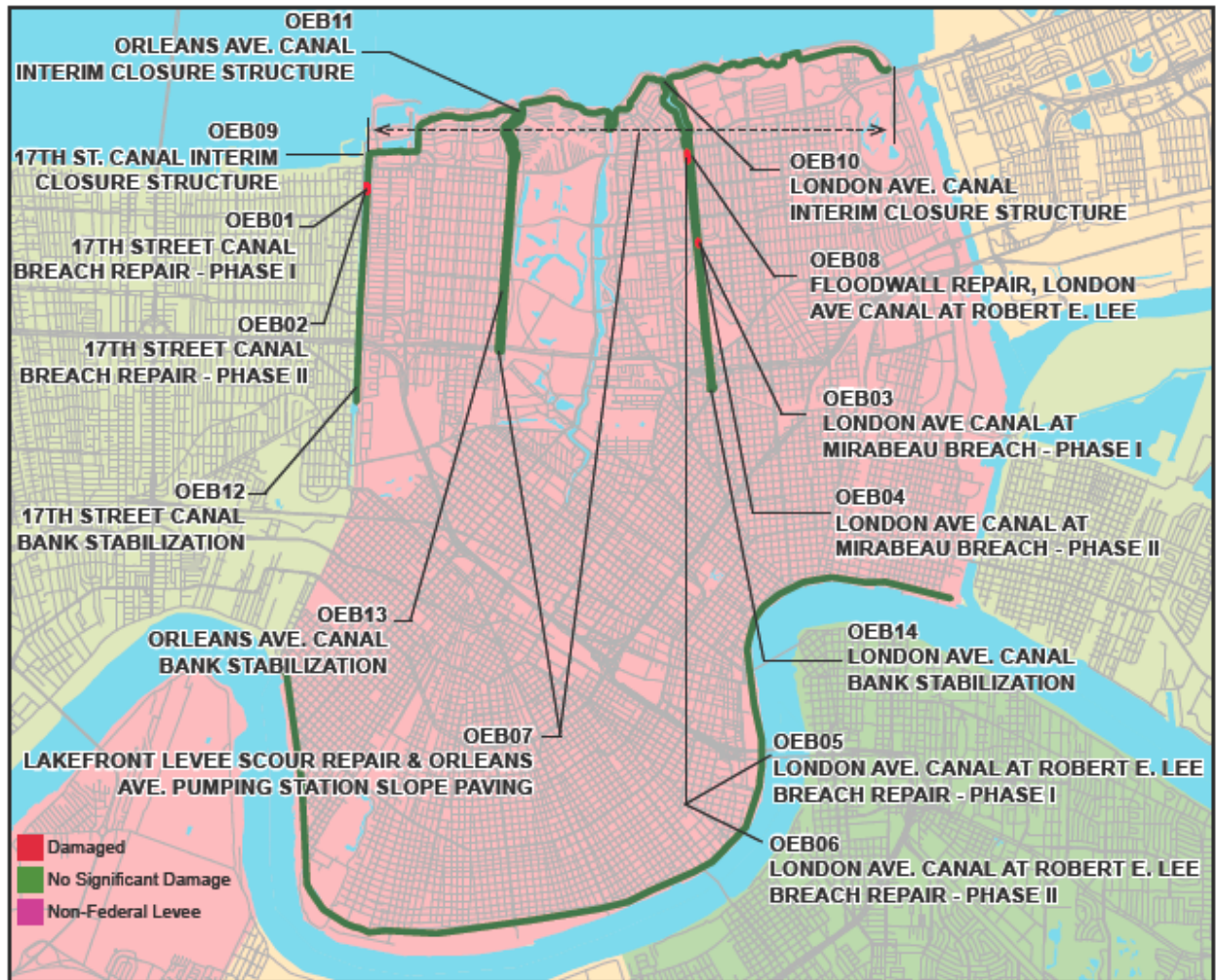

Figure 14-4. Damages and Repair Contracts – New Orleans East Bank

Primary damages to the flood protection in the Orleans East Bank basin consists of a 455- ft breach in the east side I-wall along 17th St. Canal, breaches on both the east side (425 ft) and west side (720 ft) I-wall along London Ave. Canal, breaches along the west side of IHNC floodwall and damages to all fifteen pumping stations.

New Orleans East Basin – HPP Features

The hurricane protection system for the New Orleans East (NOE) Basin was designed as part of the Lake Pontchartrain, LA and Vicinity Hurricane Protection Project. The NOE portion of the project protects 45,000 acres of urban, industrial, commercial, and industrial lands. Figure 14-5 illustrates the boundaries and basic flood protection components within the NOE Basin. The levee is constructed with a 10-ft crown width with side slopes of 1 on 3. The height of the levee varies from 13 to 19 ft. There are floodwall segments along the line of protection that consists of sheet-pile walls or concrete I-walls constructed on top of sheet-pile. The line of protection was designed to provide protection from the Standard Project Hurricane (category 3 hurricane).

Figure 14-5 is used by the New Orleans District for planning and design, specifically because it shows as-built levee and floodwall elevations. The western border coincides with the Inner Harbor Navigation Canal (IHNC) and the eastern boundary of the Orleans Basin. It is bounded by the east bank of the IHNC, the Lake Pontchartrain shoreline (between the IHNC and Southpoint), the eastern boundary of the Bayou Sauvage National Wildlife Preserve, and the north side of the Gulf Intracoastal Waterway (GIWW) (between the IHNC and eastern edge of the Bayou Sauvage National Wildlife Preserve). The main components are described in the next section moving clockwise through the basin, beginning at the Lakefront Airport and ending at the western end of the GIWW.

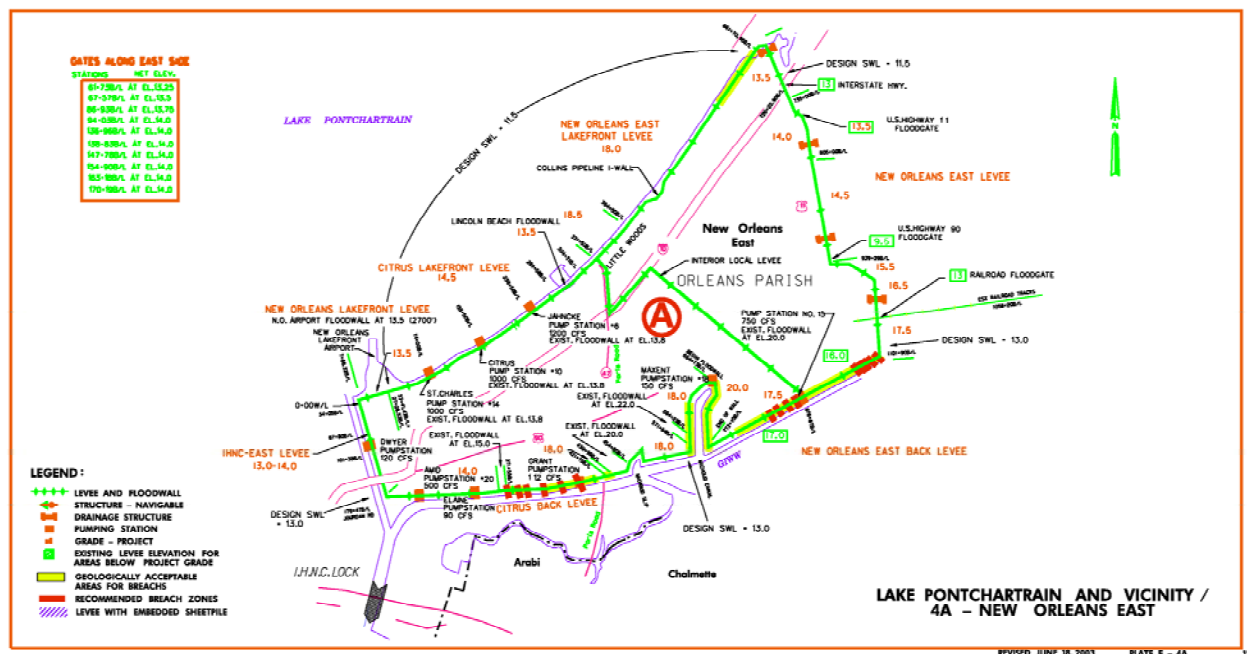

Figure 14-5. NOE Basin general components and top of levee/floodwall as-built elevations (feet) (source USACE, New Orleans District (Wayne Naquin))

New Orleans East Basin Components

New Orleans East Lakefront includes the Citrus Lakefront Levee and New Orleans East Lakefront Levee consisting of 12.4 miles of earthen levee paralleling the Lakefront from the IHNC to Southpoint. It also includes floodwalls at the Lakefront Airport and Lincoln Beach.

The New Orleans East Levee consists of 8.4 miles of earthen levee from Southpoint to the GIWW along the eastern boundary of the Bayou Sauvage National Wildlife Preserve.

GIWW - The basin includes the Citrus Back Levee and New Orleans East Back Levee which consisting of approximately 17.5 miles of earthen levees and concrete floodwalls along the northern edge of the GIWW.

IHNC - The basin protection includes approximately 2.8 miles of levee and concrete floodwall along the eastern side of the IHNC. The IHNC is described in a separate report.

Pump Stations – Eight pump stations and numerous drainage structures, pipe crossings and culverts also lay on the boundaries.

Table 14-2 is a summary of the protection features and their lengths for NOE Basin. Figure 14-6 shows the extent of damage as surveyed by the TFG. Nine repair contracts have been awarded to repair levees and floodwalls throughout the basin. The contracts are delineated on the figure.

Exterior levee and floodwall (I wall)	39 miles
Drainage Structures	4
Pump Stations	8
Highway Closure Structures	2
Railroad Closure Structure	1

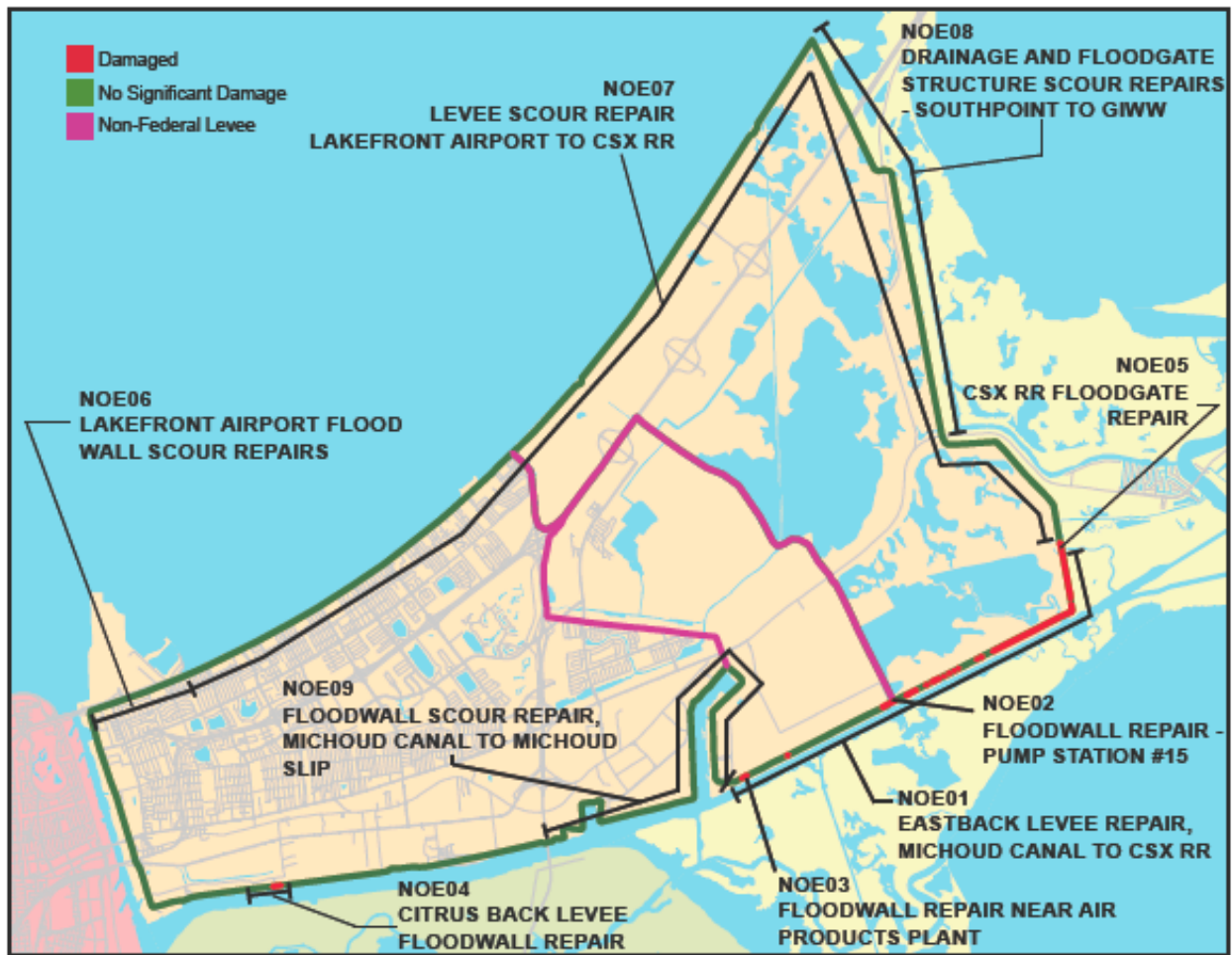

Figure 14-6. Hurricane Protection Features - New Orleans East Basin



Figure 14-7. New Orleans East IPET Characterization of Damages

West and East Sides, IHNC, Orleans Parish – HPP Features

The Inner Harbor Navigation Canal (IHNC) HPP contains approximately 12.3 miles of levee and floodwalls along the Inner Harbor Navigation Canal in a heavily industrialized area. Table 14-3 is a summary, but does not break down the floodwalls versus levees. Figure 14-8 defines some of the protection features, but was developed to show the contract repairs ongoing in the canal.

Figure 14-9 characterizes the failures with respect to IPET categories.

IPET has made six categories of levee performance to help characterize behavior. These are:

- LONB = Overtopped levees, no breaching
- WS = Overtopped floodwalls, no breaching (stable)
- LOB = Overtopped levees, breaching
- TF = Transition failure (floodwall to levee transition)
- WF = Overtopped floodwalls, breached (failure)
- WCF = Overtopped floodwalls, no breaching but came close

And have been applied to the contract maps provided by TFG as shown in Figure 14-9.

Table 14-3 Hurricane Protection System for IHNC Hurricane Protection System	
•12.3 miles	Levee and floodwall

IHNC Damages. Overtopping of the hurricane protection by Hurricane Katrina was evident along nearly all portions of the canal. There were four breaches in the protection system, two on the east side and two on the west side. The east side breaches are both located in the Lower Ninth Ward neighborhood and the west side breaches are both in the vicinity of France Road and Benefit Street.

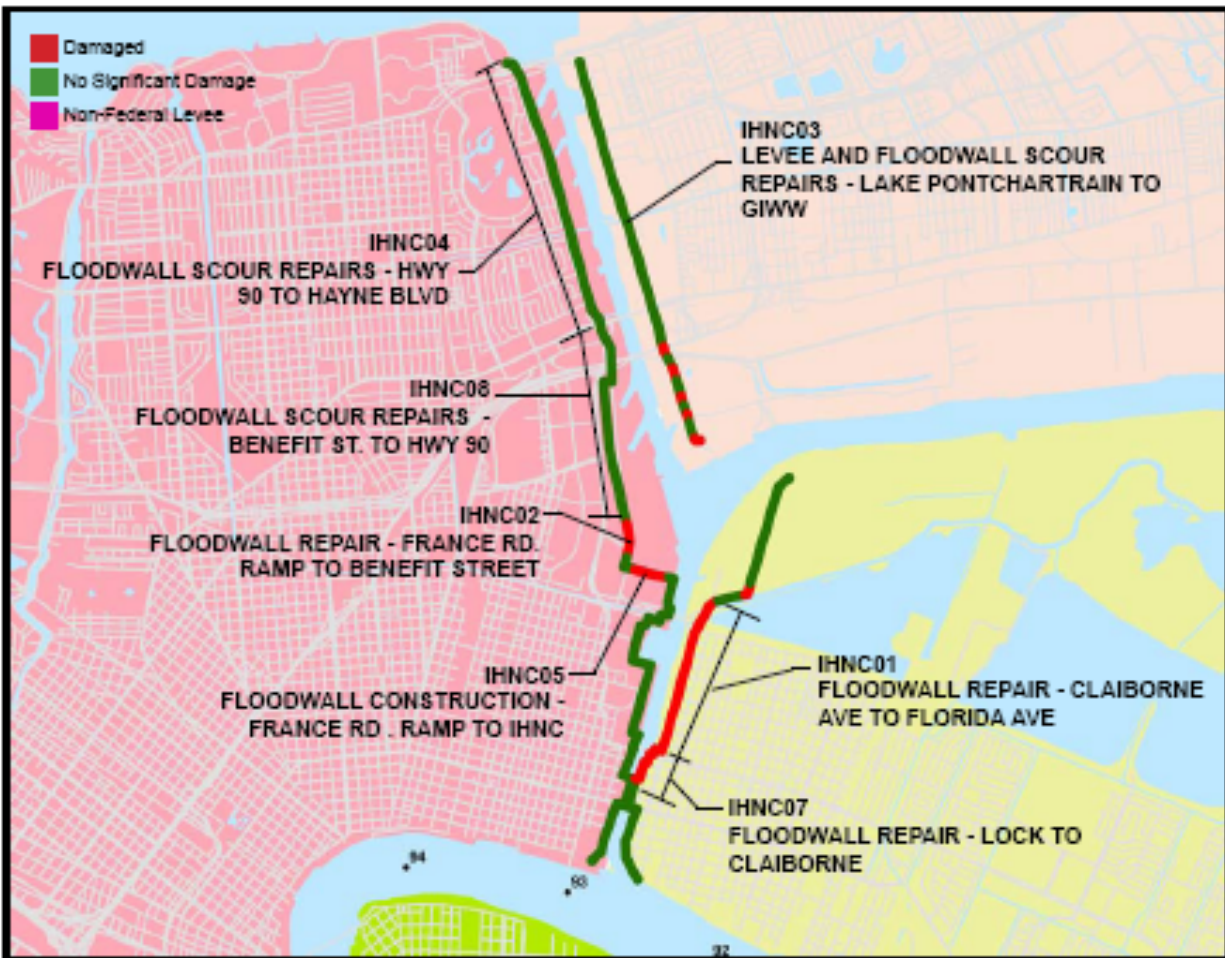

Figure 14-8. Hurricane Protection Features and Damages– IHNC

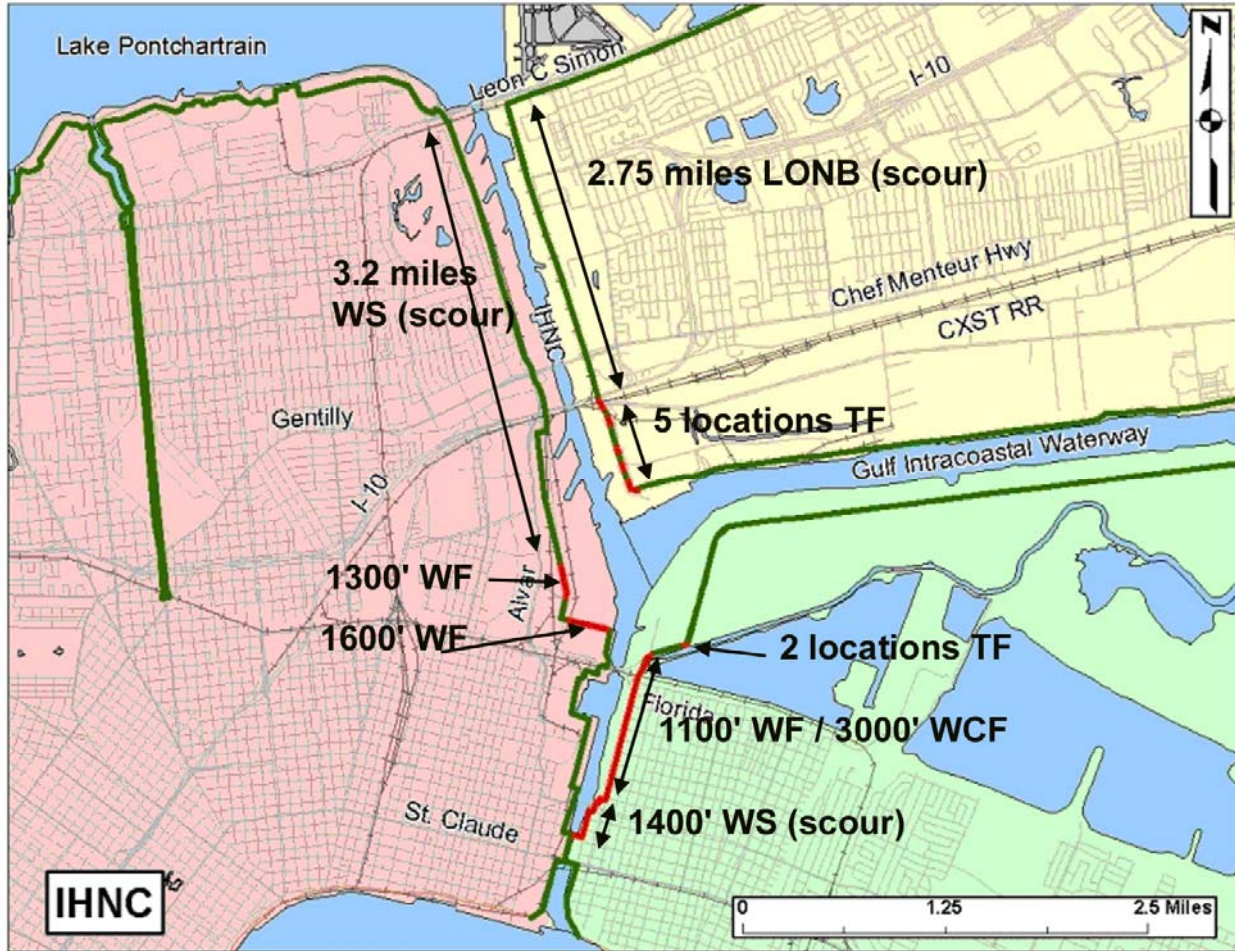

Figure 14-9. Damaged Areas Along the IHNC

St. Bernard Parish Basin – HPP Features

The St. Bernard Basin hurricane protection system includes the levee/floodwall extending from the Inner Harbor Navigation Channel (IHNC) easterly, along the Gulf Intracoastal Waterway (GIWW), to the Bayou Bienvenue Control Structure, continuing along the Mississippi River Gulf Outlet (MRGO) southeasterly, then turns generally to the west, where it ties into the Mississippi River Levee at Caernarvon, as shown on the map below. A portion of the hurricane protection system in this area also provides hurricane protection to the Lower 9th Ward area in Orleans Parish. Figure 14-10 illustrates the hurricane protection components of St. Bernard Parish, while Table 14-4 summarizes their lengths. Figure 14-11 illustrates the damaged areas and the ongoing repair contracts, and

Figure 14-12 is an example of the IPET characterization of the damages.

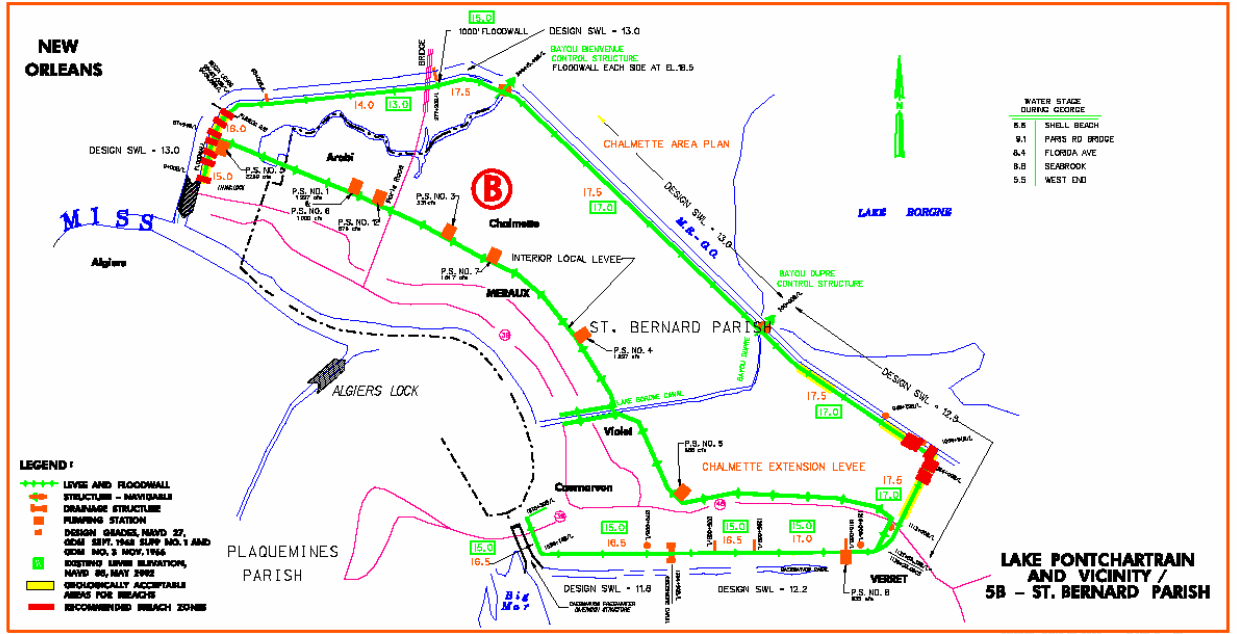

Figure 14-10. Hurricane Protection Project Features – St. Bernard

Feature Type	Length (ft)
Levees and Floodwalls	157,800
Road Closure Structures	6
Water Control Structures	2
Gravity Drainage Structure	1

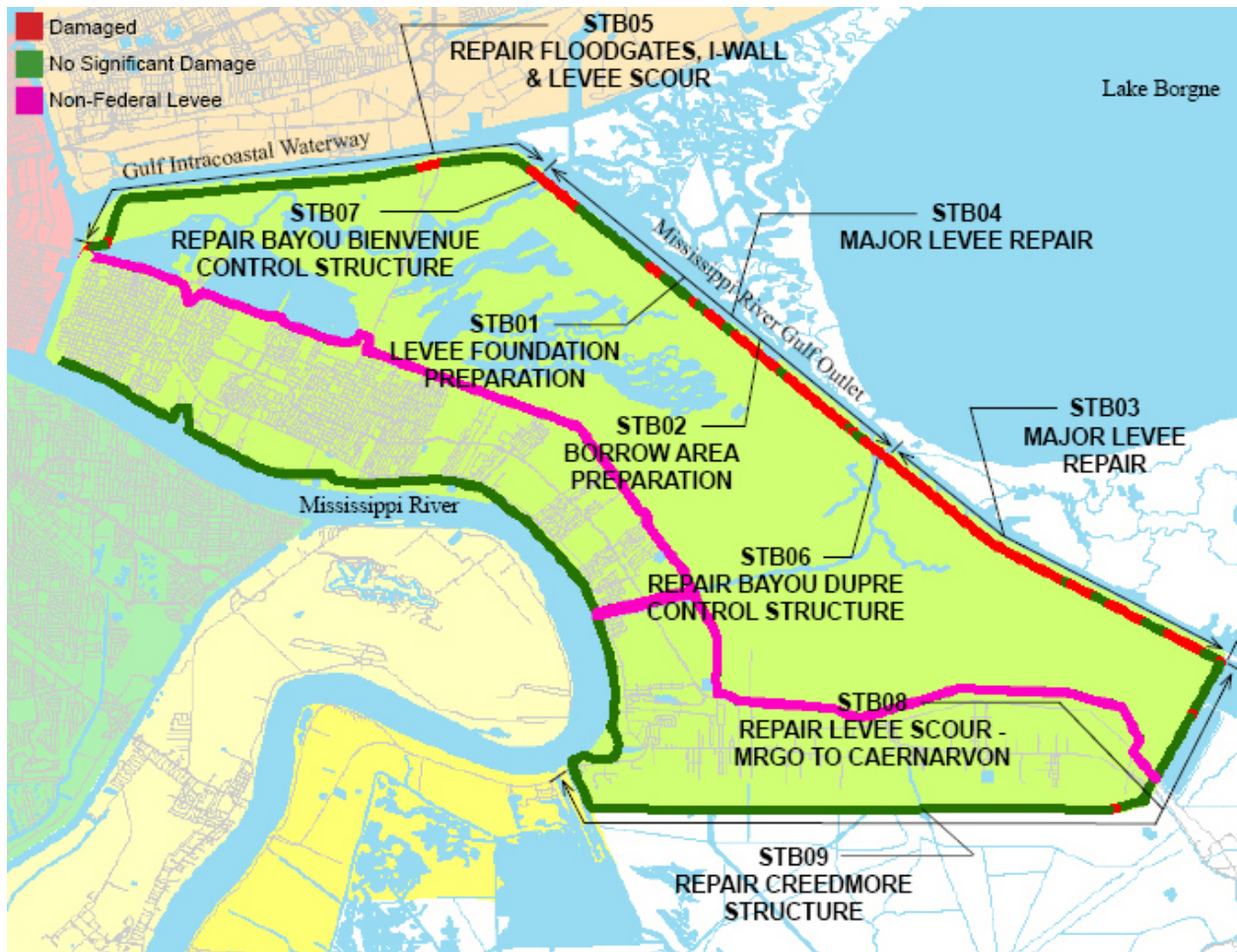

Figure 14-11. St. Bernard Damage and Contract Repair Areas

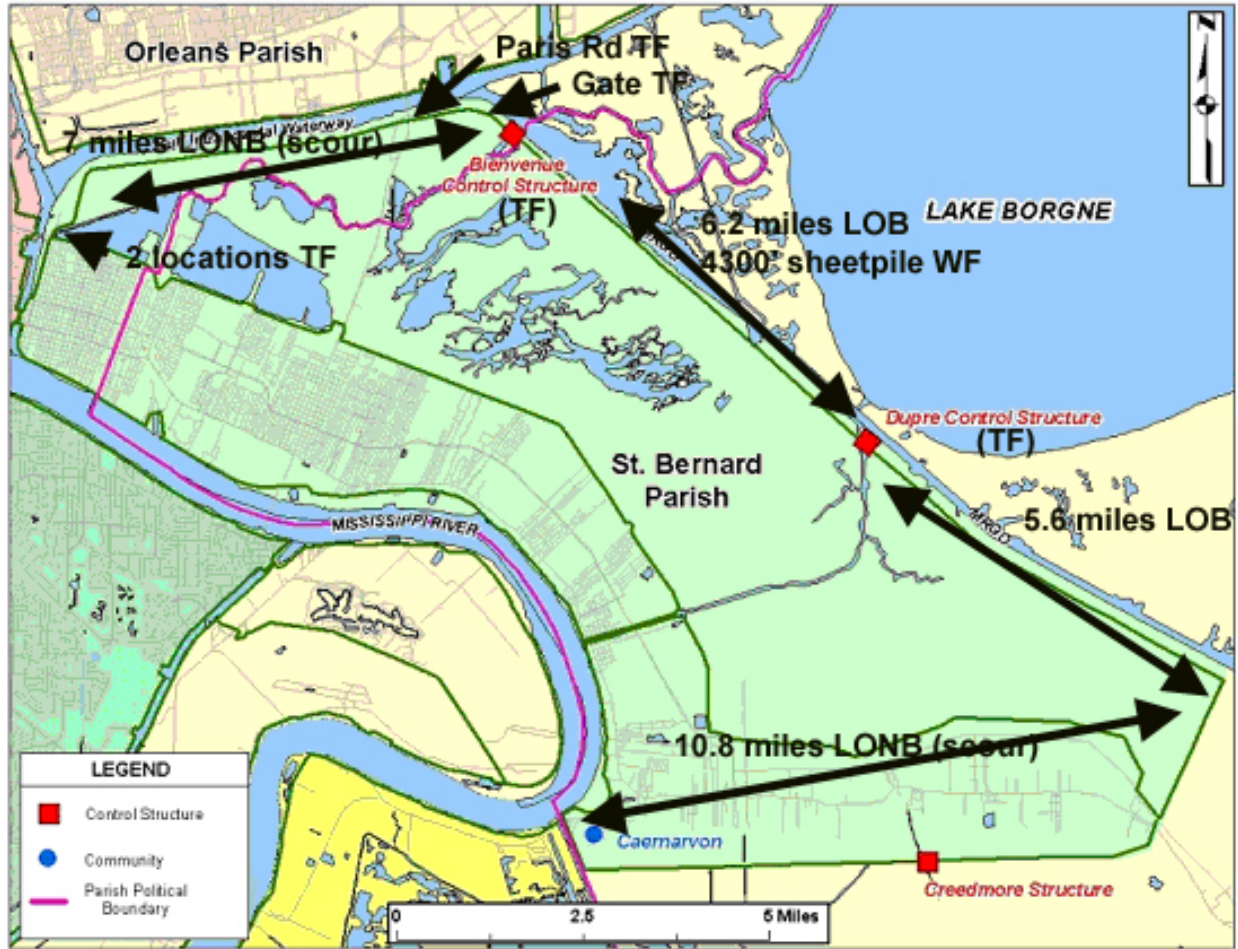

Figure 14-12. St. Bernard Parish IPET Damage Characterization

Plaquemines Parish – HPP Features

Altogether the Plaquemines Parish MRL and NOV systems include 162 miles of levee and 7 miles of floodwall. Table 14-5 summarizes the HPP components within Plaquemines Parish. Figure 14-13 illustrates the individual reaches that make up the MRL system and the NOV system. There are 19 non-federal pump stations for interior drainage. The levees are crossed by numerous pipelines, constructed in various manners. Some crossings bridge the levee without touching the embankment; some are constructed on top of the line of protection; and some pass through the line of protection with measures to prevent seepage. There is also a wicket gate closure on the back levee at Empire, where a shipping canal connects the Mississippi River to the Gulf of Mexico.

TASK FORCE GUARDIAN

Plaquemines - Project Summary

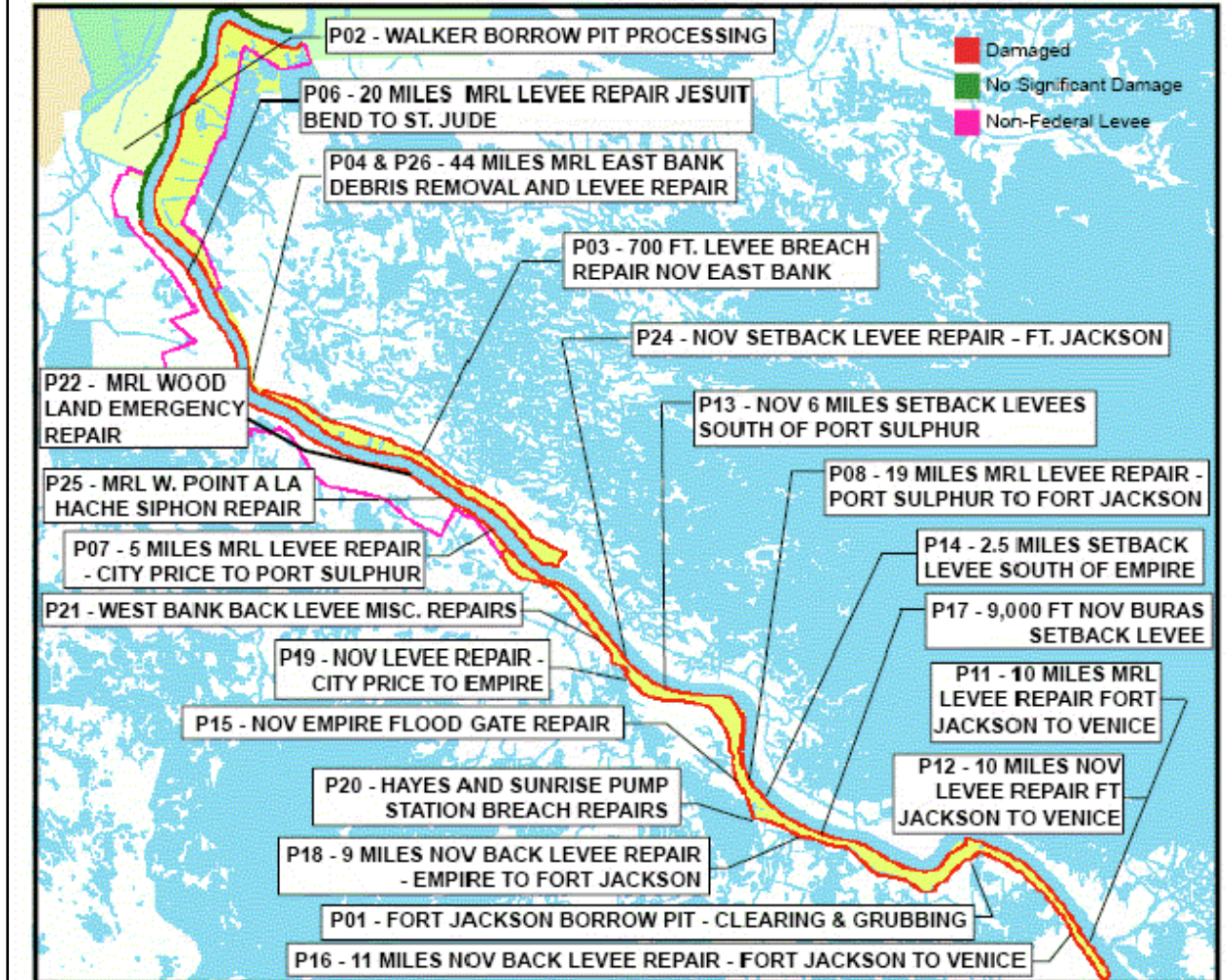

Figure 14-14. Damaged and Contract Repair Areas Along Plaquemine Parish

Mississippi River levee and Hurricane Protection back levee I	150 miles
Floodwalls	6.0 miles
Pump stations	
Marine floodgate Empire	1

West and East Sides, IHNC, Orleans Parish

The Inner Harbor Navigation Canal (IHNC) work area contains approximately 10 miles of levee and floodwalls along the Inner Harbor Navigation Canal in a heavily industrialized area. Lake Pontchartrain Barrier Plan Design Memorandum 2 (1968) describes pre-construction conditions and design details for the west side of IHNC and the east side north of the MRGO, up to the Seabrook Lock at the Lake. Chalmette Area Plan Design Memorandum 3 (1968) describes pre-construction conditions and design details for the east side of IHNC from the lock up to the MRGO.

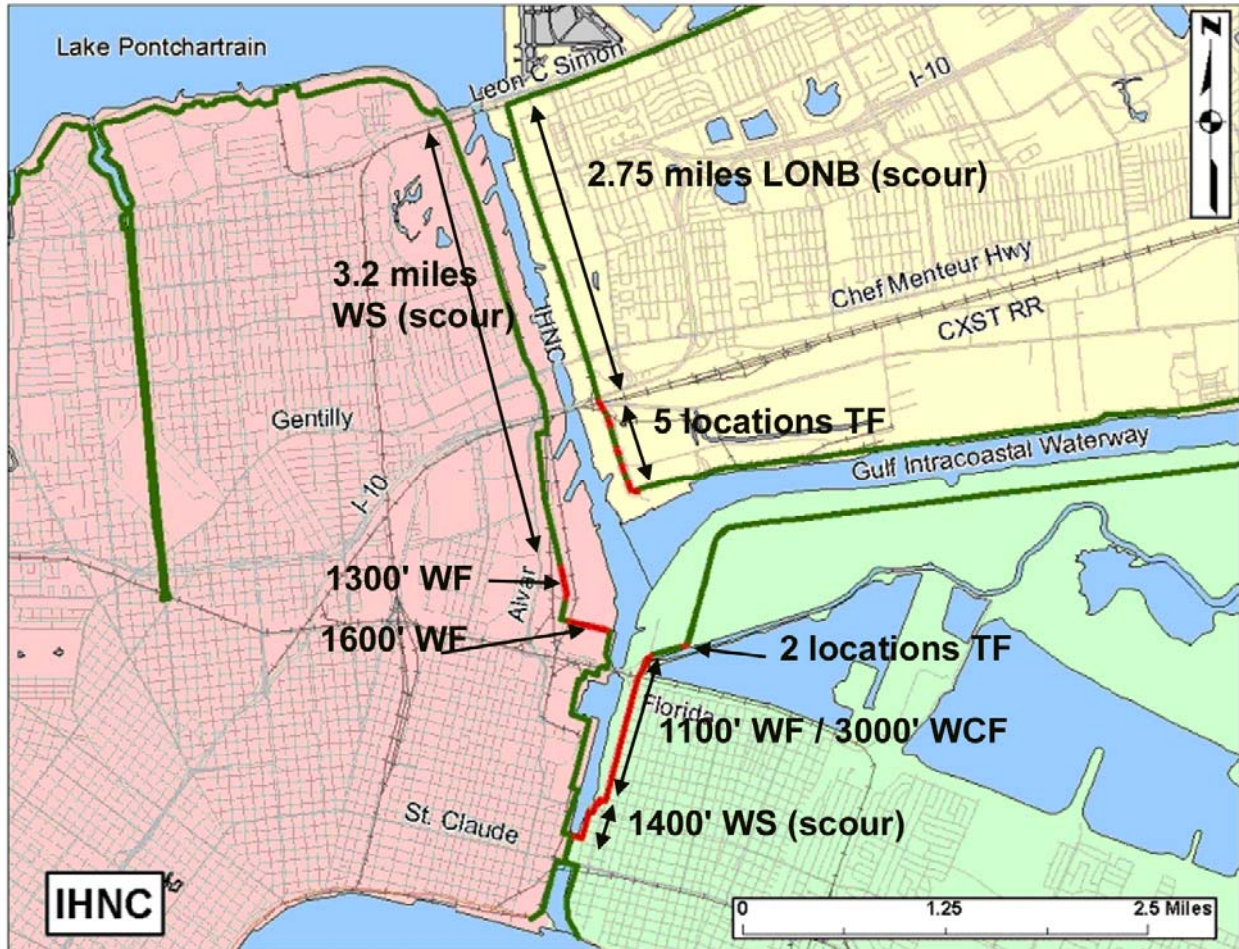

Figure 14-15. IHNC Flood Protection Damage

Damaged areas along the IHNC:

- LONB = Overtopped levees, no breaching
- WS = Overtopped floodwalls, no breaching (stable)
- LOB = Overtopped levees, breaching
- TF = Transition failure (floodwall to levee transition)
- WF = Overtopped floodwalls, breached (failure)
- WCF = Overtopped floodwalls, no breaching but came close

Overtopping was generally associated with varying degrees of scour (surface erosion), generally on the levee landside.



Figure 14-16. Photo of IHNC Area

Overtopping of the hurricane protection by Hurricane Katrina was evident along nearly all portions of the canal. There were four breaches in the protection system, two on the east side and two on the west side. The east side breaches are both located in the lower 9th ward neighborhood and the west side breaches are both in the vicinity of France Road and Benefit Street. Temporary repairs and closures have been made in these areas. Task Force Guardian will restore the protection back to pre-hurricane Katrina conditions. In the areas of the breaches, the 7 projects will replace/repair those walls back to pre-storm project authorized elevations. In the areas of scour, those walls and scour will be repaired accordingly.

The reach along the west side of the Inner Harbor Navigation Canal (IHNC) from the lock at St. Claude Avenue northward to Lake Pontchartrain consists of levee and floodwall. For the segment of this reach between the lock and Florida Avenue, damage consisted primarily of scour along the base of the floodwall. For the segment from Florida Avenue to Hwy 90, damage consisted of levee scour, scour along the base of a floodwall, and severe damage in the form of two breaches of the floodwall. For the segment of the IHNC from Hwy 90 to the lake the floodwall experienced relatively minor scour damage along its base.

In the IHNC area, seven separate construction projects have been identified to repair the damaged areas and restore flood protection to pre-hurricane Katrina conditions. These projects represent an estimated \$54 million in construction costs.

Soil borings for the area north of Florida Ave to the Lake are in DM2 Supp 8 Feb 1968.pdf

Soil borings for the area south of MRGO (East side) are in DM3Chalmette.pdf

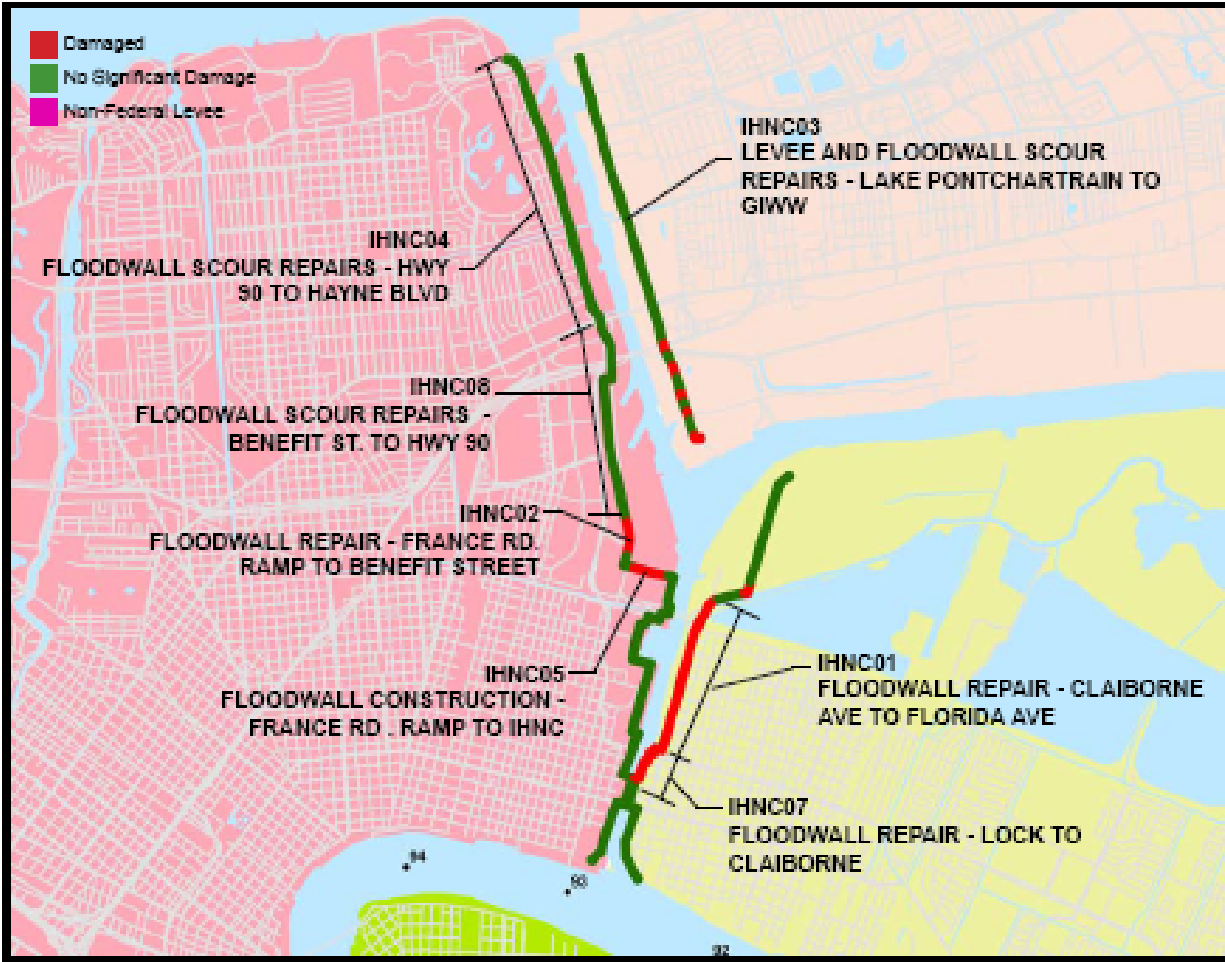

Figure 14-17. Task Force Guardian Repair Contracts

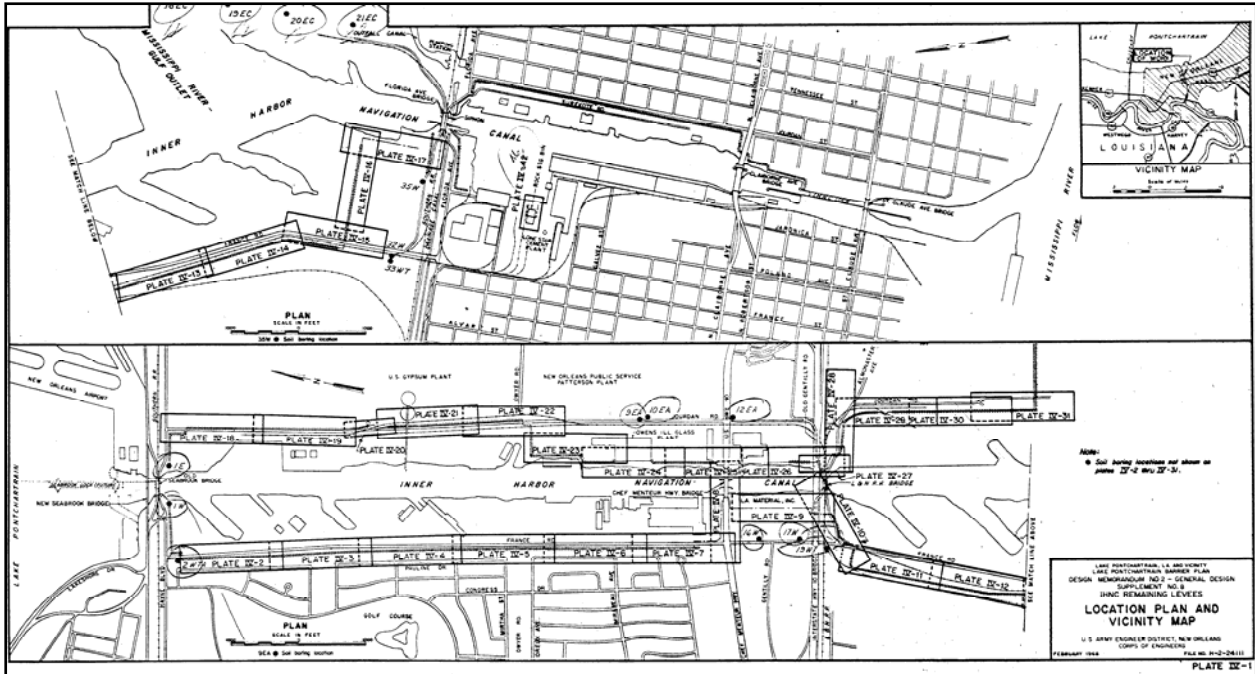

Figure 14-18. Pre-Katrina Design. Pg 154 (plate IV-1) DM2Supplement8 (GDMRemainingLeveesFeb68.pdf) shows stationing / soil borings between Fla Ave and Lake / on the IHNC west side, and between MRGO and Lake on the IHNC east side

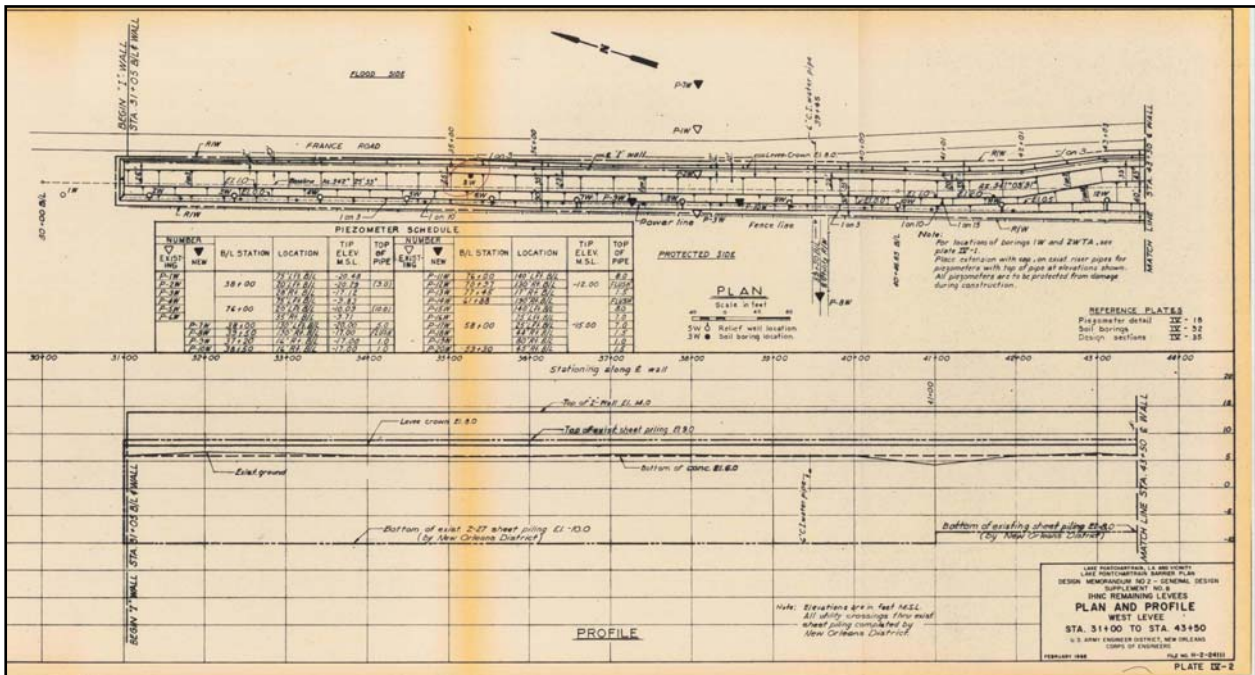

Figure 14-19. Soil Boring Layouts Begin on pg 155 (plate IV-2) of DM2Supplement8 (GDMRemainingLeveesFeb68.pdf)

IHNC EAST SIDE

Task Force Guardian (TFG) Project: IHNC01-IHNC East Side North Claiborne Avenue to Florida Avenue

Description: There is approximately 4,000 lineal feet of concrete I-wall flood barrier along the east side of the IHNC Canal between North Claiborne Avenue and Florida Avenue. The damages in this reach consisted of a breach of the floodwall immediately south of Florida Avenue (250') and one approximately 100 yards north of Claiborne Ave (850') with the remaining portions of the floodwall having areas of severe scour and tilting of the I-wall. The work includes replacement of the concrete I-wall with a concrete T-wall, supported on H-piles and sheet piling. Scheduled construction completion is 15 March 2006.

- 250' breach (WF) I-wall, south of Florida Ave
- 850' breach (WF) I-wall, 100 yds north of Claiborne Ave.
- ~3000' (WNF / WCF)



Figure 14-20. Plate 1, DM3Chalmette.pdf Showing Stationing and Soil Boring Locations for IHNC South of Fla Ave

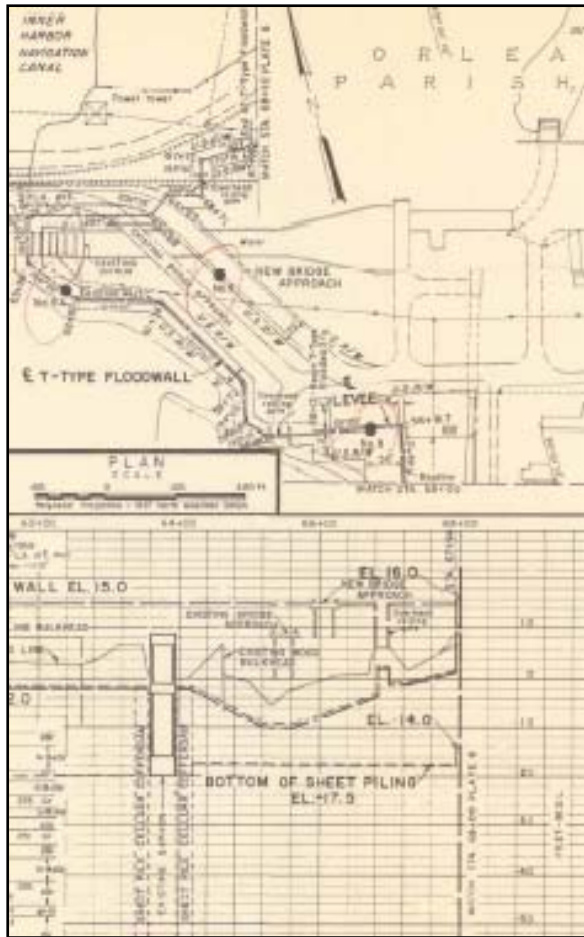

Figure 14-21. Plate 5 of DM3 Shows the Fla Ave Area, East Side IHNC

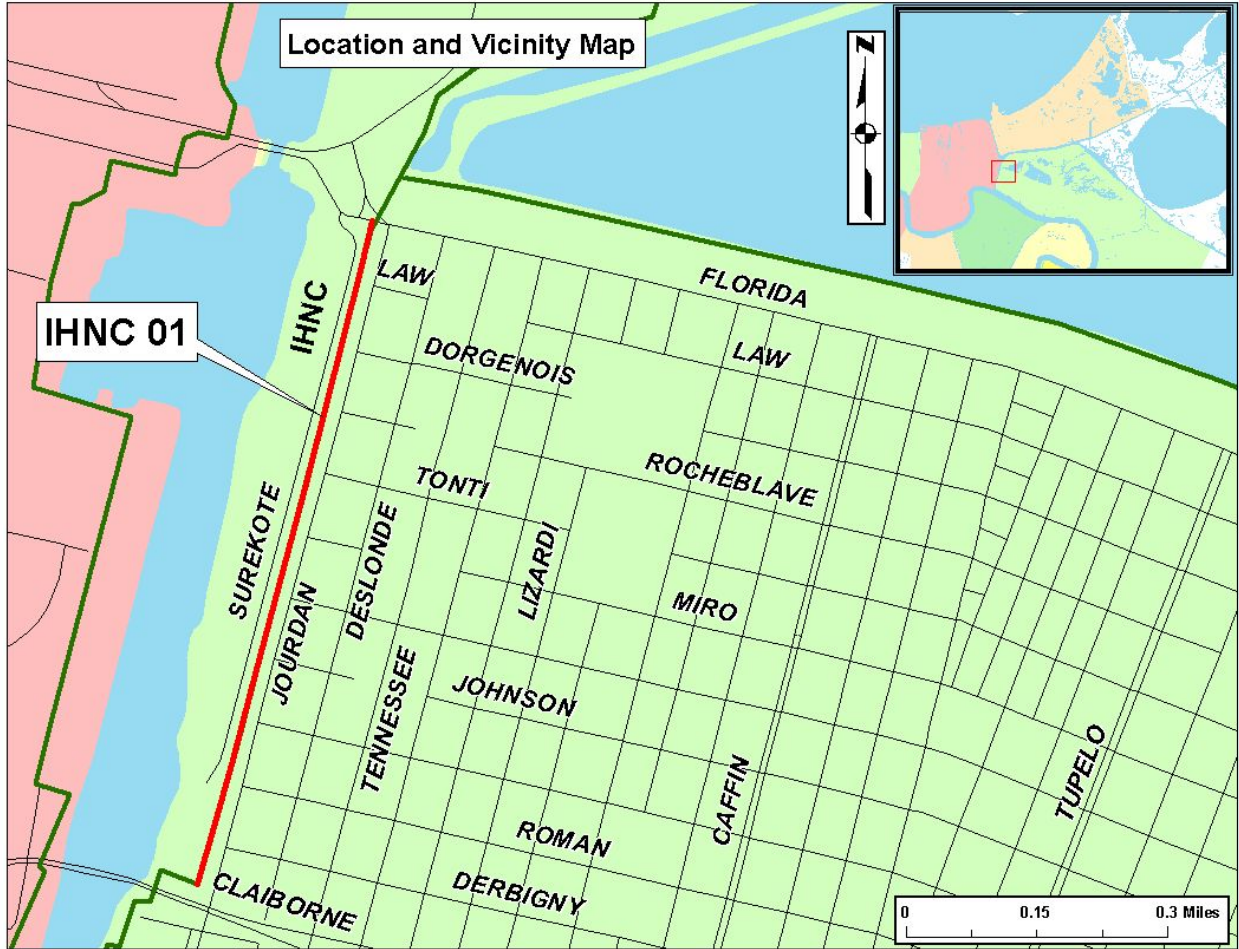

Figure 14-22. East Side IHNC Between Claiborne Ave. and Florida Ave.



Figure 14-23. During Katrina; View to East Side of IHNC South of GIWW. Breach began approximately 300 ft north of Claiborne Ave.



Figure 14-24. Closeup of Flattened I-Wall and Barge, View Toward Claiborne Ave.



Figure 14-25. Transition From Failed Wall to Intact Wall, View Toward Claiborne Ave.



Figure 14-26. Northernmost Transition From Failed Wall to Intact Wall



Figure 14-27. Demolishing Flattened I-Wall North of Claiborne Ave.

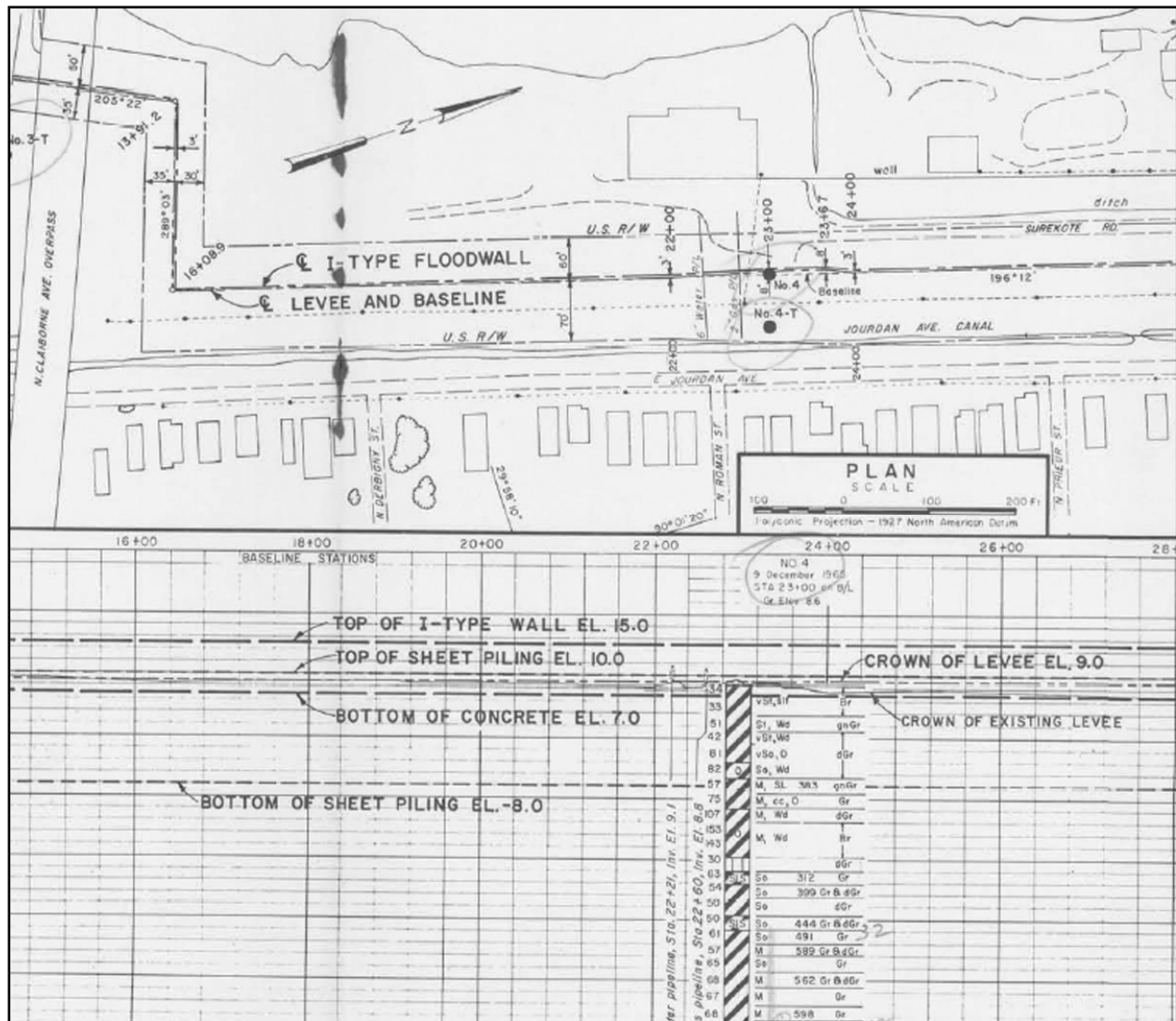

Figure 14-28. Nearby Soil Boring No. 4 Shows Existing Levee Soil and Elevations (from DM3 Chalmette drawing file H-2-23820, plate 3)



Figure 14-29. Florida Ave Bridge, View East. I-Wall Failure is Seen to Right of Bridge



Figure 14-30. Southernmost I-Wall Failure Transition Between Florida Ave and Claiborne Ave.



Figure 14-31. CPT Truck at Levee Toe on Protected Side at the Southernmost I-Wall Failure Transition Between Florida Ave and Claiborne Ave., View Toward Pump Station



Figure 14-32. Northernmost I-Wall Failure Transition Between Florida Ave and Claiborne Ave., View Toward Pump Station on the Protected Side

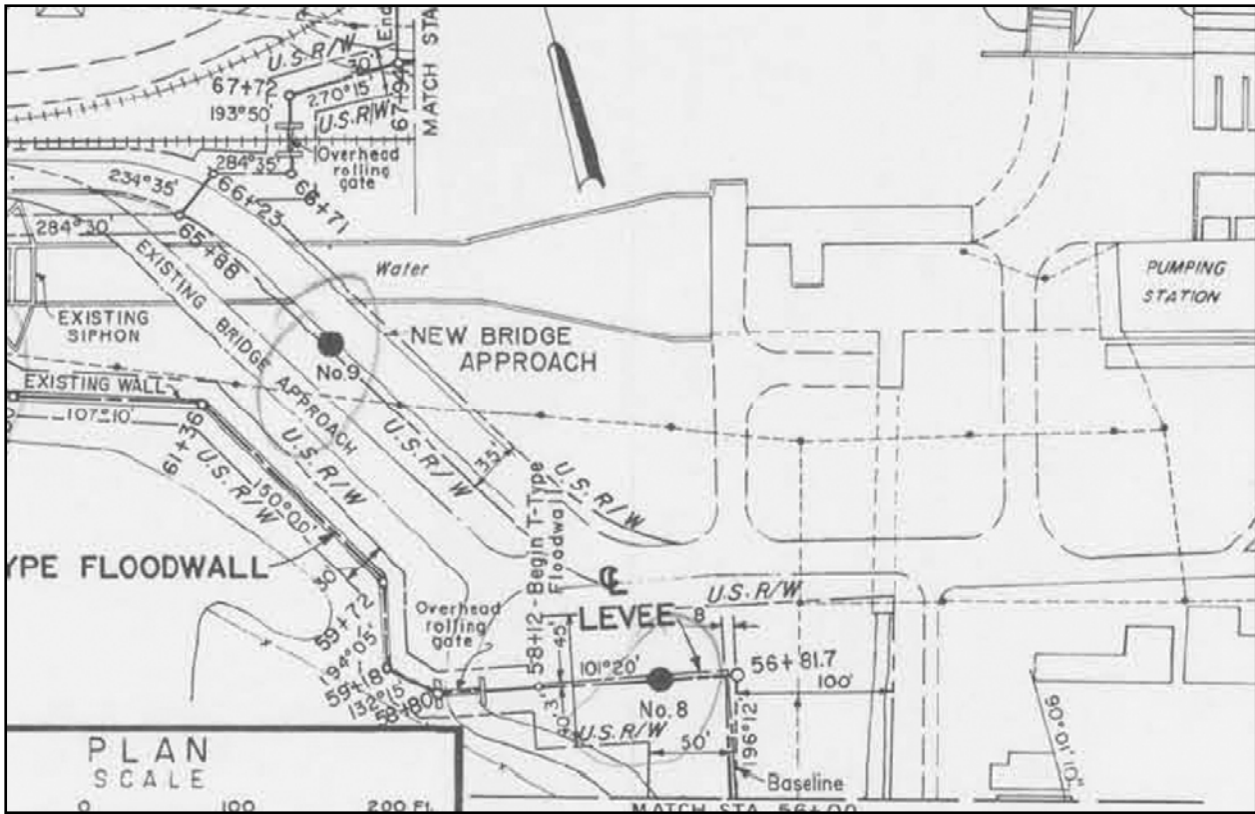

Figure 14-33. Soil boring No. 8 is Nearest to the Florida Ave Breach (from DM3 Chalmette drawing file H-2-23820, plate 5)

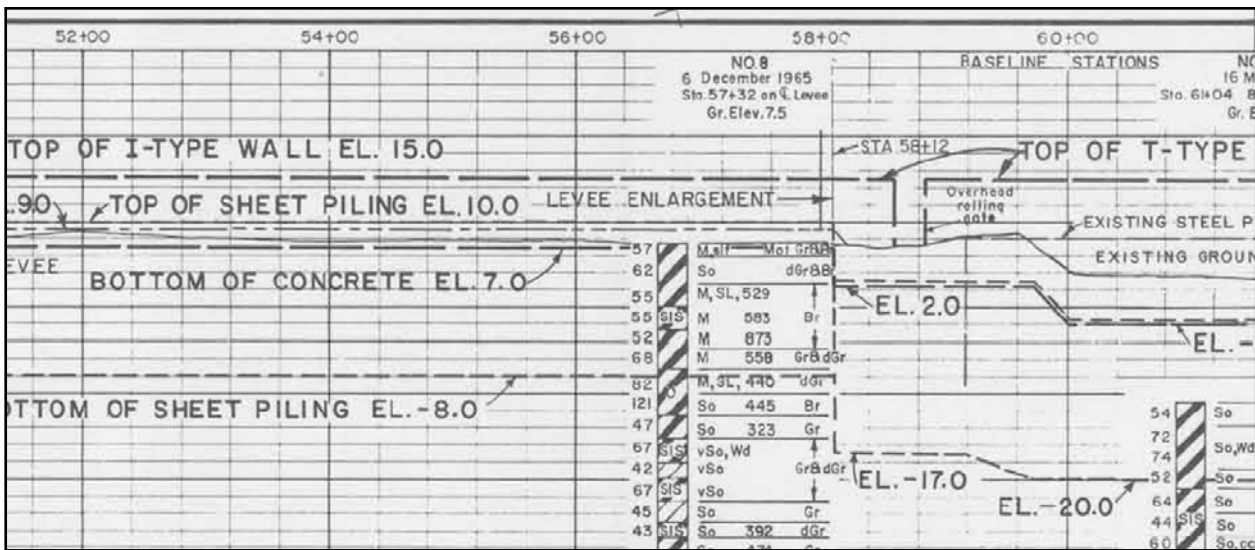

Figure 14-34. Soil Boring 8 Shows Fat Clay Soil and Sheetpile Elevation (from DM3 Chalmette drawing file H-2-23820, plate 5)

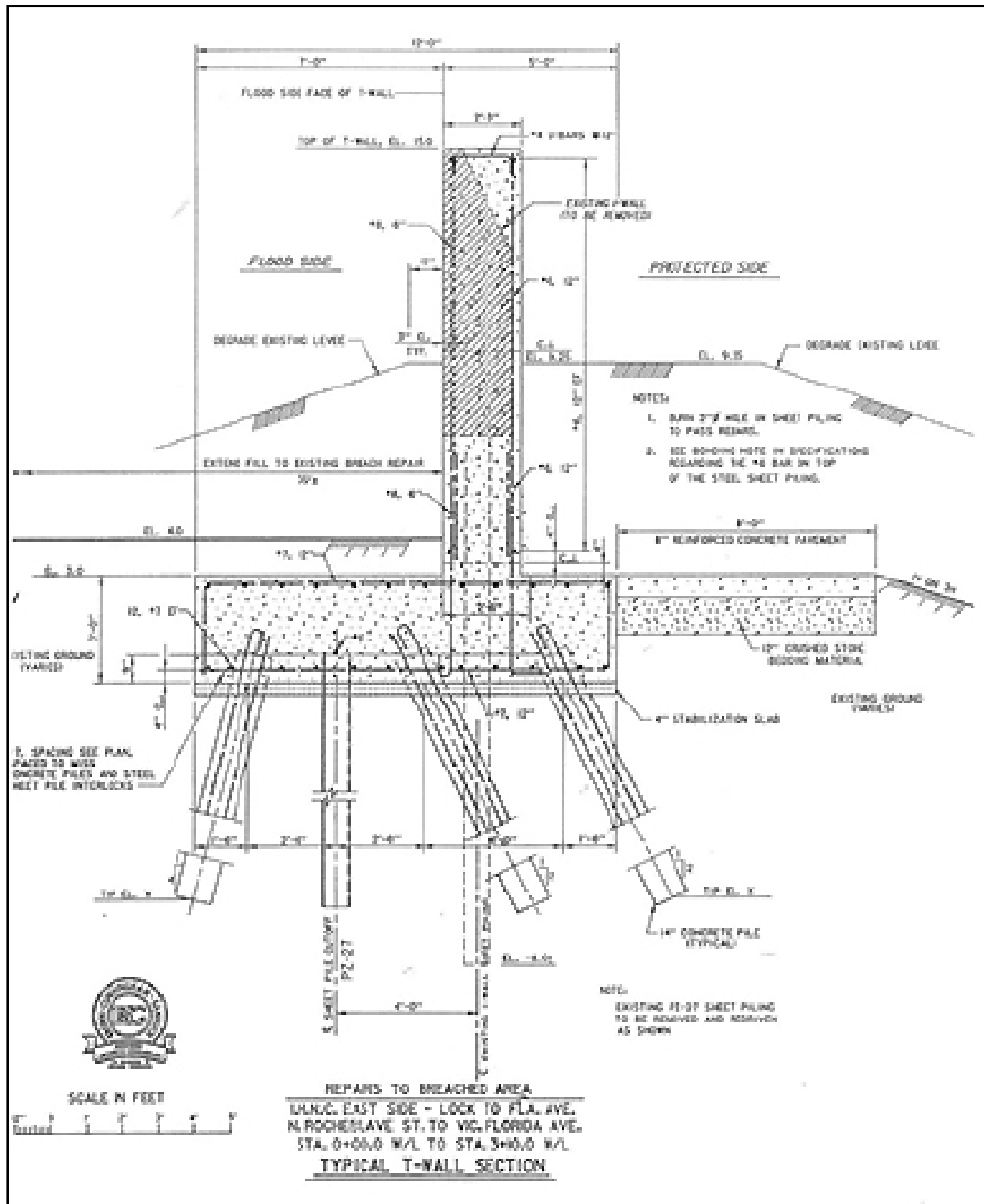

Figure 14-35. New "T" Wall Design for New Floodwall on IHNC East Side From Lock to Fla Ave., Sta 0+00 to 3+00

TFG Project: IHNC03 – East Side Levee and Floodwall Scour Repairs Lake Pontchartrain to the Gulf Intracoastal Waterway (GIWW)

Description: There are approximately 2.75 miles of floodwall and levee along the east side of the IHNC Canal between the Gulf Intracoastal Waterway and Lake Pontchartrain. The damages in this reach consisted of intermittent scour of the levee and scour and damage at the wall/gate closures and at the wall/levee interfaces. The repairs consist of filling in the scour areas, repairing the gate concrete sills and seals, installing new sheet piling, placing rock and ballast, and placing stone erosion protection. Scheduled completion is April 1, 2006.

~2.75 miles LONB (base scour on landside)

-5 locations WF / TF @ wall/levee transitions and wall/gate closure transitions, all south of the Twin Spans. Wall/gate and wall/levee locations (shown in picture on following page):

(A) under the I-10 high rise (Gate E9)

(B) 30 deg 00 min 15.82 sec N, 90 deg 01 min, 22.32 sec W (Gate E8)

(C) 30 deg 00 min 10.37 sec N, 90 deg 01 min, 19.55 sec W (Gate E7)

(D) “ 02.39 sec N, “ 16.68 sec W (Gate E6)

(E) 29 deg 59 min 55.92 sec W, “ 14.39 sec W (Gate E5)

(F) “ 48.84 sec W, “ 11.57 sec W (RRGateE4)

All these soil boring locations south of the twin span are on plates IV-27 thru IV-30, DM2Supp8



Figure 14-36. Pre-Existing Top of Wall Elevation Along IHNC 03 Was 15 ft. Gate Top Elevations Were 14 ft



Figure 14-37. Approximate B/L Sta 101+00. Top of I-wall is elev 14.75, bottom of concrete is elev 7, and levee crown is elev 9. Nearest B/L boring is Sta 96+00 (No. 9EU), 500 feet distant

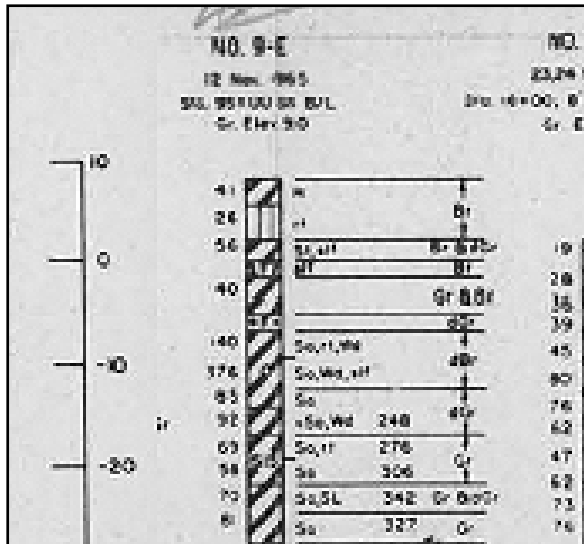

Figure 14-38. Boring 9E (Sta 95+00 B/L) Shows Approximate Depth of Fat Clay (CH) is 3 feet at Crown Elevation 9 ft

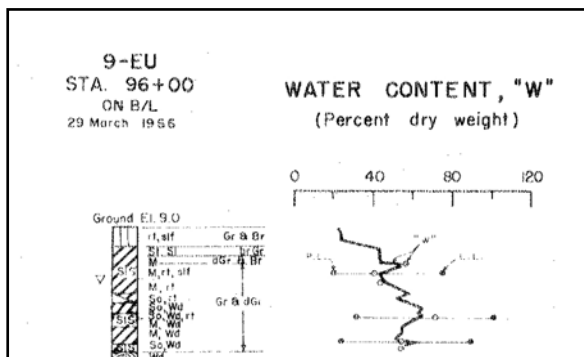

Figure 14-39. Boring 9EU (Sta 96+00 B/L) Shows Top Layer of Silt at Crown Elevation 9 ft



Figure 14-40. IHNC03 Project Repairs South of I-10 (WF / TF areas)



Figure 14-41. Scour at Gate 7E; Scour Measures 7' (w) x 30" (deep). Top of wall is at elev. 13.1 +/-



Figure 14-42. Gate E5 Looking South From Inside the Protected Area. Scour damage 7' (w) x 7' (d) around adjacent flood wall. Top of wall at gate is Elev. 13.2 +/-



Figure 14-43. Scour at Railroad Gate Closure Structure E4 at Southernmost IHNC03 Project. 29 deg 59 min 48.76 sec N, 90 deg 01 min 11.6 sec W (Sta 176+75.9)



Figure 14-44. E4 Scour Repaired

TFG Project: IHNC07 - Floodwall Repair, East Side, IHNC Lock to North Claiborne Ave.

Description: There is approximately 1,400 lineal feet of concrete I-wall flood barrier along the east side of the IHNC Canal between the IHNC lock and North Claiborne Avenue. The damages along this reach consisted of intermittent scour along the base of the floodwall. The work includes filling in the scour repairs and providing erosion protection. Contract Award NTP scheduled for early February, 2006.

1400' WNF / WS (base scour on landside)

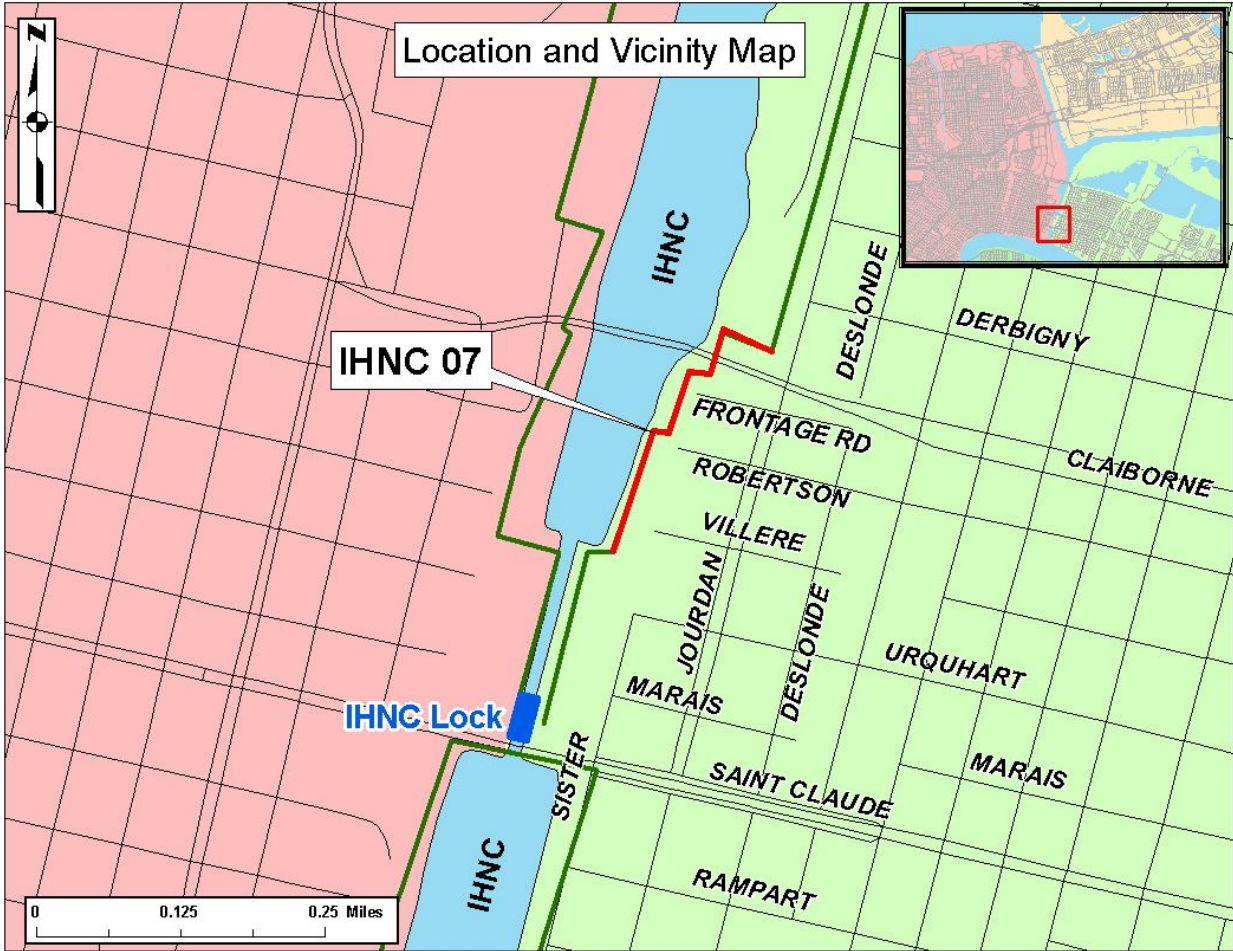

Figure 14-45.



Figure 14-46. Scour at I-Wall / Levee Transition at IHNC Lock



Figure 14-47. Approximate B/L Sta 7+00, View Toward Claiborne Ave. Bridge. Depth of scour was to the bottom of the I-wall concrete cap. Nearby soil boring 2U indicates the upper 5 ft was fat clay (CH) with sand / silt lenses

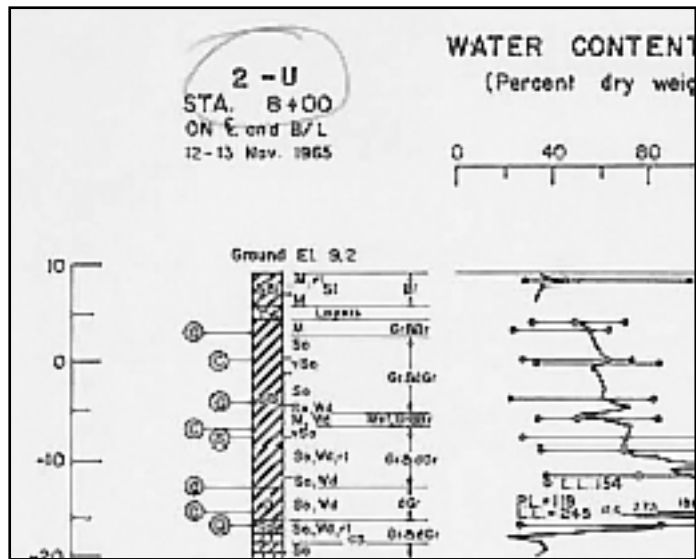

Figure 14-48. Undisturbed Boring 2U Located 100 ft Distant, Shows Fat Clay (CH) With Silt / Sand Lenses in Upper 5 ft. Undrained shear strength in upper 3.2 ft was approximately 500 psf



Figure 14-49. East Side IHNC Near N. Claiborne Ave, Approximate B/L Sta 11+00. I-wall elevation designed 15 ft (MSL), bottom of concrete elevation 7 ft (MSL), and levee crown elevation 9 ft (MSL). Nearest soil boring, No. 3, shows fat clay (CH) at surface

West Side IHNC

TFG Project: IHNC05 – IHNC West Side, Vicinity France Road Ramp to IHNC

Description: This portion of the project consists of approximately 1,600 feet of existing levee and concrete floodwall that extends from the vicinity of France Road ramp towards the IHNC. This area was breached and experienced severe scour. The repair consists of replacement with a new concrete T-Wall. Scheduled completion is April 15, 2006.

1600' WF (soil boring Plate IV-16 in DM2Supp8)

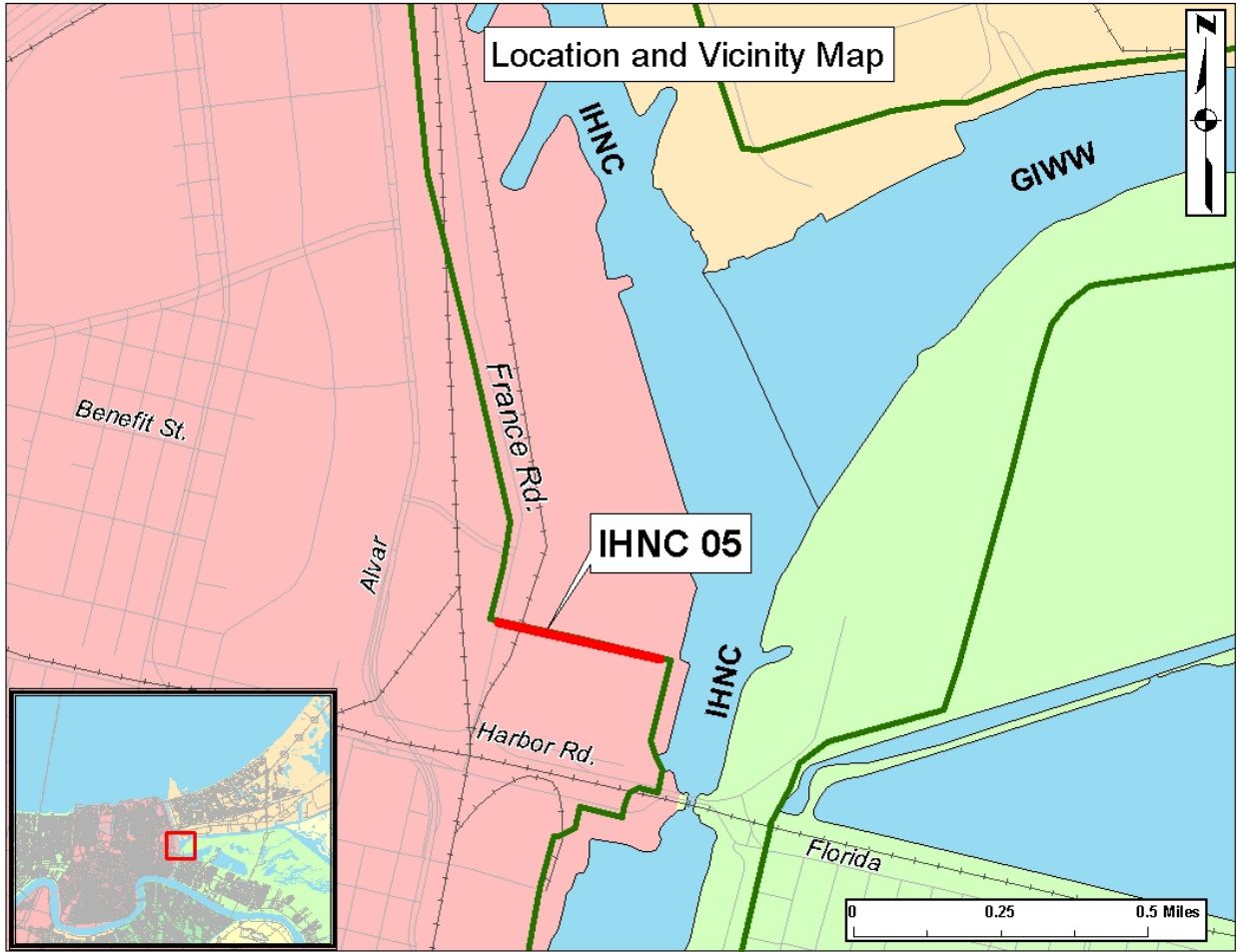

Figure 14-50.

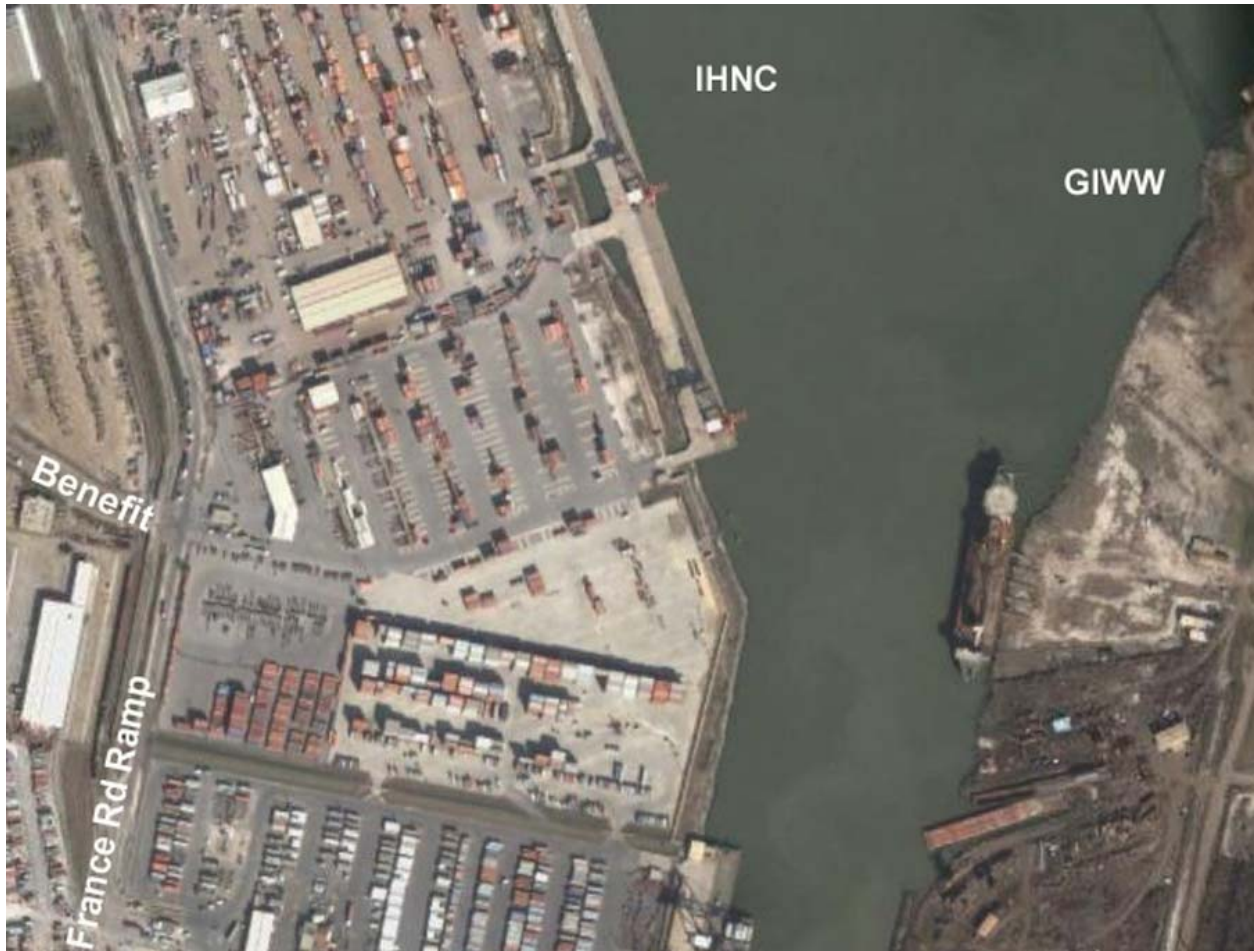

Figure 14-51. Container Terminal, West Side of IHNC Just North of Florida Ave.

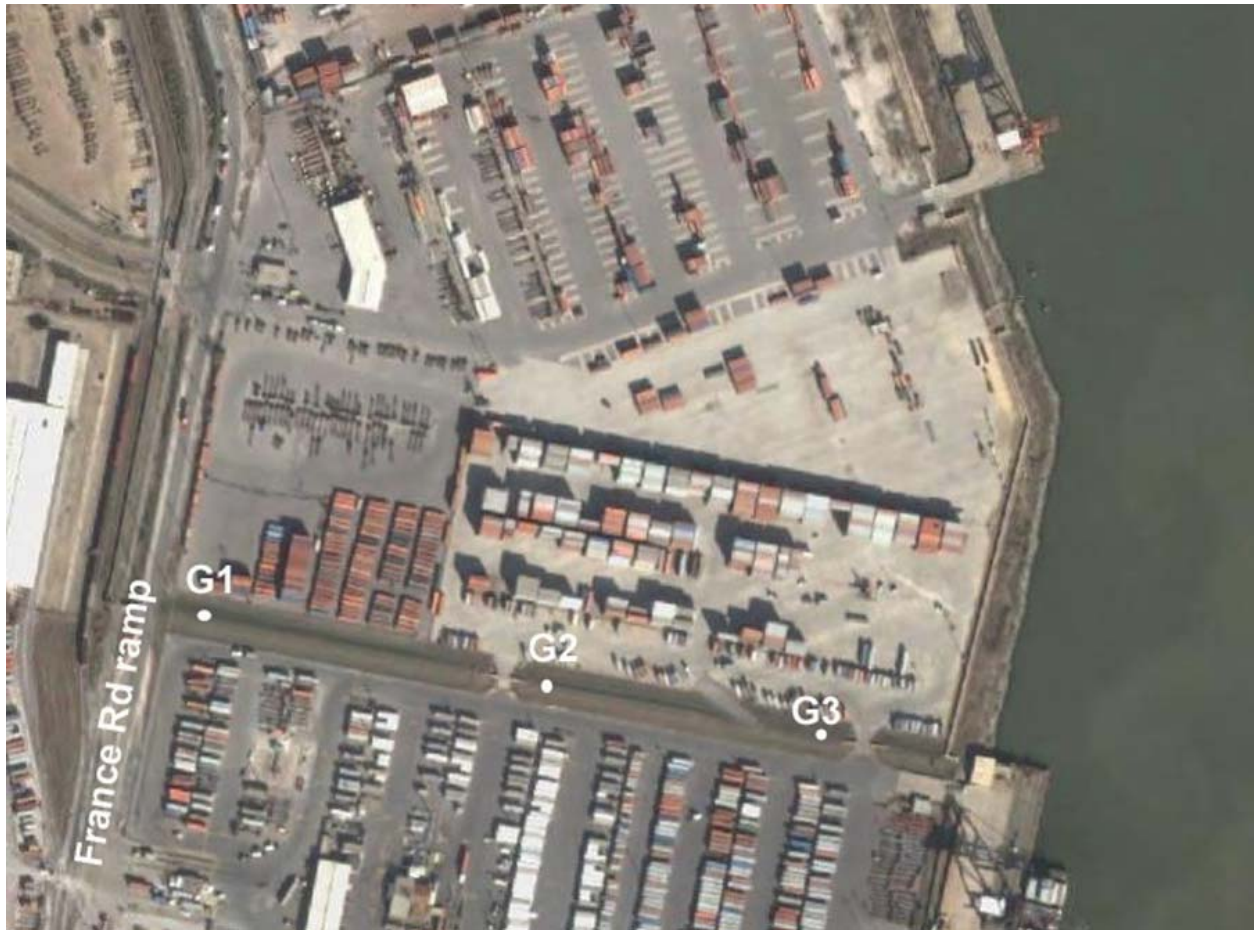

Figure 14-52. Levee / Floodwall Between IHNC and France Rd Showing Soil Boring Locations



Figure 14-53. Overtopped Levee Section With Scour. View west from approximate CL Sta 14+00, B/L Sta 222+00

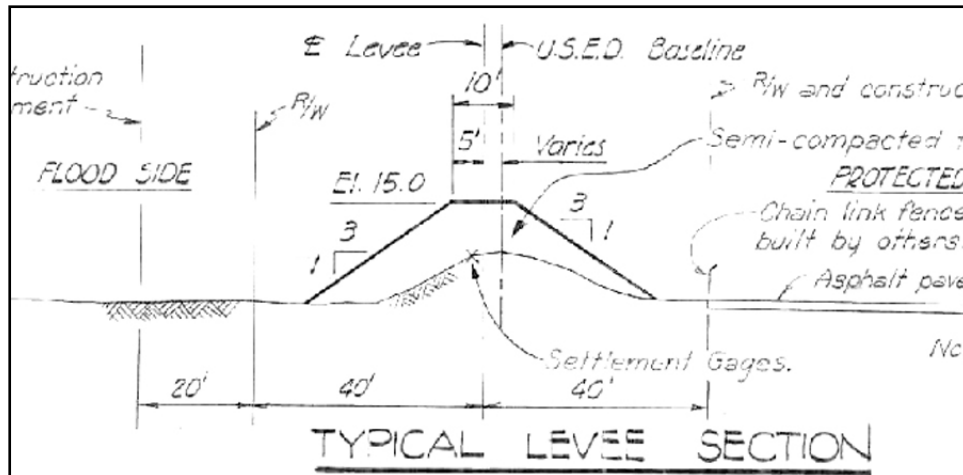

Figure 14-54. Levee Section Between IHNC and France Rd Ramp Shows Elevation 15 ft on Top of Existing Levee

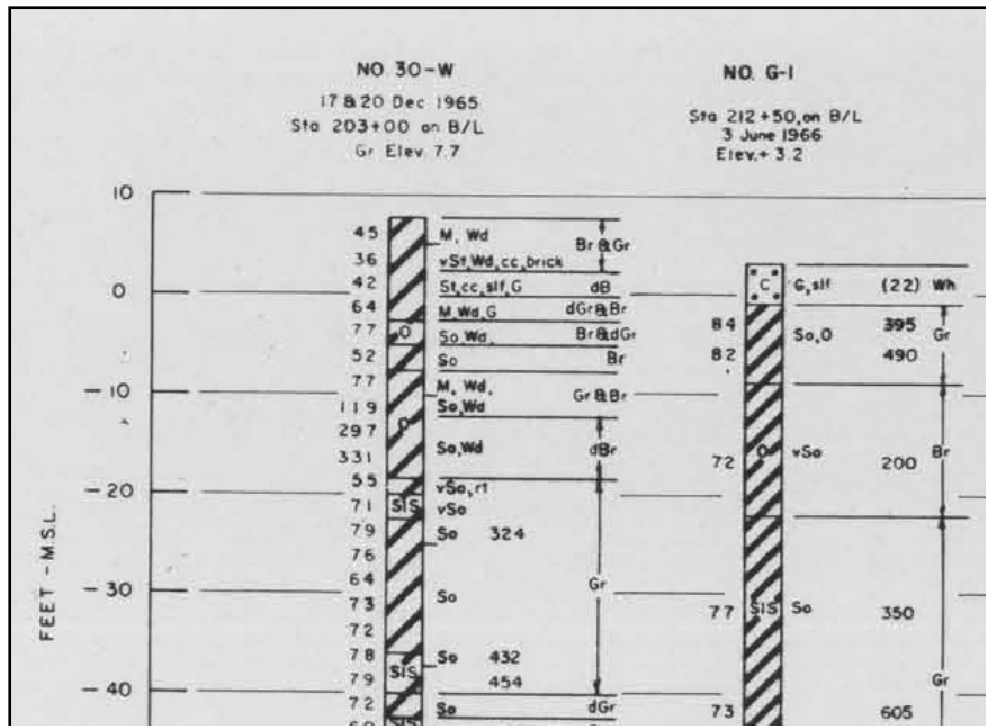

Figure 14-57. Nearest Boring G-1 Shows Sandy Material at Original Ground Surface (may have provided a zone facilitating levee failure)

TFG Project: IHNC02 – IHNC west side South France Road Ramp to 770 feet North of Benefit Street

Description: – This section of the project consists of concrete I-wall. The damage in this area consisted of a breach of the floodwall at the container terminal along France Road. There was also heavy scour of the floodwall in this area. The repairs consist of removing approximately 1,300 lineal feet of the damaged concrete I-wall and replacing the damaged section of wall with new concrete L-wall. The new wall will be supported by steel H-piles and longer steel sheet piles. Scheduled completion is April 15, 2006.

1300' WF @ container terminal along France Rd.

Profile and soil boring info for this reach is found in [SuppDesignInfo IHNC RemainingLevees.pdf \(1969\)](#) and [ModificationProtectiveAlinement IHNC Oct71.pdf \(1971\)](#)

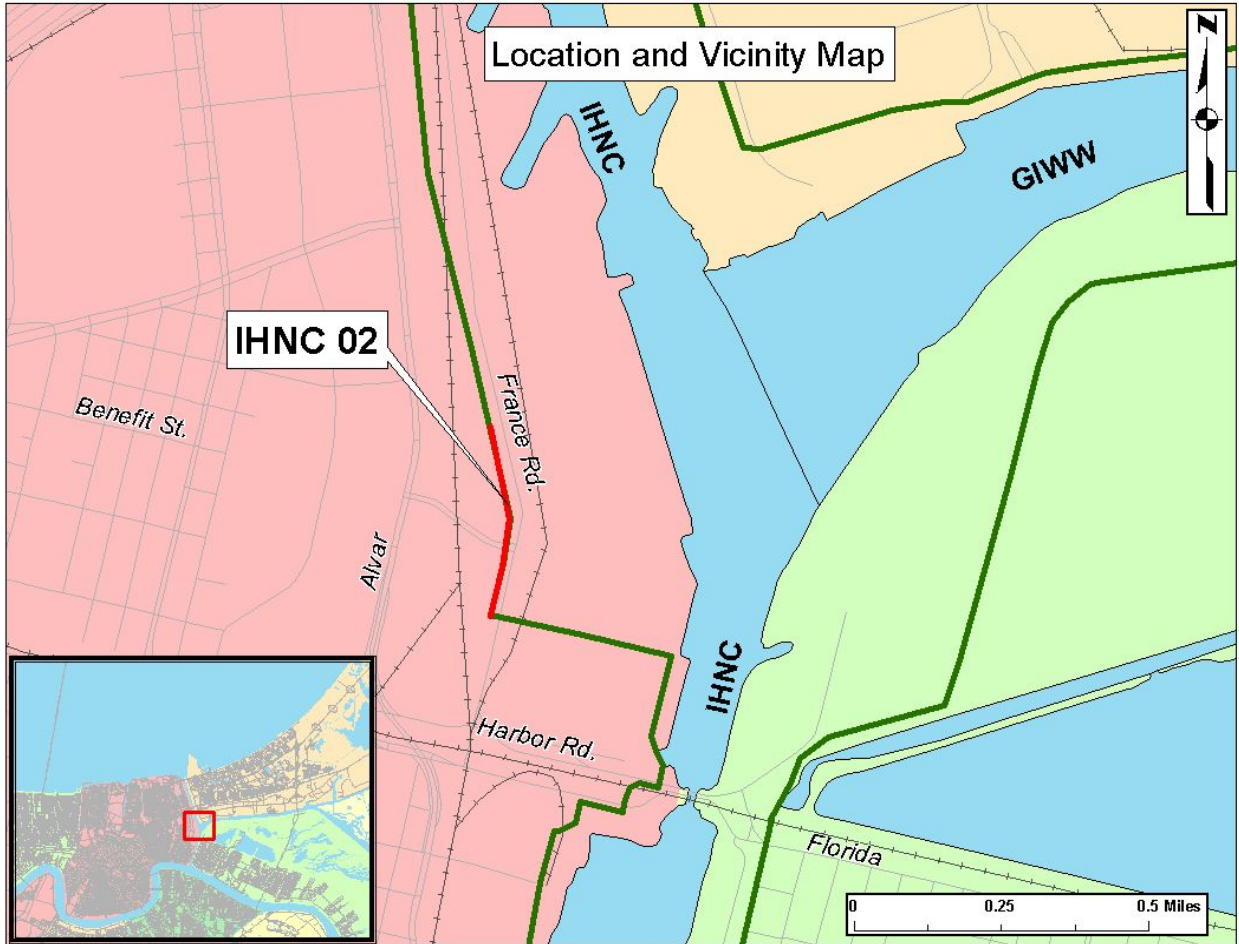

Figure 14-58.



Figure 14-59.



Figure 14-60. View South From Benefit St. Gate Toward France Rd Ramp. Approximate W/L Sta 5+56 (B/L Sta 205+44). Top of I-wall elevation 15 ft, levee crown 9 ft, bottom of concrete 7 ft, bottom of pre-existing Z-27 sheet pile (by Orleans Levee Board) at -10ft (MSL). From drawing file H-2-24111, plate IV-15. Nearest soil boring is 30W at B/L Sta 203+00

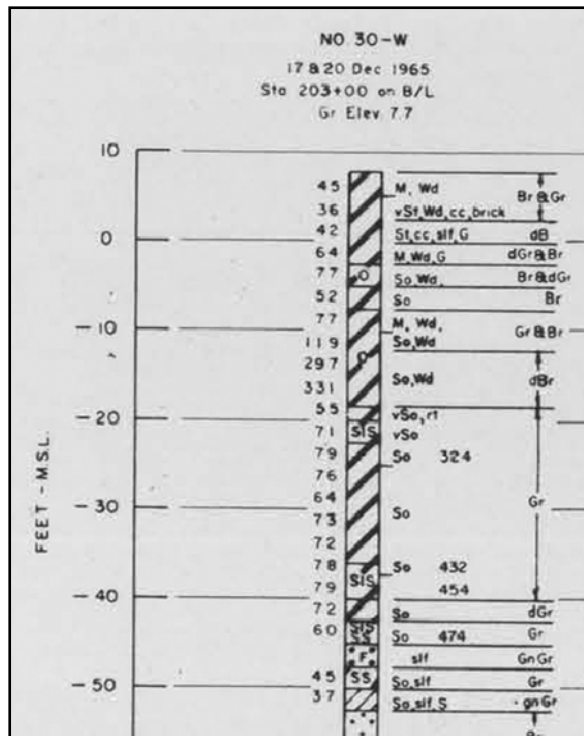

Figure 14-61. Boring 30W Near Benefit St. Gate Shows Fat Clay Soil Layers



Figure 14-62.



Figure 14-63.



Figure 14-64.



Figure 14-65.



Figure 14-66.

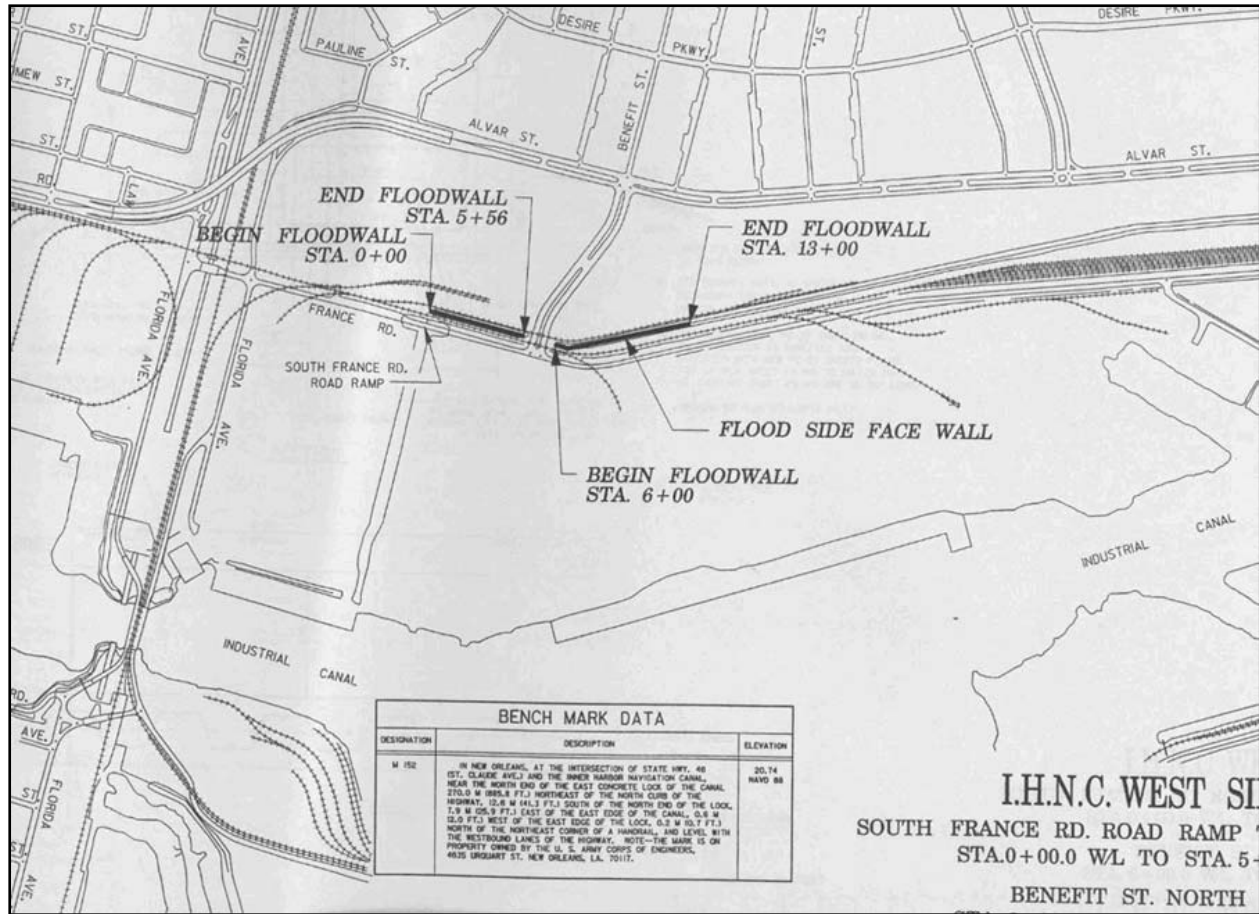

Figure 14-67. Contract Solicitation IHNC02 W912P8-05-R-0069 Layout Drawing



Figure 14-68.



Figure 14-69.

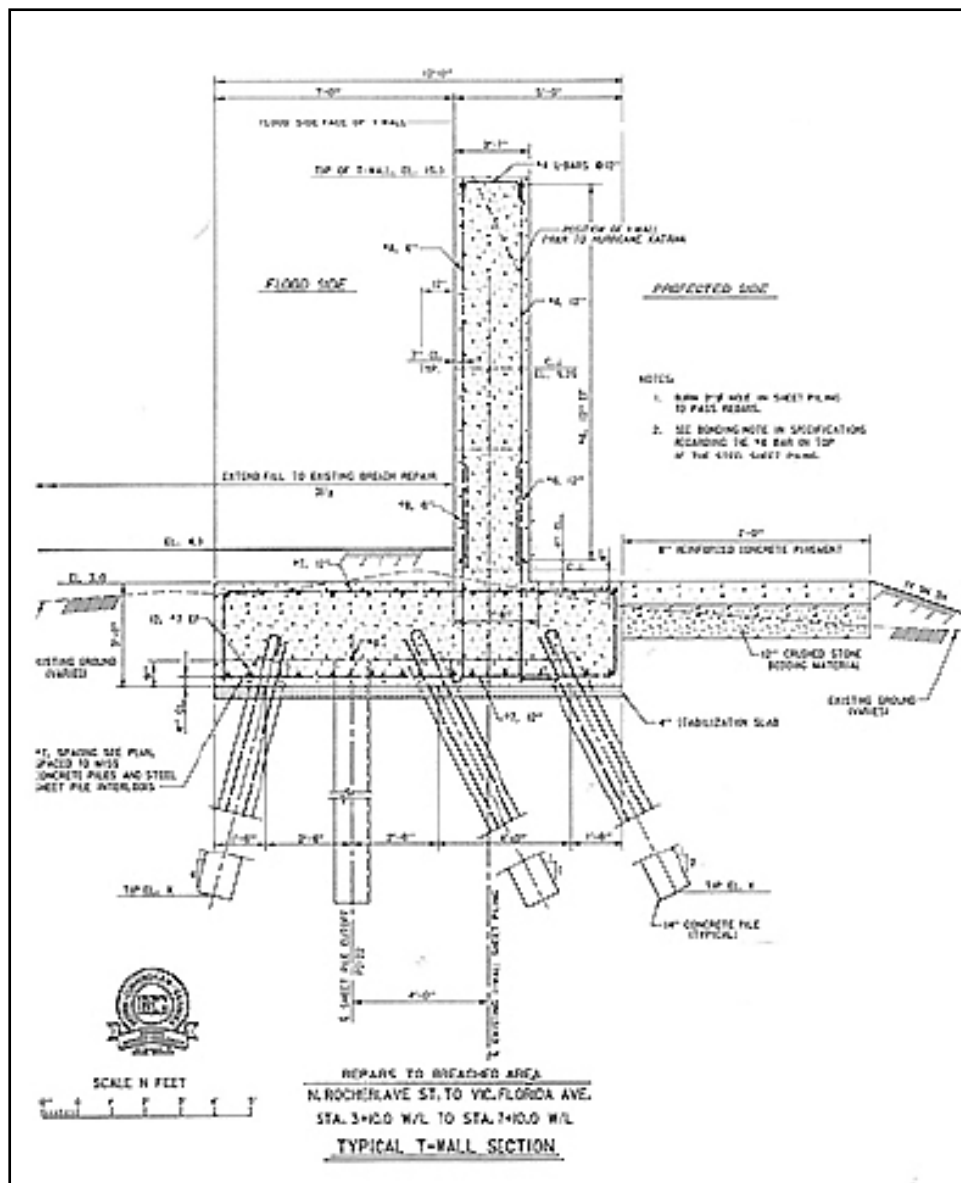

Figure 14-70. New "T" Wall Design, Sta 3+00 to 7+00

There is no IHNC06 TFG project.

TFG Project: IHNC08 – West Side 700' North of Benefit St. to Hwy 90

Description: This section of flood protection consists of concrete I-Wall embedded in compacted earthen levee embankment. The damages in this area consisted of scour along the base of the floodwall. The repairs consist of scour repair and erosion protection. Contract Award NTP scheduled for early February, 2006.

700' north of Benefit St. to Hwy 90 = ~6000' WNF / WS (base scour on landside)

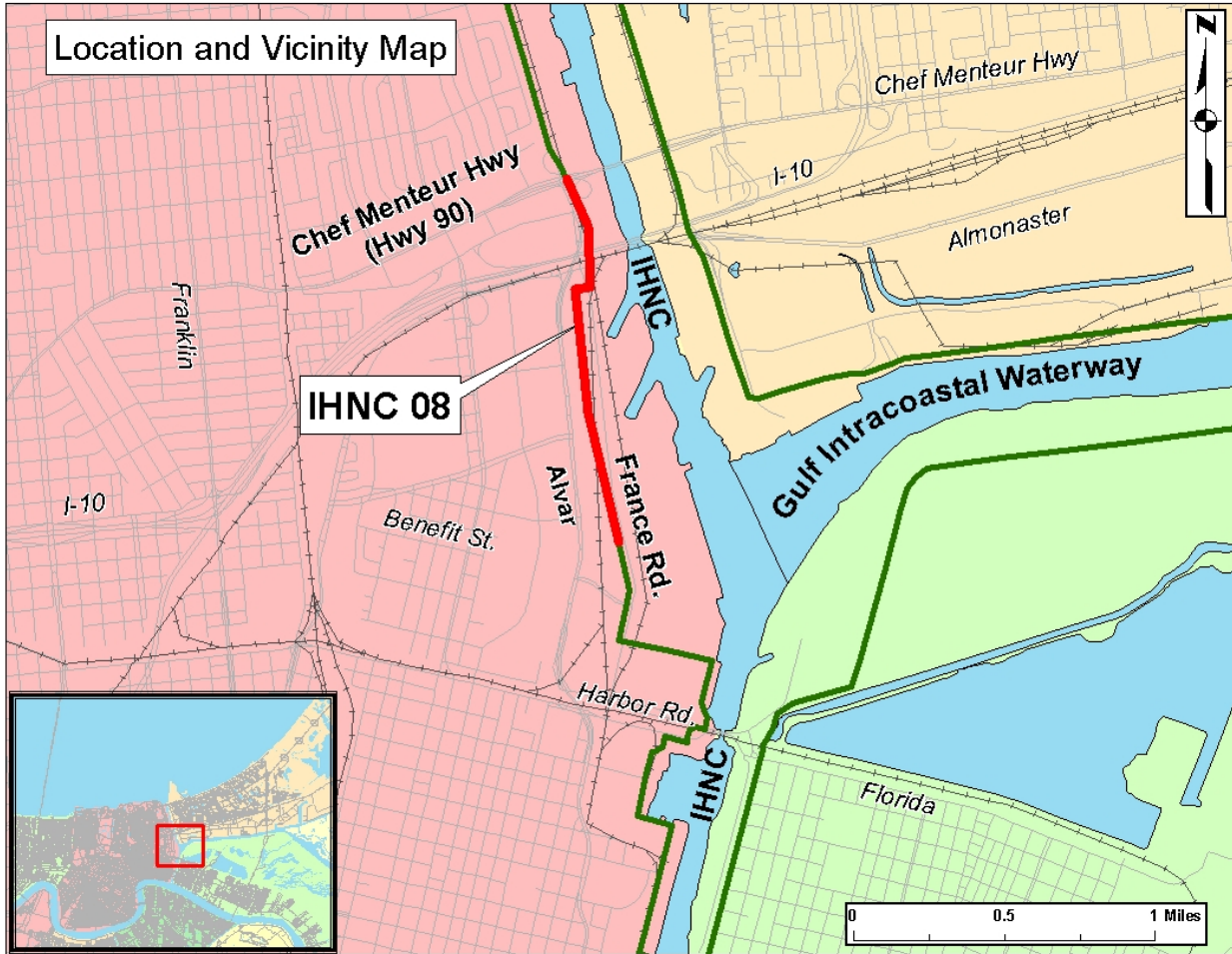

Figure 14-71.



Figure 14-72. Scour at T-Wall Base of Gate W23

TFG Project: IHNC04 – IHNC Hurricane Protection Levee Hayne Boulevard to Highway 90

Description: West Side from Hayne Blvd. to Hwy 90 - This segment of flood protection consists of concrete I-wall extending from Hwy 90 to Lake Pontchartrain. The floodwall along this segment experienced relatively minor scour damage along its base. The repairs consist of filling in the scour areas, installing steel sheet pile walls to prevent canal seepage from going beneath the wall, and cleaning existing and installing new relief wells. Scheduled completion is April 1, 2006.

8,400' WNF (base scour on landside), Hayne Blvd to Chef Menteur Hwy



Figure 14-73.



Figure 14-74.

Inner Harbor Navigation Canal - West Levee															
Summary of Damages															
DSR ID #	Type of Structure	Start/End	GPS Coordinates						Scour Dimensions (Feet)				Scour Damage Class	Condition of Floodwall	
			Degrees (N)	'	"	Degrees (W)	'	"	Length	Depth	Width	Cu-yd to fill		Type	Description
Lock to Florida Avenue (West side)															
W-1	Levee with I-wall (capped)	Start/End	29	57	59.3	90	1	37.2	20				II	I-Wall	Scour adjacent to wall
W-2	Gates W2, W3 (T-wall monoliths)	Start	29	58	65.3	90	1	37.5	500	3	15	833	I	T-Wall	Scour adjacent to wall
		End	29	58	8.9	90	1	36.1							
W-3	Gates W4, W5 (T-wall monoliths)	Start	29	58	8.9	90	1	36.1	700	3	15	1,167	I	Gate monolith	Scour adjacent to wall
		End	29	58	13.6	90	1	36.2							
W-4	Wall btwn Gates W5, W6 (T-wall monoliths)	Start	29	58	13.6	90	1	36.2	1,460	3	15	2,433	I	Gate monolith	Scour adjacent to wall
		End	29	58	27.9	90	1	31.8							
W-5	Wall between Gate W6 and Namasco Bldg to Gate W13 (T-wall, I-wall monoliths)	Start	29	58	27.9	90	1	31.8	1,330	3	5	739	I	Gate monoliths, T-wall I-wall	Scour adjacent to wall
		End	29	58	38.6	90	1	34.8							
W-6	Wall btwn Gate W14 and Gate W15 (T-wall and I-wall monoliths)	Start	29	58	40.7	90	1	33.8	300	2	5	111	I	Gate monoliths, I-wall	Scour adjacent to wall
		End	29	58	43.4	90	1	33.1							
W-7	Gate W17	Start/End	29	58	48.6	90	1	32.7	30	1	3	3	I	Gate monoliths	Scour adjacent to wall
W-8	Gate W18 to Gate W19	Start	29	58	48.6	90	1	32.3	600	2	5	222	I	I-wall	Scour adjacent to wall
		End	29	58	49.0	90	1	31.2							
W-9	Gate W19 to Gate W20	Start	29	58	49.0	90	1	31.2	200	4	5	148	I	I-wall	Scour adjacent to wall
		End	29	58	50.7	90	1	25.4							
W-10	Gate W20 to Gate W22 (adjacent to PS#19)	Start	29	58	50.7	90	1	25.4	200	2	5	74	I	I-wall	Scour adjacent to wall
		End	29	58	53.0	90	1	22.8							
Florida Avenue to Hwy 90 (West side)															
W-11	Gate W23	Start/End	29	58	56.2	90	1	27.9	30	4	15	67	II	T-wall	Scour adjacent to wall
W-12	Gate W2 to W3	Start	29	58	56.5	90	1	22.5	300	3	5	167	I	I-wall	Scour adjacent to wall
		End	29	59	4.0	90	1	19.9							
W-13	Levee	Start	29	59	4.7	90	1	23.4	150	Scour repaired			II		Scour repaired w/ aggregate
		End	29	59	4.8	90	1	25							
W-14	Gate W25B to Gate W26	Start	29	59	4.7	90	1	23.4	800	Scour repaired			III		Scour around gate W25B and on P/S of Gate W26
		End	29	59	8.0	90	1	38.2							
W-15	Gate W26 to Gate W28	Start	29	59	8.0	90	1	38.2	500	5	10	926	I	I-wall	Some scour backfilled by RR
		End	29	59	14.3	90	1	36.7							
W-16	Levee with I-wall (capped)	Start	29	59	18.7	90	1	37	200	Breach repaired			III	I-wall	I-wall rotated, breached, and scoured
		End	30	0	9.0	90	1	45.9							
W-17	Gate W29	Start	30	0	10.1	90	1	42.1	240	2	6	107	I	I-wall	Scour adjacent to wall
		End	30	0	12.3	90	1	41							
W-18	Levee with I-wall (capped)	Start	30	0	18.7	90	1	38.1	90	2	3	20	I	I-wall	Scour adjacent to wall
		End	30	0	19.6	90	1	38.3							
W-19	Gate W32 to Gate W34	Start	30	0	20.7	90	1	38.6	220	1	2	16	I	I-wall	Scour adjacent to wall
		End	30	0	26.1	90	1	40.4							

Figure 14-75.

St. Bernard Parish

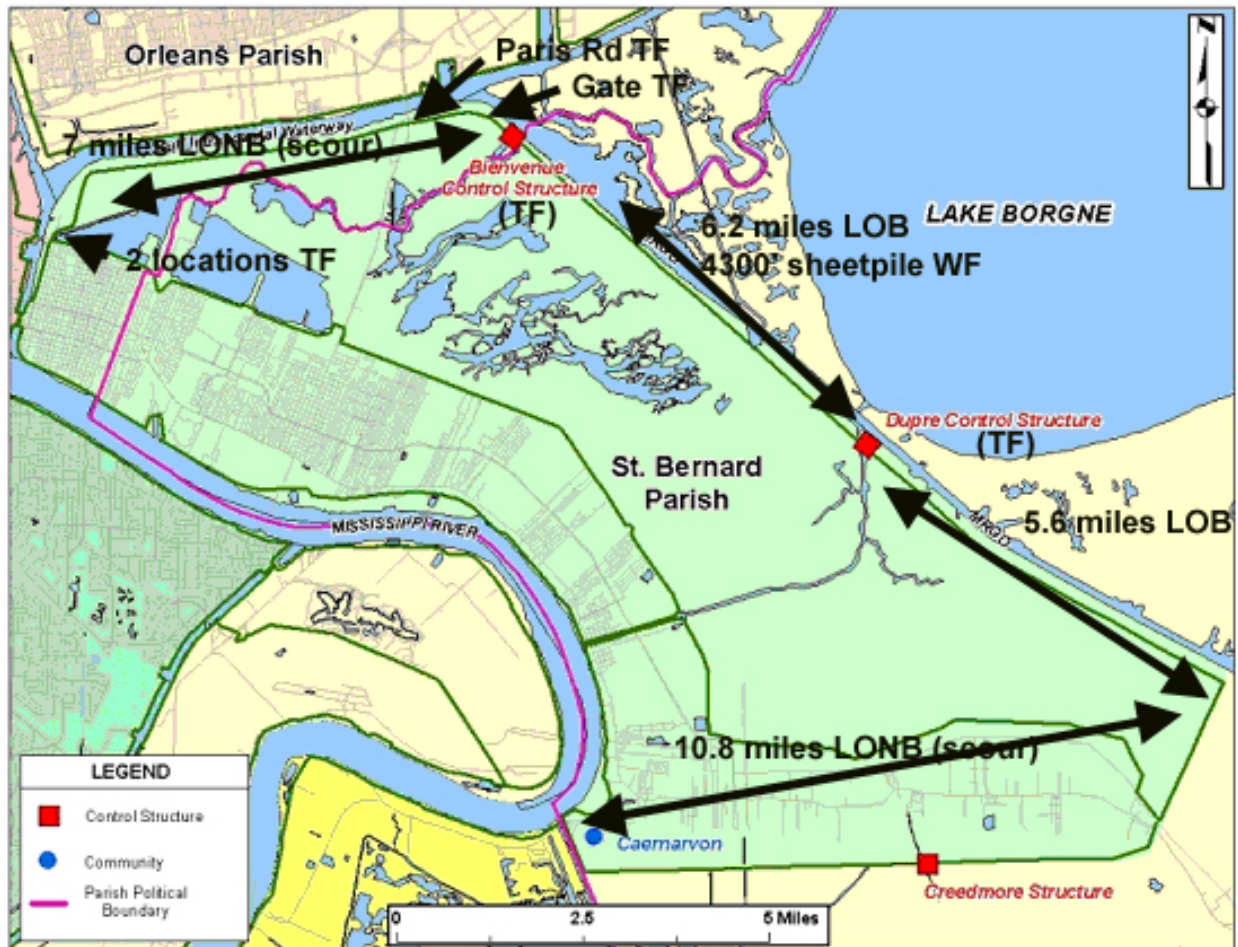

Figure 14-76. Damaged Areas in the St Bernard Basin

- LONB = Overtopped levees, no breaching
- WS = Overtopped floodwalls, no breaching (stable)
- LOB = Overtopped levees, breaching
- TF = Transition failure (floodwall to levee transition)
- WF = Overtopped floodwalls, breached (failure)
- WCF = Overtopped floodwalls, no breaching but came close

Overtopping was generally associated with varying degrees of scour (surface erosion), generally on the levee landside.

Pre-Katrina Hurricane Protection Features:

- 157,800 ft (30 miles) of Levees and Floodwalls
- 6 Road Closure Structures
- 2 Water Control Structures (Bayous Bienvenue and Dupre)

- 1 Gravity Drainage Structure (Creedmore)

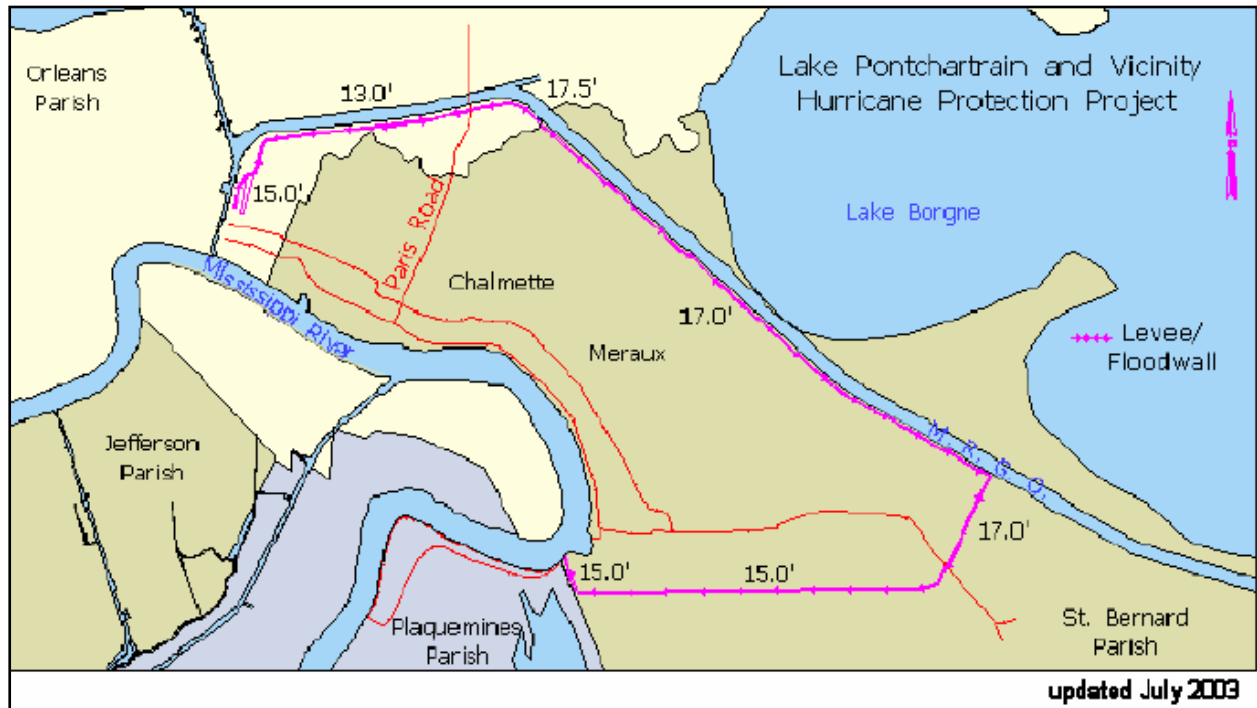

Figure 14-77. Authorized Heights. Note that St. Bernard Parish does not encompass either the IHNC East or GIWW (both of which are in Orleans Parish). However, these levee portions are geographically combined with the St. Bernard levee system

DMs:

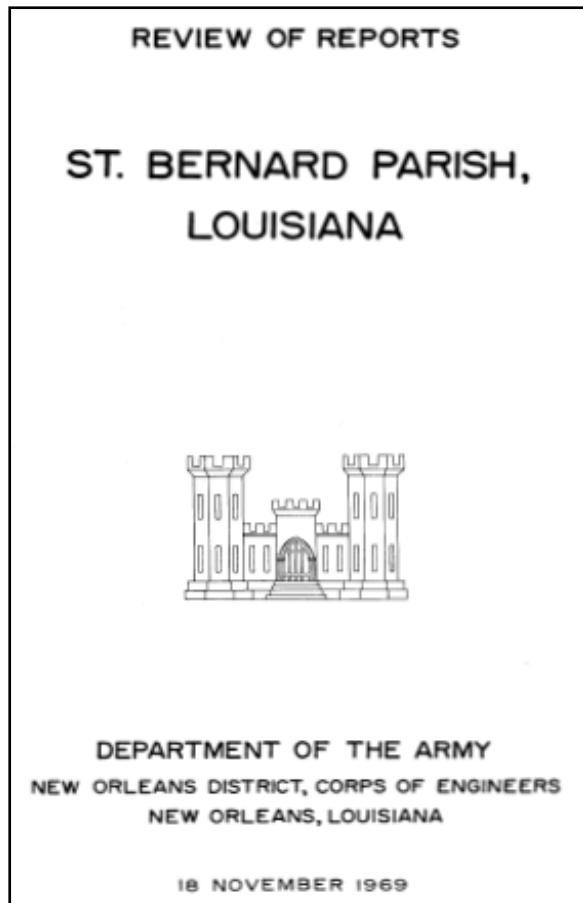

Figure 14-78. ReviewofReports.pdf provides a good background of original and modified hurricane protection authorizations for St. Bernard Parish

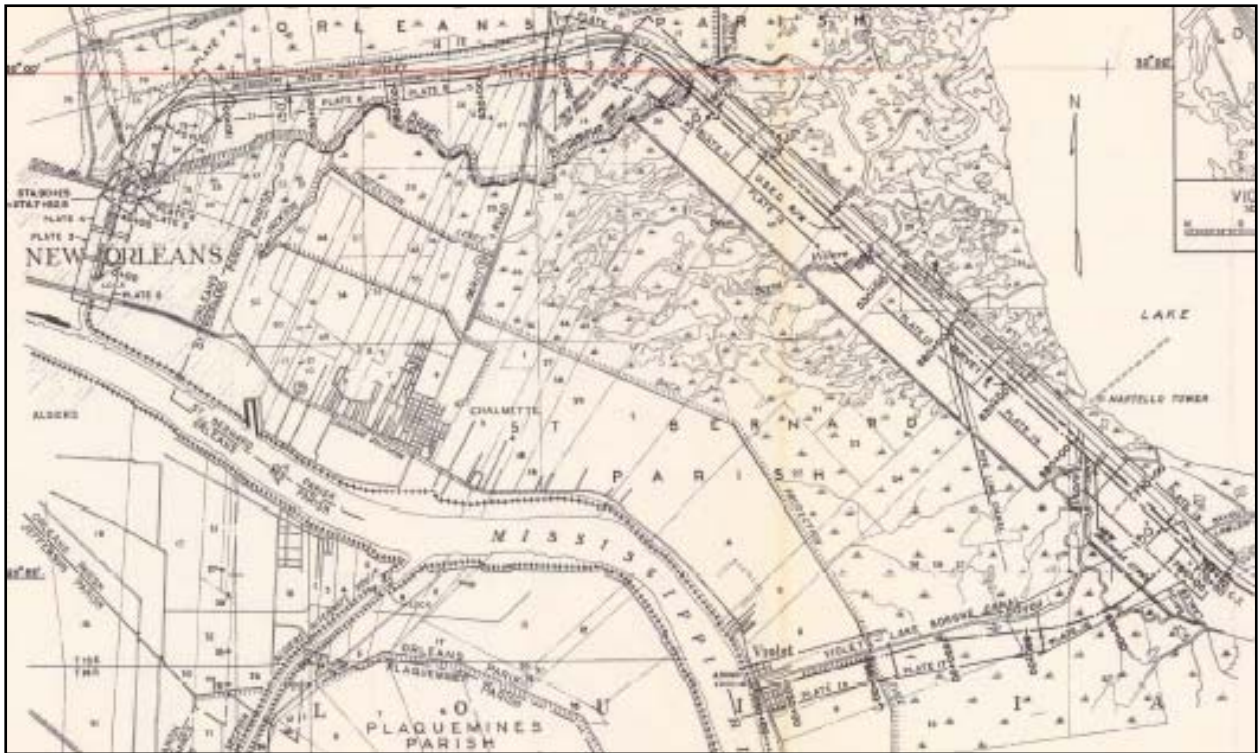

Figure 14-79. Pre-1966 Levee Sections and Soil Borings are Shown in Plates 2 thru 18 in DM3ChalmetteArea.pdf

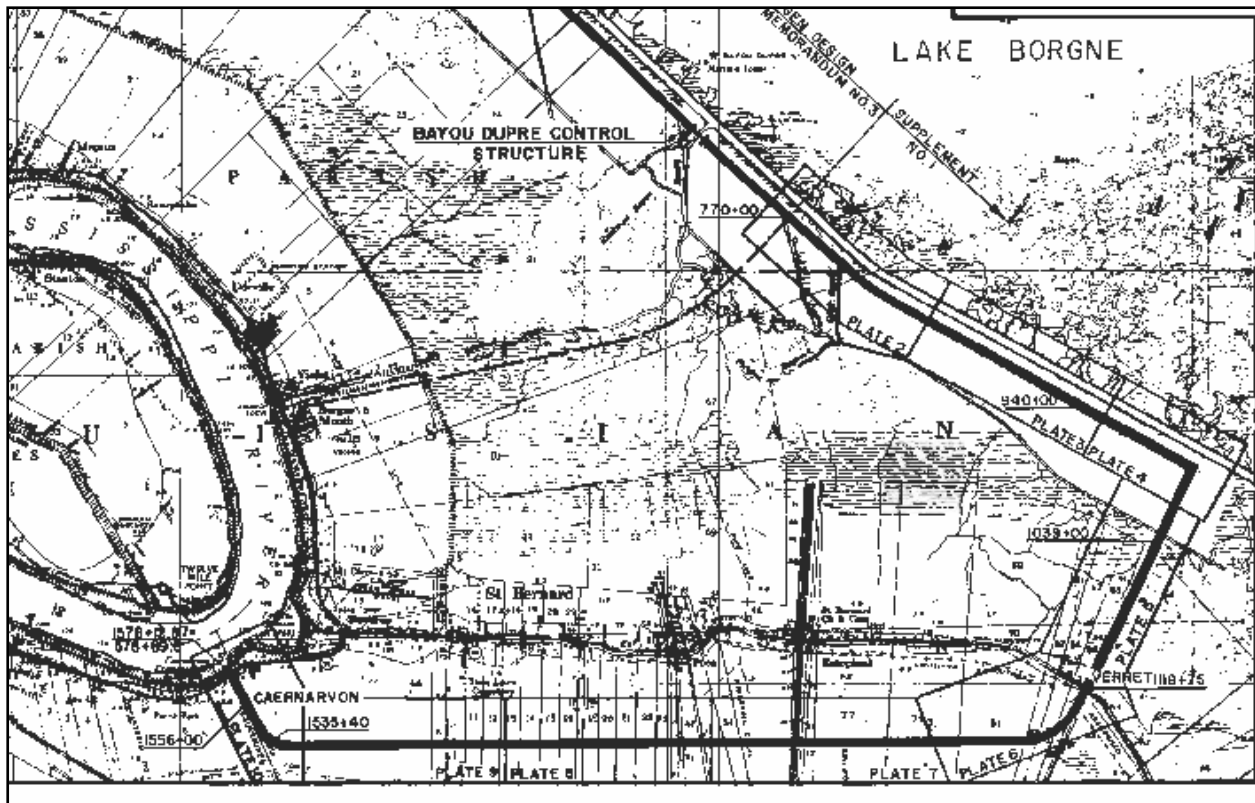

Figure 14-80. Pre-1968 Levee Sections and Soil Borings are Shown in Plates 2 thru 9, DM3ChalmetteExtension.pdf

Damages from Hurricane Katrina:

- Total Length of Levee w/o Cross Section – 27,000 ft.
- Total Length of Levee w/Reduced Cross Section – 4,800 ft.
- Total Length of Damaged Floodwall – 7,200 ft.
- 38,000 ft.

8 miles of the 30 total miles of Federal hurricane protection levee were damaged (Non-Fed levees total 22 miles and damage isn't included herein). Most severely damaged levees are along the reach adjacent to the MRGO extending from the Bayou Bienvenue Control Structure to the southeast for 11.8 miles. Minor levee scour along GIWW in Orleans Parish. Miscellaneous scour on the levee from MRGO to Caernarvon.

- Bayou Bienvenue Control Structure – steel gate, structural, mechanical and electrical damage.
- Bayou Dupre Control Structure – structural, mechanical and electrical damage.
- Paris Road Closure Structure – structural damage and scour of floodwall backfill.
- Road Closure West of Bienvenue – scour of structural backfill.
- 2 Road Closures near Southern Scrap (STA. 67+00) – scour of structural backfill.
- Creedmore Drainage Structure – debris and damage to structure and gate hoists.

Nine separate construction contracts have been let to repair damaged areas and restore flood protection to pre-Katrina conditions, with approximately \$47.2 million in construction costs (Task Force Guardian). These projects are labeled STB01 through STB09.

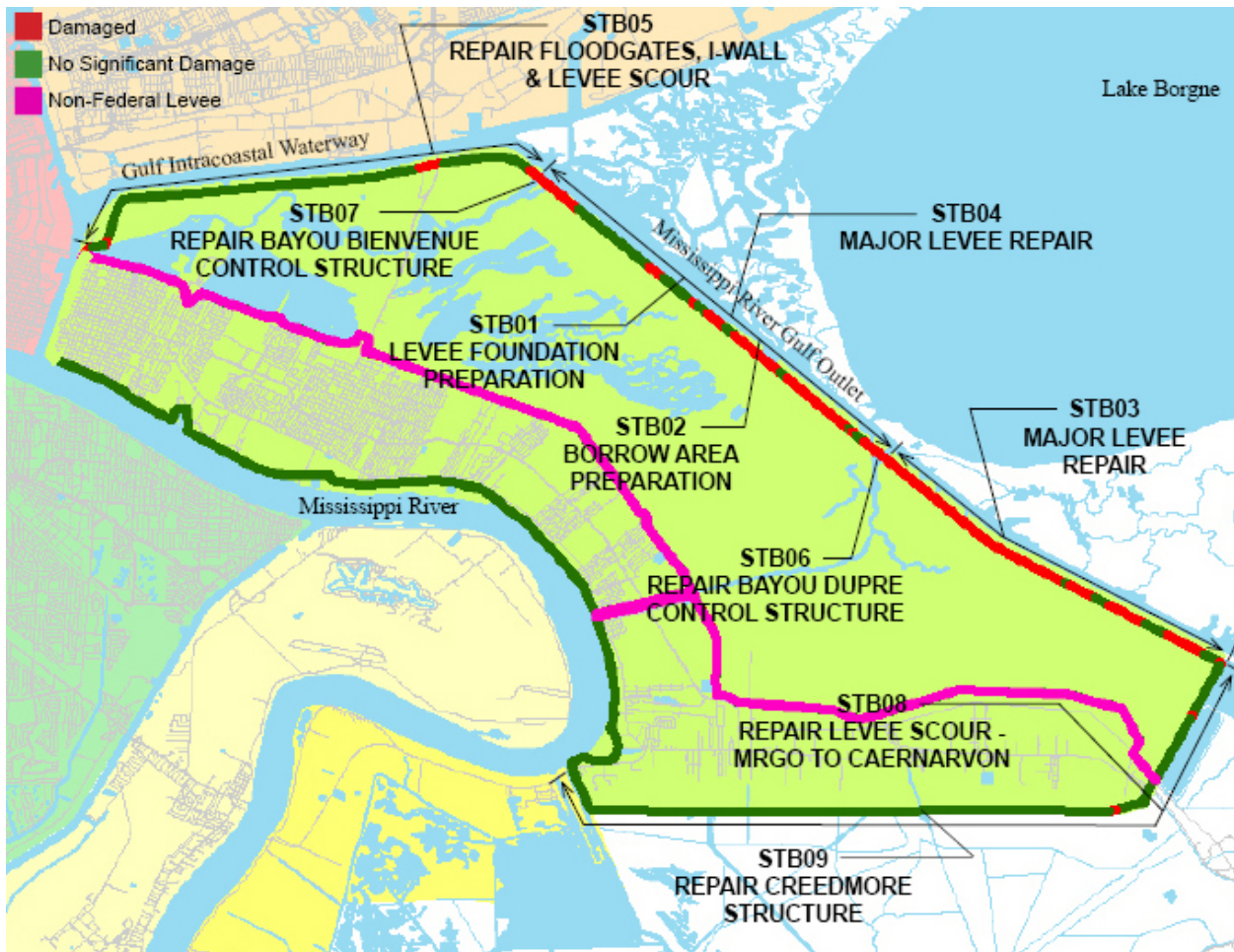

Figure 14-81. Task Force Guardian Re-Construction Contract Numbers and Locations

IHNC East Side, North of Florida Avenue (Orleans Parish) to Bayou Bienvenue.

Damage in the IHNC area is detailed in the IHNC portion of Task 7 documentation. There was damage on the IHNC east side north of Florida Ave along the south side of the GIWW (all inside Orleans Parish) that is detailed in this St. Bernard documentation.

Task Force Guardian (TFG) Project **STB05** includes repair of minor scour on the backside of the levee and structural and structural backfill scour adjacent to floodwalls and four closure structures, which are located between the Bayou Bienvenue Control Structure to the GIWW (IHNC) lock. An estimated 26,000 cubic yards of fill material will be required for this work, which is being furnished by the contractor. Scheduled completion date is 1 April 2006.



Figure 14-82. Photo of St. Bernard and Orleans Parish Levee System From IHNC East (north of Florida Ave.) to Bayou Bienvenue

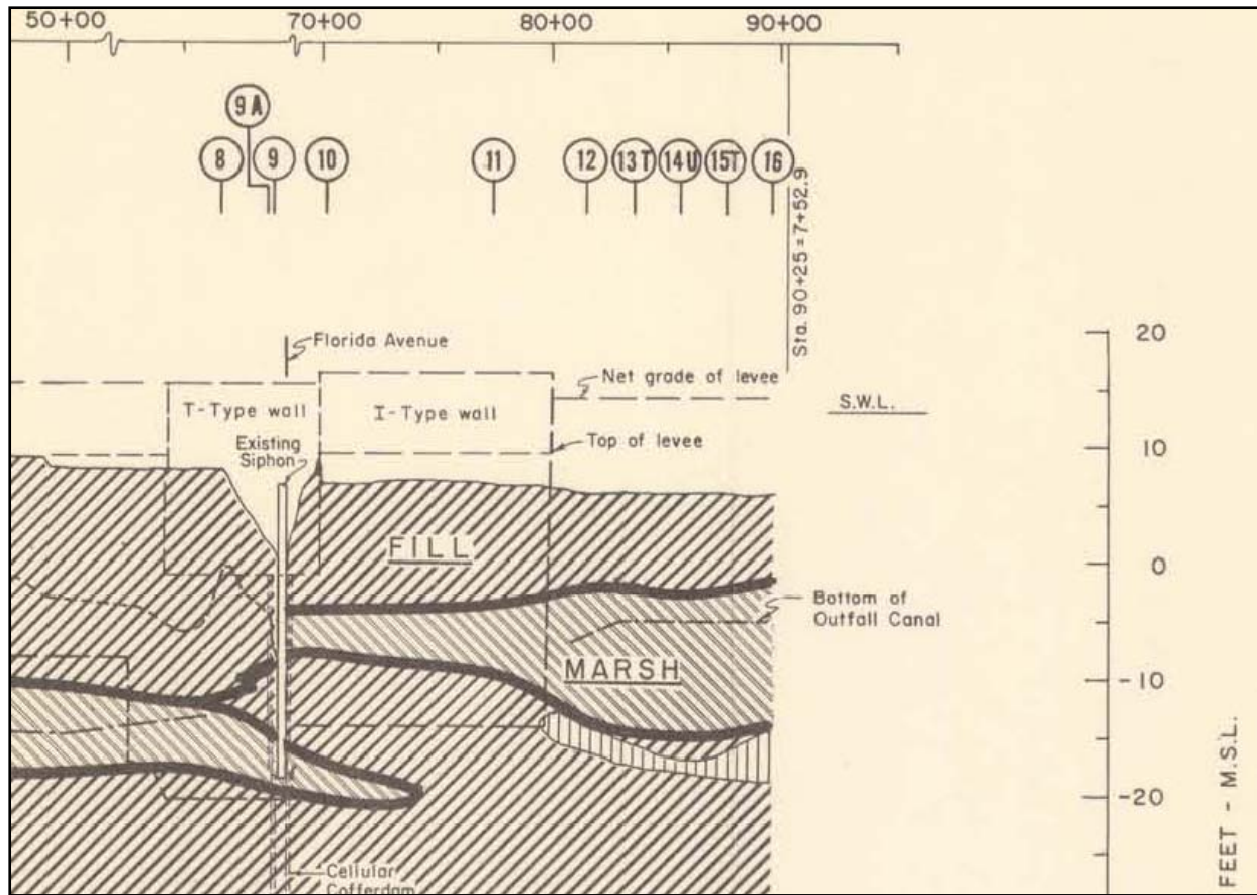

Figure 14-83. Geology Profile Between Florida Ave North to the GIWW Shows Fat Clay Layer at the Original Ground Surface

(1) Closure Structures Near Southern Scrap. There are two road closure structures that were damaged during the storm event. These closure structures are located at STA. 45+00 and STA. 67+94 at Orleans Rd. There was scour of the structural backfill resulting from overtopping of the floodwall and the closure gates.



Figure 14-84. Floodwall Between Fla Ave (IHNC East) and Southern Scrap Facility



Figure 14-85. Southern Scrap Facility Gates S2 and S3



Figure 14-86. View of Scour Outside Gates S2 and S3. IHNC/GIWW and Southern Scrap sites are on the left side of photo

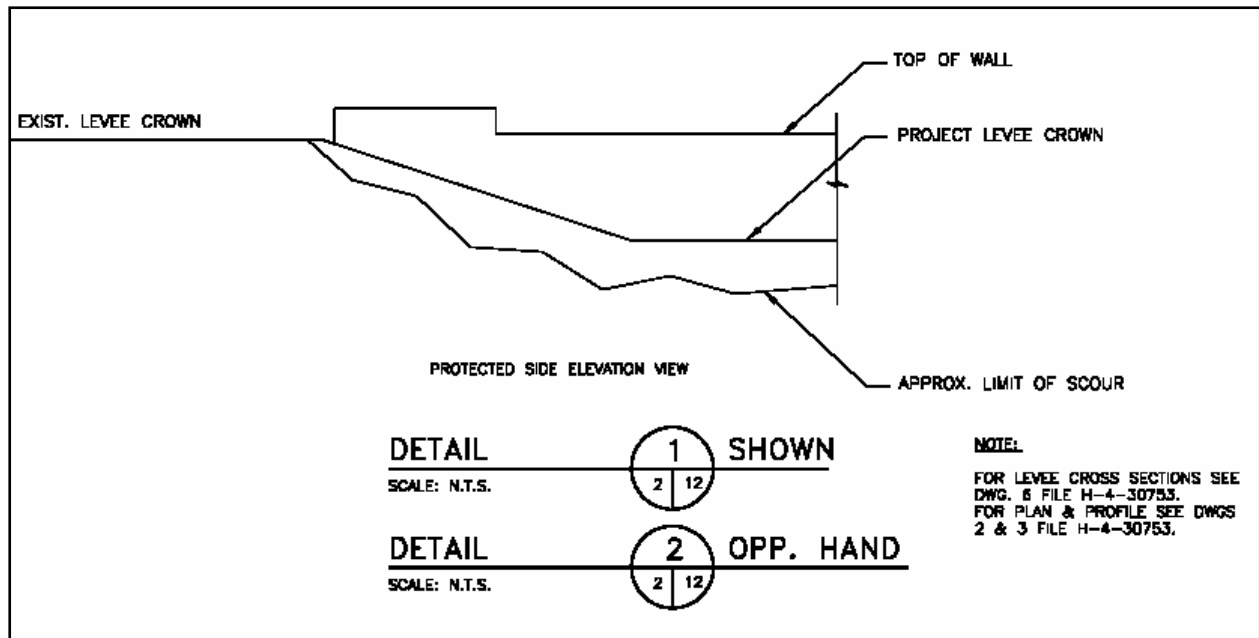

Figure 14-87. Details at Floodwall / Levee Abutments, Both Ends of Gates S2 and S3

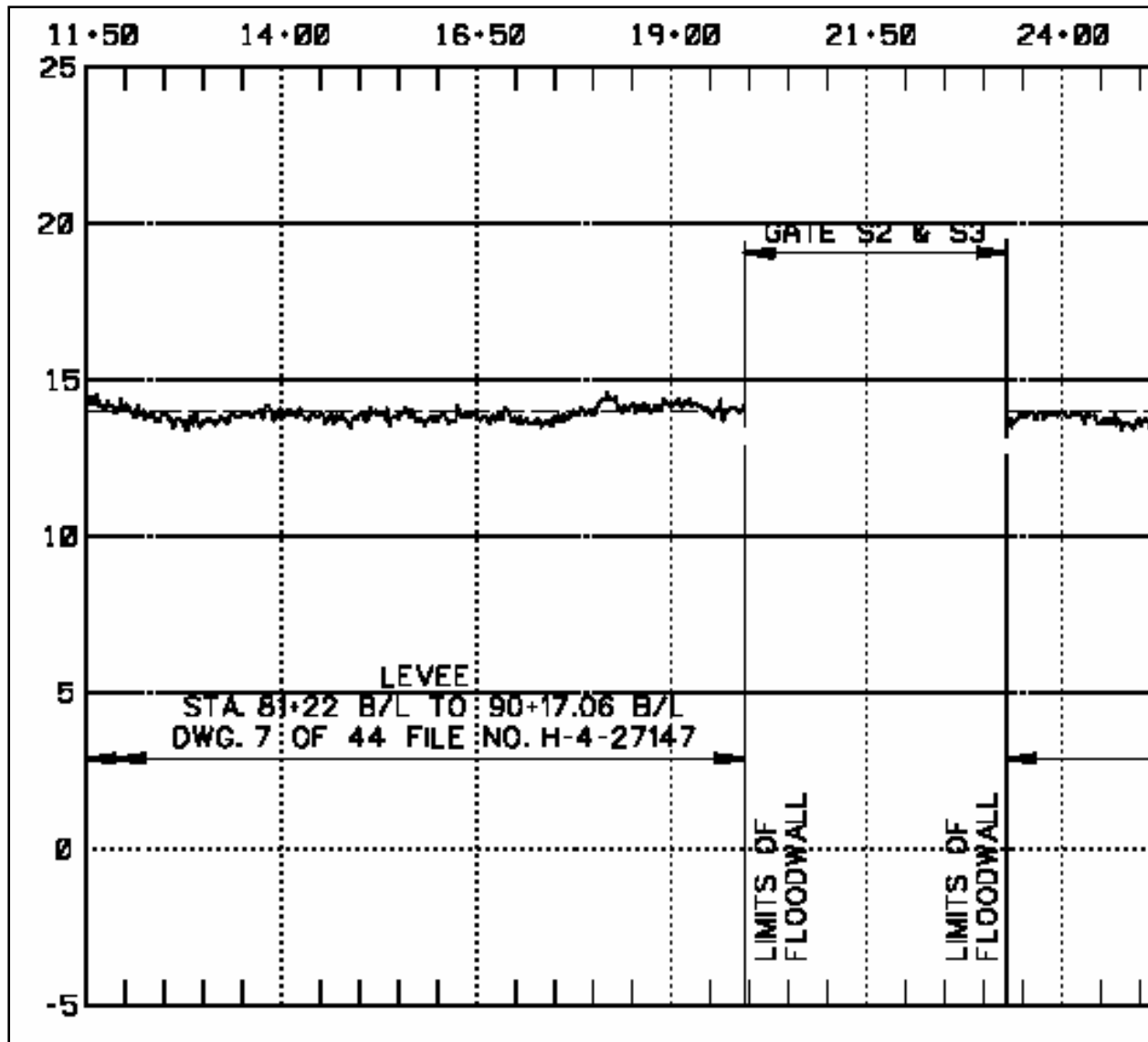

Figure 14-88. Elevations of S2, S3, and Adjacent Levee (from Chalmette Area Plan Emergency Restoration contract solicitation W912P8-06-R-0022 drawings, October 2005)

Scour Stationing and Extent (feet), from Chalmette Area Plan Emergency Restoration contract drawings, October 2005:

- D_f = scour depth on flood side
- D_p = scour depth on protected side
- W_f = scour width on flood side
- W_p = scour width on protected side

**S1, S2 & S3 - FLOOD GATES/WALL (IHNC
[0 - 2+20.00'] TO STA. 23 + 04.00 W/L)**

STATION	Df	Dp	Wf	Wp
0 - 220.00'	0.0	5.0	0.0	15.0
0 - 185.00'	0.0	4.0	0.0	15.0
0 - 185.00' TO 0 - 160.00'	0.0	0.0	0.0	0.0
0 - 160.00' TO 0 - 50.00'	0.0	5.0	0.0	10.0
0 - 50.00'	0.0	3.0	0.0	8.0
0 + 00.00	0.0	3.0	0.0	5.0
0 + 00.00 TO 0 + 73.00	0.0	7.0	0.0	15.0
1 + 23.00	0.0	5.0	0.0	15.0
1 + 23.00 TO 2 + 01.00	0.0	6.0	0.0	15.0
2 + 01.00	2.0	6.0	2.0	15.0
9 + 59.67 TO 11 + 20.56	1.0	6.0	2.0	15.0
20 + 00.00	0.0	3.5	0.0	10.0
20 + 43.00	0.0	5.5	0.0	9.0
21 + 15.00	0.0	2.0	0.0	9.0
21 + 80.00	1.0	2.0	6.0	9.0
21 + 84.00	0.0	4.0	0.0	10.0
22 + 61.06 TO 23 + 04.00	0.0	2.0	0.0	7.0

STATIONS INDICATED PER REFERENCE
DWG: FILE NO. H-4-27147 "FLOODWALL
AND LEVEE I.H.N.C. EAST - NORTH OF
FLORIDA AVENUE"

Figure 14-89. IHNC East (between Fla Ave and GIWW) Scour Stationing and Extent (feet), From Chalmette Area Plan Emergency Restoration Contract Solicitation W912P8-06-R-0022 Drawings, October 2005

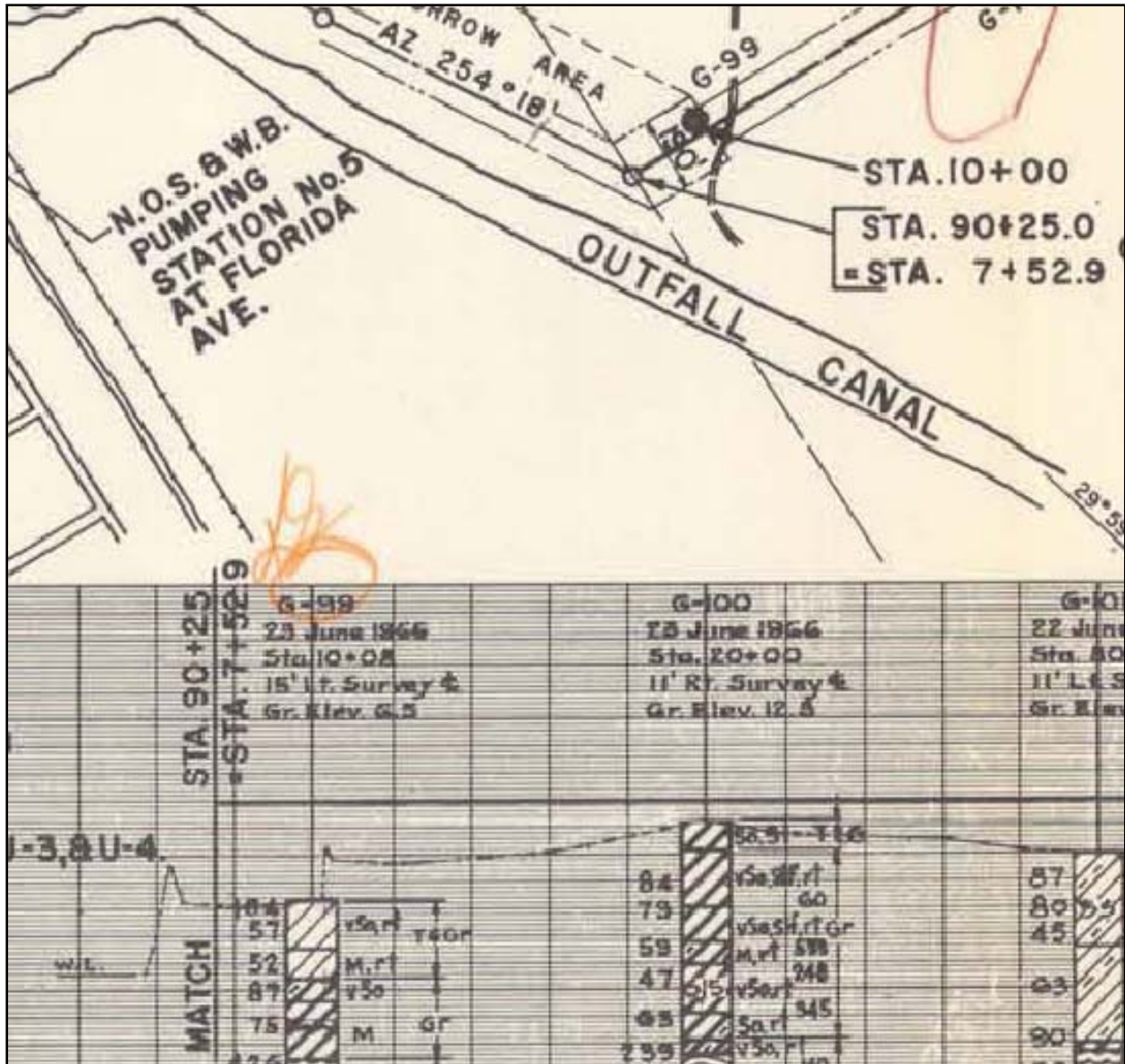

Figure 14-90. Boring G-99 Near Future Gates S2 and S3 Shows Lean Clay (CL) at Existing Ground Surface (Approximately 6' MSL). From Plate 7, DM3

(2) Levee Damage Along Intracoastal Waterway (GIWW). There are small areas of scour on the backside of the levee between STA. 65+008 and STA. 277+20 (the Paris Rd high rise bridge is approximately over Sta 270+00). This scour was the result of localized overtopping of the levees in this reach.



Figure 14-91. Localized Scour on the Levee South of the GIWW, Between IHNC and Paris Rd.

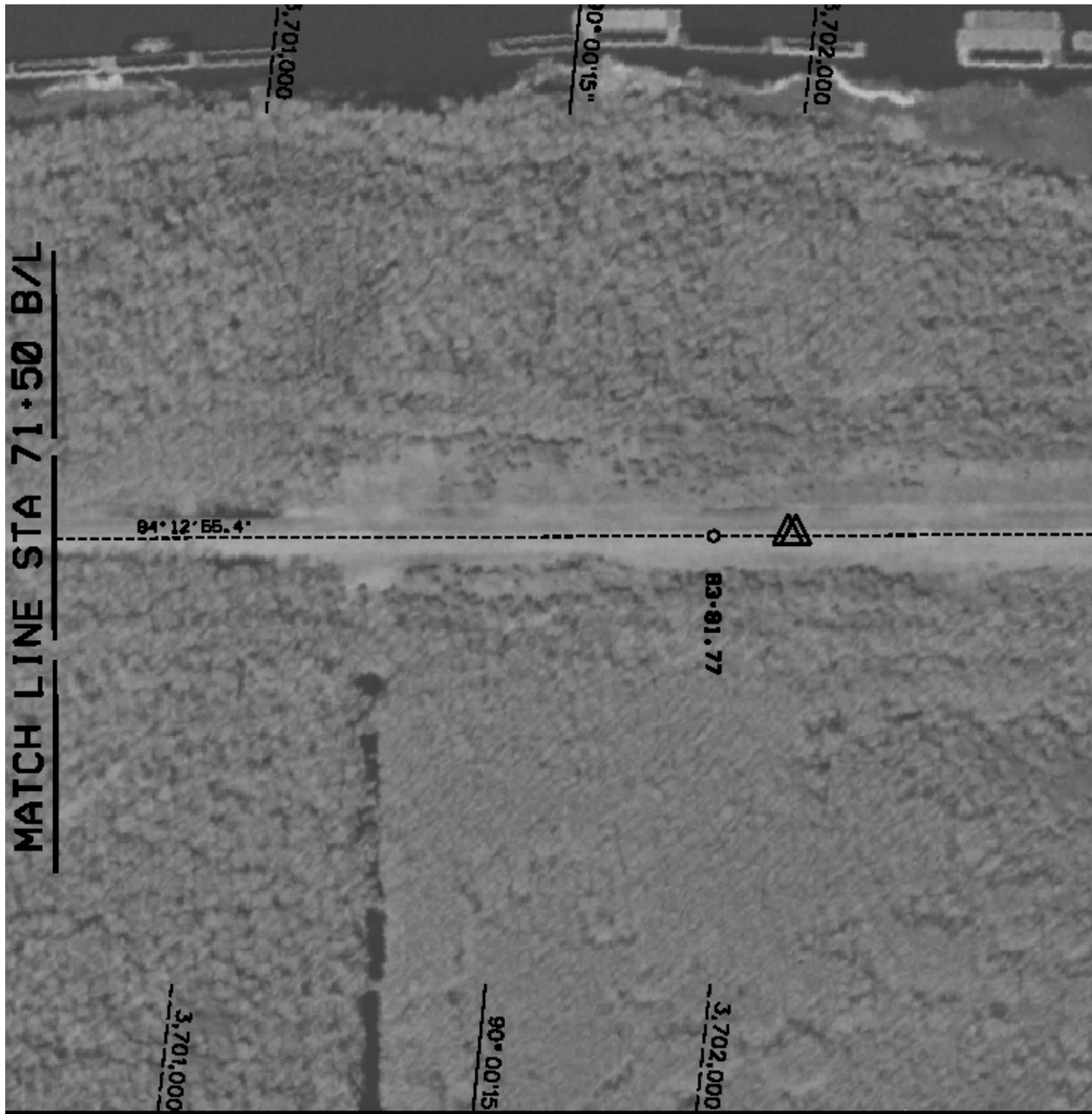

Figure 14-92. Major Scour Damage (Marked With Triangle) Identified East of B/L Sta 81+50 (From TFG Contract Solicitation W912PB-06-R-0022, Drawing 3 of 12)

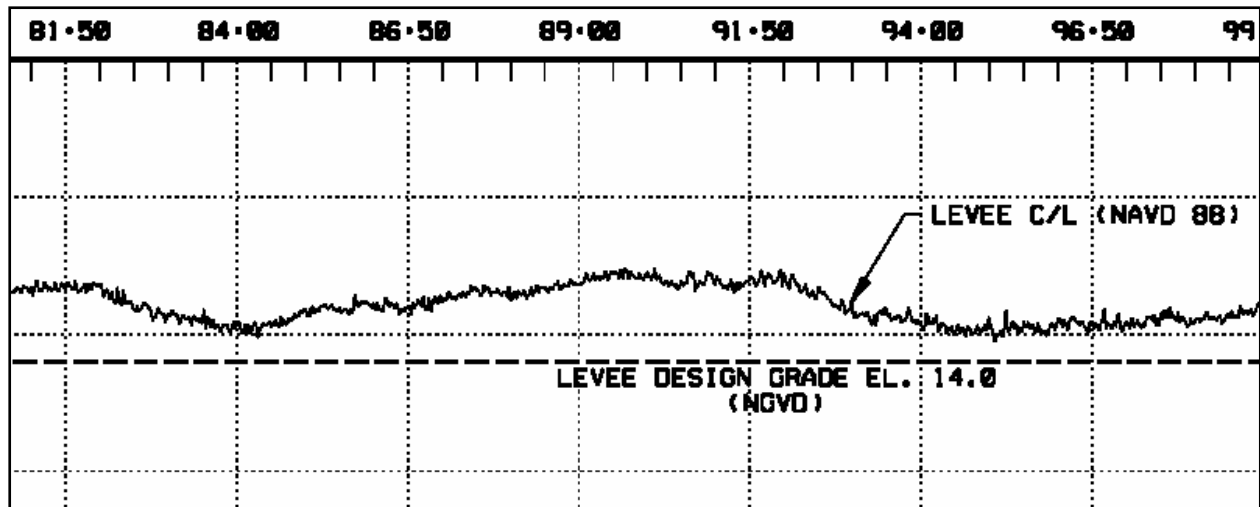

Figure 14-93. Levee Profile East of B/L Sta 81+50 (dwg 3 of 12). Note design grade elev 14 (NGVD) and lidar post-Katrina elev between 14 and 16 (NAVD 88)

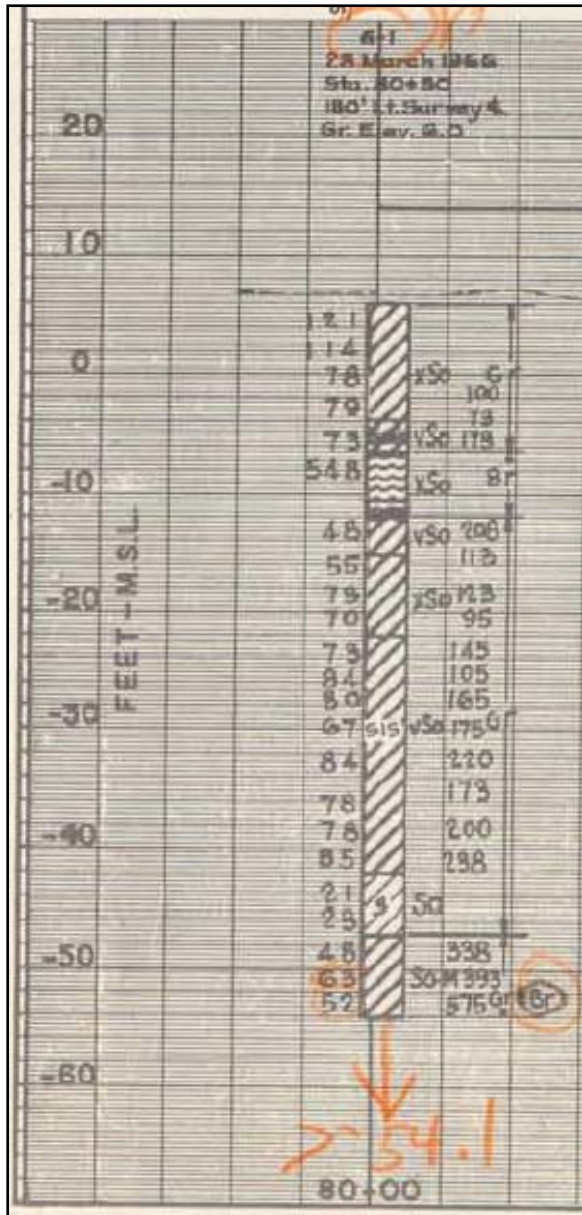

Figure 14-94. Nearest Boring at Sta 80+50, G-1, Circa 1966, From DM3, Plate 8. Original ground elevation was approximately 6 ft MSL, and surface soil was CH. Levee was built to approximate elevation +14 ft. circa 1970. Additional lift up to elevation 19 was added circa 1985

U. S. ARMY ENGINEER DISTRICT, NEW ORLEANS CORPS OF ENGINEERS NEW ORLEANS, LA.					
LAKE PONTCHARTRAIN, LOUISIANA AND VICINITY CHALMETTE AREA PLAN HURRICANE PROTECTION LEVEE STA. 65+00 TO STA. 268+00 - FIRST ENLARGEMENT ORLEANS PARISH, LA TYPICAL DESIGN SECTIONS STA. 64+40 TO STA. 209+35					
DESIGNED:	DRAWN:	CHECKED:	DATE:	SCALE:	FILE NO.:
E.W.C.	R.I.G.	R.P.L.	FEB. 1985	AS SHOWN	H-B-29768
SUBMITTED:			SPEC NO.:	DWD 4 of 9	
<i>Miller, P.C.</i>			DACW29-85-R-00-47		

Figure 14-95.

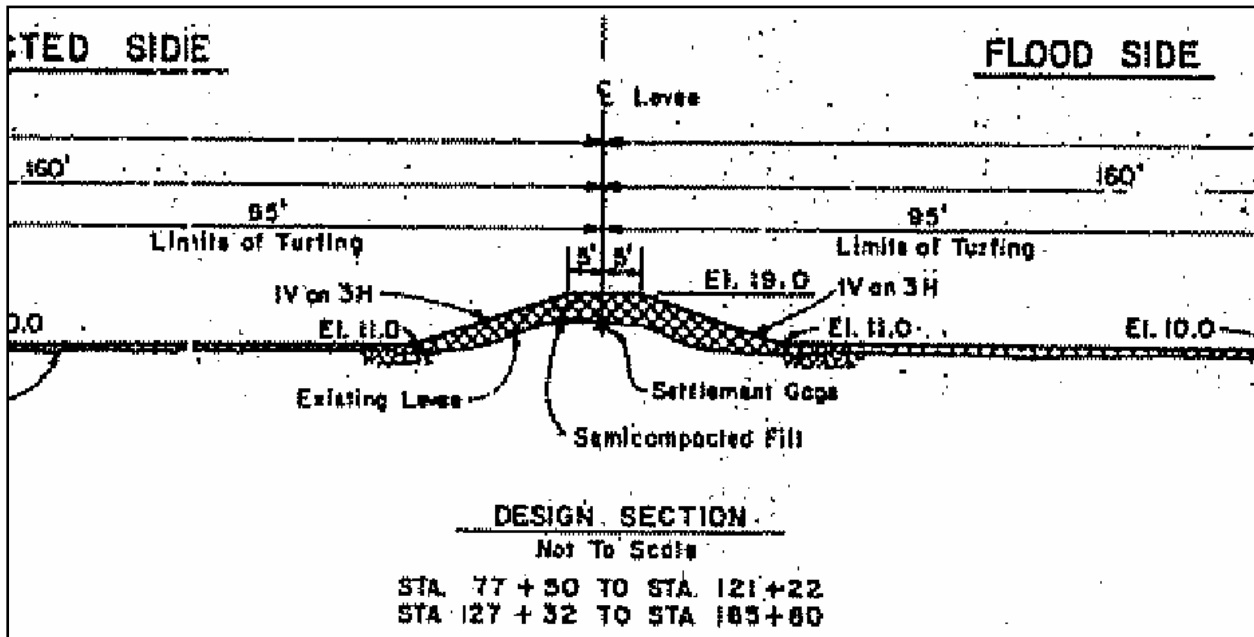

Figure 14-96. Design Section for Levee Enlargement, From Above 1985 Drawing

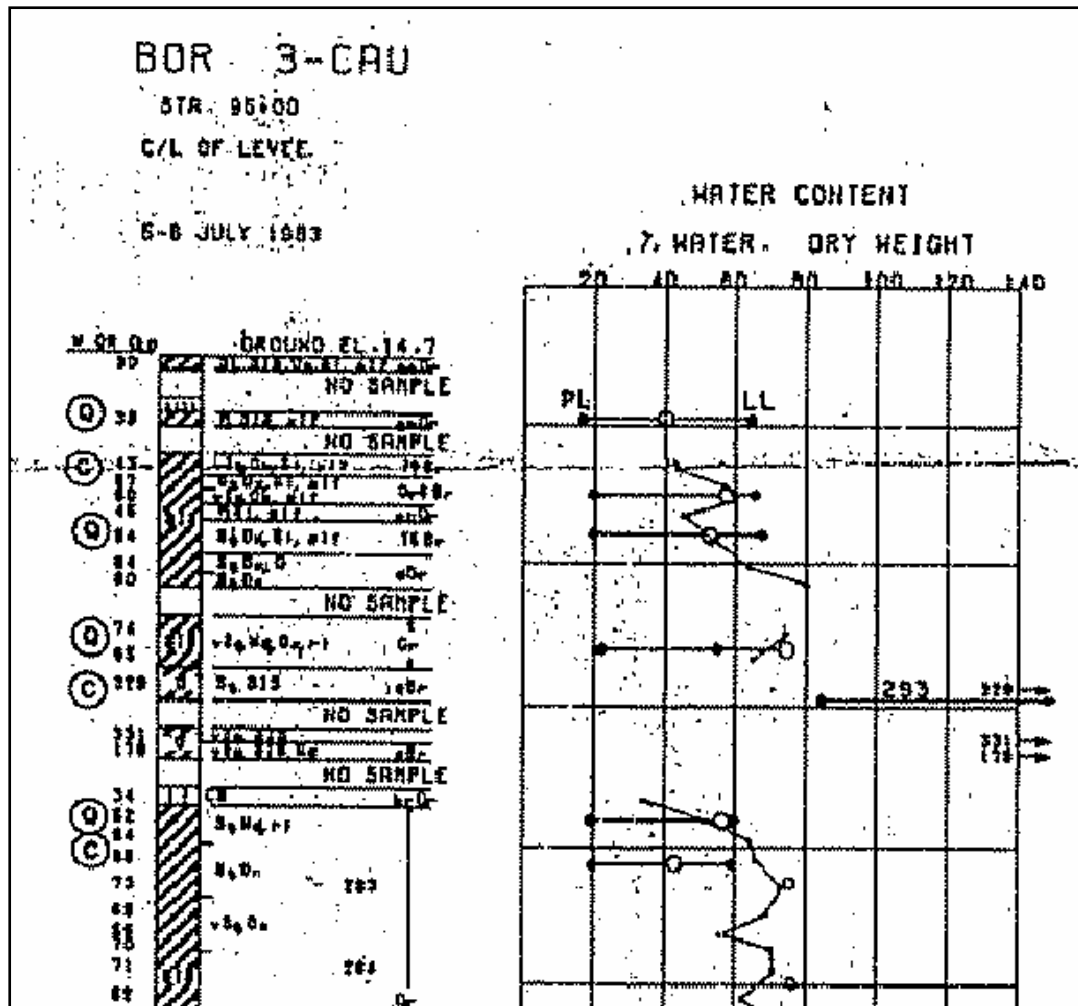

Figure 14-97. Sta 95+00 boring, 1983, shows CH soil at top of pre-existing 14' levee over a thin lens of sandy material. Note ground elevation (14.7 ft) comparison with lidar elevation (15 ft) at Sta 95+00 in Figure 14-93 above

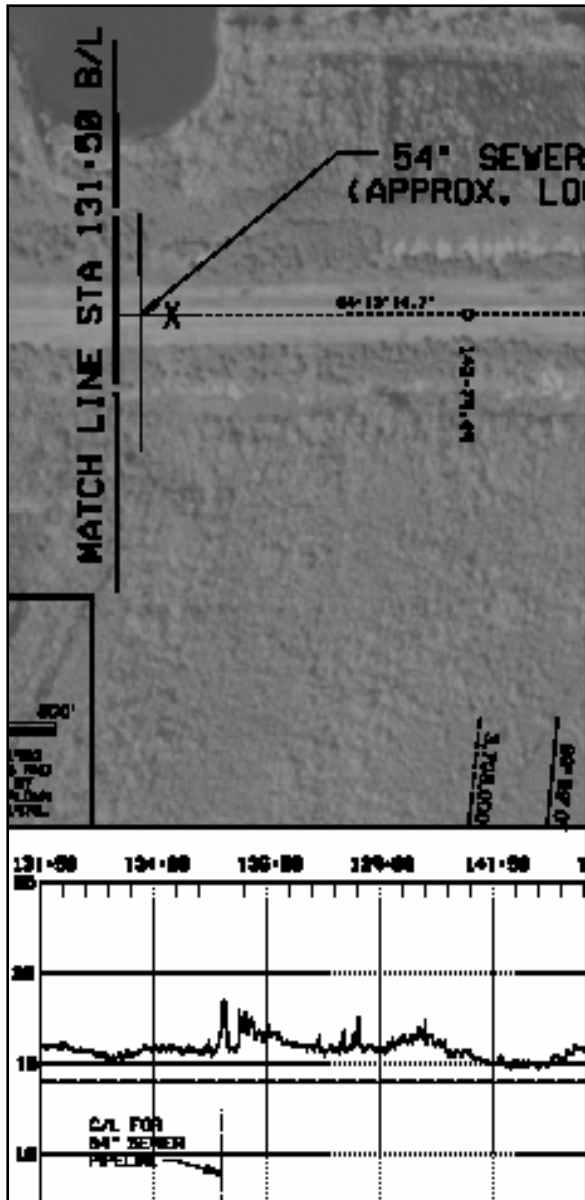

Figure 14-98. A Minor Scour Location (Marked With X) at B/L Sta 135+00 (from dwg 4 of 12, Contract Solicitation W912P8-06-R-0022)

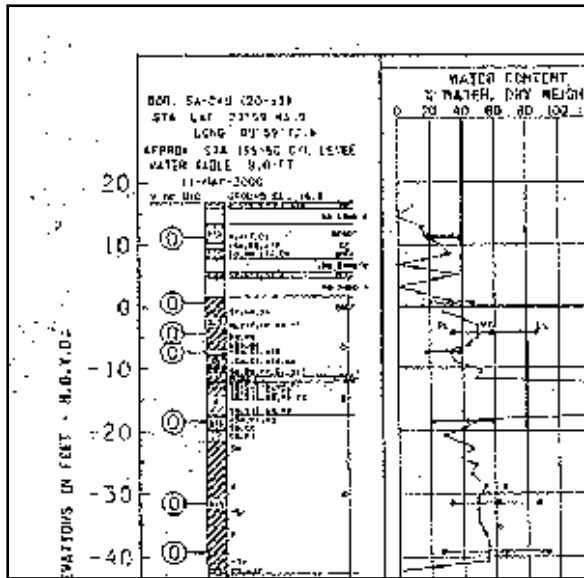

Figure 14-99. Dwg 9 of 19, New Orleans District File H-8-45533 Shows a Thin Layer of Lean Clay (CL) at Centerline Top of Levee from the 2001 Soil Boring 5A-CAU, B/L Sta 135+50

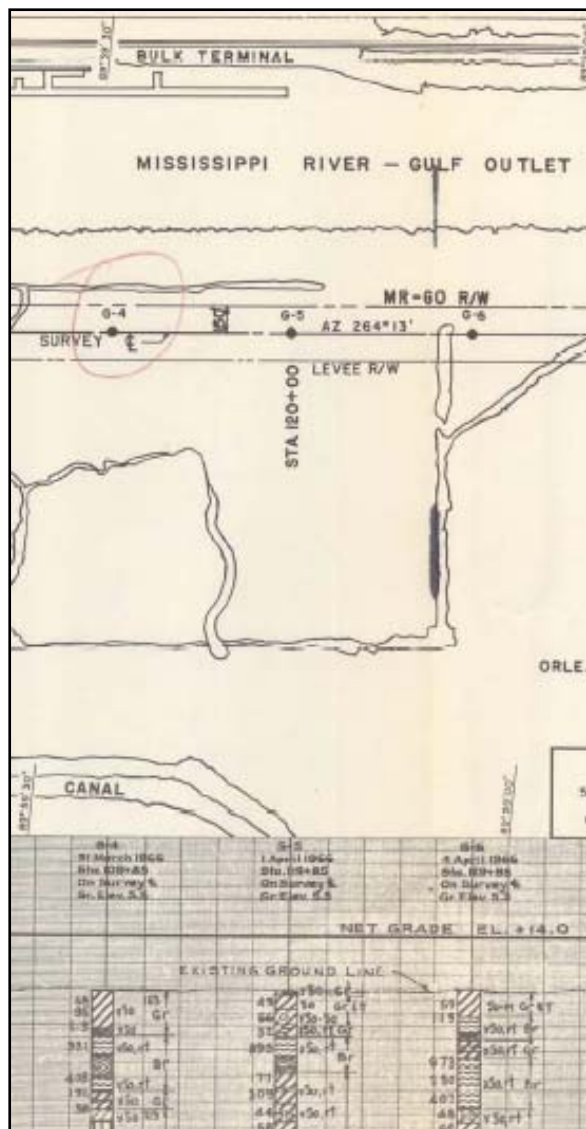

Figure 14-100. Plate 6, DM3 (1966) Soil Boring G-6 at Sta 129+80 at Levee Centerline Shows Fat Clay (CH) at Original Ground Surface

(3) Paris Road Closure Structure. This closure structure was damaged during the storm event. There was scour of the structural backfill resulting from overtopping of the closure panels and additional damages due to impact from a loose barge.

S4 - PARIS ROAD FLOOD GATE/WALL (STA. 267 + 00.00 C/L TO STA. 277+24.50 C/L)

STATION	Df	Dp	Wf	Wp
0 + 00.00 W/L (267 + 00.00 W/L)	0.0	8.0	0.0	8.5
0 + 50.00	0.0	3.0	0.0	25.0
0 + 83.00	0.0	10.0	0.0	35.0
1 + 29.00	0.0	4.0	0.0	40.0
1 + 29.00 TO 1 + 89.00	0.0	3.0	0.0	40.0
1 + 90.00	0.0	4.5	0.0	11.5
10 + 24.74	0.0	3.0	0.0	11.5

STATIONS INDICATED PER REFERENCE DWG:
FILE NO. H-4-29216 "PARIS ROAD FLOODWALL"

Figure 14-101. Scour Details for Paris Road Gate Closure Damage (From Contract Solicitation W912P8-06-R-0022)



Figure 14-102.



Figure 14-103.

(4) Closure Structure and I-Wall West of Bienvenue. This closure structure and adjacent I-wall segments were damaged during the storm event. There was scour of the structural backfill resulting from overtopping of the closure gate and I-wall.



Figure 14-104. View Looking East Toward the Bayou Bienvenue Control Structure

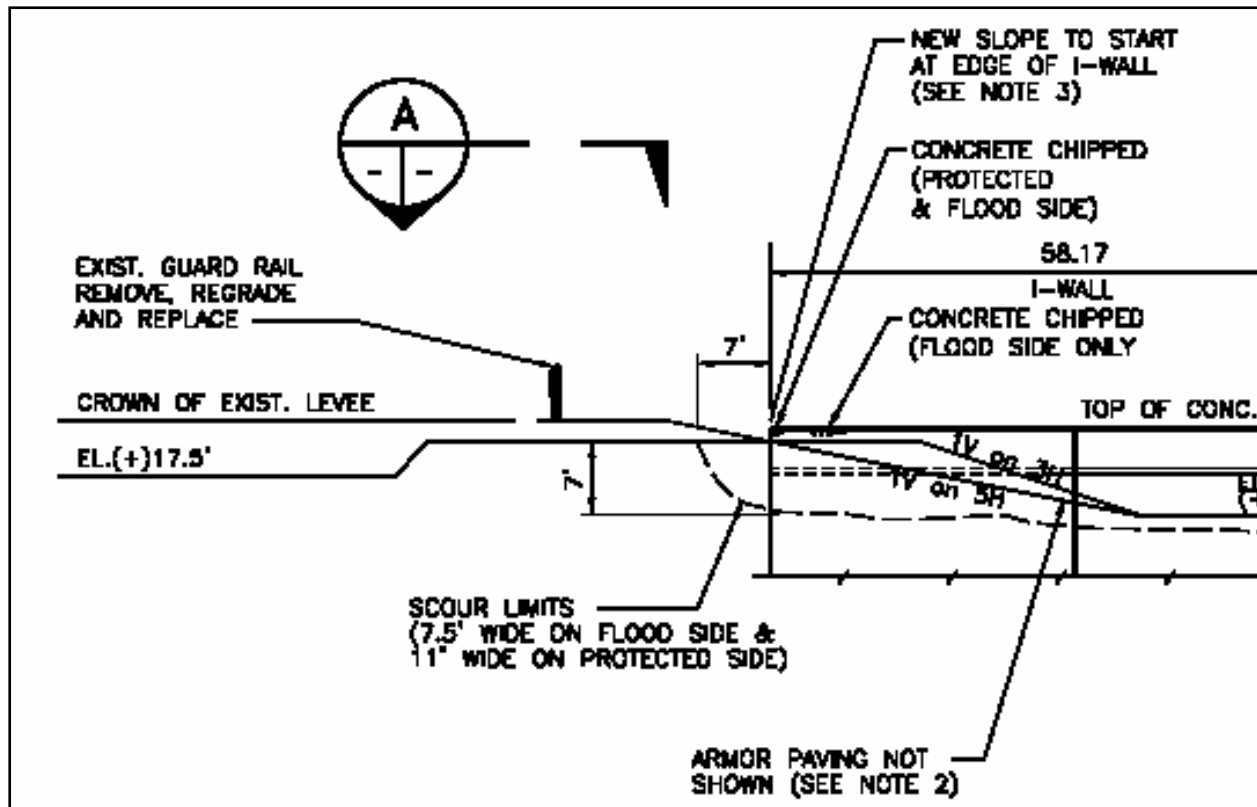

Figure 14-105. Gate S5 Scour Hole (From Levee Restoration, Misc. Gates and Floodwall Repairs, IHNC to Bienvenue, Chalmette Area Plan Emergency Restoration solicitation W912P8-06-R-0022, October 2005 contract drawing H-8)



Figure 14-106. View West From Bienvenue Control Structure Toward the Unused Floodgate Structure

**S5 - FLOOD GATE/WALL WEST OF BAYOU
BIENVENUE (STA. 354 + 00 B/L TO STA. 357+00
B/L)**

STATION	Df	Dp	Wf	Wp
354 + 24.83	8.0	8.0	7.0	11.0
354 + 40.00	2.0	4.0	5.0	15.0
354 + 83.00	0.5	2.0	2.0	15.0
354 + 83.00 TO 355 + 90.00	0.0	4.5	0.0	15.0
355 + 90.00	0.5	2.0	2.0	15.0
356 + 40.00	4.0	5.0	6.0	15.0
356 + 48.00	8.0	8.0	8.0	18.0

STATIONS INDICATED PER REFERENCE DWG:
FILE NO. H-8-29720 "STA. 277 + 20 TO 359 + 33
(PARIS ROAD TO BAYOU BIENVENUE) 2ND LIFT"

Figure 14-107. Scour Damage Details for Wall West of Bienvenue Structure

Bayou Bienvenue Control Structure. This control structure was damaged during the storm event. The adjacent floodwall was hit by a loose barge and the fill around the adjacent floodwalls was eroded away due to overtopping. In addition there was damage to the mechanical and electrical systems that operate the sector gates.

TFG Project **STB07** includes repair of structural damage and loss of structural backfill at the Bayou Bienvenue Control Structure. A significant scour hole is to be filled with 28,600 cubic yards of granular backfill and protected with grouted riprap. An estimated 32,100 tons of riprap and 3,400 cubic yards of embankment fill will be required for the repairs. All materials are to be furnished by the contractor, and scheduled completion is 1 April 2006.



Figure 14-108. Pre-Katrina



Figure 14-109. Post-Katrina. Note scour near guardrail shown in Figure 14-104



Figure 14-110. Barge Resting on T-Wall



Figure 14-111. View East, From Protected Side



Figure 14-112. View Looking East of the Bayou Bienvenue Control Structure Showing Sheetpile Damage From Scour. From this picture there is no obvious layer stratification in the scoured section profile

TC202
W461.3P6
no. 5
1968

U. S. ARMY, CORPS OF ENGINEERS

**LAKE PONTCHARTRAIN, LA. AND VICINITY
CHALMETTE AREA PLAN**

*B-11 etc.
+ D-2
as listed below*

**DESIGN MEMORANDUM No. 5
DETAIL DESIGN
BAYOU BIENVENUE AND BAYOU DUPRE
CONTROL STRUCTURES**

<u>BIENVENUE</u>	<u>DUPRE</u>	
B-11 B-4	D-4-3	D-3
B-2 B-5	D-1-11	D-4
B-3	D-1	
	D-2	

Prepared by:
 Waldemar S. Nelson & Company, Inc. U. S. Army Engineer District, New Orleans
 Engineers & Architects Corps of Engineers, U. S. Army
 New Orleans, La. New Orleans, La.

MARCH 1968

Figure 14-113. DM 5 Bayou Bienvenue & Bayou Dupre Ctrl Struct.pdf

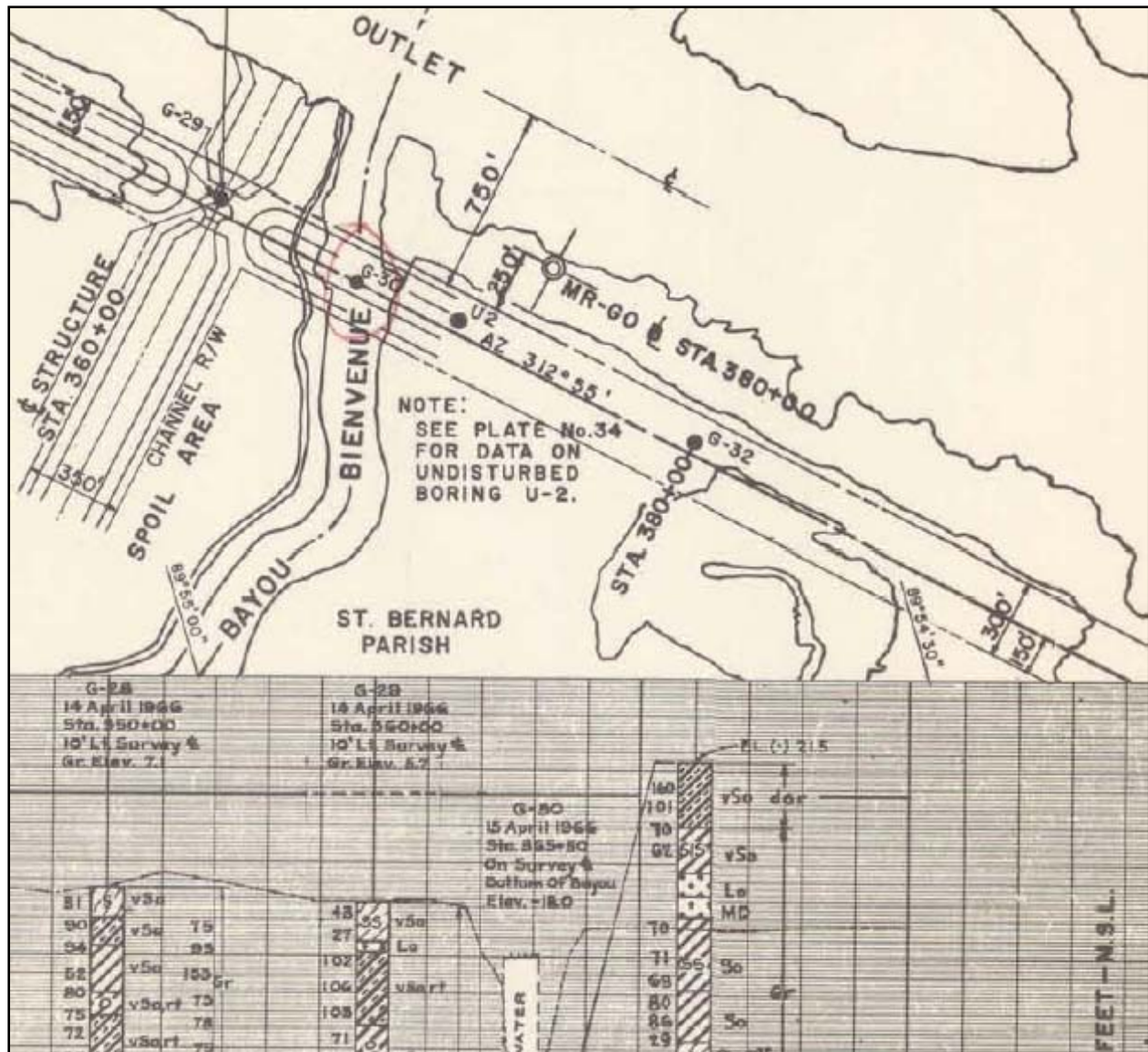

Figure 14-114. Original ground surface (1966) had sand / silt lenses overlying very soft organic clay (plate 10, DM3). Note that sheetpile east of structure (Figure 14-112) was driven to cut off old Bayou channel in addition to reduce loading on the top layer of very soft organic clay seen in boring G-32

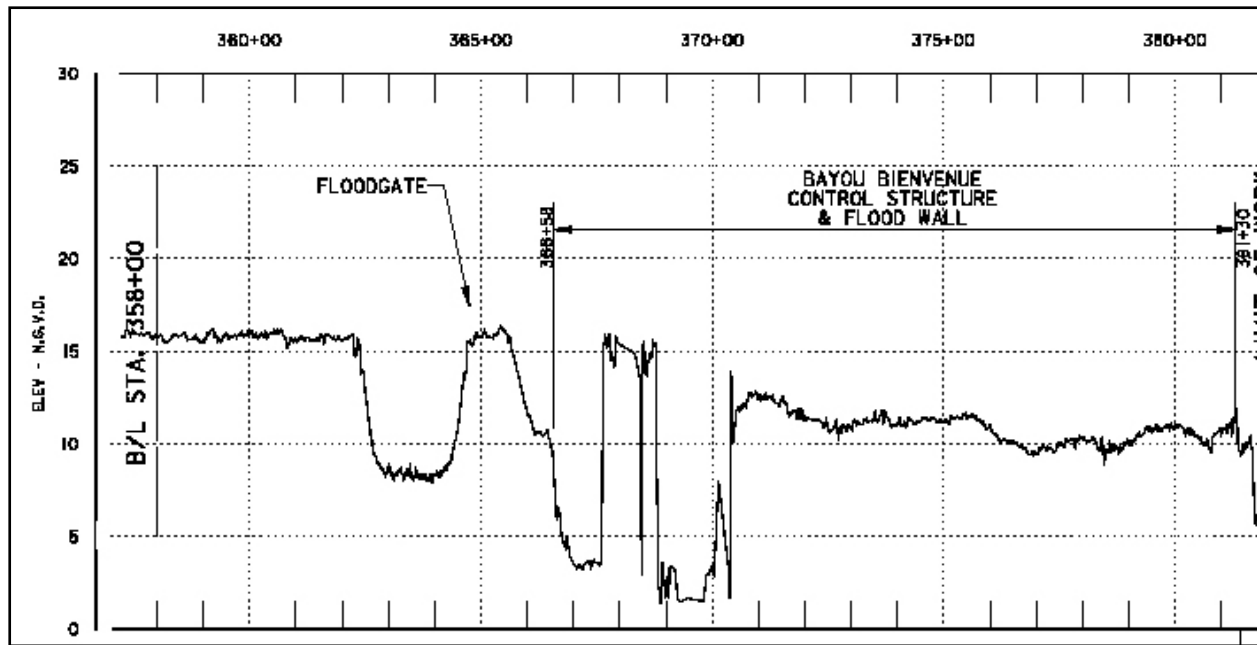

Figure 14-115. Centerline Scour Depths of Floodgate and Control Structure (From Dwg 1 of 8, Emergency Restoration B/L 383+00 to 704+00 Contract Solicitation)

Hurricane Levee Between Bayou Bienvenue and Bayou Dupre. There is 19,000 ft. of levee between Bayou Bienvenue (Sta 383+00) and Bayou Dupre (Sta 704+00) that was severely damaged from overtopping and scour, and has lost approximately 12' of levee section and was at EL 5.0.



Figure 14-116. Levee Completely Eroded Away



Figure 14-117. More Missing Levee

There is an additional 2,300 ft. of levee in this reach that has some damage (approximately 50% of the levee section was eroded away).



Figure 14-118. Partial Levee Eroded



Figure 14-119. View South From Approximate B/L Sta 570+00. MRGO is to the left of photo

The repaired levee cross section is shown below. This was the typical cross section used to estimate the required quantities.

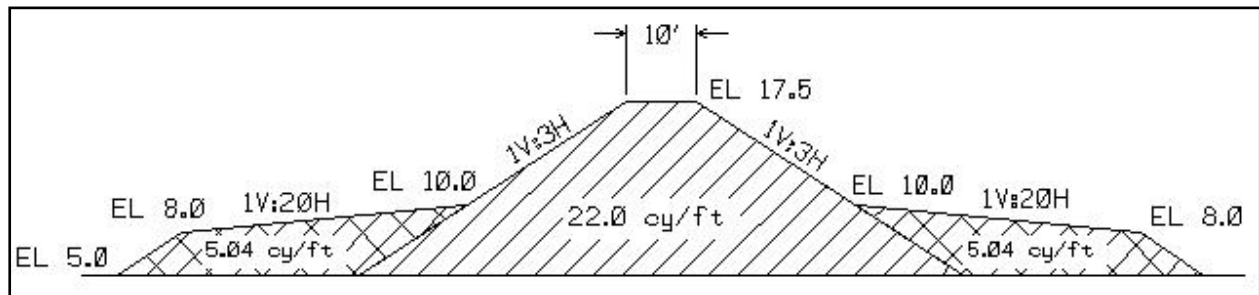

Figure 14-120.

Quantities: 660,000 cy fill – 55 acre borrow area

There is a total of 4,300 ft. of sheet pile floodwall in this reach that was badly damaged and will require replacement. There are three segments of sheetpile which makeup this quantity. These were initially planned to be replaced with 30' sheets – see section below.

Segment A: – Length – 1130 ft. Condition – badly damaged; replacement required

Segment B: – Length – 720 ft. – Condition – badly damaged; replacement required

Segment C: – Length – 2450 ft. – Condition – badly damaged; replacement required



Figure 14-121. Damaged Sheetpile Section (Utility Crossing), With Scour on the Protected Side. B/L Sta 590+70 is centerline of the two pipelines



Figure 14-122. Closeup of Damaged Sheetpile and Scour. Note stratified layers in adjacent soil profile of existing hydraulic fill from the MRGO



Figure 14-123. Note Sheetpile Elevation Differences



Figure 14-124. Additional Damaged Sheetpile at Utility Crossing, B/L Sta 600+00

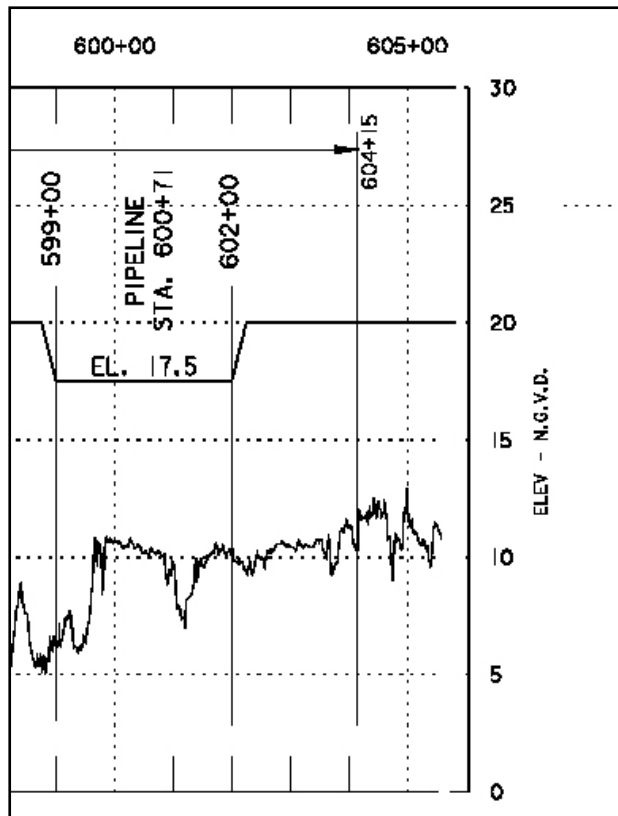

Figure 14-125. Scour Depths at Pipeline Crossing and End of Sheetpile (Sta 604+15) Transition to Levee



Figure 14-126. Exposed Soil Layer at Horizontal Scour Surface Appears to be In-Situ Fat Clay With Embedded Shell Hash, Possibly an Exposed Estuarine Deposit

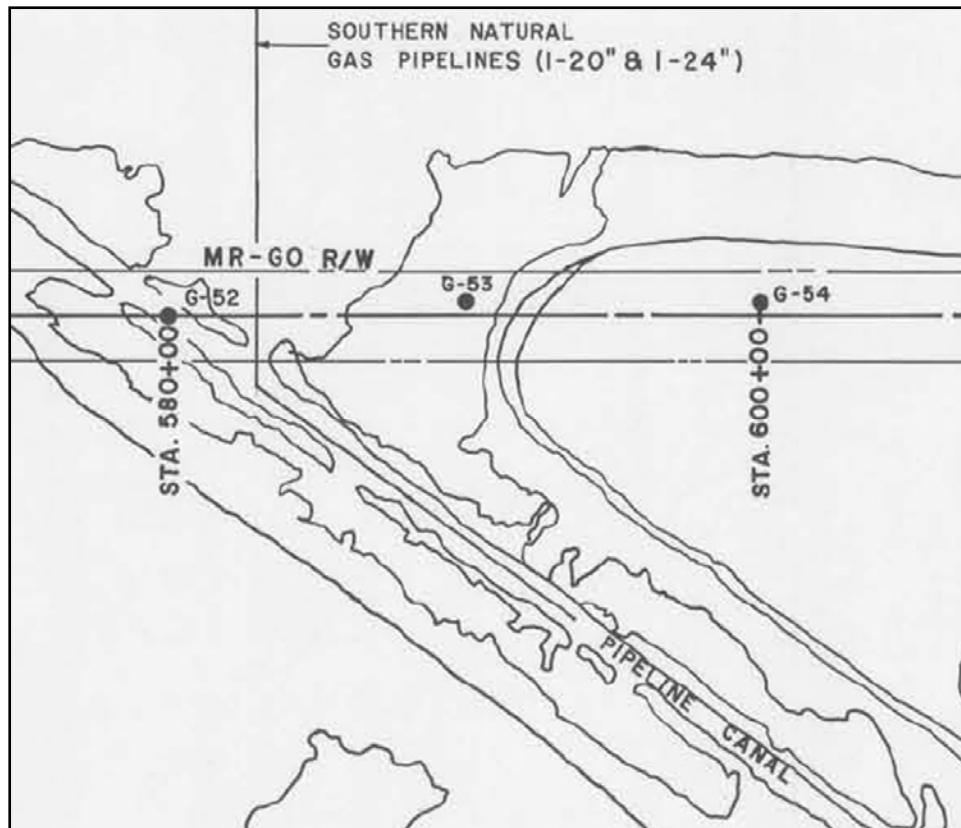

Figure 14-127. Original Pipeline Canal Prior to Backfilling and Sheetpile (From Drawing File H-2-23820, Plate 13)

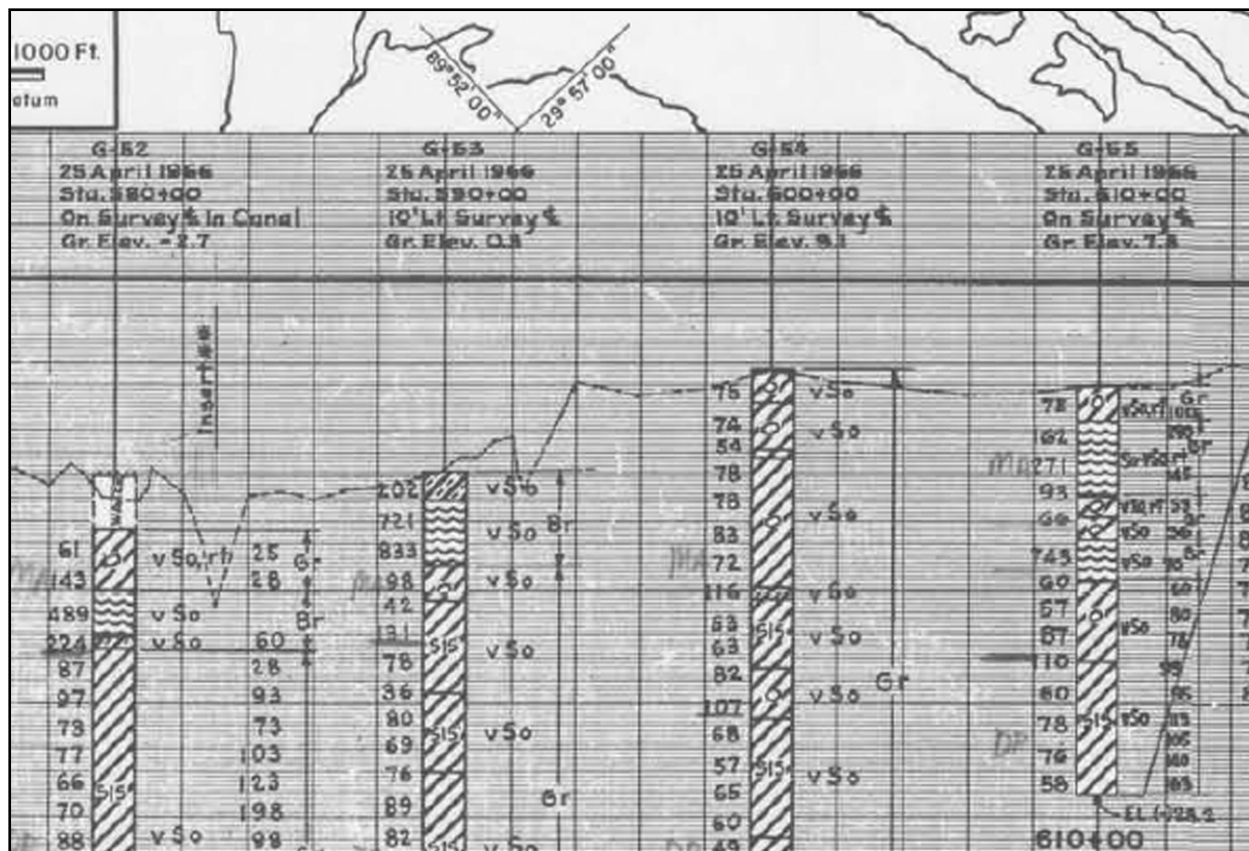

Figure 14-128. Original Borings Show Very Soft Fat Clay and Peat Layers (from drawing file H-2-23820, plate 13)

The cross section below is the cross section used to estimate repairs. The sheetpile was replaced with earthen levee to elevation 17.5'.

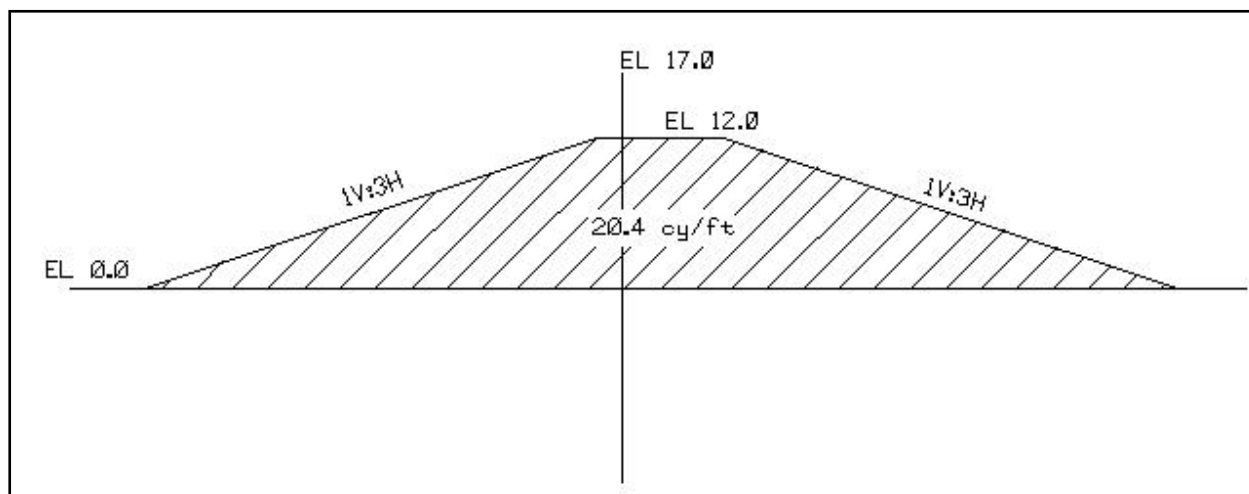

Figure 14-129.

TFG Project **STB01** included site preparation work in the areas of levee damage between the Bayou Bienvenue and Bayou Dupre Control Structures. The contracted work (rental agreement contract) is complete.



Figure 14-130. Repairs Underway, Filling Scour Holes

TFG Project **STB02** included site preparation work in the borrow areas between the Bayou Bienvenue and Bayou Dupre Control Structures. The borrow area is a strip of land adjacent to the levee, which was used as a disposal area during the construction of the MRGO canal. This rental agreement contract has not been fully utilized – some borrow area preparation work has been accomplished as part of STB01 work (same contractor). Completed contract.

TFG Project **STB04** (MRGO Baseline Station 380+00 to 705+00 - Between Bayou Dupre and Bayou Bienvenue Control Structures) includes repairing a 6.2-mile reach of levee along the MRGO between the Bayou Bienvenue and the Bayou Dupre Control Structures. Several barges are located on the levee and borrow areas. The entire levee reach will be restored to the design grade elevation (17.5'), requiring the placement of an estimated 1,000,000 cubic yards of fill material. The borrow area for this fill material is a strip of land adjacent to the levee (260 acre borrow area), which was used as a dredged disposal area during the construction of the MRGO canal. Scheduled completion is 1 April 2006.



Figure 14-131. Site Map of Area Between Bienvenue and Dupre



Figure 14-132. Barges From the MRGO



Figure 14-133. Repair Contract Work Borrow Pit and Dragline on Protected Side Right-of-Way

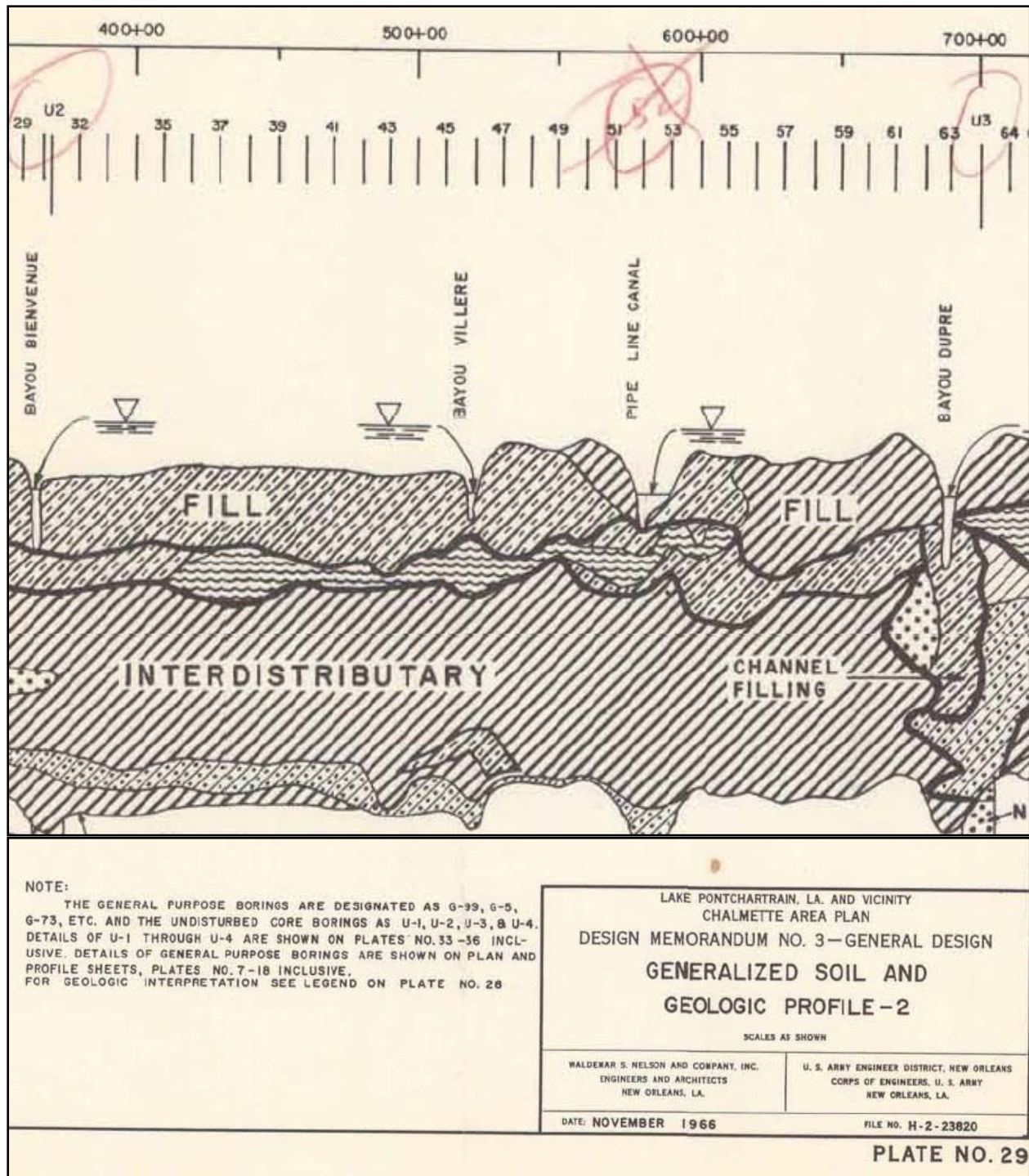

Figure 14-134. Pre-Existing Conditions Between Bienvenue and Dupre (from DM 3). The original ground surface was mostly organic clay (OH) southeast of Bayou Bienvenue. The original ground surface was fat clay (CH) between approximate Sta 612+00 and Bayou Dupre

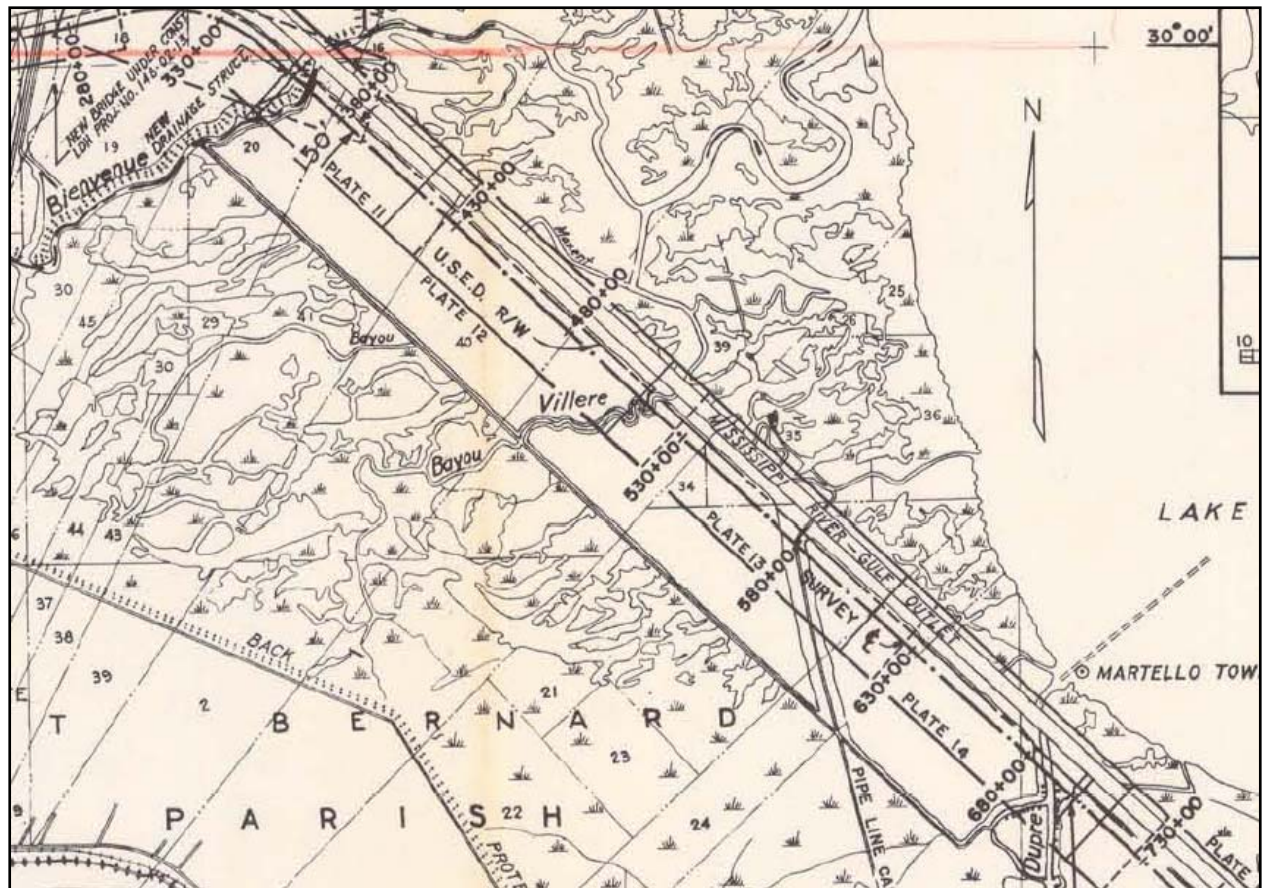

Figure 14-135. DM-3 Plates 11 thru 14 Between Bienvenue and Dupre

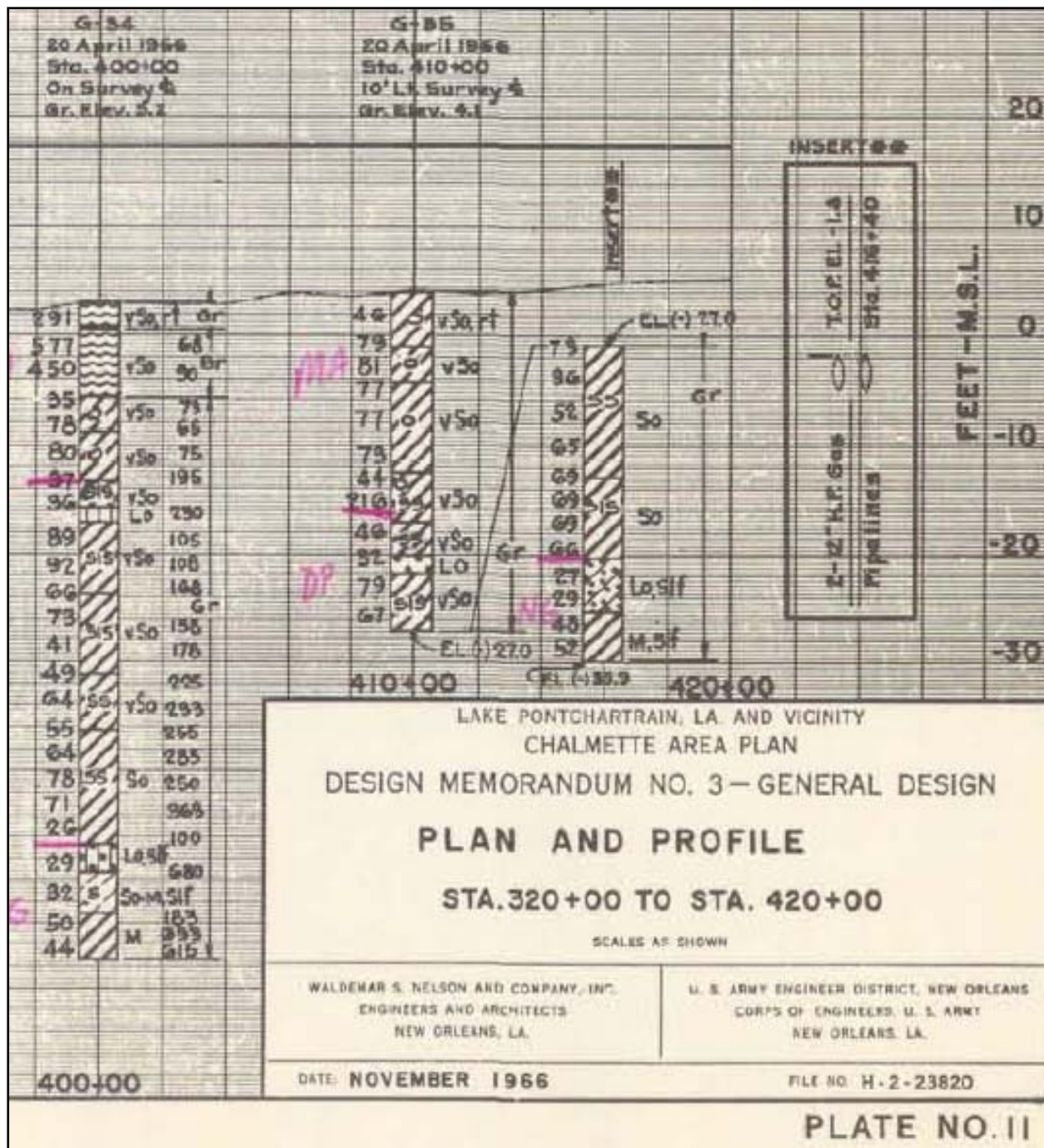

Figure 14-136. Original Ground Elevation was Approximately 5 ft Above MSL

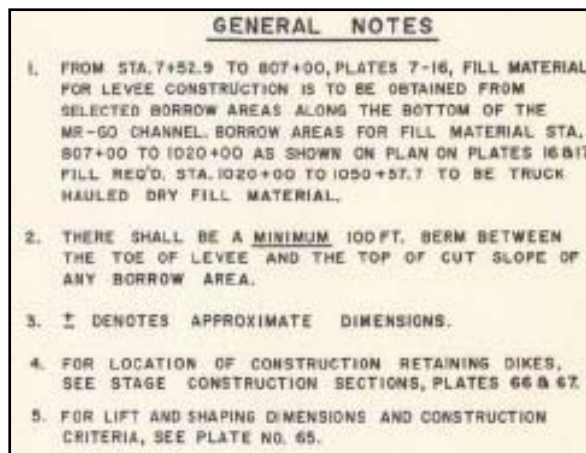

Figure 14-137. Hydraulic Fill From MRGO Channel Formed the Levee Between Bienvenue and Dupre. Southeast of Dupre (from Sta 807+00) Utilized Other Fill Materials (from 1966 DM3)

Bayou Dupre Control Structure. This control structure was damaged during the storm event. Adjacent sections of floodwall failed and the fill around other sections of floodwalls was eroded away due to overtopping. In addition there was damage to the mechanical and electrical systems that operate the sector gates.



Figure 14-138. Bayou Dupre Control Structure, Pre-Katrina View. Note the concrete walls transitioning to earth levee on both sides of the structure



Figure 14-139. Bayou Dupre Control Structure, Post-Katrina. View toward MRGO. Note the missing levees on both sides of the structure



Figure 14-140. Missing Levee and Part of Wall on West Side of Control Structure



Figure 14-141. Severe Scour on East Side of Structure



Figure 14-142. Closeup of East View, End of Concrete Wall, Showing Major Scour Holes and Complete Erosion of Levee

TFG Project **STB06** includes repair of structural damage and loss of structural backfill at the Bayou Dupre Control Structure. A significant scour hole is to be filled with 17,500 cubic yards of granular backfill and protected with grouted riprap. An estimated 22,500 tons of riprap and 13,400 cubic yards of embankment fill will be required for the repairs. Scheduled completion date is 1 April 2006.

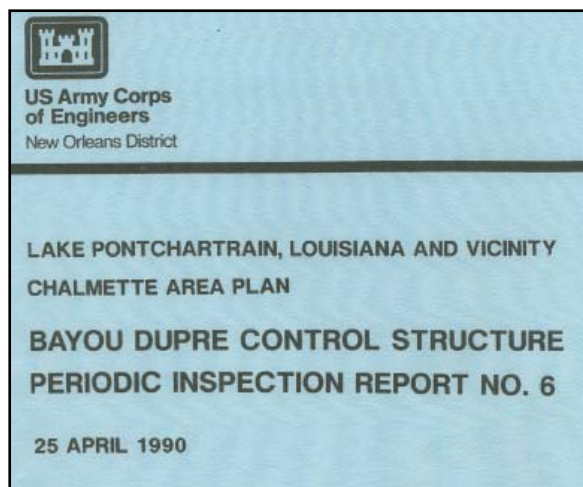

Figure 14-143. Bayou Dupre Ctrl Struct PIR No 6 25 Apr 1990.pdf Shows Pre-Katrina Condition of Structure

Hurricane Levee Between Bayou Dupre and STA. 1054+00. There is an 8,000 ft. section of the levee immediately southeast of Bayou Dupre that is severely damaged and has lost approximately 12 feet of levee section and is at approximately El. 5.0.



Figure 14-144. Major Scour on Levee Protected Side (Landside)



Figure 14-145. Scour Depths Below the Original Levee Footprint

There is 2,500 ft. of levee from Bayou Dupre to STA 1007+91 that lost approximately 8' of elevation (assume that 50% of the levee section is gone).



Figure 14-146. Scour on Landside (Protected Side) of Levee



Figure 14-147. Major Scour on Protected Side of Levee

The repaired levee cross section is shown below. This was the typical cross section used to estimate the required quantities.

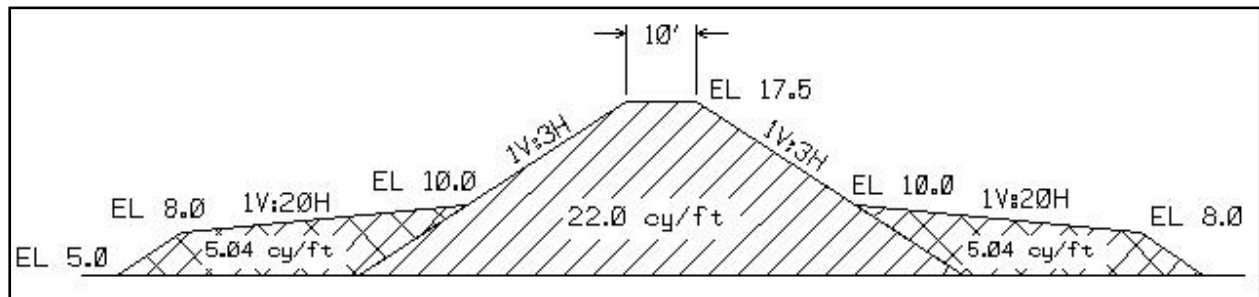

Figure 14-148.

Quantities: 650,000 cy fill – 200 acre borrow area

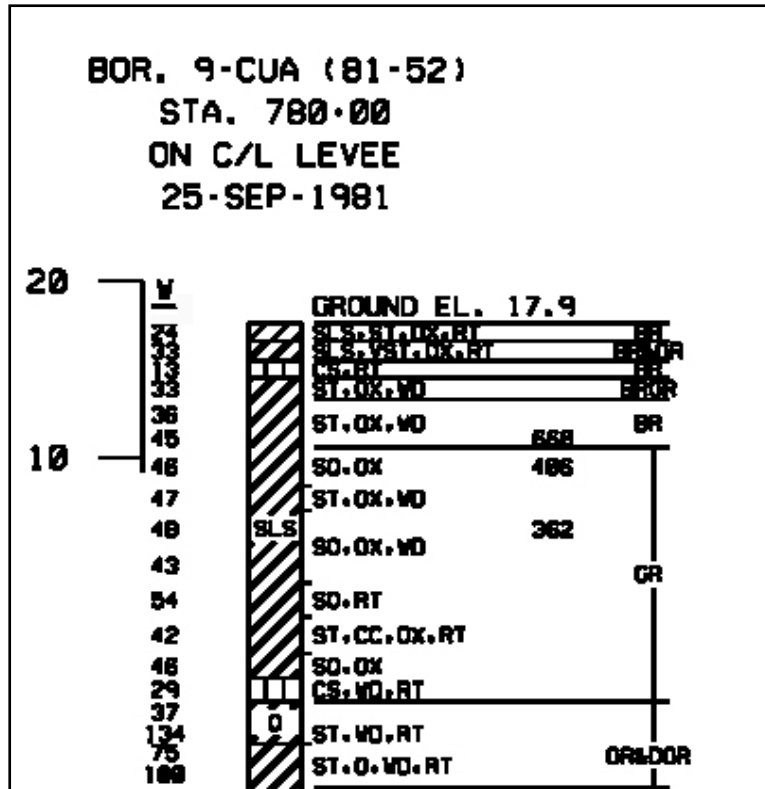

Figure 14-149. 1981 Soil Boring at Sta 780+00 Near Dupre Shows Top Layer of Lean Clay (CL) Underlain By Fat Clay (CH), Silt (ML or MH), and Silt / Sand Lenses (SLS) in the CH Material (From Drawing 9 of 10, Contract Solicitation W912P8-06-R-0002)

There is 700 ft. of this reach that is sheet pile floodwall that has been damaged and will be replaced with earthen levee. The above diagram was used to estimate required quantities.



Figure 14-150. Scour on Protected Side of Sheetpile Wall



Figure 14-151. End of Sheetpile Wall at B/L Sta 980+58

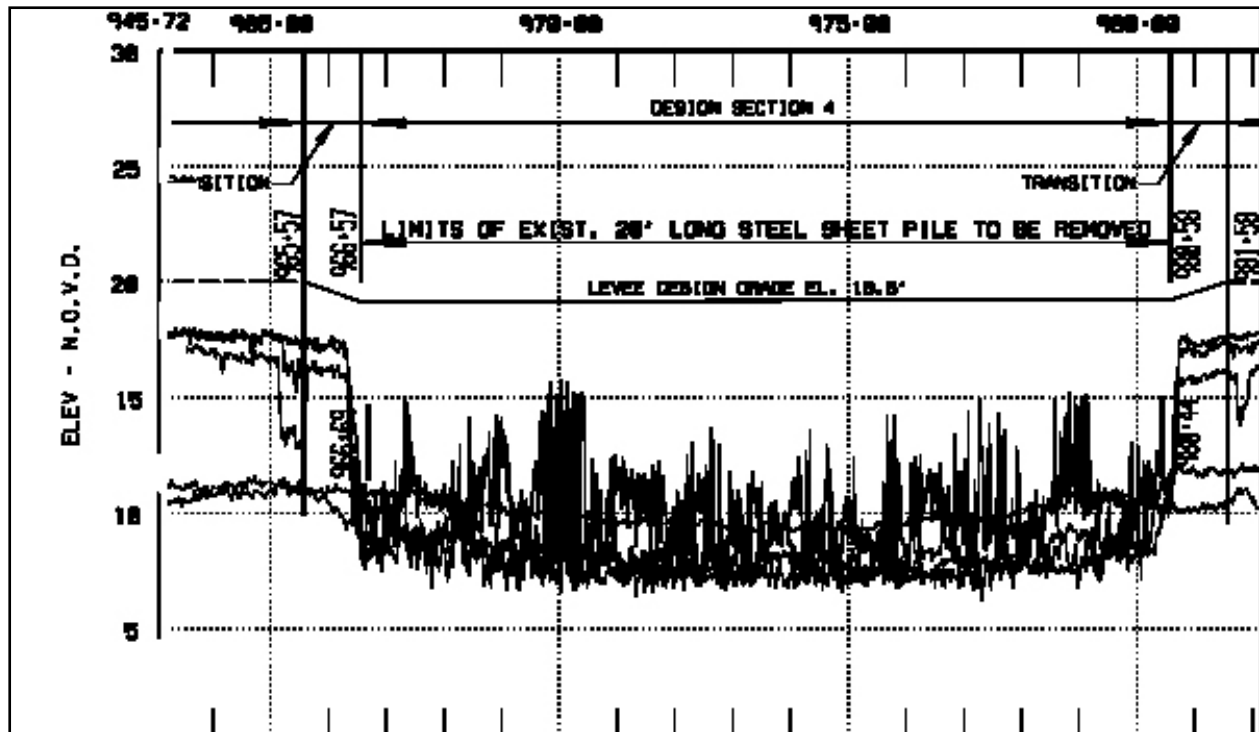

Figure 14-152. Scour Depths Along Sheetpile and at Transition to Levee. Note that scour occurred along the sheetpile reach, not at the sheetpile / levee transition (also seen in Figure 14-151), from drawing 7 of 10, contract solicitation W912P8-06-R-0002

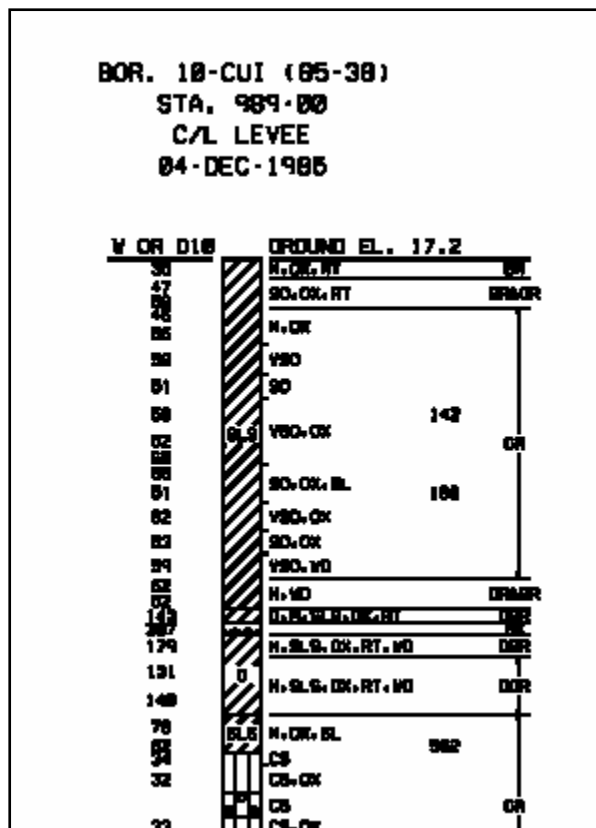

Figure 14-153. Pre-Katrina Boring at Sta 989+00 (about 800 ft beyond the sheetpile/levee transition) Shows Levee Section with Fat Clay (CH) Cap and Core, With Interbedded Silt Lenses (SLS)

TFG Project STB03 (Levee Restoration East of Bayou Dupre - MRGO Baseline Station 714+55 to 1007+91) includes repairing a 5.6-mile reach of levee along the MRGO extending east from the Bayou Dupre Control Structure. The entire levee reach will be restored to the design grade elevation (17.5'), requiring the placement of an estimated 1,120,000 cubic yards of fill material. The borrow area for this fill material is a strip of land adjacent to the levee, which was used as a disposal area during the construction of the MRGO canal. Scheduled completion date is 1 April 2006.

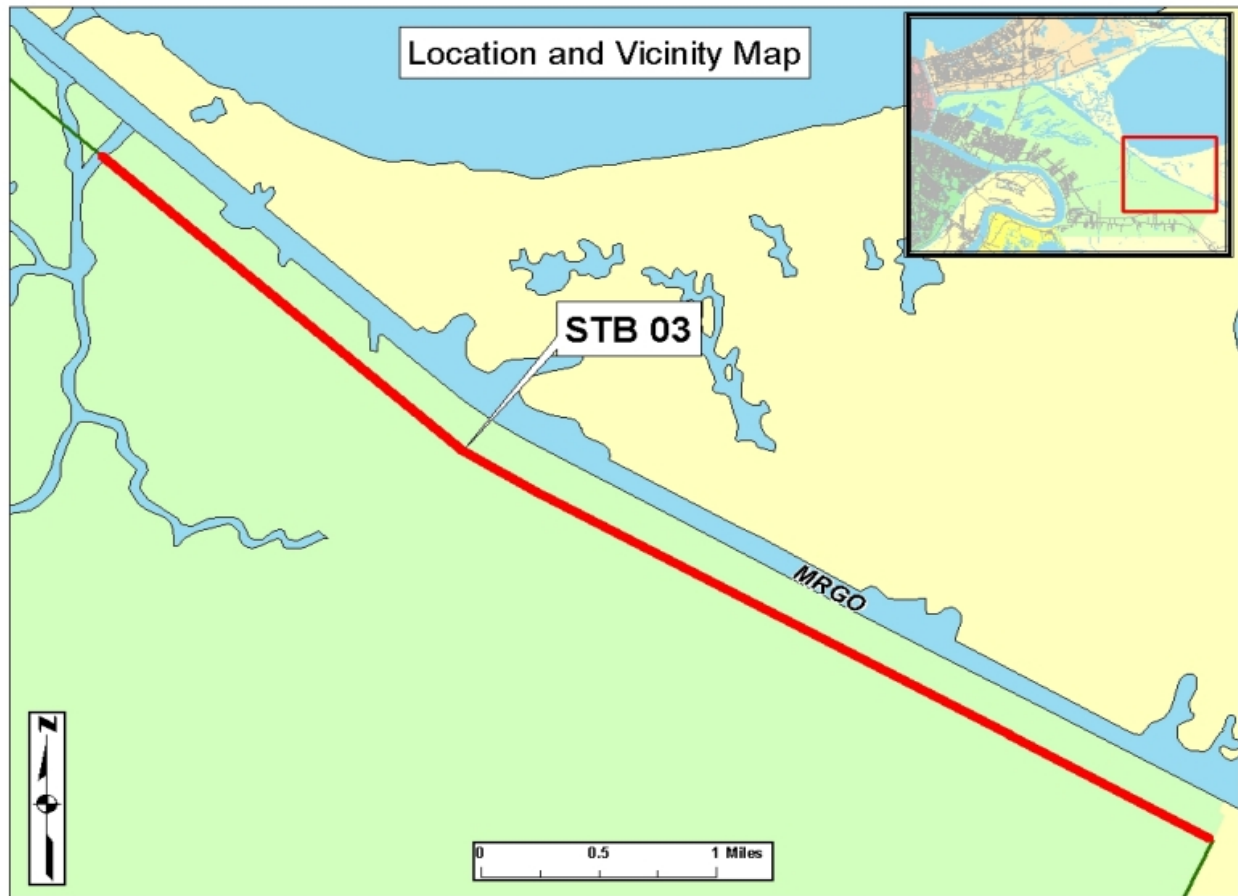

Figure 14-154.

MRGO to Caernarvon Levee. TFG Project **STB08** (Miscellaneous Scour Repair) includes repair of minor scour on the backside of the levee from the Mississippi River Gulf Outlet (MRGO) to Caernarvon, which is about 10.8 miles in length. An estimated 36,000 cubic yards of fill material will be required for this work. Scheduled completion date is 15 April 2006.



Figure 14-155. Crown Scour Along Approximate B/L Sta 1203+00 to Sta 1230+00

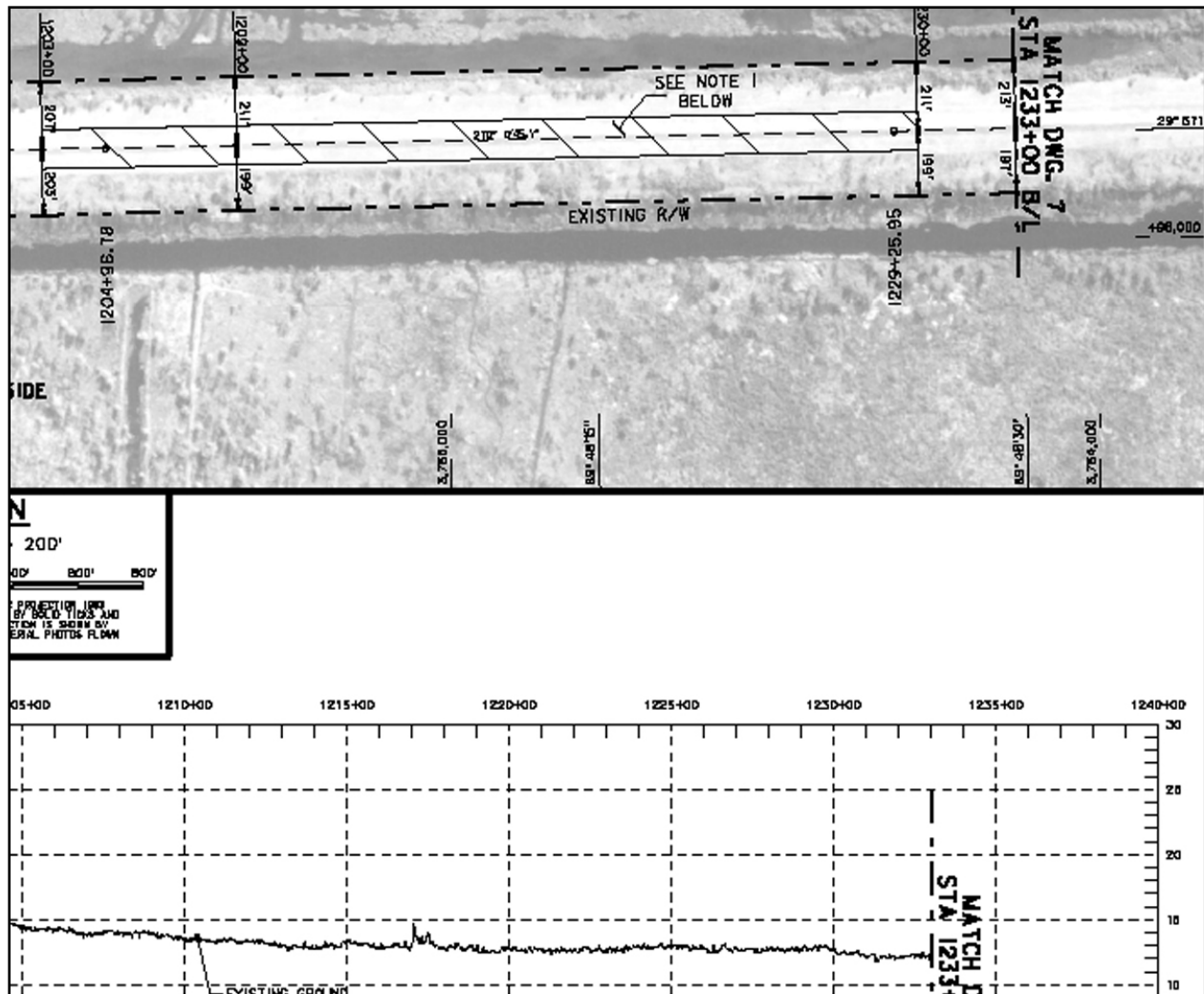

Figure 14-156. Levee Crown Elevation Drops From Elev 15 ft to Elev 12 ft in the Scour Area. Elevation 12 ft Remains Fairly Constant Along the Reach for About a Mile Beyond The Scour Section. From Contract Solicitation STB08 W912P8-06-R-0094, drawing sheet C-06

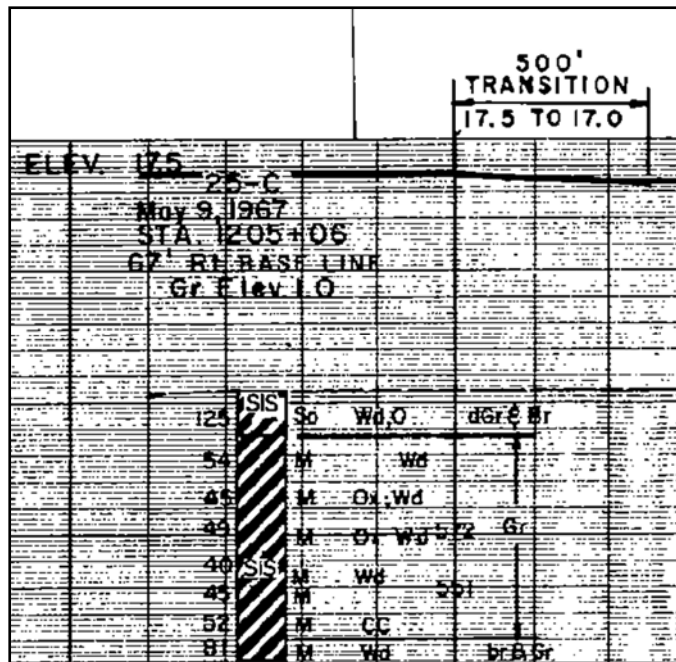

Figure 14-157. Original 1967 Boring at Ground Elevation 1 ft Shows Fat Clay With Silt / Sand Lenses (from DM3 Chalmette Extension drawing file H-2- 24306, plate 7). The levee along this reach was constructed of Miss. River hydraulic sand fill, capped with local borrow clay, and shaped to grade with Miss. River batture soil (truck-hauled fill)



Figure 14-158.

Creedmore Gravity Drainage Structure. The levee district has been unable to fully close the two 72-inch sluice gates on drainage structure. One sluice gate is approximately 50% closed and the other is approximately 90% closed. The cause of the sluice gates being stuck is apparently debris under the gate slides. Since there are trash racks on the inlet structure to these drains the debris must have come in through the outlet structure. While attempting to close the sluice gates against this debris the gate hoists were both damaged.



Figure 14-159.



Figure 14-160.

TFG Project **STB09** (Repair Creedmore Structure) includes constructing a cofferdam and removing debris from the structure to permit closure of the gates and inspection of the structure to determine if further repairs are necessary. Scheduled completion date is 1 April 2006.



Figure 14-161.

Plaquemines Parish

Levee and Floodwall Characterization

General. The Plaquemines Parish Basin includes long, narrow strips of protected land on both sides of the Mississippi River between New Orleans and the Gulf of Mexico. The Mississippi River Levees (MRL) protect the Parish from floods coming down the river. Protection from hurricane-induced tidal surges is achieved by the New Orleans to Venice (NOV) hurricane protection system. The NOV is a system of levees on the gulf side of the protected lands and additional berms and floodwalls on top of the MRL along the river. The distance

between the gulf-side levees (back levees), and the MRL is less than a mile in most places. The extent of these protection systems is shown in ____



Figure 14-162. Plaquemine Parish Mississippi River Levees (MRL East Bank, MRL West Bank) and New Orleans to Venice Hurricane Protection Levees (St. Jude to City Price, Reach A, Reach B-1, Reach B-2, and Reach C) Project Reaches

Altogether the Plaquemines Parish MRL and NOV systems include 162 miles of levee and 7 miles of floodwall. There are fifteen non-federal pump stations for interior drainage. The levees are crossed by numerous pipelines, constructed in various manners. Some crossings bridge the levee without touching the embankment; some are constructed on top of the line of protection; and some pass through the line of protection with measures to prevent seepage. There is also a wicket gate closure on the back levee at Empire, where a shipping canal connects the Mississippi River to the Gulf of Mexico.

NOV Levees. The NOV system is a hurricane protection levee or floodwall that is built on top of the MRL or setback from the MRL. The NOV includes WAVE berms on the floodside and STABILITY berms on the protected side. Floodwalls are used where real-estate is not available to build levees. The NOV system is approximately 2 to 3 ft higher than the MRL. The NOV consists of four distinct reaches; Reach C at Phoenix to City Price, Reach A from City Price to Empire, Reach B-1 from Empire to Ft. Jackson and Reach B-2 from Ft. Jackson to Venice. Figure 14-1 illustrates the NOV levee systems in Plaquemine Parish.

MRL Levees. The Plaquemines Parish East Bank MRL system extends from the Parish line at Braithwaite 33 miles downstream to Bohemia. The flood side has concrete slope pavement from the bottom of the embankment to the design high water level. The crown is surfaced with 9 inches of crushed limestone. The freeboard and protected side slopes are grassed.

The east bank NOV back levee runs between Phoenix and Bohemia, a distance of 16 miles. It is a grass-covered earthen levee.

The West Bank Plaquemines MRL system extends from the parish line at Belle Chasse, 70 miles downstream to Venice. Its composition is similar to the East Bank MRL with concrete slope pavement, crushed limestone surface course, and the remaining slopes grassed. Below Port Sulphur (29 miles above Venice), the MRL design grade is lower than the NOV hurricane design grade, so the NOV is constructed as berms or floodwalls on top of the MRL.

The west bank NOV extends from St. Jude to Venice, a distance of 34 miles. The NOV protection along the river includes 6 miles of floodwalls in 13 distinct reaches, projecting above the MRL from 2 to 8 feet. The back levee is a grass-covered earthen embankment.

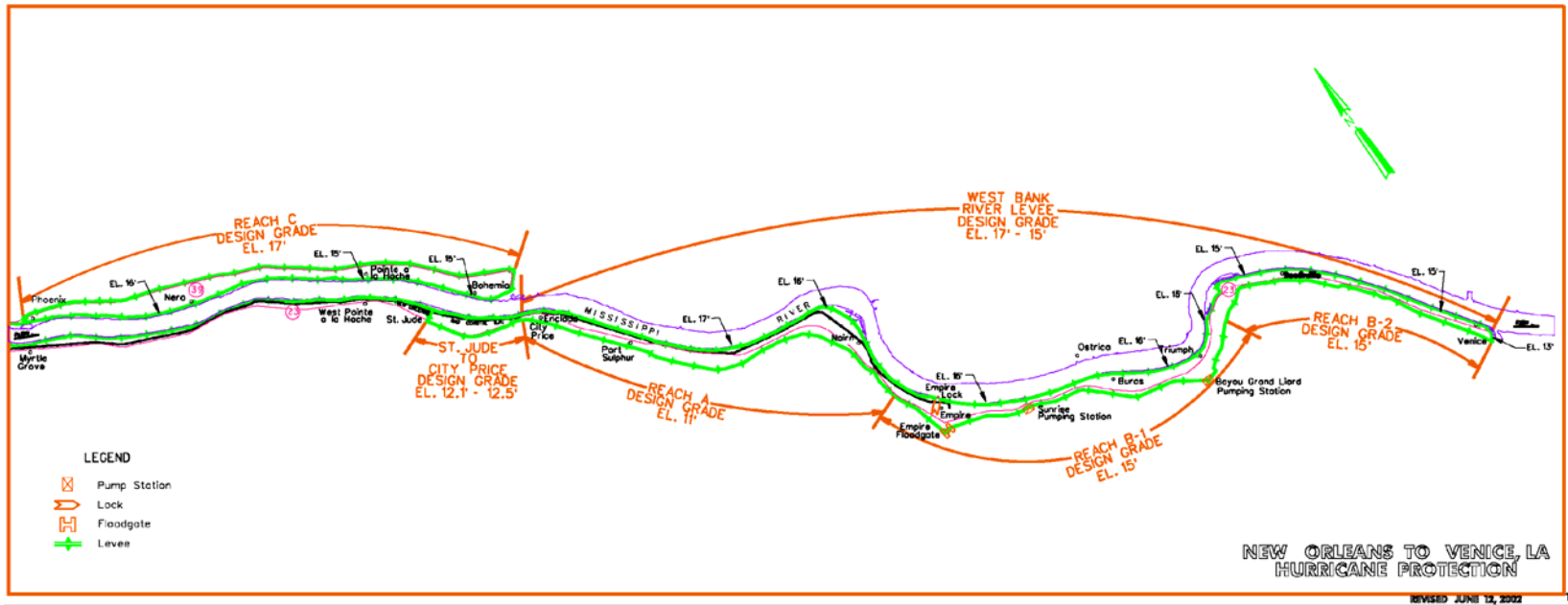

Figure 14-163. New Orleans to Venice Hurricane Protection Project

Damage from Katrina. All of the levees in Plaquemines Parish sustained damage from Hurricanes Katrina and Rita. There was considerable crown and slope scour along the total length. The MRL slope pavement sustained damage from the hundreds of ships and barges that crashed upon it. There were also several severe breaches, coinciding with pipeline crossings and with some floodwalls. Five of the six miles of NOV floodwall along the Mississippi River was damaged beyond repair. There were major breaches at sheet pile wing walls at two pump stations in the back levee. A major breach occurred at the Shell pipeline crossing near Nairn. And the West Pointe a la Hache pipeline crossing was severely damaged. Wind and water damage from Katrina and Rita severely impacted nearly every structure within the east bank area of protection and on the west bank below Myrtle Grove (50 miles above Venice).

Figure 14-3 shows the extent of contracts awarded to repair Plaquemines Parish. There are 22 projects in total that are worth approximately \$107 million. Below are descriptions of contracts which relate to floodwall failures.

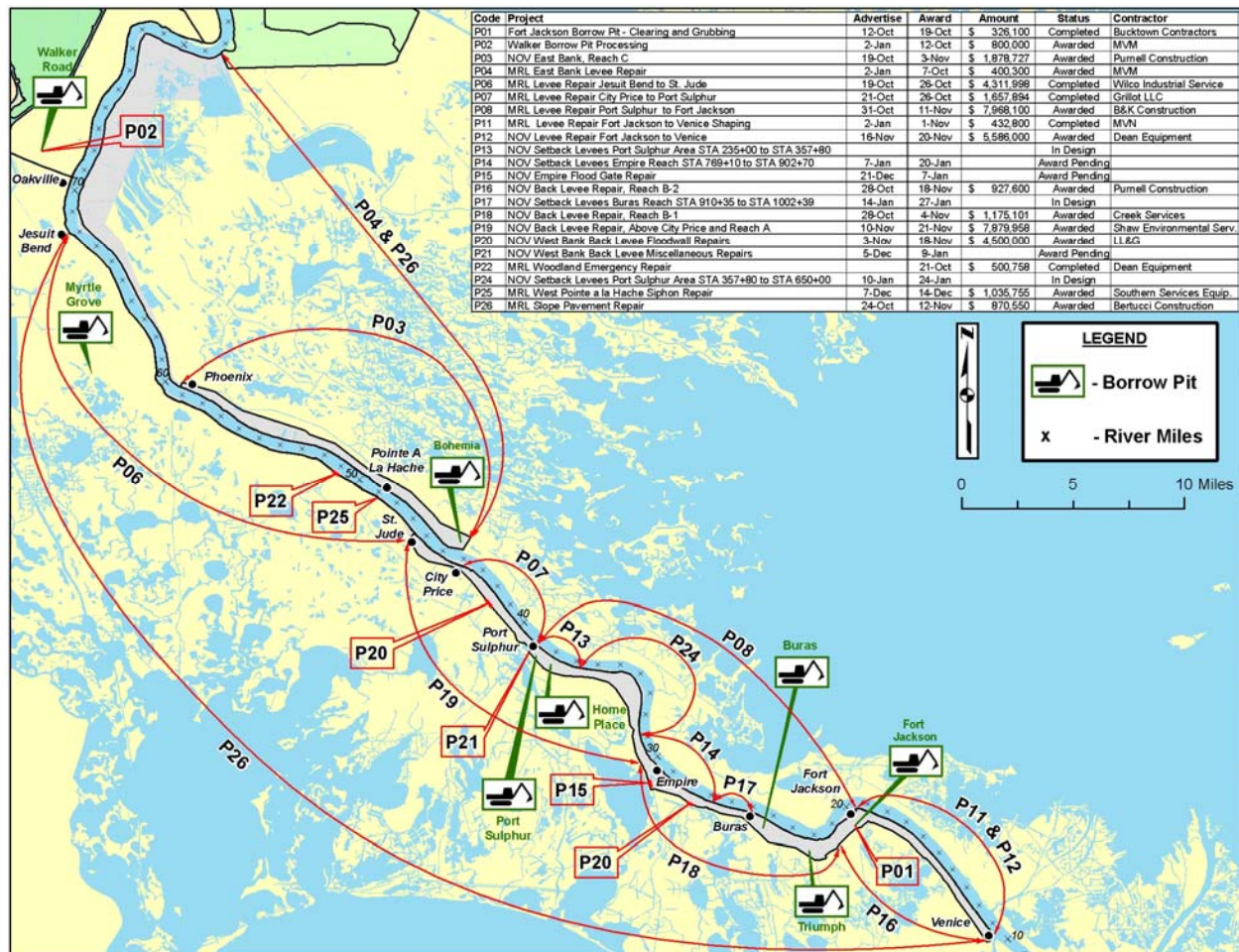

Figure 14-164. Repair Project Summary for Plaquemines Parish (TFG, Jan 2006)

Specific contracts to replace or repair damage to walls

P06 - Major scour at Woodlands Plantation and at a pipeline crossing at the West Pointe a la Hache (not sure if this is a sheetpile or levee failure)

P13 - Replace floodwalls with 6 miles of setback levees from station 114+57 to 426+99. Along the Port Sulphur Reach (south of Port Sulphur).

P14 - Replace floodwalls with 2.5 miles of setback levee along Empire Reach from Station 769+10 to 902+70.

P17 - Replace floodwalls with 9,000 feet of setback levee along Buras Reach Station 910+35 to 1002+39, severe scour behind wall

P20 – NOV, floodwall repair at Sunrise (next to Buras) and Hayes (next to Port Sulphur) pump stations. Emergency sheetpiling was installed at both locations.

P21 - West Bank, repair floodwalls at: Homeplace Marina (next to Port Sulphur), Gainard Wood Pump station-(south of Homeplace – 2 miles), and at Diamond Pump station (next to City Price). Floodwalls are I-walls and some are capped.

P24 - Replace floodwall from station 357+80 to 650+00. Port Sulphur Area just above Nairn

Floodwall Damage Plaquemines Parish							
Source: Task Force Guardian Project Information Report (October 2005)							
Reach and Station	length Riverside erosion	Length of Landside Erosion			floodwall damage	length of	
	Minor Top 1/4 48 sq-ft/ft	Minor Top 1/4 48 sq-ft/ft	Major Top 1/2 96 sq-ft/ft	Major Top 1/2 96 sq-ft/ft	both ends	landside	failure SP or I- wall
Reach A							
MRL							
113 to 144					40	6360	
150 to 156	2000				40	8020	
253 to 256					40	300	
273 to 276					40		
Reach b 1							
MRL							
278 to 224				5200	40	7750	4100
223 to 218					40	26282	6300
HPL							
191 to 188 empire					40	5729	
					40	4583	

Appendix 15

Concrete I-Wall and Sheet Piling Material Recovery, Sampling and Testing: 17th Street Canal Levee Breach

Introduction

On Monday and Tuesday, 12-13 December 2005, samples of the concrete I-wall and sheet piling were taken at or adjacent to the 17th Street Canal levee breach. The objectives of this exercise were a:) to verify conformance of material properties of the I-wall concrete and reinforcing steel, and the sheet piling with their respective specifications; b:) to verify the as driven length of the of the sheet piling and c:) potentially validate the Parallel Seismic testing that was performed in an attempt to determine, in situ, the sheet piling tip elevation

The 17th Street Canal breach is located on the east side of the canal just south of Hammond Highway. Figure 15-1 shows the breach shortly after Hurricane Katrina. The material samples were obtained from the (relatively) undisturbed I-wall sections at the north and south end of the breach. Concrete and rebar samples were obtained on Monday, 12 December and sheet piling were extracted on Tuesday, 13 December 2005.

The I-wall is comprised of a series of concrete wall panels separated by expansion joints and is founded on sheet piling driven through the levee. A typical cross section is shown in Figure 15-2.

Material Sample Recovery

The material samples recovered from the site included two four foot square by 12 inch thick wall panel samples, two nominally six inch diameter cylindrical cores, one each from the wall panel samples, six samples of reinforcing steel from the wall panels and 14 sheet piles. All samples were marked and tagged and placed into a controlled and documented chain of custody.



Figure 15-1. 17th Street Canal Breach

The I-wall panels immediately north and south of the breach were designated H22 and H38, respectively. A four foot by four foot section was sawcut from the top of the north end of the I-wall section H38 and from the top of the south end of I-wall section H22. The contractor first drilled a six inch diameter core from the designated four foot square sample at the north end of wall panel H38. The core drill and saw are shown mounted to the wall at panel H38 at the south end of the breach in Fig 15-3. Figure 15-4 shows the core being removed from panel H38. It was marked and tagged MH38C1C01 as shown in Fig. 15-5.

Prior to drilling, the cores were considered as potential compressive strength test specimens. However the core contained rebar and was not a valid test specimen. The resulting holes were used to for rigging to support and remove the four foot by four foot wall samples as shown in Figs. 15-6 and 15-7.

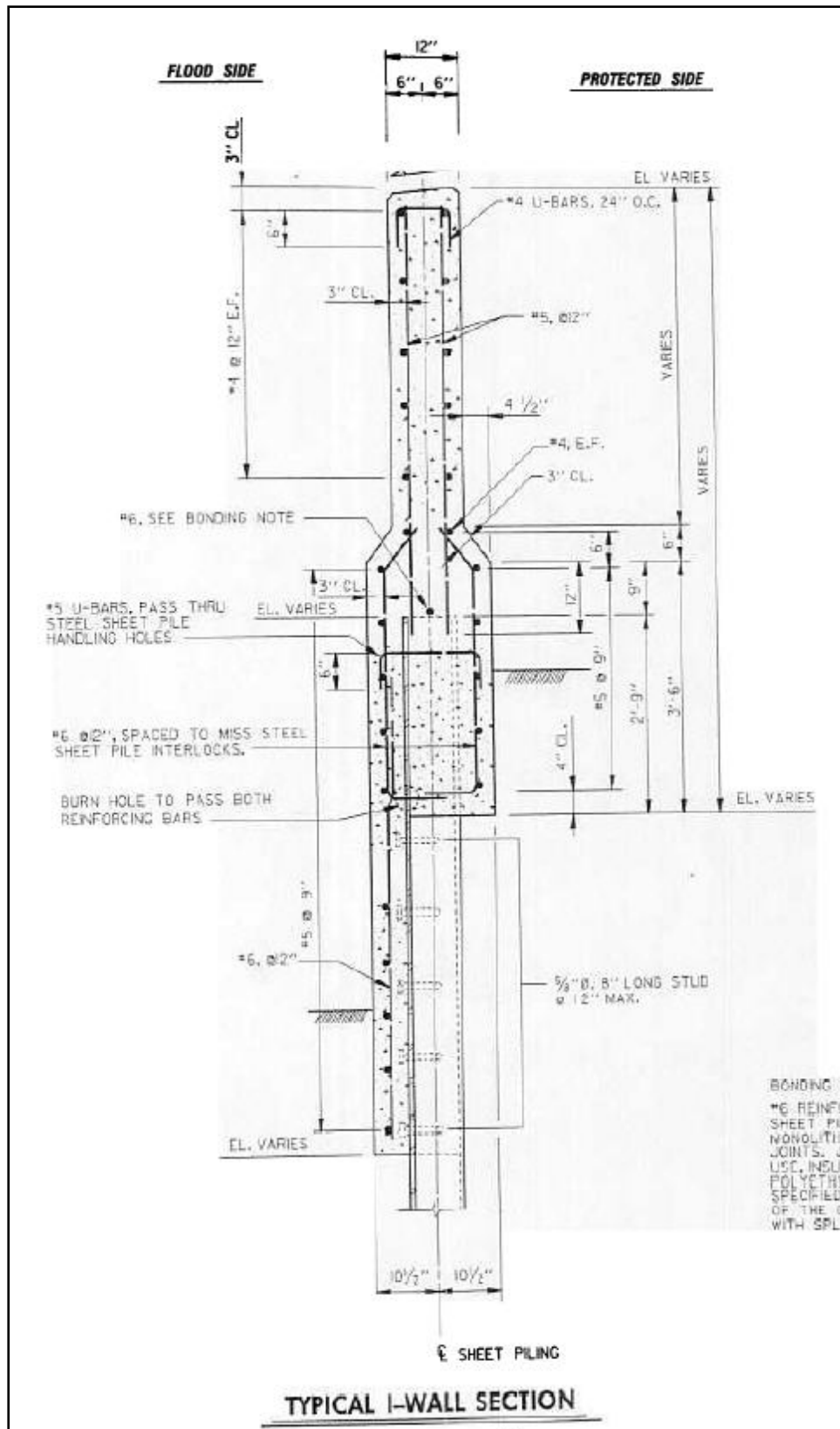

Figure 15-2. Typical I-Wall Section



Figure 15-3. Core Drill and Saw Mounted to Wall Panel H38



Figure 15-4. Core Being Removed from Panel H38



Figure 15-5. Core from Wall Panel H38



Figure 15-6. Sawing of Sample from Wall Panel H38



Figure 15-7. Removal of Sample from Wall Panel H38

A similar procedure was used to obtain a four foot square sample from the south end of wall panel H22 at the north end of the breach as shown in Figs. 15-8 and 15-9. The concrete core was marked and tagged MH22C1C01 as shown in Fig. 15-10. This core also contained rebar and was not suitable for testing. The wall panel sample was marked and tagged MH22C1 as shown in Fig. 15-11.



Figure 15-8. Core Drill and Saw Mounted at Panel H22



Figure 15-9. Sample Being Removed from Wall Panel H22



Figure 15-10. Cylindrical Core from Wall Panel H22



Figure 15-11. Wall Sample MH22C1

Rebar samples were then removed from the remaining sections of wall panels H38 and H22. A hoe ram was used for controlled demolition of wall panels in order to expose the rebar samples as shown in Fig. 15-12. Some of the demolition of the concrete around the rebar samples was done with a small hand held jack hammer as shown in Fig. 15-13. A portable electric bandsaw was used to cut the rebar samples as shown in Fig 15-14.



Figure 15-12. Demolition of Concrete for Rebar Sampling at Panel H22



Figure 15-13. Demolition of Concrete Around Rebar Sample at Panel H38



Figure 15-14. A Portable Electric Bandsaw is Used to Cut Rebar Samples

At wall panel H38 a two foot long sample of the following rebar were obtained: 1) A #4 horizontal bar from the east face of the wall approximately 29 inches down from the top of the wall. The north end of the sample terminated at the vertical sawcut for the wall sample MH38C1. 2) A #5 vertical approximately 76 inches from the north end of panel H38. 3) A #6 vertical from the west face of the lower section of the wall. This #6 bar was approximately 8 inches from the north end of panel H38. (This sample has the orange paint shown in Fig. 15-15.) These rebar samples were marked and tagged MH38R1, MH38R2 and MH38R3, respectively.



Figure 15-15. Number 6 Rebar Sample Being Taken from Panel H38

At wall panel H22 a two foot long sample of the following rebar were obtained: 1) A #4 horizontal bar from the west face of the wall, approximately six inches down from the top of the wall 2) A #5 vertical bar from the west face of the wall approximately 74 inches from the south end of the wall pane. 3) A #6 vertical from the west face of the lower end of the wall approximately 16 inches from the south end of the wall panel. These samples were marked and tagged MH22R1, MH22R2 and MH22R3, respectively.

Figure 15-16 shows the wall panel samples, cores, and rebar samples collected on Monday, 12 December 2005. Note that the cores were placed in sealed plastic bags and each core and the 3 rebar samples from each of the two wall panels were placed in individual latching boxes. These samples were transported to a secure area at a warehouse at the Corps of Engineers' New Orleans District Office.



Figure 15-16. Wall Panel Samples, Cores and Rebar Samples

After the cores, wall panel and rebar samples were obtained the contractor began demolition of the wall panels to expose the top of the sheet piles for extraction. A scissor concrete crusher was used to demolish the upper portion of the wall panels as shown in Fig. 15-17. A hoe ram was then used to remove the lower portion of the of the wall panel around the sheet piling (Reference

the wall cross section in Fig. 15-2.) as shown in Fig. 15-18. The same procedure was used for both wall panels H38 and H22.



Figure 15-17. Demolition of Top Portion of Wall Panel H38



Figure 15-18. Hoe Ram Demolishing Lower Portion of Wall Panel H38

On Tuesday, 13 December 2005, sheet piles were extracted. The location of the sheet piles extracted at or adjacent to wall panel H38 is schematically shown in Fig. 15-19. Starting from the north end of panel H38, the piles are designated MH38SP1, MH38SP2, ..., MH38SP16 (the last number of the designation is incremented going from north to south).

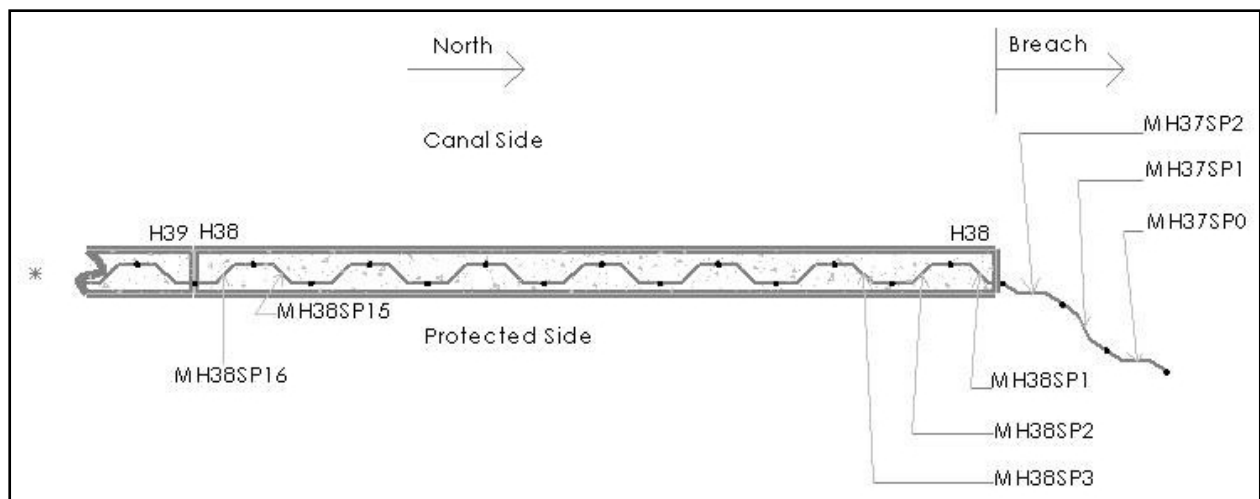

Figure 15-19. Sheet Pile Designations at Wall Panel H38

Sheet piles MH38SP2, MH38SP3 were extracted as a pair. Their lengths were approximately 23'-7" and 23'-8", respectively. MH38SP1 and MH37SP2 were then extracted as a pair. Their lengths were approximately 23'-3". The contractor then moved to the south end of wall panel H38 and extracted MH38SP15 and MH38SP16. Their lengths were approximately 23'-5". MH38SP15 and MH38SP16 were at a location corresponding to a soil boring hole where Parallel Seismic tests were conducted in an attempt to determine the length of the sheet pile in situ. The contractor then attempted to extract sheet pile MH37SP1 as a single pile, but MH37SP0 came with it. Their lengths were approximately 23'-6". Extraction of sheet piles at the south end of the breach is shown in Figs. 15-20 and 15-21. The out-of-plumb orientation (from displacement of the piling in the breach) of piles MH37SP1 and MH37SP0 is clearly evident in Fig. 15-21. Figure 15-22 shows measuring and tagging of sheet piling.



Figure 15-20. Extraction of Sheet Piles MH38SP2 and MH38SP3



Figure 15-21. Extraction of Sheet Piles MH37SP1 and MH37SP0

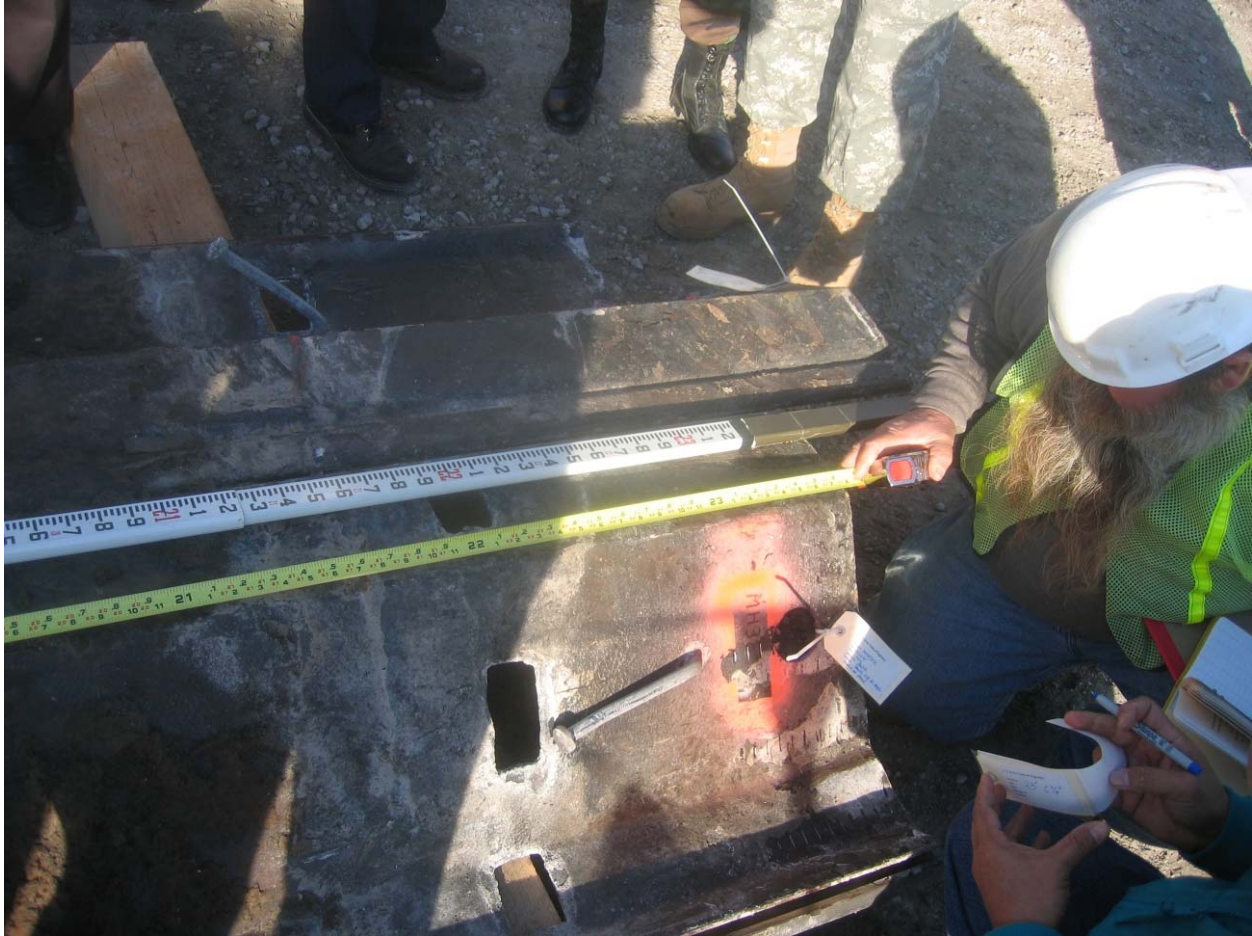

Figure 15-22. Measuring and Tagging of Sheet Piles

Sheet piles were then extracted at the location of wall panel H22, immediately north of the breach. Four sheet piles at the south end of wall panel H22 were designated MH22SP1, MH22SP2, MH22SP3 and MH22SP4. (The last number of the designation was incremented going from south to north.) Sheet piles MH22SP1 and MH22SP2 were extracted as a pair as shown in Fig. 15-23. These piles had a length of approximately 23'-7" and 23'-6", respectively. Sheet piles MH22SP3 and MH22SP4 were extracted as a pair and had a length of approximately 23'-7" and 23'-6", respectively. The contractor then pulled a pair of piles from just north of the north end of wall panel H22 at a location coincident with a boring hole where Parallel Seismic testing had been performed. These piles were designated MH21SP1 and MH21SP2. Both of these sheet piling had a length of approximately 23'-6".



Figure 15-23. Extraction of Sheet Piling MH22SP1 and MH22SP2

Figures 15-24 and 15-25 show the sheet piling extracted from the south and north ends of the breach, respectively. The sheet piles were loaded on a truck and transported to a secure location within a warehouse at the Corps of Engineers' New Orleans District Office.



Figure 15-24. Sheet Piling Extracted from South End of Breach



Figure 15-25. Sheet Piling Extracted from North End of Breach

Sheet Piling Length and Tip Elevation

The sheet piling extracted from the 17th Street Canal breach site ranged in length from 23'-3" to 23'-8". The top of the pilings were at approximately elevation 6.25 ft. (The pilings adjacent to the expansion joints between wall panels were driven slightly lower as can be seen in Fig. 15-26. This was done to improve the performance and effectiveness of the expansion joint.) A 23'-3" piling length provides for a tip elevation of -17.0 ft. Obviously, piling driven with a lower top elevation have a correspondingly lower tip elevation.



Figure 15-26. Lower Top Elevation of Sheet Piling at Expansion Joint

Material Testing

On Friday, 16 December 2005, three each, nominally six inch diameter, concrete cores were drilled from the wall panel samples MH22C1 and MH38C1. These cores were marked and tagged MH22C1-01, MH22C1-02, MH22C1-03, MH38C1-01, MH38C1-02, and MH38C1-03. A sample of steel was also flame cut from each of four sheet piling. The six cores, four steel samples and the previously obtained six samples of rebar were transferred to Beta Testing & Inspection, LLC of Gretna, LA (BTI) for testing.

The concrete cores were obtained and tested for compressive strength by BTI in accordance with ASTM C 42 and C 39. As can be seen in Table 15-1, all of the cores had a compressive strength in excess of the specified 3000 psi compressive strength. More comprehensive details of the testing are in BTI's report in Attachment A.

Table 15-1 Concrete Compressive Strength		
Core	Specified Compressive Strength (psi)	Compressive Strength As Tested (psi)
MH22C1-01	3000	4000
MH22C1-02	3000	3190
MH22C1-03	3000	3940
MH38C1-01	3000	3960
MH38C1-02	3000	4360
MH38C1-03	3000	4100

Tensile tests of the sheet piling material samples were performed, in accordance of ASTM A 370, by a subcontractor to BTI. A summary of the test results and the tensile requirements of the material specification, ASTM A 328 are provided in Table 15-2. More comprehensive details of the testing are in BTI's report in Attachment A.

Table 15-2 Sheet Piling Tensile Requirements and Tests Results			
Sample	Yield Strength (ksi)	Tensile Strength (ksi)	Elongation in 2 in. (%)
MH21SP1-01	58.5	80.9	33.0
MH22SP2-01	55.4	80.1	29.9
MH 37SP1-01	55.5	82.1	32.1
MH38SP16-01	57.0	80.0	32.7
ASTM A 328 Tensile Requirements	39	70	20

Tensile tests of the rebar samples, in accordance of ASTM A 370, were also performed. A summary of the test results and tensile requirements for the specified ASTM A 615 Grade 60 reinforcement is provided in Table 15-3. More comprehensive details are included in BTI's report in Attachment A.

Table 15-3 Reinforcing Steel Tensile Requirements and Test Results				
Sample	Bar Size Designation No.	Yield Strength (ksi)	Tensile Strength (ksi)	Elongation in 8 in. (%)
MH22R1	4	65.0	107.5	11.7
MH22R2	5	62.9	104.5	13.2
MH22R3	6	65.9	108.1	9.3
MH38R1	4	91.0	107.5	16.2
MH38R2	5	61.3	99.7	9.8
MH38R3	6	79.5	97.7	11.4
ASTM A 615 Grade 60 Tensile Requirements	3, 4, 5 or 6	60	90	9

Attachment A

Test Report from Beta Testing & Inspection, LLC

Table C.1

Sample panel MH38C1						
Core ID	Capped Length (in.)	Diameter (in)	Area (in ²)	l/d	Correction factor	Maximum load (lbs.)
MH38C1-01	11.9	5.67	25.25	2.09	1	100,000
	Compressive strength (psi)	Fracture type	Age (days)	Load application	Test date/time	Sample date/time
	3960	C	NA	vertical	12/21/05 10:00am	12/16/05 11:00am
Core ID	Capped Length (in.)	Diameter (in)	Area (in ²)	l/d	Correction factor	Maximum load (lbs.)
MH38C1-02	9.19	5.65	25.12	1.62	0.97	113,000
	Compressive strength (psi)	Fracture type	Age (days)	Load application	Test date/time	Sample date/time
	4360	A	NA	vertical	12/21/05 10:00am	12/16/05 11:00am
Core ID	Capped Length (in.)	Diameter (in)	Area (in ²)	l/d	Correction factor	Maximum load (lbs.)
MH38C1-03	11.8	5.66	25.15	2.08	1	103,000
	Compressive strength (psi)	Fracture type	Age (days)	Load application	Test date/time	Sample date/time
	4100	D	NA	vertical	12/21/05 10:00am	12/16/05 11:00am

Testing of 17th Street Canal
Floodwall Materials

February 14, 2006

Steel Reinforcing Bars

Six pieces of steel reinforcing bars each measuring 2' in length were secured and transported to BTI's laboratory. The steel reinforcing bar samples ranged in size from No. 4 to No. 6 bars. Mandina's Inspection a subcontractor of BTI tested the rebar specimens to failure in accordance with ASTM A-615 & A370. Section C3B-6.1.1 of the project specifications references ASTM A-615. ASTM A-615 requires a minimum tensile strength of 90,000psi for Grade 60 steel. The specimens tested tensile strength exceeds the minimum project requirements. See enclosure STEEL REINFORCING BAR TENSILES for test results.

Upon completion and acceptance of the testing program, all of the materials, tested and untested, will be sealed and returned to the New Orleans District Office of the US Army Corps of Engineers. Enclosed are copies of our laboratory accreditations and equipment calibration reports associated with the test performed. Should you have any questions regarding this letter or require additional information, please do not hesitate to contact us.

Sincerely,

Beta Testing & Inspection, LLC



Mark A. Cheek, P.E.
Vice-President

Enclosures

STEEL REINFORCING BAR TENSILES MH-22

MH22

MECHANICAL TESTING LABORATORY DIVISION

MTL JOB NO. _____

TENSILE NO. _____

8" Gage

SPECIMEN ID	DIA. INCHES	AREA SQ. IN.	YIELD LOAD POUNDS	YIELD STR. PSI	ULTIMATE LOAD POUNDS	TENSILE STR. PSI	ELONGATION IN 8" GAGE PERCENT	REDUCTION IN AREA PERCENT
R1	.500	.20	13,000	65,000	21500	107,500	8.935 11.68	.358 .100 50%

TENSILE NO. _____

SPECIMEN ID	DIA. INCHES	AREA SQ. IN.	YIELD LOAD POUNDS	YIELD STR. PSI	ULTIMATE LOAD POUNDS	TENSILE STR. PSI	ELONGATION IN 8" GAGE PERCENT	REDUCTION IN AREA PERCENT
R2	.624	.31	19,500	62,903	32400	164516	9.052 13.5%	.481 .181 41.6%

TENSILE NO. _____

SPECIMEN ID	DIA. INCHES	AREA SQ. IN.	YIELD LOAD POUNDS	YIELD STR. PSI	ULTIMATE LOAD POUNDS	TENSILE STR. PSI	ELONGATION IN 8" GAGE PERCENT	REDUCTION IN AREA PERCENT
R3	.750	.44	29,000	65,909	45800	104,090	8.746 9.25%	.626 .307 30.2%

TENSILE NO. _____

SPECIMEN ID	DIA. INCHES	AREA SQ. IN.	YIELD LOAD POUNDS	YIELD STR. PSI	ULTIMATE LOAD POUNDS	TENSILE STR. PSI	ELONGATION IN 8" GAGE PERCENT	REDUCTION IN AREA PERCENT

G:\WORDDATA\MSIFORMS\TT505.LAB

p-2

88916961888

David Mandina

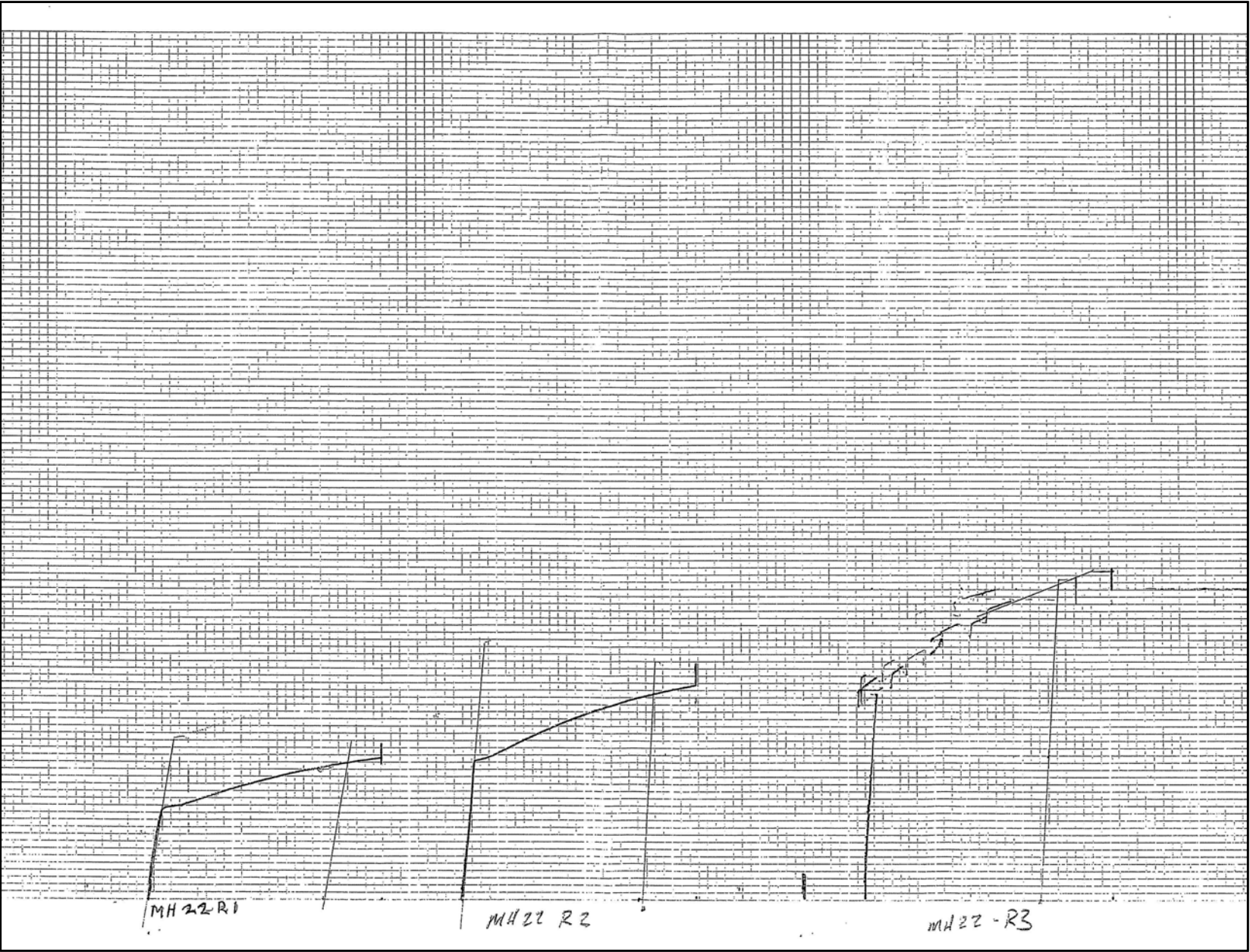

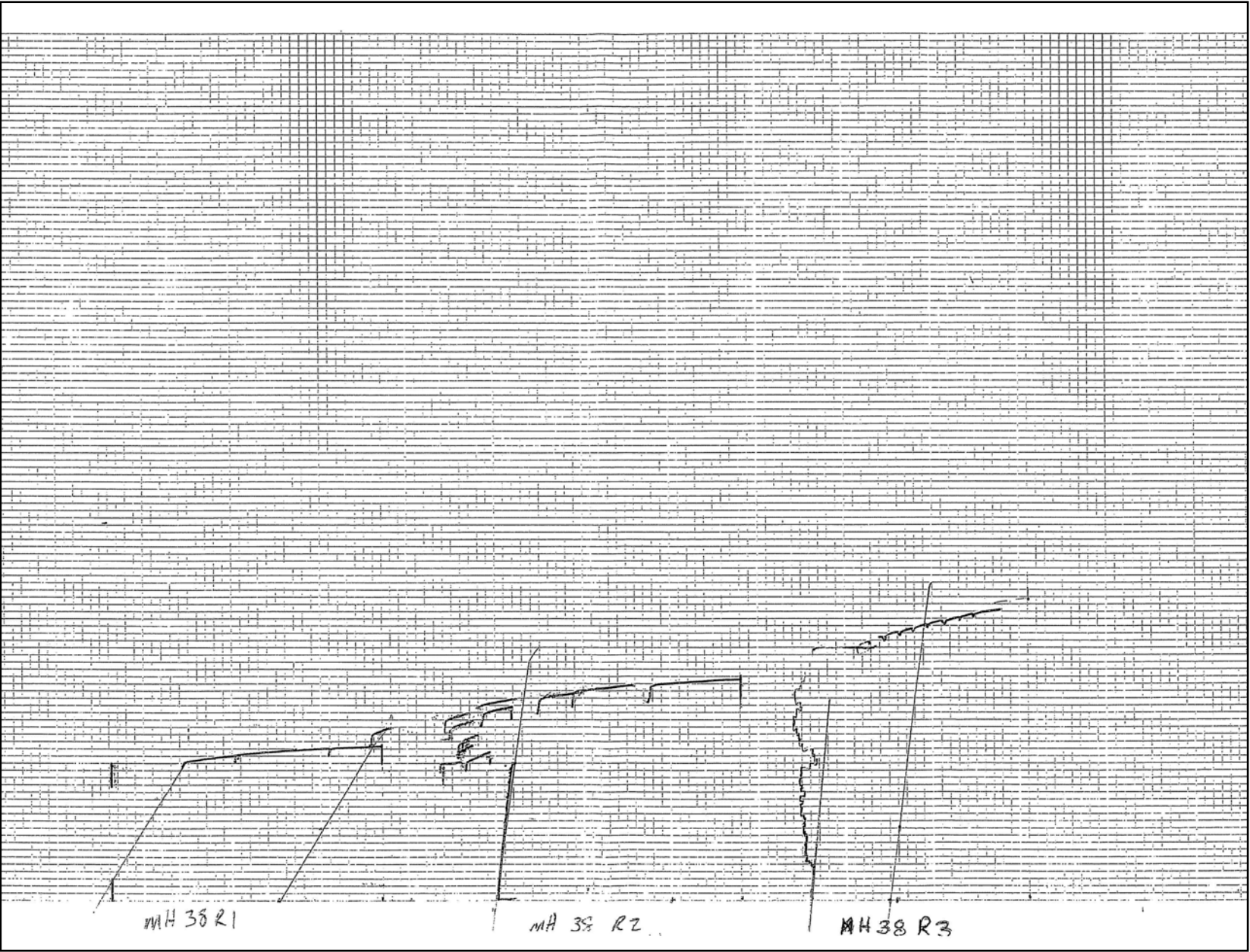

**American Association of State Highway and Transportation Officials
AASHTO Accreditation Program - Certificate of Accreditation**

This is to signify that

Beta Testing & Inspection, LLC
Gretna, Louisiana

has demonstrated proficiency for the testing of construction materials
and has met the minimum requirements in AASHTO R18
set forth by the AASHTO Highway Subcommittee on Materials.

The scope of accreditation can be obtained by viewing
the AAP Directories of Accredited Laboratories (www.nist.gov/amrl)
or by contacting AMRL.

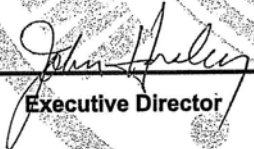
Executive Director

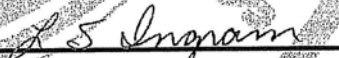
Chair, AASHTO Highway
Subcommittee on Materials



1914



DEPARTMENT OF THE ARMY
ENGINEER RESEARCH AND DEVELOPMENT CENTER, CORPS OF ENGINEERS
GEOTECHNICAL AND STRUCTURES LABORATORY
WATERWAYS EXPERIMENT STATION, 3909 HALLS FERRY ROAD
VICKSBURG, MISSISSIPPI 39180-6199

REPLY TO
ATTENTION OF:

CEERD-GS-E (1110-1-8000c)

22 Aug 05

Memorandum For Commander, USAE District, New Orleans, ATTN: CEMVN-CD-QS/Mr. Geoff Laird,
PO Box 60267, New Orleans, LA 70160-0267

SUBJECT: Validation of Beta Testing and Inspection, LLC, Gretna, LA

1. In reference to Military Interdepartmental Purchase Request No. W42HEM51322885, dated 13 May 05, an inspection of the materials testing laboratory of Beta Testing and Inspection, Gretna, LA was performed on 13 Jun 05. The results of that inspection were reported to the Commander, USAE District, New Orleans on 20 Jun 05. The laboratory reported their deficiency corrections to the Materials Testing Center (MTC) on 19 Jul and 09 Aug 05. These corrections were compared to the ASTM Standards for compliance and were found to be satisfactory. We also examined AMRL Inspection Report No. 994F, Dated 01 Jul 04, CCRL Inspection Report No. J-71, dated 18 Aug 04, and the AASHTO Accredited Laboratory List dated 18 Aug 05.
2. The Quality System of the laboratory is satisfactory and we are granting a validation of the lab to perform material tests for the U.S. Army Corps of Engineers. The material test methods that the laboratory is validated to perform are:
 - a. **Aggregate Tests:** ASTM C40, C117, C127, C128, C136, C29, C88, C131, C535, C566, C702, D75, and D4791.
 - b. **Bituminous Tests:** ASTM D2726 and D3666.
 - c. **Concrete Tests:** ASTM C31, C39, C138, C143, C172, C173, C231, C1064, C42, C78, C157, C174, C192, C293, C470, C511, C617, C1077, and C1231.
 - d. **Soil Tests:** ASTM D421, D422, D558, D698, D1140, D1556, D1557, D2168, D2216, D2217, D2487, D2488, D2922, D3017, D3740, and D4318.
3. We will add Beta Testing and Inspection, Gretna, LA to the list of commercial laboratories qualified to conduct material tests for the U.S. Army Corps of Engineers, see the MTC homepage at <http://www.wes.army.mil/SL/MTC/mtc.htm>. All Corps offices will be notified of this decision and will have the opportunity to use their services. The laboratory will remain on our list of laboratories qualified to conduct material tests until **13 Jun 08**, three (3) years from the date of the inspection.

DANIEL A. LEAVELL
Director, Materials Testing Center

CF:
Mr. Mark Cheek / Beta Testing and Inspection, Gretna, LA

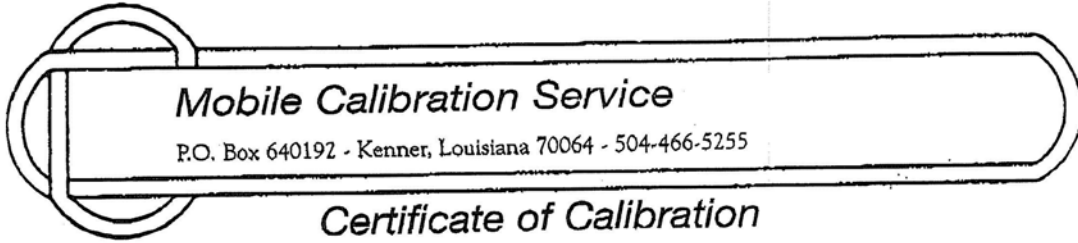

Mobile Calibration Service

P.O. Box 640192 - Kenner, Louisiana 70064 - 504-466-5255

Certificate of Calibration

This is to certify that the following described testing machine has been calibrated in accordance with ASTM E4 and found to be within a tolerance of 1%. Method of verification and pertinent data are in accordance with ASTM E-4. The testing device(s) used have been verified per ASTM E 74 and are traceable to the National Institute of Standards & Technology (N.B.S.)

CLIENT: Beta Testing & Inspection Co.
 P.O.Box 203
 Gretna, Louisiana 70054

DATE: August 1, 2005
 Recal: August, 2006
 Last Cal: August, 2004

MACHINE IDENTIFICATION: Soiltest Concrete Tester #9003

MACHINE RANGE: 0-250000 Pounds
 0-30000 Pounds

CALIBRATED RANGE: 25000-250000 Pounds
 3000-30000 Pounds

CALIBRATION APPARATUS
 Strainsense Load Cell 860916A
 Strainsense Load Cell 880305A

CLASS A RANGE
 8400-50000 Pounds
 960-12000 Pounds

CALIBRATED TO NIST
 8-04
 10-04

CALIBRATION RESULTS

MACHINE READING	ACTUAL LOAD LBS RUN #1	DIFFERENCE POUNDS	PERCENT ERROR	ACTUAL LOAD LBS	DIFFERENCE POUNDS RUN #2	PERCENT ERROR
LOW PRESSURE GAUGE						
3000	2985	15	+0.50	2990	10	+0.33
5000	4980	20	+0.40	4975	25	+0.50
10000	9965	35	+0.35	9970	30	+0.30
15000	14955	45	+0.30	14945	55	+0.37
20000	19930	70	+0.35	19940	60	+0.30
25000	24920	80	+0.32	24910	90	+0.36
30000	29880	120	+0.40	29900	100	+0.33
HIGH PRESSURE GAUGE						
25000	25100	100	-0.40	25050	50	-0.20
50000	50150	150	-0.30	50200	200	-0.40
75000	75190	190	-0.26	75270	270	-0.36
100000	100230	230	-0.23	100280	280	-0.28
125000	125210	210	-0.17	125220	220	-0.18
150000	149840	160	+0.11	149790	210	+0.14
175000	174610	390	+0.22	174670	330	+0.19
200000	199480	520	+0.26	199350	650	+0.33
250000	249260	740	+0.30	249060	940	+0.38

The above are as found readings.

MOBILE CALIBRATION SERVICE

Warren A. Meyn Jr.
 Warren A. Meyn Jr.

Certificate of Calibration

and Traceability to the

United States National Institute of Standards & Technology

MODEL SST1203U2
STRAINSense LOAD CELL, SERIAL NO. 880305A(LO)
12,000 LBF CAPACITY, TENSION & COMPRESSION
STRAINSense CONAMP 20 READOUT, SERIAL NO. 900305

The above identified instrument was calibrated in accordance with section 7 of the American Society for Testing and Materials (ASTM) Specification E74-02, entitled "Standard Practice of Calibration of Force-Measuring Instruments...". This calibration is in conformance with the requirements of Morehouse QAM Rev.7, dated 12/04/00.

Calibration was performed at the following settings:
Tension Cal No: 244.84 Compression Cal No: 244.95

The result of this calibration as determined by statistical analysis according to section 8 of ASTM E74-02, is as follows:

	<u>Uncertainty</u>	<u>Resolution</u>
Tension:	2.9 Lbf	1.0 Lbf
Compression:	2.4 Lbf	1.0 Lbf

Class A Loading Range According to ASTM E74-02:
Tension: 1,160.0 Lbf to 12,000 Lbf
Compression: 960.0 Lbf to 12,000 Lbf

Calibration was performed for a temperature of 23 degrees C.

This calibration is certified traceable to the United States National Institute of Standards & Technology according to the following documentation and calibration apparatus used:

Dead Weight Force Machine S/N M-4644 NIST Lab No. 822/255038-95

Uncertainty of Force Standard used did not exceed +/- 0.002% of applied load.

Calibrated By:



Date Calibrated:
October 05, 2004
Report No: 880305A(LO)J0504

MOREHOUSE INSTRUMENT COMPANY, INC.
FORCE CALIBRATION LABORATORY
1742 SIXTH AVENUE
YORK, PA 17403-2675 U.S.A.
PHONE: 717 / 843-0081
FAX: 717 / 846-4193
WEB: www.morehouseinst.com

12/16/2005 14:48 50444662826 WMEVYV MOBILE CAL PAGE 03
This Certificate shall not be reproduced except in full, without written approval from Morehouse Instrument Company, Inc.

Certificate of Calibration

and Traceability to the

United States National Institute of Standards & Technology

MODEL: SS504C
STRAINSENSE LOAD CELL, SERIAL NO. 860916A/M-8/96(LO)
50,000 LBF CAPACITY, COMPRESSION
ADMET-DC-16 INDICATOR, SERIAL NO. P16-0008081

The above identified instrument was calibrated in accordance with section 7 of the American Society for Testing and Materials (ASTM) Specification E74-02, entitled "Standard Practice of Calibration of Force-Measuring Instruments...". This calibration is in conformance with the requirements of Morehouse QAM Rev. 7, dated 12/04/00.

Calibration was performed at the following indicator settings:

Load Cell 1
Channel 1

The result of this calibration as determined by statistical analysis according to section 8 of ASTM E74-02, is as follows:

<u>Uncertainty</u>	<u>Resolution</u>
20.4 Lbf	12.0 Lbf

Class A Loading Range according to ASTM E74-02:

8,160.0 Lbf to 50,000 Lbf

Calibration was performed for a temperature of 23 degrees C.

This calibration is certified traceable to the United States National Institute of Standards & Technology according to the following documentation and calibration apparatus used:

Dead Weight Force Machine S/N M-7471 NIST Lab No. 822/268391-03

Uncertainty of Force Standard used did not exceed +/-0.002% of applied load

Calibrated by:



Date Calibrated:
August 18, 2004

Report No:860916A/M-8/96(LO)H1804

MOREHOUSE INSTRUMENT COMPANY, INC.
FORCE CALIBRATION LABORATORY
1742 SIXTH AVENUE
YORK, PA 17403-2675 U.S.A.
PHONE: 717 / 843-0081
FAX: 717 / 846-4193
WEB: www.morehouseinst.com

This Certificate shall not be reproduced except in full, without written approval from Morehouse Instrument Company, Inc.
12/16/2005 14:48 5044662826
PAGE 04 WMEYN MOBILE CAL

Certificate of Calibration

and Traceability to the

United States National Institute of Standards & Technology

MODEL: SS504C
STRAINSense LOAD CELL, SERIAL NO. 860916A/M-8/96(HI)
500,000 LBF CAPACITY, COMPRESSION
ADMET-DC-16 INDICATOR, SERIAL NO. P16-0008081

The above identified instrument was calibrated in accordance with section 7 of the American Society for Testing and Materials (ASTM) Specification E74-02, entitled "Standard Practice of Calibration of Force-Measuring Instruments...". This calibration is in conformance with the requirements of Morehouse QAM Rev. 7, dated 12/04/00.

Calibration was performed at the following indicator settings:

Load Cell 0
Channel 1

The result of this calibration as determined by statistical analysis according to section 8 of ASTM E74-02, is as follows:

<u>Uncertainty</u>	<u>Resolution</u>
111.0 Lbf	10.0 Lbf

Class A Loading Range according to ASTM E74-02:

44,400.0 Lbf to 500,000 Lbf

Calibration was performed for a temperature of 23 degrees C.

This calibration is certified traceable to the United States National Institute of Standards & Technology according to the following documentation and calibration apparatus used:

Dead Weight Force Machine S/N M-7471 NIST Lab No. 822/268391-03
Transfer Standard S/N 7079 NIST Lab No. 822.11/268058
Uncertainty of Applied Force from 10,000 Lbf thru 100,000 Lbf = +/-0.002% of applied load
Uncertainty of Applied Force from 150,000 Lbf thru 500,000 Lbf = 56 Lbf

Calibrated by:



Date Calibrated:

August 18, 2004

Report No:860916A/M-8/96(HI)H1804

MOREHOUSE INSTRUMENT COMPANY, INC.
FORCE CALIBRATION LABORATORY
1742 SIXTH AVENUE
YORK, PA 17403-2675 U.S.A.
PHONE: 717 / 843-0081
FAX: 717 / 846-4193
WEB: www.morehouseinst.com

PAGE 05

MMEYN MOBILE CAL

12/16/2005 14:48 5044662826

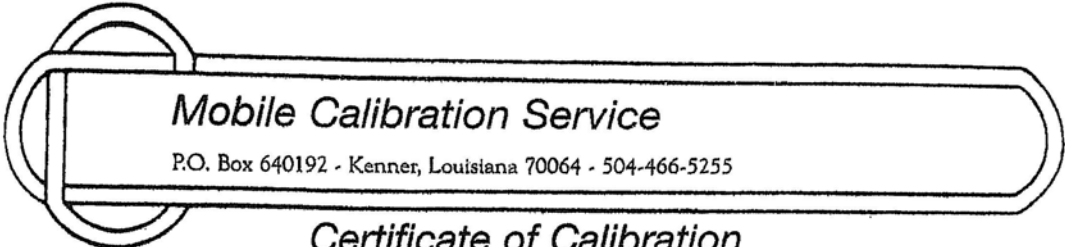

Mobile Calibration Service

P.O. Box 640192 - Kenner, Louisiana 70064 - 504-466-5255

Certificate of Calibration

This is to certify that the following described testing machine has been calibrated in accordance with ASTM E4 and found to be within a tolerance of 1%. Method of verification and pertinent data are in accordance with ASTM E-4. The testing device(s) used have been verified per ASTM E 74 and are traceable to the National Institute of Standards & Technology (N.B.S.)

CLIENT: Mandina Inspection Service
 3861 Peters Road
 Harvey, La.

DATE: June 9, 2005

MACHINE IDENTIFICATION: Tinius Olsen Universal Testing Machine
MACHINE RANGE: 0-120000 Pounds **CALIBRATED RANGE: 10000-120000 Pounds**

CALIBRATION APPARATUS	CLASS A RANGE	CALIBRATED TO NIST
Strainsense Load Cell 050106	5000-50000 Pounds	1-05
Morehouse Ring 5-4537	25000-250000 Pounds	5-04

MACHINE READING	ACTUAL LOAD LBS	DIFFERENCE POUNDS	CALIBRATION RESULTS			
			PERCENT ERROR	ACTUAL LOAD LBS	DIFFERENCE POUNDS	PERCENT ERROR
	RUN #1			RUN #2		
10000	10030	30	-0.30	10025	25	-0.25
20000	20060	60	-0.30	20050	50	-0.25
40000	40100	100	-0.25	40060	60	-0.15
60000	60120	120	-0.20	60150	150	-0.25
80000	80190	190	-0.24	80160	160	-0.20
100000	100290	290	-0.29	100220	220	-0.22
120000	120330	330	-0.28	120290	290	-0.24

The above are as found readings. No calibration adjustments required.

MOBILE CALIBRATION SERVICE

[Signature]
 Kevin Weir
 TECHNICIAN



SPECIALIZING IN CONDITION EVALUATION OF THE
CIVIL STRUCTURE & INFRASTRUCTURE



www.olsonengineering.com

January 6, 2006

U. S. Army Corps of Engineers
Engineering Research and Development Center
3909 Halls Ferry Rd.
Vicksburg, MS. 39180

Attn: Mr. Richard W. Haskins, ERDC-ITL-MS
Ofc: (601)634-2931
Fax: (601)634-2873
E-Mail: Richard.W.Haskins@erdc.usace.army.mil

Re: Nondestructive Testing Investigation Report No. 2
Parallel Seismic Re-Testing Results for Sheet Pile Lengths
New Orleans 17th Street and IHNC Levees
New Orleans, LA
Olson Engineering Job No. 1875C

Dear Sirs,

We are pleased to report herein the results of re-testing with the Parallel Seismic method of one sheet pile location at each of the 17th Street and Inner Harbor Navigational Canal (IHNC) levees. This additional work was conducted as a result of the initial incorrect prediction of sheet pile lengths at the North and South ends of the break at the 17th Street Levee (report dated December 5, 2005, Olson Job No. 1875). Actual sheet pile lengths were revealed to be about 23.5 ft in USACE excavations of sheet piles conducted on December 13, 2005 (the sheet piles were incorrectly predicted to be about 7 ft shorter in our initial report).

Discussion of Initial Sheet Pile Depth Predictions

When we learned that the USACE removal of sheet piles at the North and South ends of the 17th Street Levee breach for revealed actual total sheet pile lengths of about 23.5 ft, we immediately reviewed the PS data for ground-truthing purposes to examine the data and see if there was an indication of the actual sheet pile tips in the data or not. Our review of the data found that there was evidence of possible weaker diffraction events in the bottom 3 ft or so of the initial PS data that corresponded to the actual sheet pile tip depths.

As discussed in our draft report addendum letter of December 13th, 2005 which was

12401 W. 49th Ave., Wheat Ridge, CO 80033-1927 USA

PHONE: 303.423.1212  FAX: 303.423.6071

transmitted to the USACE at that time, we attribute our mis-interpretation of the data to the following three factors:

1. the PS data sets contained misleading apparent ground/tube vibrations that showed apparent slower velocity and weaker signals at the incorrectly predicted 7ft short sheet pile depths. This energy is now attributed to strong energy emitting from the concrete walls in to the ground due to the horizontal impacts to the concrete walls just below the chamfers;
2. the different shape of the now apparent sheet pile diffraction events due to the spreading out of energy for the wall-shaped steel sheet piles versus our experience with previous arrowhead diffraction events measured for rod-shaped steel H-piles in research and consulting by our firm; and,
3. the single biggest problem that led to the misinterpretation of the initial data was the lack of data available to clearly identify the weak diffraction of wave energy emitting from the pile tips. This was due to the fact that the borehole casings only extended a few feet beyond the actual pile tip depths. The desired typical cased borehole depth would extend 10-15 ft beyond the suspected/hoped for maximum sheet pile depths and this was recommended in our proposal of October 22, 2005 (Olson Proposal No. 2005169.1) for the project.

Borings were also recommended to be drilled as close as practical to the foundation to be tested preferably within 3-5 ft or less horizontally of the foundation, but generally no more than 10 ft away from a foundation to be tested with the PS method. We understand that the USACE borings were initially drilled in to the levees for geotechnical sampling purposes only and that PS testing was decided upon after the borings were drilled. The 4 inch diameter PVC casings that were subsequently grouted in-place in the boreholes for the PS tests were shorter than the drilled boreholes and extended only to depths of 25 ft below the levee ground surface. Such borehole casing depths would have been deep enough for successful PS tests if the sheet piles were around 16 ft in length, but the 25 ft long casings resulted in there only being about 3 feet of casing at or below the 23.5 ft long sheet pile tips. Thus there were only 3-4 PS test records from which hydrophone PS data could be obtained at or below the pile tips. As discussed above and in the report addendum, we feel that the limited PS data from below the sheet pile tips contributed significantly to our incorrect interpretation of the weak diffraction events.

A conference call about the PS results and our draft report addendum was held with Messrs. Richard Haskins and Paul Mlakar of the USACE and Larry Olson and Dennis Sack of Olson Engineering, Inc. on December 16th. As requested by Mr. Mlakar at that time, we have updated the draft addendum letter to include not only a review of the data from the PS tests at the 17th Street Levee, but also the PS data from the London Avenue and IHNC levees that was also presented in our initial report. The final report addendum is being provided as a separate letter.

Parallel Seismic Re-Test Field Investigation Overview

We were quite concerned about the initial incorrect sheet pile length predictions and this led to our decision to gather more data on the weak diffraction events that were apparently indicative of the actual sheet pile tips for the two USACE cased boreholes at the 17th Street Levee North and South breach ends. Consequently, we decided to conduct additional PS tests at the South End of the breach at Station 20+78 which was only about 7 ft from the USACE PS boring in this area. The testing was also at the South End of the 17th Street levee breach immediately adjacent to the area where the USACE excavated sheet piles and found their total lengths to be nominally 23.5 ft on December 13, 2005. We also conducted tests at the IHNC levee adjacent to the North end of the south breach at Station 17+11 within about 10 ft north of where a cased borehole PS test had been done earlier.

This additional nondestructive investigation was conducted at no cost by Olson Engineering to the USACE with the field support of Southern Earth Sciences, Inc. (SESI) of Baton Rouge, Louisiana who also provided their services at no cost. SESI had used their Seismic Cone Penetrometer (SCPT) Geoprobe rig with a biaxial geophone to investigate sheet pile tests in PS/SCPT tests of the 17th Street and London Avenue Levees for the state of Louisiana levee investigation team and their field tests were conducted after our initial field PS tests. A photograph of the Geoprobe rig is shown in Photo 1 and the SCPT tool is shown in Photo 2.



Photo 1 - Geoprobe Rig for PS/SCPT testing at South End of Breach of 17th Street Levee at Station 17+78 where sheet piles were exposed by USACE PS Cased Borehole (white PVC cap visible)



Photo 2 - Seismic Cone Penetrometer Tool with Bearing pressure at tip followed by pore pressure ring followed by skin friction sleeve followed by bi-axial horizontal geophones

The initial SESI PS/SCPT tests were able to be conducted to greater depths and much closer horizontally (typically within 3 ft of the concrete walls) without drilling borings. As discussed with USACE, we also provided consulting services to SESI in the analysis of their initial PS/SCPT results. Analyses of their initial bi-axial geophone results showed similar sheet pile depths to our initial hydrophone PS results with their findings presented in the SESI report to the State of Louisiana.

In our joint efforts with SESI at the IHNC and 17th Street Levees on December 21 and 22, 2005, respectively, SESI conducted PS/SCPT tests with their bi-axial (two perpendicular, horizontal geophones) seismic cone penetrometer tool (Photo 2). For our comparison PS testing with a small diameter hydrophone receiver, they pushed a non-retrievable dummy tip into the levee soils. Next, SESI installed a temporary 1 inch PVC casing inside the Geoprobe hollow steel push rods which were then retrieved to leave the PVC casing in the ground. Then the hole annulus and inside of the PVC casing were filled with water so we could conduct hydrophone-based Parallel Seismic (PS) tests.

The joint effort with SESI allowed for a comparison of the data obtained from the two different types of PS test transducers, i.e., the more omni-directional hydrophone receiver vs. the bi-axial horizontal geophones. In our National Cooperative Highway Research Program 21-5 and 21-5(2) research projects for Determination of Unknown Bridge Foundation Depths for scour safety studies, we compared hydrophones and tri-axial geophones in Parallel Seismic tests. Generally, the hydrophone was found to be the more sensitive receiver to the arrival of initial weak direct energy in PS tests of bridge foundations, particularly for diffraction events due to its more all-around or "omni-directional" response to wave energy emitting from the impacted bridge substructure foundation system.

Parallel Seismic Re-Test Results

The joint Olson/SESI PS re-test program was planned to evaluate both bi-axial geophones (results to be reported by SESI) and hydrophone receivers and investigate PS data results quality for impacts applied directly to sheet piles, and from horizontal to vertical impacts to the concrete walls in which the levee sheet piles are embedded. The PS re-test results of the 17th Street re-tests are presented first below followed by the IHNC results. The field effort was also made possible by USACE personnel and their subcontractors who also contributed significantly to the re-test program and assisted in the field by providing site access, excavation assistance to expose sheet piles, and testing assistance. The State of Louisiana levee investigation team also contributed their input to the re-test program and observed the field PS re-test effort as well.

17th Street PS Re-Test Results at South End of Breach - Station 20+78

Based on the stickup of the sheet piles of about 1.25 ft above the levee ground surface, the 23.5 ft long sheet piles extend to about 22.25 ft below existing grade at the south end of the 17th Street levee breach at Station 20 +78 where the 1 inch PVC casing was installed to about 30

ft deep by SESI at about 2.5 ft from the wall edge on the protected side. The locations of the impacts with a 3-lb impulse hammer with a black hard plastic tip to the sheet pile and concrete levee wall at various positions are shown in Photos 3-7 and the PVC casing is shown in Photo 8.



Photo 3 (Fig. 1) - Horizontal impact to sheet pile at 0.5 ft below concrete wall - protected levee side



Photo 4 (Fig. 2) - Horizontal impact to side of concrete wall at el. 5 about 0.5 ft below chamfer



Photo 5 (Fig. 3) - Angled downward impact to chamfer of wall at ~ el. 5.75



Photo 6 (Fig. 4) - Vertical downward impact to top of wall



Photo 7 (Fig. 5) - Angled impact to 1 inch diameter, 6 ft long steel rod held at an angle on sheet pile side at 0.5 ft below concrete - protected levee side



Photo 8 - 3-lb Impulse Hammer with black hard plastic tip and small diameter hydrophone used in PS re-tests

The PS re-test results for the impact positions shown in Photos 3-7 are respectively presented in Figures 1-5 below. The expected diffraction event should occur at a depth of about 22.25 ft from the sheet pile tip in these hydrophone-based PS results. Review of the figures shows that the weak diffraction events are now clearly evident for all of the impact locations. This is due to the increase in PS test depth 30 ft for the 1 inch diameter casing installed by the geoprobe vs. the initial grouted casing depth of only 25 ft.

The PS data presented in Figures 1-5 were produced by 5 impacts which were averaged at each 1 ft test depth interval, filtered and normalized to the largest signal strength (global maximum display) to optimize the display of the diffraction events. Review of Figure 1 shows the diffraction event at 23.0 ft deep due to direct horizontal sheet pile impacts. There is also some energy occurring in advance of the diffraction event at shallower depths. In Figure 2 the horizontal impacts to the concrete wall also show a diffraction event at 22.7 ft deep, but a little less clear with more energy emitting from the concrete wall. By comparison, the diffraction event is clear at 21.8 ft deep for the angled downward impact to the chamfer in Figure 3. Apparently the more vertical impact to the chamfer put more energy down the sheet pile with less energy emitting from the wall. In Figure 4, the impacts to the top of the wall were further away from the ground and the sheet pile, so the diffraction event is quite clear at 21.5 ft. The impacts to the angled steel rod also produced a diffraction event at 22.6 ft as shown in Figure 5, but it was comparatively weaker, likelier due to less energy being imparted by the rod impacts.

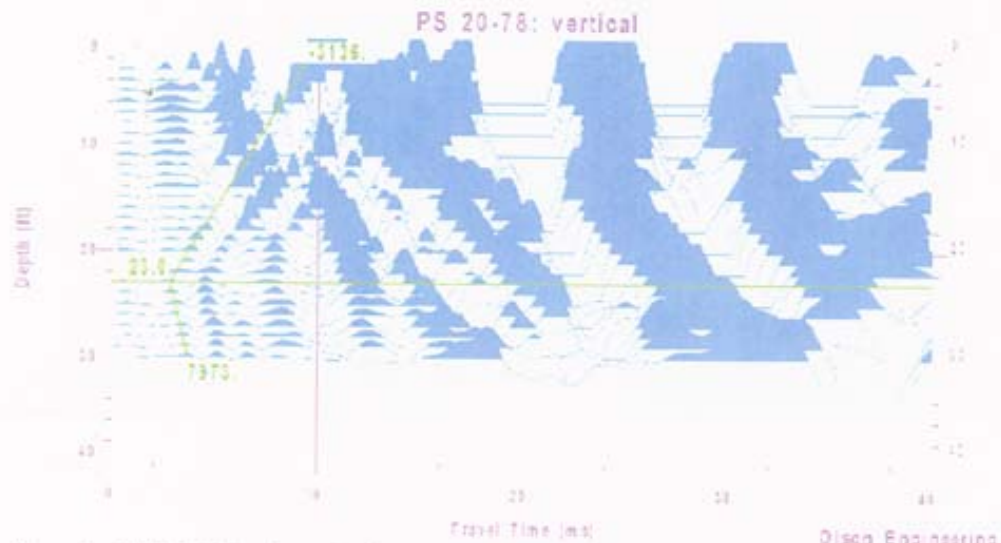

Figure 1 - 17th St. PS Results at Station 20+78 - Sheet Pile impacted at ~ el. 1.5 (0.5 ft below bottom of levee concrete wall on protected side)

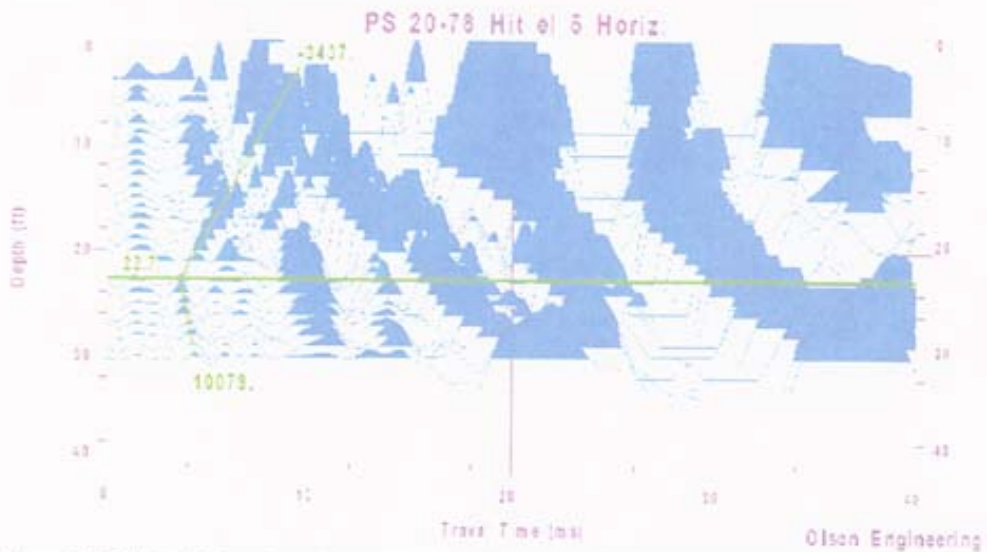

Figure 2 - 17th St. PS Results at Station 20+78 - Concrete Wall impacted horizontally at ~ el. 5 (~0.5 ft below chamfer edge on protected side)

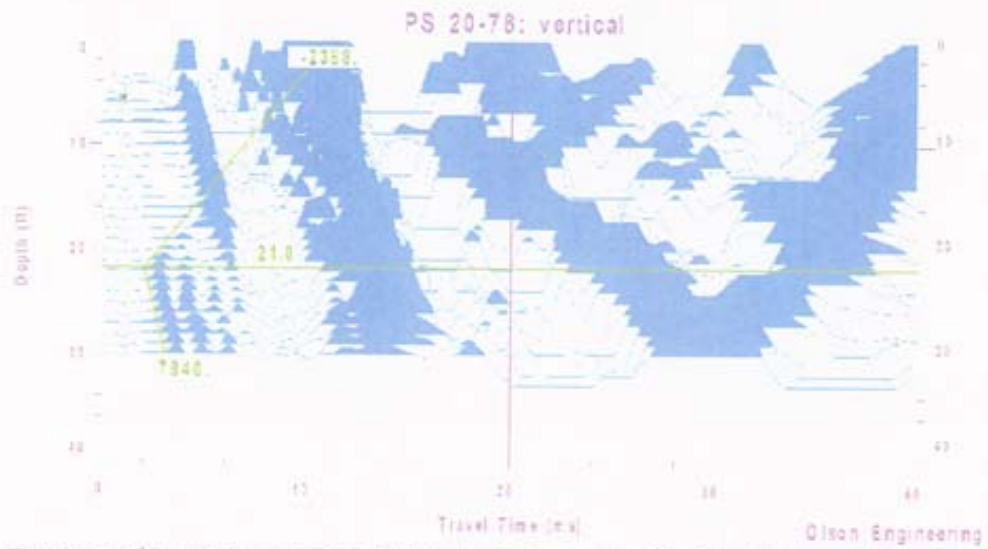

Figure 3 - 17th St. PS Results at Sta. 20+78 - Angled Impacts to Chamfer of Concrete Wall at Sta. 20+78 (~el. 5.75 on protected side)

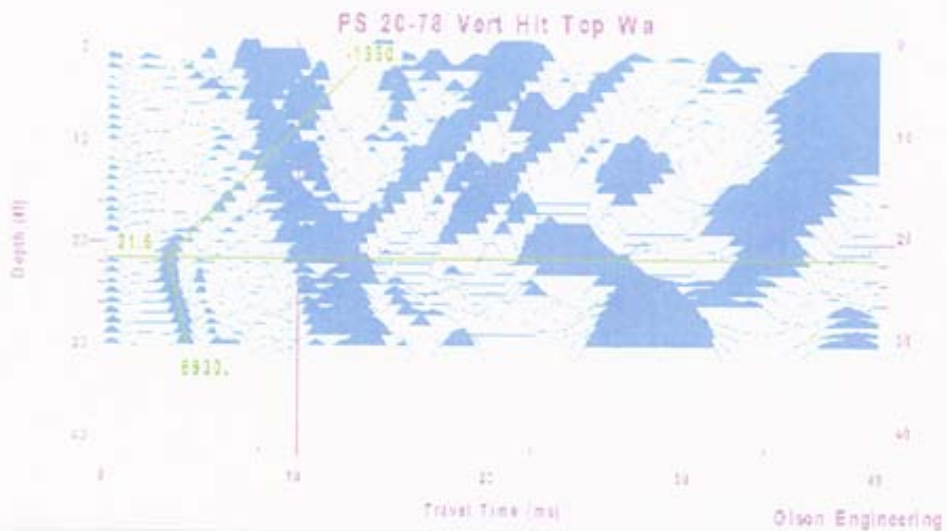

Figure 4 - 17th St. PS Results at Sta. 20+78 - Vertical Impacts to Top of Concrete Wall at Sta. 20+78

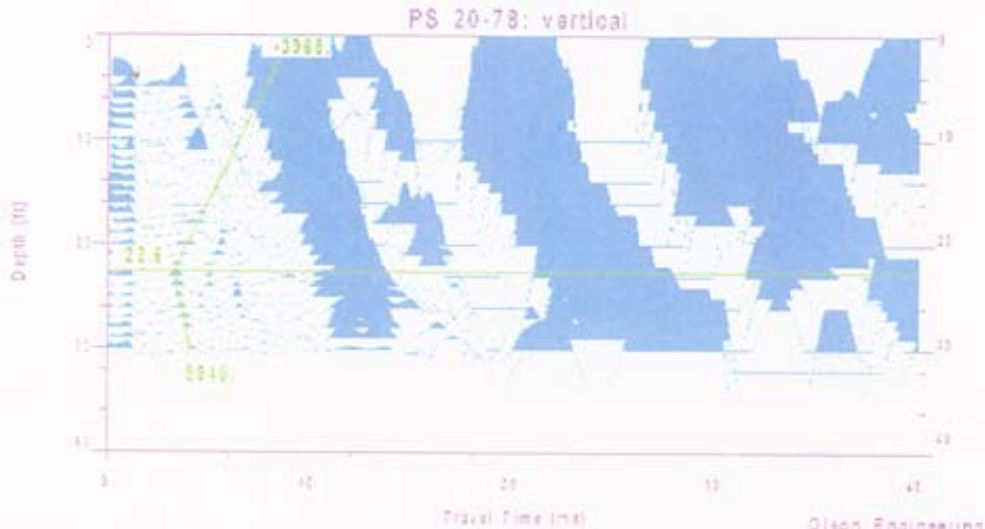

Figure 5 - 17th St. PS Results at Sta. 20+78 - Angled Impacts to 1 inch diameter, 6 ft long rod held against steel sheet pile at ~ el. 1.5 at 0.5 ft below concrete wall

IHNC PS Re-test Results at North End of South Breach - Station 17+11

The IHNC re-tests were performed in an area of the wall that had been pushed back and the levee soils dropped down to expose a sheet pile on the canal side at Station 17+11 which was about 10 ft north of the USACE cased boring in this area. Shovels were used to expose enough of the sheet pile to impact it with the 3 lb impulse hammer as shown in Photo 9. The PS tests were done using a hydrophone in the 1 inch PVC casing installed by SESI with the Geoprobe rig as shown in Photo 10.



Photo 9 - IHNC 3-lb Impulse hammer impacts to sheet pile on canal side at Station 17+11



Photo 10 - Small Hydrophone receiver on tape in 1 inch PVC casing installed by Geoprobe Rig at IHNC

Sonic Echo testing was conducted from end to end of a nearby exposed sheet pile and a compression wave velocity of about 17,000 ft/second was measured which is essentially the theoretical velocity of a steel rod of 16,600 ft/s. The Sonic Echo results did show a single clear echo from the pile tip in air, but not the multiple echoes normally measured on H-piles in air. Impulse Response analyses in the frequency did not show clear resonant echo peaks from the exposed pile tip. This is due to the spreading out of the energy in to the rest of the interlocked sheet pile wall and the lack of a resonant, rod-like shape for a sheet pile wall. When similar Sonic Echo/Impulse response tests were attempted from the exposed top of an embedded 23.5 ft long sheet pile at the South end of the 17th Street breach, no echo from the pile tip was apparent. This result was expected as the attenuation of the compression wave energy is high due to the large surface area of a steel sheet pile.

The exposed sheet pile at the north end of the south IHNC breach showed a total length of 19 ft - 6.5 inches. Of this, about 4 ft - 7 inches of the piles had been embedded in the 8 ft tall concrete wall. Thus, about 15 ft of the sheet piles are typically embedded in the levee soils. Given the 1 ft higher elevation of the top of the PVC casing on the levee soils versus the bottom of the concrete wall, the sheet pile tip is expected to be at a depth of about 16 ft in the PS hydrophone signal versus depth results which are presented below in Figures 6-8. Horizontal impacts were applied just below the concrete wall to the canal side of the exposed sheet pile (Fig. 6) and to the concrete wall at 6.5 ft below the top of the wall (Fig. 7) which was 1.5 ft above the bottom of the concrete wall while vertical impacts were applied to the top of the wall (Fig. 8).

Review of Figure 6 for the case of direct horizontal impacts to the sheet pile shows a weak direct arrival wave front that is slower below the 16 ft depth of the sheet pile. However, no diffraction events are evident in this PS-based hydrophone test data. This may be due to the evident separation of the levee soil from the canal side of the wall due to the wall being pushed back by the breach forces. This apparent lack of tight contact between the sheet pile and the levee soils may have resulted in the diffraction event energy not being well coupled into the surrounding saturated soils.

Review of Figures 7 and 8 for horizontal and vertical impacts to the concrete wall does not show clear direct arrivals when the apparent weak energy was picked as shown in the figures. No diffraction events are clearly evident in the figures either. These results further support the possibility that there is poor soil contact to the sheet pile on the canal side that diminished the diffraction effect in the IHNC re-tests.

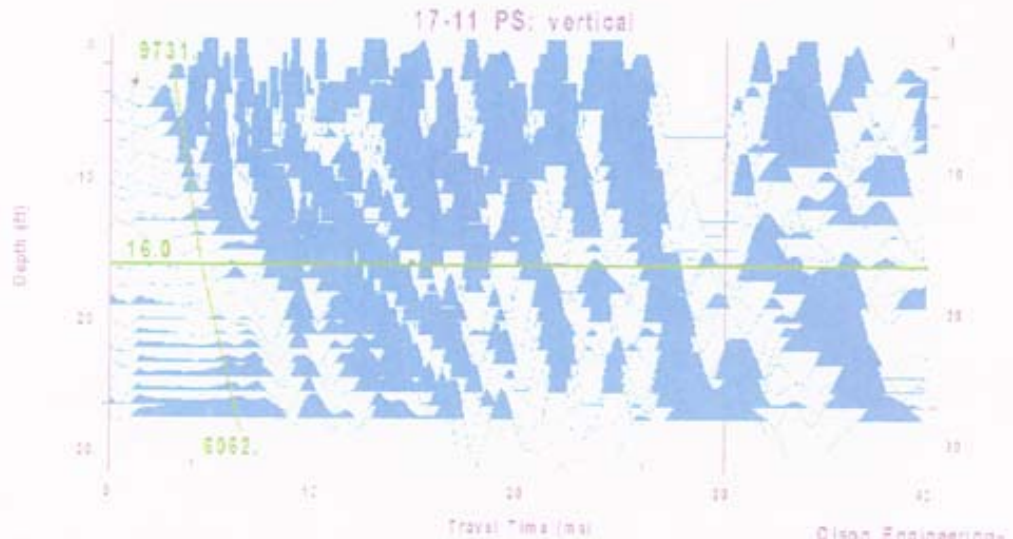

Figure 6 - PS Results at IHNC Sta. 17+11 - Impact to Sheet Pile at ~ 0.5 ft below bottom of Concrete Wall on Canal Side

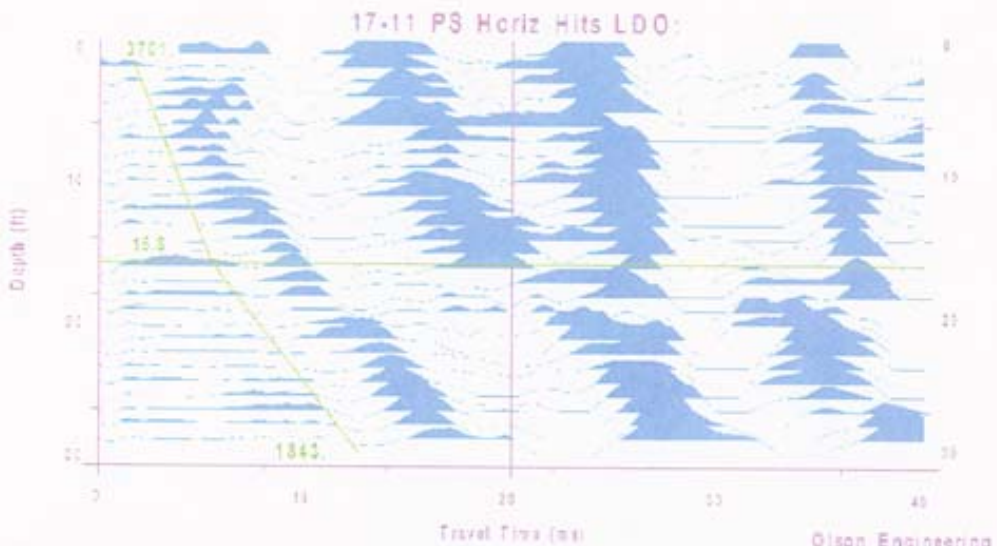

Figure 7 - PS Results at IHNC Sta. 17+11 - Horizontal Impact to Concrete Wall at ~ 6.5 ft below top of Wall on Canal Side

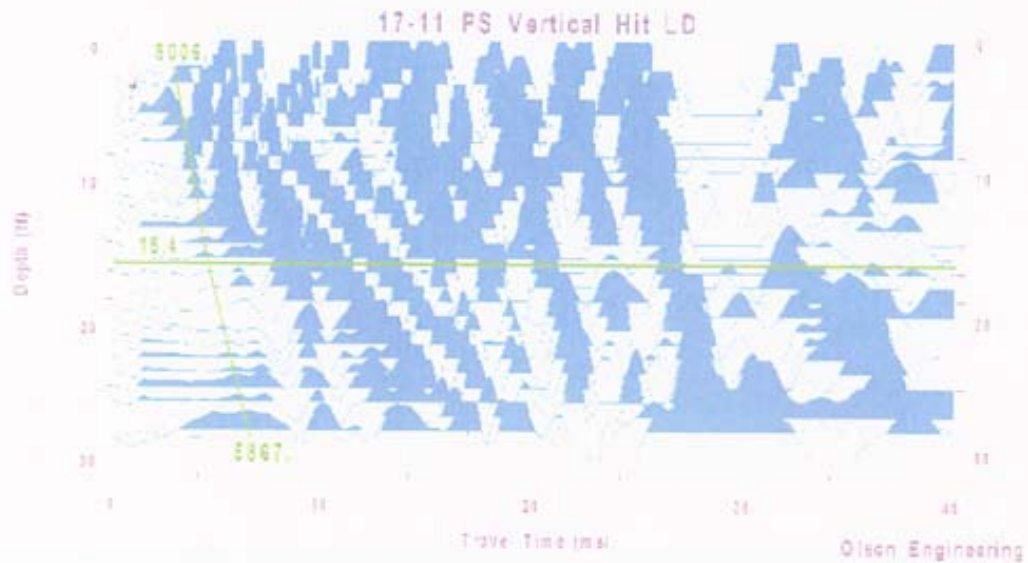

Figure 8 - PS Results for IHNC at Sta. 17+11 for Vertical Impacts to top of 8 ft tall Concrete Wall

Summary of Conclusions and Findings

17th Street Parallel Seismic (PS) Re-Test Results at Station 20+78. The hydrophone-based PS re-test results at the South End of the 17th Street breach clearly identified the pile tips within about 1 ft of the actual sheet pile depth of ~22.25 ft based on clear diffraction events at the sheet pile tip for impacts to the pile side, wall side, chamfer, wall top and even a rod held against the pile side. The results were clearest for the vertical hits on top of the wall, chamfer impacts and direct sheet pile impacts.

IHNC PS Re-Test Results at Station 17+11. The hydrophone-based PS re-test results at the North End of the south IHNC breach showed a weak direct arrival for impacts directly to the sheet pile that predicted the actual depth of 16 ft. However, only very tentative identifications of such direct arrivals were evident in PS results for either horizontal or vertical impacts to the levee concrete wall. None of the PS results at IHNC showed the clear diffraction arrival events at the pile tip depth found in all of the 17th Street PS re-test results. The lack of the diffraction arrival events may be due to the apparent lack of tight soil contact between the IHNC wall on the canal side as a result of the breach force pushing the wall back. Clear separation of the soil and wall was still evident at the surface in this area. Such lack of contact may have diminished the coupling of energy in to the soils from the diffraction event at the pile tip.

CLOSURE

The field NDT investigation was performed in accordance with generally accepted testing procedures. If there are any questions, or further information is required, please do not hesitate to call. If any additional information is developed pertinent to this study, please contact our office.

Respectfully submitted,

OLSON ENGINEERING, INC.



Dennis A. Sack
Associate Engineer



Larry D. Olson, P.E.
Principal Engineer

(1 copy e-mailed and 2 copies mailed)

e-mail cc: Mr. Paul F. Mlakar (Paul.F.Mlakar@erdc.usace.army.mil)



SPECIALIZING IN CONDITION EVALUATION OF THE
CIVIL STRUCTURE & INFRASTRUCTURE



www.olsonengineering.com

NONDESTRUCTIVE TESTING INVESTIGATION
SHEET PILE FOUNDATION LENGTHS
NEW ORLEANS LEVEES
NEW ORLEANS, LOUISIANA

Prepared for:

U. S. Army Corp of Engineers
Engineering Research and Development Center
3909 Halls Ferry Rd.
Vicksburg, MS. 39180

Attn: Mr. Richard W. Haskins, ERDC-ITL-MS
Ofc: (601)634-2931
Fax: (601)634-2873
E-Mail: Richard.W.Haskins@erdc.usace.army.mil

Olson Engineering Job No. 1875

December 5, 2005

12401 W. 49th Ave., Wheat Ridge, CO 80033-1927 USA		
PHONE: 303.423.1212		FAX: 303.423.6071

TABLE OF CONTENTS

1.0 INVESTIGATION SCOPE AND SUMMARY OF FINDINGS 1

2.0 PARALLEL SEISMIC METHOD 2

3.0 INVESTIGATION RESULTS AND SUMMARY 4

4.0 CLOSURE 6

Table I: Summary of Sheet Pile Tip Depths and Elevations
From Parallel Seismic Testing of New Orleans Levees

Appendix A - Parallel Seismic (PS) Data

1.0 INVESTIGATION SCOPE AND SUMMARY OF FINDINGS

This report presents the Nondestructive Testing (NDT) investigation results for the determination of the unknown lengths of sheet piles below concrete walls of the New Orleans levee system. The levee sheet piles were tested with the Parallel Seismic (PS) method to determine their depths. The PS tests were conducted at the 17th Street, London Avenue, and the Inner Harbor Navigational Canal (IHNC) levees in 8 cased borehole locations at undamaged levee wall locations next to breaches.

The PS results indicate the presence of piles under the concrete wall, and showed that they extended to approximately 13-15 ft below the casing top for all of the sites tested as summarized in Table I. These sheet pile depths translate to elevations of approximately 10 feet below mean sea level (range of 9.3 to 11.8 feet below mean sea level). A discussion of the PS method and the investigation results are presented below.

2.0 PARALLEL SEISMIC METHOD

The Parallel Seismic (PS) method was used to estimate the depth of the foundations. The PS test equipment used in this investigation included a 3-lb instrumented impulse hammer, single hydrophone receiver, and a dynamic signal analyzer (Olson Instruments Freedom Data PC), as illustrated in Fig. 1. When the instrumented hammer directly impacted the supported concrete wall, it (or a nearby accelerometer) triggered the PC-based signal analyzer to capture the time records. A 16-channel National Instruments digital card was used to acquire the data in an Olson Instruments portable Freedom Data PC. Photographs of the field testing are shown in Figure 2.

The PS method involves impacting the exposed portion of the foundation or substructure attached to the foundation or a location which when impacted couples sufficient energy to the pile to generate a sound or stress wave which travels down the foundation. The wave energy is tracked by a hydrophone receiver suspended in a water-filled, cased and sometimes grouted borehole drilled

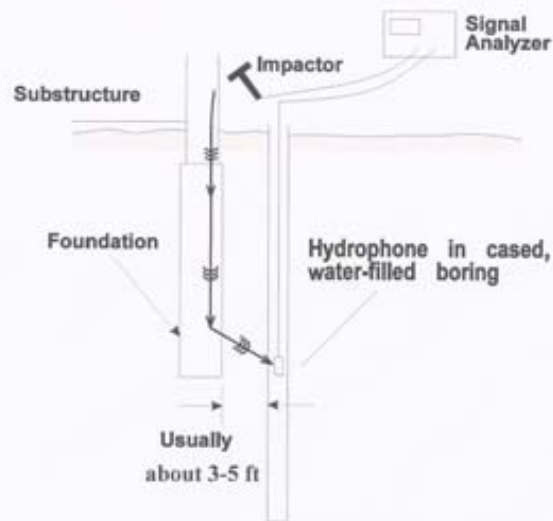

**Foundation Depth Determination
with the Parallel Seismic Test**
Figure 1 - PS test schematic

typically within 3-5 feet of the foundation edge. Note that for this investigation, the boreholes were found to be located as far as 21.1 feet from the levee wall, resulting in poorer quality data for some tests. The PS tests typically involve lowering the hydrophone(s) to the bottom of the borehole, impacting the exposed portion of the foundation structure and recording the hydrophone(s) responses. Then the hydrophone receiver(s) is raised to the next test elevation. This test sequence is repeated until the top of the casing (or the top of the water level in the casing) is reached. The pile depth is determined by plotting the hydrophone(s) response from all depths on a single display or page. For soils of constant velocity surrounding the piles, a break in the slope of the line occurs below the bottom of the piles indicating the pile depth. For soils with varying velocities, a break often cannot be identified from the slope of the lines, but the bottom of the piles can be identified by observing the traces of the hydrophone plot to identify changes in the response, such as a reduction in signal amplitude, change in signal frequency, or diffraction/reflection of tube wave energy from the foundation bottom.



Figure 2 - Photographs of impacting Wall of IHNC Levee at South Borehole of South Breach and Freedom Data PC at Cased Borehole with Hydrophone Receiver Downhole

3.0 INVESTIGATION RESULTS AND SUMMARY

The investigation was performed on October 27, 2005 and October 28, 2005 using the Parallel Seismic (PS) method by Mr. Larry D. Olson and Ms. Hunter Yarbrough of Olson Engineering, Inc., with assistance from U. S. Army Corps of Engineers personnel Mr. Richard Haskins and Mr. Don Yule. The 3 levee locations tested were at the 17th Street, London Avenue, and Inner Harbor Navigational Channel (IHNC). The PS test site at each test area was designated by the breach location and the position of the borehole. Hammer impacting was done horizontally on the levee wall face and vertically on the wall top where possible. The Parallel Seismic tests were performed with 5 impacts (horizontal and/or vertical) to the concrete walls at each of the hydrophone receiver depth intervals of nominally 1 ft for the entire water-filled length of the boreholes, starting typically 25 ft below the top of the borehole and continuing up to the top of the borehole casing at each site.

The Parallel Seismic tests were performed using a 3-lb hard-plastic tipped instrumented impulse hammer as a source and a single Olson Instruments hydrophone as a receiver. The pile locations were chosen to obtain a length measurement at the locations adjacent to levee breaks which occurred following Hurricane Katrina. Note that the reported data in Appendix A are pile tip depths measured from top of casing and that the PS predicted pile tip depths in true elevation as well as from the bottom wall chamfer can be found in Table I. Review of this table indicates sheet pile depths of 13-15 ft below the tops of the cased boreholes which corresponds to about 10 ft below mean sea level. Given the 1 ft hydrophone receiver measurement depth intervals, the PS results are believed to be accurate to within about 1 ft of the reported depths where data quality is high.

The Parallel Seismic data and results for the 17th Street Site can be found in Figures A-1 and A-2 in the Appendix. The Parallel Seismic data and results for the London Avenue Sites can be found in Figures A-3 to A-5, where Figures A-3 and A-4 are from the North breach and Figure A-5 is from the South breach. The Parallel Seismic data and results for the IHNC can be found in Figures A-6 to A-8, where Figure A-6 is from the breach near Florida Street and Figures A-7 and A-8 are

from the South breach. The exposed parts of all locations consisted of concrete retaining walls which had embedded sheet piles underneath. For the eight tested sites, PS tests were performed to a depth of 25 feet below the top of the grouted, 5 inch PVC casings which were filled with water.

The PS results presented in Appendix A are from typically horizontal hammer hits (data quality was better in one location using a vertical hammer hit as presented in Figure A-3). The horizontal hammer hits were located on the thicker wall sections just below the bottommost chamfer corner and the vertical hammer hits were located on top of the approximately 7 foot concrete retaining wall. The vertical axis in Figures A-1 and A-2 represents depth below casing top, with each waveform at 1 foot intervals starting at 25 feet at the bottom of each casing. The horizontal axis represents acoustic wave travel time in milliseconds (ms).

The generally faster compressional wave velocities of the sheet piles are represented by the shallow, usually more negatively sloped data in the figures at depths near the apparent pile tips. The more gentle, usually less negatively sloped data of the first breaks of the deeper traces represent the slower soil velocities below the pile tips. This is not the case in several of the data sets due to higher soil layer velocities at depth, likely associated with the presence of ground water which results in velocities of about 5,000 ft/second. Where the boreholes could be drilled less than ten feet away from the wall/pile (preferred), such saturated faster soil layers did not have as significant of an impact on data quality.

The PS measured pile tip depths for the eight locations indicate that there are piles present underneath the concrete retaining walls. Some of the results are of lower quality data due to a significant distance (17 to 22 ft) between the wall impact points to the boreholes as indicated in Table I. This is evidenced by the relatively weak signals from the piles compared to the signals from the impacted concrete walls on top of the piles, and from the relatively great depth at which the high-velocity pile signals finally start to arrive sooner than the low velocity signals being carried down the water-filled boreholes (tube waves). Accordingly, data quality was rated as high, medium and low (H, M and L) in Table I based on the distance between the wall-borehole and the signal quality.

4.0 CLOSURE

The field NDT investigation was performed in accordance with generally accepted testing procedures. If there are any questions, or further information is required, please do not hesitate to call. If any additional information is developed pertinent to this study, please contact our office.

Respectfully submitted,

OLSON ENGINEERING, INC.



Hunter A. Yarbrough
Geophysical Project Engineer



Larry D. Olson, P.E.
Principal Engineer

(1 copy faxed and 2 copies mailed)

**Table I: Summary of Sheet Pile Tip Depths and Elevations
From Parallel Seismic Testing of New Orleans Levees**

Levee Site	Sheet Pile Tip Depth From Top of Casing (ft) – (Data Quality)	Sheet Pile Tip Depth From Bottom Concrete Wall Chamfer (ft)	Sheet Pile Tip Elevation (ft above sea level)*	Distance Between Borehole and Levee Wall
17 th Street North End	14.4 - H	15.5	-10.6	5.5 ft
17 th Street South End	14.0 - H	15.0	-9.3	6.2 ft
London Avenue North Break North End	14.6 - L	16.1	-11.2	17.8 ft
London Avenue North Break South End	13.1 - M	14.9	-9.7	7 ft
London Avenue South Break	14.3 - M	15.3	-10.6	17.2 ft
IHNC Florida Street Break	14.8 - M	16.5	-10.3	21 ft
IHNC South Break North End	13.7 – H	16.6	-10.4	9.5 ft
IHNC South Break South End	14.4 – M	16.1	-11.8	21.1 ft

H – Indicates areas where the data quality is high and the borehole is positioned within 10 feet of the sheet pile.

M – Indicates areas where the data quality is medium and/or the borehole is positioned greater than 10 feet away from the sheet pile.

L – Indicates areas where the data quality is low and/or the bore hole is positioned greater than 10 feet away from the sheet pile.

* The elevations of the borehole casing tops were provided by the US Army Corps of Engineers and are NAVD 88 Format.

**APPENDIX A
PS DATA AND RESULTS**

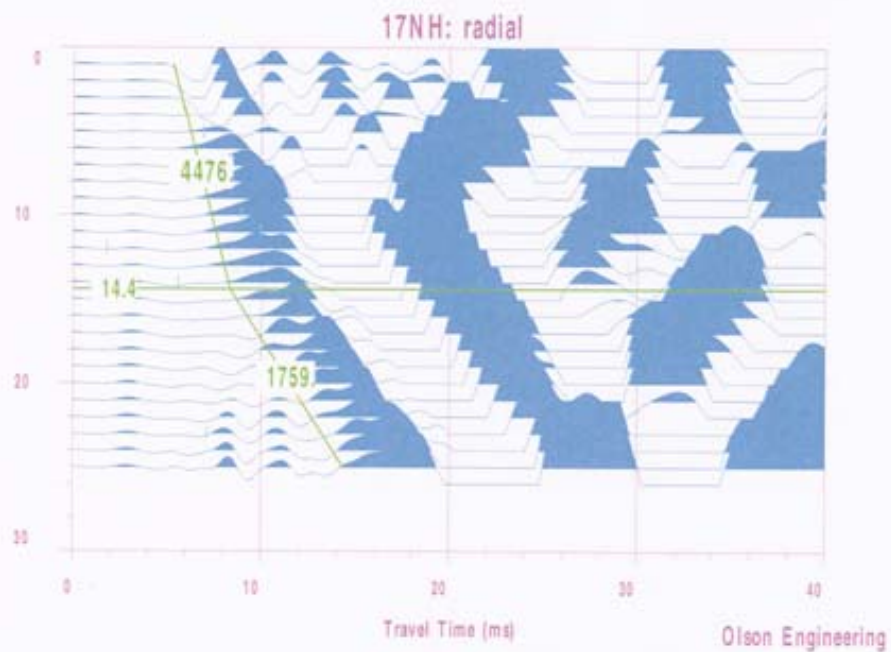

Figure A-1: 17th Street site, North borehole, depth is referenced to top of casing

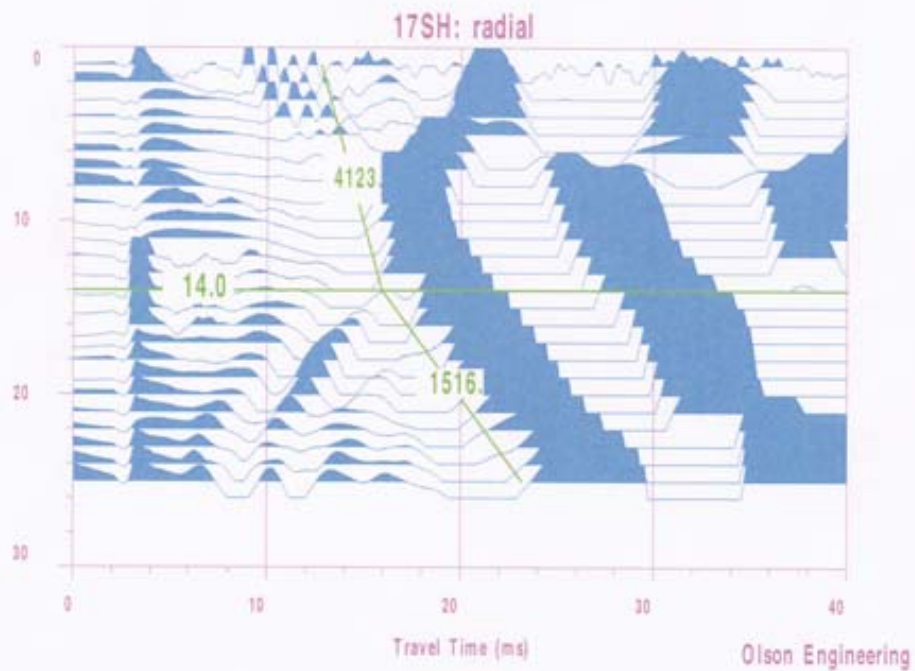

Figure A-2: 17th Street Site, South borehole, depth is referenced to top of casing

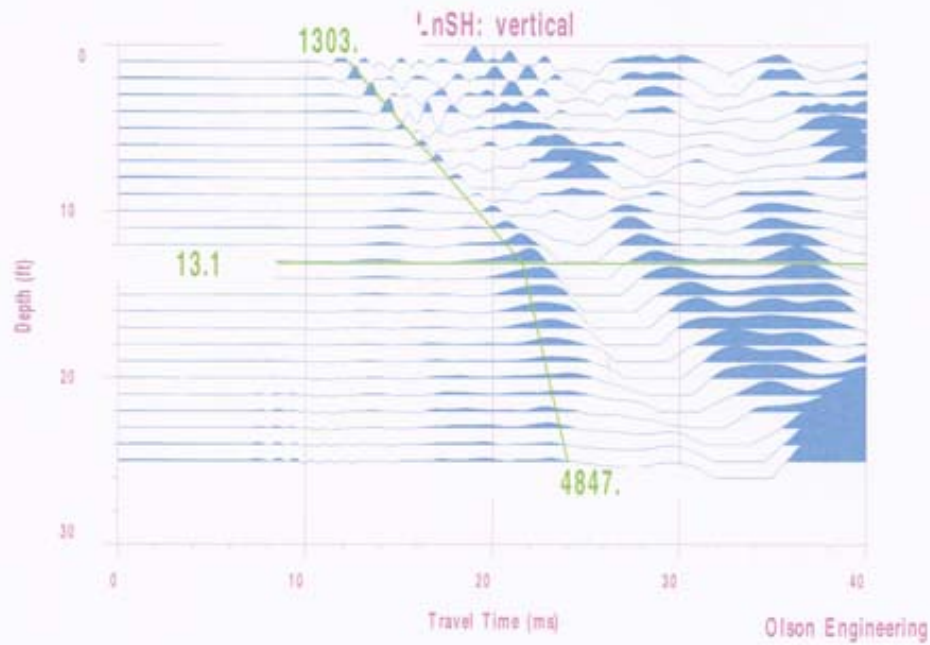

Figure A-3: London Avenue North site, North borehole, depth is referenced to top of casing

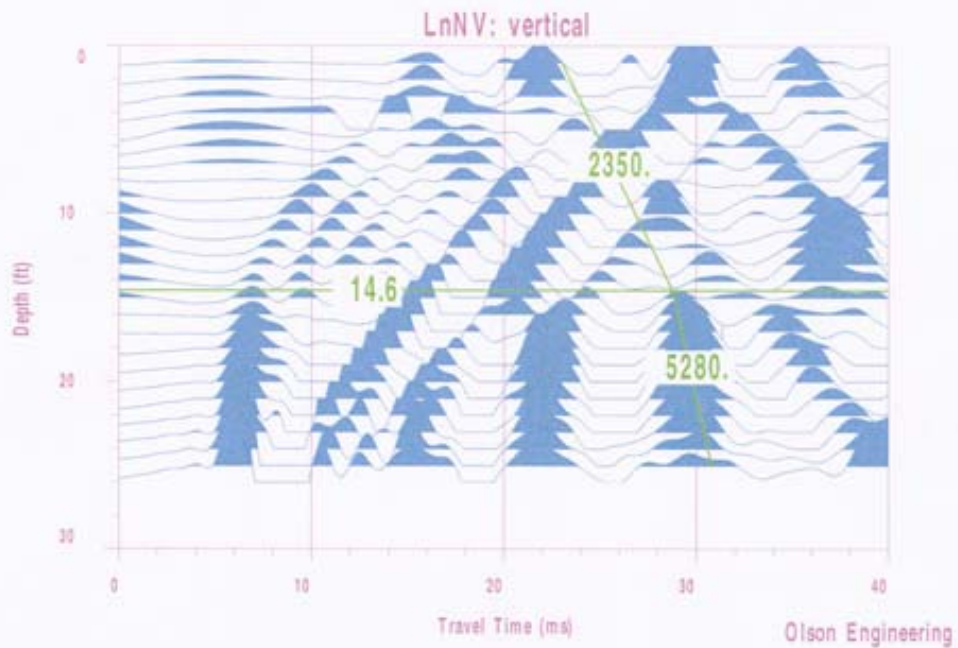

Figure A-4: London Avenue North site, South borehole, depth is referenced to top of casing

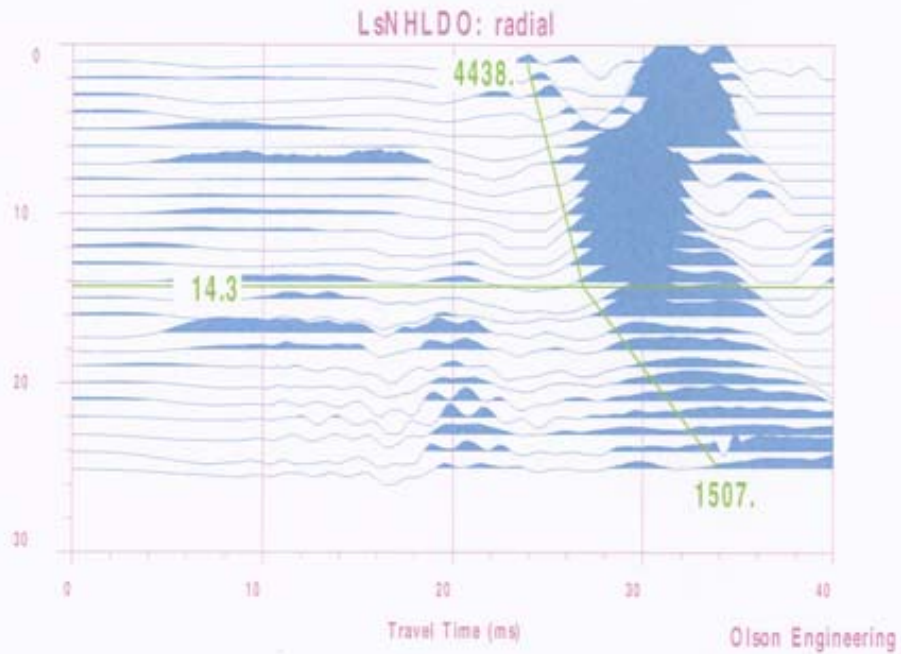

Figure A-5: London Avenue South site, North borehole, depth is referenced to top of casing

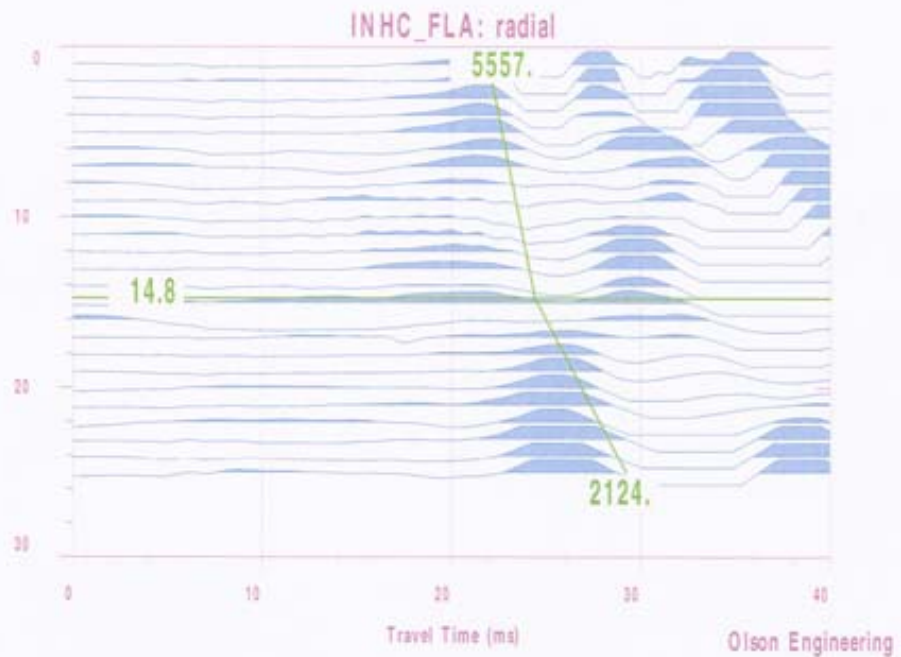

Figure A-6: IHNC Florida Street site, depth is referenced to top of casing

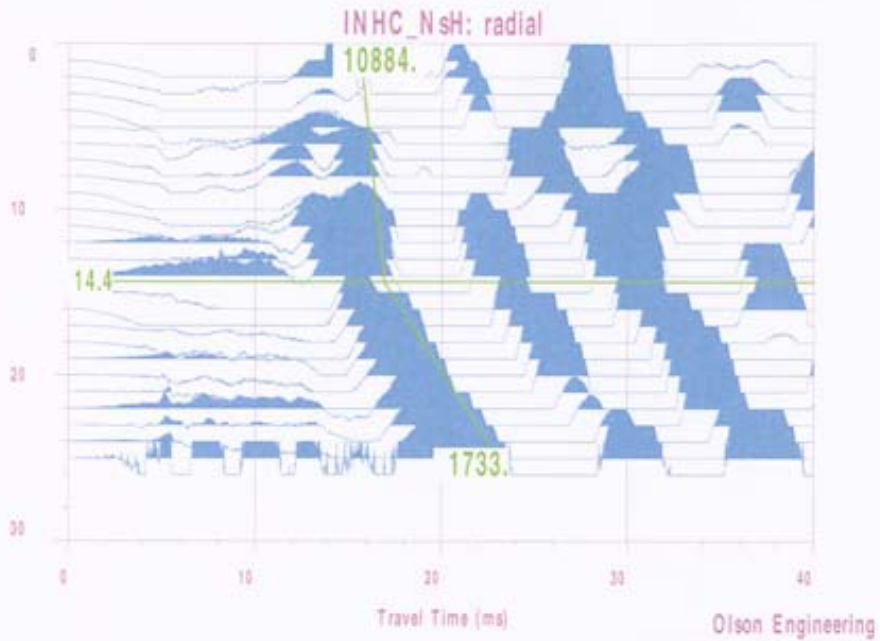

Figure A-7: IHNC South site, North borehole, depth is referenced to top of casing

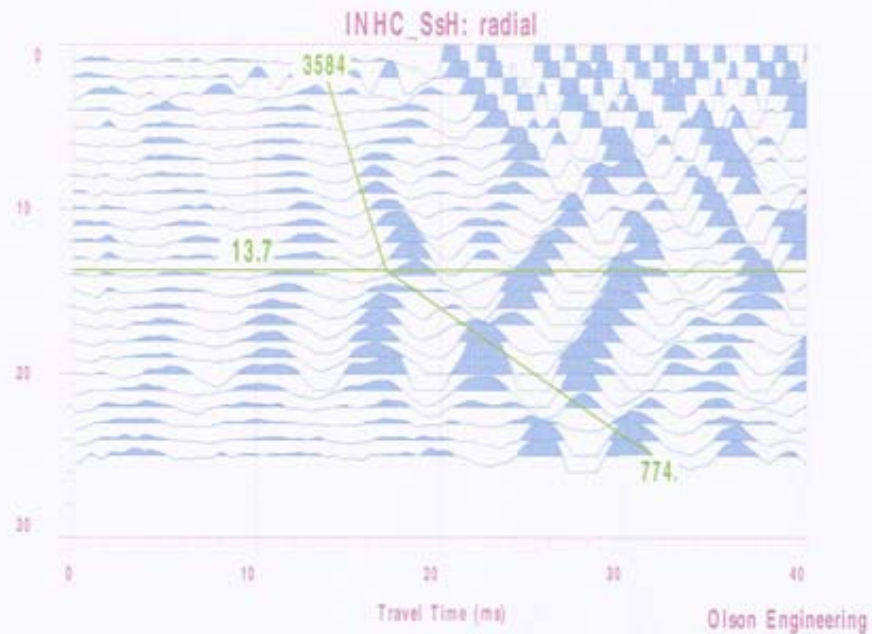

Figure A-8: IHNC South site, South borehole, depth is referenced to top of casing



SPECIALIZING IN CONDITION EVALUATION OF THE
CIVIL STRUCTURE & INFRASTRUCTURE



www.olsonengineering.com

January 9, 2006

U. S. Army Corp of Engineers
Engineering Research and Development Center
3909 Halls Ferry Rd.
Vicksburg, MS. 39180
Attn: Mr. Richard W. Haskins, ERDC-ITL-MS
Ofc: (601)634-2931
Fax: (601)634-2873
E-Mail: Richard.W.Haskins@erde.usace.army.mil

Re: Addendum to Nondestructive Testing Investigation Report
Sheet Pile Lengths
New Orleans Levees
New Orleans, LA
Olson Engineering Job No. 1875

Dear Sirs:

This letter is being sent as an addendum to a report issued to the USACE by our office on December 5, 2005 (Olson Job No. 1875) which reported the results of an investigation conducted by our firm into the determination of the unknown length of steel sheet piles which were located beneath concrete walls and formed part of the levee structure at a number of locations in the New Orleans area. The levee sheet piles were tested with the Parallel Seismic (PS) method to determine their depths. The PS tests were conducted at the 17th Street, London Avenue, and the Inner Harbor Navigational Canal (IHNC) levees in 8 cased borehole locations at undamaged levee wall locations next to breaches.

The initially reported PS test results indicated the presence of piles under the concrete wall, and were interpreted by our firm to show that they extended to approximately 13-15 ft below the casing top for all of the sites tested. These sheet pile depths translated to elevations of approximately 10 feet below mean sea level (range of 9.3 to 11.8 feet below mean sea level).

It is our understanding that four sheet piles at the north end and 4 sheet piles at the south end of the 17th Street levee breach area have been pulled, and that the our data interpretation of nearby PS results in north and south cased borings was shown to be incorrect. The actual embedded lengths were found to be approximately 17 feet below mean sea level (20-22 feet below the casing top elevation used in our investigation) with total sheet pile lengths of 23.5 ft.

Olson Job No. 1875 Addendum

Page 1

12401 W. 49th Ave., Wheat Ridge, CO 80033-1927 USA

PHONE: 303.423.1212



FAX: 303.423.6071

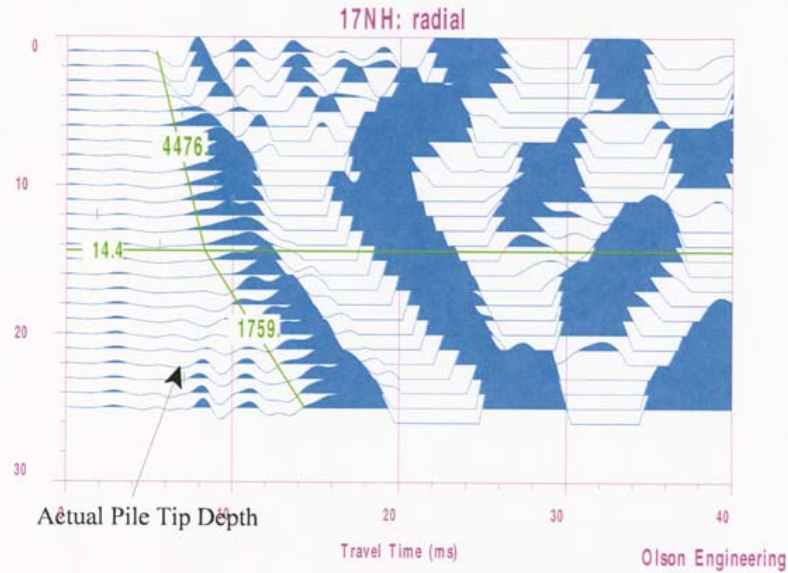

Figure 1 17th Street Levee North Site, Initial PS Data Interpretation

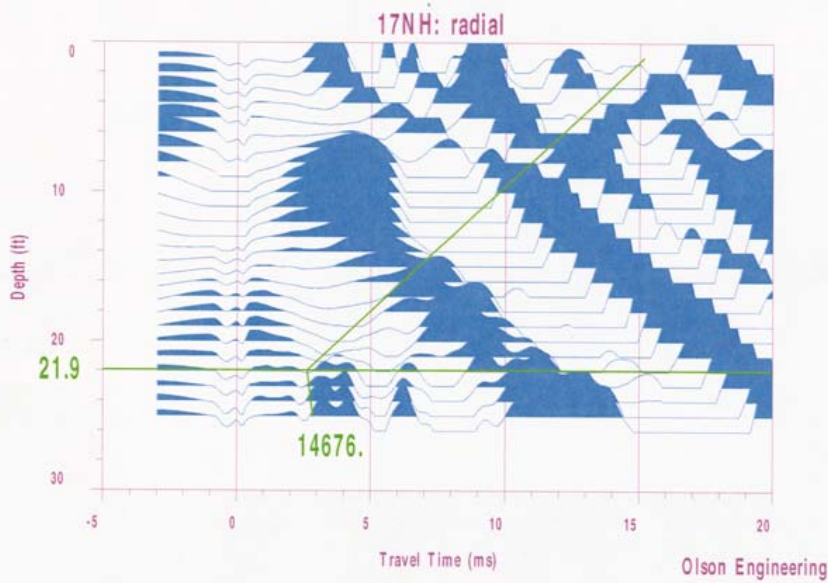

Figure 2 17th Street Levee North Site, Re-interpretation of PS Results

Olson Job No. 1875 Addendum

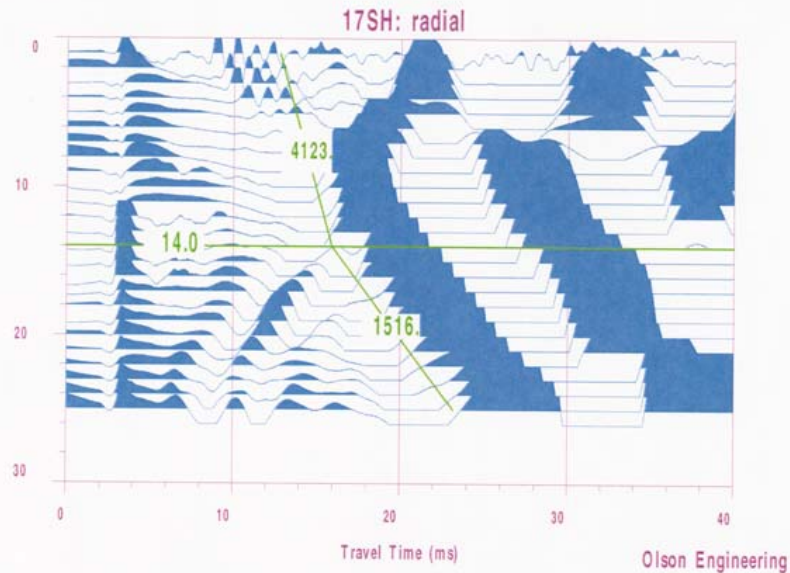

Figure 3 17th Street Levee South Site, Initial PS Data Interpretation

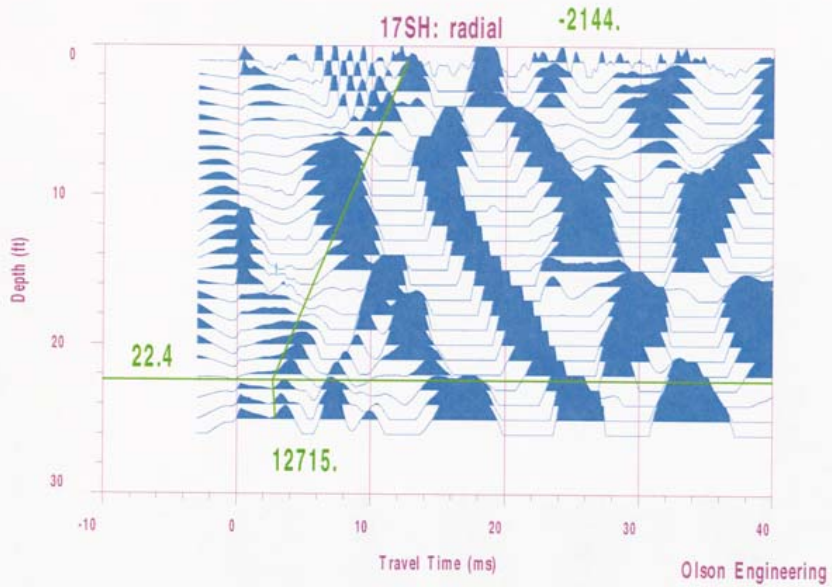

Figure 4 17th Street Levee South Site, Re-interpretation of PS Results

Olson Job No. 1875 Addendum

London Avenue North Break Data Review

The data collected from the London Ave. North site was reexamined to look for tip diffraction events similar to those seen for the 17th Street site data sets. Close examination of the data sets (Figs. A-3 and A-4 in our original report on this testing) show that there is a clear but vertical diffraction event for data at the South borehole, which was located at about 7 feet from the levee wall. The diffraction event in this figure, however, appears as a near-vertical line, with no clear “break” in the slope which would be indicative of a tip depth. It would appear likely that a break would have been seen if the casing went down the recommended 10-15 feet deeper than the expected pile tip depth, since there is a small possible indication of a break visible in the very bottom data trace for this location (at about 24 feet below casing top).

The data set from the North borehole shows a very weak set of possible diffraction events, with a similar shape as the south borehole. The diffraction events in the data from this borehole, however, are very weak. This is presumably due to the almost 18 ft horizontal separation between the borehole and the levee wall at this site. This large separation would attenuate the high-frequency diffraction energy, as well as decrease the resolution of the data that is seen.

London Avenue South Break Data Review

The data set from the South Break site borehole (Fig. A-5 in our original report) shows a very weak and distorted set of possible diffraction events, but with no clear slope change in the data indicative of a tip depth. Close examination of the data shows the first arrivals of the possible diffraction energy to be nearly vertical versus depth down to the last recorded record. Again, this is likely due to the limited depth of the casing in the borehole, which limited the test range to just a few feet deeper than the pile tip. In addition, this borehole was located 17.2 feet from the levee wall, which results in attenuated, distorted, low resolution diffraction energy from the pile tip.

IHNC Florida Street Break Data Review

The data set from the IHNC Florida Street Break site borehole (Fig. A-6 in our original report) shows no indication of tip diffraction energy. Note that this borehole was located about 21 feet from the levee wall, which is a distance greater than the expected pile tip depth. This large separation would be expected to greatly distort and attenuate any energy radiating from the pile tip. Thus, it is not unexpected that there is no visible tip diffraction energy in this data set.

IHNC South Break Data Review

The data set from the two tests conducted at the IHNC South Break site were presented in Figs. A-7 and A-8 in our original report. Figure A-7 is from the north borehole, which was located 9.5 feet from the levee wall. Figure A-8 is from the south borehole, which was located 21.1 feet from the levee wall. Examination of both data sets shows no clear indication of diffraction energy from the pile tip. This may be due to the distances between the boreholes and the wall, as well as possible separation between the sheet piles and the soil in the areas near the break.

Recommendations for Future Nondestructive Testing of Sheet Pile Lengths

The data presented in our original report does show the energy emitted by the sheet pile tips for most of the tests done in boreholes close to the levee walls, and can be made even clearer by re-processing the data from the 17th Street site to emphasize the higher frequency energy from the sheet piles as presented in Figs. 2 and 4 above. Based on this knowledge of how the PS test data behaves when testing these types of sheet piles in this environment, we have prepared these recommendations for any future NDT investigations of sheet pile lengths.

1. **Drill Cased Borings Closer to Walls and Deeper.** In our opinion, the PS method can be effectively used to measure unknown sheet pile depths with good confidence, as long as the boreholes are located and at least within 7 feet or less of the edge of the levee wall. Even closer borings will further improve the accuracy of the PS results. The borings should also be drilled and cased with PVC casings to at least 10 and preferably 15 ft below the expected pile tip depths.
2. **Impact Sheet Pile Sides Directly.** The PS data quality would be further enhanced by impacting the sheet piles at their exposed top just below the concrete wall directly. This will input significantly more energy in to the sheet pile and less into the concrete wall that was impacted in the initial investigation. This could be done with shallow excavations with a small backhoe in advance of the NDT. Alternatively, we have found that vertical impacts on the wall top or on the chamfer produce clearer diffraction energy traces than do horizontal impacts as discussed in our Report No. 2 for the re-test results.
3. **Confirmation with complimentary NDT Methods.** Magnetic metal detectors for boreholes may also be able to detect the sheet pile presence if borings are cased with plastic and able to be drilled close enough for this approach to be effective. The practicality of this can be further explored, if desired. We have already gathered some information on available equipment.

CLOSURE

The field NDT investigation was performed in accordance with generally accepted testing procedures. If there are any questions, or further information is required, please do not hesitate to call. If any additional information is developed pertinent to this study, please contact our office.

Respectfully submitted,

OLSON ENGINEERING, INC.



Dennis A. Sack
Associate Engineer



Larry D. Olson, P.E.
Principal Engineer

(1 copy e-mailed and 2 copies mailed)

e-mail cc: Mr. Paul F. Mlakar (Paul.F.Mlakar@erdc.usace.army.mil)