



US Army Corps  
of Engineers®

# Performance Evaluation of the New Orleans and Southeast Louisiana Hurricane Protection System

## Draft Final Report of the Interagency Performance Evaluation Task Force

### Volume II – Geodetic Vertical and Water Level Datums

1 June 2006

**FINAL DRAFT**  
(Subject to Revision)

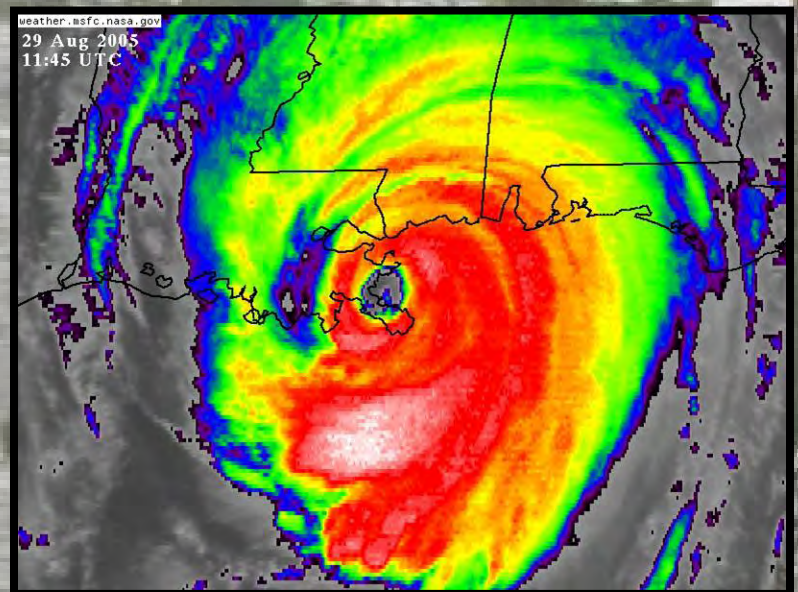

# **Volume II**

# **Geodetic Vertical and Water Level**

# **Datums**

---

This report is not intended as a final expression of the findings or conclusions of the United States Army Corps of Engineers, nor has it been adopted by the Corps as such. Rather, this is a preliminary report summarizing data and interim results compiled to date. As a preliminary report, this document and the information contained therein are subject to revisions and changes as additional information is obtained.

# Contents

Executive Summary .....	II-1
Participants.....	II-3
Scope and Purpose .....	II-4
General Background on Elevation Datums used in Coastal Engineering Design and Construction in Southeastern Louisiana .....	II-5
Overview of Vertical Datums .....	II-7
<i>Geodetic Datums</i> .....	II-7
<i>National Geodetic Vertical Datum of 1929 (NGVD29)</i> .....	II-8
<i>Equipotential Surfaces and the Geoid</i> .....	II-9
<i>Measuring Heights (Elevations) from GPS Observations</i> .....	II-10
<i>North American Vertical Datum of 1988 (NAVD88)-- Definitions and Adjustment</i> .....	II-11
<i>Development of the Time Dependent NAVD88 (2004.65) Reference Framework for Southeastern Louisiana</i> .....	II-14
<i>Accuracy Assessment of the NAVD88 (2004.65) Framework in Southeastern Louisiana</i> .	II-15
<i>Tidal Reference Datums</i> .....	II-16
Other Reference Datums used for Navigation and Flood Control Structure Construction in Southeastern Louisiana .....	II-18
<i>New Cairo Datum of 1910</i> .....	II-18
<i>Mean Gulf Level (MGL) and Mean Low Gulf (MLG) Datums</i> .....	II-19
<i>Mississippi River Low Water Reference Plane (LWRP) Datums</i> .....	II-22
GPS Data Collection and Processing to Update Reference Elevations on Southeastern Louisiana Tide Gages .....	II-24
<i>Development of GPS Survey Data Collection Network Design</i> .....	II-24
<i>Static GPS Survey Phases</i> .....	II-24
<i>GPS Data Collection and Processing Procedures</i> .....	II-28
<i>Estimated Accuracy of the Resultant GPS Vertical Control Survey</i> .....	II-30
<i>Comparison of Provisional and Final Elevation Adjustments</i> .....	II-30
<i>Comparison of CORS-Only Elevation Adjustment</i> .....	II-31
NOAA Tidal Datum Computational Procedures and Estimated Accuracies in Southeastern Louisiana.....	II-32
<i>Review of Tidal Datums and Tidal Datum Computation Procedures</i> .....	II-32
<i>NOAA Definitions of Tidal Datums</i> .....	II-32
<i>Tidal Datum Computation Overview</i> .....	II-33
<i>Errors in Determination of Tidal Datums using NOAA Procedures</i> .....	II-37
<i>Total Estimated Uncertainty in Tidal Datum Computation for Subordinate Station</i> .....	II-40
Reestablishment of New Canal (17th Street Canal) Gage Station and Associated Tidal Datum Error .....	II-41
Connection between Tidal Datums and Geodetic Datums in Southeast Louisiana.....	II-45

<i>Use of a Modified NTDE Procedure for Geographical Areas with High Rates of Sea-Level Change</i> .....	II-46
<i>Areas with Anomalous Sea Level Trends</i> .....	II-46
<i>Local Mean Sea Level (LMSL)</i> .....	II-47
Updated Tidal Datums in the IPET Study Area--LMSL Relationships to NAVD88 (2004.65)	II-48
<i>Preliminary Local Mean Sea Level Relationship (December 2005)</i> .....	II-48
<i>Rationale for Connections to Additional NOS Water Level Stations</i> .....	II-51
Local Mean Sea Level Relationships in the IPET Study Area .....	II-53
Modified 5-Year Tidal Datum Analysis for New Orleans Study Area .....	II-56
Local Mean Sea Level at IHNC Florida Avenue Gage Site (1969) .....	II-60
Relative Sea Level Trends in the IPET Study Area.....	II-62
<i>Introduction</i> .....	II-62
<i>Variation in Sea Levels and Global Sea Level Rise</i> .....	II-62
<i>Seasonal Variation</i> .....	II-62
<i>Error Estimates</i> .....	II-64
<i>Analysis Stations</i> .....	II-66
<i>Sea Level Rates at USACE Stations</i> .....	II-68
<i>Conclusions on Sea Level and Subsidence Trends</i> .....	II-70
Data Analysis and Impacts: Evaluation of Designed and Constructed Elevations on Flood Control and Hurricane Protection Structures.....	II-72
<i>Purpose</i> .....	II-72
<i>Methodology</i> .....	II-72
<i>Geodetic Vertical Datum and Tidal Epoch Elevations</i> .....	II-72
<i>Typical Geodetic and Water Level Datums used in New Orleans Area Floodwall Construction</i> .....	II-74
<i>Subsidence and Settlement Considerations in Protective Structure Elevations</i> .....	II-78
Data Analysis and Impacts: Orleans Avenue Outfall Canal Construction Reference Datums	II-80
<i>Summary of Findings</i> .....	II-80
<i>Reference Documents</i> .....	II-80
<i>Design Elevation Parameters</i> .....	II-81
<i>Reference Benchmark for Orleans Canal Floodwall Construction</i> .....	II-82
<i>Local Mean Sea Level Relationships at the Orleans Avenue Outfall Canal</i> .....	II-84
<i>Impact of Datum Variations on Constructed Floodwall Elevations</i> .....	II-84
<i>Assessment of Pre- and Post-Katrina Flood Protection Elevations (Orleans Avenue Outfall Canal)</i> .....	II-85
Data Analysis and Impacts: London Avenue Outfall Canal Construction Reference Datums.	II-88
<i>Summary of Findings</i> .....	II-88
<i>Reference Documents</i> .....	II-88
<i>Design Elevation Parameters</i> .....	II-88
<i>Reference Benchmark used in London Outfall Canal Parallel Floodwall Construction</i> ...	II-91
<i>Local Mean Sea Level Relationships at the London Avenue Outfall Canal</i> .....	II-92

<i>Impact of Datum Variations on Constructed Floodwall Elevations</i> .....	II-93
<i>Assessment of Pre- and Post-Katrina Flood Protection Elevations (London Avenue Outfall Canal)</i> .....	II-93
Data Analysis and Impacts: 17th Street Outfall Canal Construction Reference Datums .....	II-97
<i>Summary of Findings</i> .....	II-97
<i>Reference Documents</i> .....	II-97
<i>Design Elevation Parameters for 17th Street Canal</i> .....	II-97
<i>Reference Benchmark used in 17th Street Canal Parallel Floodwall Protection</i> .....	II-101
<i>Derived Elevations of Benchmark MONUMENT 14</i> .....	II-102
<i>Assessment of Pre- and Post-Katrina Flood Protection Elevations (17th Street Outfall Canal)</i> .....	II-103
Data Analysis and Impacts: Inner Harbor Navigation Canal (IHNC) Construction Reference Datums .....	II-106
<i>Summary of Findings</i> .....	II-106
<i>Reference Documents</i> .....	II-106
<i>Design Elevation Parameters for East Levee Floodwall Capping (1969)--IHNC Lock to Florida Ave Sta. 0+00 to 56+20</i> .....	II-106
<i>Historical Adjustments to Reference Benchmark M 152 (1951 to date)</i> .....	II-107
<i>Assessment of Pre- and Post-Katrina Flood Protection Elevations (IHNC East Bank Floodwall between Claiborne and Florida Avenues)</i> .....	II-109
<i>Design versus Current Floodwall Elevations in the IHNC between the GIWW Confluence to the Seabrook Bridge (East and West Banks)</i> .....	II-112
Reference Datums for Hurricane Protection Projects in St. Bernard and Plaquemines Parishes .....	II-114
<i>Lake Pontchartrain and Vicinity Projects</i> .....	II-114
<i>New Orleans to Venice Projects</i> .....	II-116
<i>Mississippi River Gulf Outlet (MRGO) Projects</i> .....	II-118
Estimating Subsidence Rates in the Southeastern Louisiana Region from Geodetic Observations .....	II-120
Corps of Engineers Policies on Use of Geodetic and Water Level Datum Relationships in Design and Construction of Hurricane Protection Structures.....	II-125
<i>Background</i> .....	II-125
<i>Assumed Relationship between Geodetic Datums and Sea Level</i> .....	II-125
<i>Corps Policy Guidance on the Redefined NAVD88 Geodetic Datum</i> .....	II-128
<i>New Orleans District Policy Memorandum on Geodetic Datum Readjustments</i> .....	II-129
<i>Historical Event Timeline on use of Geodetic Vertical Datums in USACE/New Orleans District</i> .....	II-132
Field Topographic Survey Support to Other IPET Teams.....	II-138
<i>Field Survey Procedures and Specifications</i> .....	II-140
<i>Data Processing and Submittal</i> .....	II-144
<i>Quality Control and Quality Assurance Procedures</i> .....	II-144

<i>Methodology for Converting Previous Vertical Datums/Adjustments to NAVD88 (2004.65)</i> .....	II-144
Summary of Findings and Lessons Learned.....	II-146
<i>High-Resolution Hydrodynamic Model Relationships to Geodetic and Sea Level Datums</i>	II-146
<i>Mean Low Gulf Datum Conversion to Mean Lower Low Water Datum</i> .....	II-146
<i>Dual Elevations on Flood Control and Hurricane Protection Structures</i> .....	II-146
<i>Geospatial Data Source Feature or Metadata Records</i> .....	II-147
<i>Epoch Designations of Published Topographic Elevations</i> .....	II-147
<i>Future Updates to Geodetic Elevations in Southeastern Louisiana Region</i> .....	II-147
<i>Co-located CORS and NWLON Sites for Subsidence Monitoring</i> .....	II-148
<i>New Orleans District Water Level Gages</i> .....	II-148
<i>Local Mean Sea Level Epoch Updates and Relationships</i> .....	II-149
<i>Definitions of NGVD29, NAVD88, Mean Sea Level, and Local Mean Sea Level</i> .....	II-149
<i>Hurricane Season Biases in Local Mean Sea Level Averages</i> .....	II-149
<i>Coordination of Topographic Survey Data Collection, Processing, and Management</i> ...	II-149
<i>Vertical Control Monumentation Requirements and Stakeout Procedures on Flood Control Construction Projects</i> .....	II-150
<i>LIDAR and Photogrammetric Mapping Calibration and Testing</i> .....	II-150
<i>USACE Policy and Manual on Maintaining Geodetic and Water Level Datums in High Subsidence Areas</i> .....	II-151
<i>Differential GPS and Related Survey Standards for Establishing Construction Control</i>	II-151
<i>Certification Policy on Use of Vertical Datums for All Applications</i> .....	II-151
References.....	II-152
<i>Corps of Engineers References</i> .....	II-152
<i>Federal Geographic Data Committee References</i> .....	II-154
<i>NOAA NGS References</i> .....	II-155
<i>NOAA CO-OPS References</i> .....	II-156
Glossary of Abbreviations and Acronyms.....	II-158
Appendix 1: Lidar Patch Check Areas	
Appendix 2: Topographic and Hydrographic Cross Section Data	
Appendix 3: Topographic and Hydrographic Cross Section Data	
Appendix 4: IHNC West Bank Breach Surveys	
Appendix 5: Railroad Detail	
Appendix 6: 17th Street Canal – Low Chord Elevations	
Appendix 7: Inner Harbor Navigation Canal – Low Chord Elevations	
Appendix 8: London Avenue Canal – Low Chord Elevations	
Appendix 9: Orleans Avenue Canal – Low Chord Elevations	
Appendix 10: High Water Marks – Orleans Parish, Interior	
Appendix 11: High Water Marks Inner Harbor Navigation Canal, West Bank	

Appendix 12: High Water Marks, Lower Plaquemines Parish  
Appendix 13: High Water Mark, St. Bernard Parish  
Appendix 14: Inner Harbor Navigation Canal West/SeaLand-Maresk Topographic Detail  
Appendix 15: Lake Pontchartrain/IHNC Gage Connections  
Appendix 16: Time Stamped Surge Elevations - New Orleans Lakefront Airport  
Appendix 17: Time Stamped Surge Elevations – Orleans Marina (Near New Canal at Lakefront)  
Appendix 18: Topographic and Hydrographic Cross Section Data  
Appendix 19: Topographic and Hydrographic Cross Section Data  
Appendix 20: Topographic and Hydrographic Cross Section Data  
Appendix 21: Bridge/Floodwall Ties  
Appendix 22: Orleans Outfall Canal BM ALCO to CHRYSLER Level Run  
Appendix 23: Permanent and Temporary Control Used and Established for IPET Surveys  
Appendix 24: Pump Stations Surveyed, Listed by Parish  
Appendix 25: Jefferson Parish Pump Stations  
Appendix 26: Orleans Parish Pump Stations  
Appendix 27: Plaquemines Parish Pump Stations  
Appendix 28: St. Bernard Parish Pump Stations  
Appendix 29: St. Charles Parish Pump Stations  
Appendix 30: 1985 New Orleans Policy on NGS Benchmarks  
Appendix 31: GPS Network Adjustment - IPET Project Report  
Appendix 32: IPET Digital Leveling Specifications  
Appendix 33: IPET Survey Task Order–Contract Scope of Work-20 Nov 05  
Appendix 34: NAVD88 ETL 1110-1-152 1994  
Appendix 35: NGS Data Sheet for IPET GPS Control  
Appendix 36: Outfall Canal Post-Katrina Topographic Surveys  
Appendix 37: IPET Supplemental Survey Scope of Work-10 Dec 05  
Appendix 38: ETL 1110-2-349 Coastal MLLW Datum 1 Apr 93  
Appendix 39: Monument Memo  
Appendix 40: Historical Timeline  
Appendix 41: Benchmark History  
Appendix 42: Leveling Abstracts

## Executive Summary

An interagency team to study vertical reference datums was formed consisting of U.S. Army Corps of Engineers (USACE) and U.S. Department of Commerce National Oceanic and Atmospheric Administration (NOAA) personnel. The primary purpose was to define and evaluate a vertical reference datum for the Southeastern Louisiana area that would be compatible with concurrent Interagency Performance Evaluation Task Force (IPET) teams performing hydraulic model studies in the region. A secondary purpose was to evaluate the designed, constructed, and pre-Katrina elevations of flood control and hurricane protection structures in the region. This team also provided significant field topographic surveying support to the IPET for various physical and numerical models.

The NOAA National Geodetic Survey (NGS) participants on this IPET team developed a new (October 2005) time-stamped vertical reference framework for this high subsidence region—termed North American Vertical Datum of 1988 NAVD88 (2004.65). The NOAA Center for Operational Oceanographic Products and Services (CO-OPS) participants were included on this study team given their expertise in tidal datums and defining water level-based references consistent with hydrodynamic models of the region.

A spatial and temporal variation was found to exist between the geodetic datums and the water level reference datums used to define elevations for regional hydrodynamic conditions. This 0.2-ft to 3.0-ft variation is critical in relating measurements of wave heights and water level elevations, high-resolution hydrodynamic conditions, water elevations of hydrostatic forces and loadings at levees and floodwalls, elevations of pump station inverts, and related elevations of flood inundation models deriving drainage volumes or first-floor elevations in residential areas. Flood control structures in this region were authorized, designed, and numerically modeled relative to a water level reference datum (e.g., mean sea level). However, these structures were constructed relative to a geodetic vertical datum that was incorrectly assumed as being equivalent to, or constantly offset from, a water level datum. These varied datums, coupled with redefinitions and periodic readjustments to account for the high subsidence and sea level variations in this region, significantly complicated the process of obtaining a basic reference elevation for hydrodynamic modeling, risk assessment, and design, construction, and maintenance of flood control and hurricane protection systems. An IPET follow-on study by intergovernmental teams is recommended to refine the relationships between the various datums that are numerically compatible with the varied hydraulic, hydrodynamic, geodetic, and flood inundation models such as those used by the Federal Emergency Management Agency (FEMA).

To the maximum extent possible, topographic surveys of flood control and hurricane protection structures, interior drainage regions, hurricane surge, and high water marks used in various high-resolution hydrodynamic models were performed relative to the updated geodetic vertical datum developed by the NGS for this region—NAVD88 (2004.65). Some older geospatial datasets acquired for this project were obtained from a variety of federal, state, regional, parish, and private entities. Many of these datasets had unverifiable vertical datum references and were of uncertain reliability or had not been ground-truthed. They were converted to the newer vertical datum framework, with mixed results and varying levels of confidence.



Use of terrestrial-based geodetic vertical datums instead of water-level-referenced datums for floodwall design and construction was found to have caused flood protection deficiencies throughout the region.

In the Lake Pontchartrain Lakefront Outfall Canals in Orleans and Jefferson Parishes (London Avenue, Orleans Avenue, and 17th Street Outfall Canals), protection was constructed some 1 to 2 ft lower than intended —this would have been avoided had water level datums referenced in the concept designs been used. Subsequent land subsidence since construction has resulted in additional loss of protection. In effect, current flood protection levels have lost most of the freeboard allowances provided for in the original design, even though these freeboard allowances were not intended to compensate for datum or subsidence impacts. Hurricane Katrina water surface elevations (6 to 8 ft) were well below the later maximum surge heights at the time of the 17th Street Canal and London Avenue Canal breaches. These datum and subsidence effects did not play a role in these particular floodwall failures.

Current (pre-Katrina) flood protection elevations along the Inner Harbor Navigation Canal (IHNC) were also found to be below original design/constructed elevations—just over 2 ft in places. Most of this deficiency is the result of subsidence occurring over the past 35 years. As in the Lake Pontchartrain outfall canals, this equates to a loss of most, if not all, of the design freeboard allowance. Since observed surge elevations in the IHNC at the time of failure were less than the current or pre-Katrina elevations of the floodwalls, it is uncertain whether the lost freeboard would have had any impact on the failures.

The impact of spatially or temporally varying vertical datums and subsidence on hurricane protection levees in St. Bernard and Plaquemines Parishes was not found to be significant, given the relative magnitude of Hurricane Katrina surge elevations over the design or pre-Katrina elevations of these structures. This is not to say these flood control structures are not subject to the same datum and subsidence losses in protection as those in Orleans Parish.

This Volume contains a concluding section summarizing its findings and lessons learned during the course of this project.

The members of this interagency team feel that a continued (i.e., post-IPET) interagency USACE-NOAA partnership is needed. This partnership would include HQUSACE, the New Orleans District, NOAA NGS, NOAA CO-OPS, and perhaps other federal or local agencies, such as FEMA. This continued technical cooperation will provide a long-term solution to accurately monitoring protective structure and surface drainage elevations in this region. To reach this end, however, significant institutional and technical changes will be required by both the USACE and NOAA to ensure efficient, but substantive and sustainable, engineering solutions are developed. NOAA possesses expertise in geodesy and tidal hydraulics that are essential to USACE high-resolution hydraulic modeling used in design and risk assessment. This enhanced and elevated inter-agency partnership and cooperation will provide significantly improved baseline elevation data for near-term and long-term risk/reliability assessments of hurricane protection system performance evaluations in the New Orleans region.

## Participants

This report represents a joint effort by intergovernmental agencies (USACE and NOAA) with essential contract support from 3001, Inc., a New Orleans-based geospatial surveying and mapping firm. The following is a listing of individuals that actively participated on this project during the period October 2005 through May 2006, and directly or indirectly contributed to this report.

<b>Name</b>	<b>Agency</b>	<b>Role</b>
Jim Garster	USACE/ERDC-TEC	Lead Project Coordinator & Manager
Brian Shannon	USACE/ERDC-TEC	Planning, GPS Network Design, ties to MSL/gages
MK Miles	Headquarters, USACE	HQUSACE sponsor
Bill Bergen	Headquarters, USACE	Co-Lead—On site New Orleans
Dave Zilkoski	NOAA-NGS	Co-Lead -- Director, National Geodetic Survey (NGS)
Dru Smith	NOAA-NGS	Chief Geodesist, National Geodetic Survey
Ronnie Taylor	NOAA-NGS	National Geodetic Survey
Jeff Navaille	USACE/SAJ (Jacksonville District)	On-site coordination & QC/QA of New Orleans survey crews
Mike Szabados	NOAA/CO-OPS	Co-Lead-- Director, Center for Operational Oceanographic Products and Services (CO-OPS)
Jerry Hovis	NOAA/CO-OPS	Tidal Datum Analysis and Computations
Steve Gill	NOAA/CO-OPS	Tidal Datum Analysis and Computations
Tom Landon	NOAA/CO-OPS	Tidal Datum Analysis
Mark Huber	USACE/MVN (New Orleans District)	New Orleans District IPET Representative
Bob Mesko	USACE/MVS (St. Louis District)	IPET A-E Contract support
John Purpera	A-E Contractor 3001, Inc (New Orleans)	Field Survey Coordinator
Lonnie Zurfluh	A-E Contractor 3001, Inc (New Orleans)	GPS Computations
Dillon Payne	A-E Contractor 3001, Inc (New Orleans)	3001, Inc. Project Manager, Geospatial Analyst
Thomas Wolff	Assoc. Dean, Michigan State University	Independent Technical Review
Thomas Leicht	USACE/SAJ (Jacksonville District) Chief, Design Branch	Independent Technical Review
Bruce Taylor	Taylor Engineering	Independent Technical Review
Christine Anderson	Director of Public Works, City of Long Beach, CA	ASCE External Review Panel Primary Contact

## Scope and Purpose

The primary focus of this study was to identify a common vertical reference framework for the various IPET physical models and high-resolution hydrodynamic models developed on this project. The common vertical reference framework chosen was the North American Vertical Datum of 1988—actually the 2004.65 adjustment to this datum (NAVD88 (2004.65)). This framework was adopted in order to relate flood control and hurricane protection system elevations to the local water surface reference datum used in hydrologic, hydraulic, flood inundation, and risk assessment models, e.g., local mean sea level, river low water reference planes, etc. Controlling elevations on floodwalls, levees, pump stations, and bridges through the SE Louisiana region were surveyed relative to this geodetic framework. This geodetic framework was intended to provide a consistent, or common, reference system for numerical and physical model studies, interior drainage models, and hydrodynamic models in the IPET study region. In addition to developing this basic framework, an evaluation was made of changes in flood/hurricane protection resulting from elevation changes (i.e., net land subsidence and sea level rise) throughout the region. This entailed comparing flood/hurricane structure protection elevations (and reference datums) at the time of original design/construction with the current elevations (“pre-Katrina”). This work was accomplished in the field using water level gage data (existing and historical), static and kinematic GPS observations, and conventional topographic surveying methods. Archival data from the New Orleans District, National Oceanic and Atmospheric Administration (NOAA) National Geodetic Survey (NGS), and NOAA Center for Operational Oceanographic Products and Services (CO-OPS) were used in these assessments.

## **General Background on Elevation Datums used in Coastal Engineering Design and Construction in Southeastern Louisiana**

Published elevations relative to the vertical datums in the Southeastern Louisiana area are not as reliable as in other regions of the United States. This is due to the uneven temporal and spatial movement of the land throughout this region, primarily caused by subsidence. Thus any geodetic or terrestrial-based elevation is not constant and must be periodically observed and adjusted for local subsidence. Likewise, hydraulic or sea level based reference datums are subject to variations due to subsidence and sea level rise at each gage site. Sea level datums also have time varying astronomical components making their reference definition more complex than terrestrial based datums. Hydraulic low water reference datums used to define navigation and flood protection elevations on the Mississippi River or Gulf Intracoastal Waterway systems also are subject to subsidence and long-term variations, and thus these datums are spatially and temporally variable.

Flood control structures in this region were authorized, designed, and numerically modeled relative to a water level reference datum (e.g., Mean Sea Level; local MSL). However, these structures were constructed relative to a geodetic vertical datum which was incorrectly assumed as being equivalent to, or constantly offset from a water level datum. These hydraulic datums are often erroneously assumed as being equivalent to, or constantly offset from, a terrestrial geodetic datum (e.g., SLD29, NGVD29, NAVD88, NAVD88 (2004.65)). Navigation projects in the Southeastern Louisiana area are authorized, designed, constructed, and maintained relative to low water datums (e.g., Mean Lower Low Water), river low water reference planes (e.g., Mississippi River LWRP 1974), or a mixed geodetic and sea level reference surface (Mean Low Gulf Datum). All of these geodetic and hydraulic-based reference systems have been (and still are) subject to periodic readjustments and redefinitions. These datum definitions and readjustments, coupled with the high subsidence and sea level variations in this region, have significantly complicated the process of obtaining a basic reference elevation for high resolution hydrodynamic modeling, risk assessment, design, construction, and maintenance of flood control & hurricane protection systems.

Since the terrestrial-based geodetic datums (i.e., NGVD29 and NAVD88) are not based on any local water surface elevation in the New Orleans region, they cannot be directly used to define flood inundation or flood protection structure elevations—especially in coastal regions where subsidence and sea level trends are changing. These geodetic (terrestrial) datums must be related to the local mean water surface in order to obtain true flood elevations or inundation levels for input into hydrodynamic and interior drainage models. These relationships are further complicated in that both the sea level and terrestrial elevations have spatial and temporal variations.

In the Southeastern Louisiana region, elevations on existing maps, charts, and engineering drawings (or in any digital elevation model database), are referenced to a variety of vertical datums and often different temporal epochs of those datums. Depending on their age, USGS quadrangle maps reference elevations to SLD29, NGVD29, or NAVD88 geodetic datums. Elevations on NOAA nautical/bathymetric charts are referred to a Mean High Water (MHW)

tidal datum and depths are referred to either Mean Low Water (MLW) or Mean Lower Low Water (MLLW) tidal datum, depending on the age of the chart. Corps of Engineers inland navigation charts and drawings use a variety of reference datums, such as Low Water Reference Plane (LWRP), Mean Low Gulf (MLG), Mean Pool Level, etc. In the New Orleans area, design and construction documents from different agencies variously refer elevations to datums such as Mean Tide Level, Mean Low Gulf, Mean Sea Level, LWRP, NGVD, NGVD29, NAVD88, NAVD88 (2004.65), or Cairo Datum. Relationships between these datums are often uncertain or unknown. Consolidating disparate databases on different datums for hydrodynamic modeling is difficult and, depending on the model sensitivity, can significantly impact the resultant accuracy.

The next few sections in this Volume provide additional background on the various vertical datums used in Southeastern Louisiana, and how these datums interrelate with one another—or perhaps how they do not relate to one another. Also described are satellite-based techniques developed by NOAA which should provide a consistent, time-dependent vertical reference system from which to monitor regional and local subsidence, and sea level rise, and more accurately and reliably relate these terrestrial geodetic datums to the design elevations of protective structures based on hydraulic assessments.

## Overview of Vertical Datums

Vertical datums typically represent a terrestrial or earth-based surface to which geospatial coordinates (such as elevations) are referenced. Elevations of points may be referred to local or regional reference planes. These may be either geodetic or hydraulic based reference planes. These reference planes are not necessarily “planar” and may deviate spatially over a region, due to a variety of reasons. They may also have temporal deviations due to land subsidence, sea level changes, or geodetic readjustments. Thus, it is impossible to define a truly consistent, non-varying, terrestrial-based, vertical geodetic framework for coastal areas such as the New Orleans study region. Recent (i.e., over the last 20 years) implementation of GPS satellite reference systems does provide potential mechanisms for establishing an external reference framework from which vertical datums can be related spatially and temporally. Such a framework was developed by NOAA in October 2005 and used for this IPET project.

The following discussion is intended to be a brief overview of terrestrial and hydraulic-based reference datums used in the Southeastern Louisiana region. More comprehensive treatments on geodesy specific to vertical datums can be found in NOAA, USACE, ASCE, and academic publications.

### Geodetic Datums

A geodetic vertical datum is a reference system whereby heights are consistently determined above some reference surface. Previously the reference surface for a vertical datum has been some approximation of local mean sea level, but this is not a strict requirement. By 1900, the vertical control network for the United States had grown to 21,095 km of geodetic leveling. A reference surface was determined in 1900 by holding elevations referenced to local mean sea level (LMSL) fixed at five tide stations. Data from two other tide stations indirectly influenced the determination of the reference surface. Subsequent readjustments of the leveling network were performed by the US Coast and Geodetic Survey (USC&GS) in 1903, 1907, and 1912.

Since 1929, only two official national vertical datums have been established. Due to subsidence and other factors, several readjustments have been made to the published heights in these datums in areas such as Southern Louisiana. The first of these national datums was the Sea Level Datum of 1929 (SLD29). It was created by the USC&GS as the datum to adjust all vertical control to in North America. The SLD29 is defined by 26 tide stations, held fixed to Local Mean Sea Level; 21 tide stations in the United States; and 5 tide stations in Canada. When it was established in 1929, SLD29 was believed to be a “mean sea level” datum. However, over time, with sea level rise and other factors, it was no longer considered a “mean sea level” datum. In 1973 the name of SLD29 was changed to the National Geodetic Vertical Datum of 1929 (NGVD29).

In the early 1990s, the NOAA NGS established a new geodetic vertical datum for North America—the North American Vertical Datum of 1988 (NAVD88). NAVD88 is defined by a single tidal benchmark at Father Point/Rimouski, an International Great Lakes Datum of 1985 (IGLD85) water level station at the mouth of the Lower St. Lawrence River in Quebec, Canada. This Rimouski benchmark elevation was held fixed in a minimally constrained, least square adjustment, which isn’t distorted by constraints of local mean sea level in different areas, as was

NGVD29. However, NAVD88 is not related to local mean sea level at any point—even at its original Quebec origin.

Both the name change from SLD29 to NGVD29 in 1973 and the adoption of the NAVD88 vertical datum in 1993 were approved by the Federal Geodetic Control Committee (FGCC) and the Federal Geographic Data Committee’s (FGDC), Federal Geodetic Control Subcommittee (FGCS) respectively. Both the FGCC and FGCS have representation from most federal agencies concerned with engineering, geodesy, and surveying activities, including NOAA, which chairs the FGCS, and USACE.

**National Geodetic Vertical Datum of 1929 (NGVD29)**

In 1929 the international nature of geodetic networks was well understood, and Canada provided data from its first-order vertical network to combine with the US network. The two networks were connected at 24 locations through vertical control points (benchmarks) from Maine/New Brunswick to Washington/British Columbia. Although Canada did not adopt the “Sea Level Datum of 1929” determined by the United States, Canadian-US cooperation in the general adjustment greatly strengthened the 1929 network. Table 1 lists the kilometers of leveling involved in the readjustments and the number of tide stations used to establish the datums.

<b>Table 1 Adjustments in the US between 1900 and 1929</b>		
<b>Year of Adjustment</b>	<b>Kilometers of Leveling</b>	<b>Number of Tide Stations</b>
1900	21,095	5
1903	31,789.	8
1907	38,359	8
1912	46,468	9
1929	75,159 (U.S.)	21 (U.S.)
	31,565	5 (Canada)

Holding Local Mean Sea Level (LMSL) heights fixed at these tide stations did not mean that the geodetic vertical datum and the LMSL were the same at any location outside of the 26 tide gages. Immediately after the 1929 adjustment, the relationship between NGVD29 and LMSL began to deviate due to apparent sea level rise. There were several later adjustments to the datum, but no change in the definition of the datum until 1991, when NGS established the NAVD88. Adjustments to the datum are noted by the year in parentheses after the datum name, i.e., NGVD29 (19xx) where 19xx is the year the NGVD29 datum was readjusted in a region or local area based on either new or releveing of an existing level line. It is noted that this is only an adjustment and not a new datum. Figure 1 below depicts level lines run through the CONUS portion of the primary network used in the 1929 readjustment.

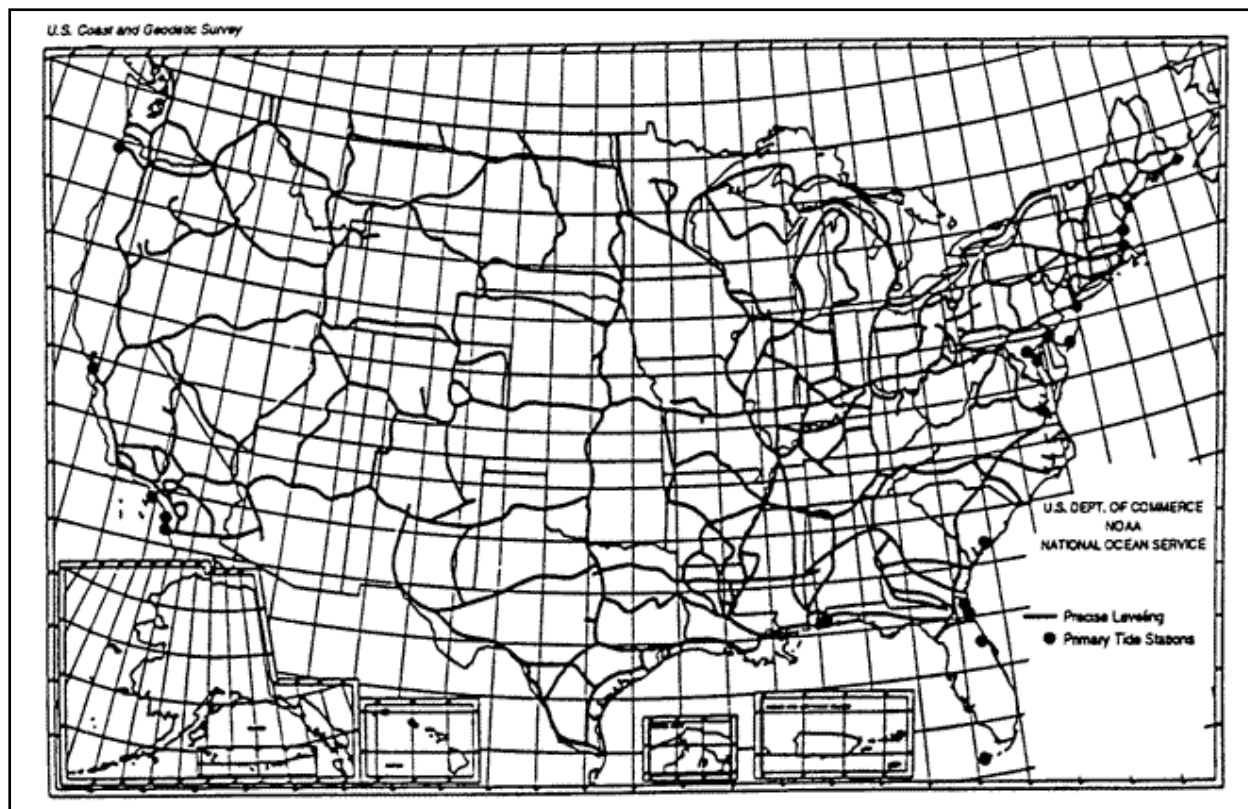

Figure 1. Precise level lines and tide gages used to define the NGVD29 datum

## Equipotential Surfaces and the Geoid

Before defining NAVD88 and understanding the difference between it and NGVD29, some key definitions of important factors must be explained. The term “equipotential surface” is defined as an irregular surface, whose gravity potential energy is constant at every point. By extension, therefore the force of gravity is perpendicular to an equipotential surface at every location on that surface. Because the value of gravity potential energy can be any number (corresponding to one equipotential surface), there are therefore an infinite number of equipotential surfaces surrounding the Earth with each equipotential surface lying either completely within or completely without another surface; they do not intersect one another. Due to the non-homogenous distribution of Earth’s masses, each of these surfaces has its own distinct shape. The “geoid” is the one equipotential surface which most closely fits global mean sea level in a least squares sense. However variations between local mean sea level and the geoid at one location may be radically different from such variations at another location. As an example the LMSL-geoid difference in New Orleans is not the same as LMSL-geoid difference in Miami, Florida since the geoid is fit to global mean sea level and its definition is therefore not strongly influenced by the local hydrodynamic phenomena which affect local mean sea level.

In the absence of all forces besides gravity, the ocean surface would lie on the geoid. However tides, currents, river runoff, wind, circulation, and other forces all impact sea level. Some of these forces do not average to zero over time, and since these forces vary from site to site, any given tide gage may determine local mean sea level but not directly determine the



geoid. Due to this difference in variations between the geoid and local mean sea level, and the fact that 26 tide stations were held fixed, the NGVD29 reference surface was warped to allow the local mean sea level at tide stations to define the “zero elevation” of heights in the NGVD29 datum; hence, NGVD29 ‘s reference surface is not equipotential. Following are definitions of some key geodetic terms.

**Geopotential number:** The numerical difference between gravity potential at the geoid and gravity potential at any other point.

**Plumb line:** The curved line between a point on the earth’s surface and a point on the geoid, everywhere tangent to the direction of gravity (or, in other words, everywhere perpendicular to all equipotential surfaces through which the line passes).

**Orthometric height:** Exactly the distance along this curved plumb line between the geoid and point on the earth’s surface. Close approximations can be made, but for absolute accuracy, gravity needs to be measured along this line, requiring a bored hole, which is impractical.

### Measuring Heights (Elevations) from GPS Observations

In recent years much emphasis has been put on the determination of orthometric heights from GPS, rather than through traditional (leveling) observations. Such a method is possible, but approaches the determination from a very different perspective. Specifically, a highly accurate model of the geoid must exist and then the purely geometric height (called “ellipsoidal height”) determined by GPS can be transformed into an orthometric height. See Figure 2 below for clarification of the connection between these height systems.

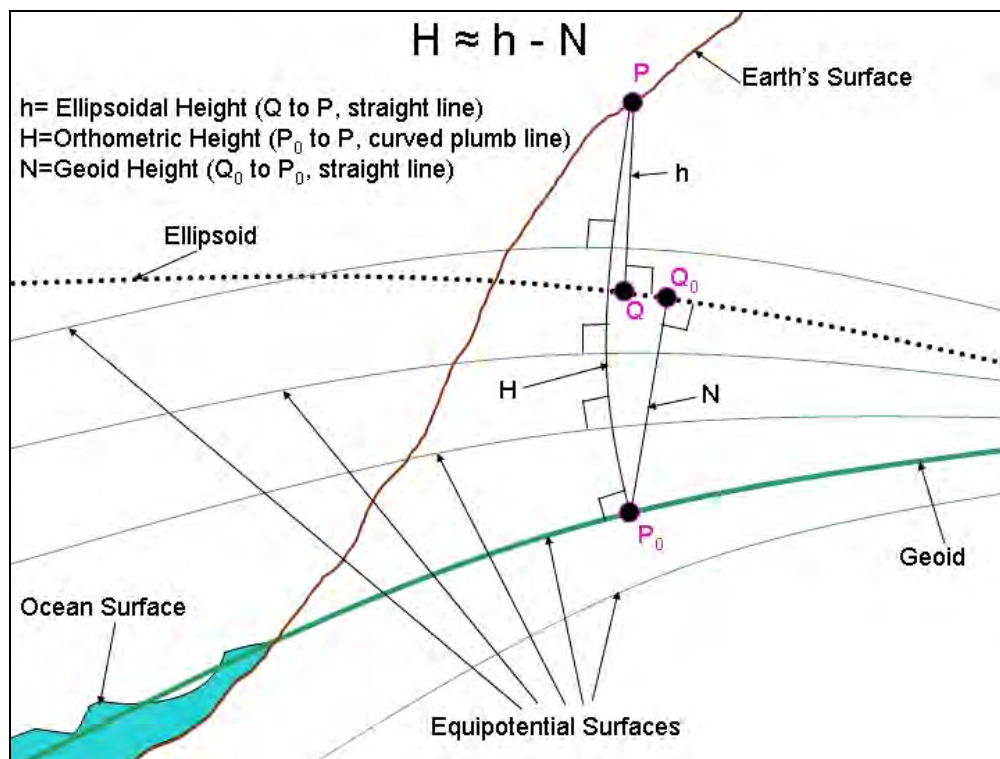

Figure 2. Relationship between the ellipsoid, geoid and orthometric heights

From the above figure one can obtain an orthometric height from the geoid height (ellipsoid-geoid separation) and the ellipsoid height (obtained from GPS). From this figure  $H \approx h - N$ , but this will generally not produce the same height that has been determined using first order leveling procedures to obtain the orthometric height as shown in the published NGS data sheets. The above figure shows the relationship of the mathematical ellipsoid surface with level surfaces and orthometric heights. The ellipsoid surface has nothing to do with the level surfaces and it cuts through all level surfaces because it is not a function of the Earth's gravity field. Therefore GPS-derived ellipsoid heights are not related to the geoid or the gravity field--requiring a model to obtain differences between the geoid and ellipsoid to determine orthometric height. Geoid height (also termed geoid separation or geoid undulation) is the difference between the geoid and ellipsoid at any given point on the earth's surface. The equation  $h \approx H + N$  shown in the above figure is accurate to 1 mm in the New Orleans region as long as all the components are known. The geoid height is always negative in CONUS (as shown in the above figure).

### **North American Vertical Datum of 1988 (NAVD88)-- Definitions and Adjustment**

Unlike the multiple points which define the “zero level” of NGVD29, NAVD88 is defined by a single tidal bench mark at Father Point/Rimouski, an International Great Lakes Datum of 1985 (IGLD85) water level station at the mouth of the Lower St. Lawrence River, in Quebec, Canada. Its elevation was held fixed in a minimally constrained, least squares adjustment, which isn't distorted by constraints of local mean sea level in different areas, as in NGVD29. The warping of NGVD29's reference surface means that the heights determined in that datum are not strictly “orthometric.” Conversely, NAVD88's reference surface is equipotential, and therefore heights in that datum are nearly orthometric. The reason they are not truly orthometric is that the reference surface of NAVD88 was not specifically chosen as the geoid. In fact, most estimates of the difference between the NAVD88 reference surface and the geoid put the difference at the level of a few decimeters.

In support of NAVD88, the NGS Vertical Network Branch converted the historic height difference links involved in the 1929 general adjustment to computer-readable form. The 1929 general adjustment was recreated by constraining the heights of the original 26 coastal stations. Free-adjustment results were then compared with the general adjustment constrained results. Several differences exceeded 50 cm. A large relative difference, 86 cm, exists between St. Augustine, Florida, and Fort Stevens, Oregon. This is indicative of the amount of distortion present in the 1929 general adjustment (see Figure 3).

NAVD 88 combined 1,300,000 kilometers of leveling surveys held in the NGS data base, into a single least squares adjustment to provide users with improved heights for over 500,000 vertical control points distributed throughout the United States, on a common datum. There had been approximately 625,000 km of leveling added to the National Geodetic Reference System (NGRS) since NGVD29 was created. An extensive inventory of the vertical control network resulted in the identification of lost benchmarks, several affected by crustal motion associated with earthquake activity, postglacial rebound (uplift), and subsidence. Other problems (distortions in the network) were caused by forcing the 625,000 km of leveling to fit previously determined NGVD29 height values. Some observed changes, amounting to as much as 9 m, are discussed in the referenced reports.

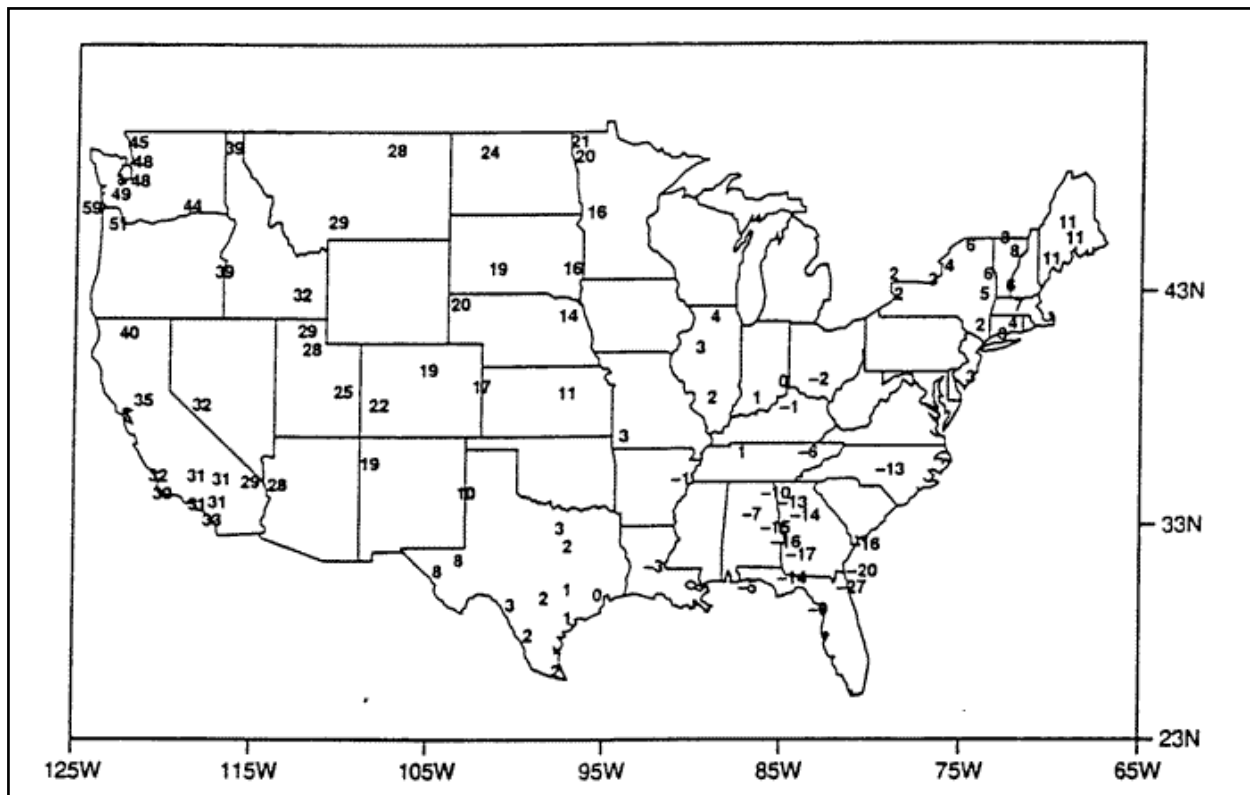

Figure 3. Differences in centimeters between NGVD29 and NAVD88

The NAVD88 datum adjustment formally began in October 1977 with the releveling of much of the first-order NGS vertical control network in the United States. The nature of such a network required a framework of newly observed height differences to obtain realistic, contemporary height values to form the readjustment. To accomplish this, NGS identified 81,500 km (50,600 miles) for releveling to be completed by NGS field crews. In addition to the NGS releveling, other federal agencies such as the USACE, many state agencies such as state Departments of Transportation, Departments of Natural Resources, etc. provided NGS with approximately another 20,000 km (32,400 miles) of new and releveled surveys. Replacement of disturbed and destroyed monuments preceded the actual leveling. This effort also included the establishment of “deep-rod” benchmarks, which provided reference points for future “traditional” and Global Positioning System (GPS) leveling techniques. Field leveling of the 81,500 km network and the 20,000 km submitted by state agencies was accomplished to Federal Geodetic Control Committee (FGCC) First-Order, Class II specifications, using the “double-simultaneous” method. NGS worked closely with both Canada and Mexico to ensure sufficient connections were made along both borders of the United States. NGS field crews also worked closely with both countries carrying the vertical control into both countries making connections to their vertical network and both countries ran into the United States making connections. Both Canada and Mexico provided NGS with their leveling data so the NAVD88 would be more extensively “North American” than NGVD29 had been.

The general adjustment of NAVD88 was completed in June 1991. The general adjustment did not include about 20 percent of the vertical network. The benchmarks that were not adjusted

were referred to as “POSTed benchmarks”. Benchmarks were POSTed due to many factors such as some of the older data being inconsistent with newer data. Other benchmarks were POSTed because they were in areas of crustal movement, such as in Southern Louisiana. POSTed benchmarks were not included in the original NAVD 88 adjustment so they would not influence the adjustment. The benchmarks that had been POSTed in Southern Louisiana were adjusted in 1994 using observation data tied to areas outside of the area of subsidence.

The leveling observations used in NAVD88 were corrected for rod scale and temperature, level collimation, and astronomic, refraction, and magnetic effects (NOAA 1992). All geopotential differences were generated and validated, using interpolated gravity values based on actual surface gravity data. Geopotential differences were used as observations in the least-squares adjustment, geopotential numbers were solved for as unknowns, and after the adjustment was complete orthometric heights were computed using the well-known Helmert height reduction.

$$H = C / (g + 0.0424 \cdot H)$$

where C is the estimated geopotential number in gpu (geopotential units), g is the gravity value at the benchmark in gals, and H is the orthometric height in kilometers. The weight of an observation was calculated as the inverse of the variance of the observation, where the variance of the observation is the square of the *a priori* standard error multiplied by the kilometers of leveling divided by the number of level sections.

Table 2 below shows the comparison between NGVD29 and NAVD88 vertical adjustment.

<b>Table 2 Comparison between NGVD29 and NAVD88 Adjustments</b>			
<b>Category</b>	<b>Sub-Category</b>	<b>NGVD29</b>	<b>NAVD88</b>
Datum Considerations	Defining Height(s)	26 Local MSL	1 Local MSL
	Tidal Epoch	Various	1960-78 (18.6 years)
Treatment of Leveling Data	Gravity Correction	Ortho Correction (normal gravity)	Geopotential Numbers (observed gravity)
	Other Corrections	Level, Rod, Temperature	Level, Rod, Astro, Temp, Magnetic, and Refraction
Adjustments Considerations	Method	Least-squares	Least-squares
	Technique	Condition Equations	Observation Equations
	Units of Measure	Meters	Geopotential Units
	Observation Type	Links Between Junction Marks	Height Differences Between Adjacent BMs
Adjustments Statistics	Number of Bench Marks	100,000 (est.)	450,000 (US only)
	Km of Leveling Data	75,159 (US) 31,565 (Canada)	1,001,500
Published Information	Orthometric Height Type	Normal	Helmert
	Orthometric Height Units	Meters	Meters
	Gravity Value	Normal	“Actual”

## **Development of the Time Dependent NAVD88 (2004.65) Reference Framework for Southeastern Louisiana**

Beginning in 2004, NGS began a series of reobservations in Louisiana for the purpose of updating the NAVD88 published heights in the region in support of hurricane evacuation route mapping. These reobservations included both GPS campaigns and leveling observations. The GPS data were collected according to the guidelines in Publication 58 “GPS Derived Ellipsoid Heights” (NOAA 1997) and the draft guidelines in Publication 59 for “GPS Derived Orthometric Heights” (NOAA 2005). These guidelines required a set of three (3) five and one half (5½) hour sessions with at least 4 hours difference in the starting time of one (1) session on different days. The data collected was processed using the NGS program PAGES and adjusted using the NGS program ADJUST. However, prior to this adjustment, the published orthometric heights of bench marks in the Gulf Coast region from Pensacola, FL west to Houston, TX (which included benchmarks occupied in the GPS reobservations in Louisiana) were updated using the most recent subsidence rates as published in Technical Report 50 (NGS 2004) applied to previous observation data and adjusted. This readjustment used 151 previously observed level lines connecting across the entire region consisting of 16,331 benchmarks. Rates of all published benchmarks included in Technical Report 50 (NGS 2004) were applied. A total of 85 such benchmarks were part of this reobservation campaign.

When the GPS-derived orthometric heights were compared with leveling data (corrected for subsidence rates and tied to non-subsiding benchmarks outside the subsidence area) at these 85 benchmarks, there was a variety of agreements and disagreements. First, 32 of the 85 benchmarks showed better than 2 cm agreement between the GPS-derived and leveling-derived orthometric heights, indicating very good subsidence rates at those points.

After finding the 32 points to have the most reliable subsidence rates, their heights were then held as stochastic constraints (along with fixing the heights of 4 points outside the subsidence area) in a constrained adjustment of all 85 benchmarks. The resultant adjustment of 85 heights was given the notation “NAVD88 (2004.65)”, where the 2004.65 is the date (in years and decimal portions of a year) of the midpoint of the observation campaign. The formal accuracy estimates on these 85 benchmarks fall in the 2 to 5 cm range. Note that even as these points have been adjusted to 2004.65, they are all susceptible to subsidence, and therefore it will be critical to use CORS data and possibly future re-leveling to re-adjust these heights and recompute their subsidence rates with a higher accuracy than the 2004.65 adjustment produced.

The NAVD88 (2004.65) adjustment, again, was not a local adjustment. It went outside of the subsidence area and held fixed what was felt to be stable benchmarks. The four bench marks held fixed were: LAKE HOUSTON 2050, which is a galvanized steel pipe driven to a depth of 2050 feet; 872 9816 TIDAL 1 a TIDAL Benchmark in Pensacola, Florida; FOREST EAST BASE in Scott County, Mississippi; and M 237 in Latanier, Louisiana. A free adjustment holding LAKE HOUSTON 2050 fixed was run with the results shown in the following table. The difference between the NAVD88 (1994) and NAVD88 (2004.65) reflects the apparent subsidence of the benchmarks due to the procedures used in the adjustment.

<b>Table 3 Louisiana VTDP Free Adjustment</b>			
<b>DESIGNATION</b>	<b>PUBLISHED meters</b>	<b>ADJUSTED meters</b>	<b>PUB-ADJ meters</b>
872 9816 TIDAL 1	1.3479	1.3741	-0.0262
FOREST EAST BASE	136.4527	136.4622	-0.0095
LAKE HOUSTON 2050	17.0714	CONSTRAINED	0.0000
M 237	20.3830	20.3422	0.0408

The geographical location of these fixed benchmarks relative to the Southern Louisiana subsidence area are shown in Figure 4 below.



Figure 4. Location of fixed benchmarks defining NAVD88 (2004.65)

### Accuracy Assessment of the NAVD88 (2004.65) Framework in Southeastern Louisiana

During IPET field survey operations in early 2006, a problem was detected at benchmark GRAHAM which is located along the Lake Pontchartrain Lakefront near the Orleans Avenue Outfall Canal. It was noted that the elevation differed by 0.29 feet (8.84 cm) between a recently

observed GPS elevation and the updated NAVD88 (2004.65) elevation. This was higher than expected and several questions were asked about the GPS procedures to ensure nothing had gone astray. It was decided to run conventional 3rd Order levels from station ALCO, one of the 85 NAVD88 (2004.65) published stations to station GRAHAM. This level run checked the published NAVD88 (2004.65) elevation of station ALCO with the unvalidated NAVD88 (2004.65) elevation of station GRAHAM by 0.03 feet (0.0091 meters), less than a centimeter. This validates station GRAHAM and indicates the network accuracy to be well within the 2 to 5 centimeters stated by the NGS as the accuracy of the 85 existing stations of the NAVD88 (2004.65) adjustment. The problem was later discovered to be a HI error on the GPS antenna setup that was subsequently corrected. This, along with other observations made during the IPET study, validates the VTDP rates and NOAA procedures used by IPET to determine the NAVD88 (2004.65) elevations on additional benchmarks established to be used as the foundation for the vertical control in Southeastern Louisiana.

### **Tidal Reference Datums**

Tidal datums are used to establish local tidal phase averages as reference levels from which to reckon height or depth observations. One of these tidal averages is the mean sea level in the water surrounding the gage. Mean sea level is the basis for hurricane protection structures in the New Orleans region. Observations are typically taken at a tide gage that has been collecting data for a period of over a 19 year National Tidal Datum Epoch (NTDE). This time period allows inclusion of all variations in the path of the moon about the sun. The Louisiana coast has anomalous relative sea level trends compared to most other geographic regions in the United States. This is due to a general subsidence of land in this area, which has been occurring at a rapid rate. Tidal datums are locally derived and should not be extended into areas which have differing hydrographic characteristics, without substantiating measurements. The most commonly used tidal datums used in engineering are:

- Mean High Water (MHW) - the average height of all high waters at a place, covering a 19-year period. Heights of bridges over navigable waterways and legal coastal shoreline boundaries are typically referred to this datum. Coastal shorelines shown on navigation charts typically (but not always) depict MHW whereas depths on the same chart are referred to Mean Lower Low Water. Exceptions to this are found in Corps of Engineers inland navigation charts.
- Mean Tide Level (MTL), a plane often confused with LMSL that lies close to LMSL. MTL is the midpoint plane exactly between the average of MHW and MLW at a tide station. The difference is MTL does not include all the tide levels (i.e. MHHW and MLLW) unless the tide at a particular location is diurnal. Hydraulic design manuals sometimes refer to MTL as being synonymous with Mean Sea Level.
- Mean Sea Level (MSL) or Local Mean Sea Level (LMSL) - the average height of the surface of the sea at a tide station for all stages of the tide, typically (but not always) covering a 19-year period which is usually determined from hourly height readings measured from a fixed and predetermined reference level.

- Mean Lower Low Water (MLLW) - the average height of the lower of the two low waters occurring in a day, at a tide gage over a 19-year period. Coastal navigation projects are referred to this datum. This datum superseded Mean Low Water (MLW) which was previously used as the navigation reference datum for the East Coast CONUS.
- Mean Low Gulf (MLG) – a low water tidal datum unique to Gulf Coast Districts, used as a navigation (and construction) reference datum in coastal waterways such as the Gulf Intracoastal Waterway (GIWW), the Mississippi River Gulf Outlet (MRGO).
- Mean Gulf Level (MGL) – a Gulf tidal datum established ca 1899 from which Mean Low Gulf (MLG) is derived and defined to this day. Presumed to be Mean Sea Level (MSL) at 1899 origin in Biloxi, MS.

Additional details on these tidal reference planes are covered in a subsequent section in this Volume, including references to NOAA technical publications in that section and listed in the References section of this Volume.



## **Other Reference Datums used for Navigation and Flood Control Structure Construction in Southeastern Louisiana**

A variety of vertical reference datums have been used in the Southeastern Louisiana region over the past 150 years. Although most of these datums have been superseded, some are still in use. Older datums still in use are basically local reference systems that bear no firm relationship to the current geodetic or water level reference frameworks. It is important to understand these datums when evaluating historical design documents. Examples include the New Cairo Datum (NCD) used to reference pump station, utility grade, and real property elevations, and the MLG Datum used for navigation and some flood protection structures.

### **New Cairo Datum of 1910**

An historical background on some of the various datums in this region is contained in the following excerpt taken from a US Army Corp of Engineers Report:

“In 1850, pursuant to an Act of Congress, the Secretary of War directed Mr. Charles Ellet Jr. to make a complete survey of the Ohio and Mississippi Rivers, with a view toward a master plan for flood prevention and navigation. In 1876, before the Mississippi River Commission was formed to coordinate all activities on the river, a survey of the Mississippi was begun in the vicinity of Cairo, Illinois, nicknamed Little Egypt. A temporary datum was adopted at 300 feet below a plane known as the Cairo City Datum of 1871. When the same survey was begun in the vicinity of Memphis in 1877, another temporary datum was adopted at 225 feet below the high water of June 23, 1858 at Memphis without any connection to the lower Delta Survey Datum of 1858. The first connection by precise levels between Memphis and Cairo was completed in 1880. The Mississippi River Commission established a tide gage at Biloxi, Mississippi. In 1882, a final value was adopted for Mean Gulf Level by the Mississippi River Commission based on the mean years of 1882, 1884, 1896, 1897, and 1898. In 1890, re-leveling was started at Fort Adams, Mississippi. The re-leveling ran south to Baton Rouge, Louisiana and north to Cairo, Illinois. In 1910 the level line from Memphis to Cairo was completed.

The U.S. Coast & Geodetic Survey (USC&GS) adopted the Mississippi River Commission value of Mean Gulf Level of 1899 and used it in the general adjustment of 1898, 1903 and 1907. The USC&GS later performed the General Adjustment of 1929, in reference to adjustments and datum relationships. The published elevations of the Mississippi River Commission for level lines between Biloxi and New Orleans and along the Mississippi River are mainly observed elevations based on one tide station, without orthometric corrections applied or corrected for closure. The relationship of Mississippi River Commission Vertical Datums with the Mean Sea Level Datum of 1929 will vary as a function of observational error and as the orthometric height varies. In 1944, the varying difference was noted between Mississippi River Commission Vertical Datum and USC&GS 1929 resulted in the tie-point method being established. However, the tie-point method seems to have faded from use. The Mississippi River Commission Vertical Datums have evolved into merely a number of indices that are transformed by algebraic addition. The true relations between the various Mississippi River Commission Vertical Datums and Mean Sea Level 1929 are now obscured by time and no longer used. The index relationships are as follows:

<b>Table 4 Historical Datums in Southeast Louisiana Region<sup>1</sup></b>	
<b>Datum</b>	<b>Conversion to Mean Sea Level 1929</b>
Ellet Datum of 1850	unknown
Delta Survey Datum of 1858	0.86
Old Memphis Datum of 1858	-8.13
Old Cairo Datum of 1871	-21.26
New Memphis Datum of 1880	-6.63
Mean Gulf Level Datum (preliminary) 1882	0.318
Mean Gulf Level Datum of 1899	0.00
New Cairo Datum of 1910	-20.434
Mean Low Gulf Level Datum of 1911	-0.78
Note: Datums and Conversions (all differences are in feet). <sup>1</sup> Reference: Point of Beginning Magazine, "Surveying Little Egypt," by Milton Denny, PLS. Reference also Mississippi River Commission Annual Report for 1899, p. 3296, and Stages of the Mississippi River for 1937, p. LXXIII.	

The Cairo Datum (also referred to as New Cairo Datum or the Cairo Datum of 1910) was originally based on a benchmark at a Corps of Engineers facility in Cairo, Illinois, at the confluence of the Ohio and Mississippi Rivers. The General Survey of 1879 ran levels down the Mississippi River to New Orleans. The starting elevation of the benchmark in Cairo was arbitrarily increased to ensure that elevations values downstream would always be positive. In the New Orleans area, the arbitrary reference for the Cairo Datum is 20.434 ft below Mean Sea Level—thus all land elevations in this region are positive on this datum. No benchmark or epoch for this Mean Sea Level relationship could be found in the literature. Thus, the arbitrary 20.434 ft relationship is no longer valid—Cairo Datum is simply a relative reference system. It is still used by the Sewerage and Water Board and the New Orleans District in pump station construction specifications.

### **Mean Gulf Level (MGL) and Mean Low Gulf (MLG) Datums**

A 1 January 1944 New Orleans District memorandum entitled "Notes on the Relationship between Various Datum Planes that have been used by the New Orleans District" describes the origins of the Gulf-based datums. This memorandum was excerpted in the "Louisiana Engineer," dated October 1991.

On June 21, 1899 a value of 6.083 ft on the staff gage at Biloxi, MI was adopted by the Mississippi River Commission (MRC) as 'mean level of the Gulf of Mexico at Biloxi, MI'

The elevations of Mean Gulf Level and Mean Sea Level at Biloxi, MI are the same as shown by the 1929 General Adjustment of the first order level net by the USC&GS, which gives the elevation of PBM [permanent benchmark] KENNOR (BOLT) as 18.097 ft above Mean Sea Level (see USC&GS Report of 1903).

The MRC stage pamphlets show that the elevation of PBM KENNOR (BOLT) 24.181 ft above the zero of the gage, or 18.098 ft above Mean Gulf level (MLG), a difference of 0.001 ft, which is negligible. See Report of Chief of Engineers, US Army, 1900 party 7, p. 4726.

The 1941 Alluvial Valley Adjustment gives the elevation of PBM KENNOR (BOLT) as 18.146 ft, or 0.049 ft higher than the 1929 General Adjustment.

The elevation of Mean Low Gulf (MLG) Datum as established by the former First New Orleans District is 0.78 ft below Mean Gulf Level.

Of significance is that the 0.78 ft difference from Mean Sea Level (i.e., Mean Gulf Level (MGL)) down to Mean Low Gulf (MLG) is still being used as a conversion factor throughout the region even though this relationship was established many decades ago at a single point in Biloxi, Mississippi. The origin of the 0.78 ft value is uncertain; however, it would most likely have been based on the tidal range at Biloxi—the average half tide range currently being about 0.79 ft (NOAA gage 874 3735). Tidal ranges are not constant in a region—they will vary based on the tidal hydraulics. Benchmarks with original MLG datum elevations may not have been updated for subsidence and sea level changes (apparent sea level rise)—potentially one to three foot differences. Since MLG is the accepted reference datum for many navigation projects, use of original MLG elevations that are not corrected for apparent sea level rise results in significant over-dredging relative to a current low water reference datum. Dredging and other construction are performed relative to the MLG datum.

Relationships between MLG and the NOAA certified Mean Lower Low Water (MLLW) reference navigation datum have been estimated for selected places in the region. These estimates are used to convert MLG to MLLW for input onto NOAA navigation charts. Figure 5 below illustrates MSL and MLG datum conversions currently used by the New Orleans District. A constant 0.78 ft conversion does not consider locally varying tidal ranges. MLG is still used as the reference datum for the GIWW, MRGO, portions of the Mississippi River, among others.

On 1 April 1993, HQUSACE issued a policy directive that local coastal datums such as Mean Low Gulf should be converted to the NOAA certified Mean Lower Low Water reference datum. This directive was promulgated in an Engineer Technical Letter (ETL 1110-2-349) titled “Requirements and Procedures for Referencing Coastal Navigation Projects to Mean Lower Low Water Datum.” (A complete copy of this technical letter is included in the Technical Appendix 38 to this Volume. This letter was subsequently superseded by inclusion in EM 1110-1-1005).

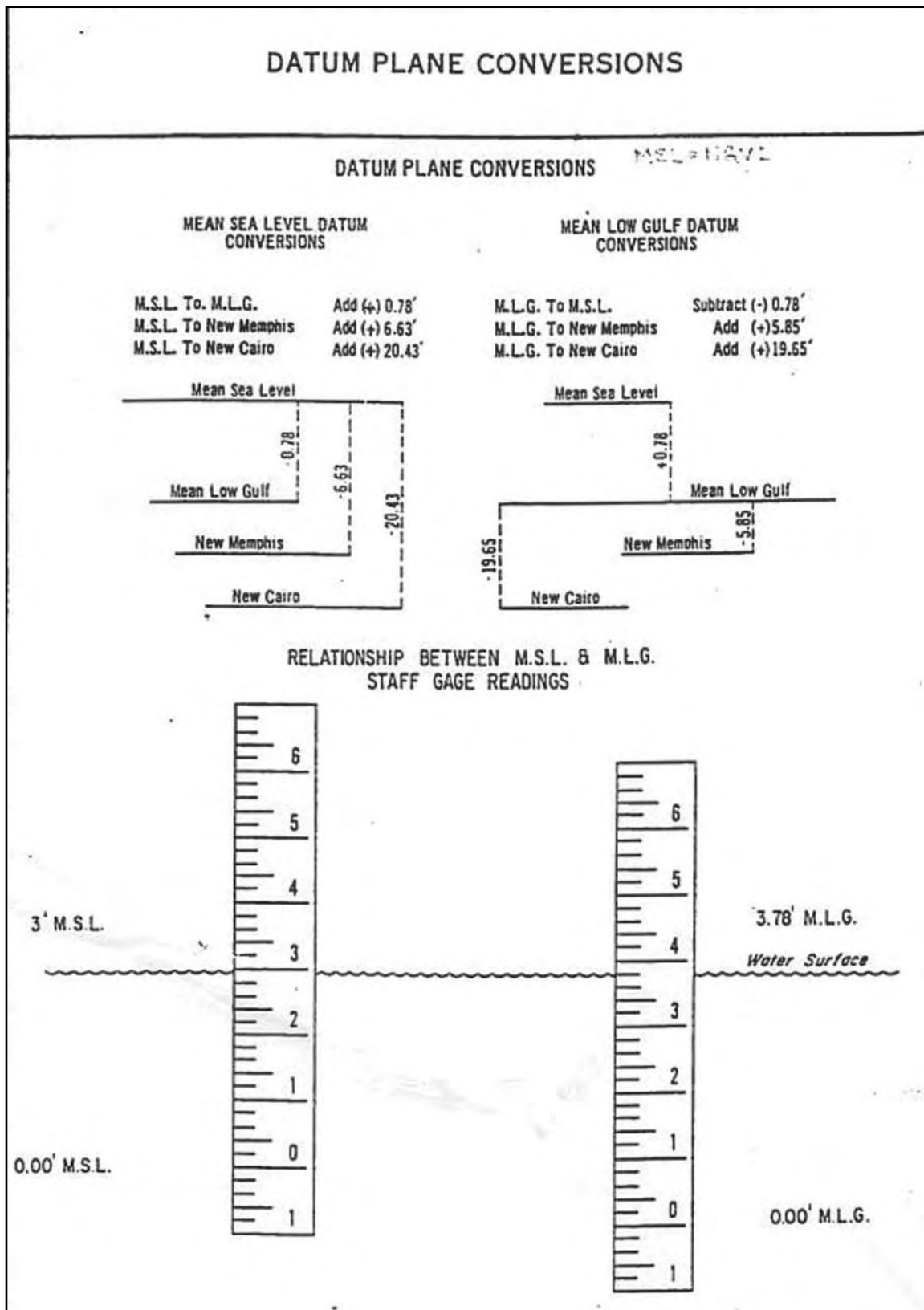

Figure 5. New Orleans District Datum Plane Conversions

As stated in the technical letter, its purpose was to "... provide guidance, technical considerations, and general implementation procedures for referencing coastal navigation projects to a consistent Mean Lower Low Water (MLLW) datum based on tidal characteristics defined and published by the U.S. Department of Commerce. This guidance is necessary to implement applicable portions of Section 224 of the Water Resources Development Act of 1992." WRDA 92, Section 224, specified that USACE project datums and NOAA marine charting datums shall be consistent. WRDA 92 amended Section 5 of the Rivers and Harbors Appropriation Act of 1915 to define project depths of operational projects as being measured relative to a MLLW reference datum for all coastal regions.

The 1993 Technical Letter specifically directed Districts to implement the WRDA 92 provisions, stating "Corps navigation projects that are referenced to older datums (e.g., Mean Low Water along the Atlantic coast or various Gulf coast low water reference planes) must be converted to and correlated with the local MLLW tidal reference established by the NOS." The letter provided technical guidance on performing the conversions. These implementation actions were apparently not implemented in the New Orleans District; presumably under the interpretation that WRDA 92 could not supersede the original project authorization documents containing the older MLG datum reference.

It should be noted that other USACE Districts on the East and Gulf Coasts have not fully implemented the provisions of ETL 1110-2-349.

### **Mississippi River Low Water Reference Plane (LWRP) Datums**

The LWRP is the statistical elevation profile of the Mississippi River from which river stage elevations are referenced. There are currently two active LWRP "epochs" of the Mississippi River: "LWRP 1974" and the "LWRP 1993."

This hydraulic-based reference plane is established from long-term observations of the river's stage, discharge rates, and flow duration periods. The low water profile was developed about the 97% flow duration line. The elevation of the LWRP drops gradually throughout the course of the Mississippi; however, some anomalies in the profile are present in places (particularly in areas containing a rock bottom or at control structures). The gradient is approximately 0.5 ft per river mile. The ever-changing river bottom will influence the LWRP gradient. Changes in the stage-discharge relationship will influence the theoretical flow line for the LWRP.

On the Mississippi River, between the mouths of the Missouri and the Ohio Rivers (the Middle Mississippi River), depths and improvements are referenced to the LWRP. No specific LWRP year is used for the Middle Mississippi north of Cairo, IL. Below Cairo, IL, south to the Head of Passes, depths and improvements along the Mississippi River are referenced to the LWRP. At Head of Passes south of Pilot Town, the LWRP merges into a tidal reference system (both MLLW and MLG). Below Head of Passes, elevations in the New Orleans District Riverbook are referenced to NGVD29. Mean Low Gulf (MLG) is also referenced at gages along these lower portions of the Mississippi River. The LWRP 1974 from mile 313.7 to mile 242.0 is based on the 97% discharge duration at Tarbert Landing (1954-1973) and corresponding stages; mile 242.0 to Head of Passes is based on the mean of 40 years (1891-1930) at regular Mississippi

River Commission (MRC) gages, and adjusted from low water information obtained between September 1931 and November 1933. Near Venice, LA the Mississippi River LWRP transitions into a purely tidal regime although the tidal characteristics are present in the flow profile as far north as Baton Rouge.

Construction and improvements along the river are performed relative to the LWRP at a particular point. Differences in LWRP elevations between successive points along the river are determined from simultaneous staff readings and are referenced to benchmarks along the bank. The LWRP slope gradients between any two points must be corrected by linear interpolation of the profile. Thus, over a typical 1-mile-long section of river with a 0.5-ft gradient, each 1,000-ft interval river cross section will have a different LWRP correction, each dropping successively at 0.1-ft increments.

Guidance in EM 1110-2-1003 (Hydrographic Surveying) noted that “...from 1993 on, NAVD88 was intended to replace NGVD29 as the common reference plane from which LWRP 1974 elevations are measured. The relationship of all project datums to both NGVD29 and NAVD88 will be clearly noted on all drawings, charts, maps, and elevation data files. All initial surveys should be referenced to both NAVD88 and NGVD29. If this is not possible then NGVD29 should be used as the common reference plane from which LWRP 1974 elevations are measured until the move to NAVD88 can be made.”

Over the past five years, the New Orleans District has conducted extensive geodetic surveys along the Mississippi River between Baton Rouge and Venice. These GPS-based vertical control surveys at various river gages effectively provided conversion references between the LWRP and NAVD88—and post-Katrina, with the updated NAVD88 (2004.65) adjustment. IPET GPS surveys performed in January and February 2006 connected these earlier GPS surveys at selected gage sites—providing additional information to update the prior surveys to the NAVD88 (2004.65) reference.

# GPS Data Collection and Processing to Update Reference Elevations on Southeastern Louisiana Tide Gages

## Development of GPS Survey Data Collection Network Design

In order to develop a relationship between the local mean sea level and the current geodetic vertical network across the project area, measurements were made between tidal stations and the geodetic vertical network. This data collection effort was referred to as the IPET Phase 1 survey. The Phase 1 survey involved GPS static survey measurements of existing and historical NOAA and USACE water level and tidal stations measured relative to NAVD88 (2004.65) benchmarks. Because of time constraints and to meet the project schedule, the idea to use existing and historical gage information was chosen versus installing gages over greater New Orleans for a period of one year. Conventional leveling, using precise digital leveling instruments, was used to measure differences between a minimum of three tidal benchmarks at each tidal station location to check for consistency as required by NOAA. GPS surveys were performed using four NAVD88 (2004.65) benchmarks and four CORS for each tidal benchmark elevation required. All GPS receivers performed two sessions at each site for a session duration of four hours. A total of seven gages were connected by GPS observations to the geodetic vertical framework.

## Static GPS Survey Phases

Three subphases of GPS surveys were planned in November 2005. Two phases were planned from a meeting in November 2005 and a third phase was added and then abandoned as the crews found tide gauge sites underwater and monuments destroyed. The phases were called Phase 1a, Phase 1b, and Phase 1c.

The Phase 1a GPS static survey design unfolded as government personnel and contractors slowly reentered restricted areas just outside the City of New Orleans. Originally six tide stations were to be measured for the purpose of tying the tidal datums to the geodetic datum in Phase 1a. Three of the six tide stations were found to be totally destroyed during a reconnaissance survey to recover monuments and take photographs of these tide station sites. On 9 November 2005, IPET team members visited the site of NOAA Tide Station 876 1426 Greens Ditch, Lake St. Catherine to recover tidal benchmarks. They reported the entire area had been destroyed by Hurricane Katrina with no sign of “All in the Family Camp” (a reference sited in the benchmark descriptions) or any of the tidal benchmarks. They reported no references existed to measure distances in order to recover the monuments. On 9 December 2005, personnel from IPET and 3001, Inc. visited Tide Station 876 1529, Martello Castle, Lake Borgne. A photograph (Figure 6) taken with a camera direction to the northeast shows the complete destruction of the castle. The three tidal benchmarks on this structure are considered destroyed. To the southeast of the castle on the marsh shoreline, four tidal benchmarks A, B, C and D were monumented in 1982; however, the personnel indicated



Figure 6. Martello Castle, Lake Borgne



that since 1982 those marks would now be 30 or 40 feet off the shoreline underwater. On 9 December 2005, personnel from IPET and 3001 visited Tide Station 876 1305, Shell Beach, Lake Borgne (Figure 7). Three photographs taken showed the total destruction of the tide station that once recorded water level measurements from a large concrete quay built in World War II. One photograph to the west with the Fort Beauregard ruins in the background depicts the shoreline difference since 1982. The tidal benchmark in the foreground assumed to be 1305F or 1305G is bent and out in the water. This shoreline retreated at least 20 to 30 feet. One tide station at the New Orleans District Office was added to the survey. NOAA named the station Carrollton. The USACE tide station was not measured to NOAA standards; however, useful information for this report will be tabulated including this tide station on the Mississippi River.



Figure 7. Shell Beach, Lake Borgne

Phase 1b changed four or five times during the reconnaissance. Access to most of the tide stations in this area are by boat. The final GPS network for this static survey included NOAA Tide Stations: 8761602, Lake Judge Perez, Hermitage Bayou and 876 1799, M.V. Petroleum Dock, Bayou St. Denis. Also included was a USACE tide station located at West Point, a la Hache on the Mississippi River. Seven benchmarks were recovered at 876 1602, Lake Judge Perez, Hermitage Bayou (Lake Judge Perez), one of which was damaged. This site was used in Phase 1b observations. The tide station USACE West Point, a la Hache, Mississippi River was visited and incorporated into the Phase 1b GPS network. At tidal station 876 1799,

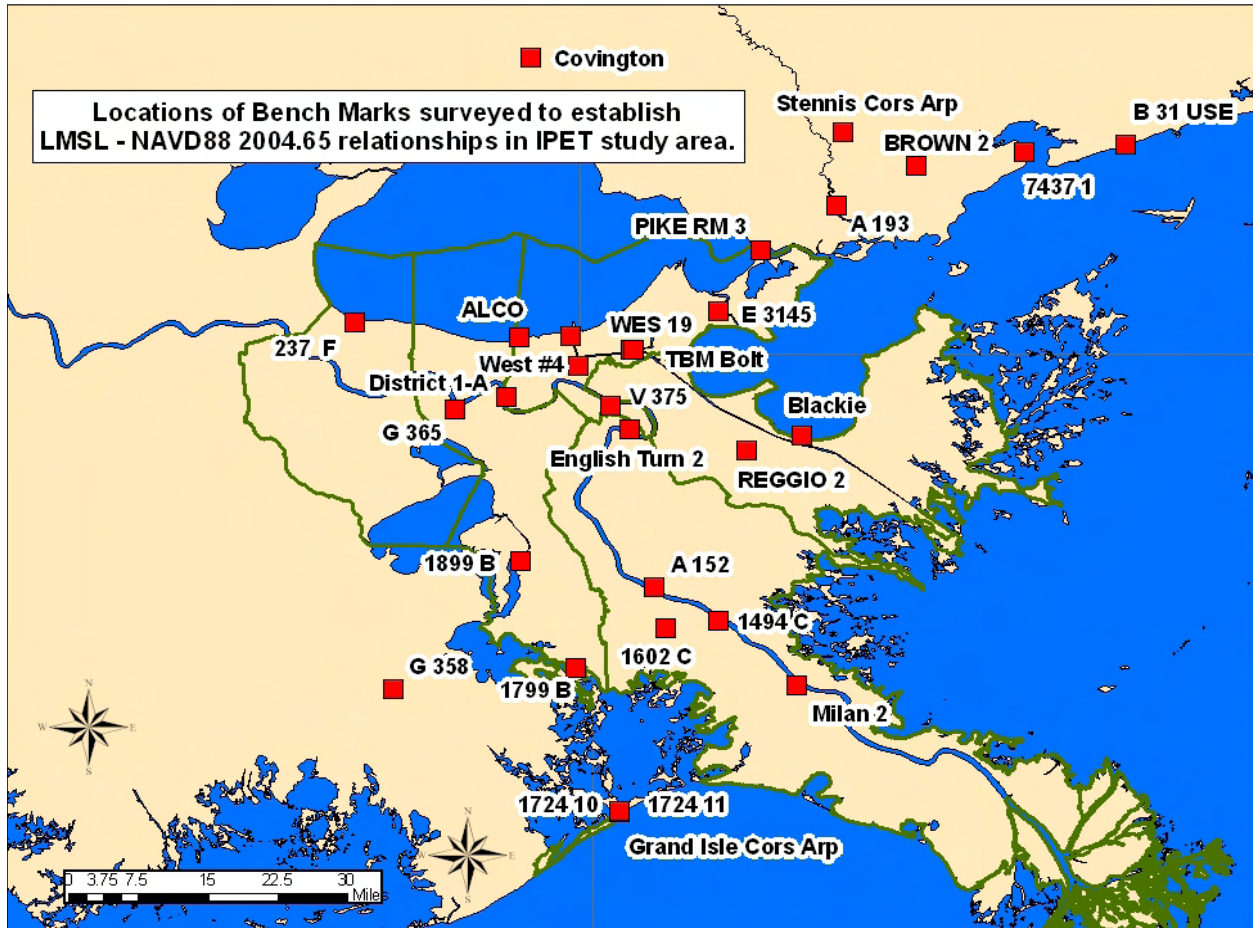

Figure 8. Phase 1a and Phase 1b geodetic connections established by 3001, Inc.

M.V. Petroleum Dock, Bayou St. Denis (MV Petro), 4 of the 5 monuments were recovered. Several tidal stations that were proposed to be included in the Phase 1b survey were reported destroyed. Only two primary NOAA benchmarks at USACE Alliance, Mississippi River (Alliance) were not recovered. Three NOAA vertical rod marks were recovered along the highway. Instead of using this site, the tidal station at Empire was used since more monumentation listed on the description sheet were recovered at that site. It was also in close proximity to one of the NAVD88 (2004.65) marks, so only level work needed to be performed here. The tidal station 876 1679 St. Mary's, Barataria Bay (St. Mary's Point) was not used since no monuments were recovered at this site as it is now in open water. The tidal station 876 1108 Bay Gardene, Gulf of Mexico, was not used since insufficient monuments were recovered for it to be considered for use in the Phase 1b scheme. One of the monuments was found bent over, another was in about three feet of water, and another was believed to be under a pile of shell material. Pictures were taken to document the site.

The initial Phase 1c survey was removed due to time constraints, access to tidal benchmarks, and speculation, based on aerial photography, that the marks would not be found in useable condition. Another task order called Phase 1c was executed 28 February 2006 to identify, if possible with GPS, a 0.1-foot difference noticed in the Phase 1a measurements at Tide Station

876 1927 U.S.C.G, New Canal relative to Tide stations 876 1487, Chef Menteur and 876 1402 , The Rigolets, east of New Orleans. This task order additionally checked the vertical control back to the primary tide gauge for Lake Pontchartrain and Lake Borgne, which is 8747437, Bay Waveland Yacht Club, Bay St. Louis, Mississippi.

The initial design of the GPS networks was based on the location and type of vehicle access to the tide stations. A NOAA requirement for at least four NAVD88 (2004.65) geodetic marks surrounding the tide stations was carried out to ensure no recent benchmark settlements were placing unwanted bias into the GPS network measurements. An IPET member developed the preliminary GPS networks that could be field modified, if necessary, by an IPET field survey coordinator on the ground. The network GPS diagrams were then sent to NOAA for pre-approval to ensure inclusion in the National Spatial Reference System (NSRS) database of geodetic information. The networks were also checked to ensure they met NGS GPS derived orthometric height specifications for data collection under the NGS two-centimeter standard—(NOAA 2005).

The Phase 1a GPS survey was exclusively land vehicle access after Martello Castle and Shell Beach tide stations were found destroyed. The Phase 1b GPS survey network went through numerous changes as many sites were either destroyed or found under water. A few USACE water level gauge sites on the Mississippi River were added and removed as field conditions changed.

### **GPS Data Collection and Processing Procedures**

All of the data collection for this task was accomplished through a St. Louis District A-E Task Order to 3001 Inc, who performed the field data collection and initial baseline processing. A copy of this Task order is attached as Technical Appendix 33 to this Volume (IPET Survey Task Order-Contract Scope of Work--20 Nov 05).

The GPS data was collected using four Trimble 4000 SSE receivers, two Trimble 4000 SSI receivers, one Trimble 4700 receiver, seven fixed-height tripods, six Trimble Compact L1/L2 antennas with ground plane, and one Trimble microcentered L1/L2 antenna with ground plane. The differential leveling was performed with a Leica DNA 03 digital bar code level with digital invar rods. As part of the QA procedure was sent to NOAA for verification that it could meet the requirements of the 2 cm/5 cm specification.

**GPS Data Collection and Processing.** The static GPS network for this part of the project was designed to provide measurements from newly published NGS control points with NAVD88 (2004.65) elevations to existing and historical tide stations. The GPS field procedures followed the NGS Bluebook specifications, as defined by (NOAA 2005), as well as the guidelines established in EM 1110-1-1003. The GPS network design was approved by the NGS IPET representative on the project. The network was designed to include enough existing local control to establish elevations and positions on the temporary benchmarks which were surveyed as part of the network. The network was also tied into Continuously Operating Reference Stations (CORS) in the region. The datasheets for the CORS and the NGS monuments occupied is included as Technical Appendix 35 to this Volume. The network was designed with multiple, simultaneous

occupations, with four hours between start times, of points in order to provide redundant vectors and loop closures.

The GPS observations were processed using Trimble Geomatics Office's baseline processing module, WAVE (Weighted Ambiguity Vector Estimator). Ionosphere-free fixed solutions were found to provide the best results. Preliminary blunder detections were undertaken using "Redundant Vectors" and Global Network Closures and any extremely large errors were eliminated.

The data were adjusted using a minimally constrained geodetic control network to test the network internally, without external constraints, and produce a statistical summary. The statistics from this process are required to be within the tolerances outlined in (FGCS 1988). These tolerances are represented as ellipsoids showing the margin of error value on a graph of the theoretical points, covariance values that indicate the degree of error of the vectors relative to the other vectors in the network, and a chi-square test that compares the predicted variance determined through a least-squares analysis to the observed variance. The summary was then evaluated to eliminate vectors that are outside of the error tolerances to be replaced with redundant vectors that are within the tolerances until all tolerances are met.

The quality of the existing horizontal control was assessed before undertaking the constrained adjustment. Geodetic inverses between the control monuments were compared with the geodetic inverses derived from the minimally constrained least square adjustment results. This distance analysis is especially useful, since it provides a datum invariant means of comparison. Once the minimally constrained network satisfies the requirements of the above tests, control points in the network are selected with an optimum spatial relationship to fully constrain the network to known control points, and have their provided values entered as the position for those points and the network readjusted. The same statistical tests are rerun on the adjusted network, as well as visually comparing adjusted values of control points to provided values of control points not used as constraints. Again, the summary is evaluated to identify vectors outside of the tolerances and constraining points reselected to obtain the best fit to the geoid where all vectors are within the prescribed tolerances.

The preliminary adjustment results showed that the a posteriori variance factor of the network was close to 1.0, as should be desired, and passed the chi-square test. None of the residual components in the network were flagged for possible rejection under the  $\tau$ -max test at the 0.05 level of significance. The relative confidence ellipses reveal that the horizontal positional accuracy between all directly connected pairs of stations in the network were better than (1:100,000) at the 95% level of confidence.

**Leveling Procedures Used.** Leveling to tidal marks in the marsh area were performed to Second Order, Class II modified guidelines that were developed by USACE and NOAA specifically for this project by IPET members. These guidelines are included as Technical Appendix 32 to this Volume (IPET Digital Leveling Specifications). All leveling that was done on land, that could be driven to, followed the Second Order Class I leveling procedures as described by the accuracy specification and standards established by the Federal Geodetic Control Subcommittee (FGCS 1984).

**Preliminary USACE processing of GPS data and network adjustments.** Preliminary processing of the GPS data collected for Phase 1a and 1b was performed by ERDC Topographic Engineering Center and USACE Jacksonville District using Trimble Geomatics Office and Waypoint GrafNet 7.50 software respectively. The preliminary results were used in the computation of the initial calculations for the local mean sea level values.

**Final NGS processing, data validating, Blue Booking, and publishing of Phase 1 survey points.** All of the GPS and leveling data was processed and adjusted to NGS Blue Booking standards for publishing control to provide the final NAVD88 (2004.65) elevations for each tidal station observed in the Phase 1 surveys. During this adjustment process, the data was reprocessed using NOAA program PAGES. This final processing was completed in mid-April 2006 and data was posted on the NGS server at that time. A copy of the final adjustment report prepared jointly by IPET team members is attached as Technical Appendix 31 to this Volume (GPS Network Adjustment-IPET Project Report). These data were used by NOAA to determine the relationship between LMSL and the NAVD88 (2004.65) datum adjustment at the various tide stations. Field leveling abstracts at individual tide gage stations are at Technical Appendix 42.

### **Estimated Accuracy of the Resultant GPS Vertical Control Survey**

The resultant vertical accuracy varied across the project with the most errors, probably settlements, on the south side of New Orleans with the exception A 193 near Mississippi to the northeast. This station was re-adjusted and assigned a vertical height different by 0.22 feet (0.067 meters). The next worst vertical residual of 0.20 feet (0.0602 meters) was in the vector from G 358 to 876 1899 B Tidal, both to the southwest of New Orleans. These are both vertical control points and 876 1899 B Tidal is no longer associated with a NOAA tide station in the current NOAA database. The next largest residual between two stations was 0.16 feet (0.0492 meters) between two different types of control points: a CORS and a NAVD88 (2004.65) vertical control point. The project error quickly drops to a tenth of a foot or 3 centimeters. Comparisons between the free and constrained adjustments described above are tabulated in Technical Appendix 31 to this Volume. With the exception of benchmark A 193 the network fit within the accuracies of the NAVD88 (2004.65) network.

Based on the results of this control survey the vertical accuracy in the New Orleans area should be measured to one hundredth of a foot with desired results to  $\pm 0.05$  ft. The entire region should be thought of as a project to 0.1 ft. The  $\pm 0.1$  ft shifts noted in the GPS static survey did not warrant a re-adjustment of the NAVD88 (2004.65) vertical control in the NGS Database. In other words, the values in the database will not change with the recent survey, except at the new locations. Some of the benchmarks along Route 1 south to Grande Isle should be re-leveled in an attempt to improve the vertical accuracy.

### **Comparison of Provisional and Final Elevation Adjustments**

Table 5 below compares the preliminary elevations of the seven new points established on Phase 1a and Phase 1b static GPS surveys. The preliminary elevations were computed using the commercial geodetic software baseline reduction and adjustment program GrafNet (Version 7.5), holding fixed the VTDP points. These baseline reductions and adjustments were performed

immediately after the observations were performed in January 2006. The computed differences are compared with the final elevations derived by NGS in April 2006.

<b>Table 5 Phase 1a &amp; 1b Comparisons between GrafNet and ADJUST</b>			
	<b>WAYPOINT GrafNet Jan 2006</b>	<b>NGS ADJUST April 06</b>	<b>DIFF Meters</b>
E3145 CHEF MENTEUR	4.834	4.818	0.016
DIST 1A	3.301	3.297	0.004
PIKE RM3	2.805	2.802	0.003
MICHOUD WES 19	-0.113	-0.113	0
1602C LAKE JUDGE PEREZ	0.165	0.163	0.002
1799B MV PETRO	0.77	0.773	-0.003
1494C A LA HATCHE	0.574	0.579	-0.005

The mean difference between the two adjustments was + 2 mm and the standard deviation  $\pm$  7 mm. These small differences indicate that commercial software is adequate to meet vertical accuracies required for engineering and construction control. Commercial software adjustments are significantly more efficient, both in time and cost.

#### **Comparison of CORS-Only Elevation Adjustment**

Table 6 below shows a comparison of a CORS-only solution with the final adjusted elevations—using all 8 hours of static GPS observations. The four CORS sites used are listed in Appendix 31. This GrafNet solution held fixed only the CORS stations and removed the VTDP points from the network.

<b>Table 6 Phase 1a &amp; 1b Comparisons between GrafNet CORS-Only Solution and ADJUST</b>			
	<b>WAYPOINT GrafNet CORS Solution Jan 2006</b>	<b>NGS ADJUST April 06</b>	<b>DIFF Meters</b>
E3145 CHEF MENTEUR	4.837	4.818	0.019
DIST 1A	3.305	3.297	0.008
PIKE RM3	2.809	2.802	0.007
MICHOUD WES 19	-0.105	-0.113	0.008
1602C LAKE JUDGE PEREZ	0.176	0.163	0.013
1799B MV PETRO	0.781	0.773	-0.008
1494C A LA HATCHE	0.584	0.579	-0.005

The mean difference between the two adjustments was + 10 mm and the standard deviation  $\pm$  5 mm. These results are likely biased from the E3145 Chef Menteur result in that this benchmark was located adjacent to a large bridge structure. This indicates that sufficient accuracy for engineering applications is available from CORS without simultaneously occupying 4 to 5 VTDP points as was done during this project. The efficiency and savings from reducing VTDP occupations is significant.

# NOAA Tidal Datum Computational Procedures and Estimated Accuracies in Southeastern Louisiana

## Review of Tidal Datums and Tidal Datum Computation Procedures

The following discussion provides an overview of the working definitions of tidal datums and how they are computed by NOAA. The text is compiled directly from two NOAA major references on tidal datums, NOS CO-OPS 1 (NOS 2001) and NOS CO-OPS 2 (NOS 2003).

### NOAA Definitions of Tidal Datums

The tide is the name given to the alternate rising and falling of the level of the sea due to the gravitational forces of the sun and moon. The observed tide at a given coastal location is a function of the response of the ocean basin from which the tide progresses onshore and any local effects that serve to modify the incoming ocean tide. Fundamentally, the tides are broadly categorized as once daily (diurnal), twice daily (semidiurnal), or a mixture of the two (mixed). The dominant tide type on the East Coast of the U.S. is semidiurnal; mixed on the West Coast. In contrast, the northern Gulf of Mexico exhibits chiefly diurnal tides or mixed tides with the switch from mixed to diurnal varying both with time at a single location and with location along the coast.

A vertical datum is termed a tidal datum when it is defined by a certain phase of the tide. Tidal datums are local datums and should not be extended into areas which have differing hydrographic characteristics without substantiating measurements. In order that they may be recovered when needed, such datums are referenced to fixed points known as benchmarks.

The NOAA definitions of tidal datums are as follows:

**MHHW** is defined as the arithmetic mean of the higher high water heights of the tide observed over a specific 19-year Metonic cycle (the National Tidal Datum Epoch). Only the higher high water of each pair of high waters of a tidal day is included in the mean. For stations with shorter series, a comparison of simultaneous observations is made with a primary control tide station in order to derive the equivalent of a 19-year value (Marmer 1951).

**MHW** is defined as the arithmetic mean of all of the high water heights observed over a specific 19-year Metonic cycle (the NTDE). For stations with shorter series, a comparison of simultaneous observations is made with a primary control tide station in order to derive the equivalent of a 19-year value.

**MSL** is defined as the arithmetic mean of hourly heights observed over a specific 19-year Metonic cycle (the NTDE). Shorter series are specified in the name, like monthly mean sea level or yearly mean sea level (e.g., Marmer 1951; Hicks 1985).



**NOTE:** It needs to be emphasized that tidal datums are locally dependent datums and should not be extended into areas which have differing hydrographic characteristics. This is particularly important in discussing MSL as the plane of the surface of the sea meeting the land which is locally variable and dependent upon topographic features and local tectonic movement. It should become the practice of all who rely on tidal datums to refer to MSL as *Local Mean Sea Level (LMSL)* and to not broaden the practical application of this datum into locations that do not share similar tidal characteristics or its relationship to geodetic datums in regions with dissimilar topography.

**MLW** is defined as the arithmetic mean of all of the low water heights observed over a specific 19-year Metonic cycle (the NTDE). For stations with shorter series, a comparison of simultaneous observations is made with a primary control tide station in order to derive the equivalent of a 19-year value.

**MLLW** is defined as the arithmetic mean of the lower low water heights of the tide observed over a specific 19-year Metonic cycle (the NTDE). Only the lower low water of each pair of low waters of a tidal day is included in the mean. For stations with shorter series, a comparison of simultaneous observations is made with a primary control tide station in order to derive the equivalent of a 19-year value.

In addition, the Mean Tide Level (MTL), Diurnal Tide Level (DTL), Mean Range (Mn), Diurnal High Water Inequality (DHQ), Diurnal Low Water Inequality (DLQ), and Great Diurnal Range (Gt) are defined as follows:

**MTL** is a tidal datum equivalent to the average of MHW and MLW.

**DTL** is a tidal datum equivalent to the average of MHHW and MLLW.

**Mn** is the difference in elevation between MHW and the MLW.

**DHQ** is the difference in elevation between MHHW and MHW.

**DLQ** is the difference in elevation between MLW and MLLW.

**Gt** is the difference in elevation between MHHW and MLLW.

### **Tidal Datum Computation Overview**

There is a variation in the path of the moon about the Earth that has a period of about 18.6 years, and is called the regression of the moon's nodes. The regression of the nodes introduces an important variation into the amplitude of the monthly and annual mean range of the tide. It is the regression of the moon's nodes which forms the basis of the definition of the National Tidal Datum Epoch (NTDE). Because the variability of the monthly mean range is larger than the regression of the nodes, the NTDE is defined as an even 19-year period so as not to bias the estimate of the tidal datum. For datum computation, the National Tidal Datum Epoch is used as the fixed period of time for the determination of tidal datums because it includes all significant tidal periods, is long enough to average out the local meteorological effects on sea level, and by specifying the NTDE, uniformity is applied to all the tidal datums. However, because of relative sea level change, as the years pass, tidal datums become out of date for



navigational purposes and for other applications. Thus, a new NTDE must be considered periodically (Hicks 1981). The policy of NOS is to consider a new tidal datum epoch every 25 years to appropriately update the tidal datums to account for the global sea level change and long-term vertical adjustment of the local landmass (e.g., due to subsidence or glacial rebound) (Gill et al. 1998). NOS has recently updated from the 1960-78 NTDE to a 1983-2001 NTDE in 2003. Estimated relative sea level trends compiled from observations at U.S. tide stations found in Zervas (2001) were used to make this determination that a new NTDE was required.

A primary determination of any tidal datum is based directly on the average of observations over a 19 year period. For example, a primary determination of Mean High Water is based directly on the average of the tabulated observed high waters at a tide station over a 19 year period. Tidal datums must be specified with regard to the NTDE. The four fundamental steps required in computing tidal datums are:

- a. *Make Observations* - Tidal datums are computed from continuous water level observations over specified lengths of time. Observations are made at specific locations called tide stations. Each tide station consists of a water level gauge or sensor(s), a data collection platform or data logger and data transmission system, and a set of tidal benchmarks established in the vicinity of the tide station. NOS collects water level data at 6-minute intervals.
- b. *Tabulate the Tide* - Once the 6-minute interval data are quality controlled and any small gaps filled, the data are processed by tabulating the high and low tides and hourly heights for each day. Tidal parameters from these daily tabulations of the tide are then reduced to mean values, typically on a calendar month basis for longer period records or over a few days or weeks for shorter-term records.
- c. *Compute Tidal Datums* - First reduction tidal datums are determined directly by averaging values of the tidal parameters over a 19-year NTDE. Equivalent NTDE tidal datums are computed from tide stations operating for shorter time periods through comparison of simultaneous data between the short-term station and a long-term station.
- d. *Compute Bench Mark Elevations* - Once the tidal datums are computed from the tabulations, the elevations are referenced to the bench marks established on the land using the elevation differences established by differential leveling between the tide gauge sensor “zero” and the benchmarks during the station operation. The benchmark elevations and descriptions are disseminated by NOS through a station specific published benchmark sheet. Connections between tidal datum elevations and geodetic elevations are obtained after leveling between tidal benchmarks and geodetic network benchmarks. Traditionally, this has been accomplished using differential leveling, however GPS surveying techniques can also be used (NGS 1997).

NOAA makes publicly available tidal datum values for most NOS currently active and historical water level stations via benchmark sheets. All tidal datum values contained in the benchmark report are referenced to MLLW by convention as the “chart datum” used by NOAA’s Office of Coast Survey (OCS) for displaying water depths on NOAA charts. The sheets are also careful to reference all of the associated benchmarks that permit accurate computation of the locally specific tidal datums. By convention all benchmark elevations are also referenced to MLLW. It is the practice of NOS to install a minimum of ten marks for National Water Level

Observation Network (NWLON) stations and a minimum of five marks for subordinate stations installed for hydrographic, photogrammetry surveys, special projects, and contract projects for the USACE (NOAA 2005).

A primary determination of any tidal datum is based directly on the average of observations over a 19 year period. For example, a primary determination of Mean High Water is based directly on the average of the tabulated observed high waters at a tide station over a 19 year period. Tidal datums must be specified with regard to the NTDE. The four fundamental steps required in computing tidal datums are:

- a. *Make Observations* - Tidal datums are computed from continuous water level observations over specified lengths of time. Observations are made at specific locations called tide stations. Each tide station consists of a water level gauge or sensor(s), a data collection platform or data logger and data transmission system, and a set of tidal benchmarks established in the vicinity of the tide station and if possible connected to the geodetic network. NOAA collects water level data at 6-minute intervals.
- b. *Tabulate the Tide* - Once the 6-minute interval data are quality controlled and any small gaps filled, the data are processed by tabulating the high and low tides and hourly heights for each day. Tidal parameters from these daily tabulations of the tide are then reduced to mean values, typically on a calendar month basis for longer period records or over a few days or weeks for shorter-term records.
- c. *Compute Tidal Datums* - First reduction tidal datums are determined directly by averaging values of the tidal parameters over a 19-year NTDE. Equivalent NTDE tidal datums are computed from tide stations operating for shorter time periods through comparison of simultaneous data between the short-term station and a long-term station.
- d. *Compute Bench Mark Elevations* - Once the tidal datums are computed from the tabulations, the elevations are referenced to the bench marks established on the land using the elevation differences established by differential leveling between the tide gauge sensor “zero” and the benchmarks during the station operation. The benchmark elevations and descriptions are disseminated by NOS through a station specific published benchmark sheet. Connections between tidal datum elevations and geodetic elevations are obtained after leveling between tidal benchmarks and geodetic network benchmarks. Traditionally, this has been accomplished using differential leveling, however GPS surveying techniques can also be used (NGS 1997).

Due to time and resource constraints, primary determinations of tidal datums (i.e., using 19 years of data) are not practical at every location along the entire coast where tidal datums are required. At intermediate locations, a secondary determination of tidal datums can usually be made using observations covering much shorter periods than 19 years. Results are corrected to an equivalent mean value by comparison with a suitable control tide station (Marmer 1951).

Conceptually, the following steps need to be completed in order to compute equivalent NTDE tidal datums at short-term stations using the method of comparison of simultaneous observations:

- a. Select the time period over which the simultaneous comparison will be made.
- b. Select the appropriate control tide station for the subordinate station of interest based on location, tidal characteristics, and availability of data.
- c. Obtain the simultaneous data from subordinate and control stations and obtain or tabulate the tides and compute monthly means, as appropriate.
- d. Obtain the accepted NTDE values of the tidal datums at the control station from NOS via the CO-OPS Website (<http://tidesandcurrents.noaa.gov>).
- e. Compute the mean differences and/or ratios (as appropriate) in the tidal parameters between the subordinate and control station over the period of comparison.
- f. Apply the mean differences and ratios computed in step 5, above, to the accepted values at the control station to obtain equivalent or corrected NTDE values for the subordinate station.

The computations use slightly different formulas depending on the type are some key datum computation methods used by NOS (in step f above) that differ slightly depending upon the tidal characteristics and the type of tide.

**Standard Method.** This method is generally used for the West Coast and Pacific Island stations and is also called the Range Ratio Method. First, equivalent NTDE values for MTL, Mn, DHQ and DLQ are determined by comparison with an appropriate control. From these, the following are then computed:

$$MLW = MTL - (0.5 \times Mn)$$

$$MHW = MLW + Mn$$

$$MLLW = MLW - DLQ$$

$$MHHW = MHW + DHQ$$

**Modified-Range Ratio Method.** This method is generally used for the East Coast, Gulf Coast, and Caribbean Island stations. First, equivalent NTDE values for MTL, DTL, Mn, and Gt as determined by comparison with an appropriate control. The difference from the Standard Method is that ratios of the DHQ and DLQ values are not used to compute MHHW and MLLW because numerically the values are very small for semidiurnal tide areas and consequently a Gt ratio about DTL is used instead. From these, the following are computed:

$$MLW = MTL - (0.5 \times Mn)$$

$$MHW = MLW + Mn$$

$$MLLW = DTL - (0.5 \times Gt)$$

$$MHHW = MLLW + Gt$$

Note: For the short-term stations in the IPET project region, the type of tide is chiefly diurnal with one and one low tide per tidal day. As such, the Modified Range Ratio method described above is used by NOAA to compute equivalent 19-year NTDE tidal datums at short-term stations.

### Errors in Determination of Tidal Datums using NOAA Procedures

Errors in determination of tidal datums are derived from the nature of the basic theory of the computational process in which equivalent NTDE 19-year tidal datums are determined from time series much shorter than 19-years. The error in a tidal datum computed from a 19-year first reduction of data is assumed to be zero (0).

Swanson (1974) performed an error analysis for determining tidal datums from short-term observations. Using the comparison of simultaneous observations method, Swanson developed datum uncertainties at 1, 3, 6, and 12 month time periods based on comparisons between NWLON station pairs proceeding along the coast. One NWLON station was selected as control, the other as subordinate. The resulting datums for the shorter time periods were compared to the accepted values based on a NTDE. This comparison resulted in the generalized accuracy estimates for tidal datums determined at short-term stations for the East Coast, West Coast, and Gulf Coast. These are summarized in Table 7.

Series Length (months)	East Coast		Gulf Coast		West Coast	
	(cm)	(ft.)	(cm)	(ft.)	(cm)	(ft.)
1	3.96	0.13	5.48	0.18	3.96	0.13
3	3.05	0.10	4.57	0.15	3.35	0.11
6	2.13	0.07	3.65	0.12	2.43	0.08
12	1.52	0.05	2.74	0.09	1.82	0.06

The uncertainties of datums for Gulf Coast stations are generally higher because of the low amplitude tidal signal in that area and the relatively larger effects of weather on the water levels than the East and West Coasts. These generalized accuracy estimates have been used operationally for error budgets and error estimates for NOAA tidal datum products since the report was issued in 1974. It is recognized that these are regional in nature and are also expressions of maximum errors as subordinate stations are typically installed between NWLON stations, thus shortening the geographic and tidal distances between control and subordinate pairs. Because of these constraints, the Swanson regional pooled analysis does not provide the most precise technique for operational purposes to estimate errors at the resolution needed for exact locations of interest.

In applied research performed by NOS (Bodnar, 1981), multiple curvilinear regression equations estimating the accuracy of computed datums were developed using a regression analysis of the standard deviations found in the Swanson (1974) report. Bodnar's analyses effectively determined which independent variables related to differences in tidal characteristics might explain the variations in the Swanson standard deviations using the standard deviations as the dependent variables. The list below summarizes the independent variables that proved to be highly significant and displays them in equation form with the slope coefficients for each variable produced by the regression model. Bodnar noted deficiencies of his approach in the sample size, interdependence of station pairs, and statistical population representation. Operationally, NOAA has adopted the formulas for Mean Low Water for use in practice to estimate the error in datum determination because the low water differences express the effects of shallow water and bottom friction better than MHW and provide the most conservative estimate.

The regression equations and parameters for estimating uncertainties in tidal datums for Mean Low Water from series lengths 1 to 12 months (from Bodnar, 1981).

$$S1M = 0.0068 \text{ ADLWI} + 0.0053 \text{ SRGDIST} + 0.0302 \text{ MNR} + 0.029$$

$$S3M = 0.0043 \text{ ADLWI} + 0.0036 \text{ SRGDIST} + 0.0255 \text{ MNR} + 0.029$$

$$S6M = 0.0019 \text{ ADLWI} + 0.0023 \text{ SRGDIST} + 0.0207 \text{ MNR} + 0.030$$

$$S12M = 0.0045 \text{ SRSMN} + 0.128 \text{ MNR} + 0.025$$

where

S = standard deviation (in feet)

M = number of months of subordinate station observation

ADLWI = absolute time difference of the Low Water Intervals between control and subordinate stations (in hours)

SRGDIST = square root of the geodetic distance between control and subordinate stations (in nautical miles)

MNR = is a mean range ratio that is defined as the absolute value of the difference in mean range between control and subordinate stations divided by the mean range of tide at the control station (using range values in feet), and

SRSMN = square root of the sum of the mean ranges at the control and subordinate stations (in feet)

These equations state that the error in determination of tidal datums at a subordinate station is a function of the geographic distance and the "tidal" distance from the long term control to which simultaneous observations are being made. Tidal distance is expressed by the differences in time and range of tide between the control/short term stations. The further away the station is and the larger the differences in tidal characteristics from the control, the larger the error will be.

Pensacola, Florida is the closest NWLON station with NTDE accepted 19-year datums near the IPET study region. The station's tidal datums are based on a first reduction of hourly height observations over the full NTDE period. The gap in NOAA NWLON coverage in this area will be discussed in the section on sea level trends. It is accepted procedure to “bring in” 19-year equivalent datums to a subordinate short-term station by using an intermediary long-term station if appropriate. Tidal datums at New Canal Station were computed by simultaneous comparison of 9 years of data with concurrent data at Bay Waveland Yacht Club. The accepted tidal datums at Bay Waveland Yacht Club were based upon a simultaneous comparison of 14 years of data with Pensacola, FL. This approach has been found to be more accurate than directly comparing data from New Canal Station with Pensacola because of the extreme geographical and “tidal” distances involved.

NOAA also uses the methodology described in Bodnar (1981) when a station has longer than one year of data to estimate errors in tidal datum determination. Based on this approach, the following procedures were applied to the estimation of the error at New Canal Station using the two-step approach:

**First Component: Error in subordinate datum at New Canal**

$$S (12\text{months}) = 0.0045 \text{ SRSMN} + 0.0128 \text{ MNR} + 0.025 \quad (\text{in feet})$$

$$\text{SRSMN} = \text{SQRT} (\text{GT}_{\text{sub}} + \text{GT}_{\text{con}})$$

$$\text{MNR} = \text{ABS} (\text{GT}_{\text{sub}} - \text{GT}_{\text{con}}) / \text{GT}_{\text{con}}$$

Where New Canal is the subordinate station (sub) and Bay Waveland Yacht Club is the Control (con). This 12-month error estimate is then interpolated to the true series length of 9 years. Thus the error difference between a 12-month estimate and a 19-year estimate for 9-years of observations can be linearly interpolated by:

$$S (9 \text{ years}) = S(12\text{Mo}) \cdot (19 \text{ years} - 9 \text{ years}) / 19 \text{ years}.$$

**Second Component: Error in control datum at Waveland Yacht Club**

$$S (12\text{months}) = 0.0045 \text{ SRSMN} + 0.0128 \text{ MNR} + 0.025 \quad (\text{in feet})$$

$$\text{SRSMN} = \text{SQRT} (\text{GT}_{\text{sub}} + \text{GT}_{\text{con}})$$

$$\text{MNR} = \text{ABS} (\text{GT}_{\text{sub}} - \text{GT}_{\text{con}}) / \text{GT}_{\text{con}}$$

Where Bay Waveland Yacht Club is the subordinate station with 14-years of data and Pensacola is the 19-year Control Station. Thus the error difference between a 12-month estimate and a 19-year estimate for 14-years of observations can be linearly interpolated by:

$$S (14\text{years}) = S (12\text{Mo}) \cdot (19 \text{ years} - 14 \text{ years}) / 19 \text{ years}$$

### **Total Estimated Uncertainty in Tidal Datum Computation for Subordinate Station**

Using the example for New Canal Station above, at the one-standard deviation level, the total uncertainty in the computation of tidal datums at Subordinate (New Canal) based on 9-years of simultaneously compared observations with the Secondary Control station (Bay Waveland Yacht Club) can be expressed as the root-sum square of the component errors described above:

$$S_{\text{total}} = \text{SQRT} (S_{\text{sub}}^2 + S_{\text{con}}^2)$$

At the 95% confidence interval (CI) , the total uncertainty is:

$$1.96 (S_{\text{total}}) = Z \text{ (95\% CI)}.$$

Actual numerical estimates for IPET study stations are presented in the next section.

## Reestablishment of New Canal (17th Street Canal) Gage Station and Associated Tidal Datum Error

One component in determining the LMSL – NAVD88 relationship for the IPET study area involved the re-establishment of the NOAA historical water level station at New Canal (876 1927) located on the southern shore of Lake Pontchartrain near the 17<sup>th</sup> Street Canal levee breach. For this IPET project, NOAA re-established the station as a means to validate datums computed for that site based on the previous 1983-1992 time period. Six minute data collected at the location for a 3-month time period from December 2005 to February 2006 were quality controlled by NOAA analysts and tabulated to obtain monthly means. The means were then compared with simultaneous observations from Waveland, MS as per NOAA standards for computing tidal datums at subordinate stations. Preliminary tidal datums were obtained for New Canal Station for the most recent data. Figure 9 below is a tabular comparison of the results showing the similarity of the elevations and ranges of tide. Mindful that the comparison is between a 9-year period and a recent 3-month period, the datum recovery is considered acceptable, indicating that the new installation and associated bench mark survey were correctly done and the new gauge is operating well. For operational purposes, the datum based on the 9-year time series is still considered the “accepted series.” NOAA is in the process of upgrading and hardening the station at New Canal for long-term operation and will be able to use this station to further update tidal datums and relative sea level trends as time series are accrued.

ACCEPTED_DATUMS 9 years Station ID - 8761927				Preliminary_DATUMS 3 months Station ID - 8761927			
EPOCH: 1983-2001				EPOCH: 1983-2001			
HWL	2.405			HWL			
MHHW	1.430	DHQ	0.000	MHHW	1.418	DHQ	0.004
MHW	1.431			MHW	1.414		
MTL	1.353		GT 0.156	MTL	1.343		GT 0.148
DTL	1.352		MN 0.156	DTL	1.344		MN 0.141
NAVD88				NAVD88			
MSL	1.350			MSL	1.374		
MLW	1.275	DLQ	0.001	MLW	1.273	DLQ	0.003
MLLW	1.274			MLLW	1.270		
LWL	0.518			LWL			
Meters				Meters			

Figure 9. Comparison of presently accepted tidal datums with preliminary tidal datums computed on most recent data from New Canal Station (8761927). Elevations are relative to arbitrary station “0”

The justification for retaining the datums computed from the data on the older, but longer data series can also be illustrated through a datum error analysis described below. The currently published tidal datums for New Canal are based on 108 months of observations from October 1983 through September 1992. These datums are based on the latest 1983-2001 NTDE through comparison of simultaneous observations with the control station Bay Waveland Yacht Club, (874 7437). The accepted tidal datums at Bay Waveland Yacht Club are in turn based on 14 years of observation from September 1979 through August 1993 referenced to the latest 1983-2001 NTDE through comparison of simultaneous observations with the Primary Control Station at Pensacola, FL (872 9840).



The estimation of the uncertainty in tidal datums at New Canal Station is determined from two separate components. The first is the uncertainty of the datums at New Canal using comparison of simultaneous observations with the long-term secondary control station at Bay Waveland Yacht Club. The second component is the uncertainty of the datums at Bay Waveland Yacht Club using the comparison of simultaneous observations with the primary control station at Pensacola. Pensacola accepted tidal datums were determined directly from a reduction of hourly heights from 19-years of observation 1983-2001.

The estimated uncertainty in the tidal datums at New Canal Station based on a 9-year comparison of simultaneous observations with Bay Waveland Yacht Club is 0.021 ft. at the one-standard deviation level. The estimated uncertainty in the tidal datums at Bay Waveland Yacht Club based on a 14-year comparison of simultaneous observations with Pensacola, FL is 0.010 ft at the one-standard deviation level. The total estimated uncertainty in the tidal datum computation for New Canal Station (876 1927) can be expressed as the square root of the sum of the squares of the component errors. As shown in Figure 10, at the one-standard deviation level, the total uncertainty in the computation of tidal datums at New Canal based on 9-years of comparison of simultaneous observations with the secondary control station at Bay Waveland Yacht Club is estimated to be 0.024 ft. At the 95% confidence interval (CI), the total uncertainty is:

$$1.96 (0.024) = 0.047 \text{ ft. (95\% CI)}$$

At the one-standard deviation level, the total uncertainty in the computation of tidal datums at New Canal Station based on a 3-month comparison of simultaneous observations with the secondary control station at Bay Waveland Yacht Club is estimated to be 0.042 ft (Figure 11).

At the 95% confidence interval (CI), the total uncertainty is:

$$1.96 (0.042) = 0.0814 \text{ ft. (95\% CI)}$$

Thus the error in the estimation of tidal datums at the 95% confidence level at New Canal for 3-months is almost twice the error for a 9-year series.

<b>Computations for Estimation of Uncertainty in Tidal Datums at USCG New Canal</b>					
			Diurnal Range (GT)		
Subordinate	New Canal	8761927	<b>0.52</b>		
Control	Bay Waveland YC	8747437	<b>1.73</b>		
$S_{RSMN} = (GT_{sub} + GT_{con})^{1/2}$					
$MNR =  (GT_{sub} - GT_{con})  / GT_{con}$					
<b>Calculation</b>					
SRSMN =		1.50			
MNR =		0.70			
Estimated uncertainty ( $\sigma$ )	Coefficient1	SRSMN	Coefficient2	MNR	Coefficient3
S(12months) =	0.0045	1.50	0.0128	0.70	0.025
<b>S(12months) = 0.0407</b>					
Sub Series Length (Years)	EPOCH	<b>Therefore</b>	S(9 Years) =	0.0214	
9	19				
<b>Second Component: Bay Waveland Yacht Club</b>					
			Diurnal Range (GT)		
Subordinate	Bay Waveland YC	8747437	<b>1.73</b>		
Control	Pensacola	8729480	<b>1.26</b>		
$S_{RSMN} = (GT_{sub} + GT_{con})^{1/2}$					
$MNR =  (GT_{sub} - GT_{con})  / GT_{con}$					
<b>Calculation</b>					
SRSMN =		1.73			
MNR =		0.37			
Estimated uncertainty ( $\sigma$ )	Coefficient1	SRSMN	Coefficient2	MNR	Coefficient3
S(12months) =	0.0045	1.73	0.0128	0.37	0.025
<b>S(12months) = 0.0376</b>					
Sub Series Length (Years)	EPOCH	<b>Therefore</b>	S(9 Years) =	0.0099	
14	19				
<b>Total Estimated Uncertainty in Tidal Datum Computation for New Canal, LA</b>					
$S_{total} = \text{Square Root}(S_{sub}^2 + S_{con}^2)$					
	$S_{sub}$	$S_{con}$	<b>S<sub>total</sub></b>		
	0.0214	0.0099	<b>0.024</b>		
<b>95% CI</b>					
		<b>0.0462</b>			

Figure 10. Estimation of uncertainty in Tidal Datum Computation for 9-year Historical Data Collected at NOAA Tide Station 876 1927 units in feet

Computations for Estimation of Uncertainty in Tidal Datums at USCG New Canal					
			Diurnal Range (GT)		
Subordinate	New Canal	8761927	<b>0.49</b>		
Control	Bay Waveland YC	8747437	<b>1.73</b>		
$S_{RSMN} = (GT_{sub} + GT_{con})^{1/2}$					
$MNR =  (GT_{sub} - GT_{con})  / GT_{con}$					
<b>Calculation</b>					
S <sub>RSMN</sub> =	1.49				
MNR =	0.72				
Estimated uncertainty ( $\sigma$ )	Coefficient1	S <sub>RSMN</sub>	Coefficient2	MNR	Coefficient3
S(12months) =	0.0045	1.49	0.0128	0.72	0.025
<b>S(12months) = 0.0409</b>					
Sub Series Length (Months)	EPOCH	<b>Therefore</b>	S(9 Years) =	0.0403	
3	228				
<b>Second Component: Bay Waveland Yacht Club</b>					
			Diurnal Range (GT)		
Subordinate	Bay Waveland YC	8747437	<b>1.73</b>		
Control	Pensacola	8729480	<b>1.26</b>		
$S_{RSMN} = (GT_{sub} + GT_{con})^{1/2}$					
$MNR =  (GT_{sub} - GT_{con})  / GT_{con}$					
<b>Calculation</b>					
S <sub>RSMN</sub> =	1.73				
MNR =	0.37				
Estimated uncertainty ( $\sigma$ )	Coefficient1	S <sub>RSMN</sub>	Coefficient2	MNR	Coefficient3
S(12months) =	0.0045	1.73	0.0128	0.37	0.025
<b>S(12months) = 0.0376</b>					
Sub Series Length (Years)	EPOCH	<b>Therefore</b>	S(9 Years) =	0.0099	
14	19				
<b>Total Estimated Uncertainty in Tidal Datum Computation for New Canal, LA</b>					
$S_{total} = \text{Square Root}(S_{sub}^2 + S_{con}^2)$					
$S_{sub}$	$S_{con}$	<b>S<sub>total</sub></b>			
0.0403	0.0099	<b>0.042</b>			
<b>95% CI 0.0814</b>					

Figure 11. Estimation of uncertainty in Tidal Datum Computation for newly collected 3-months of data at NOAA Tide Station 876 1927 units in feet

## Connection between Tidal Datums and Geodetic Datums in Southeast Louisiana

Establishment of tidal datums and connection to geodetic datum at tide stations required survey connections between tidal benchmarks and geodetic benchmarks using differential levels or GPS. Use of GPS survey equipment to occupy tidal benchmarks is the emerging state-of-the-art method for making the connections. See the NOS web site at <http://tidesandcurrents.noaa.gov> and [www.ngs.noaa.gov](http://www.ngs.noaa.gov) for further detailed information on geodetic and tidal datum elevations on benchmarks.

NOAA publishes elevation references to the NAVD88 where sufficient connections to the NSRS benchmarks exist. NOAA no longer publishes relationships of tidal datums to the NGVD29 since NOAA is not maintaining NGVD29 as a vertical reference datum and the NAVD88 is the only official recognized vertical datum. As a matter of standard procedure NOAA will not publish tidal datum relationships relative to NAVD88 at a tide station unless there has been a verified survey connection between the tidal benchmarks and at least two benchmarks with published geodetic elevations. Basing a connection on only one isolated benchmark could provide an erroneous value if that particular mark was unstable. As will be noted later, NOAA will publish these relationships for the IPET stations using one nearby geodetic benchmark because the geodetic levels and ties were not done in isolation and all the benchmarks used have established network stability shown in the IPET surveys. Figure 12 is a page from the published benchmark sheet showing the relationship of NAVD88 to tidal datums at Waveland, MS.

Station ID: 8747766	PUBLICATION DATE: 04/21/2003
Name: WAVELAND, MISSISSIPPI SOUND	
MISSISSIPPI	
NOAA Chart: 11371	Latitude: 30° 16.9' N
USGS Quad: BAY ST LOUIS	Longitude: 89° 22.0' W
T I D A L   D A T U M S	
Tidal datums at WAVELAND, MISSISSIPPI SOUND based on:	
LENGTH OF SERIES: 5 Years	
TIME PERIOD: October 1997 - September 2002	
TIDAL EPOCH: 1983-2001	
CONTROL TIDE STATION: 8729840 PENSACOLA, PENSACOLA BAY	
Elevations of tidal datums referred to Mean Lower Low Water (MLLW), in METERS:	
HIGHEST OBSERVED WATER LEVEL (09/26/2002)	= 2.403
MEAN HIGHER HIGH WATER (MHHW)	= 0.488
MEAN HIGH WATER (MHW)	= 0.465
MEAN TIDE LEVEL (MTL)	= 0.246
MEAN SEA LEVEL (MSL)	= 0.244
NORTH AMERICAN VERTICAL DATUM-1988 (NAVD)	= 0.066
MEAN LOW WATER (MLW)	= 0.027
MEAN LOWER LOW WATER (MLLW)	= 0.000
LOWEST OBSERVED WATER LEVEL (12/31/1997)	= -0.763

Figure 12. Excerpt from published benchmark sheet for Waveland, MS showing the relationship of NAVD88 to tidal datums

Since tidal datums are local datums relative to the land based upon tide gauge measurements, great care must be taken to interpolate and extrapolate tidal datum differences and relationships to geodetic datums away from a particular tide station location. In some instances, linear interpolation can be used to estimate datum relationships between two known points along a stretch of shoreline that is not very complicated in a topographic and bathymetric sense. It is known that elevation differences of LMSL relative to NAVD88 generally increase going up into estuaries and tidal rivers. Relationships of the various other tidal datums (such as MLLW and MHW) relative to LMSL and NAVD88 are sloped surfaces dependent upon geographic changes in the range of tide.

### **Use of a Modified NTDE Procedure for Geographical Areas with High Rates of Sea-Level Change**

The current NTDE used by NOAA to compute accepted tidal datums at tide stations is the 1983-2001 NTDE. The 1983-2001 NTDE was officially adopted in 2003. Prior to this update tidal datums were updated from 1941-1959 to 1960-1978. NTDE periods are updated after analyses of mean sea level trends show significant changes in mean sea level throughout stations in the NWLON. A change in mean sea level datum of approximately 0.10 foot is considered significant enough to warrant NTDE updates. The NTDE updates are made to ensure that tidal datums are the most accurate and practical for application by the navigation, surveying, and engineering communities and reflect the existing local stand of sea level.

### **Areas with Anomalous Sea Level Trends**

Analyses of relative sea level trends observed around the U.S. show an average trend of +1.5 mm/yr based on trends from 67 stations over the period 1950 through 1999. There are three main geographic areas that are strongly anomalous from this average. They are Galveston Bay, Texas; southeast Louisiana; and portions of southeast Alaska. The magnitude of the sea level trends are so large in those areas +0.02 ft/yr (+6 mm/yr) in Galveston; +0.03 ft/yr (+10 mm/yr) in Grand Isle; and -0.04 ft/yr (-13 mm/yr) in Juneau, that computation of a 19-year epoch value for mean sea level has no practical meaning. The analysis of sea level trends at these locations showed that a new NTDE period was required and NOAA has adopted a modified procedure in these areas to compute accepted tidal datums based solely on the most recent five years of observations rather than a 19-year epoch value. It is named a “modified” epoch procedure because only the LMSL, MTL, and DTL datums are determined based on the latest 5-years of data. The mean ranges of tide and the diurnal inequalities are still all determined based on the full 19-year period NTDE (1983-2001). The period of the most recent “modified” NTDE for areas with rapidly changing sea level rates was 1980-98 where the LMSL was based on data collected from last 5 years of that period. This update was necessary to ensure that the tidal datums accurately represent the existing stand of sea level. Users relying on products based on the old datums will find significant differences in products based on the new datums based on this update. As a result of analyses completed by Zervas (2001), NOAA Technical Report 50 (NGS 2004) and the current IPET surveys updates will be made more frequently than 19 years for these anomalous areas to adjust to the relatively rapidly changing sea level.

There are no changes required to the tidal prediction products put out by NOAA as a result of these datum updates. Prior to the most recent update, observed water levels were typically

always biased several tenths of a foot higher than predicted water levels because the observed water levels were based on outdated tidal datums. Users will note that predicted and observed elevations will generally agree more closely during normal weather conditions after the update than previous predicted tides versus observed water levels.

### **Local Mean Sea Level (LMSL)**

Based on the above discussion, NOAA uses two official practical working definitions of LMSL. One is for areas of relative slowly changing mean sea level relative to the land for which LMSL is determined over the standard 19-year NTDE, and other one for areas of fast changing mean sea level relative to the land for which LMSL is determined from the last five years of record in the NTDE period. In the following discussion of the IPET study area surrounding New Orleans, it has been found that this area falls into the second category, with apparent local land subsidence rates anywhere from 0.02 to 0.04 ft/yr (6-11 mm/yr). Based on the IPET analyses, the NOAA estimates for subsidence from NOAA Technical Report 50 (NGS 2004), and the NOAA estimates of sea level trends, the IPET study area falls into the second category of an area with fast-changing relative mean sea level.

## **Updated Tidal Datums in the IPET Study Area--LMSL Relationships to NAVD88 (2004.65)**

In the Mississippi Delta region diurnal tidal ranges of tide vary from 0.50 ft at USCG New Canal Station in Lake Pontchartrain to 1.0 ft at Southwest Pass to 1.50 ft at Comfort Island north of the Mississippi River Gulf Coast Outlet in Chandelier Sound. The Mississippi River proper is classified as non-tidal above the Head of Passes where the Mississippi diverges into distinct branches. NOAA refers soundings above this location to the LWRP maintained by the USACE. NOAA uses the reference datum of MLLW for all NOAA navigation products, tide tables and charts. In Louisiana, the New Orleans District uses MLG as the reference datum for hydrographic surveys. As discussed on other sections of this report, knowledge the elevation relationships between MLG and MLLW are the subject of an operational study by NOAA and the USACE and are also tied to the update of NAVD88.

NOAA has operated about 245 historical water level stations in Louisiana. NOAA has computed 1983-2001 NTDE accepted tidal datums for 49 stations and published benchmark sheets for 38, of which only 10 have any reference to NAVD88. In contrast, NOAA has operated about 1029 historical water level stations in Florida and has computed 1983-2001 NTDE accepted tidal datums for 558 stations, has published benchmark sheets for 509 of those stations, and has references to NAVD88 for 389 of those. This resulted in about 20% of Louisiana tide stations having accepted datums with geodetic connections compared to 70% in Florida. Florida has enjoyed a close continuing partnership among NOAA and the Florida Department of Environmental Protection (FLDEP) since the 1970s when many of the tide stations were established as part of a state/federal marine boundary program. A similar program in Louisiana ended with only 3 of 5 phases completed and with no follow-up activities due to lack of funding by the State and NOAA. (For more information see CO-OPS's web site referencing the NOAA VDatum program). Until this recent IPET activity, NOAA updates of tidal datums were through a cooperative effort with two stations in St. Charles parish and a few short-term stations in Atchafalaya Bay and near Port Fourchon in support of hydrographic surveys. NOAA published an exhaustive assessment of the geodetic conditions in the region in NOAA Technical Report 50 (NGS 2004).

### **Preliminary Local Mean Sea Level Relationship (December 2005)**

Utilizing the new orthometric elevations that NGS and NGS contactors provided for the Southeast Louisiana region, NOAA, in support of the IPET, began the process of updating the relationships between LMSL and NAVD88 (2004.65). Initial orthometric elevations were obtained and compared to LMSL at four locations in the IPET study area (Figure 13).

### NOS Preliminary Local Mean Sea Level (LMSL) - NAVD88 2004.65 Difference for Southern Lake Pontchartrain

In support of the IPET Task No 6 Requirement Plan, The Center for Operational Oceanographic Products and Services (CO-OPS) has been requested by the U.S. Army Corps of Engineers (USACE) to provide a statement on the PRELIMINARY elevation relationship between Local Mean Sea Level (LMSL) and the recently established NAVD88 2004.65 in the New Orleans vicinity. The elevation relationship provided here should be considered PRELIMINARY and applicable only to the region outlined in Figure 1 North of the Mississippi River. Any application of this value beyond the outlined region is not recommended. A more accurate elevation relationship will be supplied as ongoing tidal and geodetic surveys in the region are completed.

Based on a PRELIMINARY analysis of NAVD88 2004.65 elevations at benchmarks associated with NOS Tide Stations at 8761402, 8761927, and 8762372 it was determined that a **LMSL - NAVD88 2004.65 difference of 0.077 m (0.25 ft)** computed at the newly re-established NOS tide station at New Canal USCG (8761927) is most representative of the LMSL - NAVD88 2004.65 difference for the outlined region. For more information contact Jerry Hovis at 301-713-2890 x 109, [gerald.hovis@noaa.gov](mailto:gerald.hovis@noaa.gov).

NOAA Stations associated with NAVD88 2004.65 Bench Marks								
Design	PI#	NAVD 88 2004.65	NAVD 88 2004.65 Relative to MLLW	LMSL Relative to MLLW	Difference (meters)	Difference (feet)	Sta_Num	Sta_Nam
FA-E RESET	BH1164	2.480000	0.000000	0.125000	0.045000	0.147645	8761402	Rigolets
ALCO	BH1342	1.870000	0.001000	0.070000	0.077000	0.252637	8761927	USCG
2972 F 2005		0.540000	-0.051000	0.073000	0.124000	0.406844	8762372	E Bank, Labranche

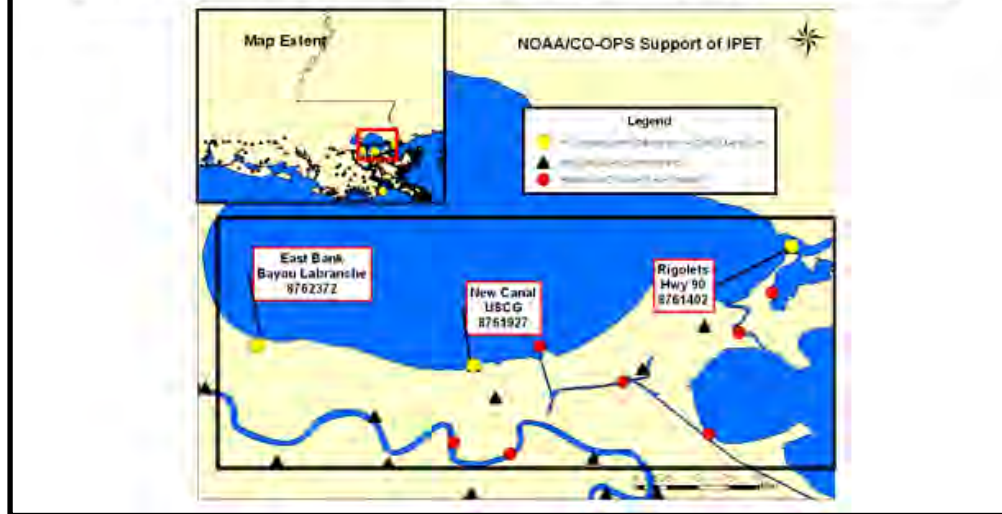

Figure 13. NOS Preliminary Local Mean Sea Level (LMSL) (1983-2001 NTDE) – NAVD88 (2004.65) differences for southern Lake Pontchartrain

The relationships were established by comparing NAVD88 (2004.65) orthometric elevations with existing 1983-2001 NTDE tidal benchmark elevations from NOAA benchmark sheets as detailed in Figure 14.



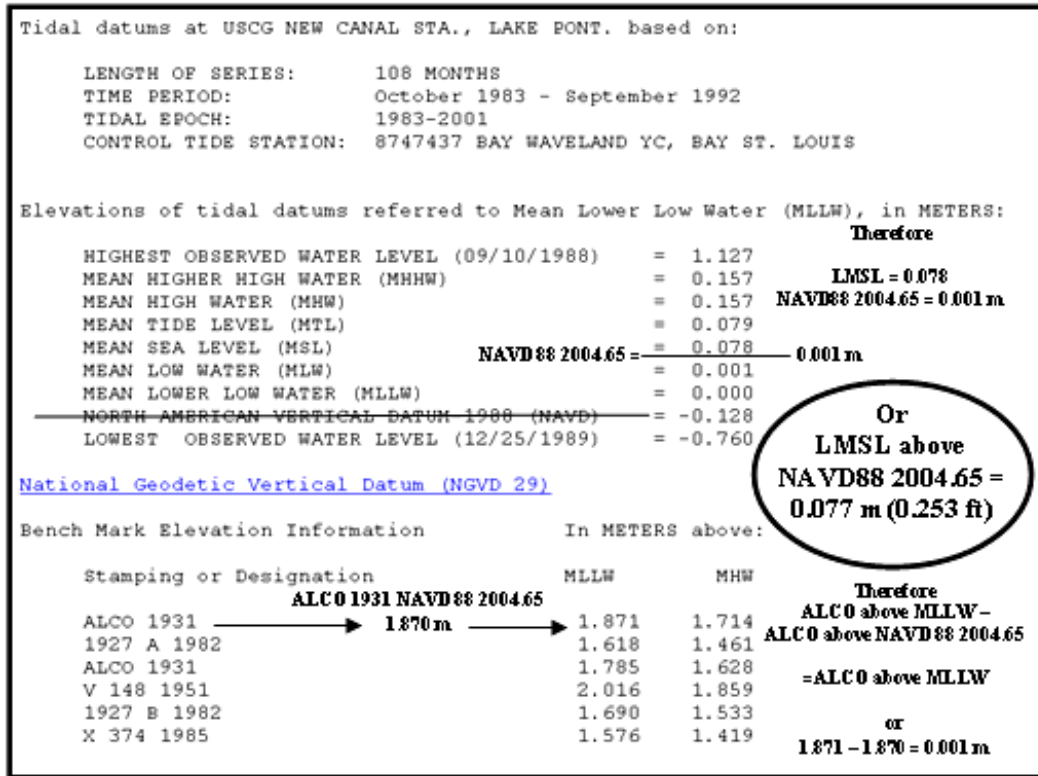

Figure 14. Excerpt from NOS Tidal Benchmark sheet summarizing the procedure used to obtain the new relationship between LMSL (1983-2001) and NAVD88 (2004.65)—December 2005

Based on the preliminary orthometric elevations NAVD88 (2004.65), 1983-2001 datums, and benchmark elevations computed from 10 years of data collected between 1983 and 1992, NOS calculated relationships between LMSL and NAVD88 (2004.65). It was determined that New Canal Station was the most representative of the southern Lake Pontchartrain region. Table 8 below summarizes all of the relationships used in analysis supporting the data in Figure 13.

**Table 8**  
**Preliminary relationships of LMSL (1983-2001 NTDE) relative to NAVD88 (2004.65)**

BM Designation	BM PID	NOS Sta_Num	NOS Sta_Nam	NAVD88 2004.65	BM above MLLW	Tidal EPOCH	NAVD88 2004.65 Relative to MLLW	LMSL Relative to MLLW	LMSL Relative to NAVD88 2004.65 (m)	LMSL Relative to NAVD88 2004.65 (ft)
Preliminary NOS Stations associated with NAVD88 2004.65 Bench Marks										
876 1724 TIDAL 11	AT0685	8761724	Grand Isle	0.950000	1.052000	83-01	0.102000	0.164000	0.062000	0.203422
PIKE RESET	BH1164	8761402	Rigolets	2.480000	2.560000	83-01	0.080000	0.125000	0.045000	0.147645
<b>ALCO</b>	<b>BJ1342</b>	<b>8761927</b>	<b>New Canal USCG</b>	<b>1.870000</b>	<b>1.871000</b>	<b>83-01</b>	<b>0.001000</b>	<b>0.078000</b>	<b>0.077000</b>	<b>0.252637</b>
2372 F 2003		8762372	East Bank*	0.540000	0.489000	83-01	-0.051000	0.073000	0.124000	0.406844
* Benchmark sheet has been removed from circulation										

## Rationale for Connections to Additional NOS Water Level Stations

Following the initial assessment of LMSL – NAVD88 2004.65 relationships USACE IPET contractor (3001 Inc.) surveyed additional benchmark elevations in the IPET region during Phase 1a and Phase 1b of its operations plan (Figure 15 below).

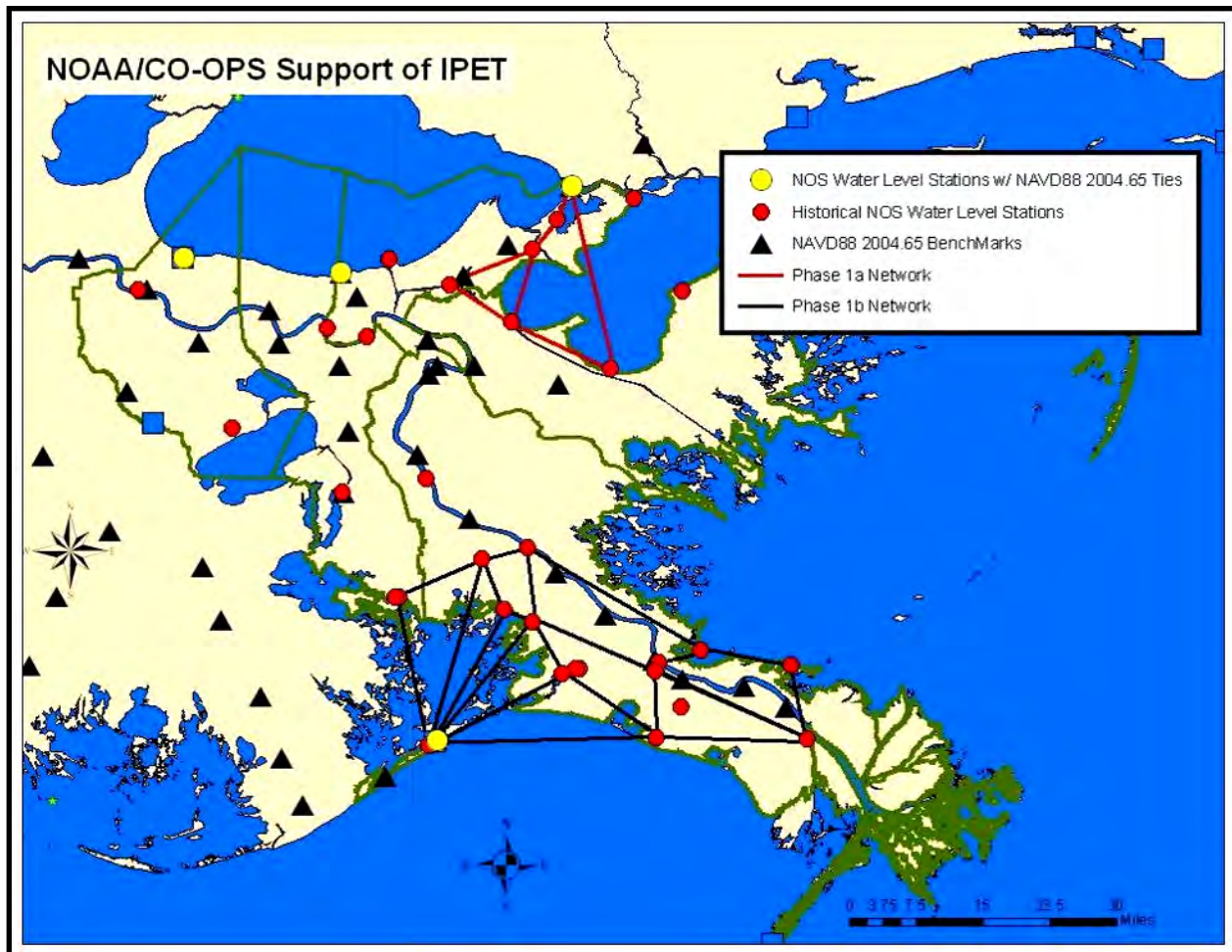

Figure 15. Planned locations of the 3001 Inc. Phase 1a and Phase 1b operations plan to tie in additional NOS water level stations in support of the IPET

Careful consideration was given to the stations that were tied into the NAVD88 (2004.65) network in an effort to provide the most accurate coverage for the IPET region. Primary consideration was given to those stations with updated NOAA 1983-2001 benchmark sheets in the IPET study area. Secondary consideration was given to water level stations that had more than one year of data. Tertiary consideration was given to water level stations that had recoverable benchmarks and were easily accessible to the 3001, Inc. field crew. Finally, the decision was made to include several of the New Orleans District water level stations in order to better establish the LMSL – NAVD88 (2004.65) relationship in the immediate vicinity of New Orleans and locations of select breached levees. Phase 1a of the field operations plan was successful in connecting four NOAA historical water level stations at Michoud, Chef Menteur, Rigolets, and Carrollton on the Mississippi River.

Phase 1b of the field operations plan was successful in connecting three additional NOS water level stations at West Point a la Hache, Lake Judge Perez, and MV Petrol. An additional surveying effort established connections at Lafitte, Alliance, Empire, and Venice. Upon completion of Phase 1a and 1b surveying operations, 14 NOS water level stations had been tied into the NGS benchmark network for use in determining the LMSL - NAVD88 (2004.65) relationship in the IPET study area, as shown in Figure 16 and Table 9 below.

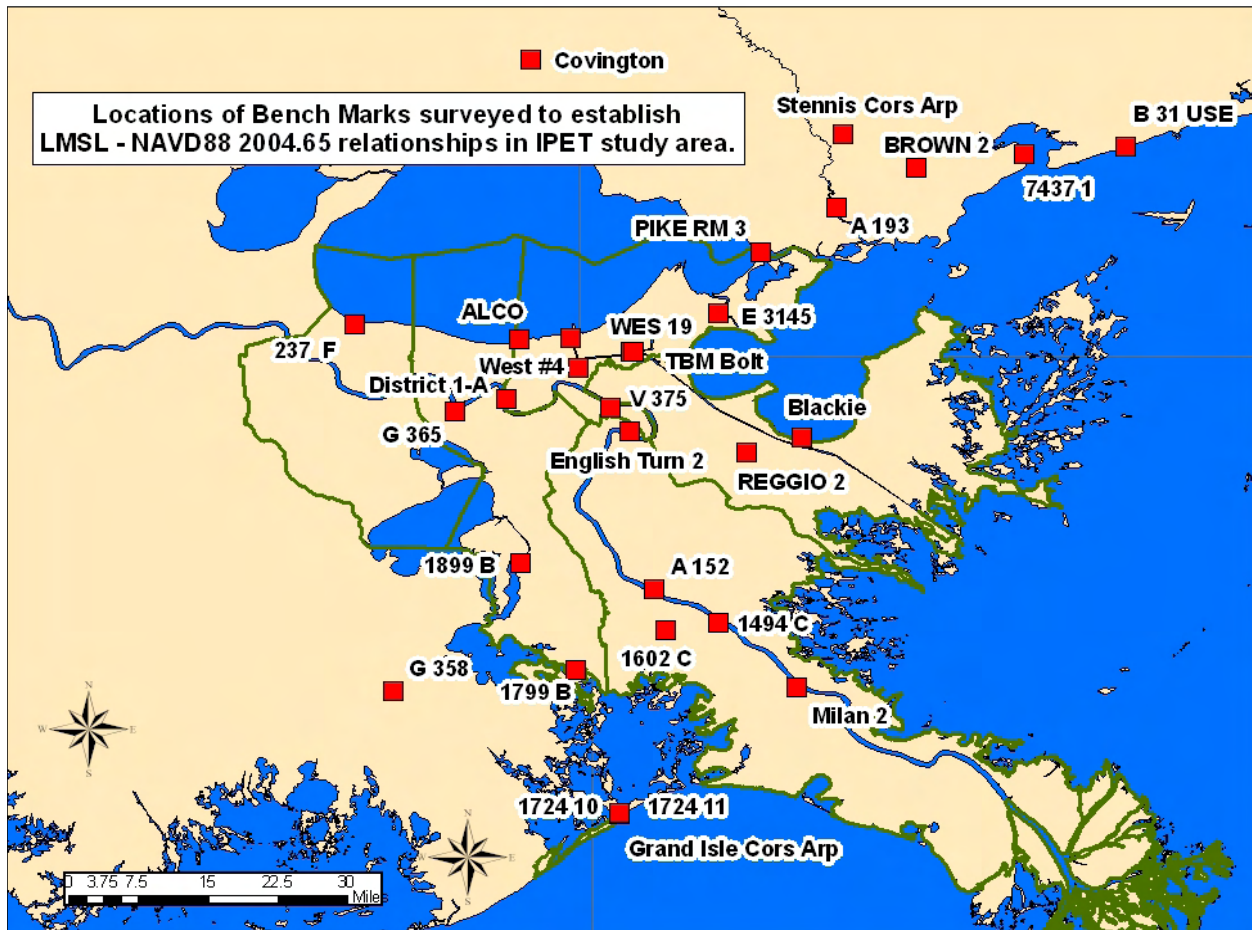

Figure 16. Phase 1a and Phase 1b geodetic connections established by 3001 Inc. in support of the IPET

3001 Inc. established geodetic connections for five stations along the Mississippi River from Venice to Carrollton during the Phase 1a and 1b surveying effort. However, only one of the stations was included in the establishment of the final LMSL – NAVD88 (2004.65) relationship for IPET. The upper four stations connected in the Mississippi River are above the Head of Passes and are classified by NOAA as non-tidal. The water level regime within the Mississippi River channel is functionally and oceanographically very different from a tidal regime and consequently these stations were not included in the analysis. A river Low Water Reference Plane is a different concept than LMSL.

**Table 9  
Summary of Geodetic Connections Established after 3001 Inc. Surveying Operations**

BM Name	NOS Designation	PID	NOS Sta_ID	NOS Sta_Name	Series	Tidal EPOCH	Comments
237 F	2372 F 2003		8762372	East Bank, Labranche	6/03-9/04	83-01	
ALCO	ALCO	BJ1342	8761927	New Canal	10/83-0992	83-01	
189 B	876 1899 B TIDAL	AU2310	8761899	Lafitte, Barataria	NA	NA	
179 B	876 1799 B TIDAL		8761799	MV Petrol	09/85-08/86	83-01	
10	Tidal 10	AT0687	8761724	Grand Isle	1997-2001	83-01	
167 A	876 1678 A TIDAL		8761678	Michoud	01/83-12/83	83-01	
160 C	876 1602 C TIDAL	AT1392	8761602	Judge Perez	11/85-09/86	83-01	
E 3145	E 3145	BH1133	8761487	Chef Menteur	01/83-12/84	83-01	
	PIKE RESET	BH1164	8761402	Rigolets	03/81-02/82	83-01	
084 A	876 0849 A TIDAL		8760849	Venice, Grand Pass	08/97-10/97	83-01	
DIST	District 1-A	AU2196	8761955	Carrollton	10/96-12/98	NA	Non-Tidal
			8761727	Alliance	9/97-12/98	NA	Non-Tidal
149 C	876 1494 C TIDAL		8761494	West Point La Hatch	11/96-12/98	NA	Non-Tidal
			8761193	Empire	11/96-2/98	NA	Non-Tidal

### Local Mean Sea Level Relationships in the IPET Study Area

Based on the validation of historic and present data from the currently operating station at New Canal Station and the orthometric geodetic elevation values supplied by 3001 Inc., it is possible to estimate the relationship between LMSL and NAVD88 (2004.65) in the IPET study region. Drawing upon methodology outlined in the previous sections and reviewed in Figure 17 below, benchmark elevations relative to MLLW were compared to NOAA validated NAVD88 (2004.65) values. Initially the elevation of benchmark ALCO 1931 (1.871 m or 6.138 ft) was compared to the NAVD88 (2004.65) elevation (1.870 m or 6.135 ft). The difference of these elevations results in the elevation of NAVD88 (2004.65) relative to MLLW, which, can then be compared to the published LMSL value (0.078 m). Following this procedure the relationship between LMSL and NAVD88 (2004.65) is shown to be 0.25 ft.

The values in Figure 18 and Table 10 suggest a regional average difference of LMSL above NAVD88 (2004.65) of approximately 0.20 ft. Outliers to this approximation are noted at Michoud near the confluence of the Mississippi River Gulf Outlet and the Gulf Intracoastal Waterway between Orleans Parish and St. Bernard Parish, and at Venice just north of the Head of Passes. The former anomaly is addressed in NOAA Technical Report 50 (NGS 2004) that shows that rates of vertical displacement for benchmarks at that location are significantly greater in the region than other areas surrounding New Orleans—as shown in Figure 19 below.

The anomaly at Venice may be explainable in terms of the tidal datums tabulated at that location. As was stated earlier NOAA considers all water of the Mississippi river north of the Head of Passes as non-tidal. Elevations in the Mississippi river north of this location are referred to the Low Water Reference Datum maintained by the USACE and not MLLW used by NOAA for charting purposes. The tidal datums at Venice have not been published as a proper long-term control on the river station has not yet been established to understand the seasonal variability. While the data collected from Jan – Oct 1986 should offer a good representation of tidal characteristics during low river stages, other historical river stations show a distinct masking of all tidal characteristics during the spring season due to periods of high river flow and river management practices.

<b>Tidal datums at USCG NEW CANAL STA., LAKE PONT. based on:</b>				
	8761927			
LENGTH OF SERIES:	108 MONTHS			
TIME PERIOD:	October 1983 - September 1992			
TIDAL EPOCH:	1983-2001			
CONTROL TIDE STATION:	8747437 BAY WAVELAND YC, BAY ST. LOUIS			
<b>Elevations of tidal datums referred to Mean Lower Low Water (MLLW), in METERS</b>				
MEAN HIGHER HIGH WATER (MHHW)	0.157	<b>LMSL above NAVD88 2004.65</b>		
MEAN HIGH WATER (MHW)	0.157			
MEAN TIDE LEVEL (MTL)	0.079	<b>LMSL/NAVD88 2004.65 (m)</b>	<b>0.077</b>	
<b>LOCAL MEAN SEA LEVEL (LMSL)</b>	<b>0.078</b>			
<b>NAVD 2004.65</b>	<b>0.001</b>			
MEAN LOW WATER (MLW)	0.001	<b>LMSL/NAVD88 2004.65 (ft)</b>	<b>0.253</b>	
MEAN LOWER LOW WATER (MLLW)	0.000			
NORTH AMERICAN VERTICAL DATUM-1988 (NAVD)	-0.128			
<b>Stamping or Designation</b>				
	<b>MLLW</b>	<b>MHW</b>	<b>NAVD 88 2004.65</b>	<b>NAVD above MLLW</b>
<b>ALCO 1931</b>	<b>1.871</b>	<b>1.714</b>	<b>1.870</b>	<b>0.001</b>
1927 A 1982	1.618	1.461		
ALCO 1931	1.785	1.628		
V 148 1951	2.016	1.859		
1927 B 1982	1.690	1.533		
X 374 1985	1.576	1.419		

Figure 17. Excerpt from NOS Tidal Benchmark sheet summarizing the procedure used to obtain the relationship between LMSL and NAVD88 (2004.65) at New Canal Station.

<b>Table 10</b>							
<b>Initial LMSL 1983-2001 NTDE – NAVD 88 2004.65 Relationships in IPET Study Area</b>							
<b>NGS BM Designation</b>	<b>NOS BM Designation</b>	<b>PID</b>	<b>Lat</b>	<b>Long</b>	<b>NOS Sta_ID</b>	<b>NOS Sta_Name</b>	<b>83.01 LMSL above NAVD 88 2004.65 (ft)</b>
237 F	2372 F 2003		30.050000	-90.368333	8762372	East Bank, Labranche	0.407
ALCO	ALCO	BJ1342	30.026812	-90.112836	8761927	New Canal	0.253
179 B	876 1799 B TIDAL		29.496271	-90.025713	8761799	MV Petrol	0.203
10	Tidal 10	AT0687	29.263300	-89.956667	8761724	Grand Isle	0.696
11	Tidal 11	AT0685	29.263300	-89.956667	8761724	Grand Isle	0.203
167 A	876 1678 A TIDAL		30.006923	-89.937572	8761678	Michoud	-0.407
160 C	876 1602 C TIDAL	AT1392	29.559398	-89.884732	8761602	Judge Perez	0.177
E 3145	E 3145	BH1133	30.068536	-89.803647	8761487	Chef Menteur	0.148
	PIKE RESET	BH1164	30.166524	-89.737612	8761402	Rigolets	0.148
PIKE RM 3	PIKE RM 3	BH1160	30.166524	-89.737612	8761402	Rigolets	0.187
084 A	876 0849 A TIDAL		29.265000	-89.353300	8760849	Venice, Grand Pass	0.919



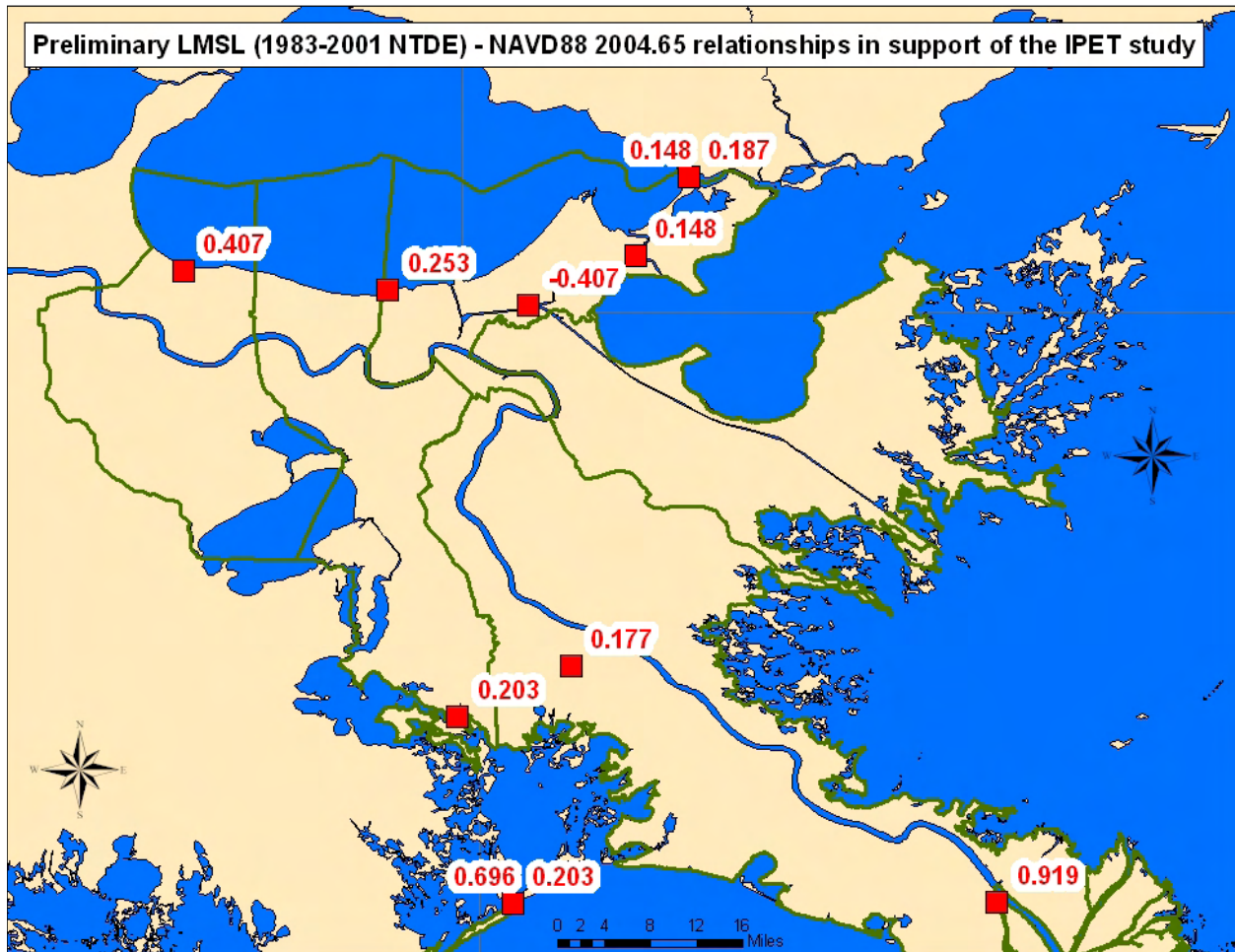

Figure 18. Preliminary LMSL (1983-2001 NTDE) – NAVD 88 2004.65 relationships in the IPET region. Values in feet

In addition, NOAA Report 50 (NGS 2004) also shows a very high rate of local subsidence in that vicinity estimated to be from -10 to -30 mm/yr vertical change.

# Modified 5-Year Tidal Datum Analysis for New Orleans Study Area

As previously stated, in areas of rapidly increasing or decreasing sea level it has become important to update tidal datums on a modified 5-year epoch. Grand Isle, LA was one of the stations chosen to have the 5-year update methodology applied due to a sea level trend of 0.03 ft/yr (10 mm/yr) (Zervas 2001). The current 83-01 tidal datums at Grand Isle are based on data from January 1997 to December 2001. Due to the rapid sea level trends seen at other locations around the IPET study region it was determined that updating all currently published datums used in the analysis would provide a better estimate of the LMSL – NAVD88 (2004.65) relationship in the region.

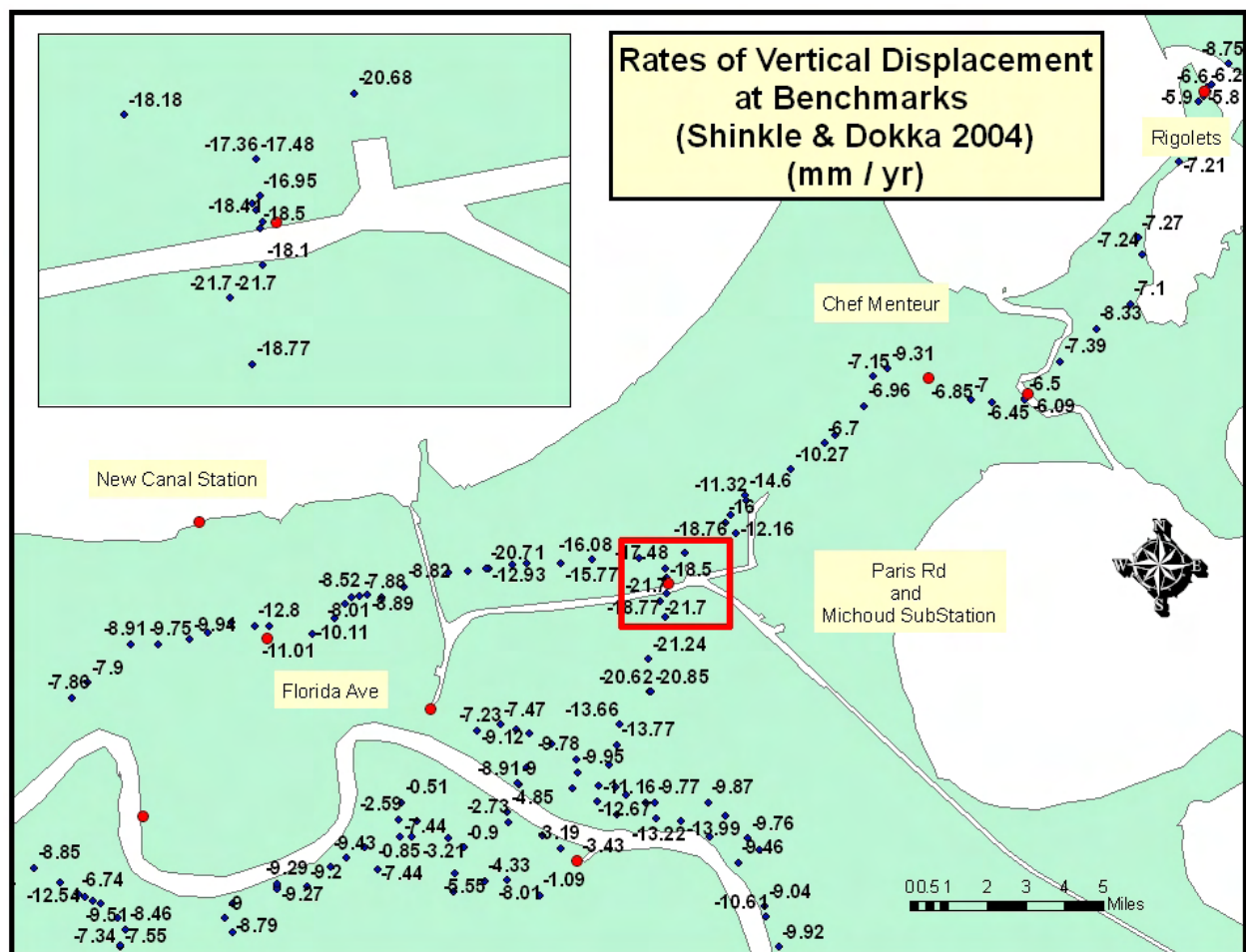

Figure 19. Rates of vertical displacement for benchmarks near Michoud Substation from NOAA Technical Report 50 (NGS 2004).

Procedurally the methodology involves establishing a 5 year tidal datum for the control station which is used in the simultaneous comparison process previously detailed. The nearest stations with reliable data that could be used for this purpose were at Waveland, MS and Grand Isle, LA. Based on a separate analysis of general sea level trends and other tidal characteristics in

the area it was determined that Waveland, MS could be used as a control for the stations in the northern region and Grand Isle, LA could be used for the southern region.

Data from January 2001 to December 2005 was processed according to standard procedures for tabulating tidal datums for primary controls. Hourly height observations collected over the most recent 5 year period was averaged providing an updated LMSL value. These values were then used in the simultaneous computation of tidal datums for all subordinate stations including data from three USACE water level stations which had hourly heights supplied by the New Orleans District. LMSL – NAVD88 (2004.65) relationships based on 2001-2005 updated tidal datums generally showed an increase of about 0.20 – 0.30 ft—see following Table 11.

**Table 11  
New LMSL (2001-2005 NTDE) – NAVD88 (2004.65) Relationships Based on 2001-2005 Updated Tidal Datums**

PID	Lat	Long	Geographic Location	Sta_ID	Sta_Na	NGS NAVD 88 2004.65 (m)	83-01 LMSL above NAVD 88 2004.65 (ft)	2001-2005 LMSL above NAVD 88 2004.65 (ft)
BJ1342	30.026812	-90.112836	USCG New Canal	8761927	USCG New Canal Station	1.873	0.25	<b>0.51</b>
BH1160	30.166524	-89.737612	The Rigolets	8761402	U S Hwy 90 The Rigolets	2.802	0.19	<b>0.46</b>
	29.496271	-90.025713	MV Petrol, Bay Dosgris	8761799	MV Petrol Dock	0.773	0.20	<b>0.39</b>
AT1392	29.559398	-89.884732	Lake Laurier	8761602	Lake Judge Perez	0.163	0.17	<b>0.18</b>
AT0685	29.263300	-89.956667	Grand Isle	8761724	Grand Isle, East Point	0.950	0.20	<b>0.29</b>
DH3787	30.050000	-90.368333	East Bank, Bayou Labranche	8762372	East Bank, Bayou Labranche	0.540	0.41	<b>0.58</b>
BH1133	30.068536	-89.803647	Chef Menteur Pass	8761487	Chef Menteur	4.818	0.15	<b>0.34</b>
BH0937	30.323897	-89.327425	Bay Waveland YC	8747437	Bay Waveland YC	1.597	0.37	<b>0.53</b>
	29.868333	-89.673333	Lake Borgne	85800	Shell Beach	1.439		<b>0.99</b>
	29.981389	-90.020833	IHNC	76120	Florida Ave	1.003		<b>0.57</b>
	30.006667	-89.934722	IHNC	76040	Paris Rd	2.423		<b>0.35</b>
	30.029167	-90.032778	IHNC	76060	Seabrook	7.520		<b>0.67</b>

Notable exceptions to this occurred at the two locations being compared with Grand Isle. The reason for the generally smaller changes at Lake Judge Perez and M V Petrol Station were that the tidal datum at Grand Isle had already been updated to a 5 year epoch so the new 2001-2005 epoch accounted for slightly less change than at Waveland, MS which was used for comparisons in the north. These are shown in Figure 20.



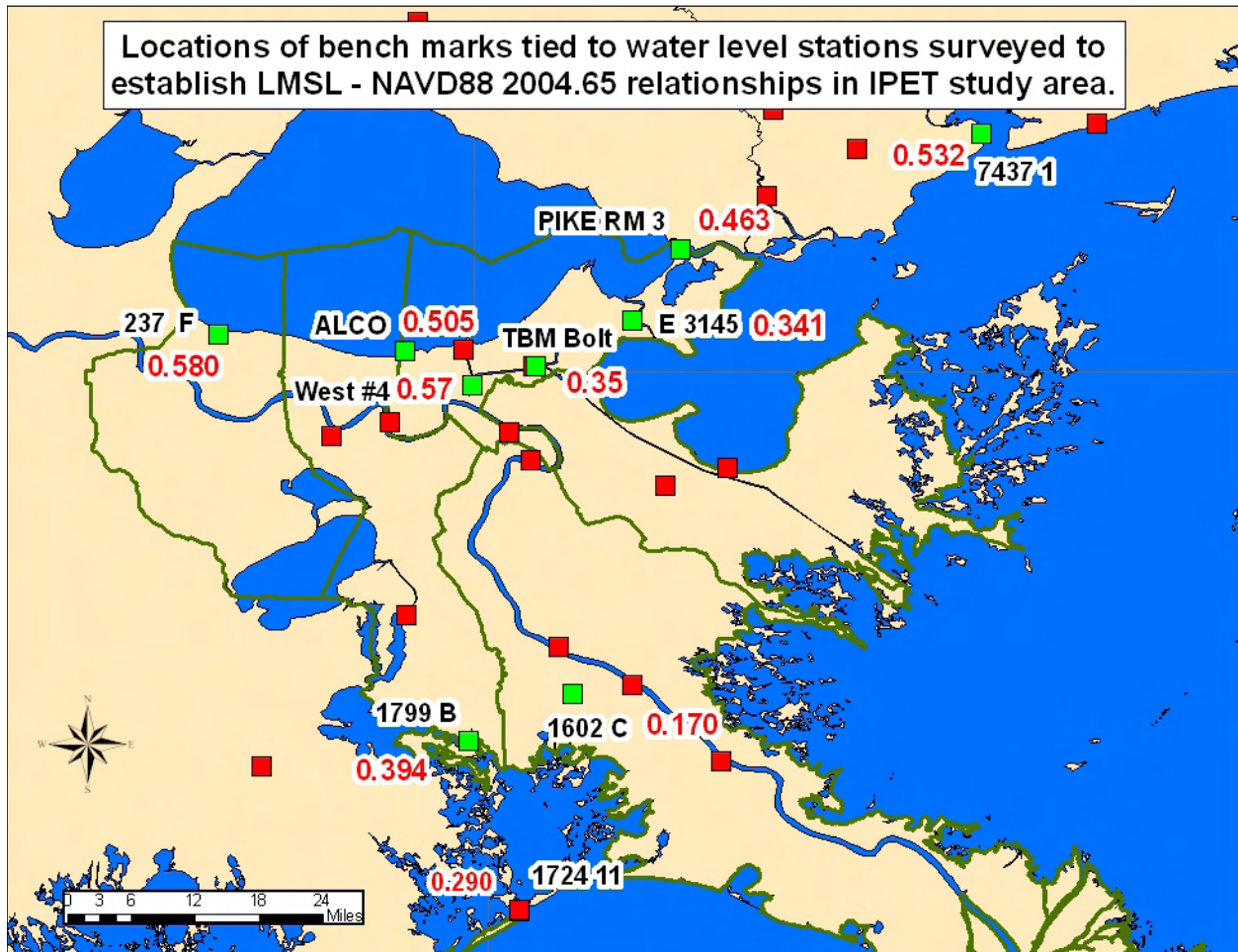

Figure 20. New LMSL (2001-2005 NTDE) – NAVD88 (2004.65) relationships based on 2001-2005 updated tidal datums

The three values calculated for the USACE stations at Florida Avenue, Paris Road, and Shell Beach were consistent with other values though the methodology in their calculation was slightly different. Hourly heights for the three USACE stations were supplied by New Orleans District. Data from these locations were referenced to NGVD29. The raw data were processed to NOS subordinate station standards using NGVD29 as “station datum.” Hourly heights were averaged and simultaneously compared to the same time period at Waveland, MS and adjusted by a preliminary 2001-2005 LMSL datum for Waveland, MS. The LMSL above NGVD29 was determined and compared to the known NGVD29 (station datum) and NAVD88 (2004.65) values supplied by New Orleans District USACE. From this comparison LMSL above NAVD88 (2004.65) was determined for Paris Road, Florida Avenue, Shell Beach, and Seabrook. See Figure 21 below for the methodology used for determining the LMSL relationship.

Methodology for determining LMSL – NAVD88 2004.65 at USACE water level stations

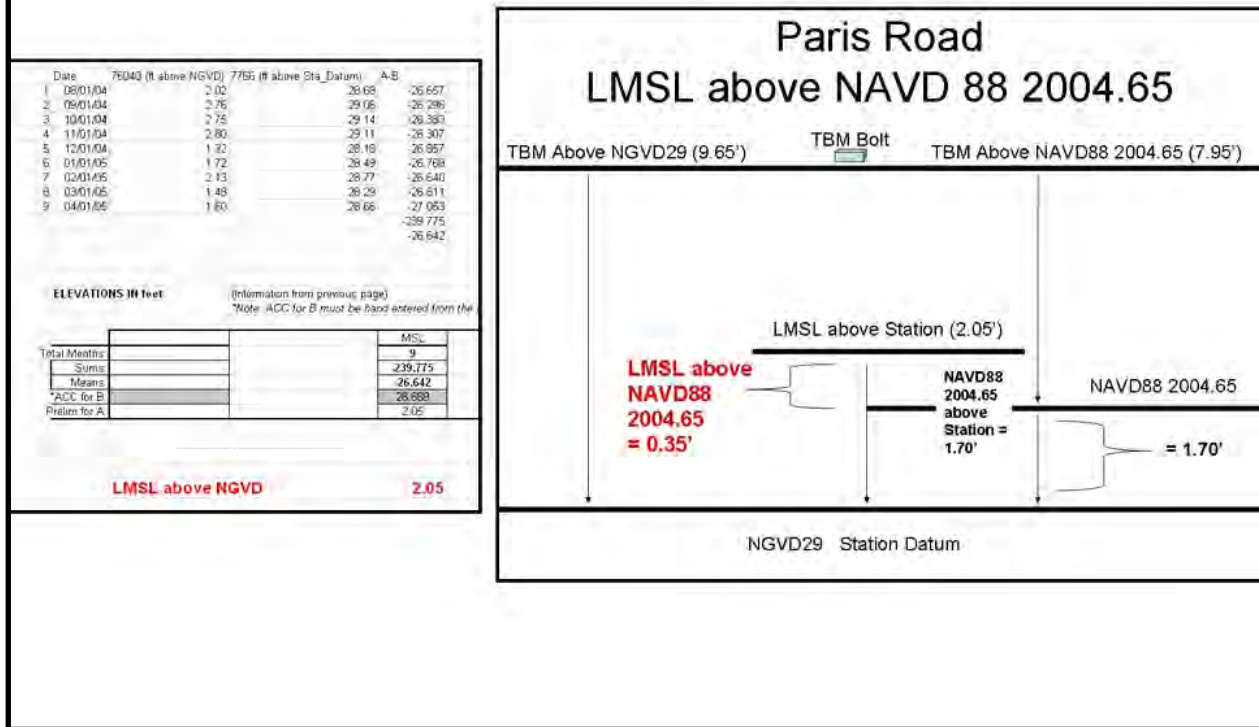

Figure 21. Methodology for determining LMSL (2001-2005 NTDE) – NAVD88 (2004.65) at USACE water level stations

## Local Mean Sea Level at IHNC Florida Avenue Gage Site (1969)

Daily water level values at Florida Avenue were supplied by New Orleans District. These data were quality checked for gaps and datum adjustments which appear to have occurred at least two times to the Florida Avenue water level data as shown in Figure 22 below.

Data from 1944 to date was further analyzed with a sea level trend comparison which showed that Grand Isle, LA was an appropriate station to use as a control for the time period near 1969, as shown in Figure 23 below. An accepted datum was obtained for Grand Isle from historical summary information for a 1964 – 1975 tidal epoch. This value was used in a comparison with Florida Avenue water level data to obtain an approximate 1969 LMSL tidal datum of 0.493 m (1.617 ft). The correct NGVD29 adjustment value used as station datum is pending. This value can be compared with the LMSL value computed for Florida Avenue based on recent data from that location which was computed to be 0.381 m (1.25 ft) used in determining LMSL – NAVD88 (2004.65) in the previous section. Figure 22 suggests that the two adjustments in 1978 and 1982 effectively lowered the computed LMSL by 0.112 m (0.4 ft) resulting in slightly higher LMSL value for data used before 1978.

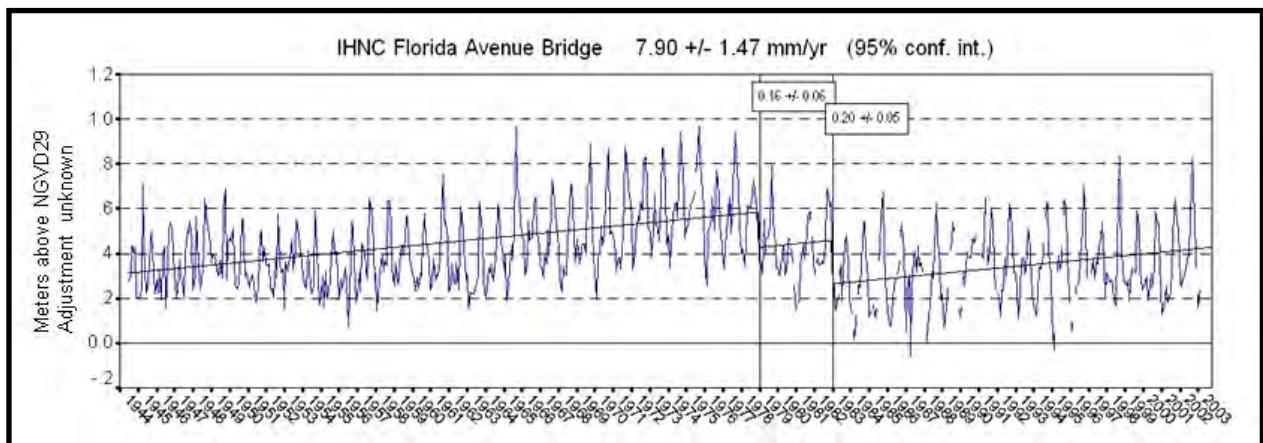

Figure 22. Long-term water level data collected at Florida Avenue, USACE water level station (1944-2003)

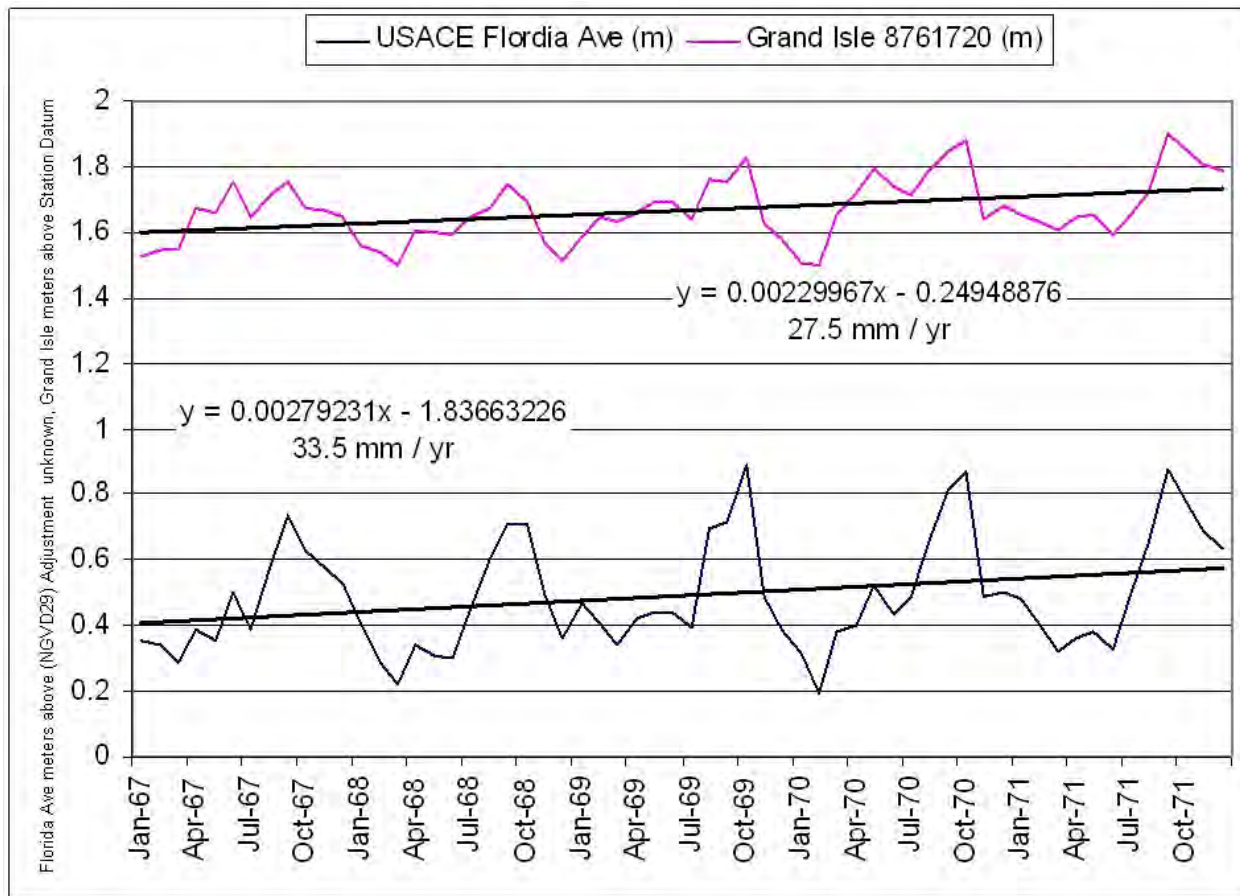

Figure 23. Long-term water level data collected at Florida Avenue, USACE water level station.

# Relative Sea Level Trends in the IPET Study Area

## Introduction

Monthly mean sea level (MSL) variations from calendar months of observed hourly heights from NOAA and USACE water level stations were analyzed to determine local mean sea level trends in the greater IPET study area. Results presented in the "NOAA Sea Level Variations of the United States 1854-1999" report (Zervas 2001) were incorporated into the analysis as a comparison and to ensure validity.

## Variation in Sea Levels and Global Sea Level Rise

Tide stations provide information on relative trends in local mean sea level as they do not distinguish sea level change due to land subsidence (or emergence) from that due to regional or global sea level rise due to climate change. Tide stations simply provide what the water is doing relative to the land. Vertical land movement at different rates may be expected during each period and consequently can cause variations in relative LMSL trends. Therefore, the trends derived from tide station records are relative LMSL trends and can be considered valid only for a region near the gage with uniform vertical land motion. Calculation of absolute LMSL trends requires the accurate determination of vertical land motion at the gauges and is beyond the scope of this description. Additionally a number of studies (Parker, 1992) have attempted to determine the global MSL trend due to the thermal expansion of seawater caused by global temperature changes and glacial melting. Although most coastal regions of the world indicate a MSL rise, some coastlines show rapidly falling LMSL. This is a consequence of water level gages measuring relative LMSL change which combines the effects of absolute MSL change and any vertical land movement. Various averaging schemes and/or corrections for vertical land motions have been devised, resulting in estimates of global MSL rise ranging from 1.0 to 2.4 mm/yr (Douglas et al., 2001), which need to be accounted for in attempting to determine local mean sea level rise for the region. The latest research in estimating potential acceleration in global sea level rise can be found in Church (2006).

## Seasonal Variation

The average seasonal cycles in monthly local mean sea level can show wide variations depending on the seasonal variations in water temperature, winds, and circulation patterns currents in the nearby coastal ocean. Zervas (2001) presents an analysis of the seasonal variations for the NWLON stations in which he shows that seasonal variations can be a significant factor in determination of sea level trends.

The following Figure 24 shows four plots of monthly local mean sea levels for the IPET region from Pensacola west to Grand Isle are shown below. It can be seen that there is as low progression from a single mode of a seasonal high and low sea level stand at Pensacola (high in September, low in January) to a bi-modal variation at Galveston, TX with secondary high and low in May and July respectively. Hurricane season, from June through November, coincides with the periods of high monthly local mean sea levels--this generally adds to the elevation of storm surge.

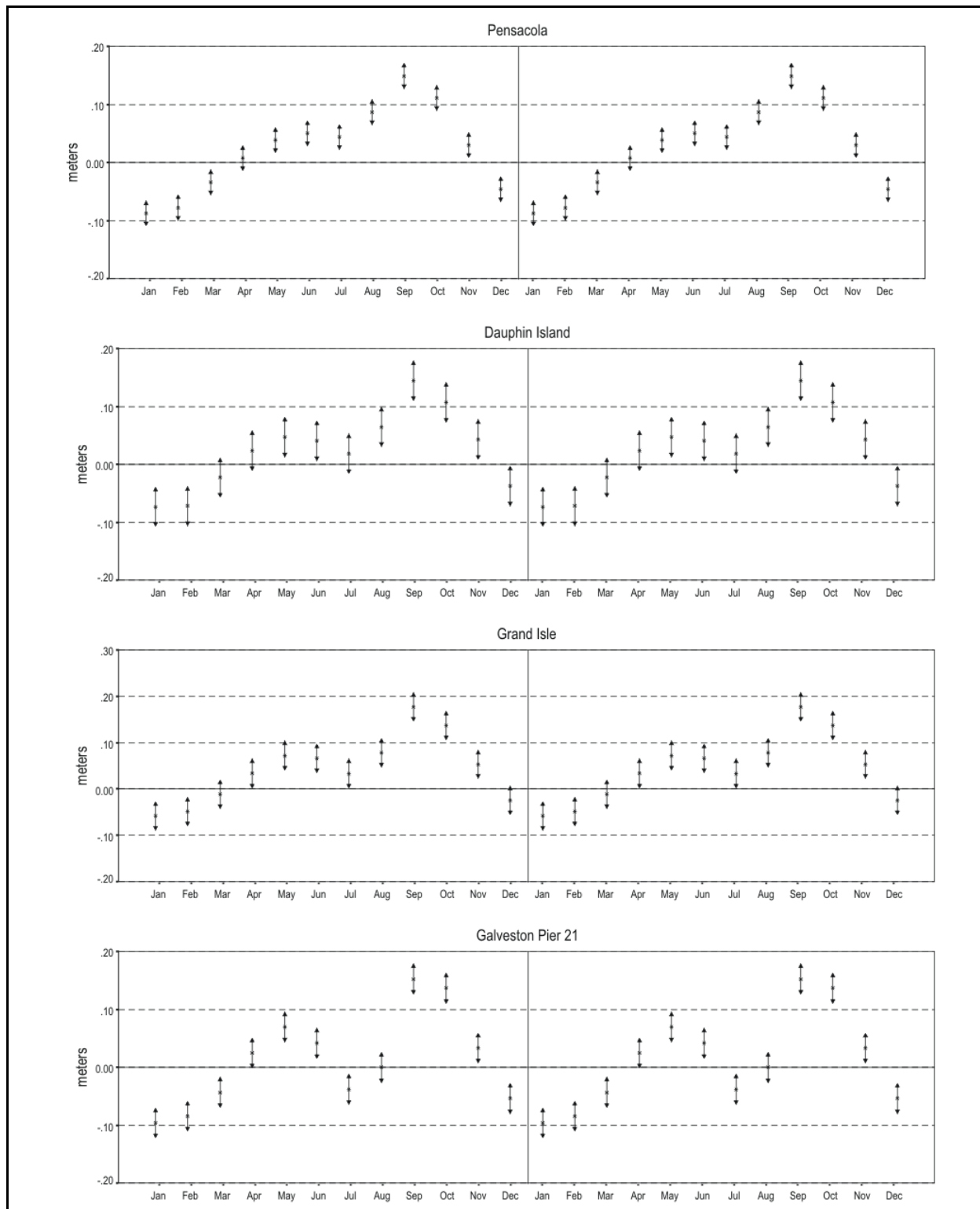

Figure 24. Monthly Local Mean Sea Levels from Pensacola to Galveston (Meters above LMSL)



Seasonal variations in the IHNC are shown in the following Figure 25 which was constructed by computing average water surface elevations for selected years at the Corps Florida Avenue gage. (Elevations are in feet and are referred to approximate LMSL or NGVD29 (1983 adjustment)).

Figure 25 clearly shows a quarter-foot bias in average surface elevation during the fall hurricane season. Hydrodynamic modeling, risk analysis, and design criteria need to consider seasonal bias in assessing flood protection elevations.

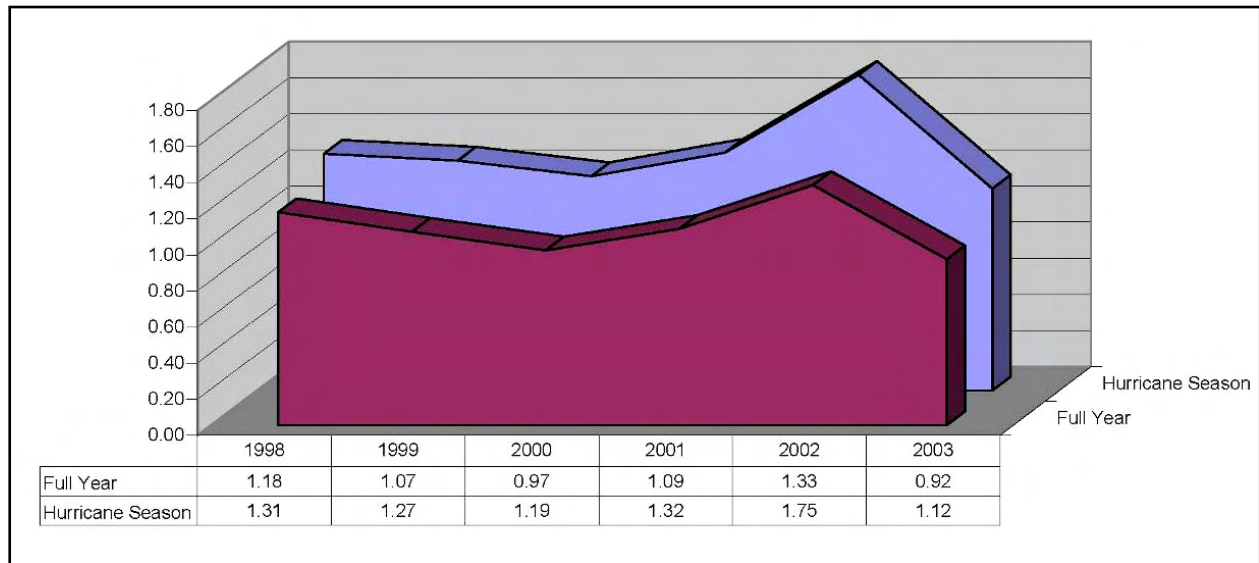

Figure 25. Seasonal variations in the IHNC (Florida Avenue gage)

### Error Estimates

The following Figure 26 from Zervas (2001) shows the standard error of the slope of the regression line on sea level versus the year range of data. The plot indicates a standard error of approximately 0.5 mm/yr in sea level trend for stations with less than 40 years of data and 1.2 mm/yr for stations with less than 20 years of data.

An estimated 50 to 60 years of data are required for obtaining linear LMSL trends having a 95% confidence interval of  $\pm 1$  mm/yr. (Zervas 2001). Any data series with less than 50 years will have a greater uncertainty as can be seen in Figure 27.

The range of the confidence interval is inversely proportional to the length of the data series. The widest confidence intervals are for the stations with the shortest time periods of data. This indicates the danger in relying on only 25 years of data to determine a long-term LMSL trend without considering the confidence interval.





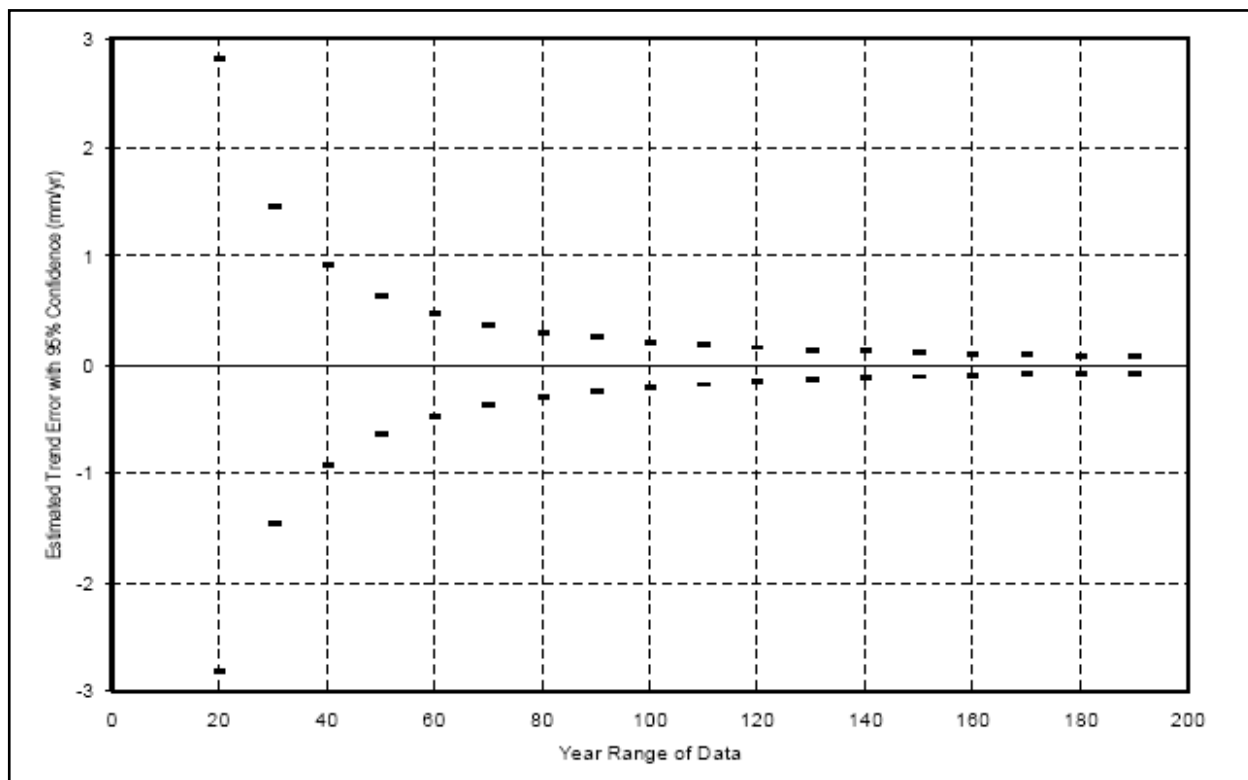

Figure 27. 95% confidence interval for linear MSL trends (mm/yr) versus year range of data

### Analysis Stations

NOS water level data from NWLON stations closest to the IPET study area at Galveston Pier 21, Pensacola, Grand Isle, and Dauphin Island were examined from the longest common time period from 1982 to the present. Data were also obtained from closely neighboring stations at Waveland, MS and Waveland Yacht Club which were combined into one series allowing for approximately 25 years of data at that location. This can be accomplished if the vertical datum (or datum of tabulation) has been carefully maintained through frequent leveling to fixed benchmarks maintained in the vicinity of the station. Figure 28 below shows the simultaneous plots, with the much shorter time series from the new Canal Station shown in red. The slopes of the simple linear regressions that follow have been shown to be similar to the work done by Zervas (2001); however, the standard error is greater and the uncertainty in LMSL trends will be underestimated because the Zervas (2001) method of using autoregressive residuals of Order 1 were not possible with the short time series. The elevations of the data series are not relative to the same reference zero and are plotted relative to arbitrary station datum to enable viewing of each plot.

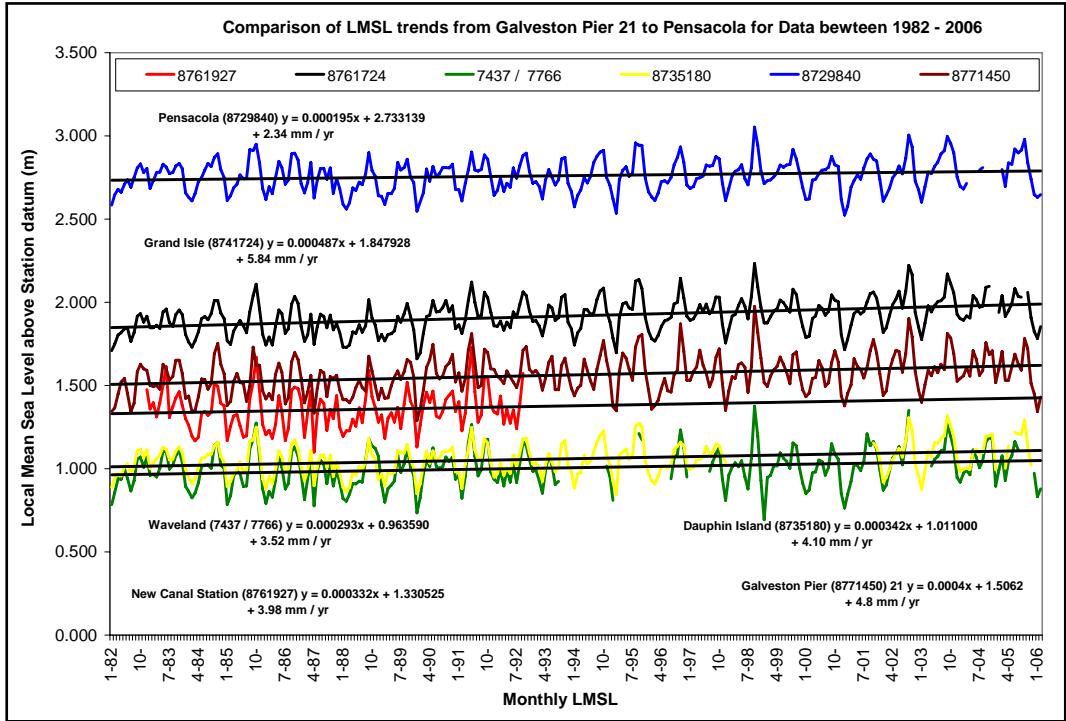

Figure 28. Local mean sea level trends from 1982 to present for select Stations in the IPET study area

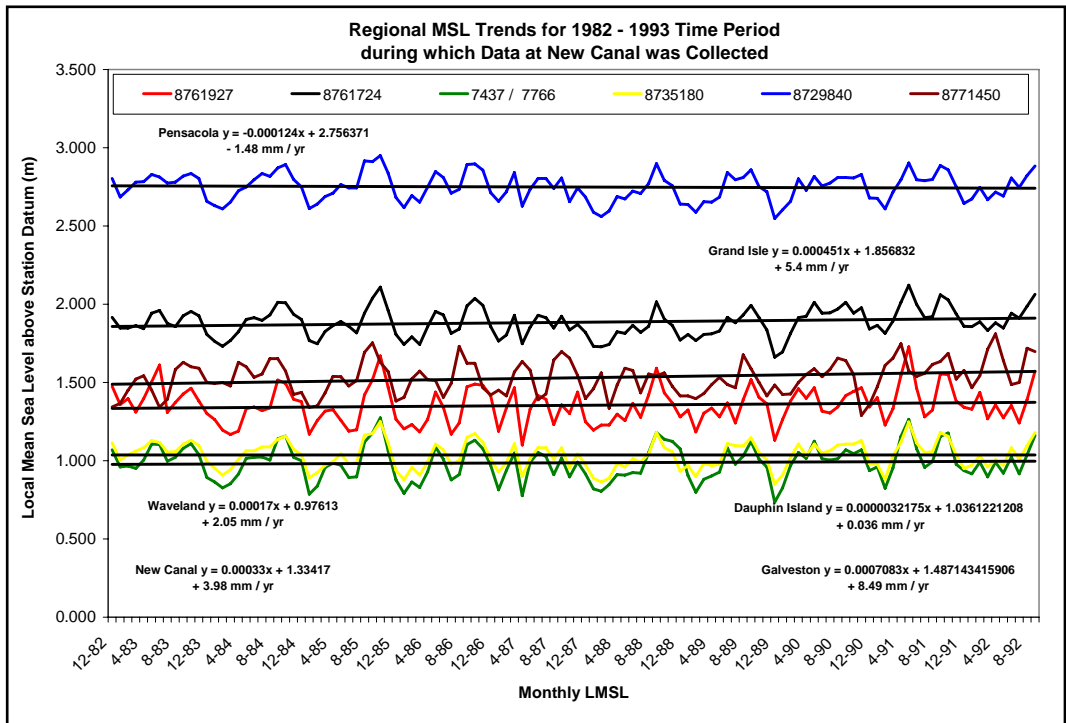

Figure 29. Local mean sea level trends from 1982 -1992 for select Stations in the IPET study area

Data series from the stations in Figure 29 above were reduced to the time period that New Canal Station was operating. The above figure compares the sea level trends for the original stations for the period of 1982 – 1992. The results show that with the exception of Galveston all sea level trends based on the shorter time series during that particular decade are underestimates of the longer term rates. This suggests that the trend obtained for New Canal Station for the period of 1982-1992 is most probably an underestimate of the actual sea level trend at that location; which is supported by Zervas (2001) for series of less than 50 years. The estimated trend at New Canal can be extrapolated to a 20 year period assuming that the ratio of the 10 year trend to the 20 year trend at Waveland is the same at New Canal. This ratio at Waveland is  $3.52\text{mm/yr (20 yrs)} / 2.05 \text{ mm/yr (10 yrs)} = 1.72$ . Applying this ratio to the  $3.98\text{mm/yr}$  trend over 10 years at New Canal results in an extrapolated trend of  $6.83 \text{ mm/yr}$  for a 20-year period.

### **Sea Level Rates at USACE Stations**

Daily values from 1944-2003 from New Orleans District water level station 76120 at Florida Avenue were examined by comparison with NOS stations at Pensacola, Dauphin Island and Grand Isle.

Daily values are once per day water level readings taken at the same time each day in contrast to the continuous hourly readings taken by the NOAA tide gauges. However, over a long enough time period, the daily readings should provide an unbiased estimate than can be used to estimate a mean sea level trend. Possible datum shifts were identified from the raw USACE data as shown in Figures 30–31. Datum shifts were analyzed further by subtracting the USACE data from the simultaneous NOAA data which effectively removed any annual trends or other regional variations that could mask datum shifts. Three separate time series in the USACE Florida Avenue data were identified that showed significant datum shifts near 1978 and 1982.

The documentation of the operation of these gauges and the exact information on the datum shifts do not exist. Without knowing the exact datum adjustment applied by New Orleans District water resource personnel in order to correct the data to a common datum, statistical software was used to calculate an overall trend based on the segments.

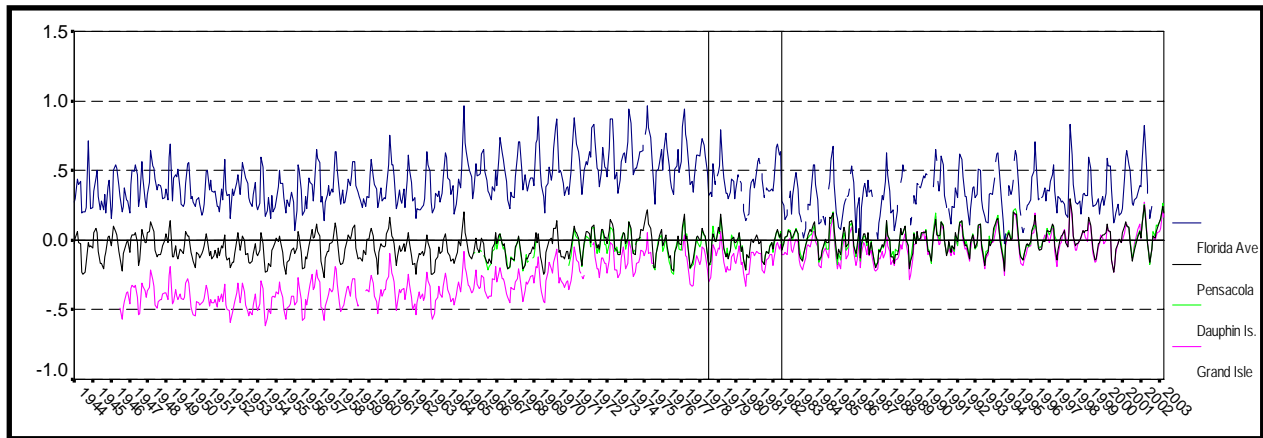

Figure 30. Possible datum shifts identified from raw COE data through comparison with NOS data series at Pensacola, Dauphin Island, and Grand Isle

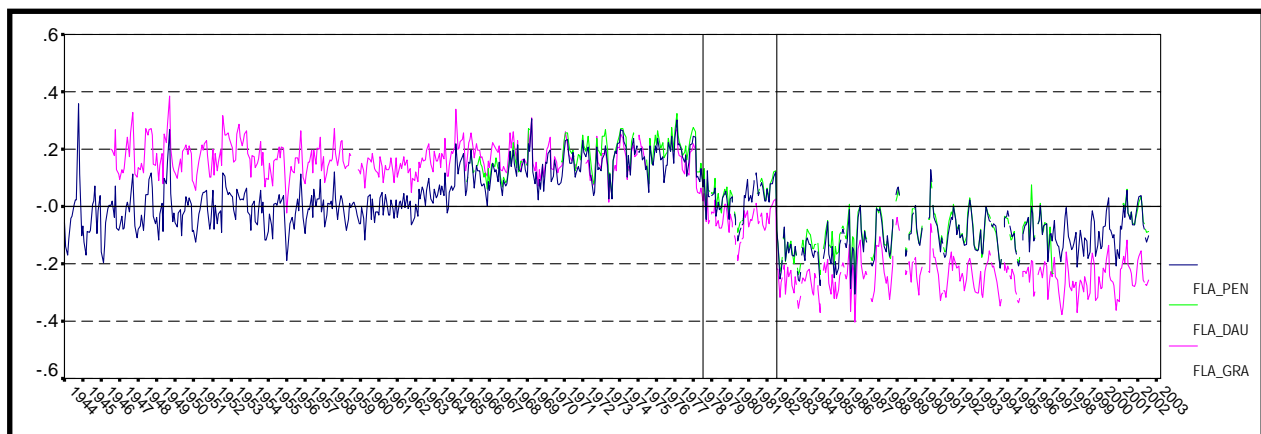

Figure 31. Three separate time series derived from simultaneous comparison of COE Florida Avenue data with NOS data identifying significant datum shifts near 1978 and 1982

The overall sea level trend calculated from the three segments identified in the analysis is approximately 7.90 mm/yr. as shown in Figure 32. This value based on 60 years of data should fall in to the 95% confidence interval identified by Zervas (2001) at  $\pm 1$  mm/yr. This trend is more in line with the benchmark subsidence rates from NOAA Technical Report 50 (NGS 2004) and is consistent with the trends of the shorter time periods, including New Canal, which underestimated the long term trends. In contrast to the NOAA stations, the details of gage changes, calibrations, and station maintenance are not known at the Florida Avenue station—this will add an undetermined amount of uncertainty to the estimated trend.

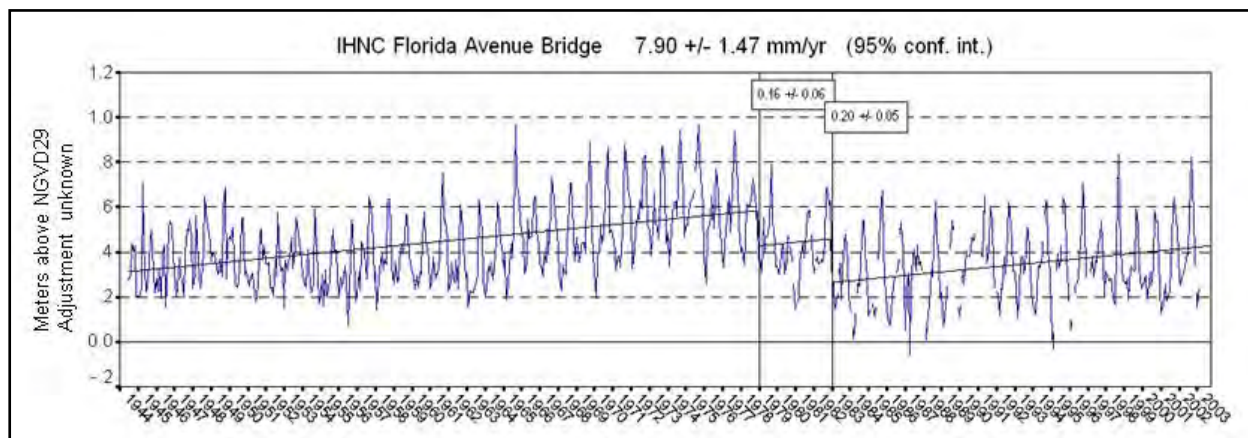

Figure 32. Sea level trend calculated from combination of the three segments identified in the previous analysis is approximately 7.90 mm/yr.

Table 12 summarizes the MSL trends from Gulf stations for the time periods of 1982 – Present, 1982 – 1992 and for long-term series examined by Zervas (2001) near the IPET study area. Calculated values for the 1982 – Present time period range from +2.34 mm/yr for Pensacola, FL to + 5.84 mm/yr at Grand Isle, LA. These values are in contrast to the shorter term series rates which range from – 1.48 mm/yr at Pensacola to 5.40 mm/yr at Grand Isle.

Station	Rate 1982-2006 (mm/yr)	Rate Zervas 2001(mm/yr)	1982-1992
Pensacola, FL	2.34	2.14 (77 Year)	-1.48
Dauphin Island, AL	4.10	2.93 (32 Years)	0.04
Waveland, MS	3.52	NA	2.05
Grand Isle, LA	5.84	9.85 (53 Years)	5.40
Galveston Pier 21, TX	4.80	6.5 (92 Years)	8.49
	<b>1982 - 1992</b>		
New Canal Station	NA	NA	3.98
Florida Avenue (USACE)	8.9	7.9 (60 Years)	9.00

Only Galveston showed an increase in sea level rise at 8.49 mm/yr. These data are compared to sea level trends calculated by Zervas (2001) for the entire length of the data series which due to length should be considered the values with the least uncertainty. Data collected from 1944-2003 at USACE Florida Avenue water level station is included for comparison.

### Conclusions on Sea Level and Subsidence Trends

Long term tide station records provide estimates of local relative sea level trends as opposed to the absolute rates of global sea level that are the subject of basic research in climate change and recent media attention. These local relative sea level trends from tide stations are a combination of whatever global sea level variations are taking place, whatever regional climate scale water level variations are taking place, and whatever local vertical land movement due to local or regional subsidence (or land emergence) is taking place. Thus the tide stations provide the infor-

mation desired by studies like IPET because they provide direct information on variations of water levels relative to the local land elevations.

NOAA has performed analyses of relative sea level trends for all of the long-term NWLON stations. Unfortunately the New Orleans area and Lake Pontchartrain are geographical areas of data gaps for locations with measurements of sea level variations necessary to estimate sea level trends with high certainty. The closest NWLON stations in this category are Dauphin Island, AL; Pensacola Fl; and Grand Isle LA. The analyses done for estimating relative sea level trends in the New Orleans area include using a 23-year monthly mean time series pieced together for Waveland, MS (3.52 mm/yr with a +/- 2.6mm/yr 95% confidence interval) and a 10-year monthly mean time series a New Canal, LA (3.98 mm/yr with an 95% confidence interval > +/-3.0 mm/yr). Historical once per day readings from long term USACE stations have also been analyzed, however, there have been many adjustments to the gages that were not readily available for this review.

- a. Analysis of the USACE record at Florida Avenue, New Orleans, LA provides a composite estimate of 7.90 mm/yr with a 95% confidence interval of  $\pm 1.5$  mm/yr.
- b. Using an assumption of similar ratio relationships of shorter period trends to longer period trends, the relative sea level trend at New Canal was estimated to be 6.83 mm/yr for a 23 year period (comparing with Waveland trends).
- c. By performing a difference of the simultaneous monthly mean sea levels between New Canal and Waveland, a trend fit to the differences shows that relative LMSL is rising 1.9 mm/yr faster at New Canal than at Waveland. Adding the 1.9 mm/yr rate to the 3.98 mm/yr estimate for 10-months gives an estimate of 5.88 mm/yr.

Although limited by the 10-year period length and with a spread of 2 mm/yr, these three independent estimates of the relative sea level trend at New Canal are consistent with independent estimates of local subsidence in the region based on NOAA Report 50 (NGS 2004) which relied on repeat geodetic surveys all within the expected uncertainty.

The results of the analyses used to estimate relative sea level trends for the IPET study area provide corroboration of the drawbacks of estimating sea level trends from only a few decades of measurement and the need to look at simultaneous time periods when comparing trends across a region.

# Data Analysis and Impacts: Evaluation of Designed and Constructed Elevations on Flood Control and Hurricane Protection Structures

## Purpose

The following sections review the various datums and elevations used in the design and construction of selected flood control and hurricane protection structures in the New Orleans region. An estimate is made of the originally constructed flood protection elevations relative to the local water surface and geodetic vertical datums then used as construction references. Pre-Katrina flood protection elevations are estimated relative to the current local mean water surface and the latest geodetic reference scheme, based on topographic and geodetic surveys performed after the hurricane. Emphasis is placed on assessing elevations relative to the local mean water surface since hydraulic analyses and flood protection elevations must be computed relative to this surface. The focus is primarily on floodwall projects in Orleans Parish where surge elevations were near the design elevation of the structures. (Note: all USACE publications referenced herein refer to the current edition unless otherwise indicated).

## Methodology

Original constructed elevations were estimated based on a review of design memorandums and contract documents associated with a project. Archive geodetic control data was obtained from NOAA NGS. Water level information was obtained from the NOAA CO-OPS, as was described in preceding sections. An evaluation of pre-Katrina (August 2005) elevations was based on post-Katrina geodetic and topographic surveys performed by New Orleans District, Task Force Guardian, and IPET survey crews.

## Geodetic Vertical Datum and Tidal Epoch Elevations

As outlined in the initial sections to this Volume, elevations throughout the IPET study area are now being referenced to a consistent, time-stamped, geodetic datum—NAVD88 (2004.65). In order to relate this geodetic reference datum to the local water surface which is used to develop flood inundation levels from hydrodynamic models, long-term observations from water level gage data need to be analyzed. The requirement to reference geodetic elevations to a water surface elevation is clearly outlined in Section II-5-4 (Water Surface Elevation Datums) of the Coastal Engineering Manual (EM 1110-2-1100):

Water level and its change with respect to time have to be measured relative to some specified elevation or datum in order to have a physical significance. In the fields of coastal engineering and oceanography this datum represents a critical design parameter because reported water levels provide an indication of minimum navigational depths or maximum surface elevations at which protective levees or berms are overtopped. It is therefore necessary that coastal datums represent some reference point which is universally understood and meaningful, both onshore and offshore. Ideally, two criteria should be expected of a datum: 1) that it provides local depth of water information, and 2) that it is fixed regardless of location such that elevations at different locations can be compared. These two criteria are not necessarily compatible.

The two criteria expected of a datum are important concepts—especially the statement that they are “not necessarily compatible.” This is exactly the case in the New Orleans area. The

local water surface (e.g., LMSL) cannot be simply correlated at different locations with a geodetic vertical datum, such as NAVD88 (2004.65). Although geodetic vertical datums are useful for providing consistent surveying, modeling, and subsidence analysis over a region, they do not provide a direct relationship to regional water surface elevations that are the basis for flood protection elevations. Where this water surface is not constant (e.g., in tidal areas or rivers), a dense gage network is needed to model this water surface relative to the geodetic vertical datum.

USACE EM 1110-2-1003 (Hydrographic Surveying) notes the importance of obtaining updated water level reference datums and tidal epochs for dredging navigation projects:

All USACE project reference datums, including those currently believed to be on MLLW, must be checked to ensure that they are properly referred to the latest tidal epoch, and that variations in secular sea level, local reference gage or benchmark subsidence/uplift, and other long-term physical phenomena are properly accounted for. In addition, projects should be reviewed to ensure that tidal phase and range characteristics are properly modeled and corrected during dredging, surveying, and other marine construction activity, and that specified project clearances above grade properly compensate for any tidal range variances. Depending on the age and technical adequacy of the existing MLLW reference (relative to NOS MLLW), significant differences could be encountered. Such differences may dictate changes in channels currently maintained. Future NOS tidal epoch revisions will also change the project reference planes. In many projects, existing NOS tidal records can be used ... tidal observations and/or comparisons will be necessary for projects in areas not monitored by NOS or in cases where no recent or reliable observations are available.

Other Corps of Engineers guidance documents emphasize the need to obtain accurate water surface profiles for use in design and construction. These include EM 1110-2-1416 (River Hydraulics), EM 1110-2-1607 (Tidal Hydraulics), EM 1110-2-1913 (Design & Construction of Levees), and EM 1110-2-1614 (Design of Coastal Revetments, Seawalls, and Bulkheads). The Hydraulic Engineering Center (HEC) Research Document No. 26 “Accuracy of Computed Water Surface Profiles” (1986) states in its Introduction that:

“Water surface profiles are computed for a variety of technical uses ... flood insurance studies, flood hazard mitigation investigations, drainage crossing analysis, and other similar design needs. The accuracy of the resulting computed profiles has profound implications. In the case of flood insurance studies, the computed profile is the determining factor in the acceptability of parcels of land for development. For flood control projects, the water surface elevation is important in planning and design of project features and in determining the economic feasibility of proposed solutions ... the relationship between mapping accuracy and resultant computed profile accuracy is therefore of major interest to engineers responsible for providing cost-effective technical analysis.”

FEMA guidance appears to differ from the above assessment. FEMA’s “Flood Insurance Study Guidelines and Specifications for Study Contractors” (FEMA 1995) counters the use of hydraulic-based datums for Flood Insurance Studies (FIS).

**Local Mean Sea Level:** The use of this designation in FISs has decreased since the introduction of NGVD 29 and will continue to do so as NAVD88 becomes the datum of reference for all Federal mapping efforts. Local mean sea level has the inherent drawback of varying from location to location in the areas of concern to the NFIP. Its use will continue as a local datum, but will no longer be referenced as a datum for use in FIS efforts. The initial use of local mean sea level as a datum reference was based on the readily observed tidal cycles of mean hourly water



elevations observed over a 19-year period (the National Tidal Datum Epoch). The arithmetic mean of these observations provided the level used as local mean sea level. However, there are many variables that affect the determination of local mean sea level, and it has been demonstrated since the adoption of NGVD 29 that differences between local mean sea level and NGVD 29 vary from location to location and from time to time. To assist in evaluating these local differences, geodesists have been searching for a datum definition that would more closely represent the true shape of the geoid.

Guidance in Appendix D (Guidance for Coastal Flooding Analyses and Mapping) of FEMA 2003 (Guidelines and Specifications for Flood Hazard Mapping Partners) variously refer still-water elevations to either MSL or NGVD29. Appendix H (Guidance for Mapping of Areas Protected by Levee Systems” refers to “water surface elevations.” The distinction between geodetic and hydraulic datums, particularly in coastal areas, is not altogether clear in this updated FEMA manual.

Given the relatively large spatial and temporal variances between geodetic and sea level datums in the New Orleans region, coupled with the small terrain gradients in the protected areas below sea level, it is obvious that the geodetic-hydraulic datum relationship is critical to hydrodynamic modeling and flood/hurricane protection structure design.

In analyzing pre- and post-Katrina levee/floodwall elevations, geodetic elevations on either NGVD29 or NAVD88 (2004.65) are adjusted to the local water level datum (e.g., sea level) published by NOAA. The latest NTDE available is the 19-year period 1983-2001, which was released by NOAA in 2003. Nearly all of the floodwalls in the study area were designed and constructed during the previous tidal epoch (1960-1978); however there is no indication in design memorandums or contract documents of this, or previous, tidal epoch. The difference between the 1960-1978 and 1983-2001 epochs at the New Canal gage in Lake Pontchartrain is 0.15 ft—primarily due to a sea level rise adjustment. In general, the MSL epoch change in the region averages about 0.2 ft.

In a high subsidence area such as New Orleans, the “apparent sea level” increase is significant—upwards of 3 ft per century. This means that an average mean sea level computed over a 19-year period may not represent the latest sea level condition, and related flood protection levels. As explained in a previous section, in high-subsidence areas NOAA has adopted alternate procedures for computing accepted tidal datums using the last several years of sea level data rather than the 19-year tidal epoch—typically the latest 5-year epoch

References to Mean Sea Level (MSL) or Local Mean Sea Level (LMSL) in the following sections generally relate to the 1983-2001 tidal epoch established by NOAA. Given the historic subsidence occurring in this area, as outlined in previous sections, elevations referenced to a later tidal epoch (e.g., 2001-2005) will be 0.1 to 0.3 ft lower than the 1983-2001 epoch elevation.

### **Typical Geodetic and Water Level Datums used in New Orleans Area Floodwall Construction**

Figure 33 below illustrates the various geodetic vertical and water level datums and adjustments existent over the years on a 1931 benchmark near the 17th Street Canal on Lake Pontchartrain. This graphic is typical of benchmarks throughout this high subsidence region. It shows that elevation differences relative to MSL/LMSL are dependent on which NGVD29/NAVD88 datum

or adjustment is selected. This is especially critical in a high subsidence area where using an outdated or superseded datum to construct a flood protection structure can result in a lower elevation than that intended in the design. Likewise, hydrologic or hydraulic models using terrain data based on disparate datums can have adverse computational impacts.

Lake Pontchartrain water level data is based on direct vertical control connections between Benchmark ALCO and the NOAA New Canal gage. This benchmark is located near the gage site. Published water level data (and reference datums) for this gage is based on data obtained between October 1983 and September 1992, and adjusted by NOAA for subsequent epoch changes. As part of this IPET project, NOAA in November 2005 reinstalled a gage at this site and data collected from that time has been used to evaluate later epoch references. As described in previous sections in this Volume, similar evaluations were made at other NOAA gage sites in the region—both at historic sites and at newly established sites. In addition, a number of Corps of Engineers gages are situated throughout the region. These gages, although not part of the NWLON network, were used by NOAA to evaluate later tidal epochs, elevations, and subsidence rates.

Figure 33 also clearly indicates the complex relationships between geodetic and hydraulic datums in this region, notwithstanding the various geodetic readjustments. Not shown are MSL/LMSL relationships before the 1980s since there was no NOAA gage at this New Canal site prior to that time. (Note that Benchmark ALCO was not directly referenced in contract plans for any floodwall construction on the 17th Street Outfall Canal).

These periodic leveling and readjustments to the geodetic vertical datums were later deemed by NOAA to have been unreliable for assessing elevations, as stated in their Technical Report 50 (NGS 2004):

The old leveling data is useless for determining current elevations. The historical data, even that of only ten years ago, describes a topography and spatial relationship between benchmarks that no longer exists. Since benchmarks, even spatially adjacent benchmarks, move at different rates, their relative elevation differences have changed over time. A readjustment of old leveling data seems pointless.

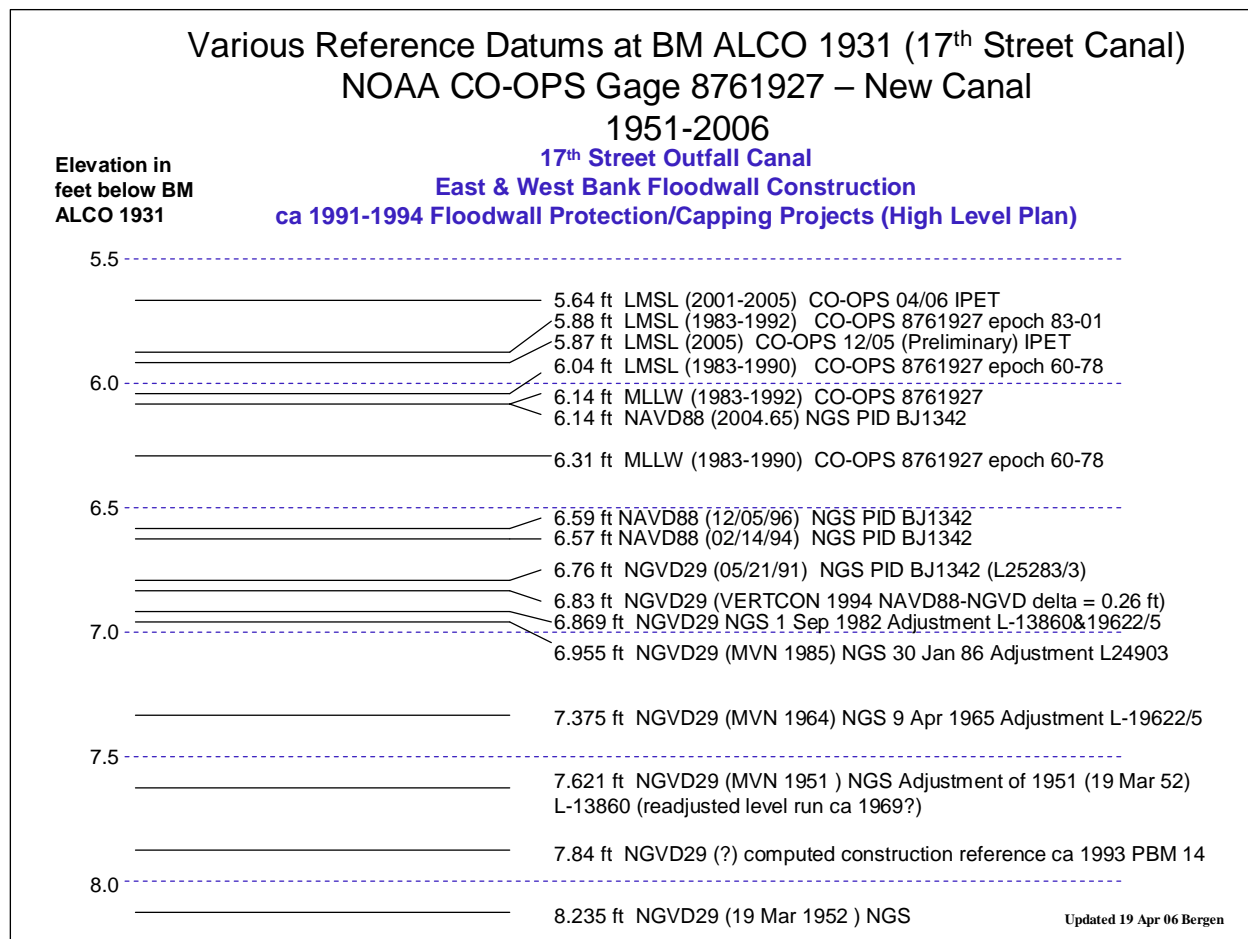

Figure 33. Datum Relationships at Benchmark ALCO and NOAA New Canal Gage (1951 to 2006)  
 (Source: NOAA)

The above realization precipitated the implementation of a time-dependent geodetic reference system—NAVD88 (2004.65)—to better and more reliably monitor subsidence in the region. Prior to Hurricane Katrina, the New Orleans District was closely involved with NOAA in this effort.

Figure 33 does not show the original presumed convergence (or equivalency) of MSL and NGVD29, perhaps prior to 1930, if ever. Although NAVD29 (and previous adjustments) was originally based (or adjusted) to a “sea level” datum, it is not absolutely certain that NGVD29 and MSL converged at Lake Pontchartrain in the 1930s. (See previous sections discussing the original adjustment of NGVD29 and sea level datums connections from Biloxi, MS).

The LMSL elevation based on the NTDE 1983-2001 was determined from NOAA estimates for LMSL at the NOAA New Canal gage (17th Street Canal) based on observations over the period 1983 to 1992, and supplemented by IPET GPS and vertical control surveys post-Katrina. The LMSL elevation averaged for the more recent NTDE 2001-2005 epoch is an indicator of the apparent sea level rise occurring between the two epoch periods.



Figure 34. IPET GPS surveys in December 2005 at Benchmark ALCO on seawall bulkhead at US Coast Guard station vicinity NOAA New Canal gage (3001, Inc)

## **Subsidence and Settlement Considerations in Protective Structure Elevations**

In reviewing the design memorandums (DM) and related documents, it was not clear how projected subsidence rates were applied in structural elevation design, if at all. Subsidence was apparently not factored into the design freeboard allowance. Most subsidence estimates in the DMs were small—e.g., less than 1 ft/century. This would seemingly be almost negligible. It is possible that subsidence was included in the settlement allowances—typically 0.5 ft was applied—or possibly in overbuild allowances. For information, the following CFR excerpts pertaining to FEMA certification do not specify or include subsidence allowances within coastal levee freeboard. It might be implied, however, that subsidence is a consideration in settlement evaluations.

### Code of Federal Regulations, Title 44, Volume: 44CFR65.10

#### FEMA Levee Elevation and Certification Requirements

(iii) For coastal levees, the freeboard must be established at one foot above the height of the one percent wave or the maximum wave runup (whichever is greater) associated with the 100-year stillwater surge elevation at the site.

(iv) Occasionally, exceptions to the minimum coastal levee freeboard requirement described in paragraph (b)(1)(iii) of this section, may be approved. Appropriate engineering analyses demonstrating adequate protection with a lesser freeboard must be submitted to support a request for such an exception. The material presented must evaluate the uncertainty in the estimated base flood loading conditions. Particular emphasis must be placed on the effects of wave attack and overtopping on the stability of the levee. Under no circumstances, however, will a freeboard of less than two feet above the 100-year stillwater surge elevation be accepted.

(5) Settlement. Engineering analyses must be submitted that assess the potential and magnitude of future losses of freeboard as a result of levee settlement and demonstrate that freeboard will be maintained within the minimum standards set forth in paragraph (b)(1) of this section. This analysis must address embankment loads, compressibility of embankment soils, compressibility of foundation soils, age of the levee system, and construction compaction methods. In addition, detailed settlement analysis using procedures such as those described in the COE manual, "Soil Mechanics Design-Settlement Analysis" (EM 1100-2-1904) must be submitted.

(d) Maintenance plans and criteria. For levee systems to be recognized as providing protection from the base flood, the maintenance criteria must be as described herein. Levee systems must be maintained in accordance with an officially adopted maintenance plan, and a copy of this plan must be provided to FEMA by the owner of the levee system when recognition is being sought or when the plan for a previously recognized system is revised in any manner. All maintenance activities must be under the jurisdiction of a Federal or State agency, an agency created by Federal or State law, or an agency of a community participating in the NFIP that must assume ultimate responsibility for maintenance. This plan must document the formal procedure that ensures that the stability, height, and overall integrity of the levee and its associated structures and systems are maintained. At a minimum, maintenance plans shall specify

the maintenance activities to be performed, the frequency of their performance, and the person by name or title responsible for their performance.

(e) Certification requirements. Data submitted to support that a given levee system complies with the structural requirements set forth in paragraphs (b)(1) through (7) of this section must be certified by a registered professional engineer. Also, certified as-built plans of the levee must be submitted. Certifications are subject to the definition given at Sec. 65.2 of this subchapter. In lieu of these structural requirements, a Federal agency with responsibility for levee design may certify that the levee has been adequately designed and constructed to provide protection against the base flood.

The above reference points out that subsidence is generally not considered in the design. Additional discussion on subsidence is covered later in this Volume.

# Data Analysis and Impacts: Orleans Avenue Outfall Canal Construction Reference Datums

## Summary of Findings

This Section covers the evaluation of the constructed and current elevations on flood protection structures along the Orleans Outfall Canal. The floodwalls on the east and west banks were found to be constructed approximately 1 foot below their intended design elevations. This was caused by using a geodetic elevation reference instead of a hydraulic (sea level) reference datum. Pre-Katrina and current flood protection elevations in the canal floodwalls are approximately 1.5 feet below design when related to the latest tidal epoch.

## Reference Documents

The following construction drawings and Design Memorandums were reviewed as part of this assessment:

- DACW29-93-C-0077: Orleans Avenue Canal—Flood Protection Improvement Project—Phase II-D (West Side: B/L Sta. 2+39.00 to Sta. 29+07.50)
- DACW29-97-C-0029: Orleans Avenue Outfall Canal—Parallel Protection-Phase II-A—East Side Floodwall (B/L Sta. 3+60.00 to Sta. 90+26.33)
- DACW29-95-B-0035: Orleans Avenue Outfall Canal—Parallel Protection-Phase II-C—West Side Floodwall (B/L Sta. 21+34.52 to Sta. 63+66.22)
- DACW29-99-C-0025: Filmore and Harrison Avenue Bridges—Phase I-C
- DACW29-00-B-0094: Robert E. Lee Boulevard Bridge—Phase I-B
- GDM No. 19—Orleans Avenue Outfall Canal (Volumes I, II, & III)—1988
- DM 01 Part III Hydrology and Hydraulic Analysis—Lake Pontchartrain & Vicinity-Lakeshore (Sep 1968)

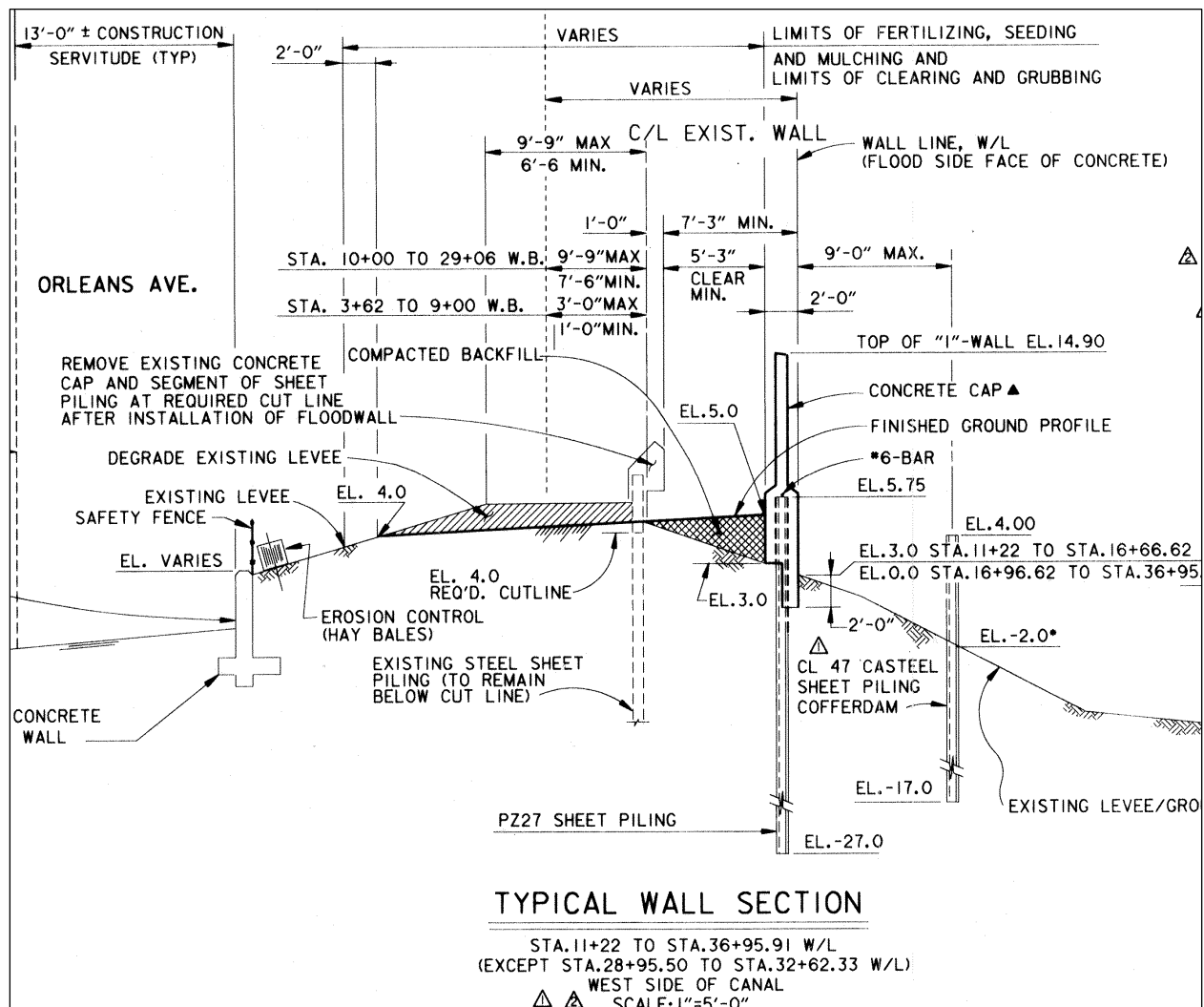

Figure 35. Typical I-Wall Section at elevation 14.90 ft (DACW29-93-C-0077)

### Design Elevation Parameters

Parallel protection elevations are shown in GDM No. 19 and on various contract plans. GDM No. 19 (Vol I) notes a Standard Project Hurricane (SPH) design stillwater surface elevation of Lake Pontchartrain at 11.5 ft NGVD (i.e., NGVD29). This base elevation was used in subsequent HEC-2 models to compute required floodwall elevation on each side of the canal and at the bridges. The design stillwater elevation in the canal at the Filmore Ave. Bridge is 12.10 ft NGVD, and 12.30 ft NGVD at the Harrison Avenue Bridge (DACW29-99-C-0025). The design canal stillwater elevation at the R.E. Lee Bridge was 11.90 ft NGVD (DACW29-00-B-0094). In these hydraulic analysis models, the stillwater elevation relative to NGVD (i.e., NGVD29) was generally assumed to be MSL. A standard freeboard (2 ft typical) and settlement (0.5 ft typical) was added to these stillwater heights to arrive at a design protection elevation referenced to NGVD. Typical design flood protection elevations in the canal thus ranged from 14.0 to 14.9 ft—see Figure 35. (DM 01 Part II noted a USACE recommendation for a 3-ft freeboard allowance vice 2 feet previously authorized—this recommendation was rejected).



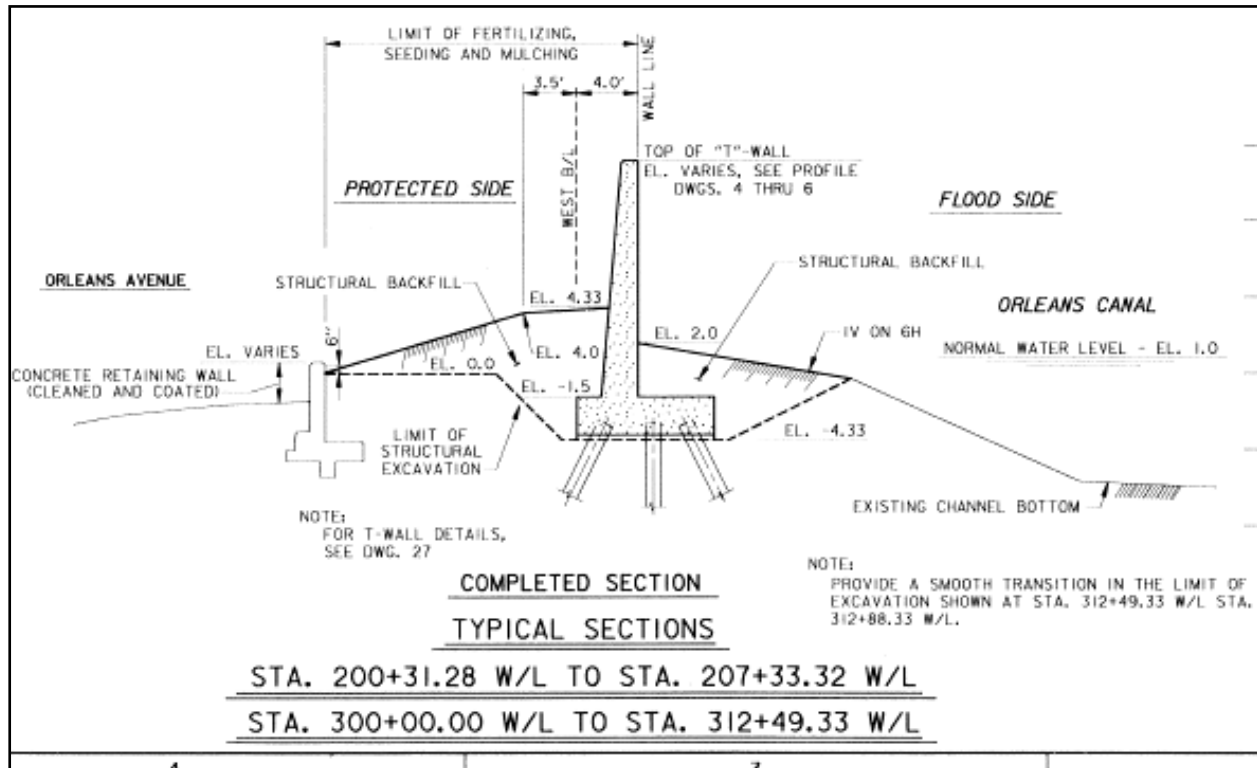

Figure 36. "Normal Water Surface" Notation on Flood Side of Orleans Outfall Canal (Typical) DACW29-95-B-0035

Various contract plans indicate a "normal water surface" or "normal water level" elevation of 1.0 ft NGVD in the canal. The source of this apparent superelevation is not noted, nor is there any indication that this value was incorporated into the hydraulic analyses used in determining floodwall heights. (This is based on discussions with MVN personnel who ran these original hydraulic models). The 1.0 ft canal superelevation is believed to have been taken from pump station hydrograph records, or perhaps from gage records on Lake Pontchartrain (Orleans marina) or on the IHNC (Seabrook Bridge). Although a "NGVD" datum is noted, the year or adjustment epoch is not shown. The superelevation does roughly correlate with the approximate 0.9 ft amount that the MSL elevation is above NGVD29 at Benchmark ALCO. A typical section showing the normal canal water elevation is shown in Figure 36, taken from DACW29-95-B-0035.

### Reference Benchmark for Orleans Canal Floodwall Construction

Contract drawings indicate that Benchmark "CHRYSLER RM" was used as the vertical reference for design and construction associated with floodwalls constructed on the Orleans Avenue Outfall Canal. This mark was used for all the projects referenced above. This benchmark, originally set in 1931 by the USC&GS (now the National Geodetic Survey), is located in a concrete retaining wall at the intersection of Lakeshore Drive and the Orleans Outfall Canal.

No other benchmarks are noted in the reviewed construction plans. It is presumed all construction stake out during the period 1993 to 2000 was performed relative to this single benchmark.

**Reference Datum of Benchmark “CHRYSLER RM.”** The Phase II-D Plans (DACW29-93-C-0077) note that PROJECT BM “CHRYSLER RM” is at elevation 7.11 ft “M.S.L.” (Mean Sea Level) and on a “1983 Datum.” The General Notes on the Phase II-D Plans indicate that “all elevations are expressed in feet and refer to National Geodetic Vertical Datum (N.G.V.D.). No reference is made to an epoch or adjustment date for the datum.

The Phase II-A Plans (DACW29-97-C-0029) and Phase I-C Plans (DACW29-99-C-0025) note in the “Tabulation of Bench Marks” that ‘CHRYSLER RM’ is at elevation “7.11 [ft] N.G.V.D. (1983 Epoch).” No reference to “NGVD29” or a subsequent adjustment is made.

The Phase I-B Plans (DACW29-00-B-0094) note CHRYSLER RM as 7.11 ft N.G.V.D. on the “1984 Epoch.”

Thus, all construction documents are consistent in specifying a constant reference elevation and benchmark, even though various datums and epochs are indicated.

**Historical Adjustments to CHRYSLER RM (1951 to date).** Table 13 below illustrates the various elevations associated with Benchmark CHRYSLER RM. Most of the changes are due to readjustments of level lines by the NOAA.

<b>Table 13 Successive Elevations on Benchmark CHRYSLER RM from 1951 to 2006</b>				
<b>Elev, ft</b>	<b>Datum</b>	<b>Adjustment</b>	<b>Agency</b>	<b>Reference</b>
8.533	NGVD29	1951 (19 Mar 52 adj)	USC&GS	
7.923	NGVD29	1951 (1957 adj)	USC&GS	L-13860
7.694	NGVD29	9 Apr 65	USC&GS	L-19622
7.108	NGVD29	1 Sep 82	NGS	L-19622/13860
7.231	NGVD29	30 Jan 86	NGS	L-24903
7.03	NGVD29	21 May 91	NGS	L-25283
6.83	NAVD88	14 Feb 94	NGS	BJ1349
6.85	NAVD88	Dec 96	NGS	BJ1349
6.42	NAVD88 (2004.65)	10 Feb 06	NGS	(unpublished/L-25517)
6.38	NAVD88 (2004.65)	11 Feb 06	USACE	IPET Survey Team
6.30	LMSL (1960-1978)	ca 1985	NOAA CO-OPS	NOAA
6.15	LMSL (1983-2001)	Dec 2005	NOAA CO-OPS	IPET Study
5.94	LMSL (2001-2005)	Apr 2006	NOAA CO-OPS	IPET Study

The “7.108” ft elevation from the 01 Sep 82 adjustment of CHRYSLER RM appears to be the source for the “7.11” ft elevation shown on the contract plans. Although more recent adjustments were available (1986 and 1991), the variance between these adjustments ( $\pm 0.1$  ft) is not significant. It appears the “1983 Epoch” referenced in various contract documents may be

referring to the horizontal adjustment datum, i.e., North American Datum of 1983 (NAD83). The above table clearly shows a subsidence trend in this area over a 50-year period, and the need to account for these relative elevation variations and trends. The 10 Feb 06 adjustment is based on unadjusted level data from 1994, as adjusted to the epoch NAVD88 (2004.65). The 11 Feb 06 adjustment is based on a Third-Order differential level line run from Benchmark ALCO to Benchmark CHRYSLER RM, holding the NGS published NAVD88 (2004.65) elevation of ALCO fixed. The difference between the two LMSL epochs is based on an approximate estimate of the sea level rise at the NOAA New Canal gage.

### Local Mean Sea Level Relationships at the Orleans Avenue Outfall Canal

The elevation of Benchmark CHRYSLER RM can be related to the local mean sea level (LMSL) of Lake Pontchartrain using the relationships at the New Canal Gage (BM ALCO), which is slightly over a mile to the west of the Orleans Outfall Canal.

From the elevation relationships at the 17th Street Canal (New Canal Gage-Benchmark ALCO):

ALCO MSL (epoch 1983-2001)	5.89 ft
ALCO NAVD88 (12/05/96)	<u>6.59 ft</u>
Difference:	(0.70 ft) [MSL — NAVD88]

CHRYSLER RM [NAVD88 (12/05/96)]	6.85 ft
Difference [MSL (epoch 1983-2001) — NAVD88]	<u>-0.70 ft</u>
LMSL at CHRYSLER RM (epoch 1983-2001)	6.15 ft

From the above, the estimated LMSL elevation of Benchmark CHRYSLER RM is 6.15 ft. This is based on the NOAA Tidal Epoch of 1983-2001.

### Impact of Datum Variations on Constructed Floodwall Elevations

Given the nearly universal presumption that “NGVD” and “MSL” were equivalent “sea level” datums, and that floodwall design was computed relative to Lake Pontchartrain MSL, the actual constructed elevation on a typical floodwall in the London Avenue Outfall Canal is reduced by approximately:

Benchmark CHRYSLER RM	7.11 ft “NGVD” (Contract Plans-1982 adjustment)
Benchmark CHRYSLER RM	<u>6.15 ft</u> LMSL (1983-2001 epoch)
Difference:	0.96 ft

In effect, floodwalls designed relative to a MSL or LMSL datum would have been constructed about a foot lower when using the NGVD29 geodetic datum from a 1982 adjustment as a reference. Thus a floodwall designed to 14.0 ft NGVD (i.e., MSL) would actually be constructed to 13.0 ft relative to LMSL (1983-2001 epoch).

## Assessment of Pre- and Post-Katrina Flood Protection Elevations (Orleans Avenue Outfall Canal)

To evaluate pre-Katrina flood protection elevations, conventional topographic survey data taken just after the hurricane were obtained—see survey extracts in the spreadsheet in Technical Appendix 36 to this Volume (Outfall Canal Post-Katrina Topographic Surveys). Post-Katrina floodwall cap elevations were observed in unbreached areas using conventional topographic surveying techniques—differential leveling and RTK methods. These elevations are also likely representative of pre-Katrina conditions in August 2005. These surveys on the NAVD88 (2004.65) geodetic reference system can be adjusted to LMSL using the 1983-2001 tidal datum epoch—e.g., topographic survey elevations observed on the NAVD88 (2004.65) geodetic datum were reduced by 0.25 ft to relate them to the LMSL (1983-2001 epoch) elevation of Lake Pontchartrain. As noted in this report, this 0.25 ft conversion is does not necessarily reflect the current (2001-2005) LMSL epoch estimates by NOAA in Lake Pontchartrain.

Designed and current floodwall elevations for selected sections of the Orleans Avenue Canal are listed in Table 14. The average elevation was computed from representative shot points taken atop the floodwall along each reach. Variances in the floodwall cap elevation were as much as  $\pm 0.5$  ft along some reaches—probably due to uneven settlement.

<b>Table 14 Design and Current Floodwall Elevations in Selected Reaches (Orleans Avenue Outfall Canal)</b>				
Reach	No. of Shot Points	Design Elevation NGVD (MSL)	Average Elevation (2005-2006)	
			NAVD88 (2004.65)	LMSL (1983-2001)
WEST BANK RE Lee Blvd. to Filmore Ave.	15	N/A	13.2 ft	13.0 ft
WEST BANK Filmore Ave. to Harrison Ave.	20	14.0 ft (T-Wall)	13.4 ft	13.2 ft
WEST BANK Harrison Ave. to PS 7 / I-610	28	N/A	14.0 ft	13.8 ft
EAST BANK RE Lee Blvd. to Filmore Ave.	21	14.4 ft (I-Wall)	13.4 ft	13.2 ft
EAST BANK Filmore Ave. to Harrison Ave.	25	14.8 ft (I-Wall)	13.8 ft	13.6 ft
EAST BANK Harrison Ave. to PS 7 / I-610	19	14.9 ft (I-Wall)	13.9 ft	13.6 ft

Applying the 0.5 ft difference between LMSL (2001-2005) and NAVD88 (2004.65) at the NOAA New Canal gage (refer to the previous discussion on 5-year tidal epochs), the following flood protection elevation differences result (Table 15).

<b>Table 15</b>					
<b>Current Flood Protection Elevations on Orleans Avenue Outfall Canal Floodwalls Relative to LMSL Epochs (elevations in feet)</b>					
Section	Design	LMSL (1983-2001)		LMSL (2001-2005)	
		Current	Difference	Current	Difference
<b>West Bank</b>					
Filmore to Harrison (T)	14.0	13.2	0.8	12.9	1.1
<b>East Bank (I-Wall)</b>					
Filmore to Harrison	14.8	13.6	1.2	13.3	1.5
RE Lee to Filmore	14.4	13.2	1.2	12.9	1.5
Harrison to I-610 PS#7	14.9	13.6	1.3	13.4	1.5

Differences between Design and current average floodwall cap elevations range between 0.8 ft and 1.3 ft relative to the 1983-2001 tidal epoch and another quarter-foot larger if the later (2001-2005) tidal epoch is used. Most of this difference is attributable to the initial construction being performed relative to an outdated geodetic datum—i.e., NGVD29 (01 Sep 82). Subsequent subsidence and perhaps settlement since ca 1993 has further reduced the protection elevation relative to LMSL, as shown above.

Figure 37 below summarizes the loss in protection resulting from using a geodetic elevation instead of a sea level-based elevation to construct the floodwalls.

# Orleans Avenue Outfall Canal

## Design v Constructed Floodwall Elevations

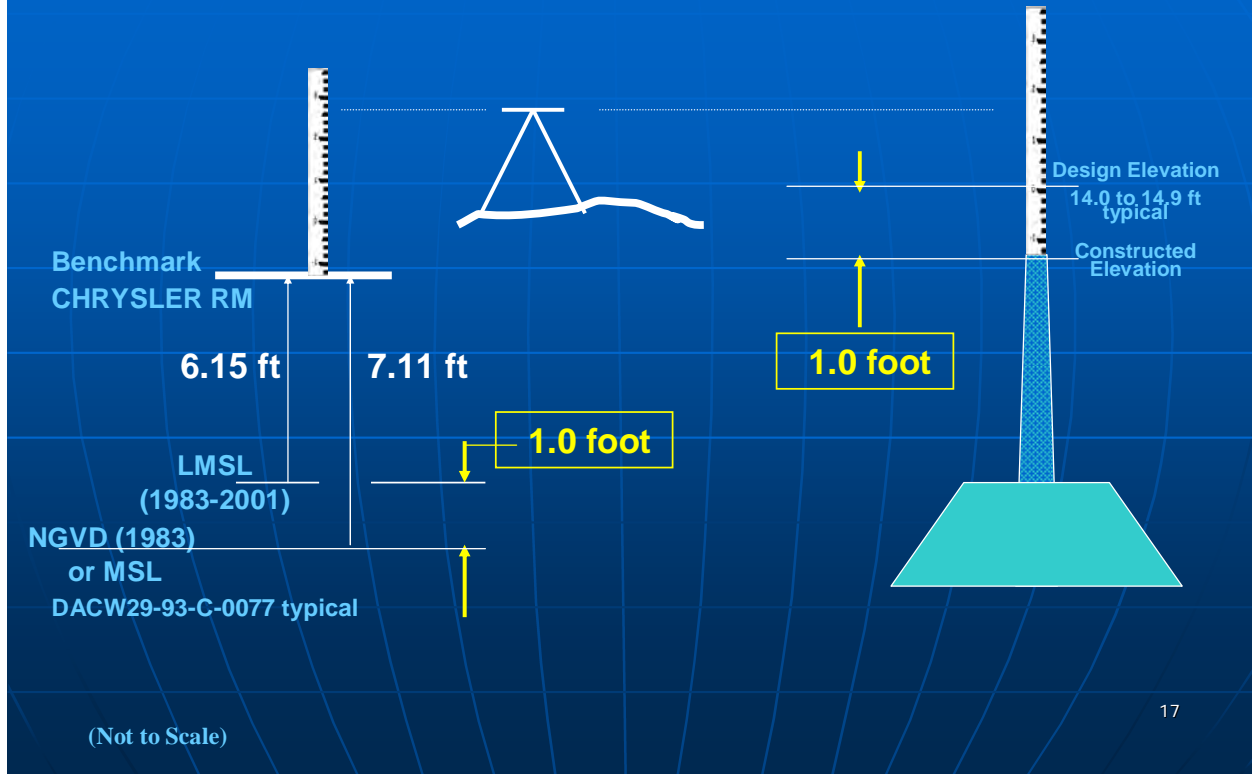

Figure 37. Impact of using NGVD elevation vice LMSL elevation for construction stake-out of Orleans Ave. Outfall Canal floodwall construction (DACW29-93-C-0077). (Elevation differences are rounded to the nearest tenth of a foot)

# Data Analysis and Impacts: London Avenue Outfall Canal Construction Reference Datums

## Summary of Findings

This Section covers the evaluation of the constructed and current elevations on flood protection structures along the London Avenue Outfall Canal. The floodwalls on the east and west banks were found to be constructed approximately 1.7 foot below their intended design elevations. This was caused by using a superseded (1965) geodetic elevation reference instead of an up-to-date hydraulic-based (sea level) reference datum. Pre-Katrina and current flood protection elevations in the canal floodwalls are approximately 2 feet below design when related to the latest tidal epoch.

## Reference Documents

The following construction drawings and Design Memorandums were reviewed as part of this assessment:

- DACW29-94-C-0079 (94-B-0047) As Built Mark Up—London Ave. Outfall Canal Parallel Protection— Mirabeau Ave.-to R.E. Lee Blvd (West Bank)—Mirabeau Ave. to Leon C. Simon Blvd. (East Bank)
- DACW29-02-C-0013 (01-B-0092) London Ave. Outfall Canal Parallel Protection— Floodproofing Mirabeau and Filmore Ave. Bridges
- DACW29-94-C-0003 (93-B-0080) As-Built London Ave. Outfall Canal Parallel Protection—Pump Station 3 to Mirabeau Ave. Floodwall
- DACW29-99-C-0005 (98-B-0060) As-Built London Ave. Outfall Canal Parallel Protection—Floodproofing Gentilly Blvd. Bridge
- DACW29-98-C-0082 (98-B-0065)As-Built London Ave. Outfall Canal Parallel Protection— Floodproofing Leon C. Simon Blvd. Bridge
- GDM 19A (Vol I and II) London Ave. Outfall Canal (1989)
- GDM 20 (Draft) London Ave. Canal Floodwalls and Levees—Orleans Levee District— Apr1986; and Revised GDM 20 (May 1990)
- DM01 Part III Hydrology and Hydraulic Analysis—Lake Pontchartrain & Vicinity- Lakeshore (Sep 1968)

## Design Elevation Parameters

Parallel protection elevations in GDM No. 19A, GDM 20, and on various contract plans, state the design SPH stillwater surface elevation of Lake Pontchartrain is 11.5 ft NGVD or MSL. This base elevation was used in subsequent HEC-2 models to compute required floodwall elevation on each side of the canal and at the bridges. As in other Lake Pontchartrain projects, the “NGVD” elevation is assumed to be MSL or LMSL—e.g., “Lake Pontchartrain Normal Water Level = 0.0 ft MSL.” Design Memorandum No. 1, Part III (1968) notes that “average high tide” in Lake Pontchartrain is 0.7 ft. It also states the average tidal range in Lake

Pontchartrain in 0.5 ft and 1.0 ft in Lake Borgne. GDM20 references all elevations to “NGVD” but does not identify any particular epoch, as shown in Figure 38 below depicting hydraulic profiles for various flood frequencies.

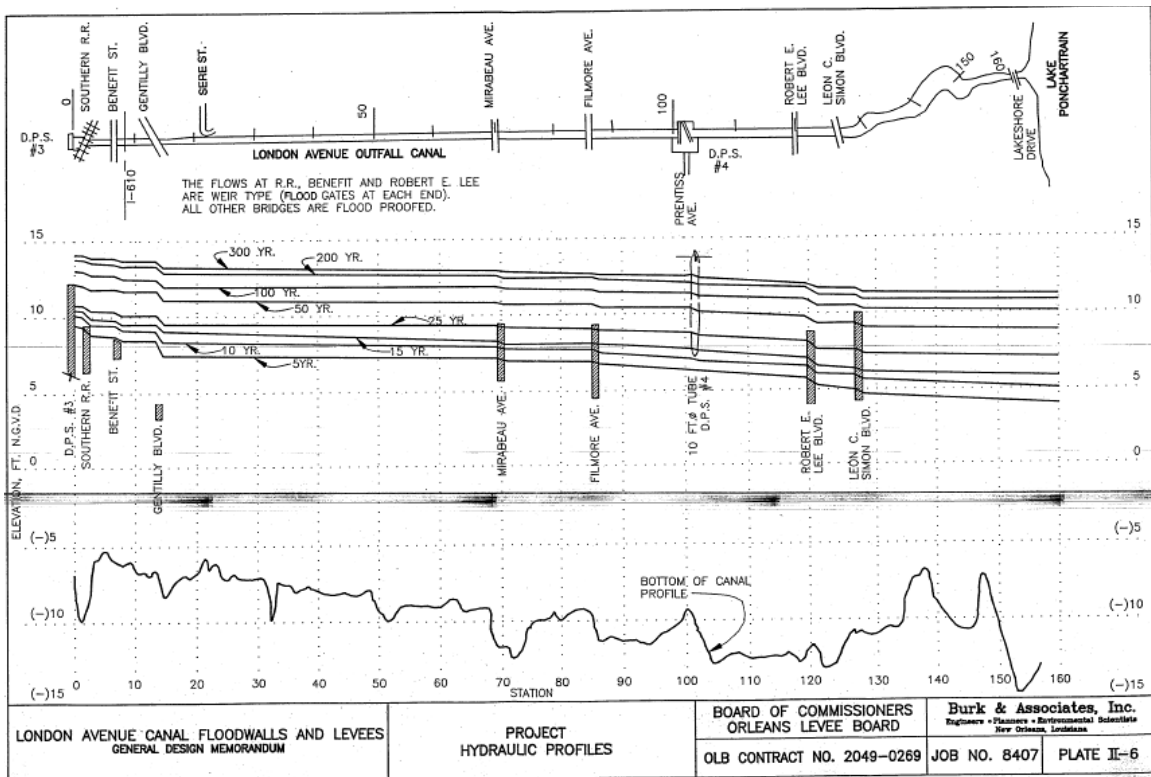

Figure 38. Hydraulic profiles referenced to “NGVD” in General Design Memorandum 20 (Revised May 1990)

The design stillwater elevation in the London Avenue Outfall Canal was 11.85 ft “NGVD.” The 14.4 ft NGVD floodwall design (Figure 39) was derived by adding 2.0 ft freeboard and 0.5 ft settlement allowances to the 11.85 ft stillwater elevation. Again, the NGVD floodwall elevation was generally assumed to be equivalent to MSL.

The As-Built DACW29-94-C-0079 hydrograph shows the canal water surface 1 to 2 ft above NGVD--this factor was not noted in 1986 GDM hydraulic study (DM01 Part III Hydrology and Hydraulic Analysis—Lake Pontchartrain & Vicinity-Lakeshore (Sep 1968). A portion from the hydrograph is shown in Figure 40 below. The referenced gage is located to the east in the IHNC south of the Seabrook Bridge.



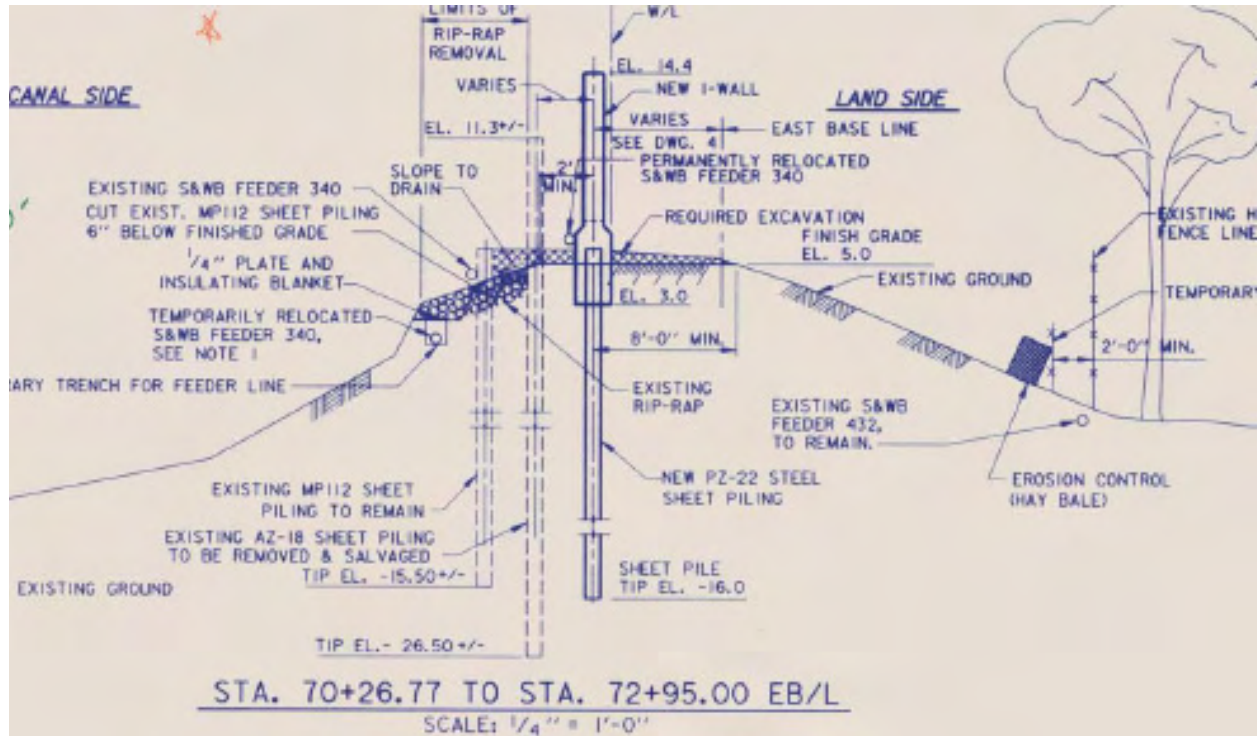

Figure 39. Typical Section of floodwall with 14.4 ft design elevation on London Avenue I-Wall

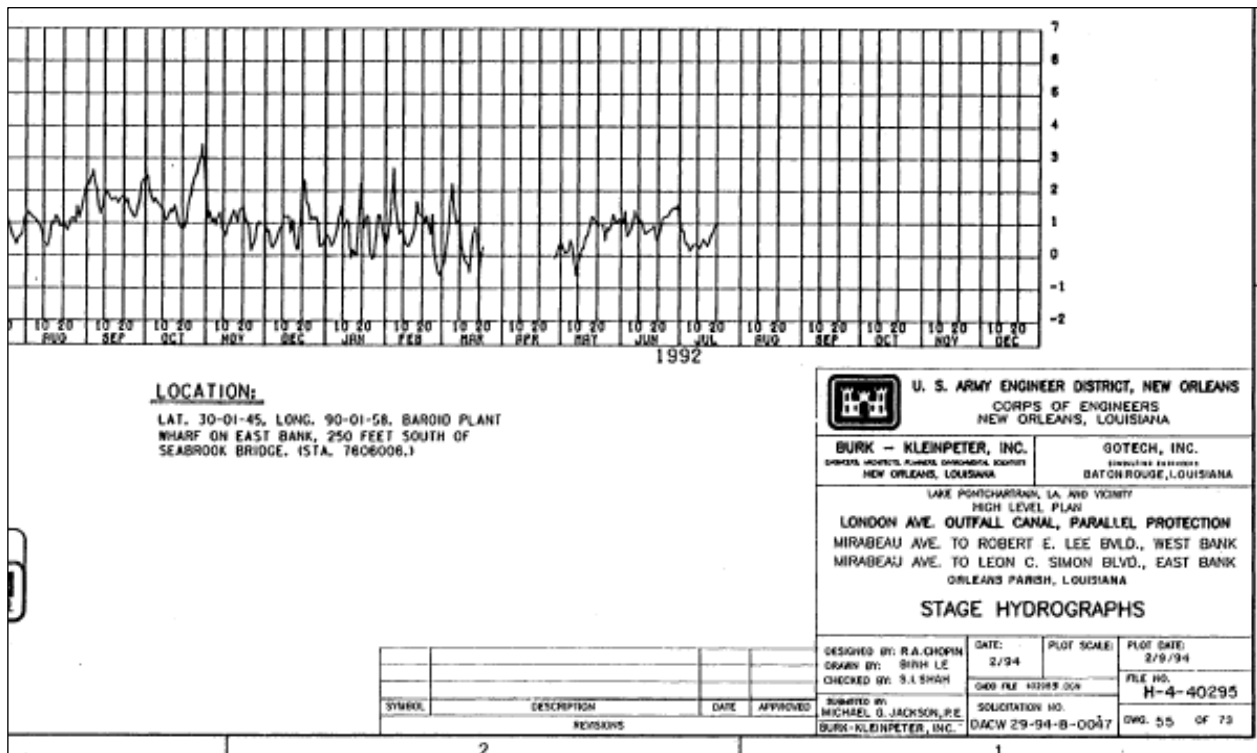

Figure 40. Typical portion of stage hydrograph on London Avenue Canal depicting 1+ ft superelevation based on the gage at the Seabrook Bridge in the IHNC (DACW29-94-C-0079 (94-B-0047)

## Reference Benchmark used in London Outfall Canal Parallel Floodwall Construction

Benchmark “P 153” was used as the vertical reference for design and construction associated with most of the floodwalls constructed on both banks of the London Avenue Outfall Canal. This benchmark, originally set in 1951 by the USC&GS, is destroyed. It was located on the Lakeshore Drive Bridge over the London Avenue Canal. The mark was destroyed ca 2002 when a new bridge was constructed. (2005/2006 post-Katrina construction and topographic surveys in the London Avenue Canal have been referenced to Benchmarks GRAHAM and GRAHAM RM, both of which were on the original USC&GS level line with P 153).

Benchmark P 153 was used for most of the floodwall projects listed above. No other benchmarks are noted in the construction plans except on the 1998 Leon Simon Bridge Floodproofing project (DACW29-98-C-0082) where Benchmark “AA 190” was listed in addition to “P 153.” On the 1999 Gentilly Blvd. Bridge floodproofing project (DACW29-99-C-0005), a Benchmark “U 153” is referenced in addition to “P 153”—as shown in Figure 41 below. Other than on these two projects, it is presumed all other floodwall construction stakeout was performed relative to the single benchmark “P 153.”

**Reference Datum of Benchmark “P 153.”** Contract DACW29-94-C-0079 is typical in referencing the elevation of Benchmark “P 153” relative to “N.G.V.D. (EPOCH 1964).” The elevation noted for the “1964 Epoch” is 11.270 ft. This elevation is actually based on a 9 April 1965 USC&GS readjustment of the NGVD29 network in this area. Bridge floodproofing projects in the late 1990s show both the 11.270 ft NGVD 1964 Epoch and a 10.39 ft elevation based on the 1991 epoch. Figure 41 below shows dual NGVD29 reference datums (epochs) for “P 153.”

REFERENCE BENCH MARK		
DESIGNATION	DESCRIPTION	ELEVATION
P 153	AT NEW ORLEANS, ABOUT 0.8 MILES ALONG LAKESHORE DR. FROM THE WEST SIDE OF TRAFFIC CIRCLE AT THE JUNCTION OF ELYSIAN FIELDS AVE., ABOUT 0.55 MILES NE ALONG LAKE TERRACE DR. FROM THE EAST END OF THE LAKESHORE DR. BRIDGE OVER BAYOU SAINT JOHN, THENCE 0.1 MILES EAST ALONG LAKESHORE DR. TO THE BRIDGE ACROSS LONDON AVE. CANAL. SET IN THE TOP OF THE EAST END OF PEDESTRIAN WALK ALONG THE SOUTH SIDE OF THE BRIDGE OVER THE EAST ABUTMENT OF THE BRIDGE, 5 FT. SOUTH OF THE SOUTH CURB OF THE DRIVE, 6 IN. WEST OF THE EAST END OF THE BRIDGE AND ABOUT 1 FT. ABOVE THE DRIVE.	11.270 N.G.V.D. (1964 EPOCH)
		10.390 N.G.V.D. (1991 EPOCH)
U 153	IN NEW ORLEANS, AT 2251 NORTH BROAD AVENUE, 33.7 M (110.6 FT.) SOUTHEAST OF THE SOUTHEAST CORNER OF PUMP STATION 3 AT 2251 NORTH BROAD STREET, 9.7 M (31.8 FT.) SOUTHWEST OF THE NORTHEAST CORNER OF A RETAINING WALL, 6.8 M (22.3 FT.) WEST OF THE NEAR RAIL OF THE SOUTHERN RAILROAD, 5.3 M (18.4 FT.) NORTHEAST OF THE NORTHWEST CORNER OF A FENCE, AND THE MONUMENT PROJECTS 0.2 M (0.7 FT.) ABOVE THE GROUND SURFACE.	4.81 N.G.V.D. (1991 EPOCH)

Figure 41. Reference Benchmarks (Gentilly Blvd. Bridge Floodproofing—DACW29-99-C-0005)

**Historical Adjustments to P 153 (1951 to date).** The following Table 16 illustrates the various elevations associated with Benchmark P 153. Most of the changes are due to readjustments of level lines by NOAA.

<b>Table 16</b>				
<b>Successive Elevations on Benchmark P 153 from 1951 to 2006</b>				
<b>Elevation, ft</b>	<b>Datum</b>	<b>Adjustment</b>	<b>Agency</b>	<b>Reference</b>
12.087	NGVD29	1951 (19 Mar 52 adj)	USC&GS	
11.476	NGVD29	1951 (1957 adj)	USC&GS	L-13860
11.270	NGVD29	9 Apr 65	USC&GS	L-19622
10.708	NGVD29	1 Sep 82	NGS	L-19622/13860
10.623	NGVD29	30 Jan 86	NGS	L-24903
10.39	NGVD29	21 May 91	NGS	L-25283
10.20	NAVD88	14 Feb 94	NGS	BJ1361
10.21	NAVD88	5 Dec 96	NGS	BJ1361
9.79	NAVD88 (2004.65)	10 Feb 06	NGS	(unpublished/L-25517)
9.54 (comp)	LMSL (1983-2001)	Dec 2005	NOAA CO-OPS	IPET Study
9.31 (comp)	LMSL (2001-2005)	Apr 2006	NOAA CO-OPS	IPET Study

The 10 Feb 06 NAVD88 (2004.65) elevation shown for P 153 is not based on recent observations since the mark no longer exists. This is the computed elevation assuming no subsidence has occurred since 1994. Likewise, the subsequent LMSL elevations are computed. The 09 Apr 65 NGVD29 elevation of 11.27 ft corresponds to that used for most of the London Avenue Canal floodwall construction during the early 1990s. This elevation is listed as “Epoch 1964.”

It is uncertain why the later readjustment elevations (i.e., 1982 and 1986) were not used for contracts issued after 1990. The 0.65 ft elevation change from 1965 to 1986 is significant. One of the As-Built from a later contract that listed the 1991 elevation of P 153 (10.39 ft) appears to have held the 1965 elevation for construction stake out in setting the top of the floodwall, in lieu of the 1991 elevation—a 0.9 ft difference. This may be a result of the 1985 New Orleans District policy memorandum on NGS datums—see the section of Corps Policy later in this Volume.

As in the other outfall canal projects in this area of Lake Pontchartrain, Table 16 clearly shows a subsidence trend over a 50-year period, and the need to account for these relative elevation variations.

The LMSL elevation based on the epoch (1983-2001) is determined from NOAA estimates for LMSL at the NOAA New Canal gage (17th Street Canal). The LMSL elevation for the more recent 2001-2005 epoch reflects the apparent sea level change occurring between the two epoch periods.

### **Local Mean Sea Level Relationships at the London Avenue Outfall Canal**

The elevation of Benchmark P 153 can be related to the LMSL (1983-2001) of Lake Pontchartrain using the relationships at the New Canal Gage (BM ALCO), which is about 2 ½ miles to the west of the London Outfall Canal.

Using geodetic-hydraulic datum elevation data the 17th Street Canal (New Canal Gage-Benchmark ALCO):

ALCO LMSL (epoch 1983-2001)	5.89 ft
ALCO NAVD88 (12/05/96)	<u>6.59 ft</u>
Difference:	(0.70 ft) [LMSL — NAVD88]

P 153 [NAVD88 (12/05/96)]	10.21 ft
Difference [LMSL (epoch 1983-2001) — NAVD88]	<u>-0.70 ft</u>
LMSL at P 153 (epoch 1983-2001)	9.51 ft

From the above, the estimated LMSL elevation of Benchmark P 153 is 9.51 ft. This is based on the NOAA Tidal Epoch of 1983-2001 and is approximately representative of the LMSL elevation at the time of construction.

### Impact of Datum Variations on Constructed Floodwall Elevations

Given the nearly universal presumption that “NGVD” and “MSL” were equivalent datums, and that floodwall design was computed relative to MSL = 0.0 ft on Lake Pontchartrain, the actual constructed elevation on a typical floodwall in the London Avenue Outfall Canal is reduced by approximately:

Benchmark P 153	11.27 ft “NGVD” (Contract Plans)
Benchmark P 153	<u>9.51 ft</u> LMSL (1983-2001epoch)
Difference:	1.76 ft

In effect, floodwall elevations designed relative to a LMSL datum would be constructed about 1.7 ft lower than intended when using the 1965 adjustment of the NGVD29 geodetic vertical datum as a reference. Thus a floodwall designed to 14.4 ft NGVD (i.e., MSL) would actually be constructed to 12.7 ft relative to LMSL (1983-2001 epoch).

### Assessment of Pre- and Post-Katrina Flood Protection Elevations (London Avenue Outfall Canal)

Designed and current floodwall elevations for selected sections of the London Avenue Canal are listed in Table 17 below. Data were obtained and adjusted using identical procedures outlined for the Orleans Avenue Outfall Canal evaluation. The average elevation was computed from representative shot points taken atop the floodwall along each reach. Variances in the floodwall cap elevation were typically  $\pm 0.2$  ft along some reaches.

During January 2006, Post-Katrina overbank cross-sections surveys were taken north and south of the breach areas by 3001 Inc. (Table 18) These surveys were performed to support IPET physical models of the two breach sites on the canal. They also provide a quality assurance check on the above Task Force Guardian surveys performed shortly after Katrina. State plane coordinates are LA 1702 South and elevations are in feet NAVD88 (2004.65). The stationing is not the floodwall alignment.

**Table 17  
Design and Current Floodwall Elevations in Selected Reaches  
(London Avenue Outfall Canal) New Orleans District/Task Force  
Guardian Post-Katrina Surveys Oct-Dec 2005**

Reach	No. of Shot Points	Design Elevation NGVD29 (MSL)	Average Elevation (2005-2006)	
			NAVD88 (2004.65)	LMSL (1983-2001)
WEST BANK Leon Simon Ave. to RE Lee Blvd.	N/A	N/A	N/A	N/A
WEST BANK RE Lee Blvd. to Filmore Ave.	18	14.4 ft	13.0 ft	12.8 ft
WEST BANK Filmore Ave. to Mirabeau Ave.	23	14.4 ft	12.9 ft	12.7 ft
WEST BANK Mirabeau Ave. to Gentilly Ave.	27	14.4 ft	12.9 ft	12.7 ft
WEST BANK Gentilly Ave. to Pump Station 3	19	14.4 ft	12.9 ft	12.7 ft
EAST BANK Leon Simon Ave. to RE Lee Blvd.	8	14.4 ft	12.8 ft	12.6 ft
EAST BANK RE Lee Blvd. to Filmore Ave.	26	14.4 ft	12.9 ft	12.6 ft
EAST BANK Filmore Ave. to Mirabeau Ave.	17	14.4 ft	12.9 ft	12.6 ft
EAST BANK Mirabeau Ave. to Gentilly Ave.	24	14.4 ft	12.9 ft	12.7 ft
EAST BANK Gentilly Ave. to Pump Station 3	18	14.4 ft	13.1 ft	12.8 ft

Comparison between the Oct-Dec 2005 MVN/Task Force Guardian surveys and the 2006 IPET surveys indicates a NAVD88 (2004.65) elevation agreement to within  $\pm 0.1$  ft. In general, current floodwall cap elevations are running about 1.7 ft below the original design elevation. This is consistent with the 1.6 ft estimated reduction computed in the preceding paragraph.

Floodwall elevations near the Mirabeau Avenue breach area are running between 12.5 and 12.6 ft LMSL (1983-2001). This assumes no abnormal undulation in the breach site—a reasonable assumption given the fairly uniform elevations in the existing floodwalls.

Current differences in flood protection elevations are shown in Table 19 below. Elevations of the floodwalls adjacent to the west and east bank breach areas are in italics. A modified NTDE 2001-2005 will reduce the current flood protection by another 0.25 ft, as was shown for the Orleans Outfall Canal.

Figure 42 below summarizes the approximate 1.7 ft loss in protection resulting from using a geodetic elevation instead of a sea level-based elevation to construct the floodwalls.

**Table 18  
Post-Katrina Floodwall Elevations Vicinity Breach Areas (London Avenue Outfall Canal) IPET Overbank Surveys January 2006 (3001, Inc.)**

X	Y	Elev (ft) NAVD88 (2004.65)	Location	Datafile reference
<b>North Breach — West Bank — South of RE Lee Blvd</b>				
Vicinity of Burbank Drive (South of RE Lee)				
Sta. 15+50				
3680399.87	554667.93	13.041	Top Edge Conc Fldwal	17thLondon.dc
3680399.17	554667.96	13.107	Top Edge Conc Fldwal	17thLondon.dc
Sta. 16+00				
3680403.85	554618.86	13.013	Top Edge Conc Fldwal	17thLondon.dc
3680403.4	554618.87	13.013	Top Edge Conc Fldwal	17thLondon.dc
<b>South Breach — East Bank — North of Mirabeau Avenue</b>				
Vicinity of Wildair Drive (North of Mirabeau)				
Sta. 51+00				
3680710.06	551132.49	12.86	TPF * (West Bank)	Book# 060856
3680709.06	551132.43	12.86	TPF (West Bank)	Book# 060856
Sta 51+50				
3680712.27	551082.53	12.86	TPF (West Bank)	Book# 060856
3680711.27	551082.47	12.87	TPF (West Bank)	Book# 060856
3680837.01	551090.56	12.87	TPF (East Bank)	Book# 060856
Sta. 52+00				
3680841.23	551040.73	12.87	TPF (East Bank)	Book# 060856
3680717.48	551032.76	12.88	TPF (West Bank)	Book# 060856
3680716.49	551032.7	12.89	TPF (West Bank)	Book# 060856
Vicinity of Mirabeau Avenue Bridge				
Sta. 58+00				
3680889.96	550392.53	12.72	TPF (East Bank)	Book# 060856
3580888.97	550392.46	12.72	TPF (East Bank)	Book# 060856
Sta. 59+00				
3680895.17	550342.76	12.77	TPF (East Bank)	Book# 060856
3680894.17	550342.69	12.77	TPF (East Bank)	Book# 060856
3680763.44	550334.28	12.87	TPF (West Bank)	Book# 060856
3680762.44	550334.21	12.87	TPF (West Bank)	Book# 060856
Sta. 59+50				
3680898.39	550292.86	12.77	TPF (East Bank)	Book# 060856
3680897.39	550292.79	12.77	TPF (East Bank)	Book# 060856
* TPF – top of concrete floodwall. Note: duplicate shots are at the flood side and protected side of the floodwall concrete cap.				

<b>Table 19 Current Flood Protection Elevations on London Avenue Outfall Canal Floodwalls Relative to LMSL (1983-2001 epoch) (elevations in feet)</b>			
Section	Design	LMSL (1983-2001)	
		Current	Difference
<b>WEST BANK</b>			
Leon Simon Ave to R.E. Lee Blvd	n/a	n/a	
R.E. Lee Blvd to Filmore Ave	14.4 ft	12.8 ft	1.6 ft
Filmore Ave to Mirabeau Ave	14.4 ft	12.7 ft	1.7 ft
Mirabeau Ave to Gentilly Ave	14.4 ft	12.7 ft	1.7 ft
Gentilly Ave to Pump Station 3	14.4 ft	12.7 ft	1.7 ft
<b>EAST BANK</b>			
Leon Simon Ave to R.E. Lee Blvd	14.4 ft	12.6 ft	1.8 ft
R.E. Lee Blvd to Filmore Ave	14.4 ft	12.6 ft	1.8 ft
Filmore Ave to Mirabeau Ave	14.4 ft	12.6 ft	1.8 ft
Mirabeau Ave to Gentilly Ave	14.4 ft	12.7 ft	1.7 ft
Gentilly Ave to Pump Station 3	14.4 ft	12.8 ft	1.6 ft

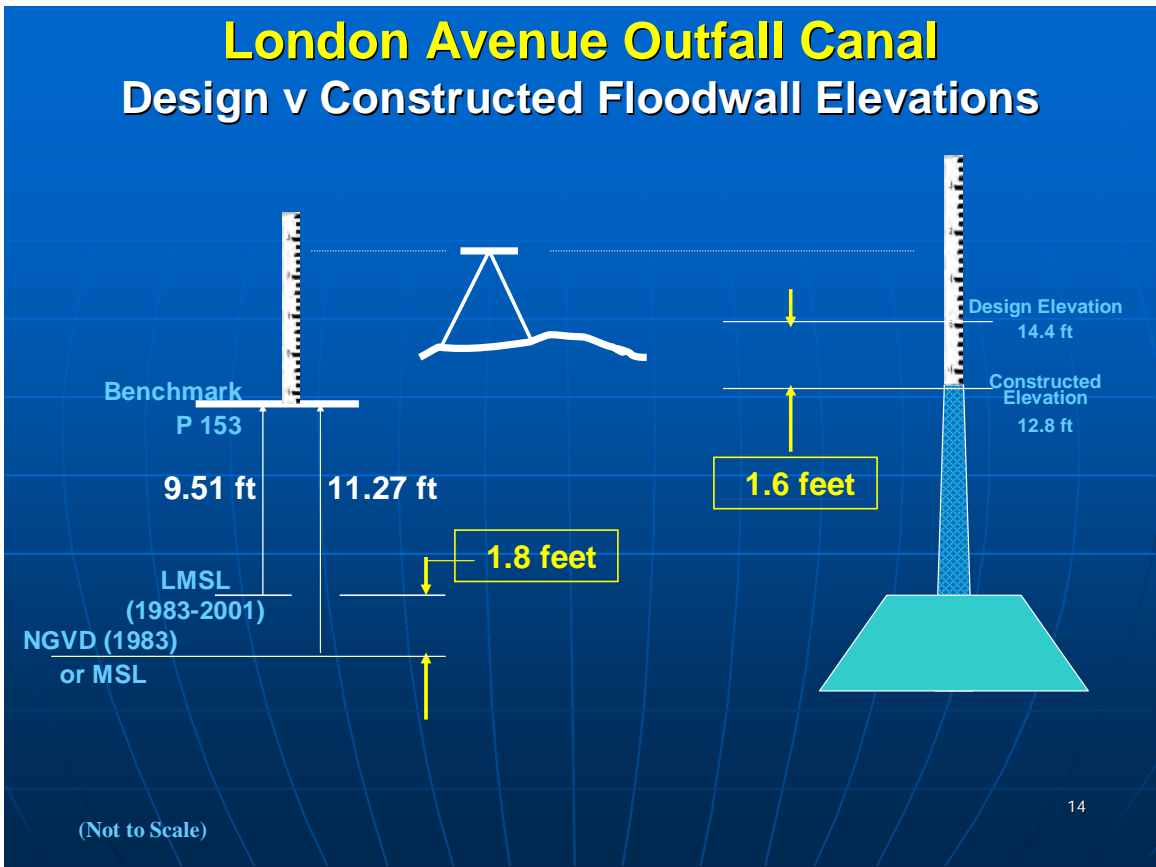

Figure 42. Impact of using NGVD elevation vice LMSL elevation for construction stake-out of London Ave. Outfall Canal floodwall construction

# Data Analysis and Impacts: 17th Street Outfall Canal Construction Reference Datums

## Summary of Findings

This Section covers the evaluation of the constructed and current elevations on flood protection structures along the 17<sup>th</sup> Street Outfall Canal. The high level plan floodwalls on the east and west banks were found to be constructed nearly 2 feet below their intended design elevations. This was caused by using a geodetic elevation reference instead of a hydraulic (sea level) reference datum and the likely use of a disturbed benchmark to set floodwall construction grades. Pre-Katrina and current flood protection elevations in the canal floodwalls are 2.0 to 2.3 feet below the intended design when related to the latest tidal epoch.

## Reference Documents

The following construction drawings and Design Memorandums were reviewed as part of this assessment:

- Contract 92-1 Board of Levee Commissioners of East Jefferson Levee District -17th Street Canal West Side Levee Improvements
- Orleans Levee District (OLD) Contract 02043-0489 As Built—17th Street Canal Phase IB—Hammond Hwy to Southern RR 1990
- DACW29-93-B-0025 Excavation and Flood Protection 17th St Canal—Capping of Floodwalls—East Side Levee Improvements
- DACW29-95-C-0093 (95-B-0095) As Built Markup—17th St Outfall Canal-Metairie Relief—Floodproofing Veterans Blvd Bridges
- GDM 20 Vol I & II-17th St Outfall Canal (Metairie Relief) Orleans Parish & Jefferson Parish 1990
- DM01 Part III Hydrology and Hydraulic Analysis—Lake Pontchartrain & Vicinity-Lakeshore (Sep 1968)

## Design Elevation Parameters for 17th Street Canal

The following paragraphs containing design parameters are extracted from the various design memorandums and construction documents listed above.

### **EAST SIDE LEVEE IMPROVEMENTS—FLOODWALL CAPPING (DACW29-93-B-0025)**

Floodwall cap elevations:

Southern Railway Sta 126+02 to I-10 Bridge Sta 97+52      elev 15.0 ft NGVD

I-10 Bridge Sta 94+17 to Vet Hwy Sta 81+52      elev 14.5 ft

Vet Hwy Sta 80+00 to Hammond Hwy Sta 8+49      elev 14.0 ft

Hammond Hwy Sta 7+03 to Sta 0+00      elev 14.0 ft

Plans state normal water surface 1.5 to 2.0 ft NGVD (source of hydrograph)



not noted in plans)

Contract plan elevations are referenced to "USCE MONUMENT 14" elevation 8.77 ft NGVD

### WEST SIDE LEVEE IMPROVEMENTS (Contract 92-1—1992)

#### As-Builts

Top of Required Floodwall Elevations:

Lakefront Levee (Sta 549+78) to Vet Hwy (Sta 625+02) elev 14.0 ft

Vet Hwy (Sta 626+25) to I-10 Bridge (Sta 638+84) elev 14.5 ft

I-10 Bridge (Sta 642+23) to South. Railway Bridge (Sta 669+17) elev 15.0 ft

Normal water surface elevation 1.5 ft to 2.0 ft

Reference construction benchmark: USCE Monument 14--elev: 8.77 NGVD

(no epoch noted)

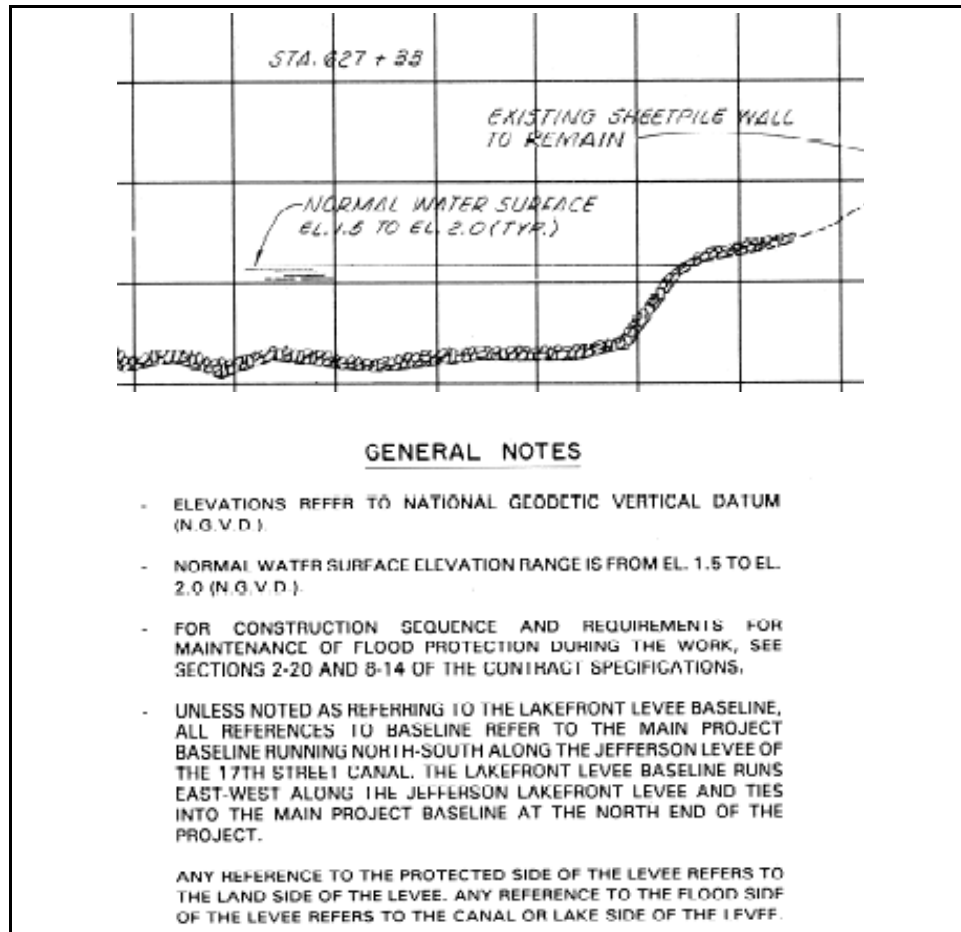

Figure 43. Typical section and General Note depicting "normal water surface" in 17th Street Canal at 1.5 to 2.0 ft elevation. (Contract 92-1 Board of Levee Commissioners of East Jefferson Levee District -17th Street Canal West Side Levee Improvements)

**VETERANS BLVD BRIDGE FLOODPROOFING (DACW29-95-C-0093)**

Still water level 12.5 NGVD  
 Wave action 14.5 NGVD  
 Design water level 12.5 ft @ 6,650 cfs @ 300 yr  
 Normal water level 1.5 to 2.0 ft NGVD @ 0 cfs  
 (no hydrograph shown in plans—  
 specifications not available)

Project Reference Benchmark: “**T-193**” elev 9.741 (NGVD 1972 epoch) on bridge abutment (last recovered 1994)

**Phase I-B HAMMOND HWY TO SOUTHERN RAILWAY (OLD Contract 02043-0489 —1990):**

Contract plans note that elevations are referred to MSL.  
 “Normal Water Surface” elevation ranges from 1.0 to 2.0 ft ... apparently either based on a pump station gage hydrograph or perhaps from a gage at Lake Pontchartrain (not indicated in the Plans). Section views indicate the normal water surface elevation is 1.0 ft (typical).  
 Floodwall sheet pile top elevations vary: 13.5, 14.0, & 14.5 ft

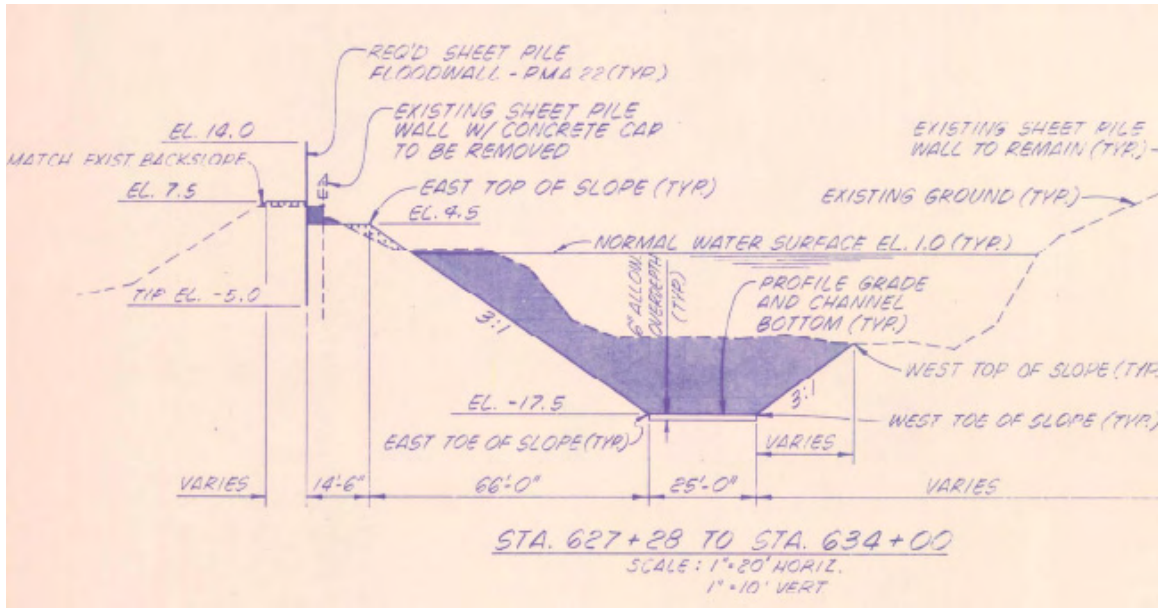

Figure 44. Typical section depicting “normal water surface” in 17th Street Canal at 1.0 ft elevation (Orleans Levee District Contract 02043-0489--1990-As Built)

**GENERAL DESIGN MEMORANDUM 20 (1990)**

Elevations referenced to NGVD (no epoch date noted).  
 Hydraulic & Structural design criteria:  
 Lake Pontchartrain stillwater elevation 11.5 ft @ 300 year SPH

Wind tide level (17th St Canal) 11.50 to 12.50 ft  
 East Bank floodwall elevations: 14.00 to 15.00 ft  
 West Bank floodwall elevations: 16.50 to 15.00 ft

17TH STREET OUTFALL CANAL  
 DESIGN FLOWLINES AND BRIDGE HEAD LOSSES  
 FOR HIGH LAKE LEVEL (11.5 FT. NGVD)  
 WITH CHANNEL DREDGED

CANAL WATER SURFACE ELEVATION (FT. NGVD)

Bridge Condition	Canal Flow (cfs)	Lake Point	CANAL WATER SURFACE ELEVATION (FT. NGVD)					
			Backflow	Hammond Highway	Veterans (2 bridges)	I-10/610 (3 bridges)	Railroad	
1) Existing-Gated								
Openings Dredged except under Bridges	6550	11.5	11.53	11.61	12.09	12.57	12.80	
Bridge Head Loss			0.03	0.08	0.36	0.46	0.15	
	9630	11.5	11.56	11.73	12.64	13.54	13.92	
Bridge Head Loss			0.07	0.18	0.67	0.86	0.24	
2) All Bridges Raised								
Bridge Head Loss	6550	11.5	11.50	11.51	11.62	11.65	11.71	
			0.00	0.00	0.00	0.01	0.00	
	9630	11.5	11.49	11.52	11.75	11.81	11.94	
Bridge Head Loss			0.00	0.00	0.00	0.01	0.00	
3) I-10/610 Raised								
Others = Existing	6550	11.5	11.53	11.57	11.83	11.87	12.07	
Bridge Head Loss			0.03	0.04	0.14	0.01	0.17	
	9630	11.5	11.56	11.65	12.16	12.22	12.62	
Bridge Head Loss			0.07	0.09	0.16	0.01	0.33	
4) All Bridges Flood Proofed Except Railroad = Existing								
Bridge Head Loss	6550	11.5	11.53	11.58	11.92	12.01	12.21	
			0.03	0.05	0.22	0.06	0.16	
	9630	11.5	11.56	11.66	12.39	12.59	12.95	
Bridge Head Loss			0.07	0.10	0.48	0.15	0.30	
5) I-10/610 Raised Hammond = Flood Proofed Vets & RR = Existing								
Bridge Head Loss	6550	11.5	11.53	11.58	11.84	11.87	12.07	
			0.03	0.05	0.14	0.00	0.16	
	9630	11.5	11.56	11.66	12.16	12.23	12.63	
Bridge Head Loss			0.07	0.10	0.25	0.01	0.33	
6) I-10/610 Raised Hammond & Vets = Flood Proofed Railroad = Existing								
Bridge Head Loss	6550	11.5	11.53	11.58	11.92	11.95	12.15	
			0.03	0.06	0.23	0.00	0.16	
	9630	11.5	11.56	11.66	12.39	12.45	12.82	
Bridge Head Loss			0.07	0.10	0.48	0.01	0.30	

12

Figure 45. DM 20 Design Flowlines

## Reference Benchmark used in 17th Street Canal Parallel Floodwall Protection

Benchmark “USACE MONUMENT 14” was apparently used as the vertical reference for nearly all the floodwall design and construction on the 17th Street Outfall Canal. The exception is the ca 1995 Veterans Blvd Bridge floodproofing project (DACW29-95-C-0093) in which a benchmark “T 193” is indicated on the contract plans. The origin of benchmark MONUMENT 14 is believed to have been established by a survey performed during March-April 1987 by Walker & Avery, Inc. It was connected by differential levels from Benchmark T 193 with a starting elevation of T 193 being 9.741 ft “NGVD.” This appears to be the 1965 adjustment. T 193 is on the bridge abutment of Veteran’s Memorial Bridge. This mark (T 193) is believed to have been disturbed and its elevation could not be verified by NOD Survey Section (according to the records). A later survey (1995) determined that MONUMENT 14 was 0.45 ft lower than the 1987 elevation. The source survey data for the elevation shown on the contract drawings (8.77 ft NGVD) is verified. The mark was never incorporated into the USC&GS/NGS database. Additional information is contained in Technical Appendix 39.

No other benchmarks are noted in the construction plans reviewed above. It is presumed all construction stakeout for the East Bank (Orleans Parish) and West Bank (Jefferson Parish) floodwalls was performed relative to a single benchmark—MONUMENT 14.

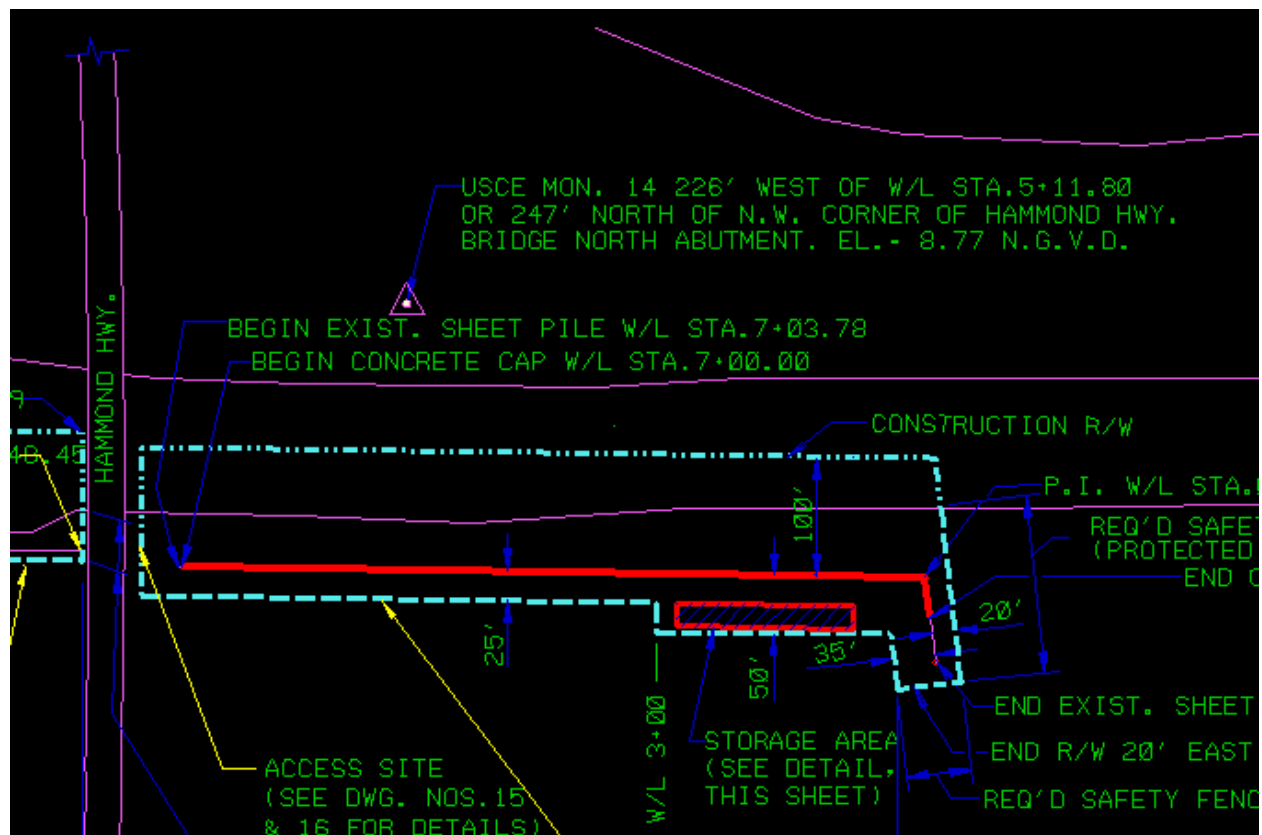

Figure 46. 17th Street Canal Reference Benchmark USACE MONUMENT 14 near Hammond Hwy

## Derived Elevations of Benchmark MONUMENT 14

Post-Katrina New Orleans District surveys to MONUMENT 14 indicated its elevation was suspect—not only currently but also most likely at the time of initial floodwall construction.

A New Orleans District differential level line run in November 2005 from primary Benchmark ALCO to MONUMENT 14 yielded an elevation of 7.06 ft NAVD88 (2004.65) on MONUMENT 14. Using geodetic elevation adjustment data from Benchmark ALCO equivalent reference datums and adjustment epochs are compared as follows:

MONUMENT 14	7.06 ft NAVD88 (2004.65)
Difference (NGVD29-NAVD88 (2004-65)) at ALCO	<u>+0.62 ft</u>
MONUMENT 14 (most probable elevation)	7.68 ft NGVD29 (05/21/91)

Thus, the most probable elevation in 1991 is 7.68 ft (assuming no significant subsidence to date). The difference in elevation due to datum epoch uncertainty is estimated as:

MONUMENT 14 (Construction Plans)	8.77 ft NGVD (unknown adjustment epoch)
MONUMENT 14 (most probable elevation)	<u>7.68 ft</u> (05/21/91)
Difference	1.09 ft (due to datum epoch readjustment)

It is not likely a datum epoch readjustment accounted for the large 1.09 ft difference.

Given “NGVD” was generally assumed to equal “MSL” on design and construction documents, the LMSL (1983-2001) elevation of MONUMENT 14 is estimated as:

MONUMENT 14	7.06 ft NAVD88 (2004.65)
Difference LMSL (1983-2001) - NAVD88 (2004-65) at ALCO	<u>-0.25 ft</u>
MONUMENT 14	6.81 ft LMSL (1983-2001)

Then,

MONUMENT 14 (Construction Plans)	8.77 ft NGVD ≈ MSL
MONUMENT 14	<u>6.81 ft</u> LMSL (1983-2001)
Difference	1.96 ft

This 1.96 ft elevation disparity at Benchmark MONUMENT 14 may be due to a number of factors:

- The 8.77 ft elevation shown on the plans is suspect due to a possible disturbed origin benchmark.
- Assumption that NGVD = MSL.
- Subsidence may have occurred since the elevation was established.
- The benchmark had incorrect elevation in 1990 (this is believed to be the likely problem based on verbal recollections by New Orleans District personnel).

The relative likelihood and significance of the above factors can be approximately evaluated using pre-Katrina LIDAR topography (2000) and/or post-Katrina conventional topographic surveys in 2005 and 2006—see following section.

### Assessment of Pre- and Post-Katrina Flood Protection Elevations (17th Street Outfall Canal)

Design and current floodwall elevations for selected sections of the 17th Street Canal are listed in the following Table 20, based on post-Katrina topographic surveys performed by MVN/Task Force Guardian and IPET survey forces. A spreadsheet containing extracts from these surveys is in Technical Appendix 36 to this Volume (Outfall Canal Post-Katrina Topographic Surveys). Data were obtained and adjusted using identical procedures outlined for the previous Orleans and London Canal evaluations. The average elevation was computed from representative shot points taken atop the floodwall along each reach. Variances in the floodwall cap elevation were typically less than  $\pm 0.2$  ft along most reaches.

<b>Table 20</b>				
<b>Design and Current Floodwall Elevations in Selected Reaches (17th Street Outfall Canal) New Orleans District/Task Force Guardian Post-Katrina Surveys Oct-Dec 2005</b>				
Reach	No. of Shot Points	Design Elevation NGVD29 (MSL)	Average Elevation (2005-2006)	
			NAVD88 (2004.65)	LMSL (1983-2001)
WEST BANK Lakefront Levee to Veterans Hwy	58	14.0 ft	12.7 ft	12.4 ft
WEST BANK Veterans Hwy to I-10 Bridge	23	14.5 ft	13.4 ft	13.1 ft
WEST BANK I-10 Bridge to Southern RR	16	15.0 ft	13.4 ft	13.1 ft
EAST BANK Hammond Hwy to Veterans Hwy	26	14.0 ft	12.4 ft	12.1 ft
EAST BANK Veterans Hwy to I-10 Bridge	37	14.5 ft	13.5 ft	13.2 ft
EAST BANK I-10 Bridge to Southern RR	18	15.0 ft	13.6 ft	13.3 ft

During January 2006, Post-Katrina Overbank Surveys were taken north and south of the breach areas by 3001 Inc. These surveys were performed in support of IPET physical models of the breach sites. They also provided a quality assurance check on Task Force Guardian surveys performed post Katrina. In the following Table 21, state plane coordinates are LA 1702 South and elevations are in feet NAVD88 (2004.65). The stationing shown is not the floodwall alignment.

Based on provisional observations, current floodwall cap elevations appear to be running about 1.5 to 2.0 ft below the intended design elevation, as shown in Table 22 below. This is somewhat consistent with the 1.96 ft estimated reduction computed in the preceding paragraphs. Thus, current elevations referenced to LMSL (1983-2001) are not significantly different from those originally constructed.

**Table 21**  
**Post-Katrina Floodwall Elevations Vicinity East Bank Breach Area**  
**(17th Street Outfall Canal) IPET Overbank Surveys January 2006**  
**(3001, Inc.)**

X	Y	Elev (ft)	Location	Datafile reference
<b>South of Hammond Hwy (Vicinity Hay Place)</b>				
Sta. 4+50				
3664412.64	554305.82	12.373	Top Conc Fldwall	17thLondon.dc
3664413.38	554305.78	12.376	Top Conc Fldwall	17thLondon.dc
Sta. 5+00				
3664409.22	554256.33	12.418	Top Conc Fldwall	17thLondon.dc
3664409.99	554256.3	12.425	Top Conc Fldwall	17thLondon.dc
Sta. 5+50				
3664406.5	554205.41	12.329	Top Conc Fldwall	17thLondon.dc
3664405.82	554205.56	12.318	Top Conc Fldwall	17thLondon.dc
<b>South of Hammond Hwy (Vicinity 40th Street)</b>				
Sta. 14+00				
3664348.77	553357.14	12.409	Top Conc Fldwall	17thLondon.dc
3664348.05	553357.13	12.36	Top Conc Fldwall	17thLondon.dc
Sta. 14+50				
3664345.33	553307.32	12.389	Top Conc Fldwall	17thLondon.dc
3664344.67	553307.28	12.414	Top Conc Fldwall	17thLondon.dc
Sta. 15+00				
3664341.03	553257.2	12.461	Top Conc Fldwall	17thLondon.dc
3664341.86	553257.23	12.475	Top Conc Fldwall	17thLondon.dc
Note: duplicate shots are at the flood side and protected side of the floodwall concrete cap. Elevations are in feet NAVD88 (2004.65)				

**Table 22**  
**Current Flood Protection Elevations on 17th Street Outfall Canal**  
**Floodwalls Relative to LMSL (1983-2001 epoch) (elevations in feet)**

Section	Design	LMSL (1983-2001)	
		Current	Difference
<b>WEST BANK</b>			
Lakefront Levee to Veterans Hwy	14.0 ft	12.4 ft	1.6 ft
Veterans Hwy to I-10 Bridge	14.5 ft	13.1 ft	1.4 ft
I-10 Bridge to Southern RR	15.0 ft	13.1 ft	1.9 ft
<b>EAST BANK</b>			
Hammond Hwy to Veterans Hwy	14.0 ft	12.1 ft	1.9 ft
Veterans Hwy to I-10 Bridge	14.5 ft	13.2 ft	1.3 ft
I-10 Bridge to Southern RR	15.0 ft	13.3 ft	1.7 ft

Floodwall elevations near the Hammond Highway breach area were running between 12.1 and 12.2 ft LMSL (1983-2001) based on the IPET surveys and slightly lower (11.9 ft to 12.1 ft) using New Orleans District survey data closer to the breach site. (Shots on floodwalls on each side of the breach indicated actual elevations as low as 11.7 ft; however it is not clear from the raw dataset if the walls were deformed/deflected at these points). A modified NTDE (2001-2005) will reduce the flood protection relative elevations even further.

The approximately 2-ft difference indicated in the above table correlates with the elevation projections made in the previous paragraphs. The above can be illustrated in the following graphic (Figure 47).

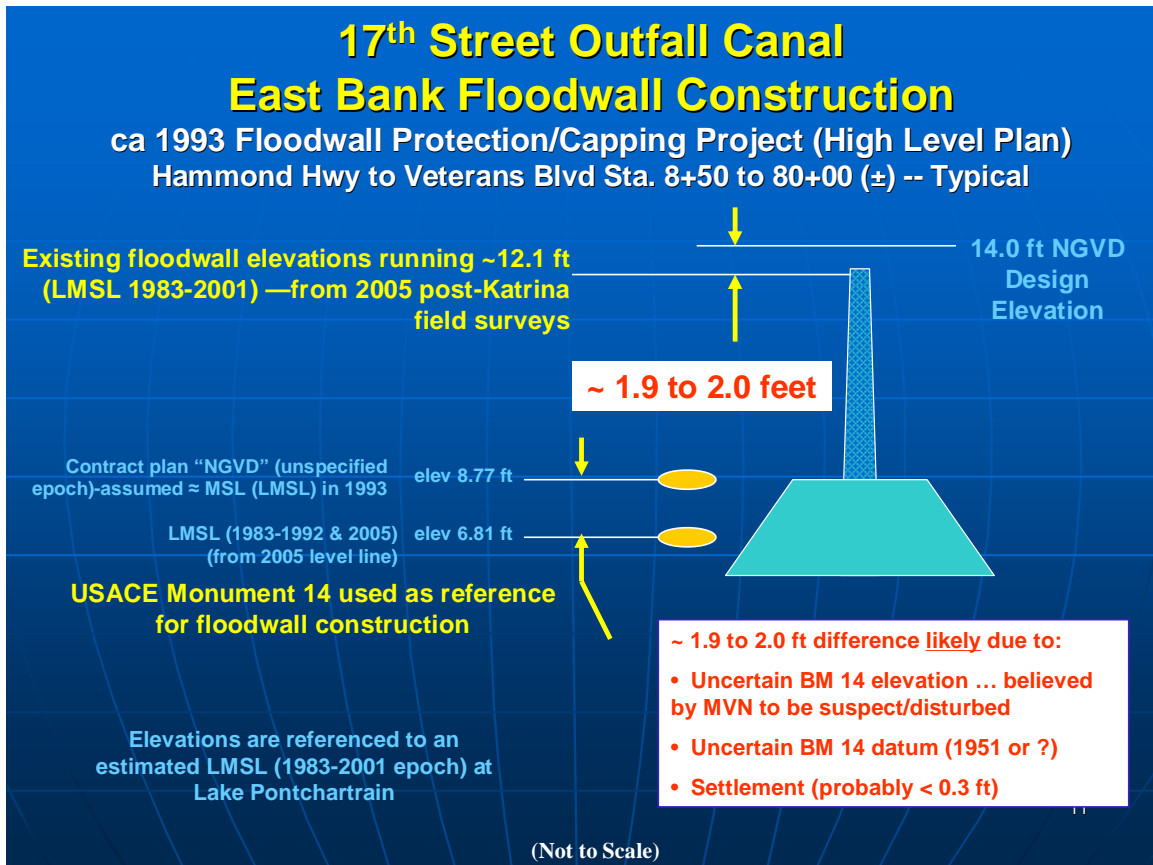

Figure 47. Design vs. Current Floodwall Elevation—East Bank 17th St Outfall Canal



# Data Analysis and Impacts: Inner Harbor Navigation Canal (IHNC) Construction Reference Datums

## Summary of Findings

This Section covers the evaluation of the constructed and current elevations on flood protection structures along selected portions of the IHNC. The floodwall on the east bank between Florida Avenue and Claiborne Avenue (i.e., Lower East 9<sup>th</sup> Ward breach area) was found to have been constructed using the best available elevation data. Subsequent subsidence since the late 1960s construction has resulted in pre-Katrina and current flood protection elevations running approximately 2.5 feet below original design—in effect, a loss of the original freeboard allowance factored into the design elevation of the protective structures. Similar subsidence rates were noted on east and west bank floodwalls between the IHNC-GIWW confluence north to the Seabrook Bridge.

## Reference Documents

The following as built construction drawing and design memorandum were reviewed as part of this assessment:

- DACW29-70-B-0088 As Built Mark Up-IHNC Inner Harbor Navigation Canal East Levee—IHNC Lock to Florida Ave Levee & Floodwall Capping
- DACW29-68-B-0148 As Built—Levee Floodwall Capping—IHNC East Levee—Hayne Blvd to Dwyer Ave—Sta 33+95 to Sta 83+00 (1968)
- DACW29-68-B-0126 As Built—Levee Floodwall Capping—IHNC West Levee—U.S. Hwy 90 to Alamanster Ave—Sta 105+66 to Sta 167+00 (1970)
- DM02 Supplement 08 GDM-IHNC Remaining Levees (Feb 1968)

Other floodwalls along the IHNC east or west bank were not evaluated in this assessment since the above area covers the critical breach site at the Lower 9th Ward.

## Design Elevation Parameters for East Levee Floodwall Capping (1969)--IHNC Lock to Florida Ave Sta. 0+00 to 56+20

Reference benchmark used for construction: “BM 1” is the same mark as USC&GS “M-152”—see Figure 48 below.

- Elevation 21.811 ft MSL (1969 contract plans)
- (Located on IHNC East Lockwall—intact 2006)
- 2005 Post-Katrina GPS connection (MVN 10 Nov 05): Elev 20.34 ft NAVD88 (2004.65)
- I-Walls constructed to 15.0 ft MSL—per As-Built Plans—see typical plan at Figure 49 below
- (No DM/GDM could be found noting design and freeboard parameters)

## Historical Adjustments to Reference Benchmark M 152 (1951 to date)

Table 23 illustrates the various elevations associated with Benchmark M 152. Most of the changes are due to readjustments of level lines by NOAA to account for apparent subsidence.

From Table 23 it is apparent that the then (1969) most current elevation (21.811 ft) of M 152 was used in the contract plans, irrespective of the fact that the NGVD29 elevation was given as MSL. The Florida Avenue gage was active since 1949 and could have been used to determine the LMSL relationship.

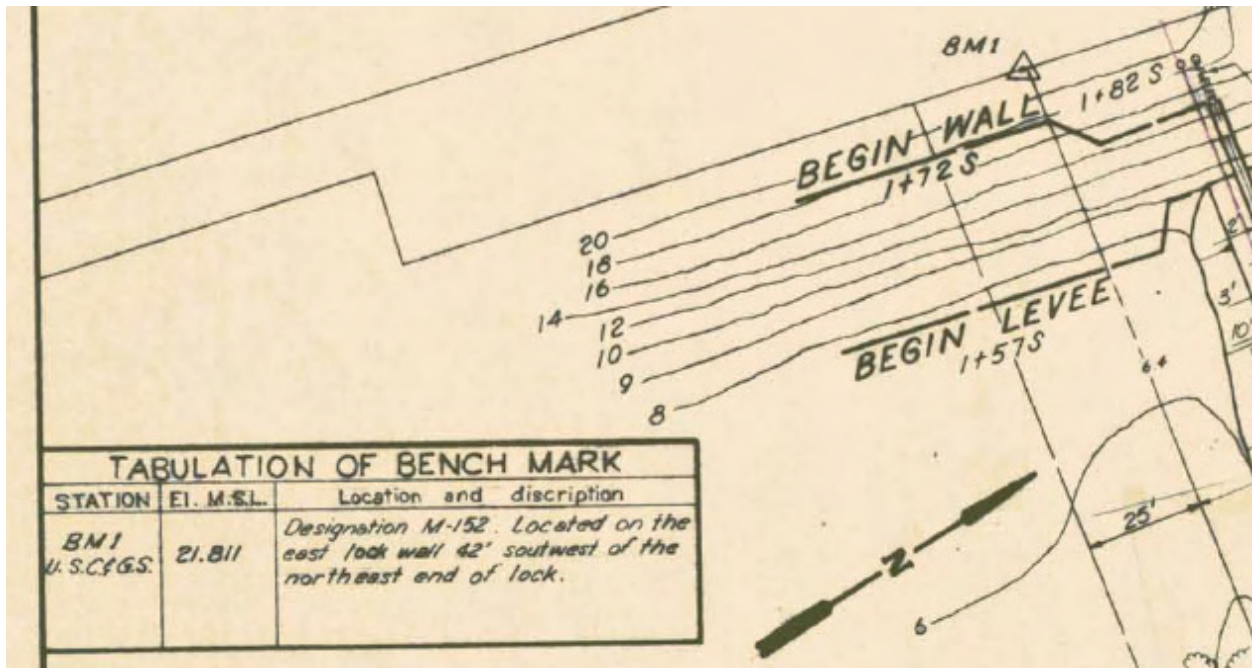

Figure 48. Location and Description for "BM 1" (M 152 USC&GS) at IHNC Lock

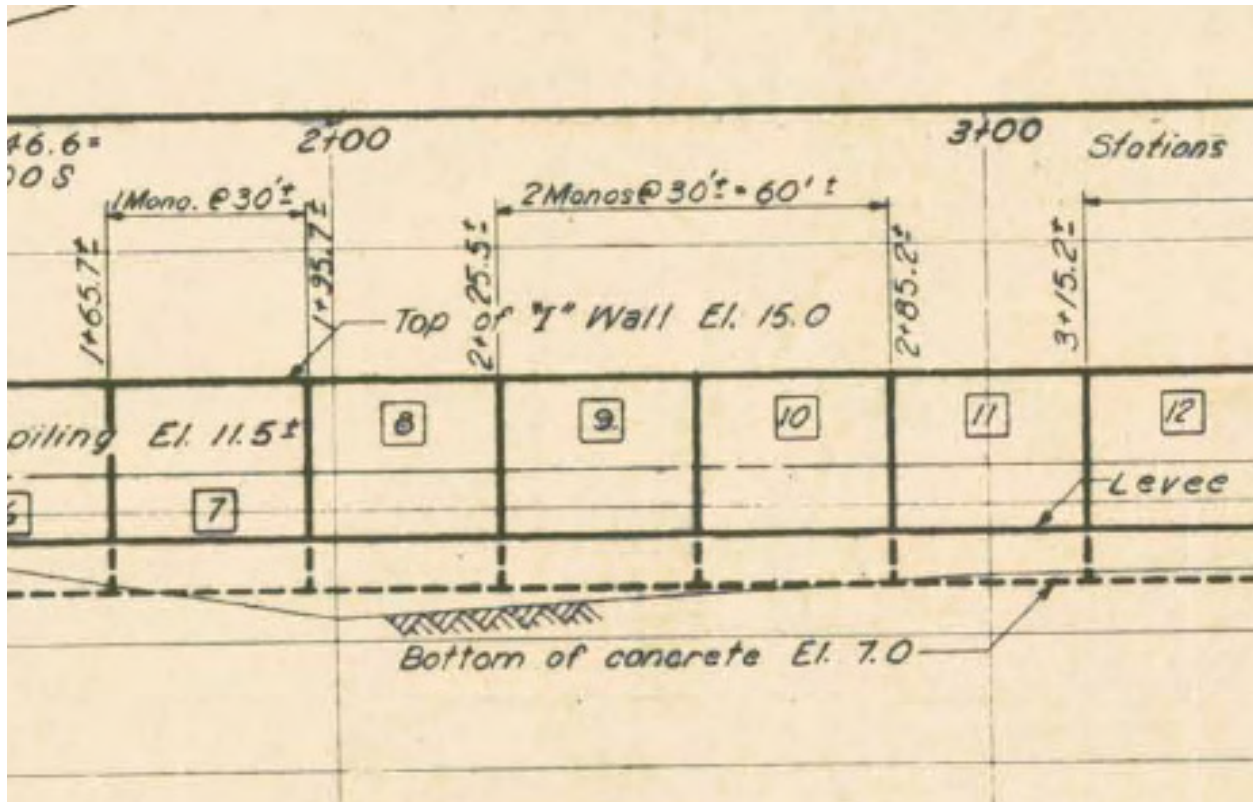

Figure 49. East Side I-Wall Design Elevation 15.0 ft (Sta. 2+00 Typical)

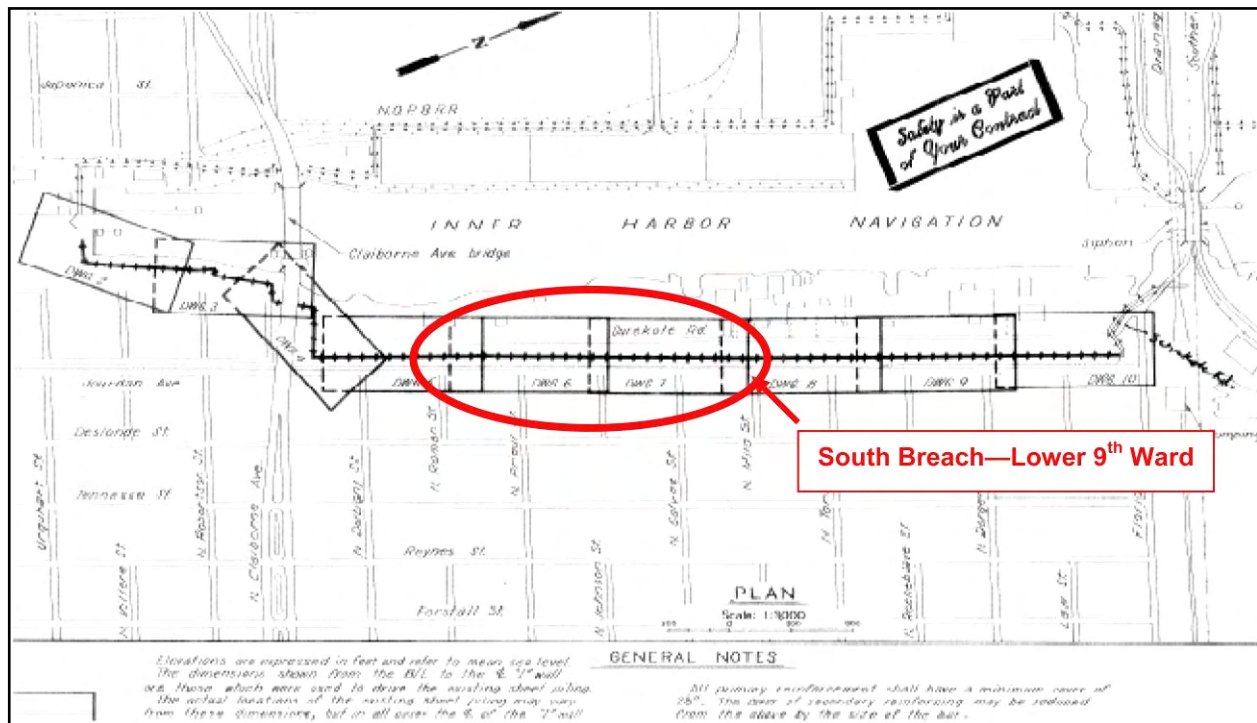

Figure 50. IHNC East Side Floodwall Capping—IHNC Lock North to Florida Avenue (Lower 9th Ward Breach at approximately Sta. 2+00)

<b>Table 23</b>				
<b>Successive Elevations on Benchmark M 152 from 1951 to 2005</b>				
<b>Elev, ft</b>	<b>Datum</b>	<b>Adjustment</b>	<b>Agency</b>	<b>Reference</b>
22.090	NGVD29	1951	USC&GS	L-13860
22.697	NGVD29	19 Mar 52	USC&GS	
21.811	NGVD29	1963/9 Apr 65	USC&GS	L-19622
21.811	MSL	1969 Contract Plans	MVN	DACW29-70-B-0088
21.070	NGVD29	1982	NGS	L-19622
21.148	NGVD29	1985/30 Jan 86	NGS	L-24903
20.96	NGVD29	21 Jun 91	NGS	L-25283/AU0668
20.963	NGVD29	1995	NGS	L-25517
20.76	NAVD88	14 Feb 94	NGS	AU0668
20.81	NAVD88	Dec 1996	NGS	AU0668
20.34	NAVD88 (2004.65)	10 Nov 05	USACE	MVN
20.0	LMSL (1983-2001)	April 2006	NOAA CO-OPS	IPET Study
19.7	LMSL (2001-2005)	April 2006	NOAA CO-OPS	IPET Study

The difference between LMSL and NGVD29 at this location on the IHNC during the 1963-1969 period was not estimated in this study. It is uncertain that data from historical USACE gages in the IHNC (Seabrook Bridge, IHNC Lock, and Florida Avenue) would be able to quantify this difference to any level of confidence since the gage references were periodically revised.

Local Mean Sea Level elevation differences in the IHNC were computed by NOAA using historical USACE gage records. The approximate LMSL (1983-2001) difference from NAVD88 (2004.65) is 0.2 ft  $\pm$  0.1 ft. The difference is approximately 0.6 ft for the later LMSL modified NTDE (2001-2005) as described in a previous section of this Volume.

#### **Assessment of Pre- and Post-Katrina Flood Protection Elevations (IHNC East Bank Floodwall between Claiborne and Florida Avenues)**

New Orleans District survey crews ran levels surveys to various points along the IHNC, as shown in the drawing (Figure 51) below.





Figure 51. Selected Post-Katrina Elevations on IHNC Floodwalls

During January 2006, Post-Katrina Overbank Surveys extracted in the following table (Table 24) were taken north and south of the breach area by 3001 Inc. These surveys were performed in support of IPET physical modeling. They also provide a quality assurance check on MVN Task Force Guardian surveys performed after Katrina. State plane coordinates are LA 1702 South and elevations are in feet NAVD88 (2004.65). The stationing is not the floodwall alignment.

<b>Table 24 Post-Katrina Floodwall Elevations in Selected Reaches (East Bank IHNCA) IPET Surveys Overbank Surveys January 2006 (3001, Inc.)</b>				
<b>X</b>	<b>Y</b>	<b>Elev, ft</b>	<b>Location</b>	<b>Datafile reference</b>
RTK shots atop East Bank floodwall vicinity Florida Avenue Bridge:				
Sta. 0+00				
3696362.82	540601.98	12.616	Top Edge Conc Fldwal	IHNCEAST.dc
3696363.6	540602.19	12.638	Top Edge Conc Fldwal	IHNCEAST.dc
Sta. 0+50				
3696375.81	540546.84	12.561	Top Edge Conc Fldwal	IHNCEAST.dc
3696374.68	540547.01	12.589	Top Edge Conc Fldwal	IHNCEAST.dc
RTK shots atop floodwall vicinity Claiborne Avenue Bridge:				
Sta. 41+65				
3695275.99	536566.87	13.402	Top Edge Conc Fldwal	IHNCEAST.dc
3695275.76	536566.93	13.399	Top Edge Conc Fldwal	IHNCEAST.dc
Sta. 44+00				
3695089.7	536384.8	13.271	Top Edge Conc Fldwal	IHNCEAST.dc
3695089.47	536384.94	13.333	Top Edge Conc Fldwal	IHNCEAST.dc
Sta. 44+50				
3695069.01	536338.05	13.323	Top Edge Conc Fldwal	IHNCEAST.dc
3695069.34	536337.93	13.296	Top Edge Conc Fldwal	IHNCEAST.dc
Note: Duplicate shots are at the flood side and protected side of the floodwall concrete cap. Elevations referenced to NAVD88 (2004.65)				

From the above data (Table 24), pre-Katrina elevations along the East Bank floodwall north of the breach area were running around 12.6 ft to 12.7 ft NAVD88 (2004.65). South of the breach area the elevations range from 12.7 ft to 13.4 ft near the Claiborne Avenue Bridge.

Assuming a 0.3 ft difference between LMSL (1983-2001) and NAVD88 (2004.65)—based on CO-OPS estimates—then the post-Katrina floodwall elevation relative to LMSL is approximately 12.5 ft. This 12.5 ft LMSL elevation would also be representative of the 2005 pre-Katrina floodwall elevation in this reach. Thus, elevations are running approximately 2.5 feet below those authorized and constructed ca 1970.

The following graph (Figure 52) from the USACE gage at Florida Avenue shows the increase in apparent sea level (i.e., including subsidence). This gage is maintained by the New Orleans District. The regression line indicates an average annual increase of 7.9 mm/year  $\pm$  1.5 mm/year, or 0.026 ft/year  $\pm$  0.005 ft/year. Over a 35 year period (1970 to 2005), this would indicate a 1 foot change. The additional measured subsidence on the floodwalls could be due to settlement, among other factors.

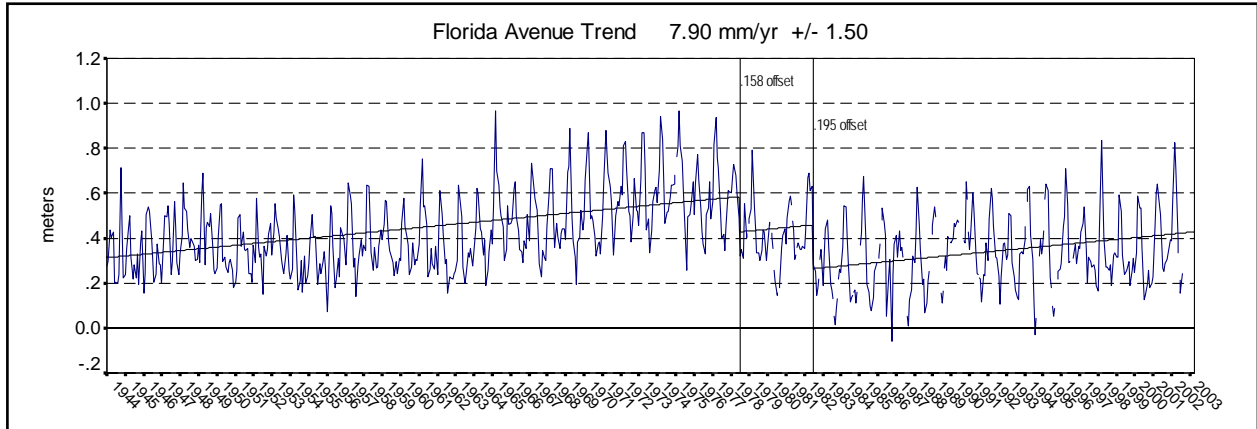

Figure 52. Apparent sea level rise at Corps IHNC Florida Ave. gage 1944 to 2003 (Source: IPET MVN and NOAA CO-OPS).

**Design versus Current Floodwall Elevations in the IHNC between the GIWW Confluence to the Seabrook Bridge (East and West Banks)**

Figure 53 below depicts differences between constructed and current floodwall elevations on the IHNC. The floodwall grades shown are only approximately located. The current elevations were obtained from Task Force Guardian post-Katrina levee profiles. These elevations are an average over the sectors—high variability (e.g., ± 1 ft) was observed in some sectors—probably due to varying settlement.

The reduced flood protection (relative to LMSL) in this portion of the GIWW is typically running between 2.0 and 2.5 ft—similar to that seen in the East Bank section below Florida Avenue. This is consistent with subsidence estimates over the past 35 years.

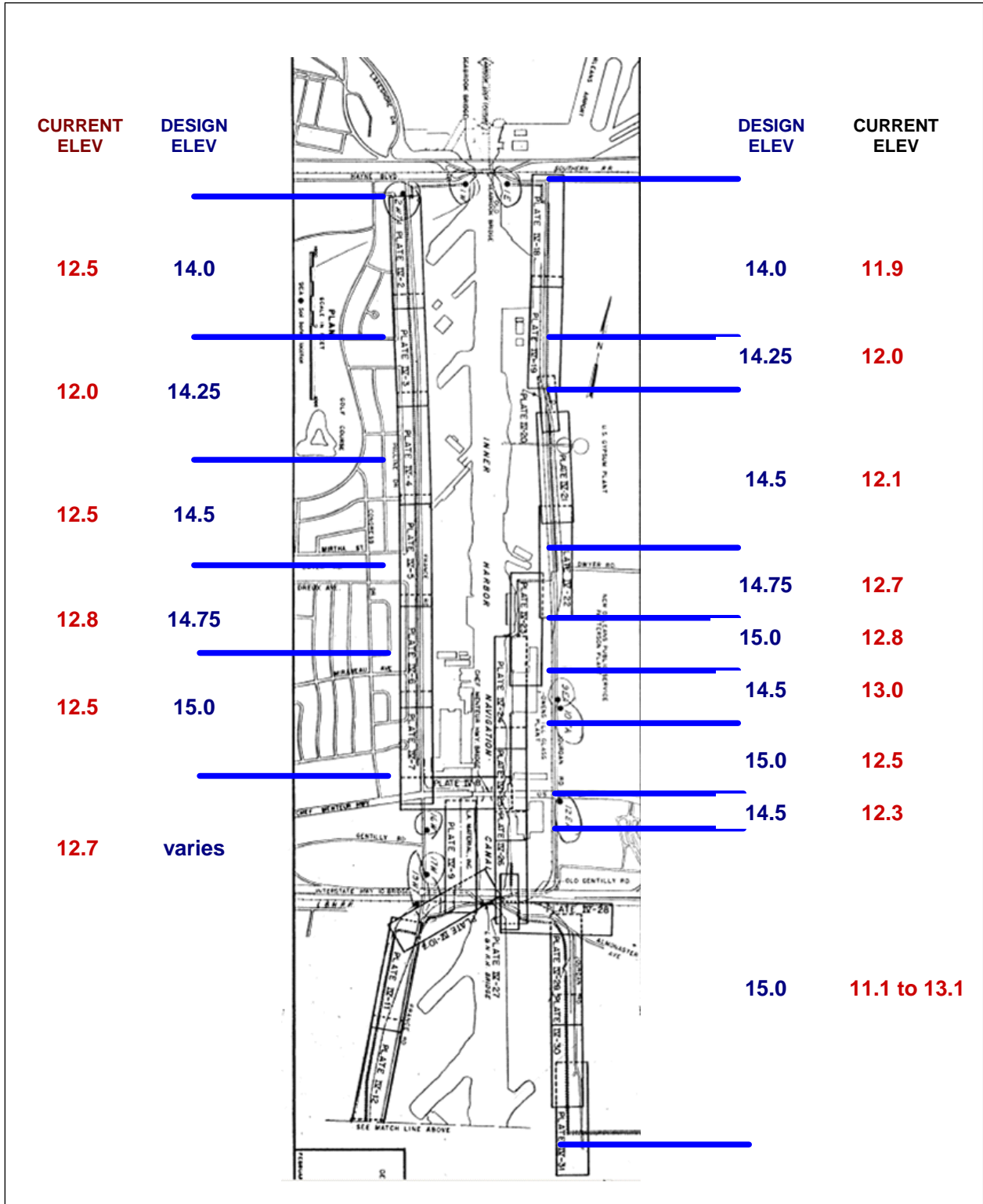

Figure 53. Design versus Current Elevations in IHNC. Design elevations in feet referenced to MSL. Current elevations in feet referenced to LMSL (2001-2005). Grade sectors and current elevations are approximate



## Reference Datums for Hurricane Protection Projects in St. Bernard and Plaquemines Parishes

This section represents a review of elevation datums on hurricane protection structures southeast of the New Orleans area. Given the magnitude of the overtopping surge heights relative to the small size of the geodetic-hydraulic datum variations, and the lack of available design and construction documents, only a cursory study was performed in this region.

Various design memorandums (DM) were reviewed to assess the reference datums used in determining hurricane design elevations on flood protection projects along the Gulf Intra coastal Waterway, the MRGO, and Mississippi River. These included:

- DM 01 Part 1 Hydrology and Hydraulic Analysis--Lake Pontchartrain & Vicinity--Chalmette (Aug 1966)
- DM 01 Part 2 Hydrology and Hydraulic Analysis--Lake Pontchartrain & Vicinity--Barrier (Aug 1967)
- DM 01 Part 3 Hydrology and Hydraulic Analysis--Lakeshore (Sep 1968)
- DM 13 Vol I GDM Orleans Parish Lakefront Levee West of IHNC (Nov 1984)

### Lake Pontchartrain and Vicinity Projects

DM 01 Part 2 (1967) states the average high tide of Lake Pontchartrain at 1.4 ft. This level is used as a base (or initial) elevation for subsequent storm surge modeling. The design memorandum notes all elevations are referred to "Mean Sea Level."

DM 01 Part 3 (1968) and DM 13 Vol 1 (1984) later noted the average high tide in Lake Pontchartrain at 0.7 ft. This was adjusted down 0.7 ft from the 1.4 ft average high tide cited in the 1967 Barrier Plan (DM 01 Part 2). This was based on a USC&GS releveling and gage adjustment.

Track	Starting	Contributions			Final lake stage
	lake stage	Rainfall	Runoff	Overflow	
	feet	feet	feet	feet	feet
A	0.7	0.6	0.1	0.2	1.6
C	0.7	0.7	0.1	0.7	2.2
F	0.7	0.7	0.1	0.6	2.1

Figure 54. Average Lake Pontchartrain stages (DM 01 Part 3—1968)

Other design memorandums note the “normal water level” of Lake Pontchartrain at 0.0 ft MSL (Appendix B of GDM 20 (Draft) London Ave. Canal Floodwalls and Levees—Orleans Levee District—(April 1986).

(Note that the Design or Hurricane Tide is the maximum stillwater surface elevation experienced at the location during the passage of a hurricane. This ‘Design Tide’ uses the initial normal (predicted) tide as a base reference, or alternately the high tide. EM 1110-2-1913 notes freeboard was, in the past, used to account for hydraulic, geotechnical, construction, operation, and maintenance uncertainties. This current EM develops a risk-based analysis to set the final levee grade to account for settlement, shrinkage, cracking, geologic subsidence, and construction tolerances.)

DM 01 Part 1—Chalmette (1966) indicates a “normal predicted tide” of 1.60 ft (MLW) and a (-) 0.60 ft correction from MLW to MSL. This implies a normal predicted tide of 1.0 ft MSL at the Chalmette area. Resultant observed and computed hurricane surge heights are relative to MSL. A plate (Figure 55 below) depicting typical tidal cycles in Lake Borgne and Lake Pontchartrain indicates MSL elevations average +1.0 ft above 0.0 MSL in both areas. DM 01 states the average tidal ranges in Lake Borgne and Lake Pontchartrain are +1.0 ft and 0.5 ft respectively, and the average elevation of the lakes “differs very little.” The elevation of Lake Borgne is given at 0.9 ft and Lake Pontchartrain 1.0 ft. The source of these elevations (i.e., gage

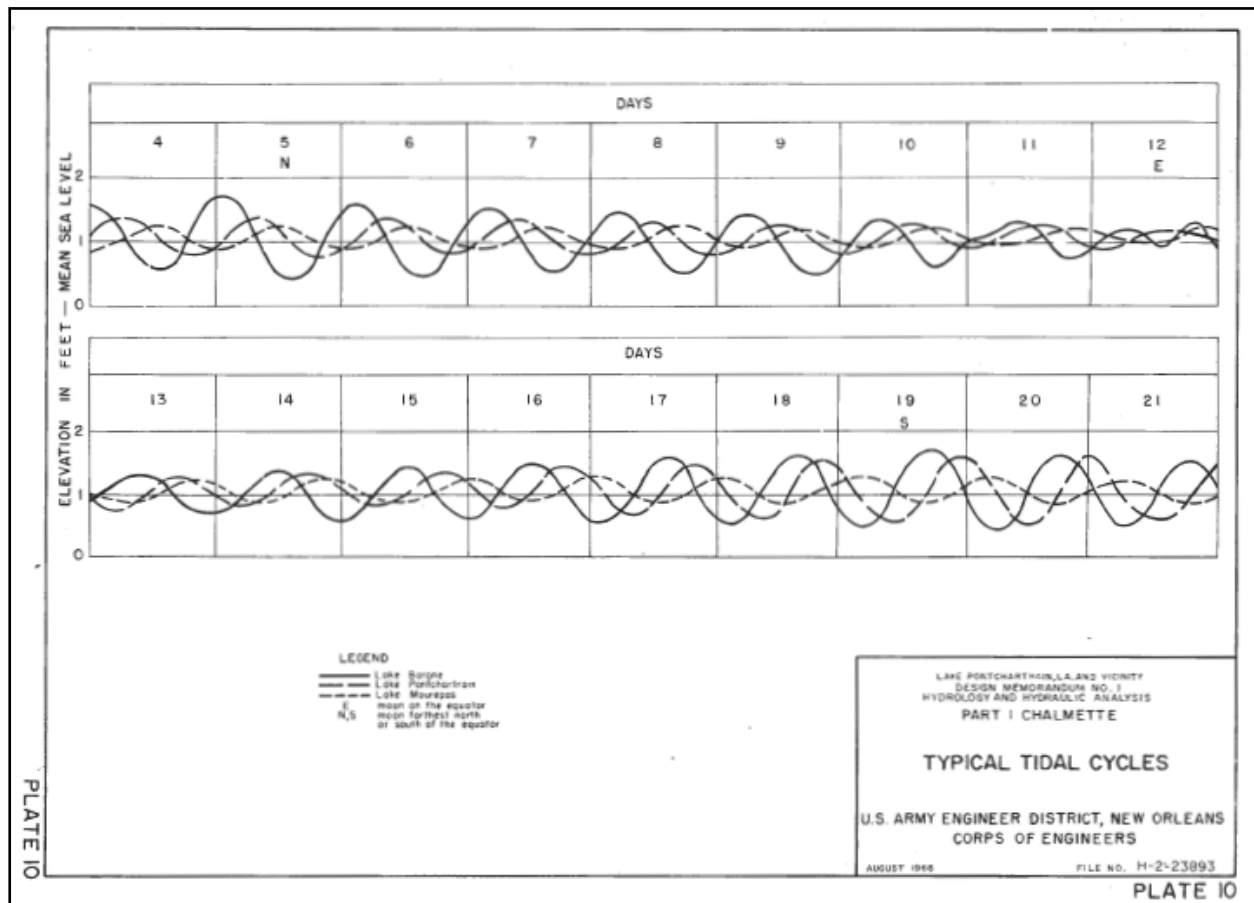

Figure 55. +1.0 ft superelevation on Lake Borgne and Lake Pontchartrain (DM 01 Part 1)

and/or leveling datum) is not readily apparent in the design memorandum. Given all elevations in the design memorandum refer to MSL it is presumed that these 0.9 ft and 1.0 ft “normal water surface” superelevations also refer to MSL. If these elevations are based on gages referenced to a “NGVD” datum, this is not apparent from the limited records viewed.

The following plate (Figure 56) from DM 01 Part 3 depicting wind tide profiles indicates the Mean Lake Level of Lake Pontchartrain as +1.0 ft.

### New Orleans to Venice Projects

Referenced design memorandums:

- DM 01 GDM Supp 04—New Orleans to Venice--Reach B2--Fort Jackson to Venice (Aug 1972)
- DM 01 GDM Supp 06--West Bank Mississippi River Levee--City Price to Venice (Mar 1987)

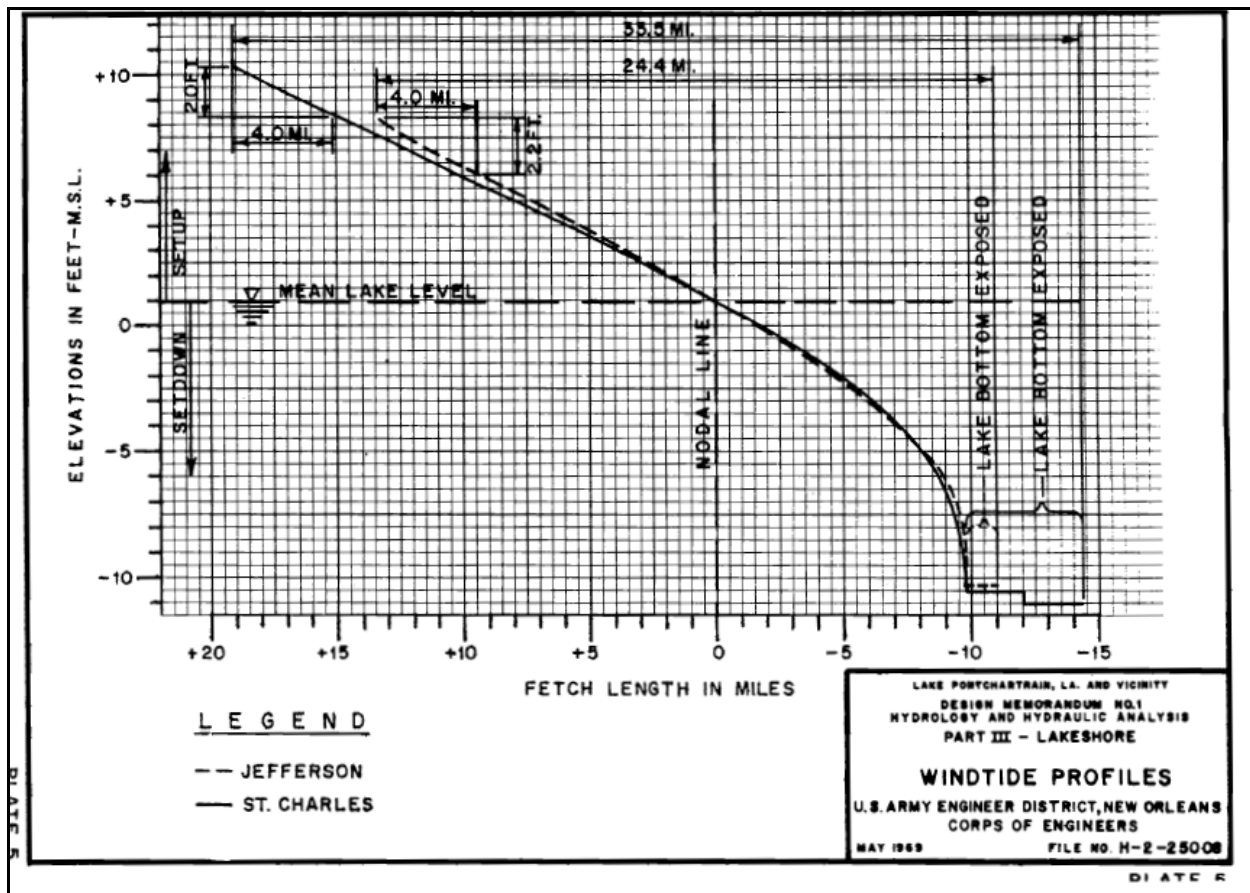

Figure 56. +1.0 ft “Mean Lake Level” relative to MSL for Lake Pontchartrain (DM 01 Part 3)

Stillwater elevations and hurricane design elevations on the New Orleans to Venice projects generally refer to the MSL datum (DM 01 GDM Supp 04--1972). Tides along the coast are noted having a mean range of 1 foot. Both headwater flooding and tidal effects are compensated for in computing surge elevations in the Mississippi River north of Venice. Page A-16 of DM 01 GDM Supp 04 states the Predicted “Mean Normal Tide” in the project area varies from 0.4 ft to 1.0 ft MSL. It is unclear if this Mean Tide is equivalent to Mean Tide Level or how it relates to Mean Sea Level. The design hurricane surge height for the project area is given as 11.5 ft MSL.

DM 01 GDM Supp 06 (1987) noted that surge studies performed after Hurricane Betsy in 1965 were in error by as much as 1 foot due to readjustments to the NGVD level network in this area—see Figure 57 below. This resulted in hurricane stages being 1 foot higher than calculated by storm surge modeling.

(4) Subsequent to completion of the NESCO study, it became apparent based on a new level network that bench mark elevations in the study area were actually as much as 1 foot lower with respect to national geodetic vertical datum than their recorded elevations. Therefore, all stages experienced during Betsy and used in the NESCO study were recorded too high with respect to national geodetic vertical datum. The undisturbed river profile and the Betsy surge crest profile used and computed in the NESCO study are shown on figure 6, plate B-10. However, the maximum stage shown at West Pointe-a-la-Hache, mile 49 AHP, was 14.4 feet rather than 15.2 feet, and the mean stage at the Carrollton gage, mile 103 AHP, prior to Betsy, was 2.0 feet rather than 2.7 feet. The 2.0-foot stage at Carrollton is the mean tide level on the day before Betsy struck the Louisiana coast. Corrected profiles are shown on plate B-7.

Figure 57. NGVD29 network adjustment impact (Appendix B--DM 01 GDM Supp 06 (1987))

### Mississippi River Gulf Outlet (MRGO) Projects

Referenced design memorandums:

- DM 01 A--MRGO Channels Mile 63.77 to 68.85 (Jul 1957)
- DM 01 B--MRGO Channels Mile 39.01 to 63.77 (May 1959)
- DM 01 C--MRGO Channels Mile 0 to 36.43 (Bayou La Loutre) Mile 0.0 to (-) 9.75 (38 ft Contour) (Nov 1959)
- DM 02 GDM Supp 03-Bayou La Loutre Reservation (Feb 1968)
- DM 01 GDM--Michoud Canal (Jul 1973)

All documents refer MRGO channel elevations to Mean Low Gulf (MLG), which is 0.78 feet below MSL. This reference is standard for dredging and navigation projects in this region—see the Background Section to this Volume.

Records from a water level recording gage on the GIWW at Paris Road indicated average yearly high and low water stages significantly above that expected for an area subject to direct tidal flow, as shown in Figure 58 below. The reason for this anomaly is unclear.

DM 02 GDM Supp 03-Bayou La Loutre Reservation (Feb 1968) notes the Average Water Surface for this section of the MRGO at 0.75 ft MSL. The maximum expected hurricane surge (SPH) is 15.0 ft MSL.

**TABLE A-7**  
**Average Annual High & Low Water Stages**  
**Gulf Intracoastal Waterway at Paris Road Bridge**

<u>Year</u>	<u>Mean High Water</u> (m.s.l.)	<u>Mean Low Water</u> (m.s.l.)
1959	Insufficient records	
1960	Insufficient records	
1961	2.58	1.66
1962	2.37	1.30
1963	2.27	1.27
1964	2.51	1.34
1965	2.77	1.37
1966	2.83	1.46
1967	Insufficient records	
1968	2.86	1.54
1969	3.30	1.87
1970	3.30	1.91

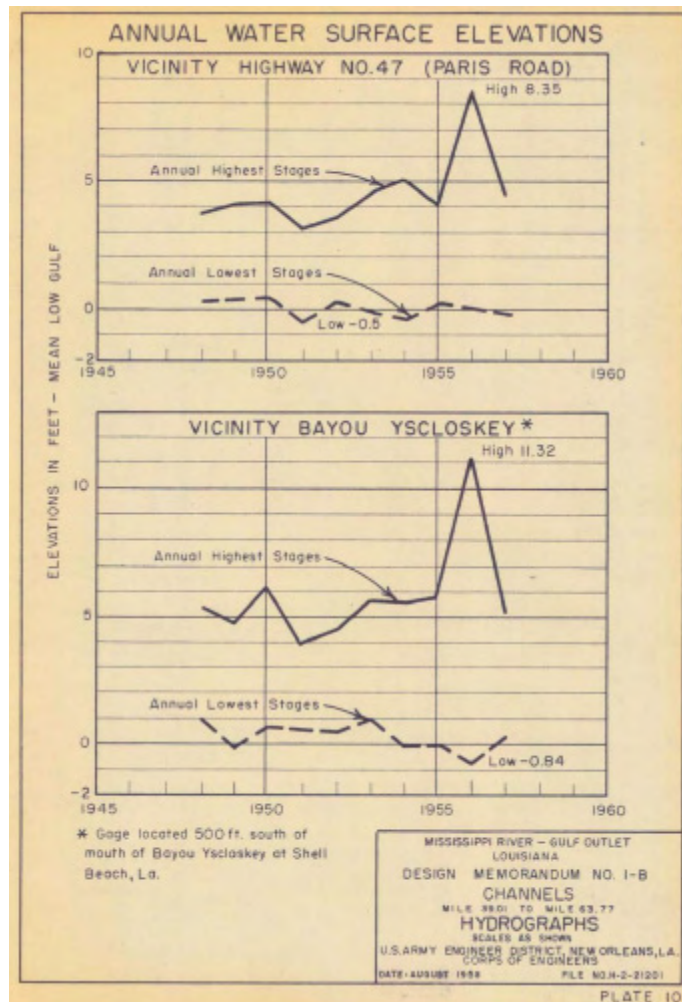

Figure 58. GIWW water level stages at Paris Road (DM 01 GDM)

## Estimating Subsidence Rates in the Southeastern Louisiana Region from Geodetic Observations

This section will focus on subsidence occurring at benchmarks throughout the IPET project area. This benchmark subsidence may be different from that occurring in the adjacent ground. Subsidence is the lowering or sinking of Earth's surface (often quantified relative to non-sinking portions of the Earth's crust). In Louisiana, subsidence is occurring at a rate of up to 0.1 foot every three years in some areas--especially in Southern Louisiana. Over the years there have been several studies that have been published documenting the subsidence of New Orleans and Southern Louisiana (Mitchell and Zilkoski 1986). There are many potential factors that contribute to the subsidence, including the geologic composition of the area and withdrawal of ground water and oil. The subsidence in New Orleans and Southern Louisiana presents unique problems for the NGS.

In November 1986, NOAA Technical Report NOS 120 NGS 38 titled "Subsidence in the Vicinity of New Orleans as Indicated by Analysis of Geodetic Leveling Data," (NOAA 1986) used three different adjustments to determine the apparent movement of benchmarks in this area. It was noted in this report that this would be helpful to engineers when planning projects, to surveyors when evaluating leveling data, and to scientists when correlating apparent movements to geologic and hydrologic parameters. Report NGS 38 does not show sea level rise--only the apparent movement of the mark. It should also be noted that the movement reflected in this report, as well as in NOAA Technical Report 50 "Rates of Vertical Displacement at Benchmarks in the Lower Mississippi Valley and the Northern Gulf Coast," (NGS 2004) reflects the movement of the mark based on leveling observations. Table 25 below shows not only the apparent subsidence but also that the subsidence is neither linear nor at the same rate based on location and different epochs.

DESIGNATION	1985.0 – 1964.0	1985 – 1951	1964 - 1951
A 148 (AU0429)	-6.88 mm/year (21 yr)	-5.57 mm/year (34 yr)	-3.1 mm/year (13 yr)
PIKE RESET (BH1164)	-1.36 mm/year	-1.59 mm/year	-1.97 mm/year
231 LAGS (BH1073)	-16.39 mm/year	-10.90 mm/year	-2.03 mm/year
A 92 (BH1136)	-2.36 mm/year	-2.66 mm/year	-3.13 mm/yr

The rate of subsidence varies from epoch to epoch (survey to survey) due to many factors, such as compaction, removal of subsurface fluids, and geologic events. Therefore, one cannot predict future subsidence with any degree of accuracy. The following Table 26 shows the rate of change reflected in at least two different epochs of First-Order, Class II leveling as published in NOAA Technical Report 50 (NGS 2004).

<b>Table 26 Apparent movement reflected in NOAA Technical Report 50</b>	
<b>DESIGNATION</b>	<b>Rates of Movement in Millimeters per year</b>
A 148 (AU0429)	-11.01
PIKE RESET (BH1164)	-6.99
231 LAGS (BH1073)	-16.08
A 92 (BH1136)	-7.39

In October 2005 NOAA updated official elevations on 85 existing benchmarks located in southern Louisiana. Prior to this time elevations of benchmarks in Southern Louisiana were questionable at best. The expected accuracy of the updated elevation values are between 2 and 5 centimeters, though it must be mentioned that these heights are continuing to change over time. Surveyors, engineers, and the USACE in New Orleans, along with other federal, state, and local governments, used heights that had not been calibrated nor checked for several years.

The average rate of apparent subsidence across the region was about 0.6 of a foot subsidence/change, over the same 10-year period. This indicates that elevations published in the 1960's, 70's, 80's, and early 90's may have changed even more than 1 foot. NOAA's long-term objective is to improve upon the current vertical reference system, the NAVD88 (2004.65) epoch, which consistently evaluates previously constructed, and proposed flood control and hurricane protection structures in New Orleans and Southeast Louisiana.

Figure 59 below depicts the apparent sea level increase (i.e., mostly subsidence) at the Florida Avenue gage on the IHNC. This gage data supports independent geodetic observations.

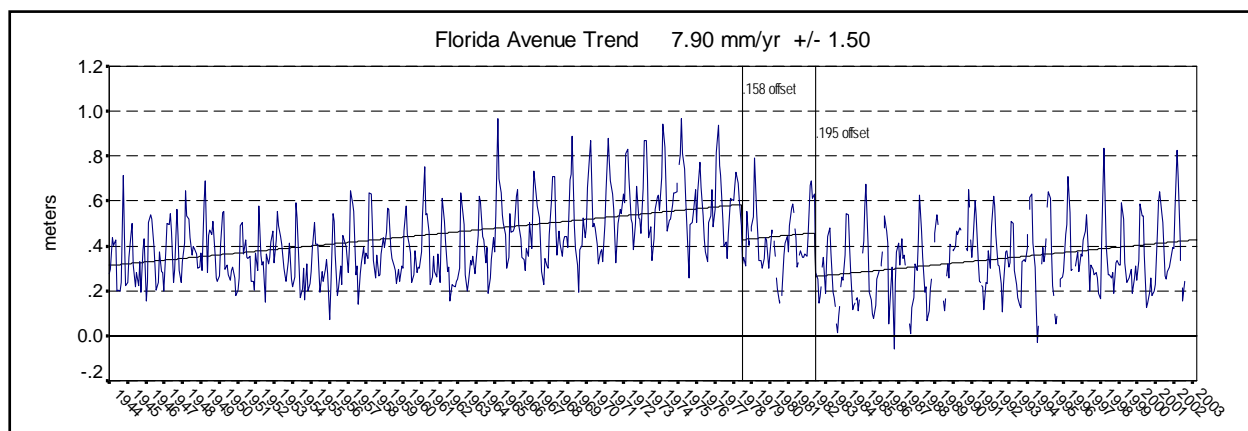

Figure 59. Apparent sea level rise at Corps IHNC Florida Ave. gage 1944 to 2003 (Source: IPET MVN and NOAA CO-OPS)

The following Table 27 depicts estimated subsidence rates occurring at 18 benchmarks in the New Orleans region based on the adjusted elevations. If you compare these rates with those published in NOAA Technical Report 50 (NGS 2004) they do not all agree since the adjusted elevations contain distributed errors from the adjustment computations. Therefore this table



points out the need to use unadjusted values in determining subsidence rates as documented in Technical Report 50.

**Table 27**  
**Estimated Subsidence Rates at Selected Benchmarks in New Orleans Region.**  
**(Source: NGS/IPET Navaille) “Sup” = superseded**

PID	Designation	Rate m/yr	2004.65 m	Procedure	Sup-Date	Sup- Meters	Sup- Feet	Leveling Year	NAVD88 (2004.65) ft
BH1119	C 189	-0.016	0.63	LEVELING(2004.65)	12/5/1996	0.794	2.60	1994	-0.54
AU2163	B 369	-0.015	1.84	LEVELING(2004.65)	12/5/1996	1.975	6.48	1995	-0.44
AU2310	876 1899 B TIDAL	-0.015	0.01	LEVELING(2004.65)	12/5/1996	0.141	0.46	1995	-0.43
AU0429	A 148	-0.015	1.77	GPS OBS(2004.65)	12/5/1996	1.915	6.28	1994	-0.48
BJ1342	ALCO	-0.014	1.87	LEVELING(2004.65)	12/5/1996	2.008	6.59	1994	-0.45
AT0804	REGGIO 2	-0.012	1.52	GPS OBS(2004.65)	2/14/1994	1.714	5.62	1988	-0.64
BH1212	A 193	-0.012	0.75	LEVELING(2004.65)	2/14/1994	0.879	2.88	1993	-0.42
AU2110	G 365	-0.011	0.24	GPS OBS(2004.65)	12/5/1996	0.342	1.12	1995	-0.33
AT1390	876 0849 A TIDAL	-0.011	0.85	GPS OBS(2004.65)	8/31/2001	0.972	3.19	1993	-0.40
AT0407	A 152	-0.010	0.67	GPS OBS(2004.65)	2/14/1994	0.870	2.85	1984	-0.66
BJ3744	S 379	-0.010	4.31	GPS OBS(2004.65)	2/14/1994	4.482	14.70	1986	-0.56
AT0376	R 194	-0.008	1.39	GPS OBS(2004.65)	2/14/1994	1.554	5.10	1984	-0.54
AT0357	D 194	-0.008	1.68	LEVELING(2004.65)	2/14/1994	1.835	6.02	1984	-0.51
AT0200	MILAN 2	-0.008	-0.15	GPS OBS(2004.65)	2/14/1994	0.005	0.02	1984	-0.51
AT0332	L 278	-0.007	2.11	LEVELING(2004.65)	2/14/1994	2.253	7.39	1984	-0.47
AT0231	EMPIRE AZ MK 2 1934 1966	-0.007	-0.01	GPS OBS(2004.65)	2/14/1994	0.129	0.42	1984	-0.46
AT0247	C 279	-0.007	-0.23	GPS OBS(2004.65)	2/14/1994	-0.100	-0.33	1984	-0.43
AT0731	N 367	-0.007	0.34	GPS OBS(2004.65)	2/14/1994	0.470	1.54	1984	-0.43

Subsidence can be measured by using either conventional leveling procedure or GPS following Publication 58 “GPS Derived Ellipsoid Heights” (NOAA 1997) and the draft guidelines Publication 59 for “GPS Derived Orthometric Heights” (NOAA 2005)--or a combination of both. Figure 60 below contains a map showing the estimated amount of subsidence between New Orleans and Venice, LA. The leveling for this line was done in 1984 and adjusted to the NGVD29 datum at that time. In 1991 NGS adjusted the entire CONUS to the NGVD29 datum getting ready for the NAVD88 adjustment. As previously mentioned, this area was POSTed for the NAVD88 original adjustment in 1991 due to the subsidence in the area. During the 1992/1994 NGS adjustment, all the area that had been POSTed to establish an NAVD88 height for each of the benchmarks in this area. In Southern Louisiana an extensive “GPS Derived Height” was completed establishing new heights (elevations) for 85 benchmarks in Southern Louisiana. The adjustment, as previously noted, held control outside of the subsidence area establishing new NAVD88 adjusted heights for the 85 benchmarks. Because the 1992/1994 NAVD88 adjustment held control outside of the area, as did the NAVD88 (2004.65) adjustment, the change in the heights reflect the apparent movement of the marks between the observation periods. In order to determine the amount of subsidence from the time the original leveling was done, it is necessary to determine the amount of movement between the original adjustment and the 1991 national readjustment of the NGVD29 and then the amount of movement between the

original NAVD88 adjustment and the NAVD88 (2004.65) adjustment. As an example of how the apparent subsidence is determined between a 1984 leveling project and then during a 1991 leveling that only had a few marks in the 1984 leveling include in the 1991 leveling and adjustment. A 1991 line of levels ran from outside

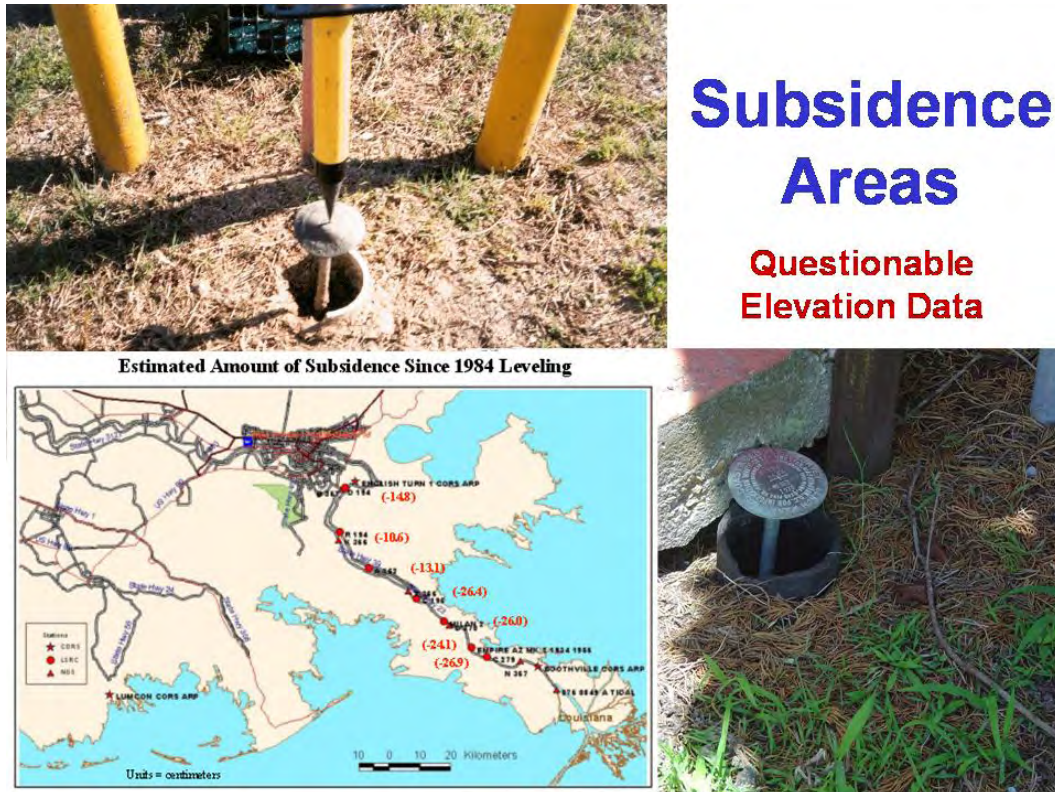

Figure 60. Estimated subsidence (in centimeters) in the New Orleans to Venice region

the area of subsidence through the New Orleans study area tied to only a few of the bench marks leveled in 1984. The marks that are connected directly in the leveling and then adjusted in the 1991 adjustment provided more accurate heights showing apparent subsidence. The other marks that were observed in 1984 also took adjustment based on the 1984 leveling and the connection made to the level line through the connection made in the 1991 leveling. This adjustment took care of some of the problems along the level line, but does not show subsidence over either a 10 year period or 20 year period based on the 2004.65 GPS Derived Orthometric Height survey determined through direct GPS observations. Therefore, the difference between the original NAVD88 adjustment, which happened in 1994, and the NAVD88 (2004.65) adjustment shows subsidence/change of a period between 1984 (date of original leveling with junction connections in 1991) and 2004.65 (midpoint of GPS Derived Orthometric Height survey) reflects the subsidence/change of a time period somewhere between 10 to 20 years except those marks directly leveled in both the 1984 and 1991 leveling. This is due to the fact as, stated above that the 1991 adjustment allow took care of some of the problems in the 1984 adjustment, but did not show how much the mark may have or have not moved. Therefore, the amount of subsidence

lies somewhere between 10 to 20 years on the level line that was ran in 1984 and the GPS observations taken in 2004.65 and adjusted in 2005.

NOAA does not predict the rates of subsidence, nor attempt to determine its causes.

# Corps of Engineers Policies on Use of Geodetic and Water Level Datum Relationships in Design and Construction of Hurricane Protection Structures

## Background

As outlined in previous sections in this Volume, numerous definitions, and adjustment epochs are associated with geodetic and water level reference datums in Southeastern Louisiana. These readjustments and various definitions, coupled with the temporal and spatially varying subsidence, resulted in inconsistent and often conflicting reference datums for flood control projects. Prior to the availability of functioning continuous GPS measurement systems in the mid-1990s, only limited technical guidance was available to the New Orleans District to reliably monitor subsidence and update the elevations in the area. Little, if any, technical guidance on geodetic vertical datums was contained in Corps of Engineers manuals until the mid-1990s. Prior to this time, Corps Districts throughout CONUS obtained guidance primarily from other Federal agencies, such as the NOAA or the US Geological Survey, and from standard civil engineering or surveying texts. Distribution of this guidance was often limited, sometimes conflicting, and normally not applicable for engineering applications. As such, many Corps Districts, including New Orleans, established internal policies on engineering uses and applications of the various geodetic datums.

## Assumed Relationship between Geodetic Datums and Sea Level

As stated in the introductory sections to this Volume, NGVD29 was originally known as the Sea Level Datum of 1929. This change was disseminated by a Federal Register Notice dated 7 May 1973—Figure 61 below.

12840 NOTICES  
NATIONAL VERTICAL CONTROL NET  
Proposed Action  
MAY 7, 1973.  
Elevations of marked points (benchmarks) in the National Vertical Control Net are based on the "Sea Level Datum of 1929." Since this datum was derived from the overall average sea, level of 26 tide stations, the official elevation at any particular one of these tide stations does not necessarily reflect the actual local "mean sea level." In order to avoid such apparent confusion and the costly errors that may result through failure to consider local sea level when engineering projects are undertaken, it is proposed to change the present name of the vertical control datum from the "Sea Level Datum of 1929" to the "National Geodetic Vertical Datum of 1929." This change is proposed to be effective on or before July 2, 1973. Comments on this proposed action may be directed to the Director, National Ocean Survey, NOAA, Rockville, Md. 20852.  
ROBERT M. WHITE, Administrator.  
[FR Doc.73-9694 Filed 5-15-73; 8:45 am]  
FEDERAL REGISTER, VOL. 38, NO. 94-WEDNESDAY, MAY 16, 1973

Figure 61. National Vertical Net Name Change



The name change from SLD29 to NGVD29 in 1973 was not disseminated to Corps Districts until HQUSACE issued Engineer Technical Letter (ETL) 1110-1-97 (Change in Name of National Vertical Control Net) on 31 October 1978. This ETL noted that elevations of the 26 controlling SLD29 tide stations did not necessarily reflect the actual local mean sea level. The Lower Mississippi Valley Division forwarded the ETL to its subordinate districts in a 9 February 1979 memorandum. This memorandum emphasized that this was a change in "nomenclature." The fact that NGVD29 elevations (aka SLD29 elevations) bore no relationship to a hydraulic water surface was not emphasized in either directive. A portion of the 1978 ETL is shown in Figure 62 below.

DAEN-CWE-DC DAEN-MPE-S	DEPARTMENT OF THE ARMY Office of the Chief of Engineers Washington, D. C. 20314	ETL 1110-1-97
Engineer Technical Letter No. 1110-1-97		31 October 1978
Engineering and Design CHANGE IN NAME OF NATIONAL VERTICAL CONTROL NET		
<p>1. <u>Purpose.</u> The purpose of this letter is to inform Corps of Engineers personnel of the change in nomenclature of vertical datum used on topographic maps.</p> <p>2. <u>Applicability.</u> This ETL is applicable to all field operating agencies having Civil Works and/or Military Construction responsibilities located within the United States.</p> <p>3. <u>References.</u></p> <p style="padding-left: 40px;">a. Federal Register, V. 38, No. 94, May 16, 1973, page 12840</p> <p style="padding-left: 40px;">b. Federal Register, V. 41, No. 96, May 17, 1976, page 20202</p> <p>4. <u>Discussion.</u> Elevations of marked points (benchmarks) in the National Vertical Control Net are based on the "Sea Level Datum of 1929." Since this datum was derived from the overall average sea level of 26 tide stations, the official elevation of any particular one of these tide stations does not necessarily reflect the actual local "mean sea level." To avoid the implication that vertical control datum elevations are referenced to a condition which may vary from one location to another, the National Ocean Survey has redesignated the "Sea Level Datum of 1929" as the "National Geodetic Vertical Datum of 1929," reference paragraph 3 above.</p> <p>5. <u>Action.</u> All new maps, revisions or documents whose elevations are those of the National Vertical Control Net will make reference to "National Geodetic Vertical Datum of 1929" rather than "Sea Level Datum of 1929."</p>		

Figure 62. ETL 1110-1-97

The assumed equivalency of NGVD29 to MSL is predominant in both government and academic texts published well after the 1973 redefinition. This is illustrated in the following excerpts which are typical throughout the literature of the period.

“Datum, Mean Sea Level: A determination of mean sea level that has been adopted as a standard datum for heights or elevations. The Sea Level Datum of 1929, the current standard datum for geodetic leveling in the United States, is based on tidal observations over a number of years at various tide stations along the coast.” (“Definitions of Surveying and Associated Terms” Joint Committee of the American Congress on Surveying and Mapping and the American Society of Civil Engineers, 1978 (reprinted 1981, 1984, 1989))

“Datum, Sea Level, 1929 [National Geodetic Vertical Datum of 1929 (see Federal Register, May 17, 1976, Vol. 41, No. 96, p. 20202)]: A determination of mean sea level that has been adopted as a standard datum for heights. The sea level is subjected to some variations from year to year, but, as the permanency of any datum is of prime importance in engineering work, a sea-level datum after adoption should, in general, be maintained indefinitely even though differing slightly from later determinations of mean sea level based on longer series of observations. The sea-level datum now used for the United States Coast and Geodetic Survey (now known as the National Ocean Survey) level net is officially known as the ‘Sea Level Datum of 1929,’ the year referring to the last general adjustment based on tide observations taken at various tide stations along the coasts of the United States over a number of years. See also ‘mean sea level’; ‘datum, tidal.’” (“Definitions of Surveying and Associated Terms” Joint Committee of the American Congress on Surveying and Mapping and the American Society of Civil Engineers, 1978 (reprinted 1981, 1984, 1989))

“NGVD29, a synonym for ‘Sea Level Datum of 1929.’ This term was officially adopted by the NGS on May 17, 1976. It was a change in name only—the datum remains the same.” (“Geodetic Glossary,” NGS, 1986)

“GPS surveys yield, at best, ellipsoidal height differences. These are rather meaningless from an engineering point of view. Therefore, extreme caution should be exercised when GPS height information, even after correction for geoidal undulations, is to be merged with height information from leveling ... In principle any equipotential surface can act as a vertical datum such as the ‘National Geodetic Vertical datum of 1929 (NGVD29). Problems may arise merging GPS heights, gravity surveys, and orthometric heights referring to NGVD29. Heights referring to NAVD88 datum will be more suitable for use with GPS surveys.” (Chapter 52, “The Civil Engineering Handbook,” Chen, 1995)

“Datum: Any level surface to which elevations are referred. Mean Sea Level is usually used for a datum.” (Chapter 21—Measurements and Field practice, Land Surveyor Reference Manual, 2nd Edition, 1989)

“Definitions ... An elevation is a vertical distance above or below a reference datum. In surveying, the reference datum that is universally employed is that of Mean Sea Level (MSL). In North America, 19 years of observations at tidal stations in 26 locations on the Atlantic, Pacific, and Gulf of Mexico shorelines were reduced and adjusted to provide the National Geodetic Vertical Datum (NGVD) of 1929.” (Chapter 3—Leveling, “Surveying With Construction Applications, Third Edition” Kavavagh, 1997)

“Vertical Control Datum: A vertical-control datum has little relationship to either a geodetic datum or a horizontal-control datum ... it is convenient to have ‘heights’ along coastlines close to zero, and this would not be the case if geodetic heights were used. So a vertical-control datum was introduced... In the United States it is approximated by a surface based on mean sea level, and the precise definition of this surface is nearly impossible ... it is based on mean sea level at 26 tidal gages ... and was known for a long time as ‘Sea Level Datum of 1929,’ and so indicated

on topographic maps. The name was changed in 1973 to 'National Geodetic Vertical Datum of 1929' to avoid the implication that the datum is mean sea level; the datum itself was left unchanged." ("Manual of Photogrammetry, 4th Edition," American Society of Photogrammetry, 1980)

"Mean Sea Level: ... arrived at from readings ... at 26 gaging stations ... The elevation of the sea differs from station to station depending on local influences of the tide ... Therefore, to provide a common reference for elevations throughout North America, it was necessary to adopt a 'mean sea level.' The [1929] adjustment ... incorporated long-term from the 26 tidal gaging stations; hence it was related to mean sea level. In fact, the network of benchmarks with their resulting adjusted elevations defined the mean sea level datum. It was called the 'National Geodetic Vertical Datum of 1929 (NGVD29) ... Throughout the years after 1929, the NGVD29 deteriorated somewhat due to changes in sea level and shifting of the earth's crust ... The [North American Vertical Datum of 1988] adjustment shifted the position of mean sea level somewhat, and thus resulted in changes to the elevations of all benchmarks in the vertical network ... [references Figure showing differences between NGVD29 and NAVD88]" ("Elementary Surveying, 9th Edition," Wolf & Brinker 1994)

From the above examples, it is apparent that many in the engineering community would (and did) continue to reasonably conclude after 1973 that geodetic datums referenced to NGVD29 were equivalent to mean sea level. Only the last example from Wolf & Brinker most completely details the nonequivalence. The impact is that many flood control and hurricane protection projects were designed and constructed under the assumption that NGVD29 closely approximated mean sea level when in fact it may have differed by as much as one foot in places. This misinterpretation continues to the present--even with the revised NAVD88 which has absolutely no relationship to a local sea level surface.

### **Corps Policy Guidance on the Redefined NAVD88 Geodetic Datum**

In January 1994 HQUSACE issued an Engineer Technical Letter to the field entitled "Conversion to the North American Vertical Datum of 1988" (ETL 1110-1-152, 1 Jan 94). This document was intended to provide "technical guidance and implementation procedures for the conversion from the National Geodetic Vertical Datum of 1929 (NGVD29) to the North American Vertical Datum of 1988 (NAVD88)." This guidance letter stated, in part, that:

"The Federal Geodetic Control Subcommittee (FGCS) of the Federal Geographic Data Committee (FGDC) has affirmed that NAVD88 shall be the official vertical reference datum for the U.S. The FGDC has prescribed that all surveying and mapping activities performed or financed by the Federal Government make every effort to begin an orderly transition to NAVD88, where practicable and feasible. Both tidal and non-tidal low water reference planes and datums are affected by the change to NAVD88. ... Elevations of reference points/datums along the various inland waterway systems will also be impacted by the change in datums. ... The transition to NAVD88 may have considerable impact on Corps projects, including maps, drawings, and other spatial data products representing those projects. However, once completed, the transition will result in a more accurate vertical reference datum that has removed leveling errors, accounts for subsidence, and other changes in elevation."

The Technical Letter also contained specific actions that should be taken regarding the datum conversion:

- USACE commands should begin the orderly transition to NAVD88. Procedural guidance for performing this conversion is given in Appendix A [to the Technical Letter].
- The conversion to NAVD88 should be accomplished on a project-by-project basis. The relationship of all project datums to both NGVD29 and NAVD88 will be clearly noted on all drawings, charts, maps, and elevation data files.
- In accordance with Section 24 of WRDA 92, when elevations are referred to a tidal reference plane in coastal waters of the U.S., Mean Lower Low Water (MLLW) shall be used as the vertical datum. Tidal BMs should be tied to NAVD88 instead of NGVD29 where NAVD88 data is available. Tidal datums shall be established in accordance with the procedures outlined in EM 1110-2-1003.
- Other hydraulic-based reference planes established by USACE for the various inland waterways, reservoirs, and pools between control structures should continue to be used for consistency; however, they should also be connected with the NAVD88 where practicable and feasible.
- In project areas where local municipal or sanitary jurisdictions have established their own vertical reference planes, every attempt should be made to obtain the relationship between that local datum and NGVD29 and/or NAVD88; and clearly note this relationship on all drawings, charts, maps, and elevation data files.

A complete copy of this 1994 Technical Letter is included Technical Appendix 34 to this Volume. This ETL was subsequently incorporated into various engineering manuals—e.g., EM 1110-1-1004 and EM 1110-1-1005.

The redefinition of the geodetic datum from NGVD29 to NAVD88 in the early 1990s did not necessarily eliminate the misconception that a geodetic datum represented a local sea level surface. A typical example where NAVD88 is equated to mean sea level is contained in the 2005 ACSE-NSF Hurricane Katrina Levee Performance Report, as follows.

It should be noted that a number of different datums have been used as elevation references throughout the historic development of the New Orleans regional levee systems, and this situation is further complicated by ongoing subsidence in the region. This investigation has not yet had time to adequately resolve differences between different datums, so all elevations stated in this preliminary report should be regarded as somewhat approximate, and should be taken as referring approximately to elevation with respect to NAVD88 or “mean sea level” in the region. (ASCE-NSF Preliminary Report on the Performance of the New Orleans Levee Systems in Hurricane Katrina on August 29, 2005 dated 2 Nov 05, Section 1-4)

### **New Orleans District Policy Memorandum on Geodetic Datum Readjustments**

In 1985 the New Orleans District issued the following proposed policy regarding periodic NGS readjustments to benchmark elevations. This particular memorandum (copied in entirety below) apparently was in response to changes or readjustments in benchmark elevations ca 1983, followed by another NGS elevation readjustment shortly thereafter. The (Lower) Mississippi Valley Division approved the proposed policy by 1<sup>st</sup> Indorsement on 19 Sep 85—see Technical Appendix 30 to this Volume (1985 New Orleans District Policy on NGS Benchmarks).



SUBJECT: NGS Benchmarks

TO: Commander, Lower Mississippi Valley Division  
ATTN: LMVED.

1. Reference is made to the following:

- a. LMNED letter 2 November 1984 to LMVED, subject supra.
- b. LMVED letter dated 5 March 1985 to RA John D. Bossler, subject: Adjustments to NGS Benchmarks.
- c. John D. Bossler letter to LMVD dated 29 March 1985 in response to reference b above.
- d. LMVED-TS letter dated 12 April 1985 to LMNED-S subject: Adjustments to NGS Benchmarks.
- e. LMVED letter dated 1 May 1985 to LMNED-S subject: Adjustments to NGS Benchmarks, and 1st End thereto.

2. In essence, it is the position of NGS as set forth in reference c above that the current (1983) benchmark elevations are correct, but that they cannot be used in conjunction with earlier values to derive estimates of subsidence which are necessarily valid even in order of magnitude. Thus we are left with a problem of setting project grades to provide the level of protection authorized. The problem is particularly acute on projects which are partially complete, in that, if we adopt the new benchmark elevations for construction without altering design flowlines, we ensure that those projects will provide inconsistent levels of protection; with the previously constructed portions offering lower levels of protection than those to be constructed in the future. At the same time, it would hardly be prudent, based on what we now know about benchmark elevations, to embark on a program of wholesale raising of previous construction to conform to the latest elevations. This is particularly true in situations in which design flowlines are primarily a function of discharge with tide level having little effect, and in tidal cases where increases in grade can only be achieved through demolition and reconstruction.

3. The problem extends as well to our stream gaging network since the gages which comprise that a network are ordinarily adjusted to conform to the latest information published by NGS. As an example, consider the Carrollton gage, which is typical of gages at and below New Orleans. It has been raised about 0.6 foot since 1952 (1983 data have not yet been applied) with the result that the reading of the staff now corresponds to a reading 0.6 foot lower on the 1952 staff. Application of the 1983 data would result in raising the staff another half-foot or a total increase of over 1 foot.

4. The problem is exacerbated by the information, recently received, that the 1983 data have been superseded by the results of releveling done in the New Orleans area at the request of local officials. New elevations for benchmarks in Jefferson, St. Bernard, Plaquemines, and Orleans Parishes have been published which, in most instances, represent significant upward revisions of the 1983 data. Additional results of the releveling are being processed and it seems reasonable to expect that they will reflect the same upward trends. The overall significance of these changes in the light of the repeated and ringing affirmations of confidence in the 1983 data which appear in NOAA's letter of 29 March 1985 is not easy to assess, but it does further weaken the case for imputing, which any reasonable confidence, hard physical significance to the changes in benchmark elevations. Yet the data promulgated by NOAA, given their presumed primacy in deciding where the earth's crust is in the vertical plane, cannot be ignored.

5. While the NGS program (cadastre) for evaluation subsidence may well produce data relevant to our problem (and for this reason alone, we would be well advised to support it) that program offers little if utility in the foreseeable future. Thus we must select a course of action without material assistance from NGS.

6. Despite the absence of firm implications to be drawn from changing benchmark data, we believe that a clearly defined policy should be derived concerning the use of benchmark data in our various activities. Accordingly, we propose the following actions:

a. All gages will be set to conform to the latest available benchmark information published by NGS. Since both the gage information and the NGS data are widely disseminated, to do otherwise would be to court public confusion.

b. Modification of projects which have been completed will not be considered. The level of precision in the current data, and the practical difficulty and cost of changing such projects combine to mandate this course of action at least for the foreseeable future.

c. The main stem features of the MR&T project, such as MRL and Atchafalaya Basin, will be constructed utilizing the latest pre-1983 benchmark elevations. The grade requirements for these features are driven primarily by discharge and since subsidence presumably affects both bed and banks, required levee heights should be little affected by it. Thus, a shift to the new, lower benchmarks would result in the construction of levees higher than required to provide the authorization level of protection. There may be some problem with this approach at the lower (gulfward) ends of the system where tide becomes an increasingly important factor, and we plan to give that continuing consideration.

d. Off-main stem projects of the MR&T which are under construction or will be constructed in the future will use the latest benchmark data published by NGS at the time construction is/was started. The need for revision will be considered as construction proceeds.

e. All O&M dredging will use the latest available benchmark data published by NGS prior to the 1983 data. A change to the new data would mean that the depth of dredging in Southwest Pass, for example, would be lowered by about 1 foot. Given the perennial commotion by navigation interests, and considering the intensity of it this past year, such a course of action will be ill advised to say the least.

f. Hurricane protection projects which are partially complete will use the NGS benchmarks current at the time of construction of the first increment of the project. To shift to the later NGS data without altering the heights of previously constructed portions would make "fuseplugs" of those portions and thus impose a gratuitous servitude on the lands and facilities they protect. And altering previously constructed works would not be practicable.

g. New hurricane protection projects will be constructed using the latest available NGS benchmark data.

h. We plan to respond affirmatively to NOAA's invitation to participate in this "cadastre" program to better evaluate subsidence. Based on NOAA's estimates, the total costs would be \$2.0 million in the first year, \$525 thousand in the second year, and \$345 thousand annually thereafter. Our participation would be in the form of membership on technical study groups and providing data. We do not, at this time, anticipate providing any direct funding.

7. Approval of the course of action set forth in paragraph 6 is recommended.

FOR THE COMMANDER;  
Encls

Chief, Engineering Division

The above memorandum appears to spell out a policy for resetting water level gages to agree with periodic NGS datum (NGVD29) readjustments. This might imply, in coastal areas, that the gages are being adjusted to correspond to some water level reference.

More significantly, the policy memorandum recommends not updating navigation dredging datums with the new NGS readjustments. It also recommends that hurricane protection projects "use the NGS benchmarks current at the time of construction of the first increment of the project." This might explain why some projects continued to use superseded benchmark elevations for design and construction. The rationale for such an approach is difficult to determine at this later point in time; however, it does appear to stem from some degree of exacerbation with the ever-changing NGS benchmark readjustments. The memorandum does note a need to get a better handle on evaluating subsidence in the region.

The above 1985 policy was superseded by an updated New Orleans District policy letter dated 26 Oct 00. This revised policy was endorsed by the Division by memorandum dated 31 Jan 01—see memorandum in the Technical Appendix 30 to this Volume (1985 New Orleans District Policy on NGS Benchmarks). The new policy emphasized that the 1985 datum policy had become “untenable” and was “causing great confusion,” and that the District would henceforth focus efforts on updating to the new NAVD88 datum supplemented by CORS observations to monitor subsidence.

Subsequently, a 20 Dec 02 “Vertical Datum Policy” memorandum was issued by the New Orleans District Engineering Division that stated all gage and protection structure elevations should be referenced to NAVD88. This memorandum emphasized that “assigned benchmark elevations represent a ‘snapshot’ and may change on future contracts depending on benchmark movement ... Engineers must use sound engineering judgment in employing the NAVD88 datum, recognizing that projects have already been designed and/or constructed using the NGVD29 datum against various epochs and that projects may require a significant number of years from conception to completion, and therefore allowances must be made for vertical movement.” The subsequent implementation of a time-dependent vertical datum concept in October 2005 further reinforces this District policy.

Since the early 2000s, the New Orleans District’s Engineering Division was actively involved with, and contributed funding to, the NGS and the Louisiana Spatial Reference Center (LSRC) in varied efforts to update the vertical control datum in Southeastern Louisiana.

These events are further detailed in the following section.

### **Historical Event Timeline on use of Geodetic Vertical Datums in USACE/New Orleans District**

1929 – The United States uses mean sea level (MSL) at 26 tide station locations around the country, including the Gulf Coast, to establish the Sea Level Datum of 1929 (SLD29).

1956 – Corps asks the U.S. Coast & Geodetic Survey (USC&GS, now NGS) about their changing of benchmark elevations in New Orleans. (See Technical Appendix 40)

1958 – USC&GS, now NGS, notifies the Corps of subsidence and vertical datum problems in New Orleans, noting there has been almost 3 feet of subsidence in the Houston-Galveston area and that no benchmark be trusted to be absolutely stable due to changes in the earth’s crust. (See Technical Appendix 40)

1973 – The United States renames its SLD29 to NGVD29, noting that it was a close approximation of MSL in 1929 near the 26 tide stations held fixed, but no longer due to subsidence and other factors. *“In order to avoid such apparent confusion and the costly errors that may result through failure to consider local sea level when engineering projects are undertaken, it is proposed to change the present name of the vertical control datum from the “Sea Level Datum of 1929” to the “National Geodetic Vertical Datum of 1929.”* (See Technical Appendix 40)

- 1978 – Corps HQ in Washington issues new technical guidance (ETL 1110-1-97) to all its field offices on the change in name of the National Vertical Control Net, noting: Elevations of some stations are not necessarily based on local mean sea level and this may vary from one location to another. (See Technical Appendix 40)
- 1979 – Corps MVD forwards HQ’s ETL 1110-1-97 to its 4 districts. (See Technical Appendix 40)
- 1981 – Corps MVD memo from Engineering to Planning on subsidence of Coastal Louisiana, including settlement of benchmarks. (See Technical Appendix 40)
- 1984 Apr – NGS and Corps meet to discuss subsidence and vertical datum problems in New Orleans. Projects impacted included drainage canals and navigation and scenarios discussed included the fact that datum changes would accentuate the need for replacement or modification of projects. It was also noted that if a steady but relatively slow settlement continues, development within the protected area will continue and we will continue to raise the protective system to protect the improvements. (See Technical Appendix 40)
- 1984 Nov – Corps New Orleans sends memo to MVD asking for meeting with NGS to discuss use of new benchmark elevations. (See Technical Appendix 40)
- 1984 Nov – NOAA/NGS briefs Corps New Orleans District and the Greater New Orleans Planning Council on a subsidence monitoring plan similar to the Houston-Galveston, Texas plan. (See Technical Appendix 40)
- 1985 Mar 5 – Corps MVD letter to NOAA/NGS notes that their 1983 adjustments to benchmark elevation would have significant implications for a number of Corps flood control and hurricane protection projects in southern Louisiana. The top elevation of some Corps facilities would be down over one foot in only 20 years. MVD asks NOAA/NGS to provide information on their level of confidence in their 1983 adjusted benchmark elevations *“before we begin using this new elevation data in current projects and before initiating any modifications to existing facilities.”* (See Technical Appendix 40)
- 1985 Mar 29 - NOAA/NGS responds to MVD that they have a very high level of confidence in their 1983 adjustment in the Gulf Coast area. They refer to the Nov 1984 meeting in New Orleans and their offer to establish a subsidence monitoring geocadastre in southern Louisiana. (See Technical Appendix 40)
- 1985 Apr – Corps MVD provides NOAA/NGS letter to New Orleans District. (See Technical Appendix 40)
- 1985 May 1 – Corps MVD, referencing the NOAA/NGS letter on regional subsidence and its potential significant consequences on projects in New Orleans District, requests the New Orleans District to reexamine the information in the NOAA/NGS letter, to consult further with the NOAA/NGS staff and to *“propose a course of action for incorporating the changes in elevation into your projects and studies and for defining*

*in a more reliable manner the subsidence of the area. Your action plan should include a schedule and cost estimate.”* (See Technical Appendix 40)

1985 May 24 – Corps New Orleans District responds to MVD that the Regional Planning Commission representing Jefferson, Orleans, St. Bernard and St. Tammany Parishes met with NOAA/NGS and are contributing funds for resurveys and that the District is planning to meet with NOAA on 12 Jun 1985 to discuss a more reliable network to predict subsidence. ((See Technical Appendix 40)

1985 Aug 7 – Corps New Orleans District recommends to MVD that (See Technical Appendix 40):

- All gages to be changed to conform to latest NGS elevations, to do otherwise would be to court public confusion.
- *Modification of completed projects will not be considered.* The level of precision of the current data and the practical difficulty and cost of changes mandate this for the foreseeable future.
- The main stem features of the MR&T project will be constructed using latest pre-1983 benchmark elevations.
- Off-main stem features of the MR&T will use latest NGS values at the time the construction is/was started. Revisions during construction will be considered.
- All O&M dredging will use pre-1983 data. A change to the new data would mean that the depth of dredging in Southwest Pass, for example, would be about 1 foot less. Given the perennial commotion by navigation interests, and considering the intensity of it this past year, such a course of action would be ill advised to say the least.
- *Hurricane protection projects which are partially complete will use the NGS elevations current at the time of construction of the first increment of the project. To shift to the later NGS data without altering the heights of previously constructed portions would make “fuseplugs” of those portions and thus impose a gratuitous servitude on the lands and facilities they protect. And altering previously constructed works would not be practicable.*
- New hurricane protection projects will be constructed using the latest NGS data.
- We plan to respond affirmatively to NOAA’s invitation to participate in this “cadastre” program to better evaluate subsidence, by membership on the study group. *We do not anticipate providing any funding to study subsidence.*

1985 Sep – Corps’ MVD approves District recommendations with caveats such as *“Consideration should be given to reanalyzing and modifying (if needed) hurricane protection work in high density urban areas where the datum changes will drastically reduce the level of protection.”* (See Technical Appendix 40)

1986 Mar – Corps HQ memo on "Relative Sea Level Change" discussing “allowance in project design.” (See Technical Appendix 40)

1986 Apr – Corps MVD forwards HQ memo to Vicksburg & New Orleans Districts. (See Technical Appendix 40)

1986 Aug – Internal Corps New Orleans District note concerning how to adjust gage readings over time to compensate for changes (subsidence). (See Technical Appendix 40)

1986 Sep – Internal Corps New Orleans District memo on how to deal with benchmark changes and their impacts on project operations, such as floodgates, in manuals. (See Technical Appendix 40))

1987 – Internal New Orleans District memo on a suggested rationale for inclusion of an extra foot of freeboard in the WBHP levees as an allowance for future change in apparent sea level. This referred to the Reevaluation Study for Lake Pontchartrain. It was noted that “*subsidence rates in some parts of the project area of as much as 2.0 – 2.5 feet per century have been observed.*” (See Technical Appendix 40)

1993 Apr – Corps HQ Engineer Technical Letter No. 1110-2-349, Requirements and Procedures for Referencing Coastal Navigation Projects to Mean Lower Low Water (MLLW) Datum, which implemented Section 224 of the Water Resources Development Act of 1992 requiring Corps coastal navigation projects to be referred to the same datum used by NOAA. (See Technical Appendix 38)

1993 Jun – Federal Register Notice of change of vertical datum to the North American Vertical Datum of 1988 (NAVD88) as the official datum for all surveying and mapping activities performed or financed by the Federal Government. (See Technical Appendix 40)

1993 Aug – Orleans Levee District requests the New Orleans District to make a datum adjustment as the “*flood protection for the Orleans Canal is higher than that for the London Canal. This appears to be an intolerable situation. Please adjust as may be required so as to provide maximum protection for both canals.*” (See Technical Appendix 40)

1994 Jan – Corps’ HQ issues new technical guidance (ETL 1110-1-152) to all its field offices on the national conversion to the new NAVD88 noting there will be considerable impact on Corps projects, but it will result in a more accurate reference to account for subsidence, among other things. Specific guidance was provided on the National Flood Insurance Program, coastal flooding, use of local MSL, mixing the old and new datum and use of stable benchmarks in subsidence areas. (See Technical Appendix 34)

2000 Oct – Corps’ New Orleans District proposes to the Corps’ MVD that they abandon their 1985 policy to rely on the old datum, noting that “*most assuredly we have witnessed continued subsidence*” and that “*it is becoming increasingly untenable to maintain the existing (1985) policy.*” They proposed using the NAVD88 datum and the Global Positioning System (GPS) and to cooperate with state and other federal agencies working in the area. (See Technical Appendix 40)

2001 Jan – Corps’ MVD concurs with the Corps’ New Orleans District proposal to use NAVD88, including hurricane protection projects under construction or to be constructed in the future. They also noted that they should begin evaluation of

completed projects to determine whether or not modifications are necessary to achieve authorized levels of protection. They also asked for semi-annual status reports showing, among other things, subsidence rates. (See Technical Appendix 40)

2002 Apr – Corps’ New Orleans District, Engineering Division Chief notifies all his Branch Chiefs that NAVD88 will be used and that the Survey Section will provide the most current elevations of benchmarks. It was also noted the GPS would be used to update elevations of benchmarks and to predict future subsidence. (See Technical Appendix 40)

2002 Dec – Corps’ New Orleans District, Engineering Division Chief notifies all his Branch Chiefs, Section Chiefs, Functional Team Leaders & Technical Managers that NAVD88 will be used for water level gages, engineering studies, designs and construction documents and for reporting of all levels of protection, etc. He also noted that the Survey Section will review all field surveying efforts to insure this policy is followed and that it is a responsibility of the design engineers to assure the correct values are used. He also noted that these elevations were “snapshots” and may change in the future based on benchmark movement and that allowances must be made for vertical movement. (See Technical Appendix 40)

2002 to Present – Corps’ New Orleans District worked with and contributed funding to NGS and the Louisiana Spatial Reference Center (LSRC) to help solve the problem. District Chiefs of Engineering, Gerry Satterlee and Walter Baomy, were members of the LSRC’s steering committee. They worked with the LSRC to recruit key participants from Louisiana Department of Natural Resources (LaDNR) and Louisiana Department of Transportation to unify the major players in the state for flood control and coastal restoration purposes. A report by NGS (NGS 2004) identified the existing vertical control system as unreliable and specified the need for action. Regarding the Lake Pontchartrain project, there was a need to reassess the system and the District plan was to start that effort when vertical control was established. Funding levels were insufficient to complete construction at existing holes in the system that were crucial to flood protection for the New Orleans East bank and levees in St. Bernard - New Orleans East. Hence levees were below design grade in quite a few areas and the outfall canals (London and Orleans) lacked fronting protection. The fronting protection was critical to stability of the pump stations and for preventing backflow through the large diameter pumps. This is evidenced by the P&S that were on the shelf and awaiting funds. A report issued by NGS & the LSRC in 2005 clearly identified the problem and formed the framework for the IPET solution. (Information provided by Walter Baomy in an Email of 11 Apr 2006).

2006 May – ERP Progress Report (See 1 May 2006 letter from ASCE to LTG Strock):

- There was a lack of consistency with existing agency guidance documents that address the critical need for carefully monitoring the geodetic and water surface elevation in the New Orleans area.

- The use of older geodetic elevation data and unsupported assumptions regarding mean sea level elevations have apparently led to significant reductions in design protection level expectations.
- The IPET 60% draft report offers a comprehensive set of recommendations to correct the problems identified. Such guidance should be reflected in a new USACE manual on maintaining geodetic and water level datums in areas of high subsidence.
- The role proposed for NOAA and the necessary coordination with other agencies require a lasting commitment.
- Given the design guidance documents already in place, there is a clear need for stronger commitment to consistent use of existing policies and procedures than has been the case in the past.



## Field Topographic Survey Support to Other IPET Teams

This section summarizes topographic survey support performed by IPET field survey crews in support of hydrodynamic, physical, and interior drainage modeling requirements needed by other IPET study teams. Approximately 75% of this Team's field survey work involved support to other IPET Teams. These surveys were performed concurrent with the primary geodetic control surveys connecting NOAA NWLON gages. Field survey operations began in early December 2005 and were completed by the end of March 2006. Surveys were performed throughout the entire study area: Orleans, St. Bernard, Plaquemines, St. Charles, and Jefferson Parishes.

Field survey operations were performed by 3001 Inc.--a Louisiana based surveying company. This firm was under an Indefinite Delivery Contract to St. Louis District. St. Louis District awarded a labor-hour type task order to 3001 Inc. on 5 December 2005. IPET Team members Bill Bergen (HQUSACE) and Jeff Navaille (Jacksonville District) arrived in New Orleans on 4 December 2005 and began working out of the New Orleans District Office. Initial efforts involved controlling pump stations, high water mark (HWM) locations, and NOAA NWLON tidal gage sites, which included setting benchmarks for subsequent GPS connections to the NGS NAVD88 (2004.65) reference network. A scope of work for this initial effort was drafted on 10 December 2005—a copy of this scope is included in Technical Appendix 37 to this Volume (IPET Supplemental Survey Scope of Work-10 Dec 05). Subsequent to this initial scope, additional survey support was continuously requested over the next four months by IPET Teams. This 10 Dec 05 scope was supplemented with these additional requests on an almost daily basis. The first 3001 Inc. survey crew arrived in New Orleans on 11 December 2005 and began static GPS surveys for benchmarks at pump stations and priority HWM sites. Three 3001 Inc. survey crews were fully operating by 14 December 2005 and continued working on the various tasks outlined below through 23 December 2005. Survey operations resumed on 3 January 2006 and continued through the end of March with some additional water level gage connections being performed into April and May of 2006.

The following list summarizes various field survey projects performed from 5 December 2005 through April 2006. Data collected on these projects is assembled in the technical appendices to this Volume, with the Technical Appendix number shown in [brackets]. The supported IPET model is shown in parenthesis. Original survey data is held in the IPET repository at ERDC and/or the New Orleans District.

- High Water Mark Surveys: Leveling to approximately 50 HWM points plus 2,000 ft of levee profile surveys along a five (5) mile levee in St. Bernard Parish (Numerical Storm Surge Models) [13]
- High Water Mark Surveys: Interior Orleans Parish—levels to various residential locations (Numerical Storm Surge Models) [10]
- High Water Mark Surveys: Plaquemines Parish—levels to various locations (Numerical Storm Surge Models) [12]
- Surge Elevation Surveys: Orleans Marina & Lakefront Airport—levels to time-stamped Katrina storm surge points (Numerical Storm Surge Models) [16 & 17]—e.g., Figure 67.

- Bridge Surveys: Low-chord elevation and obstruction surveys (Numerical Storm Surge Models) [6, 7, 8, 9, & 21]—e.g., Figures 64 and 66.  
Orleans Outfall Canal: 4 auto bridges  
London Ave Canal: 1 RR bridge and 6 auto bridges  
IHNC: 3 RR bridges  
17th St Canal: 5 auto bridges
- Pump Station Control Surveys: Approximately 69 pump station first floor elevations throughout Orleans, Jefferson, St. Bernard, and Plaquemines parishes (Pump Station Performance Assessment) [24, 25, 26, 27, & 28]—Figure 65.
- Pump Station Control Surveys: 5 pump station first floor elevations in St. Charles Parish (Pump Station Performance Assessment) [29]
- Lake Pontchartrain Water Level Gage GPS Surveys: Tie in reference marks on eight (8) USGS, NWS, and levee board gages in the vicinity of Lake Pontchartrain and the IHNC(Numerical Storm Surge Models) [15]
- IHNC West Bank Levee Profile Surveys: SeaLand/Maersk Private Levee (Numerical Storm Surge Models) [4 & 11]
- IHNC West Bank Breach Area Topographic Surveys: Florida Ave to I-10 Bridge (Interior Drainage Modeling) [14]
- Ground Truthing/Calibration Surveys of Low-Altitude 2000/2005 LIDAR DEMs: (Various hydrodynamic models) [various]
- Ground Truthing/Calibration of High-Altitude JALBTCX 2005 LIDAR: North shore of Lake Pontchartrain (Various hydrodynamic models) [1]
- Ground Truthing/Calibration of High-Altitude FEMA/LSU LIDAR: Selected side shot calibration points throughout region (Various hydrodynamic models) [various]
- Hydrographic and Topographic Canal Cross-Sections: Selected sites in Jefferson & Orleans Parishes (Interior Drainage Model) [18, 19, & 20]
- Levee/Floodwall Overbank Cross-Sections: London Avenue, 17th Street, & IHNC Breach Sites: (Physical Model of Breaches & Floodwall Performance Analysis) [various]
- Interior Drainage Topographic Sections: Approximately 85 cross-sections at selected locations throughout St. Bernard Parish (Interior Drainage Support) [3]
- Invert Elevations: London & Orleans Outfall Canal pump stations (Numerical Storm Surge Models) [25, 26, 27, 28, & 29]
- TBM Descriptions: Stable and recoverable marks to be documented and described in accordance with New Orleans District procedures (MVN/Task Force Guardian) [23]
- Orleans Outfall Canal BM ALCO to CHRYSLER Level Run [22]
- IHNC Hydrographic Multibeam Survey: Seabrook Bridge to GIWW and GIWW to Mississippi River (Storm Surge/Wave Hydrodynamics) [not included]

- High Water Mark Surveys: Orleans Parish vicinity Ninth Ward—levels to various locations (Numerical Storm Surge Models) [11]
- Cross-section surveys of railroads, culverts, etc: East Orleans Parish (Interior Drainage Models) [5]

### Field Survey Procedures and Specifications

All field surveys for supplemental topographic work were performed following established Corps of Engineers and NOAA standards and specifications.

Static GPS surveys were performed to set permanent or temporary benchmarks throughout the five-Parish area. Supplemental topographic surveys were performed from these benchmarks to HWMs, pump stations, floodwalls, etc. Over 100 benchmarks have been established to date.

These static GPS surveys were rigorously connected to the NGS approved NAVD88 (2004.65) network. Procedural GPS survey methods followed (and actually exceeded) the guidelines in the following NOAA publications:

- **NOAA 1997.** NOAA Technical Memorandum NOS NGS-58, Zilkoski, D.B., D’Onofrio, J. D., and Frakes, S. J. (Nov 1997) “Guidelines for Establishing GPS-Derived Ellipsoid Heights (Standards: 2 cm and 5 cm),” Version 4.1.3. Silver Spring, Maryland.
- **NOAA 2005.** “Guidelines for Establishing GPS Derived Orthometric Heights (Standards: 2 cm and 5 cm)” version 1.4, National Geodetic Survey (2005 DRAFT)

Procedural specifications applicable to topographic engineering and construction surveys included:

- **EM 1110-1-1003** NAVSTAR Global Positioning System Surveying
- **EM 1110-1-1005** Control and Topographic Surveying (1 January 2006 Draft)

The above guidance documents also contain the accuracy standards required for hydraulic modeling type surveys involved on these projects. In general, required vertical accuracy tolerances were  $\pm 0.1$  foot. Horizontal accuracy varied depending on the nature of the survey—e.g., HWM horizontal locations are not as critical as floodwall cap locations.

- Topographic surveys were performed using all of the following methods and equipment:
- Conventional differential leveling (spirit/compensator/digital levels)
- Electronic total stations
- Static Differential GPS surveys
- GPS real time kinematic (RTK) methods

Field survey data was collected in a standard bound survey book and/or on an electronic data collector attached to or part of a total station or RTK survey system. Digital images were taken for HWM and pump station first floor elevation shots—e.g., Figure 63.



Figure 63. (Left) Static GPS survey to establish elevation on a benchmark outside a St. Bernard Parish pump station. (Right) Leveling first floor elevation inside Jefferson Parish Pump Station No. 3

All of the above manuals were cited in the St. Louis District task order specifications.

Hydrographic surveys, including multibeam surveys, were performed following the guidance for Special Surveys (i.e., non-navigation/dredging surveys) in EM 1110-2-1003 (Hydrographic Surveying). Densely binned multibeam survey results are not included in the Technical Appendices but are available in the IPET Repository.



Figure 64. (Left) IHNC Almonaster Bridge—low chord elevation 3.51 ft NAVD88 (2004.65). (Right) Leveling to USGS recording gage and Orleans Levee District staff gage on I-10 bridge over IHNC

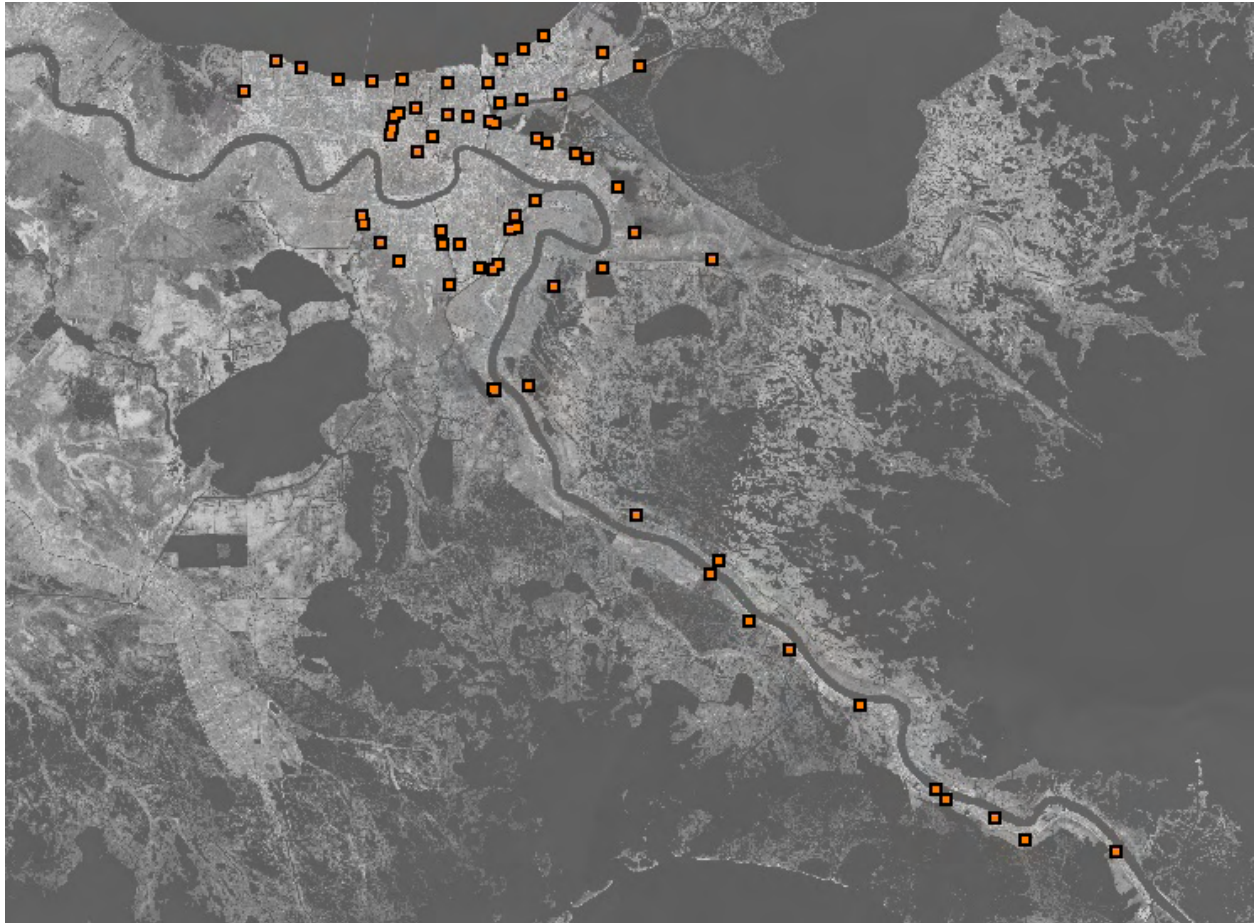

Figure 65. General map depicting locations of pump stations surveyed by IPET/3001, inc. in the five-parish area





Figure 66. Typical low chord measurement—London Avenue Canal Bridge No 4 (IPET/3001, Inc.)

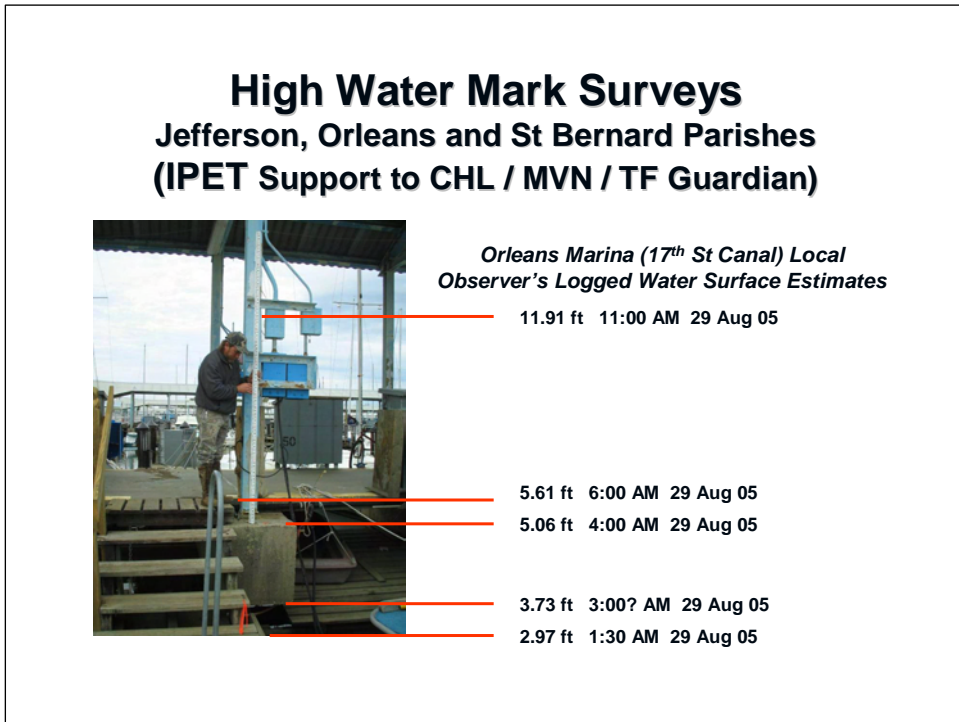

Figure 67. Surge and high water mark elevations at Orleans Marina (17th Street Canal) (IPET/3001, Inc.)

## Data Processing and Submittal

The contractor processed and reduced all survey data to a submittal format consistent with EM 1110-1-1005 and New Orleans District standards. GPS baselines were reduced and networks adjusted using standard COTS software packages — e.g., Trimble Geomatics Office. Data submittals were posted on an ERDC ftp site for transfer to the requesting IPET Team.

All data submittals contain supplemental metadata records that are compliant with the Federal Geographic Data Committee Standard “Content Standard for Digital Geospatial Metadata,” FGDC-STD-001-1998.

## Quality Control and Quality Assurance Procedures

The survey contractor (3001, Inc.) was responsible for performing quality control over all work performed, in accordance with the Quality Control Plan submitted on award of the basic Indefinite Delivery Contract. Many of the specifications listed above provide forms of quality control by requiring specific observing schemes, redundant observations, connection checks between control points, closed loop level lines, periodic RTK calibration checks, level peg tests, etc. The contractor was expected to perform additional quality control checks during data processing and prior to submittal.

Quality assurance checks were performed by both the contractor and government (IPET Survey Team). GPS observations establishing supplemental vertical control points were checked by running independent solutions from NOAA CORS stations distant from the NAVD88 (2004.65) project network. This afforded a blunder check on all points. The government performed spot checks on data submittals, including reality checks by modelers receiving the data.

A few isolated survey data errors or blunders were found by both the contractor and government, indicating a quality control/assurance process was in place.

## Methodology for Converting Previous Vertical Datums/Adjustments to NAVD88 (2004.65)

The methodology used to shift historical survey data to NAVD88 (2004.65) will vary dependent upon many factors such as time, funds, accuracy requirements, etc. Generally there are four methods to determine the datum/epoch shift.

- a. *Field Measurements w/ Known Historical Elevation:* This method will yield the most accurate values based on the historical reference marks. The reference marks will need to be recovered and occupied/surveyed using the guidelines in NGS 58 (NOAA 1997). The difference between the elevation used for the original survey and the elevation established from the new network will directly tie in the old work to the latest control. This will not account for any differential subsidence that occurred between the reference mark and the survey positions.
- b. *Field Measurements w/o Known Historical Elevation:* When the reference benchmark is not recorded and unknown, some assumptions will be required such as what mark was used and what its elevation was. Again follow the procedures in NGS 58 (NOAA 1997)

to establish new elevations on the reference mark. The historical elevation will have to be assumed based on what was available at the time of design. The difference between the assumed historical elevation and the newly established elevation will be used to shift the survey to the new datum/epoch.

- c. *Common Published Marks in Survey Area:* When time and money are constraints, the closest marks with published elevations in both datum/epochs can be used to determine an average shift for the area. This method contains many assumptions and therefore is the least accurate but may be of some use for projects that don't require accuracy.
- d. *CORPSCON:* This method does not account for subsidence or the change in elevation from epoch to epoch. CORPSCON model was also tied to the published elevations at the time the model was created which contained errors associated with the already deteriorating elevation accuracies. This method should not be used for anything other than a pure datum shift keeping in mind that subsidence is not accounted for.

Figure 68 below shows the changes in the elevation values at Benchmark ALCO 1931 from 1952 until present including an elevation of LMSL in 2005. The changes in elevation are due to various adjustments on the datums and a datum shift (between NGVD29 and NAVD88). Additional examples for other benchmarks are shown in Technical Appendix 41.

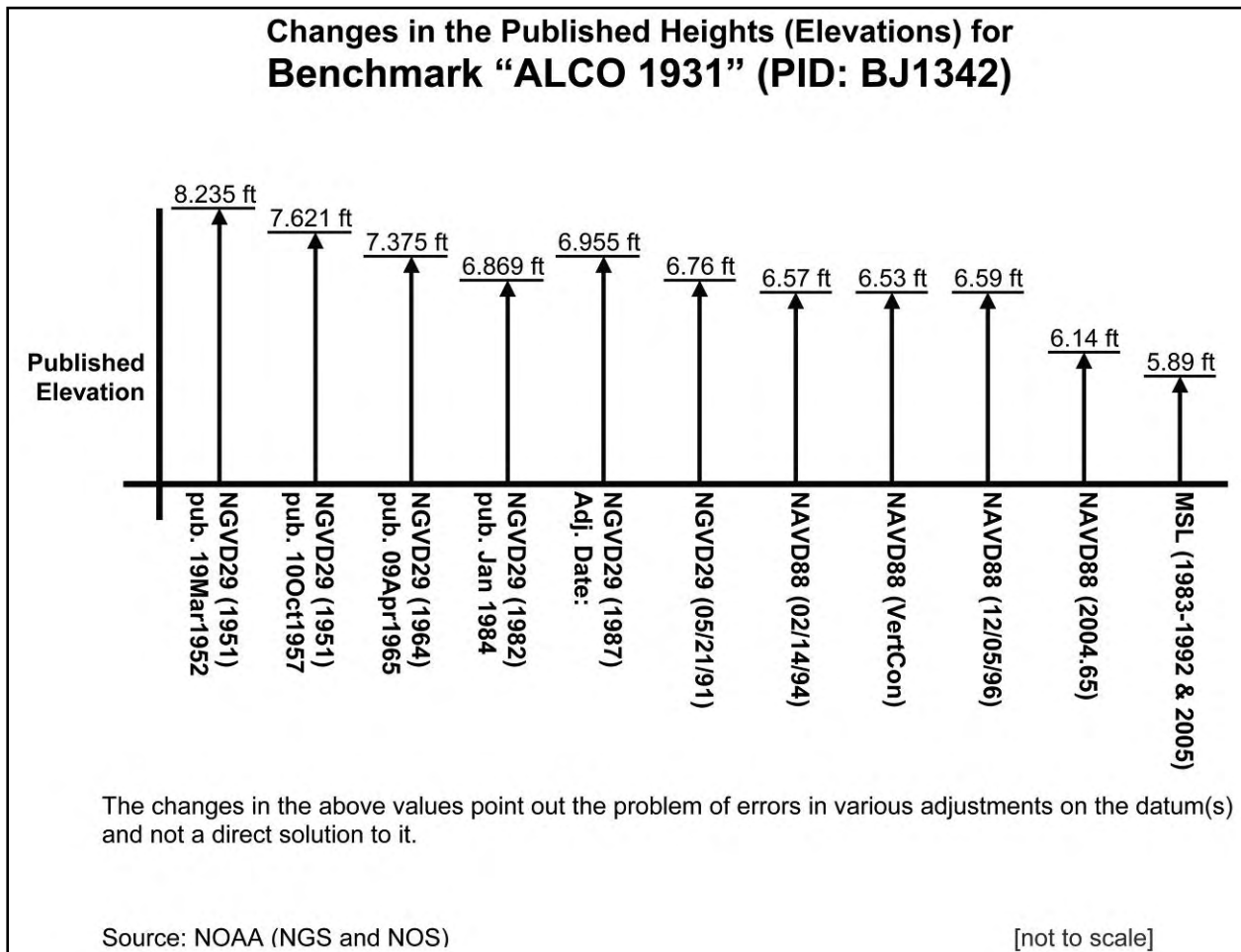

Figure 68. Elevation changes at Benchmark "ALCO 1931" since 1951



## Summary of Findings and Lessons Learned

This section summarizes the findings and lessons learned from this portion of the IPET study. For each finding a lesson learned is provided.

### High-Resolution Hydrodynamic Model Relationships to Geodetic and Sea Level Datums

**Finding:** Geodetic vertical datums have varying biases from hydraulic surfaces that were not well-correlated in the New Orleans region. High-resolution hydrodynamic model surge elevations were dependent on topographic and bathymetric data sources on varying geodetic and hydraulic datum definitions. This can impact the accuracy and reliability of calculated surge elevations, and resultant flood inundation elevations used in interior drainage flooding and first-floor elevation levels.

**Lesson Learned:** All government agencies, including USACE, NOAA, FEMA, USGS and other state and local, need to be consistent in the use of geodetic and water level surfaces in coastal regions. An IPET follow-on study by intergovernmental teams is needed to refine the relationships between the various datums that are numerically compatible with the varied hydraulic, hydrodynamic, geodetic, and flood inundation models such as those used by FEMA.

### Mean Low Gulf Datum Conversion to Mean Lower Low Water Datum

**Finding:** New Orleans District project design, construction, operations and maintenance activities still maintain elevation references to Mean Low Gulf Datum despite HQUSACE directives in 1993 to convert to Mean Lower Low Water datum, in accordance with the provisions of Section 224 of the Water Resources Development Act of 1992.

**Lesson Learned:** Implement the guidance contained in ETL 1110-2-349 (Requirements and Procedures for Referencing Coastal Navigation Projects to Mean Lower Low Water Datum) dated 1 April 1993. This action needs to include solidifying the MLLW datum relationships to the LWRP at the Head of Passes.

### Dual Elevations on Flood Control and Hurricane Protection Structures

**Finding:** The geodetic vertical datum was assumed to be equal to local mean sea level. Design and construction documents referenced both geodetic datums (e.g., NGVD29) and water level datums (e.g., MSL) without defining the geographical relationships, numerical differences, observation epochs, or other significant metadata associated with these datums.

**Lesson Learned:** Planning, design, construction, and operation & maintenance inspection documents containing elevation data on flood control structures needs to show both geodetic and water surface referenced elevations. The relative water surface reference datum (i.e., LMSL) is used as the baseline for hydraulic modeling and related levee height design computations. The terrestrial geodetic datum typically used by surveyors for construction stake out and subsequent periodic subsidence modeling must be corrected to be relative to the local water datum. The base gage with its correction to NAVD88 defining a water level datum must be clearly defined, along with applicable tidal or river stage epochs, and conversion parameters to relate water level datums to the local geodetic datum.

## Geospatial Data Source Feature or Metadata Records

**Finding:** Design and construction documents seldom identified the source of hydrographic, topographic, or construction survey records, including water level gage records. Field survey book records and reduced data collector files were also found to be lacking essential metadata indexing and archiving.

**Lesson Learned:** Planning, design, and construction documents containing survey information needs to contain detailed source (i.e., metadata) information on geospatial coordinates or terrain models included in those documents. This would include the location and repository for the original source data, field book numbers, monument descriptions, etc. Geospatial metadata incorporated in basic documents such as field survey books need to have sufficient detail such that there is no uncertainty (currently or in the future) as to the purpose and scope of the data, its origin, and other temporal relationships.

## Epoch Designations of Published Topographic Elevations

**Finding:** Design and construction documents seldom identified the epoch associated with a particular datum. This is critical in a high subsidence area where apparent sea level rise (i.e., combined sea level rise with subsidence) does have significant changes over a relatively short period.

**Lesson Learned:** Reported elevations of surface topography, subsurface bathymetry, and/or constructed structures in high subsidence areas need to contain feature (metadata) information on the source datum and applicable adjustment epoch date. This applies to both geodetic elevations (e.g., 12.34 ft NAVD88 (2004.65)) and water level based elevations (e.g., (-) 5.25 ft LMSL (2001-2005) or 35.0 ft MLLW (1983-2001) or 12.3 ft LWRP (1974)). Hard copy or CADD data files should place this metadata information in the General Notes on the first sheet or digital file of a series, with appropriate references on subsequent sheets/files that depict topographic information and source files names and locations.

## Future Updates to Geodetic Elevations in Southeastern Louisiana Region

**Finding:** Geodetic elevations are extremely time-dependent in this region and must be periodically adjusted to account for apparent sea level changes.

**Lesson Learned:** The current (2004.65) adjustment to the “vertical time-dependent” (VTDP) NAVD88 network for the Southeast Louisiana area should be periodically reviewed for subsidence relative to the nationwide spatial reference system. This review should be performed by the NGS using CORS observations and other applicable geodetic leveling sources. When periodic reviews by NGS indicates average elevation changes in the VTDP network exceed 0.13 ft (4 cm), then actions need to be taken to revise and update the time-stamped NAVD88 VTDP network for this region. This update should be performed at least every 5 years regardless of elevation changes. NGS must closely coordinate subsequent updates with the Corps of Engineers and other federal, state, parish, levee board, and local agencies, to ensure that engineers and others responsible for the planning, design, and construction of flood control and hurricane protection structures are made aware of the revised adjustments and make appropriate engineering corrections and decisions based on these updates. These subsequent adjustments

must also be closely coordinated within NOAA to ensure CO-OPS water level datum references are appropriately revised with respect to any geodetic datum revisions. The New Orleans District needs to expand its partnership with the NGS towards the densification of the CORS network in the Southeastern Louisiana region. USACE project control needs to be referenced to the latest CORS network adjustment. The periodic inspection (PICES) program needs to incorporate scheduling to include new GPS elevation surveys of structure monumentation relative to the latest network adjustment. The intervals will be determined based on the measured rate of subsidence and the accuracy tolerance. When the predicted elevation change is greater than half the tolerance, new surveys would be necessary to update the local structure control. NGS needs to provide updated elevations based on the CORS network. Given that the current adjustment is based on historical leveling and was best fit to GPS observations, a comprehensive network of new CORS stations and geodetic leveling is required to validate NAVD88 (20XX) elevations relative to stable benchmarks outside the region. This level network will also be used to better define/validate the geoid model. The geoid model for the Southeast Louisiana region needs to be periodically updated by NGS as additional information is received.

### **Co-located CORS and NWLON Sites for Subsidence Monitoring**

**Finding:** There is an insufficient density of subsidence and water level monitoring points to adequately evaluate current elevations of flood control and hurricane protection structures.

**Lesson Learned:** Subsidence and water level monitoring instrumentation at the following sites in Southeast Louisiana are needed. These sites will be used to monitor future land subsidence, reference water level datums, and the relationship between geodetic and water level datums; as required to assess and update protection elevations of flood control structures throughout the region. Each site needs to contain complete NOAA quality CORS GPS and NWLON gage instrumentation. Following are some suggested locations for future sites. This is subject to a more detailed study by NOAA.

1. Lake Pontchartrain (East end—The Rigolets area)
2. IHNC (Corps of Engineers Lock—existing gage site)
3. GIWW-MRGO (Michoud Substation area)
4. Lake Borgne (New Shell Beach area)
5. Venice, LA (New Orleans District Project Office)
6. Mississippi River (Carrollton gage site-New Orleans District Office)

### **New Orleans District Water Level Gages**

**Finding:** New Orleans District water level gages are tied to local benchmarks and are not on a consistent geodetic vertical datum.

**Lesson Learned:** To provide additional surface modeling coverage in the Region, New Orleans District gages (and possibly those maintained by the USGS, NWS, levee boards, and others) needs to be connected and referenced to the latest geodetic vertical datum and epoch published by NOAA. New Orleans District, working jointly with NOAA, needs to modify District-owned gages to meet NOAA NWLON specifications and include these gages in a local Southeastern Louisiana NWLON. This will require long-term technology and NWLON

partnering support with the New Orleans District. The New Orleans District will have to perform gage inspections and adjustments in accordance with NOAA recommendations for engineering applications. Approximately 20 gages are candidates for inclusion in the NWLON--the exact number would have to be evaluated by New Orleans District and NOAA.

### **Local Mean Sea Level Epoch Updates and Relationships**

**Finding:** The standard 19-year NTDE update to LMSL computations is too long an interval in this high subsidence area.

**Lesson Learned:** LMSL epochs need to be periodically updated by NOAA in order to monitor subsidence and/or apparent sea level rise at NWLON and other gage sites. Stations in the region need to be evaluated based on sea level trend analysis and, where appropriate, 5-year tidal datums and apparent sea level rise should be computed and reevaluated yearly. NOAA needs to perform these periodic evaluations in close coordination with New Orleans District. The New Orleans District needs to conduct gage inspections on non-NWLON gages on an annual basis, in close coordination with NOAA reevaluations and updates. NOAA needs to develop and publish an operating manual specific to the process of maintaining water level datums in this Southeast Louisiana region.

### **Definitions of NGVD29, NAVD88, Mean Sea Level, and Local Mean Sea Level**

**Finding:** NGVD29, NAVD88, Mean Sea Level, and Local Mean Sea Level are often misunderstood and used interchangeably in various documents.

**Lesson Learned:** When referring to the mean water surface at or near a specific flood control project, LMSL needs to be used. A LMSL derived elevation needs to clearly identify the water level reference gage location and the time series (epoch) over which the mean surface elevation was computed. NOAA geodetic and tidal datasheets need to be modified to clearly indicate orthometric heights/elevations differ from water level-based elevations.

### **Hurricane Season Biases in Local Mean Sea Level Averages**

**Finding:** Distinct biases were noted in average water surface elevations during the fall hurricane season. It is not clear if these biases are factored into hydrodynamic or risk assessment models, or in design criteria used in developing flood protection structure elevations and flood inundation models.

**Lesson Learned:** Applicable hydrologic and hydraulic guidance documents need to be reviewed to verify that seasonal sea level biases are being properly applied.

### **Coordination of Topographic Survey Data Collection, Processing, and Management**

**Finding:** A variety of survey data is produced by various elements within and outside the New Orleans District, primarily by contracted surveying and mapping firms. There is no standard process to locate datasets and ensure that a common reference system is used.

**Lesson Learned:** The New Orleans District needs to develop a comprehensive GIS system to maintain the hydrographic, topographic, and geodetic data requested by various engineering, construction, and operations entities within and/or external to the District. To minimize the confusion associated with several entities producing survey data, all surveys need to be coordinated and archived by a single office. This would standardize survey methods, survey control, deliverables, etc. Additionally all proposed surveys would be displayed on the GIS to prevent common requirements from being duplicated. Data formats need to be standardized based on existing Corps guidance—e.g., CADD/GIS Technology Center, EM 1110-1-1005, EM 1110-2-1003, etc.

### **Vertical Control Monumentation Requirements and Stakeout Procedures on Flood Control Construction Projects**

**Finding:** Most construction contract documents referenced only one benchmark for controlling construction. In at least one instance, an incorrect benchmark elevation contributed to a floodwall being constructed below intended design levels.

**Lesson Learned:** A minimum of three (3) permanent benchmarks (new or existing) need to be identified on design and construction drawings for all flood control projects. Having three benchmarks provides redundancy to determine the reliability of the benchmarks used during the planning, design, and construction process. These marks should be established during the planning and design phase. The marks should be situated in the middle and at each end of the project. They should be established relative to the most recent geodetic vertical datum established by NOAA, using either conventional differential leveling and/or the latest NOAA defined GPS techniques, with appropriate corrections to the local hydraulic design surface (i.e. local mean sea level). Prior to and during actual construction stake out, these primary reference marks need to be verified externally and internally. Field records of these survey verifications need to be permanently archived.

### **LIDAR and Photogrammetric Mapping Calibration and Testing**

**Finding:** Various older LIDAR mapping projects covering the region that were used for IPET model input were not independently quality assured or ground-truthed for absolute accuracy. Large anomalies and biases were found in this uncalibrated data. The original contract scopes for this mapping did not include adequate quality assurance checks. In addition, the LIDAR data was thinned to a DEM post-spacing that was too large to adequately define the terrain or floodwalls.

**Lesson Learned:** Major engineering projects, such as this IPET study, requiring accurate, up-to-date topographic detail, should not attempt to utilize older mapping data of uncertain origin, resolution, and accuracy—especially if this data was not reliably quality assured (i.e., ground truthed). Contracts for remote sensing services must contain quality assurance provisions for calibrating, ground truthing, and testing delivered mapping products. These methods should follow long-established QC/QA testing methods outlined in standards such as USACE EM 1110-1-1000 (Photogrammetric Mapping), FGDC, ASPRS, and FEMA (e.g., FEMA 2003—Appendix A “Guidance for Aerial Mapping and Surveying.”)

## **USACE Policy and Manual on Maintaining Geodetic and Water Level Datums in High Subsidence Areas**

**Finding:** USACE guidance on elevation datums used in coastal hurricane protection projects needs updating.

**Lesson Learned:** An Engineering Manual (or an addendum/update to the Coastal Engineering Manual) providing theory, guidance, and procedures on maintaining reliable reference datums in high-subsidence areas, including distinguishing engineering applications between water level and geodetic vertical datums is needed. Alternatively, this guidance may be implemented by a policy document (Engineering Regulation).

## **Differential GPS and Related Survey Standards for Establishing Construction Control**

**Finding:** Direct use of CORS data for establishing orthometric elevations, following NOAA guidelines, provides sufficient accuracy for engineering and construction applications.

**Lesson Learned:** GPS survey standards and procedures used during the Hurricane Katrina IPET project need to be promulgated by a HQUSACE policy directive. NOAA procedures must be used for establishing supplemental orthometric elevations using GPS. NOAA needs to develop and promulgate specific operating procedures applicable to this high-subsidence area. These procedures should include methods of determining orthometric elevations relative to local VTDP benchmarks as well as methods for direct establishment of orthometric elevations from CORS stations. Both geodetic accuracy and construction accuracy methods should be covered. Required accuracies are outlined in EM 1110-1-1005. Data can be adjusted using commercial off-the-shelf geodetic software routines and not require Blue Booking. Third-Order differential leveling accuracy is adequate for engineering surveys, including referencing water level gages.

## **Certification Policy on Use of Vertical Datums for All Applications**

**Finding:** There was no coordination within New Orleans District to ensure that all projects were connected to a common vertical datum. In addition, established HQUSACE policies on vertical datums were not consistently followed.

**Lesson Learned:** Mandate a survey control certification process in all work requiring surveying, mapping and GIS information, which would require a District/MS Survey Coordinator's certification of survey methods and the datum used. The Survey Coordinator needs to provide appropriate survey methods, verify existing control, check existing relationships between geodetic and tidal datums, and ensure compliance with IPET findings and lessons learned that are published in an engineer manual. When acting within this certification process, the Survey Coordinator will not be subject to management prerogatives or other non-technical infringements. They will serve as an independent technical authority in this regard. Adequate and separate project line item funding will be set aside for this purpose on all projects requiring surveying, mapping and GIS information. A training program will be established by HQ to insure certifying individuals have the necessary skills to perform this task. A reporting system will also be established to insure all USACE project datums are adequately certified via this process, which will be monitored and verified by MSC and HQ Engineering and Construction organizations.

## References

### Corps of Engineers References

Most of the following USACE publications can be downloaded from the HQUSACE home page site on the Internet. Publication dates are indicated therein or on the document itself.

**ER 1110-1-8156**

Policies, Guidance, and Requirements for Geospatial Data and Systems

**ER 1110-2-1150**

Engineering and Design for Civil Works Projects

**EM 1110-1-1000**

Photogrammetric Mapping

**EM 1110-1-1002**

Survey Markers and Monumentation

**EM 1110-1-1003**

NAVSTAR Global Positioning System Surveying

**EM 1110-1-1005**

Control and Topographic Surveying (01 Jan 06 Draft)

**EM 1110-1-2909**

Geospatial Data and Systems

**EM 1110-2-1003**

Hydrographic Surveying

**EM 1110-2-1009**

Structural Deformation Surveying

**EM 1110-2-1100**

Coastal Engineering Manual

**EM 1110-2-1416**

River Hydraulics

**EM 1110-2-1607**

Tidal Hydraulics

**EM 1110-2-1913**

Design and Construction of Levees

**EM 1110-2-1614**

Design of Coastal Revetments, Seawalls, and Bulkheads

**ERDC/ITL 1999a**

“Computer-Aided Design and Drafting (CADD) and Geographic Information System (GIS)--Concepts and Terminology, 1999,” The CADD/GIS Technology Center, The CADD/GIS Technology Center, Information Technology Laboratory, U.S. Army Engineer Research and Development Center, Vicksburg, Mississippi 39180

**ERDC/ITL 1999b**

“CADD/GIS Technology Center Guidelines for Installation Mapping and Geospatial Data,” 1999, The CADD/GIS Technology Center, The CADD/GIS Technology Center, Information Technology Laboratory, U.S. Army Engineer Research and Development Center, Vicksburg, Mississippi 39180

**ERDC/ITL 2001**

“A/E/C CADD Standard (TR-01-6),” September 2001, The CADD/GIS Technology Center, The CADD/GIS Technology Center, Information Technology Laboratory, U.S. Army Engineer Research and Development Center, Vicksburg, Mississippi 39180

**ERDC/ITL 2002a**

Spatial Data Standards for Facilities, Infrastructure, & Environment (SDSFIE) and Facility Management Standards for Facilities, Infrastructure, & Environment (FMSFIE)--History of Development and Benefits,” June 2002, The CADD/GIS Technology Center, The CADD/GIS Technology Center, Information Technology Laboratory, U.S. Army Engineer Research and Development Center, Vicksburg, Mississippi 39180

**ERDC/ITL 2002b**

Spatial Data Standards for Facilities, Infrastructure, & Environment (SDSFIE) and Facility Management Standards for Facilities, Infrastructure, & Environment (FMSFIE)--Data Model and Structure,” June 2002, The CADD/GIS Technology Center, The CADD/GIS Technology Center, Information Technology Laboratory, U.S. Army Engineer Research and Development Center, Vicksburg, Mississippi 39180

**ETL 1110-1-97**

Change in Name of National Vertical Control Net

**ETL 1110-1-152**

Conversion to the North American Vertical Datum of 1988 (Rescinded)

**ETL 1110-2-349**

Requirements and Procedures for Referencing Coastal Navigation Projects to Mean Lower Low Water Datum (Rescinded)

**FEMA 1995**

Flood Insurance Study Guidelines and Specifications for Study Contractors



**FEMA 2003**

Guidelines and Specifications for Flood Hazard Mapping Partners

**HEC 1986**

The Hydraulic Engineering Center (HEC) Research Document No. 26 “Accuracy of Computed Water Surface Profiles” (1986)

**Chen 1995**

The Civil Engineering Handbook, W.F. Chen, CRC Press, 1995

**Federal Geographic Data Committee References****FGDC 1998a**

“Geospatial Positioning Accuracy Standards, PART 1: Reporting Methodology,” Federal Geographic Data Committee, FGDC-STD-007.1-1998

**FGDC 1998b**

“Geospatial Positioning Accuracy Standards, PART 2: Standards for Geodetic Networks,” Federal Geographic Data Committee, FGDC-STD-007.2-1998

**FGDC 1998c**

“Geospatial Positioning Accuracy Standards, PART 3: National Standard for Spatial Data Accuracy,” Federal Geographic Data Committee, FGDC-STD-007.3-1998

**FGDC 1998d**

“Content Standard for Digital Geospatial Metadata (Version 2.0),” Federal Geographic Data Committee, FGDC-STD-001-1998

**FGDC 2002**

“Geospatial Positioning Accuracy Standards, PART 4: Standards for Architecture, Engineering, Construction (A/E/C) and Facility Management,” Federal Geographic Data Committee, FGDC-STD-007.4-2002

**FGCS 1984**

Federal Geodetic Control Subcommittee 1984

“Standards and Specifications for Geodetic Control Networks,” Rockville, MD.

**FGCS 1988**

Federal Geodetic Control Subcommittee 1988

“Geometric Geodetic Accuracy Standards and Specifications for Using GPS Relative Positioning Techniques (Preliminary)”, Rockville, MD. (Reprinted with Corrections: 1 Aug 1989).

## **NOAA NGS References**

### **NGS 1988**

National Geodetic Survey 1988

“Guidelines for Submitting GPS Relative Positioning Data to the National Geodetic Survey”

### **NGS 2004**

Technical Report NOS/NGS 50, Rates of Vertical Displacement at Benchmarks in the Lower Mississippi Valley and the Northern Gulf Coast, NOAA, NGS, July 2004

### **NOAA 1992**

“Results of the General Adjustment of the North American Vertical Datum of 1988”, Surveying and Land Information Systems, 52(3): 133-149; Zilkoski, D., J. Richards, and G. Young, NOAA, NOS, NGS.

### **NOAA 1994**

“Input Formats and Specifications of the National Geodetic Survey Data Base,” NOAA, National Geodetic Survey, September 1994.

### **NOAA 1997**

NOAA Technical Memorandum NOS NGS-58, Zilkoski, D.B., D’Onofrio, J. D., and Frankes, S. J. (Nov 1997) “Guidelines for Establishing GPS-Derived Ellipsoid Heights (Standards: 2 cm and 5 cm),” Version 4.1.3. Silver Spring, Maryland.

### **NOAA 2005**

Guidelines for Establishing GPS Derived Orthometric Heights (Standards: 2cm and 5cm) version 1.4, National Geodetic Survey 2005 DRAFT NOS NGS 59; Zilkoski, Carlson, and Smith, NOAA, NOS, NGS.

### **NOAA 1989**

NOAA Technical Report NOS 131 NGS 44 “Subsidence at Houston, Texas 1973-1987”, by Sandford R. Holdahi, Joseph C. Holzschuh, and David B. Zilkoski, NOAA, NOS, NGS

### **NOAA 1986**

NOAA Technical Report NOS 120 NGS 38 “Subsidence in the Vicinity of New Orleans as Indicated by Analysis of Geodetic Leveling Data”, by David B. Zilkoski and Samuel M. Reese, Jr., NOAA, NOS, NGS

### **Mitchell and Zilkoski 1986**

“A Geocadastre for New Orleans and Southern Louisiana” Presented at the 1986 Spring ACSM/ASPRS Convention, Washington, D.C. March 16-21, 1986, by Gilbert J. Mitchell and David B. Zilkoski, NOAA, NOS, NGS

## NOAA CO-OPS References

- Bodnar, A.N. (1981). Estimated Accuracies of Tidal Datums from Short Term Observations, Draft Report, Tides and Water Levels Division, National Ocean Survey, Rockville, MD, March 1981.
- Church, J. A. (2006). A 20th century acceleration in global sea-level rise. *Geophysical Research Letters*, VOL. 33.
- Dokka, R. K. (2006). Modern-day tectonic subsidence in coastal Louisiana. *Geology*; April 2006; v. 34; no. 4.
- Douglas, B. C. et al (2001) *Sea Level Rise: History of Consequences*, International Geophysics Series, Vol. 57, Academic Press.
- Hicks, Steacy D. (1985). *Tidal Datums and Their Uses*. National Ocean Survey, Rockville, MD.
- Marmer, H. A. (1951) *Tidal Datum Planes.*, NOAA Special Publication No. 135, U. S. Coast and Geodetic Survey, U. S. Govt. Printing Office, revised ed., 1951.
- Parker, B. B. (1992) Sea Level as an indicator of climate and global change, *MTS Journal*, 25, 13-24.
- Shinkle, K. D. and Dokka R. K., (2004) R. K. Rates of Vertical Displacement at Benchmarks in the Lower Mississippi Valley and the Northern Gulf Coast.
- Swanson, R. L. E. (1974). Variability of Tidal Datums and Accuracy in Determining Datums from Short Series of Observations, NOAA Technical Report NOS 64, NOAA, National Ocean Survey, Rockville, MD, October 1974.
- Zervas, C. (2001). *Sea Level Variations of the United States 1854-1999* NOAA Technical Report NOS CO-OPS 36, NOAA/NOS, Center for Operational Oceanographic Products and Services, Silver Spring MD, July 2001.
- NOS 2000. *Tide and Current Glossary*. Center for Operational Oceanographic Products and Services, Silver Spring MD, January 2000.
- NOS, 2001. *Tidal Datums and Their Applications*, NOAA Special Publication NOS CO-OPS 1, NOAA/NOS, Center for Operational Oceanographic Products and Services, Silver Spring MD, February 2001.
- NOS, 2003. *Computational Techniques for Tidal Datums Handbook*, NOAA Special Publication NOS CO-OPS 2, NOAA/NOS, Center for Operational Oceanographic Products and Services, Silver Spring MD, September 2003.

NOS 2003. Specifications and Deliverables for Installation, Operation, and Removal of Water Level Stations. NOAA Special Publication NOS CO-OPS, NOAA/NOS, Center for Operational Oceanographic Products and Services, Silver Spring MD, February 2003.

NOS 2003. User's Guide For GPS Observations. Center for Operational Oceanographic Products and Services, Silver Spring MD, January 2003.

NOS 2003. User's Guide For Writing Bench Mark Descriptions. Center for Operational Oceanographic Products and Services, Silver Spring MD, January 2003.

NOS 2005. Standing Project Instructions and Requirements For the Coastal Water Level Stations. Center for Operational Oceanographic Products and Services, Silver Spring MD, October 2005.

## Glossary of Abbreviations and Acronyms

A-E	Architect-Engineer
ACSM	American Congress on Surveying and Mapping
ASCE	American Society of Civil Engineers
ASPRS	American Society for Photogrammetry and Remote Sensing
BFE	Base Flood Elevation
BLM	Bureau of Land Management
BM	Benchmark
BS	Backsight
CADD	Computer Aided Drafting and Design
CAiCE	Computer Aided Civil Engineering
COE	Corps of Engineers
CONUS	CONTinental United States
CO-OPS	Center for Operational Oceanographic Products and Services (NOAA)
CORPSCON	CORPS CONvert
CORS	Continuously Operating Reference Stations
COTS	Commercial off the Shelf
DA	Department of the Army
DE	Difference in Elevation
DEM	Digital Elevation Model
DM	Design Memorandum
DOD	Department of Defense
DGPS	Differential Global Positioning System
DTM	Digital Terrain Model
EDM	Electronic Distance Measurement
EM	Engineer Manual
ERDC	Engineer Research and Development Center
ETL	Engineer Technical Letter
FEMA	Federal Emergency Management Agency
FGCS	Federal Geodetic Control Subcommittee
FGDC	Federal Geographic Data Committee
FIRM	Flood Insurance Rate Map
FIS	Flood Insurance Study
GDM	General Design Memorandum
GDOP	Geometric Dilution of Position
GIS	Geographic Information System
GIWW	Gulf Intracoastal Waterway
GPS	Global Positioning System
GRS 80	Geodetic Reference System of 1980
HARN	High Accuracy Reference Networks
HI	Height of Instrument
HDOP	Horizontal Dilution of Position
HPGN	High Precision Geodetic Networks
HR	Height of Reflector
HT	Height of Target

HQUSACE.....	Headquarters, US Army Corps of Engineers
IGLD55 .....	International Great Lakes Datum of 1955
IGLD85 .....	International Great Lakes Datum of 1985
IPET .....	Interagency Performance Evaluation Team
ITL .....	Information Technology Lab
ITRF.....	International Terrestrial Reference Frame
JALBTCX.....	Joint Airborne LIDAR Bathymetric Technical Center of Expertise
LIDAR .....	LIght Detection And Ranging
LMVD.....	Lower Mississippi Valley Division
LSRC.....	Louisiana Spatial Reference Center
LSU .....	Louisiana State University
LWRP .....	Low Water Reference Plane
MGL.....	Mean Gulf Level
MHW .....	Mean High Water
MLG.....	Mean Low Gulf
MLLW.....	Mean Lower Low Water
MSL .....	Mean Sea Level
MSL1912 .....	Mean Sea Level Datum of 1912
MTL .....	Mean Tide Level
MVD .....	Mississippi Valley Division
MVN .....	New Orleans District
MVS.....	St. Louis District
NAD27 .....	North American Datum of 1927
NAD83.....	North American Datum of 1983
NADCON .....	North American Datum Conversion
NAVD88.....	North American Vertical Datum of 1988
NDGPS .....	Nationwide Differential GPS
NFIP .....	National Flood Insurance Program
NGRS.....	National Geodetic Reference System
NGS .....	National Geodetic Survey
NGVD29.....	National Geodetic Vertical Datum of 1929
NOAA .....	National Oceanic and Atmospheric Administration
NOS .....	National Ocean Service
NSRS.....	National Spatial Reference System
NSSDA .....	National Standard for Spatial Data Accuracy
NTDE.....	National Tidal Datum Epoch
NVCN .....	National Vertical Control Network
NWLON.....	National Water Level Observation Network
OCONUS .....	Outside the Continental United States
OHWM .....	Ordinary High Water Mark
OPUS .....	On-Line Positioning User Service
OTF.....	On-the-Fly
P&S .....	Plans and Specifications
PBM .....	Permanent Benchmark
PDOP .....	Position Dilution of Position
PI .....	Point of Intersection

PICES.....	Periodic Inspection and Continuing Evaluation of Completed Civil Works Projects
POB.....	Point of Beginning
POT.....	Point of Tangency
PPRTK.....	Post-Processed Real-Time Kinematic
ppm.....	Parts per Million
QA.....	Quality Assurance
QC.....	Quality Control
RM.....	Reference Mark
RMS.....	Root mean Square
RTK.....	Real Time Kinematic
SI.....	International System of Units
SLD29.....	Sea Level Datum of 1929
SOW.....	Scope or Statement of Work
SPCS.....	State Plane Coordinate System
SPH.....	Standard Project Hurricane
TBM.....	Temporary Benchmark
TEC.....	Topographic Engineering Center
TFG.....	Task Force Guardian
TIN.....	Triangular Irregular Network
TM.....	Transverse Mercator
TP.....	Turning Point
US.....	United States
USACE.....	US Army Corps of Engineers
USC&GS.....	US Coast & Geodetic Survey
USCG.....	US Coast Guard
USGS.....	US Geological Survey
USNG.....	US National Grid
UTM.....	Universal Transverse Mercator
VDOP.....	Vertical Dilution of Position
VERTCON.....	VERTical CONversion
VLBI.....	Very-Long-Baseline-Interferometry
VTDP.....	Vertical Time-Dependent Position
WAAS.....	Wide Area Augmentation System
WGS84.....	World Geodetic System of 1984
WRDA.....	Water Resources Development Act