

A Method To Eliminate Explosion Hazards in Auger Highwall Mining

By Jon C. Volkwein and James P. Ulery

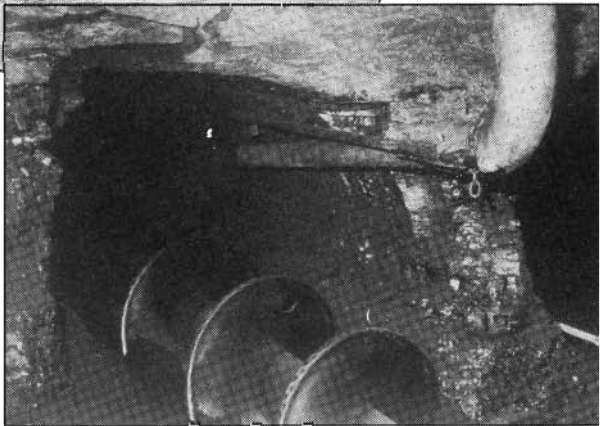

United States Department of the Interior

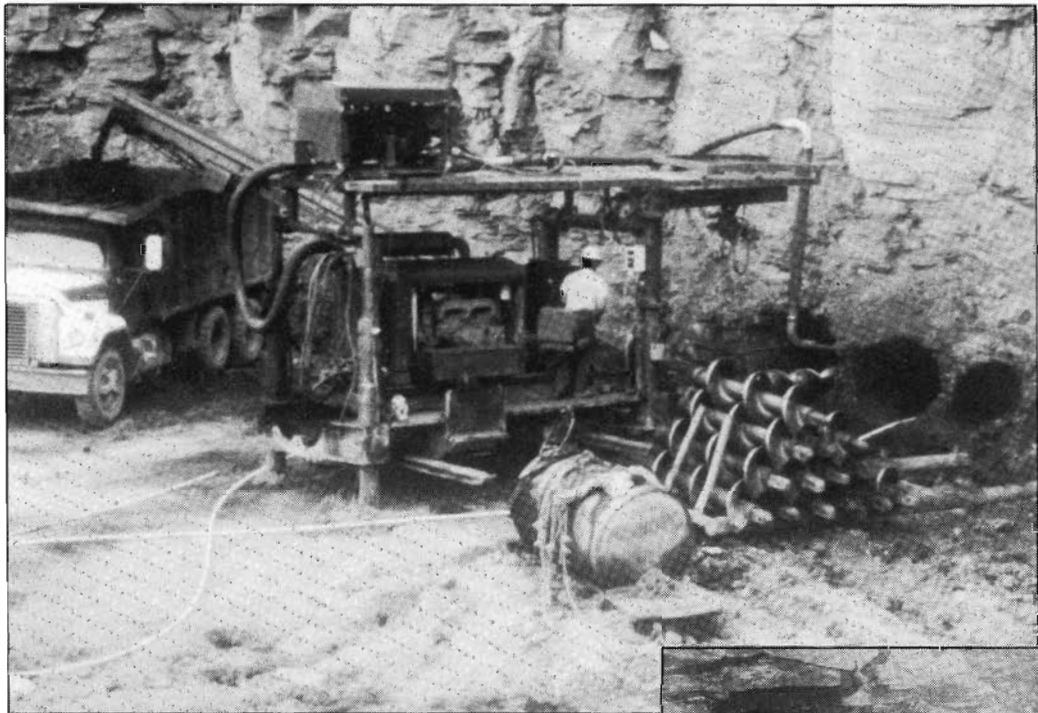

Bureau of Mines

Mission: As the Nation's principal conservation agency, the Department of the Interior has responsibility for most of our nationally-owned public lands and natural and cultural resources. This includes fostering wise use of our land and water resources, protecting our fish and wildlife, preserving the environmental and cultural values of our national parks and historical places, and providing for the enjoyment of life through outdoor recreation. The Department assesses our energy and mineral resources and works to assure that their development is in the best interests of all our people. The Department also promotes the goals of the Take Pride in America campaign by encouraging stewardship and citizen responsibility for the public lands and promoting citizen participation in their care. The Department also has a major responsibility for American Indian reservation communities and for people who live in Island Territories under U.S. Administration.

Cover Photograph: A highwall auger mining machine with roof-mounted inert gas generator safely mines coal in a gas-laden area. Photo by J. C. Volkwein, Pittsburgh Research Center, U.S. Bureau of Mines.

Report of Investigations 9462

A Method To Eliminate Explosion Hazards in Auger Highwall Mining

By Jon C. Volkwein and James P. Ulery

**UNITED STATES DEPARTMENT OF THE INTERIOR
Bruce Babbitt, Secretary**

BUREAU OF MINES

Library of Congress Cataloging in Publication Data:

Volkwein, J. C. (Jon C.)

A method to eliminate explosion hazards in auger highwall mining / by Jon C. Volkwein and James P. Ulery.

p. cm. — (Report of investigations; 9462)

Includes bibliographical references (p. 14).

1. Mine explosions—Prevention. 2. Gases, Rare—Testing. 3. Coal augers. I. Ulery, J. P. (James P.). II. Title. III. Series: Report of investigations (United States. Bureau of Mines); 9462.

TN23.U43

622 s—dc20

[622'.83]

92-42010

CIP

CONTENTS

	<i>Page</i>
Abstract	1
Introduction	2
Acknowledgments	4
Methods	4
System as tested	4
Volume testing	4
Gas testing	5
Analysis of explosibility	6
Gas content measurement	6
Personal testing	6
Results and discussion	6
Volume measurements	7
Coal volume removed	7
Inert gas volume	7
Delivery of gas to auger head	8
Preliminary test	8
Hole data	8
Explosibility diagram	8
Methane encounter	9
Hole data	9
Explosibility diagram	10
Hole profile	10
Time to reach inert conditions	11
Collar measurements	11
Gas content	11
Personal monitoring	12
System safety	13
Observations	13
Conclusions	13
References	14

ILLUSTRATIONS

1. Inert gas shroud enclosure of auger hole collar	3
2. Inert gas stub pipe used to direct inert exhaust into the hole	3
3. Schematic of inert gas system as tested	5
4. Overview of highwall mining operation as tested	7
5. Explosibility diagram for January	9
6. Explosibility diagram for March data with observed gas concentrations plotted for all holes	10
7. Profiles of methane concentrations in holes 1 and 3 at maximum hole depth with augers in place, and immediately after auger removal	10
8. Corrected infrared gas concentrations at the collar sample location for hole 3	12

TABLES

1. Hot and cooled volumes of inert gas for various engines and conditions	8
2. Hole measurement results showing low oxygen concentrations in hole interior	8
3. Measured and computed gas concentrations in hole	9
4. Gas chromatograph results—auger in hole	9
5. Overnight ventilation of open and partially sealed holes	11
6. Coalbed gas content of samples from hole 4, No. 9 Coalbed, Henderson County, KY	12

UNIT OF MEASURE ABBREVIATIONS USED IN THIS REPORT

cfm	cubic foot per minute	in ³	cubic inch
cm ³ /g	cubic centimeter per gram	lb/ft ³	pound per cubic foot
°F	degree Fahrenheit	min	minute
ft	foot	ppm	part per million
ft ³	cubic foot	psig	pound per square inch gage
ft ³ /min	cubic foot per minute	rpm	revolution per minute
h	hour	s	second
in	inch	scfh	standard cubic foot per hour

A METHOD TO ELIMINATE EXPLOSION HAZARDS IN AUGER HIGHWALL MINING

By Jon C. Volkwein¹ and James P. Ulery²

ABSTRACT

The U.S. Bureau of Mines investigated a method of using inert gas to prevent the formation of explosive gas mixtures in auger highwall mining of coal. A combination of gasoline and diesel engine exhaust gases was introduced into the auger drill hole using a short section of pipe located at the collar. Gas samples were taken and analyzed on-site with infrared detectors for oxygen, carbon dioxide, methane, and carbon monoxide. Evacuated bottle samples were also taken and analyzed by gas chromatography in the laboratory. These gas results were analyzed for explosibility. Coal samples from various depths were used to obtain the gas content of the coal using the modified direct method. Personal exposure to carbon monoxide was also monitored. The highest methane level observed was 9.55%. The levels of inert gas (carbon dioxide and nitrogen) were sufficiently high to prevent any ignition of the methane. Results showed that for all conditions during mining, gas concentrations were nonexplosive. The gas content of the coal was about 0.30 cm³/g. The maximum personal time-weighted average sample for carbon monoxide was 20 ppm. This system provides a safe, inexpensive, simple method for preventing explosions during auger mining.

¹Physical scientist.

²Geologist.

Pittsburgh Research Center, U.S. Bureau of Mines, Pittsburgh, PA.

INTRODUCTION

The auger highwall mining method is an effective method to recover coal from a reserve when removal of the overburden by surface mining equipment becomes uneconomical. In this method of mining, a horizontal auger enters the coal seam from the surface mine bench under the highwall and the coal is literally drilled in a series of parallel holes. Historically, coal mined from the surface is relatively shallow, and over time, methane associated with the coal has dissipated through the surface. In most circumstances, little methane has been found associated with auger mining. However, mining technology has enabled surface mining of deeper reserves of coal. Furthermore, environmental constraints have forced the highwall extraction method to be used to remove coal under wetlands, further increasing the chances of encountering methane. Recently, incidents of methane explosions at a few auger mining operations have resulted in injuries and increased testing for methane at the collars of auger holes. The fuel source of the reported explosions was not necessarily limited to methane, but may also have involved coal dust.

The U.S. Bureau of Mines is currently conducting research to better define the cause of the recent encounters with methane and to determine if these encounters are more common than previously thought. In the fall of 1991, Bureau personnel detected the occurrence of methane in excess of 2% in the interior of several highwall auger holes. The occurrence of methane was surprising, yet well documented. Several mining operations have been directed to stop mining because 2% methane was detected at the collar of the hole. While 2% methane in air is non-explosive, it represents 40% of the lower explosive limit and is considered in underground mining as the point at which corrective action must be taken. No technology was available to ensure the safe resumption of mining.

The Mine Safety and Health Administration (MSHA) met with the Bureau to discuss what technology might be available to enable the safe resumption of mining. The discussion included the difficulty of ventilating through the solid shafts of the augers, the probability that steel bits created the ignition source, and the potential solution of inerting the holes with low oxygen and high carbon dioxide concentrations from the machine's diesel exhaust.

Considering the ventilation aspects of the problem, it was not clear if ventilation could be reliably established. If some degree of ventilation to the front of the mining head is achieved, air may combine with methane to bring the hole atmosphere from a rich, nonexplosive mixture to an explosive mixture. Furthermore, ventilation may not prevent a dust explosion in such a mining configuration. Lack of access through the shafts of auger-type mining machines further limits the ability to add water or air to

cool bits to prevent an ignition source from developing. Either of these approaches would also be expensive.

The process of mining coal in an inert atmosphere has been considered in the past, but apparently never implemented (1).³ Clearly, implementation in underground mining would be more complicated. On a mine bench open to the atmosphere, however, adding inert gas to the mining head could provide a quick, feasible method to prevent explosions at auger highwall mining operations. Also, the problem of how to move the inert gas to the cutting head of the machine has to be considered.

Preventing explosions on auger mining machines using inert gas requires three primary considerations: first, finding a source of inert gas; second, placing the inert gas at the cutter head; and third, monitoring the hole atmosphere.

Any gas source having an effective inert gas concentration of 34 vol % or greater will prevent methane from igniting (2). Sources of inert gas considered for this application included liquid nitrogen, modified shipboard inert gas generators (for hydrocarbon shipping and transfer), jet turbine engine (3), the auger's diesel engine, and a gasoline engine. Operation cost, purchase cost, and availability limited testing to the diesel and gasoline engines. This work tested each engine, separately and combined.

Two methods were tested to direct the inert gas to the cutting head of the auger machine. The first was a shrouded enclosure (fig. 1). The second was a "stub" pipe inserted part way into the hole after the lead augers had penetrated the face (fig. 2). Either of these methods can supply inert gas to the cutting head; however, the stub pipe method appeared more practical. The gas at the cutter-head comes from the collar or entrance of the hole and reaches the cutting head by simple displacement of the extracted coal. The total gas volume of the hole is equal to the volume of coal extracted.

To ensure effectiveness, both company and enforcement personnel need to know how to monitor the condition of the inerted hole. Measurement at depth inside the hole is possible by remote sampling through rigid tubing, but this method is impractical for routine monitoring. Continuous monitoring of the exhaust gas stream is an alternative.

The U.S. Bureau of Mines evaluated an inert gas system at an auger mining operation at a surface mine near Owensboro, KY. Coal was mined from the No. 9 Coalbed in Henderson County, KY. Tests were conducted in January and March of 1992. This work was conducted as part of the Bureau's Mine Disaster Prevention Program.

³Italic numbers in parentheses refer to items in the list of references at the end of this report.



Figure 1.—Inert gas shroud enclosure of auger hole collar. Note small-diameter pipe used for collar measurements.



Figure 2.—Inert gas stub pipe used to direct inert exhaust into the hole. Note small-diameter pipe used for collar measurements.

ACKNOWLEDGMENTS

The authors gratefully acknowledge the cooperation of John Urosek, Gary Wirth, and Mike Snyder of the Mine Safety and Health Administration, Pittsburgh Technical Support, for their consultation and loan of instrumentation.

The authors also would like to express appreciation for the contributions of Michael McCullough, John McCullough, and John Wiegand, of B&E Auger Mining Co., for their help in conducting the field measurements.

METHODS

This section includes the design of the inert gas system and measurement of the exhaust gas flows and concentrations. This was accompanied by an analysis of the explosibility of the gas mixtures found, analysis of the gas content of the coals, and personal monitoring for carbon monoxide on the machine operators.

SYSTEM AS TESTED

The primary source of the inert gas was a 305-in³ General Motors⁴ gasoline combustion engine. This was a used automotive engine that was removed from a vehicle and mounted on the roof of the auger drill. A new catalytic convertor, available commercially as an off-the-shelf item, was installed immediately following the exhaust manifold of the engine. This convertor burns excess hydrocarbons and carbon monoxide for cleaner gas emissions, and in this case, lower oxygen content. This engine was operated at 3,600 to 3,900 rpm.

Originally, it was thought that the diesel engine alone might produce the necessary volume and quality of inert gas. However, the oxygen concentration in diesel engine exhaust varied with engine load. Typical diesel engine exhaust oxygen concentrations ranged from 17% at no load to 8% at full load. Preliminary testing showed that the auger drill engine load characteristics could not consistently produce low enough oxygen concentrations to reliably prevent explosions.

Although the gasoline engine alone produced oxygen concentrations in the 1% to 4% range, the volume was insufficient to replace the volume of coal being mined. To make up for this lack of volume, a small portion of the auger drill's Cummins turbocharged 270 diesel engine's exhaust was added to the gasoline engine exhaust.

Exhaust gas from the gasoline engine connected through one branch of a Y pipe, and the other branch of the Y pipe connected to a split of exhaust from the diesel

engine. The combined exhaust flows joined a piece of 5-in-diameter flexible pipe that connected to a vertical descending pipe that brought the exhaust to the level of the hole. The initial shroud design consisted of an inverted U-shaped tube that surrounded the collar of the hole. Flaps of conveyer belt extended from the U tube to the face, and pie-shaped segments shrouded the auger entry. Slots on the face side of the U tube directed the inert gas into the hole. The stub pipe method replaced the U tube shroud with an elbow and a 3-in reducing pipe fitting. A 7-ft length of 3-in pipe extended the exhaust gas discharge about 5 ft in by the collar of the hole. Figure 3 shows a schematic of the inert gas system as tested.

The diesel exhaust was conducted from the engine muffler (no catalytic convertor was used on the diesel fraction) to the roof of the auger drill through a flexible 5-in steel pipe. The flexibility was such that the engine carriage traveled freely with the operation of the auger drill. The required volume of diesel exhaust was added to the 5-in steel pipe at the Y pipe. This volume was controlled by a critical orifice-type restriction with the diesel at 2,200 rpm (normal operating condition). The orifice size allowed approximately equal proportions of diesel and gasoline exhaust. The remaining diesel exhaust was vented at the roof of the auger drill.

The cutting head and lead guide augers were 39 in. in diameter and totaled a length of 26 ft. Once these initial augers were drilled into the highwall, the stub pipe was inserted at the top of the hole. The engines ran for about 4 min to fill the initial hole depth with inert gas. Mining then proceeded with all subsequent auger sections being 20 to 24 in. in diameter and 6 ft in length. Stops were made periodically to take gas measurements.

VOLUME TESTING

The amount of gas volume required was determined by measuring the volume and rate of coal removal by the augers. Each 6-ft auger section advance removed a calculated volume of 49.7 ft³. Rate of removal was determined

⁴Reference to specific products does not imply endorsement by the U.S. Bureau of Mines.

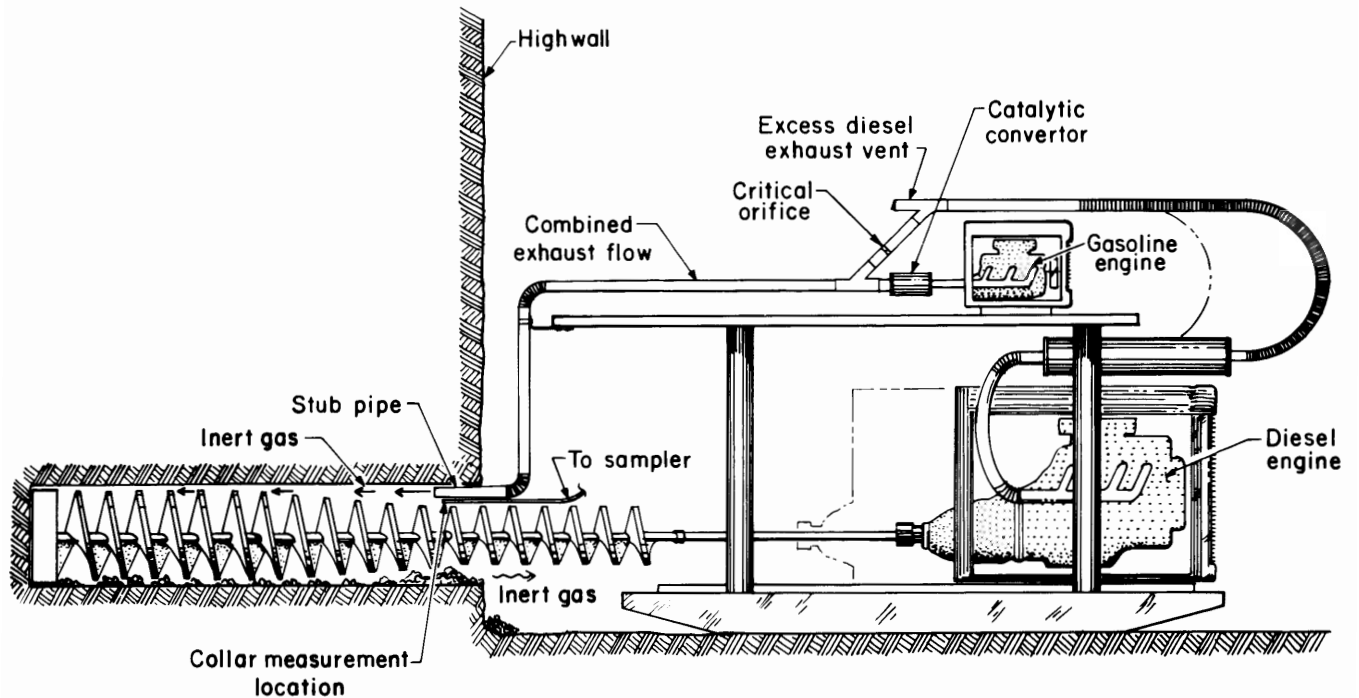

Figure 3.—Schematic of inert gas system as tested.

using a time study during initial and final auger penetration. Inert gas volumes were determined by measuring both hot and cooled gas velocities. The hot gas velocities were measured at the end of the vertical 5-in-diameter exhaust pipe using a vane anemometer or Pitot tube. A 15-s time interval was used to prevent damage to the anemometer bearings from the exhaust heat. Pitot tube readings were corrected for air density using a value of 0.0415 lb/ft^3 to reflect the elevated temperature of about 500° F . Cooled velocities were determined by measuring the actual volume exiting the auger hole using a modified brattice window method (4). This method determines low airflows by obstructing an airway with brattice, cutting a small window in the brattice, and measuring the velocity through the window. In this case, the brattice covered the auger hole while the exhaust gas entered the hole through the stubbed pipe. Cooled gas exited through the hole in the brattice, which was also the measuring point.

GAS TESTING

Three types of tests were conducted to measure the inert condition of the hole: collar measurements during mining, hole measurements with augers in place and

mining stopped, and postmining hole measurements after augers were removed from the hole.

- Collar measurements were real-time monitoring of the gas concentrations 4 ft into the collar of the hole.
- Hole measurements were taken by stopping the mining operation and pushing the appropriate length of 3/4-in PVC pipe into the hole. The sample end of the PVC pipe was surrounded by a 4-ft section of 4-in-diameter PVC drain pipe with both ends tapered and taped to the outside of the 3/4-in pipe. This "torpedo" shape bridged the auger flights and allowed easier insertion of the sample pipe. Using this method, gas concentrations could be obtained within 11 to 26 ft of the face up to a maximum insertion distance of 230 ft.
- Postmining measurements were taken after removal of the auger from the hole. This method used the 3/4-in PVC pipe inserted to various hole depths and for periods of up to 24 h after completion of the hole. Maximum depth of measurement was about 300 ft before the weight, friction, and flexibility of the pipe prevented further insertion.

Gas samples for all tests were withdrawn by a vacuum pump through 100 ft of 1/4-in Tygon tubing. This tubing

was connected to the collar sample pipe or the hole-measuring PVC pipe. Samples then passed through a water trap and the pump, where they were pressurized to between 5 and 10 psig. Samples were then pumped into a mobile laboratory established inside a van truck. Here an evacuated glass bottle sample port was located immediately prior to entry of the gas into a drying tube and the infrared gas analyzers (OFC Infrared Instruments). A Dwyer flowmeter was used to supply a dual infrared carbon monoxide-methane monitor in series with an infrared carbon dioxide monitor at a rate of 4 scfh. The gas flow to the oxygen infrared monitor was internally regulated to 1 scfh at 5 to 10 psig. The signals from the gas analyzers were recorded on a Soletch strip chart recorder and on Metrosonics data loggers. Data from the loggers were transferred to a computer disk at intervals during the testing. The strip chart produced a hard copy of the tests as they proceeded, while the computer data were used for subsequent data calculations. All data collection was time synchronized with mining and bottle sampling.

The gas sample travel time to the instrument was between 1 and 3 min depending on hole depth and sample type. Hole data were collected for at least 5 min, to ensure that representative samples were being collected. The infrared gas analyzers were warmed up each day for 40 min and then calibrated with known concentrations of gas. Bottle gas samples were also taken at intervals, especially during stable gas concentration periods that occurred during hole sampling. These bottle samples were analyzed by a gas chromatograph at the Bureau's Pittsburgh Research Center laboratory. The chromatograph results were then compared with the infrared results. Any discrepancies between the infrared data and the gas chromatograph data were corrected to reflect the gas chromatograph analysis results.

ANALYSIS OF EXPLOSIBILITY

The explosibility of a particular gas mixture was analyzed by the method of Zabetakis (2, 5). This method calculates the effective inert concentration in a particular mixture. For this testing, only methane was considered as the fuel source for explosions. While carbon monoxide

and higher hydrocarbons could also be potential fuel sources, their concentrations from gas chromatograph analysis were in the parts per million range and, therefore, not used in the calculations for explosibility. This method constructs an explosibility diagram that contains three regions: explosive, nonexplosive, and explosive when mixed with air. The last region includes situations in which the fuel source itself is so rich that it will not ignite; however, dilution with air will lean the mixture such that it may become explosive. Where these concentrations become diluted is therefore important.

GAS CONTENT MEASUREMENT

The modified direct method (MDM) test procedure was used to determine the gas content of coal samples (6). Samples were obtained periodically from the auger hole collar while augering was in progress. An attempt was made to choose samples sized from about 1 by 1 to 3 by 3 in. This was done to minimize fine material, which may have lost gas more quickly prior to sampling. Samples of even larger size, although desirable, would not fit in the air-tight sample containers. Gas content measurements were taken periodically. One major departure from the described technique was that the "lost gas" was not calculated. Lost gas refers to gas desorbed from the sample prior to sealing the sample in the air-tight container. Lost gas was not determined because of the low gas contents expected and because the original lost gas calculation was designed for use in vertical coring. Samples were obtained where the inerting procedure was being tested—the No. 9 Coalbed, Henderson County, KY.

PERSONAL TESTING

Since the exhaust from a gasoline combustion engine was used, personal exposure to carbon monoxide was monitored. Miners wore Mine Safety Appliances stain tube-type passive carbon monoxide dosimeters on their lapels for a few of the test days. Handheld CSE 270 multigas meters were also used to measure carbon monoxide at the work areas of auger placement. In addition, carbon monoxide levels were measured during collar sampling.

RESULTS AND DISCUSSION

The implementation of the inert gas concept was shown to lower oxygen concentrations sufficiently to prevent explosions when methane is encountered in highwall auger

mining. Both theoretical calculations and experimental data demonstrate the technique. Figure 4 shows an over-view of the auger mining machine during testing.

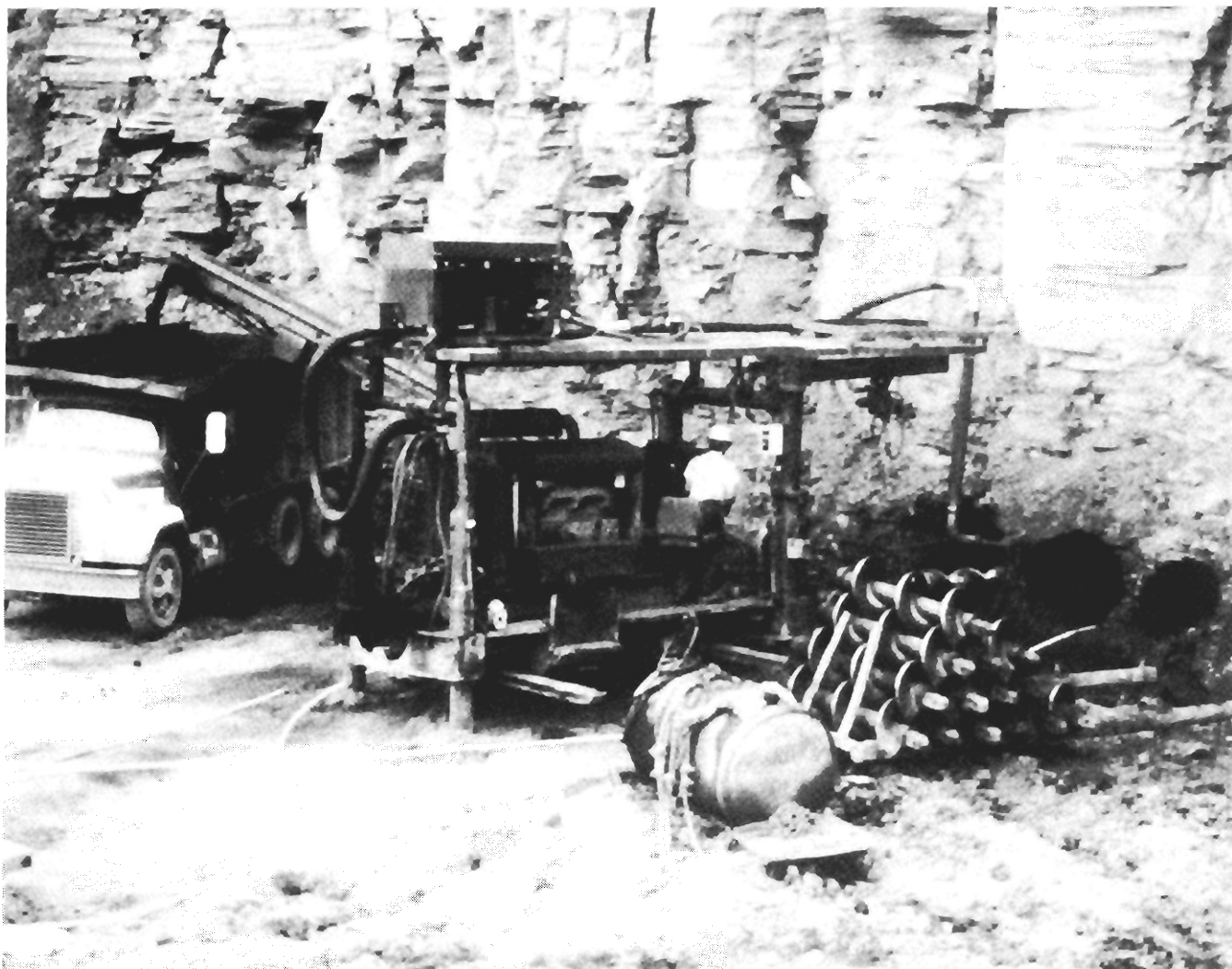

Figure 4.—Overview of highwall mining operation as tested.

VOLUME MEASUREMENTS

Coal Volume Removed

In order for inert conditions to be maintained at the head of the machine, the volume of inert gas produced must exceed the volume of coal removed. Time studies of coal removal showed that auger sections 17 through 27 required an average of 102 s per cycle. Of that cycle time, approximately 20 s was required for retraction of the Kelly bar, leaving 82 s for coal removal. The fastest cycle time recorded was 90 s, or 70 s for coal removal. Each added auger section removed a coal cylinder 3.25 ft in diameter by 6 ft long, or 49.7 ft³ of coal. Average coal removal rate was calculated to be 35 ft³/min with a maximum removal rate of 42 ft³/min. At greater hole depth,

auger numbers 55 through 60, the average rate of removal was calculated to be 27.0 ft³/min with a maximum rate of 30.3 ft³/min. Smaller diameter augers or slower penetration speeds will decrease this volume, while larger augers or faster penetration speeds will increase this volume. The inert gas generation system should be designed to supply enough inert gas to fill the maximum volume of coal removed plus a safety factor.

Inert Gas Volume

The available gas volume may be determined by the hot exhaust gas flow from the engines or the volume of gas leaving the hole. Hot engine exhaust gas condenses and contracts as it cools inside the auger hole, and consequently, a large correction factor must be used to

determine the true exhaust volume if hot gas flow is measured. A correction factor of 0.125 was derived empirically during testing in January 1992. The correction factor multiplied times the hot exhaust gas flow measurement yields the available inert gas volume for the combined engine flow. Table 1 contains the experimental data for determination of the correction factor. This correction factor may be used to quickly determine the available gas volume of the system by measuring the hot exhaust from the 5-in pipe. Subsequent testing in March confirmed the value of the correction factor. If a more direct measurement is required, the brattice window technique can be used to determine the cooled gas volume.

Table 1.—Hot and cooled volumes of inert gas for various engines and conditions

Condition	Hot ¹		Cool volume, ² cfm	Derived correction factor, cool/hot
	Velocity, ³ fpm	Volume, cfm		
January:				
Gas at 2,600 rpm . . .	740	101	13	0.129
Gas at 3,900 rpm . . .	1,680	229	28	.122
Diesel plus gas	3,280	447	⁴ 56	NA
Do.	NA	NA	64	NA
March:				
Diesel plus gas	⁵ 3,100	424	50	.118
Do.	3,100	424	55	.130
Average125

NA Not available.

¹Measured in stub pipe.

²Brattice window measured.

³5-in pipe.

⁴Calculated based on correction factor of 0.125.

⁵Measured with Pitot tube at hot air density of 0.0415 lb/ft³.

The minimum cooled gas volume found during testing with both engines was 50 cfm (table 1). The maximum rate of coal removal was determined to be 42 cfm. This calculates to a 16% excess volume of inert gas for the worst case conditions, that is, minimum gas volume and maximum coal removal. For average conditions, 56 cfm of exhaust was present and coal removal was 35 cfm, or 37% excess inert gas volume.

DELIVERY OF GAS TO AUGER HEAD

Gas concentrations introduced at the collar of the hole followed the head of the auger mining machine into the hole and remained in the hole until after removal of the auger head. Table 2 shows the oxygen concentrations in the hole measured by inserting PVC pipe over the augers. This was limited to a maximum of 230 ft. In all cases, low oxygen gas introduced with the stub pipe at the collar of the hole was found in the interior of the hole. Early, unpublished testing (7) found that the shroud technique

also produced similar results; however, owing to the effectiveness and simplicity of the stub pipe method, only that method is reported.

Table 2.—Hole measurement results showing low oxygen concentrations in hole interior

Hole	Hole depth, ft	Probe depth, ft	Oxygen concentration, vol %
1	308	225	10.28
3	360	230	9.16
4	155	140	12.78

NOTE.—Approaching darkness precluded hole measurement with the augers in place for hole 2.

PRELIMINARY TEST

Hole Data

The first results of this testing were obtained in January 1992. Hole data results with the inert gas system functioning showed that holes had only minimal concentrations of methane. The data were analyzed and extrapolated by calculating the effect of methane, as if it were added to the measured gas concentrations. This analysis showed that at any concentration of methane encountered, the atmosphere in the hole would be nonexplosive because of the presence of the inert gas and low levels of oxygen. Table 3 shows the drilling depths, probe depths, and corrected infrared gas concentrations. The table also computes the effect of adding 5% methane to the gas mixture as if a pocket of methane were encountered. With the added methane, the oxygen, carbon dioxide, and nitrogen concentrations would be diluted. New levels of these gases are computed. Using the method of Zabetakis (2, 5), the explosibility of the gas mixture is determined by computing the volume of excess nitrogen and amount of effective inert. At 5% methane, a gas with an effective inert concentration over 34 vol % is considered nonexplosive.

Explosibility Diagram

Figure 5 shows an explosibility diagram and the preliminary data extrapolated as if various methane concentrations were encountered. The figure shows that the closest approach to the explosive range at the inert gas concentrations measured occurs between 5% and 6% methane concentration. At the closest point, an 11% $[(1-34/38) \times 100]$ reduction in effective inert gas concentration is required to reach the explosive range. This figure further demonstrates that as higher levels of methane are encountered, the effective inert concentrations move further from the explosive range.

METHANE ENCOUNTER

Hole Data

Subsequent testing, delayed by weather and equipment problems, resumed in early March. This testing encountered substantial levels of methane. Gas levels in the hole were inert when methane was encountered, which agreed with the predictions from the preliminary testing. Table 4 shows the gas chromatograph results for all samples taken inside the hole with augers in place. All holes were non-explosive, but several measurements at shallow hole depth had 14% oxygen but also low methane concentrations. For the first hole, this oxygen dilution occurred during the time the hole was being measured from the interior to the exterior and the inert gas generator was off. For the second hole, the higher oxygen reading may have been caused by a leak in the gasoline engine exhaust line. In all cases of high oxygen concentrations, methane levels were low.

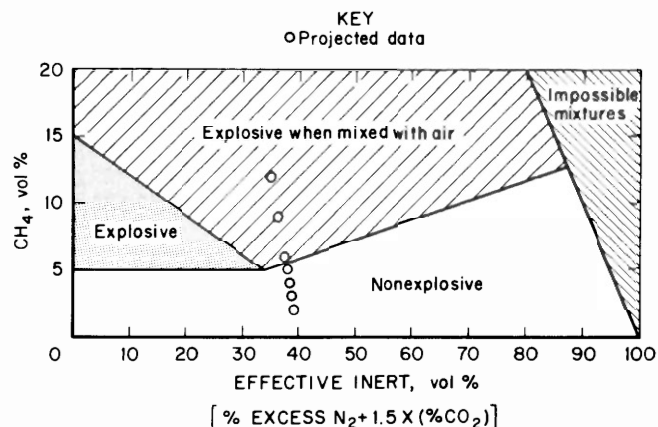

Figure 5.—Explosibility diagram for January. Gas data projected as if various levels of methane were encountered.

Table 3.—Measured and computed gas concentrations in hole, percent

Hole depth, ft	Probe depth, ft	Analysis			New gas levels ¹			Excess N ₂	Effective inert
		O ₂	CO ₂	N ₂	O ₂	CO ₂	N ₂		
26	15	12.72	5.86	81.42	12.08	5.57	77.35	31.43	39.78
50	30	12.84	5.63	81.53	12.20	5.35	77.45	31.10	39.12
68	40	13.05	5.36	81.59	12.40	5.09	77.51	30.40	38.04
80	70	12.95	5.51	81.54	12.30	5.23	77.46	30.71	38.57
92	70	12.82	5.74	81.44	12.18	5.45	77.37	31.09	39.27
104	90	11.63	6.17	82.20	11.05	5.86	78.09	36.11	44.90
116	90	12.05	6.06	81.89	11.45	5.76	77.80	34.30	42.93

¹New gas levels result from dilution by 5% added CH₄.

Table 4.—Gas chromatograph results—auger in hole

Hole	Hole depth, ft	Probe depth, ft	Analysis, vol %					
			O ₂	CO ₂	N ₂	CH ₄	Excess N ₂	Effective inert
1 ...	308	25	¹ 14.82	4.30	79.27	0.591	22.95	29.40
		75	¹ 14.57	4.45	79.37	.600	24.00	30.67
		125	10.69	4.55	78.66	5.00	38.03	44.86
		175	10.65	4.68	78.61	4.99	38.14	45.16
		225	10.28	3.71	77.33	7.61	38.26	43.83
2 ...	116	70	² 14.48	4.61	79.19	.692	24.16	31.08
3 ...	170	130	10.54	4.98	77.79	5.66	37.73	45.20
		100	11.58	5.55	80.20	1.59	36.19	44.52
		200	10.11	3.98	77.48	7.38	39.06	45.03
		230	9.16	3.27	77.07	9.55	42.26	47.16
4 ...	155	140	12.78	4.02	78.64	3.50	30.07	36.10

¹Collar air dilution, see text, inert generator off.

²Exhaust gas leak.

As methane was encountered, the oxygen levels declined. Simple dilution of the oxygen with methane accounts for this decline. This new gas mixture with diminished oxygen followed the cutting head deeper into the hole. This observation may be inferred from the data in table 4, hole 3. Note that at a hole depth of 170 ft and a sample probe depth of 130 ft, there was 10.54% oxygen and 5.66% methane. After the hole's completion at 360 ft, the gas levels 100 ft into the hole had changed to 11.58% oxygen and 1.59% methane. The original high levels of methane were now deeper in the hole. This is to be expected based on the premise that outby gases follow the cutterhead into the hole to replace the removed coal.

Because of the displacement of the coal with whatever gas is available, methane gas generated at any point in the hole will follow the auger head into the hole. The inert exhaust gas from the collar then serves as a reservoir supplying the required displaced volume minus the methane volume.

$$V_{\text{INERT}} = V_{\text{HOLE}} - V_{\text{METHANE}}$$

Theoretically, at some point, the hole could inert itself if sufficient quantities of methane were present. It is possible, but unlikely, that quantities of methane in excess of the hole volume would be encountered. In that situation, pure methane gas would reach the collar and the zone of dilution through the explosive range would take place outside of the hole.

Explosibility Diagram

Figure 6 plots the available hole data on the explosibility diagram. For all hole conditions monitored, no explosive mixtures were encountered. If high methane

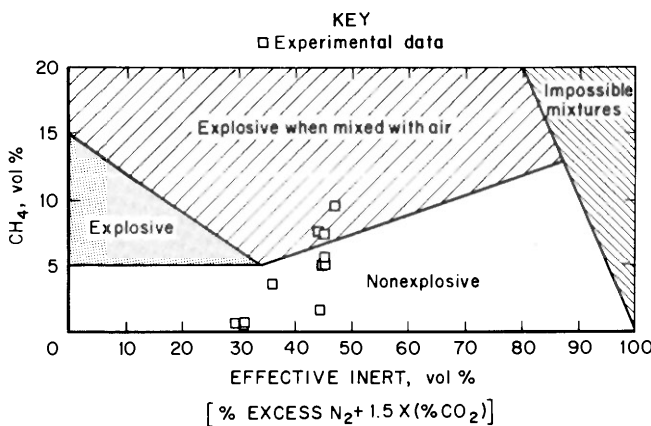

Figure 6.—Explosibility diagram for March data with observed gas concentrations plotted for all holes.

concentrations are encountered, the fuel-rich inert gas mixtures may become explosive if diluted with air (the upper portions of figure 6). Therefore, it is important to maintain the inert gas flow until the auger is removed from the hole. After a hole is completed, the auger head, which is the primary ignition source, is removed and the inert gas and methane in the hole will be ventilated with air.

Hole Profile

To better understand how the hole ventilated, holes 1 and 3 were profiled with the augers in place and immediately after auger removal. This analysis, shown in figure 7, indicated that the high methane levels present near the cutting head were gradually diluted inside the hole following extraction of the auger head. At methane concentrations over 5%, with the augers removed, sufficient inert gas was still present to preclude an explosion. When the inert gas system was left on during auger removal, the dilution of gas in the hole took place with inert gas rather than air. However, auger removal was rapid, about 25 s per cycle with 15 s per cycle required for pin pulling and stacking of the auger. Rapid removal of the auger steel volume slightly exceeded the inert gas volume. This was not considered significant based on the observed decline in methane levels.

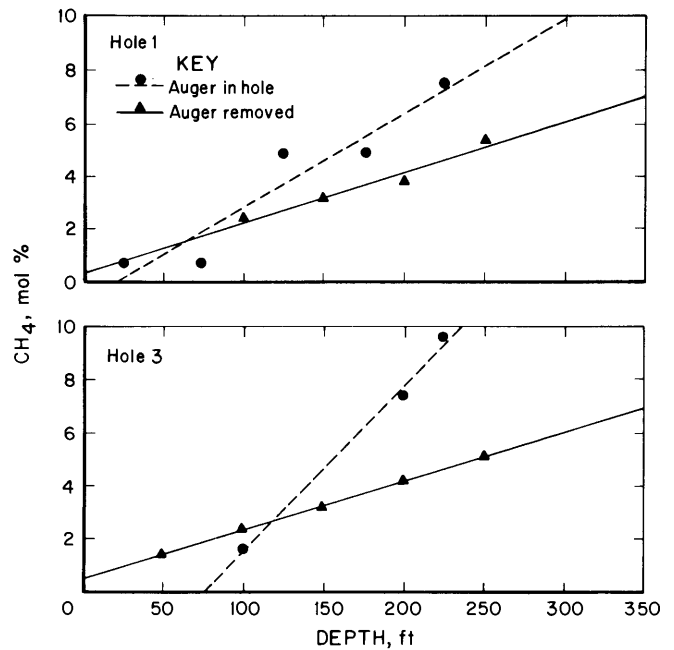

Figure 7.—Profiles of methane concentrations in holes 1 and 3 at maximum hole depth with augers in place, and immediately after auger removal.

Figure 7 also showed that methane concentrations near the collar of the hole remained less than 1.0% after auger removal. The data further showed that the high methane levels in the hole interior did not flow from the hole at that concentration. Rather, the methane was diluted inside the hole and any explosive gas mixtures created during dilution occurred inside the hole. A final observation from figure 7 was that with the augers in the hole, no methane was present at the collar despite high levels in the hole interior.

The long-term ventilation of the holes was determined by measuring holes 1 and 2 the following morning. Hole 1 was left open to the atmosphere, and hole 2 was partially sealed with brattice cloth. Table 5 contains the gas concentration differences. Concentrations the following morning showed methane levels in both holes had diminished from the previous day, although the covered hole still retained 1.7% methane. Hole 1 was ventilated with almost normal atmospheric levels of oxygen, indicating that this hole naturally ventilated. The sealed hole, in reality, was not totally sealed and was partially ventilated. From these data it is probably advisable to leave the holes open to self-ventilate rather than try to seal them to maintain inert concentrations.

Table 5.—Overnight ventilation of open and partially sealed holes

Hole and condition	Time, h	Sample depth, ft	CH ₄ , vol %	O ₂ , vol %	CO ₂ , vol %	CO, ppm
1, open . . .	0	308	5.94	11.69	3.13	538
	20	308	.38	20.60	.10	0
2, sealed . .	0	300	4.56	14.56	2.47	204
	15	300	1.7	18.9	.60	8

Time To Reach Inert Conditions

The theoretical time to fill the initial hole created by the head and lead augers (3.25 ft diameter by 26 ft deep) with inert gas depended on the gas flow rate, gas concentration, and the volume occupied by the augers and cut coal. The empty hole volume was 216 ft³ with about one-half of this volume occupied by the auger steel and cut coal. This left 108 ft³. At an inert gas flow rate of 56 cfm, one complete air change occurred in less than 2 min. Injecting the inert gas through a high-velocity jet along the top surface of the hole allowed for efficient penetration of the jet toward the auger head, which exceeded the theoretical time.

The concentration of the combined diesel and gasoline engine exhaust stream at the end of the stub pipe connector was 11.6% oxygen and 6.6% carbon dioxide. This

gas was directed into the hole with the stub pipe after the cutting head and lead augers were inserted. For the second hole, the depth was 26 ft. The hole measurement probe was at a depth of 24 ft. The time to reach inert conditions at the probe inlet was less than 2 min.

It is important to insert the stub pipe as soon as possible for two reasons. First, less time is required to reach inert conditions when the initial volume is small. Second, methane may be encountered near the highwall face. The initial portion of the data from hole 3 in figure 8 from 9:30 to 9:42 show that when the hole was drilled 44 ft prior to inserting the inert gas stub pipe, it took about 12 min to reach inert conditions at the end of the hole sample pipe located 33 ft into the hole. Furthermore, at that hole depth, the initial methane concentration was already 2%.

COLLAR MEASUREMENTS

The collar measurement location for hole 3, figure 8, showed the fluctuations of the gases found immediately inby the collar of the hole. This measurement location was 1 ft outby the end of the inert exhaust gas stub pipe. This area may be subject to influence of outside airflows; however, there was no noticeable periodicity that might be attributed to auger placement or penetration. The large fluctuation in the data at 10:44 was actually from a period when the sampling instruments were disconnected from the collar sample and shows the gas composition at a probe depth of 130 ft. As stated earlier, the initial portion of the data in figure 8 showed gas conditions 33 ft into the hole as the hole was initially inerted.

GAS CONTENT

Methane content of the samples from hole 4 taken in March averaged 0.30 cm³/g and ranged from 0.12 to 0.49 cm³/g. Ethane and higher hydrocarbons were consistently found, at a concentration of 0.001 to 0.005 cm³/g, respectively. Besides methane, ethane, and higher hydrocarbons, all samples emitted carbon dioxide. Carbon dioxide emitted was an order of magnitude less than the methane emitted. A summary of the gas content data is shown in table 6.

All samples showed a distinct affinity for oxygen and rapidly consumed all oxygen remaining in the container after sealing. This phenomenon has been well documented by Parr (8) and others, and in the past may have been partially responsible for restricting the explosibility of auger holes.

The emission rate of methane from the samples was so slow that it would seem to preclude that explosive conditions encountered in auger holes could be the result of

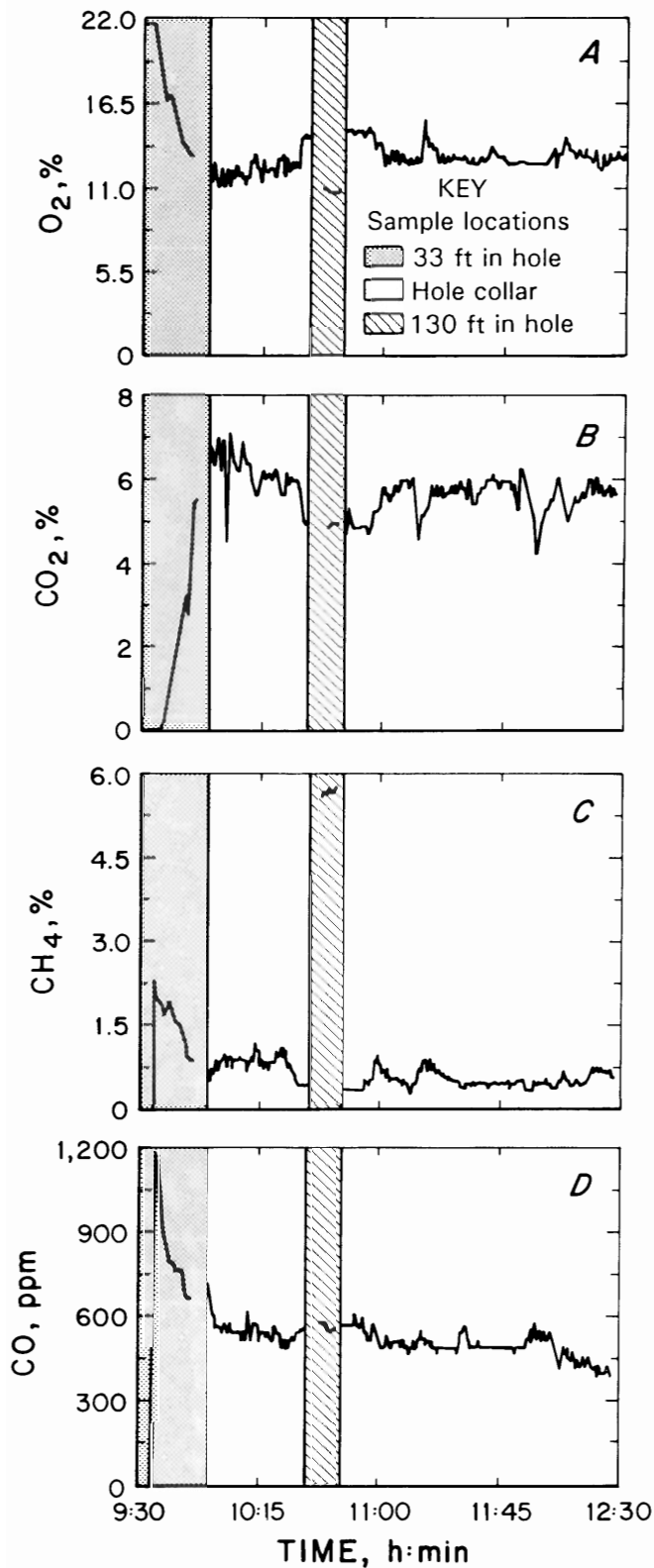

Figure 8.—Corrected infrared gas concentrations at the collar sample location for hole 3. Note data at 10:44 and initial inerting of hole were not collar samples.

desorption alone. A more likely scenario would involve slow desorption over time into a fracture or fissure in the coalbed or immediate roof. Free methane gas would build up in the crevice, the amount dependent on the size of opening and pressure conditions. When the cutting auger penetrates the methane-filled fissure, the gas immediately begins to flow into the auger hole because of the pressure differential. The large lead augers draw this methane to the face with incoming oxygen, creating potential explosive conditions. If the cutting bits strike a hard inclusion or the rock roof, the resulting hot smear could ignite the explosive mixture.

Table 6.—Coalbed gas content of samples from hole 4, No. 9 Coalbed, Henderson County, KY

Sample	Depth, ft	Date and time sampled	Analysis, cm ³ /g				
			O ₂	N ₄	CO ₂	CH ₄	C ₂ H ₆
BE3 ..	80	1/7/92 15:13	¹ -0.25	-0.02	0.014	0.49	0.005
BE4 ..	110	1/8/92 15:55	-.16	-.02	.009	.28	.004
BE5 ..	150	3/5/92 16:05	-.11	-.07	.008	.12	.001
BE6 ..	160	3/5/92 16:30	-.07	-.05	.004	.18	.001

¹Negative sign denotes gas adsorbed or consumed.

PERSONAL MONITORING

The highest personal exposure to carbon monoxide measured with the passive dosimeters was less than 20 ppm. This occurred on the auger pin puller. The conveyor side helper had only a trace of exposure, and the machine operator had no detectable exposure. It should be noted that the auger pin puller's exposure may have been due to periods when a brattice seal was being installed over the entrance of the hole. Spot measurements with the handheld CSE 270 were not able to detect carbon monoxide at the pin puller's normal work station.

Note also from the continuous carbon monoxide data in figure 8 that the collar concentrations averaged about 550 ppm inside the hole. The combination of dilution and distance from the collar of the hole accounts for the observed low personal exposure to carbon monoxide. The initial peak of 1,200 ppm occurred at startup of the gasoline engine when the catalytic converter was still cool. The effect of pit inversions was not investigated.

SYSTEM SAFETY

Since the safety of the system relies on sufficient quantity and quality of inert gas from the engines, these must be guaranteed. The system as tested in March contained two simple and independent methods of monitoring its performance. These were the functioning of the gasoline engine and the continuous oxygen monitor. Failure of either of these two components resulted in independent warnings to the operator of system malfunction.

Safety is also enhanced by the condensing water vapor from the exhaust inside the cool hole. Water vapor is also an inerting gas but was not included in this analysis. Furthermore, the condensing water may also serve to suppress dust.

OBSERVATIONS

Sampling of the interior of auger holes is not easily accomplished. Turbulence and air eddies near the collar make accurate measurements in this area difficult. The data support the thesis that gas concentrations immediately in by the collar of the hole follow the mining head into the hole. As augering proceeds, the hole remains in an inert condition provided a sufficient volume of inert gas is

present at the collar. Two measurements are required to determine this condition: a volume measurement of the exhaust gas flow and the concentration of oxygen.

The volume measurement may be taken with a vane anemometer or Pitot tube, and the appropriate correction factor applied. The brattice window technique may also be used for confirmation of the correction factor. For the operator, a visual check can be made by observing direction of movement of dust or smoke during periods of maximum penetration. This movement should always be out of the hole.

Measurement of the oxygen level of exhaust alone is sufficient to indicate the inert condition of the hole. A level of 12% oxygen in the exhaust in combination with 6% carbon dioxide provided levels in the hole that remained inert. These measurements could be made with a handheld oxygen detector, bottle samples, or an in-line continuous oxygen detector. Because of the long time for analysis, bottle samples should only be used for compliance monitoring or instrument confirmation. Since combustion engines reduce oxygen levels and produce carbon dioxide, measurement of oxygen alone from a combustion source implies the production of carbon dioxide. Therefore, it is not essential that carbon dioxide be measured on a routine basis.

CONCLUSIONS

The concept of using inert gas to prevent explosions, as described in this report, resulted in nonexplosive gas concentrations under all circumstances when an ignition was possible. The method described represents the best approach to date to prevent explosions when auger-type highwall machines encounter substantial quantities of methane.

Adequate volumes and concentrations of inert gas may be produced by a combination of diesel and gasoline engines, or a gasoline engine alone, if adequate gas volumes can be generated. The gas may be introduced into the hole via a stub pipe inserted into the hole above augers after the lead augers have been inserted. Alternatively, if augers are not reduced in size to allow placement of a stub pipe, a shroud may be used, which surrounds the collar of the hole with inert gas. Gas volumes for shroud systems were not determined.

Application of this technique is simple and easily monitored. Mine personnel have good understanding of the

engines used to produce the inert gas, and the plumbing of this gas into the hole is not complex. The method, therefore, should have high acceptance by the miners. It is recommended that the auger drill operator be provided with a real-time oxygen indicator that would monitor the oxygen levels in the exhaust gas and give the operator a warning if levels rise above 12%.

It must be pointed out that the system should be monitored closely and is dependent on adequate quantities and concentrations of inert gas as well as timely placement of the inert gas pipe into the collar of the hole. Measurement of the volume and concentration of gas at the collar of the hole is indicative of the conditions at the cutterhead. To ensure that inert conditions are present at the cutterhead during mining, a sufficient volume of low oxygen concentration gas is required. Successful implementation of this simple method will improve safety of highwall mining by eliminating possible explosion hazards.

REFERENCES

1. Federal Water Quality Administration, U.S. Department of the Interior. Feasibility Study on Mining Coal in an Oxygen Free Atmosphere. NTIS PB-197446, Aug. 1970, 162 pp.
2. Zabetakis, M. G. Flammability Characteristics of Combustible Gases and Vapors. BuMines B 627, 1965, 121 pp.
3. Paczkowski, V., G. A. Tracey, and A. Wojtyczka. CMI Inert Gas Mine Firefighting System (contract J0318080, CSE Corp., Monroeville, PA). BuMines OFR 212-83, 1982, 56 pp.; NTIS PB 84-142678.
4. Vinson, R. P. The Brattice Window Technique. BuMines RI 8240, 1977, 12 pp.
5. Zabetakis, M. G., R. W. Stahl, and H. A. Watson. Determining the Explosibility of Mine Atmospheres. BuMines IC 7901, 1959, 11 pp.
6. Ulery, J. P., and D. M. Hyman. The Modified Direct Method of Gas Content Determination: Applications and Results. Paper in Proceedings of the 1991 Coalbed Methane Symposium. Univ. AL—Tuscaloosa, 1991, pp. 489-499.
7. Urosek, J. (Mine Safety and Health Administration). Personal communication. Further information available from J. Urosek, MSHA, 4800 Forbes Ave., Pittsburgh, PA 15213.
8. Parr, S. W., and P. Barker. The Occluded Gases in Coal. Univ. IL Eng. Exp. Station Bull. 32, 1909, 28 pp.