



IC 9486  
Information Circular/2006

# Handbook for Methane Control in Mining

**Information Circular 9486**

# **Handbook for Methane Control in Mining**

**By Fred N. Kissell, Ph.D.**

DEPARTMENT OF HEALTH AND HUMAN SERVICES  
Centers for Disease Control and Prevention  
National Institute for Occupational Safety and Health  
Pittsburgh Research Laboratory  
Pittsburgh, PA

June 2006

## ORDERING INFORMATION

Copies of National Institute for Occupational Safety and Health (NIOSH)  
documents and information  
about occupational safety and health are available from

NIOSH–Publications Dissemination  
4676 Columbia Parkway  
Cincinnati, OH 45226–1998

FAX: 513–533–8573  
Telephone: 1–800–35–NIOSH  
(1–800–356–4674)  
e-mail: [pubstaft@cdc.gov](mailto:pubstaft@cdc.gov)  
Website: [www.cdc.gov/niosh](http://www.cdc.gov/niosh)

*This document is in the public domain and may be freely copied or reprinted.*

---

Disclaimer: Mention of any company or product does not constitute endorsement by the National Institute for Occupational Safety and Health (NIOSH). In addition, citations to Web sites external to NIOSH do not constitute NIOSH endorsement of the sponsoring organizations or their programs or products. Furthermore, NIOSH is not responsible for the content of these Web sites.

## CONTENTS

	<i>Page</i>
About this handbook .....	1
Acknowledgments .....	1
Chapter 1.—Facts about methane that are important to mine safety, by F. N. Kissell .....	3
Chapter 2.—Sampling for methane in mines and tunnels, by F. N. Kissell .....	27
Chapter 3.—Methane control at continuous miner sections, by F. N. Kissell, C. D. Taylor, and G. V. R. Goodman .....	37
Chapter 4.—Preventing methane ignitions at longwall faces, by F. N. Kissell and A. B. Cecala .....	55
Chapter 5.—Bleeder systems in underground coal mines, by J. E. Urosek, W. J. Francart, and D. A. Beiter .....	63
Chapter 6.—Coal seam degasification, by P. C. Thakur .....	77
Chapter 7.—Managing excess gas emissions associated with coal mine geologic features, by J. P. Ulery .....	97
Chapter 8.—Forecasting gas emissions for coal mine safety applications, by C. O. Karacan and W. P. Diamond .....	113
Chapter 9.—Control of methane during coal mine shaft excavation and filling, by F. N. Kissell .....	127
Chapter 10.—Methane control in highwall mining, by J. C. Volkwein and F. N. Kissell .....	135
Chapter 11.—Control of methane in coal silos, by F. N. Kissell .....	141
Chapter 12.—Explosion hazards of coal dust in the presence of methane, by K. L. Cashdollar and M. J. Sapko ..	147
Chapter 13.—Methane control in metal/nonmetal mines, by H. J. Head and F. N. Kissell .....	151
Chapter 14.—Preventing methane gas explosions during tunnel construction, by F. N. Kissell .....	169
Index .....	181

## ILLUSTRATIONS

1-1. Depiction of methane being diluted into a moving air stream .....	4
1-2. Methane explosibility diagram .....	5
1-3. Effect of elevated pressure on methane explosibility limits .....	6
1-4. Estimated methane content of coal versus depth and rank .....	10
1-5. Original gas content of mined coal versus mine emission .....	11
1-6. Methane layering with roof, side, and floor sources .....	14
1-7. Recirculation in a heading .....	15
1-8. Dust scrubber recirculation .....	15
1-9. Ignitions per year per gate road .....	18
1-10. Relative frequency of occurrence of major and minor gas and dust explosions .....	20
2-1. Depiction of methane being diluted into a moving air stream .....	29
2-2. Methane profile map from a simulated continuous miner face .....	32
2-3. Recorder chart from a machine-mounted methane monitor .....	33
3-1. Recorder chart from a machine-mounted methane monitor .....	37
3-2. Peak average methane emissions for several U.S. coalbeds .....	38
3-3. Ventilation setback distance .....	39
3-4. Methane dilution capacity for exhaust line curtain at setbacks of 10 ft and 20 ft .....	39
3-5. Spray fan system on a continuous miner .....	40
3-6. Methane dilution capacity of the spray fan system .....	41
3-7. Dust scrubber used in conjunction with blowing ventilation .....	42
3-8. Methane dilution capacity from MSHA scrubber tests .....	42
3-9. Test configuration used by Thimons et al. ....	43
3-10. Dust scrubber used with exhaust ventilation .....	45
3-11. Graph showing that performance of a spray fan depends on water pressure .....	47
3-12. Effect of bit wear on frictional ignition .....	49
4-1. Increased methane liberation during coal bumps .....	56
4-2. Modified shearer-clearer system .....	56
4-3. Methane concentration at shearer during tail-to-head pass .....	57
4-4. Plan view of walkway and gob curtains .....	57
4-5. Walkway curtain at support No. 3 forces air over the shearer .....	58

## ILLUSTRATIONS—Continued

	<i>Page</i>
4-6. Upwind-pointing venturi spray creates eddy zone and methane buildup . . . . .	58
4-7. L-shaped wing curtain, which can cause methane buildup . . . . .	59
4-8. Anti-ignition back spray . . . . .	60
4-9. Best methane monitor location . . . . .	61
5-1. Simplified illustration of a wrap-around bleeder system for a longwall panel . . . . .	64
5-2. Simplified illustration of a flow-through system with bleeder entries . . . . .	65
6-1. Gas content of coal versus gas pressure for some U.S. coals . . . . .	80
6-2. Generalized optimum point for methane drainage . . . . .	81
6-3. Simplified illustration of a typical longwall panel layout in a U.S. coal mine . . . . .	82
6-4. Limits of the gas emission space . . . . .	82
6-5. Longwall panel methane drainage . . . . .	83
6-6. Premining methane drainage from surface . . . . .	84
6-7. Methane drainage by the packed cavity method . . . . .	86
6-8. Partially filled longwall gob . . . . .	87
6-9. Methane drainage with cross-measure boreholes . . . . .	87
6-10. Methane drainage by the superjacent method . . . . .	89
6-11. Simplified illustration of methane drainage by vertical gob wells . . . . .	89
6-12. Underground methane pipe installation . . . . .	91
6-13. Surface installation for horizontal drainage boreholes . . . . .	92
7-1. Methane drainage scenarios for paleochannels . . . . .	99
7-2. Methane drainage of a normal fault from the “footwall” side . . . . .	102
7-3. Methane drainage of a normal fault from the “hanging” wall side . . . . .	102
7-4. Methane drainage of a reverse fault from the “hanging” wall side . . . . .	103
7-5. Methane drainage of a reverse fault from the “footwall” side . . . . .	103
7-6. Typical clay vein acting as a barrier to gas migration . . . . .	104
7-7. Methane drainage of a clay vein gas barrier . . . . .	105
7-8. Hypothetical gas cell formed by clay veins . . . . .	106
8-1. Methane content as a function of depth and coal rank . . . . .	115
8-2. Gas content versus depth and coal rank, Black Warrior basin, Alabama . . . . .	115
8-3. PFG/FGK method to predict gas emissions in a previously disturbed zone . . . . .	120
8-4. Gas pressure method: residual gas pressure lines are dependent on thickness of the mined coalbed . . . . .	121
9-1. Mine shaft under construction . . . . .	127
9-2. Ventilation airflow is restricted by work deck . . . . .	129
9-3. Water ring in shaft wall . . . . .	130
9-4. Raise bore shaft with second hole for ventilation . . . . .	131
10-1. Explosibility diagram for methane-air-inert gas mixtures . . . . .	136
10-2. Schematic of inert gas system for auger mining . . . . .	137
11-1. Desorption test apparatus . . . . .	142
11-2. Gas emitted from conveyor belt grab samples . . . . .	142
11-3. Methane concentration gradient above the coal in coal silo . . . . .	143
12-1. Flammable limits for mixtures of methane and coal dust . . . . .	149
13-1. Relation between quantitative composition and explosibility of mixtures of methane and air . . . . .	154
13-2. Examples of methane emission as reported in South African metal/nonmetal mines . . . . .	162
14-1. Low concentrations of methane gas . . . . .	170
14-2. Exhausting system of face ventilation . . . . .	173
14-3. Blowing system of face ventilation . . . . .	173
14-4. TBM ventilation system with low airflow zone where methane dilution suffers . . . . .	174
14-5. TBM ventilation system with second duct exhausting air from the face . . . . .	175
14-6. Auxiliary system with adequate overlap . . . . .	175
14-7. Auxiliary system with no overlap and poor methane dilution . . . . .	175
14-8. Loss of efficiency from mismatched airflow directions . . . . .	176

## TABLES

6-1. Major coal mine explosions in the United States, 1970–present .....	78
6-2. Gassiness of coal seams .....	79
6-3. Methane capture ratios for postmining methane drainage techniques .....	88
14-1. Initiating events for tunnel methane explosions .....	180

### UNIT OF MEASURE ABBREVIATIONS USED IN THIS REPORT

cc/g	cubic centimeter per gram	L/kg	liter per kilogram
cf/d	cubic foot per day	lb	pound
cfm	cubic foot per minute	lb/ft <sup>3</sup>	pound per cubic foot
cm	centimeter	m	meter
cm <sup>3</sup>	cubic centimeter	m <sup>3</sup>	cubic meter
ft	foot	m/sec	meter per second
ft <sup>2</sup>	square foot	m <sup>3</sup> /sec	cubic meter per second
ft <sup>3</sup>	cubic foot	mD	millidarcy
ft <sup>3</sup> /st	cubic foot per short ton	min	minute
ft/min	foot per minute	mm	millimeter
ft <sup>3</sup> /min	cubic foot per minute	oz/ft <sup>3</sup>	ounce per cubic foot
g	gram	ppm	part per million
gpm	gallon per minute	psi	pound per square inch
hr	hour	psig	pound per square inch gauge
in	inch	rpm	revolution per minute
in <sup>3</sup>	cubic inch	scfm	standard cubic foot per minute
kg/m <sup>3</sup>	kilogram per cubic meter	sec	second
kg/sec	kilogram per second	vol %	volume percent
kV	kilovolt	°C	degree Celsius
L	liter	°F	degree Fahrenheit



# HANDBOOK FOR METHANE CONTROL IN MINING

Fred N. Kissell, Ph.D.,<sup>1</sup> Editor

---

## ABOUT THIS HANDBOOK

This handbook describes effective methods for the control of methane gas in mines and tunnels. It assumes the reader is familiar with mining. The first chapter covers facts about methane important to mine safety, such as the explosibility of gas mixtures. The second chapter covers methane sampling, which is crucial because many methane explosions have been attributed to sampling deficiencies.

Subsequent chapters describe methane control methods for different kinds of mines and mining equipment, primarily for U.S. coal mines. These coal mine chapters include continuous miners and longwalls, including bleeders. Coal seam degasification is covered extensively. Other coal mine chapters deal with methane emission forecasting and predicting the excess gas from troublesome geologic features like faults. Additional coal chapters contain methane controls for shaft sinking and shaft filling, for surface highwall mines, and for coal storage silos.

Major coal mine explosion disasters have always involved the combustion of coal dust, originally triggered by methane. Thus, a chapter is included on making coal dust inert so it cannot explode. Methane is surprisingly common in metal and nonmetal mines around the world, as well as in many tunnels as they are excavated. Accordingly, a chapter is included on metal and nonmetal mines and another on tunnels.

Proper ventilation plays the major role in keeping mines free of hazardous methane accumulations. The ventilation discussed in this handbook, except for the chapter on bleeder systems, deals only with so-called face ventilation, i.e., ventilation of the immediate working face area, not ventilation of the mine as a whole. The omission of whole-mine ventilation was necessary to keep this handbook to a reasonable size and because a huge amount of excellent information is available on the subject.<sup>2</sup>

## ACKNOWLEDGMENTS

Much credit is due to Joe Schall, the Giles Writer-in-Residence at The Pennsylvania State University, for providing valuable help in editing this handbook.

---

<sup>1</sup>Research physical scientist, Pittsburgh Research Laboratory, National Institute for Occupational Safety and Health, Pittsburgh, PA (retired).

<sup>2</sup>See the following:

Hartman HL, Mutmanský JM, Ramani RV, Wang YJ [1997]. Mine ventilation and air conditioning. 3rd ed. New York: John Wiley & Sons, Inc.

McPherson MJ [1993]. Subsurface ventilation and environmental engineering. Kluwer Academic Publishers.

Tien JC [1999]. Practical mine ventilation engineering. Chicago, IL: Intertec Publications.





## CHAPTER 1.—FACTS ABOUT METHANE THAT ARE IMPORTANT TO MINE SAFETY

By Fred N. Kissell, Ph.D.<sup>1</sup>

### *In This Chapter*

- ✓ The explosibility of methane gas mixtures
- ✓ Effect of pressure and temperature on explosibility
- ✓ Less common sources of methane ignitions
- ✓ The amount of methane stored in coal
- ✓ Forecasting the methane emission rate
- ✓ Layering of methane at the mine roof
- ✓ When the recirculation of mine air is hazardous
- ✓ The importance of higher air velocity in preventing methane explosions

*and*

- ✓ Mine explosions, barometric pressure, and the seasonal trend in explosions

Dealing with methane in mines and tunnels requires knowledge of the circumstances under which dangerous accumulations of methane are likely to occur. This knowledge involves the properties of the gas itself, an awareness of where these accumulations are likely to occur, and facts on how methane mixes safely into the mine air.

The other chapters in this handbook address the handling of methane under a variety of specific circumstances, such as at continuous miner faces or coal storage silos. This chapter addresses some broad concepts that serve as a foundation for the suggestions provided in other chapters.

### THE EXPLOSIBILITY OF METHANE GAS MIXTURES

Methane entering a mine or tunnel often enters as a localized source at high concentration. Figure 1–1 depicts a cloud of methane being diluted into a moving air stream. In this illustration, methane enters the mine from a crack in the roof. As the methane emerges from the crack, it progressively mixes with the ventilation air and is diluted. In the event that this progressive dilution reduces the concentration from 100% to 1%,<sup>2</sup> as shown in Figure 1–1, the methane passes through a concentration range of 15% to 5%, known as the explosive range. In the explosive range, the mixture may be ignited. Above 15%, called the upper explosive limit (UEL), methane-air mixtures are not explosive, but will become explosive when mixed with more air.

---

<sup>1</sup>Research physical scientist, Pittsburgh Research Laboratory, National Institute for Occupational Safety and Health, Pittsburgh, PA (retired).

<sup>2</sup>Concentration percentage values refer to percent by volume.

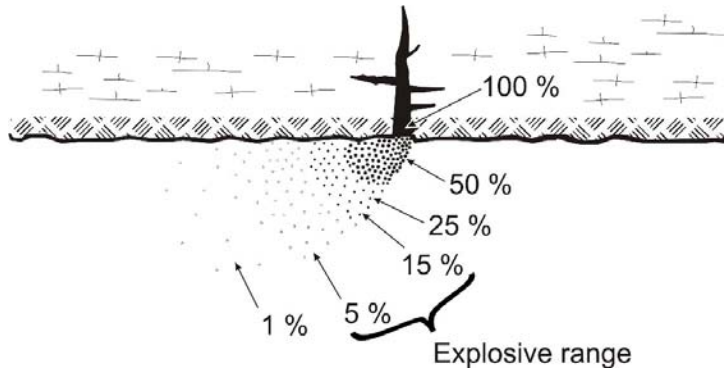

Figure 1-1.—Depiction of methane being diluted into a moving air stream.

Below 5%, called the lower explosive limit (LEL), methane-air mixtures cannot ignite.<sup>3</sup>

Because methane always passes through an explosive range during dilution, an effective mine ventilation system will ensure that this passage through the explosive range is as rapid as possible and that the volume of gas mixture in or above the explosive range is minimized.

**Even though methane-air mixtures under 5% are not explosive, worldwide experience with methane in mines has indicated that a considerable margin of safety must be provided.**

**Addition of inert gases.** An inert gas such as nitrogen or carbon dioxide cannot chemically react with methane. As a result, inert gases can be added to an explosive methane-air mixture to make it nonexplosive.

Explosibility diagrams are available to find how much inert gas is necessary. For example, Zabetakis et al. [1959] have provided a helpful explosibility diagram that shows whether a methane-air mixture is explosive after an inert gas such as nitrogen or carbon dioxide is added (Figure 1-2). This diagram shows that methane-air-inert gas mixtures fall into one of three categories: (A) explosive, (B) explosive when mixed with air, or (C) nonexplosive, depending on the percentage of methane and the percentage of “effective inert.” Effective inert is calculated from the percentage of “excess nitrogen”<sup>4</sup> and the percentage of carbon dioxide in the mixture.

<sup>3</sup>Sometimes the UEL and LEL are referred to as the upper and lower flammable limits (UFL and LFL).

<sup>4</sup>The percentage of excess nitrogen is the percentage of nitrogen in the sample minus the percentage of “normal nitrogen.” Normal nitrogen is calculated from the ratio of nitrogen to oxygen normally found in air—a factor of 3.8. To calculate the effective inert, suppose, for example, that inert gas is added to a methane-air mixture and that a gas analysis shows that the final mixture has 6.6% oxygen, 4% carbon dioxide, 4.3% methane, and 85.1% nitrogen. The effective inert is then determined in three steps. First, in this example, the oxygen percentage is 6.6%, so the percentage of normal nitrogen is 3.8 times 6.6%, or 25.1%. Second, since the percentage of excess nitrogen is the percentage of nitrogen in the sample minus the percent of normal nitrogen, the excess nitrogen is 85.1% minus 25.1%, or 60%. Third, according to the equation shown in Figure 1-2, since the carbon dioxide in the sample is 4%, the effective inert is now 60%, plus 1.5 times (4%), or 66%. This gives the “composition point” shown in Figure 1-2. (Carbon dioxide has been found to be 50% more effective than nitrogen in inerting, so a multiplying factor of 1.5 is used).

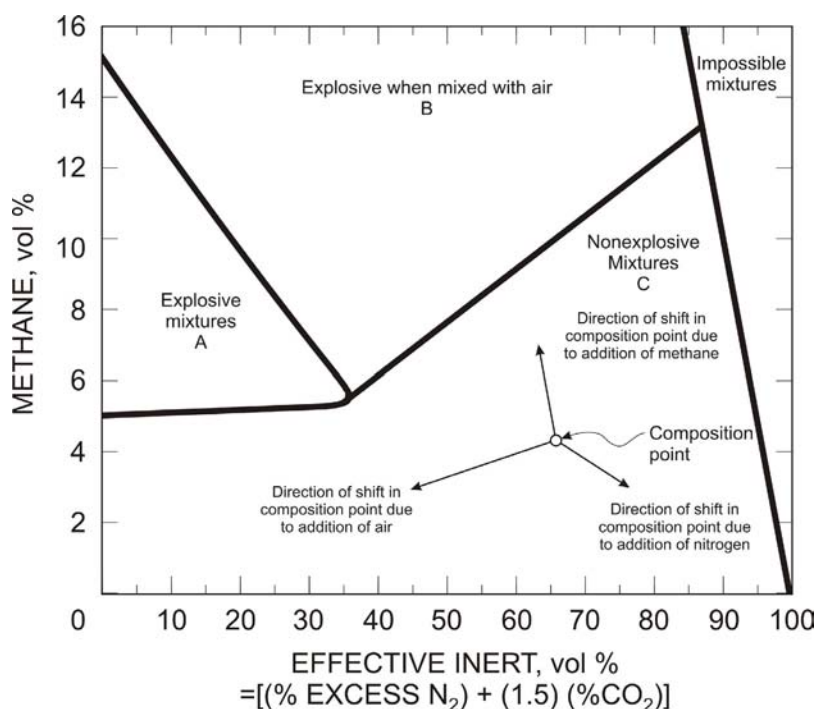

Figure 1-2.—Methane explosibility diagram (from Zabetakis et al. [1959]).

tures in air are calculated using Le Chatelier’s law [1891]. This law specifies that if one gas mixture at its lower explosive limit is added to another gas mixture also at its lower explosive limit, then the combination of the mixtures will be at the lower explosive limit of the combination. Mathematically,

$$L = \frac{100}{P_1/L_1 + P_2/L_2 + \cdots + P_X/L_X},$$

where  $P_1 + P_2 + \cdots + P_X = 100$ . Here, we have gas mixtures of gas #1, gas #2, and up through gas #X. L is the lower explosive limit of the mixture, P is the proportion of each gas in the mixture, and  $L_1$ ,  $L_2$ , and  $L_X$  are the lower explosive limits in air for each combustible gas separately [Jones 1929].

**Combinations of both flammable and inert gases.** For combinations of both flammable and inert gases in air, explosive limits can be obtained through diagrams provided by Zabetakis et al. [1959]. More explosibility diagrams are available from other sources, and Holding [1992] has reviewed the features of each of them.

## EFFECTS OF PRESSURE AND TEMPERATURE ON EXPLOSIBILITY

**Effect of pressure on explosibility limits.** According to Kuchta [1985], the flammability limits of hydrocarbon vapor-air mixtures (such as methane-air mixtures) vary only slightly with

Figure 1-2 shows a “composition point” with 4.3% methane and 66% “effective inert.” The arrows indicate how the composition point is shifted by the addition of more methane, more air, or more inert gas. For example, adding more air shifts the composition point in the direction of 100% air (0% methane, 0% effective inert), whereas adding more nitrogen shifts the composition point in the direction of 100% effective inert (0% methane, 0% air).

**Addition of other flammable gases to air.** Mine gas mixtures can contain flammable gases other than methane, principally ethane, hydrogen, and carbon monoxide. The explosive limits of these mix-

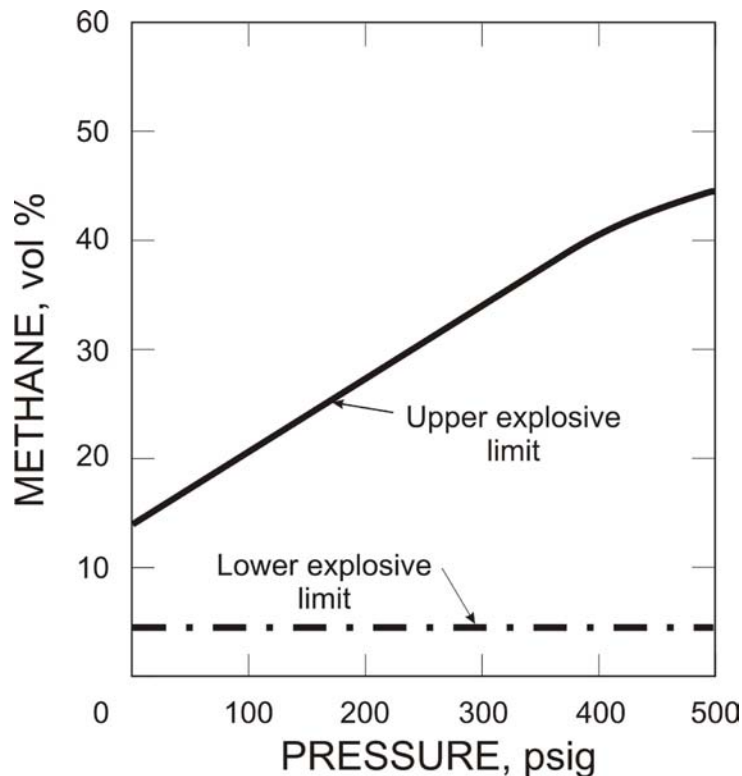

Figure 1-3.—Effect of elevated pressure on methane explosibility limits.

reduced pressure, except at very low pressures, such as below  $\frac{1}{4}$  atmosphere. At elevated pressures, the lower limits of hydrocarbon-air mixtures generally decrease slightly, but the upper limits increase greatly. Figure 1-3 shows the variation in methane lower explosive limit and upper explosive limit with elevated pressure.

**Effect of temperature on explosibility limits.** The effect of temperature on the explosibility limits of methane is modest. For example, the LEL of methane-air mixtures at  $-100\text{ }^{\circ}\text{C}$  is 5.6% methane, and at  $+100\text{ }^{\circ}\text{C}$  it is 4.8% methane. The UEL of methane-air mixtures at  $+100\text{ }^{\circ}\text{C}$  is 16.3% methane [Zabetakis 1965].

## LESS COMMON SOURCES OF METHANE IGNITIONS

There are many well-known methane ignition sources in mines, ranging from frictional ignitions caused by cutting bits (Chapter 3) to open flames, explosives, and electrical sparking. However, there are other less recognized ignition sources. A review of these is worthwhile here.

**Hot solids.** The temperature at which a hot solid can ignite methane is quite high. Coward and Ramsay [1965] report that the minimum ignition temperature in a closed vessel is about  $675\text{ }^{\circ}\text{C}$ , but when the hot surface is exposed to convection currents, the minimum temperature is higher. For example, ignition from a hot steel bar requires  $990\text{ }^{\circ}\text{C}$ . Kuchta [1985] found that ignitions by any heated surface depend on the dimensions of the surface. He reports methane ignition temperatures ranging from  $630$  to  $1,220\text{ }^{\circ}\text{C}$ .

However, when an ignitable dust is present on the hot surface, this dust is more readily ignited than methane. The burning dust can then ignite the methane. Kim [1977b] reported laboratory studies in which the spontaneous ignition temperature of coal dust layers was as low as  $160\text{ }^{\circ}\text{C}$ . As a result, Mine Safety and Health Administration (MSHA) regulations require that the surface

temperature of permissible electrical equipment and diesel equipment<sup>5</sup> in coal mines<sup>6</sup> not exceed 150 °C.

**Thermite sparking from light metal alloys.** When light metal alloys strike rusty steel, the resulting sparks can ignite methane. This so-called thermite sparking can appear in different ways. Thomas [1941] showed that striking aluminum-painted rusty iron with a tool could ignite methane. Margerson et al. [1953] readily ignited methane by dropping a piece of magnesium alloy onto a rusty steel plate. Findings such as these have inhibited the use of light metal alloys in mines.

**Today, sparking from light metals is minimized by using less incandive alloys. For example, MSHA<sup>7</sup> requires that aluminum fan blades contain no more than 0.5% magnesium.**

**Adiabatic compression.** McPherson [1995] has proposed that adiabatic compression of methane-air-coal dust mixtures by falling roof can be responsible for some methane ignitions in coal gobs. A theoretical model indicates that the temperatures attained are adequate to ignite such mixtures if the roof fall is extensive in plan area, but not necessarily of large thickness. In a later laboratory study by Lin et al. [1997], an experimental apparatus was built to simulate the adiabatic compression that might result from roof falls. This apparatus, which dropped a 1,320-lb weight, ignited the methane and dust when they were in the proper concentration range.

**Sliding (or impact) friction between blocks of rock or between rock and steel.** Sliding friction between falling blocks of sandstone or pyrites, or between hard rock and steel, can produce incandive streaks that ignite methane [Powell and Billinge 1975].

According to Coward and Ramsey [1965], methane ignitions from rock falling onto rock were reported as early as 1886. Laboratory experiments confirmed this effect. The higher the quartz content, the more likely an ignition; however, the necessary rubbing distance was always greater than could be envisioned from a fall underground. Ignitions from rock falling onto steel were reported as early as 1908 and seen throughout the 20th century, both underground<sup>8</sup> and in the laboratory. Today, the most likely source of steel-rock ignitions are cutter picks on mining machines, a topic covered in Chapter 3.

---

<sup>5</sup>The MSHA 150 °C requirement applies to diesel equipment intended for use in areas of the coal mine where permissible electrical equipment is required. Some state regulations require a surface temperature maximum of 150 °C for all diesel equipment in coal mines.

<sup>6</sup>In gassy metal/nonmetal mines, the diesel surface temperature limit is 204 °C (400 °F).

<sup>7</sup>Per 30 CFR 57. *Code of Federal Regulations*. See CFR in references.

<sup>8</sup>These ignitions were not always in coal mines. For example, an explosion in a Detroit water intake tunnel on December 11, 1971, killed 22 workers. The ignition was attributed to sparks caused by dropping a 23-in-diam drill bit a distance of 16 ft onto the concrete tunnel floor [Detroit Water and Sewerage Department 2005].

**Static electricity.** Protection against discharges of static electricity is a common feature of mine regulations. Precautions are required for electrical equipment, for explosives loaded into blastholes (30 CFR 57.6602), for nonmetallic rotating parts such as belts (30 CFR 18.26), for venturi air movers powered by compressed air, and for similar circumstances where static charges are likely to collect. The National Fire Protection Association [NFPA 2000] and many Internet sites have more information on how to prevent static electricity.

Although controlling static electricity in mines is important, it has not been a common source of methane explosions in underground mines, possibly due to higher humidity underground. Nevertheless, extra precaution should be taken where acetylene is used, since acetylene is much more easily ignited by static electricity than methane.

**Lightning.** The South African underground coal mining industry has seen many incidents related to the passage of lightning storms on the surface. These incidents included electrical shocks, visible sparking from mining equipment, premature detonation of explosives, and methane explosions. The majority were in shallow mines at depths of 300 ft or less. Precautions to prevent these lightning-related incidents included lightning warning techniques, the use of less sensitive detonators, modified blasting practices, and improved electrical grounding of mining equipment [Geldenhuys et al. 1985].

In the United States, lightning has been reported as the explosion source at two mines in Alabama [Checca and Zuchelli 1995]. Both mines had been worked since the 1970s and had large sections that had been abandoned and permanently sealed. The mines were deeper (500 and 1,200 ft) than those in South Africa. However, in the investigation following each of the explosions, it was found that the lightning strike occurred at a location where there was a convenient conduit for electrical current into a sealed area of the mine. In one instance, it was an old capped shaft; in the other, it was a test well with a metal casing that extended from a foot below the surface to a foot above the mine roof. On the surface, this test well was located in a fenced area that enclosed a methane-pumping unit.

More recently, Novak and Fisher [2000] conducted computer simulations of lightning propagation through the earth to confirm whether lightning could penetrate a 600-ft-deep mine with enough energy to trigger methane explosions. They found that the presence of a steel-cased borehole dramatically enhances the possibility of lightning starting an explosion. With a steel-cased borehole, the calculated voltage difference between a roof bolt adjacent to the borehole and a section of rail on the floor was 15.6 kV.

## THE AMOUNT OF METHANE STORED IN COAL

Coal is the major source of methane gas in mines. Smaller (but still dangerous) amounts of methane are found in oil shale, porous rock, and water. Methane in oil shale has been measured by Kissell [1975], Matta et al. [1977], and Schatzel and Cooke [1994]. Methane stored in porous

rock and water is of most concern in tunneling and has been discussed in some detail by Doyle [2001].<sup>9</sup>

**Methane in coal.** The amount of methane in coal is measured by using the “direct-method” test during exploration drilling from the surface, or it is estimated from the properties of the coal and the gas pressure or depth of the coalbed. The direct-method test for surface exploration drilling was first used by Kissell et al. [1973]. Improvements to the method were made by others [Diamond and Levine 1981; Ulery and Hyman 1991; Diamond et al. 2001]. McLennan et al. [1995] have written a thorough description of how to conduct a direct-method test and analyze the results.

In the direct method, a drill core of coal is brought to the surface, it is enclosed in an airtight container, and the methane emitted from the core is measured. The amount of gas that escaped the core as it was being brought to the surface is calculated. Later, the core is crushed and the residual gas given off during crushing is measured. Added together, these allow one to estimate the amount of gas in the coalbed.

A considerable amount of direct-method testing has taken place, so it is usually possible to get gas data for most U.S. coalbeds. For example, Diamond et al. [1986] have given the results of 1,500 direct-method tests on coal samples from more than 250 coalbeds in 17 states.

If direct-method results are not available, the amount of gas in coal may be roughly estimated from adsorption data. This estimate requires knowledge of the proximate analysis of the coal, assumes a standard moisture and ash content, and uses the hydrostatic head to estimate pressure [Kim 1977a]. Figure 1–4 summarizes methane content data for different rank coals at various depths using the hydrostatic head assumption.<sup>10</sup> However, because the actual pressure is often less than the pressure of the hydrostatic head,<sup>11</sup> the methane content values shown in Figure 1–4 are very much an upper limit.

## FORECASTING THE METHANE HAZARD

Additional hazard calls for additional precaution, so an estimate of the expected methane emission is valuable for both new and existing mines.

**Coal mines.** When an active mine is nearby, the most effective way to forecast the methane emission rate for a mine under development is to use the emission rate from a nearby mine (or section) where similar mining methods are used under similar geological conditions. Corrections can be made for those factors that are likely to shift the emission rate. Such factors are

---

<sup>9</sup>Doyle [2001] also provides a helpful discussion of methane in coal.

<sup>10</sup>The adsorption of mixed gases (methane and carbon dioxide) on coal has been measured by Lama [1988].

<sup>11</sup>Kim [1977a] has compared the actual pressure to the hydrostatic head pressure for several U.S. mines. The results varied from 50% to 100% of the hydrostatic head. For Australian mines, Lama and Bartosiewicz [1982] estimate gas pressures ranging from 50% to 90% of the hydrostatic head. For U.K. mines, Creedy [1991] reports that gas pressures are generally less than 20% of the hydrostatic head.



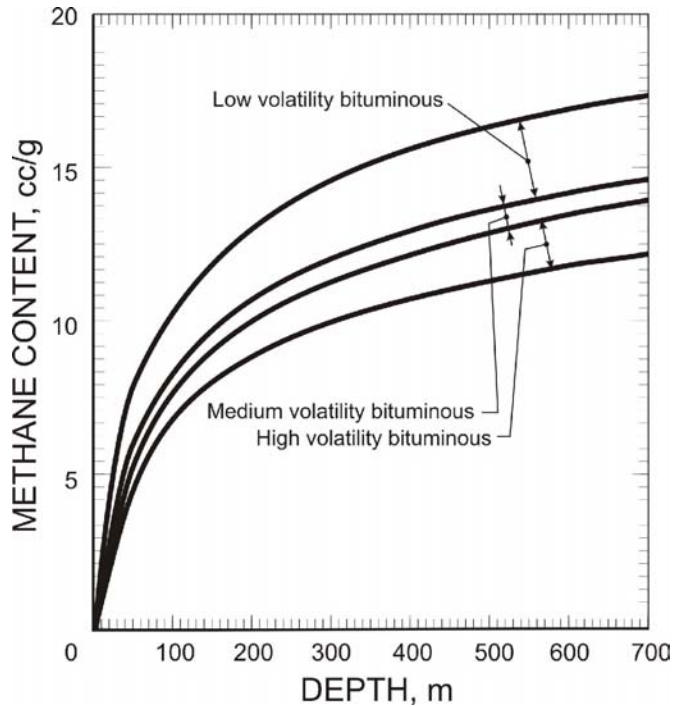

Figure 1-4.—Estimated methane content of coal versus depth and rank. Values shown are an upper limit.

differences in coalbed depth, differences in production rate, and geological anomalies<sup>12</sup> such as faults. Some of these corrections are simple, if inexact.<sup>13</sup>

When no other mine is nearby, a very rough emission forecast for the entire mine may be obtained using the gas content of the coal. For example, Saghafi et al. [1997] have reported the relationship between gas content and mine emission for Australian mines (Figure 1-5). The amount of methane released from the mine exceeded the methane in the mined coal by a factor of 4. This differs from the results of Kissell et al. [1973], who measured a factor of about 7 for some U.S. mines. The difference is probably due to methane emissions from adjacent coalbeds and porous rock. Other associations between mine emission and gas content have been made without using production data. Grau and LaScola [1984]

have correlated the mine emission of some U.S. mines in cubic feet per day with the in situ gas content in cubic feet per ton.<sup>14</sup>

**Much more on forecasting for coal mines is covered in the coal mine forecasting chapter (Chapter 8). Forecasting for metal and nonmetal mines is covered in this section. Forecasting for tunnels is covered in the tunneling chapter (Chapter 14).**

<sup>12</sup>The effect of geological anomalies is discussed in Chapter 7.

<sup>13</sup>Sometimes very inexact. For example, the methane emission can be assumed as roughly proportional to depth. However, Diamond and Garcia [1999] compared the methane emission rates of two longwall panels a mile apart. The second panel was 37% deeper than the first, but gave 61% higher emissions. The emissions were much higher because the elapsed time between development of the panel and retreat of the longwall face was much less in the second panel. Thus, there was less time for the second panel to drain gas into the returns, so when it was mined the emission was higher than expected.

<sup>14</sup>Grau and LaScola report 1980 mine emission data. Reliable U.S. data after 1980 are not available. As degasification programs became widespread, the degas quantities were retained as confidential information by coal companies.

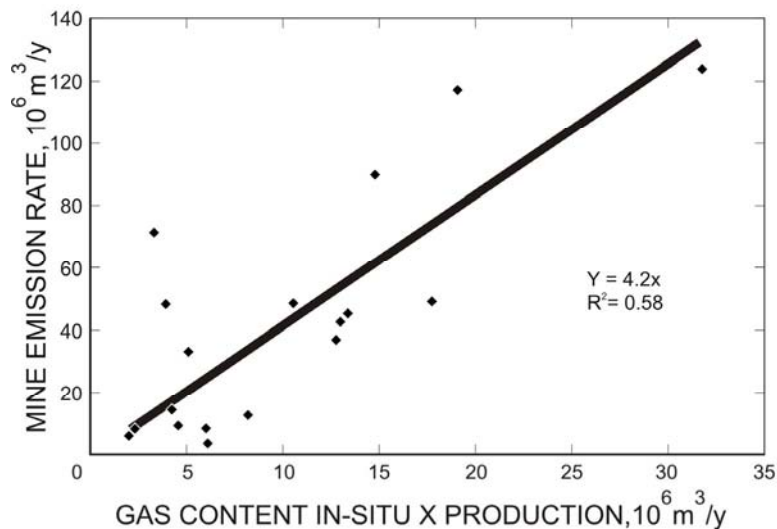

Figure 1-5.—Original gas content of mined coal versus mine emission. (Mines producing less than  $10^6$  tons/yr were omitted.)

methane explosions. Placement in these special regulatory categories (30 CFR 57, Subpart T) is usually triggered by a specific incident, such as measurement of a methane concentration of 0.25% or more, an ignition of methane in the mine, or an outburst in the mine if it is a salt mine.

Most of these incidents are probabilistic in nature. For example, as the methane hazard level increases, the chance of an ignition goes up, but an ignition (especially a small ignition that can serve as a warning) is by no means certain.

How then does the operator of a metal or nonmetal mine estimate the methane hazard level without waiting for such an incident to take place? Thimons et al. [1977] established a simple guideline that would enable mine personnel to evaluate the methane hazard. In their research, they measured trace methane concentrations in 53 metal and nonmetal mines. They found that mines with a return concentration exceeding 70 ppm of methane were inevitably classified as gassy.<sup>15</sup> Although a measurement of concentration alone is not the complete methane story,<sup>16</sup> a return concentration exceeding 70 ppm should serve as an alert to the presence of gas that has not yet shown itself in other ways.

In the last 25 years, sophisticated computer models have become available for coalbed methane forecasting. Most of these are driven by the need to estimate how much gas can be extracted to generate revenue. Chapter 8 deals with coalbed emission forecasting. Also, Creedy [1996] has provided a comprehensive report on methane prediction for coal mines.

#### **Metal and nonmetal mines.**

Metal and nonmetal mines that encounter methane emissions are placed by MSHA in a special regulatory category that requires extra precautions against

<sup>15</sup>In 1977, the MSHA classification system for mines with methane was different from the one in existence today. However, the triggers that lead to extra precautions (such as measurement of 0.25% or an ignition in the mine) are similar.

<sup>16</sup>See the section in this chapter on the importance of air velocity in preventing methane explosions.

## LAYERING OF METHANE AT THE MINE ROOF

The density of methane is roughly half that of air, so methane released at the mine roof may form a buoyant layer that does not readily mix into the ventilation air stream. Such layers have been the source of many mine explosions,<sup>17</sup> so it is important to understand the circumstances that led to the formation of methane roof layers and the methods used to dissipate them.

**Creedy and Phillips [1997] have written a thorough summary of methane layering and its implications for South African mines.**

**Detecting methane layers.** Methane layers are largely a result of inadequate ventilation. Raine [1960] asserted that a measurement of ventilation velocity is of most practical importance. He found that under conditions of “normal firedamp emission,”<sup>18</sup> an air velocity of 100 ft/min measured at the roof was enough to prevent layering.<sup>19</sup> Most current-day estimates of the necessary velocity are close to this value.<sup>20</sup>

An alternative approach to estimating the air velocity required to prevent layering is to use a “layering number,” devised by Bakke and Leach [1962]. The layering number is a dimensionless number expressed as—

$$L = \frac{U}{37 \cdot \sqrt[3]{\frac{V}{W}}}$$

where  $L$  is the layering number,  $U$  is the air velocity in feet per minute,  $V$  is the methane release rate in cubic feet per minute, and  $W$  is the entry width in feet. In layering experiments conducted by Bakke and Leach, methane was released at a single point at the mine roof, and the air velocity necessary to dilute the layer was measured. They found that mixing by turbulence began at layering numbers larger than 2, but that a layering number of 5 was necessary for adequate dilution.<sup>21</sup> Compared to the 100-ft/min criterion, the layering number concept is more difficult to apply because the methane release rate  $V$  is usually not known.

---

<sup>17</sup>For example, the 1993 Middelbult coal mine explosion in Secunda, South Africa, was attributed to a methane layer [Davies et al. 2000].

<sup>18</sup>The phrase “normal firedamp emission” was not further defined. However, it is clear that at abnormally high gas feeds, higher velocities are required. In a laboratory study, Bakke and Leach [1962] found that 230 ft/min air velocity was required to disperse a layer generated by a release of 12 ft<sup>3</sup>/min of methane.

<sup>19</sup>The 100 ft/min applies only to horizontal entries. Higher velocities are suggested for inclined entries [Bakke and Leach 1965].

<sup>20</sup>For example, McPherson [2002] suggests 0.4 m/sec, or about 80 ft/min.

<sup>21</sup>At high methane emission rates, the layering number suggests that velocities higher than 100 ft/min are necessary to prevent layering. For example, for a methane emission rate of 16 ft/min in a 16-ft-wide entry, the velocity required to prevent layering is 185 ft/min.

Aside from inadequate ventilation, there are other circumstances under which methane layers are probable. Airways next to gobs are an example. Many of the concerns about layers were sharpened by experience in the 1960s with advancing longwalls in the United Kingdom. At these longwalls, frequently traveled gate roads were directly adjacent to fresh longwall gob, where broken overburden provided a ready pathway for roof gas emissions.

Thorough gas monitoring is a key to dealing safely with methane layers. Care in monitoring is particularly important if—

- The air velocity measured at the roof level is 100 ft/min or less.
- The airway is next to a gob<sup>22</sup> or intersects a geologic anomaly, such as a fault, that can serve as a conduit for gas.
- The mine roof (or tunnel crown) is not within easy reach, so measurements at roof level are less apt to be carried out regularly.
- The airway has cavities [Titman et al. 1965; Vinson et al. 1978] or roof-level obstructions to air movement.
- The airway is inclined more than 5° [Bakke and Leach 1962].

Workers who test for methane layers should be aware that the gas concentrations in these layers may fall outside of the accurate operating range of catalytic heat of combustion sensors. For accurate operation of these sensors, the concentration of methane must be below 8% *and* the concentration of oxygen must be above 10%. Also, when measuring methane concentrations above 8%, instruments with catalytic heat of combustion sensors can act in a way that is misleading, responding with a rapid upscale reading followed by a declining or erratic reading<sup>23</sup> [CSA 1984]. Such instrument behavior is a tipoff to the possible presence of high, possibly explosive methane concentrations.

When the roof is high and beyond convenient reach, measurements may be made in two ways. First, the methane detector can be equipped with a remote “sample-draw” capability. Sample-draw systems use a small pump or a hand-squeezed bulb to pull the sample through an extension probe and pass it through the detector. Some methane detectors have an accessory sampling pump that attaches to the detector; others have a built-in pump.

Second, the methane detector can be attached to a cradle at the end of a long handle, which is then extended to the roof. This method permits a direct reading without aspiration if the user has

---

<sup>22</sup>Five miners were killed in a 1972 methane explosion at the Itmann No. 3 Mine in West Virginia. The explosion was in a trolley haulageway that ran adjacent to a longwall gob and was attributed to excessive pressure from the adjacent strata [Richmond et al. 1983].

<sup>23</sup>Some instruments will report this as an out-of-range condition. For more information, consult the operating instructions for the instrument.

good eyesight.<sup>24</sup> Otherwise, the audible alarm on the detector could be set to engage at a low methane level.

**Mitigating methane layers.** Methane layers are removed by increasing the ventilation quantity and reducing the gas flow by methane drainage. In instances where the source and layer size are limited,<sup>25</sup> a less satisfactory, but workable method is to use a (well-grounded) compressed air-powered venturi air mover or an auxiliary fan at each methane source to blow air at the source of the layer and disperse it [Creedy and Phillips 1997]. In either case, an aggressive sampling program is necessary to ensure safe conditions.

**Keep in mind that methane mixed with air cannot unmix to form a layer.**

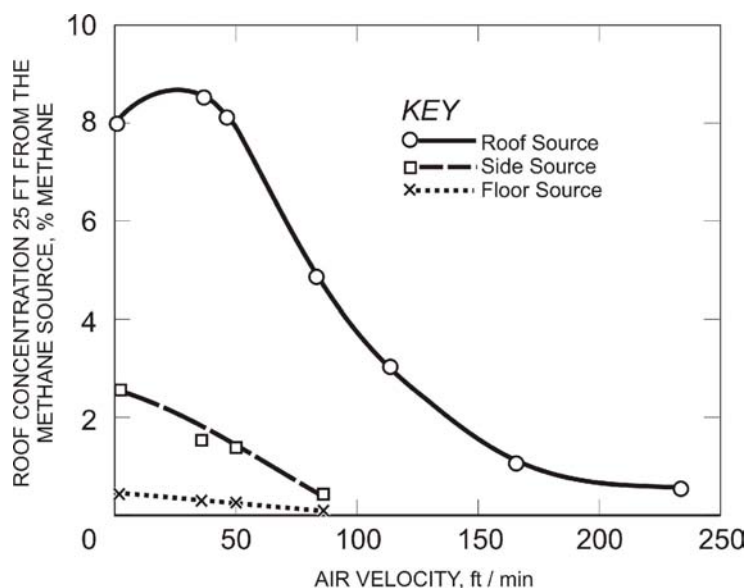

**The rib and floor as sources of methane layers.** Methane layering occurs when methane is released at the mine roof. When methane is released at the mine floor or rib, this gas readily mixes into the ventilation air stream, losing its buoyancy. Figure 1-6, from Bakke and Leach [1962], compares 2-cfm methane sources at the roof, rib, and floor of the mine entry. Only the roof source produced a significant methane layer at the 2-cfm rate.<sup>26</sup>

Figure 1-6.—Methane layering with roof, side, and floor sources (from Bakke and Leach [1962]).

## WHEN RECIRCULATION OF MINE AIR CAN BE HAZARDOUS

**Recirculation leads to higher methane levels only when recirculated air *replaces fresh air*.**

<sup>24</sup>See the sampling chapter (Chapter 2) and the sections on methane detection in the continuous miner chapter (Chapter 3).

<sup>25</sup>For example, the immediate face area in a tunnel boring machine.

<sup>26</sup>The testing did not rule out the possibility of a layer at higher methane flows.

Recirculation of mine air takes place when some portion of return air is picked up by a fan and returned to the intake, potentially raising the contaminant level of the intake air. Concerns about whether recirculation is a hazard have persisted for decades. The first theory and experiments on the recirculation of mine air were reported by Bakke et al. [1964]. They concluded from a material balance<sup>27</sup> and from experiments that the concentration of methane leaving any region is equal to the flow of methane into the region divided by the flow of fresh air into the region. The recirculation hazard is higher only if the amount of fresh air is reduced.

An example of potentially hazardous recirculation in headings is shown in Figure 1-7. Here, the region is a heading designated *ABCD*. Within the heading is an auxiliary fan moving an air quantity  $Q$ . The fan inlet is in the wrong location, so the air entering the fan is some portion of fresh air  $nQ$  and some portion of methane-laden return air  $(1 - n)Q$  (where  $n$  varies between 0 and 1). The concentration of methane is then:  $c = V/nQ$ .<sup>28</sup> Had the fan inlet been positioned at a better location, L1, the proportion of fresh air would be greater, the value of  $n$  would be higher, and the methane concentration lower. Had the fan inlet been positioned at location L2, the proportion of fresh air would be less, the value of  $n$  would be lower, and the methane concentration higher.

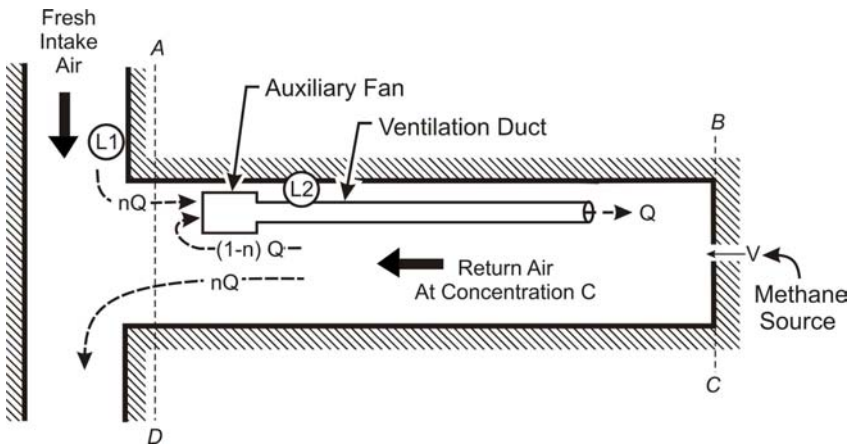

Figure 1-7.—Recirculation in a heading.

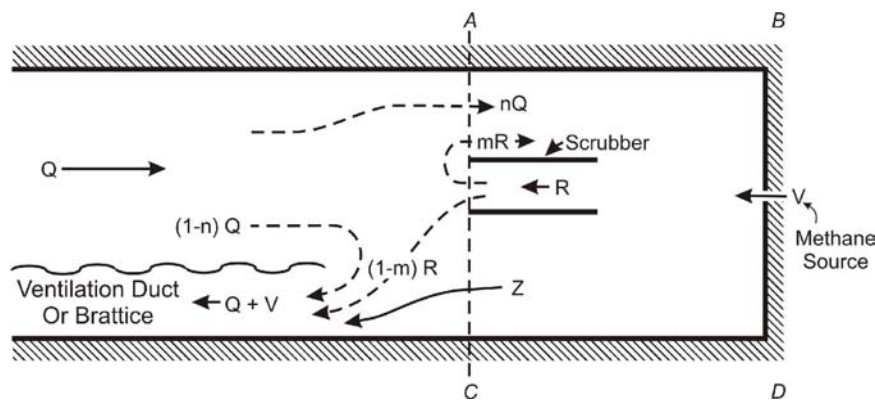

Figure 1-8.—Dust scrubber recirculation.

Recirculation caused by dust scrubbers on continuous miners was studied by Kissell and Bielicki [1975] (Figure 1-8). In this instance, the fresh air entering zone *ABCD* was also designated  $nQ$ . The scrubber moved air quantity  $R$ , of which a fraction  $mR$  recirculated back into the zone. A new variable  $Z$  was necessary to account for air leaving the zone without passing through the scrubber. As before,

<sup>27</sup>The basic material balance equations are: air entering the zone equals air leaving the zone, and methane entering the zone equals methane leaving the zone. For more details on the material balances used, see Bakke et al. [1964] and Kissell and Bielicki [1975].

<sup>28</sup>Strictly speaking, it is  $c = V/(nQ + V)$ . However, since  $nQ \gg V$ , the approximation  $c = V/nQ$  is adequate.

a material balance indicated that the concentration of methane in the zone depended only on the amount of fresh air entering the zone, or  $nQ$ , and the amount of methane entering the zone, or  $V$ . However, this left open the question of what factors determine the value of  $n$ .

During experiments conducted with a full-scale model of a mine working face, Kissell and Bielicki found that  $n$  depended on whether or not the scrubber was turned on, and if turned on, where the scrubber exhaust was directed. Turning on the scrubber raised the value of  $n$ , reducing the methane concentration in the zone. Directing the scrubber exhaust into the return (in this case, behind the exhaust line curtain) was the best exhaust configuration, yielding an  $nQ$  fresh air value over four times higher and a zone methane concentration less than  $\frac{1}{4}$  when compared to the test with the scrubber off.<sup>29</sup>

Bakke et al. and Kissell and Bielicki were primarily concerned with recirculation at coal mine working faces. Many other studies have been conducted on so-called district recirculation, i.e., recirculation of air in a major portion of a mine. District recirculation is produced by an underground fan that moves air from a return airway back into an intake airway, thus raising the total air quantity in that portion of the mine in by the underground fan. Improved dust control can be a result. Cecala et al. [1991] used  $SF_6$  tracer gas to study recirculation in a trona mine district that contained three operating continuous miner sections. The results were consistent with a methane material balance. Pritchard [1995] has discussed his own experience and the worldwide experience with controlled district recirculation. Pritchard concluded that—

1. The initial volume of fresh air to the district should be maintained.
2. The recirculation fan should be placed far enough from the face for the dust to settle out, but close enough to the face to minimize stopping leakage.
3. District recirculation systems will increase flow and pressure losses in the mine circuit, producing a small drop in main fan flow.<sup>30</sup>
4. Adequate monitoring and controls must be in place.

In summary, recirculation will raise the methane concentration only when recirculated air is substituted for fresh air. If the amount of fresh air entering a zone is unchanged, the methane concentration in the zone will be unchanged. At continuous miner faces, if operation of a scrubber creates an airflow pattern that enhances the amount of fresh air entering the face zone, then operation of the scrubber will lower the methane concentration (and vice versa).

---

<sup>29</sup>Subsequent studies have confirmed the need to direct the scrubber exhaust into the return. See Figures 3–7 and 3–10.

<sup>30</sup>The exact amount will depend on the fan locations.

## THE IMPORTANCE OF HIGHER AIR VELOCITY IN PREVENTING METHANE EXPLOSIONS

**Low air velocities can lead to poor mixing between methane and air. This poor mixing in turn leads to fluctuations in the methane concentration that make an ignition more likely.**

Bakke et al. [1967] first suggested that a measurement of the methane concentration alone is an incomplete means of assessing the ignition hazard and that other measurable ventilation quantities might be important.<sup>31</sup> A study of methane ignitions in U.K. coal mines found that the probability of an ignition is determined by both the methane concentration and the densimetric Froude number, a dimensionless quantity related to the gas-mixing process in the presence of buoyancy forces. The expression for the Froude number  $F$  is—

$$F = \frac{u^2}{g \frac{\Delta\rho}{\rho} \sqrt{A}}$$

where  $u$  is the air velocity,  $\frac{\Delta\rho}{\rho}$  is the density difference between air and methane divided by the density of air, and  $A$  is the cross-sectional area of the airway.

The data available to Bakke et al. resulted from 123 ignitions on faces and gate roads at U.K. longwalls during 1958–1965. Examination of the data indicated that the risk of an ignition was dependent on more than methane concentration alone and that it was possible to combine concentration and Froude number in one variable of the form  $c^2/F$ .

Figure 1–9 shows the normalized number of ignitions  $P$  (ignitions per year per gate road) versus  $c^2/F$  for the Bakke et al. data. The best fit to the data was  $P = 0.004 (c^2/F)^{0.9}$ . A high correlation was obtained, indicating that, absent other sources of mixing, the risk of ignition  $P$  does depend on the variable  $c^2/F$ .

In most mines,  $\sqrt{A}$  does not change much compared to changes in  $c^2$  and  $u^2$ . Also, the factor of 0.9 is close to 1.0. It follows that ignition risk varies with the quantity  $(c/u)^2$ . This departs from any notion that ignition risk depends on the concentration  $c$  alone.<sup>32</sup>

<sup>31</sup>Actually, since ignition risk also depends on human factors, there is no reason to expect that ignition risk depends only on concentration. Mines with less gas may also have a less vigilant workforce. However, Bakke et al. only sought a correlation with measurable ventilation quantities.

<sup>32</sup>Subsequent work at longwall shearers in the 1980s failed to confirm this finding [Creedy and Phillips 1997; CEC 1985], probably because water sprays on the shearer provided enough mixing between methane and air to overcome any velocity effect on mixing.



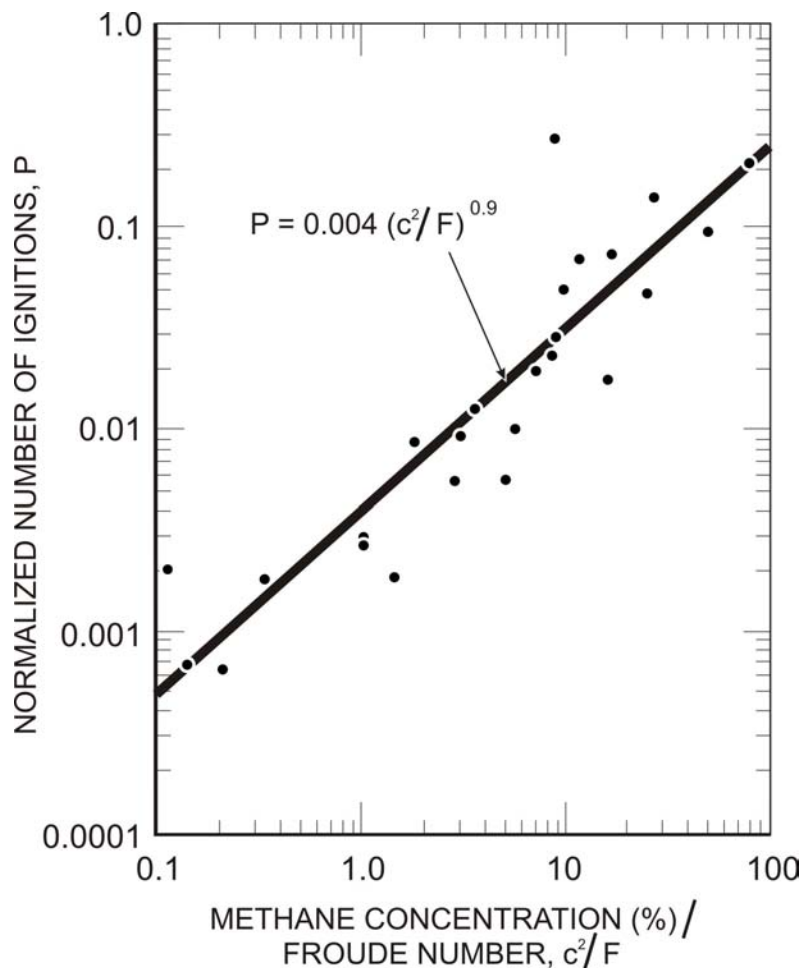

Figure 1-9.—Ignitions per year per gate road.

- At similar methane concentration levels, tunnels or mines with large cross-sectional entries and low air velocities have higher risk of ignition than those with small cross-sectional entries and higher air velocities. Both the lower velocity and higher area will work together to give a lower Froude number.

As an example, assume that the methane concentration is 1.0% and that the air velocity is 100 ft/min. If then the air velocity is raised to just 120 ft/min, the methane concentration becomes 0.83%. If the ignition risk is proportional to  $(c/u)^2$ , this modest increase in air velocity cuts the ignition risk in half.<sup>33</sup>

The findings of Bakke et al. have important implications for using higher air velocity to prevent methane explosions:

- In the absence of other means to promote mixing, raising air velocity is a highly effective way to reduce ignition risk. Higher air velocity promotes better mixing in addition to lowering the average concentration.
- Water sprays and auxiliary air movers (small fans or compressed-air venturis) that promote mixing can reduce ignition risk.

<sup>33</sup>Some confirmation of the importance of air velocity in reducing ignition risk was obtained by Bielicki and Kissell [1974], who conducted a study of the methane concentration fluctuations produced by incomplete mixing of methane and air at a model coal mine working face. Poor mixing was characterized by wider concentration fluctuations and resulted from low airflow or a high methane release rate. In other studies of methane-air mixing, Kissell et al. [1974] found that good mixing was characterized by normally distributed peaks and poor mixing by log-normally distributed peaks. Schroeder and Kissell [1983] found the same effect and suggested that the term  $\sigma(\log c)$ , the standard deviation of the logarithms of the sampled peak concentrations  $c$ , be used as an indicator of mixing.

## MINE EXPLOSIONS, BAROMETRIC PRESSURE, AND THE SEASONAL EXPLOSION TREND

Although mine explosions are far less common than in the past, this deadly hazard to miners has not disappeared. Mine operators must always be alert to the circumstances that make a mine explosion more likely. The chapter on dust explosions (Chapter 12) outlines what must be done to prevent a methane ignition from triggering a dust explosion, which is usually lethal. Two other important factors, discussed here, are barometric pressure lows and drier dust in the winter.

**In South Africa, most mine explosions have followed a low in the barometric pressure; however, there is no seasonal frequency trend. In the United States, mine explosions have been more frequent in the winter because the dust is drier.**

**Barometric pressure lows and mine explosions.** Many researchers have documented an inverse relationship between barometric pressure and the amount of methane flowing from a mine [Carter and Durst 1955; Stevenson 1968; Füssell and Hudewentz 1974; Eschenburg 1977]. A falling barometric pressure causes expansion of the methane that has accumulated in underground cavities and crevices. The methane then flows into the mine, making an ignition more likely.

Fauconnier [1992] has examined the role of barometric pressure changes in South African mine explosions. Using barometric data corresponding to 59 methane explosions (26 in coal, 33 in gold mines) for the period 1970–1989, he concluded that most of the explosions were associated with medium-term (longer than 1 day) downward trends in barometric pressure. He also concluded that explosions occur randomly during the year, in contrast with U.S. coal mines, which are known to have a seasonal trend.

**The seasonal trend in U.S. coal mine explosions.** Historically, U.S. coal mine explosions have been more frequent in the winter than the summer [Boyer 1964]. Although barometric pressure might be a cause because changes in barometric pressure are more abrupt and intense in the winter months, it is also true that mines are drier in the winter because of the low moisture content of the air [Williams 1914; Pappas et al. 2002]. This means that coal dust is drier and more easily dispersed and ignited during the cold months.

According to a study by Kissell et al. [1973], the second factor—drier coal dust—is the most influential in making winter explosions in U.S. coal mines more frequent. In this study, coal mine accident reports from 1911 to 1970 were examined to see whether winter explosions were more likely to occur in regions of the mine more susceptible to barometric pressure fluctuations (e.g., gobs). No such tendency was found. Next, based on the accident reports, explosions were divided into five different categories:

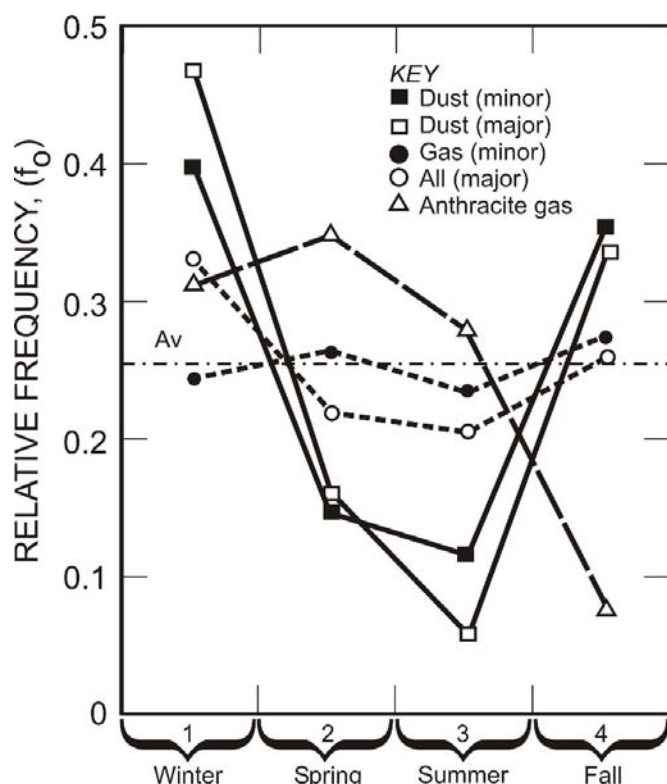

Figure 1-10.—Relative frequency of occurrence of major and minor gas and dust explosions.

When all major explosions are considered, the higher frequency in winter months is clearly evident. However, this trend is far more pronounced for the dust explosions. No trend favoring the winter months is evident in the anthracite mine explosions or those categorized as “gas only.” This provides strong evidence that it is dust, not gas, that accounts for the seasonal trend in U.S. coal mine explosions.<sup>34</sup>

- *All major explosions* (where five or more miners were killed). Most major explosions involved both gas and dust.
- *Major dust explosions*. Dust explosions are those where the accident investigators concluded that dust was directly ignited, without gas participating as an intermediate stage. Typically, these took place in mines known to be relatively free of methane and where the dust was ignited by a blown-out shot.
- *Minor dust explosions* (fewer than five miners killed).
- *Minor gas explosions*. Accident investigators concluded that dust was not involved.
- *Explosions in anthracite mines*. These were known to be “gas only” because anthracite dust is not explosive under the conditions prevailing in mining.

Figure 1-10 shows the relative frequency of each of these types of explosions for the period 1911 to 1970.

## REFERENCES

- Bakke P, Leach SJ [1962]. Principles of formation and dispersion of methane roof layers and some remedial measures. *Min Eng (U.K.) Jul*:645-669.
- Bakke P, Leach SJ [1965]. Turbulent diffusion of a buoyant layer at a wall. *Appl Sci Res 15*(sect A):97-135.
- Bakke P, Leach SJ, Slack A [1964]. Some theoretical and experimental observations on the recirculation of mine ventilation. *Colliery Eng 41*(Nov):471-477.

<sup>34</sup>The results of Kissell et al. do not contradict the conclusions by Fauconnier. The seasonal trend for coal mine explosions in the United States might be due to colder winter months or the fact that a different timeframe was examined. Also, Fauconnier combined explosions at both coal and gold mines.

- Bakke P, Leach SJ, Slack A [1967]. On the general body concentration and other ventilation data as a measure of the average risk of ignition. *Min Eng (U.K.) Aug*:762–774.
- Bielicki RJ, Kissell FN [1974]. Statistical analysis of methane concentrations produced by incomplete mixing of methane and air at a model coal mine working face. Pittsburgh, PA: U.S. Department of the Interior, Bureau of Mines, RI 7987.
- Boyer RF [1964]. Coal mine disasters: frequency by month. *Science 144*(Jun):1447–1449.
- Carter HN, Durst CS [1955]. The influence of barometric changes on the emission of firedamp. *Trans Inst Min Eng 115*:3–29.
- CEC [1985]. Investigation of methane emission and ignition risk at coalface machines. Final report on the European Coal and Steel Community (ECSC) research project 7225 – 11/08/068, October 1982 to September 1985, National Coal Board, Commission of the European Communities.
- Cecala AB, Timko RJ, Pritchard CJ [1991]. Case study of controlled district recirculation. *Min Eng 43*(11):1351–1355.
- CFR. Code of federal regulations. Washington, DC: U.S. Government Printing Office, Office of the Federal Register.
- Cecca EL, Zuchelli DR [1995]. Lightning strikes and mine explosions. In: Wala AM, ed. *Proceedings of the Seventh U.S. Mine Ventilation Symposium*. Lexington, KY: University of Kentucky, pp. 245–250.
- Creedy DP [1991]. An introduction to geologic aspects of methane occurrence and control in British deep coal mines. *Q J Eng Geol 24*:209–220.
- Creedy DP [1996]. Methane prediction in collieries. Final project report, project COL 303. Braamfontein, Republic of South Africa: Safety in Mines Research Advisory Committee (SIMRAC) ([www.simrac.co.za](http://www.simrac.co.za)).
- Creedy DP, Phillips HR [1997]. Methane layering in bord-and-pillar workings. Final project report, project COL 409. Braamfontein, Republic of South Africa: Safety in Mines Research Advisory Committee (SIMRAC) ([www.simrac.co.za](http://www.simrac.co.za)).
- CSA [1984]. Combustible gas detection instruments. Section 5.3.1, CSA standard C22.2 No. 152–M1984 (product ID 2001201). Mississauga, Ontario: Canadian Standards Association.
- Coward HF, Ramsay HT [1965]. Ignition of firedamp by means other than electricity and explosives: a review. Safety in Mines Research Establishment (U.K.), research report No. 221, October.

Davies AW, Isaac AK, Cook PM [2000]. Investigation of a coal mine explosion and relevance of risk assessment. *Trans Inst Min Metall 109*(May-Aug)(Sect A):A61–A69.

Detroit Water and Sewerage Department [2005]. Remembering those who died. [<http://www.dwsd.org/history/explosion.pdf>]. Date accessed: December 2005.

Diamond WP, Garcia F [1999]. Prediction of longwall methane emissions: an evaluation of the influence of mining practices on gas emissions and methane control systems. Pittsburgh, PA: U.S. Department of Health and Human Services, Public Health Service, Centers for Disease Control and Prevention, National Institute for Occupational Safety and Health, DHHS (NIOSH) Publication No. 99–150, RI 9649.

Diamond WP, Levine JR [1981]. Direct method determination of the gas content of coal: procedures and results. Pittsburgh, PA: U.S. Department of the Interior, Bureau of Mines, RI 8515. NTIS No. PB81196735.

Diamond WP, LaScola JC, Hyman DM [1986]. Results of direct-method determination of the gas content of U.S. coalbeds. Pittsburgh, PA: U.S. Department of the Interior, Bureau of Mines IC 9067. NTIS No. PB86205325.

Diamond WP, Schatzel SJ, Garcia F, Ulery JP [2001]. The modified direct method: a solution for obtaining accurate coal desorption measurements. In: *Proceedings of the International Coalbed Methane Symposium*. Tuscaloosa, AL: University of Alabama, pp. 331–342.

Doyle BR [2001]. *Hazardous gases underground*. New York: Marcel Dekker, Inc.

Eschenburg HWM [1977]. Note on the interaction between barometric pressure and methane issuing from fissures. *J Mine Vent Soc S Afr 30*:203–204.

Fauconnier CJ [1992]. Fluctuations in barometric pressure as a contributory factor to gas explosions in south African mines. *J S Afr Inst Min Metall 92*(5):131–147.

Füssell W, Hudewentz D [1974]. Die barometrische Ausgasung: Beobachtungen und Bekämpfungsversuche (in German). *Glückauf 110*(24).

Geldenhuis HJ, Eriksson AJ, Jackson WB, Raath, JB [1985]. Research into lightning-related incidents in shallow south African coal mines. In: *Proceedings of the 21st International Conference of Safety in Mines Research Institutes* (Sydney, New South Wales, Australia, October 21–25, 1985).

Grau RH, LaScola JC [1984]. Methane emissions from U.S. coal mines in 1980. Pittsburgh, PA: U.S. Department of the Interior, Bureau of Mines, IC 8987. NTIS No. PB85112027.

Holding W [1992]. A Re-look at explosibility diagrams. In: *Proceedings of the Fifth International Mine Ventilation Congress* (Johannesburg, Republic of South Africa, October 25–30, 1992), pp. 171–181.

- Jones GW [1929]. Inflammability of mixed gases. Washington, DC: U.S. Department of the Interior, Bureau of Mines, TP 450.
- Kim AG [1977a]. Estimating the methane content of bituminous coalbeds from adsorption data. Pittsburgh, PA: U.S. Department of the Interior, Bureau of Mines RI 8245. NTIS No. PB271218.
- Kim AG [1977b]. Laboratory studies on spontaneous combustion of coal. Pittsburgh, PA: U.S. Department of the Interior, Bureau of Mines, IC 8756. NTIS No. PB274052.
- Kissell FN [1975]. The potential hazards of methane gas in oil shale mines. *Q Colo Sch Mines* 70(4):19–27.
- Kissell FN, Bielicki RJ [1975]. Methane buildup hazards caused by dust scrubber recirculation at coal mine working faces: a preliminary estimate. Pittsburgh, PA: U.S. Department of the Interior, Bureau of Mines, RI 8015. NTIS No. PB240684.
- Kissell FN, Banfield JL, Dalzell RW, Zabetakis MG [1974]. Peak methane concentrations during coal mining: an analysis. Pittsburgh, PA: U.S. Department of the Interior, Bureau of Mines, RI 7885. NTIS No. PB233424.
- Kissell FN, McCulloch CM, Elder CH [1973]. The direct method of determining methane content of coalbeds for ventilation design. Pittsburgh, PA: U.S. Department of the Interior, Bureau of Mines, RI 7767. NTIS No. PB221628.
- Kissell FN, Nagel AE, Zabetakis MG [1973]. Coal mine explosions: seasonal trends. *Science* 173(Mar):891–892.
- Kuchta JM [1985]. Investigation of fire and explosion accidents in the chemical, mining, and fuel-related industries: a manual. Pittsburgh, PA: U.S. Department of the Interior, Bureau of Mines, B 680. NTIS No. PB87113940.
- Lama RD [1988]. Adsorption and desorption of mixed gases on coal and their implications in mine ventilation. In: Proceedings of the Fourth International Mine Ventilation Congress (Brisbane, Queensland, Australia, July 3–6, 1988), pp. 161–174.
- Lama RD, Bartosiewicz H [1982]. Determination of gas content of coal seams. In: Proceedings of the Symposium on Seam Gas Drainage, With Particular Reference to the Working Seam (Wollongong, New South Wales, Australia, May 11–14, 1982), pp. 36–52.
- Le Chatelier H [1891]. Estimation of fire damp by inflammability limits. *Ann Mines* 19:388.
- Lin W, McPherson MJ, Loomis I [1997]. The ignition of methane and coal dust by compression in collapsing gob areas. In: Dhar BB, Bhowmick BC, eds. Proceedings of the 27th International Conference of Safety in Mines Research Institutes. Vol. 1. New Delhi, India: Oxford & IBH Publishing Co. Pvt. Ltd., pp. 503–511.

Margerson SNA, Robinson H, Wilkins HA [1953]. Ignition hazard from sparks from magnesium-based alloys. Safety in Mines Research Establishment (U.K.), research report No. 75.

Matta JE, LaScola JC, Kissell FN [1977]. Methane absorption in oil shale and its potential mine hazard. Pittsburgh, PA: U.S. Department of the Interior, Bureau of Mines, RI 8243. NTIS No. PB271219.

McLennan JD, Schafer PS, Pratt TJ [1995]. A guide to determining coalbed gas content. Chicago, IL: Gas Research Institute, GRI-94/0396.

McPherson MJ [1995]. The adiabatic compression of air by large falls of roof. In: Wala AM, ed. Proceedings of the Seventh U.S. Mine Ventilation Symposium. Lexington, KY: University of Kentucky, pp. 257–262.

McPherson MJ [2002]. The Westray mine disaster. In: De Souza E, ed. Proceedings of the North American/Ninth U.S. Mine Ventilation Symposium (Kingston, Ontario, Canada, June 8–12, 2002). Lisse, Netherlands: Balkema, pp. 3–12.

NFPA [2000]. NFPA 77, static electricity: recommended practice. Quincy, MA: National Fire Protection Association.

Novak T, Fisher TJ [2000]. Lightning propagation through the earth and its potential for methane ignitions in abandoned areas of underground coal mines. In: Conference Record of the 2000 IEEE Industry Applications Conference, 35th IAS Annual Meeting and World Conference on Industrial Applications of Electrical Energy (Rome, Italy, October 1–3, 2000), pp. 2674–2681.

Pappas DM, Barton TM, Weiss ES [2002]. Developments in sealant support systems for ground control. In: Peng SS, Mark C, Khair AW, Heasley KA, eds. Proceedings of the 21st International Conference on Ground Control in Mining. Morgantown, WV: West Virginia University, pp. 344–353.

Powell F, Billinge K [1975]. The frictional ignition hazard associated with colliery rocks. *The Min Eng* 174(Jul):527–531.

Pritchard CJ [1995]. Preparatory work required for a long-term district recirculation test in a gassy underground metal-nonmetal mine. In: Wala AM, ed. Proceedings of the Seventh U.S. Mine Ventilation Symposium. Lexington, KY, University of Kentucky, pp. 443–448.

Raine EJ [1960]. Layering of firedamp in longwall working. *Trans Inst Min Eng (U.K.)* 119(10):579–597.

Richmond JK, Price GC, Sapko MJ, Kawenski EM [1983]. Historical summary of coal mine explosions in the United States. Pittsburgh, PA: U.S. Department of the Interior, Bureau of Mines, IC 8909. NTIS No. PB83184226.

- Saghafi A, Williams DJ, Lama RD [1997]. Worldwide methane emissions from underground coal mining. In: Ramani RV, ed. Proceedings of the Sixth International Mine Ventilation Congress (Pittsburgh, PA, May 17–22, 1997). Littleton, CO: Society for Mining, Metallurgy, and Exploration, Inc.: pp. 441–445.
- Schatzel SJ, Cooke GA [1994]. Organic and mineralogic factors influencing Green River oil shale methane emissions. *Fuel* 73(4):573–578.
- Schroeder WE, Kissell FN [1983]. Face ventilation analysis by probability plotting of transformed methane concentration data. *J Mine Vent Soc S Afr* 36(11):109–116.
- Stevenson JW [1968]. Effects of bleeder entries during atmospheric pressure changes. *Min Eng Jun*:61–64.
- Thimons ED, Vinson RP, Kissell FN [1977]. Forecasting methane hazards in metal and nonmetal mines. Pittsburgh, PA: U.S. Department of the Interior, Bureau of Mines, RI 8392. NTIS No. PB80100696.
- Thomas TSE [1941]. Sparks from aluminum-painted iron. Possible ignition of inflammable gas mixtures. *Colliery Guardian* 163:202.
- Titman H, Roberts AF, Brookes FR [1965]. The accumulation of methane in roof cavities. Safety in Mines Research Establishment (U.K.), research report No. 235.
- Ulery JP, Hyman DM [1991]. The modified direct method of gas content determination: applications and results. In: Proceedings of the 1991 Coalbed Methane Symposium (University of Alabama, Tuscaloosa, AL, May 13–16, 1991), pp. 489–500.
- Vinson RP, Thimons ED, Kissell FN [1978]. Methane accumulations in coal mine roof cavities. Pittsburgh, PA: U.S. Department of the Interior, Bureau of Mines, RI 8267. NTIS No. PB277919.
- Williams RY [1914]. The humidity of mine air with especial reference to coal mines in Illinois. Washington, DC: U.S. Department of the Interior, Bureau of Mines, B 83.
- Zabetakis MG [1965]. Flammability characteristics of combustible gases and vapors. Pittsburgh, PA: U.S. Department of the Interior, Bureau of Mines, B 627.
- Zabetakis MG, Stahl RW, Watson HA [1959]. Determining the explosibility of mine atmospheres. Pittsburgh, PA: U.S. Department of the Interior, Bureau of Mines, IC 7901.



## CHAPTER 2.—SAMPLING FOR METHANE IN MINES AND TUNNELS

By Fred N. Kissell, Ph.D.<sup>1</sup>

### *In This Chapter*

- ✓ Instruments available to measure methane in mines and tunnels
- ✓ Using a portable detector in both accessible and restricted spaces
- ✓ Machine-mounted monitors: placement and response time
- ✓ Calibration of catalytic detectors for different gases

*and*

- ✓ Misinterpreting warning signs

**This chapter gives guidelines for methane measurement in mines and tunnels. The emphasis is on the measurement procedure and the interpretation of the measurement rather than on the instrument itself.**

The failure to properly sample for methane is a major contributing factor to methane explosion risk. Sampling errors are most likely to occur at mines or tunnels where the presence of methane is not suspected or during nonroutine tasks at mines or tunnels known to have gas.

More specific information on methane sampling at continuous miner sections is in Chapter 3. Chapters 4 and 5 discuss sampling at longwall sections, and Chapter 14 discusses sampling at tunnels.

### METHANE DETECTORS FOR MINING

Many models of gas detectors are available to measure methane concentrations, as well as most of the other contaminant gases found in mines and tunnels. An example is the iTX Multi-Gas Monitor, a portable gas detector available from Industrial Scientific Corp., Oakdale, PA. This handheld instrument measures several gases simultaneously. The cost (2004) ranges from \$1,300 to \$2,200, depending on the number of gases measured. Similar instruments are available from other manufacturers.

Most methane detectors used in mining use a catalytic heat of combustion sensor to detect methane and other combustible gases. These have been proven through many years of reliable operation. For detection of methane, proper operation of catalytic heat of combustion sensors

---

<sup>1</sup>Research physical scientist, Pittsburgh Research Laboratory, National Institute for Occupational Safety and Health, Pittsburgh, PA (retired).

requires both a methane concentration below 8% and an oxygen content above 10%<sup>2</sup>—requirements that are usually satisfied in mining applications.<sup>3</sup>

Some methane detectors measure the methane concentration by using infrared absorption as an operating method. These detectors (infrared analyzers) can measure accurately without oxygen and in a concentration range up to 100 vol % of methane. However, water vapor and dust can cause operating difficulties. In some mines [Kim 1973], the methane may be accompanied by ethane, which can produce an exaggerated infrared detector response.

**A list of approved gas detectors and gas monitors for U.S. mines is available from MSHA's Approval and Certification Center, Triadelphia, WV.**

Based on how they are certified by the Mine Safety and Health Administration (MSHA), methane detectors used in mining fall into two categories: portable methane detectors and machine-mounted methane monitors. Portable detectors are designed to be hand-carried, so measurements can be made at any location. They are approved by MSHA under 30 CFR<sup>4</sup> 22. Among other requirements, “indicating detectors” must give indications of gas at 0.25% methane and must have an accuracy of at least 20% over most of the applicable range.

Machine-mounted methane monitors are mounted on certain types of mining machinery and operate continuously. These monitors are certified under 30 CFR 27, which has different requirements than the Part 22 used for portable detectors.<sup>5</sup> The Part 27 requirements include a design that prevents the mining equipment from operating unless the methane monitoring system is functioning, a warning device that activates when the methane concentration is above 1.0%–1.5%, and a means to shut off power<sup>6</sup> to the equipment when the methane concentration is 2.0% and above.<sup>7</sup>

**MSHA certification requirements for Part 27 monitors are different from the certification requirements of Part 22 detectors. Because of this, Part 27 monitors cannot be used for tasks requiring the use of Part 22 detectors (such as the 20-min gas check task).**

<sup>2</sup>The percentages specified in this chapter are percentages by volume.

<sup>3</sup>When the methane concentration is *over* 8% or when the oxygen concentration is *under* 10%, the sensor response declines. As a result, in these circumstances the methane concentration indicated by the instrument will be less, possibly much less, than the true methane concentration. For more specifics on operating conditions, check the documentation that accompanies the instrument.

<sup>4</sup>*Code of Federal Regulations*. See CFR in references.

<sup>5</sup>Thus the distinction between “detectors” and “monitors.”

<sup>6</sup>Either electrical or diesel power.

<sup>7</sup>For rapid-excavation machines in tunnels, the Occupational Safety and Health Administration (OSHA) requires electrical power to be shut off at 1.0% and above. See Chapter 14.

## USING PORTABLE METHANE DETECTORS

Taking a gas reading with a portable methane detector is a simple matter. Where to measure and how to interpret the reading is not simple. For this reason, the many key points on gas measuring in both “accessible” and “restricted” spaces must be addressed.

**Methane measurements in accessible spaces.** Accessible spaces are those that can be readily entered by a person making a methane measurement with a handheld portable methane detector. In accessible spaces, most methane measurements should be made as follows:

- Close to the methane source, where higher concentrations are more likely to be encountered.
- Close to the mine roof, where higher concentrations are more likely to be encountered.
- In regions where the dilution of methane is impaired, i.e., those that are poorly ventilated and those where air movement is blocked by equipment.
- While cutting is underway, because the methane release rate is higher as coal or rock is broken and the mining machinery advances.

**Fortunately, most places in mines where methane is to be measured are relatively accessible, i.e., the person making the measurement can easily reach the chosen location. The issue is how to choose the best location for measurement.**

In making measurements, consideration must always be given to how methane is released and diluted to safe levels. Methane entering a mine or tunnel often enters as a localized source at high concentration. An example is shown in Figure 2–1, which depicts a cloud of methane being diluted into a moving air stream. As shown in the figure, methane enters through a crack in the rock. If no air enters the crack, the methane concentration in the crack can be close to 100%. However, as the methane emerges from the crack, it progressively mixes with and is diluted by the ventilation air. Suppose this progressive dilution reduces the concentration from 100% to 1%, as shown in Figure 2–1. In this case, the instrument reading depends highly on the location of the measurement—a critical concern if one intends to use the reading to assess whether a

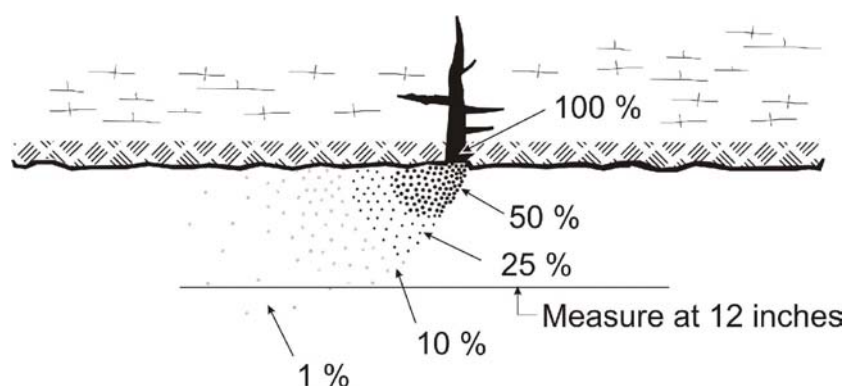

hazard exists. This problem is handled by requiring methane measurements at a distance of not less than 12 in from the roof, face, ribs, and floor. If there is enough gas coming from the crack (or other source) to exceed statutory limits at a 12-in distance, then a hazardous condition exists.

Figure 2–1.—Depiction of methane being diluted into a moving air stream.

In some cases, measurements must be taken at distances less than 12 in. For example, methane is lighter than air, so methane emerging from the roof can form a high-concentration layer along the roof of the mine (or crown of the tunnel). The thickness of such layers can be less than 12 in. Methane layers<sup>8</sup> are more likely to form if the ventilation air velocity measured at the roof is 100 ft/min or less [Raine 1960], if the roof has cavities [Vinson et al. 1978], or if the roof has drillholes that serve as emission sources. Therefore, the degree of hazard resulting from a high-concentration layer of gas must be assessed from measurements of the size of the layer, as well as the location and size of the source. This is why gas readings must be done by a qualified, competent person, as prescribed by MSHA and OSHA regulations.

**Methane measurements in restricted spaces.** For the purpose of this discussion, a restricted<sup>9</sup> space is one that cannot be readily entered to make a methane measurement. Examples of restricted spaces are a mine shaft that has been capped or a mine entry that has been closed to travel because of hazardous roof. The lack of accessibility often restricts both the ventilation air and the opportunity to make a convenient methane measurement.<sup>10</sup>

When making methane measurements in restricted spaces, simply making a measurement at the *entrance* of the restricted space is not adequate. The measurements must be made deep within and at the top of the restricted space, and also at every location within the restricted space where an ignition source (such as sparks from a torch) may be present.

Restricted-space measurements can be made in two ways. First, the methane detector can be equipped with a remote “sample draw” capability. These use a small pump or hand-squeezed bulb to pull the sample through an extension probe and pass it through the detector. Some methane detectors have an accessory sampling pump that attaches to the detector; others have a built-in pump.

Second, the methane detector can be attached to a cradle at the end of a long handle, which is then extended into the restricted space. This permits a direct reading without aspiration, provided that the instrument has a large LED readout that can be read from a distance.<sup>11</sup>

**Remember that gas detectors only sample the air that passes through the instrument.**

---

<sup>8</sup>For more information on methane layers, see Chapters 1 and 11.

<sup>9</sup>This chapter uses the term “restricted space” because it is a more appropriate distinction for mining applications. The more common “confined space” term is not used because the whole mine can be regarded as a confined space. Further, none of these special terms do a good job of describing measurements at coal mine gobs, a specialized topic not considered in this chapter.

<sup>10</sup>For example, a restricted-space methane explosion occurred in January 2003, killing three workers during a shaft-sinking operation at a coal mine near Cameron, WV. A 7-ft-high “water ring” space had been excavated back into the strata behind the shaft wall. These water rings facilitate water drainage from the exterior side of the shaft lining. Prior to pouring the concrete shaft lining, the water ring space was sealed off with corrugated sheets of steel to prevent it from being filled with concrete. After the concrete had set, the three miners were killed while in the process of opening an access door with an acetylene torch. An investigation by the West Virginia Office of Miner’s Health, Safety and Training concluded that “an adequate methane test was not made” [Mills 2003].

<sup>11</sup>See the sections on methane detection in the continuous miner chapter (Chapter 3).

**Out-of-range gas concentrations in restricted spaces.**<sup>12</sup> Because some restricted spaces have little ventilation, the gas concentrations in these spaces may fall outside of the accurate operating range of catalytic heat of combustion sensors. For accurate operation of these sensors, the concentration of methane must be below 8% *and* the concentration of oxygen must be above 10%. When measuring methane concentrations above 8%, instruments with catalytic heat of combustion sensors can act in a way that is misleading, responding with a rapid upscale reading followed by a declining or erratic reading<sup>13</sup> [CSA 1984]. Such instrument behavior should be a tipoff that very high, potentially explosive methane levels may be present.

Restricted spaces may also lack the 10% oxygen level necessary to ensure the proper operation of catalytic methane detectors. For example, the gas in exploration boreholes often contains little to no oxygen. In such circumstances, if the instrument being used has a second sensor to measure the oxygen level, an oxygen concentration less than the required 10% will be indicated, thereby alerting the user that the methane reading may be incorrect. However, even if the oxygen concentration is less than 10%, valid methane measurements are possible with other kinds of methane detectors. One approach to sampling low-oxygen atmospheres is to use a methane detector that operates by infrared absorption. Another approach is to use a catalytic methane detector that provides dilution sampling. The term “dilution sampling” refers to adding a controlled quantity of ambient air to the sample in order to raise the oxygen content of the sample.<sup>14</sup> For example, if 1 L of sample gas is added to 1 L of ambient air, the oxygen level of the mixture will be adequate to operate a catalytic methane detector, and the true concentration of methane may be obtained by multiplying the detector methane reading by a factor of two.

**The bump test.** It is a good idea to perform a quick “bump test” on every portable methane detector to ensure that it is working properly. Before every shift, briefly expose the portable detector to a known concentration of methane gas high enough to set off the methane alarm. Note the reading to ensure that it is correct. A bump test is not a calibration, but a quick way to ensure that the most important functions of the instrument are intact.<sup>15</sup>

## USING MACHINE-MOUNTED METHANE MONITORS

The disadvantage of portable handheld detectors is that a peak emission can be missed because readings at the appropriate locations are only taken at infrequent intervals. By contrast, machine-mounted monitors operate continuously and can identify emission peaks and automatically shut off electrical equipment when the methane level is excessive.

Machine-mounted methane monitors are usually mounted on mining and tunnel-boring machines. They are designed to have their readout display separated from the sensing head so

---

<sup>12</sup>This also applies to methane layers.

<sup>13</sup>Some instruments will report this as an out-of-range condition. For more information, consult the operating instructions for the instrument.

<sup>14</sup>Methane gas mixtures with 10% oxygen or less are not combustible, but may become so when mixed with more air. See Chapter 10 on using inert gas to prevent highwall methane explosions.

<sup>15</sup>A similar test is described by the Canadian Standards Association [CSA 1984].

that the readout is visible to the machine operator and the sensing head is placed in a location where methane is most likely to accumulate.

**The usefulness of machine-mounted monitors depends on three critical factors: placement of the sensing head in a location where methane accumulates, the response time of the monitor, and whether or not the sensor head is covered by a heavy layer of dust or debris.**

**Placement of the sensing head where methane accumulates.** Proper placement of monitor sensing heads is crucial to the reliable detection of methane levels. Figure 2–2 shows a typical methane profile map measured from experiments at a full-scale simulated continuous miner face [Wallhagen 1977]. A striking feature of such profile maps is the steep gradient in the methane concentration along the length of the machine. Thus, a distance of a foot or two forward or backward in the location of the sensing head will greatly change the indicated methane level. In the instance depicted, the sensing head should be as far forward as possible to measure higher methane levels.<sup>16</sup> Inevitably, some tradeoffs are involved in picking the location, for a sensor head located too far forward will quickly become damaged or clogged with dust.

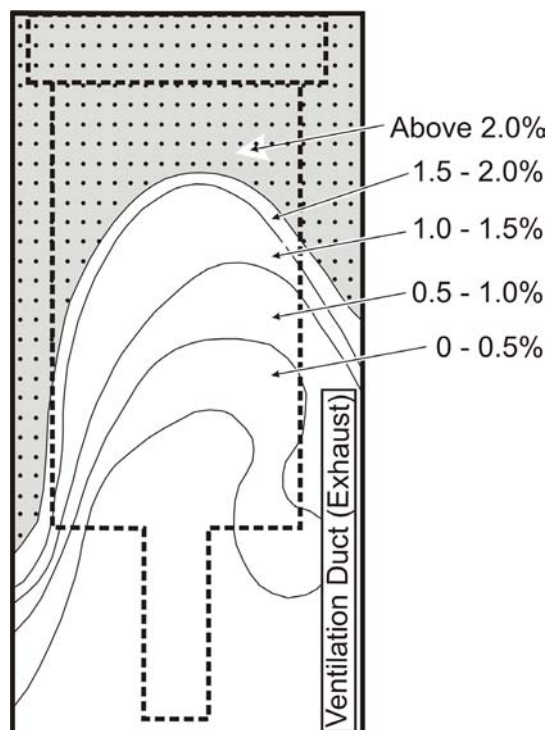

**Figure 2–2.—Methane profile map from a simulated continuous miner face.**

**Response time of the sensor head.** It is important that methane monitors have a short response time because the methane concentration can change quickly. With a short response time, the indicated concentration does not lag too far behind the true concentration. Figure 2–3 shows a recorder chart from a machine-mounted monitor at a coal mine working face [Kissell et al. 1974]. The peaks correspond to the cutting cycle of the mining machine, with the methane concentration spiking as the machine cuts into the coal. A methane monitor with a short response time will follow the spikes, giving warnings at the appropriate time. Taylor et al. [2004] reported on the response time of methane monitors in a test chamber designed to simulate mining conditions, while Taylor et al. [2002] reported on the response time using calibration caps supplied with the instrument.

<sup>16</sup>A typical sensing head location on continuous miners is on the side of the cutter head boom, a foot or two behind the cutter head.

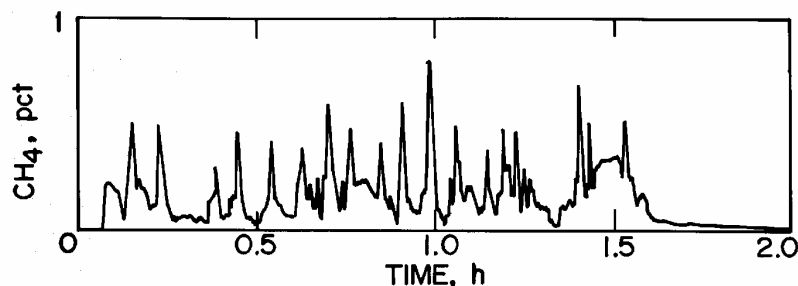

Figure 2-3.—Recorder chart from a machine-mounted methane monitor.

**Dust-clogged sensor heads.** Machine-mounted methane monitors are usually in locations where dust quickly accumulates on the sensor heads, so some care must be directed toward preventing the sensor heads from getting clogged by heavy dust accumulations or covered with debris. Whether a sensor head is clogged can be assessed

during calibration by noting the response of the monitor. All of the monitor manufacturers provide calibration caps that cover the sensing head and allow it to be flooded with calibration gas. When the sensor head is flooded with calibration gas, the instrument reading should be at least 90% of the calibration gas concentration and the response time should be similar to that obtained with a clean head.<sup>17</sup> A lower concentration reading indicates a monitor problem, possibly a dust-clogged sensor head. For this reason, sensor heads in particularly dirty locations should be cleaned and calibrated more frequently.

### CALIBRATION OF CATALYTIC INSTRUMENTS FOR DIFFERENT GASES

Methane detectors used in mining must be periodically calibrated with a known concentration of methane-air mixture that is injected into the instrument from a tank containing the gas mixture. However, combustible gases other than methane are sometimes encountered underground, and if the gas being sampled is different from the gas used to calibrate the instrument, the error in the instrument reading can be considerable. For instance, a tunnel being excavated under a leaking gasoline storage tank might contain gasoline vapor. Under these circumstances, a detector calibrated with a methane-air mixture will read low because higher molecular-weight gases (such as those in gasoline vapor) diffuse more slowly into the sensor element. As an example, suppose a methane-calibrated instrument is carried into a tunnel containing only gasoline vapor in the air, and the instrument reads 10% of the lower explosion limit (LEL).<sup>18</sup> In this circumstance, the actual gasoline vapor concentration in air is about 20% of the LEL—twice the indicated reading.

The opposite effect on instrument error can also take place. If the gas detector is calibrated with a higher molecular-weight gas such as pentane, then carried into a tunnel containing only methane, and if it reads 10% of the lower explosive limit (LEL), the actual methane concentration is 5% of the LEL, i.e., half the indicated reading.

<sup>17</sup>Using calibration caps supplied by the manufacturers, Taylor et al. [2002] measured the 90% response time of three models of methane monitors. They found that the response time depends on a host of extraneous factors, such as the calibration gas flow rate. If a calibration cap is used to assess monitor response time, the best approach is to note the response time of a clean monitor head and then look for corresponding changes as conditions change.

<sup>18</sup>Do not confuse % methane with % of the LEL. The LEL of a mixture of methane and air is 5% methane by volume. Thus, 5% methane by volume is said to be equivalent to 100% of the LEL. It follows that a concentration of 1% of methane by volume in air is 20% of the LEL. Other flammable gases have different LELs. For example, mixtures of propane and air have an LEL of 2.1% propane by volume; therefore 50% of the LEL is 1.05% by volume.

For this reason, when operators are encountering methane, they should calibrate for methane. On the other hand, if higher hydrocarbons are being encountered, operators should calibrate with a higher hydrocarbon, such as pentane or propane.

**Calibration-sampling correction value tables for a variety of combustible gases are readily available [Industrial Scientific Corp. 2004]. More information on the response of catalytic sensors to different gases is available from Firth et al. [1973].**

### MISINTERPRETING WARNING SIGNS

It is not unusual to misinterpret a gas warning sign, especially in underground workings thought to have no gas. A primary reason is that the gas flow varies with the excavation rate. Suppose, for example, a tunnel-boring machine (TBM) begins to cut into an area of gassy ground, releasing methane into the ventilation air. The machine-mounted monitor on the TBM senses this gas and shuts it down. After spending some time tracking down the source of the shutdown and figuring out what to do, a worker begins to hunt for gas with a handheld detector. The worker hunting for gas cannot find much because the emission dropped when the TBM stopped. Thus, everyone concludes that the monitor on the TBM is not working properly. Given two instruments, one with bad news and the other with good news, the tendency is to believe the good news. However, when methane detection and monitoring instruments fail, they rarely give a false alarm or a false high reading; in other words, they rarely indicate gas when there is none. The usual failure mode is to not register gas that is present. Therefore, when any instrument registers gas, it is better to trust the reading and take appropriate precautions.

Operators must be especially cautious when successive methane readings vary more than they normally do. When the airflow is low or when measurements are taken close to the source, the methane will not be well mixed into the air. This could lead to a high reading in one area with a low reading just a few feet away. This incomplete mixing can indicate that the ventilation air is deficient and that even higher concentrations of gas might be found nearby.

### REFERENCES

CFR. Code of federal regulations. Washington, DC: U.S. Government Printing Office, Office of the Federal Register.

CSA [1984]. Combustible gas detection instruments. Section 5.3.1, CSA standard C22.2 No. 152-M1984 (product ID 2001201). Mississauga, Ontario: Canadian Standards Association.

Firth JG, Jones A, Jones TA [1973]. The principles of the detection of flammable atmospheres by catalytic devices. *Combust Flame* 20:303-311.



Industrial Scientific Corp. [2004]. Gas detection made easy. P/N 1600-0029. Oakdale, PA: Industrial Scientific Corp.

Kim AG [1973]. The composition of coalbed gas. Pittsburgh, PA: U.S. Department of the Interior, Bureau of Mines, RI 7762. NTIS No. PB221574.

Kissell FN, Banfield JL, Dalzell RW, Zabetakis MG [1974]. Peak methane concentrations during coal mining: an analysis. Pittsburgh, PA: U.S. Department of the Interior, Bureau of Mines, RI 7885. NTIS No. PB233424.

Mills B [2003]. Fatal shaft explosion report investigation, McElroy Coal Co., McElroy mine, Permit No. U-83-33, Central Cambria Drilling Co., contractor No. C-618, January 22, 2003. Fairmont, WV: West Virginia Office of Miner's Health, Safety and Training.

Raine EJ [1960]. Layering of firedamp in longwall working. *Trans Inst Min Eng (U.K.)* 119(10):579-597.

Taylor CD, Chilton JE, Mal T [2002]. Evaluating performance characteristics of machine-mounted methane monitors by measuring response time. In: De Souza E, ed. *Proceedings of the North American/Ninth U.S. Mine Ventilation Symposium* (Kingston, Ontario, Canada). Lisse, Netherlands: Balkema, pp. 315-321.

Taylor CD, Chilton JE, Zimmer JA [2004]. Use of a test box to measure response times for machine-mounted monitors. In: Ganguli R, Bandopadhyay S, eds. *Mine ventilation: Proceedings of the 10th U.S./North American Mine Ventilation Symposium* (Anchorage, AK, May 16-19, 2004). Leiden, Netherlands: Balkema, pp. 177-182.

Vinson RP, Thimons ED, Kissell FN [1978]. Methane accumulations in coal mine roof cavities. Pittsburgh, PA: U.S. Department of the Interior, Bureau of Mines, RI 8267. NTIS No. PB277919.

Wallhagen RE [1977]. Development of optimized diffuser and spray fan systems for coal mine face ventilation. Waltham, MA: Foster-Miller Associates, Inc. U.S. Bureau of Mines contract No. H0230023. NTIS No. PB277987/AS.

## CHAPTER 3.—METHANE CONTROL AT CONTINUOUS MINER SECTIONS

By Fred N. Kissell, Ph.D.,<sup>1</sup> Charles D. Taylor,<sup>2</sup> and Gerrit V. R. Goodman, Ph.D.<sup>3</sup>

### *In This Chapter*

- ✓ Methane emission peaks
- ✓ Exhaust line curtain or duct
- ✓ The spray fan system
- ✓ Dust scrubbers with blowing ventilation
- ✓ Dust scrubbers with exhaust ventilation
- ✓ The ventilation of abnormally gassy faces
- ✓ Methane detection at continuous miner faces
- ✓ Ventilation and methane detection at bolter faces

*and*

- ✓ Reducing frictional ignitions

This chapter gives guidelines for preventing methane gas explosions at continuous miner sections in coal mines, both at continuous miners and at roof bolters. The need to control peak methane emissions is particularly stressed. Emphasis is also placed on ventilation principles, monitoring for gas, and reducing frictional ignitions.

### METHANE EMISSION PEAKS

Methane emission from the coal at continuous miner faces varies considerably. Plotted on a chart, methane emissions consist of a series of peaks and valleys corresponding to the cutting cycle of the mining machine, with the methane concentration spiking as the machine cuts into the coal (Figure 3-1) [Kissell et al. 1974].

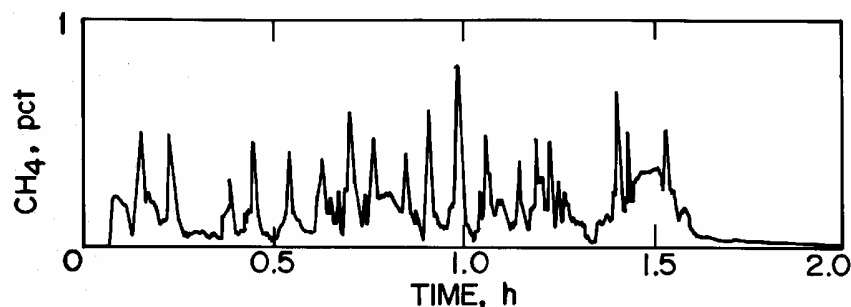

These methane peaks can be substantial. For this reason, efforts to safely dilute the methane must focus on the level of the

Figure 3-1.—Recorder chart from a machine-mounted methane monitor.

<sup>1</sup>Research physical scientist (retired).

<sup>2</sup>Industrial hygienist.

<sup>3</sup>Mining engineer.

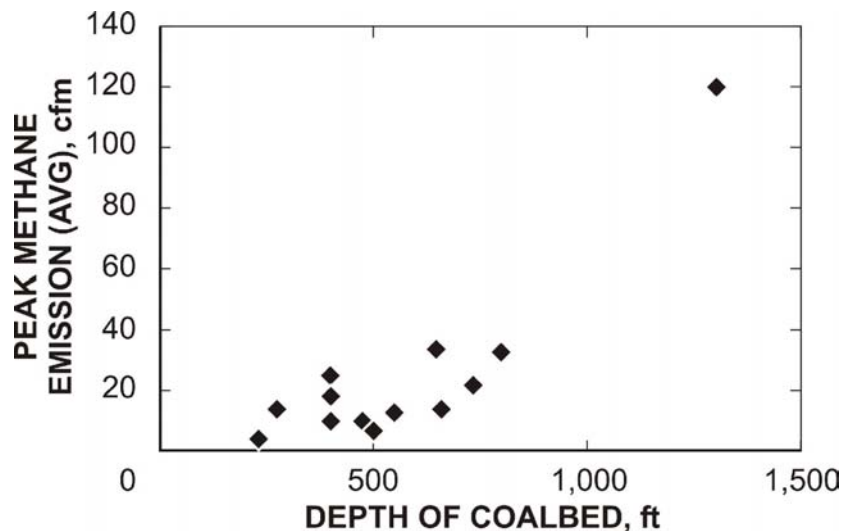

peaks, not the overall methane level. Figure 3-2 shows peak average<sup>4</sup> methane emissions in several U.S. coalbeds [Haney et al. 1983]. Except for one coalbed at 1,300 ft depth, peak average coalbed emissions range from 4 to 33 cfm, with an overall U.S. average of 17 cfm. Any face ventilation system must be able to safely handle gas flows of this magnitude.

Figure 3-2.—Peak average methane emissions for several U.S. coalbeds.

Although the values cited here are peak averages, the value for individual peaks can vary widely. For example, a study by Smith and Stoltz [1991] has shown a variation<sup>5</sup> of 46% in emission peak values. Similarly, there was a variation<sup>5</sup> of 50% in methane dilution capacity.

### VENTILATION WITH EXHAUST LINE CURTAIN OR DUCT

Prior to the development of improved face ventilation systems, most coal mine faces were ventilated with exhaust line curtain or ventilation duct. For this reason, exhaust line curtain or ventilation duct can serve as a baseline against which newer systems can be measured. Federal coal mine regulations [30 CFR<sup>6</sup> 75.330] mandate that exhaust systems have a maximum setback distance of 10 ft, i.e., the distance from the face being mined to the inlet of the line curtain or duct is 10 ft or less (Figure 3-3). However, if a mining machine starts a cutting cycle when the setback is 10 ft and subsequently advances another 10 ft, then the curtain or duct ends up at 20 ft if it has not been moved forward during the cutting cycle.

<sup>4</sup>This is the average of the emission peak values.

<sup>5</sup>Strictly speaking, the coefficient of variation, which is the standard deviation divided by the mean.

<sup>6</sup>Code of Federal Regulations. See CFR in references.

Figure 3-3 [Ruggieri et al. 1985b] shows why the methane dilution capacity of exhaust line curtain is not high. Air flowing up the entry shortcuts to the mouth of the line curtain, leaving the off-curtain side of the face poorly ventilated and subject to a buildup of methane. To further demonstrate, Figure 3-4 shows the methane dilution capacity<sup>7</sup> for exhaust line curtain<sup>8</sup> at setbacks of 10 ft and 20 ft [Kissell and Wallhagen 1976; Haney et al. 1982; Schultz et al. 1993].

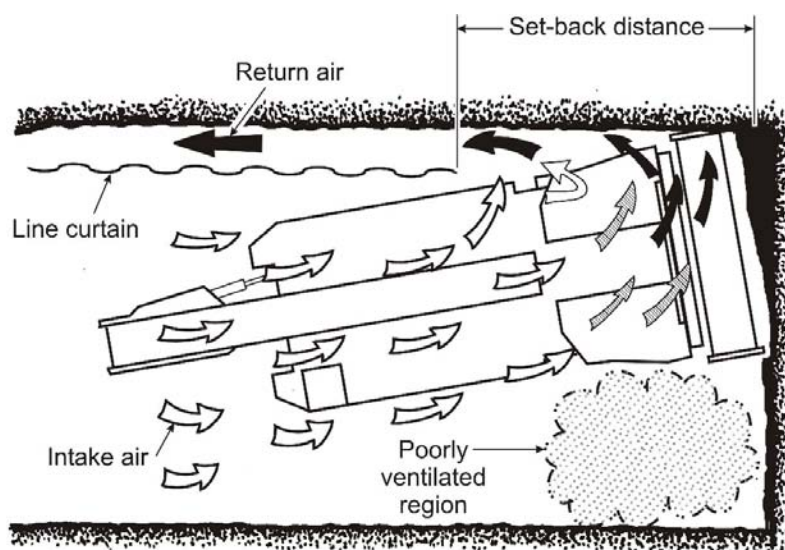

Figure 3-3.—Ventilation setback distance. With exhaust line curtain, the off-curtain side can be poorly ventilated.

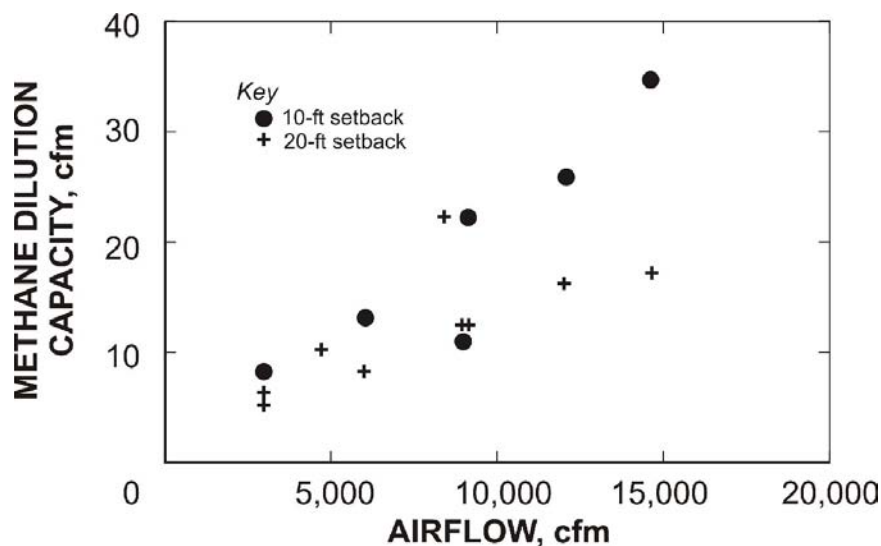

Figure 3-4.—Methane dilution capacity for exhaust line curtain at setbacks of 10 ft and 20 ft.

<sup>7</sup>Methane dilution capacity is the highest methane flow that the ventilation system can handle without exceeding a 1% methane concentration value anywhere in the face area. It is the best measure of how well a ventilation system is working. See Haney et al. [1983].

<sup>8</sup>The performance for exhaust duct is similar.

backups of 10 ft and 20 ft [Kissell and Wallhagen 1976; Haney et al. 1982; Schultz et al. 1993]. A notable feature of Figure 3-4 is the reduced dilution capacity at the 20-ft setback. This is why Mine Safety and Health Administration (MSHA) regulations specify a maximum setback of 10 ft.

For those mines using exhaust curtain and/or duct, an extensible system can be used to reduce the setback and possibly permit a deeper cut before place-changing.

Extensible duct systems are fabricated using a duct section a few inches in diameter smaller than the main duct. This smaller section is inserted into the main duct at the inlet end and is slid forward as the miner advances. A typical extensible curtain system is fabricated by attaching a 20-ft section of brattice cloth to 20 ft of 1/2-in-diam pipe. The pipe is

hung on J-hook assemblies, which are installed on the last two roof bolt plates next to the rib [Muldoon et al. 1982], and the pipe is slid forward as the miner advances. Urosek et al. [1988] described 11 extensible line curtain systems used in coal mines.

Despite the development of extensible curtain systems, the continuing need for better methane control has led to improved face ventilation systems using spray fan and scrubber systems.

### VENTILATION WITH THE SPRAY FAN SYSTEM

The spray fan system is an auxiliary ventilation system that makes use of the air-moving ability of water sprays. Moving droplets in the spray drag the surrounding air forward to create a considerable airflow, particularly when several sprays are arranged in a series as fans in a row. To install the spray fan system on a continuous miner (Figure 3-5), spray manifolds 1 and 2 are placed on the off-curtain side of the miner. These sprays move air forward to ventilate the off-curtain corner of the face (in Figure 3-5, the right corner). Spray manifold 3 moves air from right to left underneath the boom. Spray manifold 4 has 11 sprays angled 30° left to sweep air from right to left across the face and 1 spray on the right edge angled right to wet dust and clear gas from the right end of the cutter head. These manifolds are arranged for a working face that has the exhaust curtain on the left side.

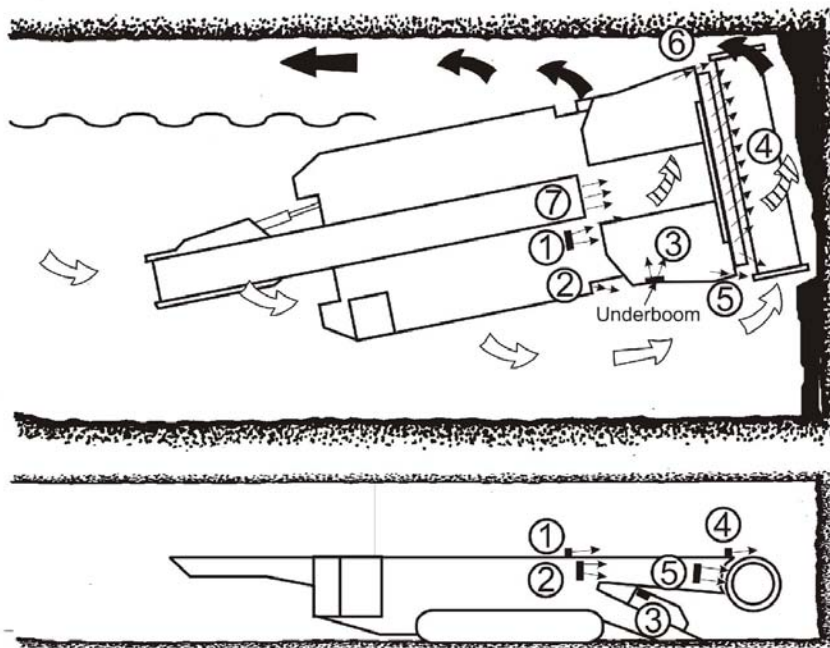

Figure 3-5.—Spray fan system on a continuous miner. The numbers correspond to the spray manifolds.

When the exhaust curtain is on the right side, another spray system, a mirror image of the one described, must be provided.

In addition to the spray manifolds already described, additional dust suppression spray manifolds 5, 6, and 7 are directed at the ends of the cutting head and into the throat. These also help to keep the cutter head ends and the throat clear of gas, and they operate whether the left- or right-side curtain is in use.

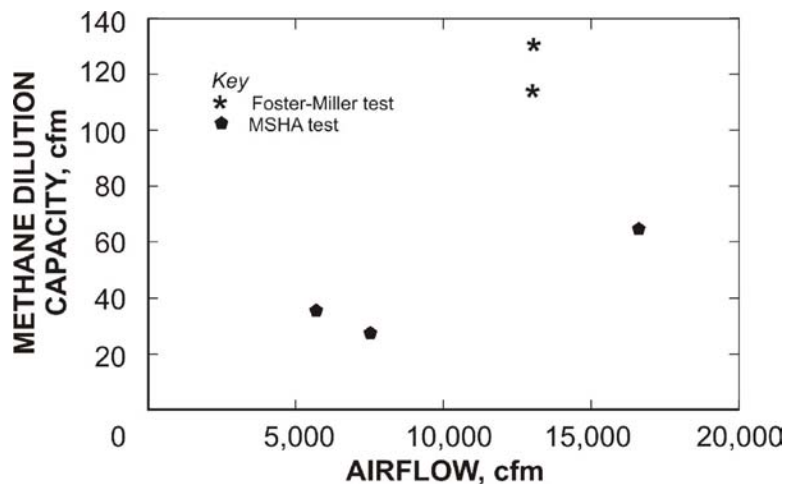

Figure 3–6.—Methane dilution capacity of the spray fan system.

The methane dilution performance of the spray fan is shown in Figure 3–6. Testing in the laboratory and underground by Foster-Miller Associates [Ruggieri et al. 1985b] at 13,000 cfm and at a water pressure of 100 and 150 psi yielded impressive methane dilution capacities of 115 and 135, respectively. Later testing by MSHA gave lower values, in part because of different design and lower water pressures.<sup>9</sup> Still, the improvement with spray fans over the baseline 10-ft setback can be substantial.

An installation guide for the spray fan is available [Ruggieri et al. 1985a]. Close control of the water pressure is particularly important. If the water pressure is too low, little air will be moved. High water pressure will move more air, but if the pressure is too high, the spray fan can move more air than the line curtain, producing an airflow imbalance that raises the dust level at the operator cab.

**Good performance from spray fan systems requires that they be used according to established spray location and water pressure guidelines [Ruggieri et al. 1985a]. Following these guidelines ensures that the amount of air moved is adequate.**

## DUST SCRUBBERS WITH BLOWING VENTILATION

Dust scrubbers were first installed on continuous miners in the 1970s. Today, almost all new machines come equipped with them. Their popularity is due to improved methane dilution at large curtain setbacks, enabling the coal industry to achieve efficiency gains through extended cutting. Figure 3–7 shows a dust scrubber used in conjunction with blowing ventilation, the most common ventilation configuration. The scrubber collects dusty air at the boom, removes the dust, and discharges the clean air at the rear corner of the miner. This section covers the methane dilution effectiveness of scrubbers with blowing ventilation and the operating factors that impact the methane dilution.

<sup>9</sup>The effectiveness of spray fan systems depends on the water pressure. See Figure 3–11.

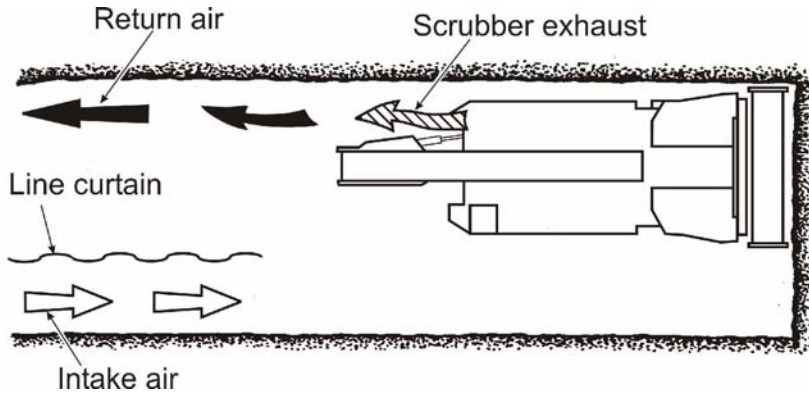

Figure 3-7.—Dust scrubber used in conjunction with blowing ventilation.

**Methane dilution effectiveness.** The first comprehensive underground study to measure the methane dilution effectiveness of a high-volume scrubber used in an extended cut with blowing ventilation was conducted by Haney et al. [1983]. With a 6,700-cfm dust scrubber, they obtained a methane dilution

capacity of 24.5 cfm using blowing line curtain located on the side of the entry opposite the scrubber exhaust. There was no deterioration in performance up to the largest line curtain setback tested (35 ft).

A subsequent test by Halfinger [1984] gave similar results. The 7,000-cfm scrubber provided a methane dilution capacity averaging 26 cfm (see footnote 12). The scrubber system performed equally well at all line curtain setbacks tested (25, 35, and 50 ft). Halfinger also noted that the methane dilution effectiveness was independent of line curtain airflow between 3,500 and 6,000 cfm, the lowest and highest line curtain airflows tested.

Subsequent to the Halfinger study, MSHA conducted an extensive series of scrubber tests in mines across the United States [Zuchelli et al. 1993; Schultz et al. 1993; Stoltz and Snyder 1991;

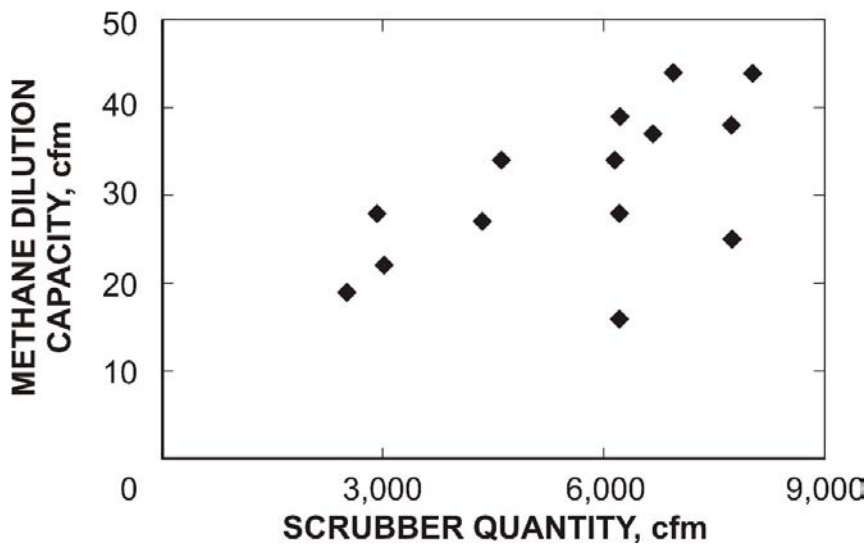

Figure 3-8.—Methane dilution capacity from MSHA scrubber tests.

Snyder et al. 1993; Smith and Stoltz 1990; Denk et al. 1988; Snyder et al. 1991; Dupree et al. 1993; Mott and Chuhta 1991; Denk et al. 1989]. Methane dilution results (Figure 3-8) indicated that methane dilution capacity was roughly related to scrubber quantity. For scrubbers over 4,000 cfm in coal heights 60 in or more, the average methane dilution capacity ranged from 28 to 44 cfm; for scrubbers over 4,000 cfm in coal under 60 in, the

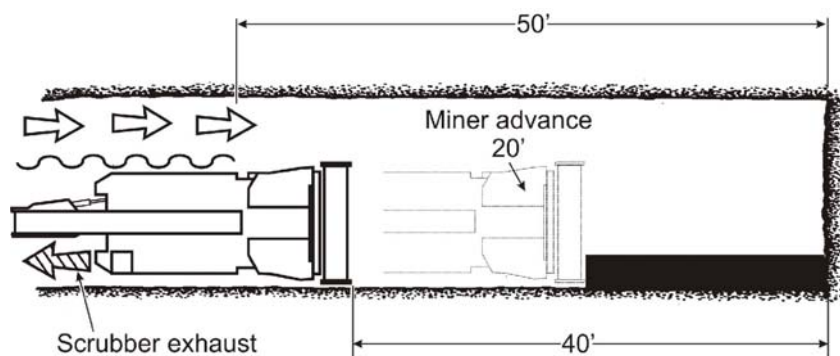

Figure 3-9.—Test configuration used by Thimons et al. [1999].

average methane dilution capacity ranged from 16 to 27 cfm.<sup>10</sup> With regard to the effect of line curtain setback, the results mirrored those of Haney and those of Halfinger. The methane dilution capacity did not decline at the largest line curtain setbacks measured, typically up to 40 ft.

An important aspect of scrubber system effectiveness is how well the box is being ventilated while the slab cut is being made. An investigation by Thimons et al. [1999] (Figure 3-9) indicated that with the blowing line curtain at 50 ft and the continuous miner at the start of a 40-ft slab, the amount of fresh air reaching the face of the box was 400–600 cfm. However, as the miner advanced, more air reached the face of the box. When half of the slab was cut—a 20-ft advance—the amount of air reaching the face of the box was 2.5 times higher. Bringing the curtain forward also helped. For example, moving the curtain from 50 ft to 40 ft increased the airflow by a factor of 1.6 to 2.0 depending on test conditions.

**Operating factors that impact methane dilution.** Many factors impact the ability of scrubbers to dilute methane safely. Some are related to the original design, others to the quality of maintenance.

**It is important to have an understanding of the operating factors that impact scrubber methane dilution: air quantity, water sprays, exhaust direction, clogging, and turning crosscuts.**

- *Scrubber air quantity.* Taylor et al. [1997] conducted studies in a full-scale surface test gallery to assess the impact of changing the scrubber air quantity and intake air quantity. On average, raising the scrubber air volume from 6,000 to 14,000 cfm produced a modest 23% decrease in methane concentration. The greatest decrease in methane concentration was at an intake airflow of 6,000 cfm, where raising the scrubber volume from 6,000 to 14,000 reduced methane levels by 38%. These results generally mirror those of MSHA's scrubber tests shown in Figure 3-8, indicating improved methane dilution at higher scrubber airflows.

- *Water sprays.* The impact of water sprays on scrubber ventilation effectiveness has been studied by Volkwein and Wellman [1989] and Taylor and Zimmer [2001]. Volkwein and Wellman

<sup>10</sup>Bear in mind that these figures are only averages. On a cut-to-cut basis, peak methane values vary widely. For example, Haney et al. [1983] found that the methane dilution capacity had a coefficient of variation of 55%. Similar variability has been found by Smith and Stoltz [1991].



found that effective scrubber operation depends on the air movement generated by the dust-suppression water sprays. Turning off the spray system doubled the methane level.<sup>11</sup>

Volkwein and Wellman also tested a directional spray system (similar in concept to the spray fan system described above) to help direct the air into the single inlet scrubber they were testing. Switching from a conventional spray system to a directional spray system yielded a 23% reduction in the methane level. Taylor and Zimmer saw no benefit from directional sprays because they were testing a dual-inlet scrubber system.

- *Exhaust direction.* Taylor and Zimmer [2001] conducted tests to assess the impact of changing the scrubber exhaust toward or away from the blowing line curtain. As might be expected, directing the exhaust toward the blowing curtain interfered with the air stream from the curtain and gave the highest methane levels. By comparison, directing the exhaust straight back lowered methane levels at the face by 30%. Directing the exhaust toward the return-side rib lowered methane an additional 25%, for a total decrease of 55%.

**When a scrubber is used in conjunction with blowing ventilation, it is important that the blowing curtain (or duct) be on the side of the entry opposite the scrubber exhaust and that the exhaust be directed at the return-side rib.**

- *Clogging.* Clogging of the flooded-bed filter panel or the scrubber ductwork will seriously inhibit the methane dilution capacity of scrubbers. Denk et al. [1988] conducted a study in an Alabama mine that measured the methane dilution impact of a clogged scrubber inlet. The scrubber being tested had a metal plate that restricted the airflow at one of the two inlets, and the methane dilution capacity of the system was 28.5 cfm. When the metal plate was removed, subsequent testing showed that the methane dilution capacity had risen to 39.3 cfm, a 38% improvement.

**Clogging from coal particulate can be very rapid. For example, Campbell and Dupree [1991] noted a scrubber air decrease of 23% after just one 30-ft cut of coal. Schultz and Fields [1999] noted that some scrubbers lose as much as one-third of their airflow after just one cut.**

Schultz and Fields [1999] reported on a method used by one mine operator to block large pieces of coal from entering the scrubber inlets under the boom. The mine had installed a flap of conveyor belt about 8 in in by each inlet, and the flaps extended downward about 8 in. The flaps forced the air to make an extra turn before entering the inlet, blocking the larger particles flying from the cutting drum. These flaps worked so well that the scrubber lost only 10% of its airflow capacity after an entire shift of operation.

<sup>11</sup>This result is not surprising. Wallhagen [1977] found the same effect with a conventional exhaust ventilation system with conventional sprays and no scrubber.

When a dust scrubber clogs, its air quantity declines. Taylor et al. [1995] investigated ways to alert the miner operator to a clogging problem. The most effective was to monitor the fan motor current, since an air quantity decline resulting from clogging will lower the fan motor current.

- *Turning crosscuts.* Using a small-scale model, Tien [1989] assessed the ventilation provided by scrubbers whenever crosscuts were being mined. Results showed that keeping the line curtain as close as practical to the rear of the miner is essential for controlling both respirable dust and methane.
- *Less critical operating factors.* Other operating factors, once thought to be important, have turned out to be less critical. For example, Taylor et al. [1997] found that changing the line curtain airflow in the range between 6,000 and 14,000 cfm does not change the average face methane concentration. Also, methane levels do not increase when the line curtain airflow is less than the scrubber airflow (6,000-cfm line curtain versus 14,000-cfm scrubber), a situation that leads to a high amount of recirculation. Many years earlier, a study by Kissell and Bielicki [1975] led to a conclusion that recirculation per se was not harmful, as long as a sufficient quantity of fresh air was provided by the line curtain.

## DUST SCRUBBERS WITH EXHAUST VENTILATION

Dust scrubbers have also been used with exhaust ventilation. However, the major drawback to using scrubbers with exhaust ventilation is the need to ventilate the empty headings that have been mined out, but not yet bolted. The jet from a blowing curtain can provide some minimal ventilation level, but an exhaust curtain may not [Luxner 1969].

Haney et al. [1983] conducted the first tests with scrubbers and exhaust curtain, obtaining a methane dilution capacity of 33.4 cfm using a 6,700-cfm dust scrubber. A subsequent study using a full-scale model [Taylor et al. 1996] gave methane dilution capacities ranging from 22 to

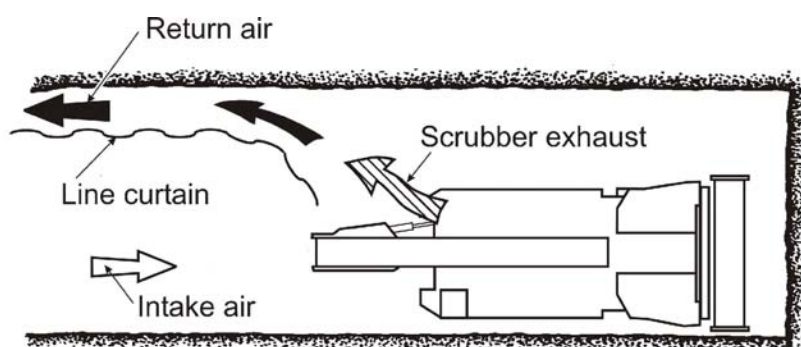

58 cfm, depending on airflow.<sup>12</sup> Both of these studies employed an exhaust line curtain located on the *same* side of the entry, so the air jet from the scrubber fed directly into the line curtain as shown in Figure 3-10.

Figure 3-10.—Dust scrubber used with exhaust ventilation.

<sup>12</sup>This study gave average methane concentrations, whereas the methane dilution capacity is normally calculated based on the highest measured concentration (see footnote 7). To obtain the methane dilution capacity values stated, we assumed that the highest measured concentration would be 30% greater than the average concentration.

When the scrubber exhaust is *not* on the *same* side of the entry as the exhaust curtain, methane dilution suffers. For example, Stoltz et al. [1991] conducted a scrubber ventilation study at a mine that had an exhaust curtain on the opposite side of the entry from the scrubber exhaust. The measured methane dilution capacity was only 13 cfm.

Another exhaust line curtain requirement is that the mouth of the curtain be *outby* the scrubber exhaust (Figure 3–10). Jayaraman et al. [1990] conducted a series of tests that included a line curtain setback of 10 ft, which was about 10 ft *inby* the scrubber exhaust. The methane dilution was one-half to one-fourth of that obtained with a curtain setback of 30 ft.

**When using a scrubber in conjunction with exhaust ventilation, keep the curtain on the same side of the entry as the scrubber exhaust and keep the mouth of the curtain outby the scrubber exhaust (as shown in Figure 3–10).**

## THE VENTILATION OF ABNORMALLY GASSY FACES

Some continuous miner faces have abnormally high methane emissions, and it is helpful to explore the various alternatives a mine operator might have to safely ventilate such faces. Although mine tests have not been conducted, a high-pressure spray fan and a high-volume scrubber have each achieved a methane dilution capacity on the order of 100 cfm in laboratory tests, provided that line curtain air quantities were large<sup>13</sup> and curtain setback distances were modest.

**Abnormally gassy faces may be ventilated with diffuser fans, high-pressure spray fans, or high-volume scrubbers.**

**However, degasification with horizontal or vertical boreholes is necessary if the section emits over 300 cfm of methane. For more on degasification, see Chapter 6.**

**Diffuser fan.** The diffuser fan is a small fan mounted on the continuous miner that directs an air jet at the working face. Used in conjunction with exhaust line curtain, it was the primary means of ventilating gassy faces before the development of the spray fan. Wallhagen [1977] developed an optimized two-nozzle, 1,750-cfm fan that essentially induced all 9,000 cfm of the line curtain

<sup>13</sup>Methods to increase airflow by decreasing line curtain and check curtain leakage have been described by Muldoon et al. [1982]. A high-capacity duct system designed to deliver 45,000–50,000 cfm has been described by Hagood [1980].

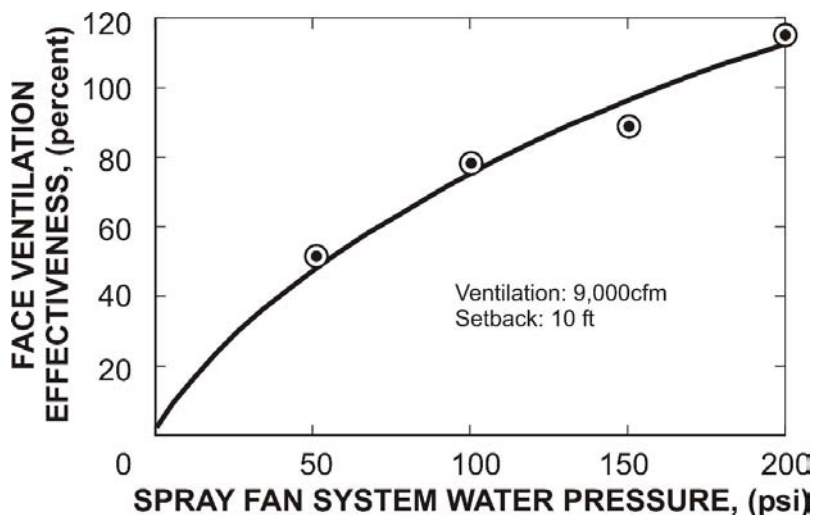

Figure 3-11.—Graph showing that performance of a spray fan depends on water pressure.

air to the face, yielding a methane dilution capacity of roughly 65 cfm (see footnote 12). The ventilation setback (duct was used) was 10 ft. Some years later, Haney et al. [1982] tested a high-volume 5,000-cfm diffuser fan. With line curtain airflows of 9,000 cfm and higher, the minimum methane dilution was 74 cfm for a 10-ft curtain setback and 67 cfm for a 20-ft curtain setback.

Although effective for diluting methane, diffuser fans were not popular in the past because they were noisy and kicked up dust. They might be more acceptable on today's remote-control machines. Wallhagen [1977] gives tips on how to design a diffuser fan system that is matched to a line curtain airflow of 15,000–20,000 cfm.

**High-pressure spray fan.** It was mentioned earlier that a spray fan tested by Ruggieri et al. [1985b] gave methane dilution capacities of 115 and 135 at pressures of 100 and 150 psi, respectively, but that subsequent MSHA tests gave much lower values. To get full performance from a spray fan system, the system must be installed and operated according to established guidelines [Ruggieri et al. 1985a] and with line curtain airflows of 15,000 cfm or more. High performance from spray fan systems also requires that they be operated at high water pressure, as shown in Figure 3-11 [Wallhagen 1977].

**High-volume scrubber.** In a full-scale laboratory test facility, Taylor et al. [1996] tested a 14,000-cfm scrubber in conjunction with a 14,000-cfm blowing line curtain. At a 25-ft curtain setback, the methane dilution capacity was 111 cfm (see footnote 12). At a 35-ft setback, the methane dilution capacity decreased to 68 cfm.

When the 14,000-cfm scrubber was used in conjunction with a 14,000-cfm *exhausting* line curtain, the methane dilution capacity was 58 and 53 cfm at 25- and 35-ft setbacks, respectively.

## METHANE DETECTION AT CONTINUOUS MINER FACES

Two methods of methane detection are used at continuous miner faces: intermittent sampling with portable methane detectors and continuous monitoring with machine-mounted methane monitors. These are both required by MSHA regulations [30 CFR 75].

Methane monitors are usually mounted on the side of the cutting boom of the continuous miner. The best practice is to select the side that normally sees the highest concentrations.<sup>14</sup> For exhaust ventilation systems, including spray fan and scrubber systems, this is normally the same side of the entry where the exhaust curtain (or duct) is located. For blowing ventilation used with scrubber systems, it is normally the opposite side of the entry from the blowing curtain (or duct) [Zuchelli et al. 1993; Schultz et al. 1993; Stoltz and Snyder 1991; Snyder et al. 1993; Smith and Stoltz 1990; Denk et al. 1988; Snyder et al. 1991; Dupree et al. 1993; Mott and Chuhta 1991; Denk et al. 1989].

The required intermittent sampling is a gas check every 20 min with a portable methane detector. A common practice is to attach the portable methane detector to the end of an extensible pole, then to extend the pole out over the continuous miner as far forward as possible. However, this is an awkward procedure that requires a long pole, a methane detector with a large readout, and good eyesight. Another approach, used at deep-cut faces, is to tram out the miner and attach the methane detector to the head using a magnet. The miner is then trammed back in and the detector read.

## **VENTILATION AND METHANE DETECTION AT BOLTER FACES**

On faces that are being bolted, the line curtain or ventilation duct must always be extended to the last row of bolts and moved forward when a new row of bolts is installed. For particularly gassy faces, it may be necessary to use an extensible curtain or duct system [Muldoon et al. 1982].

With regard to methane detection, it has always been difficult to make a methane concentration measurement at the face while, at the same time, remaining safely under bolted roof. Extended-cut mining methods have increased this difficulty because the freshly cut face can extend 40 ft or more beyond the last row of bolts. To deal with this problem, MSHA has published a new rule [68 Fed. Reg.<sup>15</sup> 40132 (2003)]. This new rule, based on the work of Taylor et al. [1999], allows methane tests to be made at intervals not exceeding 20 min by sweeping a 16-ft probe in by the last permanently supported roof, provided that a methane monitor is also mounted on the roof-bolting machine.<sup>16</sup> The methane monitor must be capable of giving a warning signal at 1.0% methane and capable of automatically deenergizing the machine at 2.0% methane, or if the monitor is not working properly.

Typical ignitions at roof bolter faces have been discussed by Urosek and Francart [1999].

## **REDUCING FRICTIONAL IGNITIONS**

Up to this point, the emphasis of this chapter has been solely on ventilation methods and monitoring for gas. However, the chance of a methane ignition may be further reduced by

---

<sup>14</sup>For additional information on methane monitor placement, see Chapter 2 on sampling.

<sup>15</sup>See Fed. Reg. in references.

<sup>16</sup>See 68 Fed. Reg. 40132 [2003] for requirements on methane testing.

dealing directly with the ignition source. When a continuous miner cutter bit strikes rock, abrasion from the rock grinds down the rubbing surface of the bit, producing a glowing hot metal streak on the rock surface behind the bit. The metal streak is often hot enough to ignite methane, causing a so-called frictional ignition.

At continuous miner faces, there are two approaches to lower the incidence of frictional ignitions. The first approach concerns the bit itself—providing a regular change-out schedule to replace worn bits, providing bits with a larger carbide tip to reduce wear, and possibly changing the bit attack angle or the type of bit.

The second approach is to mount a water spray behind each bit, aiming the spray toward the location on the rock where the hot metal streak is expected. This anti-ignition back spray quenches the hot streak, reducing its temperature and the chance of a frictional ignition.

**Bit changes to reduce frictional ignitions.** The most important action one can take to reduce frictional ignitions is to replace bits regularly, thus avoiding the formation of wear flats on the bits. Frictional ignition with a mining bit always involves a worn bit having a wear flat on the tip of the bit [Courtney 1990]. A small wear flat forms a small hot spot, which does not lead to an ignition, whereas a large wear flat forms a large hot spot that is more likely to cause an ignition. Also, mining bits consist of a steel shank with a tungsten carbide tip. The steel is more incendiary than the tungsten carbide tip, so if the tip is worn off and the steel shank exposed, the chance of an ignition is much greater. As an example, Figure 3–12 shows the results of a test in which a cutter bit was used to cut a sandstone block in the presence of an ignitable methane concentration.

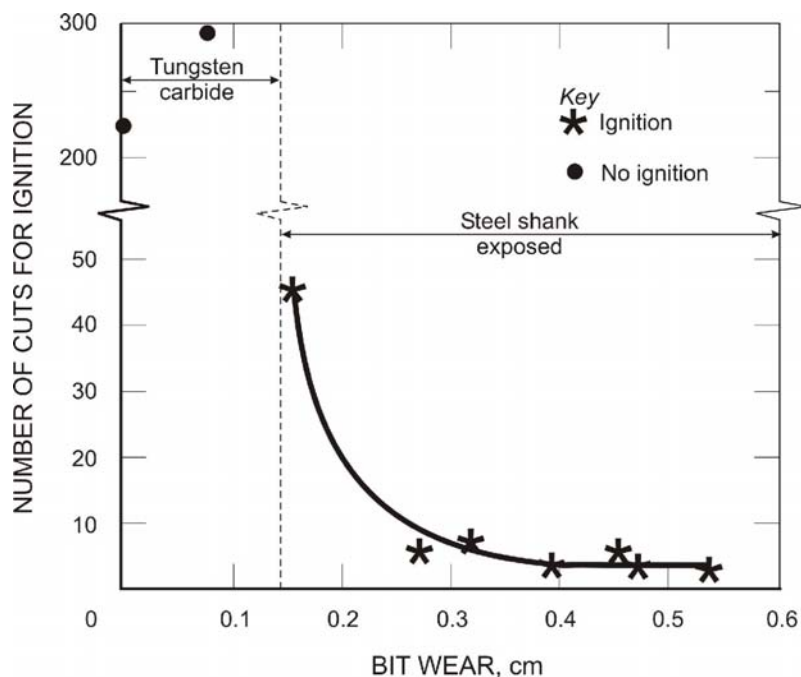

Figure 3–12.—Effect of bit wear on frictional ignition [Courtney 1990].

With the tungsten carbide tip in place, no ignitions were obtained even after 200 or more cuts. With the steel shank exposed, ignitions quickly began. With as little as 0.3-cm bit wear, fewer than 10 cuts were necessary to produce an ignition.

Bits that wear more slowly can be changed less frequently. Bit wear is reduced by using bits that have larger carbide tips or by using bits that have a highly abrasion-resistant polycrystalline diamond layer on the rake face of the tip.

Other methods to reduce frictional ignitions are to change the attack angle and tip angle of conical bits [Courtney 1990] and

to use radial bits instead of conical bits [Phillips 1996]. McNider et al. [1987] reported a decrease in frictional ignitions by using bits with larger carbide tips and by changing the bit attack angle.<sup>17</sup>

**Anti-ignition back sprays.** Anti-ignition back sprays, an effective method to reduce frictional ignitions, are discussed in the longwall chapter (Chapter 4). Bringing water to the cutter head on continuous miners has been an engineering challenge. However, in recent years, practical (if expensive) water seals for continuous miner heads have been developed. As a result, a few “wet-head” continuous miners equipped with anti-ignition back sprays have been installed in U.S. coal mines with a history of frictional ignition problems. Phillips [1997] has provided a status report on wet-head cutting drums.

**A thorough review of frictional ignitions in mines, including metal-to-metal ignitions and those from roof falls, is provided by Phillips [1996].**

## REFERENCES

68 Fed. Reg. 40132 [2003]. Mine Safety and Health Administration, 30 CFR Part 75: improving and eliminating regulations, phase 5, miscellaneous technology improvements (methane testing); final rule.

Campbell CD, Dupree WA [1991]. Evaluation of methane dilution capacity of a blowing face ventilation system using a water spray fan and dust scrubber. In: Proceedings of the Fifth U.S. Mine Ventilation Symposium (Morgantown, WV, June 3–5, 1991).

CFR. Code of federal regulations. Washington DC: U.S. Government Printing Office, Office of the Federal Register.

Courtney WG [1990]. Frictional ignition with coal mining bits. Pittsburgh, PA: U.S. Department of the Interior, Bureau of Mines, IC 9251. NTIS No. PB91110072.

Denk JM, Smith GE, Stoltz RT [1989]. Face ventilation investigation: Wabash mine, I.D. No. 11–00877, AMAX Coal Company, Keensburg, Wabash County, Illinois, August 29, 1989–September 1, 1989. Pittsburgh, PA: U.S. Department of Labor, Mine Safety and Health Administration, Pittsburgh Health Technology Center, Ventilation Division, Investigative Report No. P313–V218.

Denk JM, Younger RK, Mott ML, Chuhta EJ [1988]. Face ventilation investigations: Mary Lee No. 1 mine, I.D. No. 01–00515–0, Drummond Company, Incorporated, Goodsprings, Walker County, Alabama, October 28–November 4, 1987, and October 18–26, 1988. Pittsburgh, PA:

---

<sup>17</sup>Changing the bit attack angle can also raise the cutting force, requiring a change in drum design.

U.S. Department of Labor, Mine Safety and Health Administration, Pittsburgh Health Technology Center, Ventilation Division, Investigative Report No. P297–V203.

Dupree WA Jr., Schroeder ME, Baran JN [1993]. Face ventilation investigation: Island Creek Coal Company, Ohio No. 11 mine, I.D. No. 15–03178, Morganfield, Union County, Kentucky, May 25–27, 1993. Pittsburgh, PA: U.S. Department of Labor, Mine Safety and Health Administration, Pittsburgh Safety and Health Technology Center, Ventilation Division, Investigative Report No. P380–V283.

Hagood [1980]. A high-capacity face ventilation system. In: Proceedings of the Second International Mine Ventilation Congress (Reno, NV, November 4–8, 1979). Littleton, CO: Society of Mining Engineers.

Halfinger G Jr. [1984]. Feasibility of a machine-mounted scrubber system for ventilating coal mine working faces. Ingersoll-Rand Research, Inc. U.S. Bureau of Mines contract No. J0199080. NTIS No. PB85185742.

Haney RA, Gigliotti SJ, Banfield, JL [1982]. Face ventilation systems performance in low-height coal seams. In: Proceedings of the First Mine Ventilation Symposium (Tuscaloosa, AL, March 29–31, 1982).

Haney RA, Smith GE, Denk JM [1983]. Evaluation of a face ventilation system using a machine-mounted dust collector. In: Proceedings of the Sixth Annual Mining Institute, (Tuscaloosa, AL, October 11–12, 1983).

Jayaraman NI, Volkwein JC, Kissell FN [1990]. Update on continuous miner dust scrubber applications. *Min Eng* 42(3):281–284.

Kissell FN, Bielicki RJ [1975]. Methane buildup hazards caused by dust scrubber recirculation at coal mine working faces: a preliminary estimate. Pittsburgh, PA: U.S. Department of the Interior, Bureau of Mines, RI 8015. NTIS No. PB240684.

Kissell FN, Wallhagen RE [1976]. Some new approaches to improved ventilation of the working face. In: Proceedings of the NCA/BCR Coal Conference (Louisville, KY, October 19–21, 1976), pp. 325–338.

Kissell FN, Banfield JL, Dalzell RW, Zabetakis MG [1974]. Peak methane concentrations during coal mining: an analysis. Pittsburgh PA: U.S. Department of the Interior, Bureau of Mines, RI 7885.

Luxner JV [1969]. Face ventilation in underground bituminous coal mines. Washington, DC: U.S. Department of the Interior, Bureau of Mines, RI 7223.

McNider T, Grygiel E, Haynes J [1987]. Reducing frictional ignitions and improving bit life through novel pick and drum design. In: Proceedings of the Third Mine Ventilation Symposium (University Park, PA, October 12–14, 1987), pp. 119–125.



Mott ML, Chuhta EJ [1991]. Face ventilation investigation: Monterey No. 1 mine, ID No. 11-00726, Monterey Coal Company, Carlinville, Macoupin County, Illinois, January 15-17, 1991. Pittsburgh, PA: U.S. Department of Labor, Mine Safety and Health Administration, Pittsburgh Health Technology Center, Ventilation Division, Investigative Report No. P350-V254.

Muldoon T, Bartlett P, Schroeder W [1982]. Improving check curtains, line curtains, and extensible face ventilation systems. Waltham, MA: Foster-Miller Associates. U.S. Bureau of Mines contract No. J0100075. NTIS No. PB83216242.

Phillips HR [1996]. Identify methods to reduce the risks of frictional ignition hazards. Final project report, project COL 226. Braamfontein, Republic of South Africa: Safety in Mines Research Advisory Committee (SIMRAC) ([www.simrac.co.za](http://www.simrac.co.za)).

Phillips HR [1997]. To establish the current status of research, development, and operational experience of wet-head cutting drums for the prevention of frictional ignitions. Final project report, project COL 426. Braamfontein, Republic of South Africa: Safety in Mines Research Advisory Committee (SIMRAC) ([www.simrac.co.za](http://www.simrac.co.za)).

Ruggieri SK, Babbitt C, Burnett J [1985a]. Improved spray fan system: installation guide. Waltham, MA: Foster-Miller Associates. U.S. Bureau of Mines contract No. J0113010. NTIS No. PB86165065.

Ruggieri SK, Muldoon TL, Babbitt C, Lee E [1985b]. Improved diffuser and spray fan systems for ventilation of coal mine working faces. Waltham, MA: Foster-Miller Associates. U.S. Bureau of Mines contract No. J0113010. NTIS No. PB86168440.

Schultz MJ, Fields KG [1999]. Dust control considerations for deep cut mining sections. SME preprint 99-163. Littleton, CO: Society for Mining, Metallurgy, and Exploration, Inc., 4 pp.

Schultz MJ, Beiter DA, Watkins TR, Baran JN [1993]. Face ventilation investigation: Clark Elkhorn Coal Company, Ratliff mine No. 110, I.D. No. 15-16121, Rockhouse Creek, Pike County, Kentucky, September 21-24, 1993. Pittsburgh, PA: U.S. Department of Labor, Mine Safety and Health Administration, Pittsburgh Safety and Health Technology Center, Ventilation Division, Investigative Report No. P385-V286.

Smith GE, Stoltz RT [1990]. Face ventilation investigation: Greenwich Collieries No. 2 mine, ID No. 36-02404, Greenwich Collieries Company, a division of Rochester and Pittsburgh Coal Company, Cookport, Indiana County, Pennsylvania, August 28-30, 1990. Pittsburgh, PA: U.S. Department of Labor, Mine Safety and Health Administration, Pittsburgh Health Technology Center, Ventilation Division, Investigative Report No. P342-V246.

Smith G, Stoltz R [1991]. Deep-cut mining investigation: case study. In: Proceedings of the Fifth U.S. Mine Ventilation Symposium (Morgantown, WV, June 3-5, 1991).

Snyder MP, Schultz MJ, Baran JN [1991]. Face ventilation investigation: Margaret No. 11B, I.D. No. 36-08139, Keystone Coal Mining Corporation, Indiana, Indiana County, Pennsylvania, August 5-7, 1991. Pittsburgh, PA: U.S. Department of Labor, Mine Safety and Health Administration, Pittsburgh Safety and Health Technology Center, Ventilation Division, Investigative Report No. P356-V260.

Snyder MP, Schultz MJ, Zuchelli DR [1993]. Face ventilation investigation: Peabody Coal Company, Camp No. 11 mine, ID No. 15-08357, Union County, Kentucky, May 11-13, 1993. Pittsburgh, PA: U.S. Department of Labor, Mine Safety and Health Administration, Pittsburgh Safety and Health Technology Center, Ventilation Division, Investigative Report No. P382-V285.

Stoltz RT, Snyder MP [1991]. Face ventilation investigation: Buck Creek mine, ID No. 12-02033, Laswell Coal Company Incorporated, Sullivan, Sullivan County, Indiana, January 8-10, 1991. Pittsburgh, PA: U.S. Department of Labor, Mine Safety and Health Administration, Pittsburgh Health Technology Center, Ventilation Division, Investigative Report No. P346-V250.

Stoltz RT, Snyder MP, Baran J [1991]. Face ventilation investigation: Big Bottom mine, ID No. 15-12618, Rawl Sales and Processing Company, McCarr, Pike County, Kentucky, October 22-29, 1991. Pittsburgh, PA: U.S. Department of Labor, Mine Safety and Health Administration, Pittsburgh Safety and Health Technology Center, Ventilation Division, Investigative Report No. P358-V262.

Taylor CD, Zimmer JA [2001]. Effects of water sprays and scrubber exhaust on face methane concentrations. In: Proceedings of the Seventh International Mine Ventilation Congress (Krakow, Poland, June 17-22, 2001), pp. 465-470.

Taylor CD, Kovsky PD, Thimons ED [1995]. Monitoring machine-mounted dust scrubber performance. In: Wala AM, ed. Proceedings of the Seventh U.S. Mine Ventilation Symposium (Lexington, KY, June 5-7, 1995). Littleton, CO: Society of Mining Engineers, pp. 419-422.

Taylor CD, Rider JP, Thimons ED [1996]. Changes in face methane concentrations using high-capacity scrubbers with exhausting and blowing ventilation. SME preprint 96-167. Littleton, CO: Society for Mining, Metallurgy, and Exploration, Inc.

Taylor CD, Rider JP, Thimons ED [1997]. Impact of unbalanced intake and scrubber flows on face methane concentrations. In: Ramani RV, ed. Proceedings of the Sixth International Mine Ventilation Congress (Pittsburgh, PA, May 17-22, 1997). Littleton, CO: Society for Mining, Metallurgy, and Exploration, Inc, pp. 169-172.

Taylor CD, Thimons ED, Zimmer JA [1999]. Comparison of methane concentrations at a simulated coal mine face during bolting. In: Tien JC, ed. Proceedings of the Eighth U.S. Mine Ventilation Symposium. Rolla, MO: University of Missouri-Rolla Press, pp. 171-178.

Thimons ED, Taylor CD, Zimmer JA [1999]. Evaluating the ventilation of a 40-foot two-pass extended cut. Pittsburgh, PA: U.S. Department of Health and Human Services, Public Health

Service, Centers for Disease Control and Prevention, National Institute for Occupational Safety and Health, DHHS (NIOSH) Publication No. 99-138, RI 9648.

Tien JC [1989]. Face ventilation during crosscut development in a room and pillar operation. In: Proceedings of the Fourth U.S. Mine Ventilation Symposium (Berkeley, CA, June 5-7, 1989).

Urosek JE, Francart WJ [1999]. Methane ignitions on roof bolters in underground coal mines. In: Tien JC, ed. Proceedings of the Eighth U.S. Mine Ventilation Symposium. Rolla, MO: University of Missouri-Rolla Press.

Urosek JE, Battistoni CS, Hazuza GG [1988]. Remote brattice face ventilation systems. In: Frantz RL, Ramani RV, eds. Respirable dust in the minerals industries: health effects, characterization, and control. University Park, PA: The Pennsylvania State University.

Volkwein JC, Wellman TS [1989]. Impact of water sprays on scrubber ventilation effectiveness. Pittsburgh, PA: U.S. Department of the Interior, Bureau of Mines, RI 9259. NTIS No. PB90108820.

Wallhagen RE [1977]. Development of optimized diffuser and spray fan systems for coal mine face ventilation. Waltham, MA: Foster-Miller Associates. U.S. Bureau of Mines contract No. H0230023. NTIS No. PB277987.

Zuchelli D, Stoltz R, Baran J [1993]. Face ventilation investigation, Peabody Coal Company, Martwick mine, ID No. 15-14074, Central City, Muhlenberg County, Kentucky, January 26-28, 1993. Pittsburgh, PA: U.S. Department of Labor, Mine Safety and Health Administration, Pittsburgh Safety and Health Technology Center, Ventilation Division, Investigative Report No. P377-V280.

## CHAPTER 4.—PREVENTING METHANE IGNITIONS AT LONGWALL FACES

By Fred N. Kissell, Ph.D.<sup>1</sup> and Andrew B. Cecala<sup>2</sup>

### *In This Chapter*

- ✓ Where methane is emitted at longwall faces
- ✓ Where methane accumulates at longwall faces
- ✓ Using the modified shearer-clearer to eliminate ventilation eddy zones
- ✓ Using a walkway curtain to reduce methane buildup during the headgate cutout
- ✓ Control of frictional ignitions

*and*

- ✓ The best location for the methane monitor

The methane released along a longwall face represents only 10%–20% of the total methane emitted from the entire longwall panel. Nevertheless, in very gassy coal seams, this methane released at the face can pose a problem because the shearer is a ready ignition source.

Preventing methane ignitions at longwall faces requires four actions. The first is to provide better ventilation around the shearer to eliminate the ventilation eddy zones at the drums where methane builds up. These eddy zones are eliminated by mounting additional water sprays on the shearer to direct air into them. The second action to prevent methane ignitions is to install a water spray behind each cutter bit and regularly replace worn bits. Water sprays behind each cutter bit act to quench the hot metal streak that follows a worn bit when it strikes rock. The third is to ensure that no ventilation eddy zones are inadvertently created by poor placement of water sprays. The fourth is to ensure that the methane monitor on the shearer is in the best location to detect methane accumulations.

### ADDRESSING METHANE ACCUMULATIONS AT LONGWALL FACES<sup>3</sup>

Cecala et al. [1985a, 1989] and Denk and Wirth [1991] studied methane emission and ventilation patterns at longwall faces to find where methane accumulations are most likely. Although not always the case, the major source of methane at longwall faces is usually the breakage of coal by the shearer. Stress-related fracturing of the coal seam at the face, called bumps or bounces, can cause the release of additional gas (Figure 4–1).

---

<sup>1</sup>Research physical scientist, Pittsburgh Research Laboratory, National Institute for Occupational Safety and Health, Pittsburgh, PA (retired).

<sup>2</sup>Mining engineer, Pittsburgh Research Laboratory, National Institute for Occupational Safety and Health, Pittsburgh, PA.

<sup>3</sup>Methane accumulations in longwall gobs are addressed in Chapter 5.

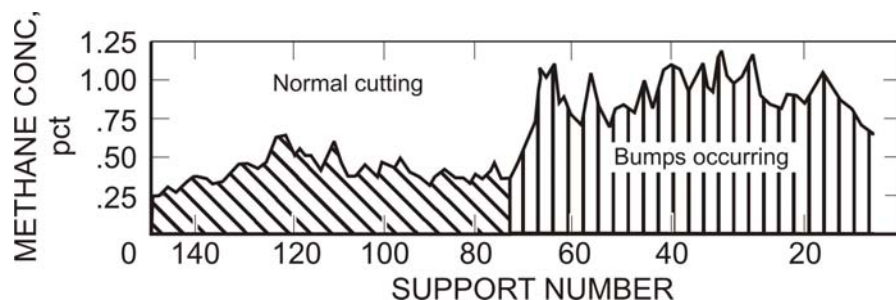

Figure 4-1.—Increased methane liberation during coal bumps.

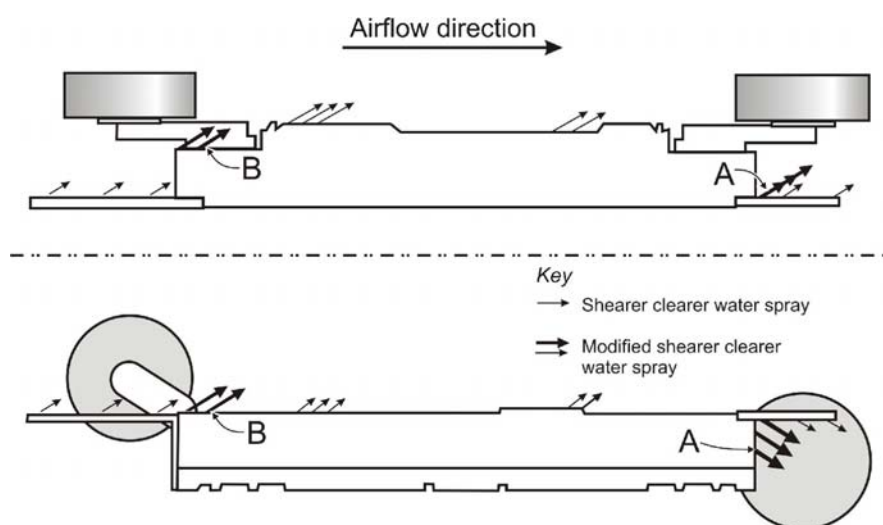

Figure 4-2.—Modified shearer-clearer system.

**Methane accumulations around the shearer body.** The quality of the ventilation around the shearer body impacts the accumulations of methane. For example, ventilation eddy zones around the shearer body are known to accumulate gas because the air exchange in and out of these zones is limited. Studies reported by Ruggieri et al. [1983] on a full-scale mockup of a longwall shearer face showed that the face-side area around both cutting drums and the entire area between the drums were less ventilated than other parts of the shearer. Further increasing the primary

airflow or changing the cutting direction had little impact on improving the ventilation of these eddy zones.

Ventilation at the shearer can be improved by using a “modified” shearer-clearer<sup>4</sup> system to bring more air into these eddy zones. The modified shearer-clearer is shown in Figure 4-2. It differs from the original shearer-clearer system by the addition of three water sprays on the return-side splitter arm (shown as A in Figure 4-2) and two sprays on the head-side corner of the shearer body (shown as B in Figure 4-2). These sprays move air<sup>5</sup> toward the face side of the shearer body and toward the return side of each shearer drum—eddy zone regions where methane accumulations are likely. These extra sprays raise the shearer water consumption by about 20 gpm. According to Cecala and Jayaraman [1994], the modified shearer-clearer system lowers methane concentrations at the shearer by 73%.

<sup>4</sup>The original shearer-clearer system was designed to reduce dust. It is an arrangement of water sprays mounted on the body of a longwall shearer. The purpose of these sprays is to induce an air current over the shearer body, which serves to hold the dust cloud against the face, keeping the dust out of the operator’s walkway.

<sup>5</sup>Many studies [Ruggieri et al. 1985] have established that water sprays mounted on mining machines can move air in the vicinity of the machine and that this air movement can benefit methane control.

Cecala and Jayaraman [1994] have provided a detailed design and installation manual for the modified shearer-clearer system. It is available as a free pdf download from NTIS<sup>6</sup> as PB95104873.

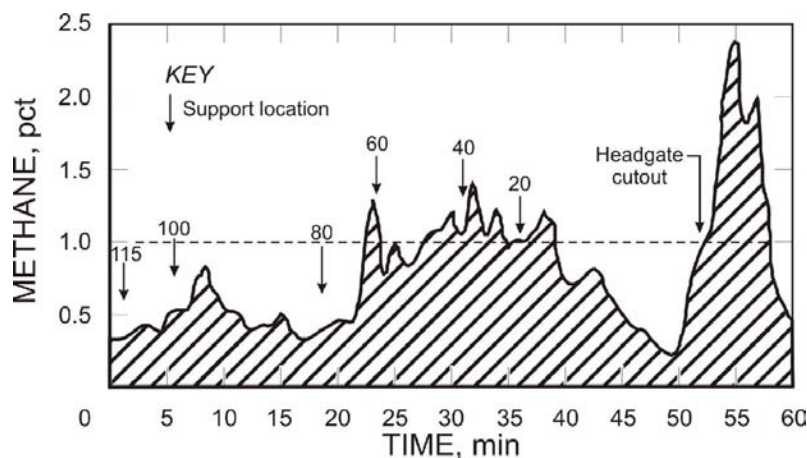

Figure 4-3.—Methane concentration at shearer during tail-to-head pass.

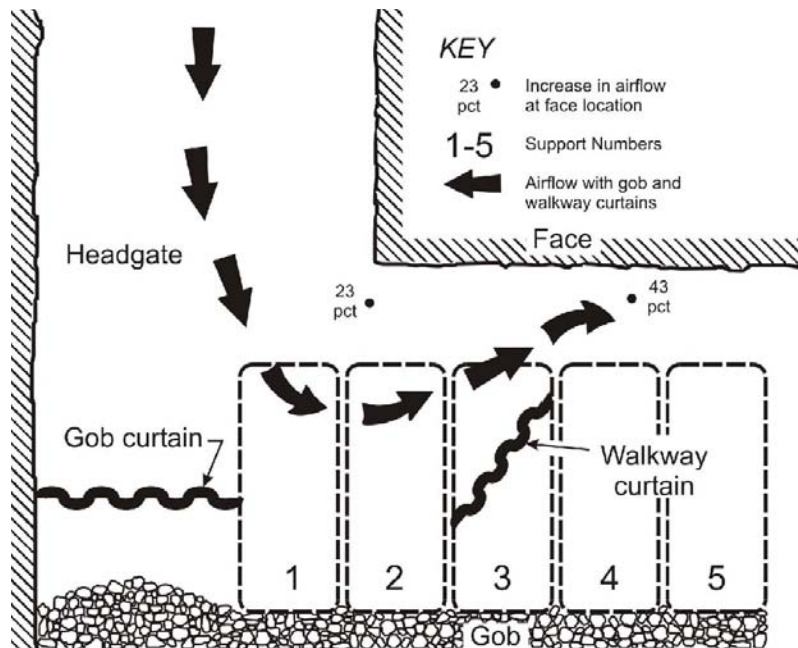

Figure 4-4.—Plan view of walkway and gob curtains (shearer not shown).

### Methane accumulations during the headgate cutout.

Ventilation at the shearer also suffers and the methane concentration rises as the shearer makes the headgate cutout (Figure 4-3). This rise in methane takes place because the air flowing down the headgate entry does not readily make the 90° turn as it reaches the long-wall face. Thus, a portion can divert to flow through the legs of the first 8-10 supports.

Because of this air diversion, the amount of air flowing over the shearer is not sufficient to avoid methane buildup. This buildup can be prevented with a walkway curtain.

The walkway curtain [Cecala et al. 1986], used to force more air over the shearer body during the headgate cutout, is shown in Figures 4-4 and 4-5. The curtain should be located across the walkway near support No. 3, extending from the support legs to the spill plate reaching from the roof to the floor. To be effective, it must be used in conjunction with a gob curtain, a dust control device already in use at most longwalls (Figure 4-4). The walkway curtain raises the air velocity over the shearer by 23% at the headgate

<sup>6</sup>National Technical Information Service, Springfield, VA. See [www.ntis.gov](http://www.ntis.gov).

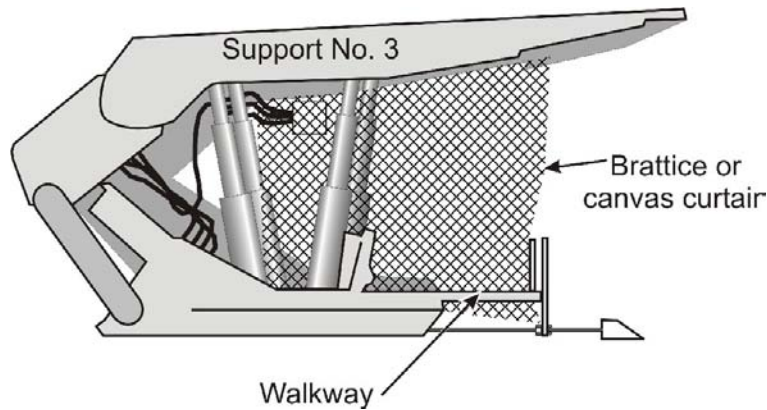

Figure 4-5.—Walkway curtain at support No. 3 forces air over the shearer.

corner and by 43% at support No. 4. These higher air velocities reduce the methane concentration by 60% during the headgate cutout.

During the longwall cutting cycle, the walkway curtain need only be in position during the headgate cutout. Since it is not needed for the remaining 95% of the cutting cycle, it should be tied up to keep it out of the way. For the remaining 95% of the cutting cycle, the modified shearer-clearer is used.

The modified shearer-clearer may need to be turned off during the headgate cutout. During testing of the combined systems, the high air velocity over the shearer created by the walkway curtain overpowered the shearer-clearer sprays and forced water mist over the tail-side shearer operator [Cecala and Jayaraman 1994].

**Methane accumulations caused by inadvertent eddy zones.** Certain ventilation practices lead to the creation of inadvertent eddy zones. Figures 4-6 and 4-7 illustrate two ventilation mistakes that can cause an accumulation of methane. Figure 4-6 shows an upwind-pointing venturi spray mounted on the headgate end of a shearer. The venturi spray creates an airflow opposing the

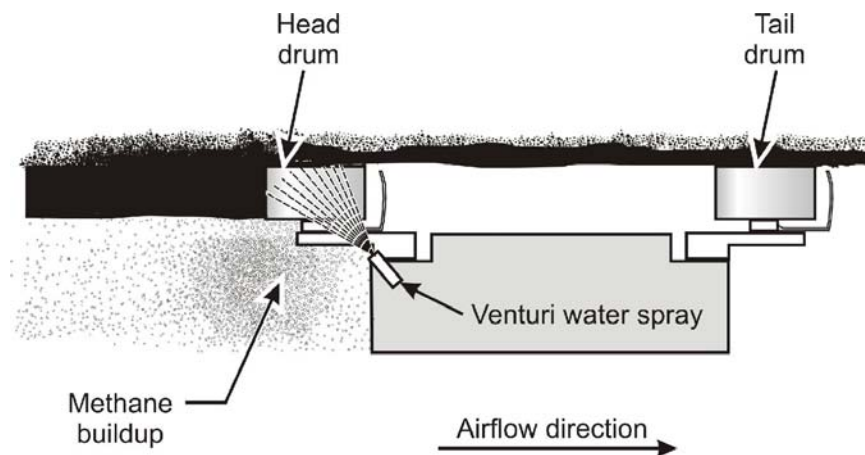

Figure 4-6.—Upwind-pointing venturi spray creates eddy zone and methane buildup.

main ventilation flow direction along the face, thus creating an eddy zone where methane builds up.

Another type of eddy zone is shown in Figure 4-7, which depicts an L-shaped wing curtain used by some operators to control dust during the headgate cutout. Although convenient to use, it can allow the accumulation of methane.

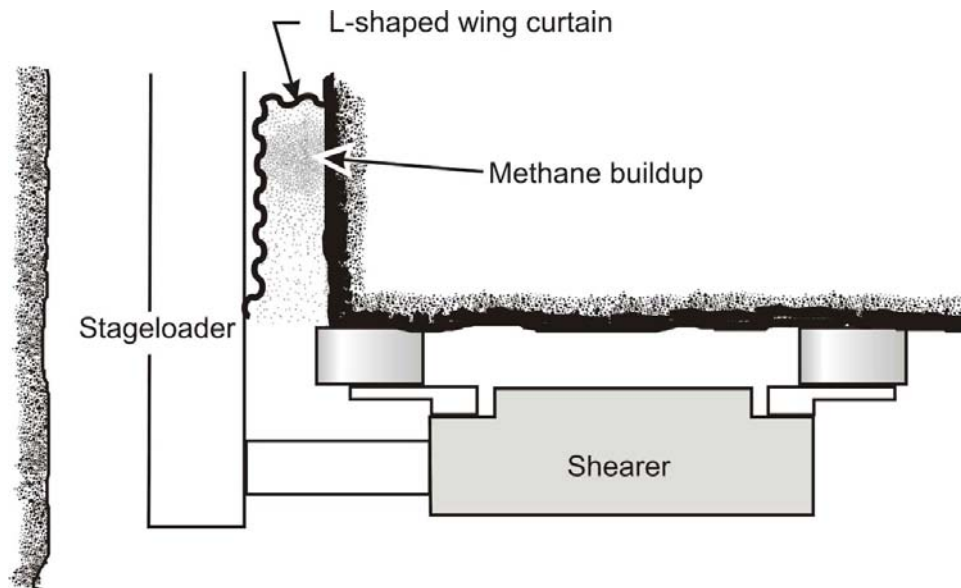

Figure 4-7.—L-shaped wing curtain, which can cause methane buildup.

## REDUCING FRICTIONAL IGNITIONS

Aside from improving the ventilation to reduce methane accumulations in eddy zones, the chance of a methane ignition can be reduced by directly addressing the ignition source. When a shearer cutter bit strikes rock, abrasion from the rock grinds down the rubbing surface of the bit, producing a glowing hot metal streak on the rock surface behind the bit. The metal streak is often hot enough to ignite methane, causing a so-called frictional ignition.

At longwalls, there are two methods to lower the incidence of frictional ignitions. The first method concerns the bit itself—providing a regular change-out schedule to replace worn bits, providing bits with a larger carbide tip to reduce wear, and possibly changing the bit attack angle or the type of bit. These topics are covered in the continuous miner chapter (Chapter 3).

The second method is to mount a water spray behind each bit, aiming the spray toward the location on the rock where the hot metal streak is expected. This anti-ignition back-spray (Figure 4-8) quenches the hot streak, reducing its temperature and the chance of a frictional ignition.

Cecala et al. [1985b] reported how a U.S. longwall lowered methane frictional ignitions by mounting a water spray behind each bit and by slightly lowering the cutting height of the shearer to avoid roof rock. Actions taken in the United Kingdom to reduce frictional ignitions on shearers have been reported by Browning [1988].



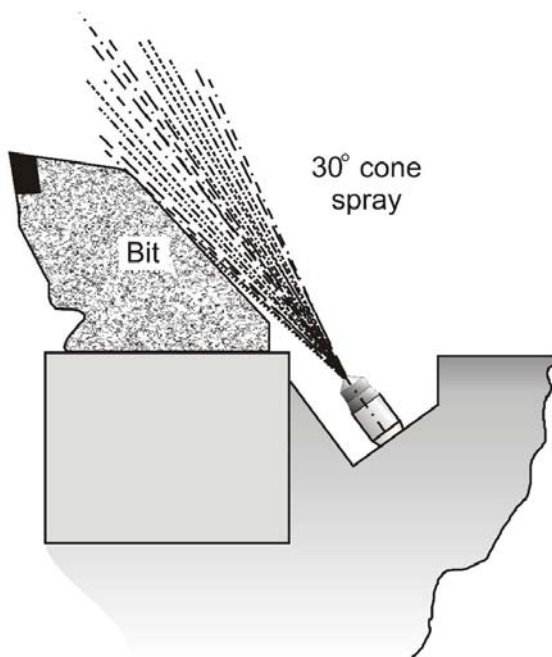

Figure 4-8.—Anti-ignition back spray.

When using water sprays to reduce frictional ignitions, the proper spray nozzle selection, nozzle placement, and operating pressure of anti-ignition back sprays are important if the full hot-streak quenching potential is to be realized [Courtney 1990; British Coal 1988]. For example, if the spray density is too low or if too much water is wasted in wetting the back of the bit, then quenching effectiveness suffers.

**Longwall drums with anti-ignition sprays are commercially available.**

A recent, comprehensive review of frictional ignitions in mines, including metal-to-metal ignitions and those from roof falls, is provided by Phillips [1996].

## THE BEST LOCATION FOR THE METHANE MONITOR

Normally, it is required to use two methane monitors at longwall faces, one located at the tailgate and another on the shearer. Because the shearer is a primary ignition source at most longwalls and because the methane concentration at the shearer is generally higher than the concentration at the tailgate,<sup>7</sup> the shearer is usually the most critical location for the monitor. For example, during the tail-to-head pass shown in Figure 4-3, the methane concentration at the shearer exceeded 1.0% several times, and during the headgate cutout it approached 2.5%. However, at no time did a methane monitor that was located at the tailgate record a concentration over 1.0%. Even if enough gas were released at the shearer to exceed 1.0% at the tailgate monitor, there can be a considerable delay as the gas cloud travels down the face from the shearer to the tailgate monitor.

Because the shearer is usually the most critical location for the methane monitor, Cecala et al. [1993] conducted a study to establish the best location on the shearer. In this study, a full-scale laboratory facility was used to simulate a longwall face with a shearer. Methane was released at the drums, and the concentration was measured at several locations on the top of the shearer body (Figure 4-9).

<sup>7</sup>On some longwalls, the tailgate concentration is higher.

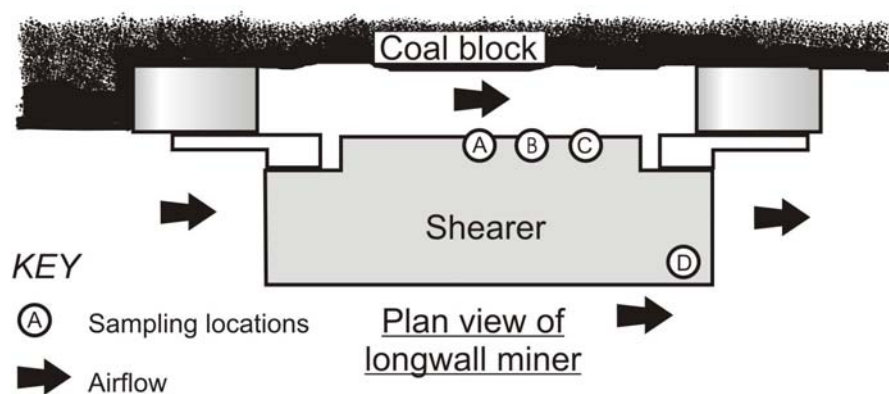

Figure 4-9.—Best methane monitor location.

choice for a monitor location is usually at the gob-side tailgate-end of the machine, shown as location D in Figure 4-9. A monitor at location D is less likely to be damaged, covered with coal, or soaked by water sprays. However, the measured methane concentration is 40%–50% lower than that measured at face-side locations A through C.

Cecala et al. found that locations A through C on the face side of the shearer gave the highest methane concentrations and were approximately the same value. However, the drawback with a location on the face side of the shearer is that the methane monitor is prone to damage or to being covered with coal. Because of this, the best

## REFERENCES

- British Coal [1988]. Control of frictional ignitions and dust on shearers: notes for guidance. British Coal, Headquarters Technical Department, August.
- Browning EJ [1988]. Frictional ignitions. In: Proceedings of the Fourth International Mine Ventilation Congress (Brisbane, Queensland, Australia).
- Cecala AB, Jayaraman NI [1994]. Modified shearer-clearer system for dust and methane control. Pittsburgh, PA: U.S. Department of the Interior, Bureau of Mines, IC 9404. NTIS No. PB95104873.
- Cecala AB, Jankowski RA, Kissell FN [1985a]. Determining face methane-liberation patterns during longwall mining. Pittsburgh, PA: U.S. Department of the Interior, Bureau of Mines, IC 9052. NTIS No. PB86156445.
- Cecala AB, Konda BW, Klinowski GW [1989]. A comparison of methane flow patterns on advancing and retreating longwalls. In: Proceedings of the Fourth U.S. Mine Ventilation Symposium (Berkeley CA, June 5–7, 1989).
- Cecala AB, O'Green J, Watson RW, Jankowski RA [1985b]. Reducing longwall face ignitions. *World Min Equip Jan*:44–46.
- Cecala AB, Rajan SR, Jankowski RA, Kissell FN [1986]. Cut longwall ignitions by lowering methane concentrations at shearers. *Coal Age 91*(8):66–67.

Cecala AB, Zimmer JA, Thimons ED [1993]. Determination of optimal longwall face methane monitoring locations. In: Proceedings of the Sixth U.S. Mine Ventilation Symposium (Salt Lake City, UT, June 21–23, 1993).

Courtney WG [1990]. Frictional ignition with coal mining bits. Pittsburgh, PA: U.S. Department of the Interior, Bureau of Mines, IC 9251. NTIS No. PB91110072.

Denk JM, Wirth GJ [1991]. Evaluating methane emissions on an extended longwall face. In: Proceedings of the Fifth U.S. Mine Ventilation Symposium (Morgantown WV, June 3–5, 1991).

Phillips HR [1996]. Identify methods to reduce the risks of frictional ignition hazards. Final project report, project COL 226. Braamfontein, Republic of South Africa, Safety in Mines Research Advisory Committee (SIMRAC) ([www.simrac.co.za](http://www.simrac.co.za)).

Ruggieri SK, Muldoon TL, Babbitt C, Lee E [1985]. Improved diffuser and spray fan systems for ventilation of coal mine working faces. Waltham, MA: Foster-Miller Associates. U.S. Bureau of Mines contract No. J0113010. NTIS No. PB86168440.

Ruggieri SK, Muldoon TL, Schroeder W, Babbitt C, Rajan S [1983]. Optimizing water sprays for dust control on longwall shearer faces. Waltham, MA: Foster-Miller, Inc. U.S. Bureau of Mines contract No. J0308019. NTIS No. PB86205408.

## CHAPTER 5.—BLEEDER SYSTEMS IN UNDERGROUND COAL MINES

By John E. Urosek, P.E.,<sup>1</sup> William J. Francart, P.E.,<sup>2</sup> and Dennis A. Beiter<sup>3</sup>

### *In This Chapter*

- ✓ Designing bleeder systems
- ✓ Examining and maintaining bleeder systems
- ✓ Evaluating bleeder system effectiveness

### INTRODUCTION

Bleeder systems are that part of the mine ventilation network used to ventilate pillared areas in underground coal mines. Pillared areas are those in which pillars have been wholly or partially removed, including the areas where coal has been extracted by longwall mining. Bleeder systems protect miners from the hazards associated with methane and other gases, dusts and fumes, and oxygen deficiency that may occur in these mined-out areas. Effective bleeder systems control the air passing through the area and continuously dilute and move any methane-air mixtures and other gases, dusts, and fumes from the worked-out area away from active workings and into a return air course or to the surface of the mine. A bleeder system includes the pillared area (including the internal airflow paths), bleeder entries, bleeder connections, and all associated ventilation control devices that control the air passing through the pillared area. Bleeder entries are special air courses designed and maintained as part of the mine ventilation system.

**This chapter focuses on the design, examination, maintenance, and evaluation of bleeder systems in underground coal mines.**

The history of coal mine explosions in the United States is a reminder of the importance of adequate ventilation. Some of those disasters were the result of inadequately ventilated pillared areas. The importance of developing bleeder systems to ventilate these pillared areas and evaluating the bleeder system's effectiveness is reflected in present-day federal regulations. For more information on bleeder systems, see Tisdale [1996] and Urosek and Francart [2002].

---

<sup>1</sup>Chief, Ventilation Division, Pittsburgh Safety and Health Technology Center, Mine Safety and Health Administration, Pittsburgh, PA.

<sup>2</sup>Mining engineer, Ventilation Division, Pittsburgh Safety and Health Technology Center, Mine Safety and Health Administration, Pittsburgh, PA.

<sup>3</sup>Supervisory mining engineer, Ventilation Division, Pittsburgh Safety and Health Technology Center, Mine Safety and Health Administration, Triadelphia, WV.

## DESIGNING BLEEDER SYSTEMS

As part of the mine ventilation system, bleeder systems should be addressed in the overall mine design. Designing a good bleeder system requires consideration of ground control and pillar design, strata characteristics, contaminant liberation, airflow distribution, and the internal workings of the bleeder system. When bleeder systems are incorporated into an existing mine ventilation system, the capacity of that ventilation system should be considered.

There are two basic design classifications for bleeder systems used in U.S. coal mines: wrap-around and flow-through. Although there are many variations, the concept by which they all function is the same.<sup>4</sup> A ventilating pressure differential is established from the active workings, across the pillared area, to the bleeder and/or return entries. Sufficient connections are established between the pillared area and these entries for the airflow to be induced and distributed through the pillared area by the applied ventilating pressure differential. Gases in the pillared area are diluted and moved away from the active workings by the airflow induced through the

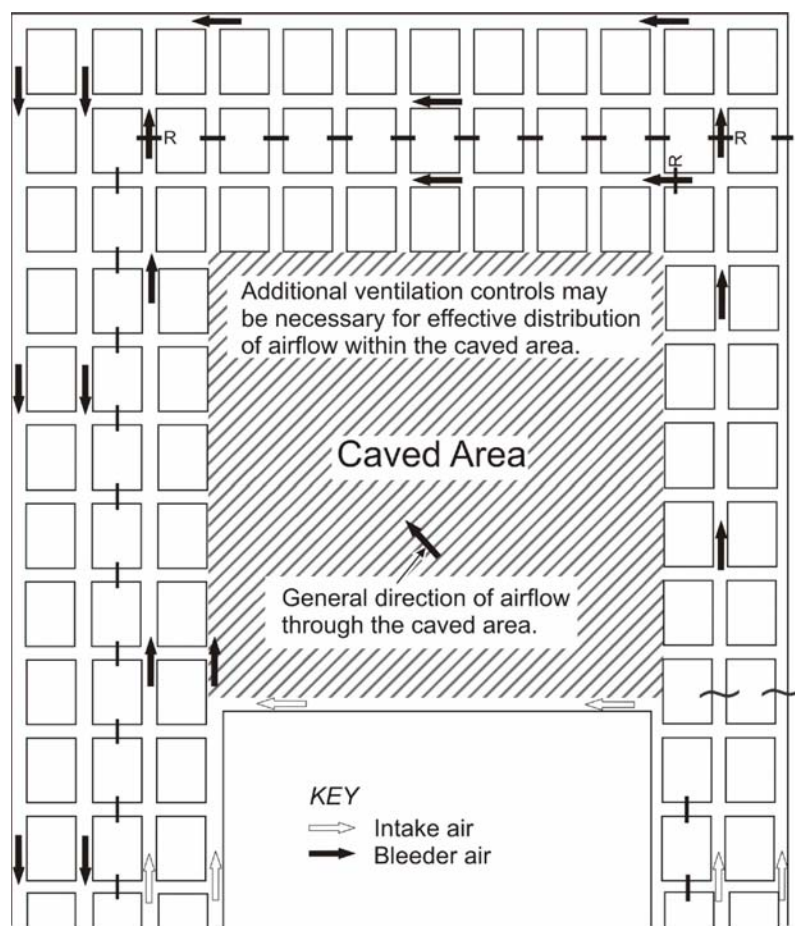
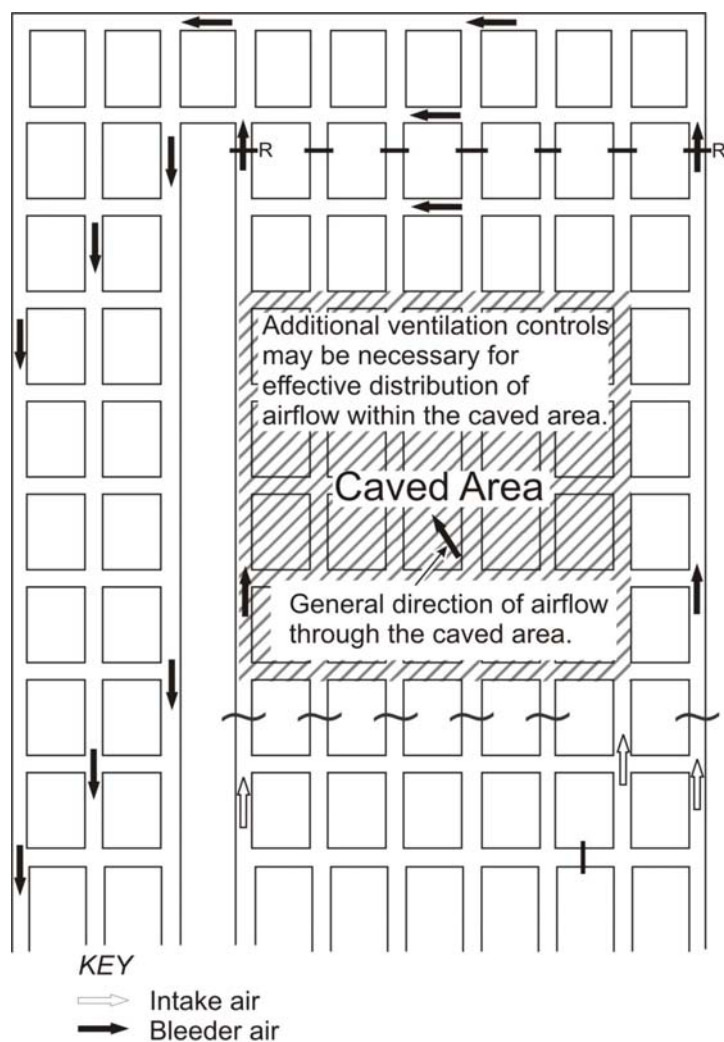

**Figure 5-1.—Simplified illustration of a wrap-around bleeder system for a longwall panel.**

pillared area. The applied ventilating pressure is that pressure which actually causes the airflow. The primary difference between the two designs is the means used to maintain the pressure differential across the pillared area.

Wrap-around system designs rely completely upon ventilation controls constructed between the pillared area and bleeder entries to establish the ventilating pressure differential. Numerous ventilation controls located close to the pillared area are often necessary with this design. The additional ground pressures from the pillared area increase the susceptibility of these ventilation controls to damage. Figure 5-1 is a simplified illustration of a wrap-around system for a longwall panel. Flow-through systems use solid coal barriers in conjunction with ventilation

<sup>4</sup>Some unique systems have been developed for ultragassy mines affected by spontaneous combustion. These special cases are not covered in this chapter.



**Figure 5-2.—Simplified illustration of a flow-through system with bleeder entries.**

pressures developed as a result of mining can be magnified in such areas and may necessitate additional support.

The life expectancy of the bleeder system must be considered during the design process. The necessity of maintaining access and protecting primary internal airflow paths within the pillared area cannot be overstated. The long-term nature of bleeder entries and their close proximity to pillared areas usually require that supplemental roof support be installed in them. The additional support should be installed in advance of overburden stresses from pillaring because, typically, limited access to bleeder entries makes remedial actions difficult or impossible.

Roof support requirements are mine-specific. Wood cribbing has long been recognized as an appropriate supplemental roof support for many bleeder systems. Technology and innovative design have provided alternative materials. Concrete donuts, canned cribs, pumpable supports, yielding posts, metal supports, cable bolts, and trusses have been used.

controls to maintain a pressure differential across the pillared area. Figure 5-2 is a simplified illustration of a flow-through system with bleeder entries. The coal barriers replace many of the ventilation controls and can provide additional protection for the bleeder entries from the ground pressures created as a result of extracting the coal pillars. These simplified illustrations do not show all of the ventilation controls sometimes necessary to direct the airflow, nor do they show the additional multiple entries that may be necessary to carry the required quantity of air.

#### **Ground control and pillar design.**

Ground control and pillar design are critical to the overall stability of bleeder systems. Some factors to be considered include mining parameters (e.g., mine opening dimensions, pillar size, panel size, bleeder geometry, and intersection dimensions), overburden and horizontal stresses, roof control systems, and multiple-seam interaction. Irregular shapes in the bleeder system that concentrate abutment loads generally require additional attention. Ground

**Caved area characteristics.** The characteristics of the caved material and the overlying strata in areas where pillars have been extracted are influenced by several factors. These include the geology of the roof strata, the degree of extraction, and the distance between supporting pillars. Mining method and percentage of pillar recovery greatly affect the strata response to the extraction. Increased extraction generally results in less permeable caved areas. If the main roof subsides, compaction of the caved material occurs and decreases void space and permeability. Compaction occurs in the caved areas created by most longwalls. The limited void space and decreased permeability of compacted caved areas limits the volume of gases that can accumulate in the rubble of the caved area and diminishes their interaction with mine airstreams.

**Contaminant liberation.** Estimation of liberation rates for gaseous contaminants, such as methane and carbon dioxide, is an important factor in determining ventilation requirements. However, this can be difficult to determine prior to mining when no liberation history has been developed. Even with historical data available for the engineer to use, other factors must be considered. The source of the contaminants is one factor that can impact the bleeder system design. Some mines considered to be very gassy produce significant methane volumes only while cutting coal. In other gassy mines, a majority of the methane is liberated when the strata are broken due to second mining. Fractures caused by caving in the pillared area can permit methane and other contaminants to enter the mine from overlying and underlying mines as well as from the surrounding strata. Contaminants are also liberated from the coal ribs of the bleeder entries. Another factor is the relationship between the size of the pillared area and the total volume of contaminants liberated. Liberation of contaminants can increase as the pillared area increases in size. Although methane is the primary contaminant in many mines, carbon dioxide can also be a concern.

A relationship exists between production rates and methane liberation in most mines. Increased production rates result in increased methane liberation, both in the face area and the pillared area. Contaminants in the face ventilation airflow directed into the pillared area will also impact the bleeder system. Bleeder system design that addresses the capacity to dilute contaminants such that production need not be curtailed is prudent and reduces the potential for exceeding the dilution capacity of the system.

In some gassy mines, vertical degasification boreholes have been used effectively to reduce the methane to be diluted by underground bleeder systems. Horizontal degasification boreholes have been used to drain methane from the coal seam in advance of mining and can assist in reducing ventilation requirements during development as well.

Oxidation within the pillared area, as well as contaminants liberated from the strata, can contribute to oxygen deficiency. Oxygen deficiency in the bleeder entries and at measurement point locations can impede continued access to examination locations needed for evaluating bleeder system effectiveness. Consideration must be given to providing sufficient airflow through the pillared area and bleeder entries to prevent oxygen deficiency so that the bleeder entries and measurement point locations are maintained safe for access.

**Airflow distribution.** The bleeder system should be designed such that the pillared area is continuously under the influence of mechanical ventilation that will induce the necessary quantities of airflow in the intended direction. The design should preclude air that has ventilated the pillared area from flowing toward or by the working section. The bleeder system must continuously control and distribute airflow through the area.

Airflow distribution and ventilation capacity affect dilution of contaminants. Proper distribution of airflow through the bleeder system facilitates dilution of the contaminants and minimizes the possibility of accumulations of methane and other contaminant gases. Managed airflow distribution requires openings, including primary internal airflow paths within the pillared area, bleeder connectors, and bleeder entries that function for the duration needed. Connections with the pillared area provide inlets and outlets through which the airflow is distributed and enable gathering of information used in evaluating the effectiveness of the airflow distribution.

Airflow is controlled using ventilation controls and mine layout. Standard construction techniques, considering the life of the system and the conditions anticipated, should be adopted for ventilation controls in the bleeder system. Some types of controls, such as curtains, are more susceptible to damage by the mine environment or inadvertent change by mine personnel. Unplanned changes may adversely impact bleeder system effectiveness. Critical controls should remain accessible because adjustments are usually necessary throughout the life of a system. Removal of unneeded ventilation controls decreases the likelihood that they will cause unintentional restrictions.

**Internal workings of the bleeder system.** It is recognized that the characteristics of individual pillared areas vary. However, the primary internal airflow paths of many bleeder systems are the remaining development entries and crosscuts between and around the caved material in the pillared area and the perimeter of the caved area. Except for the perimeter, airflow across and through much of the caved area generally occurs only to a limited degree unless the permeability of the caved material is high and/or the applied ventilating pressure is large. With contemporary bleeder system designs, inclusion and support of mine entries within the pillared area often are necessary to provide internal airflow paths through which air will continually pass to dilute and carry the contaminant gases away from the active areas and into bleeder and/or return entries or directly to the surface.

In longwall bleeder systems, the ventilation of the longwall face area cannot be separated from the bleeder system. In longwall panels where caving has occurred, the amount of air flowing across the face directly impacts the airflow passing through the parallel primary internal airflow path immediately behind the shields. Increased longwall face airflow results in better dilution and removal of contaminants in this critical portion of the pillared area closest to the face.

Loss of the primary internal airflow paths that provide a direct conduit from the active workings can compromise bleeder system effectiveness and the ability to evaluate the system's effectiveness. Although some of the contaminant gases may continue to be moved away from the active areas, insufficient airflow through the primary internal airflow paths may result in accumulations of hazardous gas concentrations in close proximity to active areas, such as locations behind the shields in longwall systems or other open areas near the face. A roof fall or air reversal could



then move this gas into the active area. Because of limited access, it may not be possible to determine the extent of the accumulation or how close it is to the active areas. The failure to adequately address the internal workings of the bleeder system may result in hazardous conditions for miners.

**Capacity of the ventilation system.** The total ventilation resistance of the pillared area of a bleeder system depends not only on the permeability of the caved material, but also on the size and shape of the pillared area, including the length and integrity of the primary internal airflow paths through and around the caved material. As the pillared area increases in size or age, the resistance of the primary airflow paths generally increases. Experience has shown that significant changes to the resistance of primary internal airflow paths can even occur during the mining of one panel.

The mine ventilation system must maintain a ventilating pressure able to overcome the resistance in the bleeder system and sustain airflow. The importance of a reserve ventilating pressure capacity, as evidenced by the regulation of the air splits, was recognized by ventilation engineers over 30 years ago. The reserve ventilating capacity provides flexibility to increase airflow when needed and to provide additional ventilating pressure differential across the pillared area [Kalasky and Krickovic 1973].

Recent trends in longwall mining require more emphasis on the ability of the ventilation system to provide and maintain greater ventilating pressure differentials across the pillared areas of bleeder systems. Individual longwall panels are increasing in length and width, the number of development (gate) entries is decreasing, and the number of connected panels in an individual bleeder system is increasing. The result is higher resistance airflow paths and extended longevity. Both often result in greater ventilation requirements. Thus, the need for designing bleeder systems with sufficient reserve ventilating pressure capacity is vital.

Ventilating pressure is an important consideration in the design of all bleeder systems. In some mines, the main mine fan can provide adequate airflow for the bleeder system. Other mine operators have found that incorporating bleeder shafts and high-pressure bleeder fans into flow-through bleeder systems with bleeder entries is necessary to meet the required capacity of today's larger systems, especially in mines with high methane liberation rates. But even these high-pressure exhaust fans have limitations. Applying ventilating pressure differential in itself is not the equivalent of effectively ventilating the pillared area. Airflow is necessary to dilute and carry away the contaminants. Accumulations of hazardous gases can still develop if sufficient airflow is not continuously diluting and carrying away the contaminants.

Other factors also impact bleeder system capacity. The configuration of some bleeder systems can severely limit ventilating capacity. The resistance of the airflow paths within the bleeder system must be considered. Compared to multiple entries, pressure losses in single bleeder entries will reduce the ventilating pressure available to move air through the pillared area. Ventilating pillared areas such that the ventilating pressure is applied in opposing directions may have adverse impact on both the airflow through the internal workings of the bleeder system and the ability to evaluate the system performance. Additional splits of air directed into the bleeder entries, for the purpose of ventilating electrical installations and dewatering systems or to

provide greater access, displaces bleeder airflow and may eliminate a bleeder entry that could otherwise carry bleeder airflow. Finally, leakage from splits of air located adjacent to bleeder airflow can impact the system capacity, including its ability to dilute contaminants from the pillared area.

**Water drainage.** The design of the bleeder system should include the means to prevent water accumulations that might cause obstructions. The mine water drainage infrastructure should be installed before pillar mining limits access to an area. Consideration should also be given to preventing water accumulations within the pillared area that could impact bleeder system effectiveness. A mine layout that considers anticipated mine floor elevations can impact the drainage of water in the bleeder system.

**Sealing.** Bleeder systems should be designed to provide ventilation and enable evaluation of system effectiveness for the anticipated life of the system. Realistic consideration of the size and number of panels and the length of time that ventilation can be provided and the bleeder system can be evaluated is essential. Prudent mine operators limit the size and age of the bleeder system before a decline in system performance or an inability to evaluate the system necessitates sealing. If it is determined that the bleeder system is not effective or it cannot be determined that the bleeder system is effective, the worked-out area must be sealed. The ability to seal the pillared area ventilated by the bleeder system must be considered in the design process. Federal regulations require that each mining system be designed so that each worked-out area can be sealed. The location and the sequence of construction of proposed seals are required to be specified by federal regulations.

## EXAMINING AND MAINTAINING BLEEDER SYSTEMS

**Weekly examination requirements for bleeder systems are specified in 30 CFR<sup>5</sup> 75.364.**

Examinations provide the means of collecting the information needed to evaluate bleeder system effectiveness. 30 CFR 75.364 specifies the minimum requirements for the examination of bleeder systems. Weekly examinations are required at all locations where air enters the worked-out area (inlets) and in the bleeder system airflow immediately before the air enters a return split of air (outlets). Measurements of methane and oxygen concentrations and of air quantity and a test to determine if the air is moving in its proper direction are to be made at all the locations.

During the weekly examinations, at least one entry of each set of bleeder entries is to be traveled in its entirety. Measurement point locations at which examinations are to be made are required to be specified in the ventilation plan. These locations are not in lieu of traveling the bleeder entries, but rather are the locations within the bleeder system, in addition to the inlets and outlets, where the examiner will measure the methane and oxygen concentrations and air quantities and

---

<sup>5</sup>*Code of Federal Regulations.* See CFR in references.

perform tests to determine whether the air is moving in the proper direction. Knowledge of the specific conditions of each mine and an understanding of how the system functions, including the internal airflow patterns, are necessary when considering specific measurement point locations. Examinations should also evaluate the condition of ventilation controls critical to the proper function of the bleeder system. Provisions exist for an alternative method of evaluation to be specified in the ventilation plan, provided it results in proper evaluation of the effectiveness of the bleeder system.

Mine examiners or persons working or traveling in remote areas, especially in bleeder entries, should always be on the alert for changing conditions, such as accumulations of methane or oxygen-deficient air. Persons should not enter connectors and the pillared area unless they are well-informed about the areas to be entered, have sufficient detection instruments, and have discussed their intent with other persons who will then know their whereabouts.

Some mine operators have increased the frequency of monitoring the air quality and quantity at examination locations by installing sensors connected to the central atmospheric monitoring system. In this way, the mine operator can continuously monitor and record this important information. Sensors for methane, oxygen, carbon monoxide, and air velocity have been installed to enhance the evaluation of the ventilation system.

Maintenance of bleeder systems can directly impact system effectiveness and/or the ability to determine the effectiveness of the bleeder system. Failure to provide and maintain adequate control of the ground conditions often results in roof falls and floor heave. Failure to provide and maintain a means to control water often results in water accumulations. The most significant consequences of roof falls and water accumulations are the potential for reducing or preventing airflow and preventing the completion of the examinations that are required to determine the system's effectiveness. Due to access limitations and practical constraints, deteriorated conditions and obstructions may not be possible to remediate. These same types of conditions and obstructions may impact the primary internal airflow paths as well, with fewer or no options to remediate. Thus, the need to prevent obstructions within a bleeder system through adequate preventive measures cannot be overstated.

The records that federal regulations require to be maintained concerning the weekly examinations include the results of particular tests and measurements and notations for hazardous conditions observed. Other information not required can also be beneficial. Notes, records, or communications of pertinent information made by the examiner can be useful in determining whether problems are developing in the bleeder system. This information includes changes in water levels and their locations, roof conditions, floor heave, pillar and roof deterioration, and damage or deterioration of important ventilation controls.

Roof fall and water accumulations in bleeder entries have contributed to many serious accidents involving coal mine bleeder systems. In one incident, an accumulation of water was a major reason that a mine examiner did not travel the bleeder entries of a room-and-pillar wrap-around bleeder system. The examiner determined that water had begun to accumulate in a corner of the bleeder system. A month later, water had risen to a depth considered by the examiner to be too hazardous through which to travel. Consequently, the bleeder entries were examined only to the

edge of the water. Roof falls in the bleeder entry were not addressed. As a result, the effectiveness of the bleeder system was not evaluated. The bleeder system became ineffective and failed to properly remove methane from the mined-out area. Methane accumulated in the mined-out area just inby the retreat section pillar line. Removal of ventilation controls on the retreat section permitted movement of the accumulated methane to the active workings, where it was ignited. Ten miners were fatally injured in the ensuing explosion.

## EVALUATING BLEEDER SYSTEMS

Examiners, inspectors, and engineers should be trained to evaluate bleeder systems and recognize deficiencies. As they inspect or analyze a bleeder system, they must be able to recognize hazardous conditions and take appropriate action. They must have knowledge of the three basic factors governing the ventilation of mines: ventilating pressure, airflow, and air quality. In addition, they must have an understanding of the particular bleeder system they are examining or evaluating, including airflow directions and air quantities, as well as normal methane or other critical gas concentrations; the location of potential problems from inadequate roof support or water accumulation; and the location of critical ventilation controls. This knowledge provides a base of information with which to evaluate the importance of subtle changes from previous examinations and to recognize deteriorating conditions that might cause system failure.

**Control and direction.** A bleeder system must continuously control and distribute air throughout the system. Established airflow patterns enable collection of information that is important in evaluating the bleeder system's effectiveness. Effective bleeder systems maintain the established airflow patterns. At inlets, outlets, and in the bleeder entries, airflow should be sufficient to be readily discernible and be in the proper direction. Airflow direction within the pillared area should also be in the proper direction. A bleeder system that does not produce discernible airflow through the pillared area is ineffective. A bleeder system in which the airflow direction has changed should be scrutinized. The bleeder system may no longer be effective, or the ability to evaluate its effectiveness may have been adversely impacted. Additional information may be needed to evaluate the bleeder system's effectiveness.

**Air quality.** Air quality is another essential consideration in determining bleeder system effectiveness. The primary air quality considerations for most bleeder systems are: keeping methane concentrations to no greater than 2% in the bleeder split of air immediately before it joins another split of air, diluting methane concentrations elsewhere within the bleeder system, and maintaining oxygen and limiting carbon dioxide concentrations in areas where persons work or travel.

In some highly gassy mines, the air currents coming from the pillared area can contain methane concentrations higher than 2% and must be diluted by the air moving in the bleeder entry. As a practical matter, when methane in the air moving in the bleeder entries approaches 2%, it can no longer dilute additional methane, from the pillared area or that liberated into the bleeder entries, to the 2% limit. The bleeder system is no longer effective when methane concentrations in the bleeder split cannot be reduced to 2% before entering another split of air.

A major purpose of the bleeder system is to keep methane accumulations away from mining activities, including the primary airflow paths that provide a conduit to the active section. Accumulations of unusually high methane concentrations in locations other than small pockets, such as in a corner, in the interstices of the rubble material, or in a small roof cavity, indicate that changes to the bleeder system may be necessary.

Methane exists in the pillared area and must be diluted by the air currents within the bleeder system and not be allowed to accumulate in open areas. Explosive mixtures of methane in open entries or crosscuts can constitute imminent danger. Relevant considerations include the location and extent of the accumulation, potential ignition sources, the primary internal airflow paths that provide a conduit to the active areas, and the potential for explosive methane-air mixtures to move to active areas, including the working section. It is imperative for miner safety that the portions of the pillared area adjacent to the working section and the primary internal airflow paths providing a conduit to the active working section be free of methane to the extent that a pillar fall might displace, or air reversals might move, an explosive methane-air mixture to the working section. Several accidents have resulted from the ignition of methane accumulations that existed within the pillared area near the working section.

All possible sources of methane need to be considered carefully. For example, some coal seams liberate large amounts of methane continuously from virgin coal ribs. In some instances, barometric pressure changes may cause higher liberation from the mined-out area. However, a bleeder system with adequate pressure differentials and air distribution will not be substantially affected by normal barometric changes. Inactive panels in a mined-out area tend to liberate constant amounts of methane and in lesser quantities than active panels. Increases in methane concentration or reduction in airflows from older panels should be investigated to determine if the system is still functioning as designed. Factors influencing methane levels include coal production levels, the production day of the week, the gas-bearing characteristics of the strata near the active mining, the proximity of the last vertical methane degasification borehole, recent ventilation changes, and changes in barometric pressure. Changes or trends of deteriorating air quality at measurement point locations or other examination locations may indicate an ineffective bleeder system.

Usually, the oxygen concentration in the bleeder system is a problem only from the standpoint of the safety of persons making examinations or assigned to work in the bleeder system. However, oxygen deficiency found in traveled areas of the bleeder system may indicate insufficient airflow in the bleeder system and should be further investigated. In bleeder systems with insufficient airflow, oxygen deficiency may result in the inability to evaluate the effectiveness of the system. Oxygen deficiency could also present a hazard to the working section if the bleeder system is ineffective and allows a sizable volume of oxygen-deficient air to exist in the pillared area or bleeder entries near the working section. Persons inspecting or examining bleeder systems must be alert to locations where low levels of oxygen may exist. The oxygen concentration in areas of bleeder entries and mined-out areas where persons work or travel must be at least 19.5%. The carbon dioxide levels must not exceed 0.5% time-weighted average and 3% short-term exposure limit in areas of bleeder entries and mined-out areas where persons work or travel. Oxygen can be displaced by methane, especially in high spots or cavities above roof falls, where the buoyancy of methane can cause it to collect. Oxygen is depleted as coal, wood, or other organic

materials oxidize. In mines that liberate small amounts of methane, low airflows could result in oxygen deficiency before elevated methane levels occur.

The information collected at the examination locations and recorded in mine records should be used in evaluating the effectiveness of the bleeder system. Trends can be monitored. However, a thorough understanding of the system is needed to fully assess bleeder system performance. In complex systems or those with which there are concerns over limited capacity or effectiveness, there may be times when an investigation beyond the regular examination locations, such as into the primary internal airflow paths, may be appropriate if an investigation can be conducted safely. Confirmation of the internal airflow patterns and assessment of the dilution of contaminants may be appropriate to ensure that the examination locations provide the necessary information and can also provide a better understanding of what the trends at specific measurement point locations reflect about the internal workings of the bleeder system.

**Situational indicators.** As bleeder systems change, some conditions can develop as a result of, or in response to, declining system performance. These circumstances often warrant closer scrutiny to determine the impact of the condition on bleeder system effectiveness. The location and number of the present measurement point locations should be reassessed as to the adequacy for providing sufficient information for evaluation. Routine changes in the bleeder system can also cause problems. Situations such as the following should raise the level of interest and caution of persons evaluating bleeder system effectiveness.

- *Separate mine fans.* Directing airflow from the pillared area to separate mine fans may diminish the pressure differential established across segments of the pillared area, sometimes resulting in poorly ventilated areas, unventilated areas, or complication of the evaluation of the bleeder system effectiveness. Similar problems can result when the airflow ventilating the face area is directed to a mine fan separate from the mine fan ventilating the pillared area. Some of the airflow ventilating the active face should always be directed into the pillared area to prevent unventilated areas of the pillared area close to the active working section. Depending on the configuration of the system and the control of the airflow in the system, similar problems can occur even when a single mine fan is ventilating the face area and the mined-out area.
- *Splits of air directed into the pillared area (other than the split ventilating the active working section).* Although other splits are often necessary and important to maintain ventilation of the pillared area, understanding the impact of introducing other splits on the bleeder system is important. Splits of air directed into the pillared area (other than the split ventilating the face(s) from the active working section) can decrease ventilating pressure across the pillared area and adversely affect airflow away from the active working section. Depending on ventilating pressure differentials, poorly ventilated areas may develop within the pillared area. Extreme conditions would be stagnation of the airflow entering the pillared area from the face area or the airflow from the mined-out area moving to or toward the active working section. The proposed introduction of other splits of air into the pillared area should be evaluated to predict what overall effect the change will have on the system. Following implementation of changes, the bleeder system should be evaluated through in-mine examinations to determine if the changes produced the expected results.

- *Inlets to the pillared area near locations where air exits from the pillared area.* Inlets to the pillared area near locations where air exits from the pillared area can mask the effectiveness of the airflow distribution and complicate or prevent evaluation of the bleeder system. This condition should be closely scrutinized and is generally discouraged.
- *Inlets to the pillared area from intake air courses.* The pressure differential that exists across regulators separating intake air courses from pillared areas should be sufficient to prevent air from the pillared area from entering the intake air courses due to normal mining activities that affect ventilating pressures in the area.
- *Splits of air separate from the bleeder split.* Small splits of intake air that are used to ventilate electrical installations are permitted to enter the bleeder airflow and do not generally affect the location of the regulatory 2% methane limit, assuming they have been determined to be insignificant in their effect on the bleeder split and ventilation of the pillared area. Leakage from separate splits of air located adjacent to bleeder airflow may improve the air quality in the bleeder entries while actually decreasing the ventilating capacity of the pillared area by reducing the available ventilating pressure and airflow quantity. A full consideration of the significance of separate splits of air located adjacent to bleeder airflow should include leakage from that split into the bleeder airflow. The location of the regulatory 2% methane limit in the bleeder split may be affected.
- *Startup and recovery ventilation.* The ventilation of the face and pillared area at the startup of both longwall and room-and-pillar systems is dynamic. Significant caving in the pillared area sometimes does not readily occur when retreat mining begins. Larger open areas often exist in the pillared area, and the primary internal airflow paths that will exist during mining of the majority of the panel are not fully established. The ability to maintain airflow on a longwall face can be impaired. The conditions often warrant close scrutiny of the distribution of the airflow through the pillared area until the primary internal airflow paths are established. Additional ventilation controls may be needed during this period to ensure adequate distribution of airflow.

Setup and recovery of longwall face equipment is another critical time when close scrutiny is warranted. Airflow is often being redistributed in the bleeder system by mine management as the new longwall face is set up and equipment on the finished longwall face is recovered. Since methane liberation at the face decreases after production is stopped, longwall recovery faces are also often ventilated with decreased airflow quantities. That decrease in face airflow directly impacts the ventilation of the pillared area nearest the recovery area. Quality examinations are needed to ensure that the bleeder system is effective and that methane and other hazardous gases do not accumulate.

- *Changes in gas concentrations, ventilating pressures, and air quantities.* If examiners find rising methane concentrations with no changes in air quantities or pressures, then it can be concluded that methane liberation is increasing. Rising methane or decreasing oxygen levels with decreasing air quantities and ventilating pressures can indicate possible restrictions in the bleeder system. However, relying on just one parameter such as air quantity measurements without considering other related information can sometimes result in a misdiagnosis of the condition.

- *Dilution capacity of bleeder system less than contaminant production.* The ventilating capacity of a bleeder system is insufficient if it cannot dilute the amount of contaminants that can result from normal coal production. It can be difficult to assess the success of limiting production as a corrective action when the capacity to produce coal results in the production of more contaminants than the bleeder system can adequately dilute. The full effect of excessive coal production cannot be readily assessed in a bleeder system. Because of the delay between when methane is liberated and when it exits the pillared area, methane can accumulate in the pillared area of a system with insufficient capacity before it can be detected at examination locations. This can also result in a continuing increase of methane concentration at examination locations after mining has ceased. Ceasing production after changes are detected does not have the same impact as decreasing the capable production rate because contaminants have accumulated before detection is possible. This process can result in repetitious excursions beyond the bleeder system's capacity to safely dilute contaminants. Such repeated excursions indicate an ineffective bleeder system. A more appropriate response would be to improve the capacity of the bleeder system. Because of inadequate planning, some mine operators have had to resort to sinking bleeder shafts, installing bleeder fans, and drilling degasification boreholes as remedial measures to improve the capacity of existing bleeder systems.

**A bleeder system should be designed to provide adequate ventilation of the pillared area at the maximum expected coal production rate.**

- *Reserve ventilating pressure relative to the applied ventilating pressure.* The magnitude of the applied ventilating pressure across the pillared area is often not easily determined. The applied ventilating pressure cannot usually be determined merely from a measure of the pressure differential across ventilation controls. This information can be obtained from altimeter surveys or tube and pressure gauge surveys. Knowledge of the magnitude of the applied ventilating pressure is useful in assessing the capacity of the reserve ventilating pressure. This ventilating pressure can be compared with the pressure differentials across regulators controlling airflow through the pillared area. Some mine operators have installed permanent pressure measurement stations at these locations.
- *Confusing examination records.* Organization of the examination records greatly improves the ability to adequately consider the information collected when evaluating bleeder system effectiveness. If the examination records seem unorganized or the information specific to the bleeder system is difficult to collectively review, changes that have occurred in the bleeder system are not as easily observed or evaluated.



## REFERENCES

CFR. Code of federal regulations. Washington DC: U.S. Government Printing Office, Office of the Federal Register.

Kalasky JD, Krickovic S [1973]. Ventilation of pillared areas by bleeder entries, bleeder systems, or equivalent means. *Trans Soc Min Eng, AIME*, December, Vol. 254, pp. 284–291.

Tisdale J, ed. [1996]. *Bleeder and gob ventilation systems*. Arlington, VA: U.S. Department of Labor, Mine Safety and Health Administration.

Urosek JE, Francart WJ [2002]. Bleeder systems in underground coal mines. In: De Souza E, ed. *Proceedings of the North American/Ninth U.S. Mine Ventilation Symposium* (Kingston, Ontario, Canada, June 8–12, 2002). Lisse, Netherlands: Balkema.

## CHAPTER 6.—COAL SEAM DEGASIFICATION

By Pramod C. Thakur, Ph.D.<sup>1</sup>

### *In This Chapter*

- ✓ Origins of coalbed methane
- ✓ Reservoir properties of coal seams
- ✓ Thresholds for coal seam degasification
- ✓ Methane emissions in mines
- ✓ Methane drainage techniques
- ✓ How to transport gas safely in mine pipelines

*and*

- ✓ Economics of coal seam degasification

**Recommended publications on coal seam degasification are *Gas Control in Underground Coal Mining* [Creedy et al. 1997], *Coalbed Methane Extraction* [Davidson et al. 1995], and *Methane Control for Underground Coal Mines* [Diamond 1994].**

### ORIGINS OF COALBED METHANE AND RESERVOIR PROPERTIES OF COAL SEAMS

**Origins of coalbed methane.** Coal seams form over millions of years by the biochemical decay and metamorphic transformation of plant materials. This coalification process produces large quantities of byproduct gases, such as methane and carbon dioxide. The amount of these byproducts increases with the rank of coal. It is the highest for anthracite, where for every ton of coal nearly 1,900 lb of water, 2,420 lb (20,000 ft<sup>3</sup>) of carbon dioxide, and 1,186 lb (27,000 ft<sup>3</sup>) of methane are produced [Hargraves 1973]. Most of these gases escape to the atmosphere during the coalification process, but a small fraction is retained in the coal. The amount of gas retained in the coal depends on a number of factors, such as the rank of coal, the depth of burial, the type of rock in the immediate roof and floor, local geologic anomalies, and the tectonic pressures and temperatures prevalent at that time. The gases are contained under pressure and mainly adsorbed on the surface of the coal matrix, but a small fraction of gases is also present in the fracture network of the coal. Methane is the major component of gases in coal, comprising 80%–90% or more of the total gas volume. The balance is made up of ethane, propane, butane, carbon dioxide, hydrogen, oxygen, and argon.

---

<sup>1</sup>Manager, Coal Seam Degasification, CONSOL Energy, Inc., Morgantown, WV.

Methane is released into each mine airway from the coal seam as mining proceeds. Large volumes of air, sometimes as much as 20 tons of air for each ton of coal mined, is circulated constantly to dilute and carry methane away from coal mines. Methane is a colorless, odorless, combustible gas that forms an explosive mixture with mine air in the concentration range of 5%–15% by volume. The maximum concentration of methane in mine air is restricted by law to 1%–1.25% in all major coal-producing countries. Nevertheless, methane-air explosions are quite common even today. Table 6–1 shows a list of major coal mine explosions since 1970 in the United States. In these 13 explosions, 167 lives were lost despite coal seam degasification taking place in some mines.

**Table 6–1.—Major coal mine explosions in the United States, 1970–present**

Year	Mine and location	Deaths
2006.....	Sago Mine, Tallmansville, WV .....	12
2001.....	Blue Creek No. 5 Mine, Brookwood, AL .....	13
1992.....	No. 3 Mine, Norton, VA .....	8
1989.....	William Station No. 9 Mine, Wheatcroft, KY.....	10
1983.....	McClure No. 1 Mine, McClure, VA .....	7
1982.....	No. 1 Mine, Craynor, KY .....	7
1981.....	No. 21 Mine, Whitwell, TN.....	13
1981.....	No. 11 Mine, Kite, KY .....	8
1981.....	Dutch Creek No. 1 Mine, Redstone, CO.....	15
1980.....	Ferrell No. 17 Mine, Uneeda, WV .....	5
1976.....	Scotia Mine, Oven Fork, KY.....	26
1972.....	Itmann No. 3 Mine, Itmann, WV .....	5
1970.....	No. 15 and 16 Mines, Hyden, KY.....	38

Coal has been mined throughout the world for hundreds of years, and the history of coal mining is replete with mine explosions and consequent loss of lives. Even today, 60 countries around the world mine about 5 billion tons of coal annually with more than 10,000 fatalities per year. Before 1950, when coal seam degasification was generally unknown and ventilation was the only method of methane control, mine explosions in the United States were much more disastrous with a very high number of fatalities. To mitigate this problem, in many instances, mine ventilation can be supplemented by coal seam degasification prior to mining and even after mining.

**Reservoir properties of coal seams.** Coal seam degasification techniques to be used in a mine depend on the reservoir properties of the coal seams being mined. Good methane control planning depends on accurate information on the reservoir properties of the coal seam and the total gas emission space created by the mining process. Reservoir properties governing the emission of methane from coal seams can be divided into two groups: (1) properties that determine the capacity of the seam for total gas production, e.g., adsorbed gas and porosity, and (2) properties that determine the rate of gas flow, e.g., permeability, reservoir pressure, and diffusivity of coal. The reservoir properties are highly dependent on the depth and rank of the coal seam. The most important of these properties is the seam gas content.

**Seam gas content.** Based on their gas contents, coal seams can be classified as mildly gassy, moderately gassy, and highly gassy, as shown in Table 6–2.

**Table 6–2.—Gassiness of coal seams**

Category	<sup>1</sup> Depth, ft	Gas content of coal, ft <sup>3</sup> /ton
Mildly <sup>2</sup> gassy .....	<600	<100
Moderately gassy .....	600–1,200	100–300
Highly gassy .....	1,200–3,000	300–700

<sup>1</sup>Depth figures are for high-volatile bituminous coals.

<sup>2</sup>The term “mildly” is not intended to imply that such mines are free from gas problems. The potential for gas problems involves many factors, not just the coal gas content. If an area of a mildly gassy mine were inadequately ventilated, it could easily attain an atmosphere in the explosive range. It is likely that many of the mines with explosion fatalities shown in Table 6–1 were in mildly gassy coals.

By definition, seam gas content is the amount of gas contained in a ton of coal. It includes both adsorbed gases and gases in the fracture matrix. Formerly, gas content of a coal seam or the gassiness of a coal seam was measured by the specific emission of methane from the mine, expressed as the volume of methane emitted from the mine per ton of coal produced. Although a rough correlation exists between specific emission and actual gas content of coal, it is not very reliable nor can it be used effectively for forecasting.<sup>2</sup> Today, gas content of a coal seam is best measured directly [Diamond and Schatzel 1998]. If the reservoir pressure is known, an indirect estimate of gas content can also be obtained by Langmuir’s equation [Langmuir 1918] for monolayer adsorption:

$$V = VmBP/(1 + BP),$$

where  $V$  is the estimated gas content of coal,  $Vm$  is the volume of gas for full saturation of coal,  $B$  is a characteristic constant of the coal seam, and  $P$  is the reservoir pressure. For U.S. coalbeds, the reservoir pressure is roughly correlated with the depth of the coal seam [Thakur and Davis 1977] and is estimated at 0.303 psi/ft, or roughly 70% of the hydrostatic head.

Since coal seams and gas in coal are formed together, it is a misnomer to call a coal seam nongassy. All coal seams are gassy by definition, but they vary in their degree of gassiness, i.e., gas content per ton of coal. The depth of a coal seam and its rank are good indicators of its gassiness, but direct measurement of gas content is highly recommended.

Figure 6–1 shows the gas content of coal versus gas pressure for some U.S. coals [Kissell et al. 1973]. Both the type of coal and the gas pressure are important.

<sup>2</sup>See Figure 1–5 in Chapter 1.

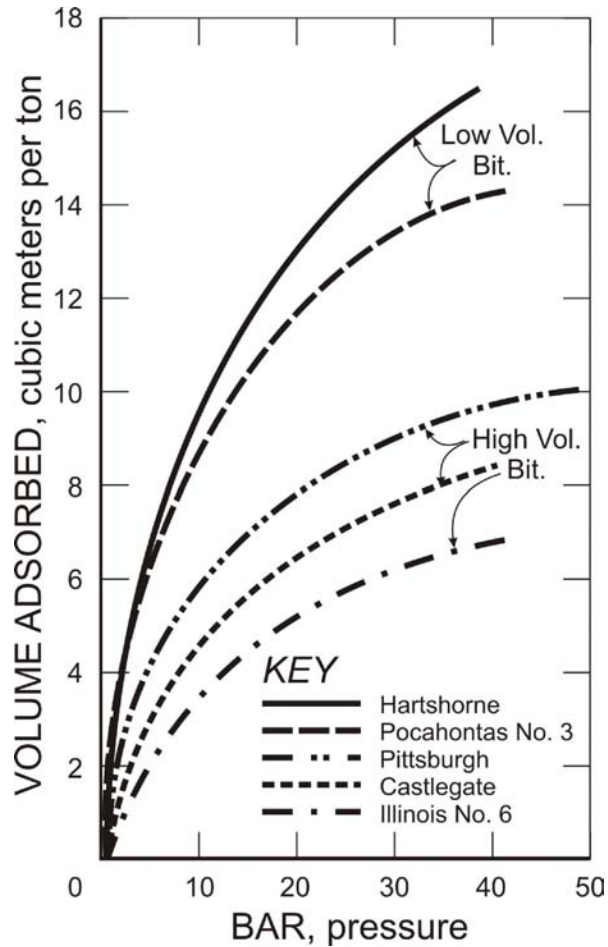

Figure 6-1.—Gas content of coal versus gas pressure for some U.S. coals [Kissell et al. 1973].

## THRESHOLDS FOR COAL SEAM DEGASIFICATION

**Methane drainage must be performed when the ventilation air cannot dilute the methane emissions in the mine to a level below the statutory limits.**

Generally, it is economically feasible to handle specific methane emissions<sup>3</sup> from a mine up to 1,000 ft<sup>3</sup>/ton with a well-designed ventilation system. At higher specific emission rates, a stage is reached where ventilation cost becomes excessive or it becomes impossible to stay within

<sup>3</sup>Specific methane emission is the total amount of gas released from the mine divided by the total amount of coal mined. Specific emission values are much higher than the gas content of the coal because of methane emission from coal that is not mined (ribs and pillars) and methane emission from strata adjacent to the mined coalbed.

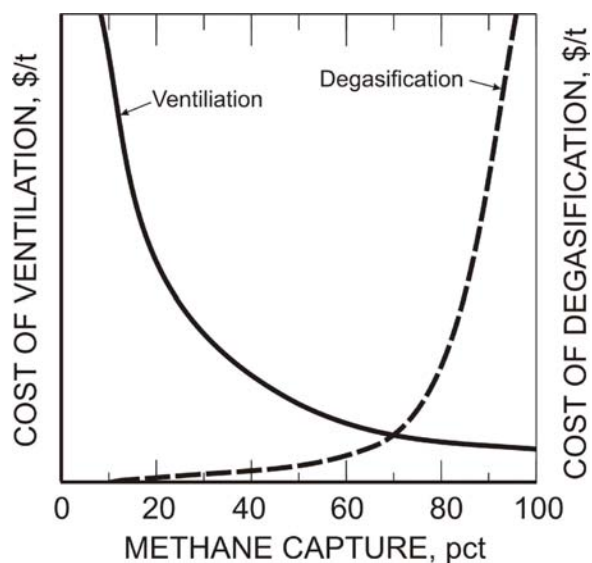

Figure 6-2.—Generalized optimum point for methane drainage, shown here at 70%.

statutory methane limits with mine ventilation alone. However, with a well-planned methane drainage system and a well-designed ventilation system, even highly gassy mines with specific methane emissions in excess of 4,000 ft<sup>3</sup>/ton can be safely operated.

In some mines, there is often a choice regarding how much methane should be drained and how much should be handled by mine ventilation air. Figure 6-2 shows a generalized optimum point. The actual optimum point depends on a number of factors, including the rate of mining, size of longwall panel, specific methane emission, and cost of ventilation and methane drainage.

Advantages of coal seam degasification can be summarized as follows:

1. Reduced methane concentrations in the mine air, leading to improved safety.
2. Reduced air requirements and corresponding savings in ventilation costs.
3. Faster advance of development headings and economy in the number of airways.
4. Improved coal productivity.
5. Additional revenue from the sale of coal mine methane.
6. Additional uses of degasification boreholes, such as water infusion to control respirable dust.
7. Advance exploration of coal seams to locate geological anomalies in the longwall panel.

## METHANE EMISSIONS IN MINES

Underground mining is done in two phases: (1) development and (2) pillar extraction. Development work involves the drivage of a network of tunnels (entries) into the coal seam to create a large number of pillars or longwall panels to be mined later. This drivage is usually done with a continuous mining machine. This machine cuts and loads coal into a shuttle car, which in turn hauls and dumps the coal onto a moving belt. The coal travels out of mines on a series of belts and is finally brought to the surface via a slope or shaft. Figure 6-3 shows a typical longwall panel layout in a U.S. coal mine.

All methane produced during the development phase of mining is from the coal seam being mined. Methane is emitted at the working face as well as in the previously developed areas. All emitted methane is mixed with ventilation air, diluted to safe levels, and discharged on the surface. Methane drainage during or prior to development becomes necessary if the development headings will experience a high rate of methane emissions. This is called premining methane drainage. Horizontal drilling of longwall panels prior to mining also falls into this category.

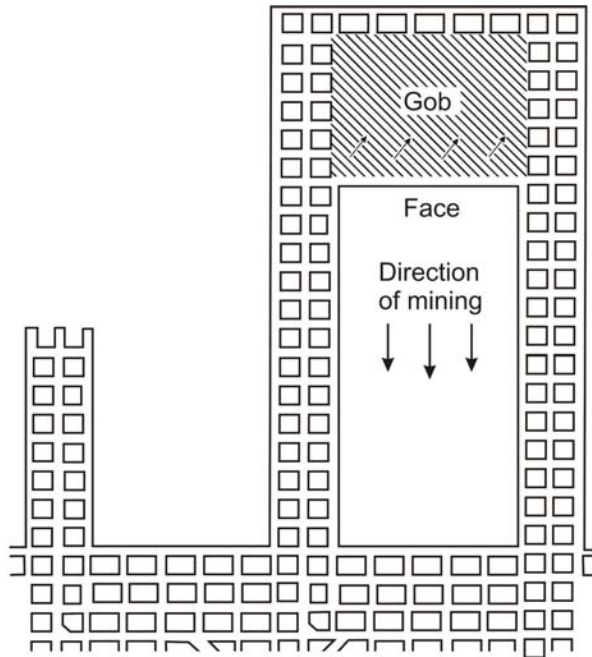

Figure 6-3.—Simplified illustration of a typical longwall panel layout in a U.S. coal mine. Ventilation controls are not shown.

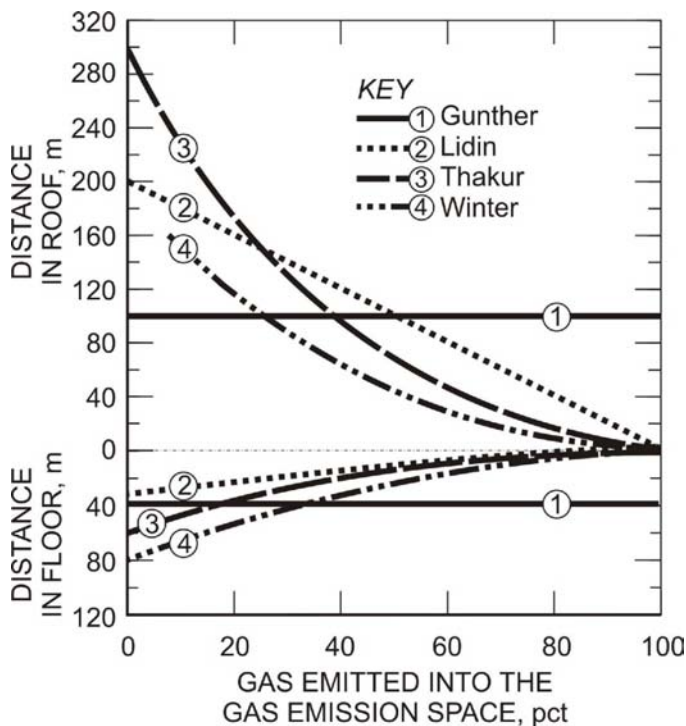

Figure 6-4.—Limits of the gas emission space.

The second phase of underground mining involves complete or partial extraction of the coal pillars. Smaller pillars are extracted by continuous mining machines by splitting them into even smaller pillars. Larger panels of coal (up to 1,000 ft by 10,000 ft or more) are extracted by the longwall method of mining. In either case, the mined coal produces methane. In addition, extracting these pillars or longwall panels causes the overlying strata to subside<sup>4</sup> and the underlying strata to heave. The ventilated mine workings constitute a natural pressure sink, into which methane flows from the entire disturbed area, or what is known as the gas emission space. Figure 6-4 shows the limits of the gas emission space as suggested by four different authors [Lidin 1961; Thakur 1981; Winter 1975; Gunther and Bélin 1967]. The gas emission space may extend to 270 ft below the coal seam being mined and approximately 1,000 ft above it.

The gob methane emission rate mainly depends on the rate of longwall advance, the geology, the size of the longwall panel, and the gas content and thickness of any coal seams in the gas emission space.

<sup>4</sup>In the United States, the subsided region is called a gob.

## METHANE DRAINAGE TECHNIQUES

**The ultimate goal of coal seam degasification should be to reduce the gas content of the coal seam below 100 ft<sup>3</sup>/ton prior to mining and capture at least 50%, preferably 75%, of the postmining emission.**

Various methane drainage techniques are used to capture the gas from the gob so that the mine ventilation air does not have to handle all of it. Depending on the magnitude of the problem, methane drainage can be performed prior to mining, known as premining methane drainage. Methane drainage can also be performed during mining and after the area is completely mined out and sealed. These two stages are generally grouped together as postmining methane drainage.

**Premining methane drainage.** Techniques for premining drainage can be broadly classified into four categories:

1. Horizontal in-seam boreholes
2. In-mine vertical or inclined (cross-measure) boreholes in the roof and floor
3. Vertical wells that have been hydraulically fractured (so-called frac wells)
4. Short-radius horizontal boreholes drilled from surface

*1. Horizontal in-seam boreholes:* Early work in premining methane drainage was done with short horizontal in-seam boreholes [Spindler and Poundstone 1960]. Figure 6–5 shows the two most commonly used variations of degasification with in-seam horizontal boreholes. Success of the technique is predicated on good coalbed permeability ( $\geq 5$  mD). The horizontal drilling technique and its application to degas coal seams are well-documented in published literature [Thakur and Davis 1977; Thakur and Poundstone 1980; Thakur et al. 1988]. In highly permeable coal seams, e.g., the Pittsburgh Seam of the Appalachian Basin, nearly 50% of the in situ gas can be removed by this technique prior to mining. The major drawback of this technique is that only about 6 months to a year—the time between development and longwall extraction—is available for degasification.

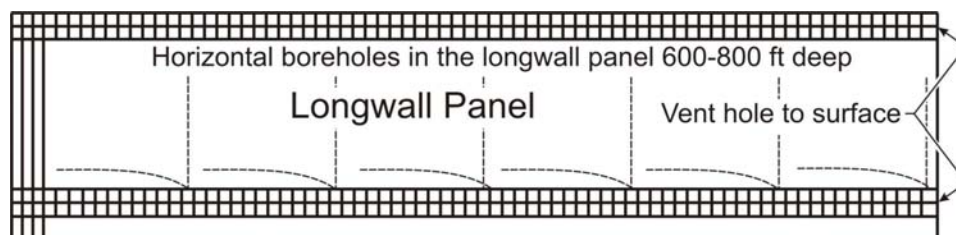

Figure 6–5.—Longwall panel methane drainage.



2. *In-mine inclined or vertical boreholes:* Short vertical or long inclined boreholes have been drilled from an existing mine (or roadways expressively driven for this purpose) to intersect other coal seams in the gas emission space, allowing for the seams to be degassed prior to mining. Again, success depends on high permeability. A far better way to degas these coal seams lying in close proximity to each other is to use vertical frac wells.

3. *Vertical frac wells:* Vertical frac wells are ideally suited to highly gassy, deep, low-permeability coal seams where it takes several years prior to mining to adequately degas the coal. These wells are drilled from the surface on a grid pattern over the entire property or only on longwall panels to intersect the coal seam to be mined in the future.

Vertical wells drilled into the coal seam seldom produce measurable amounts of gas without hydraulic stimulation. High-pressure water (or other fluids) with sand are pumped into the coal seam to create fractures (Figure 6–6). The fluid (water) is then pumped out, but the sand remains, keeping the fractures open for gas to escape to the well bore. Under ideal conditions, if the vertical frac wells are drilled more than 5–10 years in advance of mining, 60%–70% of the methane in the coal seam can be removed prior to mining.

Vertical frac wells have been very successful in the Appalachian and San Juan Coal Basins of the United States. They have also been attempted in the United Kingdom, Germany, Poland, China, and Australia, but met with only limited success. Major reasons for the lack of success abroad are (1) cost and (2) lack of sufficient permeability, which are further explained below.

1. The cost of drilling and hydrofracing a well in Europe and Australia is typically three times the cost in the United States. The cost of permitting and site preparation is also higher. In many countries, the drilling and hydrofracing equipment are not conveniently available.

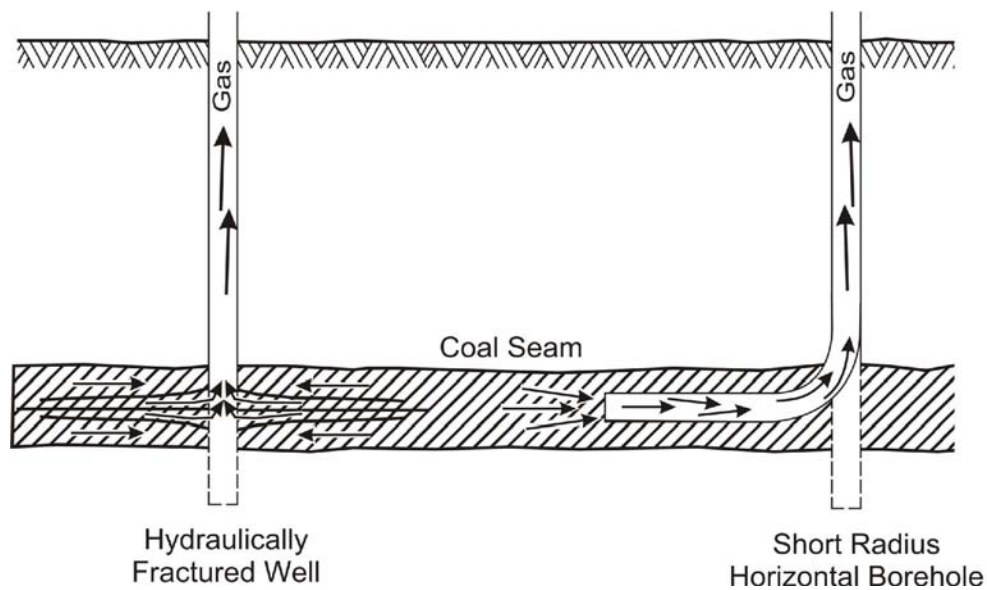

Figure 6–6.—Premining methane drainage from surface.

2. Lower permeability (<1 mD) of many European, Asian, and Australian coal seams contributes to the limited success of frac wells. Even well-designed and well-executed frac jobs in the Bowen Basin of Australia were ineffective. A solution to this problem may lie in “gas flooding,” i.e., injection of an inert gas such as nitrogen or carbon dioxide to drive methane out [Puri and Yee 1990]. Increased methane production is, however, obtained with an increase in the inert gas content of the produced gas. This may affect the marketing of produced gas adversely.

4. *Short-radius horizontal boreholes:* In coal seams with high permeability, methane drainage can be performed with boreholes drilled vertically from the surface and then turned through a short radius to intersect the coal seam horizontally. The horizontal extension can be up to 3,000 ft. Methane then flows from the coal seam under its own pressure, as shown in Figure 6–6. The technique is well-proven in oil fields, but it has found a very limited application in coal mines for two reasons:

- Cost: A short-radius borehole drilled vertically to a depth of 1,000 ft and horizontally extended to 3,000 ft may cost up to \$500,000.
- Water accumulation in the horizontal borehole: As can be seen in Figure 6–6, any water accumulation in the horizontal leg of the borehole will seriously inhibit gas production. A solution may lie in deepening the vertical leg below the coal seam being drilled and installing a dewatering pump in it, as is commonly done for vertical frac wells.

Of the above four techniques, vertical frac wells have been the most effective option for premining degasification of most coal seams. Vertical frac wells also allow access to all coal seams in the gas emission space for predrainage. Such access becomes necessary in highly gassy mines in order to achieve high productivity. The only possible exception is for shallower, very permeable coal seams where in-mine drilling is sufficient and more economical. In shallow formations, the fracture system created by hydrofracing is like a horizontal pancake and is not very productive because the fracture system does not extend far enough from the borehole.<sup>5</sup> Strong<sup>6</sup> roof and floor are also necessary to contain the fracture system within the coal seam.

Recently, short-radius horizontal boreholes drilled from the surface have been used to recover methane from permeable coalbeds. In the future, carbon dioxide flooding may be used.

**Postmining methane drainage.** Techniques for postmining drainage can be broadly classified into four categories:

1. The packed cavity method and its variants
2. The cross-measure borehole method
3. The superjacent method
4. The vertical gob well method

---

<sup>5</sup>The ideal fracture is vertical, entirely within the coal, just a few inches wide, and extends upwards of 1,000 ft from the borehole.

<sup>6</sup>A roof with rock compressive strength over 10,000 psi.

1. *Packed cavity method and its variants:* This technique is used mainly in Russian coal mines. Early methods of methane control consisted of simply isolating the worked-out area in the mine using packed walls, partial or complete stowing, and plastic sheets or massive stoppings. A network of pipeline that passed through these isolation barriers was laid in the gob, and methane was drained using vacuum pumps. Lidin [1961] reviewed several variants of this technique. Figures 6-7 and 6-8 show typical layouts for caving and partially stowed longwall gobs.

Methane capture ratios achieved in practice are shown in Table 6-3. The ratios generally seem to improve in going from caving (20%–40%) to fully stowed longwall gobs (60%–80%). In Figure 6-7, the gate roads are protected by a packed wall against the gob. Pipelines are laid through the packed wall to reach nearly the center line of the gob, then manifolded to a larger-diameter pipe in the gate road. In Figure 6-8, the partially stowed longwall gob, cavities are purposely left between alternate packs. The overlying strata in the cavity area crack and provide a channel for gas to flow into these packed cavities. Pipelines are laid to connect the cavity with methane drainage mains. Methane extraction is usually done under suction.

2. *Cross-measure borehole method:* This is by far the most popular method of methane control on European longwall faces. Figure 6-9 shows a typical layout for a retreating longwall face. Boreholes 2–4 inches in diameter and about 80 ft apart are drilled from the top gate to a depth of 60–500 ft.

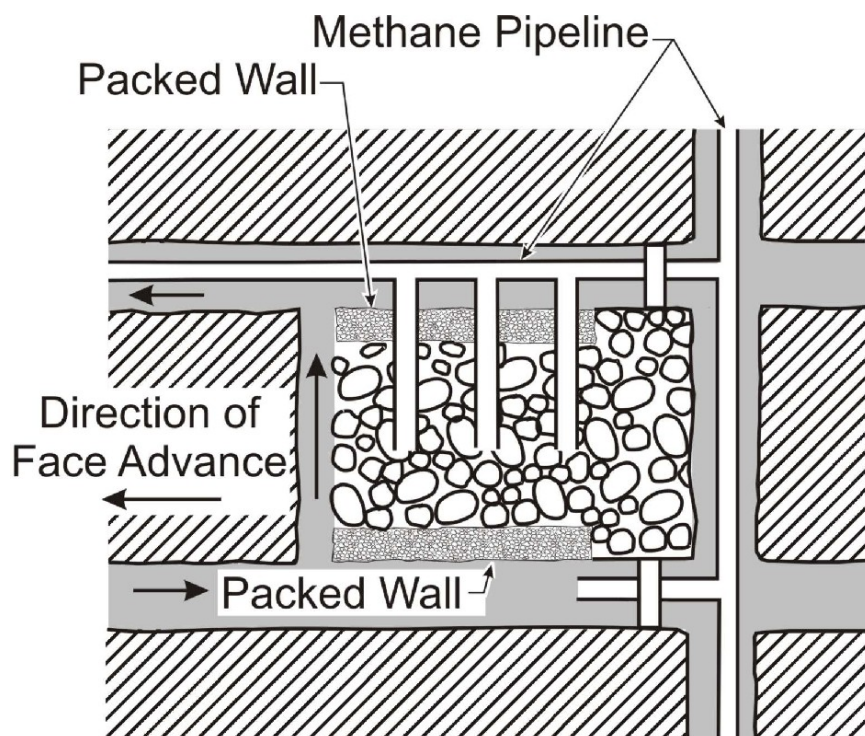

Figure 6-7.—Methane drainage by the packed cavity method.

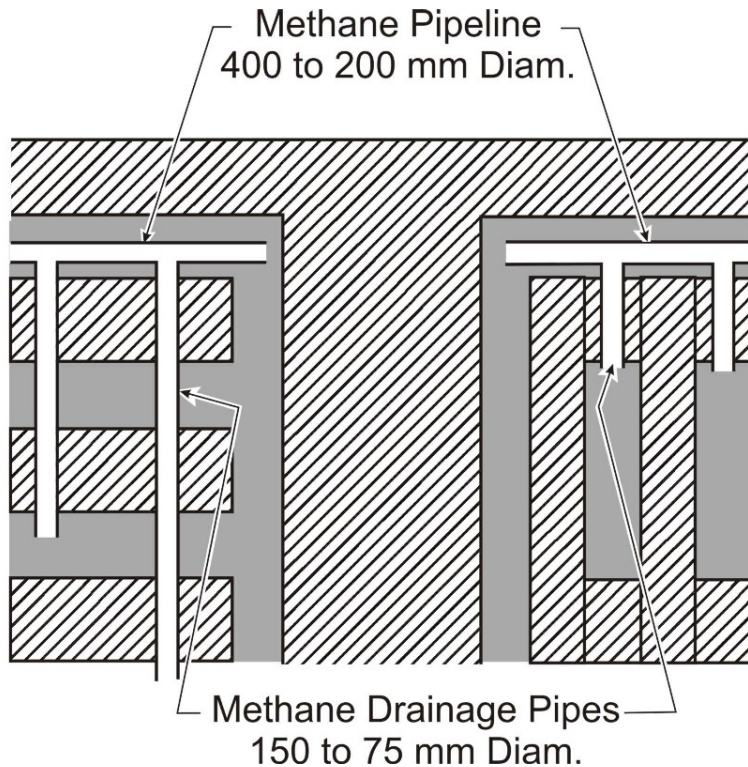

Figure 6-8.—Partially filled longwall gob.

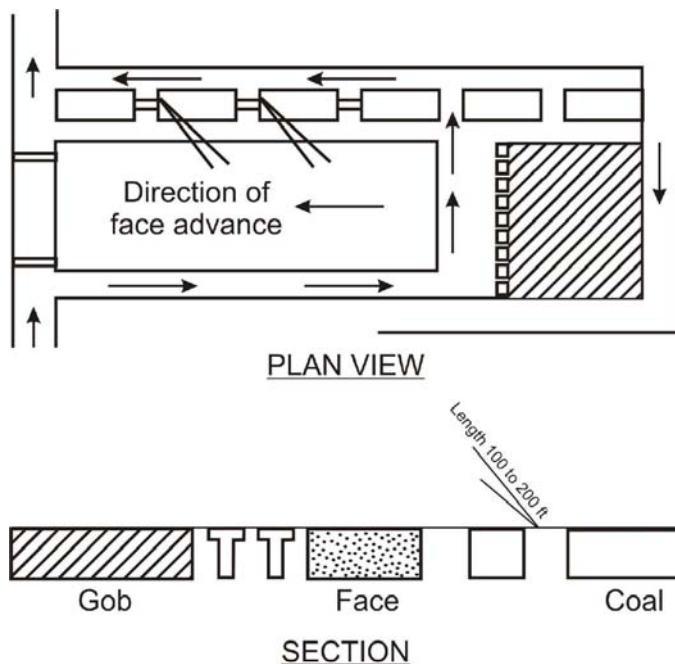

Figure 6-9.—Methane drainage with cross-measure boreholes.

The angle of these boreholes with respect to horizon varies from  $20^\circ$  to  $50^\circ$ , while the axis of the borehole is inclined to the longwall axis at  $15^\circ$  to  $30^\circ$ . At least one hole in the roof is drilled at each site, but several boreholes in the roof and floor can be drilled at varying inclinations depending on the degree of gassiness. These holes are then manifolded to a larger pipeline system, and gas is withdrawn using a vacuum pump. Vacuum pressures vary from 4 to 120 in w.g.

The amount of methane captured by the drainage system, expressed as a percentage of total methane emission in the section, varies from 30% to 70%. Some typical data for U.K. and U.S. mines are given by Kimmins [1971] and Thakur et al. [1983], respectively, and are shown in Table 6-3.

The cross-measure borehole method is generally more successful for advancing longwall panels than for retreat faces. The flow from individual boreholes is typically  $20 \text{ ft}^3/\text{min}$ , but can occasionally reach  $100 \text{ ft}^3/\text{min}$  for deeper holes. Sealing of the casing at the collar of the borehole is very important and is usually done with quick-setting cement. Sometimes a liner (a pipe of smaller diameter than the borehole) is inserted in the borehole and sealed at the collar to preserve the production from the borehole even when it is sheared by rock movements.

**Table 6–3.—Methane capture ratios for postmining methane drainage techniques**

Methane drainage technique and methane capture ratios	Remarks
Packed cavity method (after Lidin [1961]):	
20%–40% .....	Caving longwalls.
30%–50% .....	Partially stowed longwalls.
60%–80% .....	Fully stowed gobs.
Cross-measure boreholes (after Kimmins [1971]):	
59%–70% .....	Highly gassy mines with specific emissions 3,000–6,000 ft <sup>3</sup> per ton.
Superjacent method:	
50% .....	For multiple coal seams in the gas emission space.
Vertical gob wells:	
30%–80% .....	The methane capture efficiency depends on the number of gob wells per longwall panel and production techniques.

3. *Superjacent method:* This method was used mainly for retreating longwall faces in highly gassy seams in French mines. Figure 6–10 shows a typical layout. A roadway is driven 70–120 ft above the longwall face, preferably in an unworkable coal seam. The roadway is sealed, and vacuum pressures up to 120 in w.g. are applied. To improve the flow of gas, inclined boreholes in the roof and floor are drilled to intersect with other gassy coalbeds. If the mining scheme proceeds from the top to the bottom seams in a basin, the entries in a working mine can be used to drain coal seams at lower levels. Methane flow from these entries is high, averaging 700–1,000 ft<sup>3</sup>/min for highly gassy seams. Nearly 50% of total emissions have been captured using this method.

4. *Vertical gob well method:* This technique, most commonly used in longwall mining in the United States, is relatively new and differs from European systems in several ways. U.S. coal seams are generally thin, shallow, and relatively more permeable. Typically, only one seam is mined in a given area and retreat longwall mining is the only method being practiced at present. Methane emission rates from gobs in various coal basins vary depending on the geological conditions, but deep-seated longwall gobs (e.g., those in the Pocahontas No. 3 Seam in Virginia and the Mary Lee Seam in Alabama) produce methane in the range of 1,800–18,000 ft<sup>3</sup>/min. Multiple entries (typically four) are driven to develop longwall panels so that necessary air quantities can be delivered to the longwall faces via the mine ventilation system. In many cases, however, some type of additional methane control becomes necessary.

The most popular method of methane control is to drill vertical boreholes above the longwall prior to mining, as shown in Figure 6–11. Depending on the length of the longwall panel (typically 10,000 ft) and the rate of mining, 3 to 30 vertical gob degas boreholes are needed. The first hole is usually within 150–500 ft of the start line of the longwall face. The borehole is drilled to within 30–90 ft from the top of the coal. The casing is cemented through the fresh water zones near the surface, and a slotted liner is provided over the lower open section to prevent closing of the hole by caving. These boreholes are completed prior to mining. Usually, no measurable methane production is realized until the longwall face mines past the borehole.

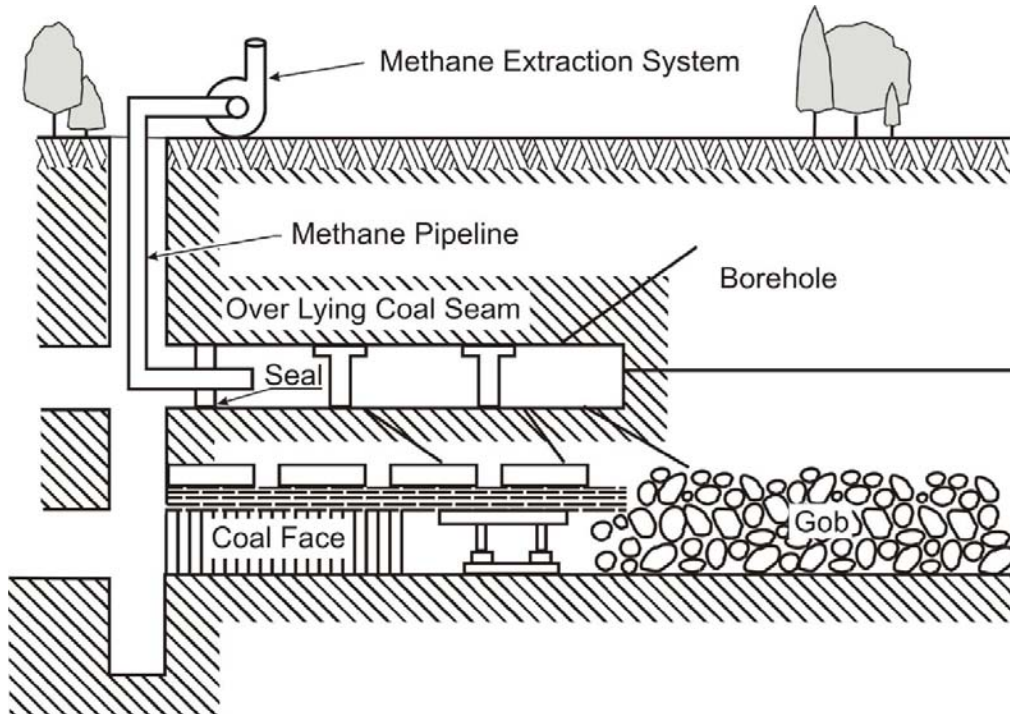

Figure 6-10.—Methane drainage by the superjacent method.

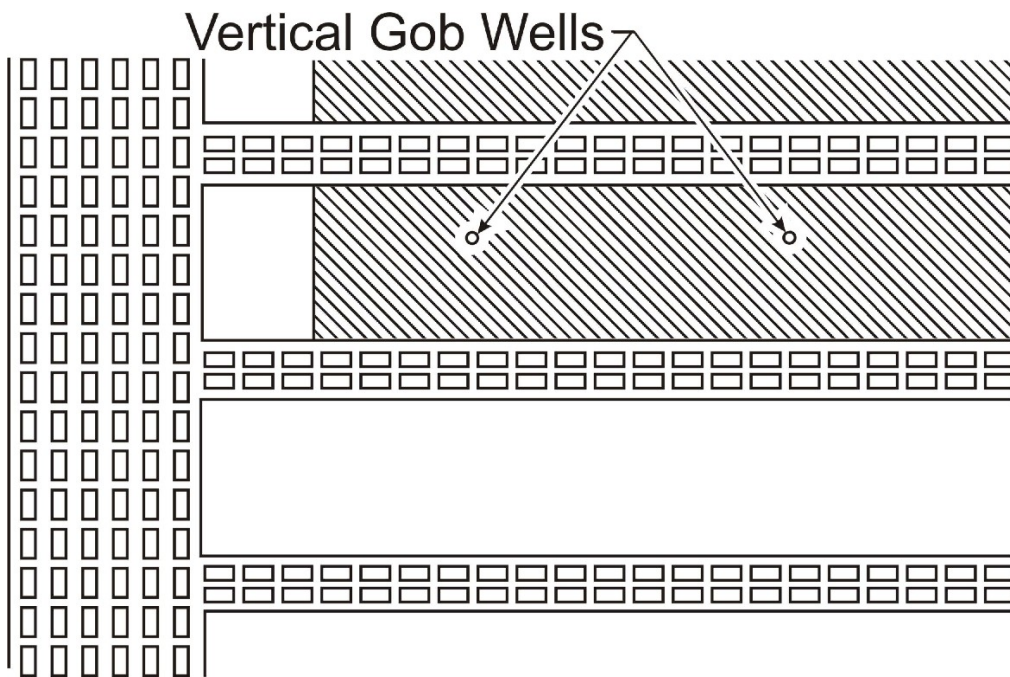

Figure 6-11.—Simplified illustration of methane drainage by vertical gob wells. Ventilation controls are not shown.

Early experiences with this method of gob degasification have been described by Moore et al. [1976] for the Lower Kittanning Seam, by Moore and Zabetakis [1972] for the Pocahontas Seam, and by Davis and Krickovic [1973] and Mazza and Mlinar [1977] for the Pittsburgh Seam. Many gob degasification boreholes produce naturally when the longwall face intersects them, but vacuum pumps are often added to further improve the flow and, in some cases, to prevent the reversal of flow. The capture ratios vary from 30% to 80% depending on the number and size of gob wells per panel and the size of vacuum pumps.

A summary of methane capture ratios for the abovementioned postmining methane drainage techniques is presented in Table 6–3. Although each technique offers high capture efficiency in some cases, it is the author's experience that vertical gob wells, if properly designed, offer the most universal application with consistently high capture ratios. In addition, this technique is a natural outgrowth of the premining degasification technique using vertical frac wells. These frac wells can be converted easily into postmining gob wells with minimal additional expense.

## HOW TO TRANSPORT GAS IN UNDERGROUND MINES

In-mine horizontal drilling and cross-measure boreholes drilled to degas longwall gobs produce large volumes of gas. This gas must be conducted out of the mine without being allowed to mix with the mine ventilation air. The U.S. coal industry, working with the Mine Safety and Health Administration (MSHA), has developed general<sup>7</sup> guidelines for installing and operating underground methane pipelines, as follows:

1. Underground methane pipeline will be made of well-designed plastic or steel, as detailed in Figure 6–12.
  - a. All underground steel pipelines will be 3½- to 8½-in O.D. schedule 40 pipes joined together with threaded couplings. These pipes will be made up tightly using a good grade of thread lubricant. Mill collars will be broken out, doped, and remade. A flange connection will be used every 10 joints (approximately 210 ft apart) so that a section of the pipeline can be removed without cutting the line if one or more joints need to be replaced later.
  - b. All underground plastic line will be 3- to 6-in high-density polyethylene pipe. Plastic flange adapters will be fusion bonded to the pipe ends in fresh air. Steel flange backup rings installed prior to fusion bonding will be used to connect plastic to plastic and plastic to steel.
2. The entire length of pipeline between the bottom of the venthole and the well head will be pressure tested to 1.25 times the shut-in pressure of the borehole or 90 psi, whichever is greater.
3. Pipeline will be generally laid in the return airway and will not be buried. Whenever the pipeline must cross a fresh air entry, it will be conducted through a steel line.

---

<sup>7</sup>The specifics will vary from mine to mine.

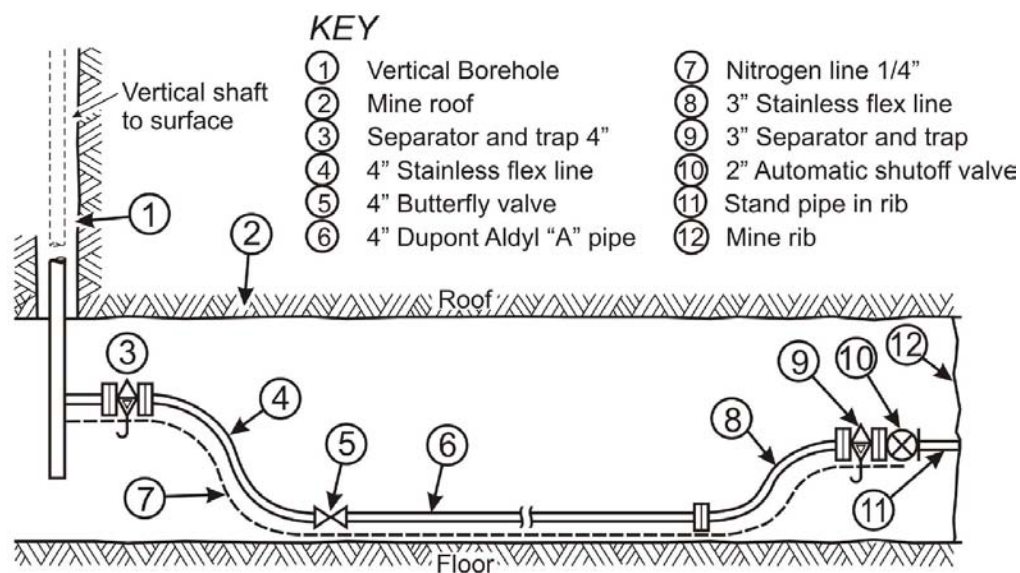

**Figure 6-12.—Underground methane pipe installation.**

4. No hoses will be used in the system, except while a hole is being drilled. Stress-relieving flexible tubing will be used at critical points, such as the head-to-pipeline connection. This will be stainless steel tubing with a triple wire braid cover.
5. The steel pipeline will be firmly supported, with no unsupported span greater than 2 ft.
6. A gas water separator will be installed at the bottom of the vertical venthole to remove condensation that falls back down the casing. Other separators will be installed on the holes or on the pipeline if water production from coal warrants. All separators will preferably be commercially made. Water drains will be provided on the line wherever necessary.
7. If steel pipeline is used, a potential survey will be made and cathodic protection provided where needed.
8. Automatic shut-in valves will be installed at each well head. These will be held open by nitrogen or air under pressure contained in a fragile plastic pilot line running parallel to and secured on top of the pipeline. Any roof fall or fires serious enough to damage the pipeline will damage the pilot line first and close the boreholes immediately.
9. The pipeline system will be inspected weekly by a competent person familiar with system operation.
10. If the quantity of mine ventilation air flowing over the pipeline is such that a complete rupture of the pipeline and consequent discharge of methane in mine air will raise its concentration above the legal limits, a methane monitor will be used.



11. At the surface installation (Figure 6–13), a commercially made flame arrestor will be installed within 10 ft of the top of the vent stack. A check valve shall be used to guard against reversal of flow. The check valve can be manually defeated if it is desired to purge the pipeline for repairs. An orifice meter may be installed if needed. All surface installations will be periodically inspected to ensure satisfactory performance.

12. All boreholes drilled for degasification will be accurately surveyed either during or after drilling is completed using commercially available borehole surveying tools. These boreholes will be accurately plotted on mine maps to prevent any inadvertent mining through them.

13. Should an occasion arise in the future when cutting into an abandoned, unplugged borehole will be necessary, a detailed mining plan will be submitted to MSHA.

14. A compressor will be required at the surface if beneficial use is made of the gas at a future date. Plans for installation will be discussed with MSHA at the appropriate time.

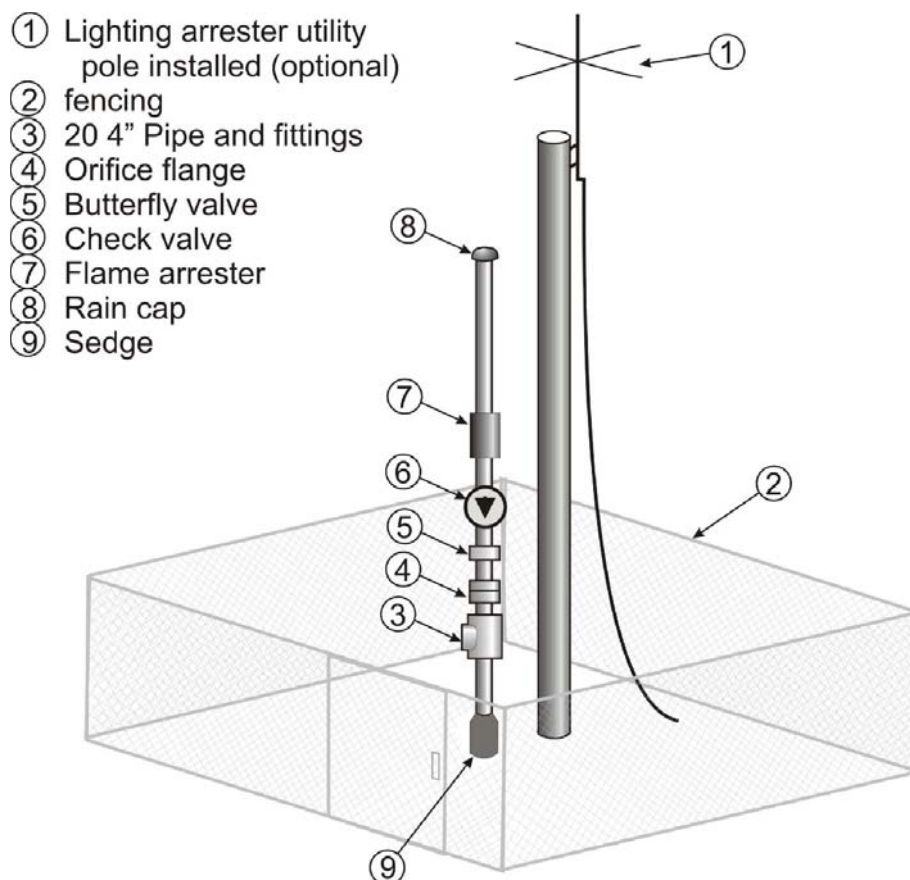

Figure 6–13.—Surface installation for horizontal drainage boreholes.

## ECONOMICS OF COAL SEAM DEGASIFICATION

**The economics of coal seam degasification depend on—**

- 1. The gas contents of the coal seam mined and the other coal seams contained in the gas emission space.**
- 2. The fraction of the mine methane emissions captured.**
- 3. Infrastructure costs and the market price of the processed gas.**

In general, unless the specific methane emission from the mine (cubic feet of methane per ton of mined coal) is high (above 3,000 ft<sup>3</sup>/ton), it may not be profitable to process the gas for marketing. The cost of compressing and processing the coal mine methane and a complete economic analysis to reflect rates of return on the investment is beyond the scope of this chapter. A rough estimate of costs associated with coal seam degasification can be derived, however, as shown here.

For all underground longwall mining, a generalized scheme of degasification depending on the gassiness of the coal seam has been proposed by Thakur and Zachwieja [2001]. The following assumptions were made:

1. The longwall panel is 1,000 ft wide and 10,000 ft long.
2. The coal seam has an average thickness of 6 ft.
3. The coal block to be degassed is 1,300 ft by 10,000 ft, assuming that the width of chain pillars is 300 ft.
4. The cost of contract drilling for the in-mine horizontal drilling is \$50/ft.
5. The cost of a gob well is \$50,000–\$200,000, depending on the depth of the mine and the size of the borehole.
6. The cost of hydrofracing a well is \$250,000.

If the total cost of in-mine drilling, including all of the underground pipeline costs, all vertical frac wells, and all other gob wells, is added and then divided by the tons of coal in the longwall block, the result is the cost of coal seam degasification per ton of coal.

- *Estimated cost for mildly gassy coal seams less than 100 ft<sup>3</sup>/ton (see Table 6–2):*

Premining degasification: For coal seams with gas contents less than 100 ft<sup>3</sup>/ton,<sup>8</sup> there is generally no need for premining degasification.

Postmining degasification: Two gob wells are recommended for the longwall panel. The first gob well should be installed within 1,000 ft of the setup entry and the second one in the middle of the panel.

The total cost is \$100,000, or \$0.03/ton.

---

<sup>8</sup>Remember that this figure represents the gas content of the coal, not the specific mine emission.

- *Estimated cost for moderately gassy coal seams, 100–300 ft<sup>3</sup>/ton (see Table 6–2):*

Premining degasification: The longwall panel should be drilled horizontally at 1,000-ft intervals, and development boreholes should be drilled to degas development sections. Total in-mine drilling footage for a typical panel may total 25,000 ft.

Postmining degasification: In moderately gassy coal seams, a proposed longwall panel may need five to six gob wells. The diameter and size of exhaust fans will depend on local conditions.

The total cost is approximately \$1.55 million, or \$0.50/ton.

- *Estimated cost for highly gassy coal seams over 300 ft<sup>3</sup>/ton (see Table 6–2):*

Premining degasification: Highly gassy coal seams must be drained several years ahead of mining with vertical frac wells (wells that have been hydraulically fractured). These frac wells can be placed at about a 20-acre spacing. Frac wells drilled about 5 years ahead of mining can drain nearly 50% of the in situ gas prior to mining, but this may not be sufficient. Additional degasification with in-mine horizontal drilling can raise the gas drained to nearly 70%. Horizontal boreholes are drilled 200–300 ft apart to a depth of 900 ft. Assuming a 200-ft interval, nearly 45,000 ft of horizontal drilling and about 15 vertical frac wells may be needed to properly degas the panel.

Postmining degasification: Because of very high gas emissions from the gob, the first gob well must be installed within 50–100 ft from the setup entry. Subsequent gob wells may be drilled at a 6- to 15-acre spacing, depending on the rate of mining and the gas emission per acre of gob. In Virginia and Alabama, which have some highly gassy coal seams, gob wells are generally 9–12 inches in diameter. Powerful exhaust fans capable of a suction of 5–10 inches of mercury are needed to capture up to 70% of gob gas emissions.

The total cost of degasifying a longwall panel in a highly gassy coal seam is approximately \$11 million, or \$3.52/ton. Coal seam degasification is needed for mine safety and high productivity, but in highly gassy mines it becomes quite expensive. In these mines, the processing and marketing of coal mine methane becomes necessary to defray the cost.

## REFERENCES

Creedy DP, Saghafi A, Lama R [1997]. Gas control in underground coal mining. IEACR/91. London: IEA Coal Research.

Davidson RM, Sloss LL, Clarke LB [1995]. Coalbed methane extraction. IEACR/76. London: IEA Coal Research.

Davis JG, Krickovic S [1973]. Gob degasification research: a case history. In: Methane control in eastern U.S. coal mines. Proceedings of the Symposium of the Bureau of Mines/Industry Technology Transfer Seminar, Morgantown, WV, May 30–31, 1973. Washington, DC: U.S. Department of the Interior, Bureau of Mines, IC 8621, pp. 62–72.

Diamond WP [1994]. Methane control for underground coal mines. Pittsburgh, PA: U.S. Department of the Interior, Bureau of Mines, IC 9395. NTIS No. PB94189289.

Diamond WP, Schatzel SJ [1998]. Measuring the gas content of coal: a review. *Int J Coal Geol* 35:311–331.

Gunther J, Bélin J [1967]. Forecasting methane emission at faces in flat seams. In: Proceedings of the 12th International Conference of Mine Safety Research Establishments (Dortmund, Germany, September 11–15, 1967). Vol. 3. Paper No. 45. Detmold, Germany: Hermann Bösmann GmbH.

Hargraves AJ [1973]. Planning and operation of gaseous mines. *CIM Bull*, March.

Kimmins EJ [1971]. Firedamp drainage in the northwestern area. *Colliery Guardian*, Annual Review, pp. 39–45.

Kissell FN, McCulloch CM, Elder CH [1973]. The direct method of determining methane content of coalbeds for ventilation design. Pittsburgh, PA: U.S. Department of the Interior, Bureau of Mines, RI 7767.

Langmuir I [1918]. The adsorption of gases on plane surfaces of glass, mica, and platinum. *J Am Chem Soc*.

Lidin GD [1961]. Control of methane in coal mines. Washington, DC: Israel Program for Scientific Translations.

Mazza RL, Mlinar MP [1977]. Reducing methane in coal mine gob areas with vertical boreholes. Continental Oil Co. U.S. Bureau of Mines contract No. H0322851. NTIS No. PB272768.

Moore TD Jr., Zabetakis MG [1972]. Effect of a surface borehole on longwall gob degasification (Pocahontas No. 3 coalbed). Pittsburgh, PA: U.S. Department of the Interior, Bureau of Mines, RI 7657.

Moore TD Jr., Deul M, Kissell FN [1976]. Longwall gob degasification with surface ventilation boreholes above the lower Kittanning coalbed. Pittsburgh, PA: U.S. Department of the Interior, Bureau of Mines, RI 8195.

Puri R, Yee D [1990]. Enhanced coalbed methane recovery. In: Proceedings of the 65th Annual Technical Conference and Exhibition of the Society of Petroleum Engineers (New Orleans LA, September 23–26, 1990). Richardson, TX: Society of Petroleum Engineers, pp. 193–202.

Spindler GR, Poundstone WN [1960]. Experimental work in the degasification of the Pittsburgh coal seam by horizontal and vertical Drilling. Preprint No. 60F106. Littleton, CO: American Institute of Mining, Metallurgical, and Petroleum Engineers.

Thakur PC [1981]. Methane control for longwall gobs. In: Ramani RV, ed. Longwall-shortwall mining: state of the art. Littleton CO: American Institute of Mining, Metallurgical, and Petroleum Engineers, pp. 81–86.

Thakur PC, Davis JG [1977]. How to plan for methane control in underground coal mines. *Min Eng Oct*:41–45.

Thakur, PC, Poundstone WN [1980]. Horizontal drilling technology for advance degasification. *Min Eng Jun*:676–680.

Thakur PC, Zachwieja J [2001]. Methane control and ventilation for 1,000-ft wide longwall faces. In: Proceedings of Longwall USA, International Exhibition and Conference (Pittsburgh, PA, June 13–15, 2001), pp. 167–180.

Thakur PC, Cervik J, Lauer SD [1983]. Methane drainage with cross-measure boreholes on a retreat longwall face. Preprint No. 83–398. Littleton, CO: American Institute of Mining, Metallurgical, and Petroleum Engineers.

Thakur PC, Christopher DA, Bockhorst R W [1988]. Horizontal drilling technology for coal seam methane recovery. In: Gillies ADS, ed. Proceedings of the Fourth International Mine Ventilation Congress (Brisbane, Queensland, Australia, July 3–6, 1988), pp. 201–207.

Winter K [1975]. Extent of gas emission zones influenced by extraction. In: Proceedings of the International Conference on Coal Mine Safety Research, Washington DC), pp. V3.1–V3.17.

## CHAPTER 7.—MANAGING EXCESS GAS EMISSIONS ASSOCIATED WITH COAL MINE GEOLOGIC FEATURES

By James P. Ulery<sup>1</sup>

### *In This Chapter*

- ✓ Geologic features associated with anomalous methane emissions
- ✓ Gas outbursts and blowers
- ✓ Methane drainage strategies for mitigating anomalous methane emissions

*and*

- ✓ General considerations for a methane drainage program

This chapter summarizes how certain geologic features may be associated with unexpected increases in gas emissions during coal mining. These unexpected emissions have the potential to create explosive conditions in the underground workplace. Also discussed are the generally used practices to alleviate potential hazards caused by gas emissions associated with these geologic features.

### INTRODUCTION

Unforeseen mine gas emissions in quantities sufficient to create hazardous conditions have been attributed to sources outside the mined coalbed since the first documentation of methane explosions in coal mines [Payman and Statham 1930]. Geologic features such as faults have long been recognized as conduits for gas flow from strata adjacent to mined coalbeds [Moss 1927; Payman and Statham 1930]. Other features such as sandstone paleochannels, clay veins, and localized folding have also been recognized for their impact on gas emissions into mine workings [Darton 1915; Price and Headlee 1943; McCulloch et al. 1975; Ulery and Molinda 1984].

The fact that strata adjacent to mined coalbeds can emit large quantities of methane gas into mine workings is not surprising from a theoretical perspective. Many researchers have recognized that during the burial and diagenesis of the organic matter forming today's minable coalbeds, similar dispersed organic matter in adjacent strata has produced methane in quantities far exceeding the storage capacity of the coal and surrounding rock [Juntgen and Klein 1975]. It is not surprising then that large quantities of methane can remain trapped in these strata. A potential hazard occurs when mining of a nearby coalbed causes pressure differentials and mining-induced fractures conducive to gas flow into the mine workings from these strata. This gas flow may be facilitated or temporarily impeded by the presence of geologic structures or anomalies.

---

<sup>1</sup>Research geologist, Pittsburgh Research Laboratory, National Institute for Occupational Safety and Health, Pittsburgh, PA.

**Anomalous, unanticipated methane emissions are often related to the interception of geologic features, such as paleochannels, faults, and clay veins, by mine workings. Furthermore, these features can also contribute methane emissions before being intercepted by mining.**

For the purpose of discussion in this chapter, gas emissions associated with geologic features are divided into two categories. The first includes subtle emission events that are often associated with various geologic features or anomalies. These emissions are often not easily detected without instrumentation, but may lead to hazardous accumulations of methane if not remedied. The second category includes large-scale, easily recognizable emission events such as blowers or outbursts that potentially have immediate and often catastrophic consequences. Documented methods to recognize and remedy both types of hazards have been established worldwide and are discussed here.

This chapter summarizes current technologies for recognizing and remediating gas emission hazards associated with various geologic features. Although emphasis is placed on recognized hazards in U.S. coal mines, hazards not well-documented in these mines, such as gas outbursts, are also discussed due to the potential for such occurrences in the future as mines extract deeper and gassier seams.

## **INCREASED GAS EMISSIONS ASSOCIATED WITH GEOLOGIC FEATURES**

In the United States, gas emission events associated with geologic features constitute a fairly common hazard in coal mining. These events are neither as obvious nor as immediate as outbursts or blowers, which are discussed later. However, they can pose significant risks. These emission events are often difficult to detect without instrumentation and underground surveys.

**Detailed mapping of geologic features can assist in predicting potential emission hazards and designing methane drainage systems to prevent them.**

This section will consider techniques to detect and remediate anomalous gas emissions associated with geologic features such as sandstone channels/lenses, adjacent source beds, clay veins, joints, fractures, and small-scale faulting. Also included is a discussion of igneous intrusions and their potential impact on gas storage and emissions.

**Sandstone channels/lenses.** Sandstone paleochannel deposits or other lenticular sandstone deposits adjacent to mined coalbeds historically have been documented as gas reservoirs [Darton 1915; Price and Headlee 1943]. The gas may have been generated in situ from organic matter

deposited with the sand, or it may have migrated to the paleochannel from subjacent coalbeds or other organic-rich rock strata. These gas-bearing sandstones generally have a greater permeability than other rock strata in coal mining areas. Once a gas flow pathway is established to the mine workings, via either the relaxing of naturally occurring joints, clay veins, faults, or mining-induced fractures, then gas emissions from these sandstones may be quite pronounced and often produces hazardous conditions.

Methane emissions from sandstone paleochannels is a well-known problem in the Pittsburgh Coalbed in Pennsylvania and West Virginia [McCulloch et al. 1975]. At a mine in northern West Virginia, gas was documented to be migrating from a sandstone channel to mine workings through clay vein-related fractures [Ulery and Molinda 1984]. The sandstone paleochannel deposit above the Pittsburgh Coalbed was a significant gas reservoir that was still flowing 370,000 cfd of gas into a methane drainage system 2 years after it was installed.

Delineating problematic sandstone bodies is best accomplished by an exploratory core drilling program of sufficiently close spacing to accurately delineate the extent and trend of the sand unit [Houseknecht 1982]. Also, evaluating the gas content/flow potential of sandstone units is necessary to determine if emissions will be of sufficient volume to pose a potential hazard. This can be accomplished by laboratory testing of core samples for reservoir properties such as porosity and permeability, well testing, or direct gas measurements underground in the vicinity of the feature [Diamond 1994].

When sandstone bodies, either in floor or roof strata, are encountered that pose a gas emission hazard, remediation may be accomplished by vertical surface methane drainage boreholes (Figure 7-1, borehole A). However, in-mine methane drainage boreholes may be the most economically viable solution. In Figure 7-1, boreholes B, C, and D show vertical, in-mine cross-measure, and horizontal degasification borehole configurations, respectively, for methane drainage of a gas-bearing paleochannel deposit in the roof strata. The same configurations of surface or in-mine boreholes would also be applicable to gas-bearing sandstone deposits in floor strata.

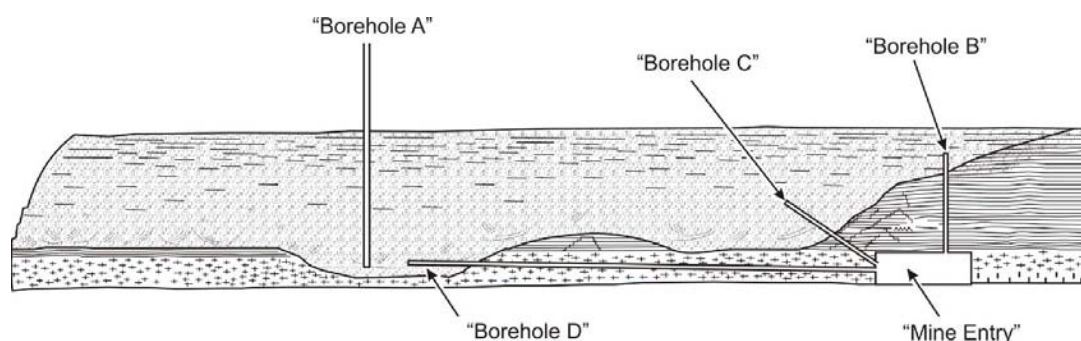

Figure 7-1.—Methane drainage scenarios for paleochannels.



Vertical methane drainage boreholes drilled from the surface usually require both dewatering and hydraulic fracturing for maximum effectiveness. Horizontal, cross-measure, or vertical underground degasification boreholes may also need to remove water to effectively produce gas. These methane drainage systems are fully explained and referenced by Diamond [1994].

**Gas-bearing paleochannel deposits or adjacent coalbeds may require surface or cross-measure methane drainage boreholes.**

**Coalbeds and other adjacent gas source beds.** Historical mining experience and research have shown that coalbeds adjacent to the mined seam can contribute significant quantities of methane gas into active workings [Finfinger and Cervik 1979; Ayruni 1984; Diamond et al. 1992]. Degasification of these coalbeds may be accomplished through vertical or directional boreholes drilled from the surface. Occasionally, in-mine vertical, cross-measure, or directional boreholes are used to reduce potentially explosive accumulations of gas [Finfinger and Cervik 1979; Ayruni 1984; Diamond 1994].

In addition to nearby coalbeds, other adjacent strata may also be significant gas reservoirs and contribute unexpected emissions into mine workings. Shales and siltstones rich in organic matter often contain significant quantities of methane gas [Darton 1915; Johnson and Flores 1998]. Although these formations may have a large gas storage capacity, permeability is usually very low. Thus, these rocks may not release gas until mining-induced fractures increase their permeability and provide a pathway for gas migration to the mine workings. In studying the gas content of U.K. coalbeds, Creedy [1988] concluded that although the gas contents and porosities of these rocks are low, a well-developed joint or fracture system could facilitate gas release from these strata. Therefore, it may be assumed that if certain organic-rich rocks adjacent to mined coalbeds have sufficient gas content, migration via joints or fractures into the workings could generate hazardous explosive conditions. Methane drainage methods similar to those discussed previously for adjacent coalbeds are usually appropriate for adjacent noncoal gas-bearing strata as well.

**Large- and small-scale structural faulting.** For this discussion, large-scale faults are loosely defined as having tectonically activated and structurally mappable features, with lengths greater than 500 m (1,640 ft) and vertical movement of at least 10–20 m (33–66 ft). Small-scale faults are distinguished from large-scale faults by their limited extent both horizontally and vertically. Faults may have a profound effect on gas emissions into mine workings and may also be associated with outbursts and blowers. Usually, the presence of large-scale faulting is known from regional geologic mapping and/or exploration boreholes. In certain cases, these large faults may act as barriers to gas flow, especially if they contain impermeable fault gouge or the displacement causes impermeable rock above or below the mined coalbed to abut against it [Diamond 1982]. In these situations, large volumes of gas can be trapped behind the fault at pressures higher than that of the mine atmosphere. If mine development proceeds through the fault by ramping upward or downward into the displaced, high-pressure coalbed gas reservoir, the potential for sudden, excess gas emissions must be addressed.

Large-scale faults may also act as conduits for gas flow or blowers into the mine workings from gas-enriched strata above or below the mined coalbed. This is especially likely due to stress redistributions as mining approaches a large-scale fault. In Germany, Thielemann et al. [2001] showed that in nonmined regions, normal faults regularly act as gas conduits for surface emissions into the atmosphere from deep (60–870 m (197–2,854 ft)) formations such as coalbeds. Thielemann et al. further demonstrated that distinctly higher surface gas emission rates occurred from normal faults in mined areas, presumably caused by the increased permeability of the fault and associated strata in response to mining. Therefore, it would seem likely that such faults could easily become pathways for gas emissions into mine workings from adjacent source beds. In the United States, Clayton et al. [1993] noted similar findings in the Black Warrior Basin.

Methane drainage from potential gas problem areas associated with large-scale faulting may best be accomplished through surface boreholes if the faulted areas in question are well mapped. In lieu of this, unexpected problems associated with large-scale faulting may be alleviated by underground cross-measure boreholes designed to penetrate the fault zone and/or the gas source bed.

Small-scale faults have limited lateral extent and are often vertically confined to one or two strata layers. In coal mining districts, small-scale faults are often, but not exclusively, related to differential sediment compaction phenomena. Examples of these faults are illustrated by Iannacchione et al. [1981].

Little documentation is available on the effects of small-scale faults on gas emissions. However, based on descriptions by Iannacchione et al. [1981], it would seem reasonable to conclude that these types of faults, if they have any effect at all, could possibly act as more limited barriers to gas migration compared to the previously discussed large-scale faults. Prediction of these small-scale features can be difficult, even with detailed underground mapping. The coalbed near these features often displays abnormal thickening, undulations, or pulverizing, which may indicate that these types of faults are being approached. However, if small-scale faults are encountered and found to adversely influence gas emissions, degasification through short horizontal or cross-measure-type boreholes ahead of the working face is feasible if these faults can be mapped and/or anticipated.

Whether large- or small-scale, displacement faults are generally of two basic types: normal or reverse. Small-scale normal faults are often associated with differential compaction phenomena near sandstone channels. Large-scale normal faulting is often associated with regional uplifts and/or deep plutonic activity. Reverse faults, on the other hand, are often associated with mountain-building tectonics and regional compressional forces. Low-angle reverse faults are termed “thrust faults” and are often very large-scale regional features. Because normal faults are usually associated with tensional forces and reverse faults with compressional forces, they would seem most likely to act as gas conduits and barriers, respectively. However, there is no conclusive documentation to that effect.

**Geologic mapping of faults is needed to determine the most efficient gas drainage system.**

Figure 7–2 shows a mine entry approaching a normal fault on the “footwall” side. The remaining coal reserve ahead of (and below, due to the fault) the approaching entry often poses an emission hazard, i.e., although the normal fault may potentially be a gas conduit, until mining redistributes stresses, it is not generally an open conduit for gas flow as is the normal coal cleat system. Therefore, when the entry is ramped downward to mine the remaining reserve, hazardous conditions may occur when the gas trapped behind the fault is suddenly released into the mine entry. Optimum degasification of such potential hazards is best accomplished via vertical methane drainage boreholes drilled from the surface (Figure 7–2, borehole B). Alternatively, directional methane drainage boreholes from the mine entry (Figure 7–2, borehole A) could be used.

If a normal fault is encountered from the lower “hanging” wall side (Figure 7–3), vertical methane drainage boreholes drilled from the surface (Figure 7–3, borehole A) are probably the only viable method to remediate the hazard due to the geometry of this condition.

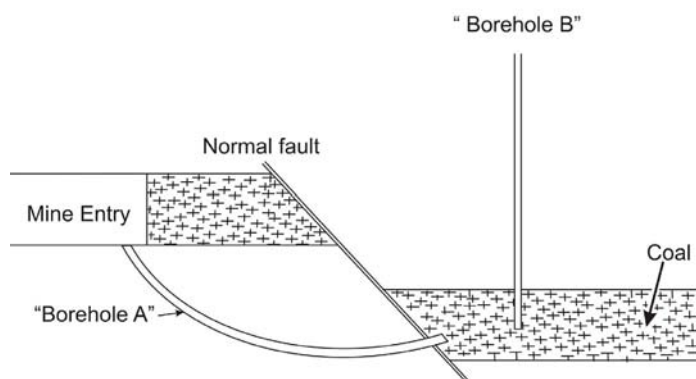

**Figure 7–2.—Methane drainage of a normal fault from the “footwall” side.**

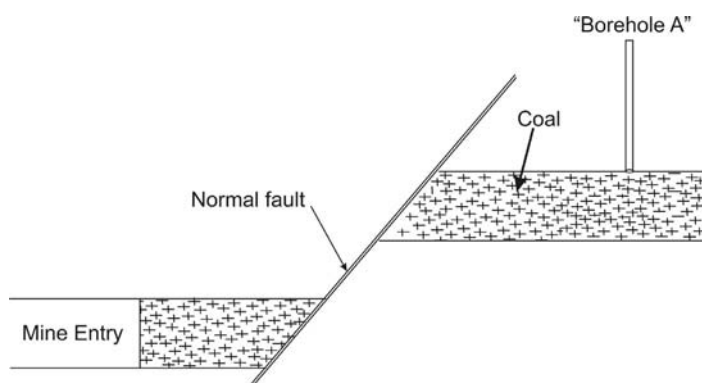

**Figure 7–3.—Methane drainage of a normal fault from the “hanging” wall side.**

Reverse faults tend to form by compressional forces and therefore may often act as barriers to flow, causing gas buildup behind them. Figure 7–4 shows a mine entry approaching a reverse fault on the “hanging” wall side. In most cases, but especially if the faulting is large-scale, vertical methane drainage boreholes drilled from the surface (Figure 7–4, borehole C) are probably the most viable option to alleviate potential emission hazards. Other options include vertical in-mine boreholes (Figure 7–4, borehole A) or directional in-mine boreholes (Figure 7–4, borehole B). Reverse faults, where mining approaches from the “footwall” side, are optimally addressed with in-mine cross-measure-type boreholes (Figure 7–5, borehole A) or vertical methane drainage boreholes drilled from the surface (Figure 7–5, borehole B).

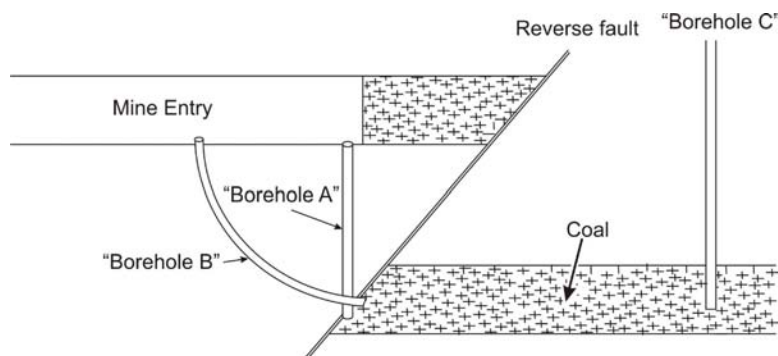

Figure 7-4.—Methane drainage of a reverse fault from the “hanging” wall side.

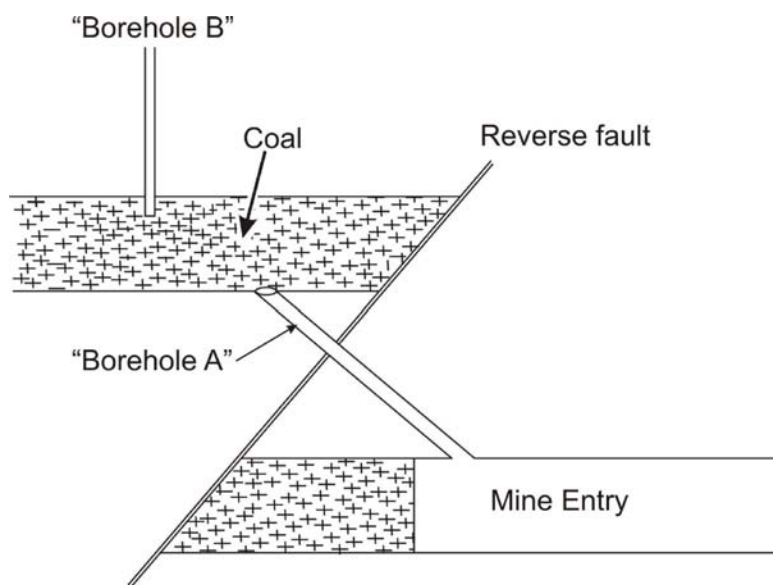

Figure 7-5.—Methane drainage of a reverse fault from the “footwall” side.

### Joints, cleats, and fractures.

Joints, cleats, and fractures are ubiquitous features in most coal measure rocks and are related to the confining stress fields acting upon those strata during burial, diagenesis, and uplift. Generally, these features follow a systematic pattern. Joints are closely spaced with even walls, whereas fractures are more widely spaced with irregular walls [Nickelsen and Hough 1967]. Joints usually occur in orthogonal pairs (at an approximately 90° orientation to each other), and in coalbeds, these joint sets are referred to as “cleats.”

The main joints and cleats of any given set are generally more continuous and are the dominant migration pathways for gas [McCulloch et al. 1974]. They are referred to as “systematic joints” and “face cleats,” respectively. The corresponding joints and cleats at 90° to the main features are referred to as “nonsystematic joints” and “butt cleats,” respectively. These joints and cleats generally terminate against the systematic joints and face cleats, making them notably less continuous. When

coalbeds are mined, the redistribution of stresses allows cleats to expand and facilitates gas migration through the coal to the face. Similarly, the stress redistribution opens joints and fractures in roof and floor strata, facilitating gas migration from adjacent strata.

The ubiquitous nature of joints and the unpredictable spacing of fractures make prediction and remediation of abnormal gas emissions related to these features difficult. It is important for operators to realize that although joints and fractures may contain free gas at the face, their real hazard potential is as a conduit for unexpected gas flows to the mine workings from within the coalbed and/or other source beds adjacent to the mined coalbed. These types of conditions are most often recognized when the continuous miner or longwall shearer is deenergized due to the machine-mounted methane sensors reading concentrations above the allowable limits. The most

obvious solution to this problem would be to increase the face ventilation, if not already at the practical limit.





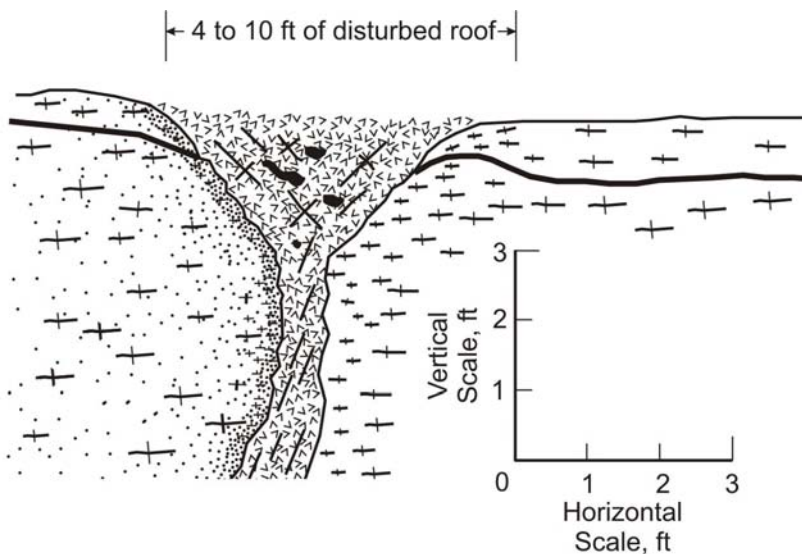

**If past experience indicates that excess emissions may be encountered in a developing section, the mine operator should consider an underground horizontal borehole methane drainage system or vertical methane drainage boreholes drilled from the surface to remove gas prior to mining. Mine operators should always be aware of regional joint and fracture trends to facilitate prediction and remediation of abnormal emissions associated with joints and fractures.**

**Clay veins.** Clay veins or clastic dikes (Figure 7–6) are sedimentary intrusions, usually from overlying strata, that invade the coal in a vertical or near-vertical orientation. Their appearance in cross-section is not unlike an igneous dike, hence their name. Clay veins tend to be systematic in occurrence and are often related to differential compaction/diagenetic processes, but can also be influenced by tectonic processes.

These features, their characteristics, and modes of formation have been widely documented in U.S. coal mines [Chase and Ulery 1987]. Clay veins, which are generally composed of very



**LEGEND**

	Gray limestone inclusions		Bone porting
	Coal with cleat		CH <sub>4</sub>
	Slickensided planes		Clay vein matrix: dark to black, silty shale to shale

fine-grain sediment or clay, are virtually impermeable barriers to gas migration in coalbeds. Therefore, they tend to have a “damming” effect on gas flow when approached in a developing section. When a continuous miner or longwall shearer penetrates a clay vein with gas trapped behind it, the abnormally high emissions may cause production interruptions due to methane concentrations above the legal limit, and in a worst-case scenario, an explosive methane/air mixture could ignite.

**Figure 7–6.—Typical clay vein acting as a barrier to gas migration.**

Clay veins have a well-documented history of causing unexpected high gas emissions in the Pittsburgh Coalbed during mining [McCulloch et al. 1975]. Prosser et al. [1981] measured increases in gas flow from 47,000 to 80,000 cfd when a horizontal in-mine methane drainage borehole penetrated a clay vein approximately 800 ft from the face. For a different horizontal borehole in the same study, the gas flow increased from 144,000 to 214,000 cfd when a clay vein was penetrated approximately 2,175 ft from the face. High gas flow rates (>80,000 cfd) from low-angle cross-measure boreholes penetrating clay veins near a gas-bearing sandstone above the Pittsburgh Coalbed have been documented in northern West Virginia [Ulery and Molinda 1984].

**In-mine horizontal boreholes can effectively drain gas trapped behind clay veins in advance of mining.**

Only experience at a given mine can indicate to the operator if clay veins have the potential for gas emission problems. If methane emission problems are encountered, then underground mapping of clay veins is needed to predict where they will occur in developing sections. Because clay veins can frequently extend hundreds of feet along a given trend [Chase and Ulery 1987], predicting their occurrence in a developing section will allow the operator to anticipate and/or alleviate the potential gas problem.

If the clay vein network in a specific mine has a history of gas emission problems, then horizontal methane drainage boreholes drilled ahead of the face and penetrating the clay vein are probably the most economical and timely method to remediate the potential problem (Figure 7-7, borehole A). Theoretically, if a clay vein network is well-mapped and a large, isolated "cell" is delineated (Figure 7-8), then the gas could be drained through a surface borehole (Figure 7-7, borehole B). Generally, however, this would be a cost-prohibitive course of action, necessitated only in extreme cases or where drilling costs would be low due to shallow depths.

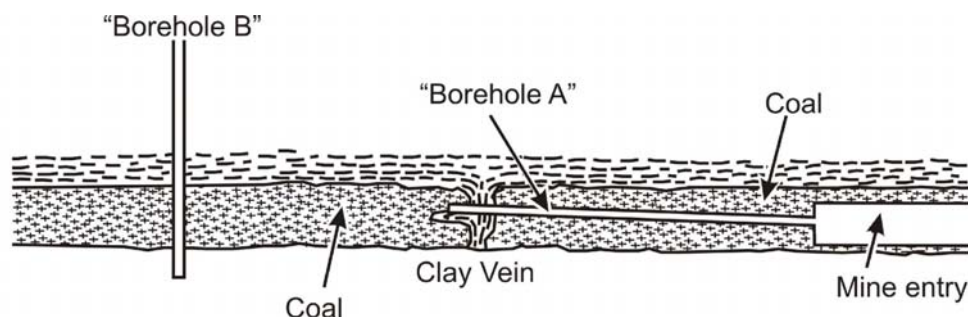

**Figure 7-7.—Methane drainage of a clay vein gas barrier.**

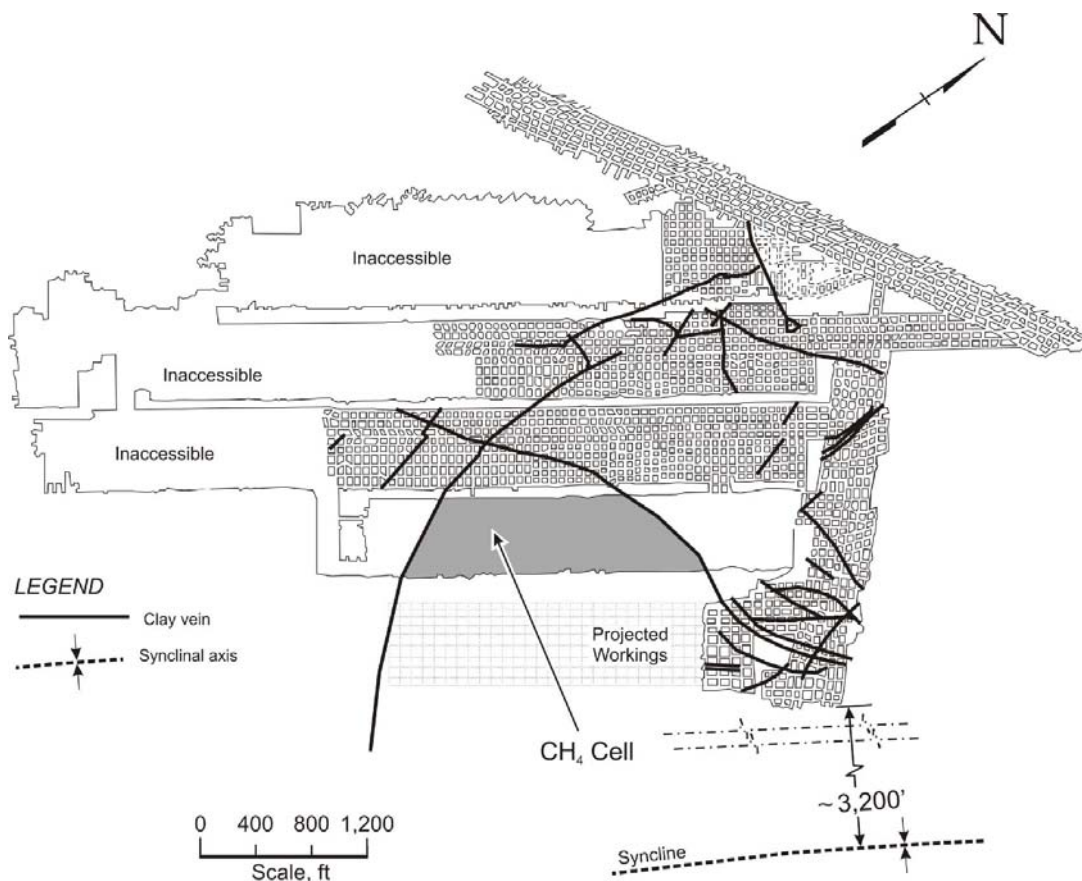

Figure 7-8.—Hypothetical gas cell formed by clay veins (adapted from Chase and Ulery [1987]).

**Igneous intrusions.** Igneous intrusions into coalbeds and coal measure rocks are not frequent, but not uncommon either. Igneous intrusions into coal measure strata generally will be either discordant features such as dikes, which cut across bedding planes, or concordant features such as sills, which are injected parallel to bedding. Massive discordant features such as plutons are rare in coal measures.

Because igneous intrusions involve magmatic rock injected at elevated temperatures, they cause an alteration and increase in the thermal maturity (rank) of nearby coalbeds and organic matter in rocks [Dutcher et al. 1966]. The degree of coal alteration caused by an igneous intrusion depends on many factors, including the intrusion's temperature, thickness, distance from the coal seam, and cooling rate. Such thermal alteration of organic matter is accompanied by methane gas generation. Therefore, for a given coalbed, localized areas affected by igneous intrusions can be expected to have higher gas contents than normal [Gurba and Weber 2001]. Larger igneous intrusions such as sills may also be responsible for potentially high carbon dioxide concentrations in some coal basins [Clayton 1998].

Discordant igneous dikes, which cut across the coalbed, may not only be expected to increase the in situ gas content due to thermal alteration, they can also act as a barrier or "dam" to gas

migration and present hazards similar to clastic dikes when mined through. Predicting the location and orientation of igneous dikes in developing sections is best accomplished by detailed underground mapping in adjacent developed sections. Remediating potential gas emission hazards associated with igneous dikes, as with clastic dikes, is best accomplished by horizontal boreholes drilled from the face to penetrate the dike.

Concordant igneous features such as sills usually cover a far greater area than dikes and can elevate the thermal maturity and gas content of a coalbed over a similarly large area [Gurba and Weber 2001]. However, the greater extent of these features is more conducive to prediction and mapping through conventional exploratory core drilling programs. If associated gas contents and emissions are expected to present a potential hazard, premining methane drainage through vertical methane drainage boreholes drilled from the surface is the optimal method to alleviate the hazard.

## **GAS OUTBURSTS AND BLOWERS**

Although not generally considered to be hazards in domestic mines at present, both outbursts and blowers historically have occurred in certain U.S. mining districts [Darton 1915; Campoli et al. 1985]. The two features are mainly distinguished by their duration of occurrence. Outbursts are sudden, often violent expulsions of large quantities of gas, usually methane, and are generally associated with the ejection of great quantities of coal or other rock material. Blowers, on the other hand, historically have been viewed as the release of large quantities of gas, but over an extended time period of months or even years. Also, blowers are not associated with the expulsion of coal or rock material. A subset of blowers is methane bleeders, which also continually emit gas, but at lower rates and generally for shorter timeframes.

Although not typically associated with U.S. coal mines, gas outbursts occur regularly in certain mining districts worldwide. Typically, the mines in these districts are in a coalbed with high in-place gas contents, coupled with steeply dipping and/or very deep workings. As shallower, more easily extracted coal reserves are depleted in the United States and as mining progresses to deeper, more structurally complex and gassier coalbeds, the potential for gas outbursts will likely increase. Campoli et al. [1985] delineate more than a dozen U.S. coalbeds with outburst potential based on internationally recognized criteria. In fact, gas outbursts have been documented throughout history in U.S. mines with similar conditions.

Historical examples of U.S. outbursts are mentioned by Darton [1915] as occurring in Pennsylvania. Two of these occurred in anthracite mines in steeply dipping coalbeds. Another took place in western Pennsylvania near Connellsville, where Darton noted that 100,000 ft<sup>3</sup> of fresh air per minute for 3 days was required to reduce the methane concentration in the mine air to safe levels. Little additional documentation is presented, and it is not known if rock material was also ejected with the gas. Darton also summarized extensive European documentation of gas outbursts and concluded that these phenomena were usually related to crushed coal zones associated with folds, buckles, and faults.



Lama and Bodziony [1998] compiled a comprehensive overview of outbursts worldwide and their causative factors and prevention. They conclude that the following factors contribute to outbursts: (1) gas content, (2) gas pressure, (3) permeability, (4) sorption/desorption characteristics, (5) stress conditions, (6) coal strength, and (7) geologic factors (often related to tectonic activity). Other modern research on these phenomena has demonstrated two major indicators of outburst potential in coal mines. The first indicator is the coal lithotype. Beamish and Crosdale [1998] demonstrated that coals with high vitrain and/or inertodetrinite lithotypes were more likely to retain the large quantities of gas needed to produce outbursts. A second indicator, documented by Cao et al. [2001], is the association of outbursts with tectonically altered, faulted coals. Cao et al. noted that outbursts in China seem to be associated with tectonic activity that has produced regional thrust and reverse faulting. Such faulting often manifests itself in coalbeds because of their brittle nature compared to the surrounding strata. The coal adjacent to such faults is often severely crushed and pulverized, resulting in significant local changes in the gas storage and migration characteristics of the coal.

Blowers, like outbursts, are not normally associated with coal mining in the United States, but historically they have been noted in the United States and in other mining districts abroad. Darton [1915] summarized documented blower occurrences worldwide and noted the occurrence of blowerlike features in the Pennsylvania anthracite district.

**Detection and remediation of outbursts and blowers.** Based on past observations, outbursts and blowers are often associated with tectonically disturbed and faulted strata where gassy coals are mined at considerable depth. Thus, mine planners who are aware of such conditions should give some thought to the possibility that they will be extracting coal under conditions that have produced outbursts and blowers in other mining districts.

If large-scale faulting is known and adequately mapped in future development areas, a detailed core-drilling program, coupled with gas content testing of core samples and in situ gas pressure measurements, can detect potential outburst-prone areas. Beamish and Crosdale [1998] recommend, as do Lama and Bodziony [1998], the use of any one of several published gas emission indices as an indicator of proneness to outbursting.

Since outbursts often occur in “nests” or clusters, when such conditions are encountered or anticipated, remediation may be achieved by using gas drainage techniques such as vertical methane drainage boreholes drilled from the surface, horizontal boreholes drilled underground ahead of the face, or (if outburst-prone strata are in the roof rock) cross-measure boreholes [Diamond 1994]. Typically, these boreholes will penetrate the fault system that has altered the coal structure and allowed large quantities of gas to accumulate at great pressure behind it. The boreholes are used to drain gas from the outburst-prone area and to relieve the gas overpressure that drives outbursts. Lama and Bodziony [1998] stress that vertical surface boreholes may be preferred over holes drilled in the coalbed because of the difficulty of maintaining borehole integrity during horizontal drilling in the outburst-prone strata. The difficulty of maintaining borehole integrity is due to the crushed nature of the coal in these areas. Beamish and Crosdale [1998] also recommend water infusion to reduce outburst hazards.

Outbursts are often driven not only by gas pressure, but also by inherent, concentrated stress fields in the rock mass. Hyman [1987] summarizes several methods to reduce in situ strata gas pressures to prevent outbursts. These techniques include the use of modified mine opening geometries, shot firing, and water infusion, all of which have been successfully used abroad to abate outbursts.

Blowers most often emanate from underlying strata. The recommended remediation technique is the use of cross-measure holes angled downward from the mine heading to intercept the fissure or fault, which acts as a gas conduit. The borehole(s) may then be used to drain gas away from the blower outlet in the mine workings.

### GENERAL REMEDIATION CONSIDERATIONS

**When unanticipated gas emissions cause repeated production interruptions, mine operators must understand that they have a gas problem.**

In order to determine the most appropriate course of action to remediate a gas emission problem, the mine operator must make a thorough evaluation of the cause, extent, and severity of the problem. The cause of the problem may be as simple as underestimating the original gas content of the coalbed, or it may be more complex and involve gas sources outside the mined coalbed. Determining the extent of the problem may only entail additional gas content testing [Diamond and Schatzel 1998] of the mined coalbed through exploratory boreholes, or it may require extensive underground methane monitoring surveys or gas monitoring instrumentation. Also, detailed underground mapping of geologic features may be needed to delineate and predict gas emission trends. Remediation may require only an increase in ventilation airflow to the face, or it may require an extensive mapping and drilling program to delineate and alleviate the problem.

Often when unusually high methane emissions are unexpectedly encountered during mining, operators must make quick decisions about how to address the problem. A prudent operator should weigh several pertinent factors before embarking on any course of action.

If increased ventilation capacity alone cannot alleviate the problem, operators, especially smaller ones, do not always have the available expertise, human resources, or equipment to evaluate the problem and implement either a surface or in-mine borehole methane drainage program and will need to rely on outside consultants. Methane drainage systems drilled from the surface generally require fewer boreholes, but need good geologic control to effectively hit the gas-bearing zone. These boreholes generally require dewatering, hydraulic fracturing, and sufficient time to be optimally effective. Methane drainage systems drilled from the surface have associated issues with the procurement of appropriate and accessible drilling sites and environmental concerns for water disposal and site reclamation.

In-mine methane drainage systems generally require more boreholes and may also require dewatering. However, they can be drilled relatively quickly and require less time to be optimally effective. Additionally, in-mine methane drainage systems will require an underground gas-gathering system to transport gas from the boreholes to the surface, usually via one or more vertical boreholes drilled for that purpose. In-mine systems may also have accessibility constraints due to poor roof or floor conditions or other mining-related safety issues in the area where holes need to be drilled.

It should be noted that there may be regulatory requirements that need to be addressed when methane drainage systems are associated with mining operations. In the United States, a recent bulletin issued by the Mine Safety and Health Administration (MSHA) states that “MSHA has determined that [coalbed methane] wells are subject to the ventilation plan and mapping requirements that apply to methane degas holes” [McKinney 2005]. If coalbed gas of sufficient quality and quantity is produced by the methane drainage system, the gas has the potential to be sold for commercial use, which helps defray the costs of methane drainage.

After a methane drainage system is put into place, it can only be effective as long as it is operating properly. Operators must consider who will operate and maintain the system once it is installed. If installed in-house, personnel may need to be permanently assigned to the project. If outside contractors are used for the installation, will they be retained for long-term operation and maintenance, or will mine personnel need training to operate and maintain the system once the contractor leaves?

The economics of any methane drainage system under consideration involves weighing the pros and cons of all of the factors discussed above. The final remediation plan will hopefully be one that, under the site-specific circumstances, will create a safer underground workplace for the miners while minimizing capital investment and human resources.

## REFERENCES

Ayruni AT [1984]. Theory and practice of mine gas control at deep levels. Rockville, MD: Terraspace, Inc.

Beamish BB, Crosdale PJ [1998]. Instantaneous outbursts in underground coal mines: an overview and association with coal type. *Int J Coal Geol* 35:27–55.

Campoli AA, Trevits MA, Molinda GM [1985]. Coal and gas outbursts: prediction and prevention. *Coal Min* 22(12):42–44, 47.

Cao Y, He D, Glick DC [2001]. Coal and gas outbursts in footwalls of reverse faults. *Int J Coal Geol* 48(1–2):47–63.

Chase FE, Ulery JP [1987]. Clay veins: their occurrence, characteristics, and support. Pittsburgh, PA: U.S. Department of the Interior, Bureau of Mines, RI 9060. NTIS No. PB87204517.

Clayton JL [1998]. Geochemistry of coalbed gas: a review. *Int J Coal Geol* 35(1–4):159–173.

Clayton JL, Leventhal JS, Rice DD, Pashin JC, Mosher B, Czepiel P [1993]. Atmospheric methane flux from coals: preliminary investigation of coal mines and geologic structures in the Black Warrior basin, Alabama. In: Howell DG, ed. *The future of energy gases*. USGS Professional Paper 1570. Reston, VA: U.S. Department of the Interior, U.S. Geological Survey, pp. 471–492.

Creedy DP [1988]. Geological controls on the formation and distribution of gas in British coal measure strata. *Int J Coal Geol* 10(1):1–31.

Darton NH [1915]. Occurrence of explosive gases in coal mines. Washington, DC: U.S. Department of the Interior, Bureau of Mines, Bulletin 72.

Diamond WP [1982]. Site-specific and regional geologic considerations for coalbed gas drainage. Pittsburgh, PA: U.S. Department of the Interior, Bureau of Mines, IC 8898. NTIS No. PB83157685.

Diamond WP [1994]. Methane control for underground coal mines. Pittsburgh, PA: U.S. Department of the Interior, Bureau of Mines, IC 9395. NTIS No. PB94189289.

Diamond WP, Schatzel SJ [1998]. Measuring the gas content of coal: a review. *Int J Coal Geol* 35(1–4):311–331.

Diamond WP, Ulery JP, Kravits SJ [1992]. Determining the source of longwall gob gas: lower Kittanning coalbed, Cambria County, PA. Pittsburgh, PA: U.S. Department of the Interior, Bureau of Mines, RI 9430.

Dutcher RR, Campell DL, Thornton CP [1966]. Coal metamorphism and igneous intrusives in Colorado. In: *Coal Science American Chemical Society, Advances in Chemistry Series*, vol. 55, pp. 708–723.

Finfinger GL, Cervik J [1979]. Drainage of methane from the overlying Pocahontas No. 4 coalbed from workings in the Pocahontas No. 3 coalbed. Pittsburgh, PA, U.S. Department of the Interior, RI 8359. NTIS No. PB296882.

Gurba LW, Weber CR [2001]. Effects of igneous intrusions on coalbed methane potential, Gunedah basin, Australia. *Int J Coal Geol* 46(2–4):113–131.

Houseknecht DW [1982]. Probability of encountering coalbed discontinuities during vertical and horizontal borehole drilling. Washington, DC: U.S. Department of the Interior, Bureau of Mines, RI 8665. NTIS No. PB82232091.

Hyman DM [1987]. A review of the mechanisms of gas outbursts in coal. Pittsburgh, PA: U.S. Department of the Interior, Bureau of Mines, IC 9155. NTIS No. PB88231717.

- Iannacchione AT, Ulery JP, Hyman DM, Chase FE [1981]. Geologic factors in predicting coal mine roof-rock stability in the upper Kittanning coalbed, Somerset County, PA. Pittsburgh, PA: U.S. Department of the Interior, Bureau of Mines, RI 8575. NTIS No. PB82145376.
- Johnson RC, Flores RM [1998]. Developmental geology of coalbed methane from shallow to deep in Rocky Mountain basins and in Cook Inlet-Matanuska basin, Alaska, U.S.A. and Canada. *Int J Coal Geol* 35(1–4):241–282.
- Juntgen H, Klein J [1975]. Formation of natural gas from coaly sediments (in German). *Erdöl und Kohle Erdgas Petrochemie* 28(2):65–73.
- Lama RD, Bodziony J [1998]. Management of outburst in underground coal mines. *Int J Coal Geol* 35(1–4):83–115.
- McCulloch CM, Deul M, Jeran PW [1974]. Cleat in bituminous coalbeds. Pittsburgh, PA: U.S. Department of the Interior, Bureau of Mines, RI 7910. NTIS No. PB233420.
- McCulloch CM, Diamond WP, Bench BM, Deul M [1975]. Selected geologic factors affecting mining of the Pittsburgh coalbed. Pittsburgh, PA: U.S. Department of the Interior, Bureau of Mines, RI 8093. NTIS No. PB249851.
- McKinney R [2005]. Coalbed methane wells. Program information bulletin No. P05–10. May 10, 2005. Arlington, VA: U.S. Department of Labor, Mine Safety and Health Administration. [<http://www.msha.gov/regs/complian/PIB/2005/pib05-10.asp>].
- Moss KN [1927]. Gases, dust, and heat in mines. London: Charles Griffen and Co., Ltd.
- Nickelsen RP, Hough VD [1967]. Jointing in the Appalachian plateau of Pennsylvania. *Geol Soc Am Bull* 78:609–629.
- Payman W, Statham ICF [1930]. Mine atmospheres. London: Methun & Co. Ltd.
- Price PH, Headlee AJW [1943]. Natural coal gas in West Virginia. *AAPG Bull* 27(4):529–537.
- Prosser LJ Jr., Finfinger GL, Cervik J [1981]. Methane draining study using an underground pipeline: Marianna mine 58. Pittsburgh, PA: U.S. Department of the Interior, Bureau of Mines, RI 8577. NTIS No. PB82142860.
- Thielemann T, Krooss BM, Littke R, Welte DH [2001]. Does coal mining induce methane emissions through the lithosphere/atmosphere boundary in the Ruhr Basin, Germany? *J Geochem Explor* 74(1–3):219–231.
- Ulery JP, Molinda GM [1984]. Influence of overlying strata on methane emissions in a northern West Virginia coal mine. Pittsburgh, PA: U.S. Department of the Interior, Bureau of Mines, RI 8879. NTIS No. PB84235282.

## CHAPTER 8.—FORECASTING GAS EMISSIONS FOR COAL MINE SAFETY APPLICATIONS

By C. Ozgen Karacan, Ph.D.<sup>1</sup> and William P. Diamond<sup>2</sup>

### *In This Chapter*

- ✓ Measuring the gas content of coal
- ✓ Predicting gas emissions based on geologic and coal reservoir property data
- ✓ Determining the gas storage capacity of coalbeds and other gas-bearing strata
- ✓ Methane drainage borehole monitoring to forecast the remaining gas-in-place and the influence on mine emissions
- ✓ Forecasting gas emissions during mining as a function of mining parameters

*and*

- ✓ Gas emission prediction based on numerical simulation

This chapter provides guidelines for determining the gas content of coalbeds, estimating the gas-in-place, and predicting gas flow and emissions before and during coal mining operations. The techniques are discussed briefly in the following sections. However, detailed information on the techniques is provided in the cited references.

### INTRODUCTION

Coalbed methane, if not properly controlled in the underground mine environment, is a safety concern due to the potential risk for an explosion. This is a particular problem during longwall mining, where the high rate and volume of coal extraction can result in the release of large amounts of methane from the mined coalbed and other adjacent gas-bearing strata. The variability and potential hazards of these sometimes unexpectedly high gas flows provide the impetus to develop methods to predict methane emissions into the underground workplace. A forecast of the volume of gas that might be released during coal mining is helpful for designing ventilation systems and for implementing optimum methane drainage strategies to help mitigate expected gas emission problems.

A complete assessment of the need for methane drainage prior to mine development generally requires both an empirical and a theoretical approach. If there are active mines in the general area with similar geologic conditions and coal characteristics, a review of gas problems in those mines provides an initial insight into the level of gas emissions to be expected at a new location. In addition, relatively simple methods exist to determine the in situ gas content (volume of gas per unit weight of coal) of the coalbeds in a particular mining area, as well as the gas-in-place (volume of gas in the coalbed(s) within a defined geographic area).

---

<sup>1</sup>Senior service fellow.

<sup>2</sup>Supervisory physical scientist.

Pittsburgh Research Laboratory, National Institute for Occupational Safety and Health, Pittsburgh, PA.

More sophisticated reservoir engineering methods are also available not only to estimate the gas-in-place, but also to simulate gas flow patterns in the mining horizon, as well as in the surrounding strata. With a reservoir modeling approach, gas flow to various configurations of methane drainage boreholes can be investigated to optimize the interception and extraction of coalbed methane before it can enter the mine ventilation system.

Although potentially providing valuable insights about gas flow and methane drainage in the mining environment, the site-specific input data required for reservoir modeling is not routinely available at many, if not most, mine sites. For this reason, it is recommended that if the reservoir modeling approach is anticipated due to high in situ gas contents, then the necessary geologic, engineering, and reservoir data should be obtained early so that methane drainage options can be evaluated before methane emission problems become acute.

**Forecasting gas emissions requires knowledge of the relationships among gas storage in coal (and adjacent strata), the factors affecting gas emissions, and the techniques used to predict emissions.**

### **METHANE CONTENT OF COAL**

The gas content of coal can be measured or estimated using various techniques. These techniques usually fall into two categories: (1) direct methods that actually measure the volume of gas released from a coal sample (preferably wire line core) sealed in a desorption canister, and (2) indirect methods based on empirical correlations or laboratory-derived gas storage capacity data from sorption isotherms. An extensive review of direct techniques for gas content measurement for coal was published by Diamond and Schatzel [1998]. One of the most commonly used methods to determine the gas content of coal is the U.S. Bureau of Mines direct method [Diamond and Levine 1981; Diamond et al. 1986]. Properly conducted direct-method testing of coal cores provides relatively accurate estimates of in-place gas contents for most mine planning purposes while allowing for resource evaluation at a reasonably low cost. A modified-direct-method procedure [Ulery and Hyman 1991] provides an increased level of accuracy, but at a higher level of instrumentation sophistication, procedural complexity, and cost.

**Direct-method testing of coal cores provides sufficient estimates of in-place gas contents for most mine planning purposes. Greater accuracy can be obtained by using the modified direct method.**

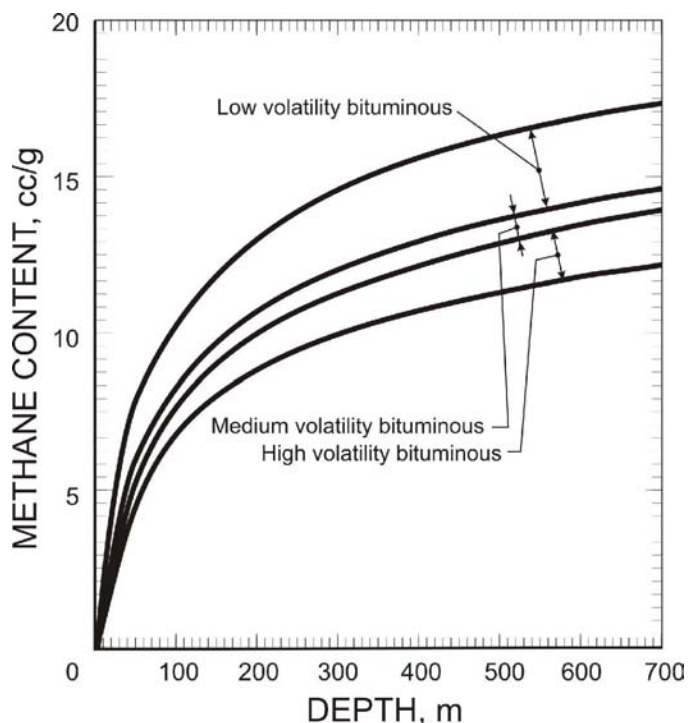

Figure 8-1.—Methane content as a function of depth and coal rank (modified from Kim [1977]).

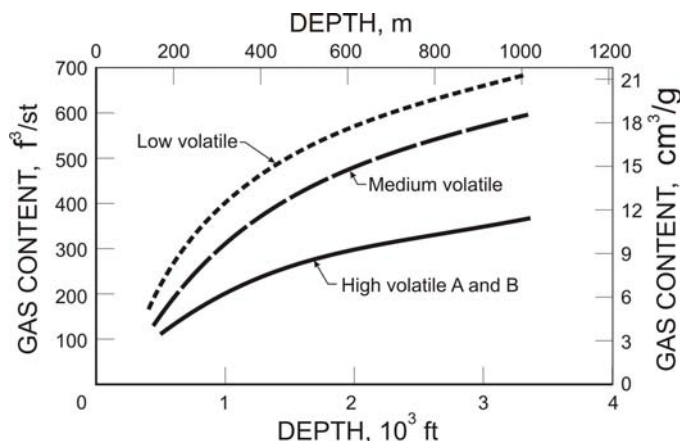

Figure 8-2.—Gas content versus depth and coal rank, Black Warrior Basin, Alabama (McFall et al. [1986]).

In the absence of extensive measured gas contents in an area of interest, an alternative approach to obtain the gas content is to use the relations proposed by Kim [1977] based on gas content determinations from adsorption analysis on different coals of various ranks and depths (Figure 8-1). This approach can be considered in parts of a basin where coal samples are initially not available for direct gas content testing. However, it is important to note that these are only estimated values and should be confirmed with subsequent direct gas content testing within the actual area of interest.

For estimating in-place gas contents for a specific area, regional gas content data on individual coal samples can be used along with data on coal rank and/or depth to construct curves such as those in Figure 8-2. Such curves are generated for a particular coalbed or closely associated group of coalbeds and can be used to estimate gas content values only if the rank or depth are known for the coalbed of interest. As an example, the graph in Figure 8-2 presents such curves for the Black Warrior Basin in Alabama [McFall et al. 1986]. Coal lithotype characteristics also affect the methane content of coal. For instance, significantly higher methane capacity was observed for bright bands ( $850 \text{ ft}^3/\text{ton}$ ) versus dull bands ( $570 \text{ ft}^3/\text{ton}$ ) in the same coalbed during an evaluation of

compositional effects on coals from western Canada [Lamberson and Bustin 1993]. Total gas content varied with the amount of vitrinite and liptinite, which usually offer high methane storage capacity, whereas no obvious relationship was observed with the inertinite content. Some studies report increases in gas yield with fusain content, which tends to allow rapid desorption of methane [Creedy 1986]. Despite these examples, while the general influence of



coal lithotype on gas content is of interest, it cannot be sufficiently quantified for use as a predictive gas content method.

**Estimated gas contents should only be used for preliminary assessments. They are not a substitute for site-specific gas content determinations.**

### GAS-IN-PLACE CALCULATION

One of the key steps in forecasting gas emissions during and after mining is to calculate the volume of gas-in-place that will potentially migrate to the underground mining environment. During mining, these emissions are primarily from the mined coalbed, whereas postmining emissions include not only the mined coalbed (ribs and pillars), but also gas-bearing strata above (gob) and below the mined coalbed.

The simplest method for calculating the gas-in-place for coalbeds is based on commonly available geologic mapping data for the mine site and the site-specific gas content data [Diamond 1982], as follows:

$$GIP_c = (\rho \times h \times A)GC, \quad (1)$$

where  $GIP_c$  = coal gas-in-place, ft<sup>3</sup>;  
 $\rho$  = coal density, tons/acre ft;  
 $h$  = coal thickness, ft;  
 $A$  = area, acres;  
 and  $GC$  = gas content (volume-to-mass ratio), ft<sup>3</sup> gas/ton of coal.

Depending on the variability of measured gas contents within the area of interest, multiple gas-in-place calculations for individual zones (based on gas content versus depth and/or coal rank data as shown in Figure 8–2) may be necessary to obtain the best total gas-in-place value. For gas-bearing strata other than coal (organic shales, etc.) where the gas is primarily stored by adsorption (as in coal) or for low matrix permeability rocks such as siltstones where the stored gas cannot readily escape from a core sample before it is sealed in a desorption canister, the gas-in-place estimate can be calculated as follows [Diamond et al. 1992]:

$$GIP_r = (h \times A)GC, \quad (2)$$

where  $GIP_r$  = rock gas-in-place, ft<sup>3</sup>;  
 $h$  = rock strata unit thickness, ft;  
 $A$  = area, ft<sup>2</sup>;  
 and  $GC$  = gas content (volume-to-volume ratio), ft<sup>3</sup> gas/ft<sup>3</sup> rock.

For high matrix permeability rock units, like some sandstones, where the direct-method-type gas content determinations are not appropriate, traditional reservoir engineering methods for estimating the volume of gas-in-place are more appropriate. These methods may include the use of well logs, laboratory reservoir property core testing, and well/production testing.

**There are various approaches to determine an area's in-place gas volume. The preference usually depends on data availability, degree of sophistication required in the analysis, and the technical background of the personnel conducting the analysis.**

Reservoir-analysis-based approaches may also be used to determine the gas-in-place for coalbeds in a specific geographic area. These approaches relate the volume of gas in the reservoir at reservoir conditions to the volume at STP<sup>2</sup> conditions and use the differences in remaining gas volumes as the reservoir pressure is depleting. Although reservoir-based approaches can be an essential part of gas-in-place calculations, particularly for mines that are considering marketing the produced methane, these approaches require significantly more data (at a relatively high cost) than is usually available for most mine safety applications. Two of the reservoir-analysis-based methods for calculating gas-in-place are the volumetric calculation and the material balance calculation.

The volumetric method of calculation (Equation 3) is very similar to Equation 1 above. In addition to estimating the gas-in-place (free gas, if any, and adsorbed gas) for the coal in an area based on the direct-method gas content data, this method also calculates the amount of gas in the cleats and fractures by taking into account the water saturation ( $Swf_i$ ), cleat/fracture porosity ( $\phi_f$ ), and gas formation volume factor ( $Bg_i$ ).<sup>3</sup>

$$G_i = Ah \left( \frac{43560\phi_f(1-Swf_i)}{Bg_i} + 1.359Cg_i\rho_c(1-f_a-f_m) \right) \quad (3)$$

Another reservoir engineering method of estimating gas-in-place is the use of material balance calculations derived for coalbeds from conventional material balance equations. Terms are added to the equations to account for desorption mechanisms. However, this is an iterative technique and requires more data and calculation complexity than the previous methods. Details on the use of material balance calculations for coalbed methane applications were published by King [1993].

<sup>2</sup>Standard temperature and pressure.

<sup>3</sup>Refer to McLennan et al. [1995] for more information on the volumetric method of calculation and for further definition of the terms in Equation 3.

## **FORECASTING REMAINING GAS-IN-PLACE FROM PRODUCING METHANE DRAINAGE BOREHOLES IN THE AREA OF INTEREST (PRODUCTION DECLINE ANALYSIS)**

Analysis of production decline trends for premining methane drainage boreholes in an area of interest, when combined with the original gas-in-place estimate, can provide a reasonably accurate estimate of the volume of gas remaining in the coalbed and available for flow to the mining environment. This method is widely accepted in the natural gas industry due to its ease of application and requires only the gas production histories from existing wells. However, in contrast to conventional gas reservoirs, it usually takes a long time (potentially a year or longer) for a coalbed methane borehole to exhibit a production decline. Thus, there may be a long delay before the data can be analyzed. Also, borehole spacing, formation permeability, desorption properties of coal, and production problems not related to the reservoir can affect the production profile.

Production decline analysis can be used for forecasting the future methane flow and emission potential from a coalbed by analyzing the time-resolved production trends of methane drainage boreholes. However, these boreholes are generally completed only at the mined coalbed interval, which makes analysis for mine safety applications more complex and difficult. During longwall mining, gas emissions in the relaxed strata are usually a combination of different sources of migrating gas (from coalbeds plus other gas-bearing strata in the overburden and underburden) due to horizontal and vertical fracturing of the surrounding strata. Therefore, it is difficult to compare the estimated gas flow and emission rates from decline analysis of methane drainage boreholes completed in the mined coalbed with the actual gas emissions observed during mining. The result is that the forecasts of gas emissions based on decline curve analysis of commercial coalbed methane wells (or vertical degasification wells), completed at a single interval (the mined coalbed), will likely underestimate the volume of gas that will be released from the mined coalbed and surrounding strata into the mine environment.

In a case where one can be sure that there is no gas source other than the mined coalbed, the decline curve analysis technique may be applicable for estimating the remaining gas-in-place for that coalbed that might still migrate to the ventilation system during future mining activities. In order to be able to use decline curve techniques for this situation, all or most of the criteria below need to be met for a high degree of confidence in production forecasts:

- Decreasing gas and water rates
- A stable slope in gas rates for at least 6 months
- A length of producing well life greater than 2 years
- Bounded wells and well spacing

It is also recommended that decline-based gas-in-place and future methane flow/emission potential projections be compared against projections from volumetric or other available analytical techniques [Hanby 1991].

Alternatively, type-curve matching techniques are a reservoir engineering tool in which the solutions of complex equations for various situations are represented in graphical form. The

techniques rely on matching the actual gas production data plots (prepared with the same set of units and graphical form as in the type-curves) to the theoretical curves. These techniques can also be used to analyze production decline curves to predict remaining gas-in-place and future emissions for mine safety assessments [Chen and Teufel 2000]. In addition, if the gas production is exclusively from the coalbed to be mined, type-curve analysis can provide other reservoir information that needs to be determined for emission forecasting studies (e.g., modeling).

In summary, type-curves can contribute to:

- Stimulation (fracturing) effectiveness diagnosis
- Recovery efficiency (recovery factor based on initial gas-in-place)
- Estimation of reservoir flow properties (permeability, flow capacity, etc.)
- Reservoir storage properties
- Future prediction of production

**Both production decline analysis and type-curve matching techniques can be used to analyze methane drainage boreholes for future production rates and thus predict the remaining gas-in-place at the time of mining. However, gas emissions from different gas sources may be commingled, especially during longwall mining. Therefore, one can expect higher emission rates during mining compared to what is predicted by the analysis.**

## PREDICTING GAS EMISSIONS DURING MINING

The main sources for gas (generally predominantly methane) that can be released into the underground mine workings are the mined and adjacent coalbeds and other surrounding gas-bearing strata [Mucho et al. 2000; Diamond et al. 1992]. Mining activities disturb the existing stress equilibrium in the rock mass and create changes to the structural integrity of the affected strata. The mining processes can thus create sudden and unstable gas problems, which may increase the risk of an explosion in the underground workplace. Gas flow from these sources is initiated and maintained by differential pressures between the source (higher pressure) and the mine workings (lower pressure). The flow paths are both the naturally occurring rock joints, faults, and coal cleat, as well as mining-induced fractures in the surrounding strata.

It is generally observed that the amount of gas released during the mining process is greater than that contained in the actual volume of coal mined at the face [Kissell et al. 1973]. This apparent discrepancy is due to the continual emission of gas from the coal that is left in place as ribs and pillars, as well as the migration of gas from the surrounding strata, including the longwall gob [Mucho et al. 2000]. Methane emission rates change over time in the life cycle of a mine because of the interaction of variable geotechnical, mine design, and operational factors. The following mathematical formula by Lunarzewski [1998] addresses this phenomenon and calculates the quantity of gas released into a mine during various stages in the life of a mine:

$$Q(y) = \frac{g}{CA} \left( \left( \sum_0^{y+1} C \right)^m + 1 - \left( \sum_0^y C \right)^m + 1 \right), \quad (4)$$

where  $Q(y)$  is the average methane emission (cubic meters of methane) in a year “Y” of the mine’s existence,  $CA$  is the coal output in 1 year only (tons),  $C$  is the total coal output for the life of the mine up to year “Y”, and  $g$  and  $m$  are coefficients dependent upon geological and mining conditions.

The highest gas emissions can be expected as the coal is extracted and the floor and roof strata are relaxed. The instantaneous volume of gas released from all potential sources when 1 ton of coal is extracted can be calculated, and practical experience has shown that gas emissions are related to daily and weekly coal production levels and to the time factor, as follows [Lunarzewski 1998]:

$$Q = a\sqrt{CP} + b, \quad (5)$$

where  $Q$  is the total methane emission rate expressed in liters of methane per second,  $CP$  is the daily coal production rate in tons, and  $a$  and  $b$  are empirical constants related to weekly coal production levels and number of working days per week [Lunarzewski 1998].

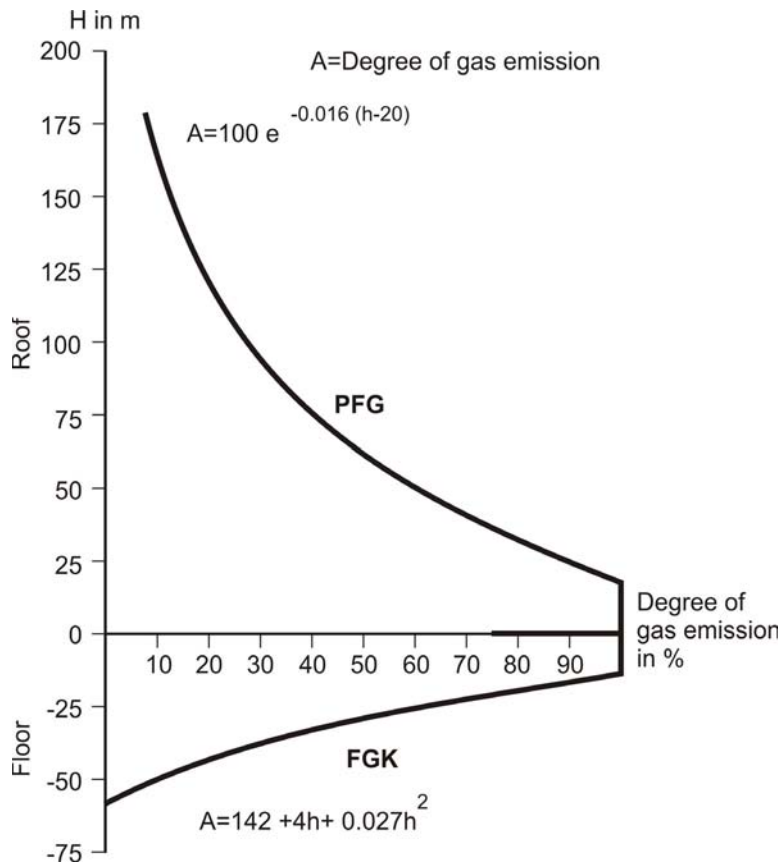

Figure 8-3.—PFG/FGK method to predict gas emissions in a previously disturbed zone [Noack 1998]. PFG = degree of gas emission curve for the roof; FGK = degree of gas emission curve for the floor.

Another empirical method to predict the total gas emissions from longwall mining is the use of degree-of-gas emission curves. Figure 8-3 is an example of a degree-of-gas emission curve for previously disturbed roof and floor strata in a slightly to moderately dipping coalbed [Noack 1998]. In such a condition, the prediction can be made assuming that the emitted methane proportion is not a function of the initial gas content, but rather a function of the geometric location with respect to the longwall face [Noack 1998]. For practical purposes, the upper boundary of the zone from which gas can be released is assumed to be at +541 ft (+165 m), whereas the lower boundary is at -194 ft (-59 m). In the absence of gas emission measurements, a mean degree of gas emission of 75% of the gas content in the mined

coalbed is assumed, as is the case for Figure 8–3. Above the coalbed from 0 to 66 ft (20 m) and below the coalbed from 0 to -36 ft (-11 m), the degree of gas emission is assumed to be 100%.

Because these curves are empirical correlations or standard assumed degrees of emissions, there may be considerable variations when they are applied to other locations. As always, it should be remembered that the best information for prediction is the measured data and the derived empirical correlations at a specific site of interest.

On the other hand, if the roof and floor have not been fractured before, the prediction can be based on gas pressure, and thus a remaining gas content. In this case, the proportion of gas emitted depends on the gas pressure (gas content) and the location of the strata. The gas emission prediction for such a situation can be based on the remaining gas profiles, as shown in Figure 8–4. There are three zones designated in the roof and two in the floor, which are characterized by varying the remaining gas gradients.

Based on Figure 8–4, the residual gas pressures are first determined layer by layer in accordance with the mean normal distance of a gas-bearing layer from the mined coal seam. The residual

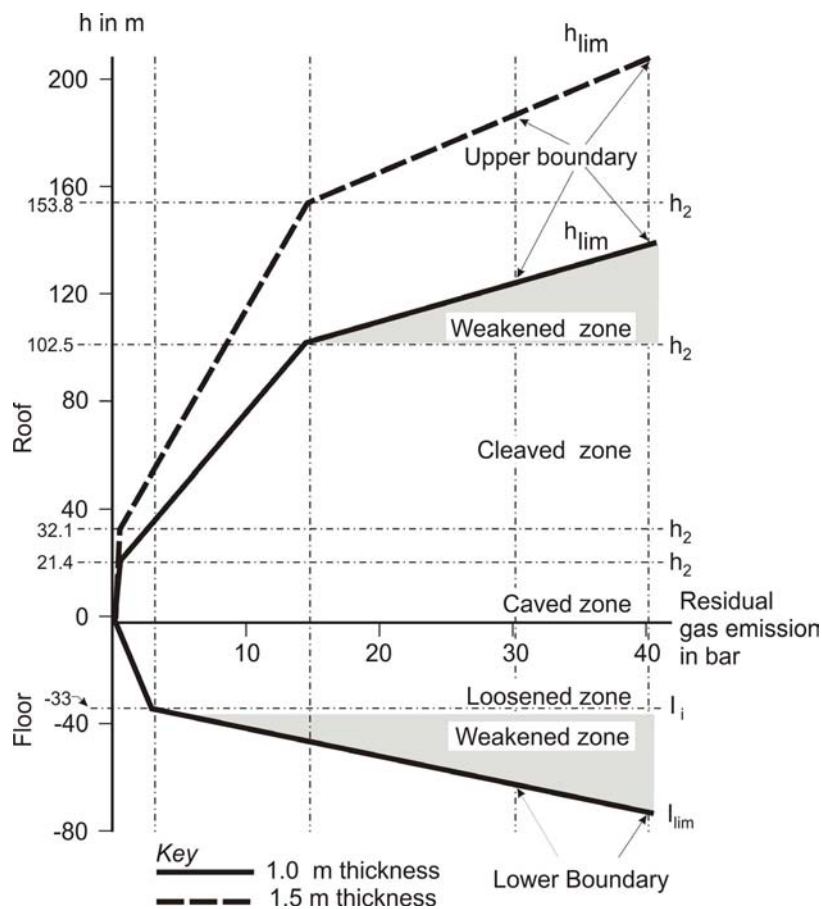

Figure 8–4.—Gas pressure method: residual gas pressure lines are dependent on thickness of the mined coalbed [Noack 1998].

gas pressures are converted to remaining gas contents using the Langmuir isotherm. The difference between the remaining and initial gas contents represents the emitted portion of the adsorbed gas, which is the required value [Noack 1998]. Free gas is then added to this value.

The gas pressure method has the advantage of not defining upper and lower zones strictly compared to the prediction based on the degree of gas emission. Also, this method takes into account both the adsorbed gas and the free gas in the surrounding strata.

There is another method based on using zones of emission, reviewed extensively by Curl [1978]. This model describes methane emissions in terms of the geometry of the zone of emissions, the size of the zone of emissions, and the degree of

emissions. The geometry and size of the zone of emissions simply refer to the shape and extent of the zone. The degree of emissions refers to the percentage of desorbable gas that is released into the mine workings at a given location near the coalbed being mined. In this model, underburden emission zones and the degree of emissions are generally more limited in extent. The lateral extent of the zone of emissions is generally limited to the dimensions of the panel. In these models, sandstone units within the emission zone are ascribed 10% of the gas contained in a nearby coalbed of equal thickness, whereas shale is assigned 1% of the gas contained in coalbeds of equal thickness.

Schatzel et al. [1992] used such a model to predict methane emissions from longwall panels. They reported that this approach performed well for longwall panels in Cambria County, PA, but poorly in the Central Appalachian Basin of southwestern Virginia. This suggests that although the simplistic predictive techniques and empirical methods may offer quick calculation advantages, in general they are not sufficiently reliable for making emission estimates given the complex interplay of the geotechnical and mining variables involved. Thus, the use of numerical models to simulate the physics of both the failure mechanics of rock strata and the fluid flow in porous media is more appropriate for obtaining reliable emission estimates, for flexibility in adapting the models to different situations, and for optimizing methane drainage systems and mine designs accordingly.

**Simple calculations and empirical models are usually site-specific and are very limited in their capabilities to estimate methane emissions. Realistic numerical simulations offer flexibility, confidence in estimates, and guidance for optimizing methane drainage systems and mine designs.**

## **GAS PREDICTION TECHNIQUES BASED ON NUMERICAL SIMULATION**

Reservoir simulation is the process of integrating geology, petrophysics, reservoir engineering, and production operations to more effectively develop and produce hydrocarbon resources. Numerical reservoir simulations can also be useful in mine safety applications. In fact, reservoir simulations are currently the only analytical method that can be used to establish the complex relationships between coalbed methane reservoir properties, methane drainage, and mining operations in a reliable and cost-effective manner. Numerical simulation is also the only practical method to describe how reservoir properties affect both gas and water flow and can address the intricate mechanisms of gas desorption and diffusion in coal due to either methane drainage and/or mining of the coalbed reservoir.

Reservoir simulators can be used to perform a variety of analyses. The primary applications relative to coalbed methane/mining are:

- Determining the volume of gas-in-place
- Developing optimum methane drainage systems to reduce the flow of gas into underground mine workings
- Predicting the methane emission consequences of changing mining methods and practices

- Identifying and diagnosing production problems in operating methane drainage systems
- Predicting gas recovery from methane drainage systems associated with underground mines

In general, three different types of coalbed methane reservoir simulators are available: gas sorption and diffusion simulators, compositional simulators, and black oil simulators. The compositional simulators with coalbed methane options that can handle the sorption and diffusion processes are widely used and are more appropriate for coalbed methane applications due to their capability for simulating different gas mixtures.

Reservoir simulators for coalbed methane applications are also classified based on their treatment of the gas sorption process. More than 50 coalbed methane reservoir simulators are described in the literature [King and Ertekin 1989a,b; 1991], which are classified as equilibrium sorption (pressure-dependent) and nonequilibrium sorption (time- and pressure-dependent) simulators. The basic difference between these two classifications is that when using equilibrium simulators, it is implicitly assumed that as the pressure declines, the gas immediately enters the fracture system. This oversimplification gives optimistic gas flow rates in some cases. Nonequilibrium models, which take the sorption time into account and include modifications to the conventional dual-porosity models, are more realistic. The primary modifications required to enhance the simulation capability of the dual-porosity models are to account for methane storage by adsorption on the matrix-coal surface and control of gas transport through the coal matrix by diffusion until the gas reaches the fracture network, where conventional Darcy flow mechanics are the controlling transport factor.

**The most realistic simulations of gas flows in coalbeds are provided by compositional, nonequilibrium, dual-porosity reservoir models. These models account for sorption time, methane storage by adsorption, and gas transport by diffusion through the coal matrix to the fracture network.**

Although numerical reservoir simulation techniques offer more reliable emission predictions and guidance for optimum methane drainage system designs, building objective-oriented models requires more time and effort for gathering site-specific data, careful analysis of field data, and detailed planning.

The basic steps of performing a gas flow/production study using a reservoir simulator are as follows [Saulsberry et al. 1996]:

- State the study objectives
- Select a reservoir simulator
- Collect and evaluate all geologic and engineering data
- Construct a geologic model for reservoir
- Design the simulation grid
- Digitize the maps
- Install engineering data into the model
- Define the well operating constraints
- Perform simulations



Reservoir models require a substantial amount of site-specific data to provide reliable simulations of gas flow and production from boreholes/wells. Commonly, all of the reservoir property data required to conduct a simulation are not available or are unknown. This is particularly true in the mining industry where reservoir modeling is relatively new and coalbed reservoir property base data acquisition is not part of the routine site evaluations. However, as more mines are considering the commercial production of coalbed methane, the value of obtaining coalbed reservoir data is becoming more widely recognized. It is an accepted reservoir engineering practice to use measured gas production data from boreholes and wells in “history matching” exercises to estimate some of the unknown reservoir properties. For mining-related applications, gas production data from both vertical and horizontal methane drainage boreholes and gob gas ventholes can be used for history matching. Because of the potential for gas production variabilities due to non-reservoir-related reasons (such as mechanical problems with pumps, etc.), using multiwell data sets for history matching is usually more dependable than single-well simulations, and they provide a better representation of the reservoir.

Although reservoir simulators are very successful in the representation of the multiphase flow and time-dependent gas diffusion processes in coalbeds, they do not readily model the dynamics of the mining process on the coalbed reservoir and surrounding strata. The progressive advance of the mine face and associated removal of the coalbed reservoir is a key dynamic that must be accounted for in mining-related simulations and can be accomplished with “frequent restart” files representing periodic updates of the reservoir geometry consistent with expansion of the mine.

Another aspect of longwall mining that cannot be predicted by conventional reservoir simulators is the geomechanical response in the surrounding strata, causing permeability changes that influence the drainage of gob gas. This problem can be manually overcome by computing the changes in rock properties (in particular, permeability) with a geomechanical program such as FLAC<sup>4</sup> [Itasca Consulting Group 2000] and representing those reservoir property changes in the appropriate reservoir simulation steps. Karacan et al. [2005] discuss how these dynamic mining-related processes can be addressed in a longwall mining simulation to optimize gob gas venthole methane drainage.

Other alternatives to reservoir simulation to predict gas emissions due to mining are “Roofgas” and “Floorgas” programs specifically designed for mining applications. They produce graphical representations of strata relaxation and gas flow using boundary-element and bed separation techniques to calculate the strata response and the rate of gas release [Lunarzewski 1998].

**Numerical analysis and modeling techniques are the most powerful tools available to simulate gas flows and emissions in the mining environment. However, the successful application of these methods is highly dependent on the availability of valid, site-specific, reservoir property data.**

---

<sup>4</sup>Fast Lagrangian Analysis of Continua.

## REFERENCES

- Chen H–Y, Teufel LW [2000]. A new rate-time type curve for analysis of tight-gas linear and radial flows. SPE paper 63094. Richardson, TX: Society of Petroleum Engineers.
- Creedy DP [1986]. Methods for the evaluation of seam gas content from measurements on coal samples. *Min Sci Technol* 3(2):141–160.
- Curl SJ [1978]. Methane prediction in coal mines. London: IEA Coal Research.
- Diamond WP [1982]. Site-specific and regional geologic considerations for coalbed gas drainage. Pittsburgh, PA: U.S. Department of the Interior, Bureau of Mines, IC 8898. NTIS No. PB83157685.
- Diamond WP, Levine JR [1981]. Direct method determination of the gas content of coal: procedures and results. Pittsburgh, PA: U.S. Department of the Interior, Bureau of Mines, RI 8515. NTIS No. PB81196735.
- Diamond WP, Schatzel SJ [1998]. Measuring the gas content of coal: a review. *Int J Coal Geol* 35(1–4):311–331.
- Diamond WP, LaScola JC, Hyman DM [1986]. Results of direct-method determination of the gas content of U.S. coalbeds. Pittsburgh, PA: U.S. Department of the Interior, Bureau of Mines IC 9067. NTIS No. PB86205325.
- Diamond WP, Ulery JP, Kravits SJ [1992]. Determining the source of longwall gob gas: lower Kittanning coalbed, Cambria County, PA. Pittsburgh, PA: U.S. Department of the Interior, Bureau of Mines, RI 9430.
- Hanby KP [1991]. The use of production profiles for coalbed methane valuation. Paper 9117. In: Proceedings of the International Coalbed Methane Symposium (Tuscaloosa, AL, May 13–16, 1991). Tuscaloosa, AL: University of Alabama.
- Itasca Consulting Group [2000]. Fast Lagrangian analysis of continua. 2nd ed. Minneapolis, MN: Itasca Consulting Group, Inc.
- Karacan CO, Diamond WP, Esterhuizen GS, Schatzel SJ [2005]. Numerical analysis of the impact of longwall panel width on methane emissions and performance of gob gas ventholes. In: Proceedings of the International Coalbed Methane Symposium (Tuscaloosa, AL, May 18–19, 2005). Tuscaloosa, AL: University of Alabama, pp. 1–28.
- Kim AG [1977]. Estimating methane content of bituminous coalbeds from adsorption data. Pittsburgh, PA: U.S. Department of the Interior, Bureau of Mines, RI 8245. NTIS No. PB271218.
- King GR [1993]. Material balance techniques for coal seam and Devonian shale gas reservoirs with limited water influx. *SPE Reservoir Eng Feb*:67–72.

- King GR, Ertekin T [1989a]. A survey of mathematical models related to methane production from coal seams. Part 1: Empirical and equilibrium sorption models. In: Proceedings of the International Coalbed Methane Symposium (Tuscaloosa, AL, April 17–21, 1989). Tuscaloosa, AL: University of Alabama, pp. 125–138.
- King GR, Ertekin T [1989b]. A survey of mathematical models related to methane production from coal seams. Part 2: Nonequilibrium sorption models. In: Proceedings of the International Coalbed Methane Symposium (Tuscaloosa, AL, April 17–21, 1989). Tuscaloosa, AL: University of Alabama, pp. 139–155.
- King GR, Ertekin T [1991]. State-of-the-art modeling for unconventional gas recovery. *SPE Formation Eval Mar*:63–71.
- Kissell FN, McCulloch CM, Elder CH [1973]. The direct method of determining methane content of coalbeds for ventilation design. Pittsburgh, PA: U.S. Department of the Interior, Bureau of Mines, RI 7767. NTIS No. PB221628.
- Lamberson MN, Bustin RM [1993]. Coalbed methane characteristics of Gates Formation coals, northeastern British Columbia: effect of maceral composition. *AAPG Bull* 77(12):2062–2076.
- Lunarzewski LW [1998]. Gas emission prediction and recovery in underground coal mines. *Int J Coal Geol* 35(1–4):117–145.
- McFall KS, Wicks DE, Kuuskraa VA [1986]. A geologic assessment of natural gas from coal seams in the Warrior basin, Alabama. Gas Research Institute, GRI Topical Report 86/0272.
- McLennan JD, Shafer PS, Pratt TJ [1995]. A guide to determining coalbed gas content. GRI–94/0396. Chicago, IL: Gas Research Institute.
- Mucho TP, Diamond WP, Garcia F, Byars JD, Cario SL [2000]. Implications of recent NIOSH tracer gas studies on bleeder and gob gas ventilation design. SME preprint 00–8. Littleton, CO: Society for Mining, Metallurgy, and Exploration, Inc.
- Noack K [1998]. Control of gas emissions in underground coal mines. *Int J Coal Geol* 35(1–4): 57–82.
- Saulsberry JL, Shafer PS, Schraufnagel RA, eds. [1996]. A guide to coalbed methane reservoir engineering. GRI–94/0397. Chicago, IL: Gas Research Institute.
- Schatzel SJ, Garcia F, McCall FE [1992]. Methane sources and emissions on two longwall panels of a Virginia coal mine. In: Proceedings of the Ninth Annual International Pittsburgh Coal Conference (Pittsburgh, PA, October 12–16, 1992), pp. 991–998.
- Ulery JP, Hyman DM [1991]. The modified direct method of gas content determination: application and results. In: Proceedings of the International Coalbed Methane Symposium (Tuscaloosa, AL, May 13–16, 1991). Tuscaloosa, AL: University of Alabama, pp. 489–500.

## CHAPTER 9.—CONTROL OF METHANE DURING COAL MINE SHAFT EXCAVATION AND FILLING

By Fred N. Kissell, Ph.D.<sup>1</sup>

### *In This Chapter*

- ✓ Ventilation and methane sampling guidelines for conventional shafts
- ✓ Dealing with restricted spaces where methane can accumulate
- ✓ Ventilation and methane sampling at raise bore drills

*and*

- ✓ Filling shafts at closed coal mines

It is not unusual to encounter methane gas during shaft excavation or shaft-filling operations. Shafts into coalbeds usually produce the most methane, so the information in this chapter applies primarily to shafts at coal mines. Nevertheless, much of the information is relevant for noncoal mines that have methane in the mine or in the overlying strata.

### METHANE IN SHAFTS EXCAVATED BY CONVENTIONAL MEANS (DRILL, BLAST, MUCK)

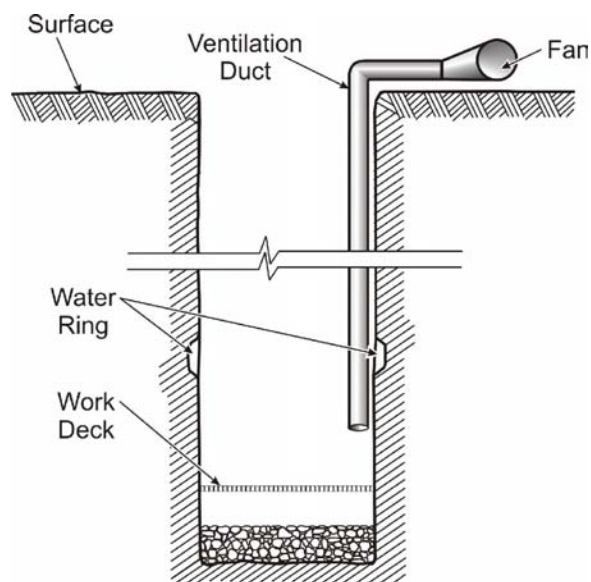

Figure 9–1.—Mine shaft under construction.

**Ventilation.** Shafts excavated by conventional means are ventilated with a fan on the surface connected to ductwork that extends down into the shaft (Figure 9–1). Shafts into coalbeds should have ventilation systems designed to handle the higher gas flows to be expected as the shaft excavation passes through any overlying gas-containing strata and nears the coalbed to be mined. Following are some simple ventilation guidelines for the minimum amount of air required and the selection of the ventilation duct:

- Provide enough air to meet the minimum OSHA tunnel requirement of 30 ft/min air velocity in the open shaft, as specified in 29 CFR<sup>2</sup> 1926.800(k)(3). For example, a 20-ft-diam shaft having

<sup>1</sup>Research physical scientist, Pittsburgh Research Laboratory, National Institute for Occupational Safety and Health, Pittsburgh, PA (retired).

<sup>2</sup>*Code of Federal Regulations.* See CFR in references.

an area of 314 ft<sup>2</sup> would require 9,420 cfm at the inby, or bottom, end of the ventilation duct.

- Assume at least 35% leakage between the fan and the inby end of the ventilation duct. Using the 9,420-cfm figure above, the fan would have to deliver at least 14,500 cfm.
- Size the ventilation duct diameter to achieve a duct velocity of 3,000 ft/min or less. Using the 14,500-cfm fan quantity above, the duct would have an area of 4.8 ft<sup>2</sup> or more and a diameter of at least 2.5 ft.
- Locate the inby end of a duct exhausting air from the shaft within 10 ft of the point of deepest penetration. If exhaust ventilation is used, auxiliary ventilation of the space below the work deck may be necessary.
- Locate the inby end of a duct blowing air into the shaft within 15 duct diameters of the point of deepest penetration. For example, using the 2.5-ft duct diameter figure above, the maximum distance between the end of the duct and the point of deepest penetration would be 37.5 ft.
- Limit fan shutdown times when workers are in the shaft to a maximum of 15 min. Monitor the methane level in the air during fan shutdowns.

**Gas sampling.** Preshift and on-shift examinations for methane are governed by federal coal mine regulations at 30 CFR 77.1901. This regulation requires that methane be measured by a certified person within 90 min before each shift, at least once during the shift, and both before and after blasting. Other examinations for methane must be made immediately before and periodically during any welding or cutting in the shaft, per 30 CFR 77.1916(c). In all instances, work must not continue when the air contains 1.0 vol % or more of methane.

Particular attention should be paid to sampling the gas level in restricted spaces (as described in the later section on water rings) and in any portion of the shaft where the free movement of air is restricted. Figure 9–2 illustrates how the free movement of ventilation air is inhibited by the presence of a work deck, even if the deck is fabricated from metal grating. In such circumstances, methane measurements must be made with an extensible probe positioned to draw air samples immediately below the work deck and at regular intervals all the way down to the muck pile. Measurements are necessary at regular intervals because assumptions cannot be made as to where the methane is likely to accumulate.<sup>3</sup>

---

<sup>3</sup>Cook [1998] describes a shaft explosion in a South African mine where the workers assumed that any methane would layer just below the work deck, making any measurements further down unnecessary. They failed to recognize that methane released from the muck at the bottom is very unlikely to layer and that once the methane is mixed into the air, it cannot unmix to form a layer. Because of this, measurements must be made at regular intervals over the entire distance between the work deck and the muck pile. For more information on layering, see Chapters 1 and 11.

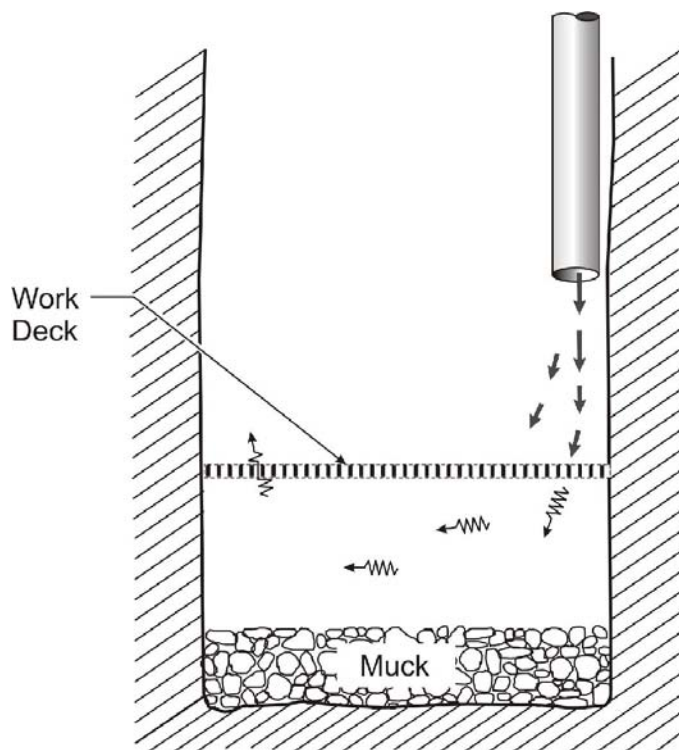

Figure 9–2.—Ventilation airflow is restricted by work deck. Therefore, methane must be monitored at regular distances between the work deck and the muck pile.

**Welding and cutting.** To the extent possible, welding and cutting should be done on the surface. When welding and cutting in the shaft cannot be avoided, gas check procedures must be carefully followed, and the number of people in the shaft must be held to the minimum required to conduct the work and check for gas—usually two individuals.

**Water rings.** A water ring cross-section is shown in Figure 9–3. Water rings are circular spaces excavated from the rock in a shaft wall. They are used to provide water drainage from the exterior side of the concrete shaft lining and are often located to drain water from an adjacent aquifer. Methane gas may be drained along with the water, resulting in additional hazard.

**Water ring spaces in shaft walls are an example of a so-called restricted space, where the ventilation and methane sampling require extra effort.<sup>4</sup>**

Failure to monitor restricted spaces such as water rings can have disastrous consequences. For example, in January 2003, three miners were killed by a methane explosion during a shaft-sinking operation in West Virginia [Mills 2003]. A water ring space had been excavated back into the strata from the shaft wall. Before pouring the concrete shaft lining, the water ring space was sealed off with corrugated sheets of steel to prevent it from being filled with concrete. After the concrete had set, the three workers were killed while in the process of opening an access door with an acetylene torch. The torch ignited methane that had accumulated in the water ring space after it was sealed off.

<sup>4</sup>Sampling for methane in restricted spaces is described in more detail in the sampling chapter (Chapter 2).

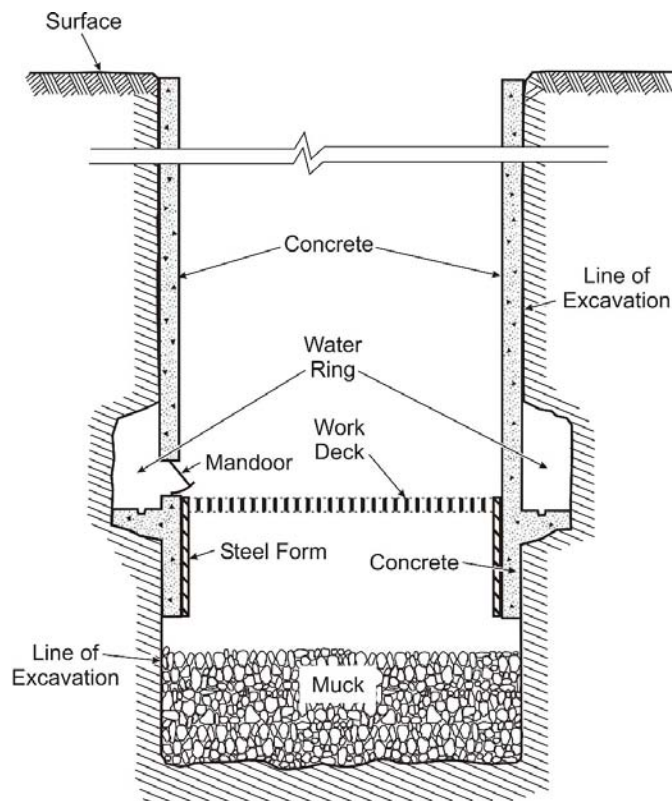

Figure 9-3.—Water ring in shaft wall (adapted from Oakes et al. [2003]).

In the case of the abovementioned West Virginia mine, any one of the following measures would have reduced the chance of an explosion:

- Thoroughly ventilating the water ring space with compressed air.
- Carefully checking for methane using a methane detector with a probe inserted into the water ring space.
- Opening the access door without using an acetylene torch.

To avoid methane problems when dealing with water rings, the appropriate action is to incorporate all three measures into standard operating practice.

## METHANE IN SHAFTS EXCAVATED WITH RAISE BORE DRILLS

Like conventional shafts, raise bore shafts at coal mines must be well-ventilated and the methane level must be monitored frequently. Maksimovic [1981] reported on some methods to ventilate raise bore shafts. These involve moving air through the drill stem or the annular space between the drill stem and the wall of the pilot hole. A more recent approach is to drill a second hole for ventilation and methane sampling (Figure 9-4).

The methods reported by Maksimovic involve the use of air compressors to inject air into the shaft in quantities ranging from 600 to 3,000 cfm, and vacuum pumps to withdraw air from the shaft in quantities ranging from 600 to 1,000 cfm. These are used separately or in combination as follows:

- *Alternating the use of the air compressor and vacuum pump.* Compressed air is injected down the drill stem<sup>5</sup> for a period of 2–4 hr, and then a vacuum pump is used for a short interval to bring an air sample through the drill stem to the surface for a methane measurement.

<sup>5</sup>At the same time, air can also be forced down through the annulus.

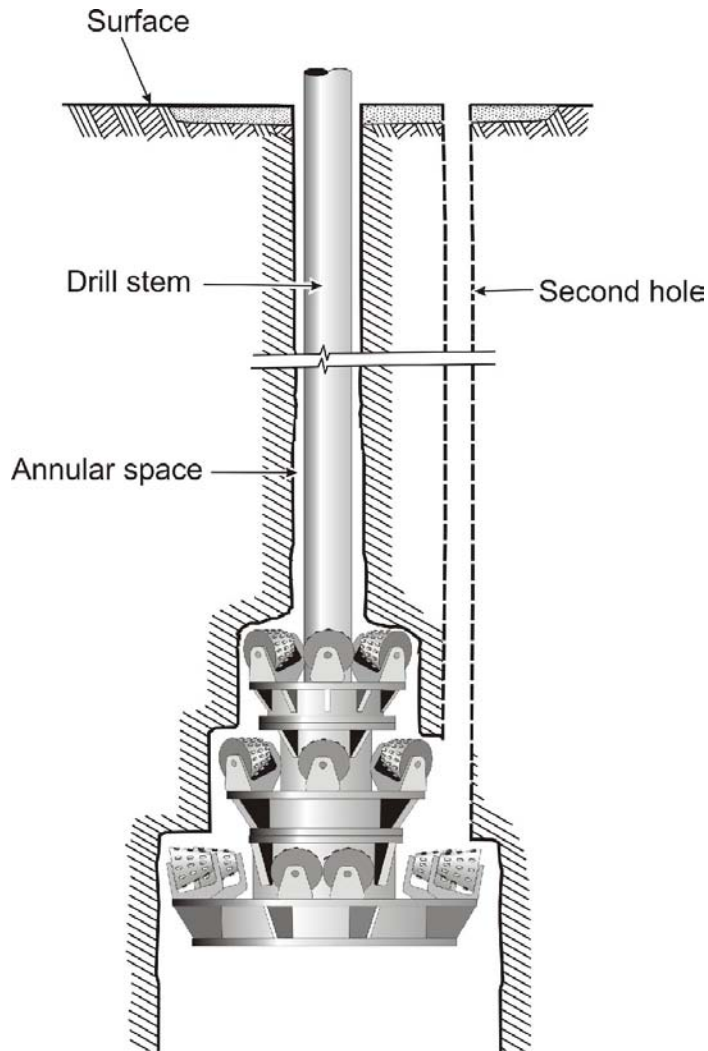

**Figure 9-4.—Raise bore shaft with second hole for ventilation.**

- *Simultaneous use of the air compressor and vacuum pump.* Compressed air is continuously injected down the drill stem. At the same time, for methane sampling, a vacuum pump is used to draw air up through the annulus between the drill stem and pilot hole wall. This method allows for continuous sampling of methane, but requires the installation of a seal (a stuffing box) around the drill stem at the surface to prevent surface air from entering the annulus and contaminating the sample. Any leaks in this seal will cause the indicated methane concentration to be lower than it actually is.
- *Use of the vacuum pump only.* A vacuum pump is used to draw air up through the drill stem. This approach may be suitable when the methane level is very low, and it allows for continuous sampling. However, dust builds up inside the drill stem and accumulates on the joints when sections are removed.

In recent years, an alternative technique to ventilate raise bore shafts has been to drill a second hole for ventilation and methane sampling. This second hole is drilled close to the pilot hole and within the perimeter of the hole to be reamed by the raise drill (Figure 9-4). For gassier mines or those that are likely to have gas in the overburden, this is a better method than using the drill stem or the annulus. Larger quantities of air can be drawn to the surface using a vacuum pump, and the methane concentration can be monitored continuously. Surface leaks are also less of a problem. Finally, the diameter of the hole can be matched to the air quantity requirements.

A disadvantage of using a second hole for ventilation and sampling is that it can only be used for reamed hole diameters of about 8 ft or more. It also requires careful drilling to ensure that the holes do not wander too far apart.



## FILLING SHAFTS AT CLOSED MINES

**Filling a shaft at a closed coal mine can be hazardous because of methane accumulations in the shaft or at the surface. This gas may be ignited by rock dumped into the shaft or by cutting torches used to dismantle surface structures such as fan housings. The key to maintaining safe conditions is adequate methane and barometric pressure monitoring.**

**Shaft filling at U.S. coal mines.** Under 30 CFR 75.1711-1, the Mine Safety and Health Administration (MSHA) requires that shafts be filled with incombustible material or covered with a 6-in-thick concrete cap that is equipped with a 2-in vent pipe extending upward 15 ft or more.<sup>6</sup> In addition, precautions to deal with methane are necessary during the shaft-filling operation.

Denk et al. [1987] discussed the methods used to monitor methane and the precautions taken to ensure worker safety during a shaft filling operation at a U.S. coal mine. At this mine, an explosion occurred as rock was being initially dumped into the 16-ft-diam, 953-ft-deep shaft. Following the explosion, MSHA measured the shaft methane concentration by extending a sampling tube down the shaft to the bottom and pumping air samples through the tube to the surface.<sup>7</sup> The methane concentration ranged from 2.2% to over 12%.<sup>8</sup>

At this mine, the most cost-effective way of dealing with this gas was to pump compressed air into the shaft to dilute it. Air from a compressor rated at 750 scfm and 100 psi was delivered to the shaft bottom through a 2-in PVC<sup>9</sup> natural gas line secured with a hemp rope. A copper ground wire was attached along the entire length of the gas line to guard against explosion due to static electricity. The gas line was to be pulled up as the shaft was filled. After 4 hr of operation with this system, methane at the 835-ft level in the 16-ft-diam shaft was reduced from 9.5% to 1.4%.

Subsequently, MSHA specified that while work was being conducted in the shaft area, the methane concentration at the bottom of the shaft was to be maintained at 2.0% or less and elsewhere in the shaft at 3.0% or less. Alternating 1-hr periods with the air compressor turned on and off was enough to keep the methane concentration within these limits as the shaft was being filled.

---

<sup>6</sup>Under MSHA regulations, shafts must be either filled or capped. Other federal or state agencies may require that shafts be filled.

<sup>7</sup>An alternative method, using newer technology, is to lower a data-logging methane detector into the shaft.

<sup>8</sup>MSHA used an infrared analyzer to measure the methane concentration. Infrared analyzers are accurate at high methane concentrations and/or low oxygen levels. Bear in mind that methane detection instruments that use heat of combustion sensors are not accurate at methane concentrations above 8% or oxygen concentrations below 10%. See the sampling chapter (Chapter 2) for more information on the distinction between infrared analyzers and heat of combustion sensors.

<sup>9</sup>Polyvinyl chloride.

After the shaft was filled, mine gases continued to leak to the surface. Explosive concentrations of methane were measured at the surface, so air-powered tools were used to dismantle the fans. In addition, elevated carbon dioxide levels and oxygen deficiencies persisted in the fan housing and the structures surrounding the shaft collar. Nevertheless, the project was completed without further incident.

**Shaft filling in Germany.** Hinderfeld [1995] reported on the methane safety precautions taken during shaft filling in Germany, where more than 100 shafts had been filled in the previous 10 years. When shafts are not under the influence of a fan, the flow of methane is controlled by the barometric pressure. High flows of methane have been observed when the barometric pressure falls and the gas-laden mine air expands and fills the shaft from below. In this situation, it is important to monitor the barometric pressure.

The preferred approach to shaft filling at each mine is to ensure that the shaft being filled is downcast and ventilated with a fan in another shaft. The last two shafts at the mine are then closed off simultaneously and filled as quickly as possible.

During filling, the methane concentration is continuously measured at a point 50 m (164 ft) below the surface. If a threshold value—established for that particular shaft—is reached, then filling work stops and the shaft is probed to the bottom.

When high methane concentrations are recorded, and if these are not diluted during a subsequent barometric pressure increase, the shaft atmosphere is inerted by adding enough carbon dioxide or nitrogen to reduce the oxygen content below 10%.<sup>10</sup>

## REFERENCES

CFR. Code of federal regulations. Washington DC: U.S. Government Printing Office, Office of the Federal Register.

Cook AP [1998]. The occurrence, emission, and ignition of combustible strata gases in Witwatersrand gold mines and Bushveld platinum mines, and means of ameliorating related ignition and explosion hazards. Final project report, project GAP 504. Braamfontein, Republic of South Africa, Safety in Mines Research Advisory Committee (SIMRAC) ([www.simrac.co.za](http://www.simrac.co.za)).

Denk JM, Francart WJ, Baran JN [1987]. Monitoring mine gases during shaft filling operations. In: Proceedings of the Third Mine Ventilation Symposium (University Park, PA, October 12–14, 1987).

---

<sup>10</sup>When a shaft is under the influence of barometric pressure, adding carbon dioxide or nitrogen can be a better approach than diluting methane with compressed air. When compressed air is used, a spike in the methane flow due to a falling barometer may move the shaft atmosphere into the explosive range. When the shaft is inerted, a spike in the methane flow may drive the shaft atmosphere at the bottom further into the inert range.

Hinderfeld G [1995]. Ventilation-technical and gas management measures within closing down of coal mines. In: Proceedings of the 26th International Conference of Safety in Mines Research Institutes (Katowice, Poland, September 4–8, 1995). Vol. 2. Katowice, Poland: Central Mining Institute, pp. 201–217.

Maksimovic SD [1981]. Control of methane by ventilation of shafts during raise drilling. Pittsburgh, PA: U.S. Department of the Interior, Bureau of Mines, IC 8847. NTIS No. PB81234502.

Mills B [2003]. Fatal shaft explosion report investigation, McElroy Coal Co., McElroy mine, Permit No. U–83–33, Central Cambria Drilling Co., contractor No. C–618, January 22, 2003. Fairmont, WV: West Virginia Office of Miner’s Health, Safety and Training.

Oakes JK, Tortorea JS, Stoltz RT, Stephan CR, Brown VF, Penigar RA, et al. [2003]. Report of investigation, fatal shaft sinking explosion, January 22, 2003. McElroy mine, McElroy Coal Company (subsidiary of CONSOL Energy Incorporated), Cameron, Marshall County, West Virginia, ID No. 46–01437. Arlington, VA: U.S. Department of Labor, Mine Safety and Health Administration.

## CHAPTER 10.—METHANE CONTROL IN HIGHWALL MINING

By Jon C. Volkwein<sup>1</sup> and Fred N. Kissell, Ph.D.<sup>2</sup>

### *In This Chapter*

- ✓ How inert gas works to prevent methane explosions
- ✓ How inert gas is generated and delivered at highwall mines
- ✓ Volume and quality requirements for inert gas at highwall mines
- ✓ How an inert gas system is operated

*and*

- ✓ Precautions to take during mining to prevent methane explosions

This chapter discusses a method, originally developed by Volkwein and Ulery [1993], to prevent methane explosions during highwall mining. In highwall mining, a horizontal auger or a mining machine enters the coal seam from a surface mine pit at the bottom of a highwall, and the coal is mined out from a series of parallel holes. Explosions can be prevented by injecting inert gas into each hole as it is mined.

Coal near the surface has lost most of its methane gas over time. However, in recent years, surface mining has been used for deeper reserves of coal. This trend toward mining deeper reserves has increased the chance of encountering methane, and methane explosions at highwall mining operations have resulted in injuries.

### HOW INERT GAS WORKS TO PREVENT METHANE EXPLOSIONS

A methane explosion requires the presence of sufficient amounts of both methane and oxygen, as well as an ignition source. If the methane cannot be reduced and the ignition source cannot be eliminated, then explosions may be prevented by adding an inert gas, which contains little to no oxygen, to the mixture [FWQA 1970]. Just how much inert gas must be added depends on the mining rate, as well as the composition of the inert gas.

An explosibility diagram can be used to show whether a methane mixture is explosive after inert gas is added [Zabetakis et al. 1959] (Figure 10–1). This diagram indicates that gas mixtures fall into one of three range categories—explosive, explosive when mixed with air, and nonexplosive—depending on the percentage of methane and percentage of “effective inert.” Effective inert is calculated from the percentage of “excess nitrogen”<sup>3</sup> and percentage of carbon dioxide in the mixture.

---

<sup>1</sup>Research physical scientist, Pittsburgh Research Laboratory, National Institute for Occupational Safety and Health, Pittsburgh, PA.

<sup>2</sup>Research physical scientist, Pittsburgh Research Laboratory, National Institute for Occupational Safety and Health, Pittsburgh, PA (retired).

<sup>3</sup>The percentage of excess nitrogen is the percentage of nitrogen in the sample minus the percentage of “normal nitrogen.” Normal nitrogen is calculated from the ratio of nitrogen to oxygen normally found in air—a factor of 3.8.

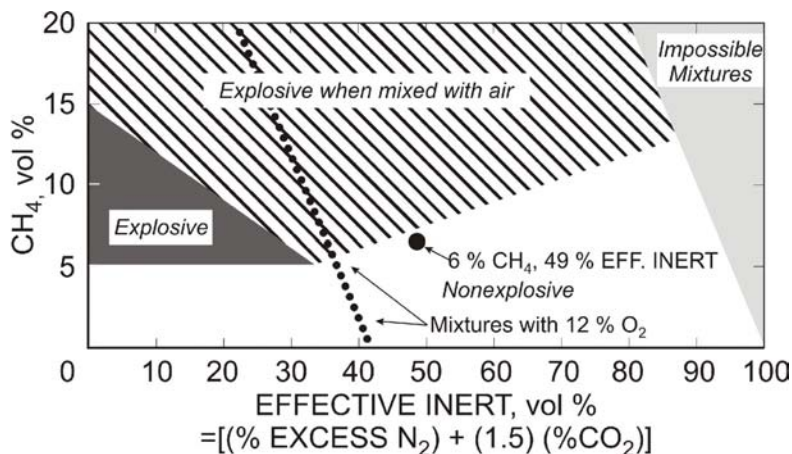

Figure 10–1.—Explosibility diagram for methane-air-inert gas mixtures.

percentage of excess nitrogen is the percentage of nitrogen in the sample minus the percent of normal nitrogen, the excess nitrogen is 78% minus 38%, or 40%. Third, according to the equation shown in Figure 10–1, since the carbon dioxide in the sample is 6%, the effective inert is now  $40\% + (1.5 \times 6\%)$ , or 49%.<sup>4</sup>

The point representing a gas mixture containing 6% methane and 49% effective inert is shown in Figure 10–1, placing this mixture in the “nonexplosive” range. To minimize the explosion hazard during highwall mining, the objective is to add enough inert gas to keep the final mixture well out of the explosive range.

A handy rule of thumb is that the oxygen content of the mixture must be reliably maintained below 12%. Nitrogen-oxygen-methane mixtures with 12% oxygen fall along the dotted line in Figure 10–1. Mixtures with less than 12% oxygen fall to the right of this line and are either “nonexplosive” or “explosive when mixed with air.”

The explosibility of mixtures with more than 12% oxygen must be evaluated in the context of Figure 10–1. For example, a mixture of 15% methane, 15% oxygen, and 70% nitrogen has 13% effective inert, so it falls in the “explosive when mixed with air” range.

## THE INERT GAS SYSTEM

Preventing explosions on highwall mining machines using inert gas requires a source of inert gas and a method to keep the hole completely filled with inert gas as it is mined. As Figure 10–1 indicates, if an inert gas completely displaces all of the air in the hole, then any gas source having an effective inert concentration of 34% or greater (or an oxygen concentration of 12% or less) will prevent methane from igniting. To ensure that all of the air in the hole is displaced, the

<sup>4</sup>Carbon dioxide has been found to be 50% more effective than nitrogen in inerting, so a multiplying factor of 1.5 is used.

To calculate the effective inert, suppose, for example, that inert gas is added to a methane-air mixture and that a gas analysis shows that the final mixture has 10% oxygen, 6% carbon dioxide, 6% methane, and 78% nitrogen. The effective inert is then determined in three steps. First, in this example, the oxygen percentage is 10%, so the percentage of normal nitrogen is 3.8 times 10%, or 38%. Second, since the

volume of inert gas delivered to the hole must equal or exceed the volume of coal extracted from the hole.

**Auger mining.** Logical sources of inert gas for auger mining are the auger machine's diesel engine and an auxiliary gasoline engine. The inert gas system that was originally developed by Volkwein and Ulery [1993] is shown in Figure 10-2.

The Volkwein and Ulery system was evaluated at an auger mining operation at a surface mine in Kentucky. During initial testing of their system, Volkwein and Ulery found that the oxygen content of the diesel engine powering the auger (a Cummins turbocharged 270) was not always low enough to prevent explosions. The diesel engine exhaust oxygen concentrations range from 8% at full load to 17% at no load (typical for diesel engines).

It is known that gasoline engine exhaust has consistently lower oxygen concentrations than diesel engine exhaust, so a 305-in<sup>3</sup> gasoline engine was used as the primary source of the inert gas. This gasoline engine was mounted on the roof of the auger drill, and a new catalytic converter was installed on its exhaust manifold. The catalytic converter burned excess hydrocarbons and carbon monoxide, further lowering the oxygen content of the exhaust. This engine was operated at 3,600–3,900 rpm. Although the gasoline engine alone produced oxygen concentrations in the 1%–4% range, the exhaust volume was insufficient to keep the hole completely filled with inert gas. To make up for this lack of volume, a portion of the diesel engine exhaust was added to the gasoline engine exhaust.

As shown in Figure 10-2, the diesel engine exhaust was conducted from the engine muffler (no catalytic converter was used on the diesel) to the roof of the auger drill through a flexible 5-in steel pipe. This flexibility allowed the engine carriage to travel freely as the auger drill moved forward. The volume of diesel exhaust entering the auger hole was controlled by a critical orifice restriction, selected to allow equal proportions of diesel and gasoline engine

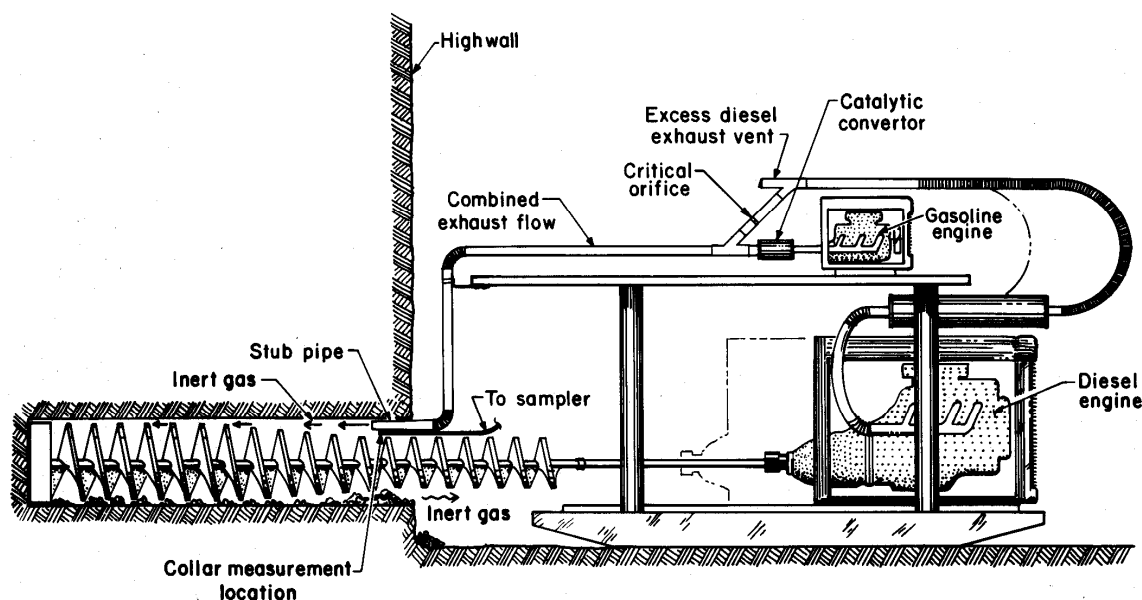

Figure 10-2.—Schematic of inert gas system for auger mining.

exhaust. The remaining diesel exhaust was vented at the roof of the auger drill. The combined exhaust flows were routed through a section of 5-in-diam flexible pipe that connected to a vertical descending pipe that brought the exhaust to the level of the hole. A 7-ft length of 3-in stub pipe extended the exhaust gas discharge about 5 ft into the hole.

With this system, inert gas mixture was released at the collar of the hole, reaching the cutting head by simple displacement of the extracted coal. The inert gas followed the auger head into the hole. As angering proceeded, the hole remained in an inert condition provided that a sufficient volume of inert gas always flowed out of the hole to keep out the surrounding air.

**Ripper-head miners.** Adapting inert gas technology from auger miners to ripper-head miners involves few changes. Ripper-head systems are in use in Australia with the addition of an automated stub pipe that discharges the inert gas farther into the hole. The inert gas has to be discharged farther into the hole because the hole is wider. With a short stub pipe, the wider openings may allow equipment movement and external wind to dilute the inert gas before it can displace the removed coal.

**An inert gas system designed and used by a mine operator does not have to be identical to the one designed by Volkwein and Ulery. However, any inert gas generation system must deliver an adequate quantity of gas with a sufficiently low oxygen concentration.**

## SYSTEM REQUIREMENTS AND OPERATION

**Inert gas quantity.** In order for inert conditions to be maintained at the cutting head of the auger string, the volume of inert gas produced must exceed the volume of coal removed and the inert gas must be supplied continuously as angering proceeds. This keeps the surrounding air out of the hole.

During testing of the system designed by Volkwein and Ulery [1993], time studies of coal removal showed that auger sections 17 through 27 required an average of 102 sec per cycle. Of that cycle time, approximately 20 sec was required for retraction of the kelly bar, leaving 82 sec for coal removal. The fastest cycle time recorded was 70 sec for coal removal. Each added auger section removed a coal cylinder 3.25 ft in diameter by 6 ft long, or 49.7 ft<sup>3</sup> of coal. The average coal removal rate was calculated to be 35.0 ft<sup>3</sup>/min, with a maximum removal rate of 42.0 ft<sup>3</sup>/min. At greater hole depth (auger numbers 55 through 60), the average removal rate was calculated to be 27.0 ft<sup>3</sup>/min, with a maximum rate of 30.3 ft<sup>3</sup>/min. Smaller diameter augers or slower penetration speeds will decrease this volume, and vice versa.

Since the engine gas cools and water vapor condenses inside the auger hole, the amount of inert gas actually available is the cooled gas, not the hot gas. When the volume of hot gas is measured, a large correction factor must be used to determine the available inert gas volume. A correction factor of 0.125 was obtained during the testing, so 0.125 was multiplied by the hot

exhaust gas volume to yield the available inert gas volume.<sup>5</sup> Hot gas velocities can be measured with a pitot tube installed in the gas delivery pipe. The readings must be corrected for air density using a value of 0.0415 lb/ft<sup>3</sup> to reflect the elevated temperature of about 500 °F.

For the system tested, the minimum cooled gas volume found during testing with the combined engine exhaust was 50 ft<sup>3</sup>/min. The maximum rate of coal removal was 42 ft<sup>3</sup>/min. This calculates to a 16% excess volume of inert gas for the worst-case conditions—minimum gas volume and maximum coal removal.

**Oxygen concentration.** If the oxygen concentration can be maintained at 12% or less, measurement of the oxygen concentration alone is sufficient to indicate the inert condition of the gas. These measurements could be made with a handheld oxygen detector or an in-line continuous oxygen detector.

During testing [Volkwein and Ulery 1993], a level of 12% oxygen was maintained along with 6% carbon dioxide. Since combustion engines always produce carbon dioxide in addition to lowering the oxygen level, the presence of carbon dioxide will provide a safety factor if the oxygen is 12% or less.

**Placement of the stub pipe and purging the starter hole.** For inert gas to be continuously maintained at the front of the auger hole, the region just inside the collar of the hole must be continuously provided with inert gas. However, when the head and lead guide augers are starting the drilling, there is no room to insert the stub pipe. The ideal time to extend the stub pipe into the collar of the hole is after a smaller-diameter auger is attached and the hole is just deep enough to make room for the stub pipe (see Figure 10–2). Then the auger is stopped and the stub pipe is installed. After the stub pipe is installed, the auger is not rotated until the starter hole is purged with inert gas.

**When placing a stub pipe, be certain that it extends at least 5 ft into the hole. The jet from a shorter stub pipe might entrain outside air.**

Purging of the starter hole is necessary because of the air drawn in by the head and lead guide augers. The time required to purge the starter hole depends on the volume of the hole and the gas flow rate. During testing in the Volkwein and Ulery study, the empty hole volume was 216 ft<sup>3</sup> (3.25 ft diameter by 26 ft deep) with about one-half of this volume occupied by the auger steel and cut coal, leaving 108 ft<sup>3</sup>. At an inert gas flow rate of 56 ft<sup>3</sup>/min, one complete air change occurred in less than 2 min. During testing, engines were run for about 4 min to fill the starter hole with inert gas before augering proceeded.

When insertion of the inert gas stub pipe is delayed, deeper starter holes require much longer times to become inert. For example, during testing when the hole was augered 44 ft before inserting the stub pipe, it took about 12 min to reach inert conditions. By contrast, a 26-ft hole

---

<sup>5</sup>This seems like a surprisingly large reduction in volume, but much of it is due to water vapor condensation.



required only 4 min. As a result, timely placement of the stub pipe is important so that the starter hole does not become too deep before inert gas is added.

## PRECAUTIONS TO TAKE DURING MINING

An inert gas system will not prevent explosions if it is not operating properly. During mining, the operator of the system must ensure that the concentration of engine exhaust gases stays at or below 12% oxygen, that the workplace is free of carbon monoxide, and that there is a steady movement of gas from the hole.

**The oxygen level in the engine exhaust gases is easily measured with a real-time oxygen indicator that has a readout and provides a warning if the level rises above 12%.**

Because the exhaust gas from engines contains carbon monoxide, personal exposure to carbon monoxide should be monitored. During the testing by Volkwein and Ulery [1993], the highest personal exposure to carbon monoxide measured with the passive dosimeters was less than 20 ppm. This occurred near the auger pin puller. The conveyor side helper had only a trace of exposure, and the machine operator had no detectable exposure. The combination of dilution and distance from the collar of the hole accounted for the observed low personal exposure to carbon monoxide.

A steady movement of inert gas from the hole will keep out the surrounding air. This requires the operator to observe the direction of movement of dust or smoke during periods of maximum auger penetration. This direction of movement should always be out of the hole.

**Auger removal.** The inert gas system should be left on during auger removal so that the dilution of gas in the hole takes place with inert gas rather than with air. However, auger removal is usually rapid—about 25 sec per cycle, with 15 sec of that cycle required for pin pulling and stacking of the auger. During the testing by Volkwein and Ulery [1993], rapid removal of the auger steel volume slightly exceeded the inert gas volume, but this excess was not considered to be significant.

## REFERENCES

FWQA [1970]. Feasibility study on mining coal in an oxygen-free atmosphere. Washington, DC: U.S. Department of the Interior, Federal Water Quality Administration. NTIS No. PB197446.

Volkwein JC, Ulery JP [1993]. A method to eliminate explosion hazards in auger highwall mining. Pittsburgh, PA: U.S. Department of the Interior, Bureau of Mines, RI 9462.

Zabetakis MG, Stahl RW, Watson HA [1959]. Determining the explosibility of mine atmospheres. Pittsburgh, PA: U.S. Department of the Interior, Bureau of Mines, IC 7901.

## CHAPTER 11.—CONTROL OF METHANE IN COAL SILOS

By Fred N. Kissell, Ph.D.<sup>1</sup>

### *In This Chapter*

- ✓ Measuring the gas emission from the coal
- ✓ Methane at the top of the silo
- ✓ Methane at the load-out area

*and*

- ✓ Actions taken after a silo explosion

Methane accumulations in coal silos have resulted in the occasional silo explosion. These can be quite violent and dangerous because coal dust adds to the strength of the blast. However, with the appropriate precautionary measures, methane accumulations in silos can be greatly reduced.

Mine Safety and Health Administration (MSHA) regulations at 30 CFR<sup>2</sup> 77.201 require that the methane content in the air of any coal silo be maintained below 1.0 vol %.<sup>3</sup> Also, MSHA requires that methane tests be conducted before any electrical equipment is energized, unless a continuous monitor capable of deenergizing the electrical equipment is used.<sup>4</sup>

**Measuring the gas emission from the coal.** The first necessary step in dealing with silo methane issues is to measure the gas emission from the coal going into the silo. Such measurements allow one to estimate the silo ventilation needs and permit a comparison with the methane controls used at other mines that have similar gas levels.

The gassiness of the coal can be measured by taking conveyor belt grab samples.<sup>5</sup> Matta et al. [1978] measured the gas emission from conveyor belt grab samples using a simple desorption test. To conduct the test, they collected several grab samples of coal, weighing a few pounds each, from the conveyor belt entering the silo.<sup>6</sup> They then sealed the coal into an airtight sample container that was equipped with a valve and short hose along with a pressure gauge. Every few hours they opened the valve and bled the emitted gas into a water-filled graduated cylinder that had been inverted and placed in a pan of water (Figure 11–1). The results are shown in Figure 11–2.

---

<sup>1</sup>Research physical scientist, Pittsburgh Research Laboratory, National Institute for Occupational Safety and Health, Pittsburgh, PA (retired).

<sup>2</sup>*Code of Federal Regulations*. See CFR in references.

<sup>3</sup>The presence of coal dust reduces the methane lower explosive limit (LEL) value below 5%, and so the safety factor from the specification of a 1% value can be less than 5. For more information, see Chapter 12 on dust explosions.

<sup>4</sup>Equally important, monitor heads must be placed in locations where methane is likely to accumulate.

<sup>5</sup>This must be done safely, i.e., the belt must be stopped before the sample is removed.

<sup>6</sup>Most of these mines had an overall mine emission rate exceeding 1million ft<sup>3</sup> per day, placing them in the ranks of the gassiest U.S. mines.

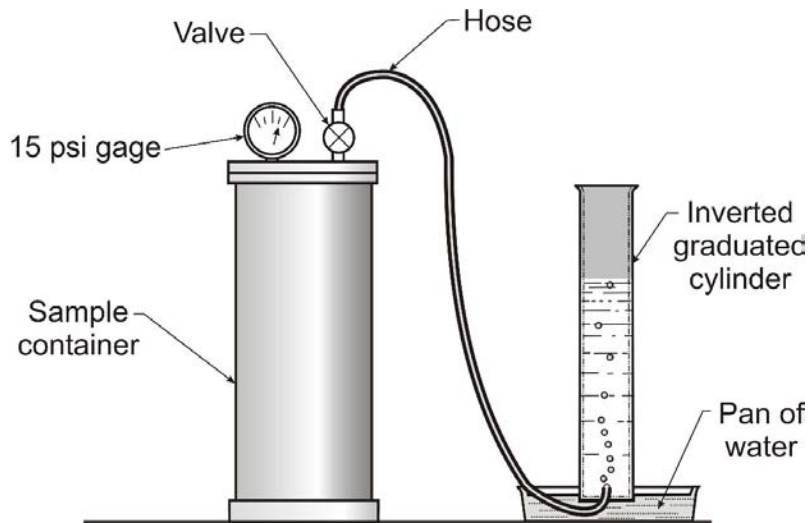

Figure 11-1.—Desorption test apparatus.

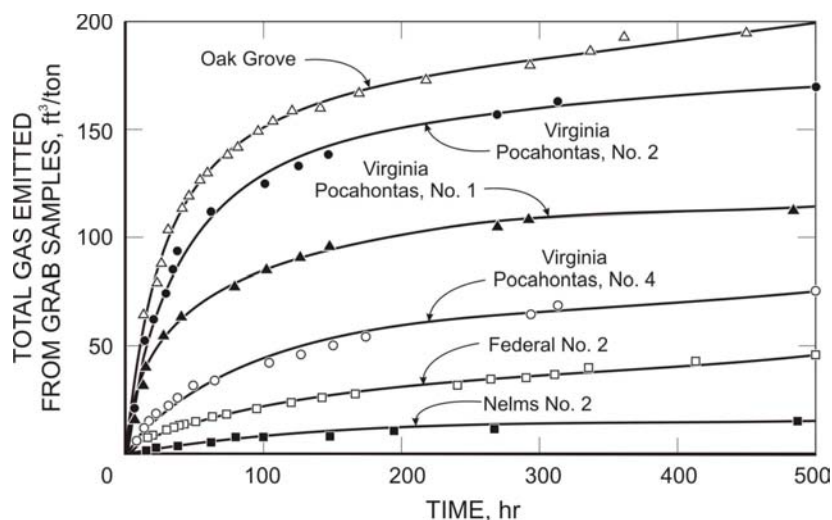

Figure 11-2.—Gas emitted from conveyor belt grab samples.

instances, the clean coal had been passed through a fluidized bed dryer to remove moisture and its temperature was 40 °C as it was being loaded into the silo. The higher temperature greatly increased the methane emission rate.<sup>8</sup>

LaScola et al. [1981] also collected conveyor belt grab samples. Since the coal in the silos they investigated was usually stored in the silo for about 24 hr, they used the 24-hr cumulative emission value as a comparative index. These 24-hr emission rates ranged from 3.3 to 86 ft<sup>3</sup>/ton. LaScola et al. noted that all of the mines with 24-hr emission values exceeding 14 ft<sup>3</sup>/ton had open-top silos to provide better ventilation at the top. Also, most had forced ventilation of the reclaiming areas, at ventilation rates ranging from 5,600 to 20,000 cfm.

Kolada [1985] reported similar gas amounts from silo conveyor belt samples at Canadian mines.<sup>7</sup> Interestingly, grab samples from coal entering clean coal silos sometimes gave emission rates five times higher than coal entering raw coal silos. This is not what one would expect since clean coal has been out of the mine longer. However, in these

<sup>7</sup>More information on this study is available from AMCL [1985].

<sup>8</sup>The breakage of coal during the cleaning process could also have been a contributing factor to the elevated methane emission. Friable coals will fracture into smaller size particles during coal cleaning, and smaller size particles will give off methane more quickly [Mikhail and Patching 1980].

**Closed-top silos should always be recognized as a potential methane problem. Provision must be made for continuous mechanical ventilation if the silo has a closed top.**

**Methane at the top of the silo.** LaScola et al. [1981] also measured the silo gas concentration above the stored coal pile at a wide variety of coal mines. Both open-top and closed-top silos were visited. Open-top silos allow large air movements above the coal pile, reducing the hazard of a methane explosion at the top. However, dust emissions during silo loading can be a problem. Closed-top silos are usually ventilated by openings at the top of the silo. These are typically 1- by 2-ft holes spaced around the perimeter immediately below the concrete roof. Some closed-top silos have ventilation fans or dust collectors.

In the LaScola et al. study, gas measurements of the open space above the coal pile were conducted by lowering flexible plastic tubing down the center line of the silo and pumping the gas to a methane detector. Measurements were made at 10-ft increments until the coal pile was reached. The results are shown in Figure 11-3. Methane concentrations were not excessive, and there was no layering<sup>9</sup> of methane at the top of the silos.

Kolada [1985] conducted measurements above the coal pile in Canadian coal silos following a similar procedure. The methane found was within a few inches of the coal, where the concentration ranged from 0% to 2% methane. When the silo was discharging, the methane concentration

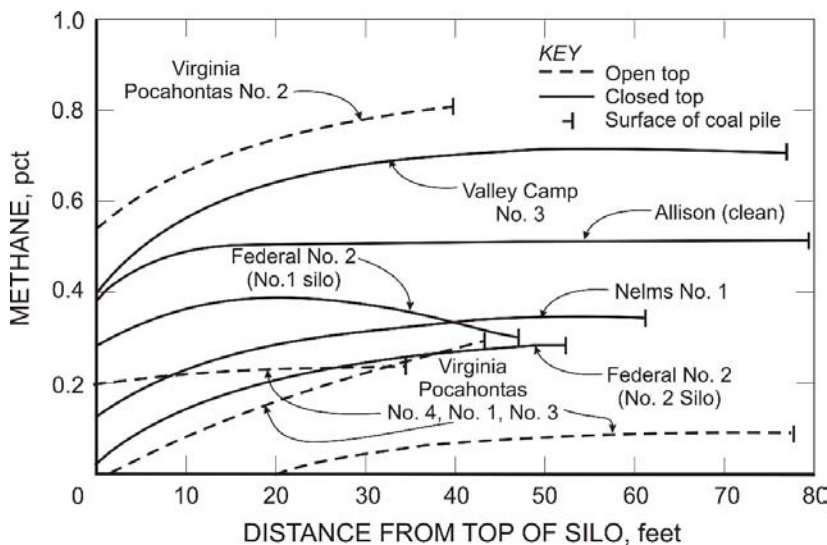

**Figure 11-3.—Methane concentration gradient above the coal in coal silo.**

within a few inches of the coal ranged from 0% to 6% methane.

**Methane at the load-out area.** The load-out area at the bottom of the silo is always a potential location for methane accumulations. These accumulations may increase if the coal has been stored for longer than normal periods. Methane detectors and adequate ventilation must be provided. Electrical switchgear should be minimized in load-out areas, especially if the load-out is

<sup>9</sup>The lack of layering is not surprising since the coal pile where methane is released is below the silo roof. Studies on methane layering in mine entries have usually measured mine roof layers caused by methane released at the roof of the mine. When methane is released at the mine rib, the tendency to layer at the roof is much less, and the tendency to layer at the roof is even less so for methane released at the mine floor. Moreover, once methane is mixed into the air, it does not unmix to form layers. See the discussion on layering in Chapter 1.

enclosed in a tunnel-like structure. Special attention should be given to railroad load-outs when electrical locomotives are used because of the additional ignition source.

**At the bottom of every silo, the methane emission should be measured as coal is reclaimed, and mechanical ventilation should be provided if there is any likelihood of methane buildup.**

Although methane measurements taken during the reclaiming of coal are valuable, the values obtained only reflect the circumstances at the time. These measurements can be supplemented by an estimation of ventilation requirements calculated from the gas concentration in the coal pile.

Gas concentration inside the coal pile has been measured directly and also calculated from the coal emission measurements. In the study by Kolada [1985], tubing was extended down into several silos, where it was buried with coal as the silo was filled. At the same time, a conveyor belt grab sample was taken and the emission from the grab sample was measured. At one silo, the conveyor belt grab sample emitted 0.013 L/kg in the first 30 min. The coal pile was known to have a bulk density of 800 kg/m<sup>3</sup> and 41% void space, so the amount of gas given off by a cubic meter of coal pile was 0.013 × 800, or 10.4 L of methane. Next, the concentration of methane in the coal pile was calculated to be equal to the volume of methane divided by the volume of air plus methane, or 2.5%.<sup>10</sup> The measured value, which Kolada obtained by pumping air from a tube buried in the coal pile for 30 min, was about the same as this calculated concentration value.

Using the above approach at several silos, Kolada obtained methane concentration values as high as 35%. However, for any given silo the concentration will depend on both the emission rate and the amount of time the coal remains in the silo.

During the reclaiming of coal, methane gas in the void space will emerge into the coal discharge gallery. Kolada has given a sample calculation, assuming a peak coal discharge rate of 1,021 kg/sec, a bulk density of 800 kg/m<sup>3</sup>, 41% void space, and a methane concentration of 35%<sup>11</sup> in the void space. A discharge rate of 1,021 kg/sec corresponds to 1,021/800 = 1.28 m<sup>3</sup>/sec. The methane discharged is then 1.28 × 0.41 × 0.35 = 0.184 m<sup>3</sup>/sec = 389 cfm. Reducing this flow of methane to a 1% concentration will require an airflow of 38,900 cfm.

**Actions taken after a silo explosion in British Columbia.** Stokes [1986] reported on the actions taken after an explosion at a closed-top silo in British Columbia, Canada. These postexplosion actions serve as a good model for mines desiring to prevent a methane explosion in a coal silo.

<sup>10</sup>If 41% of the coal pile is void space, the void space in the cubic meter would be 410 L and the concentration of methane in the void space would be 10.4/(410 + 10.4), equal to a calculated concentration value of 2.5%.

<sup>11</sup>A value of 35% may seem high, but Kolada and Chakravorty [1987] measured methane concentrations as high as 40% in a silo coal pile within an hour of filling the silo. These concentrations are not in the flammable range, but will become so when mixed with air. See the discussion on flammability in Chapter 1.

The coal had been surface mined. Surface-mined coal normally has a very low methane emission; however, the coal had been heated in a dryer<sup>12</sup> to remove moisture just before being loaded into the silo. The 24-hr conveyor belt grab sample emission was measured at 14 ft<sup>3</sup>/ton. Before the explosion, the top was ventilated with a 7,500-cfm wet dust scrubber system that operated only during loading. An unworkable<sup>13</sup> natural ventilation methane stack was located on the silo roof. There was also a methane detector at the roof of the silo (probably in a location where the methane did not accumulate).

After the explosion, the silo was put back into operation with these new methane control and damage prevention measures:

- Continuous ventilation was provided at the top. A 14,000-cfm dust scrubber system<sup>14</sup> operated when the silo was loading. When loading stopped, another fan, a 20,000-cfm forcing fan, automatically turned on, and this fresh air was deflected downward toward the coal surface.
- Other openings at the top were provided to supply fresh air in the event of fan failure.
- A new methane monitoring system that used several sensing heads was installed. Using several heads reduced the chance that a methane accumulation would be missed.
- A large portion of the roof was provided with a lightweight sheet metal cover that could provide some explosion relief without damage to the main structure of the silo.<sup>15</sup>

These measures provided for continuous ventilation in a quantity matched to the gas level and provided for monitoring in locations where methane was likely to accumulate. They considerably reduced the chance of a silo explosion.

## REFERENCES

AMCL [1985]. Survey of methane accumulation within coal silos. Calgary, Alberta, Canada: Associated Mining Consultants Ltd.

CFR. Code of federal regulations. Washington DC: U.S. Government Printing Office, Office of the Federal Register.

---

<sup>12</sup>Hot coals from the dryer were a probable source of the ignition. Hot coal detection systems can flag this problem and should be installed if the coal is gassy.

<sup>13</sup>The idea behind a natural ventilation methane stack is to use the density difference between methane and air to produce a chimney effect that ventilates the silo. However, neither the stack height nor the methane concentration at any silo would ever be high enough to make a natural ventilation methane stack function.

<sup>14</sup>Dust problems precluded the conversion to an open-top silo.

<sup>15</sup>The National Fire Protection Association has a guide for venting of deflagrations [NFPA 1998], i.e., methane and dust explosions.

Kolada RJ [1985]. Investigation into methane accumulation in coal storage silos. SME preprint 85-346. Littleton, CO: Society for Mining, Metallurgy, and Exploration, Inc.

Kolada RJ, Chakravorty RN [1987]. Controlling the hazard of methane explosions in coal storage facilities. In: Mutmansky JM, ed. Proceedings of the Third Mine Ventilation Symposium (University Park, PA, October 12-14, 1987), pp. 334-339.

LaScola JC, Matta JE, Kissell FN [1981]. Assessing the methane hazard of gassy coals in storage silos. Pittsburgh, PA: U.S. Department of the Interior, Bureau of Mines, RI 8525. NTIS No. PB81226920.

Matta JE, LaScola JC, Kissell FN [1978]. Methane emissions from gassy coals in storage silos. Pittsburgh, PA: U.S. Department of the Interior, Bureau of Mines, RI 8269. NTIS No. PB277912.

Mikhail MW, Patching TH [1980]. Size degradation of bituminous coal from western Canada. CIM Bull *May*:105-110.

NFPA [1998]. NFPA 68: Guide for venting of deflagrations. Quincy, MA: National Fire Protection Association.

Stokes DA [1986]. Fording Coal Ltd. silo explosion. CIM Bull 75(891):56-60.

## CHAPTER 12.—EXPLOSION HAZARDS OF COAL DUST IN THE PRESENCE OF METHANE

By Kenneth L. Cashdollar<sup>1</sup> and Michael J. Sapko<sup>2</sup>

### *In This Chapter*

- ✓ Methane ignition as initiation source for much larger secondary coal dust explosions
- ✓ Rock dusting requirements to prevent coal dust explosions
- ✓ Dangers of hybrid mixtures of methane and coal dust

Although methane explosions are dangerous, those that involve coal dust are even more so. If exploding methane disperses and ignites the coal dust that has accumulated on the mine ribs and floor, the burning coal dust immeasurably increases the strength of the explosion. Such methane-dust explosions are prevented by inerting the coal dust in a way that prevents the exploding methane from igniting it. This chapter discusses the dust hazard and how it is prevented in U.S. coal mines.

### METHANE IGNITION AS INITIATION SOURCE FOR MUCH LARGER SECONDARY COAL DUST EXPLOSIONS

The typical scenario for coal mine explosions starts with the ignition of a flammable methane-air atmosphere near the face. The turbulent winds from the primary methane explosion then disperse the coal dust. If there is insufficient rock dust (usually limestone), a secondary coal dust explosion then propagates throughout large sections of the mine. These scenarios have been studied extensively at the Bruceton Experimental Mine (BEM) and the Lake Lynn Experimental Mine (LLEM) of the NIOSH Pittsburgh Research Laboratory.

The minimum quantity of methane required to initiate a coal dust explosion was studied in 1930 in the BEM [Rice et al. 1933; Nagy 1981] and then later in the LLEM, whose cross-sectional area (130 ft<sup>2</sup>) is over twice that of the BEM [Sapko et al. 1987a]. Studies conducted in the BEM closely simulated conditions that existed in operating mines in the early 20th century. The later tests in the 20-ft-wide entries of the LLEM simulated the geometries of modern mines with advanced roof support technology.

The data from the BEM tests show that 13 ft<sup>3</sup> was the minimum quantity of methane at the face that, when ignited, would disperse and ignite coal dust. In the BEM, this amount of methane was mixed with air to form a total flammable volume of about 140 ft<sup>3</sup> of a 9% methane-in-air mixture. In the wider entries of the LLEM, about 37 ft<sup>3</sup> of methane was required to disperse pure coal dust and start a self-sustained coal dust explosion. This amount of methane was mixed with

---

<sup>1</sup>Research physicist.

<sup>2</sup>Research physical scientist.

Pittsburgh Research Laboratory, National Institute for Occupational Safety and Health, Pittsburgh, PA.



air in a 6-ft by 9-ft by 6.5-ft high plastic containment zone to form a total flammable volume of about 350 ft<sup>3</sup> of a 10% methane-air mixture. Based on the 54-ft<sup>2</sup> cross-section of the BEM and the 130-ft<sup>2</sup> cross-section of the LLEM, both of these methane-air volumes would correspond to a linear distance of about 2.5 ft from the face.

Although the entire cross-sections are used for this comparison, the actual methane-air zones in both the BEM and LLEM only partially filled the cross-sections. If obstacles were added to the methane zones to create turbulence, the methane explosions could be even more effective at dispersing coal dust. It should also be noted that these experimental mine tests were somewhat idealized conditions because there was no rock dust mixed with the coal dust, as would normally be the case under real mining conditions. In addition, the dust was all on shelves near the roof. This arrangement provided the easiest conditions for initiating a dust explosion. In a mine with rock dust added to the coal dust and with most of the dust deposited on the floor, more methane would be required to disperse and ignite the dust mixture.

## ROCK DUSTING REQUIREMENTS TO PREVENT COAL DUST EXPLOSIONS

**The primary method of preventing coal dust explosions in underground mines is to add sufficient amounts of an incombustible rock dust (usually limestone) to the coal dust. Then, even if the coal and rock dust mixture is dispersed into the air by a methane explosion, a secondary dust explosion will not occur. The rock dust acts as a heat sink to cool the explosion temperature below the temperature needed for continued propagation.**

30 CFR<sup>3</sup> 75.402 to 75.404 requires rock dusting in all underground bituminous coal mines:

All underground areas of a coal mine, except those areas in which the dust is too wet or too high in incombustible content to propagate an explosion, shall be rock dusted to within 40 feet of all working faces...Where rock dust is required to be applied, it shall be distributed upon the top, floor, and sides of all underground areas of a coal mine and maintained in such quantities that the incombustible content of the combined coal dust, rock dust, and other dust shall be not less than 65 per centum, but the incombustible content in the return aircourses shall be no less than 80 per centum.

The higher incombustible content required for returns is based on the finer size of coal dust found in returns. The regulations further state that—

Where methane is present in any ventilating current, the per centum of incombustible content of such combined dusts shall be increased 1.0 and 0.4 per centum for each 0.1 per centum of methane where 65 and 80 per centum, respectively, of incombustibles are required.

---

<sup>3</sup>*Code of Federal Regulations.* See CFR in references.

The above paragraph means that the incombustible content of the dust in intakes must be increased from 65% to 75% if the ventilating air contains 1% methane. Similarly, the incombustible content of the dust in returns must be increased from 80% to 84% if the ventilating air contains 1% methane. The incombustible content of the dust mixture includes the rock dust, the ash content of the coal dust, and the moisture content. These regulations are based on research conducted at the BEM [Rice and Greenwald 1929; Rice et al. 1933; Nagy 1981].

There is an additional hazard when the rock dust is not well mixed with the coal dust. If there is a thin layer of float coal dust (dust that has been carried and deposited by the ventilation air) on top of a thick layer of properly rock-dusted floor dust, a weak methane explosion may preferentially lift the top layer of coal dust. The explosion can then continue to propagate through and beyond the length of the float coal dust deposit. This has been demonstrated in full-scale experimental mine tests [Nagy et al. 1965; Sapko et al. 1987b].

### DANGERS OF HYBRID MIXTURES OF METHANE AND COAL DUST

Chapter 1 discusses the lower flammable limit (LFL)<sup>4</sup> for methane and some of the ways that methane can be ignited. With only methane present, the LFL is 5% methane in air. However, when coal dust is added to the methane-air mixture, the LFL of the mixture is reduced. This can occur at the mining face, where methane is being liberated and coal dust is being generated.

The Le Chatelier linear mixing law<sup>5</sup> for the LFL of gases is also roughly applicable to a hybrid mixture of methane gas and coal dust. Figure 12–1 shows flammable limit data from BEM tests

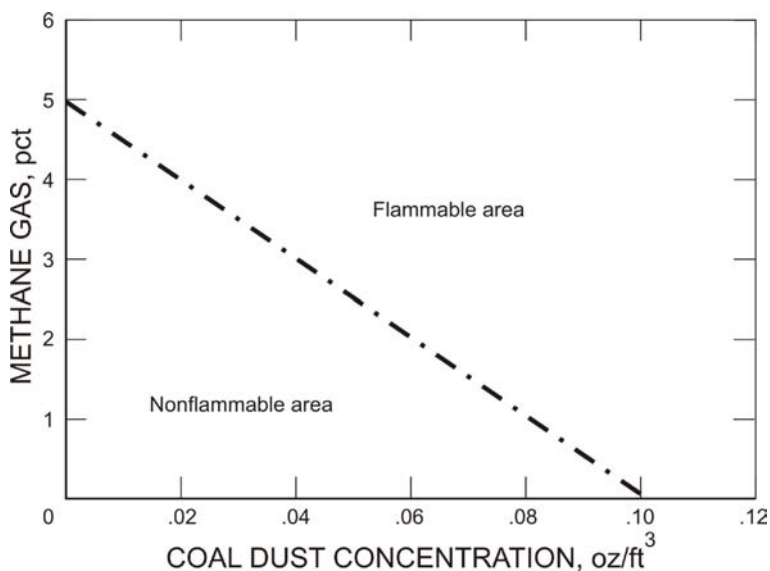

**Figure 12–1.—Flammable limits for mixtures of methane and coal dust.**

[Cashdollar et al. 1987] for coal dust dispersed with methane. Additional laboratory data [Cashdollar 1996; Cashdollar et al. 1987] confirm the roughly linear relationship for various coal dusts mixed with methane. In the example in Figure 12–1, the LFL of methane alone is 5% and the LFL of the coal dust by itself is 0.10 oz/ft<sup>3</sup>. It should be noted that this is only an example and that the LFL of various coal dusts will vary with the particle size and volatility. The area below and to the left of the dashed line in the figure represents nonflammable mixtures. The area above and to the right of the dashed line

<sup>4</sup>Also called the lower explosive limit (LEL).

<sup>5</sup>See the section entitled “Addition of other flammable gases to air” in Chapter 1.

represents flammable mixtures. For example, if 3.5% methane is present, then any coal dust concentrations above 0.03 oz/ft<sup>3</sup> are flammable when mixed with the methane. If 2% methane is present, then any coal dust concentrations above 0.06 oz/ft<sup>3</sup> are flammable. This means that, if sufficient coal dust is present, an ignition can still occur at the mine face even if the methane concentration is below the 5% LFL.

## REFERENCES

Cashdollar KL [1996]. Coal dust explosibility. *J Loss Prev Process Ind* 9(1):65–76.

Cashdollar KL, Sapko MJ, Weiss ES, Hertzberg M [1987]. Laboratory and mine dust explosion research at the Bureau of Mines. In: *Industrial dust explosions*. ASTM Special Technical Publication (STP) 958. West Conshohocken, PA: American Society for Testing and Materials, pp. 107–123.

CFR. Code of federal regulations. Washington DC: U.S. Government Printing Office, Office of the Federal Register.

Nagy J [1981]. The explosion hazard in mining. Arlington, VA: U.S. Department of Labor, Mine Safety and Health Administration, Informational Report (IR) 1119.

Nagy J, Mitchell DW, Kawenski EM [1965]. Float coal hazard in mines: a progress report. Washington, DC: U.S. Department of the Interior, Bureau of Mines, RI 6581.

Rice GS, Greenwald HP [1929]. Coal dust explosibility factors indicated by experimental mine investigations, 1911 to 1929. Washington, DC: U.S. Department of the Interior, Bureau of Mines, Technical Paper (TP) 464.

Rice GS, Greenwald HP, Howarth HC [1933]. Explosion tests of Pittsburgh coal dust in the experimental mine, 1925 to 1932 inclusive. Washington, DC: U.S. Department of the Interior, Bureau of Mines, Bulletin 369.

Sapko MJ, Hertzberg M, Watson RW, Cashdollar KL [1987a]. Dust explosion size scaling. In: *Proceedings of the Shenyang International Symposium on Dust Explosions* (Shenyang, China, September 14–16, 1987).

Sapko MJ, Weiss ES, Watson RW [1987b]. Explosibility of float coal dust distributed over a coal-rock dust substratum. In: *Proceedings of the 22nd International Conference of Safety in Mines Research Institutes* (Beijing, China, November 2–6, 1987).

## CHAPTER 13.—METHANE CONTROL IN METAL/NONMETAL MINES

By H. John Head, P.E., C.Eng.,<sup>1</sup> and Fred N. Kissell, Ph.D.<sup>2</sup>

### *In This Chapter*

- ✓ Gas reports from around the world
- ✓ Regulations for gassy mines in the United States
- ✓ Differences between metal/nonmetal mines and coal mines
- ✓ Monitoring for methane and taking action
- ✓ Diluting methane with additional ventilation
- ✓ Eliminating ignition sources
- ✓ What experienced mine operators say about methane control

### *and*

- ✓ Looking for methane when starting a new mine or expanding an existing mine

This chapter gives guidelines for preventing methane gas explosions during metal and nonmetal mine development and subsequent production operations.<sup>3</sup> Emphasis is placed on recognizing the differences between coal mines, where the potential for methane hazards is relatively well understood, and metal/nonmetal mines, where methane may accumulate unexpectedly. Also, interviews with experienced mine operators add much to a complete understanding of what must be done to address methane problems in metal/nonmetal mines.

### METHANE GAS IN METAL/NONMETAL MINES

**Gas reports from around the world.** The presence of methane gas in metal/nonmetal mines around the world is more common than one might imagine [Edwards and Durucan 1991]. For example:

- The former Soviet republics have occurrences of methane and hydrogen in apatite, gold, and diamond ores, where solid or liquid bitumen occurs in the rock.
- Scandinavian iron ore deposits include methane and other hydrocarbons in boreholes that intersect pitch and asphalt within the deposits, and methane and nitrogen in boreholes and fissures in arsenic and sulfide ores.

<sup>1</sup>Senior principal engineer, Continental Placer, Inc., Wheaton, IL.

<sup>2</sup>Research physical scientist, Pittsburgh Research Laboratory, National Institute for Occupational Safety and Health, Pittsburgh, PA (retired).

<sup>3</sup>Those mines extracting metallic ores such as copper or nickel are referred to as “metal mines.” Those mines extracting nonmetallic minerals such as salt, potash, trona, and limestone are referred to as “nonmetal mines.”

- In Eastern Europe, petroleum and gas has been observed in igneous and metamorphic rocks in Yugoslavia, in some copper mines in Hungary, and in mica schists containing limestone intrusions in Romania.
- In the United Kingdom, granites in Cornwall and Aberdeen and iron ore deposits in Cleveland all report hydrocarbon gases associated with overlying bituminous shales. Also, Derbyshire lead mines have reported methane along with bitumen.
- Canadian Shield mines contain methane, other hydrocarbons, and sometimes hydrogen and helium [Fritz et al. 1987; Andrews 1987]. These are widespread and occur in almost all the mines, particularly where carbonaceous materials are found in the rocks. The emissions are usually associated with boreholes [Sherwood et al. 1988] and are relatively short-lived and easily dissipated. The Kidd Creek mines have methane pockets associated with sulfide deposits. At some mines, the occurrences of methane and hydrogen increase with depth, and the resulting gas mixtures reduce the lower explosive limit to as low as 4.5%.<sup>4</sup> The Ontario Ministry of Labour (OML) has approximately eight reports per year of combustible gas in an underground working place [OML 1996]. These reports are almost always for boreholes, with measured concentrations of 0.1%–10%. Gas is very seldom detected in the general body of the mine's atmosphere, although methane ignitions due to cigarette smoking and friction between metal and sandstone have been reported to the OML.
- U.S. mines report methane emissions associated with oil shales, salt, trona, potash, limestone, copper, and uranium ores.
- In Australia, hydrocarbon gases are reported from copper mines and from Precambrian rocks at Kalgoorlie. The usual type of methane encounter is a diamond drill blower and methane is readily dispersed.
- The Republic of South Africa has combustible gases in almost all gold and platinum mines, as well as kimberlite pipes. Along with the methane, there can be hydrogen and helium. The usual assumption is that the methane is associated with overlying Karoo strata, which are coal-bearing [Searra 1990; Eschenburg 1980; Jackson 1957]. The gas is transported downward through the rock dissolved in water.

### **REGULATIONS FOR GASSY METAL/NONMETAL MINES IN THE UNITED STATES**

The United States developed new federal standards for controlling methane hazards in metal/nonmetal mines in 1985. These are contained in 30 CFR<sup>5</sup> 57, Subpart T—Safety Standards for Methane in Metal and Nonmetal Mines. Considering that there is such a wide variety of metal/nonmetal mines in the United States, these standards are quite comprehensive and detailed.

---

<sup>4</sup>For more information on the lower explosive limit, see Chapter 1.

<sup>5</sup>*Code of Federal Regulations*. See CFR in references.

Because of this, any discussion of controlling methane must first begin with a discussion of the regulations and their history.

The impetus for the revision to the standard, which previously had been based on the simple observation and measurement of methane in the mine atmosphere, was the Belle Isle Mine disaster of 1979 [Plimpton et al. 1979]. The Belle Isle Mine was an underground salt mine in a salt dome in southern Louisiana. The salt domes are known for their proximity to petroleum production facilities, with oil and gas often found in the sedimentary structures adjacent to the sides of the up-thrusting salt domes. The mine had produced gas intermittently for many years since it was opened in 1962. There had also been “outbursts”<sup>6</sup> of salt found after regular production blasts. What was not understood at the time was the mechanism for the release of huge quantities of methane gas from these outbursts. When postblast crew members went down into the mine after a blast at Belle Isle, an ignition source, possibly the diesel pickup truck that they were riding in, set off a massive explosion, killing all five members of the crew underground at the time.

Earlier, a gas explosion at the Cane Creek potash mine in Utah had occurred in 1963 wherein 18 miners were killed during development operations [Westfield et al. 1963]. Several of these miners survived the initial explosion itself, only to die in a barricaded dead-end drift when their oxygen supply ran out.

**Significantly, neither Belle Isle Mine nor Cane Creek Mine had reached the threshold of 0.25% methane in the general atmosphere of the mine (as required by the regulations of the time). Therefore, neither was considered to be a “gassy mine.”**

There is a wide variety of metal/nonmetal mines, with many different ways in which methane is released into the mine atmosphere. To address the numerous mine-specific potential methane hazards, the Mine Safety and Health Administration (MSHA) defined various categories of gassy mines (30 CFR 57.22003) in the 1985 federal standards, as summarized below.<sup>7</sup>

*Category I* applies to mines that operate within a combustible ore body and either liberate methane or have the potential to liberate methane. Within Category I, there are several subcategories, depending on the actual presence of methane gas (at 0.25% or more) or the occurrence of an ignition (Subcategory I–A) or not (Subcategory I–B). Subcategory I–C is intended to include the potential hazard from flammable dust. Category I applies mainly to oil shale and gilsonite mines.

---

<sup>6</sup>An outburst is a sudden, violent release of solids and high-pressure occluded gases, including methane, in a domal salt mine (30 CFR 57.22002).

<sup>7</sup>A precedent for developing gassy mine standards in this manner that took into account the different hazards associated with differing methane gas occurrences was found in Spanish mining regulations [Lumsden and Talbot 1983].

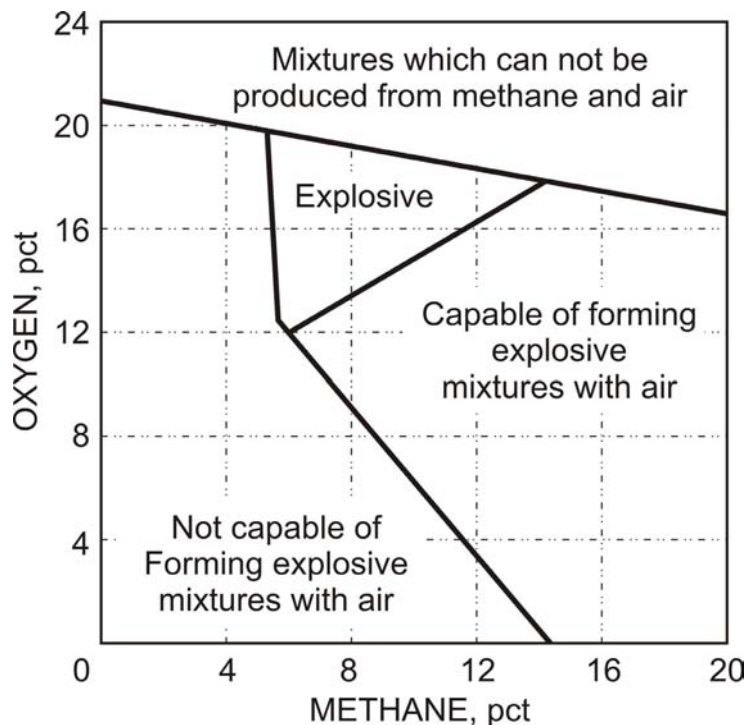

**Figure 13-1.—Relation between quantitative composition and explosibility of mixtures of methane and air (from 30 CFR 57.22003(3)).**

*Category II* applies to domal salt mines where the history of the mine or geological area indicates the occurrence of or potential for an outburst. As with *Category I*, there are two subcategories, depending on the occurrence of an outburst that released 0.25% or more of methane (*Subcategory II-A*) or not (*Subcategory II-B*).

*Category III* applies to mines in which noncombustible ore is extracted and which liberate a concentration of methane that is explosive, or is capable of forming explosive mixtures with air, or has the potential to do so based on the history of the mine or the geological area in which the mine is located. The flammability of the gas is determined by its position on Figure 13-1, an illustration contained at 30 CFR 57.22003(a)(3). *Category III* applies mainly to trona mines.

*Category IV* applies to mines in which noncombustible ore is extracted and which liberate a concentration of methane that is not explosive or capable of forming explosive mixtures with air. This somewhat unusual concept derives from the fact that New Mexico potash mines have methane contained within the clay and shale seams in the strata along with high percentages of inert nitrogen. The flammability of this gas mixture is determined by its position on Figure 13-1. *Category IV* applies mainly to potash mines.

*Category V* applies mainly to petroleum mines.

All mines that are not placed in any of the above categories or subcategories are considered to be *Category VI*, or nongassy, mines.

Each category (or industry sector) has its own set of requirements for monitoring and control measures. *Categories I, III, and V* most closely match coal mining standards, with fully permissible equipment in production settings. *Category II* recognizes that gas is only likely to be liberated in hazardous quantities during drilling, cutting, and blasting, so those activities are controlled. *Category IV* has few limitations, with monitoring of gas being the primary requirement.

## DEALING WITH METHANE IN METAL/NONMETAL MINES

**Dealing with methane in metal/nonmetal mines requires an understanding of five important issues:**

- 1. The differences between coal mines and metal/nonmetal mines, and recognizing why explosions happen even with low gas emission rates.**
- 2. How to monitor for gas and what gas concentrations require action.**
- 3. The importance of continuously diluting methane with ventilation air.**
- 4. The importance of eliminating all ignition sources.**
- 5. Avoiding outburst hazards.**

Although the regulations discussed in the previous section are important to preventing methane explosions in metal/nonmetal mines, they represent only a starting point in achieving a safe mine. A broader understanding of five important issues is necessary, which are detailed below.

**1. Why metal/nonmetal mines are different from coal mines.** Unlike coal mines, methane emission rates in metal/nonmetal mines are not consistent. This irregularity often makes an accumulation of methane an unexpected event, and an unexpected event by definition is difficult to anticipate.<sup>8</sup> Methane can be detected in coal mines everywhere and almost all the time; therefore, monitoring becomes a regular pattern of activity. Ventilation controls are rigorously maintained, and large quantities of ventilation air are blown through the mine to sweep the gas away. Permissible equipment is used to minimize ignition sources, and workers are constantly on notice that coal mines are potentially dangerous places. All of these factors lead to a constant awareness of the potential methane hazard, promoting consistent efforts to reduce the risk of an ignition or explosion.

By contrast, workers in metal/nonmetal mines may never detect methane gas or only encounter it infrequently. It is easy to become complacent, testing for gas in a cursory or offhand fashion, or not even bothering to test at all. Also, the same attention to ventilation controls is lacking, with series<sup>9</sup> ventilation circuits and recirculation being common practices.

**See Chapter 14 for a parallel discussion on ventilation controls. Poor ventilation allows for a dangerous accumulation of gas in a location where little to no gas had been previously detected.**

<sup>8</sup>In the manufacturing industry, quality inspections have recognized the problem of unexpected events, which is why deliberately faulty parts are slipped into an inspection line to keep the inspectors on their toes.

<sup>9</sup>In series ventilation, the return from one working area is used as the intake to the next one downstream.



## 2. Monitoring for gas and taking control measures.

**An important part of methane monitoring is knowing what control measures to take when gas is detected. The actions described here for methane testing are only a summary. For complete details, consult the Code of Federal Regulations.**

Metal/nonmetal mines with a history of gas emissions are already on notice that they have a methane problem. The U.S. regulatory standards have very specific monitoring requirements and actions to be taken depending on the category of mine and its methane history. These provide a good, commonsense approach to methane monitoring and control measures.

Those mines that liberate significant quantities of gas must monitor for it each shift in a preshift examination similar to that for coal mines (30 CFR 57.22226 and 57.22228). No testing is mandated for those mines where methane is not expected to be present, but there are action levels and prescribed actions when gas is detected at certain levels,<sup>10</sup> as follows:

*Actions at 0.25% methane:* If the mine had never before measured 0.25% or more or never had an ignition, then changes must be made to improve ventilation, and MSHA must be notified immediately.

*Actions at 0.5% methane:* Ventilation changes are required to reduce methane below 0.5%. In the meantime, depending on the category of mine, one or more of the following are necessary: electrical power must be deenergized, diesel equipment must be shut off or removed, and/or work must stop.

*Actions at 1.0% methane:* Ventilation changes are required to reduce the methane. In the meantime, depending on the category of mine, one or more of the following are necessary: all workers from the affected areas must be withdrawn except those needed to make the ventilation changes, electrical power must be deenergized, and/or diesel equipment must be shut off or removed.

All persons must be withdrawn from the mine if the 1.0% accumulation results from a main fan failure or if 1.0% is measured at a main exhaust fan.

*Actions at 2.0% methane:* Ventilation changes are required to reduce the methane, and all persons must be withdrawn except those necessary to make the ventilation changes. Depending on the category of mine, one or more of the following are necessary: MSHA must be informed, the methane must be reduced to below 0.5%, and/or the methane must be reduced to below 1.0%.

For all of the above scenarios, the mine category also impacts (1) the frequency and location of methane testing, (2) the use of atmospheric monitoring systems, (3) the use of methane monitors on mining equipment, and (4) whether explosion-proof electrical equipment is used, among other factors.

---

<sup>10</sup>Keep in mind that one needs to regularly test for gas only in the mine atmosphere, not in boreholes. Chapter 2 contains more information on sampling for methane.

In Canada, Ontario has similar requirements in Section 35 of its regulations for mines and mining plants under the Ontario Occupational Health and Safety Act [1990],<sup>11</sup> but with a few additional features (such as the need to provide written instructions), which makes Section 35 worthwhile to read. It is reproduced in Appendix A of this chapter.

**Chapter 2 gives more information on sampling for methane.**

**3. Diluting the gas with more ventilation.** Gas only presents a flammability or explosion problem in the explosive range: 5%–15% methane. If it is diluted with sufficient air, then it ceases to be an immediate hazard. The emphasis on adequate ventilation to dilute methane is specifically mentioned by knowledgeable mining operators.

In addition to diluting methane, it is important that the potential for layering of methane gas be eliminated.<sup>12</sup> Thus, fans must not only add air into the general body of the mine atmosphere, but must also stir up the air within a roadway or heading. Gas can collect in cavities in the roof or in the end of an inclined ramp or at the top of a raise, and the ventilation must be directed to stir this gas up and dilute it into the body of the mine atmosphere.

In the U.S. standards for gassy metal/nonmetal mines, several sections address airflow requirements:

30 CFR 57.22213 – Air flow (Category III mines).—The quantity of air coursed through the last open crosscut in pairs or sets of entries, or through other ventilation openings nearest the face, shall be at least 6,000 cubic feet per minute, or 9,000 cubic feet per minute in longwall and continuous miner sections. The quantity of air across each face at a work place shall be at least 2,000 cubic feet per minute.

This standard for Category III gassy mines includes all underground trona mines. These mines may experience gas emissions on a regular basis, so the standard provides a useful guideline for quantities and for the importance of those quantities to be directed at each workplace.

Another method of specifying airflow has been adopted in the standard for oil shale mines:

30 CFR 57.22211 – Air flow (Category I–A mines).—The average air velocity in the last open crosscut in pairs or sets of developing entries, or through other ventilation openings nearest the face, shall be at least 40 feet per minute. The velocity of air ventilating each face at a work place shall be at least 20 feet per minute.

<sup>11</sup>Section 35 applies wherever mining is being carried out and methane is likely to be present.

<sup>12</sup>More information on controlling with methane layers is presented in Chapter 1.

These mines typically have large openings, e.g., 25 ft high by 50 ft wide, and therefore slow air velocities despite relatively large air volumes. In this case, the standard recognizes that actual air velocity, rather than the total volume of air flowing in a mine roadway, provides the necessary turbulence to remove methane gas layers. A 20 ft/min flow in a 25-ft by 50-ft roadway translates to a total air volume of 25,000 ft<sup>3</sup>/min.<sup>13</sup> Obviously, a much smaller 6,000 ft<sup>3</sup>/min is required in the trona mines, which typically have smaller roadways, say, 12 ft high by 20 ft wide. In this case, the 6,000 ft<sup>3</sup>/min translates to a velocity of 25 ft/min.

A more general standard exists for mines experiencing gas emissions on an irregular or intermittent basis, such as salt and oil reservoir mines, along with mines containing combustible dust:

30 CFR 57.22212 – Air flow (I–C, II–A, and V–A mines).—Air flow across each working face shall be sufficient to carry away any accumulation of methane, smoke, fumes, and dust.

This is a “performance-oriented” standard that outlines the desired result: the airflow should “carry away any accumulation of methane.” The standard does not specify exactly what airflow quantities are needed to accomplish the desired result.

**The key to methane control is to dilute and render harmless the methane gas in the mine. Good ventilation is required to accomplish this.**

**4. Eliminating ignition sources.** Electric and diesel-powered mining equipment can provide the spark to ignite a gas explosion, and if this equipment is to be used in gassy atmospheres, it must be approved by MSHA. MSHA-approved diesel equipment is designed so that no external surface gets hot enough to ignite methane.

MSHA-approved electrical equipment can take two forms. “Intrinsically safe” equipment implies that no electrical spark will have enough energy to ignite a gas mixture. An example would be portable methane detectors. The electrical circuit in these detectors is designed not to provide a spark strong enough to ignite gas. The other form of approved equipment surrounds electrical circuits with an explosion-proof box. If gas enters the box and if it is ignited by sparking inside the box, the resulting explosion is contained within the box and cannot propagate into the external atmosphere.

One of the most common forms of removing ignition sources has nothing to do with equipment. In Category II–A (mainly domal salt) mines in the United States that are considered to be outburst-prone, all blasting is done with the mine evacuated of all personnel. Only when the mine is determined to be clear of gas, using remote methane monitoring systems, are workers allowed to enter the mine to conduct a preshift examination.

<sup>13</sup>Air volume (ft<sup>3</sup>/min) = Air velocity (ft/min) × roadway area (ft<sup>2</sup>).

**The most obvious ignition source has nothing to do with equipment. The thought of risking your life for a cigarette is dreadful to contemplate. Yet one of the recent U.S. mining disasters was almost certainly caused by a miner smoking in a coal mine. It takes continued vigilance by all miners to make sure that accidents like that never happen again.**

**Matches and other smoking materials must not be carried into mines where methane gas may be present.**

**5. Avoiding outburst hazards.** To avoid outburst hazards in domal salt mines, continuous mining machines used in these mines should be operated only in areas that are known to be relatively gas-free. This is because methane gas trapped within the salt mass can be at high pressure. This pressure represents a source of mechanical energy that could be suddenly released as an “outburst.” An outburst is a sudden, violent release of solids and high-pressure occluded gases.<sup>14</sup> The key word here is “occluded.” Typically, the gas is trapped in tiny pockets within the crystal structure of salt or voids of an impermeable rock mass. During a change in stress conditions, these pockets can link up, resulting in a significant volume of gas—at full lithostatic pressure—immediately beneath the surface. If the pressure is sufficient, the thin layer of containment is burst, releasing the gas amid a shower of broken rock. The secondary shock wave caused by this primary burst of gas sometimes starts a chain reaction, with several million cubic feet of gas and several thousand tons of rock being ejected, resulting in voids a hundred feet or more in height [Plimpton et al. 1979].<sup>15</sup> This is the reason for the precautions taken at the Boulby potash mine in the United Kingdom, where the excavation is required to stay well beneath potentially gas-bearing shale formations [Lumsden and Talbot 1983].

Outbursts can be triggered by the stress redistribution that follows blasting or excavation by continuous mining machines [Lumsden and Talbot 1983]. Blasting is performed only with workers on the surface; however, continuous mining machines require an operator. This is why continuous mining machines used in domal salt mines should be operated only in areas that are known to be relatively gas-free.

### **WHAT EXPERIENCED MINE OPERATORS HAVE TO SAY ABOUT METHANE CONTROL**

The perspective of experienced mine operators adds much to a complete understanding of what must be done to address methane problems in metal/nonmetal mines. In our discussions with operators of gassy mines, the one concern expressed by all was the need to be vigilant. Safety precautions can always be defeated by careless or foolish actions. Below are summaries of interviews with five such operators across the United States.

<sup>14</sup>More information on outbursts in domal salt mines is available from Iannacchione et al. [1984], Schatzel and Hyman [1984], Molinda [1988], and Grau et al. [1988].

<sup>15</sup>Small quantities of methane gas may also be liberated while drilling or undercutting in domal salt mines, thus the need for permissible equipment in Category II–A mines.

**Dave Graham** is the safety and health manager of General Chemical's trona mine in Green River, WY. This mine liberates large quantities of methane from the oil shales above and below the trona beds. Dave says that everyone knows what to do in "normal" mining operations, where continuous-reading methanometers keep track of gas levels. However, his concern is whether miners will recognize unusual and infrequent situations. Once they are aware of a hazard, they know what to do, but it may not be obvious that a hazard exists. Dave comments that "Miners can't let their guard down. They have to be constantly asking themselves, 'Will this situation create a hazardous buildup of gas?' "

**Charlie Young** is the plant manager of the Weeks Island Mine in New Iberia, LA, a large domal salt mine prone to gas outbursts. They blast with the mine evacuated and must test for gas remotely from the surface before sending miners back underground. Charlie concentrates on three approaches to methane control:

- *Ventilation.* The primary ventilation system must be capable of flushing out large quantities of gas if a methane outburst occurs after a remote blast, without the use of auxiliary ventilation, because the power to the mine is automatically deenergized by the mine-wide methane monitoring system.
- *Remote gas monitoring.* Remote gas monitoring depends on sensors placed close to the face line to detect gas concentrations well below the explosive limit (the sensors are sensitive to .01% methane).
- *Maintenance of permissible equipment.* Face and bench undercutting and drilling equipment, along with auxiliary face fans, must be approved by MSHA as permissible and maintained in approved condition.

**Rick Steenberg** is the mine manager of FMC's trona mine in Green River, WY. The mine is classified as a Category III gassy mine, so all production equipment must conform to MSHA standards of permissibility.

Rick is constantly aware of the need to make sure that methane is flushed out of the mine with adequate quantities of fresh air. Also, a comprehensive audit system designed to check the equipment for permissibility compliance has become institutionalized and has proven effective.

**Jim Lekas** owns and operates the ITM Mine in Vernal, UT, which produces gilsonite. Gilsonite is solid hydrocarbon resin, a black carbonaceous mass. Gilsonite mines include an additional hazard along with methane gas: the high flammability of the carbon-rich dust.

Jim emphasizes training to be alert for possible gas problems in poorly ventilated working places and to make sure that there is enough air to dilute any accumulations before hand-operated metal tools that could create sparks are used.

Ventilation is accomplished by introducing fresh outside air into the upper levels of active mining areas through surface-mounted, forced-air ventilating fans, with the pneumatic conveying system exhausting air from the lower levels back to the surface. The fans that provide the intake

air and the motive force for the pneumatic conveyors are all outside of the mine. No electric equipment is used in the mine, permissible or otherwise.

**Dick Heinen** is the manager of mines for the Intrepid potash mines in Carlsbad, NM. The potash mines have gas within the evaporite strata and are classified as Category IV gassy mines.

The noncombustible ore is extracted and liberates a concentration of methane that is not explosive or capable of forming explosive mixtures with air based on the history of the potash mines. However, gas accumulating in possible bed separations in the roof of the mine can provide additional pressure to cause slabbing in mine intersections.

Dick insists that pressure relief holes be drilled 20–27 ft deep in the roof of every intersection. These serve both as detectors for bed separation and also as gas relief vents. The mine checks for methane gas every shift in every panel. The measured gas levels are almost always below the detection levels of the instruments. Any gas coming from relief holes is effectively diluted by the mine's ventilation system.

### **LOOKING FOR METHANE WHEN OPENING A NEW OR EXPANDING AN EXISTING METAL/NONMETAL MINE**

From both safety and economic perspectives, when opening a new or expanding<sup>16</sup> an existing metal/nonmetal mine, it is critical to know whether methane will be present. For example, the presence of methane will impact ventilation design and permissible equipment purchases, two of the many items that will affect the safety and profitability of the mine. Answers can be provided by knowledge of the local geology and by gas testing.

**Knowledge of the local geology.** The most obvious source of information about the potential for gas in any new mine or new section of an existing mine is the geology and history of the area and any nearby mines. If mines that are geologically similar to the new mine have gas problems, then the new mine will almost certainly share in those problems.

If no mines exist in the area to allow for comparison, then other geological information should be studied. The key geological factors to look for are the presence of coal seams, carbonaceous shales, and other strata containing oil or gas production wells. All of these raise the risk of having gas in the mine. Methane originates from the decay of the carbonaceous materials inherent in coal seams, oil shales, and other carbon-bearing rocks. Methane is also embedded within the deep mantle rocks of the earth. It can be dissolved under pressure within water and other fluids and carried with them until the liquid emerges into an underground void. As the void is reached, the reduction in pressure releases the gas into the atmosphere. Methane can also remain in its gaseous form and migrate, independently of any carrier fluids, over great distances.

---

<sup>16</sup>This includes shaft excavation. For more information on controlling methane during shaft excavation, see Chapter 9.

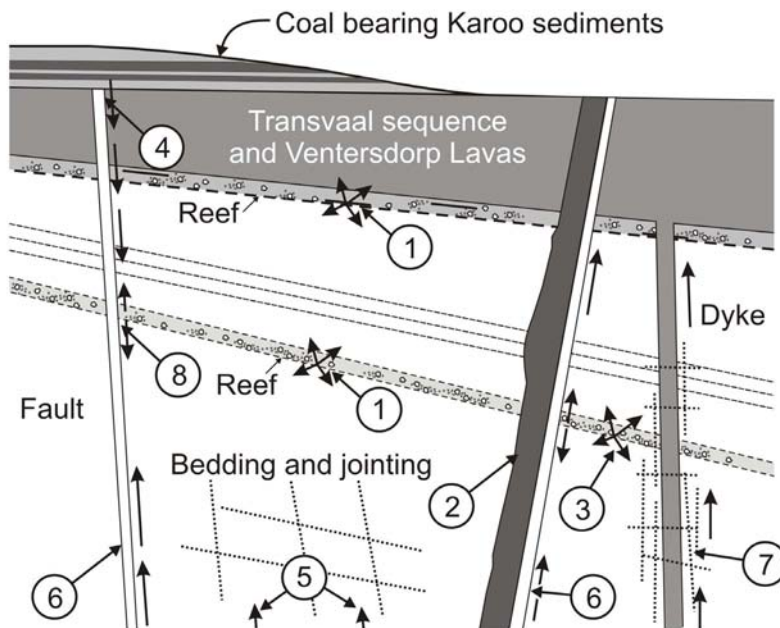

Figure 13-2.—Examples of methane emission as reported in South African metal/nonmetal mines [Cook 1998]. (Courtesy of SIMRAC.)

**KEY:**

- 1 - Associated with carbonaceous material in reefs.
- 2 - In inclusions in alkaline dykes (although unlikely in dykes generally).
- 3 - Thermogenic methane where dykes have heated carbon in reefs.
- 4 - Coal seams in overlying Karoo sediments, with transportation to Witwatersrand strata in solution in water via fault planes.
- 5 - General seepage of mantle methane via joints and bedding.
- 6 - Strong seepage of methane along major faults, which are often along dyke contacts.
- 7 - Collection of methane in highly jointed areas, e.g., adjacent to dykes.
- 8 - Seepage of methane from reef carbonaceous material into fault systems.

Methane can be carried in joints, faults, dykes, sills, and other geologic discontinuities. The more prevalent the discontinuities, the more permeable the rock and the greater the potential for gas storage and transportation.

Figure 13-2 illustrates most of the mechanisms for methane transport in South African mines. In Figure 13-2, emission source No. 1 results from the simple decomposition of the carbonaceous material in the gold ore body (the reef),<sup>17</sup> whereas No. 3 requires heat to release the methane gas from the carbon in the ore body. Nos. 2, 6, and 7 are variations on the same theme, without regard to the original source of the gas. Nos. 4 and 8 represent a common origin for methane gas in metal/nonmetal mines. The methane comes from coal or other carbonaceous seams and is carried into the mine via joints and faults. In the case of No. 4, the gas is carried in solution in the hot, pressurized ground water, but No. 8 shows the gas entering the mine via direct connections, such as geologic discontinuities or exploration drillholes.

<sup>17</sup>A “reef” is a lode or vein, a term commonly used in South Africa to describe the quartzite host rock for the flat-lying, gold-bearing formations.

Exploration drillholes can be a major conduit for gas migration. Typically, these will be drilled during the initial phases of opening up an ore body or new sections of the same ore body.<sup>18</sup> In at least one case in the United States, decades-old deep wells that had not been plugged properly may have provided a link between coal measures and permeable strata, which in turn funneled the gas into a major fault system. Gas subsequently entered the mine via water carried along a secondary fault that had branched off from the major fault zone.

**Gas testing.** Another primary task when opening up a new mine or expanding an existing mine is testing for methane gas at all stages in the exploration and development of the mine. Gas tests must be conducted at the collar of exploration drillholes<sup>19</sup> and at the roof of newly exposed faces. If no gas is found during those two stages, it is less likely to be present in the production phase of the mine's life. However, gas at just one drillhole or at one newly exposed face indicates a potentially larger gas problem. Immediate measures must be taken to confirm the presence of methane by laboratory analysis and to carefully sample all of the other drillholes and newly exposed faces that are part of the project.<sup>20</sup>

Methane can sometimes be associated with water in underground mines. Any gas bubbling from water coming from a fault zone or from pools of water collecting in the floor of the mine or tunnel should be sampled and analyzed for methane and other gases, such as carbon dioxide and hydrogen sulfide.

For mines where the presence of methane is not definitely established, Thimons et al. [1979] established a simple guideline that would enable mine personnel to evaluate the methane hazard. In their research, they measured trace methane concentrations in 53 metal/nonmetal mines, finding that mines with a return concentration exceeding 70 ppm of methane were inevitably classified as gassy.<sup>21</sup> Although a measurement of concentration alone is not the complete methane story, a return concentration exceeding 70 ppm should serve as an alert to the presence of gas that has not yet shown itself in other ways.

---

<sup>18</sup>In the Republic of South Africa, there has been considerable study of the occurrence of methane gas associated with gold mining in the Witwatersrand. The Chamber of Mines published a comprehensive text on mitigating gas problems entitled *Flammable Gas in Metal Mines: A Guide to Managers to Assist in Combating Flammable Gas in Metal Mines* [Association of Mine Managers 1989]. This guide contains specific sections on methane occurrence and detection, the prevention of flammable gas accumulations, ventilation systems, mining methods, equipment modifications, "hot work" permits, and the responsibilities of mine officials with regard to methane control.

<sup>19</sup>For more on sampling from boreholes, see Chapter 2.

<sup>20</sup>In addition to methane, laboratory analysis should test for other gases that may be flammable or toxic, such as ethane or hydrogen sulfide.

<sup>21</sup>In 1979, the MSHA classification system for metal/nonmetal mines with methane was different from the current standard. However, the triggers that lead to extra precautions (such as measurement of 0.25% or an ignition in the mine) are similar.



## REFERENCES

- Andrews JN [1987]. Noble gases in groundwaters from crystalline rocks. In: Saline water and gases in crystalline rocks. St. John's, Newfoundland, Canada: Geological Association of Canada, Special Paper 33, pp. 234–244.
- Association of Mine Managers [1989]. Flammable gas in metal mines: a guide to managers to assist in combating flammable gas in metal mines. Johannesburg, Republic of South Africa: Chamber of Mines of South Africa, Safety and Technical Services.
- CFR. Code of federal regulations. Washington DC: U.S. Government Printing Office, Office of the Federal Register.
- Cook AP [1998]. The occurrence, emission, and ignition of combustible strata gases in Witwatersrand gold mines and Bushveld platinum mines, and means of ameliorating related ignition and explosion hazards. Final project report, project GAP 504. Braamfontein, Republic of South Africa, Safety in Mines Research Advisory Committee (SIMRAC) ([www.simrac.co.za](http://www.simrac.co.za)).
- Edwards JS, Durucan S [1991]. The origins of methane. *Min Sci Technol* 12(2):193–204.
- Eschenburg HMW [1980]. Sources and control of methane in gold mines. *J Mine Vent Soc S Afr*, August.
- Fritz P, Frapce S K, Miles M [1987]. Methane in the crystalline rocks of the Canadian shield. In: Saline water and gases in crystalline rocks. St. John's, Newfoundland, Canada: Geological Association of Canada, Special Paper 33, pp. 211–223.
- Grau RH, Marshall TE, Finfinger GL [1988]. Evaluation of methane liberations from production blasts in domal salt mines. In: Proceedings of the Fourth International Mine Ventilation Congress (Brisbane, Queensland, Australia, July 3–6, 1988). Carlton, Victoria, Australia: Australasian Institute of Mining and Metallurgy.
- Iannacchione AT, Grau RH III, Sainato A, Kohler TM, Schatzel SJ [1984]. Assessment of methane hazards in an anomalous zone of a Gulf Coast salt dome. Pittsburgh, PA: U.S. Department of the Interior, U.S. Bureau of Mines, RI 8861. NTIS No. PB84214162.
- Jackson KAB [1957]. Methane on St. Helena Gold Mined Limited. Association of Mine Managers of South Africa.
- Lumsden AM, Talbot R [1983]. Develop data for review of metal and nonmetal mine methane hazard classification. Golder Associates, Inc. U.S. Bureau of Mines contract No. J010060. NTIS No. PB83258624.
- Molinda GM [1988]. Investigation of methane occurrence and outbursts in the Cote Blanche domal salt mine, Louisiana. Pittsburgh, PA: U.S. Department of the Interior, Bureau of Mines, RI 9186. NTIS No. PB90270083.

OML [1996]. Health and safety guidelines, draft #4. Sudbury Ontario, Canada: Ontario Ministry of Labour.

Ontario Occupational Health and Safety Act [1990]. Revised regulations of Ontario (R.R.O.) 1990, regulation 854, mines and mining plants. Part II, fire protection. Section 35. [[http://www.e-laws.gov.on.ca/DBLaws/Regs/English/900854\\_e.htm#BK3](http://www.e-laws.gov.on.ca/DBLaws/Regs/English/900854_e.htm#BK3)]. Date accessed: February 2006.

Plimpton HG, Foster RK, Risbeck JS, Rutherford RP, King RF, Buffington GL, et al. [1979]. Final report of mine explosion disaster, Belle Isle mine, Cargill, Inc., Franklin, St. Mary Parish, Louisiana, June 8, 1979. Arlington, VA: U.S. Department of Labor, Mine Safety and Health Administration.

Schatzel SJ, Hyman DM [1984]. Methane content of Gulf Coast domal rock salt. Pittsburgh, PA: U.S. Department of the Interior, Bureau of Mines, RI 8889. NTIS No. PB85109593.

Searra JA [1990]. Gas-related problems in the Witwatersrand supergroup [Thesis]. Johannesburg, Republic of South Africa: University of the Witwatersrand.

Sherwood B, Fritz P, Frappe SK, Macko SA, Weise SM, Welhan JA [1988]. Methane occurrences in the Canadian shield. *Chem Geol* 71(1–3):223–236.

Thimons ED, Vinson RP, Kissell FN [1979]. Forecasting methane hazards in metal and non-metal mines. Pittsburgh, PA: U.S. Department of the Interior, Bureau of Mines, RI 8392. NTIS No. PB80100696.

Westfield J, Knill LD, Moschetti AC [1963]. Final report of major mine explosion disaster, Cane Creek mine, Potash Division, Texas Gulf Sulphur Company, Grand County, Utah, August 27, 1963. Washington, DC: U.S. Department of the Interior, Bureau of Mines.

**APPENDIX A.—ONTARIO OCCUPATIONAL HEALTH AND SAFETY ACT**  
**R.R.O.<sup>22</sup> 1990, REGULATION 854**  
**MINES AND MINING PLANTS, SECTION 35**

**35.** (1) If a flow of flammable gas is encountered in a mine or in an enclosed building housing a diamond drill on the surface and the concentration of the flammable gas is *unknown*<sup>23</sup>,

- (a) all sources of ignition in the affected area shall be eliminated;
- (b) all electrical equipment in the affected area shall be de-energized;
- (c) the affected area shall be evacuated;
- (d) precautions shall be taken to prevent persons from entering the affected area inadvertently;
- (e) a supervisor shall be notified;
- (f) the affected area shall be tested by a competent person; and
- (g) the affected area shall be designated as a fire hazard area. O. Reg.<sup>24</sup> 236/99, s. 3.

(2) Subject to subsections (3), (4) and (5), work may resume if the concentration of flammable gas is below 1.0 per cent. O. Reg. 236/99, s. 3.

(3) If the concentration is less than 0.25 per cent and the affected area is tested periodically to ensure that the level of concentration is known, no precautions are required. O. Reg. 236/99, s. 3.

(4) If the concentration is 0.25 per cent or greater but not more than 0.5 per cent, all of the following precautions shall be taken:

1. The supervisor shall provide written instructions of any special precautions.
2. The instructions, if any, shall be communicated to the workers.
3. The affected area shall be designated as a fire hazard area.
4. The affected area shall be tested at least once per shift before work begins and, again, on release of any further flow of gas.
5. A flammable gas detector shall remain in the affected area for the purpose of continued testing. O. Reg. 236/99, s. 3.

---

<sup>22</sup>Revised Regulations of Ontario (Canada).

<sup>23</sup>Emphasis ours.

<sup>24</sup>“O. Reg.” stands for Ontario Regulation.

(5) If the concentration is 0.5 per cent or greater but not more than 1.0 per cent, all of the precautions set out in subsection (4) shall be taken and the electrical equipment, diesel engines, tools and other material used in the workplace shall be designed to function safely in a flammable gas atmosphere. O. Reg. 236/99, s. 3.

(6) If concentrations of flammable gas exceed 1.0 per cent in an area, all of the following precautions shall be taken:

1. All sources of ignition in the affected area shall be eliminated.
2. All electrical equipment in the affected area shall be de-energized.
3. All persons, other than competent persons necessary to measure the concentration of flammable gas and to make ventilation changes, shall be removed from the affected area. O. Reg. 236/99, s. 3.

(7) In mines where flammable gas is known to occur, workers who are underground or diamond drillers who are on the surface shall be advised of,

- (a) the probability of encountering a flow of the gas; and
- (b) the measures and procedures prescribed in this section. O. Reg. 236/99, s. 3.

(8) For the purposes of this section, the concentration of flammable gas means the percentage, by volume, of flammable gas in the general atmosphere. O. Reg. 236/99, s. 3.



## CHAPTER 14.—PREVENTING METHANE GAS EXPLOSIONS DURING TUNNEL CONSTRUCTION

By Fred N. Kissell, Ph.D.<sup>1</sup>

### *In This Chapter*

- ✓ Early indicators of a gas problem
- ✓ How the methane hazard is reduced
- ✓ Ventilation principles for gassy tunnels
- ✓ Monitoring for gas
- ✓ Eliminating ignition sources

*and*

- ✓ The all-important human factors component

This chapter gives guidelines for preventing methane gas explosions during tunnel construction. Emphasis is placed on assessing the hazard potential, on ventilation principles, and on monitoring for gas.

The chapter also emphasizes the importance of human factors in reducing explosion risk. Ensuring safe conditions is much more than just good engineering design. It also involves the everyday vigilance of those working underground. This does not imply that the engineering design can be ignored, only that the job of providing safe conditions has just begun with design.

### EARLY INDICATORS OF A GAS PROBLEM

For the engineer planning a tunnel project, reliable early indicators of methane are scarce. However, the local geology can often provide some information.<sup>2</sup> Carbonaceous rocks and tar sands are a likely methane source. Gas is also a distinct possibility if it is known to be present elsewhere in the same sequence of geologic formations. Swampy areas, sewerage systems, and landfills are also candidates because the decomposition of organic materials produces methane. The gas in a tunnel can originate in the strata being excavated, or it can migrate a considerable distance from adjacent strata.

Test borings at the project site can also serve as initial indicators of gas. Methane has no odor, but may be emitted along with gases that do. If gas is emitted from the borehole, a sample may be collected by inserting a tube into the hole as far as possible and pumping the gas out. The gas sample should be collected in a sampling bag or canister for later analysis by a chemical laboratory.<sup>3</sup>

---

<sup>1</sup>Research physical scientist, Pittsburgh Research Laboratory, National Institute for Occupational Safety and Health, Pittsburgh, PA (retired).

<sup>2</sup>A good source of information on hazardous ground gases is Doyle [2001].

<sup>3</sup>Most handheld methane detectors require the presence of 10% oxygen in the sample to operate properly, and this much oxygen is not normally found in borehole samples. For more information on methane detection, see the sampling chapter (Chapter 2).

Gas flowing from just one test boring indicates a potentially larger gas problem. Immediate measures must be taken to confirm the presence of methane by laboratory analysis and to sample all of the other boreholes that are part of the project. In addition to testing for methane, laboratory analysis should also test for other gases that may be flammable or toxic, such as ethane or hydrogen sulfide.

## INDICATORS OF GAS UNDERGROUND

**In tunneling and hard-rock mining, methane is not normally encountered. Therefore, the mistaken inclination is to not suspect the presence of gas.**

There have been many methane explosions in places where the existence of gas was never suspected or was thought to be minimal. A basic problem is that the commonly used catalytic detectors are not very good at detecting very low concentrations of gas. Figure 14–1 illustrates a representative situation (the ventilation quantities in the figures are only provided as examples). In this figure, the main tunnel fan moves air at a rate of 10,000 cfm and the scavenger fan moves air at 5,000 cfm. Methane gas enters the tunnel at the face at a rate of 1 cfm. First, the gas concentration is measured in the main fan line. With 1 cfm of methane in 10,000 cfm of air, the concentration will be 1/10,000, or 0.01%. Next, the methane concentration in air returning from the scavenger fan duct is measured; here, the concentration is 1/5,000 or 0.02%. With most commonly used catalytic detectors, these low percentages will show up as zero. However, even if methane were detected, such low concentrations would usually be considered negligible.

Is this level of gas hazardous? Obviously not under the conditions in which the measurements were made. However, consider the following scenario. The 5,000-cfm scavenger ventilation goes off for 10 min because of an electrical problem. Ten cubic feet of methane then accumulates in the face area. This quickly dilutes to 100 ft<sup>3</sup> of a 10% methane explosive mixture, and thus an explosion occurs in a tunnel where no one had initially measured any gas.

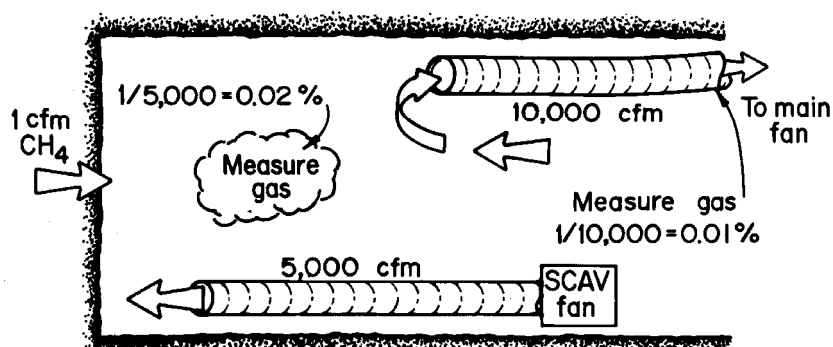

Figure 14–1.—Low concentrations of methane gas.

This might sound far-fetched, but many workers have died under very similar circumstances. Gas checks had been made when the ventilation system was working well. Later, the ventilation failed for some reason, and lethal quantities of gas accumulated, causing an explosion.

**Ways to confirm the presence of gas underground.** Given that low emissions of methane can be hazardous, how does one determine if there is a potential methane problem, assuming that there were no clues from exploration boreholes? There are three possible ways.

1. *Look for gas in the parts-per-million range.* When testing for methane gas, return air samples should be collected in a bag or bottle specially designed for gas sampling. A laboratory analysis that uses a chromatograph to look for gas in the parts-per-million range is then conducted. Applying this method to the scenario in Figure 14–1, the return air sample would have shown 100 ppm, a definite indicator of gas in low quantities.<sup>4</sup> When sampling, the ambient air on the surface should also be measured, as it generally contains a few parts per million of methane.

2. *Hunt for gas when ventilation is temporarily off.* It is common for tunnel ventilation systems to be down for short periods while fan changes are being made or ductwork extended. Because even low gas emissions accumulate to measurable levels quickly, this is an opportune time to hunt for gas accumulations with a handheld methane detector. If gas has already been shown to exist, this hunt is an important safety measure.

3. *Look for gas in those places where it is most likely to accumulate.* Gas emitted at the face will accumulate in unventilated corners near the face. Emissions from small cracks or fissures near the crown may produce a methane layer there because methane is much lighter than air. In operations using a tunnel boring machine (TBM), gas accumulations near the muck discharge point are likely. If the tunnel is unlined, any location along the entire length is a potential site for a methane layer at the crown.

As with surface samples, the initial presence of gas underground must be confirmed to a higher level of accuracy by laboratory analysis. If a field instrument shows that gas is present, an air sample must be collected in a bag or bottle specifically designed for gas sampling. The analysis is normally conducted with a carefully calibrated gas chromatograph. To be effective, the hunt for gas in tunnels must be conducted at frequent intervals. This is the only way to detect gas in isolated pockets. If the presence of gas is suspected but not yet confirmed, the tunnel air should be tested for methane with a handheld instrument at least twice per shift.

## PROVIDING ADEQUATE VENTILATION

**Ample dilution to safe levels.** Enough ventilation air must be provided to immediately dilute the methane gas to safe levels as soon as the gas enters the tunnel. Methane is combustible when mixed with air in the range between 5 and 15 vol % of gas. The 5 vol % value is the lower explosive limit (LEL). Methane concentrations in air that are below the LEL are not explosive. The 15 vol % value is the upper explosive limit. Gas mixtures with concentrations above this limit are not explosive, but may become so if mixed with more air.

---

<sup>4</sup>Low levels of methane gas have been found in a wide variety of hard-rock and noncoal mines. For mines classified as gassy by the Mine Safety and Health Administration, Thimons et al. [1979] found that the return air methane concentrations were 70 ppm or higher. No similar research on methane has been conducted in tunnels, but there is little doubt that a comparable value in a return airflow of 10,000 cfm would show hazardous quantities of gas.



**Simultaneous application of three basic elements reduces the methane hazard:**

- **Adequate ventilation.**
- **Regular monitoring of air quantities and gas concentrations, with automatic equipment shutoff at high gas concentrations.**
- **Elimination of ignition sources, including those that are worker-related.**

**The simultaneous application of several elements is necessary because if one fails, the others continue to ensure safety.**

When methane is emitted from the strata, it is usually at high concentration. As it progressively mixes with air, the concentration will pass through the explosive range and down below the LEL. A good ventilation system will supply enough fresh air to reduce all of the gas to far below the LEL as soon as the gas is emitted from the strata.

In referring to gas concentrations, different government agencies may use different terminology. For example, in regulating coal mines, the Mine Safety and Health Administration (MSHA) specifies that the concentrations of methane at coal mine working faces remain below 1.0 vol %. This is the same as 20% of the LEL. With the LEL of methane in air at 5 vol %, 20% of 5 vol % is 1.0 vol %. Specifying a percentage of the LEL is advantageous when mixtures of flammable gases are emitted.

**Main ventilation systems.** Main ventilation systems carry air from the portal into the TBM trailing gear. These are classified as either blowing or exhausting. In blowing systems, fans located on the surface and along the ductwork push air through the ductwork into the tunnel. In exhaust systems, air in the ductwork flows out of the tunnel. Each system has its advantages. Selection of either an exhaust or a blowing main ventilation system will depend on whether a face shield and scrubber are used, on whether or not a scavenger system is used, and on the type of ductwork used.<sup>5</sup>

**Face ventilation systems.** Face ventilation systems carry air from the trailing gear to the face of the tunnel where rock is broken and removed. In most instances, the primary source of gas is at the face, so it is vital to provide adequate ventilation air all the way to the face, that is, to the *last foot*.<sup>6</sup> For this reason, the ventilation focus of this chapter is on face ventilation.

<sup>5</sup>When planning a tunnel ventilation system, make a simple diagram of all ductwork and airflow movement to ensure that the ventilation mistakes described in this section are not incorporated into your plans.

<sup>6</sup>In some instances it is also necessary to focus attention on the muck discharge point. For example, in earth pressure balance machines most of the methane may be released at the end of the screw conveyor. A nearby fan or compressed air venturi can be used to dilute this gas, but does not relieve the need to provide adequate ventilation all the way to the *last foot*.

The tunnel face is usually ventilated with much less air than you think. If 20,000 cfm goes down the shaft but only 2,000 cfm reaches the face, then as far as methane control is concerned the tunnel is being ventilated with only 2,000 cfm.

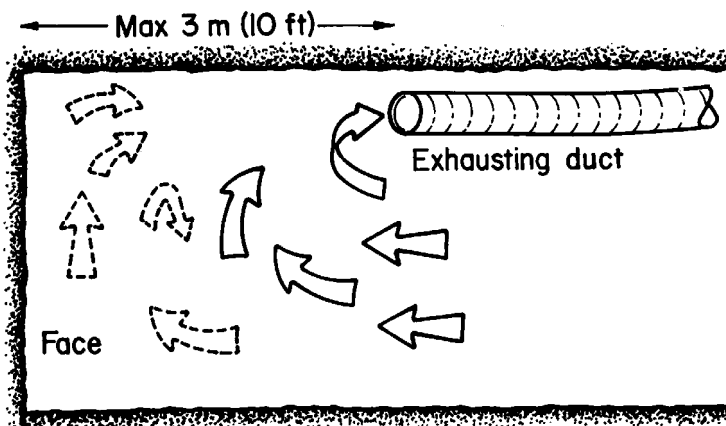

Figure 14-2.—Exhausting system of face ventilation. For clarity, the equipment is not shown.

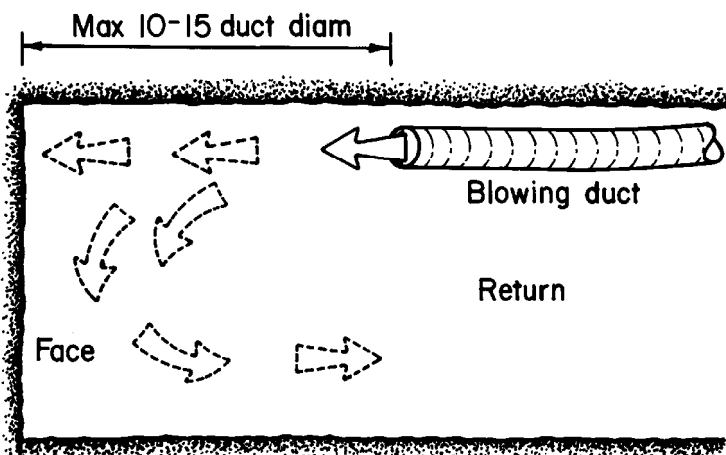

Figure 14-3.—Blowing system of face ventilation. If the blowing duct diameter is 2 ft, the maximum distance from the face would be 20-30 ft.

There are two categories of face ventilation: exhausting (Figure 14-2) and blowing (Figure 14-3). The exhausting system is the less efficient in clearing out gas from the face. For example, the face ventilation effectiveness<sup>7</sup> (FVE) of a 10,000-cfm, 24-in-diam exhaust duct located 10 ft from a mine face is only about 0.10. In other words, the concentration of methane measured near the face is 10 times higher than the concentration in the air passing through the duct [Wallhagen 1977]. If the end of the exhaust duct is more than 10 ft from the face, the FVE is even less. Therefore, the end of an exhaust duct must always be 10 ft or less from the tunnel face unless other means are used to ventilate the face, such as venturi air movers powered by compressed air.

Blowing face ventilation (Figure 14-3) is better for clearing out gas than exhaust ventilation because the momentum of the air in a blowing jet carries it farther. However, blowing systems also lose effectiveness as the face-to-duct distance increases. The duct must be kept as close to the face as possible, with the end of the

<sup>7</sup>FVE is an indicator of the proportion of air reaching the last foot, i.e., a distance of 1 ft from the face.

duct not more than 10–15 duct diameters from the face. There also must be no obstructions that would prevent the emerging jet of air from reaching the face.

Studies of blowing ventilation at coal mine faces show that the FVE for a 10,000-cfm, 24-in-diam blowing duct at 20 ft (10 duct diameters) is about 0.40, indicating that the concentration at the face is 2.5 times that in the return [Wallhagen 1977]. Thus, although 10,000 ft<sup>3</sup> of air emerges from the duct per minute, only 4,000 ft<sup>3</sup> of air actually reaches the face. If the face emits 20 ft<sup>3</sup> of gas per minute, the average concentration in the immediate face area will be 20/4,000 or 0.5%, rather than 20/10,000 or 0.2%.

Whether exhausting or blowing ventilation is used, the end of the duct should be kept as close to the face as possible. If the face is drilled and blasted, keeping the ductwork in place is particularly difficult. Blast shields can help, but may hinder clearing the face. It is sometimes possible to move flexible ductwork forward and back on a trolley wire. Another possibility is inflatable cloth ductwork, which is inexpensive and may be considered expendable. Whatever method is used, when methane is present the need to keep the ventilation ductwork within the required face distance cannot be ignored, regardless of cost or inconvenience.

**Which face ventilation system is best?** In principle, blowing ventilation systems provide better dilution of methane at the face, but it does not always follow that it is better to use blowing face ventilation in a tunnel. For example, Figure 14–4 illustrates the face ventilation of a small-diameter TBM with an enclosed cutter head. In this example, 5,000 cfm is withdrawn from the cutter head enclosure through duct #1. An airflow above 5,000 cfm would be better, but there is not space for larger ductwork at the front of the TBM. So, an additional 5,000 cfm is provided with a second ventilation duct (duct #2) that extends to the front of the trailing gear and blows air toward the face.

The problem with this system is that it has equal duct airflows moving in opposite directions, leading to a stagnant zone of low airflow (see Figure 14–4) where methane may accumulate. Also, it only delivers 5,000 cfm to the face, even with the two ducts. To avoid zones of low airflow, ventilation designs that move air through ductwork in opposite directions should be avoided. To demonstrate, if ventilation duct #2 exhausted air from the face instead of blowing toward it (as shown in Figure 14–5), then the front of the tunnel would be ventilated with

10,000 cfm of air instead of 5,000 cfm, and there would be no zone of low air movement.

In this example, venturi air movers powered by compressed air are used for additional air movement in the space between the end of duct #2 and the cutter head enclosure.

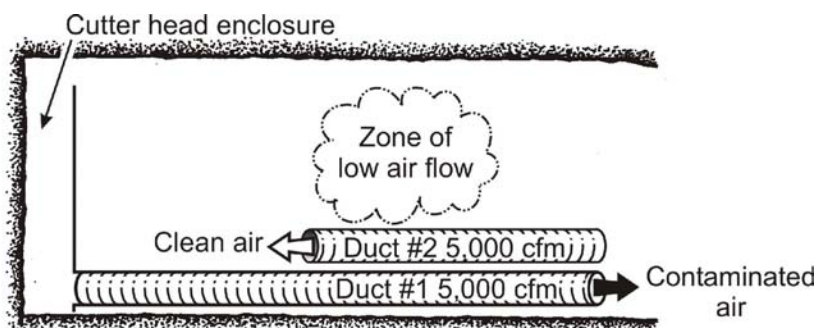

Figure 14–4.—TBM ventilation system with low airflow zone where methane dilution suffers.

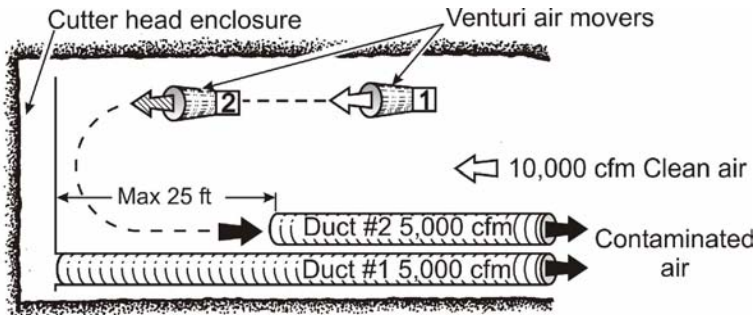

Figure 14-5.—TBM ventilation system with second duct exhausting air from the face. Venturi air movers provide additional air movement.

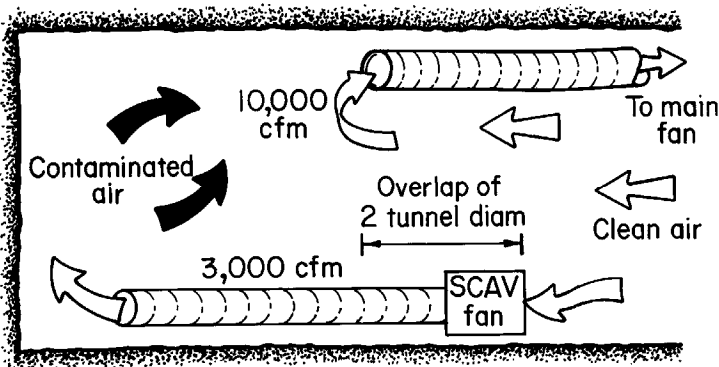

Figure 14-6.—Auxiliary system with adequate overlap (not to scale).

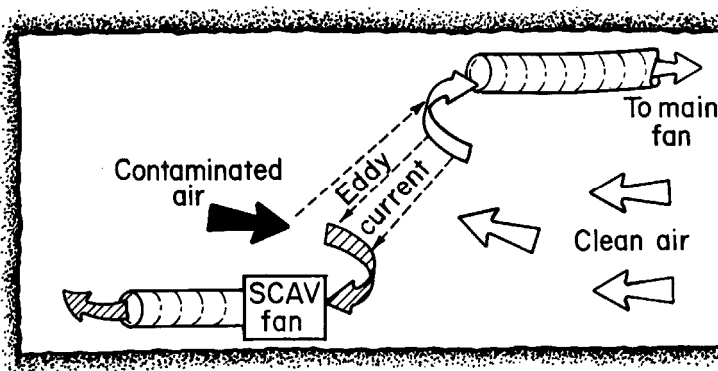

Figure 14-7.—Auxiliary system with no overlap and poor methane dilution.

dilute methane. To prevent this scenario, the two ducts must overlap by at least twice the tunnel diameter (Figure 14-6).

**Auxiliary face ventilation systems.** A common way to ventilate the tunnel face is to use an auxiliary ventilation system (Figure 14-6). Auxiliary face ventilation systems ventilate the tunnel face with a fan and duct that are separate from the main ventilation system. Auxiliary systems are often called scavenger fans.

A critical feature of auxiliary systems is the required overlap with the main ventilation duct, since auxiliary systems that do not overlap properly suffer huge efficiency losses. Figure 14-6 shows a simple two-duct auxiliary system that is working properly. The main duct is on exhaust, with the fan on the surface; the scavenger, or auxiliary fan, is blowing toward the face. Note that the inlet of the scavenger fan is in the fresh air stream of the main ventilation duct. Figure 14-7 shows the same arrangement, but with no overlap. The inlet of the scavenger fan picks up contaminated air returning from the face rather than fresh air, creating recirculation. Eddy currents between the two inlets provide the only air to the face, greatly reducing the amount of fresh air available to

Unfortunately, overlap is not something that can be engineered into the system from the start. New sections of fan line must be promptly added as the tunnel advances. Adequate overlap is maintained only through continued around-the-clock vigilance of the tunnel crew. For this reason, it is a major problem area.

With auxiliary systems, ventilation efficiency also suffers when airflow directions are not coordinated. Figure 14–8 depicts a scenario in which the airflow directions are not coordinated. Figure 14–8 is similar to Figure 14–6 except that the main duct is now blowing. The scavenger fan inlet is now in the contaminated return air, and contaminants are recirculated back to the face. The impact is that the fresh air reaching the face is reduced by up to one-half. Whatever the arrangement of ducts and fans, workers must check carefully to be sure that fresh air is not being replaced by recirculated air (see footnote 5).

**A scavenger fan with inadequate overlap can recirculate 90% of the air returning from the face. In such an instance, a 3,000-cfm scavenger fan will deliver only 10% or 300 cfm of fresh air to the face.**

**Minimizing leakage.** Leakage in both main and face ventilation systems is another source of airflow losses. Factors that impact leakage are fan placement, ductwork diameter and length, pressure drop, and duct condition. It is not unusual to lose half of the airflow in a long run of ductwork. In planning, the largest practical diameter of ductwork should be used. Damaged ductwork should never be installed, particularly if the ends are buckled.

Another major source of leakage (and recirculation) is the “trombone” section in the trailing gear, where concentric ventilation ducts slide apart and new sections of duct are added as the trailing gear moves forward. Recirculation of contaminated air can be particularly high as new sections of ductwork are added. This leakage and recirculation may be minimized by locating fans on both sides of the trombone section and balancing the fan flows to minimize the pressure drop between the air passing through the trombone and the outside tunnel air.

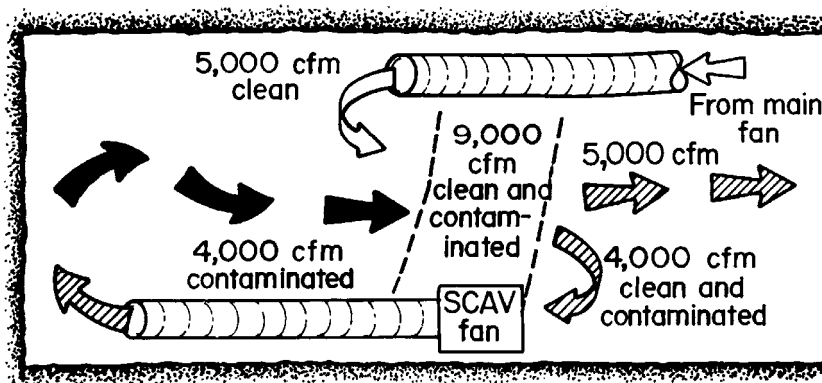

Figure 14–8.—Loss of efficiency from mismatched airflow directions.

drop between the air passing through the trombone and the outside tunnel air.

**Cumulative ventilation inefficiencies.** Cumulative ventilation inefficiencies include leakage in the main duct, leakage at the trombone connection, auxiliary system problems, and low face ventilation effectiveness because the end of the ductwork is too far from the

face. While one of these elements alone may not be significant, the cumulative effect of several will certainly be.

**Venturi air movers.** Compressed air is ineffective as a primary fresh air source because it cannot deliver enough air for adequate dilution of gas. However, there are some circumstances where compressed air can serve as an adjunct to conventional ventilation, particularly to enhance the air velocity over short distances. For example, if an exhaust ventilation system is being used, a venturi-type air mover powered by compressed air can provide better dilution of methane at the face, *provided* that the air mover is located in fresh air.<sup>8</sup>

A good way to align venturi air movers is shown in Figure 14–5. Here the air movers are placed on the opposite side from the exhaust duct so as to generate a U-shaped airflow pattern that feeds contaminated air to the duct inlet. Note in Figure 14–5 that venturi #1 is outby the inlet of duct #2 and is in the 10,000-cfm fresh air stream produced by both ducts #1 and #2. Also, venturi #2 is placed directly forward of venturi #1.

Venturi systems will recirculate a high proportion of the airflow, and the amount of recirculation will grow as the distance and the number of venturis grow. As a result, a venturi system is not effective for distances over 25 ft, as indicated in Figure 14–5.

**Checking the ventilation system.** To adequately check the ventilation system, a regular program of airflow measurements must be used, with airflows measured at least weekly. Airflow in all ducts must be measured, along with the airflow in the center line of the tunnel. Even if there are no leaks, it is common for ductwork to be clogged with muck.

**Tunnel workers should always be on the lookout for ventilation danger signals. Does ventilation duct always extend throughout the tunnel and close to the face? Is there always an adequate overlap? Is the ductwork sealed against leaks? Are the fans always running? Unless the tunnel has a diameter of 20 ft or more, is there obvious air movement everywhere in the tunnel? Is the air unusually warm or dusty?**

## MONITORING FOR METHANE

If methane is found, either at boreholes or during tunnel construction, regular monitoring must be scheduled. The most likely place to find methane is in the face area of the tunnel.<sup>9</sup> Gases emitted at the face will collect there in unventilated corners. Emission from feeders or faults near the crown may produce a methane layer there, particularly in unlined tunnels. On faces that are drilled and blasted, workers must check for methane before blasting. If a TBM is being used,

<sup>8</sup>Venturi air movers must be grounded to prevent the buildup of static electricity.

<sup>9</sup>There may be exceptions. See footnote 6.

methane can accumulate at the muck discharge and behind the face shield. Finally, workers should also check for gas before and during welding and cutting operations.

In tunnels known to have methane, preshift and midshift gas checks are minimum requirements. The frequency of other checks depend on whether continuous detectors are also present, the extent of the hazard, and the applicable regulations. The Occupational Safety and Health Administration (OSHA) safety and health standards for underground construction [29 CFR<sup>10</sup> 1926.800] require continuous monitoring when rapid TBMs are used. Other flammable gas requirements from 29 CFR 1926.800 are as follows:

<i>When an air sample indicates—</i>	<i>The necessary action is—</i>
5% or more of the LEL	Increase ventilation, control gas. <sup>1</sup>
10% or more of the LEL	Suspend hot work such as welding or cutting.
20% or more of the LEL	Cease work, cut power, withdraw employees. <sup>2</sup>

<sup>1</sup>A flammable gas concentration of 5% of the LEL or higher (0.25 vol % of methane) indicates an action level to take improved safety measures. OSHA requires steps to increase ventilation air or otherwise control the gas in such cases. However, it is wise to also implement a better monitoring program and training for workers. Any ventilation improvements should generally be permanent, the goal being to consistently operate below 5% of the LEL if at all possible.

<sup>2</sup>Detector warnings and equipment shutdowns triggered by high gas levels indicate an *immediate* need for better ventilation.

Handheld detectors are used to check for gas in any location. However, a peak emission can be missed because readings are taken at infrequent intervals. Fixed-site monitors operate continuously and can identify emission peaks and shut off electrical equipment when the methane level is excessive. Fixed-site monitors typically have two or more heads; the important ones are near the face and/or the muck discharge point.

Monitor heads should not be located where they are directly bathed by a stream of fresh air; this can prevent gas from reaching the head. Also, regular cleaning of monitor heads is necessary. Dirt-clogged heads can fail to detect methane, so monitor heads should not be located where muck spatter or water sprays will make them ineffective.

**As part of a monitor check, use a “shutdown test” to ensure that the fixed-site monitor is hard-wired into the tunnel electrical system properly. Bathe each monitor head with a gas mixture that has more than 1% methane, and check to see that the TBM and its auxiliary equipment shut down as they should.**

**Do the shutdown test as excavation begins, and then a few more times over the course of the project.**

<sup>10</sup>Code of Federal Regulations. See CFR in references.

## ELIMINATING IGNITION SOURCES

Electrical equipment in tunnels may or may not be explosion-proof, depending on the level of the hazard. The OSHA safety and health standards for underground construction [29 CFR 1926.800] contain the applicable requirements and definitions. OSHA has two hazard classifications, denoted “potentially gassy” and “gassy.” These are based on the results of air monitoring, on the local geology, on whether there has been a flammable gas ignition, and on whether there is a connection to another tunnel that is gassy. For the air monitoring, the classification trigger level is 10% of the LEL, and the specific classification depends on the length of time for which this gas level or higher is observed. Tunnels so classified must meet additional ventilation, gas monitoring, and equipment requirements. Some states have their own regulations as well.

It was mentioned earlier that a flammable gas concentration of 5% of the LEL or higher should be regarded as an action level to improve safety. Taking action at the 5% level will improve the chances that the 10% level will not be reached.

In the event that a large pocket of gas is encountered, some equipment may still be used. At a minimum, this includes fans and telephones. However, such equipment must always be explosion-proof.

Tunnel contractors must bear in mind that providing explosion-proof equipment does not in itself eliminate the possibility of a spark source. For instance, sparks generated by cutting tools striking rock often have enough energy to ignite an explosive mixture. Welding or striking a match to light a cigarette can have the same effect.

## THE IMPORTANCE OF HUMAN FACTORS AND MULTIPLE PREVENTIVE ACTIONS

The importance of human factors and multiple preventive actions in reducing methane explosion risk was identified in a study by Kissell and Goodman [1991]. Using a fault tree, they examined the possible causes of tunnel methane explosions. The intent was to provide a relative ranking of the events or combinations of events most likely to contribute to an explosion.

**Human factors.** In the Kissell and Goodman study, 15 “initiating events” were identified to represent starting conditions that lead to an explosion (Table 14–1). As evidenced in Table 14–1, most initiating events involve a human factor rather than an engineering specification. In other words, safe conditions require the everyday vigilance of those working underground. This does not undermine the importance of good engineering design, only that the job of providing safe conditions just begins with design. For example, workers must maintain overlap in auxiliary systems as mining advances, regularly check the ventilation quantity and methane concentration, and adequately service the methane monitors. Equally important, workers must not smoke underground; those who do risk causing an explosion if methane is present.

**Multiple preventive actions.** Another conclusion from the fault-tree study was that large reductions (over 90%) in the risk of an explosion only result from *multiple* preventive actions. For example, a ventilation upgrade or a methane monitor upgrade by itself offers risk reductions under 50%. A risk reduction of 90% or more would typically require both of these, plus additional actions such as a no-smoking rule and more thorough gas checks during welding.



**Table 14-1.—Initiating events for tunnel methane explosions**  
(from Kissell and Goodman [1991])

*Human factors primarily involved:*

1. Ventilation duct setback from face is too great
2. Use of a scavenger system with inadequate overlap
3. A fan is turned off
4. Fan performance is seriously degraded
5. Ductwork has serious leaks
6. Ductwork is seriously pinched
7. Smoking or welding occurs
8. Methane monitor calibration is off
9. Equipment used is not explosion-proof operationally
10. Gas checks are not made before or during welding

*Combination of human factors and engineering specifications:*

1. Methane monitor disabled or not present
2. No other warnings of excess gas are provided

*Engineering specifications primarily involved:*

1. Ductwork is seriously undersized
2. Equipment not explosion-proof by design

*Neither engineering or human factors involved:*

1. Cutter pick sparking

## REFERENCES

CFR. Code of federal regulations. Washington, DC: U.S. Government Printing Office, Office of the Federal Register.

Doyle BR [2001]. Hazardous gases underground: applications to tunnel engineering. New York: Marcel Dekker, Inc.

Kissell FN, Goodman GVR [1991]. Preventing tunnel methane explosions: what's most important. In: Proceedings of the Fifth U.S. Mine Ventilation Symposium (Morgantown, WV, June 3–5, 1991). Littleton, CO: Society for Mining, Metallurgy, and Exploration, Inc., pp. 605–610.

Thimons ED, Vinson RP, Kissell FN [1979]. Forecasting methane hazards in metal and nonmetal mines. Pittsburgh, PA: U.S. Department of the Interior, Bureau of Mines, RI 8392. NTIS No. PB80100696.

Wallhagen RE [1977]. Development of optimized diffuser and spray fan systems for coal mine face ventilation. Waltham, MA: Foster-Miller Associates. U.S. Bureau of Mines contract No. H0230023. NTIS No. PB277987.

## INDEX

- A**
- Abnormally gassy faces.....46  
 Air velocity, effect of..... 12, 17  
 Anomalous methane emissions.....98  
 Anti-ignition back spray .....59  
 Auger mining – See *Highwall mining* ..... 135  
 Auxiliary air movers.....18  
 Auxiliary fans ..... 18
- B**
- Barometric pressure, shaft sealing ..... 133  
 Bit wear, ignitions.....49  
 Bleeder splits .....68–69  
 Bleeder systems .....63–76  
   additional air splits.....68–69  
   designing .....64  
   evaluating .....71  
   examining .....69  
   flow-through.....65  
   maintaining .....69  
   water drainage.....69  
   wrap-around.....64  
 Blowers.....107  
 Blowing ventilation .....41  
 Bolter faces.....48  
 Boreholes, degas  
   cross-measure .....86  
   horizontal .....83  
   short-radius .....85  
   vertical .....84  
 Bump test, methane detectors .....31
- C**
- Calibration of catalytic detectors, different gases....33  
 Catalytic heat of combustion sensors..... 13  
 Clastic dikes.....104  
 Clay veins .....104  
 Cleats .....103  
 Coal dust and methane mixtures, explosibility ..... 149  
 Coal dust explosions ..... 147  
 Coal seam degasification  
   economics .....93  
   thresholds.....80  
 Coal silos ..... 141–146  
   closed-top silos ..... 143  
   explosion in British Columbia, Canada ..... 144  
   load-out areas.....143  
   reclaiming areas.....143  
 Crosscuts, ventilation.....45  
 Cross-measure boreholes .....86
- D**
- Degasification of coal seams .....77–96  
   economics of.....93  
   horizontal boreholes .....83  
   methane capture ratios .....83–90  
   vertical frac wells.....84  
 Diffuser fans .....46  
 Dikes.....104  
 Dilution capacity of bleeder systems .....75  
 Dilution of methane .....3  
 Direct method ..... 10, 114  
 District recirculation .....16  
 Domal salt mines .....154  
 Drainage of methane.....83  
 Dust collectors .....41, 45  
 Dust explosions .....147  
 Dust scrubber recirculation.....15  
 Dust scrubbers .....41, 45
- E**
- Economics of coal seam degasification .....93  
 Eddy zones, longwall.....56, 58  
 Effective inert, in explosibility diagram .....4  
 Emission peaks .....37  
 Emission rate .....9  
 Excess nitrogen, in explosibility diagram.....4  
 Exhaust ventilation .....45  
 Explosibility  
   inert gases, effect on .....4  
   pressure, effect on.....5  
   temperature, effect on .....5  
 Explosibility diagram .....5  
 Explosibility of gas mixtures .....3  
 Explosions .....78  
 Explosive range .....3  
 Extensible curtain systems.....39
- F**
- Fan spray system .....40  
 Faults .....100–104  
   large-scale.....101  
   normal.....102  
   reverse.....103  
   small-scale .....101  
 Filling shafts at closed mines.....132  
 Forecasting methane emissions .....9, 119  
 Frac wells.....84  
 Fractures .....103  
 Frictional ignitions.....48, 59  
 Froude number.....17

**G**

Gas accumulation, longwall.....	56–58
Gas blowers .....	107
Gas content of coal .....	114, 116
Gas detector .....	27
Gas emission from coal in silos .....	141
Gas emission sources, longwall.....	55
Gas from bumps, longwall.....	55
Gas-in-place.....	116
Gas mixtures, explosive range.....	3
Gas outbursts .....	107
Gas readings .....	29
Gassiness of coal seams.....	79
Gilsonite mines .....	153
Gob curtain, longwall .....	57

**H**

Headgate cutout, longwall .....	57
Heat of combustion sensors.....	13, 27
High-volume scrubbers.....	47
Higher air velocity, effect of.....	12, 17
Highly gassy coal seams.....	79
Highwall mining .....	135–140
auger removal .....	140
inert gas quantity .....	138
oxygen concentration.....	139
purgings.....	139
starter hole .....	139
Horizontal boreholes, degasification .....	83
Human factors .....	179
Hydrofracing, degasification .....	84

**I**

Igneous intrusions.....	106
Ignition .....	59
Ignition of methane by—	
adiabatic compression.....	7
hot solids.....	6
lightning.....	8
sliding friction.....	7
static electricity .....	8
thermite sparking .....	7
Ignition sources in metal/nonmetal mines .....	158
Indirect method.....	114
Inert gas .....	4, 135
Inert gas generator .....	137
Infrared absorption, sampling.....	28
Inlets to pillared areas.....	74
Instruments to measure methane .....	27

**J**

Joints.....	103
-------------	-----

**L**

Large cross-sectional entries.....	18
Layering number.....	12
Layering of methane.....	12
Le Chatelier's law.....	5
Lightning .....	8
Lower explosive limit.....	3, 5
Lower flammable limit .....	3, 5
L-shaped wing curtain, longwalls.....	59

**M**

Machine-mounted methane monitors .....	28
Metal and nonmetal mines, methane in .....	151–167
actions to take .....	156
Australia .....	152
Canada .....	152
difference from coal mines .....	155
estimating the hazard .....	161
Europe.....	152
ignition sources.....	158
Scandinavia.....	151
South Africa, Republic of.....	152
starting a new mine.....	161
United Kingdom .....	152
Methane	
explosions .....	78
origins .....	77
Methane and coal dust mixtures, explosibility .....	149
Methane capture ratios, degasification .....	83–90
Methane content, coal seams .....	79
Methane detection.....	47–48
Methane detectors	
calibration of.....	33
dust-clogged heads .....	33
machine-mounted .....	28
portable.....	27–28
sensor head response .....	32
where to take readings .....	29–30
Methane dilution by scrubbers.....	42, 45
Methane dilution capacity of scrubbers .....	39
Methane drainage techniques .....	83
Methane emission peaks.....	37
Methane ignition.....	59
Methane layers.....	12
Methane monitor, longwall.....	60
Methane pipeline, degasification .....	90
Methane stored in coal.....	8
Mildly gassy coal seams .....	79
Mine emissions.....	119
Mixing into air, methane .....	4, 17
Modeling techniques, methane reservoirs .....	124
Moderately gassy coal seams.....	79
Modified shearer-clearer.....	56

<b>N</b>	
Natural ventilation, coal silos .....	145
Numerical simulation, methane reservoirs .....	122

<b>O</b>	
Oil shale mines .....	153
Origins of coalbed methane .....	77
Outbursts.....	107
Oxygen deficiency .....	66

<b>P</b>	
Paleochannels .....	98
Petroleum mines .....	154
Pipelines in mines.....	90
Placement of sensing heads, methane monitors.....	32
Portable methane detectors .....	27–28
Potash mines .....	154
Prediction of gas emissions .....	119
Pressure, effect on explosibility.....	5
Production decline analysis, degas boreholes .....	118

<b>R</b>	
Raise bore drills, ventilation of.....	130
Recirculation, hazards of .....	14
district .....	16
dust scrubber.....	15
in headings.....	15
Reserve ventilating capacity, bleeders.....	68
Reservoir engineering methods .....	114, 117–118
Reservoir modeling.....	122–123
Reservoir properties, coal seams .....	78
Restricted spaces, sampling in .....	30
Rock dusting requirements .....	148

<b>S</b>	
Sample draw systems in methane detectors.....	13
Sampling accessible spaces for methane .....	29
Sampling restricted spaces for methane.....	30–31
Sandstone channels.....	98
Scrubber clogging, continuous miners.....	44
Scrubber exhaust direction, continuous miners ..	44–45
Scrubbers, continuous miners .....	41, 45
Sealing pillared areas.....	69
Seasonal trend in explosions.....	19
Sedimentary intrusions .....	104
Separate mine fans, effect on bleeders.....	73
Setback, brattice, continuous miners .....	39

Shafts .....	127–134
barometric pressure.....	133
cutting and welding .....	129
filling, at closed mines.....	132
restricted spaces.....	129–130
sampling guidelines .....	128
ventilation guidelines.....	127
water rings .....	129
work decks.....	128
Shearer-clearer, longwalls .....	56
Silos – See <i>Coal silos</i> .....	141
Specific methane emission .....	80
Splits of air, bleeders .....	73
Spray fan system, continuous miners .....	40
Sprays, longwall .....	56, 58
Startup and recovery ventilation, bleeders.....	74
Static electricity .....	8

<b>T</b>	
Temperature, effect on explosibility.....	5
Thresholds for coal seam degasification.....	80
Trona mines .....	154
Tunnels .....	169–180
assessing the hazard.....	169–171
auxiliary ventilation.....	175
blowing ventilation .....	173
checking the ventilation system.....	177
cumulative ventilation inefficiencies .....	176
dilution of methane to safe levels .....	171
early indicators of a gas problem.....	169
exhaust ventilation .....	173
face ventilation effectiveness.....	173
face ventilation systems.....	172
fixed-site methane monitors .....	178
gas checks.....	177
handheld methane detectors.....	178
human factors .....	179
ignition sources.....	179
inadequate overlap in auxiliary systems .....	175
lower explosive limit .....	171
main ventilation systems.....	172
monitoring for methane .....	177
multiple preventive actions.....	172
overlap in auxiliary systems .....	175
planning .....	169
potentially gassy .....	179
recirculation.....	175
shutdown test .....	178
stagnant zones.....	174
upper explosive limit .....	171
ventilation efficiency .....	176

**U**

Underground methane pipeline, degasification .....	90
Unforeseen gas emissions.....	98
Upper explosive limit .....	3, 5
Upper flammable limit.....	3, 5

**V**

Ventilation eddy zones .....	56, 58
Ventilation failure, tunnels .....	170

Ventilation setback .....	39
Ventilation systems, tunnels .....	172
Venturi air movers, tunnels.....	177
Vertical frac wells, degasification .....	84

**W**

Walkway curtain, longwalls .....	57
Warning signs during sampling .....	31, 34
Water sprays, longwalls.....	56, 58
Wells, oil or gas at metal/nonmetal mines .....	161



***Delivering on the Nation's Promise:  
Safety and health at work for all people  
through research and prevention***

For information about occupational safety and health topics contact NIOSH at:

1-800-35-NIOSH (1-800-356-4674)  
Fax: 513-533-8573  
E-mail: [pubstaft@cdc.gov](mailto:pubstaft@cdc.gov)  
[www.cdc.gov/niosh](http://www.cdc.gov/niosh)

**SAFER • HEALTHIER • PEOPLE<sup>TM</sup>**

**DHHS (NIOSH) Publication No. 2006-127**

**Handbook for Methane Control in Mining • IC 9486**