

NATIONAL TOXICOLOGY PROGRAM
Technical Report Series
No. 421



TOXICOLOGY AND CARCINOGENESIS

STUDIES OF TALC

(CAS NO. 14807-96-6)

IN F344/N RATS AND B6C3F₁ MICE

(INHALATION STUDIES)

U.S. DEPARTMENT OF HEALTH AND HUMAN SERVICES
Public Health Service
National Institutes of Health

FOREWORD

The National Toxicology Program (NTP) is made up of four charter agencies of the U.S. Department of Health and Human Services (DHHS): the National Cancer Institute (NCI), National Institutes of Health; the National Institute of Environmental Health Sciences (NIEHS), National Institutes of Health; the National Center for Toxicological Research (NCTR), Food and Drug Administration; and the National Institute for Occupational Safety and Health (NIOSH), Centers for Disease Control. In July 1981, the Carcinogenesis Bioassay Testing Program, NCI, was transferred to the NIEHS. The NTP coordinates the relevant programs, staff, and resources from these Public Health Service agencies relating to basic and applied research and to biological assay development and validation.

The NTP develops, evaluates, and disseminates scientific information about potentially toxic and hazardous chemicals. This knowledge is used for protecting the health of the American people and for the primary prevention of disease.

The studies described in this Technical Report were performed under the direction of the NIEHS and were conducted in compliance with NTP laboratory health and safety requirements and must meet or exceed all applicable federal, state, and local health and safety regulations. Animal care and use were in accordance with the Public Health Service Policy on Humane Care and Use of Animals. The prechronic and chronic studies were conducted in compliance with Food and Drug Administration (FDA) Good Laboratory Practice Regulations, and all aspects of the chronic studies were subjected to retrospective quality assurance audits before being presented for public review.

These studies are designed and conducted to characterize and evaluate the toxicologic potential, including carcinogenic activity, of selected chemicals in laboratory animals (usually two species, rats and mice). Chemicals selected for NTP toxicology and carcinogenesis studies are chosen primarily on the bases of human exposure, level of production, and chemical structure. Selection *per se* is not an indicator of a chemical's carcinogenic potential.

These NTP Technical Reports are available for sale from the National Technical Information Service, U.S. Department of Commerce, 5285 Port Royal Road, Springfield, VA 22161 (703-487-4650). Single copies of this Technical Report are available without charge while supplies last from the NTP Central Data Management, NIEHS, P.O. Box 12233, MD A0-01, Research Triangle Park, NC 27709 (919-541-1371).

NTP TECHNICAL REPORT
ON THE
TOXICOLOGY AND CARCINOGENESIS
STUDIES OF TALC
(CAS NO. 14807-96-6)
IN F344/N RATS AND B6C3F₁ MICE
(INHALATION STUDIES)

NATIONAL TOXICOLOGY PROGRAM
P.O. Box 12233
Research Triangle Park, NC 27709

September 1993

NTP TR 421

NIH Publication No. 93-3152

U.S. DEPARTMENT OF HEALTH AND HUMAN SERVICES
Public Health Service
National Institutes of Health

CONTRIBUTORS

National Toxicology Program

Evaluated and interpreted results and reported findings

K.M. Abdo, Ph.D.
 C.J. Alden, Ph.D.
 G.A. Boorman, D.V.M., Ph.D.
 D.A. Bridge, B.S.
 M. Dieter, Ph.D.
 S.L. Eustis, D.V.M., Ph.D.
 T.J. Goehl, Ph.D.
 R.A. Griesemer, D.V.M., Ph.D.
 J.K. Haseman, Ph.D.
 R.D. Irwin, Ph.D.
 G.N. Rao, D.V.M., Ph.D.
 K.L. Witt, M.S., Oak Ridge Associated Universities

Lovelace Biomedical and Environmental Research Institute

Conducted studies, evaluated pathology findings

C.H. Hobbs, D.V.M., Principal Investigator
 E.B. Barr, M.S.
 J.M. Benson, Ph.D.
 N. Gillette, D.V.M., Ph.D.
 F.F. Hahn, D.V.M., Ph.D.
 R.K. Jones, M.D.
 J.L. Mauderly, D.V.M.
 J.A. Pickrell, D.V.M., Ph.D.

Experimental Pathology Laboratories, Inc.

Provided pathology quality assurance

J.F. Hardisty, D.V.M., Principal Investigator

Integrated Laboratory Systems

Prepared quality assurance audits

S.L. Smith, J.D., Principal Investigator

Biotechnical Services, Inc.

Prepared Technical Report

D.D. Lambright, Ph.D., Principal Investigator
 P. Chaffin, M.S.
 G.F. Corley, D.V.M.
 C.J. Fitz, M.A.
 A.B. James-Stewart, B.S.

NTP Pathology Working Group

*Evaluated slides, prepared pathology report on rats
(4 October 1990)*

D.G. Goodman, V.M.D., Chair
 PATHCO, Inc.
 G.A. Boorman, D.V.M., Ph.D.
 National Toxicology Program
 S.L. Eustis, D.V.M., Ph.D.
 National Toxicology Program
 J.R. Hailey, D.V.M.
 National Toxicology Program
 J.F. Hardisty, D.V.M.
 Experimental Pathology Laboratories, Inc.
 J.F. Mahler, D.V.M.
 National Toxicology Program
 M.M. McDonald, D.V.M., Ph.D.
 National Toxicology Program
 M. Menard, D.V.M.
 North Carolina State University (observer)
 A. Pinter, M.D., Ph.D.
 National Institute of Hygiene, Hungary
 C. Van Pelt, D.V.M., Ph.D.
 E.I. DuPont De Nemours

*Evaluated slides, prepared pathology report on mice
(18 October 1990)*

M.A. Stedham, D.V.M., Chair
 PAI
 G.A. Boorman, D.V.M., Ph.D.
 National Toxicology Program
 J.F. Hardisty, D.V.M.
 Experimental Pathology Laboratories, Inc.
 C.R. Jeng, B.V.M.
 North Carolina State University (observer)
 A.W. Macklin, D.V.M., Ph.D.
 Burroughs Wellcome
 M.M. McDonald, D.V.M., Ph.D.
 National Toxicology Program
 C.C. Shackelford, D.V.M., M.S., Ph.D.
 National Toxicology Program

CONTENTS

ABSTRACT	5
EXPLANATION OF LEVELS OF EVIDENCE OF CARCINOGENIC ACTIVITY	9
TECHNICAL REPORTS REVIEW SUBCOMMITTEE	10
SUMMARY OF TECHNICAL REPORTS REVIEW SUBCOMMITTEE COMMENTS	11
INTRODUCTION	13
MATERIALS AND METHODS	19
RESULTS	25
DISCUSSION AND CONCLUSIONS	49
REFERENCES	57
APPENDIX A Summary of Lesions in Male Rats in the Lifetime Inhalation Study of Talc	63
APPENDIX B Summary of Lesions in Female Rats in the Lifetime Inhalation Study of Talc	95
APPENDIX C Summary of Lesions in Male Mice in the 2-Year Inhalation Study of Talc	129
APPENDIX D Summary of Lesions in Female Mice in the 2-Year Inhalation Study of Talc	161
APPENDIX E Organ Weights and Organ-Weight-to-Body-Weight Ratios	193
APPENDIX F 4-Week Repeated Inhalation Studies in Rats and Mice	203
APPENDIX G Lung Burden, Pulmonary Function, and Lung Biochemistry in Rats	215
APPENDIX H Lung Burden and Lung Biochemistry in Mice	243
APPENDIX I Chemical Characterization, Analysis, and Generation of Chamber Concentrations	261
APPENDIX J Ingredients, Nutrient Composition, and Contaminant Levels in NIH-07 Rat and Mouse Ration	277
APPENDIX K Sentinel Animal Program	283

ABSTRACT

TALC (Non-Asbestiform)

CAS No. 14807-96-6

Molecular Formula: $Mg_3Si_4O_{10}(OH)_2$ Molecular Weight: 379.26

Synonyms: talcum; agalite; emtal 596; non-asbestiform talc; non-fibrous talc; steatite; hydrous magnesium silicate

Talc ore may contain several other minerals including calcite, dolomite, magnesite, tremolite, anthophyllite, antigorite, quartz, pyrophyllite, micas, or chlorites. Talc products are sold in a multitude of grades which have physical or functional characteristics especially suited for particular applications, so occupational and consumer exposures to talc are complex. Epidemiology studies have suggested an association between non-fibrous talc and lung cancer risk. Talc was nominated by the National Institute of Occupational Safety and Health (NIOSH) for study by the NTP because of widespread human exposure and because of the lack of adequate information on its chronic toxicity and potential carcinogenicity. Toxicology and carcinogenicity studies of talc (non-asbestiform, cosmetic grade), a finely powdered hydrous magnesium silicate, were conducted by exposing groups of F344/N rats to aerosols for 6 hours per day, 5 days per week for up to 113 weeks (males) or 122 weeks (females). Groups of B6C3F₁ mice were exposed similarly for up to 104 weeks.

LIFETIME STUDY IN RATS

Groups of 49 or 50 male and 50 female rats were exposed to aerosols of 0, 6, or 18 mg/m³ talc until mortality in any exposure group reached 80% (113 weeks for males and 122 weeks for females). These exposures were selected based on 4-week inhalation studies of the terminal lung talc burden in F344/N rats; concentrations greater than 18 mg/m³ were expected to overwhelm lung clearance mechanisms and impair lung function. These exposure concentrations provided a dose equivalent of 0, 2.8, or 8.4 mg/kg per day for male rats and 0, 3.2, or 9.6 mg/kg per day for female rats. In a special study, additional groups of 22 male and 22 female rats were

similarly exposed and examined for interim pathology evaluations or pulmonary function tests after 6, 11, 18, and 24 months and lung biochemistry and cytology studies after 24 months. The talc aerosols had a median mass aerodynamic diameter of 2.7 μm in the 6 mg/m³ chamber and a median diameter of 3.2 μm in the 18 mg/m³ chamber, with geometric standard deviations of 1.9 μm. However, there was a 7-week period beginning at study week 11 during which the chamber concentration for the 18 mg/m³ rats varied from approximately 30 to 40 mg/m³ because of difficulties with the aerosol concentration monitoring system. Further, there was a 12-week period beginning at approximately week 70 during which there were difficulties in generating the talc aerosol, and the chamber concentrations for rats and mice were substantially lower than the target concentrations.

Survival, Body Weights, and Clinical Findings

The survival of male and female rats exposed to talc was similar to that of the controls. Mean body weights of rats exposed to 18 mg/m³ were slightly lower than those of controls after week 65. No clinical findings were attributed to talc exposure.

Pathology Findings

Absolute and relative lung weights of male rats exposed to 18 mg/m³ were significantly greater than those of controls at the 6-, 11-, and 18-month interim evaluations and at the end of the lifetime study, while those of female rats exposed to 18 mg/m³ were significantly greater at the 11-, 18-, and 24-month interim evaluations and at the end of the lifetime study. Inhalation exposure of rats to talc produced a spectrum of inflammatory, reparative, and proliferative processes in the lungs. Granulomatous inflammation occurred in nearly all exposed rats and the

severity increased with exposure duration and concentration. Hyperplasia of the alveolar epithelium and interstitial fibrosis occurred in or near foci of inflammation in many exposed rats, while squamous metaplasia of the alveolar epithelium and squamous cysts were also occasionally seen. Accumulations of macrophages (histiocytes), most containing talc particles, were found in the peribronchial lymphoid tissue of the lung and in the bronchial and mediastinal lymph nodes. In female rats, the incidences of alveolar/bronchiolar adenoma, carcinoma, and adenoma or carcinoma (combined) in the 18 mg/m³ group were significantly greater than those of controls. The incidences of pulmonary neoplasms in exposed male rats were similar to those in controls.

Minor alterations attributed to talc exposure were also observed in the upper respiratory tract. Hyperplasia of the respiratory epithelium of the nasal mucosa in males and accumulation of cytoplasmic, eosinophilic droplets in the nasal mucosal epithelium in male and female rats occurred with a concentration-related increased incidence in the exposed groups.

Adrenal medulla pheochromocytomas [benign, malignant, or complex (combined)] occurred with a significant positive trend in male and female rats, and the incidences in the 18 mg/m³ groups were significantly greater than those of controls. Although adrenal medulla hyperplasia occurred with similar frequency among exposed and control females, the incidences of hyperplasia in exposed males were significantly lower than in controls.

Lung Talc Burden

Lung talc burdens of male and female rats exposed to 6 mg/m³ were similar and increased progressively from 6 to 24 months. Lung talc burdens of females exposed to 18 mg/m³ also increased progressively from 6 to 24 months, while those of males exposed to 18 mg/m³ remained about the same after 18 months. Lung burdens were generally proportional to exposure concentration at each interim evaluation.

Pulmonary Function, Bronchoalveolar Lavage, and Lung Biochemistry

In exposed male and female rats there was a concentration-related impairment of respiratory function which increased in severity with increasing exposure duration. The impairment was characterized by

reductions in lung volume (total lung capacity, vital capacity, and forced vital capacity), lung compliance, gas exchange efficiency (carbon monoxide diffusing capacity), and nonuniform intrapulmonary gas distribution.

After 24 months, males exposed to 6 mg/m³ talc had a significant increase in β -glucuronidase and polymorphonuclear leukocytes; males exposed 18 mg/m³ had significant increases in β -glucuronidase, lactate dehydrogenase, alkaline phosphatase, and total protein in bronchoalveolar lavage fluid. All exposed females had significantly increased β -glucuronidase, lactate dehydrogenase, alkaline phosphatase, total protein, and polymorphonuclear leukocytes; 18 mg/m³ females also had significantly increased glutathione reductase. Viability and phagocytic activity of macrophages recovered from lavage fluid were not affected by talc exposure.

Total lung collagen was significantly increased in rats at both exposure concentrations after 24 months, while collagenous peptides in lavage fluid and the percentages of newly synthesized protein from females, but not males, were also significantly increased at the 6 or 18 mg/m³ levels. In addition, lung proteinase activity, primarily cathepsin D-like activity, was significantly greater in exposed males and females. Rats exposed to talc also had significant increases in collagenous peptides and acid proteinase in lung homogenates.

2-YEAR STUDY IN MICE

Groups of 47 to 49 male and 48 to 50 female mice were exposed to aerosols containing 0, 6, or 18 mg/m³ talc for up to 104 weeks. These exposures were selected based on 4-week inhalation studies of the terminal lung talc burden in B6C3F₁ mice; concentrations greater than 18 mg/m³ were expected to overwhelm lung clearance mechanisms and impair lung function. These exposure concentrations provide a dose equivalent of 0, 2, or 6 mg/kg per day for male mice and 0, 1.3, or 3.9 mg/kg per day for female mice. In a special study, additional groups of 39 or 40 male and 39 or 40 female mice similarly exposed were examined for interim pathology evaluations, lung biochemistry, and cytology studies after 6, 12, and 18 months of exposure. The talc aerosols had a median mass aerodynamic diameter of 3.3 μ m with a geometric standard deviation of 1.9 μ m in the 6 mg/m³ chamber, and a median diameter of 3.6 μ m with a geometric standard deviation of 2.0 μ m in the

18 mg/m³ chamber. Further, there was a 12-week period beginning at approximately week 70 during which there were difficulties in generating the talc aerosol, and the chamber concentrations for rats and mice were substantially lower than the target concentrations.

Survival, Body Weights, and Clinical Findings

Survival and final mean body weights of male and female mice exposed to talc were similar to those of the controls. There were no clinical findings attributed to talc exposure.

Pathology Findings

Inhalation exposure of mice to talc was associated with chronic active inflammation and the accumulation of macrophages in the lung. In contrast to rats, hyperplasia of the alveolar epithelium, squamous metaplasia, or interstitial fibrosis were not associated with the inflammatory response in mice, and the incidences of pulmonary neoplasms in exposed and control groups of mice were similar. Accumulations of macrophages (histiocytes) containing talc particles were also present in the bronchial lymph node.

In the upper respiratory tract, cytoplasmic alteration, consisting of the accumulation of cytoplasmic eosinophilic droplets in the nasal mucosal epithelium, occurred with a concentration-related increased incidence in exposed male and female mice.

Lung Talc Burden

Lung talc burdens of mice exposed to 6 mg/m³ were similar between males and females and increased progressively from 6 to 24 months, except for males at 18 months. The lung talc burdens of mice exposed to 18 mg/m³ were also similar between the sexes at each interim evaluation. Although the talc burdens of males and females increased substantially from 6 to 24 months, the values at 12 and 18 months were similar. Generally, lung burdens of mice exposed to 18 mg/m³ were disproportionately greater than those of mice exposed to 6 mg/m³, suggesting that clearance of talc from the lung was impaired, or impaired to a greater extent, in mice exposed to 18 mg/m³ than in mice exposed to 6 mg/m³.

Bronchoalveolar Lavage and Lung Biochemistry

Increases in total protein, β -glucuronidase, lactate dehydrogenase, glutathione reductase, total nucleated cells, and polymorphonuclear leukocytes in bronchoalveolar lavage fluid were observed primarily in mice exposed to 18 mg/m³, although some parameters were also increased in mice exposed to 6 mg/m³.

The amount of collagenous peptides in lavage fluid and total lung collagen were increased in male and female mice exposed to 18 mg/m³. Acid proteinase activity, principally cathepsin D-like activity, of lung homogenate supernatant fluid was also significantly increased in mice at the 18 mg/m³ exposure concentration.

CONCLUSIONS

Under the conditions of these inhalation studies, there was *some evidence of carcinogenic activity** of talc in male F344/N rats based on an increased incidence of benign or malignant pheochromocytomas of the adrenal gland. There was *clear evidence of carcinogenic activity* of talc in female F344/N rats based on increased incidences of alveolar/bronchiolar adenomas and carcinomas of the lung and benign or malignant pheochromocytomas of the adrenal gland. There was *no evidence of carcinogenic activity* of talc in male or female B6C3F₁ mice exposed to 6 or 18 mg/m³.

The principal toxic lesions associated with inhalation exposure to the same concentrations of talc in rats included chronic granulomatous inflammation, alveolar epithelial hyperplasia, squamous metaplasia and squamous cysts, and interstitial fibrosis of the lung. These lesions were accompanied by impaired pulmonary function characterized primarily by reduced lung volumes, reduced dynamic and/or quasi-static lung compliance, reduced gas exchange efficiency, and nonuniform intrapulmonary gas distribution. In mice, inhalation exposure to talc produced chronic inflammation of the lung with the accumulation of alveolar macrophages.

* Explanation of Levels of Evidence of Carcinogenic Activity is on page 9. A summary of Technical Reports Review Subcommittee comments and the public discussion on this Technical Report appears on page 11.

Summary of the Lifetime and 2-Year Carcinogenicity Studies of Talc

	Male F344/N Rats	Female F344/N Rats	Male B6C3F ₁ Mice	Female B6C3F ₁ Mice
Exposure levels	0, 6, or 18 mg/m ³ (equivalent to 0, 2.8, or 8.4 mg/kg per day)	0, 6, or 18 mg/m ³ (equivalent to 0, 3.2, or 9.6 mg/kg per day)	0, 6, or 18 mg/m ³ (equivalent to 0, 2, or 6 mg/kg per day)	0, 6, or 18 mg/m ³ (equivalent to 0, 1.3, or 3.9 mg/kg per day)
Body weights	18 mg/m ³ group slightly lower than controls	18 mg/m ³ group slightly lower than controls	Exposed groups similar to controls	Exposed groups similar to controls
Survival rates	9/49, 14/50, 16/50	11/50, 13/49, 9/50	30/47, 28/48, 32/49	30/49, 23/48, 25/50
Nonneoplastic effects	Lung: granulomatous inflammation (2/49, 50/50, 49/50); interstitial fibrosis (1/49, 16/50, 33/50); alveolar epithelial hyperplasia (5/49, 26/50, 38/50); cyst (0/49, 0/50, 3/50); alveolar squamous metaplasia (0/49, 0/50, 2/50)	Lung: granulomatous inflammation (2/50, 47/48, 50/50); interstitial fibrosis (1/50, 24/48, 44/50); alveolar epithelial hyperplasia (2/50, 27/48, 47/50); cyst (0/50, 1/48, 7/50); alveolar squamous metaplasia (0/50, 0/48, 8/50)	Lung: chronic inflammation (0/45, 16/47, 40/48); macrophage hyperplasia (3/45, 46/47, 48/48)	Lung: chronic inflammation (0/46, 25/48, 38/50); macrophage hyperplasia (2/46, 45/48, 43/50)
Neoplastic effects	Adrenal medulla: benign or malignant pheochromocytoma (26/49, 32/48, 37/47)	Lung: alveolar/ bronchiolar adenoma (1/50, 0/48, 9/50); alveolar/bronchiolar carcinoma (0/50, 0/48, 5/50); alveolar/bronchiolar adenoma or carcinoma (1/50, 0/48, 13/50) Adrenal medulla: benign or malignant pheochromocytoma (13/48, 14/47, 23/49)	None	None
Level of evidence of carcinogenic activity	Some evidence	Clear evidence	No evidence	No evidence

EXPLANATION OF LEVELS OF EVIDENCE OF CARCINOGENIC ACTIVITY

The National Toxicology Program describes the results of individual experiments on a chemical agent and notes the strength of the evidence for conclusions regarding each study. Negative results, in which the study animals do not have a greater incidence of neoplasia than control animals, do not necessarily mean that a chemical is not a carcinogen, inasmuch as the experiments are conducted under a limited set of conditions. Positive results demonstrate that a chemical is carcinogenic for laboratory animals under the conditions of the study and indicate that exposure to the chemical has the potential for hazard to humans. Other organizations, such as the International Agency for Research on Cancer, assign a strength of evidence for conclusions based on an examination of all available evidence, including animal studies such as those conducted by the NTP, epidemiologic studies, and estimates of exposure. Thus, the actual determination of risk to humans from chemicals found to be carcinogenic in laboratory animals requires a wider analysis that extends beyond the purview of these studies.

Five categories of evidence of carcinogenic activity are used in the Technical Report series to summarize the strength of the evidence observed in each experiment: two categories for positive results (**clear evidence** and **some evidence**); one category for uncertain findings (**equivocal evidence**); one category for no observable effects (**no evidence**); and one category for experiments that cannot be evaluated because of major flaws (**inadequate study**). These categories of interpretative conclusions were first adopted in June 1983 and then revised in March 1986 for use in the Technical Report series to incorporate more specifically the concept of actual weight of evidence of carcinogenic activity. For each separate experiment (male rats, female rats, male mice, female mice), one of the following five categories is selected to describe the findings. These categories refer to the strength of the experimental evidence and not to potency or mechanism.

- **Clear evidence** of carcinogenic activity is demonstrated by studies that are interpreted as showing a dose-related (i) increase of malignant neoplasms, (ii) increase of a combination of malignant and benign neoplasms, or (iii) marked increase of benign neoplasms if there is an indication from this or other studies of the ability of such tumors to progress to malignancy.
- **Some evidence** of carcinogenic activity is demonstrated by studies that are interpreted as showing a chemical-related increased incidence of neoplasms (malignant, benign, or combined) in which the strength of the response is less than that required for clear evidence.
- **Equivocal evidence** of carcinogenic activity is demonstrated by studies that are interpreted as showing a marginal increase of neoplasms that may be chemical related.
- **No evidence** of carcinogenic activity is demonstrated by studies that are interpreted as showing no chemical-related increases in malignant or benign neoplasms.
- **Inadequate study** of carcinogenic activity is demonstrated by studies that, because of major qualitative or quantitative limitations, cannot be interpreted as valid for showing either the presence or absence of carcinogenic activity.

When a conclusion statement for a particular experiment is selected, consideration must be given to key factors that would extend the actual boundary of an individual category of evidence. Such consideration should allow for incorporation of scientific experience and current understanding of long-term carcinogenesis studies in laboratory animals, especially for those evaluations that may be on the borderline between two adjacent levels. These considerations should include:

- adequacy of the experimental design and conduct;
- occurrence of common versus uncommon neoplasia;
- progression (or lack thereof) from benign to malignant neoplasia as well as from preneoplastic to neoplastic lesions;
- some benign neoplasms have the capacity to regress but others (of the same morphologic type) progress. At present, it is impossible to identify the difference. Therefore, where progression is known to be a possibility, the most prudent course is to assume that benign neoplasms of those types have the potential to become malignant;
- combining benign and malignant tumor incidence known or thought to represent stages of progression in the same organ or tissue;
- latency in tumor induction;
- multiplicity in site-specific neoplasia;
- metastases;
- supporting information from proliferative lesions (hyperplasia) in the same site of neoplasia or in other experiments (same lesion in another sex or species);
- presence or absence of dose relationships;
- statistical significance of the observed tumor increase;
- concurrent control tumor incidence as well as the historical control rate and variability for a specific neoplasm;
- survival-adjusted analyses and false positive or false negative concerns;
- structure-activity correlations; and
- in some cases, genetic toxicology.

**NATIONAL TOXICOLOGY PROGRAM BOARD OF SCIENTIFIC COUNSELORS
TECHNICAL REPORTS REVIEW SUBCOMMITTEE**

The members of the Technical Reports Review Subcommittee who evaluated the draft NTP Technical Report on talc on June 23, 1992, are listed below. Subcommittee members serve as independent scientists, not as representatives of any institution, company, or governmental agency. In this capacity, subcommittee members have five major responsibilities in reviewing NTP studies:

- to ascertain that all relevant literature data have been adequately cited and interpreted,
- to determine if the design and conditions of the NTP studies were appropriate,
- to ensure that the Technical Report presents the experimental results and conclusions fully and clearly,
- to judge the significance of the experimental results by scientific criteria, and
- to assess the evaluation of the evidence of carcinogenic activity and other observed toxic responses.

Gary P. Carlson, Ph.D., Chair
Department of Pharmacology and Toxicology
Purdue University
West Lafayette, IN

Paul T. Bailey, Ph.D.
Toxicology Division
Mobil Oil Corporation
Princeton, NJ

Louis S. Beliczky, M.S., M.P.H.*
Department of Industrial Hygiene
United Rubber Workers International Union
Akron, OH

Kowetha A. Davidson, Ph.D.
Health and Safety Research Division
Oak Ridge National Laboratory
Oak Ridge, TN

Harold Davis, D.V.M., Ph.D.
School of Aerospace Medicine
Brooks Air Force Base, TX

Jay I. Goodman, Ph.D., Principal Reviewer
Department of Pharmacology and Toxicology
Michigan State University
East Lansing, MI

David W. Hayden, D.V.M., Ph.D.
Department of Veterinary Pathobiology
College of Veterinary Medicine
University of Minnesota
St. Paul, MN

Curtis D. Klaassen, Ph.D.*
Department of Pharmacology and Toxicology
University of Kansas Medical Center
Kansas City, KS

Daniel S. Longnecker, M.D.*
Department of Pathology
Dartmouth Medical School
Lebanon, NH

Barbara McKnight, Ph.D., Principal Reviewer*
Department of Biostatistics
University of Washington
Seattle, WA

Ellen K. Silbergeld, Ph.D.
University of Maryland Medical School
Baltimore, MD

Lauren Zeise, Ph.D.
California Department of Health Services/RCHAS
Berkeley, CA

Matthew J. van Zwieten, D.V.M., Ph.D.
Principal Reviewer
Department of Safety Assessment
Merck, Sharp & Dohme Research Laboratories
West Point, PA

* Did not attend

SUMMARY OF TECHNICAL REPORTS REVIEW SUBCOMMITTEE COMMENTS

On June 23, 1992, the draft Technical Report on the toxicology and carcinogenesis studies of talc received public review by the National Toxicology Program Board of Scientific Counselors' Technical Reports Review Subcommittee. The review meeting was held at the National Institute of Environmental Health Sciences, Research Triangle Park, NC.

Dr. K.M. Abdo, NIEHS, introduced the toxicology and carcinogenesis studies of talc by discussing the rationale for study, describing the experimental design, reporting on survival and body weight effects, describing effects on respiratory function, and commenting on compound-related neoplasms in rats and nonneoplastic lesions in rats and mice. The proposed conclusions were *some evidence of carcinogenic activity* of talc in male F344/N rats, *clear evidence of carcinogenic activity* in female F344/N rats, and *no evidence of carcinogenic activity* in male or female B6C3F₁ mice.

Dr. van Zwieten, a principal reviewer, agreed with the proposed conclusions. He said that if available, information should be added to the Introduction regarding particle sizes of talc to which humans are exposed during various industrial and cosmetic uses. This would allow a comparison with the aerosol particle size distribution of talc in the animal studies. Dr. Abdo said such information was not available but since the material used was cosmetic grade he assumed humans were exposed to similar particle sizes. Dr. van Zwieten stated that the section dealing with the histopathologic description of pulmonary neoplasms in rats indicates that uncertainty existed regarding diagnosis of hyperplasia and benign and malignant neoplasia and asked for clarification. Dr. S.L. Eustis, NIEHS, said the pathologists were confident that the lesions diagnosed were neoplasms, but there was difficulty in determining whether or not a small number of lesions of inflammatory or hyperplastic nature were preneoplastic.

Dr. Goodman, the second principal reviewer, said his initial position was to disagree with the proposed conclusion. However, he said that he would defer a recommendation pending discussion of whether or not the maximum tolerated dose (MTD) was exceeded in female rats and consideration of the data concerning the trend towards an increased incidence of spontaneous pheochromocytomas in rats. Dr. Eustis argued that in this particular study the appearance of

lung neoplasms together with impaired pulmonary function is relevant to what might occur in humans with dust overload. Thus, he said, even though the MTD may have been exceeded, the study is valid. Dr. Goodman believed that lung neoplasms produced in female rats following exposure to talc might have been secondary to chronic toxicity. He noted that the recommended time-weighted average human exposure level for talc containing no asbestos fibers is 2 mg/m³ and thought that this dose should have been used in the current study. Dr. Abdo agreed.

Because Dr. McKnight, the third principal reviewer, was unable to attend the meeting, Dr. L. Hart, NIEHS, read her review into the record. Dr. McKnight agreed in principle with the conclusions with the exception that consideration should be given to raising the level of evidence in male rats to clear evidence, since one of the arguments for the level chosen, i.e., no supporting hyperplasia in the adrenal gland, was not warranted. Further, there was strong supporting evidence from the increases in malignant pheochromocytomas and benign and malignant pheochromocytomas (combined) among female rats. Dr. Eustis said because of the high incidence of bilateral pheochromocytomas there was not enough tissue present to find hyperplasia. When considering all the evidence, including a preponderance of benign neoplasms in male rats, the level of evidence seemed appropriate. Dr. McKnight had commented that evidence from humans suggests that direct effects on the adrenal gland may be possible. Dr. Eustis said that although the possibility cannot be ruled out that talc may reach the adrenal gland, its lack of solubility in aqueous fluids and the way the substance is cleared by the lungs would make a direct effect on the adrenal gland very unlikely. Dr. McKnight thought that a sentence should be added to the conclusions stating that male and female mice might have tolerated higher doses. Dr. Eustis noted that as reported in the conclusions, exposure to talc produced chronic inflammation of the lungs in mice which supported an MTD being reached.

Dr. Goodman asked if the conclusion for female rats could be worded "clear evidence of carcinogenic activity only under those circumstances in which there was an indication of chronic toxicity." Dr. Eustis replied that in the discussion the appearance of neoplasms is clearly placed in the context of the chronic toxicity. Dr. Silbergeld said she was increasingly

concerned about a rigid criterion whereby evidence of carcinogenicity is discounted if toxicity is present. Dr. Eustis commented that the degree of chronic disease, based on fibrosis and inflammation, was quite similar between male and female rats so it would be difficult to argue that the MTD was exceeded in one sex and not the other. Dr. J.K. Haseman, NIEHS, pointed out that after the levels of evidence there is a paragraph in the conclusion that delineates all toxic lesions associated with chemical exposure in the lung.

Dr. J. Haartz, NIOSH, asked that more details be provided for the spatial distribution of the talc in the chambers, and analyses of contaminants such as metals from impurities in the compressed air used. During the public comment period, Dr. Carlson read from a letter from Dr. Frank Mirer, Health and Safety Department, United Auto Workers. Dr. Mirer said the dose selection should be considered in light of current enforceable Permissible Exposure Limits, which are 5 mg/m³ respirable fraction and 15 mg/m³ for total dust. Thus, the low dose selected for this experiment is below the OSHA limit when time-weighted averaging is considered. Dr. Mirer suggested that the studies in male rats and male and female mice should be considered inadequate for determination of carcinogenicity of talc.

Dr. Goodman moved that the conclusion be modified to state that in light of lung toxicity previously noted,

the MTD was exceeded in female rats. Dr. Bailey seconded the motion which was defeated by two yes (Drs. Bailey, Goodman) to five no votes with one abstention (Dr. Silbergeld). Dr. Silbergeld abstained because she thought the notion as framed was not informative given that complexities known about the MTD for these types of compounds. Dr. van Zwieten moved that the Technical Report on talc be accepted with the revisions discussed and with the conclusions as written for male rats, *some evidence of carcinogenic activity*, for female rats, *clear evidence of carcinogenic activity*, and for male and female mice, *no evidence of carcinogenic activity*. Dr. Hayden seconded the motion. Dr. Goodman offered an amendment to insert a clause in the second sentence of the conclusions between "rats" and "based" as follows: "under conditions in which there was evidence of chronic lung toxicity." The amendment was tabled for lack of a second. Dr. Silbergeld offered an amendment to insert "the same doses of" between "to" and "talc" in the first sentence of the second paragraph of the conclusions. Dr. Zeise seconded the motion, which was accepted by six yes votes to two no votes (Drs. Davis, Goodman). Dr. Zeise offered an amendment that a sentence be added to the effect that mice may have been able to tolerate higher doses. The amendment was tabled for lack of a second. Dr. van Zwieten's original motion as amended by Dr. Silbergeld was then accepted by seven yes votes to one no vote (Dr. Goodman).

INTRODUCTION

TALC (Non-Asbestiform)

CAS No. 14807-96-6

Molecular Formula: $Mg_3Si_4O_{10}(OH)_2$ Molecular Weight: 379.26

Synonyms: talcum; agalite; emtal 596; non-asbestiform talc; non-fibrous talc; steatite; hydrous magnesium silicate

CHEMICAL AND PHYSICAL PROPERTIES

Talc is a fine powder, white to grayish white in color, with a greasy feel and luster. It is insoluble in water, cold acids, and alkalis (*Merck Index*, 1983) and has a density of 2.7 to 2.8 and a melting point of 900° to 1,000° C (Hawley, 1977). Talc as a pure mineral is composed of 63.5% SiO_2 , 31.7% MgO , and 4.8% H_2O (Pooley and Rowlands, 1977).

PRODUCTION, USE, AND HUMAN EXPOSURE

Talc is produced by open pit or underground mining of talc rocks and processed by crushing, drying, and milling. Contaminating minerals including iron, nickel, manganese, chromium, aluminum, and titanium are separated from talc by flotation or elutriation. Talc is then finely powdered, treated with boiling diluted hydrochloric acid, washed well, and dried (Osol *et al.*, 1980). Geological formation of talc rock results from the alteration of magnesia- and silica-rich ultramafic rocks under a range of temperatures and pressures. These hydrothermal alterations may lead to the formation of other mineral phases such as tremolite and serpentine minerals, including chrysotile. These mineral phases may occur as microscopic intergrowths, nodules, or discrete zones within or adjacent to talc (Rohl *et al.*, 1976).

United States production of talc for 1985 was estimated at 1.1 million metric tons, with industrial pattern of use as follows: ceramics, 37%; paints, 19%; paper, 10%; roofing, 10%; plastics, 7%; cosmetics, 5%; rubber, 3%; insecticides, 1%; and other uses, 9% (Bureau of Mines, 1986). Commercial talc is categorized into cosmetic grade, which is free of

asbestos, and industrial grade, which contains other minerals including asbestos (Hildick-Smith, 1976).

A comprehensive review of the literature before 1987 on the use, exposure, and biological effects of talc was published by IARC (1987). Talc is used as a dusting powder, including baby powder, either alone or with starch or boric acid, for medicinal or toiletry preparations; as an excipient and filler for pills and tablets; and for dusting tablet molds (*Merck Index*, 1983). It is also used as a filler and pigment for paints, putty, and plaster; as a carrier and diluent for pesticides; as an additive to clay in ceramic manufacture; in paper coatings; and for the manufacture of rubber and roofing materials (Hawley, 1977). The recommended time-weighted average (TWA) human exposure level for talc containing no asbestos fibers is 2 mg/m^3 (ACGIH, 1989).

A large segment of the population is potentially exposed to talc. The number of workers exposed to talc has been estimated at 1,371,201, which includes 349,228 females (NIOSH, 1990). In addition, the public is potentially exposed to talc through its many uses in pharmaceuticals and consumer products. Based on its uses, human exposure to talc can occur via inhalation, ingestion, or dermal exposure.

ABSORPTION, DISTRIBUTION, AND EXCRETION

Experimental Animals

The absorption and disposition of 3H -labeled talc in rats, mice, and guinea pigs administered a single oral dose, as well as its translocation in rabbits administered a single or multiple intravaginal dose was

studied by Phillips *et al.* (1978). The oral doses were 50 mg/kg for rats, 40 mg/kg for mice, and 25 mg/kg for guinea pigs. Rabbits were administered either a single intravaginal dose of 50 mg/kg or the same dose once a day for 6 days. In rats, mice, and guinea pigs, more than 95% of the dose was excreted in the feces 3 to 4 days after dosing. Less than 2% of the radioactivity was recovered in the urine. This radioactivity probably reflected contamination of urine samples with feces. No radioactivity was found in the liver or kidneys of these animals. No translocation of talc was found in the ovaries of rabbits.

Hanson *et al.* (1985) and Pickrell *et al.* (1989) studied the lung burden in groups of five male and five female F344/N rats and B6C3F₁ mice following inhalation exposure to concentrations of talc for 6 hours per day, 5 days per week, for 4 weeks. The mean exposure concentrations used were 2.3, 4.3, or 17 mg/m³ for rats and 2.2, 5.7, or 20.6 mg/m³ for mice. The resulting lung talc burdens were 0.08, 0.19, and 0.87 mg/g of lung for rats and 0.1, 0.33, and 1.2 mg/g of lung for mice. These data clearly indicate that the amount of talc retained per unit of lung tissue was proportional to the exposure concentration of talc.

Pulmonary deposition, translocation, and clearance of neutron-activated talc was studied in hamsters after a single, 2-hour, nose-only inhalation exposure (Wehner *et al.*, 1977a,b). Deposition of talc in the lung was demonstrated by X-ray fluorescence and X-ray diffraction. An estimated 6% to 8% of the inhaled quantity was deposited in the alveoli. The biological half-life of the talc deposited in the alveoli was estimated at 7 to 10 days. No translocation of talc to liver, kidneys, ovaries, or other parts of the body was found.

Humans

Talc, a filler in some drugs injected by addicts, was found in the lung (Groth *et al.*, 1972; Lamb and Roberts, 1972; Farber *et al.*, 1981; Crouch and Churg, 1983), spleen, kidney, liver, brain, adrenal gland, thyroid gland (Groth *et al.*, 1972), and retina (Atlee, 1972) of some addicts. In the lung, most of the talc particles were seen within the vessels of the alveolar walls and were often associated with marked foreign body granulomas (Crouch and Churg, 1983).

TOXICITY

Experimental Animals

The LD₅₀ for talc has not been established. Talc caused death in guinea pigs administered 2 or 3 injections of 25 mg talc in saline (Dogra *et al.*, 1977) and in rats receiving a splenic injection of 1,400 mg/kg body weight (Eger and DaCanalis, 1964). Deaths occurred in rats exposed to a very dense atmosphere of talc (particle size <5 μm) 3 hours a day, for 12 days (Policard, 1940). The concentration of talc in the atmosphere was not known and the observed mortality may have been due to suffocation.

Wagner *et al.* (1977) reported on the toxic effects of talc in rats exposed orally or by inhalation. No significant decrease in mean life span and no pathologic effects were found in rats fed 100 mg talc for 101 days. Rats exposed to talc atmospheres of 10.8 mg/m³ (particle size, 25 μm) for 3 months showed minimal lung fibrosis, and no change in severity occurred during the post-exposure period. By contrast, rats exposed to the same atmospheres for a year had minimal to slight fibrosis, and the severity had increased to moderate within a year after cessation of exposure. Rats exposed to atmospheres of 30 to 383 mg/m³ "industrial" or "pharmaceutical" talc for 9 months developed chronic inflammatory changes, including thickening of the pulmonary artery walls and emphysema (Bethege-Iwanska, 1971). There were no histopathologic changes in the lung, heart, liver, renal tissue, or uterus of hamsters exposed to respirable aerosols containing 8 mg/m³ of cosmetic grade talc for 150 minutes a day, 5 days per week, for 300 days (Wehner, 1980).

Rats administered a single intratracheal injection of 50 mg of pure talc in water did not show lung fibrosis or lymph node abnormalities. Those receiving the same dose of "calcined" talc developed lung and lymph node fibrosis (Luchtrath and Schmidt, 1959). These differing results may be related to differences in the crystal structures of "pure" and "calcined" talc. Bronchiolar inflammation occurred in rats 4 days after an intratracheal injection of 25 mg talc (containing tremolite) in water; collagenous tissue developed within a few months after injection (Gross *et al.*, 1970).

Injection of 10 mg of talc containing some asbestos into the pleural cavity of mice produced granulomas (Davis, 1972). A single injection of 20 mg of talc into the right pleural cavity of rats produced granulomas at the injection site; one lung adenoma was also observed but no other changes related to talc administration were observed in the lung (Wagner *et al.*, 1977). Rats with abdominal muscle implants of suture materials dusted with talc or talc pellets initially had mild to moderate acute inflammation, followed by chronic inflammation and granuloma formation within 3 days (Sheikh *et al.*, 1984).

Rats with subcutaneous inflammation caused by talc had a decrease in bone formation as evidenced by hypozincemia and a decrease in metaphyseal trabecular surfaces. Both hypozincemia and the decrease in osteoblast trabecular surfaces were directly proportional to the number of granulomas present (Marusic *et al.*, 1990).

Talc produced retinopathy in adult Rhesus monkeys administered intravenous injections of talc once every 2 weeks for 3.5 to 10 months. Talc particles were found lodged in the precapillary arterioles and capillaries, producing a focal occlusion of retinal and choroidal capillaries (Kaga *et al.*, 1982a,b).

Humans

Exposure to industrial grade talc dust causes pulmonary fibrosis; however, reports on cosmetic grade talc dust are conflicting. Hildick-Smith (1976) reported that cosmetic grade talc did not appear to be injurious to health, while Vallyathan and Craighead (1981) reported that it was. Four of seven workers exposed to heavy concentrations (0.4 to 36 mg/m³) of cosmetic grade talc for 4 to 27 years had histologic evidence of pulmonary fibrosis at death (Therriault *et al.*, 1974). Wells *et al.* (1979) also noted chronic pulmonary degenerative disease in a housewife who reported heavy use of cosmetic talc. Inhalation of pure talc is known to result in a disease known as talcosis, which may include acute or chronic bronchitis and interstitial inflammation. Radiographically, the lesion appears as a small, irregular nodule, typical of a small-airway obstruction. Intravenous administration of talc-containing oral medications by abusers causes vascular granulomas (Feigin, 1986). Intravenous talcosis was diagnosed in a 36-year-old woman who was a drug abuser (Hill *et al.*, 1990). Talcosis in this patient was identified by the presence of peripheral nodular lesions on chest X-rays and was confirmed by the presence of birefringent particles in a trans-

bronchial biopsy. Pulmonary talc granulomatosis was diagnosed in a cocaine sniffer (Oubeid *et al.*, 1990). Chest X-rays of a heroin addict who later died of respiratory failure showed a progressive massive fibrosis of the lung secondary to intravenous injection of the drug (Crouch and Churg, 1983). Microscopic examination of lung lesions revealed an active granulomatous reaction with associated vascular obliteration. Throughout the lesion, refractile birefringent plates of particulate material were noted. Interstitial perivascular and vascular granulomas were noted in the periphery of the lung. The particulate material was identified as talc by X-ray spectroscopy and diffraction methods. Intravenous injection of talc-containing drugs intended for oral use was the cause of pulmonary granulomatosis and pulmonary hypertension in 19 patients (Arnett *et al.*, 1976). In patients with pulmonary hypertension, talc granuloma was found in the pulmonary arteries. In patients without hypertension, talc granuloma was found in the pulmonary interstitium. Patients suffering from talc granulomatosis (confirmed by lung biopsy) as a result of intravenous injection of crushed tablets of pentazocine had dyspnea, increased angiotensin-converting enzyme concentrations, and increased lymphocytes by bronchoalveolar lavage (Farber *et al.*, 1982). Pneumoconiosis (talcosilicosis) was diagnosed in a 54-year-old female confectionery worker who was exposed to talc dust for 5 years (Canessa *et al.*, 1990). Talc, administered by intrapleural instillation to promote pleural symphysis in the palliation of recurrent malignant pleural effusions, caused adult respiratory distress syndrome (ARDS) in three patients (Rinaldo *et al.*, 1983). Symptoms of ARDS included fever, dyspnea, and respiratory failure. ARDS occurred in a 16-month-old baby inhaling baby powder. Normal pulmonary function returned in this patient after 6 years, as determined by a follow-up study (Reyes and Brown, 1989).

CARCINOGENICITY

Experimental Animals

Results of carcinogenicity studies of talc in animals were reviewed by the IARC (1987). The following is an excerpt of this review:

No significant difference in neoplasm incidence was observed between two groups of 25 male and 25 female Wistar rats (10 weeks old) that received an equivalent of 50 mg/kg per day of commercial talc (composition not specified) in the diet or the basal diet for life (Gibel *et al.*, 1976). Similar results were

obtained in groups of 16 male and 16 female Wistar rats (21 to 26 weeks old) that received 100 mg of Italian talc (particle size, 25 μm ; containing 92% talc, 3% chlorite, 1% carbonate minerals, and 0.5 to 1% quartz) per rat per day in the diet or the basal diet for 5 months and observed for life (Wagner *et al.*, 1977). In both studies small numbers of animals were used.

Groups of 24 male and 24 female Wistar rats, 6 to 8 weeks of age, were exposed by inhalation to 10.8 mg/m^3 Italian talc aerosol 7.5 hours a day, 5 days per week, for 6 or 12 months. Ten days after the end of each exposure period, six rats in each group were killed; an additional four rats were killed one year later. Within 28 months from the beginning of the study, 12 animals in each group had died. No lung neoplasms were observed in rats exposed to talc for 6 months; one lung adenoma occurred in a rat exposed for 12 months. No lung neoplasms were found in the control rats (Wagner *et al.*, 1977).

Three groups of 50 male and 50 female hamsters, 4 weeks of age were exposed to talc aerosol (37.1 mg/m^3 , mean respirable fraction 9.8 mg/m^3) for 3, 30, or 150 minutes per day, 5 days a week, for 30 days. Two additional groups of hamsters were exposed to talc aerosol (27.4 mg/m^3 , mean respirable fraction 8.11 mg/m^3) for 30 or 150 minutes per day, for 300 days. Two groups of 25 male and 25 female hamsters were exposed to air and served as controls. No primary neoplasms were found in the respiratory system of any hamster. Twenty-five percent of the hamsters exposed to the aerosols for 30 or 150 minutes for 300 days had alveolar cell hyperplasia compared to 10% in the controls (Wehner *et al.*, 1977a, 1979).

No local neoplasms were found in 50 female R3 mice, 3 to 6 months of age, administered a 0.2 mL subcutaneous injection of talc of unspecified composition (80 mg talc in peanut oil) and observed for life (Neukomm and de Trey, 1961).

Forty Swiss albino rats, 6 weeks of age (sex unspecified) received a single intraperitoneal injection of 20 mg commercial talc (unspecified composition) in saline. Sixteen animals died by the end of 6 months. Of the 24 mice that lived to termination (time not specified) three had peritoneal mesotheliomas compared to three of 46 of the controls (Ozesmi *et al.*,

1985). This study was considered inadequate because of poor reporting.

Forty female Wistar rats, 8 to 12 weeks of age, were given four intraperitoneal injections of 25 mg granular talc in 2 mL saline at weekly intervals. Similarly, 80 females were injected with saline and served as controls. The rats were observed until termination or death (average survival time, 602 days). A mesothelioma occurred in one of 36 rats given talc but none was found in the controls (Pott *et al.*, 1974, 1976a,b).

No mesothelioma was observed in two groups of 24 male and 24 female Wistar rats administered a single intrapleural injection of 20 mg Italian talc in saline or saline alone. A pulmonary adenoma occurred in one rat that died at 25 months. Mean survival time (655 days for the talc group versus 691 for the controls) was not affected (Wagner *et al.*, 1977).

Groups of 30 to 50 female Osborne-Mendel rats, 12 to 20 weeks of age, received intrapleural implantation of one of seven grades of refined commercial talc from separate sources in hardened gelatin. Rats were observed for up to 2 years at which time survivors were killed. Pleural sarcoma incidences were: grade 1, 1/26; grade 2, 1/30; grade 3, 1/29; grade 4, 1/29; grade 5, 0/30; grade 6, 0/30; grade 7, 0/29. The incidence of pleural sarcoma was three of 491 in untreated controls, 17 of 615 in controls receiving implants of "nonfibrous" material described by the authors as "noncarcinogenic," and 14 of 29 in rats receiving UICC crocidolite asbestos (Stanton *et al.*, 1981).

The IARC Working Group noted that in most of the talc studies, little or no characterization of the mineralogy, fiber content, or particle size of the samples was given. Thus, the group concluded that there was inadequate evidence on the carcinogenicity of talc to experimental animals.

Humans

An epidemiology study of pottery workers in the United States revealed an association between exposure to non-fibrous talc and increased mortality and lung cancer incidence (Thomas and Stewart, 1987). Increased incidences of lung cancer occurred exclusively among pottery workers employed in the manufacture of plumbing fixtures. A later study of

employees in three ceramic plumbing fixture factories showed increased mortality from respiratory disease and from lung cancer. The increased incidence in lung cancer was highest among workers who were simultaneously exposed to silica and talc. The lung cancer mortality risk increased with the number of years of exposure to talc, but showed no pattern by the number of years of exposure to silica. Among men exposed to talc, lung cancer risk decreased with age at first exposure to non-fibrous talc and increased with years since first exposure (Thomas, 1990). Whether or not exposure to silica had a promoting effect on lung cancer is not known. No increased risk for lung cancer or benign respiratory disease was found in millers or miners of non-asbestiform talc (Wergeland *et al.*, 1990).

A case-control study found that women who had perineal exposure to deodorizing powders alone or in combination with other talc-containing powders, had a 2.8 times higher risk of developing borderline ovarian neoplasms than women who were not perineally exposed to powder (Harlow and Weiss, 1989). In an earlier study, the use of talc as a dusting powder on the perineum or on sanitary napkins by women was associated with an increased risk of epithelial ovarian cancer. Women engaged in both practices had a relatively higher risk of developing this type of cancer (Cramer *et al.*, 1982). No information was presented regarding exposure levels or the content of contaminating minerals of the talc used. In another study, the role of exposure to talcum powder, tobacco, alcohol, and coffee, and the histories of tubal sterilization and hysterectomy on ovarian cancer risk was assessed. The study involved 188 women diagnosed with epithelial ovarian cancer and 539 control women. No association was found between the incidence of epithelial ovarian cancer and increasing frequency or duration of talc use. Patients did not differ from control women in the use of talc on sanitary pads, contraceptive diaphragms, or both. (Whittemore *et al.*, 1988).

REPRODUCTIVE AND TERATOGENIC EFFECTS

Experimental Animals

Talc produced nonspecific abnormalities in chicken eggs at incidences similar to those caused by thalidomide and sulphadimethoxine (Yang, 1977).

No teratologic effects were observed in hamsters, rats, mice, or rabbits after oral administration of talc. The doses used were 1,600 mg/kg for rats and mice on days 6 through 15 of gestation, 1,200 mg/kg for hamsters on days 6 through 10 of gestation, and 900 mg/kg for rabbits on days 6 through 18 of gestation (Food and Drug Research Laboratories, 1973).

Humans

No information on the reproductive or teratogenic effects of talc in humans has been reported.

GENETIC TOXICITY

There are no published studies on the genotoxicity of talc. The IARC (1987) review of talc included unpublished results from a 1974 study conducted by Litton Bionetics that showed no mutagenic activity for talc *in vitro* or *in vivo*. Talc did not induce mutations in *Salmonella typhimurium* strains TA1530 or HisG46, or in the yeast, *Saccharomyces cerevisiae*. No chromosomal aberrations were observed in human fibroblasts treated with talc *in vitro*. *In vivo* tests conducted in rats gave negative results for induction of chromosomal aberrations in bone marrow cells and dominant lethal mutations in germinal cells.

STUDY RATIONALE

Talc was nominated by NIOSH in 1978 for testing by NTP because of the paucity of adequate information on its carcinogenicity and because of widespread human exposure. The inhalation route was chosen because it is the most common route for human exposure.

MATERIALS AND METHODS

PROCUREMENT AND CHARACTERIZATION OF TALC

Talc (MP 10-52 Grade) was obtained from Walsh and Associates (North Kansas City, MO) in two lots (W101882 and B5415). The talc was manufactured by the Minerals, Pigments, and Metals Division of Pfizer, Inc. and is one of their microtalc series of products. Both lots were from Pfizer's Barretts, Montana, mine which is a strip mine located between Barretts and Three Brother, Montana. This mine is the only source for the MP 10-52 grade talc. The grade designation is for high purity talc that has a top particle size of 10 μm and according to the manufacturer contains no tremolite or any asbestiform minerals. Lot W101882 was used from the beginning of the 2-year studies through January 1986. Lot B5415 was used in the 2-year studies from 27 January 1986 to the end of the studies on 31 October 1986. The talc was extensively characterized by the analytical chemistry laboratory, Midwest Research Institute (Kansas City, MO), and by McCrone Associates (Norcross, GA). The methods and results of these studies are detailed in Appendix I.

The study mineral, a finely powdered white solid, was identified as talc by infrared spectroscopy, elemental analysis, Karl Fischer water analysis, thermogravimetric analyses, spark source mass spectrometry, automated scanning electron probe analyses, X-ray diffraction, polarized light microscopy, and transmission electron microscopy. Both lots were found to be asbestos free by polarized light microscopy and transmission electron microscopy. Results of automated scanning electron microprobe analysis of lot W101882 indicated that the sample was virtually free of silica (1 particle of silica in 1,466 particles examined). Bulk chemical stability studies were not conducted due to the physical and chemical properties of talc. During the study the compound was stored in tightly sealed plastic bags at 25° C.

GENERATION AND MONITORING OF CHAMBER CONCENTRATIONS

Talc aerosols were generated in a single fluidized-bed generator by injecting compressed air into the bed

(Figure I2). The aerosolized talc particles were then mixed with diluting air before being delivered to the exposure chambers (Hazleton 1000 and 2000, Lab Products, Inc.). A second fluidized-bed generator for the control chamber contained only the stainless steel bed material (Figures I3 and I4).

Aerosol concentrations were monitored daily in each chamber by taking three, 2-hour filter samples. Background concentrations of suspended particles were measured daily in the control chamber by taking a 6-hour filter sample. A RAM-S forward light scattering monitor (GCA, Bedford, MA) was used to determine the stability of the aerosol concentrations and the need to adjust the aerosol generation system during the exposure. Determinations were made at the beginning, middle, and end of each filter sampling period. The overall mean concentrations were 6.1 and 18.6 mg/m^3 for the rat study and 5.9 and 16.7 mg/m^3 for the mouse study. While the overall means were very close to target concentrations, there were problems experienced in maintaining control of chamber concentrations. Weekly mean exposure concentrations for the 2-year studies are presented in Figures I5 through I8.

Chamber Atmosphere Characterization

Uniformity of the aerosol concentrations in each chamber was determined at approximately 3-month intervals with the RAM-S. The spatial variation as estimated by the relative standard deviation was higher in the mouse study than in the rat study with values from 12% to 44% relative standard deviation for mice and 2% to 31% relative standard deviation for rats. To minimize the variation in talc concentrations, the animal cages were rotated weekly.

The time to reach 90% of the target concentration (T_{90}) was approximately 10 minutes. Therefore, the length of the exposure was defined as 6 hours plus the T_{90} of 10 minutes.

The aerosol size distribution was determined once each month for each chamber using a cascade impactor. The average mass mean aerodynamic diameter and the geometric standard deviation were calculated to be $2.7 \pm 1.9 \mu\text{m}$ and $3.2 \pm 1.9 \mu\text{m}$ for

the 6 and 18 mg/m³ rat chambers. The values were 3.3 ± 1.9 μm and 3.6 ± 2.0 μm for the 6 and 18 mg/m³ mouse chambers. The individual values are presented in Tables I1 and I2.

Study Design

Groups of 50 male and 50 female rats and mice were selected for whole body inhalation to talc at target concentrations of 0, 6, or 18 mg/m³. These exposure concentrations provided a dose equivalent of 0, 2.8, or 8.4 mg/kg per day for male rats, 0, 3.2, or 9.6 mg/kg per day for female rats, 0, 2, or 6 mg/kg per day for male mice, and 0, 1.3, or 3.9 mg/kg per day for female mice. Rats were exposed for 6 hours per day, 5 days a week until mortality in any exposure group reached 80% (113 weeks for males and 122 weeks for females). Exposure of rats to talc was extended beyond 2 years based on the report that 80% of pulmonary neoplasms induced in rats by inhalation exposure to diesel exhaust occurred after 2 years (Mauderly *et al.*, 1986). Mice were exposed for 103 or 104 weeks. At the conclusion of the exposures, rats were exposed to filtered air for 10 or 11 days, while mice were exposed to filtered air for 10 to 14 days. All animals were necropsied and received a complete pathology evaluation.

Additional special study groups of 22 male and 22 female rats and 40 male and 40 female mice similarly exposed to 0, 6, or 18 mg/m³ were designated for interim pathology evaluations; lung talc burden measurements; serial pulmonary function measurements (rats only); and lung biochemistry, cytology, and phagocytosis measurements. Rats were evaluated at 6, 11, 18, and 24 months, while mice were evaluated at 6, 12, and 18 months. Insufficient numbers of rats remained alive at week 103 of exposure for both pulmonary function and/or lung biochemistry/cytology and pathology distribution groups, therefore the remaining rats in these groups were combined. The numbers of rats and mice evaluated for pulmonary function and lung biochemistry, cytology, and phagocytosis and the methods used for each of the parameters are presented in Appendix G for rats and Appendix H for mice.

Source and Specification of Animals

Male and female F344/N rats were obtained from Lovelace Inhalation Toxicology Research Institute (Albuquerque, NM). Male and female B6C3F₁ mice were obtained from Frederick Cancer Research Center (Frederick, MD). Rats and mice were held 3 weeks before the studies began. Rats were 6 to

7 weeks old, and mice were 7 weeks old when the studies began. Animal health was monitored by serologic analyses during the studies under the protocols of the NTP Sentinel Animal Program (Appendix K).

Animal Maintenance

Rats and mice were housed individually throughout the studies. Drinking water was available *ad libitum*. Further details of animal maintenance are given in Table 1.

Clinical Examinations and Pathology

All rats and mice were observed twice daily. Clinical observations and body weights were recorded at the beginning of the studies, weekly for 13 weeks, and monthly thereafter.

A necropsy was performed on all rats in the lifetime core study and all mice in the 2-year core study. Organ weights were recorded for the brain, heart, right kidney, liver, and lung at the end of the studies. During necropsy, all organs and tissues were examined for grossly visible lesions. A complete histopathologic examination was performed on all animals. Tissues for microscopic examination were fixed in 10% neutral buffered formalin, embedded in paraffin, sectioned to a thickness of 5 μm, and stained with hematoxylin and eosin.

Microscopic evaluations were completed by the study laboratory pathologist and the pathology data were entered into the Toxicology Data Management System. The slides, paraffin blocks, and residual wet tissues were sent to the NTP Archives for inventory, slide/block match, and wet tissue audit for accuracy of labeling and animal identification and for thoroughness of tissue trimming. The slides, individual animal data records, and pathology tables were evaluated by an independent quality assessment laboratory. The individual animal records and tables were compared for accuracy, slides and tissue counts were verified, and histotechnology was evaluated. A quality assessment pathologist reviewed lung and bronchial and mediastinal lymph nodes in rats and mice and the nose in male mice for accuracy and consistency of lesion diagnosis.

The quality assessment report and slides were submitted to the Pathology Working Group (PWG) chair, who reviewed tissues for which there was a disagreement in diagnosis between the laboratory and quality assessment pathologists. All pulmonary neoplasms in

female rats and representative histopathology slides of adrenal gland (rats), bronchial lymph node, lung, mediastinal lymph node (rats), and nose, or lesions of general interest were presented by the chair to the PWG for review. The PWG included the quality assessment pathologist as well as other pathologists experienced in rodent toxicologic pathology who examined these tissues without knowledge of dose group or previously rendered diagnoses. When the consensus diagnosis of the PWG differed from that of the laboratory pathologist, the final diagnosis was changed to reflect the opinion of the PWG. Details of these review procedures have been described, in part, by Maronpot and Boorman (1982) and Boorman *et al.* (1985). For subsequent analysis of pathology data, the diagnosed lesions for each tissue type were evaluated separately or combined according to the guidelines of McConnell *et al.* (1986).

Statistical Methods

Survival Analyses

The probability of survival was estimated by the product-limit procedure of Kaplan and Meier (1958) and is presented in the Results section of this report. Animals were censored from the survival analyses at the time they were found dead from other than natural causes or were missing, culled, or missexed; animals dying from natural causes were not censored. Statistical analyses for possible dose-related effects on survival used Cox's (1972) method for testing two groups for equality and Tarone's (1975) life table tests to identify dose-related trends. All reported P values for the survival analysis are two sided.

Calculation of Incidence

The incidences of neoplasms or nonneoplastic lesions presented in Tables A1, A4, B1, B4, C1, C4, D1, and D4 are given as the number of animals bearing such lesions at a specific anatomic site and the number of animals with that site examined microscopically. For calculation of statistical significance, the incidences of all nonneoplastic lesions and most neoplasms (Tables A3, B3, C3, and D3) are given as the ratio of the number of affected animals to the number of animals with the site examined microscopically. However, when macroscopic examination was required to detect neoplasms in certain tissues (e.g., skin, intestine, harderian gland, and mammary gland) before microscopic evaluation, or when neoplasms had multiple potential sites of occurrence (e.g., leukemia or lymphoma), the denominators consist of the number of animals on which a necropsy was performed.

Analysis of Neoplasm Incidences

The majority of neoplasms in these studies were considered to be incidental to the cause of death or not rapidly lethal. Thus, the primary statistical method used was logistic regression analysis, which assumed that the diagnosed neoplasms were discovered as the result of death from an unrelated cause and thus did not affect the risk of death. In this approach, neoplasm prevalence was modeled as a logistic function of chemical exposure and time. Both linear and quadratic terms in time were incorporated initially, and the quadratic term was eliminated if it did not significantly enhance the fit of the model. The exposed and control groups were compared on the basis of the likelihood score test for the regression coefficient of dose. This method of adjusting for intercurrent mortality is the prevalence analysis of Dinse and Lagakos (1983), further described and illustrated by Dinse and Haseman (1986). When neoplasms are incidental, this comparison of the time-specific neoplasm prevalences also provides a comparison of the time-specific neoplasm incidences (McKnight and Crowley, 1984).

In addition to logistic regression, alternative methods of statistical analysis were used, and the results of these tests are summarized in the appendixes. These include the life table test (Cox, 1972; Tarone, 1975), appropriate for rapidly lethal neoplasms, and the Fisher exact test and the Cochran-Armitage trend test (Armitage, 1971; Gart *et al.*, 1979), procedures based on the overall proportion of neoplasm-bearing animals.

Tests of significance include pairwise comparisons of each exposure group with controls and a test for an overall dose-response trend. Continuity-corrected tests were used in the analysis of neoplasm incidence, and reported P values are one sided. The procedures described above also were used to evaluate selected nonneoplastic lesions. For further discussion of these statistical methods, see Haseman (1984).

Analysis on Nonneoplastic Lesion Incidences

Because all nonneoplastic lesions in this study were considered to be incidental to the cause of death or not rapidly lethal, the primary statistical analysis used was a logistic regression analysis in which lesion prevalence was modeled as a logistic function of chemical exposure and time. For lesions detected at the interim evaluation, the Fisher exact test was used, a procedure based on the overall proportion of affected animals.

Analysis of Continuous Variables

Two approaches were employed to assess the significance of pairwise comparisons between exposed and control groups in the analysis of continuous variables. Organ and body weight data that had approximately normal distributions were analyzed using the parametric multiple comparison procedures of Williams (1971, 1972) and Dunnett (1955). Lung burden parameters that had skewed distributions were analyzed using the nonparametric multiple comparison methods of Shirley (1977) and Dunn (1964). Jonckheere's test (Jonckheere, 1954) was used to assess the significance of the dose-response trends and to determine whether a trend-sensitive test (Williams' or Shirley's test) was more appropriate for pairwise comparisons than a test that does not assume a monotonic dose-response trend (Dunnett's or Dunn's test).

Quality Assurance Methods

The lifetime and 2-year studies were conducted in compliance with Food and Drug Administration Good Laboratory Practice Regulations (21 CFR, Part 58). In addition, as study records were submitted to the NTP Archives, they were audited by an independent quality assurance contractor. Separate audits covering completeness and accuracy of the pathology data, pathology specimens, final pathology tables, and preliminary review draft of this NTP Technical Report were conducted. Audit procedures are presented in the reports, which are on file at the NIEHS. The audit findings were reviewed and assessed by the NTP staff so that all discrepancies had been resolved or were otherwise addressed during the preparation of this Technical Report.

TABLE 1
Experimental Design and Materials and Methods in the Lifetime and 2-Year Inhalation Studies of Talc

Study Laboratory

Lovelace Inhalation Toxicology Research Institute (Albuquerque, NM)

Strain and Species

Rats: F344/N

Mice: B6C3F₁

Animal Source

Rats: Lovelace Inhalation Toxicology Research Institute (Albuquerque, NM)

Mice: Frederick Cancer Research Center (Frederick, MD)

Time Held Before Studies

3 weeks

Average Age When Placed on Studies

Rats: 6-7 weeks

Mice: 7 weeks

Date of First Exposure

Rats: 2 July 1984

Mice: 4 June 1984

Duration of Exposure

Rats: 6 hours/day, 5 days/week for 113 weeks (males) and 122 weeks (females)

Mice: 6 hours/day, 5 days/week for 103-104 weeks

Date of Last Exposure

Rats: 29 August 1986 (males) and 31 October 1986 (females)

Mice: 30 May 1986

Average Age When Killed

Rats: 120-121 weeks (males) and 129-130 weeks (females)

Mice: 112-113 weeks

Method of Sacrifice

Injection of T-61 solution for all rats in the lifetime study, all rats designated for pathologic evaluation, and all mice. Halothane anesthesia for all rats designated for biochemical interim evaluations.

Necropsy Dates

Rats: 8-9 September 1986 (males) and 10-11 November 1986 (females)

Mice: 9-13 June 1986 (males) and 2-6 June 1986 (females)

Size of Study Groups

50 males and 50 females

Method of Animal Distribution

Assigned to groups by weight and sex using computer-generated random numbers.

Animals per Cage

1

Method of Animal Identification

Toe clip and ear tag

Diet

NIH-07 Rat and Mouse Ration (Zeigler Bros., Gardner, PA) available *ad libitum* during nonexposure periods

Maximum Storage Time for Feed

90 days

TABLE 1**Experimental Design and Materials and Methods in the Lifetime and 2-Year Inhalation Studies of Talc**
(continued)

Water

Automatic Watering System (Edstrom), available *ad libitum*

Cages

Stainless steel mesh cages (Hazleton, Aberdeen, MD)

Chambers

Rats: Stainless steel multitiered whole-body exposure chambers (H2000, Hazleton Systems, Aberdeen, MD), washed weekly

Mice: Stainless steel multitiered whole-body exposure chambers (H1000, Hazleton Systems, Aberdeen, MD), washed weekly

Bedding

Untreated paper cage board (Shepherd Specialties Paper, Inc., Kalamazoo, MI), changed twice a day

Filters

Room Air and Chamber Air High Efficiency Particulate Air (HEPA) Filter (prefilter and exit filter), MIL Spec MIL-F-51068C (Flanders, Washington, DC)

Animal Room Environment**Rats**

Average temperature: 25° C

Relative humidity: 6%-100%

Fluorescent light: 12 hours/day

Room air changes: minimum of 10 changes/hour

Mice

Average temperature: 23° C

Relative humidity: 0%-100%

Fluorescent light: 12 hours/day

Room air changes: minimum of 10 changes/hour

Exposure Concentrations

0, 6, and 18 mg/m³ by inhalation

Type and Frequency of Observation

Observed twice daily; body weights and clinical findings recorded at study initiation, weekly through week 13, and monthly thereafter

Necropsy

Necropsy performed on all animals. Organ weights recorded for brain, heart, right kidney, liver, and lung.

Histopathology

Complete histopathologic examinations performed on all animals. In addition to tissue masses and gross lesions, tissues examined included: adrenal gland, bone (including marrow), brain, clitoral gland (female rats), epididymis, esophagus, gallbladder (mice), harderian gland (female rats and mice), heart, kidney, large intestine (cecum, colon, rectum), larynx, liver, lung, lymph nodes (bronchial, mandibular, mediastinal, mesenteric), mammary gland, nose, ovary, pancreas, parathyroid gland, pituitary gland, preputial gland (male rats), prostate gland, salivary gland, seminal vesicle, skin, small intestine (duodenum, ileum, jejunum), spleen, stomach (forestomach, glandular), testis, thymus, thyroid gland, trachea, urinary bladder, and uterus.

RESULTS

RATS

4-WEEK STUDY DOSE SELECTION

Results of previous studies (Bethege-Iwansha, 1971; Wagner *et al.*, 1977; Wehner, 1980) indicated that talc produces its toxic effects after prolonged (1 year) exposure. Based on these results it was concluded that lung talc burden and not talc toxicity would be the limiting factor for dose selection for the chronic studies. For this reason the NTP chose to conduct a 4-week lung burden study rather than the conventional 13-week study.

Selection of 6 and 18 mg talc/m³ as the exposure concentrations was based on the results of a 4-week inhalation study in F344/N rats to determine lung talc burden and histopathologic changes associated with talc exposure. These studies indicated that the amount of talc retained in the lung was similar between sexes and proportional to exposure concentration (Appendix F). Microscopic examination of the lungs revealed an accumulation of alveolar macrophages in the lungs only at the 18 mg/m³ concentration. Based on these findings it was predicted that aerosol concentrations greater than 18 mg/m³ would overwhelm lung clearance mechanisms, impair lung function, and possibly shorten survival.

LIFETIME STUDY

Survival

Estimates of survival probabilities for male and female rats are shown in Table 2 and in the Kaplan-Meier curves in Figure 1. Survival of exposed male and female rats was similar to that of the controls.

Body Weights and Clinical Findings

The mean body weights of male and female rats exposed to 6 mg talc/m³ were similar to those of

controls throughout the study (Tables 3 and 4, and Figure 2). Mean body weights of male and female rats exposed to 18 mg/m³ were slightly lower than those of controls, particularly after week 65. The final mean body weight of males in the 18 mg/m³ group was 4% lower than that of the controls, while the final mean body weight of females in the 18 mg/m³ group was 14% lower than that of the controls.

All serological tests performed prior to the beginning of the study and after 6, 12, and 18 months of exposure were negative. After 24 months and 28 and 30 months (females), serological tests for Kilham rat virus (KRV), Sendai virus, and rat coronavirus/sialodacryoadenitis virus (RCV/SDA) were positive (Table K1). The significance of the positive KRV titer is unknown since it was found in only one rat and was not observed at later times. No clinical findings or gross or microscopic lesions that could be attributed to Sendai virus or RCV/SDA infections were observed in the exposed or control groups. Since there was no clinical or pathological evidence of disease and since the infection occurred very late in the study, these subclinical infections are believed to have had no impact on the study results.

Pathology and Statistical Analyses of Results

This section describes the statistically significant or biologically noteworthy changes in the incidences of neoplastic or nonneoplastic lesions of the lung, lymph node, nose, and adrenal medulla. Summaries of the incidences of nonneoplastic lesions and neoplasms, the individual animal tumor diagnoses, and the statistical analyses of primary neoplasms that occurred with an incidence of at least 5% in at least one group are presented in Appendix A for male rats and Appendix B for female rats.

TABLE 2
Survival of Rats in the Lifetime Inhalation Study of Talc

	0 mg/m ³	6 mg/m ³	18 mg/m ³
Male			
Lifetime Study Groups			
Animals initially in study	49	50	50
Moribund	23	19	20
Natural deaths	17	17	14
Animals surviving to study termination ^a	9	14	16
Percent probability of survival at end of study ^b	18	28	32
Mean survival (days) ^c	696	707	711
Survival analysis ^d	P=0.217N	P=0.422N	P=0.192N
Special Study Groups^e			
Animals initially in study	22	22	22
Moribund	9	5	6
Natural deaths	2	2	6
Scheduled evaluation	11	15	10
Females			
Lifetime Study Groups			
Animals initially in study	50	50	50
Missing ^f	0	1	0
Moribund	28	17	27
Natural deaths	11	19	14
Animals surviving to study termination	11	13	9
Percent probability of survival at end of study	22	28	18
Mean survival (days)	743	753	758
Survival analysis	P=0.846	P=0.805N	P=0.977
Special Study Groups			
Animals initially in study	22	22	22
Moribund	5	3	8
Natural deaths	2	1	2
Scheduled evaluation	15	18	12

^a Includes animals that died during the last week of the study

^b Kaplan-Meier determinations

^c Mean of all deaths (uncensored, censored, and terminal sacrifice).

^d The result of the life table trend test (Tarone, 1975) is in the control column, and the results of the life table pairwise comparisons (Cox, 1972) with the controls are in the exposed columns. A negative trend or lower mortality in a group is indicated by N.

^e Not included in survival analyses

^f Censored from survival analyses

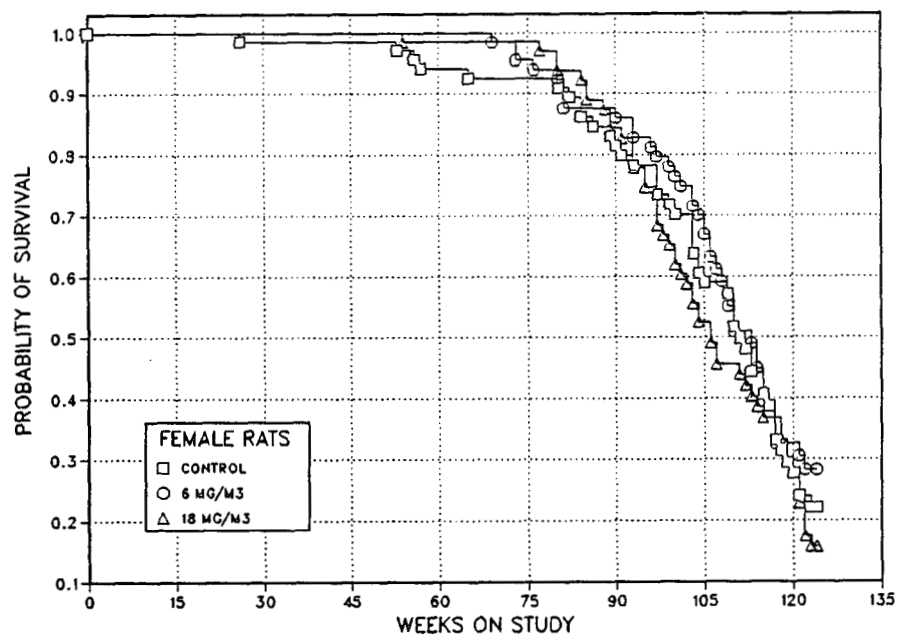
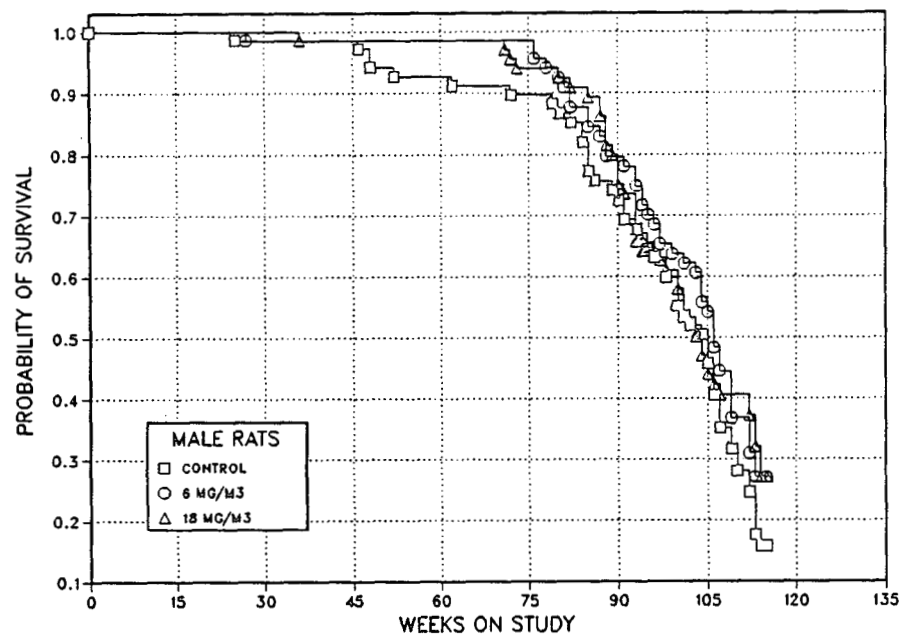

FIGURE 1
Kaplan-Meier Survival Curves for Male and Female Rats Administered Talc by Inhalation for Their Lifetime

TABLE 3
Mean Body Weights and Survival of Male Rats in the Lifetime Inhalation Study of Talc

Weeks on Study	0 mg/m ³		6 mg/m ³			18 mg/m ³		
	Av. Wt. (g)	Number of Survivors	Av. Wt. (g)	Wt. (% of controls)	Number of Survivors	Av. Wt. (g)	Wt. (% of controls)	Number of Survivors
1	118	72	121	103	72	119	101	72
2	174	72	174	100	72	174	100	72
3	201	72	200	100	72	202	101	72
4	225	72	215	95	72	219	97	72
5	237	72	239	101	72	238	101	72
6	250	72	252	101	72	251	100	72
7	265	72	263	99	72	263	99	72
8	275	72	270	98	72	269	98	72
9	287	72	280	98	72	281	98	72
10	297	72	293	99	72	293	99	72
11	304	72	300	99	72	297	98	72
13	317	72	315	100	72	312	98	72
17	339	72	338	100	72	331	98	72
21	359	72	355	99	72	351	98	72
25	374	71	370	99	72	367	98	72
29 ^a	380	68	378	99	68	369	97	69
33	398	68	393	99	68	386	97	69
38	407	68	405	100	68	393	97	68
41	413	68	412	100	68	401	97	68
45	421	68	420	100	68	410	97	68
49 ^a	431	63	428	99	65	418	97	65
53	434	62	432	100	65	422	97	65
57	435	62	432	99	65	424	97	65
61	443	62	442	100	65	430	97	65
65	450	61	444	99	65	432	96	65
69	448	61	440	98	65	429	96	65
73	453	60	442	98	65	432	95	63
77	452	60	441	98	63	429	95	62
81 ^a	444	55	434	98	57	423	95	59
85	450	49	434	97	53	424	94	57
89	447	47	437	98	50	424	95	51
93	434	43	429	99	48	408	94	46
97	429	40	427	100	41	407	95	40
101	410	34	395	96	40	394	96	34
105 ^a	390	29	391	100	35	385	99	28
109	377	18	390	104	19	376	100	24
113	358	11	389	109	15	342	96	21
Mean for weeks								
1-13	246		244	99		243	99	
14-52	391		389	99		381	97	
53-113	428		425	99		411	96	

^a Interim evaluations occurred during weeks 27, 47, 79, and 105.

TABLE 4
Mean Body Weights and Survival of Female Rats in the Lifetime Inhalation Study of Talc

Weeks on Study	0 mg/m ³		6 mg/m ³			18 mg/m ³		
	Av. Wt. (g)	Number of Survivors	Av. Wt. (g)	Wt. (% of controls)	Number of Survivors	Av. Wt. (g)	Wt. (% of controls)	Number of Survivors
1	97	72	101	104	72	98	101	72
2	126	72	127	101	72	125	99	72
3	136	72	139	102	72	138	101	72
4	149	72	144	97	72 ^a	145	97	72
5	153	72	159	104	72	154	100	72
6	160	72	165	103	72	160	101	72
7	165	72	169	102	72	166	101	72
8	168	72	171	102	72	168	100	72
9	174	72	176	101	72	173	100	72
10	178	72	182	102	72	179	101	72
11	181	72	184	102	72	181	100	72
13	186	72	191	103	72	187	101	72
17	194	72	201	104	72	197	101	72
21	206	72	211	103	72	207	101	72
25	213	72	216	101	72	214	100	72
29 ^b	215	68	219	101	69	213	99	69
33	224	68	227	101	69	221	99	69
38	233	68	237	102	69	229	98	69
41	239	68	242	101	69	235	98	69
45	248	68	251	101	69	242	98	69
49 ^b	256	65	259	101	66	252	98	66
53	266	65	270	102	66	260	98	66
57	276	62	277	101	66	269	98	65
61	285	62	288	101	66	276	97	65
65	290	61	288	100	66	277	96	65
69	296	61	292	99	66	281	95	65
73	300	61	295	98	64	284	95	65
77	303	61	297	98	62	284	94	64
81 ^b	300	57	301	100	55	283	94	59
85	306	54	302	99	55	283	93	57
89	307	52	305	99	55	287	94	53
93	307	49	305	99	53	286	93	49
97	303	46	304	100	50	281	93	43
101	291	44	296	102	47	271	93	39
105 ^b	288	37	295	103	43	271	94	33
109	290	32	288	99	28	273	94	26
113	289	24	273	94	24	260	90	23
117	283	18	264	93	18	256	90	21
121	277	13	264	95	14	231	84	13
123	268	13	260	97	13	231	86	10
Mean for weeks								
1-13	156		159	102		156	100	
14-52	225		229	102		223	99	
53-123	291		288	99		271	93	

^a The number of animals weighed for this week is fewer than the number of animals surviving.

^b Interim evaluations occurred during weeks 27, 47, 79, and 105.

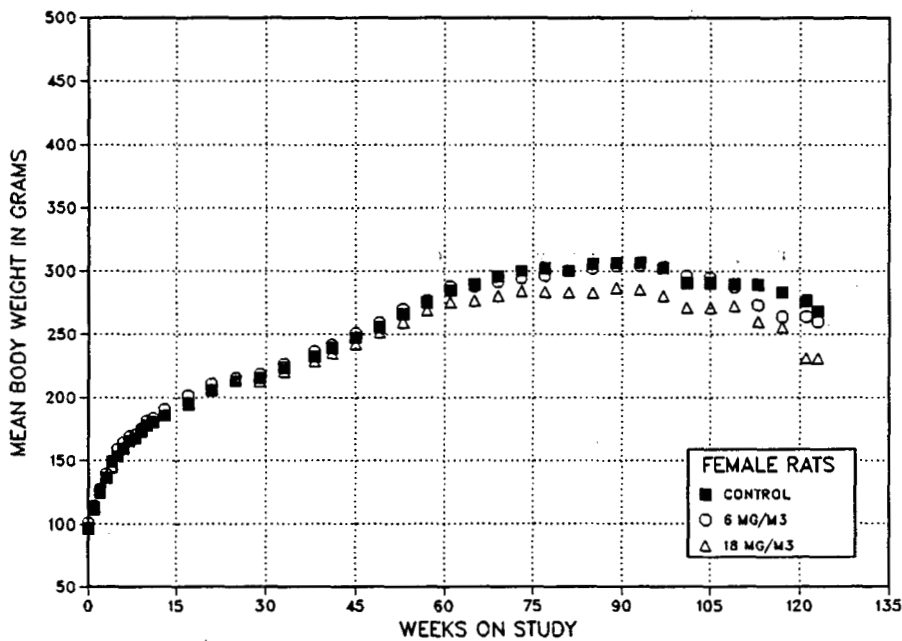
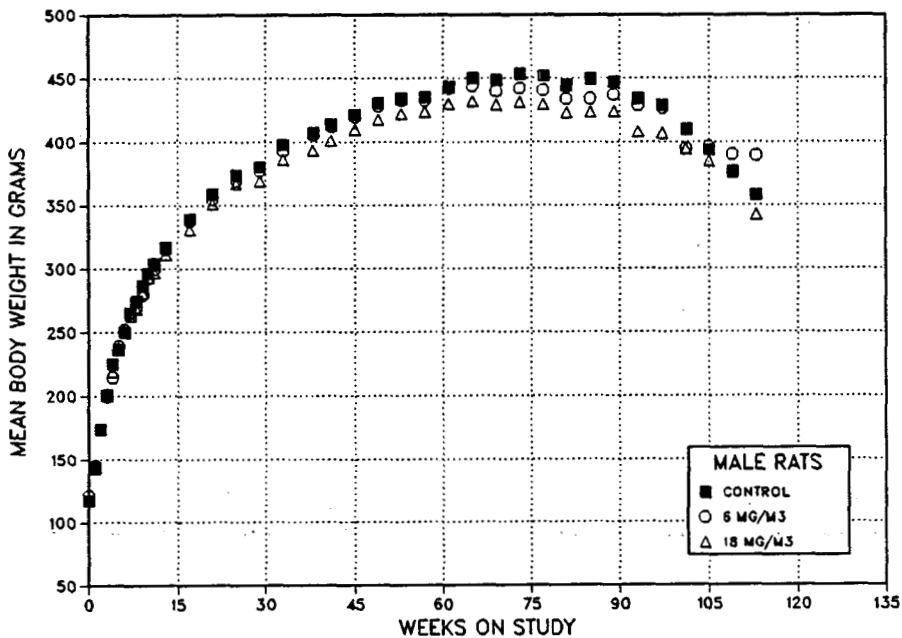

FIGURE 2
Growth Curves for Male and Female Rats Administered Talc by Inhalation for Their Lifetime

Lung: Absolute and relative lung weights of male rats exposed to 18 mg/m³ were significantly greater than those of controls at the 6-, 11-, and 18-month interim evaluations and at the end of the study, while those of female rats exposed to 18 mg/m³ were significantly greater than those of controls at the 11-, 18-, and 24-month interim evaluations and at the end of the study (Appendix E). Although lung weights of males exposed to 6 mg/m³ were not significantly different from controls at any of the interim evaluations, those of females at the 18-month interim evaluation and at the end of the lifetime study were significantly greater.

Pulmonary lesions in male and female rats occurring in response to the inhalation of talc aerosols were generally similar at the interim evaluations and the end of the study, but varied in incidence, extent, and severity with exposure concentration and duration (Table 5). At necropsy, the lungs of exposed rats had multiple small, round, pale white lesions visible through the visceral pleura. These lesions were generally larger and more extensive in rats exposed to 18 mg/m³ than in those exposed to 6 mg/m³, and at the end of the study than at the earlier interim evaluations.

At the 6-month interim evaluation, the pulmonary lesions consisted of multiple, focal accumulations of alveolar macrophages and infrequent neutrophils within alveolar lumens (inflammation, granulomatous). When viewed under polarized light, the cytoplasm of the alveolar macrophages contained birefringent particles believed to be talc. In two female rats, the alveolar epithelium in some affected areas had increased numbers of low cuboidal type II pneumocytes (alveolar epithelial hyperplasia), but there was no apparent increase in the amount of collagen within the alveolar septa. The peribronchial lymphoid aggregates of several rats also contained focal accumulations of macrophages that varied from a few to approximately 10 cells in the plane of section (peribronchial hyperplasia, histiocytic).

In contrast to the first interim evaluation, hyperplasia of type II pneumocytes was associated with the intra-alveolar accumulations of macrophages in all exposed rats examined at 11 months. Moreover, in the most severely affected foci, the alveolar septa were thickened by the accumulation of reticulin and collagen fibers (interstitial fibrosis). The lesions in rats examined at 18 and 24 months and in core study rats were similar but generally larger and more extensive (Plates 1 and 2). Although alveolar macrophages

predominated in the inflammatory lesions, varying numbers of neutrophils were also present and the interstitium contained infiltrates of mononuclear inflammatory cells (lymphocytes and macrophages). Moreover, epithelioid macrophages and multinucleated giant cells were also observed within foci of inflammation at these later time points. In some rats, there were well-delineated areas of fibrosis that completely obliterated the alveoli (Plates 3 and 4). Hyperplasia of the alveolar epithelium was often prominent at the margins of these lesions (Plate 5). The affected cells were cuboidal or columnar with prominent nucleoli and exhibited some pleomorphism.

In addition to the changes described above, squamous metaplasia of the alveolar epithelium was observed in two male and eight female rats in the 18 mg/m³ groups of the core study (Table 5). The metaplasia was usually associated with inflammation and was characterized by the replacement of alveolar type I and type II pneumocytes by well-differentiated keratinized squamous cells. Squamous cysts were also observed in three males and seven females in the 18 mg/m³ groups and in one 6 mg/m³ female. The cysts had outer walls of well-differentiated, stratified squamous epithelium without cellular atypia and central lumens often containing sloughed keratin.

While it was the consensus of the Pathology Working Group that the squamous cysts represented a form of squamous metaplasia, there was some uncertainty regarding the biological potential of these lesions. Clearly, squamous metaplasia in the upper respiratory tract induced by some chemicals is preneoplastic. Currently, however, there is little known about the potential of these squamous cysts for autonomous growth or for progression to malignancy.

Although an alveolar/bronchiolar adenoma was observed in one 6 mg/m³ female at the 18-month interim evaluation, the remainder of the pulmonary neoplasms were seen in rats in the core study (Table 6). The incidences of alveolar/bronchiolar adenoma, carcinoma, and adenoma or carcinoma (combined) in female rats exposed to 18 mg/m³ were significantly greater than those of controls. A squamous cell carcinoma was also observed in an 18 mg/m³ female. Alveolar/bronchiolar neoplasms occurred in two males exposed to talc aerosols, one at each of the exposure concentrations, and none were seen in control males. Because of the low number of affected male rats, these neoplasms could not be attributed to talc exposure.

TABLE 5
Incidences of Selected Lung Lesions in Rats in the Lifetime Inhalation Study of Talc

	Male			Female		
	0 mg/m ³	6 mg/m ³	18 mg/m ³	0 mg/m ³	6 mg/m ³	18 mg/m ³
6-Month Interim Evaluation						
Lung ^a	3	3	3	3	3	3
Inflammation, Granulomatous ^b	0	3* (1.3) ^c	3* (2.3)	0	3* (1.3)	3* (3.0)
Peribronchial Hyperplasia, Histiocytic	0	1 (1.0)	2 (2.0)	0	1 (1.0)	2 (1.0)
Hyperplasia, Alveolar Epithelium	0	0	0	0	1 (1.0)	1 (1.0)
11-Month Interim Evaluation						
Lung	2	3	3	3	3	3
Inflammation, Granulomatous	0	3* (1.7)	3* (3.0)	0	3* (1.7)	3* (2.7)
Peribronchial Hyperplasia, Histiocytic	0	0	0	0	1 (1.0)	2 (1.5)
Hyperplasia, Alveolar Epithelium	0	3* (2.0)	3* (1.7)	0	3* (1.0)	3* (2.3)
Interstitial, Fibrosis, Focal	0	2 (1.0)	3* (1.0)	0	2 (1.0)	3* (1.0)
18-Month Interim Evaluation						
Lung	3	3	2	3	3	3
Inflammation, Granulomatous	1 (1.0)	3 (1.3)	2 (2.0)	0	3* (1.7)	3* (2.0)
Peribronchial Hyperplasia, Histiocytic	0	2 (1.0)	2 (1.0)	0	1 (1.0)	2 (1.0)
Hyperplasia, Alveolar Epithelium	1 (1.0)	3 (1.0)	2 (1.0)	1 (1.0)	3 (1.0)	3 (1.3)
Interstitial, Fibrosis, Focal	0	3* (1.0)	2 (1.5)	0	3* (1.3)	3* (1.7)
Alveolar/bronchiolar Adenoma	0	0	0	0	1	0
24-Month Interim Evaluation						
Lung	3	6	2	5	9	3
Inflammation, Granulomatous	0	6* (1.5)	2 (2.0)	1 (1.0)	9** (1.4)	3 (1.7)
Peribronchial Hyperplasia, Histiocytic	0	1 (1.0)	1 (2.0)	0	2 (1.0)	0
Hyperplasia, Alveolar Epithelium	0	6* (1.0)	2 (1.5)	1 (1.0)	9** (1.4)	3 (2.3)
Interstitial, Fibrosis, Focal	0	5* (1.0)	2 (1.5)	0	8** (1.4)	3* (3.0)
Core Study						
Lung	49	50	50	50	48	50
Inflammation, Granulomatous	2 (1.0)	50** (1.6)	49** (2.3)	2 (1.5)	47** (1.5)	50** (2.8)
Peribronchial Hyperplasia, Histiocytic	0	12** (1.3)	8** (1.9)	0	8** (1.3)	9** (1.3)
Alveolar Epithelium, Hyperplasia	5 (2.0)	26** (1.3)	38** (1.7)	2 (1.0)	27** (1.2)	47** (2.1)
Alveolus, Metaplasia, Squamous	0	0	2 (1.0)	0	0	8** (1.1)
Interstitial, Fibrosis, Focal	1 (1.0)	16** (1.2)	33** (1.8)	1 (1.0)	24** (1.5)	45** (2.1)
Cyst (Squamous)	0	0	3	0	1	7**

* Significantly different ($P \leq 0.05$) from the control by Fisher's exact test (interim evaluation) or logistic regression (lifetime study)

** $P \leq 0.01$

^a Number of animals with lung examined microscopically.

^b Number of animals with lesion.

^c Average severity grades of lesions in affected animals: 1 = minimal, 2 = mild, 3 = moderate, 4 = marked

TABLE 6
Incidences of Lung Neoplasms in Rats in the Lifetime Inhalation Study of Talc

	Male			Female		
	0 mg/m ³	6 mg/m ³	18 mg/m ³	0 mg/m ³	6 mg/m ³	18 mg/m ³
Core Study						
Alveolar/bronchiolar Adenoma						
Overall rates ^a	0/49 (0%)	1/50 (2%)	1/50 (2%)	1/50 (2%)	0/48 (0%)	9/50 (18%)
Terminal rates ^b	0/9 (0%)	0/14 (0%)	1/16 (6%)	0/11 (0%)	0/13 (0%)	1/9 (11%)
First incidence (days)	- ^d	781	799 (T)	805	-	716
Logistic regression test ^c	P=0.494	P=0.527	P=0.615	P<0.001	P=0.503N	P=0.010
Alveolar/bronchiolar Carcinoma						
Overall rates	0/49 (0%)	0/50 (0%)	1/50 (2%)	0/50 (0%)	0/48 (0%)	5/50 (10%)
Terminal rates	0/9 (0%)	0/14 (0%)	1/16 (6%)	0/11 (0%)	0/13 (0%)	3/9 (33%)
First incidence (days)	-	-	799 (T)	-	-	828
Logistic regression test	P=0.370	-	P=0.615	P=0.003	-	P=0.028
Alveolar/bronchiolar Adenoma or Carcinoma						
Overall rates	0/49 (0%)	1/50 (2%)	1/50 (2%)	1/50 (2%)	0/48 (0%)	13/50 (26%)
Terminal rates	0/9 (0%)	0/14 (0%)	1/16 (6%)	0/11 (0%)	0/13 (0%)	4/9 (44%)
First incidence (days)	-	781	799 (T)	805	-	716
Logistic regression test	P=0.494	P=0.527	P=0.615	P<0.001	P=0.503N	P<0.001
Squamous Cell Carcinoma						
Overall rates	0/49 (0%)	0/50 (0%)	0/50 (0%)	0/50 (0%)	0/48 (0%)	1/50 (2%)

(T) Terminal sacrifice

^a Number of neoplasm-bearing animals/number of animals examined microscopically.

^b Observed incidence at terminal kill

^c Beneath the control incidence are the P values associated with the trend test. Beneath the exposed group incidence are the P values corresponding to pairwise comparisons between the controls and that exposed group. The logistic regression test regards these lesions as nonfatal. A lower incidence in an exposure group is indicated by N.

^d Not applicable; no neoplasms in animal group

The adenomas were irregular, circumscribed masses consisting of cuboidal to columnar epithelium arranged in alveolar, tubular, or papillary formations and separated by varying amounts of collagenous connective tissue. The neoplastic epithelium generally formed a single layer and was relatively uniform with minimal cellular atypia. The carcinomas were distinguished from the adenomas on the basis of having greater cellular pleomorphism and atypia, but they exhibited little evidence of invasion and none metastasized (Plates 6 and 7). In several benign and malignant neoplasms, the central portion of the mass was composed primarily of dense collagen and the epithelial component was located at the periphery. The extent of fibrosis in these neoplasms is not typical of spontaneous alveolar/bronchiolar neoplasms in control F344/N rats. The fibrous connective tissue was not interpreted as being a primary scirrhous response to the neoplastic epithelium, but

rather a component of the prolonged inflammatory reaction to talc.

Lymph node: Histiocytic hyperplasia, consisting of accumulations of macrophages in the subscapular and medullary sinuses, occurred in the bronchial lymph nodes (male: 0 mg/m³, 0/41; 6 mg/m³, 44/48; 18 mg/m³, 46/49; female: 0/46, 40/47, 45/47) and in the mediastinal lymph nodes of rats exposed to talc (male: 0/48, 40/49, 43/47; female: 0/47, 33/44, 40/47) (Tables A4 and B4). The macrophages had foamy cytoplasm filled with birefringent particles of talc.

Nose: Hyperplasia of the respiratory epithelium of the nasal mucosa occurred in three male rats exposed to 6 mg/m³ and 14 male rats exposed to 18 mg/m³, but not in the control group (Table A4). The lesion consisted of an increase in the number of goblet cells

primarily in the mucosa of the nasal septum. Hyperplasia of the respiratory epithelium also occurred in several female rats, but the incidences in the exposed groups were not significantly increased (Table B4).

During the pathology review process, it was noted that male and female rats in control and exposed groups had large eosinophilic droplets in the cytoplasm of the olfactory and, to a lesser extent, the respiratory epithelium. The lesion (cytoplasmic alteration) was focal or multifocal and usually located near the junction of the two epithelial types. Although present in the controls, the incidences were increased in exposed rats (males: 3/49, 18/48, 40/47; females: 5/48, 23/45, 46/48).

Adrenal medulla: Focal adrenal medulla hyperplasia or pheochromocytoma were observed in rats at the various interim evaluations, but the number of affected rats was too small to draw definitive conclusions. However, in the core study, benign, malignant, or complex (combined) pheochromocytomas occurred with a significant positive trend in male and female rats, and the incidences in the 18 mg/m³ groups were significantly greater than those of controls by pairwise comparisons (Table 7). Moreover, bilateral pheochromocytomas were more frequent in exposed male rats than in controls (Tables A3 and B3). Although adrenal medulla hyperplasia occurred with similar frequency among exposed and control female rats, the incidences of hyperplasia in exposed males were significantly lower than controls. The lower incidences in exposed males are possibly due, in part, to the reduced amount of normal medullary tissue (e.g., medullary tissue without a pheochromocytoma) in which to observe hyperplasia.

Focal hyperplasia and pheochromocytoma constitute a morphological continuum. Focal hyperplasia consisted of irregular, small foci of small to normal sized medullary cells arranged in packets or solid clusters slightly larger than normal; compression of the surrounding tissue was minimal or absent. Pheochromocytomas were generally larger than focal hyperplasia and caused variable compression of the surrounding parenchyma; many obscured much or all of any remaining normal medullary tissue. The neoplastic cells were arranged in variably sized

aggregates, large solid clusters, and/or trabecular cords several layers thick separated by a delicate fibrovascular stroma. The larger neoplasms usually exhibited greater cellular pleomorphism and atypia than smaller neoplasms. Because the only morphological criterion that unambiguously distinguishes malignant from benign pheochromocytomas is frank invasion or metastasis, a diagnosis of malignant pheochromocytoma was made only when there was invasion of the capsule. Complex pheochromocytomas consisted of an admixture of neoplastic pheochromocytes and neuroblasts, ganglion cells, and/or Schwann cells.

Lung Talc Burden

The lung talc burdens of exposed rats, normalized to control lung weight or exposure level, are presented in Tables G2 and G3. The lung talc burden normalized to control lung weight (mg talc/g control lung) adjusts for differences in lung weight between sexes or at different ages. The lung burden normalized to control lung weight and exposure level adjusts for exposure level to determine the effect of exposure concentration on talc clearance from the lung.

The data, normalized to control lung weight, show that talc burdens of rats exposed to 6 mg/m³ were similar between males and females and increased progressively from 6 to 24 months (Table G2). Lung talc burdens in females exposed to 18 mg/m³ also increased progressively from 6 to 24 months. In contrast, lung talc burdens of males at the 18 mg/m³ exposure concentration increased from 6 to 18 months, but remained about the same at 18 and 24 months.

The exposure-normalized data show that lung talc burdens were generally proportional to exposure concentration at each interim evaluation. The exposure-normalized lung burdens of rats exposed to 6 or 18 mg/m³ were generally similar at each of the interim evaluations except for slight increases for males at 6 and 11 months and females at 6 months (Table G3). This suggests that either clearance of talc was not substantially impaired by increasing the exposure concentration, or that clearance of talc was impaired similarly at both exposure levels.

TABLE 7
Incidences of Neoplasms and Nonneoplastic Lesions of the Adrenal Medulla in Rats
in the Lifetime Inhalation Study of Talc

	Male			Female		
	0 mg/m ³	6 mg/m ³	18 mg/m ³	0 mg/m ³	6 mg/m ³	18 mg/m ³
11-Month Interim Evaluation						
Adrenal Medulla ^a	2	3	3	3	3	3
Hyperplasia ^b	0	0	0	0	0	0
Pheochromocytoma, Benign	1	0	0	0	0	0
18-Month Interim Evaluation						
Adrenal Medulla	3	3	2	2	3	3
Hyperplasia	0	1	0	0	1	1
Pheochromocytoma, Benign	0	0	1	0	0	0
24-Month Interim Evaluation						
Adrenal Medulla	3	6	2	5	9	3
Hyperplasia	2	2	0	3	0	0
Pheochromocytoma, Benign	0	2	0	0	4	0
Pheochromocytoma, Benign, Bilateral	1	1	2	0	1	3
Core Study						
Adrenal Medulla	49	48	47	48	47	49
Hyperplasia	20	8**	9*	22	20	16
Pheochromocytoma, Benign						
Overall rates ^c	25/49 (51%)	30/48 (63%)	36/47 (77%)	13/48 (27%)	14/47 (30%)	18/49 (37%)
Terminal rates ^d	6/9 (67%)	11/14 (79%)	16/16 (100%)	5/11 (45%)	5/13 (38%)	6/9 (67%)
First incidence (days)	429	558	614	678	705	697
Logistic regression test ^e	P=0.007	P=0.213	P=0.009	P=0.185	P=0.541	P=0.225
Pheochromocytoma, Malignant						
Overall rates	3/49 (6%)	3/48 (6%)	7/47 (15%)	0/48 (0%)	1/47 (2%)	10/49 (20%)
Terminal rates	1/9 (11%)	1/14 (7%)	3/16 (19%)	0/11 (0%)	0/13 (0%)	3/9 (33%)
First incidence (days)	670	544	645	- ^f	849	784
Logistic regression test	P=0.096	P=0.662	P=0.178	P<0.001	P=0.509	P=0.001
Pheochromocytoma, Complex						
Overall rates	0/49 (0%)	2/48 (4%)	1/47 (2%)	0/48 (0%)	0/47 (0%)	0/49 (0%)
Terminal rates	0/9 (0%)	1/14 (7%)	0/16 (0%)	0/11 (0%)	0/13 (0%)	0/9 (0%)
First incidence (days)	-	558	743	-	-	-
Logistic regression test	P=0.486	P=0.230	P=0.503	-	-	-
Pheochromocytoma, Benign, Malignant, or Complex						
Overall rates	26/49 (53%)	32/48 (67%)	37/47 (79%)	13/48 (27%)	14/47 (30%)	23/49 (47%)
Terminal rates	7/9 (78%)	12/14 (86%)	16/16 (100%)	5/11 (45%)	5/13 (38%)	8/9 (89%)
First incidence (days)	429	544	614	678	705	697
Logistic regression test	P=0.007	P=0.147	P=0.006	P=0.014	P=0.541	P=0.024

* Significantly different ($P \leq 0.05$) from the control by logistic regression

** $P \leq 0.01$

^a Number of animals with adrenal medulla examined microscopically.

^b Number of animals with lesion.

^c Number of animals with neoplasm per number of animals with adrenal medulla examined microscopically.

^d Observed incidence at terminal kill

^e Beneath the control incidence are the P values associated with the trend test. Beneath the exposed group incidence are the P values corresponding to pairwise comparisons between the controls and that exposed group. The logistic regression test regards these lesions as nonfatal.

^f Not applicable; no neoplasms in animal group

Pulmonary Function

Results of the respiratory function measurements are presented in Tables G9 through G41. A progressive dose and time-related impairment of respiratory function was observed in both male and female rats exposed to talc. The impairment was restrictive in nature, consisting of reduced lung volume, increased lung stiffness, reduced gas exchange efficiency, and nonuniform intrapulmonary gas distribution.

6-Month Interim Evaluation: At 6 months there were few significant differences between values for rats exposed to 18 mg/m³ and controls, and no significant differences between values for rats exposed to 6 mg/m³ and controls. There were, however, slight trends among both males and females toward smaller lung volumes and reduced forced expiratory flow. Total lung capacity, vital capacity, and forced vital capacity were all slightly smaller in the 18 mg/m³ groups, but only the forced vital capacity of females differed significantly from controls. All forced expiratory flow rates were lower in the 18 mg/m³ groups, but only those of males were significantly lower than those of the controls. The reduced flow rates were partly related to the smaller lungs, but even volume-normalized flow tended to be reduced in the exposed rats. The reduced flow rates most likely reflected changes in small airways. Total pulmonary resistance, which primarily reflects flow resistance in large airways, was unaffected.

11-Month Interim Evaluation: Functional alterations were clearly apparent in exposed males and females after 11 months. Total lung capacity, vital capacity, and forced vital capacity were significantly lower in males and females exposed to 18 mg/m³ and males exposed to 6 mg/m³. The reduced volume was accompanied by significant reductions in quasistatic lung compliance in males, and both dynamic and quasistatic lung compliance in females. The volume and compliance changes indicate a stiffening of the lung (or increase in elastic recoil). Forced expiratory flows during mid to late expiration were slightly lower in exposed males than in controls, but the differences were not significant.

A reduction of alveolar-capillary gas exchange efficiency was reflected by a significant reduction of carbon monoxide diffusing capacity in the 18 mg/m³ male and female rat groups. Although diffusing capacity is somewhat volume dependent, the reduced

lung volume did not completely account for the change. Volume-normalized diffusing capacity was also significantly reduced in male and female rats exposed to 18 mg/m³.

18-Month Interim Evaluation: Total lung capacity, vital capacity, and forced vital capacity of all exposed groups of male and female rats were significantly lower than those of controls at 18 months, except for vital capacity of males exposed to 6 mg/m³. In females exposed to 18 mg/m³, these decreases were accompanied by significant increases in resting (functional residual capacity) and minimum (residual) volumes. The decrease in volume at maximum inflations (total lung capacity, vital capacity, and forced vital capacity) reflected the inability of the stiffened lungs to stretch normally. Volume-normalized forced expiratory flows of exposed male and female rats were generally greater than those of controls, due to the reduced lung volume and little or no reduction in flow.

All parameters of lung compliance in male and female rats exposed to 18 mg/m³ were also significantly lower than controls at 18 months, while two of the three compliance parameters were significantly lower at the 6 mg/m³ exposure level. The carbon monoxide diffusing capacities in males and females exposed to 18 mg/m³ were significantly lower than controls at 18 months, which is consistent with the findings at 11 months.

The slope of phase III of the single-breath N₂ wash-out of male and female rats exposed to 18 mg/m³ was significantly greater than controls, apparently due to uneven mixing of oxygen with residual nitrogen in the lung during maximal inflation. This finding reflects a nonuniform distribution of inhaled air.

24-Month Interim Evaluation: Because of reduced survival in all groups of male and female rats, fewer animals remained alive at 24 months for evaluation of pulmonary function. Because of the smaller group sizes (three rats each from the control and 18 mg/m³ groups were evaluated), few of the differences were statistically significant. Nevertheless, there were reductions in lung volume parameters (total lung capacity, vital capacity, and forced vital capacity), lung compliance, and carbon monoxide diffusing capacity in exposed male and female rats consistent with the findings at the earlier time periods.

The progression of the functional impairments over the course of the study are illustrated in Figure 3, which plots the data for three functional parameters obtained from the three male and three female rats in the 18 mg/m³ exposure groups surviving until 24 months.

Bronchoalveolar Lavage and Lung Biochemistry

Following the completion of the pulmonary function tests at the 24-month interim evaluation, bronchoalveolar lavage was performed on the remaining rats in these groups and the lavage fluid was evaluated for enzymes, protein, and cell content as shown in Tables G4 and G5. Values for glucose-6-phosphate dehydrogenase and glutathione peroxidase are not reported because they were below the limits of detection.

The values for β -glucuronidase, alkaline phosphatase, lactate dehydrogenase, and total protein in both male and female rats exposed to 18 mg/m³ talc were significantly greater than those of controls. In addition, females in this group had a significantly higher value of glutathione reductase. Both male and female rats exposed to 6 mg/m³ talc had significantly greater β -glucuronidase values, but only female rats exposed to 6 mg/m³ had higher values of alkaline phosphatase, lactate dehydrogenase, and protein. The percentages of polymorphonuclear leukocytes in the lavage fluid were also significantly greater in male and female rats exposed to talc at both concentration levels. The increases in enzymes, total protein, and

leukocytes are consistent with the morphological findings of a chronic active inflammatory process and cellular degenerative changes.

The viability and phagocytic activity of alveolar macrophages recovered from the lungs of rats exposed to 6 or 18 mg talc/m³ or from the chamber controls ranged from approximately 60% to 80%. Neither the viability nor phagocytic activity were significantly affected by exposure to talc (Table G6).

Table G7 summarizes the effects of talc exposure on collagen metabolism and protein synthesis. Collagenous peptides in lavage fluid and collagen production (% newly synthesized protein) from female rats, but not males, exposed to 6 or 18 mg/m³ were significantly greater than controls. Total lung collagen from males and females at both exposure levels was also significantly greater. Values for non-collagenous protein synthesis were significantly greater in males exposed to 6 or 18 mg/m³ and in females exposed to 18 mg/m³ than in controls.

Lung proteinase activity, as determined from lavage fluid and homogenate supernatant fluid, is shown in Table G8. Acid proteinase activity, primarily cathepsin D, was significantly greater in both males and females exposed to 6 or 18 mg/m³ than in controls. Neutral proteinase activity in homogenate supernatant fluid was also greater in rats exposed to talc. The activity was mostly serine proteinase, like that of polymorphonuclear leukocyte elastase and cathepsin G.

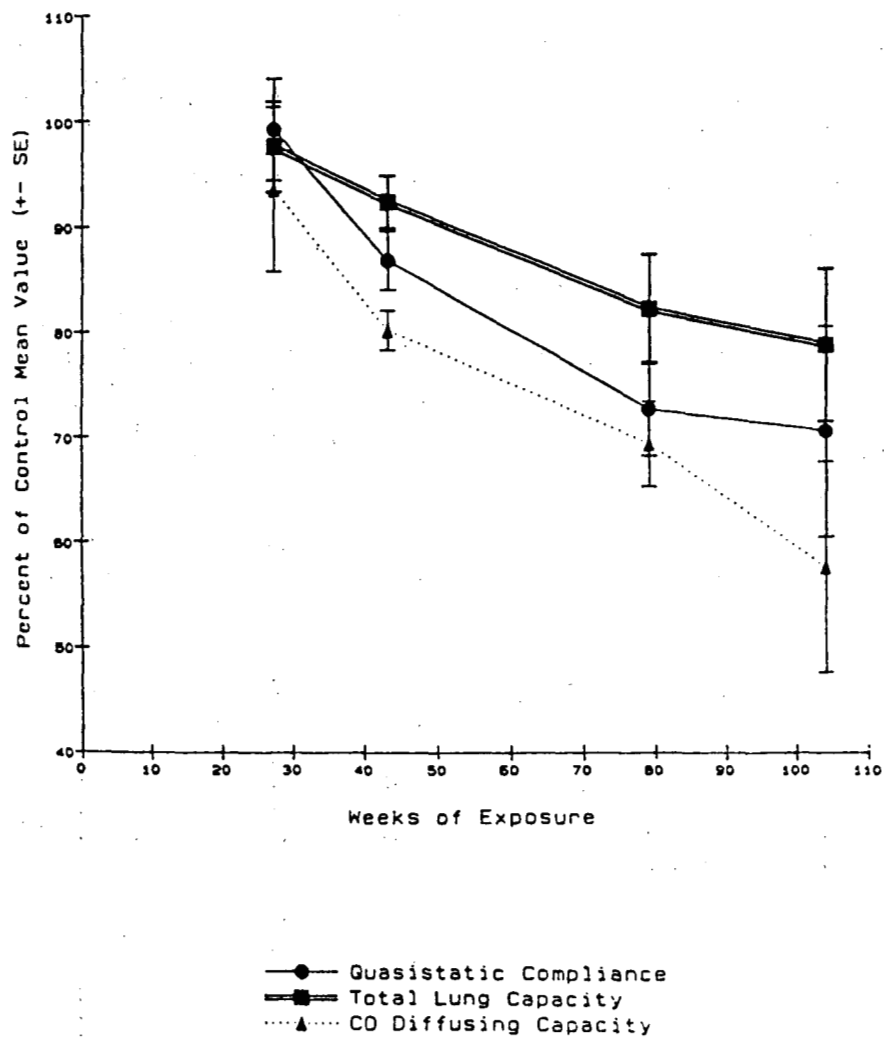

FIGURE 3
Effect of 18 mg Talc/m³ Exposure on Respiratory Function of Male and Female Rats Surviving to 104 Weeks

MICE

4-WEEK STUDY DOSE SELECTION

Selection of 6 and 18 mg talc/m³ as the exposure concentrations was based on the results of a 4-week inhalation study in B6C3F₁ mice to determine lung talc burden and histopathologic changes associated with talc exposure. These studies indicated that the amount of talc retained in the lung was similar between sexes and proportional to exposure concentration (Appendix K). Microscopic examination of the lungs revealed an accumulation of alveolar macrophages in the lungs only at 18 mg/m³. Based on these findings it was predicted that aerosol concentrations greater than 18 mg/m³ would overwhelm lung clearance mechanisms, impair lung function, and possibly shorten survival.

2-YEAR STUDY

Survival

Estimates of survival probabilities for male and female mice are shown in Table 8 and in the Kaplan-Meier curves in Figure 4. Survival of male

and female mice exposed to talc was similar to that of the controls throughout most of the study. One female mouse exposed to 18 mg/m³ died on day 20 and six others died of undetermined causes on day 28 of the study.

Body Weights and Clinical Findings

Mean body weights of male and female mice exposed to talc were similar to controls throughout the study (Tables 9 and 10, and Figure 5). There were no clinical findings in exposed mice that could be attributed to exposure to talc.

Prior to the start of the study and after 6 months of exposure, all serological tests were negative. At 12 months, 8/24 mice were positive for mouse hepatitis virus (MHV), but retesting of the serum by the enzyme linked immunosorbent assay (ELISA) showed all to be negative (Table K1). At the end of the study, 7/30 were positive for *Mycoplasma arthritidis* and 21/30 were positive for epizootic diarrhea of infant mice (EDIM). No clinical signs or gross or microscopic evidence of disease associated with *M. arthritidis* was observed. EDIM does not cause clinical disease or pathology in adult mice.

TABLE 8
Survival of Mice in the 2-Year Inhalation Study of Talc

	0 mg/m ³	6 mg/m ³	18 mg/m ³
Male			
Core Study Groups			
Animals initially in study	50	50	50
Missexed ^a	1	1	0
Missing ^a	2	1	1
Moribund	1	2	3
Natural deaths	16	18	14
Animals surviving to study termination	30	28	32
Percent probability of survival at end of study ^b	65	58	66
Mean survival (days) ^c	648	648	645
Survival analysis ^d	P=0.886N	P=0.771	P=1.000N
Special Study Groups^e			
Animals initially in study	39	40	40
Missing	0	1	1
Moribund	0	1	1
Natural deaths	4	5	7
Scheduled evaluation	35	33	31
Females			
Core Study Groups			
Animals initially in study	50	50	50
Culled ^a	0	1	0
Missing ^a	1	1	0
Moribund	2	4	4
Natural deaths	17	21	21
Animals surviving to study termination	30	23	25
Percent probability of survival at end of study	62	48	50
Mean survival (days)	663	648	590
Survival analysis	P=0.321	P=0.322	P=0.286
Special Study Groups			
Animals initially in study	39	40	40
Moribund	2	5	1
Natural deaths	7	5	10
Scheduled evaluation	30	30	29

^a Censored from survival analyses

^b Kaplan-Meier determinations

^c Mean of all deaths (uncensored, censored, and terminal sacrifice).

^d The result of the life table trend test (Tarone, 1975) is in the control column, and the results of the life table pairwise comparisons (Cox, 1972) with the controls are in the exposed columns. A negative trend or lower mortality in an exposure group is indicated by N.

^e Not included in survival analyses

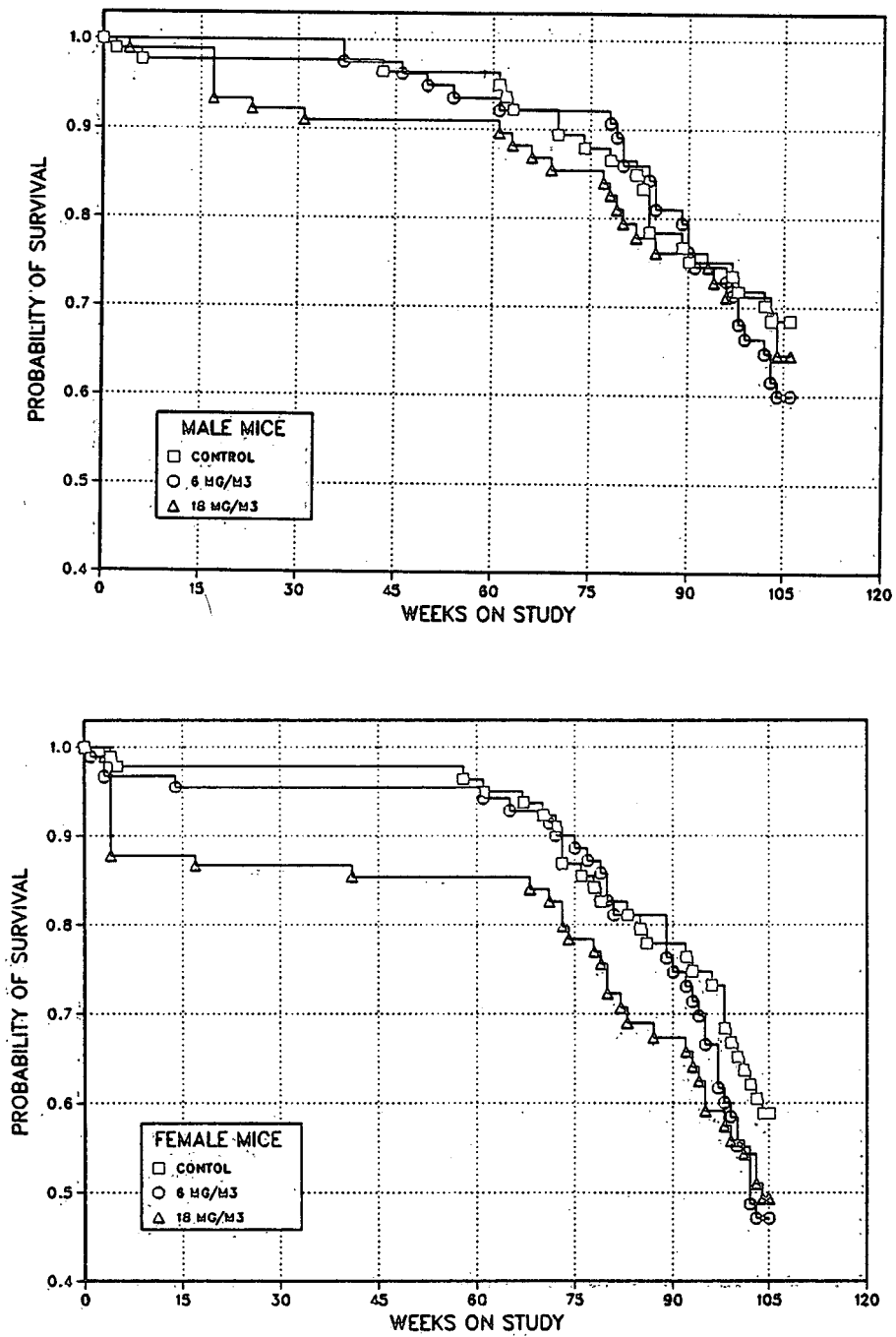

FIGURE 4
Kaplan-Meier Survival Curves for Male and Female Mice Administered Talc by Inhalation for 2 Years

TABLE 9
Mean Body Weights and Survival of Male Mice in the 2-Year Inhalation Study of Talc

Week on Study	0 mg/m ³		6 mg/m ³			18 mg/m ³		
	Av. Wt. (g)	Number of Survivors	Av. Wt. (g)	Wt. (% of controls)	Number of Survivors	Av. Wt. (g)	Wt. (% of controls)	Number of Survivors
1	23.3	50	23.8	102	50	23.7	102	50
2	24.0	48	23.9	100	49	24.3	101	50
3	25.0	47	25.4	102	49	24.8	99	50
4	25.4	47	26.4	104	49	25.0	98	50
5	26.1	47	26.2	100	49	26.6	102	49
6	27.3	47	27.4	100	49	26.9	99	49
7	27.8	47	27.4	99	49	27.5	99	49
8	25.8	47	27.9	108	49	29.7	115	49
9	28.1	47	28.3	101	48	28.5	101	49
10	28.8	47	28.5	99	48	28.7	100	49
11	29.1	47	29.5	101	48	28.3	97	49
12	29.0	47	29.2	101	48	28.7	99	49
13	30.1	47	30.5	101	48	29.8	99	49
17	31.5	47	30.8	98	48	31.0	98	47
21	32.2	47	30.9	96	48	31.4	98	47
25	33.4	47	31.8	95	48	32.5	97	46
29	33.0	47	32.3	98	48	32.7	99	46
33	33.9	47	33.3	98	48	33.2	98	46
37	34.7	47	34.2	99	46	33.8	97	46
42	35.7	47	35.4	99	46	34.7	97	46
45	36.9	47	36.0	98	46	35.7	97	46
49	36.4	47	35.5	98	45	35.5	98	46
53	36.4	47	36.6	101	44	36.3	100	46
57	36.9	47	35.8	97	44	35.7	97	46
61	36.8	46	37.6	102	43	36.6	100	45
65	37.2	44	37.1	100	43	36.4	98	44
69	36.5	44	37.1	102	43	36.0	99	42
73	37.2	42	36.5	98	43	35.1	94	42
77	36.9	41	35.1	95	43	35.0	95	42
81	37.6	40	36.8	98	40	35.2	94	39
85	37.0	35	37.1	100	37	35.2	95	39
89	36.7	35	35.9	98	37	34.8	95	38
93	34.9	34	36.3	104	34	33.4	96	38
97	34.2	33	35.2	103	34	33.3	97	36
101	33.9	31	34.1	101	31	33.3	98	36
Mean for weeks								
1-13	26.9		27.3	101		27.1	101	
14-52	34.2		33.4	98		33.4	98	
53-101	36.3		36.2	100		35.1	97	

TABLE 10
 Mean Body Weights and Survival of Female Mice in the 2-Year Inhalation Study of Talc

Week on Study	0 mg/m ³		6 mg/m ³			18 mg/m ³		
	Av. Wt. (g)	Number of Survivors	Av. Wt. (g)	Wt. (% of controls)	Number of Survivors	Av. Wt. (g)	Wt. (% of controls)	Number of Survivors
1	19.3	50	19.3	100	50	19.6	102	50
2	19.9	50	20.1	101	50	20.5	103	50
3	21.0	50	21.3	101	50	21.1	101	50
4	22.4	50	22.5	100	49	21.5	96	49
5	22.5	49	22.7	101	49	23.2	103	43
6	24.4	49	23.7	97	49	23.8	98	43
7	24.6	49	24.5	100	49	24.3	99	43
8	22.1	49	24.2	110	49	26.8	121	43
9	24.6	49	24.9	101	49	25.2	102	43
10	25.2	49	25.4	101	49	25.3	100	43
11	25.6	49	26.2	102	49	25.0	98	43
12	25.5	49	25.1	98	49	25.2	99	43
13	26.3	49	26.4	100	49	25.9	99	43
17	27.5	49	26.7	97	47	27.3	99	43
21	28.4	49	27.2	96	47	27.7	98	43
25	29.5	49	28.1	95	47	28.9	98	43
29	29.8	49	28.6	96	47	28.9	97	43
33	30.1	49	29.7	99	47	29.5	98	43
37	30.7	49	29.9	97	47	29.9	97	43
42	31.7	49	30.8	97	47	30.3	96	43
45	32.4	49	31.7	98	47	31.1	96	43
49	32.2	49	31.2	97	47	31.0	96	43
53	32.7	49	31.4	96	47	31.9	98	43
57	32.7	49	31.0	95	47	31.2	95	43
61	33.1	49	32.9	99	46	32.3	98	43
65	33.0	48	32.4	98	46	32.7	99	43
69	32.7	47	32.4	99	46	32.1	98	42
73	32.8	43	32.1	98	44	31.0	95	41
77	32.6	43	31.3	96	43	31.3	96	40
81	33.5	41	32.7	98	39	32.1	96	37
85	32.5	40	33.0	102	39	32.7	101	35
89	32.7	39	32.1	98	36	32.1	98	35
93	31.7	37	31.7	100	33	31.2	98	33
97	31.5	35	31.7	101	30	30.6	97	30
101	31.8	31	31.4	99	27	31.0	98	27
Mean for weeks								
1-13	23.3		23.6	101		23.6	101	
14-52	30.3		29.3	97		29.4	97	
53-101	32.6		32.0	98		31.7	97	

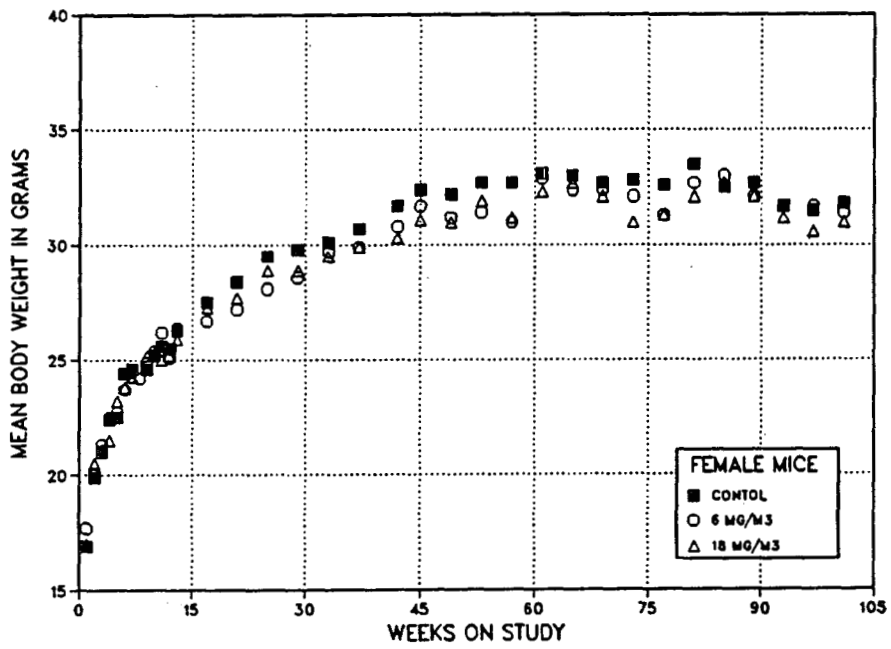
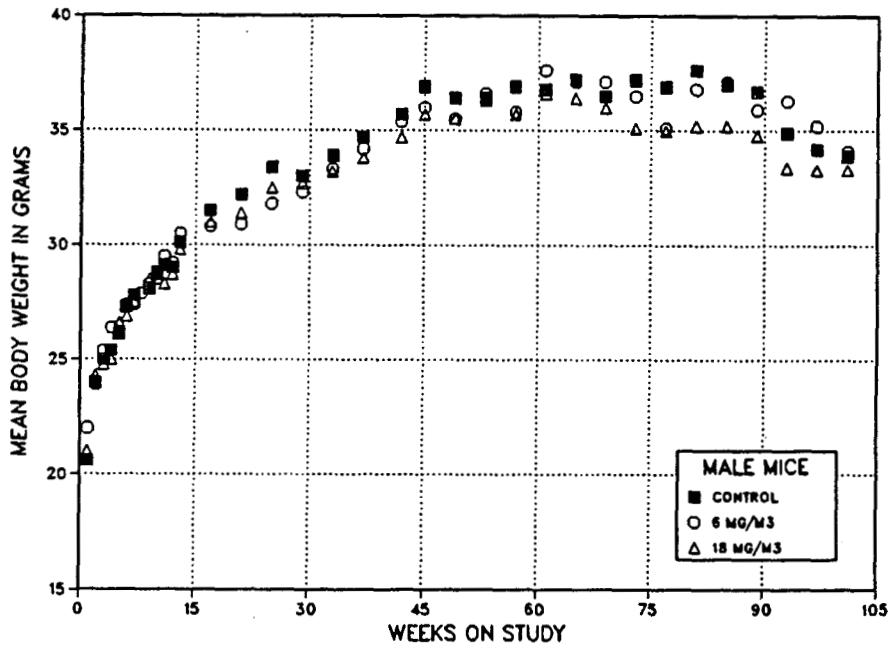

FIGURE 5
Growth Curves for Male and Female Mice Administered Talc by Inhalation For 2 Years

Pathology and Statistical Analyses of Results

This section describes the statistically significant or biologically noteworthy changes in the incidences of neoplastic or nonneoplastic lesions of the lung, lymph node, and nose. Summaries of the incidences of nonneoplastic lesions and neoplasms, the individual animal tumor diagnoses, and the statistical analyses of primary neoplasms that occurred with an incidence of at least 5% in at least one group are presented in Appendix C for male mice and Appendix D for female mice.

Lung: Absolute and relative lung weights of male and female mice exposed to 18 mg talc/m³ were significantly greater than those of the controls at the 12-month interim evaluation and at the end of the study. Absolute lung weights of 18 mg/m³ males and absolute and relative lung weights of 18 mg/m³ females were significantly greater at the 18-month interim evaluation. Lung weights of mice exposed to 6 mg/m³ were similar to controls at each of the interim evaluations.

The pulmonary lesions in mice exposed to talc were similar at the interim evaluations and at the end of the study, but the lesions varied in extent and severity with exposure concentration and duration (Table 11). The principal lung lesion occurring in exposed mice was an accumulation of alveolar macrophages in the alveoli surrounding terminal bronchioles (hyperplasia, macrophage) (Plate 8). The macrophages had abundant, slightly foamy to granular, eosinophilic cytoplasm containing birefringent talc particles. Small numbers of neutrophils were sometimes observed in the affected areas, and the interstitium contained infiltrates of mononuclear inflammatory cells (inflammation, chronic active) (Plates 9 and 10). In contrast to the pulmonary lesions in rats, hyperplasia of type II pneumocytes or fibrosis were not prominent components of the lesions in mice. The incidences of pulmonary neoplasms were similar among exposed groups and controls.

Lymph node: The bronchial lymph nodes of mice exposed to talc contained accumulations of macrophages in the medullary sinuses (hyperplasia, histiocytic - male: 0 mg/m³, 1/32; 6 mg/m³, 32/39; 18 mg/m³, 42/44; female: 0/38, 25/37, 39/43; Tables C4 and D4). The macrophages had abundant, slightly foamy to

granular, eosinophilic cytoplasm filled with birefringent particles of talc.

Nose: The incidences of focal cytoplasmic alteration were increased in groups of mice exposed to talc (male: 5/45, 23/46, 40/47; female: 29/46, 37/46, 40/50; Tables C4 and D4). Focal cytoplasmic alteration was characterized by the formation of large eosinophilic droplets in the cytoplasm of olfactory and respiratory epithelial cells and was similar to that observed in rats.

Lung Talc Burden

The lung talc burdens, normalized to control lung weight or exposure level, are presented in Tables H2 and H3. Lung talc burden normalized to control lung weights (mg talc/g control lung) adjusts for differences in lung weight between sexes or at different ages. The lung burden normalized to control lung weight and exposure level adjusts for exposure level to determine the effect of exposure concentration on talc clearance from the lung.

The data, normalized to control lung weight, show that talc burdens of mice exposed to 6 mg/m³ were similar between males and females and increased progressively from 6 to 24 months, except for males at 18 months (Table H2). However, because of the small sample size of males at 18 months (two animals), the lung talc burden of this sample may not be representative of the group as a whole. The lung talc burdens of mice exposed to 18 mg/m³ were also similar between sexes at each interim evaluation. Although the talc burdens of males and females increased substantially from 6 to 24 months, the values at 12 and 18 months were similar.

The exposure-normalized data show that lung talc burdens of mice exposed to 18 mg/m³ were disproportionately greater than those of mice exposed to 6 mg/m³ (Table H2). The slight increases in exposure-normalized lung talc burden were statistically significant in males and females at 12 and 24 months, but not at 6 or 18 months. The lack of statistical significance at 18 months might be explained, in part, by the small sample size. These data suggest that clearance of talc from the lung was impaired, or impaired to a greater extent, in mice exposed to 18 mg/m³ than in mice exposed to 6 mg/m³.

TABLE 11
Incidences of Selected Lung Lesions in Mice in the 2-Year Inhalation Study of Talc

	Male			Female		
	0 mg/m ³	6 mg/m ³	18 mg/m ³	0 mg/m ³	6 mg/m ³	18 mg/m ³
6-Month Interim Evaluation						
Lung ^a	4	4	4	4	4	4
Hyperplasia, Macrophage ^b	0	3 (1.0) ^c	4* (1.0)	0	0	4* (1.0)
Inflammation, Chronic Active	0	0	1 (1.0)	0	0	0
12-Month Interim Evaluation						
Lung	4	4	4	3	4	4
Hyperplasia, Macrophage	0	4* (1.0)	4* (1.8)	0	4* (1.0)	4* (2.0)
Inflammation, Chronic Active	0	0	2 (2.0)	0	0	1 (3.0)
18-Month Interim Evaluation						
Lung	4	4	4	4	4	4
Hyperplasia, Macrophage	0	4* (1.3)	4* (2.5)	0	4* (1.3)	4* (2.5)
Inflammation, Chronic Active	0	0	2 (1.5)	0	0	0
Alveolar/bronchiolar Adenoma	0	1	0	1	0	0
Alveolar/bronchiolar Carcinoma	1	0	0	0	0	0
2-Year Study						
Lung	4	47	48	46	48	50
Hyperplasia, Macrophage	3 (2.3)	46** (1.4)	48** (2.8)	2 (2.5)	45** (1.6)	43** (2.8)
Inflammation, Chronic Active	0	16** (1.1)	40** (2.2)	0	25** (1.4)	38** (2.3)
Alveolar Epithelium, Hyperplasia	1 (1.6)	0	0	0	0	1 (1.0)
Alveolar/bronchiolar Adenoma						
Overall rates ^d	6/45 (13%)	4/47 (9%)	9/48 (19%)	3/46 (7%)	2/49 (4%)	2/50 (4%)
Logistic regression test ^e	P=0.251	P=0.411N	P=0.371	P=0.467N	P=0.499N	P=0.515N
Alveolar/bronchiolar Carcinoma						
Overall rates	7/45 (16%)	2/47 (4%)	2/48 (4%)	2/46 (4%)	4/49 (8%)	1/50 (2%)
Logistic regression test	P=0.069N	P=0.073N	P=0.070N	P=0.325N	P=0.356	P=0.500N
Alveolar/bronchiolar Adenoma or Carcinoma						
Overall rates	12/45 (27%)	5/47 (11%)	11/48 (23%)	5/46 (11%)	6/49 (12%)	3/50 (6%)
Logistic regression test	P=0.522N	P=0.043N	P=0.423N	P=0.269N	P=0.519	P=0.367N

* Significantly different ($P \leq 0.05$) from the control by Fisher's exact test (interim evaluation) or logistic regression (2-year study)

** $P \leq 0.01$

^a Number of animals with lung examined microscopically.

^b Number of animals with lesion.

^c Average severity grades of lesions in affected animals: 1 = minimal, 2 = mild, 3 = moderate, 4 = marked

^d Number of animals with neoplasm per number of animals examined microscopically.

^e Beneath the control incidence are the P values associated with the trend test. Beneath the exposed group incidence are the P values corresponding to pairwise comparisons between the control and that exposed group. The logistic regression test regards these lesions as nonfatal. A negative trend or a lower incidence in an exposure group is indicated by N.

Bronchoalveolar Lavage and Lung Biochemistry

Bronchoalveolar lavage was performed and lung homogenate supernatants collected for analyses at 6, 12, 18, and 24 months. A summary of the changes occurring in bronchoalveolar fluid enzymes, protein and cells are shown in Tables H4 through H22. Values for glucose-6-phosphate dehydrogenase, glutathione peroxidase, and alkaline phosphatase were not reported because they were below the limit of detection.

β -Glucuronidase activity of lavage fluid from male and female mice exposed to 18 mg/m³ was greater than that of controls at 12, 18, and 24 months, but not at 6 months. In mice exposed to 6 mg/m³, β -glucuronidase activity was greater than that of controls only at the 24-month interim evaluation. Lactate dehydrogenase and glutathione reductase activities in male and female mice exposed to 18 mg/m³ were significantly greater than those of controls at 18 and 24 months. Glutathione activity of males exposed to 18 mg/m³ was also greater than that of controls at 12 months. Values for total protein in lavage fluid from males and females in the 18 mg/m³ groups were significantly greater than those of controls at 18 months; at 24 months only that of males was significantly greater.

Significant differences in total and differential cell counts between exposed and control mice were observed only at 18 and 24 months at the high concentration level (Tables H8 to H11). The numbers of total nucleated cells, polymorphonuclear leukocytes, and macrophages were significantly greater in males and females exposed to 18 mg/m³ than in controls. Exposure of mice to 6 or 18 mg talc/m³ produced a concentration-related decrease in phagocytic activity of macrophages

derived from lavage fluid (Tables H12 to H14). The number of macrophages containing phagocytized sheep erythrocytes from male and female mice exposed to 18 mg/m³ was significantly lower than that from control mice at 12, 18, and 24 months. Although phagocytic activity of macrophages from mice exposed to 6 mg/m³ was intermediate between controls and the high concentration groups, only the difference between the exposed and control males at 12 months was statistically significant.

The effects of talc exposure on lavage fluid collagenous peptides and total lung collagen are shown in Tables H15 through H18. The amount of collagenous peptides in lavage fluid from male mice exposed to 18 mg/m³ was significantly greater than that of controls at 12, 18, and 24 months, while collagenous peptides of females exposed to 18 mg/m³ were significantly increased only at 24 months. Consistent with these findings, total lung collagen was significantly greater in 18 mg/m³ at 18 and 24 months and in females at 24 months. Collagenous peptides and total lung collagen from mice exposed to 6 mg/m³ were similar to controls at each of the interim evaluations.

The acid and neutral proteinase activity of lung homogenate supernatant fluid and the acid proteinase activity of lavage fluid are shown in Tables H19 through H22. Although there were no consistent exposure-related changes in lavage fluid acid proteinase activity at any of the interim evaluations, acid proteinase activity in supernatant fluid from male and female mice exposed to 18 mg/m³ was significantly greater than controls at 12, 18, and 24 months. The increase in acid proteinase activity was primarily due to cathepsin D-like activity. There were no consistent exposure-related changes in neutral proteinase activity at any of the interim evaluations.

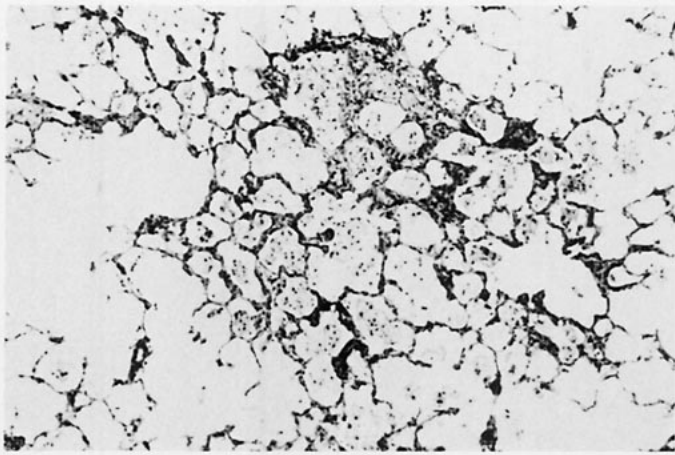

PLATE 1

Mild focal inflammation with thickening of the alveolar septa and distortion of the alveoli in the lung of a male F344/N rat exposed to 18 mg talc/m³ at the 18-month interim evaluation of the lifetime inhalation study. H&E, 25X

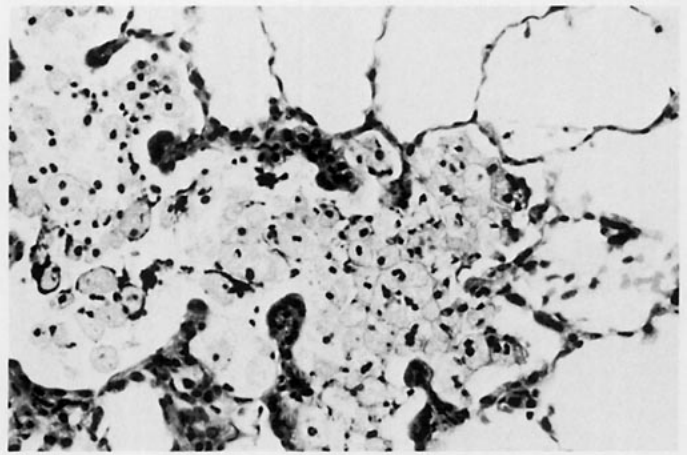

PLATE 2

Lung of a male F344/N rat exposed to 18 mg talc/m³ at the 18-month interim evaluation of the lifetime inhalation study. Note the accumulation of alveolar macrophages with pale granular cytoplasm in the alveolar duct and slight thickening of the septal walls. H&E, 80X

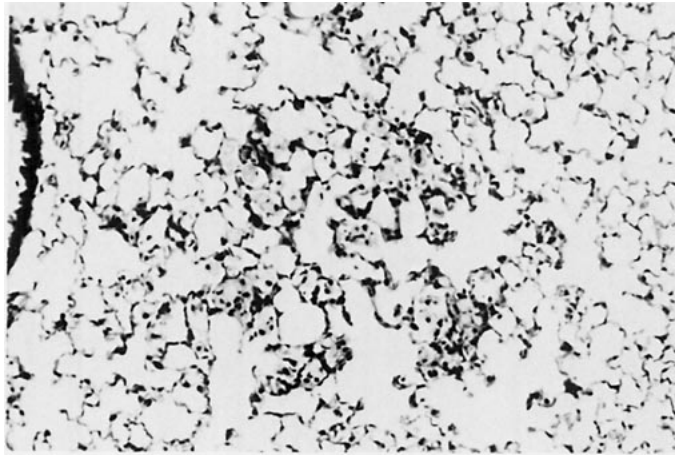

PLATE 3

Individual and confluent foci of interstitial fibrosis extend throughout the pulmonary parenchyma of a male F344/N rat exposed to 18 mg talc/m³ at the 24-month interim evaluation of the lifetime inhalation study. H&E, 6.6X

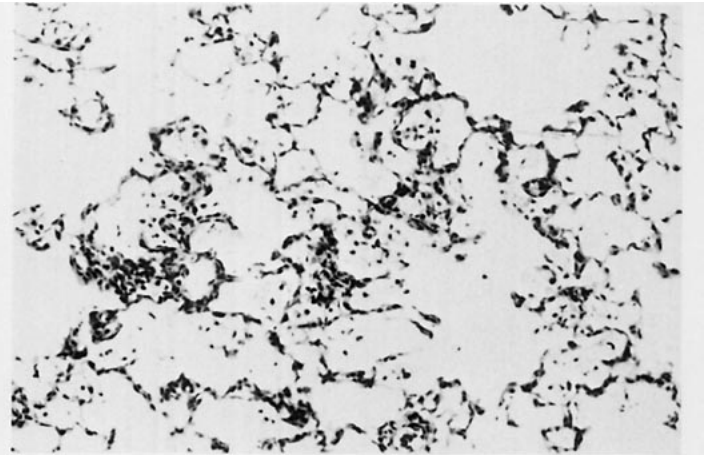

PLATE 4

Higher magnification of Plate 3 showing accumulation of fibrous tissue and interspersed inflammatory cells which obliterate the alveoli. H&E, 33X

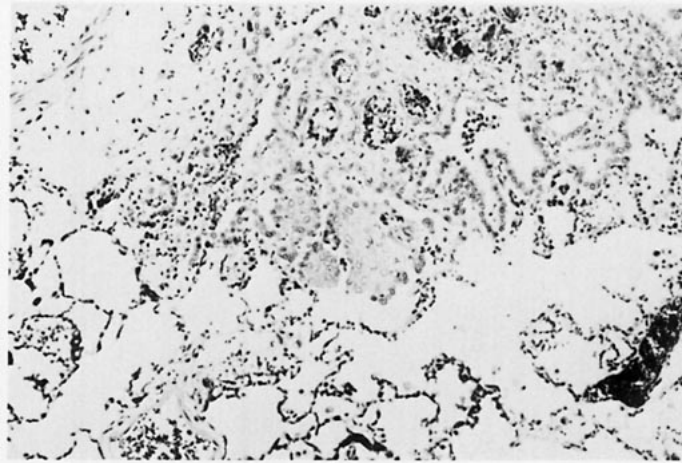

PLATE 5

Squamous metaplasia and hyperplasia of the alveolar epithelium adjacent to an area of chronic inflammation and interstitial fibrosis in the lung of a male F344/N rat exposed to 18 mg talc/m³ in the lifetime inhalation study. H&E, 40X

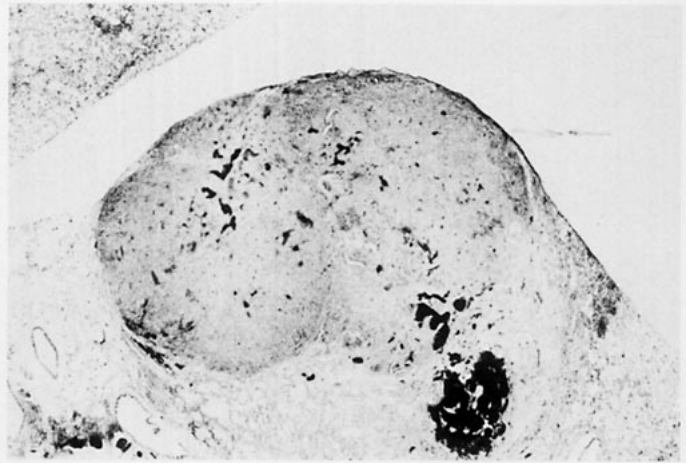

PLATE 6

Alveolar/bronchiolar carcinoma in a male F344/N rat exposed to 18 mg talc/m³ in the lifetime inhalation study. Note the large mass obliterating the pulmonary parenchyma. H&E, 2.5X

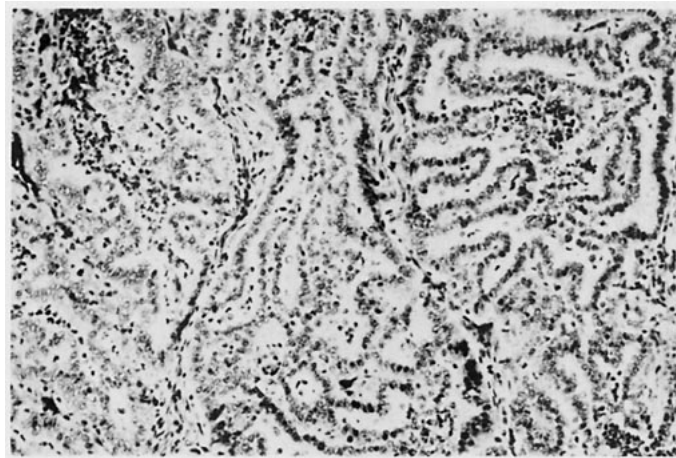

PLATE 7

Higher magnification of the alveolar/bronchiolar carcinoma shown in Plate 6. Note the neoplastic epithelium arranged in irregular papillary formations. H&E, 50X

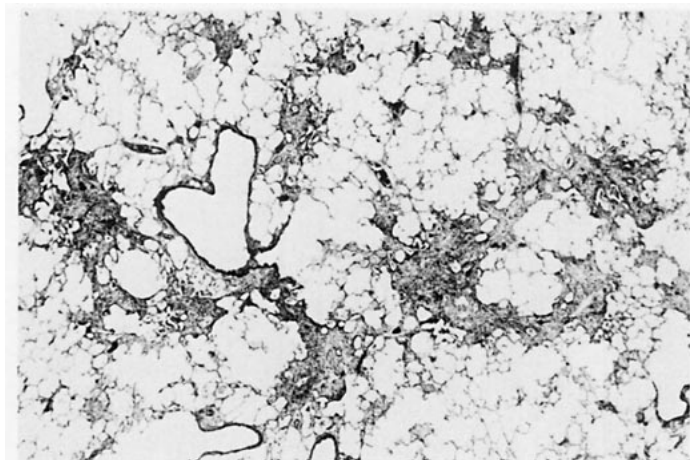

PLATE 8

Minimal focal accumulation of alveolar macrophages in the lung of a male B6C3F₁ mouse exposed to 18 mg talc/m³ at the 12-month interim evaluation of the 2-year inhalation study. H&E, 50X

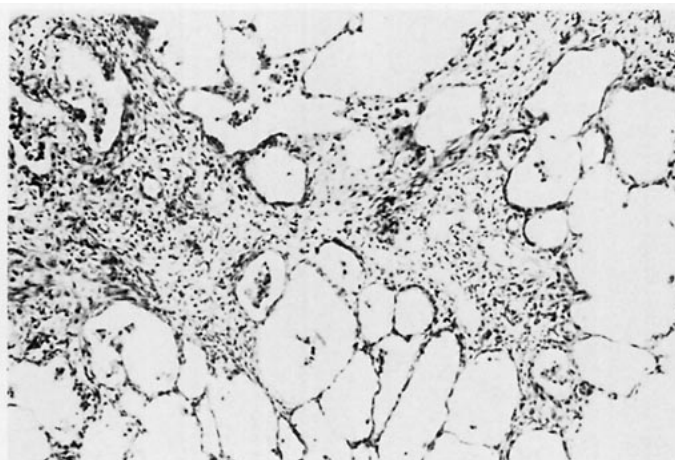

PLATE 9

Mild chronic active inflammation with slight thickening of the alveolar septa in the lung of a female B6C3F₁ mouse exposed to 18 mg talc/m³ in the 2-year inhalation study. H&E, 50X

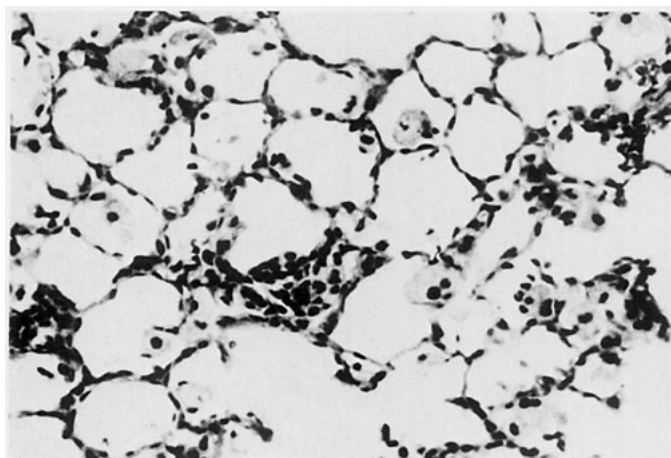

PLATE 10

Alveolar macrophages in alveoli and mononuclear cells in the interstitium of the lung of a male B6C3F₁ mouse exposed to 18 mg talc/m³ in the 2-year inhalation study. H&E, 100X

DISCUSSION AND CONCLUSIONS

Talc ore may contain several other minerals, including calcite, dolomite, magnesite, tremolite, anthophyllite, antigorite, quartz, pyrophyllite, micas, or chlorites. Since talc products are sold in a multitude of grades which have physical or functional characteristics especially suited for particular applications, occupational and consumer exposures to talc are complex. Exposure to industrial grade talc is known to cause pulmonary fibrosis, but the limited data on exposure to cosmetic grade talc are conflicting. Recently, epidemiology studies have suggested an association between nonfibrous talc and lung cancer risk (Thomas and Stewart, 1987). Talc was nominated by NIOSH for study by the NTP because of widespread human exposure and because of the lack of adequate information on its chronic toxicity and potential carcinogenicity.

The NTP toxicity and carcinogenicity studies of non-asbestiform, cosmetic grade talc, a finely powdered hydrous magnesium silicate, were conducted by exposing groups of male and female F344/N rats and B6C3F₁ mice to target aerosol concentrations of 0, 6, or 18 mg talc/m³ for 6 hours per day, 5 days per week. Rats were exposed to talc until mortality in any group reached 80% (113 weeks for males and 122 weeks for females). Mice were exposed for 103 or 104 weeks. Exposure concentrations for the long-term studies were based on talc deposition and clearance patterns obtained from 4-week inhalation studies (Hanson *et al.*, 1985). In these studies, the amount of talc retained per gram of lung tissue was 79, 190, or 840 μg for male rats and 76, 185, or 770 μg for female rats exposed to 2, 6, or 18 mg/m³, respectively. The amount of talc retained per gram of lung tissue in mice exposed at the same concentration levels were 130, 330, or 1,140 μg for males and 110, 330, or 1,160 μg for females. Only rats and mice at the highest exposure level had talc-containing macrophages within the alveolar spaces. Because there was a direct relationship between chamber concentration and lung talc burden and because of the talc-containing alveolar macrophages at the 18 mg/m³ concentration, it was predicted that higher levels would overwhelm lung clearance mechanisms

in both species and cause deterioration of lung functions. Thus, 18 mg/m³ was chosen as the top exposure concentration for the NTP long-term studies.

The overall mean chamber concentrations achieved in the NTP long-term studies were 6.1 and 18.6 mg/m³ for the rat study and 5.9 and 16.7 mg/m³ for the mouse study. The average mass mean aerodynamic diameter of the talc particles was calculated to be 2.7 μm and 3.2 μm for the 6 and 18 mg/m³ rat chambers and 3.3 μm and 3.6 μm for the 6 and 18 mg/m³ mouse chambers, respectively. Seventy-five percent of the talc particles counted in four samples were in the 1 to 3 μm range. Monodisperse aluminosilicate particles larger than 10 μm are nearly all removed by inertial impaction in the nasal chamber or at bifurcation of the airways in rats, while particle deposition in the alveolar ducts and alveoli rises from almost zero for 10 μm particles to about 10% for 1 μm particles (Raabe *et al.*, 1977). Thus, the large proportion of talc particles in these NTP studies were in the respirable range.

Because of difficulties with the aerosol concentration monitoring system for the 18 mg/m³ rat chamber, there was a 7-week period beginning at study week 11 during which the chamber concentration for the high-dose rats varied from approximately 30 to 40 mg/m³. Further, there was a 12-week period beginning at approximately week 70 during which there were difficulties in generating the talc aerosol and the chamber concentrations for rats and mice were substantially lower than the target concentrations (Figures I5 to I8). Although the exposure concentrations varied substantially from target concentrations during these periods, this does not preclude drawing conclusions regarding the chronic toxicity and carcinogenicity of talc. Since talc is a relatively inert particle, the amount of talc deposited and retained at the target site (lung talc burden) is a more relevant measure of talc exposure than chamber concentration. The problems with maintaining the target concentrations in the NTP studies had no apparent substantive effect on lung talc burdens.

The lung talc burden represents the difference between the amount of talc deposited in the lung and the amount removed by the clearance mechanisms. Inhaled particles deposited on the mucosal surface of the trachea, bronchi, or bronchioles are transported up the airways and from the lung through the ciliary activity of the respiratory epithelium, while particles reaching the alveolar region are phagocytized by alveolar macrophages and, to a lesser extent, other phagocytic inflammatory cells. Some alveolar macrophages migrate to the ciliated epithelium of the airways while others cross the alveolar epithelium to enter the interstitium and finally the lymphatics. Phagocytic cells reaching the lymphatics are transported in the lymph to the bronchial and mediastinal lymph nodes. Depending on the physicochemical properties of the inhaled particles, they may be partially or completely degraded within phagolysosomes of the macrophages and soluble components released from the cell. Talc is insoluble in water, cold acids, and alkalis and is likely to be insoluble in biological fluids. Talc particles were observed within macrophages in the lung and bronchial and mediastinal lymph nodes of rats and mice in these inhalation studies.

The lung talc burden of rats was greater than that of mice at each of the exposure concentrations and interim evaluations. The difference in lung talc burden is most likely related to species anatomical and physiological differences known to influence particle deposition and retention including air flow pattern and velocity, respiratory rate, tidal volume, and clearance rate (McMahon *et al.*, 1977; Raabe *et al.*, 1977). The lung talc burdens of exposed rats and mice were generally similar between males and females at each exposure concentration and increased progressively with exposure duration. This indicated that the amount of talc deposited in the lung exceeded the clearance from the lung. The lung talc burden of rats was also generally proportional to exposure concentration at each interim evaluation, indicating that clearance of talc was not substantially impaired by increasing the exposure concentration, or that clearance of talc was impaired similarly at both exposure levels. In contrast, the lung talc burden of mice exposed to 18 mg/m³ was disproportionately greater than that of mice exposed to 6 mg/m³, indicating that clearance of talc from the lung was impaired, or impaired to a greater extent, in mice exposed to the higher concentration.

Analysis of bronchoalveolar lavage fluid has been used in human medicine for diagnosing the type or stage of various forms of interstitial lung disease and more recently as a rapid *in vivo* method of evaluating lung injury in toxicologic studies (Henderson *et al.*, 1985). Bronchoalveolar lavage was performed on rats and mice exposed to talc to evaluate its usefulness in chronic toxicology studies. Qualitatively similar changes in lavage fluid enzymes and cytology were observed in both species. Increases in neutrophils and total protein in lavage fluid are sensitive indicators of inflammation, and the increases in these parameters in rats and mice exposed to talc are consistent with the inflammation observed histologically in the lungs. Increases in cytoplasmic (lactate dehydrogenase and glutathione reductase) and lysosomal (β -glucuronidase) enzymes, which are indicative of cellular injury, were also observed in both species. Whether lactate dehydrogenase and glutathione reductase were derived from parenchymal cells or inflammatory cells is unknown. The increase in glutathione reductase activity suggests that cellular injury may have involved an oxidative process involving free radicals produced during phagocytosis.

The phagocytic ability of alveolar macrophages recovered from lavage fluid was not impaired in rats exposed to talc for 24 months, as indicated by the lack of a significant difference in the number of viable macrophages and the percentage of cells phagocytizing sheep erythrocytes in exposed and control rats. In contrast, both the viability and the phagocytic ability of alveolar macrophages from exposed mice were significantly lower than those of macrophages from controls. The percentage of macrophages containing phagocytized erythrocytes decreased as aerosol concentration and exposure duration increased. Since alveolar macrophages play a major role in the clearance of particles from the lung, the decreased viability and phagocytic ability of these cells may explain the disproportionately greater lung talc burden in mice exposed to 18 mg/m³ than in mice exposed to 6 mg/m³ and the difference in talc lung burdens between exposed rats and mice.

Due to limitations in chamber size and the number of animals that could be exposed, the numbers of animals utilized in the lung biochemistry studies were generally small. Therefore, some of the apparent inconsistencies in the results of these studies can be attributed to the small sample sizes and the biologic

variation in pulmonary response among individuals. Despite these limitations, increases in lavage fluid collagenous peptides and total lung collagen were observed in both rats and mice exposed to 18 mg talc/m³. In rats, these changes were also accompanied by increases in noncollagenous protein synthesis (total ¹⁴C-proline incorporated into lung tissue minus that incorporated into collagen), and, in females only, an increase in collagen production (fraction of total ¹⁴C-proline incorporated into collagen). Some parameters were also significantly increased in rats exposed to 6 mg talc/m³. While these results are consistent with the fibrosis observed histologically in rats, fibrosis was not seen histologically in mice.

Talc exposure was associated with a dose- and time-related impairment of respiratory functions in male and female rats. Although only slight trends were observed at 6 months in rats exposed to 18 mg/m³, functional alterations in rats at the high concentration were clearly evident after 11 months. In rats exposed to 6 mg/m³, decrements in respiratory function were observed in males at 11 months and in males and females at 18 months. The functional impairment was characterized by reduced lung volumes and reduced dynamic and/or quasistatic lung compliance, indicating an increase in elastic recoil (increased lung stiffness). Further, reduced gas exchange efficiency and nonuniform intrapulmonary gas distribution were also observed. These changes are consistent with the multifocal fibrosis and inflammation that was located in the centriacinar region of the lung.

Deposition of talc in the lungs of rats and mice produced an inflammatory response characterized primarily by the accumulation of alveolar macrophages and, to a lesser extent, neutrophils and monocytes within alveolar lumens. Smaller numbers of lymphocytes and plasma cells were also observed in the interstitial tissue surrounding airways, blood vessels, and alveolar septa. The lesions developed at the junction of the alveolar ducts and terminal bronchioles where particles of the size range used are known to be deposited (Brody and Roe, 1983). Although the inflammatory response was basically similar in rats and mice, there were important species differences. The lesions in rats were generally more extensive and more severe than those in mice at similar exposure concentrations. In rats, foreign body giant cells were occasionally observed and some of

the alveolar macrophages developed the morphological characteristics of epithelioid macrophages. More importantly, the inflammatory lesions in rats were accompanied by interstitial fibrosis, hyperplasia of alveolar type II epithelial cells, and, infrequently, squamous metaplasia of the alveolar epithelium.

The differences in pulmonary response cannot be attributed to differences in lung talc burden, since fibrosis and alveolar epithelial hyperplasia were observed in rats exposed to 6 mg/m³, which had lung talc burdens less than that of mice exposed to 18 mg/m³. Saffiotti and Stinson (1988) have reported similar differences in pulmonary response between rats and mice following intratracheal instillation of silica. These authors found that silica-induced alveolar epithelial hyperplasia in mice was transient, returning to normal within several months, while that in rats was generally more severe and persisted until the end of the study. Since inhalation studies using both rats and mice are seldom performed, it is uncertain if this species difference might exist for other particulate substances.

The difference in pulmonary response between rats and mice may be related, in part, to species differences in reactivity of alveolar macrophages following phagocytosis of the talc particles. As the principal phagocytic cell of the lung, the alveolar macrophage is believed to play a major role in the inflammatory and fibrogenic reactions to inhaled particles (Brain, 1980; Brody, 1991). Much of the early work in this area centered on the differential cytotoxicity of phagocytized particles, particularly the various crystalline forms of asbestos and silica, to alveolar macrophages and the subsequent release of lysosomal enzymes which have proteolytic, elastolytic, and inflammatory properties (Brody and Davis, 1982; Nathan, 1987). More recently, alveolar macrophages have been found to produce arachidonic acid metabolites (Kouzan *et al.*, 1985) and various cytokines that regulate cell proliferation, differentiation, and extracellular matrix production (Kelley, 1990). Of particular interest, rat alveolar macrophages exposed to iron spheres and asbestos fibers have been found to produce increased amounts of a homologue of platelet-derived growth factor (PDGF), the most potent mitogen known for mesenchymal cells (Bonner *et al.*, 1989, 1990), and TGF- β , a potent inhibitor of mesenchymal cell proliferation and stimulator of matrix production (Kalter *et al.*, 1989). Little is known about the putative role of PDGF and

TGF- β and other macrophage-derived products in the pathogenesis of lung disease, but they are likely to be important mediators of many cellular events.

The lesions in the lungs of rats exposed to aerosols of talc are very similar, qualitatively, to those reported to occur following long-term (approximately 2 years) exposure to other inorganic, non-fibrous, particulate substances including titanium dioxide (Lee *et al.*, 1985), chromium dioxide (Lee *et al.*, 1988), antimony trioxide and antimony ore concentrate (predominantly antimony trisulfide) (Groth *et al.*, 1986), and volcanic ash (Wehner *et al.*, 1986). Aerosols of each of these particulate substances were reported to elicit pulmonary inflammation, characterized primarily by the accumulation of alveolar macrophages, hyperplasia and squamous metaplasia of the alveolar epithelium, and fibrosis. Since the various components of the pulmonary response were not quantified in these studies, there may be quantitative differences in the degree of inflammation, fibrosis, and cellular degenerative hyperplastic and metaplastic changes to these particulate substances.

The lesions in rats exposed to talc are also similar to those observed in rats exposed to silica, but with important differences. Silica generally produces an inflammatory response that is more pronounced and persistent than the response to the relatively more inert particles like titanium dioxide and talc (Saffiotti and Stinson, 1988; Driscoll *et al.*, 1990). Further, while only occasional multinucleated foreign body giant cells and epithelioid macrophages were seen in the cellular response to talc, rats exposed to silica develop discrete nodular aggregates of epithelioid macrophages with multinucleated cells more typical of granulomatous inflammation.

The quantitative and qualitative differences in pulmonary toxicity of inhaled particles are likely related to the particle size, structure (amorphous, crystalline, and/or fibrous), surface chemistry, solubility (or durability), chemistry of soluble components, cytotoxicity, and other factors. While much of the research in this area has focused on asbestos (as well as other fibers) and silica, the same principles are likely to explain the differences in biological activity of other particulate substances. Although a complete discussion of these factors is beyond the scope of this report, some of the evidence is presented here.

A number of studies of the various forms of silicon dioxide have found that amorphous silica produces

the mildest, slowest developing pulmonary changes followed, in ascending order, by quartz, cristobalite and tridymite (Allison, 1977; Hemenway *et al.*, 1986). Amorphous silica generally lacks a detectable crystalline X-ray diffraction pattern, while, of the crystalline forms, quartz has a less ordered symmetry than cristobalite and tridymite. Moreover, stishovite, which lacks the tetrahedral structure of other forms of silica, also lacks the fibrogenicity and cytotoxicity of the other forms (Brieger and Gross, 1967).

In general, the ability of various forms of silica to elicit pulmonary fibrosis parallels their cytotoxicity *in vitro* to alveolar macrophages (Reiser and Last, 1979). Further, there is a correlation between cytotoxicity and hemolytic activity *in vitro* (Allison, 1977). The biochemical basis of macrophage cytotoxicity and hemolytic activity is not fully understood, but the surface of crystalline silica presents highly reactive hydroxyl groups of silicic acid residues (silanol) that act as proton donors and may combine with constituents of cellular membranes (Langer and Nolan, 1986). Kaolinite (aluminum silicate), mica (potassium aluminum silicate), and talc (magnesium silicate) are also hemolytic *in vitro* (Narang *et al.*, 1977). Dissolution of silicic acid residues from kaolinite, mica, and talc reduces the toxicity of these particulates, supporting the hypothesis that the reactive hydroxyl groups play an important role in cytotoxicity and hemolytic activity.

Following phagocytosis of silica (Allison, 1977) or kaolinite (Brody and Davis, 1982) particles by alveolar macrophages, hydrolytic enzymes are released from secondary lysosomes apparently as a result of the interaction of the particles with the lysosomal membrane. While the release of lysosomal enzymes into the cytoplasm may be directly responsible for cell death, it is less clear to what extent lysosomal enzymes released from the cells contribute to the other pulmonary lesions. Certainly, the ability to kill alveolar macrophages (cytotoxicity) is likely to inhibit or delay removal of the particles from the lung, increase the lung burden, and allow other biological effects to occur.

As already mentioned, macrophages secrete a large number of molecules including polypeptide hormones or cytokines, complement components, coagulation factors, arachidonic acid and its metabolites, bioactive lipids (prostaglandins and leukotrienes), binding proteins, enzyme inhibitors, extracellular matrix or cell adhesion proteins, and others (Nathan, 1987).

Some, or perhaps many, of the apparent differences in the pulmonary response of rats to the various particulate substances may be related to the extent to which they cause cytotoxicity and nonspecific release of lysosomal enzymes or cause macrophages to secrete specific effector substances like the cytokines and inflammatory mediators.

Exposure of female rats to 18 mg talc/m³ was associated with increased incidences of alveolar/bronchiolar adenoma (0 mg/m³, 1/50; 6 mg/m³, 0/48; 18 mg/m³, 9/50), alveolar/bronchiolar carcinoma (0/50, 0/48, 5/50), and squamous cell carcinoma (0/50, 0/48, 1/50). The overall incidence of alveolar/bronchiolar adenoma or carcinoma (combined) in female rats of the 18 mg/m³ was significantly ($P \leq 0.001$) greater than that of controls (1/50, 0/48, 13/50). The incidence of pulmonary neoplasms in female rats exposed to 18 mg/m³ also greatly exceeds that of control females (8/529, 1.5%) in the NTP lifetime studies reported by Solleveld *et al.* (1984). While comparison with the historical controls from NTP lifetime studies has some limitations (e.g., the studies were conducted about a decade earlier and are not contemporary), such a comparison provides some perspective. The increased incidence of pulmonary neoplasms in the 18 mg/m³ female rats was considered clear evidence of carcinogenic activity based on a) the strength of the statistical evidence ($P \leq 0.001$), b) the increase in malignant as well as benign neoplasms, and c) comparison with lifetime historical controls.

In contrast to female rats, there was no increase in the incidence of pulmonary neoplasms in male rats or in male or female mice exposed to talc aerosols. While precise comparisons between studies of talc and other particulate substances cannot be made because of differences in route of administration (intratracheal versus inhalation), strain of rat used, and exposure duration, such comparison provides some perspective (Table 12). In 2-year inhalation studies of titanium dioxide (Lee *et al.*, 1985), chromium dioxide (Lee *et al.*, 1988), antimony trioxide and antimony ore concentrate (predominantly antimony trisulfide) (Groth *et al.*, 1986), volcanic ash (Wehner *et al.*, 1986), and quartz (Dagle *et al.*, 1986), female rats had greater incidences of pulmonary neoplasms than male rats. Chromium dioxide, volcanic ash, antimony trioxide, and antimony ore concentrate induced pulmonary neoplasms only in female rats, whereas titanium dioxide and quartz induced pulmonary neoplasms in

male and female rats with a preponderance of neoplasms in females.

The morphological types of neoplasms induced by the particulates in the studies cited above also vary somewhat. The neoplasms in female rats exposed to talc were primarily alveolar/bronchiolar adenomas and carcinomas, although one squamous cell carcinoma also occurred. In female rats exposed to antimony trioxide or antimony ore concentrate (Groth *et al.*, 1986), there were similar numbers of alveolar/bronchiolar neoplasms and squamous cell carcinomas (Table 12). Further, several scirrhous carcinomas were observed in antimony exposed rats. In female rats exposed to titanium dioxide (Lee *et al.*, 1985), the incidences of alveolar/bronchiolar neoplasms and squamous cell carcinoma were also similar, whereas all but one of the neoplasms in males were alveolar/bronchiolar neoplasms. In contrast, nearly all the pulmonary neoplasms induced by quartz (Dagle *et al.*, 1986), volcanic ash (Wehner *et al.*, 1986) or chromium dioxide (Lee *et al.*, 1988) were squamous cell (epidermoid) carcinomas.

The pathogenesis of pulmonary neoplasms induced by relatively insoluble particulate substances, such as talc, is currently unknown. Although a genotoxic mechanism cannot be ruled out, there are several lines of evidence to suggest that a direct effect of the particulate on the target cell genome is not involved. First, the insoluble nature of these particulates makes it unlikely that any chemical constituents will reach sufficient concentration to affect the target cells within the relatively short period between the time they are deposited on the alveolar surface and the time they are phagocytized. Further, although occasional alveolar epithelial cells have been observed to contain particles following intratracheal or inhalation exposure (Sorokin and Brian, 1975; Lee *et al.*, 1979), the majority of particles are rapidly phagocytized by alveolar macrophages, some within minutes of deposition in the lung (Lauweryns and Baert, 1974). It is also clear that physical characteristics (crystalline structure, fiber dimension) and surface chemistry (presence of reactive groups on the particle surface), rather than soluble chemical components, are principal determinants of tissue reaction, and perhaps of carcinogenicity. The carcinogenicity of many fibrous materials (fiberglass, attapulgitite, silicon carbide, mineral wool, and potassium titanate) decreases as fiber diameter exceeds 2.5 μm and as fiber length decreases below 10 μm (Stanton and Wrench, 1972; Stanton *et al.*, 1977).

TABLE 12
Results of Selected Whole Body Inhalation Carcinogenicity Studies of Particulate Materials

Compound and Dose	Study Duration	Species	Effects on Lungs ^a
Talc at 0, 6, or 18 mg/m ³ (this study)	Male: 113 weeks Female: 122 weeks	F344/N rats	Females: alveolar/bronchiolar adenoma (1/50, 0/48, 9/50); alveolar/bronchiolar carcinoma (0/50, 0/48, 5/50); squamous cell carcinoma (0/50, 0/48, 1/50)
Titanium dioxide at 0, 10, 50, or 250 mg/m ³ (Lee <i>et al.</i> , 1985)	104 weeks	CD rats	Females: alveolar/bronchiolar adenoma (0/77, 0/75, 0/74, 13/74); squamous cell carcinoma (0/77, 0/75, 0/74, 13/74)
Titanium tetrachloride at 0, 0.1, 1.0, or 10 mg/m ³ (Lee <i>et al.</i> , 1986)	104 weeks	CrI:CD rats	Females: squamous cell carcinoma (0/77, 0/75, 0/79, 3/75); Males: squamous cell carcinoma (0/79, 0/77, 0/78, 2/75)
Chromium dioxide at 0, 0.5, 0.5 ^b , or 25 mg/m ³ (Lee <i>et al.</i> , 1988)	104 weeks	Sprague-Dawley rats	Females: squamous cell carcinoma (0/106, 0/103, 0/108, 2/108); keratin cyst (0/106, 0/103, 0/108, 6/108)
Antimony trioxide at 0 or 45 mg/m ³ (Groth <i>et al.</i> , 1986)	73 weeks	Wistar rats	Females: alveolar/bronchiolar neoplasms (0/90, 11/90); squamous cell carcinoma (0/90, 9/90); scirrhous carcinoma (0/90, 5/90)
Antimony trisulfide at 0 or 40 mg/m ³ (Groth <i>et al.</i> , 1986)	72 weeks	Wistar rats	Females: alveolar/bronchiolar neoplasms (0/90, 6/90); squamous cell carcinoma (0/90, 9/90); scirrhous carcinoma (0/90, 4/90)
Volcanic ash at 0, 5, or 50 mg/m ³ (Wehner <i>et al.</i> , 1986)	up to 104 weeks	F344 rats	Females: several ^c squamous cell carcinomas in the 50 mg/m ³ group. Male: one squamous cell carcinoma in the 50 mg/m ³ group.
Quartz at 0 or 50 mg/m ³ (Wehner <i>et al.</i> , 1986)	up to 104 weeks	F344 rats	Females: moderate ^c numbers of squamous cell carcinomas in the 50 mg/m ³ group. Males: one squamous cell carcinoma in the 50 mg/m ³ group.

^a Neoplasm incidences are given as the number of animals with neoplasm per number of animals examined. The incidences are given in the order of increasing exposure concentration.

^b This dose represents unstabilized chromium dioxide; the other doses represent stabilized chromium dioxide.

^c Precise numbers not available in journal article.

A potential mechanism for the development of pulmonary neoplasms associated with insoluble particulate substances is that the prolonged stimulus for cell replication, due not only to cell injury but to the release of mitogenic growth factors from alveolar macrophages, provides a favorable environment for the promotion and progression of spontaneously initiated cells. The interim evaluations in the NTP talc study clearly demonstrate a progressive impairment of homeostatic growth regulation in the areas of chronic inflammation and fibrosis associated with

talc deposition in rats. Hyperplasia of the alveolar epithelium was evident at 6 months and became more extensive and severe with duration of exposure. Not only were there increased numbers of cells (hyperplasia), but some cells assumed morphologic features atypical of regenerating or differentiated type II cells (epithelial dysplasia). The altered or dysplastic epithelium was particularly evident in areas of fibrosis. The squamous metaplasia observed in female rats also represents altered differentiation of populations of alveolar epithelial cells and is notable in light

of the development of squamous cysts and squamous cell carcinomas.

The lack of a carcinogenic effect in male rats or in mice exposed to talc aerosols does not negate the possibility of a mechanism as described above. First, the difference between male and female rats may be one of magnitude rather than an absolute difference in effect. The influence of the length of exposure on the development of these late appearing lung neoplasms cannot be discounted; the length of exposure was 113 weeks for males and 122 weeks for females. Further, the promotion and progression of neoplasia involve a complex series of molecular events that are likely to differ qualitatively or quantitatively in males and females. Clearly, there are sex differences in the incidence of spontaneous and chemically induced neoplasms. As for mice exposed to talc, there was no histologic evidence of impaired growth regulation or fibrosis, consistent with the mechanism proposed above.

Pheochromocytomas (benign, malignant, or complex) of the adrenal medulla occurred with significant positive trends in both male and female rats exposed to talc (males: 26/49, 32/48, 37/47; females: 13/48, 14/47, 23/49). Further, the numbers of male and female rats with bilateral pheochromocytomas were also increased in the exposed groups. The overall incidences of this neoplasm in the 18 mg/m³ groups were significantly greater than those of the controls. Comparison with historical controls of NTP lifetime studies is not considered relevant, since there has been a pronounced increase in the spontaneous occurrence of pheochromocytomas in male rats in studies conducted by the NTP over the last 10 years (Rao *et al.*, 1990).

In contrast to the pheochromocytomas, the incidences of adrenal medulla hyperplasia in exposed male rats were lower than in controls, and the incidences were similar in all female groups. Because of the small size of the adrenal medulla, pheochromocytomas tend to obscure much or all of the remaining tissue. Therefore, the lower incidences of hyperplasia in groups of exposed males can be attributed, in part, to the larger number of pheochromocytomas.

While the increased incidences of pheochromocytomas in male rats were exposure related, the increase was considered to represent some, rather than clear,

evidence of carcinogenic activity because a) the increase was associated primarily with benign neoplasms and b) there was no supporting increase in the incidence of hyperplasia. The increased incidence of pheochromocytomas in female rats was also exposure related.

Although the strength of the statistical association indicates that the pheochromocytomas are exposure related, a plausible mechanism for their increased occurrence in rats exposed to talc aerosols is not readily apparent. Since talc is relatively insoluble, it is extremely unlikely that any soluble components could have reached concentrations high enough in the blood to affect the adrenal medulla cells. Although purely speculative, there are two general hypotheses that might be considered. First, the increased incidence of adrenal pheochromocytomas may be a nonspecific effect of stress as a result of the chronic pulmonary inflammation. The body is known to respond to an exogenous challenge such as injury, inflammation, or infection by a set of distinct physiologic, metabolic, and endocrine changes including increases in serum adrenocorticotrophic hormone and cortisone levels, growth hormone, and catecholamine synthesis. Further, the adrenal medulla, as a modified sympathetic ganglia, reacts to neural as well as hormonal stimuli in the secretion of catecholamines. While prolonged stimulus of secretion is coupled with cellular hypertrophy and hyperplasia (cell proliferation) in many endocrine tissues, it is unknown if this occurs in the adrenal medulla. Moreover, if prolonged stress were to increase the rate of occurrence or growth of medullary proliferative lesions, similar exposure-related increases in pheochromocytoma incidence might be expected in other chronic toxicity/carcinogenicity studies. This has not generally been the case. Exposure-related increased incidences of pheochromocytoma were not observed or not reported in the 2-year inhalation studies of other particulate substances reported above.

A second hypothesis to consider is that cytokines (growth factors), released from macrophages or other cells in the lung, might be responsible for increasing the rate of growth of pheochromocytomas. Although alveolar macrophages have been found to secrete a number of cytokines known to stimulate proliferation of a variety of cell types, cytokines are generally believed to affect cells only in close proximity within the same organ. However, it has recently been found

that measurable levels of hepatocyte growth factor are present in the plasma after two-thirds hepatectomy (Lindroos *et al.*, 1992). Thus, some cytokines or growth factors may have wider effects than currently known.

CONCLUSIONS

Under the conditions of these inhalation studies, there was *some evidence of carcinogenic activity** of talc in male F344/N rats based on an increased incidence of benign or malignant pheochromocytomas of the adrenal gland. There was *clear evidence of carcinogenic activity* of talc in female F344/N rats based on increased incidences of alveolar/bronchiolar adenomas and carcinomas of the lung and benign or malignant pheochromocytomas of the adrenal gland.

There was *no evidence of carcinogenic activity* of talc in male or female B6C3F₁ mice exposed to 6 or 18 mg/m³.

The principal toxic lesions associated with inhalation exposure to the same concentrations of talc in rats included chronic granulomatous inflammation, alveolar epithelial hyperplasia, squamous metaplasia and squamous cysts, and interstitial fibrosis of the lung. These lesions were accompanied by impaired pulmonary function characterized primarily by reduced lung volumes, reduced dynamic and/or quasistatic lung compliance, reduced gas exchange efficiency, and nonuniform intrapulmonary gas distribution. In mice, inhalation exposure to talc produced chronic inflammation of the lung with the accumulation of alveolar macrophages.

* Explanation of Levels of Evidence of Carcinogenic Activity is on page 9. A summary of Technical Reports Review Subcommittee comments and the public discussion on this Technical Report appears on page 11.

REFERENCES

- Allison, A.C. (1977). Mechanisms of macrophage damage in relation to the pathogenesis of some lung diseases. In *Respiratory Defense Mechanisms, Part II* (J.D. Brain, D.F. Proctor, and L.M. Reid, Eds.), pp. 1075-1102. Marcel Dekker, Inc., New York.
- American Conference of Governmental Industrial Hygienists (ACGIH) (1988). Threshold Limit Values and Biological Exposure Indices for 1988-1989. Cincinnati, OH.
- Armitage, P. (1971). *Statistical Methods in Medical Research*, pp. 362-365. John Wiley and Sons, New York.
- Arnett, E.N., Battle, W.E., Russo, J.V., and Roberts, W.C. (1976). Intravenous injection of talc-containing drugs intended for oral use: A cause of pulmonary granulomatosis and pulmonary hypertension. *Am. J. Med.* 60, 711-718.
- Atlee, W.E., Jr. (1972). Talc and cornstarch emboli in eyes of drug abusers. *J. Am. Med. Assoc.* 219, 49-51.
- Bethege-Iwanska, J. (1971). Pathomorphological changes of respiratory system in experimental talcosis (Czech.). *Med. Prac.* 22, 45-57.
- Bonner, J.C., Hoffman, M., and Brody, A.R. (1989). Alpha-macroglobulin secreted by alveolar macrophages serves as a binding protein for a macrophage-derived homologue of platelet-derived growth factor. *Am. J. Respir. Cell Mol. Biol.* 1, 171-179.
- Bonner, J.C., Badgett, A., Osornio-Vargas, A.R., Hoffman, M., and Brody, A.R. (1990). PDGF-stimulated fibroblast proliferation is enhanced synergistically by receptor recognized α_2 -macroglobulin. *J. Cell Physiol.* 145, 1-8.
- Boorman, G.A., Montgomery, C.A., Jr., Eustis, S.L., Wolfe, M.J., McConnell, E.E., and Hardisty, J.F. (1985). Quality assurance in pathology for rodent carcinogenicity studies. In *Handbook of Carcinogen Testing* (H.A. Milman and E.K. Weisburger, Eds.), pp. 345-357. Noyes Publications, Park Ridge, NJ.
- Brain, J.D. (1980). Macrophage damage in relation to the pathogenesis of lung diseases. *Environ. Health Perspect.* 35, 21-28.
- Brieger, H., and Gross, P. (1967). On the theory of silicosis. III. Stishovite. *Arch. Environ. Health* 15, 751-757.
- Brody, A.R. (1991). Production of cytokines by particle-exposed lung macrophages. In *Cellular and Molecular Aspects of Fiber Carcinogenesis* (C.C. Harris, J.F. Lechner, and B.R. Brinkley, Eds.), pp. 83-103. Cold Spring Harbor Laboratory Press, Cold Spring Harbor, NY.
- Brody, A.R., and Davis, G.S. (1982). Alveolar macrophage toxicology. In *Mechanisms in Respiratory Toxicology* Vol. II (H. Witschi and P. Nettekheim, Eds.), pp. 3-28. CRC Press, Boca Raton, FL.
- Brody, A.R., and Roe, M.W. (1983). Deposition pattern of inorganic particles at the alveolar level in the lungs of rats and mice. *Am. Rev. Respir. Dis.* 128, 724-729.
- Bureau of Mines (1986). Mineral Commodity Summaries. Vol. 156.
- Canessa, P.A., Torraca, A., Lavecchia, M.A., Patelli, M., and Poletti, V. (1990). Pneumoconiosis (silicosis) in the confectionery industry. *Sarcoidosis* 7, 75-77.
- Code of Federal Regulations (CFR), 21, Part 58.
- Cox, D.R. (1972). Regression models and life-tables. *J. R. Stat. Soc.* B34, 187-220.
- Cramer, D.W., Welch, W.R., Scully, R.E., and Wojciechowski, C.A. (1982). Ovarian cancer and talc. A case-control study. *Cancer* 50, 372-376.
- Crouch, E., and Churg, A. (1983). Progressive massive fibrosis of the lung secondary to intravenous injection of talc. A pathologic and mineralogic analysis. *Am. J. Clin. Pathol.* 80, 520-526.

- Dagle *et al.* (1986). In *Silica, Silicosis, and Cancer* (D.F. Goldsmith, D.M. Winn, and C.M. Shy, Eds.), Praeger, New York.
- Davis, J.M.G. (1972). The fibrogenic effects of mineral dusts injected into the pleural cavity of mice. *Br. J. Exp. Pathol.* **53**, 190-201.
- Dinse, G.E., and Haseman, J.K. (1986). Logistic regression analysis of incidental-tumor data from animal carcinogenicity experiments. *Fundam. Appl. Toxicol.* **6**, 44-52.
- Dinse, G.E., and Lagakos, S.W. (1983). Regression analysis of tumour prevalence data. *Appl. Statist.* **32**, 236-248.
- Dogra, R.K.S., Iyer, P.K.R., Shanker, R., and Zaidi, S.H. (1977). Effect of talc injected intravenously in guinea pigs. *Toxicology* **7**, 197-206.
- Driscoll, K.E., Lindenschmidt, R.C., Maurer, J.K., Higgins, J.M., and Ridder, G. (1990). Pulmonary response to silica or titanium dioxide: Inflammatory cells, alveolar macrophage-derived cytokines, and histopathology. *Am. J. Respir. Cell Mol. Biol.* **2**, 381-390.
- DuBois, A.B., Botelho, S.Y., Bedell, G.N., Marshall, R., and Comroe, J.H. Jr. (1956). A rapid plethysmographic method for measuring thoracic gas volume: A comparison with a nitrogen washout method for measuring functional residual capacity in normal subjects. *J. Clin. Invest.* **35**, 322-326.
- Dunn, O.J. (1964). Multiple comparisons using rank sums. *Technometrics* **6**, 241-252.
- Dunnett, C.W. (1955). A multiple comparison procedure for comparing several treatments with a control. *J. Am. Stat. Assoc.* **50**, 1096-1121.
- Eger, W., and DaCanalis, S. (1964). Organ - especially liver - alterations resulting from a single injection of quartz, asbestos or talc into the portal circulation of the rat (Ger.). *Beitr. Silikoseforsch.* **81**, 12-42.
- Farber, H.W., Fairman, R.P., and Glauser, F.L. (1981). Bronchoalveolar lavage: A new technique for the diagnosis of talc granulomatosis. *Chest* **80**, 342. (Abstr.)
- Farber, H.W., Fairman, R.P., and Glauser, F.L. (1982). Talc granulomatosis: Laboratory findings similar to sarcoidosis. *Am. Rev. Respir. Dis.* **125**, 258-261.
- Feigin, D.S. (1986). Talc: Understanding its manifestations in the chest. *Am. J. Roentgenol.* **146**, 295-301.
- Food and Drug Research Laboratories (1973). Teratologic Evaluation of FDA 71-43 (Talc) (PB-223 828). Washington, DC.
- Gart, J.J., Chu, K.C., and Tarone, R.E. (1979). Statistical issues in interpretation of chronic bioassay tests for carcinogenicity. *J. Natl. Cancer Inst.* **62**, 957-974.
- Gibel, W., Lohs, K., Horn, K.H., Wildner, G.P., and Hoffmann, F. (1976). Experimental study on carcinogenic activity of asbestos filters (Ger.). *Arch. Geschwulstforsch.* **46**, 437-442.
- Gregory, R.E., and Pickrell, J.A. (1982). Determination and partial characterization of the endogenous proteolytic activity present in rat lung. 1981-1982 Annual Report, pp. 455-459. Lovelace Inhalation Toxicology Research Institute, Albuquerque, NM.
- Gross, P., deTreville, R.T.P., Cralley, L.J., Granquist, W.T., and Pundsack, F.L. (1970). The pulmonary response to fibrous dusts of diverse compositions. *Am. Ind. Hyg. Assoc. J.* **31**, 125-132.
- Groth, D.H., Mackay, G.R., Crable, J.V., and Cochran, T.H. (1972). Intravenous injection of talc in a narcotics addict. *Arch. Pathol.* **94**, 171-178.
- Groth, D.H., Stettler, L.E., Burg, J.R., Busey, W.M., Grant, G.C., and Wong, L. (1986). Carcinogenic effects of antimony trioxide and antimony ore concentrate in rats. *J. Toxicol. Environ. Health* **18**, 607-626.
- Hanson, R.L., Benson, J.M., Henderson, T.R., Carpenter, R.L., Pickgel, J.A., and Brown, S.C. (1985). Method for determining the lung burden of talc in rats and mice after inhalation exposure to talc aerosols. *J. Appl. Toxicol.* **5**, 283-286.
- Harkema, J.R., Mauderly, J.L., and Hahn, F.F. (1982). The effects of emphysema on oxygen toxicity in rats. *Am. Rev. Respir. Dis.* **126**, 1058-1065.

- Harkema, J.R., Mauderly, J.L., Gregory, R.E., and Pickrell, J.A. (1984). A comparison of starvation and elastase models of emphysema in the rat. *Am. Rev. Respir. Dis.* 129, 584-591.
- Harlow, B.L., and Weiss, N.S. (1989). A case-control study of borderline ovarian tumors: The influence of perineal exposure to talc. *Am. J. Epidemiol.* 130, 390-394.
- Harmsen, A.G., and Jeska, E.L. (1980). Surface receptors on porcine alveolar macrophages and their role in phagocytosis. *J. Reticuloendoth. Soc.* 27, 631-637.
- Haseman, J.K. (1984). Statistical issues in the design, analysis and interpretation of animal carcinogenicity studies. *Environ. Health Perspect.* 58, 385-392.
- Hawley, G.G. (Ed.) (1977). *The Condensed Chemical Dictionary*, 9th ed, p. 835. Van Nostrand Reinhold Co., New York.
- Hemenway, D.R., Absher, M., Landesman, M., Trombley, L., and Emerson, R.J. (1986). Differential lung response following silicon dioxide polymorph aerosol exposure. In *Silica, Silicosis, and Cancer* (D.F. Goldsmith, D.M. Winn, and C.M. Shy, Eds.), pp. 105-116. Praeger, New York.
- Henderson, R.F., Benson, J.M., Hahn, F.F., Hobbs, C.H., Jones, R.K., Mauderly, J.L., McClellan, R.O., and Pickrell, J.A. (1985). New approaches for the evaluation of pulmonary toxicity: Bronchoalveolar lavage fluid analysis. *Fundam. Appl. Toxicol.* 5, 451-458.
- Hildick-Smith, G.Y. (1976). The biology of talc. *Br. J. Ind. Med.* 33, 217-229.
- Hill, A.D., Toner, M.E., and Fitzgerald, M.X. (1990). Talc lung in a drug abuser. *Ir. J. Med. Sci.* 159, 147-148.
- International Agency for Research on Cancer (IARC) (1987). Monographs on the Evaluation of the Carcinogenic Risk of Chemicals to Humans, Vol. 42. IARC, Lyon, France.
- Jonckheere, A. (1954). A distribution-free k -sample test against ordered alternatives. *Biometrika* 41, 133-145.
- Kaga, N., Tso, M.O., and Jampol, L.M. (1982a). Talc retinopathy in primates: A model of ischemic retinopathy. III. An electron microscopic study. *Arch. Ophthalmol.* 100, 1649-1657.
- Kaga, N., Tso, M.O., Jampol, L.M., Setogawa, T., and Rednam, K.R.V. (1982b). Talc retinopathy in primates: A model of ischemic retinopathy. II. A histopathologic study. *Arch. Ophthalmol.* 100, 1644-1648.
- Kalter, V.G., Bonner, J.C., and Brody, A.R. (1989). Secretion of TGF β by rat alveolar macrophages and characterization of receptors for TGF β on rat lung fibroblasts. *Cytokine* 1, 76. (Abstr.)
- Kaplan, E.L., and Meier, P. (1958). Nonparametric estimation from incomplete observations. *J. Am. Stat. Assoc.* 53, 457-481.
- Kelley, J. (1990). Cytokines of the lung. *Am. Rev. Respir. Dis.* 141, 765-788.
- Kouzan, S., Brody, A.R., Nettesheim, P., and Eling, T. (1985). Production of arachidonic acid metabolites by macrophages exposed *in vitro* to asbestos, carbonyl iron particles, and calcium ionophore. *Am. Rev. Respir. Dis.* 131, 624-632.
- Lamb, D., and Roberts, G. (1972). Starch and talc emboli in drug addicts' lungs. *J. Clin. Pathol.* 25, 876-881.
- Langer, A.M., and Nolan, R.P. (1986). Physicochemical properties of quartz controlling biological activity. In *Silica, Silicosis, and Cancer* (D.F. Goldsmith, D.M. Winn, and C.M. Shy, Eds.), pp. 125-135. Praeger, New York.
- Lauweryns, J.M., and Baert, J.H. (1974). The role of the pulmonary lymphatics in the defense of the distal lung: Morphological and experimental studies of the transport mechanisms of intratracheally instilled particles. *Ann. N.Y. Acad. Sci.* 221, 244-275.
- Lee, K.P., Barras, C.E., Griffith, F.D., and Waritz, R.S. (1979). Pulmonary response to glass fiber by inhalation exposure. *Lab. Invest.* 40, 123-133.
- Lee, K.P., Trochimowicz, H.J., and Reinhardt, C.F. (1985). Pulmonary response of rats exposed to titanium dioxide by inhalation for two years. *Toxicol. Appl. Pharmacol.* 79, 179-192.

- Lee, K.P., Kelly, D.P., Schneider, P.W., and Trochimowicz, H.J. (1986). Inhalation toxicity study on rats exposed to titanium tetrachloride atmospheric hydrolysis products for two years. *Toxicol. Appl. Pharmacol.* **83**, 30-45.
- Lee, K.P., Ulrich, C.E., Geil, R.G., and Trochimowicz, H.J. (1988). Effects of inhaled chromium dioxide dust on rats exposed for two years. *Fundam. Appl. Toxicol.* **10**, 125-145.
- Lindroos, P., Tsai, W.H., Zarnegar, R., and Michalopoulos, G.K. (1992). Plasma levels of HGF in rats treated with tumor promoters. *Carcinogenesis* **13**, 139-141.
- Luchtrath, H., and Schmidt, K.G. (1959). Talc and steatite, their relation to asbestos and their effects in intratracheal experiments in rats (Ger.). *Beitr. Silikoseforsch.* **61**, 1-60.
- Maronpot, R.R., and Boorman, G.A. (1982). Interpretation of rodent hepatocellular proliferative alterations and hepatocellular tumors in chemical safety assessment. *Toxicol. Pathol.* **10**, 71-80.
- Marusic, A., Kos, K., Stavljenic, A., and Vukicevic, S. (1990). Talc granulomatosis in the rat: Involvement of bone in the acute-phase response. *Inflammation* **14**, 205-216.
- Mauderly, J.L. (1977). Bronchopulmonary lavage of small laboratory animals. *Lab. Anim. Sci.* **27**, 255-261.
- Mauderly, J.L., Jones, R.K., McClellan, R.O., Henderson, R.F., and Griffith, W.C. (1986). Carcinogenicity of diesel exhaust inhaled chronically by rats. In *Carcinogenic and Mutagenic Effects of Diesel Engine Exhaust* (N. Ishinishi, A. Koizumi, R.O. McClellan, and W. Stober, Eds.), pp. 397-409. Elsevier, Amsterdam.
- McConnell, E.E., Solleveld, H.A., Swenberg, J.A., and Boorman, G.A. (1986). Guidelines for combining neoplasms for evaluation of rodent carcinogenesis studies. *JNCI* **76**, 283-289.
- McKnight, B., and Crowley, J. (1984). Tests for differences in tumor incidence based on animal carcinogenesis experiments. *J. Am. Stat. Assoc.* **79**, 639-648.
- McMahon, T.A., Brain, J.D., and Lemott, S. (1977). Species differences in aerosol deposition. In *Inhaled Particles IV, Part 1* (W.H. Walton, Ed.), pp. 23-32. Pergamon Press, New York.
- The Merck Index* (1983). 10th ed. (M. Windholz, Ed.), p. 8920. Merck & Company, Rahway, NJ.
- Narang, S., Rahman, Q., Kaw, J.L., and Zaidi, S.H. (1977). Dissolution of silicic acid from dusts of kaolin, mica and talc and its relation to their hemolytic activity - an *in vitro* study. *Exp. Pathol.* **13**, 346-349.
- Nathan, C.F. (1987). Secretory products of macrophages. *J. Clin. Invest.* **79**, 319-326.
- National Cancer Institute (NCI) (1976). Guidelines for Carcinogen Bioassay in Small Rodents. Technical Report Series No. 1. NIH Publication No. 76-801. National Institutes of Health, Bethesda, MD.
- National Institute for Occupational Safety and Health (NIOSH) (1990), National Occupational Exposure Survey (NOES) (1981-1983), unpublished provisional data as of July 1, 1990.
- National Institutes of Health (NIH) (1978). Open Formula Rat and Mouse Ration (NIH-07). Specification NIH-11-1335. U.S. Department of Health, Education, and Welfare, Public Health Service, National Institutes of Health, Bethesda, MD.
- Neukomm, S., and de Trey, M. (1961). Study of possible carcinogenic and/or co-carcinogenic brightening agents (Fr.). *Med. Exp.* **4**, 298-306.
- Neuman, R.E., and Logan, M.A. (1950). The determination of hydroxyproline. *J. Biol. Chem.* **184**, 299-306.
- Olgivie, C.M., Forster, R.E., Blackmore, W.S., and Morton, J.W. (1957). A standardized breath holding technique for the clinical measurement of the diffusing capacity of the lung for carbon monoxide. *J. Clin. Invest.* **36**, 1-17.
- Osol, A., Chase, G.D., Gennaro, A.R., Gibson, M.R., Granberg, C.B., Harvey, S.C., King, R.E., Martin, A.N., Swinyard, E.A., and Zink, G.L. (Eds.) (1980). *Remington's Pharmaceutical Sciences*, 16th ed, p. 1266. Mack Publishing Co., Easton, PA.

- Oubeid, M., Bickel, J.T., Ingram, E.A., and Scott, G.C. (1990). Pulmonary talc granulomatosis in a cocaine sniffer. *Chest* 98, 237-239.
- Özesmi, M., Patiroglu, T.E., Hillerdal, G., and Özesmi, C. (1985). Peritoneal mesothelioma and malignant lymphoma in mice caused by fibrous zeolite. *Br. J. Ind. Med.* 42, 746-749.
- Phillips, J.C., Young, P.J., Hardy, K., and Gangolli, S.D. (1978). Studies on the absorption and disposition of ³H-labelled talc in the rat, mouse, guinea-pig and rabbit. *Food Cosmet. Toxicol.* 16, 161-163.
- Pickrell, J.A., Hahn, F.F., Rebar, A.H., Horoda, R.A., and Henderson, R.F. (1987). Changes in collagen metabolism and proteinolysis after repeated inhalation exposure to ozone. *Exp. Mol. Pathol.* 46, 159-167.
- Pickrell, J.A., Snipes, M.B., Benson, J.M., Hanson, R.L., Jones, R.K., Carpenter, R.L., Thompson, J.J., Hobbs, C.H., and Brown, S.C. (1989). Talc deposition and effects after 20 days of repeated inhalation exposure of rats and mice to talc. *Environ. Res.* 49, 233-245.
- Policard, A. (1940). Effect of talc dusts on lungs. Experimental study (Fr.). *Arch. Mal. Prof.* 2, 530-539.
- Pooley, F.D., and Rowlands, N. (1977). Chemical and physical properties of British talc powders. In *Inhaled Particles* (W.H. Walton and B. McGovern, Eds.), Vol. IV, Part 2, pp. 639-646. Pergamon Press, Oxford.
- Pott, F., Huth, F., and Friedrichs, K.-H. (1974). Tumorigenic effect of fibrous dusts in experimental animals. *Environ. Health Perspect.* 9, 313-315.
- Pott, F., Friedrichs, K.-H., and Huth, F. (1976a). Results of animal experiments concerning the carcinogenic effect of fibrous dusts and their interpretation with regard to the carcinogenesis in humans. *Zentralbl. Bakteriol. Mikrobiol. Hyg. [B]* 162, 467-505.
- Pott, F., Dolgner, R., Friedrichs, K.-H., and Huth, F. (1976b). Oncogenic effect of fibrous dusts. Animal experimentation and its relation to human carcinogenesis (Fr.). *Ann. Anat. Pathol.* 21, 237-246.
- Raabe, O.G., Yeh, H.-C., Newton, G.J., Phalen, R.F., and Velasquez, D.J. (1977). Deposition of inhaled monodisperse aerosols in small rodents. In *Inhaled Particles IV, Part 1* (W.H. Walton, Ed.), pp. 3-20. Pergamon Press, New York.
- Rao, G.N., Haseman, J.K., Grumbein, S., Crawford, D.D., and Eustis, S.L. (1990). Growth, body weight, survival, and tumor trends in F344/N rats during an eleven-year period. *Toxicol. Pathol.* 18, 61-69.
- Reiser, K.M., and Last, J.A. (1979). Silicosis and fibrogenesis: Fact and artifact. *Toxicology* 13, 51-72.
- Reyes, de la Rocha, S., and Brown, M.A. (1989). Normal pulmonary function after baby powder inhalation causing adult respiratory distress syndrome. *Pediatr. Emerg. Care* 5, 43-48.
- Rinaldo, J.E., Owens, G.R., and Rogers, R.M. (1983). Adult respiratory distress syndrome following intrapleural instillation of talc. *J. Thorac. Cardiovasc. Surg.* 85, 523-526.
- Rohl, A.N., Langer, A.M., Selikoff, I.J., Tordini, A., Klimentidis, R., Bowes, D.R., and Skinner, D.L. (1976). Consumer talcums and powders: Mineral and chemical characterization. *J. Toxicol. Environ. Health* 2, 255-284.
- Sadtler Standard Spectra*. IR No. 1737. Sadtler Research Laboratories, Philadelphia, PA.
- Saffiotti, U., and Stinson, S.F. (1988). Lung cancer induction by crystalline silica: Relationships to granulomatous reactions and host factors. *Environ. Carcinog. Revs. (J. Environ. Sci. Health [C])* 6, 197-222.
- Sheikh, K.M.A., Duggal, K., Relfson, M., Gignac, S., and Rowden, G. (1984). An experimental histopathologic study of surgical glove powders. *Arch. Surg.* 119, 215-219.
- Shirley, E. (1977). A non-parametric equivalent of Williams' test for contrasting increasing dose levels of a treatment. *Biometrics* 33, 386-389.
- Solleveld, H.A., Haseman, J.K., and McConnell, E.E. (1984). Natural history of body weight gain, survival, and neoplasia in the F344 rat. *JNCI* 72, 929-940.

- Sorokin, S.P., and Brian, J.D. (1975). Pathways of clearance in mouse lungs exposed to iron oxide aerosols. *Anat. Rec.* **181**, 581-625.
- Stanton, M.F., and Wrench, C. (1972). Mechanisms of mesothelioma induction with asbestos and fibrous glass. *J. Natl. Cancer Inst.* **48**, 797-821.
- Stanton, M.F., Layard, M., Tegeris, A., Miller, E., May, M., and Kent, E. (1977). Carcinogenicity of fibrous glass: Pleural response in the rat in relation to fiber dimension. *J. Natl. Cancer Inst.* **58**, 587-603.
- Stanton, M.F., Layard, M., Tegeris, A., Miller, E., May, M., Morgan, E., and Smith, A. (1981). Relation of particle dimension to carcinogenicity in amphibole asbestoses and other fibrous minerals. *J. Natl. Cancer Inst.* **67**, 965-975.
- Tarone, R.E. (1975). Tests for trend in life table analysis. *Biometrika* **62**, 679-682.
- Theriault, G.P., Burgess, W.A., DiBerardinis, L.J., and Peters, J.M. (1974). Dust exposure in the Vermont Granite Sheds. *Arch. Environ. Health* **28**, 12-17.
- Thomas, T.L. (1990). Lung cancer mortality among pottery workers in the United States. *LARC Sci. Publ.* **97**, 75-81.
- Thomas, T.L., and Stewart, P.A. (1987). Mortality from lung cancer and respiratory disease among pottery workers exposed to silica and talc. *Am. J. Epidemiol.* **125**, 35-43.
- Vallyathan, N.V., and Craighead, J.E. (1981). Pulmonary pathology in workers exposed to nonasbestiform talc. *Hum. Pathol.* **12**, 28-35.
- Wagner, J.C., Berry, G., Cooke, T.J., Hill, R.J., Pooley, F.D., and Skidmore, J.W. (1977). Animal experiments with talc. In *Inhaled Particles* (W.H. Walton and B. McGovern, Eds.), Vol. IV, Part 2, pp. 647-654. Pergamon Press, Oxford.
- Wehner, A.P. (1980). Effects of inhaled asbestos, asbestos plus cigarette smoke, asbestos cement and talc baby powder in hamsters. In *Biological Effects of Mineral Fibres* (J.C. Wagner, Ed.), IARC Scientific Publications No. 30, Vol. 1, pp. 373-376. Lyon, France.
- Wehner, A.P., Zwicker, G.M., Cannon, W.C., Watson, C.R., and Carlton, W.W. (1977a). Inhalation of talc baby powder by hamsters. *Food Cosmet. Toxicol.* **15**, 121-129.
- Wehner, A.P., Wilkerson, C.L., Cannon, W.C., Buschbom, R.L., and Tanner, T.M. (1977b). Pulmonary deposition, translocation and clearance of inhaled neutron-activated talc in hamsters. *Food Cosmet. Toxicol.* **15**, 213-224.
- Wehner, A.P., Stuart, B.O., and Sanders, C.L. (1979). Inhalation studies with Syrian golden hamsters. *Prog. Exp. Tumor Res.* **24**, 177-198.
- Wehner, A.P., Dagle, G.E., Clark, M.L., and Buschbom, R.L. (1986). Lung changes in rats following inhalation exposure to volcanic ash for two years. *Environ. Res.* **40**, 499-517.
- Wells, I.P., Dubbins, P.A., and Whimster, W.F. (1979). Pulmonary disease caused by the inhalation of cosmetic talcum powder. *Br. J. Radiol.* **52**, 586-588.
- Wergeland, E., Andersen, A., and Bærheim, A. (1990). Morbidity and mortality in talc-exposed workers. *Am. J. Ind. Med.* **17**, 505-513.
- Whittemore, A.S., Wu, M.L., Paffenberger, R.S., Jr., Sarles, D.L., Kampert, J.B., Grosser, S., Jung, D.L., Ballon, S., and Hendrickson, M. (1988). Personal and environmental characteristics related to epithelial ovarian cancer. II. Exposures to talcum powder, tobacco, alcohol, and coffee. *Am. J. Epidemiol.* **128**, 1228-1240.
- Williams, D.A. (1971). A test for differences between treatment means when several dose levels are compared with a zero dose control. *Biometrics* **27**, 103-117.
- Williams, D.A. (1972). The comparison of several dose levels with a zero dose control. *Biometrics* **28**, 519-531.
- Yang, T.S. (1977). Studies on sulfonamide-induced anomalies in chick embryos (2). *Jpn. J. Steril.* **22**, 32-40.

APPENDIX A
SUMMARY OF LESIONS IN MALE RATS
IN THE LIFETIME INHALATION STUDY
OF TALC

TABLE A1	Summary of the Incidence of Neoplasms in Male Rats in the Lifetime Inhalation Study of Talc	64
TABLE A2	Individual Animal Tumor Pathology of Male Rats in the Lifetime Inhalation Study of Talc	68
TABLE A3	Statistical Analysis of Primary Neoplasms in Male Rats in the Lifetime Inhalation Study of Talc	86
TABLE A4	Summary of the Incidence of Nonneoplastic Lesions in Male Rats in the Lifetime Inhalation Study of Talc	90

TABLE A1
Summary of the Incidence of Neoplasms in Male Rats in the Lifetime Inhalation Study of Talc^a

	0 mg/m ³	6 mg/m ³	18 mg/m ³
Disposition Summary			
Animals initially in study	49	50	50
Early deaths			
Moribund	23	19	20
Natural deaths	17	17	14
Survivors			
Died last week of study	1	2	3
Terminal sacrifice	8	12	13
Animals examined microscopically	49	50	50
Alimentary System			
Intestine large, cecum	(42)	(38)	(37)
Intestine large, colon	(43)	(43)	(46)
Intestine small, duodenum	(48)	(44)	(46)
Intestine small, ileum	(39)	(34)	(35)
Intestine small, jejunum	(40)	(38)	(40)
Liver	(49)	(50)	(48)
Neoplastic nodule			1 (2%)
Neoplastic nodule, multiple	2 (4%)	1 (2%)	3 (6%)
Osteosarcoma, metastatic, multiple, bone	1 (2%)		
Hepatocyte, adenoma		1 (2%)	
Mesentery	(2)		(1)
Pancreas	(48)	(46)	(47)
Salivary glands	(49)	(50)	(50)
Fibroma		1 (2%)	
Stomach, forestomach	(49)	(47)	(47)
Fibrosarcoma			1 (2%)
Stomach, glandular	(49)	(47)	(47)
Fibrosarcoma			1 (2%)
Cardiovascular System			
Heart	(49)	(50)	(50)
Endocrine System			
Adrenal gland, cortex	(49)	(49)	(48)
Adrenal gland, medulla	(49)	(48)	(47)
Osteosarcoma, metastatic, uncertain primary site			1 (2%)
Pheochromocytoma malignant	2 (4%)	3 (6%)	6 (13%)
Pheochromocytoma complex		2 (4%)	1 (2%)
Pheochromocytoma benign	13 (27%)	9 (19%)	20 (43%)
Bilateral, pheochromocytoma malignant	1 (2%)		1 (2%)
Bilateral, pheochromocytoma benign	12 (24%)	21 (44%)	16 (34%)
Islets, pancreatic	(47)	(41)	(43)
Adenoma	1 (2%)		2 (5%)
Carcinoma	1 (2%)		
Parathyroid gland	(45)	(45)	(46)
Adenoma		1 (2%)	
Pituitary gland	(47)	(50)	(49)
Pars distalis, adenoma	12 (26%)	11 (22%)	10 (20%)
Pars distalis, carcinoma		1 (2%)	
Pars intermedia, adenoma			2 (4%)

TABLE A1
Summary of the Incidence of Neoplasms in Male Rats in the Lifetime Inhalation Study of Talc (continued)

	0 mg/m ³	6 mg/m ³	18 mg/m ³
Endocrine System (continued)			
Thyroid gland	(45)	(46)	(46)
C-cell, adenoma	3 (7%)	4 (9%)	3 (7%)
C-cell, carcinoma		1 (2%)	
Follicular cell, adenoma			1 (2%)
General Body System			
Tissue NOS	(1)	(1)	
Pheochromocytoma malignant, metastatic, adrenal gland		1 (100%)	
Genital System			
Epididymis	(49)	(50)	(49)
Preputial gland	(48)	(49)	(48)
Adenoma	1 (2%)	1 (2%)	1 (2%)
Carcinoma	1 (2%)	6 (12%)	1 (2%)
Prostate	(49)	(45)	(48)
Seminal vesicle	(49)	(48)	(47)
Testes	(49)	(50)	(50)
Bilateral, interstitial cell, adenoma	18 (37%)	24 (48%)	24 (48%)
Interstitial cell, adenoma	13 (27%)	15 (30%)	12 (24%)
Hematopoietic System			
Bone marrow	(48)	(48)	(47)
Lymph node	(49)	(50)	(50)
Lymph node, bronchial	(41)	(48)	(49)
Lymph node, mandibular	(46)	(48)	(47)
Lymph node, mediastinal	(48)	(49)	(47)
Lymph node, mesenteric	(49)	(48)	(47)
Spleen	(49)	(50)	(48)
Fibrosarcoma	1 (2%)		
Fibrous histiocytoma		1 (2%)	
Osteosarcoma, metastatic, bone	1 (2%)		
Thymus	(48)	(40)	(43)
Thymoma malignant	1 (2%)		
Integumentary System			
Mammary gland	(45)	(48)	(50)
Adenocarcinoma	1 (2%)		
Skin	(48)	(50)	(50)
Basosquamous tumor malignant			1 (2%)
Fibroma		2 (4%)	
Fibrous histiocytoma			1 (2%)
Keratoacanthoma		2 (4%)	2 (4%)
Neurofibroma		1 (2%)	
Squamous cell carcinoma		1 (2%)	
Subcutaneous tissue, fibroma		1 (2%)	
Subcutaneous tissue, fibrosarcoma		1 (2%)	
Subcutaneous tissue, schwannoma malignant	1 (2%)		

TABLE A1
Summary of the Incidence of Neoplasms in Male Rats in the Lifetime Inhalation Study of Talc (continued)

	0 mg/m ³	6 mg/m ³	18 mg/m ³
Musculoskeletal System			
Bone	(49)	(50)	(50)
Pelvis, osteosarcoma		1 (2%)	
Scapula, osteosarcoma	1 (2%)		
Vertebra, osteosarcoma			1 (2%)
Skeletal muscle	(1)		
Nervous System			
Brain	(49)	(50)	(50)
Astrocytoma malignant	1 (2%)		
Respiratory System			
Lung	(49)	(50)	(50)
Alveolar/bronchiolar adenoma		1 (2%)	1 (2%)
Alveolar/bronchiolar carcinoma, multiple			1 (2%)
Fibrosarcoma, metastatic, salivary glands	1 (2%)		
Osteosarcoma, metastatic		1 (2%)	
Osteosarcoma, metastatic, uncertain primary site			1 (2%)
Osteosarcoma, metastatic, multiple, bone	1 (2%)		
Nose	(49)	(48)	(47)
Chondroma	1 (2%)		
Sarcoma		1 (2%)	
Special Senses System			
None			
Urinary System			
Kidney	(49)	(49)	(48)
Renal tubule, carcinoma	2 (4%)		
Urinary bladder	(49)	(48)	(47)
Papilloma	1 (2%)		
Systemic Lesions			
Multiple organs ^b	(49)	(50)	(50)
Leukemia mononuclear	24 (49%)	21 (42%)	23 (46%)
Lymphoma malignant lymphocytic	1 (2%)		
Mesothelioma benign	1 (2%)		
Mesothelioma malignant			1 (2%)

TABLE A1
Summary of the Incidence of Neoplasms in Male Rats in the Lifetime Inhalation Study of Talc (continued)

	0 mg/m ³	6 mg/m ³	18 mg/m ³
Neoplasm Summary			
Total animals with primary neoplasms ^c	48	49	50
Total primary neoplasms	116	135	137
Total animals with benign neoplasms	42	45	45
Total benign neoplasms	78	96	98
Total animals with malignant neoplasms	34	33	33
Total malignant neoplasms	38	39	39
Total animals with metastatic neoplasms	2	2	1
Total metastatic neoplasms	4	2	2
Total animals with malignant neoplasms, uncertain primary site			1

^a Number of animals examined microscopically at site and number of animals with lesion

^b Number of animals with any tissue examined microscopically

^c Primary neoplasms: all neoplasms except metastatic neoplasms

TABLE A2
Individual Animal Tumor Pathology of Male Rats in the Lifetime Inhalation Study of Talc: 0 mg/m³

Number of Days on Study	3	3	4	5	5	5	5	5	5	6	6	6	6	6	6	6	6	6	6	7	7	7	7	7	7	
	3	6	2	5	6	8	9	9	2	2	3	3	5	5	7	8	8	9	0	0	0	0	2	3		
	4	0	9	1	8	6	0	3	2	8	1	5	0	6	0	2	2	8	0	0	4	9	4	9		
Carcass ID Number	3	3	3	3	4	2	2	3	3	4	3	3	3	4	3	3	3	3	3	3	3	3	2	4		
	6	0	6	4	1	9	9	1	8	2	3	4	6	1	4	4	4	1	1	8	9	1	9	1		
	1	0	8	0	3	4	5	8	7	0	9	2	3	8	5	3	8	7	6	5	0	3	6	4		
	1	1	1	1	1	1	1	1	1	1	1	1	1	1	1	1	1	1	1	1	1	1	1	1		
Alimentary System																										
Esophagus	+	+	+	+	+	+	+	+	+	+	+	+	+	+	+	+	+	+	+	+	+	+	+	+	+	
Intestine large	+	+	+	+	+	+	+	+	+	+	+	+	+	A	+	+	+	+	+	+	+	+	+	+	+	
Intestine large, cecum	+	+	+	+	+	+	+	+	+	+	+	+	+	+	+	+	+	+	+	+	+	+	+	+	+	
Intestine large, colon	+	+	+	M	+	+	+	+	+	+	+	+	+	A	+	+	+	+	+	+	+	+	+	+	+	
Intestine large, rectum	M	+	+	+	+	+	+	+	+	M	+	+	+	A	M	+	+	+	+	+	+	+	+	+	+	
Intestine small	+	+	+	+	+	+	+	+	+	+	+	+	+	+	+	+	+	+	+	+	+	+	+	+	+	
Intestine small, duodenum	+	+	+	+	+	+	+	+	+	+	+	+	+	+	+	+	+	+	+	+	+	+	+	+	+	
Intestine small, ileum	A	+	+	+	+	+	+	+	+	+	+	+	+	A	+	+	+	A	+	+	+	+	A	+	A	
Intestine small, jejunum	A	+	+	+	+	+	+	+	+	+	+	+	+	A	+	+	A	+	+	+	+	+	+	+	A	
Liver	+	+	+	+	+	+	+	+	+	+	+	+	+	+	+	+	+	+	+	+	+	+	+	+	+	
Neoplastic nodule, multiple																									X	
Osteosarcoma, metastatic, multiple, bone												X														
Mesentery	+																									
Pancreas	+	+	+	+	+	+	+	+	+	M	+	+	+	+	+	+	+	+	+	+	+	+	+	+	+	
Salivary glands	+	+	+	+	+	+	+	+	+	+	+	+	+	+	+	+	+	+	+	+	+	+	+	+	+	
Stomach	+	+	+	+	+	+	+	+	+	+	+	+	+	+	+	+	+	+	+	+	+	+	+	+	+	
Stomach, forestomach	+	+	+	+	+	+	+	+	+	+	+	+	+	+	+	+	+	+	+	+	+	+	+	+	+	
Stomach, glandular	+	+	+	+	+	+	+	+	+	+	+	+	+	+	+	+	+	+	+	+	+	+	+	+	+	
Cardiovascular System																										
Blood vessel				+																						
Heart	+	+	+	+	+	+	+	+	+	+	+	+	+	+	+	+	+	+	+	+	+	+	+	+	+	
Endocrine System																										
Adrenal gland	+	+	+	+	+	+	+	+	+	+	+	+	+	+	+	+	+	+	+	+	+	+	+	+	+	
Adrenal gland, cortex	+	+	+	+	+	+	+	+	+	+	+	+	+	+	+	+	+	+	+	+	+	+	+	+	+	
Adrenal gland, medulla	+	+	+	+	+	+	+	+	+	+	+	+	+	+	+	+	+	+	+	+	+	+	+	+	+	
Pheochromocytoma malignant																									X	
Pheochromocytoma benign				X														X	X		X	X				
Bilateral, pheochromocytoma malignant																										
Bilateral, pheochromocytoma benign																									X	
Islets, pancreatic	+	+	+	+	+	+	+	+	+	M	+	+	+	+	+	+	+	+	+	+	+	+	+	+	+	
Adenoma																										
Carcinoma																										
Parathyroid gland	+	+	+	+	+	+	+	+	+	+	+	+	+	+	+	+	+	+	+	+	+	+	M	+	+	+
Pituitary gland	+	+	+	+	+	+	+	+	+	+	+	+	+	+	I	+	+	+	+	+	+	I	+	+	+	+
Pars distalis, adenoma																									X	
Pars distalis, carcinoma																									X	
Pars distalis, adenoma																									X	
Thyroid gland	+	+	+	+	+	+	+	+	+	+	+	+	+	+	A	+	+	+	+	+	+	+	+	+	+	
C-cell, adenoma																									X	

+: Tissue examined microscopically
 A: Autolysis precludes examination

M: Missing tissue
 I: Insufficient tissue

X: Lesion present
 Blank: Not examined

TABLE A2
Individual Animal Tumor Pathology of Male Rats in the Lifetime Inhalation Study of Talc: 0 mg/m³ (continued)

Number of Days on Study	3 3 4 5 5 5 5 5 6 6 6 6 6 6 6 6 6 6 7 7 7 7 7 7
	3 6 2 5 6 8 9 9 2 2 3 3 5 5 7 8 8 9 0 0 0 0 2 3
	4 0 9 1 8 6 0 3 2 8 1 5 0 6 0 2 2 8 0 0 4 9 4 9
Carcass ID Number	3 3 3 3 4 2 2 3 3 4 3 3 3 4 3 3 3 3 3 3 3 3 2 4
	6 0 6 4 1 9 9 1 8 2 3 4 6 1 4 4 4 1 1 8 9 1 9 1
	1 0 8 0 3 4 5 8 7 0 9 2 3 8 5 3 8 7 6 5 0 3 6 4
	1 1
General Body System	
Tissue NOS	+
Genital System	
Epididymis	+ +
Preputial gland	+ +
Adenoma	X
Carcinoma	X
Prostate	+ +
Seminal vesicle	+ +
Testes	+ +
Bilateral, interstitial cell, adenoma	X X
Interstitial cell, adenoma	X X X X X
Hematopoietic System	
Bone marrow	+ + + + + + + + + + + + + A + + + + + + + + + +
Lymph node	+ +
Lymph node, bronchial	+ + + + M M + + + + + + + + + + + + + + + +
Lymph node, mandibular	+ + + + + + + + + + + + + + + + + + + M + + + +
Lymph node, mediastinal	+ +
Lymph node, mesenteric	+ +
Spleen	+ +
Fibrosarcoma	X
Osteosarcoma, metastatic, bone	X
Thymus	+ +
Thymoma malignant	X
Integumentary System	
Mammary gland	M + + + + + + + + + + + + + M M + + + + + + + +
Adenocarcinoma	
Skin	M +
Subcutaneous tissue, schwannoma malignant	X
Musculoskeletal System	
Bone	+ +
Scapula, osteosarcoma	X
Skeletal muscle	+

TABLE A2
Individual Animal Tumor Pathology of Male Rats in the Lifetime Inhalation Study of Talc: 18 mg/m³ (continued)

Number of Days on Study	7	7	7	7	7	7	7	7	7	7	7	7	7	7	7	7	7	7	8	8	8	8	8	8	8	8	8	8	Total Tissues/Tumors	
Carcass ID Number	2	2	2	1	2	2	2	1	1	1	1	1	1	1	1	1	1	1	1	2	2	2	2	2	2	2	2	2	2	
	2	0	4	9	4	7	7	9	4	5	5	6	7	8	9	9	9	9	9	0	0	0	0	0	0	0	0	0	0	
	3	8	3	8	1	1	3	4	8	9	9	9	9	9	9	9	9	9	9	0	0	0	0	0	0	0	0	0	0	
Alimentary System																														
Esophagus	+	+	+	+	+	+	+	+	+	+	+	+	+	+	+	+	+	+	+	+	+	+	+	+	+	+	+	+	+	49
Intestine large	A	A	+	+	+	+	+	+	+	+	+	+	+	+	+	+	+	+	+	+	+	+	+	+	+	+	+	+	+	47
Intestine large, cecum	A	A	+	+	A	+	A	+	A	A	+	+	+	+	+	+	+	+	+	+	+	+	+	+	+	+	+	A	+	37
Intestine large, colon	A	A	+	+	+	+	+	+	+	+	+	+	+	+	+	+	+	+	+	+	+	+	+	+	+	+	+	+	A	46
Intestine large, rectum	A	A	M	+	+	M	+	+	+	+	+	+	+	+	+	+	+	+	+	M	+	+	M	+	+	+	+	+	34	
Intestine small	A	A	+	+	+	+	+	+	+	+	+	+	+	+	+	+	+	+	+	+	+	+	+	+	+	+	+	+	+	46
Intestine small, duodenum	A	A	+	+	+	+	+	+	+	+	+	+	+	+	+	+	+	+	+	+	+	+	+	+	+	+	+	+	+	46
Intestine small, ileum	A	A	+	+	+	A	+	+	A	+	+	+	+	+	+	+	+	+	+	+	+	+	+	+	+	+	+	A	A	35
Intestine small, jejunum	A	A	+	+	+	+	+	+	+	+	+	+	+	+	+	+	+	+	+	+	+	+	+	+	+	+	+	A	A	40
Liver	A	A	+	+	+	+	+	+	+	+	+	+	+	+	+	+	+	+	+	+	+	+	+	+	+	+	+	+	+	48
Neoplastic nodule																														1
Neoplastic nodule, multiple																												X		3
Mesentery																														1
Pancreas	A	A	+	+	+	+	+	+	+	+	+	+	+	+	+	+	+	+	+	+	+	+	+	+	+	+	+	+	+	47
Salivary glands	+	+	+	+	+	+	+	+	+	+	+	+	+	+	+	+	+	+	+	+	+	+	+	+	+	+	+	+	+	50
Stomach	A	A	+	+	+	+	+	+	+	+	+	+	+	+	+	+	+	+	+	+	+	+	+	+	+	+	+	+	+	47
Stomach, forestomach	A	A	+	+	+	+	+	+	+	+	+	+	+	+	+	+	+	+	+	+	+	+	+	+	+	+	+	+	+	47
Fibrosarcoma																														1
Stomach, glandular	A	A	+	+	+	+	+	+	+	+	+	+	+	+	+	+	+	+	+	+	+	+	+	+	+	+	+	+	+	47
Fibrosarcoma																														1
Tongue						+																								1
Cardiovascular System																														
Blood vessel				+																+										5
Heart	+	+	+	+	+	+	+	+	+	+	+	+	+	+	+	+	+	+	+	+	+	+	+	+	+	+	+	+	+	50
Endocrine System																														
Adrenal gland	+	A	+	+	+	+	+	+	+	+	+	+	+	+	+	+	+	+	+	+	+	+	+	+	+	+	+	+	+	49
Adrenal gland, cortex	A	A	+	+	+	+	+	+	+	+	+	+	+	+	+	+	+	+	+	+	+	+	+	+	+	+	+	+	+	48
Adrenal gland, medulla	+	A	+	+	+	+	+	+	+	+	+	+	+	+	+	+	+	+	+	+	+	+	+	+	+	+	+	+	+	47
Osteosarcoma, metastatic, uncertain																														
primary site																														1
Pheochromocytoma malignant			X		X														X		X	X								6
Pheochromocytoma complex	X																													1
Pheochromocytoma benign	X		X		X				X	X				X	X				X	X	X	X	X							20
Bilateral, pheochromocytoma malignant					X																									1
Bilateral, pheochromocytoma benign				X		X	X	X	X		X	X			X	X										X	X			16
Islets, pancreatic	A	A	+	+	+	+	+	+	+	+	+	M	M	+	+	+	+	+	+	+	+	+	+	M	+	+	+	+	43	
Adenoma																												X		2
Parathyroid gland	+	+	+	+	+	M	+	+	+	+	+	+	+	+	+	+	+	+	+	+	+	+	+	+	+	+	+	+	+	46
Pituitary gland	+	+	+	+	+	+	+	+	+	+	+	+	+	+	+	+	+	+	+	+	+	+	+	+	+	+	+	+	+	49
Pars distalis, adenoma				X		X	X	X	X										X	X						X				10
Pars intermedia, adenoma																														2
Thyroid gland	A	A	+	+	+	M	+	+	+	+	+	+	+	+	+	+	+	+	+	+	+	+	+	+	+	+	+	+	+	46
C-cell, adenoma												X																		3
Follicular cell, adenoma																											X			1

TABLE A2
Individual Animal Tumor Pathology of Male Rats in the Lifetime Inhalation Study of Talc: 18 mg/m³ (continued)

Number of Days on Study	2	4	5	5	6	6	6	6	6	6	6	6	6	6	6	6	6	6	6	6	7	7	7	7	7	
	4	9	0	9	0	0	1	1	1	1	2	3	4	5	5	5	7	8	9	9	0	0	1	2	3	
	8	2	0	4	7	9	4	5	5	7	8	4	5	1	1	3	6	3	7	8	1	5	9	2	7	
Carcass ID Number	2	1	2	1	2	1	1	1	2	2	1	2	2	2	2	2	2	2	1	1	2	1	2	1	1	
	1	4	0	7	4	7	7	4	2	6	9	1	5	0	2	6	7	2	7	5	2	5	5	5	7	
	9	5	3	7	4	4	5	9	4	6	5	7	1	2	7	7	0	6	6	2	5	1	2	0	2	
	1	1	1	1	1	1	1	1	1	1	1	1	1	1	1	1	1	1	1	1	1	1	1	1	1	
General Body System																										
None																										
Genital System																										
Epididymis	+	+	+	+	+	+	+	M	+	+	+	+	+	+	+	+	+	+	+	+	+	+	+	+	+	+
Penis																										
Preputial gland	+	+	+	+	+	+	+	+	+	M	+	+	+	+	+	+	+	+	+	M	+	+	+	+	+	+
Adenoma																										
Carcinoma																										
Prostate	+	+	+	A	+	+	+	+	+	+	+	+	+	+	+	+	+	+	+	+	+	+	+	+	+	+
Seminal vesicle	+	+	+	A	+	+	+	+	+	+	+	+	+	+	+	+	+	+	+	+	A	+	+	+	+	+
Testes	+	+	+	+	+	+	+	+	+	+	+	+	+	+	+	+	+	+	+	+	+	+	+	+	+	+
Bilateral, interstitial cell, adenoma																										
Interstitial cell, adenoma					X	X			X		X		X			X	X	X			X	X	X		X	
Hematopoietic System																										
Bone marrow	+	+	+	+	+	+	+	+	+	+	+	+	+	+	A	+	+	+	+	+	+	+	+	+	+	+
Lymph node	+	+	+	+	+	+	+	+	+	+	+	+	+	+	+	+	+	+	+	+	+	+	+	+	+	+
Lymph node, bronchial	+	+	+	+	+	+	+	+	+	+	+	+	+	+	+	+	+	+	+	M	+	+	+	+	+	+
Lymph node, mandibular	+	+	+	A	+	+	+	+	+	+	I	+	+	+	+	+	+	+	+	+	+	+	+	+	+	+
Lymph node, mediastinal	I	M	+	+	+	+	+	+	+	+	+	+	+	+	+	+	+	+	+	+	+	+	+	+	+	+
Lymph node, mesenteric	+	+	+	+	+	+	+	+	+	+	+	+	+	+	+	+	+	+	+	+	+	+	+	+	+	+
Spleen	+	+	+	A	+	+	+	+	+	+	+	+	+	+	+	+	+	+	+	+	+	+	+	+	+	+
Thymus	I	+	+	+	+	+	+	+	+	M	+	M	+	+	+	+	+	+	+	M	+	+	+	+	+	+
Integumentary System																										
Mammary gland	+	+	+	+	+	+	+	+	+	+	+	+	+	+	+	+	+	+	+	+	+	+	+	+	+	+
Skin	+	+	+	+	+	+	+	+	+	+	+	+	+	+	+	+	+	+	+	+	+	+	+	+	+	+
Basosquamous tumor malignant																										
Fibrous histiocytoma																										
Keratoacanthoma																										
Musculoskeletal System																										
Bone	+	+	+	+	+	+	+	+	+	+	+	+	+	+	+	+	+	+	+	+	+	+	+	+	+	+
Vertebra, osteosarcoma	X																									

TABLE A3
Statistical Analysis of Primary Neoplasms in Male Rats in the Lifetime Inhalation Study of Talc

	0 mg/m ³	6 mg/m ³	18 mg/m ³
Adrenal Medulla: Benign Pheochromocytoma			
Overall rates ^a	25/49 (51%)	30/48 (63%)	36/47 (77%)
Adjusted rates ^b	87.6%	90.2%	100.0%
Terminal rates ^c	6/9 (67%)	11/14 (79%)	16/16 (100%)
First incidence (days)	429	558	614
Life table tests ^d	P=0.434	P=0.515N	P=0.499
Logistic regression tests ^d	P=0.007	P=0.213	P=0.009
Cochran-Armitage test ^d	P=0.007		
Fisher exact test ^d		P=0.175	P=0.008
Adrenal Medulla: Malignant Pheochromocytoma			
Overall rates	3/49 (6%)	3/48 (6%)	7/47 (15%)
Adjusted rates	17.2%	15.2%	31.5%
Terminal rates	1/9 (11%)	1/14 (7%)	3/16 (19%)
First incidence (days)	670	544	645
Life table tests	P=0.242	P=0.552N	P=0.376
Logistic regression tests	P=0.096	P=0.662	P=0.178
Cochran-Armitage test	P=0.083		
Fisher exact test		P=0.651	P=0.142
Adrenal Medulla: Benign, Malignant, or Complex Pheochromocytoma			
Overall rates	26/49 (53%)	32/48 (67%)	37/47 (79%)
Adjusted rates	91.7%	93.6%	100.0%
Terminal rates	7/9 (78%)	12/14 (86%)	16/16 (100%)
First incidence (days)	429	544	614
Life table tests	P=0.483	P=0.549N	P=0.539
Logistic regression tests	P=0.007	P=0.147	P=0.006
Cochran-Armitage test	P=0.007		
Fisher exact test		P=0.123	P=0.007
Liver: Hepatocellular Adenoma or Neoplastic Nodule			
Overall rates	2/49 (4%)	2/50 (4%)	4/48 (8%)
Adjusted rates	11.2%	14.3%	14.9%
Terminal rates	0/9 (0%)	2/14 (14%)	1/16 (6%)
First incidence (days)	698	799 (T)	615
Life table tests	P=0.359	P=0.586N	P=0.434
Logistic regression tests	P=0.248	P=0.661N	P=0.333
Cochran-Armitage test	P=0.237		
Fisher exact test		P=0.684N	P=0.329
Pancreatic Islets: Adenoma			
Overall rates	1/47 (2%)	0/41 (0%)	2/43 (5%)
Adjusted rates	12.5%	0.0%	9.9%
Terminal rates	1/8 (13%)	0/13 (0%)	1/13 (8%)
First incidence (days)	799 (T)	- ^e	617
Life table tests	P=0.387	P=0.403N	P=0.612
Logistic regression tests	P=0.308	P=0.403N	P=0.479
Cochran-Armitage test	P=0.304		
Fisher exact test		P=0.534N	P=0.466

TABLE A3
Statistical Analysis of Primary Neoplasms in Male Rats in the Lifetime Inhalation Study of Talc (continued)

	0 mg/m ³	6 mg/m ³	18 mg/m ³
Pancreatic Islets: Adenoma or Carcinoma			
Overall rates	2/47 (4%)	0/41 (0%)	2/43 (5%)
Adjusted rates	25.0%	0.0%	9.9%
Terminal rates	2/8 (25%)	0/13 (0%)	1/13 (8%)
First incidence (days)	799 (T)	-	617
Life table tests	P=0.650	P=0.135N	P=0.560N
Logistic regression tests	P=0.544	P=0.135N	P=0.683
Cochran-Armitage test	P=0.531		
Fisher exact test		P=0.282N	P=0.657
Pituitary Gland (Pars Distalis): Adenoma			
Overall rates	12/47 (26%)	11/50 (22%)	10/49 (20%)
Adjusted rates	53.6%	42.8%	42.1%
Terminal rates	3/9 (33%)	3/14 (21%)	4/16 (25%)
First incidence (days)	568	558	697
Life table tests	P=0.174N	P=0.334N	P=0.160N
Logistic regression tests	P=0.307N	P=0.419N	P=0.324N
Cochran-Armitage test	P=0.344N		
Fisher exact test		P=0.432N	P=0.362N
Pituitary Gland (Pars Distalis): Adenoma or Carcinoma			
Overall rates	12/47 (26%)	12/50 (24%)	10/49 (20%)
Adjusted rates	53.6%	45.8%	42.1%
Terminal rates	3/9 (33%)	3/14 (21%)	4/16 (25%)
First incidence (days)	568	558	697
Life table tests	P=0.159N	P=0.411N	P=0.160N
Logistic regression tests	P=0.287N	P=0.509N	P=0.324N
Cochran-Armitage test	P=0.325N		
Fisher exact test		P=0.524N	P=0.362N
Preputial Gland: Carcinoma			
Overall rates	1/48 (2%)	6/49 (12%)	1/48 (2%)
Adjusted rates	2.3%	22.5%	2.5%
Terminal rates	0/9 (0%)	1/14 (7%)	0/16 (0%)
First incidence (days)	586	527	628
Life table tests	P=0.361N	P=0.090	P=0.753N
Logistic regression tests	P=0.440N	P=0.058	P=0.750
Cochran-Armitage test	P=0.425N		
Fisher exact test		P=0.059	P=0.753N
Preputial Gland: Adenoma or Carcinoma			
Overall rates	2/48 (4%)	7/49 (14%)	2/48 (4%)
Adjusted rates	4.4%	28.5%	8.6%
Terminal rates	0/9 (0%)	2/14 (14%)	1/16 (6%)
First incidence (days)	429	527	628
Life table tests	P=0.331N	P=0.134	P=0.632N
Logistic regression tests	P=0.454N	P=0.078	P=0.673
Cochran-Armitage test	P=0.436N		
Fisher exact test		P=0.084	P=0.692N

TABLE A3
Statistical Analysis of Primary Neoplasms in Male Rats in the Lifetime Inhalation Study of Talc (continued)

	0 mg/m ³	6 mg/m ³	18 mg/m ³
Skin: Keratoacanthoma or Squamous Cell Carcinoma			
Overall rates	0/49 (0%)	3/50 (6%)	2/50 (4%)
Adjusted rates	0.0%	13.5%	6.6%
Terminal rates	0/9 (0%)	1/14 (7%)	0/16 (0%)
First incidence (days)	—	663	594
Life table tests	P=0.414	P=0.161	P=0.331
Logistic regression tests	P=0.323	P=0.128	P=0.239
Cochran-Armitage test	P=0.319		
Fisher exact test		P=0.125	P=0.253
Testes: Adenoma			
Overall rates	31/49 (63%)	39/50 (78%)	36/50 (72%)
Adjusted rates	100.0%	100.0%	97.0%
Terminal rates	9/9 (100%)	14/14 (100%)	15/16 (94%)
First incidence (days)	551	544	609
Life table tests	P=0.198N	P=0.524	P=0.245N
Logistic regression tests	P=0.333	P=0.056	P=0.268
Cochran-Armitage test	P=0.295		
Fisher exact test		P=0.082	P=0.238
Thyroid Gland (C-cell): Adenoma			
Overall rates	3/45 (7%)	4/46 (9%)	3/46 (7%)
Adjusted rates	24.5%	28.6%	14.5%
Terminal rates	2/9 (22%)	4/14 (29%)	2/16 (13%)
First incidence (days)	682	799 (T)	614
Life table tests	P=0.348N	P=0.620N	P=0.476N
Logistic regression tests	P=0.511N	P=0.641	P=0.625N
Cochran-Armitage test	P=0.560N		
Fisher exact test		P=0.512	P=0.651N
Thyroid Gland (C-cell): Adenoma or Carcinoma			
Overall rates	3/45 (7%)	5/46 (11%)	3/46 (7%)
Adjusted rates	24.5%	33.0%	14.5%
Terminal rates	2/9 (22%)	4/14 (29%)	2/16 (13%)
First incidence (days)	682	787	614
Life table tests	P=0.296N	P=0.568	P=0.476N
Logistic regression tests	P=0.467N	P=0.502	P=0.625N
Cochran-Armitage test	P=0.523N		
Fisher exact test		P=0.369	P=0.651N
All Organs: Mononuclear Cell Leukemia			
Overall rates	24/49 (49%)	21/50 (42%)	23/50 (46%)
Adjusted rates	70.3%	59.9%	62.5%
Terminal rates	3/9 (33%)	4/14 (29%)	6/16 (38%)
First incidence (days)	334	529	492
Life table tests	P=0.298N	P=0.232N	P=0.269N
Logistic regression tests	P=0.501N	P=0.317N	P=0.479N
Cochran-Armitage test	P=0.486N		
Fisher exact test		P=0.310N	P=0.462N

TABLE A3

Statistical Analysis of Primary Neoplasms in Male Rats in the Lifetime Inhalation Study of Talc (continued)

	0 mg/m ³	6 mg/m ³	18 mg/m ³
All Organs: Benign Neoplasms			
Overall rates	42/49 (86%)	45/50 (90%)	45/50 (90%)
Adjusted rates	100.0%	100.0%	100.0%
Terminal rates	9/9 (100%)	14/14 (100%)	16/16 (100%)
First incidence (days)	429	544	594
Life table tests	P=0.161N	P=0.314N	P=0.153N
Logistic regression tests	P=0.463	P=0.430	P=0.480
Cochran-Armitage test	P=0.353		
Fisher exact test		P=0.365	P=0.365
All Organs: Malignant Neoplasms			
Overall rates	34/49 (69%)	34/50 (68%)	34/50 (68%)
Adjusted rates	88.4%	80.9%	80.0%
Terminal rates	6/9 (67%)	7/14 (50%)	9/16 (56%)
First incidence (days)	334	527	248
Life table tests	P=0.222N	P=0.308N	P=0.216N
Logistic regression tests	P=0.534N	P=0.539N	P=0.571N
Cochran-Armitage test	P=0.505N		
Fisher exact test		P=0.527N	P=0.527N
All Organs: Benign or Malignant Neoplasms			
Overall rates	48/49 (98%)	49/50 (98%)	50/50 (100%)
Adjusted rates	100.0%	100.0%	100.0%
Terminal rates	9/9 (100%)	14/14 (100%)	16/16 (100%)
First incidence (days)	334	527	248
Life table tests	P=0.154N	P=0.241N	P=0.139N
Logistic regression tests	P=0.337	P=0.771	P=0.506
Cochran-Armitage test	P=0.348		
Fisher exact test		P=0.747	P=0.495

(T) Terminal sacrifice

^a Number of neoplasm-bearing animals/number of animals examined. Denominator is number of animals examined microscopically for adrenal gland, bone marrow, brain, epididymis, heart, kidney, larynx, liver, lung, nose, pancreas, parathyroid gland, pituitary gland, preputial gland, prostate gland, salivary gland, spleen, testes, thyroid gland, and urinary bladder; for other tissues, denominator is number of animals necropsied.

^b Kaplan-Meier estimated neoplasm incidence at the end of the study after adjustment for intercurrent mortality

^c Observed incidence at terminal kill

^d Beneath the control incidence are the P values associated with the trend test. Beneath the exposed group incidence are the P values corresponding to pairwise comparisons between the controls and that exposed group. The life table test regards neoplasms in animals dying prior to terminal kill as being (directly or indirectly) the cause of death. The logistic regression test regards these lesions as nonfatal. The Cochran-Armitage and Fisher exact tests compare directly the overall incidence rates. For all tests, a negative trend or a lower incidence in an exposure group is indicated by N.

^e Not applicable; no neoplasms in animal group

TABLE A4
Summary of the Incidence of Nonneoplastic Lesions in Male Rats in the Lifetime Inhalation Study of Talc^a

	0 mg/m ³	6 mg/m ³	18 mg/m ³
Disposition Summary			
Animals initially in study	49	50	50
Early deaths			
Moribund	23	19	20
Natural deaths	17	17	14
Survivors			
Died last week of study	1	2	3
Terminal sacrifice	8	12	13
Animals examined microscopically	49	50	50
Alimentary System			
Esophagus	(49)	(50)	(49)
Inflammation			1 (2%)
Intestine large, cecum	(42)	(38)	(37)
Hemorrhage		1 (3%)	
Inflammation	9 (21%)	2 (5%)	5 (14%)
Parasite metazoan	3 (7%)	4 (11%)	4 (11%)
Ulcer	1 (2%)		
Intestine large, colon	(43)	(43)	(46)
Hyperplasia, lymphoid	1 (2%)		
Inflammation	1 (2%)		1 (2%)
Mineralization			1 (2%)
Parasite metazoan	2 (5%)	1 (2%)	1 (2%)
Intestine large, rectum	(38)	(41)	(34)
Inflammation	6 (16%)	1 (2%)	1 (3%)
Metaplasia, squamous, focal			1 (3%)
Parasite metazoan		2 (5%)	
Intestine small, duodenum	(48)	(44)	(46)
Inflammation			1 (2%)
Mineralization	1 (2%)		
Necrosis, focal	1 (2%)		
Ulcer	1 (2%)	1 (2%)	
Intestine small, ileum	(39)	(34)	(35)
Hyperplasia, lymphoid		1 (3%)	2 (6%)
Lymphatic, ectasia		1 (3%)	
Liver	(49)	(50)	(48)
Angiectasis, focal	1 (2%)		
Atrophy	1 (2%)		
Basophilic focus	18 (37%)	18 (36%)	19 (40%)
Clear cell focus	3 (6%)	7 (14%)	4 (8%)
Congestion		1 (2%)	
Degeneration, cystic	9 (18%)	17 (34%)	9 (19%)
Degeneration, diffuse			1 (2%)
Eosinophilic focus	2 (4%)	7 (14%)	7 (15%)
Fatty change	16 (33%)	14 (28%)	12 (25%)
Fibrosis	1 (2%)		
Hematocyst		1 (2%)	
Hyperplasia, focal			1 (2%)
Inflammation, granulomatous, focal	3 (6%)	1 (2%)	
Inflammation, necrotizing, focal			1 (2%)
Necrosis, focal	3 (6%)		1 (2%)
Thrombosis	1 (2%)		
Bile duct, hyperplasia	39 (80%)	46 (92%)	44 (92%)

TABLE A4
Summary of the Incidence of Nonneoplastic Lesions in Male Rats in the Lifetime Inhalation Study of Talc (continued)

	0 mg/m ³	6 mg/m ³	18 mg/m ³
Alimentary System (continued)			
Liver (continued)			
Centrilobular, atrophy	9 (18%)	4 (8%)	7 (15%)
Centrilobular, degeneration	8 (16%)	12 (24%)	9 (19%)
Centrilobular, degeneration, fatty			1 (2%)
Centrilobular, necrosis	5 (10%)		2 (4%)
Mesentery	(2)		(1)
Inflammation			1 (100%)
Pancreas	(48)	(46)	(47)
Lobules, atrophy	11 (23%)	7 (15%)	8 (17%)
Salivary glands	(49)	(50)	(50)
Inflammation	1 (2%)		
Necrosis			1 (2%)
Stomach, forestomach	(49)	(47)	(47)
Hyperkeratosis			1 (2%)
Inflammation	1 (2%)		
Mineralization	1 (2%)	4 (9%)	1 (2%)
Ulcer	5 (10%)	5 (11%)	8 (17%)
Stomach, glandular	(49)	(47)	(47)
Mineralization	6 (12%)	6 (13%)	6 (13%)
Ulcer	3 (6%)	3 (6%)	2 (4%)
Cardiovascular System			
Blood vessel	(4)	(5)	(5)
Aorta, mineralization	3 (75%)	5 (100%)	4 (80%)
Mesenteric artery, aneurysm			2 (40%)
Mesenteric artery, inflammation			1 (20%)
Mesenteric artery, mineralization	3 (75%)	5 (100%)	3 (60%)
Mesenteric artery, thrombosis	1 (25%)	1 (20%)	1 (20%)
Heart	(49)	(50)	(50)
Cardiomyopathy	42 (86%)	47 (94%)	50 (100%)
Atrium, thrombosis	9 (18%)	5 (10%)	11 (22%)
Epicardium, hyperplasia	1 (2%)		
Myocardium, inflammation		1 (2%)	
Myocardium, mineralization	2 (4%)	6 (12%)	5 (10%)
Endocrine System			
Adrenal gland, cortex	(49)	(49)	(48)
Degeneration	1 (2%)		
Degeneration, fatty	8 (16%)		2 (4%)
Degeneration, focal	1 (2%)		
Hyperplasia, diffuse			2 (4%)
Hyperplasia, focal	11 (22%)	4 (8%)	9 (19%)
Necrosis, focal	1 (2%)		
Adrenal gland, medulla	(49)	(48)	(47)
Hyperplasia	19 (39%)	8 (17%)	8 (17%)
Bilateral, hyperplasia	1 (2%)		1 (2%)
Islets, pancreatic	(47)	(41)	(43)
Hyperplasia			1 (2%)
Parathyroid gland	(45)	(45)	(46)
Hyperplasia	6 (13%)	11 (24%)	12 (26%)
Bilateral, hyperplasia	1 (2%)		

TABLE A4

Summary of the Incidence of Nonneoplastic Lesions in Male Rats in the Lifetime Inhalation Study of Talc (continued)

	0 mg/m ³	6 mg/m ³	18 mg/m ³
Endocrine System (continued)			
Pituitary gland	(47)	(50)	(49)
Angiectasis, focal		1 (2%)	
Cyst		1 (2%)	1 (2%)
Pars distalis, hyperplasia	8 (17%)	8 (16%)	7 (14%)
Pars nervosa, hyperplasia		1 (2%)	
Thyroid gland	(45)	(46)	(46)
C-cell, hyperplasia	5 (11%)	7 (15%)	2 (4%)
General Body System			
None			
Genital System			
Epididymis	(49)	(50)	(49)
Spermatocele		1 (2%)	
Preputial gland	(48)	(49)	(48)
Hyperplasia	3 (6%)		1 (2%)
Inflammation	7 (15%)	2 (4%)	5 (10%)
Prostate	(49)	(45)	(48)
Atrophy	1 (2%)		1 (2%)
Inflammation	22 (45%)	14 (31%)	19 (40%)
Seminal vesicle	(49)	(48)	(47)
Atrophy	1 (2%)		
Inflammation	1 (2%)		
Testes	(49)	(50)	(50)
Atrophy	14 (29%)	11 (22%)	16 (32%)
Hyperplasia, lymphoid		2 (4%)	
Hyperplasia, lymphoid, focal			1 (2%)
Interstitial cell, hyperplasia	2 (4%)	1 (2%)	3 (6%)
Serosa, proliferation			1 (2%)
Hematopoietic System			
Bone marrow	(48)	(48)	(47)
Atrophy			2 (4%)
Atrophy, focal		1 (2%)	
Inflammation		1 (2%)	
Myelofibrosis		1 (2%)	1 (2%)
Myeloid cell, hyperplasia	2 (4%)	3 (6%)	6 (13%)
Lymph node	(49)	(50)	(50)
Hemorrhage, chronic		1 (2%)	
Pancreatic, atrophy	1 (2%)		
Pancreatic, hyperplasia, lymphoid	1 (2%)		
Lymph node, bronchial	(41)	(48)	(49)
Atrophy	2 (5%)		
Hemorrhage		1 (2%)	
Hemorrhage, acute	1 (2%)		
Hemorrhage, chronic	4 (10%)		
Hyperplasia, histiocytic		44 (92%)	46 (94%)
Lymph node, mandibular	(46)	(48)	(47)
Hemorrhage		1 (2%)	
Hyperplasia, lymphoid		2 (4%)	
Hyperplasia, plasma cell		2 (4%)	5 (11%)
Inflammation, chronic active			2 (4%)

TABLE A4

Summary of the Incidence of Nonneoplastic Lesions in Male Rats in the Lifetime Inhalation Study of Talc (continued)

	0 mg/m ³	6 mg/m ³	18 mg/m ³
Hematopoietic System (continued)			
Lymph node, mediastinal	(48)	(49)	(47)
Atrophy	1 (2%)		
Hemorrhage		3 (6%)	
Hemorrhage, acute	1 (2%)		
Hemorrhage, chronic	6 (13%)		
Hyperplasia, histiocytic		40 (82%)	43 (91%)
Pigmentation, hemosiderin	1 (2%)		
Lymph node, mesenteric	(49)	(48)	(47)
Atrophy	1 (2%)		
Hemorrhage		2 (4%)	
Hemorrhage, acute	1 (2%)		
Hyperplasia, lymphoid	1 (2%)	2 (4%)	3 (6%)
Hyperplasia, plasma cell			1 (2%)
Inflammation, chronic active			1 (2%)
Spleen	(49)	(50)	(48)
Atrophy	1 (2%)		2 (4%)
Autolysis			1 (2%)
Congestion, chronic	1 (2%)		
Cyst			1 (2%)
Fibrosis		1 (2%)	
Fibrosis, focal		5 (10%)	2 (4%)
Hematopoietic cell proliferation	1 (2%)	2 (4%)	3 (6%)
Hyperplasia, histiocytic		1 (2%)	
Hyperplasia, lymphoid		1 (2%)	1 (2%)
Infarct	3 (6%)		
Inflammation, granulomatous, focal	1 (2%)		1 (2%)
Thymus	(48)	(40)	(43)
Atrophy		2 (5%)	
Cyst	1 (2%)		
Integumentary System			
Mammary gland	(45)	(48)	(50)
Galactocele	1 (2%)		
Skin	(48)	(50)	(50)
Cyst epithelial inclusion		1 (2%)	
Subcutaneous tissue, inflammation			1 (2%)
Tail, necrosis	1 (2%)		
Musculoskeletal System			
Bone	(49)	(50)	(50)
Fibrous osteodystrophy	3 (6%)	4 (8%)	5 (10%)
Coccygeal, necrosis	1 (2%)		
Pelvis, fracture		1 (2%)	
Nervous System			
Brain	(49)	(50)	(50)
Compression	5 (10%)	2 (4%)	2 (4%)
Hemorrhage		1 (2%)	
Infarct			1 (2%)
Necrosis, focal	1 (2%)	2 (4%)	
Spinal cord			(1)
Degeneration			1 (100%)

TABLE A4
Summary of the Incidence of Nonneoplastic Lesions in Male Rats in the Lifetime Inhalation Study of Talc (continued)

	0 mg/m ³	6 mg/m ³	18 mg/m ³
Respiratory System			
Larynx	(48)	(49)	(49)
Inflammation, suppurative	6 (13%)		
Lung	(49)	(50)	(50)
Congestion	1 (2%)		
Crystals, focal	1 (2%)		
Cyst			3 (6%)
Hemorrhage, chronic	2 (4%)		
Infarct	1 (2%)		
Inflammation, granulomatous	2 (4%)	50 (100%)	49 (98%)
Inflammation, suppurative		2 (4%)	
Mineralization		4 (8%)	
Alveolar epithelium, hyperplasia	5 (10%)	26 (52%)	38 (76%)
Alveolus, hemorrhage, focal	1 (2%)		
Alveolus, metaplasia, squamous			2 (4%)
Artery, thrombosis	1 (2%)		
Interstitial, fibrosis, focal	1 (2%)	16 (32%)	33 (66%)
Interstitial, mineralization	2 (4%)	1 (2%)	4 (8%)
Peribronchial, hyperplasia, histiocytic		12 (24%)	8 (16%)
Nose	(49)	(48)	(47)
Inflammation, suppurative	2 (4%)	1 (2%)	
Lumen, foreign body	1 (2%)		
Lumen, hemorrhage			1 (2%)
Mucosa, inflammation, suppurative	4 (8%)	5 (10%)	2 (4%)
Nasolacrimal duct, inflammation, suppurative		1 (2%)	
Respiratory epithelium, hyperplasia		3 (6%)	14 (30%)
Trachea	(49)	(50)	(48)
Inflammation, suppurative	3 (6%)		1 (2%)
Special Senses System			
Eye	(3)	(2)	(2)
Cataract	1 (33%)	1 (50%)	2 (100%)
Inflammation, chronic			1 (50%)
Cornea, inflammation, necrotizing			1 (50%)
Cornea, necrosis	1 (33%)		
Lens, cataract	1 (33%)		
Retina, degeneration	2 (67%)	1 (50%)	1 (50%)
Urinary System			
Kidney	(49)	(49)	(48)
Calculus micro observation only			1 (2%)
Cyst	3 (6%)		1 (2%)
Hydronephrosis		1 (2%)	1 (2%)
Nephropathy	45 (92%)	47 (96%)	43 (90%)
Medulla, inflammation		1 (2%)	1 (2%)
Renal tubule, necrosis		1 (2%)	
Ureter			(1)
Calculus micro observation only			1 (100%)
Urethra			(1)
Fibrosis			1 (100%)
Urinary bladder	(49)	(48)	(47)
Calculus gross observation			1 (2%)
Inflammation	1 (2%)		
Mucosa, hyperplasia			1 (2%)

^a Number of animals examined microscopically at site and number of animals with lesion

APPENDIX B
SUMMARY OF LESIONS IN FEMALE RATS
IN THE LIFETIME INHALATION STUDY
OF TALC

TABLE B1	Summary of the Incidence of Neoplasms in Female Rats in the Lifetime Inhalation Study of Talc	96
TABLE B2	Individual Animal Tumor Pathology of Female Rats in the Lifetime Inhalation Study of Talc	100
TABLE B3	Statistical Analysis of Primary Neoplasms in Female Rats in the Lifetime Inhalation Study of Talc	118
TABLE B4	Summary of the Incidence of Nonneoplastic Lesions in Female Rats in the Lifetime Inhalation Study of Talc	123

TABLE B1
Summary of the Incidence of Neoplasms in Female Rats in the Lifetime Inhalation Study of Talc^a

	0 mg/m ³	6 mg/m ³	18 mg/m ³
Disposition Summary			
Animals initially in study	50	50	50
Early deaths			
Moribund	28	17	27
Natural deaths	11	19	14
Survivors			
Terminal sacrifice	11	13	9
Missing		1	
Animals examined microscopically	50	49	50
Alimentary System			
Intestine small, ileum	(44)	(32)	(38)
Liver	(50)	(48)	(50)
Granulosa-theca tumor malignant, metastatic, ovary			1 (2%)
Hepatocellular carcinoma		1 (2%)	
Neoplastic nodule		3 (6%)	1 (2%)
Pancreas	(50)	(46)	(49)
Pharynx			(1)
Squamous cell carcinoma			1 (100%)
Salivary glands	(50)	(48)	(50)
Fibrosarcoma			1 (2%)
Sarcoma		1 (2%)	
Stomach, forestomach	(50)	(45)	(49)
Stomach, glandular	(50)	(47)	(50)
Tongue		(2)	
Sarcoma, metastatic		1 (50%)	
Squamous cell papilloma		1 (50%)	
Tooth		(1)	
Adamantinoma benign		1 (100%)	
Cardiovascular System			
Heart	(50)	(48)	(50)
Granulosa-theca tumor malignant, metastatic, ovary			1 (2%)
Endocrine System			
Adrenal gland, cortex	(50)	(47)	(49)
Granulosa-theca tumor malignant, metastatic, ovary			1 (2%)
Adrenal gland, medulla	(48)	(47)	(49)
Granulosa-theca tumor malignant, metastatic, ovary			1 (2%)
Pheochromocytoma malignant		1 (2%)	7 (14%)
Pheochromocytoma benign	13 (27%)	10 (21%)	11 (22%)
Bilateral, pheochromocytoma malignant			3 (6%)
Bilateral, pheochromocytoma benign		4 (9%)	7 (14%)
Islets, pancreatic	(50)	(45)	(49)
Adenoma	1 (2%)	1 (2%)	1 (2%)
Parathyroid gland	(43)	(42)	(47)
Pituitary gland	(50)	(47)	(50)
Pars distalis, adenoma	19 (38%)	18 (38%)	21 (42%)
Pars distalis, carcinoma	3 (6%)	3 (6%)	2 (4%)

TABLE B1
Summary of the Incidence of Neoplasms in Female Rats in the Lifetime Inhalation Study of Talc (continued)

	0 mg/m ³	6 mg/m ³	18 mg/m ³
Endocrine System (continued)			
Thyroid gland	(50)	(47)	(49)
Bilateral, C-cell, carcinoma	1 (2%)		
C-cell, adenoma	5 (10%)		6 (12%)
C-cell, carcinoma	2 (4%)	2 (4%)	2 (4%)
Follicular cell, adenoma		1 (2%)	
General Body System			
None			
Genital System			
Clitoral gland	(47)	(44)	(46)
Adenoma			1 (2%)
Carcinoma	2 (4%)		1 (2%)
Ovary	(50)	(47)	(50)
Granulosa cell tumor malignant	1 (2%)		
Granulosa cell tumor benign		2 (4%)	
Granulosa-theca tumor benign		1 (2%)	
Bilateral, granulosa-theca tumor malignant			1 (2%)
Uterus	(50)	(48)	(50)
Polyp stromal	5 (10%)	7 (15%)	4 (8%)
Sarcoma stromal		1 (2%)	
Hematopoietic System			
Bone marrow	(50)	(43)	(49)
Lymph node	(50)	(48)	(50)
Lymph node, bronchial	(46)	(47)	(47)
Adenocarcinoma, metastatic, thyroid gland	1 (2%)		
Squamous cell carcinoma, metastatic, lung			1 (2%)
Lymph node, mandibular	(47)	(46)	(47)
Sarcoma, metastatic		1 (2%)	
Lymph node, mediastinal	(47)	(44)	(47)
Adenocarcinoma, metastatic, thyroid gland	1 (2%)		
Carcinoma, metastatic, uncertain primary site			1 (2%)
Fibrosarcoma, metastatic, skin			1 (2%)
Granulosa-theca tumor malignant, metastatic, ovary			1 (2%)
Lymph node, mesenteric	(49)	(47)	(47)
Spleen	(50)	(48)	(50)
Thymus	(47)	(44)	(47)
Mixed tumor malignant		1 (2%)	
Myxoma		1 (2%)	
Schwannoma benign			1 (2%)
Thymoma benign	1 (2%)		
Integumentary System			
Mammary gland	(50)	(48)	(50)
Adenocarcinoma	2 (4%)		2 (4%)
Adenoma	1 (2%)	2 (4%)	2 (4%)
Fibroadenoma	11 (22%)	10 (21%)	13 (26%)
Fibroma	1 (2%)	1 (2%)	
Fibrosarcoma			1 (2%)

TABLE B1
Summary of the Incidence of Neoplasms in Female Rats in the Lifetime Inhalation Study of Talc (continued)

	0 mg/m ³	6 mg/m ³	18 mg/m ³
Integumentary System (continued)			
Skin	(50)	(49)	(50)
Keratoacanthoma		1 (2%)	1 (2%)
Subcutaneous tissue, fibrosarcoma		1 (2%)	1 (2%)
Musculoskeletal System			
Bone	(50)	(48)	(50)
Mandible, sarcoma	1 (2%)		
Mandible, sarcoma, metastatic		1 (2%)	
Skeletal muscle	(1)	(1)	
Liposarcoma		1 (100%)	
Nervous System			
Brain	(50)	(48)	(50)
Astrocytoma benign	1 (2%)		
Carcinoma, metastatic, pituitary gland	2 (4%)	1 (2%)	1 (2%)
Ependymoma malignant	1 (2%)		
Respiratory System			
Larynx	(50)	(48)	(48)
Adenocarcinoma, metastatic, thyroid gland	1 (2%)		
Lung	(50)	(48)	(50)
Adenocarcinoma, metastatic, multiple, mammary gland	1 (2%)		
Alveolar/bronchiolar adenoma	1 (2%)		8 (16%)
Alveolar/bronchiolar adenoma, multiple			1 (2%)
Alveolar/bronchiolar carcinoma			4 (8%)
Alveolar/bronchiolar carcinoma, multiple			1 (2%)
Granulosa-theca tumor malignant, metastatic, ovary			1 (2%)
Squamous cell carcinoma			1 (2%)
Special Senses System			
None			
Urinary System			
Kidney	(49)	(47)	(49)
Lipoma		1 (2%)	
Urinary bladder	(50)	(45)	(50)
Systemic Lesions			
Multiple organs ^b	(50)	(49)	(50)
Leukemia mononuclear	13 (26%)	20 (41%)	18 (36%)
Lymphoma malignant lymphocytic		2 (4%)	
Lymphoma malignant mixed		1 (2%)	

TABLE B1
Summary of the Incidence of Neoplasms in Female Rats in the Lifetime Inhalation Study of Talc (continued)

	0 mg/m ³	6 mg/m ³	18 mg/m ³
Neoplasm Summary			
Total animals with primary neoplasms ^c	44	47	49
Total primary neoplasms	85	100	124
Total animals with benign neoplasms	38	35	39
Total benign neoplasms	59	65	78
Total animals with malignant neoplasms	23	31	35
Total malignant neoplasms	26	35	46
Total animals with metastatic neoplasms	4	3	4
Total metastatic neoplasms	6	8	10
Total animals with malignant neoplasms, uncertain primary site			1

^a Number of animals examined microscopically at site and number of animals with lesion

^b Number of animals with any tissue examined microscopically

^c Primary neoplasms: all neoplasms except metastatic neoplasms

TABLE B2
Individual Animal Tumor Pathology of Female Rats in the Lifetime Inhalation Study of Talc: 6 mg/m³ (continued)

Number of Days on Study	4 5 5 5 5 5 6 6 6 6 6 6 7 7 7 7 7 7 7 7 7 7
	8 0 2 5 6 6 6 4 5 6 7 9 9 0 2 2 2 3 4 4 5 6 6 6 6
	2 8 6 7 1 6 6 7 1 8 8 0 7 5 0 4 9 8 0 7 5 0 2 6 8
Carcass ID Number	0 0 0 1 0 0 0 1 0 1 1 0 0 0 0 1 1 0 1 0 1 0 0 0 0
	3 4 6 3 6 4 9 1 9 4 1 4 9 7 4 0 1 8 1 3 1 6 2 1 6
	8 8 8 7 9 3 5 0 6 1 8 5 2 0 0 9 6 9 5 9 2 7 3 7 3
	1 1
Musculoskeletal System	
Bone	+ A +
Mandible, sarcoma, metastatic	X
Skeletal muscle	
Liposarcoma	
Nervous System	
Brain	+ A +
Carcinoma, metastatic, pituitary gland	X
Respiratory System	
Larynx	+ A +
Lung	+ A +
Nose	+ A + + + + + A + + + + + + + + + A + + + A + + + +
Trachea	+ A +
Special Senses System	
Harderian gland	+ +
Urinary System	
Kidney	+ A + + + + + A + + + + + + + + + + + + + + + +
Lipoma	
Lymphoma malignant lymphocytic, metastatic	
Urinary bladder	+ A + M + + + + A + + + + + + + + + + + + + + + +
Systemic Lesions	
Multiple organs	+ +
Leukemia mononuclear	X X X X X X X X X X
Lymphoma malignant lymphocytic	X
Lymphoma malignant mixed	X

TABLE B2
Individual Animal Tumor Pathology of Female Rats in the Lifetime Inhalation Study of Talc: 18 mg/m³ (continued)

Number of Days on Study	7 7 7 8	
	8 8 9 0 2 2 2 2 3 4 4 4 4 5 5 5 6 6 6 6 6 6 6 6	
	4 6 6 3 2 3 8 9 5 1 1 2 8 0 4 7 2 2 2 2 2 3 3 3 3	
Carcass ID Number	2 2 2 2 1 1 1 2 2 1 1 2 2 2 2 1 1 1 1 1 2 2 2 2 2	Total Tissues/ Tumors
	5 8 3 5 6 6 5 7 1 9 9 0 5 6 3 6 5 6 6 8 3 3 5 5 8	
	7 7 3 3 2 4 7 7 5 0 1 5 8 4 1 5 8 3 6 2 2 8 4 9 6	
	1 1	
Endocrine System (continued)		
Pituitary gland	+ +	50
Pars distalis, adenoma	X X	21
Pars distalis, carcinoma		2
Thyroid gland	+ +	49
C-cell, adenoma	X X	6
C-cell, carcinoma		2
General Body System		
None		
Genital System		
Clitoral gland	+ + + + + M + + + + + + + + + + M + + + + + + + + + +	46
Adenoma		1
Carcinoma		1
Ovary	+ +	50
Bilateral, granulosa-theca tumor malignant		1
Uterus	+ +	50
Polyp stromal	X X	4
Hematopoietic System		
Bone marrow	+ +	49
Lymph node	+ +	50
Lymph node, bronchial	+ +	47
Squamous cell carcinoma, metastatic, lung		1
Lymph node, mandibular	+ + + + + + + + + + + + + + + + M + + + + + + + + +	47
Lymph node, mediastinal	+ + + + + + + + + + + + + + + + M + + + + + M + + + M	47
Carcinoma, metastatic, uncertain primary site		1
Fibrosarcoma, metastatic, skin		1
Granulosa-theca tumor malignant, metastatic, ovary		1
Lymph node, mesenteric	+ + + + + + + + + + + + + + + + M + + M + + + + + + +	47
Spleen	+ +	50
Thymus	M +	47
Schwannoma benign		1

TABLE B3
Statistical Analysis of Primary Neoplasms in Female Rats in the Lifetime Inhalation Study of Talc

	0 mg/m ³	6 mg/m ³	18 mg/m ³
Adrenal Medulla: Benign Pheochromocytoma			
Overall rates ^a	13/48 (27%)	14/47 (30%)	18/49 (37%)
Adjusted rates ^b	61.3%	59.7%	82.5%
Terminal rates ^c	5/11 (45%)	5/13 (38%)	6/9 (67%)
First incidence (days)	678	705	697
Life table tests ^d	P=0.135	P=0.529	P=0.183
Logistic regression tests ^d	P=0.185	P=0.541	P=0.225
Cochran-Armitage test ^d	P=0.180		
Fisher exact test ^d		P=0.474	P=0.212
Adrenal Medulla: Malignant Pheochromocytoma			
Overall rates	0/48 (0%)	1/47 (2%)	10/49 (20%)
Adjusted rates	0.0%	7.1%	56.9%
Terminal rates	0/11 (0%)	0/13 (0%)	3/9 (33%)
First incidence (days)	- ^e	849	784
Life table tests	P<0.001	P=0.531	P=0.002
Logistic regression tests	P<0.001	P=0.509	P=0.001
Cochran-Armitage test	P<0.001		
Fisher exact test		P=0.495	P<0.001
Adrenal Medulla: Benign or Malignant Pheochromocytoma			
Overall rates	13/48 (27%)	14/47 (30%)	23/49 (47%)
Adjusted rates	61.3%	59.7%	95.2%
Terminal rates	5/11 (45%)	5/13 (38%)	8/9 (89%)
First incidence (days)	678	705	697
Life table tests	P=0.016	P=0.529	P=0.033
Logistic regression tests	P=0.014	P=0.541	P=0.024
Cochran-Armitage test	P=0.021		
Fisher exact test		P=0.474	P=0.034
Liver: Neoplastic Nodule			
Overall rates	0/50 (0%)	3/48 (6%)	1/50 (2%)
Adjusted rates	0.0%	13.6%	10.0%
Terminal rates	0/11 (0%)	0/13 (0%)	0/9 (0%)
First incidence (days)	-	724	857
Life table tests	P=0.550	P=0.114	P=0.464
Logistic regression tests	P=0.561	P=0.117	P=0.496
Cochran-Armitage test	P=0.556		
Fisher exact test		P=0.114	P=0.500
Liver: Neoplastic Nodule or Hepatocellular Carcinoma			
Overall rates	0/50 (0%)	4/48 (8%)	1/50 (2%)
Adjusted rates	0.0%	20.2%	10.0%
Terminal rates	0/11 (0%)	1/13 (8%)	0/9 (0%)
First incidence (days)	-	724	857
Life table tests	P=0.575	P=0.066	P=0.464
Logistic regression tests	P=0.602	P=0.060	P=0.496
Cochran-Armitage test	P=0.599		
Fisher exact test		P=0.054	P=0.500

TABLE B3

Statistical Analysis of Primary Neoplasms in Female Rats in the Lifetime Inhalation Study of Talc (continued)

	0 mg/m ³	6 mg/m ³	18 mg/m ³
Lung: Alveolar/bronchiolar Adenoma			
Overall rates	1/50 (2%)	0/48 (0%)	9/50 (18%)
Adjusted rates	4.5%	0.0%	40.8%
Terminal rates	0/11 (0%)	0/13 (0%)	1/9 (11%)
First incidence (days)	805	—	716
Life table tests	P<0.001	P=0.529N	P=0.015
Logistic regression tests	P<0.001	P=0.503N	P=0.010
Cochran-Armitage test	P<0.001		
Fisher exact test		P=0.510N	P=0.008
Lung: Alveolar/bronchiolar Carcinoma			
Overall rates	0/50 (0%)	0/48 (0%)	5/50 (10%)
Adjusted rates	0.0%	0.0%	41.7%
Terminal rates	0/11 (0%)	0/13 (0%)	3/9 (33%)
First incidence (days)	—	—	828
Life table tests	P=0.002	—	P=0.027
Logistic regression tests	P=0.003	—	P=0.028
Cochran-Armitage test	P=0.004		
Fisher exact test		—	P=0.028
Lung: Alveolar/bronchiolar Adenoma or Carcinoma			
Overall rates	1/50 (2%)	0/48 (0%)	13/50 (26%)
Adjusted rates	4.5%	0.0%	65.8%
Terminal rates	0/11 (0%)	0/13 (0%)	4/9 (44%)
First incidence (days)	805	—	716
Life table tests	P<0.001	P=0.529N	P=0.001
Logistic regression tests	P<0.001	P=0.503N	P<0.001
Cochran-Armitage test	P<0.001		
Fisher exact test		P=0.510N	P<0.001
Mammary Gland: Fibroadenoma			
Overall rates	11/50 (22%)	10/49 (20%)	13/50 (26%)
Adjusted rates	47.6%	41.4%	64.0%
Terminal rates	2/11 (18%)	3/13 (23%)	4/9 (44%)
First incidence (days)	634	482	678
Life table tests	P=0.304	P=0.489N	P=0.394
Logistic regression tests	P=0.363	P=0.508N	P=0.428
Cochran-Armitage test	P=0.343		
Fisher exact test		P=0.521N	P=0.408
Mammary Gland: Fibroma, Fibroadenoma, or Adenoma			
Overall rates	13/50 (26%)	13/49 (27%)	15/50 (30%)
Adjusted rates	54.7%	59.0%	68.6%
Terminal rates	3/11 (27%)	6/13 (46%)	4/9 (44%)
First incidence (days)	634	482	678
Life table tests	P=0.314	P=0.544N	P=0.404
Logistic regression tests	P=0.394	P=0.585	P=0.434
Cochran-Armitage test	P=0.371		
Fisher exact test		P=0.567	P=0.412

TABLE B3
Statistical Analysis of Primary Neoplasms in Female Rats in the Lifetime Inhalation Study of Talc (continued)

	0 mg/m ³	6 mg/m ³	18 mg/m ³
Mammary Gland: Fibroma, Fibroadenoma, Adenoma, or Adenocarcinoma			
Overall rates	15/50 (30%)	13/49 (27%)	16/50 (32%)
Adjusted rates	56.6%	59.0%	70.1%
Terminal rates	3/11 (27%)	6/13 (46%)	4/9 (44%)
First incidence (days)	370	482	678
Life table tests	P=0.378	P=0.386N	P=0.494
Logistic regression tests	P=0.457	P=0.425N	P=0.531
Cochran-Armitage test	P=0.430		
Fisher exact test		P=0.437N	P=0.500
Pituitary Gland (Pars Distalis): Adenoma			
Overall rates	19/50 (38%)	18/47 (38%)	21/50 (42%)
Adjusted rates	62.1%	60.5%	78.3%
Terminal rates	3/11 (27%)	3/13 (23%)	4/9 (44%)
First incidence (days)	568	697	633
Life table tests	P=0.360	P=0.512N	P=0.425
Logistic regression tests	P=0.409	P=0.557N	P=0.457
Cochran-Armitage test	P=0.380		
Fisher exact test		P=0.571	P=0.419
Pituitary Gland (Pars Distalis): Carcinoma			
Overall rates	3/50 (6%)	3/47 (6%)	2/50 (4%)
Adjusted rates	17.1%	12.2%	5.6%
Terminal rates	1/11 (9%)	1/13 (8%)	0/9 (0%)
First incidence (days)	696	566	676
Life table tests	P=0.438N	P=0.636N	P=0.506N
Logistic regression tests	P=0.427N	P=0.634	P=0.497N
Cochran-Armitage test	P=0.418N		
Fisher exact test		P=0.631	P=0.500N
Pituitary Gland (Pars Distalis): Adenoma or Carcinoma			
Overall rates	22/50 (44%)	21/47 (45%)	23/50 (46%)
Adjusted rates	69.8%	66.2%	79.5%
Terminal rates	4/11 (36%)	4/13 (31%)	4/9 (44%)
First incidence (days)	568	566	633
Life table tests	P=0.429	P=0.502N	P=0.488
Logistic regression tests	P=0.506	P=0.570N	P=0.545
Cochran-Armitage test	P=0.471		
Fisher exact test		P=0.554	P=0.500
Thyroid Gland (C-cell): Adenoma			
Overall rates	5/50 (10%)	0/47 (0%)	6/49 (12%)
Adjusted rates	33.5%	0.0%	34.0%
Terminal rates	2/11 (18%)	0/13 (0%)	2/9 (22%)
First incidence (days)	805	-	678
Life table tests	P=0.253	P=0.030N	P=0.467
Logistic regression tests	P=0.283	P=0.029N	P=0.505
Cochran-Armitage test	P=0.276		
Fisher exact test		P=0.033N	P=0.486

TABLE B3
Statistical Analysis of Primary Neoplasms in Female Rats in the Lifetime Inhalation Study of Talc (continued)

	0 mg/m ³	6 mg/m ³	18 mg/m ³
Thyroid Gland (C-cell): Carcinoma			
Overall rates	3/50 (6%)	2/47 (4%)	2/49 (4%)
Adjusted rates	11.1%	12.2%	4.9%
Terminal rates	0/11 (0%)	0/13 (0%)	0/9 (0%)
First incidence (days)	677	818	675
Life table tests	P=0.430N	P=0.507N	P=0.493N
Logistic regression tests	P=0.462N	P=0.516N	P=0.533N
Cochran-Armitage test	P=0.463N		
Fisher exact test		P=0.530N	P=0.510N
Thyroid Gland (C-cell): Adenoma or Carcinoma			
Overall rates	8/50 (16%)	2/47 (4%)	8/49 (16%)
Adjusted rates	40.9%	12.2%	37.2%
Terminal rates	2/11 (18%)	0/13 (0%)	2/9 (22%)
First incidence (days)	677	818	675
Life table tests	P=0.418	P=0.051N	P=0.579
Logistic regression tests	P=0.435	P=0.048N	P=0.599N
Cochran-Armitage test	P=0.414		
Fisher exact test		P=0.056N	P=0.590
Uterus: Stromal Polyp			
Overall rates	5/50 (10%)	7/49 (14%)	4/50 (8%)
Adjusted rates	22.3%	34.4%	19.5%
Terminal rates	1/11 (9%)	3/13 (23%)	1/9 (11%)
First incidence (days)	398	678	678
Life table tests	P=0.439N	P=0.400	P=0.532N
Logistic regression tests	P=0.376N	P=0.372	P=0.505N
Cochran-Armitage test	P=0.386N		
Fisher exact test		P=0.365	P=0.500N
Uterus: Stromal Polyp or Stromal Sarcoma			
Overall rates	5/50 (10%)	8/49 (16%)	4/50 (8%)
Adjusted rates	22.3%	35.8%	19.5%
Terminal rates	1/11 (9%)	3/13 (23%)	1/9 (11%)
First incidence (days)	398	557	678
Life table tests	P=0.412N	P=0.298	P=0.532N
Logistic regression tests	P=0.360N	P=0.265	P=0.505N
Cochran-Armitage test	P=0.363N		
Fisher exact test		P=0.264	P=0.500N
All Organs: Mononuclear Cell Leukemia			
Overall rates	13/50 (26%)	20/49 (41%)	18/50 (36%)
Adjusted rates	45.7%	73.3%	60.1%
Terminal rates	1/11 (9%)	8/13 (62%)	3/9 (33%)
First incidence (days)	390	526	536
Life table tests	P=0.234	P=0.164	P=0.232
Logistic regression tests	P=0.226	P=0.084	P=0.152
Cochran-Armitage test	P=0.250		
Fisher exact test		P=0.088	P=0.194

TABLE B3
Statistical Analysis of Primary Neoplasms in Female Rats in the Lifetime Inhalation Study of Talc (continued)

	0 mg/m ³	6 mg/m ³	18 mg/m ³
All Organs: Malignant Lymphoma			
Overall rates	0/50 (0%)	3/49 (6%)	0/50 (0%)
Adjusted rates	0.0%	10.3%	0.0%
Terminal rates	0/11 (0%)	0/13 (0%)	0/9 (0%)
First incidence (days)	—	724	—
Life table tests	P=0.525N	P=0.124	—
Logistic regression tests	P=0.497N	P=0.118	—
Cochran-Armitage test	P=0.499N		
Fisher exact test		P=0.117	—
All Organs: Benign Neoplasms			
Overall rates	38/50 (76%)	35/49 (71%)	39/50 (78%)
Adjusted rates	97.2%	96.9%	97.4%
Terminal rates	10/11 (91%)	12/13 (92%)	8/9 (89%)
First incidence (days)	398	482	558
Life table tests	P=0.338	P=0.350N	P=0.440
Logistic regression tests	P=0.544	P=0.312N	P=0.562N
Cochran-Armitage test	P=0.415		
Fisher exact test		P=0.387N	P=0.500
All Organs: Malignant Neoplasms			
Overall rates	23/50 (46%)	31/49 (63%)	35/50 (70%)
Adjusted rates	69.3%	85.8%	90.5%
Terminal rates	4/11 (36%)	9/13 (69%)	6/9 (67%)
First incidence (days)	370	526	536
Life table tests	P=0.054	P=0.189	P=0.061
Logistic regression tests	P=0.013	P=0.056	P=0.010
Cochran-Armitage test	P=0.016		
Fisher exact test		P=0.064	P=0.013
All Organs: Benign or Malignant Neoplasms			
Overall rates	44/50 (88%)	47/49 (96%)	49/50 (98%)
Adjusted rates	97.6%	97.9%	100.0%
Terminal rates	10/11 (91%)	12/13 (92%)	9/9 (100%)
First incidence (days)	370	482	536
Life table tests	P=0.248	P=0.447	P=0.279
Logistic regression tests	P=0.053	P=0.145	P=0.060
Cochran-Armitage test	P=0.049		
Fisher exact test		P=0.141	P=0.056

^a Number of neoplasm-bearing animals/number of animals examined. Denominator is number of animals examined microscopically for adrenal gland, bone marrow, brain, clitoral gland, heart, kidney, larynx, liver, lung, nose, ovary, pancreas, parathyroid gland, pituitary gland, salivary gland, spleen, thyroid gland, and urinary bladder; for other tissues, denominator is number of animals necropsied.

^b Kaplan-Meier estimated neoplasm incidence at the end of the study after adjustment for intercurrent mortality

^c Observed incidence at terminal kill

^d Beneath the control incidence are the P values associated with the trend test. Beneath the exposed group incidence are the P values corresponding to pairwise comparisons between the controls and that exposed group. The life table test regards neoplasms in animals dying prior to terminal kill as being (directly or indirectly) the cause of death. The logistic regression test regards these lesions as nonfatal. The Cochran-Armitage and Fisher exact tests compare directly the overall incidence rates. For all tests, a negative trend or a lower incidence in an exposure group is indicated by N.

^e Not applicable; no neoplasms in animal group

TABLE B4

Summary of the Incidence of Nonneoplastic Lesions in Female Rats in the Lifetime Inhalation Study of Talc^a

	0 mg/m ³	6 mg/m ³	18 mg/m ³
Disposition Summary			
Animals initially in study	50	50	50
Early deaths			
Moribund	28	17	27
Natural deaths	11	19	14
Survivors			
Terminal sacrifice	11	13	9
Missing		1	
Animals examined microscopically	50	49	50
Alimentary System			
Intestine large, cecum	(46)	(34)	(43)
Hemorrhage, focal		1 (3%)	
Inflammation	11 (24%)	1 (3%)	6 (14%)
Parasite metazoan	7 (15%)	3 (9%)	6 (14%)
Ulcer	1 (2%)	1 (3%)	1 (2%)
Intestine large, colon	(48)	(41)	(45)
Inflammation		1 (2%)	2 (4%)
Parasite metazoan	2 (4%)	3 (7%)	3 (7%)
Intestine large, rectum	(38)	(37)	(41)
Inflammation	4 (11%)		
Parasite metazoan	2 (5%)	1 (3%)	1 (2%)
Intestine small, duodenum	(48)	(44)	(47)
Necrosis, focal	1 (2%)		
Intestine small, ileum	(44)	(32)	(38)
Hyperplasia, lymphoid	2 (5%)		
Liver	(50)	(48)	(50)
Atrophy		1 (2%)	1 (2%)
Basophilic focus	27 (54%)	17 (35%)	21 (42%)
Clear cell focus	1 (2%)	2 (4%)	1 (2%)
Cyst multilocular	1 (2%)		
Degeneration, cystic		2 (4%)	1 (2%)
Eosinophilic focus	2 (4%)	5 (10%)	4 (8%)
Fatty change	18 (36%)	18 (38%)	14 (28%)
Hematopoietic cell proliferation	1 (2%)		
Infiltration cellular, mononuclear cell			1 (2%)
Inflammation, granulomatous, focal	13 (26%)	3 (6%)	4 (8%)
Inflammation, necrotizing, focal		1 (2%)	
Inflammation, suppurative	1 (2%)		
Necrosis, focal	5 (10%)	1 (2%)	2 (4%)
Pigmentation, hemosiderin	1 (2%)		
Thrombosis			1 (2%)
Bile duct, hyperplasia	36 (72%)	38 (79%)	36 (72%)
Centrilobular, atrophy		2 (4%)	6 (12%)
Centrilobular, degeneration	10 (20%)	14 (29%)	10 (20%)
Centrilobular, necrosis	2 (4%)	2 (4%)	2 (4%)
Hepatocyte, atrophy, focal			1 (2%)
Serosa, thrombosis		3 (6%)	
Mesentery	(1)	(2)	
Granuloma	1 (100%)	1 (50%)	
Inflammation, chronic active		1 (50%)	

TABLE B4

Summary of the Incidence of Nonneoplastic Lesions in Female Rats in the Lifetime Inhalation Study of Talc
(continued)

	0 mg/m ³	6 mg/m ³	18 mg/m ³
Alimentary System (continued)			
Pancreas	(50)	(46)	(49)
Hyperplasia, nodular	1 (2%)		
Inflammation		1 (2%)	
Lobules, atrophy	7 (14%)	7 (15%)	9 (18%)
Salivary glands	(50)	(48)	(50)
Inflammation	2 (4%)		
Stomach, forestomach	(50)	(45)	(49)
Hyperkeratosis	1 (2%)		1 (2%)
Inflammation	1 (2%)		2 (4%)
Mineralization		1 (2%)	
Ulcer	9 (18%)	4 (9%)	3 (6%)
Stomach, glandular	(50)	(47)	(50)
Erosion			1 (2%)
Inflammation	1 (2%)	1 (2%)	
Mineralization	2 (4%)	2 (4%)	2 (4%)
Ulcer	3 (6%)	2 (4%)	3 (6%)
Ulcer, multiple	1 (2%)		1 (2%)
Arteriole, muscularis, lamina propria, mineralization		1 (2%)	
Cardiovascular System			
Blood vessel	(3)	(3)	(1)
Aorta, mineralization		3 (100%)	1 (100%)
Mesenteric artery, aneurysm	1 (33%)		
Mesenteric artery, inflammation	3 (100%)		
Mesenteric artery, mineralization		1 (33%)	1 (100%)
Mesenteric artery, thrombosis	1 (33%)	1 (33%)	
Heart	(50)	(48)	(50)
Cardiomyopathy	35 (70%)	40 (83%)	36 (72%)
Inflammation, focal	1 (2%)		1 (2%)
Atrium, thrombosis	5 (10%)	8 (17%)	5 (10%)
Myocardium, embolus		2 (4%)	
Myocardium, inflammation, focal		1 (2%)	
Myocardium, mineralization	1 (2%)	4 (8%)	3 (6%)
Endocrine System			
Adrenal gland, cortex	(50)	(47)	(49)
Degeneration, cystic	1 (2%)		
Degeneration, fatty	3 (6%)		
Degeneration, focal	1 (2%)	1 (2%)	
Hyperplasia, diffuse		1 (2%)	1 (2%)
Hyperplasia, focal	9 (18%)	12 (26%)	13 (27%)
Necrosis			2 (4%)
Necrosis, focal	1 (2%)	1 (2%)	
Pigmentation, hemosiderin	1 (2%)		
Adrenal gland, medulla	(48)	(47)	(49)
Cyst	1 (2%)		
Hyperplasia	20 (42%)	18 (38%)	14 (29%)
Bilateral, hyperplasia	2 (4%)	2 (4%)	2 (4%)

TABLE B4
Summary of the Incidence of Nonneoplastic Lesions in Female Rats in the Lifetime Inhalation Study of Talc
(continued)

	0 mg/m ³	6 mg/m ³	18 mg/m ³
Endocrine System (continued)			
Parathyroid gland	(43)	(42)	(47)
Hyperplasia	3 (7%)	4 (10%)	2 (4%)
Bilateral, hyperplasia	1 (2%)		
Pituitary gland	(50)	(47)	(50)
Cyst	2 (4%)		1 (2%)
Pars distalis, hyperplasia	10 (20%)	6 (13%)	4 (8%)
Pars distalis, necrosis			1 (2%)
Thyroid gland	(50)	(47)	(49)
C-cell, hyperplasia	10 (20%)	8 (17%)	4 (8%)
General Body System			
None			
Genital System			
Clitoral gland	(47)	(44)	(46)
Hyperplasia	2 (4%)		1 (2%)
Inflammation	1 (2%)	1 (2%)	1 (2%)
Ovary	(50)	(47)	(50)
Cyst	5 (10%)		1 (2%)
Uterus	(50)	(48)	(50)
Cyst	1 (2%)	1 (2%)	1 (2%)
Inflammation	1 (2%)	1 (2%)	
Endometrium, hyperplasia	3 (6%)		
Lamina propria, fibrosis	20 (40%)	39 (81%)	19 (38%)
Hematopoietic System			
Bone marrow	(50)	(43)	(49)
Atrophy	1 (2%)	2 (5%)	1 (2%)
Hyperplasia, histiocytic	1 (2%)		1 (2%)
Inflammation, granulomatous, focal	1 (2%)		
Myelofibrosis	1 (2%)	3 (7%)	3 (6%)
Necrosis, focal		1 (2%)	
Myeloid cell, hyperplasia	2 (4%)	2 (5%)	3 (6%)
Lymph node	(50)	(48)	(50)
Axillary, hemorrhage, chronic			1 (2%)
Lymph node, bronchial	(46)	(47)	(47)
Cyst	1 (2%)		
Fibrosis		1 (2%)	
Hemorrhage, chronic		1 (2%)	
Hyperplasia, histiocytic		40 (85%)	45 (96%)
Inflammation, suppurative	1 (2%)		
Pigmentation, hemosiderin	1 (2%)		
Lymph node, mandibular	(47)	(46)	(47)
Hyperplasia, lymphoid		1 (2%)	1 (2%)
Hyperplasia, plasma cell	2 (4%)	1 (2%)	1 (2%)
Inflammation, chronic active	1 (2%)		1 (2%)
Inflammation, suppurative			1 (2%)

TABLE B4
Summary of the Incidence of Nonneoplastic Lesions in Female Rats in the Lifetime Inhalation Study of Talc
 (continued)

	0 mg/m ³	6 mg/m ³	18 mg/m ³
Hematopoietic System (continued)			
Lymph node, mediastinal	(47)	(44)	(47)
Hemorrhage, chronic	1 (2%)		
Hyperplasia, histiocytic		33 (75%)	40 (85%)
Hyperplasia, lymphoid	1 (2%)		1 (2%)
Inflammation, chronic active			1 (2%)
Inflammation, suppurative	1 (2%)	1 (2%)	
Lymph node, mesenteric	(49)	(47)	(47)
Hemorrhage		1 (2%)	
Hyperplasia, lymphoid	2 (4%)	1 (2%)	2 (4%)
Hyperplasia, plasma cell	1 (2%)		
Inflammation, chronic active	4 (8%)	1 (2%)	
Inflammation, granulomatous			1 (2%)
Spleen	(50)	(48)	(50)
Atrophy	2 (4%)	2 (4%)	2 (4%)
Fibrosis, focal	3 (6%)	1 (2%)	1 (2%)
Hematopoietic cell proliferation	4 (8%)	6 (13%)	7 (14%)
Hyperplasia, lymphoid			1 (2%)
Inflammation, granulomatous, focal	1 (2%)		
Pigmentation, hemosiderin	2 (4%)		
Capsule, hemorrhage			1 (2%)
Thymus	(47)	(44)	(47)
Inflammation	1 (2%)		
Integumentary System			
Mammary gland	(50)	(48)	(50)
Galactocele		1 (2%)	
Hyperplasia, cystic		2 (4%)	
Lobules, hyperplasia			1 (2%)
Skin	(50)	(49)	(50)
Inflammation, focal	1 (2%)		
Musculoskeletal System			
Bone	(50)	(48)	(50)
Fibrous osteodystrophy	4 (8%)	3 (6%)	4 (8%)
Hyperostosis	4 (8%)	1 (2%)	3 (6%)
Pelvis, fracture	1 (2%)		
Vertebra, cyst	1 (2%)		
Nervous System			
Brain	(50)	(48)	(50)
Compression	8 (16%)	7 (15%)	9 (18%)
Hemorrhage		1 (2%)	1 (2%)
Hydrocephalus			1 (2%)
Inflammation, focal		1 (2%)	
White matter, necrosis, focal			2 (4%)

TABLE B4
Summary of the Incidence of Nonneoplastic Lesions in Female Rats in the Lifetime Inhalation Study of Talc
(continued)

	0 mg/m ³	6 mg/m ³	18 mg/m ³
Respiratory System			
Larynx	(50)	(48)	(48)
Inflammation, necrotizing			1 (2%)
Inflammation, suppurative	2 (4%)	1 (2%)	1 (2%)
Lung	(50)	(48)	(50)
Crystals, focal	1 (2%)		
Cyst		1 (2%)	5 (10%)
Cyst, multiple			2 (4%)
Edema	1 (2%)		
Hemorrhage		1 (2%)	1 (2%)
Hyperplasia, adenomatous, diffuse			2 (4%)
Inflammation, granulomatous	2 (4%)	47 (98%)	50 (100%)
Inflammation, suppurative	2 (4%)	1 (2%)	
Mineralization		2 (4%)	
Alveolar epithelium, hyperplasia	2 (4%)	27 (56%)	47 (94%)
Alveolus, metaplasia, squamous			8 (16%)
Bronchus, epithelium, degeneration, focal	1 (2%)		
Interstitial, fibrosis			1 (2%)
Interstitial, fibrosis, focal	1 (2%)	24 (50%)	44 (88%)
Interstitial, mineralization		1 (2%)	1 (2%)
Peribronchial, hyperplasia, histiocytic		8 (17%)	9 (18%)
Nose	(48)	(45)	(48)
Inflammation, suppurative		1 (2%)	
Lumen, foreign body			1 (2%)
Mucosa, inflammation, suppurative		3 (7%)	5 (10%)
Nasolacrimal duct, inflammation, suppurative	1 (2%)		
Nerve, developmental malformation	1 (2%)		
Olfactory epithelium, metaplasia		1 (2%)	
Respiratory epithelium, hyperplasia	1 (2%)	1 (2%)	2 (4%)
Respiratory epithelium, metaplasia, squamous		1 (2%)	
Trachea	(50)	(48)	(50)
Inflammation, necrotizing			1 (2%)
Inflammation, suppurative	3 (6%)	1 (2%)	2 (4%)
Special Senses System			
Eye	(2)		(2)
Cataract	2 (100%)		2 (100%)
Retina, degeneration	2 (100%)		2 (100%)
Harderian gland	(5)	(7)	(15)
Inflammation	4 (80%)	3 (43%)	3 (20%)

TABLE B4
Summary of the Incidence of Nonneoplastic Lesions in Female Rats in the Lifetime Inhalation Study of Talc
 (continued)

	0 mg/m ³	6 mg/m ³	18 mg/m ³
Urinary System			
Kidney	(49)	(47)	(49)
Abscess	1 (2%)		
Cyst		1 (2%)	1 (2%)
Cyst, multiple	1 (2%)		
Embolus, multiple		1 (2%)	
Infarct	1 (2%)		
Infarct, multiple			1 (2%)
Inflammation	1 (2%)	1 (2%)	
Nephropathy	44 (90%)	43 (91%)	42 (86%)
Capsule, inflammation		1 (2%)	
Medulla, inflammation		1 (2%)	1 (2%)
Renal tubule, necrosis	1 (2%)		2 (4%)
Urinary bladder	(50)	(45)	(50)
Inflammation			1 (2%)

^a Number of animals examined microscopically at site and number of animals with lesion

APPENDIX C
SUMMARY OF LESIONS IN MALE MICE
IN THE 2-YEAR INHALATION STUDY
OF TALC

TABLE C1	Summary of the Incidence of Neoplasms in Male Mice in the 2-Year Inhalation Study of Talc	131
TABLE C2	Individual Animal Tumor Pathology of Male Mice in the 2-Year Inhalation Study of Talc	134
TABLE C3	Statistical Analysis of Primary Neoplasms in Male Mice in the 2-Year Inhalation Study of Talc	152
TABLE C4	Summary of the Incidence of Nonneoplastic Lesions in Male Mice in the 2-Year Inhalation Study of Talc	156

TABLE C1
Summary of the Incidence of Neoplasms in Male Mice in the 2-Year Inhalation Study of Talc^a

	0 mg/m ³	6 mg/m ³	18 mg/m ³
Disposition Summary			
Animals initially in study	50	50	50
Early deaths			
Moribund	1	2	3
Natural deaths	16	18	14
Survivors			
Terminal sacrifice	30	28	32
Missexed	1	1	
Missing	2	1	1
Animals examined microscopically	46	47	49
Alimentary System			
Gallbladder	(31)	(29)	(35)
Intestine large, colon	(36)	(38)	(39)
Intestine small, duodenum	(32)	(30)	(34)
Intestine small, ileum	(33)	(32)	(35)
Adenocarcinoma		1 (3%)	
Liver	(45)	(47)	(48)
Hemangiosarcoma	1 (2%)		1 (2%)
Hemangiosarcoma, metastatic, spleen	1 (2%)		
Hepatocellular carcinoma	6 (13%)	5 (11%)	11 (23%)
Hepatocellular adenoma	1 (2%)	8 (17%)	4 (8%)
Hepatocellular adenoma, multiple	2 (4%)	1 (2%)	
Pancreas	(42)	(39)	(42)
Hepatocellular carcinoma, metastatic, liver	1 (2%)		
Salivary glands	(45)	(46)	(47)
Stomach, glandular	(39)	(43)	(43)
Cardiovascular System			
Heart	(45)	(46)	(49)
Alveolar/bronchiolar carcinoma, metastatic, lung			1 (2%)
Endocrine System			
Adrenal gland	(43)	(46)	(47)
Spindle cell, adenoma	1 (2%)	1 (2%)	1 (2%)
Adrenal gland, cortex	(43)	(46)	(47)
Adenoma		1 (2%)	1 (2%)
Adrenal gland, medulla	(39)	(39)	(42)
Pheochromocytoma malignant	1 (3%)		
Pituitary gland	(44)	(44)	(46)
Adenoma	1 (2%)		
Pars intermedia, adenoma		2 (5%)	
Thyroid gland	(45)	(46)	(45)
Follicular cell, adenoma			2 (4%)
General Body System			
Tissue NOS		(3)	(2)
Hemangioma			1 (50%)
Hemangiosarcoma, metastatic, spleen			1 (50%)

TABLE C1
Summary of the Incidence of Neoplasms in Male Mice in the 2-Year Inhalation Study of Talc (continued)

	0 mg/m ³	6 mg/m ³	18 mg/m ³
Genital System			
Epididymis	(39)	(39)	(42)
Prostate	(40)	(43)	(44)
Seminal vesicle	(41)	(43)	(39)
Testes	(43)	(44)	(45)
Hemangiosarcoma	1 (2%)		
Hematopoietic System			
Bone marrow	(40)	(42)	(43)
Hemangiosarcoma, metastatic, spleen	1 (3%)		
Lymph node	(45)	(46)	(48)
Lymph node, bronchial	(32)	(39)	(44)
Alveolar/bronchiolar carcinoma, metastatic, lung			1 (2%)
Lymph node, mandibular	(23)	(23)	(19)
Hemangiosarcoma, metastatic, spleen			1 (5%)
Lymph node, mediastinal	(9)	(10)	(7)
Lymph node, mesenteric	(36)	(39)	(40)
Hemangiosarcoma, metastatic, spleen			1 (3%)
Spleen	(44)	(44)	(47)
Hemangiosarcoma	2 (5%)		2 (4%)
Thymus	(34)	(33)	(40)
Alveolar/bronchiolar carcinoma, metastatic, lung			1 (3%)
Integumentary System			
None			
Musculoskeletal System			
Bone	(46)	(47)	(49)
Hemangiosarcoma, metastatic, spleen			1 (2%)
Skeletal muscle			(1)
Thoracic, alveolar/bronchiolar carcinoma, metastatic, lung			1 (100%)
Nervous System			
None			
Respiratory System			
Lung	(45)	(47)	(48)
Alveolar/bronchiolar adenoma	6 (13%)	4 (9%)	7 (15%)
Alveolar/bronchiolar adenoma, multiple			2 (4%)
Alveolar/bronchiolar carcinoma	6 (13%)	2 (4%)	2 (4%)
Alveolar/bronchiolar carcinoma, multiple	1 (2%)		
Hemangiosarcoma, metastatic, liver	1 (2%)		
Hemangiosarcoma, metastatic, spleen			1 (2%)
Hepatocellular carcinoma, metastatic, liver		1 (2%)	2 (4%)

TABLE C1
Summary of the Incidence of Neoplasms in Male Mice in the 2-Year Inhalation Study of Talc (continued)

	0 mg/m ³	6 mg/m ³	18 mg/m ³
Special Senses System			
Harderian gland	(1)		(4)
Adenoma	1 (100%)		4 (100%)
Urinary System			
Kidney	(45)	(46)	(48)
Carcinoma, metastatic, uncertain primary site	1 (2%)		
Urinary bladder	(43)	(38)	(43)
Sarcoma	1 (2%)		
Systemic Lesions			
Multiple organs ^b	(46)	(47)	(49)
Lymphoma malignant lymphocytic		1 (2%)	
Lymphoma malignant mixed	2 (4%)		
Lymphoma malignant undifferentiated cell	3 (7%)		
Neoplasm Summary			
Total animals with primary neoplasms ^c	26	20	28
Total primary neoplasms	36	26	38
Total animals with benign neoplasms	11	16	18
Total benign neoplasms	12	17	22
Total animals with malignant neoplasms	20	8	15
Total malignant neoplasms	24	9	16
Total animals with metastatic neoplasms	4	1	4
Total metastatic neoplasms	5	1	11
Total animals with malignant neoplasms, uncertain primary site	1		

^a Number of animals examined microscopically at site and number of animals with lesion

^b Number of animals with any tissue examined microscopically

^c Primary neoplasms: all neoplasms except metastatic neoplasms

TABLE C2
Individual Animal Tumor Pathology of Male Mice in the 2-Year Inhalation Study of Talc: 0 mg/m³

Number of Days on Study	0 4 4 4 4 5 5 5 5 5 5 5 6 6 6 7 7 7 7 7 7 7
	0 3 3 8 8 1 4 7 7 8 8 8 2 7 8 1 3 3 3 3 3 3
	8 2 7 4 6 8 3 1 9 5 7 7 9 7 4 0 6 6 6 6 6 6
Carcass ID Number	4 3 4 5 3 3 4 4 5 3 4 5 5 4 4 5 3 3 3 3 3 3
	3 9 5 1 7 7 9 0 1 9 8 1 2 9 5 1 6 6 6 7 7 7
	5 1 4 2 4 2 4 5 5 5 9 8 3 3 5 7 1 4 7 0 1 5
	1 1
Alimentary System	
Esophagus	M M + M + + + + M + M + + + + + + + + +
Gallbladder	M M M M A A A A M + + A A + + A M + M + + +
Intestine large	A + A A A A A A A + + A + + + A + + + + +
Intestine large, cecum	A + A A A A A A A + A A A + + A + + + + +
Intestine large, colon	A + A A A A A A A + + A + + + A + + + + +
Intestine large, rectum	A + A A A A A A A + A A M M + A + + + + +
Intestine small	A + A A A A A A A + A A A + + A + + + + +
Intestine small, duodenum	A A A A A A A A A + A A A + + A + + + + +
Intestine small, ileum	A + A A A A A A A + A A A A + A + + + + +
Intestine small, jejunum	A + A A A A A A A + A A A A + A + + + + +
Liver	A +
Hemangiosarcoma	
Hemangiosarcoma, metastatic, spleen	
Hepatocellular carcinoma	
Hepatocellular adenoma	
Hepatocellular adenoma, multiple	
Pancreas	M + + + + A + A + + + + + + + A + + + + +
Hepatocellular carcinoma, metastatic, liver	
Salivary glands	A +
Stomach	A +
Stomach, forestomach	A + + + + + + + + I + + M + + + + + + + +
Stomach, glandular	A + A + A M + A + + + A + + + + + + + + +
Cardiovascular System	
Heart	A +
Endocrine System	
Adrenal gland	A + + + M + + + + + + + + + + I + + + + +
Spindle cell, adenoma	
Adrenal gland, cortex	A + + + M + + + + + + + + + + I + + + + +
Adrenal gland, medulla	A + + + M M + + + + + + I + + + M + + + + M
Pheochromocytoma malignant	
Islets, pancreatic	M + I + + M + A + M + A + I M I + + + + + M
Parathyroid gland	M M M + M M M + + + + + M + + + M M M + M
Pituitary gland	M +
Adenoma	
Thyroid gland	A +

+: Tissue examined microscopically
A: Autolysis precludes examination

M: Missing tissue
I: Insufficient tissue

X: Lesion present
Blank: Not examined

TABLE C2
Individual Animal Tumor Pathology of Male Mice in the 2-Year Inhalation Study of Talc: 6 mg/m³ (continued)

Number of Days on Study	2 2 3 4 5 5 5 5 5 5 6 6 6 6 6 6 7 7 7 7 7 7 7
	5 5 4 2 4 5 5 8 9 9 2 2 3 8 8 8 1 1 2 3 3 3 3
	3 3 4 3 6 0 8 4 0 1 4 6 3 1 5 8 0 9 2 6 6 6 6
Carcass ID Number	0 1 0 0 1 1 0 1 1 1 0 0 0 1 1 0 0 1 1 0 0 0 0
	3 3 4 0 2 6 4 5 5 2 4 7 3 5 0 6 1 5 3 0 0 0 0
	5 3 2 7 1 4 0 1 6 9 1 4 8 7 0 1 5 4 2 1 4 5 8
	1 1
General Body System	
Tissue NOS	+ + +
Genital System	
Epididymis	A + + + + + + + + + + + + A + + + + + + + +
Preputial gland	+ + + + + + + + + + + + + + + + + + + +
Prostate	+ + M A I A + + + + + + + + + + + + + + + +
Seminal vesicle	A + + A + A + + + + + + + + + A + + + + + + + +
Testes	A + + + + A + + + + + + + + + A + + + + + + + +
Hematopoietic System	
Bone marrow	+ + + + A A + A A A + + + + + + + + + + + +
Lymph node	+ M +
Lymph node, bronchial	+ + + + M + I + + + + + + + + M + + + + + M +
Lymph node, mandibular	M M + M M + + + + M + M M M + M + + + + M M M
Lymph node, mediastinal	M M M M M + M M M + M M M M M M M + + M M M
Lymph node, mesenteric	M M M M + M + + + + + + + + M + + + + M +
Spleen	A + + + + A A + + + + + + + + + + + + + + + +
Thymus	A M M M + + + I + + M + M + I M + + + + + + +
Integumentary System	
Mammary gland	M M M M M A M M M M M M M M + M + + M + M M
Skin	+ +
Musculoskeletal System	
Bone	+ +
Nervous System	
Brain	+ +
Respiratory System	
Larynx	A + + A + A A + + + + + A + + + + + + + I + +
Lung	+ +
Alveolar/bronchiolar adenoma	+ +
Alveolar/bronchiolar carcinoma	+ +
Hepatocellular carcinoma, metastatic, liver	+ +
Nose	+ + + + + A + + + + + + + + + + + + + + + +
Trachea	+ + + + + A I + + + + + A + + + + + + + + + +

TABLE C2
Individual Animal Tumor Pathology of Male Mice in the 2-Year Inhalation Study of Talc: 6 mg/m³ (continued)

Number of Days on Study	2 2 3 4 5 5 5 5 5 5 6 6 6 6 6 6 7 7 7 7 7 7 7
	5 5 4 2 4 5 5 8 9 9 2 2 3 8 8 8 1 1 2 3 3 3 3
	3 3 4 3 6 0 8 4 0 1 4 6 3 1 5 8 0 9 2 6 6 6 6
Carcass ID Number	0 1 0 0 1 1 0 1 1 1 0 0 0 1 1 0 0 1 1 0 0 0 0
	3 3 4 0 2 6 4 5 5 2 4 7 3 5 0 6 1 5 3 0 0 0 0
	5 3 2 7 1 4 0 1 6 9 1 4 8 7 0 1 5 4 2 1 4 5 8
	1 1
Special Senses System	
None	
Urinary System	
Kidney	+ + + + + A + + + + + + + + + + + + + + + + +
Urinary bladder	A + + A + A A A + + + + A + A + A + + + + + +
Systemic Lesions	
Multiple organs	+ +
Lymphoma malignant lymphocytic	
	X

TABLE C2
Individual Animal Tumor Pathology of Male Mice in the 2-Year Inhalation Study of Talc: 6 mg/m³ (continued)

Number of Days on Study	7 7	
	3 3 3 3 3 3 3 3 3 3 3 3 3 3 3 3 3 3 4 4 4 4 4	
	6 6 7 7 7 7 7 7 7 7 8 8 8 8 8 8 9 9 9 0 0 0 0 0	
Carcass ID Number	0 0 0 0 0 0 0 0 0 0 0 0 0 0 1 1 1 1 1 0 0 1 1 1 1	Total Tissues/ Tumors
	1 1 3 3 6 6 6 7 7 9 9 9 9 9 0 0 2 3 5 3 9 2 2 5 6	
	0 4 3 6 4 5 6 1 2 3 5 6 9 1 5 7 5 5 2 2 4 5 8 2	
	1 1	
Special Senses System None		
Urinary System		
Kidney	+ +	46
Urinary bladder	+ + + + + + + + + + + + + + + + + + + M + + + +	38
Systemic Lesions		
Multiple organs	+ +	47
Lymphoma malignant lymphocytic		1

TABLE C3
Statistical Analysis of Primary Neoplasms in Male Mice in the 2-Year Inhalation Study of Talc

	0 mg/m ³	6 mg/m ³	18 mg/m ³
Harderian Gland: Adenoma			
Overall rates ^a	1/46 (2%)	0/47 (0%)	4/49 (8%)
Adjusted rates ^b	3.3%	0.0%	12.0%
Terminal rates ^c	1/30 (3%)	0/28 (0%)	3/32 (9%)
First incidence (days)	736 (T)	- ^e	725
Life table tests ^d	P=0.073	P=0.514N	P=0.204
Logistic regression tests ^d	P=0.075	P=0.514N	P=0.216
Cochran-Armitage test ^d	P=0.065		
Fisher exact test ^d		P=0.495N	P=0.201
Liver: Hepatocellular Adenoma			
Overall rates	3/45 (7%)	9/47 (19%)	4/48 (8%)
Adjusted rates	10.0%	29.5%	11.8%
Terminal rates	3/30 (10%)	7/28 (25%)	3/32 (9%)
First incidence (days)	736 (T)	633	672
Life table tests	P=0.489N	P=0.050	P=0.539
Logistic regression tests	P=0.493N	P=0.061	P=0.552
Cochran-Armitage test	P=0.515N		
Fisher exact test		P=0.070	P=0.536
Liver: Hepatocellular Carcinoma			
Overall rates	6/45 (13%)	5/47 (11%)	11/48 (23%)
Adjusted rates	16.7%	13.7%	27.3%
Terminal rates	2/30 (7%)	1/28 (4%)	5/32 (16%)
First incidence (days)	571	546	438
Life table tests	P=0.114	P=0.491N	P=0.187
Logistic regression tests	P=0.116	P=0.445N	P=0.203
Cochran-Armitage test	P=0.097		
Fisher exact test		P=0.469N	P=0.177
Liver: Hepatocellular Adenoma or Carcinoma			
Overall rates	9/45 (20%)	13/47 (28%)	14/48 (29%)
Adjusted rates	25.6%	38.1%	34.5%
Terminal rates	5/30 (17%)	8/28 (29%)	7/32 (22%)
First incidence (days)	571	546	438
Life table tests	P=0.256	P=0.228	P=0.230
Logistic regression tests	P=0.216	P=0.257	P=0.223
Cochran-Armitage test	P=0.225		
Fisher exact test		P=0.269	P=0.217
Lung: Alveolar/bronchiolar Adenoma			
Overall rates	6/45 (13%)	4/47 (9%)	9/48 (19%)
Adjusted rates	20.0%	14.3%	27.0%
Terminal rates	6/30 (20%)	4/28 (14%)	8/32 (25%)
First incidence (days)	736 (T)	736 (T)	672
Life table tests	P=0.224	P=0.411N	P=0.333
Logistic regression tests	P=0.251	P=0.411N	P=0.371
Cochran-Armitage test	P=0.210		
Fisher exact test		P=0.342N	P=0.336

TABLE C3
Statistical Analysis of Primary Neoplasms in Male Mice in the 2-Year Inhalation Study of Talc (continued)

	0 mg/m ³	6 mg/m ³	18 mg/m ³
Lung: Alveolar/bronchiolar Carcinoma			
Overall rates	7/45 (16%)	2/47 (4%)	2/48 (4%)
Adjusted rates	23.3%	5.9%	5.2%
Terminal rates	7/30 (23%)	1/28 (4%)	0/32 (0%)
First incidence (days)	736 (T)	558	438
Life table tests	P=0.068N	P=0.093N	P=0.068N
Logistic regression tests	P=0.069N	P=0.073N	P=0.070N
Cochran-Armitage test	P=0.065N		
Fisher exact test		P=0.069N	P=0.065N
Lung: Alveolar/bronchiolar Adenoma or Carcinoma			
Overall rates	12/45 (27%)	5/47 (11%)	11/48 (23%)
Adjusted rates	40.0%	16.4%	30.8%
Terminal rates	12/30 (40%)	4/28 (14%)	8/32 (25%)
First incidence (days)	736 (T)	558	438
Life table tests	P=0.533N	P=0.063N	P=0.426N
Logistic regression tests	P=0.552N	P=0.043N	P=0.423N
Cochran-Armitage test	P=0.554N		
Fisher exact test		P=0.043N	P=0.429N
Pituitary Gland (Pars Intermedia): Adenoma			
Overall rates	0/44 (0%)	2/44 (5%)	0/46 (0%)
Adjusted rates	0.0%	6.5%	0.0%
Terminal rates	0/29 (0%)	1/27 (4%)	0/32 (0%)
First incidence (days)	-	681	-
Life table tests	P=0.547N	P=0.238	-
Logistic regression tests	P=0.566N	P=0.239	-
Cochran-Armitage test	P=0.564N		
Fisher exact test		P=0.247	-
Spleen: Hemangiosarcoma			
Overall rates	2/44 (5%)	0/44 (0%)	2/47 (4%)
Adjusted rates	6.9%	0.0%	5.5%
Terminal rates	2/29 (7%)	0/28 (0%)	0/32 (0%)
First incidence (days)	736 (T)	-	672
Life table tests	P=0.595	P=0.246N	P=0.650N
Logistic regression tests	P=0.581	P=0.246N	P=0.668N
Cochran-Armitage test	P=0.577		
Fisher exact test		P=0.247N	P=0.666N
All Organs: Hemangiosarcoma			
Overall rates	4/46 (9%)	0/47 (0%)	3/49 (6%)
Adjusted rates	12.9%	0.0%	8.4%
Terminal rates	3/30 (10%)	0/28 (0%)	1/32 (3%)
First incidence (days)	710	-	672
Life table tests	P=0.529N	P=0.071N	P=0.448N
Logistic regression tests	P=0.545N	P=0.060N	P=0.456N
Cochran-Armitage test	P=0.554N		
Fisher exact test		P=0.056N	P=0.464N

TABLE C3
Statistical Analysis of Primary Neoplasms in Male Mice in the 2-Year Inhalation Study of Talc (continued)

	0 mg/m ³	6 mg/m ³	18 mg/m ³
All Organs: Hemangioma or Hemangiosarcoma			
Overall rates	4/46 (9%)	0/47 (0%)	4/49 (8%)
Adjusted rates	12.9%	0.0%	11.4%
Terminal rates	3/30 (10%)	0/28 (0%)	2/32 (6%)
First incidence (days)	710	-	672
Life table tests	P=0.515	P=0.071N	P=0.590N
Logistic regression tests	P=0.505	P=0.060N	P=0.598N
Cochran-Armitage test	P=0.492		
Fisher exact test		P=0.056N	P=0.607N
All Organs: Malignant Lymphoma (Lymphocytic, Mixed, or Undifferentiated Cell Type)			
Overall rates	5/46 (11%)	1/47 (2%)	0/49 (0%)
Adjusted rates	16.7%	3.6%	0.0%
Terminal rates	5/30 (17%)	1/28 (4%)	0/32 (0%)
First incidence (days)	736 (T)	736 (T)	-
Life table tests	P=0.019N	P=0.116N	P=0.027N
Logistic regression tests	P=0.019N	P=0.116N	P=0.027N
Cochran-Armitage test	P=0.020N		
Fisher exact test		P=0.097N	P=0.024N
All Organs: Benign Neoplasms			
Overall rates	11/46 (24%)	16/47 (34%)	18/49 (37%)
Adjusted rates	35.2%	51.1%	51.4%
Terminal rates	10/30 (33%)	13/28 (46%)	15/32 (47%)
First incidence (days)	587	633	672
Life table tests	P=0.158	P=0.135	P=0.127
Logistic regression tests	P=0.154	P=0.188	P=0.138
Cochran-Armitage test	P=0.139		
Fisher exact test		P=0.199	P=0.128
All Organs: Malignant Neoplasms			
Overall rates	20/46 (43%)	8/47 (17%)	15/49 (31%)
Adjusted rates	58.3%	23.3%	35.9%
Terminal rates	16/30 (53%)	4/28 (14%)	6/32 (19%)
First incidence (days)	571	546	438
Life table tests	P=0.253N	P=0.012N	P=0.166N
Logistic regression tests	P=0.262N	P=0.005N	P=0.152N
Cochran-Armitage test	P=0.245N		
Fisher exact test		P=0.005N	P=0.139N
All Organs: Benign or Malignant Neoplasms			
Overall rates	26/46 (57%)	20/47 (43%)	28/49 (57%)
Adjusted rates	76.2%	58.0%	66.5%
Terminal rates	22/30 (73%)	14/28 (50%)	18/32 (56%)
First incidence (days)	571	546	438
Life table tests	P=0.442	P=0.208N	P=0.554
Logistic regression tests	P=0.344	P=0.102N	P=0.503
Cochran-Armitage test	P=0.399		
Fisher exact test		P=0.127N	P=0.558

TABLE C3

Statistical Analysis of Primary Neoplasms in Male Mice in the 2-Year Inhalation Study of Talc (continued)

(T) Terminal sacrifice

- ^a Number of neoplasm-bearing animals/number of animals examined. Denominator is number of animals examined microscopically for adrenal gland, bone marrow, brain, epididymis, gallbladder, heart, kidney, larynx, liver, lung, nose, pancreas, parathyroid gland, pituitary gland, preputial gland, prostate gland, salivary gland, spleen, testes, thyroid gland, and urinary bladder; for other tissues, denominator is number of animals necropsied.
- ^b Kaplan-Meier estimated neoplasm incidence at the end of the study after adjustment for intercurrent mortality
- ^c Observed incidence at terminal kill
- ^d Beneath the control incidence are the P values associated with the trend test. Beneath the exposed group incidence are the P values corresponding to pairwise comparisons between the controls and that exposed group. The life table test regards neoplasms in animals dying prior to terminal kill as being (directly or indirectly) the cause of death. The logistic regression test regards these lesions as nonfatal. The Cochran-Armitage and Fisher exact tests compare directly the overall incidence rates. For all tests, a negative trend or a lower incidence in an exposure group is indicated by N.
- ^e Not applicable; no neoplasms in animal group

TABLE C4
Summary of the Incidence of Nonneoplastic Lesions in Male Mice in the 2-Year Inhalation Study of Talc^a

	0 mg/m ³	6 mg/m ³	18 mg/m ³
Disposition Summary			
Animals initially in study	50	50	50
Early deaths			
Moribund	1	2	3
Natural deaths	16	18	14
Survivors			
Terminal sacrifice	30	28	32
Missexed	1	1	
Missing	2	1	1
Animals examined microscopically	46	47	49
Alimentary System			
Gallbladder	(31)	(29)	(35)
Dilatation			1 (3%)
Epithelium, hyperplasia, papillary			1 (3%)
Intestine large, cecum	(34)	(35)	(37)
Hyperplasia, lymphoid		1 (3%)	3 (8%)
Intestine large, colon	(36)	(38)	(39)
Hyperplasia, lymphoid	1 (3%)		
Intestine large, rectum	(32)	(32)	(31)
Serosa, inflammation, suppurative		1 (3%)	
Intestine small, duodenum	(32)	(30)	(34)
Hyperplasia, lymphoid			1 (3%)
Mucosa, atrophy	3 (9%)	7 (23%)	3 (9%)
Intestine small, ileum	(33)	(32)	(35)
Hyperplasia, lymphoid	5 (15%)	3 (9%)	5 (14%)
Mucosa, atrophy	3 (9%)	5 (16%)	4 (11%)
Peyer's patch, necrosis	1 (3%)		
Intestine small, jejunum	(32)	(31)	(36)
Hyperplasia, lymphoid			1 (3%)
Mucosa, atrophy	3 (9%)	3 (10%)	2 (6%)
Liver	(45)	(47)	(48)
Abscess	1 (2%)		1 (2%)
Focal cellular change	4 (9%)	3 (6%)	5 (10%)
Hematocyst		1 (2%)	
Hematopoietic cell proliferation	2 (4%)	2 (4%)	
Infarct	2 (4%)		
Inflammation, focal		3 (6%)	1 (2%)
Mineralization, focal		1 (2%)	
Necrosis, focal	4 (9%)	5 (11%)	4 (8%)
Pigmentation, hemosiderin, focal			1 (2%)
Bile duct, hyperplasia, focal			1 (2%)
Serosa, inflammation, suppurative			1 (2%)
Pancreas	(42)	(39)	(42)
Serosa, inflammation, suppurative			1 (2%)
Stomach, forestomach	(43)	(41)	(46)
Hyperplasia, squamous, focal		1 (2%)	1 (2%)
Tooth		(3)	
Dysplasia		3 (100%)	

TABLE C4

Summary of the Incidence of Nonneoplastic Lesions in Male Mice in the 2-Year Inhalation Study of Talc (continued)

	0 mg/m ³	6 mg/m ³	18 mg/m ³
Cardiovascular System			
Heart	(45)	(46)	(49)
Thrombosis		1 (2%)	1 (2%)
Coronary artery, mineralization		1 (2%)	
Myocardium, degeneration, focal	1 (2%)		
Myocardium, fibrosis, focal		1 (2%)	
Endocrine System			
Adrenal gland	(43)	(46)	(47)
Spindle cell, hyperplasia	38 (88%)	37 (80%)	35 (74%)
Adrenal gland, cortex	(43)	(46)	(47)
Atrophy	1 (2%)		
Hyperplasia, focal		1 (2%)	
Vacuolization cytoplasmic, focal		3 (7%)	4 (9%)
Parathyroid gland	(25)	(21)	(26)
Cyst	3 (12%)	1 (5%)	
Pituitary gland	(44)	(44)	(46)
Cyst	1 (2%)		1 (2%)
Pigmentation, lipofuscin	1 (2%)		
Thyroid gland	(45)	(46)	(45)
Cyst	2 (4%)	1 (2%)	1 (2%)
Follicular cell, hyperplasia	4 (9%)	8 (17%)	8 (18%)
General Body System			
None			
Genital System			
Epididymis	(39)	(39)	(42)
Inflammation, suppurative	1 (3%)	1 (3%)	
Preputial gland	(8)	(6)	(8)
Dilatation	7 (88%)	6 (100%)	8 (100%)
Inflammation	3 (38%)		1 (13%)
Prostate	(40)	(43)	(44)
Inflammation, suppurative	3 (8%)	7 (16%)	4 (9%)
Epithelium, hyperplasia		1 (2%)	
Seminal vesicle	(41)	(43)	(39)
Inflammation, suppurative		2 (5%)	1 (3%)
Testes	(43)	(44)	(45)
Aspermatogenesis, diffuse			1 (2%)
Atrophy, diffuse			1 (2%)
Hypospermia	1 (2%)	2 (5%)	
Inflammation, suppurative		1 (2%)	
Seminiferous tubule, degeneration, focal	3 (7%)	4 (9%)	1 (2%)
Hematopoietic System			
Bone marrow	(40)	(42)	(43)
Hyperplasia	4 (10%)	1 (2%)	1 (2%)
Myelofibrosis	2 (5%)	2 (5%)	
Myeloid cell, hyperplasia	4 (10%)	7 (17%)	1 (2%)

TABLE C4
Summary of the Incidence of Nonneoplastic Lesions in Male Mice in the 2-Year Inhalation Study of Talc (continued)

	0 mg/m ³	6 mg/m ³	18 mg/m ³
Hematopoietic System (continued)			
Lymph node	(45)	(46)	(48)
Iliac, hyperplasia, lymphoid	1 (2%)		
Iliac, hyperplasia, plasma cell	1 (2%)		
Lumbar, hyperplasia, lymphoid	1 (2%)	1 (2%)	
Lumbar, hyperplasia, plasma cell		1 (2%)	
Pancreatic, inflammation, granulomatous		1 (2%)	
Renal, depletion lymphoid			1 (2%)
Renal, hyperplasia, lymphoid			1 (2%)
Lymph node, bronchial	(32)	(39)	(44)
Abscess			1 (2%)
Hyperplasia, histiocytic	1 (3%)	32 (82%)	42 (95%)
Hyperplasia, histiocytic, lymphoid		1 (3%)	
Hyperplasia, lymphoid	3 (9%)	10 (26%)	23 (52%)
Infiltration cellular, mixed cell	3 (9%)	1 (3%)	3 (7%)
Inflammation, acute	1 (3%)		
Follicular, necrosis	1 (3%)		
Lymph node, mandibular	(23)	(23)	(19)
Hyperplasia, histiocytic		1 (4%)	
Hyperplasia, lymphoid			1 (5%)
Follicular, necrosis			1 (5%)
Lymph node, mediastinal	(9)	(10)	(7)
Hyperplasia, histiocytic	1 (11%)	1 (10%)	2 (29%)
Hyperplasia, lymphoid		2 (20%)	
Lymph node, mesenteric	(36)	(39)	(40)
Depletion lymphoid	1 (3%)		2 (5%)
Hyperplasia, lymphoid	4 (11%)	3 (8%)	6 (15%)
Infiltration cellular, mixed cell	18 (50%)	20 (51%)	13 (33%)
Inflammation, granulomatous		1 (3%)	
Thrombosis			1 (3%)
Follicular, necrosis		6 (15%)	2 (5%)
Spleen	(44)	(44)	(47)
Hematocyst		1 (2%)	
Hematopoietic cell proliferation	6 (14%)	7 (16%)	10 (21%)
Hyperplasia, lymphoid	3 (7%)	2 (5%)	3 (6%)
Hyperplasia, mast cell			1 (2%)
Inflammation, granulomatous		1 (2%)	
Lymphoid follicle, depletion lymphoid		2 (5%)	5 (11%)
Lymphoid follicle, necrosis	2 (5%)	5 (11%)	1 (2%)
Thymus	(34)	(33)	(40)
Cyst	3 (9%)	2 (6%)	1 (3%)
Hyperplasia, lymphoid			1 (3%)
Inflammation, granulomatous		1 (3%)	
Necrosis	1 (3%)		2 (5%)
Cortex, depletion lymphoid	6 (18%)	10 (30%)	8 (20%)
Epithelial cell, hyperplasia, focal	1 (3%)		
Integumentary System			
Skin	(44)	(45)	(48)
Abscess		1 (2%)	
Alopecia	1 (2%)		1 (2%)
Inflammation, acute		2 (4%)	
Ulcer, focal		2 (4%)	

TABLE C4
Summary of the Incidence of Nonneoplastic Lesions in Male Mice in the 2-Year Inhalation Study of Talc (continued)

	0 mg/m ³	6 mg/m ³	18 mg/m ³
Musculoskeletal System			
Bone	(46)	(47)	(49)
Rib, cartilage, fracture healed	1 (2%)		
Nervous System			
Brain	(46)	(47)	(48)
Mineralization, focal	37 (80%)	39 (83%)	38 (79%)
Respiratory System			
Larynx	(42)	(41)	(46)
Inflammation, acute	1 (2%)		1 (2%)
Lung	(45)	(47)	(48)
Congestion	3 (7%)	1 (2%)	1 (2%)
Hyperplasia, macrophage	3 (7%)	46 (98%)	48 (100%)
Inflammation, chronic active		16 (34%)	40 (83%)
Thrombosis			1 (2%)
Alveolar epithelium, hyperplasia, focal	1 (2%)		
Peribronchiolar, inflammation, chronic active		1 (2%)	
Perivascular, inflammation, suppurative	1 (2%)		
Nose	(45)	(46)	(47)
Cytoplasmic alteration, focal	5 (11%)	23 (50%)	40 (85%)
Erosion, focal	1 (2%)	1 (2%)	2 (4%)
Inflammation, acute	4 (9%)	4 (9%)	7 (15%)
Special Senses System			
Ear	(1)		
Inflammation, granulomatous	1 (100%)		
Urinary System			
Kidney	(45)	(46)	(48)
Casts protein	1 (2%)		
Cyst	2 (4%)		
Hydronephrosis	3 (7%)	1 (2%)	
Inflammation, suppurative, focal	3 (7%)	5 (11%)	3 (6%)
Metaplasia, osseous, focal		3 (7%)	
Nephropathy, chronic	3 (7%)		2 (4%)
Capsule, inflammation, suppurative			1 (2%)
Pelvis, inflammation, suppurative	2 (4%)	5 (11%)	1 (2%)
Urinary bladder	(43)	(38)	(43)
Dysplasia, focal	1 (2%)		
Inflammation, chronic active	6 (14%)	5 (13%)	2 (5%)
Ulcer, focal			1 (2%)
Transitional epithelium, hyperplasia		1 (3%)	

^a Number of animals examined microscopically at site and number of animals with lesion

APPENDIX D
SUMMARY LESIONS IN FEMALE MICE
IN THE 2-YEAR INHALATION STUDY
OF TALC

TABLE D1	Summary of the Incidence of Neoplasms in Female Mice in the 2-Year Inhalation Study of Talc	163
TABLE D2	Individual Animal Tumor Pathology of Female Mice in the 2-Year Inhalation Study of Talc	166
TABLE D3	Statistical Analysis of Primary Neoplasms in Female Mice in the 2-Year Inhalation Study of Talc	184
TABLE D4	Summary of the Incidence of Nonneoplastic Lesions in Female Mice in the 2-Year Inhalation Study of Talc	188

TABLE D1
Summary of the Incidence of Neoplasms in Female Mice in the 2-Year Inhalation Study of Talc^a

	0 mg/m ³	6 mg/m ³	18 mg/m ³
Disposition Summary			
Animals initially in study	50	50	50
Early deaths			
Moribund	2	4	4
Natural deaths	17	21	21
Survivors			
Terminal sacrifice	30	23	25
Missing	1	1	
Culled		1	
Animals examined microscopically	46	48	50
Alimentary System			
Esophagus	(43)	(47)	(48)
Gallbladder	(31)	(28)	(29)
Intestine large, cecum	(35)	(29)	(34)
Leiomyoma			1 (3%)
Intestine large, colon	(38)	(33)	(32)
Leiomyosarcoma		1 (3%)	
Intestine small, ileum	(33)	(27)	(31)
Liver	(46)	(46)	(50)
Hemangioma		1 (2%)	
Hepatocellular carcinoma	7 (15%)	5 (11%)	4 (8%)
Hepatocellular adenoma	5 (11%)	1 (2%)	4 (8%)
Mesentery	(2)		
Pancreas	(42)	(39)	(44)
Salivary glands	(46)	(48)	(50)
Hemangioma	1 (2%)		
Stomach, glandular	(45)	(39)	(46)
Cardiovascular System			
Heart	(46)	(48)	(50)
Alveolar/bronchiolar carcinoma, metastatic, lung		1 (2%)	
Endocrine System			
Adrenal gland	(46)	(45)	(50)
Spindle cell, adenoma	1 (2%)		
Adrenal gland, cortex	(46)	(44)	(50)
Adenoma	1 (2%)		
Adrenal gland, medulla	(41)	(43)	(45)
Pheochromocytoma malignant	1 (2%)		
Pituitary gland	(42)	(42)	(48)
Adenoma	5 (12%)	4 (10%)	2 (4%)
Carcinoma		2 (5%)	
Thyroid gland	(43)	(47)	(49)
Follicular cell, adenoma	1 (2%)	2 (4%)	2 (4%)

TABLE D1
Summary of the Incidence of Neoplasms in Female Mice in the 2-Year Inhalation Study of Talc (continued)

	0 mg/m ³	6 mg/m ³	18 mg/m ³
General Body System			
Tissue NOS	(4)	(1)	(2)
Fibrosarcoma	1 (25%)		
Hemangioma	1 (25%)		1 (50%)
Hemangiosarcoma			1 (50%)
Genital System			
Ovary	(38)	(43)	(46)
Adenocarcinoma, metastatic, uterus	1 (3%)		
Adenoma	1 (3%)	1 (2%)	
Cystadenoma		1 (2%)	
Luteoma	2 (5%)		
Uterus	(44)	(45)	(49)
Adenocarcinoma	1 (2%)		
Carcinoma adenosquamous			1 (2%)
Hematopoietic System			
Bone marrow	(41)	(43)	(45)
Lymph node	(46)	(46)	(49)
Lymph node, bronchial	(38)	(37)	(43)
Adenocarcinoma, metastatic, kidney		1 (3%)	
Adenocarcinoma, metastatic, uterus	1 (3%)		
Alveolar/bronchiolar carcinoma, metastatic, lung		3 (8%)	
Lymph node, mandibular	(35)	(38)	(36)
Lymph node, mediastinal	(13)	(17)	(14)
Adenocarcinoma, metastatic, kidney		1 (6%)	
Alveolar/bronchiolar carcinoma, metastatic, lung		1 (6%)	
Lymph node, mesenteric	(35)	(31)	(37)
Spleen	(45)	(44)	(50)
Hemangiosarcoma			1 (2%)
Thymus	(40)	(40)	(41)
Alveolar/bronchiolar carcinoma, metastatic, lung		2 (5%)	
Integumentary System			
Mammary gland	(41)	(45)	(48)
Fibrosarcoma			1 (2%)
Musculoskeletal System			
Bone	(46)	(48)	(50)
Vertebra, alveolar/bronchiolar carcinoma, metastatic, lung		1 (2%)	
Nervous System			
Spinal cord			(1)
Thoracic, ganglioneuroma			1 (100%)

TABLE D1
Summary of the Incidence of Neoplasms in Female Mice in the 2-Year Inhalation Study of Talc (continued)

	0 mg/m ³	6 mg/m ³	18 mg/m ³
Respiratory System			
Lung	(46)	(48)	(50)
Adenocarcinoma, metastatic, kidney		1 (2%)	
Alveolar/bronchiolar adenoma	3 (7%)	2 (4%)	2 (4%)
Alveolar/bronchiolar carcinoma	2 (4%)	4 (8%)	1 (2%)
Hemangiosarcoma, metastatic, tissue NOS			1 (2%)
Hepatocellular carcinoma, metastatic, liver	2 (4%)	2 (4%)	
Trachea	(40)	(36)	(45)
Special Senses System			
Harderian gland	(2)	(2)	(1)
Adenocarcinoma			1 (100%)
Adenoma	2 (100%)	1 (50%)	
Urinary System			
Kidney	(46)	(46)	(50)
Adenocarcinoma		1 (2%)	
Hepatocellular carcinoma, metastatic, liver	1 (2%)		
Urinary bladder	(44)	(40)	(41)
Systemic Lesions			
Multiple organs ^b	(46)	(48)	(50)
Lymphoma malignant histiocytic			1 (2%)
Lymphoma malignant lymphocytic	2 (4%)	3 (6%)	3 (6%)
Lymphoma malignant mixed	3 (7%)	4 (8%)	2 (4%)
Lymphoma malignant undifferentiated cell	2 (4%)		2 (4%)
Neoplasm Summary			
Total animals with primary neoplasms ^c	31	26	21
Total primary neoplasms	42	33	31
Total animals with benign neoplasms	18	9	10
Total benign neoplasms	23	13	13
Total animals with malignant neoplasms	19	19	15
Total malignant neoplasms	19	20	18
Total animals with metastatic neoplasms	3	5	1
Total metastatic neoplasms	5	13	1

^a Number of animals examined microscopically at site and number of animals with lesion

^b Number of animals with any tissue examined microscopically

^c Primary neoplasms: all neoplasms except metastatic neoplasms

TABLE D2
Individual Animal Tumor Pathology of Female Mice in the 2-Year Inhalation Study of Talc: 0 mg/m³

Number of Days on Study	0	4	4	4	5	5	5	5	5	5	6	6	6	6	6	7	7	7	7	7	7
	3	2	6	8	0	0	0	4	5	9	4	8	8	8	9	2	2	2	2	2	2
	0	6	5	7	5	6	9	4	2	8	1	0	3	6	2	3	9	9	9	9	9
Carcass ID Number	5	5	5	3	4	4	3	4	4	4	5	5	4	5	4	4	3	3	3	3	3
	3	0	3	7	1	2	8	1	7	7	0	2	9	0	4	9	7	8	8	8	8
	3	0	4	6	7	0	2	5	5	3	5	8	7	7	6	6	7	1	4	6	9
	1	1	1	1	1	1	1	1	1	1	1	1	1	1	1	1	1	1	1	1	1
Alimentary System																					
Esophagus	+	+	M	+	+	M	M	+	+	+	+	+	+	+	+	+	+	+	+	+	+
Gallbladder	A	M	A	M	A	M	A	+	A	A	A	A	+	A	A	+	+	+	+	+	+
Intestine large	A	+	+	A	A	A	+	+	A	+	A	+	+	+	+	+	+	+	+	+	+
Intestine large, cecum	A	+	A	A	A	A	A	A	+	A	+	A	+	A	+	+	+	+	+	+	+
Intestine large, colon	A	+	A	A	A	A	+	+	A	+	A	+	+	+	+	+	+	M	+	+	+
Intestine large, rectum	A	M	+	M	M	A	+	+	M	A	A	M	+	+	+	+	+	+	+	+	M
Intestine small	A	+	A	A	A	A	A	+	A	A	A	A	A	+	+	+	+	+	+	+	+
Intestine small, duodenum	A	+	A	A	A	A	A	A	A	A	A	A	A	+	+	A	+	+	+	+	M
Intestine small, ileum	A	+	A	A	A	A	A	A	A	A	A	A	A	+	+	+	+	+	+	+	+
Intestine small, jejunum	A	+	A	A	A	A	A	+	A	A	A	A	A	+	A	+	+	+	+	+	+
Liver	+	+	+	+	+	+	+	+	+	+	+	+	+	+	+	+	+	+	+	+	+
Hepatocellular carcinoma			X				X				X			X							X
Hepatocellular adenoma																					X
Mesentery								+													
Pancreas	+	+	A	+	A	A	+	+	+	+	+	I	+	+	+	+	+	+	+	+	+
Salivary glands	+	+	+	+	+	+	+	+	+	+	+	+	+	+	+	+	+	+	+	+	+
Hemangioma																					
Stomach	+	+	+	+	+	A	+	+	+	+	+	+	+	+	+	+	+	+	+	+	+
Stomach, forestomach	+	+	+	+	+	A	+	+	+	+	+	+	+	+	+	+	+	+	+	+	+
Stomach, glandular	+	+	+	+	+	A	+	+	+	+	+	+	+	+	+	+	+	+	+	+	+
Cardiovascular System																					
Heart	+	+	+	+	+	+	+	+	+	+	+	+	+	+	+	+	+	+	+	+	+
Endocrine System																					
Adrenal gland	+	+	+	+	+	+	+	+	+	+	+	+	+	+	+	+	+	+	+	+	+
Spindle cell, adenoma																					
Adrenal gland, cortex	+	+	+	+	+	+	+	+	+	+	+	+	+	+	+	+	+	+	+	+	+
Adenoma																					
Adrenal gland, medulla	+	+	+	+	M	+	M	+	+	+	I	I	+	+	+	+	+	+	+	+	+
Pheochromocytoma malignant																					
Islets, pancreatic	+	+	M	+	A	A	M	+	I	M	I	M	I	M	+	+	+	+	+	+	+
Parathyroid gland	M	M	+	M	+	+	M	+	M	I	+	M	+	+	+	M	M	M	I	M	+
Pituitary gland	M	+	+	+	M	M	+	+	+	+	I	+	+	+	+	+	+	+	+	+	+
Adenoma															X	X	X				X
Thyroid gland	A	+	+	+	+	+	M	+	+	+	+	+	+	+	+	+	+	+	+	+	+
Follicular cell, adenoma																					

+: Tissue examined microscopically
A: Autolysis precludes examination

M: Missing tissue
I: Insufficient tissue

X: Lesion present
Blank: Not examined

TABLE D2
Individual Animal Tumor Pathology of Female Mice in the 2-Year Inhalation Study of Talc: 6 mg/m³

Number of Days on Study	0 0 4 4 5 5 5 5 5 5 6 6 6 6 6 6 6 6 6 6 6 6 7 7 7
	2 9 2 9 0 3 4 5 5 6 1 2 2 4 4 6 7 7 8 9 9 0 0 1
	0 2 2 1 0 4 8 4 9 4 8 1 8 1 5 5 6 8 6 2 9 9 9 2
Carcass ID Number	1 0 0 1 0 1 1 1 0 1 0 1 0 0 1 1 0 1 1 0 0 1 1 0
	1 5 1 1 5 4 7 4 1 7 2 2 5 8 3 0 5 7 3 8 6 1 4 2
	7 5 6 5 0 7 6 8 9 5 2 0 6 1 6 8 8 1 9 3 0 8 0 0
	1 1
Alimentary System	
Esophagus	+ + + + M + + + + + + + + + + + + + + + + + +
Gallbladder	A M M M A A + + + A A A A A A A A M A A + A +
Intestine large	A + A A A + A + + A + + A A A + A + A + A + A +
Intestine large, cecum	A A A A A A A + + A A + A A A + A A A A A + A +
Intestine large, colon	A A A A A + A + + A + + A A A + A + A + A + A +
Leiomyosarcoma	
Intestine large, rectum	A + A A A M M I M A + M M A A M A + A A A + A +
Intestine small	A A A A A A A + + A A + A A A + A A A A A + A +
Intestine small, duodenum	A A A A A A A + + A A + A A A A A A A A A + A +
Intestine small, ileum	A A A A A A A + + A A + A A A A A A A A A + A +
Intestine small, jejunum	A A A A A A A + + A A + A A A + A A A A A + A +
Liver	+ + + A + + + + + + + + + + + + + + + + + +
Hemangioma	
Hepatocellular carcinoma	
Hepatocellular adenoma	
Pancreas	+ + + A A + + + + + + + I M + + A + A + A + + I
Salivary glands	+ +
Stomach	+ + + A + + + + + + + + + + + + + + + + + +
Stomach, forestomach	+ + + A + + + + + + + + + + + + + + + + + +
Stomach, glandular	A + + A A + + + + A A + + A + + A + + + + A +
Cardiovascular System	
Heart	+ +
Alveolar/bronchiolar carcinoma, metastatic, lung	X
Endocrine System	
Adrenal gland	+ + + A + + + + + + + + + + + + A + + + + + + +
Adrenal gland, cortex	+ + + A + + + + + + + + M + + + A + + + + + + +
Adrenal gland, medulla	+ + + A + + + + + + + + + + + + A + + + + + + +
Islets, pancreatic	M I + A A I I + + M I M M M + + A + M I M M I I
Parathyroid gland	I + + A M M + + M M M + + M + + M M I + M I + M
Pituitary gland	M + + + + + + + + + + + I + + + M + + M I + + +
Adenoma	
Carcinoma	
Thyroid gland	+ + + A + + + + + + + + + + + + + + + + + +
Follicular cell, adenoma	

TABLE D2
Individual Animal Tumor Pathology of Female Mice in the 2-Year Inhalation Study of Talc: 6 mg/m³ (continued)

Number of Days on Study	0 0 4 4 5 5 5 5 5 6 6 6 6 6 6 6 6 6 6 6 6 7 7 7
	2 9 2 9 0 3 4 5 5 6 1 2 2 4 4 6 7 7 8 9 9 0 0 1
	0 2 2 1 0 4 8 4 9 4 8 1 8 1 5 5 6 8 6 2 9 9 9 2
Carcass ID Number	1 0 0 1 0 1 1 1 0 1 0 1 0 0 1 1 0 1 1 0 0 1 1 0
	1 5 1 1 5 4 7 4 1 7 2 2 5 8 3 0 5 7 3 8 6 1 4 2
	7 5 6 5 0 7 6 8 9 5 2 0 6 1 6 8 8 1 9 3 0 8 0 0
	1 1
Respiratory System	
Larynx	+ + + A A I + + + + A + + + + + + + + + + + + + + +
Lung	+ +
Adenocarcinoma, metastatic, kidney	
Alveolar/bronchiolar adenoma	
Alveolar/bronchiolar carcinoma	X
Hepatocellular carcinoma, metastatic, liver	
Nose	+ + + + A +
Trachea	+ + + A A + M + + A A + A A + + M + M + + + + + + + + +
Special Senses System	
Eye	
Harderian gland	
Adenoma	
Urinary System	
Kidney	+ + + A + + + + + + + + + + + + + + A + + + + + + + + +
Adenocarcinoma	
Urinary bladder	A A + A + + + + + A + + + A A + A + + + + + + + + +
Systemic Lesions	
Multiple organs	+ +
Lymphoma malignant lymphocytic	
Lymphoma malignant mixed	

TABLE D2
Individual Animal Tumor Pathology of Female Mice in the 2-Year Inhalation Study of Talc: 18 mg/m³

Number of Days on Study	0 0 0 0 0 0 0 4 5 5 5 5 5 5 5 6 6 6 6 6 6 6 7 7 7
	2 2 2 2 2 2 2 7 0 1 4 5 5 6 8 4 4 5 6 6 8 9 0 1 1
	0 8 8 8 8 8 8 3 8 6 8 4 8 9 1 2 6 5 1 5 6 2 6 6 8
Carcass ID Number	2 1 2 2 2 2 2 3 3 2 2 3 3 3 2 3 2 3 2 2 2 2 2 2 2
	9 9 0 0 0 0 0 4 4 0 3 1 5 6 7 2 3 5 2 2 3 6 9 6 5
	2 6 1 3 4 6 7 9 6 2 9 6 3 0 0 8 2 2 7 8 6 6 6 7 9
	1 1
Alimentary System	
Esophagus	+ + + + + M + + M + + + + + + + + + + + + + + + +
Gallbladder	A M M A A A M M + M A A A A + A A + A A A + + A +
Intestine large	A A A + + A A + + A + A + A + A + A A A + + A A +
Intestine large, cecum	A A A + A A A + + A + A A A + A + A A A + + A A +
Leiomyoma	
Intestine large, colon	A A A + A A A I + A + A A A + A A A A A + + A A +
Intestine large, rectum	A A A + + A A M I M M A + A + A + M A M + + M A +
Intestine small	A A A + A A A + + A + A + A + A + A A A A + A A +
Intestine small, duodenum	A A A + A A A + + A M A A A + A A A A A A + A A +
Intestine small, ileum	A A A A A A A + A A + A A A + A + A A A A + A A +
Intestine small, jejunum	A A A + A A A + A A A A + A + A A A A A + A A +
Liver	+ +
Hepatocellular carcinoma	
Hepatocellular adenoma	
Pancreas	A + + + M A + + + A + + + A + + + + + + + + + A +
Salivary glands	+ +
Stomach	+ +
Stomach, forestomach	+ +
Stomach, glandular	+ + + + + + + + A + + A I + + + + A + + + + + + +
Cardiovascular System	
Heart	+ +
Endocrine System	
Adrenal gland	+ +
Adrenal gland, cortex	+ +
Adrenal gland, medulla	+ I I M + + I + + + + + + + + + + + + + + + + + +
Islets, pancreatic	A + + I M A M + + M M + + I I M + + + M I I + A +
Parathyroid gland	+ M M + + M M M M M + + + + M M + + I + M M + + +
Pituitary gland	+ + + + M I + + + + + + + + + + + + + + + + + + +
Adenoma	
Thyroid gland	+ + M +
Follicular cell, adenoma	
General Body System	
Tissue NOS	
Hemangioma	+
Hemangiosarcoma	X

TABLE D2
Individual Animal Tumor Pathology of Female Mice in the 2-Year Inhalation Study of Talc: 18 mg/m³ (continued)

Number of Days on Study	0 0 0 0 0 0 0 4 5 5 5 5 5 5 5 6 6 6 6 6 6 6 7 7 7
	2 2 2 2 2 2 2 7 0 1 4 5 5 6 8 4 4 5 6 6 8 9 0 1 1
	0 8 8 8 8 8 8 3 8 6 8 4 8 9 1 2 6 5 1 5 6 2 6 6 8
Carcass ID Number	2 1 2 2 2 2 2 3 3 2 2 3 3 3 2 3 2 3 2 2 2 2 2 2 2
	9 9 0 0 0 0 0 4 4 0 3 1 5 6 7 2 3 5 2 2 3 6 9 6 5
	2 6 1 3 4 6 7 9 6 2 9 6 3 0 0 8 2 2 7 8 6 6 6 7 9
	1 1
Genital System	
Ovary	+ + + + + + + + + + + + + + I + M + + M + + + +
Uterus	+ + M +
Carcinoma adenosquamous	
Hematopoietic System	
Bone marrow	+ + + + + + + A + A A + + A A + + + + + + + + + +
Lymph node	+ M +
Lymph node, bronchial	M M M + M M M + + I + + + + + + + + + + + + + +
Lymph node, mandibular	+ M M M + + + + + + + + M M + + + + + + + + + +
Lymph node, mediastinal	M M M M M M M M M M + M M M M M + + + M + M + +
Lymph node, mesenteric	M M A + M M M + + A + A + + + M + + + + M + M + +
Spleen	+ +
Hemangiosarcoma	
Thymus	M M + M + + M M + + + + + + + + + + + + M + + M I
Integumentary System	
Mammary gland	+ + M + + + + + + + + I + + + + + + + + + + + + +
Fibrosarcoma	
Skin	+ +
Musculoskeletal System	
Bone	+ +
Nervous System	
Brain	+ +
Spinal cord	
Thoracic, ganglioneuroma	
Respiratory System	
Larynx	+ + M +
Lung	+ +
Alveolar/bronchiolar adenoma	
Alveolar/bronchiolar carcinoma	
Hemangiosarcoma, metastatic, tissue NOS	
Nose	+ +
Trachea	+ + + + + + + + + + + + + + + + A + M + + + + + + + +

TABLE D2
Individual Animal Tumor Pathology of Female Mice in the 2-Year Inhalation Study of Talc: 18 mg/m³ (continued)

Number of Days on Study	0 0 0 0 0 0 0 4 5 5 5 5 5 5 5 6 6 6 6 6 6 6 7 7 7
	2 2 2 2 2 2 2 7 0 1 4 5 5 6 8 4 4 5 6 6 8 9 0 1 1
	0 8 8 8 8 8 8 3 8 6 8 4 8 9 1 2 6 5 1 5 6 2 6 6 8
Carcass ID Number	2 1 2 2 2 2 2 3 3 2 2 3 3 3 2 3 2 3 2 2 2 2 2 2 2
	9 9 0 0 0 0 0 4 4 0 3 1 5 6 7 2 3 5 2 2 3 6 9 6 5
	2 6 1 3 4 6 7 9 6 2 9 6 3 0 0 8 2 2 7 8 6 6 6 7 9
	1 1
Special Senses System	
Harderian gland	
Adenocarcinoma	+
	X
Urinary System	
Kidney	+ +
Urinary bladder	A A + + + + A + + + + A + + + A + A + + A + A A +
Systemic Lesions	
Multiple organs	+ +
Lymphoma malignant histiocytic	X
Lymphoma malignant lymphocytic	
Lymphoma malignant mixed	X
Lymphoma malignant undifferentiated cell type	X

TABLE D3
Statistical Analysis of Primary Neoplasms in Female Mice in the 2-Year Inhalation Study of Talc

	0 mg/m ³	6 mg/m ³	18 mg/m ³
Liver: Hepatocellular Adenoma			
Overall rates ^a	5/46 (11%)	1/47 (2%)	4/50 (8%)
Adjusted rates ^b	16.7%	4.3%	14.0%
Terminal rates ^c	5/30 (17%)	1/23 (4%)	2/25 (8%)
First incidence (days)	729 (T)	729 (T)	581
Life table tests ^d	P=0.565	P=0.169N	P=0.602N
Logistic regression tests ^d	P=0.603N	P=0.169N	P=0.539N
Cochran-Armitage test ^d	P=0.523N		
Fisher exact test ^d		P=0.097N	P=0.447N
Liver: Hepatocellular Carcinoma			
Overall rates	7/46 (15%)	5/47 (11%)	4/50 (8%)
Adjusted rates	19.1%	18.4%	15.4%
Terminal rates	3/30 (10%)	3/23 (13%)	3/25 (12%)
First incidence (days)	426	645	718
Life table tests	P=0.308N	P=0.487N	P=0.344N
Logistic regression tests	P=0.243N	P=0.372N	P=0.255N
Cochran-Armitage test	P=0.197N		
Fisher exact test		P=0.364N	P=0.216N
Liver: Hepatocellular Adenoma or Carcinoma			
Overall rates	11/46 (24%)	6/47 (13%)	7/50 (14%)
Adjusted rates	31.1%	22.5%	25.2%
Terminal rates	7/30 (23%)	4/23 (17%)	5/25 (20%)
First incidence (days)	426	645	581
Life table tests	P=0.329N	P=0.262N	P=0.330N
Logistic regression tests	P=0.253N	P=0.147N	P=0.227N
Cochran-Armitage test	P=0.184N		
Fisher exact test		P=0.131N	P=0.163N
Lung: Alveolar/bronchiolar Adenoma			
Overall rates	3/46 (7%)	2/49 (4%)	2/50 (4%)
Adjusted rates	10.0%	6.7%	6.4%
Terminal rates	3/30 (10%)	1/23 (4%)	1/25 (4%)
First incidence (days)	729 (T)	559	548
Life table tests	P=0.505N	P=0.589N	P=0.562N
Logistic regression tests	P=0.467N	P=0.499N	P=0.515N
Cochran-Armitage test	P=0.425N		
Fisher exact test		P=0.470N	P=0.460N
Lung: Alveolar/bronchiolar Carcinoma			
Overall rates	2/46 (4%)	4/49 (8%)	1/50 (2%)
Adjusted rates	6.7%	11.6%	2.6%
Terminal rates	2/30 (7%)	0/23 (0%)	0/25 (0%)
First incidence (days)	729 (T)	491	558
Life table tests	P=0.383N	P=0.286	P=0.539N
Logistic regression tests	P=0.325N	P=0.356	P=0.500N
Cochran-Armitage test	P=0.309N		
Fisher exact test		P=0.369	P=0.468N

TABLE D3

Statistical Analysis of Primary Neoplasms in Female Mice in the 2-Year Inhalation Study of Talc (continued)

	0 mg/m ³	6 mg/m ³	18 mg/m ³
Lung: Alveolar/bronchiolar Adenoma or Carcinoma			
Overall rates	5/46 (11%)	6/49 (12%)	3/50 (6%)
Adjusted rates	16.7%	17.5%	8.9%
Terminal rates	5/30 (17%)	1/23 (4%)	1/25 (4%)
First incidence (days)	729 (T)	491	548
Life table tests	P=0.337N	P=0.394	P=0.428N
Logistic regression tests	P=0.269N	P=0.519	P=0.367N
Cochran-Armitage test	P=0.235N		
Fisher exact test		P=0.545	P=0.311N
Ovary: Luteoma			
Overall rates	2/38 (5%)	0/43 (0%)	0/46 (0%)
Adjusted rates	8.0%	0.0%	0.0%
Terminal rates	2/25 (8%)	0/21 (0%)	0/24 (0%)
First incidence (days)	729 (T)	- ^e	-
Life table tests	P=0.177N	P=0.277N	P=0.246N
Logistic regression tests	P=0.177N	P=0.277N	P=0.246N
Cochran-Armitage test	P=0.146N		
Fisher exact test		P=0.217N	P=0.202N
Pituitary Gland (Unspecified Site): Adenoma			
Overall rates	5/42 (12%)	4/43 (9%)	2/48 (4%)
Adjusted rates	15.1%	18.2%	7.1%
Terminal rates	2/30 (7%)	4/22 (18%)	1/25 (4%)
First incidence (days)	683	729 (T)	665
Life table tests	P=0.239N	P=0.610	P=0.290N
Logistic regression tests	P=0.189N	P=0.604N	P=0.220N
Cochran-Armitage test	P=0.133N		
Fisher exact test		P=0.485N	P=0.166N
Pituitary Gland (Unspecified Site): Carcinoma			
Overall rates	0/42 (0%)	2/43 (5%)	0/48 (0%)
Adjusted rates	0.0%	5.5%	0.0%
Terminal rates	0/30 (0%)	0/22 (0%)	0/25 (0%)
First incidence (days)	-	534	-
Life table tests	P=0.591N	P=0.237	-
Logistic regression tests	P=0.515N	P=0.274	-
Cochran-Armitage test	P=0.542N		
Fisher exact test		P=0.253	-
Pituitary Gland (Unspecified Site): Adenoma or Carcinoma			
Overall rates	5/42 (12%)	6/43 (14%)	2/48 (4%)
Adjusted rates	15.1%	22.7%	7.1%
Terminal rates	2/30 (7%)	4/22 (18%)	1/25 (4%)
First incidence (days)	683	534	665
Life table tests	P=0.216N	P=0.352	P=0.290N
Logistic regression tests	P=0.150N	P=0.451	P=0.220N
Cochran-Armitage test	P=0.111N		
Fisher exact test		P=0.517	P=0.166N

TABLE D3

Statistical Analysis of Primary Neoplasms in Female Mice in the 2-Year Inhalation Study of Talc (continued)

	0 mg/m ³	6 mg/m ³	18 mg/m ³
All Organs: Hemangioma or Hemangiosarcoma			
Overall rates	2/46 (4%)	1/49 (2%)	3/50 (6%)
Adjusted rates	6.7%	4.3%	10.1%
Terminal rates	2/30 (7%)	1/23 (4%)	2/25 (8%)
First incidence (days)	729 (T)	729 (T)	473
Life table tests	P=0.323	P=0.593N	P=0.434
Logistic regression tests	P=0.356	P=0.593N	P=0.495
Cochran-Armitage test	P=0.399		
Fisher exact test		P=0.476N	P=0.540
All Organs: Malignant Lymphoma (Histiocytic, Lymphocytic, Mixed, or Undifferentiated Cell Type)			
Overall rates	7/46 (15%)	7/49 (14%)	8/50 (16%)
Adjusted rates	21.3%	26.7%	27.4%
Terminal rates	5/30 (17%)	5/23 (22%)	5/25 (20%)
First incidence (days)	509	628	642
Life table tests	P=0.358	P=0.454	P=0.387
Logistic regression tests	P=0.406	P=0.607	P=0.463
Cochran-Armitage test	P=0.514		
Fisher exact test		P=0.563N	P=0.571
All Organs: Benign Neoplasms			
Overall rates	18/46 (39%)	9/49 (18%)	10/50 (20%)
Adjusted rates	54.5%	36.4%	33.0%
Terminal rates	15/30 (50%)	8/23 (35%)	6/25 (24%)
First incidence (days)	683	559	548
Life table tests	P=0.148N	P=0.125N	P=0.145N
Logistic regression tests	P=0.094N	P=0.044N	P=0.071N
Cochran-Armitage test	P=0.050N		
Fisher exact test		P=0.022N	P=0.033N
All Organs: Malignant Neoplasms			
Overall rates	19/46 (41%)	19/49 (39%)	15/50 (30%)
Adjusted rates	51.9%	55.4%	45.6%
Terminal rates	13/30 (43%)	9/23 (39%)	8/25 (32%)
First incidence (days)	426	491	473
Life table tests	P=0.372N	P=0.340	P=0.441N
Logistic regression tests	P=0.241N	P=0.546N	P=0.279N
Cochran-Armitage test	P=0.143N		
Fisher exact test		P=0.483N	P=0.173N
All Organs: Benign or Malignant Neoplasms			
Overall rates	31/46 (67%)	26/49 (53%)	21/50 (42%)
Adjusted rates	81.4%	75.1%	58.9%
Terminal rates	23/30 (77%)	15/23 (65%)	11/25 (44%)
First incidence (days)	426	491	473
Life table tests	P=0.141N	P=0.537	P=0.168N
Logistic regression tests	P=0.036N	P=0.162N	P=0.035N
Cochran-Armitage test	P=0.011N		
Fisher exact test		P=0.112N	P=0.011N

TABLE D3

Statistical Analysis of Primary Neoplasms in Female Mice in the 2-Year Inhalation Study of Talc (continued)

(T)Terminal sacrifice

- ^a Number of neoplasm-bearing animals/number of animals examined. Denominator is number of animals examined microscopically for adrenal gland, bone marrow, brain, clitoral gland, gallbladder, heart, kidney, larynx, liver, lung, nose, ovary, pancreas, parathyroid gland, pituitary gland, salivary gland, spleen, thyroid gland, and urinary bladder; for other tissues, denominator is number of animals necropsied.
- ^b Kaplan-Meier estimated neoplasm incidence at the end of the study after adjustment for intercurrent mortality
- ^c Observed incidence at terminal kill
- ^d Beneath the control incidence are the P values associated with the trend test. Beneath the exposed group incidence are the P values corresponding to pairwise comparisons between the controls and that exposed group. The life table test regards neoplasms in animals dying prior to terminal kill as being (directly or indirectly) the cause of death. The logistic regression test regards these lesions as nonfatal. The Cochran-Armitage and Fisher exact tests compare directly the overall incidence rates. For all tests, a negative trend or a lower incidence in an exposure group is indicated by N.
- ^e Not applicable; no neoplasms in animal group

TABLE D4
Summary of the Incidence of Nonneoplastic Lesions in Female Mice in the 2-Year Inhalation Study of Talc^a

	0 mg/m ³	6 mg/m ³	18 mg/m ³
Disposition Summary			
Animals initially in study	50	50	50
Early deaths			
Moribund	2	4	4
Natural deaths	17	21	21
Survivors			
Terminal sacrifice	30	23	25
Missing	1	1	
Culled		1	
Animals examined microscopically	46	48	50
Alimentary System			
Intestine large, cecum	(35)	(29)	(34)
Hyperplasia, lymphoid			1 (3%)
Serosa, inflammation, suppurative		1 (3%)	
Intestine large, colon	(38)	(33)	(32)
Serosa, inflammation, suppurative		2 (6%)	
Intestine small, duodenum	(27)	(25)	(27)
Ulcer, focal	1 (4%)		
Mucosa, atrophy	2 (7%)	6 (24%)	4 (15%)
Serosa, inflammation, suppurative		2 (8%)	
Intestine small, ileum	(33)	(27)	(31)
Hyperplasia, lymphoid	1 (3%)	1 (4%)	
Mucosa, atrophy	4 (12%)	6 (22%)	6 (19%)
Peyer's patch, necrosis			1 (3%)
Serosa, inflammation, suppurative		2 (7%)	1 (3%)
Intestine small, jejunum	(33)	(28)	(31)
Mucosa, atrophy	2 (6%)	7 (25%)	3 (10%)
Serosa, inflammation, suppurative		2 (7%)	1 (3%)
Liver	(46)	(46)	(50)
Eosinophilic focus		1 (2%)	
Fibrosis, focal		1 (2%)	
Focal cellular change	2 (4%)	3 (7%)	1 (2%)
Hematopoietic cell proliferation	1 (2%)	2 (4%)	2 (4%)
Inflammation, focal	1 (2%)	2 (4%)	1 (2%)
Necrosis, focal	1 (2%)	2 (4%)	2 (4%)
Pigmentation, hemosiderin, focal		1 (2%)	
Centrilobular, degeneration		1 (2%)	
Centrilobular, necrosis, coagulative		1 (2%)	
Serosa, inflammation, suppurative	4 (9%)	7 (15%)	5 (10%)
Sinusoid, inflammation	2 (4%)		
Pancreas	(42)	(39)	(44)
Inflammation, focal			2 (5%)
Acinus, hyperplasia, focal	1 (2%)		
Serosa, inflammation, suppurative	1 (2%)	5 (13%)	4 (9%)
Salivary glands	(46)	(48)	(50)
Inflammation, acute		1 (2%)	1 (2%)
Stomach	(45)	(45)	(50)
Serosa, inflammation, granulomatous			1 (2%)
Serosa, inflammation, suppurative	1 (2%)	2 (4%)	1 (2%)
Stomach, forestomach	(45)	(45)	(50)
Hyperplasia, mast cell, focal			1 (2%)
Hyperplasia, squamous, focal	2 (4%)	4 (9%)	2 (4%)
Ulcer, focal	1 (2%)	3 (7%)	

TABLE D4

Summary of the Incidence of Nonneoplastic Lesions in Female Mice in the 2-Year Inhalation Study of Talc (continued)

	0 mg/m ³	6 mg/m ³	18 mg/m ³
Alimentary System (continued)			
Stomach, glandular	(45)	(39)	(46)
Inflammation, suppurative			1 (2%)
Ulcer, focal	1 (2%)	1 (3%)	
Fore stomach, inflammation, focal		1 (3%)	2 (4%)
Cardiovascular System			
Heart	(46)	(48)	(50)
Myocardium, degeneration, focal	1 (2%)		
Myocardium, inflammation, focal		1 (2%)	
Myocardium, mineralization, focal	1 (2%)		
Pericardium, inflammation, suppurative	1 (2%)	2 (4%)	4 (8%)
Endocrine System			
Adrenal gland	(46)	(45)	(50)
Capsule, inflammation, suppurative	4 (9%)	7 (16%)	5 (10%)
Corticomedullary junction, hemorrhage	2 (4%)	3 (7%)	1 (2%)
Spindle cell, hyperplasia	46 (100%)	45 (100%)	47 (94%)
Adrenal gland, cortex	(46)	(44)	(50)
Cyst	2 (4%)	3 (7%)	
Inflammation, suppurative, focal			1 (2%)
Vacuolization cytoplasmic, focal	3 (7%)		
Adrenal gland, medulla	(41)	(43)	(45)
Hyperplasia, focal	2 (5%)		
Parathyroid gland	(23)	(18)	(25)
Hyperplasia	1 (4%)		
Pituitary gland	(42)	(42)	(48)
Cyst	2 (5%)		
Hemorrhage, focal	2 (5%)		
Hyperplasia, focal	2 (5%)		
Pigmentation, lipofuscin	1 (2%)		
Thyroid gland	(43)	(47)	(49)
Cyst	2 (5%)		
Inflammation, acute, focal			2 (4%)
C-cell, hyperplasia	1 (2%)		1 (2%)
Follicular cell, hyperplasia	9 (21%)	12 (26%)	10 (20%)
General Body System			
Tissue NOS	(4)	(1)	(2)
Thrombosis, chronic	1 (25%)		
Genital System			
Ovary	(38)	(43)	(46)
Abscess	4 (11%)	10 (23%)	7 (15%)
Cyst	6 (16%)	11 (26%)	10 (22%)
Thrombosis	1 (3%)	2 (5%)	
Uterus	(44)	(45)	(49)
Angiectasis			1 (2%)
Hyperplasia, histiocytic, focal			1 (2%)
Metaplasia, squamous		1 (2%)	

TABLE D4

Summary of the Incidence of Nonneoplastic Lesions in Female Mice in the 2-Year Inhalation Study of Talc (continued)

	0 mg/m ³	6 mg/m ³	18 mg/m ³
Genital System (continued)			
Uterus (continued)			
Thrombosis	1 (2%)		
Endometrium, hyperplasia, cystic	34 (77%)	30 (67%)	35 (71%)
Mucosa, inflammation, suppurative	3 (7%)	7 (16%)	4 (8%)
Serosa, inflammation, suppurative	1 (2%)	4 (9%)	2 (4%)
Hematopoietic System			
Bone marrow	(41)	(43)	(45)
Hyperplasia	1 (2%)	4 (9%)	5 (11%)
Myelofibrosis	28 (68%)	23 (53%)	27 (60%)
Myeloid cell, hyperplasia	1 (2%)	6 (14%)	3 (7%)
Lymph node	(46)	(46)	(49)
Iliac, hyperplasia, lymphoid			1 (2%)
Iliac, inflammation	1 (2%)		1 (2%)
Pancreatic, hyperplasia, lymphoid	1 (2%)		1 (2%)
Pancreatic, infiltration cellular, mixed cell			1 (2%)
Pancreatic, follicular, necrosis			1 (2%)
Renal, hyperplasia, lymphoid		2 (4%)	2 (4%)
Renal, infiltration cellular, mixed cell			1 (2%)
Renal, inflammation	1 (2%)	1 (2%)	1 (2%)
Renal, follicular, necrosis		2 (4%)	1 (2%)
Lymph node, bronchial	(38)	(37)	(43)
Hyperplasia, histiocytic		25 (68%)	39 (91%)
Hyperplasia, lymphoid		16 (43%)	20 (47%)
Infiltration cellular, mixed cell	1 (3%)		
Inflammation, acute	1 (3%)	1 (3%)	1 (2%)
Lymph node, mandibular	(35)	(38)	(36)
Cyst			1 (3%)
Depletion lymphoid	1 (3%)		
Hyperplasia, histiocytic	1 (3%)		
Hyperplasia, lymphoid		1 (3%)	3 (8%)
Hyperplasia, plasma cell	1 (3%)		
Infiltration cellular, mixed cell		1 (3%)	
Inflammation		1 (3%)	1 (3%)
Follicular, necrosis		1 (3%)	
Lymph node, mediastinal	(13)	(17)	(14)
Hyperplasia, histiocytic	1 (8%)	3 (18%)	2 (14%)
Hyperplasia, lymphoid		1 (6%)	2 (14%)
Infiltration cellular, mixed cell	1 (8%)		
Lymph node, mesenteric	(35)	(31)	(37)
Depletion lymphoid		1 (3%)	2 (5%)
Hematocyst			1 (3%)
Hyperplasia, histiocytic		1 (3%)	1 (3%)
Hyperplasia, lymphoid		2 (6%)	2 (5%)
Hyperplasia, plasma cell			1 (3%)
Infiltration cellular, mixed cell	5 (14%)	5 (16%)	5 (14%)
Inflammation		2 (6%)	1 (3%)
Follicular, necrosis	3 (9%)	12 (39%)	7 (19%)
Spleen	(45)	(44)	(50)
Congestion	2 (4%)		
Hematopoietic cell proliferation	8 (18%)	12 (27%)	10 (20%)
Hyperplasia, lymphoid	5 (11%)	8 (18%)	6 (12%)

TABLE D4

Summary of the Incidence of Nonneoplastic Lesions in Female Mice in the 2-Year Inhalation Study of Talc (continued)

	0 mg/m ³	6 mg/m ³	18 mg/m ³
Hematopoietic System (continued)			
Spleen (continued)			
Inflammation, suppurative	2 (4%)		1 (2%)
Capsule, inflammation, suppurative	2 (4%)	3 (7%)	3 (6%)
Lymphoid follicle, depletion lymphoid	2 (4%)	3 (7%)	5 (10%)
Lymphoid follicle, necrosis	2 (4%)	4 (9%)	2 (4%)
Thymus	(40)	(40)	(41)
Cyst	2 (5%)	2 (5%)	
Hyperplasia, plasma cell		1 (3%)	
Inflammation, suppurative		1 (3%)	1 (2%)
Necrosis	3 (8%)	5 (13%)	
Cortex, depletion lymphoid	8 (20%)	12 (30%)	15 (37%)
Integumentary System			
Mammary gland			
Abscess	(41)	(45)	(48)
Edema	1 (2%)		1 (2%)
Skin	(46)	(46)	(50)
Alopecia	2 (4%)	2 (4%)	
Musculoskeletal System			
Bone			
Periosteum, femur, proliferation connective tissue	(46)	(48)	(50)
	1 (2%)		
Nervous System			
Brain			
Hydrocephalus	(46)	(48)	(50)
Mineralization, focal	36 (78%)	33 (69%)	29 (58%)
Respiratory System			
Larynx			
Inflammation, acute	(42)	(43)	(48)
	1 (2%)		
Lung			
Congestion	(46)	(48)	(50)
Hyperplasia, histiocytic	1 (2%)	3 (6%)	1 (2%)
Hyperplasia, macrophage	2 (4%)	45 (94%)	43 (86%)
Inflammation, chronic active		25 (52%)	38 (76%)
Metaplasia, osseous, focal	1 (2%)		
Alveolar epithelium, hyperplasia, focal			1 (2%)
Perivascular, inflammation, suppurative		3 (6%)	1 (2%)
Pleura, inflammation, suppurative	1 (2%)	2 (4%)	5 (10%)
Nose			
Cytoplasmic alteration, focal	(46)	(46)	(50)
Developmental malformation	29 (63%)	37 (80%)	40 (80%)
Erosion, focal	1 (2%)		
Inflammation, acute	3 (7%)		1 (2%)
Inflammation, acute	6 (13%)	4 (9%)	5 (10%)
Ulcer, focal	1 (2%)		

TABLE D4
Summary of the Incidence of Nonneoplastic Lesions in Female Mice in the 2-Year Inhalation Study of Talc (continued)

	0 mg/m ³	6 mg/m ³	18 mg/m ³
Special Senses System			
Eye		(1)	
Inflammation, suppurative		1 (100%)	
Harderian gland	(2)	(2)	(1)
Inflammation, suppurative		1 (50%)	
Urinary System			
Kidney	(46)	(46)	(50)
Casts protein		2 (4%)	
Infarct	1 (2%)	1 (2%)	
Inflammation, focal	1 (2%)	1 (2%)	1 (2%)
Metaplasia, osseous, focal	1 (2%)		2 (4%)
Nephropathy, chronic	1 (2%)	1 (2%)	
Capsule, inflammation, suppurative	3 (7%)	6 (13%)	5 (10%)
Renal tubule, hyperplasia, focal		1 (2%)	
Urinary bladder	(44)	(40)	(41)
Serosa, inflammation, suppurative		3 (8%)	3 (7%)
Submucosa, hyperplasia, lymphoid	1 (2%)		
Submucosa, inflammation, suppurative			1 (2%)

^a Number of animals examined microscopically at site and number of animals with lesion

APPENDIX E
ORGAN WEIGHTS
AND ORGAN-WEIGHT-TO-BODY-WEIGHT RATIOS

TABLE E1	6-Month Interim Evaluation in the Lifetime Inhalation Study of Talc in Rats	194
TABLE E2	11-Month Interim Evaluation in the Lifetime Inhalation Study of Talc in Rats	195
TABLE E3	18-Month Interim Evaluation in the Lifetime Inhalation Study of Talc in Rats	196
TABLE E4	24-Month Interim Evaluation in the Lifetime Inhalation Study of Talc in Rats	197
TABLE E5	End of the Lifetime Inhalation Study of Talc in Rats	198
TABLE E6	6-Month Interim Evaluation in the 2-Year Inhalation Study of Talc in Mice	199
TABLE E7	12-Month Interim Evaluation in the 2-Year Inhalation Study of Talc in Mice	200
TABLE E8	18-Month Interim Evaluation in the 2-Year Inhalation Study of Talc in Mice	201
TABLE E9	End of the 2-Year Inhalation Study of Talc in Mice	202

TABLE E1
Organ Weights and Organ-Weight-to-Body-Weight Ratios for Rats at the 6-Month Interim Evaluation
in the Lifetime Inhalation Study of Talc^a

	0 mg/m ³	6 mg/m ³	18 mg/m ³
Male			
n	3	3	3
Necropsy body wt	379 ± 2	365 ± 9	351 ± 4*
Brain			
Absolute	2.061 ± 0.073	1.962 ± 0.035	1.964 ± 0.041
Relative	5.44 ± 0.22	5.38 ± 0.22	5.59 ± 0.10
Heart			
Absolute	1.087 ± 0.024	0.984 ± 0.047	1.008 ± 0.018
Relative	2.87 ± 0.07	2.69 ± 0.07	2.87 ± 0.03
R. Kidney			
Absolute	1.203 ± 0.055	1.155 ± 0.028	1.143 ± 0.025
Relative	3.17 ± 0.16	3.16 ± 0.01	3.25 ± 0.04
Liver			
Absolute	12.969 ± 0.336	11.658 ± 0.483	11.644 ± 0.613
Relative	34.20 ± 0.79	31.89 ± 0.65	33.11 ± 1.43
Lungs			
Absolute	1.196 ± 0.049	1.201 ± 0.060	1.600 ± 0.073**
Relative	3.15 ± 0.11	3.29 ± 0.19	4.55 ± 0.19**
Female			
n	3	3	3
Necropsy body wt	216 ± 10	210 ± 5	212 ± 7
Brain			
Absolute	1.801 ± 0.020	1.800 ± 0.030	1.860 ± 0.031
Relative	8.39 ± 0.33	8.57 ± 0.28	8.82 ± 0.39
Heart			
Absolute	0.679 ± 0.023	0.691 ± 0.031	0.716 ± 0.055
Relative	3.16 ± 0.11	3.29 ± 0.13	3.38 ± 0.20
R. Kidney			
Absolute	0.700 ± 0.043	0.775 ± 0.025	0.751 ± 0.030
Relative	3.25 ± 0.17	3.69 ± 0.10	3.55 ± 0.07
Liver			
Absolute	7.579 ± 0.502	7.253 ± 0.172	6.875 ± 0.409
Relative	35.13 ± 1.09	34.51 ± 0.33	32.47 ± 1.21
Lungs			
Absolute	1.006 ± 0.112	0.986 ± 0.064	1.090 ± 0.010
Relative	4.71 ± 0.65	4.69 ± 0.29	5.17 ± 0.21

* Significantly different ($P \leq 0.05$) from the control group by Williams' or Dunnett's test

** $P \leq 0.01$

^a Organ weights and body weights are given in grams; organ-weight-to-body-weight ratios are given as mg organ weight/g body weight (mean ± standard error)

TABLE E2
Organ Weights and Organ-Weight-to-Body-Weight Ratios for Rats at the 11-Month Interim Evaluation
in the Lifetime Inhalation Study of Talc^a

	0 mg/m ³	6 mg/m ³	18 mg/m ³
Male			
n	2	3	3
Necropsy body wt	425 ± 10	406 ± 15	395 ± 14
Brain			
Absolute	2.018 ± 0.010	1.616 ± 0.306	2.020 ± 0.012
Relative	4.75 ± 0.13	3.97 ± 0.74	5.13 ± 0.16
Heart			
Absolute	1.161 ± 0.080	1.051 ± 0.063	1.079 ± 0.048
Relative	2.73 ± 0.12	2.58 ± 0.06	2.73 ± 0.09
R. Kidney			
Absolute	1.313 ± 0.008	1.242 ± 0.062	1.216 ± 0.069
Relative	3.09 ± 0.09	3.07 ± 0.26	3.07 ± 0.07
Liver			
Absolute	12.824 ± 0.065	12.454 ± 0.424	12.223 ± 0.618
Relative	30.20 ± 0.86	30.72 ± 1.47	30.92 ± 0.50
Lungs			
Absolute	1.228 ± 0.143	1.152 ± 0.043	1.979 ± 0.077 ^{oo}
Relative	2.90 ± 0.40	2.85 ± 0.18	5.02 ± 0.16 ^{oo}
Female			
n	3	3	3
Necropsy body wt	254 ± 7	249 ± 5	247 ± 10
Brain			
Absolute	1.863 ± 0.003	1.867 ± 0.036	1.845 ± 0.030
Relative	7.36 ± 0.22	7.52 ± 0.18	7.50 ± 0.19
Heart			
Absolute	0.858 ± 0.032	0.796 ± 0.020	0.753 ± 0.063
Relative	3.38 ± 0.06	3.20 ± 0.06	3.05 ± 0.19
R. Kidney			
Absolute	0.830 ± 0.007	0.839 ± 0.002	0.735 ± 0.034 ^o
Relative	3.28 ± 0.11	3.38 ± 0.07	2.99 ± 0.13
Liver			
Absolute	7.878 ± 0.275	7.774 ± 0.130	7.537 ± 0.354
Relative	31.13 ± 1.53	31.30 ± 0.47	30.57 ± 0.50
Lungs			
Absolute	0.959 ± 0.037	1.039 ± 0.034	1.551 ± 0.163 ^{oo}
Relative	3.79 ± 0.20	4.18 ± 0.09	6.27 ± 0.48 ^{oo}

^o Significantly different (P≤0.05) from the control group by Williams' or Dunnett's test

^{oo} P≤0.01

^a Organ weights and body weights are given in grams; organ-weight-to-body-weight ratios are given as mg organ weight/g body weight (mean ± standard error)

TABLE E3
Organ Weights and Organ-Weight-to-Body-Weight Ratios for Rats at the 18-Month Interim Evaluation in the Lifetime Inhalation Study of Talc^a

	0 mg/m ³	6 mg/m ³	18 mg/m ³
Male			
n	3	3	2
Necropsy body wt	446 ± 14	428 ± 10	430 ± 2
Brain			
Absolute	2.019 ± 0.043	1.965 ± 0.035	2.092 ± 0.004
Relative	4.53 ± 0.10	4.60 ± 0.17	4.86 ± 0.01
Heart			
Absolute	1.077 ± 0.065	1.027 ± 0.030	1.131 ± 0.103
Relative	2.41 ± 0.09	2.40 ± 0.07	2.63 ± 0.23
R. Kidney			
Absolute	1.913 ± 0.599	1.328 ± 0.063	1.317 ± 0.023
Relative	4.27 ± 1.31	3.10 ± 0.12	3.06 ± 0.06
Liver			
Absolute	14.329 ± 1.434	13.866 ± 0.882	12.520 ± 0.189
Relative	32.10 ± 3.01	32.38 ± 1.68	29.10 ± 0.56
Lungs			
Absolute	1.691 ± 0.100	1.852 ± 0.058	3.169 ± 0.121**
Relative	3.78 ± 0.13	4.34 ± 0.21	7.36 ± 0.25**
Female			
n	3	3	3
Necropsy body wt	305 ± 5	275 ± 4**	280 ± 4*
Brain			
Absolute	1.840 ± 0.028	1.827 ± 0.045	1.847 ± 0.013
Relative	6.04 ± 0.17	6.63 ± 0.11*	6.61 ± 0.13*
Heart			
Absolute	0.772 ± 0.015	0.706 ± 0.010*	0.765 ± 0.011
Relative	2.53 ± 0.08	2.56 ± 0.03	2.74 ± 0.01*
R. Kidney			
Absolute	0.929 ± 0.023	0.902 ± 0.038	0.955 ± 0.047
Relative	3.05 ± 0.12	3.28 ± 0.17	3.41 ± 0.13
Liver			
Absolute	8.750 ± 0.223	8.540 ± 0.648	8.904 ± 0.596
Relative	28.71 ± 0.35	31.03 ± 2.47	31.84 ± 1.94
Lungs			
Absolute	1.130 ± 0.026	1.395 ± 0.046**	2.600 ± 0.030**
Relative	3.71 ± 0.12	5.07 ± 0.11**	9.31 ± 0.18**

* Significantly different (P≤0.05) from the control group by Williams' or Dunnett's test

** P≤0.01

^a Organ weights and body weights are given in grams; organ-weight-to-body-weight ratios are given as mg organ weight/g body weight (mean ± standard error)

TABLE E4
Organ Weights and Organ-Weight-to-Body-Weight Ratios for Rats at the 24-Month Interim Evaluation in the Lifetime Inhalation Study of Tale^a

	0 mg/m ³	6 mg/m ³	18 mg/m ³
Male			
n	3	6	2
Necropsy body wt	406 ± 29	422 ± 12	392 ± 30
Brain			
Absolute	2.068 ± 0.015	2.023 ± 0.025	1.989 ± 0.008
Relative	5.15 ± 0.42	4.81 ± 0.11	5.10 ± 0.37
Heart			
Absolute	1.065 ± 0.022	1.126 ± 0.044	0.993 ± 0.026
Relative	2.66 ± 0.25	2.69 ± 0.18	2.54 ± 0.13
R. Kidney			
Absolute	1.720 ± 0.138	1.577 ± 0.048	1.649 ± 0.068
Relative	4.25 ± 0.32	3.76 ± 0.19	4.24 ± 0.50
Liver			
Absolute	15.298 ± 0.187	14.924 ± 0.480	14.344 ± 1.253
Relative	38.11 ± 3.23	35.55 ± 1.80	37.05 ± 6.03
Lungs			
Absolute	1.766 ± 0.177	2.150 ± 0.230	2.473 ± 0.674
Relative	4.40 ± 0.55	5.18 ± 0.69	6.48 ± 2.21
Female			
n	5	9	3
Necropsy body wt	296 ± 17	296 ± 10	262 ± 25
Brain			
Absolute	1.821 ± 0.023	1.826 ± 0.011	1.865 ± 0.012
Relative	6.24 ± 0.42	6.24 ± 0.21	7.23 ± 0.63
Heart			
Absolute	0.826 ± 0.014	0.826 ± 0.032	0.824 ± 0.045
Relative	2.83 ± 0.19	2.81 ± 0.10	3.16 ± 0.13
R. Kidney			
Absolute	1.118 ± 0.055	1.137 ± 0.044	1.021 ± 0.022
Relative	3.82 ± 0.26	3.85 ± 0.10	3.97 ± 0.44
Liver			
Absolute	11.218 ± 0.527	12.127 ± 0.672	9.966 ± 0.246
Relative	38.38 ± 2.74	41.16 ± 2.12	38.84 ± 4.59
Lungs			
Absolute	1.014 ± 0.104	1.447 ± 0.219	3.261 ± 0.115 ^{oo}
Relative	3.40 ± 0.23	4.88 ± 0.67	12.73 ± 1.62 ^{oo}

^{oo} Significantly different (P≤0.01) from the control group by Williams' or Dunnett's test

^a Organ weights and body weights are given in grams; organ-weight-to-body-weight ratios are given as mg organ weight/g body weight (mean ± standard error)

TABLE E5
Organ Weights and Organ-Weight-to-Body-Weight Ratios for Rats at the End
of the Lifetime Inhalation Study of Talc^a

	0 mg/m ³	6 mg/m ³	18 mg/m ³
Male			
n	8	12	13
Necropsy body wt	379 ± 17	397 ± 6	326 ± 12**
Brain			
Absolute	2.030 ± 0.016	2.041 ± 0.015	2.014 ± 0.019
Relative	5.45 ± 0.28	5.16 ± 0.09	6.29 ± 0.25*
Heart			
Absolute	1.385 ± 0.104	1.288 ± 0.041	1.302 ± 0.064
Relative	3.68 ± 0.26	3.26 ± 0.13	4.05 ± 0.22
R. Kidney			
Absolute	1.899 ± 0.151	1.847 ± 0.125	1.737 ± 0.101
Relative	5.09 ± 0.49	4.69 ± 0.37	5.39 ± 0.35
Liver			
Absolute	15.501 ± 0.861	16.562 ± 0.540	14.055 ± 0.936
Relative	41.03 ± 1.67	41.92 ± 1.73	42.85 ± 1.76
Lungs			
Absolute	2.154 ± 0.124	2.509 ± 0.068	4.026 ± 0.196**
Relative	5.76 ± 0.38	6.34 ± 0.21	12.65 ± 0.85**
Female			
n	12	13	9
Necropsy body wt	260 ± 14	247 ± 14	231 ± 9
Brain			
Absolute	1.975 ± 0.122	1.860 ± 0.020	1.847 ± 0.028
Relative	8.03 ± 0.95	7.89 ± 0.51	8.06 ± 0.27
Heart			
Absolute	1.020 ± 0.039	1.006 ± 0.026	1.047 ± 0.027
Relative	4.03 ± 0.24	4.33 ± 0.39	4.58 ± 0.20
R. Kidney			
Absolute	1.313 ± 0.047	1.235 ± 0.049	1.281 ± 0.079
Relative	5.21 ± 0.34	5.22 ± 0.36	5.66 ± 0.55
Liver			
Absolute	12.005 ± 0.660	12.567 ± 0.903	12.247 ± 0.678
Relative	46.35 ± 1.68	51.25 ± 2.90	53.65 ± 3.82
Lungs			
Absolute	1.575 ± 0.109	2.673 ± 0.362**	4.050 ± 0.228**
Relative	6.11 ± 0.35	11.77 ± 2.10*	17.83 ± 1.43**

* Significantly different ($P \leq 0.05$) from the control group by Williams' or Dunnett's test

** $P \leq 0.01$

^a Organ weights and body weights are given in grams; organ-weight-to-body-weight ratios are given as mg organ weight/g body weight (mean ± standard error)

TABLE E6
Organ Weights and Organ-Weight-to-Body-Weight Ratios for Mice at the 6-Month Interim Evaluation in the 2-Year Inhalation Study of Talc^a

	0 mg/m ³	6 mg/m ³	18 mg/m ³
Male			
n	4	4	4
Necropsy body wt	31.3 ± 0.9	31.1 ± 0.9	32.1 ± 0.6
Brain			
Absolute	0.431 ± 0.028	0.458 ± 0.006	0.469 ± 0.008
Relative	13.81 ± 0.90	14.74 ± 0.23	14.60 ± 0.38
Heart			
Absolute	0.159 ± 0.003	0.165 ± 0.008	0.157 ± 0.011
Relative	5.10 ± 0.07	5.31 ± 0.33	4.88 ± 0.25
R. Kidney			
Absolute	0.303 ± 0.022	0.297 ± 0.018	0.292 ± 0.011
Relative	9.66 ± 0.40	9.58 ± 0.70	9.10 ± 0.33
Liver			
Absolute	1.737 ± 0.079	1.792 ± 0.066	1.731 ± 0.060
Relative	55.51 ± 1.06	57.75 ± 2.77	53.84 ± 1.19
Lungs			
Absolute	0.165 ± 0.008	0.149 ± 0.010	0.173 ± 0.017
Relative	5.29 ± 0.35	4.78 ± 0.27	5.35 ± 0.44
Female			
n	4	4	4
Necropsy body wt	27.1 ± 0.9	27.2 ± 1.7	29.5 ± 1.4
Brain			
Absolute	0.474 ± 0.007	0.482 ± 0.008	0.474 ± 0.019
Relative	17.52 ± 0.36	17.85 ± 0.81	16.10 ± 0.67
Heart			
Absolute	0.142 ± 0.004	0.133 ± 0.005	0.145 ± 0.006
Relative	5.27 ± 0.30	4.92 ± 0.19	4.92 ± 0.15
R. Kidney			
Absolute	0.201 ± 0.011	0.203 ± 0.004	0.217 ± 0.008
Relative	7.40 ± 0.20	7.53 ± 0.34	7.37 ± 0.13
Liver			
Absolute	1.541 ± 0.099	1.640 ± 0.138	1.628 ± 0.033
Relative	56.86 ± 2.92	60.01 ± 1.74	55.38 ± 1.91
Lungs			
Absolute	0.190 ± 0.019	0.164 ± 0.011	0.178 ± 0.011
Relative	7.11 ± 0.96	6.03 ± 0.28	6.04 ± 0.26

^a Organ weights and body weights are given in grams; organ-weight-to-body-weight ratios are given as mg organ weight/g body weight (mean ± standard error)

TABLE E7
Organ Weights and Organ-Weight-to-Body-Weight Ratios for Mice at the 12-Month Interim Evaluation
in the 2-Year Inhalation Study of Talc^a

	0 mg/m ³	6 mg/m ³	18 mg/m ³
Male			
n	4	4	4
Necropsy body wt	34.6 ± 1.7	37.2 ± 0.3	33.1 ± 1.3
Brain			
Absolute	0.478 ± 0.020	0.475 ± 0.009	0.475 ± 0.009
Relative	13.87 ± 0.31	12.76 ± 0.16	14.39 ± 0.38
Heart			
Absolute	0.196 ± 0.023	0.195 ± 0.005	0.205 ± 0.023
Relative	5.62 ± 0.37	5.23 ± 0.10	6.21 ± 0.69
R. Kidney			
Absolute	0.334 ± 0.007	0.339 ± 0.020	0.311 ± 0.027
Relative	9.71 ± 0.28	9.12 ± 0.52	9.41 ± 0.86
Liver			
Absolute	1.612 ± 0.052	1.886 ± 0.124	1.928 ± 0.240
Relative	46.77 ± 0.79	50.72 ± 3.25	58.55 ± 8.01
Lungs			
Absolute	0.157 ± 0.009	0.216 ± 0.018	0.243 ± 0.032*
Relative	4.54 ± 0.17	5.80 ± 0.46	7.30 ± 0.72**
Female			
n	3	4	4
Necropsy body wt	32.1 ± 2.4	33.3 ± 1.3	28.7 ± 1.2
Brain			
Absolute	0.478 ± 0.006	0.488 ± 0.005	0.491 ± 0.008
Relative	15.04 ± 1.16	14.74 ± 0.70	17.16 ± 0.55
Heart			
Absolute	0.151 ± 0.004	0.162 ± 0.008	0.190 ± 0.010*
Relative	4.72 ± 0.23	4.91 ± 0.42	6.64 ± 0.47*
R. Kidney			
Absolute	0.225 ± 0.010	0.231 ± 0.008	0.230 ± 0.011
Relative	7.03 ± 0.22	6.97 ± 0.40	8.01 ± 0.10
Liver			
Absolute	1.470 ± 0.105	1.796 ± 0.036*	1.477 ± 0.093
Relative	46.04 ± 3.71	54.20 ± 2.55	51.40 ± 2.48
Lungs			
Absolute	0.151 ± 0.019	0.191 ± 0.014	0.207 ± 0.015*
Relative	4.68 ± 0.23	5.78 ± 0.61	7.19 ± 0.24**

* Significantly different ($P \leq 0.05$) from the control group by Williams' or Dunnett's test

** $P \leq 0.01$

^a Organ weights and body weights are given in grams; organ-weight-to-body-weight ratios are given as mg organ weight/g body weight (mean ± standard error)

TABLE ES
Organ Weights and Organ-Weight-to-Body-Weight Ratios for Mice at the 18-Month Interim Evaluation in the 2-Year Inhalation Study of Talc^a

	0 mg/m ³	6 mg/m ³	18 mg/m ³
Male			
n	4	4	4
Necropsy body wt	33.1 ± 3.0	37.5 ± 2.1	35.4 ± 1.7
Brain			
Absolute	0.467 ± 0.007	0.470 ± 0.009	0.496 ± 0.014
Relative	14.51 ± 1.44	12.63 ± 0.58	14.10 ± 0.76
Heart			
Absolute	0.193 ± 0.017	0.186 ± 0.011	0.203 ± 0.006
Relative	6.18 ± 1.29	5.00 ± 0.35	5.77 ± 0.22
R. Kidney			
Absolute	0.342 ± 0.007	0.361 ± 0.021	0.350 ± 0.009
Relative	10.66 ± 1.23	9.66 ± 0.47	9.91 ± 0.22
Liver			
Absolute	1.844 ± 0.228	1.796 ± 0.080	1.748 ± 0.113
Relative	57.08 ± 7.95	48.07 ± 1.26	49.28 ± 1.45
Lungs			
Absolute	0.229 ± 0.034	0.238 ± 0.013	0.345 ± 0.032 ^o
Relative	7.45 ± 2.01	6.42 ± 0.57	9.79 ± 0.91
Female			
n	4	4	4
Necropsy body wt	32.1 ± 1.2	31.9 ± 1.6	27.6 ± 1.0 ^o
Brain			
Absolute	0.483 ± 0.007	0.467 ± 0.019	0.501 ± 0.038
Relative	15.10 ± 0.59	14.73 ± 0.90	18.33 ± 1.91
Heart			
Absolute	0.155 ± 0.008	0.154 ± 0.011	0.164 ± 0.010
Relative	4.85 ± 0.28	4.87 ± 0.47	5.96 ± 0.48
R. Kidney			
Absolute	0.238 ± 0.009	0.233 ± 0.011	0.228 ± 0.007
Relative	7.41 ± 0.28	7.35 ± 0.45	8.32 ± 0.55
Liver			
Absolute	1.446 ± 0.056	1.592 ± 0.034	1.318 ± 0.055 ^b
Relative	45.10 ± 1.35	50.17 ± 2.02	48.69 ± 0.30 ^b
Lungs			
Absolute	0.223 ± 0.008	0.242 ± 0.018	0.299 ± 0.018 ^{oo}
Relative	6.96 ± 0.07	7.65 ± 0.73	10.90 ± 0.87 ^{oo}

^o Significantly different (P≤0.05) from the control group by Williams' or Dunnett's test

^{oo} P≤0.01

^a Organ weights and body weights are given in grams; organ-weight-to-body-weight ratios are given as mg organ weight/g body weight (mean ± standard error)

^b n=3

TABLE E9
Organ Weights and Organ-Weight-to-Body-Weight Ratios for Mice at the End
of 2-Year Inhalation Study of Talc^a

	0 mg/m ³	6 mg/m ³	18 mg/m ³
Male			
n	30	28	32
Necropsy body wt	33.4 ± 0.5	32.1 ± 0.8	31.2 ± 0.4**
Brain			
Absolute	0.461 ± 0.004	0.458 ± 0.004	0.460 ± 0.005
Relative	13.90 ± 0.22	14.50 ± 0.34	14.78 ± 0.19*
Heart			
Absolute	0.183 ± 0.003	0.181 ± 0.004	0.183 ± 0.005
Relative	5.52 ± 0.12	5.68 ± 0.10	5.88 ± 0.15
R. Kidney			
Absolute	0.361 ± 0.010	0.362 ± 0.010	0.354 ± 0.006
Relative	10.85 ± 0.27	11.28 ± 0.16	11.34 ± 0.18
Liver			
Absolute	1.845 ± 0.064	1.733 ± 0.073 ^b	1.535 ± 0.033** ^c
Relative	55.64 ± 2.21	53.14 ± 1.72 ^b	49.27 ± 1.03 ^c
Lungs			
Absolute	0.252 ± 0.008 ^c	0.258 ± 0.009 ^b	0.408 ± 0.011**
Relative	7.47 ± 0.25 ^c	8.01 ± 0.24 ^b	13.08 ± 0.33**
Female			
n	30	23	25
Necropsy body wt	31.4 ± 0.6	31.7 ± 0.7	30.7 ± 0.5
Brain			
Absolute	0.484 ± 0.004	0.469 ± 0.006	0.477 ± 0.003
Relative	15.53 ± 0.26	14.93 ± 0.28	15.59 ± 0.20
Heart			
Absolute	0.164 ± 0.005	0.190 ± 0.009**	0.163 ± 0.003
Relative	5.24 ± 0.15	6.02 ± 0.28**	5.32 ± 0.09
R. Kidney			
Absolute	0.251 ± 0.007 ^d	0.265 ± 0.010	0.257 ± 0.007 ^e
Relative	8.03 ± 0.17 ^d	8.38 ± 0.27	8.37 ± 0.14 ^e
Liver			
Absolute	1.816 ± 0.089	1.770 ± 0.107 ^f	1.761 ± 0.083 ^e
Relative	57.41 ± 2.25	55.45 ± 3.13 ^f	56.94 ± 1.93 ^e
Lungs			
Absolute	0.276 ± 0.014	0.293 ± 0.012	0.410 ± 0.010**
Relative	8.80 ± 0.42	9.28 ± 0.34	13.39 ± 0.28**

* Significantly different ($P \leq 0.05$) from the control group by Williams' or Dunnett's test

** $P \leq 0.01$

^a Organ weights and body weights are given in grams; organ-weight-to-body-weight ratios are given as mg organ weight/g body weight (mean ± standard error)

^b n=27

^c n=28

^d n=29

^e n=24

^f n=22

APPENDIX F

4-WEEK INHALATION STUDIES IN RATS AND MICE

MATERIALS AND METHODS	204
TABLE F1	Experimental Design and Materials and Methods in the 4-Week Inhalation Studies of Talc	206
	208
RESULTS	
TABLE F2	Survival and Mean Body Weights of Rats in the 4-Week Inhalation Study of Talc	209
TABLE F3	Organ Weights and Organ-Weight-to-Body-Weight Ratios of Rats in the 4-Week Inhalation Study of Talc	210
	211
TABLE F4	Lung Talc Burden of Rats in the 4-Week Inhalation Study of Talc	211
TABLE F5	Normalized Lung Talc Burden of Rats in the 4-Week Inhalation Study of Talc	211
TABLE F6	Survival and Mean Body Weights of Mice in the 4-Week Inhalation Study of Talc	212
TABLE F7	Organ Weights and Organ-Weight-to-Body-Weight Ratios of Mice in the 4-Week Inhalation Study of Talc	213
	214
TABLE F8	Lung Talc Burden of Mice in the 4-Week Inhalation Study of Talc	214
TABLE F9	Normalized Lung Talc Burden of Mice in the 4-Week Inhalation Study of Talc	214

MATERIALS AND METHODS

Procurement and Characterization of Talc

Talc was obtained from Walsh and Associates (North Kansas City, MO) in one lot (W101882). Identity and purity analyses were performed by the analytical chemistry laboratory, Midwest Research Institute (Kansas City, MO).

The study chemical, a finely powdered white solid, was identified as talc by infrared spectroscopy, elemental analysis, and microscopic analyses. The moisture content of the bulk chemical was analyzed and was determined to be stable throughout the studies. Bulk chemical studies were not conducted due to the physical and chemical properties of talc. The compound was stored in sealed Nalgene containers.

Generation and Monitoring of Chamber Concentrations

Talc aerosols were generated in a fluidized bed generator by injecting filtered air into the bed. Samples were collected continuously during the 6-hour exposure day on glass fiber filters. Only one sampling port position was used each day to collect the samples from each chamber. Once a week, samples were collected on Zefluor filters so that the magnesium content of aerosolized talc could be determined and be compared to the magnesium content of bulk talc. Cascade impactor samples were collected 3 to 6 times a week to determine aerosol particle size. The amount of talc collected on the filters and impactor stages was quantitated gravimetrically. The extent of carry-over of the stainless steel material from the fluidized bed generator was quantitated by measuring the amount of acid-soluble nickel and chromium in filter samples taken from the exposure atmosphere twice during the studies.

Study Design

Groups of 10 male and 10 female F344/N rats and B6C3F₁ mice were exposed by inhalation to talc at target concentrations of 0, 2, 6, and 18 mg/m³. Rats and mice were exposed for 6 hours daily, 5 days a week, for 4 weeks.

Source and Specification of Animals

Male and female F344/N rats were obtained from Lovelace Inhalation Toxicology Research Institute (Albuquerque, NM). Male and female B6C3F₁ mice were obtained from Simonsen Laboratory (Gilroy, CA). Rats and mice were held 3 weeks before the studies began, and were 6 to 7 weeks old when the studies began. Animal health was monitored by serologic analyses during the studies under the protocols of the NTP Sentinel Animal Program.

Animal Maintenance

Rats and mice were housed individually throughout the studies. Drinking water was available *ad libitum*. Further details of animal maintenance are given in Table F1.

Clinical Examinations and Pathology

All rats and mice were observed twice daily. Clinical observations and body weights were recorded at the beginning of the studies, each week, and at the end of the studies. Organ weights were recorded for the heart, right kidney, liver, and lung at the end of the studies.

A necropsy was performed on all animals. During necropsy, all organs and tissues were examined for grossly visible lesions. A complete histopathologic examination was performed on all 18 mg/m³ and control animals. Tissues for microscopic examination were fixed in 10% neutral buffered formalin, embedded in paraffin, sectioned to a thickness of 5 μm, and stained with hematoxylin and eosin.

Lung Burden Analysis

Groups of five male and five female rats and mice were analyzed for lung talc burden. Lungs were homogenized using water and the proteins were precipitated with 70% perchloric acid. The individual

samples were filtered and washed with 5% trichloroacetic acid (TCA) to remove perchlorates. Washing continued until magnesium levels in the wash were within 10% of levels in the TCA solution (≤ 0.03 ppm magnesium). Filters and tissue residues were placed in 15-mL porcelain crucibles, dried slowly (200° C), and then ashed at 600° C for 1 hour. Ashed samples were transferred to Teflon beakers using 2 mL HCl and evaporated to dryness. Samples were then digested in hydrofluoric acid (HF), and the HF evaporated. Additional HF was added and reevaporated. Sulfuric acid was added to remove trace HF, and samples were then diluted with distilled water and analyzed for magnesium by atomic absorbance (Perkin Elmer, Model 307, Atomic Absorption Spectrophotometer) with a magnesium hollow cathode lamp and an air acetylene flame (Hanson *et al.*, 1985).

TABLE F1
Experimental Design and Materials and Methods in the 4-Week Inhalation Studies of Talc

Study Laboratory

Lovelace Inhalation Toxicology Research Institute (Albuquerque, NM)

Strain and Species

Rats: F344/N rats

Mice: B6C3F₁ mice

Animal Source

Rats: Lovelace Inhalation Toxicology Research Institute (Albuquerque, NM)

Mice: Simonsen Laboratory (Gilroy, CA)

Time Held Before Studies

3 weeks

Average Age When Placed on Studies

6-7 weeks

Date of First Exposure

Rats: 20 April 1983

Mice: 16 June 1983

Duration of Exposure

6 hours/day, 5 days/week for 4 weeks

Date of Last Exposure

Rats: 18 May 1983

Mice: 13 July 1983

Average Age When Killed

10 to 11 weeks

Method of Sacrifice

Intraperitoneal injection of T-61 solution

Necropsy Dates

Rats: 19-20 May 1983

Mice: 14-15 July 1983

Size of Study Groups

10 males and 10 females

Method of Animal Distribution

Randomized by weight

Animals per Cage

1

Method of Animal Identification

Ear tag and toe clip

Diet

NIH-07 Rat and Mouse Ration (Zeigler, Bros., Gardner, PA) available *ad libitum* during non-exposure periods

Maximum Storage Time for Feed

90 days

TABLE F1
Experimental Design and Materials and Methods in the 4-Week Inhalation Studies of Talc (continued)

Water

Automatic Watering System (Edstrom Industries, Waterford, WI), available *ad libitum*

Cages

Stainless steel mesh cages (Hazleton, Aberdeen, MD), changed weekly

Chambers

Stainless steel multitiered whole-body exposure chambers (H2000 and H1000, Hazleton Systems, Aberdeen, MD) washed weekly

Excreta Pan

Techboard untreated paper (Shepherd Specialties Paper, Inc., Kalamazoo, MI), changed twice a day

Filters

Room Air and Chamber Air High Efficiency Particulate Air (HEPA) Filter, MIL Spec MIL-F-51068C (Flanders, Washington, DC), changed as required

Animal Room Environment**Rats**

Average temperature: 23° C

Relative humidity: 40.3%

Fluorescent light: 12 hours/day

Room air changes: minimum of 10 changes/hour

Mice

Average temperature: 24° C

Relative humidity: 42%

Fluorescent light: 12 hours/day

Room air changes: minimum of 10 changes/hour

Exposure Concentrations

0, 2, 6, and 18 mg/m³ by inhalation

Type and Frequency of Observation

Observed twice daily; body weights and clinical findings recorded at study initiation and weekly thereafter

Necropsy

Necropsy was performed on all animals. Organ weights recorded for heart, right kidney, liver, and lung

Histopathology

Complete histopathologic examinations performed on all 18 mg/m³ and control animals. In addition to tissue masses, gross lesions, and associated lymph nodes, tissues examined included: larynx, lung, nasal turbinates, trachea, and tracheobronchial lymph nodes.

Lung Talc Burden

Groups of 5 male and 5 female rats and mice were evaluated for lung talc burden.

RESULTS

Rats

All rats survived to the end of the study and there were no clinical findings related to talc exposure. The final mean body weights of exposed male and female rats were similar to the controls (Table F2).

There were no significant increases in any organ-weight-to-body-weight ratios in male or female rats (Table F3). The talc lung burdens increased with talc exposure level (Table F4); however, the ratio of lung burden to exposure concentration was somewhat higher at the 6 and 18 mg/m³ exposure levels (Table F5). The increase in talc lung burden with exposure concentration may have been because the maximum ability of the respiratory tract to clear particles was exceeded at the 6 and 18 mg/m³ exposure levels.

There was a minimal increase in the number of intra-alveolar macrophages in the lung of male and female rats exposed to 18 mg/m³. The lesion was diffuse in nature and in no instance were clusters of greater than three alveolar macrophages observed. The individual macrophages were slightly larger than normal and had cytoplasm which contained fine eosinophilic granules.

Mice

One male mouse exposed to 2 mg/m³ and one male mouse exposed to 6 mg/m³ died before the end of the study. The final mean body weights of exposed male and female mice were similar to those of the controls (Table F6). There were no clinical findings associated with exposure to talc aerosols.

There were no significant changes in any organ-weight-to-body-weight ratios in exposed male or female mice (Table F7). Talc lung burdens increased with talc exposure level (Table F8). However, the ratio of lung burden to exposure concentration was constant at all exposure levels (Table F9). In contrast to rats, the maximum ability of the respiratory tract to clear particles was apparently not exceeded at the 18 mg/m³ level.

The only lesions related to inhalation of talc aerosols were observed in the lung of male and female mice exposed to 18 mg/m³. The changes were minimal and consisted of a diffuse increase in the number of intra-alveolar macrophages. In most cases, pulmonary macrophages did not exceed two per alveolus, but occasional clusters of up to 10 alveolar macrophages were observed. The individual macrophages were two to three times normal size with foamy granular cytoplasm.

TABLE F2
Survival and Mean Body Weights of Rats in the 4-Week Inhalation Study of Talc

Dose (mg/m ³)	Survival ^a	Mean Body Weight ^b (g)			Final Weight Relative to Controls (%)
		Initial	Final	Change	
Male					
0	5/5	144 ± 5	221 ± 5	78 ± 3	
2	5/5	144 ± 5	233 ± 9	89 ± 12	105
6	5/5	150 ± 8	223 ± 9	73 ± 2	101
18	5/5	145 ± 4	213 ± 4	6 ± 11	96
Female					
0	5/5	110 ± 2	151 ± 2	41 ± 2	
2	5/5	109 ± 2	151 ± 5	42 ± 6	100
6	5/5	110 ± 2	150 ± 6	40 ± 6	100
18	5/5	110 ± 2	150 ± 2	40 ± 2	100

^a Number of animals surviving/number initially in group

^b Weights and weight changes are given as mean ± standard error. Subsequent calculations are based on animals surviving to the end of the studies.

TABLE F3
Organ Weights and Organ-Weight-to-Body-Weight Ratios for Rats in the 4-Week Inhalation Study of Talc^a

	0 mg/m ³	2 mg/m ³	6 mg/m ³	18 mg/m ³
Male				
n	5	5	5	5
Necropsy body wt	219 ± 5	226 ± 9	218 ± 9	212 ± 10
Heart				
Absolute	0.796 ± 0.020	0.828 ± 0.020	0.828 ± 0.020	0.826 ± 0.070
Relative	3.64 ± 0.07	3.67 ± 0.09	3.82 ± 0.19	3.89 ± 0.21
R. Kidney				
Absolute	0.882 ± 0.047	0.856 ± 0.040	0.856 ± 0.040	0.898 ± 0.035
Relative	4.02 ± 0.14	3.82 ± 0.30	3.93 ± 0.09	4.25 ± 0.09
Liver				
Absolute	8.640 ± 0.383	8.952 ± 0.614	8.952 ± 0.614	9.076 ± 0.520
Relative	39.42 ± 1.10	39.90 ± 3.59	40.96 ± 1.71	42.82 ± 0.59
Lungs				
Absolute	0.990 ± 0.025	1.058 ± 0.039	1.050 ± 0.040	0.994 ± 0.042
Relative	4.53 ± 0.13	4.68 ± 0.06	4.83 ± 0.18	4.70 ± 0.07
Female				
n	5	5	5	5
Necropsy body wt	148 ± 1	144 ± 5	146 ± 5	150 ± 1
Heart				
Absolute	0.600 ± 0.019	0.632 ± 0.023	0.630 ± 0.023	0.632 ± 0.022
Relative	4.05 ± 0.11	4.40 ± 0.15	4.31 ± 0.06	4.23 ± 0.17
R. Kidney				
Absolute	0.628 ± 0.014	0.638 ± 0.025	0.638 ± 0.025	0.630 ± 0.025
Relative	4.24 ± 0.06	4.43 ± 0.10	4.37 ± 0.15	4.21 ± 0.17
Liver				
Absolute	5.950 ± 0.286	5.766 ± 0.262	5.766 ± 0.262	6.156 ± 0.269
Relative	40.17 ± 1.63	40.26 ± 2.46	39.43 ± 1.21	41.20 ± 1.94
Lungs				
Absolute	0.846 ± 0.032	0.820 ± 0.035	0.822 ± 0.040	0.866 ± 0.035
Relative	5.72 ± 0.20	5.69 ± 0.06	5.62 ± 0.17	5.79 ± 0.23

^a Organ weights and body weights are given in grams; organ-weight-to-body-weight ratios are given as mg organ weight/g body weight (mean ± standard error)

TABLE F4
Lung Talc Burden of Rats in the 4-Week Inhalation Study of Talc^a

	0 mg/m ³	2 mg/m ³	6 mg/m ³	18 mg/m ³
Male				
n	5	5	5	5
μg talc	4.28 ± 1.63	81.60 ± 2.06 ^{oo}	186.00 ± 9.27 ^{oo}	846.00 ± 45.45 ^{oo}
μg talc/g lung	4.50 ± 1.86	78.80 ± 2.75 ^{oo}	190.00 ± 7.75 ^{oo}	842.00 ± 69.96 ^{oo}
Female				
n	5	4	5	5
μg talc	0.58 ± 0.24	56.50 ± 1.56 ^o	127.20 ± 9.27 ^{oo}	546.00 ± 35.16 ^{oo}
μg talc/g lung	0.66 ± 0.27	76.00 ± 3.24 ^o	185.00 ± 10.41 ^{oo} ^b	770.00 ± 51.28 ^{oo}

^o Significantly different (P≤0.05) from the control group by Dunn's or Shirley's test

^{oo} P≤0.01

^a Mean ± standard error

^b n=4

TABLE F5
Lung Talc Burden (Normalized to Exposure Concentration) of Rats
in the 4-Week Inhalation Study of Talc^a

	0 mg/m ³	2 mg/m ³	6 mg/m ³	18 mg/m ³
Male				
n	5	5	5	5
	^b	34.25 ± 1.21 ^{oo}	44.22 ± 1.80 ^{oo}	49.52 ± 4.12 ^{oo}
Female				
n	5	4	4	5
	-	33.05 ± 1.40 ^{oo}	43.03 ± 2.41 ^{oo}	45.30 ± 3.01 ^{oo}

^{oo} Significantly different (P≤0.01) from the control group by Dunn's or Shirley's test

^a Mean ± standard error; units are presented as μg talc/g control lung per mg/m³.

^b Values of magnesium in sample pools of 2 to 3 control lungs were less than the limit of detectability (0.1 ppm). Therefore no equivalent of measurement of talc was calculated to be present in control lungs.

TABLE F6
Survival and Mean Body Weights of Mice in the 4-Week Inhalation Study of Talc

Dose (mg/m ³)	Survival ^a	Mean Body Weight ^b (g)			Final Weight Relative to Controls (%)
		Initial	Final	Change	
Male					
0	5/5	25.8 ± 0.1	28.1 ± 0.2	2.3 ± 0.2	
2	4/5	25.8 ± 0.2	27.5 ± 0.4	1.9 ± 0.4	98
6	4/5	25.8 ± 0.2	27.3 ± 0.3	1.5 ± 0.4	97
18	5/5	25.8 ± 0.2	27.0 ± 0.7	1.2 ± 0.6	96
Female					
0	5/5	20.6 ± 0.2	22.7 ± 1.1	2.1 ± 1.2	
2	5/5	20.6 ± 0.2	22.6 ± 0.9	2.0 ± 0.9	99
6	5/5	20.7 ± 0.2	23.6 ± 0.8	2.9 ± 0.8	104
18	5/5	20.6 ± 0.2	22.7 ± 0.7	2.1 ± 0.8	100

^a Number of animals surviving/number initially in group

^b Weights and weight changes are given as mean ± standard error. Subsequent calculations are based on animals surviving to the end of the studies.

TABLE F7
Organ Weights and Organ-Weight-to-Body-Weight Ratios for Mice in the 4-Week Inhalation Study of Talc^a

	0 mg/m ³	2 mg/m ³	6 mg/m ³	18 mg/m ³
Male				
n	5	4	4	5
Necropsy body wt	28.8 ± 0.3	24.8 ± 0.6 ^{oo}	26.8 ± 0.5 ^{oo}	25.3 ± 0.1 ^{oo}
Heart				
Absolute	0.194 ± 0.015	0.198 ± 0.021	0.235 ± 0.018	0.218 ± 0.010
Relative	6.73 ± 0.47	7.97 ± 0.87	8.78 ± 0.62	8.62 ± 0.36
R. Kidney				
Absolute	0.278 ± 0.007	0.245 ± 0.012	0.263 ± 0.009	0.242 ± 0.009 ^a
Relative	9.66 ± 0.26	9.86 ± 0.33	9.81 ± 0.28	9.57 ± 0.34
Liver				
Absolute	1.868 ± 0.051	1.383 ± 0.079 ^{oo}	1.673 ± 0.045	1.678 ± 0.050
Relative	64.89 ± 1.53	55.59 ± 2.23 ^{oo}	62.49 ± 0.70	66.36 ± 1.77
Lungs				
Absolute	0.254 ± 0.007	0.230 ± 0.007	0.288 ± 0.038	0.228 ± 0.007
Relative	8.83 ± 0.29	9.26 ± 0.12	10.72 ± 1.31	9.02 ± 0.28
Female				
n	5	5	5	5
Necropsy body wt	23.1 ± 0.3	20.9 ± 0.7 ^a	22.3 ± 0.4	22.7 ± 0.3
Heart				
Absolute	0.168 ± 0.014	0.162 ± 0.016	0.180 ± 0.011	0.152 ± 0.015
Relative	7.26 ± 0.54	7.78 ± 0.82	8.05 ± 0.44	6.67 ± 0.61
R. Kidney				
Absolute	0.192 ± 0.004	0.174 ± 0.005 ^{oo}	0.188 ± 0.002	0.198 ± 0.002
Relative	8.31 ± 0.23	8.33 ± 0.14	8.44 ± 0.20	8.71 ± 0.10
Liver				
Absolute	1.458 ± 0.057	1.208 ± 0.025 ^{oo}	1.374 ± 0.029	1.458 ± 0.029
Relative	63.02 ± 2.02	57.88 ± 1.14 ^a	61.56 ± 0.62	64.12 ± 1.07
Lungs				
Absolute	0.218 ± 0.005	0.215 ± 0.009 ^b	0.234 ± 0.005	0.220 ± 0.005
Relative	9.43 ± 0.16	10.47 ± 0.12 ^{oo} ^b	10.49 ± 0.23 ^{oo}	9.67 ± 0.17

^o Significantly different ($P \leq 0.05$) from the control group by Williams' or Dunnett's test

^{oo} $P \leq 0.01$

^a Organ weights and body weights are given in grams; organ-weight-to-body-weight ratios are given as mg organ weight/g body weight (mean ± standard error)

^b n=4

TABLE F8
Lung Talc Burden of Mice in the 4-Week Inhalation Study of Talc^a

	0 mg/m ³	2 mg/m ³	6 mg/m ³	18 mg/m ³
Male				
n	5	5	5	5
μg talc	— ^b	19.60 ± 1.29	50.20 ± 2.84	197.00 ± 5.75
μg talc/g lung	—	128.0 ± 9.7	322.0 ± 19.6	1,138.0 ± 10.7
Female				
n	5	5	5	5
μg talc	—	15.40 ± 1.21	49.80 ± 1.66	180.60 ± 6.61
μg talc/g lung	—	101.6 ± 8.4	328.0 ± 13.6	1,162.0 ± 66.4

^a Mean ± standard error

^b Values of magnesium in sample pools of 2 to 3 control lungs were less than the limit of detectability (0.1 ppm). Therefore no equivalent of measurement of talc was calculated to be present in control lungs.

TABLE F9
Lung Talc Burden (Normalized to Exposure Concentration) of Mice in the 4-Week Inhalation Study of Talc^a

	0 mg/m ³	2 mg/m ³	6 mg/m ³	18 mg/m ³
Male				
n	5	5	5	5
μg talc/g control lung per mg/m ³	— ^b	58.170 ± 4.405	56.480 ± 3.443	55.240 ± 0.512
Female				
n	5	5	5	5
μg talc/g control lung per mg/m ³	—	46.180 ± 3.820	57.540 ± 2.372	56.400 ± 3.223

^a Mean ± standard error; units are presented as μg talc/g control lung per mg/m³.

^b Values of magnesium in sample pools of 2 to 3 control lungs were less than the limit of detectability (0.1 ppm). Therefore no equivalent of measurement of talc was calculated to be present in control lungs.

APPENDIX G

LUNG BURDEN, PULMONARY FUNCTION, AND LUNG BIOCHEMISTRY IN RATS

METHODS	216
TABLE G1 Number of Rats Evaluated for Lung Talc Burden, Pulmonary Function, and Lung Biochemistry	220
TABLE G2 Lung Talc Burden (Normalized to Control Lung Weight) of Rats	221
TABLE G3 Lung Talc Burden (Normalized to Exposure Concentration) of Rats	221
TABLE G4 Bronchoalveolar Lavage Fluid Enzymes of Rats at the 24-Month Interim Evaluation	222
TABLE G5 Bronchoalveolar Lavage Fluid Cell Populations of Rats at the 24-Month Interim Evaluation	222
TABLE G6 Viability and Phagocytic Activity of Macrophages in Bronchoalveolar Fluid of Rats at the 24-Month Interim Evaluation	223
TABLE G7 Lung Collagen Metabolism and Protein Synthesis in Rats at the 24-Month Interim Evaluation	223
TABLE G8 Proteinase Activity in Lavage Fluid and Lung Homogenate Supernatant Fluid of Rats at the 24-Month Interim Evaluation	224
TABLE G9 Respiratory Frequency of Rats	225
TABLE G10 Total Lung Capacity of Rats	225
TABLE G11 Total Lung Capacity/Kilogram Body Weight of Rats	226
TABLE G12 Tidal Volume of Rats	226
TABLE G13 Minute Volume of Rats	227
TABLE G14 Minute Volume/Kilogram Body Weight of Rats	227
TABLE G15 Residual Volume of Rats	228
TABLE G16 Residual Volume/Total Lung Capacity of Rats	228
TABLE G17 Vital Capacity of Rats	229
TABLE G18 Vital Capacity/Total Lung Capacity of Rats	229
TABLE G19 Forced Vital Capacity of Rats	230
TABLE G20 Forced Vital Capacity/Kilogram Body Weight of Rats	230
TABLE G21 Functional Residual Capacity of Rats	231
TABLE G22 Functional Residual Capacity/Total Lung Capacity of Rats	231
TABLE G23 Total Pulmonary Resistance of Rats	232
TABLE G24 Maximum Quasistatic Compliance of Rats	232
TABLE G25 Quasistatic Chord Compliance of Rats	233
TABLE G26 Dynamic Compliance of Rats	233
TABLE G27 Peak Expiratory Flow of Rats	234
TABLE G28 Peak Expiratory Flow/Forced Vital Capacity of Rats	234
TABLE G29 Expiratory Flow 10% Forced Vital Capacity of Rats	235
TABLE G30 Expiratory Flow 10% Forced Vital Capacity/Forced Vital Capacity of Rats	235
TABLE G31 Expiratory Flow 25% Forced Vital Capacity of Rats	236
TABLE G32 Expiratory Flow 25% Forced Vital Capacity/Forced Vital Capacity of Rats	236
TABLE G33 Expiratory Flow 50% Forced Vital Capacity of Rats	237
TABLE G34 Expiratory Flow 50% Forced Vital Capacity/Forced Vital Capacity of Rats	237
TABLE G35 Mean Midexpiratory Flow of Rats	238
TABLE G36 Mean Midexpiratory Flow/Forced Vital Capacity of Rats	238
TABLE G37 Carbon Monoxide Diffusing Capacity of Rats	239
TABLE G38 Carbon Monoxide Diffusing Capacity/Lung Volume of Rats	239
TABLE G39 Carbon Monoxide Diffusing Capacity/Kilogram Body Weight of Rats	240
TABLE G40 Percent Forced Vital Capacity Expired in 0.1 Second of Rats	240
TABLE G41 Slope III of N ₂ Washout of Rats	241

METHODS

Lung Burden

Lung talc burden was measured to determine the relationship between the exposure concentration and the amount of talc deposited and retained within the pulmonary region of the respiratory tract. The method used for analyzing for talc in lungs has been published (Hanson *et al.*, 1985). Lung burdens were determined on three male and three female rats from each exposure group sacrificed at 6, 10, 18, and 24 months after the start of exposure. The analysis was based on determination of acid-insoluble magnesium in the lung. Midwest Research Institute reported that the value for the magnesium was 19.33% for batch 02 and 19.47% for batch 03. These values and the results of the analysis at Lovelace Inhalation Toxicology Research Institute were close to the theoretical value of magnesium for talc (19.22%). Since rats sacrificed at 27, 47, and 79 weeks had been exposed to only batch 02 of talc, 19.33% magnesium was used to calculate the quantity of talc for these rats. Because batch 03 was used for the last 4 months of exposure and lung burdens of rats after 105 weeks of exposure to talc would be expected to contain substantial amounts of batch 03 talc, 19.47% magnesium was used to calculate the quantity of talc deposited in the lungs of these rats.

All operations in conjunction with tissue analysis for talc were done while wearing talc-free gloves. Left lung lobes were weighed at necropsy and stored frozen (-20° C) until used. Lungs were homogenized using water and the proteins were precipitated with 70% perchloric acid. The individual samples were filtered and washed with 5% trichloroacetic acid (TCA) to remove perchlorates. Washing continued until magnesium levels in the wash were within 10% of levels in the TCA solution (≤ 0.03 ppm magnesium). Filters and tissue residues were placed in 15 mL porcelain crucibles, dried slowly (200° C), and then ashed at 600° C for 1 hour. Ashed samples were transferred to Teflon beakers using 2 mL HCl and evaporated to dryness. Samples were then digested in hydrofluoric acid (HF), and the HF evaporated. Additional HF was added and reevaporated. Sulfuric acid was added to remove trace HF, and samples were then diluted with distilled water and analyzed for magnesium by atomic absorbance (Perkin Elmer, Model 306, Atomic Absorption Spectrophotometer) with a magnesium hollow cathode lamp and an air acetylene flame (Hanson *et al.*, 1985).

Pulmonary Function

Groups of 10 male and 10 female rats from each exposure group were assigned for respiratory function analyses. Respiratory function was measured at 6 months, 10 months, and 18 months. At 24 months of exposure, respiratory function was performed on all surviving rats not assigned to the lifetime study. Respiratory function was measured by noninvasive techniques, using methods previously published (Harkema *et al.*, 1982).

Tests were conducted using a 1.4 L combination flow and pressure plethysmograph. Flows were measured by measuring differential pressures across a wire screen pneumotachograph in the plethysmograph wall. Volumes were obtained by integration (Model 6, Pulmonary Mechanics Analyzer, Buxco Electronics, Sharon, CT). In the pressure mode, used only for measuring functional residual capacity, the pneumotachograph hole was sealed and volume changes were measured as pressure changes. The plethysmograph was maintained at approximately 37° C by a resistance element. Transpulmonary pressure was measured using transducers connected to the external airway and a liquid-filled, 2.2 mm O.D. esophageal catheter.

A positive-negative pressure respirator system was used to induce quasistatic and forced respiratory movements. Reservoirs maintained at +40 and -50 cm H₂O were connected to the airway by solenoid valves. Inspiratory and quasistatic expiratory flow rates were limited by calibrated needle valves to 5 and 3 mL/sec, respectively. Inspirations were stopped automatically at a transpulmonary pressure of 30 cm H₂O, defining the lung volume at that distending pressure as total lung capacity. Forced inhalations were induced from total lung capacity by opening the airway to the negative pressure

reservoir via a rapidly opening valve having a 9.5 mm I.D., with no intentional flow restriction between the valve and the reservoir.

The rats were anesthetized with halothane and intubated orally with a tracheal catheter 5.5 cm long \times 1.8 mm I.D., fabricated from a 14-gauge intravenous catheter as previously described (Mauderly, 1977). The breathing port in the plethysmograph wall was a Luer fitting drilled to 2.5 mm I.D. The frequency response of the plethysmograph-respirator-tracheal catheter system has been tested and found adequate for forced expiratory events in rats. No phase lag among flow, pressure, and volume signals has been found in the frequency range of spontaneous breathing.

Rats were anesthetized, intubated and placed prone in the plethysmograph. The esophageal catheter was adjusted to maximize the recorded transpulmonary pressure signal. Anesthetic depth was adjusted to yield a respiratory frequency of 50 to 60 per minute. Respiratory frequency, tidal volume, minute volume, dynamic lung compliance, and total pulmonary resistance were recorded during spontaneous respiration, time-averaged by a data logger and displayed on a teletype terminal.

Prior to each subsequent measurement procedure, the rat's lung was manually inflated with a syringe to induce apnea. A quasistatic deflation from total lung capacity to residual volume allowed measurement of vital capacity and the quasistatic expiratory pressure-volume curve. Quasistatic lung chord compliance was measured as the slope of the curve over the chord between the apneic lung volume and the volume at +10 cm H₂O pressure. Maximum quasistatic compliance was measured as the steepest slope of the pressure-volume curve over any 2 cm H₂O pressure interval. Functional residual capacity was measured by the barometric method (Dubois *et al.*, 1956) from recordings of lung volume and airway pressure changes as the rat resumed breathing against a blocked airway. From these measurements, all subdivisions of lung volume, including residual volume, were calculated.

Alveolar-capillary gas exchange was evaluated by a single-breath, CO diffusing capacity test (Ogilvie *et al.*, 1957). The lungs were inflated with a gas mixture containing CO and Ne in air to 20 cm H₂O transpulmonary pressure. After 6 seconds, one-half of the gas was withdrawn and the remaining gas collected for analysis by gas chromatography. The lung volume when inflated with the mixture was measured by neon dilution.

A forced inhalation was performed as described above, and the maneuver analyzed by a microprocessor in the data logger (Model D-12, Buxco). Data included forced vital capacity (FVC), the percentage of FVC exhaled in 0.1 second, flow rates at peak flow, and at 50%, 25%, and 10% of FVC.

A single-breath nitrogen washout was performed by recording volume and nitrogen concentration of expirate during a slow deflation after an inflation to total lung capacity with oxygen. The slope of phase III ("alveolar plateau") of the washout curve was calculated to assess the uniformity of intrapulmonary gas distribution.

Lung Biochemistry

All surviving rats from each exposure group (the 3 males and 3 females originally assigned for lung burden/histology and the 10 males and 10 females from physiology/biochemistry) were sacrificed after 105 weeks of exposure.

The rats were anesthetized with halothane and sacrificed by exsanguination from the abdominal aorta or renal artery. The heart and lung block was removed, the right apical, right cardiac, and right intermediate portions of each rat lung were given endobronchial saline lavage (6 mL total volume in three, 2.0 mL washes of saline), and the bronchoalveolar lavage (BAL) fluid was centrifuged at $300 \times G$ to separate the cells from the supernatant fluid.

Airway Fluid Enzymes and Cytology Measurements

In this study, BAL fluid was analyzed to determine the degree of:

- 1) Cell injury as indicated by concentration of lactate dehydrogenase (LDH).
- 2) Chronic inflammatory response as indicated by presence of increased numbers of polymorphonuclear leukocytes (PMN) and pulmonary alveolar macrophages (AM) as well as increased protein and alkaline phosphatase activity.
- 3) Lysosomal activation as indicated by β -glucuronidase and acid proteinase activity. Elevated enzyme activities have been observed in BAL fluid from rodents exposed to particles. These enzymes may be associated with the breakdown of necrotic tissues.
- 4) Response to oxidant injury as indicated by increased glutathione reductase activity.

The supernatant fluid was analyzed by spectrophotometric, kinetic, and enzymatic analyses for the activities of β -glucuronidase, LDH, glucose-6-phosphate dehydrogenase, alkaline phosphatase, glutathione reductase, and glutathione peroxidase. Acid proteinase was measured by the release of radiolabeled globin peptides from the trichloroacetic acid-precipitable protein substrate, and total protein was analyzed colorimetrically (Henderson *et al.*, 1985).

Numbers of total nucleated cells recovered in lavage fluid were determined using a cell counter (Coulter Electronic, Hialeah, FL) or a hemocytometer. Cytocentrifuge preparations of resuspended cells were made, stained with Wright's stain (Diff-Quick, Curtin Matheson Scientific, Denver, CO) and the differential cell count determined.

Alveolar macrophages (AM) were recovered from BAL fluid of the same rats as described above. The cells (1×10^6) were suspended in Roswell Park Memorial Institute (RPMI) 1640 culture medium and pelleted by centrifugation and the supernatant removed. Cells were resuspended in 1 mL of a 1% suspension of IgG antibody-sensitized sheep red blood cells (SRBC) in RPMI 1640. The antibody-sensitized SRBC were made as previously described (Harmsen and Jeska, 1980). The subagglutinating titer of heat-inactivated rabbit anti-SRBC serum was used to sensitize the SRBC. The AM and SRBC suspensions were incubated at 37° C for 1 hour in a humidified atmosphere of 5% CO₂ in air. The AM and SRBC were sedimented by centrifugation and the supernatant discarded. Unphagocytized SRBC were removed by lysing the red blood cells with water for 30 seconds. Lysing of unphagocytized SRBC was stopped by the addition of an equal volume of saline and cytocentrifuge preparations were made. The slides were stained with Wright's stain (Diff-Quik, American Scientific Products, McGaw Park, IL) and the percent of AM phagocytizing SRBC was determined by light microscopy. Three fields of 100 cells per preparation were counted. Viability was determined by trypan blue exclusion.

Lung Tissue Collagen and Proteinase

In this study, rats sacrificed at 105 weeks of talc exposure were used for collagen metabolism, protein synthesis, and proteinase activity measurements. Tissue and BAL fluid from single rats were used for analyses.

To estimate collagen and protein synthesis, ¹⁴C-proline (0.1 μ Ci/g body weight) was injected intraperitoneally approximately 2 to 3 hours prior to sacrifice. Lung lobes to be analyzed for collagen were frozen in liquid nitrogen and pulverized. The pulverized lungs were extracted overnight in 0.5 M acetic acid at 4° C, and centrifuged to separate the insoluble material from the supernatant fluid. The supernatant fluid was separated into high and low molecular weight fractions using Amicon Cones with a size cutoff of approximately 50 kDa.

All samples for collagen analyses from lung and lavage supernatant fluid were hydrolyzed for approximately 18 hours in 6N HCl at 110° C to convert proteins to their individual amino acids, were evaporated to dryness to remove the HCl, and were resuspended in 0.001 N HCl prior to analysis.

Collagen quantity was measured and multiplied by 7.46 to convert BAL or lung tissue hydroxyproline content to BAL or lung tissue collagen content, taking into account that collagen is approximately 13% hydroxyproline by weight (Neuman and Logan, 1950).

Radioactive proline and hydroxyproline were quantitated in the low molecular weight supernatant fluid fraction and in a sample containing both the high molecular weight supernatant fluid fraction and the acetic acid insoluble fraction. Following this, the radioactive proline and hydroxyproline quantities were used to calculate the noncollagenous protein synthesis, the collagen production, and the intracellular collagen degradation.

Noncollagenous protein synthesis was measured as the total radioactive proline incorporation into lung tissue minus the incorporation into lung tissue which was related to collagen synthesis. The radioactive proline in collagen was assumed to be equal to the radioactive hydroxyproline, thus, incorporation into collagen was calculated as twice the radioactive hydroxyproline. Collagen production (% of newly synthesized protein that was collagen) was calculated as the percentage of the total incorporation of proline into all proteins constituted by collagen, and adjusted for the 5.4-fold difference in the content of total amino acids (proline and hydroxyproline) between collagen and noncollagenous protein (Pickrell *et al.*, 1987). Intracellular collagen degradation (as a percent of newly synthesized collagen) was calculated as the percentage of total radioactive hydroxyproline in collagen constituted by low molecular weight radioactive hydroxyproline-containing peptides.

Lung tissue proteinase activity was measured as the release of ^{14}C -leucine from prelabeled globin at pH 4.2 and 7.5 (Gregory and Pickrell, 1982; Harkema *et al.*, 1984; Pickrell *et al.*, 1987). Acid proteinase activity was inhibited by leupeptin to indicate either neutrophil and macrophage cathepsin B (inhibited) or macrophage cathepsin D (not inhibited)-like activity. Neutral proteinase activity was inhibited by 1,10-phenanthroline to indicate either macrophage elastase (inhibited) or neutrophil elastase-cathepsin G (not inhibited)-like activity.

TABLE G1
Number of Rats Evaluated for Lung Talc Burden, Pulmonary Function, and Lung Biochemistry

	Male			Female		
	0 mg/m ³	6 mg/m ³	18 mg/m ³	0 mg/m ³	6 mg/m ³	18 mg/m ³
Lung Burden						
6-Month Interim	- ^a	3	3	-	3	3
11-Month Interim	-	3	3	-	3	3
18-Month Interim	-	3	3	-	2	3
24-Month Interim	-	6	9	-	2	3
Pulmonary Function						
6-Month Interim	9	10	10	10	10	10
11-Month Interim	9	10	10	10	10	10
18-Month Interim	9	10	10	9	9	9
24-Month Interim	3	6	3	6	9	3
Lung Biochemistry						
24-Month Interim	3	6	2	5	9	3

^a Lung burden not measured in 0 mg/m³ rats.

TABLE G2
Lung Talc Burden (Normalized to Control Lung Weight) of Rats^a

	6 months	12 months	18 months	24 months
Male				
0 mg/m ³	- ^b	-	-	-
6 mg/m ³	2.63 ± 0.24	4.38 ± 0.59 ^o	7.31 ± 0.71 ^{oo}	10.45 ± 1.26 ^{oo}
18 mg/m ³	10.83 ± 0.23	20.96 ± 2.04 ^o	27.57 ± 0.91 ^o	24.15 ± 3.41 ^o
Female				
0 mg/m ³	-	-	-	-
6 mg/m ³	2.43 ± 0.19	4.71 ± 0.26 ^o	7.66 ± 0.34 ^{oo}	9.10 ± 0.88 ^{oo}
18 mg/m ³	8.34 ± 0.12	14.16 ± 3.36	24.33 ± 0.63 ^o	29.40 ± 2.40 ^{oo}

^o Significantly different (P≤0.05) from the 6 month group by Dunn's or Shirley's test

^{oo} P≤0.01

^a Mean ± standard error; units are presented as mg talc/g control lung.

^b No measurements taken

TABLE G3
Lung Talc Burden (Normalized to Exposure Concentration) of Rats^a

	Male		Female	
	6 mg/m ³	18 mg/m ³	6 mg/m ³	18 mg/m ³
6-Month Interim	0.439 ± 0.040	0.602 ± 0.013 ^o	0.406 ± 0.032	0.464 ± 0.007 ^o
12-Month Interim	0.731 ± 0.098	1.165 ± 0.113 ^o	0.785 ± 0.043	0.787 ± 0.187
18-Month Interim	1.22 ± 0.12	1.53 ± 0.05	1.28 ± 0.06	1.35 ± 0.04
24-Month Interim	1.74 ± 0.21	1.34 ± 0.19	1.52 ± 0.15	1.63 ± 0.13

^o Significantly different (P≤0.05) from the 6 mg/m³ group by Dunn's or Shirley's test

^a Mean ± standard error; units are presented as mg talc/g control lung per mg talc/m³.

TABLE G4
Bronchoalveolar Lavage Fluid Enzymes of Rats at the 24-Month Interim Evaluation^a

	0 mg/m ³	6 mg/m ³	18 mg/m ³
Male			
β-Glucuronidase	1.09 ± 0.40	18.86 ± 3.20*	89.24 ± 14.24**
Lactate Dehydrogenase	1,634 ± 545	3,193 ± 606	8,262 ± 380*
Alkaline Phosphatase	364.7 ± 147	572.8 ± 86.8	1,604.7 ± 143*
Glutathione Reductase	103.03 ± 16.43	99.35 ± 19.79	110.99 ± 51.27
Total Protein ^b	1.78 ± 0.40	3.12 ± 0.64	5.79 ± 0.55*
Female			
β-Glucuronidase	3.33 ± 0.97	41.05 ± 4.39**	154.16 ± 17.21**
Lactate Dehydrogenase	1,655 ± 266	3,906 ± 444*	14,436 ± 1,218**
Alkaline Phosphatase	427.8 ± 30.9	853.6 ± 79.7**	2,504.7 ± 221**
Glutathione Reductase	100.6 ± 1.7	135.2 ± 22.4	460.0 ± 44.8*
Total Protein	1.20 ± 0.22	4.30 ± 0.36**	12.96 ± 0.28**

* Significantly different ($P \leq 0.05$) from the control group by Dunn's or Shirley's test

** $P \leq 0.01$

^a Mean ± standard error; units presented as mIU/g control lung.

^b Mean ± standard error; units presented as mg/g control lung.

TABLE G5
Bronchoalveolar Lavage Fluid Cell Populations of Rats at the 24-Month Interim Evaluation^a

	0 mg/m ³	6 mg/m ³	18 mg/m ³
Male			
Polymorphonuclear Cells	0.333 ± 0.167	24.417 ± 2.557*	32.500 ± 3.000*
Lymphocytes	0.000 ± 0.000	0.500 ± 0.258	0.500 ± 0.500
Macrophages	93.67 ± 3.72	70.25 ± 2.53*	62.75 ± 1.75*
Epithelial Cells	6.00 ± 3.61	4.83 ± 1.41	4.25 ± 1.75
Female			
Polymorphonuclear Cells	0.625 ± 0.315	25.778 ± 2.673**	37.000 ± 1.528**
Lymphocytes	0.000 ± 0.000	0.722 ± 0.188*	1.333 ± 0.667*
Macrophages	91.38 ± 1.75	71.22 ± 2.95**	57.33 ± 4.67**
Epithelial Cells	8.00 ± 2.01	2.28 ± 0.50*	4.33 ± 2.60

* Significantly different ($P \leq 0.05$) from the control group by Dunn's or Shirley's test

** $P \leq 0.01$

^a Mean ± standard error; units presented as percent of total cells.

TABLE G6

Viability and Phagocytic Activity of Macrophages in Bronchoalveolar Fluid of Rats at the 24-Month Interim Evaluation

	0 mg/m ³	6 mg/m ³	18 mg/m ³
Male			
Viability ^a	63.67 ± 5.91	66.73 ± 1.59	57.70 ± 5.00
Phagocytic Activity ^b	83.13 ± 4.54	63.12 ± 8.14	65.30 ^c
Female			
Viability	82.65 ± 9.65	74.64 ± 3.24	61.00 ± 4.42
Phagocytic Activity	75.60 ± 5.14	66.51 ± 8.09	70.15 ± 2.85

^a Mean ± standard error; units are presented as percent viable cells.^b Mean ± standard error; units are presented as percent cells phagocytizing sheep erythrocytes.^c n=1; no standard error calculated

TABLE G7

Lung Collagen Metabolism and Protein Synthesis in Rats at the 24-Month Interim Evaluation

	0 mg/m ³	6 mg/m ³	18 mg/m ³
Male			
Lavage Fluid Collagenous Peptides ^a	39.79 ± 5.07	46.99 ± 6.51	79.21 ± 13.73
Total Lung Collagen ^b	13.87 ± 0.60	15.98 ± 0.39 [*]	18.88 ± 3.35 [*]
Collagen Production ^c	1.58 ± 0.17	1.60 ± 0.17	1.63 ± 0.22
Collagen Degradation ^d	31.67 ± 1.72	27.74 ± 1.42	9.18 ± 2.38 [*]
Non-Collagenous Protein Synthesis ^e	142.1 ± 14.5	199.8 ± 22.1 [*]	312.2 ± 10.6 ^{**}
Female			
Lavage Fluid Collagenous Peptides	78.27 ± 11.64	115.36 ± 8.61 [*]	174.71 ± 13.56 ^{**}
Total Lung Collagen	14.32 ± 0.66	19.95 ± 1.58 [*]	36.47 ± 3.39 ^{**}
Collagen Production	0.982 ± 0.185	1.804 ± 0.144 [*]	2.264 ± 0.347 ^{**}
Collagen Degradation	14.41 ± 2.44	21.59 ± 4.99	9.38 ± 1.63
Non-Collagenous Protein Synthesis	173.9 ± 34.5	325.8 ± 90.9	554.3 ± 107 [*]

^{*} Significantly different (P≤0.05) from the control group by Dunn's or Shirley's test^{**} P≤0.01^a Mean ± standard error; units are presented as µg/g control lung.^b Mean ± standard error; units are presented as mg/g control lung.^c Mean ± standard error; units are presented as percent new protein.^d Mean ± standard error; units are presented as percent new collagen.^e Mean ± standard error; units are presented as disintegrations per minute x 10⁻³/g control lung.

TABLE G8
Proteinase Activity in Lavage Fluid and Lung Homogenate Supernatant Fluid of Rats
at the 24-Month Interim Evaluation^a

	0 mg/m ³	6 mg/m ³	18 mg/m ³
Male			
Lavage Fluid			
Acid Proteinase	0.994 ± 0.329	1.866 ± 0.174	4.307 ± 0.218*
Cathepsin D	0.147 ± 0.147	0.599 ± 0.150	2.420 ± 0.147**
Cathepsin B	0.924 ± 0.415	1.267 ± 0.094	1.887 ± 0.365
Homogenate Supernatant Fluid			
Acid Proteinase	10.92 ± 0.64	17.51 ± 0.90*	25.13 ± 1.50**
Cathepsin D	8.53 ± 0.91	14.04 ± 0.62*	21.03 ± 1.56**
Cathepsin B	2.39 ± 0.41	3.48 ± 0.37	4.10 ± 0.06*
Neutral Proteinase	0.715 ± 0.168	2.417 ± 0.304*	4.505 ^b
PMN Elastase Cathepsin G	0.490 ± 0.218	1.936 ± 0.242*	4.457 ± 0.377**
Macrophage Elastase Collagenase	0.225 ± 0.099	0.482 ± 0.077	0.000 ^b
Female			
Lavage Fluid			
Acid Proteinase	1.52 ± 0.12	3.46 ± 0.33*	6.05 ± 0.73**
Cathepsin D	0.015 ± 0.015	1.310 ± 0.292*	4.043 ± 0.578**
Cathepsin B	1.61 ± 0.26	2.15 ± 0.22	2.01 ± 0.17
Homogenate Supernatant Fluid			
Acid Proteinase	14.04 ± 0.95	29.43 ± 1.18**	38.61 ± 1.81**
Cathepsin D	10.05 ± 0.68	22.97 ± 1.07**	30.25 ± 1.60**
Cathepsin B	3.99 ± 0.58	6.46 ± 0.60*	8.37 ± 0.42**
Neutral Proteinase	0.648 ± 0.087	5.040 ± 0.418**	12.293 ± 1.598**
PMN Elastase Cathepsin G	0.785 ± 0.142	4.351 ± 0.261**	10.313 ± 2.694**
Macrophage Elastase Collagenase	0.054 ± 0.037	0.683 ± 0.175*	2.012 ± 1.126*

* Significantly different ($P \leq 0.05$) from the control group by Dunn's or Shirley's test

** $P \leq 0.01$

^a Mean ± standard error; units are presented as mg/hour per gram control lung.

^b n=1; no standard error calculated

TABLE G9
Respiratory Frequency of Rats^a

	0 mg/m ³	6 mg/m ³	18 mg/m ³
Male			
6-Month Interim	57.11 ± 0.86	55.00 ± 1.13	54.00 ± 0.75 ^o
11-Month Interim	55.33 ± 1.11	56.10 ± 0.92	53.50 ± 0.99
18-Month Interim	56.50 ± 1.34	55.40 ± 1.08	54.60 ± 1.13
24-Month Interim	57.67 ± 1.20	56.50 ± 1.80	56.67 ± 1.86
Female			
6-Month Interim	52.10 ± 0.55	54.50 ± 1.19	54.30 ± 0.90
11-Month Interim	53.60 ± 0.73	53.70 ± 1.10	55.20 ± 0.94
18-Month Interim	55.44 ± 1.12	54.56 ± 0.93	55.22 ± 1.41
24-Month Interim	57.67 ± 1.23	54.44 ± 0.93	59.00 ± 0.58

^o Significantly different ($P \leq 0.05$) from the control by Dunn's or Shirley's test

^a Mean ± standard error; units are presented as breaths/min.

TABLE G10
Total Lung Capacity of Rats^a

	0 mg/m ³	6 mg/m ³	18 mg/m ³
Male			
6-Month Interim	19.86 ± 0.54	19.48 ± 0.46	19.25 ± 0.39
11-Month Interim	20.06 ± 0.32	18.44 ± 0.39 ^{oo}	17.67 ± 0.45 ^{oo}
18-Month Interim	20.30 ± 0.45	18.87 ± 0.41 ^o	16.34 ± 0.52 ^{oo}
24-Month Interim	20.50 ± 0.83	20.20 ± 0.28	16.47 ± 1.53
Female			
6-Month Interim	14.20 ± 0.25	14.56 ± 0.27	13.80 ± 0.27
11-Month Interim	13.29 ± 0.21	12.91 ± 0.17	12.06 ± 0.26 ^{oo}
18-Month Interim	13.94 ± 0.26	12.68 ± 0.28 ^{oo}	11.43 ± 0.31 ^{oo}
24-Month Interim	14.85 ± 0.31	13.73 ± 0.34 ^o	11.50 ± 1.07 ^{oo}

^o Significantly different ($P \leq 0.05$) from the control by Dunn's or Shirley's test

^{oo} $P \leq 0.01$

^a Mean ± standard error; units are presented as mL.

TABLE G11
Total Lung Capacity/Kilogram Body Weight of Rats^a

	0 mg/m ³	6 mg/m ³	18 mg/m ³
Male			
6-Month Interim	51.63 ± 1.05	51.45 ± 1.03	52.32 ± 0.78
11-Month Interim	47.71 ± 0.99	44.11 ± 0.87*	43.42 ± 0.74**
18-Month Interim	45.92 ± 1.58	42.98 ± 1.15	38.74 ± 1.50**
24-Month Interim	51.05 ± 4.36	48.49 ± 1.40	44.16 ± 1.29
Female			
6-Month Interim	67.73 ± 1.26	67.06 ± 1.65	65.41 ± 1.50
11-Month Interim	55.21 ± 1.91	52.37 ± 1.05	50.24 ± 1.19
18-Month Interim	45.78 ± 1.26	43.40 ± 1.18	43.26 ± 2.42
24-Month Interim	49.03 ± 1.31	48.93 ± 2.49	44.54 ± 0.51

* Significantly different ($P \leq 0.05$) from the control by Dunn's or Shirley's test

** $P \leq 0.01$

^a Mean ± standard error; units are presented as mL/kg.

TABLE G12
Tidal Volume of Rats^a

	0 mg/m ³	6 mg/m ³	18 mg/m ³
Male			
6-Month Interim	1.83 ± 0.09	1.90 ± 0.08	2.01 ± 0.10
11-Month Interim	1.94 ± 0.06	1.91 ± 0.06	1.93 ± 0.06
18-Month Interim	1.66 ± 0.08	1.63 ± 0.08	1.74 ± 0.08
24-Month Interim	1.50 ± 0.00	1.85 ± 0.16	2.13 ± 0.19*
Female			
6-Month Interim	1.65 ± 0.07	1.53 ± 0.11	1.40 ± 0.07*
11-Month Interim	1.66 ± 0.07	1.68 ± 0.06	1.43 ± 0.09
18-Month Interim	1.54 ± 0.04	1.34 ± 0.06*	1.40 ± 0.03*
24-Month Interim	1.43 ± 0.08	1.39 ± 0.09	1.37 ± 0.15

* Significantly different ($P \leq 0.05$) from the control by Dunn's or Shirley's test

^a Mean ± standard error; units are presented as mL.

TABLE G13
Minute Volume of Rats^a

	0 mg/m ³	6 mg/m ³	18 mg/m ³
Male			
6-Month Interim	102.5 ± 3.9	104.8 ± 4.2	104.8 ± 3.4
11-Month Interim	104.5 ± 3.4	106.2 ± 2.3	100.5 ± 2.8
18-Month Interim	97.34 ± 2.79	90.83 ± 3.45	95.87 ± 4.61
24-Month Interim	92.53 ± 2.64	107.25 ± 6.34	117.77 ± 11.70
Female			
6-Month Interim	85.43 ± 4.22	83.05 ± 4.44	76.36 ± 3.45
11-Month Interim	87.89 ± 3.95	88.18 ± 3.26	78.78 ± 3.81
18-Month Interim	87.14 ± 2.71	73.54 ± 3.02 ^{oo}	76.83 ± 2.29 ^{oo}
24-Month Interim	83.87 ± 5.04	79.64 ± 5.29	82.07 ± 5.95

^{oo} Significantly different (P=0.01) from the control by Dunn's or Shirley's test

^a Mean ± standard error; units are presented as mL/min.

TABLE G14
Minute Volume/Kilogram Body Weight of Rats^a

	0 mg/m ³	6 mg/m ³	18 mg/m ³
Male			
6-Month Interim	266.0 ± 7.0	277.7 ± 12.8	285.1 ± 9.5
11-Month Interim	247.9 ± 5.9	254.5 ± 7.2	247.6 ± 8.2
18-Month Interim	219.4 ± 4.6	206.8 ± 8.2	226.8 ± 10.5
24-Month Interim	229.5 ± 12.7	256.9 ± 14.8	319.9 ± 38.1
Female			
6-Month Interim	408.7 ± 23.3	381.7 ± 19.5	362.7 ± 19.2
11-Month Interim	365.0 ± 18.9	359.3 ± 18.1	330.1 ± 20.7
18-Month Interim	286.2 ± 11.0	250.6 ± 7.6	291.6 ± 17.7
24-Month Interim	276.9 ± 17.4	282.5 ± 21.4	328.8 ± 57.7

^a Mean ± standard error; units are presented as mL/min per kg.

TABLE G15
Residual Volume of Rats^a

	0 mg/m ³	6 mg/m ³	18 mg/m ³
Male			
6-Month Interim	2.90 ± 0.21	2.99 ± 0.17	2.64 ± 0.11
11-Month Interim	2.06 ± 0.17	1.63 ± 0.10	1.70 ± 0.16
18-Month Interim	1.96 ± 0.15	1.74 ± 0.13	1.98 ± 0.16
24-Month Interim	3.23 ± 0.48	2.83 ± 0.19	2.20 ± 0.32
Female			
6-Month Interim	2.18 ± 0.14	2.39 ± 0.22	2.47 ± 0.15
11-Month Interim	1.22 ± 0.15	1.25 ± 0.17	1.65 ± 0.14
18-Month Interim	1.28 ± 0.11	1.52 ± 0.13	1.83 ± 0.13**
24-Month Interim	1.68 ± 0.11	1.72 ± 0.23	1.73 ± 0.19

** Significantly different ($P \leq 0.01$) from the control by Dunn's or Shirley's test

^a Mean ± standard error; units are presented as mL.

TABLE G16
Residual Volume/Total Lung Capacity of Rats^a

	0 mg/m ³	6 mg/m ³	18 mg/m ³
Male			
6-Month Interim	0.146 ± 0.009	0.154 ± 0.009	0.137 ± 0.004
11-Month Interim	0.102 ± 0.008	0.088 ± 0.005	0.096 ± 0.008
18-Month Interim	0.097 ± 0.007	0.092 ± 0.007	0.121 ± 0.010
24-Month Interim	0.157 ± 0.019	0.140 ± 0.010	0.133 ± 0.011
Female			
6-Month Interim	0.153 ± 0.009	0.163 ± 0.013	0.179 ± 0.011
11-Month Interim	0.091 ± 0.010	0.096 ± 0.013	0.137 ± 0.011*
18-Month Interim	0.091 ± 0.007	0.120 ± 0.010*	0.160 ± 0.009**
24-Month Interim	0.113 ± 0.007	0.125 ± 0.016	0.151 ± 0.005

* Significantly different ($P \leq 0.05$) from the control by Dunn's or Shirley's test

** $P \leq 0.01$

^a Mean ± standard error; units are presented as mL/mL.

TABLE G17
Vital Capacity of Rats^a

	0 mg/m ³	6 mg/m ³	18 mg/m ³
Male			
6-Month Interim	16.96 ± 0.49	16.49 ± 0.44	16.61 ± 0.32
11-Month Interim	18.01 ± 0.27	16.82 ± 0.37 ^o	15.97 ± 0.42 ^{oo}
18-Month Interim	18.35 ± 0.45	17.15 ± 0.38	14.36 ± 0.51 ^{oo}
24-Month Interim	17.27 ± 0.48	17.35 ± 0.34	14.27 ± 1.26
Female			
6-Month Interim	12.02 ± 0.22	12.17 ± 0.20	11.33 ± 0.28
11-Month Interim	12.06 ± 0.20	11.68 ± 0.18	10.40 ± 0.25 ^{oo}
18-Month Interim	12.66 ± 0.21	11.14 ± 0.31 ^{oo}	9.61 ± 0.26 ^{oo}
24-Month Interim	13.15 ± 0.27	11.99 ± 0.32 ^o	9.77 ± 0.90 ^{oo}

^o Significantly different (P≤0.05) from the control by Dunn's or Shirley's test

^{oo} P≤0.01

^a Mean ± standard error; units are presented as mL.

TABLE G18
Vital Capacity/Total Lung Capacity of Rats^a

	0 mg/m ³	6 mg/m ³	18 mg/m ³
Male			
6-Month Interim	0.854 ± 0.009	0.846 ± 0.009	0.863 ± 0.004
11-Month Interim	0.898 ± 0.008	0.912 ± 0.005	0.904 ± 0.008
18-Month Interim	0.904 ± 0.007	0.909 ± 0.006	0.878 ± 0.010
24-Month Interim	0.843 ± 0.019	0.859 ± 0.010	0.867 ± 0.011
Female			
6-Month Interim	0.847 ± 0.009	0.837 ± 0.013	0.821 ± 0.011
11-Month Interim	0.908 ± 0.010	0.905 ± 0.012	0.862 ± 0.010 ^o
18-Month Interim	0.908 ± 0.007	0.879 ± 0.010 ^o	0.841 ± 0.009 ^{oo}
24-Month Interim	0.886 ± 0.007	0.874 ± 0.016	0.849 ± 0.005

^o Significantly different (P≤0.05) from the control by Dunn's or Shirley's test

^{oo} P≤0.01

^a Mean ± standard error; units are presented as mL/mL.

TABLE G19
Forced Vital Capacity of Rats^a

	0 mg/m ³	6 mg/m ³	18 mg/m ³
Male			
6-Month Interim	17.88 ± 0.40	17.15 ± 0.45	17.38 ± 0.41
11-Month Interim	19.03 ± 0.38	18.07 ± 0.43*	17.25 ± 0.45*
18-Month Interim	19.45 ± 0.45	17.92 ± 0.34*	15.28 ± 0.56**
24-Month Interim	17.27 ± 0.61	17.53 ± 0.46	14.90 ± 1.08
Female			
6-Month Interim	12.53 ± 0.33	12.38 ± 0.26	11.27 ± 0.33*
11-Month Interim	12.86 ± 0.25	12.44 ± 0.26	11.22 ± 0.25**
18-Month Interim	13.39 ± 0.24	11.91 ± 0.28**	10.24 ± 0.27**
24-Month Interim	13.08 ± 0.30	12.33 ± 0.33	10.03 ± 0.93**

* Significantly different ($P \leq 0.05$) from the control by Dunn's or Shirley's test

** $P \leq 0.01$

^a Mean ± standard error; units are presented as mL.

TABLE G20
Forced Vital Capacity/Kilogram Body Weight of Rats^a

	0 mg/m ³	6 mg/m ³	18 mg/m ³
Male			
6-Month Interim	46.48 ± 0.61	45.32 ± 1.18	47.32 ± 1.25
11-Month Interim	45.26 ± 0.95	43.22 ± 0.95	42.42 ± 0.89
18-Month Interim	44.00 ± 1.56	40.82 ± 1.01	36.23 ± 1.57**
24-Month Interim	42.85 ± 2.67	42.00 ± 0.93	40.18 ± 2.32
Female			
6-Month Interim	59.78 ± 1.75	57.01 ± 1.49	53.37 ± 1.48*
11-Month Interim	53.35 ± 1.68	50.43 ± 1.16	46.69 ± 0.90**
18-Month Interim	43.95 ± 1.18	40.76 ± 1.08	38.75 ± 2.17**
24-Month Interim	43.23 ± 1.51	43.87 ± 2.08	38.85 ± 0.48

* Significantly different ($P \leq 0.05$) from the control by Dunn's or Shirley's test

** $P \leq 0.01$

^a Mean ± standard error; units are presented as mL/kg.

TABLE G21
Functional Residual Capacity of Rats^a

	0 mg/m ³	6 mg/m ³	18 mg/m ³
Male			
6-Month Interim	4.48 ± 0.25	4.48 ± 0.22	4.17 ± 0.10
11-Month Interim	3.34 ± 0.24	3.16 ± 0.09	3.19 ± 0.12
18-Month Interim	3.24 ± 0.16	3.07 ± 0.11	3.53 ± 0.14
24-Month Interim	4.53 ± 0.52	3.98 ± 0.24	4.37 ± 0.59
Female			
6-Month Interim	3.51 ± 0.12	3.72 ± 0.16	3.57 ± 0.15
11-Month Interim	2.78 ± 0.12	2.74 ± 0.10	2.87 ± 0.14
18-Month Interim	2.47 ± 0.08	2.82 ± 0.12 ^o	3.17 ± 0.14 ^{oo}
24-Month Interim	3.07 ± 0.13	3.31 ± 0.26	3.27 ± 0.18

^o Significantly different ($P \leq 0.05$) from the control by Dunn's or Shirley's test

^{oo} $P \leq 0.01$

^a Mean ± standard error; units are presented as mL.

TABLE G22
Functional Residual Capacity/Total Lung Capacity of Rats^a

	0 mg/m ³	6 mg/m ³	18 mg/m ³
Male			
6-Month Interim	0.226 ± 0.012	0.230 ± 0.009	0.217 ± 0.006
11-Month Interim	0.166 ± 0.011	0.172 ± 0.006	0.181 ± 0.007
18-Month Interim	0.159 ± 0.006	0.163 ± 0.005	0.217 ± 0.008 ^{oo}
24-Month Interim	0.220 ± 0.020	0.197 ± 0.012	0.268 ± 0.042
Female			
6-Month Interim	0.248 ± 0.008	0.255 ± 0.009	0.258 ± 0.008
11-Month Interim	0.209 ± 0.008	0.212 ± 0.006	0.238 ± 0.010 ^o
18-Month Interim	0.177 ± 0.007	0.223 ± 0.010 ^{oo}	0.277 ± 0.010 ^{oo}
24-Month Interim	0.207 ± 0.009	0.240 ± 0.016	0.287 ± 0.021 ^o

^o Significantly different ($P \leq 0.05$) from the control by Dunn's or Shirley's test

^{oo} $P \leq 0.01$

^a Mean ± standard error; units are presented as mL/mL.

TABLE G23
Total Pulmonary Resistance of Rats^a

	0 mg/m ³	6 mg/m ³	18 mg/m ³
Male			
6-Month Interim	0.117 ± 0.018	0.105 ± 0.010	0.115 ± 0.009
11-Month Interim	0.097 ± 0.007	0.107 ± 0.010	0.098 ± 0.008
18-Month Interim	0.075 ± 0.014	0.096 ± 0.009	0.120 ± 0.009*
24-Month Interim	0.110 ± 0.025	0.087 ± 0.028	0.067 ± 0.020
Female			
6-Month Interim	0.144 ± 0.008	0.143 ± 0.016	0.152 ± 0.014
11-Month Interim	0.131 ± 0.008	0.150 ± 0.009	0.146 ± 0.010
18-Month Interim	0.130 ± 0.012	0.131 ± 0.016	0.180 ± 0.010*
24-Month Interim	0.138 ± 0.020	0.131 ± 0.014	0.150 ± 0.035

* Significantly different ($P \leq 0.05$) from the control by Dunn's or Shirley's test

^a Mean ± standard error; units are presented as cm H₂O/mL per second.

TABLE G24
Maximum Quasistatic Compliance of Rats^a

	0 mg/m ³	6 mg/m ³	18 mg/m ³
Male			
6-Month Interim	1.97 ± 0.15	1.84 ± 0.12	2.01 ± 0.13
11-Month Interim	2.32 ± 0.10	1.92 ± 0.12*	1.91 ± 0.09*
18-Month Interim	2.35 ± 0.07	2.09 ± 0.16	1.57 ± 0.07**
24-Month Interim	2.00 ± 0.30	2.01 ± 0.11	1.48 ± 0.20
Female			
6-Month Interim	1.37 ± 0.11	1.47 ± 0.11	1.37 ± 0.08
11-Month Interim	1.273 ± 0.062	1.276 ± 0.033	0.968 ± 0.057**
18-Month Interim	1.704 ± 0.108	1.123 ± 0.050**	0.908 ± 0.068**
24-Month Interim	1.538 ± 0.055	1.263 ± 0.062**	0.883 ± 0.093**

* Significantly different ($P \leq 0.05$) from the control by Dunn's or Shirley's test

** $P \leq 0.01$

^a Mean ± standard error; units are presented as mL/cm H₂O.

TABLE G25
Quasistatic Chord Compliance of Rats^a

	0 mg/m ³	6 mg/m ³	18 mg/m ³
Male			
6-Month Interim	1.18 ± 0.05	1.16 ± 0.04	1.17 ± 0.03
11-Month Interim	1.34 ± 0.02	1.20 ± 0.04 ^o	1.15 ± 0.04 ^{oo}
18-Month Interim	1.343 ± 0.037	1.205 ± 0.040 ^o	0.982 ± 0.037 ^{oo}
24-Month Interim	1.167 ± 0.104	1.220 ± 0.035	0.890 ± 0.124
Female			
6-Month Interim	0.824 ± 0.030	0.895 ± 0.091	0.802 ± 0.024
11-Month Interim	0.841 ± 0.020	0.809 ± 0.016	0.684 ± 0.025 ^{oo}
18-Month Interim	0.879 ± 0.019	0.749 ± 0.027 ^{oo}	0.607 ± 0.030 ^{oo}
24-Month Interim	0.883 ± 0.035	0.764 ± 0.024 ^o	0.573 ± 0.084 ^{oo}

^o Significantly different (P≤0.05) from the control by Dunn's or Shirley's test

^{oo} P≤0.01

^a Mean ± standard error; units are presented as mL/cm H₂O.

TABLE G26
Dynamic Compliance of Rats^a

	0 mg/m ³	6 mg/m ³	18 mg/m ³
Male			
6-Month Interim	0.546 ± 0.053	0.575 ± 0.043	0.536 ± 0.058
11-Month Interim	0.748 ± 0.041	0.647 ± 0.048	0.687 ± 0.046
18-Month Interim	0.990 ± 0.080	0.741 ± 0.043 ^a	0.685 ± 0.050 ^{oo}
24-Month Interim	0.930 ± 0.173	0.987 ± 0.130	1.173 ± 0.186
Female			
6-Month Interim	0.399 ± 0.029	0.445 ± 0.032	0.380 ± 0.034
11-Month Interim	0.492 ± 0.024	0.426 ± 0.027 ^o	0.393 ± 0.020 ^{oo}
18-Month Interim	0.618 ± 0.053	0.527 ± 0.027	0.372 ± 0.025 ^{oo}
24-Month Interim	0.650 ± 0.065	0.618 ± 0.045	0.377 ± 0.077 ^o

^o Significantly different (P≤0.05) from the control by Dunn's or Shirley's test

^{oo} P≤0.01

^a Mean ± standard error; units are presented as mL/cm H₂O.

TABLE G27
Peak Expiratory Flow of Rats^a

	0 mg/m ³	6 mg/m ³	18 mg/m ³
Male			
6-Month Interim	139.9 ± 1.9	138.7 ± 2.8	132.5 ± 4.0
11-Month Interim	136.6 ± 1.4	133.5 ± 4.5	132.9 ± 2.0
18-Month Interim	132.2 ± 1.2	132.3 ± 0.7	129.5 ± 0.6**
24-Month Interim	126.1 ± 2.7	124.5 ± 1.9	124.0 ± 1.0
Female			
6-Month Interim	120.1 ± 8.7	122.3 ± 6.6	113.5 ± 5.7
11-Month Interim	125.3 ± 4.3	123.9 ± 4.9	123.2 ± 2.1
18-Month Interim	120.6 ± 3.0	113.2 ± 2.3	114.3 ± 2.5
24-Month Interim	117.1 ± 2.5	116.7 ± 3.4	110.1 ± 4.7

** Significantly different ($P \leq 0.01$) from the control by Dunn's or Shirley's test

^a Mean ± standard error; units are presented as mL/second.

TABLE G28
Peak Expiratory Flow/Forced Vital Capacity of Rats^a

	0 mg/m ³	6 mg/m ³	18 mg/m ³
Male			
6-Month Interim	7.85 ± 0.18	8.12 ± 0.22	7.63 ± 0.16
11-Month Interim	7.21 ± 0.18	7.44 ± 0.33	7.74 ± 0.20
18-Month Interim	6.82 ± 0.15	7.40 ± 0.14*	8.57 ± 0.29**
24-Month Interim	7.31 ± 0.14	7.13 ± 0.21	8.40 ± 0.52
Female			
6-Month Interim	9.56 ± 0.62	9.82 ± 0.35	10.08 ± 0.47
11-Month Interim	9.73 ± 0.22	9.95 ± 0.31	11.01 ± 0.23**
18-Month Interim	9.02 ± 0.20	9.57 ± 0.37	11.21 ± 0.32**
24-Month Interim	8.96 ± 0.22	9.47 ± 0.19	11.16 ± 1.13**

* Significantly different ($P \leq 0.05$) from the control by Dunn's or Shirley's test

** $P \leq 0.01$

^a Mean ± standard error; units are presented as mL/second per mL.

TABLE G29
 Expiratory Flow 10% Forced Vital Capacity of Rats^a

	0 mg/m ³	6 mg/m ³	18 mg/m ³
Male			
6-Month Interim	28.22 ± 2.04	24.20 ± 1.77	19.60 ± 2.67 ^o
11-Month Interim	26.33 ± 1.82	20.80 ± 1.14 ^o	21.60 ± 1.50
18-Month Interim	19.00 ± 1.87	18.00 ± 1.61	20.70 ± 1.17
24-Month Interim	11.33 ± 1.20	18.67 ± 1.50	18.33 ± 1.76
Female			
6-Month Interim	17.40 ± 2.88	18.10 ± 3.10	16.60 ± 2.68
11-Month Interim	19.20 ± 2.36	19.50 ± 1.97	23.30 ± 2.29
18-Month Interim	19.67 ± 1.62	19.00 ± 1.45	21.78 ± 0.66
24-Month Interim	12.67 ± 1.65	18.44 ± 1.51 ^o	17.00 ± 2.52

^o Significantly different ($P \leq 0.05$) from the control by Dunn's or Shirley's test

^a Mean ± standard error; units are presented as mL/second.

TABLE G30
 Expiratory Flow 10% Forced Vital Capacity/Forced Vital Capacity of Rats^a

	0 mg/m ³	6 mg/m ³	18 mg/m ³
Male			
6-Month Interim	1.58 ± 0.11	1.41 ± 0.09	1.13 ± 0.16 ^o
11-Month Interim	1.39 ± 0.10	1.16 ± 0.08	1.27 ± 0.11
18-Month Interim	0.986 ± 0.106	1.002 ± 0.085	1.372 ± 0.085 ^o
24-Month Interim	0.661 ± 0.085	1.057 ± 0.065 ^o	1.256 ± 0.188 ^o
Female			
6-Month Interim	1.37 ± 0.21	1.43 ± 0.23	1.45 ± 0.22
11-Month Interim	1.47 ± 0.17	1.55 ± 0.14	2.07 ± 0.19 ^{oo}
18-Month Interim	1.47 ± 0.13	1.62 ± 0.15	2.14 ± 0.09 ^{oo}
24-Month Interim	0.959 ± 0.109	1.488 ± 0.102 ^o	1.693 ± 0.170 ^o

^o Significantly different ($P \leq 0.05$) from the control by Dunn's or Shirley's test

^{oo} $P \leq 0.01$

^a Mean ± standard error; units are presented as mL/second per mL.

TABLE G31
Expiratory Flow 25% Forced Vital Capacity of Rats^a

	0 mg/m ³	6 mg/m ³	18 mg/m ³
Male			
6-Month Interim	63.56 ± 3.30	55.00 ± 5.57	44.30 ± 6.59*
11-Month Interim	62.00 ± 2.89	60.40 ± 3.46	59.30 ± 3.36
18-Month Interim	50.50 ± 2.57	54.20 ± 2.45	62.20 ± 2.80**
24-Month Interim	47.00 ± 2.89	51.33 ± 3.97	60.00 ± 3.79
Female			
6-Month Interim	44.30 ± 7.73	41.20 ± 7.14	35.60 ± 5.59
11-Month Interim	50.40 ± 5.68	43.00 ± 5.69	54.60 ± 4.01
18-Month Interim	52.33 ± 4.57	42.56 ± 4.76	49.00 ± 3.67
24-Month Interim	40.67 ± 3.80	49.33 ± 6.17	46.00 ± 12.49

* Significantly different (P≤0.05) from the control by Dunn's or Shirley's test

** P≤0.01

^a Mean ± standard error; units are presented as mL/second.

TABLE G32
Expiratory Flow 25% Forced Vital Capacity/Forced Vital Capacity of Rats^a

	0 mg/m ³	6 mg/m ³	18 mg/m ³
Male			
6-Month Interim	3.56 ± 0.19	3.21 ± 0.31	2.54 ± 0.37
11-Month Interim	3.26 ± 0.14	3.35 ± 0.20	3.47 ± 0.24
18-Month Interim	2.61 ± 0.15	3.03 ± 0.14*	4.14 ± 0.27**
24-Month Interim	2.72 ± 0.07	2.92 ± 0.20	4.06 ± 0.35*
Female			
6-Month Interim	3.50 ± 0.59	3.25 ± 0.53	3.10 ± 0.43
11-Month Interim	3.88 ± 0.42	3.43 ± 0.44	4.88 ± 0.37
18-Month Interim	3.91 ± 0.34	3.60 ± 0.44	4.75 ± 0.27
24-Month Interim	3.10 ± 0.24	3.95 ± 0.44	4.66 ± 1.28

* Significantly different (P≤0.05) from the control by Dunn's or Shirley's test

** P≤0.01

^a Mean ± standard error; units are presented as mL/second per mL.

TABLE G33
 Expiratory Flow 50% Forced Vital Capacity of Rats^a

	0 mg/m ³	6 mg/m ³	18 mg/m ³
Male			
6-Month Interim	111.33 ± 7.11	94.00 ± 7.61	78.70 ± 10.05 ^o
11-Month Interim	111.7 ± 4.4	100.1 ± 7.1	102.1 ± 6.2
18-Month Interim	98.75 ± 6.00	97.10 ± 3.59	107.70 ± 5.25
24-Month Interim	99.33 ± 10.17	92.33 ± 4.47	94.67 ± 9.02
Female			
6-Month Interim	75.30 ± 11.98	73.90 ± 10.54	66.00 ± 8.52
11-Month Interim	85.50 ± 8.87	78.00 ± 10.09	94.10 ± 5.57
18-Month Interim	93.00 ± 8.40	76.11 ± 9.60	87.67 ± 6.91
24-Month Interim	86.50 ± 7.12	85.89 ± 10.40	83.67 ± 23.90

^o Significantly different (P≤0.05) from the control by Dunn's or Shirley's test

^a Mean ± standard error; units are presented as mL/second.

TABLE G34
 Expiratory Flow 50% Forced Vital Capacity/Forced Vital Capacity of Rats^a

	0 mg/m ³	6 mg/m ³	18 mg/m ³
Male			
6-Month Interim	6.23 ± 0.39	5.50 ± 0.47	4.49 ± 0.55 ^o
11-Month Interim	5.86 ± 0.18	5.55 ± 0.40	5.95 ± 0.40
18-Month Interim	5.08 ± 0.30	5.43 ± 0.21	7.18 ± 0.50 ^{oo}
24-Month Interim	5.73 ± 0.44	5.30 ± 0.36	6.38 ± 0.62
Female			
6-Month Interim	5.95 ± 0.90	5.85 ± 0.77	5.79 ± 0.67
11-Month Interim	6.58 ± 0.62	6.21 ± 0.77	8.39 ± 0.48 ^o
18-Month Interim	6.92 ± 0.59	6.48 ± 0.90	8.49 ± 0.54
24-Month Interim	6.63 ± 0.55	6.88 ± 0.77	8.50 ± 2.50

^o Significantly different (P≤0.05) from the control by Dunn's or Shirley's test

^{oo} P≤0.01

^a Mean ± standard error; units are presented as mL/second per mL.

TABLE G35
Mean Midexpiratory Flow of Rats^a

	0 mg/m ³	6 mg/m ³	18 mg/m ³
Male			
6-Month Interim	101.90 ± 5.20	89.30 ± 7.34	74.27 ± 9.38*
11-Month Interim	102.52 ± 3.54	94.92 ± 6.02	94.11 ± 4.51
18-Month Interim	93.12 ± 3.99	91.41 ± 2.81	98.44 ± 3.67
24-Month Interim	87.13 ± 6.27	87.78 ± 3.74	90.33 ± 7.07
Female			
6-Month Interim	71.07 ± 12.01	70.72 ± 10.66	60.65 ± 7.99
11-Month Interim	81.38 ± 7.94	73.24 ± 9.19	87.91 ± 5.04
18-Month Interim	85.98 ± 6.80	69.51 ± 7.53	81.79 ± 5.58
24-Month Interim	78.28 ± 5.27	79.94 ± 9.44	75.13 ± 19.66

* Significantly different ($P \leq 0.05$) from the control by Dunn's or Shirley's test

^a Mean ± standard error; units are presented as mL/second.

TABLE G36
Mean Midexpiratory Flow/Forced Vital Capacity of Rats^a

	0 mg/m ³	6 mg/m ³	18 mg/m ³
Male			
6-Month Interim	5.71 ± 0.30	5.23 ± 0.44	4.24 ± 0.51
11-Month Interim	5.39 ± 0.16	5.27 ± 0.35	5.49 ± 0.32
18-Month Interim	4.78 ± 0.13	5.11 ± 0.18	6.55 ± 0.39**
24-Month Interim	5.04 ± 0.24	5.03 ± 0.29	6.10 ± 0.56
Female			
6-Month Interim	5.62 ± 0.91	5.59 ± 0.78	5.31 ± 0.62
11-Month Interim	6.27 ± 0.56	5.83 ± 0.70	7.85 ± 0.45*
18-Month Interim	6.41 ± 0.48	5.90 ± 0.72	7.94 ± 0.41
24-Month Interim	5.99 ± 0.39	6.40 ± 0.69	7.65 ± 2.13

* Significantly different ($P \leq 0.05$) from the control by Dunn's or Shirley's test

** $P \leq 0.01$

^a Mean ± standard error; units are presented as mL/second per mL.

TABLE G37
Carbon Monoxide Diffusing Capacity of Rats^a

	0 mg/m ³	6 mg/m ³	18 mg/m ³
Male			
6-Month Interim	0.364 ± 0.014	0.347 ± 0.008	0.336 ± 0.010
11-Month Interim	0.400 ± 0.010	0.373 ± 0.010	0.331 ± 0.020 ^{°°}
18-Month Interim	0.338 ± 0.022	0.301 ± 0.015	0.235 ± 0.009 ^{°°}
24-Month Interim	0.303 ± 0.027	0.288 ± 0.011	0.177 ± 0.035 [°]
Female			
6-Month Interim	0.238 ± 0.012	0.241 ± 0.008	0.213 ± 0.010
11-Month Interim	0.233 ± 0.008	0.231 ± 0.005	0.190 ± 0.003 ^{°°}
18-Month Interim	0.233 ± 0.010	0.207 ± 0.009	0.137 ± 0.011 ^{°°}
24-Month Interim	0.198 ± 0.007	0.183 ± 0.006	0.113 ± 0.017 ^{°°}

[°] Significantly different (P≤0.05) from the control by Dunn's or Shirley's test

^{°°} P≤0.01

^a Mean ± standard error; units are presented as mL/minute per mm Hg.

TABLE G38
Carbon Monoxide Diffusing Capacity/Lung Volume of Rats^a

	0 mg/m ³	6 mg/m ³	18 mg/m ³
Male			
6-Month Interim	0.020 ± 0.001	0.020 ± 0.000	0.019 ± 0.000
11-Month Interim	0.021 ± 0.000	0.021 ± 0.001	0.019 ± 0.001 [°]
18-Month Interim	0.017 ± 0.001	0.025 ± 0.008	0.014 ± 0.001 [°]
24-Month Interim	0.015 ± 0.002	0.015 ± 0.001	0.010 ± 0.002 [°]
Female			
6-Month Interim	0.019 ± 0.001	0.019 ± 0.001	0.017 ± 0.001
11-Month Interim	0.018 ± 0.001	0.019 ± 0.000	0.017 ± 0.000 [°]
18-Month Interim	0.017 ± 0.001	0.016 ± 0.001	0.012 ± 0.001 ^{°°}
24-Month Interim	0.013 ± 0.001	0.013 ± 0.001	0.009 ± 0.001

[°] Significantly different (P≤0.05) from the control by Dunn's or Shirley's test

^{°°} P≤0.01

^a Mean ± standard error; units are presented as mL/minute per mm Hg per mL.

TABLE G39
Carbon Monoxide Diffusing Capacity/Kilogram Body Weight of Rats^a

	0 mg/m ³	6 mg/m ³	18 mg/m ³
Male			
6-Month Interim	0.949 ± 0.039	0.917 ± 0.017	0.914 ± 0.026
11-Month Interim	0.951 ± 0.021	0.892 ± 0.021	0.812 ± 0.043**
18-Month Interim	0.759 ± 0.043	0.683 ± 0.029	0.554 ± 0.016**
24-Month Interim	0.749 ± 0.056	0.691 ± 0.025	0.465 ± 0.062*
Female			
6-Month Interim	1.13 ± 0.05	1.11 ± 0.04	1.01 ± 0.04
11-Month Interim	0.968 ± 0.045	0.939 ± 0.033	0.792 ± 0.019**
18-Month Interim	0.766 ± 0.034	0.705 ± 0.028	0.502 ± 0.028**
24-Month Interim	0.656 ± 0.031	0.650 ± 0.027	0.435 ± 0.036*

* Significantly different (P≤0.05) from the control by Dunn's or Shirley's test

** P≤0.01

^a Mean ± standard error; units are presented as mL/minute per mm Hg per kg.

TABLE G40
Percent Forced Vital Capacity Expired in 0.1 Second of Rats^a

	0 mg/m ³	6 mg/m ³	18 mg/m ³
Male			
6-Month Interim	61.11 ± 1.52	59.80 ± 2.15	53.90 ± 2.64
11-Month Interim	58.22 ± 0.98	57.40 ± 2.74	60.30 ± 1.63
18-Month Interim	55.00 ± 0.63	58.30 ± 0.90*	66.50 ± 2.13**
24-Month Interim	58.67 ± 1.20	57.00 ± 1.71	64.00 ± 2.89
Female			
6-Month Interim	62.80 ± 5.17	64.20 ± 3.82	63.40 ± 3.86
11-Month Interim	67.00 ± 2.82	65.20 ± 3.61	75.50 ± 1.78*
18-Month Interim	66.44 ± 2.60	64.56 ± 3.57	75.78 ± 1.56*
24-Month Interim	65.83 ± 2.09	66.78 ± 3.31	73.00 ± 9.17

* Significantly different (P≤0.05) from the control by Dunn's or Shirley's test

** P≤0.01

^a Mean ± standard error; units are presented as percent forced vital capacity.

TABLE G41
Slope III of N₂ Washout of Rats^a

	0 mg/m ³	6 mg/m ³	18 mg/m ³
Male			
6-Month Interim	0.400 ± 0.023	0.431 ± 0.037	0.481 ± 0.049
11-Month Interim	0.449 ± 0.019	0.446 ± 0.037	0.437 ± 0.040
18-Month Interim	0.393 ± 0.037	0.361 ± 0.035	0.555 ± 0.041 ^o
24-Month Interim	0.627 ± 0.077	0.438 ± 0.045	0.597 ± 0.083
Female			
6-Month Interim	0.587 ± 0.059	0.528 ± 0.049	0.596 ± 0.042
11-Month Interim	0.704 ± 0.027	0.735 ± 0.029	0.813 ± 0.076
18-Month Interim	0.601 ± 0.053	0.699 ± 0.074	1.008 ± 0.087 ^{oo}
24-Month Interim	0.535 ± 0.040	0.580 ± 0.071	1.520 ± 0.409 ^o

^o Significantly different (P≤0.05) from the control by Dunn's or Shirley's test

^{oo} P≤0.01

^a Mean ± standard error; units are presented as percent N₂/mL.

APPENDIX H

LUNG BURDEN AND LUNG BIOCHEMISTRY IN MICE

METHODS	244
TABLE H1 Number of Mice Evaluated for Lung Talc Burden and Lung Biochemistry	247
TABLE H2 Lung Talc Burden (Normalized to Control Lung Weight) of Mice	248
TABLE H3 Lung Talc Burden (Normalized to Exposure Concentration) of Mice	248
TABLE H4 Bronchoalveolar Lavage Fluid Enzymes of Mice at the 6-Month Interim Evaluation	249
TABLE H5 Bronchoalveolar Lavage Fluid Enzymes of Mice at the 12-Month Interim Evaluation	249
TABLE H6 Bronchoalveolar Lavage Fluid Enzymes of Mice at the 18-Month Interim Evaluation	250
TABLE H7 Bronchoalveolar Lavage Fluid Enzymes of Mice at the 24-Month Interim Evaluation	250
TABLE H8 Bronchoalveolar Lavage Fluid Cell Populations of Mice at the 6-Month Interim Evaluation	251
TABLE H9 Bronchoalveolar Lavage Fluid Cell Populations of Mice at the 12-Month Interim Evaluation	251
TABLE H10 Bronchoalveolar Lavage Fluid Cell Populations of Mice at the 18-Month Interim Evaluation	252
TABLE H11 Bronchoalveolar Lavage Fluid Cell Populations of Mice at the 24-Month Interim Evaluation	252
TABLE H12 Phagocytic Activity of Macrophages in Bronchoalveolar Fluid of Mice at the 12-Month Interim Evaluation	253
TABLE H13 Phagocytic Activity of Macrophages in Bronchoalveolar Fluid of Mice at the 18-Month Interim Evaluation	253
TABLE H14 Viability and Phagocytic Activity of Macrophages in Bronchoalveolar Fluid of Mice at the 24-Month Interim Evaluation	254
TABLE H15 Measurements of Lung Collagen in Mice at the 6-Month Interim Evaluation	255
TABLE H16 Measurements of Lung Collagen in Mice at the 12-Month Interim Evaluation	255
TABLE H17 Measurements of Lung Collagen in Mice at the 18-Month Interim Evaluation	255
TABLE H18 Lung Collagen Metabolism and Protein Synthesis in Mice at the 24-Month Interim Evaluation	256
TABLE H19 Proteinase Activity in Lavage Fluid and Lung Homogenate Supernatant Fluid of Mice at the 6-Month Interim Evaluation	257
TABLE H20 Proteinase Activity in Lavage Fluid and Lung Homogenate Supernatant Fluid of Mice at the 12-Month Interim Evaluation	258
TABLE H21 Proteinase Activity in Lavage Fluid and Lung Homogenate Supernatant Fluid of Mice at the 18-Month Interim Evaluation	259
TABLE H22 Proteinase Activity in Lavage Fluid and Lung Homogenate Supernatant Fluid of Mice at the 24-Month Interim Evaluation	260

METHODS

Lung Burden

Lung talc burden was measured to determine the relationship between the exposure concentration and the amount of talc deposited and retained within the pulmonary region of the respiratory tract. The method used for determination of talc in the lungs of rats and mice has been published (Hanson *et al.*, 1985). Lung talc burdens were determined on the left lung of four male and four female mice from each exposure group sacrificed at 6, 12, and 18 months after the start of exposure. At 24 months, lung burdens were determined on the left lungs of two mice from the biochemistry group. The analysis was based on determination of acid insoluble magnesium in the lung. Midwest Research Institute reported that the value for the magnesium was 19.33% for batch 02, and 19.47% for batch 03. The values reported by Midwest Research Institute and the results of the analysis at Lovelace Inhalation Toxicology Research Institute were close to the theoretical value of magnesium for talc (19.22%). Since mice sacrificed at 6, 12, and 18 months had been exposed to only batch 02 of talc, 19.33% magnesium was used to calculate quantity of talc for these mice. Since batch 03 was used for the last 4 months of exposure, and lung burdens of mice after 24 months of exposure talc would be expected to contain substantial amounts of batch 03 talc, 19.47% magnesium was used to calculate quantity of talc in lungs for these mice.

All operations in conjunction with the tissue analysis for talc were done with talc-free gloves. Left lung lobes were weighed at necropsy and stored frozen (-20° C) until used. Lungs were homogenized using water and the proteins precipitated with 70% perchloric acid. The individual samples were filtered and washed with 5% trichloroacetic acid (TCA) to remove perchlorates. Washing continued until magnesium levels in the wash were within 10% of levels in the TCA solution (≤ 0.03 ppm magnesium). Filters and tissue residues were placed in 15-mL porcelain crucibles, dried slowly (200° C), and then ashed at 600° C for 1 hour. Ashed samples were transferred to Teflon beakers using 2 mL HCl and evaporated to dryness. Samples were digested in hydrofluoric acid (HF), and the HF evaporated. Additional HF was added and reevaporated. Sulfuric acid was added to remove trace HF, and samples were diluted with distilled water and analyzed for magnesium by atomic absorbance (Perkin Elmer, Model 306, Atomic Absorption Spectrophotometer) with a magnesium hollow cathode lamp and an air acetylene flame (Hanson *et al.*, 1985).

Lung Biochemistry

In this study, bronchoalveolar lavage (BAL) fluid enzyme activity and cell numbers were measured as biochemical and cytological indicators of pulmonary injury from inhalation of talc. Four male and four female mice from each exposure group were sacrificed at 27, 52, and 79 weeks, and all remaining lung toxicology mice were sacrificed at 24 months. Numbers of animals sacrificed at each interim evaluation are shown in Table H1.

Mice were anesthetized with halothane and sacrificed by exsanguination from the abdominal aorta or renal artery. The heart and lung block were removed. Mice were administered endobronchial saline lavage (3 to 4 mL total volume in four, 0.75 to 1.0 mL washes) and the BAL fluid centrifuged at $300 \times G$ to separate the cells from the supernatant fluid.

At all sacrifices, biochemical analyses were done on lavage fluid from single mice. At the 24-month terminal sacrifice where lung burden measurements were also performed on the left lung lobes, mouse lavage fluids were paired (from two mice) to obtain sufficient cells for the analyses and paired mouse lung tissue samples (from two mice) were analyzed to obtain sufficient lung tissue for collagen analyses.

Airway Fluid Enzymes and Cytology

In this study, BAL fluid was analyzed to determine degree of:

- 1) Cell injury as indicated by quantities of BAL fluid lactate dehydrogenase (LDH).
- 2) Chronic inflammatory response as indicated by presence of increased numbers of polymorphonuclear leukocytes (PMN) and pulmonary alveolar macrophages (AM) as well as increased BAL fluid protein and alkaline phosphatase activity.
- 3) Lysosomal activation as indicated by quantities of BAL fluid β -glucuronidase and acid proteinase. Elevated quantities of these enzymes have been observed in BAL fluid from rodents exposed to particulates. These enzymes may be associated with the breakdown of necrotic tissues.
- 4) Response to oxidant injury as indicated by increased quantities of glutathione reductase and peroxidase activity.

The supernatant fluid was analyzed for the activities of β -glucuronidase, LDH, glucose-6-phosphate dehydrogenase, alkaline phosphatase, glutathione reductase, and glutathione peroxidase by spectrophotometric, kinetic, and enzymatic techniques. Acid proteinase was measured by release of radiolabeled globin from the trichloroacetic acid precipitable protein substrate, and total protein was analyzed colorimetrically (Henderson *et al.*, 1985). β -Glucuronidase was not performed at the 6-month interim evaluation, but was performed at all other sacrifice times.

Numbers of total nucleated cells recovered in lavage fluid were determined on each sample using a cell counter (Coulter Electronics, Hialeah, FL) or a hemocytometer. Cytocentrifuge preparations of resuspended cells were made, stained with Wrights stain (Diff-Quik, Curtin Matheson Scientific, Denver, CO) and differential cell counts were determined. At the 6-, 12-, and 18-month interim sacrifices, analyses were done on individual mice.

Alveolar macrophages (AM) were recovered from BAL fluid of the same mice as described above. Cells (0.5×10^6) in Roswell Park Memorial Institute (RPMI) culture medium were pelleted by centrifugation and the supernatant removed. Cells were resuspended in 1 mL of a 1% suspension of IgG antibody-sensitized sheep red blood cells (SRBC) in RPMI 1640. The antibody sensitized SRBC were made as previously described (Harmsen and Jeska, 1980). The subagglutinating titer of heat-inactivated rabbit anti-SRBC serum was used to sensitize the SRBC. The AM and SRBC suspensions were incubated at 37° C for 1 hour in a humidified atmosphere of 5% CO₂ in air. The AM and SRBC were sedimented by centrifugation and the supernatant discarded. Unphagocytized SRBC were removed by lysing the red blood cells with water for 30 seconds. The lysing of unphagocytized SRBC was stopped by the addition of an equal volume of saline and cytocentrifuge preparations were made. The slides were stained with a rapid Wright's stain (Diff-Quik, American Scientific Products, McGaw Park, IL) and the number of AM phagocytizing 0, 1, 2, 3 to 4, and > 4 SRBC was determined by light microscopy. Three fields of 100 cells per preparation were counted. Viability of macrophages was not determined at the 6-, 12-, and 18-month week sacrifices because the small number of cells recovered from these mice lungs precluded the measurement of cell viability. Viability determination of macrophages was made on macrophages obtained at the final sacrifice because sufficient numbers of cells were generally available at this time.

Lung Tissue Collagen and Proteinase

At 6-, 12-, and 18-month sacrifices, collagen content of lungs and lavage fluid was measured. At the 24-month sacrifice, additional collagen metabolism and protein synthesis measurements were made on survivors from each group. Proteinase activities were measured at all sacrifice times.

The supernatant BAL fluid was analyzed for hydroxyproline and acid proteinase. Lung tissue and bronchoalveolar lavage (BAL) fluid samples were hydrolyzed with 6N HCl at 110° C for approximately 18 hours to convert proteins to their individual amino acids. Collagen quantity was measured and multiplied by 7.46 to convert BAL or lung tissue hydroxyproline content to BAL or lung tissue collagen content, taking into account that collagen is approximately 13% hydroxyproline by weight (Neuman and Logan, 1950).

Additional collagen metabolism measurements were made on the mice sacrificed after 24 months of talc exposure to further define collagen metabolism. Approximately 2 to 3 hours prior to sacrifice, ¹⁴C-proline (0.1 μCi/g body weight) was injected intraperitoneally to estimate collagen and protein synthesis. Radioactive proline and hydroxyproline were quantitated in lung hydrolysate. Following this, the radioactive proline and hydroxyproline quantities were used to calculate the noncollagenous protein synthesis, and the collagen production.

Noncollagenous protein synthesis was indicated as total ¹⁴C-proline incorporation into lung tissue minus the incorporation into lung tissue which was related to collagen synthesis. The radioactive proline in collagen was assumed to be equal to the radioactive hydroxyproline, thus, incorporation into collagen was calculated as twice the radioactive hydroxyproline. Collagen production (% of newly synthesized protein that was collagen) was calculated as the percent of the total incorporation of proline into all proteins constituted by collagen, and adjusted for the 5.4-fold difference in the content of total amino acids (proline and hydroxyproline) between collagen and noncollagenous protein (Pickrell *et al.*, 1987).

At each sacrifice time, lung tissue proteinase activity was measured as the release of ¹⁴C-leucine from prelabeled globin at pH 4.2 and 7.5 (Gregory and Pickrell, 1982; Harkema *et al.*, 1984; Pickrell *et al.*, 1987). Acid proteinase activity was inhibited by leupeptin to indicate either cathepsin B (inhibited) or cathepsin D (not inhibited)-like activity. Neutral proteinase activity was inhibited by 1,10-phenanthroline to indicate either macrophage elastase (inhibited) or neutrophil elastase-cathepsin G (not inhibited)-like activity.

TABLE H1
 Number of Mice Evaluated for Lung Talc Burden and Lung Biochemistry

	Male			Female		
	0 mg/m ³	6 mg/m ³	18 mg/m ³	0 mg/m ³	6 mg/m ³	18 mg/m ³
Lung Burden						
6-Month Interim	- ^a	2	4	-	4	4
12-Month Interim	-	4	4	-	4	4
18-Month Interim	-	2	1	-	4	3
24-Month Interim	-	8	6	-	6	5
Lung Biochemistry						
6-Month Interim	4	4	4	4	4	4
12-Month Interim	4	4	4	4	4	4
18-Month Interim	4	4	4	4	4	4
24-Month Interim	9	8	6	7	6	5

^a Lung burden not measured in 0 mg/m³ mice

TABLE H2
Lung Talc Burden (Normalized to Control Lung Weight) of Mice^a

	6 months	12 months	18 months	24 months
Male				
0 mg/m ³	- ^b	-	-	-
6 mg/m ³	0.415 ± 0.114	1.084 ± 0.130	0.426 ± 0.040	2.973 ± 0.762*
18 mg/m ³	1.41 ± 0.29	9.00 ± 1.45*	8.36 ^c	19.73 ± 4.03**
Female				
0 mg/m ³	-	-	-	-
6 mg/m ³	0.524 ± 0.056	0.707 ± 0.170	1.387 ± 0.178**	2.667 ± 0.720**
18 mg/m ³	1.35 ± 0.24	6.17 ± 1.39*	7.83 ± 1.36*	20.05 ± 0.98**

* Significantly different ($P \leq 0.05$) from the 6 month group by Dunn's or Shirley's test

** $P \leq 0.01$

^a Mean ± standard error; units are presented as mg talc/g control lung.

^b Not examined

^c n=1; no standard error calculated

TABLE H3
Lung Talc Burden (Normalized to Exposure Concentration) of Mice^a

	Male		Female	
	6 mg/m ³	18 mg/m ³	6 mg/m ³	18 mg/m ³
6-Month Interim	0.069 ± 0.019	0.078 ± 0.016	0.087 ± 0.009	0.075 ± 0.013
12-Month Interim	0.181 ± 0.022	0.500 ± 0.081*	0.118 ± 0.028	0.343 ± 0.077*
18-Month Interim	0.071 ± 0.007	0.464 ^b	0.231 ± 0.030	0.435 ± 0.075
24-Month Interim	0.496 ± 0.127	1.096 ± 0.224*	0.445 ± 0.120	1.114 ± 0.055*

* Significantly different ($P \leq 0.05$) from the 6 mg/m³ group by Dunn's or Shirley's test

^a Mean ± standard error; units are presented as mg talc/g control lung per mg talc/m³

^b n=1; no standard error calculated

TABLE H4
Bronchoalveolar Lavage Fluid Enzymes of Mice at the 6-Month Interim Evaluation^a

	0 mg/m ³	6 mg/m ³	18 mg/m ³
Male			
Lactate Dehydrogenase	1,408 ± 658	1,317 ± 106	2,107 ± 336
Glutathione Reductase	148.4 ± 33.8	123.3 ± 28.3	227.2 ± 65.6
Total Protein ^b	3.57 ± 0.89	1.92 ± 0.70	6.24 ± 1.23
Female			
Lactate Dehydrogenase	1,988 ± 157	2,351 ± 180	1,400 ± 197
Glutathione Reductase	206.8 ± 14.7	166.0 ± 21.3	148.5 ± 29.4
Total Protein ^b	2.55 ± 0.53	4.43 ± 0.34	6.89 ± 4.29

^a Mean ± standard error; units are presented as mIU/g control lung.

^b Mean ± standard error; units are presented as mg/g control lung.

TABLE H5
Bronchoalveolar Lavage Fluid Enzymes of Mice at the 12-Month Interim Evaluation^a

	0 mg/m ³	6 mg/m ³	18 mg/m ³
Male			
β-Glucuronidase	0.188 ± 0.114	0.486 ± 0.346	12.787 ± 3.604 ^o
Lactate Dehydrogenase	1,107.6 ± 545	540.2 ± 59.0	1,487.1 ± 456
Glutathione Reductase	89.50 ± 11.65	91.67 ± 6.60	302.40 ± 65.15 ^o
Total Protein ^b	2.21 ± 0.74	1.56 ± 0.33	6.19 ± 2.63
Female			
β-Glucuronidase	0.073 ± 0.073	0.413 ± 0.251	9.786 ± 2.271 ^{oo}
Lactate Dehydrogenase	1,209.7 ± 305	447.5 ± 76.1	1,805.3 ± 285
Glutathione Reductase	113.57 ± 19.78	97.93 ± 14.93	198.65 ± 23.44
Total Protein ^b	3.54 ± 1.27	3.61 ± 1.38	4.82 ± 2.88

^o Significantly different (P≤0.05) from the control group by Dunn's or Shirley's test

^{oo} P≤0.01

^a Mean ± standard error; units are presented as mIU/g control lung.

^b Mean ± standard error; units are presented as mg/g control lung.

TABLE H6
Bronchoalveolar Lavage Fluid Enzymes of Mice at the 18-Month Interim Evaluation^a

	0 mg/m ³	6 mg/m ³	18 mg/m ³
Male			
β-Glucuronidase	0.000 ± 0.000	1.344 ± 1.267	9.937 ± 4.196**
Lactate Dehydrogenase	434.0 ± 45.7	642.4 ± 119	1,039.9 ± 168**
Glutathione Reductase	63.93 ± 14.16	106.38 ± 12.15	217.18 ± 45.29*
Total Protein ^b	3.43 ± 0.62	6.23 ± 0.97*	9.45 ± 1.95**
Female			
β-Glucuronidase	4.243 ± 4.203	0.334 ± 0.334	19.064 ± 9.200
Lactate Dehydrogenase	501.4 ± 46.9	404.2 ± 97.6	1,217.6 ± 255*
Glutathione Reductase	73.19 ± 14.94	71.27 ± 12.11	240.55 ± 44.06*
Total Protein ^b	2.96 ± 0.40	3.41 ± 0.92	9.59 ± 1.23*

* Significantly different ($P \leq 0.05$) from the control group by Dunn's or Shirley's test

** $P \leq 0.01$

^a Mean ± standard error; units are presented as mIU/g control lung.

^b Mean ± standard error; units are presented as mg/g control lung.

TABLE H7
Bronchoalveolar Lavage Fluid Enzymes of Mice at the 24-Month Interim Evaluation^a

	0 mg/m ³	6 mg/m ³	18 mg/m ³
Male			
β-Glucuronidase	0.000 ± 0.000	1.811 ± 0.878**	16.571 ± 3.932**
Lactate Dehydrogenase	1,769 ± 259	1,439 ± 295	2,965 ± 131*
Glutathione Reductase	73.66 ± 9.75	87.55 ± 25.16	229.53 ± 58.46*
Total Protein ^b	1.69 ± 0.20	2.34 ± 0.22	4.68 ± 0.70**
Female			
β-Glucuronidase	0.000 ± 0.000	2.624 ± 1.176**	13.778 ± 2.640**
Lactate Dehydrogenase	1,082 ± 155	1,596 ± 197*	2,026 ± 279**
Glutathione Reductase	68.66 ± 7.42	73.37 ± 13.91	163.46 ± 33.43*
Total Protein ^b	1.111 ± 0.310	0.872 ± 0.261	2.228 ± 0.501

* Significantly different ($P \leq 0.05$) from the control group by Dunn's or Shirley's test

** $P \leq 0.01$

^a Mean ± standard error; units are presented as mIU/g control lung.

^b Mean ± standard error; units are presented as mg/g control lung.

TABLE H8
Bronchoalveolar Lavage Fluid Cell Populations of Mice at the 6-Month Interim Evaluation^a

	0 mg/m ³	6 mg/m ³	18 mg/m ³
Male			
Polymorphonucleated Cells	0.250 ± 0.250	3.250 ± 1.250	12.000 ± 3.764 ^{oo}
Lymphocytes	0.750 ± 0.750	0.750 ± 0.479	0.000 ± 0.000
Macrophages	92.50 ± 3.23	95.75 ± 1.44	84.75 ± 2.95
Epithelial Cells	6.500 ± 3.775	0.250 ± 0.250	3.250 ± 1.250
Female			
Polymorphonuclear Cells	0.000 ± 0.000	1.250 ± 0.629 ^o	1.750 ± 0.854 ^o
Lymphocytes	0.000 ± 0.000	1.000 ± 1.000	0.000 ± 0.000
Macrophages	95.00 ± 2.16	94.75 ± 1.44	96.00 ± 1.22
Epithelial Cells	5.00 ± 2.16	3.00 ± 1.73	2.25 ± 1.31

^o Significantly different (P≤0.05) from the control group by Dunn's or Shirley's test

^{oo} P≤0.01

^a Mean ± standard error; units are presented as percent of total cells.

TABLE H9
Bronchoalveolar Lavage Fluid Cell Populations of Mice at the 12-Month Interim Evaluation^a

	0 mg/m ³	6 mg/m ³	18 mg/m ³
Male			
Polymorphonuclear Cells	26.75 ± 15.12	7.50 ± 5.85	15.00 ± 14.01
Lymphocytes	0.750 ± 0.250	2.250 ± 1.436	0.333 ± 0.333
Macrophages	70.50 ± 14.56	83.25 ± 6.91	73.33 ± 12.14
Epithelial Cells	2.00 ± 1.41	7.00 ± 2.12	11.33 ± 7.36
Female			
Polymorphonuclear Cells	1.33 ± 1.33	34.50 ± 10.27 ^o	2.25 ± 0.85
Lymphocytes	1.000 ± 0.577	3.500 ± 1.500	0.000 ± 0.000
Macrophages	92.67 ± 0.33	58.25 ± 11.65	91.00 ± 2.04
Epithelial Cells	5.00 ± 1.53	3.75 ± 1.75	6.75 ± 2.84

^o Significantly different (P≤0.05) from the control group by Dunn's or Shirley's test

^a Mean ± standard error; units are presented as percent of total cells.

TABLE H10
Bronchoalveolar Lavage Fluid Cell Populations of Mice at the 18-Month Interim Evaluation^a

	0 mg/m ³	6 mg/m ³	18 mg/m ³
Male			
Polymorphonuclear Cells	0.250 ± 0.250	8.750 ± 4.404	19.000 ± 6.258*
Lymphocytes	0.000 ± 0.000	0.500 ± 0.500	1.000 ± 0.577
Macrophages	89.00 ± 1.22	82.75 ± 5.81	75.75 ± 4.73
Epithelial Cells	10.75 ± 1.44	8.00 ± 4.74	4.25 ± 2.39
Female			
Polymorphonuclear Cells	0.250 ± 0.250	1.000 ± 0.577	16.000 ± 3.606*
Lymphocytes	0.000 ± 0.000	0.000 ± 0.000	1.333 ± 0.882*
Macrophages	84.50 ± 5.52	92.67 ± 0.88	79.00 ± 3.06
Epithelial Cells	15.25 ± 5.54	6.33 ± 0.88	3.67 ± 2.33

* Significantly different ($P \leq 0.05$) from the control group by Dunn's or Shirley's test

^a Mean ± standard error; units are presented as percent of total cells.

TABLE H11
Bronchoalveolar Lavage Fluid Cell Populations of Mice at the 24-Month Interim Evaluation^a

	0 mg/m ³	6 mg/m ³	18 mg/m ³
Male			
Polymorphonuclear Cells	0.200 ± 0.200	13.000 ± 2.345*	16.500 ± 1.803**
Lymphocytes	0.000 ± 0.000	0.375 ± 0.239	0.500 ± 0.289
Macrophages	89.10 ± 2.50	78.25 ± 1.61*	80.33 ± 0.60*
Epithelial Cells	10.70 ± 2.61	8.38 ± 1.01	2.67 ± 1.59
Female			
Polymorphonuclear Cells	0.000 ± 0.000	7.500 ± 1.607*	20.667 ± 5.918**
Lymphocytes	0.000 ± 0.000	0.500 ± 0.500	0.500 ± 0.500
Macrophages	86.38 ± 3.57	87.00 ± 2.08	73.67 ± 8.46
Epithelial Cells	13.63 ± 3.57	5.00 ± 1.00	5.17 ± 3.03

* Significantly different ($P \leq 0.05$) from the control group by Dunn's or Shirley's test

** $P \leq 0.01$

^a Mean ± standard error; units are presented as percent of total cells.

TABLE H12

Phagocytic Activity of Macrophages in Bronchoalveolar Fluid of Mice at the 12-Month Interim Evaluation^a

	0 mg/m ³	6 mg/m ³	18 mg/m ³
Male			
Phagocytic Activity	85.50 ± 1.44	56.10 ± 2.23 ^o	16.77 ± 2.98 ^{oo}
Female			
Phagocytic Activity	77.07 ± 9.88	52.10 ± 9.22	17.37 ± 6.17 ^{oo}

^o Significantly different (P≤0.05) from the control by Dunn's or Shirley's test^{oo} P≤0.01^a Mean ± standard error; units are presented as percent cells phagocytizing sheep erythrocytes.

TABLE H13

Phagocytic Activity of Macrophages in Bronchoalveolar Fluid of Mice at the 18-Month Interim Evaluation^a

	0 mg/m ³	6 mg/m ³	18 mg/m ³
Male			
Phagocytic Activity	37.43 ± 8.55	14.10 ± 4.54	11.98 ± 2.22 ^o
Female			
Phagocytic Activity	46.85 ± 11.08	20.03 ± 7.45	6.65 ± 0.35 ^o

^o Significantly different (P≤0.05) from the control by Dunn's or Shirley's test^a Mean ± standard error; units are presented as percent cells phagocytizing sheep erythrocytes.

TABLE H14
Viability and Phagocytic Activity of Macrophages in Bronchoalveolar Fluid of Mice
at the 24-Month Interim Evaluation

	0 mg/m ³	6 mg/m ³	18 mg/m ³
Male			
Viability ^a	79.20 ± 3.44	64.60 ± 4.15	83.23 ± 0.87
Phagocytic Activity ^b	37.14 ± 9.80	11.90 ± 4.64	3.56 ± 2.25**
Female			
Viability	60.50 ± 8.80	47.17 ± 2.74	59.77 ± 3.21
Phagocytic Activity	21.57 ± 6.77	13.60 ± 4.71	4.35 ± 2.65*

* Significantly different ($P \leq 0.05$) from the control by Dunn's or Shirley's test

** $P \leq 0.01$

^a Mean ± standard error; units are presented as percent viable cells.

^b Units are presented as percent cells phagocytizing sheep erythrocytes.

TABLE H15
Measurements of Lung Collagen in Mice at the 6-Month Interim Evaluation

	0 mg/m ³	6 mg/m ³	18 mg/m ³
Male			
Lavage Fluid Collagenous Peptides ^a	67.13 ± 9.76	24.83 ± 8.18	79.64 ± 18.03
Total Lung Collagen ^b	7.42 ± 0.48	7.51 ± 1.38	12.27 ± 4.53
Female			
Lavage Fluid Collagenous Peptides	42.92 ± 8.49	70.83 ± 9.09	51.17 ± 5.14
Total Lung Collagen	4.69 ± 0.35	5.85 ± 0.89	11.00 ± 3.88

^a Mean ± standard error; units are presented as µg/g control lung.

^b Mean ± standard error; units are presented as mg/g control lung.

TABLE H16
Measurements of Lung Collagen in Mice at the 12-Month Interim Evaluation

	0 mg/m ³	6 mg/m ³	18 mg/m ³
Male			
Lavage Fluid Collagenous Peptides ^a	74.23 ± 9.42	68.73 ± 4.11	117.62 ± 11.07 ^o
Total Lung Collagen ^b	11.94 ± 0.47	12.44 ± 0.82	13.30 ± 1.11
Female			
Lavage Fluid Collagenous Peptides	89.88 ± 12.99	73.66 ± 11.58	108.55 ± 7.56
Total Lung Collagen	11.64 ± 0.48	11.84 ± 0.45	13.78 ± 1.09

^o Significantly different (P≤0.05) from the control by Dunn's or Shirley's test

^a Mean ± standard error; units are presented as µg/g control lung.

^b Mean ± standard error; units are presented as mg/g control lung.

TABLE H17
Measurements of Lung Collagen in Mice at the 18-Month Interim Evaluation

	0 mg/m ³	6 mg/m ³	18 mg/m ³
Male			
Lavage Fluid Collagenous Peptides ^a	42.54 ± 2.15	51.18 ± 5.40	70.67 ± 8.41 ^{oo}
Total Lung Collagen ^b	6.60 ± 0.49	7.13 ± 0.30	9.70 ± 0.70 ^{oo}
Female			
Lavage Fluid Collagenous Peptides	54.09 ± 11.27	37.68 ± 6.01	64.88 ± 6.56
Total Lung Collagen	6.16 ± 0.25	6.96 ± 0.31	7.34 ± 0.43

^{oo} Significantly different (P≤0.01) from the control by Dunn's or Shirley's test

^a Mean ± standard error; units are presented as µg/g control lung.

^b Mean ± standard error; units are presented as mg/g control lung.

TABLE H18
Lung Collagen Metabolism and Protein Synthesis in Mice at the 24-Month Interim Evaluation

	0 mg/m ³	6 mg/m ³	18 mg/m ³
Male			
Lavage Fluid Collagenous Peptides ^a	54.39 ± 4.42	65.98 ± 5.01	91.92 ± 4.93**
Total Lung Collagen ^b	8.53 ± 0.71	8.55 ± 0.59	13.71 ± 2.81*
Collagen Production ^c	1.133 ± 0.274	0.779 ± 0.151	1.554 ± 0.291
Non-Collagenous Protein Synthesis ^d	68.48 ± 10.41	58.84 ± 4.19	93.73 ± 9.73
Female			
Lavage Fluid Collagenous Peptides	38.09 ± 4.38	39.26 ± 4.01	62.14 ± 9.04*
Total Lung Collagen	6.04 ± 0.27	6.41 ± 0.36	7.91 ± 0.35*
Collagen Production ^c	1.15 ± 0.33	1.65 ± 0.13	1.33 ± 0.12
Non-Collagenous Protein Synthesis ^d	52.46 ± 8.60	47.55 ± 6.94	84.51 ± 4.84

* Significantly different (P≤0.05) from the control by Dunn's or Shirley's test

** P≤0.01

^a Mean ± standard error; units are presented as µg/g control lung.

^b Mean ± standard error; units are presented as mg/g control lung.

^c Mean ± standard error; units are presented as percent new protein.

^d Mean ± standard error; units are presented as disintegrations per minute x 10⁻³/g control lung.

TABLE H19
 Proteinase Activity in Lavage Fluid and Lung Homogenate Supernatant Fluid of Mice
 at the 6-Month Interim Evaluation^a

	0 mg/m ³	6 mg/m ³	18 mg/m ³
Male			
Lavage Fluid			
Acid Proteinase	1.27 ± 0.24	1.65 ± 0.47	2.05 ± 0.23
Cathepsin D	0.078 ± 0.038	0.656 ± 0.321 ^o	0.876 ± 0.107 ^o
Cathepsin B	1.006 ± 0.239	0.992 ± 0.716	0.954 ± 0.010
Homogenate Supernatant Fluid			
Acid Proteinase	5.83 ± 1.07	8.10 ± 0.78	7.45 ± 0.64
Cathepsin D	2.27 ± 0.46	3.30 ± 0.57	- ^b
Cathepsin B	3.56 ± 0.80	4.80 ± 0.58	-
Neutral Proteinase	0.634 ± 0.039	0.360 ± 0.043 ^o	-
PMN Elastase Cathepsin G	0.446 ± 0.014	0.418 ± 0.357	-
Macrophage Elastase Collagenase	0.207 ± 0.058	0.340 ± 0.154	-
Female			
Lavage Fluid			
Acid Proteinase	0.762 ± 0.089	1.595 ± 0.038 ^{**}	1.346 ± 0.097
Cathepsin D	0.457 ± 0.166	0.998 ± 0.016	0.628 ± 0.113
Cathepsin B	0.260 ± 0.068	0.571 ± 0.063	0.718 ± 0.094 ^o
Homogenate Supernatant Fluid			
Acid Proteinase	4.35 ± 0.31	6.95 ± 0.61 ^o	5.77 ± 0.61
Cathepsin D	1.78 ± 0.12	3.89 ± 1.52 ^o	3.12 ± 0.06 ^o
Cathepsin B	2.57 ± 0.22	3.06 ± 1.01	2.65 ± 0.56
Neutral Proteinase	0.522 ± 0.047	0.535 ± 0.039	0.848 ^c
PMN Elastase Cathepsin G	0.416 ± 0.033	0.347 ± 0.066	-
Macrophage Elastase Collagenase	0.106 ± 0.043	0.188 ± 0.058	-

^o Significantly different ($P \leq 0.05$) from the control group by Dunn's or Shirley's test

^{oo} $P \leq 0.01$

^a Mean ± standard error; units are presented as mg/hour per gram control lung.

^b n=0; no data recorded

^c n=1; no standard error calculated

TABLE H20
Proteinase Activity in Lavage Fluid and Lung Homogenate Supernatant Fluid of Mice
at the 12-Month Interim Evaluation^a

	0 mg/m ³	6 mg/m ³	18 mg/m ³
Male			
Lavage Fluid			
Acid Proteinase	1.65 ± 0.13	2.11 ± 0.82	3.25 ± 0.28
Cathepsin D	0.403 ± 0.163	0.970 ± 0.244	1.796 ± 0.306**
Cathepsin B	1.25 ± 0.10	1.25 ± 0.78	1.46 ± 0.05
Homogenate Supernatant Fluid			
Acid Proteinase	7.21 ± 0.50	9.35 ± 0.07*	16.50 ± 0.95**
Cathepsin D	5.32 ± 0.27	7.71 ± 0.16*	14.32 ± 1.27**
Cathepsin B	1.89 ± 0.48	1.64 ± 0.10	2.18 ± 0.39
Neutral Proteinase	0.386 ± 0.055	1.029 ± 0.416	1.088 ± 0.271*
PMN Elastase Cathepsin G	0.110 ± 0.110	0.005 ± 0.005	0.209 ± 0.148
Macrophage Elastase Collagenase	0.426 ± 0.159	1.127 ± 0.422	0.879 ± 0.162
Female			
Lavage Fluid			
Acid Proteinase	1.94 ± 0.17	1.79 ± 0.35	3.60 ± 0.33*
Cathepsin D	0.526 ± 0.263	0.463 ^b	1.525 ± 0.266*
Cathepsin B	1.50 ± 0.41	2.14 ^b	2.08 ± 0.08
Homogenate Supernatant Fluid			
Acid Proteinase	7.88 ± 0.24	10.48 ± 0.50*	16.92 ± 1.84**
Cathepsin D	6.40 ± 0.70	8.44 ± 0.51	14.76 ± 1.59**
Cathepsin B	1.55 ± 0.54	2.04 ± 0.22	2.16 ± 0.55
Neutral Proteinase	0.423 ± 0.183	0.601 ± 0.108	0.824 ± 0.057
PMN Elastase Cathepsin G	0.215 ± 0.125	0.213 ± 0.213	0.190 ± 0.124
Macrophage Elastase Collagenase	0.280 ± 0.116	0.446 ± 0.127	0.653 ± 0.158

* Significantly different ($P \leq 0.05$) from the control group by Dunn's or Shirley's test

** $P \leq 0.01$

^a Mean ± standard error; units are presented as mg/hour per gram control lung.

^b n=1; no standard error calculated

TABLE H21
 Proteinase Activity in Lavage Fluid and Lung Homogenate Supernatant Fluid of Mice
 at the 18-Month Interim Evaluation^a

	0 mg/m ³	6 mg/m ³	18 mg/m ³
Male			
Lavage Fluid			
Acid Proteinase	0.264 ± 0.044	0.428 ± 0.120	0.384 ± 0.066
Cathepsin D	0.212 ± 0.046	0.073 ± 0.013 ^o	0.051 ± 0.035 ^o
Cathepsin B	0.069 ± 0.037	0.355 ± 0.127 ^o	0.342 ± 0.057 ^o
Homogenate Supernatant Fluid			
Acid Proteinase	3.29 ± 0.58	4.76 ± 0.49	8.38 ± 0.85 ^{oo}
Cathepsin D	2.71 ± 0.24	4.98 ± 0.63 ^o	8.45 ± 0.63 ^{oo}
Cathepsin B	0.607 ± 0.327	0.053 ± 0.053	0.403 ± 0.270
Neutral Proteinase	0.425 ± 0.079	0.548 ± 0.022	0.528 ± 0.034
PMN Elastase Cathepsin G	0.158 ± 0.066	0.242 ± 0.061	0.254 ± 0.017
Macrophage Elastase Collagenase	0.286 ± 0.093	0.306 ± 0.041	0.275 ± 0.031
Female			
Lavage Fluid			
Acid Proteinase	0.267 ± 0.103	0.561 ± 0.126	0.382 ± 0.040
Cathepsin D	0.219 ± 0.085	0.012 ± 0.012	0.062 ± 0.036
Cathepsin B	0.088 ± 0.034	0.587 ± 0.095 ^o	0.358 ± 0.098 ^o
Homogenate Supernatant Fluid			
Acid Proteinase	3.97 ± 0.41	5.57 ± 0.26 ^o	9.03 ± 0.88 ^{oo}
Cathepsin D	3.28 ± 0.23	5.37 ± 0.16 ^o	9.17 ± 0.75 ^{oo}
Cathepsin B	0.694 ± 0.284	0.232 ± 0.096	0.265 ± 0.265
Neutral Proteinase	0.381 ± 0.041	0.540 ± 0.036 ^o	0.583 ± 0.035 ^o
PMN Elastase Cathepsin G	0.265 ± 0.038	0.391 ± 0.038	0.268 ± 0.041
Macrophage Elastase Collagenase	0.116 ± 0.033	0.149 ± 0.054	0.315 ± 0.045 ^o

^o Significantly different ($P \leq 0.05$) from the control group by Dunn's or Shirley's test

^{oo} $P \leq 0.01$

^a Mean ± standard error; units are presented as mg/hour per gram control lung.

TABLE H22
Proteinase Activity in Lavage Fluid and Lung Homogenate Supernatant Fluid of Mice
at the 24-Month Interim Evaluation^a

	0 mg/m ³	6 mg/m ³	18 mg/m ³
Male			
Lavage Fluid			
Acid Proteinase	1.62 ± 0.14	1.92 ± 0.18	3.56 ± 0.67*
Cathepsin D	0.000 ± 0.000	0.260 ± 0.156	1.613 ± 0.632**
Cathepsin B	1.94 ± 0.19	1.72 ± 0.28	1.78 ± 0.29
Homogenate Supernatant Fluid			
Acid Proteinase	9.23 ± 1.16	13.85 ± 1.56	24.34 ± 2.66*
Cathepsin D	6.63 ± 0.96	10.82 ± 0.98*	18.75 ± 1.73**
Cathepsin B	2.60 ± 0.39	3.03 ± 0.78	5.58 ± 1.11*
Neutral Proteinase	0.417 ± 0.072	0.568 ± 0.104	0.862 ± 0.164*
PMN Elastase Cathepsin G	0.251 ± 0.034	0.382 ± 0.093	0.341 ± 0.106
Macrophage Elastase Collagenase	0.166 ± 0.063	0.186 ± 0.040	0.521 ± 0.250
Female			
Lavage Fluid			
Acid Proteinase	0.854 ± 0.077	1.012 ± 0.149	0.998 ± 0.212
Cathepsin D	0.194 ± 0.089	0.114 ± 0.114	0.402 ± 0.146
Cathepsin B	0.708 ± 0.118	1.000 ± 0.365	0.596 ± 0.305
Homogenate Supernatant Fluid			
Acid Proteinase	7.83 ± 1.11	9.76 ± 0.56	22.54 ± 1.29*
Cathepsin D	5.10 ± 0.67	8.04 ± 0.95	17.93 ± 0.55**
Cathepsin B	2.73 ± 0.47	1.71 ± 0.57	4.61 ± 1.00
Neutral Proteinase	0.454 ± 0.096	0.646 ± 0.143	0.922 ± 0.077*
PMN Elastase Cathepsin G	0.172 ± 0.063	0.341 ± 0.082	0.360 ± 0.093
Macrophage Elastase Collagenase	0.421 ± 0.293	0.314 ± 0.162	0.563 ± 0.102

* Significantly different ($P \leq 0.05$) from the control group by Dunn's or Shirley's test

** $P \leq 0.01$

^a Mean ± standard error; units are presented as mg/hour per gram control lung.

APPENDIX I

CHEMICAL CHARACTERIZATION, ANALYSIS, AND GENERATION OF CHAMBER CONCENTRATIONS

PROCUREMENT AND CHARACTERIZATION OF TALC	262
GENERATION AND MONITORING OF CHAMBER CONCENTRATIONS	264
FIGURE I1 Infrared Absorption Spectrum of Talc	266
FIGURE I2 Fluid Bed Generator	267
FIGURE I3 Aerosol Dilution/Delivery System	268
FIGURE I4 Talc Chronic Exposure System	269
FIGURE I5 Talc Aerosol Filter Concentrations in the 6 mg/m ³ Rat Chamber	270
FIGURE I6 Talc Aerosol Filter Concentrations in the 18 mg/m ³ Rat Chamber	271
FIGURE I7 Talc Aerosol Filter Concentrations in the 6 mg/m ³ Mouse Chamber	272
FIGURE I8 Talc Aerosol Filter Concentrations in the 18 mg/m ³ Mouse Chamber	273
TABLE I1 Summary of Aerosol Size Measurements for the 6 and 18 mg/m ³ Rat Chambers	274
TABLE I2 Summary of Aerosol Size Measurements for the 6 and 18 mg/m ³ Mouse Chambers	275

CHEMICAL CHARACTERIZATION, ANALYSIS, AND GENERATION OF CHAMBER CONCENTRATIONS

PROCUREMENT AND CHARACTERIZATION OF TALC

Talc was obtained from Walsh and Associates (North Kansas City, MO) in two lots (W101882 and B5415). Lot W101882 was used from the beginning of the 2-year studies through 26 January 1986. Lot B5415 was used in the 2-year studies from 27 January 1986 to the end of the studies. The talc was extensively characterized by the analytical chemistry laboratory, Midwest Research Institute (MRI; Kansas City, MO) and McCrone Associates (Norcross, GA). Reports on analyses performed in support of the talc studies are on file at the National Institute of Environmental Health Sciences.

The two lots of the chemical, a finely powdered white solid, were identified as talc by infrared spectroscopy. All spectra were consistent with those expected for the structure and with the literature spectra of talc (*Sadtler Standard Spectra*), as shown in Figure I1.

Lot W101882 was divided into three subbatches, which were analyzed separately. Each subbatch was characterized by elemental analyses, Karl Fischer water analysis, spark source mass spectrometry, and microscopic analyses. Microscopic analysis of each lot consisted of polarized light microscopy (PLM) and transmission electron microscopy (TEM). For PLM the sample was mounted in refractive index liquids and the optical parameters were determined. Dispersion staining has the advantage that small quantities of asbestos can easily be detected since the optical properties are interpreted from bright colors seen on a black background. The colors seen are the results of differences in refractive index dispersion for a liquid and a solid. TEM was performed by sonically dispersing approximately 0.1 g of talc in a solution of 0.001% methyl cellulose in particle-free water. A drop of the suspension was placed on a carbon coated 200-mesh copper grid, and 20 grid openings were examined. The detection limit was 0.1% by weight. No asbestos fibers were detected in any of the subbatches by polarized light microscopy or transmission electron microscopy.

Elemental analyses of hydrogen, magnesium, and silicon for all three subbatches of the lot were in agreement with the theoretical values for talc. The major impurities were 0.7% aluminum and 1.0% iron. Karl Fischer water analysis indicated approximately 0.2% absorbed water. Spark source mass spectrometry for the three subbatches also indicated approximately 0.1% phosphorus, 0.5% fluorine, and 0.05% calcium, while the remaining elemental impurities were less than 0.01%.

A special study was performed on this lot to determine if the sample met the American Society for Testing and Materials standard specifications for magnesium silicate. Results indicated that lot W101882 met the standard specifications.

Automated scanning electron microscopic analysis demonstrated that the talc was virtually free of silica. In the analysis a sample of talc is suspended in methylcellulose. Under computer control the particles are located, and maximum, minimum, and average diameters are determined; then a chemical analysis is performed. Of the 1,466 particles that were examined, one was identified as silica, 1,241 were talc, 136 were of tremolite type composition, 77 were mixed silicates, one was possibly zircon, and 10 were not identified. The single silica particle had an average diameter of 3.9 μm .

Lot B5415 was characterized by elemental analyses, Karl Fischer water analysis, spark source mass spectrometry, and microscopic analyses using the same methods described for lot W101882. Elemental analyses values were similar to results obtained for lot W101882. The major impurities present were 0.1% calcium, 0.5% aluminum, and 1% iron. Karl Fischer water analysis indicated 1.2% absorbed water. Spark source mass spectrometry also indicated 0.04% phosphorus, >0.5% aluminum, 0.03% sodium,

0.35% fluorine, and all other impurities were less than 0.03%. Microscopic analyses using PLM and TEM detected no asbestos fibers.

Comparative purity analyses of the two lots used in these studies were conducted due to problems with the generation of inhalation concentrations. Four samples of talc were used, two samples each from lots W101882 and B5415. Samples A and B were from lot W101882, sample C was from lot B5415, and sample D was a frozen reference from lot B5415 that had been stored at MRI.

Analyses performed included elemental analyses, microscopic analyses (PLM, TEM, determination of particle size distribution, and aspect ratios), X-ray diffraction, and thermogravimetric analysis (TGA). PLM and TEM analyses were performed on samples C and D. Analysis by PLM followed the procedures described earlier; TEM followed the same procedure described earlier except the talc was sonically dispersed in a solution of 90% isopropanol in particle-free water. The determinations of particle size distribution and aspect ratios were performed on all four samples. Using TEM for both analyses, selected area diffraction (SAD) patterns were used to confirm that the particles being measured were talc. The particle size was taken as the average of two diameters 90° to each other and aspect ratios were taken as the ratio of the two diameters. Thermogravimetric analysis (TGA) was performed on samples A, B, and C on a DuPont 910 differential scanning calorimeter (DSC) with calcium oxalate monohydrate used as a calibrating standard, at an initial temperature of 50° C with a programmed maximum temperature of 1,100° C, at a rate of 20° C per minute.

Elemental analyses for hydrogen, magnesium, and silicon for all four samples were in agreement with theoretical values. PLM and TEM detected no asbestos fibers in any of the samples. The results for particle size distribution and aspect ratios indicated that there were only minor differences in particle size between the samples and more than 75% of the particles were in the 1.0 to 3.0 μm range. More than 90% of the talc particles had aspect ratios between 1 and 1.4, and less than 1% had ratios greater than 3:1. X-ray diffraction confirmed that all four samples were primarily talc with small quantities of chlorite and dolomite. Thermogravimetric analysis indicated that samples A, B, and C were similar. A main peak at 912° C in all three samples caused by the loss of chemically combined water was equal to a loss of 4.7% by weight. A minor peak at 590° C in all three samples may represent the loss of CO₂ from dolomite and amounted to a loss of 0.7% by weight which is equivalent to 1.5% dolomite.

Size Distribution Analysis of Talc Samples
(% of Total Particles Counted)

Size Range (μm)	Talc A	Talc B	Talc C	Talc D
0.5-1.0	5.88	2.97	12.50	1.94
1.0-1.5	15.69	9.90	19.23	11.65
1.5-2.0	26.47	26.73	24.04	26.21
2.0-2.5	20.59	17.82	21.15	23.30
2.5-3.0	11.76	18.81	10.58	8.74
3.0-3.5	5.88	12.87	4.81	7.77
3.5-4.0	3.92	5.94	2.88	5.83
4.0-4.5	2.94	1.98	1.92	4.85
4.5-5.0	2.94	0.99	0.96	3.88
5.0-5.5	1.96	0.99	0.96	2.91
5.5-6.0	1.96	0.99	0.96	1.94
6.0-6.5	-	-	-	0.97

The moisture content of the bulk chemical was reanalyzed every 4 months at the study laboratory by determining the weight loss following heating at 120° C for 16 hours. The results indicated that the moisture content of the talc was similar between the two lots and did not change during the 2-year studies. Bulk chemical stability studies were not performed on talc because the physical and chemical

properties of talc indicate that it should be stable over a wide range of temperatures. The compound was stored in tightly sealed plastic bags at 25° C.

GENERATION AND MONITORING OF CHAMBER CONCENTRATIONS

Aerosol Generation System: Talc aerosol was generated from one 4-inch, fluid bed generator (FBG). Figure I2 shows the schematic of the FBG with the gravity feed and collecting pan collection systems. The FBG bed contained type 316 stainless steel powder (Hoeganaes Corporation, Riverton, NJ), consisting of irregularly shaped particles 125 to 180 μm in diameter. The stainless steel powder was cleaned prior to use. The cleaning system used a 4-inch FBG with dry, filtered air flowing through at a flow rate of 80 ft^3/min . The high flow rate through the bed removed the finest stainless steel particles. The cleaning system was run for 24 hours to ensure that all the "fines" were removed.

Following cleaning of the bed material, talc was mixed with the stainless steel powder at approximately 1 to 2.5 g of talc per 500 g bed material. The concentration of talc in the bed material was one method used to adjust exposure concentrations in the chamber. During the time period of November 1985 to January 1986, when difficulty in maintaining target concentrations was experienced, higher loadings were used in an effort to maintain target concentrations.

For generation of the talc aerosol, fluidization of the bed material mixed with talc occurred when compressed air (≈ 200 Lpm) was injected into the bed through a porous metal distribution plate which supports the bed. The motion of the bed released the much smaller talc particles into the air; the larger, heavier stainless steel particles were retained in the bed. A Kr-85 discharger was placed above the bed to reduce the particle charges. The aerosolized talc particles were mixed with diluting air (≈ 200 Lpm) to achieve the desired concentrations and were then delivered to the exposure chambers (Figures I3 and I4). As the talc powder was removed from the bed, the bed material was continually drained from the FBG through an overflow port located at the side of the generator. As spent bed material was drained from the generator, fresh talc-containing bed material was constantly added into the generator from a hopper located above the generator.

Stainless steel multi-tiered whole-body exposure chambers (H2000, Lab Products, Inc.) were used to expose the rats in this study while the smaller H1000 chambers were used for the mice. Flow rates through the chambers were 12 ± 2 ft^3/min . To reduce the spatial variation of aerosol concentration and to increase the uniformity of mixing, the aerosol was diluted using a dilutor prior to its introduction into the chamber. Also, animal cages were rotated weekly to reduce the variation of concentrations of talc aerosols that the rodents were exposed to during the 2-year studies.

Aerosol Concentration Monitoring: Aerosol concentrations in each exposure chamber were monitored by collecting filter samples for three, 2-hour periods during each 6-hour exposure day. The background concentration of total suspended particles in each control chamber was monitored each exposure day by collecting one 6-hour filter sample. Overnight filter samples for total suspended particles were collected from the 18 mg/m^3 chambers monthly. All filter samples were taken at a flow rate of 3 L/minute. Each filter was weighed before and after the sample was collected, and the aerosol mass concentrations were calculated by dividing the mass increment (mg) by the volume sampled (m^3); the means and standard deviations for each chamber were calculated for each exposure day. Weekly mean exposure concentrations for the 2-year studies are presented in Figures I5 through I8. The concentrations during non-exposure hours in the 18 mg/m^3 chambers ranged from 0.02 to 1.1 mg/m^3 .

A RAM-S continuous aerosol monitor was used to monitor the stability of the aerosol concentrations and to determine the need to adjust the aerosol generation system during exposures. The RAM-S was used to monitor each chamber for at least 5 minutes at the beginning, middle, and end of the filter sampling period. A 2 L/minute flow rate through the RAM-S was achieved using an internal pump in the device. Both RAM-S and filter samples were taken at one point of the chambers above the animal cage. A Y-shaped probe was used, allowing simultaneous filter sampling and RAM-S aerosol mass

monitor operation. The overall temporal variation in chamber concentrations in the 2-year studies were 33% and 27% relative standard deviation (RSD) for the mouse 6 and 18 mg/m³ chambers. The variations were 31% and 36% RSD for the rat 6 and 18 mg/m³ chambers. At least a portion of this variability may be ascribed to the period when talc generation problems were encountered (November 1985 through February 1986). In addition, a portion of the variability for the 18 mg/m³ rat chamber may be ascribed to the time when higher concentrations were being generated (September through November, 1984).

During the period of November 5, 1985, through January 27, 1986, difficulties were experienced maintaining the required exposure levels of talc for the lifetime and 2-year exposure studies. Concentrations of aerosolized talc were significantly below target. Attempts were made to increase the flow of talc into the generator and raise the concentration; however, the talc-laden stainless steel bed material fed into the generator less freely than it had prior to November 1985. There were no observable chemical changes in either the talc or the stainless steel bed material and no malfunctions in the generation system which could be pinpointed as the underlying cause for the poor flow characteristics of the bed material. On January 27, 1986, the generator was restarted with a new batch of talc. After a stabilization period of 3 weeks, the flow properties of the bed material showed significant improvement.

It was also observed during February 1986, that when the ratio of talc to bed material was increased above 1.6 g talc per 500 g bed material, the bed began to show the poor flow properties characteristic of the previous batch of talc. When the bed loading was reduced below 1.6 g talc per 500 g bed material, the flow properties stabilized. This indicated that the bed has a maximum loading limit which must not be exceeded. By March 1986, the generator had stabilized and chamber target concentrations were achieved. The exact cause of these generation problems was never resolved.

In November 1984 it was noticed that the RAM-S monitor indicated an off-scale reading (>10 V which is equivalent to 20 mg/m³) for the 18 mg/m³ rat chamber. Reasonable agreement was found between RAM-S readings and filter samples in the other chambers. Investigations of this discrepancy indicated that the airflow through the critical orifice controlling flow through the filter was reduced. Evaluation of the previously collected pressure drop associated with this orifice and one having nearly identical nominal flow revealed that the flow to the sampling filter of the high level rat chamber dropped significantly on September 24, 1984. These data suggest that the sampling orifice had become partially clogged. In order to obtain a correction factor to recalculate the chamber concentration data, the filter pressure drop and exposure chamber pressure drop data were retrieved and used to determine the actual pressure drop across the sampling filter for the time period of September 24 through November 14, 1984. A group of 18 filters from different lots of the type used to sample the talc exposure chambers were tested to determine the pressure drop across them as a function of the flow through the filter. These data indicated that values for flow could be calculated from the pressure drop data. The relationship between pressure drop and filter flow rate was used to recalculate the sampling filter flow for each day. When the chamber sampling orifice flow rate was taken into account, the best estimate of the correction factor is 2.06. This factor has been used to multiply the originally recorded chamber concentrations for those dates. The corrected values are reported.

Aerosol size distribution was determined once a month for each chamber using a cascade impactor operated at a flow rate of 15 L/minute. Stainless steel disks coated with apiezon grease were used as impactor substrates and the amount of talc collected on each stage was determined by the difference in stage weight before and after the sample was collected. The mass median aerodynamic diameter and the geometric standard deviation were calculated from the mass data, effective cutoff diameter of each stage, and impactor flow rate. The results are presented in Tables I1 and I2.

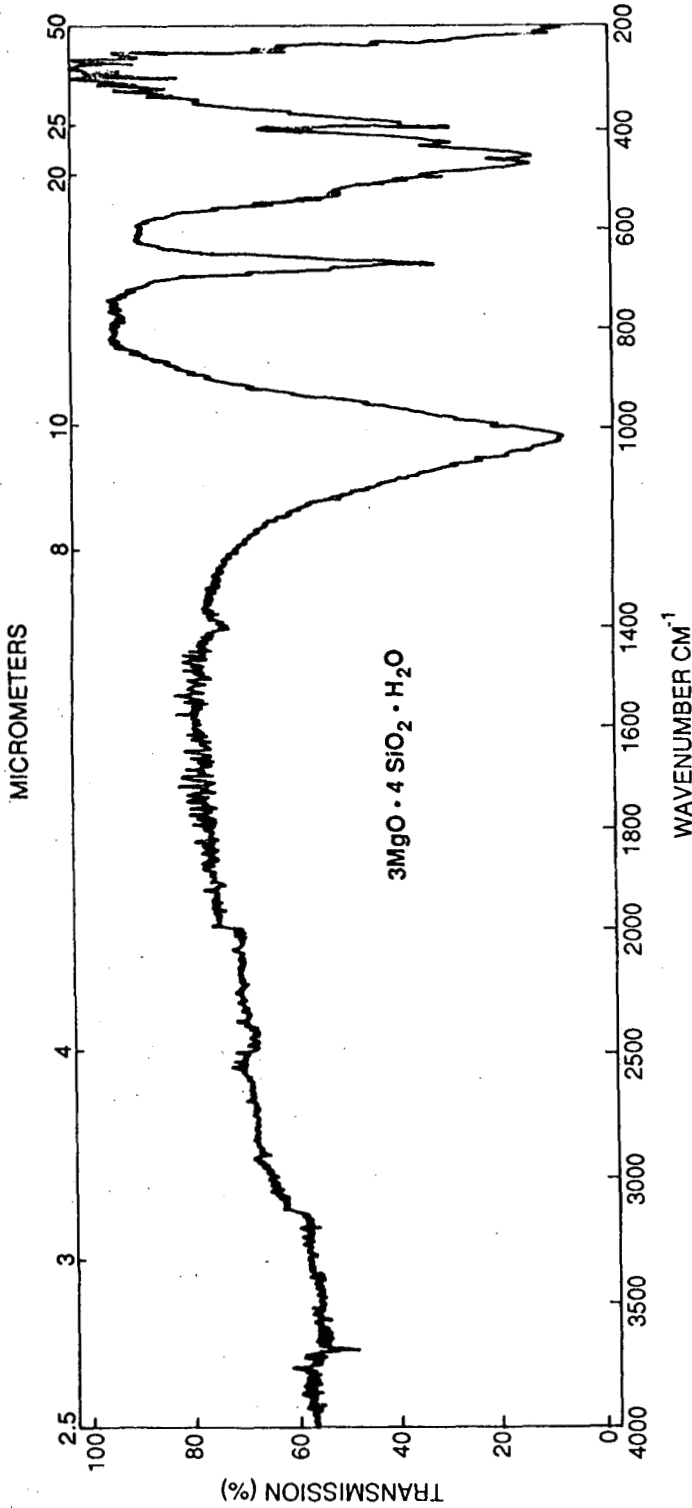

FIGURE II
Infrared Absorption Spectrum of Talc

ABSCISSA EXPANSION 1 SUPPRESSION --	ORDINATE EXPANSION 1 %T 0-100 ABS --	SCAN TIME 24 min RESPONSE 1 SLIT PROGRAM 6	REP. SCAN -- SINGLE BEAM -- TIME DRIVE -- PRE SAMPLE CHOP -- OPERATOR A.Clark DATE 11/9/82
SAMPLE: Talc Lot W101882 Batch 02 Subbatch A	REMARKS Trimmer comb in reference beam	SOLVENT -- CONCENTRATION 1% in KBr	CELL PATH -- REFERENCE 154N

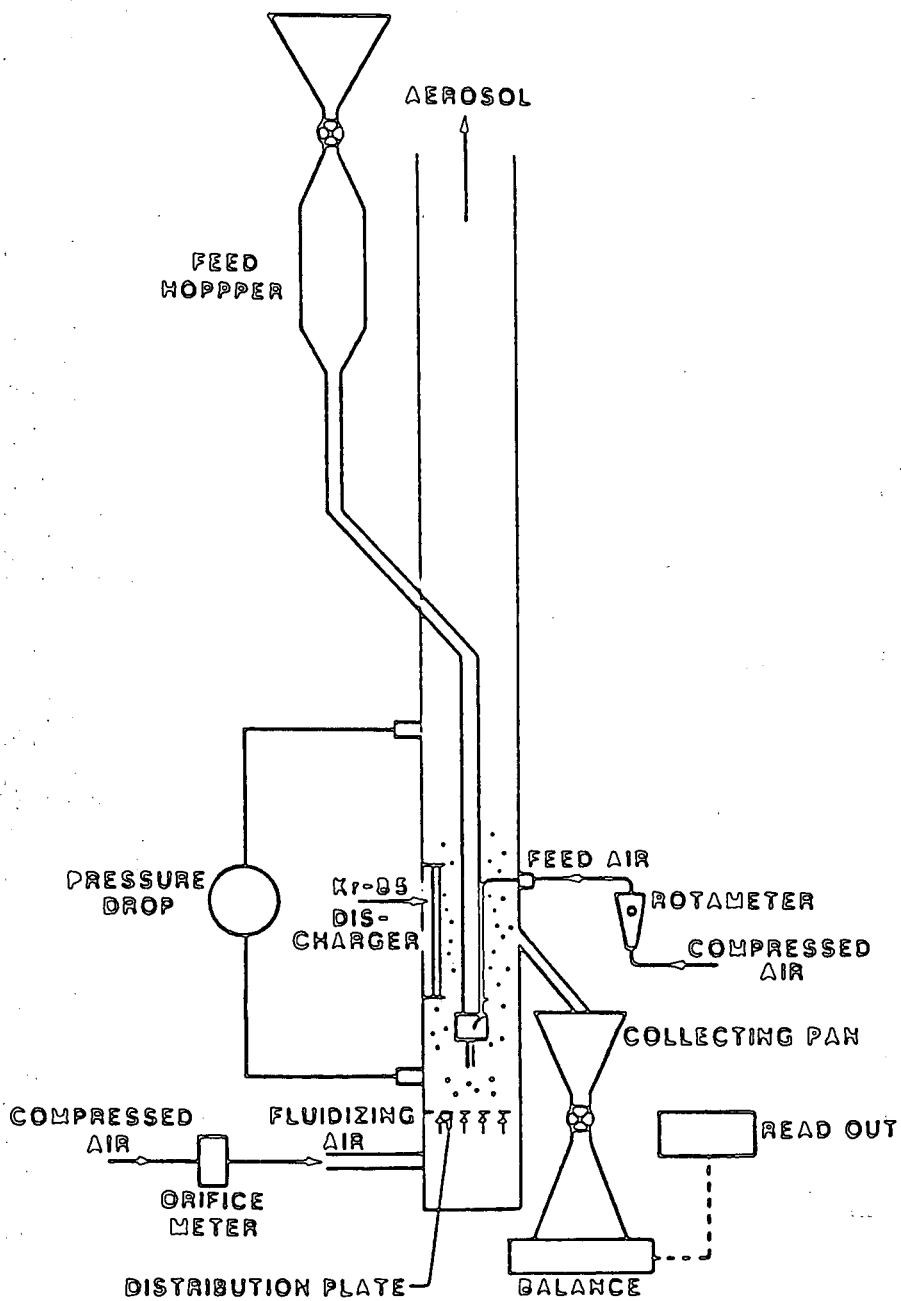

FIGURE 12
Fluid Bed Generator

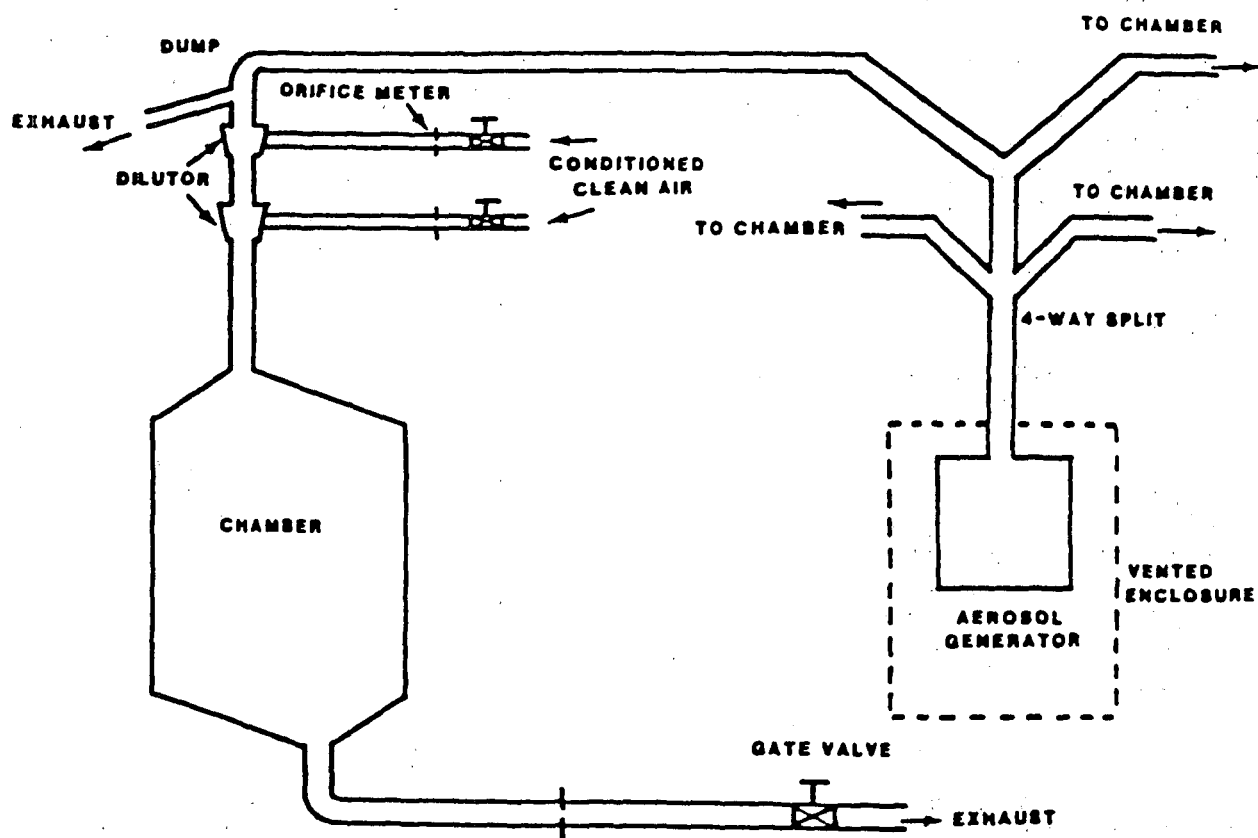

FIGURE I3
Aerosol Dilution/Delivery System

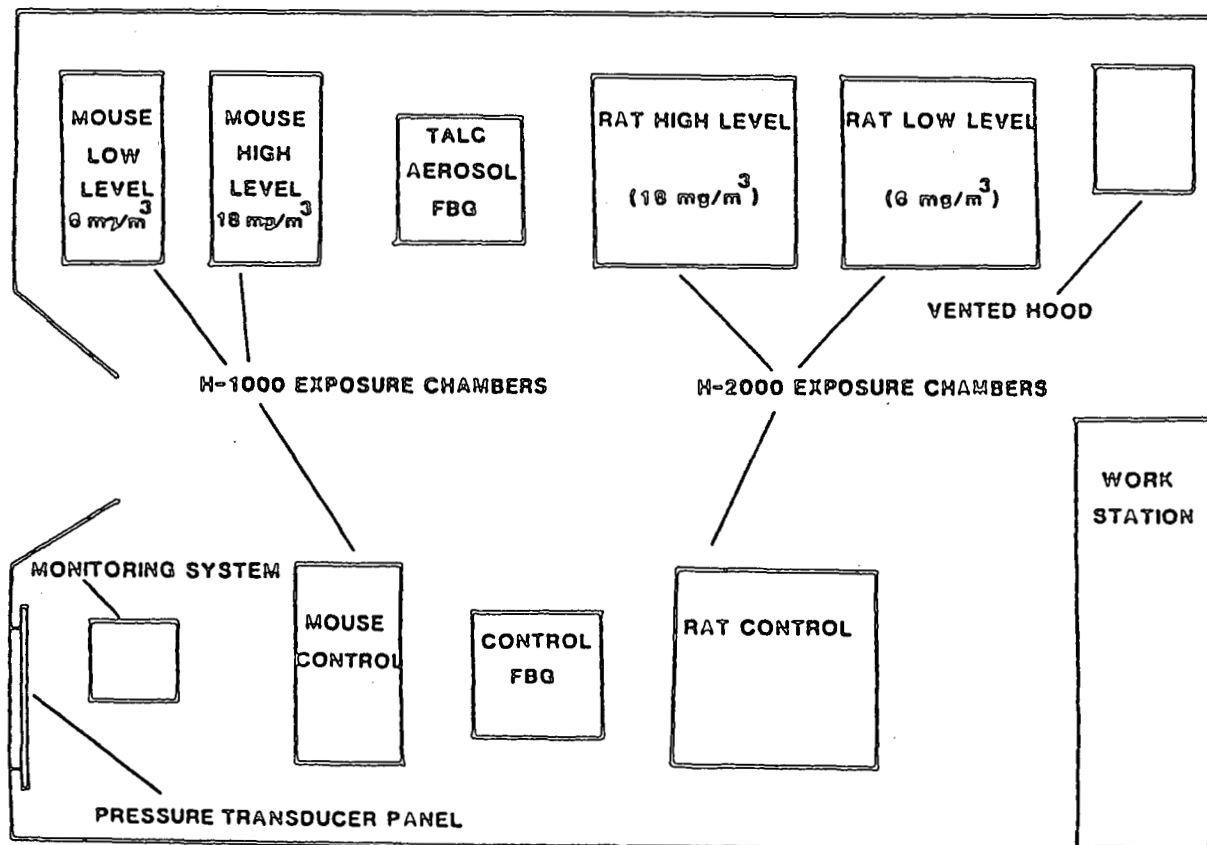

FIGURE I4
Talc Chronic Exposure System

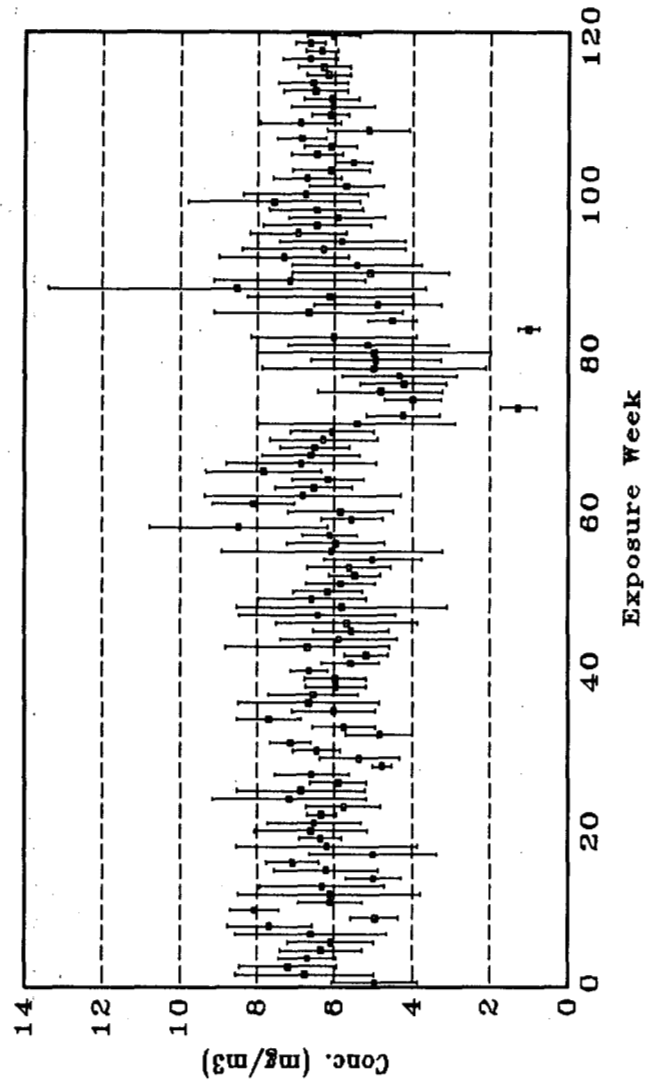

FIGURE I5
Talc Aerosol Filter Concentrations in the 6 mg/m³ Rat Chamber

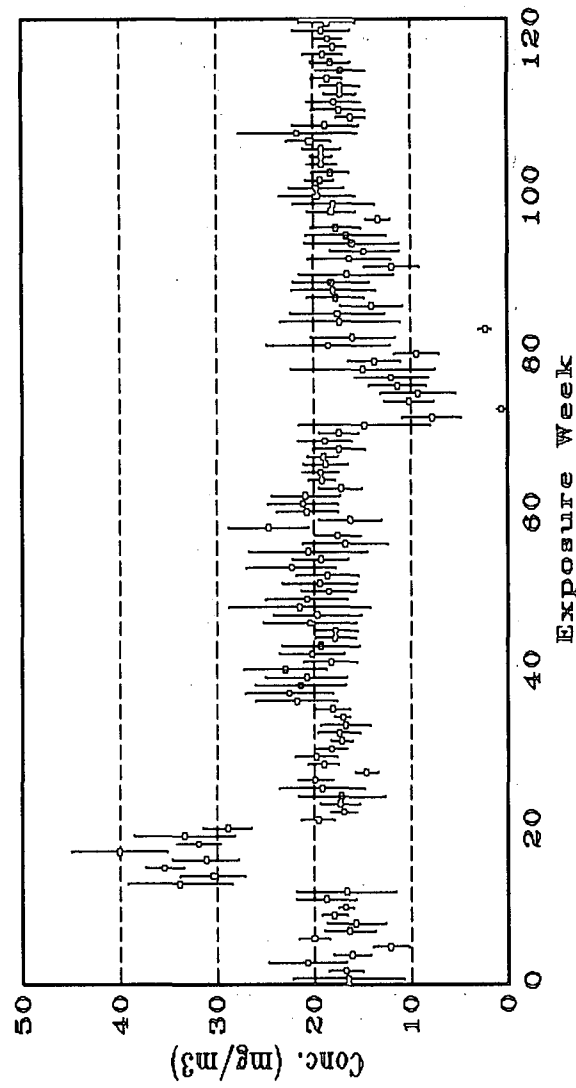

FIGURE I6
Talc Aerosol Filter Concentrations in the 18 mg/m³ Rat Chamber

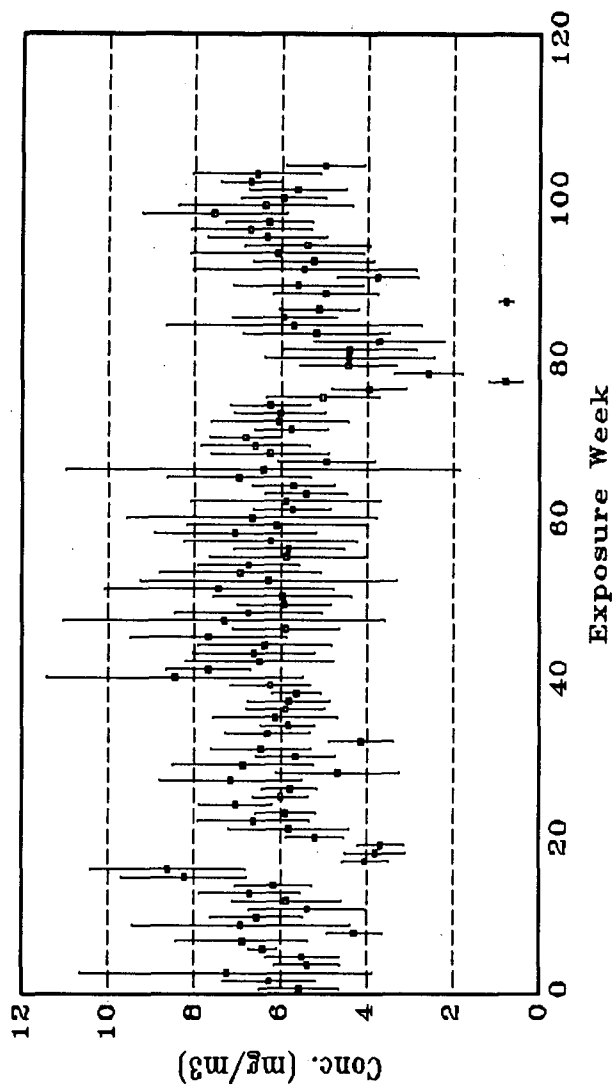

FIGURE I7
Talc Aerosol Filter Concentrations in the 6 mg/m³ Mouse Chamber

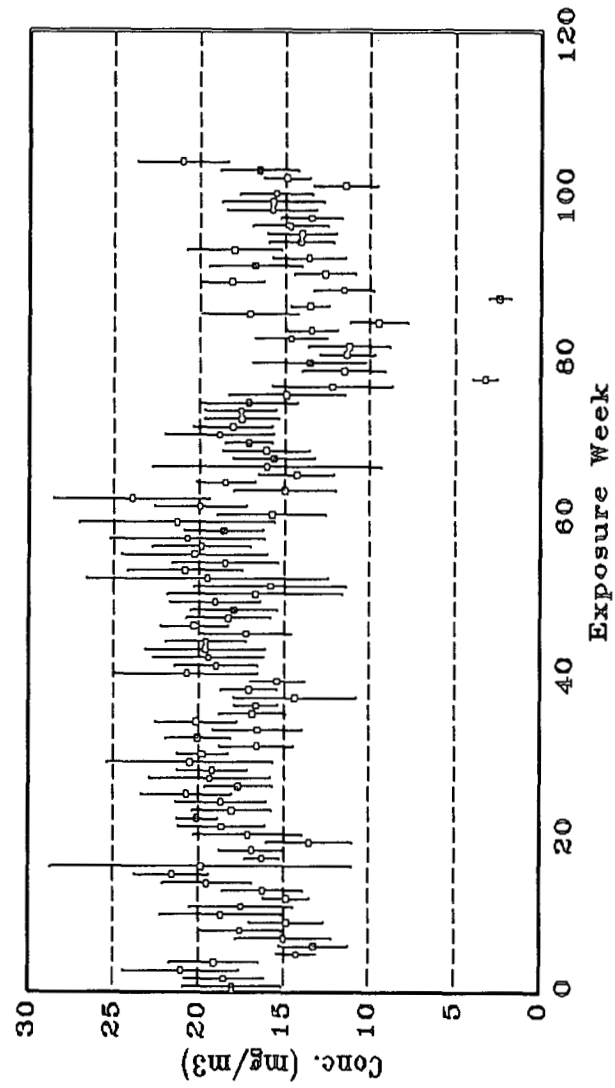

FIGURE 18
Talc Aerosol Filter Concentrations in the 18 mg/m³ Mouse Chamber

TABLE II
Summary of Aerosol Size Measurements for the 6 and 18 mg/m³ Rat Chambers

6 mg/m ³			18 mg/m ³		
Date	Mass Median Aerodynamic Diameter (μm)	Geometric Standard Deviation	Date	Mass Median Aerodynamic Diameter (μm)	Geometric Standard Deviation
9 July 1984	2.3	2.6	25 June 1984	3.6	2.0
6 August 1984	2.6	1.7	1 August 1984	3.0	1.8
4 September	2.8	1.8	27 August 1984	3.2	1.9
3 October 1984	2.6	1.8	26 September 1984	2.9	1.8
31 October 1984	2.9	1.8	24 October 1984	3.2	1.9
27 November 1984	2.5	1.8	20 November 1984	3.0	1.9
4 January 1985	2.6	1.8	24 December 1984	2.8	1.8
25 January 1985	2.5	1.7	14 January 1985	2.9	1.8
25 February 1985	2.6	1.8	19 February 1985	2.8	1.8
19 March 1985	2.8	1.8	15 March 1985	3.1	2.0
22 April 1985	2.9	1.7	12 April 1985	3.1	1.8
13 June 1985	3.0	1.9	8 May 1985	2.9	1.9
9 July 1985	2.8	1.8	10 June 1985	3.0	1.9
9 August 1985	2.7	1.9	5 July 1985	3.5	1.8
3 September 1985	2.7	1.5	1 August 1985	3.1	1.9
30 September 1985	2.3	1.3	26 August 1985	2.9	1.9
28 October 1985	2.6	1.4	23 September 1985	2.6	1.6
2 December 1985	3.1	1.7	21 October 1985	2.7	1.5
18 December 1985	3.0	1.7	25 November 1985	4.0	2.1
3 January 1986	1.8	2.8	17 December 1985	3.3	1.9
8 January 1986	3.6	1.9	30 December 1985	3.7	1.8
13 January 1986	3.1	1.8	3 January 1986	4.0	2.2
24 February 1986	2.9	2.2	8 January 1986	3.8	1.9
24 March 1986	3.4	1.9	18 February 1986	3.2	2.1
22 April 1986	3.2	2.3	17 March 1986	3.6	1.9
23 May 1986	2.4	1.9	14 April 1986	4.0	2.0
23 May 1986	2.9	1.9	19 May 1986	3.2	1.8
27 May 1986	2.3	1.9	2 June 1986	3.2	2.1
16 June 1986	2.7	2.7	17 June 1986	3.3	1.9
30 June 1986	2.2	2.4	15 July 1986	3.4	2.0
28 July 1986	2.5	2.3	11 August 1986	3.1	1.9
25 August 1986	2.1	2.5	9 September 1986	2.9	1.9
22 September 1986	2.5	2.0	6 October 1986	2.7	2.3
20 October 1986	2.7	2.3			
Mean ± standard deviation	2.7 ± 0.4	1.9 ± 0.4		3.2 ± 0.4	1.9 ± 0.2

TABLE I2
Summary of Aerosol Size Measurements for the 6 and 18 mg/m³ Mouse Chambers

6 mg/m ³			18 mg/m ³		
Date	Mass Median Aerodynamic Diameter (μm)	Geometric Standard Deviation	Date	Mass Median Aerodynamic Diameter (μm)	Geometric Standard Deviation
18 June 1984	3.9	1.8	25 June 1984	3.6	2.0
16 July 1984	3.4	1.9	23 July 1984	3.7	1.9
14 August 1984	3.5	1.8	20 August 1984	3.5	1.8
18 September 1984	3.3	1.8	10 September 1984	3.9	2.0
10 October 1984	3.1	1.9	17 October 1984	3.8	1.9
7 November 1984	3.3	1.8	19 November 1984	3.5	1.7
4 December 1984	3.0	1.8	12 December 1984	3.3	1.9
7 January 1985	3.4	1.6	7 January 1985	3.4	1.8
4 February 1985	3.2	1.8	8 February 1985	3.6	1.9
1 March 1985	2.9	1.9	7 March 1985	3.6	1.9
29 March 1985	3.1	1.8	5 April 1985	3.5	1.9
23 April 1985	3.6	1.8	2 May 1985	3.6	1.8
22 May 1985	3.1	2.0	29 May 1985	3.5	2.2
21 June 1985	3.3	1.8	26 June 1985	3.7	2.0
23 July 1985	3.4	1.8	29 July 1985	3.5	1.9
15 August 1985	3.5	1.8	20 August 1985	3.8	1.9
9 September 1985	2.6	1.3	16 September 1985	3.3	1.8
7 October 1985	2.7	1.5	14 October 1985	2.8	1.7
4 November 1985	2.5	1.5	12 November 1985	4.1	2.1
9 December 1985	3.4	1.6	16 December 1985	3.8	2.0
19 December 1985	3.6	2.0	3 January 1986	3.6	1.9
3 January 1986	3.9	2.0	8 January 1986	5.0	2.0
8 January 1986	4.0	2.1	10 February 1986	3.3	2.4
20 January 1986	3.7	1.8	13 March 1986	3.1	2.5
3 March 1986	3.0	2.1	7 April 1986	3.4	2.0
31 March 1986	2.9	2.1	5 May 1986	3.3	2.2
28 April 1986	3.2	4.7			
Mean ± standard deviation	3.3 ± 0.4	1.9 ± 0.6		3.6 ± 0.4	2.0 ± 0.2

APPENDIX J
INGREDIENTS, NUTRIENT COMPOSITION,
AND CONTAMINANT LEVELS
IN NIH-07 RAT AND MOUSE RATION

TABLE J1	Ingredients of NIH-07 Rat and Mouse Ration	278
TABLE J2	Vitamins and Minerals in NIH-07 Rat and Mouse Ration	278
TABLE J3	Nutrient Composition of NIH-07 Rat and Mouse Ration	279
TABLE J4	Contaminant Levels in NIH-07 Rat and Mouse Ration	280

TABLE J1
Ingredients of NIH-07 Rat and Mouse Ration^a

Ingredients ^b	Percent by Weight
Ground #2 yellow shelled corn	24.50
Ground hard winter wheat	23.00
Soybean meal (49% protein)	12.00
Fish meal (60% protein)	10.00
Wheat middlings	10.00
Dried skim milk	5.00
Alfalfa meal (dehydrated, 17% protein)	4.00
Corn gluten meal (60% protein)	3.00
Soy oil	2.50
Dried brewer's yeast	2.00
Dry molasses	1.50
Dicalcium phosphate	1.25
Ground limestone	0.50
Salt	0.50
Premixes (vitamin and mineral)	0.25

^a NCI, 1976; NIH, 1978

^b Ingredients were ground to pass through a U.S. Standard Screen No. 16 before being mixed.

TABLE J2
Vitamins and Minerals in NIH-07 Rat and Mouse Ration^a

	Amount	Source
Vitamins		
A	5,500,000 IU	Stabilized vitamin A palmitate or acetate
D ₃	4,600,000 IU	D-activated animal sterol
K ₃	2.8 g	Menadione
<i>d</i> - α -Tocopheryl acetate	20,000 IU	
Choline	560.0 g	Choline chloride
Folic acid	2.2 g	
Niacin	30.0 g	
<i>d</i> -Pantothenic acid	18.0 g	<i>d</i> -Calcium pantothenate
Riboflavin	3.4 g	
Thiamine	10.0 g	Thiamine mononitrate
B ₁₂	4,000 μ g	
Pyridoxine	1.7 g	Pyridoxine hydrochloride
Biotin	140.0 mg	<i>d</i> -Biotin
Minerals		
Iron	120.0 g	Iron sulfate
Manganese	60.0 g	Manganous oxide
Zinc	16.0 g	Zinc oxide
Copper	4.0 g	Copper sulfate
Iodine	1.4 g	Calcium iodate
Cobalt	0.4 g	Cobalt carbonate

^a Per ton (2,000 lb) of finished product

TABLE J3
Nutrient Composition of NIH-07 Rat and Mouse Ration

Nutrient	Mean \pm Standard Deviation	Range	Number of Samples
Protein (% by weight)	22.22 \pm 0.72	21.1-23.5	13
Crude fat (% by weight)	5.59 \pm 0.55	4.7-6.4	13
Crude fiber (% by weight)	3.36 \pm 0.30	2.7-3.8	13
Ash (% by weight)	6.55 \pm 0.23	6.1-7.0	13
Amino Acids (% of total diet)			
Arginine	1.308 \pm 0.606	1.210-1.390	8
Cystine	0.306 \pm 0.084	0.181-0.400	8
Glycine	1.150 \pm 0.047	1.060-1.210	8
Histidine	0.576 \pm 0.024	0.531-0.607	8
Isoleucine	0.917 \pm 0.029	0.881-0.944	8
Leucine	1.946 \pm 0.055	1.850-2.040	8
Lysine	1.270 \pm 0.058	1.200-1.370	8
Methionine	0.448 \pm 0.128	0.306-0.699	8
Phenylalanine	0.987 \pm 0.140	0.665-1.110	8
Threonine	0.877 \pm 0.042	0.824-0.940	8
Tryptophan	0.236 \pm 0.176	0.107-0.671	8
Tyrosine	0.676 \pm 0.105	0.564-0.794	8
Valine	1.103 \pm 0.040	1.050-1.170	8
Essential Fatty Acids (% of total diet)			
Linoleic	2.393 \pm 0.258	1.830-2.570	7
Linolenic	0.280 \pm 0.040	0.210-0.320	7
Vitamins			
Vitamin A (IU/kg)	9,846 \pm 2,839	5,600-15,000	13
Vitamin D (IU/kg)	4,450 \pm 1,382	3,000-6,300	4
α -Tocopherol (ppm)	37.95 \pm 9.41	22.5-48.9	8
Thiamine (ppm)	20.77 \pm 2.01	17.0-23.0	13
Riboflavin (ppm)	7.92 \pm 0.87	6.10-9.00	8
Niacin (ppm)	103.4 \pm 26.59	65.0-150.0	8
Pantothenic acid (ppm)	29.54 \pm 3.60	23.0-34.0	8
Pyridoxine (ppm)	9.55 \pm 3.48	5.60-14.0	8
Folic acid (ppm)	2.25 \pm 0.73	1.80-3.70	8
Biotin (ppm)	0.254 \pm 0.042	0.19-0.32	8
Vitamin B ₁₂ (ppb)	38.45 \pm 22.01	10.6-65.0	8
Choline (ppm)	3,089 \pm 328.69	2,400-3,430	8
Minerals			
Calcium (%)	1.17 \pm 0.09	1.06-1.41	13
Phosphorus (%)	0.92 \pm 0.03	0.87-0.99	13
Potassium (%)	0.883 \pm 0.078	0.772-0.971	6
Chloride (%)	0.526 \pm 0.092	0.380-0.635	8
Sodium (%)	0.313 \pm 0.390	0.258-0.371	8
Magnesium (%)	0.168 \pm 0.010	0.151-0.181	8
Sulfur (%)	0.280 \pm 0.064	0.208-0.420	8
Iron (ppm)	360.5 \pm 100	255.0-523.0	8
Manganese (ppm)	92.0 \pm 6.01	81.70-99.40	8
Zinc (ppm)	54.72 \pm 5.67	46.10-64.50	8
Copper (ppm)	11.06 \pm 2.50	8.090-15.39	8
Iodine (ppm)	3.37 \pm 0.92	1.52-4.13	6
Chromium (ppm)	1.79 \pm 0.36	1.04-2.09	8
Cobalt (ppm)	0.681 \pm 0.14	0.490-0.780	4

TABLE J4
Contaminant Levels in NIH-07 Rat and Mouse Ration

	Mean \pm Standard Deviation ^a	Range	Number of Samples
Contaminants			
Arsenic (ppm)	0.72 \pm 0.19	0.33–0.94	13
Cadmium (ppm)	<0.1		13
Lead (ppm)	0.57 \pm 0.31	0.14–1.32	13
Mercury (ppm)	<0.05		13
Selenium (ppm)	0.35 \pm 0.08	0.21–0.44	13
Aflatoxins (ppb)	<5.0		13
Nitrate nitrogen (ppm) ^b	12.56 \pm 4.47	2.80–18.0	13
Nitrite nitrogen (ppm) ^b	0.14 \pm 0.11	<0.10–0.50	13
BHA (ppm) ^c	2.54 \pm 1.05	<2.00–5.00	13
BHT (ppm) ^c	2.39 \pm 1.33	<1.00–4.00	13
Aerobic plate count (CFU/g) ^d	39,523 \pm 39,878	3,400–130,000	13
Coliform (MPN/g) ^e	3.72 \pm 1.79	<3.00–9.00	11
Coliform (MPN/g) ^f	9.46 \pm 14.11	<3.00–43.0	13
<i>E. coli</i> (MPN/g) ^g	3.08 \pm 0.28	<3.0–4.00	13
Total nitrosamines (ppb) ^h	6.99 \pm 4.13	1.80–16.00	13
<i>N</i> -Nitrosodimethylamine (ppb) ^h	5.67 \pm 3.79	0.80–15.00	13
<i>N</i> -Nitrosopyrrolidine (ppb) ^h	1.32 \pm 0.73	1.00–3.40	13
Pesticides (ppm)			
α -BHC ⁱ	<0.01		13
β -BHC	<0.02		13
γ -BHC	<0.01		13
δ -BHC	<0.01		13
Heptachlor	<0.01		13
Aldrin	<0.01		13
Heptachlor epoxide	<0.01		13
DDE	<0.01		13
DDD	<0.01		13
DDT	<0.01		13
HCB	<0.01		13
Mirex	<0.01		13
Methoxychlor	<0.05		13
Dieldrin	<0.01		13
Endrin	<0.01		13
Telodrin	<0.01		13
Chlordane	<0.05		13
Toxaphene	<0.1		13
Estimated PCBs	<0.2		13
Ronnel	<0.01		13
Ethion	<0.02		13
Trithion	<0.05		13
Diazinon	<0.1		13
Methyl parathion	<0.02		13
Ethyl parathion	<0.02		13
Malathion ^j	0.09 \pm 0.07	0.05–0.28	13
Endosulfan I	<0.01		13
Endosulfan II	<0.01		13
Endosulfan sulfate	<0.03		13

TABLE J4
Contaminant Levels in NIH-07 Rat and Mouse Ration (continued)

- ^a For values less than the limit of detection, the detection limit is given for the mean.
- ^b Sources of contamination: alfalfa, grains, and fish meal
- ^c Sources of contamination: soy oil and fish meal
- ^d CFU = colony forming unit
- ^e MPN = most probable number
- ^f Includes two high values of 39 and 43 MPN/g obtained from lots milled 15 March 1984 and 9 May 1984, respectively.
- ^g One lot milled 17 October 1984 contained 4.00 MPN/g; all other lots contained 3.00 MPN/g
- ^h All values were corrected for percent recovery.
- ⁱ BHC = hexachlorocyclohexane or benzene hexachloride.
- ^j Seven lots contained more than 0.05 ppm.

RESEARCH REPORT
TALC NTP TR 421

... of the ...
... of the ...
... of the ...

APPENDIX K SENTINEL ANIMAL PROGRAM

METHODS	284
TABLE K1 Murine Virus Antibody Determinations for Rats and Mice in the 2-Year and Lifetime Inhalation Studies of Talc	286

SENTINEL ANIMAL PROGRAM

METHODS

Rodents used in the Carcinogenesis Program of the National Toxicology Program are produced in optimally clean facilities to eliminate potential pathogens that may affect study results. The Sentinel Animal Program is part of the periodic monitoring of animal health that occurs during the toxicologic evaluation of chemical compounds. Under this program, the disease state of the rodents is monitored via serology on sera from extra (sentinel) animals in the study rooms. These animals and the study animals are subject to identical environmental conditions. The sentinel animals come from the same production source and weanling groups as the animals used for the studies of chemical compounds.

Rats

Prior to the beginning of the lifetime study, five male and five female F344/N rats of each sex were sacrificed and serum samples were taken for serological evaluation by Microbiological Associates (Bethesda, MD). Serum samples were also taken from selected rats for serology testing at each of the interim evaluations: three male and three female rats at 6 months; eight male and nine female rats at 12 and 18 months; 11 male and 17 female rats at 24 months; and 15 male and 15 female rats at the terminal sacrifice (male, 113 weeks; female, 122 weeks). Blood collected from each animal was allowed to clot and the serum was separated. The serum was cooled on ice and shipped to Microbiological Associates (Bethesda, MD) for determination of antibody titers. The following tests were performed:

Method of Analysis

Time of Analysis

ELISA

CARB (cilia-associated respiratory bacillus)
Mycoplasma arthritidis
Mycoplasma pulmonis
 PVM (pneumonia virus of mice)
 RCV/SDA (rat coronavirus/sialodacryoadenitis virus)

Sendai

Study termination (males only)
 12, 18, 24 months, study termination
 12, 18, 24 months, study termination
 6, 12, 18, 24 months, study termination
 Study initiation, 6, 12, 18, 24 months,
 study termination
 6, 12, 18, 24 months, study termination

Hemagglutination Inhibition

H-1 (Toolan's H-1 virus)
 KRV (Kilham rat virus)

Study initiation,
 6, 12, 18, 24 months, study termination
 Study initiation, 6, 12,
 18, 24, study termination

PVM
 Sendai

Study initiation
 Study initiation

Immunofluorescence Assay

KRV
 RCV
 RCV/SDA

24 months (males only)
 24 months (males only)
 28 months (males only)

Mice

Prior to the beginning of the 2-year study, five male and five female B6C3F₁ mice were sacrificed and serum samples were taken for serological evaluation by Microbiological Associates (Bethesda, MD). Serum samples for serology testing were also taken from control males and females at each of the interim evaluations (four males and four females at 6 months; 12 males and 12 females at 12 months) and at the terminal sacrifice (15 males and 15 females). (Samples were inadvertently omitted for mice evaluated after 18 months of exposure on 4-5 December, 1985.) Blood collected from each animal was allowed to clot and the serum was separated. The serum was cooled on ice and shipped to Microbiological Associates (Bethesda, MD) for determination of antibody titers. The following tests were performed:

Method of Analysis**Time of Analysis****Complement Fixation**

LCM (lymphocytic choriomeningitis virus)
 Mouse adenoma virus

Study initiation, 6, 12, 24 months
 Study initiation

ELISA

Ectromelia virus
 GDVII (mouse encephalomyelitis virus)
 Mouse adenoma virus
 MHV (mouse hepatitis virus)
M. arthritidis
M. pulmonis
 PVM
 Reovirus 3
 Sendai

6, 12, 24 months
 Study initiation, 6, 12, 24 months
 6, 12, 24 months
 Study initiation, 6, 12, 24 months
 6, 12, 24 months
 6, 12, 24 months
 6, 12, 24 months
 6, 12, 24 months

Hemagglutination Inhibition

Ectromelia virus
 K (papovirus)
 MVM (minute virus mice)
 PVM
 Polyoma virus
 Reovirus 3
 Sendai

Study initiation
 12, 24 months
 Study initiation, 6, 12, 24 months
 Study initiation
 Study initiation, 6, 12, 24 months
 Study initiation
 Study initiation

Immunofluorescence Assay

EDIM (Epizootic diarrhea of infant mice)
 Reovirus 3

6, 12, 24 months
 24 months

TABLE K1
Murine Virus Antibody Determinations for Rats and Mice in the 2-Year and Lifetime Inhalation Studies of Talc

	Interval (months)	Incidence of Antibody in Sentinel Animals	Positive Serologic Reaction for
Rats			
	6 months	0/6	None positive
	12 months	0/17	None positive
	18 months	0/17	None positive
	24 months (males)	1/11 9/11 6/11	KRV Sendai RCV
	(females)	13/17 13/17	Sendai RCV/SDA
	28 months	15/15 3/15	Sendai RCV/SDA
	30 months	15/15 1/15	Sendai RCV/SDA
Mice			
	6 months	0/8	None positive
	12 months	0/24	MHV
	24 months	2/30 7/30 21/30	Reovirus 3 <i>M. arthritis</i> EDIM

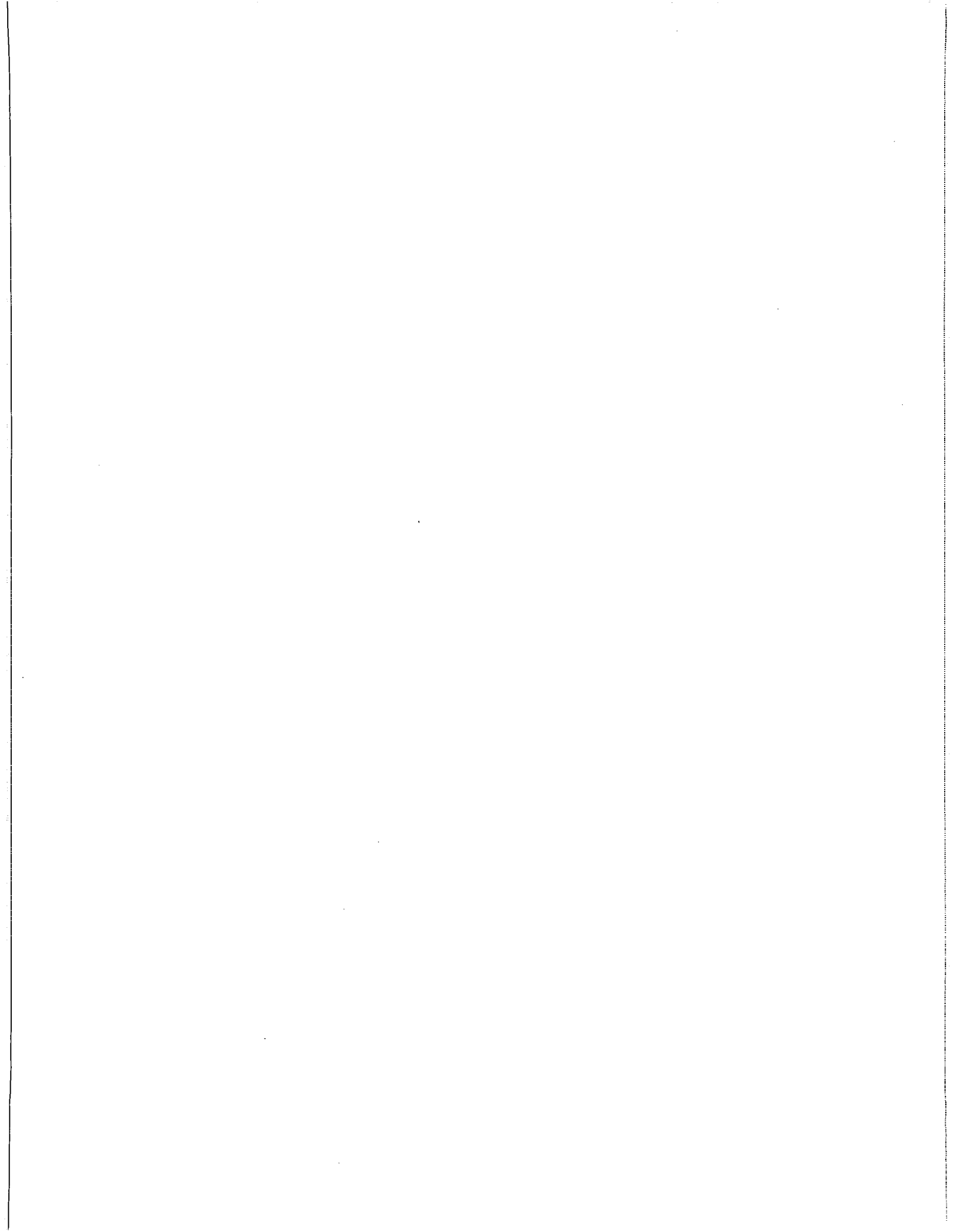

NATIONAL TOXICOLOGY PROGRAM TECHNICAL REPORTS
PRINTED AS OF SEPTEMBER 1993

TR No. CHEMICAL

201 2,3,7,8-Tetrachlorodibenzo-*p*-dioxin (Dermal)
 206 1,2-Dibromo-3-chloropropane
 207 Cytembena
 208 FD & C Yellow No. 6
 209 2,3,7,8-Tetrachlorodibenzo-*p*-dioxin (Gavage)
 210 1,2-Dibromoethane
 211 C.I. Acid Orange 10
 212 Di(2-ethylhexyl)adipate
 213 Butyl Benzyl Phthalate
 214 Caprolactam
 215 Bisphenol A
 216 11-Aminoundecanoic Acid
 217 Di(2-Ethylhexyl)phthalate
 219 2,6-Dichloro-*p*-phenylenediamine
 220 C.I. Acid Red 14
 221 Locust Bean Gum
 222 C.I. Disperse Yellow 3
 223 Eugenol
 224 Tara Gum
 225 D & C Red No. 9
 226 C.I. Solvent Yellow 14
 227 Gum Arabic
 228 Vinylidene Chloride
 229 Guar Gum
 230 Agar
 231 Stannous Chloride
 232 Pentachloroethane
 233 2-Biphenylamine Hydrochloride
 234 Allyl Isothiocyanate
 235 Zearalenone
 236 *D*-Mannitol
 237 1,1,1,2-Tetrachloroethane
 238 Ziram
 239 Bis(2-chloro-1-Methylethyl)ether
 240 Propyl Gallate
 242 Diallyl Phthalate (Mice)
 243 Trichlorethylene (Rats and Mice)
 244 Polybrominated Biphenyl Mixture
 245 Melamine
 246 Chrysotile Asbestos (Hamsters)
 247 L-Ascorbic Acid
 248 4,4'-Methylenedianiline Dihydrochloride
 249 Amosite Asbestos (Hamsters)
 250 Benzyl Acetate
 251 2,4- & 2,6-Toluene Diisocyanate
 252 Geranyl Acetate
 253 Allyl Isovalerate
 254 Dichloromethane (Methylene Chloride)
 255 1,2-Dichlorobenzene
 257 Diglycidyl Resorcinol Ether
 259 Ethyl Acrylate
 261 Chlorobenzene
 263 1,2-Dichloropropane
 266 Monuron
 267 1,2-Propylene Oxide
 269 Telone II® (1,3-Dichloropropene)
 271 HC Blue No. 1
 272 Propylene

TR No. CHEMICAL

273 Trichloroethylene (Four Rat Strains)
 274 Tris(2-ethylhexyl)phosphate
 275 2-Chloroethanol
 276 8-Hydroxyquinoline
 277 Tremolite
 278 2,6-Xylidine
 279 Amosite Asbestos
 280 Crocidolite Asbestos
 281 HC Red No. 3
 282 Chlorodibromomethane
 284 Diallylphthalate (Rats)
 285 C.I. Basic Red 9 Monohydrochloride
 287 Dimethyl Hydrogen Phosphite
 288 1,3-Butadiene
 289 Benzene
 291 Isophorone
 293 HC Blue No. 2
 294 Chlorinated Trisodium Phosphate
 295 Chrysotile Asbestos (Rats)
 296 Tetrakis(hydroxymethyl) phosphonium Sulfate & Tetrakis(hydroxymethyl) phosphonium Chloride
 298 Dimethyl Morpholinophosphoramidate
 299 C.I. Disperse Blue 1
 300 3-Chloro-2-methylpropene
 301 *o*-Phenylphenol
 303 4-Vinylcyclohexene
 304 Chlorendic Acid
 305 Chlorinated Paraffins (C₂₃, 43% chlorine)
 306 Dichloromethane (Methylene Chloride)
 307 Ephedrine Sulfate
 308 Chlorinated Paraffins (C₁₂, 60% chlorine)
 309 Decabromodiphenyl Oxide
 310 Marine Diesel Fuel and JP-5 Navy Fuel
 311 Tetrachloroethylene (Inhalation)
 312 *n*-Butyl Chloride
 313 Mirex
 314 Methyl Methacrylate
 315 Oxytetracycline Hydrochloride
 316 1-Chloro-2-methylpropene
 317 Chlorpheniramine Maleate
 318 Ampicillin Trihydrate
 319 1,4-Dichlorobenzene
 320 Rotenone
 321 Bromodichloromethane
 322 Phenylephrine Hydrochloride
 323 Dimethyl Methylphosphonate
 324 Boric Acid
 325 Pentachloronitrobenzene
 326 Ethylene Oxide
 327 Xylenes (Mixed)
 328 Methyl Carbamate
 329 1,2-Epoxybutane
 330 4-Hexylresorcinol
 331 Malonaldehyde, Sodium Salt
 332 2-Mercaptobenzothiazole
 333 *N*-Phenyl-2-naphthylamine
 334 2-Amino-5-nitrophenol
 335 C.I. Acid Orange 3

NATIONAL TOXICOLOGY PROGRAM TECHNICAL REPORTS
PRINTED AS OF SEPTEMBER 1993 (CONT.)

TR No.	CHEMICAL	TR No.	CHEMICAL
336	Penicillin VK	378	Benzaldehyde
337	Nitrofurazone	379	2-Chloroacetophenone
338	Erythromycin Stearate	380	Epinephrine Hydrochloride
339	2-Amino-4-nitrophenol	381	<i>d</i> -Carvone
340	Iodinated Glycerol	382	Furfural
341	Nitrofurantoin	385	Methyl Bromide
342	Dichlorvos	386	Tetranitromethane
343	Benzyl Alcohol	387	Amphetamine Sulfate
344	Tetracycline Hydrochloride	388	Ethylene Thiourea
345	Roxarsone	389	Sodium Azide
346	Chloroethane	390	3,3'-Dimethylbenzidine Dihydrochloride
347	D-Limonene	391	Tris(2-chloroethyl) Phosphate
348	α -Methyldopa Sesquihydrate	392	Chlorinated Water and Chloraminated Water
349	Pentachlorophenol	393	Sodium Fluoride
350	Tribromomethane	394	Acetaminophen
351	<i>p</i> -Chloroaniline Hydrochloride	395	Probenecid
352	N-Methylolacrylamide	396	Monochloroacetic Acid
353	2,4-Dichlorophenol	397	C.I. Direct Blue 15
354	Dimethoxane	398	Polybrominated Biphenyls
355	Diphenhydramine Hydrochloride	399	Titanocene Dichloride
356	Furosemide	401	2,4-Diaminophenol Dihydrochloride
357	Hydrochlorothiazide	402	Furan
358	Ochratoxin A	403	Resorcinol
359	8-Methoxypsoralen	405	C.I. Acid Red 114
360	N,N-Dimethylaniline	406	γ -Butyrolactone
361	Hexachloroethane	407	C.I. Pigment Red 3
362	4-Vinyl-1-Cyclohexene Diepoxide	408	Mercuric Chloride
363	Bromoethane (Ethyl Bromide)	409	Quercetin
364	Rhodamine 6G (C.I. Basic Red 1)	410	Naphthalene
365	Pentaerythritol Tetranitrate	411	C.I. Pigment Red 23
366	Hydroquinone	412	4,4-Diamino-2,2-Stilbenedisulfonic Acid
367	Phenylbutazone	413	Ethylene Glycol
368	Nalidixic Acid	414	Pentachloroanisole
369	Alpha-Methylbenzyl Alcohol	415	Polysorbate 80
370	Benzofuran	416	<i>o</i> -Nitroanisole
371	Toluene	417	<i>p</i> -Nitrophenol
372	3,3-Dimethoxybenzidine Dihydrochloride	418	<i>p</i> -Nitroaniline
373	Succinic Anhydride	419	HC Hellow 4
374	Glycidol	427	Turmeric Oleoresin
375	Vinyl Toluene	434	1,3-Butadiene
376	Allyl Glycidyl Ether	443	Oxazepam
377	<i>o</i> -Chlorobenzalmalononitrile		

These NTP Technical Reports are available for sale from the National Technical Information Service, U.S. Department of Commerce, 5285 Port Royal Road, Springfield, VA 22161 (703-487-4650). Single copies of this Technical Report are available without charge (and while supplies last) from the NTP Central Data Management, NIEHS, P.O. Box 12233, MD A0-01, Research Triangle Park, NC 27709.

**DEPARTMENT OF
HEALTH & HUMAN SERVICES**

Public Health Service
National Toxicology Program
Central Data Management
P.O. Box 12233, MD A0-01
Research Triangle Park, NC 27709

**SPECIAL FOURTH-CLASS RATE
POSTAGE AND FEES PAID
DHHS/NIH
Permit No. G-763**

**Official Business
Penalty for Private Use - \$300**

**NIH Publication No. 93-3152
September 1993**