

nuclear
weapons
journal

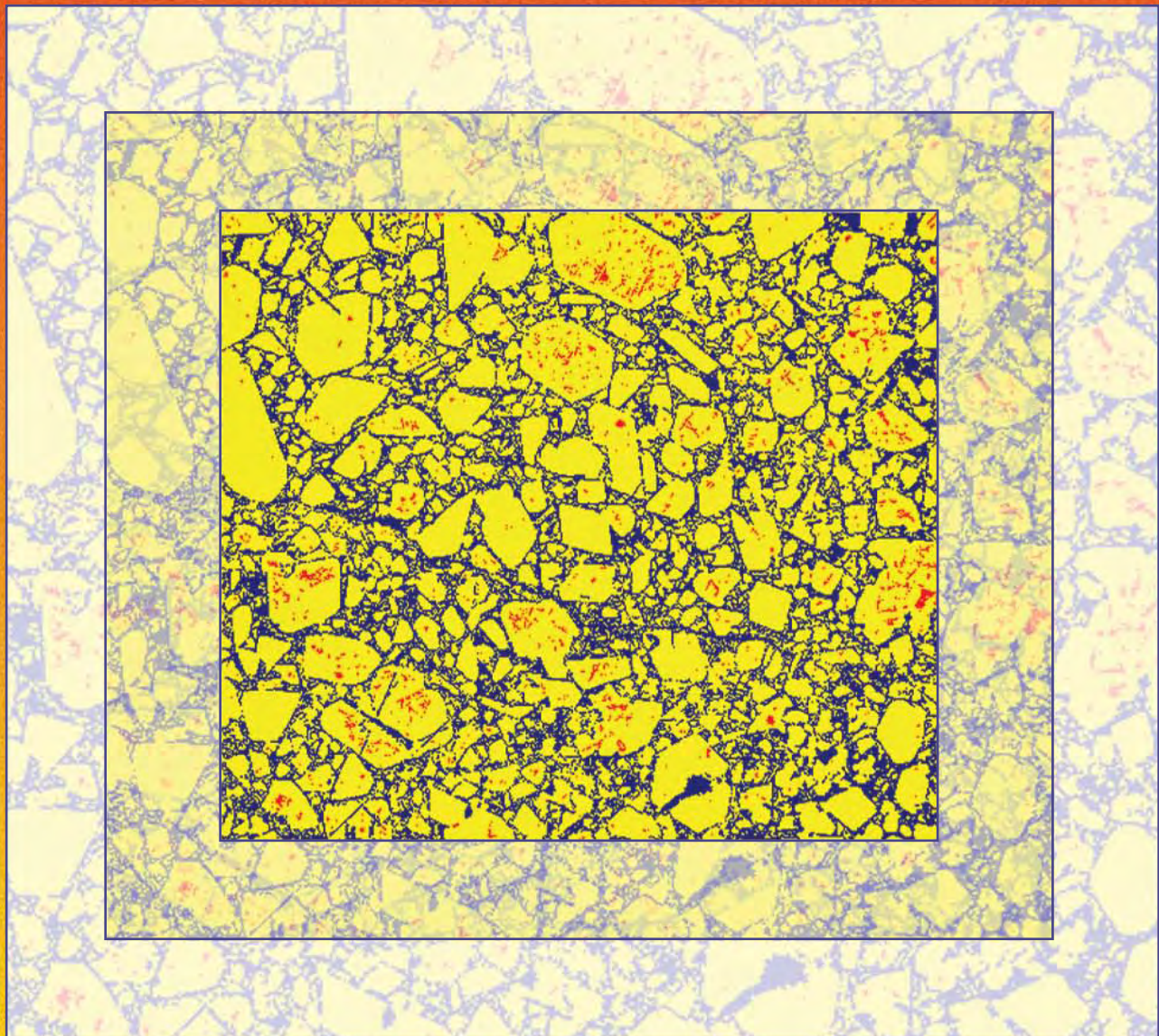

March/April 2003

■ HERT ■ HE Microstructure ■ Recycling ■ DARHT Approval ■
■ Stockpile Stewardship Exhibit ■

Weapons Science and Engineering at Los Alamos National Laboratory

Point of View

*Raymond J. Juzaitis
Deputy Associate Director
Weapons Physics*

Informatics, Complexity Science, and National Security

Informatics and complexity science play a critical role in much of what we do at Los Alamos. Informatics uses a suite of information management tools to understand, manage, and predict complex phenomena. Complexity science requires an understanding of the global nature of complex systems and crosses the boundaries that have classically separated the scientific disciplines.

Los Alamos has long been involved in studies of complex systems, from our early work on turbulence in the 1940s and continuing through the pioneering work of Metropolis, Stein, and Ulam on non-linear systems; our research in chaos theory; and the breakthrough work of Mitchell Feigenbaum in the late 1970s that led to the establishment of our Center for Nonlinear Studies in 1981. Our capabilities today in informatics and complexity science emerge from our core strengths—development of transdisciplinary approaches to solving very large and complex problems; integration of theory, modeling, simulation, experimentation, and visualization; our computational capabilities; and our ability to study phenomena from the nanoscale to the macroscale.

These capabilities are of enormous relevance to the Los Alamos national security mission. They define who we are and how we approach problem solving. We utilize a science-based predictive capability as the fundamental tool in helping us understand complex phenomena in a number of key areas—weapons, threat reduction, bioscience, energy,

environment, climate, and infrastructure. This ability requires integrating the Laboratory's strengths in computation and large-scale simulation, experimental science, and theory and modeling.

Stockpile Stewardship

Our special responsibility as stewards of the nuclear stockpile changed in 1992, when President Bush initiated a nuclear testing moratorium and, later, when President Clinton created the Stockpile Stewardship Program to ensure the safety, reliability, and performance of the nuclear stockpile in the absence of

Stockpile stewardship motivates us to pursue a predictive understanding of **extremely complex** systems and **high-impact problems** such as the **spread of disease** and the **impact of global climate change**.

full-system nuclear testing. Stockpile stewardship constitutes the core mission of our Laboratory and is one of the most difficult technical challenges this nation has ever faced. This program requires our weapons scientists to formally assess the current health—safety, reliability, and performance—of the warheads designed and built by Los Alamos and to base the validity of complex 3-D simulations on laboratory experiments and data from prior nuclear tests.

For 50 years, weapons designers relied heavily on nuclear testing. They extrapolated their designs from a known region of tested performance and tried to avoid “cliffs,” or regions of performance space that were marginal with respect to performance. Our limited understanding of these cliffs was due to nonlinear behavior that could not be

Continued on page 18



High-Explosive Radio Telemetry

High-explosive radio telemetry (HERT) is a system for monitoring high-explosive (HE) performance in a high-fidelity flight test unit (FTU). The high-fidelity FTU contains a warhead with nonfissile in place of fissile materials and with HE components connected to an arming, firing, and fuzing system—all mounted in a reentry body (RB) identical to that of an actual weapon system. The HERT system consists of two main elements:

- (1) a set of sensors imbedded in the HE components of the FTU to monitor the performance of these components as they explode and
- (2) a telemetry unit that transmits these data from the FTU to receiver stations on the ground.

The constraints on the HERT system are formidable. First, the sensors used in this system must be nonintrusive and safe, i.e., they must be sufficiently small to not interfere with the HE components they are monitoring, and they must not be capable of initiating premature detonation in these components. Second, the telemetry must be small enough to fit within the limited space of the RB and lightweight to not perturb the RB flight characteristics. The telemetry must also be extremely fast to collect data from the sensors and transmit to the ground receivers before the exploding FTU completely disassembles.

The HERT sensors consist of 0.005-in.-diameter quartz fibers that extend from the telemetry to the sensor tips, which are embedded in the HE. The

use of glass fiber obviates electromagnetic energy transmission into the HE, thereby preventing a mechanism for premature detonation. When a detonation wave strikes the tip of a fiber sensor, a light pulse is created that travels along the fiber to the telemetry unit. The sensor tip is gold coated (blinded) to prevent the detonation-wave precursor light from prematurely reaching the telemetry. A thin coat of lutetium oxy-orthosilicate (LSO) is applied to the tip of the gold-coated fiber. The LSO emits a very rapid (few-nanosecond rise time), very intense light pulse when struck by a shock wave. Finally, for mechanical protection and further blinding, the entire tip is coated with a layer of Krylon™ black paint.

The current version of the HERT unit measures approximately $2 \times 3 \times 5.5$ in. and weighs 1.5 lb. The light impulses from the sensors are first converted to electrical impulses. The programmable logic array then encodes the arrival times of these impulses into a hexadecimal (16-symbol) data format. The quadrature modulator modifies both the frequency and amplitude (I and Q) of the carrier wave from the frequency source, according to the values of these hexadecimal data, and sends the modulated signal to the amplifier. Next, this signal goes to the antenna that sends it to ground receivers. This custom-designed, 16-state, quadrature-amplitude modulation scheme allows data to be transmitted a factor of four times faster than by using standard binary coding with frequency-modulated

transmission only. The data are transmitted at 100 Mbit/s to ensure capture before the FTU disassembles.

The HERT system shown here is being tested as part of the W76 Lifetime Extension Program. The first flight of this system, which will be primarily an instrumentation test, will occur on a US Navy Mk4A/D5 submarine-launched test flight, designated FCET 30, planned for November 2003. *

Erwin Schwegler, 667-2993, erwin@lanl.gov

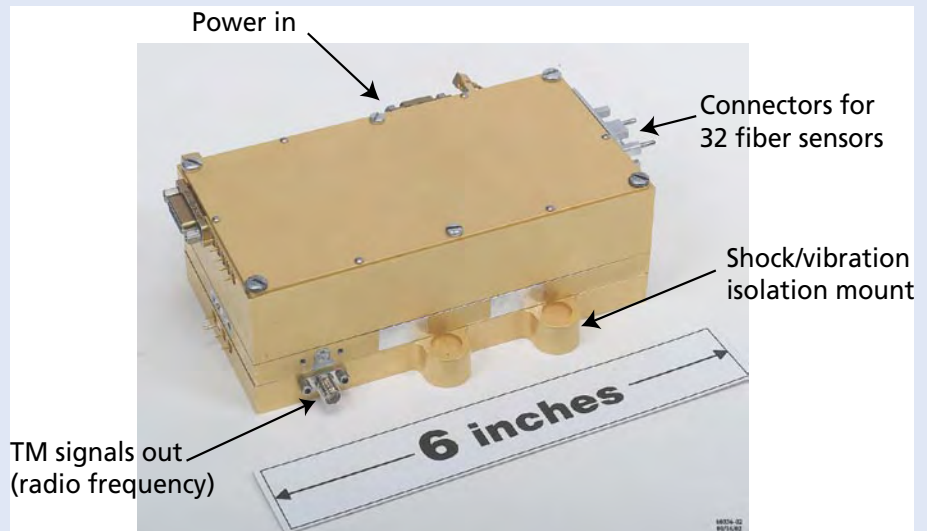

HERT mod 2B telemetry unit.

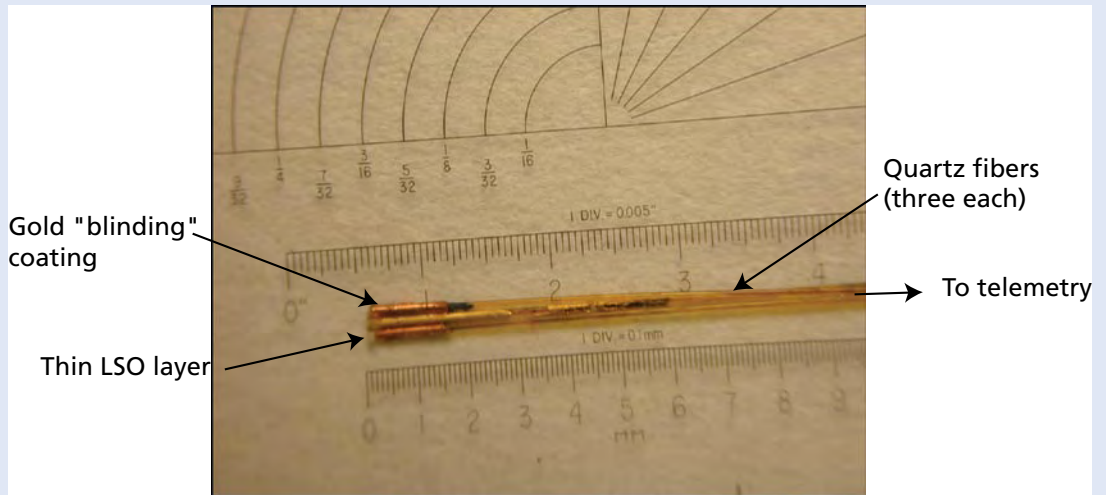

Three HERT fiber-optic shock sensors.

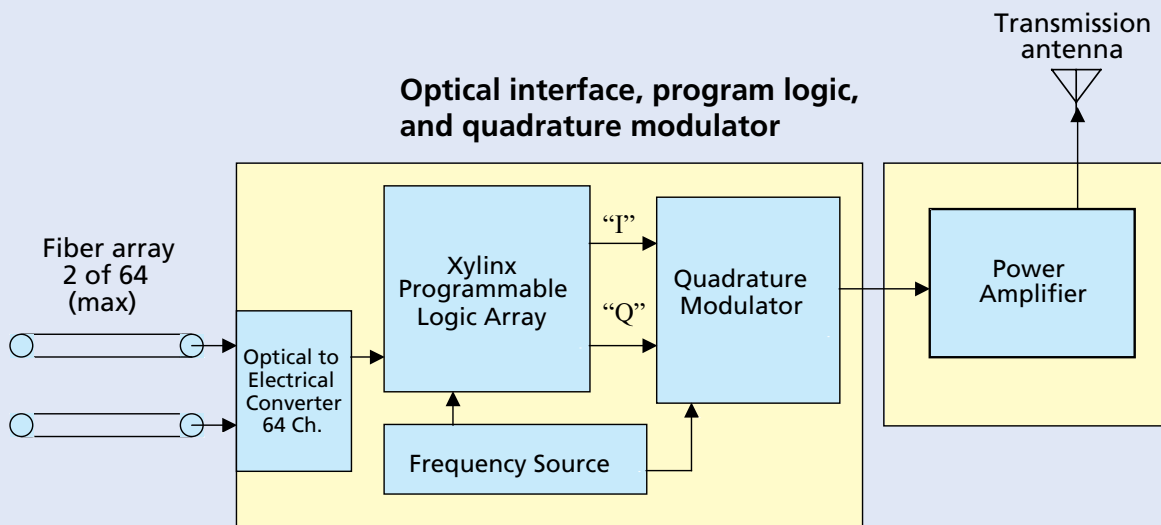

HERT block diagram.

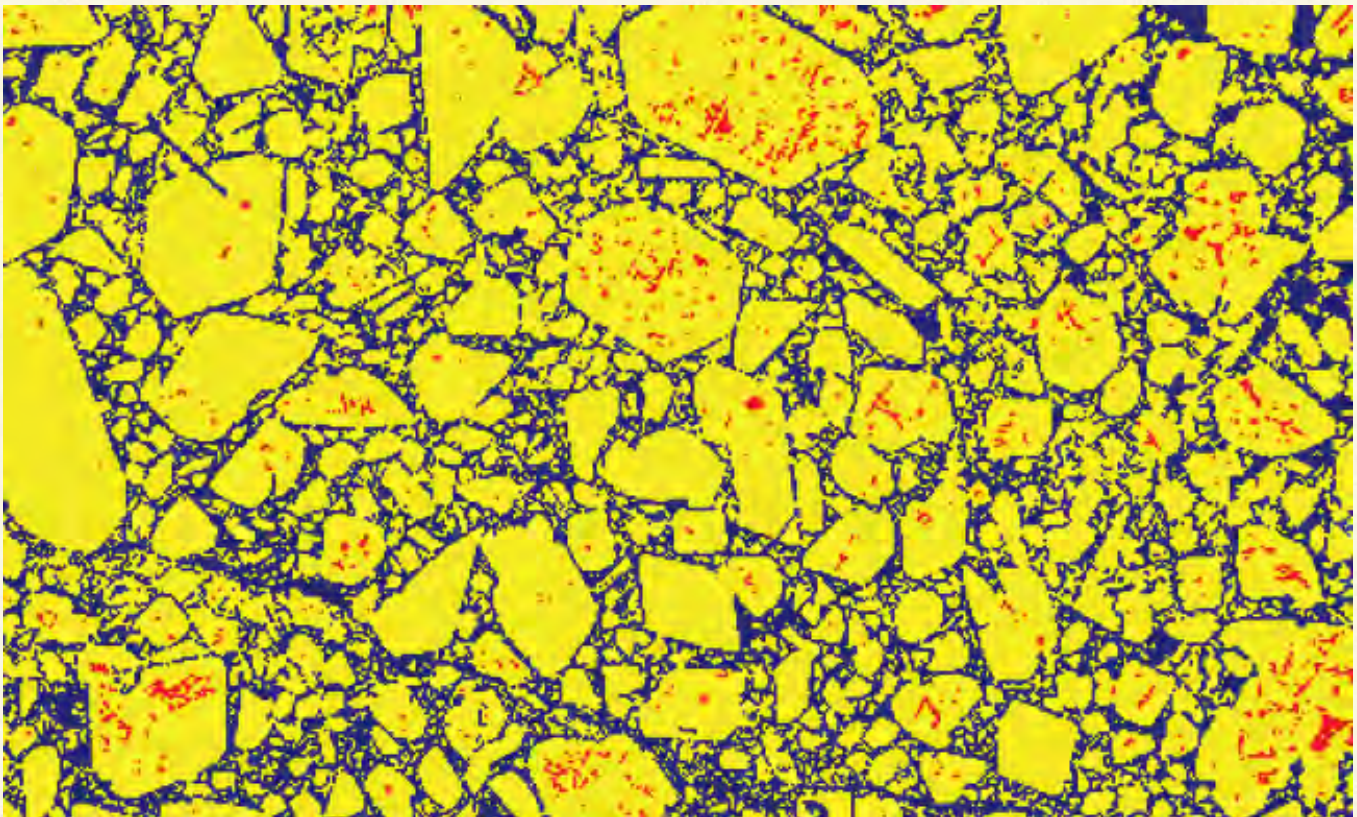

Microstructural Characterization of High-Explosive Materials

Microstructural aspects of HE materials are known to influence both shock and nonshock initiation events and are thus of great interest from both safety and performance perspectives. Differences in particle size and the number and size of defects (cracks, pores, etc.) can dramatically affect HE performance. Microstructural changes may be induced during formulation and processing, may be generated by aging, or may result from physical or thermal insult. A quantitative description of these features is important for advanced computer modeling of HE material properties and hence the predictability of weapon performance.

A complete description of HE microstructure requires the ability to probe features with sizes that range from millimeters to angstroms. Because no single characterization method can cover this entire

range of length scales, several techniques must be incorporated: polarized light microscopy, scanning electron microscopy, and small-angle scattering techniques. We combine these techniques to create a comprehensive description of the microstructure over length scales ranging from 10^{-10} to 10^{-2} m. Here, we present a brief description of these three techniques and examples of their application.

Polarized light microscopy (PLM) studies allow us to probe relatively large features (1 μm to 10 mm) of HE materials. For PLM analysis, the HE material is mounted in a low-viscosity epoxy, then cured and polished. The samples are examined in reflected light and photographed with a high-resolution digital camera. Historically, one of the inherent weaknesses of PLM has been the qualitative nature of the results. To extract quantitative

details from the PLM images, such as area percentages and crystal size distributions, we are employing commercial image-processing software that uses customizable routines that involve varying levels of color thresholding and geometric constraints to differentiate between microstructural components.

Scanning electron microscopy (SEM) is used to probe microstructural features ranging in size from 10 nm to 1 mm. We have recently acquired a field emission scanning electron microscope (FESEM). With a conventional SEM, nonconductive materials must be coated with a conductive material to prevent charging and damage under high electron beam voltages. However, the FESEM allows imaging at relatively low voltages (200 eV to 30 keV), and in many cases even nonconductive materials can be imaged without applying a conductive coating. In addition, we employ both an energy-dispersive x-ray spectrometer (EDS) and a wavelength-dispersive x-ray spectrometer (WDS) to further identify, quantify, and map elemental compositions.

Small-angle scattering (SAS) techniques, employing neutrons (SANS) or x-rays (SAXS), are used to probe length scales from 10 Å to 1 μm. In a SAS experiment, each microstructural feature (interface, pore, particle, etc.) contributes to the total observed scattering. Additional methods are used to separate

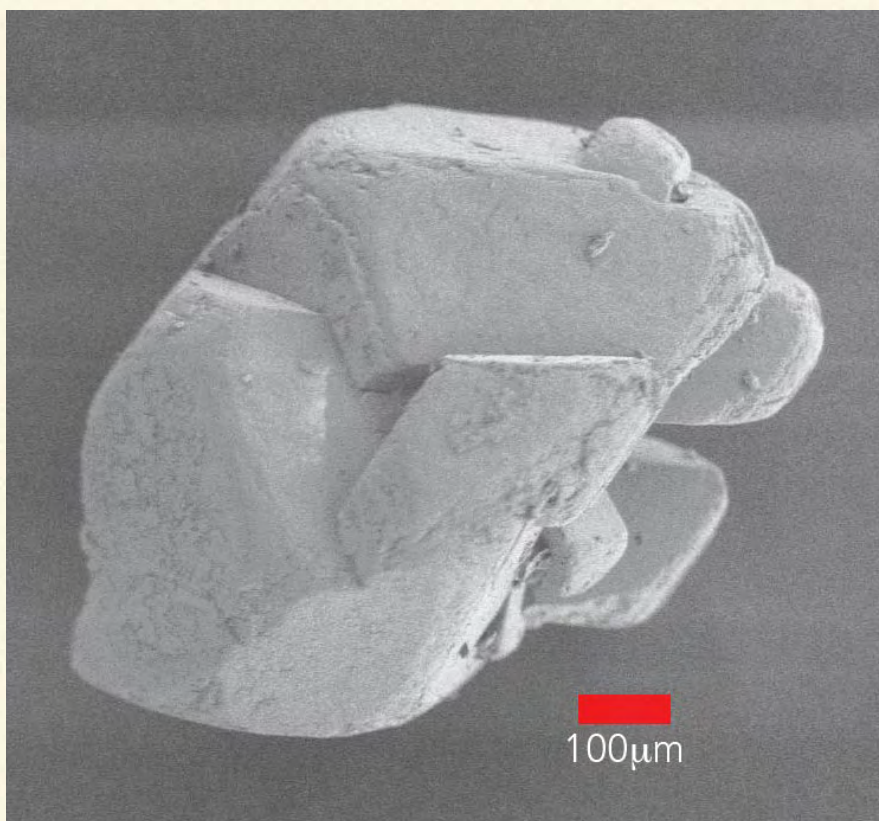

SEM image of typical HMX crystals before pressing.

these contributions, allowing for quantitative assessment of microstructural features. Due to the penetrating nature of neutrons and x-rays, SAS techniques are highly applicable to the study of porosity in pressed and plastic-bonded systems, as well as loose HE powders, and allow for a direct correlation between in-situ and microstructural changes.

We have recently applied these techniques to study the microstructure of the HE formulation PBX 9501, which is composed of regions of crystalline high explosive (HMX), polymeric binder, voids, and interfaces. During pressing of PBX 9501, significant cracking and fracturing of HMX crystals occurs, as shown in the PLM image on

page 6. By using these various imaging tools, we have quantified the decrease in the average size of the HMX crystals with increasing pressure and have found variations of induced crystal damage across a pressed pellet.

We have also exposed samples of PBX 9501 to linear thermal gradients and measured the results by using SAS techniques. With increasing temperature, we found that pores formed and grew due to the thermal insult at small length scales. Parallel analysis of PLM images showed an increase in both the overall crystal percentage within the material and the average crystal size, at longer length scales, between 163 °C and 175 °C. Above

176 °C, the overall percentage of crystals in the material and the average crystal size decreased. These results suggest some of the physical and chemical mechanisms that may occur prior to thermally induced detonation.

Using this combination of analysis techniques, we have demonstrated our ability to quantify changes due to different types of insult in the microstructure of HE materials. This information will aid our understanding of damage and how it relates to the performance and safety of weapon systems. We are continuing our studies of the PBX 9501 system as well as applying our techniques to other areas such as the aging of binder systems and the characterization of nanoscale metastable intermolecular composite (MIC) materials. *

Joe Mang, 665-6856, jtmang@lanl.gov;

Paul Peterson, 667-9622, pdp@lanl.gov

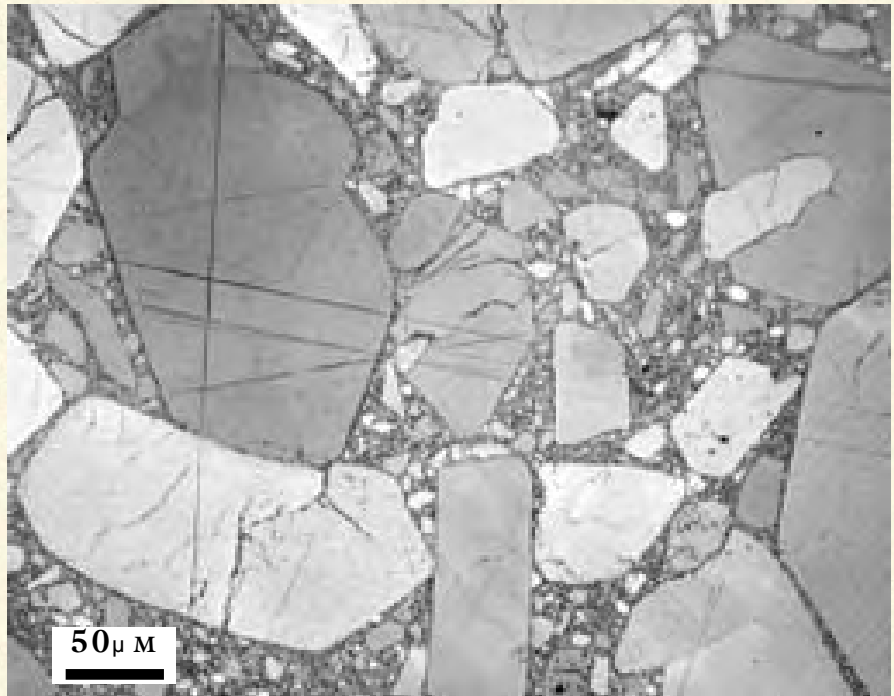

PLM image of a pressed piece of the high explosive PBX 9501, showing significant cracking and fracturing of the HMX crystals that occurred during pressing. The darker regions between the larger crystals in the image are composed of fine particles of HMX and polymeric binder.

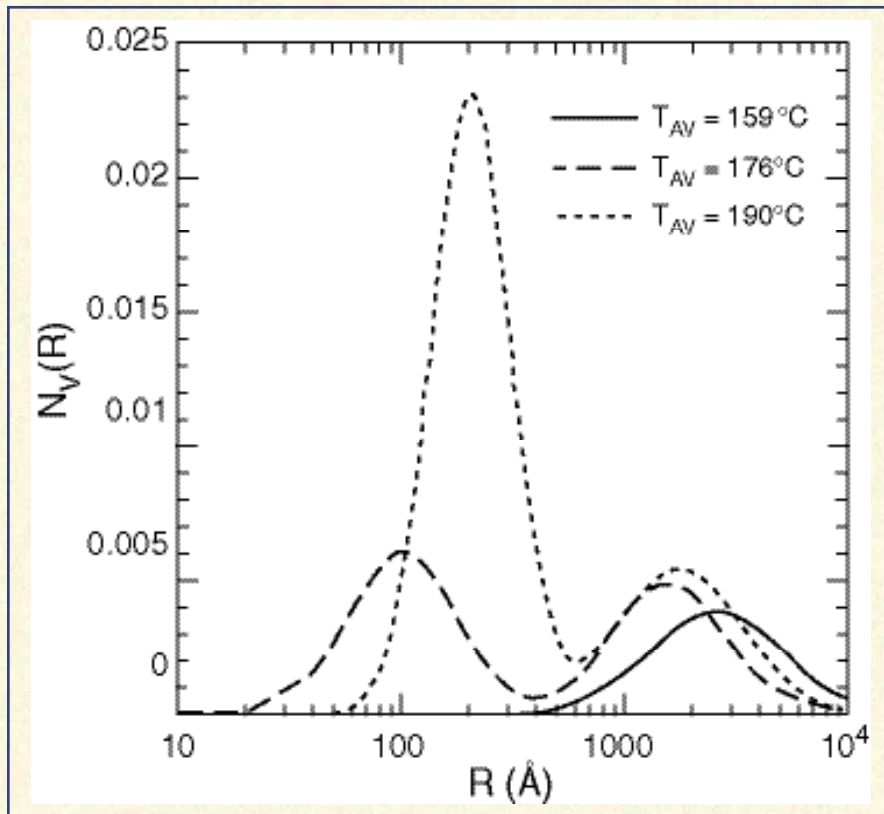

Volume fraction of pores having radius R , measured by SAS techniques, in PBX 9501 that was exposed to a linear thermal gradient. With increasing temperature, a new distribution of pores develops and grows, indicating further microstructural damage.

Recycling and Pollution Prevention

Closing the FeCl₃ Loop

An audit of hazardous waste disposal records in FY2000 identified spent ferric chloride (FeCl₃) solution as the single, largest, routine hazardous waste stream produced at Los Alamos National Laboratory.

DX-1 uses FeCl₃ solution to etch copper found in flexible detection cables. A counterflow chamber system in the process helps maintain the appropriate concentration of FeCl₃ for each step, while minimizing the amount of concentrated FeCl₃ solution that is added to the system. Despite this technology, every drum of concentrated FeCl₃ used ultimately creates about three drums of spent FeCl₃ solution. This spent solution was formerly treated as hazardous waste, but now it is recycled.

DX-1 buys concentrated FeCl₃ solution from Phibrotech, a California company that also recycles spent FeCl₃ solution. Phibrotech removes the copper and aluminum from the solution for reuse in other applications and regenerates concentrated FeCl₃ solution to resell. DX-1 closed the loop on its former waste stream by sending its spent FeCl₃ solution to Phibrotech and then buying back the concentrated FeCl₃ solution. Hazardous Waste Transportation Services coordinates shipping between the Laboratory and Phibrotech so that when new FeCl₃ solution is delivered to DX-1, spent FeCl₃ is picked up at the same time for shipment back to Phibrotech.

Recycling spent FeCl₃ helps to fulfill the Laboratory's goals to reduce waste. In addition, the recycling option is about \$250 cheaper per 55-gal. drum than the traditional hazardous waste disposal method—even considering transportation costs to California. During the first year of the project, the Laboratory realized a net savings of approximately \$8,000.

DX-1 recycles approximately 1,100 gal. of spent FeCl₃ solution annually, representing about 20% of the total routine hazardous waste generated at the Laboratory every year. Since November 2001, DX-1 has eliminated approximately 9,000 lb of spent FeCl₃ solution per year from the hazardous waste stream by recycling and reusing all that the group produces. This project is very successful, and DX-1 expects to recycle all spent FeCl₃ solution for as long as it is used in operations. ✪

Joe Bonner, 665-5053, jbonner@lanl.gov

Dry Machining Plutonium

Pat Montoya and Steve Boggs of NMT-5 won a pollution prevention award from the Laboratory for inventing a process to machine plutonium parts without using cutting oil. Unlike the standard wet-machining process, which uses cutting oil, the dry-machining process does not generate any waste.



Plutonium part being created with the dry-machining process developed at Los Alamos.

Between the 1950s and the late 1980s, the Rocky Flats Plant used a wet-machining process to fabricate plutonium parts and annually generated 10,000 L of waste cutting oil contaminated with carbon tetrachloride and plutonium. Cutting oil contaminated with plutonium is one of the most difficult and expensive waste streams to treat. If current waste-disposal practices and prices were applied to the Rocky Flats waste stream, we estimate the cost for treatment and disposal would be \$1.8 million annually.

Although the Laboratory never produced as many plutonium parts as Rocky Flats and did not use cutting oil as a lubricating agent for machining plutonium, the advance to the dry-machining process was extremely significant in minimizing waste.

Before the dry-machining process was implemented in 1987, the Laboratory used freon as the lubricating agent for machining plutonium parts. A new process had to be developed after the manufacture and import of freon was banned in the United States. Creating the dry-machining process

took approximately 18 months and included development of new tools, procedures, machining parameters, and airtight gloveboxes with alarms that would sound when the oxygen concentration reaches 2%. Because plutonium is a pyrophoric material, the oxygen level is usually kept below 0.2% by filling the glovebox with nitrogen or an inert gas like argon.

The dry-machining system allows machinists to fabricate plutonium parts without using cutting oil as a lubricant. No chemical changes take place on the surface of the plutonium parts because no liquid is involved. Plutonium is very expensive to produce since it is manufactured, not naturally occurring, and all the valuable plutonium shavings are easily collected from the airtight glovebox for reuse after the part is finished. Therefore, no plutonium waste is generated by this dry-machining process. ✨

*Pat Montoya, 667-2372, patm@lanl.gov;
Steve Boggs, 665-3786, sboggs@lanl.gov*

Recycling Nitric Acid

The award-winning Nitric Acid Recycling System (NARS) implemented by NMT Division is running at the Plutonium Facility at TA-55. As a result, nearly all of the Laboratory's plutonium contaminated nitric acid waste stream has been eliminated.

Nitric acid (HNO_3) is used at TA-55 for a variety of plutonium-dissolution processes. Effluents from these processes go to evaporators that separate HNO_3 and water distillate from residual salts. These salts are later stabilized by cementation at the Plutonium Facility. Previously, the distillate was transferred to the Radioactive Liquid Waste Treatment Facility (RLWTF) for treatment, but now the liquid is sent to the distillation column at the Plutonium Facility. Together with the Atlanta Technology Group, the staff at the Plutonium Facility designed this distillation column, which has special design and operation techniques. It

is located inside a facility, in contrast to industrial units that are much larger and located outside. Different controls are required, too, because the unit must be started and shut down each day; industrial distillation columns operate for days, weeks, or months without shutting down.

The distillation column separates the HNO_3 from the water by removing almost pure water with no plutonium from the top of the column, allowing us to reclaim concentrated HNO_3 from the bottom of the column for onsite reuse. The traces of plutonium and other actinides are removed and recycled with the concentrated acid.

Retaining the HNO_3 at the Plutonium Facility helps the RLWTF by reducing the concentration of nitrates that need treatment. Eliminating HNO_3 waste that enters the RLWTF is especially valuable since permitted concentrations of nitrates in outfalls of treated water have been decreasing over time. If the HNO_3 waste were not significantly reduced at the Plutonium Facility, the RLWTF would have to engage in a costly process to degrade nitrates on site to maintain compliance with their outfall permit.

Results from the NARS are excellent so far. The Plutonium Facility now purchases about 80% less new concentrated HNO_3 than before the NARS was implemented, and the distillation column decreases the volume of waste HNO_3 contaminated with plutonium by over 99%. The return on investment for the NARS project was calculated to be 128%; the approximately \$2 million capital expenditure was recovered within a year.

The NARS project won two major awards in 2002: a DOE Pollution Prevention Award and a White House Closing the Circle Award. The latter award is the most prestigious pollution prevention award in the nation, and NARS is only the second project submitted by the Laboratory to receive this honor. ✪

Don Mullins, 665-4689, don.mullins@lanl.gov

According to the White House Task Force on Waste Prevention and Recycling, although recycling often has environmental benefits, it can be difficult to locate quantitative information about those benefits; the following awards recognize that hard-to-find benefit.

The Office of the Federal Environmental Executive promotes sustainable environmental stewardship throughout the federal government by focusing on six areas, one of which is waste prevention and recycling. The Closing the Circle Award recognizes achievement in this category.

The DOE Pollution Prevention Program defines pollution prevention as the use of materials, processes, and practices that reduce or eliminate the generation and release of pollutants, contaminants, hazardous substances, and wastes into land, water, and air. DOE also states that two waste techniques, waste segregation and recycling, are key to reducing total amounts of waste as well as additional treatment and disposal.

NNSA approves DARHT

The Dual-Axis Radiographic Hydrodynamic Test (DARHT) facility construction project was officially completed within budget on March 26, 2003, with NNSA/DOE approval. The 1st axis is the world's most advanced hydrodynamic test facility and has provided pivotal data to the Stockpile Stewardship Program since 2000. Both LLNL and LANL have exercised DARHT's full radiographic capability on experiments of nonnuclear mockups of weapons systems. DARHT is therefore a national asset and a cornerstone for the national hydrotesting program. The formal dedication of the DARHT facility, scheduled for April 22, is part of the Laboratory's 60th anniversary celebration.

On December 21, 2002, the 2nd axis of this premier facility passed a major technical hurdle by transporting an electron beam through its accelerator that met all of the major criteria. All four major critical-decision (CD) milestones for closeout of the project have been achieved.

- Demonstration of the 2nd axis injector (CD-4a). This milestone was met on July 2, 2002, when the injector exceeded the requirement of >250 A and >2.0 MeV. The next day the injector produced an electron beam at 1.22 kA and at a peak energy of 2.77 MeV. This was almost five times the beam current required to meet the milestone.
- Demonstration of the 2nd axis accelerator (CD-4d). This milestone was achieved on December 21, 2002, when the accelerator exceeded the requirement of >1.0 kA at >12.0 MeV for longer than 350 ns. The beam achieved 1,025–1,150 A at 12.45 MeV \pm 0.1 MeV for longer than 400 ns.

- Completion of the delivery of the 2nd axis camera system (CD-4b). This milestone was achieved on February 6, 2003. This new camera system will allow the capture of four high-quality x-ray images over 2 μ s.
- Completion of the construction of the Vessel Preparation Facility (CD-4c). This milestone was achieved on February 10, 2003. This facility will provide for the cleanout of experimental debris from single-walled containment vessels. Use of this facility will reduce future emissions from currently performed open-air experiments.

The success of the milestones on the 2nd axis, which incorporates complex and innovative technology, demonstrates the strong design collaboration of three UC-managed national laboratories (LBNL, LLNL, and LANL) and one DoD laboratory (MIT Lincoln Laboratory).

The DARHT facility, when fully operational in late 2004 (after commissioning of the 2nd axis is completed), will provide time-resolved, quasi-3-D radiographs of nonnuclear mockups of nuclear weapons systems. The first axis will produce a single x-ray pulse; the 2nd axis (at a right angle to the 1st axis) is designed to produce four pulses over 2 μ s. Both axes will provide one quasi-3-D radiograph and three 2-D time-sequenced radiographs. The data from these two axes will be used to validate the computer codes needed for continued certification of stockpile weapons without underground testing. The completed test facility will provide the first quasi-3-D x-rays of hydrodynamic experiments using both axes. 
Rollin Whitman, 667-7542, rollin@lanl.gov

Wilhelm Conrad Roentgen discovered x-rays on November 8, 1895, and it wasn't long before he began using these new rays to look deep into objects and into the human body. His wife held her hand between his x-ray source and a sheet of photographic film for 15 min to produce a picture of the bones in her hand and a ring on her finger. Not long after that, Roentgen produced an x-ray image of his hunting rifle. That image revealed a flaw inside the metal of his gun—the first time a hidden structural flaw had been exposed without first destroying the flawed object.

At DARHT, we use intense bursts of x-rays to produce images of our dynamic experiments.

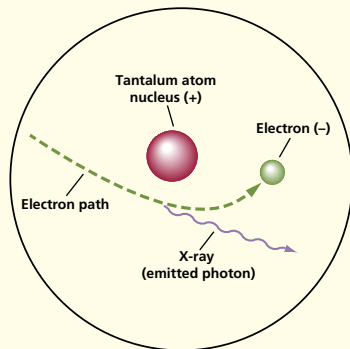

When a negatively charged electron passes close to the positively charged nucleus of a tantalum atom, the strong attractive electric forces cause a change in the electron's trajectory. Whenever a charged particle undergoes a change of motion, it emits energy.

So the electron radiates a high-energy photon (an x-ray) and that loss of energy causes the electron brake. This electromagnetic energy is called bremsstrahlung radiation.

To generate x-rays, we need three things: (1) a source of electrons; (2) a means of increasing their energy, or accelerating them; and (3) a target to stop the electrons and, as a result, produce the x-rays.

In an accelerator, an electron source, called an injector, produces electrons that are then accelerated. DARHT's injector essentially consists of two plates between which a pulsed, high electric field is introduced. The flood of electrons emitted by the first plate is accelerated across the gap between the plates. A magnetic field then focuses those electrons through a hole in the second plate to produce an electron beam that is injected into the accelerator at nearly the speed of light.

Magnetic fields focus and steer the stream of electrons down the length of the accelerator. Electrical energy is added along the way by a series of circular metal plates with high electric fields between them. The electrons pass through holes in the plates and pick up energy from those electric fields, gathering kinetic energy as they speed toward their target. As the electron beam leaves the accelerator, it is refocused with magnets onto a target made of tantalum.

When the beam of electrons is stopped in the tantalum target, the result is an intense burst of x-ray radiation.

A dentist uses a similar process to produce x-rays of teeth. But since a dentist is interested in looking at stationary teeth—not rapidly imploding heavy metals—the dentist's x-rays are much less intense and are produced over a much longer time than the x-rays used at DARHT.

When the burst of x-rays is directed toward an object, some of the rays are absorbed, some are deflected, and others pass through. Where the object is thin, more x-rays pass through, and the result is a brighter area on the radiographic image.

Where the object is thick or dense, fewer x-rays pass through, and the result is a darker area on the image.

Blumlein pulse-forming line for very fast electrical energy transfer from capacitor to accelerator

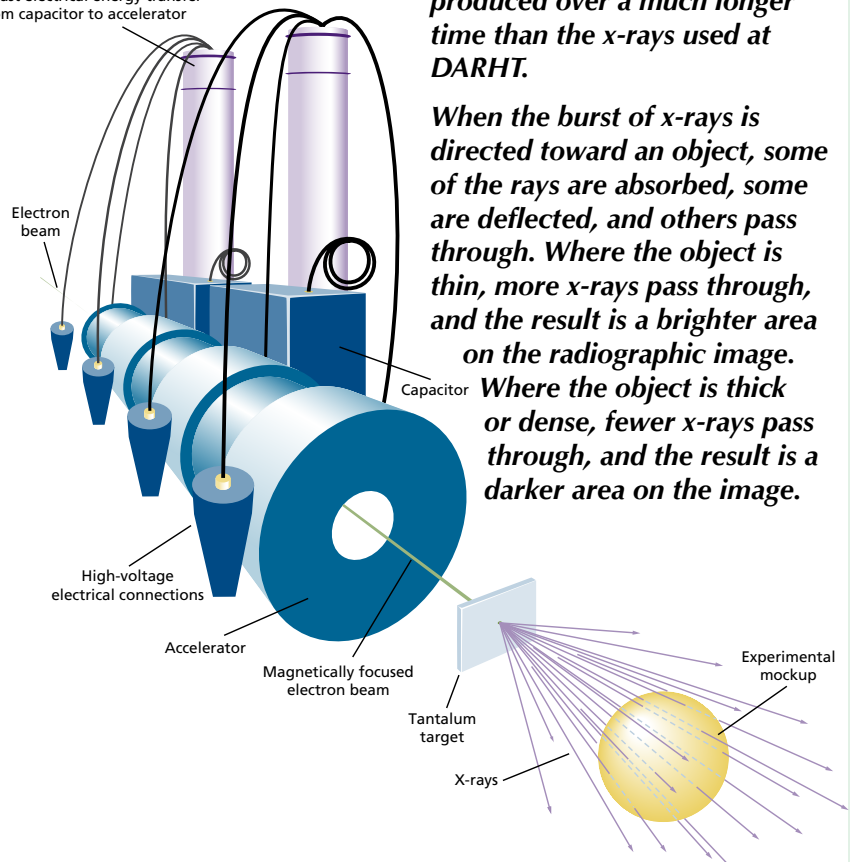



Security & Project Management

bringing ISSM to construction projects

The Strategic Planning Team in S-1 is developing a support process to improve safeguards and security awareness in Laboratory construction and programmatic projects. This evolving process will enhance the Laboratory's implementation of Integrated Safeguards and Security Management (ISSM).

Identify the Project

A key driver behind this evolving process is *Construction Project Management*, a LIR that requires project leaders to have security representatives assigned at the earliest stages of all projects over \$500K. This requirement has helped S Division identify many projects at the preconceptual stage because project managers now ask S Division to assign a security representative to their project. Nearly 50 projects initiated at the Laboratory since March 2002 are examples of this process in action.

Other methods of ensuring security representation on projects are assigning security-planning representatives to Laboratory committees such as Institutional Siting, Site Planning and Construction, and Integrated Nuclear Planning. Their participation keeps LANL organizations informed

about new and ongoing projects—whether they involve construction, facility modification, programmatic work, or mission changes.

Communication with the Security Help Desk, with the senior security advisors who are assigned to each Laboratory associate director, and with “campus” representatives who are strategic planners for DX and ESA Divisions also facilitate security awareness across the institution.

Establish Contact

For each new project, a security representative is assigned to serve as the single point of contact and to coordinate security requirements, such as vault certification, sensor design and installation for certain protection areas, access controls, and fencing or other barriers. The team considers potential issues and security requirements in making these assignments; for example, projects associated with Category I nuclear materials will require a highly trained special nuclear materials control and accountability staff member, as well as a support team structured to address vulnerability analysis, materials control and accountability, protective force, and security-systems issues. Projects

that do not involve classified matter or nuclear material do not require such complicated lines of communication and support from the security standpoint. In some cases, an initial review reveals no security issues other than property protection or access controls.

Start the Project

For complex projects of high consequence, the team conducts a formal, security project initiation meeting, at which representatives from various security disciplines interface with the project leaders and project manager. At this meeting, we establish the “links” and lines of communication for total security support—security systems, physical security, information and personnel security, material control and accountability, secure communications, internal security, operations security, and cyber security.

Resolve Issues

Throughout the project, the security representative coordinates and facilitates the resolution of issues and tracks these issues until the identified activities have been completed. In addition to supporting specific projects, the Strategic Planning Team addresses issues that span multiple projects such as the concurrent fire alarm and security alarm replacements. Project managers, project leaders, schedulers, and program and line managers are involved resolving potential conflicts among projects, and they work together with a standing security team from S Division.

Close the Project

Closing out a project and reviewing operational readiness gives the security team an opportunity to identify any lessons learned that may have been overlooked during the life of the project. The process continues to evolve, and this journey benefits ISSM and helps Laboratory project managers to succeed. ✨

Cam Campbell, 665-1467, ccam@lanl.gov



John F. Harvey

Director's Safety Initiative

focus on working safely

Interim Laboratory Director Pete Nanos recently instituted a Director's Safety Initiative—an exercise to focus employees' attention on explanations and solutions for the current upward trend in the Laboratory's injury and illness rates. The exercise started with Nested Safety and Security Committee (NSSC) meetings at the team level and culminated with the Director's Central Safety and Security Committee (DCSSC).

I want the **best safety record in the world.**

Pete Nanos

At the NSSC meetings, employees discussed a specific set of questions:

- What barriers do you see to doing your work safely?
- What can be done to further enhance worker involvement to improve workplace safety?
- What could your team leader or group leader do differently to improve workplace safety?
- What could your senior managers do differently to improve workplace safety?
- What can be done, and what will you do, to reduce workplace injuries?

Answers to these questions were carried forward through groups, divisions, and directorates to the DCSSC. Ten institutional categories of concerns were identified at their February 13 meeting:

1. Model behavior – Managers should look for, support, and demonstrate safe performance of work.
2. Ergonomics – Employees want a no-fault system for diagnosis, treatment, and work-station improvements.
3. Stress – Managers must ensure safe performance of work while meeting programmatic milestones.

4. Slow or no response – Workers view responsiveness to safety concerns as slow or nonexistent.
5. Inadequate worker involvement – Workers want to be included in solutions to safety problems.
6. Facility condition – Remediation of facility hazards must be completed or operations will be shut down until improvements are made.
7. Work control – Work control processes must lead to increased worker safety.
8. Traffic, parking, and walking – Managers need to reinforce and exhibit safe driving, and planners must consider driving, parking, and pedestrian access before demolition or construction.
9. Schedule pressure – Managers must be aware that schedule pressures at the expense of safety model wrong behavior and contribute to worker stress.
10. Leased space – Safety and security services provided by landlords for leased space are inconsistent with services provided on Laboratory property.

Owners and corrective actions for these institutional issues are being identified. ✿

Ron Geoffrion, 667-0300, rgeoffrion@lanl.gov

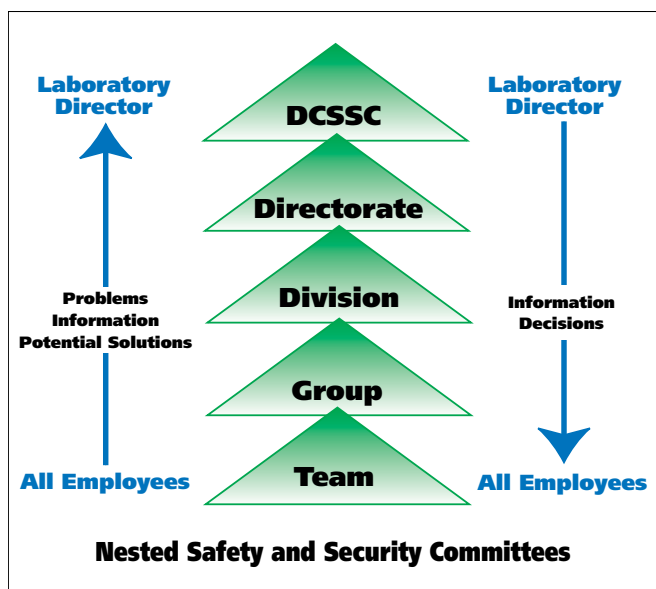

LANL combined injury and illness rates reflect 12-month rolling averages normalized to 200,000 h, which equal 100 full-time employees. The TRC line documents the total recordable cases; DART data include days away from work, restricted work activity, or transfers to another job.

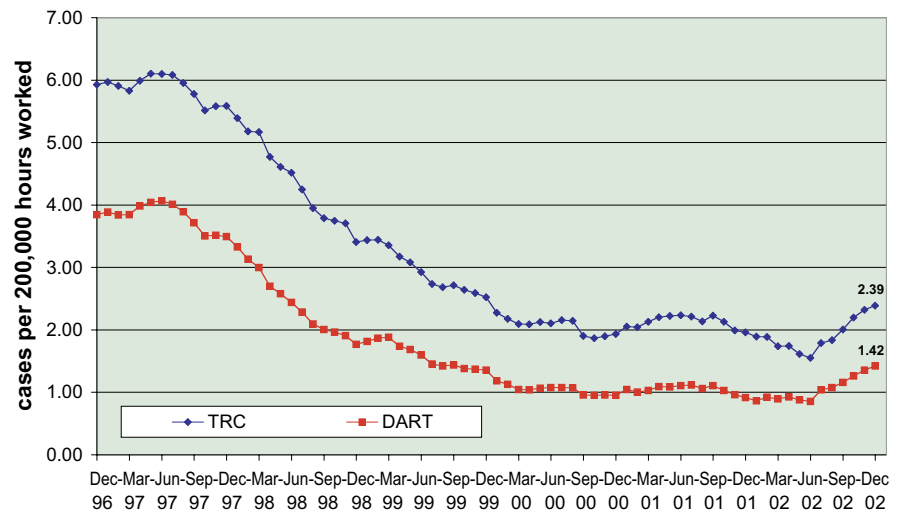

What are NSSCs?

“Nested Safety and Security Committees reside within the line organizations as conduits for sharing information and communicating decisions. Directorates, divisions, group-level, and team-level organizations have NSSCs. Every employee should be a member of a first-level team or group committee. The leaders of each level become members of the next level in continuous succession to the DCSSC.”

—*Laboratory Integrated Safety Management (ISM) Description Document Section 3.8.6.*
(LA-UR-98-2837, Rev. 4)

The *Laboratory ISM Description Document* directs the use of NSSCs; safeguards and security issues were added to their charter in a January 2002 letter from John Browne to NNSA. The *Nested Safety Committee Expectations* (July 2, 2001) explained that NSSCs should

- meet at least monthly at team, group, and division levels, and bimonthly at directorate and institutional levels;
- be the principal vehicle for communication and problem solving;
- include information on injuries, illnesses, incidents, and audit reports; and
- be the line organization’s mechanism and process for managing environment, safety, health, and security in the organization.

Does every worker have to participate? Yes—NSSCs are designed to involve all workers (UC employees and subcontractors) at all levels in opportunities to discuss and help solve safety and security issues.

The International Atomic Energy Agency *Safety Reports Series No. 11, Developing Safety Culture in Nuclear Activities: Practical Suggestions to Assist Progress*, Section 5.7, *Employees’ Contribution to Improving Safety Performance*, states, “All employees have a primary responsibility to contribute to their personal safety [and security] and to that of their fellow employees. Many organizations have found by experience that this contribution is best facilitated by encouraging employee involvement since individuals tend to take a personal interest in matters related to their personal safety.”

NSSCs are a mechanism to expedite solutions that can be implemented at the team or group level or to escalate those problems to a higher level for resolution.

Stockpile Stewardship

Informing the public about the Laboratory's national security mission

The Bradbury Science Museum recently opened a large-scale exhibit on stockpile stewardship and its importance to our national security mission. The Weapons Engineering and Manufacturing and Weapons Physics Directorates collaborated with the Museum to develop the exhibit, which showcases the new film *Mission: Stockpile Stewardship* in a theater designed specifically for this exhibit. A weapons corral shows casings, specifications, and delivery mechanisms for four weapon systems, and eight stations include interactive exhibits for visitors to learn more about science and technology in the nuclear weapons program at Los Alamos.



Richard C. Robinson

Chain-link fence topped with concertina wire separates the visitor's experience of the exhibit into two sections: "outside the fence" and "behind the fence."

STEWARDSHIP
DEDICATED TO OUR MISSION

What if you had to write a letter to the president of the United States certifying that the aging weapons in the country's nuclear arsenal would work if ever needed? What if some critical components in the weapons had to be replaced, but you didn't have spare parts identical to the originals? How would you be sure the weapons were safe and reliable if you couldn't conduct a nuclear test?

MEMORANDUM FOR THE PRESIDENT'S SUBJECT: Nuclear Stockpile Certification

It is the responsibility of the Laboratory to ensure the safety, security, and reliability of our nuclear stockpile. This requires a comprehensive program of stockpile stewardship that includes the development and testing of new weapons, the maintenance and repair of existing weapons, and the development of new technologies to improve the performance and reliability of our nuclear stockpile.

These are the challenges being tackled by the Stockpile Stewardship Program, an enormous scientific undertaking to ensure the safety, security, and reliability of our country's nuclear deterrent. The stewardship mission involves all the nuclear weapons laboratories and plants nationwide, and it's managed by the Department of Energy's National Nuclear Security Administration.

Most of the weapon systems in the stockpile were designed at Los Alamos, so scientists and engineers here are involved in virtually every aspect of stockpile stewardship.

Weapons Science and Experiments
We conduct a wide range of physics and materials science experiments, large and small, to gather data that will strengthen our understanding of nuclear weapons systems.

Simulation and Computing
We use extremely large-scale, three-dimensional computer models to predict the effects of age-related changes and simulate the performance of nuclear weapons.

Manufacturing and Production
We are responsible for producing and assembling precision parts, test articles, and other weapon components.

Maintaining Capabilities
We are required by government mandates to maintain the ability to design and produce new weapons and related support equipment if ever needed again.

Surveillance, Assessment, and Certification
We use complex sensors, sensors, and verify the safety and reliability of the types of nuclear weapons designed at Los Alamos.

Jay B. Tracy

Outside the Fence

Four large panels and interactive displays focus on the world community and set the Laboratory and our nuclear weapons mission in a global context.

- Nuclear weapons: A global reality and a national priority
- Understanding how a nuclear weapon works
- Changing times and changing numbers in the US stockpile
- Stockpile stewardship and our mission

& the Bradbury Science Museum

Behind the Fence

By using a badge reader, visitors go behind the fence, where four stations invite learning about specific aspects of the Los Alamos stockpile stewardship program.

- Aging materials
- Hydrodynamic testing
- Test readiness at NTS
- Modeling and

What's Going On Underground?

Eighty-five miles northwest of Las Vegas, Nevada, the desert looks like a lunar landscape dotted with craters. A few miles away and deep below the surface, the scene resembles a mine with long tunnels ending in chambers carved from the earth. But no minerals are being mined here, only knowledge about the strange element plutonium.

In this part of the Nevada Test Site, called the U1a experimental facility, scientists conduct subcritical experiments. These experiments test the basic properties of plutonium and other nuclear materials under high pressures to determine how aging affects them. Most importantly, these experiments do not generate nuclear explosions—that's why they're called subcritical. No critical mass forms, and no sustaining nuclear chain reaction occurs.

The Nevada Test Site
Covering 1,350 square miles, an area larger than Rhode Island, the Nevada Test Site is one of the largest outdoor laboratories in the United States. From its first aboveground test on January 27, 1951, to the last underground test on September 23, 1992, the site served as the primary place the United States conducted nuclear testing.

Past Nuclear Testing
Some of these tests were conducted to gather technical data on nuclear weapons; some were to study safety, storage, and transportation issues; other tests helped determine the effects of nuclear explosions, and some tests were for the United Kingdom. In all, **more than 900 tests were done at the Nevada Test Site, and more than 600 of these were underground nuclear tests.**

The Test Site Today
In 1992, President George H. W. Bush suspended underground nuclear testing. As a result, testing changed considerably. No longer could a defective, integrated test be done. Instead, we would have to rely on results from substantial experiments and laboratory experiments conducted on individual components and integrated in a computer simulation. The test site diversified its mission by adding programs to train emergency response personnel, test conventional weapons, and study environmental issues—first underground spaces to the global climate.

The Pressure's On Conducting a Subcritical Experiment
About 1,000 feet below the surface, at the end of a long tunnel is a permanently sealed chamber. At an experiment with a small amount of plutonium. Some distance away is a thin stainless-steel fiber plate loaded with six small explosives. The explosives accelerate the plate into the plutonium sample, and the impact causes shockwaves to move through them. When the waves emerge from the back side of the sample, light is produced, sending a signal along fiber-optic cables to a series of recording stations. The data collected by these stations will help us better understand how plutonium's aging affects the performance of nuclear weapons and their components. Such knowledge will improve the ability to compute simulations, which in turn, will help ensure weapons reliability and safety without nuclear testing.

Test Readiness
To ensure the nation's nuclear deterrent, the President has mandated that the test site and the weapons laboratories be ready to resume nuclear testing if necessary. Conducting substantial experiments is one way to maintain some of the needed skills and facilities.

Modeling and Simulation
This subcritical test is a key to understanding the behavior of nuclear weapons. The main understanding of the behavior of nuclear weapons is gained through computer simulations.

Subcritical Testing
This subcritical test is a key to understanding the behavior of nuclear weapons. The main understanding of the behavior of nuclear weapons is gained through computer simulations.

Test Readiness
To ensure the nation's nuclear deterrent, the President has mandated that the test site and the weapons laboratories be ready to resume nuclear testing if necessary. Conducting substantial experiments is one way to maintain some of the needed skills and facilities.

Modeling and Simulation
This subcritical test is a key to understanding the behavior of nuclear weapons. The main understanding of the behavior of nuclear weapons is gained through computer simulations.

Andrea M. Gaskoy

Bradbury Science Museum

<http://www.lanl.gov/museum>

The Bradbury Science Museum serves as a bridge between the Laboratory and the community by helping to improve science education and science literacy. The Museum presents the Laboratory's history and current research in many exhibits that are interactive and feature videos, computers, and science demonstrations.

The Museum (1) interprets Laboratory research, activities, and history to official visitors, the general public, and Laboratory employees;

(2) promotes greater public understanding of the Laboratory's role in national security programs; (3) assists the public in making informed judgments in these matters; and (4) contributes to visitors knowledge of science and technology and improves the quality of math and science education in northern New Mexico.

Point of View from page 1

accurately calculated or easily measured, given the limited number of nuclear tests. Now we must understand and predict the performance of a weapon by relying on large-scale predictive simulations with more rigorous estimates of levels of accuracy, limits of applicability, and degree of confidence in our predictions. We need improved experimental and computational tools to predict and respond to issues as the stockpile ages beyond its design lifetime.

Because we are no longer able to experimentally validate the integral performance of nuclear weapons, the success of our Stockpile Stewardship Program requires us to extend science-based prediction by improving the physics models, the numerical methods, and the precision of experiments. Our goals are to more accurately predict complex phenomena; to simulate the performance of aging nuclear weapons; and to determine the effect of observed anomalies in a weapon's condition on safety, reliability, and performance. Similarly, these enhanced assessment capabilities are also required to evaluate the impact of remanufactured components on weapons performance.

We must develop an understanding of the integrated behavior of a system—like the performance of nuclear weapons—with its own set of complex subsystems; produce simulations of high-impact problems with an acceptable degree of uncertainty; and generate, analyze, and understand vast experimental data. The numerous challenges we face in developing this capability are applicable beyond our Stockpile Stewardship Program. In fact, the broader-based scientific challenge is truly worthy of the dedicated effort of a national laboratory.

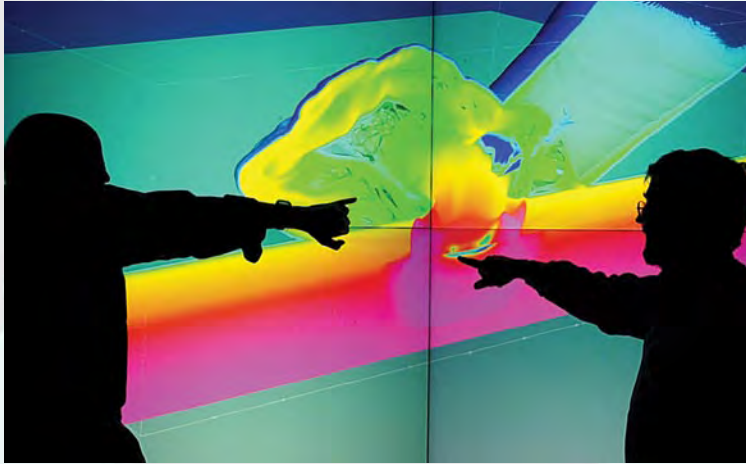

The new Los Alamos PowerWalls—each of which provides a 4 × 2-m stereo display—can immerse weapons scientists in a full-color, 3-D movie of the temperature or density field of simulated and evolving, coupled, hydrodynamic and radiation interactions.

These challenges include a lack of knowledge about the systemic net of causal relationships in complex systems (e.g., instabilities and turbulence), incomplete data, discrepancies between observations and simulations, and the search for a physical understanding of those discrepancies. We design our experiments to constrain theories and

simulations and to bound uncertainties in the choice of a model or its parameters. We develop tools to quantify numerical solution errors and pursue multiscale science (scale-up) to allow coarser but accurate simulations of microphysical phenomena. The result of this assessment is to provide a quantitative metric of margins and uncertainties that allows us to maintain

the certification of a previously tested system.

One element in developing this approach is the creation of a powerful and comprehensive computational infrastructure—hardware, architecture, software, and programming expertise—and other tools, such as visualization, databases, scientific libraries, and computing languages. The history and development of computing is intimately tied to Los Alamos and to the nuclear weapons program. We now have computer hardware and new codes that offer astonishingly high-resolution simulations of our systems from initiation to nuclear yield, and we are using these to tackle and resolve real stockpile issues. But the challenges associated with understanding and archiving the data produced by these machines are significant.

These vast quantities of data present a major informatics challenge to building a predictive science capability, and they require us to decipher knowledge from exceedingly large data sets. We are developing new visualization tools to extract knowledge from huge quantities of data. These tools are

being used to present the huge volumes of information produced by a weapon simulation in ways that scientists can quickly grasp. During this past year, we completed the first 3-D simulation of a full W76 nuclear weapon system explosion by using Livermore's 12-TeraOPS White computer. This calculation represents the first time that we have been able to compute a fully coupled primary and secondary explosion to analyze weapon performance. It represents a breakthrough for the program and offers unprecedented detail for designers and analysts. The next five years hold the promise of extending these simulations to even higher resolution with greatly improved speeds.

However, these simulations must be meticulously validated with experimental laboratory data that test the physics models of these complex systems and allow us to better understand the results of prior nuclear tests. Without this validation, the simulation can fool us with respect to its representation of connected phenomena that cannot be fully tested in a laboratory environment. Neither the simulations nor the experiments alone are sufficient to understand these systems. Ultimately, we must apply these tools to manage technical risks of certification by ensuring that uncertainties associated with predicting key weapon performance metrics do not overwhelm the margins designed into the system. This assessment would be applied to weapon systems that have aged past their intended lifetimes.

The challenge of stockpile stewardship is to maintain the US nuclear stockpile without nuclear testing. Whether we can maintain the safety and reliability of the existing weapons indefinitely without nuclear testing probably cannot be answered. If the nation requires different nuclear weapons to meet the threats of the 21st century, the challenge becomes even greater. For either the existing weapons or new weapons, we will need the tools of the Stockpile Stewardship Program to succeed with or without nuclear testing.

Fundamental Science

Not only does our work in basic science and research strengthen the technical capabilities needed

for our primary national security mission, it provides the foundation for virtually all of our programmatic work.

For example, trying to understand the extraordinary complexity and diversity of life presents a significant scientific challenge. This complex system extends over an enormous range of scales from the microscopic nanoscale to macroscopic plants and animals. Nanoscience—a field defined by the integration across scientific disciplines, length scales, experiment, and theory—is one focus of our efforts in basic science that is closely coupled with complexity and offers great promise for the development of technologies that will be critical to our national security mission.

As an example of our work at the interface of nanoscience and bioscience, scientists at the Laboratory are trying to understand the basic physics of protein folding—one of the great mysteries of computational biology. Proteins are the basic building blocks of life, and protein folding is the foundation of cellular growth and the health of a biological system. It is the process by which proteins reconfigure themselves and adopt a well-defined structure. When proteins incorrectly fold, the malfunction can give rise to a variety of diseases. Although the protein-folding problem was postulated in the 1960s, we have yet to understand the chemical and physical principles that guide the folding process.

Theoretical biophysicists at Los Alamos and UC San Diego have now created the first computer simulation of full-system protein folding. As part of the checkout phase of the new, second 10-TeraOPS part (called QB) of the ASCI Q machine, six extremely complex and computationally intensive unclassified “science runs” have been conducted before QB is put into classified mode. One of those simulations is the dynamics of protein folding. Atomic simulations were conducted to study the process of insertion and folding of a protein fragment into a biological lipid membrane. Protein insertion into biological membranes is the first step in many important biological processes (transport, cell signaling).

This application has used about 200,000 processor hours on the QB. We were able to perform simulations efficiently with sets of 512 CPUs, but the code scaled well to 1,024 CPUs. These calculations are the most extensive simulations on protein/membrane systems and may represent a major advance toward the understanding of protein/membrane interactions.

On the Horizon

The future of complexity science holds enormous promise for science, research, and the development of new technologies. The DOE is developing a Center for Integrated Nanotechnologies that will be a national resource and will bring together the distinctive capabilities of Los Alamos and Sandia in conducting science and research at the interface of materials and biology; in melding theory, modeling, and simulation of systems with multiscale

phenomena; in characterizing materials; and in developing fabrication technologies.

The Stockpile Stewardship Program motivates us to develop capabilities and expertise to pursue a predictive understanding of other extremely complex systems, especially those that involve high-impact problems facing the nation and the world, such as the spread of diseases, possible threats to critical infrastructures, and the impact of environmental remediation or global climate change. And as our role in threat reduction accelerates, we are extending the research that we have traditionally done on countermeasures for weapons of mass destruction (chemical, biological, and nuclear weapons) to work in multiple areas of complex science and engineering that have implications for a wide variety of technologies. 🌟

Acronyms and Abbreviations

ASCI	Accelerated Strategic Computing Initiative	HSR	Health, Safety, and Radiation Protection Division		Administration
CD	DOE critical decision	ISM	Integrated Safety Management	NSSC	nested safety and security committee
DARHT	Dual-Axis Radiographic Hydrodynamic Test	ISSM	Integrated Safeguards and Security Management	NTS	Nevada Test Site
DART	days away from work, restricted work activity, or transfers to another job	LANL	Los Alamos National Laboratory	PBX	plastic bonded explosive
DCSSC	Director's Central Safety and Security Committee	LBNL	Lawrence Berkeley National Laboratory	PLM	polarized light microscopy
DoD	US Department of Defense	LIR	Laboratory Implementation Requirements	RB	reentry body
DOE	US Department of Energy	LLNL	Lawrence Livermore National Laboratory	RLWTF	Radioactive Liquid Waste Treatment Facility
DX	Dynamic Experimentation Division	LSO	lutetium oxy-orthosilicate	S	Security and Safeguards Division
DX-1	Detonation Science and Technology Group	MIC	metastable intermolecular composite (material)	S-1	Security Plans and Programs Group
EDS	energy-dispersive x-ray spectrometer	MIT	Massachusetts Institute of Technology	SANS	small-angle neutron scattering
ESA	Engineering Sciences and Applications Division	NARS	nitric acid recycling system	SAS	small-angle scattering
FESEM	field emission scanning electron microscope	NMT	Nuclear Materials Technology Division	SAXS	small-angle x-ray scattering
FTU	flight test unit	NMT-5	Weapon Component Technology Group	SEM	scanning electron microscopy
HE	high explosive	NNSA	National Nuclear Security	TeraOPS	trillion floating-point operations per second
HERT	high-explosive radio telemetry			TRC	total recordable cases
HMX	high melting explosive			UC	University of California
				WDS	wavelength-dispersive x-ray spectrometer

A BACKWARD GLANCE

Over the years, captions for this photograph of a 1942 Plymouth sedan outside the McDonald ranch house have generated confusion.

At some point, the photo was captioned “Bomb Core Arrives,” and it stated that the men were unloading the “bomb” into the house, which is incorrect. Another error is promulgated by the Internet, where a search for “bomb car” (rather than “bomb core”) directs you to this photo and continues an ongoing misconception that the infamous sedan was used in 1945 to transport the fully assembled atomic bomb directly from

Los Alamos to Trinity Site—a 300-mile journey that would have required driving through Santa Fe and Albuquerque.

Many types of vehicles—cars, trucks, buses—delivered various components from Los Alamos to Trinity Site for assembly. According to *Reach to the Unknown: The Trinity Story*, July 16, 1945, “As many as ten trucks left Los Alamos every evening after dark to avoid both blistering desert heat and unnecessary notice.”

In front of the rock wall at the ranch house, a frame was erected for hanging a hoist to unload heavy items. Inside, the master bedroom was transformed into a dust-free clean room, where the plutonium core was assembled. In addition to the house, Manhattan Project personnel used the water storage tanks to the east of the



TR00312 colorized photo

home—it was a long hot summer, and they filled one tank to use as a swimming pool.

Although the photo above shows Herbert Lehr and Harry Daghljan carrying the ventilated box that contains the plutonium components, the direction in which they are walking remains unclear. What is certain is that the plutonium core was assembled at the ranch house and driven the few miles to

ground zero at Trinity Site. On July 16, the first atomic bomb was tested.

In 1984, the National Park Service restored the McDonald ranch house to its condition on July 12, 1945, and opened it as part of the biannual tours to Trinity Site that are held each April and October.



For more information:

<http://www.lanl.gov/worldview/welcome/history.shtml>

<http://www.wsmr.army.mil/paopage/pages/trinst.htm>



TR00244 colorized photo