



*“Transparency, Accountability, and
Oversight”*

Recipient Reporting
Data Model
V2.0.1

FINAL

June 22, 2009

Table of Contents

Introduction	1
Spreadsheet Template	2
Data Dictionary	5
XML Schema Definition (XSD) - Summary	30

Introduction

The Recovery Act has specified that the Recovery Act Accountability and Transparency Board (The Board) establish a website called Recovery.gov. Recovery.gov is the central government portal for providing information on the Recovery Act to the public. Recovery.gov Version 2.0 is the implementation of Recipient Reporting as required under the American Recovery and Reinvestment Act of 2009 (ARRA).

This document is the data model for recipient reporting that includes the following:

- Reporting Template – Excel spreadsheet for data submission.
- Data Dictionary – description of the data elements for recipient reporting.
- XML Schema Definition – data definition for machine readable recipient reporting.

Each aspect of the Recipient Reporting data model is further described in the subsequent sections.

Spreadsheet Template

This Recipient Reporting spreadsheet template is to be used for non-machine recipient reporting. It enables manual data entry and collection of recipient reporting information in a familiar excel format. The spreadsheet template appears as follows: (two parts)

Figure 1 - Recipient Reporting Spreadsheet Template (Part 1 of 2)

Recipient Report Version 2.0							
Prime Recipient Report							
Funding Agency Name:		Project/Grant Period:				Total Number of Subcontracts and Sub-awards less than \$25,000/award and awarded to individuals:	Total Amount of Subcontracts and Sub-awards less than \$25,000/award and awarded to individuals:
Program Source (TAFS):		Report Period End Date:					
Grant/Award Number:		Final Report:					
FB0/CFDA Number:		Report Frequency:					
Project Name:		Award Date (Data Signed):					
Transaction Type:		Award Description:					
Recipient DUNS No.:		Amount of Award (Obligation):				Recipient highly compensated officers	
Recipient Account Number:		Federal Expenditure:				Officer Name	Officer Compensation
Recipient Area of Benefit:		Project Description (HAKSI):				1	
		Project Status:				2	
						3	
						4	
Primary Place of Performance - Location Name:		Jobs Created:				5	
Primary Place of Performance - City:		Total Infrastructure Expenditure:					
Primary Place of Performance - State:		Total Federal ARRA Expenditure:				Infrastructure Expenditure:	
Primary Place of Performance - County:		Total Federal non-ARRA Expenditure:					
Primary Place of Performance - Congressional District:		Total non-Federal Share of Expenditure:				Number of Jobs:	
		Jobs Retained:					
Subrecipient				Subaward			
No.	Subrecipient DUNS No.	Subcontract Number	Subrecipient Congressional District	Subrecipient Type	Amount of Subaward	Ultimate Value of Subaward	Subrecipient Area of Benefit
1							

Microsoft Excel - Template - Recipient Report v2.0 200906015.xls

File Edit View Insert Format Tools Data Window Help

AG 2

Recipient Report Version 2.0									
Subrecipient Report									
1	PrimeRecipient DUNS No.								
2	Grant/Award Number								
3	Transaction Type								
Subrecipient					Subaward				
No.	Subrecipient DUNS No.	Subcontract Number	Subrecipient Congressional District	Subrecipient Type	Amount of Subaward (Disbursed)	Ultimate Value of Subaward	Subrecipient Area of Benefit	Subaward Date	Si
1									
2									
3									
4									
5									
6									
7									
8									
9									
10									
11									
12									
13									
14									
15									
16									
17									
18									

Ready Sun=39894 NUM

Data Dictionary

The data dictionary describes the data elements specifically required for recipient reporting under the American Recovery and Reinvestment Act of 2009 (ARRA).

Table 1 - Recipient Reporting Data Dictionary

Yellow – Input (user provided)
Blue – System provided (e.g. CCR)

Data Element - XML Tag	Definition	Type	Max Length	Example	Comments	Control	Existing Source Systems	Validation and Business Rule(s)
RECIPIENT DATA ELEMENTS								
FundingAgencyName	Name of Federal Agency Managing the Funds. Awarding Federal agency and Organizational Element to Which Report is Submitted.	string	55	68 - ENVIRONMENTAL PROTECTION AGENCY 47 - GENERAL SERVICES ADMINISTRATION		April 1, 2009 Federal Register Transparency Act Guidance March 30, 2007	eSRS USASpending FPDS	fips95-2.pdf
FundingTAS	Agency Treasury Account Symbol (TAS) - Program Source	string	11	TRAGENCY (2) + "-" + TRACCT (4) + "-" + BUD_AGENCY(3)	Assuming that Agencies will provide the code to Recipient	Transparency Act Guidance March 30, 2007	FPDS USASpending	OMB TAS list

				68-0102-020 47-0112-023				
AwardId	Federal Grant or Other Identifying Number Assigned by the awarding Federal agency. For grants: agency assigned award number For contracts: FPDS Data element 1A (Procurement Instrument Identifier or PIID, Order#).	string	50	Varies by award and agencies	FOR CONTRACT : The PIID shall consist of alpha characters in the first positions to indicate the agency, followed by alphanumeric characters identifying bureaus, offices, or other administrative subdivisions.	April 1, 2009 Federal Register Transparency Act Guidance March 30, 2007	FAADS OFPP FPDS eSRS USASpending	
RecipientDUNSNumber	Unique Identifier of Entity (DUNS No.) The prime recipient organization's 9 digit Data Universal Numbering System (DUNS) number or Central Contractor Registration plus 4 extended DUNS number.	string	13	123456789111 1	DUNS# 9digit is mandatory but the 4digit extension is optional	April 1, 2009 Federal Register Transparency Act Guidance March 30, 2007	D&B CCR eSRS FPDS USASpending	Either length 9 or 13
RecipientMPINNumber	The MPIN is a mandatory data element created by the CCR registrant and must have nine characters: at least one letter (upper or lower case) and one number. No spaces or special characters are permitted. .	string	9	Personal to the Prime Recipient	The Prime Recipient is prompted at report submission to provide the MPIN#. Currently Recipients with Loan award are		CCR	A Marketing Partner ID Number (MPIN) is a personal code that allows you to access other government applications

					not registered in CCR, hence do not have a MPIN#.			such as the Past Performance Information Retrieval System (PPIRS) and the Online Representations and Certifications Application (ORCA). The MPIN acts as your password in these other systems, and you should guard it as such. ONLINE ONLY for validation.
ParentDunsNumber	Unique Identifier of Parent Organization / Company (DUNS No.)	string	13	This field is inferred; obtained through CCR.	The System will pull this parent organization DUNS# from CCR	Transparency Act Guidance March 30, 2007	D&B CCR eSRS FPDS USASpending	Mandatory if there exists a parent organization.
RecipientEIN	The recipient organization's Employer Identification Number (EIN) provided by the Internal Revenue Service.	string	13	This field is inferred; obtained through CCR.	The System will pull EIN from CCR	April 1, 2009 Federal Register	CCR	

CFDANumber	Catalog of Federal Domestic Assistance: GSA, OMB; published description of Federal assistance program. Catalog of Federal Domestic Assistance (CFDA) number on the award document or provided by the awarding agency. If this award is being funded through multiple programs, provide each CFDA number.	string	6	66.039	The CFDA number should be the same as the one found in CFDA.gov for Recovery.	April 1, 2009 Federal Register Transparency Act Guidance March 30, 2007	CFDA FAADS USASpending	Only used for grants and loans
RecipientName	Recipient Name and Address of Organization. The legal name of recipient organization and address, including zip code. This should be the same name and address that appears in recipient's Central Contractor Registration profile.	string	55	This field is inferred; obtained through CCR.	The System will pull this information from CCR	April 1, 2009 Federal Register Transparency Act Guidance March 30, 2007	D&B CCR eSRS FPDS USASpending	Data Populated from details found in CCR through the DUNS# look-up
RecipientAddress1		string	55	This field is inferred; obtained through CCR.	The System will pull this information from CCR			
RecipientAddress2		string	55	This field is inferred; obtained through CCR.	The System will pull this information from CCR			
RecipientAddress3		string	55	This field is inferred; obtained through CCR.	The System will pull this information from CCR			
RecipientCity		string	55	This field is inferred; obtained through CCR.	The System will pull this information from CCR			
RecipientState		string	2	This field is inferred; obtained through CCR.	The System will pull this information from CCR			
RecipientZipcode		string	10	This field is inferred; obtained through CCR.	The System will pull this information from CCR			

RecipientsAccountNumber	Recipient's internal account number for project/award. The account number or any other identifying number assigned by the recipient to the award. This number is strictly for the recipient's use only and is not required by the awarding Federal agency.	string	55	This field is optional	This is an internal tracking number for the Prime Recipient community.	April 1, 2009 Federal Register		Optional
ProjectGrantPeriod	Project/Grant Period (Period of performance) Indicates the project/grant period established in the award document during which Federal sponsorship begins and ends. Note: Some agencies award multi-year grants for a project/grant period (e.g., 5 years) that are funded in increments known as budget periods or funding periods. These are typically annual increments. Please provide the total project/grant period, not the individual budget period or funding period.	Date Range (YYYYMMDD-YYYYMMDD)	17	(YYYYMMDD-YYYYMMDD)-20090615-20100615		April 1, 2009 Federal Register	FPDS USASpending	
ReportPeriodEndDate	Reporting Period End Date. The frequency of required reporting is quarterly. Provide the ending date of the reporting period. For quarterly reports, the following calendar quarter reporting period end dates shall be used: 6/30; 9/30; 12/31; or 3/31. For final reports, the reporting period end date shall be the end date of the project/grant period.	Date (YYYYMMDD)	8	(YYYYMMDD) 20100615		April 1, 2009 Federal Register	eSRS USASpending FPDS	
FinalReport	Final Project Report Indicator (i.e. no future reports) (Y or N) Check "yes" only if this is the final report for the project / grant period specified	string	1	Y		April 1, 2009 Federal Register	eSRS	
ReportTypeFreq	Report or Frequency. Select "quarterly" for quarterly reports.	string	22	QUARTERLY	if "N" on FinalReport then "Quarterly"	April 1, 2009 Federal Register		

AwardType	Transaction Type—Grant, Contract or Loan	string	8	CONTRACT		Transparency Act Guidance March 30, 2007	FPDS USASpending FAADS+	
AwardDate	Award Date (Date Signed)	Date (YYYYMMDD)	8	(YYYYMMDD) 20090530		Transparency Act Guidance March 30, 2007	eSRS FPDS USASpending	
AwardDescription	Award Title Description w/ purpose of each funding action. A brief descriptive title of the project or activity funded in whole or in part with Recovery Act funds. If this award funds multiple projects or activities, provide a descriptive title that captures the general focus area, e.g., "community development," "comprehensive community mental health services to adults with a serious mental illness," etc.	string	4000	In a world...		April 1, 2009 Federal Register Transparency Act Guidance March 30, 2007	eSRS FPDS USASpending	
AwardAmount	Total Amount of Recovery Funds Received from Federal Agency - Federal Dollar Amount (obligation)	Currency (Dollar value - numeric)	20	20000000.01	Total specific federal funding as indicated on the award document	April 1, 2009 Federal Register Transparency Act Guidance March 30, 2007	FPDS USASpending	
Project Name	Name of Project	string	256	F006: Land Treatment Practices Services (plowing/clearing, etc.)	Title as indicated on the Award document/Product or Service Code-contracts	April 1, 2009 Federal Register		

Activity_Code	Description of Project or Activity (NAICS code(s) or NTEE-NPC code(s)). For awards primarily funding infrastructure projects or activities, as defined by the awarding agency, provide the North American Industry Classification System (NAICS) code(s) that describe the Recovery Act projects or activities under this award. A searchable code list is at http://www.census.gov/naics/ . For all other awards, provide the National Center for Charitable Statistics "NTEE-NPC" code(s) that describe the Recovery Act projects or activities under this award. A searchable code list is at http://nccsdataweb.urban.org/PubApps/nteeSearch.php?gQry=all-core&codeType=NPC .	string	20	115310	NAICS Code-Contracts	April 1, 2009 Federal Register	eSRS FPDS USASpending	NAICS - annual; NPC - annual
Activity_description	Description of Project or Activity	string	2000	Support Activities for Forestry)-Contracts			eSRS FPDS USASpending	Inferred from Activity Code
ProjectDescription	Description of Project or Activity (brief narrative). A description of the overall purpose and expected outputs and outcomes or results of the award and first-tier subaward(s), including significant deliverables and, if appropriate, units of measure. For an award that funds multiple projects or activities, such as a formula block grant, the purpose and outcomes or results may be stated in broad terms.	string	2000	Powers and Gold Beach Ranger Districts Curry County OR Haz Fuels Item 1 Chetco Area and Item 3 - Powers Area	Contract Description-Contracts	April 1, 2009 Federal Register	eSRS FPDS USASpending	

<p>ProjectStatus</p>	<p>Evaluation of completion status of the project or activity. The status of the work that has been completed. This evaluation should be based on performance progress reports and other relevant non-financial performance information. For awards funding a single project or activity, please choose one of the following options: Not started; Less than 50% completed; Completed 50% or more; Fully Completed. For awards funding multiple projects or activities, such as formula block grants, provide your best estimate of completion of all projects and/or activities based on any aggregate data and information.</p>	<p>string</p>	<p>20</p>	<p>"Fully Completed"</p>		<p>April 1, 2009 Federal Register</p>	<p>FAADS</p>	
----------------------	---	---------------	-----------	--------------------------	--	---	--------------	--

<p>JobCreation</p>	<p>A narrative description of the employment impact of the Recovery Act funded work. This narrative should be cumulative for each calendar quarter and at a minimum, address the impact on the recipient's workforce, and if known, the impact on the workforces of subrecipients. At a minimum, the recipient shall provide— (i) A brief description of the types of jobs created and jobs retained in the United States and outlying areas. "Jobs or positions created" means those new positions created and filled, or previously existing unfilled positions that are filled, as a result of Recovery Act funding. "Jobs or positions retained" means those previously existing filled positions that are retained as a result of Recovery Act funding. This description may rely on job titles, broader labor categories, or the contractor's existing practice for describing jobs as long as the terms used are widely understood and describe the general nature of the work; and (ii) An estimate of the number of jobs created and jobs retained in the United States and outlying areas. At a minimum, this estimate shall include any new positions created and any existing filled positions that were retained to support or carry out Recovery Act projects or activities managed directly by the recipient, and if known, by subrecipients. The number shall be expressed as "full-time equivalent" (FTE), calculated</p>	<p>string</p>	<p>4000</p>			<p>April 1, 2009 Federal Register ARRA</p>		
--------------------	--	---------------	-------------	--	--	--	--	--

	<p>cumulatively as all hours worked divided by the total number of hours in a full-time schedule, as defined by the recipient. For instance, two full-time employees and one part-time employee working half days would be reported as 2.5 FTE in each calendar quarter.</p> <p>(iii) A job cannot be reported as both created and retained. As used in this instruction, United States means the 50 States and the District of Columbia, and outlying areas means—</p> <p>(1) Commonwealths. (i) Puerto Rico. (ii) The Northern Mariana Islands;</p> <p>(2) Territories. (i) American Samoa. (ii) Guam. (iii) U.S. Virgin Islands; and</p> <p>(3) Minor outlying islands. (i) Baker Island. (ii) Howland Island. (iii) Jarvis Island. (iv) Johnston Atoll. (v) Kingman Reef. (vi) Midway Islands. (vii) Navassa Island. (viii) Palmyra Atoll. (ix) Wake Atoll.</p>							
--	---	--	--	--	--	--	--	--

<p>NumberOfJobs</p>	<p>(ii) An estimate of the number of jobs created and jobs retained in the United States and outlying areas. At a minimum, this estimate shall include any new positions created and any existing filled positions that were retained to support or carry out Recovery Act projects or activities managed directly by the recipient, and if known, by subrecipients. The number shall be expressed as "full-time equivalent" (FTE), calculated cumulatively as all hours worked divided by the total number of hours in a full-time schedule, as defined by the recipient. For instance, two full-time employees and one part-time employee working half days would be reported as 2.5 FTE in each calendar quarter.</p>	<p>Number</p>	<p>10</p>	<p>1200.00</p>				
---------------------	--	---------------	-----------	----------------	--	--	--	--

<p>FedExpenditure</p>	<p>Amount of recovery funds received that were expended to projects or activities ("Federal Share of Expenditures"). The cumulative total for the amount of Federal fund expenditures. For reports prepared on a cash basis, expenditures are the sum of cash disbursements for direct charges for property and services; the amount of indirect expense charged; the value of third-party in-kind contributions applied; and the amount of cash advance payments and payments made to subcontractors and subawardees. For reports prepared on an accrual basis, expenditures are the sum of cash disbursements for direct charges for property and services; the amount of indirect expense incurred; the value of in-kind contributions applied; and the net increase or decrease in the amounts owed by the recipient for (1) goods and other property received; (2) services performed by employees, contractors, subcontractors, subawardees, and other payees; and (3) programs for which no current services or performance are required. Do not include program income expended.</p>	<p>Currency (Dollar value - numeric)</p>	<p>18</p>	<p>200000000.01</p>		<p>April 1, 2009 Federal Register ARRA</p>		<p>TotalFedARR AExpenditure should not exceed the FedExpenditure</p>
<p>TotalInfrastructureExpenditure</p>	<p>Total cost of infrastructure investment made by State and Local governments. Provide the cumulative total cost of investment. This amount should include the total cumulative federal expenditures and non-federal expenditures for the infrastructure investment: Federal (Recovery Act funds): \$#####.</p>	<p>Currency (Dollar value - numeric)</p>	<p>18</p>	<p>200000000.01</p>		<p>April 1, 2009 Federal Register</p>		<p>Warning Business Rule: This amount is the SUM of TotalFedARRAExpenditure + TotalFedNonARRAExpenditure</p>

	Federal (non-Recovery Act funds): \$IIIIIIII. NonFederal: \$IIIIIIII.							+TotalNonFedExpenditure
TotalFedARRAExpenditure	Total federal ARRA expenditure	Currency (Dollar value - numeric)	18	160000000.00		April 1, 2009 Federal Register		
TotalFedNonARRAExpenditure	Total federal non-ARRA expenditure	Currency (Dollar value - numeric)	18	45000000.01		April 1, 2009 Federal Register		
TotalNonFedExpenditure	Total non-federal expenditure	Currency (Dollar value - numeric)	18	190000000.00		April 1, 2009 Federal Register		

InfrastructureRationale	<p>Rationale of the Award Recipient for funding the infrastructure investment with funds made available under the Recovery Act. Explain how the infrastructure investment will contribute to one or more purposes of the Recovery Act: Purposes: (1) To preserve and create jobs and promote economic recovery. (2) To assist those most impacted by the recession. (3) To provide investments needed to increase economic efficiency by spurring technological advances in science and health. (4) To invest in transportation, environmental protection, and other infrastructure that will provide long-term economic benefits. (5) To stabilize State and local government budgets, in order to minimize and avoid reductions in essential services and counterproductive state and local tax increases.</p>	string	Variable (Maximum 4000 characters)			April 1, 2009 Federal Register ARRA		
StateLocalContactName	Name, phone number, address and email address of the appropriate contact in the state/local government.	string	55	This field is inferred; obtained through CCR.	The System will pull this information from CCR	April 1, 2009 Federal Register Transparency Act Guidance March 30, 2007	CCR Egov	Data Populated from details found in CCR through the DUNS# look-up
StateLocalContactStreetAddress1		string	55	This field is inferred; obtained through CCR.	The System will pull this information from CCR			
StateLocalContactStreetAddress2		string	55	This field is inferred; obtained through CCR.	The System will pull this information from CCR			

StateLocalContactStreetAddress3		string	55	This field is inferred; obtained through CCR.	The System will pull this information from CCR			
StateLocalContactCity		string	55	This field is inferred; obtained through CCR.	The System will pull this information from CCR			
StateLocalContactState		string	2	This field is inferred; obtained through CCR.	The System will pull this information from CCR			
StateLocalContactZIPCode		string	10	This field is inferred; obtained through CCR.	The System will pull this information from CCR			
StateLocalContactCountyCode		string	3	This field is inferred; obtained through CCR.	The System will pull this information from CCR			
StateLocalContactCongressionalDistrict (optional)		string	2	05	This field is optional			
StateLocalContactEmail		string	320	This field is inferred; obtained through CCR.	The System will pull this information from CCR			
PopStateCode	Recipient Primary Place of Performance (city, state, congressional district, and country) physical location of primary place of performance.	string	2	MD (Maryland)	FIPS- 55	April 1, 2009 Federal Register Transparency Act Guidance March 30, 2007		FIPS-55
PopLocationCode		string	5	67675 (Rockville)	FIPS- 55			FIPS-55
PopCountyCode		string	3	031 (Montgomery)	FIPS- 55			FIPS-55
PopLocationName		string	53	Rockville	FIPS- 55			
PopCongressDist		string	2	08	FIPS- 55			
RecipientAreaOfBenefit	The area of benefit may be: State, County, City, School District	string	16	County	FIPS- 55			fixed list: State, County, City, School District

<p>RecipientOfficerName(5)</p>	<p>For the five most highly compensated officers of the entity: names. the names and total compensation of the five most highly compensated officers of the subrecipient entity if— (1) the recipient in its preceding fiscal year received— (a) 80 percent or more of its annual gross revenues in Federal awards; and (b) \$25,000,000 or more in annual gross revenues from Federal awards; and (2) the public does not have access to information about the compensation of the senior executives of the entity through periodic reports filed under section 13(a) or 15(d) of the Securities Exchange Act of 1934 (15 U.S.C. 78m(a), 78o(d)) or section 6104 of the Internal Revenue Code of 1986 [26 USC § 6104]. “Total compensation” means the cash and noncash dollar value earned by the executive during the subrecipient’s past fiscal year of the following (for more information see 17 CFR 229.402(c)(2)): (i). Salary and bonus. (ii). Awards of stock, stock options, and stock appreciation rights. Use the dollar amount recognized for financial statement reporting purposes with respect to the fiscal year in accordance with FAS 123R. (iii). Earnings for services under non-equity incentive plans. Does not include group life, health, hospitalization or medical reimbursement plans that do</p>	<p>string array</p>	<p>55</p>	<p>Tom Jones John Doe Mary Smith Ivana B. Rich Amanda King</p>		<p>April 1, 2009 Federal Register</p>		
--------------------------------	--	---------------------	-----------	--	--	--	--	--

	<p>not discriminate in favor of executives, and are available generally to all salaried employees.</p> <p>(iv). Change in pension value. This is the change in present value of defined benefit and actuarial pension plans.</p> <p>(v). Above-market earnings on deferred compensation which are not tax-qualified.</p> <p>(vi). Other compensation. For example, severance, termination payments, value of life insurance paid on behalf of the employee, perquisites or property if the value for the executive exceeds \$10,000.</p>							
RecipientOfficerTotalCompensation(5)	For the five most highly compensated officers of the entity: total compensation	Currency Array (Dollar value - numeric)	20	1000000 500000 400000 350000 700000		April 1, 2009 Federal Register		
TotalNumberSmallSubawards	Total Number of Subcontracts and Sub-awards less than \$25,000/award and awarded to individuals.	string	6	10		April 1, 2009 Federal Register		
TotalAmountSmallSubawards	Total Amount of Subcontracts and Subawards less than \$25,000/award and awarded to individuals.	Currency (Dollar value - numeric)	20	240000.00	No single award can exceed \$24,999 or must be submitted individually	April 1, 2009 Federal Register		

Subrecipient Data Elements								
SubRecipientDUNS_number	Subrecipient DUNS Number. the subrecipient organization's 9 digit Data Universal Numbering System (DUNS) number or Central Contractor Registration plus 4 extended DUNS number.	string	13	100456789111	DUNS# 9digit is mandatory but the 4digit extension is optional	April 1, 2009 Federal Register	D&B CCR eSRS FPDS USASpending	
SubContractNumber	Award Number or Other Identifying Number Assigned by the Recipient Entity	string	55	Sub-award number provided by Prime Recipient	Prime Recipient assigns a sub-award number (contract, grant, loan) to the Sub Recipient	April 1, 2009 Federal Register	FAADS OFPP FPDS eSRS USASpending	
SubRecipientName	Subrecipient Name. the legal name of subrecipient as registered in the Central Contractor Registration (www.ccr.gov).	string	55	This field is inferred; obtained through CCR or D&B.	The System will pull this information from CCR or D&B	April 1, 2009 Federal Register	D&B CCR eSRS FPDS USASpending	Data Populated from details found in CCR through the DUNS# look-up
SubRecipientAddress1	Subrecipient Location. Physical location as listed in the Central Contractor Registration. For congressional district, use the format: 2 characters State Abbreviation—3 characters District Number, e.g., CA-005 for California 5th district, CA-012 for California 12th district, NC-13 for North Carolina's 13rd district. If the program/project is outside the US, enter 00-000.	string	55	This field is inferred; obtained through CCR or D&B.	The System will pull this information from CCR or D&B	April 1, 2009 Federal Register		
SubRecipientAddress2		string	55	This field is inferred; obtained through CCR or D&B.	The System will pull this information from CCR or D&B			
SubRecipientAddress3		string	55	This field is inferred; obtained through CCR or D&B.	The System will pull this information from CCR or D&B			
SubRecipientCity		string	55	This field is inferred; obtained through CCR or D&B.	The System will pull this information from CCR or D&B			

SubRecipientState		string	2	This field is inferred; obtained through CCR or D&B.	The System will pull this information from CCR or D&B			
SubRecipientZipcode		string	10	This field is inferred; obtained through CCR or D&B.	The System will pull this information from CCR or D&B			
SubRecipientCongressDistrict (optional)		string	2	05	This field is optional	April 1, 2009 Federal Register		Optional

<p>SubRecipientType</p>	<p>Subrecipient Type Select primary category from the list of categories below.A. State Government.B. County Government.C. City or Township Government.D. Special District Government.E. Regional Organization.F. U.S. Territory or Possession.G. Independent School District.H. Public/State Controlled Institution of Higher Education.I. Indian/Native American Tribal Government (Federally Recognized).J. Indian/Native American Tribal Government (Other than Federally Recognized).K. Indian/Native American Tribally Designated Organization.L. Public/Indian Housing Authority.M. Nonprofit with 501C3 IRS Status (Other than Institution of Higher Education).N. Nonprofit without 501C3 IRS Status (Other than Institution of Higher Education).O. Private Institution of Higher Education.P. Individual.Q. For-Profit Organization (Other than Small Business).R. Small Business.S. Hispanic-serving Institution.T. Historically Black Colleges and Universities (HBCUs).U. Tribally Controlled Colleges and Universities (TCCUs).V. Alaska Native and Native Hawaiian Serving Institutions.W. Non-domestic (non-US) Entity.X. Other.</p>	<p>string</p>	<p>8</p>	<p>This field is inferred; obtained through CCR (Business Types)</p>	<p>The System will pull this "business type" field from CCR</p>	<p>April 1, 2009 Federal Register</p>	<p>FPDS USASpending FAADS+</p>	<p>fixed list</p>
<p>SubcontractAmountDisbursed</p>	<p>Amount of Subcontract or Subaward Disbursed. the cumulative amount of cash disbursed to the subawardee or subcontractor as of the reporting period end date.</p>	<p>Currency (Dollar value - numeric)</p>	<p>20</p>	<p>240000.01</p>		<p>April 1, 2009 Federal Register</p>		

SubcontractValue	Total Amount of Subcontract or Subaward (Ultimate Contract/Award Value). the anticipated total amount of cash to be disbursed to the subawardee or subcontractor by the expiration date of the subaward or subcontract, respectively.	Currency (Dollar value - numeric)	20	240000.00		April 1, 2009 Federal Register		
SubawardDate	Subaward Date. the date the subcontract or subaward was signed (mm/dd/yyyy).	Date (YYYYMMDD)	8	20091212		April 1, 2009 Federal Register		
SubawardProjectGrantPeriod	Subaward Project/Grant Period. the project/grant period established in the subaward document during which sponsorship begins and ends. For multi-year awards for a project/grant period (e.g., 5 years) that are funded in increments known as budget periods or funding periods, please provide the total project/grant period, not the individual budget period or funding period.	Date Range (YYYYMMDD-YYYYMMDD)	17	20091212-20101212	This date range should start from the "start date" to the "end date"	April 1, 2009 Federal Register		
SubRecipientPopStateCode	Subrecipient Place of Performance (city, state, congressional district, and country). physical location of primary place of performance.	string	2	MD (Maryland)		April 1, 2009 Federal Register Transparency Act Guidance March 30, 2007		
SubRecipientPopLocationCode		string	5	67675 (Rockville)				
SubRecipientPopCountyCode		string	3	031 (Montgomery)				
SubRecipientPopLocationName		string	55	Rockville				
SubRecipientPopCongressDistrict		string	2	08	This field is optional			
SubRecipientAreaOfBenefit		The area of benefit may be: State, County, City, School District	string	8	County			

<p>SubRecipientOfficerName(5)</p>	<p>For the five most highly compensated officers of the entity: names. the names and total compensation of the five most highly compensated officers of the subrecipient entity if— (1) the recipient in its preceding fiscal year received— (a) 80 percent or more of its annual gross revenues in Federal awards; and (b) \$25,000,000 or more in annual gross revenues from Federal awards; and (2) the public does not have access to information about the compensation of the senior executives of the entity through periodic reports filed under section 13(a) or 15(d) of the Securities Exchange Act of 1934 (15 U.S.C. 78m(a), 78o(d)) or section 6104 of the Internal Revenue Code of 1986 [26 USC § 6104]. “Total compensation” means the cash and noncash dollar value earned by the executive during the subrecipient’s past fiscal year of the following (for more information see 17 CFR 229.402(c)(2)): (i). Salary and bonus. (ii). Awards of stock, stock options, and stock appreciation rights. Use the dollar amount recognized for financial statement reporting purposes with respect to the fiscal year in accordance with FAS 123R. (iii). Earnings for services under non-equity incentive plans. Does not include group life, health, hospitalization or medical reimbursement plans that do</p>	<p>string array</p>	<p>55</p>	<p>Tom Jones John Doe Mary Smith Ivana B. Rich Amanda King</p>		<p>April 1, 2009 Federal Register</p>		
-----------------------------------	--	---------------------	-----------	--	--	--	--	--

	<p>not discriminate in favor of executives, and are available generally to all salaried employees.</p> <p>(iv). Change in pension value. This is the change in present value of defined benefit and actuarial pension plans.</p> <p>(v). Above-market earnings on deferred compensation which are not tax-qualified.</p> <p>(vi). Other compensation. For example, severance, termination payments, value of life insurance paid on behalf of the employee, perquisites or property if the value for the executive exceeds \$10,000.</p>							
SubRecipientOfficerTotalCompensation(5)	For the five most highly compensated officers of the entity: total compensation	Currency Array(Dollar value - numeric)	20	1000000 500000 400000 350000 700000		April 1, 2009 Federal Register		

Vendor Data Elements								
AwardId	Federal Grant or Other Identifying Number Assigned by the awarding Federal agency. For grants: agency assigned award number For contracts: FPDS Data element 1A (Procurement Instrument Identifier or PIID).	string	50	Varies by award and agencies	FOR CONTRACT : The PIID shall consist of alpha characters in the first positions to indicate the agency, followed by alphanumeric characters identifying bureaus, offices, or other administrative subdivisions.	April 1, 2009 Federal Register Transparency Act Guidance March 30, 2007	FAADS OFPP FPDS eSRS USASpending	
SubContractNumber	Award Number or Other Identifying Number Assigned by the Recipient Entity	string	55	Sub-award number provided by Prime Recipient	Prime Recipient assigns a sub-award number (contract, grant, loan) to the Sub Recipient	April 1, 2009 Federal Register	FAADS OFPP FPDS eSRS USASpending	
VendorDUNS_number	Subrecipient DUNS Number. the subrecipient organization's 9 digit Data Universal Numbering System (DUNS) number or Central Contractor Registration plus 4 extended DUNS number.	string	13	100456789111	DUNS# 9digit is mandatory but the 4digit extension is optional	April 1, 2009 Federal Register	D&B CCR eSRS FPDS USASpending	
VendorHQZipcode	The zipcode of the subrecipient's headquarters.	string	9					
VendorName	The name of the vendor	string	55					

ProdSrvcDescription	A description of the product or service provided by the vendor	string	20	115310	NAICS Code-Contracts	April 1, 2009 Federal Register		
PaymentAmt	The amount paid to the vendor.	Currency Array(Dollar value - numeric)	20	1000000 500000 400000 350000 700000		April 1, 2009 Federal Register		

XML Schema Definition (XSD) - Summary

The elements defined in the data dictionary are formalized in XML by means of the schema definition (XSD). The formal XML tags are given in the XSD. A pictorial representation of the XSD follows:

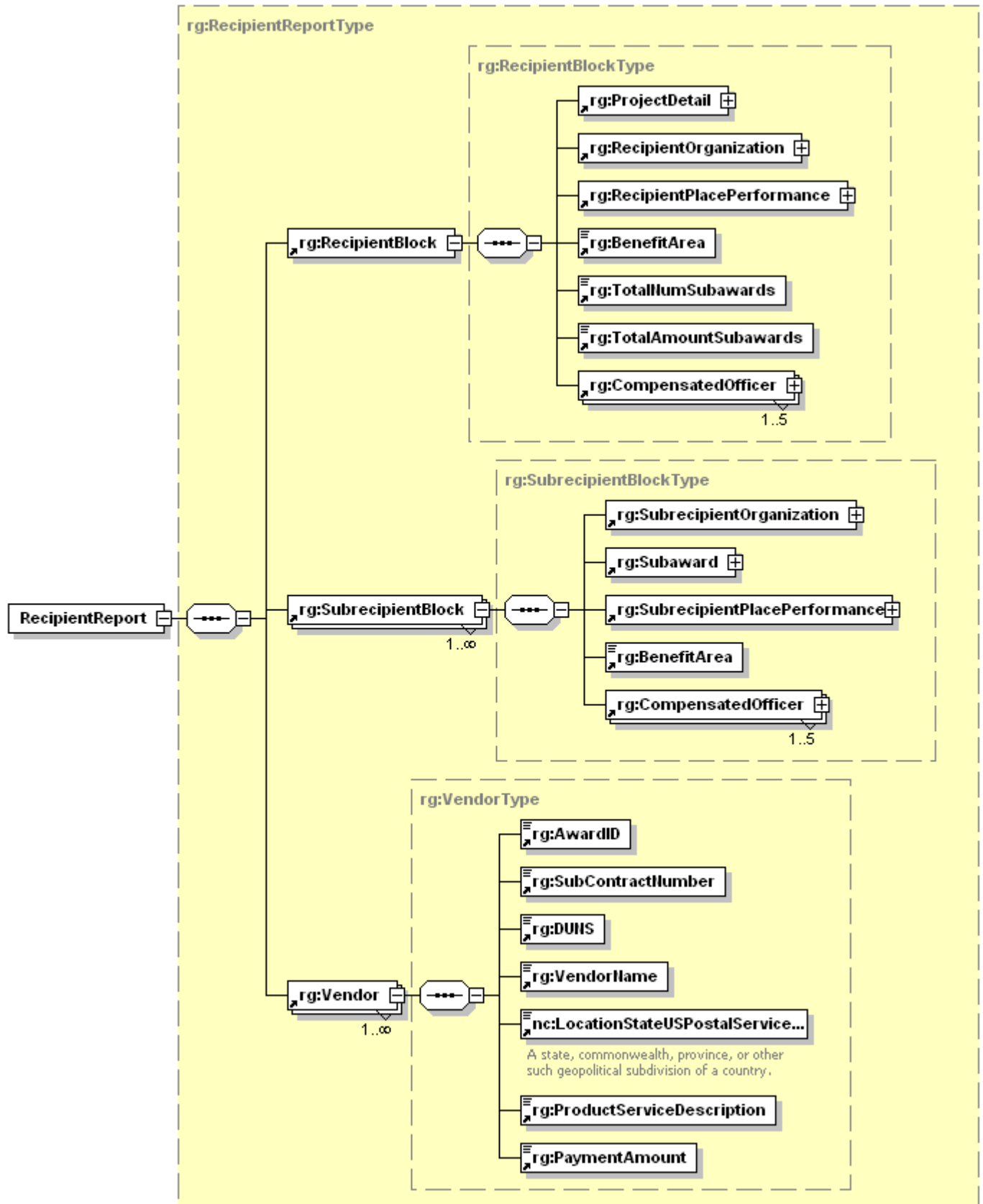

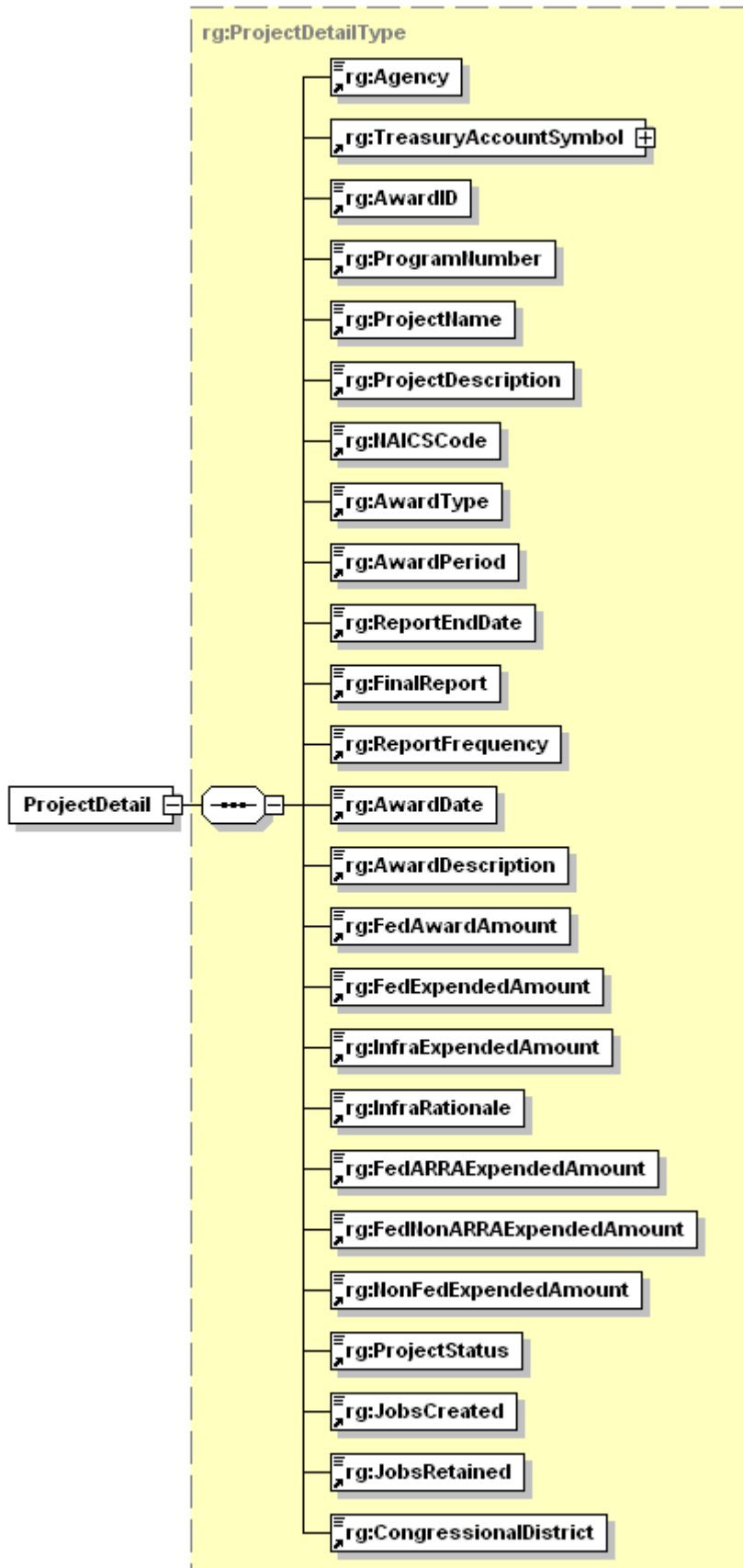

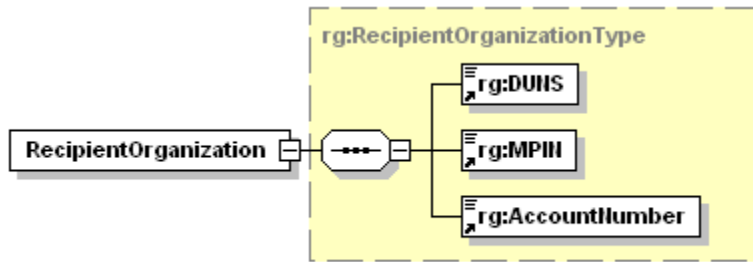

Generated with XMLSpy Schema Editor www.xmlspy.com

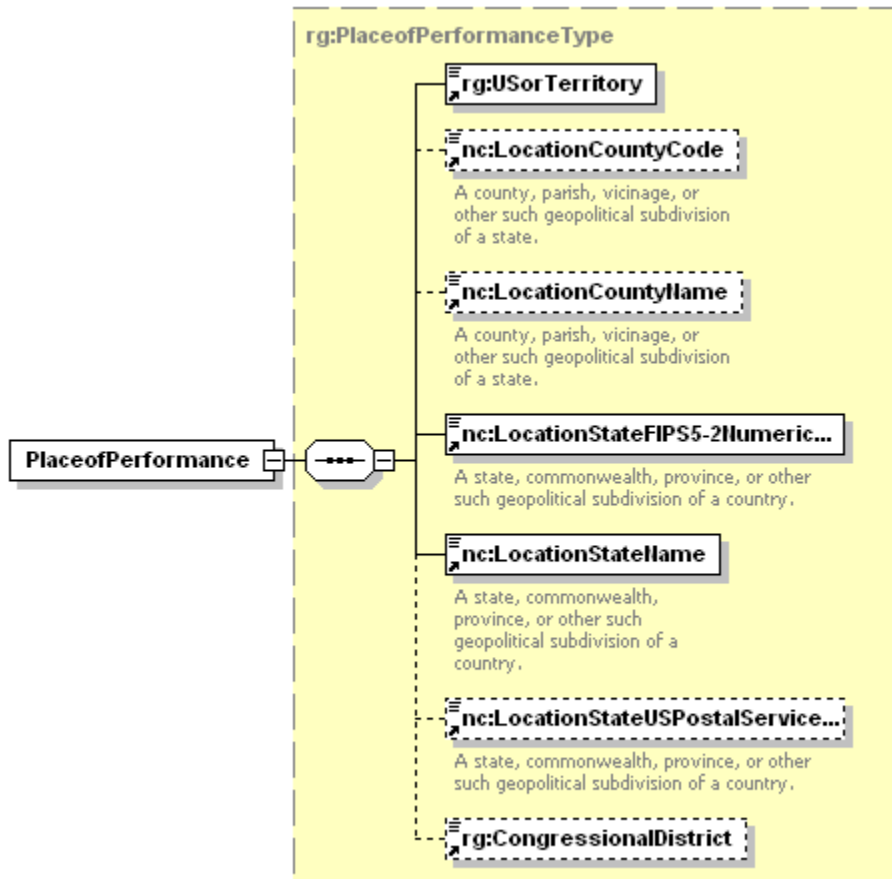

Generated with XMLSpy Schema Editor www.xmlspy.com

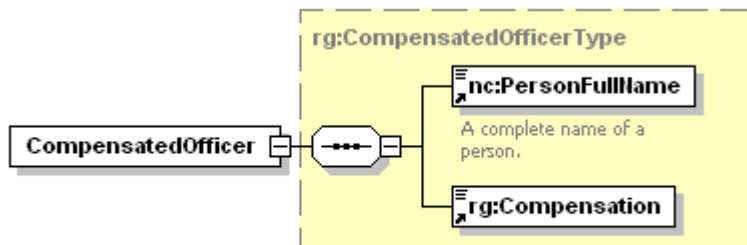

Generated with XMLSpy Schema Editor www.xmlspy.com

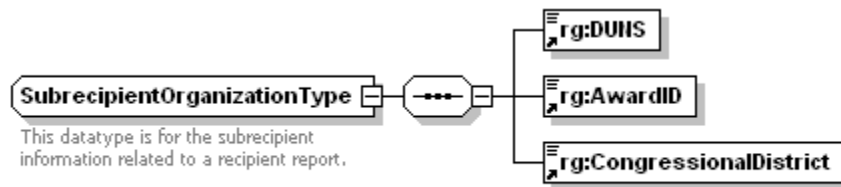

Generated with XMLSpy Schema Editor www.xmlspy.com

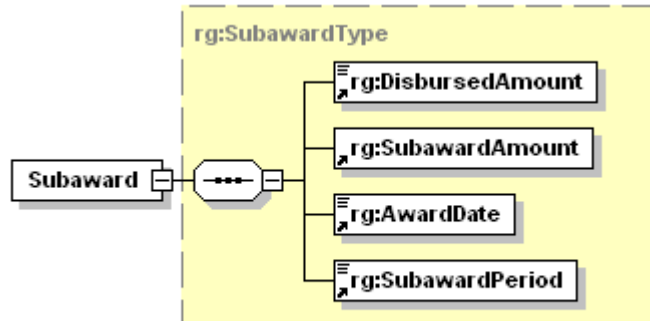

Generated with XMLSpy Schema Editor www.xmlspy.com

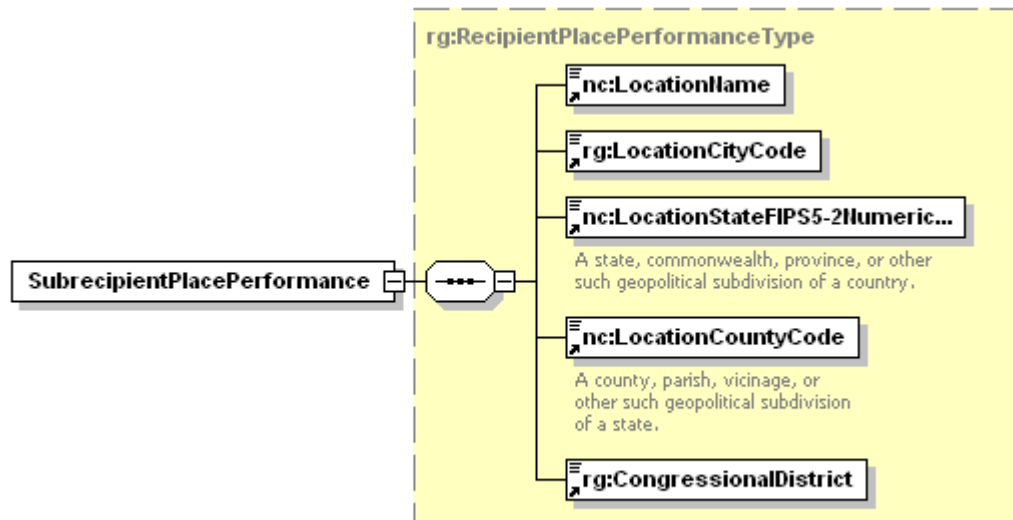

Generated with XMLSpy Schema Editor www.xmlspy.com

A Sample XML Output for Recipient Reporting follows:

```

<?xml version="1.0" encoding="UTF-8"?>
<rg:RecipientReport xsi:schemaLocation="http://niem.gov/niem/recovery-gov/2.0 recovery-gov_NIEM_06152009.xsd"
xmlns:nc="http://niem.gov/niem/niem-core/2.0" xmlns:rg="http://niem.gov/niem/recovery-gov/2.0"
xmlns:xsi="http://www.w3.org/2001/XMLSchema-instance">
  <rg:RecipientBlock>
    <rg:ProjectDetail>
      <rg:Agency>String</rg:Agency>
      <rg:TreasuryAccountSymbol>
        <rg:AgencyCode>aa</rg:AgencyCode>
        <rg:AccountCode>aaaa</rg:AccountCode>
        <rg:BeginningFiscalYear>2001</rg:BeginningFiscalYear>
        <rg:EndingFiscalYear>2001</rg:EndingFiscalYear>
      </rg:TreasuryAccountSymbol>
      <rg:AwardID>String</rg:AwardID>
      <rg:ProgramNumber>aaaaaaa</rg:ProgramNumber>
      <rg:ProjectName>String</rg:ProjectName>
      <rg:ProjectDescription>String</rg:ProjectDescription>
      <rg:NAICSCode>String</rg:NAICSCode>
      <rg:AwardType>Contracts and Orders</rg:AwardType>
      <rg:AwardPeriod>String</rg:AwardPeriod>
      <rg:ReportEndDate>1967-08-13</rg:ReportEndDate>
      <rg:FinalReport>String</rg:FinalReport>
      <rg:ReportFrequency>String</rg:ReportFrequency>
      <rg:AwardDate>1967-08-13</rg:AwardDate>
      <rg:AwardDescription>String</rg:AwardDescription>
      <rg:FedAwardAmount>0.0</rg:FedAwardAmount>
      <rg:FedExpendedAmount>0.0</rg:FedExpendedAmount>
      <rg:InfraExpendedAmount>0.0</rg:InfraExpendedAmount>
      <rg:InfraRationale>String</rg:InfraRationale>
      <rg:FedARRAExpendedAmount>0.0</rg:FedARRAExpendedAmount>
      <rg:FedNonARRAExpendedAmount>0.0</rg:FedNonARRAExpendedAmount>
      <rg:NonFedExpendedAmount>0.0</rg:NonFedExpendedAmount>
      <rg:ProjectStatus>String</rg:ProjectStatus>
      <rg:JobsCreated>0</rg:JobsCreated>
      <rg:JobsRetained>0</rg:JobsRetained>
      <rg:CongressionalDistrict>aa</rg:CongressionalDistrict>
    </rg:ProjectDetail>
    <rg:RecipientOrganization>
      <rg:DUNS>aaaaaaaaaaaa</rg:DUNS>
      <rg:MPIN>String</rg:MPIN>
      <rg:AccountNumber>String</rg:AccountNumber>
    </rg:RecipientOrganization>
    <rg:RecipientPlacePerformance>
      <nc:LocationName>String</nc:LocationName>
      <rg:LocationCityCode>aaaa</rg:LocationCityCode>
      <nc:LocationStateFIPS5-2NumericCode>01</nc:LocationStateFIPS5-2NumericCode>
      <nc:LocationCountyCode>000</nc:LocationCountyCode>
      <rg:CongressionalDistrict>aa</rg:CongressionalDistrict>
    </rg:RecipientPlacePerformance>
    <rg:BenefitArea>State</rg:BenefitArea>
    <rg:TotalNumSubawards>0</rg:TotalNumSubawards>
    <rg:TotalAmountSubawards>0.0</rg:TotalAmountSubawards>
    <rg:CompensatedOfficer>
      <nc:PersonFullName>String</nc:PersonFullName>
      <rg:Compensation>0.0</rg:Compensation>
    </rg:CompensatedOfficer>
  </rg:RecipientBlock>
  <rg:SubrecipientBlock>
    <rg:SubrecipientOrganization>
      <rg:DUNS>aaaaaaaaaaaa</rg:DUNS>
    </rg:SubrecipientOrganization>
  </rg:SubrecipientBlock>
</rg:RecipientReport>

```

```

        <rg:SubContractNumber>String</rg:SubContractNumber>
        <rg:CongressionalDistrict>aa</rg:CongressionalDistrict>
    </rg:SubrecipientOrganization>
    <rg:Subaward>
        <rg:DisbursedAmount>0.0</rg:DisbursedAmount>
        <rg:SubawardAmount>text</rg:SubawardAmount>
        <rg:AwardDate>1967-08-13</rg:AwardDate>
        <rg:SubawardPeriod>String</rg:SubawardPeriod>
    </rg:Subaward>
    <rg:SubrecipientPlacePerformance>
        <nc:LocationName>String</nc:LocationName>
        <rg:LocationCityCode>aaaaa</rg:LocationCityCode>
        <nc:LocationStateFIPS5-2NumericCode>01</nc:LocationStateFIPS5-2NumericCode>
        <nc:LocationCountyCode>000</nc:LocationCountyCode>
        <rg:CongressionalDistrict>aa</rg:CongressionalDistrict>
    </rg:SubrecipientPlacePerformance>
    <rg:BenefitArea>State</rg:BenefitArea>
    <rg:CompensatedOfficer>
        <nc:PersonFullName>String</nc:PersonFullName>
        <rg:Compensation>0.0</rg:Compensation>
    </rg:CompensatedOfficer>
    </rg:SubrecipientBlock>
    <rg:Vendor>
        <rg:AwardID>String</rg:AwardID>
        <rg:SubContractNumber>String</rg:SubContractNumber>
        <rg:DUNS>aaaaaaaaaaaaa</rg:DUNS>
        <rg:VendorName>String</rg:VendorName>
        <nc:LocationStateUSPostalServiceCode>AA</nc:LocationStateUSPostalServiceCode>
        <rg:ProductServiceDescription>String</rg:ProductServiceDescription>
        <rg:PaymentAmount>0.0</rg:PaymentAmount>
    </rg:Vendor>
</rg:RecipientReport>
    
```

Note: The actual XSD that defines all data elements for Recipient Reporting is included in Appendix A.

Appendix A – XML Schema Definition (XSD) – Detail

This XSD defines all data elements for Recovery including Recipient Reporting.

```
<?xml version="1.0" encoding="UTF-8"?>
<!-- edited with XMLSpy v2009 sp1 (http://www.altova.com) by Justin Stekervetz (Department of Homeland Security) -->
<xsd:schema targetNamespace="http://niem.gov/niem/recovery-gov/2.0" xmlns:georss="http://www.georss.org/georss/10"
xmlns:s="http://niem.gov/niem/structures/2.0" xmlns:rg="http://niem.gov/niem/recovery-gov/2.0"
xmlns:nc="http://niem.gov/niem/niem-core/2.0" xmlns:niem-xsd="http://niem.gov/niem/proxy/xsd/2.0"
xmlns:xsd="http://www.w3.org/2001/XMLSchema">
  <xsd:import namespace="http://niem.gov/niem/niem-core/2.0" schemaLocation="niem/niem-core/2.0/niem-core.xsd"/>
  <xsd:import namespace="http://niem.gov/niem/structures/2.0" schemaLocation="niem/structures/2.0/structures.xsd"/>
  <xsd:import namespace="http://www.georss.org/georss/10" schemaLocation="niem\georss\georss11.xsd"/>
  <xsd:import namespace="http://niem.gov/niem/proxy/xsd/2.0" schemaLocation="niem/proxy/xsd/2.0/xsd.xsd"/>
  <xsd:element name="AccountCode" type="rg:AccountCodeType" nillable="true"/>
  <xsd:element name="AccountNumber" type="nc:TextType"/>
  <xsd:element name="Address" type="rg:AddressType" nillable="false"/>
  <xsd:element name="AddressLine" substitutionGroup="nc:AddressDeliveryPoint" nillable="true"/>
  <xsd:element name="Agency" type="nc:TextType" nillable="true"/>
  <xsd:element name="AgencyCode" type="rg:AgencyCodeType" nillable="true"/>
  <xsd:element name="AnnouncementBody" type="rg:AnnouncementBodyType" nillable="true"/>
  <xsd:element name="AnnouncementLink" type="niem-xsd:anyURI" nillable="true"/>
  <xsd:element name="AnnouncementTitle" type="rg:AnnouncementTitleType" nillable="true"/>
  <xsd:element name="AnnouncementTimestamp" type="niem-xsd:dateTime" nillable="true"/>
  <xsd:element name="AnnouncementType" type="rg:AnnouncementTypeType" nillable="true"/>
  <xsd:element name="AwardDate" type="niem-xsd:date" nillable="true"/>
  <xsd:element name="AwardDescription" type="nc:TextType" nillable="true"/>
  <xsd:element name="AwardID" type="nc:TextType" nillable="true"/>
  <xsd:element name="AwardPeriod" type="nc:TextType"/>
  <xsd:element name="AwardTitle" type="nc:TextType" nillable="true"/>
  <xsd:element name="AwardType" type="rg:AwardTypeType" nillable="true"/>
  <xsd:element name="BenefitArea" type="rg:BenefitAreaType"/>
  <xsd:element name="BeginningFiscalYear" type="niem-xsd:gYear"/>
  <xsd:element name="Bureau" type="niem-xsd:string" nillable="true"/>
  <xsd:element name="CitizenTags" type="rg:CitizenTagsType" nillable="true"/>
  <xsd:element name="CompensatedOfficer" type="rg:CompensatedOfficerType"/>
  <xsd:element name="Compensation" type="nc:AmountType"/>
  <xsd:element name="CongressionalDistrict" type="rg:CongressionalDistrictType" nillable="true"/>
  <xsd:element name="DisbursedAmount" type="nc:AmountType"/>
  <xsd:element name="DUNS" type="rg:DUNSType" nillable="true"/>
  <xsd:element name="EIN" type="nc:TextType"/>
  <xsd:element name="EndingFiscalYear" type="niem-xsd:gYear" nillable="true"/>
  <xsd:element name="FedAwardAmount" type="nc:AmountType" substitutionGroup="nc:ObligationTotal" nillable="true"/>
  <xsd:element name="FedARRAExpendedAmount" type="nc:AmountType" substitutionGroup="nc:ObligationTotal"
nillable="true"/>
  <xsd:element name="FederalDomesticAssistanceDetails" type="rg:FederalDomesticAssistanceDetailsType"
nillable="true"/>
  <xsd:element name="FedExpendedAmount" type="nc:AmountType" substitutionGroup="nc:ObligationTotal"
nillable="true"/>
  <xsd:element name="FedNonARRAExpendedAmount" type="nc:AmountType" substitutionGroup="nc:ObligationTotal"
nillable="true"/>
  <xsd:element name="FinalReport" type="nc:TextType"/>
  <xsd:element name="FinancialStatus" type="rg:FinancialStatusType" nillable="false"/>
  <xsd:element name="FinancialActivityReport" type="rg:FinancialActivityReportType" nillable="true"/>
  <xsd:element name="FundingNotification" type="rg:FundingNotificationType" nillable="true"/>
  <xsd:element name="FundingNotifications" type="rg:FundingNotificationsType" nillable="true"/>
  <xsd:element name="FundingNotificationAmount" type="nc:AmountType" nillable="true"/>
  <xsd:element name="FundingNotificationDesc" type="rg:FundingNotificationDescType" nillable="true"/>
  <xsd:element name="FundingNotificationFaceValueAmount" type="nc:AmountType" nillable="true"/>
  <xsd:element name="InfraExpendedAmount" type="nc:AmountType" substitutionGroup="nc:ObligationTotal"
nillable="true"/>
  <xsd:element name="InfraRationale" type="nc:TextType"/>
  <xsd:element name="JobsCreated" type="niem-xsd:integer" nillable="false"/>
  <xsd:element name="JobsRetained" type="niem-xsd:integer" nillable="false"/>
</xsd:schema>
```

```

<xsd:element name="LocationCityCode" type="rg:LocationCityCodeType" nillable="true"/>
<xsd:element name="MajorAgency" type="nc:TextType" nillable="true"/>
<xsd:element name="MajorCommunication" type="rg:MajorCommunicationType" nillable="true"/>
<xsd:element name="MajorCommunications" type="rg:MajorCommunicationsType" nillable="true"/>
<xsd:element name="MajorCompletedActions" type="rg:MajorCompletedActionsType" nillable="true"/>
<xsd:element name="MajorPlannedActions" type="rg:MajorPlannedActionsType" nillable="true"/>
<xsd:element name="MPIN" type="nc:TextType"/>
<xsd:element name="NAICSCode" type="nc:TextType"/>
<xsd:element name="NonFedExpendedAmount" type="nc:AmountType" substitutionGroup="nc:ObligationTotal"
nillable="true"/>
<xsd:element name="ParentDUNS" type="rg:DUNSType"/>
<xsd:element name="PaymentAmount" type="nc:AmountType"/>
<xsd:element name="PlaceofPerformance" type="rg:PlaceofPerformanceType" nillable="true"/>
<xsd:element name="ProductServiceDescription" type="nc:TextType"/>
<xsd:element name="ProgramNumber" type="rg:ProgramNumberType" nillable="true"/>
<xsd:element name="ProgramTitle" type="rg:ProgramTitleType" nillable="true"/>
<xsd:element name="ProjectDescription" type="nc:TextType" nillable="true"/>
<xsd:element name="ProjectDetail" type="rg:ProjectDetailType" nillable="true"/>
<xsd:element name="ProjectName" type="nc:TextType" nillable="false"/>
<xsd:element name="ProjectStatus" type="nc:TextType" nillable="true"/>
<xsd:element name="RecipientBlock" type="rg:RecipientBlockType"/>
<xsd:element name="RecipientOrganization" type="rg:RecipientOrganizationType" nillable="true"/>
<xsd:element name="RecipientPlacePerformance" type="rg:RecipientPlacePerformanceType"/>
<xsd:element name="RecipientReport" type="rg:RecipientReportType" nillable="true"/>
<xsd:element name="ReportEndDate" type="niem-xsd:date"/>
<xsd:element name="ReportFrequency" type="nc:TextType"/>
<xsd:element name="ShortOverview" type="rg:ShortOverviewType" nillable="true"/>
<xsd:element name="SubAccountCode" type="rg:SubAccountCodeType" nillable="true"/>
<xsd:element name="Subaward" type="rg:SubawardType"/>
<xsd:element name="SubawardAmount"/>
<xsd:element name="SubContractNumber" type="nc:TextType"/>
<xsd:element name="SubawardPeriod" type="nc:TextType"/>
<xsd:element name="Submission" type="rg:SubmissionType" nillable="true"/>
<xsd:element name="SubmissionDate" type="niem-xsd:date" nillable="true"/>
<xsd:element name="SubrecipientBlock" type="rg:SubrecipientBlockType"/>
<xsd:element name="SubrecipientOrganization" type="rg:SubrecipientOrganizationType"/>
<xsd:element name="SubrecipientPlacePerformance" type="rg:RecipientPlacePerformanceType"/>
<xsd:element name="TotalAmountSubawards" type="nc:AmountType"/>
<xsd:element name="TotalGrossOutlaysAmount" type="nc:AmountType" nillable="true"/>
<xsd:element name="TotalNumSubawards" type="niem-xsd:integer"/>
<xsd:element name="TransactionNumber" type="rg:TransactionNumberType"/>
<xsd:element name="TreasuryAccountSymbol" type="rg:TreasuryAccountSymbolType" nillable="true"/>
<xsd:element name="USorTerritory" type="rg:USorTerritoryType"/>
<xsd:element name="VendorName" type="nc:TextType"/>
<xsd:element name="WeekEndDate" type="niem-xsd:date" nillable="true"/>
<xsd:element name="Vendor" type="rg:VendorType"/>
<xsd:simpleType name="AccountCodeSimpleType">
  <xsd:annotation>
    <xsd:documentation>This element type is for an agency Treasury main account code restricted by the length of
the string.</xsd:documentation>
  </xsd:annotation>
  <xsd:restriction base="xsd:string">
    <xsd:length value="4"/>
  </xsd:restriction>
</xsd:simpleType>
<xsd:complexType name="AccountCodeType">
  <xsd:annotation>
    <xsd:documentation>This element type is for an agency Treasury main account code restricted by the length of
the string.</xsd:documentation>
  </xsd:annotation>
  <xsd:simpleContent>
    <xsd:extension base="rg:AccountCodeSimpleType">
      <xsd:attributeGroup ref="s:SimpleObjectAttributeGroup"/>
    </xsd:extension>
  </xsd:simpleContent>
</xsd:complexType>

```



```

        </xsd:simpleContent>
    </xsd:complexType>
    <xsd:complexType name="AddressType">
        <xsd:annotation>
            <xsd:documentation>This element type represents a generic address.</xsd:documentation>
        </xsd:annotation>
        <xsd:complexContent>
            <xsd:extension base="s:ComplexObjectType">
                <xsd:sequence>
                    <xsd:element ref="nc:AddressRecipientName"/>
                    <xsd:element ref="rg:AddressLine" maxOccurs="3"/>
                    <xsd:element ref="nc:LocationCityName"/>
                    <xsd:element ref="nc:LocationStateName"/>
                    <xsd:element ref="nc:LocationStateUSPostalServiceCode"/>
                </xsd:sequence>
            </xsd:extension>
        </xsd:complexContent>
    </xsd:complexType>
    <xsd:simpleType name="AgencyCodeSimpleType">
        <xsd:annotation>
            <xsd:documentation>This element type is for the agency's code that makes up the Treasury Account
            Symbol.</xsd:documentation>
        </xsd:annotation>
        <xsd:restriction base="xsd:string">
            <xsd:length value="2"/>
        </xsd:restriction>
    </xsd:simpleType>
    <xsd:complexType name="AgencyCodeType">
        <xsd:annotation>
            <xsd:documentation>This element type is for the agency's code that makes up the Treasury Account
            Symbol.</xsd:documentation>
        </xsd:annotation>
        <xsd:simpleContent>
            <xsd:extension base="rg:AgencyCodeSimpleType">
                <xsd:attributeGroup ref="s:SimpleObjectAttributeGroup"/>
            </xsd:extension>
        </xsd:simpleContent>
    </xsd:complexType>
    <xsd:simpleType name="AnnouncementBodySimpleType">
        <xsd:annotation>
            <xsd:documentation>This datatype is for the body of a major communication report.</xsd:documentation>
        </xsd:annotation>
        <xsd:restriction base="xsd:string">
            <xsd:maxLength value="65535"/>
        </xsd:restriction>
    </xsd:simpleType>
    <xsd:complexType name="AnnouncementBodyType">
        <xsd:annotation>
            <xsd:documentation>This datatype is for the body of a major communication report.</xsd:documentation>
        </xsd:annotation>
        <xsd:simpleContent>
            <xsd:extension base="rg:AnnouncementBodySimpleType">
                <xsd:attributeGroup ref="s:SimpleObjectAttributeGroup"/>
            </xsd:extension>
        </xsd:simpleContent>
    </xsd:complexType>
    <xsd:simpleType name="AnnouncementTitleSimpleType">
        <xsd:annotation>
            <xsd:documentation>This datatype is for the title of a major communication report.</xsd:documentation>
        </xsd:annotation>
        <xsd:restriction base="xsd:string">
            <xsd:maxLength value="45"/>
        </xsd:restriction>
    </xsd:simpleType>
    
```

```

<xsd:complexType name="AnnouncementTitleType">
  <xsd:annotation>
    <xsd:documentation>This datatype is for the title of a major communication report.</xsd:documentation>
  </xsd:annotation>
  <xsd:simpleContent>
    <xsd:extension base="rg:AnnouncementTitleSimpleType">
      <xsd:attributeGroup ref="s:SimpleObjectAttributeGroup"/>
    </xsd:extension>
  </xsd:simpleContent>
</xsd:complexType>
<xsd:simpleType name="AnnouncementTypeSimpleType">
  <xsd:annotation>
    <xsd:documentation>This datatype is for the type of major communication.</xsd:documentation>
  </xsd:annotation>
  <xsd:restriction base="xsd:string">
    <xsd:enumeration value="Press Event"/>
    <xsd:enumeration value="Press Release"/>
    <xsd:enumeration value="Video"/>
    <xsd:enumeration value="Other"/>
  </xsd:restriction>
</xsd:simpleType>
<xsd:complexType name="AnnouncementTypeType">
  <xsd:annotation>
    <xsd:documentation>This datatype is for the type of major communication.</xsd:documentation>
  </xsd:annotation>
  <xsd:simpleContent>
    <xsd:extension base="rg:AnnouncementTypeSimpleType">
      <xsd:attributeGroup ref="s:SimpleObjectAttributeGroup"/>
    </xsd:extension>
  </xsd:simpleContent>
</xsd:complexType>
<xsd:simpleType name="AwardTypeSimpleType">
  <xsd:annotation>
    <xsd:documentation>This datatype is for the type of award.</xsd:documentation>
  </xsd:annotation>
  <xsd:restriction base="xsd:string">
    <xsd:enumeration value="Contracts and Orders"/>
    <xsd:enumeration value="Cooperative Agreement"/>
    <xsd:enumeration value="Discretionary Grant"/>
    <xsd:enumeration value="Direct Loan"/>
    <xsd:enumeration value="Entitlements"/>
    <xsd:enumeration value="Formula and Block Grant"/>
    <xsd:enumeration value="Guaranteed Loan"/>
    <xsd:enumeration value="Other"/>
  </xsd:restriction>
</xsd:simpleType>
<xsd:complexType name="AwardTypeType">
  <xsd:annotation>
    <xsd:documentation>This datatype is for the type of award.</xsd:documentation>
  </xsd:annotation>
  <xsd:simpleContent>
    <xsd:extension base="rg:AwardTypeSimpleType">
      <xsd:attributeGroup ref="s:SimpleObjectAttributeGroup"/>
    </xsd:extension>
  </xsd:simpleContent>
</xsd:complexType>
<xsd:simpleType name="BenefitAreaSimpleType">
  <xsd:annotation>
    <xsd:documentation>This datatype is for the area of benefit for a recipient award. Valid values include State,
    County, City, or School District.</xsd:documentation>
  </xsd:annotation>
  <xsd:restriction base="xsd:string">
    <xsd:enumeration value="State"/>
    <xsd:enumeration value="County"/>
  </xsd:restriction>

```

```

        <xsd:enumeration value="City"/>
        <xsd:enumeration value="School District"/>
    </xsd:restriction>
</xsd:simpleType>
<xsd:complexType name="BenefitAreaType">
    <xsd:annotation>
        <xsd:documentation>This datatype is for the area of benefit for a recipient award. Valid values include State,
County, City, and School District.</xsd:documentation>
    </xsd:annotation>
    <xsd:simpleContent>
        <xsd:extension base="rg:BenefitAreaSimpleType">
            <xsd:attributeGroup ref="s:SimpleObjectAttributeGroup"/>
        </xsd:extension>
    </xsd:simpleContent>
</xsd:complexType>
<xsd:simpleType name="CitizenTagsSimpleType">
    <xsd:annotation>
        <xsd:documentation>This datatype is for citizen tags for the major communication.</xsd:documentation>
    </xsd:annotation>
    <xsd:restriction base="xsd:string">
        <xsd:maxLength value="45"/>
    </xsd:restriction>
</xsd:simpleType>
<xsd:complexType name="CitizenTagsType">
    <xsd:annotation>
        <xsd:documentation>This datatype is for citizen tags for the major communication.</xsd:documentation>
    </xsd:annotation>
    <xsd:simpleContent>
        <xsd:extension base="rg:CitizenTagsSimpleType">
            <xsd:attributeGroup ref="s:SimpleObjectAttributeGroup"/>
        </xsd:extension>
    </xsd:simpleContent>
</xsd:complexType>
<xsd:complexType name="CompensatedOfficerType">
    <xsd:annotation>
        <xsd:documentation>This datatype is for the highly compensated officers in the recipient
report.</xsd:documentation>
    </xsd:annotation>
    <xsd:complexContent>
        <xsd:extension base="s:ComplexObjectType">
            <xsd:sequence>
                <xsd:element ref="nc:PersonFullName"/>
                <xsd:element ref="rg:Compensation"/>
            </xsd:sequence>
        </xsd:extension>
    </xsd:complexContent>
</xsd:complexType>
<xsd:simpleType name="CongressionalDistrictSimpleType">
    <xsd:annotation>
        <xsd:documentation>This element type contains the Congressional District of the
recipient.</xsd:documentation>
    </xsd:annotation>
    <xsd:restriction base="xsd:string">
        <xsd:length value="2"/>
    </xsd:restriction>
</xsd:simpleType>
<xsd:complexType name="CongressionalDistrictType">
    <xsd:annotation>
        <xsd:documentation>This element type contains the Congressional District of the
recipient.</xsd:documentation>
    </xsd:annotation>
    <xsd:simpleContent>
        <xsd:extension base="rg:CongressionalDistrictSimpleType">
            <xsd:attributeGroup ref="s:SimpleObjectAttributeGroup"/>
        </xsd:extension>
    </xsd:simpleContent>

```

```

        </xsd:extension>
    </xsd:simpleContent>
</xsd:complexType>
<xsd:simpleType name="DUNSSimpleType">
    <xsd:annotation>
        <xsd:documentation>This element type contains the Receipt DUNS number.</xsd:documentation>
    </xsd:annotation>
    <xsd:restriction base="xsd:string">
        <xsd:maxLength value="13"/>
    </xsd:restriction>
</xsd:simpleType>
<xsd:complexType name="DUNSType">
    <xsd:annotation>
        <xsd:documentation>This element type contains the Receipt DUNS number.</xsd:documentation>
    </xsd:annotation>
    <xsd:simpleContent>
        <xsd:extension base="rg:DUNSSimpleType">
            <xsd:attributeGroup ref="s:SimpleObjectAttributeGroup"/>
        </xsd:extension>
    </xsd:simpleContent>
</xsd:complexType>
<xsd:complexType name="FederalDomesticAssistanceDetailsType">
    <xsd:annotation>
        <xsd:documentation>This element type is for the CFDA elements belonging to the grant which is an element
        restricted by the length of the string.</xsd:documentation>
    </xsd:annotation>
    <xsd:complexContent>
        <xsd:extension base="s:ComplexObjectType">
            <xsd:sequence>
                <xsd:element ref="rg:ProgramNumber" minOccurs="0"/>
                <xsd:element ref="rg:ProgramTitle" minOccurs="0"/>
            </xsd:sequence>
        </xsd:extension>
    </xsd:complexContent>
</xsd:complexType>
<xsd:complexType name="FinancialStatusType">
    <xsd:annotation>
        <xsd:documentation>This datatype creates contains elements related to the financial status (budget account
        information) for the Financial Activity Report being produced.</xsd:documentation>
    </xsd:annotation>
    <xsd:complexContent>
        <xsd:extension base="s:ComplexObjectType">
            <xsd:sequence>
                <xsd:element ref="rg:Bureau"/>
                <xsd:element ref="rg:TreasuryAccountSymbol"/>
                <xsd:element ref="rg:SubAccountCode" minOccurs="0"/>
                <xsd:element ref="rg:AwardType"/>
                <xsd:element ref="rg:PlaceofPerformance"/>
                <xsd:element ref="nc:ObligationTotalAmount"/>
                <xsd:element ref="rg:TotalGrossOutlaysAmount" minOccurs="0"/>
                <xsd:element ref="georss:point" minOccurs="0"/>
            </xsd:sequence>
        </xsd:extension>
    </xsd:complexContent>
</xsd:complexType>
<xsd:complexType name="FinancialActivityReportType">
    <xsd:annotation>
        <xsd:documentation>This datatype creates the Financial and Activity Report structure.</xsd:documentation>
    </xsd:annotation>
    <xsd:complexContent>
        <xsd:extension base="s:ComplexObjectType">
            <xsd:sequence>
                <xsd:element ref="rg:Agency"/>
                <xsd:element ref="rg:WeekEndDate"/>
            </xsd:sequence>
        </xsd:extension>
    </xsd:complexContent>
</xsd:complexType>

```

```

        <xsd:element ref="rg:FinancialStatus" maxOccurs="unbounded"/>
        <xsd:element ref="rg:MajorCompletedActions" maxOccurs="unbounded"/>
        <xsd:element ref="rg:MajorPlannedActions" maxOccurs="unbounded"/>
    </xsd:sequence>
</xsd:extension>
</xsd:complexContent>
</xsd:complexType>
<xsd:complexType name="FundingNotificationType">
    <xsd:annotation>
        <xsd:documentation>This datatype is for the definition of the Funding Notifications Report.</xsd:documentation>
    </xsd:annotation>
    <xsd:complexContent>
        <xsd:extension base="s:ComplexObjectType">
            <xsd:sequence>
                <xsd:element ref="rg:AwardID"/>
                <xsd:element ref="rg:AwardTitle"/>
                <xsd:element ref="rg:AwardType"/>
                <xsd:element ref="rg:AwardDate"/>
                <xsd:element ref="rg:FundingNotificationAmount"/>
                <xsd:element ref="rg:FundingNotificationFaceValueAmount" minOccurs="0"/>
                <xsd:element ref="rg:FederalDomesticAssistanceDetails" minOccurs="0"/>
                <xsd:element ref="rg:FundingNotificationDesc" minOccurs="0"/>
                <xsd:element ref="rg:PlaceofPerformance" minOccurs="0"/>
                <xsd:element ref="nc:ObligationTotalAmount" minOccurs="0"/>
                <xsd:element ref="rg:TreasuryAccountSymbol"/>
                <xsd:element ref="rg:SubAccountCode" minOccurs="0"/>
                <xsd:element ref="georss:point" minOccurs="0"/>
            </xsd:sequence>
        </xsd:extension>
    </xsd:complexContent>
</xsd:complexType>
<xsd:complexType name="FundingNotificationsType">
    <xsd:annotation>
        <xsd:documentation>This datatype is for the definition of the Funding Notifications Report.</xsd:documentation>
    </xsd:annotation>
    <xsd:complexContent>
        <xsd:extension base="s:ComplexObjectType">
            <xsd:sequence>
                <xsd:element ref="rg:Submission"/>
                <xsd:element ref="rg:FundingNotification" maxOccurs="unbounded"/>
            </xsd:sequence>
        </xsd:extension>
    </xsd:complexContent>
</xsd:complexType>
<xsd:simpleType name="FundingNotificationDescSimpleType">
    <xsd:annotation>
        <xsd:documentation>This datatype is for the description of the funding notification.</xsd:documentation>
    </xsd:annotation>
    <xsd:restriction base="xsd:string">
        <xsd:maxLength value="800"/>
    </xsd:restriction>
</xsd:simpleType>
<xsd:complexType name="FundingNotificationDescType">
    <xsd:annotation>
        <xsd:documentation>This datatype is for the type of major communication.</xsd:documentation>
    </xsd:annotation>
    <xsd:simpleContent>
        <xsd:extension base="rg:FundingNotificationDescSimpleType">
            <xsd:attributeGroup ref="s:SimpleObjectAttributeGroup"/>
        </xsd:extension>
    </xsd:simpleContent>
</xsd:complexType>
<xsd:complexType name="HighlyCompensatedOfficersType">
    <xsd:annotation>

```

```

        ion>This datatype is for the highly compensated officers in the recipient
report.</xsd:documentation>
</xsd:annotation>
<xsd:complexContent>
  <xsd:extension base="s:ComplexObjectType">
    <xsd:sequence>
      <xsd:element ref="rg:CompensatedOfficer" minOccurs="5" maxOccurs="5"/>
    </xsd:sequence>
  </xsd:extension>
</xsd:complexContent>
</xsd:complexType>
<xsd:simpleType name="LocationCityCodeSimpleType">
  <xsd:annotation>
    <xsd:documentation>5 digit FIPs number representing the city code.</xsd:documentation>
  </xsd:annotation>
  <xsd:restriction base="xsd:string">
    <xsd:length value="5"/>
  </xsd:restriction>
</xsd:simpleType>
<xsd:complexType name="LocationCityCodeType">
  <xsd:annotation>
    <xsd:documentation>5 digit FIPS number representing the city code.</xsd:documentation>
  </xsd:annotation>
  <xsd:simpleContent>
    <xsd:extension base="rg:LocationCityCodeSimpleType">
      <xsd:attributeGroup ref="s:SimpleObjectAttributeGroup"/>
    </xsd:extension>
  </xsd:simpleContent>
</xsd:complexType>
<xsd:complexType name="MajorCommunicationType">
  <xsd:annotation>
    <xsd:documentation>This datatype is for the submission of a major communication report derived from the
SubmissionType complexType.</xsd:documentation>
  </xsd:annotation>
  <xsd:complexContent>
    <xsd:extension base="s:ComplexObjectType">
      <xsd:sequence>
        <xsd:element ref="rg:AnnouncementTitle"/>
        <xsd:element ref="rg:AnnouncementLink"/>
        <xsd:element ref="rg:AnnouncementType"/>
        <xsd:element ref="rg:ShortOverview"/>
        <xsd:element ref="rg:AnnoucementBody"/>
        <xsd:element ref="rg:AnnouncementTimestamp"/>
        <xsd:element ref="rg:CitizenTags"/>
        <xsd:element ref="georss:featureName" minOccurs="0"/>
        <xsd:element ref="georss:point" minOccurs="0"/>
      </xsd:sequence>
    </xsd:extension>
  </xsd:complexContent>
</xsd:complexType>
<xsd:complexType name="MajorCommunicationsType">
  <xsd:annotation>
    <xsd:documentation>This datatype is for the submission of a major communication report derived from the
SubmissionType complexType.</xsd:documentation>
  </xsd:annotation>
  <xsd:complexContent>
    <xsd:extension base="s:ComplexObjectType">
      <xsd:sequence>
        <xsd:element ref="rg:Submission"/>
        <xsd:element ref="rg:MajorCommunication" maxOccurs="unbounded"/>
      </xsd:sequence>
    </xsd:extension>
  </xsd:complexContent>
</xsd:complexType>

```

```

<xsd:simpleType name="MajorCompletedActionsSimpleType">
  <xsd:annotation>
    <xsd:documentation>This element type is for a major completed actions element restricted by the length of the
string.</xsd:documentation>
  </xsd:annotation>
  <xsd:restriction base="xsd:string">
    <xsd:maxLength value="65535"/>
  </xsd:restriction>
</xsd:simpleType>
<xsd:complexType name="MajorCompletedActionsType">
  <xsd:annotation>
    <xsd:documentation>This element type is for a major completed actions element restricted by the length of the
string.</xsd:documentation>
  </xsd:annotation>
  <xsd:simpleContent>
    <xsd:extension base="rg:MajorCompletedActionsSimpleType">
      <xsd:attributeGroup ref="s:SimpleObjectAttributeGroup"/>
    </xsd:extension>
  </xsd:simpleContent>
</xsd:complexType>
<xsd:simpleType name="MajorPlannedActionsSimpleType">
  <xsd:annotation>
    <xsd:documentation>This element type is for a major planned actions element restricted by the length of the
string.</xsd:documentation>
  </xsd:annotation>
  <xsd:restriction base="xsd:string">
    <xsd:maxLength value="65535"/>
  </xsd:restriction>
</xsd:simpleType>
<xsd:complexType name="MajorPlannedActionsType">
  <xsd:annotation>
    <xsd:documentation>This element type is for a major planned actions element restricted by the length of the
string.</xsd:documentation>
  </xsd:annotation>
  <xsd:simpleContent>
    <xsd:extension base="rg:MajorPlannedActionsSimpleType">
      <xsd:attributeGroup ref="s:SimpleObjectAttributeGroup"/>
    </xsd:extension>
  </xsd:simpleContent>
</xsd:complexType>
<xsd:complexType name="PlaceofPerformanceType">
  <xsd:annotation>
    <xsd:documentation>This element type is contains the Recipient Address belonging to the
grant.</xsd:documentation>
  </xsd:annotation>
  <xsd:complexContent>
    <xsd:extension base="s:ComplexObjectType">
      <xsd:sequence>
        <xsd:element ref="rg:USorTerritory"/>
        <xsd:element ref="nc:LocationCountyCode" minOccurs="0"/>
        <xsd:element ref="nc:LocationCountyName" minOccurs="0"/>
        <xsd:element ref="nc:LocationStateFIPS5-2NumericCode"/>
        <xsd:element ref="nc:LocationStateName"/>
        <xsd:element ref="nc:LocationStateUSPostalServiceCode" minOccurs="0"/>
        <xsd:element ref="rg:CongressionalDistrict" minOccurs="0"/>
      </xsd:sequence>
    </xsd:extension>
  </xsd:complexContent>
</xsd:complexType>
<xsd:simpleType name="ProgramNumberSimpleType">
  <xsd:annotation>
    <xsd:documentation>This element type is for the CFDA program number belonging to the grant which is an
element restricted by the length of the string.</xsd:documentation>
  </xsd:annotation>

```

```

        <xsd:restriction base="xsd:string">
            <xsd:maxLength value="7"/>
        </xsd:restriction>
    </xsd:simpleType>
    <xsd:complexType name="ProgramNumberType">
        <xsd:annotation>
            <xsd:documentation>This element type is for the CFDA program number belonging to the grant which is an
            element restricted by the length of the string.</xsd:documentation>
        </xsd:annotation>
        <xsd:simpleContent>
            <xsd:extension base="rg:ProgramNumberSimpleType">
                <xsd:attributeGroup ref="s:SimpleObjectAttributeGroup"/>
            </xsd:extension>
        </xsd:simpleContent>
    </xsd:complexType>
    <xsd:simpleType name="ProgramTitleSimpleType">
        <xsd:annotation>
            <xsd:documentation>This element type is for the CFDA program number belonging to the grant which is an
            element restricted by the length of the string.</xsd:documentation>
        </xsd:annotation>
        <xsd:restriction base="xsd:string">
            <xsd:maxLength value="74"/>
        </xsd:restriction>
    </xsd:simpleType>
    <xsd:complexType name="ProgramTitleType">
        <xsd:annotation>
            <xsd:documentation>This element type is for the CFDA program number belonging to the grant which is an
            element restricted by the length of the string.</xsd:documentation>
        </xsd:annotation>
        <xsd:simpleContent>
            <xsd:extension base="rg:ProgramTitleSimpleType">
                <xsd:attributeGroup ref="s:SimpleObjectAttributeGroup"/>
            </xsd:extension>
        </xsd:simpleContent>
    </xsd:complexType>
    <xsd:complexType name="ProjectDetailType">
        <xsd:annotation>
            <xsd:documentation>This element type is for the project detail contained in the recipient
            report.</xsd:documentation>
        </xsd:annotation>
        <xsd:complexContent>
            <xsd:extension base="s:ComplexObjectType">
                <xsd:sequence>
                    <xsd:element ref="rg:Agency"/>
                    <xsd:element ref="rg:TreasuryAccountSymbol"/>
                    <xsd:element ref="rg:AwardID"/>
                    <xsd:element ref="rg:ProgramNumber"/>
                    <xsd:element ref="rg:ProjectName"/>
                    <xsd:element ref="rg:ProjectDescription"/>
                    <xsd:element ref="rg:NAICSCCode"/>
                    <xsd:element ref="rg:AwardType"/>
                    <xsd:element ref="rg:AwardPeriod"/>
                    <xsd:element ref="rg:ReportEndDate"/>
                    <xsd:element ref="rg:FinalReport"/>
                    <xsd:element ref="rg:ReportFrequency"/>
                    <xsd:element ref="rg:AwardDate"/>
                    <xsd:element ref="rg:AwardDescription"/>
                    <xsd:element ref="rg:FedAwardAmount"/>
                    <xsd:element ref="rg:FedExpendedAmount"/>
                    <xsd:element ref="rg:InfraExpendedAmount"/>
                    <xsd:element ref="rg:InfraRationale"/>
                    <xsd:element ref="rg:FedARRAExpendedAmount"/>
                    <xsd:element ref="rg:FedNonARRAExpendedAmount"/>
                    <xsd:element ref="rg:NonFedExpendedAmount"/>
                </xsd:sequence>
            </xsd:extension>
        </xsd:complexContent>
    </xsd:complexType>
    
```



```

        <xsd:element ref="rg:ProjectStatus"/>
        <xsd:element ref="rg:JobsCreated"/>
        <xsd:element ref="rg:JobsRetained"/>
        <xsd:element ref="rg:CongressionalDistrict"/>
    </xsd:sequence>
</xsd:extension>
</xsd:complexContent>
</xsd:complexType>
<xsd:complexType name="RecipientBlockType">
    <xsd:annotation>
        <xsd:documentation>This element is for the elements that make up the recipient block of the recipient
report.</xsd:documentation>
    </xsd:annotation>
    <xsd:complexContent>
        <xsd:extension base="s:ComplexObjectType">
            <xsd:sequence>
                <xsd:element ref="rg:ProjectDetail"/>
                <xsd:element ref="rg:RecipientOrganization"/>
                <xsd:element ref="rg:RecipientPlacePerformance"/>
                <xsd:element ref="rg:BenefitArea"/>
                <xsd:element ref="rg:TotalNumSubawards"/>
                <xsd:element ref="rg:TotalAmountSubawards"/>
                <xsd:element ref="rg:CompensatedOfficer" maxOccurs="5"/>
            </xsd:sequence>
        </xsd:extension>
    </xsd:complexContent>
</xsd:complexType>
<xsd:complexType name="RecipientOrganizationType">
    <xsd:annotation>
        <xsd:documentation>This element type is for a recipient organization represented in a recipient
report.</xsd:documentation>
    </xsd:annotation>
    <xsd:complexContent>
        <xsd:extension base="s:ComplexObjectType">
            <xsd:sequence>
                <xsd:element ref="rg:DUNS"/>
                <xsd:element ref="rg:MPIN"/>
                <xsd:element ref="rg:AccountNumber"/>
            </xsd:sequence>
        </xsd:extension>
    </xsd:complexContent>
</xsd:complexType>
<xsd:complexType name="RecipientPlacePerformanceType">
    <xsd:annotation>
        <xsd:documentation>This element type contains the recipient's primary place of performance for the recipient
report.</xsd:documentation>
    </xsd:annotation>
    <xsd:complexContent>
        <xsd:extension base="s:ComplexObjectType">
            <xsd:sequence>
                <xsd:element ref="nc:LocationName"/>
                <xsd:element ref="rg:LocationCityCode"/>
                <xsd:element ref="nc:LocationStateFIPS5-2NumericCode"/>
                <xsd:element ref="nc:LocationCountyCode"/>
                <xsd:element ref="rg:CongressionalDistrict"/>
            </xsd:sequence>
        </xsd:extension>
    </xsd:complexContent>
</xsd:complexType>
<xsd:complexType name="RecipientReportType">
    <xsd:annotation>
        <xsd:documentation>This element type is for a recipient report.</xsd:documentation>
    </xsd:annotation>
    <xsd:complexContent>

```

```

        <xsd:extension base="s:ComplexObjectType">
            <xsd:sequence>
                <xsd:element ref="rg:RecipientBlock"/>
                <xsd:element ref="rg:SubrecipientBlock" maxOccurs="unbounded"/>
                <xsd:element ref="rg:Vendor" maxOccurs="unbounded"/>
            </xsd:sequence>
        </xsd:extension>
    </xsd:complexContent>
</xsd:complexType>
<xsd:simpleType name="ShortOverviewSimpleType">
    <xsd:annotation>
        <xsd:documentation>This datatype is for a short overview description of the major
communication.</xsd:documentation>
    </xsd:annotation>
    <xsd:restriction base="xsd:string">
        <xsd:maxLength value="65535"/>
    </xsd:restriction>
</xsd:simpleType>
<xsd:complexType name="ShortOverviewType">
    <xsd:annotation>
        <xsd:documentation>This datatype is for a short overview description of the major
communication.</xsd:documentation>
    </xsd:annotation>
    <xsd:simpleContent>
        <xsd:extension base="rg:ShortOverviewSimpleType">
            <xsd:attributeGroup ref="s:SimpleObjectAttributeGroup"/>
        </xsd:extension>
    </xsd:simpleContent>
</xsd:complexType>
<xsd:simpleType name="SubAccountCodeSimpleType">
    <xsd:annotation>
        <xsd:documentation>This element type is for an agency subaccount code restricted by the length of the
string.</xsd:documentation>
    </xsd:annotation>
    <xsd:restriction base="xsd:string">
        <xsd:length value="3"/>
    </xsd:restriction>
</xsd:simpleType>
<xsd:complexType name="SubAccountCodeType">
    <xsd:annotation>
        <xsd:documentation>This element type is for an agency subaccount code restricted by the length of the
string.</xsd:documentation>
    </xsd:annotation>
    <xsd:simpleContent>
        <xsd:extension base="rg:SubAccountCodeSimpleType">
            <xsd:attributeGroup ref="s:SimpleObjectAttributeGroup"/>
        </xsd:extension>
    </xsd:simpleContent>
</xsd:complexType>
<xsd:complexType name="SubmissionType">
    <xsd:annotation>
        <xsd:documentation>This datatype is for the submission of reports from an external
source.</xsd:documentation>
    </xsd:annotation>
    <xsd:complexContent>
        <xsd:extension base="s:ComplexObjectType">
            <xsd:sequence>
                <xsd:element ref="rg:Agency"/>
                <xsd:element ref="nc:PersonFullName"/>
                <xsd:element ref="nc:EmailSenderAddressID" minOccurs="0"/>
                <xsd:element ref="nc:FullTelephoneNumber" minOccurs="0"/>
                <xsd:element ref="rg:SubmissionDate"/>
            </xsd:sequence>
        </xsd:extension>
    </xsd:complexContent>

```

```

        </xsd:complexContent>
    </xsd:complexType>
    <xsd:complexType name="SubrecipientBlockType">
        <xsd:annotation>
            <xsd:documentation>This datatype is the overall container for subrecipient, subaward, place of performance,
            and highly compensated individuals.</xsd:documentation>
        </xsd:annotation>
        <xsd:complexContent>
            <xsd:extension base="s:ComplexObjectType">
                <xsd:sequence>
                    <xsd:element ref="rg:SubrecipientOrganization"/>
                    <xsd:element ref="rg:Subaward"/>
                    <xsd:element ref="rg:SubrecipientPlacePerformance"/>
                    <xsd:element ref="rg:BenefitArea"/>
                    <xsd:element ref="rg:CompensatedOfficer" maxOccurs="5"/>
                </xsd:sequence>
            </xsd:extension>
        </xsd:complexContent>
    </xsd:complexType>
    <xsd:complexType name="SubrecipientOrganizationType">
        <xsd:annotation>
            <xsd:documentation>This datatype is for the subrecipient information related to a recipient
            report.</xsd:documentation>
        </xsd:annotation>
        <xsd:complexContent>
            <xsd:extension base="s:ComplexObjectType">
                <xsd:sequence>
                    <xsd:element ref="rg:DUNS"/>
                    <xsd:element ref="rg:SubContractNumber"/>
                    <xsd:element ref="rg:CongressionalDistrict"/>
                </xsd:sequence>
            </xsd:extension>
        </xsd:complexContent>
    </xsd:complexType>
    <xsd:complexType name="SubawardType">
        <xsd:annotation>
            <xsd:documentation>This element type contains the subaward detail related to a subrecipient in the recipient
            report.</xsd:documentation>
        </xsd:annotation>
        <xsd:complexContent>
            <xsd:extension base="s:ComplexObjectType">
                <xsd:sequence>
                    <xsd:element ref="rg:DisbursedAmount"/>
                    <xsd:element ref="rg:SubawardAmount"/>
                    <xsd:element ref="rg:AwardDate"/>
                    <xsd:element ref="rg:SubawardPeriod"/>
                </xsd:sequence>
            </xsd:extension>
        </xsd:complexContent>
    </xsd:complexType>
    <xsd:simpleType name="TransactionNumberSimpleType">
        <xsd:annotation>
            <xsd:documentation>This element type is for a component of the award id element and is restricted by
            length.</xsd:documentation>
        </xsd:annotation>
        <xsd:restriction base="xsd:int">
            <xsd:totalDigits value="6"/>
        </xsd:restriction>
    </xsd:simpleType>
    <xsd:complexType name="TransactionNumberType">
        <xsd:annotation>
            <xsd:documentation>This element type is for a component of the award id element and is restricted by
            length.</xsd:documentation>
        </xsd:annotation>
    
```

```

        <xsd:simpleContent>
            <xsd:extension base="rg:TransactionNumberSimpleType">
                <xsd:attributeGroup ref="s:SimpleObjectAttributeGroup"/>
            </xsd:extension>
        </xsd:simpleContent>
    </xsd:complexType>
    <xsd:complexType name="TreasuryAccountSymbolType">
        <xsd:annotation>
            <xsd:documentation>This datatype is for the definition of a Treasury Account Symbol and all data contained
within.</xsd:documentation>
        </xsd:annotation>
        <xsd:complexContent>
            <xsd:extension base="s:ComplexObjectType">
                <xsd:sequence>
                    <xsd:element ref="rg:AgencyCode"/>
                    <xsd:element ref="rg:AccountCode"/>
                    <xsd:element ref="rg:BeginningFiscalYear"/>
                    <xsd:element ref="rg:EndingFiscalYear"/>
                </xsd:sequence>
            </xsd:extension>
        </xsd:complexContent>
    </xsd:complexType>
    <xsd:simpleType name="USorTerritorySimpleType">
        <xsd:annotation>
            <xsd:documentation>This datatype is for the definition of an enumeration for whether the Funding Notification
place of performance is within a territory or within the United States.</xsd:documentation>
        </xsd:annotation>
        <xsd:restriction base="xsd:string">
            <xsd:enumeration value="Territory"/>
            <xsd:enumeration value="United States"/>
        </xsd:restriction>
    </xsd:simpleType>
    <xsd:complexType name="USorTerritoryType">
        <xsd:annotation>
            <xsd:documentation>This datatype is for the definition of an enumeration for whether the Funding Notification
place of performance is within a territory or within the United States.</xsd:documentation>
        </xsd:annotation>
        <xsd:simpleContent>
            <xsd:extension base="rg:USorTerritorySimpleType">
                <xsd:attributeGroup ref="s:SimpleObjectAttributeGroup"/>
            </xsd:extension>
        </xsd:simpleContent>
    </xsd:complexType>
    <xsd:complexType name="VendorType">
        <xsd:annotation>
            <xsd:documentation>This datatype is for the definition of vendor data elements. </xsd:documentation>
        </xsd:annotation>
        <xsd:complexContent>
            <xsd:extension base="s:ComplexObjectType">
                <xsd:sequence>
                    <xsd:element ref="rg:AwardID"/>
                    <xsd:element ref="rg:SubContractNumber"/>
                    <xsd:element ref="rg:DUNS"/>
                    <xsd:element ref="rg:VendorName"/>
                    <xsd:element ref="nc:LocationStateUSPostalServiceCode"/>
                    <xsd:element ref="rg:ProductServiceDescription"/>
                    <xsd:element ref="rg:PaymentAmount"/>
                </xsd:sequence>
            </xsd:extension>
        </xsd:complexContent>
    </xsd:complexType>
</xsd:schema>
    
```