

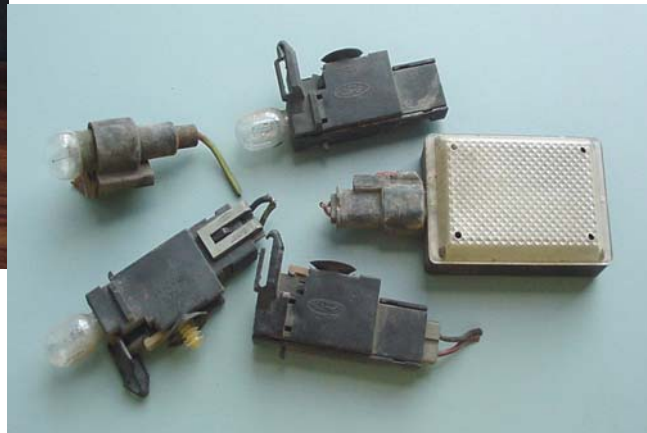

# Recycling Mercury Vehicle Switches In Illinois

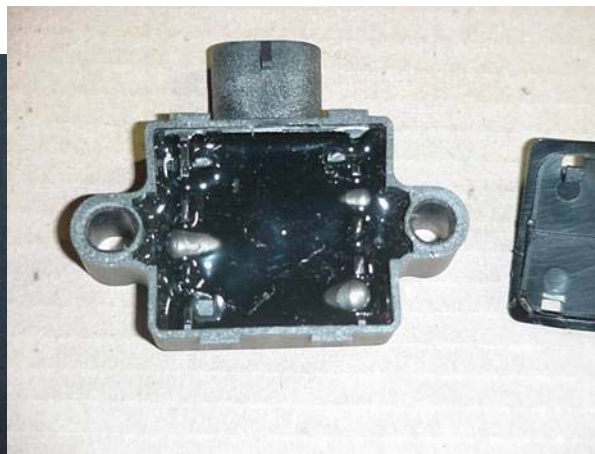

---

## Why is mercury a concern?

---

Mercury poses a health risk to everybody, but especially to children and fetuses because they are still developing. The National Academy of Sciences says that over 60,000 children born each year may suffer learning disabilities and other problems because of their mothers' exposure to small amounts of mercury. Exposure to mercury continues throughout one's life. Prolonged, low level exposure may cause learning disabilities by hurting the ability of children to think and learn. Adults who have been exposed to high levels of mercury may experience trembling hands and numbness or tingling in their lips, tongues, fingers and toes. Mercury can harm wildlife that eats contaminated fish, particularly bald eagles, loons and other fish-eating birds and mammals.

State public health officials have issued a statewide fish consumption advisory due to the concentration of mercury found in predator fish caught in Illinois waterways. The advisory cautions pregnant women, women of childbearing age and young children to eat no more than one meal a week of predator fish. This includes all species of black bass (largemouth, smallmouth and spotted), striped bass, white bass, hybrid striped bass, walleye, sauger, saugeye, flathead catfish, muskellunge and northern pike. In addition, there are more restrictive advisories for fish caught from several water bodies within the state. For more information, visit Illinois Department of Public Health Website at <http://www.idph.state.il.us/envhealth/fishadv/specialmercury.htm>.

Mercury emissions from human activity contribute to the problem. Sources include commonly used products that contain mercury. For example, fluorescent lamps sold in the U.S. in 2001 are reported to contain over 9 tons of mercury. Mercury is released when the lamps break, as inevitably happens when they are put in the trash. That is why it is important to recycle fluorescent lamps.

In the case of motor vehicles, mercury is released when scrapped vehicles are shredded and smelted to make recycled steel. The Illinois EPA estimates that motor vehicles in Illinois currently contain about 5,200 pounds of mercury in convenience light and anti-lock braking g-force sensor (ABS) switches. Most of this mercury eventually will be released to the air unless these switches are removed before the vehicles are crushed or flattened.

This is why the Illinois Legislature created a program to facilitate the removal of these switches before vehicles are flattened for recycling. Under the program, auto dismantlers and automakers share responsibility. Your role as a dismantler or salvage yard operator is to remove the switches and store them for recycling. Automakers will recycle the switches and pay you \$2 per switch to help offset your removal costs.

# Table of Contents

Switch Removal Requirements in Illinois.....	Page 1
Vehicles with Mercury Light Switches.....	Page 2
Removing Light Switches.....	Page 5
Important Note about Audi and Volvo Switches.....	Page 7
Anti-lock Braking Systems.....	Page 7
Finding ABS g-force Sensors.....	Page 9
Removing ABS g-force Sensors.....	Page 10
Recycling Switches after Removal.....	Page 14
Cleaning Up Broken Switches or other Mercury Spills.....	Page 15
Table 1 Vehicles Containing Mercury Convenience Light Switches.....	Page 3
Table 2 Vehicles Containing Mercury Anti-lock Brake g-forces Sensors.....	Page 8
Appendix A - Switch Removal Log	
Appendix B - Mercury Recycling and Disposal Facilities	
Appendix C: Contacts for Illinois Mercury Switch Removal Program	

The content in this guidance document was taken directly from materials created by the Maine Department of Environmental Protection and the Vermont Department of Environmental Conservation.

---

## Switch Removal Requirements in Illinois

---

Beginning September 1, 2008, Illinois law requires that mercury switches be removed and collected for recycling before a motor vehicle is flattened, crushed, shredded or otherwise processed. Vehicle recyclers are required to remove them from a scrap vehicle before they send the vehicle to a scrap metal recycler or vehicle crusher. If for some reason mercury switches are not removed from an unflattened or uncrushed vehicle that they receive for processing, vehicle crushers and scrap metal processors are required to remove the switches.

For purposes of this law:

- “mercury switch” means a mercury-containing convenience light switch and mercury-containing anti-lock brake g-force sensor;
- “scrap metal processor” means a person who engages in the business of shredding or otherwise processing end-of-life vehicles or other scrap metal into prepared grades and whose principal product is scrap iron, scrap steel, or nonferrous metallic scrap for sale for remelting purposes;
- “vehicle crusher” means a person, other than a vehicle recycler or a scrap metal recycler, who engages in the business of flattening, crushing, or otherwise processing end-of-life vehicles for recycling. Vehicle crushers include, but are not limited to, persons who use fixed or mobile equipment to flatten or crush end-of-life vehicles for a vehicle recycler or a scrap recycler; and
- “vehicle recycler” means a person who engages in the business of acquiring, dismantling, removing parts from, or destroying 6 or more end-of-life vehicles in a calendar year for the primary purpose of reselling the vehicle parts.

The automakers formed a corporation for recycling mercury switches known as End of Life Vehicle Solutions (ELVS), mercury switches from vehicles must be recycled through ELVS. **Illinois scrap metal recyclers, vehicle crushers, and vehicle recyclers will be reimbursed \$2 for every mercury switch they collect and return to ELVS.** Recyclers and crushers must enroll in the ELVS program to be reimbursed. To enroll contact ELVS at (877) 225-3587 or go to <http://www.elvsolutions.org/contact.html>.

After enrolling in the ELVS program, you will be sent a bucket in which to collect mercury switches, information on makes and models which contain switches, switch locations and how to remove the switches. This information is also available at <http://www.elvsolutions.org/>. Participants are required to submit documentation listing the make, model and year of each vehicle from which switches were removed. This form is provided in the buckets sent by ELVS.

You are also required, by law, to keep records of the number of mercury switches removed by make, model and year of vehicle, the number of vehicles received that contained mercury switches and the number of vehicles flattened, crushed, shredded or otherwise processed. These records must be maintained on site for at least three years. You must file an annual report on your switch removal activities with Illinois EPA by August 15 of each year. The annual report form is available online at <http://www.epa.state.il.us/mercury/auto-switch-annual-report.pdf>. You will also send you a copy by mail in July of each year.

For more information about the mercury switch removal program please contact Becky Jayne at [Becky.Jayne@illinois.gov](mailto:Becky.Jayne@illinois.gov) or (217) 524-9642.

---

## Vehicles with Mercury Light Switches

---

Passenger cars and pickups - Mercury light switches are common in U.S. made passenger cars and pickups manufactured prior to 2003. The switches were used for convenience lights on hoods, trunks, and vanity mirrors on visors. **Mercury switch information for specific brands and model years are listed in Table 1 on pages 3 and 4. Page 6 contains a photo showing common light switches.**

As a general rule, you should assume there is a mercury switch in hood or trunk convenience lights on:

- Model year 2002 or older for GM vehicles;
- Model year 2001 or older for Ford vehicles;
- Model year 1998 or older for Chrysler vehicles; and
- Model year 1999 or older Audi, Mazda, Porsche, and Volvo.

Some Volvo models may contain mercury light switches in the vanity mirror visor units (see Table 1 for models).

The use of mercury switches in convenience lights ended for all makes beginning with model year 2003.

**NOTE.** Automakers may have used a non-mercury, ball bearing switch in some vehicle light assemblies in the late 1990s. The only way to tell them apart is to shake them; the ball bearing type rattles.

**YOU ARE NOT REQUIRED TO COLLECT BALL-BEARING SWITCHES,** nor are automakers under any obligation to reimburse you for them.

**Table 1 Vehicles Containing Mercury Convenience Lighting Switches**

MAKE / MODEL	MODEL YEAR	SWITCH LOCATION
<b>AUDI</b>		
Audi 100	1977-1988	Trunk
Audi 200	1980-1988	Trunk
<b>CHRYSLER GROUP</b>		
All	Dodge, Chrysler, Jeep, Plymouth, Eagle	
	1998 and prior	Hood ✓ Trunk
<b>FORD</b>		
	Ford, Lincoln, Mercury, Mazda, Merkur, Volvo	
Ford Mustang	2000 and prior	Hood ✓ Trunk
Ford Crown Victoria	2000 and prior	Hood ✓ Trunk
Mercury Grand Marquis	2000 and prior	Hood ✓ Trunk
Lincoln Town Car	2000 and prior	Hood ✓ Trunk
Ford, Lincoln, Mercury, and Merkur Cars	1996 and prior	Hood ✓ Trunk
Ford, Lincoln, and Mercury Trucks, SUV's, and Vans	2001 and prior	Hood ✓ Trunk
* Excludes: 1999 and newer model year Ford Econoline, Ford Windstar, Ford Ranger, and Mercury Villager		
* Ranger/B-Series phased out of mercury switches with 1999 model year.		
Volvo (hood & trunk switches)	1991 and prior	Hood ✓ Trunk
Volvo (vanity mirror switch) -- Excludes Volvo 240	1986 -1991	Hood ✓ Trunk
* Volvo convenience switches may contain glass mercury capsules. Use care when removing convenience switches from these vehicles.		
<b>GENERAL MOTORS</b>		
	Chevrolet, GMC, Cadillac, Buick, Oldsmobile, Pontiac, Saturn, Saab	
All Vehicles	1999 and prior	Hood ✓ Trunk
* Excludes: 1999 model year Chevrolet Astro, Chevrolet Silverado, GMC Safari, GMC Sierra		
Cadillac Escalade	2000	Hood ✓ Trunk
Chevrolet Blazer	2000, 2001, 2002	Hood ✓ Trunk
Chevrolet Cavalier	2000, 2001	Hood ✓ Trunk
Chevrolet Corvette	2000	Hood ✓ Trunk
Chevrolet Express	2000, 2001, 2002	Hood ✓ Trunk
Chevrolet S-10 Crew cab	2002	Hood ✓ Trunk
GMC Denali	2000	Hood ✓ Trunk
GMC Envoy	2000, 2001	Hood ✓ Trunk
GMC Jimmy	2000, 2001	Hood ✓ Trunk
GMC Savana	2000, 2001, 2002	Hood ✓ Trunk
GMC Sonoma Crew cab	2002	Hood ✓ Trunk
Luxury G-Van	2001, 2002	Hood ✓ Trunk
Oldsmobile Bravada	2000, 2001, 2002	Hood ✓ Trunk
Pontiac Sunfire	2000, 2001	Hood ✓ Trunk

**Table 1 Vehicles Containing Mercury Convenience Lighting Switches continued**

MAKE / MODEL	MODEL YEAR	SWITCH LOCATION			
<b>MAZDA</b>					
Mazda Navajo	1993 -1997	✓	Hood	Trunk	Vanity Mirror
Mazda B-Series Pick-Up	1995 -1999	✓	Hood	Trunk	Vanity Mirror
<b>PORSCHE</b>					
924	1976 - 1985	✓	Hood	Trunk	Vanity Mirror
924 S	1986 - 1988	✓	Hood	Trunk	Vanity Mirror
944	1982 - 1988	✓	Hood	Trunk	Vanity Mirror
944 S	1987 - 1988	✓	Hood	Trunk	Vanity Mirror
944 S2	1989 - 1991	✓	Hood	Trunk	Vanity Mirror
944 Turbo	1986 - 1991	✓	Hood	Trunk	Vanity Mirror
928	1978 - 1983	✓	Hood	Trunk	Vanity Mirror
928 S	1980 - 1983	✓	Hood	Trunk	Vanity Mirror
928 S / S4	1984 - 1990	✓	Hood	Trunk	Vanity Mirror
<ul style="list-style-type: none"> <li>● BMW, MITSUBISHI, NISSAN, SUBARU, VOLKSWAGEN, and TOYOTA vehicles <u>DO NOT</u> contain mercury convenience switches.</li> <li>● Vehicles manufactured 2003 Model Year and beyond <u>DO NOT</u> contain mercury convenience switches.</li> <li>● Vehicles without trunks including SUVs, station wagons, and hatchbacks <u>DO NOT</u> contain a mercury convenience switch in the "Trunk" or rear of the vehicle.</li> </ul>					



---

## Removing Light Switches

---

Removal is quick and easy. It usually takes one to two minutes (including documenting the removal) per switch if done at the same time you remove fluids, batteries and other wastes that require special handling.

### Step 1: Remove the convenience light assembly from vehicle hood or trunk

- (a) Locate the small lighting fixture on the underside of the vehicle hood or trunk. The mercury switch itself may be in the base of the fixture or along the wiring harness leading to the fixture.
- (b) Disconnect and properly dispose of the battery.
- (c) Cut the power supply wire at the base of the fixture.
- (d) Remove any fasteners in order to separate the entire fixture from the vehicle.

### Step 2: Place the light assembly in the bucket and securely close the lid.

### Step 3: Complete the Mercury Switch Log.

Use the log sheet in Appendix A to keep track of the number of switches in the storage bucket. You must record the make, model and year of each vehicle from which you remove mercury switches in order to receive the \$2/switch reimbursement from automakers (see page 14).

### PHOTOS OF TYPICAL LIGHT ASSEMBLIES CONTAINING MERCURY SWITCHES

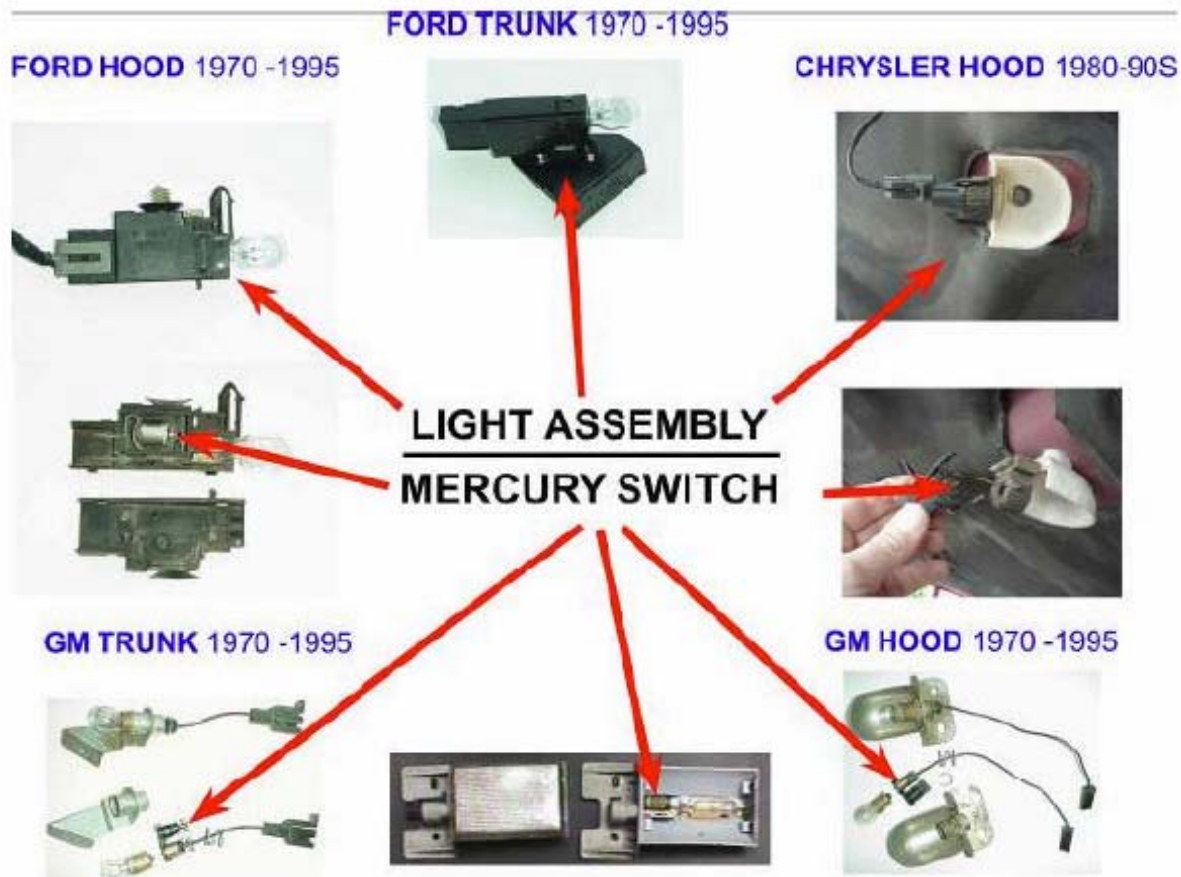



---

## Removing Light Switches continued

---

### Removing Vanity Mirror Sun Visor Switches from Volvos

**Step 1: Check 1986 - 1991 MY Volvos (except the 240) for a sun visor switch.**

**Step 2: Remove the switch**

- (a) If present disconnect the battery.
- (b) Find the light assembly in the sun visor.
- (c) Remove the light assembly and cut the power supply.

**Step 3: Place the light assembly in the bucket.**

**Step 4: Complete the Mercury Switch Removal log.**

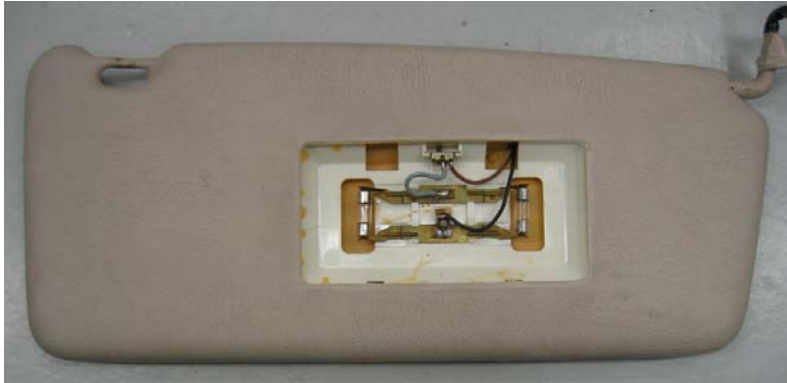

---

## Important note about Volvo and Audi mercury switches!

---

The mercury switches in Volvo and Audi convenience lights are unique in that the mercury can be encased in glass rather than metal. Special care should be taken when removing these switches to avoid breaking the glass and spilling the mercury. **DO NOT MIX GLASS SWITCHES IN THE COLLECTION BUCKET WITH THE METAL-ENCASED MERCURY SWITCHES FROM OTHER VEHICLES.** If you do and the glass breaks, the entire bucket of switches will be contaminated and must then be handled as hazardous waste.

To avoid this costly result, manage glass switches as follows:

- DO NOT REMOVE THE GLASS SWITCH FROM THE SWITCH ASSEMBLY.
- Put the switch assembly in a plastic bag.
- Put the bag and switch assembly in a rigid plastic container that can be sealed such as a plastic peanut butter jar. A recycled food storage container with a screw top or snap-on lid will do.
- Other glass-encased switch assemblies can be stored in the same container. Use sawdust, cat litter or other packing material to minimize the risk of breakage.
- Store the container in the screw-top bucket provided by ELVS (see page 14).

Volvo stopped using mercury convenience light switches after model year 1991. Prior to that, the switches were used in Volvo hood and trunk lights at least as far back as model year 1975. You also may find mercury switches in vanity mirror lights on 1986 through 1991 Volvos (except Volvo 240). Audi reportedly used the glass mercury switches in engine compartment lights on its 1988 and earlier vehicles.

---

## Anti-lock Braking Systems

---

Not all vehicles with anti-lock braking systems (ABS) have g-force sensors contain mercury switches. BMW, General Motors, Toyota and Volkswagen did not use mercury switches in the ABS G-Force sensors.

Several other automakers, including Mitsubishi and Subaru, phased out the use of mercury switches in ABS in the mid-90s.

**USE OF MERCURY SWITCHES WAS PHASED OUT IN ALL VEHICLES AS OF MODEL YEAR 2003.**

Table 2 lists the make, model and model year of vehicles reported to have mercury-containing g-force sensors. The sensors contain two or three mercury switches.

**Table 2 Vehicles Containing Mercury Anti-lock Brake G-Force Sensors**

<b>VEHICLES THAT CONTAIN MERCURY ABS G-FORCE SENSORS</b>					
<b>MAKE / MODEL</b>	<b>MODEL YEAR</b>			<b>SWITCH LOCATION</b>	
<b>AUDI</b>					
Audi 80 / 90	1987 - 1993	✓	Rear Seat		
Audi 100 / Avant	1987 - 1993	✓	Rear Seat		
Audi V8	1989 - 1995	✓	Rear Seat		
Audi 200	1987 - 1991	✓	Rear Seat		
Audi Coupe quattro	1987 - 1992	✓	Rear Seat		
<b>CHRYSLER LLC</b>					
4WD Dodge Stealth	1992 - 1996			✓	Rear Center
Jeep Cherokee	1992 - 2001	✓	Rear Seat		
Jeep Grand Cherokee	1993 - 2001	✓	Rear Seat		
Jeep Wrangler	1992 - 2003				✓ Driver Seat
<b>FORD MOTOR COMPANY</b>					
Ford Bronco	1993 - 1997				✓ Driver Seat
Ford Explorer	1993 - 2002				✓ Driver Seat
4x4 Ford Ranger	1995 - 2001				✓ Driver Seat
AWD Mercury Mountaineer	1997 - 2002				✓ Driver Seat
<b>MAZDA</b>					
Mazda Navajo	1993 - 2002				✓ Driver Seat
Mazda B-Series Pick-up	1995 - 2001				✓ Driver Seat
<b>MITSUBISHI</b>					
3000 GT 4WD	1991 - 1994			✓	Rear Center
Galant 4WD	1990 - 1992			✓	Rear Center
Expo 4WD	1991 - 1993			✓	Rear Center
Expo LVR 4WD	1991 - 1993			✓	Rear Center
Eclipse 4WD	1991 - 1993			✓	Rear Center
<b>NISSAN</b>					
Pathfinder 4x4	1996			✓	Rear Center
<b>SUBARU</b>					
Subaru Legacy w/ 5MT AWD	1990 - 1995				✓ Right Front
Subaru Impreza w/ 5MT AWD	1993 - 1996				✓ Right Front

---

## Finding ABS g-force Sensors

---

### What they look like

ABS g-force sensors consist of two or three mercury switches embedded in plastic. The sensors are about 2 to 3 inches long by about 1½ to 2 inches wide. The entire component with mounting bolts weighs about 3 to 4 ounces. Important Note: ABS wheel speed sensors located in wheel units do not contain mercury and should not be removed. Only the ABS control modules should be removed. ABS control modules are normally housed in other areas of the vehicle. Please see removal instructions for specific vehicle types.

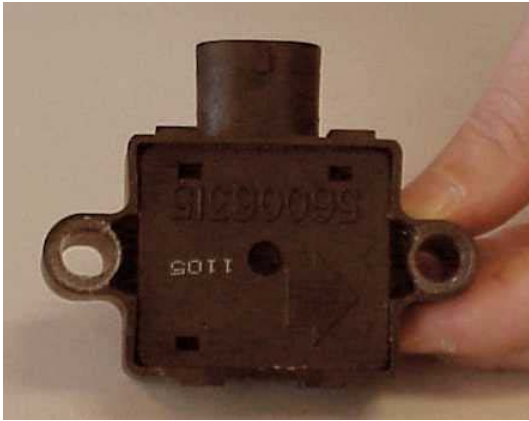

**ABS g-force sensor—Jeep**



**ABS g-force sensor—Ford**

### Where they are located

The diagram below shows the three locations where the ABS g-force sensor commonly is found: the drive tunnel; below the rear seat on the floor pan; and on the left frame rail, directly below the driver.

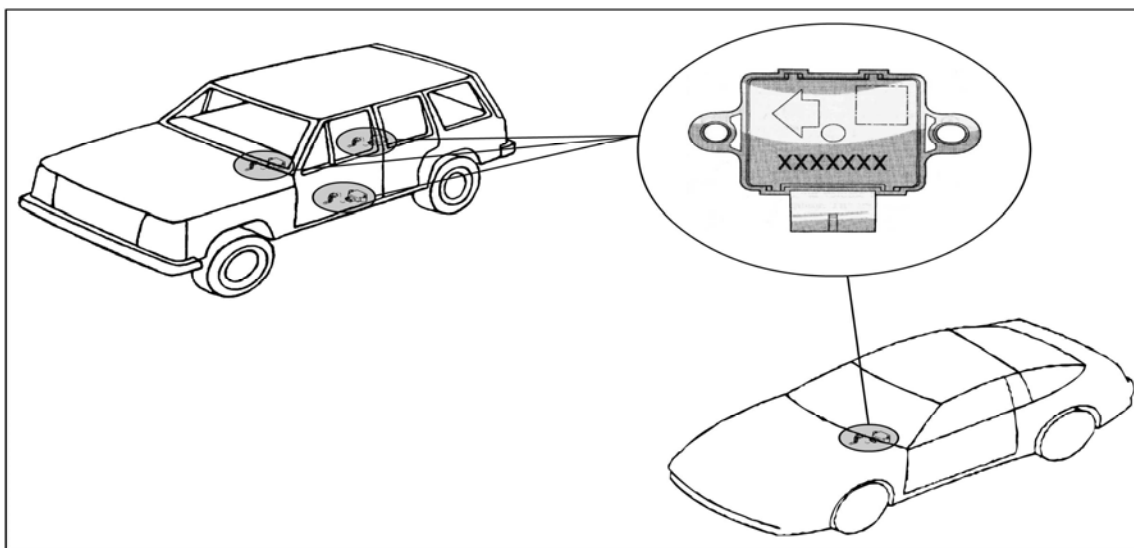

---

## Removing ABS g-Force Sensors

---

The removal procedure varies as described below depending on the vehicle model. Estimated average removal time is 5-7 minutes if done in conjunction with fluid removal; 15 minutes if the vehicle is not already on a lift.

### General Procedure for removing ABS G-Force Sensor

1. Confirm vehicle is equipped with ABS.
2. Disconnect the battery.
3. Locate the ABS G-Force sensor on the vehicle (varies on different vehicles).
4. Remove the sensor.
5. Collect and recycle the sensor with care.

Note: Please do not attempt to remove the switches from the sensor.

### Vehicle Specific procedures for removing ABS G-Force Sensors

#### Audi:

**1987–1993 Audi 80/90**  
**1987–1993 Audi 100/Avant**  
**1987–1991 Audi 200;**  
**1989–1995 Audi V8**  
**1987–1992 Audi Coupe Quattro**

1. Remove rear seat bottom and locate ABS Sensor mounted in the middle under seat on seat support.
2. Disconnect the harness connector from switch mounting hardware.
3. Remove the securing nuts to release the sensor.

#### Chrysler:

**1992–1996 Dodge Stealth 4WD**

1. Locate the ABS G-Force Sensor under the center floor console.
2. Remove center floor console.
3. Disconnect the harness connector.
4. Remove the two bolts to release the sensor.

**1992–2001 Jeep Cherokee**

1. Fold the rear seat assembly forward for access to the sensor.
2. Locate the ABS G-Force Sensor.
3. Disconnect the harness connector.
4. Remove the two bolts to release the sensor.

---

## Removing ABS g-Force Sensors continued

---

### Chrysler:

#### **1993-2001 Jeep Grand Cherokee**

1. Fold rear seat assembly forward and roll back the carpeting to gain access to the sensor.
2. Locate the ABS G-Force Sensor.
3. Disconnect the harness connector.
4. Remove the two bolts to release the sensor.

#### **1992-2003 Jeep Wrangler**

1. From the driver's side, lift carpet back in front of console/shifter.
2. Locate the ABS G-Force Sensor in front of the console/shifter mounted to a bracket on the floor pan.
3. Disconnect the harness connector.
4. Remove the two bolts to release the sensor.

### Ford/ Mercury:

#### **1993-1997 Ford Bronco**

#### **1993-2002 Ford Explorer**

#### **1995-2001 4x4 Ford Ranger**

#### **1997-2002 AWD Mercury Mountaineer**

1. Raise and support the vehicle.
2. Locate the ABS G-Force Sensor on the left frame rail, directly below the driver.
3. Remove the two nuts.
4. Unclip the fuel filter from the vehicle frame (on some models).
5. Disconnect the harness connector.
6. Remove ABS G-Force Sensor.

### Mazda:

#### **1993-2002 Mazda Navajo**

#### **1995-2001 Mazda B-Series Pickup**

1. Raise and support the vehicle.
2. Locate the ABS G-Force Sensor on the left frame rail, directly below the driver.
3. Remove the two nuts.
4. Unclip the fuel filter from the vehicle frame (on some models).
5. Disconnect the harness connector.
6. Remove ABS G-Force Sensor.

---

## Removing ABS g-Force Sensors continued

---

### Mitsubishi:

**1991 -1994 3000 GT 4WD**

**1991 - 1993 Eclipse 4WD**

**1991 - 1993 Expo 4WD / Expo LVR 4WD**

**1990 - 1992 Galant 4WD**

1. Locate the ABS G-Force Sensor under the center floor console.
2. Remove the center floor console.
3. Disconnect the harness connector.
4. Remove the two bolts to release the ABS G-Force sensor.

### Nissan:

**4x4 Pathfinder**

1. Locate the ABS G-Force Sensor under the center floor console.
2. Remove the center floor console.
3. Disconnect the harness connector.
4. Remove the two bolts to release the ABS G-Force sensor.

### Subaru:

**1990-1995 Subaru Legacy with 5MT AWD**

**1993-1996 Subaru Impreza with 5MT AWD**

1. Locate the ABS G-Force Sensor on the right front wheel apron.
2. Disconnect the harness connector from the switch and mounting hardware (two screws).

See illustration for ABS G-Force Sensor removal on Subaru models on the next page.



## Removing ABS g-Force Sensors continued

### Subaru G-Force Sensor Location

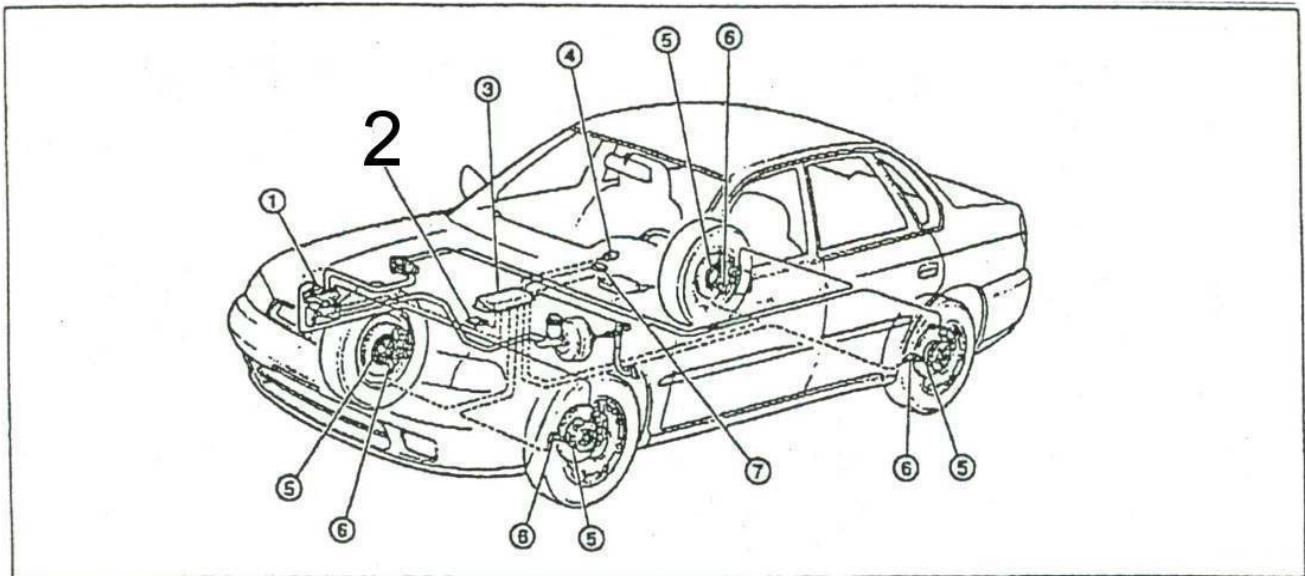

- |                              |                        |
|------------------------------|------------------------|
| 1. Hydraulic control unit    | 5. Tone wheel          |
| → 2. G-sensor (AWD MT model) | 6. A.B.S. sensor       |
| 3. A.B.S. control module     | 7. Diagnosis connector |
| 4. Warning light             |                        |

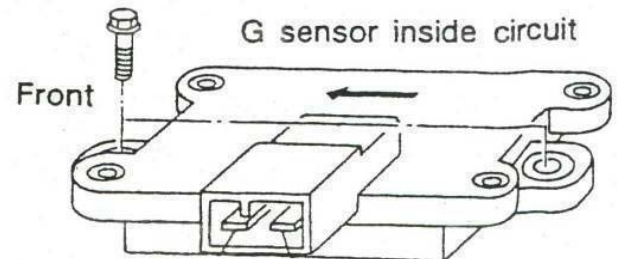
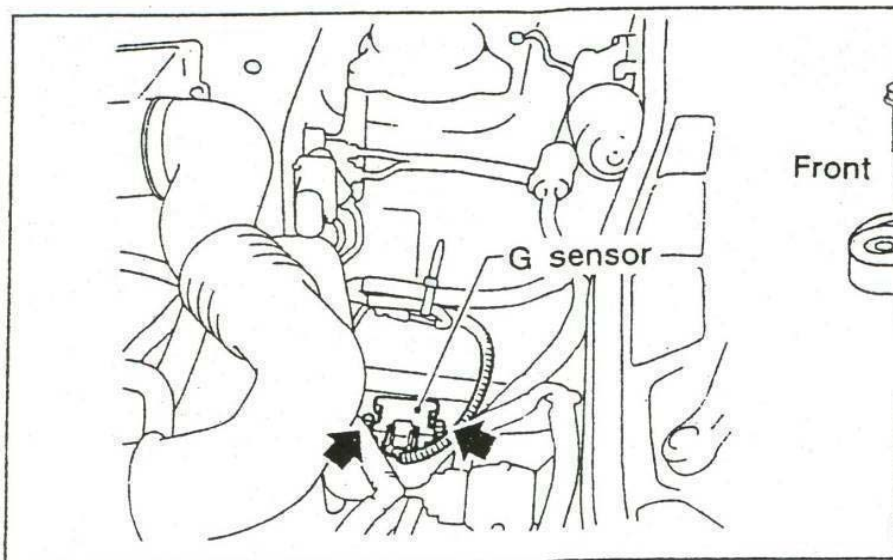

Hg-7B

### What do after removing the ABS g-force sensor

- Put the sensor in the same bucket provided by ELVS for storing the mercury bullets from light switches. Store the bucket as described on page 17 until you are ready to transport the switches for recycling.
- Using the Mercury Switch Log sheet from Appendix B, record the make, model and year of the vehicle from which the sensor was removed and note it is an ABS g-sensor in the column.

---

## Recycling Switches After Removal

---

- **Storage** - Place the switches in the screw top plastic bucket provided by ELVS. You will be provided with a “Universal Waste” sticker to place on the outside of the bucket. On the sticker under “Accumulation Start Date,” mark the month, day and year you first put switches in the bucket. Keep the bucket in a lockable storage area out of the weather and keep the container closed.
- **Log** - Use the Mercury Switch Log in Appendix B to keep track of how many switches are in the bucket. Record the make, model and year of the vehicles from which you remove switches. We recommend the log be kept on a clipboard in the switch storage area.
- **Shipping for recycling** - ELVS provides a shipping label with every bucket they send. Call the shipper listed on the shipping label to arrange for them to pickup the bucket.

**Buckets must be sent for recycling within 1 year from when the first switch was placed in the bucket, even if there is only one switch in the bucket.**

You can turn a partially-filled bucket in at any time to receive your bounty payment.

ELVS has contracted the Environmental Quality Company (EQ) to administer the recycling portion of the program. On the day you ship the bucket to EQ:

1. Mark the date (the “Accumulation End Date”) on the Universal Waste sticker;
  2. Enter your business information in the shipper portion of the Universal Waste sticker;
  3. Complete the top of the Mercury Switch Removal Log sheets; and
  4. Sign the certification statement on the log sheet and place one copy of the log sheet in the bucket. Keep a copy for your records. You are required to retain the records for at least 3 years from the date the bucket is shipped.
- **Reimbursement for removing switches** - Provided you supply the make, model and year of every vehicle from which switches were removed on the Mercury Switch Removal Log, automakers will compensate you as follows:
    - \$2 for each mercury light switch; and
    - \$6 for each mercury ABS sensor .

You can expect payment 60 days after shipping the switches.

- **Replacement storage container** - If you are not sent a new storage bucket after shipping a bucket to EQ or you need a replacement bucket for another reason, call (734) 547-2511.

---

## Cleaning up broken switches or other mercury spills

---

Spills and releases of mercury can be hazardous to your health. If you do not feel confident with your expertise or ability to safely clean up a mercury spill, we recommend you hire a professional environmental contractor to do the cleanup. They have the specialized equipment needed to test the spill area for residual contamination and make sure it is safe.

### Spill reporting

All mercury spills from switches must be reported immediately by calling the Illinois Emergency Management Agency at **1-800-782-7860**.

### Spill cleanup

Follow the guidelines below to clean up a mercury spill.

*Note: Mercury clean up kits are available on the market and are recommended. The following guidelines presume that you have not purchased a spill kit.*

#### All spills

- Block off the immediate area to prevent any accidental tracking of the mercury. Lower the heat and increase cooling and ventilation in the spill area.
- Avoid skin contact with mercury or surfaces that have been contaminated with mercury. Always wear safety glasses and disposable rubber gloves.
- Thoroughly wash your hands and face after cleanup is complete.

#### Leaking or broken switches

The risk of a mercury spill from automotive switches is small. The mercury is encased in a durable metal capsule. In the unlikely event you rupture the capsule, we recommend the following clean-up steps:

- Place the broken switch in a sealable hard plastic or metal container.
- Using cardboard, scoop up as much of the mercury as possible and place it in the container.
- Go over the area with masking tape or duct tape to pick up small particles of mercury.
- Wipe the spill area thoroughly with a wet sponge.
- Put the sponge, tape, cardboard and any other material used to clean up the spill in the container.
- Seal the container and arrange for disposal. The container must be handled as hazardous waste, which means that it must be given to a licensed hazardous waste transporter. Some of the businesses listed in Appendix C may be able to provide this service.

### Special precautions for cleaning up mercury spills

- **Never use a broom or vacuum to clean up the spill.** Use disposable items (e.g., rags, cardboard, duct tape, sponges) for cleanup.
- Sweeping will spread the mercury, making it harder to collect, and will contaminate the broom.
- Vacuuming a mercury spill will cause the mercury to be dispersed into the air where it can be inhaled. The mercury also sticks to the metal parts of the vacuum and will be discharged every time the vacuum is used. This poses a serious health risk and should be avoided. Once a vacuum has been contaminated with mercury, the only sure way to avoid spreading the contamination is to discard the vacuum.

# **Appendix A**

## **Switch Removal Log**



**Illinois Automotive Mercury Switch Removal Log For  
Scrap Metal Processors, Shredders, Vehicle Crushers, and Vehicle Recyclers**

Date Put 1<sup>st</sup> switch in bucket: \_\_\_\_\_ Date Bucket Shipped to ELVS: \_\_\_\_\_

Business Name		
Site Address		
Mailing Address		
E-Mail		Phone:

I certify that the switches listed below were removed from vehicles processed in the State of Illinois.

\_\_\_\_\_  
*Signature of Authorized Agent* \_\_\_\_\_  
*Date*

	Year	Make	Model	#LIGHT Switches	# ABS Switches	Crushed Y / N
1						
2						
3						
4						
5						
6						
7						
8						
9						
10						
11						
12						
13						
14						
15						
16						
17						
18						
19						
20						
21						
22						

**Illinois Automotive Mercury Switch Removal Log For  
Scrap Metal Processors, Shredders, Vehicle Crushers, and Vehicle Recyclers**

	<b>Year</b>	<b>Make</b>	<b>Model</b>	<b>#LIGHT</b>	<b># ABS</b>	<b>Crushed</b>
22						
23						
24						
25						
26						
27						
28						
29						
30						
31						
32						
33						
34						
35						
36						
37						
38						
39						
40						
41						
42						
43						
44						
45						
46						
47						
48						
49						
50						
51						
52						
53						
54						
55						
56						
57						
58						
59						
60						

# Appendix B

## Mercury Recycling and Disposal Facilities



## Mercury Recycling and Disposal Facilities

*For information purposes only; inclusion does not constitute endorsement; omission does not constitute disapproval. Compliance status should be verified with the environmental agency of the state where the facility is located.*

<b>Illinois</b>	<b>Waste(s) Accepted</b>
<a href="#">Air Cycle Corp.</a> 2000 S. 25th Avenue, Suite C Broadview, IL 60155 Tel: 800-909-9709 Fax: 708-344-7875 <a href="mailto:sales@aircycle.com">sales@aircycle.com</a>	All kinds of lamps, batteries, ballasts, and electronic equipment
<a href="#">Everlights Lamp and Ballast Recycling</a> 9901 S. Torrence Avenue Chicago, IL 60617 Tel: 773-734-9873 Fax: 773-723-9874 <a href="mailto:info@everlights.com">info@everlights.com</a>	Fluorescent lamps, ballasts, batteries, computers, hazardous and special waste, electrical supplies
<a href="#">Fluorecycle, Inc.</a> 27780 W. Concrete Dr., Unit A Ingleside, IL 60041 Tel: 815-363-4411 Fax 815-363-4422 <a href="mailto:sales@fluorecycle.com">sales@fluorecycle.com</a>	All mercury-containing lamps
<b>Indiana</b>	<b>Waste(s) Accepted</b>
<a href="#">Heritage Environmental Services</a> 7901 W. Morris St. Indianapolis, IN. 46231 Tel: 317-243-0811 or 877-436-8778 Fax: 317-486-5085	Lamps, batteries, ballasts, electronics
<a href="#">Lighting Resources Inc.</a> 498 Park 800 Drive Greenwood, IN 46143 Tel: 317-888-3889 Fax: 317-888-3890 <a href="mailto:jane.hutchinson@lightingresourcesinc.com">jane.hutchinson@lightingresourcesinc.com</a>	Fluorescent lamps and ballasts
<a href="#">Retrofit Recycling, Inc.</a> 2156 South Lynhurst Drive Indianapolis, IN 46241 Tel: 317-381-0628 or 866-97-RETRO Fax: 317-381-0638	Fluorescent and HID lamps, ballasts, batteries, PCB material, electronics, mercury devices

## Mercury Recycling and Disposal Facilities

*For information purposes only; inclusion does not constitute endorsement; omission does not constitute disapproval. Compliance status should be verified with the environmental agency of the state where the facility is located.*

<b>Iowa</b>	<b>Waste(s) Accepted</b>
<p><a href="#">A-Tec Recycling Inc.</a>            Box 7391            Des Moines, IA 50309            Tel: 800-551-4912            Fax: 515-263-6970  <a href="mailto:lyoung@atecrecycling.com">lyoung@atecrecycling.com</a></p>	<p>Fluorescent and HID lamps, ballasts, capacitors, mercury devices, batteries, computers</p>
<b>Michigan</b>	<b>Waste(s) Accepted</b>
<p><a href="#">Cleanlites Recycling Inc.</a>            Box 212, 665 Hull Road            Mason, MI 48854            Tel: 517-676-0044            Fax: 517-676-4449  <a href="mailto:cri_m@tir.com">cri_m@tir.com</a></p>	<p>Lamps, batteries, and ballasts</p>
<b>Minnesota</b>	<b>Waste(s) Accepted</b>
<p><a href="#">Mercury Technologies of Minn. Inc.</a>             Pine City Industrial Park, Box 13            Pine City, MN 55063-0013            Tel: 800-864-3821 or 320-629-7888            Fax: 320-629-7799  <a href="mailto:mercotech@ecenet.com">mercotech@ecenet.com</a></p>	<p>Fluorescent lamps</p>
<p><a href="#">Mercury Waste Solutions Inc.</a>            2007 W. County Road C-2            Roseville, MN 55113-1211            Tel: 651-628-9370 or 877-636-6514            Fax: 651-628-9371</p>	<p>Lamps, mercury devices</p>
<p><a href="#">Retrofit Recycling, Inc.</a>            2960 Yorkton Blvd.            Little Canada, MN 55117            Tel: 651-766-7422 or 800-274-1309            Fax: 651-766-9900</p>	<p>Fluorescent and HID lamps, ballasts, batteries, PCB material, electronics, mercury devices</p>
<b>Missouri</b>	<b>Waste(s) Accepted</b>
<p><a href="#">HTR-GROUP</a>            P.O. Box 185            Lake Ozark, MO 65049            Tel: 888-537-4874 or 573-302-7575            Fax: 573-302-7579  <a href="mailto:sales@htr-group.com">sales@htr-group.com</a></p>	<p>Lamps, ballasts, batteries, computers</p>

## Mercury Recycling and Disposal Facilities

*For information purposes only; inclusion does not constitute endorsement; omission does not constitute disapproval. Compliance status should be verified with the environmental agency of the state where the facility is located.*

<b>Ohio</b>	<b>Waste(s) Accepted</b>
<a href="#">Environmental Recycling</a> PO Box 167 527 East Woodland Circle Bowling Green, OH 43402 Tel: 800-284-9107 Fax: 419-354-5110 <a href="mailto:sales@envrecycle.com">sales@envrecycle.com</a>	Lamps, batteries, mercury devices
<a href="#">USA Lamp and Ballast Recycling</a> 7806 Anthony Wayne Ave. Cincinnati, OH 45216 Tel: 513-641-4155 or 800-778-6645 Fax: 513-641-4156	Lamps, batteries, ballasts, CRTs
<b>Wisconsin</b>	<b>Waste(s) Accepted</b>
<a href="#">Budget Lamp Reclaimers</a> 3224 Kingsley Way Madison, WI 53713 Tel: 608-275-6766 or 800-311-963 Fax: 608-275-6765	Lamps, ballasts, batteries
Environmental Solutions W7485 County Road U Plymouth, WI 53073 Tel: 800-779-3050 Fax: 920-528-0035 <a href="mailto:mcdla3@carr.com">mcdla3@carr.com</a>	Lamps, refrigeration devices, batteries
<a href="#">Lamp Recyclers Inc.</a> 3055 Holmgren Way Green Bay, WI 54304 Tel: (920) 592-1161 or 800-558-1166 <a href="mailto:customerservice@lamprecyclers.com">customerservice@lamprecyclers.com</a>	Lamps, ballasts, batteries, computer stuff
<a href="#">Mercury Waste Solutions Inc.</a> 21211 Durand Ave. Union Grove, WI 53182-9711 Tel: 262-878-2599 or 800-741-3343 Fax: 262-878-2699 <a href="mailto:recycle@mwsinc.com">recycle@mwsinc.com</a>	Lamps, mercury devices

## Mercury Recycling and Disposal Facilities

*For information purposes only; inclusion does not constitute endorsement; omission does not constitute disapproval. Compliance status should be verified with the environmental agency of the state where the facility is located.*

Wisconsin	Waste(s) Accepted
<a href="#">Recycle Technologies Inc.</a> 1480 N. Springdale Road Waukesha, WI 53186 Tel: 262-798-3040 or 800-305-3040 Fax: 262-798-3053	Lamps, electronics, ballasts, batteries, mercury-containing things, non-hazardous industrial waste
<a href="#">Veolia Environmental Services</a> 1275 Mineral Springs Drive Port Washington, WI 53074 Tel: 262 268-9168 Fax 608 356-9669	Mercury containing items, ballasts, batteries, electronics
<a href="#">Wisconsin Ballast Inc.</a> W193S6817 Hillendale Drive Muskego, WI 53150 Tel: 262-679-2080 or 800-345-4437 Fax: 262-679-4748 <a href="mailto:info@wiballast.com">info@wiballast.com</a>	Ballasts and lamps

# Appendix C

## Contacts for Illinois Mercury Switch Removal Program

## **Contacts for Illinois Mercury Switch Removal Program**

### **Auto and Truck Recyclers of Illinois**

Michelle Lechner, Executive Director

ph: 877/880-2874

fax: 815/744-2277

E-mail: [illautorecyclers@aol.com](mailto:illautorecyclers@aol.com)

Website: [www.IllinoisAutoRecyclers.com](http://www.IllinoisAutoRecyclers.com)

### **End of Life Vehicles Solutions**

For answers to questions or to enroll in the program:

- Enroll on line at [www.elvsolutions.org/contact.html](http://www.elvsolutions.org/contact.html);
- call 877-225-ELVS (3587) or 248-788-6656; or
- E-mail [info@elvsolutions.org](mailto:info@elvsolutions.org)

To get a replacement bucket call 734-547-2511

### **Illinois Environmental Protection Agency**

Becky Jayne

Office of Pollution Prevention

P. O. Box 19276

Springfield, IL 62794-9276

E-mail: [Becky.Jayne@illinois.gov](mailto:Becky.Jayne@illinois.gov)

Phone: 217-524-9642

Fax: 217-557-2125

Website: [www.epa.state.il.us/mercury/auto-switch/index.html](http://www.epa.state.il.us/mercury/auto-switch/index.html)

