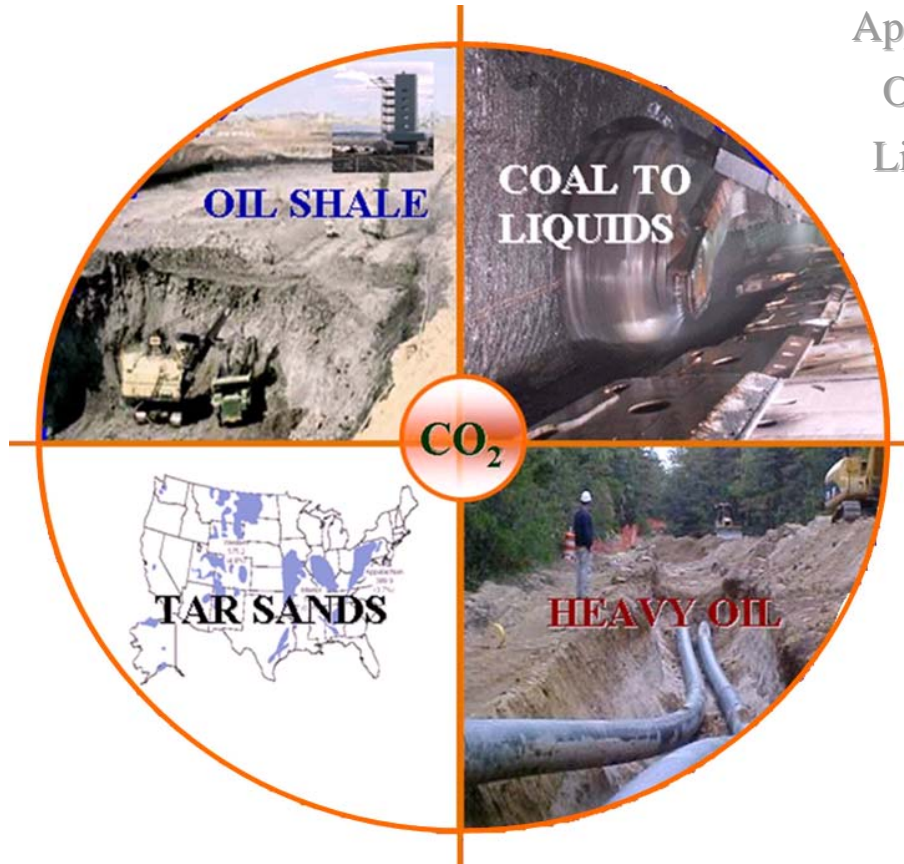


# National Strategic Unconventional Resource Model

## A Decision Support System

Concept  
Approach  
Assumptions  
Application  
Operation  
Limitation



Deputy Assistant Secretary  
For Petroleum Reserves  
Office of Naval Petroleum and Oil Shale Reserves  
U.S. Department of Energy



April 2006

### **Disclaimer**

This report was prepared as an account of work sponsored by an agency of the United States Government. Neither the United States Government nor any agency thereof, nor any of their employees or contractors, makes any warranty, express or implied, or assumes any legal liability or responsibility for the accuracy, completeness, or usefulness of any information, apparatus, product, or process disclosed, or represents that its use would not infringe privately owned rights. Reference herein to any specific commercial product, process or service by trade name, trademark, manufacture, or otherwise, does not necessarily constitute or imply its endorsement, recommendation, or favoring by the United States Government or any agency thereof. The views and opinions of authors expressed herein do not necessarily state or reflect those of the United States Government or any agency thereof.

## Table of Contents

Acknowledgements.....	ix
Summary.....	x
I. Introduction.....	1
A. Background.....	1
B. Objective.....	2
II. Analytical Approach.....	3
A. Methodology Introduction.....	3
1. NSURM Structure.....	3
2. NSURM Analytical Logic.....	4
B. Resource Database.....	5
1. Oil Shale.....	5
2. Coal to Liquids.....	9
3. Tar Sands.....	12
4. Heavy Oil.....	15
5. CO <sub>2</sub> Enhanced Oil Recovery.....	17
C. Development Schedule and Constraints.....	20
1. Development Schedule.....	20
2. Resource Development Constraints.....	22
3. Project Production Profile.....	23
D. Project Economics.....	24
1. Capital Costs.....	26
2. Operating Cost.....	28
3. Fiscal Data.....	31
4. Feedstock & Product Prices.....	34
E. Project Timing and Aggregation.....	36
1. Project Timing.....	36
2. Aggregation.....	37
F. Benefits Estimation.....	37
G. System Limitations.....	38
H. Summary.....	39
III. Potential Applications.....	40
A. Potential Incentives Modeled.....	40
B. Economics of a Generic Project.....	40
C. Results of the Measured Case.....	42
1. Production Potential.....	42
2. Reserves.....	43
3. Public Sector Revenues.....	45
4. Increased National Benefits.....	47
Abbreviations and Acronyms.....	A-35
References.....	A-37

## Appendix Table of Contents

Appendix A.....	A-1
Technology .....	A-3
Resource Data.....	A-7
Economic Data.....	A-11
Run Options .....	A-19
Results of the Minimum Economic Price Run .....	A-20
Results of the Future Potential Run .....	A-21

## List of Figures

Figure I-1. National Strategic Unconventional Resources Model .....	2
Figure II-1. NSURM Logic Flow .....	4
Figure II-2. U.S. Oil Shale Deposits .....	5
Figure II-3. Overview of the Oil Shale Resource .....	6
Figure II-4. Oil Shale Technology Options .....	8
Figure II-5. Major U.S. Coal Deposits.....	9
Figure II-6. Fischer Tropsch Coal Liquefaction Process .....	12
Figure II-7. Distribution of U.S. Tar Sands Resource .....	13
Figure II-8. Modeled Tar Sand Technologies.....	15
Figure II-9. Distribution of U.S. Heavy Oil Resource (Original Oil in Place, Billion Barrels) ..	15
Figure II-10. U.S. Heavy Oil Resource Potential .....	16
Figure II-11. Steam Flooding.....	17
Figure II-12. Remaining Oil in Place for Candidate Reservoirs for CO <sub>2</sub> Flooding.....	18
Figure II-13. Miscible Recovery.....	19
Figure II-14. Process Module Flowchart .....	20
Figure II-15. Current Natural Sources of CO <sub>2</sub> .....	22
Figure II-16. Economic Module Flowchart .....	24
Figure II-17. Hypothetical Cumulative After Tax Cashflow Graphs .....	25
Figure II-18. Oil, Natural Gas, and Product Price Tracks .....	34
Figure II-19. NSURM Coal Regions .....	35
Figure II-20. Development & Timing Module Logic Flow.....	37
Figure III-1. Economics of a Generic Project.....	41
Figure III-2. Potential Liquid Production of the Measured Case.....	43
Figure III-3. Potential Natural Gas Production of the Measured Case .....	44
Figure III-4. Measured Case Reserves.....	44
Figure III-5. Direct Federal Revenues for the Measured Case .....	45
Figure III-6. Direct State Revenues for the Measured Case .....	45
Figure III-7. Comparison of the Federal & State Revenues .....	46
Figure III-8. Cumulative Public Sector Revenues .....	46
Figure III-9. Cumulative Contribution to GDP.....	47
Figure III-10. Cumulative Value of Imports Avoided.....	48
Figure III-11. Annual Direct & Indirect Petroleum Sector Jobs.....	48

## List of Figures in Appendix

Figure A-1. NSURM Model .....	A-1
Figure A-2. NSURM Main Menu.....	A-2
Figure A-3. NSURM Interface Structure.....	A-2
Figure A-4. Technology Display Main Menu.....	A-3
Figure A-5. Oil Shale Technologies Modeled .....	A-3
Figure A-6. Oil Shale Underground Mining Process Diagram.....	A-4
Figure A-7. Oil Shale Surface Mining Process Diagram.....	A-4
Figure A-8. Oil Shale True In-Situ Process Diagram.....	A-4
Figure A-9. Tar Sands Technologies Modeled .....	A-5

Figure A-10. Tar Sands Underground Mining Process Diagram .....	A-5
Figure A-11. Tar Sands SAGD Process Diagram.....	A-5
Figure A-12. Coal to Liquids Process Diagram.....	A-6
Figure A-13. CO <sub>2</sub> Enhanced Oil Recovery Process Diagram.....	A-6
Figure A-14. Heavy Oil Process Diagram .....	A-7
Figure A-15. Oil Shale Resource Database .....	A-7
Figure A-16. Tar Sand Resource Database.....	A-8
Figure A-17. Tar Sand Development Schedule .....	A-8
Figure A-18. Coal to Liquid Resource Database .....	A-9
Figure A-19. Coal to Liquids Prototype Projects.....	A-9
Figure A-20. State Specific Product Yield Factors.....	A-10
Figure A-21. Sample CO <sub>2</sub> EOR Resource Database .....	A-10
Figure A-22. Sample Heavy Oil Resource Database.....	A-11
Figure A-23. Economic Data Menu.....	A-11
Figure A-24. Resource Specific Cost Data Menu.....	A-12
Figure A-25. Capital Costs for Oil Shale Processes .....	A-12
Figure A-26. Operating Costs for Oil Shale Processes.....	A-13
Figure A-27. Operating Costs for Oil Shale Processes Contd.....	A-13
Figure A-28. Tar Sands Mining Costs .....	A-14
Figure A-29. Tar Sands SAGD Costs.....	A-14
Figure A-30. Natural Gas Price Track .....	A-14
Figure A-31. Coal to Liquids Capital and Operating Costs .....	A-15
Figure A-32. 25 Year Regional Coal Price Projections.....	A-15
Figure A-33. CO <sub>2</sub> EOR Capital and Operating Costs.....	A-16
Figure A-34. CO <sub>2</sub> Pipeline Capacity and Location.....	A-16
Figure A-35. Heavy Oil Capital and Operating Costs .....	A-17
Figure A-36. Royalty Data.....	A-17
Figure A-37. Federal Tax Rate and Discount Rates .....	A-17
Figure A-38. State Corporate and Severance Tax Rates (Oil Shale).....	A-18
Figure A-39. Product, Byproduct, and Feedstock Price Tracks .....	A-18
Figure A-40. Incentive Options Menu .....	A-19
Figure A-41. Run Options Menu .....	A-19
Figure A-42. The Two Types of Possible Model Runs .....	A-20
Figure A-43. Model Run Display .....	A-20
Figure A-44. National Summary for Minimum Economic Price Run.....	A-21
Figure A-45. Sample of the Process Specific Minimum Economic Price Run .....	A-21
Figure A-46. National Report Menu.....	A-22
Figure A-47. National Report: Liquid Production.....	A-22
Figure A-48. National Report: Gas Production .....	A-23
Figure A-49. National Report: Reserves.....	A-23
Figure A-50. National Report: Direct Federal Revenue .....	A-24
Figure A-51. National Report: Direct State Revenues.....	A-24
Figure A-52. National Report: Total Public Sector Revenues.....	A-25
Figure A-53. National Report: Contribution to GDP.....	A-25
Figure A-54. National Report: Value of Imports Avoided.....	A-26
Figure A-55. National Report: Employment .....	A-26

Figure A-56. National Report: Data.....	A-27
Figure A-57. Process Specific Report Menu .....	A-28
Figure A-58. Process Specific Report: Liquid Production .....	A-28
Figure A-59. Process Specific Report: Gas Production.....	A-29
Figure A-60. Process Specific Report: Capital Investments.....	A-29
Figure A-61. Process Specific Report: Operating Costs.....	A-30
Figure A-62. Process Specific Report: Direct Federal Revenue.....	A-30
Figure A-63. Process Specific Report: Direct State Revenues .....	A-31
Figure A-64. Process Specific Reports: Direct Public Sector Revenues .....	A-31
Figure A-65. Process Specific Reports: Contribution to GDP .....	A-32
Figure A-66. Process Specific Reports: Value of Imports Avoided.....	A-32
Figure A-67. Process Specific Reports: Employment .....	A-33
Figure A-68. Process Specific Reports: Resource Specific Data .....	A-34

## List of Tables

Table II-1. Resource Data: 25 Industry Nominated Tracts.....	7
Table II-2. Elements of COALQUAL Databases.....	10
Table II-3. Coal Resource Characterization.....	11
Table II-4. An Example of Six Fischer-Tropsch Prototype Projects.....	11
Table II-5. Tar Sand Resource Properties from U.S. Bitumen Database.....	13
Table II-6. Tar Sands Resource Data, Deposits.....	14
Table II-7. Heavy Oil Resource Data.....	16
Table II-8. CO <sub>2</sub> Enhanced Oil Recovery Resource Data.....	19
Table II-9. Development Schedule Properties.....	22
Table II-10. CO <sub>2</sub> Pipeline Capacities.....	23
Table II-11. Characteristics of the Production Profile.....	23
Table II-12 Resource/Process Independent Capital Costs.....	26
Table II-13. Oil Shale Capital Costs.....	27
Table II-14. Coal to Liquids Capital Cost Categories.....	27
Table II-15. Tar Sands Capital Cost Categories.....	28
Table II-16. Heavy Oil Capital Cost Categories.....	28
Table II-17. CO <sub>2</sub> EOR Capital Cost Categories.....	28
Table II-18 Resource/Process Independent Operating Costs.....	29
Table II-19. Oil Shale Operating Cost Categories.....	29
Table II-20. Coal to Liquid Operating Cost Categories.....	30
Table II-21. Tar Sands Operating Cost Categories.....	30
Table II-22. Heavy Oil Operating Cost Categories.....	30
Table II-23. CO <sub>2</sub> EOR Operating Cost Categories.....	31
Table II-24. Regional CO <sub>2</sub> Prices (\$/Mcf).....	31
Table II-25. Default Depreciation Schedule.....	32
Table II-26. Eight Year Amortization Schedule.....	32
Table II-27. Resource Specific Royalty Rates.....	32
Table II-28. Utah Oil Shale Royalty Structure.....	33
Table II-29. Oil Shale Severance Taxes.....	33
Table II-30. Oil Severance Rates.....	33
Table II-31 Regional Coal Price Range.....	35
Table II-32. Other Feedstock & Byproduct Prices.....	35
Table II-33. Resource Specific Products & Byproducts.....	36
Table III-1. Potential Incentive Cases.....	41



# Acknowledgements

“*National Strategic Unconventional Resource Model - A Decision Support System*” is a Model Developed by the U.S. Department of Energy, Office of Petroleum Reserves, Office of the Naval Petroleum and Oil Shale Reserves (DOE/NPOSR). Mr. Anton R. (Tony) Dammer, the Director of NPOSR served as the Program Director. The work was completed under Contract No. DE-AC01-03FE67758 (Task 28 and 32). Mr. Khosrow Biglarbigi of INTEK Inc. served as the Contractor’s Project Director.

The DOE/NPOSR acknowledges a broad range of experts in oil shale mining, technology, policy, resources, economics, and energy modeling, for their invaluable contributions and guidance in the development of the Model. These experts include:

Mr. Gary Aho, Sage Geotechnical

Dr. James W. Bunger, JWBA

Mr. Jeremy J. Cusimano, DOE/NPOSR

Mr. F.J. Gangle, DOE/NPOSR

Dr. Larry Lukens, Consultant

Mr. Terry O’Connor, Shell Oil

Dr. James Patten, Battelle

Dr. Don Repici, Consultant

Special recognition is due to the staff of INTEK Inc who developed the *Model* and prepared the *Documentation*. Mr. Khosrow Biglarbigi served as the Project Director responsible for the architectural design and overall implementation of the Model. Mr. Hitesh Mohan served as the Project Manager, responsible for the system design, coding, testing/validation, and supervision of the day-to-day activities. Critical staff included; Mr. Marshall Carolus (System Coding, Integration, and User Interface), Mr. Jeremy Larrieu (User Interface and Research Support), Ms. Emily Knaus (Research and Documentation Support), and Ms. Victoria Spriggs (Production Support). Mr. Harry Johnson provided important guidance for the development of the Documentation.

Dr. Larry Lukens (Consultant) and Mr. Gary Aho (Sage Geotechnical) are further recognized for providing invaluable guidance for the oil shale economic assessment and technology commercialization process. Mr. Butch Gangle and Mr. Jeremy J. Cusimano of DOE/NPOSR are acknowledged for their immense efforts in the review and critique of this documentation. Mr. Bill Harrison of the Department of Defense (DOD) and Mr. Ted Sheridan (Consultant) are recognized for providing process data for CTL Technology. Mr. David Olson of the *International Centre for Heavy Hydrocarbon* is acknowledged for providing Tar Sand data base. The NPOSR wishes to recognize the U.S. *Geologic Survey (USGS)* for providing the Coal Resource data base.

While acknowledging the significant contributions of participating individuals and organizations, any error of facts, omission, or inconsistency remains the responsibility of the Program Director.

# Summary

The *National Strategic Unconventional Resources Model* was developed by U.S. Department of Energy (DOE), Office of Naval Petroleum and Oil Shale Reserves (NPOSR) in the winter of 2005 – 2006. The model was developed, from the existing *National Oil Shale Model*<sup>1</sup>, specifically to support the Task Force mandated by Congress in section 369 of the Energy Policy Act of 2005. The model will be used in evaluating the potential for domestic unconventional liquid production from oil shale, tar sands, coal to liquids, heavy oil, and CO<sub>2</sub> Enhanced Oil Recovery.

The model relies on publicly available information to evaluate the economics of several resource development technologies. For oil shale, the model evaluates: 1) Surface Mining, 2) Underground Mining, 3) Modified In-Situ, and 4) True In-Situ. For tar sands, the model considers: 1) Integrated Mining and Upgrading, and 2) Steam Assisted Gravity Drainage. For coal to liquids, the model examines the Fischer-Tropsch process. For heavy oil and CO<sub>2</sub> EOR, the model respectively evaluates steam flooding and carbon dioxide flooding. The model contains a resource database containing detailed petrochemical and geologic data on the Western oil shale resources, the tar sands resources, the coal resources, and the existing oil reservoirs which are candidates for steam flooding and carbon dioxide flooding. An engineering based process screening module assesses the applicability of each technology and determines the most appropriate recovery method. Based upon the recovery technology and the resource characteristics, the potential production is determined. An integrated economic module evaluates the potential development of each resource through a detailed cash flow analysis. The resource and process specific costs were obtained through a variety of DOE and industry sources and updated through 2004. Project development schedules and lead times were also developed for each resource and technology modeled. These were based upon the best available industry data and incorporated into the modeling system.

The model evaluates each project individually and aggregates the results of the economically viable projects at the technology, resource, and national levels. At present, the model estimates a range of benefits including: production, reserves, transfer payments, investment and operating requirements, cash flow before and after tax, direct federal revenue, direct state revenue, direct public sector revenue, the contribution to GDP, the value of imports avoided, and the indirect and direct sector employment. With these capabilities, the modeling system proves to be a “unique” analytical tool for the cost and benefit analysis of alternative local, state, and federal actions in the area of economic incentives, technology, and environmental regulation as they relate to domestic unconventional fuel resources.

To increase credibility, the NPOSR has developed the model system from existing, vetted models wherever possible. The oil shale component has been thoroughly reviewed by experts in oil shale industry, policy and program analysts from DOE, as well as consultants specialized in resource evaluation, technology characterization, project economics, and resource modeling. The heavy oil and CO<sub>2</sub> EOR components were developed from existing DOE process models which have been thoroughly examined and accepted by industry.

# I. Introduction

## A. Background

The United States and other countries of the world are endowed with substantial unconventional fossil resources that could be produced and converted to liquid fuels. These resources include oil shale, coal (and coal-derived liquids), tar sands, heavy oil, and oil produced by enhanced recovery techniques. Deemed unconventional due to technical uncertainties and high costs relative to crude oil, these resources have gone largely undeveloped in the United States.

Production from domestic unconventional resources would reduce imports, reduce vulnerability to supply disruptions, assure fuel supplies for domestic security and military needs, and sustain domestic economic activity and growth. In this context, these resources, can and should be viewed as vital strategic assets of the United States. Development of our unconventional resources would greatly increase the nation's proved reserves and create new opportunities for economic and industrial development.

Technologies for transforming these resources to high-quality fuels continue to advance. Rising world prices for conventional oil are making these resources increasingly attractive to industry. Still, development of these resources entails significant investment risk, particularly until the point where they are demonstrated to be technically feasible and economically competitive at a commercial scale. Numerous impediments and uncertainties must be mitigated before private industry will invest in commercial scale development.

The range of impediments and uncertainties that affect development of unconventional resources includes: lack of access to resources on public lands, uncertain technology performance and efficiency; uncertain capital and operating costs; unfavorable royalty and fiscal regimes; challenging environmental standards; unknown permitting timelines; sizable public infrastructure requirements; uncertain need for and availability of water supplies; significant socio-economic impacts; availability of up-front funds for community planning and infrastructure; and uncertainty regarding government and social acceptance.

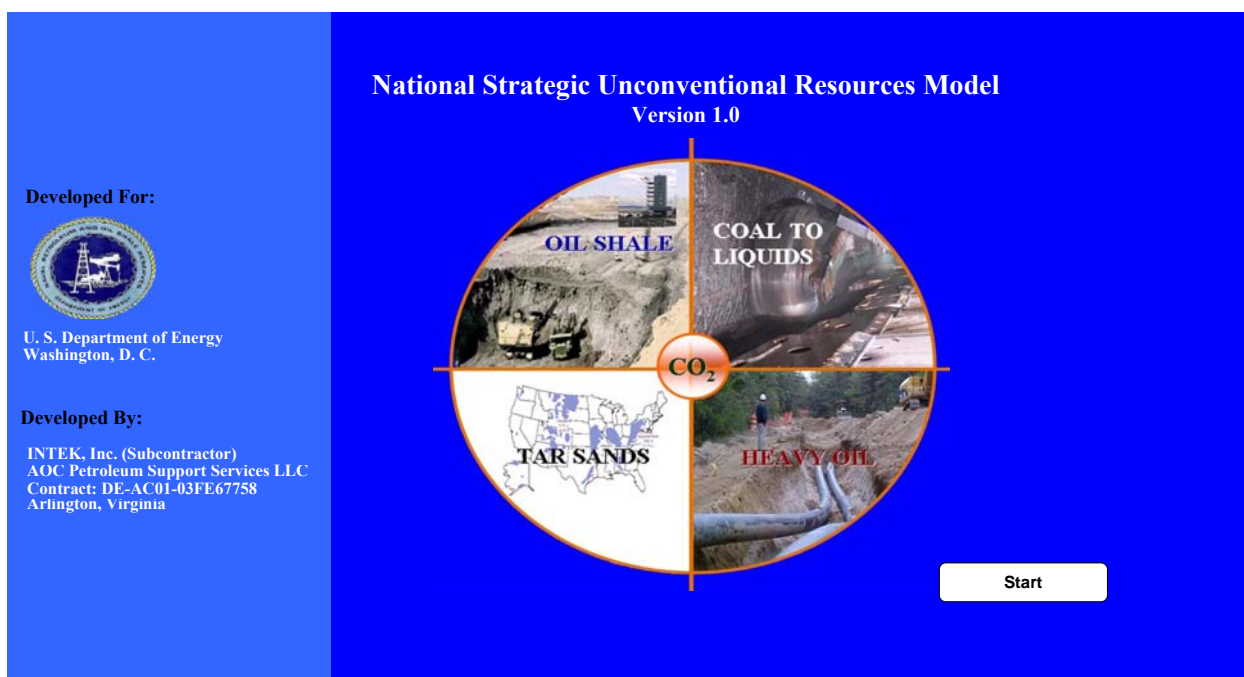
In section 369 of the Energy Policy Act of 2005, Congress recognized that declining domestic oil production and rising domestic oil demand increase the nation's dependence on imports of foreign oil. This growing import dependence represents challenges to the strategic interests of the United States, particularly as global oil production may soon peak.

Congress determined that significant opportunities exist for producing fuels from the nation's vast unconventional resources, including oil shale and tar sands, heavy oil, enhanced oil recovery, and coal liquids. Domestic production from unconventional resources would reduce import dependence and the strategic risks posed by global supply and demand trends.

To promote the development of unconventional resources Congress directed the Secretary of Energy to establish a Strategic Unconventional Fuels Task Force, supported by the Department of Energy's Office of Petroleum Reserves. The Task Force has the responsibility of developing and implementing a Commercial Strategic Fuels Development Program for the United States.

The Office of Petroleum Reserves has initiated supporting analyses in each energy resource area to assist program development and to provide the bases and “metrics” for establishing and tracking progress relative to the plan. To conduct these analyses, The Office of Petroleum Reserves has expanded the National Oil Shale Model (NOSM) created for oil shale analysis to the full suite of unconventional resources to be considered by the Task Force, including coal-derived liquids, heavy oil, tar sands, and enhanced oil recovery. The expanded model system is called the National Strategic and Unconventional Resources Model (NSURM), shown in figure I-1. The model analyzes known resources, technologies, economics, and fiscal regimes to determine supply potential and to assess the potential of specific actions and policy options to stimulate industry investment and increased production. The model also estimates the impacts of policy options on oil prices and Federal and state revenues, and other economic indicators.

**Figure I-1. National Strategic Unconventional Resources Model**



## B. Objective

The objective of this report is to provide a technical documentation for the NSURM model system. Section II of the report describes the methodology, resource modeled, development schedules and constraints, economics, project timing, benefits estimation methodology, and system limitations. Section III describes the potential applications and possible incentives modeled and provides a summary of a hypothetical case. Finally, the operations of the model are described in the appendix. Data sources and references are provided as appropriate throughout the report.

# II. Analytical Approach

The National Strategic Unconventional Resources Model was developed as an extension of the existing vetted National Oil Shale Model. This process included the integration of DOE developed heavy oil and CO<sub>2</sub> Enhanced Oil Recovery models, and the development of models for coal to liquids and tar sands. All of these were unified in a single data driven structure developed using FORTRAN. In addition, a Visual Basic interface was designed to ease the creation and analysis of model scenarios without a reduction in execution time.

In this chapter, the analytical approach to the NSURM system will be detailed. In the following sections the methodology, resource database, development schedules and constraints, project economics, benefits estimation, and system limitations will be discussed.

## A. Methodology Introduction

The structure and the system logic of the model system will be described in this section. NSURM was developed using a modular data-driven structure. This structure allows the model to be easily updated and expanded to incorporate additional resource data or recovery technologies.

### 1. NSURM Structure

The National Strategic and Unconventional Resources Model is a data-driven model with a modular structure consisting of five major components. These components are: 1) the resource database, 2) the process screening module, 3) the economics module, 4) the development and timing module, and 5) the reports module.

The resource database contains the raw production and resource data for the oil shale, tar sands, coal to liquids, heavy oil, and CO<sub>2</sub> enhanced oil recovery projects that are evaluated by the model. This component will be described in Section B.

The process screening module, to be described in Section C, evaluates the geologic and petrophysical characteristics of each project and determines the most applicable recovery process for the project. In addition, it determines the potential product and byproduct production and feedstock requirement profiles. These profiles, along with the required resource properties, are processed by the economics module to determine its economic viability.

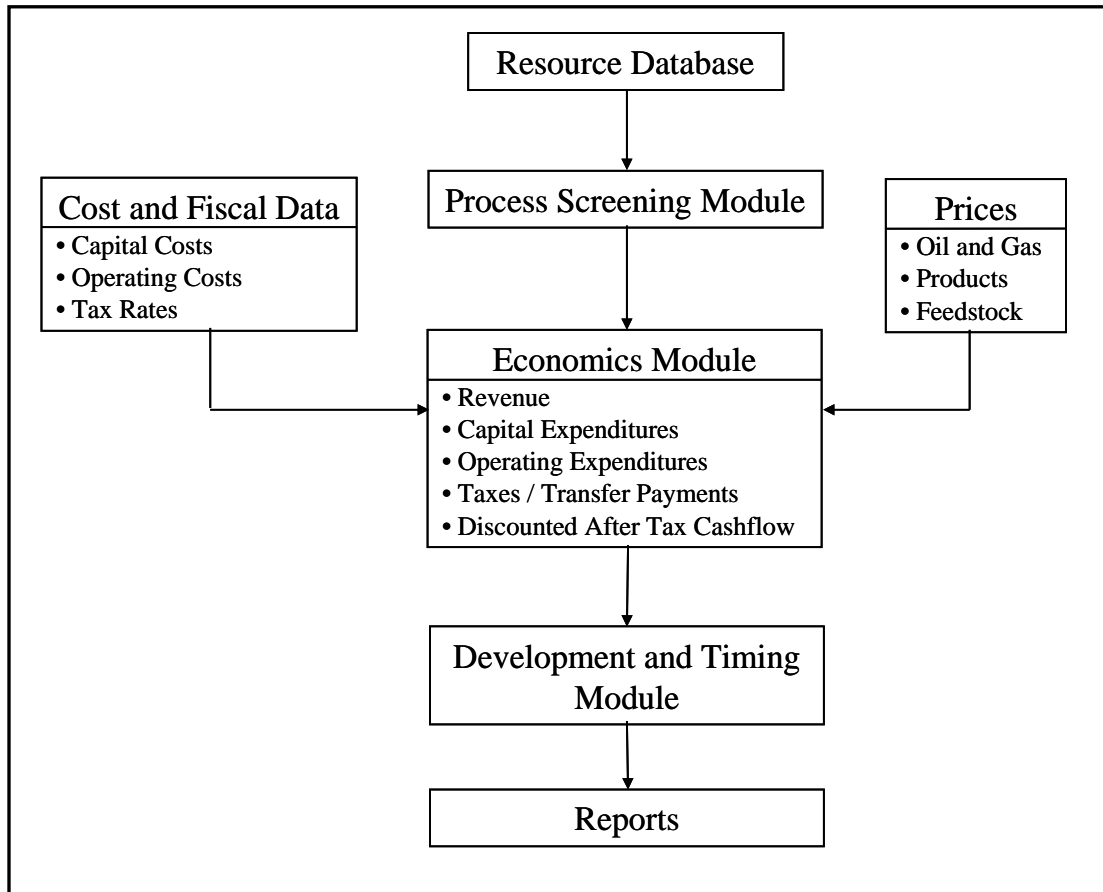
The economics module performs a detailed cashflow analysis which includes revenues, resource, capital expenditures, operating costs, and taxes. The module then calculates the discounted after tax cash flow and determines the economic viability of the project. The economics module and its data requirements will be discussed in Section D.

The development and timing module ranks the potential projects according to economic viability. It then uses project specific development schedules and resource development constraints to develop projects during the NSURM forecast period. This component will be discussed in further detail in Section E.

The reports module passes the production and economic statistics of the timed and economic projects to the NSURM interface and user. These results are provided at several levels of aggregation and described in Section F.

In addition to the five modules, there are two types of external data files: 1) cost and fiscal data files and 2) the prices file. The cost and fiscal data contains process and resource specific capital and operating costs as well as the tax structures and other data required by the economics module. The price file contains the projected costs for products, byproducts, and feedstock, which are used by the economic module to calculate revenues. The external data files will also be described in Section D. These components are shown in Figure II-1.

Figure II-1. NSURM Logic Flow



## 2. NSURM Analytical Logic

The NSURM system determines the potential production, reserves, economic statistics, and national benefits of the resources modeled at the project level. These projects are subject to a detailed analysis to determine the most economically viable recovery technology and the benefits associated with it. The analytical methodology applied to each project contains the following steps:

- The project specific resource data is screened by the process screening module in order to determine the process technologies which are applicable.
- The technology specific production profiles for products, byproducts and feedstocks required are generated by the process module.
- Process specific development schedules are used to generate the capital investment schedule for each project.

- The project economics are evaluated by the economics module using a detailed cashflow analysis. The analysis includes determining the annual revenues, capital investments, operating costs, and transfer payments and other taxes. Where multiple technologies are applicable for a project, the most economic process is determined.
- The development constraints are applied, especially to the development of CO<sub>2</sub> enhanced oil recovery projects to determine the feasibility of these projects based upon CO<sub>2</sub> availability.
- The production and economic results are aggregated at the resource and national levels.
- The reports containing the resource level and national level results are generated and passed to the user.

The following sections of this chapter will provide the details of each component of the NSURM system.

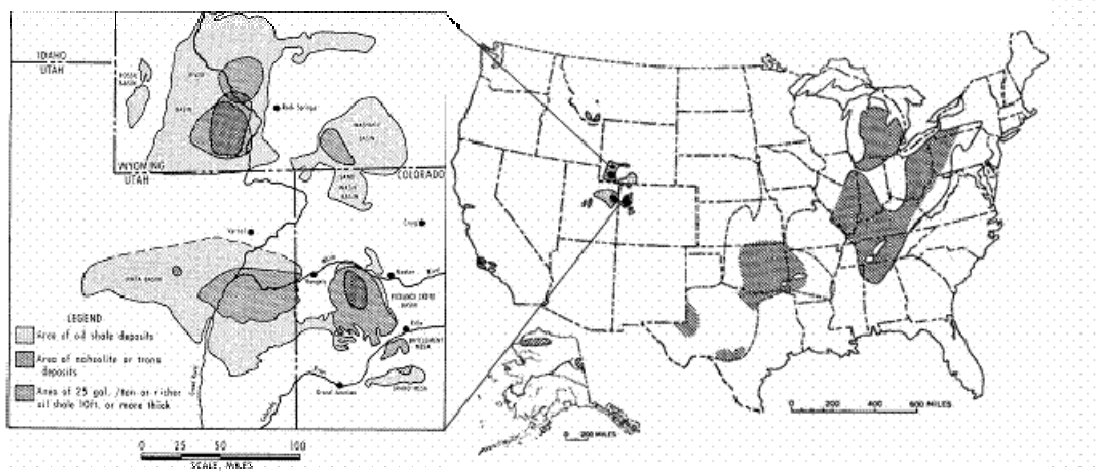
## B. Resource Database

The resource database contains the petrophysical, geological, and other data required for the analysis of the resources considered by the model. This section describes the NSURM's resource database and its sources of data. Data includes the U.S. volume of each of the resources, distribution, quality, and access to each resource. Technical screening and production processes are also covered in this section.

### 1. Oil Shale

America's oil shale resource exceeds 2 trillion barrels. Figure II-2 displays major U.S. oil shale deposits<sup>2</sup>. The richest, most concentrated deposits, amounting to approximately 1.8 trillion barrels of oil equivalent, are found in the Green River Formation in western Colorado, southeastern Utah, and southern Wyoming.<sup>3</sup>

**Figure II-2. U.S. Oil Shale Deposits**

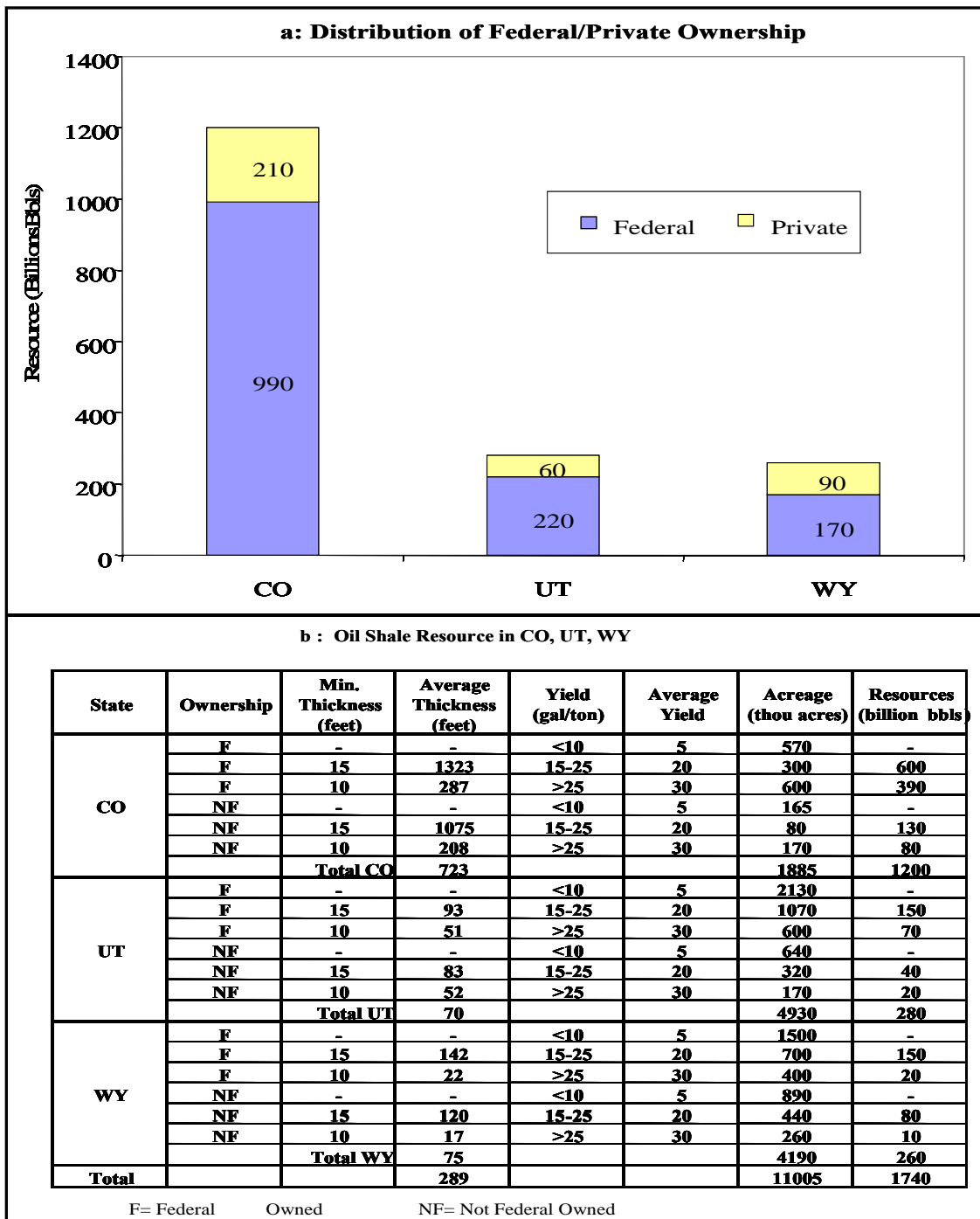


The entire western oil shale resource (including federal, state lands, tribal lands, and privately owned “fee lands”) is located within the Green River Basin and contains nearly 1.8 trillion barrels of oil in place. Nearly 80 percent of this western oil shale resource is owned and managed by federal agencies (Figure II-3a). The resource within the states of Colorado, Utah,

and Wyoming was characterized by the USGS and the Bureau of Mines according to its ownership, minimum thickness, average yield, and acreage (Figure II-3b).

Detailed characterization of the resource geology was conducted during the prototype leasing program. As part of the prototype leasing program several tracts were nominated by the industry for detailed study. These nominated tracts provide a solid technical basis for the present analysis.

Figure II-3. Overview of the Oil Shale Resource





## Resource Database

The resource database currently contains 25 tracts on federal lands in Colorado, Utah, and Wyoming (Table II-1). These tracts were nominated by industry for possible development under the Department of the Interior's 1973 Prototype Oil Shale Leasing Program<sup>4</sup>. Petrophysical and geological characteristics of each tract were used to define the lease and its technical recovery. Each tracts' location, geologic description, areal extent (acres), thickness of net pay (feet), average overburden (feet), dip (feet/mile), oil shale richness (gallons/ton), and oil shale yield (barrels) was compiled. In combination, the 25 tracts represent more than 70 billion barrels of resource in place and about 125,000 acres of area in the three states. This provides an excellent resource sample for the purpose of assessing development economics and the potential of various incentives to stimulate applications of technologies in real-world settings.

**Table II-1. Resource Data: 25 Industry Nominated Tracts**

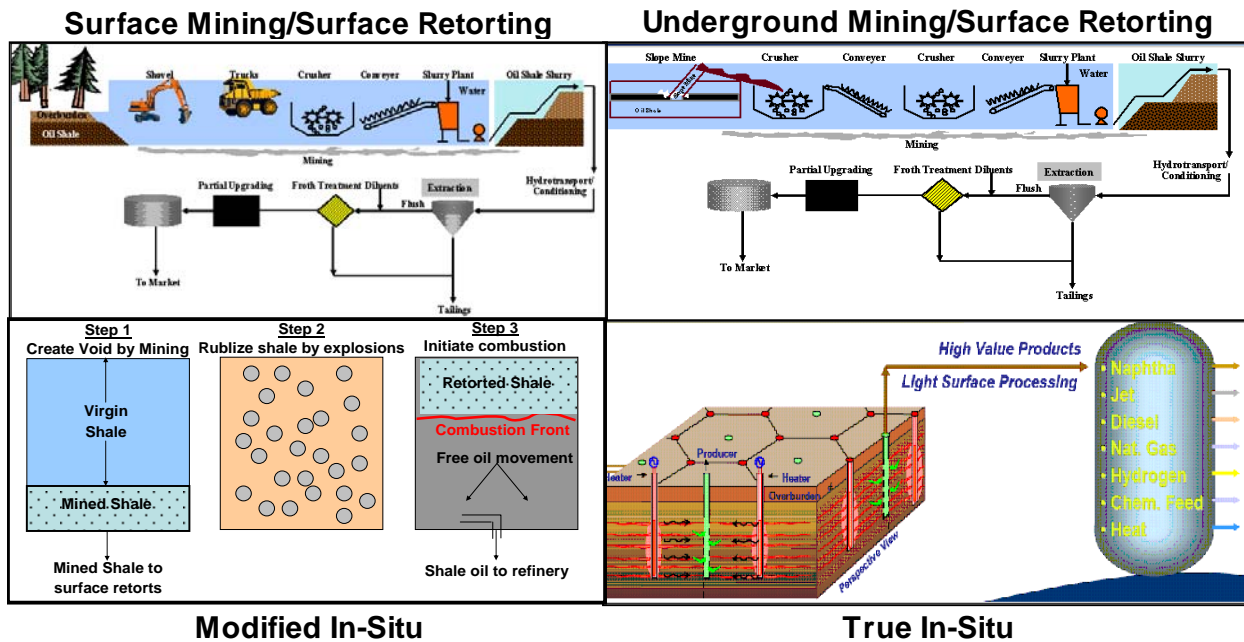
Resource ID	Tract Name	Basin Name	State	Depth	Acreage	Net Pay	Yield	Resource
				Feet	Acres	Feet	Gal/ton	MMBLS
1	c1	Piceance	CO	1100.00	5120.00	500.00	26.8859	5202.17
2	c2	Piceance	CO	700.00	5120.00	115.00	26.9228	1198.14
3	c3	Piceance	CO	500.00	5120.00	130.00	26.4613	1331.20
4	c4	Piceance	CO	700.00	5090.00	495.00	30.0000	5712.99
5	c5	Piceance	CO	700.00	5090.00	495.00	30.0000	5712.99
6	c7	Piceance	CO	700.00	5090.00	495.00	30.0000	5712.99
7	c8	Piceance	CO	700.00	5090.00	495.00	30.0000	5712.99
8	c17	Piceance	CO	700.00	5090.00	495.00	30.0000	5712.99
9	c6	Piceance	CO	1100.00	5018.00	600.00	26.4613	6021.60
10	c9	Piceance	CO	1000.00	5128.00	125.00	27.2736	1321.36
11	c10	Piceance	CO	900.00	5126.00	770.00	26.4613	7894.04
12	c11	Piceance	CO	1100.00	5118.00	900.00	26.4613	9212.40
13	c12	Piceance	CO	300.00	5120.00	20.00	30.0000	232.19
14	c13	Piceance	CO	1350.00	5094.00	350.00	30.0000	4042.67
15	c14	Piceance	CO	900.00	5120.00	125.00	26.7444	1293.69
16	c15	Piceance	CO	1000.00	5120.00	125.00	26.7444	1293.69
17	c16	Piceance	CO	1100.00	5120.00	615.00	26.4613	6297.60
18	u1	Uinta	UT	850.00	5120.00	40.00	26.4613	409.60
19	u2	Uinta	UT	850.00	5120.00	45.00	30.0000	522.42
20	u3	Uinta	UT	2300.00	5120.00	25.00	26.4613	256.00
21	u4	Uinta	UT	700.00	5120.00	50.00	30.0000	580.47
22	u5	Uinta	UT	700.00	5120.00	50.00	30.0000	580.47
23	w1	Washakie	WY	600.00	5120.00	90.00	20.0000	696.57
24	w2	Washakie	WY	600.00	5120.00	90.00	20.0000	696.57
25	w3	Washakie	WY	600.00	5120.00	90.00	20.0000	696.57

Additional tracts for the eastern oil shale can be added to the resource database if data is available on a deposit including the depth, acreage, net pay, yield, and resource volume.

## Technology Options

There are four types of technology options for producing oil shale: surface mining with surface retorting, underground mining with surface retorting, true in-situ, and modified in-situ. All of the four processes are represented in the model. Figure II-4 displays the four technology options.

Figure II-4. Oil Shale Technology Options



Surface mining is likely to be used for those zones that are near the surface or that are situated with an overburden-to-pay ratio of less than about 1:1. Numerous opportunities exist for the surface mining of ore averaging better than 25 gallon/ton, with overburden-to-pay ratios of less than 1, especially in Utah.

Once the shale has been mined, it must be heated to temperatures between 400 and 500 degrees centigrade to convert, or retort the kerogen, and create shale oil and combustible gases. Numerous approaches to surface retorting were tested at pilot and semi-works scales during the 1970s and 1980s.

Underground mining can be accomplished by room and pillar mining or horizontal adit. Room and pillar mining is likely to be used for resources that outcrop along steep erosions. Once the oil shale is extracted from the ground, it then is processed by surface retorting using the same methodology as in the surface mining operation.

In-situ processing involves heating the resource in-place, underground. True in-situ processes do not involve any mining. The shale is fractured, air is injected, the shale is ignited to heat the formation, and shale oil moves through fractures to production wells. There are some difficulties in controlling the flame front that can leave some areas unheated and some oil unrecovered.

Shell Oil is researching a novel in-situ conversion process (ICP) that shows promise for recovering oil from rich, thick resources, lying beneath several hundred to more than one-thousand feet of overburden. The process uses electric heaters, placed in closely spaced vertical wells, to heat the shale for 2 to 4 years. The slow heating creates microfractures in the rock to facilitate fluid flow to production wells. Resulting oil and gases are moved to the surface by conventional recovery technologies.

The ICP's slow heating is expected to improve product quality and recover shale oil at greater depths than other oil shale technologies. Additionally, the ICP process may reduce environmental impacts by eliminating subsurface combustion. An innovative "freeze wall"

technology is being tested to isolate the production area from groundwater intrusion until oil shale heating, production, and post production flushing has been completed.

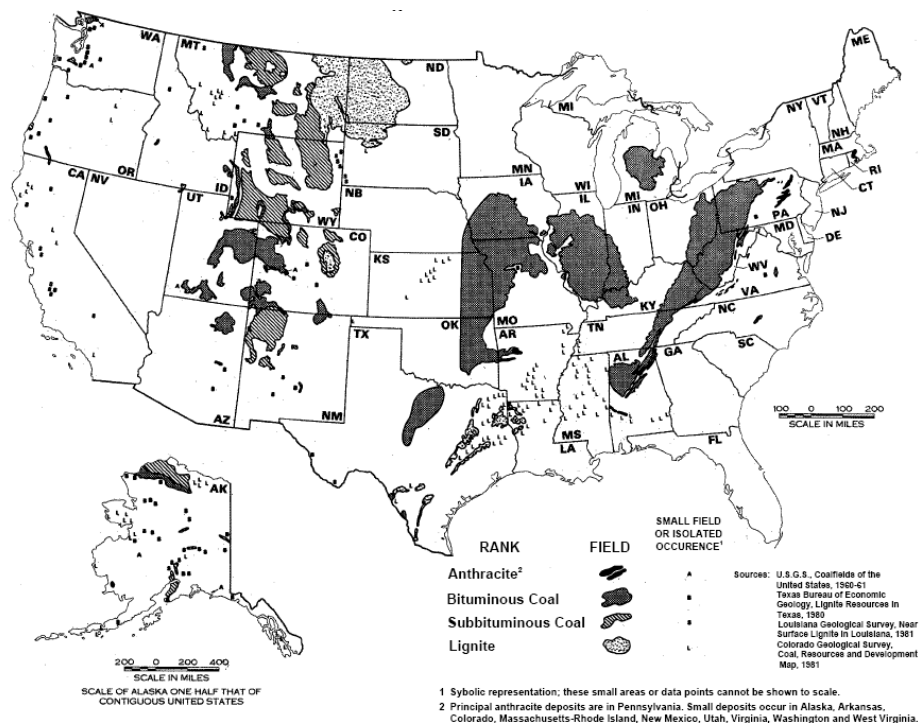
Modified In-Situ (MIS) involves mining below the target shale before heating. MIS requires fracturing the target deposit above the mined area to create void space of 20 to 25 percent. The shale is heated by igniting the top of the target deposit. MIS processes can improve performance by heating more of the shale, improving the flow of gases and liquids through the rock, and increasing volumes and quality of the oil produced.

## 2. Coal to Liquids

The demonstrated coal reserves base of the United States is approximately 495 billion tons of which 267 billion tons is considered technically and economically recoverable<sup>5</sup>. About 60 percent of recoverable reserves are located in western states; and 40 percent occur in the east. Figure II-5 displays the distribution of coal in the U.S.

As shown in the figure, there are four types of coal found in the U.S. These four types vary in quality and yield. Approximately 45 percent of U.S. coal is anthracite or bituminous coal which are both high in heat content and thus highly ranked. The remaining 55 percent consists of lower ranked subbituminous coal and lignite.<sup>6</sup>

Figure II-5. Major U.S. Coal Deposits



### Resource Database

The data for the coal resource database was derived from two sources: the COALQUAL<sup>7</sup> Database and the Bechtel report.

COALQUAL Database - The USGS prepares the COALQUAL database which is a subset of the 13,035 samples contained in the National Coal Resources Data System and contains coal quality

data in which a complete record represents a coal sample with a possible total of 136 fields.<sup>8</sup> Elements included in the database are provided in table II-2.

**Table II-2. Elements of COALQUAL Databases**

<b>Location</b>	<ul style="list-style-type: none"> <li>• Moisture Content</li> <li>• Volatile Matter Content</li> <li>• Carbon Content</li> <li>• Hydrogen Content</li> <li>• Nitrogen Content</li> <li>• Oxygen Content</li> </ul>
<ul style="list-style-type: none"> <li>• State</li> <li>• County</li> <li>• Latitude</li> <li>• Longitude</li> <li>• Coal Province</li> <li>• Coal Region</li> <li>• Coal Field</li> <li>• District</li> </ul>	
<b>Lithology</b>	<b>Impurities</b>
<ul style="list-style-type: none"> <li>• Formation</li> <li>• Bed</li> <li>• Depth</li> <li>• Thickness</li> <li>• Ash Temperature</li> <li>• Coal Rank</li> </ul>	<ul style="list-style-type: none"> <li>• Sulfur</li> <li>• Ash</li> <li>• Silicone Dioxide</li> <li>• Aluminum Oxide</li> <li>• Calcium Oxide</li> <li>• Magnesium Oxide</li> <li>• Manganese Oxide</li> <li>• Sodium Oxide</li> <li>• Potassium Oxide</li> </ul>
<b>Coal Characteristics</b>	<ul style="list-style-type: none"> <li>• Ferric Oxide</li> <li>• Others</li> </ul>
<ul style="list-style-type: none"> <li>• BTU</li> </ul>	

A summary of the proved, produced, and remaining coal resource is displayed in table II-3. This data was derived from the COALQUAL Database.

Bechtel Report - The Bechtel Corporation produced a report entitled “Baseline Design/Economics for Advanced Fischer-Tropsch Technology” for the U.S. Department of Energy Federal Energy Technology Center in 1998<sup>9</sup>. As a part of this report, evaluations of several varying cases using F-T technology were completed.

Data from the USGS COALQUAL Database and the Bechtel Report is utilized in the resource database of the model. Rather than predefined tracts as in the oil shale case, the user has the option to choose the location and size for a Fischer-Tropsch (F-T) project. Based on their input, the model draws data from the COALQUAL Database to determine the resource that is available in that location. The model also determines the yield of the coal resource depending on the region based on the Bechtel Report. The user defined input and resource data together create a prototype project. Table II-4 provides six examples of prototype projects set in various states. The columns that are highlighted represent the data points that are extracted from the USGS COALQUAL Database (reserves) and the Bechtel Report (yield, propane, butane, jet/gasoline, and diesel).

**Table II-3. Coal Resource Characterization**

	State	Rank	Coal Reserves (Million Tons)		
			Proved	Produced	Remaining
Eastern Coal	AL	Bituminous	13,754	1,716	12,038
	KY - Eastern	Bituminous	33,440	5,031	28,409
	KY - Western	Bituminous	40,989	2,344	38,645
	MD	Bituminous	859	358	501
	OH	Bituminous	46,274	3,456	42,818
	PA	Bituminous	71,008	10,905	60,103
	TN	Bituminous	1,884	641	1,243
	VA	Bituminous	10,775	2,100	8,675
	WV	Bituminous	100,299	11,087	89,212
Western Coal	AK	Bituminous	19,429		
		Subbituminous	110,697		
	AZ	Bituminous	10,830	134	10,696
		Subbituminous	9,625	118	9,507
	CO	Bituminous	63,259	731	62,528
		Subbituminous	18,492	213	18,278
	IL	Bituminous	137,330	5,680	131,650
	IN	Bituminous	37,293	2,073	35,220
	MT	Subbituminous	132,151	553	131,598
	ND	Lignite	350,910	639	350,271
	NM	Bituminous	10,948	108	10,840
		Subbituminous	50,801	502	50,299
	TX	Bituminous	8,977	516	8,461
		Lignite	7,059	405	6,654
	UT	Bituminous	25,885	658	25,228
WY	Bituminous	13,235	321	12,914	
	Subbituminous	123,628	2,994	120,634	

40% of Existing Coal Resources

60% of Existing Coal Resources

**Table II-4. An Example of Six Fischer-Tropsch Prototype Projects**

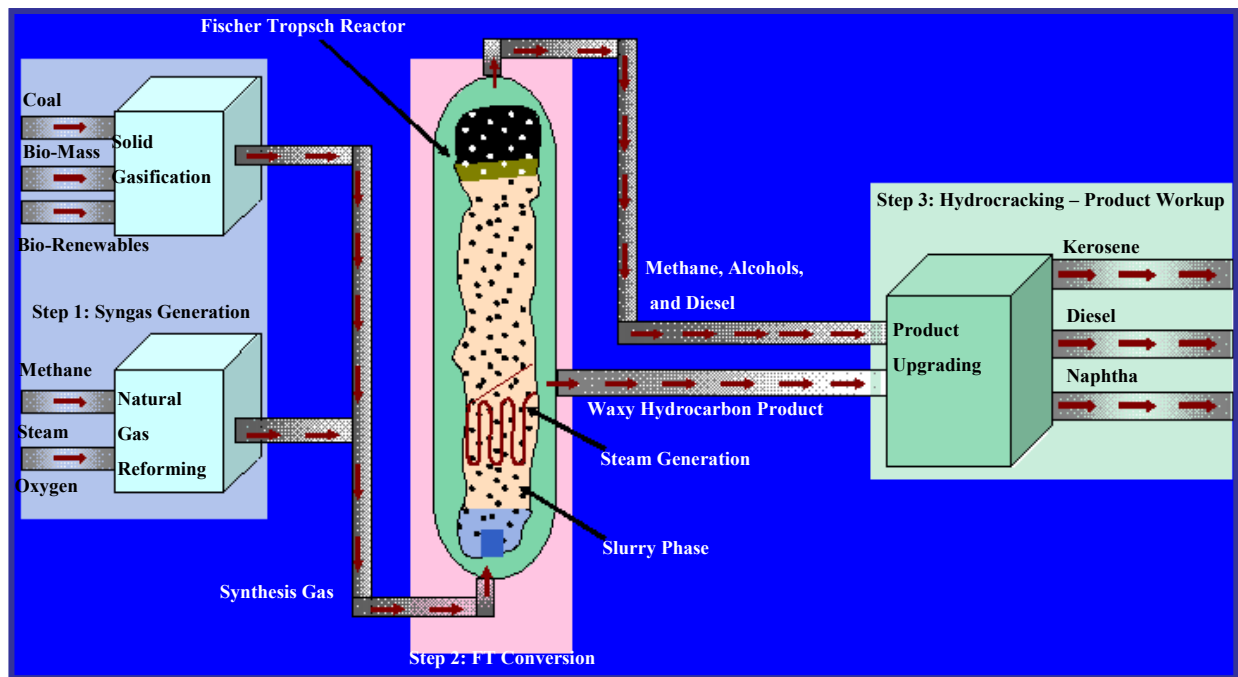
Capacity is Barrels of Liquid per Day				Plant Details				Yield: BOE/day per Plant			
Project Number	Project Name	State	Plant Size	Reserves (million tons)	Life	Yield (bbl/ton)	Max Number of Plants	Propane	Butane	Jet/Gasoline	Diesel
G01	Pennsylvania	PA	5,000	60,103	40	2.28	1,874	39	18	3,154	1,652
G02	KY East	KY - Eastern	34,000	28,409	40	2.28	130	263	119	21,446	11,231
G03	KY East	KY - Eastern	34,000	28,409	40	2.28	130	263	119	21,446	11,231
G04	KY East	KY - Eastern	34,000	28,409	40	2.28	130	263	119	21,446	11,231
G05	Illinois	IL	34,000	131,650	20	2.28	1,207	263	119	21,446	11,231
G06	Illinois	IL	34,000	131,650	40	2.28	603	263	119	21,446	11,231

**Technology Options**

Coal can be converted to liquid fuels through either direct or indirect liquefaction. The model currently only includes indirect liquefaction. Indirect liquefaction involves gasifying the coal and converting the resulting “synthesis gas” to liquid fuels by Fischer-Tropsch (F-T) or other conversion technology. Indirect liquefaction appears to be the favored technology for conversion of coal to liquids on a significant scale. The model represents indirect liquefaction using the F-T Conversion process. Figure II-6 displays the process for this technology.

This technology produces hydrocarbon liquids from syngas by using an F-T process reactor, developed to convert CO and hydrogen to liquid hydrocarbons using iron and cobalt catalysts. The F-T process is comparable with a polymerization process resulting in a distribution of potential products from the process. In general the product range includes the light hydrocarbons methane and ethane, LPG, gasoline, diesel, and waxes.

Figure II-6. Fischer Tropsch Coal Liquefaction Process



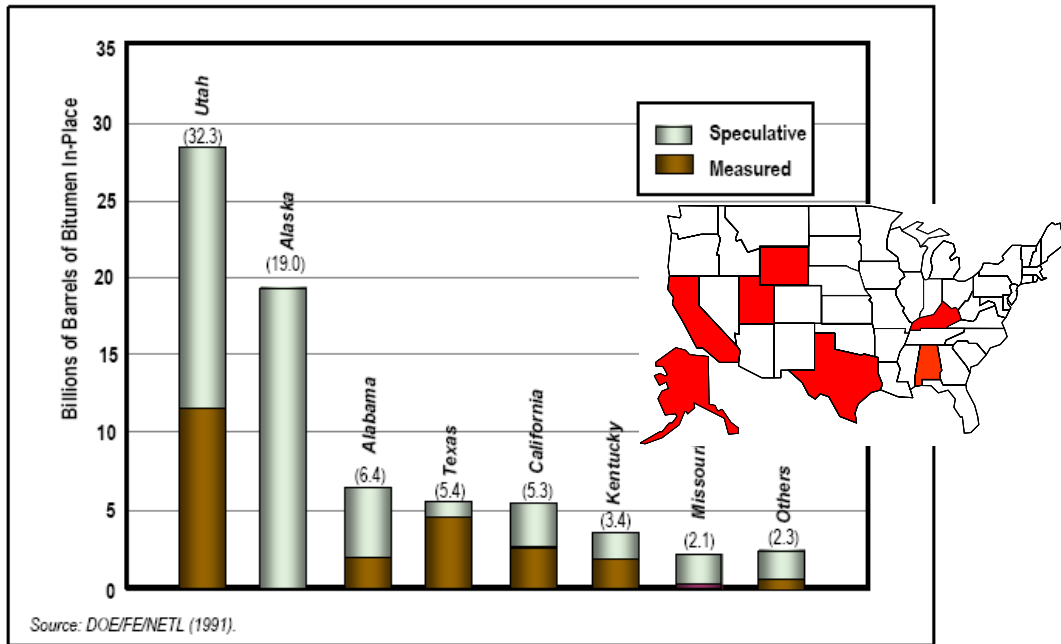
### 3. Tar Sands

The U.S. tar sands resource in place is estimated to be 60 to 80 billion barrels of tar sands<sup>10</sup>. About 11 billion barrels of U.S. tar sands resources may ultimately be recoverable. The U.S.'s largest measured tar sands deposits are found in Utah. Utah has about one-third of the domestic resource, of which the majority is concentrated in the eastern portion of the state, predominantly on public land. The rest is found in deposits located in Alabama, Texas, California, Kentucky, and other states.

The tar sands resource is characterized by both measured and speculative volumes. Figure II-7 displays the location of the tar sands resource, as well as the distribution of measured and speculated volumes of tar sands in place in the U.S.

A significant portion of tar sands deposits on public land overlay oil and gas deposits. In addition, a considerable share of the resource is located in or in close proximity to national or state parks, wilderness areas, or pristine environments<sup>11</sup>. Both of these factors may constrain development or restrict the application of some technologies.

**Figure II-7. Distribution of U.S. Tar Sands Resource**



**Resource Database**

To construct the resource database for tar sands, the International Centre for Heavy Hydrocarbons U.S. Bitumen Database 1993<sup>12</sup> was utilized. This source includes data on: tar sands location, depth, area, pay, geologic properties, and fluid properties. Table II-5 provides a summary of the variables contained within the Bitumen Database. Each deposit is evaluated on a lease by lease basis, with each lease having a size of 5,120 acres.

**Table II-5. Tar Sand Resource Properties from U.S. Bitumen Database**

Location	Tar Sands Characteristics
<ul style="list-style-type: none"> <li>• Deposit Name</li> <li>• Reservoir Name</li> <li>• State</li> </ul>	<ul style="list-style-type: none"> <li>• Resource in Place</li> <li>• Size</li> <li>• Porosity</li> <li>• Permeability</li> <li>• Bitumen Saturation</li> <li>• Thickness</li> <li>• API Gravity</li> <li>• Sulfur Content</li> </ul>
<b>Lithology</b> <ul style="list-style-type: none"> <li>• Depth</li> <li>• Rock Type</li> </ul>	

Twenty-eight deposits from the International Centre for Heavy Hydrocarbons U.S. Bitumen Database were used, eliminating those deposits that did not have complete information from consideration. Table II-6 displays the deposits with a sample of the data that is used in the resource database.

**Table II-6. Tar Sands Resource Data, Deposits**

Deposit Number	Deposit Name	State	Depth Range (ft)		Original Oil In Place (MMBbl)	Size (Acres)	Net Thickness (ft)	Recovery Process		Yield (Bbls/ton)
			From	To				Mine	In-situ	
204	Burnt Hollow	WY	600	1,000	120	3,500	33	0	1	0.11
189	Tar Sand Triangle	UT	200	1,500	2,300	93,000	158	0	1	0.70
186	Sunnyside	UT	0	500	4,400	35,000	105	1	1	0.07
177	P.R. Spring	UT	0	300	2,100	60,000	29	1	1	0.11
154	Asphalt Ridge	UT	20	600	800	29,000	21	1	1	0.23
164	Hill Creek	UT	0	300	190	10,100	80	1	1	1.00
165	Hill Creek	UT	200	400	130	6,400	87	0	1	0.47
152	San Miguel	TX	0	2,400	3,200	115,000	29	1	1	0.27
144	Anacacho	TX	0	500	550	8,400	34	1	1	0.07
149	Hensel	TX	1,000	0	120	8,100	13	0	1	0.15
103	Big Clifty	KY	0	600	1,190	150,000	11	1	1	0.11
104	Caseyville	KY	20	170	300	35,000	8	1	1	0.05
107	Hardinsburg	KY	125	440	250	66,000	6	0	1	0.13
46	Cat Canyon	CA	3,500	0	610	6,000	79	0	1	0.17
74	Oxnard Vaca Tar Sand	CA	1,800	2,500	500	1,765	139	0	1	0.09
53	Edna-Arroyo Grande	CA	0	460	310	2,140	140	1	1	0.23
54	Edna-Indian Knob	CA	0	670	230	1,450	142	1	1	0.13
47	Cat Canyon	CA	3,000	0	220	740	122	0	1	0.10
93	Zaca - Laguna Ranch	CA	10	340	90	620	134	1	1	0.21
41	Casmalia	CA	0	790	140	297	342	0	0	0.18
4	Hartselle	AL	0	1,000	1,760	534,000	12	1	1	0.24

Note that a “one” in under the mine or in-situ categories for recovery process indicates that the deposit is suitable for that recovery technology. A “zero” indicates that the deposit is not suitable for the process. For the deposits with ones in both categories, the model evaluates the deposit for both technologies and selects the most economic process.

### ***Technology Options***

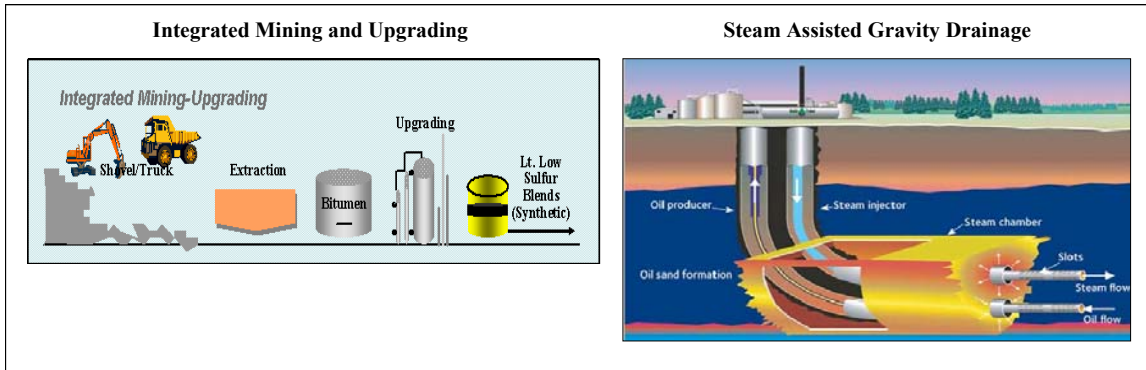
The technology to be used for producing tar sands varies with the nature of the resource and its depositional setting. Shallower, colder resources are more viscous, but more easily accessible by surface mining. Deeper, warmer resources are less viscous, but may still require heating to make them producible by pumping technologies. Mining and in-situ processing are the two general categories of processing for tar sands.

Tar sands deposits near the surface can be recovered by open pit mining techniques. The systems use large hydraulic and electrically powered shovels to dig up tar sands and load them into enormous trucks that can carry up to 320 tons of tar sands per load. Once the tar sands have been mined, the bitumen is extracted from the sand. If it works similar to oil sand extraction in Canada, hot water is added to the sand and the slurry is agitated, causing the bitumen to float to the top of the vessel, where it is skimmed off. The bitumen is later upgraded into synthetic crude oil. About two tons of tar sands will yield one barrel of oil and roughly 75% of the bitumen is recovered using this process.

In-situ production methods are used on bitumen deposits buried too deep for mining to be economical. The predominant technique for in-situ production is steam assisted gravity drainage (SAGD). It works with paired horizontal wells; steam is injected in the upper well and oil is extracted through the lower well. This process has a 60-70% recovery rate of original oil in place. Figure II-8 illustrates both technologies modeled by the NSURM system.



**Figure II-8. Modeled Tar Sand Technologies**

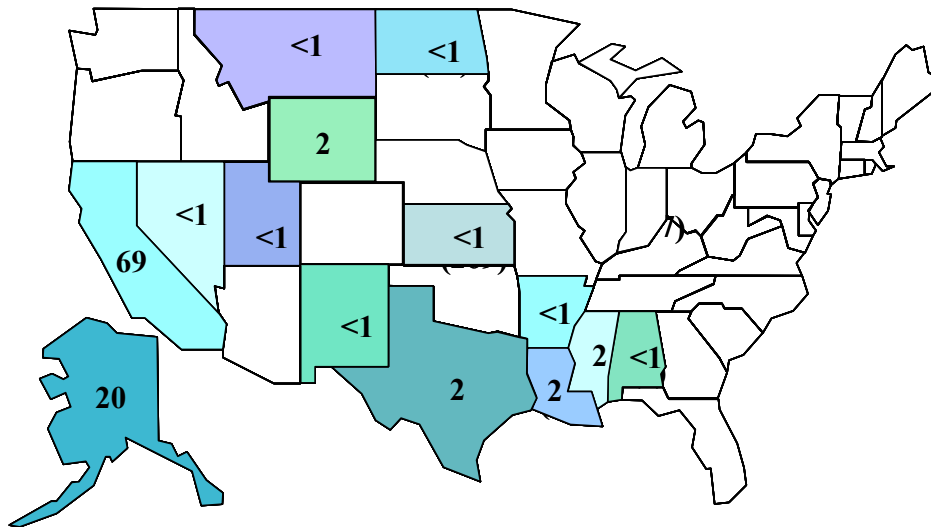


#### 4. Heavy Oil

The heavy oil resource base of the United States is approximately 98 billion barrels, which is mostly concentrated in California and Alaska<sup>13</sup>. Eighteen billion barrels have already been produced and 3 billion are estimated reserves. The remaining 77 billion barrels represent the target resource for future applications of heavy oil technologies.

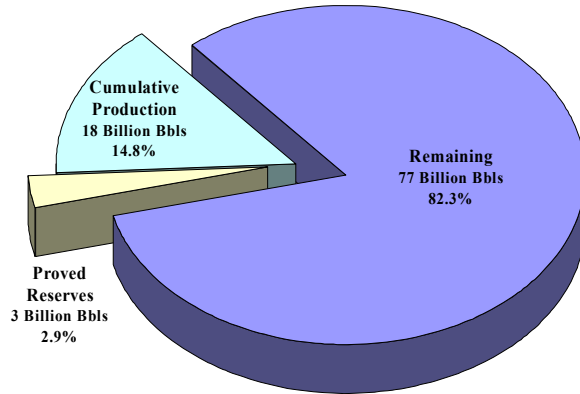
Figure II-9 shows the distribution of the Nation’s heavy oil resources by state. California has the majority of the heavy oil resources with 70% of the total. Alaska has the next largest concentration of heavy oil deposits with 20%. The remaining heavy oil resources are largely concentrated in states that border the Gulf of Mexico and in Wyoming.

**Figure II-9. Distribution of U.S. Heavy Oil Resource (Original Oil in Place, Billion Barrels)**



Heavy oil is found in both shallow and deep reservoirs. The porosity, permeability, thickness, and depth were characterized in the “Status of Heavy Oil and Tar Sands Resource in the U.S.” by Edward J. Hanzlick in 1998<sup>14</sup>. As seen in figure II-10, the target resource for heavy oil production in 77 billion barrels.

**Figure II-10. U.S. Heavy Oil Resource Potential**



**Resource Database**

For the purpose of the heavy oil resource database, DOE’s TORIS and COGAM Models were used as sources of data. A total of 761 fields/reservoirs in 14 states are characterized by the DOE. The data on these fields/reservoirs that is available from these models includes: heavy oil resource location, reservoir properties, geologic properties, PVT properties, development history, production history, and well counts. Table II-7 displays a subset of the reservoirs characterized in the resource database.

**Technology Options**

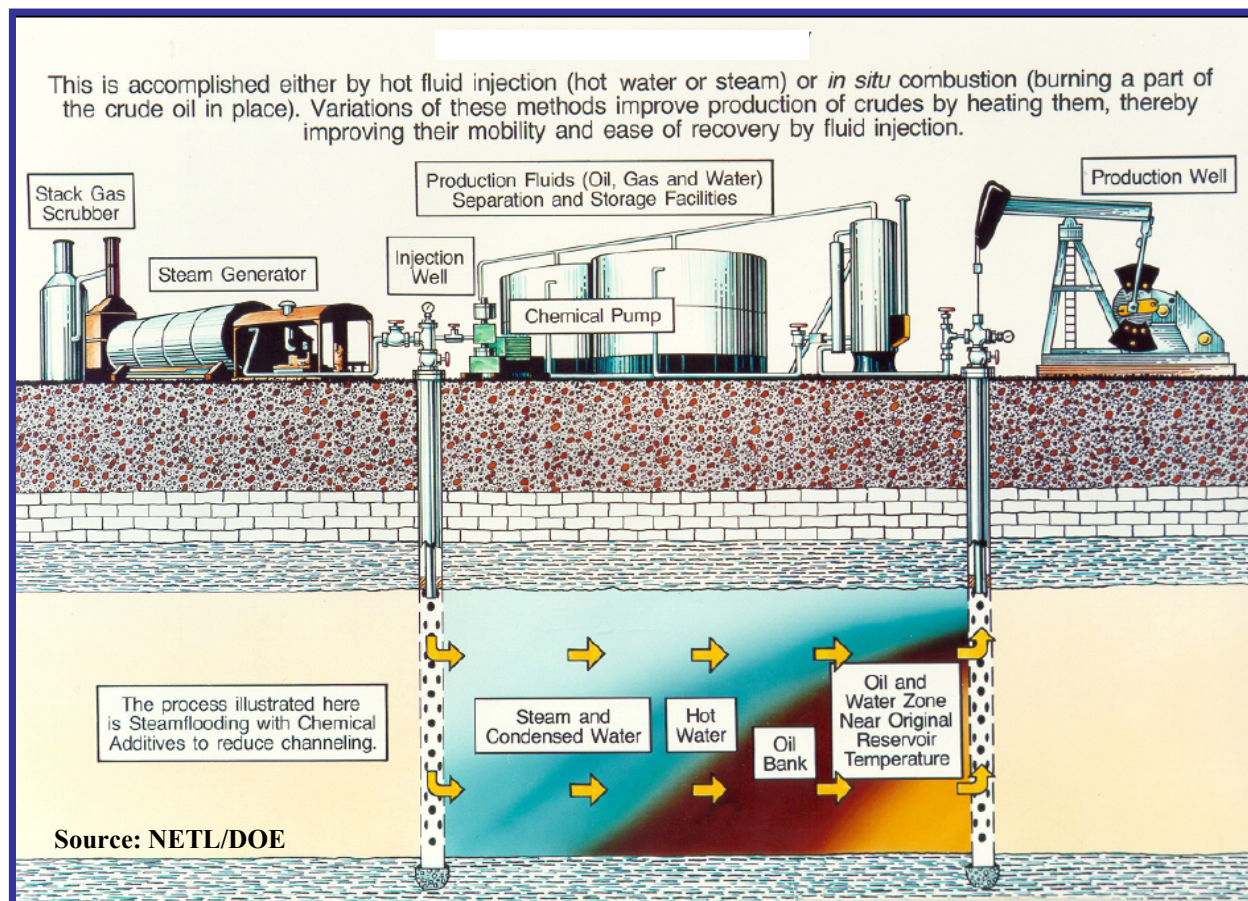
For shallow (<3,000’) heavy and extra-heavy crude oil and bitumen deposits, thermal processes are the predominant recovery methods. These thermal processes reduce the oil viscosity and permit oil to flow toward wells where it is produced. Steam flooding is the primary technology used to mobilize heavy oil and is represented by the model.

**Table II-7. Heavy Oil Resource Data**

Formation Name	Reservoir Name	State	Lithology	Original Oil In Place (MMBbl)	Area (Acres)	Depth (Ft)	Pay (Ft)	API (Deg)
Tabasco	Schrader Bluff	AK	Sandstone	56	80	3,128	533	17
El Dorado, East	Nacatoch	AR	Sandstone	210	10	2,165	59	21
Aliso Canyon: Main	Aliso	CA	Sandstone	22	143	4,203	89	15
Hasley Canyon	Model	CA	Sandstone	33	200	4,019	200	16
Los Angeles City	Puente	CA	Sandstone	82	56	937	62	16
Deer Creek	Santa Margarita	CA	Sandstone	7	290	727	20	16
Antelope Hills: Williams	Agua	CA	Sandstone	59	450	2,151	85	17
Tejon: Southeast	Fruitvale	CA	Sandstone	26	200	1,761	102	17
Wheeler Ridge: Northeast	Fruitvale	CA	Sandstone	5	60	2,923	39	18
Whittier: Rideout Heights	Repetto	CA	Sandstone	18	57	1,776	214	20
Midway-Sunset	Monterey	CA	Unknown	73	260	3,237	50	21
Catharine, Northwest	Arbuckle	KS	Dolomite	4	90	3,603	21	21
Iberia	Pliocene	LA	Sandstone	99	440	833	55	20
Langsdale	Eutaw	MS	Sandstone	69	40	3,638	27	19
Big Wall	Aslaka Bench	MT	Carbonate/Lime	6	120	2,508	17	19

Steam flooding, illustrated in figure II-11, requires reservoir management. This has been improved by California operators who have pioneered the collection and application of geo-statistical data to visualize and manage thermal recovery processes. Technical data collected from hundreds of thermal observation wells (temperature profiles, oil saturation changes, and other technical data) are linked to reservoir description models by computer. The operator uses this information to visualize movement of oil in the reservoir and to adjust process conditions to optimize performance. Confidence in this improved ability to characterize the reservoir and monitor steam flood performance permitted Texaco to drastically change its Kern River strategy from one of flooding zones one at a time to one of flooding many zones simultaneously.

**Figure II-11. Steam Flooding**



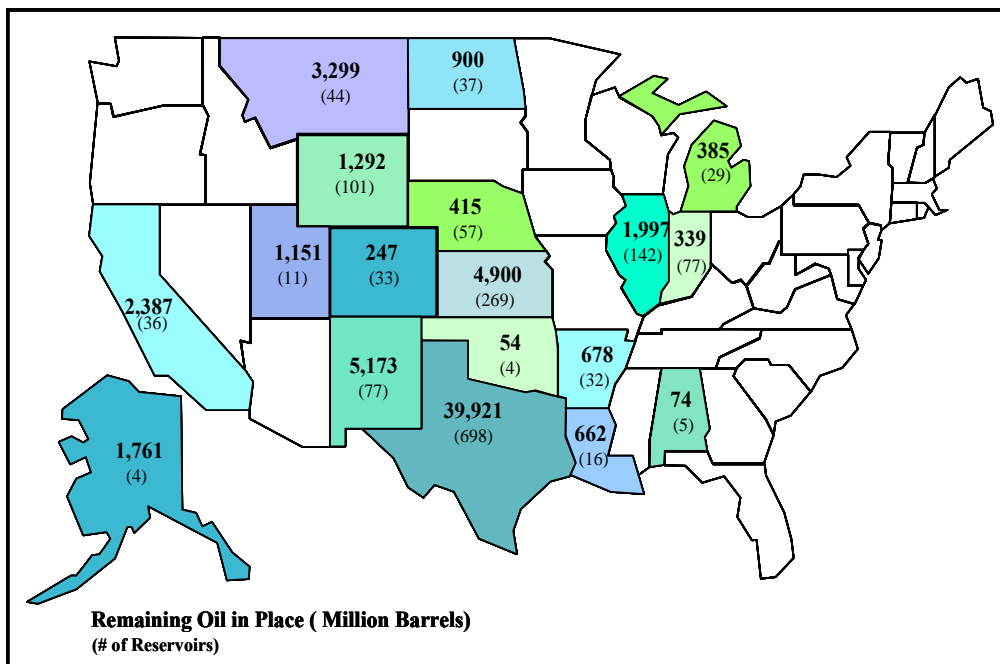
## 5. CO<sub>2</sub> Enhanced Oil Recovery

The total known original oil-in-place (OOIP) for conventional oil fields ever discovered in the U.S. is estimated at 630 billion barrels<sup>15</sup>. By the end of 2004, about 198 billion barrels had already been produced. A portion of the remaining OOIP can be produced under current economic conditions, while 410 billion barrels remaining in the reservoirs is considered a target for newer, more efficient, and more cost effective extraction technologies.

Figure II-12 provides a distribution of the number of candidate fields/reservoirs and their target resource, by state. More than two-thirds of the target resources are located in the Permian Basin, where the majority of the existing CO<sub>2</sub>-Miscible projects are located. The balance of the target

resource is located in fifteen states. The candidate CO<sub>2</sub> enhanced oil recovery projects are in existing oil producing fields, and are located both on public and private lands.

**Figure II-12. Remaining Oil in Place for Candidate Reservoirs for CO<sub>2</sub> Flooding**



**Resource Database**

There are a total of 1,673 fields/reservoirs in 17 states that have been identified as candidates for CO<sub>2</sub>-Miscible flooding in the United States by the Department of Energy. These fields and reservoirs collectively account for 146 billion barrels of OOIP, with 65 billion barrels of remaining immobile oil as the target resource for CO<sub>2</sub>-miscible flooding.

The DOE TORIS and COGAM Models are the sources of data for the heavy oil resource database. Statistics available from these models include: heavy oil resource location, reservoir properties, geologic properties, PVT properties, development history, production history, and well counts. Table II-8 displays a subset of the reservoirs characterized in the resource database.

**Technology Options**

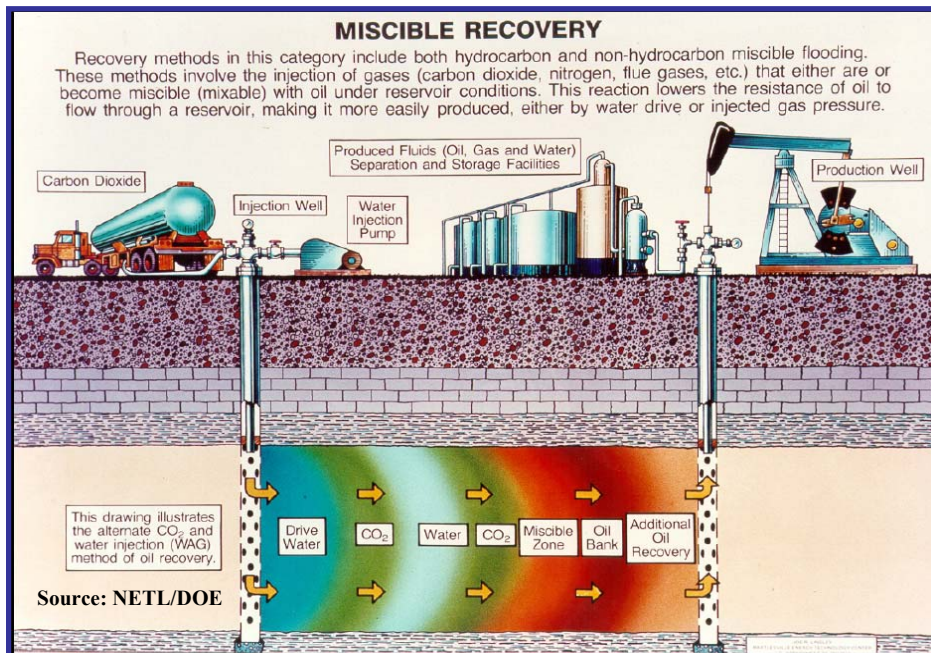
To achieve recovery of stranded oil in conventional wells, CO<sub>2</sub> enhanced oil recovery (EOR) can be utilized. The model represents CO<sub>2</sub> EOR. It has been shown to be highly effective in both sandstone and carbonate reservoirs. The process works especially well if injected at a pressure high enough to cause the injected gas and the oil to completely mix and stay mixed. The injected CO<sub>2</sub> flows into the previously water-swept portion of the reservoir, where it displaces the mobile water and mixes and swells the oil left in the pore space. With repeated contact of injected gas and oil, the CO<sub>2</sub> extracts the more volatile portions of the crude to form an enriched CO<sub>2</sub>-hydrocarbon mixture. This mixture then displaces most of the oil it contacts, leaving behind a very small quantity of tar-like oil.

**Table II-8. CO<sub>2</sub> Enhanced Oil Recovery Resource Data**

Formation Name	Reservoir Name	State	Lithology	Original Oil In Place (MMBbl)	Area (Acres)	Depth (Ft)	Pay (Ft)	API (Deg)
Endicott	Ivishak	AK	Sandstone	60	100	10,147	245	25
Trading Bay	Middle Ground S	AK	Sandstone	277	840	2,386	143	26
Sandy Bend	Nacatoch	AR	Sandstone	209	10	2,271	35	25
Montebello	Repetto	CA	Sandstone	344	651	2,324	207	25
Sansinena Area	Puente	CA	Sandstone	39	35	3,990	450	25
Seal Beach	Repetto	CA	Sandstone	199	73	2,817	345	26
Dopita	Arbuckle	KS	Dolomite	19	1,060	3,415	10	26
Pennfield 35-01S-07W	A-1 Carbonate	MI	Dolomite	19	880	2,877	62	26
Haas & North	Madison	ND	Carbonate/Lime	81	4,400	3,931	21	25
Bird	Minnelusa	NE	Sandstone	4	240	6,892	14	26
Flying M	San Andres	NM	Dolomite	95	7,520	4,512	16	26
South Sand Belt	Yates-Seven	TX	Carbonate/Lime	5,270	24,705	2,339	65	25
Seventy-Six, South	Cole	TX	Sandstone	6	54	1,384	74	25
Duvall Ranch	Minnelusa	WY	Sandstone	77	1,040	8,116	49	25
Gebo	Tensleep	WY	Sandstone	32	345	4,932	150	25

Because the injected CO<sub>2</sub> has a low viscosity relative to the residual oil and water, it tends to finger through the more permeable parts of the reservoirs, and often move quickly through the top of the reservoir, thus overriding the oil. To minimize these effects, water is often injected with the CO<sub>2</sub> in alternating “slug”, which increases the portion of the previously swept zone contacted by the injectant. The combination of swelling, mixing, and sweeping, can effectively recover a portion of the immobile oil. As CO<sub>2</sub> injection continues, water, oil, and CO<sub>2</sub> are recovered at the producing wells. The recovered CO<sub>2</sub> is separated, re-pressured, and re-injected. The CO<sub>2</sub>-Miscible flooding, if designed properly, could produce up to 15% of OOIP in a given reservoir. Figure II-13 displays the CO<sub>2</sub> EOR process.

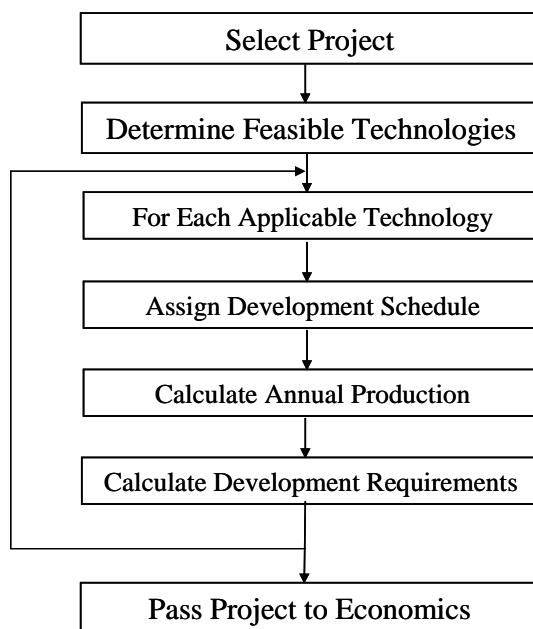
**Figure II-13. Miscible Recovery**



## C. Development Schedule and Constraints

The process screening module prepares the projects contained in the resource database for analysis by the economic module. In this step, the technology is assigned to the project, and necessary data and profiles are generated. After the project data is prepared it is passed to the economic module for detailed analysis. The steps performed by the process screening module are illustrated in figure II-14, and described below.

Figure II-14. Process Module Flowchart



In order to determine the applicable technology or technologies, the process screening module applies a series of rules. These rules are based upon current mining and drilling practices, and have been vetted by experts in resource modeling and other industry experts. These rules use resource properties such as: depth, thickness, overburden, dip angle, area, original oil in place, API gravity, porosity, permeability, viscosity, and other geological and petrochemical properties.

In addition to selecting the technology, the process screening module assigns the project's development schedule, determines the resource development requirements, and develops the profiles for the project's annual product and byproduct production and feedstock requirements.

The following sections will provide details of the development schedule, resource development constraints, and production profiles.

### 1. Development Schedule

Resource and process specific development schedules are assigned to each tract. The schedules are defined by three factors: the number of stages, the maximum capacity, and the developmental lead time for each stage. These factors will be described for each resource considered.

#### *Oil Shale*

The model allows the user to specify the number and capacity of the development stages as well as determine the lead time for the project. A set of technology specific default schedules have

been developed using current understanding of mining practices and other industry data. These schedules have been thoroughly reviewed by oil shale, mining, DOE, and other industry experts.

### ***Coal to Liquids***

The user may specify the state, capacity, and product slate of the coal to liquid projects. The capacity is measured in barrels of liquid produced daily. The product slate includes propane, butane, diesel, and either jet fuel or gasoline. The model uses state specific yield factors dependent upon the quality of the state's coal. These factors are used to determine the components of the product slate:

- The number of barrels of liquid produced from a ton of coal
- The fraction of the liquid production which is diesel, gasoline, or jet fuel
- The volume of propane and butane produced from a ton of coal
- The amount of sulfur produced from a ton of coal
- The number of tons of coal required to meet the user specified plant capacity

### ***Tar Sands***

For each tar sand lease in the database, the model calculates the maximum capacity of the project. The plant capacity for the mining projects is equal to the production rate, dependent upon the reserves and the deposit's yield, which can be sustained throughout the life of the project. The maximum capacity for a tar sand mining project is 90,000 barrels per stream day. The maximum capacity of a SAGD project is dependent upon the recovery factors calculated using the deposit specific petrophysical properties. The capacity of the tar sand project includes both the extraction and the upgrading facilities.

The development schedules and lead times for the tar sand mining projects were developed based upon the Canadian Oil Sand industry<sup>16</sup>. The development schedules for the SAGD projects are determined using the maximum production rate for the individual deposits and the development of existing heavy oil projects.

### ***Heavy Oil***

The capacity of the heavy oil project is calculated by the model. It is the maximum production rate for the reservoir.

### ***CO<sub>2</sub> Enhanced Oil Recovery***

The capacity of the CO<sub>2</sub> EOR project is calculated by the model. It is the maximum production rate for the reservoir.

Table II-9 presents the maximum capacity and the number of stages for each process modeled by NSURM. The plant capacity is specified as 1000 Bbl per stream day (MBbl/SD).

**Table II-9. Development Schedule Properties**

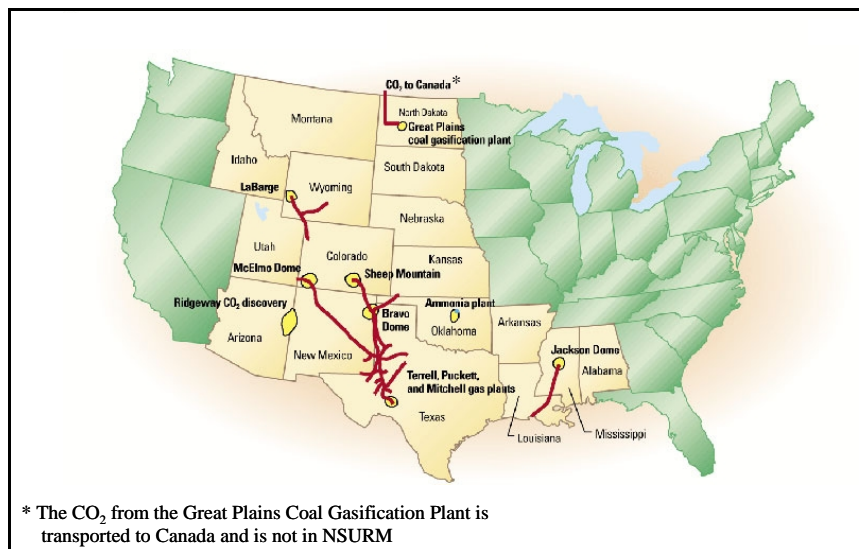
Resource	Process	Maximum Capacity (MBbl/SD)	Number of Stages
Oil Shale	Surface Mining	100	4
	Underground Mining	100	4
	Modified In-Situ	100	2 – 3
	True In-Situ	300	1
Coal to Liquids	Fischer Tropsch	34	1
Tar Sands	Mining	90	2 – 4
	SAGD	Deposit Specific	2
Heavy Oil	Steam Flood	Reservoir Specific	1
CO <sub>2</sub> EOR	Carbon Dioxide Flood	Reservoir Specific	1

## 2. Resource Development Constraints

Unlike conventional resources, unconventional resources are systematically developed over time using the following steps: siting and permitting, engineering, environmental impact statements, and investments. As described in the previous section, each resource is developed differently based on technology.

In addition to the above resources, depleted oil reservoirs subject to CO<sub>2</sub> flooding are constrained by the availability of CO<sub>2</sub>. The existing CO<sub>2</sub> sources and pipelines have been incorporated into the NSURM system. There are currently seven pipeline systems that transport CO<sub>2</sub> to areas where the CO<sub>2</sub> flooding projects are located. For the existing projects in the Permian Basin, the sources are McElmo Dome, Sheep Mountain, and Bravo Dome, all natural sources of CO<sub>2</sub>. In the Gulf Coast area, the sources of the CO<sub>2</sub> are Jackson Dome in Mississippi, and LaBarge Dome in Wyoming. Figure II-15 shows the location of these pipeline systems, and table II-10 provides their throughputs. These pipelines collectively transport about 2.6 BCF per day of CO<sub>2</sub> from their sources to the projects. It should be noted that the CO<sub>2</sub> produced in North Dakota is currently being sent to the Weyburn project in Canada. This CO<sub>2</sub> is not being modeled by NSURM. The primary source of the data on CO<sub>2</sub> pipelines and availability was Kinder Morgan.

**Figure II-15. Current Natural Sources of CO<sub>2</sub>**





Additional sources of CO<sub>2</sub> may be available from coal to liquid plants if they are strategically located. The volumes of CO<sub>2</sub> produced by the project were developed from available industry data, particularly the Great Plains Coal Gasification Plant. The model currently assumes that the additional CO<sub>2</sub> produced at coal to liquid plants is available for future CO<sub>2</sub> projects.

**Table II-10. CO<sub>2</sub> Pipeline Capacities**

Source	Pipeline	States Supplied	Daily Rate
			MMCF/D
LaBarge	LaBarge	Wyoming	250
		Colorado	
Jackson Dome	Denbury-Jackson	Mississippi	220
McElmo Dome	Cortez	Texas	1,100
	McElmo Creek	Utah	60
Sheep Mountain Dome	Sheep Mountain	Texas	480
Bravo Dome	Bravo	Texas	382
Val Verde Gas Plants	Val Verde	Texas	70
Oklahoma Fertilizer Plant	Local Pipeline	Oklahoma	35
Total Daily Rate			2,597

### 3. Project Production Profile

The process screening module also determines the annual production profile for each project. These profiles are developed based upon the current understanding of the recovery technology and the resource data contained in the resource database.

Table II-11 lists the resource properties used by the model to determine the annual production profile.

**Table II-11. Characteristics of the Production Profile**

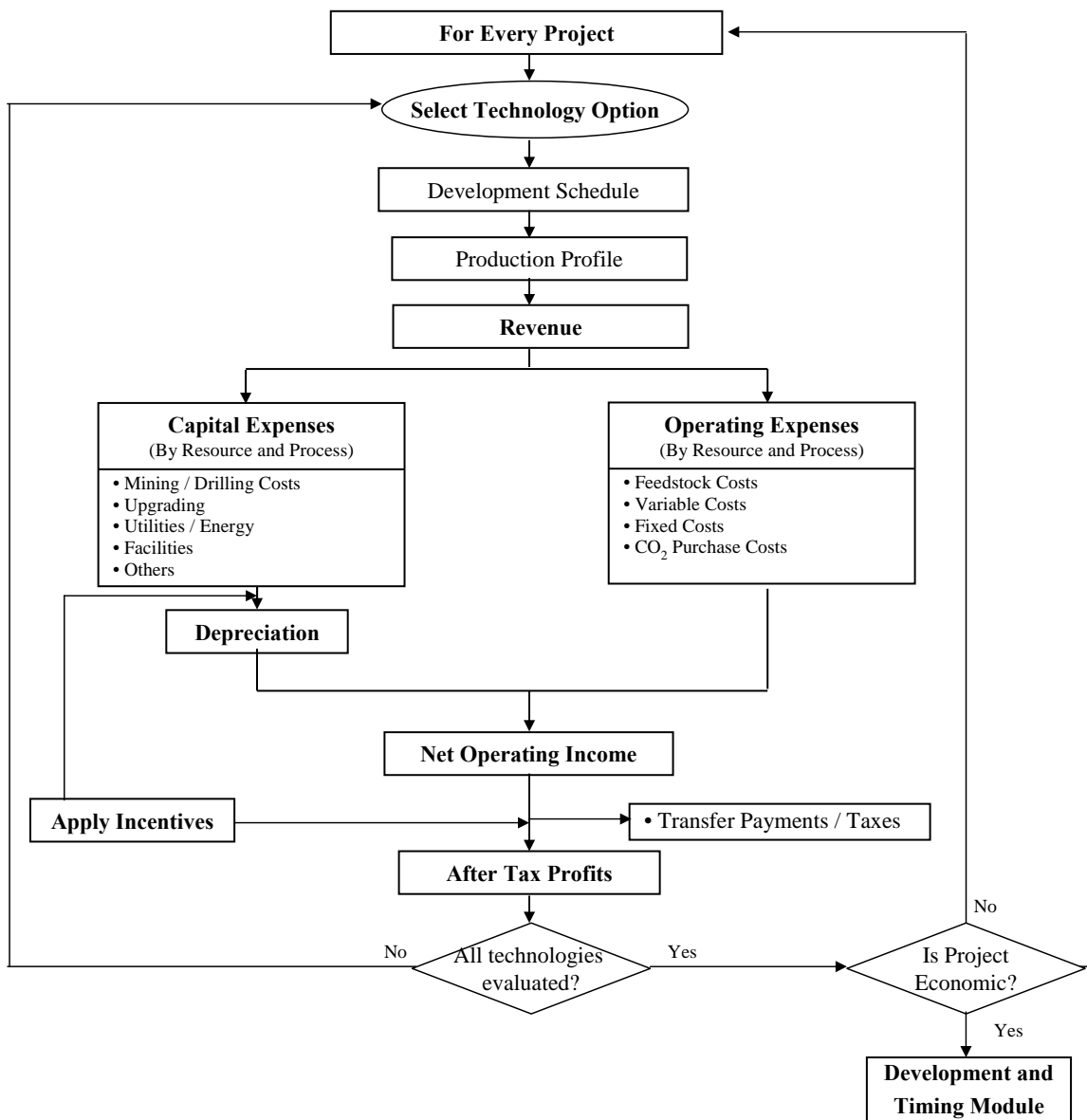
Resource	Process	Key Variables
Oil Shale	Surface Mining	Downtime, wasted tonnage, ooip, area, yield
	Underground Mining	Downtime, wasted tonnage, ooip, area, yield
	Modified in-Situ	Downtime, wasted tonnage, ooip, area, yield
	True in-Situ	Downtime, recovery efficiency, GOR, ooip, area, yield, heating time
Coal to Liquids	Fischer Tropsch	Downtime, wasted coal, coal type, coal source, btu content, ash content, sulfur content
Tar Sands	Mining	Downtime, area, ooip, yield, wasted sand
	Steam Assisted Gravity Drainage	Downtime, SOR, bitumen saturation, porosity, API gravity, depth, net pay, area, ooip, GOR
Heavy Oil	Steam Flooding	Pay, area, depth, temperature, viscosity, API gravity, Permeability, SOI, SOR, steam quality & injection rate, lithology
CO <sub>2</sub> EOR	Carbon Dioxide Flooding	Pay, area, depth, temperature, viscosity, API gravity, minimum miscibility pressure, SOI, SOR, porosity, permeability, WAG ratio, CO <sub>2</sub> injection rate, lithology

## D. Project Economics

This section describes the analytical methodology and the data required by the economics module. This module is the heart of the NSURM system. It performs the project level economic evaluation, using a standard cashflow analysis, for every project evaluated by the model. This module also determines the potential national benefits of the project. The results of this analysis are used in the timing and development module and the reports module to determine the project development order.

Each project evaluated by NSURM is subjected to a detailed economic cashflow analysis. This analysis, performed by the economics module, is used to determine the economic viability of a project. A brief description of the steps in the cashflow analysis, illustrated in figure II-16, is provided.

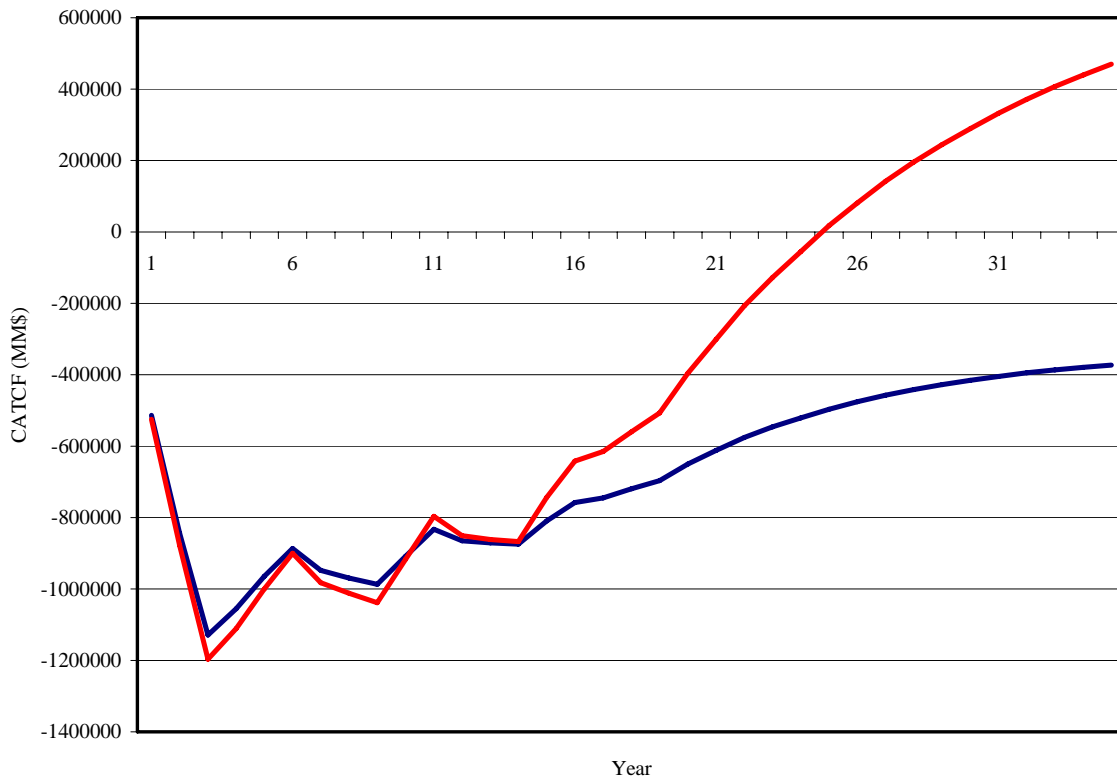
Figure II-16. Economic Module Flowchart



As seen in figure II-16, first a project is selected. The economic module then selects the first applicable technology option. The development schedule is used to determine the project's annual production. For oil shale, the products include oil, gas, and ammonia; for coal to liquids the products are gasoline (or jet fuel), diesel, propane, butane, sulfur, and carbon dioxide; for tar sands, heavy oil, and CO<sub>2</sub> EOR, the products are oil and natural gas. The product prices are used to calculate net revenue. The capital and operating expenditures are calculated using resource/process specific, and resource/process independent costs, the project development schedule, and the annual production. After calculating the depreciation for the project, the net operating income is determined. The incentives are applied both before the depreciation is calculated and to the net operating income. The transfer payments and taxes are calculated and used to determine the cumulative after tax cashflow. This process is repeated for each year of the project's lifespan. If there are more applicable technologies the model evaluates the next potential technology; otherwise it determines the economic viability of the project. If the project is economic, it is passed to the timing and development module.

Economic viability is determined through the net present value (NPV). The net present value is the cumulative after tax cash flow discounted using a specific rate of return. If the net present value is positive, the project is profitable and considered economic. However, a project with a negative NPV does not recoup its investments and is uneconomic at that rate of return. The cumulative after tax cashflow of a hypothetical project under two scenarios is shown in figure II-17.

**Figure II-17. Hypothetical Cumulative After Tax Cashflow Graphs**



The top line, which rises above the x-axis, is an economic project with a positive NPV. The other project, which remains below the axis, is an uneconomic project. In this case, the project represented by the top red line would be considered for development while the other is not.

The national economic benefits, discussed in section F, are calculated for each economic project. These benefits include the contribution made by the project to GDP, the value of imports avoided due to increased domestic production, the cumulative production of liquid and gaseous products, and the number of petroleum sector jobs created by the project. After the project is evaluated by the cash flow module, the results of the analysis are transferred to the development and timing module and the next project in the resource database is evaluated.

The cost and economic data required by the module are divided into four categories: (1) Capital costs, (2) Operating costs, (3) Fiscal data, and (4) Price data. Detailed descriptions of each of these categories will be provided in this section.

## 1. Capital Costs

Capital costs encompass the costs of extraction, retorting, upgrading, and other equipment necessary for the production of oil. There are two types of capital costs: (1) resource/process independent costs, and (2) resource/process specific costs. Resource/process independent costs are applied to all recovery methods. The resource/process specific costs pertain to the specific technologies applied to the resource.

### *Resource/Process Independent*

Resource/Process independent capital costs are applied to all resources and all recovery technologies. Table II-12 provides the resource/process independent capital costs and the resource and technologies to which they are applied.

**Table II-12 Resource/Process Independent Capital Costs**

Cost Category	Oil Shale				Tar Sands		Enhanced Oil Recovery	
	U	S	MIS	TIS	Mining	SAGD	CO2	Heavy Oil
Drilling and Completion				√		√	√	√
Equipment costs for new producers				√		√	√	√
Lifting costs				√		√	√	√
Injection costs						√	√	√
Cost of capital	√	√	√	√	√	√	√	√

### *Resource/Process Specific*

The resource/process specific capital costs are specific to the resource type and the technology used to produce oil. These costs include extraction, retorting, upgrading, and the other equipment required for production.

#### Oil Shale

Capital costs for oil shale are specific to the production technology. These categories include mining, retorting, upgrading, and energy. For underground mining, surface mining, and modified in-situ, the costs were developed based on information available from a variety of sources, particularly the Prototype Leasing Program in the early 80's<sup>17</sup>. These costs were also escalated to 2004 dollars using Bureau of Labor Statistics (BLS) data. The capital costs were further validated with venter quotes. The true in-situ capital costs were obtained from industry sources. The capital cost categories for oil shale are provided in table II-13.

**Table II-13. Oil Shale Capital Costs**

Process					
Capital Cost	Unit	Surface	Underground	True In-Situ	Modified In-Situ
Mining	\$/Ton of Capacity	√	√		√
Retorting	\$/Ton of Capacity	√	√		√
Oil Recovery	\$/Bbl of Capacity	√	√	√	√
Oil Upgrading	\$/Bbl of Capacity	√	√	√	√
Utililites	\$/Bbl of Capacity	√	√	√	√
Facilites	\$/Bbl of Capacity	√	√		√
Others	\$/Bbl of Capacity	√	√		√

Coal to Liquids

The capital costs for coal to liquids are specific to the Fischer-Tropsch process. They include the cost of coal preparation, gasification, liquefaction, and other equipment required for the production of liquid products. The costs were developed using information from a variety of sources, particularly the 1998 DOE Baseline Design and Economic Analysis<sup>18</sup>. The costs were escalated to 2004 dollars and used to develop average costs. These costs were then validated and benchmarked with publicly available presentations and documents. The capital cost categories are provided in table II-14.

**Table II-14. Coal to Liquids Capital Cost Categories**

Capital Cost	Unit	Cost
Mining	\$/ton of capacity	√
Coal Preparation	\$/ton of capacity	√
Gasification	\$/ton of capacity	√
Catalysts	\$/ton of capacity	√
Liquefaction Synthesis	\$/ton of capacity	√
Gas Recovery/Separation	\$/bbl of capacity	√
Water Reclamation	\$/bbl of capacity	√
Others	\$/bbl of capacity	√
Chemical Recovery	\$/bbl of capacity	√
Utilities	\$/bbl of capacity	√
Site Preparation	\$/bbl of capacity	√

The mining cost is currently not included in the model because it assumes the coal is purchased on the market.

Tar Sands

The capital costs for tar sand processes include costs associated with both integrated mining and upgrading and the SAGD process. These costs include the extraction and upgrading of the bitumen. The costs for the mining process were developed using data from the Canadian Oil Sand industry<sup>19</sup>. The costs were converted and escalated to 2004 U.S. dollars and used to calculate average costs.

The capital costs for SAGD were developed using the Alberta Oil Sand data and heavy oil cost data derived from the Comprehensive Oil and Gas Model. The Canadian costs were converted and escalated to 2004 dollars before being used to calculate average costs. The categories are presented in table II-15.

**Table II-15. Tar Sands Capital Cost Categories**

	<b>Mining</b>	<b>SAGD</b>
Extraction	Underground/Surface mining operations	Drilling and Completion (horizontal wells)
	Crushing	Steam Generators
	Transportation	Manifolds & Pipelines
Upgrading	Upgrading Facilities	Upgrading Facilities

### Heavy Oil

The heavy oil capital costs include the cost of equipment required to perform steam flooding. The cost data used by NSURM is collected from the existing DOE Comprehensive Oil and Gas Analysis Model (COGAM). The cost categories are provided in table II-16.

**Table II-16. Heavy Oil Capital Cost Categories**

<b>Capital Cost</b>	<b>Unit</b>	<b>Cost</b>
Steam Generator	\$/generator	√
Manifolds	\$/acre	√

### CO<sub>2</sub> Enhanced Oil Recovery

The CO<sub>2</sub> EOR specific capital costs include the cost of equipment required to perform carbon dioxide flooding. The cost data used by NSURM is collected from the existing DOE Comprehensive Oil and Gas Analysis Model. The cost categories are provided in table II-17.

**Table II-17. CO<sub>2</sub> EOR Capital Cost Categories**

<b>Capital Cost</b>	<b>Unit</b>	<b>Cost</b>
CO <sub>2</sub> Recycling and Injection Plant	\$/Mmcf of Injection Capacity	√

## **2. Operating Cost**

The economic module calculates operating expenditures using average resource/process independent costs and resource/process specific costs. The cost categories used for each process and resource will be described in this section.

### ***Resource/Process Independent***

The economic module uses operating costs which are independent of the resource and the technology of the individual project. The costs and the resources and processes to which they are applied are provided in table II-18.

**Table II-18 Resource/Process Independent Operating Costs**

Cost Category	Oil Shale				Tar Sands		Enhanced Oil Recovery	
	U	S	MIS	TIS	Mining	SAGD	CO2	Heavy Oil
Lifting costs						√	√	√
Overhead	√	√	√	√	√	√	√	√
Maintenance	√	√	√	√	√	√	√	√
G&A on capital investments	√	√	√	√	√	√	√	√
G&A on operating expenditures	√	√	√	√	√	√	√	√

***Resource/Process Specific***

The resource and process specific operating costs are different for the various resources and technologies depending upon the extraction, retorting, and upgrading facilities required for each project.

Oil Shale

The operating and management costs for oil shale were developed based on the information available through a variety of sources, particularly the Prototype Leasing Program from the early 1980's<sup>20</sup>. These costs were escalated to 2004 dollars using the BLS data. The operating cost categories used by the economic module are provided in table II-19.

**Table II-19. Oil Shale Operating Cost Categories**

Operating Cost	Unit	Process			
		Surface	Underground	True In-Situ	Modified In-Situ
Mining	\$/Ton	√	√		√
Plant	\$/Bbl	√	√		√
Maintenance	\$/Bbl	√	√		
Finance and Administration	\$/Bbl	√	√		
Environmental, health and safety	\$/Bbl	√	√		
Electricity	\$/Bbl	√	√		
Natural Gas	\$/Bbl	√	√		
Chemicals	\$/Bbl	√	√		
Nitrogen/Water	\$/Bbl	√	√		
Contingency	\$/Bbl	√	√		√
Surface	\$/Bbl			√	
Subsurface	\$/Bbl			√	
Energy	\$/Bbl			√	

Coal to Liquids

The O&M costs for coal to liquids were developed based upon a number of studies and presentations performed for the Department of Energy and the Department of Defense. The primary sources of data were the 1998 Baseline Design and Economics Study. These costs were escalated to 2004 dollars and used to calculate average costs for the categories in table II-20.

**Table II-20. Coal to Liquid Operating Cost Categories**

Operating Cost	Unit	Cost
Water	\$/bbl	√
Contingency	\$/bbl	√
Electricity	\$/MegaWatt	√
Coal	\$/Ton	√
Catalysts	\$/bbl	√

Tar Sands

The O&M costs for tar sand projects were developed using available data from a variety of sources. The primary sources of data for the mining projects were the studies and annual reports made for the Canadian Oil Sand industry<sup>21</sup>. These costs were converted and escalated to U.S. dollars and used to determine average costs. The operating costs for SAGD projects were determined using the Canadian Oil Sand industry data and the cost data, for heavy oil production, gathered by EIA<sup>22</sup>. The operating cost categories are provided in table II-21.

**Table II-21. Tar Sands Operating Cost Categories**

Operating Costs	Unit	Process	
		Mining	SAGD
Overburden Removal	\$/Ton	√	
Production (Bitumen)	\$/Ton	√	
Purchased Energy (Bitumen)	\$/Ton	√	
Turnarounds & Catalyst	\$/Bbl	√	
Production (Upgrading)	\$/Bbl	√	√
Purchased Energy (Upgrading)	\$/Bbl	√	√
Corporate admin/research	\$/Bbl	√	
Steam Generation	\$/Bbl		√
Gas Processing	\$/Mcf		√

Heavy Oil

The O&M costs for heavy oil projects are collected from the existing DOE Comprehensive Oil and Gas Analysis Model (COGAM). The model and the costs have previously been vetted by industry and the DOE. The operating cost categories for heavy oil are provided in table II-22.

**Table II-22. Heavy Oil Operating Cost Categories**

Operating Cost	Unit	Cost
Fixed Annual Cost	\$/Bbl of Oil	√
Annual Cost for Secondary Production	\$/Bbl of Oil	√
Water Disposal Cost	\$/Bbl of Water	√
Water Injection Cost	\$/Bbl of Water	√
Operating Produced Water Plants	\$/Bbl of Water	√



## CO<sub>2</sub> EOR

The O&M costs for CO<sub>2</sub> Enhanced Oil Recovery projects are collected from the existing DOE Comprehensive Oil and Gas Analysis Model (COGAM). The model and the costs have previously been vetted by industry and the DOE. The operating costs are provided in table II-23.

**Table II-23. CO<sub>2</sub> EOR Operating Cost Categories**

Operating Cost	Unit	Cost
Fixed Annual Cost	\$/Bbl of Oil	√
Annual Cost for Secondary Production	\$/Bbl of Oil	√
CO <sub>2</sub> Recycling Cost	\$/Mcf of CO <sub>2</sub>	√
CO <sub>2</sub> Purchase Cost	\$/Mcf of CO <sub>2</sub>	√
Water Injection	\$/Bbl of Water	√

Carbon Dioxide prices are determined at the state level. This is done to reflect the transportation costs within the various states and regions. The economic module calculates CO<sub>2</sub> prices based upon oil price and regional cost factors. Table II-24 provides the CO<sub>2</sub> price by state for a range of oil prices.

**Table II-24. Regional CO<sub>2</sub> Prices (\$/Mcf)**

Oil Price (\$/Bbl)	U.S. Region						
	West TX, NM	CO	LA	MS	UT	WY	Other
\$ 30.00	\$ 0.89	0.89	\$ 1.11	\$ 0.89	\$ 0.89	\$ 0.89	\$ 1.78
\$ 40.00	\$ 1.02	1.02	\$ 1.28	\$ 1.02	\$ 1.02	\$ 1.02	\$ 2.04
\$ 50.00	\$ 1.15	1.15	\$ 1.44	\$ 1.15	\$ 1.15	\$ 1.15	\$ 2.30
\$ 60.00	\$ 1.28	1.28	\$ 1.60	\$ 1.28	\$ 1.28	\$ 1.28	\$ 2.56

### 3. Fiscal Data

The economic module uses fiscal data to calculate the transfer payments, taxes, and other elements required for the cashflow analysis. The fiscal data is specific to the resource and the states. The data includes: depreciation and amortization schedules, royalty, severance taxes, federal tax, state taxes, and tax credits for enhanced oil recovery. In this section, each type of data will be described.

#### *Depreciation and Amortization Schedules*

The user can select various depreciation schedules within the model. The schedules were obtained from the Internal Revenue Service. Tangible assets are depreciated using one of the following schedules:

- ❖ *Straight Line Depreciation*: expenses for tangible investments are evenly spread over a user-defined period with annual depreciation rates of 20%, 10%, or 5%. As seen in table II-25, the model uses the 20 year straight line depreciation as a default.

**Table II-25. Default Depreciation Schedule**

Year	Depreciation Rate	Year	Depreciation Rate
1	2.5%	12	5.0%
2	5.0%	13	5.0%
3	5.0%	14	5.0%
4	5.0%	15	5.0%
5	5.0%	16	5.0%
6	5.0%	17	5.0%
7	5.0%	18	5.0%
8	5.0%	19	5.0%
9	5.0%	20	5.0%
10	5.0%	21	2.5%
11	5.0%		

- ❖ *Modified Accelerated Recovery Schedule (MACRS)*: expenses for tangible investments follow the Internal Revenue Service’s MACRS schedule, which applies higher depreciation rates for a short period of time. The user can also select a period length for the MACRS.
- ❖ *Amortization*: In the model intangible investments are amortized using the schedule in table II-26. Amortization expenses are spread over a period of eight years, with progressively decreasing amortization rates.

**Table II-26. Eight Year Amortization Schedule**

Year	Amortization Rate	Year	Amortization Rate
1	14.29%	5	8.92%
2	24.49%	6	8.92%
3	17.49%	7	8.92%
4	12.49%	8	4.46%

**Royalty**

The economic module uses resource specific royalty structures to calculate the transfer payments for each project on federal lands. These rates are provided in table II-27.

**Table II-27. Resource Specific Royalty Rates**

Resource	Royalty Rate (%)
Oil Shale	Utah Royalty Structure
Coal to Liquids	0
Tar Sands	12.5
Heavy Oil	12.5
CO <sub>2</sub> EOR	12.5

Currently, there is no royalty rate defined by BLM/DOI for oil shale on federal lands. In the absence of this, the model assumes a royalty rate based on the Utah (state lands) royalty structure for oil shale production (table II-28). This rate structure is currently under review by the BLM/DOI as a potential model for oil shale production on federal lands.

**Table II-28. Utah Oil Shale Royalty Structure**

Year of Production	Royalty Rate	Year of Production	Royalty Rate
1 - 4	5.00%	9	10.00%
5	6.00%	10	11.00%
6	7.00%	11	12.00%
7	8.00%	12+	12.50%
8	9.00%		

The model assumes no royalty is paid for coal to liquids products. This is due to the assumption that coal required for the projects is purchased from the market. However, a royalty schedule would be applied if the project is assumed to have a captive mine producing coal.

**Severance Tax**

Severance tax (also reported as a production tax) is estimated based on the actual tax rates. The model incorporates actual state tax rate schedules for oil shale (table II-29), and for oil (table II-30).

**Table II-29. Oil Shale Severance Taxes**

State	Year of Production				Exemption BOPD
	1	2	3	4+	
CO	1.00%	2.00%	3.00%	4.00%	10,000
UT	3.00%	3.00%	3.00%	3.00%	0
WY	6.00%	6.00%	6.00%	6.00%	0

**Table II-30. Oil Severance Rates**

State	Oil Tax Rate	State	Oil Tax Rate
AL	10.00	MS	6.00
AK	15.00	MT	5.00
AZ	0.00	NE	3.00
AR	5.00	NM	7.79
CA	2.50	ND	5.00
CO	5.00	OK	7.00
FL	8.00	SD	4.50
IL	0.00	TX	4.60
IN	1.00	UT	3.50
KA	8.00	WV	5.00
LA	12.50	WY	6.00
MI	6.60		

**Federal Income Tax:**

For the purpose of this model, federal income taxes are calculated based on a marginal rate of 34.5 percent.

**State Income Tax:**

State income tax schedules for all states were determined and incorporated into the model.

### ***Tax Credits:***

The model incorporates the EOR tax credits established in FY91. These provide a 15% tax credit on tangible and intangible costs, including the costs of injectant, for qualified enhanced oil recovery projects. In addition, the following tax credits can be modeled:

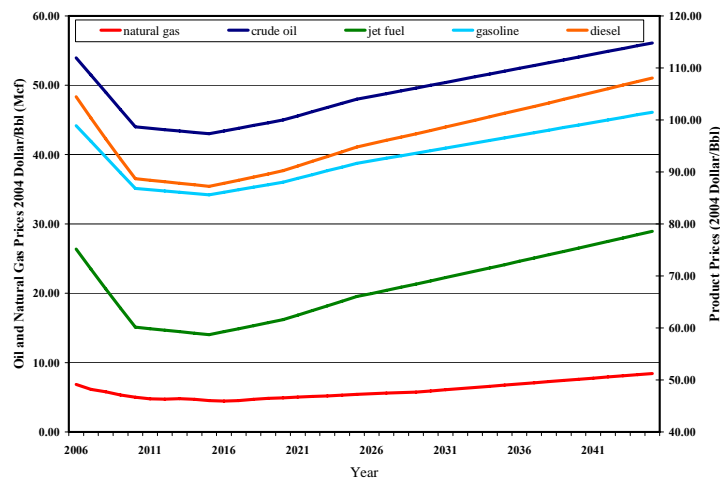
- ❖ Investment tax credit
  - Intangible cost
  - Tangible cost
- ❖ Production tax credit
- ❖ Depletion tax credit
- ❖ Royalty incentive on federal lands
- ❖ Environmental tax credits

## **4. Feedstock & Product Prices**

The model conducts cashflow analysis based on constant feedstock, product, and byproduct prices with options for a “price track”. The product and byproduct prices are used in the economic module to determine revenue. The products, which are the primary outputs of the processes, include oil, natural gas, diesel, gasoline, and jet fuel. The byproducts, which are the incidental outputs of the recovery processes, include ammonia and sulfur. The feedstocks are the products required and purchased for the projects. These include water, electricity, coal, and carbon dioxide. The feedstock prices are used in the operating expense calculations.

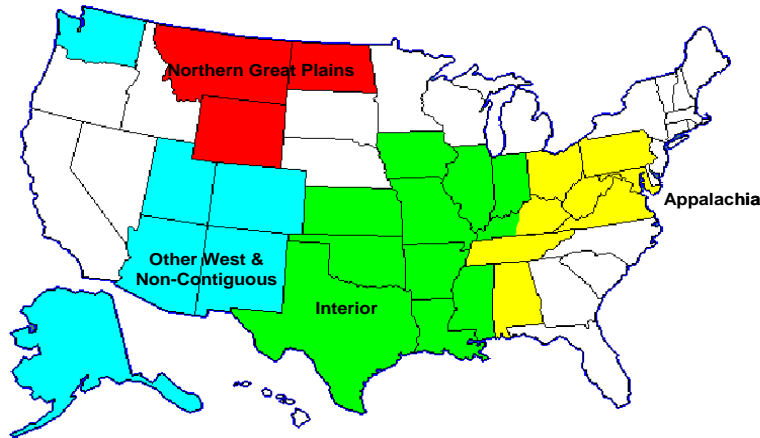
For the oil and natural gas price tracks, the model presently uses the *Annual Energy Outlook* (AEO 2006)<sup>23</sup> reference case prices. Equations, using the oil price, were generated for diesel, gasoline, and jet fuel prices, from historical data. The decision was made to use price equations in order to allow the model to iterate prices and determine the minimum economic price for coal to liquids projects following the methodology used for other resources. The price tracks for crude oil, natural gas, and the liquid products are graphed in figure II-18.

**Figure II-18. Oil, Natural Gas, and Product Price Tracks**



The regional coal price tracks were determined using the U.S. average coal price forecast by the AEO 2006 reference case and regional price differentials calculated from the 2004 Coal Production Report<sup>24</sup>. Price tracks were developed for the Appalachian region, Interior region, Western states, Northern Great Plains region, Other West & Non-contiguous States, and the U.S. The states which comprise the regions are illustrated in figure II-19, and the regional average price ranges are displayed in table II-31. The differences in the regional coal prices reflect the regional differences in coal quality and type available.

**Figure II-19. NSURM Coal Regions**



**Table II-31 Regional Coal Price Range**

Region	Range	
	Min	Max
Appalachia	30	34
Interior	21	30
Western Average	10	14
Northern Great Plains	7	10
Other West and Non-contiguous	21	28
United States Total	18	21

The prices for other feedstocks and byproduct prices were determined for the model. Average regional electricity prices were calculated using EIA data<sup>25</sup>. The other prices were determined using industry data. These prices are listed in table II-32.

**Table II-32. Other Feedstock & Byproduct Prices**

	Product	Unit	Cost
<b>Feedstocks</b>	Water	\$/Bbl	0.03
	Electricity (Eastern U.S.)	\$/MW	47.72
	Electricity (Rockies)	\$/MW	48.51
	Electricity (Average U.S.)	\$/MW	52.68
<b>Byproducts</b>	Sulfur	\$/Ton	32.50
	Ammonia	\$/Ton	218.00

The economics module calculates the annual revenue according to resource and technology specific product and byproduct slates. The model uses the natural gas prices to calculate the revenue from the sale of propane and butane. Product slates for each resource are provided in table II-33.

**Table II-33. Resource Specific Products & Byproducts**

<b>Resource</b>	<b>Product</b>	<b>Byproduct</b>
Oil Shale	Oil Natural Gas	Ammonia
Coal to Liquids	Diesel Gasoline /Jet Fuel Propane Butane	Sulfur
Tar Sands	Oil Natural Gas	
Heavy Oil	Oil Natural Gas	
CO <sub>2</sub> EOR	Oil Natural Gas	

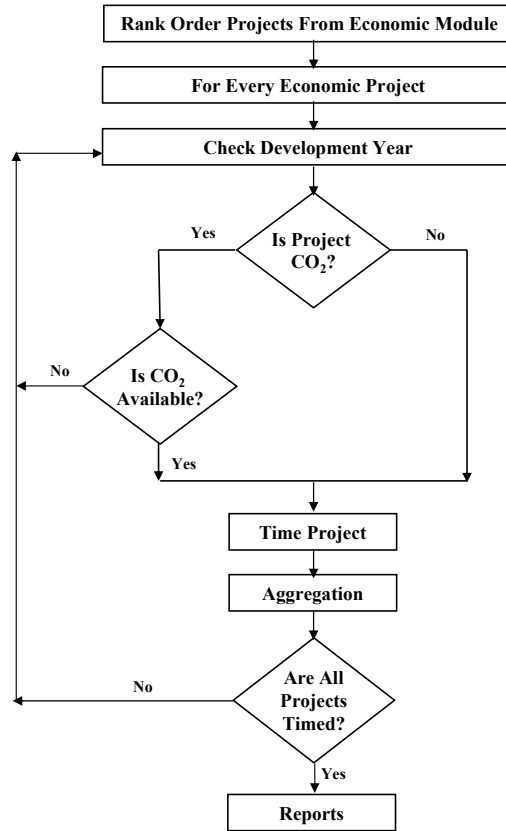
## **E. Project Timing and Aggregation**

After all projects have been analyzed by the economic module to determine their economic viability, they are passed to the development and timing module. This module determines the development order for each resource based upon the economic viability of each project, the development schedule provided by the user, and the resource development constraints. The production and other statistics of the timed economic projects are then aggregated and reported to the user. These steps are described in greater detail in this section.

### **1. Project Timing**

The timing and development module uses the economic viability of the project, development constraints, and the user specified development schedule to determine the order in which projects are to be developed during the 40 years evaluated by the system. The timing process begins with the ordering of projects by net present value. This allows the model to mimic the industry practice of developing the most economic projects first. The development year of each economic project is examined. For oil shale, tar sands, coal to liquids, and heavy oil projects, they are timed in the development year. If the project is CO<sub>2</sub> EOR, the development constraints are first checked. If there is sufficient carbon dioxide available in the project's region, it is timed in that year; otherwise it is considered again in the following years. The economic CO<sub>2</sub> projects are considered for timing every year of the model forecast period. Once all economic projects are timed, they are then aggregated. This process is illustrated in figure II-20.

Figure II-20. Development & Timing Module Logic Flow



## 2. Aggregation

The annual production and economic statistics of the economic and developed projects are aggregated at the process level. The specific variables aggregated are: production, capital and operating costs, and the benefits to the local and national economies. These specific benefits will be described in the following section. These results are aggregated at the process, resource, and national levels.

## F. Benefits Estimation

The model uses the process level aggregated results to estimate a number of economic benefits at state and national levels. The benefits to local, state, and federal treasuries are attributed to the implementation of economically feasible projects over the next 40 years. These benefits include: 1) Direct Federal Revenues - defined as the sum of business taxes as well as one-half of royalty payments on total production from federal lands, 2) Direct State Revenues - defined as the sum of business taxes, production taxes, as well as one-half of royalty payments on production from federal lands, and 3) Direct Public Sector Revenues - defined as the sum of the Direct Federal and Direct State Revenues.

The nation as a whole also benefits from unconventional liquid fuel production. Each additional barrel of domestic production can replace a barrel of oil imports. Each dollar of increased Gross Domestic Product (GDP), which would otherwise pay for imports, reduces the trade deficit by a dollar. To estimate the direct effects on the GDP (excluding the multiplier effect), the model uses the gross revenue from the potential production, inclusive of oil, natural gas, liquid

products, and byproducts. Similarly, the value of potential liquid production is used to measure the impact on the trade deficit. The model also estimates potential employment associated with the unconventional fuel and EOR projects. Labor costs (wages and fringe benefits) are calculated by isolating the labor component of all major cost elements. Labor costs are then converted into estimated annual employment using average wages (including benefits) for the petroleum industry as reported by the U.S. Department of Labor<sup>26</sup>. NSURM uses an employment multiplier for the energy industry to disaggregate the total jobs created into two categories: the direct jobs required for the projects, and the indirect jobs in service and other related industries<sup>27</sup>.

## G. System Limitations

The model has important limitations that should be considered before using its results. The predicted results are intended to provide a baseline calculation of the potential benefits of a domestic unconventional oil industry, rather than a forecast of what is likely to happen over the next 25 to 35 years under current and assumed future economic conditions. The model results, although not a forecast, provide a roadmap for the type and the level of benefits that could be targeted by the industry, and local, state, and federal governments through concerted and collaborative efforts.

The success of a domestic unconventional oil industry, of any size, depends very strongly on many factors including access to the resource, technology improvement through field demonstration at commercial scale, economic climate assurance, and environmental permit streamlining. The assumptions and limitations of the model relative to these areas are discussed below:

- The resource module contains only 25 federal oil shale tracts. These tracts collectively account for about 70 billion barrels of oil shale resource in the states of Colorado, Utah, and Wyoming. The model assumes that these tracts are accessible for development.
- The resource module contains 28 tar sands deposits. These deposits collectively account for about 61 billion barrels of resource, of which 19.5 are measured. The extent to which the speculated resource may change as it is characterized may change the production potential from tar sands. The model assumes that all deposits are accessible for development.
- The model assumes that only one recovery process will be applied to each tar sand deposit. To the extent that the deposits are produced through a suite of technologies, selected to meet localized resource characteristics, the potential production could change.
- The coal resources include all coal in the United States. No consideration was made for the economic viability of producing these reserves. To the extent that the producible reserves are lessened by coal mining economics, the number of potential coal to liquid projects will be impacted.
- The resource module contains the remaining coal reserves in the United States. The model does not take into account the future coal production for electrical power generation or other industry requirements. To the extent that future production goes to these industries, the number of potential coal to liquids projects will change. The model also assumes that all coal deposits are accessible for development.



- The resource module contains all of the existing oil reservoirs suitable for steam flooding and carbon dioxide flooding. While the model uses the CO<sub>2</sub> requirement for the development of these resources, there are other constraints not incorporated. These constraints include the availability of drilling rigs, capital, and resource access.
- The model assumes that current oil shale, tar sand, and coal to liquid technologies are successfully demonstrated to be viable at commercial scale over the next five to ten years. To the extent that this is not achieved, the development of the resource will be impeded.
- The model assumes the environmental permitting process for the projects could be completed within the lead time of each project. To the extent that the permitting process is not streamlined, and additional time is required, the timing of the production predicted by the model will be impacted.
- The economics are based on the use of average costing algorithms. Although developed from the best available data and explicitly adjusted for variations in energy costs, they do not reflect site-specific cost variations applicable to specific operators. To the extent that the average costs (used) understate or overstate the true project costs, the model results will be impacted accordingly.
- The estimates of potential contribution to GDP, values of imports avoided, and employment do not take into account potential impacts to other sectors of the U.S. economy from altering trade patterns. It is possible that reduction in petroleum imports, depending on where the petroleum was coming from, could reduce the quantity being exported of some other good. It is likely, however, that such effects would be minimal.
- The model assumes that operators have access to capital to start and sustain the projects. The oil shale, tar sands, and coal to liquid projects are typically characterized as “capital intensive” and have longer payback periods relative to oil and gas development projects. To the extent that capital is constrained, the potential benefit estimated in the model may be overestimated.

None of the above limitations, however, invalidate the model and its analysis if they are viewed for what they are intended for, which is an estimate of upside potential. Given the uncertainty of the size and combinations of the optimistic and pessimistic biases introduced by these limitations, it is assumed that the approach is valid, and the model yields reasonable results.

## **H. Summary**

In order to develop a comprehensive analytical tool to support the policy analysis of the Task Force, the existing National Oil Shale Model was extended to include other unconventional resources as well as enhanced oil recovery processes. The new model now contains oil shale, tar sands, coal to liquids, heavy oil, and reservoirs to which CO<sub>2</sub> flooding can be applied. This model should be used to determine the upside of potential production under various policy scenarios, but not as a forecast of what will actually occur in the coming decades. The model is currently based on the best available cost and technology data – work that has been done between the late 1970’s and the present day. Components of the model have been thoroughly reviewed by government and industry practices and reflect the best available understanding of current recovery technologies.

# III. Potential Applications

The NSURM system was developed to assist the Unconventional Resource Task Force analyze the costs and benefits of potential policy decisions. To do this, a suite of potential incentives was incorporated into the model. In this chapter, the existing incentives are described and their impact on the project economics of a generic project discussed.

## A. Potential Incentives Modeled

Private investment in the development of an unconventional oil industry is constrained by a range of economic, technology, and investment risks and uncertainties. Coupled with the volatility of crude oil and product prices, these risks make project financing difficult. First-of-a-kind plants are often characterized by high front end costs as well as low operating efficiencies which can lead to higher than expected production costs. Such hurdles may make investment less attractive to companies and investors than other investment options.

The NSURM system can assess the impacts on production, reserves, and other economics statistics, caused by potential incentive packages. These incentives can be targeted to specific resources or applied to all. The model currently has the following incentive options incorporated:

- Royalty Relief
- Investment Tax Credits
- EOR Tax Credits
- Production Tax Credits
- Depreciation Schedule Changes
- Risk Reduction
- Price Assurance
- Resource Access

## B. Economics of a Generic Project

To illustrate the impact of the incentives on project economics, four example scenarios were applied to a generic unconventional fuels project. The sample scenarios are:

- **Reference Case:** Assumes future oil prices at the level predicted by the EIA in its 2006 Annual Energy Outlook (the reference case). Further, it assumes the price is guaranteed through market assurance as discussed above. This is considered to be the reference case in the analysis that follows.
- **Production Tax Credits:** Assumes a \$5.00 per barrel of oil equivalent (similar to the Section 29 tax credit). The market assurance assumptions are the same as in the Reference Case.
- **Investment Tax Credit:** Assumes a tax credit of 10% (similar to that proposed for coal-to-liquids projects). The tax credit would reduce up-front capital costs and accelerate payback.

- Risk Reduction through Research, Development, and Demonstration (RD&D):** The impact of RD&D is modeled by reducing the risk component of the minimum rate of return (the hurdle rate) in the cash flow model. The market assurance assumption is the same as in the Reference case.

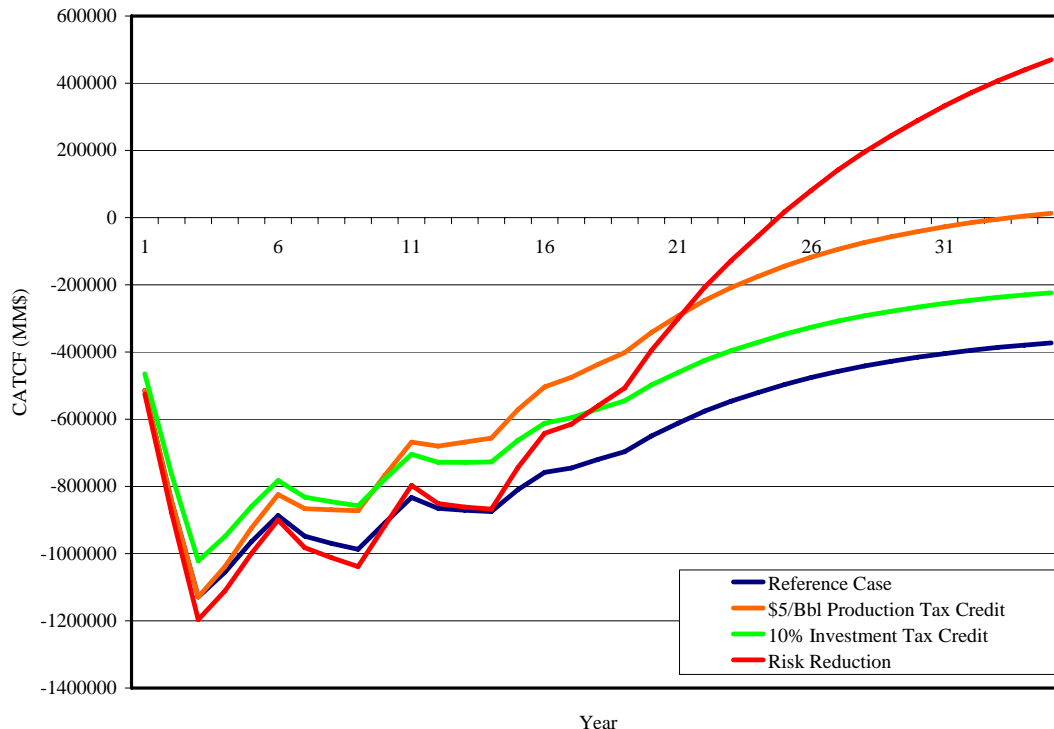
Other key assumptions for these sample scenarios are summarized in table III-1.

**Table III-1. Potential Incentive Cases**

Cases				
Economic Parameters	Market Assurance	Production Tax Credit	Risk Reduction	Investment Tax Credit
Oil Price	AEO 2006	AEO 2006	AEO 2006	AEO 2006
Rate of Return	15%	15%	10%	15%
Incentives (Production Tax Credit)	0	\$5/Bbl	0	0
Incentive (Investment Tax Credit)	0	0	0	10%
Depreciation Schedule	20 Year Straight Line	20 Year Straight Line	20 Year Straight Line	20 Year Straight Line

Figure III-1 indicates that the generic oil shale project is best characterized as “capital intensive” with a relatively long payout period, the time to reach the breakeven point when the investments are recovered. The projected cash flow is on a discounted after tax basis and is shown over a period of 35 years. The future oil price assumption for these cash flows is the AEO 2006 projection (the reference). Figure III-1 further indicates that the policy options considered could shorten the payout period to a more attractive and perhaps acceptable range.

**Figure III-1. Economics of a Generic Project**



As shown in figure III-1, both the reference and the investment tax credit cases, the project failed to become economically viable. With the production tax credit, the project became economically viable in year 33. The payout time was decreased by 9 years through the reduction in risk.

The model also has the ability to establish the minimum economic price for analyzed resources, technologies, and projects. The minimum economic price is defined as the “breakeven” price at which the project becomes economically viable, assuming a specified hurdle rate (return on capital).

## **C. Results of the Measured Case**

The hypothetical measured case assumes that private capital will be attracted to the development of unconventional fuels projects. In addition, the government will stimulate the development of the industry by providing resource access, regulatory reform, attractive fiscal regimes, and an organizational structure to expedite planning and decision making. These conditions are assumed to result in the development of oil shale, coal to liquids, and tar sands resources.

The following aspects of the measured case are discussed: (1) production potential, (2) reserves, (3) public sector revenues, and (4) increased national benefits.

The results are not intended to be a forecast of what will occur. Rather, they represent estimates of production potential under the economic and technological assumptions articulated by the scenario.

### **1. Production Potential**

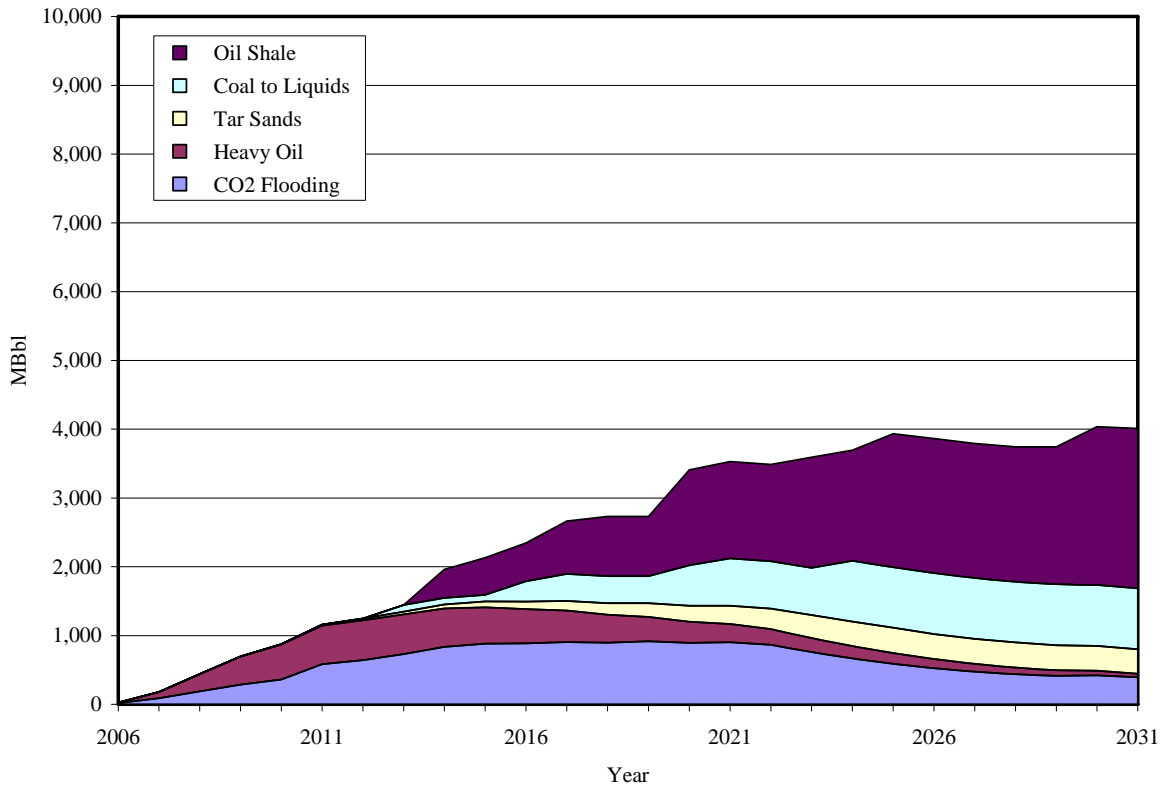
The potential production includes both liquid production and gas production. The liquid production includes the following products:

- ❖ Shale oil from oil shale projects,
- ❖ Bitumen production from tar sands projects,
- ❖ Liquid products (gasoline, diesel, and jet fuel) from coal to liquids projects, and
- ❖ Crude oil from heavy oil and CO<sub>2</sub> EOR projects

The graph of the daily production for all resources is provided in figure III-2. The conditions assumed in the measured case have a combined potential of nearly 4,000,000 barrels of daily liquid production from oil shale, tar sands, coal to liquid, heavy oil, and CO<sub>2</sub> EOR projects. As seen in figure III-2, the early production is from both heavy oil and CO<sub>2</sub> EOR. The production from these resource declines during the period graphed. The production from the unconventional resources begins in later years and continues to increase during the period shown. By 2031, the oil shale production could be as much as 2 million barrels per day, the production from coal to liquids projects could be approximately 1 million, and the tar sand production could be nearly 300,000 barrels per day. The remaining production would come from the heavy oil and CO<sub>2</sub> EOR projects.

The unconventional fuels production is not, however, expected until successful completion of the demonstration phase of the candidate projects. If successful, the projects could then enter into their commercial phase and production could increase gradually over time.

**Figure III-2. Potential Liquid Production of the Measured Case**

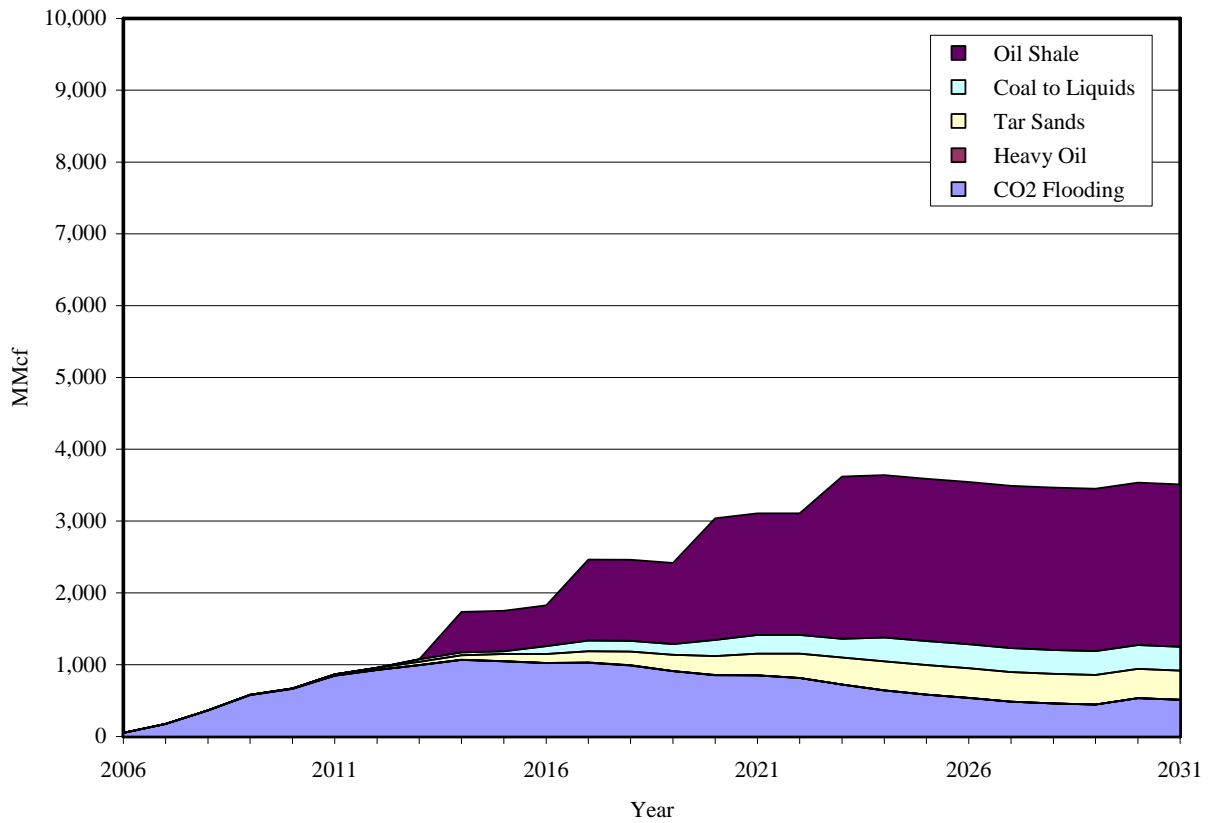


In addition to the oil and liquid products, a significant quantity of hydrocarbon gas would be produced. The quantity of gas produced in barrels of oil equivalent (BOE) by each resource varies as a percentage of total production depending on the resource and the technology process applied. Gas production could reach as much as 3.5 billion cubic feet per day. More than half of that gas would come from the oil shale projects. Although a significant quantity of produced gas could be consumed within oil shale and tar sands facilities for process heat, power generation, or other process requirements, much of this gas could be upgraded to pipeline quality and contribute to meet regional and national natural gas demand (Figure III-3).

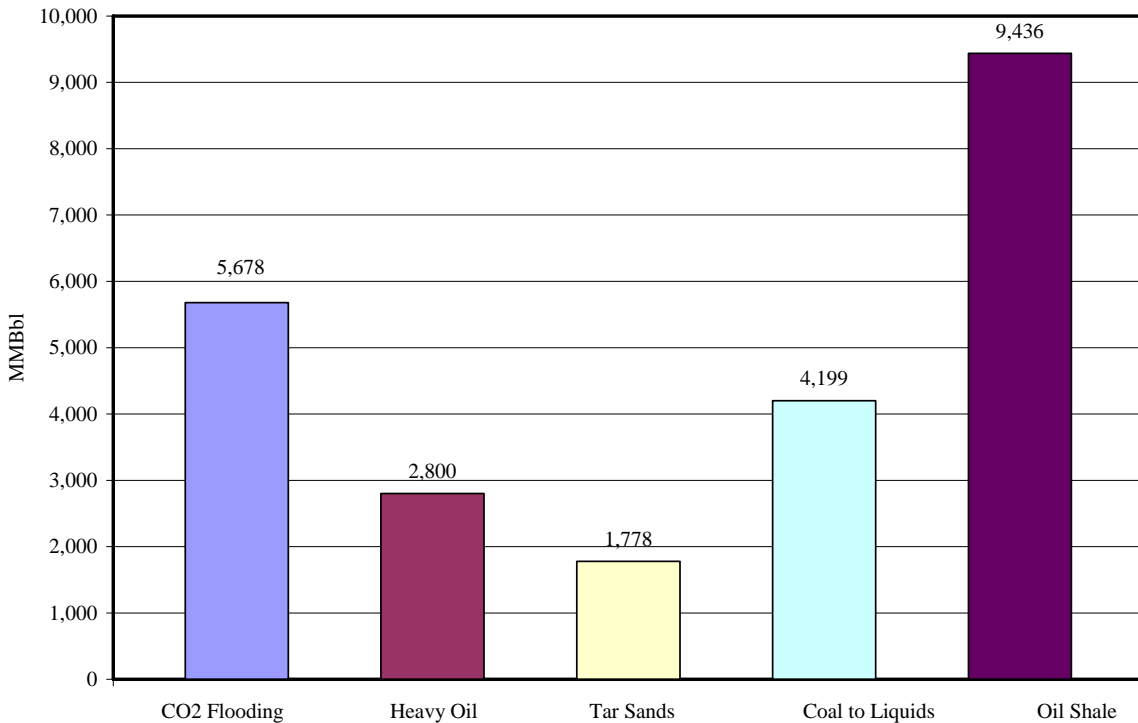
## 2. Reserves

Under the measured case assumptions, significant reserves will be generated by each resource base. Reserves, defined as the cumulative liquid production over 25 years, for oil shale could reach nearly 9.4 billion barrels. Tar Sands projects could generate approximately 1.8 billion barrels of reserves, while coal to liquids will produce more than 4 billion barrels over twenty five years. An additional 5.6 billion and 2.8 billion barrels could be produced by CO<sub>2</sub> EOR and heavy oil respectively. A total potential upside of 24 billion barrels of reserves is possible over 25 years. The reserves, disaggregated by resource base, are presented in figure III-4.

**Figure III-3. Potential Natural Gas Production of the Measured Case**



**Figure III-4. Measured Case Reserves**

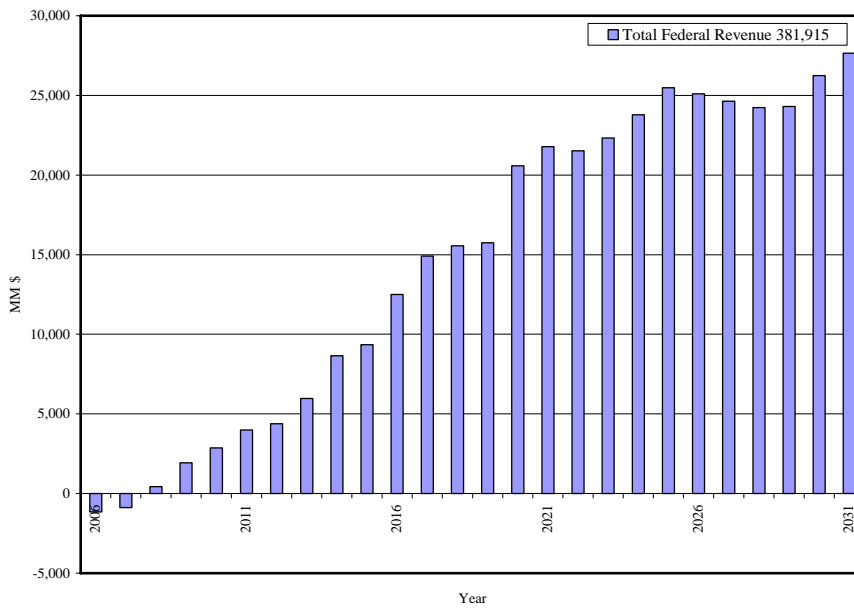


### 3. Public Sector Revenues

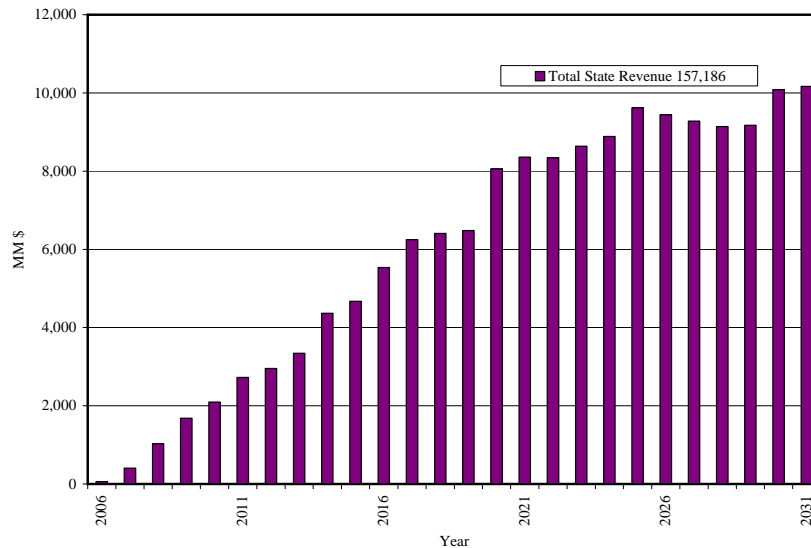
Public sector revenues include the direct federal revenues, the direct state revenues, and the total direct public sector revenues. These categories follow the definitions provided in Chapter 2, Section F (benefit estimation).

In the Measured case annual Direct Federal Revenues from unconventional fuel and EOR projects could range from \$2 billion to more than \$28 billion as production capacity reaches its peak level (figure III-5). As seen in the graph, the federal revenue is negative in the first years. This is due to the EOR tax credits applied to heavy oil and CO<sub>2</sub> projects. Annual Direct State Revenues would range from about \$200 million in the early years to as much as \$10 billion when peak base case capacity is reached (Figure III-6).

**Figure III-5. Direct Federal Revenues for the Measured Case**

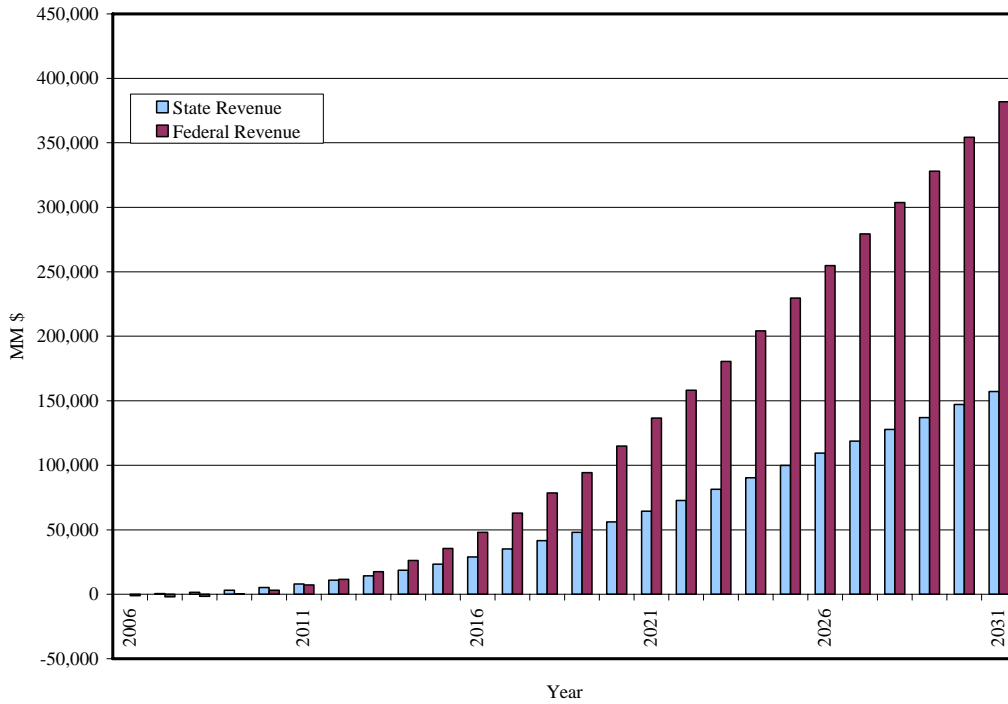


**Figure III-6. Direct State Revenues for the Measured Case**

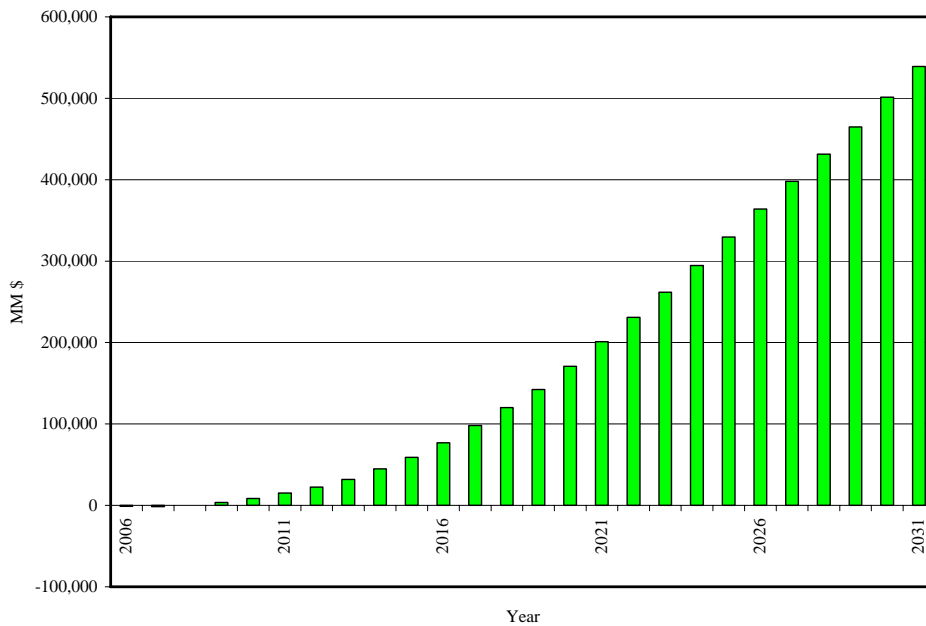


Cumulatively, the federal and state revenues (figure III-7) could reach as high as \$400 billion for federal revenues and \$150 billion for state revenues after 25 years. The total public sector revenues, which are the sum of direct federal and direct state revenues, could reach a cumulative total of \$550 billion over 25 years. The cumulative total public sector revenues are illustrated in figure III-8.

**Figure III-7. Comparison of the Federal & State Revenues**



**Figure III-8. Cumulative Public Sector Revenues**





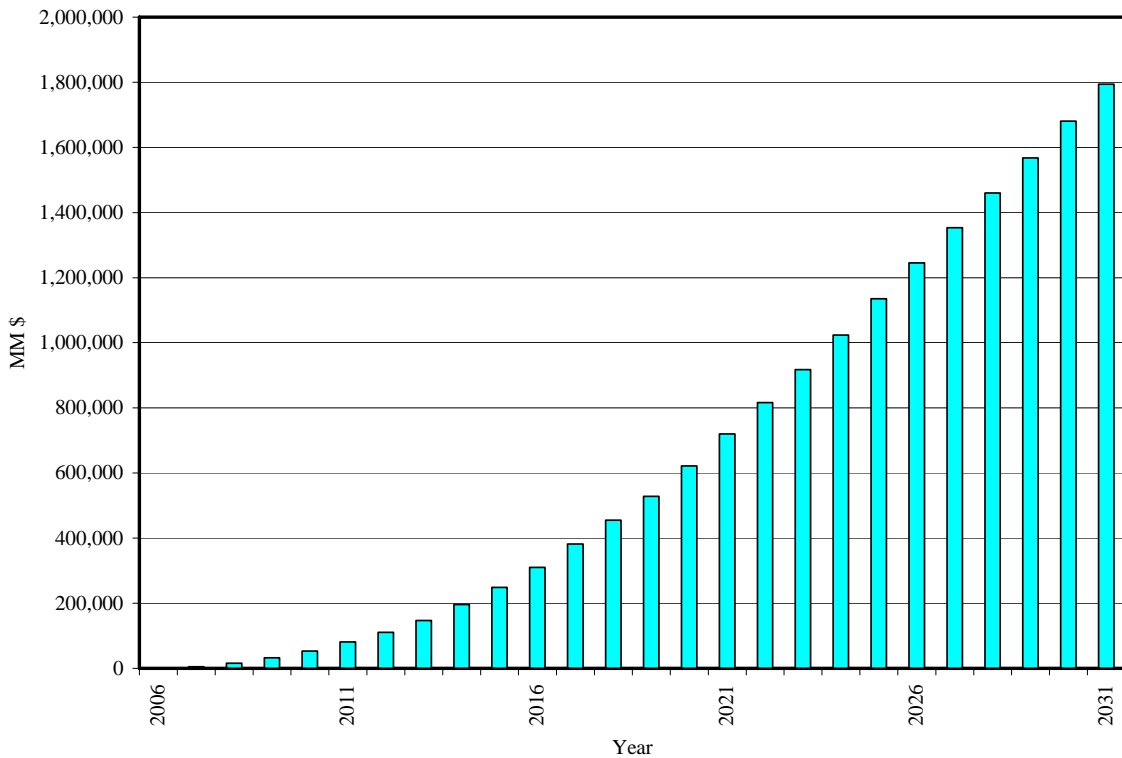
#### 4. Increased National Benefits

In addition to providing substantial net public revenues to the states and to the federal government, the development of an unconventional fuels industry and the development of heavy oil and CO<sub>2</sub> EOR projects could provide other national benefits. These benefits include supplementing domestic supply, reducing oil imports and the costs of those imports, creating employment opportunities, and making a significant contribution to the U.S. Gross Domestic Product.

##### Contribution to GDP

In the measured case, assuming that the private capital and limited government involvement are sufficient to cause industry initiation, annual direct contributions to GDP from the unconventional fuels industry activities rises from \$10 billion dollars per year in the early years, to more than \$100 billion per year, achieving a \$1,780 billion cumulative GDP benefit over the first 25 years of industry development and operation (Figure III-9).

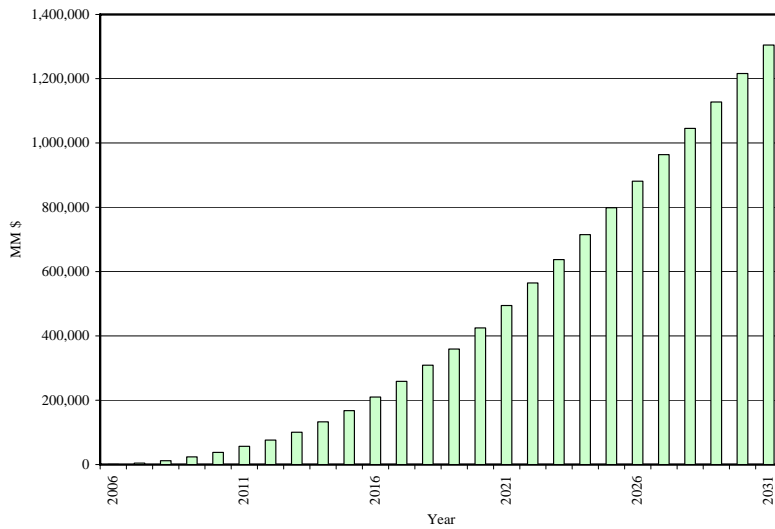
**Figure III-9. Cumulative Contribution to GDP**



##### Value of Imports

In the measured case, it is estimated that domestic production of unconventional and EOR fuels could reduce the cost of oil imports to the economy by between \$3 and \$90 billion dollars per year between industry inception and year 25, with a cumulative savings of \$1,300 billion (figure III-10).

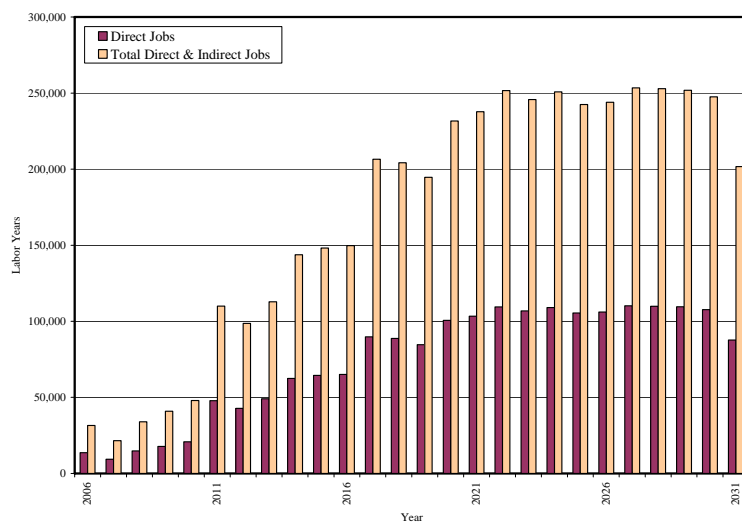
**Figure III-10. Cumulative Value of Imports Avoided**



Employment

In the measured case, unconventional fuels industry development will result in the addition of thousands of new, high-value, long-term jobs in the construction, manufacturing, mining, shale production, and refining sectors of the domestic economy. NSURM estimates total sector employment based on industry expenditures. Not all of the direct employment shown will be new jobs to the economy. Some will be filled by workers shifting from one industry sector to another. Further, not all of the jobs created will be in the states where unconventional fuels are produced. Other states that manufacture trucks, engines, steel, mining equipment, pumps, tubular goods, process controls, and other elements of the physical complex, as well as states where the projects are designed and managed or where upgraded liquids are refined into premium fuels and byproducts, will also share in the jobs creation. Total annual direct and indirect sector employment could range from 30,000 to 150,000 personnel in the measured case. Figure III-11 displays the direct and total jobs that could be created over the next 25 years.

**Figure III-11. Annual Direct & Indirect Petroleum Sector Jobs**

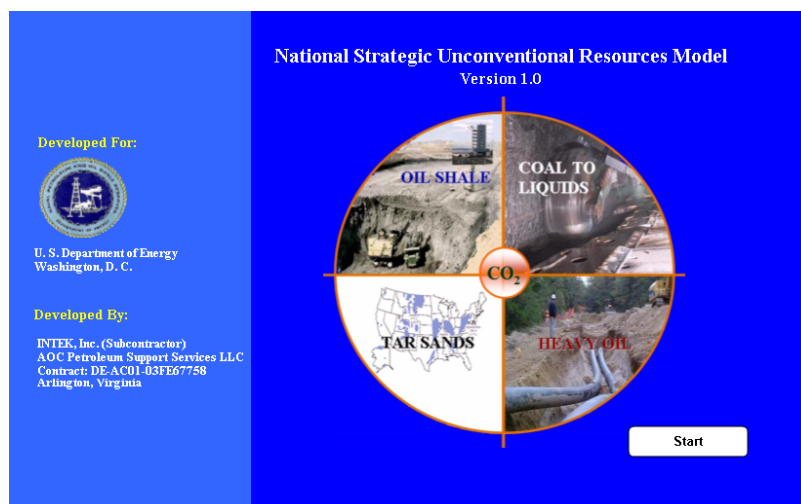


# Appendix A

The NSURM system is an Excel based program which has several FORTRAN applications running in the background. This decision was made to offer ease of development and evaluation of scenarios while ensuring quick execution time. In this appendix, the operations of the NSURM model are provided.

Opening the NSURM model displays a welcome page containing the model name and contract information (figure A-1).

**Figure A-1. NSURM Model**



Clicking  opens up the NSURM Main Menu. The main menu contains four input buttons, a run button, two run settings, and six report buttons. The input buttons include technology, resource data, economic data, and run options. The report buttons include the national and resource-specific summaries (figure A-2).

Figure A-2. NSURM Main Menu

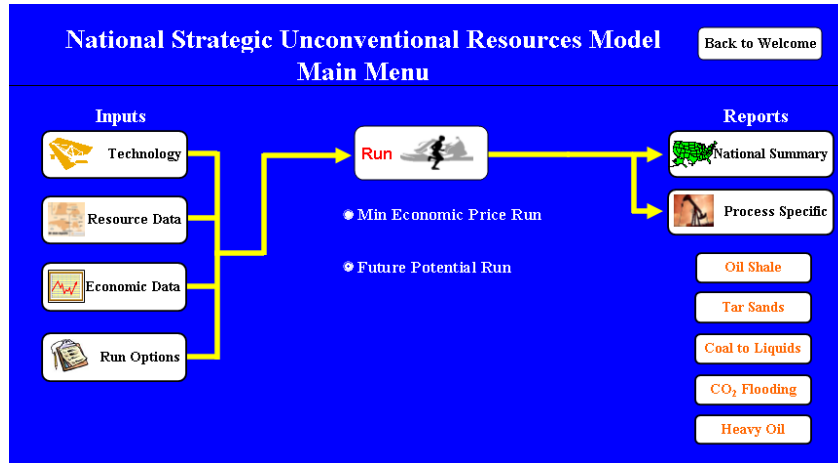


Figure A-3. NSURM Interface Structure

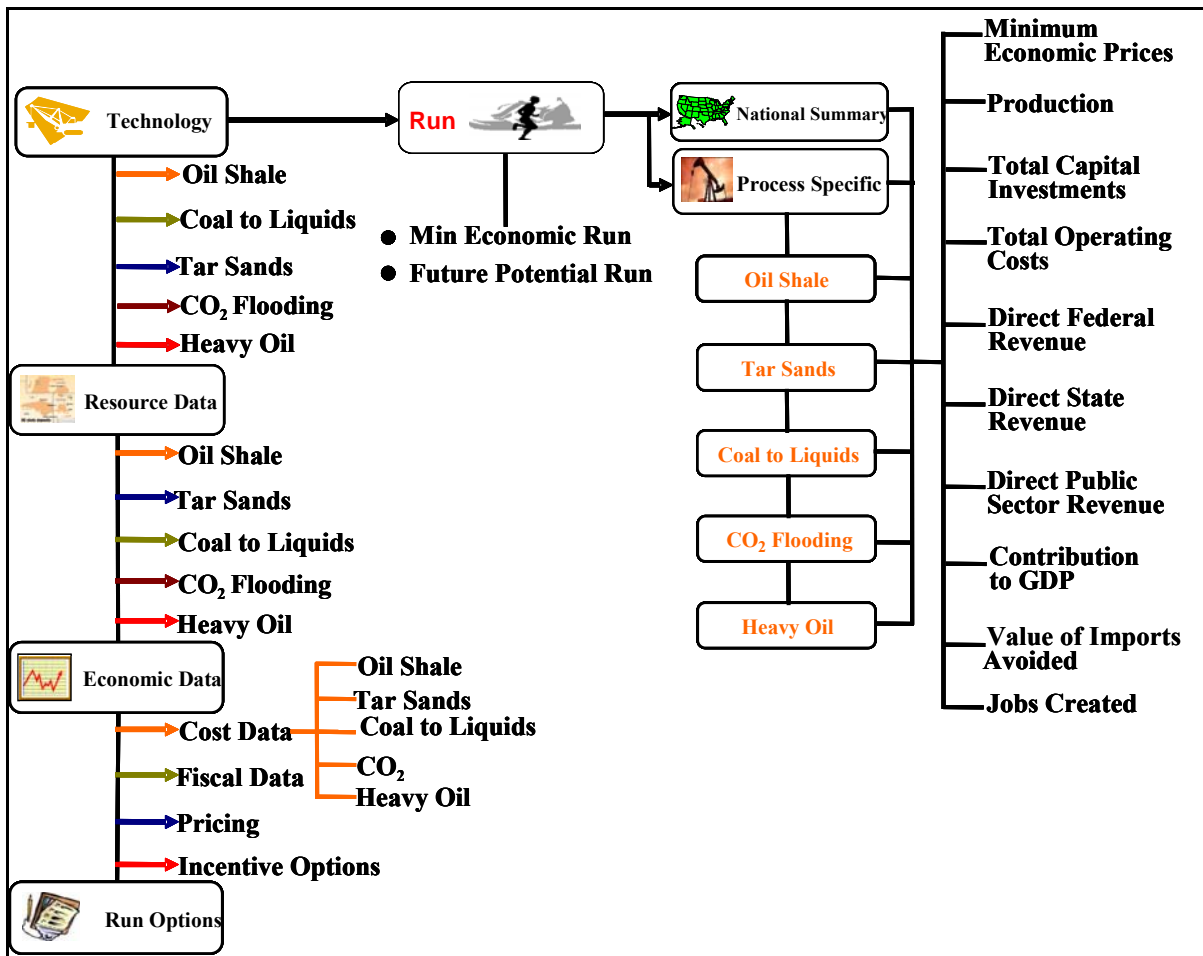



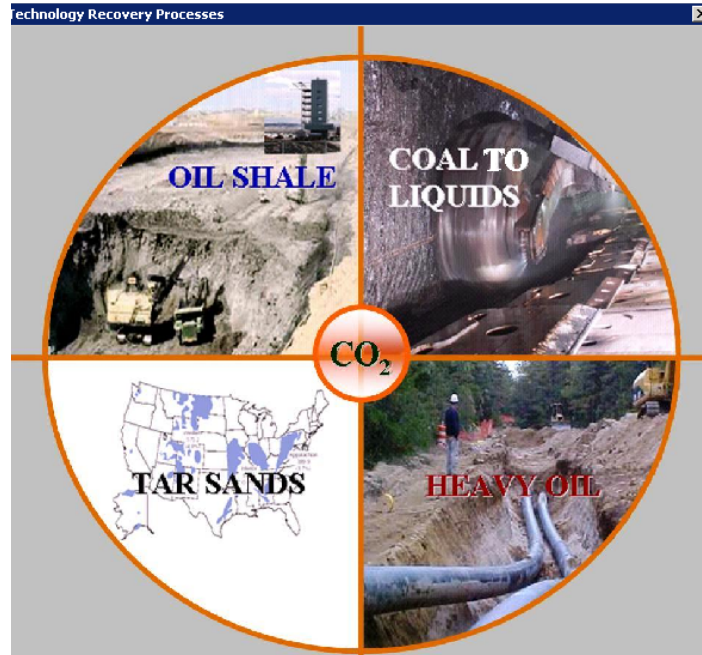
Figure A-3 provides a schematic representation for each option of the model main menu. In the following sections, all of the elements of the NSURM controls will be described.

## Technology

Process diagrams are available for each recovery technology modeled in the National Strategic Unconventional Resources Model.

Clicking  displays a pop-up menu displaying the resources modeled: Oil Shale, Tar Sands, Coal to Liquids, CO<sub>2</sub> Flooding, and Heavy Oil (figure A-4).

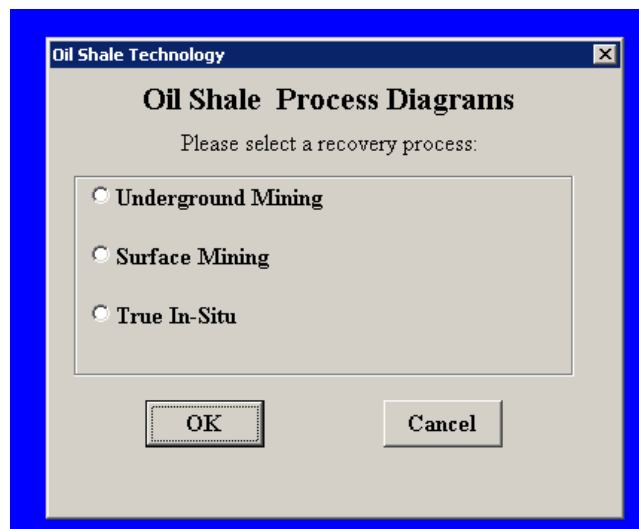
**Figure A-4. Technology Display Main Menu**



### 1. Oil Shale Technologies Modeled

Clicking "Oil Shale" displays a menu listing the various Oil Shale recovery technologies available in the model: Underground Mining, Surface Mining, and True In-Situ (figure A-5).

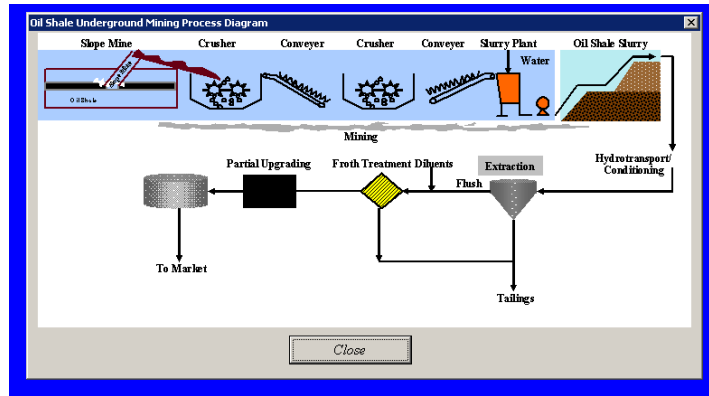
**Figure A-5. Oil Shale Technologies Modeled**



*i Underground Mining*

Selecting “Underground Mining” displays the oil shale underground mining recovery process diagram (figure A-6).

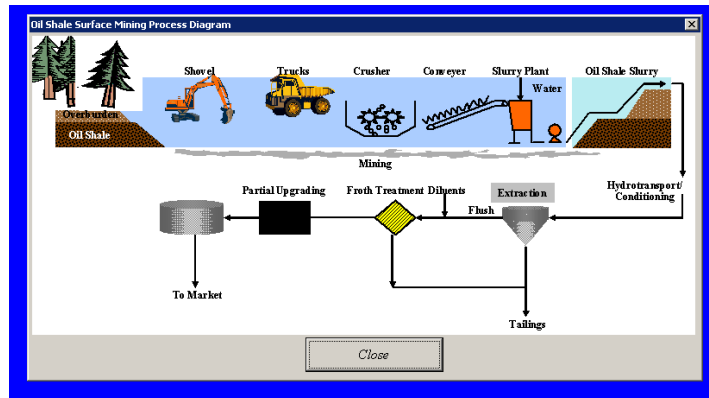
**Figure A-6. Oil Shale Underground Mining Process Diagram**



*ii Surface Mining*

Selecting “Surface Mining” displays the oil shale surface mining recovery process diagram (figure A-7).

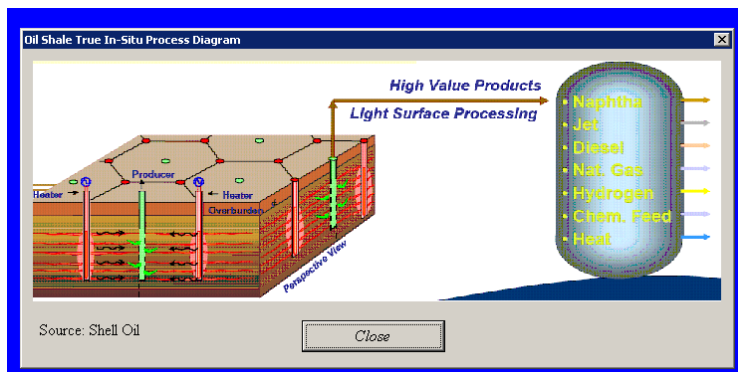
**Figure A-7. Oil Shale Surface Mining Process Diagram**



*iii True In-Situ*

Selecting “True In-Situ” displays the oil shale true in-situ recovery process diagram (figure A-8).

**Figure A-8. Oil Shale True In-Situ Process Diagram**



## 2. Tar Sand Technologies Modeled

Clicking “Tar Sands” displays a menu listing the two Tar Sands recovery technologies available in the model: Underground Mining and Steam Assisted Gravity Drainage (figure A-9).

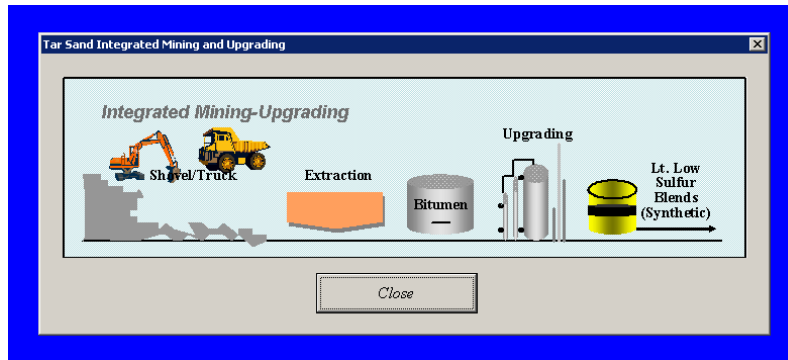
Figure A-9. Tar Sands Technologies Modeled



### *i Underground Mining*

Selecting “Underground Mining” displays the tar sands underground mining recovery process diagram (figure A-10).

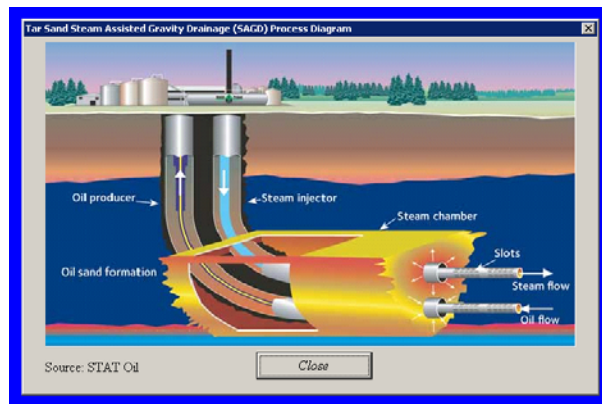
Figure A-10. Tar Sands Underground Mining Process Diagram



### *ii Steam Assisted Gravity Drainage*

Selecting “Steam Assisted Gravity Drainage (SAGD)” displays the tar sands SAGD recovery process diagram (figure A-11).

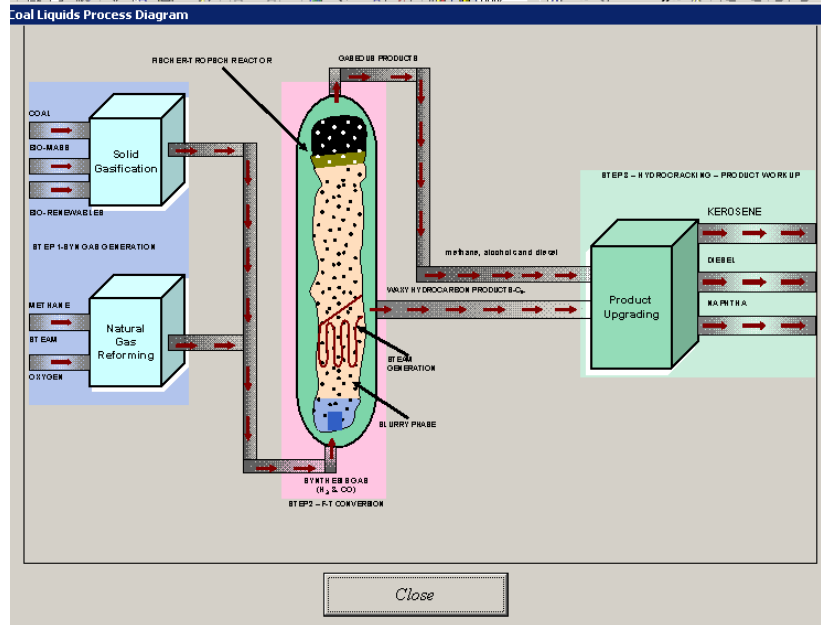
Figure A-11. Tar Sands SAGD Process Diagram



### 3. Coal To Liquids Technology Modeled

Clicking “Coal to Liquids” displays the Fischer-Tropsch Coal-to-Liquids process diagram (figure A-12).

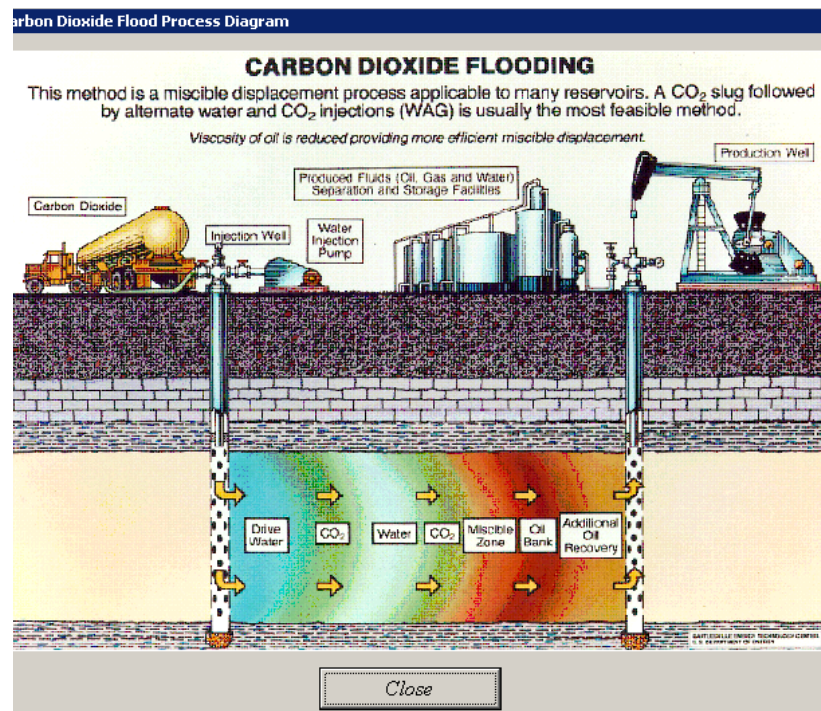
Figure A-12. Coal to Liquids Process Diagram



### 4. CO<sub>2</sub> Enhanced Oil Recovery Technology Modeled

Clicking “CO<sub>2</sub>” displays the CO<sub>2</sub> Flooding recovery process diagram (figure A-13).

Figure A-13. CO<sub>2</sub> Enhanced Oil Recovery Process Diagram

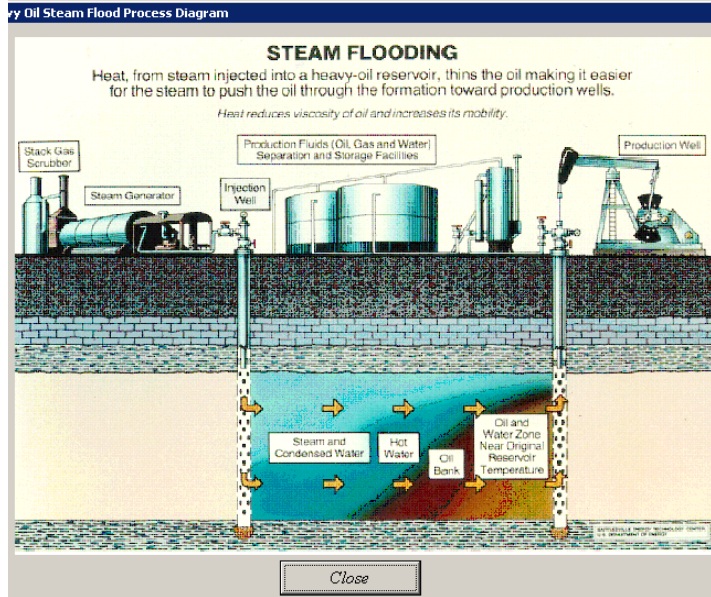




## 5. Heavy Oil Technology Modeled

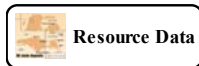
Clicking “Heavy Oil” displays the Steam Flooding recovery process diagram (figure A-14).

Figure A-14. Heavy Oil Process Diagram



## Resource Data

Detailed resource data is available for each resource modeled.



Clicking **Resource Data** displays a pop-up menu listing the resources modeled: Oil Shale, Tar Sands, Coal to Liquids, CO<sub>2</sub> Flooding, and Heavy Oil.

Selecting “Oil Shale” displays a spreadsheet containing the detailed Oil Shale resource data used in the model. Information provided includes tract location, area, average resource depth, shale oil yield, and other petrophysical characteristics (figure A-15).

Figure A-15. Oil Shale Resource Database

Number of resources:		FEDERAL LANDS ONLY													
Resource	Tract	Basin	State	Depth Feet	Acreage Acres	Net Pay Feet	Yield Gal/Ton	Resource MMBLS	Stripping Ratio	Process S/U	GOR	Tonnage Percent	Downtime Percent	Ownership (F./S./P)	Start Year
1	c1	Piceance	CO	1100.00	5120.00	500.00	26.8859	5202.17	2.20	TIS	0.00	0.00	0.00	F	12
2	c2	Piceance	CO	700.00	5120.00	115.00	26.9228	1198.14	6.09	MIS	0.00	0.00	0.05	F	6
3	c3	Piceance	CO	500.00	5120.00	130.00	26.4613	1331.20	3.85	U	0.00	0.00	0.00	F	6
4	c4	Piceance	CO	700.00	5090.00	495.00	30.0000	5712.99	1.41	S	0.00	0.00	0.00	F	6
5	c5	Piceance	CO	700.00	5090.00	495.00	30.0000	5712.99	1.41	S	0.00	0.00	0.00	F	6
6	c7	Piceance	CO	700.00	5090.00	495.00	30.0000	5712.99	1.41	S	0.00	0.00	0.00	F	6
7	c8	Piceance	CO	700.00	5090.00	495.00	30.0000	5712.99	1.41	S	0.00	0.00	0.00	F	6
8	c17	Piceance	CO	700.00	5090.00	495.00	30.0000	5712.99	1.41	S	0.00	0.00	0.00	F	6
9	c6	Piceance	CO	1100.00	5018.00	600.00	26.4613	6021.60	1.83	TIS	0.00	0.00	0.00	F	9
10	c9	Piceance	CO	1000.00	5128.00	125.00	27.2736	1321.36	8.00	U	0.00	0.00	0.00	F	6
11	c10	Piceance	CO	900.00	5126.00	770.00	26.4613	7894.04	1.17	S	0.00	0.00	0.00	F	6
12	c11	Piceance	CO	1100.00	5118.00	900.00	26.4613	9212.40	1.22	S	0.00	0.00	0.00	F	6
13	c12	Piceance	CO	300.00	5120.00	20.00	30.0000	232.19	15.00	U	0.00	0.00	0.00	F	6
14	c13	Piceance	CO	1350.00	5094.00	350.00	30.0000	4042.67	3.86	TIS	0.00	0.00	0.00	F	15
15	c14	Piceance	CO	900.00	5120.00	125.00	26.7444	1293.69	7.20	U	0.00	0.00	0.00	F	6
16	c15	Piceance	CO	1000.00	5120.00	125.00	26.7444	1293.69	8.00	U	0.00	0.00	0.00	F	6
17	c16	Piceance	CO	1100.00	5120.00	615.00	26.4613	6297.60	1.79	TIS	0.00	0.00	0.00	F	6
18	u1	Uinta	UT	850.00	5120.00	40.00	26.4613	409.60	21.25	U	0.00	0.00	0.00	F	6
19	u2	Uinta	UT	850.00	5120.00	45.00	30.0000	622.42	18.99	U	0.00	0.00	0.00	F	6
20	u3	Uinta	UT	2300.00	5120.00	25.00	26.4613	255.00	32.00	MIS	0.00	0.00	0.05	F	6
21	u4	Uinta	UT	700.00	5120.00	50.00	30.0000	580.47	14.00	MIS	0.00	0.00	0.05	F	6
22	u5	Uinta	UT	700.00	5120.00	50.00	30.0000	580.47	14.00	MIS	0.00	0.00	0.05	F	6
23	w1	Washakie	WY	600.00	5120.00	90.00	20.0000	696.57	6.67	MIS	0.00	0.00	0.05	F	6
24	w2	Washakie	WY	600.00	5120.00	90.00	20.0000	696.57	6.67	MIS	0.00	0.00	0.05	F	6
25	w3	Washakie	WY	600.00	5120.00	90.00	20.0000	696.57	6.67	MIS	0.00	0.00	0.05	F	6





Figure A-20. State Specific Product Yield Factors

Yield Factors by State											
state	state	propane	butane	gasoline	diesel	reserves	yield	electricity	water	sulfur	jet fuel
AK	Alaska	0.046	0.020	0.562	0.413	-	2.461	0.109	10.491	0.002	0.562
AL	Alabama	0.044	0.020	0.631	0.330	12038	2.277	0.076	13.932	0.007	0.631
AZ	Arizona	0.046	0.020	0.562	0.413	10696	2.461	0.109	10.491	0.002	0.562
CO	Colorado	0.046	0.020	0.562	0.413	62528	2.461	0.109	10.491	0.002	0.562
IL	Illinois	0.044	0.020	0.631	0.330	131650	2.277	0.076	13.932	0.007	0.631
IN	Indiana	0.044	0.020	0.631	0.330	35220	2.277	0.076	13.932	0.007	0.631
KY - Eastern	Eastern Kentucky	0.044	0.020	0.631	0.330	28409	2.277	0.076	13.932	0.007	0.631
KY - Western	Western Kentucky	0.044	0.020	0.631	0.330	38645	2.277	0.076	13.932	0.007	0.631
MD	Maryland	0.044	0.020	0.631	0.330	501	2.277	0.076	13.932	0.007	0.631
MT	Montana	0.044	0.020	0.631	0.330	131598	2.277	0.076	13.932	0.007	0.631
ND	North Dakota	0.044	0.020	0.631	0.330	350271	2.277	0.076	13.932	0.007	0.631
NM	New Mexico	0.046	0.020	0.562	0.413	10840	2.461	0.109	10.491	0.002	0.562
OH	Ohio	0.044	0.020	0.631	0.330	42818	2.277	0.076	13.932	0.007	0.631
PA	Pennsylvania	0.044	0.020	0.631	0.330	60103	2.277	0.076	13.932	0.007	0.631
TN	Tennessee	0.044	0.020	0.631	0.330	1243	2.277	0.076	13.932	0.007	0.631
TX	Texas	0.044	0.020	0.631	0.330	8461	2.277	0.076	13.932	0.007	0.631
UT	Utah	0.046	0.020	0.562	0.413	25228	2.461	0.109	10.491	0.002	0.562
VA	Virginia	0.044	0.020	0.631	0.330	8675	2.277	0.076	13.932	0.007	0.631
WV	West Virginia	0.044	0.020	0.631	0.330	89212	2.277	0.076	13.932	0.007	0.631
WY	Wyoming	0.044	0.020	0.631	0.330	12914	2.277	0.076	13.932	0.007	0.631

Clicking on **Coal Reserves** returns to the coal reserves data table (figure A-19).

Selecting “CO<sub>2</sub> Flooding” displays a spreadsheet containing a snapshot of the CO<sub>2</sub> resource data used in the model. Information is provided for all 1,673 U.S. CO<sub>2</sub> Flooding reservoirs, and includes formation name, reservoir name, state, lithology, original oil in place, area, depth, pay, and API gravity (figure A-21).

Figure A-21. Sample CO<sub>2</sub> EOR Resource Database

Total number of Reservoirs		1,673									
Total OOIP of Reservoirs (MMbbls)		146,524									
Formation Name	Reservoir Name	State	Lithology	Original Oil In Place	Area	Depth	Pay	API			
				MMBbl	Acres	Ft	Ft	Deg			
ADELL	LANSING-KANSAS CITY	KS	Carbonate/Limestone	18	300	3764	26	36			
ADELL, NORTHWEST	LANSING-KANSAS CITY	KS	Carbonate/Limestone	20	210	3396.4	54	39			
AIRBASE	LANSING-KANSAS CITY	KS	Carbonate/Limestone	4	200	3219	5	37			
AIRBASE, EAST	LANSING-KANSAS CITY	KS	Carbonate/Limestone	3	320	3092.8	8	31			
ALBRIGHT	MISSISSIPPIAN LIME	KS	Carbonate/Limestone	13	2000	3132	10	43			
ALFORD	MISSISSIPPIAN	KS	Carbonate/Limestone	133	13200	5041	10	37			
AMES	ARBUCKLE	KS	Dolomite	5	382	3320.6	21	35			
ANTONINO, SOUTH	LANSING	KS	Carbonate/Limestone	2	280	3515.4	9	37			
ATYEO-PIXLEE	BARTLESVILLE	KS	Sandstone	48	1840	2262	20	40			
AUGUSTA	LANSING	KS	Carbonate/Limestone	82	1800	1706	10	34			
AUGUSTA	ORDOVICIAN	KS	Dolomite	82	1800	2451	10	33			
AUGUSTA, NORTH	LANSING-KANSAS CITY	KS	Carbonate/Limestone	29	600	1671	35	34			
BADGER HILL	KANSAS CITY	KS	Carbonate/Limestone	6	240	4043.2	17	37			
BAILEY	LANSING	KS	Carbonate/Limestone	4	360	3191.6	16	43			
BARRY	LANSING-KANSAS CITY	KS	Carbonate/Limestone	26	160	2391	35	32			
BAYER	SIMPSON	KS	Sandstone	2	80	3743.8	13	32			
BEAUMONT	MISSISSIPPIAN LIME	KS	Carbonate/Limestone	7	320	2454.6	16	35			
BEAYER	LANSING-KANSAS CITY	KS	Carbonate/Limestone	8	280	3000	16	33			
BECKMAN	LANSING-KANSAS CITY	KS	Carbonate/Limestone	3	480	3203.4	4	35			
BEMIS-SHUTTS	LANSING-KANSAS CITY	KS	Carbonate/Limestone	249	7600	3286.6	11	34			
BEMIS-SHUTTS	ARBUCKLE	KS	Dolomite	249	7600	3573.8	8	36			
BENEDICT	BARTLESVILLE	KS	Sandstone	12	1300	1009	15	33			
BERRYMAN	MORROW	KS	Sandstone	19	1726	4937	20	38			
BIG SANDY	BARTLESVILLE	KS	Sandstone	45	1820	1260	50	40			
BITIKOFER, NORTH	MISSISSIPPIAN LIME	KS	Carbonate/Limestone	20	1040	2914.2	12	29			
BLANKENSHIP	BARTLESVILLE	KS	Sandstone	19	805	2680	50	35			
BLAZIER	LANSING	KS	Carbonate/Limestone	4	120	3789.8	8	39			
BLEES	LANSING-KANSAS CITY	KS	Carbonate/Limestone	9	840	3257.2	12	32			
BOYD	LANSING-KANSAS CITY	KS	Carbonate/Limestone	20	640	3180.6	6	37			
BOYD	ARBUCKLE	KS	Carbonate/Limestone	20	640	3374.2	12	32			
BRAMPT, CEMENBAYICH	ARBUCKLE	KS	Carbonate/Limestone	14	600	2696.8	9	40			

Selecting “Heavy Oil” displays a spreadsheet containing a snapshot of the heavy oil resource data used in the model. Information is provided for all 761 U.S. heavy oil reservoirs, and

includes formation name, reservoir name, state, lithology, original oil in place, area, depth, pay, and API gravity (figure A-22).

Figure A-22. Sample Heavy Oil Resource Database

Total number of Reservoirs	761	
Total OOIP of Reservoirs (MMbbls)	46,496	

Formation Name	Reservoir Name	State	Lithology	Original Oil In Place	Area	Depth	Pay	API
				MMBbl	Acres	Ft	Ft	Deg
FOURBEAR	DARWIN	WY	Dolomite	15	75	3198	35	14
ALISO CANYON: MAIN	ALISO	CA	Sandstone	22	142.5	4203.4	89	15
FERGUSON RANCH	TENSLEEP	WY	Sandstone	79	270	3810.2	177	15
SPRING CREEK, SOUTH	PHOSPHORIA	WY	Carbonate/Limestone	12	200	3666	18	15
WILLISVILLE, WEST	NACATOCH	AR	Sandstone	5	15	1215	25	15
HALF MOON	TENSLEEP	WY	Sandstone	47	400	3622	120	15
SPRING CREEK, SOUTH	TENSLEEP	WY	Sandstone	97	550	3920.4	184	15
CLARK RANCH	TENSLEEP	WY	Sandstone	4	100	4685.2	17	16
HASLEY CANYON	MODELO	CA	Sandstone	33	200	4019	200	16
LOS ANGELES CITY	PUENTE	CA	Sandstone	82	56	937	62	16
DEER CREEK	SANTA MARGARITA	CA	Sandstone	7	290	727	20	16
WINN-DULCE	SAN MIGUEL	TX	Sandstone	156	5890	2586	30	17
TABASCO	SCHRADER BLUFF	AK	Sandstone	56	80	3127.8	533	17
ANTELOPE HILLS: WILLIAMS	AGUA	CA	Sandstone	59	450	2151	85	17
TEJON: SOUTHEAST	FRUITVALE	CA	Sandstone	26	200	1761	102	17

## Economic Data




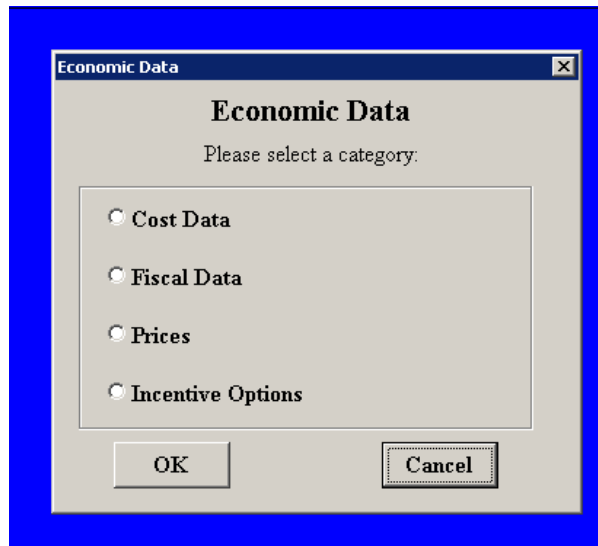
Clicking  displays a pop-up menu listing the four types of economic data available in the model: cost data, fiscal data, prices, and incentive options (figure A-23).

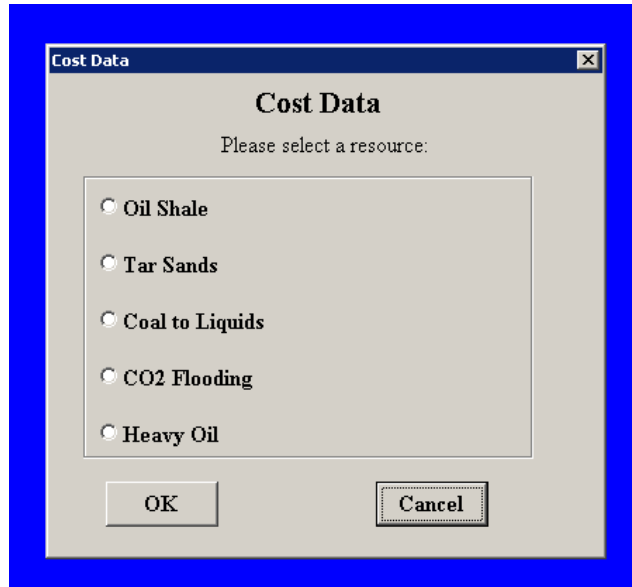
Figure A-23. Economic Data Menu



### 6. Cost Data

Selecting “Cost Data” displays a new pop-up menu (figure A-24) listing the five resources modeled: oil shale, tar sands, coal to liquids, CO<sub>2</sub> flooding, and heavy oil.

**Figure A-24. Resource Specific Cost Data Menu**



*i Oil Shale*

Selecting “Oil Shale” displays a spreadsheet containing the detailed Oil Shale cost data used in the model. Information provided includes capital and operating costs broken down by category, plant size, and recovery process (figures A-25 to A-27).

**Figure A-25. Capital Costs for Oil Shale Processes**

<b>Capital Costs (\$/bbl capacity)</b>			
	<b>Surface</b>	<b>Underground</b>	<b>True Insitu</b>
Mining	x,xxx	x,xxx	0
Retorting	x,xxx	x,xxx	0
Oil Recovery	x,xxx	x,xxx	x,xxx
Oil Upgrading	x,xxx	x,xxx	x,xxx
Utilites	x,xxx	x,xxx	x,xxx
Facilites	x,xxx	x,xxx	0
Others	xx,xxx	xx,xxx	0

**Figure A-26. Operating Costs for Oil Shale Processes**

<b>Surface Mining - Operating Costs</b>	
<b>Variable Operating Costs (\$/bbl)</b>	
Mining	x.xx
Electricity	x.xx
Natural Gas	x.xx
Chemicals	x.xx
Nitrogen/Water	x.xx
Contingency	x.xx
<b>Fixed Operating Costs (\$/bbl)</b>	
Mining	x.xx
Plant	x.xx
Maintenance	x.xx
Finance and Administration	x.xx
Environmental, health and safety	x.xx
<b>Underground Mining - Operating Costs</b>	
<b>Variable Operating Costs (\$/bbl)</b>	
Mining	x.xx
Electricity	x.xx
Natural Gas	x.xx
Chemicals	x.xx
Nitrogen/Water	x.xx
Contingency	x.xx
<b>Fixed Operating Costs (\$/bbl)</b>	
Mining	x.xx
Plant	x.xx
Maintenance	x.xx
Finance and Administration	x.xx
Environmental, health and safety	x.xx

**Figure A-27. Operating Costs for Oil Shale Processes Contd.**

<b>Modified Insitu - Cost Equations for Capital Investments</b>			
	A	B	C
Mining, retorting, waste disposal (\$/ton of capacity)	-0.00555	0	3,777.94
Refining and upgrading (\$/ton of capacity)	0	0	5,499.78
plant utilities (\$/bbl of capacity)	0	0	2,640.07
plant facilities (\$/bbl of capacity)	0	0	910.24
initial catalyst (\$/bbl of capacity)	0	0	592.58
<b>Modified Insitu - Cost Equations for Operating Costs</b>			
	50 MBOPD	100MBOPD	300 MBOPD
Mining, retorting, waste disposal (\$/ton shale processed)	0.00	0.00	7.30
refining and upgrading (\$/bbl oil produced)	0.00	0.00	2.35
<b>True Insitu - Operating Costs (\$/bbl)</b>			
	50 MBOPD	100MBOPD	300 MBOPD
Surface	xx.xx	xx.xx	xx.xx
Subsurface	xx.xx	xx.xx	xx.xx
Energy	xx.xx	xx.xx	xx.xx
<b>True Insitu - Capital Cost Factors</b>			
	50 MBOPD	100MBOPD	300 MBOPD
Surface	xx.xx	xx.xx	xx.xx
Subsurface	xx.xx	xx.xx	xx.xx
Energy	xx.xx	xx.xx	xx.xx
<b>True Insitu - Capital and Operating Cost Multipliers</b>			
	50 MBOPD	100MBOPD	300 MBOPD
Capex 1	xx.xx	xx.xx	xx.xx
Capex 2	xx.xx	xx.xx	xx.xx
Opex 1	xx.xx	xx.xx	xx.xx
Opex 2	xx.xx	xx.xx	xx.xx
G&A on Operating Expenses	xx.xx	xx.xx	xx.xx
G&A on Capital Expenses	xx.xx	xx.xx	xx.xx

ii **Tar Sands**

Selecting “Tar Sands” displays a spreadsheet containing the detailed Tar Sands cost data used in the model. Information provided includes capital and operating Mining costs (figure A-28).

**Figure A-28. Tar Sands Mining Costs**

<b>Mining Costs</b>				
<b>Capital Cost Equations</b>				
Category	Equation Form	Coefficients		
		a	b	c
Size of Plant (bbls/D)	X			
Mining (\$M)	$a*(Q^{**b})$	x.xxx	x.xxx	x.xxx
Upgrading (\$M)	$a*(x^3)+b*(x^2)+c*x$	x.xxx	x.xxx	x.xxx

<b>Operating Costs for Surface Mining</b>		
Category	Unit	Cost
Overburden Removal	\$/ton of bitumen	x.xxx
Production (Bitumen)	\$/ton of bitumen	x.xxx
Purchased Energy (Bitumen)	\$/ton of bitumen	x.xxx
Turnarounds & Catalyst	\$/bbl SSB	x.xxx
Production (Upgrading)	\$/bbl SSB	x.xxx
Purchased Energy (Upgrading)	\$/bbl SSB	x.xxx
Corporate admin/research	\$/bbl SSB	x.xxx
Overhead for Operating Costs	fraction	x.xxx
Maintenance for Operating Costs	fraction	x.xxx
Overhead for Capital Costs	fraction	x.xxx
Maintenance for Capital Costs	fraction	x.xxx

Clicking SAGD displays the detailed capital and operating costs for the SAGD recovery process (figure A-29).

**Figure A-29. Tar Sands SAGD Costs**

<b>SAGD Costs</b>				
<b>Capital Cost Equations</b>				
Category	Equation Form	Coefficients		
		a	b	c
Size of Plant (bbls/D)	X			
Upgrading (\$M)	$a*x^b$	x.xxx	x.xxx	x.xxx

<b>Operating Costs</b>		
Category	Unit	Cost
Production (Upgrading)	\$/bbl SSB	x.xxx
Power	\$/MW	x.xxx
Steam SAGD	\$/Bbl	x.xxx
Lifting cost SAGD	\$/Bbl	x.xxx

Clicking Natural Gas Prices - EIA 25 Year displays the Energy Information Administration’s (EIA) projections for Natural Gas prices through 2025 (figure A-30).

**Figure A-30. Natural Gas Price Track**

<b>Natural Gas Prices - EIA 25 year Projection</b>																				
2005	2006	2007	2008	2009	2010	2011	2012	2013	2014	2015	2016	2017	2018	2019	2020	2021	2022	2023	2024	2025
7.62	6.85	6.13	5.78	5.34	5.03	4.78	4.72	4.80	4.71	4.52	4.46	4.53	4.71	4.85	4.90	5.03	5.12	5.19	5.30	5.43



Clicking [Back to SAGD Operating Costs](#) returns the user to the SAGD operating costs table (figure A-29)

### iii Coal to Liquids

Selecting “Coal to Liquids” displays spreadsheet containing the detailed coal to liquids cost data used in the model. Information provided includes capital and operating costs for the installation and operation of a coal to liquids plant (figure A-31).

Figure A 31. Coal to Liquids Capital and Operating Costs

Capital Costs		
Category	Unit	Cost
Mining	\$/ton	x,xxx. xxx
Coal Preparation	\$/ton	x,xxx. xxx
Gasification	\$/ton	x,xxx. xxx
Catalysts	\$/ton	x,xxx. xxx
Liquification Synthesis	\$/ton	x,xxx. xxx
Gas Recovery/Separation	\$/bbl	x,xxx. xxx
Water Reclamation	\$/bbl	x,xxx. xxx
Others	\$/bbl	x,xxx. xxx
Chemical Recovery	\$/bbl	x,xxx. xxx
Utilities	\$/bbl	x,xxx. xxx
Site Preparation	\$/bbl	x,xxx. xxx

Operating Costs		
Category	Unit	Cost
Water	bbl/ton	xx. xxx
Water	\$/bbl	xx. xxx
Electricity Requirement	MegaWatt/ton of Coal	xx. xxx
Electricity - Eastern U.S.	\$/MegaWatt	xx. xxx
Electricity - Rockies	\$/MegaWatt	xx. xxx
Electricity - Average U.S.	\$/MegaWatt	xx. xxx
Catalysts	\$/bbl	xx. xxx
Overhead	fraction	xx. xxx
Maintenance	fraction	xx. xxx

Clicking [Coal Prices - EIA 25 Year Projection](#) displays the Energy Information Administration’s (EIA) projections for regional coal prices through 2045 (figure A-32).

Figure A-32. 25 Year Regional Coal Price Projections

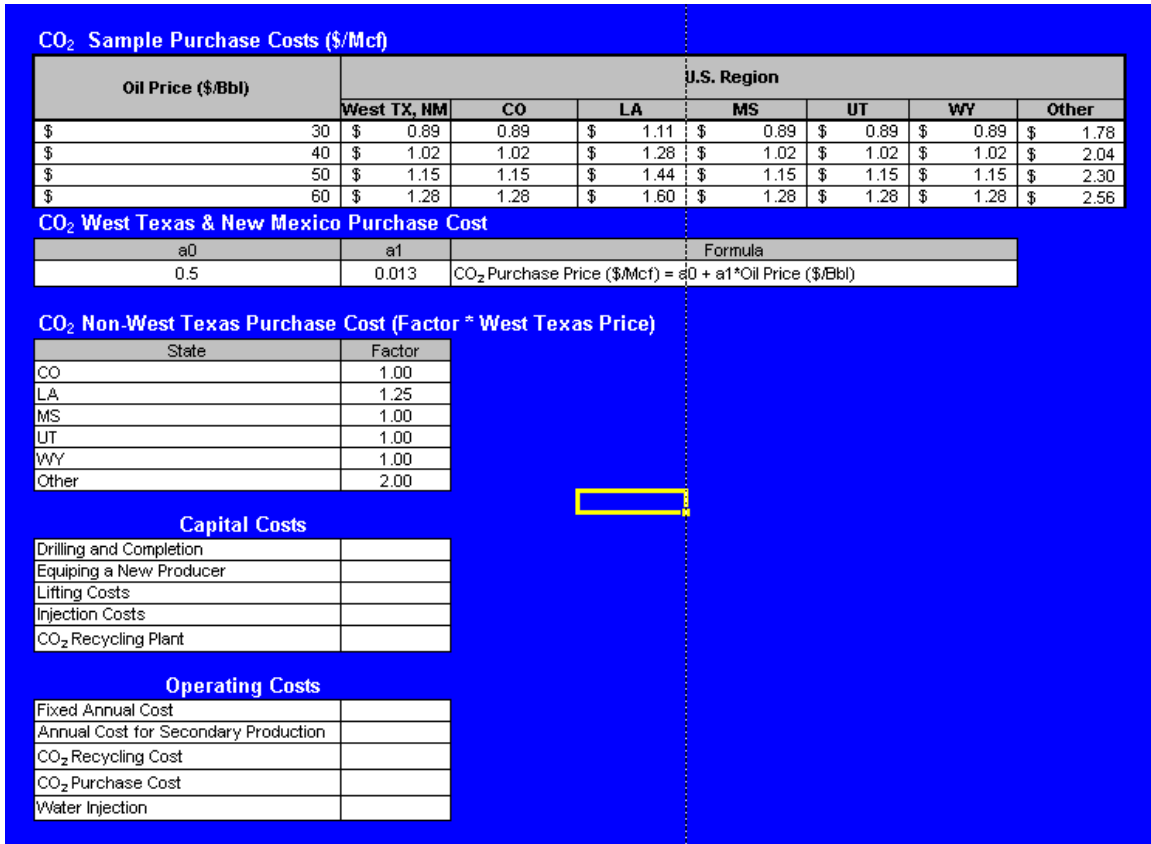
25 year EIA Projections for Regional Coal Prices (\$/ton)												
Region	2006	2007	2008	2009	2010	2011	2012	2013	2014	2015	...	2045
Appalachia	29.92	30.17	29.58	29.34	29.27	29.14	28.82	28.72	28.71	28.67	...	33.77
Interior	20.82	21.57	21.33	21.07	20.99	20.82	21.20	21.38	21.34	21.10	...	29.78
Western Average	10.20	10.20	10.20	10.20	10.20	10.20	10.20	10.20	10.20	10.20	...	12.20
Northern Great Plains	7.92	8.09	7.86	7.79	7.80	7.84	7.79	7.82	7.82	7.85	...	9.99
Other West & Non-Contiguous	20.98	21.17	20.98	20.78	20.79	20.54	20.20	19.83	19.53	19.47	...	22.74
United States Average	18.52	18.61	18.21	17.95	17.78	17.56	17.30	17.16	17.01	16.87	...	22.63

Clicking [Back to Operating Costs](#) returns the user to the coal to liquids operating costs table (figure A-31)

### iv CO<sub>2</sub> Flooding

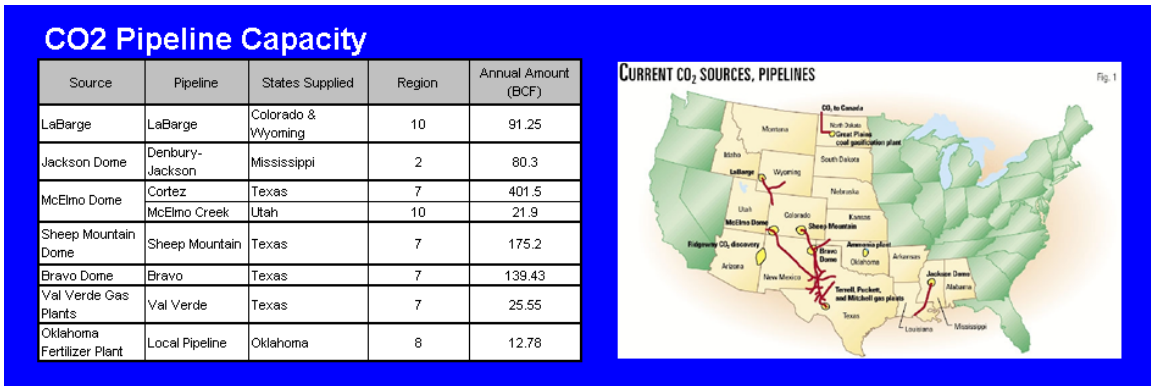
Selecting “CO<sub>2</sub> Flooding” displays spreadsheet containing the detailed CO<sub>2</sub> Flooding cost data used in the model. Information provided includes CO<sub>2</sub> purchase costs for various regions and oil prices (figure A-33).

Figure A-33. CO<sub>2</sub> EOR Capital and Operating Costs



Clicking **CO<sub>2</sub> Pipeline Capacities** displays the current U.S. CO<sub>2</sub> pipeline capacities and throughputs, as well as their geographic location (figure A-34).

Figure A-34. CO<sub>2</sub> Pipeline Capacity and Location



Clicking **CO<sub>2</sub> Cost Data** returns the user to the CO<sub>2</sub> purchase costs table (figure A-33)

v **Heavy Oil**

Selecting “Heavy Oil” displays spreadsheet containing the drilling and completion costs used for heavy oil (figure A-35).

**Figure A-35. Heavy Oil Capital and Operating Costs**

<b>Capital Costs</b>	
Drilling and Completion	
Equiping a New Producer	
Lifting Costs	
Injection Costs	
Manifolds	
Steam Generators	

<b>Operating Costs</b>	
Fixed Annual Cost	
Annual Cost for Secondary Production	
Water Disposal Cost	
Water Injection Cost	
Operating Produced Water Plants	

## 7. Fiscal Data

Selecting “Fiscal Data” displays a spreadsheet containing royalty rates by resource (figure A-36), federal tax rates and discount rates (figure A-37) and detailed state tax rates including corporate taxes and severance taxes (figure A-38).

**Figure A-36. Royalty Data**

<b>Royalty Data</b>					
Process	Y/N	Royalty Rate (%)	Parameters for Royalty Relief		
			Royalty Relief	First Year of Royalty Relief	No of Years of Royalty Relief
Oil Shale	Y	12.50	N	1	0
FT Liquids	N	12.50	N	1	0
Tar Sands	Y	12.50	N	1	0
CO2 Flooding	Y	12.50	N	1	0
Heavy Oil	Y	12.50	N	1	0

**Figure A-37. Federal Tax Rate and Discount Rates**

<b>Tax Data</b>	
Federal Tax Rate	34.50
State Tax Rate	By State

Process	Discount Rate
Oil Shale	15.00
FT Liquids	15.00
Tar Sands	15.00
CO2 Flooding	15.00
Heavy Oil	15.00

Figure A-38. State Corporate and Severance Tax Rates (Oil Shale)

State Corporate and Severance Tax Rate Table						
State	Corporate Tax rate (%)	Oil Shale Severance Tax Rate (%) for Years of Production				Exemption
		1	2	3	4+	BOPD
AL	5.00					
AZ	9.00					
AR	6.00					
CA	9.30					
CO	5.00	1.00	2.00	3.00	4.00	10000
CT	11.50					
DE	8.70					
DC	9.98					
FL	5.50					
GA	6.00					
ID	8.00					
IL	7.20					
IN	7.90					
IA	12.00					
KS	6.75					
KY	6.00					
LA	8.00					
ME	8.93					
MD	7.00					
MA	9.50					
MI	2.30					
MN	9.80					
MS	4.00					
MO	5.00					
MT	6.75					
NE	6.65					

Prices

Selecting “Prices” displays a spreadsheet containing price tracks for crude oil, natural gas, ammonia, gasoline, diesel, jet fuel, sulfur, and coal. The correlations between oil price and various product prices are also displayed (figure A-39).

Figure A-39. Product, Byproduct, and Feedstock Price Tracks

Year	2006	2007	2008	2009	2010	2011	2012	2013	2014	2015	2016	...	2045
Oil (\$/Bbl)	60.00	60.00	60.00	60.00	60.00	60.00	60.00	60.00	60.00	60.00	60.00	...	60.00
Gas (\$/Mcf)	7.00	7.00	7.00	7.00	7.00	7.00	7.00	7.00	7.00	7.00	7.00	...	7.00
Ammonia (\$/Ton)	218.00	218.00	218.00	218.00	218.00	218.00	218.00	218.00	218.00	218.00	218.00	...	218.00
Gasoline (\$/Bbl)	106.19	106.19	106.19	106.19	106.19	106.19	106.19	106.19	106.19	106.19	106.19	...	106.19
Diesel (\$/Bbl)	114.88	114.88	114.88	114.88	114.88	114.88	114.88	114.88	114.88	114.88	114.88	...	114.88
Jet Fuel (\$/bbl)	84.90	84.90	84.90	84.90	84.90	84.90	84.90	84.90	84.90	84.90	84.90	...	84.90
Sulfur (\$/Ton)	32.50	32.50	32.50	32.50	32.50	32.50	32.50	32.50	32.50	32.50	32.50	...	32.50
Coal (\$/Ton)													
Appalachia	29.92	30.17	29.58	29.34	29.27	29.14	28.82	28.72	28.71	28.67	28.76	...	33.77
Interior	20.82	21.57	21.33	21.07	20.99	20.82	21.20	21.38	21.34	21.10	21.09	...	29.78
Northern Great Plains	7.92	8.09	7.86	7.79	7.80	7.84	7.79	7.79	7.82	7.85	7.90	...	9.99
Other West	20.98	21.17	20.98	20.78	20.79	20.54	20.20	19.83	19.53	19.47	19.64	...	22.74

Category	Formula	Coefficients			
		a	b	c	d
Crude Oil (\$/bbl)	X				
Motor Gasoline (\$/bbl)	(a*(X**b)+(c*X)+d)	-0.0001	2	1.2209	33.298
Diesel (\$/bbl)	(a*(X**b)+(c*X)+d)	0.0092	2	0.6777	41.096
Jet Fuel	(a*(X**b)+(c*X)+d)	0.0062	2	0.9017	8.4788

8. Incentive Options


Selecting “Incentive Options” displays a menu of the various incentive options available in the model. Incentives include enhanced oil recovery tax credits, depreciation, production tax credits and investment tax credits (figure A-40).

**Figure A-40. Incentive Options Menu**

Resource	Rate	Years Applied
Enhanced Oil Recovery Tax Credit (percentage)	15	10
CO2 Flooding	<input checked="" type="checkbox"/>	
Heavy Oil	<input checked="" type="checkbox"/>	
Number of Years in the Straight Line Depreciation Schedule		20
Production Tax Credit (\$/bbl)	5	40
Oil Shale	<input type="checkbox"/>	
Tar Sands	<input type="checkbox"/>	
Investment Tax Credit (percentage)		10
Oil Shale	<input type="checkbox"/>	
Tar Sands	<input type="checkbox"/>	
Coal to Liquids	<input type="checkbox"/>	

Okay

## Run Options

Clicking  displays a pop-up menu listing the name of the run, start year, and the resources the user would like to run (figure A-41).

**Figure A-41. Run Options Menu**

Resource	Yes	No
Enter the Name of the Run	<input type="text"/>	
Enter the Start Year	2006	
<b>Unconventional Resources</b>		
Oil Shale	<input type="checkbox"/>	<input checked="" type="checkbox"/>
Tar Sands	<input type="checkbox"/>	<input checked="" type="checkbox"/>
Coal to Liquids	<input type="checkbox"/>	<input checked="" type="checkbox"/>
<b>Enhanced Oil Recovery</b>		
CO2 Flooding	<input type="checkbox"/>	<input checked="" type="checkbox"/>
Heavy Oil	<input type="checkbox"/>	<input checked="" type="checkbox"/>

Okay

The user can enter anything in the “Enter the Name of the Run” textbox.

The user can select the first year of analysis by entering it in the “Enter the Start Year” textbox.

The user can run any resource or any combination of resources by selecting “Yes” in the row corresponding to each resource name.

Before running the model, the user must choose between the two types of model runs available: “Minimum Economic price Run”, and “Future Potential Run” (Figure A-42).

Figure A-42. The Two Types of Possible Model Runs



## Results of the Minimum Economic Price Run


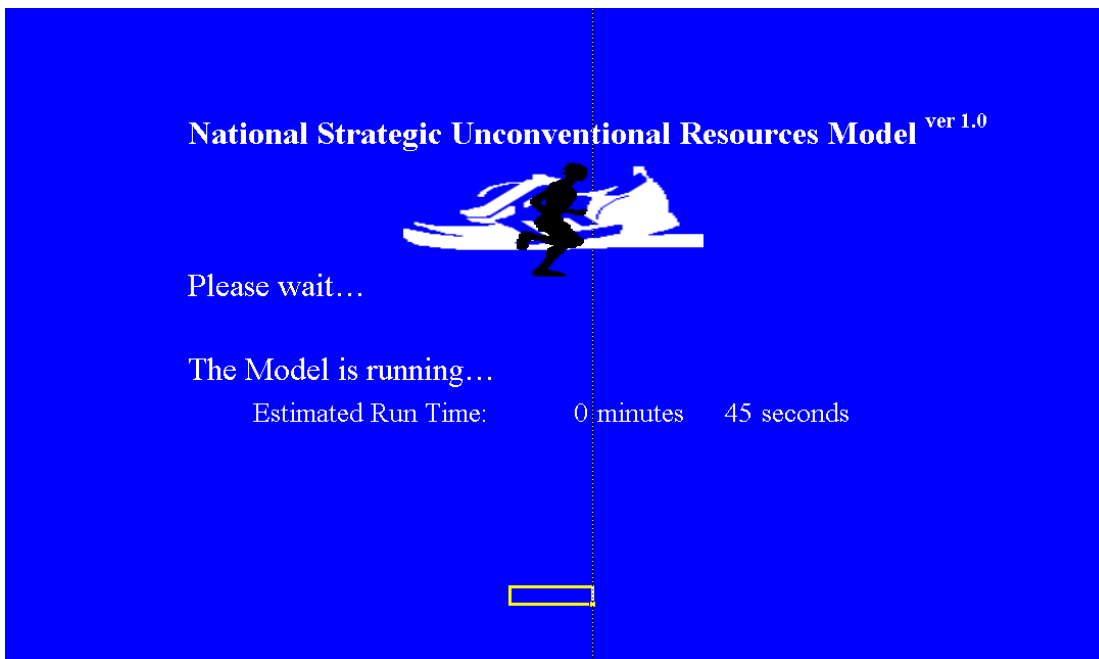
Selecting “Minimum Economic Price” and clicking  will determine the minimum World oil price for which each project is economic. While the model is running, a screen will be displayed containing the estimated length of the model run (figure A-43).

Figure A-43. Model Run Display



Two sets of reports are generated: “National Summary”, and “Process-Specific” reports.








Clicking  displays a table containing the average capital costs, operating costs, and minimum economic prices of each recovery process (figure A-44). The ranges of capital costs, operating costs, and minimum economic prices for each recovery process are also provided.

Figure A-44. National Summary for Minimum Economic Price Run

Resource Type	Technology	Number of Projects	Capital Costs (K\$/Bbl capacity)			Operating Costs (\$/Bbl)			Minimum Economic Price (\$/Bbl)		
			Min	Avg	Max	Min	Avg	Max	Min	Avg	Max
Oil Shale	Surface Mining	7									
	Underground Mining	7									
	True In-Situ	4									
	Modified In-Situ	7									
Tar Sands	SAGD	20									
	Underground Mining	11									
Coal to Liquids	Coal to Liquid	37									
CO <sub>2</sub> EOR	CO <sub>2</sub> Miscible Flood	971									
Heavy Oil	Steam Flood	457									


Clicking any of the  **Process Specific** buttons, such as , , , , and , will display a table containing detailed economic data for each project, including total oil, total gas, maximum capacity, capital costs, operating costs, internal rate of return, net present value, first year economic, and breakeven price.

As an example, figure A-44 displays the oil shale table. Tables for tar sands, coal to liquids, CO<sub>2</sub> flooding, and heavy oil, are similar to the oil shale table.


Figure A-45. Sample of the Process Specific Minimum Economic Price Run

Reservoir Id	State	Reservoir Name	Technology	Total Oil	Total Gas	Maximum Capacity	Capital Costs		Operating Costs		Internal Rate of Return	Net Present Value	First Year Economic	Breakeven Price
							Capcost per Bbl	Total Capital Costs	Opcost per Bbl	Total Operating Costs				
				MMBbl	MMcf	BOFPD	K\$/Bbl	MM\$	\$/Bbl	MM\$		K\$		\$/Bbl
c1 TIS129S0900023210 1	CO	c1	True In-Situ											
c2 MIS 69S0900023210 2	CO	c2	Modified In-Situ											
c3 U 69S0900023210 3	CO	c3	Underground Mining											
c4 S 69S0900023210 4	CO	c4	Surface Mining											
c5 S 69S0900023210 5	CO	c5	Surface Mining											
c7 S 69S0900023210 6	CO	c7	Surface Mining											
c8 S 69S0900023210 7	CO	c8	Surface Mining											
c17S 69S0900023210 8	CO	c17	Surface Mining											
c6 TIS 99S0900023210 9	CO	c6	True In-Situ											
c9 U 69S0900023210 10	CO	c9	Underground Mining											
c10S 69S0900023210 11	CO	c10	Surface Mining											
c11S 69S0900023210 12	CO	c11	Surface Mining											
c12U 69S0900023210 13	CO	c12	Underground Mining											
c13TIS169S0900023210 14	CO	c13	True In-Situ											
c14U 69S0900023210 15	CO	c14	Underground Mining											
c15U 69S0900023210 16	CO	c15	Underground Mining											
c16TIS 69S0900023210 17	CO	c16	True In-Situ											
u1 U 69S0900023210 18	UT	u1	Underground Mining											
u2 U 69S0900023210 19	UT	u2	Underground Mining											
u3 MIS 69S0900023210 20	UT	u3	Modified In-Situ											
u4 MIS 69S0900023210 21	UT	u4	Modified In-Situ											
u5 MIS 69S0900023210 22	UT	u5	Modified In-Situ											
w1 MIS 69S0900023210 23	WY	w1	Modified In-Situ											
w2 MIS 69S0900023210 24	WY	w2	Modified In-Situ											

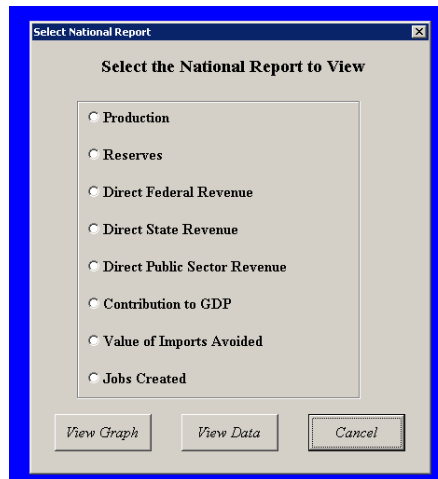
## Results of the Future Potential Run


Selecting “Future Potential Run” and clicking  will determine the production from economic projects at the prices specified by the user, and their macroeconomic impacts. Two sets of reports are generated: “National Summary”, and “Process-Specific” reports.



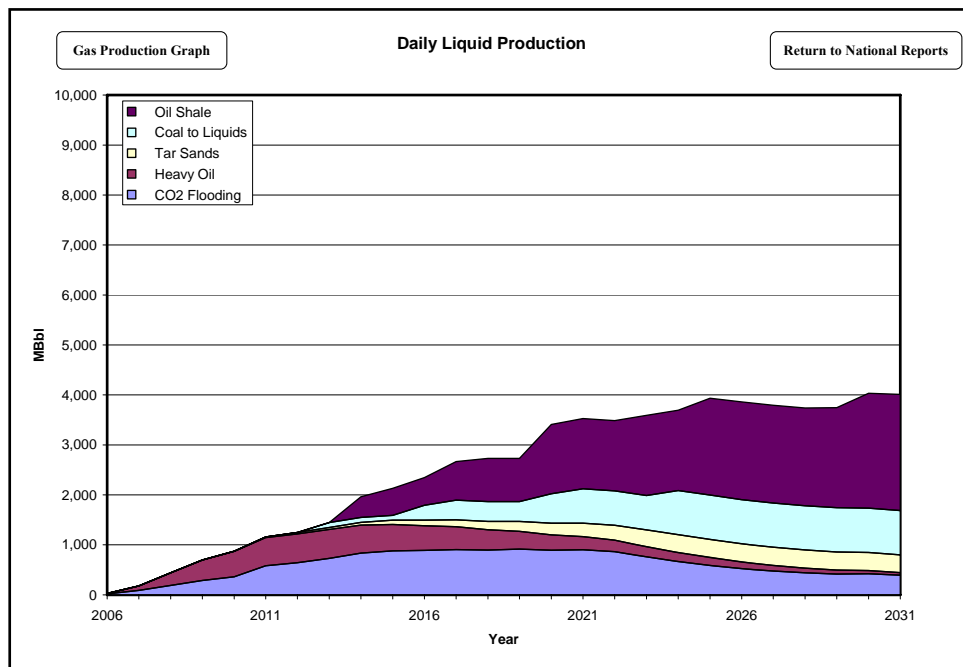
Clicking  displays a pop-up menu listing the national reports available: production, reserves, direct federal revenue, direct state revenue, direct public sector revenue, contribution to GDP, value of imports avoided, and jobs created (figure A-46). For each of these reports, the user can choose to display a graph or the data.

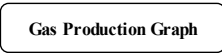
**Figure A-46. National Report Menu**



Selecting “Production” and  displays the daily liquid production for each resource for 25 years (figure A-47).

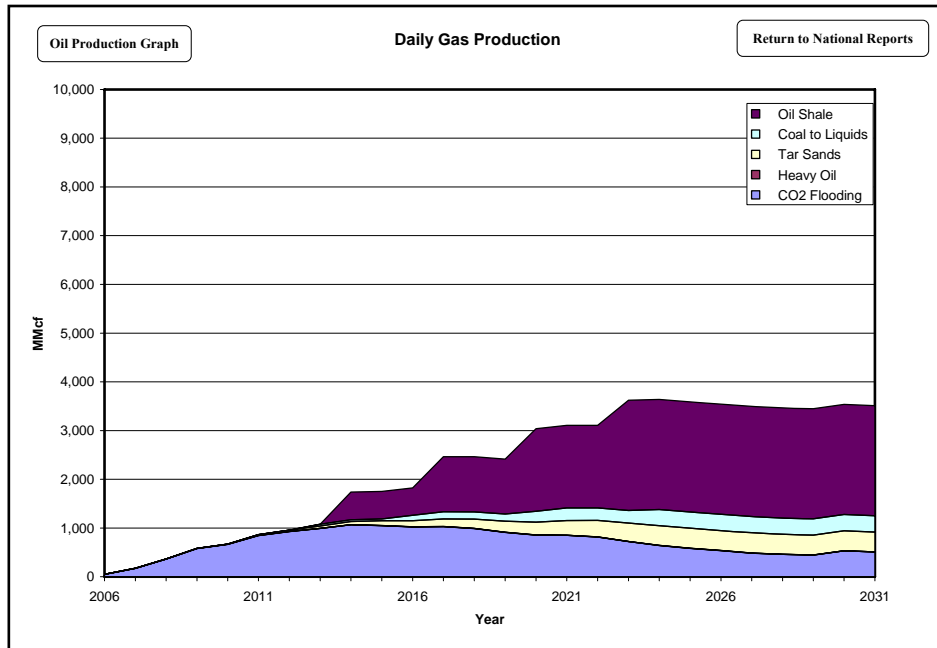
**Figure A-47. National Report: Liquid Production**



Clicking  displays the daily gas production for each resource for 25 years (figure A-48).

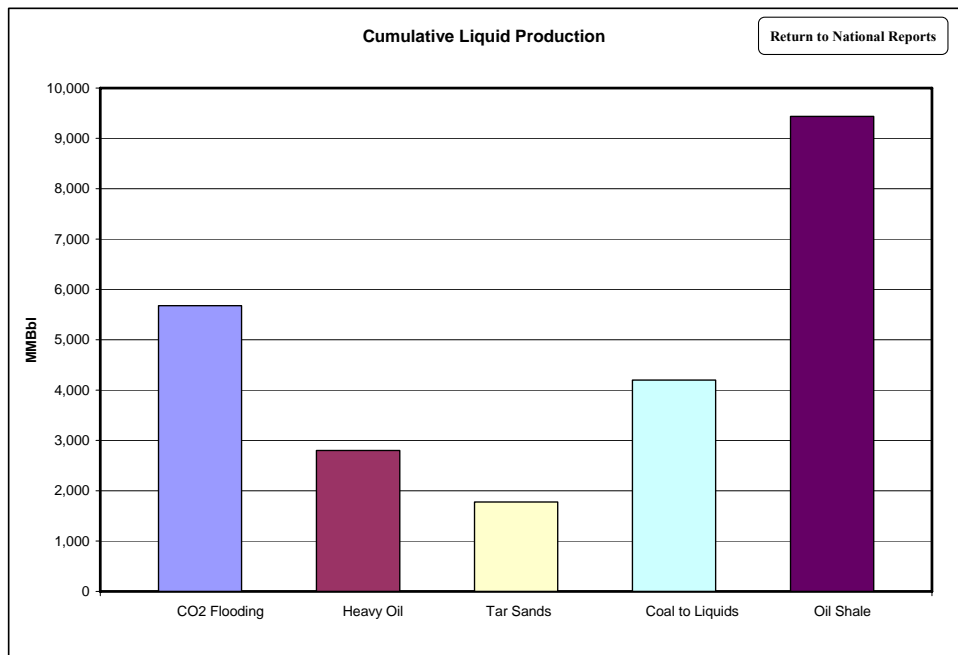


**Figure A-48. National Report: Gas Production**



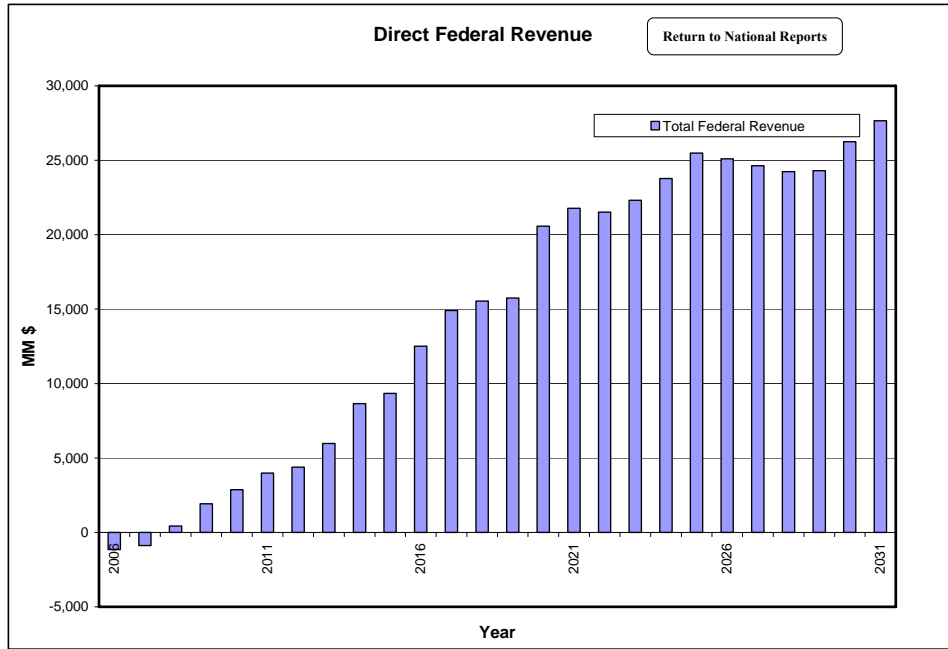
Selecting “Reserves” and [View Graph](#) displays the cumulative liquid production for each resource for 25 years (figure A-49).

**Figure A-49. National Report: Reserves**



Selecting “Direct Federal Revenue” and [View Graph](#) displays the annual direct federal revenues for all resources for 25 years (figure A-50).

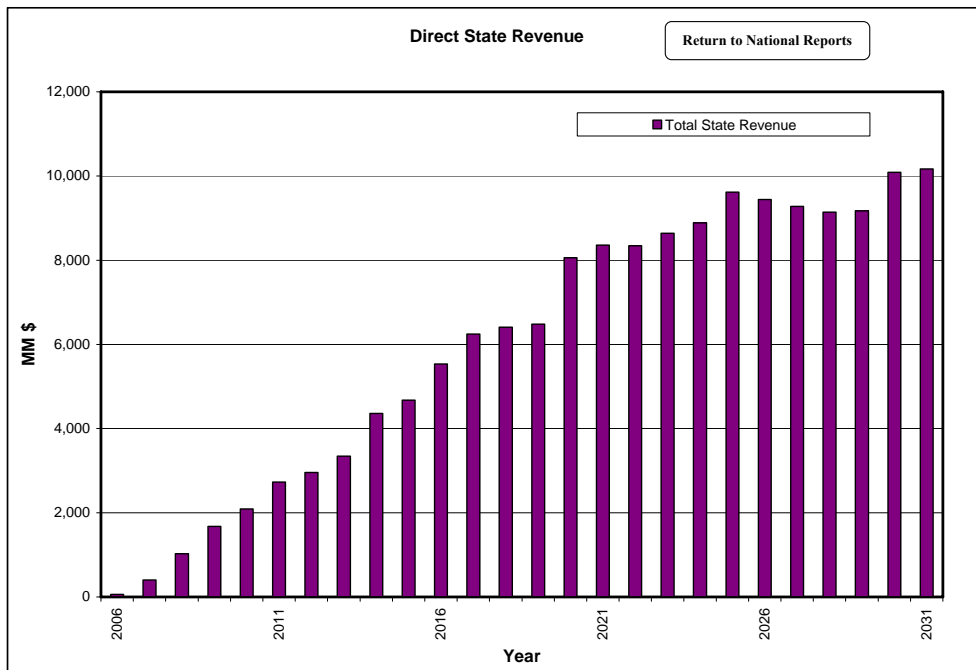
**Figure A-50. National Report: Direct Federal Revenue**



[View Graph](#)

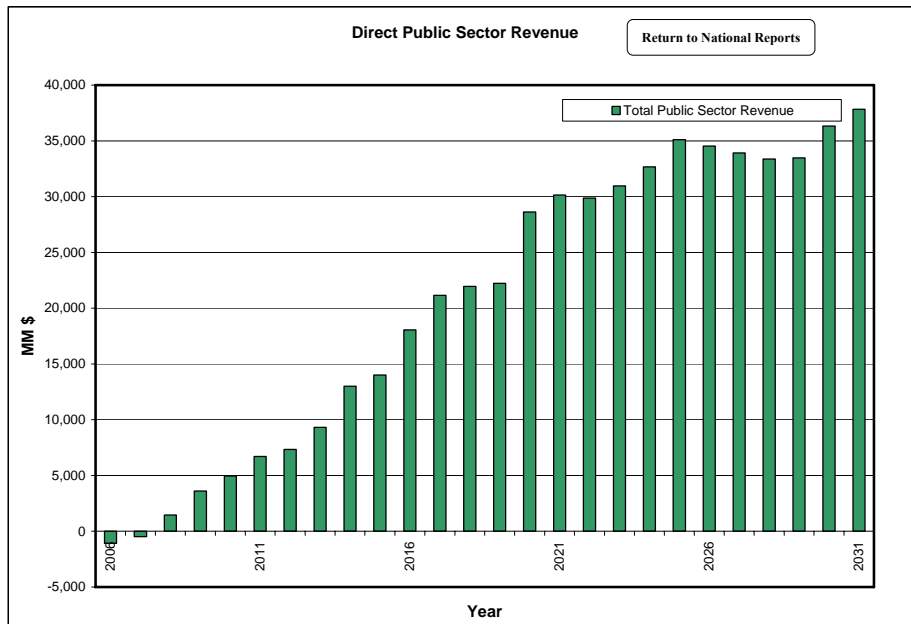
Selecting “Direct State Revenue” and [View Graph](#) displays the annual direct state revenues, aggregated for all resources for 25 years (figure A-51).

**Figure A-51. National Report: Direct State Revenues**



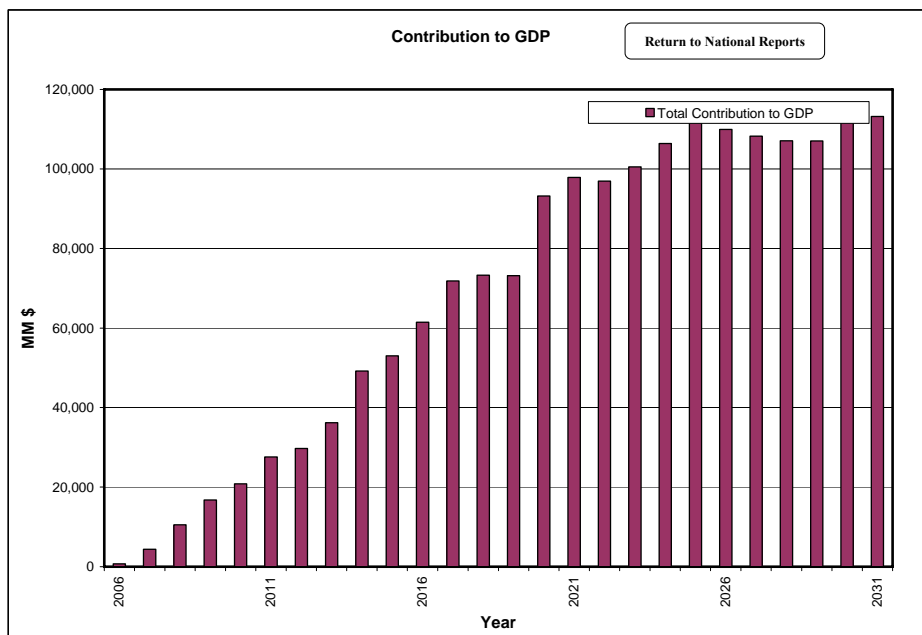
Selecting “Direct Public Sector Revenue” and [View Graph](#) displays the annual direct public sector revenues, aggregated for all resources for 25 years (figure A-52). Direct public sector revenue is the sum of the direct federal and state revenues.

**Figure A-52. National Report: Total Public Sector Revenues**



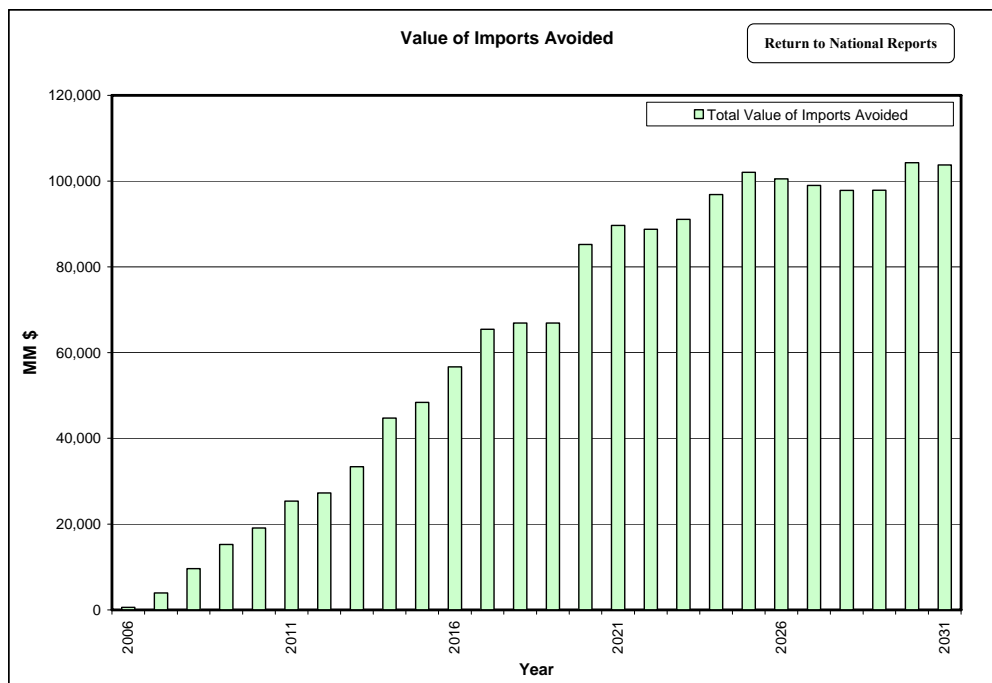
Selecting “Contribution to GDP” and [View Graph](#) displays the annual contribution to the U.S. GDP, aggregated for all resources for 25 years (figure A-53).

**Figure A-53. National Report: Contribution to GDP**



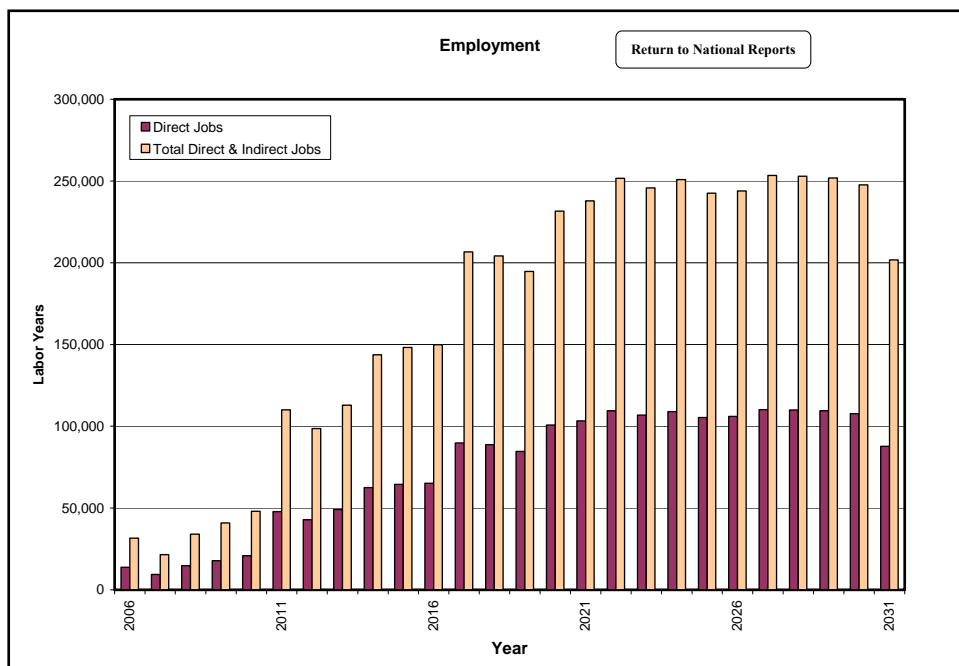
Selecting “Value of Imports Avoided” and [View Graph](#) displays the annual value of imports avoided (liquids only), aggregated for all resources for 25 years (figure A-54).

**Figure A-54. National Report: Value of Imports Avoided**




Selecting “Jobs Created” and [View Graph](#) displays the number of direct and indirect jobs created by all resources for 25 years (figure A-55).

**Figure A-55. National Report: Employment**



[View Data](#)







Selecting any report with  displays a spreadsheet containing the data used for all the previously described graphs. The data provided is annual through 2045 and broken down by resource. The table (figure A-56) includes annual and daily liquids production, annual and daily gas production, and direct federal revenue, direct state revenue, direct public sector revenue, contribution to GDP, value of imports avoided, total direct and indirect jobs, and direct jobs.

**Figure A-56. National Report: Data**

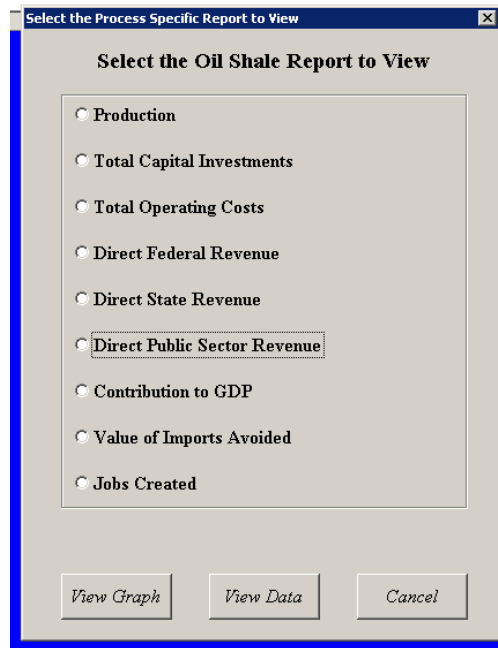
	Unit	2006	2007	2008	2009	2010	...	2045
<b>Annual Liquid Production</b>	MMBbl							
Oil Shale	MMBbl	8,000	8,000	8,000	8,000	8,000		88,000
Tar Sands	MMBbl	8,000	8,000	8,000	8,000	8,000		88,000
Coal to Liquids	MMBbl	8,000	8,000	8,000	8,000	8,000		88,000
CO <sub>2</sub> Flooding	MMBbl	8,000	8,000	8,000	8,000	8,000		88,000
Heavy Oil	MMBbl	8,000	8,000	8,000	8,000	8,000		88,000
<b>Total Annual Production</b>	MMBbl	8,000	8,000	8,000	8,000	8,000		88,000
<b>Annual Gas Production</b>	MMcf							
Oil Shale	MMcf	8,000	8,000	8,000	8,000	8,000		88,000
Tar Sands	MMcf	8,000	8,000	8,000	8,000	8,000		88,000
Coal to Liquids	MMcf	8,000	8,000	8,000	8,000	8,000		88,000
CO <sub>2</sub> Flooding	MMcf	8,000	8,000	8,000	8,000	8,000		88,000
Heavy Oil	MMcf	8,000	8,000	8,000	8,000	8,000		88,000
<b>Total Annual Production</b>	MMcf	8,000	8,000	8,000	8,000	8,000		88,000
<b>Daily Liquid Production</b>	MBbl							
Oil Shale	MBbl	8,000	8,000	8,000	8,000	8,000		88,000
Tar Sands	MBbl	8,000	8,000	8,000	8,000	8,000		88,000
Coal to Liquids	MBbl	8,000	8,000	8,000	8,000	8,000		88,000
CO <sub>2</sub> Flooding	MBbl	8,000	8,000	8,000	8,000	8,000		88,000
Heavy Oil	MBbl	8,000	8,000	8,000	8,000	8,000		88,000
<b>Total Annual Production</b>	MBbl	8,000	8,000	8,000	8,000	8,000		88,000
<b>Daily Gas Production</b>	MMcf							
Oil Shale	MMcf	8,000	8,000	8,000	8,000	8,000		88,000
Tar Sands	MMcf	8,000	8,000	8,000	8,000	8,000		88,000
Coal to Liquids	MMcf	8,000	8,000	8,000	8,000	8,000		88,000
CO <sub>2</sub> Flooding	MMcf	8,000	8,000	8,000	8,000	8,000		88,000
Heavy Oil	MMcf	8,000	8,000	8,000	8,000	8,000		88,000
<b>Total Annual Production</b>	MMcf	8,000	8,000	8,000	8,000	8,000		88,000
<b>Direct Federal Revenue</b>	MM\$	8,000	8,000	8,000	8,000	8,000		88,000
<b>Direct State Revenue</b>	MM\$	8,000	8,000	8,000	8,000	8,000		88,000
<b>Direct Public Sector Revenue</b>	MM\$	8,000	8,000	8,000	8,000	8,000		88,000
<b>Contribution to GDP</b>	MM\$	88,000	88,000	88,000	88,000	88,000		88,000
<b>Value of Imports Avoided</b>	MM\$	88,000	88,000	88,000	88,000	88,000		88,000
<b>Total Direct &amp; Indirect Jobs</b>	Labor years	88,000	88,000	88,000	88,000	88,000		88,000
<b>Direct Jobs</b>	Labor years	88,000	88,000	88,000	88,000	88,000		88,000




Process Specific

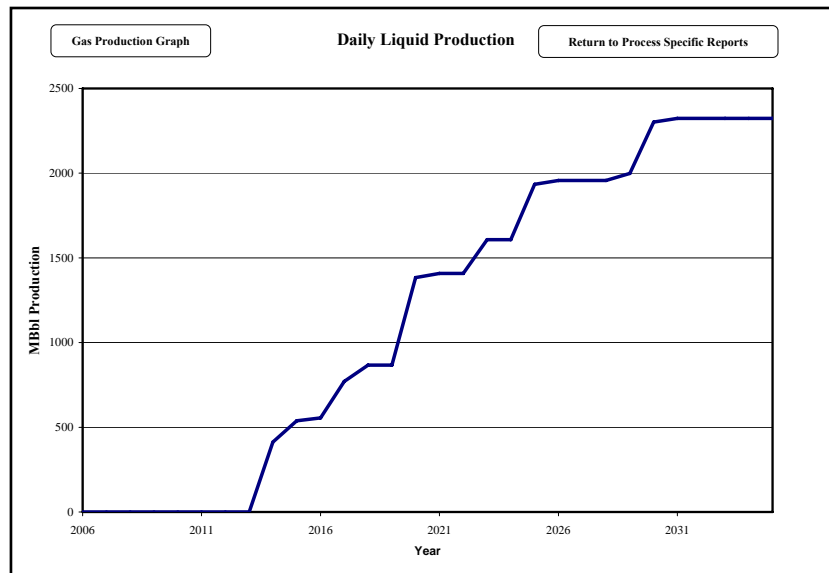
Clicking any of the  buttons, such as , , , , and , will display a popup menu listing the reports available for the specific resource selected (figure A-57). As an example, we will go through the Oil Shale reports. Reports for tar sands, coal to liquids, CO<sub>2</sub> flooding, and heavy oil, are similar to the oil shale reports.

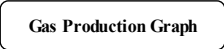
**Figure A-57. Process Specific Report Menu**



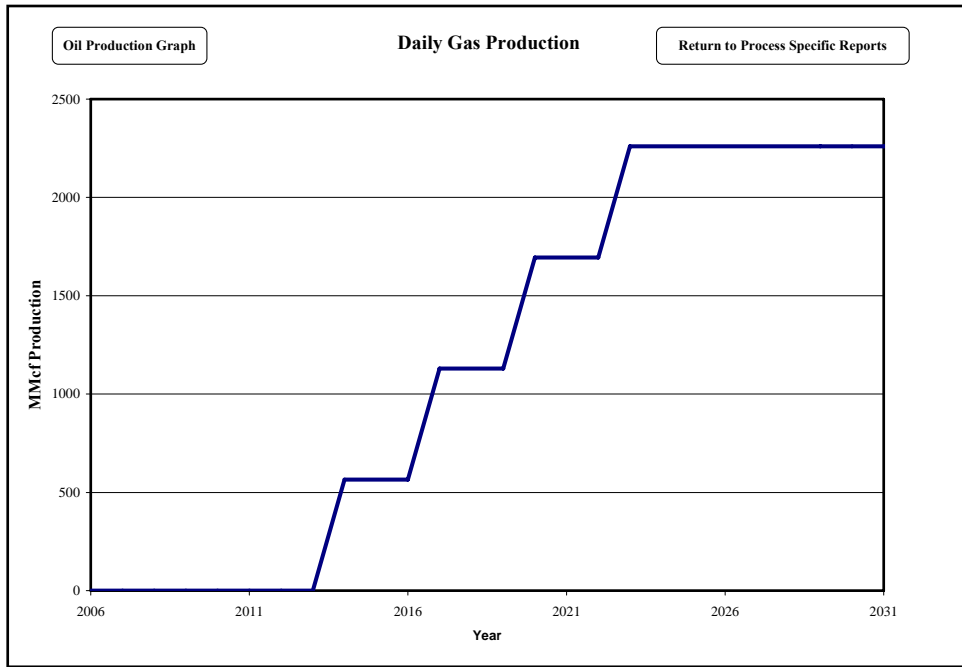
Selecting “Production” and  displays the daily shale oil production for all oil shale projects for 25 years (figure A-58).

**Figure A-58. Process Specific Report: Liquid Production**



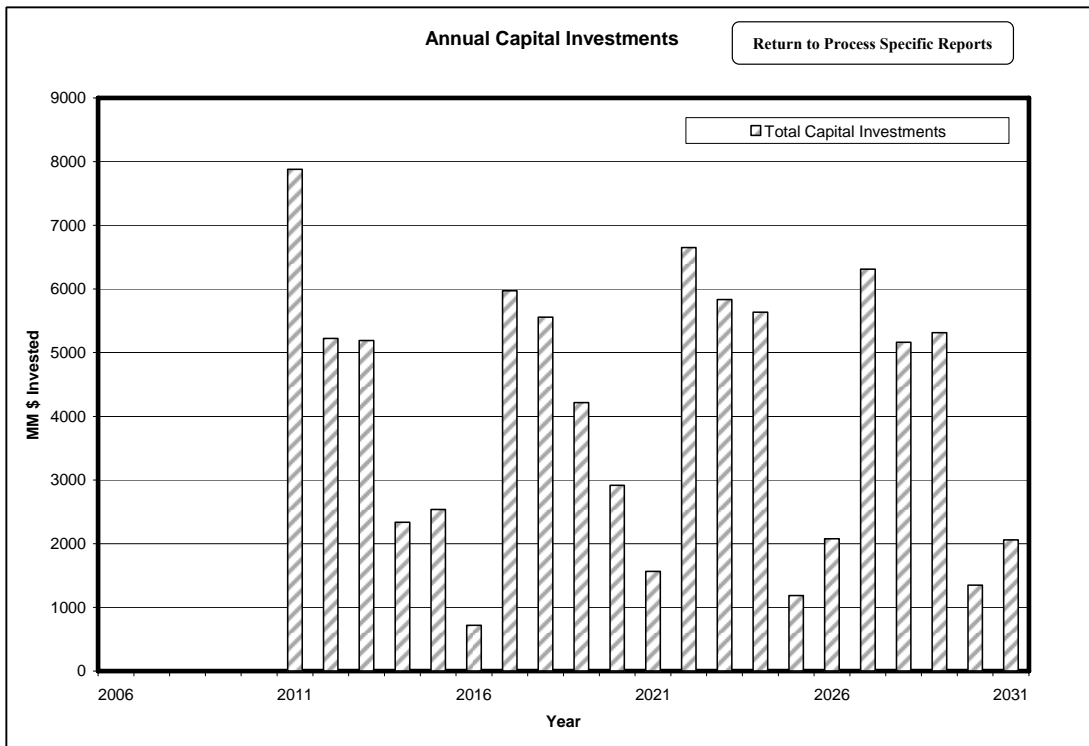
Clicking  displays the daily gas production for all oil shale projects for 25 years (figure A-59).

**Figure A-59. Process Specific Report: Gas Production**



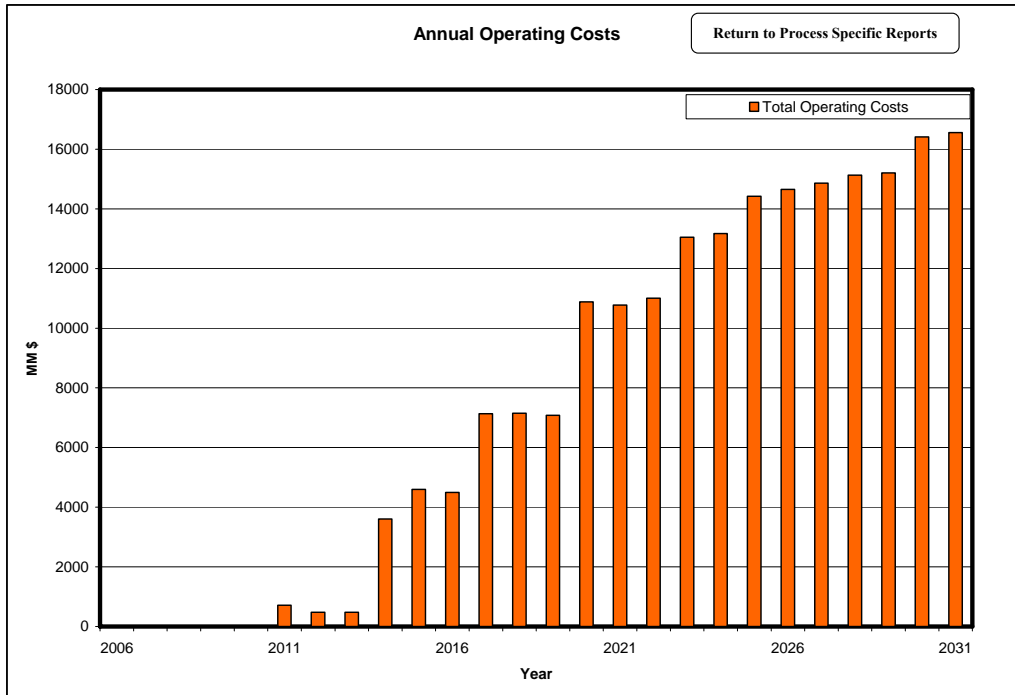
Selecting “Total Capital Investments” displays the total annual capital investments for all oil shale projects for 25 years (figure A-60).

**Figure A-60. Process Specific Report: Capital Investments**



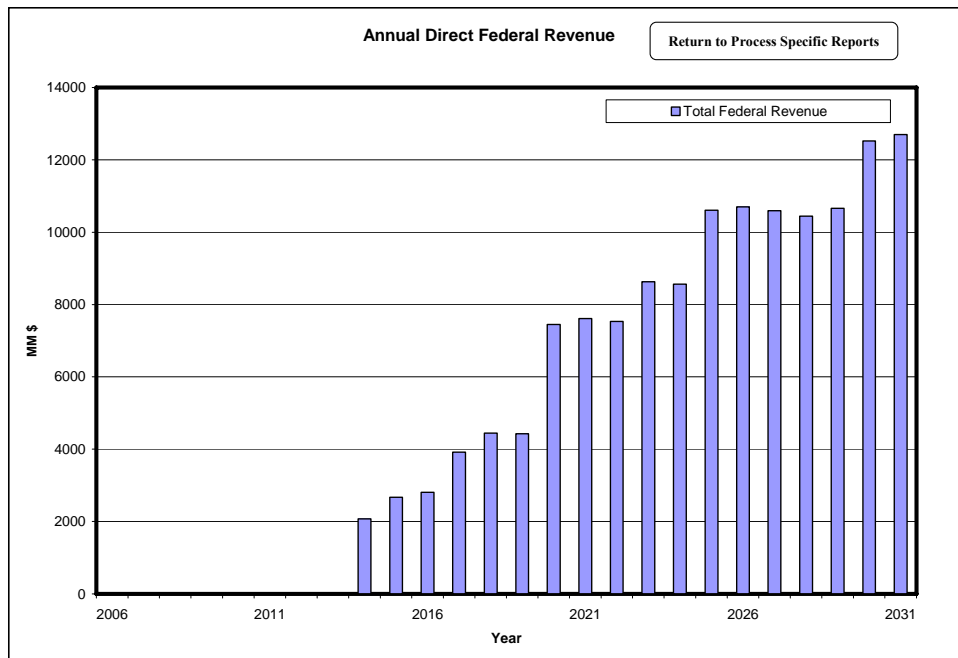
Selecting “Total Operating Costs” displays the total annual operating costs for all oil shale projects for 25 years (figure A-61).

**Figure A-61. Process Specific Report: Operating Costs**



Selecting “Direct Federal Revenue” and [View Graph](#) displays the annual direct federal revenues from shale oil production for 25 years (figure A-62).

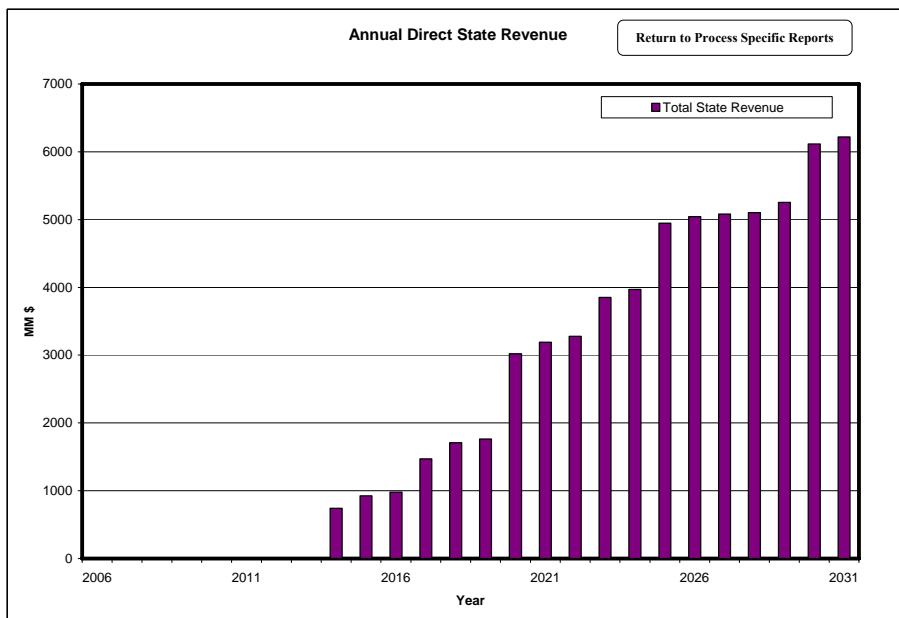
**Figure A-62. Process Specific Report: Direct Federal Revenue**





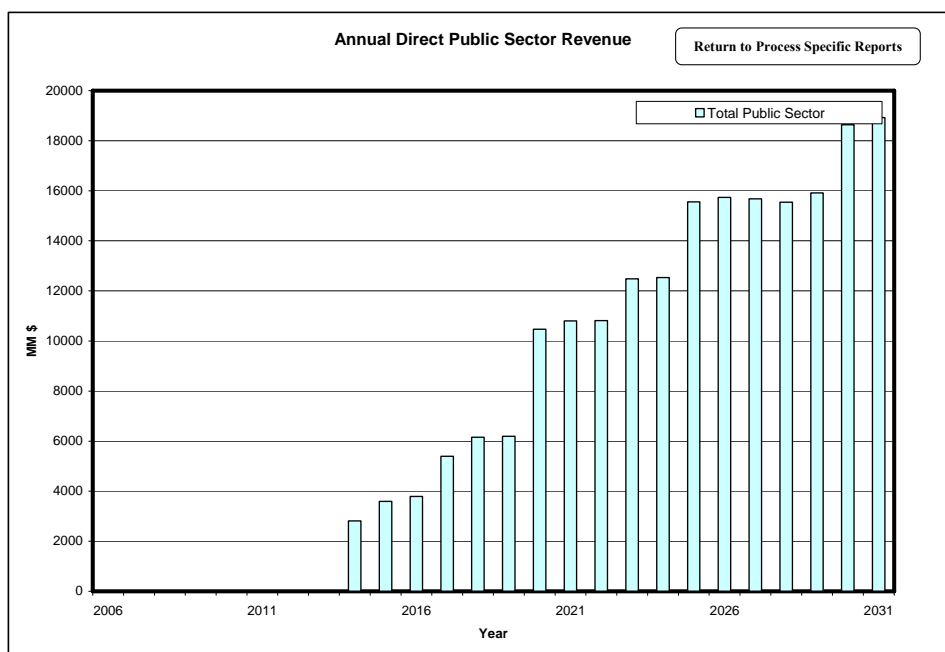
Selecting “Direct State Revenue” and [View Graph](#) displays the annual direct state revenues from shale oil production for 25 years (figure A-63)

**Figure A-63. Process Specific Report: Direct State Revenues**



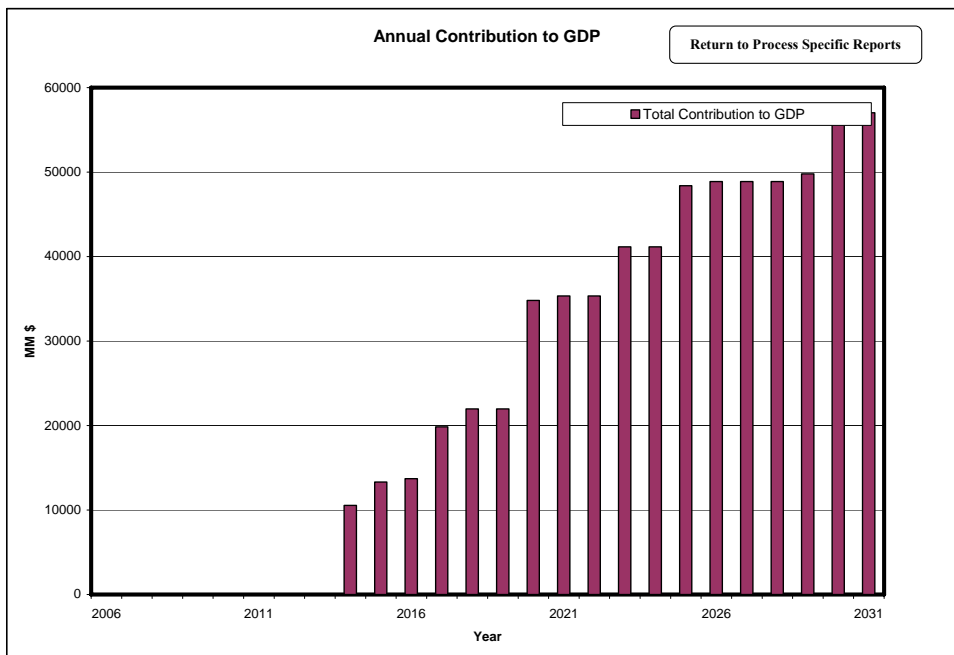
Selecting “Direct Public Sector Revenue” and [View Graph](#) displays the annual direct public sector revenues from shale oil production for 25 years (figure A-64). Direct public sector revenue is the sum of the direct federal and state revenues.

**Figure A-64. Process Specific Reports: Direct Public Sector Revenues**



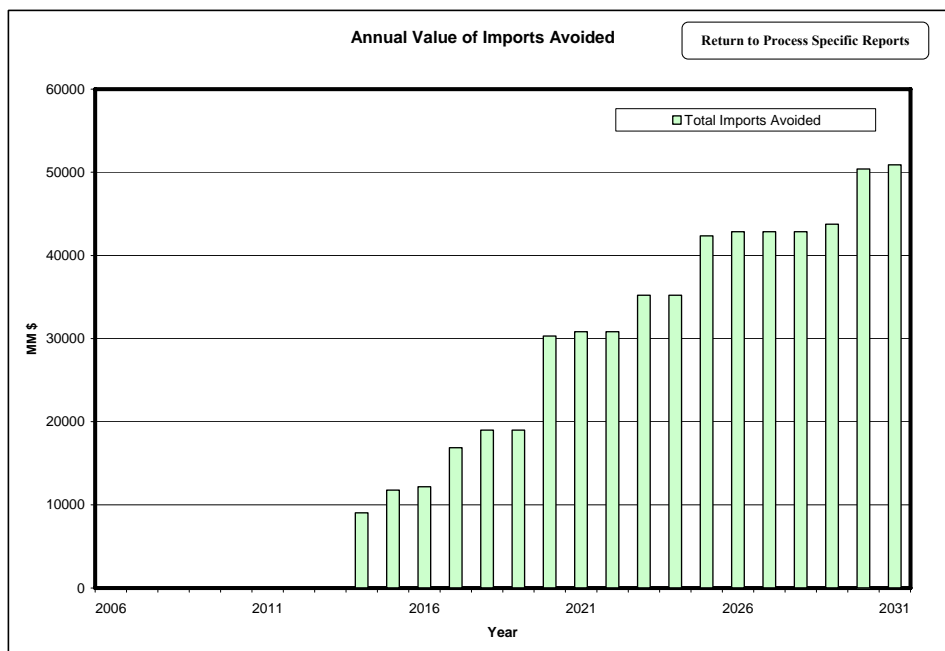
Selecting “Contribution to GDP” and [View Graph](#) displays the annual contribution to the U.S. GDP from shale oil production for 25 years (figure A-65).

**Figure A-65. Process Specific Reports: Contribution to GDP**



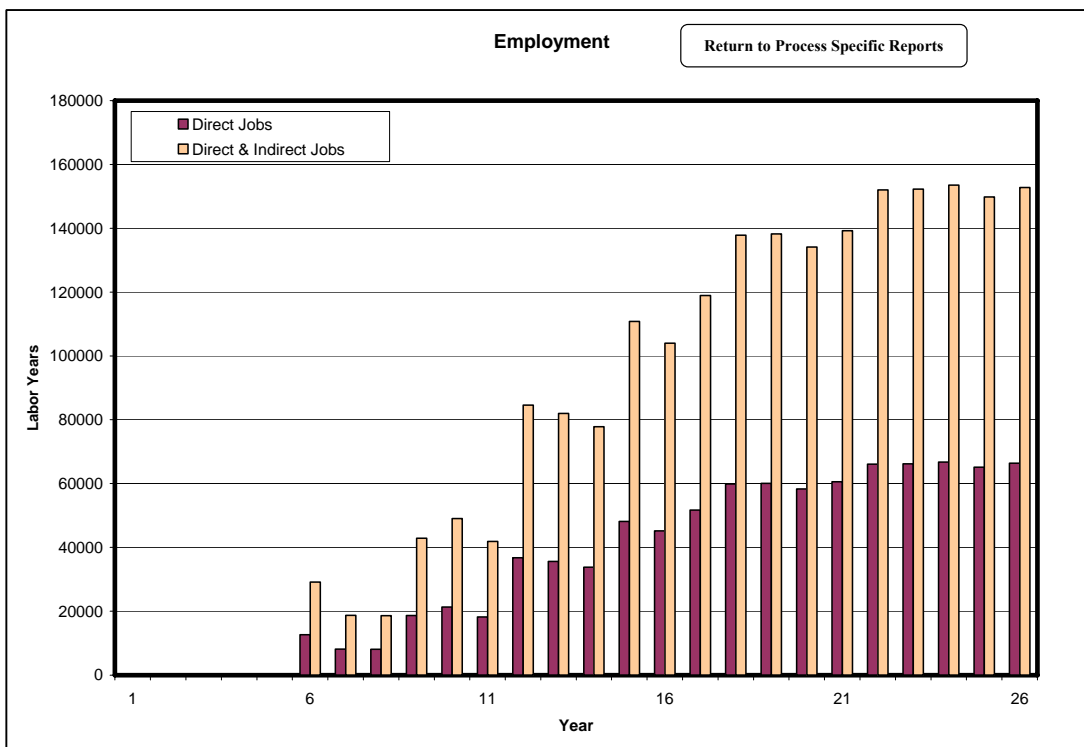
Selecting “Value of Imports Avoided” and [View Graph](#) displays the annual value of imports avoided (liquids only) due to shale oil production for 25 years (figure A-66).

**Figure A-66. Process Specific Reports: Value of Imports Avoided**



Selecting “Jobs Created” and [View Graph](#) displays the number of direct and indirect jobs created by shale oil production for 25 years (figure A-67).

**Figure A-67. Process Specific Reports: Employment**



Selecting any report with [View Data](#) displays a spreadsheet containing the data used for all the previously described graphs. The data provided is annual through 2045 and reflects all the oil shale projects operational in a given year. The table (figure A-68) includes annual and daily liquids production, annual and daily gas production, annual ammonia production, total capital investments, total operating costs, annual G&A costs, direct federal revenue, and direct state revenue, direct public sector revenue, contribution to GDP, value of imports avoided, total direct and indirect jobs, and direct jobs.

Figure A-68. Process Specific Reports: Resource Specific Data

	Unit	2006	2007	2008	2009	2010	2011	2012	2013	.....	2045
<b>Annual Liquid Production</b>	<b>MMBbl</b>										
Surface Mining	MMBbl	x,xxx	x,xxx	x,xxx	x,xxx	x,xxx	x,xxx	x,xxx	x,xxx		xx,xxx
Underground Mining	MMBbl	x,xxx	x,xxx	x,xxx	x,xxx	x,xxx	x,xxx	x,xxx	x,xxx		xx,xxx
Modified In-Situ	MMBbl	x,xxx	x,xxx	x,xxx	x,xxx	x,xxx	x,xxx	x,xxx	x,xxx		xx,xxx
True In-Situ	MMBbl	x,xxx	x,xxx	x,xxx	x,xxx	x,xxx	x,xxx	x,xxx	x,xxx		xx,xxx
<b>Total Annual Production</b>	<b>MMBbl</b>	x,xxx	x,xxx	x,xxx	x,xxx	x,xxx	x,xxx	x,xxx	x,xxx		xx,xxx
<b>Annual Gas Production</b>	<b>MMcf</b>										
Surface Mining	MMcf	x,xxx	x,xxx	x,xxx	x,xxx	x,xxx	x,xxx	x,xxx	x,xxx		xx,xxx
Underground Mining	MMcf	x,xxx	x,xxx	x,xxx	x,xxx	x,xxx	x,xxx	x,xxx	x,xxx		xx,xxx
Modified In-Situ	MMcf	x,xxx	x,xxx	x,xxx	x,xxx	x,xxx	x,xxx	x,xxx	x,xxx		xx,xxx
True In-Situ	MMcf	x,xxx	x,xxx	x,xxx	x,xxx	x,xxx	x,xxx	x,xxx	x,xxx		xx,xxx
<b>Total Annual Production</b>	<b>MMcf</b>	x,xxx	x,xxx	x,xxx	x,xxx	x,xxx	x,xxx	x,xxx	x,xxx		xx,xxx
<b>Daily Liquid Production</b>	<b>MBbl</b>										
Surface Mining	MBbl	x,xxx	x,xxx	x,xxx	x,xxx	x,xxx	x,xxx	x,xxx	x,xxx		xx,xxx
Underground Mining	MBbl	x,xxx	x,xxx	x,xxx	x,xxx	x,xxx	x,xxx	x,xxx	x,xxx		xx,xxx
Modified In-Situ	MBbl	x,xxx	x,xxx	x,xxx	x,xxx	x,xxx	x,xxx	x,xxx	x,xxx		xx,xxx
True In-Situ	MBbl	x,xxx	x,xxx	x,xxx	x,xxx	x,xxx	x,xxx	x,xxx	x,xxx		xx,xxx
<b>Total Annual Production</b>	<b>MBbl</b>	x,xxx	x,xxx	x,xxx	x,xxx	x,xxx	x,xxx	x,xxx	x,xxx		xx,xxx
<b>Daily Gas Production</b>	<b>MMcf</b>										
Surface Mining	MMcf	x,xxx	x,xxx	x,xxx	x,xxx	x,xxx	x,xxx	x,xxx	x,xxx		xx,xxx
Underground Mining	MMcf	x,xxx	x,xxx	x,xxx	x,xxx	x,xxx	x,xxx	x,xxx	x,xxx		xx,xxx
Modified In-Situ	MMcf	x,xxx	x,xxx	x,xxx	x,xxx	x,xxx	x,xxx	x,xxx	x,xxx		xx,xxx
True In-Situ	MMcf	x,xxx	x,xxx	x,xxx	x,xxx	x,xxx	x,xxx	x,xxx	x,xxx		xx,xxx
<b>Total Annual Production</b>	<b>MMcf</b>	x,xxx	x,xxx	x,xxx	x,xxx	x,xxx	x,xxx	x,xxx	x,xxx		xx,xxx
<b>Annual Ammonia Production</b>	<b>Mtons</b>	x,xxx	x,xxx	x,xxx	x,xxx	x,xxx	x,xxx	x,xxx	x,xxx		xx,xxx
<b>Annual Capital Investments</b>	<b>MM\$</b>										
Surface Mining	MM\$	x,xxx	x,xxx	x,xxx	x,xxx	x,xxx	x,xxx	x,xxx	x,xxx		xx,xxx
Underground Mining	MM\$	x,xxx	x,xxx	x,xxx	x,xxx	x,xxx	x,xxx	x,xxx	x,xxx		xx,xxx
Modified In-Situ	MM\$	x,xxx	x,xxx	x,xxx	x,xxx	x,xxx	x,xxx	x,xxx	x,xxx		xx,xxx
True In-Situ	MM\$	x,xxx	x,xxx	x,xxx	x,xxx	x,xxx	x,xxx	x,xxx	x,xxx		xx,xxx
<b>Total Capital Investment</b>	<b>MM\$</b>	x,xxx	x,xxx	x,xxx	x,xxx	x,xxx	x,xxx	x,xxx	x,xxx		xx,xxx
<b>Annual Operating Costs</b>	<b>MM\$</b>										
Surface Mining	MM\$	x,xxx	x,xxx	x,xxx	x,xxx	x,xxx	x,xxx	x,xxx	x,xxx		xx,xxx
Underground Mining	MM\$	x,xxx	x,xxx	x,xxx	x,xxx	x,xxx	x,xxx	x,xxx	x,xxx		xx,xxx
Modified In-Situ	MM\$	x,xxx	x,xxx	x,xxx	x,xxx	x,xxx	x,xxx	x,xxx	x,xxx		xx,xxx
True In-Situ	MM\$	x,xxx	x,xxx	x,xxx	x,xxx	x,xxx	x,xxx	x,xxx	x,xxx		xx,xxx
<b>Total Operating Costs</b>	<b>MM\$</b>	x,xxx	x,xxx	x,xxx	x,xxx	x,xxx	x,xxx	x,xxx	x,xxx		xx,xxx
<b>Annual G &amp; A Costs</b>	<b>MM\$</b>										
Surface Mining	MM\$	x,xxx	x,xxx	x,xxx	x,xxx	x,xxx	x,xxx	x,xxx	x,xxx		xx,xxx
Underground Mining	MM\$	x,xxx	x,xxx	x,xxx	x,xxx	x,xxx	x,xxx	x,xxx	x,xxx		xx,xxx
Modified In-Situ	MM\$	x,xxx	x,xxx	x,xxx	x,xxx	x,xxx	x,xxx	x,xxx	x,xxx		xx,xxx
True In-Situ	MM\$	x,xxx	x,xxx	x,xxx	x,xxx	x,xxx	x,xxx	x,xxx	x,xxx		xx,xxx
<b>Total Operating Costs</b>	<b>MM\$</b>	x,xxx	x,xxx	x,xxx	x,xxx	x,xxx	x,xxx	x,xxx	x,xxx		xx,xxx
<b>Direct Federal Revenue</b>	<b>MM\$</b>	x,xxx	x,xxx	x,xxx	x,xxx	x,xxx	x,xxx	x,xxx	x,xxx		xx,xxx
<b>Direct State Revenue</b>	<b>MM\$</b>	x,xxx	x,xxx	x,xxx	x,xxx	x,xxx	x,xxx	x,xxx	x,xxx		xx,xxx
<b>Direct Public Sector Reven</b>	<b>MM\$</b>	x,xxx	x,xxx	x,xxx	x,xxx	x,xxx	x,xxx	x,xxx	x,xxx		xx,xxx
<b>Contribution to GDP</b>	<b>MM\$</b>	x,xxx	x,xxx	x,xxx	x,xxx	x,xxx	x,xxx	x,xxx	x,xxx		xx,xxx
<b>Value of Imports Avoided</b>	<b>MM\$</b>	x,xxx	x,xxx	x,xxx	x,xxx	x,xxx	x,xxx	x,xxx	x,xxx		xx,xxx
<b>Total Direct &amp; Indirect Jobs</b>	<b>Labor years</b>	x,xxx	x,xxx	x,xxx	x,xxx	x,xxx	x,xxx	x,xxx	x,xxx		xx,xxx
<b>Total Direct Jobs</b>	<b>Labor years</b>	x,xxx	x,xxx	x,xxx	x,xxx	x,xxx	x,xxx	x,xxx	x,xxx		xx,xxx

## Abbreviations and Acronyms

This table lists the abbreviations and acronyms used in the “*National Strategic Unconventional Resources Model Documentation*”.

<b>Abbreviation/ Acronym</b>	<b>Full Text</b>
AEO	Annual Energy Outlook
BCF	Billion Cubic Feet
BLM	Bureau of Land Management
BLS	Bureau of Labor Statistics
BOE	Barrel of Oil Equivalent
BOPD	Barrel of Oil Per Day
BTU	British Thermal Unit
CATCF	Cumulative After Tax Cash Flow
CO	Carbon Monoxide
CO <sub>2</sub>	Carbon Dioxide
COALQUAL	Coal Quality Database
COGAM	Comprehensive Oil and Gas Analysis Model
DOD	Department of Defense
DOE	Department of Energy
DOI	Department of Interior
EIA	Energy Information Administration
EOR	Enhanced Oil Recovery
FY	Fiscal Year
F-T	Fischer – Tropsch
GDP	Gross Domestic Product
GOR	Gas Oil Ratio
G&A	General and Administration
ICP	In-situ Conversion Process
LPG	Liquefied Petroleum Gas
MACRS	Modified Accelerated Recovery Schedule
MBbl	Thousand Barrels
MCF	Thousand Cubic Feet
MIS	Modified In-Situ
MM	Million
MMBbl	Million Barrels
MMCF	Million Cubic Feet
MW	Mega Watt

NETL	National Energy Technology Laboratory
NOSM	National Oil Shale Model
NPOSR	Naval Petroleum and Oil Shale Reserves
NPV	Net Present Value
NSURM	National Strategic Unconventional Resources Model
OOIP	Original Oil In Place
OPR	Office of Petroleum Reserves
O&M	Operating and Maintenance
PVT	Reservoir Properties
RD&D	Research Development & Demonstration
SAGD	Steam Assisted Gravity Drainage
SD	Stream Day
SOI	Initial Oil Saturation
SOR	Steam Oil Ratio
SSB	Synthetic Sweet Blend
TORIS	Total Oil Recovery Information System
USGS	United States Geological Survey
WAG	Water Associated Gas (Ratio)

## References

- <sup>1</sup> “National Oil Shale Model: A Decision Support System”, Office of Naval Petroleum and Oil Shale Reserves, Department of Energy, June 2005.
- <sup>2</sup> Much of this section is derived from “Oil Shale Resource Profile”, Office of Petroleum Reserves, Department of Energy, March 2006.
- <sup>3</sup> Culbertson, W.J. and Pitman, J.K. “Oil Shale” in United States Mineral Resources, USGS Professional Paper 820, Probst and Pratt, eds. P. 497 - 503, 1973.
- <sup>4</sup> Final Environmental Statement for the Prototype Leasing Program –U.S. Department of the Interior, Bureau of Land Management, Volume I, 1973.
- <sup>5</sup> Much of this section is derived from “Coal Derived Liquids Technology Profile”, Office of Petroleum Reserves, Department of Energy, March 2006.
- <sup>6</sup> Annual Coal Report 2004, Energy Information Administration, Department of Energy, 2005.
- <sup>7</sup> U.S. GEOLOGICAL SURVEY OPEN-FILE REPORT 97-134, National Coal Resources Data System, *L.J. Bragg, J.K. Oman, S.J. Tewalt, C.J. Oman, N.H. Rega, P.M. Washington, and R.B. Finkelman*, <http://energy.er.usgs.gov/products/databases/CoalQual/intro.htm>.
- <sup>8</sup> U.S. GEOLOGICAL SURVEY OPEN-FILE REPORT 97-134, National Coal Resources Data System, *L.J. Bragg, J.K. Oman, S.J. Tewalt, C.J. Oman, N.H. Rega, P.M. Washington, and R.B. Finkelman*, <http://energy.er.usgs.gov/products/databases/CoalQual/intro.htm>.
- <sup>9</sup> Baseline Design Economics for Advanced Fischer-Tropsch Technology, Bechtel Corp. for U.S. Department of Energy Federal Energy Technology Center under contract DE-AC22-91PC90027, April 1998.
- <sup>10</sup> Much of this section is derived from “U.S. Tar Sands Resource Profile”, Office of Petroleum Reserves, Department of Energy, March 2006.
- <sup>11</sup> National Energy Technology Laboratory, Department of Energy, 1991
- <sup>12</sup> International Centre for Heavy Hydrocarbons website. <http://www.oildrop.org>
- <sup>13</sup> Much of this section is derived from “U.S. Heavy Oil Resource Profile”, Office of Petroleum Reserves, Department of Energy, March 2006.
- <sup>14</sup> Hanzlik, Edward J., “Status of Heavy Oil and Tar Sands Resources in the United States”, 1998.
- <sup>15</sup> Much of this section is derived from “U.S. CO<sub>2</sub> Miscible Enhanced Oil Recovery Profile”, Office of Petroleum Reserves, Department of Energy, March 2006.
- <sup>16</sup> Syncrude Canada LTD. 2004 Sustainability Report
- <sup>17</sup> Final Environmental Statement for the Prototype Leasing Program –U.S. Department of the Interior, Bureau of Land Management, Volume I, 1973.
- <sup>18</sup> Baseline Design Economics for Advanced Fischer-Tropsch Technology, Bechtel Corp. for U.S. Department of Energy Federal Energy Technology Center under contract DE-AC22-91PC90027, April 1998.
- <sup>19</sup> TD Securities, “Overview of Canada’s Oil Sands” January 2004.
- <sup>20</sup> Final Environmental Statement for the Prototype Leasing Program –U.S. Department of the Interior, Bureau of Land Management, Volume I, 1973.
- <sup>21</sup> Syncrude Canada LTD. 2004 Sustainability Report.
- <sup>22</sup> “Oil Sands Technology Roadmap: *Unlocking the Potential*”. Alberta Chamber of Resources.
- <sup>23</sup> “Annual Energy Outlook 2006”, Energy Information Administration, Department of Energy.

---

<sup>24</sup> “2004 Annual Coal Production Report”, Energy Information Administration, Department of Energy.

<sup>25</sup> “2004 Annual Electric Power Industry Report”, Energy Information Administration, Department of Energy.

<sup>26</sup> “NAICS 211000 Oil and Gas Extraction”, Bureau of Labor Statistics, U.S. Department of Labor.

<sup>27</sup> “Energy and Minerals Industries in National, Regional, and State Economies”, U.S. Department of Agriculture, p.58.