

**LESSONS
LEARNED**

June 1, 2006; Issue No. 47

Second Quarter FY 2006

Quality + Leadership = NEPA SuccessLEADING
A TOP-NOTCH
NEPA
PROGRAMN
C
O

Whether writing a statement of work for NEPA document preparation, checking raw data, model selection, and impact calculations, or reviewing a preliminary draft environmental impact statement (EIS) to ensure that references, appendices, main text, tables, and the summary are consistent, quality assurance (QA) makes a significant difference in the outcome of the NEPA process. The importance of QA – from start to finish and bottom to top – was a recurrent theme at the Department of Energy (DOE) NEPA Compliance Officer (NCO) meeting in Washington, DC, on May 9 and 10, 2006.

“NCOs are leaders in helping DOE achieve timely and excellent NEPA compliance in support of program missions,” said Carol Borgstrom, Director, Office of NEPA Policy and Compliance. She and her staff emphasized quality throughout the meeting on *Leading a Top-Notch NEPA Program*. NCOs representing 28 DOE Program and Site Offices discussed their roles and responsibilities in assuring quality. They shared NEPA lessons learned with each other and with Headquarters NEPA and General Counsel staff.

Quality at Every Step

In the meeting’s opening session on “Building Quality into NEPA Documents,” Jeanie Loving and Ralph Barr, NEPA Office, explained how the broad principles of QA can be applied to EISs and environmental assessments (EAs). Noting Secretary of Energy Samuel W. Bodman’s April 26, 2006, memorandum on QA, they emphasized that QA is essential to continuous improvement in DOE’s NEPA program. They reviewed how the criteria for QA Plans identified in DOE Order 414.1C, *Quality Assurance* (June 17, 2005), apply to NEPA documents.



DOE’s NEPA Compliance Officers discussed quality assurance during the interactive meeting of more than 50 NEPA practitioners. Participating in meetings such as this is an important part of DOE’s NEPA Lessons Learned Program. (See more photos, page 8.)

Federal oversight of NEPA contractors is important when applying QA principles, explained Harold Johnson, NCO, Carlsbad Field Office. “Check what your contractors do,” he said, “even calculations in spreadsheets.” He added, “You don’t have to be a technical expert on everything, but find technical experts to review those portions of NEPA documents that may be outside the scope of your knowledge.”

“Say it once, say it well, don’t say it again,” recommended Jack Depperschmidt, NCO, Idaho Operations Office, as a way to simplify the process of ensuring consistency throughout a NEPA document. This approach also can help keep a NEPA document concise, he added.

(continued on page 4)**NEPA 35 Earns Special Award from NAEP; see page 3**

Inside *LESSONS LEARNED*

Welcome to the 47th quarterly report on lessons learned in the NEPA process. The quality of our NEPA process affects the quality of DOE's decisions. Our appreciation goes out to all the NCOs and NEPA Document Managers who work every day to build quality into NEPA documents. As always, we welcome your suggestions for continuous improvement.

NAEP Presents Award for <i>NEPA 35</i> Conference	3
FedCenter Website.....	7
CRS Report on NEPA Streamlining	9
Global Nuclear Energy Partnership EIS	10
Sites Proposed for FutureGen Project	11
Hanford EIS Scoping.....	11
2006 NAEP Conference	12
Renewed Emphasis on EMS.....	13
DOE Headquarters, Field Sites Celebrate Earth Day	14
Good Contracting Practices	16
DOE-wide NEPA Contracts Update.....	16
Litigation Updates.....	17
Training Opportunities	20
EAs and EISs Completed This Quarter	22
Cost and Time Facts	22
Recent EIS Milestones	23
Second Quarter FY 2006 Questionnaire Results	27

Carol Borgstrom

Director
Office of NEPA Policy and Compliance

Be Part of Lessons Learned

We Welcome Your Contributions

We welcome suggestions, comments, and contributed drafts for the *Lessons Learned Quarterly Report*. We especially seek case studies illustrating successful NEPA practices. Draft articles for the next issue are requested by August 1, 2006. Contact Yardena Mansoor at yardena.mansoor@eh.doe.gov or 202-586-9326.

Quarterly Questionnaires Due August 1, 2006

Lessons Learned Questionnaires for NEPA documents completed during the third quarter of fiscal year 2006 (April 1 through June 30, 2006) should be submitted by August 1, but preferably as soon as possible after document completion. The Questionnaire is available interactively on the DOE NEPA website at www.eh.doe.gov/nepa under Lessons Learned Quarterly Reports. For Questionnaire issues, contact Vivian Bowie at vivian.bowie@eh.doe.gov or 202-586-1771.

LLQR Online

Current and past issues of the *Lessons Learned Quarterly Report* are available on the DOE NEPA website at www.eh.doe.gov/nepa. Also on the website is a cumulative index of the *Lessons Learned Quarterly Report*. The index is printed in the September issue each year.

Printed on recycled paper



Security Reviews Needed for EISs on DOE NEPA Website

Sixty-five EISs were publicly available on the DOE NEPA website prior to September 11, 2001. Today, as a result of security changes implemented in November 2001, all those EISs remain archived on a secure server on the DOE NEPA website and are not accessible to the public. These archived EISs will remain there unless DOE completes security reviews and determines that these EISs can be placed on the publicly-accessible portion of the DOE NEPA website. (See *LLQR*, December 2001, page 1.)

DOE still relies on many of these archived documents for decisions, Eric Cohen, NEPA Office, pointed out at the May 2006 NEPA Compliance Officer (NCO) meeting. The documents include several key programmatic and site-wide EISs, such as the Waste Management Programmatic EIS (DOE/EIS-0200), Waste Isolation Pilot Plant Supplemental EIS (DOE/EIS-0026-S2), and Storage and Disposition of Weapons-Usable Fissile Materials Programmatic EIS (DOE/EIS-0229). Mr. Cohen provided a list of the archived documents and asked NCOs to work

with their organizations to conduct the necessary security reviews.

The public continues to request copies of these EISs, which often are referenced in new NEPA documents, said Denise Freeman, DOE NEPA Webmaster. She provides a CD of these EISs upon request, but said that some people have expressed disappointment that DOE cannot provide them a password and has not restored public Internet access to the archived documents.

DOE provides a password upon request only to DOE staff, DOE NEPA contractors, and Federal, state, and tribal officials. A recent upgrade of the secure server to meet new requirements resulted in a need to issue new passwords. All users of the secure server, including persons with a "doe.gov" e-mail address (who did not need a password under the old system), must apply for a password by completing an electronic form available at www.eh.doe.gov/nepa under DOE NEPA Documents. **LL**



NAEP Presents Special Achievement Award to DOE and CEQ for *NEPA 35* Conference

In a ceremony at DOE Headquarters on April 13, 2006, the National Association of Environmental Professionals (NAEP) recognized *NEPA 35: Spotlight on Environmental Excellence*, the conference that DOE presented in partnership with the Council on Environmental Quality (CEQ) in November 2005. In presenting the Special Achievement Award, NAEP President Gary Kelman praised DOE's leadership and contributions, particularly during a time when "NEPA was placed in the spotlight, and in some cases, more like heat lamps." He noted that the nomination of *NEPA 35* for an Environmental Excellence Award helped illuminate the importance of celebrating 35 years of NEPA's core values of environmental stewardship, sound decisionmaking, and engaging stakeholders and the public.

The DOE Office of NEPA Policy and Compliance was recognized for developing and presenting the conference, which included more than 260 NEPA practitioners from over 50 agencies and organizations; high-level officials from Federal, state, and tribal organizations; and Members of Congress (via video). For a complete description of the conference, see *LLQR*, December 2005, page 1. 



NAEP President Gary Kelman (far left) and Awards Committee Chairman Jim Melton (far right) presented the Special Achievement Award to Acting Assistant Secretary for Environment, Safety and Health C. Russell H. Shearer (center left) and CEQ Associate Director for NEPA Oversight Horst Greczmiel for their partnership in sponsoring the conference.



The NEPA Office was recognized for a **Significant Contribution to the Understanding and Implementation of the Principles of NEPA** – as noted in the plaque held by Office Director Carol Borgstrom. Left to right: Brian Costner, Vivian Bowie, Eric Cohen, Jim Sanderson, Deputy Assistant Secretary for Environment Andy Lawrence, Denise Freeman, Gary Kelman (NAEP), Carolyn Osborne, Carol Borgstrom, Russell Shearer, Jim Daniel, Horst Greczmiel (CEQ), Brian Mills, Jim Melton (NAEP), and Ralph Barr. (Not present: Lee Jessee, Jeanie Loving, and Yardena Mansoor.)

NCO Meeting *(continued from page 1)*

Mr. Depperschmidt emphasized an NCO's responsibility for ensuring that source data has been validated and verified. "We need to evaluate the original data and make sure we stand behind it," agreed Hitesh Nigam, NCO, Office of Fissile Materials Disposition.

Echoing that thought, Ms. Loving said that QA starts with the raw data – the foundation for building the NEPA document. Using the diagram reproduced below, she described how the nature of the QA activity will change as the document is prepared. For example, the methods for checking the accuracy of a calculation differ from those for checking the consistency of analysis and conclusions, she explained. "Good documentation of 'QA checks' throughout document preparation will pay off in the end," Ms. Loving said.

Example QA Review Components for an EIS

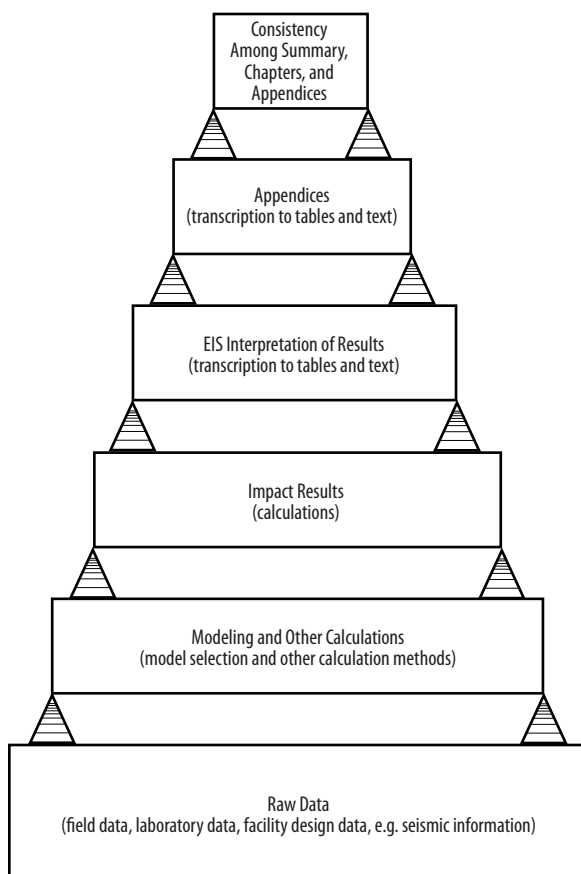

QA relies on a bottom-to-top approach. Ensuring QA checks at each step in developing a NEPA document allows early identification of mistakes and helps avoid errors in succeeding steps.



Guidance on QA and EIS QA Plans

During discussion aimed at rethinking and revitalizing DOE's approach to QA for NEPA documents, most NCOs said they rely on a QA Plan provided by the NEPA document preparation contractor. Mr. Johnson explained that he nonetheless provides leadership in the QA process. "The contractor doesn't start work until I approve the QA Plan," he said.

Mr. Depperschmidt recommended that the NEPA Document Manager develop EIS-specific QA Plans in coordination with the NCO and organizational QA manager. He offered to share QA procedures, forms, and related materials with NCOs. (To request a copy, contact him at depperjd@id.doe.gov.)

NCOs supported developing QA guidance for NEPA documents and a DOE-wide model NEPA QA Plan. Alice Williams, NCO, National Nuclear Security Administration, said it could be helpful to have such a model QA Plan in place soon for future EISs. Several NCOs suggested that a model QA Plan be provided to contractors through the next DOE-wide NEPA contracts procurement process (related article, page 16).

Teamwork Strengthens EA/EIS Reviews

The focus on QA continued during a lively group discussion on EA and EIS reviews led by Brian Costner, NEPA Office. NCOs described how they assess what will be important to the decisionmaking process, in part, by reviewing documents related to the proposed action, such as existing NEPA documents, regulatory and permitting documents, congressional testimony, and DOE policy statements. When reviewing an EA or EIS, they ask, "Do all the pieces fit together?"

Most NCOs have used the EA and EIS Checklists (available on the DOE NEPA website at www.eh.doe.gov/nepa under Selected Guidance Tools) issued by the NEPA Office to facilitate document preparation and review. "It's a good way to do a topical review," said Mark Matarrese, NCO, Office of Fossil Energy, adding that the checklists encourage the reviewer to evaluate the factors listed, not just check a box. Marthea Rountree, Office of Federal Activities, Environmental Protection Agency (EPA), explained that in reviewing DOE EISs for EPA, she looks for consistency in data and terminology, and for compliance with regulations.

(continued on next page)

NCO Meeting *(continued from previous page)*



“If you can follow a conclusion backward to the original data, then we can go to court and explain it,” said Richard Ahern, Office of the Assistant General Counsel for Environment. He emphasized, though, that his Office’s first goal is to keep DOE out of court. Reviews by legal counsel focus on whether DOE has met the “hard look” standard commonly used by the courts, he said (related article, page 19).

If a NEPA document is challenged, Mr. Ahern said a court might ask: Do the alternatives make sense vis-à-vis the purpose and need? Has the agency listened to comments and taken them seriously? Has the agency been thorough? Is the EIS coherent and consistent?

Jane Summerson, NCO, Office of Repository Development, shared with the group a technique that was successful in the Yucca Mountain EIS to ensure consistency in terminology and policy. DOE prepared “white papers,” in which all interested organizations agreed on the words to use to address key topics, and then these papers were referred to throughout preparation of the EIS, including responses to comments, she explained.

Several NCOs recounted the benefits of maintaining a team of contractors, subject matter experts, NEPA practitioners, and legal counsel from the beginning of the document preparation process to make sure there were “no surprises” during the review. NCOs also agreed that it is very beneficial to develop and maintain the involvement of senior management throughout the NEPA process.

Senior Management Attention Helps DOE Meet EIS Schedules

A root cause analysis of data on EIS completion times underscores the importance of senior management involvement in NEPA efforts, reported Eric Cohen, NEPA Office. “When senior managers get involved in key issues, resolution is reached, and EISs get done,” he said. Other factors supporting timely EISs are teamwork and having document preparers with strong skill sets. However, he noted a “troubling trend” that, after a promising decrease, the average EIS completion time has run close to 30 months for the past two years. (See *LLQR*, March 2006, page 32.)

Involving multiple cooperating agencies has contributed to the long completion times for several EISs, Mr. Cohen said, adding that experience shows that the time was well spent because the resulting EISs were made stronger by reflecting all agency views. Other causes for long EIS durations include involving multiple sites or programs, changes in the proposed action, delayed identification of data needs, and placing EISs “on hold” to meet changing program needs.

NCO Responsibilities

1. Office NEPA Procedures
2. CX Determinations
3. EA and EIS Lessons Learned
4. NEPA Strategies
5. NEPA Advice
6. EA vs. EIS Recommendations
7. Process and Document Assistance
8. Document Adequacy Recommendations
9. NEPA Meeting Participation, Training, Guidance Dissemination
10. NEPA Office Notifications
11. NEPA Office Copies

Adapted from DOE Order 451.1B, NEPA Compliance Program

Jim Daniel, NEPA Office, reminded NCOs of the submittal requirements for Annual Planning Summaries. He explained that the Summaries are a tool for senior managers that can help NCOs to plan and budget for their EAs and EISs. Use the Summaries to schedule timely and accurate NEPA reviews, including sufficient time for QA, he said. NCOs agreed that senior management involvement is crucial to their NEPA efforts. Jim Hartman, NCO, Western Area Power Administration, Rocky Mountain Region, observed that planning for a year’s worth of sometimes unpredictable NEPA activities can be difficult. In addition, NCOs noted that budget uncertainties can impact NEPA plans.

LLQR: A Lasting NEPA Resource

As part of an effort to track cost and completion time data for NEPA documents, the DOE NEPA Office has published *LLQR* since 1994, recalled Carolyn Osborne, NEPA Office. *LLQR* has grown in size and scope since its first, seven-page issue and now also includes litigation updates, mini-guidance, and other information that NEPA practitioners need to know to do their jobs well. It is the most practical means for sharing lessons learned among the DOE NEPA Community, apart from the annual meetings, she said. NCOs are expected to read each issue from cover to cover and to contribute case studies. *LLQR* has proved to be useful as a readily available record of DOE NEPA activities, noted Ms. Osborne.

(continued on next page)

NCO Meeting (continued from previous page)



LLQR, which is available to the public via the DOE NEPA website, has attracted the interest of NEPA practitioners and scholars from outside of DOE, noted Yardena Mansoor, NEPA Office. It was cited frequently at this year's National Association of Environmental Professionals conference, she said (related article, page 12).

CEQ Updates, Perspectives

"The relationship between CEQ and DOE highlights the benefits of collaboration," said Horst Greczmiel, Associate Director for NEPA Oversight, Council on Environmental Quality (CEQ). "Working with you on our guidance products is critical in maintaining our credibility across the board."

Mr. Greczmiel provided participants at the NCO meeting a brief update on activities by the interagency Work Groups developing guidance to improve NEPA implementation. (See text box on page 7 and *LLQR*, March 2006, page 10.) He encouraged everyone to provide input on the draft guidance documents as they are circulated. He then remained for an extended question and answer session, during which NCOs sought his advice on a broad range of topics. Highlights of the discussion are summarized below.

- **EA Public Involvement Required.** "Public involvement for an EA is required," said Mr. Greczmiel, "but what you do varies because EAs vary in terms of their potential significance." There are few situations when public involvement in an EA is not practicable, he said. He encouraged NCOs to issue a notice to those who typically are interested in the type of proposed action, collect their feedback, and reflect those concerns in the EA. "You owe it to yourself and your organization," he said, "to reach out and provide quality information to the people who care, so that they have an opportunity to participate in a meaningful way."
- **Other Agency Cooperation Encouraged.** Mr. Greczmiel encouraged NCOs to "take every opportunity to bring other agencies into the fold." If the agency declines to be a cooperating agency, work with the agency to identify a way they can participate, such as in the scoping process or on a particular analysis, he said.

- **Benchmarking, Regional CXs**

Supported. Using another Federal agency's categorical exclusion (CX) is not allowed, Mr. Greczmiel said, but an agency can draw on the experience of another agency as a form of "benchmarking." In this way, an agency might establish a class of actions as a CX based, in part, on the experience of other agencies implementing comparable actions.

In addition, Mr. Greczmiel supported the possibility of "regional CXs" in cases where a class of actions has been demonstrated not to have significant environmental impacts in a particular region of the country, even though it may have significant impacts in another region.

"Do It Right the First Time"

"We need systems to ensure quality," said Ms. Borgstrom at the close of the meeting. "I would prefer we do it right the first time. Most of the time, we, the Department of Energy, do excellent work on NEPA," she concluded. "DOE is well served by this cadre of NCOs."

The Secretary's memorandum on QA is available on the Quality Assurance portion of the Office of Environment, Safety and Health's website at www.eh.doe.gov/qa. For information on QA lessons learned at the Hanford Site, see *LLQR*, March 2006, page 1. 

NCOs Complete NEPA Training

Following the NCO meeting, the NEPA Office offered a repeat of three training courses initially presented at the *NEPA 35* Conference in November 2005. (See *LLQR*, December 2005, page 14.) Eight NCOs participated in training on EIS Comment-Response and EIS Distribution, eight in training on Using the *Green Book* to Avoid NEPA Pitfalls, and six in training on the DOE Supplement Analysis Process. Each training session included discussion, and each participant completed a test and will receive a certificate.



Check It Out: FedCenter

FedCenter – the Federal Facilities Environmental Stewardship and Compliance Assistance Center – is a Web-based joint initiative that seeks to provide an “all-services technical and compliance assistance center to help federal environmental officials, especially those in the civilian sector, better address their environmental needs” (from www.FedCenter.gov).

NEPA is one of 11 Program Areas for which the website provides links to regulations, guidance, and policy; supporting information and tools; lessons learned; training, presentations, and briefings; and conferences and events. In the NEPA Program Area, a user can access the Council on Environmental Quality’s regulations and guidance, including the Council’s NEPANet, Federal agency NEPA regulations, websites, and contacts; and environmental justice and environmental conflict resolution resources, among other things.

The other Program Areas on *FedCenter.gov* are Environmental Compliance, Buying Green, Environmental Management Systems (EMSs), Energy, Green Buildings, Pollution Prevention, Chemical Management, Cleanup, Sustainability, and Natural Resources. The website also tracks progress in rulemakings, provides a calendar of upcoming environmental events, and features an overview of activities commonly found at Federal facilities, with applicable regulations and data systems for accessing

site-specific information. Plans for the website include assistance in EMS training and auditing, an “Ask an Expert” hotline service, and subject matter expert discussion lists.

Federal employees as well as contractors currently working with an agency may join FedCenter via the website. Members receive a daily, weekly, or monthly newsletter with notices and events of interest to the Federal environmental community. Members are also able to take advantage of other services offered through the FedCenter site, such as work group hosting and environmental reporting and tracking tools.

FedCenter is operated by the U.S. Army Corps of Engineers Construction Engineering Research Laboratory, under an agreement with the Environmental Protection Agency’s (EPA’s) Office of Enforcement and Compliance Assurance. FedCenter is overseen by a multi-agency Board with initial funding by EPA, Department of Veterans Affairs, Department of Homeland Security, and DOE. DOE serves on the Board, helping to direct the ongoing development of information resources and services offered through FedCenter.

For more information, contact Josh Silverman, Office of Pollution Prevention and Resource Conservation, at josh.silverman@eh.doe.gov or 202-586-6535. 



NEPA Guidance Under Development

As leaders in NEPA implementation, NCOs use and disseminate guidance issued by the Office of Environment, Safety and Health that reflects the collective NEPA experience of the entire Department. In addition, CEQ issues guidance applicable to all Federal agencies. NEPA guidance is available on the DOE NEPA website at www.eh.doe.gov/nepa. The status of several guidance documents under development was discussed at the NCO meeting.

- **Categorical Exclusions (CXs).** CEQ is preparing guidance on establishing and applying CXs. (CEQ sent a draft to Federal contacts on May 31, 2006, which the NEPA Office will distribute to NCOs, then collect comments for feedback to CEQ.) Separately, any NCO who wants to suggest adding a CX to the DOE NEPA regulations or modifying one of the existing 103 CXs (10 CFR Part 1021 Subpart D, Appendices A and B) should contact Carolyn Osborne, NEPA Office, at carolyn.osborne@eh.doe.gov or 202-586-4596.
- **NEPA and Environmental Management Systems (EMSs).** CEQ plans to issue guidance on EMSs and NEPA later this year. Subsequently, the NEPA Office will update and distribute for NCO comment draft guidance it is preparing on integrating NEPA with EMSs. CEQ also plans to issue an adaptive management handbook.
- **EIS Distribution.** A final draft of guidance on *EIS Distribution* was distributed and discussed at the meeting. The guidance addresses comments from NCOs on a draft distributed in April 2006.
- **EA/EIS Checklists.** The NEPA Office is updating the EA and EIS Checklists to reflect additions to and changes in the organization of the 2nd edition of *Recommendations for the Preparation of Environmental Assessments and Environmental Impact Statements* (the *Green Book*, December 2004), as well as other DOE NEPA guidance.

LEADING
A TOP-NOTCH
NEPA
PROGRAM



Congressional Research Service Report Reviews NEPA Streamlining Proposals



A federal project may stop and restart for any number of reasons that are unrelated to NEPA or any other environmental requirement.

– Congressional Research Service Report
February 2006

Given the differences among Federal agencies, one size may not fit all when it comes to streamlining the NEPA process. “Due to the nature of NEPA implementation, determining the time it takes to prepare NEPA documentation, assessing the nature of delays related to NEPA, and finding remedies to those delays may be more appropriately accomplished agency by agency,” concludes the Congressional Research Service (CRS) in a February 2006 report, *The National Environmental Policy Act: Streamlining NEPA*.

The report summarizes efforts to expedite the NEPA process through administrative changes by individual agencies and the work of recent Task Forces, including the Council on Environmental Quality’s (CEQ’s) NEPA Task Force (*LLQR*, December 2003, page 1) and the House Resources Committee’s Task Force on Updating NEPA (*LLQR*, March 2006, page 3).

The report also summarizes legislation enacted between 2003 and 2005 that affected NEPA implementation for certain land management activities, transportation projects, and energy projects. (See *LLQR*, March 2006, page 16, and September 2005, pages 3 and 18, for related articles.) The report identifies six types of NEPA streamlining measures contained in these laws affecting particular agencies:

- **Establishing a coordinated compliance process**, such as specifying the decisionmaking authorities of the lead and participating agencies or methods for concurrent review under NEPA and other environmental requirements.
- **Codifying aspects of existing regulations in law**, including requirements similar to those in CEQ NEPA regulations to initiate the NEPA process early, emphasize interagency cooperation, and set time limits for completing EISs.

- **Delineating lead agency authority** by designating a lead agency for certain categories of projects and authorizing the lead agency to take certain actions in the NEPA process (e.g., set deadlines, implement dispute resolution).
- **Delegating authority to states** to make certain NEPA determinations (e.g., application of categorical exclusions).
- **Specifying categorically excluded or exempt projects** through legislation rather than an agency’s rulemaking process.
- **Establishing limits on judicial review**, such as a statute of limitations on the time to file a challenge to certain final agency actions under NEPA.

CRS notes that only DOE and the Department of Transportation routinely maintain data on the time to complete NEPA documents. This is one factor that makes it “difficult to determine the degree to which the NEPA process itself is the source of delays,” the report says. The report explains that funding issues, changes in agency priorities, community opposition, engineering requirements, and other non-NEPA factors can contribute to delays. In addition, the report says, “The use of NEPA as an umbrella statute blurs the distinction between the time to complete the NEPA process and the time it takes to address other environmental requirements.”

CRS is the public policy research arm of the U.S. Congress. Additional information on CRS is available on the Web at www.loc.gov/crsinfo under About CRS. The report is available through the Open CRS Network, a project of the nonprofit Center for Democracy and Technology, at www.opencrs.com (search for report RL33267).

EIS to Examine Technologies for Proposed Nuclear Fuel Cycle

As part of President Bush's Advanced Energy Initiative, DOE has launched the Global Nuclear Energy Partnership (GNEP). The broad goals of GNEP are to meet increasing demand for electricity without emitting greenhouse gases, recycle nuclear fuel using new proliferation-resistant technologies to recover more energy and reduce the volume of waste, encourage prosperity and clean development around the world, and utilize the latest technologies to reduce the risk of nuclear proliferation worldwide. (See www.gnep.energy.gov.) To accomplish these goals, GNEP would rely on a significant change in the "nuclear fuel cycle" used in the United States – from a "once through" approach in which reactor fuel is used and then disposed of, to a "closed" cycle in which reactor fuel is used and reprocessed (separated) so that some radioactive material can be reused before disposal.

To determine the feasibility of implementing this new nuclear fuel cycle, DOE proposes to demonstrate three technologies: (1) proliferation-resistant processes that would separate the usable elements in commercial spent nuclear fuel from its waste elements; (2) the conversion of transuranics into shorter-lived radioisotopes; and (3) an advanced fuel fabrication process. Together, DOE refers to these three projects as the GNEP Technology Demonstration Program.

DOE published an Advance Notice of Intent (Advance NOI) to prepare an EIS for the GNEP Technology Demonstration Program on March 22, 2006 (71 FR 14505), and is reviewing comments received during the comment period that ended May 8, 2006. DOE plans to publish an NOI and hold public scoping meetings later this year.

"We look forward to public involvement throughout the NEPA process to help us complete a thorough review of all potential environmental impacts," said Tim Frazier, NEPA Document Manager.

"While DOE has had some success at bench-scale testing of these technologies," the Advance NOI states, "it has not yet proven that these technologies will be feasible in demonstration-scale facilities." The EIS would evaluate all reasonable alternative technologies, as well as the siting, construction (or modification), and operation of related facilities. The EIS would evaluate several DOE sites as potential locations for the demonstration-scale facilities. In addition, DOE plans to award funds for site studies to facilitate consideration of non-DOE sites. The site studies would provide detailed information about the proposed location, existing facilities that could be used in the demonstration projects, regulatory and permitting requirements, cost, and other factors.

DOE expects to eventually prepare a programmatic EIS on potential future actions to encourage the commercial-scale adoption of these technologies, the Advance NOI states.

Public Responds to Advance NOI

DOE received comments on the Advance NOI from more than 250 individuals and organizations. Comments, for example, questioned whether the technologies are sufficiently developed to undertake the demonstration projects, asked DOE to immediately prepare a programmatic EIS on the overall GNEP program (e.g., the international components in addition to the technologies), identified alternatives for consideration in the EIS, suggested that the EIS address a variety of potential environmental impacts (e.g., associated with wastes generated by reprocessing, decontamination and decommissioning), and requested a nonproliferation impact assessment.

More information on GNEP and the EIS for the GNEP Technology Demonstration Program is available on the Web at www.gnep.energy.gov or by contacting Mr. Frazier, Office of Nuclear Energy, Science and Technology, at GNEPTechDemo@nuclear.energy.gov or 866-645-7803. 

Key
 ABTR – Advanced Burner Test Reactor
 AFCF – Advanced Fuel Cycle Facility
 ESD – Engineering-Scale Demonstration
 LWR – Light Water Reactor

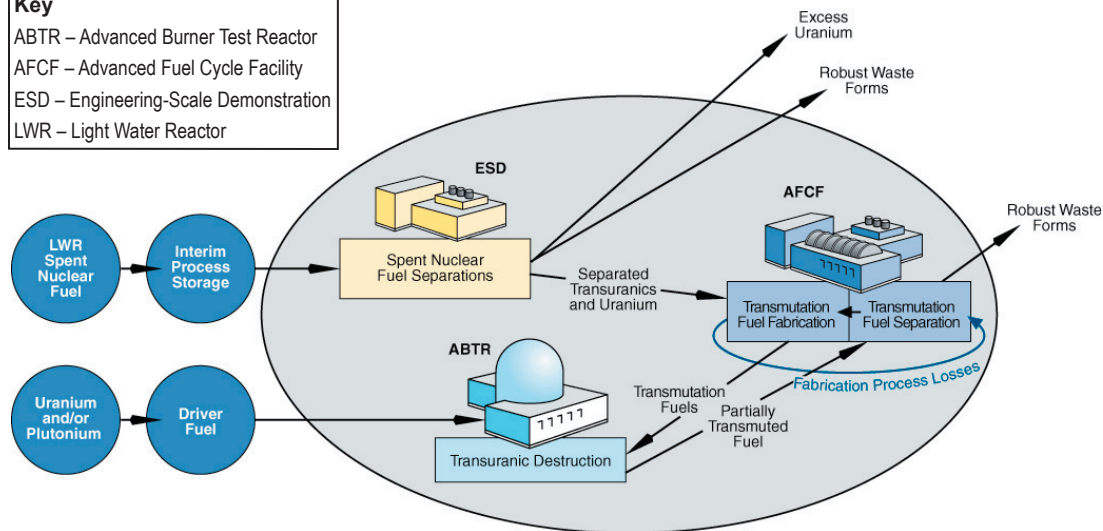

Under GNEP, spent nuclear fuel from commercial reactors would be reprocessed to provide transuranic fuel for a new type of burner reactor that would convert plutonium and some other radioactive material into shorter-lived radioisotopes.

12 Sites Proposed for FutureGen Coal Project

Secretary of Energy Bodman recently announced that 12 sites in seven states are in the running to host the FutureGen Project. “One of these sites ultimately will become known worldwide as the place where a new generation of zero-emission energy plants made its debut,” he remarked at the 5th Annual Conference on Carbon Capture and Sequestration on May 9, 2006.

FutureGen is a proposed prototype facility that would produce hydrogen and generate 275 megawatts of electricity from coal with near-zero emissions. (See *LLQR*, March 2006, page 7.)

Representatives for the candidate sites responded to a request for proposals issued by the FutureGen Industrial Alliance in March 2006. The Alliance, a consortium of some of the world’s largest coal and electric utilities, is managing the site selection process for FutureGen with oversight from DOE under a Cooperative Agreement. As described in the Cooperative Agreement and the Department’s Advance Notice of Intent (71 FR 8283; February 16, 2006), the Alliance is using a set of criteria approved by DOE to evaluate the 12 proposals. The Alliance will report to DOE those sites from among the 12 candidates that the Alliance determines to be reasonable from a technical, environmental, and economic perspective. Based on DOE’s review of the Alliance’s report and other relevant information, DOE will identify a preliminary range of reasonable alternative sites to be

analyzed in an EIS, which DOE will announce in a Notice of Intent expected in July 2006. DOE plans to complete the NEPA process in July 2007.

Additional information about FutureGen is available on the Office of Fossil Energy website at www.fossil.energy.gov/programs/powersystems/futuregen and the Alliance website at www.futuregenalliance.org. The NEPA Document Manager is Mark McKoy, who can be reached at mmckoy@netl.doe.gov or 304-285-4426. 

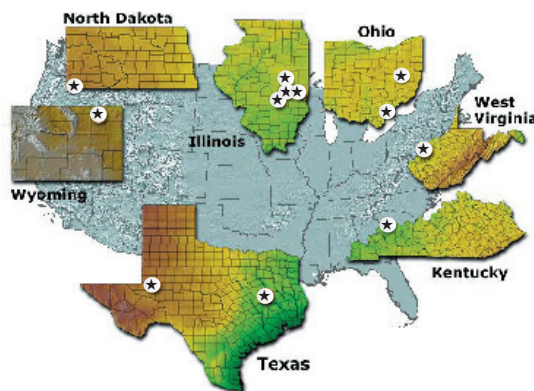

Interest in hosting the approximately \$1 billion FutureGen Project is widespread. The site must have characteristics needed for a large coal power plant, such as transportation infrastructure and access to electricity transmission interconnections, as well as appropriate geologic features to demonstrate safe storage for carbon dioxide.

Public Comments on New Hanford EIS at Scoping Meetings



Todd Martin, Chairman, Hanford Advisory Board, praised the planned quantitative cumulative impact analysis, but questioned the feasibility of completing the EIS in mid-2008.

Washington and Oregon stakeholders expressed differing views on some aspects of the *Hanford Tank Closure and Waste Management EIS* (DOE/EIS-0391), but protecting groundwater and the Columbia River remained a widespread regional concern during four public scoping meetings held in late March 2006. This EIS will implement a January 2006 Settlement Agreement with the Washington State Department of Ecology (Ecology) that resolved litigation on the adequacy of the Hanford Solid Waste EIS (2004). The new EIS will include a site-wide reanalysis of groundwater impacts, and, upon completion, will supersede the Hanford Solid Waste EIS. (See *LLQR*, March 2006, page 1.)

DOE and Ecology, a cooperating agency, held the meetings in Seattle and Pasco, Washington, and in Portland and Hood River, Oregon. Among the approximately 200 participants, some stakeholders agreed with the EIS’s integrated approach to analyzing waste management activities at the Hanford Site, while others expressed concern about the EIS becoming unwieldy – the “mother of all EISs.”

In response to questions about the State’s ability to legally challenge the EIS, the Ecology representatives pointed out that, by its participation as a cooperating agency, the State had not relinquished any option for a subsequent challenge to the EIS, and that its role offers an excellent opportunity to help ensure quality in the EIS. Several speakers commended DOE and Ecology for resolving the litigation and for DOE’s agreement to reanalyze significant portions of the Hanford Solid Waste EIS.

DOE is reviewing the comments received at the meetings, along with all written comments received during the scoping period, which concluded on April 10, 2006. For further information, contact Mary Beth Burandt, NEPA Document Manager, at TC&WMEIS@saic.com or 509-372-7772. 

2006 NAEP Conference: Focus on the Future

By: Yardena Mansoor, Office of NEPA Policy and Compliance



How can environmental professionals apply lessons learned at the local or regional level to global concerns? Focusing on *Global Perspectives on Regional Issues: The Future for Environmental Professionals in the Next 30 Years*, participants at the 31st annual conference of the National Association of Environmental Professionals (NAEP), held in Albuquerque, New Mexico, April 23–26, 2006, addressed this and other questions.

Keynote speaker Dr. Ray Powell combined a philosophical approach to sustainable resource management with hands-on lessons from his recent term as New Mexico State Land Commissioner, the official responsible for managing millions of acres of state lands. Noting that revenue from energy and mineral development, agricultural leasing, and commercial activity on trust lands funds public education in New Mexico, Dr. Powell urged the promotion of children's identification with their environment. He advocated increased use of community-focused environmental initiatives and collaborative public/private partnerships for land use improvements.

NEPA Symposium Addresses Forecasting and Uncertainty

Twenty presentations comprised the conference's "NEPA Symposium," an exploration of many aspects of NEPA theory and practice, including case studies and litigation. The broadest perspective on the conference theme was provided by Richard Burke, Kennedy/Jenks Consultants, who discussed approaches for improved forecasting of long-term environmental problems. He noted that some forecasts made 25 to 35 years ago – for example, of atmospheric carbon dioxide levels and loss of biological diversity through extinction – have proven surprisingly accurate. He asked: what practices can we implement now to identify, address, and avoid future problems that may occur 30 years from now?

To make sound decisions in the face of long-term uncertainties, Mr. Burke advocated multifaceted NEPA strategies that:

- **Are highly adaptive.** For example, he recounted that after issuing an EIS and record of decision in 1994 for a secondary water treatment plant, the International Boundary and Water Commission and co-lead Environmental Protection Agency responded to technological changes and new information by preparing a supplemental EIS in 1996 to operate it as an advanced primary plant, and a 1998 supplemental EIS to address long-term treatment options.

- **Employ near-term milestones.**

Mr. Burke observed that many political calls for reducing dependence on imported oil have not identified the incremental steps that must be made to achieve the long-term goal. He also cautioned that any programmatic EIS that is not based on pilot project experience is likely to misrepresent important aspects of the impact analysis.

- **Make risk-based choices.** For an offshore oil lease, the Minerals Management Service prepared an EA that tiered from an earlier EIS. It focused on changed conditions and mitigation of possible impacts to sensitive species and resources instead of repeating unchanged analysis.
- **Use a diversity of measures and values to judge success.** He reported on an EIS that the Federal Aviation Administration and National Park Service are now preparing for noise reduction in Grand Canyon National Park. Agencies and the public will have an opportunity to propose metrics for noise impacts in addition to average sound level, such as time above a threshold level and metrics that would take into account seasonal variations and noise from natural forces.

NAEP's NEPA Working Group

NAEP announced expanding roles for its NEPA Working Group. Established as a forum for NAEP members to foster broader appreciation of NEPA's value, improvements in the EIS process, and full consideration of the environment in the planning process, the Working Group is now responding to NAEP members' wish for an organizational voice in current NEPA debates and proposals. The NEPA Working Group will operate through committees to address: NAEP's interface with the Council on Environmental Quality (CEQ), analysis of litigation and rulemaking, development of the NEPA presentations and training at the NAEP annual conferences, and improvements to the NAEP website.

In the course of the 2006 conference, activities suggested as priorities for the NEPA Working Group for the coming year include commenting on legislative proposals, preparing an annual NEPA "Year-in-Review" report, reviewing draft guidance prepared by CEQ work groups, and providing suggestions on improving CEQ's NEPA website (www.nepa.gov). For additional information on the NEPA Working Group, contact Michael D. Smith, Humboldt State University, at michael.smith@humboldt.edu or 707-826-4291.

(continued on next page)

2006 NAEP Conference (continued from previous page)

Environmental Excellence Awards

NAEP conferred eight Environmental Excellence Awards to recognize significant achievements in environmental practice. Awards Chairman Jim Melton and NAEP President Gary Kelman presented the award for excellence in environmental education to DOE's Western Area Power Administration, represented by NEPA Compliance Officer Nick Stas and NEPA Document Manager Dirk Shulund, along with team members Affinity Consultants, Inc., and United States-Asia Environmental Partnership (a program of U.S. Agency for International Development) for their technical education and assistance in developing a polychlorinated biphenyl management plan for Electricity Vietnam, the state-owned utility.

The award for NEPA Excellence was presented to the Utah Department of Transportation, Federal Highway Administration, U.S. Army Corps of Engineers, and Jones & Stokes Associates, Inc., for the supplemental EIS they prepared for the Legacy Parkway, a highway project that includes mitigation designed to provide wildlife habitat and wetland protection.

NEPA 35: Spotlight on Environmental Excellence, the conference sponsored by DOE in partnership with CEQ in observance of the 35th anniversary of NEPA, was recognized with a "Special NEPA Achievement Award." (This award was first announced in a ceremony held on April 13 in Washington, DC; see related article, page 3.)

2007 Conference in Orlando

Environmental Leadership: Science, Education, Alliances is the theme for the 2007 NAEP Conference, which will be held April 22–25 in Orlando, Florida. Conference information is provided on the Association's website (www.naep.org), including instructions for submitting an abstract for a paper or poster session (due September 30, 2006) or a nomination for an Environmental Excellence Award (due February 1, 2007). 



Heard at the NAEP Conference

- *Actions are truth.*
- *Reread the NEPA regulations often.*
- *Aim for public participation, not public pacification.*
- *Excellent doesn't mean exhaustive, or as Thoreau put it: "Not that the story need be long, but it will take a long while to make it short."*
- *"What we call Man's power over Nature turns out to be a power exercised by some men over other men with Nature as its instrument," said C.S. Lewis. This may explain why NEPA is so often a forum for conflict.*

Renewed Emphasis on Environmental Management Systems



The Council on Environmental Quality (CEQ) and the Office of Management and Budget (OMB), in a memorandum to Department and Agency Heads, dated April 11, 2006, reaffirmed the importance of implementing environmental management systems (EMSs) at all appropriate Federal facilities. Executive Order 13148, *Greening the Government Through Leadership in Environmental Management* (April 21, 2000), requires agencies to implement EMSs by December 31, 2005. CEQ and OMB noted that only about 15% of Federal facilities have met this deadline. The good news is that more than 90% of DOE facilities have implemented an EMS. CEQ is developing guidance on aligning the EMS and NEPA processes; see related text box on page 7 and *LLQR*, March 2006, page 10. The memorandum can be found on FedCenter at www.fedcenter.gov/programs/EMS under Regulations, Guidance, and Policy. (See related article, page 7.) 

DOE Celebrates Earth Day

At DOE Headquarters . . .

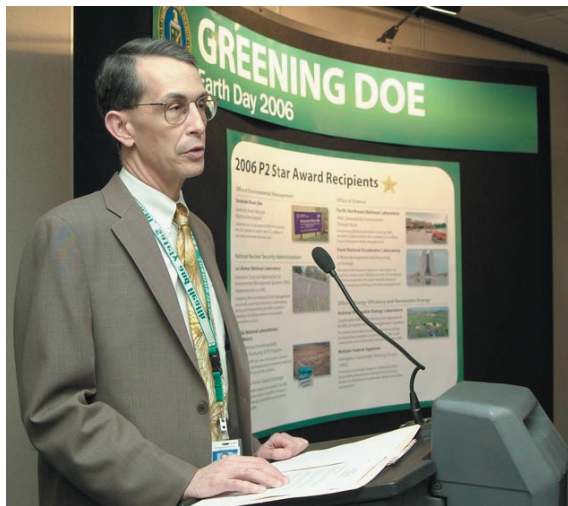

Andy Lawrence, Deputy Assistant Secretary for Environment, addressed DOE Field and Headquarters employees, including P2 Star Award winners, for Earth Day. He emphasized that pollution prevention activities contribute to the safety of our operations, the health of our workers, and environmental protection while enhancing mission operations.



The Federal Energy Management Program within DOE's Office of Energy Efficiency and Renewable Energy asks "Federal employees across the country to join us in celebrating and conserving our energy resources not only on Earth Day April 22nd, but everyday," on its website referenced to the right.

DOE Headquarters celebrated Earth Day 2006 from April 18–28 with displays highlighting DOE's environmental accomplishments and innovations.

Environment, Safety and Health Offices had several displays:

- **Air, Water and Radiation Protection Policy and Guidance** emphasized watershed management and protection of threatened and endangered species.
- **Pollution Prevention and Resource Conservation Policy and Guidance** displayed P2 Star Awards, a nationwide map of DOE sites with Environmental Management Systems, and a poster, "DOE Buys Bio for Energy Security."
- **NEPA Policy and Compliance** featured posters on "DOE NEPA *Lessons Learned Quarterly Report*" and "NEPA and DOE Through the Years," and provided copies of DOE NEPA guidance.

Earth Day is both a CELEBRATION of the world environment and a REMINDER that we all share the Earth equally and we must continue striving to protect the natural gifts our home Earth has given us.

*– Office of Environment, Safety and Health
Earth Day 2006 Brochure*

Energy Efficiency and Renewable Energy's poster, "A Good Deal For Everyone," showed a winning hand of "Aces" representing a portfolio of energy efficient technologies that will help strengthen America's energy security and environmental quality, such as hydrogen and biofuels. More information on materials available from this Office on adopting and using cleaner, more efficient forms of energy is available at www.eere.energy.gov/femp/services/earthday.html.

Fossil Energy highlighted the development of new technologies for traditional fuels, such as the FutureGen Project, fuel cell development, and carbon sequestration.

National Nuclear Security Administration highlighted 23 Pollution Prevention Awards received for the year by NNSA Offices and Sites.

(continued on next page)

Earth Day *(continued from previous page)*

At DOE Field Sites . . .

Kicking the (Trash) Can. Using desktop mini-trash bins the size of a 48-ounce cup instead of their usual, much larger wastebaskets, volunteers at the **Strategic Petroleum Reserve Project Management Office** in New Orleans participated in a month-long pollution prevention project that encouraged diligent recycling and waste avoidance. Participants tracked their recycling behaviors and completed a survey at the end of the project. DOE and DynMcDermott, the management and operations contractor, teamed to provide a week of special Earth Day events at the Project Office and the four petroleum storage sites – including an employee “Gardening Over Lunch” to swap seeds and plants, emissions and tire pressure testing of employee vehicles, and children’s activities. The photos at right show setup and results of emissions “sock test.”



Cleaning Up the Creek. To celebrate Earth Day, the **Naval Petroleum Reserves/Rocky Mountain Oilfield Testing Center** team picked up debris along a creek that runs through Naval Petroleum Reserve No. 3. The approximately 300 pounds of material collected included tin, wood, and wire rope for recycling.

Rolling Up Sleeves. In recognition of Earth Day, volunteers from **Bonneville Power Administration (BPA)** participated in four simultaneous projects at Hoyt Arboretum in Portland, Oregon: spreading gravel on trails, mulching trees, weeding the Visitor Center, and removing invasive ivy. This was the fourth year of BPA’s volunteering for Earth Day projects at the Arboretum. Volunteers at the BPA Ross Complex in Vancouver, Washington, pulled ivy from their buildings and for 3 weeks held a plastic foam recycling drive. 



Good Contracting Practices: Important Element in NEPA Quality

An important contributor to NEPA document quality, and therefore the success of a NEPA process, is the contractor supporting NEPA document preparation. At their May 2006 meeting, the NEPA Compliance Officers (NCOs) reviewed the background and benefits of the DOE-wide NEPA contracts. They explored techniques and tools that NCOs and NEPA Document Managers can use to raise the quality of contractors' work products and achieve desired results.



Contract administrator Agustin Archuleta advised that the task order process under the DOE-wide NEPA contracts can only be started when all required elements are submitted.

Manage the Contractor

The DOE-wide NEPA contracts provide a choice of qualified contractors available to start work expeditiously, without the delay of conducting a procurement process. Program and Site Office contracting officers can write their own task orders and select contractors, with a NEPA Document Manager serving as the contracting officer's representative for a task, explained Carolyn Osborne, Office of NEPA Policy and Compliance. "It would be hard to manage a NEPA document without managing the contractor who's doing the work," observed Jane Summerson, NEPA Document Manager and NCO for the Office of Repository Development.

Get Results with Statements of Work, Performance Evaluations

Hitesh Nigam, NCO for the Office of Fissile Materials Disposition and a member of the 2002 contracts acquisition team, shared recommendations for managing NEPA contractors to achieve quality NEPA documents in a timely and efficient manner:

- Make the task statement of work as specific as possible to give clear direction, establish roles and responsibilities, and eliminate from scope those activities to be performed by DOE staff (e.g., defining purpose and need, selecting alternatives for analysis, responding to policy issues in comments, and writing the record of decision).
- Evaluate contractor performance with the aim of identifying potential improvements, which may be especially useful if evaluation is done periodically, e.g., after the draft EIS is issued. "Be tougher – it now seems that *all* contractors are well above average."

Use New Task Order Guide

Agustin Archuleta, the administrator of the DOE-wide NEPA contracts, announced that the NNSA Service Center has issued *NEPA Contracting Desk Procedures* (March 22, 2006, available on the DOE NEPA website at www.eh.doe.gov/nepa/contracting.html) to help in the issuance and management of task orders under the contracts. The guide provides instructions for submitting an acquisition plan, purchase requisition, and statement of work – the elements needed to issue a task order.

Work will begin in late summer on acquisition of new DOE-wide NEPA contracts, to be issued in 2007 when the current ones expire. NCOs and NEPA Document Managers interested in assisting in the acquisition process should contact Mr. Archuleta at aarchuleta2@doeal.gov or 505-845-4686. 

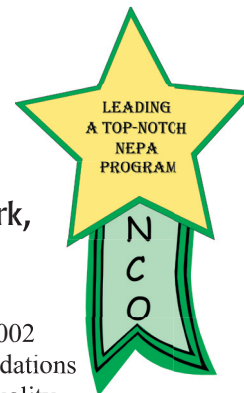

DOE-wide NEPA Contracts Update

The following tasks have been awarded recently under the DOE-wide NEPA contracts.

Description	DOE Contact	Date Awarded	Contract Team
Supplement Analysis for Enriched Uranium Global Transport at the NNSA Y-12 Complex	Robert Hamby 865-576-9281 hambyre@yso.doe.gov	12/19/05	SAIC
Global Nuclear Energy Partnership Technology Demonstration Program EIS	Tim Frazier 866-645-7803 GNEPTechDemo@nuclear.energy.gov	5/11/06	Tetra Tech, Inc.



Litigation Updates

Lawsuit Challenges Proposed Detonation at Nevada Test Site

Two Federally-recognized tribes and several individuals filed a complaint in the U.S. District Court for the District of Nevada on April 20, 2006 (amended April 25 and May 22, 2006), alleging that the Defense Threat Reduction Agency (DTRA, an agency of the Department of Defense) and DOE must complete an EIS before conducting a proposed experiment known as Divine Strake. The experiment involves the detonation of 700 tons of ammonium nitrate-fuel oil mixture above an existing tunnel in a central area of the Nevada Test Site. The Divine Strake experiment would “validate and assess the capability of computer codes to predict the ground-shock environment and how the tunnel responds to that shock,” states DTRA on its website (www.dtra.mil/divinestrake).

The plaintiffs allege that the agencies violated NEPA by failing to provide adequate notice and opportunity for comment before issuing a finding of no significant impact (FONSI). The plaintiffs also allege that the environmental assessment (EA), *Large-Scale, Open-Air Explosion Detonation DIVINE STRAKE at Nevada Test Site* (DOE/EA-1550), reflects the failure of the agencies to test the soil at the site of the proposed experiment

for radionuclides, which the plaintiffs allege could be dispersed by the detonation.

DOE distributed a pre-approval draft EA in December 2005 and, after receiving no substantive comments, signed a FONSI on January 30, 2006. DOE subsequently issued a revised EA on May 5, 2006, to incorporate additional data and correct some inconsistencies, then issued a revised FONSI on May 9, 2006. DOE announced its intent to withdraw the FONSI on May 26, 2006, “to clarify and provide further information regarding background levels of radiation from global fallout in the vicinity of the Divine Strake experiment.” The experiment, originally scheduled for June 2, 2006, has been delayed.

DTRA was a cooperating agency in preparing the EA. The revised EA and FONSI are available on the Nevada Site Office website at www.nv.doe.gov/library/publications/environmental.aspx. In addition to the NEPA charges, the plaintiffs allege several violations of the Ruby Valley Treaty of 1863, which relates to the land now occupied by the Nevada Test Site, and violations of the Clean Air Act and Clean Water Act. The case is cited as *Winnemucca Indian Colony v. U.S.* [Case No.: 06-00497]

DOE NEPA Litigation in Brief

Border Power Plant Working Group v. Department of Energy et al. (S.D. Calif.) The plaintiff alleges that DOE and the Bureau of Land Management violated NEPA by preparing an inadequate *EIS for the Imperial-Mexicali 230-kV Transmission Lines* (DOE/EIS-0365, December 2004), which was completed after the court found the agencies’ 2001 EA inadequate. The plaintiff also alleges that the agencies violated the Clean Air Act by failing to prepare a conformity determination. A conformity determination is a process by which Federal agencies assess how their actions would conform to applicable state implementation plans for achieving and maintaining the National Ambient Air Quality Standards for criteria pollutants. A hearing is scheduled for October 6, 2006. (See *LLQR* March 2006, page 20; December 2005, page 36; September 2005, page 25; June 2004, page 16; December 2003, page 7; and September 2003, page 22.) [Case No.: 02-0513]

Center for Biological Diversity et al. v. Department of Energy et al. (N.D. Calif.): The court ordered on March 6, 2006, that DOE must undertake a rulemaking to

modify a goal for the use of non-petroleum replacement fuels in light-duty motor vehicles and, based on that goal, to assess whether to require large private and municipal fleets of motor vehicles to acquire alternative fuel vehicles. These actions are required to comply with the Energy Policy Act of 1992, the court concluded. The court ruled that an EIS is not necessary for the rulemaking because Congress mandated the action, leaving DOE no discretion in regard to whether to act. Moreover, the court concluded that the Energy Policy Act of 1992 promotes the purposes of NEPA by requiring that DOE consider the effect on greenhouse gases and provide an opportunity for public comment. (See *LLQR*, June 2005, page 23.) [Case Nos.: 02-00027 and 05-01526]

Coalition on West Valley Nuclear Wastes et al. v. Department of Energy (W.D. N.Y.): The plaintiffs allege that DOE is in violation of NEPA and a stipulation settling a prior lawsuit because DOE segmented its NEPA analysis at the West Valley Demonstration Project (WVDP) site in New York by analyzing its proposed action in two separate EISs (one on waste management,

(continued on next page)

Litigation Updates (continued from previous page)

a second being prepared on decommissioning). The plaintiffs also allege that the *West Valley Demonstration Project Waste Management Environmental Impact Statement* (DOE/EIS-0337, December 2003) does not support the Record of Decision's (70 FR 35073; June 16, 2005) reference to the possible use of a waste-incident-to-reprocessing evaluation to determine that certain wastes at West Valley can be managed as low-level waste (LLW) or mixed low-level waste.

DOE responded to the complaint on December 7, 2005, stating that the off-site disposal of wastes analyzed in the WVDP Waste Management EIS has independent utility and will not prejudice the analysis of alternatives in the ongoing *Decommissioning and/or Long-Term Stewardship at the WVDP and the Western New York Nuclear Service Center EIS* (DOE/EIS-0226-R). DOE also states that it has not made any waste-incident-to-reprocessing determination, and so the plaintiffs' related claim is premature. The court issued a scheduling order on February 15, 2006, that allows for filing the administrative record and briefing of the case by October 31, 2006. (See *LLQR*, September 2005, page 24.) [Case No.: 05-0614]

The County of Los Alamos v. Department of Energy et al. (D. NM): DOE and Los Alamos County have agreed to build separate portions of a bypass road to facilitate traffic flow outside a new security perimeter at Los Alamos National Laboratory (LANL). The agreement settles a lawsuit in which the County alleged that DOE failed to prepare an adequate EA for proposed modifications to the LANL security perimeter. DOE proposed physical security enhancements in 2002 that would restrict vehicular traffic to certain areas within LANL and change traffic flow patterns. DOE evaluated the proposal in the *Environmental Assessment for Proposed Access Control and Traffic Improvements at Los Alamos National Laboratory, Los Alamos, New Mexico* (DOE/EA-1429, August 2002) and issued a FONSI. Subsequently, DOE modified its proposal to reduce costs. After completing a review similar to the supplement analysis process (10 CFR 1021.314(c)), DOE concluded in March 2004 that the proposed modifications are bounded by the analyses in the 2002 EA and five other relevant EAs and that, therefore, no new EA is required. (See *LLQR*, March 2006, page 20.) [Case No.: 05-1343]

Natural Resources Defense Council et al. v. Department of Energy et al. (N.D. Calif.): The court has scheduled a hearing on summary judgment for June 23, 2006. The plaintiffs allege that DOE's cleanup activities at the Energy Technology Engineering Center are in violation of NEPA, the Comprehensive Environmental Response, Compensation, and Liability Act, and the Endangered Species Act. The lawsuit challenges the adequacy of DOE's *Environmental Assessment for Cleanup and Closure of the Energy Technology Engineering Center* (DOE/EA-1345, March 2003) and its associated FONSI. (See *LLQR*, December 2004, page 16.) In a brief filed on April 12, 2006, DOE states that the EA is adequate and that an EIS is not required. [Case No.: 04-04448]

Natural Resources Defense Council et al. v. Department of Energy (D. Idaho): The district court dismissed this case, which involved DOE's waste-incident-to-reprocessing provisions, on March 6, 2006. This followed instructions from the U.S. Court of Appeals for the Ninth Circuit, which in its November 5, 2004, decision found that the plaintiffs' claims were not ripe for review. In an earlier decision, the district court ruled that a provision of the Manual for DOE Order 435.1, *Radioactive Waste Management*, is invalid. That provision allows waste resulting from reprocessing spent nuclear fuel that is determined to be incidental to reprocessing to be managed as LLW if certain conditions are met. The appeals court vacated the district court's judgment and directed that the district court dismiss the case. The appeals court held that any challenge to DOE's waste-incident-to-reprocessing criteria and process should be framed as a challenge to an actual application of those criteria and that process, not in the abstract. (See *LLQR*, December 2004, page 16; and September 2003, page 23.) [Case No.: 01-0413]

Tri-Valley Communities Against a Radioactive Environment et al. v. U.S. Department of Energy et al. (9th Cir.): This case is an appeal of the district court's ruling on September 10, 2004, that DOE's EA for the Biosafety Level 3 facility at Lawrence Livermore National Laboratory is sufficient. (See *LLQR*, June 2005, page 23; December 2004, page 18; March 2004, pages 2 and 16; and September 2003, page 23.) The court has scheduled a hearing for June 13, 2006. [Case No.: 04-17232]

(continued on next page)

Litigation Updates (continued from previous page)



Court Orders Navy to Take a “Harder Look”

In the decision summarized below, the U.S. Court of Appeals for the Fourth Circuit applied the “hard look” standard – an approach commonly used by the courts in NEPA cases – to evaluate the adequacy of an EIS prepared by the U.S. Navy. The court’s analysis is instructive to all NEPA practitioners.

The Navy began preparation of a Supplemental EIS in June 2005, following a decision by the U.S. District Court for the Eastern District of North Carolina that the analysis of potential environmental impacts in the Navy’s *Final EIS for the Introduction of the F/A-18E/F (Super Hornet) Aircraft to the East Coast of the United States* is inadequate. The Navy had decided, based on that EIS, to construct and operate an Outlying Landing Field (Field) in Washington and Beaufort Counties, North Carolina. The district court issued an injunction on February 18, 2005, barring the Navy from undertaking any “activity associated with the planning, development, or construction” of the Field until the Navy fully complies with NEPA. The Navy appealed.

On September 7, 2005, the U.S. Court of Appeals for the Fourth Circuit upheld the need for a Supplemental EIS, but allowed the Navy to take certain actions while the Supplemental EIS is being prepared.

What Constitutes a Hard Look?

The appeals court based its ruling on the principle that its role is to determine whether an agency has taken a “hard look” at an action’s environmental impacts. “A ‘hard look’ is necessarily contextual,” the court wrote, and should be based on “a holistic view of what the agency has done to assess environmental impact The hallmarks of a ‘hard look’ are thorough investigation into environmental impacts and forthright acknowledgment of potential environmental harms.” *National Audubon Society et al. v. Department of the Navy et al.*, U.S. Court of Appeals for the Fourth Circuit, September 7, 2005.

Training Flights Could Impact Birds

The principal purpose of the Navy’s proposed Field in North Carolina would be to conduct Field Carrier Landing Practice, where a pilot practices “touch and go” procedures (landing and immediate take off) on a simulated aircraft carrier deck marked out on the Field. The majority of the more than 30,000 planned training procedures each year would be conducted at night. The Navy is evaluating five alternative locations in eastern North Carolina for the proposed Field in the Supplemental EIS, including the site in Washington and Beaufort Counties (Site C).

Site C is located about five miles from the Pocosin Lakes National Wildlife Refuge (www.fws.gov/pocosinlakes), and the flight pattern for training exercises would come within 0.2 mile of the Refuge. More than 200 species of birds can be found at the Refuge, including migratory waterfowl, some 100,000 of which winter there and forage in the fields surrounding Site C. The plaintiffs – environmental groups and the two potentially-impacted counties – challenged the Navy’s evaluation of potential impacts on birds (among other issues).

Appeals Court Reviews EIS Analyses of Selected Site

The appeals court found inadequacies in five elements of the Navy’s evaluation of Site C in the initial EIS. First, in regard to the Navy’s site investigation, the court found that four one-day visits were insufficient to “conduct systematic observations or perform species-specific studies” and that a subsequent month-long radar study was a positive step, but had its own limitations.

Second, the Navy contended that the bird-aircraft strike potential at Site C was similar to that at other flight training facilities. The appeals court found, though, that “this comparative assessment provided only a useful starting point” and that further analysis is necessary, for example, to consider specific species and variation in aircraft features that were not accounted for by the Navy’s model.

Third, the Navy’s literature review identified, among other relevant studies, research indicating that snow geese (who winter at the Refuge) “may be especially sensitive to aircraft activity,” the appeals court wrote. The court added, however, that the EIS needed to go beyond “citing the articles or abstracts that contradict the conclusions reached [by the Navy that impacts would be minor] If anything, the obligation to carefully parse contrary findings is magnified when a congressionally protected National Wildlife Refuge is only miles away.”

Fourth, the Navy relied on an analysis of environmental effects of aircraft overflights at three existing military facilities to draw conclusions about potential impacts at Site C. The appeals court noted differences between circumstances at Site C and the existing facilities and found that the Navy had failed to provide a proper factual basis for a comparative analysis.

(continued on page 26)

Training Opportunities

NEPA-related courses are listed in the Lessons Learned Quarterly Report for information only, without endorsement. Cost and schedule information are subject to change; check with the course provider.

- **NEPA/309 Review**

(FED 103: NEPA/309 Review)
Washington, DC: June 6-8
Denver, CO: August 1-3
No fee

- **Cumulative Impacts Assessment**

(FED 104: Cumulative Impacts Assessment)
Washington, DC: July 18-20
No fee

Environmental Protection Agency
Office of Federal Activities
202-564-7164
totten.arthur@epa.gov
www.netionline.com

- **NEPA: The Utah Experience**

Salt Lake City, UT: June 9
Fee: \$395 (GSA contract: \$345)

Continuing Legal Education (CLE)
800-873-7130
www.cle.com

- **Section 106 and Beyond: An Introductory Workshop on Cultural Resources Management in Indian Country**

Denver, CO: June 13-14
Fee: \$495

International Institute for Indigenous
Resource Management
303-733-0481
iirm@iirm.org
www.iirm.org

- **NEPA: What Every Engineer and Project Manager Should Know about NEPA**

Orlando, FL: June 8-9
Denver, CO: September 14-15
Fee: contact Tetra Tech

- **Effective Public Outreach**

Denver, CO: September 12 (half day)
Fee: contact Tetra Tech

- **Wetlands Workshop**

Denver, CO: September 12 (half day)
Fee: contact Tetra Tech

- **Assessing Cumulative Impacts**

Denver, CO: September 13
Fee: contact Tetra Tech

- **Endangered Species**

Denver, CO: September 13 (half day)
Fee: contact Tetra Tech

Tetra Tech, Inc.
877-468-3872
www.tetrattechNEPA.com

- **How to Manage the NEPA Process and Write Effective NEPA Documents**

Atlanta, GA: June 13-16
Fee: \$1,110 (GSA contract: \$995)
Salt Lake City, UT: September 20-22
Fee: \$835 (GSA contract: \$745)
until August 1

- **Reviewing NEPA Documents**

Las Vegas, NV: June 27-29
Fee: \$885 (GSA contract: \$795)

- **NEPA Cumulative Effects Analysis and Documentation**

Baltimore, MD: July 11-13
Fee: \$885 (GSA contract: \$795)
Dallas/Ft. Worth, TX: August 22-24
Fee: \$835 (GSA contract: \$745)
until July 10

- **Right Writing for Environmental and Technical Specialists**

San Diego, CA: July 19-20
Fee: \$660 (GSA contract: \$595)

- **Advanced Writing for NEPA Specialists**

Portland, OR: July 25-27
Fee: \$835 (GSA contract: \$745)
until June 24

- **NEPA Process Management**

Las Vegas, NV: August 7-8
Fee: \$660 (GSA contract: \$595)

- **NEPA Writing Workshop**

Las Vegas, NV: August 9-11
Fee: \$885 (GSA contract: \$795)

- **How to Manage the NEPA/CEQA Process and Write Effective NEPA Documents**

San Francisco, CA: August 22-24
Fee: \$835 (GSA contract: \$745)
until July 10

The Shipley Group
888-270-2157 or 801-298-7800
shipley@shipleygroup.com
www.shipleygroup.com

(continued on next page)

Training Opportunities

(continued from previous page)

- **NEPA Certificate Program**

Conducted through Utah State University. Requires successful completion of four core and three elective courses offered by The Shipley Group. Courses completed in 2000 or later may be applied toward the certificate. Also requires completion of course exams and a final project.

Fee: \$4,955 (includes tuition, course fees, and all course materials)

Natural Resources and
Environmental Policy Program
Utah State University
435-797-0922
judy.kurtzman@usu.edu
www.cnr.usu.edu/policy

- **Preparing and Documenting Environmental Impact Analyses**

Durham, NC: June 12-15

Fee: \$1,100

- **Implementation of the National Environmental Policy Act**

Durham, NC: July 10-14

Fee: \$1,100

- **NEPA Certificate Program**

Requires one core and three elective Duke University NEPA short courses and a paper. Previously completed courses may be applied. Co-sponsored by the Council on Environmental Quality.

Fee: Included in registration for constituent courses

Nicholas School of the Environment
and Earth Sciences
Duke University
919-613-8082
del@nicholas.duke.edu
www.env.duke.edu/del/continuinged/certificates.html

- **Species Protection and the Law: Endangered Species Act, Biodiversity Protection, and Invasive Species Control**

Washington, DC: November 15-17

Fee: \$995

American Law Institute -
American Bar Association
800-253-6397
www.ali-aba.org

- **Environmental Impact Training**

Courses cover topics such as environmental impact assessment, cumulative effects, environmental justice, reviewing NEPA documents, computer-based models, and adaptive management. Topics from several courses can be packaged together to meet the specific training needs of clients.

Environmental Impact Training
830-596-8804
info@eiatraining.com
www.eiatraining.com

- **NEPA Toolbox™ Training**

Courses are custom-designed to meet specific needs and are conducted at the requestor's facility. Example course content includes essentials, cumulative impacts, public participation, and EA and EIS preparation. A specialized DOE NEPA Document Manager course also is available. Services are available through a GSA contract.

A free audio file, "Six Keys to Environmental Compliance," is available at www.envirotrain.com/sixkeys.html and a free podcast series, currently with selections on cumulative impacts assessment and the 2006 NAEP Conference, is available at web.mac.com/envirotrain.

Environmental Training & Consulting
International, Inc.
503-274-1790
info@envirotrain.com
www.envirotrain.com

EAs and EISs* Completed January 1 to March 31, 2006

EAs

Office of Civilian Radioactive Waste Management

DOE/EA-1549 (12/26/05)**

Environmental Assessment for the Proposed Withdrawal of Public Lands Within and Surrounding the Caliente Rail Corridor, Nevada

Cost: \$245,000

Time: 5 months

National Energy Technology Laboratory/ Office of Fossil Energy

DOE/EA-1546 (2/24/06)

Liquefied Natural Gas from Coal Mine Methane for Industrial and Transportation Applications, Monongalia County, West Virginia

Cost: \$27,000

Time: 9 months

Richland Operations Office/ Office of Environmental Management

DOE/EA-1547 (3/31/06)

Sodium Residuals Reaction/Removal and Other Deactivation Work Activities, Fast Flux Test Facility (FFTF) Project, Hanford Site, Richland, Washington

Cost: \$121,000

Time: 9 months

Western Area Power Administration

DOE/EA-1427 (1/27/06)

Headgate Rock - Blythe No. 1, 161 kV Transmission Line Structure Replacement and Black Point Mesa Reroute, Blythe, California

Cost: \$100,000

Time: 46 months

DOE/EA-1487 (12/22/05)**

Parker - Gila 161 kV Transmission Line Relocation, Quartzsite, Arizona

Cost: \$123,000

Time: 25 months

* No EISs completed during this quarter

** Not previously reported in LLQR

NEPA Document Cost and Time Facts

EA Costs and Completion Times

- For this quarter, the median cost for the preparation of 5 EAs was \$121,000; the average was \$123,000.
- Cumulatively, for the 12 months that ended March 31, 2006, the median cost for the preparation of 17 EAs for which cost data were applicable was \$64,000; the average was \$127,000.
- For this quarter, the median completion time of 5 EAs was 9 months; the average was 19 months.
- Cumulatively, for the 12 months that ended March 31, 2006, the median completion time for 21 EAs was 6 months; the average was 11 months.

EIS Costs and Completion Times

- No EISs were completed during this quarter.
- Cumulatively, for the 12 months that ended March 31, 2006, the median cost for the preparation of 3 EISs for which cost data were applicable was \$3,300,000; the average was \$2,800,000.
- Cumulatively, for the 12 months that ended March 31, 2006, the median completion time for 5 EISs was 32 months; the average was 28 months.

Recent EIS-Related Milestones (March 1 to May 31, 2006)

Advance Notice of Intent

Office of Nuclear Energy, Science and Technology
DOE/EIS-0396
Global Nuclear Energy Partnership Technology Demonstration Program
March 2006 (71 FR 14505, 3/22/06)

Notice of Intent

Western Area Power Administration
DOE/EIS-0323-S1
Construction and Operation of the Sacramento Area Voltage Support Project, Sacramento, Sutter, and Placer Counties, California
May 2006 (71 FR 26961, 5/9/06)

Notice of Floodplain and Wetland Actions

Office of Fossil Energy
DOE/EIS-0385
Site Selection for the Expansion of the Strategic Petroleum Reserve, Louisiana, Mississippi, and Texas
March 2006 (71 FR 15398, 3/28/06)

Draft EISs

Bonneville Power Administration
DOE/EIS-0374
Klondike III Wind Project Interconnection, Sherman County, Oregon
May 2006 (71 FR 26498, 5/5/06)

Office of Fossil Energy
DOE/EIS-0385
Site Selection for the Expansion of the Strategic Petroleum Reserve, Louisiana, Mississippi, and Texas
May 2006 (71 FR 30400, 5/26/06)

Western Area Power Administration
DOE/EIS-0377
Big Stone II Power Plant and Transmission Project, Proposed Power Plant, Transmission Alternatives, and Substation Modification, South Dakota and Minnesota
May 2006 (71 FR 29148, 5/19/06)

Record of Decision

Bonneville Power Administration
DOE/EIS-0353
South Fork Flathead Watershed Westslope Cutthroat Trout Conservation Project, Powell and Missoula Counties, Montana
May 2006 (71 FR 27714, 5/12/06)

Supplement Analyses

Bonneville Power Administration
Wildlife Mitigation Program Environmental Impact Statement
(DOE/EIS-0246)

DOE/EIS-0246-SA-51
Preserve and Restore Columbia River Estuary - Crims Island Vegetation Control and Wildlife Monitoring, Columbia County, Oregon
(Decision: No further NEPA review required)
April 2006

Watershed Management Program Environmental Impact Statement
(DOE/EIS-0265)

DOE/EIS-0265-SA-250*
Idaho Fish Screening Improvement - Bohannon Creek Diversions, Lemhi County, Idaho
(Decision: No further NEPA review required)
February 2006

DOE/EIS-0265-SA-251*
Tapteal Bend Riparian Corridor Restoration Project (AMENDMENT), Benton County, Washington
(Decision: No further NEPA review required)
February 2006

DOE/EIS-0265-SA-252*
Umatilla Basin Anadromous Fish Habitat Enhancement Project - B&G Resources Easement, Umatilla County, Oregon
(Decision: No further NEPA review required)
February 2006

DOE/EIS-0265-SA-253
Wind River Watershed Project, Skamania County, Washington
(Decision: No further NEPA review required)
March 2006

* Not previously reported in LLQR

(continued on next page)

Recent EIS-Related Milestones (March 1 to May 31, 2006)

(Supplement Analyses, continued from previous page)

DOE/EIS-0265-SA-254

Yakima Tributary Access and Habitat Program - Fogarty Ditch Diversion, Kittitas County, Washington
(Decision: No further NEPA review required)
March 2006

DOE/EIS-0265-SA-255

Fulton Diversion Dam Fish Passage Project - Phase 1, Okanogan County, Washington
(Decision: No further NEPA review required)
March 2006

DOE/EIS-0265-SA-256

Grande Ronde Model Watershed - Mahogany Creek Culvert Replacement, Wallowa County, Oregon
(Decision: No further NEPA review required)
March 2006

DOE/EIS-0265-SA-257

Idaho Fish Screening Improvement - Squaw Creek SSC-01 Diversion Project, Clayton, Idaho
(Decision: No further NEPA review required)
April 2006

DOE/EIS-0265-SA-258

Custer Soil and Water Conservation District (SWCD) Habitat Projects for FY 06, S-40 Diversion Modification and Rocky Mountain Ranch Riparian Protection Fence, Custer County, Idaho
(Decision: No further NEPA review required)
April 2006

DOE/EIS-0265-SA-259

Idaho Fish Screening Improvement - SEF-15 Diversion Project, Idaho
(Decision: No further NEPA review required)
April 2006

Transmission System Vegetation Management Program Environmental Impact Statement (DOE/EIS-0285)

DOE/EIS-0285-SA-275*

Vegetation Management for the Wautoma and Tucannon River Substations, Benton and Columbia Counties, Washington
(Decision: No further NEPA review required)
December 2005

DOE/EIS-0285-SA-276*

Vegetation Management along the Chehalis - Raymond No. 1, 115 kV Transmission Line Corridor from Chehalis Substation Heading West to Raymond Substation, Lewis and Pacific Counties, Washington
(Decision: No further NEPA review required)
January 2006

DOE/EIS-0285-SA-277*

Vegetation Management along the Colville - Republic No. 1, 115 kV Transmission Line Corridor Right of Way, Ferry and Stevens Counties, Washington
(Decision: No further NEPA review required)
January 2006

DOE/EIS-0285-SA-278*

Vegetation Management along the Addy - Cusick No. 1, 230 kV Transmission Line Corridor Right of Way, Stevens and Pend Oreille Counties, Washington
(Decision: No further NEPA review required)
January 2006

DOE/EIS-0285-SA-279*

Vegetation Management along the Keller Tap to Grand Coulee - Okanogan No. 2, 115 kV Transmission Line Corridor Right of Way, Okanogan and Ferry Counties, Washington
(Decision: No further NEPA review required)
January 2006

DOE/EIS-0285-SA-280*

Vegetation Management along the Pearl - Marion No. 1, 115 kV Transmission Line Corridor, Clackamas and Marion Counties, Oregon
(Decision: No further NEPA review required)
January 2006

DOE/EIS-0285-SA-281*

Vegetation Management along the McNary - Ross No. 1, 345 kV Transmission Line Corridor, Skamania and Clark Counties, Washington
(Decision: No further NEPA review required)
February 2006

DOE/EIS-0285-SA-282*

Vegetation Management (Danger Tree Removal) along the Nasselle Tap to Allston Astoria No. 1, 115 kV Transmission Line Corridor, Pacific and Wahkiakum Counties, Washington
(Decision: No further NEPA review required)
February 2006

* Not previously reported in LLQR

(continued on next page)

Recent EIS-Related Milestones (March 1 to May 31, 2006)

(Supplement Analyses, continued from previous page)

DOE/EIS-0285-SA-283*

Vegetation Management along the Schultz - Raver Transmission Line Corridor Right of Way, Kittitas County, Washington

(Decision: No further NEPA review required)
February 2006

DOE/EIS-0285-SA-284*

Vegetation Management along the Santiam - Albany No. 1 Line, Linn County, Oregon

(Decision: No further NEPA review required)
February 2006

DOE/EIS-0285-SA-286

Vegetation Management along the Holcomb - Naselle No. 1, Pacific County, Washington

(Decision: No further NEPA review required)
March 2006

DOE/EIS-0285-SA-287

Vegetation Management along the Rattlesnake - Garrison No. 1, 230 kV Transmission Line Corridor Right of Way, Missoula, Granite, and Powell Counties, Montana

(Decision: No further NEPA review required)
March 2006

DOE/EIS-0285-SA-288

Vegetation Management along the Garrison - Anaconda No. 1, 230 kV Transmission Line Corridor Right of Way, Powell and Deer Lodge Counties, Montana

(Decision: No further NEPA review required)
March 2006

DOE/EIS-0285-SA-289

Vegetation Management along the Libby - Conkelley No. 1, 230 kV Transmission Line Corridor Right of Way, Lincoln and Flathead Counties, Montana

(Decision: No further NEPA review required)
March 2006

DOE/EIS-0285-SA-290

Vegetation Management along the Fairmount - Port Angeles No. 1, 230 kV Transmission Line Corridor from Fairmount Substation Heading West to Port Angeles Substation, Jefferson and Clallam Counties, Washington

(Decision: No further NEPA review required)
April 2006

DOE/EIS-0285-SA-291

Vegetation Management along the Libby - Bonners Ferry No. 1, 115 kV Transmission Line Corridor Right of Way, Lincoln County, Montana, and Boundary County, Idaho

(Decision: No further NEPA review required)
April 2006

DOE/EIS-0285-SA-292

Vegetation Management along the Raymond - Cosmopolis No. 1, Pacific and Grays Harbor Counties, Washington

(Decision: No further NEPA review required)
April 2006

DOE/EIS-0285-SA-293

Vegetation Management Activities along the Right of Way of the Pilot Butte - Lapine Transmission Line Corridor, Deschutes County, Oregon

(Decision: No further NEPA review required)
April 2006

DOE/EIS-0285-SA-294

Vegetation Management along the Wendson - Tahkenitch No. 1 and No. 2 Transmission Line Corridor, Lane and Douglas Counties, Oregon

(Decision: No further NEPA review required)
April 2006

DOE/EIS-0285-SA-295

Vegetation Management along the Taft - Hot Springs No. 1, 500 kV Transmission Line Corridor Right of Way, Mineral and Sanders Counties, Montana

(Decision: No further NEPA review required)
April 2006

**Northeast Oregon Hatchery (NEOH) Program
Grande Ronde - Imnaha Spring Chinook
Hatchery Project
Environmental Impact Statement
(DOE/EIS-0340)**

DOE/EIS-0340-SA-01

Supplement Analysis for NEOH Grande Ronde - Imnaha Spring Chinook Hatchery Project, Wallowa County, Oregon

(Decision: No further NEPA review required)
March 2006

* Not previously reported in LLQR

(continued on next page)

Recent EIS-Related Milestones (March 1 to May 31, 2006)

(Supplement Analyses, continued from previous page)

Idaho Operations Office/ Office of Environmental Management

Advanced Mixed Waste Treatment Project Environmental Impact Statement (DOE/EIS-0290)

DOE/EIS-0290-SA-01*

Regarding Remote-Handled Transuranic Waste Identified in the Department of Energy Programmatic Spent Nuclear Fuel Management and Idaho National Engineering Laboratory Environmental Restoration and Waste Management Programs Final Environmental Impact Statement and the Advanced Mixed Waste Treatment Project Final Environmental Impact Statement

(Decision: No further NEPA review required)
January 2006

* Not previously reported in LLQR

Lawrence Livermore National Laboratory/ National Nuclear Security Administration

Site-wide Environmental Impact Statement for Continued Operation of Lawrence Livermore National Laboratory and Supplemental Stockpile Stewardship and Management Programmatic Environmental Impact Statement (DOE/EIS-0348)

DOE/EIS-0348-SA-01*

The Proposed Construction and Operation of Evidence Receiving and Temporary Storage Facilities in Support of the Nuclear and Radiological Attribution Program and Forensic Science Center's Analyses Programs at the Livermore Site and Site 300, Lawrence Livermore National Laboratory, Livermore, California

(Decision: No further NEPA review required)
February 2006 

Litigation Updates (continued from page 19)

Fifth, the appeals court found that the Navy had not adequately evaluated the potential cumulative impacts of the proposed action and other current and reasonably foreseeable proposals that would affect airspace near the Refuge.

“Considered together,” the appeals court concluded, these elements of the EIS “reveal neither a complete investigation into environmental impacts nor a frank admission of environmental harms. The end result of this study was the far from self-evident conclusion that repetitive take-offs and landings of advanced fighter aircraft near mass gatherings of waterfowl will have only the most minor of impacts upon them. Maybe so, but this needs to be explained.”

Appeals Court Allows Interim Actions

The appeals court directed the district court to modify its injunction to allow the Navy to undertake certain activities before the Supplemental EIS is complete. The allowed activities include site-specific impact assessments, land purchases and certain related activities, architectural and engineering work for planning and design, and permit applications. “Rather than treat ‘development of the [Field]’ as a single indivisible activity, the district court



An F/A-18F Super Hornet launches from the flight deck of an aircraft carrier. (U.S. Navy photo by Photographer's Mate 3rd Class Jonathan Chandler.)

should have subdivided it to determine which of its component steps (either in isolation or in combination)” would cause environmental harm or limit the choice of reasonable alternatives, the appeals court wrote.

During the past year, the Navy has conducted fieldwork in support of the Supplemental EIS. More information on the Supplemental EIS is available at www.faircraft.ene.com. 

What Worked and Didn't Work in the NEPA Process

To foster continuing improvement in the Department's NEPA Compliance Program, DOE Order 451.1B requires the Office of NEPA Policy and Compliance to solicit comments on lessons learned in the process of completing NEPA documents and distribute quarterly reports. This Quarterly Report covers documents completed between January 1 and March 31, 2006, and one not previously reported.

The material presented here reflects the personal views of individual questionnaire respondents, which (appropriately) may be inconsistent. Unless indicated otherwise, views reported herein should not be interpreted as recommendations from the Office of Environment, Safety and Health (EH).

Scoping

What Worked

- *Early public scoping meeting.* A public meeting held before the EA was underway helped identify stakeholders' concerns, which were addressed in the EA.
- *Status meetings.* Numerous meetings among document preparers and project managers were held to communicate progress.

What Didn't Work

- *Combined EISs.* Including a Supplemental Programmatic EIS within a site-wide EIS was confusing to involved DOE organizations and delayed document approval.

Data Collection/Analysis

What Worked

- *Management control procedure.* The management control procedure established for the project was effective in ensuring that the proper Federal and contractor personnel were available for the EIS.
- *Updated schedule.* A regularly updated EIS schedule ensured that all personnel were aware of the deliverables and due dates.
- *Teamwork.* The EA preparers worked well together, discussing key impact analyses for noise and traffic.

What Didn't Work

- *Unclear data requests.* The initial data call was not specific, but was a generic list of required documents. As a result, material received did not meet the needs of the EIS.

- *Inconsistency between accident and safety analyses.* Differences in accident analysis for NEPA and safety documents should have been reconciled. The same information should be in both document types.
- *Difficulty setting deadline.* Establishing a cutoff date for data initially proved difficult.
- *Incomplete data.* Having the contractor try to analyze incomplete data generated unexpected costs.

Schedule

Factors that Facilitated Timely Completion of Documents

- *Established points of contact.* Developing points of contact (POCs) for all involved organizations locally and at Headquarters improved coordination of reviews and assured that POCs were always aware of major issues and changes to the EIS.
- *Management involvement.* Significant management involvement from both Field and Headquarters Offices facilitated timely completion of the EA.
- *Effective scheduling and updates.* Thorough scheduling and updating of activities and time frames for each phase of the EA contributed to timely completion of the document.
- *Document preparation by DOE.* The NEPA Document Manager, NEPA Compliance Officer, and DOE legal counsel took over completion of the EA from the contractor to enable timely completion.
- *Headquarters support.* Strong support from EH facilitated timely EA completion.
- *Communication.* Close and constant communication between management, DOE project staff, and contractor staff contributed to timely completion of the EA.

(continued on next page)

What Worked and Didn't Work

(continued from previous page)

Factors that Inhibited Timely Completion of Documents

- *Unclear comment-response process.* The process for responding to public comments on the draft and final EISs was not clear. As a result, there was considerable delay in the review of the comment-response sections.
- *Difference in lead agency's procedures.* DOE was a cooperating agency and had very different NEPA procedures and standards than the lead agency for the EA.
- *Expiration of contract.* The EA preparation contract expired and a new contract had to be awarded.
- *Coordination with cooperating agencies.* Coordinating EA review processes and comment resolution with a cooperating agency was challenging.
- *Change in scope.* A change in scope to include additional project components delayed EA completion.
- *Unanticipated changes.* Several changes and external needs, such as tribal requests for more information, were encountered that could not have been anticipated.
- *Tribal coordination.* The EA team was not aware that tribal views could change.
- *Project and procurement obstacles.* Issues arising from the project procurement and the project itself changed the scope of the EA and hindered timely completion.
- *Administrative support unavailable.* No experienced DOE administrative support was available to support preparation and publication of the draft and final EA. The NEPA Document Manager had to do this work.

Teamwork

Factors that Facilitated Effective Teamwork

- *Coordination between Program Offices.* Coordination with Headquarters Program Offices and EH improved understanding of program needs and shortened the EIS completion time.
- *Management involvement.* Continued management focus on the development and evolution of the EA facilitated a common understanding of the schedule for the review cycles and final production of the EA.

- *Contractor resources.* Sufficient on-site contractor resources during the development of the draft site-wide EIS and comment-response document proved essential.
- *Good contractor.* The EA contractor was easy to work with and eager to please.

Factors that Inhibited Effective Teamwork

- *Limited participation by NEPA Compliance Officer.* The NEPA Compliance Officer had limited participation on the EIS for the first two years of the project.
- *Conflicting objectives.* Balancing project objectives and minimizing EA legal vulnerabilities sometimes created conflict overcome by working as a team.
- *Conflicting schedules for project and NEPA contractors.* There was a lack of apparent support by the EA preparation contractor to complete the EA to meet the project schedule.
- *Contractor change-control management.* The draft EIS was prepared using a team of contractors from different organizations that spent several weeks on-site and then left to develop the respective sections. Unfortunately, the contractor project manager was the only individual responsible for coordinating the different sections. When changes were made in one section, the manager needed to ensure they were reflected in the other sections. It would have been better to have several contractors remain at the site until draft EIS completion.

Process

Successful Aspects of the Public Participation Process

- *Newsletters.* Sending out newsletters to thousands of individuals and organizations ensured that everyone interested in the EIS was aware of meetings and opportunities to provide input.
- *Meetings with interested stakeholders.* Meetings with local governmental officials, press, other local organizations, and individuals helped them understand the EIS.
- *Sufficient comment opportunity.* The public had ample opportunity for input on the EA.
- *Public meetings.* Two informational public meetings, conducted before issuing the draft EA, were effective vehicles for listening to stakeholders.

(continued on next page)

What Worked and Didn't Work

(continued from previous page)

- *Public availability of the draft EA.* Making the draft EA available to members of the public seemed to help maintain public acceptance of the project.
- *Willingness to discuss issues.* Public reaction was favorable regarding our willingness to analyze in the EA issues of concern (noise, traffic, and safety).
- *Public poster sessions.* Public poster sessions were helpful in allowing the public to ask questions in an informal setting.
- *Timely public comments.* Public comments on the draft EA, conveyed largely by e-mail, were submitted in a timely manner, which supported efficient drafting of DOE responses and timely EA completion.
- *Procurement-directed agenda.* The project procurement, ongoing during the scoping and planning of the document, drove the agenda for the EA.
- *Configuration management plan not established.* A configuration management plan for the EIS, which included a documents control system, should have been established at the beginning of the project to ensure that changes were incorporated throughout the document.

Unsuccessful Aspects of the Public Participation Process

- *Difficulty focusing on proposed action.* The public did not appear to focus on the proposed action in the EA. Many comments addressed unrelated or non-environmental project issues.

Usefulness

Agency Planning and Decisionmaking: What Worked

- *Resolution of issues.* The EIS process was instrumental in ensuring that senior managers met to resolve issues concerning programmatic requirements. Once decisions were made, it was relatively easy to obtain consensus on the appropriate range of alternatives to be analyzed and to select the preferred alternative.
- *Role identification.* The EA process helped DOE understand its role on the project and helped identify critical areas for coordination with the owner and operator of the proposed facility.
- *Discussion of impact analysis.* Impact analysis was discussed at length and resulted in a sound decisionmaking process for the EA.

What Didn't Work

- *Multiple complications.* While the EA process probably allowed informed and sound decisionmaking, the project was complicated. Project Managers were frustrated by issues beyond their control.

Enhancement/Protection of the Environment

- *Wetland protection and native landscaping.* The environment may be protected or enhanced because the EA recognizes wetland protection and native landscaping features that were not required.
- *Noise issues resolved.* The environment was protected by solving issues dealing with noise.
- *Tribal awareness.* Issues with tribes were identified. A Memorandum of Understanding was established to identify the appropriate contacts within the tribes.
- *Environmental protection practices and procedures.* The environment was not protected or enhanced as a result of the NEPA process; however, the document covers practices and procedures to ensure that the environment is protected.

Other Issues

Guidance Needs Identified

- *Independent quality assurance (QA) review.* Guidance should be established for an independent QA review of EIS-level documents prior to the issuance of the final document.
- *Biological hazards.* DOE staff found it difficult to analyze risks related to biological hazards, which differ from more familiar radiological and chemical hazards.
- *Guidance needs for public involvement.* Better guidance on the depth and breadth of public involvement is needed, including step-by-step procedures to meet needs for community relations and public involvement.

(continued on next page)

What Worked and Didn't Work

(continued from previous page)

- *Accident analyses.* Clear procedures for the development of accident analyses would help improve the process and shorten the time required to develop accident analyses that are acceptable to all organizations. DOE guidance on accident analysis, such as the types of aircraft to use, would be helpful. **Editor's Note:** Recommendations for Analyzing Accidents under the National Environmental Policy Act, July 2002, states: "DOE document preparers must apply considerable judgment to determine the appropriate scope and analytical requirements of accident analyses . . ." Guidance specifying the size of aircraft to use in all accident analyses would be inappropriate. The accident guidance discusses relevant "sliding scale" principles and example language regarding aircraft crashes.
- *Comment-response.* Improved guidance on response to comments following the draft and final EIS would be useful. A determination should be made as to whether a full response needs to be provided in the Record of Decision (ROD) or just a summary of the comments. **Editor's Note:** As explained in The EIS Comment-Response Process, October 2004, DOE's approach has been to address comments on a final EIS in the ROD. The guidance states that this need not be an exhaustive treatment. (See also LLQR, September 1995, page 12.)

Effectiveness of the NEPA Process

For the purposes of this section, "effective" means that the NEPA process was rated 3, 4, or 5 on a scale from 0 to 5, with 0 meaning "not effective at all" and 5 meaning "highly effective" with respect to its influence on decisionmaking.

For the past quarter, in which 6 questionnaire responses were received for 5 EAs and one EIS, 6 out of 6 respondents rated the NEPA process as "effective."

- A respondent who rated the process as "4" stated that the EIS process was used to decide on the increased use of radioactive materials at the facility. This decision had been pending for more than 15 years. The NEPA process was instrumental in ensuring that DOE, facility management, and the public were aware of the issues and concerns surrounding this decision; management was better able to make an informed decision.
- A respondent who rated the process as "4" stated that the EA process was a way for DOE to have a dialogue with stakeholders for a potentially controversial action.
- A respondent who rated the process as "4" stated that the EA process worked well as a planning tool.
- A respondent who rated the process as "3" stated that the NEPA process was important in evaluating DOE's decision to pursue a Public Land Order.
- A respondent who rated the process as "3" stated that NEPA triggered the need to address other important issues such as developing better relationships with agencies and tribes.
- A respondent who rated the process as "3" stated that project personnel assumed and planned for a finding of no significant impact prior to completion of the EA. 