

Department of the Interior
Bureau of Reclamation

OPERATION AND MAINTENANCE EQUIPMENT AND PROCEDURES

RELEASE NO. 36

April, May and June 1961



P50-303-2210-5

CONTENTS

- Full-time Program Beneficial to Everybody
- Extended Life for Electric Lamps
- Ladder Safety Strap
- Safe Circular Saw Storage
- Improvement in Hydrologic Recorder Operation
- Microswitches for Striptograph Recorders
- Preparing Metal Surfaces for Painting with Rotary Cleaning Tool
- Oiling the Troubled Soil
- Barrel Buoys Protect Swimmers
- Lifting Heavy Trailer Drawbars
- Stream Gaging From the Bank

LAST COPY - DO NOT REMOVE

LAST COPY - DO NOT REMOVE

Front Cover: A cableway device being used on the "A" Canal, Gila Project, Arizona, permits accurate measurements of flows in the canal by an operator standing on the bank. The easily portable installation is less expense to install than the conventional cable car. Photo No. P50-303-2210-5

OPERATION AND MAINTENANCE
EQUIPMENT AND PROCEDURES
Release No. 36

April, May, and June - 1961

INTRODUCTION

We are indebted to the Central Nebraska Irrigator, a publication of the Central Nebraska Public Power and Irrigation District, for the article "Full-Time Program Beneficial to Everybody." The article beginning on page 1 recognizes the need for keeping competent help in the operation and maintenance of irrigation projects and has found one way to make work available and accomplish needed maintenance during the "off" season.

Several useful hints have been borrowed from Grist, a publication of the National Conference on State Parks, for this issue of the bulletin. Several suggestions of our own project people also are included and "Preparing Metal Surfaces for Painting with Rotary Cleaning Tool," page 10, is a followup on the field performance of the tool. "Stream Gaging from the Bank," page 16, is an evaluation of a device that has been in use for several years and offers some advantages in this type of work. The device is the development of a former Bureau of Reclamation engineer.

This bulletin, published quarterly, is circulated for the benefit of irrigation project operation and maintenance people. Its principal purpose is to serve as a medium of exchanging operation and maintenance information. It is hoped that the laborsaving devices or less costly equipment developed by the resourceful water users will be a step toward commercial development of equipment for use on irrigation projects in a continued effort to reduce costs and increase operating efficiency.

To assure proper recognition of those individuals whose suggestions are published in this and subsequent bulletins, the suggestion number as well as the person's name is given. All Bureau offices are reminded to notify their Suggestions Awards Committee when a suggestion is adopted.

* * * * *

Division of Irrigation Operations
Office of Assistant Commissioner and Chief Engineer
Denver, Colorado

FULL-TIME PROGRAM BENEFICIAL TO EVERYBODY

(The following article is taken from THE CENTRAL NEBRASKA IRRIGATOR with the permission of Jack W. Boyd, General Manager of the Central Nebraska Public Power and Irrigation District, Holdrege, Nebraska)

The Central Nebraska District's established policy of employing men for irrigation division work on a full-time, year-around basis was reviewed in connection with the comprehensive and detailed study made relative to the feasibility of building a new precast concrete structure plant at Minden, Nebraska. The District has had a precasting plant in operation in the Holdrege area. The study conducted by General Manager and Chief Engineer Jack W. Boyd and the District's engineering staff concluded that the policy is of benefit to the employees, to the District, to the water users and to the cities and communities in the irrigation areas.

The conclusions contained in Boyd's report to the Board of Directors emphasized that if patrolmen were employed only for the irrigation season it would not be possible to employ men of family-raising age since these men could not afford to sit idle all winter. This would result in employing "floating labor" instead of permanent residents who own their homes and are part of the community. Patrolmen employed on a one-season-at-a-time basis would not be as capable as full-time employees and would have to be trained each year prior to the beginning of the irrigation season.

The report stressed the need for patrolmen who know every detail of their patrol, who know and get along well with the water users and whose loyalty to The District and its philosophy of service is reflected in the manner in which they go about their job. It stated that it is the patrolman, and only the patrolman, who almost daily comes in contact with the 1,500 irrigation customers of The District. The actions of this patrolman, his ability, his cooperation, his willingness, all have more effect upon the attitude of the water user than any amount of other public relations work done by The District.

In addition it was pointed out that the patrolman must successfully cope with the problems of operating an irrigation system without wasteways, always having enough water everywhere, but never too much anywhere, even at times when the system is picking up a good deal of surplus water during and after rainstorms. He must know how to determine the requirements of his patrol in relationship to the system, its losses, computing and ordering his water daily and sufficiently in advance so that it will be at his headgate when he needs it and at the farmer's headgate at the time ordered. He must know the weak points of his system and where to go and what to do when a storm occurs or other trouble pops up. It is necessary that he be able to handle and get along with people and be sufficiently industrious and physically capable of making emergency repairs

to his system. All this knowledge is gained only through experience and the seasonal use of new people or subquality people would definitely hurt the District's operations.

The report stated that the off-season workload for the Minden and Holdrege field crews and patrolmen is becoming smaller as bridge replacement and other maintenance and repair jobs are approaching a "caught-up" stage. It also pointed out that the successful operation of an irrigation system with seasonal employment can be carried on only in communities where winter season work is available to the irrigation season employees, such as sugar beet processing plants, cattle feeding operations, etc., and that such winter season employment is generally not obtainable in the Tri-County Area.

In summary the report emphasized that, "The primary and most important job of the irrigation division of The District is not building structures or bridges, but rather is that of operating the system during the irrigation season, beginning with the computation and compiling of water schedules in the late winter and ending with the last water deliveries in October," and



PX-D-26494

Boyd submitted his recommendations to the Board of Directors with this comment, "It is therefore my opinion that it would be of considerable value to The District's entire operation to work a pre-cast structure program around the present employee organization, rather than to set up any kind of extra labor program, in order to help in keeping the year around employment policy that The District has been able to follow thus far."

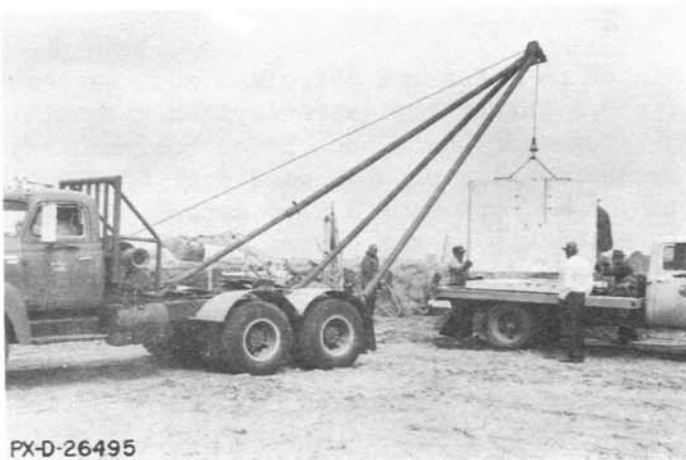

PX-D-26495

The District's structure replacement program calls for the replacement of 3,161 wooden structures consisting of 1,844 private turnouts, 185 lateral turnouts, 30 checks, and 38 drop structures. A typical wooden turnout structure, built in 1958, which is to be replaced with precast concrete structure is shown in photograph at upper left.

The photograph at lower left on the preceding page shows pre-cast parts of a turnout hauled to the site of the installation on a flat-bed truck. The winch truck is used to lower the parts into place.

Experimentation with precast structures during the past year in the Holdrege Area indicated huge savings over casting-in-place or replacement with timber structures. A study showed that the precast program over a 40-year period would be \$920,600 cheaper than replacing with timber and \$431,000 cheaper than cast-in-place structures.

The Minden Plant will have a capacity of 130 units to be built during the off-irrigation season. The plan is to cast the units during the day to be steam-cured during the night so that the next morning they can be taken from the curing room, the forms stripped and the units stock-piled. The forms then will be reassembled and a pour made in the afternoon. This way one complete unit, consisting of the bottom, two sides and two ends can be completed each 24 hours. The 130 units to be constructed each year at Minden will be part of the 300 units per year program to be carried on during the next 10 years. Forty units will be cast at Holdrege during the wintertime and the balance of the 300 units will be split up between the two plants during the rest of the year.



The photographs at left and on the following page show the various stages in assembling one unit of a precast concrete structure. The units went together exactly as planned and in place checked out to be within 1/16 of an inch of their designed dimensions.



The placing of precast farm and lateral turnouts has proved to be efficient and economical. The major advantage and saving in the precast program in addition to the utilization of regular employees during the winter slack-time is the elimination of the need for building forms for each structure, and extremely

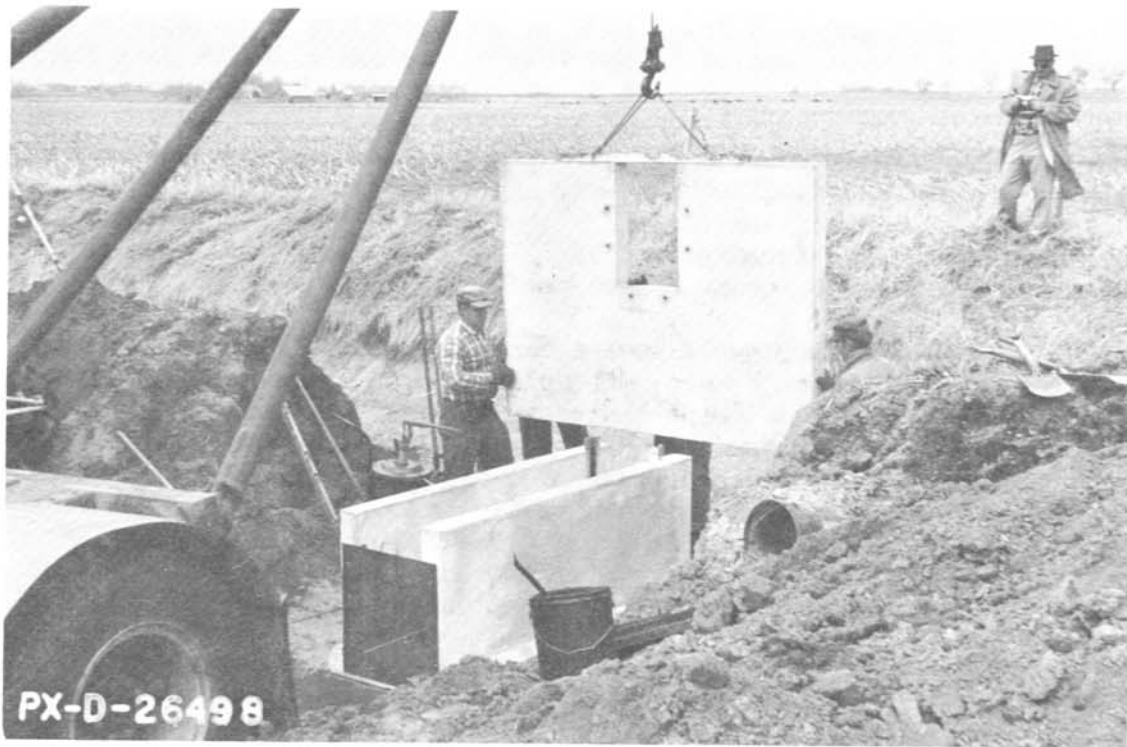



important, the ability to install them in record time during the rush period between the coming of favorable weather in the spring and the start of the irrigation season.

The picture above shows a completed turnout. It was erected in 45 minutes. It required five pieces, 8,740 pounds of precast concrete, 16 galvanized lag screws, 10 pounds mastic. When the turnout is in place, the earthfill is tamped in and a permanent structure has replaced the old wooden one similar to that shown on page 2.

* * * * *

EXTENDED LIFE FOR ELECTRIC LAMPS

One phase of laboratory tests being conducted by the regional and project Power Operation and Maintenance forces at the Folsom Power Plant on the Central Valley Project, California, is a comparison of the service life and efficiency of incandescent lamps. Tests made thus far have included the larger sizes of lamps used in the "high-bay" fixtures of the generator room of the power plant. The testing of other types and smaller sizes of lamps is planned for the future.

Results of the tests made to date in comparing "extended-service" type lamps with the less costly "general-service" type lamps, show that the former have a service life 2.21 times longer and at

1.41 times the initial cost of the latter. In effect this means that the "extended-service" type lamps operate at a cost of 65 percent of that of the initially less expensive general-service lamps. This does not take into consideration the cost of lamp replacement which could be a sizeable additional saving.

The savings to be realized from the use of the "extended-service" lamps can become considerable in time where they are used in numbers such as at the Folsom Powerplant. The "extended-service" lamps are obtainable from dealers throughout the country or through the Government's Treasury Procurement Schedule. If additional information is desired, write the Office of the Assistant Commissioner and Chief Engineer, Bureau of Reclamation, Denver Federal Center, Denver, Colorado, or the Regional Director, Bureau of Reclamation, Sacramento, California.

* * * * *

LADDER SAFETY STRAP

(Reprinted from the January-February 1961 issue of Grist, a publication of the National Conference on State Parks, Washington, D.C.)

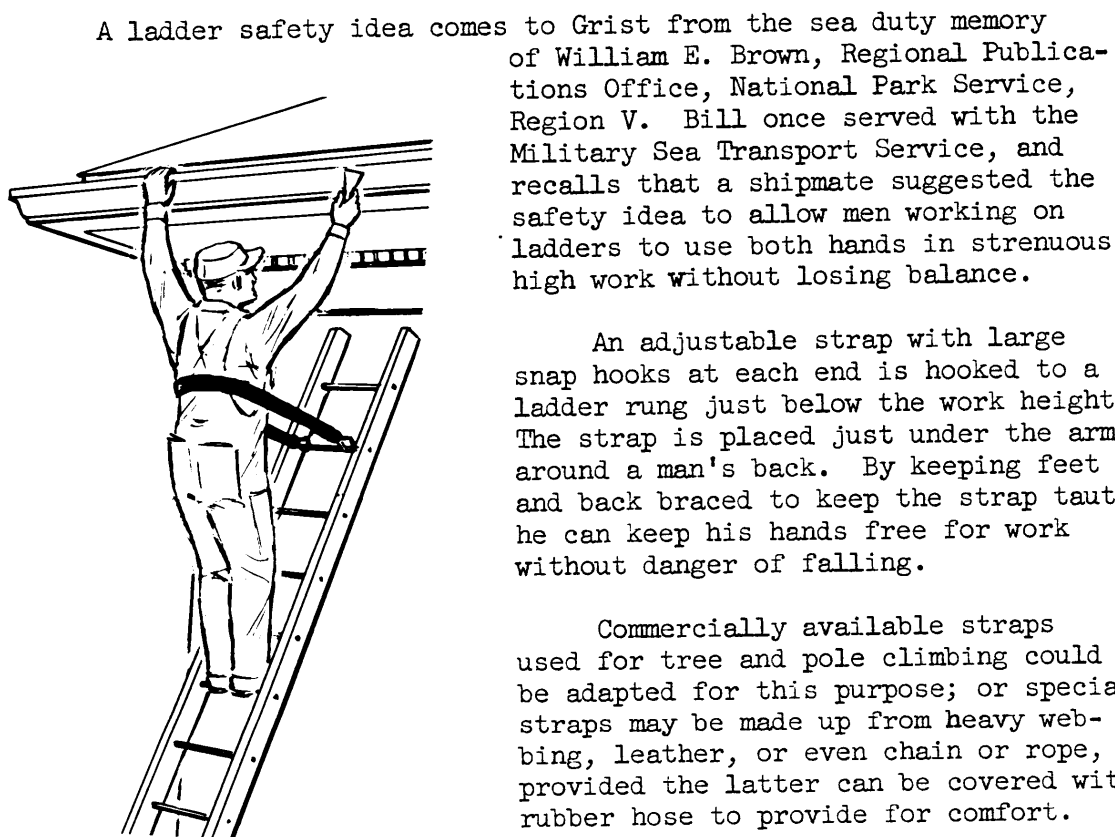

A ladder safety idea comes to Grist from the sea duty memory

of William E. Brown, Regional Publications Office, National Park Service, Region V. Bill once served with the Military Sea Transport Service, and recalls that a shipmate suggested the safety idea to allow men working on ladders to use both hands in strenuous high work without losing balance.

An adjustable strap with large snap hooks at each end is hooked to a ladder rung just below the work height. The strap is placed just under the arms around a man's back. By keeping feet and back braced to keep the strap taut, he can keep his hands free for work without danger of falling.

Commercially available straps used for tree and pole climbing could be adapted for this purpose; or special straps may be made up from heavy webbing, leather, or even chain or rope, provided the latter can be covered with rubber hose to provide for comfort.

* * * * *

SAFE CIRCULAR SAW STORAGE

(Reprinted from the January-February 1961 issue of *Grist*, a publication by the National Conference on State Parks, Washington, D. C.)

Two keen-eyed reporters have spotted a safe storage cabinet for circular saw blades in use at Harpers Ferry National Monument and sent information about it to *GRIST* at different times. The cabinet, designed by Willie T. Moore, Building Restoration Specialist, is shown in the photograph below.

The two reporters, James F. Davenport, Supervisory Park Ranger at Harpers Ferry, and Paul Perricone, Personnel Officer of the Eastern Office of Design and Construction, National Park Service, were both impressed with the good design of the cabinet. As they pointed out, when this cabinet is used, sharp edges of blades are preserved by storing them one to a compartment. Blades cannot roll out and injure anyone, because of the backward slope in the blade compartment section. The drop lid also insures safety.



IMPROVEMENT IN HYDROLOGIC RECORDER OPERATION
(Suggestion R2-57-16)

John D. Harris, Salinity Unit, Tracy Operations Field Branch, Central Valley Project, has suggested that the clock weight cable on weight driven recorders be marked to prevent the weight from being retrieved beyond a safe operating position. The suggestion is widely applicable throughout the realm of weight driven regulator devices--water stage recorders, recording rain gages, etc.,--where the suspended weight and cable may be obscured by instrument cases or supporting structures. Marking the cable above the weight hanger as illustrated in the photograph at lower left with bright colored paint makes it possible for the person rewinding the recorder clock to watch for the painted cable and minimizes the loss of important hydrologic records caused by the weight being raised beyond a safe operating position during the servicing of these instruments.



The suggestion was especially applicable in the water stage recorder that was adapted for use on a salinity recorder on the project. The construction of the adaptive element that was secured to the recorder obscured the weight as it was raised in servicing the instrument. Frequently the connecting device between the weight and the recorder became immobilized by wedging into the slot in the instrument support or otherwise rendering it inoperative. With a little care and observation while winding the clock this can now be avoided.

* * * * *

MICROSWITCHES FOR STRIPTOGRAPH RECORDERS
(Suggestion R2-60-155)

The rotor switch is an electromechanical component of the Striptograph Instrument. It consists of three fingers in contact with a 180° rotor. The switch function is to alternate the incoming impulses which actuate the basic control motors of the instrument. Proper functioning of the switches is imperative for the instrument to operate in calibration. Observations have shown when the switches are slightly worn, sparking occurs at the finger and rotor break points. This creates pitting

and corrosion of the rotor. Also, atmospheric temperatures of 90° plus induces the oil-light bearings in the switch housings to oversecrete, causing additional shorting of the switches. Frequent cleaning and adjusting is necessitated by these conditions.

To eliminate these conditions, microswitches following 180° lobed cams as shown in the photograph below, were substituted for the rotor switches. The conversion has operated satisfactorily on one of the instruments for three irrigation seasons. Recent inspection of the conversion components shows them to be in excellent condition and operating trouble free.

The microswitch adaptation to striptograph recorders developed by William R. Turmon, Delano Unit, Fresno Operations Field Branch, Central Valley Project, has proven to be more than satisfactory. It eliminated the labor required in cleaning and adjusting the rotor-type switches and also is more economical. Rotor switches cost \$7.50 each and microswitches \$1.50 plus or minus each. By periodic cleaning and adjusting of the rotor switches (the fingers can be repositioned slightly by bending), it was found that one year's service can be obtained from a switch, whereas microswitches last much longer. Based on the excellent results obtained from the one unit converted 3 years ago, the project has converted 27 more units to microswitches and have experienced no operating trouble in spite of extreme high temperatures.

MICROSWITCH INSTALLATION

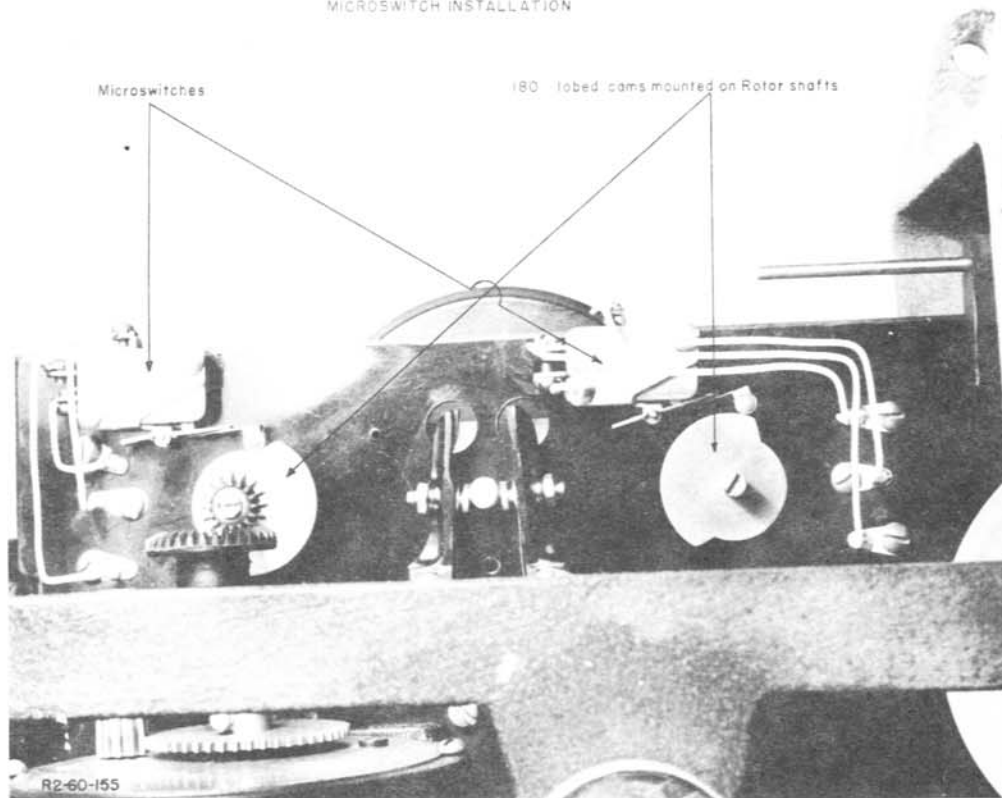

PREPARING METAL SURFACES FOR PAINTING
WITH ROTARY CLEANING TOOL

The preparation of a metal surface for repainting often proceeds under adverse circumstances in Bureau maintenance work. The location and access conditions for metal cleaning frequently eliminates sandblasting as a means of surface preparation, and power wire brushing is a relatively ineffective substitute which can lead to poor coating performance.

In Release No. 21 of the Operation and Maintenance Equipment and Procedures bulletin (July, August and September 1957) field experience with a rotary cleaning tool was reported. The reported good performance in the field led the Bureau's Engineering Laboratories in Denver to investigate the cleaning device further in the hope of providing a superior method by which maintenance personnel could conveniently perform effective touch-up painting, and if necessary, do a larger job with the expectation of durable results.

The device is obtainable either in pneumatically or electrically powered models. A 110-volt, electric-powered model weighing about 20 pounds, was tested by the laboratory, and was used to clean a variety of coatings from 12- by 12-inch steel panels. The coatings had aged and deteriorated for various periods of time in laboratory coating evaluation tests and were selected to represent the different types of surfaces which might be encountered in maintenance painting. In addition, the severely

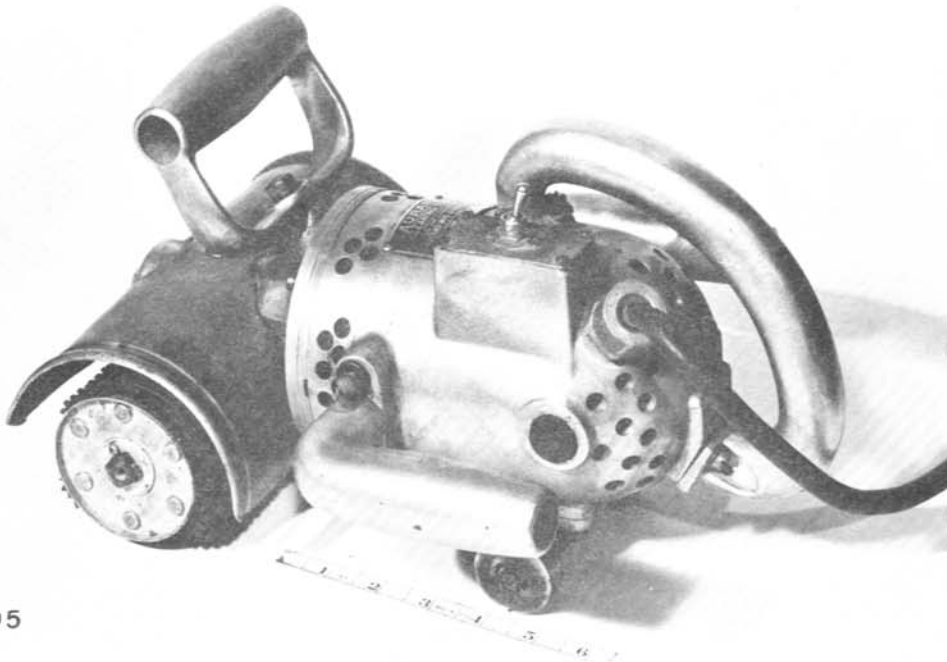

PX-D-26505

Figure 1

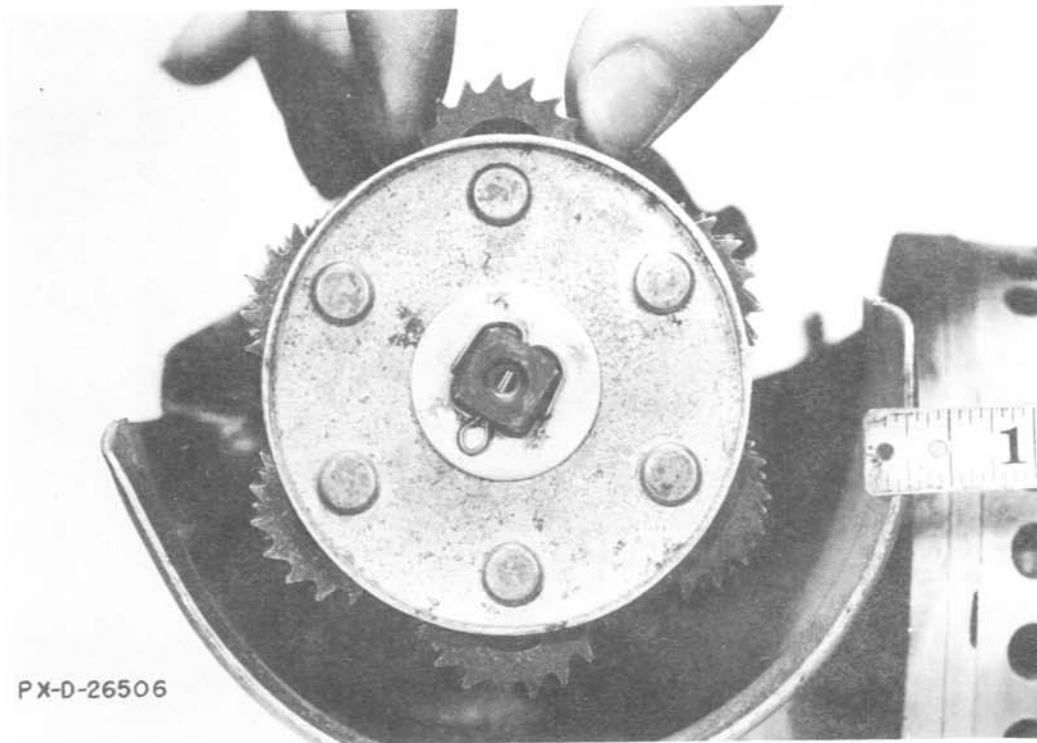

Figure 2

rusted and pitted surfaces of sheet steel and the sleeve of a 9-inch diameter coupling were cleaned. Note was taken of the capability of the rotary tool to produce a desirable surface for repainting. The rate at which the cleaning could be accomplished was not determined and is indicated only qualitatively in the laboratory report.

Figures 1, 2, and 3 show the tool, and its cutter blades. Note the large center holes in the discs in Figures 2 and 3 which allow them to rotate and move outward from the center of the shaft. Figure 3 was taken of the tool in operation by means of a high-speed flash which stopped the action to show how the discs are thrown outward by centrifugal force.

In Figure 4, a thin, brittle, poorly bonded coating at the left of the photograph was rapidly removed by the tool. Red rust under the paint was not removed in the area cleaned at right. Removal of cold-applied coal-tar paint, CA-50, is illustrated in Figure 5. The tool was quite effective in removing this fairly soft, thick coating as shown in the upper half of the photograph.

As a result of the laboratory tests it was concluded that the tool should provide faster and better quality metal surface preparation than wire brushing under almost any circumstances. The surface produced is not equal for painting purposes to that obtained from sandblasting, but is free of loose and poorly bonded material and is roughened somewhat. Geometrical considerations limit the tool's use primarily to flat or large radius curved surfaces.

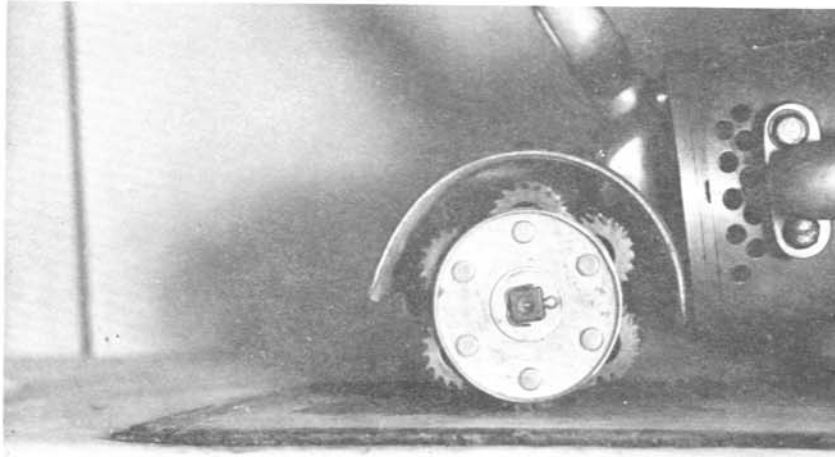

Figure 3



Figure 4

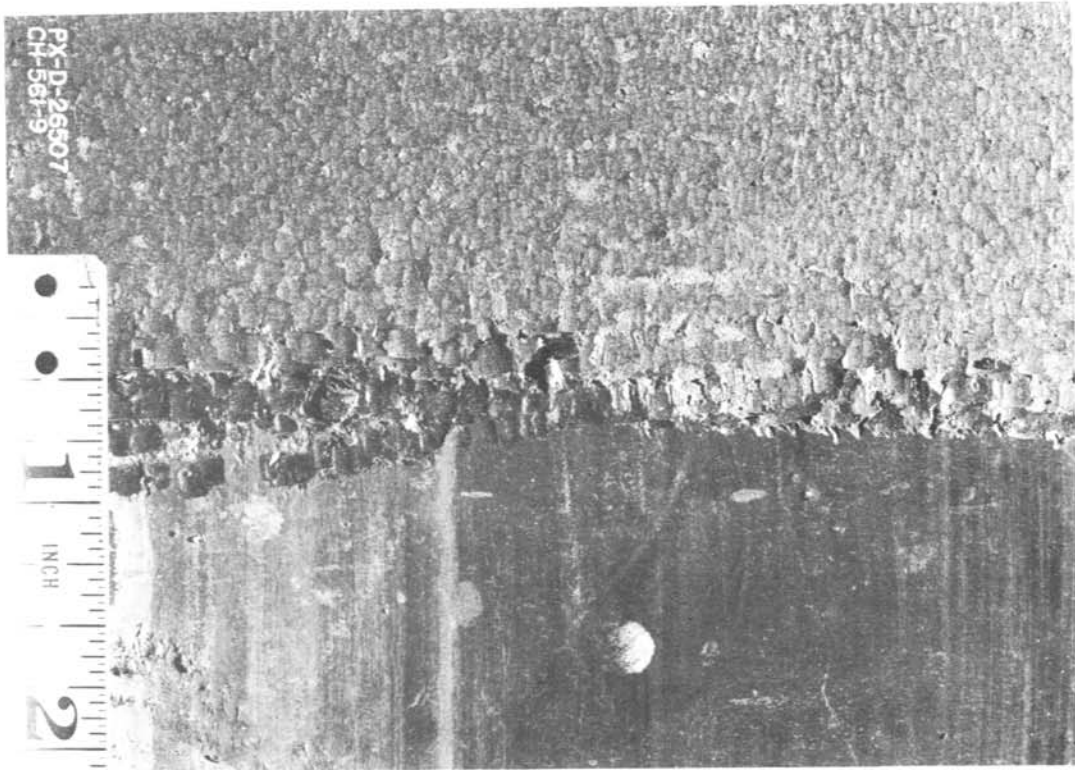

Figure 5

Brittle and poorly bonded coatings and other foreign materials, such as rust, are removed rapidly and effectively. Tough and tightly bonded materials can be removed, but at a much slower rate. (These coatings would be virtually unaffected by wire brushing).

Ordinarily, following the removal of foreign materials with the tool, further cleaning by light wire brushing or wiping with solvent or other treatment solution will be necessary to insure removal of loose dust and rust from the metal surface before painting commences.

Additional information concerning the tool can be supplied by the Office of Assistant Commissioner and Chief Engineer, U. S. Bureau of Reclamation, Denver Federal Center, Denver 25, Colorado, Attention: Code 400.

* * * * *

OILING THE TROUBLED SOIL

(Reprinted from the January-February 1961 issue of *Grist*, a publication by the National Conference on State Parks, Washington, D. C.)

You've heard of pouring oil on troubled waters, but did you know that oil can hold down the troublesome expansive soils that sometimes cause concrete slabs to be pushed up and let down at various seasons?

Lemuel A. Garrison, Superintendent of Yellowstone National Park, reports success in using a half-and-half mixture of used crankcase oil and No. 2 diesel fuel, poured into the soil.

From the time of construction of one park building, Superintendent Garrison reports, the floor slabs had moved up and down in response to seasonal moisture changes in the underlying soil. After this first happened, extensive drainage was installed, but this did not help--the floor slabs went up in April and May and back to normal in the fall. The rise was as much as 2 inches, preventing several doors from opening.

Following the advice of Supervising Structural Engineer Lada Kucera of the National Park Service Western Office of Design and Construction, the Superintendent had half-inch holes made in one large slab and had the oil mixture poured in until a saturated condition was achieved. The work was done in October. In the spring, he found that the treated floor slab had not risen at all, whereas all others had moved as usual.

Now he has treated all other slabs in the building the same way.

* * * * *

BARREL BUOYS PROTECT SWIMMERS

(Reprinted from the January-February 1961 issue of Grist, a publication by the National Conference on State Parks, Washington, D. C.)

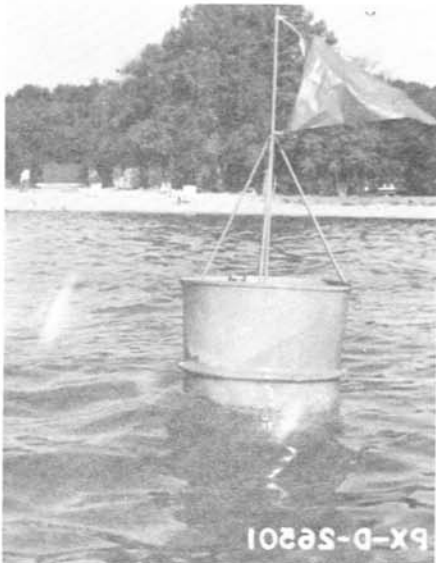

Manager Clinton Besonen of Sibley State Park, Minnesota, needed to keep boats out and swimmers inside the swimming area off his park beach, so he got busy and made up 12 barrel buoys from salvaged materials, using his own design. The buoys have worked out very well and the same design will be useful in other parks, see photograph at left.

Either 30-gallon or 15-gallon steel barrels (drums) can be used for the buoys. Clint tried both, but found the 15-gallon size is just as good as the larger, and much easier to handle.

The main flag shaft, 30 inches long, is welded to the center of the head of the barrel. Three supporting braces, 14



PX-D-26502

inches long, made of 3/8-inch reinforcing rod or similar material, are welded to the rim. A loop of reinforcing rod is welded to the bottom to hold an anchor line.

Using a fluid mixture of portland cement and sand, the lower part of each barrel is filled through the bunghole, using enough cement mix to make the barrel float slightly less than half out of the water. The barrel must be kept level until the cement sets.

Anchors are made of concrete, 24 inches square and 3 inches thick, with a metal loop to hold the line. Clint uses 3/16-inch rust-proof coil chain for the anchor line, allowing enough slack so that the barrel buoy can ride the waves easily.

Flags are triangular plastic, 12 by 18 inches, such as those used for advertising by gas stations. Each buoy is painted a bright color: Clint used bright orange equipment enamel.

* * * * *

LIFTING HEAVY TRAILER DRAWBARS

(Reprinted from the January-February 1961 issue of Grist, a publication by the National Conference on State Parks, Washington, D. C.)

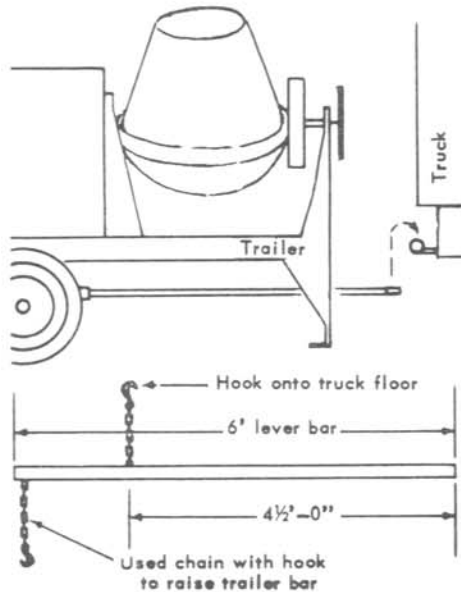

That desperate, hernia-producing heave by which a lone man sometimes tries to hitch up the drawbar of heavily loaded trailers to the pulling truck is not needed when you have the handy portable lever outfit designed by Jack Weddle of Indiana University.

The sketch below shows how the simple but effective device, which can be stashed away in either the trailer or the truck without taking up too much room, works to ease that aching back.

* * * * *

STREAM GAGING FROM THE BANK

Modified cableway devices similar to that shown on the cover of this issue of the bulletin are in use in the southwest to gage water flowing in irrigation canals. Two installations made by the Bureau of Reclamation forces on the Gila Project are installed on the "A" and Gila Gravity Main Canals. One installation made by the United States Geological Service is being used on the Main Canal of the Yuma Project. As the title to this article implies, the canals can be accurately measured and sounded by an operator standing on the bank.

The modified cableway installations described were developed in 1953 by Engineer Roy E. Goss, formerly of the Bureau of Reclamation, but now on home leave after an assignment with International Cooperation Administration and soon to be sent to Korea. Mr. Goss developed the device while employed on the Bureau's Gila Project.

The gaging installation developed by Mr. Goss is inexpensive to install, compared with the usual cable-car type installation, and can be used either as a permanent station or by attachment to vehicles on either bank as a mobile station. The device shown below consists of a



"head tower" from which all operations are controlled; a traveling block on an endless 1/8-inch cable; and a "tail tower," containing a sheave. The equipment at the head and tail towers are mounted on 10-foot long railroad rails set 6 feet in the ground. More detail of the head tower and traveling block are shown on Drawings No. 50-303-7895 and -7896 attached at the end of this article; however, some special details should be noted. They are:

Head Tower

The head tower equipment, Photographs No. P50-303-2210-1 and -3, is attached to the railroad rail by two 1/2-inch stud bolts through a plate welded to the top of the rail. The back hole in this plate is drilled to receive a stud and the front hole should be slotted on a circular arc in order to correct any irregularities in alinement of the plate while setting the rail.

Counters

The counters on both the head tower and reel, as shown in Photograph No. P50-303-2210-3, and in outline on Drawing No. 50-303-7895

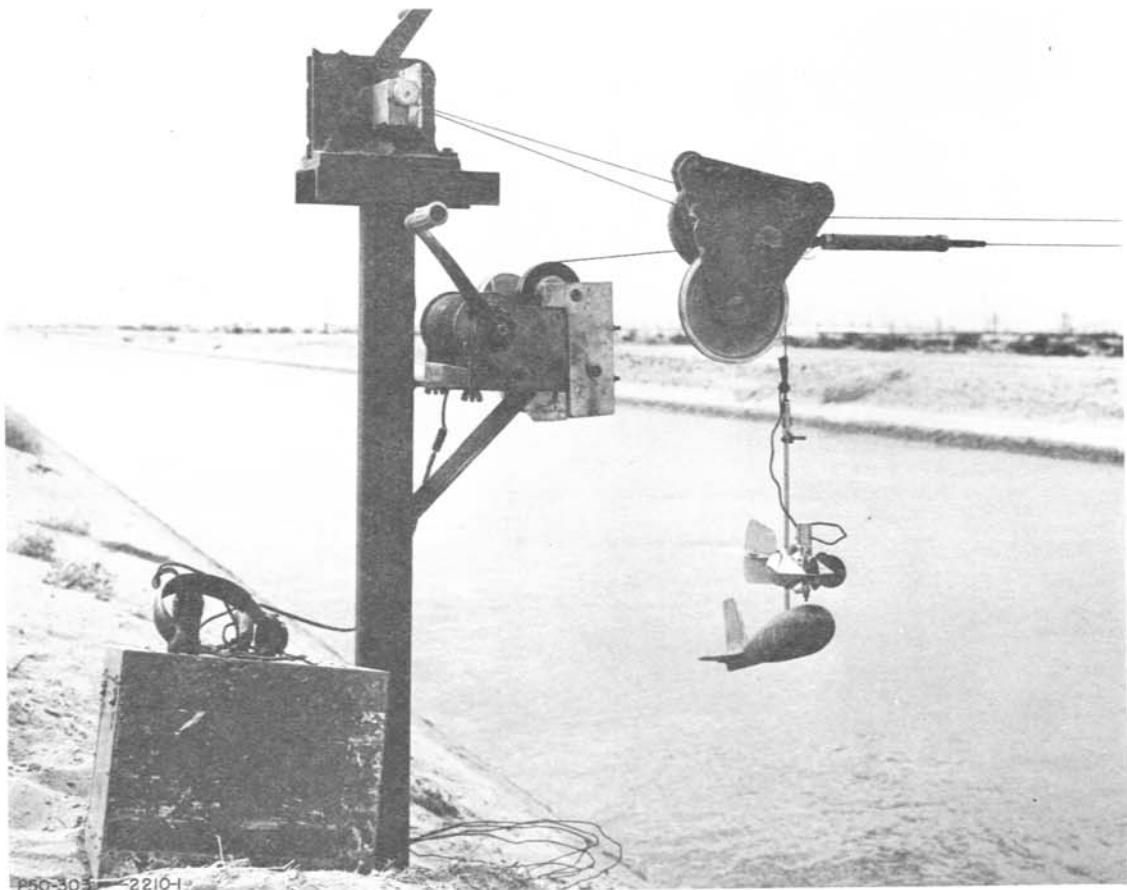



are the same as those used on a Stevens Type "A" reel and can be purchased as a unit.

Tail Sheave

Any ball-bearing sheave approximately 6 inches in diameter, grooved to take a 1/8-inch cable, is satisfactory.

Reel

The reel, Photograph No. P50-303-2210-2 shown at the bottom of the preceding page, is a standard Type "A" reel modified with a level winding device to handle 300 feet of cable. The reel is mounted on a bracket immediately below the head tower plate so that the head tower and reel can be operated simultaneously by the operator as shown in Photograph No. P50-303-2210-4 below.

Cables

Airplane strand cable is used on the head tower line, but the meter line is standard steel wire with copper wire coil as is used by the U. S. Geological Survey and others.



Operation

In operation the counter on the reel is reset to zero when the weight touches the water, and thus the depth of water is taken at any point. The upper counter can be reset to zero at the water's edge. However, as used on the Yuma Project, the distance from the initial point is measured by a tape attached to the carrier so that the small error caused by the sag in the cable is eliminated.

Some Advantages

Some of the advantages are:

The device would be particularly useful in canal and stream-flow measurement where velocities are low or moderate.

The installation in 1953 cost about \$500 as compared with the estimated cost of \$5,000 or \$7,000 for a conventional cable car gaging station.

The installations made, replaced boat measurements that resulted in the saving of one man's time.

The installations move the operator to the bank and thus eliminate the hazard of operating over water.

The installations can be easily and inexpensively moved in the event the selected site should prove unsatisfactory due to operation procedures, weeds, moss growth, etc.

Attached to two mobile vehicles, the device can be used for sounding a section of canal in making special studies. Such a use was made of the device in sounding the All-American Canal to determine the extent of erosion in the bottom of the canal. Since the canal could not conveniently be taken out of service, repairs were made under water and the results were checked with the mobile units.

The device has also been used because of its portability and the fact that measurements can be obtained on wide canals at locations required to determine seepage losses or to establish rating curves for canal gates. It is believed the device will find applicability on other Bureau projects where current meter measurements must be made on wide canals and streams. With larger cables, pulleys, etc., and a suitable power drive, the equipment could be adapted for most any metering station.

It has been suggested that the device might also be satisfactorily used in sediment sampling on wide canals and streams. Equipment similar to that described was used in carrying out flood studies in Tunisia, where the magnitude of the velocities in the streams and the water depth made it impossible to manipulate current meter from fixed mountings

usually employed. A description of the device appeared in the article "Methods Used in Carrying Out the Study of the Medjerdah Floods in Tunisia," published in French in the June-July, 1953, issue of the bi-monthly French magazine La Houille Blanche. The "Station Teleferique" (Cableway Station) used in the Tunisian work was developed by the Neyrpic firm of Grenoble, France.

* * * * *

