

United States
Environmental Protection
Agency

Office of Research and
Development
Washington DC 20460

Office of
Water
Washington DC 20460

EPA/625/6-91/027
Revised August 1998



Handbook

Optimizing Water Treatment Plant Performance Using the Composite Correction Program

1998 Edition

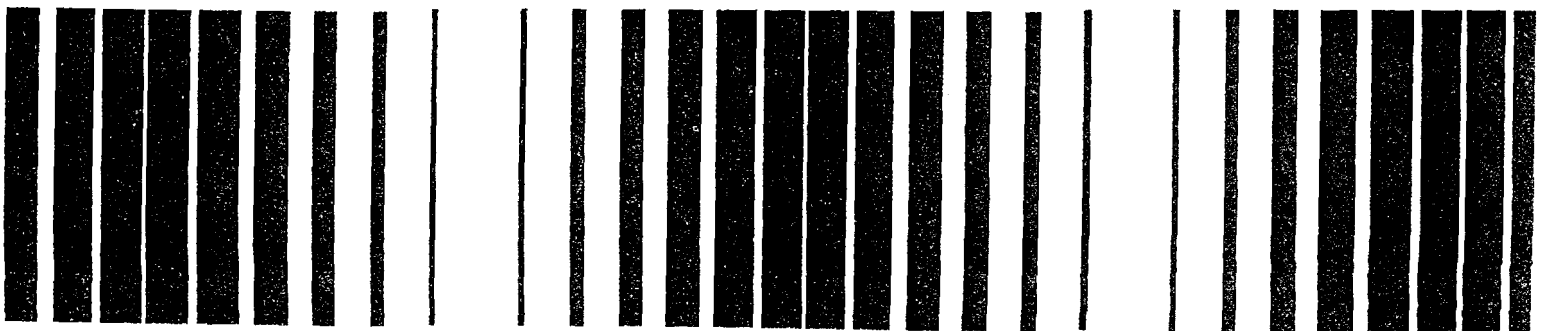

Handbook

Optimizing Water Treatment Plant
Performance Using the
Composite Correction Program

1998 Edition

Technical Support Center
Standards and Risk Management Division
Office of Ground Water and Drinking Water
Office of Water
Cincinnati, Ohio 45268

Center for Environmental Research Information
Technology Transfer and Support Division
National Risk Management Research Laboratory
Office of Research and Development
U.S. Environmental Protection Agency
Cincinnati, Ohio 45268

Notice

This document has been reviewed in accordance with the U.S. Environmental Protection Agency's peer and administrative review policies and approved for publication. Mention of trade names or commercial products does not constitute endorsement or recommendation for use.

Acknowledgments

This handbook was prepared for the United States Environmental Protection Agency (U.S. EPA) by Process Applications, Inc. Although many individuals contributed to the preparation and review of this document, the assistance of the individuals listed below is especially acknowledged.

Major Authors:

Bob A. Hegg and Larry D. DeMers, Process Applications, Inc., Fort Collins, Colorado
Jon H. Bender, Eric M. Bissonette, and Richard J. Lieberman, U.S. EPA Office of Groundwater and Drinking Water (OGWDW) Technical Support Center (TSC), Cincinnati, Ohio

Project Managers:

James E. Smith, Jr., U.S. EPA Office of Research and Development, Technology Transfer and Support Division, National Risk Management Research Laboratory (NRMRL)
Jon H. Bender, U.S. EPA OGWDW, TSC, Cincinnati, Ohio

Reviewers:

Frank Evans, U.S. EPA, NRMRL, Cincinnati, Ohio
Julie Z. LeBlanc, U.S. Army Corps of Engineers, New Orleans, Louisiana
David Parker, U.S. EPA, Region IV, Atlanta, Georgia
Chuck Schwarz, Texas Natural Resource Conservation Commission, Tyler, Texas
Jeff Robichaud, U.S. EPA, OGWDW, Washington, D.C.

Editing and Production:

M. Lynn Kelly, Process Applications, Inc., Fort Collins, Colorado

Contents

Chapter	Page
Acknowledgments	iii
List of Figures	x
List of Tables	xi
1 Introduction	1
1.1 Purpose	1
1.2 Background	1
1.2.1 Wastewater Treatment Compliance	1
1.2.2 Water Treatment Optimization	2
1.2.3 Broad-Scale Application of CCP Concepts	2
1.3 Scope	3
1.3.1 Update of the CCP Approach and Implementation	3
1.3.2 Support for Future Regulations	3
1.3.3 Technical Resource for the <i>Partnership for Safe Water</i>	4
1.3.4 Considerations for Total System Optimization	4
1.4 Using the Manual	4
1.5 References	4
2 Protection Of Public Health From Microbial Pathogens	7
2.1 Background	7
2.2 Waterborne Disease History	7
2.3 Relationship Between Optimized Performance and Public Health Protection	8
2.3.1 Multiple Barrier Strategy	8
2.3.2 Basis for Optimization Goals	9
2.4 Optimization Performance Goals	10
2.4.1 Minimum Data Monitoring Requirements	10
2.4.2 Individual Sedimentation Basin Performance Goals	10
2.4.3 Individual Filter Performance Goals	10
2.4.4 Disinfection Performance Goal	11
2.5 Role of the Water Treatment Plant Staff in Public Health Protection	11
2.6 References	11
3 Assessing Composite Correction Program Application	13
3.1 Introduction	13
3.2 Optimization Program Experience	13
3.3 Area-Wide Optimization Model	14
3.3.1 Status Component	14
3.3.2 Evaluation Component	14
3.3.3 Follow-Up Component	14
3.3.4 Maintenance Component	14
3.4 Implementation of an Area-Wide Model	14
3.4.1 Establish Criteria to Prioritize Water Systems	16
3.4.2 Assess Water System Performance Relative to Optimization Goals	16
3.4.3 Prioritize Water Systems Based on Selected Criteria	17
3.4.4 Assess Response to Prioritized Water Systems	18
3.5 References	19

Con tents (continued)

Chapter	Page
4 Comprehensive Performance Evaluation	21
4.1 Introduction	21
4.2 CPE Methodology	21
4.2.1 Assessment of Plant Performance	21
4.2.1.1 Review and Trend Charting of Plant Operating Records	21
4.2.1.2 Supplemental Data Collection	22
4.2.2 Evaluation of Major Unit Processes	25
4.2.2.1 Overview	25
4.2.2.2 Approach	27
4.2.2.3 Determining Peak Instantaneous Operating Flow	28
4.2.2.4 Rating Individual Unit Processes	29
Flocculation	30
Sedimentation	30
Filtration	31
Disinfection	32
Post-Disinfection	32
Pre-Disinfection	34
4.2.3 Identification and Prioritization of Performance Limiting Factors	35
4.2.3.1 Identification of Performance Limiting Factors	35
Identification of Administrative Factors	36
Policies	37
Budgeting	38
Staffing	38
Identification of Design Factors	38
Identification of Operational Factors	39
Plant Flow Rate and Number of Basins in Service	39
Chemical Dose Control	39
Filter Control	40
Process Control Activities	41
Other Controls	42
Identification of Maintenance Factors	42
4.2.3.2 Prioritization of Performance Limiting Factors	42
4.2.4 Assessment of the Applicability of a CTA	44
4.2.5 CPE Report	44
4.3 Conducting a CPE	44
4.3.1 Overview	49
4.3.2 Initial Activities	49
4.3.2.1 Key Personnel	50
4.3.2.2 CPE Resources	50
4.3.2.3 Scheduling	50
4.3.3 On-Site Activities	51
4.3.3.1 Kick-Off Meeting	51
4.3.3.2 Plant Tour	51
Pretreatment	52
Mixing/Flocculation/Sedimentation	52
Chemical Feed Facilities	53
Filtration	53
Disinfection	54
Backwash Water and Sludge Treatment and Disposal	54
Laboratory	54
Maintenance	54

Contents (continued)

Chapter	Page
4.3.3.3	Data Collection Activities 54
4.3.3.4	Evaluation of Major Unit Processes 55
4.3.3.5	Performance Assessment 55
4.3.3.6	Field Evaluations 55
4.3.3.7	Interviews 57
4.3.3.8	Evaluation of Performance Limiting Factors..... 57
4.3.3.9	Exit Meeting 58
4.3.4	CPE Report 60
4.4	Case Study 60
4.4.1	Facility Information 60
4.4.2	Performance Assessment 61
4.4.3	Major Unit Process Evaluation 61
4.4.3.1	Flocculation Basin Evaluation 61
4.4.3.2	Sedimentation Basin Evaluation 62
4.4.3.3	Filter Evaluation 62
4.4.3.4	Disinfection Process Evaluation 62
4.4.4	Performance Limiting Factors 63
4.4.5	Assessing Applicability of a CTA 64
4.4.6	CPE Results 64
4.5	References 64
5	Comprehensive Technical Assistance..... 67
5.1	Objective.. 67
5.2	Conducting CTAs 68
5.2.1	Overview 68
5.2.2	Implementation 69
5.2.2.1	Approach 70
	CTA Facilitator 70
	On-Site CTA Champion 71
	CTA Framework 71
5.2.2.2	Tools..... 73
	Contingency Plans 73
	Action Plans 73
	Special Studies 73
	Operational Guidelines 74
	Data Collection and Interpretation 74
	Priority Setting Tools 75
	Topic Development Sheets 75
	Internal Support 76
	What If Scenarios 77
5.2.2.3	Correcting Performance Limiting Factors 77
	Design Performance Limiting Factors 77
	Maintenance Performance Limiting Factors 78
	Administrative Performance Limiting Factors 78
	Operational Performance Limiting Factors 79
	Process Sampling and Testing 80
	Chemical Pretreatment and Coagulant Control 80
	Unit Process Controls 82

Contents (continued)

Chapter	Page
5.3 Case Study	85
5.3.1 CPE Findings	85
5.3.2 CTA Activities	86
5.3.2.1 Initial Site Visit	86
5.3.2.2 Off-Site Activities	87
5.3.2.3 Follow-Up Site Visit	87
5.3.2.4 Other CTA Activities	88
5.3.2.5 CTA Results	88
5.4 References	91
6 Findings From Field Work	93
6.1 Introduction	93
6.2 Results of Comprehensive Performance Evaluations	93
6.2.1 Major Unit Process Capability	93
6.2.2 Factors Limiting Performance	94
6.2.3 Summary of CPE Findings	96
6.3 Results of Comprehensive Technical Assistance Projects	97
6.4 References	98
7 The Future: Changing Regulations and New Optimization Challenges	99
7.1 Introduction	99
7.2 Background on M-DBP Regulations	99
7.3 M-DBP Requirements Relative to Optimized Performance Goals	100
7.3.1 Treatment Technique Turbidity Requirements	100
7.3.2 Removal/Inactivation Requirements	101
7.3.3 DBP Maximum Contaminant Levels (MCLs)	102
7.3.4 Enhanced Coagulation Requirements	103
7.3.5 Microbial Backstop	103
7.4 Summary	104
7.5 References	105
8 Other CCP Considerations	107
8.1 Introduction	107
8.2 Developing CCP Skills	107
8.2.1 CPE Training Approach	107
8.2.2 CTA Training Approach	107
8.3 Quality Control	108
8.3.1 CPE Quality Control Guidance	108
8.3.2 CTA Quality Control Guidance	109
8.4 Total System Optimization	110
8.5 References	112

Con tents (continued)

Appendices	Page
Appendix A	Data Collection Spreadsheets and Macros for the Partnership for Safe Water 115
Appendix B	Drinking Water Treatment Plant (DWTP) Advisor Software 123
Appendix C	Major Unit Process Capability Evaluation Performance Potential Graph Spreadsheet Tool for the Partnership for Safe Water 125
Appendix D	CT Values for Inactivation of Giardia and Viruses by Free Cl ₂ and Other Disinfectants 135
Appendix E	Performance Limiting Factors Summary Materials and Definitions 145
Appendix F	Data Collection Forms 159
Appendix G	Example CPE Report 205
Appendix H	Example CPE Scheduling Letter.. . . . 221
Appendix I	Example Special Study 225
Appendix J	Example Operational Guideline 227
Appendix K	Example Process Control Daily Report.. . . . 231
Appendix L	Example Jar Test Guideline 233
Appendix M	Chemical Feed Guidelines 237
Appendix N	Conversion Chart 245

List of Figures

Chapter	Page
Figure 2-1. Multiple barrier strategy for microbial contaminant protection	9
Figure 3-1. Area-wide optimization model	15
Figure 3-2. Area-wide treatment plant performance status	16
Figure 3-3. Example turbidity monitoring data for 12-month period	18
Figure 4-1. Example performance assessment trend charts	23
Figure 4-2. Example of individual filter monitoring..25
Figure 4-3. Major unit process evaluation approach	26
Figure 4-4. Example performance potential graph27
Figure 4-5. Major unit process rating criteria	28
Figure 4-6. Example factors summary and supporting notes	45
Figure 4-7. CPE/CTA schematic of activities	47
Figure 4-8. Schematic of CPE activities	48
Figure 4-9. Flow schematic of Plant A	60
Figure 4-1 0. Performance potential graph for Plant A	61
Figure 5-1. CTA results showing finished water quality improvements	67
Figure 5-2. CTA priority setting model68
Figure 5-3. Schematic of CTA framework	72
Figure 5-4. Example action plan	73
Figure 5-5. Special study format	74
Figure 5-6. Short term trend chart showing relationship of raw, settled and filtered water turbidities	75
Figure 5-7. Example priority setting results from CTA site visit activity..76
Figure 5-8. Example topic development sheet	76
Figure 5-9. A basic process control sampling and testing schedule	81
Figure 5-1 0. Performance improvement during CTA project – filter effluent..89
Figure 5-1 1. Performance improvement during CTA project – sedimentation basin effluent89
Figure 5-1 2. Performance improvement during CTA project – filter backwash spikes..90
Figure 5-1 3. Plant performance after CTA	90
Figure 7-1. Historic perspective of turbidity goal and regulations	101
Figure 7-2. Example of disinfection profile daily variations in log inactivation..104

List of Tables

Number		Page
Table 1-1.	Information Pertinent to Specific User Groups	5
Table 2-1.	U.S. Outbreaks of Cryptosporidiosis in Surface Water Supplies.. ..	8
Table 3-1.	Example Prioritization Criteria for Surface Water Systems	17
Table 3-2.	Example Prioritization Database	18
Table 4-1.	Percentile Distribution Analysis of Water Quality Data.. ..	24
Table 4-2.	Major Unit Process Evaluation Criteria	29
Table 4-3.	Expected Removals of <i>Giardia</i> Cysts and Viruses by Filtration	33
Table 4-4.	Factors for Determining Effective Disinfection Contact Time Based on Basin Characteristics	34
Table 4-5.	Classification System for Prioritizing Performance Limiting Factors.. ..	43
Table 4-6.	Evaluation Team Capabilities	49
Table 6-1.	Geographical Distribution of CPEs and CTAs	93
Table 6-2.	Summary of the Major Unit Process Ratings for 69 Plants	94
Table 6-3.	Most Frequently Occurring Factors Limiting Performance at 69 CPEs	95
Table 8-1.	Training Approach to Achieve Transfer of CPE Skills	108
Table 8-2.	Quality Control Checklist for Completed CPEs	109
Table 8-3.	Quality Control Checklist for Completed CTAs	110
Table 8-4.	Total System Optimization Considerations for Drinking Water Utilities.....	111

Chapter 1 Introduction

1.1 Purpose

Maintaining public health protection at water supply systems has become more challenging in recent years with the resistance of some pathogens to disinfection using chlorination and an increase in the immuno-compromised population (e.g., people with HIV, organ transplant patients, the elderly). Also, as evidenced by recent outbreaks, compliance with the 1989 Surface Water Treatment Rule (SWTR) does not always assure maximum protection of the public from waterborne disease (1). Based on this awareness, the U.S. Environmental Protection Agency (USEPA) is developing regulations to control contamination from microbial pathogens in drinking water while concurrently addressing other concerns such as disinfection by-products (2,3). These new and interrelated regulations are moving the water supply industry toward meeting increasingly more stringent water treatment requirements.

Research and field work results support optimizing particle removal from water treatment facilities to maximize public health protection from microbial contamination (4,5,6). Since 1988 the Composite Correction Program (CCP) has been developed and demonstrated as a method of optimizing surface water treatment plant performance with respect to protection from microbial pathogens in the United States and Canada (7,8). The approach is based on establishing effective use of the available water treatment process barriers against passage of particles to the finished water.

Specific performance goals are used by the CCP approach to define optimum performance for key treatment process barriers such as sedimentation, filtration, and disinfection. These include a maximum individual sedimentation basin effluent turbidity goal of less than 2 nephelometric turbidity units (NTUs) to assure that the integrity of this barrier is consistently maintained and to provide a low particle loading to the filters. For the filtration barrier, optimum performance has been described as individual filter effluent turbidities of less than 0.1 NTU with a maximum post backwash "spike" to 0.3 NTU and returning to less than 0.1 NTU in less than 15 minutes. The disinfection goal has been based on achieving the log inactivation

requirement for *Giardia* and/or viruses described in the SWTR guidance (9).

This handbook is an updated version of the USEPA Handbook: Optimizing Water Treatment Plant Performance Using the Composite Correction Program published in 1991 (7). It is intended to serve as a resource document for optimizing the performance of existing surface water treatment facilities to provide protection from microbial contamination.

1.2 Background

1.2.1 Wastewater Treatment Compliance

The CCP approach was initially developed to address compliance problems at wastewater treatment facilities that were constructed in the late 1960's and 1970's. A survey involving over one hundred facilities was conducted to identify the reasons for this non-compliance (10,11,12). The survey revealed that operations and maintenance factors were frequently identified as limiting plant performance, but also disclosed that administrative and design factors were contributing limitations. Most importantly, each plant evaluated had a unique list of factors limiting performance.

Based on these findings, an approach was developed to identify and address performance limitations at an individual facility and to obtain improved performance. Significant success was achieved in improving performance at many wastewater treatment facilities without major capital improvements (13). Ultimately, a handbook was developed that formalized the evaluation and correction procedures (14). The formalized approach was defined as the Composite Correction Program (CCP), and it consists of two components—a Comprehensive Performance Evaluation (CPE) and Comprehensive Technical Assistance (CTA). As a point of clarification, the technical assistance phase was initially referred to as a Composite Correction Program; however, the name of this phase was changed to Comprehensive Technical Assistance to better differentiate the two phases. A CPE is a thorough review and analysis of a plant's performance-based capabilities and associated administrative, operation, and

maintenance practices. It is conducted to identify factors that may be adversely impacting a plant's ability to achieve permit compliance without major capital improvements. A CTA is the performance improvement phase that is implemented if the CPE results indicate improved performance potential. During the CTA phase, identified plant-specific factors are systematically addressed and eliminated.

The wastewater CCP handbook was updated in 1989 to include specific low cost modifications that could be used to optimize an existing facility's performance (15). An "expert system" (POTW Expert) was also developed to supplement the handbook (16).

7.2.2 Water Treatment Optimization

Based on the state of Montana's successful use of the CCP approach for improving compliance of their mechanical wastewater treatment facilities, state personnel evaluated the feasibility of using the CCP to optimize the performance of small surface water treatment facilities. With financial assistance from USEPA Region 8, nine CPEs and three CTAs were completed from April 1988 until September 1990. Through these efforts, each of the existing facilities where CTAs were implemented showed dramatic improvements in the quality of finished water turbidity. Additionally, improved performance was achieved at three plants where only the evaluation phase (CPE) of the program was completed (17). The encouraging results from Montana's adoption of the CCP approach to surface water treatment plants led to the USEPA's Office of Ground Water and Drinking Water involvement with the program in 1989.

USEPA decided to further develop and demonstrate use of the CCP approach as it applied to compliance with drinking water regulations to ensure its applicability nation-wide. In pursuit of this goal, a cooperative project was initiated between USEPA's Office of Ground Water and Drinking Water, Technical Support Center (TSC) and Office of Research and Development, Technology Transfer and Support Division, National Risk Management Research Laboratory (NRMRL). This project provided resources to: conduct an additional twelve CPEs in the states of Ohio, Kentucky, West Virginia, Maryland, Montana, Vermont, and Pennsylvania; prepare a summary report (8); and develop a water CCP Handbook (7).

Following these initial efforts, work continued, through a cooperative agreement between TSC and the University of Cincinnati, on further refinement and development of the CCP approach. Formal efforts were implemented to incorporate the CCP into state programs. It was anticipated that application of the CCP by state regulatory personnel would achieve desired performance levels with a minimum financial impact on the utilities in their jurisdiction. Pilot programs were implemented in eight states (West Virginia, Massachusetts, Maryland, Rhode Island, Kentucky, Pennsylvania, Texas, and Colorado) which focused on developing CPE capability for state staff. A progressive training process was developed within each state. The training process included the completion of a seminar followed by three CPEs conducted by a state core team that was facilitated by USEPA and Process Applications, Inc. Similar pilot programs were also completed in USEPA Regions 6 and 9. Typically, state regulatory staff selected the CPE candidate plants based on their perception of the plant's inability to meet the SWTR turbidity requirements.

The progressive training approach proved to be successful; however, other issues and challenges related to implementation within the existing state regulatory program structure became apparent. As the state pilot programs progressed, these challenges to implementation became known collectively as *institutional barriers*. The impact of institutional barriers on state-wide optimization efforts is discussed further in Chapter 3.

1.2.3 Broad-Scale Application of CCP Concepts

The optimization concepts included within the CCP approach have been expanded to a variety of water industry and regulatory activities. A partial list of current optimization efforts that utilize components of the CCP is described below.

- The states of Alabama, Georgia, Kentucky, and South Carolina, in cooperation with EPA Region 4, are currently pursuing a multi-state effort that focuses on optimization of their surface water treatment facilities through a pilot program based on the application of the CCP concepts and tools.
- The *Partnership for Safe Water* is a voluntary program for enhancing water treatment to

provide higher quality drinking water. Organizations involved in the Partnership include the U.S. Environmental Protection Agency, American Water Works Association, Association of Metropolitan Water Agencies, National Association of Water Companies, Association of State Drinking Water Administrators, and the American Water Works Association Research Foundation. The Partnership utilized the CCP as the basis of its Phase III comprehensive water treatment self-assessment (18). Use of the CCP is also being considered for the Phase IV third party assessment of participating utilities. As of, May 1998, 217 water utilities serving nearly 90 million people are participating in the Partnership for Safe Water.

- In 1996 the American Water Works Association Research Foundation conducted an optimization workshop with national water quality and treatment experts from throughout the industry. As a result of this workshop, a self-assessment handbook was published by AWWARF (19). This handbook, which follows the CCP approach, is intended to be a resource for water utilities that choose to conduct a self-assessment to improve performance.

1.3 Scope

Since publication of the predecessor of this handbook in 1991, several modifications have been made to the CCP and its use for optimizing surface water treatment plants. In addition, other complementary drinking water optimization activities (e.g., *Partnership for Safe Water*) have developed and continue to have positive impacts in this area. The purpose of this handbook update is to incorporate new information and to integrate the other complementary programs.

1.3.1 Update of the CCP Approach and Implementation

Experience gained from over 70 CPEs and 9 CTAs provides the basis for updating the CCP approach presented in this handbook. In addition, eight state pilot programs have provided the basis for the area-wide application of the CCP. Significant additions and modifications to the CCP included in this handbook are:

- An expanded discussion of the relationship between optimized performance and public health protection.
- An expanded definition of optimized performance goals for microbial contaminant protection.
- Considerations for selection of CPE and CTA candidates.
- Clarification on CCP terminology.
- Description and use of the *Partnership for Safe Water* software for compiling and analyzing turbidity data.
- Updated process criteria for completing the major unit process evaluation.
- An updated database of completed CPEs and CTAs and a summary of typical factors found limiting performance.
- Streamlined forms for collection of field data.

1.3.2 Support for Future Regulations

The initial CCP handbook focused on meeting the requirements of the Surface Water Treatment Rule (SWTR) (20). As the challenges of protecting the public health from microbial contamination became more paramount, the emphasis was shifted from the SWTR requirements to achieving optimized performance goals.

Pursuant to the requirements under the 1996 Amendments to the Safe Drinking Water Act (SDWA), the USEPA is developing interrelated regulations to control microbial pathogens and disinfectants/disinfection byproducts in drinking water, collectively known as the microbial/disinfection byproducts (M/DBP) rules. The 1996 Amendment to the SDWA set a deadline for promulgation of the Interim Enhanced Surface Water Treatment Rule (IESWTR) of November 1998. USEPA's Notice of Data Availability (3) indicates that this rule will include a revised finished water turbidity requirement of 0.3 NTU, new individual filter monitoring requirements, and requirements for states to have authority to

require the conduct of CCPs for water utilities that experience difficulties in meeting the turbidity requirements of the rule. This handbook is intended to provide a technical resource to support the implementation of the IESWTR.

1.3.3 Technical Resource for the Partnership for Safe Water

This updated handbook is also intended to complement and enhance the existing **Partnership for Safe Water** documentation and program activities. In addition to supporting the ongoing Phase III self-assessment activities, the handbook will also support the anticipated Phase IV activities. A possible Phase IV approach could involve an independent third party review of a utility using the CCP format. This final step in the Partnership process ensures that some of the potential limitations of self-assessment (e.g., difficulty in identifying operational and administrative factors) are not overlooked.

1.3.4 Considerations for Total System Optimization

Although this handbook is intended to be a technical resource for surface water treatment facilities to pursue optimized performance for protection against microbial contamination, it is recognized that as the regulations change and optimum performance is pursued, the focus of optimization activities will expand to other parameters. Anticipated future areas for optimization include source water protection, disinfection by-products, corrosion control, groundwater disinfection, and distribution system water quality. This expanded scope is called total system optimization. Minor additions are included in this handbook to address some of these areas; however, future handbook modifications or additional handbooks are envisioned to more thoroughly address total system optimization concepts and topics.

1.4 Using the Manual

The primary intended users of this handbook include regulators (e.g., federal and state agency personnel) and non-regulators (e.g., utility personnel and consultants). To facilitate the *use* of this handbook, information has been separated into the following chapters:

- Chapter 1 - Introduction
- Chapter 2 - Protection of Public Health from Microbial Pathogens
- Chapter 3 - Assessing Composite Correction Program Application
- Chapter 4 - Comprehensive Performance Evaluations
- Chapter 5 - Comprehensive Technical Assistance
- Chapter 6 - Findings From Field Work
- Chapter 7 - Current and Future Regulation Impacts on Optimization
- Chapter 8 - Other CCP Considerations

Table I-I provides guidance on where specific user groups can locate within this handbook information that is considered pertinent to their unique interest or intended use.

1.5 References

When an NTIS number is cited in a reference, that reference is available from:

National Technical Information Service
5285 Port Royal Road
Springfield, VA 22161
(703) 487-4650

1. Kramer, M.H., et al. 1996. "Waterborne Disease: 1993 and 1994." *Journal AWWA*, **88(3):66**.
2. USEPA. 1997. National Primary Drinking Water Regulations: Disinfectants and Disinfection Byproducts; Notice of Data Availability; Proposed Rule. *Fed. Reg.*, **62:212:59338** (November 3, 1997).
3. USEPA. 1997. National Primary Drinking Water Regulations: Interim Enhanced Surface Water Treatment Rule Notice of Data Availability; Proposed Rule. *Fed. Reg.*, **62:212:59486** (November 3, 1997).

Table I-1. Information Pertinent to Specific User Groups

User	Purpose	Chapter Source
USEPA/State Regulatory Personnel	• Assess application of the CCP as part of an area-wide optimization strategy	⇒ Chapter 3
	• Identify priority plants for CCP application	⇒ Chapter 3
	• Review/learn the CPE protocol	⇒ Chapter 4
	• Review/learn the CTA protocol	⇒ Chapter 5
	• Review CCP database for common factors limiting performance	⇒ Chapter 6
	• Review quality control criteria for assessment of third party CCPs	⇒ Chapter 8
Utility Personnel	• Utilize the CCP as a self-assessment resource	⇒ Chapters 4 & 5
	• Assess capabilities of CCP providers	⇒ Chapter 8
Consultants/ Peer Assessment Team Members	• Review/learn the CPE protocol	⇒ Chapter 4
	• Review/learn the CTA protocol	⇒ Chapter 5
	• Review CCP database for common factors limiting performance	⇒ Chapter 6

4. Patania, N.L., et al. 1996. Optimization of Filtration for Cvst Removal. AWWARF, Denver, co.
5. Nieminski, E.C., et al. 1995. "Removing *Giardia* and *Cryptosporidium* by Conventional Treatment and Direct Filtration." *Journal AWWA*, 87(9):96.
6. Consonery, P.J., et al. 1996. "Evaluating and Optimizing Surface Water Treatment Plants: How Good is Good Enough?" Paper presented at AWWA Water Quality Technology Conference, Boston, MA.
7. Renner, R.C., B.A. Hegg, J.H. Bender, and E.M. Bissonette. 1991. Optimizing Water Treatment Plant Performance Using the Composite Correction Program. EPA/625/6-91/027, USEPA Center for Environmental Research Information, Cincinnati, OH.
8. Renner, R.C., B.A. Hegg, and J.H. Bender. 1990. Summary Report: Optimizing Water Treatment Plant Performance With the Composite Correction Program. EPA 625/8-90/01 7, USEPA Center for Environmental Research Information, Cincinnati, OH.
9. Guidance Manual for Compliance With the Filtration and Disinfection Requirements for Public Water Systems Using Surface Water Sources. 1989. NTIS No. PB-90148016, USEPA, Cincinnati, OH.
10. Hegg, B.A., K.L. Rakness, and J.R. Schultz. 1979. Evaluation of Operation and Maintenance Factors Limiting Municipal Wastewater Treatment Plant Performance. EPA 600/2-79-034, NTIS No. PB-300331, USEPA, Municipal Environmental Research Laboratory, Cincinnati, OH.

-
11. Gray, A.C., Jr., P.E. Paul, and H.D. Roberts. 1979. Evaluation of Operation and Maintenance Factors Limiting Biological Wastewater Treatment Plant Performance. EPA 600/2-79-087, NTIS No. PB-297491, **USEPA**, Municipal Environmental Research Laboratory, Cincinnati, OH.
 12. Hegg, B.A., K.L. Rakness, J.R. Schultz, and L.D. **DeMers**. 1980. Evaluation of Operation and Maintenance Factors Limiting Municipal Wastewater Treatment Plant Performance - Phase II. EPA 600/2-80-1 29, NTIS No. **PB-81-1 12864**, **USEPA**, Municipal Environmental Research Laboratory, Cincinnati, OH.
 13. Hegg, B.A., K.L. Rakness, and J.R. Schultz. 1979. A Demonstrated Approach for Improving Performance and Reliability of Biological Wastewater Treatment Plants. EPA 600/2-79-035, NTIS No. PB-300476, **USEPA**, Cincinnati, OH.
 14. Hegg, B.A., J.R. Schultz, and K.L. Rakness. 1984. EPA Handbook: Improving POTW Performance Using the Composite Correction Program Approach. EPA **625/6-84-008**, NTIS No. PB-88184007, **USEPA** Center for Environmental Research Information, Cincinnati, OH.
 15. Hegg, B.A., L.D. **DeMers**, and J.B. Barber. 1989. EPA Technology Transfer Handbook: Retrofitting POTWs. EPA **625/6-89-020**, NTIS No. PB-90182478, **USEPA** Center for Environmental Research Information, Cincinnati, OH.
 16. Publicly Owned Treatment Works Expert Users Guide and Software. 1990. Eastern Research Group, Inc. and Process Applications, Inc. for **USEPA** Center for Environmental Research Information, Cincinnati, OH.
 17. Renner, R.C., B.A. Hegg, and D.L. Fraser. 1989. "Demonstration of the Comprehensive Performance Evaluation Technique to Assess Montana Surface Water Treatment Plants." Presented at the 4th Annual ASDWA Conference, Tucson, AZ.
 18. **Bender**, J.H., R.C. Renner, B.A. Hegg, E.M. Bissonette, and R. Lieberman. 1995. "Partnership for Safe Water Voluntary Water Treatment Plant Performance Improvement Program Self-Assessment Procedures." **USEPA**, AWWA, AWWARF, Association of Metropolitan Water Agencies, Association of State Drinking Water Administrators, and National Association of Water Companies.
 19. Renner, R.C., and B.A. Hegg. 1997. **Self-Assessment Guide for Surface Water Treatment Plant Optimization**. AWWARF, Denver, CO.
 20. **USEPA**. 1989. Surface Water Treatment Rule. **Fed. Reg.**, **54:124:27486** (June 29, 1989).

Chapter 2

Protection of Public Health From Microbial Pathogens

2.1 Background

One of the major objectives of water supply systems is to provide consumers with drinking water that is sufficiently free of microbial pathogens to prevent waterborne disease. Water supply systems can achieve this level of public health protection by providing treatment to assure that pathogens found in the raw water supply are removed or inactivated. The relationship between optimized water treatment plant performance and protection of public health from microbial pathogens is presented in this chapter.

2.2 Waterborne Disease History

Several well documented disease outbreaks that were associated with the use of untreated surface water, contaminated well water, treatment plant deficiencies, and contaminated distribution systems have occurred over the past 20 years. During this period the most common suspected causes of waterborne disease outbreaks were the protozoan parasites *Giardia lamblia* and *Cryptosporidium parvum* (1). These parasites exist in the environment in an encysted form where the infectious material is encapsulated such that they are resistant to inactivation by commonly used disinfectants. These parasites are transmitted to their hosts by ingestion of cysts that have been excreted in the feces of infected humans or animals. Infection can occur through ingestion of fecally contaminated water or food or contact with fecally contaminated surfaces. Recent studies have indicated that these parasites are routinely detected in surface water supplies throughout North America (2,3,4). They can enter surface water supplies through natural runoff, wastewater treatment discharges, and combined sewer overflows,

A recent review of waterborne disease in the U.S. during the period 1993 through 1994 identified 30 disease outbreaks associated with drinking water. The outbreaks caused over 400,000 people to become ill-the majority from a 1993 outbreak in Milwaukee. Twenty-two of the outbreaks were known or suspected to be associated with infectious agents and eight with chemical contaminants. *Giardia* or *Cryptosporidium* was identified

as the causative agent for 10 of the outbreaks, and six of these systems were associated with a surface water source. All six systems provided chlorination, and four also provided filtration. In the filtered systems, deficiencies in the distribution system were identified for one outbreak, inadequate filtration for one, and no apparent deficiencies were identified in two cases (1).

Cryptosporidium presents a unique challenge to the drinking water industry because of its resistance to chlorination and its small size, making it difficult to remove by filtration. Cryptosporidiosis is the diarrhea illness in humans caused by *Cryptosporidium parvum*. Cryptosporidiosis outbreaks from surface water supplies have been documented in the United States, Canada and Great Britain (5,6,7). A summary of U.S. outbreaks associated with surface water supplies is shown in Table 2-1. Five of the outbreaks were associated with filtered drinking waters. Three systems (Carroll, Jackson - Talent, and Milwaukee) were experiencing operational deficiencies and high finished water turbidities at the time of the outbreaks. All three plants utilized conventional treatment processes that included rapid mix, flocculation, sedimentation, and filtration. The Clark County outbreak was the only outbreak associated with a filtered drinking water for which no apparent treatment deficiencies were noted. All five systems were in compliance with the federal drinking water regulations in effect at that time.

Recent research has shown that free chlorine and monochloramine provide minimal disinfection of *Cryptosporidium* oocysts at the dosage and detention time conditions found at most treatment facilities (8). Disinfection requirements based on CT in the 1989 SWTR guidance were developed solely on inactivation of *Giardia lamblia* cysts. Research conducted by Finch (9) showed approximately 0.2 log or less inactivation of *Cryptosporidium* when free chlorine was used alone (5 to 15 mg/L @ 60 to 240 min.). Monochloramine was slightly more effective than free chlorine. Inactivation of *Cryptosporidium* through the use of stronger disinfectants (e.g., ozone, chlorine dioxide) and combined disinfectants is currently being investigated by the water industry and research institutions.

Table 2-1. U.S. Outbreaks of Cryptosporidiosis in Surface Water Supplies (5)

Location	Year	Type of System	Estimated Number of Cases
Bernalillo County, New Mexico	1986	Untreated surface water supply	78
Carroll County, Georgia	1987	Treated surface water supply	13,000
Jackson County, Oregon	1992	Medford – chlorinated spring Talent – treated surface water	15,000
Milwaukee County, Wisconsin	1993	Treated surface water supply	403,000
Cook County, Minnesota	1993	Treated surface water supply	27
Clark County, Nevada	1994	Treated surface water supply	78

The recent incidence of waterborne disease associated with protozoan parasites and the resistance of some pathogens to conventional disinfection presents a challenge to the water industry. Use of a single barrier, such as disinfection alone, or operation of a conventional treatment plant that had not been optimized has contributed to several disease outbreaks. For surface supplied filtration plants, minimizing consumer’s risk from microbial pathogens will require a proactive approach to water treatment, including plant optimization.

2.3 Relationship Between Optimized Performance and Public Health Protection

2.3.7 Multiple Barrier Strategy

Microbial pathogens, including protozoan parasites, bacteria, and viruses, can be physically removed as particles in flocculation, sedimentation, and filtration treatment processes or inactivated in disinfection processes. Consequently, the level of protection achieved in a water system can be increased by optimizing the particle removal processes in a system and by proper operation of the disinfection processes. In a conventional plant, the coagulation step is used to develop particles that can be physically removed by sedimentation and filtration processes. Effective use of these processes as part of a multiple barrier strategy for microbial protection represents an opera-

tional approach for water systems that choose to optimize performance. This strategy is also being proposed as a method for addressing *Cryptosporidium* in the Interim Enhanced Surface Water Treatment Rule (10).

Particle removal through a water treatment process can be monitored and assessed by various methods including turbidity, particle counting, and microscopic particulate analysis (MPA). An increasing number of water systems treating a surface water supply have turbidimeters installed to monitor turbidity at various locations throughout the process. Some systems are supplementing turbidity monitoring with particle counting and microscopic particulate analysis. However, because turbidity monitoring is the most common method of assessing particle removal in surface water systems, performance goals based on this parameter have been developed for the CCP to define optimized system performance.

The role of multiple treatment barriers in optimizing water treatment for protection from microbial pathogens and the associated performance goals are shown in Figure 2-1. Despite variability in source water quality, surface water treatment plants must produce consistently high quality finished water. To meet this objective, each treatment process must consistently produce treated water of a specific quality. To this end,

Figure 2-1. Multiple barrier strategy for microbial contaminant protection.

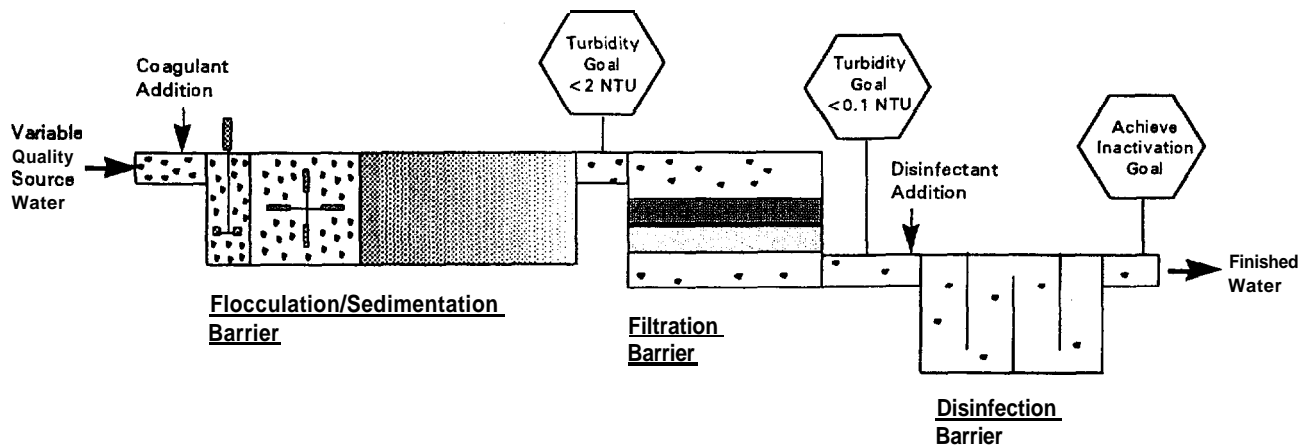

performance goals have been established for each of the treatment barriers in a plant.

When plants include a sedimentation process, the maximum sedimentation basin effluent turbidity goal of less than 2 NTU is used to define optimum process performance. A sedimentation performance goal ensures the integrity of this barrier and provides a consistent particle loading to the filtration process. With respect to optimum particle removal for the filtration process, the optimum performance goal is defined as achieving individual filter effluent turbidities of less than 0.1 NTU.

The performance of the disinfection barrier is based on the log inactivation requirement for *Giardia* and virus, as established by the Surface Water Treatment Rule guidance manual (11). This document provides tables of the required CT (i.e., disinfectant concentration (C) times the time (T) that the disinfectant must be in contact with the water) to achieve different levels of inactivation based on the temperature and pH of the water. The amount of log inactivation, and hence the CT value that the plant must achieve, is based on SWTR guidance.

Inactivation requirements for *Cryptosporidium* based on CT have not been established but would be significantly higher than those for *Giardia* and virus. Since inactivation of *Cryptosporidium* is difficult to achieve with chlorine disinfection, maximizing particle removal could represent the most cost effective and viable option for maximizing public health protection from this microorganism.

2.3.2 Basis for Optimization Goals

Strong evidence exists in support of maximizing public health protection by optimizing particle removal in a plant. Recent supportive evidence from water treatment research and field evaluations is summarized below:

- Pilot study work conducted by Patania (12) showed that when treatment conditions were optimized for turbidity and particle removal, very effective removal of both *Cryptosporidium* and *Giardia* was observed. *Cryptosporidium* removal ranged from 2.7 to 5.9 logs, and *Giardia* removal ranged from 3.4 to 5.1 logs during stable filter operation. Under the conditions tested, meeting a filter effluent turbidity goal of 0.1 NTU was indicative of treatment performance producing the most effective cyst and oocyst removal. A small difference in filter effluent turbidity (from 0.1 or less to between 0.1 and 0.3 NTU) produced a large difference (up to 1.0 log) in cyst and oocyst removal.
- Pilot study and full-scale plant work performed by Nieminski (13) demonstrated that consistent removal rates of *Giardia* and *Cryptosporidium* were achieved when the treatment plant was producing water of consistently low turbidity (0.1 - 0.2 NTU). As soon as the plant's performance changed and water turbidity fluctuated, a high variability in cyst concentration was observed in collected effluent samples. The pilot study work, confirmed by full-scale plant studies, showed that in a properly

operated treatment plant producing finished water of 0.1 to 0.2 NTU, either conventional treatment or direct filtration can achieve 3-log removal of *Giardia* cysts.

- An extensive amount of water filtration research was conducted at Colorado State University on low turbidity water (14,151). Using field-scale pilot filters, researchers demonstrated greater than 2-log *Giardia* removal when proper chemical coagulation was practiced on low turbidity raw water (i.e., 0.5 to 1.5 NTU), resulting in filter effluent turbidity values of less than 0.1 NTU.
- Filter plant performance evaluations conducted by Consonery (16) at 284 Pennsylvania filtration plants over the past eight years have included a combination of turbidity, particle counting, and microscopic particulate analysis to assess the performance of plant processes. The person completing the evaluation uses this information to rate the plant as to whether it provides an acceptable level of treatment for microbial pathogens. Evaluation results have shown that when filter effluent turbidity was less than or equal to 0.2 NTU, 60 percent of the plants were given an acceptable rating. When filter effluent turbidity was greater than or equal to 0.3 NTU, only 11 percent of the plants were given an acceptable rating. Although this work did not assess plant performance at the 0.1 NTU level, the increased acceptable rating that occurred when effluent turbidity was less than 0.2 NTU versus 0.3 NTU indicates the benefit of lowering finished water turbidity.

An extensive amount of research and field work results support a filtered water turbidity goal of 0.1 NTU. These findings are also compatible with a long standing AWWA Policy Statement supporting treatment to this level (17). It is important to understand that achieving this level of filter performance (i.e., 0.1 NTU) does not guarantee that microbial pathogens will not pass through filters; however, it represents the current best practice for water treatment plants to achieve the greatest level of public health protection.

Particle counting can be used to support and enhance turbidity measurements, and can be especially useful when source water turbidity is low (< 5 NTU). At low source water turbidity levels, it is difficult to assess the level of particle reduction being achieved in the filtration process

with turbidity measurements alone. This is due to the insensitivity of turbidimeters at extremely low turbidity measurements (i.e., below about 0.05 NTU) (18,19,20).

2.4 Optimization Performance Goals

For purposes of this handbook, optimized water treatment performance for protection against microbial pathogens is defined by specific measurements and goals. This section presents the performance goals for surface water treatment systems. These goals are based on CCP field work performed by the authors and experience gained from the *Partnership for Safe Water* and state optimization pilot programs. It is important to note that these goals are the foundation for all assessments in this handbook and that obtaining this performance level exceeds present regulatory requirements.

2.4.1 Minimum Data Monitoring Requirements

- Daily raw water turbidity
- Settled water turbidity at 4-hour time increments from each sedimentation basin
- On-line (continuous) turbidity from each filter
- One filter backwash profile each month from each filter

2.4.2 Individual Sedimentation Basin Performance Goals

- Settled water turbidity less than 1 NTU 95 percent of the time when annual average raw water turbidity is less than or equal to 10 NTU.
- Settled water turbidity less than 2 NTU 95 percent of the time when annual average raw water turbidity is greater than 10 NTU.

2.4.3 Individual Filter Performance Goals

- Filtered water turbidity less than 0.1 NTU 95 percent of the time (excluding 15-minute period following backwashes) based on the

maximum values recorded during 4-hour time increments.

- If particle counters are available, maximum filtered water measurement of less than 10 particles (in the 3 to 18 μm range) per milliliter. (Note: The current state-of-the-art regarding calibration of particle counters and the inherent problems in comparisons of readings between different counters must be considered in using particle count information to assess optimized performance. Higher readings than the above 10 particles/ml goal from a counter that is properly calibrated may be a function of differences between instruments. Relative changes in particle count data will be of greater use in assessing optimized performance than the absolute values from the particle counter).
- Maximum filtered water measurement of 0.3 NTU.
- Initiate filter backwash immediately after turbidity breakthrough has been observed and before effluent turbidity exceeds 0.1 NTU.
- Maximum filtered water turbidity following backwash of less than 0.3 NTU.
- Maximum backwash recovery period of 15 minutes (e.g., return to less than 0.1 NTU).

2.4.4 Disinfection Performance Goal

- CT values to achieve required log inactivation of *Giardia* and virus.

2.5 Role of the Water Treatment Plant Staff in Public Health Protection

The information presented in this chapter demonstrates that the quality of water leaving a water treatment plant has the potential to directly impact the health of the consumers of its finished water. All staff associated with the plant, from the operator to the highest level administrator, have an important role in protecting public health and a responsibility to provide finished water that minimizes the possibility of a disease outbreak. Experience gained from implementing CCP optimization activities at plants has demonstrated that, in most

situations, once utility staff become aware of the importance of achieving optimized performance goals, they have enthusiastically pursued these goals through a variety of activities. Later chapters present comprehensive procedures for assessing and achieving the level of performance described in this chapter.

2.6 References

1. Kramer, M.H., et al. 1996. "Waterborne Disease: 1993 and 1994." *Journal A WWA*, 88(3):66.
2. Chauret, C., et al. 1995. "Correlating *Cryptosporidium* and *Giardia* With Microbial Indicators." *Journal AWWA*, 87(11):76.
3. LeChevallier, M.W., et al. 1995. "*Giardia* and *Cryptosporidium* in Raw and Finished Water." *Journal A WWA*, 87(9):54.
4. States, S., et al. 1997. "Protozoa in River Water: Sources, Occurrence, and Treatment." *Journal A WWA*, 89(9): 74.
5. Solo-Gabriele, H., et al. 1996. "U.S. Outbreaks of Cryptosporidiosis." *Journal A WWA*, 88(9):76.
6. Pett, B., et al. 1993. "Cryptosporidiosis Outbreak From an Operations Point of View: Kitchener-Waterloo, Ontario." Paper presented at AWWA Water Quality Technology Conference, Miami, FL.
7. Richardson, A.J., et al. "An Outbreak of Waterborne Cryptosporidiosis in Swindon and Oxfordshire." *Epidemiol. Infect.*, 107(3)485.
8. Korich, D.G., et al. 1990. "Effects of Ozone, Chlorine Dioxide, Chlorine, and Monochloramine on *Cryptosporidium parvum* Oocyst Viability." *Applied and Environmental Microbiology*, 56(5):1423.
9. Finch, G.R., et al. 1995. "Ozone and Chlorine Inactivation of *Cryptosporidium*." In Proceedings of Water Quality Technology Conference, November 6-10, 1994, San Francisco, CA. AWWA, Denver, CO.
10. USEPA. 1997. National Primary Drinking Water Regulations: Interim Enhanced Surface Water Treatment Rule; Notice of Data

-
- Availability; Proposed Rule. **Fed. Reg.**, **62:212:59486** (November 3, 1997).
11. Guidance Manual for Compliance With the Filtration and Disinfection Requirements for Public Water Systems Using Surface Water Sources. 1989. NTIS No. PB-90148016, USEPA, Cincinnati, OH.
 12. Patania, N.L., et al. 1996. Optimization of Filtration for Cyst Removal. AWWARF, Denver, CO.
 13. Nieminski, E.C., et al. 1995. "Removing *Giardia* and *Cryptosporidium* by Conventional Treatment and Direct Filtration." **Journal AWWA**, **87(9):96**.
 14. Mosher, R.R., et al. 1986. "Rapid Rate Filtration of Low Turbidity Water Using Field-Scale Pilot Filters." **Journal AWWA**, **78(3):42**.
 15. Al-Ani, M.Y., et al. 1986. "Removing *Giardia* Cysts From Low Turbidity Water by Rapid Sand Filtration." **Journal AWWA**, **78(5):66**.
 16. Consonery, P.J., et al. 1996. "Evaluating and Optimizing Surface Water Treatment Plants: How Good is Good Enough?" Paper presented at AWWA Water Quality Technology Conference, November 1996, Boston, MA.
 17. AWWA Statement of Policy. 1968. Quality Goals for Potable Water, **Journal AWWA**, **60(12):1317**.
 18. Cleasby, J.L., et al. 1989. Design and Operation Guidelines for Optimization of the High Rate Filtration Process: Plant Survey Results. AWWARF, Denver, CO.
 19. West, T., P. Demeduk, G. Williams, J. Labonte, A. DeGraca, and S. Teefy. 1997. "Using Particle Counting to Effectively Monitor and Optimize Treatment." Paper presented at AWWA Annual Conference, Atlanta, Georgia.
 20. Veal, C., and B. Riebow. 1994. "Particle Monitor Measures Filter Performance." **Opflow**, **20(5):1**.

Chapter 3

Assessing Composite Correction Program Application

3.1 Introduction

The CCP is currently used as an optimization tool by several EPA regional offices and state drinking water programs, and its use could increase as the result of possible new turbidity requirements when the Interim Enhanced Surface Water Treatment Rule (IESWTR) is promulgated (1). However, the most effective application of the approach has not always been achieved. Results from CCP field experience and state pilot programs have indicated that the CCP is most effective when it is strategically integrated into a program that focuses on area-wide optimization of water treatment systems. This chapter describes a developing program for regulatory agencies and others to initiate effective CCP-based optimization activities through the implementation of an area-wide optimization model.

3.2 Optimization Program Experience

The experience gained from the transfer of CCP capability to state drinking water programs is discussed in Chapter 1. These activities provided valuable insights into the use of the CCP as an optimization tool by primacy agencies. The objective of the early pilot programs was to demonstrate the capability to effectively transfer CCP skills to state personnel and to facilitate state-wide implementation of these activities. Several challenges became apparent during the implementation phase. The CCP approach, while considered extremely valuable, was also considered to be resource intensive and, therefore, in competition with other state program activities. In some states with decentralized programs, field and central office personnel had difficulty defining their roles and responsibilities for implementing optimization activities. Primacy agency policies guiding the implementation of follow-up efforts were sometimes challenged (e.g., enforcement versus assistance responsibilities). As the state pilot programs progressed, these challenges to implementation became known collectively as **institutional barriers**. In some cases these institutional barriers were pervasive enough to prevent state teams trained in CCP procedures from using their new

technical skills at plants with potential public health concerns.

Despite the identified institutional barriers, the continued success of the CCP efforts at individual facilities could not be ignored (2). In addition, experience gained from the broad-scale implementation of the CCP through state optimization pilot programs and the **Partnership for Safe Water** demonstrated that improvement in water treatment performance could be achieved through multiple activities that are based on CCP concepts. Some specific examples include:

- Self-Assessment Based on CCP Can Positively Impact Performance: Activities that involve water utilities with the development and interpretation of their turbidity data have provided utility staff with a different perspective on assessing their performance and have resulted in utility-directed changes to their operation and system that have improved performance. Specifically, many water utilities that have participated in the **Partnership for Safe Water** have acknowledged that associated turbidity data trending activities have focused them on improving their plant performance to achieve the Partnership goals (3).
- Centralized Training Using CCP Principles Can Impact Multiple Facilities: The application of CCP-based principles through centralized, facilitated training workshops represents an effective and efficient approach to assist a group of utilities with achieving optimization goals. Specifically, a training facilitator in Pennsylvania, working with a group of water utilities, used CCP-based process control procedures in a workshop format to improve coagulant dosing understanding and application (41).
- CCP Components Can be Used to Enhance Existing State Program Activities: Aligning existing programs (e.g., sanitary surveys, facility outreach) with the CCP approach can enhance achievement of performance goals. For example, existing state sanitary survey

programs in Texas and Pennsylvania were modified to include performance-related CPE activities (e.g., individual filter evaluations, filter backwash special studies, process control interviews) (5).

These findings supported a strategic change in the CCP direction. The result was an organizational framework for implementing optimization activities on an area-wide basis.

3.3 Area-Wide Optimization Model

An area-wide optimization model was developed that creates an environment to effectively apply existing resources (e.g., state programs and personnel) with proven performance improvement tools (e.g., CCP). Major components of the current model include: Status, Evaluation, Follow-Up and Maintenance. These components are described in Figure 3-1. This model represents a proactive approach to public health protection, serving to promote continuous improvement and addressing performance-related issues when they first become apparent. Pervasive throughout the area-wide optimization program is an awareness building process linking treatment plant performance with public health protection. It is important to note that an area-wide optimization program is an ongoing activity with an overall objective to improve the performance level of all water systems.

Future activities are planned to enhance the **area-wide** optimization model. Potential activities include expanded optimization efforts at surface water treatment facilities (e.g., disinfection by-products, source water protection, distribution system water quality), and optimization activities related to ground water systems.

3.3.1 Status Component

Status Component activities are designed to determine the status of water systems relative to optimized performance goals within a defined area (e.g., state, region, district). Implementers of optimization programs then use the results of these activities in a prioritization process to continuously focus available resources where they are most needed, typically at high risk public health systems. A key activity under the Status Component is continuous performance monitoring, which can be used to effectively measure the success of

the various optimization efforts associated with the model.

3.3.2 Evaluation Component

Evaluation Component activities focus on the determination of factors limiting performance for those water systems where performance problems were identified from Status Component activities. Existing evaluation programs can be utilized by incorporating performance-focused activities. The most resource-intensive evaluation tools, such as CPEs, are applied at water systems presenting the greatest risk to public health.

3.3.3 Follow-Up Component

Follow-Up Component activities focus on identifying and developing technical assistance methodologies, such as the CTA, to systematically address performance limiting factors at these systems. Coordination and training of available technical resources (e.g., state drinking water program trainers, non-profit organizations, water system peers, consultants) are important activities to assure consistency and effectiveness of this component. The degree of involvement of regulatory agency personnel in follow-up activities may be impacted by the agency's policies on enforcement versus technical assistance. In these situations, policies should be clearly established and agreed upon by agency staff prior to implementing **follow-up** activities.

3.3.4 Maintenance Component

The Maintenance Component formalizes a feedback loop to integrate the "lessons learned" from the various component activities back into the model. In addition, these "lessons learned" can provide opportunities to coordinate findings with other related programs.

3.4 Implementation of an Area-Wide Model

Figure 3-2 shows the status of filtration plant turbidity performance during a two-year period when a state was initiating an area-wide optimization program (5). For those plants that achieved improved performance levels, this progress was accomplished through their participation in Status

Component activities such as turbidity monitoring and Follow-Up Component activities such as chemical feed training. This figure demonstrates some of the benefits of using the Status Component to continuously monitor the water system's level of performance relative to the desired performance goal. For example, systems representing the greatest public health risk are apparent. In

addition, systems showing improved performance can be assessed to ascertain the reasons for such improvement. In some cases, an awareness of the importance of optimized performance by the water system has been identified as a major contributing factor for the change.

Figure 3-1. Area-wide optimization model.

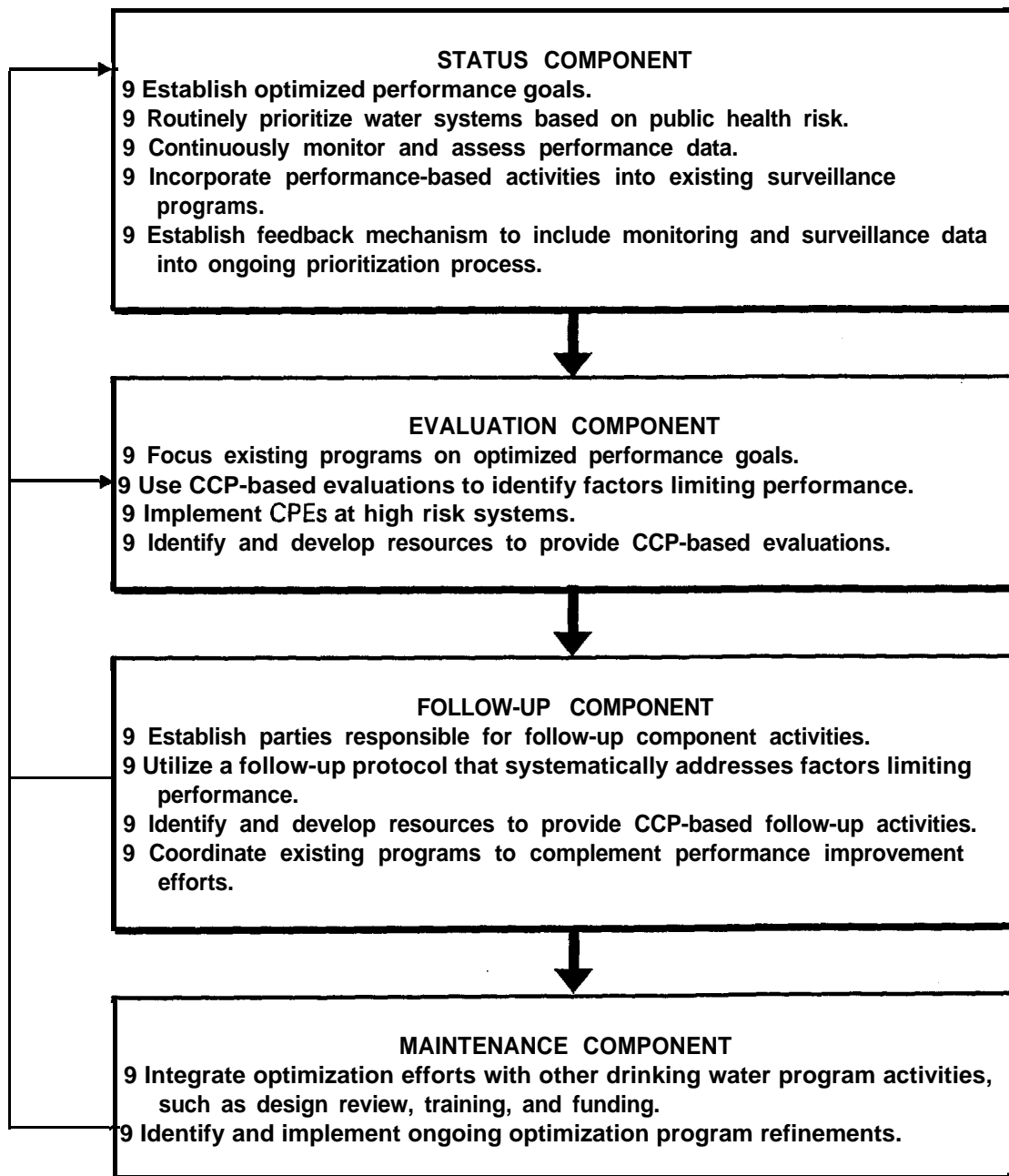
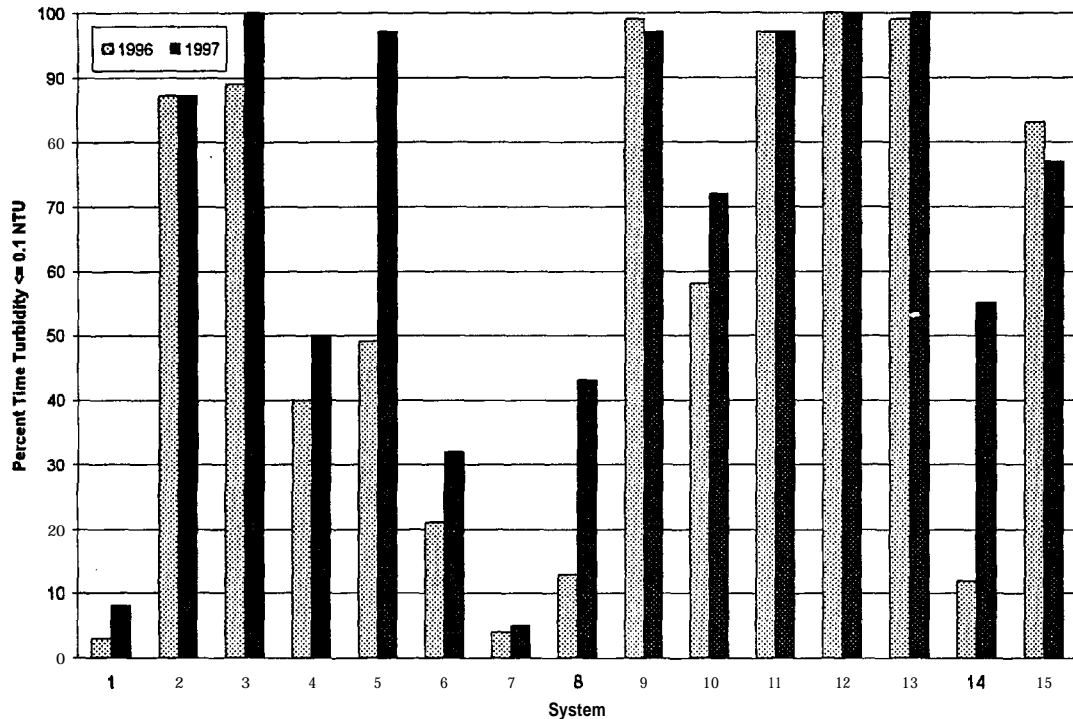

Figure 3-2. Area-wide treatment plant performance status.



In the following sections, the Status Component is further defined to provide a systematic procedure for assessing applicability of the CCP. The four steps of the procedure are: 1) establish performance focused goals to prioritize water systems, 2) assess performance relative to defined optimization goals, 3) prioritize water systems based on selected criteria, and 4) assess the response to the prioritized water systems.

3.4.1 Establish Criteria to Prioritize Water Systems

The initial step in the development of a prioritized facility database is the selection of performance focused criteria. Example prioritization criteria for surface water treatment systems are shown in Table 3-1. In this example, criteria were selected based on specific performance goals (e.g., turbidity) and operations and management practices that support optimized performance (e.g., process control, staffing level).

Points are applied to each criterion relative to their potential to impact public health risk. For example, the ability to meet the filtered water turbidity goal of 0.1 NTU is given a higher number of points

as the percentage of time meeting this goal decreases. Additional data required to complete the assessment outlined in Table 3-1 can usually be obtained from existing resources (e.g., plant performance charts, water system monthly reports, sanitary surveys). It may be necessary to expand the data collection requirements from water systems to assure that sufficient performance focused information is available for this activity.

3.4.2 Assess Water System Performance Relative to Optimization Goals

Typically, each water system utilizing a surface water source collects and records plant performance data on a daily basis. These data can be entered into a computer by either water system staff, regulators, or others on a monthly basis using a spreadsheet program such as the *Partnership for Safe Water* software included in Appendix A. Data are then used to develop turbidity trend charts and percentile tables. Specific types of turbidity data included in the assessment are listed below.

- Raw water turbidity (daily value; maximum value recorded for the day preferred).
- Sedimentation basin effluent turbidity (daily; maximum value recorded for the day preferred).
- Filter effluent turbidity (daily for each filter; maximum value preferred; combined filter or finished water as alternative).

plotted for a 12-month period. In this example, overall filtered water quality is excellent; however, occasional turbidity spikes occur in the filtered water that correspond to increases in the raw water turbidity.

A minimum of 12 months of turbidity data is desired to assess water system performance under variable source water conditions. An example turbidity monitoring chart for a surface water treatment system is shown in Figure 3-3. Raw, settled, and filtered water turbidity values are

3.4.3 Prioritize Water Systems Based on Selected Criteria

When prioritization criteria data are available for the water systems that are to be included in the area-wide optimization program, each of the systems can be assigned points, as shown in Table 3-2. The water systems are then ranked from highest priority (i.e., most points) to lowest priority (i.e., least points). Ideally, a prioritized water

Table 3-1. Example Prioritization Criteria for Surface Water Systems

Prioritization Criteria	Points (0 if No)
Has the water system had an imminent health violation within the last two (2) years (turbidity, CT, positive coliform)?	10 - 15
Does the water system achieve the optimization turbidity goal for filtered water of 0.1 NTU? ≥ 95 % time 50 - < 95 % time < 50 % time	0 5 10
Does the water system experience post filter backwash turbidity of > 0.3 NTU for greater than 15 minutes?	0 - 10
Does the water system achieve the optimization turbidity goal for settled water (e.g., < 2 NTU 95% time)?	0 - 5
Does the water system have operation and treatment problems (e.g., improper chemical feed, improper jar testing, inadequate procedures)?	0 - 5
Does the water system experience sedimentation and filtered water turbidity variability given changing raw water quality?	0 - 5
Does the water system lack administrative support (e.g., inadequate funding, inadequate support of system operational needs)?	0 - 5
Does the water system have poor source water quality (e.g., high turbidity variability, high presence of protozoan parasites)?	0 - 3
Does consistent, high-quality source water lead to complacency in the operation and management of the water system?	0 - 3
Does the water system fail to monitor raw, settled and filtered water turbidity?	0 - 3

Figure 3-3. Example turbidity monitoring data for 12-month period.

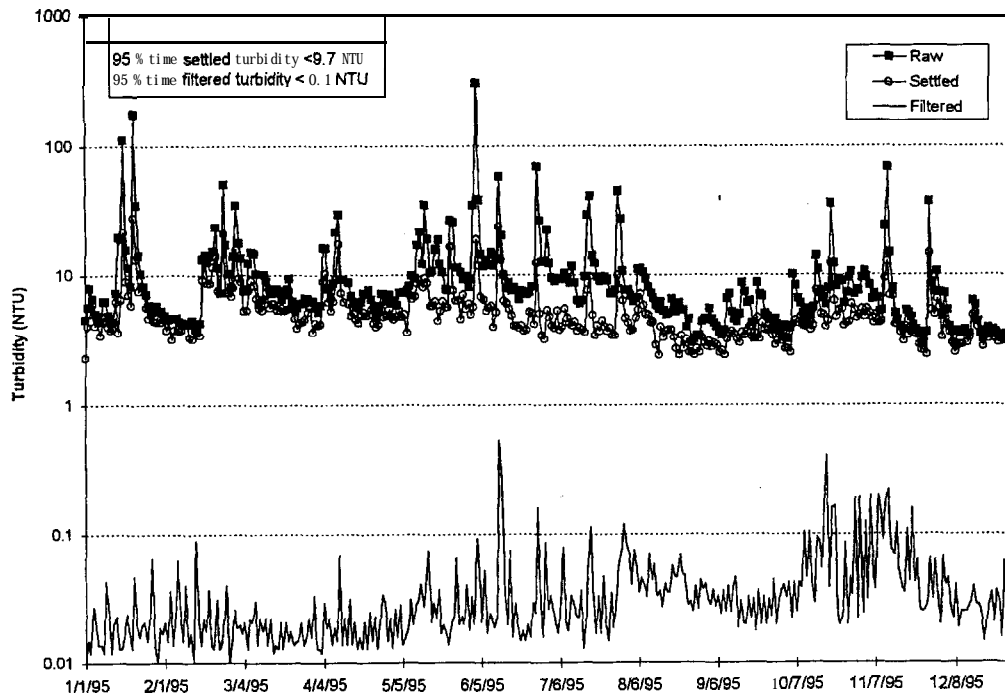

Table 3-2. Example Prioritization Database

Water System	Violations	Filter Turbidity Performance	Settled Turbidity Performance	O&M Problems	Variability	Backwash Spikes	Admin Support	Poor Source Water	Complacency & Reliability	Lack of Monitoring	Total Points
2	12	5	5	5	5	5	5	0	3	3	48
1	15	10	3	5	3	5	2	0	0	3	46
5	10	5	3	3	3	4	2	2	0	3	35
3	10	5	3	5	3	3	0	0	0	3	32
7	0	2	3	2	3	4	3	2	4	4	27
6	0	2	2	3	3	2	4	0	4	5	25
10	0	2	4	3	3	3	5	0	0	3	23
9	0	0	3	3	2	0	4	3	4	0	19
6	0	2	3	1	3	0	2	3	0	0	14
4	0	0	2	0	0	0	2	0	0	0	4

system database would include each system and their total point score. This database should be updated routinely (e.g., quarterly) to reflect new information from system reports, field surveys, and performance data.

3.4.4 Assess Response to Prioritized Water Systems

Information gained from the prioritization database provides the basis for determining the appropriate

response to achieving performance goals. For example, some specific actions that could result from an area-wide prioritization database include:

- High scoring utilities:
 - Apply CCP
 - Modifications/major construction
 - Enforcement action

- Moderate scoring utilities:
 - Performance-focused sanitary survey
 - Centralized training using CCP principles (focus on high ranking performance limiting factors)
- Low scoring utilities:
 - Telephone contact
 - Self-assessment
 - Maintain or reduce frequency of sanitary surveys

Use of a performance-based prioritization database provides assurance that the identified responses are commensurate with the level of public health risk. Following this approach, the CCP, a proven process that can result in optimized performance, is applied at water systems that have the highest public health risk.

3.5 References

1. USEPA. 1997. National Primary Drinking Water Regulations: Interim Enhanced Surface Water Treatment Rule; Notice of Data Availability; Proposed Rule. *Fed. Reg.*, 62:212:59486 (November 3, 1997).
2. Renner, R.C., B.A. Hegg, J.H. Bender, and E.M. Bissonette. 1993. "Composite Correction Program Optimizes Performance at Water Plants." *Journal AWWA*, 85(3):67.
3. Pizzi, N.G., B.A. Hegg, J.H. Bender, and J. DeBoer. 1997. "Cleveland's Self-Assessment and Contribution to the Partnership for Safe Water Peer Review Process." Proceedings - AWWA Annual Conference, June 1997, Atlanta, GA.
4. Jespersion, K. 1997. "Pilot Program Ripples Through PA DEP." *E-Train*, Published by the National Environmental Training Center for Small Communities.
5. Hoover, J.T., R.J. Lieberman, L.D. DeMers, and J. Borland. 1997. "Public Water Supply Area-Wide Optimization Strategy." Presentation at the Association of State Drinking Water Administrators Annual Conference, October 1997, Savannah, GA.

Chapter 4 Comprehensive Performance Evaluation

4.1 Introduction

This chapter provides information on the evaluation phase of the CCP, which is a two-step process to optimize the performance of existing surface water treatment plants. For purposes of this handbook, optimization is defined as achieving the performance goals as outlined in Chapter 2. The evaluation phase, called a Comprehensive Performance Evaluation (CPE), is a thorough review and analysis of a facility's design capabilities and associated administrative, operational, and maintenance practices as they relate to achieving optimum performance from the facility. A primary objective is to determine if significant improvements in treatment performance can be achieved without major capital expenditures. This chapter covers three main areas related to CPEs. First, a CPE methodology section presents all of the major technical components of a CPE and their theoretical basis. The following section discusses how to implement the CPE methodology when conducting a CPE. This section also includes many practical considerations based on the field experience gained by conducting actual CPEs. The last section of this chapter includes a case history of an actual CPE.

4.2 CPE Methodology

Major components of the CPE process include: 1) assessment of plant performance, 2) evaluation of major unit processes, 3) identification and prioritization of performance limiting factors, 4) assessment of applicability of the follow-up phase, and 5) reporting results of the evaluation. Although these are distinct components, some are

conduct of an actual CPE. A discussion of each of these components follows.

4.2.7 Assessment of Plant Performance

from plant records supplemented by data collected relative to achieving the optimized performance

less-than-optimized performance. optimized performance, a water treatment plant source of variable quality and produce a consistent ance of each unit process must demonstrate its ticles at all times. The performance assessment sistently perform at optimum levels to provide ance is not optimized, it also provides valuable problems and serves as the basis for other CPE findings.

4.2.1.1 Review and Trend Charting of Plant Operating Records

The performance assessment is based on turbidity data located in plant operating records. These records, along with a review of laboratory quality control procedures (especially calibration of turbidimeters) and sample locations, are first assessed to ensure that proper sampling and analysis have provided data that is representative of plant performance. The next step is to prepare trend graphs of the maximum daily turbidities for the raw water, settled water, finished water, and individual filter effluents, if available. Data for the most recent one-year period is used in this evaluation and can typically be obtained from the plant's process control data sheets. Maximum values are used in these trend charts since the goal is to assess the integrity of each barrier at its most vulnerable time. A twelve-month period is utilized because it includes the impacts of seasonal variations and provides a good indicator of long term performance.

Data development can be accomplished by using a commercial computer spreadsheet. However, spreadsheets that work with several commercially available spreadsheet programs were developed *Partnership for Safe Water* (1) and have proven valuable in making the desired performance assessment trend charts. The Partnership data how to use them are provided in Appendix A.

Figure 4-1 shows an example of performance assessment trend charts prepared for a typical plant. In addition to the trend charts, a percentile analysis can also be made using the data to determine the percent of time that raw, settled and finished water quality is equal to or less than a certain turbidity. This information can be used to assess the variability of raw water turbidity and the performance of sedimentation and filtration unit processes. The percentile analysis of settled and finished water quality are useful to project a plant's capability to achieve optimized performance objectives. An example of the percentile analysis for the data shown in Figure 4-1 is presented in Table 4-1. It is noted that the trend charts and the percentile analysis are developed as a portion of the Partnership data development spreadsheets and are shown in Appendix A. The data provided in Table 4-1 was taken from the yearly summary on the percentile portion of the software output. It is often useful to summarize the data in this fashion since the spreadsheet provides a significant amount of information.

Once the trend charts and percentile analysis have been developed, interpretation of the data can be accomplished. A good indication of the stability of plant operation can be obtained from comparing a plot of raw water, settled water and finished water turbidity. When comparing these data, the evaluator should look for consistent settled and filtered water turbidities even though raw water quality may vary significantly. In Figure 4-1 the raw water turbidity shows variability and several significant spikes. Variability is also evident in the settled and finished water turbidities. In addition a raw water "spike" on March 9th carried through the plant resulting in a finished water turbidity close to 1 NTU. These "pass through variations and spikes" indicate that the performance of this plant is not optimized and that a threat of particle and possibly pathogen passage exists. In plants that have consistent low raw water turbidities, periodic spikes in sedimentation and finished water that appear related to changes in raw water quality may indicate that the plant staff are complacent and lack process control skills. The administrative support for the plant may also play a role in this complacency.

Optimized performance for the sedimentation basin in the example is assessed based on achieving settled water turbidities consistently less than 2 NTU in 95 percent of the samples, since the average raw water turbidity exceeds 10 NTU (e.g., 19 NTU). In the example shown, the settled

water turbidity was less than or equal to 5.3 NTU at the 95th percentile. This indicates less-than-optimum performance from this process barrier.

Optimized performance for the finished water is assessed based on achieving 0.1 NTU or less in 95 percent of the samples. For the example shown, the finished water was 0.48 NTU or less in 95 percent of the samples; consequently, optimum performance was not being achieved by this barrier. In summary, the interpretation of the data shown in Figure 4-1 and Table 4-1 indicates that optimum performance is not being achieved, and it will be necessary to identify the causes for this less-than-optimum performance during the conduct of the CPE.

CPEs conducted to date have revealed that operating records often do not have adequate information to complete the performance assessment. Maximum daily turbidities are often not recorded and settled water turbidity information often does not exist. The fact that this type of information is not available provides a preliminary indication about the priority that the utility has on pursuing achievement of optimum performance goals.

Particle data, when available, can also be used to assess optimized performance. Typically, particle data will provide a more sensitive assessment of filter performance when the turbidity is less than 0.1 NTU. Particle counts will normally show more subtle changes in filter performance than indicated by the turbidimeters. This does not mean that turbidimeter information should be ignored when particle count data is available. It is important that the evaluator have confidence in the filter's performance relative to producing water that is less than 0.1 NTU.

4.2.1.2 Supplemental Data Collection

Plant records used for the trend charting performance assessment activities are usually based on clearwell samples collected at four-hour intervals as required by regulations. Complete assessment of optimized performance, however, also requires knowledge of the instantaneous performance of individual treatment units; especially for individual filters. Many plants currently do not have separate turbidimeters on individual treatment units, and most of these do not have equipment that will provide continuous recording of the data. To supplement the performance data available from the

Figure 4-1. Example performance assessment trend charts.

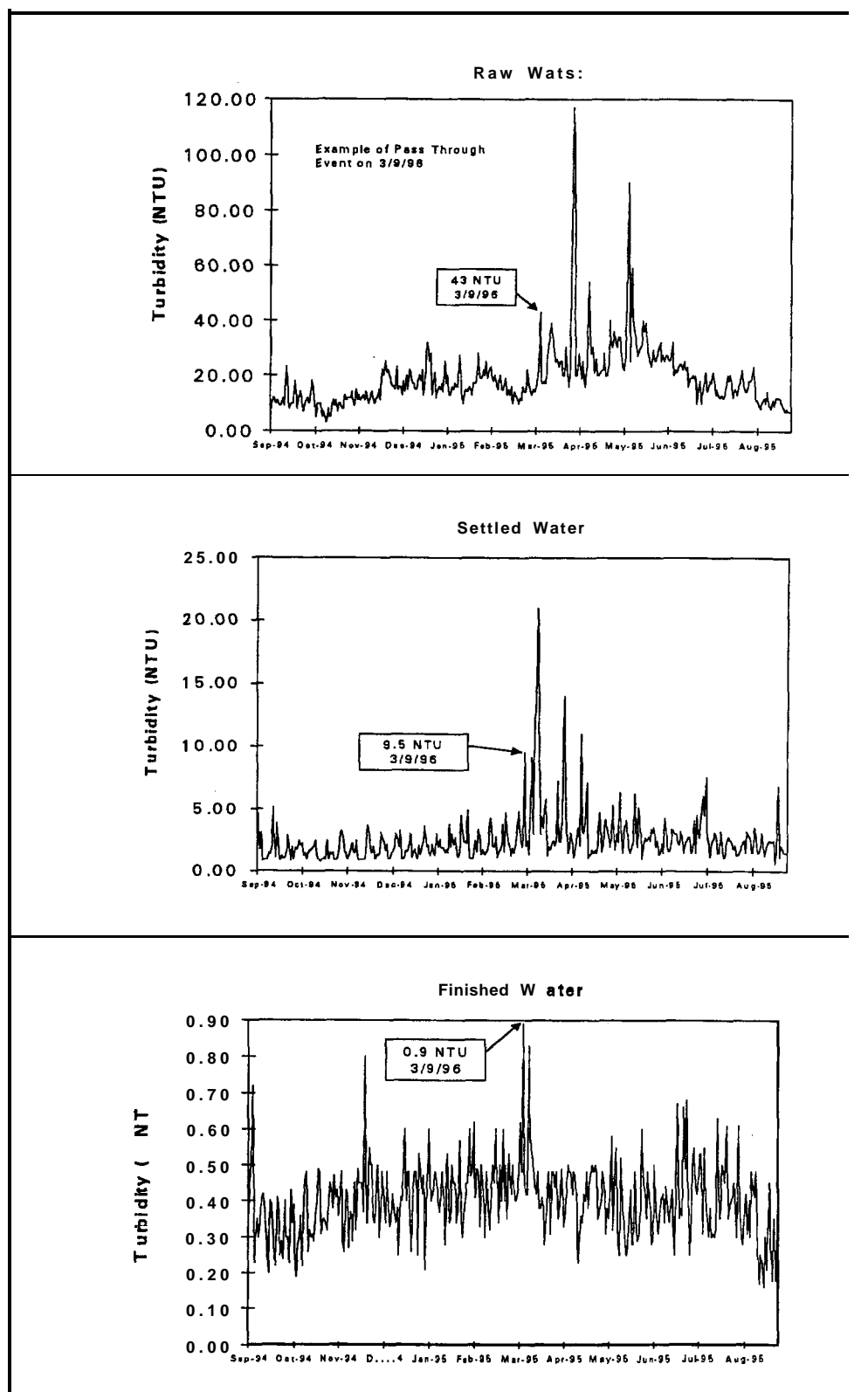

Table 4-1. Percentile Distribution Analysis of Water Quality Data*

Percent of Time Values Less Than or Equal To Value Shown	Raw Water Turbidity NTU	Settled Water Turbidity NTU	Finished Water Turbidity NTU
50	17	2.1	0.30
75	22	3.0	0.38
90	29	4.1	0.44
95	34	5.3	0.48
Average	19	2.6	0.31

*Percentile analysis is based on peak daily turbidities measured for each sample source for the twelve-month evaluation period.

plant records, additional turbidity performance data is usually collected during the CPE.

Optimum performance cannot be assessed without an evaluation of individual filter performance. Finished water samples are often obtained from the clearwell. The clearwell “averages” the performance of the individual filters and thus may mask the impact of damaged underdrains, of “blown media” on an individual filter, or of malfunctioning filter rate control valves. A malfunctioning individual filter could allow the passage of sufficient microbial contamination to threaten public health despite the plant as a whole producing a low finished water turbidity. A second reason for the need of supplemental data collection is that most plants do not keep records of their filter backwash recovery profiles. These are needed to assess if the plant is meeting the filter backwash recovery optimized performance goals.

Since this instantaneous individual filter performance data is so critical, it is usually best if one or two independently calibrated on-line continuous recording turbidimeters are available during the CPE. Along with providing the ability to assess the performance of individual filters, these units also allow a quality control check on the plant’s monitoring equipment. On-line units will provide more information on the impacts of various

operational changes such as filter backwashes and changes in flow rates. Grab sampling from individual filters can provide useful insights about the performance of individual filter units, but a continuous recording turbidimeter provides more accurate results. Grab sampling to assess individual filter performance is also cumbersome because many samples at short time increments (e.g., 1 minute intervals) are needed to get an accurate filter backwash recovery profile. It is noted, however, that in a plant with multiple filters it is advantageous to collect grab samples from individual filters for turbidity analysis before selecting the filter that is to be monitored by the continuous recording turbidimeter. The filter demonstrating the poorest performance should be selected for analysis. If all filters demonstrate similar performance, it is desirable to install the on-line turbidimeter on a filter to be backwashed to allow observation of the backwash recovery profile.

Continuous monitoring and recording of turbidity from each filter allows identification of short term turbidity excursions such as: impacts of malfunctioning filter rate control valves, impacts of hydraulic changes such as adjustments to plant flow, impacts of hydraulic loading changes during backwash of other filters, impacts of plant start-up, and impacts of backwashing on individual filters. When the plant staff can properly apply process control concepts they can eliminate these variations in turbidity either through proper control of the hydraulic loadings to the treatment processes or through chemical conditioning. These types of turbidity fluctuations on the filter turbidimeters are often indicators of inadequate process control that must be verified during the CPE.

Figure 4-2 shows results of continuous recording of turbidity from a filter that was backwashed. As indicated, optimized performance of 0.1 NTU or less was not being achieved prior to the backwash. Also, the post backwash turbidity spike of 0.95 NTU exceeded the optimized performance goal of 0.3 NTU, and the filtered water turbidity did not recover to 0.1 NTU or less within a 15-minute period.

These same goals are also used to assess backwash spikes and optimized performance at plants that use filter-to-waste. The 15-minute recovery period starts when the filter begins filtering after backwash even though the plant may filter-to-waste for longer periods of time. The rationale for

Figure 4-2. Example of individual filter monitoring.

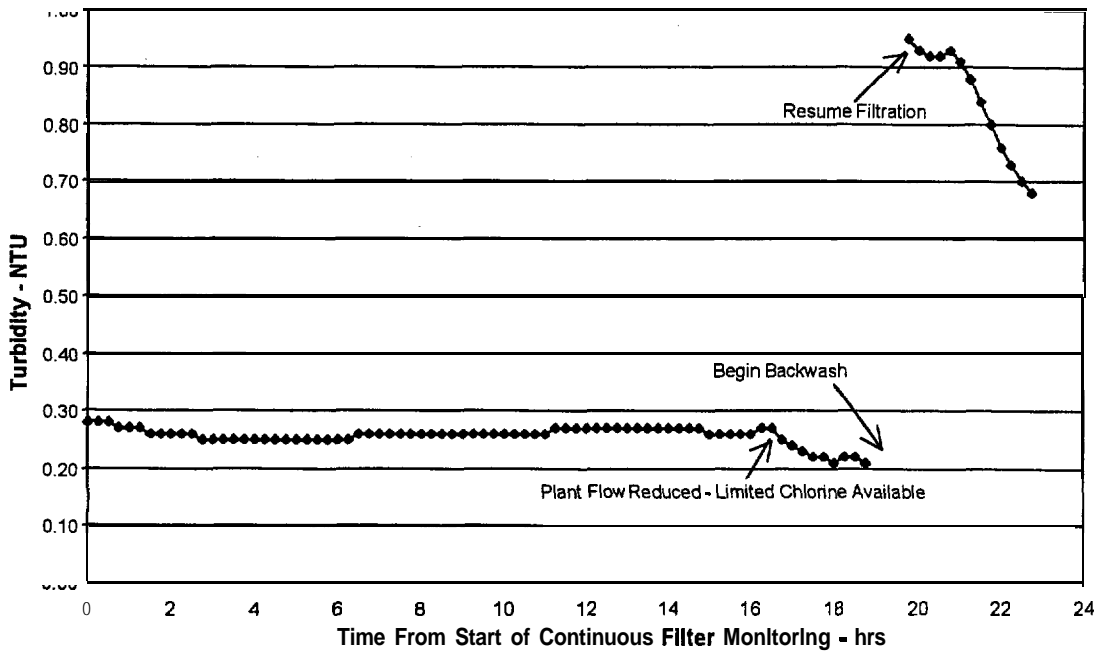

this approach is that the control of backwash spikes is a key indicator of the adequacy of the plant's process control program and chemical conditioning of the filters. Waiting until the filter-to-waste is completed to assess backwash spikes could hide key information relative to the process control capability of the plant staff.

As discussed above, many plants do not collect and/or record data on sedimentation basin performance. During a CPE, therefore, it may be necessary to collect sedimentation basin performance data to assess if this process is meeting the optimized performance goals. It may be necessary to collect data on individual sedimentation units if one appears to have worse performance than the others. Usually, grab sampling of these units will suffice.

4.2.2 Evaluation of Major Unit Processes

4.2.2.1 Overview

The major unit process evaluation is an assessment of treatment potential, from the perspective of capability of existing treatment processes to achieve optimized performance levels. If the evaluation indicates that the major unit processes are of adequate size, then the opportunity to opti-

mize the performance of existing facilities by addressing operational, maintenance or administrative limitations is available. If, on the other hand, the evaluation shows that major unit processes are too small, utility owners should consider construction of new or additional processes as the initial focus for pursuing optimized performance.

It is important to understand that the major unit process evaluation only considers if the existing treatment processes are of adequate size to treat current peak instantaneous operating flows and to meet the optimized performance levels. The intent is to assess if existing facilities in terms of concrete and steel are adequate and does not include the adequacy or condition of existing mechanical equipment. The assumption here is that if the concrete and steel are not of adequate size then major construction may be warranted, and the pursuit of purely operational approaches to achieve optimized performance may not be prudent. The condition of the mechanical equipment around the treatment processes is an important issue, but in this part of the CPE it is assumed that the potential exists to repair and/or replace this equipment without the disruption of the plant inherent to a major construction project. These types of issues are handled in the factors limiting performance component of the CPE, discussed later in this chapter. It is also projected in the major unit

process evaluation that the process control requirements to meet optimized performance goals are being met. By assuming that the equipment limitations can be addressed and that operational practices are optimized, the evaluator can project the performance potential or capability of a unit process to achieve optimized performance goals.

The evaluation approach uses a rating system that allows the evaluator to project the adequacy of each major treatment process and the overall plant as either Type 1, 2 or 3, as graphically illustrated in Figure 4-3. Type 1 plants are those where the evaluation shows that existing unit process size should not cause performance difficulties. In these cases, existing performance problems are likely related to plant operation, maintenance, or administration. Plants categorized as Type 1 are projected to most likely achieve optimized performance through implementation of non-construction-oriented follow-up assistance (e.g., a CTA as described in Chapter 5).

Figure 4-3. Major unit process evaluation approach.

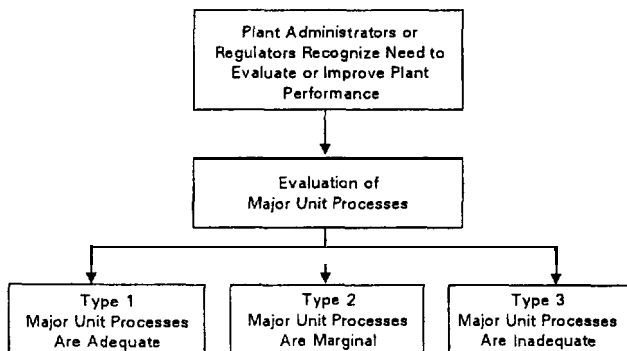

The Type 2 category is used to represent a situation where marginal capability of unit processes could potentially limit a plant from achieving an optimum performance level. Type 2 facilities have marginal capability, but often these deficiencies can be “operated around” and major construction is not required. In these situations, improved process control or elimination of other factors through implementation of a CTA may allow the unit process to meet performance goals.

Type 3 plants are those in which major unit processes are projected to be inadequate to provide required capability for the existing plant flows. For Type 3 facilities, major modifications are

believed to be required to achieve optimized performance goals. Although other limiting factors may exist, such as the operator’s lack of process control capability or the administration’s unfamiliarity with plant needs, consistent acceptable performance cannot be expected to be achieved until physical limitations of major unit processes are corrected.

Owners with a Type 3 plant are probably looking at significant expenditures to modify existing facilities so they can meet optimized performance goals. Depending on future water demands, they may choose to conduct a more detailed engineering study of treatment alternatives, rate structures, and financing mechanisms. CPEs that identify Type 3 facilities are still of benefit to plant administrators in that the need for construction is clearly defined. Additionally, the CPE provides an understanding of the capabilities and weaknesses of all existing unit processes, operation and maintenance practices, and administrative policies.

As discussed in Chapter 2, water suppliers have a key role to play in public health protection and a responsibility to water quality that they must meet on a continuous basis. If a facility is found to pose a severe health risk because of its performance, some action must be taken even if it is found to be Type 3. In the short term, other weaknesses in the plant that are identified in other components of the CPE may need to be addressed to improve performance as much as possible. If these actions do not result in satisfactory performance, a boil water order or water restriction may have to be implemented until modifications are completed and performance is improved. This may require coordination with appropriate state regulatory agencies. The water system must also make long term plans to upgrade or replace deficient treatment processes.

Another situation that must be considered in completing the major unit process evaluation is the age and condition of the plant. Though the CCP approach attempts to minimize construction of new facilities, some plants are so old that they are not structurally sound and/or contain antiquated equipment (e.g., outdated filter rate-of-flow control valves). It is possible that the major unit process evaluation will show these plants as Type 1 because they were designed based on conservative loadings and/or the water demand of the area has not increased. In these cases, the owner of the plant will have to look at the plant needs, both long term and short term. In addition, the plant

may be able to optimize performance to meet short term public health protection, but will also have to consider construction of a new plant in order to provide high quality water on a long term basis.

4.2.2.2 Approach

Major unit processes are evaluated based on their capability to handle current peak instantaneous flow requirements. The major unit processes included in the evaluation are flocculation, sedimentation, filtration and disinfection. These processes were selected for evaluation based on the concept of determining if the basin sizes are adequate. The performance potential of a major unit process is not lowered if “minor modifications”, such as providing chemical feeders or installing baffles, could be accomplished by the utility. This approach is consistent with the CPE intent of assessing adequacy of existing facilities to determine the potential of non-construction alternatives. Other design-related components of the plant processes, such as rapid mix facilities, are not included in the major unit process evaluation but rather are evaluated separately as factors that may be limiting performance. For purposes of the major unit process evaluation, these components are projected to be addressed through “minor modifications.” It is important to note that the major unit process evaluation should not be viewed as a comparison to the original design capability of a plant. The major unit process evaluation is based on an assessment of existing unit processes to meet optimized performance goals. These goals are most likely not the goals that the existing facility was designed to achieve.

A performance potential graph is used to evaluate major unit processes. As an initial step in the development of the performance potential graph, the CPE evaluators are required to use their judgment to select loading rates which will serve as the basis to project peak treatment capability for each of the major unit processes. It is important to note that the projected capability ratings are based on achieving optimum performance from flocculation, sedimentation, filtration and disinfection such that each process maintains its integrity as a “barrier” to achieve microbial protection. This allows the total plant to provide a “multiple barrier” to the passage of pathogenic organisms into the distribution system.

The projected unit process treatment capability is then compared to the peak instantaneous operating flow rate experienced by the water treatment plant during the most recent twelve months of operation. If the most recent twelve months is not indicative of typical plant flow rates, the evaluator may choose to review a time period considered to be more representative. The peak instantaneous operating flow is utilized because unit process performance is projected to be most challenged during these peak loading events and it is necessary that high quality finished water be produced on a continuous basis.

An example performance potential graph is shown in Figure 4-4. The major unit processes evaluated are shown on the left of the graph and the various flow rates assessed are shown across the top. Horizontal bars on the graph depict projected capability for each unit process, and the vertical line represents the actual peak operating flow experienced at the plant. Footnotes are used to explain the loading criteria and conditions used to rate the unit processes.

Figure 4-4. Example performance potential graph.

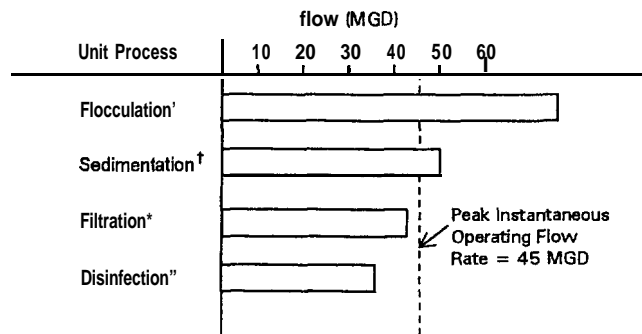

- * Rated at 20 min hydraulic detention time (HDT); assumes variable speed drive would be added to existing flocculator.
- † Rated at 0.6 gpm/sq ft surface overflow rate (SOR); 12.5 ft depth.
- ‡ Rated at 4 gpm/sq ft hydraulic loading rate (HLR); dual media: assumes adequate media depth and backwashing capability.
- ** Rated at CT = 127 mg/L-min based on 2.4 mg/L Cl₂ residual, 53-min HDT, total 4 log *Giardia* reduction (1.5 log by disinfection), pH = 8, temperature = 5 °C, 10% of usable clearwell volume, and depth in clearwell maintained > 9 feet.

The approach to determine whether a unit process is Type 1, Type 2 or Type 3 is based on the relationship of the position of horizontal bars to the position of the peak instantaneous operating flow rate. It is noted that if a plant operates at peak instantaneous operating flow with one unit out of service, then the evaluation would be based on these conditions. As presented in Figure 4-5, a unit process would be rated Type 1 if its projected capability exceeds the peak instantaneous operating flow rate, Type 2 if its projected capability was 80 to 100 percent of peak, or Type 3 if its projected capability is less than 80 percent of peak.

Figure 4-5. Major unit process rating criteria.

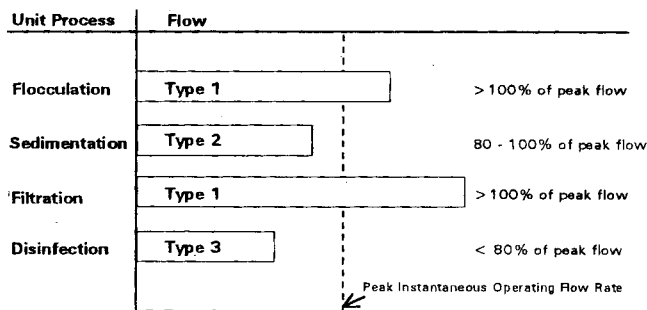

4.2.2.3 Determining Peak Instantaneous Operating Flow

A key aspect of the major unit process evaluation is the determination of peak instantaneous operating flow rate. This is the flow rate against which the capability of each of the major unit processes is assessed. Based on this assessment, the unit process type is projected, which determines if major construction will be required at the plant.

An additional evaluation of both the peak instantaneous operating flow rate and plant operating time allows the evaluator to determine if plant capability can be enhanced by reducing the plant flow rate and extending the plant operating time. Some plants only operate for part of the day and shut down at night. In these cases, the peak instantaneous operating flow rate of the plant could be occurring only over a 12-hour period, and the plant may be able to operate at half the flow rate for a 24-hour period. In this example, a unit process that received a Type 3 rating may be able to achieve Type 2 or Type 1 status. When a plant decides to reduce flows, however, there probably will be additional expenses for staff to operate the

plant for the extended time periods needed to meet water demand. Basically the plant is trading off the costs for staff with those required to construct additional treatment capacity. In addition, it may be possible for a community to take steps to reduce demand by activities such as increasing water rates, water rationing, or leak detection and repair of their distribution system.

The peak instantaneous operating flow rate and unit process loadings need to be carefully selected and assessed by the evaluator since these parameters in the unit process evaluation can direct the utility either toward construction or pursuing optimization with existing facilities. During a CPE every effort should be made to direct the plant toward optimization with existing facilities. In completion of the major unit process evaluation, this means that selection of parameter(s) such that it directs a plant to pursue major construction should be made after much consideration of the impacts on optimized performance and public health protection.

Peak instantaneous operating flow rate is identified through review of operating records and observation of operation practices and flow control capability. A review of plant flow records can be misleading in determining peak instantaneous flow. For example, records may indicate a peak daily water production value, and discussions with the operating staff may indicate that the plant was not operated for a full 24-hour period. If the recorded production was not for the full 24-hour period but had been determined by calculating an average flow rate over the 24-hour period, a rate that was less than the actual peak instantaneous operating flow would be identified. Peak instantaneous operating flow is that flow rate which the unit processes actually receive. For example, a plant may have two constant speed raw water pumps each capable of pumping at 1,000 gpm. If only one is operated at a time for 12 hours per day, the peak instantaneous flow rate would be established at 1,000 gpm. If, however, operating personnel indicate that a control valve is used to throttle the pump to 750 gpm on a continuous basis, the peak instantaneous flow rate would be established at 750 gpm. In a third situation, the plant staff may operate both pumps during times of the peak water demand (e.g., summer) which ideally would make the peak instantaneous flow rate 2,000 gpm. It is noted that the peak flow rate when both pumps are operated is often lower than when using a single pump. The maximum value for the two pumps should be used even if the

plant only operates this way for a few days at a time.

4.2.2.4 Rating Individual Unit Processes

The next step in preparing a performance potential graph is selecting appropriate loading rates for each of the major unit processes. Once the loading rates are selected, the performance potential of a unit process to achieve optimized performance goals can be projected. The criteria presented in Table 4-2 can be used to assist in selecting loading rates for individual unit processes. There is a wide range in the criteria which can translate into large differences in the projected unit process capabilities. Criteria to help in "adjusting" loading rates for site-specific conditions are provided. However, using the performance potential graph approach requires a great deal of judgment on behalf of an experienced water treatment plant evaluator to properly project capability of a major unit process.

It is noted that other resources are available to assist less experienced evaluators in completing a major unit process evaluation. One of these

resources is the Water Advisor expert system (2) which prepares a major unit process evaluation based on pre-selected loading rates. This program, developed to assess plants based on 1989 SWTR compliance, is several years old; and the loading rates have not been recently updated. When using this program, the evaluator has no opportunity to change loading rates based on the unique conditions of a particular plant. An inexperienced evaluator may find this a useful tool to check the major unit process evaluation completed using the procedures in this handbook. A further description of this software is contained in Appendix B.

An additional resource is the Partnership for Safe Water software (1). A copy of this software, as well as a description of its use, is located in Appendix C. The Partnership for Safe Water software provides suggested loading rates based on industry standards and operating experience, but also allows the CPE evaluator to easily change loading rates and plot different performance potential graphs.

The criteria presented in Table 4-2 are considered to be the most current, relative to achieving

Table 4-2. Major Unit Process Evaluation Criteria (1,2,3,4,5,6,7)

Flocculation		Hydraulic Detention Time
Base		20 minutes
Single-Stage	Temp $\leq 0.5^{\circ}\text{C}$	30 minutes
	Temp $> 0.5^{\circ}\text{C}$	25 minutes
Multiple Stages	Temp $\leq 0.5^{\circ}\text{C}$	20 minutes
	Temp $> 0.5^{\circ}\text{C}$	15 minutes

Filtration	Air Binding	Loading Rate
Sand Media	None	2.0 gpm/ft ²
	Exists	1.0-1.5 gpm/ft ²
Dual/Mixed Media	None	4.0 gpm/ft ²
	Exists	2.0-3.0 gpm/ft ²
Deep Bed (Typically anthracite >60 in. in depth)	None	6.0 gpm/ft ²
	Exists	3.0-4.5 gpm/ft ²

Sedimentation (cold seasonal water $< 5^{\circ}\text{C}$)*				
Conventional (circular and rectangular) and solids contact units				
Operating Mode				
Conventional Depth (ft)	Solids Contact Depth (ft)	Turbidity Removal SOR (gpm/ft ²)	Softening SOR (gpm/ft ²)	Color Removal SOR (gpm/ft ²)
10	12 - 14	0.5	0.5	0.3
12 - 14	14 - 16	0.6	0.75	0.4
>14	>16	0.7	1.0	0.5
Conventional (circular and rectangular) and solids contact units - with vertical ($> 45^{\circ}$) tube settlers				
Operating Mode				
Depth (ft)	Turbidity Removal SOR (gpm/ft ²)	Softening SOR (gpm/ft ²)	Color Removal SOR (gpm/ft ²)	
10	1.0	1.5	0.5	
12 - 14	1.5	2.0	0.75	
>14	2.0	2.5	1.0	

*If long term (12 months) data monitoring indicates capability to meet performance goals at higher loading rates, then these rates can be used.

optimized performance goals and are the criteria that are used for development of the major unit process evaluation for this handbook. However, the performance of the unit process in meeting the optimized performance goals should be a major consideration in the selection of evaluation criteria. The situation where a unit process continuously performs at optimized levels should not be rated as a Type 2 or Type 3 unit process merely based on the criteria in Table 4-2. Specific guidance for assessing each unit process is described in the following sections.

Flocculation

Proper flocculation requires sufficient time to allow aggregation of particles so that they are easily removed in the sedimentation or filtration processes. The capability of the flocculation process is projected based on the hydraulic detention time in minutes required to allow floc to form at the lowest water temperature. Judgment is used to adjust the selected times based on the type of treatment plant, number of stages, and ability to control mixing intensity.

Selection of the required detention time for adequate flocculation can vary widely depending on water temperature. For example, at plants where water temperatures of less than 5°C (41°F) occur, floc formation can be delayed because of the cold water. In these instances, longer (e.g., 30-minute) detention times may be required. If temperatures are not as severe, detention times as low as 15 minutes or less could be considered adequate.

Other factors to consider include the number of flocculation stages and the availability of variable energy input to control flocculation. A minimum of three stages of flocculation is desirable. However, because the baffling and variable mixing energy can often be added or modified through minor modifications, these items are not considered as significant in determining the basin capability rating. Baffling a flocculation basin to better achieve plug flow conditions can often significantly improve the size and settleability of the floc. If adequate basin volume is available (i.e., typically a Type 1 unit process), a one-stage flocculation basin may result in a Type 2 rating with the stipulation that baffling could be provided to overcome the single-stage limitation if it was shown to be limiting in follow-up CTA activities.

The following guidelines are provided to aid in selecting a hydraulic detention time to be used in development of the flocculation unit process performance potential:

- Desired hydraulic detention times for floc formation are:
 - Typical range: 15 to 30 minutes.
 - Cold low turbidity waters (e.g., <0.5° C and < 5 NTU): 30 minutes or greater for a conventional plant.
 - With tapered mixing and at least three stages, use lower end of ranges. Twenty minutes is commonly used for multiple stages in temperate climates.
 - With single-stage, use upper end of ranges shown in Table 4-2.
- Lower hydraulic detention times than those shown in Table 4-2 can be used to project capacity in cases where plant data demonstrates that the flocculation basin contributes to the plant achieving the desired performance goals at higher loading rates.

Sedimentation

Except for consistent low turbidity waters, sedimentation is one of the multiple barriers normally provided to reduce the potential of cysts from passing through the plant. The sedimentation process is assessed based on achieving a settled water turbidity of less than 1 NTU 95 percent of the time when the average raw water turbidity is less than or equal to 10 NTU and less than 2 NTU when the average raw water turbidity exceeds 10 NTU.

Sedimentation performance potential is projected primarily based on surface overflow rate (SOR) with consideration given to the basin depth, enhanced settling appurtenances (e.g., tube settlers), and sludge removal mechanisms. Greater depths generally result in more quiescent conditions and allow higher SORs to be used (see Table 4-2). Sludge removal mechanisms also must be considered when establishing an SOR for projecting sedimentation capability. If sludge is manually removed from the sedimentation basin(s), additional depth is required to allow volume for

sludge storage. For these situations, the selected SOR should be lowered.

Sedimentation capacity ratings can be restricted to certain maximum values because of criteria established by state regulatory agencies on hydraulic detention time. In these cases, state criteria may be used to project sedimentation treatment capability. However, if data exists that indicates the sedimentation basins can produce desired performance at rates above the state rate, it may be possible to obtain a variance from the state criteria.

As shown in Table 4-2, the availability of or the addition of tube or plate settlers in existing tankage can be used to enhance the performance potential of the sedimentation process (e.g., perform at higher SORs). Upflow-solids-contact clarifiers represent a unique sedimentation configuration since they contain both a flocculation and sedimentation process that have been designed as a single unit. These units can be rated using the center volume to assess the flocculation capability and the clarifier surface area to rate the sedimentation capability.

The following guidelines are suggested to aid in selecting a surface overflow rate to be used in the development of the sedimentation unit process capability.

- SORs to project performance potential for rectangular, circular, and solids contact basins, operating in a temperate climate with cold seasonal water (< 5°C) are shown in Table 4-2.
- SORs to project performance potential for basins with vertical (> 45°) tube settlers, operating in a temperate climate with cold seasonal water (< 5°C) are shown in Table 4-2.
- SORs for projecting performance potential of proprietary settling units are:
 - . Lamella plates:
 - * 10 ft long plates with 2-inch spacing at 55° slope
 - * 4 gpm/ft² (based on surface area above plates)
 - Contact adsorption clarifiers (CACs):
 - * 6 - 8 gpm/ft²

- Higher SORs than those shown in Table 4-2 can be used to project capability in cases where plant data demonstrates that a sedimentation basin achieves the desired performance goals at these higher loading rates.

Filtration

Filtration is typically the final unit treatment process relative to the physical removal of microbial pathogens and, therefore, high levels of performance are essential from each filter on a continuous basis. Filters are assessed based on their capability to achieve a treated water quality of less than or equal to 0.1 NTU 95 percent of the time (excluding the 15-minute period following backwash) based on the maximum values recorded during 4-hour time increments. Additional goals include a maximum filtered water turbidity following backwash of less than or equal to 0.3 NTU with a recovery to less than 0.1 NTU within 15 minutes.

The performance potential of the filtration process is projected based on a filtration rate in gpm/ft² which varies based on the type of media as shown in Table 4-2. For mono-media sand filters a maximum filtration rate of 2 gpm/ft² is used because of the tendency of this filter to surface bind by removing particles at the top of the filter. Dual or mixed-media filters use a filtration rate of 4 gpm/ft² because of their ability to accomplish particle removal throughout the depth of the anthracite layer. Using the anthracite layer allows higher filtration rates to be achieved while maintaining excellent filtered water quality. Filtration rates can be, and often are, restricted to certain maximum values because of criteria established by state regulatory agencies. In these cases, state criteria may be used to project filter performance potential. However, if data exists that indicates the filters can produce desired performance at filtration rates above the state rate, it may be possible to obtain a variance from the state criteria.

Limitations caused by air binding can also impact the selected loading rate for projecting a filter's performance potential and could bias the selected loading rate toward more conservative values (see Table 4-2). Air binding is a condition that occurs in filters when air comes out of solution as a result of pressure decreases or water temperature increases (i.e., the water warms as it passes through the filter. The air clogs the voids between the media grains, which causes the filter to behave

as though it were clogged and in need of backwashing. The result is shorter filter runs and limitations in hydraulic capability.

Inadequate backwash or surface wash facilities, rate control systems, and media and underdrain integrity are areas that can be addressed through minor modifications. As such, these items are assessed during a CPE as factors limiting performance and are typically not used to lower the filtration loading rate.

Disinfection

Disinfection is the final barrier in the treatment plant, and is responsible for inactivating any microbial pathogens that pass through previous unit processes. For purposes of this handbook, assessment of disinfection capability will be based on the SWTR (8). The rule requires a minimum of 99.9 percent (3 log) inactivation and/or removal of *Giardia lamblia* cysts and at least 99.99 percent (4 log) inactivation and/or removal of viruses. Under the rule, each state was required to develop its own regulations to assure that these levels of disinfection are achieved.

USEPA has published a guidance manual that presents an approach to assure that required levels of disinfection are achieved (9). The approach uses the concept of the disinfectant concentration (C) multiplied by the actual time (T) that the finished water is in contact with the disinfectant. In the guidance manual, CT values are provided that can be used to project the various log removals for various disinfectants at specific operating conditions (e.g., temperature, pH, disinfectant residual). The guidance manual also indicates that, while the 3-log and 4-log inactivation and/or removals are the minimum required, the log inactivation and/or removal may need to be increased if the raw water source is subject to excessive contamination from cysts and/or viruses. Cyst and virus removal credits for the different types of treatment processes (e.g., conventional, direct filtration) are also provided in the guidance manual.

The following procedures present an approach for projecting the capability of a plant to meet the disinfection requirements based on the CT values presented in the SWTR guidance manual. Procedures are presented for both pre- and post-disinfection, with pre-disinfection defined as adding the disinfectant ahead of the filtration process and post-disinfection defined as adding the disinfectant

following filtration. Whether or not a utility can use pre-disinfection depends on how the utility's state has developed its disinfection requirements. Some states discourage pre-disinfection because of concerns with disinfection by-products and the possible ineffectiveness of disinfectants in untreated water. Other states allow pre-disinfection because of concerns with the limited capabilities of post-disinfection systems (e.g., limited contact time). Although the approach used in this Handbook is based on the SWTR requirements, it is important to note that the major unit process evaluation for disinfection will have to be based on the disinfection requirements adopted by the utility's state regulatory agency.

Future regulations may affect the following approach for assessing disinfection unit process capability. CPE evaluators will need to carefully assess and modify the following procedures as more details concerning disinfection requirements are established.

Post-Disinfection:

The following procedure is used to assess the plant's disinfection capability when using only post-disinfection.

- *Project the total log Giardia reduction and inactivation required by water treatment processes based on the raw water quality or watershed characteristics.* Typically, *Giardia* inactivation requirements are more difficult to achieve than the virus requirements; consequently, *Giardia* inactivation is the basis for this assessment. State health departments may have established these values for a specific plant. If not, the standard requirement for a watershed of reasonable quality is a 3.0 log reduction/inactivation of *Giardia* cysts. A 4.0 or more log reduction/inactivation may be required for an unprotected watershed exposed to factors such as wastewater treatment effluents.
- *Project the log reduction capability of the existing treatment plant.* Expected removals of *Giardia* and viruses by various types of filtration plants are presented in Table 4-3. As shown, a 2.5 log reduction may be allowed for a conventional plant with adequate unit treatment process capability (e.g., Type 1 units preceding disinfection). If a Type 1 plant does not exist, the evaluator may choose to lower the projection of log removal capability for the

facility. For purposes of the projection of major unit process capability, it is assumed that the plant will be operated to achieve optimum performance from existing units.

Table 4-3. Expected Removals of *Giardia* Cysts and Viruses by Filtration (9)

Filtration	Expected Log Removals	
	<i>Giardia</i>	Viruses
Conventional	2.5	2.0
Direct	2.0	1.0
Slow Sand	2.0	2.0
Diatomaceous Earth	2.0	1.0

- Select a required CT value from the tables in the SWTR guidance document (also provided in Appendix D) based on the required log reduction/inactivation, the log reduction capability projected for the plant, the maximum pH and minimum temperature of the water being treated, and the projected maximum disinfectant residual.** The maximum pH and the minimum temperature, of the water being treated are selected to ensure capability under worst case conditions. When chlorine is used as the disinfectant, the maximum residual utilized in the evaluation should not exceed 2.5 mg/L free residual, based on research which indicates that contact time is more important than disinfectant concentration at free chlorine residuals above 2.5 mg/L (10). Maximum chlorine residual may also be impacted by maximum residuals tolerated by the consumer.
- Using these parameters, calculate a required detention time (e.g., CT required value divided by the projected operating disinfectant residual) to meet the required CT.** The following equation is used to complete this calculation.

$$T_{req}(\text{min}) = \frac{CT_{req}(\text{mg/L} \cdot \text{min})}{\text{Disinfectant Residual (mg/L)}}$$

Where:

T_{req} = **Required** detention time in post disinfection unit processes.

CT_{req} = **CT** requirements from tables in Appendix D for post disinfection conditions.

Disinfectant Residual = Selected operating residual maintained at the discharge point from the disinfection unit processes.

- Select an effective volume of the existing clearwell and/or distribution pipelines to the first user.** Effective volume refers to the volume of a basin or pipeline that is available to provide adequate contact time for the disinfectant. Effective volumes are calculated based on worst case operating conditions using the minimum operating depths, in the case of basins. This is especially critical in plants where high service pumps significantly change the operating levels of the clearwell and in plants that use backwash systems supplied from the clearwell. Depending on the information available, there are two ways to determine the effective volume.

Some plants have conducted tracer studies to determine the actual contact time of basins. Adequate contact time is defined in the regulations as T_{10} , which is the time it takes 10 percent of a tracer to be detected in the basin effluent (9). For these plants the effective volume is the peak instantaneous operating flow rate (gpm) multiplied by the T_{10} value (min) determined from the tracer studies. If a tracer study has been conducted, the results should be utilized in determining the effective contact time. It is important to note that the tracer study results must also consider peak instantaneous operating flows as well as minimum operating depths in order to project an accurate CT.

For those plants where tracer studies have not been conducted, the effective volume upon which contact time will be determined can be calculated by multiplying the nominal clearwell or pipeline volumes by a factor. Nominal volumes are based on worst case operating conditions. For example, an unbaffled clearwell may have an effective volume of only 10% (factor = 0.1) of actual basin volume because of the potential for short-circuiting; whereas, a transmission line could be based on 100% of the line volume to the first consumer because of the plug flow characteristics. A summary of factors to determine effective volume is presented in Table 4-4. Typically, for unbaffled clearwells a factor of 0.1 has been used because of the fill and draw operational practices (e.g., backwashing, demand changes) and the lack of baffles. A factor of 0.5 has been used when calculating the effective volume of flocculation and sedimentation basins when rating prechlorination, and a factor of

1.0 has been used for pipeline flow. However, each disinfection system must be assessed on individual basin characteristics, as perceived by the evaluator. Caution is urged when using a factor from Table 4-4 of greater than 0.1 to project additional disinfection capability for unbaffled basins. Available tracer test information indicates that actual T_{10}/T ratios in typical full-scale clearwells are close to 10 percent of theoretical time (10).

Table 4-4. Factors for Determining Effective Disinfection Contact Time Based on Basin Characteristics* (9)

Baffling Condition	Factor	Baffling Description
Unbaffled	0.1	None; agitated basin, high inlet and outlet flow velocities, variable water level
Poor	0.3	Single or multiple unbaffled inlets and outlets, no intra-basin baffles
Average	0.5	Baffled inlet or outlet with some intra-basin baffling
Superior	0.7	Perforated inlet baffle, serpentine or perforated intra-basin baffles, outlet weir or perforated weir
Excellent	0.9	Serpentine baffling throughout basin.
Perfect (plug flow)	1.0	Pipeline flow.

*Based on hydraulic detention time at minimum operating depth.

- Calculate a flow rate where the plant will achieve the required CT values for post-disinfection. The following equation is used to complete this calculation.

$$Q(\text{gpm}) = \left(\frac{V_{\text{post}} (\text{gal})}{T_{\text{req}} (\text{min})} \right)$$

Where:

Q = Flow rate where required CT_{99.9} can be met.

V_{post} = Effective volume for post-disinfection units.

Pre-Disinfection:

The following procedure is used to assess the plant's disinfection capability when using pre-disinfection along with post-disinfection. For purposes of the calculations, the approach assumes that the disinfection requirements can be met independently by both pre- and post-disinfection; and, therefore, these capabilities are additive when projecting plant disinfection unit process capability. The procedure is used to determine the additional disinfection capability provided if pre-disinfection is actually being practiced at the utility being evaluated. If pre-disinfection is practiced and the utility is concerned about disinfection by-products, the performance potential graph should be developed with two bars for disinfection: one including pre- and post-disinfection and one including only post-disinfection capability. This allows the evaluators and the utility to assess capability if pre-disinfection was excluded.

- Project the total Jog Giardia reduction and inactivation required by water treatment processes based on the raw water quality or watershed characteristics as presented in the post-disinfection procedure.
- Project the log reduction capability of the existing treatment plant as presented in the post-disinfection procedure.
- Select a required CT value for pre-disinfection from the tables in the SWTR guidance document. This value should be based on the required log reduction, the log reduction capability of the plant, the maximum pH and minimum temperature of the water being treated, and the projected maximum disinfectant residual. The required pre-disinfection CT value may be different than the post-disinfection conditions if different temperatures, pHs, and residuals exist for the two conditions (e.g., addition of lime or soda ash to increase the pH of finished water would change the required post-disinfection CT value relative to the pre-disinfection value). CT values for inactivation of *Giardia* cysts and viruses are presented in Appendix D.

NOTE: If chlorine is used as the pre-disinfectant, a 1.5 mg/L free chlorine residual can be used as a value in the calculations unless actual plant records support selection of a different residual.

- Calculate T_{req} (e.g., CT required value divided by the projected operating disinfectant residual) as presented in the post-disinfection procedure.
- Select an effective volume available to provide adequate contact time for pre-disinfection. Assess which basins and lines will provide contact time. These are typically the flocculation and sedimentation basins, but could include raw water transmission lines if facilities exist to inject disinfectant at the intake structure. Filters typically have not been included because of the short detention times typically inherent in the filters and the reduction in chlorine residual that often occurs through filters. However, increasingly plants are adding free chlorine ahead of the filters and ammonia after the filters to improve particle removal while minimizing DBP formation. Free residuals of 2.0 mg/L in the filter effluent are common. These residuals with a filter bed contact time of 10 to 15 minutes may meet the majority, if not all, of the CT requirement. The actual basin volumes should be converted to effective volumes by applying factors described in Table 4-4 and discussed previously in the post-disinfection procedure. Add the individual effective volumes together to obtain the total effective pre-disinfection volume.
- Calculate a flow rate where the plant will achieve the required CT values for both pre- and post-disinfection using the formula below. Use this flow rate to project the pre- and post-disinfection system capability on the performance potential graph.

$$Q \text{ (gpm)} = \left(\frac{V_{pre} \text{ (gal)}}{T_{reqpre} \text{ (min)}} \right) + \left(\frac{V_{post} \text{ (gal)}}{T_{reqpost} \text{ (min)}} \right)$$

Where:

Q = Flow rate where required CT_{req} can be met.

V_{pre} = Effective volume for pre-disinfection units.

V_{post} = Effective volume for post-disinfection units.

4.2.3 Identification and Prioritization of Performance Limiting Factors

423.1 Identification of Performance Limiting Factors

A significant aspect of any CPE is the identification of factors that limit the existing facility's performance. This step is critical in defining the future activities that the utility needs to focus on to achieve optimized performance goals. To assist in factor identification, a list of 50 different factors, plus definitions, that could potentially limit water treatment plant performance are provided in Appendix E. These factors are divided into the four broad categories of administration, design, operation, and maintenance. This list and definitions are based on the results of over 70 water treatment plant CPEs. Definitions are provided for the convenience of the user and also as a reference to promote consistency in the use of factors from plant to plant. If alternate names or definitions provide a clearer understanding to those conducting the CPE, they can be used. However, if different terms are used, each factor should be defined, and these definitions should be made readily available to others conducting the CPE and interpreting the results. Adopting and using a list of standard factors and definitions as provided in this handbook allows the effective comparison of factors identified from different plants which will enhance the usefulness of the findings for improving water system performance on an area-wide basis.

It is noted that several of the design factors refer to capability of major unit processes. If the major unit process evaluation resulted in a Type 2 or 3 classification for an individual unit process, these results are also indicated in the CPE findings as an identified factor limiting the existing facility's performance. This also applies to those situations where major unit processes are rated Type 1, but have equipment-related problems that are limiting performance. This would include key equipment that needs to be repaired and/or replaced.

A CPE is a performance-based evaluation and, therefore, factors should only be identified if they impact performance. An observation that a utility does not meet a particular "industry standard" (e.g., utility does not have a documented preventive maintenance program or does not practice good housekeeping) does not necessarily indicate that a performance limiting factor exists in these

areas. An actual link between poor plant performance and the identified factor must exist.

Properly identifying a plant's unique list of factors is difficult because the actual problems in a plant are often masked. This concept is illustrated in the following example:

A review of plant records revealed that a conventional water treatment plant was periodically producing finished water with a turbidity greater than 0.5 NTU. The utility, assuming that the plant was operating beyond its capability, was beginning to make plans to expand both the sedimentation and filtration unit processes. Field evaluations conducted as part of a CPE revealed that settled water and finished water turbidities averaged about 5 NTU and 0.6 NTU, respectively. Filtered water turbidities peaked at 1.2 NTU for short periods following a filter backwash. Conceivably, the plant's sedimentation and filtration facilities were inadequately sized. However, further investigation revealed that the poor performance was caused by the operator adding coagulants at excessive dosages, leading to formation of a pin floc that was difficult to settle and filter. Additionally, the plant was being operated at its peak capacity for only 8 hours each day, further aggravating the washout of solids from the sedimentation basins. It was assessed that implementing proper process control of the plant (e.g., jar testing for coagulant control, calibration and proper adjustment of chemical feed) and operating the plant at a lower flow rate for a longer time period would allow the plant to continuously achieve optimized finished water quality. When the operator and administration were questioned about the reasons that the plant was not operated for longer periods of time, it was identified that it was an administrative decision to limit the plant staffing to one person. This limitation made additional daily operating time as well as week-end coverage difficult.

It was concluded that three major factors contributed to the poor performance of the plant:

1. **Application of Concepts and Testing to Process Control:** Inadequate operator knowledge existed to determine proper coagulant doses and to set chemical feed pumps to apply the correct chemical dose.

2. **Administrative Policies:** A restrictive administrative policy existed that prohibited hiring an additional operator to allow increased plant operating time at a reduced plant flow rate.

3. **Process Control Testing:** The utility had inadequate test equipment and an inadequate sampling program to provide process control information.

In this example, pursuing the perceived limitation regarding the need for additional sedimentation and filtration capacity would have led to improper corrective actions (i.e., plant expansion). The CPE indicated that addressing the identified operational and administrative factors would allow the plant to produce a quality finished water on a continuous basis without major expenditures for construction.

This example illustrates that a comprehensive analysis of a performance problem is essential to identify the actual performance limiting factors. The CPE emphasis of assessing factors in the broad categories of administration, design, operation, and maintenance helps to ensure the identification of root causes of performance limitations. The following sections provide useful observations in identifying factors in these broad categories.

Identification of Administrative Factors

For purposes of a CPE administrative personnel are those individuals who can exercise control over water treatment but do not work "on-site" at the plant on a day-to-day basis. This definition includes personnel with job titles such as: off-site superintendents, Directors of Public Works, council personnel, mayors, etc.

The identification of administrative performance limiting factors is a difficult and subjective effort. Identification is primarily based on interpretation of management and staff interview results. Typically, the more interviews that can be conducted the better the interpretation of results will be. In small plants the entire staff, budgetary personnel, and plant administrators, including a minimum of one or two elected officials, can be interviewed. In larger facilities all personnel cannot typically be interviewed, requiring the CPE evaluator to select key personnel.

Interviews are more effective after the evaluator has been on a plant tour and has completed enough of the data development activities (including the performance assessment and major unit process evaluations) to become familiar with plant capabilities and past performance. With this information, the evaluator is better informed to ask insightful questions about the existing plant. Accurately identifying administrative factors requires aggressive but non-threatening interview skills. The evaluator must always be aware of this delicate balance when pursuing the identification of administrative factors.

Policies, budgeting, and staffing are key mechanisms that plant owners/administrators generally use to implement their objectives. Therefore, evaluation of these aspects is an integral part of efforts to identify the presence of administrative performance limiting factors.

Policies:

In order for a utility to strive for optimized performance, there needs to be a commitment to excellence in the form of supplying a high quality treated water. This commitment must be based on an understanding of the importance of water treatment to the protection of public health. Administrators must understand that to minimize the potential for exposure of consumers to pathogenic organisms in their drinking water, all unit processes must be performing at high levels on a continuous basis. Accordingly, administrators should develop goals for high quality water and should emphasize to the operating staff the importance of achieving these goals. Relative to particulate removal, administrators should encourage pursuit of optimized performance goals as described in this handbook.

Typically, all administrators verbally support goals of low cost, safe working conditions; good plant performance; and high employee morale. An important question that must be answered is, "Is priority given to water quality?" Often administrators are more concerned with water quantity than water quality, and this question can be answered by observing the items implemented or supported by the administrators. If a multi-million dollar storage reservoir project is being implemented while the plant remains unattended and neglected, priorities regarding water quality and quantity can be easily discerned.

An ideal situation is one in which the administrators function with the awareness that they want to achieve high quality finished water as the end product of their treatment efforts. At the other end of the spectrum is an administrative attitude that "We just raised rates last year, and we aren't willing to pursue additional revenues. Besides *my* family used to drink untreated water from the river and no one ever got sick." Also, plant administrators may emphasize cost savings as a priority to plant staff. The staff may be told to keep chemical cost down and to cut back if the finished water turbidity falls below the regulated limit (i.e., 0.5 NTU). For instance, one administrator indicated to a plant superintendent that he would be fired if he did not cut chemical costs. Administrators who fall into this category usually are identified as contributing to inadequate performance during an administrative assessment.

Another area in which administrators can significantly, though indirectly, affect plant performance is through personnel motivation. A positive influence exists if administrators: encourage personal and professional growth through support of training; encourage involvement in professional organizations; and provide tangible rewards for pursuing certification. If, however, administrators eliminate or skimp on essential operator training, downgrade operator or other positions through substandard salaries, or otherwise provide a negative influence on staff morale, administrators can have a significant detrimental effect on plant performance.

When the CPE evaluator finds that the operations staff exhibit complacency, the role of the utility's management in this situation needs to be assessed. Utility management must support development of a work environment that generates a commitment to excellence as the best defense against complacency. This requires involvement of the entire utility to create an empowered staff that can effectively respond to changing conditions.

Utility administrators also need to be aware of the impact that their policies have on treatment plant performance. For example, at one small utility the city manager forbid the plant operators to backwash filters more than once a week because operating the backwash pump caused excessive power demand and increased the utility's power bill. This administrative policy's negative impact on plant performance is obvious.

When a plant is using key process equipment (e.g., filter rate controllers) that appear to be antiquated and are impacting plant performance currently or potentially long-term, concerns with plant reliability must be assessed. In these cases the utility administrator's role in 'influencing the plant to use the antiquated equipment past its useful life should be determined. For example, utility administrators may have delayed replacement of the key equipment way beyond its useful life because there was no immediate problem and they wanted to keep the utility's budget low. Identification of this situation would be used to support an administrator's policies factor limiting performance.

Budgeting:

Minor plant modifications to address performance problems identified by the utility staff can often serve as a basis for assessing administrative factors limiting performance. For example, the plant staff may have correctly identified needed minor modifications for the facility and presented these needs to the utility manager, but had their requests declined. The CPE evaluator must solicit the other side of the story from the administrators to see if the administration is indeed non-supportive in correcting the problem. There have been numerous instances in which operators or plant superintendents have convinced administrators to spend money to "correct" problems that resulted in no improvement in plant performance.

Smaller utilities often have financial information combined with other utilities, such as wastewater treatment, street repairs, and parks and recreation. Additionally, nearly every utility's financial information is set up differently. Therefore, it is necessary to review information with the assistance of plant and/or budgetary personnel to rearrange the line items into categories understood by the evaluator. Forms for comprehensively collecting plant information, including financial information, have been developed and are included in Appendix F.

When reviewing financial information, it is important to determine the extent of bond indebtedness of the community and whether the rate structure creates sufficient revenue to adequately support the plant, Water system revenues should provide an adequate number of fairly paid staff and exceed expenditures enough to allow establishment of a reserve fund for future plant modifications. Criteria for determining key financial ratios for a utility

and guidance on their use are included in Appendix F.

Staffing:

Administrators can directly impact performance of a plant by providing inadequate staffing levels such that there is not an operator at the plant when it is in operation. Inadequate plant coverage often results in poor performance since no one is at the plant to adjust chemical dosages relative to raw water quality changes. Non-staffed plant operation can sometimes be justified if remote monitoring associated with performance parameters and alarm and plant shutdown capability exists.

Identification of Design Factors

Data gathered during a plant tour, review of plant drawings and specifications, completion of design information forms in Appendix F, and the completed evaluation of major unit processes, including the performance potential graph, provide information needed to assess design-related performance limiting factors. Typically, the identification of design factors falls into two categories: major unit process limitations, as indicated by the performance potential graph, and other design factors indicated in the list in Appendix E.

When considering identifying major unit process limitations, the evaluator needs to exercise a great deal of judgment since identification of these factors directs the utility toward construction alternatives. If at all possible, the evaluator should assess options for operational alternatives (e.g., lower plant loading during periods where the raw water quality is poor or extended operational time to bring loading more in-line with assessed capability). This emphasis is especially true for Type 2 unit processes.

When the CPE evaluator has concerns with plant reliability because the plant is using antiquated process equipment, the root cause of the reliability must be assessed beyond just identifying this as a design factor. Typically, a reliability issue from use of antiquated equipment is an administrative factor. In rare cases preventive maintenance programs can lead to reliability problems.

Frequently, to identify design factors the evaluator must make field evaluations of the various unit

processes to assess design limitations. Identification of these factors often offers great potential to improve facility performance (e.g., baffling of basins or improvement of flow splitting). Field evaluations will be discussed later in this chapter. It is important to note that any field evaluations undertaken during a CPE should be completed in cooperation with the plant staff. This approach is essential since the evaluator may wish to make changes that could improve plant performance but could be detrimental to equipment at the plant. Plant staff have worked and maintained the equipment, are familiar with control systems, and are in the best position to ascertain any adverse impact of proposed changes.

Identification of Operational Factors

The approach and methods used in maintaining process control can significantly affect performance of plants that have adequate physical facilities (3,7). As such, identification of operationally-based performance limiting factors offers the greatest potential in improving the performance of an existing utility. Information for identifying the presence or absence of operational factors is obtained throughout the CPE activities and includes the plant tour, interviews, and the field evaluation activities.

A plant tour provides an opportunity to initially assess process control efforts. For example, the process control capability of an operator can be subjectively assessed during a tour by noting if the operator discusses the importance of process adjustments that are made to correlate with changes in raw water quality. A solid foundation for a viable process control program exists if the operator presents this key information.

It is also important to assess issues of complacency and reliability with respect to the staff's process control capabilities. It is especially critical to determine if all of the staff have the required process control skills or if plant reliability is jeopardized because only one person can make process control decisions. Causes for this situation could be administrative policies, staff technical skills, or supervisory style.

After the tour, the focus of the identification of operational factors is the assessment of the utility's process control testing, data interpretation, and process adjustment techniques. Key process controls available to a water treatment plant

operator are flow rate; number of basins in service; chemical selection and dosage; and filter backwash frequency, duration and rate. Other controls include flocculation energy input and sedimentation sludge removal. Process control testing includes those activities necessary to gain information to make decisions regarding available plant controls. Information to assist in evaluating process control testing, data interpretation, and process adjustment efforts is presented below.

Plant Flow Rate and Number of Basins in Service:

Plant flow rate dictates the hydraulic loading rate on the various plant unit processes. In plants that operate 24 hours each day, water demand dictates water production requirements. However, many small plants operate at maximum flow rates for short (e.g., 8-hour) periods of time. Also, some plants have multiple treatment trains, and flexibility exists to vary the number in service. If the operator is not aware that operating for longer periods of time at a lower flow rate or increasing the number of trains in service could improve plant performance, an operations factor may be indicated. Rapid increases in plant flow rate can also have a significant effect on plant performance by forcing particles through the filters.

Chemical Dose Control:

Chemical coagulants and flocculant and filter aids are utilized to neutralize charges on colloidal particles and to increase the size and strength of particles to allow them to be removed in sedimentation and filtration unit processes. Either overdosing or underdosing these chemicals can result in a failure to destabilize small particles, including pathogens, and allow them to pass through the sedimentation and filtration processes. If disinfection is inadequate to eliminate the pathogens that pass through the plant, a significant public health risk exists. Chemicals used for stabilization, disinfection, taste and odor control, and fluoridation must also be controlled.

The following are common indicators that proper chemical application is not practiced:

- Calibration curves are not available for chemical feed pumps.

- Operations staff cannot explain how chemicals, such as polymers, are diluted prior to application.
- Operations staff cannot calculate chemical feed doses (e.g., cannot convert a mg/L desired dose to lb/day or ml/min to allow proper setting of the chemical feeder).
- Operations staff cannot determine the chemical feeder setting for a selected dose rate.
- Operations staff do not adjust chemical feed rates for varying raw water quality conditions.
- Chemicals are utilized in combinations that have detrimental effects on plant performance. An example is the practice of feeding lime and alum at the same point without consideration of the optimum pH for alum coagulation.
- Chemicals are not fed at the optimum location (e.g., non-ionic polymer fed before rapid mix unit).
- Chemical feed rates are not changed when plant flow rate is adjusted.
- Chemical coagulants are not utilized when raw water quality is good (e.g., less than 0.5 to 1 NTU).

Filter Control:

The effectiveness of the filtration unit process is primarily established by proper coagulant control; however, other factors, such as hydraulic loading rate and backwash frequency, rate, and duration, also have a significant effect on filter performance. Filters can perform at relatively high filtration rates (e.g., 8 gpm/ft²) if the water applied is properly conditioned (11, 12). However, because particles are held in a filter by relatively delicate forces, rapid flow rate changes can drive particles through a filter, causing a significant degradation in performance (7, 11, 12). Rapid rate changes can be caused by increasing plant flow, by bringing a high volume constant rate pump on-line, by a malfunctioning filter rate control valve, or by removing a filter from service for backwashing without reducing overall plant flow.

Filters must be backwashed periodically to prevent accumulated particles from washing through the filter or to prevent the filter from reaching terminal

headloss. Filters should be backwashed based on effluent turbidity if breakthrough occurs before terminal headloss to prevent the production of poor filtered water quality. Backwash based on headloss should be a secondary criteria. For example, particles that are initially removed by the filter are often “shed” when velocities and shear forces increase within the filter as headloss accumulates as the filter becomes “dirty.” This significant breakthrough in particles can be prevented by washing a filter based on turbidity or particle counting. Also, inadequate washing, both in terms of rate and duration, can result in an accumulation of particles in the filter, resulting in poor filtered water quality. When a filter is continually returned to service with a significant amount of particles still within the media, these particles can accumulate to form mudballs. The accumulation of mudballs displaces filter surface area and raises the filtration rate through those areas of the filter where water can still pass. The filter can also reach a point where minimal additional particles can be removed because available storage sites within the media already have an accumulation of filtered particles. The evaluator must determine whether inadequate washing is caused by a design or an operational limitation. Field evaluations, such as bed expansion and rise rate, that can be conducted to determine the capability of backwash facilities are discussed later in this chapter.

Another key process control activity is returning a filter to service following a backwash. Since start-up of filters can often result in loss of particles and high turbidities, process control practices should be developed to minimize this impact on performance. Operational practices that have provided improved quality from filters during start-up have included: ramping the backwash rate down in increments to allow better media gradation, resting a filter after backwash for several minutes or up to several hours before putting the filter in service, adding a polymer to the backwash water, and slowly increasing the hydraulic loading on the filter as it is brought back on line. These process control practices should be implemented and observed at each utility to develop the optimum combination of activities that provides the best filter performance.

The following are common indicators that proper filter control is not practiced:

- Filters are started dirty (i.e., without backwashing).

- Rapid increases in overall plant flow rate are made without consideration of filtered water quality.
- Filter to waste capability is not being utilized or is not monitored if utilized.
- Filters are removed from service without reducing plant flow rate, resulting in the total plant flow being directed to the remaining filters.
- Operations staff backwash the filters without regard for filter effluent turbidity.
- Operations staff backwash at a low rate for a longer period of time, or stop the backwash when the filter is still dirty to “conserve” water.
- Filters have significantly less media than specified, damage to underdrains or support gravels, or a significant accumulation of mudballs; and these conditions are unknown to the operating staff because there is no routine examination of the filters.
- Operations staff cannot describe the purpose and function of the rate control device.

Process Control Activities:

It is necessary for the operations staff to develop information from which proper process adjustments can be made. As a minimum, a method of coagulation control must be practiced, such as jar testing. Samples of raw water, settled water, and individual filter effluent should be monitored for turbidity. Operations staff that properly understand water treatment should be able to show the evaluator a recorded history of raw, settled, and filtered water quality and jar test results; and be able to describe how chemical dosages are determined and calculated and how chemical feeders are set to provide the desired chemical dose. They should also be able to explain how chemical feed rates are adjusted, depending on raw water quality.

Two similar factors are described in Appendix E which often are difficult to discern when identifying operational factors: Water Treatment Understanding and Application of Concepts and Testing to Process Control. Identification of the proper factor is key since follow-up efforts to address

each factor are different. Water Treatment Understanding is identified when the technical skills of the staff are not adequate to implement proper process control procedures. This limitation would require training in the fundamentals of water treatment. Application of Concepts and Testing to Process Control is identified if the staff have basic technical skills but are not appropriately applying their knowledge to the day-to-day process control of the unit processes. This factor can often be best addressed with site-specific hands-on training.

The following are common indicators that required process control activities are not adequately implemented at a plant:

- Specific performance objectives for each major unit process (barrier) have not been established.
- A formalized sampling and testing schedule has not been established.
- Data recording forms are not available or not used.
- Jar tests or other methods (e.g., streaming current monitor, zeta potential, or pilot filter) of coagulation control are not practiced.
- The operator does not understand how to prepare a jar test stock solution or how to administer various chemical doses to the jars.
- The staff collects one sample per day for raw water turbidity despite a rapidly changing raw water source.
- Settled water turbidities are not measured or are not measured routinely (e.g., minimum of once each shift).
- Individual filtered water quality is not monitored.
- Recycle water quality is not monitored or its impact on plant performance is not controlled (e.g., intermittent high volume recycle pumping).
- Raw water used in jar testing does not include recycle streams.

- There are no records available which document performance of the individual sedimentation or filtration unit processes.
- Performance following backwash is not monitored or recorded.
- Recorded data are not developed or interpreted (e.g., trend charts are not developed for assessing unit process performance).
- Calibration and other quality control procedures are not practiced.
- An emergency response procedure has not been developed for the loss of chemical feeds or for unacceptable finished water quality occurrences.

Other Controls:

Other controls available to the operations staff include rapid mixing, flocculation energy input, sedimentation sludge removal, and disinfection control. The following are indicators that these controls are not fully utilized to improve plant performance:

- The rapid mixer is shut down (e.g., to conserve power) and no other means exists to effectively mix coagulant chemicals with raw water (e.g., through a pump or prior to a valve).
- Variable speed flocculation drives are not adjusted (e.g., they remain at the setting established when the plant was constructed).
- There is no routine removal of sludge from sedimentation basins.
- There is no testing to control sludge quantities in an upflow solids contact clarifier (e.g., routine sludge withdrawal is not practiced).
- Clearwell or disinfection contact basin levels are not monitored or maintained above a minimum level to ensure that CT values can be met.

Identification of Maintenance Factors

Maintenance performance limiting factors are typically associated with limitations in keeping critical

pieces of equipment running to ensure optimum unit process performance or with reliability issues related to a lack of ongoing preventive maintenance activities.

Maintenance performance limiting factors are evaluated throughout the CPE by data collection, observations, and interviews concerning reliability and service requirements of pieces of equipment critical to plant performance. If units are out of service routinely or for extended periods of time, maintenance practices may be a significant contributing cause to a performance problem. For example, key equipment, such as chemical feeders, require back-up parts and on-site skills for repair to ensure their continued operation. Another maintenance limitation could be a smaller raw water pump that was out of service for an extended period of time. In this example, the staff may be forced to use a larger raw water pump that overloads the existing unit processes during periods of poor raw water quality.

Another key distinction to make when trying to identify maintenance factors is to assess the quality of the preventive maintenance program relative to the reliability of the equipment due to age. Many utilities have excellent maintenance programs and personnel that have kept equipment running long beyond its useful/reliable lifetime. In these cases frequent breakdowns of the aging equipment can lead to performance problems. However, the root cause of the performance limitation may be plant administrators that have made a decision to forego the costs of replacement and continue to force the plant to rely on the old equipment. In this example, the CPE evaluator must identify whether the lack of reliability is due to poor maintenance or is an attitude related to the administration staff.

4.2.3.2 Prioritization of Performance Limiting Factors

After performance limiting factors are identified, they are prioritized in order of their adverse impact on plant performance. This prioritization establishes the sequence and/or emphasis of follow-up activities necessary to optimize facility performance. For example, if the highest ranking factors (i.e., those having the most negative impact on performance) are related to physical limitations in unit process capacity, initial corrective actions are directed toward defining plant modifications and obtaining administrative funding for their

implementation. If the highest ranking factors are process control-oriented, initial emphasis of follow-up activities would be directed toward plant-specific operator training.

Prioritization of factors is accomplished by a two-step process. First, all factors that have been identified are individually assessed with regard to their adverse impact on plant performance and assigned an "A", "B" or "C" rating (Table 4-5). The summary of factors in Appendix E includes a column to enter this rating. The second step of prioritizing factors is to list those receiving "A" rating in order of severity, followed by listing those receiving "B" rating in order of severity. "C" factors are not prioritized.

Table 4-5. Classification System for Prioritizing Performance Limiting Factors

Rating	Classification
A	Major effect on a long term repetitive basis
B	Mpderate effect on routine basis or major effect on a periodic basis
C	Minor effect

"A" factors are the major causes of performance deficiencies and are the central focus of any subsequent improvement program. An example "A" factor would be an operations staff that has not developed or implemented process control adjustments to compensate for changing raw water quality.

Factors are assigned a "B" rating if they fall in one of two categories:

1. Those that routinely contribute to poor plant performance but are not the major problem. An example would be insufficient plant process control testing where the primary problem is that the operations staff does not sample and test to determine process efficiency for the sedimentation basins.
2. Those that cause a major degradation of plant performance, but only on a periodic basis. Typical examples are sedimentation basins that cause periodic performance problems due to

excessive loading during spring run-off or a short flocculation detention time that limits floc formation during cold water periods.

Factors receive a "C" rating if they have a minor effect on performance. For example, the lack of laboratory space could be a "C" factor if samples had to be taken off-site for analysis. The problem could be addressed through the addition of bench space and, thus, would not be a major focus during follow-up activities.

A particular factor can receive an "A", "B", or "C" rating at any facility, depending on the circumstances. For example, a sedimentation basin could receive an "A" rating if its size was inadequate to produce optimized performance under all current loading conditions. The basin could receive a "B" rating if the basin was only inadequate periodically, for example, during infrequent periods of high raw water turbidity. The basin would receive a "C" rating if the size and volume were adequate, but minor baffling would improve the consistency of its performance.

Typically, 5 to 10 unique factors are identified for a particular CPE. The remaining factors that are not identified as performance limiting represent a significant finding. For example, in the illustration that was previously presented in the Identification of Performance Limiting Factors section of this chapter, neither sedimentation nor filtration were identified as performance limiting factors. Since they were not identified, plant personnel need not focus on sedimentation basin or filter modifications and the associated capital to upgrade these facilities. Factors that are not identified are also a basis for providing recognition to plant personnel for adequately addressing these potential sources of problems.

Once each identified factor is assigned an "A", "B", or "C" classification, those receiving "A" or "B" ratings are listed on a one-page summary sheet (see Appendix E) in order of assessed severity on plant performance. Findings that support each identified factor are summarized on an attached notes page. An example of a Factors Summary Sheet and the attached notes is shown in Figure 4-6. The summary of prioritized factors provides a valuable reference for the next step of the CPE, assessing the ability to improve performance, and serves as the foundation for implementing correction activities if they are deemed appropriate.

All factors limiting facility performance may not be identified during the CPE phase. It is often necessary to later modify the original corrective steps as new and additional information becomes available during conduct of the performance improvement phase (CTA).

4.2.4 Assessment of the Applicability of a CTA

Proper interpretation of the CPE findings is necessary to provide the basis for a recommendation to pursue the performance improvement phase (e.g., Chapter 5). The initial step in assessment of CTA applicability is to determine if improved **performance** is achievable by evaluating the capability of major unit processes. A CTA is typically recommended if unit processes receive a Type 1 or Type 2 rating. However, if major unit processes are deficient in capability (e.g., Type 3), acceptable performance from each “barrier” may not be achievable; and the focus of follow-up efforts may have to include construction alternatives. Another important consideration with Type 3 facilities is the immediate need for public health protection regardless of the condition of the plant. Even if a facility has serious unit process deficiencies and antiquated equipment, the plant still has a responsibility to protect public health until new treatment processes are designed and constructed. In these situations every effort should be made, therefore, to operate around marginal unit processes and unreliable equipment if it represents the best short-term solution for providing safe drinking water. This concept is shown schematically in Figure 4-7.

Although all performance limiting factors can theoretically be eliminated, the ultimate decision to conduct a CTA may depend on the factors that are identified during the CPE. An assessment of the list of prioritized factors helps assure that all factors can realistically be addressed given the unique set of factors identified. There may be reasons why a factor cannot be approached in a straightforward manner. Examples of issues that may not be feasible to address directly are: replacement of key personnel, increases in rate structures, or training of uninformed or uncooperative administrators to support plant needs. In the case of recalcitrant administrators who refuse to recognize the importance of water quality and minimizing public health risk, regulatory pressure may be necessary before a decision is made to implement a CTA.

For plants where a decision is made to implement a CTA, all performance limiting factors should be considered as feasible to address. These are typically corrected with adequate “training” of the appropriate personnel. The training is directed toward the operations staff for improvements in plant process control and maintenance, toward the plant administrators for improvements in administrative policies and budget limitations, and toward administrators and operations staff to achieve minor facility modifications. Training, as used in this context, describes activities whereby information is provided to facilitate understanding and implementation of corrective actions.

4.2.5 CPE Report

Results of a CPE are summarized in a brief written report to provide guidance for utility staff and, in some cases, state regulatory personnel. It is important that the report be kept brief so that maximum resources are used for the evaluation rather than for preparation of an all-inclusive report. The report should present sufficient information to allow the utility decision-makers to initiate efforts toward achieving desired performance from their facility. It should not provide a list of specific recommendations for correcting individual performance limiting factors. Making specific recommendations often leads to a piecemeal approach to corrective actions, and the goal of improved performance is not achieved. For Type 1 and Type 2 plants, the necessity of comprehensively addressing the combination of factors identified by the CPE through a CTA should be stressed. For Type 3 plants, a recommendation for a more detailed study of anticipated modifications may be warranted. Appendix G demonstrates a sample CPE report.

4.3 Conducting a CPE

A CPE involves numerous activities conducted within a structured framework. A schematic of CPE activities is shown graphically in Figure 4-8. Initial activities are conducted prior to on-site efforts and involve notifying appropriate utility personnel to ensure that they, as well as necessary resources, will be available during the CPE. The kick-off meeting, conducted on-site, allows the evaluators to describe forthcoming activities, to coordinate schedules, and to assess availability of the materials that will be required. Following

Figure 4-6. Example factors summary and supporting notes.

CPE PERFORMANCE LIMITING FACTORS SUMMARY		
Plant Name/Location: XYZ Water Treatment Plant		
CPE Performed By: Process Applications, Inc.		
CPE Date: June 15 - 18, 1998		
Plant Type: Conventional with mixed media filters		
Source Water: Wolf Creek		
<p>Performance Summary:</p> <p>Plant was not able to meet the Surface Water Treatment Rule turbidity requirement of 0.5 NTU 95 percent of the time during March - May 1998. Optimized performance to achieve maximum public health protection from microbial contaminants by producing a filtered water turbidity of 0.1 or less 95 percent of the time has not been achieved.</p>		
Ranking Table		
Rank	Rating	Performance Limiting Factor (Category)
1	A	Alarm Systems (Design)
2	A	Process Flexibility (Design)
3	A	Policies (Administration)
4	A	Application of Concepts and Testing to Process Control (Operation)
5	B	Process Instrumentation/Automation (Design)

Rating Description

- A — Major effect on long-term repetitive basis.
- B — Moderate effect on a routine basis or major effect on a periodic basis.
- C — Minor effect.

Figure 4-6. Example factors summary and supporting notes (continued).

Performance Limiting Factors Notes		
Factor	Rating	Notes
Alarm Systems	A	<ul style="list-style-type: none"> No alarm/plant shutdown capability on chlorine feed, chlorine residual, raw water turbidity, and finished water turbidity.
Process Flexibility	A	<ul style="list-style-type: none"> Inability to select plant flow rate (e.g., set at 2,100 gpm). No ability to feed filter aid polymer to the filters. Inability to gradually increase and decrease backwash flow rate.
Policies	A	<ul style="list-style-type: none"> Lack of established optimization goals (e.g., 0.1 NTU filtered water turbidity) to provide maximum public health protection and associated support to achieve these performance goals.
Applications of Concepts and Testing to Process Control	A	<ul style="list-style-type: none"> No sampling of clarifier performance. inadequate testing to optimize coagulant type and dosages. No individual filter turbidity monitoring. Starting “dirty” filters without backwash. Incomplete jar testing to optimize coagulant dose. Non-optimized feed point for flocculant aid addition.
Process Instrumentation/ Automation	B	<ul style="list-style-type: none"> No turbidimeters on individual filters. Start and stop of filters without backwash or filter-to-waste (due to storage tank demand). Location of raw water turbidity monitor cell resulting in inaccurate readings.

Figure 4-7. CPE/CTA schematic of activities.

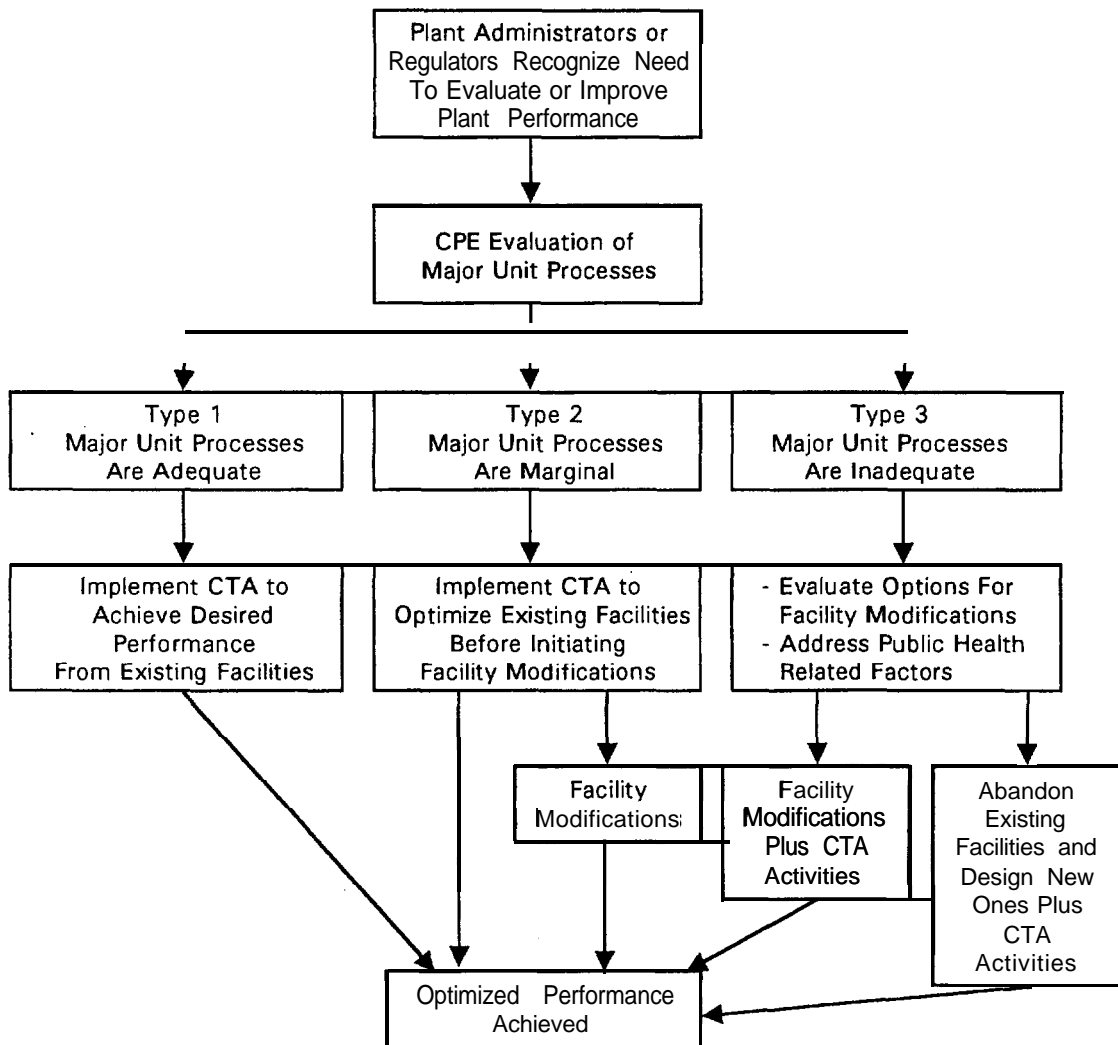

the kick-off meeting, a plant tour is conducted by the superintendent or process control supervisor. During the tour, the evaluators ask questions regarding the plant and observe areas that may require additional attention during data collection activities. For example, an evaluator might make a mental note to investigate more thoroughly the flow splitting arrangement prior to flocculation basins.

Following the plant tour, data collection activities begin. Depending on team size, the evaluators split into groups to facilitate simultaneous collection of the administrative, design, operations, maintenance and performance data. After data are collected, the performance assessment and the major unit process evaluation are conducted. It is noted that often the utility can provide the per-

formance data prior to the site visit. In this case the performance graphs can be initially completed prior to the on-site activities. However, it is important to verify the sources of the samples and quality of the data during field efforts.

Field evaluations are also conducted to continue to gather additional information regarding actual plant performance and confirm potential factors. Once all of this information is collected a series of interviews are completed with the plant staff and administrators. Initiating these activities prior to the interviews provides the evaluators with an understanding of current plant performance and plant unit process capability, which allows interview questions to be more focused on potential factors.

Figure 4-8. Schematic of CPE activities.

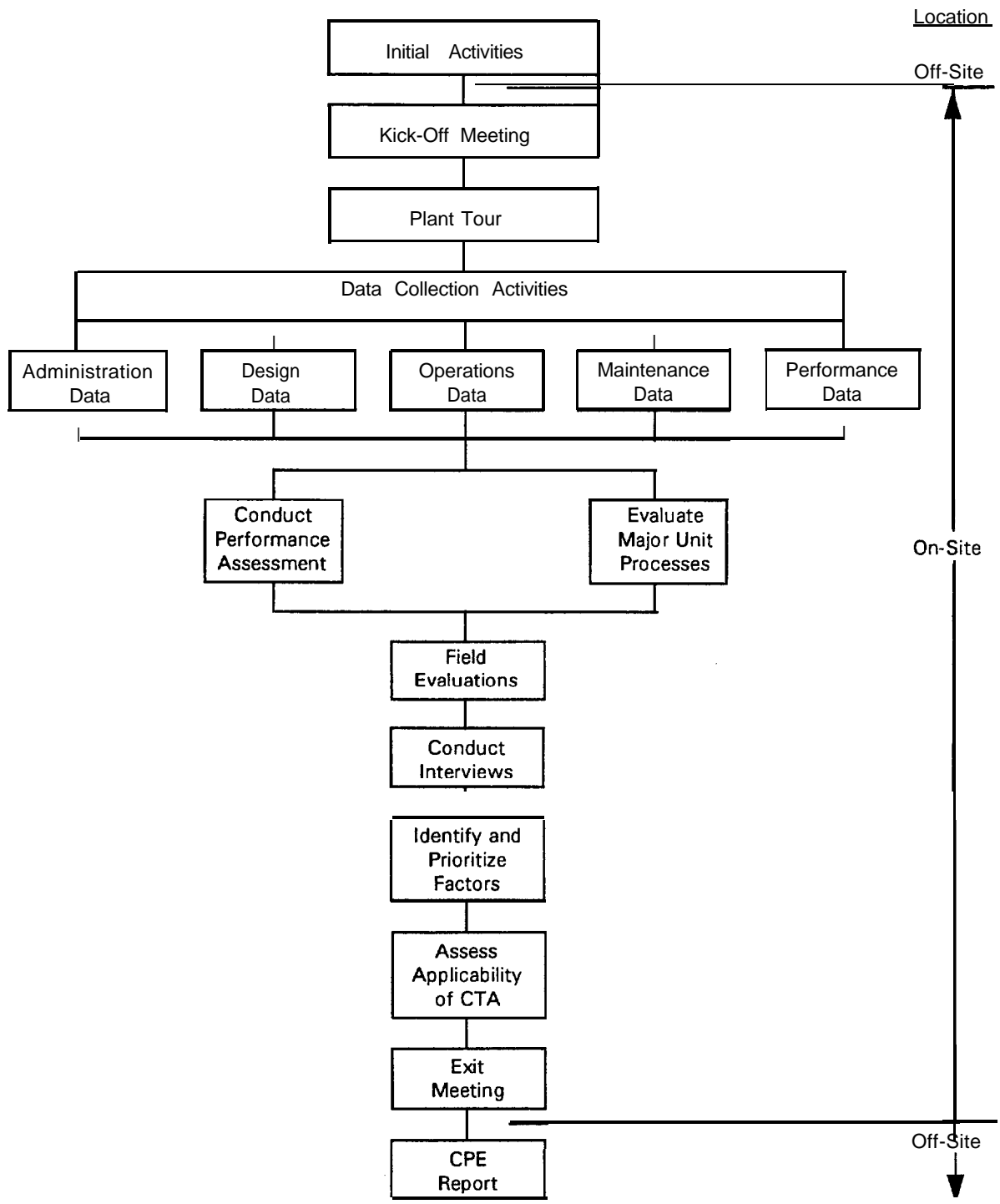

After all information is 'collected, the evaluation team meets at a location isolated from the utility personnel to review findings. At this meeting, factors limiting performance of the plant are identified and prioritized and an assessment of the applicability of a follow-up CTA is made. The prioritized list of factors, performance data, field evaluation results, and major unit process evaluation data are then compiled and copied for use as handouts during the exit meeting. An exit meeting is held with appropriate operations and administration personnel where all evaluation findings are presented. Off-site activities include completing and distributing the written report. A more detailed discussion of each of these activities follows.

4.3.7 Overview

A CPE is typically conducted over a three to five-day period by a team comprised of a minimum of two personnel. A team approach is necessary to allow a facility to be evaluated in a reasonable time frame and for evaluation personnel to jointly develop findings on topics requiring professional judgment. Professional judgment is critical when evaluating subjective information obtained during the on-site CPE activities. For example, assessing administrative versus operational performance limiting factors often comes down to the evaluators' interpretation of interview results. The synergistic effect of two people making this determination is a key part of the CPE process.

Because of the wide range of areas that are evaluated during a CPE, the evaluation team needs to have a broad range of available skills. This broad skills range is another reason to use a team approach in conducting CPEs. Specifically, persons should have capability in the areas shown in Table 4-6.

Regulatory agency personnel with experience in evaluating water treatment facilities; consulting engineers who routinely work with plant evaluation, design and start-up; and utility personnel with design and operations experience represent the types of personnel with appropriate backgrounds to conduct CPEs. Other combinations of personnel can be used if they meet the minimum experience requirements outlined above. Although teams composed of utility management and operations personnel associated with the CPE facility can be established, it is often difficult for an internal team to objectively assess administrative and operational factors. The strength of the CPE is best represented by an objective third party review.

4.3.2 Initial Activities

The purpose of the initial activities is to establish the availability of the required personnel and documentation. To assure an efficient and comprehensive evaluation, key utility personnel and

Table 4-6. Evaluation Team Capabilities

Technical Skills	Leadership Skills
<ul style="list-style-type: none"> Water treatment plant design 	<ul style="list-style-type: none"> Communication (presenting, listening, interviewing)
<ul style="list-style-type: none"> Water treatment operations and process control 	<ul style="list-style-type: none"> Organization (scheduling, prioritizing)
<ul style="list-style-type: none"> Regulatory requirements 	<ul style="list-style-type: none"> Motivation (involving people, recognizing staff abilities)
<ul style="list-style-type: none"> Maintenance 	<ul style="list-style-type: none"> Decisiveness (completing CPE within time frame allowed)
<ul style="list-style-type: none"> Utility management (rates, budgeting, planning) 	<ul style="list-style-type: none"> Interpretation (assessing multiple inputs, making judgments)

specific information need to be available. Required information includes basic data on the plant design, staffing and performance. A letter should be sent to the utility describing the schedule of activities that will take place and outlining the commitment required of plant and administrative staff. An example letter is presented in Appendix **H**. Topics that are discussed in the letter are presented below.

4.3.2.1 Key Personnel

It is necessary to have key people available during the conduct of the CPE. The plant superintendent, manager or other person in charge of the water treatment facility must be available. If different persons are responsible for plant maintenance and process control, their presence should also be required. These individuals should be available throughout the three to five-day on-site activities.

A person knowledgeable about details of the utility budget must also be available. A one- to two-hour meeting with this person will typically be required during the on-site activities to assess the financial information. In many small communities, this person is most often the City Clerk; in small water districts it may be the Chairman of the Board or a part-time clerk. In larger communities, the Finance Director, Utilities Director, or Plant Superintendent can usually provide the required information.

Availability of key administrative personnel is also required. In many small communities or water districts, an operator or plant superintendent may report directly to the mayor or board chairman or to the elected administrative body (e.g., City Council or District Board). In larger communities, the key administrative person is often the Director of Public Works/Utilities, City Manager, or other non-elected administrator. In all cases the administrator(s) as well as representative elected officials who have the authority to effect a change in policy or budget for the plant should be available to participate in the evaluation. Typically these people are needed for a one-half to three-quarter hour interview and to attend the kick-off and exit meetings.

4.3.2.2 CPE Resources

Availability of specific utility and plant information is required during a CPE. The following list of the necessary items should be provided to the utility

contact for review at the kick-off meeting and before initiating on-site activities:

- Engineering drawings and specifications which include design information on the individual unit processes, and plant equipment.
- A plant flow schematic.
- Daily plant performance summaries showing the results of turbidity measurements on raw, settled, and filtered water for the most recent twelve-month period.
- Financial information showing budgeted and actual revenues and expenditures (i.e., chemicals, salaries, energy, training), long-term debt, water rates and connection fees.
- An organizational chart of the utility.
- A list of utility staff members.

In addition to the information listed, meeting and work rooms are required during the conduct of the CPE. A meeting room large enough for the evaluation team and utility personnel should be available for the kick-off and exit meetings. During the CPE, a somewhat private work room with a table and electrical outlets is desirable. Two or three small rooms or offices are necessary for the individual interviews.

Some facilities do not have a sample tap available on the effluent from each individual filter. If these taps are not available they should be requested prior to the on-site activities. During the CPE, existing taps should be checked to see if they are functional. All taps both new and existing must be located at points that assure a continuous sample stream that is representative of the filter effluent.

4.3.2.3 Scheduling

A typical schedule for on-site CPE activities for a small to medium-sized water treatment facility is presented below:

- First Day - a.m. (travel)
- First Day - p.m.:
 - Conduct kick-off meeting.

- Conduct plant tour.
- Set-up and calibrate continuous recording turbidimeter (if available).
 - Coordinate location of CPE resources.
- Second Day - a.m.:
 - Compile data on plant performance, design, administration, operations and maintenance.
- Second Day - p.m.:
 - Continue data compilation.
 - Develop performance assessment and performance potential graph.
- Third Day - a.m.:
 - Conduct interviews with plant staff and utility officials.
 - Conduct field evaluations.
- Third Day - p.m.:
 - Shut down continuous recording turbidimeter (if available).
 - Meet to identify and prioritize performance limiting factors.
 - Prepare materials for exit meeting.
- Fourth Day - a.m.:
 - Conduct exit meeting.
 - Meet to debrief and make follow-up assignments.

4.3.3 On-Site Activities

4.3.3.1 Kick-Off Meeting

A short (i.e., 30-minute) meeting between key plant operations and administration staff and the evaluators is held to initiate the field work. The major purposes of this meeting are to present the objectives of the CPE effort, to coordinate and establish the schedule, and to initiate the administrative evaluation activities. Each of the specific

activities that will be conducted during the on-site effort should be described. Meeting times for interviews with administration and operations personnel should be scheduled. Some flexibility with the interview schedules should be requested since time for data development, which is essential prior to conducting interviews, is variable from facility to facility. A sign-up sheet (see Appendix F) may be used to record attendance and as a mechanism for recognizing names. Information items that were requested in the letter should be reviewed to ensure their availability during the CPE.

Observations that can contribute to the identification of factors are initiated during the kick-off meeting. More obvious indications of factors may be lack of communication between the plant staff and administration personnel or the lack of familiarity with the facilities by the administrators. More subtle indications may be the priority placed on water quality or policies on facility funding. These initial perceptions often prove valuable when formally evaluating administrative factors later in the CPE effort.

4.3.3.2 Plant Tour

A plant tour follows the kick-off meeting. The objectives of the tour include: 1) familiarize the evaluation team with the physical plant; 2) make a preliminary assessment of operational flexibility of the existing processes and chemical feed systems; and 3) provide a foundation for discussions on performance, process control and maintenance and continued observations that may indicate performance limiting factors. A walk-through tour following the flow through the plant (i.e., source to clearwell) is suggested. Additionally, the tour should include backwash and sludge treatment and disposal facilities, and the laboratory and maintenance areas. The evaluator should note the sampling points and chemical feed locations as the tour progresses.

The CPE evaluation is often stressful, especially initially, for plant personnel. Consequently, during the conduct of a tour, as well as throughout the on-site activities, the evaluation team should be sensitive to this situation. Many of the questions asked by the evaluation team on the plant tour are asked again during formal data collection activities. The plant staff should be informed that this repetitiveness will occur. Questions that challenge current operational practices or that put plant personnel on the defensive must be avoided. It is

imperative that the CPE evaluators create an open, non-threatening environment so that all of the plant staff feel free to share their perspective as various questions are asked. The evaluator should try to maintain an information gathering posture at all times. It is not appropriate to recommend changes in facilities or operational practices during the plant tour or the conduct of on-site activities. This is often a challenge since the evaluation team will frequently be asked for an opinion. Handle these requests by stating that observations of the CPE team will be presented at the conclusion of the on-site activities after all information is collected and analyzed.

The plant tour continues the opportunity for the evaluator to observe intangible items that may contribute to the identification of factors limiting performance (i.e., operator knowledge of the plant operation and facilities, relationship of process control testing to process adjustments, the quality of the relationships between various levels, etc.). The tour also presents an opportunity to assess the potential of using minor modifications to enhance current facility capability. Suggestions to help the evaluation team meet the objectives of the plant tour are provided in the following sections.

Pretreatment

Pretreatment facilities consist of raw water intake structures, raw water pumps, presedimentation basins and flow measurement equipment. Intake structures and associated screening equipment can have a direct impact on plant performance. For example, if the intake configuration is such that screens become clogged with debris or the intake becomes clogged with silt, maintaining a consistent supply of water may be a problem. While at the raw water source, questions should be asked regarding variability of the raw water quality, potential upstream pollutant sources, seasonal problems with taste and odors, raw water quantity limitations, and algae blooms.

Presedimentation facilities are usually only found at water treatment plants where high variability in raw water turbidities occurs. If plants are equipped with presedimentation capability, basin inlet and outlet configurations should be noted, and the ability to feed coagulant chemicals should be determined. Typically, most presedimentation configurations lower turbidities to a consistent level to allow conventional water treatment plants

to perform adequately. If presedimentation facilities do not exist, the evaluator must assess the capability of existing water treatment unit processes to remove variable and peak raw water turbidities.

Raw water pumping should be evaluated regarding the ability to provide a consistent water supply and with respect to how many pumps are operated at a time. Frequent changing of high volume constant speed pumps can cause significant hydraulic surges to downstream unit processes, degrading plant performance. In addition, operational practices as they relate to peak flow rates, peak daily water production, and plant operating hours should be discussed to assist in defining the peak instantaneous operating flow rate.

Flow measurement facilities are important to accurately establish chemical feed rates, wash water rates, and unit process loadings. Questions should also be asked concerning location, maintenance, and calibration of flow measurement devices. Discussions of changes in coagulant dosages with changes in plant flow rate are also appropriate at this stage of the tour.

Mixing/Flocculation/Sedimentation

Rapid mixing is utilized to provide a complete instantaneous mix of coagulant chemicals to the water. The coagulants neutralize the negative charges on the colloidal particles allowing them to agglomerate into larger particles during the gentle mixing in the flocculation process. These heavier particles are then removed by settling in the quiescent area of the sedimentation basin. These facilities provide the initial barrier for particle removal and, if properly designed and operated, reduce the particulate load to the filters, allowing them to "polish" the water. During the tour, observations should be made to determine if the mixing, flocculation, and sedimentation unit processes are designed and operated to achieve this goal. The evaluators should also observe flow splitting facilities and determine if parallel basins are receiving equal flow distribution.

Rapid mix facilities should be observed to determine if adequate mixing of chemicals is occurring throughout the operating flow range. The operator should be asked what type of coagulants are being added and what process control testing is employed to determine their dosage. Observations should be made as to the types of chemicals that

are being added together in the mixing process. For example, the addition of alum and lime at the same location may be counter-productive if no consideration is given to maintaining the optimum pH for alum coagulation. If coagulant chemicals are added without mixing, observations should be made as to possible alternate feed locations, such as prior to valves, orifice plates or hydraulic jumps, where acceptable mixing might be achieved.

When touring flocculation facilities, the evaluator should note inlet and outlet conditions, number of stages, and the availability of variable energy input. Flocculation facilities should be baffled to provide even distribution of flow across the basin and to prevent velocity currents from disrupting settling conditions in adjacent sedimentation basins. If multiple stages are not available, the capability to baffle a basin to create additional staging should be observed. The ability to feed flocculation aids to the gentle mixing portion of the basin should be noted. The operator should be asked how often flocculation energy levels are adjusted or if a special study was conducted to determine the existing levels. In the case of hydraulic flocculation, the number of stages, the turbulence of the water, and the condition of the **floc** should be noted to determine if the unit process appears to be producing an acceptable **floc**. For **upflow** solids contact units, questions concerning control of the amount of solids in the unit and sludge blanket control procedures should be asked.

Sedimentation basin characteristics that should be observed during the tour include visual observations of performance and observations of physical characteristics such as configuration and depth. Performance observations include clarity of settled water, size and appearance of **floc**, and presence of flow or density currents. The general configuration, including shape, inlet conditions, outlet conditions, and availability of a sludge removal mechanism should be observed. Staff should be asked about process control measures that are utilized to optimize sedimentation, including sludge removal.

Chemical Feed Facilities

A tour of the chemical feed facilities typically requires a deviation from the water flow scheme in order to observe this key equipment. Often all chemical feed facilities are located in a central

location that supplies various chemicals to feed points throughout the plant. Chemical feed facilities should be toured to observe the feed pumps, day tanks, bulk storage facilities, flow pacing facilities, and chemical feeder calibration equipment. Availability of backup equipment to ensure continuous feeding of each chemical during plant operation should also be observed.

Filtration

Filters represent the key unit process for the removal of particles in water treatment. Careful observation of operation and control practices should occur during the tour. The number and configuration of filters should be noted, including the type of filter media. The filter rate control equipment should be observed and discussed to ensure that it regulates filter flow in an even, consistent manner without rapid fluctuations. The flow patterns onto each filter should be noted to see if there is an indication of uneven flow to individual filters. Backwash equipment, including pumps and air compressors, should be noted. The availability of back-up backwash pumping is desirable to avoid interruptions in treatment if a breakdown occurs.

The operator should be asked how frequently filters are backwashed and what process control procedures are used to determine when a filter should be washed. Since turbidity represents an indication of particles in the water, it should be the parameter utilized to initiate a backwash unless the plant has on-line particle counters. The operator's response to this inquiry helps to demonstrate his understanding and priorities concerning water quality.

The tour guide should also be questioned concerning the backwash procedure and asked if all operators follow the same technique. The evaluation team should determine if filter to waste capability exists and, if so, how it is controlled. Questions concerning individual filter monitoring should also be asked. The availability of turbidity profiles following backwash should be determined. Some facilities utilize particle counting to assess filter performance, and the availability of this monitoring tool should be determined during the plant tour.

The tour is an excellent time to discuss the selection of a filter and the location of the sampling point for continuous turbidity monitoring to be

conducted during the field evaluation activities. Ideally, the filter that is most challenged to produce high quality water **should** be monitored by the evaluation team. Often, the operational staff will be able to quickly identify a “problem filter.”

Disinfection

The evaluation team should tour disinfection facilities to become familiar with the equipment feed points and type of contact facilities. Special attention should be given to the configuration and baffling of clearwells and finished water reservoirs that provide contact time for final disinfection. Observation of in-line contact time availability should be made by noting the proximity of the “first user” to the water treatment plant. Often, distribution piping cannot be used in the assessment of contact time since the plant staff represents the first user.

The availability of back-up disinfection equipment should be determined to assess the capability of providing an uninterrupted application of disinfectant. The addition of a disinfectant prior to filtration, either as an oxidizing agent or disinfectant, should also be noted. The capability to automatically control the disinfection systems by flow pacing should be determined.

Backwash Water and Sludge Treatment and Disposal

The location of any recycle streams should be identified during the tour. Recycle of water should be assessed with respect to the potential for returning a high concentration of cysts to the plant raw water stream. Since this practice represents a potential risk, the evaluator should determine the method of treatment or other methods used to handle the impact of recycle streams (e.g., storage for equalization of flows with continuous return of low volumes of recycle to the raw water). It is also important to assess if plant piping allows collection of a representative sample of recycle to be used in jar tests to determine coagulant dose.

Typically, the main sources of recycle flows are the settled filter backwash water and sedimentation basin sludge decant. If these streams are discharged to a storm sewer system or a waterway, questions should be asked to determine if the discharge is permitted and if permit requirements are being complied with. If recycle treatment facilities

exist, questions should be asked to determine the method of controlling the performance of these facilities.

Laboratory

The laboratory facilities should be included as part of the plant tour. Source water and performance monitoring, process control testing, and quality control procedures should be discussed with laboratory personnel. It is especially important to determine if turbidity measurements represent actual plant performance. The use of laboratory results should be discussed and a review of the data reporting forms should also be made. The laboratory tour also offers the opportunity to assess the availability of additional plant data that could be used to assess plant performance (e.g., special studies on different **coagulants**, individual turbidity profiles). Available analytical capability should also be noted. An assessment should also be **made** if all of the analytical capability resides in the laboratory and, if so, does the operations staff have sufficient access to make process control adjustments?

Maintenance

A tour of the maintenance facilities provides an opportunity to assess the level of maintenance support at the plant. Tools, spare parts availability, storage, filing systems for equipment **catalogues**, general plant appearance, and condition of equipment should be observed. Questions on the preventive maintenance program, including methods of initiating work (e.g., work orders), are appropriate. Equipment out of service should also be noted.

4.3.3.3 Data Collection Activities

Following the plant tour, data collection procedures are initiated. Information is collected through discussions with plant and administrative staff utilizing a formalized data collection format as shown in Appendix F. Categories covered by these forms are listed below:

- Kick-Off Meeting
- Administration Data
- Design Data

-
- Operations Data
 - Maintenance Data
 - Field Evaluation Data
 - Interview Guidelines
 - Exit Meeting

When collecting information requested on the forms, the evaluation team should solicit the participation of the most knowledgeable person in each of the evaluation areas. For example, those persons actually implementing the maintenance activities should be included in the maintenance data collection efforts.

When collecting information, the evaluator should be aware that the data are to be used to evaluate the performance capability of the existing facilities. The evaluator should continuously be asking "How does this information affect plant performance?". If the area of inquiry appears to be directly related to plant performance, the evaluator should spend sufficient time to fully develop the information. Often this pursuit of information will go beyond the constraints of the forms. In this way, some of the most meaningful information obtained is "written on the back of the forms."

4.3.3.4 Evaluation of Major Unit Processes

An evaluation of the plant's major unit processes is conducted to determine the performance potential of existing facilities at peak instantaneous operating flow. This is accomplished by developing a performance potential graph and rating the major unit processes as Type 1, 2, or 3, as previously discussed in 4.2.2 *Evaluation of Major Unit Processes*.

It is important that the major unit process evaluation be conducted early during the on-site activities, since this assessment provides the evaluator with the knowledge of the plant's treatment capability. If the plant major unit processes are determined to be Type 1 or 2 and they are not performing at optimum levels, then factors in the areas of administration, operation or maintenance are likely contributing to the performance problems. The completed major unit process assessment aids the evaluation personnel in focusing later interviews and field evaluations to identify those performance limiting factors.

4.3.3.5 Performance Assessment

An assessment of the plant's performance is made by evaluating existing recorded data and by conducting field evaluations to determine if unit process and total plant performance have been optimized. Typically, the most recent twelve months of existing process control data is evaluated and graphs are developed to assess performance of the plant. Additional data (e.g., backwash turbidity profiles, particle counting data, individual filter 24-hour continuous turbidimeter performance) can be developed if they aid in the determination of the existing plant performance relative to optimized goals. Evaluations are also conducted during the performance assessment activities to determine if existing plant records accurately reflect actual plant-treated water quality. Calibration checks on turbidimeters or a review of quality control procedures in the laboratory are part of these evaluations.

It is conceivable that a public health threat could be indicated by the data during the development of the data for the performance assessment component. The CPE evaluation team will have to handle these situations on a case-by-case basis. An immediate discussion of the potential threat should be conducted with the plant staff and administration and they should be encouraged to contact the appropriate regulatory agency. Voluntary actions such as plant shut-down or a voluntary boil water notice should also be discussed. It is important that the CPE evaluation team not assume responsibility for the process adjustments at the plant.

Another key part of the performance assessment is the use of a continuous recording turbidimeter during the conduct of the on-site activities. This effort will be further described in the next section of this chapter. A detailed discussion of the methods utilized in the performance assessment was presented previously in the Assessment of Plant Performance section of this chapter.

4.3.3.6 Field Evaluations

Field evaluations are an important aspect of the on-site activities. Typically, field evaluations are conducted to verify accuracy of monitoring and flow records, chemical dosages, record drawings, filter integrity, and backwash capability. Forms to assist in the documentation of the data collected

during field evaluations have been included in Appendix F.

Performance monitoring records can be verified by utilizing a continuous recording turbidimeter to assess an individual filter's performance over a twenty-four hour period. A backwash cycle is conducted during this monitoring effort. It is important that the evaluation team acquire or have made available to them a properly calibrated turbidimeter to support this field effort. If a recording on-line turbidimeter is not available, an instrument that allows individual analysis of grab samples can be used. If the evaluation team does not have access to a turbidimeter, the plant's turbidimeter, which must be calibrated prior to the sampling and testing activities, can be used.

Treated water quality obtained from the field evaluation can be compared with recorded data to make a determination if performance monitoring records accurately represent treated water quality. Differences in actual versus recorded finished water quality can be caused by sampling location, sampling time, sampling procedures, and testing variations. The evaluation team's instrument can also be used to assess the plant's turbidimeter and calibration techniques.

The accuracy of flow records can be verified by assessing the calibration of flow measurement equipment. This is often difficult because of the type of meters utilized (e.g., propeller, venturi, magnetic). If these types of meters are utilized, it may be necessary to require a basin to be filled or drawn down over a timed period to accurately check the metering equipment. If accuracy of metering equipment is difficult to field-verify, the frequency of calibration of the equipment by the plant staff or outside instrumentation technicians can be evaluated. If flow metering equipment is being routinely (e.g., quarterly or semiannually) calibrated, flow records typically can be assumed to be accurate.

Dosages of primary coagulant chemicals should be verified. Feed rates from dry feeders can be checked by collecting a sample for a specified time and weighing the accumulated chemical. Similarly, liquid feeders can be checked by collecting a sample in a graduated cylinder for a specified time. In both cases the feed rate in lb/min or mL/min of chemical should be converted to mg/L and compared with the reported dosage. During this evaluation the operating staff should be asked how they conduct chemical feed calculations, pre-

pare polymer dilutions, and make chemical feeder settings. Additionally, the plant staff should be asked how they arrived at the reported dosage. If jar testing is used, the evaluation team should discuss this procedure, including preparation of stock solutions. Often, a discussion can be used to assess the validity and understanding of this coagulation control technique. Performing jar tests is typically not part of the CPE process.

The integrity of the filter media, support gravels, and underdrain system for a selected filter should be evaluated. This requires that the filter be drained and that the evaluation team inspect the media. The filter should be investigated for surface cracking, proper media depth, mudballs and segregation of media in dual media filters. The media can be excavated to determine the depth of the different media layers in multi or dual media filters. The media should be placed back in the excavations in the same sequence that it was removed. The filter should also be probed with a steel rod to check for displacement of the support gravels and to verify the media depth within the filter. Variations in depth of support gravels of over two inches would signify a potential problem. Variations in media depth of over two inches would also indicate a potential problem. If possible, the clear well should be observed for the presence of filter media. Often, plant staff can provide feedback on media in the clearwell if access is limited. If support gravels or media loss are apparent, a more detailed study of the filter would then be indicated, which is beyond the scope of a CPE.

Filter backwash capability often can be determined from the flow measurement device on the backwash supply line. If this measurement is in question or if the meter is not available, the backwash rate should be field-verified by assessing either the backwash rise rate or bed expansion. Rise rate is determined by timing the rise of water for a specific period. For example, a filter having a surface area of 150 ft² would have a backwash rate of 20 gpm/ft² if the rise rate was 10.7 inches in 20 seconds. This technique is not suitable for filters where the peak backwash rate is not reached until the washwater is passing over the troughs.

Bed expansion is determined by measuring the distance from the top of the unexpanded media to a reference point (e.g., top of filter wall) and from the top of the expanded media to the same reference point. The difference between these two

measurements is the bed expansion. A variety of techniques can be used to determine the top of the expanded bed. A light-colored can lid attached to the end of a pole is effective. The bed expansion measurement divided by the total depth of expandable media (i.e., media depth less gravels) multiplied times 100 gives the percent bed expansion. A proper wash rate should expand the filter media a minimum of 20 to 25 percent (4).

Record drawings may have to be field-verified by measuring basin dimensions with a tape measure if there is doubt as to their accuracy. If no drawings are available, all basin dimensions will have to be measured.

Additional field tests such as verification of equal flow splitting and calibration of monitoring or laboratory equipment can also be conducted. Field verification to support identified factors limiting performance should always be considered by the evaluation team; however, time requirements for these activities must be weighed against meeting the overall objectives of the CPE.

4.3.3.7 Interviews

Prior to conducting personnel interviews, it is necessary to complete the data collection forms, the major unit process evaluation, and performance assessment. This background information allows the evaluator to focus interview questions on anticipated factors limiting performance. It is also advantageous for the CPE evaluators to be familiar with the factors outlined in Appendix E prior to conducting the interviews. This awareness also helps to focus the interviews and to maintain the performance emphasis of the interview process. For example, an adamantly stated concern regarding supervision or pay is only of significance if it can be directly related to plant performance.

Unless the number of the utility staff is too large, interviews should be conducted with all of the plant staff and with key administrative personnel in order to obtain feedback from both resources. Example key administrators include the mayor, board members from the Water Committee, and the Utility Director.

Interviews should be conducted privately with each individual. The persons being interviewed should be informed that the responses are presented in the findings as an overall perception, and individual responses are not utilized in the exit

meeting or final report. Approximately 30 to 45 minutes should be allowed for each interview.

Interviews are conducted to clarify information obtained from plant records and on-site activities and to ascertain differences between real or perceived problems. Intangible items such as communication, administrative support, morale, and work attitudes are also assessed during the interview process. The interviews also offer an opportunity to ask questions about potential factors. During the conduct of on-site activities, the CPE evaluators begin to form preliminary judgments. The interviews offer the opportunity to ask, in an information gathering forum, what the utility personnel may think of the perceived limitation. An adamant response may justify additional data collection to strengthen the evaluation team's convictions prior to the exit meeting. On the other hand, sensitive findings such as operational and administrative limitations can be introduced in a **one-on-one** setting and will allow the affected parties to be aware that these issues may be discussed at the exit meeting.

Interview skills are a key attribute for CPE evaluators. Avoidance of conflict, maintaining an information gathering posture, utilizing initial on-site activity results, creating an environment for open communication, and pursuing difficult issues (e.g., supervisory traits) are a few of the skills required to conduct successful interviews. An additional challenge to the CPE evaluators is to avoid providing "answers" for the person being interviewed. A major attribute is the ability to ask a question and wait for a response even though a period of silence may exist.

A key activity after conducting several interviews is for the evaluation team members to discuss their perceptions among themselves. Often, conflicting information is indicated, and an awareness of these differences can be utilized to gather additional information in remaining interviews. To assist in conducting interviews, guidelines have been provided in Appendix F - Interview Guidelines.

4.3.3.8 Evaluation of Performance Limiting Factors

The summarizing effort of the on-site activities is identification and prioritization of performance limiting factors. This activity should be completed at a location that allows open and objective

discussions to occur (e.g., away from utility personnel). Prior to the discussion, a debriefing session that allows the evaluation team to discuss pertinent findings from their respective efforts should be held. This step is especially important since each team member is typically not involved in every aspect of the CPE. All data compiled during the evaluations should be readily available to support the factor identification efforts.

The checklist of performance limiting factors presented in Appendix E, as well as the factor definitions, provides the structure for an organized review of potential factors in the evaluated facility. The intent is to identify, as clearly as possible, the factors that most accurately describe the causes of limited performance. Often, a great deal of discussion is generated in this phase of the CPE effort. Sufficient time (i.e., 2 to 8 hours) should be allocated to complete this step, and all opinions and perceptions should be solicited. It is particularly important to maintain the performance focus during this activity. A natural bias is to identify all factors that may have even a remote application at the current facility. Persons new to this phase of a CPE often want to make sure that they do not miss anything in identifying deficiencies. An excellent method to maintain focus is to remember that the list of factors is the evaluation team's attempt to prioritize the future efforts for the utility. If the total number of factors is greater than 10, the evaluation team should reassess the factors identified and look for ways to clarify the message that will be sent during the exit meeting. One option would be to combine factors and use the examples given when the factor was identified to provide greater justification as to why the "combined factor" is limiting performance. Another incentive to reduce the number of factors is that extraneous factors can confuse the utility's future activities and divert focus from priority optimization efforts. Often, it is the factors that are not identified that are important since by not identifying factors, the team discourages future emphasis in these areas.

One of the most difficult challenges facing a CPE evaluator can be the identification of administrative factors since the team may find itself criticizing high level administrators and the culture that they have created. This can be especially difficult in situations where these same administrators have contracted for the CPE and may be current and future clients. Given these pressures, the CPE team may find themselves avoiding identifying any administrative factors when there is clear evidence

that the administrator in question is having a direct impact on performance. If a CPE team finds themselves in this situation they should review their responsibility in protecting public health and the long term good that will occur if the administrative factors are addressed. Those responsible for the review of CPE reports should also question a CPE report that fails to identify any administrative factors.

Each factor identified as limiting performance should be assigned an "A", "B", or "C" rating. Further prioritization is accomplished by completing the Summary Sheet presented in Appendix E. Only those factors receiving either an "A" or "B" rating are prioritized on this sheet. A goal of the prioritization activity is to provide a clear story and an associated clear set of priorities for the utility to use to pursue optimized performance at the conclusion of the CPE. Additional guidance for identifying and prioritizing performance limiting factors was provided in the Identification and Prioritization of Performance Limiting Factors section previously discussed in this chapter.

4.3.3.9 Exit Meeting

Once the evaluation team has completed the on-site activities, an exit meeting should be held with the plant administrators and staff. A presentation of CPE results should include descriptions of the following:

- Overview of optimized treatment goals
- Plant performance assessment
- Evaluation of major unit processes
- Prioritized performance limiting factors
- Assessment of applicability of follow-up

The overview of optimized treatment goals is presented to establish the basis upon which the utility was evaluated. It is important to identify that the CPE evaluation was based on goals, likely more stringent than the plant was designed for and more stringent than regulated performance criteria. The positive public health aspects of achieving this level of performance should also be discussed. Chapter 2 described the optimized performance goals and the public health benefits of achieving these goals. A synopsis of this information should be presented at the beginning of the exit meeting. A brief presentation on the function of each water treatment unit process and the effort required to

produce acceptable finished water quality can also be made to enhance water treatment understanding for the administrators.

Handouts, based on information developed during the on-site activities, can be utilized to assist in presenting the other exit meeting topics. Graphs are effective for presenting the performance assessment findings. Typically, the time versus turbidity plots (one year of data) and percentile plots for raw, settled and filtered and/or finished water are presented. Additionally, results of field evaluations such as turbidity profiles following a filter backwash, 24-hour individual filter performance profiles, or particle counting data may be presented. The objective of this portion of the exit meeting is to clearly establish the utility's historical and existing performance relative to optimized performance goals. If optimized performance is not being achieved, this presentation establishes the foundation for the remaining exit meeting topics. If the CPE reveals that the treatment plant performance represents a significant health risk, this should be carefully explained to the utility staff. Regulatory personnel conducting such a CPE should determine if administrative or regulatory action should be implemented and should establish a time frame to protect public health (e.g., immediately).

The performance potential graph summarizes the major unit process evaluation. If Type 1 unit processes are indicated, the utility participants can be told that physical facilities were not determined to be limiting the plant's ability to achieve optimized performance goals. Type 2 unit processes do not necessarily indicate a construction need, and the potential of "operating around" these deficiencies can be presented. Type 3 unit processes demonstrate the need for construction alternatives.

The summary of prioritized performance limiting factors and a supplemental summary of key points that were used to identify these factors are the handouts utilized for this portion of the exit meeting. Throughout the presentation, the evaluator must remember that the purpose is to identify and describe facts to be used to improve the current situation, not to place blame for any past or current problems. Depending on the factors identified, this portion of the exit meeting can be the most difficult to present. Factors in the areas of operation and administration offer the greatest challenge. The evaluation team must "tell it like it is" but in a constructive and motivational manner. Little impact can be expected if this presentation is

softened to avoid conflict or adverse feedback from the utility staff. At the same time, it is also important that the factors not be presented so harshly that it creates an overly hostile environment, where the plant staff are so angry that they don't listen to CPE findings. Experience is valuable in balancing the presentation of difficult findings and achieving a motivational response. Often, it is valuable to have one person initiate the presentation of the findings with the option available for other team members to support the discussion. Arguments should be avoided during presentation of the factors.

It is emphasized that findings, and not recommendations, be presented at the exit meeting. The CPE, while comprehensive, is conducted over a short time and is not a detailed engineering study. Recommendations made without appropriate follow-up could confuse operators and administrators, lead to inappropriate or incorrect actions on the part of the utility staff, and ultimately result in improper technical guidance. For example, a recommendation to set coagulant dosages at a specific level could be followed literally to the extent that operations staff set coagulant dosages at the recommended level and never change them even though time and highly variable raw water conditions should have resulted in dosage adjustments.

An assessment of the value of follow-up activities should be discussed at the exit meeting. The utility may choose to pursue addressing performance limiting factors on their own. The CPE evaluators should emphasize the need to comprehensively address the factors identified. A piecemeal approach to address only the design limitations likely would not result in improved performance if adverse operation and administration factors continue to exist. It should also be made clear at the exit meeting that other factors are likely to surface during the conduct of any follow-up activities. These factors will also have to be addressed to achieve the desired performance. This understanding of the short term CPE evaluation capabilities is often missed by local and regulatory officials, and efforts may be developed to address only the items prioritized during the CPE. The evaluator should stress that a commitment must be made to achieve the desired optimized performance, not to address a "laundry list" of currently identified problems.

It is important to present all findings at the exit meeting with utility staff. This approach eliminates surprises when the CPE report is received.

An ideal conclusion for an exit meeting is that the utility fully recognizes its responsibility to provide a high quality finished water and that, provided with the findings from the CPE, the utility staff are enthusiastic to pursue achievement of this goal.

4.3.4 CPE Report

At the conclusion of the on-site activities, a CPE report is prepared. The objective of a CPE report is to summarize findings and conclusions. Ten to fifteen typed pages are generally sufficient for the text of the report. The CPE report should be available within a month following the on-site activities to reinforce the need to address factors limiting optimized performance. An example report is presented in Appendix G. Typical contents are:

- Introduction
- Facility Information
- Performance Assessment
- Major Unit Process Evaluation
- Performance Limiting Factors
- Assessment of Applicability of a CTA

As a minimum, the CPE report should be distributed to plant administrators, and they should be requested to distribute the report to key plant personnel. Further distribution of the report (e.g., to regulatory personnel or to the design consultant) depends on the circumstances of the CPE.

4.4 Case Study

The following case study provides insights on the conduct of a CPE at an actual water utility. The state regulatory agency had identified in their review of monthly monitoring reports that a conventional water treatment plant was routinely violating the 0.5 NTU limit on finished water turbidity. The state notified the community that they intended to conduct a CPE to identify the reasons for non-compliance with current regulatory requirements.

4.4.7 Facility Information

Facility A serves a community of 10,000 people and is located in an area with a temperate climate. The facility was designed to treat 5.0 MGD. Normally during the year the plant is operated for periods ranging from 5 to 12 hours each day. During operation, the facility is always operated at a flow rate of 5 MGD. A flow schematic of the facility is shown in Figure 4-9.

The following data were compiled from the completed data collection forms, as presented in Appendix F.

- Design Flow: 5.0 MGD
- Average Daily Flow: 1.2 MGD
- Peak Daily Flow: 4.0 MGD
- Peak Instantaneous Operating Flow: **5.0 MGD**

Figure 4-9. Flow schematic of Plant A.

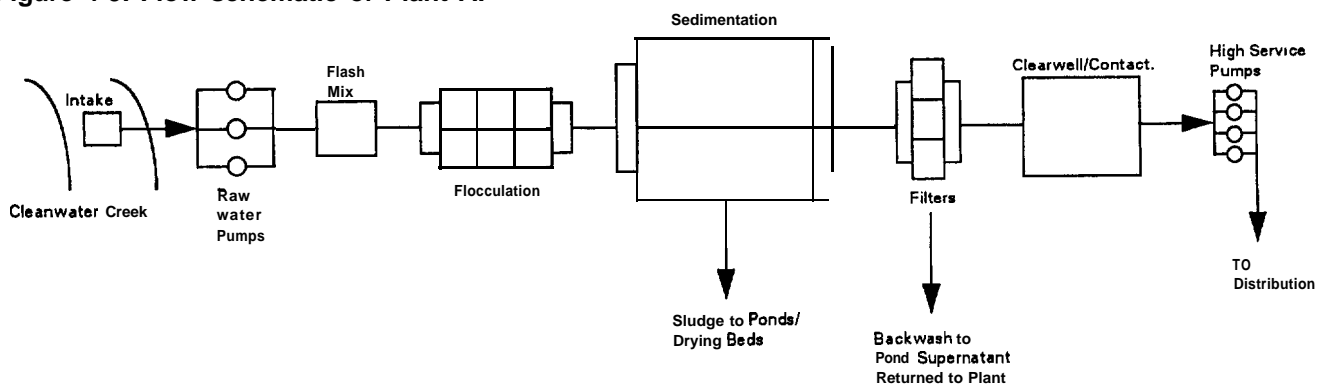

Flocculation:

- Number Trains: 2
- Type: Mechanical turbines, 3 stages
- Dimensions:
 - * Length: 15.5 ft
 - * Width: 15.5 ft
 - * Depth: 10.0 ft

Sedimentation:

- Number Trains: 2
- Type: Conventional rectangular
- Dimensions:
 - * Length: 90 ft
 - * Width: 30 ft
 - * Depth: 12 ft

Filtration:

- Number: 3
- Type: Dual media (i.e., anthracite, sand), gravity
- Dimensions:
 - * Length: 18 ft
 - * Width: 18 ft

Disinfection:

- Disinfectant: Free chlorine
- Application Point: Clearwell
- Number: 1
- Clearwell Dimensions:
 - * Length: 75 ft
 - * Width: 75 ft
 - * Maximum operating level: 20 ft
 - * Minimum operating level: 14 ft
- Baffling factor: 0.1 based on unbaffled basin

4.4.2 Performance Assessment

The performance assessment, using the most recent 12 months of data, indicated that the finished water turbidity was not meeting the regulated quality of <0.5 NTU in 95 percent of the samples collected each month. In fact, the 95 percent requirement was exceeded in 5 of 12 months, The raw water turbidity averaged

approximately 15 NTU and the settled water turbidity was measured at 4.3 NTU during the CPE. Routine sampling of settled water was not being practiced. Field evaluation of one of three filters during the on-site activities indicated a turbidity spike of 1.1 NTU following backwash with a reduction to 0.6 NTU after one hour of operation. The results of the performance assessment indicated that optimized performance goals were not being achieved.

4.4.3 Major Unit Process Evaluation

A performance potential graph (Figure 4-10) was prepared to assess the capability of Plant A's major unit processes. The calculations that were conducted to complete the graph are shown in the following four sections.

FIGURE 4-10. Performance potential graph for Plant A.

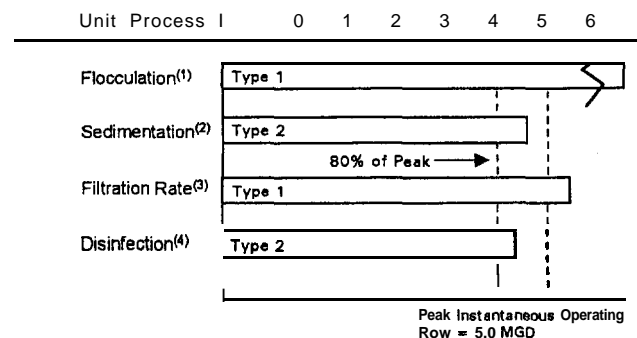

- (1) Rated at 20 min (HDT) – 7.6 MGD
- (2) Rated at 0.6 gpm/ft² – 4.7 MGD
- (3) Rated at 4.0 gpm/ft² – 5.6 MGD
- (4) Rated at 20 min HDT – 4.2 MGD

4.4.3.1 Flocculation Basin Evaluation

The flocculation basins were rated at a hydraulic detention time of 20 minutes because the flocculation system has desirable flexibility (i.e., three stages with each stage equipped with variable speed flocculators). The plant is also located in a temperate climate, so the temperature criteria is < 0.5°C.

1. Basin Volume = 6 basins x 15.5 ft x 15.5 ft x 10 ft x 7.48 gal/ft³
= 107,824 gallons
2. Select 20-minute detention time to determine peak rated capability.
3. Rated Capability = 107,824 gal/20 minutes
= 5,391 gpm x $\frac{1 \text{ MGD}}{694.4 \text{ gpm}}$
= 7.8 MGD

The 20-minute detention time results in a rated capability of 7.8 MGD. Therefore, the flocculation system is rated Type 1 because the 7.8 MGD exceeds the peak instantaneous plant flow of 5.0 MGD.

4.4.3.2 Sedimentation Basin Evaluation

The sedimentation basins were rated at 0.6 gpm/ft² surface overflow rate. This mid-range criteria was selected based on the basin depth of 12 ft and the observed poor performance during the on-site activities.

1. Basin Surface Area = 2 basins x 90 ft x 30 ft
= 5,400 ft²
2. Select 0.6 gpm/ft² surface overflow rate to determine peak rated capability.
3. Rated Capability = 5,400 ft² x 0.6 gpm/ft²
= 3,240 gpm x $\frac{1 \text{ MGD}}{694.4 \text{ gpm}}$
= 4.7 MGD

The 0.6 gpm/ft² overflow rate results in a rated capability of 4.7 MGD. The sedimentation basins are rated Type 2 because the 4.7 MGD rating falls within 80 percent of the 5 MGD peak instantaneous operating flow.

4.4.3.3 Filter Evaluation

The filters were rated at 4 gpm/ft² filtration rate based on dual-media with adequate backwashing capability.

1. Filter Area = 3 filters x 18 ft x 18 ft
= 972 ft²
2. Select 4 gpm/ft² to determine peak rated capability.
3. Rated Capability = 972 ft² x 4 gpm/ft²
= 3,888 gpm x $\frac{1 \text{ MGD}}{694.4 \text{ gpm}}$
= 5.6 MGD

The 4 gpm/ft² rate results in a rated capability of 5.6 MGD. The filters were rated Type 1 because 5.6 MGD exceeds the peak instantaneous operating flow of 5.0 MGD.

4.4.3.4 Disinfection Process Evaluation

The disinfection system was evaluated based on post-disinfection capability only since prechlorination was not practiced at Plant A.

1. Determine required *Giardia* log reduction/inactivation based on raw water quality. Select 3.0 log, based on state regulatory agency requirement.
2. Determine CT based on minimum water temperature and maximum treated water pH. From plant records select:
Temperature (minimum) = 0.5 °C
pH (maximum) = 7.5
3. Determine log inactivation required by disinfection.
Allow 2.5 log reduction because plant is conventional facility in reasonable condition with a minimum Type 2 rating in previous unit process evaluation.
Log inactivation required by disinfection = 3.0 - 2.5 = 0.5
4. Determine CT required for 0.5 log inactivation of *Giardia* at pH = 7.5
T = 0.5°C, free chlorine residual = 2.5 mg/L.
From tables in Appendix D, CT = 50.5 mg/L-min

5. Determine required contact time based on maximum free chlorine residual that can be maintained.

$$\begin{aligned} \text{Required contact time} &= \frac{50.5 \text{ mg/L} \cdot \text{min}}{2.5 \text{ mg/L}} \\ &= 20 \text{ min} \end{aligned}$$

6. Determine effective clearwell (contact basin) volume required to calculate peak rated capacity.

$$\begin{aligned} \text{Effective volume}^* &= 75 \text{ ft} \times 75 \text{ ft} \times \\ &14 \text{ ft} \times 0.1 \times 7.48 \text{ gal/ft}^3 \\ &= 58,905 \text{ gallons} \end{aligned}$$

*Basin is unbaffled so use T_{10}/T factor of 0.1. Use 14' minimum operating depth.

7. Determine rated capability:

$$\begin{aligned} \text{Rated Capacity} &= \frac{58,905 \text{ gal}}{20 \text{ min}} \\ &= 2,945 \text{ gpm} \times \frac{1 \text{ MGD}}{694.4 \text{ gpm}} \\ &= 4.2 \text{ MGD} \end{aligned}$$

The 20 minute HDT results in a rated capability of 4.2 MGD. The disinfection system was rated Type 2 because 4.2 MGD falls within 80 percent of the peak instantaneous plant flow of 5.0 MGD.

Based on the above calculations, a performance potential graph was prepared. The performance potential graph for Plant A is shown in Figure 4-10. As shown, flocculation and filtration were rated Type 1 because their rated capabilities exceeded the peak instantaneous operating flow rate of 5.0 MGD. Sedimentation and post-disinfection unit process were rated Type 2 because rated capacity was within 80% of the

It is noted that the option to operate the facility for a longer period of time to lower the peak instanta-

age daily flow rate on an annual basis is 1.2 MGD. If the plant were operated for 8 hours per day at

flow rate below the projected capability of all of the major unit processes. For peak demand days,

longer periods of operation. This option offers the capability to avoid major construction and still pur-

4.4.4 Performance Limiting Factors

The following performance limiting factors were "A" or "B." was also conducted, as indicated by the number

1. Application of Concepts and Testing to Process Control - Operation (A)
 - The plant operators had established no process control program to make decisions regarding plant flow rate, coagulant dose and filter operation.
 - Coagulant dosages had not been established based on jar tests or other means and were typically maintained at a constant setting despite raw water quality variations.
 - Filters were started dirty on a routine basis and the plant was operated at maximum capacity when a much lower rate was possible.
 - Filter effluent turbidities exceeded regulatory requirements for extended periods following backwash of a filter.
 - The operator's lack of awareness of the existence or impact of these spikes demonstrated a limited understanding of water treatment technology and the importance of producing high quality treated water on a continuous basis.
2. Process Control Testing - Operation (A)
 - The only process control testing that was conducted was turbidity on daily grab samples of raw water and treated water from the clearwell and chlorine residual on treated water after the high service pumps.
 - No process control testing was done to establish coagulant dosages or optimized sedimentation and filtration unit process performance.

-
3. Plant Coverage - Administration (A)
 - Plant operators were only allowed enough time to be at the plant to fill the reservoir, approximately six hours each day.
 - On occasion, the alum feed line would plug and go unnoticed, resulting in periods of poor treated water quality.
 - The operators were expected to conduct other activities, such as monitoring the city swimming pool, assisting wastewater treatment plant operators, and assisting street maintenance crews during summer months.
 4. Disinfection - Design (B)
 - Operation of the plant at maximum flow rate does not allow sufficient contact time for disinfection. However, operation of the plant at or below 4.2 MGD allows the disinfection unit process to be in compliance with existing regulations.
 5. Sedimentation - Design (B)
 - The sedimentation basin was not projected to be capable of achieving optimized performance criteria at flows above 4.7 MGD. Reducing the flow would allow the basin to perform adequately during most periods of the year.
 6. Sample Taps - Design (B)
 - Sample taps do not exist to allow samples to be obtained from the individual filters. This prevents the plant staff from obtaining needed information to optimize individual filter performance.

4.4.5 Assessing Applicability of a CTA

The most serious of the performance limiting factors identified for Plant A were process control-oriented. The evaluation of major unit processes resulted in a Type 2 rating at the present peak instantaneous operating flow. However, it was determined that the rating could be upgraded to Type 1 if the plant peak instantaneous operating flow rate could be reduced by operating for longer periods of time each day. This adjustment will require addressing the plant coverage factor by convincing administrators to allow operators to spend additional time at the treatment facility. If

plant flow can be reduced and operator coverage increased, it appears that the utility would be able to achieve improved performance through implementation of a follow-up CTA. These conditions would require approval by the City Council before a CTA could be initiated. Documentation of improvement in finished water turbidity, including reduction of spikes after dirty filter start-up and backwashing, should result from CTA efforts. Additionally, maintaining settled water turbidity at < 2 NTU on a continuous basis would be the expected result from a CTA. These improvements to optimized performance will enhance the treatment barriers that this facility provides and, thus, enhance public health protection.

4.4.6 CPE Results

The success of conducting CPE activities can be measured by plant administrators selecting a follow-up approach and implementing activities to achieve the required performance from their water treatment facility. If definite follow-up activities are not initiated within a reasonable time frame, the objectives of conducting a CPE have not been achieved. Ideally, follow-up activities must comprehensively address the combination of factors identified (e.g., implement a CTA) and should not be implemented in a piecemeal approach. In the previous example, plant administrators decided to hire a third party to implement a CTA. The CTA addressed the identified factors and resulted in the existing plant achieving optimized performance goals without major capital improvements.

4.5 References

1. Bender, J.H., R.C. Renner, B.A. Hegg, E.M. Bissonette, and R. Lieberman. 1995. "Partnership for Safe Water Voluntary Water Treatment Plant Performance Improvement Program Self-Assessment Procedures." USEPA, AWWA, AWWARF, Association of Metropolitan Water Agencies, Association of State Drinking Water Administrators, and National Association of Water Companies.
2. Eastern Research Group, Inc. 1992. Water Advisor Utilizing the CCP Approach (Expert System). USEPA Work Assignment No. 7391-55. Eastern Research Group, Inc., Arlington, MA.

-
3. Renner, R.C., B.A. Hegg, J.H. Bender, and E.M. Bissonette. February 1991. Handbook - Optimizing Water Treatment Plant Performance Using the Composite Correction Program. EPA 625/9-91 /027. USEPA, Cincinnati, OH.

American Society of Civil Engineers and American Water Works Association. 1990. Water Treatment Plant Design. McGraw-Hill, 2nd ed.
 5. James M. Montgomery Consulting Engineers, Inc. 1985. Water Treatment Principles and Design. John Wiley & Sons, Inc.
 6. Sanks, R.L., ed.. 1978. Water Treatment Plant Design for the Practicing Engineer. Ann Arbor Science Publishers, Kent, England.

Renner, R.C., B.A. Hegg, and J.H. Bender. March 1990. EPA Summary Report: Optimizing Water Treatment Plant Performance With the Composite Correction Program. EPA 625/8-90/017, USEPA Center for Environmental Research Information, Cincinnati, OH.
 8. "Surface Water Treatment Rule", from Federal Register, Vol. 54, No. 124, U.S. Environmental Protection Agency, 40 CFR, Parts 141 and 142, Rules and Regulations, Filtration/Disinfection (June 1989).
 9. USEPA. 1989. Guidance Manual for Compliance With the Filtration and Disinfection Requirements for Public Water Systems Using Surface Water Sources. NTIS No. PB 90148016. USEPA, Washington, DC.
 10. Regli, S. June 1990. "How's and Why's of CTs." Presented at AWWA Annual Conference, Cincinnati, OH.
 11. Cleasby, J.L., M.M. Williamson, and E.R. Baumann. 1963. "Effect of Filtration Rate Changes on Quality." Journal AWWA, 55:869-878.
 12. Cleasby, J.L., A.H. Dharmarajah, G.L. Sindt, and E.R. Baumann. September 1989. Design and Operation Guidelines for Optimization of the High Rate Filtration Process: Plant Survey Results. AWWA Research Foundation and AWWA, Denver, CO.

Chapter 5 Comprehensive Technical Assistance

5.1 Objective

The objective of conducting Comprehensive Technical Assistance (CTA) activities is to achieve and sustain optimized performance goals, as *was* described in Chapter 2. Given this objective, the results of a successful CTA can be easily depicted in graphical form. Results from an actual CTA are presented in Figure 5-1. As shown, plant performance was inconsistent as depicted by the variations in finished water turbidity. However, after CTA activities had been implemented (April 1997) the treated water quality gradually improved to a level that has been consistently less than 0.1 NTU. It is noted that other parameters, such as improved operator capability, cost savings, and improved plant capacity are **often** associated with the conduct of a CTA, but the true measure of success is the ability to achieve optimized performance goals and demonstrate the capability to meet these goals long-term under changing raw water quality conditions. It is recommended that CTA results be presented graphically to indicate that the primary objective has been achieved.

An additional objective of a CTA is to achieve optimized performance from an existing water treatment facility (i.e., avoid, if possible, major modifications). If the results of a Comprehensive Performance Evaluation (CPE) indicate a Type 1 plant (see Figure 4-3), then existing major unit processes have been assessed to be adequate to meet optimized treatment requirements at current plant loading rates. For these facilities, the CTA can focus on systematically addressing identified performance limiting factors to achieve optimized performance goals.

For Type 2 plants, some or all of the major unit processes have been determined to be marginal. Improved performance is likely through the use of a CTA; however, the plant may or may not meet optimized performance goals without major facility modifications. For these plants, the CTA focuses on obtaining optimum capability of existing facilities. If the CTA does not achieve the desired finished water quality, unit process deficiencies will be clearly identified and plant administrators can be confident in pursuing the indicated facility modifications.

Figure 5-1. CTA results showing finished water quality improvements.

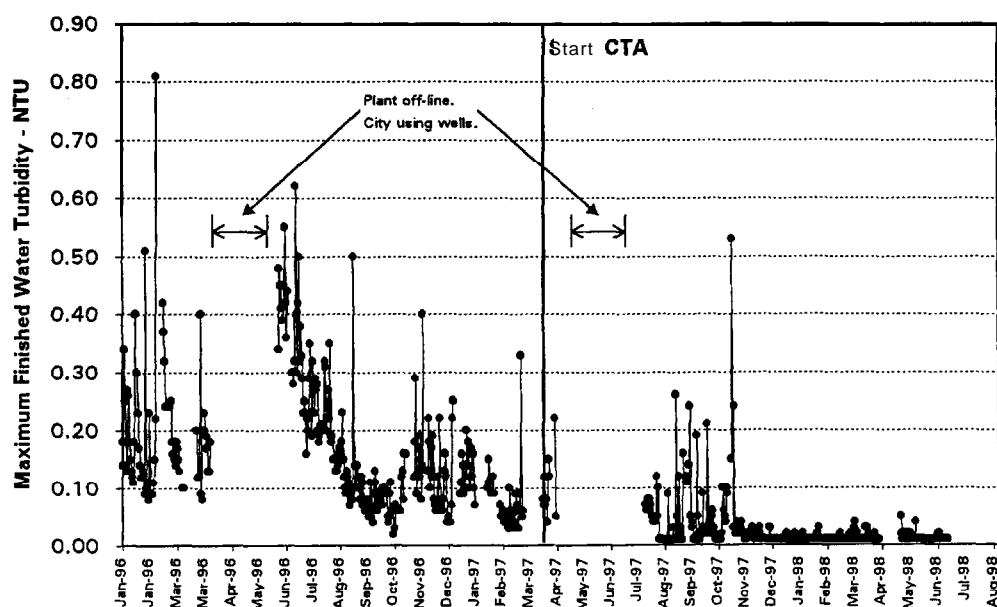

For Type 3 plants, major unit processes have been determined to be inadequate to meet performance objectives. For these facilities, major construction is indicated and a comprehensive engineering study that focuses on alternatives to address the indicated construction needs is warranted. The study should also look at long term water needs, raw water source or treatment alternatives, and financing mechanisms.

If an existing Type 3 plant has performance problems with the potential to cause serious public health risk, officials may want to try to address any identified limitations, in addition to the design factors, to improve plant performance. In these cases, activities similar to a CTA could be implemented to obtain the best performance possible with the existing facilities, realizing that optimum performance would not be achieved. Additionally, administrative actions such as a boil order or water restrictions may have to be initiated by regulators until improvements and/or construction can be completed for Type 3 facilities.

5.2 Conducting CTAs

5.2.1 Overview

The CTA was developed as a methodology to address the unique combination of factors that limit an individual facility's performance through use of a consistent format that could be applied at multiple utilities. This foundation for the CTA necessarily required a flexible approach. Concepts that define the general CTA approach are further discussed.

Implementation of a CTA is guided by an unbiased third party who is in a position to pursue correction of factors in all areas such as addressing politically sensitive administrative or operational limitations. This person, called the CTA facilitator, initiates and supports all of the CTA activities. The CTA facilitator uses a priority setting model as a guide to address the unique combination of factors that have been identified in a CPE. Based on the priorities indicated by this model, a systematic long term approach is used to transfer priority setting and problem solving skills to utility personnel. The priority setting model is illustrated graphically in Figure 5-2.

The first step in implementation of a CTA is establishing the optimized performance goals that will be the objectives to achieve during the conduct of

the CTA. Since these goals exceed regulated requirements, the plant administration has to embrace achieving this level of performance from a public health perspective. For example, administrators must be aware that even momentary excursions in water quality must be avoided to prevent *Giardia* and *Cryptosporidium* or other pathogenic organisms from passing through the treatment plant and into the distribution system. To this end, all unit processes must be performing at high levels on a continuous basis, thus providing a "multiple barrier" to passage of pathogenic organisms through the treatment plant. Ultimately, administrators must adopt the concept of optimized performance goals and be willing to emphasize the importance of achieving these goals within the framework of the CTA.

Figure 5-2. CTA priority setting model.

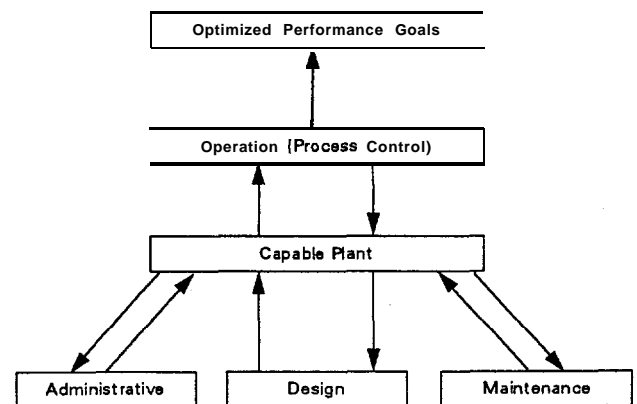

When the performance objectives are established, the focus turns to operation (i.e., process control) activities. Implementing process control is the key to achieving optimized performance goals with a capable facility. Administration, design and maintenance are necessary to support a capable plant. Any limitations in these areas hinder the success of the process control efforts. For example, if filtered water turbidity cannot be consistently maintained at optimized levels because operating staff is not at the plant to make chemical feed adjustments in response to changing raw water quality, then improved performance will require more staff coverage. In this case, identified limitations in making chemical feed adjustments established the priority for improving staff coverage (i.e., an administrative policy). Additional staff coverage would alleviate the identified deficiency (i.e., support a capable plant) and allow process adjustments to be made so that progress toward the

optimized performance goals could be continued. In this manner, factors can be prioritized and addressed, ensuring efficient pursuit of the optimized performance goals.

The results of the CPE (Chapter 4) provide the initial prioritized list of performance limiting factors impacting an individual facility. The CTA facilitator utilizes these factors, coupled with the priority setting model, to establish the direction for the CTA. It is important to note that a CTA is a dynamic process, and the facilitator will have to constantly readjust priorities as the events unfold. The model can be used repetitively to assist in the prioritization of CTA activities.

A systematic long term process is used to transfer priority setting and problem solving skills to the utility personnel during a CTA. Typically, 6 to 18 months are required to implement a CTA. This long time period is necessary for several reasons:

- **Time necessary to identify and develop a local champion or champions.** Since the CTA facilitator is off-site, one or more personnel that can implement the CTA activities need to be identified. These persons are called champions since they are the focal point for CTA implementation. They are designated as the person at the plant responsible to understand the implementation of the CTA and to assist the plant staff with CTA activities on a day-to-day basis. This person is also the key contact for communications with the CTA facilitator and the local personnel. The champion is also the focal point for the transfer of priority setting and problem solving skills. The champion will ultimately be responsible for transfer of these skills to the other utility personnel. This transfer is essential to ensure the continuity of water quality improvements after the facilitator is gone. Ideally, the champion would be the superintendent or lead operator.
- **Greater effectiveness of repetitive training techniques.** Operator and administrator training should be conducted under a variety of actual operating conditions (e.g., seasonal water quality or demand changes). This approach allows development of observation, interpretation, and implementation skills necessary to maintain desired finished water quality during periods of variable raw water quality.
- **Time required to make minor facility modifications.** For changes requiring financial expenditures, a multiple step approach is typically required to gain administrative (e.g., City Council) approval. First, the need for minor modifications to support a capable facility must be demonstrated. Then, council/administrators must be shown the need and ultimately convinced to approve the funds necessary for the modifications. This process results in several months before the identified modification is implemented and operational.
- **Time required to make administrative changes.** Administrative factors can prolong CTA efforts. For example, if the utility rate structure is inadequate to support plant performance, extensive time can be spent facilitating the required changes in the rate structure. Communication barriers between “downtown” and the plant or among staff members may have to be addressed before progress can be made on improved performance. If the staff is not capable, changes in personnel may be required for the CTA to be successful. The personnel policies and union contracts under which the utility must operate may dictate the length of time these types of changes could take.
- **Time required for identification and elimination of any additional performance limiting factors that may be found during the CCP.** It is important to note that additional performance limiting factors, not identified during the short duration of the CPE, often become apparent during conduct of the CTA. These additional limitations must also be removed in order to achieve the desired level of performance.

5.2.2 Implementation

Experience has shown that no single approach to implementing a CTA can address the unique combination of factors at every water treatment plant. However, a systematic approach has been developed and specific tools have been used to increase the effectiveness of CTA activities. The approach requires involvement of key personnel and establishes the framework within which the CTA activities are conducted. Key personnel for the implementation of the CTA are the CTA facilitator and

the utility champions. The framework for conducting the activities includes site visits, communication events, and data and records review conducted over a sufficient period of time (e.g., 6 to 18 months),

The tools utilized for conducting CTAs have been developed to enhance the transfer of capability to utility administrators and staff. Actual implementation of each CTA is site-specific, and the combination of tools used is at the discretion of the CTA facilitator. Additional approaches to addressing performance limiting factors exist, and a creative facilitator may choose other options,

Implementation of a successful CTA requires that the CTA facilitator constantly adjust the priorities and implementation techniques to match the facility and personnel capabilities at the unique site. The bottom line is that optimized performance goals, that can be graphically depicted, need to be achieved as a result of the CTA efforts (see Figure 5-1). Components of CTA implementation are further described.

5.2.2.1 Approach

CTA Facilitator

The CTA facilitator is a key person in the implementation of CTA activities and must possess a variety of skills due to the dynamic nature of the process. Desired skills include a comprehensive understanding of water treatment unit processes and operations and strong capabilities in leadership, personnel motivation, priority setting, and problem solving.

Comprehensive understanding of water treatment unit processes and operations is necessary because of the broad range of unit processes equipment and chemicals utilized. For example, numerous sedimentation devices exist such as spiral flow, reactor type, lamella plate, tube settlers, pulsators and solids contact units. Additionally, multiple possibilities exist in terms of types, combinations and dosages of coagulant, flocculant and filter aid chemicals.

Operations capability is necessary to understand the continually changing and sometimes conflicting requirements associated with water treatment. Optimization for particulate removal ultimately has to be coordinated with control of other regulated parameters such as disinfection by-products or

lead and copper. In addition, those responsible for implementing a CTA must have sufficient process control capability to establish an appropriate approach that is compatible with the personnel capabilities available at the utility.

A CTA facilitator must often address improved operation, improved maintenance, and minor design modifications with personnel already responsible for these water treatment functions. A "worst case situation" is one in which the plant staff is trying to prove that "the facilitator can't make it work either." The CTA facilitator must be able to create an environment to maintain communications and enthusiasm and to allow all parties involved to focus on the common goal of achieving optimized plant performance. Ultimately, the CTA facilitator must transfer priority setting and problem solving skills to the utility staff. The objective here is to leave the utility with the necessary skills after the facilitator leaves so that the performance goals can be met long term. To accomplish this transfer, the facilitator must create situations for local personnel to "self discover" solutions to ongoing optimization challenges so that they have the knowledge and confidence to make all necessary changes. In almost all cases the facilitator must avoid assuming the role of troubleshooter or the person with all of the answers. Each situation has to be evaluated for its learning potential for the staff.

A CTA facilitator must be able to conduct training in both formal and on-the-job situations. Training capabilities must also be developed so they are effective with both operating as well as administrative personnel. When addressing process control limitations, training must be geared to the specific capabilities of the process control decision makers. Some may be inexperienced; others may have considerable experience and credentials. "Administrative" training is often a matter of clearly providing information to justify or support CTA objectives or activities. Although many administrators are competent, some may not know what to expect from their facilities or what their facilities require in terms of staffing, minor modifications, or specific funding needs.

CTA facilitators can be consultants, state and federal regulatory personnel, or utility employees. For consultants, the emphasis of optimizing the "existing facility" without major construction must be maintained. A substantial construction cost can be incurred if an inexperienced facilitator is not able to bring a capable water treatment plant

to the desired level of performance. For example, a consultant, involved primarily with facility design, may not have the operational experience to utilize the capability of existing unit processes to their fullest extent and may be biased toward designing and constructing new processes.

If utility personnel try to fill the role as CTA facilitator, they should recognize that some inherent problems may exist. The individuals implementing the CTA, for example, often find it difficult to provide an unbiased assessment of the area in which they normally work (i.e., operations personnel tend to look at design and administration as problem areas; administrators typically feel the operations personnel should be able to do better with existing resources). These biases should be recognized, and they must be continually challenged by utility personnel who assume the role of CTA facilitator.

Individuals who routinely work with water utilities to improve water treatment plant performance will likely be the best qualified CTA facilitators. These people are typically engineers or operators who have gained experience in correcting deficiencies at plants of various types and sizes. CTA facilitators that have experience in a variety of plants have a definite advantage in their ability to recognize and correct true causes of limited performance.

On-Site CTA Champion

In addition to the capabilities of the CTA facilitator, it is necessary to have one or several utility personnel who “champion” the objectives and implementation of the CTA process. The champion is the person who assumes the day-to-day responsibilities of pursuing the implementation of the established priorities. This person is also responsible for the transfer of problem solving skills learned from the CTA facilitator to the rest of the staff.

Identification of the champion is a key step in the success of the CTA. Ideally, the superintendent or lead operator is the person that would fill the champion role. However, many times these individuals may be part of the limitation to achieving optimized performance because they tend to stick to the old ways of conducting business. New operators or laboratory personnel often offer the greatest potential for the role as champion. To resolve some of the issues with the selection of these “junior” personnel, a champion team con-

sisting of the selected personnel and the personnel that normally would assume the role (e.g., the superintendent) can be selected.

Ideally the role of the champion is formally identified during the CTA activities. In other cases, however, it may be necessary to use an informal approach where the champion is only recognized by the CTA facilitator. For example, in some cases the champion may not be the typical person, based on the “chain of command.” In these cases the use of a junior person to assist the supervisor or superintendent in the actual implementation may be the only option available to ensure progress on CTA activities. This is a delicate situation for the facilitator, and extra effort is required to maintain open communications and acceptance for project activities. In any event, the closer the characteristics of the champion are to those outlined for the CTA facilitator, the easier the implementation of the CTA will be.

CTA Framework

A consistent framework has been developed to support the implementation of a CTA. The framework consists of on-site involvement (e.g., site visits) interspersed with off-site activities (e.g., communication events such as phone/fax/e-mail and data and guidelines review). A graphical illustration of the CTA framework is shown in Figure 5-3.

- **Site visits** are used by the facilitator to verify or clarify plant status, establish optimization performance goals, initiate major process control changes, test completed facility modifications, provide on-site plant or administrative training, and report progress to administrators and utility staff. Dates for site visits cannot be established at specific intervals and must be scheduled based on plant status (e.g., process upsets), training requirements, communications challenges, etc. As shown in Figure 5-3, site visits and communication events typically taper off as the CTA progresses. This is in line with the transfer of skills to the plant staff that occurs throughout the CTA. The number of site visits required by a CTA facilitator is dependent on plant size and on the specific performance limiting factors. For example, some administrative (e.g., staffing and rate changes) and minor design modifications could significantly increase the number of site visits required to complete a CTA. Typically, the

Figure 5-3. Schematic of CTA framework.

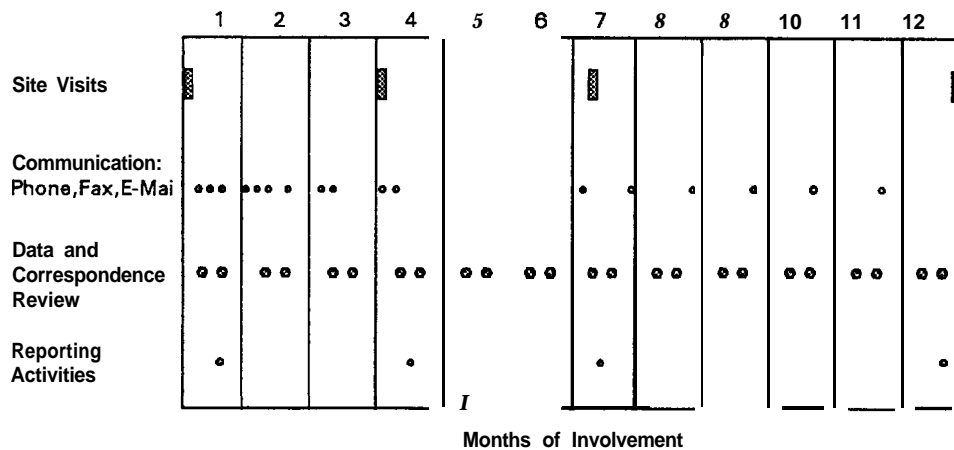

initial site visit is conducted over three to four days and intermediate site visits are conducted over two to three days. CTA accomplishments and proposed future activities are presented to plant and administrative personnel at an exit meeting at the conclusion of each site visit.

- **Communication events** such as telephone calls, faxes and e-mail are used to routinely assess CTA progress. Communication activities are normally conducted with the on-site CTA champion. Routine contact is used to train and encourage plant personnel to pursue data collection and interpretation, encourage progress on prioritized activities, and provide feedback on special studies and guideline development. The CTA facilitator should always summarize important points, describe decisions that have been reached, and identify actions to be taken. Further, both the CTA facilitator and plant personnel should maintain written phone logs. It is noted that communication events have limited ability to address all identified factors. As such, the CTA facilitator should always monitor the progress being accomplished in the effectiveness of the communication events to assess the need for a site visit.
- **Data and correspondence review** are activities where the CTA facilitator reviews the information provided routinely by the utility. A format for submittal of weekly performance data is established during the initial site visit. This information is provided in hard copy or electronically by the utility. Results of special

studies or draft operational guidelines are also submitted to the CTA facilitator for review. Review and feedback by the CTA facilitator are key to demonstrate the importance of efforts by the utility personnel. Findings from data and records review are related to the staff by communications events. The routine feedback enhances the data development and interpretation skills of the utility staff.

- **Reporting activities** are used to document progress and to establish future direction. Short letter reports are typically prepared at the conclusion of each site visit. These reports can be used to keep interested third parties (e.g., regulatory personnel) informed and to maintain a record of CTA progress and events. They also provide the basis for the final CTA report, Short reports or summaries can also be developed to justify minor facility upgrades or changes in plant coverage or staffing. A final CTA report is typically prepared for delivery at the last site visit. The report should be brief (e.g., eight to twelve pages are typically sufficient for the text of the report). Graphs documenting the improvement in plant performance should be presented. If other benefits were achieved these should also be documented. Typical contents are:
 - **Introduction:**
 - * Reasons for conducting the CTA.
 - **CPE Results:**
 - * Briefly summarize pertinent information from the CPE report.

- . CTA Significant Events:
 - * Chronological summary of activities conducted.
 - * Include special study results.
- . CTA Results:
 - * Graph of plant performance plus other benefits.
- . Conclusions:
 - * Efforts required to maintain improved performance.
- . Appendices:
 - * Compilation of site specific guidelines developed by the plant staff.

5.2.2.2 Tools

Contingency Plans

Contingency plans should be prepared for facilities producing finished water quality that is not meeting current regulated requirements and for possible instances when finished water degrades during implementation of changes during the CTA. The contingency plan should include actions such as reducing plant flow rate to improve performance, shutting down the plant, initiating a voluntary public notification, and initiating a voluntary boil order. If plant finished water exceeds a regulated maximum contaminant level (MCL), the State regulatory agency should be immediately informed, and public notification procedures mandated by the Public Notification Regulation Rule (1) should be followed. To minimize the chance of producing unacceptable finished water while conducting a CTA, all experimentation with chemical doses and different coagulant products should be done on a bench scale (e.g., jar test) before implementing changes on a full scale basis. Full scale experimentation can be done on an isolated treatment train or during low demand conditions that would allow “dumping” of improperly treated water.

Action Plans

Action plans can be utilized to ensure progressive implementation of performance improvement activities. The action plan summarizes items to be completed, including the name of the person that

is assigned a particular task and the projected due date. The plan is normally developed during the CTA site visits and distributed by the CTA facilitator. The plan should identify tasks that are clear to the person responsible and within their area of control. The person should have been involved in the development of the action item and should have agreed to the assignment and the due date. The action plan is provided to administrators and plant personnel after site visits or communication events. Communication events are used to encourage and monitor progress on the assigned action items. An example format for an “Action” plan is shown in Figure 5-4.

Figure 5-4. Example action plan.

Item	Action	Person Responsible	Date Due
1	Develop calibration curve for polymer feed pump.	Jon	4/4
2	Draft special study procedure to evaluate use of a flocculant aid to improve sedimentation basin performance.	Bob	5/1
3	Process control: a. Develop daily data collection sheet. b. Develop routine sampling program. c. Draft guideline for jar testing.	Larry Eric Rick	4/17 4/24 4/28

Special Studies

Special studies can be used to evaluate and optimize unit processes, to modify plant process control activities, or to justify administrative or design changes necessary to improve plant performance. They are a structured, systematic approach for assessing and documenting plant optimization activities. The format for development of a special study is shown in Figure 5-5. The major components include the special study topic, hypothesis, approach, duration of the study, expected results, documentation/conclusions, and implementation plan. The hypothesis should have a focused scope and should clearly define the objective of the special study. The approach should provide detailed information on how the study is to be conducted including: when and where samples are to be collected, what analyses are to be conducted, and which specific equipment or processes will be used. The approach should be

developed in conjunction with the plant staff to obtain staff commitment and to address any challenges to implementation that may exist prior to initiating the study. Expected results ensure that measures of success or failure are discussed prior to implementation. It is important that the study conclusions be documented. Ideally, data should be developed using graphs, figures and tables. This helps to clarify the findings for presentation to interested parties (e.g., plant staff, administrators, regulators). Special study findings serve as a basis for continuing or initiating a change in plant operation, design, maintenance or administration. An implementation plan in conjunction with conclusions identifies the procedural changes and support required to utilize special study results. If all of the steps are followed, the special study approach ensures involvement by the plant staff, serves as a basis for ongoing training, and increases confidence in plant capabilities. An example special study is presented in Appendix I.

Operational Guidelines

Operational guidelines can be used to formalize activities that are essential to ensure consistent plant performance. Examples of guidelines that can be developed include: jar testing, polymer dilution preparation, polymer and coagulant feed calculations, filter backwashing, chemical feeder calibration, sampling locations and data recording. The CTA facilitator may provide examples, but guidelines should be developed by the plant staff. Through staff participation, operator training is enhanced and operator familiarity with equipment manuals is achieved. Additionally, communication among operators and shifts is encouraged in the preparation of guidelines. The guidelines should be prepared using word processing software and should be compiled in a three-ring binder so that they can be easily modified as optimization practices are enhanced. An example guideline is presented in Appendix J.

Data Collection and Interpretation

Data collection and interpretation activities are used to formalize the recording of results of process control testing that is initiated. Typically, a daily sheet is used to record operational data such as lab test results, flow data, and chemical use. These data are transferred to monthly sheets that are used to report necessary information to the

regulatory agency and to serve as a historic record for plant operation. Examples of daily and monthly process control sheets are presented in Appendix K. Graphs or trend charts can be used to enhance the interpretation of process monitoring results. The data developed can be plotted over long periods to show seasonal trends and changes in water demand or over shorter periods to show instantaneous performance. Examples of data development over a several month period are shown in Figure 5-1. A short term trend chart showing raw, settled and filtered water turbidities over a one-day period is depicted in Figure 5-6. During this period no change in coagulant dose was initiated, despite the change in raw water turbidity. As a result, settled water and finished water quality deteriorated several hours after the raw water turbidity increased. Without the use of a trend chart this correlation would be difficult to observe.

Figure 5-5. Special study format.

<p>Special Study Topic: Identify name of the special study and briefly describe why the study is being conducted (i.e., one to two sentences).</p>
<p>Hypothesis: Focused scope. Try to show definite cause/effect relationship.</p>
<p>Approach: Detailed information on conducting study. Involve plant staff in development.</p>
<p>Duration of Study: Important to define limits of the study since "extra work" is typically required.</p>
<p>Expected Results: Projection of results focuses attention on interim measurements and defines success or limitations of effort.</p>
<p>Conclusions: Documented impact of study allows the effort to be used as a training tool for all interested parties. Allows credit to be given for trying an approach.</p>
<p>Implementation: Identifies changes or justifies current operating procedures. Formalizes demonstrated mechanisms to optimize plant performance.</p>

Figure 5-6. Short term trend chart showing relationship of raw, settled and filtered water turbidities.

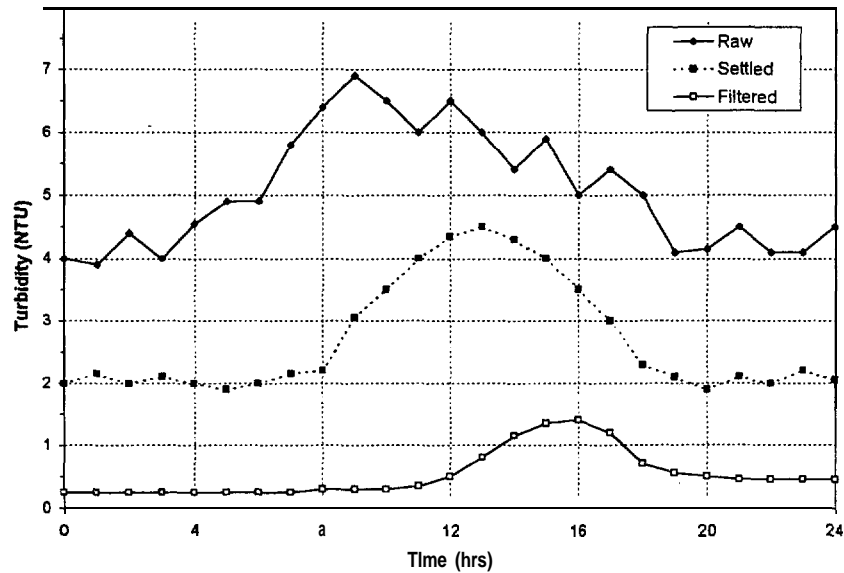

Priority Setting Tools

The CTA facilitator uses the priority setting model (i.e., Figure 5-2) to aid in establishing priorities for implementing a CTA. Awareness of this model can be provided to utility personnel to aid them in setting routine priorities for utility activities.

Another method that is useful for utility personnel to aid in developing their priority setting skills is the nominal group process. This mechanism uses a facilitator (e.g., the CTA facilitator initially and the utility champion or other staff as the CTA progresses) to solicit input from plant personnel during a formal meeting by asking an open-ended question concerning optimization activities. A question such as “What concerns, activities, or modifications, can we address to continue to pursue optimization performance goals at our utility?” can be asked to start the discussion. Participants are given time to develop ideas and the facilitator then solicits responses one at a time from each person in a round-robin fashion. After all ideas are documented (e.g., on a flip chart or chalk board) the ideas are discussed for clarity and overlap. The participants then priority vote on the issues (e.g., vote for the top five issues, allowing five points for the top issue, four for the second issue, etc.). Topics are prioritized by the number of votes that they get, and ties are differentiated by the number of points. Based on the combined results of all of the voting, the highest priority issues are identified. These issues are discussed,

and action steps are identified and placed on an action list. Example results from a priority setting activity are shown in Figure 5-7.

The nominal group process encourages involvement of all parties and provides significant training during the open discussion of prioritized topics. The CTA facilitator can interrupt the discussions if technical inaccuracies exist; but, for the most part, the facilitator should try to maintain a neutral role. It is important to note, however, that the nominal group process is only effective after the CTA is underway and the initial key priorities have been implemented. After the initial efforts, the utility personnel are more aware of the purpose of the CTA and better equipped to contribute meaningful suggestions concerning optimization activities. It is up to the CTA facilitator to ascertain when utility personnel are able to effectively utilize this tool.

Topic Development Sheets

Topic development sheets (see Figure 5-8) can be used to develop problem solving skills in utility personnel. In utilizing the topic development sheet, the issue should be clearly defined. An ideal starting point would be a prioritized issue developed from the nominal group process. The CTA facilitator, initially, and utility champion, as the CTA progresses, would lead the discussion on using the topic development sheet format.

Figure 5-7. Example priority setting results from CTA site visit activity.

Question: *What concerns, activities or modifications can be addressed to continue to pursue optimization goals at your utility?*

List of Responses:

1. Post backwash turbidity spikes
2. Retention of trained staff
3. End point for CTA project
4. Eliminate washwater return
5. Drought impact (color, taste and odor, rationing)
6. Flow indicators on chemical feeders
7. Reconsider particle counter capability
8. Recognition for utility staff by regulatory agency
9. Recent budget constraints
10. Public relations on optimization efforts

1 1. Maintaining optimization approach

Prioritized Topics:

Rank	Item	Votes	Points
1	Flow indicators on chemical feeders	6	24
2	Post backwash turbidity spikes	6	23
3	Retention of trained staff	5	17
4	End point for CTA project	4	7
5	Maintaining optimization approach	3	10
6	Recognition for utility staff	3	5

Figure 5-8, provides a section listing obstacles. Typically, it is easier for participants to discuss the reasons why an idea will not work. After the obstacles are presented, the facilitator should focus the group on possible solutions. The facilitator should have the group pursue a solution for each obstacle. While the discussion occurs, the benefits for making the change can be listed in the benefits section of the sheet. The solutions should be converted to action steps and documented on the sheet. The action steps should be subsequently transferred to the optimization action plan.

Use of the topic development sheet is effective in enhancing the problem solving skills of utility personnel. The tool allows obstacles to be presented but requires that solutions and action steps also be developed. Use of the topic development sheet

and the associated activity also enhances communication skills among the staff.

Figure 5-8. Example topic development sheet.

TOPIC DEVELOPMENT SHEET	
Topic/Issue:	
Benefits:	
Possible Obstacles:	Possible Solutions:
Action Steps: •	

* transfer to an Action Plan.

Internal Support

The CTA facilitator must ensure that internal communication to maintain support for the CTA occurs at all levels of the organization. This is typically done through routine meetings (e.g., during site visits) or with summary letters and communication events. Internal support is key to develop during the conduct of a CTA and can be useful in accomplishing desired changes. Typically, a CTA introduces a “new way of doing business” to the water utility. This new approach is not always embraced by the existing personnel. Support from the personnel department or the administrative staff can be utilized in establishing the “acceptable behavior” required of the utility staff to support the CTA objectives. For example, the CTA facilitator and utility champion may have clearly defined a new sampling procedure to support the optimization efforts. If a staff member will not comply with the approach or continues to resist the change, administrative pressure can be

solicited if internal support for project activities has been maintained.

What-If Scenarios

Many facilities have very stable raw water sources and as such are not challenged with variations that test the capability of facilities and personnel to respond and maintain optimized performance goals. In some facilities this is true even if the duration of the CTA is over a period of a year or greater. In these facilities, factors relating to reliability and complacency often need to be addressed. The CTA facilitator can create “what-if scenarios” for the utility personnel to address. Development of these scenarios may be the only opportunity during the conduct of the CTA to prepare local personnel for challenging situations. “What-if scenarios” should only be utilized after the plant staff have gained experience and confidence from CTA training activities.

5.2.2.3 Correcting Performance Limiting Factors

A major emphasis of a CTA is addressing factors identified as limiting performance in the CPE phase as well as additional limiting factors that may be identified during the CTA. Correcting these factors provides a capable plant and allows the operational staff to utilize improved process control (operation) to move the plant to achievement of optimized performance goals. Approaches that can be implemented to enhance efforts at addressing factors in the areas of design, administration, maintenance and operation are discussed in the following sections.

Design Performance Limiting Factors

The performance of Type 3 plants is limited by design factors that require major modifications to correct. Major modifications require the development of contract documents (i.e., drawings and specifications) and hiring a construction company to complete the improvements. Examples include the addition of a sedimentation basin or expansion of a clear well. Major modifications can sometimes be avoided by operating the plant at a lower flow rate for longer periods of time; thereby reducing the unit process hydraulic loading rate to a range that allows adequate performance to be achieved. CTA experience with Type 2 facilities

may support the need for major construction; and once this has been established, utility staff should pursue this direction similar to a Type 3 facility.

The performance of Type 1 and Type 2 plants can often be improved by making minor modifications to the plant. A minor modification is defined as a modification that can be completed by the plant staff without development of extensive contract documents. Examples of minor modifications include: adding a chemical feeder, developing additional chemical feed points, or installing baffles in a sedimentation basin.

A conceptual approach to improving design performance limiting factors is based on the premise that if each proposed design modification can be related to an increased capability to achieve optimized performance goals, then the modification will be supported. For example, if a chemical feeder is necessary to provide a feed rate in a lower range than current equipment can provide, then the design modifications are needed to provide a capable plant so that desired process control objectives can be met (see Figure 5-2). The need for this minor modification can be easily documented and justified to the administration. Support for the modification would be expected.

The degree of documentation and justification for minor modifications usually varies with the associated costs and specific plant circumstances. For example, little justification may be required to add a sampling tap to a filter effluent line. However, justification for adding baffles to a flocculation basin would require more supporting information. Extensive justification may be required for a facility where water rates are high and have recently been raised, yet there is no money available for an identified modification.

The CTA facilitator should assist in developing the plant staff skills to formally document the need for minor modifications. This documentation is valuable in terms of presenting a request to supervisory personnel and in providing a basis for the plant staff to continue such requests after the CTA has been completed. For many requests the special study format can be used as the approach for documenting the change (see Special Studies section previously discussed in this chapter). For modifications with a larger cost, the following items may have to be added to the special study format.

- Purpose and benefit of the proposed change (i.e., how does the change relate to the development of a capable plant so that process control can be used to achieve performance goals?).
- Description of the proposed change and an associated cost estimate.

Many state regulatory agencies require that modifications, other than repair and maintenance items, be submitted for their approval. Improvements requiring state approval may consist of items such as changing types of chemicals added to the water (e.g., substituting iron salts for aluminum salts), adding another chemical feeder (e.g., filter aid polymer feeder), or modifying filter media. If there is any doubt as to whether approval is needed, the facilitator should recommend submitting the proposed modification to the regulatory agency for approval. Typically, the same documentation that would be prepared to obtain administrative approval can be used for the submittal to the regulatory agency.

Once the proposed modification has been approved by plant administrators and the state regulatory agency, the CTA facilitator should serve as a technical reference throughout the implementation of the modification. Following completion of a modification, the CTA facilitator should ensure that a formal presentation of the improved plant capability is presented to the administration. This feedback is necessary to build rapport with the plant administrators and to ensure support for future requests. The intent of the presentation should be to identify the benefits in performance obtained from the expended resources.

Maintenance Performance Limiting Factors

Maintenance can be improved in nearly all plants, but it is a significant performance limiting factor in only a small percentage of plants (2,3,4). The first step in addressing maintenance factors is to document any undesirable results of the current maintenance effort. If plant performance is degraded as a result of maintenance-related equipment breakdowns, the problem is easily documented. Likewise, if extensive emergency maintenance events are experienced, a need for improved preventive maintenance is easily recognized. Ideally, maintenance factors should have been previously identified and prioritized during a CPE. However, most plants do not have such

obvious evidence directly correlating poor maintenance practices with poor performance; therefore, maintenance factors often do not become apparent until the conduct of a CTA. For example, in many cases CTA activities utilize equipment and processes more extensively than they have been used in the past, such as running a facility for longer periods of time. The expanded use emphasizes any maintenance limitations that may exist.

Implementing a basic preventive maintenance program will generally improve maintenance practices to an acceptable level in many plants. A suggested four-step procedure for developing a maintenance record keeping system is to: 1) list all equipment, 2) gather manufacturers' literature on all equipment, 3) complete equipment information summary sheets for all equipment, and 4) develop and implement time-based preventive maintenance activities. Equipment lists can be developed by touring the plant and by reviewing available equipment manuals. As new equipment is purchased it can be added to the list. Existing manufacturers' literature should be inventoried to identify missing but needed materials. Maintenance literature can be obtained from the manufacturer or from local equipment representatives.

Equipment maintenance sheets that summarize recommended maintenance activities and schedules are then developed for each piece of equipment. Once these sheets are completed, a comprehensive review of the information allows a time-based schedule to be developed. This schedule typically includes daily, weekly, monthly, quarterly, semiannual, and annual activities. Forms to remind the staff to complete the tasks at the desired schedule (e.g., check-off lists) can be developed.

The above system for developing a maintenance record keeping system provides a reliable foundation for implementing a preventive maintenance program. However, there are many other good maintenance systems, including computer-based systems. The important concept to remember is that adequate maintenance is essential to reliably achieve optimized performance goals.

Administrative Performance Limiting Factors

Administrators who are unfamiliar with plant needs, and thus implement policies that conflict with plant performance, are a commonly identified factor. For example, such items as implementing

minor modifications, purchasing testing equipment, or expanding operator coverage may be recognized by plant operating personnel as needed performance improvement steps, but changes cannot be pursued due to lack of support by non-technical administrators. Administrative support and understanding are essential to the successful implementation of a CTA. The following techniques have proven useful in addressing administrative factors limiting performance:

- Focus administrators on their responsibility to provide a “product” that not only meets but exceeds regulatory requirements on a continuous basis to maximize public health protection. Often, administrators are reluctant to pursue actions aimed at improving plant performance because of a lack of understanding of both the health implications associated with operating a water treatment plant and of their responsibilities in producing a safe finished water. The CTA facilitator must inform and train administrators about their public health responsibilities and the associated objectives of achieving optimized performance goals from their facilities. As an endpoint, administrators should be convinced to adopt the optimum performance goals described in Chapter 2. Administrators should also be encouraged to emphasize to the operating staff the importance of achieving these goals.
- Build a rapport with administrators such that candid discussions concerning physical and personnel resources can take place (e.g., see Internal Support section previously discussed in this chapter).
- Involve plant administrators from the start. Site visits should include time with key administrators to explain the CTA activities. If possible, conduct a plant tour with the administrators to increase their understanding of plant processes and problems. Share performance results on a routine basis.
- Listen carefully to the concerns of administrators so that they can be addressed. Some of their concerns or ideas may be unrelated to the technical issues at the plant, but are very important in maintaining internal support for ongoing CTA activities.
- Use technical data based on process needs to convince administrators to take appropriate actions.

- Solicit support for involvement of plant staff in the budgeting process. Budget involvement has been effective in encouraging more effective communication, in motivating plant staff, and in improving administrative awareness and understanding. This activity also helps to ensure continued success after the CTA facilitator is gone.
- Encourage development of a “self-sustaining utility” attitude. This requires financial planning for modification and replacement of plant equipment and structures, which encourages communication between administrators and plant staff concerning the need to accomplish both short and long term planning. It also requires development of a fair and equitable rate structure that requires each water user (i.e., domestic, commercial, and industrial) to pay their fair share. The revenues generated should be sufficient to support ongoing operating costs as well as short term modification and long term replacement costs. The CTA facilitator may choose to encourage the utility to gain professional help in this area, depending on the circumstances. Information is also available from other sources (5,6,7).

Operational Performance Limiting Factors

Obtaining optimized performance goals is ultimately accomplished by implementing formal process control procedures, tailored for the particular personnel and plant. Additionally, the process control skills must be transferred to the local staff for the CTA to result in the plant having the long term capability to maintain the desired performance goals.

Initial efforts should be directed toward the training of the key process control decision-makers (i.e., on-site CTA champion). In most plants with flows less than 0.5 MGD, one person typically makes and implements all major process control decisions. In these cases, on-the-job training is most effective in developing skills and transferring capability. If possible, in plants of this size a “back-up” person should also be trained. This person may be an administrator or board member at a very small utility. As the number of operators to be trained increases with plant size, the need for classroom training also increases. However, a significant aspect of the CTA's effectiveness is the “hands-on” training approach; therefore, any classroom training must be supported by actual

“hands-on” applicability and use. The only exception to this emphasis is in addressing complacency issues with “what if scenarios” (see What If Scenarios section previously discussed in this chapter).

A generic discussion of process control for water treatment facilities is presented. The CTA facilitator must identify deficiencies in any of the following areas and implement activities to address these limitations, recognizing existing facility and personnel capabilities.

Process Sampling and Testing:

Successful process control of a water treatment plant involves producing a consistent, high quality treated water despite the variability of the raw water source. To accomplish this goal, it is necessary that the performance of each unit process be optimized. This is important because a breakdown in any one unit process places a greater burden on the remaining processes and increases the chance of viable pathogenic organisms reaching the distribution system and consumers’ taps. By optimizing each unit process, the benefit of providing multiple barriers prior to the consumer is realized.

To optimize each unit process, information must be routinely obtained and recorded on raw water quality and on the performance of the various unit processes in the plant so that appropriate controls can be exercised to maintain consistent treated water quality. The term “routinely” is stressed because it is necessary to have the plant achieve performance objectives at all times when it is in operation. To allow information to be gathered and for process control adjustments to be made whenever water quality conditions dictate, staff should be available during all periods of operation. If staffing is not available, continuous water quality monitoring with alarms and shutdown capability should exist.

The gathering of information in an organized and structured format involves development of a process control sampling and testing schedule. A basic process control sampling and testing schedule for a conventional plant is shown in Figure 5-9. Turbidity is the primary test because it provides a quick and easily conducted measurement to determine particulate levels and particle removal effectiveness of individual plant unit processes. Particle counting can be used in conjunction with

turbidity; however, most small facilities are not yet using this technology. Raw water turbidity testing should be conducted on a frequent basis (e.g., every four hours) to identify changes in quality. During periods of rapid change, raw water turbidity should be measured on a more frequent basis to allow adjustment of coagulant aids. Settled water turbidity from each basin should be measured a minimum of every four hours to monitor the effectiveness of the settling process and to document that the integrity of this barrier is being maintained. If the effectiveness of sedimentation deteriorates (e.g., due to the unexpected failure of an alum feeder), the monitoring allows immediate corrective actions to be taken to minimize or lessen the impact on downstream unit processes. Filtered water turbidity should be measured and recorded on a continuous basis from each filter to allow constant monitoring of filtered water quality. Continuous monitoring of filtered water tremendously enhances the operators’ capability to properly time backwashing of filters, to determine the extent of post backwash turbidity breakthrough, and to observe if filter control valve fluctuations are impacting filtered water turbidity.

The process control data should be recorded on daily sheets, and this data should be transferred to monthly sheets to allow observation of water quality trends. For turbidity measurement, maximum daily values are recorded since this represents the worst case potential for the passage of particles. Appendix K includes examples of both daily and monthly process control sheets. The daily sheets should include space for recording actual chemical feed rates and the conversion of these values to a mg/L dosage so that dosage and water quality can be correlated. This database can then be used by the operator to better predict chemical feed requirements during different raw water quality events. Graphs and trend charts greatly enhance these correlation efforts. The use of computer spreadsheets is encouraged to support data development and the use of trend charts.

Chemical Pretreatment and Coagulant Control:

The selection and control of chemical coagulants, flocculants and filter aids is the most important aspect of improving water treatment plant performance. Therefore, a method to evaluate different coagulants and to control the selected coagulant is a primary focus in implementing a process control program. The special study format is

especially effective for systematically optimizing chemical pretreatment.

A coagulant control technique must exist or be implemented during a CTA if optimized performance is to be achieved. Example coagulant control techniques include: jar testing, streaming current monitors, zeta potential, and pilot filters. Jar testing is the most common technique and is discussed in more detail.

To successfully implement jar testing as a coagulant control technique requires understanding of stock solution preparation and conducting the test so that it duplicates plant operating conditions as closely as possible. A typical procedure for preparing stock solutions, conducting jar tests, and determining mixing energy settings is shown in Appendix L. Stock solutions must be prepared for all coagulant chemicals (e.g., metal salts and polymers) that are going to be added to the jars.

The jar test can be set up to represent plant operating conditions by setting jar test mixing energy inputs, mixing times, and settling detention times similar to those found in the plant (Appendix L). Plant mixing energy (i.e., G-values) can be determined by using worksheets presented in the design section of Appendix F. The use of square jars is recommended because square jars break up the circular motion inherent in cylinders and more accurately represent plant operating conditions.

Chemicals should also be added to the jars to try to duplicate plant operating conditions. For example, if alum is added to the plant flash mix and polymer is added to a pipeline approximately 30 seconds downstream from the flash mix, the

same sequence should be used in the jar test. The use of syringes without needles to measure and deliver the appropriate chemical dose to each jar simplifies the chemical addition step (i.e., 1 cc = 1 mL). Syringes are available from pharmacies or veterinary/farm supply stores. The jar test procedure should be adjusted to more closely duplicate the plant processes. In direct filtration plants, a small volume (about 50 mL) of flocculated water should be removed from the jars and passed through filter paper. Typically, 40 micron filter paper (e.g., Whatman #40, Schleicher and Schuell #560) can be used to approximate filter performance. The filtered samples should be tested for turbidity, and the sample with the lowest turbidity represents the optimum chemical dose.

In conventional plants, the jar contents should be allowed to settle for a period of time relative to the surface overflow rate of the basins. The approach for determining the sampling time for settled water is shown in Appendix L. Allowing the water in the jar to settle for 30 to 60 minutes and then taking a sample for turbidity measurement has no relationship to a full-scale plant and should not be done for collecting useful jar test information. After the correct sampling time is determined, samples should be drawn from the sample tap located 10 cm from the top of the jar, and the turbidity of the sample should be determined. The lowest turbidity represents the best chemical dosage. If sample taps are not available on the jars, pipettes can be used to draw-off samples from the jars. Excellent references are available to guide the facilitator in implementing jar testing techniques to obtain optimum coagulant doses (8,9,10,11).

Figure 5-9. A basic process control sampling and testing schedule.

Sample	Sample Location	Tests	Frequency	Sample By
Plant Influent	Tap by Raw Water Turbidimeter	Turbidity pH Alkalinity Flow Rate Jar Test Temperature	Continuous Daily Weekly Continuous As Needed Daily	Meter Operator Operator Meter Operator Operator
Sedimentation Basin	Top of Filter	Turbidity	Every 2 Hours	Operator
Filter Effluent	Turbidimeter	Turbidity	Continuous	Meter
Treated or Finished Water	Lab Tap	pH Cl ₂ Residual Turbidity	Daily Continuous Every 4 Hours	Meter Meter Operator/Mater

Once the correct chemical dose is determined, the staff must be able to adjust the chemical feeders to deliver the desired dosage. This requires the ability to conduct chemical calculations and to develop and utilize calibration curves for chemical feeders. For example, a mg/L dose has to be converted to a feed rate (e.g., lb/day or mL/min) in order to correctly adjust chemical feed equipment. Calibration curves which indicate feed rate setting versus feeder output must be developed for all chemical feeders to assure the correct feeder setting for a given desired chemical dosage. Some chemicals, such as polymers, must often be prepared in dilute solutions prior to introduction into the plant flow stream. Therefore, the capability to prepare chemical dilutions must be transferred to the operators during the CTA. Example chemical feed calculations are presented in Appendix M, and a procedure to develop a chemical feeder calibration curve is shown in Appendix J.

Chemical addition must not only be carefully controlled, but the correct type of coagulants, flocculants and filter aids must be applied.

- A positively charged product (e.g., metal salt, cationic polymer, polyaluminum chloride) should be added for coagulation. Coagulants typically require good mixing so they should be added to the rapid mix.
- If alum is being utilized with a raw water pH exceeding 8.0 to 8.5, consideration should be given to switching to iron salts, sodium aluminate or polymerized products.
- The use of a flocculant polymer to enhance floc formation and settling can also be investigated.
- Investigation of filter aid polymers should be conducted since these products are often required if filtered water turbidities less than 0.1 NTU are to be achieved on a continuous basis. Flocculant and filter aids typically have an anionic or nonionic charge, and they should be introduced into the plant flow stream at a point of gentle mixing, since excessive turbulence will shear the polymer chains and reduce the product effectiveness.
- For low alkalinity waters (e.g., <20 mg/L), consideration should be given to adding alkalinity (e.g., soda ash, lime).

Some chemicals should not be added at the same location. For example, the addition of lime and alum at the same point is counter-productive if the lime is raising the pH to the extent that the optimum range for alum coagulation is exceeded. The addition of powdered activated carbon at the same location as chlorine is also detrimental since the carbon will quickly adsorb the chlorine, inhibiting the ability of both chemicals. The addition of chlorine, potassium permanganate or other oxidant, in combination with some polymers, will result in the oxidation of the polymer, with a subsequent reduction in its effectiveness.

Unit Process Controls:

Optimization of unit processes requires that those parameters that can be controlled to adjust process performance be identified and incorporated into a plant specific process control program. Ideally, existing process control procedures and input from plant staff are used to develop this program. This usually must be supplemented by information from the CTA facilitator based on experience at other facilities, equipment manuals, or networking with peers. Multiple unit processes and their unique control features exist in water treatment facilities. An overview of the more conventional unit processes and their associated controls is presented in the following sections.

Mixing, Flocculation, and Sedimentation. The main controls for mixing, flocculation and sedimentation unit processes include the following:

- Plant process flow rate and flow splitting between unit processes operating in parallel
- Type of chemical and chemical feed rate (see Chemical Pretreatment and Coagulation Control section previously discussed in this chapter)
- Flocculation energy input
- Sludge removal
- Floc break-up at the effluent of sedimentation tanks

Plant flow rate is a primary control at many small plants that are operated for less than 24 hours each day. At these plants an excessive hydraulic loading rate on the flocculation/sedimentation processes can be avoided by operating at a lower

flow rate for a longer period of time. This provides an option to meet more rigorous performance requirements with existing units without major capital improvements. The capability to reduce plant flow rate to improve performance is offset by the need to staff the plant for longer periods of time, which adds to operating costs. Therefore, plant administrators and staff, in conjunction with the CTA facilitator, must evaluate these options.

If multiple basins exist, flow splitting to ensure equal loading to the units should be monitored and controlled. Often, performance monitoring (e.g., turbidity) of individual sedimentation basins can be used to indicate unequal flow splits.

Flocculation energy input is often fixed at small plants, either by hydraulic flocculation systems or by constant speed flocculation drives. However, flocculation energy, if low enough to allow formation of settleable floc, is not considered an essential variable to achieve desired performance of a small plant. More important are the plug flow characteristics of the flocculation system. Plug flow characteristics, similar to those found in most hydraulic flocculation systems, result in the formation of floc particles of uniform size, which greatly aids settleability. As such, greater priority may be placed on installing baffling in flocculation systems rather than trying to optimize mixing energies. Adequate time for chemical reaction is typically more important when the water temperature is less than 5°C, and under these conditions performance can be improved by reducing plant flow rate.

Sludge needs to be removed from conventional sedimentation basins frequently enough to prevent solids carryover to the filters. The frequency of sludge removal can be determined by using a core sampler to monitor build-up in the basin. The duration of sludge removal can be determined by collecting samples during draw-off (e.g., every 30 seconds) and determining when the sludge begins to thin. A centrifuge, graduated cylinder, or Imhoff cone can be used to observe the density changes.

Sludge control is very important in the operation of reactor type upflow sedimentation basins that operate using a sludge blanket. The reactor section of the basin must be monitored daily, and the appropriate amount of sludge must be removed from the basin to maintain the optimum reactor concentration and sludge blanket depth. Inade-

quate monitoring of the basin can lead to a loss of the sludge blanket over the weirs, which significantly degrades unit process performance and, ultimately, filter performance. A 100 mL graduated cylinder has been used to monitor sludge mass in a reactor type basin. A volume of 18 - 25 mL of sludge in a 100 mL cylinder, after five minutes of settling, has provided satisfactory performance at one location (12).

Another issue to consider is the possibility of floc breakup after the settled water leaves the sedimentation basins. Depending on the chemical conditioning used in the plant, coagulated particles may break apart because of turbulence when the settled water is conveyed to the filtration process (e.g., sedimentation effluents with large elevation changes at the discharge of the basin). If floc breakup is suspected, operational changes, such as flooding the effluent weirs, can be tried to assess if performance improves. Additionally, the use of a filter aid can assist in overcoming the detrimental impacts of floc breakup.

Filtration. The controls for the filtration process include the following:

- Coagulation control
- Filtration rate control
- Filter aid chemical and chemical feed rate
- Backwash frequency, duration and rate
- Filter to waste

Proper chemical pretreatment of the water prior to filtration is the key to acceptable filter performance. Improper coagulation (e.g., incorrect feed rate, inappropriate coagulant) fails to produce particles that can be removed within the filter or to produce particles large enough that they can be removed by sedimentation. Because of this impact, the importance of a good plant specific coagulant control technique cannot be overemphasized.

For waters that are properly chemically conditioned, filter flow rate becomes less critical. The most important aspect of flow rate relative to filter performance is the magnitude and rate of change of flow rate adjustments (4,131). Rapid, high magnitude flow rate can cause a large number of particles to be washed through the filter. This can be observed by the associated increases in turbidity measurements or particle counts. Since the filters are the most effective barriers to cysts,

even short term performance deviations can potentially expose consumers to significant concentrations of cysts.

Filtration rate changes most often occur during backwashing events, raw water pumps cycling on and off, start-up of filters, and periods when filter rate controllers malfunction.

- When one filter is removed from service for backwashing, many operators leave plant flow rate the same and direct the entire plant flow to the remaining filter or filters. At plants with a limited number of filters this places an instantaneous, high magnitude flow increase on the remaining filters. This is frequently inherent in automatic backwash control systems where the plant was not designed to adjust flow during backwash. This can be prevented by lowering the plant flow rate prior to removing the filter from service, thereby controlling the hydraulic loading to the remaining on-line filters.
- Rapid changes in plant influent flow by starting and stopping constant speed raw water pumps also encourages the loss of particles from filters. This may be prevented by using a manual or automatic control valve to slowly adjust plant influent flow rate.
- Start-up of dirty filters can also result in the washout of entrained particles. Backwashing of filters prior to returning them to service is essential to maintain the integrity of this unit process.
- Malfunctioning filter rate control valves can result in rapid changes in filtration rates. The impact of filter rate control valve malfunctioning is difficult to identify without continuous on-line monitoring. An ongoing preventive maintenance program can be effective to keep the valves in good working order and to avoid this source of poor filter performance.

The utilization of a low dose of filter aid polymer can improve filtered water quality from dual or mixed media filters. These products are very effective but, if overdosed, can quickly blind a filter. They, therefore, should be used at optimum doses (i.e., typically less than 0.1 mg/L) to avoid excessively short filter runs. Once activated, these products are subject to shearing because of their long polymer chains and should be fed at

points of low turbulence, such as flocculation basins or sedimentation basin effluent lines,

During a filter run, backwashing must occur before particle breakthrough occurs. Filtered water turbidity should be monitored continuously, and the filter should be backwashed at the first indication of an increasing turbidity trend. Particle counters have recently been used to monitor individual filters at some plants. Results have shown that particle breakthrough is indicated prior to deterioration in filtered water turbidity (14,15). Excessive filter runs (e.g., greater than 48 hours) can sometimes make filters difficult to clean during backwash due to media compaction and can cause an increase in biological growth on the filter. However, filter run times are site-specific and should be determined at each treatment plant. One method to assess filter run time is to conduct a special study involving microscopic evaluations of filtered water throughout the filter run (16,17). Particle breakthrough, as measured by turbidity or particle counting, should always remain a primary control in establishing filter run times.

The filter backwash duration and intensity must be sufficient to clean the filter, but not so great that damage occurs with the support gravel and underdrain system or media is washed out of the filter. A filter bed expansion test can be used to assess the adequacy of backwash rate (see the Field Evaluations section discussed in Chapter 4). The backwash duration should be long enough to adequately clean the media, otherwise filter performance will degrade and mudballs could form in the media. The filter should be probed periodically (e.g., semi-annually) to inspect for support gravel problems and to check media depths. Proper cleaning can be evaluated by inspecting the filter media for mudballs and overall cleanliness. Filters occasionally require the addition of media (i.e., topping due to washout of media during backwash).

Operating guidelines should be developed to describe consistent methods of backwashing filters. Guideline content should include measures to: 1) prevent rapid flow rate increases to the remaining on-line filter(s), 2) ensure that the filter is properly cleaned, 3) prevent damage to the filter by operating at excessive flow rates or opening valves too quickly, and 4) return a filter to service. When a filter is returned to service following washing, it should be rested for a period of time to allow the media to consolidate before it is restarted, or it should be slow-started by gradually

increasing the filtration rate over a period of 30 minutes (18). Conducting a special study to define backwash procedures that result in the achievement of optimized performance goals should be completed and serve as the foundation for the backwash guideline.

At some plants where operational adjustments do not allow filters to return to optimized performance goals within 15 minutes following backwash, more aggressive steps may be required. These include addition of coagulant to the water used to backwash the filter or modifications to provide filter to waste capabilities. Some utilities have found that addition of coagulants to the backwash water helps in minimizing turbidity spikes by conditioning the filter prior to returning it to service. Filter to waste allows the initial filtered water to be directed to a drain until the quality achieves the performance criteria, at which time it can be redirected to the clearwell. These approaches should only be implemented after other less costly approaches described above have proven ineffective during a series of special studies.

Disinfection. The controls for the disinfection process include the following:

- Contact time
- Disinfectant concentration
- Disinfectant application point

To prove adequate disinfection, the plant unit processes, including disinfection, must meet a state-specified criteria for log reduction/inactivation of *Giardia* and viruses. Presently, this criteria is defined as achieving a CT value outlined in the SWTR Guidance Manual (19). The CT value, which is the concentration of disinfectant (mg/L) multiplied by the effective contact time (minutes) prior to the first user's tap, is affected both by plant flow rate and the concentration of the disinfectant applied. The maximum concentration of disinfectant that can be added because of effectiveness and aesthetic concerns (taste and odor) is normally 2.5 mg/L as free chlorine residual. Therefore, adjustments to contact time offer the best process control option for optimizing disinfection. Most plants apply chlorine as a disinfectant to the filtered water prior to a clearwell. The clearwell is typically designed as a storage basin for backwash water or a wet well for finished water pumps and not as a disinfectant contactor. As a result, there are no baffles or other means to make the basin plug flow, and the clearwell

basin's small size provides limited contact time. Reducing the plant flow rate, operating at greater clearwell depth, or baffling the basin can often be used to gain more effective contacting.

Adding a chlorine application point prior to the plant rapid mix to provide contact time in raw water transmission lines and flocculation, and sedimentation basins can also be evaluated. However, this practice, while allowing greater CT values to be obtained, may cause the formation of excessive disinfection by-products. State regulatory personnel should be consulted prior to initiating this practice.

If operational changes cannot be made to achieve the specified CT values, modifications to the plant may be required to provide sufficient disinfectant contact time. It is noted that actual levels of disinfection required for water treatment plants is presently established by the state where the plant is located. Additionally, future regulations may impact disinfection practices (20). Modifications to a plant's disinfection system should include a thorough review of proposed regulations and coordination with the state regulators.

5.3 Case Study

A case study of a CTA is difficult to present because many of the activities are conducted over a long period of time and include numerous events such as on-site training, transfer of technical and interpersonal skills, weekly data review, phone consultations and site visits, and multiple special studies. Since these activities do not lend themselves readily to the case study format, an abbreviated overview of a CTA will be presented.

5.3.7 CPE Findings

A CPE was conducted at a conventional water treatment plant that included facilities for chemical addition, rapid mixing, flocculation, sedimentation, filtration, and clearwell storage. Raw water was supplied to the plant from a reservoir fed by a river. The facility was constructed in 1994 and had a rated design capacity of 13 MGD. The plant is operated 24 hours per day and serves approximately 23,000 people.

The performance assessment of the plant revealed that this new facility had not consistently met the 0.5 NTU turbidity limit required by the 1989

SWTR (21) during its first year of operation. In fact, enforcement action was being considered by the state regulatory personnel due to the frequent violations. Turbidity values at the levels observed indicated that the plant was definitely not achieving optimized performance goals as described in Chapter 2. Along with not meeting the filtered water optimization goals, the plant had inconsistent sedimentation basin performance with peaks as high as 8 NTU. Turbidity spikes of 0.6 NTU after backwash were also found.

The major unit process evaluation revealed that all of the major unit processes had sufficient physical capacity to support achievement of optimized performance goals. The rated design capacity of the facility was 13 MGD, and the peak instantaneous flow rate was 7.5 MGD. All of the major unit processes were rated above the 13 MGD capability.

Three major performance limiting factors were identified in the CPE. The highest ranking factor was related to the operations staff's capability to apply proper process control concepts to improve the performance of their facility. Performance monitoring and process control testing were not consistent, and data was not developed nor used to make process adjustments. Limited efforts had been completed to define optimum chemical feed strategies. Backwashing practices were inconsistent and not focused on limiting turbidity spikes or shortening recovery time after filters were placed back in service.

The second factor was related to administration. Specific administrative policies were limiting performance of the plant by failing to create an environment necessary to support optimization. Start-up training for the operators in connection with the new facilities was deleted as a cost saving measure. Optimization goals were not embraced by administrative personnel, and personnel changes at the plant had resulted in conflicting directives to the plant staff and confusion over who was in charge.

The third factor was related to design with several issues related to process controllability. The location of the recycle line from the sludge and backwash storage pond was after the point of chemical addition to the raw water. This prevented the plant staff from properly monitoring and controlling the coagulation chemistry of the blended raw water. Chemical feed facilities were also contributing to the performance problems since several

chemical feed pumps were oversized for current flows and sufficient flexibility had not been provided with respect to adding chemicals at various locations in the plant.

A CTA was initiated at the plant to attempt to achieve optimized performance goals. The duration of the CTA was about 18 months, and highlights from the project are summarized below.

5.3.2 CTA Activities

5.3.2.1 Initial Site Visit

During the initial site visit, the CTA facilitator used the CPE results and the priority setting model to prioritize activities. At the CTA facility, caution had to be taken to consider the potential adverse impact of any changes on plant performance and public health since the facility was producing unacceptable finished water quality. A contingency plan was developed that included plant shutdown, lowering plant flow rate, and initiating an order to boil water. Fortunately, the staff had improved process monitoring (e.g., began individual filter monitoring and initiated sedimentation basin monitoring) after the CPE exit meeting. These steps had resulted in process control changes that allowed improved performance and, for the most part, compliance with the SWTR. After the CPE, the plant staff had also dealt with the oversized chemical feed pumps by interchanging with others within the plant. They also made provisions for some additional chemical feed points.

A key step in the CTA was the identification of the local CTA champion. The person selected was the new superintendent for the utility. Although he was new to the position, it was felt that he was the best choice for utility champion and was the best person to assist the CTA facilitator in making the necessary changes to the "old ways of doing business."

Jar testing procedures were developed, and routine testing was initiated. A sampling and jar test set-up modification was implemented to allow jar testing to be conducted on the blended raw water and recycle water. Based on the jar test results, the need for coagulant dosage adjustments was indicated. The operations staff participated in all of the testing and data development. Despite the results, the staff was reluctant to make changes. This stemmed from the fact that jar testing had

never been a routine activity at the plant and, thus, the operators lacked the confidence to take jar tests results and use the information to make chemical feed changes in the plant. However, a staff consensus of "We don't think it will work, but we can try it" was achieved. Preliminary results during the site visit were very encouraging.

A formal meeting was set up between the CTA facilitator and the plant staff to discuss additional high priority items. The topics for discussion were established by the CTA facilitator. During this meeting, optimized unit process performance goals were established. The guidelines in Chapter 2 were used to set the performance goals. Limited staff acceptance for the goals was accomplished at this meeting because they were more focused on just being able to meet the SWTR requirements. In addition, they did not have the confidence that the optimized treatment goals could be met. Sampling, monitoring and data recording procedures were also discussed. The negative impact of the location of the recycle line was also discussed, and it was decided to pursue modification of this line with the utility administration.

An action list was developed which included assignments to the staff to develop operational guidelines on jar testing and unit process performance sampling, monitoring, and data recording. Arrangements were made with the on-site CTA champion to provide plant monitoring and performance data to the CTA facilitator on a weekly basis.

Prior to the conclusion of the site visit, the CTA facilitator and the on-site CTA champion met with the City Manager and the Director of Public Works. The basis for the meeting was to report on the process control changes and the action list and to initiate discussions on the desired recycle line modification. The initial response on the need for the recycle line was "Wasn't that the design consultant's responsibility?". The CTA facilitator identified that the optimized performance goals that were being pursued required much closer control than would be required to just meet the SWTR requirements. The utility was encouraged to pursue modifications on their own, and the administrators agreed to begin an evaluation of the possible approaches for completion of the modification and associated costs. A discussion was also held concerning the less-than-enthusiastic response by the staff to the new procedures and performance goals. This information was provided to lay the groundwork for administrative support if condi-

tions didn't change. Questions were received from the administrators concerning the need and costs of achieving water quality goals that exceeded regulatory requirements. The public health implications were explained by the CTA facilitator, with only limited acceptance on behalf of the administrative personnel. A report which summarized the progress made and the action list that was developed was prepared by the facilitator at the conclusion of the site visit.

5.3.2.2 Off-Site Activities

The on-site CTA champion provided drafts of the agreed upon guidelines as well as weekly summaries of plant data. The CTA facilitator reviewed the guidelines and provided written comments to the utility. Data review was also completed by the CTA facilitator, and trend charts were developed to aid in data interpretation.

Phone calls were made on a weekly basis to discuss data trends and to follow up on action items. Feedback from the CTA champion indicated that even after his best efforts, the plant staff were still balking at the increased sampling and laboratory activities and that the administration had not pursued the recycle line modification. A decision was made to make a return site visit to address these issues,

5.3.2.3 Follow-Up Site Visit

During the second site visit the nominal group process was used to establish priorities for continued optimization activities (see Priority Setting Tools section previously presented in this chapter). The issue of increased work load and lack of recognition was rated high and received extensive discussion. The CTA facilitator used the trend charts developed from plant data to show the improvements that had been accomplished in achieving optimized performance goals. Several of the operators took pride in these accomplishments and voiced support for the increased process control activities. However, one operator remained adamantly opposed to the changes. At the conclusion of the discussion it was decided to continue the additional process control effort for at least several more months.

The concept of special studies was introduced during the staff meeting, and two special studies were developed to evaluate the use of a filter aid

polymer and to assess control of backwash spikes. Additional guidelines for turbidimeter calibration and sludge removal from the sedimentation basins were also discussed. An action list was developed to conduct the special studies, draft the additional guidelines, and to pursue the modification to the recycle line.

At the conclusion of the site visit, an administrative exit meeting was held where the preliminary graph of improved performance was presented. The results of the plant meeting and discussions were presented, and support for the recycle line modification was again requested. These discussions revealed that the administrators did not completely understand the importance of the recycle line modifications with respect to being able to perform effective process control. Once they understood the need for timely modifications to the recycle line, these modifications were quickly made.

A report was prepared by the facilitator at the conclusion of the second site visit which summarized the progress made and the updated action list. The site visit was an effective mechanism to demonstrate improved performance to the utility staff, provide positive feedback on achieving interim milestones, and reinforce the long term project goals. This site visit also demonstrated the importance of the facilitator in resolving issues that the CTA champion finds difficult to resolve on his/her own.

5.3.2.4 Other CTA Activities

Activities conducted by the CTA facilitator off-site and on-site (an additional two site visits) continued, using a similar format for another twelve months. During that time, the modification to the recycle line was accomplished, and process control skills were transferred to all of the plant staff. A significant part of transferring process control skills was getting all of the operators to accurately record individual filter effluent turbidities on the plant's process control sheets. Procedures had to be developed and implemented where readings above a certain level (0.1 NTU) had to be verified before being recorded. A total of 23 operational guidelines were developed by the plant staff.

Acceptance of the optimization goals and the process control procedures to achieve them were

not quickly accepted by all of the operators. One recalcitrant operator was found to be undermining the CTA champion's efforts to get consistent process control procedures implemented. A significant amount of the time during the CTA was involved in obtaining the administrative support to reassign this person to maintenance.

After the CPE, the plant staff made changes to the existing piping so that polymers could be added before and after the rapid mix basin. During the CTA, a decision was made that a separate polymer feed system would also be needed so that a filter aid could be added to the sedimentation basin effluent. This was deemed necessary to meet the filter effluent and backwash spike turbidity goals.

Controlling the turbidity spikes after filter backwash required a significant effort by the plant staff. Many special studies were completed to evaluate a variety of filter backwash procedures, including gradual ramping of the backwash flow and resting of the filter before returning it to service. Problems were also found with the sample tap locations when the special study results showed that the spikes were eliminated on two of the filters but remained on the other two.

5.3.2.5 CTA Results

Figure 5-10 graphically depicts the success of the case history CTA. There was a dramatic change from highly variable finished water prior to the CPE to stable, high quality finished water after the CTA.

Along with the optimized performance from their filters, Figure 5-1 1 shows how the plant also achieved the settled water turbidity performance goals. Additionally, after much effort, the plant has essentially eliminated the turbidity spikes after backwash, as shown in Figure 5-1 2. A significant benefit achieved from the CTA was the development of staff tenacity to address any deviations from the optimized water quality goals. This tenacity, coupled with the experience and confidence that the staff gained during the CTA, supports the long term achievement of the optimization goals. This is demonstrated in Figure 5-13 which shows the performance of this plant for a year after completion of the CTA without the assistance of the facilitator.

Figure 5-10. Performance improvement during CTA project - filter effluent.

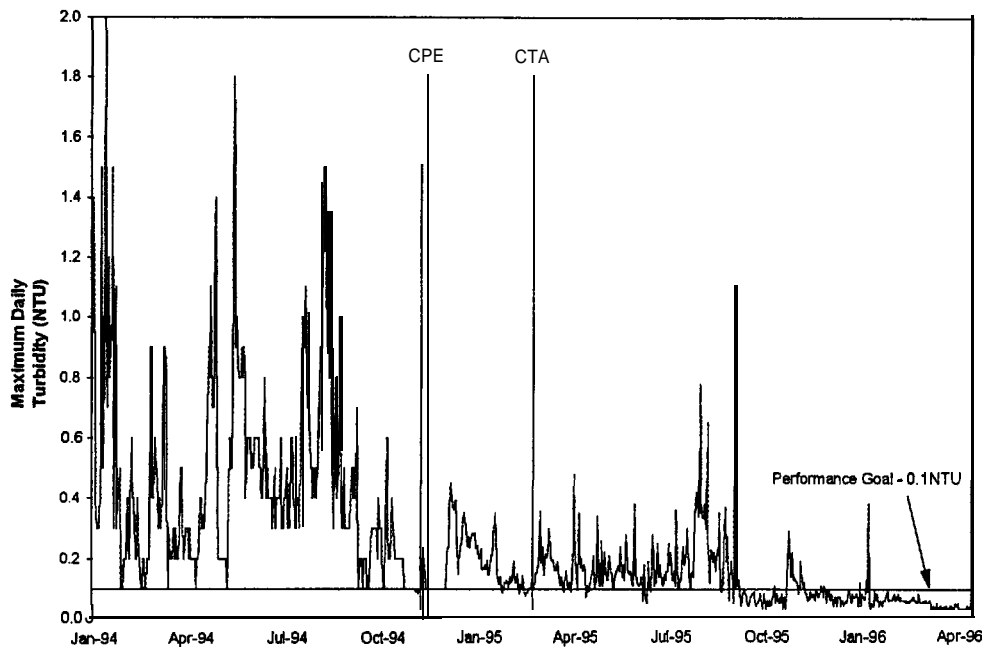

Figure 5-11. Performance improvement during CTA project - sedimentation basin effluent.

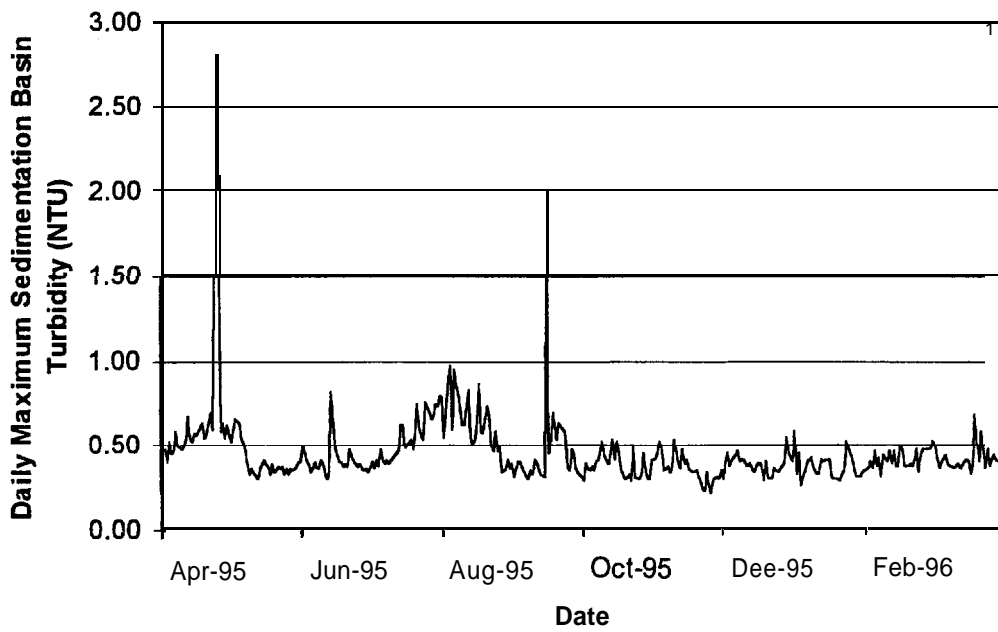

Figure 5-12. Performance improvement during CTA project – filter backwash spikes.

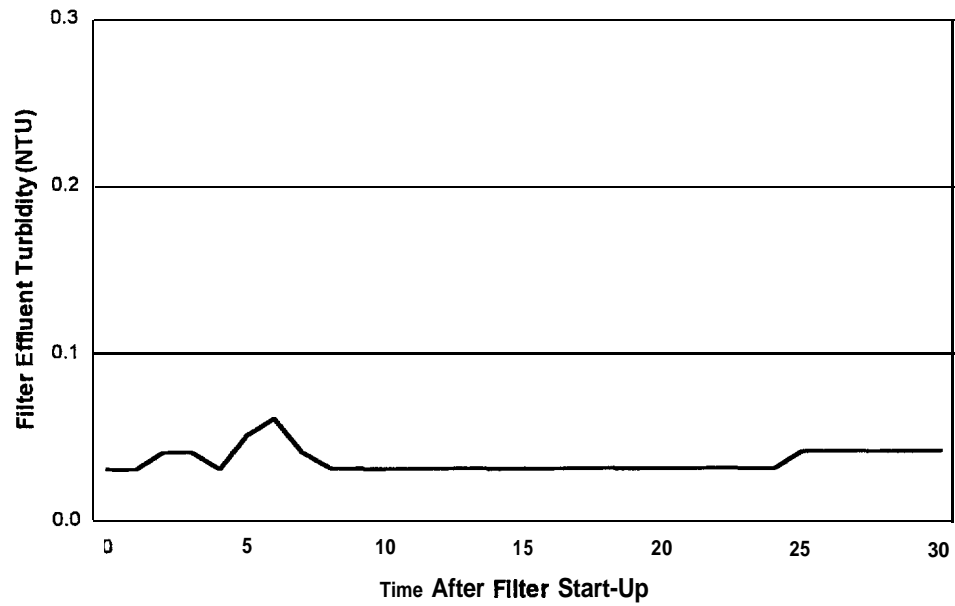
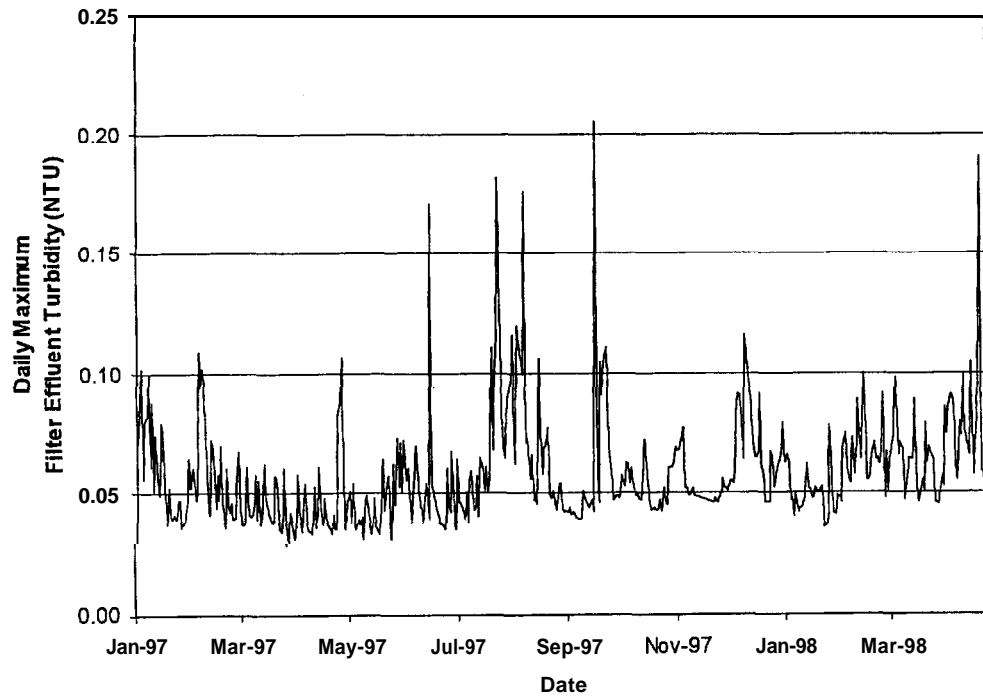

Figure 5-13. Plant performance after CTA.



Additionally, the administrators developed pride in their utility's capability to maintain consistent, high quality treated water that exceeds regulatory requirements. Most importantly, the consumers of the utility's water have benefited from the high level of protection against water-borne disease outbreaks.

A final CTA report was prepared and was used to present the benefits of utilizing the CTA process to plant administrators.

5.4 References

When an NTIS number is cited in a reference, that reference is available from:

National Technical Information Service
5285 Port Royal Road
Springfield, VA 22161
(703) 487-4650

1. Public Notification Regulation Rule. October 1987. U.S. Environmental Protection Agency, 40 CFR, Part 141, Subpart D, Reporting, Public Notification and Record Keeping.
2. Renner, R.C., B.A. Hegg, and J.H. Bender. March 1990. EPA Summary Report: "Optimizing Water Treatment Plant Performance With the Composite Correction Program. EPA 625/8-90/017, USEPA Center for Environmental Research Information, Cincinnati, OH.
3. Renner, R.C., B.A. Hegg, and D.L. Fraser. February 1989. "Demonstration of the Comprehensive Performance Evaluation Technique to Assess Montana Surface Water Treatment Plants." Presented at the 4th Annual ASDWA Conference, Tucson, AZ.
4. USEPA. February 1991. Handbook: Optimizing Water Treatment Plant Performance Using the Composite Correction Program. EPA 625/6-91/027, USEPA Office of Research and Development, Cincinnati, OH.
5. Water Rates and Related Charges (M25). 1986. AWWA Reference Manual, No. 30026, Denver, CO.
6. Small System Guide to Rate Setting. Community Resource Group, Inc., Springdale, AK.
7. USEPA. 1989. A Water and Wastewater Manager's Guide for Staying Financially Healthy. USEPA (#430-09-89-004), Cincinnati, OH.
8. Hudson, H.E., Jr. 1980. Water Clarification Processes: Practical Design and Evaluation, Van Nostrand Reinhold Co.
9. Singley, H.E. June 1981. "Coagulation Control Using Jar Tests." Coagulation and Filtration: Back to Basics, Seminar Proceedings, 1981 Annual Conference, p.85. AWWA, Denver, CO.
10. Hudson, H.E. and J.E. Singley. June 1974. "Jar Testing and Utilization of Jar Test Data." Upgrading Existing Water Treatment Plants, AWWA Seminar Proceedings, VI-79. Denver, CO.
11. AWWA. 1992. Operational Control of Coagulation and Filtration Process. AWWA Manual M37. AWWA, Denver, CO.
12. Process Applications, Inc. December 1990. "Summary Report - Loma, Montana Water Treatment Plant Composite Correction Program." Unpublished report.
13. Cleasby, J.L., M.M. Williamson, and E.R. Baumann. 1963. "Effect of Filtration Rate Changes on Quality," *Journal AWWA*, 55:869-878. Denver, CO.
14. West, T., P. Demeduk, G. Williams, J. Labonte, A. DeGraca, and S. Teefy. June 1997. "Using Particle Counting to Effectively Monitor and Optimize Treatment." Presented at AWWA Annual Conference, Atlanta, GA.
15. Veal, C., and B. Riebow. May 1994. "Particle Monitor Measures Filter Performance." *Opflow*, Vol. 20, No. 5. AWWA, Denver, CO.
16. Hibler, C.P. and CM. Hancock. "Interpretation - Water Filter Particulate Analysis." CH Diagnostic & Consulting Service, Inc., Fort Collins, CO.
17. Hibler, C.P. "Protocol - Sampling Water for Detection of Waterborne Particulates, *Giardia*, and *Cryptosporidium*." CH Diagnostic & Consulting Service, Inc., Fort Collins, CO.

-
18. Pizzi, N. 1996. "Optimizing Your Plant's Filter Performance." *Opflow*, Vol.22, No.5. AWWA, Denver, CO.
19. USEPA. October 1989. Guidance Manual for Compliance With the Filtration and Disinfection Requirements for Public Water Svstems Using Surface Water Sources. NTIS No. PB-90 148-016, USEPA, Cincinnati, OH.
20. USEPA. 1997. Microbial/Disinfection By-Products Federal Advisory Committee Agreement in Principle. Dated June 9, 1997. Signed July 15, 1997.
21. "Surface Water Treatment Rule." June 1989. From Federal Register, Vol. 54, No. 124, U.S. Environmental Protection Agency, 40 CFR, Parts 141 and 142, Rules and Regulations, Filtration/Disinfection.

Chapter 6 Findings From Field Work

6.1 introduction

This chapter summarizes findings from the field activities and draws conclusions concerning future efforts and potential impacts of utilizing the CCP approach in improving performance of surface water treatment plants.

The field activities conducted to refine the CCP approach have focused on three distinct areas:

- Development/application of the process to water treatment plants.
- Demonstration and transfer of principles and practices to state, third-party and utility personnel.
- Incorporation of the process into an area-wide optimization program (see Chapter 3).

In addition, the CCP approach has evolved from a focus of achieving compliance with the Surface Water Treatment Rule (1) to one of minimizing the passage of *Cryptosporidium* oocysts through the treatment plant by achieving optimized performance goals (see Chapter 2).

The basis for the conclusions and results described in this chapter is drawn from 69 CPEs and 8 CTAs conducted in 17 states and Canada. The geographical distribution of the CPEs and CTAs is described in Table 6-1. The plants had a wide range of peak instantaneous operating flow rates and populations served. Thirty-five percent of the plants served communities with populations less than 3,300, with peak flow rates typically less than 3.0 MGD, while 10 percent of the plants provided service to populations in excess of 50,000 persons. The majority of the systems served small to medium-sized communities. Larger plants typically required more time to conduct the plant tour and interviews; otherwise, the CPE process was only minimally affected by plant size.

All of the plants evaluated used surface water for their raw water source. The majority of the plants utilized conventional treatment consisting of rapid mix, flocculation, sedimentation, filtration and disinfection. Several of the plants that were

evaluated operated in a direct or in-line direct filtration mode. Three lime softening plants were evaluated. In addition, several types of unique filtration processes were evaluated; they included automatic valveless gravity filters, traveling bridge backwashing filters, and several types of pressure filters. The CCP approach was found to be applicable regardless of plant size or type.

Table 6-1. Geographical Distribution of CPEs and CTAs

	CPEs	CTAs		CPEs
Montana	11	3	Louisiana	3
Maryland	10		Rhode Island	3
West Virginia	8	1	Wisconsin	3
Texas	7	1	Kentucky	2
Massachusetts	4		Ohio	2
Pennsylvania	4	1	California	1
Canada	4		Vermont	1
Colorado	3	1	Washington	1
Navajo Tribal Lands in Utah, New Mexico	2	1		

6.2 Results of Comprehensive Performance Evaluations

6.2.7 Major Unit Process Capability

A summary of the major unit process capability for the 69 plants is shown in Table 6-2. The unit processes were assigned a rating of Type 1, 2 or 3 depending on their projected ability to consistently meet optimized performance goals at the peak instantaneous operating flow rates under ideal conditions. Ideal conditions are those in which all ancillary features of a unit process are operational (e.g., paddles, drive motors and inter-basin baffles are functional in a flocculation basin) and process control activities have been optimized.

As described in Chapter 4, a Type 1 or 2 rating indicates that the unit processes are potentially adequate to consistently meet optimized performance goals. A unit process rated as Type 3 would not be expected to perform adequately.

Table 6-2. Summary of the Major Unit Process Ratings for 69 Plants

	Type 1 Percent of Plants	Type 2 Percent of Plants	Type 3 Percent of Plants
Flocculation	88%	7%	5%
Sedimentation	77%	17%	6%
Filtration	86%	13%	1%
Post-Disinfection Only	46%	3%	51%
Pre- & Post- Disinfection	86%	5%	9%

The basis for rating the major unit processes has been consistent for all 69 CPEs except for the disinfection process. The disinfection process initially was evaluated on the ability of a plant to provide two hours of theoretical detention time. This was done for the initial nine plants evaluated in Montana. The disinfection evaluation was later modified based on the SWTR CT requirements. The disinfection ratings for the initial nine Montana CPE sites are not included in the summary in Table 6-2.

As shown in Table 6-2, the flocculation, sedimentation and filtration unit processes were typically judged adequate to justify attempts to optimize performance using existing facilities (e.g., major unit processes rated either Type 1 or 2). Only 5 percent of the flocculation and 6 percent of the sedimentation processes were judged to require major capital improvements. Also, the filtration processes were almost always rated as being Type 1. In some circumstances filters that had been rated as Type 1 were found to require modifications such as media replacement because of damaged underdrains or support gravels; however, media replacement was not judged to be a major construction requirement. In some circumstances, reducing the peak instantaneous flow rate and operating the plant longer enabled a Type 3 unit process to be reclassified as Type 2 or 1. Based on these findings, it was projected that 92 percent

of the plants evaluated could meet optimized performance goals without major capital construction.

Disinfection was evaluated at 60 of the facilities with respect to their ability to meet the CT requirements of the SWTR. Post-disinfection alone was only found capable to meet the CT requirements in 49 percent of the plants. The primary deficiency was the limited contact time of the clearwells that were typically designed to provide backwash water storage or wet wells for high service pumps. The majority of disinfection contact basins were un baffled and operated on a fill and draw basis. This operation is less than ideal for optimizing contact time.

For facilities where both pre- and post-disinfection was practiced, 91 percent of the plants were projected to comply with the SWTR CT requirements. Although use of both pre- and post-disinfection may allow some plants to provide adequate disinfection capability with existing facilities, its application may be limited due to requirements related to the allowable levels of disinfection by-products (DBPs). Proposed requirements of the Disinfectants and Disinfection By-Products Rule (2) would establish DBP requirements for all systems. The final regulations regarding CT credit for pre-disinfection will be established by individual states. Because the regulations governing disinfection are changing, it is likely that capability projected from the historical CPE disinfection unit process evaluations will change.

6.2.2 Factors Limiting Performance

Factors limiting performance were identified for each of the 69 CPEs utilizing the list of factors described in Appendix E. An average of eight factors was identified at each plant. Each factor was given a rating of A, B, or C, depending on its impact on performance (see Chapter 4). To assess the degree of impact from an overall basis, A factors (i.e., major impact on performance) were assigned 3 points, B factors (i.e., moderate impact on performance on a continuous basis or a major impact on performance on a periodic basis) were assigned 2 points, and C factors (i.e., minor impact on performance) were assigned 1 point. The summary of factors that occurred most frequently and the degree of impact of the factors identified during the 69 CPEs are presented in Table 6-3.

Table 6-3. Most Frequently Occurring Factors Limiting Performance at 69 CPEs

Rank	Factor	Category	Number of Points	Number of Plants
1	Applications of Concepts	Operations	113	43
2	Disinfection	Design	112	39
3	Process Control Testing	Operations	88	36
4	Sedimentation	Design	79	39
5	Filtration	Design	72	29
6	Administrative Policies	Administrative	69	29
7	Process Flexibility	Design	58	29
8	Process Controllability	Design	47	22
9	Flocculation	Design	45	23
10	Water Treatment Understanding	Operations	41	14
11	Plant Staff	Administrative	40	18
12	Ultimate Sludge Disposal and/or Backwash Water Treatment	Design	39	15

Three of the top twelve factors were related to operations: Number 1- Application of Concepts, Number 3 - Process Control Testing, and Number 10 - Water Treatment Understanding. The overall high ranking of operational-related factors is of major significance. Consistently achieving optimized performance goals requires optimization of each unit process in the treatment scheme. Additionally, achieving optimized performance goals requires timely adjustments in response to changing raw water quality.

Essentially, inadequate or marginal process control programs existed in over half of the plants where CPEs were conducted. At 62 percent of the plants, the operators had problems applying their knowledge of water treatment to the control of the treatment processes. These operators could discuss coagulation chemistry and filter operation but had difficulty in demonstrating that they could apply this knowledge to changing raw water quality and subsequently to achieving optimized performance goals. Water treatment understanding was identified at 14 of the 69 plants. A lack of understanding means that the operators did not have the basic knowledge of water treatment, which would make successful implementation of a process control testing program impossible. Since operator limitations in applications of concepts and

limitations in water treatment understanding are mutually independent in identifying CPE factors, these results can be combined, which indicates that 85 percent of the plants had operational limitations that adversely impacted performance.

Seven of the top 12 factors were related to design aspects of the facility. While most flocculation, sedimentation, and filtration processes were found to be of adequate size during the major unit process evaluation, limitations associated with these unit processes contributed to their identification as factors limiting performance. Sedimentation processes were projected to be marginal at 39 plants, typically due to the inability to treat seasonal high raw water turbidities, improper placement of effluent weirs that disrupted quiescent settling, and effluent conditions that resulted in floc shear prior to filtration. Problems such as backwash limitations, improperly maintained rate-of-flow controllers, and disrupted support gravels and underdrains contributed to filtration being identified as a performance limiting factor. Flocculation problems were typically related to marginal volume, lack of multiple stages, fixed speed mixer drives that made tapered flocculation impossible, and inoperative mechanical equipment.

Disinfection was also identified as a top factor limiting performance. As noted, the adoption of final regulations by the states may affect the future results in identifying the ranking of this factor. Although plants may be able to improve contact time by installing baffles, some plants may require major capital improvements (e.g., new contact basins, alternate disinfectant capabilities) to accommodate the need for greater contact time and/or reduced DBP levels.

Process flexibility, process controllability and ultimate sludge disposal/backwash water treatment were the other design factors that were consistently identified. The identification of these factors was usually attributed to plants that were not equipped with the capability to add chemicals at different points in the plant, were unable to operate processes in different configurations (e.g., series or parallel), were unable to measure or control flows through processes, or lacked appropriate backwash water treatment facilities that limited the plant's ability to backwash filters based on performance degradation.

It was projected that implementing minor modifications, reducing peak flows, and improving process control could provide alternatives at individual facilities to avoid major modifications. Ideally, CTAs implemented at these facilities could be used to implement these alternatives. If the CTA results were unsuccessful, a construction alternative could be more clearly pursued. It was concluded that, despite the high ranking for design factors, immediate construction of major plant modifications was not indicated or warranted.

Two administrative factors, policies and inadequate plant staff, were among the top factors identified. Plant administrative policies were observed in 29 CPEs to be detrimental to performance. Typically, these administrators were not aware of the significance of finished water quality. For example, most were unaware of the impact on public health of even short-term excursions from high quality treated water. Additional items contributing to the identification of these factors included plant administrators that: 1) were not aware of plant resources or training requirements, 2) could not relate the impact of their decisions on plant performance and thus public health, 3) had policies related to minimizing production cost at the expense of performance, and 4) maintained plant staffing at levels too low to support process control requirements.

Eighteen of the 69 plants had a plant staff size considered to be too small to properly operate and monitor the treatment plant. This was considered to be critical with respect to the projected need for increased levels of process control and monitoring required to achieve optimized performance goals. Staffing limitations were felt to be especially critical for plants that were being operated for periods without staff on-site and without alarm and shutdown capability triggered by performance parameters.

It was interesting to note that insufficient resources *were* not found to be a significant factor limiting performance of the water plants evaluated despite the fact that lack of resources is a widely publicized reason for noncompliance of small systems. Insufficient funding was identified in only 13 of 69 plants. Furthermore, in only 4 of the 13 plants where insufficient funding was identified, it was considered to be a major factor limiting performance. Numerous utilities had sizable capital reserve funds, and those that did not often had water rates set at unreasonably low levels. It was projected that resources could be made available to address operations limitations and to implement minor design modifications at these facilities. Time would be required in follow-up CTAs at these utilities to gain administrative support and understanding for reallocation or development of resources, but the option to achieve this support was projected to be viable.

The lack of identification of any significant maintenance-related factors is also important to note. Maintenance-related factors were assessed as having a lessor or minor impact relative to the operations and administrative factors. Only 2 of the 69 CPEs had a maintenance factor identified as having a major impact on performance. At both facilities, total neglect was apparent. At these facilities administrative policies that were contrary to supporting the integrity of the infrastructure were also identified as factors.

6.2.3 Summary of CPE Findings

- The flocculation, sedimentation and filtration processes in 92 percent of the plants were projected to have adequate capacity to handle plant peak instantaneous operating flows.
- Construction would be required for 13 percent of the plants if only post-disinfection were

allowed, and baffling of existing clear-wells is not sufficient. Disinfection capabilities are dependent on the final interpretation and implementation of the disinfection regulations by individual states.

- Operations factors limited performance in 60 percent of the CPEs performed. This finding, coupled with the fact that 92 percent of the existing facilities were assessed to have adequate capacity to meet turbidity removal requirements, indicates that addressing operations factors could significantly improve water treatment plant performance.
- Although design factors represent half of the top factors identified, it was projected that these deficiencies could be satisfactorily addressed in many cases by utilizing minor modifications, decreasing plant flows, and improving process control/operations.
- Administrative factors were identified as having a significant impact on plant performance. Training of plant administrators must be an integral part of implementation of programs to optimize performance.
- Administrators must assure that adequate provisions have been made to deal with complacency and reliability issues. These issues are prevalent for systems using stable high quality source waters where administrators and staff may be lulled into a false sense of security by over-relying on the source water to protect them from performance degradation. Administrators need to encourage operational staff to maintain skills relative to proper process control for changing source water quality.
- Impacts due to plant size only affected the amount of time that it took to conduct the actual CPE. Larger plants required more time to conduct the interview process due to larger operational and administrative staffs, yet the approach was still applicable to large systems.
- On-site performance assessments indicated that reported finished water turbidities were often not representative of true performance. Continuous recording of turbidity from each filter is considered essential to provide operators with enough information to minimize excursions in treated water turbidities.

- Numerous plant-specific impacts on performance were identified during the conduct of the CPEs:

- Lack of attention to filter rate control devices resulted in deteriorated filter performance.
- Lack of attention to the impact of flow rate changes on operating filters resulted in deteriorated filter performance.
- Starting dirty filters resulted in deteriorated filter performance.
- Filter performance immediately following backwash was often unsatisfactory and posed a significant health threat during this critical operational period. Improved operational practices, chemical conditioning of the backwash water, or use of existing filter-to-waste provisions are alternatives to address this negative impact on filter performance.
- Adequate process control was only practiced in just over half of the plants where CPEs were conducted.
- Decreased flows and increased operating time offer a significant alternative to construction of new facilities for many small water treatment plants.
- Exit meetings with the administrators were identified as one of the major advantages of the CPE over other surveys and inspections.

6.3 Results of Comprehensive Technical Assistance Projects

CTAs have been conducted at eight facilities to establish that plant performance improved. Seven facilities achieved improved performance without major capital expenditures.

remaining CTA, and improved performance was not documented at this facility. facilities where successful CTAs were implemented, four were completed when the goal was

SWTR. The remaining three facilities were completed when the performance objective was the

optimized performance criteria outlined in Chapter 2. It is noted that performance results of all seven of the facilities where CTAs were completed would meet the proposed turbidity performance objectives outlined in the IESWTR. (3)

The potential in existing facilities to achieve current and proposed regulatory requirements is a viable alternative for many water treatment utilities. More importantly, the CTA component has demonstrated that optimized performance goals can be achieved at small to medium-sized facilities without major construction. This capability should be utilized, especially at high risk facilities, as described in Chapter 3, to obtain maximum benefit toward public health protection from existing plants.

6.4 References

When an NTIS number is cited in a reference, that reference is available from:

National Technical Information Service
5285 Port Royal Road
Springfield, VA 22161
(703) 487-4650

1. Surface Water Treatment Rule From Federal Register, Vol. 54, No. 124. June 1989. U.S. Parts 141 and 142, Rules and Regulations, Filtration/Disinfection.
2. USEPA. November 3, 1997. National Primary Drinking Water Regulations: Disinfectants and Disinfection Byproducts; Notice of Data Availability; Proposed Rule. *Fed. Reg.*, 62:212:59338.
3. USEPA. November 3, 1997. National Primary Drinking Water Regulations: Interim Enhanced Surface Water Treatment Rule; Notice of Data Availability; Proposed Rule. *Fed. Reg.*, 62:212:59486.

Chapter 7

The Future: Changing Regulations and New Optimization Challenges

7.1 Introduction

This handbook presents procedures for optimizing filtration plant performance for particle removal. It is the intent of this chapter to discuss how, even when a water system has used these procedures and attained the desired turbidity performance goals, the challenges of plant optimization will continue. Water systems face other regulatory requirements, both current and future, that they will need to consider as they maintain the optimized turbidity performance achieved through use of the CCP procedures. While water systems must comply with a wide variety of drinking water regulations, this chapter will focus on a series of regulations known as the microbial-disinfectants/disinfection by-product regulations (M-DBP) which, from a regulatory perspective, represent one of the biggest challenges facing water suppliers over the next several years. It is not intended that this chapter discuss the detailed requirements of these regulations or serve as the definitive resource on the technical issues around these regulations. Most of these regulations have not been finalized; and, when finalized, USEPA will provide detailed guidance on the specific requirements and the relevant technical information needed to comply.

7.2 Background on M-DBP Regulations

The M-DBP regulations were the result of a regulatory negotiation process (Reg-Neg) in 1993 (1,2,3) between the USEPA and representatives of the water supply industry over mutual concerns about the possible health impacts of microbial pathogens and DBPs. The following concerns were identified during discussions to identify ways to minimize health risks:

1. The adequacy of microbial control, especially for *Cryptosporidium*, under the current Surface Water Treatment Rule (SWTR).
2. The possibility that, if systems were to reduce levels of disinfection to control DBPs, microbial control could be compromised.

Control of microbial pathogens and DBPs were linked together in these regulatory discussions because of a fundamental concern that operational changes to control DBPs could potentially lead to changes in treatment. These changes could adversely impact microbial pathogen control. Regulations for microbials and DBPs, therefore, needed to simultaneously consider the inherent tradeoff of public health risks associated with changing treatment practices for reducing levels of DBPs along with the potential risks of lower microbial pathogen control. In order to balance these “risk-risk” tradeoffs, separate regulations for microbial pathogens and DBPs are to be promulgated with effective dates set such that water systems will have to comply with both regulations at the same time.

The original M-DBP Reg-Neg agreement included the following:

- A “Stage 1 ” DBP regulation that would apply to all systems. This regulation would initially apply to systems with a population of > 10,000. Systems with a population of < 10,000 would have extended compliance dates.
- A “Stage 2” DBP regulation to evaluate the need for further reductions in DBPs when more health effects and occurrence information becomes available.
- An “Interim” Enhanced SWTR (IESWTR) for PWSs > 10,000 to address improvements in microbial control and risk-risk trade-off issues related to the “Stage 1 ” DBP regulation which would be implemented at the same time.
- A “Long Term” ESWTR (LTESWTR) that would apply to PWSs < 10,000 which would be implemented when they are required to comply with the “Stage 1 ” DBP regulation. This regulation could also include enhancements that would also apply to the large systems.

During the Reg-Neg process there was also agreement that additional data and research was needed on occurrence, treatment capabilities, and health effects of both microbials and DBPs to provide a sound technical basis for these regulations. These issues were to be resolved by:

- An Information Collection Rule (ICR) to collect occurrence and treatment information to evaluate possible components of an IESWTR, LTESWTR, and "Stage 2" DBP regulations.
- Additional research, including health effects studies, to support regulatory development.

In July 1994, USEPA proposed a "Stage 1 " DBP regulation (4) and an IESWTR (5) which reflected the 1992-93 negotiations. The ICR was promulgated in May 1996 (6) with data collection starting in July 1997 and continuing for 18 months. Based on this schedule, the ICR data will not be collected, validated and available for regulation development until January 2000.

In August 1996 congress passed amendments to the Safe Drinking Water Act (SDWA) (7) that included the following statutory deadlines for USEPA to promulgate the M-DBP regulations:

- IESWTR and "Stage 1" DBPs - November 1998
- LTESWTR - November 2000
- "Stage 2" DBPs - May 2002

These deadlines were such that it would be impossible to use the ICR data to develop the IESWTR and LTESWTR as intended by Reg-Neg. In early 1997, USEPA formed the M-DBP Advisory Committee under the Federal Advisory Committee Act (FACA) to help the Agency meet the new SDWA deadlines. This resulted in an agreement in principle that formed the basis for the Notice of Data Availability (NODA) for the "Stage 1 " DBP (8) and the IESWTR (9) to supplement the 1994 proposal for these regulations. Based on comments on the 1994 proposals and these NODAs, the IESWTR will be promulgated in November 1998. USEPA plans to promulgate the LTESWTR in 2000 in order to meet the SDWA mandate with a compliance date that will correspond to the "Stage 1 " DBP regulations for PWSs < 10,000. Even though the LTESWTR applies to PWSs < 10,000, it could include refinements for larger systems.

USEPA also plans to promulgate a "Long Term 2" ESWTR (LT2ESWTR) at the same time that the "Stage 2" DBP regulation is promulgated in order to address risk-risk trade-offs.

7.3 M-DBP Requirements Relative to Optimized Performance Goals

The discussions above indicate that by the year 2002 USEPA will have promulgated several different SWTRs and DBP regulations, and water systems will be facing compliance. It is also apparent that these regulations are interrelated such that water systems will need to consider the impacts of treatment process changes from the perspective of both regulations. The remainder of this section will discuss some of the major areas where special consideration of optimization with respect to M-DBP will need to be considered.

7.3.7 Treatment Technique Turbidity Requirements

Figure 7-1 presents a historical perspective of turbidity goals and regulations. The original SDWA passed by congress in 1974 (10) required USEPA for the first time to regulate turbidity. A requirement of 1 NTU was established, which was to be measured at the combined plant effluent based on one sample per day. There was also a maximum turbidity level of 5 NTU. In 1989 the original SWTR (11) was promulgated that lowered the combined plant turbidity levels to 0.5 NTU based on samples every four hours, but retained the maximum of 5 NTU.

The 1997 Microbial and Disinfectants/Disinfection Byproducts (M-DBP) Federal Advisory Committee meetings, resulted in the collection, development, evaluation, and presentation of substantial data and information related to turbidity control. The FACA committee recommended that the turbidity performance requirements be changed such that the combined filter effluent limit be reduced to 0.3 NTU and that the maximum value be reduced to 1 NTU. In addition, the Committee recommended that systems conduct individual filter monitoring and that exceptions reports be provided to states under specific circumstances, namely:

1. any individual filter with a turbidity level greater than 1.0 NTU based on two consecutive measurements fifteen minutes apart; and
2. any individual filter with a turbidity level greater than 0.5 NTU at the end of the first four hours of filter operation based on two consecutive measurements fifteen minutes apart.

The Committee also recommended that if an individual filter has turbidity levels greater than 1.0 NTU based on two consecutive measurements fifteen minutes apart at any time in each of three consecutive months, the system should be required to conduct a self-assessment of the filter, utilizing as guidance relevant portions of guidance issued by the Environmental Protection Agency for Comprehensive Performance Evaluation (CPE). Also, if an individual filter has turbidity levels greater than 2.0 NTU based on two consecutive measurements fifteen minutes apart at any time in each of two consecutive months, the system should be required to arrange for the conduct of a CPE by the State or a third party approved by the State.

The IESWTR is scheduled for promulgation in November 1998, at which time the specific turbidity requirements and provisions will be available. EPA will issue detailed guidance at that time on the relevant technical information needed to comply with the rule. Both the LTE1ESWTR and LT2ESWTR are in pre-developmental stages.

Figure 7-1 also shows the turbidity goal of 0.1 NTU that was discussed in previous chapters of this handbook and how regulated turbidity levels are approaching this long held turbidity goal. This is not intended to predict that future regulations will be set at the 0.1 NTU level, but to encourage plants to pursue the 0.1 NTU performance goals outlined in this handbook, as a way to assure regulatory compliance on a combined plant basis.

7.3.2 Removal/Inactivation Requirements

The original SWTR required water systems to provide a minimum of 3-log removal/inactivation of *Giardia* cysts. State regulatory agencies that received primacy from USEPA were given broad latitude in how plants would meet this requirement, including the option to increase the removal/inactivation requirements for water systems that may have higher levels of cysts in their source water. Rule guidance stated that properly operating filtration plants could be expected to remove between 2.0 to 2.5-log of *Giardia* cysts, and this removal could be credited against the 3-log requirement. The remaining log removal was to be achieved with disinfection. Log removal credits for various disinfectants and operating conditions were provided in tables of disinfectant concentration (C) multiplied by the contact time (T).

A major impetus for the IESWTR was that *Cryptosporidium* was not regulated under the original

Figure 7-1. Historic perspective of turbidity goal and regulations.

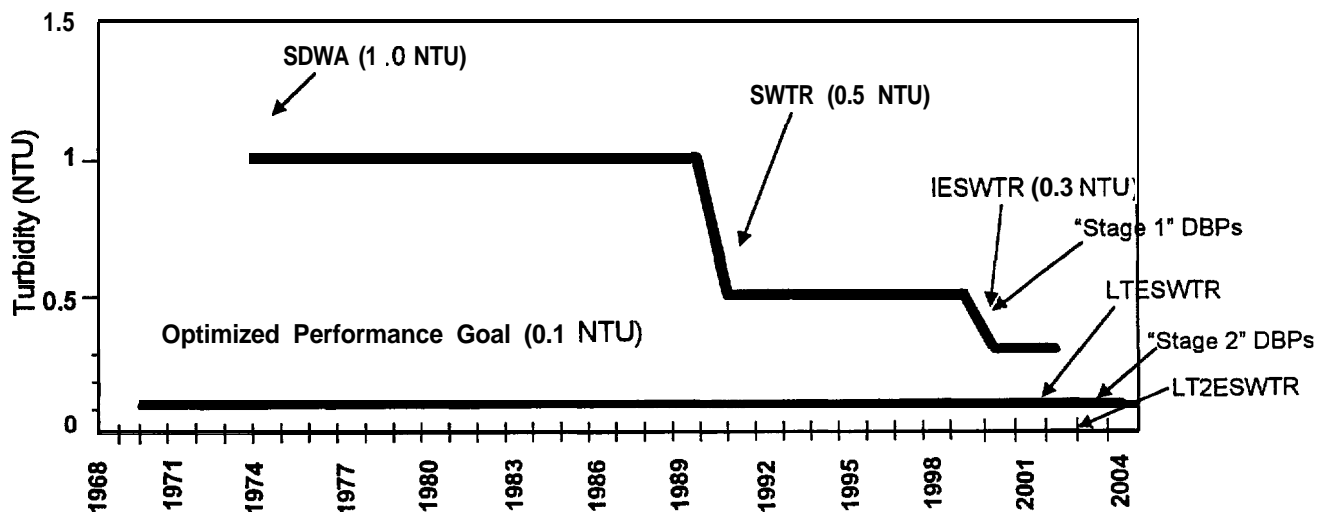

SWTR. This was of concern since chlorine is not an effective disinfectant against *Cryptosporidium*, and the impact of other disinfectants (e.g., ozone, chlorine dioxide) has not been well established.

The 1997 M-DBP Federal Advisory Committee recommended adoption of a 2-log *Cryptosporidium* removal requirement for all surface water systems that serve more than 10,000 people and are required to filter. The committee also recommended that systems which use rapid granular filtration (direct filtration or conventional filtration treatment - as currently defined in the SWTR) and meet strengthened turbidity requirements would be assumed to achieve at least a 2-log removal of *Cryptosporidium*. Systems which use slow sand filtration and diatomaceous earth filtration and meet existing SWTR turbidity performance requirements (less than 1 NTU for the 95th percentile or alternative criteria as approved by the State) also would be assumed to achieve at least a 2-log removal of *Cryptosporidium*.

The IESWTR is scheduled for promulgation in November 1998, at which time the specific removal requirements and provisions will be available. EPA will issue detailed guidance at that time on the relevant technical information needed to comply with the rule. Both the L T E1ESWTR and L T 2ES WTR are in pre-developmental stages.

7.3.3 DBP Maximum Contaminant Levels (MCLs)

DBPs were first regulated in 1979 (12) when an MCL of 0.10 mg/L was established for the sum of four trihalomethanes (THM), which applied to only those water systems serving populations > 10,000 persons. As discussed above, the purpose of the M-DBP regulations is to reduce the health risk for these compounds and other DBPs by promulgation of disinfectant and disinfectant by-product (D/DBP) regulations to be implemented in two stages. The NODA for Stage 1 of the D/DBP rule has lowered the MCL for THMs and a new MCL has been added for the sum of five additional compounds called haloacetic acids (HAA₅). The NODA also contains maximum residual disinfectant levels (MRDLs) permitted in the distribution system.

Fundamental control procedures for THMs and HAAs remain essentially the same and include:

- Removal of natural organic matter (NOM), which are precursors, in the raw water.
- Altering the point of disinfectant addition.
- Reducing the amount of disinfectant used. (NOTE: This may not be feasible because of microbial backstop requirements.)
- Switching to alternate disinfectants,

In conventional treatment, NOM is removed by a coagulation/adsorption mechanism accomplished by changing the coagulation process to enhance the removal of these organics. A potential conflict exists from the standpoint of plant process

meet the optimized turbidity performance goals described in this handbook may not be compatible

goals. Some research has shown, however, that enhanced coagulation conditions also achieved

ies have evaluated the impacts of enhanced coagulation on filterability which may be more of a problem.

Altering the plant's disinfection practices to meet the DBP MCLs, either through changing the point of disinfectant addition or lowering the disinfectant dose, can potentially also lead to other types of conflicts. When disinfectants are added ahead of

can also provide additional important benefits (e.g., enhance the coagulation process for turbidity removal, enhance iron and manganese control, etc.) along with meeting the plant's CT requirements. Lowering pre-disinfection doses to reduce DBP formation, therefore, could result in turbidity performance problems or higher levels of iron and manganese in the finished water. The major consideration in changing disinfection practices to control DBPs, however, is to assure that the change will not result in compliance problems with state SWTR disinfection and the IESWTR microbial backstop requirements. The major unit process evaluation described in Chapter 4 presents disinfection conditions (e.g., chlorine residual, pH) that are necessary to achieve desired inactivation levels.

If none of the above process control changes are sufficient to control DBPs, then the utility may have to consider alternate disinfection including

ozone, chlorine dioxide, or chloramines. Ozone and chlorine dioxide will result in major modifications to the treatment plant and will require the design and installation of new treatment processes and equipment. Chloramines, depending on the plant, may be considered a modification that would be addressed as part of a CTA.

7.3.4 Enhanced Coagulation Requirements

The Stage 1 DBP regulations, proposed in the NODA for the first time require surface water systems that use conventional treatment or softening to remove a specified minimum percentage of the total organic carbon (TOC) from their raw water using a process called enhanced coagulation. TOC removal is required because other DBPs besides THMs and HAAs are formed when disinfectants react with a NOM, measured as TOC. The occurrence and health effects of these unidentified DBPs are unknown at this time. The intent of this part of the proposed regulation is to control the formation of unknown, as well as known, DBPs by requiring that a minimum percentage of NOM in the raw water, measured as TOC, is removed by the plant.

The percentage of TOC removal required is based on the TOC and alkalinity levels of the plant's raw water. These TOC removal requirements are broken down into nine different percent TOC removal categories. They are presented in a table for three different alkalinities and raw water TOC levels.

Plants that cannot meet the specified percent TOC removals will follow a "Step 2" procedure to determine what levels of TOC removal are "reasonable and practical" to achieve. The plant uses this information to request an alternative TOC removal requirement from its primacy regulatory agency.

The "Step 2" procedures consist of special jar tests to determine the maximum percent TOC removal that they can achieve by incremental increases in coagulant dose. Coagulant dose is increased in 10 mg/L increments until a specified pH level (depending on the raw water alkalinity) is achieved. Residual TOC levels in each jar are then measured, and an analysis is made of the "point of diminishing return" (PODR). The PODR is defined as when a 10 mg/L increase in coagulant does not decrease the residual TOC by more than 0.3 mg/L. This percentage TOC removal would then be con-

sidered "reasonable and practical" and would be used in discussions with the primacy agency relative to giving the plant an alternate enhanced coagulation requirement.

When a water system meets one of a variety of conditions it may be exempted from the enhanced coagulation part of the regulation. It was recognized that only the humic fraction of the raw water TOC is amenable to removal by enhanced coagulation. Plants, therefore, with high levels of non-humic TOC may not be able to meet any of the enhanced coagulation removal requirements and could be exempt from this part of the regulations. Plants can assess the amount of humics in their raw water by measuring its specific UV absorbance or SUVA. SUVA is defined as the UV absorbance divided by the dissolved organic carbon (DOC). SUVAs of < 3 L/mg-cm represent largely non-humic materials, and SUVAs in the 4-5 L/mg-cm range are mainly humic. SUVA values can also be used to request exemption from the regulations and to determine PODR.

Plants may find that achieving desired TOC removal will require some significant changes in plant process control procedures. Enhanced coagulation typically requires that additional coagulant and/or acid is added to depress the pH to a point where the TOC is removed in the coagulation process. As with control of DBPs, potential conflicts exist from the standpoint of plant process control procedures. Chemical feed rates needed to meet the turbidity performance goals in this handbook may not be compatible with those needed for enhanced coagulation.

7.3.5 Microbial Backstop

As discussed above, the Reg-Neg agreement required that the M-DBP regulations would balance the risk-risk tradeoffs between control of microbial contaminants and DBPs. Control of DBPs was not to result in any decrease in microbial protection. Since alteration of disinfection practices is one way of controlling DBPs, major concern was expressed during the 1997 FACA process regarding reduced disinfection capability. An approach was needed to make sure that water systems did not change disinfection practices to control DBPs and decrease microbial protection.

The approach that resulted from these discussions was the microbial backstop. As part of the microbial backstop requirements, water systems will be

required to prepare a disinfection profile when they approach specified levels of THMs and HAAs. A disinfection profile is a historical characterization of the system's disinfection practices over a period of time using new or "grandfathered" daily monitoring data. A disinfection profile consists of a compilation of daily *Giardia* log inactivation values based on SWTR CT tables. These calculations will be based on daily measurements of operational data (disinfectant residual concentration(s); contact time(s); temperature(s); and, where necessary, pH(s)).

The second part of the microbial backstop requirement is benchmarking, which quantifies the lower bound of the system's current disinfection practices. It is intended that water systems take the results from the profiling and work with the state regulatory agency to evaluate changes in disinfection practices which could be used to control DBPs so that these changes result in no significant decreases in microbial protection. Benchmarking is only required if a PWS intends to make a significant change to its disinfection practices such as moving the point of disinfection, changing disinfectants, changing the disinfection process, or any changes the state considers significant.

Part of the concern that led to the microbial backstop was based on data that showed water plants with widely varying disinfection levels. Figure 7-2 shows a profile where it is apparent that the plant

was not operating their disinfection systems at any common baseline. Day-to-day variations above the state disinfection requirement could be caused by plants not determining their required CT based on seasonal changes in water temperature and pH and/or not having close operational control over the actual CT provided by the plant. An example would be not changing the applied disinfectant dose to respond to changes in the required CT, disinfectant demand, and/or operating flow. Plants could also be adding disinfectant for other treatment issues such as to control Fe, Mn, algae, and/or taste and odor. The microbial backstop would require water systems to understand in more detail how much disinfectant they are applying on a daily basis, and it would force them to make rational decisions on why they are adding higher levels of disinfectant above that required for the state's disinfection requirements.

7.4 Summary

Water systems pursuing optimization for public health protection must remain vigilant concerning the ramifications of new and changing regulations. Those plants that have met the optimized performance goals defined in this handbook should be well positioned to take those regulations in stride and continue to meet the ever more stringent challenges facing the water industry.

Figure 7-2. Example of disinfection profile daily variations in log inactivation.

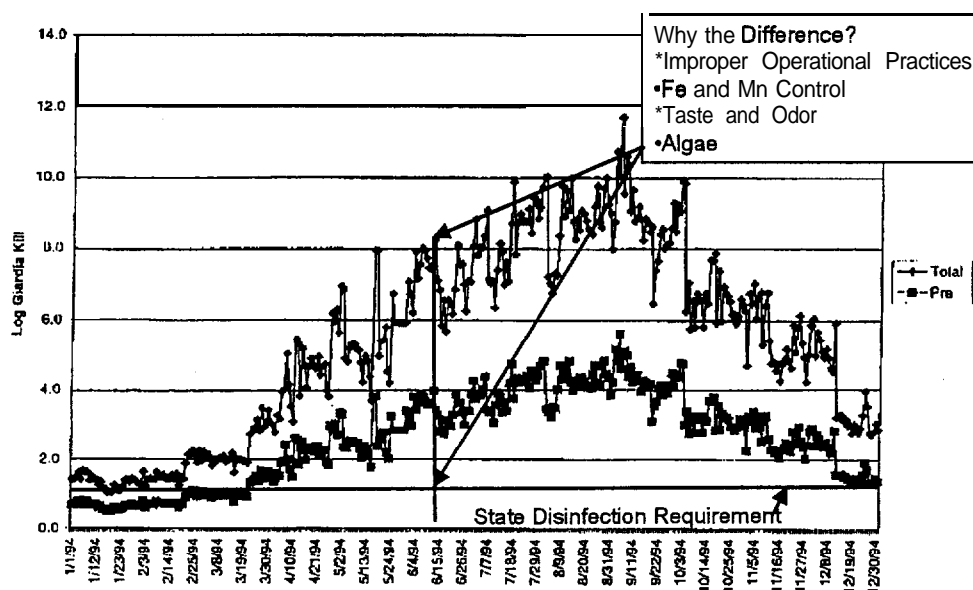

7.5 References

1. Means, E.G. and SW. Krasner. February 1993. "D-DBP Regulation: Issues and Ramifications." *Journal A WWA*, 85:2:68. Denver, co.
2. Pontius, F.W. September 1993. "Reg-Neg Process Draws to a Close." *Journal AWWA*, 85:9:18. Denver, CO.
3. Roberson J.A., J.E. Cromwell, S.W. Krasner, M.J. McGuire, D.M. Owen, S. Regli, and R.S. Summers. October 1995. "The D/DBP Rule: Where did the Numbers Come From?" *Journal A WWA*, 87:10:48. Denver, CO.
4. USEPA. July 29, 1994. National Primary Drinking Water Regulations: Enhanced Surface Water Treatment Requirements; Proposed Rule. *Fed. Reg.*, 59:145:38832.
5. USEPA. July 29, 1994. National Primary Drinking Water Regulations: Disinfectants and Disinfection By-products; Proposed Rule. *Fed. Reg.*, 59:145:38668.
6. USEPA. May 14, 1996. National Primary Drinking Water Regulations: Monitoring Requirements for Public Drinking Water Supplies. *Fed. Reg.*, 61:94:24353.
7. US Code. August 6, 1996. Title XIV of the Public Health Service Act (The Safe Drinking Water Act) as Amended by Public Law 104-182.
8. USEPA. November 3, 1997. National Primary Drinking Water Regulations: Disinfectants and Disinfection By-products; Notice of Data Availability; Proposed Rule. *Fed. Reg.*, 62:212:59338.
9. USEPA. November 3, 1997. National Primary Drinking Water Regulations: Interim Enhanced Surface Water Treatment Rule; Notice of Data Availability; Proposed Rule. *Fed. Reg.*, 62:212:59486.
10. USEPA. December 4, 1975. National Interim Primary Drinking Water Regulations. EPA-570/9-76-003.
11. USEPA. June 29, 1989. Filtration and Disinfection: Turbidity, *Giardia lamblia*, Viruses, *Legionella*, and Heterotrophic Bacteria; Final Rule. *Fed. Reg.*, 54:124:27486.
12. USEPA. November 29, 1979. National Primary Drinking Water Regulations: Control of Trihalomethanes in Drinking Water; Final Rule. *Fed. Reg.*, 44:231:68624.

Chapter 8 Other CCP Considerations

8.1 Introduction

The purposes of this chapter are to present training requirements for persons wanting to conduct CCP activities and to identify parameters that can be used by CCP providers or recipients of CCP services to assure quality control of the CCP approach. In addition, a brief discussion is presented concerning the applicability of the CCP approach to other optimization and compliance activities that a utility may be required to achieve now or in the future.

8.2 Developing CCP Skills

8.2.1 CPE Training Approach

In Chapters 4 and 5 the type of training and experience necessary to implement CPEs and CTAs was discussed. In addition to these basic skill requirements, it has been demonstrated that hands-on training is very effective for developing CCP skills in interested parties. For conducting CPEs, a training approach has been formalized and demonstrated with several state drinking water program personnel. The training consists of trainees participating in a one-day seminar that provides instruction and workshop opportunities for them to become familiar with the CPE terminology and approach. This seminar is followed by three actual CPEs where the trainees gain CPE skills through progressive training that is facilitated by experienced CPE providers. The roles of the CPE provider and trainee are described in Table 8-1. During the first CPE, the trainees are involved in the data collection and special study activities but are largely in an observation role during the kick-off meeting, interview, and exit meeting activities. Involvement in the remaining two CPEs is gradually increased such that by the time the third CPE is conducted the trainees are responsible for all of the activities. CPE provider observation and involvement take place only when necessary.

This approach has proven to be very effective in transferring CPE skills to trainees. Currently, the training process is scheduled over a four to six-

month period. It is noted that in addition to the training activities, a quality CPE must be provided to the water utility. Because of this expectation, the number of participants that can be trained while still completing the CPE must be limited to about four to six people.

8.2.2 CTA Training Approach

Participation in the CPE training, as described in the previous section, is considered a prerequisite to participation in CTA training. Training for personnel to implement CTAs has followed a format similar to the one used for CPE training. CTA providers can be used to progressively transfer skills to trainees through the conduct of actual CTA activities. The difficulty with this approach is the fact that the CTA typically occurs over a 6 to 18-month period. Also, routine telephone contact with the facility can only be effectively implemented by one person. The current training approach consists of CTA provider and trainee involvement at site visits, with the provider supplying technical assistance to a designated trainee who maintains routine contact with the utility personnel. The CTA provider utilizes telephone calls and exchange of materials (e.g., telephone memos, operations guidelines, plant data) to maintain trainee involvement. Although the approach and time commitment limit the number of trainees involved, effective transfer of CTA skills has been achieved.

A key component of CTA training is the emphasis on providing problem solving and priority setting capability to the utility staff. Using this approach, the trainees must learn not to "lead with their troubleshooting skills" but rather to recognize how to utilize situations to enhance utility priority setting and problem solving skills. This does not mean that CTA providers do not give technical or administrative guidance when necessary; they only use these activities when they are absolutely necessary to accomplish the long term transfer of capability to the utility staff and administration.

Table 8-1. Training Approach to Achieve Transfer of CPE Skills

Training Activity	CPE Provider Role	Trainee Role
CCP Seminar (1 day)	<ul style="list-style-type: none"> • Present CPE seminar 	<ul style="list-style-type: none"> • Participate in seminar
First CPE (3-4 days)	<ul style="list-style-type: none"> • Conduct kick-off meeting • Facilitate data collection • Conduct special studies • Conduct interviews • Facilitate information exchange with team • Prepare exit meeting materials • Conduct exit meeting • Facilitate feedback session with team • Prepare final report 	<ul style="list-style-type: none"> • Observe kick-off meeting • Participate in data collection • Participate in special studies • Observe interviews • Review exit meeting materials • Observe exit meeting • Review final report
Second CPE (3-4 days)	<ul style="list-style-type: none"> • Conduct kick-off meeting • Facilitate data collection • Conduct special studies • Conduct interviews • Facilitate information exchange with team • Finalize exit meeting materials • Facilitate exit meeting • Facilitate feedback session with team • Review draft report 	<ul style="list-style-type: none"> • Participate in kick-off meeting • Participate in data collection • Participate in special studies • Participate in interviews • Prepare exit meeting materials • Participate in exit meeting • Prepare final report
Third CPE (3-4 days)	<ul style="list-style-type: none"> • Observe kick-off meeting • Participate in data collection • Observe special studies • Participate in interviews • Review exit meeting materials • Observe exit meeting • Facilitate feedback session with team • Review draft report 	<ul style="list-style-type: none"> • Conduct kick-off meeting • Facilitate data collection • Conduct special studies • Conduct interviews • Facilitate information exchange with team • Prepare exit meeting materials • Conduct exit meeting • Prepare final report

8.3 Quality Control

It is important for CCP providers and recipients of CCPs to be aware of appropriate CCP applications, expectations of the process, and maintenance of program integrity. Maintaining the integrity of the CCP approach can best be accomplished by following the protocols described in this handbook. However, to assure effective and consistent CCP results, quality control considerations have been developed and are presented in this section.

8.3.1 CPE Quality Control Guidance

Table 8-2 presents a checklist for CPE providers and recipients to assess the adequacy of a CPE relative to the guidance provided in this handbook. Some of the key areas are discussed in more detail in this section.

A challenging area for the CPE provider is to maintain the focus of the evaluation on performance (i.e., public health protection). Often, a provider

will tend to identify limitations in a multitude of areas which may not be related to optimized performance criteria. Typical areas may include poor plant housekeeping practices, lack of preventive maintenance, or lack of an operation and maintenance manual. Limitations in these areas are easily observed and do not challenge the capability of the operations staff. While they demonstrate a thoroughness by the provider to identify all issues, their identification may cause the utility to focus resources on these areas and to ignore areas more critical to achievement of optimized performance goals. The evaluator should be aware that a utility will have the tendency to take the CPE results and only address those factors that are considered relatively easy to correct without consideration of priority or the inter-relatedness of the factors.

Table 8-2. Quality Control Checklist for Completed CPEs

- Findings demonstrate emphasis on achievement of optimized performance goals (i.e., performance emphasis is evident in the discussion of why prioritized factors were identified).
- Lack of bias associated with the provider’s background in the factors identified (e.g., all design factors identified by a provider with a design background or lack of operations or administrative factors identified by the utility personnel conducting a CPE).
- Emphasis in the CPE results to maximize the use of existing facility capability.
- All components of the CPE completed and documented in a report (i.e., performance assessment, major unit process evaluation, identification and prioritization of factors, and assessment of CTA application).
- Less than 15 factors limiting performance identified (i.e., excessive factors indicates lack of focus for the utility).
- Specific recommendations are not presented in the CPE report, but rather, clear examples that support the identification of the factors are summarized.
- Identified limitations of operations staff or lack of site specific guidelines instead of a need for a third party-prepared operation and maintenance manual.
- Findings address administrative, design, operation and maintenance factors (i.e., results demonstrate provider’s willingness to identify/present all pertinent factors).

When implementing a CPE, it is important to understand that specific recommendations involving plant modifications or day-to-day operational practices should not be made. For example, direction on changing coagulants or chemical dosages is not appropriate during the conduct of a CPE. There is a strong bias for providers to give specific recommendations and for recipients to want specific checklists to implement. CPE providers should focus their observations during the evaluation on two key areas: 1) identification of factors limiting the facility from achieving optimized performance goals and 2) provision of specific examples to support these factors.

Another significant challenge in conducting an effective CPE is the tendency for providers to identify limitations that are non-controversial rather than real factors that may challenge utility personnel’s roles and responsibilities. For example, it is often easy to identify a design limitation, since the utility could not be expected to achieve optimum performance with inadequate facilities. It is much more difficult to identify “lack of administrative support for optimized performance goals” or an operators’ “inability to apply process control concepts” as the causes of poor performance. Failing to appropriately identify these difficult factors is a disservice to all parties involved. A common result of this situation is the utility will address a design limitation without addressing existing administrative or operational issues. Ultimately, these administrative and operational issues remain and impact the utility’s ability to achieve optimized performance. The challenge to properly identify the true factors can best be achieved by the CPE provider focusing on the “greater good” (i.e., achieving sustainable water quality goals). Understanding this concept allows the CPE provider to present the true factors, even though they may not be well received at the exit meeting.

8.3.2 GTA Quality Control Guidance

Table 8-3 presents a checklist for CTA providers and recipients to assess the quality of a CTA. A review of the components of the checklist would be a good way to ensure that the integrity of the CTA approach has been maintained. Some of the key components are discussed further in this section.

Table 8-3. Quality Control Checklist for Completed CTAs

- Plant specific guidelines developed by utility staff.
- Demonstrated problem solving skills of utility staff.
- Demonstrated priority setting skills of utility administration and staff.
- Tenacity of plant staff to pursue process changes when optimized performance goals are exceeded (i.e., filtered water turbidity begins to increase and approaches 0.1 NTU).
- Utility policy established by administrators to achieve optimized performance goals.
- Demonstrated communication between utility management and staff.
- Training plan that supports front line operators to be capable of achieving performance goals under all raw water conditions. For very stable raw water conditions the training plan should include capability to address "what if" situations (e.g., avoid complacency).
- Adequate staffing or alarm and shut down capability to ensure continuous compliance with optimized performance goals.
- Adequate funding to support maintaining optimized performance goals.
- Clear direction for utility personnel if optimized performance goals are not achieved.
- Trend charts showing unit processes meeting optimized performance objectives over long time periods despite changes in raw water quality.

Quality control for a CTA is more easily measured than for a CPE, since the bottom line is achievement of unit process and plant optimized performance goals. Consequently, a graphical depiction of performance results can be used to demonstrate the CTA endpoint. In some cases the desired performance graph cannot be achieved because of physical limitations (e.g., a Type 2 unit process was not able to perform as desired); however, the utility officials can then proceed with confidence in addressing the limiting factor.

Some attributes of a successful CTA are subtle and difficult to measure. However, they ensure that the integrity of the process is maintained after the CTA provider is gone. Long term performance can only be achieved by an administrative and

operations staff that have established water quality goals and demonstrated a commitment to achieve them. A successful CTA will result in a tenacious staff that utilize problem solving and priority setting skills in their daily routine. Plant staff recognition of the role that they play in protecting the public health of their customers can create a strong professional image. These attributes can often be difficult to assess, but they are obvious to the utility personnel and the CTA provider if they have been developed during the CTA.

One of the most difficult challenges for a CTA provider and utility personnel is to address the issue of complacency. Complacency can occur for all parties if stable raw water quality exists or if stable performance occurs due to the efforts of a few key personnel. It is important that a CTA provider and the utility personnel look beyond the comfort of existing good performance and develop skills to address the scenarios that could upset the current stable situation.

8.4 Total System Optimization

As current and future regulations continue to be implemented, the challenges facing the water treatment industry will also expand. One of the challenges will be the integration of optimizing particle removal with other, sometimes competing, optimization goals (e.g., control of disinfection by-products, corrosion control). The CCP approach has been successfully applied to wastewater treatment, water treatment (i.e., microbial protection), and ozone applications for water treatment (1,2). Based on this success, it is anticipated that the CCP approach can be adapted to new drinking water regulations and associated requirements. Future areas for optimization, such as watershed management, balancing disinfection by-product control with microbial protection, and controlling water quality in distribution systems, are believed to be suitable for development utilizing the CCP approach. This overall approach is called total system optimization, and the concept is intended to be developed through additional publications that will enhance this handbook. Table 8-4 presents a summary of total system optimization considerations for drinking water utilities.

The USEPA is funding the development of a Center for Drinking Water Optimization that will focus research on the impacts of new regulations on water treatment plant process control. Results of this research, coupled with field applications and

Table 8-4. Total System Optimization Considerations for Drinking Water Utilities

Optimization Area	Performance Focus	Optimization Activities	Possible Treatment Conflicts
Watershed/ Source Water Protection	Microbial Protection	<ul style="list-style-type: none"> Monitor for sources of microbial contamination Develop watershed protection program Remove/address known sources of contamination: develop pollution prevention partnerships Develop emergency response plans 	
Disinfection By- products	THMs HAAs Bromate	<ul style="list-style-type: none"> Reduce current level of prechlorination Relocate prechlorination to post sedimentation Increase TOC removal Change disinfectant type; change from chlorine to chloramines for maintaining residual 	<ul style="list-style-type: none"> Reduction in prechlorination reduces preoxidation effects and reduces particle removal Increased TOC removal increases sludge production/impacts facilities Lowering disinfectant residual causes regrowth Lowering oxidant level increases T&O Lowering disinfectant residual reduces disinfection capability
Lead Copper	Lead and Copper	<ul style="list-style-type: none"> Corrosion control; feed corrosion inhibitor, adjust pH to achieve stable water 	<ul style="list-style-type: none"> Increased pH levels could reduce available CT for disinfection
<i>Cryptosporidium</i> Control	Microbial Protection	<ul style="list-style-type: none"> Achieve optimization criteria defined in Chapter 2 Stop recycle practices 	
Plant Recycle	Microbial Protection	<ul style="list-style-type: none"> Stop recycle to plant; discharge wastewater to sewer or obtain permit to discharge to receiving water Provide treatment of recycle for particle removal 	<ul style="list-style-type: none"> Discharge of water treatment' residuals to sewer impacts wastewater treatment capacity
Distribution System	Microbial Protection	<ul style="list-style-type: none"> Develop monitoring program: include routine, construction, and emergency coverage Maintain minimum disinfectant in system; consider booster stations, changing from chlorine to chloramines; eliminate dead-end zones Develop unidirectional flushing program Cover treated water storage reservoirs Develop storage tank inspection program, provide vent screens, routine cleaning procedure Maintain turnover rate in storage tanks based on monitoring results 	<ul style="list-style-type: none"> Optimizing storage tank turnover impacts disinfection capability

Table 84. Total System Optimization Considerations for Drinking Water Utilities (Continued)

Groundwater Treatment	Microbial Protection	<ul style="list-style-type: none"> · Eliminate contaminants from entering wells (i.e., well head protection program) · Monitor for microbial contamination · Provide disinfection (e.g., establish policy to achieve virus inactivation, CT) 	
-----------------------	----------------------	-------------------------------------------------------------------------------------------------------------------------------------------------------------------------------------------------------------------------------------------------------------------------------	--

evaluations, will be used to integrate total system optimization components with the CCP approach.

tric Power Research Institute Community Environmental Center, St. Louis, MO.

8.5 References

1. DeMers, L.D., K.L. Rakness, and B.D. Blank. 1996. Ozone System Energy Optimization Handbook. AWWARF, Denver, CO and Electric Power Research Institute Community Environmental Center, St. Louis, MO.
2. Hegg, B.A., L.D. DeMers, and J.B. Barber. 1989. Handbook: Retrofitting POTWs. EPA/625/6-89/020, USEPA Center for Environmental Research Information, Cincinnati, OH.

Appendices

Appendix A'
***Data Collection Spreadsheets and Macros for
the Partnership for Safe Water***

Section 1	Background on the Data Collection Spreadsheets and Macros
Section 2	Selecting the Spreadsheet and Macros for Your Applications
Section 3	Loading the Spreadsheet and Macros
Section 4	Running the Macro Self-Test
Section 5	Entering Performance Data
Section 6	Activating the Macros
Section 7	Printing Spreadsheet Output
Section 8	Important Rules to Remember When Using the Spreadsheets and Macros
Figure A-1	Example performance assessment data collection spreadsheet output
Table A-1	File Designations for Various Software Spreadsheets - Single Sample Per Day Format
Table A-2	File Designations for Various Software Spreadsheets - Multiple Sample Per Day Format

¹ Developed by Eric M. Bissonette, Technical Support Center, USEPA.

Section 1 - Background on the Data Collection Spreadsheets and Macros

Spreadsheets have been prepared to assist utility performance data (raw, settled, and filtered turbidity) of the Self-Assessment. Spreadsheets will also form the basis of reports to the Partnership activities.

The spreadsheets have been developed to capture turbidity data from raw water, sedimentation basin effluent and filter effluent, but can be used to manage repetitive data of any kind (e.g., particle counts in certain size ranges, turbidity data from an individual filter, chemical dosages and flows) from any point in the process for up to 365 days worth of data. Macros have been written to generate frequency distributions, on a monthly and annual basis, to help evaluate trends and summarize the large amounts of data. Graphics capabilities of the spreadsheets are also built in to automatically plot trend charts and frequency distributions. There are also capabilities for generating summaries of the data to report as background information or on an annual basis. Other data summaries within the capabilities of each spreadsheet software version could be generated as well. The spreadsheets accommodate up to six values per day or one value per day.

Interpretation of data from the performance assessment is addressed in Chapter 4 of this handbook. In general, turbidity fluctuations in raw water being propagated through the sedimentation basin and filter effluents could indicate inadequate process control or physical limitations in one or all of the major unit treatment processes. The trend charts and frequency distributions can indicate variability of turbidity and trends in performance. Individual filter turbidity or particle data can be examined to determine if individual filters are not performing up to expectations,

Each spreadsheet has memory requirements of 1 MB of RAM, of which 250 KB at minimum has been allocated as expanded or enhanced memory. Systems with computers incapable of allocating memory above 640 KB should restrict data entry to one turbidity value per day for six months

worth of data per spreadsheet. If memory constraints persist, memory management techniques specified for individual software versions should be utilized.

Execution of the spreadsheet macros to analyze data, generate trend graphs, and calculate monthly percentile distributions is straightforward. The following instructions for loading selected spreadsheets, entering data, activating macros, and printing output were, however, generated assuming that users have some familiarity with spreadsheet software packages. Specific instructions for entering data are discussed in Section 5. Macro execution for LOTUS 123 Release 2.4 spreadsheets is approximately 15 minutes on a 486 25 MHz computer for twelve months of data. The WINDOWS spreadsheet macros take four minutes to complete once activated.

The spreadsheets are designed such that upon macro execution the user may simply print the previously defined range containing the percentile tables and graphs and submit this as the baseline report (please see the attached example Performance Assessment Data Collection Spreadsheet Output). Users requiring assistance in data entry and macro execution should contact Eric Bissonette of USEPA/OGWDW Technical Support Division at (5 13) 569-7933 or e-mail requests for assistance to bissonette.eric@epamail.epa.gov.

Users are encouraged to continue to use the spreadsheets to collect and analyze data after the baseline collection effort has been completed. Simply copy the provided spreadsheet with a new filename and continue data entry as defined for each spreadsheet type. Continued long term use of the data management spreadsheets will assist users in the conduct of Phase III - the self-assessment/self-correction phase and Phase IV - the third party assessment/correction phase of the Partnership for Safe Water, as well as provide fundamental input to a plant process control testing program.

PLEASE NOTE: Never work from the diskette containing the master copy of the data collection spreadsheets. Follow instructions for copying the appropriate spreadsheet and files described in Section 3 and work from that copy.

Section 2 - Selecting the Spreadsheet and Macros for Your Applications

Spreadsheets with macros have been developed to execute in LOTUS 123 Release 2.4 for DOS and 5.0 for WINDOWS, EXCEL Release 4.0 and 5.0 for WINDOWS, and QUATTRO PRO Release 5.0 for WINDOWS software systems. The spreadsheets will accommodate data entry of a single value per day or up to six values per day. Files preceded by the letter "d" represent spreadsheets capable of accommodating one sample per day. Files preceded by the number "4" represent spreadsheets capable of accommodating six samples per day (a sample every four hours). Select the files corresponding to your application and data entry needs from the following table and proceed to Section 3.

Section 3 - Loading the Spreadsheet and Macros

The Spreadsheet files with macros have been stored in a compressed mode on the diskette and must be "exploded" to create the "working" files listed in Section 2. Files may be "exploded" as follows:

- Start from the drive prompt of the desired directory (e.g., C:\123\PA_data\).
- Copy the appropriate "compressed" file for your spreadsheet software application as specified in Section 2 from the Spreadsheet Master Diskette to a directory resident on your hard drive.

Table A-1. File Designations for Various Software Spreadsheets - Single Sample Per Day Format

Single Component Spreadsheets	for DOS	for WINDOWS		
	LOTUS 123 2.4	LOTUS 123 5.0	EXCEL 4.0 or 5.0	QUATTRO PRO 5.0
Compressed Files	D_L24.EXE	D_L5W.EXE	D_XCL.EXE	D_QP.EXE
Working Files	D-1 23R24.WK1	D-1 23R5W.WK4	D_EXCEL4.XLS	D_OUTPRO.WB1
External Format Files	D-1 23R24.FMT	None	None	None
External Macros	None	None	MACRO 1 .XLM	None

Table A-2. File Designations for Various Software Spreadsheets - Multiple Sample Per Day Format

Multiple Component Spreadsheets	for DOS	for WINDOWS		
	LOTUS 123 2.4	LOTUS 123 5.0	EXCEL 4.0 or 5.0	QUATTRO PRO 5.0
Compressed Files	4_L24.EXE	4_L5W.EXE	4_XCL.EXE	4_QP.EXE
Working Files	4_123R24.WK1	4_123R5W.WK4	4_EXCEL4.XLS	4_OUTPRO.WB1
External Format Files	4_123R24.FMT	None	None	None
External Macros	None	None	MACRO4.XLM	None

- For non-WINDOWS applications, simply type the compressed filename with the .EXE extension and press return (e.g., type D_L5W.EXE at the C:\123\PA_data> prompt and press return).
- For WINDOWS applications, select Run from the File submenu and type the compressed filename with the .EXE extension and click on OKAY.

When control of the keyboard is returned to the user:

- Copy the required "External" format and macro files and "DATA1.WK1" from the Master Diskette to the directory containing the newly created "working" file.
- Return to the menu or WINDOWS screen.
- Select the icon or menu option to enter the spreadsheet package (e.g., click on the LOTUS 123 Release 5.0 icon). (NOTE: WYSIWYG needs to be invoked for the LOTUS 123 Release 2.4 spreadsheets.)
- Open the newly created "working" file as specified in Section 2 and save the file under a new file name. Please note: The EXCEL spreadsheets require that the macro files "MACRO1.XLM" or "MACRO4.XLM" are opened in addition to the spreadsheet file. Once the macro file has been opened, utilize the HIDE feature under the WINDOW command to redisplay the data entry worksheet.
- Proceed to Section 4 to run the macro self-test or Section 5 to begin entering performance data.

Section 4 - Running the Macro Self-Test

Should users have concerns about the compatibility of the spreadsheets and macros and their spreadsheet software package, they should conduct a self-test of the macro. The self-test output will resemble the attached Example Performance Assessment Data Collection Spreadsheet Output. Run the self-test as follows:

- Open the "working" file created in Section 3 (refer to Section 2 table file name) and save/rename the file.

- For a single component (one sample per day) self-test: Copy range B1..B365 from the file "DATA1.WK1" to cell B49..B413. Go to the Single Component portion of Section 5 and proceed.
- For a multiple component (up to six samples per day) self-test: Copy range D1..I365 from the file "DATA1.WK1" to Cell D49..I413. Go to the Multiple Component portion of Section 5 and proceed.
- Activate the macro using steps specified in Section 6.
- Print output using steps specified in Section 7.

The printed output should resemble the attached Example Performance Assessment Data Collection Spreadsheet Output. Please note: Outputs generated will vary slightly due to differences in the spreadsheet software package being used. Should the macro prove inoperable, reinstall the files from the Master Diskette and repeat the process and/or refer to Section 8 prior to requesting assistance.

Section 5 - Entering Performance Data

Prior to entering data, users should set the worksheet recalculation mode to manual to decrease data entry and macro execution time. To begin the data entry process:

- Open or Retrieve the working and external files specified in Section 3.
- Enter the appropriate Utility/Plant specific information in cells F39.. F44.
- Enter the last two digits of the start year in cell B40 (e.g., 94 for 1994).
- Enter the start month in cell B41 (e.g., 7 for July).
- Data entry should always begin on the first of each month and include the entire month.
- All graphical and percentile table computations key on the entered dates. Therefore, no dates should be left blank.

For Single Component Spreadsheets (for use when entering one value per day):

- The formula residing in cell A50 will automatically increase the date entered in A49 by one day. Copy cell A50 to A51, A52, A53 and so on to the end of the year or the data entry period.
- After the column of dates has been generated in Column A, begin entering data (turbidity or particle counts, etc.) one value at a time in cell B49, B50, B51, etc. until all data has been entered. Note: The data entry section of the spreadsheet is highlighted in yellow. Skip cells when no data exists for those days.
- Do NOT enter data in Column A.

For Multiple Component Spreadsheets (for use when entering six values per day - e.g., 4-hour data):

- The formula residing in cell A50 will automatically increase the date entered into A49 by one day. Copy cell A50 to A51, A52, A53 and so on to the end of the year or the data entry period.
- The formula residing in cell B49 calculates the maximum value of the six daily entries. Copy cell B49 to B50, B51, B52 and so on to the end of the year or until the end of the data entry period. Note: Until data is entered in Columns D through I, the value in Column B will show an "ERR" message. Ignore this message.
- After the column of dates and formulas for daily maximums has been generated in Columns A and B, begin entering the 40 hour data (turbidity or particle counts, etc.) one value at a time in cells D49 and E49 and F49 and G49 and H49 and I49, etc. until all data has been entered. Note: The data entry section is highlighted in yellow. Skip cells when no data exists for those days.
- Do NOT enter data in Column A or B.
- After all data has been entered the worksheet should be saved with a new file name. This will protect the data in the unlikely event of error during execution of the macro.

Section 6 - Activating the Macros

To activate the macros when using:

- LOTUS 123 Release 2.4 for DOS, press the ALT and F3 keys simultaneously. Highlight A and press <Enter> or <Return>. Note: the LOTUS 123 Release 2.4 spreadsheets generate graphs during execution, and users must press <Return> or <Enter> when graphics appear on the screen to proceed through execution. These graphs summarize previous entries and may be confusing during the first entry process.
- LOTUS 123 Release 5.0 for WINDOWS or QUATTRO PRO Release 5.0 for WINDOWS, position and click the mouse button on any button contained within the spreadsheet labeled "Run Macro."
- EXCEL Release 4.0 or 5.0 for WINDOWS, press the CTRL and A keys simultaneously.

Section 7 - Printing Spreadsheet Output

To print the percentile tables and graphs generated during macro execution using:

- LOTUS 123 Release 2.4, invoke the WYSIWYG add-in and print the previously defined range by pressing <Shift:> then selecting <Print > and <Go> after the system has been configured to the user's printer. If the WYSIWYG add-in is unavailable, users should generate and print the graph PIC files Filtyear.PIC and Filtprob.PIC using the LOTUS Printgraph procedures.
- LOTUS 123 Release 5.0 or QUATTRO PRO Release 5.0 or EXCEL Release 4.0 or 5.0, follow printing techniques specified for WINDOWS applications by clicking on a printer icon (which will print the previously defined range) or select PRINT from the File submenu (and select "previously defined range") when the system requests a printing option. Users may have to adjust margins to accommodate individual applications in order to print output to a single sheet of paper.

Section 8 - Important Rules to Remember When Using the Spreadsheets and Macros

- Please remember that the spreadsheets and macros were developed and tested to operate on the DOS spreadsheet in a Release 2.3 operation. The spreadsheets were developed for other release versions. Users have had success for DOS spreadsheet in a Release 2.3 operation to execute the WINDOWS QUATTRO PRO 5.0 spreadsheet. Press ALT and F2 in lieu of depressing the RUN key for WINDOWS applications. Please remember that the spreadsheet was tested by the Partnership for Safe Water software development group.
- The only DOS version of the spreadsheets is LOTUS 123 Release 2.4. All other spreadsheets are WINDOWS applications.
- Make certain that the correct spreadsheet and macros are used for analyzing the appropriate data based on the number of daily samples (e.g., 1 sample per day versus 6 samples per day).
- Do NOT enter more than 12 months of data on any spreadsheet. Users should create a separate spreadsheet for each 12 months worth of data. The spreadsheet will inaccurately depict percentiles in the table and on the probability graph when data entry exceeds one year.
- Do NOT expect the percentile tables and trend and percentile graphs to update with correct values until the macros for the spreadsheets have been executed. Prior to macro execution, the spreadsheet percentile tables and graphs contain data generated from the test data.
- When using the EXCEL spreadsheets do NOT open both external macro files simultaneously. Use only the designated macro for the appropriate spreadsheet.
- Individual spreadsheets need to be created for handling raw, settled, and filtered/finished data. Memory constraints preclude accommodating all sampling points within a single spreadsheet.
- Table and graph titles, when working in WINDOWS applications, may be edited by simply positioning the mouse pointer on the appropriate cells and double clicking the cell. This enters the edit mode.
- When using the DOS spreadsheet, the titles may be edited by depressing the F2 key in the appropriate cell and typing in the changes. Users must enter the graph mode to modify the chart/graph titles.

Figure A-I. Example performance assessment data collection spreadsheet output.

Daily Filtered Water Turbidity														
Percentile	Yearly	Jun-94	Jul-94	Aug-94	Sep-94	Oct-94	Nov-94	Dec-94	Jan-95	Feb-95	Mar-95	Apr-95	May-95	
50	0.03	0.02	0.02	0.02	0.02	0.02	0.02	0.03	0.04	0.03	0.04	0.06	0.03	
75	0.04	0.02	0.03	0.02	0.02	0.03	0.05	0.08	0.05	0.03	0.10	0.12	0.04	
90	0.07	0.03	0.04	0.02	0.03	0.04	0.09	0.08	0.06	0.04	0.17	0.19	0.04	
95	0.11	0.05	0.06	0.03	0.03	0.07	0.24	0.11	0.07	0.04	0.19	0.20	0.06	
96	0.14	0.05	0.06	0.03	0.03	0.07	0.24	0.11	0.07	0.04	0.19	0.20	0.06	
97	0.16	0.07	0.09	0.03	0.07	0.07	0.54	0.12	0.08	0.05	0.40	0.22	0.07	
98	0.19	NA	IA	NA	A	NA	NA	NA	NA	NA	NA	IA	IA	
99	0.20	NA	IA	NA	A	NA	NA	NA	NA	NA	NA	IA	IA	
Av:	0.04	0.02	0.02	0.02	0.02	0.03	0.06	0.04	0.04	0.03	0.07	0.09	0.03	
Mi:	0.01	0.01	0.01	0.01	0.01	0.01	0.02	0.01	0.03	0.02	0.02	0.02	0.01	
Ma:	0.54	0.07	0.09	0.03	0.07	0.07	0.54	0.12	0.08	0.05	0.40	0.22	0.07	
RSI	121.9%	57.3%	07.4%	27.8%	50.3%	48.2%	170.5%	71.1%	28.5%	28.8%	104.4%	72.7%	40.0%	

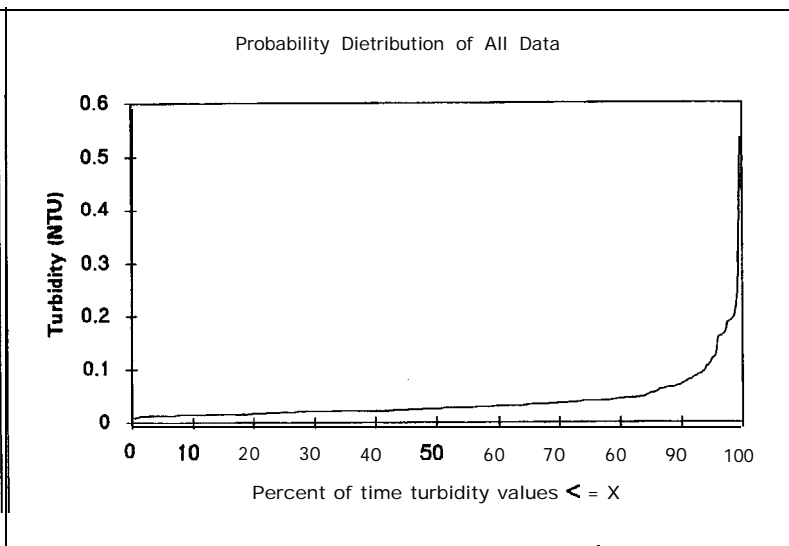
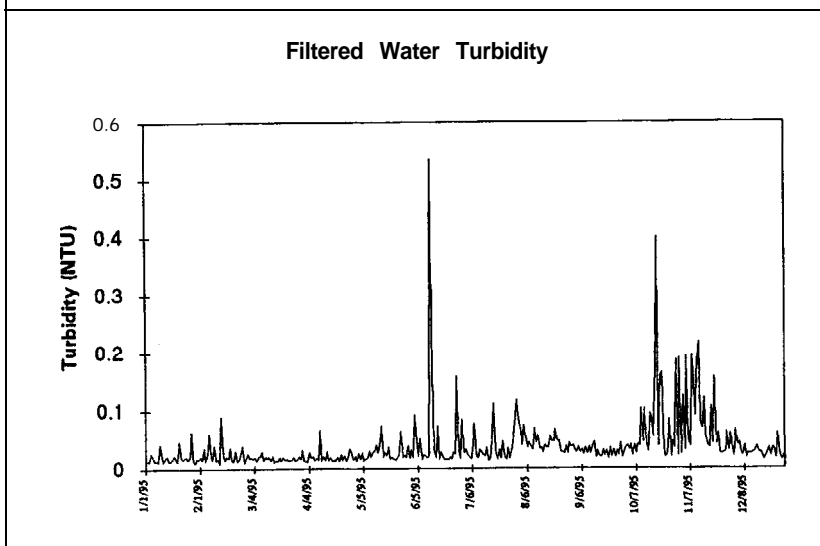

Start Year 94 365 = Total Days
 Month 6 12.00 = Total Months
 Day 1

Utility Name _____
 Plant Name _____
 Plant Street Address _____
 Plant City, state, Zip _____
 Plant Contact Name _____
 Plant Phone _____

Appendix B

Drinking Water Treatment Plant (DWTP) Advisor Software

Development of the DWTP Advisor

The DWTP Advisor is a computer software application designed as an “expert system” to provide assistance in the evaluation of drinking water treatment plants. The program was based on the source document Interim Handbook: Optimizing Water Treatment Plant Performance Using the Composite Correction Program Approach (1). The Interim Handbook is the predecessor document to this handbook, of which this appendix is a part. The software was developed to assist personnel responsible for improving the performance of existing water treatment plants in order to achieve compliance with the 1989 SWTR.

The system consists of two major components: Major Unit Process Evaluation and Performance Limiting Factors. These two component parts were designed to work together. The evaluator, therefore, cannot choose to use only one of the program’s components. In addition, the evaluator cannot modify the loading values, some of which are currently outdated. The software leads the evaluator through a series of questions and provides responses based on the experience and judgment of a group of experts that were used to delineate the logic for the program. The complexity of the multiple interrelated factors limiting performance and the uniqueness of individual plants makes production of an expert system with broad scale application difficult. This coupled with the fact that the program has not been updated for several years, should make persons considering use of the software aware of these inherent limitations.

Even though an expert system like the DWTP Advisor would theoretically have many uses, its current level of development limits its usefulness in conducting CPEs. Persons familiar with the fundamental CCP concepts and who understand the limitations of the software, however, may find it a useful tool.

Technical Information

Hardware Requirements

The DWTP Advisor requires an IBM AT or compatible computer with the following components:

- A hard disk with at least 5.0 megabytes of free space
- At least 640 Kbytes of RAM (560,000 bytes user-available)
- A high density floppy disk drive (5.25” 1.2 MB or 3.5” 1.4 MB)
- DOS version 3.0 or higher
- A printer (EPSON compatible) configured as system device PRN (optional)

If you installed the DWTP Advisor, but are unable to run the program, you may need to check your computer’s memory configuration. Although your computer may have the minimum memory required, memory resident programs may use some of this memory. “User-available” memory is the amount of memory remaining after the operating system and memory resident programs are loaded. If memory resident programs are installed and adequate memory is not available for the DWTP Advisor, an error message will appear on the screen when you attempt to run the program. If this occurs, memory resident programs should be disabled (e.g., by editing your computer’s configuration files, config.sys and autoexec.bat) and your computer rebooted before running the system. To check the status of your computer’s disk and available memory, run the MS-DOS CHKDSK program by typing CHKDSK and pressing <Enter>. For more information, see the MS-DOS manual that came with your computer or consult your PC support staff.

Software Specifications

The DWTP Advisor has been developed using several commercially available software tools. The system interface was developed using Turbo Pascal 6. The “reasoning” or evaluating portion of the system uses the expert system shell 1ST Class. The system also consists of data files in dBase.dbf format.

Contents of the System

The DWTP Advisor package includes one double-sided, high density disk and complete User Documentation.

A copy of the Water Advisor Software may be obtained by contacting:

**ORD Publications (G-721
26 West Martin Luther King Drive
U. S. Environmental Protection Agency
Cincinnati, Ohio 45268-1072
Telephone: 513-569-7562
Fax: 513-569-7566**

**Ask for: Drinking Water Treatment Plant
Advisor Software: 625/R-96/02**

Appendix C
Major Unit Process Capability Evaluation
Performance Potential Graph Spreadsheet Tool
for the Partnership for Safe Water

Section 1	Background on the Major Unit Process Capability Evaluation
Section 2	The Performance Potential Graph Spreadsheet Tool
Section 3	Selecting the Appropriate Spreadsheet for Your Application
Section 4	Loading the Spreadsheet
Section 5	Entering Plant Information/Data
Section 6	Printing Spreadsheet Output
Section 7	Important Rules to Remember When Using the Performance Potential Graph Spreadsheet Tool
Figure C-1	Example performance potential graph output for LOTUS 123 files.
Figure C-2	Example performance potential graph output for EXCEL and QUATTRO PRO files.
Figure C-3	Example performance potential graph data entry section for all files.
Figure C-4	Performance potential graph data entry guide.
Table C-1	Various Software Spreadsheets - The Designations for Performance Potential Graph
Table C-2	Major Unit Process Evaluation Criteria

Section 1 - Background on the Major Unit Process Capability Evaluation

Water treatment plants are designed to take a raw water source of variable quality and produce a consistent, high quality finished water using multiple treatment processes in series to remove turbidity and prevent microbial contaminants from entering the finished water. Each treatment process represents a barrier to prevent the passage of microbial contaminants and particulates in the plant. By providing multiple barriers, any microorganisms passing one unit process can possibly be removed in the next, minimizing the likelihood of microorganisms passing through the entire treatment system and surviving in water supplied to the public.

The performance potential graph (see Figures C-1 and C-2) is used to characterize capabilities of individual treatment processes to continuously function as a barrier for removing particulates and harmful pathogens. Each of the major unit processes is assessed with respect to its capability to consistently contribute to an overall plant treated water quality of less than 0.1 NTU turbidity during peak flows. Specific considerations are given only to process basin size and capability under optimum conditions. Limitations in process capability due to minor deficiencies or incorrect operation (e.g., degraded baffles which allow short-circuiting or improper process control) do not contribute to development of the performance potential graph. These operational or minor modification limitations are addressed during the evaluation of the other aspects of the treatment plant conducted as part of the *Partnership for Safe Water* self-assessment procedures.

Specific performance goals for the flocculation, sedimentation, filtration, and disinfection unit processes are used when developing the performance potential graph. These include settled water turbidities of less than 2 NTU and filtered effluent turbidities of less than 0.1 NTU. Capabilities of the disinfection process are assessed based on the CT values outlined in a USEPA guidance manual for meeting filtration and disinfection requirements. Rated capacities are determined for each of the unit processes based on industry standard loading rates and detention times with demonstrated capability to achieve specific unit process performance goals. These evaluation criteria are defined in Table C-2 of this appendix. The resulting unit process rated capacities are compared to

the peak instantaneous operating flow for the treatment plant. Any unit process rated capacities which do not exceed the plant's peak instantaneous operating flow are suspect in their ability to consistently meet desired performance goals that will maximize protection against the passage of microbial contaminants through the treatment plant. Specific interpretation of the results of the performance potential graph are discussed in Section 3 of the *Partnership for Safe Water* self-assessment procedures. It is important that the

Figure C-1. Example performance potential graph spreadsheet output for LOTUS 123 releases.

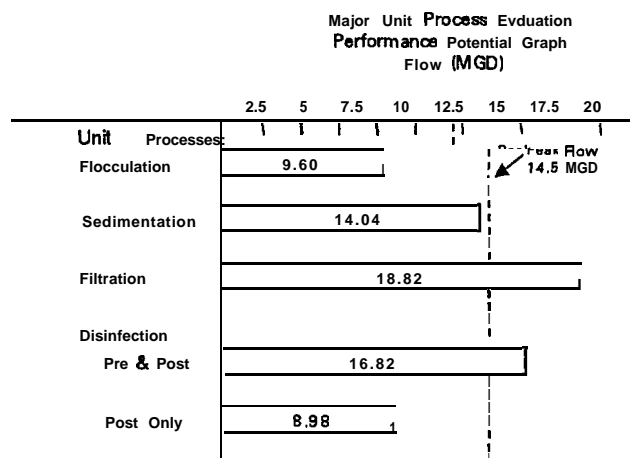
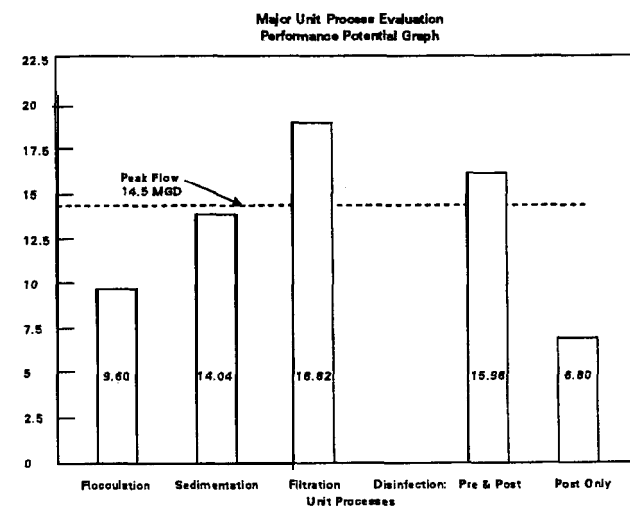

Figure C-2. Example performance potential graph spreadsheet output for EXCEL and QUATTRO PRO releases.



evaluator recognize that the guidance provided by this computer software should not exceed the evaluators' judgement in projecting unit process capability. Options to change loading rate projections to values different from those provided are available and should be considered if data or the evaluators' experience justifies the modification.

Section 2 - The Performance Potential Graph Spreadsheet Tool

Spreadsheets have been generated to assist Utility Partners in creating the performance potential graph required for Section 3 for use in the *Partnership for Safe Water* self-assessment procedures. Generating the performance potential graph requires opening the appropriate spreadsheet file and entering specific physical plant information in the defined cells (see Figure C-4). A performance potential graph will be generated automatically. Rated capacities for each unit process are generated from user-defined criteria as well as from criteria defined in Table C-2 and discussed in Section 3 of the *Partnership for Safe Water* self-assessment procedures. The user may print a hard copy of the performance potential graph by following steps defined in Section 6 of this appendix.

Users requiring expanded instructions for entering appropriate information in the spreadsheet cells should refer to Figure C-3. Should users require additional assistance in preparing a performance potential graph using the spreadsheet, please contact Eric Bissonette of USEPA/OGWDW Technical Support Division at (513) 569-7933.

Section 3 - Selecting the Appropriate Spreadsheet for Your Application

Performance Potential Graph Spreadsheets have been developed in LOTUS 123 Release 2.4 for DOS and 5.0 for WINDOWS, EXCEL Release 4.0 and 5.0 for WINDOWS, and QUATTRO PRO Release 5.0 for WINDOWS software systems. Select the files corresponding to your application and data entry needs from Table C-I and proceed to Section 4.

Table C-I. File Designations for Various Software Spreadsheets - Performance Potential Graph

	for DOS	for WINDOWS		
Performance Potential Graphs	LOTUS 123 2.4	LOTUS 123 5.0	EXCEL 4.0 or 5.0	QUATTRO PRO 5.0
Working Files	PPG.WK1	PPG.WK4	PPGXLC-XLS	PPGQP.WB1
External Format Files	PPG.FMT	None	None	None

Section 4 - Loading the Spreadsheet

- Copy the required working file and external format file from the Master Diskette to a directory resident on the hard drive of your computer. Do NOT work from the files contained on the Master Diskette.
- Enter your spreadsheet software by selecting the appropriate icon or menu option (e.g., click on the LOTUS 123 Release 5.0 icon). (Note: WYSIWYG needs to be invoked for the LOTUS 123 Release 2.4 spreadsheets.)
- Open the working file as specified in Section 3 and save the file under a new file name.

Section 5 - Entering Plant Information

Each spreadsheet contains a data entry section and a chart which depicts the resulting individual unit process rated capacities. The LOTUS 123 spreadsheets generate a performance potential graph with the unit process rated capacities characterized by horizontal bars (see Figure C-1). Contrarily, the EXCEL and QUATTRO PRO performance potential graphs characterize the unit process capacities by vertical bars (see Figure C-2). The data entry sections are identical for the LOTUS 123, EXCEL, and QUATTRO PRO performance potential graph files (see Figure C-3).

- Begin entering appropriate physical plant data in cells B31..B71 and E32..E69. Figure C-4 contains in-depth description of the acceptable entries for each of the cells in the spreadsheet.
- The entered physical plant data will appear in blue. Cells containing black values are calculated from data entered in other cells and cannot be modified.

Figure C-3. Performance potential graph data entry guide.

Peak Instantaneous Flow What is the peak flow in MGD at any instant through the treatment plant? This peak flow is based on historical records and pumping capacity. (See Section 3 of the Self-Assessment for further discussion.1)

Predisinfection

Presedimentation Does the plant have and utilize a presedimentation basin? Enter Yes or No.

Presed. Basin Volume What is the volume (in gallons) of the presedimentation basin(s)?

Presed. Basin Baffling What is the baffling condition of the presedimentation basin(s)? Unbaffled Poor Average Superior Impacts effective volume calculation regarding predisinfection contact time based on estimated T_{10} to T ratios.

Predisinfection Practiced Temperature (°C) Does the plant apply a disinfectant prior to the clearwell? Enter Yes or No.

pH What is the coldest water temperature (in degrees Celsius) at the predisinfectant application point?

Predisinf. Residual (mg/L) What is the maximum pH at the predirinfectant application point?

Predisinf. Application Point What is the maximum predisinfectant residual (in mg/L)?

Required CT Where is the predisinfectant applied? Prior to the presedimentation or flocculation or sedimentation or filtration unit processes?

Predisinfection Volume Using the predisinfection operating conditions (pH and Temp and required log removals), obtain the required CT value from Appendix C of the Surface Water Treatment Rule Guidance Manual or Appendix A of the CCP Handbook.

Effective Predisinf. Volume Calculated from data entered in other areas. No entry is required here.

Effective Predisinf. Volume Calculated from data entered in other areas. Incorporates effective contact of the disinfectant based on baffling in each of the unit processes.

Flocculation

Basin Volume What is the total volume (in gallons) of the flocculation basin(s)?

Temperature (°C) What is the coldest water temperature (in Celsius) that the flocculation basin experiences?

Mixing Stages Describe the stages contained within the flocculation basin(s). Single or Multiple? No baffling or interbasin compartments equals single-staged. All other conditions equal multiple-staged.

Detention Time

Suggested Suggested detention time calculated using above information from existing conditions (see Attachment 21. No entry is required here.

Assigned Enter a detention time (in minutes). Use the suggested detention time or select one based on site-specific circumstances.

Rated Capacity This is the rated capacity of the unit process (in MGD) calculated from the Assigned hydraulic detention time. No entry is required here.

Sedimentation

Basin Volume This volume is calculated from other entered data. No entry is required here.

Surface Area What is the total area (in square feet) of the sedimentation basin(s)?

Basin Depth What is the average depth (in feet) of the sedimentation basin(s)?

Operation Mode Enter Turbidity or Softening, depending on the process used. Is the process operated mainly to remove turbidity or to provide softening?

Process Type What settling process is utilized? Enter Rectangular/Circular/Contact/Lamella Plates/Adsorption Clarifier or SuperPulsator.

Tubes Present What type of settling tubes is present in the sedimentation basin(s)? Enter None or Vertical (>45°) or Horizontal (<45°).

Figure C-3. Performance potential graph data entry guide (continued).

Process SOR	
Suggested	Suggested surface overflow rate calculated using above information from existing conditions (see Attachment 21. No entry is required here.
Assigned	Enter a surface overflow rate (SOR) (in gpm/ft ²). Use the suggested SOR or select one based on site-specific circumstances.
Rated Capacity	This is the rated capacity of the unit process (in MGD) calculated from the Assigned surface overflow rate. No entry is required.

Filtration

Total Filter Surface Area	What is the total surface area (in square feet) of the filter(s)?
Total Number of Filters	What is the total number of filters in the treatment plant?
Filters Typically In Service	What number of filters are typically in service?
Total Volume Above Filters	What is the total volume of water above the filter media (in gallons)?
Media Type	What media configuration is present in the filters? Enter Sand, Dual, Mixed, Deep Bed.
Operation Mode	How are the filters operated? Enter Conventional Direct, Inline Direct.
Raw Turbidity	What is the yearly 95th percentile raw water turbidity value? Refer to the raw water turbidity spreadsheet output table.
Air Binding	What level of air binding is noticeable in the filter(s)? Enter None, Moderate, High.

Loading Rate	
Suggested	Suggested filter loading rate calculated using above information from existing conditions (see Attachment 2). No entry is required here.
Assigned	Enter a filter loading rate (in gpm/ft ²). Use the suggested rate or select one based on site-specific circumstances.
Rated Capacity	This is the rated capacity of the unit process (in MGD) calculated from the Assigned filter loading rate. No entry is required here.

Disinfection

Clearwell Volume	What is the total volume (in gallons) of the clearwell(s)?
Effective Baffling	What is the baffling condition of the clearwell(s)? Enter Unbaffled, Poor, Average, Superior. Impacts effective volume calculation regarding disinfection contact time.
Temperature (°C)	What is the temperature (in degrees Celsius) at the disinfectant application point?
pH	What is the pH at the disinfectant application point?
Disinfectant Residual (mg/L)	What is the maximum disinfectant residual (in mg/L)?
Required Log Inactivation	Enter the total number of log removals required for the plant. Enter 3 or 4 or >4 (must be a numeric value).
Reqd. Disinfection Log Inactivation	Required disinfection log removals calculated from other dots. No entry is required here.
Pipe Distance to First User	What is the transmission distance (in feet) to the first user/customer?
Pipe Diameter	What is the pipe diameter (in inches) of the transmission pipe?

Figure C-3. Performance potential graph data entry guide (continued).

Required CT		Using the disinfection operating conditions (pH end Temp end required log removals), obtain the required CT value from Appendix C of the Surface Water Treatment Rule Guidance Manual or Appendix A of the Composite Correction Program Handbook.
Effective Contact Volume		Calculated from data entered in other areas. No entry is required here.
	Detention Time	
Suggested		Suggested detention time calculated using above information from existing conditions (see Attachment 2). No entry is required here.
Assigned		Enter a detention time (in minutes). Use the suggested detention time or select one based on site-specific circumstances.
Post Disinfection Rated Capacity		This is the rated capacity of the unit process (in MGD) calculated from the Assigned detention time and required CTs. No entry is required here.
Pre & Post Disinf. Rated Capacity		This is the rated capacity of the unit process (in MGD) calculated from the Assigned detention time and required CTs. No entry is required here.

Figure C-4. Example performance potential graph data entry section.

Plant Name
 Peak instantaneous flow

Predisinfection/Presedimentation Contact

Basin Type None, Predis, Predis, both
 Basin Volume (gallons)
 Basin Baffling Unbaffled Poor Average Superior
 Disinfectant Applied None, Chlorine, Chloramines, Chlorine Dioxide, Ozone
 Temperature (C)
 pH
 Disinfect residual (mg/L)
 Required CT See Guidance Manual Appendix C

Flocculation

Basin Volume (gallons)
 Temperature (C)
 Mixing Stages Single or Multiple
 Disinfectant Applied None, Chlorine, Chloramines, Chlorine Dioxide
 pH
 Disinfect residual (mg/L)
 Required CT See Guidance Manual Appendix C

Detention Time

Suggested (min) HDT
 Assigned (min) HDT

Rated Capacity MGD

Sedimentation

Basin Volume (gallons)
 Surface Area (ft²)
 Basin Depth (ft)
 Operation Mode Turbidity or Softening
 Process Type None/Rectangular/Circular/Contact
 LamellaPlates/AdsorpClarifier/SuperPulsator
 Tubes Present None or Vertical or Horizontal
 Percent Tube Area % of basin containing tubes
 Disinfectant Applied None, Chlorine, Chloramines, Chlorine Dioxide
 pH
 Disinfect residual (mg/L)
 Required CT See Guidance Manual Appendix C

Process SOR

Suggested gpm/ft²
 Assigned gpm/ft²

Rated Capacity MGD

Filtration

Total Filter Surface Area (ft²)
 Total Number of Filters
 Filters Typically in Service
 Total Volume Above Filters (gallons)
 Media Type Sand Dual Mbed
 DeepBed
 Operation Mode Conventional Direct Inline
 Raw Turbidity (NTU) >0
 Air Binding None Moderate High

Disinfectant Applied Chlorine, Chloramines
 None, Chlorine Dioxide

Disinfect residual (mg/L)
 Required CT See Guidance Manual Appendix C

Loading Rate

Suggested gpm/ft²
 Assigned gpm/ft²

Rated Capacity MGD

Disinfection

Clearwell Volume (gallons)
 Effective Baffling Unbaffled Poor
 Average Superior
 Disinfectant Applied Chlorine, Chloramines
 None, Chlorine Dioxide

Temperature (C)
 pH

Disinfectant residual (mg/L)
 Required Log Inactivation 3 or 4 or >4
 Required Disinfection Log Removals

Distribution Pipe Distance to First User (feet)
 Pipe diameter (inches)
 Required CT see SWTR Guidance Manual Appendix C

Effective Contact Volume (gallons)

Detention Time

Suggested (min) HDT
 Assigned (min) HDT

Post Disinfection Rated Capacity MGD

Pre & Post Disinfection Rated Capacity MGD

Table C-2. Major Unit Process Evaluation Criteria*

Flocculation		Hydraulic Detention Time
Base		20 minutes
Single Stage	Temp $\leq 0.5^{\circ}\text{C}$	+ 10 minutes
	Temp $> 0.5^{\circ}\text{C}$	+ 5 minutes
Multiple Stages	Temp $\leq 0.5^{\circ}\text{C}$	+0 minutes
	Temp $> 0.5^{\circ}\text{C}$	-5 minutes

Filtration	Air Binding	Loading Rate
Sand Media	None	2.0 gpm/ft ²
	Moderate	1.5 gpm/ft ²
	High	1.0 gpm/ft ²
Dual/Mixed Media	None	4.0 gpm/ft ²
	Moderate	3.0 gpm/ft ²
	High	2.0 gpm/ft ²
Deep Bed	None	6.0 gpm/ft ²
	Moderate	4.5 gpm/ft ²
	High	3.0 gpm/ft ²

Sedimentation		Surface Overflow Rate
Rectangular/Circular/Contact Turbidity Mode	Basin Depth	
	> 14 ft	0.7 gpm/ft ²
	12 - 14 ft	0.6 gpm/ft ²
	10 - 12 ft	0.5 - 0.6 gpm/ft ²
Softening Mode	< 10 ft	0.1 - 0.5 gpm/ft ²
	> 14 ft	1.0 gpm/ft ²
	12 - 14 ft	0.75 gpm/ft ²
	10 - 12 ft	0.5 - 0.75 gpm/ft ²
Vertical (>45°) Tube Settlers Turbidity Mode	< 10 ft	0.1 - 0.5 gpm/ft ²
	> 14 ft	2.0 gpm/ft ²
	12 - 14 ft	1.5 gpm/ft ²
	10 - 12 ft	1.0 - 1.5 gpm/ft ²
Softening Mode	< 10 ft	0.2 - 1.0 gpm/ft ²
	> 14 ft	2.5 gpm/ft ²
	12 - 14 ft	2.0 gpm/ft ²
	10 - 12 ft	1.5 - 2.0 gpm/ft ²
Horizontal (<45°) Tube Settlers	< 10 ft	0.7 - 1.5 gpm/ft ²
		2.0 gpm/ft ²
Adsorption Clarifier		9.0 gpm/ft ²
Lamella Plates		4.0 gpm/ft ²
SuperPulsator		1.5 gpm/ft ²
	with tubes	1.7 gpm/ft ²
Claricone Turbidity Mode		1.0 gpm/ft ²
Claricone Softening Mode		1.5 gpm/ft ²

*If long term (12-month) data monitoring indicates capability to meet performance goals at higher loading rates, then these rates can be used.

Renner, R.C., B.A. Hegg, J.H. Bender, and E.M. Bissonette. 1991. *Handbook - Optimizing Water Treatment Plant Performance Using the Composite Correction Program*. EPA 625/9-91/027. Cincinnati, OH: USEPA.

AWWARF Workshop. 1995. *Plant Optimization Workshop*. Colorado Springs, CO: AWWARF.

Eastern Research Group, Inc. 1992. *Water Advisor Utilizing the CCP Approach (Expert System)*. USEPA Work Assignment No. 7391-55. Eastern Research Group, Inc., Arlington, MA.

USEPA, AWWA, AWWARF, Association of Metropolitan Water Agencies, Association of State Drinking Water Administrators, and National Association of Water Companies. 1995. *Partnership for Safe Water Voluntary Water Treatment Plant Performance Improvement Program*.

- Each major unit process section contains a suggested and assigned evaluation criteria cell (e.g., the flocculation section contains a suggested and an assigned hydraulic detention time cell). The suggested loading rates, summarized in Table C-2 of this appendix, for specified situations are representative of conditions in which identified unit processes have demonstrated effectiveness in serving as a multiple barrier in the prevention of cyst and microorganism passage through the treatment plant.
- The actual rated capacities for each of the unit processes are calculated from the loading rates entered into the cells labeled “assigned loading rates.” Users must enter a value into the assigned cell, either selecting the “suggested” value or entering their own loading rate.
- The performance potential graph contained at the top of each spreadsheet will instantaneously update after each data entry. Complete the entire data entry process prior to proceeding to printing the spreadsheet output described in Section 6.

Section 6 - Printing Spreadsheet Output

To print the performance potential graph using:

- LOTUS 123 Release 2.4 for DOS, invoke the WYSIWYG add-in and print the previously defined range by pressing <Shift : > then selecting <Print > and <Go> after the system has been configured to the user’s printer. If the WYSIWYG add-in is unavailable, users should generate and print the graph PIC file

PPG. PIC, using the LOTUS Printgraph procedures.

- LOTUS 123 Release 5.0 for WINDOWS, or QUATTRO PRO Release 5.0 for WINDOWS, or EXCEL Release 4.0 or 5.0 for WINDOWS, follow printing techniques specified for WINDOWS applications by clicking on a printer icon (which will print the previously defined range) or select PRINT from the File submenu (and select “previously defined range” when the system requests a printing option). Users may have to adjust margins to accommodate individual applications in order to print output to a single sheet of paper.

Section 7 - Important Rules to Remember When Using the Performance Potential Graph Spreadsheet Tool

- Cells containing “Black” values are calculated from other pertinent data entries and cannot be modified because the cells have been protected.
- The actual rated capacities for each of the unit processes are calculated from the loading rate entered into the cells labeled “assigned loading rates.” Users must enter a value into the assigned cell, either selecting the “suggested” value or entering their own loading rate.
- The external format file must be copied from the Master Diskette to the same directory as the working file or the Performance Potential Graph will not be visible when using LOTUS 123 Release 2.4 for DOS.

Appendix D
CT Values for Inactivation of Giardia and Viruses
by Free Cl₂ and Other Disinfectants

All tables in this appendix are taken from *Guidance Manual for Compliance With the Filtration and Disinfection Requirements for Public Water Systems Using Surface Water Sources*, Appendix E, Science and Technology Branch, Criteria and Standards Division, Office of Drinking Water, USEPA, Washington, D.C., October 1989.

Table D-I. CT Values for Inactivation of *Giardia* Cysts by Free Chlorine at 0.5 °C or Lower

Chlorine concentration (mg/L)	pH ≤ 8.0						pH = 8.5						pH = 7.0						pH = 7.5					
	Log Inactivation						Log Inactivation						Log Inactivation						Log Inactivation					
	0.5	1.0	1.5	2.0	2.5	3.0	0.5	1.0	1.5	2.0	2.5	3.0	0.5	1.0	1.5	2.0	2.5	3.0	0.5	1.0	1.6	2.0	2.5	3.0
< 0.0	23	48	80	01	114	137	27	54	82	109	138	183	33	85	98	130	163	195	40	79	119	158	198	237
0.8	24	47	71	04	119	141	28	58	84	112	140	188	33	87	100	133	187	200	40	80	120	150	109	230
0.8	24	48	73	97	121	145	20	57	88	115	143	172	34	68	103	137	171	205	41	82	123	184	205	248
1	25	49	74	99	123	148	20	50	88	117	147	176	35	70	105	140	175	210	42	64	127	169	211	253
1.2	25	51	78	101	127	152	30	60	90	120	150	160	38	72	109	143	179	215	43	88	130	173	218	259
1.4	26	52	78	103	129	155	31	81	92	123	153	164	37	74	111	147	184	221	44	89	133	177	222	288
1.8	26	52	70	105	131	157	32	63	95	126	159	199	38	75	113	151	199	228	46	01	137	162	228	273
1.8	27	54	81	108	135	182	32	84	07	129	181	193	39	77	118	154	193	231	47	93	140	186	233	279
2	28	55	83	110	138	165	33	86	09	131	164	197	39	79	118	157	197	236	49	95	143	191	238	266
2.2	26	58	85	113	141	169	34	87	101	134	169	201	40	51	121	161	202	242	50	99	149	106	248	297
2.4	20	57	88	115	143	172	34	66	103	137	171	205	41	92	124	185	209	247	50	99	149	199	248	288
2.8	20	58	86	117	148	175	35	70	105	130	174	200	42	84	126	166	210	252	51	101	152	203	253	304
2.8	30	59	89	119	146	176	38	71	107	142	176	213	43	86	120	171	214	257	62	103	155	207	259	310
3.0	60	91	121	151	191	38	72	100	145	181	217	44	87	131	174	216	281	53	105	156	211	283	318	
Chlorine Concentration (mg/L)	pH = 8.0						pH = 8.5						pH < 9.0											
	Log Inactivation						Log Inactivation						Log Inactivation											
	0.5	1.0	1.5	2.0	2.5	3.0	0.5	1.0	1.6	2.0	2.5	3.0	0.5	1.0	1.5	2.0	2.5	3.0						
< 0.0	46	92	130	185	231	277	55	110	165	219	274	329	65	130	195	280	325	300						
0.6	49	05	143	101	238	286	57	114	171	229	285	342	88	136	204	271	339	407						
0.9	49	08	148	197	248	205	59	119	177	238	295	354	70	141	211	261	352	422						
1	51	101	152	203	253	304	61	122	183	243	304	365	73	148	219	201	364	437						
1.2	52	104	157	209	281	313	63	125	188	251	313	378	75	150	226	301	376	451						
1.4	54	107	161	214	266	321	65	120	104	258	323	397	77	155	232	300	387	484						
1.6	55	110	185	219	274	320	88	132	199	285	331	307	80	159	239	316	398	477						
1.6	58	113	189	225	292	336	88	138	204	271	330	407	82	183	245	328	409	469						
2	58	115	173	231	288	348	70	130	209	278	346	417	83	187	250	333	417	500						
2.2	50	118	177	235	204	353	71	142	213	284	355	428	85	170	258	341	428	511						
2.4	80	120	191	241	301	381	73	145	216	200	383	435	87	174	281	346	435	522						
2.6	81	123	184	245	307	386	74	148	222	208	370	444	89	178	287	355	444	533						
2.6	63	125	168	250	313	375	75	151	228	301	377	452	01	181	272	362	453	543						
	64	127	101	255	318	382	77	153	230	307	393	480	02	184	276	368	460	552						

NOTE: CT 00.0 = CT for 3-log inactivation.

Table D-2. CT Values for Inactivation of *Giardia* Cysts by Free Chlorine at 5 °C

Chlorine concentration (mg/L)	pH <= 6.0 Log Inactivation						pH = 6.5 Log Inactivation						pH = 7.0 Log Inactivation						pH = 7.5 Log Inactivation					
	0.5	1.0	1.5	2.0	2.5	3.0	0.5	1.0	1.5	2.0	2.5	3.0	0.5	1.0	1.5	2.0	2.5	3.0	0.5	1.0	1.5	2.0	2.5	3.0
< = 0.	18	32	49	85	81	97	20	39	59	78	98	117	23	46	70	03	118	139	28	55	a3	111	138	166
0.6	17	33	50	87	83	100	20	40	80	80	100	120	24	48	72	95	119	143	29	57	88	114	143	171
0.8	17	34	52	69	98	103	20	41	61	a1	102	122	24	40	73	97	122	146	29	58	88	117	146	175
1	18	35	53	70	86	105	21	42	83	83	104	125	25	50	75	99	124	149	30	60	00	119	140	179
1.2	18	38	54	71	69	107	21	42	64	a5	106	127	25	51	78	101	127	152	31	81	02	122	153	183
1.4	18	38	55	73	01	100	22	43	85	87	108	130	26	52	78	103	129	155	31	82	94	125	158	197
1.6	19	37	58	74	93	111	22	44	86	88	110	132	26	53	79	105	132	158	32	64	96	129	160	192
1.6	19	38	57	78	95	114	23	45	68	90	113	135	27	54	81	108	135	1a2	33	65	98	131	183	198
2	19	39	56	77	97	118	23	46	69	92	115	138	26	55	a3	110	138	165	33	67	100	133	187	200
2.2	20	39	59	79	98	118	23	47	70	93	117	140	28	56	65	113	141	189	34	86	102	138	170	204
2.4	20	40	60	80	100	120	24	48	72	95	110	143	29	57	86	115	143	172	35	70	105	130	174	209
2.8	20	41	81	81	102	122	24	49	73	07	122	148	29	59	89	117	148	175	38	71	107	142	178	213
2.9	21	41	82	83	103	124	25	49	74	so	123	148	30	59	89	119	148	178	36	72	109	145	181	217
3	21	42	63	84	105	128	25	50	78	101	128	151	30	81	91	121	152	182	37	74	111	147	184	221
Chlorine concentration (mg/l)	pH = 8.0 Log Inactivation						pH = 8.5 Log Inactivation						pH <= 9.0 Log Inactivation											
	0.5	1.0	1.5	2.0	2.5	3.0	0.5	1.0	1.5	2.0	2.5	3.0	0.5	1.0	1.5	2.0	2.5	3.0						
< = 0	33	66	99	132	165	198	39	70	118	157	107	238	47	03	140	188	233	270						
0.8	34	89	102	136	170	204	41	a1	122	163	203	244	49	97	148	194	243	291						
0.8	35	70	105	140	175	210	42	64	128	186	210	252	50	100	151	201	251	301						
1	36	72	108	144	180	216	43	87	130	173	217	260	52	104	158	208	280	312						
1.2	37	74	111	147	194	221	45	89	134	178	223	267	53	107	180	213	287	320						
1.4	38	78	114	151	180	227	48	91	137	183	229	274	55	110	185	219	274	320						
1.6	39	77	118	155	193	232	47	04	141	167	234	261	56	112	160	225	281	337						
1.8	40	79	119	159	198	239	48	98	144	191	230	287	58	115	173	230	299	345						
2	41	81	122	162	203	243	40	09	147	198	245	294	59	118	177	235	204	353						
2.2	41	a3	124	185	207	248	50	100	150	200	250	300	80	120	181	241	301	381						
2.4	42	84	127	189	211	253	51	102	153	204	255	308	81	123	184	245	307	368						
2.8	43	a8	129	172	215	258	52	104	158	208	280	312	83	125	188	250	313	375						
2.8	44	88	132	175	219	263	53	108	159	212	265	318	84	127	191	255	318	382						
3	46	89	134	170	223	288	54	108	182	218	270	324	85	130	105	259	324	389						

NOTE: CT 08.0 = CT for 3-log inactivation.

Table D-3. CT Values for Inactivation of *Giardia* Cysts by Free Chlorine at 10 °C

Chlorine concentration (mg/L)	pH < 6.0 Log Inactivation						pH = 6.5 Log Inactivation						pH = 7.0 Log Inactivation						pH = 7.5 Log Inactivation					
	0.5	1	1.5	2	2.5	3.0	0.5	1	1.5	2	2.5	3.0	0.5	1	1.5	2	2.5	3.0	0.5	1	1.5	2	2.5	3.0
0.4	12	24	37	49	81	73	15	20	44	50	73	88	17	35	52	69	87	104	21	42	63	83	104	125
0.8	13	25	38	50	63	75	15	30	45	80	75	90	18	36	54	71	89	107	21	43	84	85	107	128
0.9	13	28	39	52	85	78	15	31	48	61	77	102	18	37	55	73	102	110	22	44	88	87	109	131
1	13	28	40	53	66	79	16	31	47	83	78	104	10	37	58	75	93	112	22	45	87	89	112	134
1.2	13	27	40	53	67	80	16	32	48	63	79	95	19	38	57	76	95	114	23	48	80	101	114	137
1.4	14	27	41	55	88	62	18	33	49	85	82	98	19	39	58	77	107	118	23	47	70	103	117	140
1.8	14	26	42	55	89	63	17	33	50	66	93	99	20	40	80	79	99	119	24	46	72	96	120	144
1.6	14	29	43	57	72	88	17	34	51	67	84	101	20	41	61	81	102	122	25	40	74	98	123	147
2	15	20	44	58	73	87	17	35	52	69	87	104	21	41	82	83	103	124	25	50	75	100	125	150
2.2	15	30	45	59	74	89	18	35	53	70	88	105	21	42	84	85	106	127	26	51	77	102	128	153
2.4	15	30	45	60	75	90	18	36	54	71	89	107	22	43	65	88	108	129	28	52	79	105	131	157
2.6	15	31	48	81	77	92	10	37	55	73	102	110	22	44	66	87	100	131	27	53	80	107	133	160
2.8	18	31	47	62	78	103	10	37	56	74	93	111	22	45	87	80	112	134	27	54	82	109	136	163
3	16	32	49	63	70	105	19	38	57	75	104	113	23	46	69	101	114	137	29	55	63	111	138	168
Chlorine concentration (mg/L)	pH = 8.0 Log Inactivation						pH = 6.5 Log Inactivation						pH < 9.0 Log Inactivation											
	0.5	1	1.5	2.0	2.5	3.0	0.5	1.0	1.5	2.0	2.5	3.0	0.5	1.0	1.5	2.0	2.5	3.0						
0.4	25	50	75	100	124	149	30	59	89	119	148	177	35	70	105	139	174	209						
0.8	28	51	77	102	128	153	31	61	92	122	153	183	38	73	109	145	182	218						
0.8	28	53	79	105	132	158	32	63	95	126	158	180	38	75	113	151	188	228						
1	27	54	81	108	135	182	33	85	98	130	183	195	39	78	117	156	195	234						
1.2	28	55	83	111	136	188	33	87	100	133	187	200	40	80	120	180	200	240						
1.4	28	57	85	113	142	170	34	89	103	137	172	208	41	82	124	165	208	247						
1.8	20	58	87	116	145	174	35	70	106	141	178	211	42	84	127	188	211	243						
1.8	30	80	100	110	149	179	36	72	108	143	179	215	43	96	130	173	218	250						
2	30	61	101	121	152	182	37	74	111	147	184	221	44	88	133	177	221	285						
2.2	31	82	93	124	155	186	38	75	113	150	188	225	45	100	136	161	228	271						
2.4	32	83	95	127	159	100	38	77	115	153	192	230	46	92	138	184	230	278						
2.8	32	85	97	129	162	104	39	79	117	158	195	234	47	94	141	187	234	281						
2.8	33	66	99	131	184	107	40	80	120	159	189	230	48	96	144	191	230	287						
3	34	87	101	134	188	201	41	81	122	182	203	243	40	97	148	195	243	202						

NOTE: CT 99.9 = CT for 3-log inactivation.

Table D-4. CT Values for Inactivation of *Giardia* Cysts by Free Chlorine at 15 °C

Chlorine concentration (mg/L)	pH <= 6.0 Log Inactivation						pH = 6.5 Log Inactivation						pH = 7.0 Log Inactivation						pH = 7.5 Log Inactivation					
	0.5	1.0	1.5	2.0	2.5	3.0	0.5	1.0	1.5	2.0	2.5	3.0	0.5	1.0	1.5	2.0	2.5	3.0	0.5	1.0	1.5	2.0	2.5	3.0
< 0.4		16	25	33	41	49	1	20	30	39	49	59	12	23	35	47	58	70	14	29	42	55	69	83
0.6	8	17	25	33	42	50	1	20	30	40	50	60	12	24	36	48	60	72	14	28	43	57	72	86
0.6	9	17	26	35	43	52	1	20	31	41	51	61	12	24	37	49	61	73	15	29	44	59	73	88
1	9	18	27	35	44	53	11	21	32	42	53	63	13	25	38	50	63	75	15	30	45	60	75	90
1.2	9	18	27	36	45	54	11	21	32	43	53	64	13	25	38	51	63	76	15	31	46	61	77	92
1.4	9	18	26	37	46	55	11	22	33	43	54	65	13	26	39	52	65	78	18	31	47	63	78	94
1.6	9	19	26	37	47	58	11	22	33	44	55	66	13	26	40	53	66	79	16	32	46	64	80	96
1.8	10	19	29	36	48	57	11	23	34	45	57	68	14	27	41	54	68	81	18	33	49	65	82	98
2	10	19	29	39	49	58	12	23	35	46	58	69	14	26	42	55	69	83	17	33	50	67	83	100
2.2	10	20	30	39	49	59	12	23	35	47	58	70	14	28	43	57	71	85	17	34	51	68	85	102
2.4	10	20	30	40	50	60	12	24	36	46	60	72	14	29	43	57	72	86	18	35	53	70	88	105
2.6	10	20	31	41	51	61	12	24	37	49	61	73	15	29	44	59	73	88	18	36	54	71	89	107
2.8	10	21	31	41	52	62	12	25	37	49	62	74	15	30	45	59	74	89	19	36	55	73	91	109
3	11	21	32	42	53	63	13	25	38	51	63	76	15	30	46	61	76	91	19	37	56	74	93	111
Chlorine concentration (mg/L)	pH = 8.0 Log Inactivation						pH = 8.5 Log Inactivation						pH < -0.0 Log Inactivation											
0.5	1.0	1.5	2.0	2.5	3.0	0.5	1.0	1.5	2.0	2.5	3.0	0.5	1.0	1.5	2.0	2.5	3.0							
< 0.4	17	33	50	66	83	99	20	39	59	79	96	116	23	47	70	93	117	140						
0.6	17	34	51	68	85	102	20	41	61	81	102	122	24	49	73	97	122	146						
0.6	16	35	53	70	86	105	21	42	63	84	105	126	25	50	76	101	126	151						
1	18	36	54	72	90	108	22	43	65	87	109	130	26	52	78	104	130	156						
1.2	19	37	56	74	93	111	22	45	67	89	112	134	27	53	80	107	133	160						
1.4	19	38	57	76	95	114	23	46	69	91	114	137	28	55	83	110	139	165						
1.6	19	39	58	77	97	116	24	47	71	94	118	141	28	56	85	113	141	169						
1.6	20	40	60	79	99	119	24	46	72	96	120	144	29	56	87	115	144	173						
2	20	41	61	81	102	122	25	49	74	96	123	147	30	58	89	118	146	177						
2.2	21	41	62	83	103	124	25	50	75	100	125	150	30	60	91	121	151	181						
2.4	21	42	64	85	106	127	26	51	77	102	126	153	31	61	92	123	153	184						
2.6	22	43	65	86	108	129	26	52	78	104	130	156	31	63	94	125	157	186						
2.6	22	44	66	88	110	132	27	53	80	106	133	159	32	64	96	127	158	191						
3	22	45	67	89	112	134	27	54	81	106	135	162	33	65	98	130	163	195						

NOTE: CT 99.9 = CT for 3-log inactivation.

Table D-5. CT Values for Inactivation of *Giardia* Cysts by Free Chlorine at 20 °C

Chlorine concentration (mg/L)	pH <= 6.0 Log Inactivation						pH = 6.5 Log Inactivation						pH = 7.0 Log Inactivation						pH = 7.5 Log Inactivation					
	0.5	1.0	1.5	2.0	2.5	3.0	0.5	1.0	1.5	2.0	2.5	3.0	0.5	1.0	1.5	2.0	2.5	3.0	0.5	1.0	1.5	2.0	2.5	3.0
<= 0.4	6	12	18	24	30	36	7	15	22	28	37	44	9	17	26	35	43	52	10	21	31	41	52	62
0.6	6	13	18	25	32	38	8	15	23	30	36	45	3	16	27	38	45	54	11	21	32	43	53	64
0.8	7	13	20	26	33	38	8	15	23	31	36	46	9	18	26	37	48	55	11	22	33	44	55	66
1	7	13	20	26	33	39	8	16	24	31	38	47	9	13	28	37	47	56	11	22	34	45	56	67
1.2	7	13	20	27	33	40	8	16	24	32	40	48	10	19	29	38	48	57	12	23	35	46	58	69
1.4	7	14	21	27	34	41	8	16	25	33	41	49	10	19	29	39	48	58	12	23	35	47	56	70
1.6	7	14	21	28	35	42	8	17	25	33	42	50	10	20	30	39	49	59	12	24	36	48	60	72
1.8	7	14	22	28	36	43	9	17	26	34	43	51	10	20	31	41	51	61	12	25	37	49	62	74
2	7	15	22	28	37	44	9	17	26	35	43	52	10	21	31	41	52	62	13	25	38	50	83	75
2.2	7	15	22	29	37	44	a	18	27	35	44	53	11	21	32	42	53	63	13	26	39	51	84	77
2.4	8	15	23	30	38	45	9	18	27	36	45	54	11	22	33	43	54	65	13	26	39	52	65	78
2.6	8	15	23	31	38	46	9	16	28	37	46	55	11	22	33	44	55	66	13	27	40	53	67	80
2.9	8	16	24	31	39	47	9	19	28	37	47	56	11	22	34	45	56	67	14	27	41	54	88	81
3	8	16	24	31	39	47	10	19	29	38	48	57	11	23	34	45	57	68	14	28	42	55	69	83
Chlorine concentration (mg/L)	pH = 8.0 Log Inactivation						pH = 8.5 Log Inactivation						pH <= 9.0 Log Inactivation											
0.5	1	1.5	2.0	2.5	3.0	0.5	1.0	1.5	2.0	2.5	3.0	0.5	1.0	1.5	2.0	2.5	3.0							
<= 0.4	12	25	37	49	62	74	15	30	45	59	74	69	18	35	53	70	88	105						
0.6	13	26	39	51	84	77	15	31	46	61	77	92	18	36	55	73	91	109						
0.8	13	26	40	53	88	79	16	32	48	63	79	95	13	38	57	75	94	113						
1	14	27	41	54	68	61	16	33	49	65	62	98	20	39	59	78	98	117						
1.2	14	26	42	55	69	63	17	33	50	87	33	100	20	40	60	80	100	120						
1.4	14	26	43	57	71	65	17	34	52	69	86	103	21	41	62	82	103	123						
1.6	15	23	44	56	73	87	18	35	53	70	66	105	21	42	63	64	105	126						
1.6	15	30	45	59	74	89	18	36	54	72	90	108	22	43	65	86	108	120						
2	15	30	46	61	76	91	18	37	55	73	92	110	22	44	66	86	110	132						
2.2	16	31	47	62	78	93	19	36	57	75	94	113	23	45	68	90	113	135						
2.4	16	32	48	63	79	95	18	38	58	77	96	115	23	48	69	92	115	138						
2.6	16	32	49	65	81	87	20	39	59	78	96	117	24	47	71	94	118	141						
2.8	17	33	50	66	83	98	20	40	60	79	89	119	24	48	72	95	119	143						
3	17	34	51	87	84	101	20	41	61	81	102	122	24	49	73	97	122	146						

NOTE: CT **99.9** = CT for 3-log inactivation.

Table D-6. CT Values for Inactivation of *Giardia* Cysts by Free Chlorine at 25 °C

Chlorine concentration (mg/L)	pH < 6.0 Log Inactivation						pH = 6.5 Log Inactivation						pH = 7.0 Log Inactivation						pH = 7.5 Log Inactivation					
	0.5	1.0	1.5	2.0	2.5	3.0	0.5	1.0	1.5	2.0	2.5	3.0	0.5	1.0	1.5	2.0	2.5	3.0	0.5	1.0	1.5	2.0	2.5	3.0
< = 0.4	4	8	12	16	20	24	5	10	15	18	24	29	6	12	19	23	29	35	7	14	21	26	35	42
0.6	4	8	13	17	21	25	5	10	15	20	25	30	6	12	16	24	30	36	7	14	22	28	36	43
0.9	4	9	13	17	22	26	5	10	16	21	26	31	6	12	19	25	31	37	7	15	22	29	37	44
1	4	9	13	17	22	26	5	10	16	21	26	31	6	12	19	25	31	37	6	15	23	30	36	45
1.2	5	9	14	16	23	27	5	11	16	21	27	32	6	13	19	25	32	38	8	15	23	31	38	46
1.4	5	9	14	18	23	27	6	11	17	22	28	33	7	13	20	28	33	39	6	16	24	31	39	47
1.6	5	9	14	19	23	29	6	11	17	22	28	33	7	13	20	27	33	40	8	16	24	32	40	48
1.9	5	10	15	19	24	29	6	11	17	23	26	34	7	14	21	27	34	41	8	16	25	33	41	49
2	5	10	15	19	24	29	6	12	18	23	29	35	7	14	21	27	34	41	6	17	25	33	42	50
2.2	5	10	15	20	25	30	6	12	18	23	29	35	7	14	21	26	35	42	9	17	26	34	43	51
2.4	5	10	15	20	25	30	6	12	16	24	30	36	7	14	22	29	36	43	9	17	26	35	43	52
2.6	5	10	16	21	26	31	6	12	19	25	31	37	7	15	22	29	37	44	9	18	27	35	44	53
2.8	5	10	16	21	26	31	6	12	19	25	31	37	6	15	23	30	39	45	9	16	27	36	45	54
3	5	11	16	21	27	32	6	13	19	25	32	39	6	15	23	31	36	46	9	19	26	37	46	55
Chlorine concentration (mg/L)	pH = 8.0 Log Inactivation						pH = 8.5 Log Inactivation						pH < 9.0 Log Inactivation											
	0.5	1.0	1.5	2.0	2.5	3.0	0.5	1.0	1.5	2.0	2.5	3.0	0.5	1.0	1.5	2.0	2.5	3.0						
< = 0.4	8	17	25	33	42	50	10	20	30	39	49	59	12	23	35	47	58	70						
0.6	9	17	26	34	43	51	11	20	31	41	51	61	12	24	37	49	61	73						
0.8	9	18	27	35	44	53	11	21	32	42	53	63	13	25	38	50	63	75						
1	9	18	27	36	45	54	11	22	33	43	54	65	13	26	39	52	65	76						
1.2	9	18	28	37	46	55	11	22	34	45	56	67	13	27	40	53	67	80						
1.4	10	19	29	38	48	57	12	23	35	46	56	69	14	27	41	55	68	82						
1.6	10	19	29	39	48	56	12	23	35	47	56	70	14	26	42	56	70	84						
1.6	10	20	30	40	50	60	12	24	36	48	60	72	14	29	43	57	72	86						
2	10	20	31	41	51	61	12	25	37	49	62	74	15	29	44	59	73	88						
2.2	10	21	31	41	52	62	13	25	36	50	63	75	15	30	45	60	75	90						
2.4	11	21	32	42	53	63	13	26	39	51	84	77	15	31	46	61	77	92						
2.8	11	22	33	43	54	65	13	28	39	52	65	78	16	31	47	63	76	94						
2.8	11	22	33	44	55	66	13	27	40	53	67	80	16	32	40	64	80	96						
3	11	22	34	45	56	67	14	27	41	54	66	81	16	32	49	65	81	97						

NOTE: CT 99.9 = CT for 3-log inactivation.

Table D-7. CT Values for Inactivation of Viruses by Free Chlorine

pH	Log Inactivation					
	2.0		3.0		4.0	
Temperature (C)	6-9	10	6-9	10	6-9	10
0.5	6	45	9	66	12	90
5	4	30	6	44	8	60
10	3	22	4	33	6	45
15	2	15	3	22	4	30
20	1	11	2	16	3	22
25	1	7	1	11	2	15

Table D-8. CT Values for Inactivation of *Giardia* Cysts by Chlorine Dioxide

	Temperature (C)					
	< = 1	5	10	15	20	25
0.5-log	10	4.3	4	3.2	2.5	2
1-log	21	8.7	7.7	6.3	5	3.7
1.5-log	32	13	12	10	7.5	5.5
2-log	42	17	15	13	10	7.3
2.5-log	52	22	19	16	13	9
3-log	63	26	23	19	15	11

Table D-9. CT Values for Inactivation of Viruses by Chlorine Dioxide pH 6-9

	Temperature (C)					
	< = 1	5	10	15	20	25
2-log	8.4	5.6	4.2	2.8	2.1	1.4
3-log	25.6	17.1	12.8	8.6	6.4	4.3
4-log	50.1	33.4	25.1	16.7	12.5	8.4

Table D-10. C . Values for Inactivation of *Giardia* Cysts by Ozone

	Temperature (C)					
	< = 1	5	10	15	20	25
0.5-log	0.48	0.32	0.23	0.16	0.1	0.08
1-log	0.97	0.63	0.48	0.32	0.2	0.16
1.5-log	1.5	0.95	0.72	0.48	0.36	0.24
2-log	1.9	1.3	0.95	0.63	0.48	0.32
2.5-log	2.4	1.6	1.2	0.79	0.6	0.4
3-log	2.9	1.9	1.43	0.95	0.72	0.48

Table D-I 1. CT Values for Inactivation of Viruses by Ozone

	Temperature (C)					
	< =1	5	10	15	20	25
2-log	0.9	0.6	0.5	0.3	0.25	0.15
3-log	1.4	0.9	0.8	0.5	0.4	0.25
4-log	1.8	1.2	1	0.6	0.5	0.3

Table D-12. CT Values for Inactivation of *Giardia* Cysts by Chloramine pH 6-9

	Temperature (C)					
	< =1	5	10	15	20	25
0.5-log	635	365	310	250	185	125
1-log	1270	735	615	500	370	250
1.5-log	1900	1100	930	750	550	375
2-log	2535	1470	1230	1000	735	500
2.5-log	3170	1830	1540	1250	915	625
3-log	3800	2200	1850	1500	1100	750

Table D-13. CT Values for Inactivation of Viruses by Chloramine

	Temperature (C)					
	< =1	5	10	15	20	25
2-log	1243	857	643	428	321	214
3-log	2063	1423	1067	712	534	356
4-log	2883	1988	1491	994	746	497

Table D-14. CT Values for Inactivation of Viruses by UV

Log Inactivation	
2	3
21	36

Appendix E
Performance Limiting Factors Summary Materials
and Definitions

CPE Factor Summary Sheet Terms

Plant Type	Brief but specific description of plant type (e.g., conventional with flash mix, flocculation, sedimentation, filtration and chlorine disinfection; or direct filtration with flash mix, flocculation and chlorine disinfection).
Source Water	Brief description of source water (e.g., surface water including name of water body).
Performance Summary	Brief description of plant performance based on performance assessment component of the CPE (i.e., ability of plant to meet optimized performance goals).
Ranking Table	A listing of identified performance limiting factors that directly impact plant performance and reliability.
Rank	Relative ranking of factor based on prioritization of all “A” and “B” rated factors identified during the CPE.
Rating	Rating of factor based on impact on plant performance and reliability: A – Major effect on a long-term repetitive basis B – Moderate effect on a routine basis or major effect on a periodic basis C – Minor effect
Performance Limiting Factor (Category)	Factor identified from Checklist of Performance Limiting Factors, including factor category (e.g., administration, design, operation, and maintenance).
Notes	Brief listing of reasons each factor was identified (e.g., lack of process control testing, no defined performance goals).

CPE Performance Limiting Factors Summary

Plant Name/Location:

CPE Performed By:

CPE Date:

Plant Type:

Source Water:

Performance Summary:

Ranking Table

Rank	Rating	Performance Limiting Factor (Category)

Rating Description

- A — Major effect on long-term repetitive basis.
- B — Moderate effect on a routine basis or major effect on a periodic basis.
- C — Minor effect.

Performance Limiting Factors Notes	
Factor	Notes
	.
	•
	•
	•
	•
	•
	•
	•
	•
	•

Checklist of Performance Limiting Factors

A. ADMINISTRATION

1. Plant Administrators

- a. Policies _____
- b. Familiarity With Plant Needs _____
- c. Supervision _____
- d. Planning _____
- e. Complacency _____
- f. Reliability _____
- g. Source Water Protection _____

2. Plant Staff

- a. Number _____
- b. Plant Coverage _____
- c. Personnel Turnover _____
- d. Compensation _____
- e. Work Environment _____
- f. Certification _____

3. Financial

- a. Operating Ratio _____
- b. Coverage Ratio _____
- c. Reserves _____

B. DESIGN

1. Source Water Quality

- a. Microbial Contamination _____

2. Unit Process Adequacy

- a. Intake Structure _____
- b. Pre-sedimentation Basin _____
- c. Raw Water Pumping _____
- d. Flow Measurement _____
- e. Chemical Storage and Feed Facilities _____
- f. Flash Mix _____
- g. Flocculation _____
- h. Sedimentation _____
- i. Filtration _____
- j. Disinfection _____
- k. Sludge/Backwash Water Treatment and Disposal _____

-
- 3. Plant Operability
 - a. Process Flexibility _____
 - b. Process Controllability _____
 - c. Process Instrumentation/ Automation _____
 - d. Standby Units for Key Equipment _____
 - e. Flow Proportioning _____
 - f. Alarm Svstems _____
 - g. Alternate Power Source _____
 - h. Laboratorv Space and Equipment _____
 - i. Sample Taos _____

C. OPERATION

- 1. Testing
 - a. CI Process Control Testing _____
 - b. Reoresentative Sampling _____
- 2. Process Control
 - a. Time on the Job _____
 - b. Water Treatment Understanding _____
 - c. Application of Concepts and Testina to Process Control _____
- 3. Operational Resources
 - a. Trainina Proaram _____
 - b. Technical Guidance _____
 - c. Ooerational Guidelines/Procedures _____

D. MAINTENANCE

- 1. Maintenance Program
 - a. EI Preventive _____
 - b. Corrective _____
 - c. Housekeeping _____
- 2. Maintenance Resources
 - a. Materials and Equioment _____
 - b. CI Skills or Contract Services _____

Definitions for Assessing Performance Limiting Factors

NOTE: The following list of defined factors is provided to assist the evaluator with identifying performance limitations associated with protection against microbial contaminants in water treatment systems. Performance limiting factors are described below using the following format.

<p>A. CATEGORY</p> <p>1. Subcategory</p> <p>a. <u>Factor Name</u></p> <ul style="list-style-type: none">• Factor description <p>9 <i>Example of factor applied to specific plant or utility</i></p>

A. Administration

1. Plant Administrators

a. Policies

- ◆ Do existing policies or the lack of policies discourage staff members from making required operation, maintenance, and management decisions to support plant performance and reliability?

9 *Utility administration has not communicated a clear policy to optimize plant performance for public health protection.*

9 *Multiple management levels within a utility contribute to unclear communication and lack of responsibility for plant operation and performance.*

9 *Cost savings is emphasized by management at the expense of plant performance.*

9 *Utility managers do not support reasonable training and certification requests by plant staff.*

9 *Administration continues to allow connections to the distribution system without consideration for the capacity of the plant.*

b. Familiarity With Plant Needs

- ◆ Do administrators lack first-hand knowledge of plant needs?

9 *The utility administrators do not make plant visits or otherwise communicate with plant staff.*

9 *Utility administrators do not request input from plant staff during budget development.*

c. Suoverision

- Do management styles, organizational capabilities, budgeting skills, or communication practices at any management level adversely impact the plant to the extent that performance is affected?

9 *A controlling supervision style does not allow the plant staff to contribute to operational decisions.*

9 *A plant supervisor's inability to set priorities for staff results in insufficient time allocated for process control.*

d. Planning

- ◆ Does the lack of long range planning for facility replacement or alternative source water quantity or quality adversely impact performance?

9 *A utility has approved the connection of new customers to the water system without considering the water demand impacts on plant capacity.*

9 *An inadequate capital replacement program results in utilization of outdated equipment that cannot support optimization goals.*

e. Complacency

- ◆ Does the presence of consistent, high quality source water result in complacency within the water utility?
 - 9 *Due to the existence of consistent, high quality source water, plant staff are not prepared to address unusual water quality conditions.*
 - 9 *A utility does not have an emergency response plan in place to respond to unusual water quality conditions or events.*

f. Reliability

- ◆ Do inadequate facilities or equipment, or the depth of staff capability, present a potential weak link within the water utility to achieve and sustain optimized performance?
 - 9 *Outdated filter control valves result in turbidity spikes in the filtered water entering the plant clearwell.*
 - 9 *Plant staff capability to respond to unusual water quality conditions exists with only the laboratory supervisor.*

g. Source Water Protection

- ◆ Does the water utility lack an active source water protection program?
 - 9 *The absence of a source water protection program has resulted in the failure to identify and eliminate the discharge of failed septic tanks into the utility's source water lake.*
 - 9 *Utility management has not evaluated the impact of potential contamination sources on water quality within their existing watershed.*

2. Plant Staff

a. Number

- ◆ Does a limited number of people employed have a detrimental effect on plant operations or maintenance?
 - 9 *Plant staff are responsible for operation and maintenance of the plant as well as distribution system and meter reading, limiting the time available for process control testing and process adjustments.*

b. Plant Coverage

- ◆ Does the lack of plant coverage result in inadequate time to complete necessary operational activities? (Note: This factor could have significant impact if no alarm/shutdown capability exists - see design factors).
 - 9 *Staff are not present at the plant during evenings, weekends, or holidays to make appropriate plant and process control adjustments.*
 - 9 *Staff are not available to respond to changing source water quality characteristics.*

c. Personnel Turnover

- ◆ Does high personnel turnover cause operation and maintenance problems that affect process performance or reliability?
 - 9 *The lack of support for plant needs results in high operator turnover and, subsequently, inconsistent operating procedures and low staff morale.*

d. Compensation

- Does a low pay scale or benefit package discourage more highly qualified persons from applying for operator positions or cause operators to leave after they are trained?
 - 9 *The current pay scale does not attract personnel with sufficient qualifications to support plant process control and testing needs.*

e. Work Environment

- ◆ Does a poor work environment create a condition for “sloppy work habits” and lower operator morale?
 - 9 *A small, noisy work space is not conducive for the recording and development of plant data.*

f. Certification

- ◆ Does the lack of certified personnel result in poor O & M decisions?
9 *The lack of certification hinders the staff's ability to make proper process control adjustments.*

3. Financial

a. Operating Ratio

- ◆ Does the utility have inadequate revenues to cover operation, maintenance, and replacement of necessary equipment (i.e., operating ratio less than 1.0)?
9 *The current utility rate structure does not provide adequate funding and limits expenditures necessary to pursue optimized performance (e.g., equipment replacement, chemical purchases, spare parts).*

b. Coverage Ratio

- ◆ Does the utility have inadequate net operating profit to cover debt service requirements (i.e., coverage ratio less than 1.25)?
9 *The magnitude of a utility's debt service has severely impacted expenditures on necessary plant equipment and supplies.*

c. Reserves

- ◆ Does the utility have inadequate reserves to cover unexpected expenses or future facility replacement?
9 *A utility has a 40-year-old water treatment plant requiring significant modifications; however, no reserve account has been established to fund these needed capital expenditures.*

B. Design

1. Source Water Quality

a. Microbial Contamination

- ◆ Does the presence of microbial contamination sources in close proximity to the water treatment plant intake impact the plant's ability to provide an adequate treatment barrier?
9 *A water treatment plant intake is located downstream of a major wastewater treatment plant discharge and is subject to a high percentage of this flow during drought periods.*

2. Unit Process Adequacy

a. Intake Structure

- ◆ Does the design of the intake structure result in excessive clogging of screens, build-up of silt, or passage of material that affects plant equipment?
9 *The location of an intake structure on the outside bank of the river causes excessive collection of debris, resulting in plugging of the plant flow meter and static mixer.*
9 *The design of a reservoir intake structure does not include flexibility to draw water at varying levels to minimize algae concentration.*

b. Presedimentation Basin

- ◆ Does the design of an existing presedimentation basin or the lack of a presedimentation basin contribute to degraded plant performance?
9 *The lack of flexibility with a presedimentation basin (i.e., number of basins, size, bypass) causes excessive algae growth, impacting plant performance.*
9 *A conventional plant treating water directly from a "flashy" stream experiences performance problems during high turbidity events.*

-
- c. Raw Water Pumping
- ◆ Does the use of constant speed pumps cause undesirable hydraulic loading on downstream unit processes?
9 *The on-off cycle associated with raw water pump operation at a plant results in turbidity spikes in the sedimentation basin and filters.*
- d. Flow Measurement
- ◆ Does the lack of flow measurement devices or their accuracy limit plant control or impact process control adjustments?
9 *The flow measurement device in a plant is not accurate, resulting in inconsistent flow measurement records and the inability to pace chemical feed rates according to flow.*
- e. Chemical Storage and Feed Facilities
- Do inadequate chemical storage and feed facilities limit process needs in a plant?
9 *Inadequate chemical storage facilities exist at a plant, resulting in excessive chemical handling and deliveries.*
9 *Capability does not exist to measure and adjust the coagulant and flocculant feed rates.*
- f. Flash Mix
- Does inadequate mixing result in excessive chemical use or insufficient coagulation to the extent that it impacts plant performance?
9 *A static mixer does not provide effective chemical mixing throughout the entire operating flow range of the plant.*
9 *Absence of a flash mixer results in less than optimal chemical addition and insufficient coagulation.*
- g. Flocculation
- ◆ Does a lack of flocculation time, inadequate equipment, or lack of multiple flocculation stages result in poor floc formation and degrade plant performance?
9 *A direct filtration plant, treating cold water and utilizing a flocculation basin with short detention time and hydraulic mixing, does not create adequate floc for filtration.*
- h. Sedimentation
- ◆ Does the sedimentation basin configuration or equipment cause inadequate solids removal that negatively impacts filter performance?
9 *The inlet and outlet configurations of the sedimentation basins cause short-circuiting, resulting in poor settling and floc carryover to the filters.*
9 *The outlet configuration causes floc break-up, resulting in poor filter performance*
9 *The surface area of the available sedimentation basins is inadequate, resulting in solids loss and inability to meet optimized performance criteria for the process.*
- i. Filtration
- ◆ Do filter or filter media characteristics limit the filtration process performance?
9 *The filter loading rate in a plant is excessive, resulting in poor filter performance.*
9 *Either the filter underdrain or support gravel have been damaged to the extent that filter performance is impacted.*
 - ◆ Do filter rate-of-flow control valves provide a consistent, controlled filtration rate?
9 *The rate-of-flow control valves produce erratic, inconsistent flow rates that result in turbidity and/or particle spikes.*
 - Do inadequate surface wash or backwash facilities limit the ability to clean the filter beds?
9 *The backwash pumps for a filtration system do not have sufficient capacity to adequately clean the filters during backwash.*

-
- 9 *The surface wash units are inadequate to properly clean the filter media.*
 - 9 *Backwash rate is not sufficient to provide proper bed expansion to properly clean the filters.*
 - j. **Disinfection**
 - ◆ Do the disinfection facilities have limitations, such as inadequate detention time, improper mixing, feed rates, proportional feeds, or baffling, that contribute to poor disinfection?
 - 9 *An unbaffled clearwell does not provide the necessary detention time to meet the Giardia inactivation requirements of the SWTR.*
 - k. **Sludge/Backwash Water Treatment and Disposal**
 - ◆ Do inadequate sludge or backwash water treatment facilities negatively influence plant performance?
 - 9 *The plant is recycling backwash decant water without adequate treatment.*
 - 9 *The plant is recycling backwash water intermittently with high volume pumps.*
 - 9 *The effluent discharged from a sludge/backwash water storage lagoon does not meet applicable receiving stream permits.*
 - 9 *Inadequate long-term sludge disposal exists at a plant, resulting in reduced cleaning of settling basins and recycle of solids back to the plant.*
3. **Plant Operability**
- a. **Process Flexibility**
 - ◆ Does the lack of flexibility to feed chemicals at desired process locations or the lack of flexibility to operate equipment or processes in an optimized mode limit the plant's ability to achieve desired performance goals?
 - 9 *A plant does not have the flexibility to feed either a flocculant aid to enhance floc development and strength or a filter aid to improve filter performance.*
 - 9 *A plant includes two sedimentation basins that can only be operated in series.*
 - b. **Process Controllability**
 - Do existing process controls or lack of specific controls limit the adjustment and control of a process over the desired operating range?
 - 9 *Filter backwash control does not allow for the ramping up and down of the flow rate during a backwash event.*
 - 9 *During a filter backwash, the lack of flow control through the plant causes hydraulic surging through the operating filters.*
 - 9 *The level control system located in a filter influent channel causes the filter effluent control valves to overcompensate during flow rate changes in a plant.*
 - 9 *Flows between parallel treatment units are not equal and cannot be controlled.*
 - 9 *The plant influent pumps cannot be easily controlled or adjusted, necessitating automatic start-up/shutdown of raw water pumps.*
 - 9 *Plant flow rate measurement is not adequate to allow accurate control of chemical feed rates.*
 - 9 *Chemical feed rates are not easily changed or are not automatically changed to account for changes in plant flow rate.*
 - c. **Process Instrumentation/Automation**
 - Does the lack of process instrumentation or automation cause excessive operator time for process control and monitoring?
 - 9 *A plant does not have continuous recording turbidimeters on each filter, resulting in extensive operator time for sampling.*

-
- 9 *The indication of plant flow rate is only located in the pipe gallery, which causes difficulty in coordinating plant operation and control.*
 - 9 *Automatic shutdown/start-up of the plant results in poor unit process performance.*
 - d. **Standby Units for Key Equipment**
 - ◆ Does the lack of standby units for key equipment cause degraded process performance during breakdown or during necessary preventive maintenance activities?
 - 9 *Only one backwash pump is available to pump water to a backwash supply tank, and the combination of limited supply tank volume and an unreliable pump has caused staff to limit backwashing of filters during peak production periods.*
 - e. **Flow Proportioning**
 - ◆ Does inadequate flow splitting to parallel process units cause individual unit overloads that degrade process performance?
 - 9 *In fluent flow to a plant is hydraulically split to multiple treatment trains, and uneven flow distribution causes overloading of one flocculation/sedimentation train over the others.*
 - f. **Alarm Systems**
 - Does the absence or inadequacy of an alarm system for critical equipment or processes cause degraded process performance?
 - 9 *A plant that is not staffed full-time does not have alarm and plant shut-down capability for critical finished water quality parameters (i. e., turbidity, chlorine residual).*
 - g. **Alternate Power Source**
 - Does the absence of an alternate power source cause reliability problems leading to degraded plant performance?
 - 9 *A plant has frequent power outages, and resulting plant shutdowns and start-ups cause turbidity spikes in the filtered water.*
 - h. **Laboratory Space and Equipment**
 - Does the absence of an adequately equipped laboratory limit plant performance?
 - 9 *A plant does not have an adequate process control laboratory for operators to perform key tests (i.e., turbidity, jar testing).*
 - i. **Sample Taps**
 - ◆ Does the lack of sample taps on process flow streams prevent needed information from being obtained to optimize performance?
 - 9 *Filter-to-waste piping following plant filters does not include sample taps to measure the turbidity spike following back wash.*
 - 9 *Sludge sample taps are not available on sedimentation basins to allow process control of the sludge draw-off from these units.*

C. Operation

1. Testing

a. **Process Control Testing**

- Does the absence or wrong type of process control testing cause improper operational control decisions to be made?
 - 9 *Plant staff do not measure and record raw water pH, alkalinity, and turbidity on a routine basis: consequently, the impact of raw water quality on plant performance cannot be assessed.*
 - 9 *Sedimentation basin effluent turbidity is not measured routinely in a plant.*

b. Representative Sampling

- Do monitoring results inaccurately represent plant performance or are samples collected improperly?
 - 9 *Plant staff do not record the maximum turbidity spikes that occur during filter operation and following filter back wash events.*
 - 9 *Turbidity sampling is not performed during periods when the reclaim backwash water pump is in operation.*

2. Process Control

a. Time on the Job

- ◆ Does staff's short time on the job and associated unfamiliarity with process control and plant needs result in inadequate or improper control adjustments?
 - 9 *Utility staff, unfamiliar with surface water treatment, were given responsibility to start a new plant; and lack of experience and training contributed to improper coagulation control and poor performance.*

b. Water Treatment Understanding

- ◆ Does the operator's lack of basic water treatment understanding contribute to improper operational decisions and poor plant performance or reliability?
 - 9 *Plant staff do not have sufficient understanding of water treatment processes to make proper equipment or process adjustments.*
 - 9 *Plant staff have limited exposure to water treatment terminology, limiting their ability to interpret information presented in training events or in published information.*

c. Application of Concepts and Testing to Process Control

- ◆ Is the staff deficient in the application of their knowledge of water treatment and interpretation of process control testing such that improper process control adjustments are made?
 - *Plant staff do not perform jar testing to determine appropriate coagulant dosages for different water quality conditions.*
 - *Plant filters are placed back in service following backwash without consideration for effluent turbidity levels.*
 - *Filter to waste valves are available but are not used following filter backwash.*
 - *Plant staff do not calculate chemical dosages on a routine basis.*
 - *Plant staff do not change chemical feed systems to respond to changes in raw water quality.*
 - *Filters are backwashed based on time in service or headloss rather than on optimized performance goal for turbidity or particle removal.*
 - *Plant staff "bump" filters by increasing the hydraulic loading to see if backwashing is necessary.*
 - *Sedimentation basin performance is controlled by visual observation rather than process control testing.*

3. Operational Resources

a. Training Program

- Does inadequate training result in improper process control decisions by plant staff?
 - 9 *A training program does not exist for new operators at a plant, resulting in inconsistent operator capabilities.*

b. Technical Guidance

- Does inappropriate information received from a technical resource (e.g., design engineer, equipment representative, regulator, peer) cause improper decisions or priorities to be implemented?
9 *A technical resource occasionally provides recommendations to the plant staff; however, recommendations are not based on plant-specific studies.*

c. Operational Guidelines/Procedures

- Does the lack of plant-specific operating guidelines and procedures result in inconsistent operational decisions that impact performance?
9 *The lack of operational procedures has caused inconsistent sampling between operator shifts and has led to improper data interpretation and process control adjustments.*

D. Maintenance

1. Maintenance Program

a. Preventive

- Does the absence or lack of an effective preventive maintenance program cause unnecessary equipment failures or excessive downtime that results in plant performance or reliability problems?
9 *Preventive maintenance is not performed on plant equipment as recommended by the manufacturer, resulting in premature equipment failures and degraded plant performance.*
9 *A work order system does not exist to identify and correct equipment that is functioning improperly.*

b. Corrective

- ◆ Does the lack of corrective maintenance procedures affect the completion of emergency equipment maintenance?
9 *A priority system does not exist on completion of corrective maintenance activities, resulting in a critical sedimentation basin being out of service for an extended period.*
9 *Inadequate critical spare parts are available at the plant, resulting in equipment down time.*

c. Housekeeping

- ◆ Does a lack of good housekeeping procedures detract from the professional image of the water treatment plant?
9 *An unkempt, cluttered working environment in a plant does not support the overall good performance of the facility.*

2. Maintenance Resources

a. Materials and Equipment

- ◆ Does the lack of necessary materials and tools delay the response time to correct plant equipment problems?
9 *Inadequate tool resources at a plant results in increased delays in repairing equipment.*

b. Skills or Contract Services

- Do plant maintenance staff have inadequate skills to correct equipment problems or do the maintenance staff have limited access to contract maintenance services?
9 *Plant maintenance staff do not have instrumentation and control skills or access to contract services for these skills, resulting in the inability to correct malfunctioning filter rate control valves.*

Appendix F
Data Collection Forms

Contents

Section	Page
Kick-Off Meeting	161 - 163
Administration Data	164 - 169
Design Data	170 - 180
Operations Data	181 - 189
Maintenance Data	190 - 191
Field Evaluation Data	192 - 197
Interview Data	198 - 200
Exit Meeting	201 - 203

KICK-OFF MEETING

A. Kick-Off Meeting Agenda

1. Purpose of the CPE

- Background on CCP process development and application
- Basis for conducting the CPE at the utility
- Assess ability of plant to meet optimized performance goals
 - Optimized performance criteria description
 - Multiple barrier concept for microbial protection
- Identify factors limiting plant performance
- Describe follow-up activities

2. Schedule CPE events

Utility Staff Involved

Date/Time

- Plant tour

- On-site data collection
 - Performance

 - Design

 - Operations

 - Maintenance

 - Administration

- Special studies

- Interviews

- Exit meeting

KICK-OFF MEETING

3. Information Resources

- Performance monitoring records _____
- Plant operating records _____
- As-built construction drawings _____
- Plant flow schematic _____
- As-built construction drawings _____
- O & M manuals _____
- Equipment manuals _____
- Previous and current year budgets _____
- Organizational structure _____
- Water rate structure _____

ADMINISTRATION DATA

A. Name and Location

1. Name of Facility _____

2. Utility Name _____

3. Current Date _____

4. Contact Information:

	Administration	Plant	
Contact Name			
Title			
Mailing Address			
Phone			
Fax			

B. Organization

1. Governing Body (name and scheduled meetings)

2. Utility structure (attach organizational chart if available)

ADMINISTRATION DATA

3. Plant Organizational Structure (include operations, maintenance, laboratory personnel; attach chart if available)

C. Communications

1. Utility Mission Statement

2. Water Quality Goals

ADMINISTRATION DATA

3. Communication Mechanisms:

Type	Description
CI Staff Meetings	
<input type="checkbox"/> Administrator/Board Visits to Plant	
<input type="checkbox"/> Reports (plant staff to manager; manager to governing board)	
<input type="checkbox"/> Public Relations/ Education	

D. Planning

1. Short-Term Needs

2. Long-Term Needs

ADMINISTRATION DATA

E. Personnel

Title/Name	No.	Certification	Pay Scale	% Time at Plant
Comments (e.g., vacant positions, adequacy of current staffing):				

F. Plant Coverage

1. Shift Description (e.g., length, number per shift, weekend/holiday coverage)

2. Unstaffed Operation Safeguards (e.g., alarm/shutdown capability, dialer)

ADMINISTRATION DATA

G. Financial Information

1. Budget (basis for budget: total utility plant only)

	Last Year Actual	Current Year Budget
Enter Year		
1. Beginning Cash on Hand		
2. Cash Receipts		
a. Water Sales Revenue		
b. Other Revenue (connection fees, interest)		
c. Total Water Revenue (2a + 2b)		
d. Number of Customer Accounts		
e. Average Charge per Account (2a ÷ 2d)		
3. Total Cash Available (1 + 2c)		
4. Operating Expenses		
a. Total O&M Expenses*		
b. Replacement Expenses		
c. Total O,M&R Expenses (4a + 4b)		
d. Total Loan Payments (interest + principal)		
e. Capital Purchases		
f. Total Cash Paid Out (4c + 4d + 4e)		
g. Ending Cash Position (3 - 4f)		
5. Operating Ratio (2a ÷ 4c) [±]		
6. Coverage Ratio (2c - 4c) ÷ (4d) [†]		
7. Year End Reserves (debt, capital improvements)		
8. End of Year Operating Cash (4g - 7)		
Source: USEPA Region 8 Financial Analysis Document (1997)		

* Includes employee compensation, chemicals, utilities, supplies, training, transportation, insurance, etc.

± Measure of whether operating revenues are sufficient to cover O,M&R expenses. An operating ratio of 1.0 is considered minimum for a self-supporting utility.

† Measure of the sufficiency of net operating profit to cover debt service requirements of the utility. Bonding requirements may require a minimum ratio (e.g., 1.25).

ADMINISTRATION DATA

2. Supporting Financial Information:

Category	Information
<input type="checkbox"/> Rate Structure <ul style="list-style-type: none"> • User fees • Connection fees • Planned rate changes 	
<input type="checkbox"/> Debt Service <ul style="list-style-type: none"> • Long-term debt • Reserve account 	
<input type="checkbox"/> Capital Improvements <ul style="list-style-type: none"> • Planning • Reserve account 	
<input type="checkbox"/> Budget Process <ul style="list-style-type: none"> • Staff involvement 	
<input type="checkbox"/> Spending Authorization <ul style="list-style-type: none"> • Administrator • Plant staff 	

DESIGN DATA

A. Plant Schematic and Capacity Information

1. Attach or draw plant flow schematic; include the following details:

- Source water type/location
- Major unit processes
- Flow measurement locations
- Chemical injection locations
- Piping flexibility
- On-line monitoring type/location

2. Flow Conditions:

Parameter	Flow	
Design Capacity		
Average Annual Flow		
Peak Instantaneous Flow		

DESIGN DATA

B. Major Unit Process Information

1. Flocculation:

Topic	Description	Information
1. Description	Type (reel, turbine, hydraulic)	
	Number trains/stages per train	
	Control (constant/variable speed)	
2. Dimensions	Length per stage:	
	Width per stage:	
	Depth per stage:	
	Total volume:	
3. Major Unit Process Evaluation	Selected Process Parameter(s):	
	Detention time (min)	
	Assigned process capacity	
4. Other Design Information (G values)		

Calculation of mixing energy as expressed by the mean velocity gradient (G) for mechanical mixing:

$$G = \left(\frac{P}{\mu v} \right)^{1/2}$$

G = Velocity gradient, sec⁻¹

μ = viscosity, lb-sec/ft²

v = volume, ft³

P = energy dissipated, ft-lb/sec
= hp x 550 ft-lb/sec/hp

Calculation of G for hydraulic mixing:

$$G = \left(\frac{\rho h_L}{\mu t} \right)^{1/2}$$

ρ = water density, 62.4 lb/ft³

h_L = head loss, ft

t = detention time, sec

Viscosity of Water Versus Temperature

Temp. (°F)	Temp. (°C)	Viscosity x 10 ⁻⁵ (lb-sec/ft ²)
32	0	3.746
40	4	3.229
50	10	2.735
60	16	2.359
70	21	2.050
80	27	1.799
90	32	1.595
100	38	1.424

DESIGN DATA

B. Major Unit Process Information (cont.)

2. Sedimentation:

Topic	Description	information
1 . Description	Type (conventional, tube settlers)	
	Number trains	
	Weir location	
	Sludge collection	
2. Dimensions	Width:	
	Depth:	
	Total surface area:	
3. Major Unit Process Evaluation	Selected Process Parameter(s):	
	Surface loading rate	
	Assigned process capacity	
4. Other Design Information		

DESIGN DATA

B. Major Unit Process Information (cont.)

3. Filtration:

Topic	Description	Information
1. Description	Type (mono, dual, mixed)	
	Number of filters	
	Filter control (constant, declining)	
	Surface wash type (rotary, fixed)	
2. Dimensions	Length or diameter:	
	Width:	
	Total surface area:	
3. Media design conditions (depth, effective size, uniformity coefficient):		
4. Backwash	Backwash initiation (headloss, turbidity, time):	
	Sequence (surface wash, air scour, flow ramping up/down, filter-to-waste):	

DESIGN DATA

B. Major Unit Process Information (cont.)

3. Filtration (cont.):

Topic	Description	Information
5. Major Unit Process Evaluation	Selected Process Parameter(s);	
	Surface loading rate	
	Assigned process capacity	
6. Other Design Information		

DESIGN DATA

B. Major Unit Process Information (cont.)

4. Disinfection:

Topic	Description	Information
1 . Description	Contact type (clearwell, storage)	
	T₁₀/T factor (see Table 4-4 or use tracer study results)	
2. Dimensions	Length or diameter:	
	Width:	
	Minimum operating depth:	
	Total volume:	
	Volume adjusted for T₁₀/T:	
3. Major Unit Process Evaluation	Selected Process Parameters:	
	Disinfectant (chlorine, chloramines)	
	Max. disinfectant residual (mg/L)	
	Maximum pH	
	Minimum temperature (°C)	
	Required <i>Giardia</i> inactivation	
	Required virus inactivation	
	Assigned process capacity	
5. Other Design Information		

DESIGN DATA

C. Miscellaneous Equipment Information

1. Miscellaneous Equipment/Unit Processes:

Equipment/Process	Description/Information
1. Intake Structure <ul style="list-style-type: none">▸ Location▸ Size of screen opening• Design limitations	
2. Presedimentation <ul style="list-style-type: none">• Detention time• Flexibility to bypass• Chemical feed capability• Design limitations	
3. Rapid Mix <ul style="list-style-type: none">• Type (mech., inline)• Chemical feed options• Mixing energy• Design limitations	

DESIGN DATA

C. Miscellaneous Equipment Information (cont.)

1. Miscellaneous Equipment/Unit Processes (cont.):

Equipment/Process	Description/Information
4. Backwash/Sludge Decant Treatment • • • Design limitations	
5. Sludge Handling • Onsite storage volume • Long-term disposal • Design limitations	

DESIGN DATA

C. Miscellaneous Equipment Information (cont .)

4. Pumping:

Flow Stream Pumped <ul style="list-style-type: none">• Location• Number of pumps• Rated capacity	Pump Type <ul style="list-style-type: none">• Turbine• Centrifugal	Comments <ul style="list-style-type: none">• Flow control method• Design issues• Source of rated capacity (name plate, specifications, flow meter)
1.		
2.		
3.		
4.		
5.		
6.		
7.		

OPERATIONS DATA

A. Process Control Strategy and Communication

Describe the process control strategy used by the staff and associated communication mechanisms.

Topic	Description/Information
1. Process Control Strategy <ul style="list-style-type: none"> ▸ Does the staff set specific performance targets? Are they posted? ▸ Who sets process control strategies and decisions? ▸ Are appropriate staff members involved in process control and optimization activities? 	
2. Communication Methods <ul style="list-style-type: none"> ▸ Does the staff have routine plant/shift meetings? ▸ How is communication conducted among operations, maintenance, and lab? ▸ Does the staff develop and follow operational procedures? 	

OPERATIONS DATA

B. Process Control Procedures

Describe specific process control procedures for the following available processes.

Process	Description/Information
1. Intake Structure <ul style="list-style-type: none"> • Flexibility to draw water from different locations & depths • Operational problems 	
2. Pumping/Flow Control <ul style="list-style-type: none"> • Flow measurement and control • Proportioning to multiple units • Operational problems 	
3. Presedimentation <ul style="list-style-type: none"> • Chemicals used/dose control • Monitoring (turbidity) • Sludge removal • Operational problems 	
4. Preoxidation <ul style="list-style-type: none"> • Chemicals used/dose control • Monitoring (residual) • Operational problems 	

OPERATIONS DATA

Describe specific process control, procedures for the following available processes (cont.)

Process	Description/Information
5. Coagulation/Softening <ul style="list-style-type: none"> • Chemicals used/feed location • Dose control (adjustment for flow changes; adjustment for water quality - jar testing, streaming current, pilot filter) • Monitoring (turbidity, particle counting) • Operational problems 	
6. Flocculation <ul style="list-style-type: none"> • Mixing energy adjustment • Use of flocculant aid • Monitoring • Operational problems 	
7. Sedimentation <ul style="list-style-type: none"> • Performance objective/ monitoring (turbidity) • Sludge removal (control, adjustment) • Operational problems 	

OPERATIONS DATA

Describe specific process control procedures for the following available processes (cont.)

Process	Description/Information
<p>8. Filtration</p> <ul style="list-style-type: none"> ▸ Performance objective/ monitoring (turbidity, particles, headloss, run time) ▸ Rate control due to demand, filter backwash ▸ Use of filter aid polymer ▸ Basis for backwash initiation (turbidity, particles, headloss, time) ▸ Backwash procedures (wash sequence, duration and rates, basis for returning filter to service) ▸ Filter/media inspections (frequency and type) ▸ Operational problems 	
<p>9. Disinfection</p> <ul style="list-style-type: none"> ▸ Performance objective/ monitoring (residual, CT) ▸ CT factors (pH, minimum depth of contactor, T_{10}/T, maximum residual) ▸ Operational problems 	

OPERATIONS DATA

Describe specific process control procedures for the following available processes (cont.)

Process	Description/Information
10. Stabilization <ul style="list-style-type: none"> • Chemical used/feed location • Performance objective/ monitoring (pH, index) • Operational problems 	
11. Decant Recycle <ul style="list-style-type: none"> • Duration, % of plant flow • Type of treatment (settling, chemical addition) • Operational problems 	
12. Sludge Treatment	

OPERATIONS DATA

C. Data Management

Describe data collection and management approaches and tools used by plant staff.

Topic	Description/Information
1. Data Collection <ul style="list-style-type: none"> • Type of forms used (water quality testing, shift rounds, plant log) • Computer (SCADA, database) 	
2. Data Application <ul style="list-style-type: none"> • Development of daily, monthly reports • Development of trend charts 	

D. Problem Solving and Optimization Activities

Describe specific approaches and tools used to solve problems or optimize plant processes.

Topic	Description/Information
1. Problem Solving/Optimization <ul style="list-style-type: none"> • Use of special studies • Pilot plant • List recent and ongoing problem solving/optimization activities • Available resources (technical assistance providers, training, manuals of practice) 	

OPERATIONS DATA

E. Complacency and Reliability

Describe specific approaches used to address complacency and reliability issues in the plant.

Topic	Description/Information
<p>1. Complacency</p> <ul style="list-style-type: none"> ▶ How does staff respond to unusual water quality conditions? ▶ Does staff have an emergency response plan? How does staff train for unusual conditions or events? <p>2. Reliability</p> • Does staff capability to make process control decisions exist at more than one level? 	

OPERATIONS DATA

F. Laboratory Capability

1. Describe available analytical testing capability.

Analytical Capability	Capability ✓	Description/Comments
. Color		
• Jar test		
• Particle counting		
• pH		
• Solids (dissolved)		
• Taste and odor		
• Temperature		
• Turbidity		
• Aluminum		
• Calcium		
• Fluoride		
• Hardness		
• Iron		
• Magnesium		
• Manganese		
• Sodium		
• Alkalinity		
• Ammonia Nitrogen		
• Nitrite/nitrate		
• Phosphate		
• Sulfate		
• Chlorine residual		
• Bacteriological		
• Disinfection byproducts		

OPERATIONS DATA

2. Describe laboratory space/equipment and procedures.

Process	Description/Information
Lab Space and Equipment <ul style="list-style-type: none"> • Does adequate lab space exist? 	
<ul style="list-style-type: none"> • Do adequate equipment and facilities exist? 	
Lab Procedures <ul style="list-style-type: none"> • Is testing conducted following standard procedures? • Where is lab data recorded? • Describe quality control procedures. 	
Equipment Calibration <ul style="list-style-type: none"> • Describe procedure for calibrating turbidimeters. • Describe procedures for calibrating other equipment (continuous chlorine and pH monitors). 	

MAINTENANCE DATA

A. Maintenance Program

Describe the plant maintenance program.

Topic	Description/Information
<p>1. Preventive Maintenance</p> <ul style="list-style-type: none"> ▸ Describe equipment inventory method (cards, computer). ▸ Describe maintenance scheduling method (daily, weekly, monthly, annual). 	
<p>2. Corrective Maintenance</p> <ul style="list-style-type: none"> ▸ Describe the work order system (issuing orders/documentation). ▸ Describe priority setting (relationship to process control and plant performance needs). ▸ List major equipment out of service within last 6 months. 	
<p>3. Predictive Maintenance</p> <ul style="list-style-type: none"> • Describe methods used to predict maintenance needs (vibration, infrared analysis). 	
<p>4. Housekeeping</p> <ul style="list-style-type: none"> • Does poor housekeeping detract from plant performance/image? 	

MAINTENANCE DATA

B. Maintenance Resources

Describe the available maintenance resources at the plant.

Topic	Description/Information
1. Equipment Repair and Parts <ul style="list-style-type: none"> • Are critical spare parts stored at the plant? • Can vendors provide quick response to spare parts needs? • What is the policy on parts procurement by staff? 	
2. Maintenance Expertise <ul style="list-style-type: none"> • Describe staff expertise (mechanical, electrical, instrumentation). • Does the staff use any contract maintenance services? How responsive are they to needs? • Does staff develop and use maintenance procedures? 	
3. Work Space and Tools <ul style="list-style-type: none"> • Does the plant have adequate work space and tools to perform maintenance tasks? 	
4. Performance Monitoring <ul style="list-style-type: none"> • How is maintenance performance measured (time to complete task, work order backlog)? 	

FIELD EVALUATION DATA

B. Water Usage

- Determine the water usage per capita based on water production records and population served. Water usage statistics for the United States are shown in the table below.

$$Q_c = \frac{Q_T}{P}$$

Q_c = Usage per capita per day
 Q_T = Total flow in 24-hour period
 P = Population served

Population _____

Q_c Avg. _____

Q_c Peak _____

State	Use (gpcpd)	State	Use (gpcpd)
Alabama	191	Nebraska	174
Alaska	134	Nevada	306
Arizona	191	New Hampshire	85
Arkansas	154	New Jersey	131
California	175	New Mexico	184
Colorado	188	New York	166
Connecticut	120	North Carolina	107
Delaware	124	North Dakota	114
Florida	146	Ohio	127
Georgia	160	Oklahoma	175
Hawaii	180	Oregon	164
Idaho	163	Pennsylvania	128
Illinois	154	Rhode Island	115
Indiana	115	South Carolina	148
Iowa	131	South Dakota	121
Kansas	144	Tennessee	148
Kentucky	128	Texas	176
Louisiana	147	Utah	255
Maine	81	Vermont	80
Maryland	165	Virginia	119
Massachusetts	119	Washington	217
Michigan	136	West Virginia	96
Minnesota	105	Wisconsin	118
Mississippi	127	Wyoming	188
Missouri	131	Puerto Rico	115
Montana	164	Virgin Islands	63

Source: Solley, W.B. Preliminary Estimates of Water Use in the United States, 1995, U.S. Geological Survey (1997).

FIELD EVALUATION DATA

2. Determine unaccounted for water based on monthly or annual water production and meter records. Unaccounted for water typically varies from 10 to 12 percent for new systems and 15 to 30 percent for older systems (Metcalf and Eddy, Inc. 1991).

$$Q_{\%} = \frac{(Q_T - Q_M)}{Q_T} \times 100$$

$Q_{\%}$ = % unaccounted

Q_T = Total plant water production for month or year

Q_M = Total metered water for month or year

Q_T _____

Q_M _____

$Q_{\%}$ _____

3. Determine backwash water percent based on volume of water filtered and volume of water used for backwash. Typically, the amount of water used for backwash ranges for 2 to 6 percent for conventional plants. Higher percentages can occur for direct filtration plants.

$$BW_{\%} = \frac{(V_F - V_{BW})}{V_F} \times 100$$

$BW_{\%}$ = % backwash water

V_F = Volume of water filtered

V_{BW} = Volume of water used for backwash

V_F _____

V_{BW} _____

$BW_{\%}$ _____

FIELD EVALUATION DATA

c. In-Plant Studies

Describe results of in-plant studies conducted during the CPE.

Topic	Description/Information/Findings
1. Filter Media Evaluation <ul style="list-style-type: none"> • Check media depth and type. • Check media condition (presence of chemicals/debris, mudballs, worn media). • Check support gravel level (variation of less than 2 inches acceptable). 	
2. Backwash Evaluation <ul style="list-style-type: none"> • Check backwash rate (measure rise rate in the filter versus time and convert to backwash rate; > 15 gpm/ft² acceptable). • Check bed expansion > 20 percent acceptable). 	

FIELD EVALUATION DATA

C. In-Plant Studies (cont.)

Describe results of in-plant studies conducted during the CPE.

Topic	Description/Information/Findings
<p>2. Backwash Evaluation (cont.)</p> <ul style="list-style-type: none"> • Observe backwash procedure (flow distribution, ramping of flow rate, turbidity of water at end of backwash). 	
<p>3. Coagulant Dosage Evaluation</p> <ul style="list-style-type: none"> • Verify reported dose with actual; measure liquid or dry feed rate (lb/min, mL/min) and convert to dose (mg/L). 	
<p>4. Turbidity Meter Evaluation</p> <ul style="list-style-type: none"> • Check meter calibration or compare with calibrated meter. 	

A. Interview Guidelines

The following interview guidelines are provided to assist CPE providers with the interview process.

1. **Conduct interviews with one staff person at a time in a private location.**
 - It is important to create a comfortable environment for the interview process to take place. Confidentiality of the interview should be explained.
2. **Keep the interview team size small.**
 - The number of people included on each interview team should be kept to a minimum (e.g., 1 to 3) to avoid overwhelming the person being interviewed. If more than one person is included on the team, one person should be assigned as the lead interviewer.
3. **Allow 30 to 45 minutes for each interview.**
 - Interview times will vary depending on the personality of the individual being interviewed and the number and type of issues involved. It is the responsibility of the interviewer to maintain the focus on performance-related issues. Interviews can easily be detracted by individuals who find an “open ear” for presenting grievances.
4. **Explain the purpose of the interview and use of the information.**
 - It is important for the people being interviewed to understand that any information obtained from this process is only used to support identification of factors limiting performance (i.e., areas impacting performance). The interview information is not used to place blame on specific individuals or departments.
5. **Conduct interviews after sufficient information has been gathered from CPE activities.**
 - Utilize results and observations gained from the plant tour, performance assessment, major unit process evaluation, and data collection activities to identify areas of emphasis during the interviews.
6. **Prooress through the interview In a logical order.**
 - For example, if an administrator is being interviewed, focus questions on administrative support, then on design issues, followed by operation and maintenance capabilities,
7. **Ask relevant auestions with respect to staff area of involvement.**
 - For example, when interviewing maintenance personnel, ask questions related to relevant topics such as maintenance responsibilities, communication with supervisors, and administrative support for equipment.
8. **Ask open-ended auestions.**
 - For example, a question such as “Are you aware of any design deficiencies with the current plant? ” would provide better information than a question like “Do you think that the flocculation basin provides sufficient detention time for flocculation?”.

INTERVIEW DATA

9. Ask the questions; don't give the answers.

- The purpose of the interview is to gain the perspective of the person being interviewed. Ask the question and wait for the response (i.e., don't answer your own question based on information you may have received from previous activities). Rephrasing the question may sometimes be necessary to provide clarity.

10. Repeat a response to a question for clarification or confirmation.

- For example, the interviewer can confirm a response by stating, "If I understand you correctly, you believe that the reason for poor plant performance during April was due to excessive algae growth in the source water."

11. Avoid accusatory statements.

- Accusatory statements will likely lead to defensiveness by the person being interviewed. Rather, if an area of concern is suspected, ask questions that can confirm or clarify the situation.

12. Use the interview to clarify or confirm field information.

- For example, if performance problems occurred during one month of the past year, ask questions to clarify the perceived reasons for these problems.

13. Note specific responses that support factor identification.

- During or following the interview, the interviewer may want to note or underline specific responses that support the identification of possible factors limiting performance. This summary can then be used during team debriefing and factor identification meetings.

B. Multiple Barrier Concept for Microbial Contaminant Protection

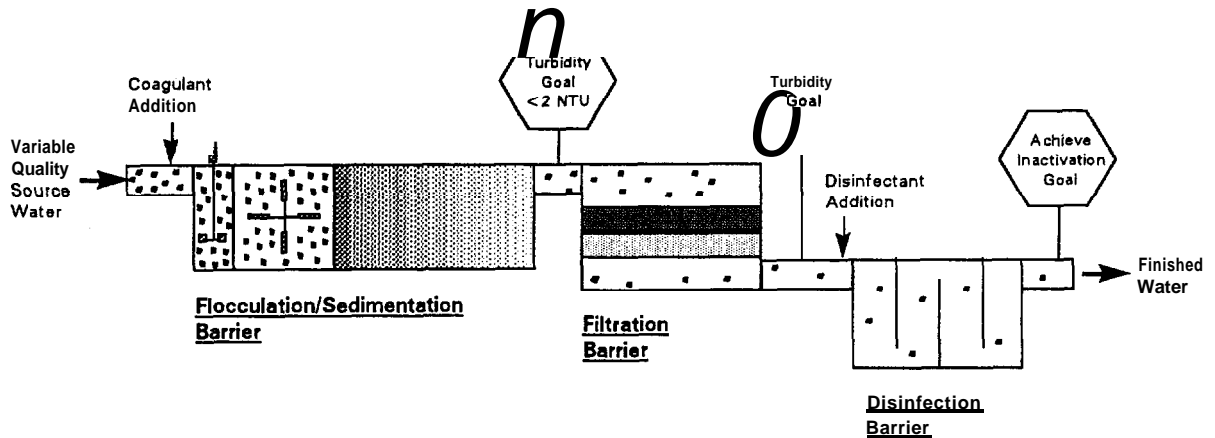

- Given a variable quality source water, the treatment objective is to produce a consistent, high quality finished water.
- Protozoan parasites, such as *Giardia* and *Cryptosporidium*, are found in most source waters; however, it is difficult to quantify their presence and assess their viability.
- Microbial pathogens in the source water, such as protozoan parasites, bacteria, and viruses, can be physically removed as particles in treatment processes and inactivated through disinfection.
- Multiple barriers are provided in a treatment plant to remove or inactivate microbial pathogens.
- Key treatment barriers include flocculation/sedimentation, filtration, and disinfection.
- Since measurement of protozoan parasites is difficult, surrogate parameters, such as turbidity, particle counting, and pathogen inactivation, are used to assess the performance of each barrier.

C. Optimization Performance Criteria

A summary of performance criteria for surface water treatment plants to provide protection against microbial contaminants is presented below:

1. Minimum Data Monitoring Requirements

- Daily raw water turbidity
- Settled water turbidity at 4-hour time increments from each sedimentation basin
- On-line (continuous) turbidity from each filter
- One filter backwash profile each month from each filter

2. Individual Sedimentation Basin Performance Criteria

- Settled water turbidity less than 1 NTU 95 percent of the time when annual average raw water turbidity is less than or equal to 10 NTU
- Settled water turbidity less than 2 NTU 95 percent of the time when annual average raw water turbidity is greater than 10 NTU

3. Individual Filter Performance Criteria

- Filtered water turbidity less than 0.1 NTU 95 percent of the time (excluding 15-minute period following backwashes) based on the maximum values recorded during 4-hour time increments
- Maximum filtered water measurement of 0.3 NTU
- Initiate filter backwash immediately after turbidity breakthrough has been observed and before effluent turbidity exceeds 0.1 NTU.
- Maximum filtered water turbidity following backwash of 0.3 NTU
- Maximum backwash recovery period of 15 minutes (i.e., return to less than 0.1 NTU)
- Maximum filtered water measurement of less than 10 particles (in the 3 to 18 μm range) per milliliter (if particle counters are available)

4. Disinfection Performance Criteria

- CT values to achieve required log inactivation of *Giardia* and virus

Appendix G
Example CPE Report

**Results of the
Comprehensive Performance Evaluation
of Water Treatment Plant No. 005**

Prepared by:

Prepared for:

Site Visit Information

Mailing Address:

Date of Site Visit:

Utility Personnel:

CPE Team:

Table of Contents

	<u>Page No.</u>
INTRODUCTION	210
FACILITY INFORMATION	211
PERFORMANCE ASSESSMENT	212
MAJOR UNIT PROCESS EVALUATION	216
PERFORMANCE LIMITING FACTORS	218
Alarms (Design) A	218
Process Flexibility (Design) A	218
Policies (Administration) A	218
Insufficient Time on the Job (Operation) A	218
Process Instrumentation/Automation (Design) B	218
Presedimentation (Design) B	219
EVALUATION FOLLOW-UP	219
REFERENCES	219

List of Figures

		<u>Page No.</u>
FIGURE 1	Comprehensive Performance Evaluation methodology.	210
FIGURE 2	Water treatment flow schematic.	211
FIGURE 3	Daily maximum plant influent water turbidity.	213
FIGURE 4	Daily maximum finished water turbidity.	214
FIGURE 5	Filter effluent turbidity profile after backwash.	215
FIGURE 6	Major unit process evaluation.	216
FIGURE 7	Process evaluation for individual treatment unit.	217

List of Tables

TABLE 1	Frequency Analysis of Raw Water Turbidity	213
TABLE 2	Frequency Analysis of Finished Water Turbidity	215

Introduction

The Composite Correction Program (CCP) (1) is an approach developed by the U. S. Environmental Protection Agency and Process Applications, Inc. to improve surface water treatment plant performance and to achieve compliance with the Surface Water Treatment Rule (SWTR). Its development was initiated by Process Applications, Inc. and the State of Montana (2), who identified the need for a program to deal with performance problems at their surface-supplied facilities. The approach consists of two components, a Comprehensive Performance Evaluation (CPE) and Comprehensive Technical Assistance (CTA).

The methodology followed during a CPE is described in Figure 1. A comprehensive assessment of the unit process design, administration and maintenance support is performed to establish whether a capable plant exists. Additionally, an assessment is made on the plant staff's ability to apply process control principles to a capable plant to meet the overall objective of providing safe and reliable finished water. The results of this assessment approach establish the plant capability and a prioritized set of factors limiting performance. Utility staff can address all or some of the identified factors, and improved performance can occur as the result of these efforts. A CTA is used to improve performance of an existing plant when challenging or difficult-to-address factors are identified during the CPE. Therefore, the CCP

approach can be utilized to evaluate the ability of a water filtration plant to meet the turbidity and disinfection requirement of the SWTR and then to facilitate the achievement of cost effective compliance.

In recent years, the CCP has gained prominence as a mechanism that can be used to assist in optimizing the performance of existing surface water treatment plants to levels of performance that exceed the requirements in the SWTR. The current standards do not always adequately protect against some pathogenic microorganisms, as evidenced by recent waterborne disease outbreaks. Producing a finished water with a turbidity of <0.1 NTU provides much better protection against pathogens like *Cryptosporidium* (3,4,5, 6,7,8,9,10,11), the microorganism responsible for a large outbreak of *Cryptosporidiosis* in Milwaukee in April 1993, where 403,000 people became ill and at least 79 people died.

USEPA has chosen to use the CCP approach to evaluate selected surface water treatment plants in this region. Water Treatment Plant No. 005 was selected as the first candidate for a CPE. This plant has experienced difficulties with continuously meeting the turbidity requirements of the SWTR, and the water system manager and staff expressed interest in receiving assistance with correcting this situation.

FIGURE 1. Comprehensive Performance Evaluation methodology.

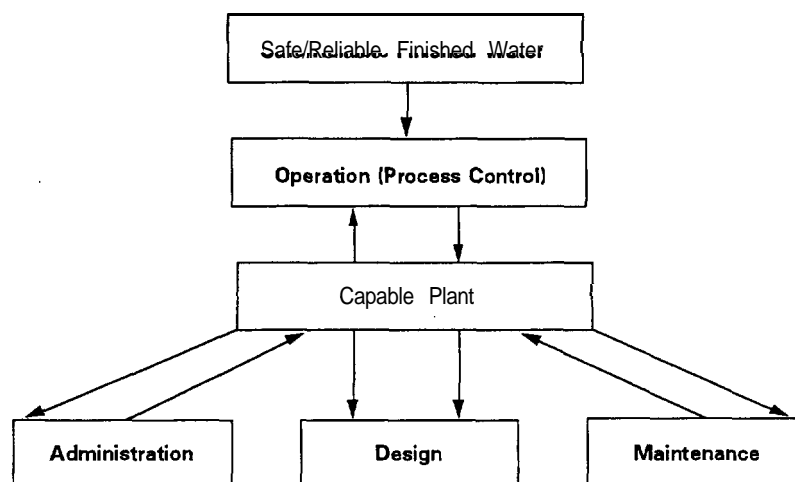

The following report documents the findings of the CPE conducted at Water Treatment Plant No. 005. The CPE identifies and prioritizes the reasons for less-than-optimum performance. The CPE may be followed by the second phase of the CCP, Comprehensive Technical Assistance (CTA), if appropriate.

Facility Information

A flow schematic of Water Treatment Plant No. 005 is shown in Figure 2. The water source for the plant is Clear Creek. Staff reported that turbidity in the creek reaches a maximum level of 50 - 80 NTU. The Clear Creek Basin can be characterized as mountainous and forested. Sources of potential contamination include wildlife and human sources (e.g., recreation use, camping etc.).

The intake for the treatment plant is located in Clear Creek upstream of a small diversion dam. The turbidity in the raw water pipeline has not been recorded regularly since the treatment plant began operation. Limited raw water pipeline turbidity data from before plant start-up was reviewed during the CPE. The data indicate that turbidity in the raw water pipeline was typically low (i.e., < 1.5 NTU) with some peaks in the spring that were less than 5 NTU. About 100 cubic yards of sediment is dredged and removed at two-year intervals in the vicinity of the intake, upstream of the diversion dam. Settling of particulates at this location may partially account for the low raw water turbidity values observed. The utility is also constructing a dam upstream of the intake; and, as a result, even less raw water turbidity variations are expected in the future.

FIGURE 2. Water treatment flow schematic.

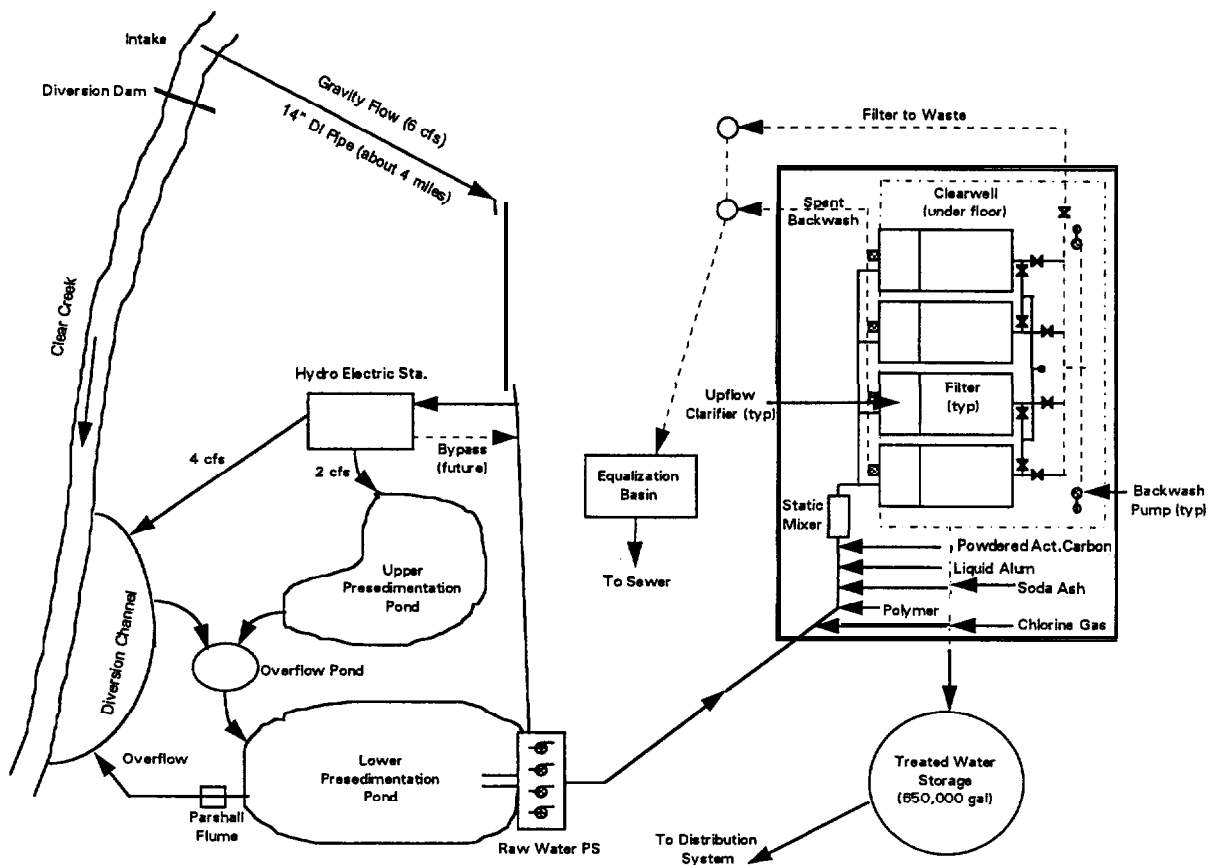

About 6 cfs of water flows by gravity from the intake through about four miles of 14-inch diameter ductile iron pipe to a utility-owned hydroelectric power generating station near the water treatment plant. After the hydroelectric station, about 4 cfs flows back into Clear Creek and the remaining 2 cfs flows through two large presedimentation ponds. Detention time through these ponds is estimated to be about 14 days. A raw water pump station located beside the lower pond includes four constant speed raw water pumps, each with a 700 gpm capacity.

The amount of water that can be run through the presedimentation ponds and discharged to the creek is limited by the capacity of the Parshall flume on the overflow of the lower pond. Also, there are no provisions to bypass an individual pond to reduce the detention time. The ponds can be bypassed by directing the raw water to the pump station intake; however, this results in the bypassing of the hydroelectric station. The utility is planning to install another pipeline from the hydroelectric station to the raw water pumping station before the spring runoff occurs. This will allow the ponds to be bypassed without interfering with the hydroelectric station operation.

The water treatment plant began operation in August 1996. Prior to that, chlorination was provided after the settling ponds before entering the distribution system. The plant has a reported firm design capacity of about 3 MGD. Major treatment components include chemical feed equipment, four package treatment trains consisting of an upflow clarifier and filter basins, a 110,000 gallon clearwell, and a 600,000 gallon finished water storage tank. Each of the upflow clarifier and filter units has a reported capacity of 1 MGD. The plant is designed to operate at 1 MGD incremental flow rates with one raw water pump dedicated to each treatment train in operation. Unique characteristics of the plant are summarized as follows.

- Large presedimentation ponds prior to treatment.
- Static mixer for coagulant mixing.
- Chemical feed capability: alum, polymer, soda ash, powdered activated carbon, chlorine.
- Upflow clarifiers with gravel media (1 to 5 mm size).

- Mixed media filters.
- Filter-to-waste capability set by a common control valve to 1 MGD. (NOTE: This flow rate is not easily adjusted and limits the flexibility to change the individual treatment train flow rate to a value other than 1 MGD.)
- Two continuously monitoring particle counters on filter effluent (one shared by two trains).
- Clearwell with intra-basin baffles

Performance Assessment

During the CPE, the capability of the Water Treatment Plant No. 005 was evaluated to assess whether the facility, under existing conditions, could comply with the turbidity and disinfection requirements that are used to define optimized performance. Optimized performance, for purposes of this CPE, represents performance criteria that exceeds the SWTR requirements. Optimized performance would require that the facility take a source water of variable quality and consistently produce a high quality finished water. Multiple treatment processes (e.g., flocculation, sedimentation, filtration, disinfection) are provided in series to remove particles, including microbial pathogens, and provide disinfection to inactivate any remaining pathogens.

Water Treatment Plant No. 005 utilizes a package water treatment process that includes combined flocculation/sedimentation in an upflow clarifier and filtration. Each of the available processes represents a barrier to prevent the passage of microbial pathogens through the plant. By providing multiple barriers, any microorganisms passing one process can be removed in the next, minimizing the likelihood of microorganisms passing through the entire treatment system and surviving in water supplied to the public. The role of the water treatment operator is to optimize the treatment processes (i.e., barriers) under all conditions because even temporary loss of a barrier could result in the passage of microorganisms into the distribution system and represents a potential health risk to the community.

A major component of the CPE process is an assessment of past and present performance of the plant. This performance assessment is intended to identify if specific unit treatment

processes are providing multiple barrier protection through optimum performance. The performance assessment is based on data from plant records and data collected during special studies performed during the CPE.

Specific turbidity performance targets were used during this assessment. These specific performance targets include:

- Sedimentation - turbidity of less than 1 NTU 95 percent of the time, since average annual raw water turbidity is less than 10 NTU.
- Filtration - individual filter turbidity less than 0.1 NTU 95 percent of the time (excluding 15-minute period following backwash); also, maximum filtered water turbidity following backwash of 0.3 NTU.
- Disinfection - CT values to achieve required log *Giardia* cyst and virus inactivation.

A plant influent turbidimeter and strip chart recorder are provided, but the plant operators do not routinely record daily influent water turbidity in their operating log. The plant influent turbidity strip charts for the past year were reviewed during the evaluation. A frequency analysis of these data is summarized in Table 1. As indicated, the raw

water turbidity is less than or equal to 4 NTU 95 percent of the time. Maximum daily plant influent turbidity varied from less than 1 NTU to 10 NTU, as shown in Figure 3.

TABLE 1. Frequency Analysis of Raw Water Turbidity

Percentile	Raw Water NTU*
50	2.2
75	3.0
90	3.6
95	4.0
Average	2.6

*Daily maximum value

The turbidimeter is located a long distance from the influent pipe. A significant number of brief (a few minutes to less than 1 hour) turbidity spikes were noted on the strip chart. A special study would be required to determine the cause of these brief influent turbidity spikes. Influent turbidity during the CPE was less than 1 NTU.

FIGURE 3. Daily maximum plant influent water turbidity.

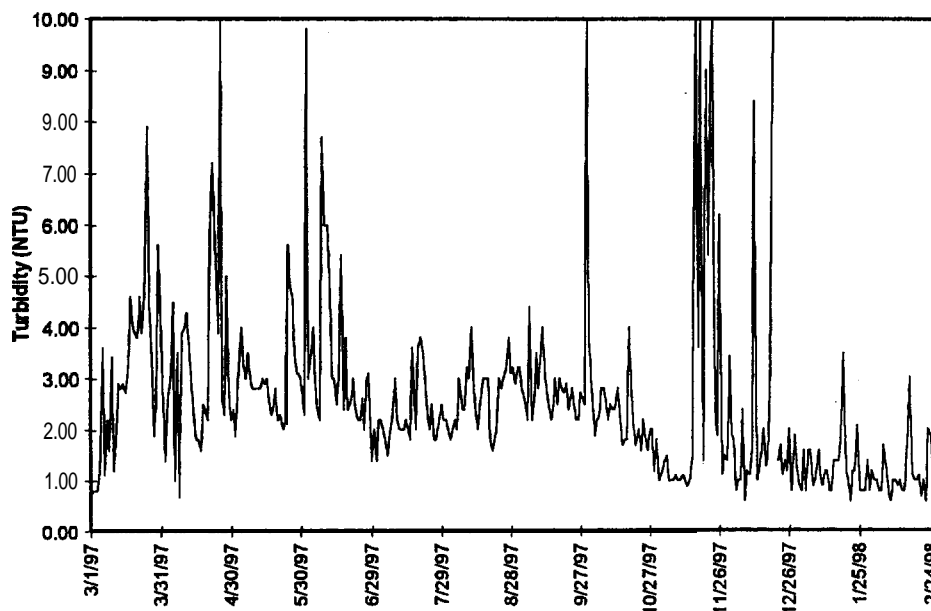

The finished water turbidimeter is located at the outlet of the 600,000 gallon finished water storage tank. This meter has a strip chart recorder, and operators routinely record this data for water quality reporting purposes.

The plant operators do not routinely sample and measure turbidity after the upflow clarifiers. During the CPE, turbidities of 0.56 to 0.71 NTU were measured between the upflow clarifier and the filter over a two-hour period. During the same period the plant influent turbidity ranged from 0.5 to 0.7 except for a 15-minute spike from 3 to 10 NTU after a brief filter shutdown. Because of the low influent water turbidity conditions during the CPE and the lack of historical turbidity data at the clarifier outlet, the ability of the plant to meet the 1 NTU turbidity goal on a long-term basis could not be determined.

The plant does not have on-line turbidimeters for monitoring turbidity following individual filters, and plant operators do not routinely collect grab samples to measure turbidity at this location. Two on-line particle counters are available for monitoring filter performance; however, staff have experienced operating problems with at least one of the units. To assess historical plant performance, turbidity values from after the treated water storage

tank were used. The daily maximum finished water turbidity for the previous 12 months is shown in Figure 4. The results of a frequency analysis of the finished water data are shown in Table 2 and indicate that 95 percent of the time the filtered water turbidity was less than 0.87 NTU.

During several months, plant performance did not meet the turbidity requirement of the SWTR (i.e., <0.50 NTU 95 percent of the time on monthly basis). From April through June, filtered water turbidity consistently exceeded the regulated limit of 0.50 NTU. Plant staff reported that this period of poor performance was due to a bad batch of alum and poor water quality from the ponds. A large amount of algae or other filamentous material from the ponds caused clogging problems on the media support screens of the upflow clarifiers for several weeks. This material was cleaned manually with great difficulty, and during the worst period cleaning was required on a daily frequency. Hand-cleaned screens have been installed on the raw water pump intakes in the lower pond to assist with removing this material before it reaches the treatment units. It is also possible that post flocculation may have occurred in the clearwell and finished water storage tank during this period.

FIGURE 4. Daily maximum finished water turbidity.

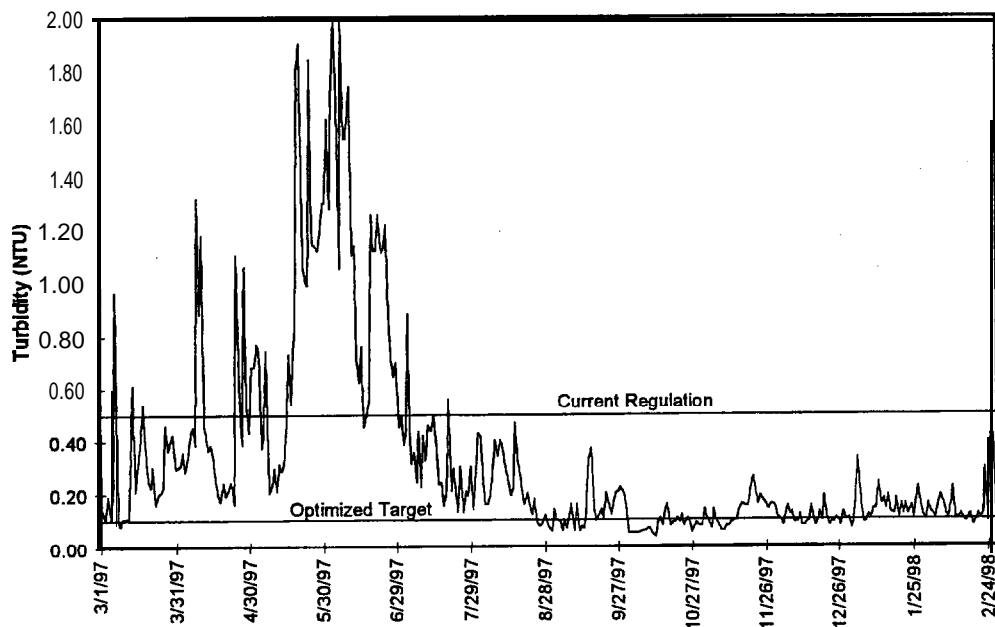

TABLE 2. Frequency Analysis of Finished Water Turbidity

Percentile	Finished Water NTU*
50	0.16
75	0.32
90	0.55
95	0.87
Average	0.33

*Daily maximum value

Although significant improvement in performance has recently occurred, the plant did not achieve the optimized filtered water turbidity target of less than 0.1 NTU during the past year. This performance allows an increased opportunity for pathogens, such as *Cryptosporidium* oocysts, to pass into the public water supply.

During the CPE a special study was conducted on the filter media, backwash procedure, and performance of a filter following a backwash. Prior to backwashing, filter unit #2 was drained to allow physical observation of the filter media. The total depth of the mixed media was consistently about

31.5 inches. Of this mixed media depth, about 18 inches was anthracite. Inspection of the media at and below the surface showed that the media was very clean. During the backwash, a filter bed expansion of 21.8 percent was calculated, which is within the acceptable range of 20 to 25%.

Immediately after completion of the filter backwash, the filtered water turbidity was measured periodically for about 35 minutes. These data are shown in Figure 5. The current procedure is to filter to waste for ten minutes after the end of the backwash cycle. As indicated by the performance graph, the filter did not meet the backwash optimization criteria of a maximum turbidity spike of 0.3 NTU and return to less than 0.1 NTU within 15 minutes.

In summary, performance data for the last year show that Water Treatment Plant No. 005 has not been in compliance with the SWTR on a consistent basis. In addition, the plant has not met the optimized performance goal of 0.1 NTU for filtered water. Consequently, this performance assessment indicates that the water system is at risk of passing microbial pathogens to consumers.

FIGURE 5. Filter effluent turbidity profile after backwash.

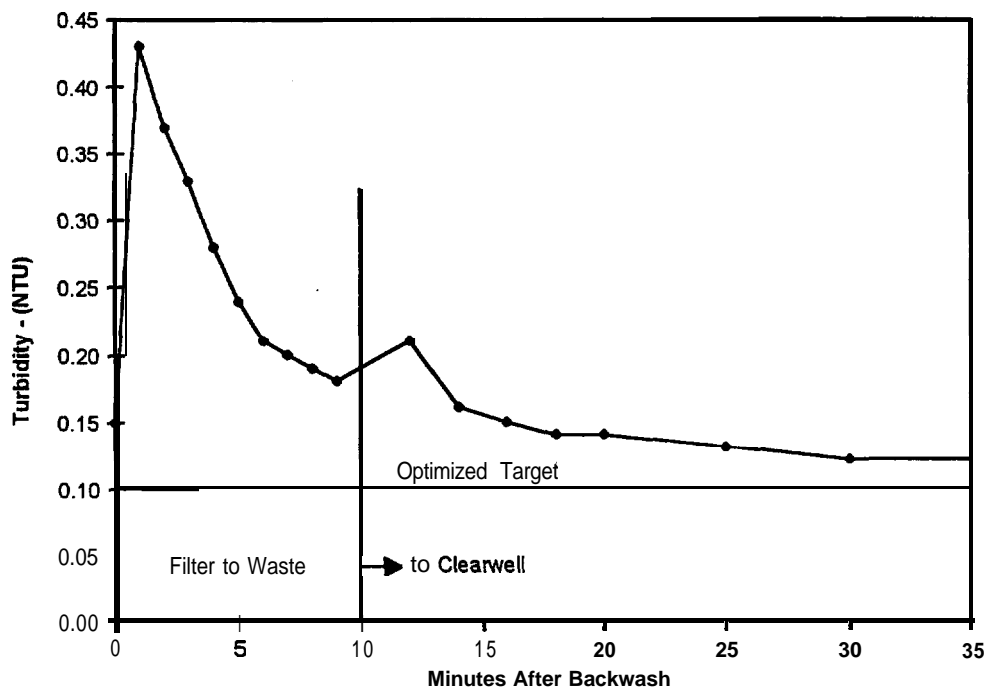

Major Unit Process Evaluation

Major unit processes were assessed with respect to their capability to provide consistent performance and an effective barrier to passage of microorganisms on a continuous basis. The performance goal used in this assessment for the filtration process was a settled water turbidity of less than 2 NTU and a filtered water turbidity of less than 0.1 NTU. Capabilities of the disinfection system were based on the USEPA guidance manual (12) requirements for inactivation of *Giardia* and viruses.

Since the plant's treatment processes must provide an effective barrier at all times, a peak instantaneous operating flow is typically determined. The peak instantaneous operating flow represents the maximum flow rate that the unit processes are subjected to, which represents the hydraulic conditions where the treatment processes are the most vulnerable to the passage of microorganisms. If the treatment processes are adequate at the peak instantaneous flow, then the major unit processes are projected to be capable of providing the necessary effective barriers at lower flow rates.

Water Treatment Plant No. 005 has a maximum raw water pumping capacity of 4 MGD. The plant was designed for a maximum treatment capacity of 3 MGD with one treatment unit out of service. A peak instantaneous flow rate of 3 MGD is used for the major unit process evaluation, based on the highest instantaneous flow rate reported by the staff.

Major unit process capability was assessed by projecting treatment capacity of each major unit process against the peak instantaneous flow rate. The major unit process evaluation for the entire treatment plant is shown in Figure 6. The unit processes evaluated are shown on the left side of the graphs, and the flow rates against which the processes were assessed are shown across the top. Horizontal bars on the graph represent the projected peak capability of each unit process to achieve the desired optimized process performance. These capabilities were projected based on the combination of treatment processes at the plant, the CPE team's experience with other similar processes, industry guidelines, and regulatory standards. The shortest bar represents the unit process which limits plant capability the most relative to achieving the desired plant performance.

FIGURE 6. Major unit process evaluation.

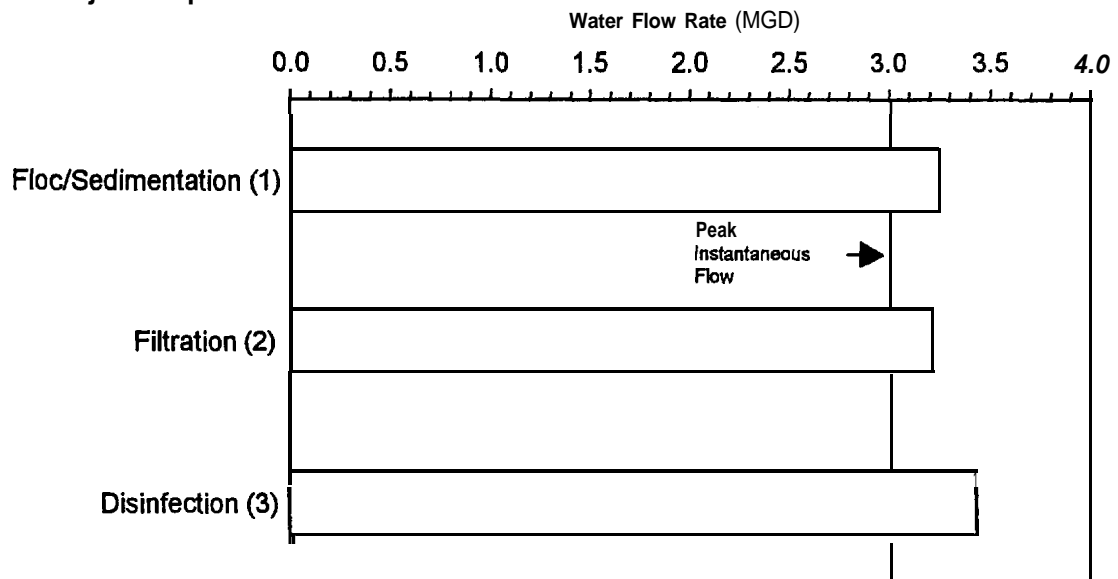

- (1) Surface area = 280 ft²; rated at 8.0 gpm/ft², upflow clarifier with rock gravel media
- (2) Surface area = 580 ft²; rated at 4 gpm/ft²; mixed media
- (3) Volume = 98,000 gal; total 3-log *Giardia* inactivation/removal required; assume 2.5-log removal allowed through conventional plant credit and OS-log required by disinfection; pH = 7.5; temp = 0.5°C; chlorine residual ≈ 1.8 mg/L; T₁₀/T = 0.7; 3 ft minimum cleatwell depth

The major unit processes evaluated were the upflow clarifiers (flocculation and sedimentation), filtration, and disinfection processes. Criteria used to assess each major unit process are described in the notes below the graph.

The upflow clarifiers were rated based on their surface overflow rate. Typically, conventional sedimentation basin capability is rated based on a surface overflow rate of 0.5 to 0.7 gpm/ft². A surface overflow rate of 10 gpm/ft² is used by the package plant manufacturer for the design rating of their upflow clarifier units. Because of the combined flocculation and sedimentation function and the short detention time of these units, they were rated based on an overflow rate of 2 gpm/ft². This produced a combined flocculation/sedimentation capability rating of 3.23 MGD when using all four treatment units.

The filtration process was rated based on a loading rate of 4 gpm/ft² and use of all four filters. These criteria resulted in a combined filtration capability of 3.23 MGD.

The disinfection process was assessed based on USEPA Surface Water Treatment Rule requirements for inactivation of 3-log of *Giardia* cysts and 4 log of viruses. The *Giardia* removal/inactivation is the most stringent criteria; consequently, it was used as the basis of the disinfection evaluation. A

well-operated conventional filtration plant is allowed a 2.5-log removal credit for *Giardia* cysts, and the remaining 0.5-log removal is achieved by meeting specified CT requirements associated with chemical disinfection. CT is the disinfectant concentration (C) in mg/L multiplied by the time (T) in minutes that the water is in contact with the disinfectant. The required CT value was obtained from the USEPA guidance manual (3), using typical plant values for free chlorine residual (i.e., 1.0 mg/L) and pH (i.e., 7.5) and a worst case water temperature of 0.5°C. The volume of the clearwell was adjusted for the minimum operating depth of 3 feet. A T₁₀/T ratio of 0.70 was used because of the superior baffling conditions in the clearwell. Under this scenario, the disinfection process is capable of treating 3.44 MGD, using a required free chlorine CT value of 46 mg/L-min.

The results of the major unit process evaluation indicate that the plant should be capable of treating the peak instantaneous flow rate of about 3.2 MGD with four treatment trains in service (i.e., 0.8 MGD per train). However, the control of the plant is set up so that each treatment train operates at a constant flow rate of 1 MGD (see Figure 7), and flexibility does not exist to easily operate each train at lower flow rates without modifying the filter to waste piping from the filters.

FIGURE 7. Process evaluation for individual treatment unit.

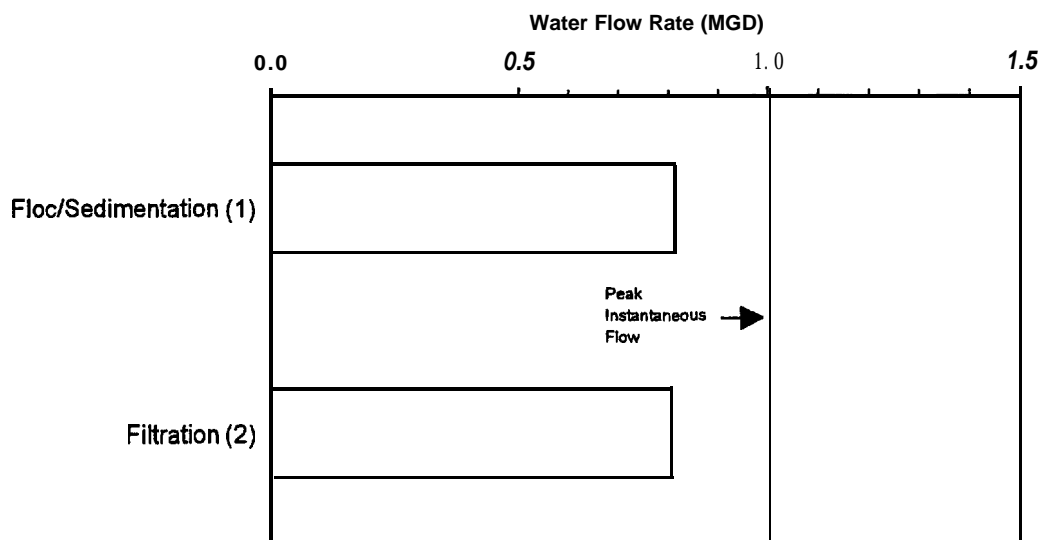

- (1) Surface area = 70 ft²; rated at 8.0 gpm/ft²; upflow clarifier with gravel media
- (2) Surface area = 140 ft²; rated at 4 gpm/ft²; mixed media

The major unit process evaluation indicates that the current practice of operating individual treatment units at a constant flow rate of 1 MGD, as required by the design and control system, may be contributing to the less-than-optimum performance of the flocculation/sedimentation and filtration processes.

Performance Limiting Factors

The areas of design, operation, maintenance, and administration were evaluated in order to identify factors which limit performance. These evaluations were based on information obtained from the plant tour, interviews, performance and design assessments, special studies, and the judgment of the evaluation team. Each of the factors was classified as A, B, or C according to the following guidelines:

A — Major effect on a long term, repetitive basis

B — Minimal effect on a routine basis or major effect on a periodic basis

C — Minor effect

The A and B factors were prioritized as to their relative impact on performance and are summarized below. In developing this list of factors limiting performance, 50 potential factors were reviewed; and their impact on the performance of Water Treatment Plant No. 005 was assessed. The evaluation team identified six factors that are limiting plant performance. Numerous other factors were not felt to be affecting plant performance. The factors and the findings that support their selection are summarized below in prioritized order.

Alarms (Design) A

- The plant does not have alarm and shutdown capability on chlorine feed, chlorine residual, influent turbidity and finished water turbidity.

Process Flexibility (Design) A

- Inability to automatically change the filter to waste flow rate to values other than 1 MGD. (NOTE: This lack of flexibility limits the flow rate of the individual treatment trains, since the plant flow rate must be 1 MGD to match

the filter to waste flow rate of 1 MGD; otherwise, the water level in a filter changes.)

- No ability to feed filter aid polymer to the filters. (NOTE: This flexibility can be used to enhance filter performance, especially during times when clarifier performance is less than optimum.)
- Inability to gradually increase and decrease backwash flow rate. (NOTE: This flexibility provides better cleaning of the filter media, less opportunity for loss of media, and better re-stratification of the media following backwash.)

Policies (Administration) A

- Lack of established performance goals for the plant, such as 0.1 NTU filtered water turbidity, that would provide maximum public health protection and associated support to achieve these performance goals.

Insufficient Time on the Job (Operation) A

- No sampling and evaluation of upflow clarifier performance.
- Inadequate testing to optimize coagulant type and dosages. (NOTE: Some jar testing was completed by staff; however, standard testing procedures were not followed to determine optimum dosages.)
- No monitoring of individual filter turbidity.
- Excessive caution on use of the creek source to achieve optimized performance.
- Starting "dirty" filters without backwashing or using filter to waste.
- Non-optimized feed point for flocculant aid addition. (NOTE: Flocculant aid products are typically fed at a location with gentle mixing to avoid breaking the long-chain organic molecules.)

Process Instrumentation/Automation (Design) B

- No turbidimeters are located on individual filters and creek source (i.e., at turbine).

- Plant is designed to automatically start and stop operation based on storage tank level and upflow clarifier backwash requirements. (NOTE: Without initiating a filter backwash or the filter to waste mode after each shutdown, the potential exists to pass trapped particles (i.e., potential pathogens) through the plant due to hydraulic surging.)
- Location of influent turbidity sample line relative to the monitor cell may cause inaccurate readings.

Presedimentation (Design) B

- Long detention time and subsequent low turnover contributes to excessive algae growth and poor water quality.
- Lack of flexibility to operate one, or portion of one, presedimentation pond to reduce detention time and increase turnover.
- Lack of flexibility to bypass ponds without bypassing the turbine. (NOTE: A new bypass is under construction which will provide this flexibility.)
- Limited ability to maintain high turnover through ponds when not in use because of restriction in Parshall flume from pond 2 to creek.

Evaluation Follow-Up

The potential exists to achieve optimized performance goals and, therefore, enhance public health protection with Water Treatment Plant No. 005. Implementation of a Comprehensive Technical Assistance (CTA) project by a qualified facilitator has been demonstrated to be an effective approach to achieve optimum performance goals (13). Through a CTA project, the performance limiting factors identified during the Comprehensive Performance Evaluation would be addressed in a systematic manner. A partial list of potential CTA activities that could be implemented by a facilitator and plant staff is presented below:

- Facilitate development of optimization performance goals by the city administration to provide adequate direction and support to operation and maintenance staff.

- Establish a process control program based on prioritized data collection, database development, data and trend interpretation, and process adjustments.
- Provide technical guidance on use of the creek source versus the presedimentation ponds during seasonal water quality changes.
- Facilitate special studies with plant staff to assist them with optimizing plant performance and establishing the need for minor plant modifications.
- Provide training to assist operators with optimizing coagulant type and dosages.

References

1. Renner, R.C., B.A. Hegg, J.H. Bender, and E.M. Bissonette. February 1991. Handbook - Optimizing Water Treatment Plant Performance Using the Composite Correction Program. EPA 625/6-91/027. Cincinnati, OH: USEPA.
2. Renner, R.C., B.A. Hegg, and D.F. Fraser. February 1989. "Demonstration of the Comprehensive Performance Evaluation Technique to Assess Montana Surface Water Treatment Plants." Association of State Drinking Water Administrators Conference. Tucson, AZ.
3. AWWA Statement of Policy. 1968. "Quality Goals for Potable Water." *Jour.A WWA*, 60(12):1317. Denver, CO.
4. AWWA White Paper. 1995. "What Water Utilities Can Do to Minimize Public Exposure to *Cryptosporidium* in Drinking Water." *AWWA Mainstream*. Denver, CO.
5. Logsdon, G.S. and E.C. Lippy. December 1982. "The Role of Filtration in Preventing Waterborne Disease." *Jour.AWWA*:654. Denver, CO.
6. USEPA Water Engineering Research Laboratory. 1985. Project Summary - Filtration of Giardia Cysts and Other Substances: Volume 3 - Rapid Rate Filtration. EPA/600/S2-85/027. Cincinnati, OH: USEPA.

-
7. Logsdon, G.S., L. Mason, and J.B. Stanley, Jr. 1988. "Troubleshooting an Existing Treatment Plant." In *Proc. of A WWA Seminar - Filtration: Meeting New Standards: 109-1 25*. Denver, CO.
 8. Consonery, P.J., et. al. November 1996. "Evaluating and Optimizing Surface Water Treatment Plants: How Good is Good Enough." Paper presented at AWWA Water Quality Technology Conference. Boston, MA.
 9. Nieminski, E.C., et. al. 1995. "Removing *Giardia* and *Cryptosporidium* by Conventional Treatment and Direct Filtration." *Journal AWWA*, 87(9):96. Denver, CO.
 10. West, T., P. Daniel, P. Meyerhofer, A. DeGraca, S. Leonard, and C. Gerba. 1994. "Evaluation of *Cryptosporidium* Removal Through High Rate Filtration." In Proceedings of 1994 AWWA Annual Conference - New York, NY. AWWA. Denver, CO.
 11. Patania, N.L., et. al. 1996. "Optimization of Filtration for Cyst Removal." Denver, CO: AWWARF.
 12. Guidance Manual for Compliance With the Filtration and Disinfection Requirements for Public Water Systems Using Surface Water Sources. 1989. USEPA Office of Drinking Water. Washington, D.C.
 13. Schwarz, C., J.H. Bender, and B.A. Hegg. December 1997. "Final Report - Comprehensive Technical Assistance Project - City of Greenville Water Treatment Plant." Texas Natural Resource Conservation Commission.

Appendix H
Example CPE Scheduling Letter

April 6, 1998

Chairman/Mayor/Public Works Director
Water Authority/City/Town

RE: Evaluation of the _____ Water Authority/City/Town Water Treatment Plant
May 18 - 21, 1998

Dear Mr./Ms. _____

You were recently contacted by _____ of the _____ (regulatory agency) regarding an evaluation of your water treatment facility. This letter is intended to provide you with some information on the evaluation and describe the activities in which the _____ Water Authority/City/Town will be involved. The evaluation procedure that will be used at your facility is part of an overall water treatment optimization approach called the Composite Correction Program.

The Composite Correction Program (CCP) was developed by the U. S. Environmental Protection Agency and Process Applications, Inc. to optimize surface water treatment plant performance for protection against microbial contaminants such as *Giardia* and *Cryptosporidium*. The approach consists of two components, a Comprehensive Performance Evaluation (CPE) and Comprehensive Technical Assistance (CTA). The first component, the Comprehensive Performance Evaluation, will be conducted at your facility the week of _____. During the CPE, all aspects of your water treatment administration, design, operation, and maintenance will be reviewed and evaluated with respect to their impact on achieving optimized performance.

The evaluation will begin with a brief entrance meeting on Monday, May 18, 1998 at approximately 2:00 P.M. The purpose of the entrance meeting is to discuss with the plant staff and administrators the purpose of the evaluation and the types of activities occurring during the next three days. Any questions and concerns regarding the evaluation can also be raised at this time. It is important that the plant administrators and those persons responsible for plant budgeting and planning be present because this evaluation will include an assessment of these aspects of the plant. Following the entrance meeting, which should last approximately 30 minutes, the plant staff will be requested to take the evaluation team on an extensive plant tour. After the plant tour, the team will begin collecting performance and design data. Please make arrangements so that the monitoring records for the previous 12 months, operating records, and any design information for the plant are available for the team. Also, a continuous recording on-line turbidimeter will be installed on one or more of your filters. Sample taps to accommodate this connection should be available.

On Tuesday, the evaluation team will be involved in several different activities. The major involvement of the plant staff will be responding to the evaluation team's questions on plant performance and operation and maintenance practices. Several special studies may also be completed by the team to investigate the performance capabilities of the plant's different unit treatment processes. Requests to inspect filter media and monitor filter backwashes will be coordinated with staff to minimize the impact on plant operation.

Also on Tuesday, a member of the evaluation team will meet with the administrators to review the administrative policies and procedures and financial records associated with the plant. We would like to review your water treatment budget for the previous and current fiscal years. We would expect that most of this information would be available in your existing accounting system.

April 6, 1998
Page 2

We request that the plant staff and administrators be available for interviews either Tuesday afternoon or Wednesday morning. We will be flexible in scheduling these interviews around other required duties of you and your staff. Each of the interviews will require about 30 to 45 minutes of time.

We are anticipating that an exit meeting will be held on Thursday morning at 8:30 A.M., and it will last about 1 hour. During the exit meeting, the results of the evaluation will be discussed with all of those who participated. The performance capabilities of the treatment processes will be presented, and any factors found to limit the performance of the plant will be discussed. The evaluation team will also answer any questions regarding the results of the evaluation. The results presented in the exit meeting will form the basis of the final report, which will be completed in about one month.

We look forward to conducting the CPE at your facility. If you have any questions prior to the evaluation, please don't hesitate to contact us.

Very truly yours,

Evaluation Team Contact

Appendix I
Example Special Study

Example Special Study
(as developed by CTA facilitator and plant staff prior to implementation)

- I. Hypothesis
 - A. Increasing the ferric chloride dosage for low turbidity water (< 5.0 NTU) will improve the finished water turbidity and increase plant stability.
 - B. Increasing the ferric dosage may decrease alkalinity below level to maintain finished water pH target.

- II. Approach
 - A. Conduct series of jar tests using established jar testing guidelines that vary ferric chloride dosages (start with 0.5 mg/L increments and bracket down to 0.1 mg/L).
 - B. Add filter aid at the end of the flocculation time to simulate plant dosage (up to 0.1 mg/L).
 - C. Measure pH, alkalinity, temperature and turbidity of raw and finished water.
 - D. Document and interpret test results.
 - E. Test optimum dosage at full plant scale (pilot mode where filtered water is directed to waste).
 - F. Measure same parameters as above.
 - G. If results indicate alkalinity limitation is necessary (finished water alkalinity c 20 mg/L), conduct jar tests with soda ash addition.

- III. Duration of Study
 - A. Two weeks to complete jar and full-scale testing.

- IV. Expected Results
 - A. Improved finished water turbidity and increased plant stability at higher ferric chloride dosages.
 - B. Deficiency in finished water alkalinity.
 - C. Loss of finished water pH.
 - D. Potential change in primary coagulant.
 - E. Potential need for alkalinity (soda ash) addition.

- V. Conclusions
 - A. To be compiled in summary report after completion of study.

- VI. Implementation
 - A. To be determined after completion of study.

Appendix J
Example Operational Guideline

Example Operational Guideline

Subject: Process Control Data Collection
Objective: To establish a data collection method

Number: 5
Date Adopted: 4/29/97
Date Revised:

- I. Measure and record the following water quality, chemical usage, and flow data at the frequency noted.
 - A. Raw water parameters (measure/record once per day):
 1. Plant flow rate - MGD (8:00 a.m. to 8:00 a.m.)
 2. Raw turbidity - 7 days per week
 3. pH - units - 7 days per week
 4. Alkalinity - mg/L - 5 days per week
 5. Temperature - °C - 7 days per week
 - B. Chemical usage data (record once per day):
 1. Coagulant use - gal/day
 2. Coagulant batch density - lb/gal
 3. Filter aid use - gal/day
 4. Filter aid batch density - lb/gal
 5. Chlorine use - lb/day
 6. Orthophosphate use - lb/day
 - C. Finished water parameters (measure/record once per day, unless noted otherwise):
 1. Alkalinity - mg/L - 5 days per week
 2. pH - 7 days per week
 3. Free chlorine residual - mg/L - 7 days per week (minimum value for day from chart)
 4. Turbidity - NTU - value at established 4-hour increments
- II. Individual sedimentation basin turbidity.
 - A. Collect samples once each 4-hour period from the effluent of each basin and use lab turbidimeter to measure turbidity.
- III. Individual filter monitoring data collection methods.
 - A. Circular recording charts will be used for turbidity monitoring.
 1. Individual turbidity charts are located on top of the individual turbidity monitors.
 2. Twenty-four hour charts will be used.
 3. When changing charts, record the "change chart time" for the 24-hour period.
 - B. Data to record from individual filter charts.
 1. Start of all backwashes (note time and record on chart).
 2. Return to service after all backwashes (note time and record on chart).
 3. Backwash turbidity spike (highest turbidity value after filter is back on-line).
 4. Recovery turbidity (turbidity 15 minutes after filter placed back in service).
 5. Highest turbidity recorded every 4 hours for each individual filter, excluding backwash spike and recovery turbidities.

Process Control Data Collection (Continued)

- IV. Utilize the process control data entry form below for data recording.
- A. Complete the data entry form once per day, 7 days per week.
 - B. Enter daily data into computer database program and print out daily report.
 - C. At the end of each month, print monthly process control report from the database program and distribute as follows:
 - 1. Public Works Director
 - 2. Monthly process control file in filing cabinet
 - 3. Post copy on plant bulletin board

Water Treatment Plant Process Control Data Entry Form							
Parameter	Units	Data	Parameter	Units	Data		
Date	m/d/y		Filter aid batch density	lb/gal			
Flow rate	MGD		Other chemical use	gal/day			
Raw turbidity	NTU		Other chemical density	lb/day			
Raw pH	units		Finished alkalinity	mg/L			
Raw alkalinity	mg/L		Finished pH	units			
Raw temperature	C		Finished free chlorine	mg/L			
Coagulant daily use	gal/day		<i>Giardia</i> Inact. target	log			
Coag. batch density	lb/gal		Chlorine use	lb/day			
Filter aid daily use	gal/day		Orthophosphate use	lb/day			
Turbidity Data	Time	2400-0400	0400-0800	0800-1200	1200-1600	1600-2000	2000-2400
Max. Sedimentation 1	NTU						
Max. Sedimentation 2	NTU						
Max. filter 1 turbidity	NTU						
Max. filter 2 turbidity	NTU						
Max. filter 3 turbidity	NTU						
Max. filter 4 turbidity	NTU						
Finished turbidity	NTU						
Post Backwash Data	Filter No.	1	2	3	4		
BW turbidity spike	NTU						
Turb. 15 min. on-line	NTU						

Appendix K
Example Process Control Daily Report

Water Treatment Plant Process Control Daily Report

28-Feb-98

Parameter	Units	Data	Parameter	Units	Data		
Date	m/d/y	2/28/98	Filter aid batch density	lb/gal	0.3		
Flow rate	MGD	1.00	Other chemical use	gal/day	0.000		
Raw turbidity	NTU	5.00	Other chemical density	lb/day	0.0		
Raw pH	units	7.5	Finished alkalinity	mg/L	30.0		
Raw alkalinity	mg/L	34.0	Finished pH	units	7.2		
Raw temperature	C	5.0	Finished free chlorine	mg/L	1.0		
Coagulant daily use	gal/day	13.0	Giardia Inact. target	log	1.0		
Coag. batch density	lb/gal	3.36	Chlorine use	lb/day	12.0		
Filter aid daily use	gal/day	2.00	Orthophosphate use	lb/day	16.0		
Turbidity Data	Time	2400-0400	0400-0800	0800-1200	1200-1600	1600-2000	2000-2400
Max. Sedimentation 1	NTU	0.55	0.60	0.75	0.80	0.70	0.50
Max. Sedimentation 2	NTU	0.60	0.70	0.85	0.90	0.80	0.60
Max. filter 1 turbidity	NTU	0.05	0.04	0.04	0.06	0.06	0.05
Max. filter 2 turbidity	NTU	0.02	0.02	0.03	0.02	0.03	0.04
Max. filter 3 turbidity	NTU	0.08	0.07	0.09	0.10	0.11	0.07
Max. filter 4 turbidity	NTU	0.05	0.04	0.04	0.03	0.03	0.04
Finished turbidity	NTU	0.04	0.04	0.05	0.06	0.06	0.05
Post Backwash Data	Filter No.	1	2	3	4		
BW turbidity spike	NTU	0.20	0.15	0.25	0.18		
Turb. 15 min. on-line	NTU	0.07	0.06	0.11	0.07		

Calculated Parameters

Coagulant dose	mg/L	5.24	Required CT	mg/L-min	57.2
Filter aid dose	mg/L	0.060	Measured CT	mg/L-min	103.7
Other chemical dose	mg/L	0.00	CT ratio		1.8
Chemical cost	\$/m gal	47.91			

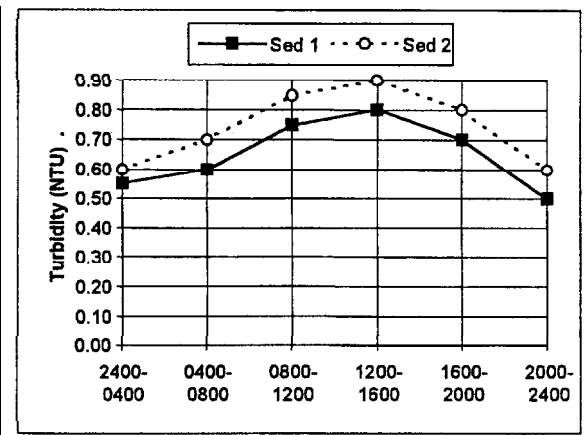
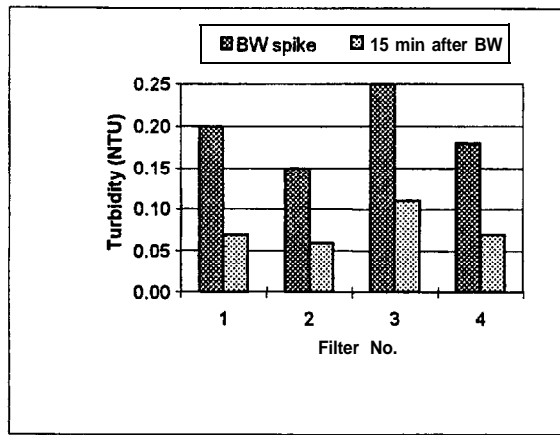
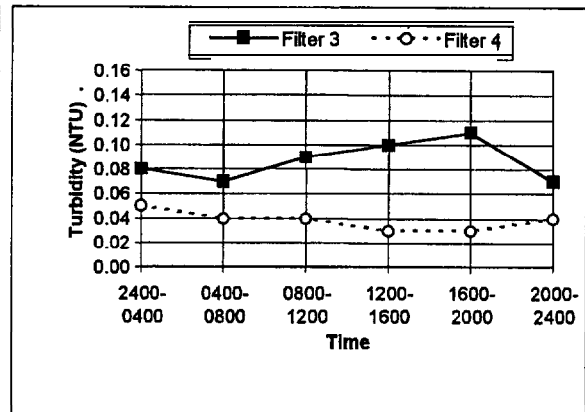
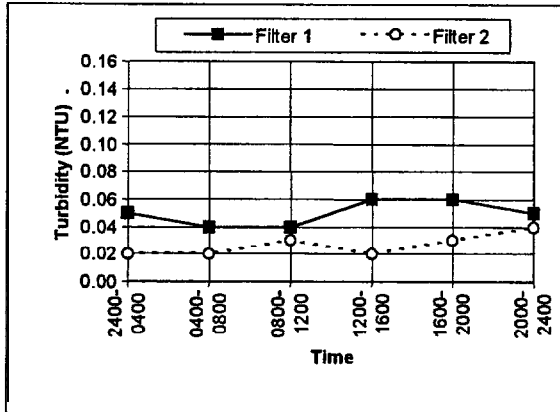

Appendix L
Example Jar lest Guideline

JAR TEST PROCEDURE (page 1)

EST CONDITIONS

Facility	Date	Time	Turbidity	Temperature	pH	Alkalinity	
Water Source		Coagulant		Coagulant Aid			

REPARING STOCK SOLUTIONS

Step 1 Select desired stock solution concentration (see Table 1).
Choose a stock solution concentration that will be practical for transferring chemicals to jars.

Table 1		
Stock Solution (%)	Concentration (mg/L)	mg/L dosage per mL of stock solution added to 2 liter jar
0.01	100	0.05
0.05	500	0.25
0.1	1,000	0.5
0.2	2,000	1.0
0.5	5,000	2.5
1.0	10,000	5.0
1.5	15,000	7.5
2.0	20,000	10.0

Desired Stock Solution (%)	Coagulant	Coag. Aid	

Step 2 Determine chemical amount to add to 1 liter flask.
If using dry products, see Table 2. If using liquid products, go to step 3.

Table 2		
Stock Solution (%)	Conc. (mg/L)	mg of alum added to 1 liter flask
0.01	100	100
0.05	500	500
0.1	1,000	1,000
0.2	2,000	2,000
0.5	5,000	5,000
1.0	10,000	10,000
1.5	15,000	15,000
2.0	20,000	20,000

Desired Amount in 1 liter flask (mL)	Coagulant	Coag. Aid	

Step 3 Determine liquid chemical amount to add to volumetric flask.
For **liquid** chemicals, use the equation below -

$$\text{mL coagulant} = \frac{(\text{stock solution \%}) \times (\text{flask volume, mL}) \times (8.34 \text{ lb/gal})}{100 \times (\text{chemical strength, lb/gal})}$$

	Coagulant	Polymer	
Chemical Strength (lb/gal) ¹			
Stock Solution Volume (mL)			
Desired Volume of Chemical to add to Flask (mL)			

¹ Note: Chemical Strength = chemical density x % strength

JAR TEST PROCEDURE (page 2)

JAR SETUP

Set up individual jar doses based on desired range of test.
Determine amount of stock solution by dividing dose by mg/L per mL (see Table 1).

Coagulant - Jar #	1	2	3	4	5	6	
Dose (mg/L)							
Stock Solution (mL)							
Coagulant Aid - Jar #	1	2	3	4	5	6	
Dose (mg/L)							
Stock Solution (mL)							
	1	2	3	4	5	6	
Dose (mg/L)							
Stock Solution (mL)							

TEST PROCEDURE

Step 1 Set rapid mix time equal to rapid mix detention time.
To determine rapid mix time, use the following equation -

$$\text{Rapid mix time (min)} = \frac{(\text{rapid mix volume, gal}) \times (1,440 \text{ min/day}) \times (60 \text{ sec/min})}{(\text{plant flow rate, gal/d})}$$

Mix Volume (gal)	
Plant Flow Rate (gal/day)	
Mix Time (sec)	

Step 2 Set total flocculation time equal to total flocculation detention time in plant.
To determine total flocculation time, use the following equation -

$$\text{Floc time (min)} = \frac{(\text{flocculator volume, gal}) \times (1,440 \text{ min/day})}{(\text{plant flow rate, gal/d})}$$

Floc Volume (gal)			
Floc Time (min)			

Step 3 Use Figure 1 to determine the jar mixing energy values (rpm) that correspond to the approximate flocculator mixing energy values (G). Flocculator mixing energy can be estimated from plant design information (O&M manual) or can be calculated from the equation described in Appendix F - B.1. Flocculation.

Flocculator Stage	1st	2nd	3rd	
Flocculator Mixing (G)				
Jar Mixing (rpm)				

Step 4 Set sample time based on particle settling velocity. Use the equation below to determine sample time when using 2 liter gator jars as described in Figure 1.

$$\text{Sample time (min)} = \frac{(10 \text{ cm}) \times (\text{surface area, ft}^2) \times (1,440 \text{ min/day}) \times (7.48 \text{ gal/ft}^3)}{(\text{plant flow rate, gal/d}) \times (30.48 \text{ cm/ft})}$$

Sedimentation Surface Area (ft ²)	
Plant Flow Rate (gal/day)	
Sample Time (min)	

JAR TEST PROCEDURE (page 3)

TEST RESULTS

Record test results in the table below.

	1	2	3	4	5	6
Settled Turbidity (NTU)						
Settled pH						
Filtered Turbidity (NTU)						

Comments:

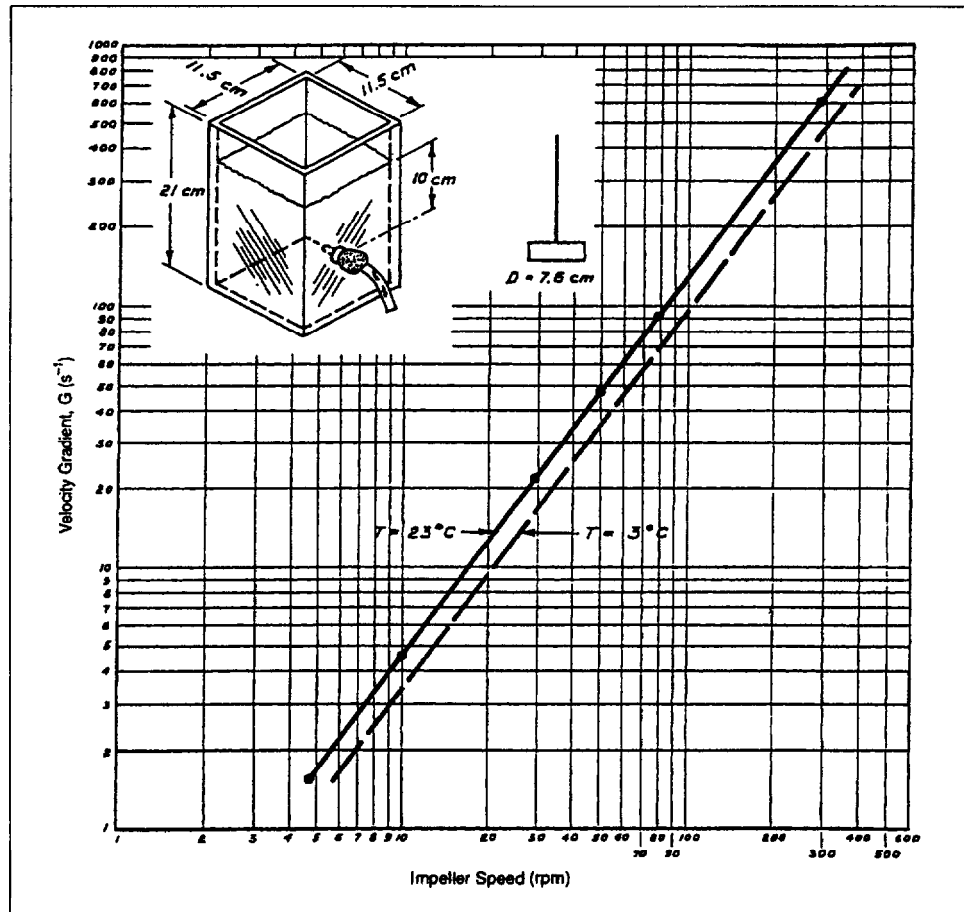

Figure 1. Laboratory G Curve for Flat Paddle in 2 Liter Gator Jar

Appendix M
Chemical Feed Guidelines

Chemical Feed Guidelines

The following guidelines provide information on the use of water treatment chemicals for coagulation and particle removal. Typical chemicals used for these applications include coagulants, flocculants, and filter aids. To use these chemicals properly, it is necessary to understand how the specific chemicals function and the type of calculations that are required to assure accurate feeding. Although these guidelines focus on coagulation and particle removal, the discussion on determining feed rates and preparing feed solutions applies to other water treatment chemical applications such as corrosion and taste and odor control.

Chemicals for Coagulation and Particle Removal

Coagulation Chemicals

Alum

1. Alum (aluminum sulfate) is one of the most widely used coagulants in water treatment. When alum is added to water, insoluble precipitates such as aluminum hydroxide ($\text{Al}(\text{OH})_3$) are formed.
2. The optimum pH range for alum is generally about 5 to 8.
3. Alkalinity is required for the alum reaction to proceed. If insufficient alkalinity is present in the raw water, the pH will be lowered to the point where soluble aluminum ion is formed instead of aluminum hydroxide. Soluble aluminum can cause post flocculation to occur in the plant clearwell and distribution system.
4. As a rule of thumb, about 1.0 mg/L of commercial alum will consume about 0.5 mg/L of alkalinity. At least 5 to 10 mg/L of alkalinity should remain after the reaction to maintain optimum pH.
5. 1.0 mg/L of alkalinity expressed as CaCO_3 is equivalent to:
 - 0.66 mg/L 85% quicklime (CaO)

- 0.78 mg/L 95% hydrated lime ($\text{Ca}(\text{OH})_2$)
 - 0.80 mg/L caustic soda (NaOH)
 - 1.08 mg/L soda ash (Na_2CO_3)
 - 1.52 mg/L sodium bicarbonate (NaHCO_3)
6. If supplemental alkalinity is used it should be added before coagulant addition, and the chemical should be completely dissolved by the time the coagulant is added.
 7. When mixing alum with water to make a feed solution, maintain the pH below 3.5 to prevent hydrolysis from occurring which will reduce the effectiveness of the chemical. A 10 to 20 percent alum solution by weight will maintain this pH requirement in most applications.
 8. Density and solution strength values for commercial alum can be found in Table M-I. A solution strength of 5.4 lb/gal can be used for approximate chemical calculations.

Ferric Chloride

1. The optimum pH range for ferric chloride is 4 to 12.
2. When mixing ferric chloride with water to make a feed solution, maintain the pH below 2.2.
3. Ferric chloride consumes alkalinity at a rate of about 0.75 mg/L alkalinity for every 1 mg/L of ferric chloride.
4. Ferric chloride dosage is typically about half of the dosage required for alum.
5. Density and solution strength values for commercial ferric chloride vary with the supplier. A solution strength of 3.4 lb FeCl_3 /gallon can be used for approximate chemical calculations (i.e., product density of 11.3 lb/gal and 30 percent FeCl_3 by weight).

Table M-I. Densities and Weight Equivalents of Commercial Alum Solutions¹

Specific Gravity	Density lb/gal	% Al ₂ O ₃	Equivalent % Dry Alum ²	Strength lb alum/gallon	Strength g alum/liter
1.0069	8.40	0.19	1.12	0.09	11.277
1.0140	8.46	0.39	2.29	0.19	23.221
1.0211	8.52	0.59	3.47	0.30	35.432
1.0284	8.58	0.80	4.71	0.40	48.438
1.0357	8.64	1.01	5.94	0.51	61.521
1.0432	8.70	1.22	7.18	0.62	74.902
1.0507	8.76	1.43	8.41	0.74	88.364
1.0584	8.83	1.64	9.65	0.85	102.136
1.0662	8.89	1.85	10.88	0.97	116.003
1.0741	8.96	2.07	12.18	1.09	130.825
1.0821	9.02	2.28	13.41	1.21	145.110
1.0902	9.09	2.50	14.71	1.34	160.368
1.0985	9.16	2.72	16.00	1.47	175.760
1.1069	9.23	2.93	17.24	1.59	190.830
1.1154	9.30	3.15	18.53	1.72	206.684
1.1240	9.37	3.38	19.88	1.86	223.451
1.1328	9.45	3.60	21.18	2.00	239.927
1.1417	9.52	3.82	22.47	2.14	256.540
1.1508	9.60	4.04	23.76	2.28	273.430
1.1600	9.67	4.27	25.12	2.43	291.392
1.1694	9.57	4.50	26.47	2.58	309.540
1.1789	9.83	4.73	27.82	2.74	327.970
1.1885	9.91	4.96	29.18	2.89	346.804
1.1983	9.99	5.19	30.53	3.05	365.841
1.2083	10.08	5.43	31.94	3.22	385.931
1.2185	10.16	5.67	33.35	3.39	406.370
1.2288	10.25	5.91	34.76	3.56	427.131
1.2393	10.34	6.16	36.24	3.74	449.122
1.2600	10.43	6.42	37.76	3.93	472.000
1.2609	10.52	6.67	39.24	4.12	494.777
1.2719	10.61	6.91	40.65	4.31	517.027
1.2832	10.70	7.16	42.12	4.51	540.484
1.2946	10.80	7.40	43.53	4.71	563.539
1.3063	10.89	7.66	45.06	4.91	588.619
1.3182	10.99	7.92	46.59	5.12	614.149
1.3303	11.09	8.19	48.18	5.34	640.938
1.3426	11.20	8.46	49.76	5.57	668.078
1.3551	11.30	8.74	51.41	5.81	696.657
1.3679	11.41	9.01	53.00	6.05	724.987

¹From Allied Chemical Company "Alum Handbook", modified by adding gm/L dry alum column.

²17% Al₂O₃ in Dry Alum + 0.03% Free Al₂O₃.

Polyaluminum Chloride (1)

1. Polyaluminum chloride (PACl) products are less sensitive to pH and can generally be used over the entire pH range generally found in drinking water treatment (i.e., 4.5 to 9.5).
2. Alum and PACl products are not compatible; a change from feeding alum to PACl requires a complete cleaning of the chemical storage tanks and feed equipment.
3. The basicity of the product determines its most appropriate application:
 - Low basicity PACls (below 20 percent): Applicable for waters high in color and total organic carbon (TOC).
 - Medium basicity PACls (40 to 50 percent): Applicable for cold water, low turbidity, and slightly variable raw water quality.
 - High basicity PACls (above 70 percent): Applicable for waters with highly variable quality, as a water softening coagulant, for direct filtration, and some waters with high color and TOC.
4. Check specific manufacturer's product information for density and strength values.

Polymers (Coagulation)

1. Polymer can be added as either the primary coagulant or as a coagulant aid to partially replace a primary coagulant (e.g., alum).
2. Polymers used for coagulation are typically low molecular weight and positively charged (cationic).
3. The dosage for polymers used for coagulation is dependent on raw water quality.
4. Product density and solution strength information can be obtained from the individual polymer manufacturers.

Flocculation Chemicals

1. Polymers used as flocculants generally have a high molecular weight and have a charge that is positive, negative (anionic), or neutral (non-ionic).
2. The purpose of a flocculant is to bridge and enmesh the neutralized particles into larger floc particles, and they are generally fed at a dosage of less than 1 mg/L.
3. Flocculants should be fed at a point of gentle mixing (e.g., diffuser pipe across a flocculation basin) to prevent breaking apart the long-chained organic molecules.
4. Product density and solution strength information can be obtained from the individual polymer manufacturers.

Filter Aid Chemicals

1. Polymers used as filter aids are similar to flocculants in both structure and function.
2. Filter aid polymers are typically fed at dosages less than 0.1 mg/L; otherwise, when fed in excess concentrations they can contribute to filter head loss and short filter run times.
3. Filter aid polymers are fed at a point of gentle mixing (e.g., filter influent trough).
4. Product density and solution strength information can be obtained from the individual polymer manufacturers.

Feeding Chemicals in the Plant

Step 1. Determining the Required Chemical Dosage

1. The appropriate chemical dosage for coagulants is typically determined by lab or pilot scale testing (e.g., jar testing, pilot plant), on-line monitoring (e.g., streaming current meter, particle counter), and historical experience. A guideline on performing jar testing is included in Appendix L.

- Flocculants are typically fed at concentrations less than 1 mg/L. Jar testing can be used to estimate the optimum dosage.
- The typical dosage for filter aid polymers is less than 0.1 mg/L. Jar testing, including filtering the samples, is typically not effective for determining an optimum dose. The polymer manufacturers can provide guidelines on use of their products as filter aids.

Step 2. Determining the Chemical Feed Rate

- Once the chemical dosage is determined, the feed rate can be calculated by the equation below:

$$\text{Feed Rate (lb/day)} = \text{Flow Rate (MGD)} \times \text{Chemical Dose (mg/L)} \times 8.34 \text{ lb/gal}$$

Step 3. Determining the Chemical Feeder Setting

- Once the chemical feed rate is known, this value must be translated into a chemical feeder setting. The approach for determining the setting depends on whether the chemical is in a dry or liquid form.
- For dry chemicals, a calibration curve should be developed for all feeders that are used in the plant. A typical calibration curve is shown in Figure M-1. The points on the curve are determined by operating the feeder at a full operating range of settings and collecting a sample of the chemical over a timed period for each setting. Once the sample weight is determined by a balance, the feed rate can be determined for that set point. For example, the feed rate for the 100 setting was determined by collecting a feeder output sample over a 2-minute period. The sample weight was 5.8 lb. The associated feed rate can then be converted into an equivalent hourly feed rate as follows:

$$\text{Feed Rate} = \frac{5.8 \text{ lb}}{2 \text{ min}} \times \frac{60 \text{ min}}{\text{hr}} = \frac{174 \text{ lb}}{\text{hr}}$$

- For liquid chemicals, a calibration curve should also be developed for all liquid feeders used in

a plant. An approach similar to dry feeder calibration is followed; however, a volumetric cylinder is typically used to collect the sample. For example, 50 mL of liquid chemical collected over 2 minutes would equate to a feed rate of 25 mL/min. A graph similar to Figure M-1 can be developed showing pump setting (e.g., % speed) versus feed rate in mL/min.

- For liquid chemicals, an additional step is necessary to convert the required weight-based feed rate to a volume-based pumping rate. The following equation can be used to determine the pumping rate:

$$\text{Pump Rate (mL/min)} = \frac{F_R \text{ (lb/day)}}{C_S \text{ (lb/gal)}} \times \frac{\text{day}}{1,440 \text{ min}} \times \frac{3,785 \text{ mL}}{\text{gal}}$$

F_R = Feed Rate (lb/day)

C_S = Chemical Strength (lb/gal)

Preparation of Feed Solutions

Liquid solutions of both dry and liquid chemicals are frequently prepared in a plant to prepare the chemical for feeding (e.g., activating polymer) and to allow the feeding of the chemical in an efficient manner. Two examples are presented below to describe approaches for preparing chemical solutions from dry and liquid chemicals.

Preparation of an Alum Feed Solution

- Determine the desired percent solution for feeding the alum. As described under the previous alum discussion, a percent solution of 10 to 20 percent is typically used. In this example, assume a 15 percent solution.
- Based on the volume of alum solution to be prepared, determine the weight of alum to add to the solution tank. For an alum solution volume of 500 gallons, determine the alum weight as follows:

$$\text{Alum Weight} = 500 \text{ gal} \times \frac{8.34 \text{ lb}}{\text{gal}} \times 0.15 = 625 \text{ lb}$$

Figure M-1. Example dry chemical feeder calibration chart.

Setting	Sample Wt. (lb)	Time (minutes)	Feed Rate (lb/hr)
0	0	0	0
100	5.8	2.0	174
200	5.1	1.0	306
300	7.3	1.0	438
400	4.8	0.5	576
500	5.7	0.5	684

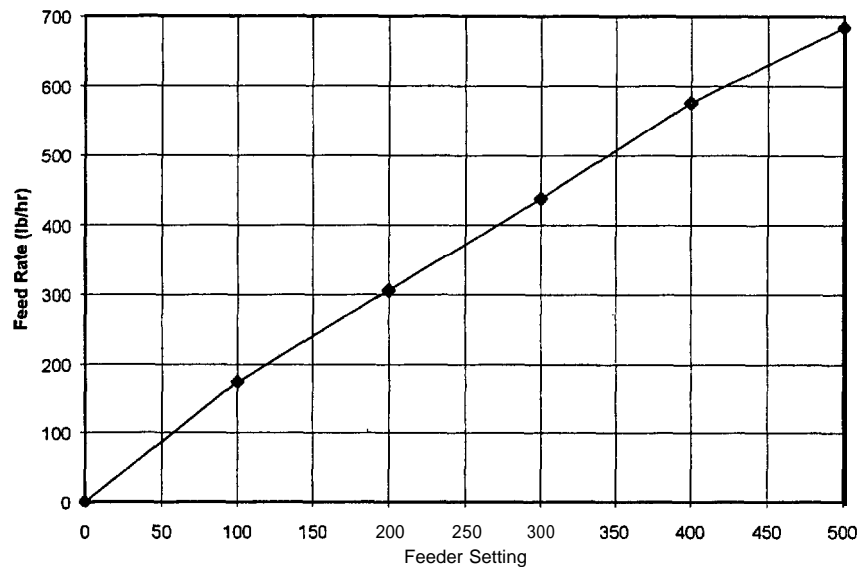

3. Determine the alum strength (A₁) for use in calculating feed rates. The alum strength for the example above is calculated as follows:

$$\text{Alum Strength (A}_1\text{)} = \frac{625 \text{ lb}}{500 \text{ gal}} = \frac{1.25 \text{ lb}}{\text{gal}}$$

2. Based on the volume of solution to be prepared, determine the weight of polymer to add to the solution tank. For a solution volume of 200 gallons, determine the polymer weight as follows:

$$\text{Polymer Weight} = 200 \text{ gal} \times \frac{8.34 \text{ lb}}{\text{gal}} \times 0.01 = 16.7 \text{ lb}$$

Preparation of a Polymer Feed Solution

1. Polymer manufacturers provide guidelines on preparation of their products, including whether the product is fed neat (i.e., undiluted) or in a diluted form. Diluted polymers are typically mixed at 2% by weight or less; otherwise, they become difficult to mix effectively. For this example, assume a 1% solution is to be prepared.

3. It is frequently easier to measure polymer volumetrically rather than by weight, so the weight of polymer can be converted to an equivalent volume by obtaining the product density from the manufacturer. For example, if the polymer density is 9.5 lb/gal, the volume is calculated as follows:

$$\text{Polymer Volume} = 16.7 \text{ lb} \times \frac{\text{gal}}{9.5 \text{ lb}} = 1.76 \text{ gal}$$

-
4. Determine the polymer strength (P_s) for use in calculating feed rates. The polymer strength for the example above is calculated as follows:

$$\text{Polymer Strength } (P_s) = \frac{16.7 \text{ lb}}{200 \text{ gal}} = \frac{0.0835 \text{ lb}}{\text{gal}}$$

References

1. Lind, Chris. 1996. "Top 10 Questions about Alum and PACl." *Opflow*, 22(8):7. AWWA, Denver, CO.

Appendix N
Conversion Chart

Conversion Chart

English Unit	Multiplier	SI Unit
acre	0.405	ha
acre-ft	1,233.5	cu m
cfs	1.7	cu m/min
cu ft	0.0283	cu m
cu ft	28.32	l
°F	$5/9 \times ({}^{\circ}\text{F} - 32)$	°C
ft	0.3048	m
ft/sec	30.48	cm/sec
gal	3.785	l
gpm	0.0631	liter/sec
gpm	8.021	cu ft/hr
gpd/sq ft	0.0408	cu m/day/sq m
gpm/sq ft	40.7	l/min/sq m
inch	2.54	cm
lb	0.454	kg
lb	454	g
MGD	3,785	cu m/day
psi	0.070	kg/sq cm
sq ft	0.0929	sq m

United States
Environmental Protection Agency
Center for Environmental Research Information
Cincinnati, OH 45268

Please make all necessary changes on the below label,
detach or copy, and return to the address in the upper
left-hand corner.

If you do not wish to receive these reports CHECK HERE ;
detach, or copy this cover, and return to the address in the
upper left-hand corner.

Official Business
Penalty for Private Use
\$300

EPA/625/6-91/027