

# Asphalt Roadway Rehabilitation Alternatives

---

## A Training Course

Participant's Handbook

Publication No. FHWA-SA-97-048



U.S. Department  
of Transportation  
**Federal Highway  
Administration**





# Asphalt Pavement Rehabilitation Alternatives

## Table of Contents

### Module 1 Introduction

1. Introduction and Objectives .....	1-1
2. Scope of Course .....	1-1
3. Overview .....	1-2
Module Organization, 1-2	
Glossary, 1-2	
Course Organization, 1-2	

### Module 2 Evaluation of Existing Asphalt Roadways

1. Condition Survey .....	2-1
References, 2-1	
Goals of Distress Survey, 2-1	
2. Functional Quality .....	2-2
3. Structural Capacity .....	2-5
4. Rating Scheme .....	2-8
5. Drainage .....	2-10
6. Materials .....	2-11
7. Other Considerations .....	2-12
References .....	2-13

*Table of Contents*

---

**Module 3 Full-Depth Asphalt Roadways**

1. Introduction ..... 3-1

2. Appropriate Rehab Options ..... 3-2  
    Recycling, 3-3  
    Resurfacing, 3-16  
    Surface Treatment, 3-18

3. Selection of the Most Appropriate Rehab Option ..... 3-22  
    Noneconomic Factors, 3-23  
    Economic Factors, 3-26

References ..... 3-33

**Module 4 Thick-Lift Asphalt Roadways**

1. Introduction ..... 4-1

2. Appropriate Rehab Options ..... 4-2  
    Recycling, 4-3  
    Resurfacing, 4-16  
    Surface Treatment, 4-18

3. Selection of the Most Appropriate Rehab Option ..... 4-22  
    Noneconomic Factors, 4-23  
    Economic Factors, 4-25

References ..... 4-33

**Module 5 Thin-Lift Hot-Mix Asphalt Roadways**

1. Introduction ..... 5-1

2. Appropriate Rehab Options ..... 5-2  
    Recycling, 5-3  
    Resurfacing, 5-13  
    Surface Treatment, 5-15

3. Selection of the Most Appropriate Rehab Option ..... 5-20  
    Noneconomic Factors, 5-21  
    Economic Factors, 5-23

References ..... 5-31



**Module 6 Thin-Lift Cold-Mix Asphalt Roadways**

1. Introduction ..... 6-1

2. Appropriate Rehab Options ..... 6-2  
    Recycling, 6-3  
    Resurfacing, 6-13  
    Surface Treatment, 6-15

3. Selection of the Most Appropriate Rehab Option ..... 6-20  
    Noneconomic Factors, 6-21  
    Economic Factors, 6-23

References ..... 6-31

**Module 7 Surface-Treated Roadways**

1. Introduction ..... 7-1

2. Appropriate Rehab Options ..... 7-2  
    Recycling, 7-2  
    Resurfacing, 7-14  
    Surface Treatments, 7-16

3. Selection of the Most Appropriate Rehab Options ..... 7-21  
    Noneconomic Factors, 7-22  
    Economic Factors, 7-25

References ..... 7-33

**Glossary**

**LTAP Address List**

**List of Figures**

Figure 2-1.	Example of severe surface raveling .....	2-3
Figure 2-2.	Example of deteriorated transverse cracks .....	2-3
Figure 2-3.	Example of slippage cracking .....	2-4
Figure 2-4.	Example of intermediate-sized block cracking .....	2-4
Figure 2-5.	Example of slight to moderate rutting .....	2-6
Figure 2-6.	Example of reflective cracking .....	2-6
Figure 2-7.	Example of typical alligator cracking pattern .....	2-7
Figure 2-8.	Example of edge wedging .....	2-7
Figure 2-9.	Evidence of pumping shown by material on surface at cracks ...	2-8
Figure 3-1.	Typical full-depth asphalt pavement cross-section .....	3-1
Figure 3-2.	Pavement deterioration versus time and/or traffic .....	3-3
Figure 3-3.	Rehab options with heater-planer .....	3-6
Figure 3-4.	General sequence of Type 1 CIR operation .....	3-10
Figure 3-5.	General sequence of Type 2 CIR operation .....	3-11
Figure 3-6.	Type 3 CIR recycling train .....	3-12
Figure 3-7.	Expected life of various rehab methods .....	3-27
Figure 3-8.	Example of different rehab strategies for a given analysis period .....	3-28
Figure 3-9.	Example of present-worth method of economic analysis .....	3-31
Figure 3-10.	Example of annualized method of economic analysis .....	3-32
Figure 4-1.	Typical thick-lift asphalt roadway cross-section .....	4-1
Figure 4-2.	Pavement deterioration versus time/traffic .....	4-3

Figure 4-3. Rehab options with heater-planer ..... 4-6

Figure 4-4. General sequence of Type 1 CIR operation ..... 4-10

Figure 4-5. General sequence of Type 2 CIR operation ..... 4-11

Figure 4-6. Type 3 CIR recycling train ..... 4-12

Figure 4-7. Expected life of various rehab methods ..... 4-27

Figure 4-8. Example of different rehab strategies for a given  
analysis period ..... 4-28

Figure 4-9. Example of present-worth method of economic analysis ..... 4-31

Figure 4-10. Example of annualized method of economic analysis ..... 4-32

Figure 5-1. Typical thin-lift hot-mix asphalt pavement cross-section ..... 5-1

Figure 5-2. Pavement deterioration versus time/traffic ..... 5-3

Figure 5-3. General sequence of Type 1 CIR operation ..... 5-8

Figure 5-4. General sequence of Type 2 CIR operation ..... 5-9

Figure 5-5. Type 3 CIR recycling train ..... 5-10

Figure 5-6. Expected life of various rehab methods ..... 5-25

Figure 5-7. Example of different rehab strategies for a given  
analysis period ..... 5-26

Figure 5-8. Example of present-worth method of economic analysis ..... 5-29

Figure 5-9. Example of annualized method of economic analysis ..... 5-30

Figure 6-1. Typical thin-lift cold-mix asphalt pavement cross-section ..... 6-1

Figure 6-2. Pavement deterioration versus time and/or traffic ..... 6-2

Figure 6-3. General sequence of Type 1 CIR operation ..... 6-8

Figure 6-4. General sequence of Type 2 CIR operation ..... 6-9

*Table of Contents*

---

Figure 6-5.	Type 3 CIR recycling train .....	6-10
Figure 6-6.	Expected life of various rehab methods .....	6-25
Figure 6-7.	Example of different rehab strategies for a given analysis period .....	6-26
Figure 6-8.	Example of present-worth method of economic analysis .....	6-29
Figure 6-9.	Example of annualized method of economic analysis .....	6-30
Figure 7-1.	General sequence of Type 1 CIR operation .....	7-7
Figure 7-2.	General sequence of Type 2 CIR operation .....	7-8
Figure 7-3.	Type 3 CIR recycling train .....	7-9
Figure 7-4.	Example of performance over time .....	7-26
Figure 7-5.	Expected life of various rehab methods .....	7-27
Figure 7-6.	Example of different rehab strategies for a given analysis period .....	7-28
Figure 7-7.	Example of present-worth method of economic analysis .....	7-31
Figure 7-8.	Example of annualized method of economic analysis .....	7-32

**List of Tables**

Table 2-1. Asphalt pavement functional distress types and descriptions ... 2-2

Table 2-2. Asphalt pavement structural distress types and descriptions ... 2-5

Table 2-3. Summary of condition ratings ..... 2-9

Table 3-1. Suitable objectives of various surface recycling processes ..... 3-7

Table 3-2. Guide for selection of AC recycling method ..... 3-15

Table 4-1. Suitable objectives of various surface recycling processes ..... 4-7

Table 4-2. Guide for selection of AC recycling method ..... 4-14

Table 5-1. Suitable objectives of cold-milling surface recycling process .... 5-5

Table 5-2. Guide for selection of AC recycling method ..... 5-11

Table 6-1. Suitable objectives of cold-milling surface recycling process .... 6-5

Table 6-2. Guide for selection of AC recycling method ..... 6-11

Table 7-1. Suitability of various surface recycling processes ..... 7-5

Table 7-2. Guide for selection of AC recycling method ..... 7-11



# MODULE 1

## INTRODUCTION

### 1. INTRODUCTION AND OBJECTIVES

The information presented in this course has been designed to provide useful information about asphalt pavement repair to persons who may not be experienced in this area but who are still responsible for the upkeep of asphalt pavements in their particular agency. This course has been prepared to address asphalt road problems for local agencies in both rural and urban areas. The target audience for this information is city managers, mayors, county commissioners, and others who must oversee asphalt roads for their agency. Only asphalt roads, that is roads made with asphaltic materials such as hot-mix asphalt concrete, cutback asphalts, or emulsified asphalts, are considered in this course.

The objectives for persons taking this course are:

- To gain a basic understanding of the different types of asphalt roads.
- To understand the construction and maintenance procedures used for asphalt roads.
- To interpret the significance of surface distress and determine the appropriate actions to be taken for different distress types and severities.
- To understand the basic concepts of life-cycle cost analysis and how to use it to compare different maintenance and rehabilitation alternatives.

### 2. SCOPE OF COURSE

This training course discusses the different types of asphalt roads, presents various methods of building and maintaining asphalt roads, and describes the types of surface distress that are common in asphalt roads. Guidance is given to help decide what action should be taken to fix an old asphalt road, how to build a new asphalt road, and how traffic may affect which actions will be most effective.

This course is intended to assist agencies with the cost-effective maintenance of asphalt roads. Although the course addresses numerous pavement types and conditions, there may be instances when additional information is needed. Such information may be found in the reference list at the end of each module, or from the local Technology Transfer (T<sup>2</sup>) centers.

### **3. OVERVIEW**

This manual is organized into seven different modules, including this introductory module. The modules include:

- Introduction
- Evaluation of Existing Asphalt Pavements.
- Full-Depth Asphalt Roadways.
- Thick-Lift Asphalt Roadways.
- Thin-Lift Hot-Mix Asphalt Roadways.
- Thin-Lift Cold-Mix Asphalt Roadways.
- Surface-Treated Roadways.

#### **Module Organization**

Module 2, "Evaluation of Existing Asphalt Pavements" is intended to provide methods for determining the current condition of an asphalt pavement, and to provide some indication as to what actions should be taken to either maintain or repair that pavement.

Modules 3 through 7 are intended to provide specific information about different types of asphalt pavements that an agency may have. In each of these modules, information is provided on the different feasible rehabilitation options. This information includes lists of resources needed for different options, construction options, drainage recommendations, performance considerations, and directions for estimating the life-cycle cost of each option. At the end of each module are lists of references that contain more detailed information about the topic presented in the module.

#### **Glossary**

The final section of the course manual is a glossary of terms used throughout the manual. Further explanation of terms from the manual may also be found in the references listed for each module.

#### **Course Organization**

The modules contained in this course are intended to be taught either individually or sequentially. The information contained in this manual can be presented in a single day. If only one or two modules are to be presented in a single day, the instructor may need to obtain additional material. The references listed after each module can provide this type of additional information.



## MODULE 2

# EVALUATION OF EXISTING ASPHALT ROADWAYS

### 1. CONDITION SURVEY

The first step in determining the condition of a road is conducting a pavement condition survey. This process involves recording different surface distress types, severities, and quantities for each road section. Based on the distress information, a rating is given to each road section that indicates its relative condition, with higher numbers indicating roads in better condition.

Several types of distresses are used to determine the condition of an asphalt road surface. These include ravelling, bleeding, polishing, rutting, corrugations, shoving, settling, heaving, pumping, cracking, patches, and potholes.<sup>(1,2)</sup>

The distresses identified along a road are used to identify whether the road is in need of functional or structural improvements, or whether some other actions need to be taken. Information on road geometry and the condition of drainage structures (ditches, culverts, pipes, curbs, and gutters) are also used to help determine the overall condition of a section of road.

#### References

Several good references are available that contain photographs of distress types and their relative severity levels. The use of photos when performing a distress survey will greatly improve the accuracy and consistency of the data collected. The following sections contain short descriptions of the different distress types, along with photos of some of the distress types. It is highly recommended to obtain copies of at least the *Asphalt-PASER Manual* and the *SHRP Distress Identification Manual for the Long-Term Pavement Performance Project* listed in the reference list to help in performing actual distress surveys.<sup>(1)</sup>

#### Goal of Distress Survey

The goal of the distress survey is to assess the overall condition of the existing pavement, to identify the cause(s) of the pavement deterioration, and to determine whether the pavement is in need of functional or structural improvement. A road in need of only functional improvements will need repairs that improve the skid resistance and rideability of the pavement surface. A road in need of structural improvement will require reconstruction or the placement of an overlay so that the pavement can withstand the current or expected traffic levels.

2. FUNCTIONAL QUALITY

The functional quality of a road refers primarily to the rideability and the skid resistance of the road surface. Generally, problems with the functional quality of a road are attributable to the age of the road. The distresses shown in table 2-1 usually indicate that a new surface layer is needed. Also included in table 2-1 are suggested repair methods for a particular distress. Figures 2-1 through 2-4 illustrate several of the distress types contained in table 2-1.

Table 2-1. Asphalt pavement functional distress types and descriptions.

Distress	Description	Suggested repair methods
Ravelling	Wearing away of the pavement surface caused by the dislodging of aggregate particles and loss of asphalt binder.	Sealcoat or thin overlay
Bleeding	Excessive asphalt that is squeezed to the surface by traffic over time.	Sand blotting or overlay
Polishing	Wearing of rocks in the road surface over time by traffic.	Sealcoat or thin overlay
Frost Heave	Raising of the road surface as water in the subgrade freezes and expands.	Removal and replacement
Settling	Localized area of the road that sinks, sometimes associated with utility patches or other localized repairs.	Patching or overlay
Transverse Cracks	Cracks across the road, related either to aging of the surface, or movement of lower layers (see reflective cracks).	Seal cracks greater than 6 mm
Reflective Cracks	Cracks that appear in overlays at previous cracks or joints in the underlying road surface.	Crack sealing or overlay
Slippage Cracks	Crescent-shaped cracks that form in the asphalt surface in areas of turning or stopping vehicles.	Remove top surface and resurface using tack coat.
Longitudinal Cracks	Cracks parallel to the centerline, either at the centerline, or over widening joints.	Seal cracks greater than 6 mm
Block Cracks	Regularly-spaced cracks that form as road ages	Seal coat (early); overlay (late)



Figure 2-1. Example of severe surface ravelling.<sup>(1)</sup>

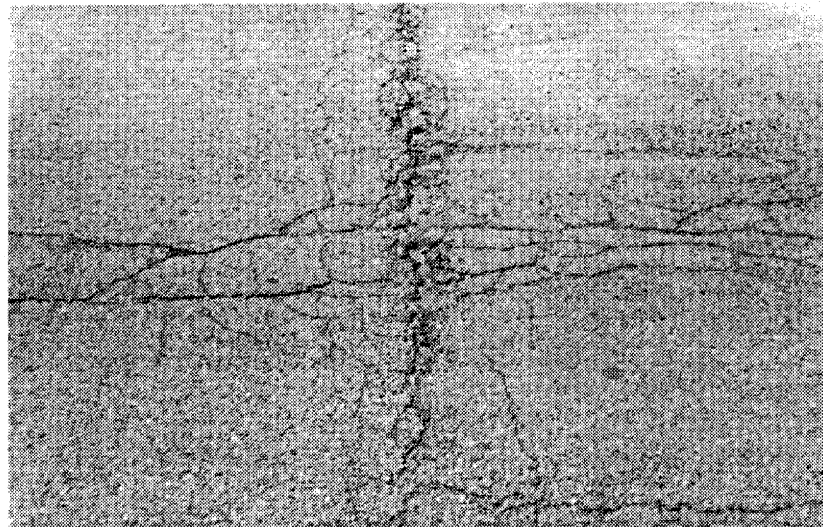

Figure 2-2. Example of deteriorated transverse cracks.<sup>(1)</sup>



Figure 2-3. Example of slippage cracking.<sup>(1)</sup>



Figure 2-4. Example of intermediate-sized block cracking.<sup>(1)</sup>

### 3. STRUCTURAL CAPACITY

The structural capacity of a road refers to its ability to carry traffic without experiencing large deformations, potholes, or other distress associated with an overloaded or weak road. The distresses shown in table 2-2 usually indicate that there is a problem with the thickness of the road, the drainage conditions, or both. Figures 2-5 through 2-9 illustrate several of the distress types contained in table 2-2.

Table 2-2. Asphalt pavement structural distress types and descriptions.

Distress	Description	Repair method
Rutting	Depressions in road along wheelpaths, caused by truck traffic over time	Overlay (less than 50 mm); mill and resurface (more than 50 mm)
Corrugation, Rippling	Movement in surface caused by vehicles stopping. Distress often resembles a "washboard" pattern.	Mill surface and overlay with stable mix
Fatigue (Alligator) Cracking	Cracks concentrated along the wheelpaths, usually occurring in an "alligator skin" or "chickenwire" pattern.	Remove and replace base and surface (local); reconstruct large areas, improve drainage
Patches	Full- and partial-depth patches placed after utility cuts and at areas of severe deterioration.	Remove and replace base and patch if distress reappears
Potholes	Localized areas where road is broken into small pieces, and traffic pulls pieces out of the pavement until a pothole is formed.	Repair areas using quality cold mix or hot mix (if available)
Pumping	Water and fine material being pushed onto the road surface as traffic pushes down on the pavement.	Remove and replace base and surface (local); reconstruct large areas, improve drainage



Figure 2-5. Example of slight to moderate rutting.<sup>(1)</sup>

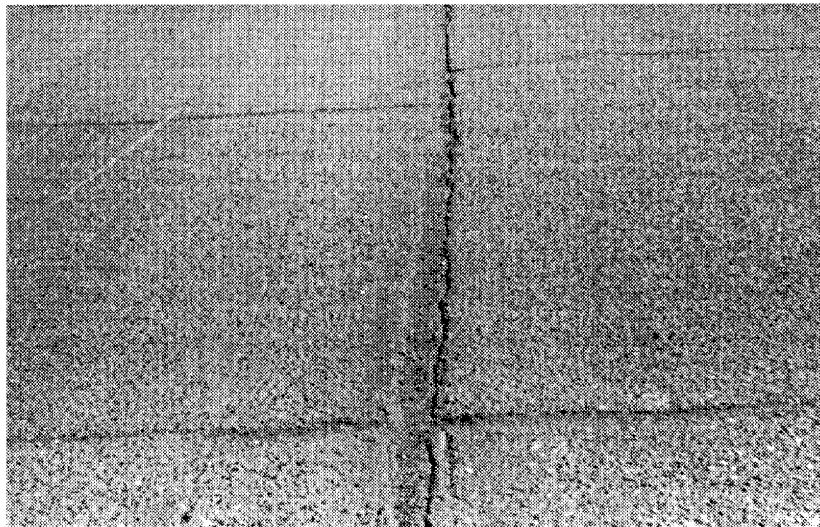

Figure 2-6. Example of reflective cracking.<sup>(1)</sup>

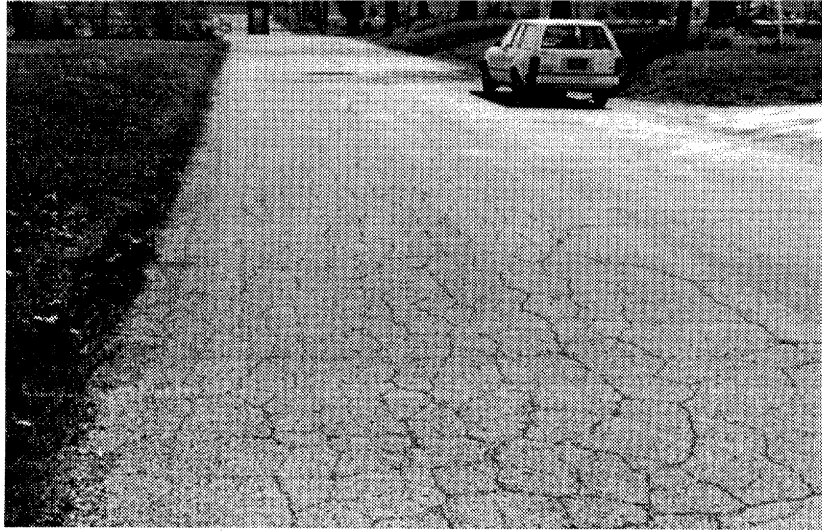

Figure 2-7. Example of typical alligator cracking pattern.<sup>(1)</sup>

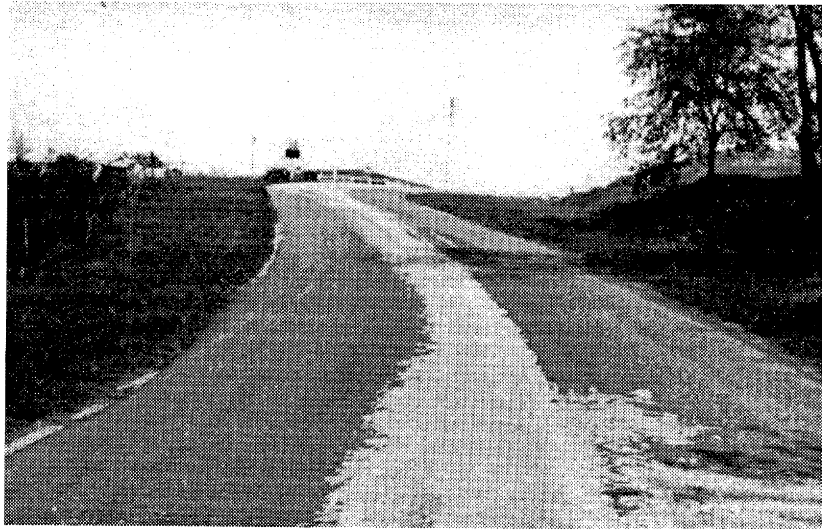

Figure 2-8. Example of edge wedging.<sup>(1)</sup>



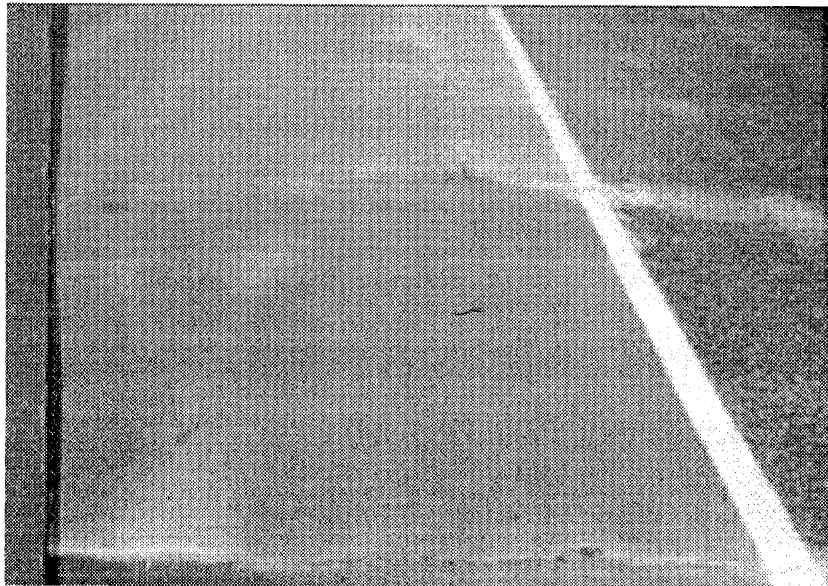

Figure 2-9. Evidence of pumping shown by material on surface at cracks.<sup>(2)</sup>

#### 4. RATING SCHEME

In order to make informed decisions about repairing roads, it is important to have an objective rating scheme that allows for all roads to be judged by the same set of criteria, especially when roads are inspected at different times and by different people. Table 2-3 can be used as a guide for deciding what rating a road section should have.<sup>(1)</sup>

In using this rating procedure, the worst distress ratings should be chosen for a road section when more than one distress type is observed. For example, if a section has transverse cracks that are 6 mm wide (rating of 7), with moderate ravelling (rating 5), and only a few patches in good condition (rating 7), then the overall rating for that section is 5 based on the presence of moderate ravelling. The PASER Manual includes a series of photographs to help in identifying the appropriate rating for a road section.<sup>(1)</sup> Again, the purpose of the rating scheme is to determine what problems exist in the pavement, which in turn helps identify what the best fix is for that pavement.



Table 2-3. Summary of condition ratings.<sup>(1)</sup>

Rating	Visible distress	General condition/ Treatment measures
10	None	New construction.
9	None	Recent overlay, like new.
8	<ul style="list-style-type: none"> <li>• No longitudinal cracks except reflection of paving joints.</li> <li>• Occasional transverse cracks, widely spaced (12 m or greater).</li> <li>• All cracks sealed or tight (open 6 mm or less).</li> </ul>	Recent sealcoat or new road mix. Little or no maintenance required.
7	<ul style="list-style-type: none"> <li>• Very slight or no ravelling, surface shows some traffic wear.</li> <li>• Longitudinal cracks (open 6 mm) due to reflection or paving joints.</li> <li>• Transverse cracks (open 6 mm) spaced 3 m or more apart little or slight crack ravelling.</li> <li>• No patching or very few patches in excellent condition.</li> </ul>	First signs of aging. Maintain with routine crack filling.
6	<ul style="list-style-type: none"> <li>• Slight ravelling (loss of fines) and traffic wear.</li> <li>• Longitudinal cracks (open 6-13 mm) due to reflection and paving joints.</li> <li>• Transverse cracking (open 6-13 mm) some spaced less than 3 m.</li> <li>• First sign of block cracking.</li> <li>• Slight to moderate flushing or polishing.</li> <li>• Occasional patching in good condition.</li> </ul>	Show signs of aging, sound structural condition. Could extend life with surface treatment..
5	<ul style="list-style-type: none"> <li>• Moderate to severe ravelling (loss of fine and course aggregate).</li> <li>• Longitudinal and transverse cracks (open 13 mm) show first signs of slight ravelling and secondary cracks. First signs of longitudinal cracks near pavement edge.</li> <li>• Block cracking up to 50 percent of surface.</li> <li>• Extensive to severe flushing or polishing.</li> <li>• Some patching or edge wedging in good condition.</li> </ul>	Surface aging, sound structural condition. Needs surface treatment or nonstructural overlay.

Table 2-3. Summary of condition ratings (continued).<sup>(1)</sup>

Rating	Visible Distress	General condition/ Treatment measures.
4	<ul style="list-style-type: none"> <li>● Severe surface ravelling.</li> <li>● Multiple longitudinal and transverse cracking, with slight ravelling.</li> <li>● Longitudinal cracking in wheel path.</li> <li>● Block cracking (over 50 percent of surface).</li> <li>● Patching in fair condition.</li> <li>● Slight rutting or distortions (13 mm or less).</li> </ul>	Significant aging and first signs of need for strengthening. Would benefit from recycling or overlay.
3	<ul style="list-style-type: none"> <li>● Closely spaced longitudinal and transverse cracks often showing ravelling and crack erosion.</li> <li>● Severe block cracking.</li> <li>● Some alligator cracking (less than 25 percent of surface).</li> <li>● Patches in fair to poor condition.</li> <li>● Moderate rutting or distortion (13 to 25 mm deep).</li> <li>● Occasional potholes.</li> </ul>	Needs patching and major overlay or complete recycling.
2	<ul style="list-style-type: none"> <li>● Alligator cracking (over 25 percent of surface).</li> <li>● Severe distortions (50 mm deep).</li> <li>● Extensive patching in poor condition.</li> <li>● Potholes.</li> </ul>	Severe deterioration. Needs reconstruction with extensive base repair.
1	<ul style="list-style-type: none"> <li>● Severe distress with extensive loss of surface integrity.</li> <li>● Roadway is hazardous to drive on.</li> </ul>	Failed. Needs total reconstruction.

## 5. DRAINAGE

Many of the problems seen in asphalt roads such as rutting and alligator (fatigue) cracking are the result of poor drainage. If water is allowed to stay in the base, subbase, and subgrade layers, then the road becomes weaker and deteriorates more quickly.

In most cases, water is removed from a road using ditches, curbs, or gutters, which run along the road. Several items that should be checked to make sure that the drainage along a road is performing as well as possible are:<sup>(1)</sup>

- Ditch lines should be at least 600 mm below the center of a road.
- Ditches, curbs, and gutters should be clean and free of debris. Grass-lined ditches should be free of plants and trees that would slow the flow of water. Curbs and gutters should be free of debris which could clog storm sewer grates and prevent drainage.
- The road should be crowned and there should be no areas of ponding along the road. These areas cause the subgrade and base layers to soften and the asphalt surface to deteriorate more quickly.

## 6. MATERIALS

The type and quality of materials used in a road will affect how long the road will last and what type of repairs can be done. For asphalt roads, it may be possible to mill the surface and use the material in a plant-mix recycling process. For surface treatment roads, this process would not be feasible, but it may be possible to recycle in-place, mixing the surface and base materials before placing a new surface treatment.

One other area where material selection and quality will be important is in the performance of routine maintenance, such as crack sealing and pothole repair. The correct choice of materials and procedures for performing these operations can have a large impact on the quality of the operation and the durability of the repairs. A recent study by the Strategic Highway Research Program (SHRP) and the Federal Highway Administration (FHWA) has produced a reference that provides guidance on the best way to perform crack sealing and pothole patching operations.<sup>(3)</sup>

Poor materials may also be the cause of problems present in an existing road. Some examples are:

- Not enough asphalt cement or an asphalt cement that is not hard enough may result in ravelling, premature cracking, or loss of skid resistance (due to loose material) on the road.<sup>(4)</sup>
- Use of rounded rocks rather than crushed for a base layer may provide less support and result in more fatigue cracking.
- Failure to stabilize water-sensitive soils may lead to weak layers which also result in more fatigue cracking.
- Use of rocks that absorb asphalt cement will leave less material to coat the rocks, resulting in the same problems as if not enough asphalt cement were added, ravelling, premature cracking, or loss of skid resistance.
- Low asphalt cement content: ravelling, cracking, loss of skid resistance.
- High asphalt cement content: bleeding.
- Improper aggregate gradation: rutting.

- Soft subgrades: alligator cracking, rutting.
- Soft aggregates: surface polishing.

## **7. OTHER CONSIDERATIONS**

In addition to the condition of a road and the particular drainage conditions, many other factors are important when considering what action to take to either maintain or rehabilitate a section of road. These factors include:

- Availability of construction equipment and materials.
- Whether work will be performed by agency or contractor.
- Traffic levels along the road, and the impact of temporarily closing a road.
- The levels of heavy truck traffic.
- The time of year when work will be performed.
- The climatic area where the road is located.
- The availability of funds.
- The condition of other roads for which the agency is responsible.

Of all the factors, the last two are probably the most difficult to address. For most agencies, the need for funds is always greater than the availability of funds. The question then becomes how to decide which sections of road are in the greatest need for repair, and how that decision affects the budget and overall condition of the road network.

The use of a pavement management system can assist in making many of these decisions. A pavement management system can be thought of as a set of tools for those responsible for making decisions about pavements. These tools enable the individuals to better identify and apply cost-effective strategies to keep their pavements in the best possible condition (based on available funding) and to evaluate the long-term impacts of their decisions on the entire network.

**REFERENCES**

1. *Asphalt-PASER Manual—Pavement Surface Evaluation and Rating*, University of Wisconsin-Madison, Department of Engineering Professional Development, November 1987, revised May 1989, reprinted February 1992.
2. *Distress Identification Manual for the Long-Term Pavement Performance Project*, Strategic Highway Research Program, National Academy of Sciences, Report No. SHRP-P-338, May 1993.
3. *Asphalt Pavement Repair Manual of Practice*, Strategic Highway Research Program, National Academy of Sciences, Report No. SHRP-H-348, August 1993.
4. *Maintenance Techniques for Road Surfacing*, Organization for Economic Co-Operation and Development, Road Research Group, October 1978.

---

# MODULE 3

## FULL-DEPTH ASPHALT ROADWAYS

### 1. INTRODUCTION

One type of roadway pavement that has become increasingly popular in some States in recent years is full-depth asphalt pavement. This type of pavement structure is characterized by two distinct layers of asphalt-aggregate mixtures placed on a prepared soil foundation, as illustrated in figure 3-1. In contrast, a conventional asphalt pavement consists of a thin AC surface layer placed on a thicker layer of aggregate (gravel) material.

The top layer, referred to as the surface course or wearing course, consists of either asphalt concrete (AC) or an asphalt surface treatment. Its main function is to provide a smooth and skid-resistant driving surface, and to act as a waterproof layer that effectively reduces the infiltration of water into the pavement system.

The second layer, referred to as the asphalt-treated base layer, consists of one or more lifts (i.e., paving layers) of either AC or emulsified asphalt-aggregate mixture. The primary purpose of this layer is to provide the bulk of the support for traffic loadings applied to the pavement.

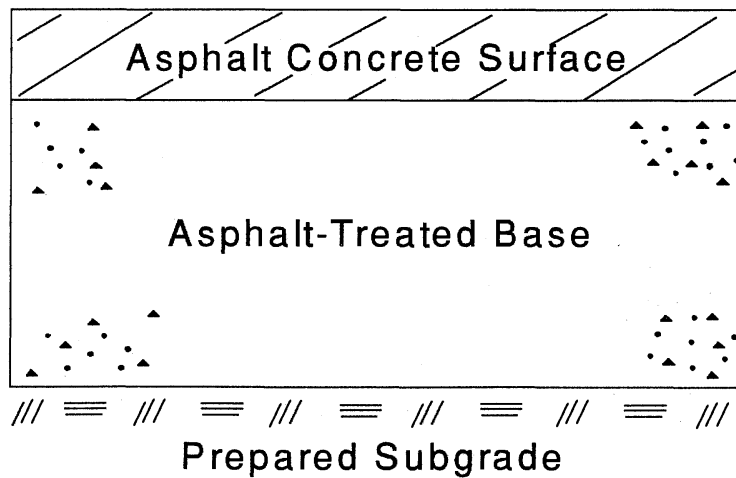

Figure 3-1. Typical full-depth asphalt pavement cross-section.

The foundation on which the two asphalt-aggregate layers rest usually consists of the natural soil that exists along the roadway. Occasionally, however, the existing soil may be too soft or unstable to provide an adequate platform for paving work or for the pavement itself. In this case, the deficient soil may be replaced with higher quality soils or may be treated with an additive (e.g., lime or cement) to strengthen or stabilize the soil.

Full-depth asphalt pavement is often used instead of conventional asphalt pavement for roadways where subsurface moisture and freezing are cause for concern. It is also generally considered to yield a more cost-effective base layer for roads subject to heavy loads or medium to heavy traffic volumes.

## **2. APPROPRIATE REHAB OPTIONS**

When a roadway is first constructed, it is built to a relatively high level of ride quality, or serviceability. As time goes on, the combined effects of traffic, age, and climate cause the pavement to deteriorate, or decrease in serviceability. The general pattern of pavement deterioration is such that serviceability remains high for a period of time and then begins to drop off fairly quickly, as shown in figure 3-2.

At some point along the serviceability-time curve, a decision must be made to rehabilitate the pavement in order to restore it to a more acceptable serviceability level. Typically, rehabilitation is considered appropriate for pavements ranging in serviceability between poor and good. Reconstruction is often the more cost-effective strategy for pavements having very poor serviceability.

There are essentially three main rehab options available for full-depth asphalt concrete. These options include the following:

- Recycling.
- Resurfacing.
- Surface treatment.

Descriptions and appropriate uses of these options, as well as the specific applications and procedures available under each option, are provided in the following sections.



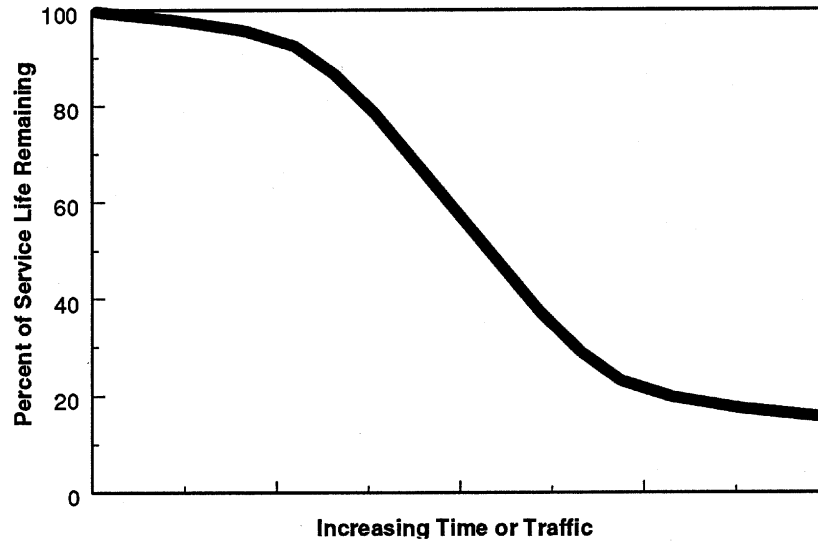

Figure 3-2. Pavement deterioration versus time and/or traffic.

### Recycling

Recycling refers to any process that utilizes materials from an existing pavement for reuse in the same or other pavements. In the case of the former, the reclaimed materials may be reprocessed immediately through an on-the-spot recycling train or in a relatively short time through a central asphalt plant. In the case of the latter, the reclaimed materials may be reprocessed and then used on a different roadway.

The major advantages of asphalt pavement recycling include reduced costs and the conservation of materials (e.g., asphalt binder, aggregate) and the energy required to process those materials. Additional benefits include eliminating the need for material disposal and, occasionally, preserving roadway geometrics (i.e., eliminating the need for raising manholes, accommodating vertical clearances).

The major disadvantages of asphalt pavement recycling include the possible lack of experienced or properly equipped local contractors and of suitable in-place materials for recycling. The consequence of each of these is usually higher rehabilitation costs.

Various classification schemes have been applied to asphalt pavement recycling operations, based on one or more of the following items:

- Absence/inclusion of heat in the recycling process (cold or hot process).
- Location of material remixing (in-place or at central mixing plant).
- Depth of pavement removal or reworking (surface, surface and base).

One of the more common classification schemes consists of the following three categories:

- Surface recycling.
- Cold-mix recycling.
- Hot-mix recycling.

Surface recycling is a hot or cold, in-place process that targets the top 25 to 50 mm of pavement. Both cold- and hot-mix recycling operations target the surface and a portion or all of the base. However, cold-mix recycling can be done either in-place or at a central plant, while hot-mix recycling is performed at a central plant.

Each recycling category contains several different procedures, with each procedure generally best suited for certain situations. Furthermore, the application of a surface layer (e.g., surface treatment, AC overlay) on top of the recycled layer may be required.

#### Surface Recycling

Surface recycling is the process by which the surface of an asphalt pavement is removed or reworked to a depth of less than 25 to 50 mm. This operation is divided into two basic processes: pavement removal and hot surface recycling. Each process, unique in terms of objectives and the equipment and procedures used, is discussed in further detail below.

Because surface recycling does not affect the base layer and soil foundation, it cannot be seriously considered as a rehabilitation option for pavements containing structural, moisture, or subsurface material problems. Such problems can be addressed by hot-mix and cold-mix recycling operations.

#### *Pavement Removal*

Removal of the top 25 to 50 mm of surface material can be a useful rehabilitation technique by itself or in preparation for resurfacing with AC. Situations that are generally appropriate for pavement removal include the following:<sup>7)</sup>

- Correction of low- and medium-severity rutting that has developed in the upper layer of asphalt.
- Corrections to areas of bleeding, ravelling, and poor skid-resistance.
- Reestablishing cross-slope for proper surface drainage.
- Removing bumps and, consequently, pavement roughness.
- Reducing or eliminating the need for feathering of a subsequent overlay along gutters or near bridge abutments.
- Improvement of bond between existing asphalt surface and subsequent AC overlay.

Pavement removal is most often accomplished with one of three pieces of equipment. These include:

- Heater-Planer.
- Cold Milling Machine.
- Hot Milling Machine.

The heater-planing operation consists of a mobile heating unit equipped with, or followed by, a blading device. Auxiliary clean-up equipment (e.g., front-end loader and dump truck) are required to remove the bladed material from the pavement.

The heater-planer appropriately heats the top fraction of pavement, which is then bladed off and removed for possible reuse as a recycled mix. The heating systems typically used include radiant-heat emitters or open-flame burners, both of which are enclosed by a hood that directs the heat onto the pavement. A diagram of the various construction options available using the heater-planer is shown in figure 3-3.

Surface recycling is often performed with a cold milling machine. The cold milling machine uses carbide-tipped cutter bits mounted on a large revolving drum to grind the pavement surface into small asphalt millings and allows for various depths of removal. The millings are typically picked up by the milling machine and then loaded onto a dump truck using an attached conveyor belt. The millings may be used later as a recycled or unrecycled base course or as a recycled surface course.

Because of the efficiencies of current cold milling devices, hot milling has seen limited use in the United States. This operation, suitable only for asphalt pavements, is quite similar to cold milling with the exception of an added step of heating the pavement prior to grinding. The greater operational cost of hot milling may be justifiable where high production rates are needed or very cold weather is expected.

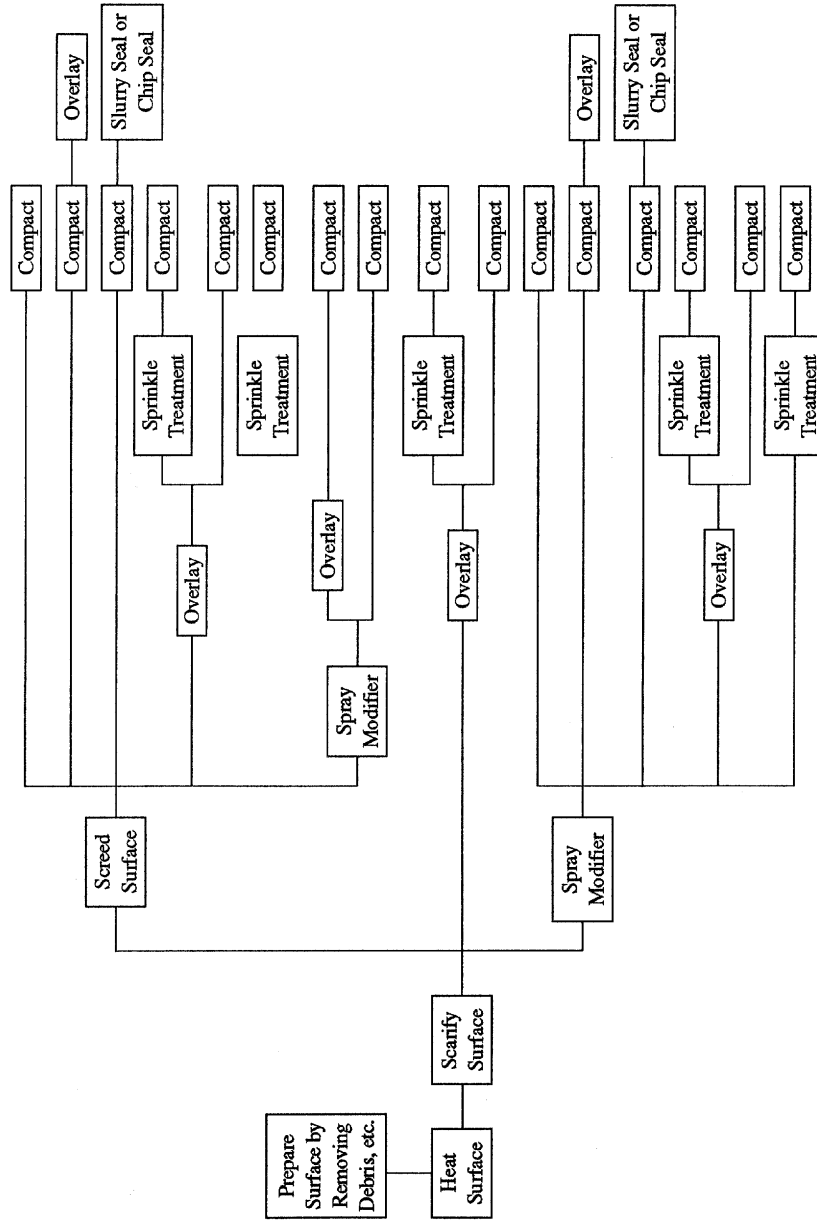

Figure 3-3. Rehab options with heater-planer.<sup>(7)</sup>

Table 3-1 lists the primary objectives for which heater-planing and cold milling are most suitable. Hot milling is typically performed for the same purposes as cold milling. For improvement of skid resistance by the heater-planing method, the heating system may be used in conjunction with a steel-wheeled roller to seat previously spread aggregate chips into the surface.

#### *Hot Surface Recycling*

Hot surface recycling is a recycling process whereby the top 25 to 50 mm of asphalt pavement is reworked on the roadway using a heater-scarifier. The process involves heating and scarifying the surface, adding new aggregate or asphalt rejuvenator if required, remixing, and relaying and compacting the material.

The heater-scarifier is a self-contained unit equipped with a heating system and a scarifying attachment. The heating system may be a radiant-heat emitter or an open-flame heater. The scarifying device consists of carbide-tipped steel blades that act as teeth and tear into the heated asphalt. A steel blade or heavy chain is usually attached behind the scarifier to assist in leveling the loosened material. More advanced heater-scarifiers might contain an attached screed, for better spreading and leveling, or an integral spray system, for immediate application of a rejuvenator.

Table 3-1. Suitable objectives of various surface recycling processes.

Objective	Heater-Planing	Cold-Milling
Remove bumps and reduce pavement roughness	X	X
Reestablish cross-slope	X	X
Removal of low-quality slurry or chip seals	X	
Removal of surface deterioration (e.g., ravelling, bleeding)	X	X
Maintain proper clearances for underpasses, tunnels, and sign bridges	X	X
Improve skid resistance	X	X
Promote bonding with AC overlay		X

After the surface has been heated and scarified, a rejuvenating agent may be sprayed on the material. If required, new aggregate may also be added. Remixing and relaying is then performed using either the heater-scarifier or by a mixing unit or motor grader that follows the heater-scarifier. Pneumatic rollers or steel-wheeled rollers follow immediately behind the laydown operation and compact the heated material.

Hot surface recycling is often done for one or more of the following reasons:

- Remove surface defects (e.g., ravelling, bleeding).
- Remove bumps (less than 50 mm) and reduce roughness.
- Reestablish cross-slope.
- Retard reflection cracking.
- Promote bonding with subsequent overlays.
- Improve aesthetics.

Furthermore, by adding new materials, key surface material characteristics can be corrected or improved. For instance, bleeding and ravelling can be corrected by adding proper amounts of aggregate or asphalt rejuvenator. Skid resistance can be improved by incorporating the proper type or amount of aggregate, and aged asphalt can be softened for increased life by adding a rejuvenator.

#### Cold-Mix Recycling

Cold-mix recycling is a process in which reclaimed asphalt pavement (RAP) materials are combined with new recycling agent and/or aggregate to produce cold-mix paving materials. This process, which can be done in-place or at a central mixing plant, requires no heat and is performed to a depth greater than 25 to 50 mm. The resulting cold-mix material is most often used as a base course, on which a protective asphalt surface layer is placed.

Cold-mix recycling operations largely involve cold, in-place recycling (CIR) procedures. These procedures have been used for many years, with more widespread use occurring only in the last 20 years. In general, CIR is appropriate for low-volume asphalt roads that are severely cracked and broken, highly rutted, or very rough. It is not recommended for roads with obvious soil foundation problems or with asphalt mixture problems that cannot be adequately corrected with CIR.

The benefits of CIR are numerous and include the following:<sup>(8,9)</sup>

- Significant structural improvements can be achieved without changes in horizontal and vertical geometry.
- Most types and severities of pavement distress can be treated.

- Reflection cracking can be delayed or eliminated.
- Pavement ride quality can be improved.
- Hauling costs can be minimized.
- Pavement profile, crown, and cross-slope can be improved.
- Production rate is high.
- Engineering costs are low.

Among the disadvantages of CIR are the following:<sup>(4,8)</sup>

- Construction variation is larger for in-place than for central-plant operations (i.e., lower quality control in the field than at the plant).
- Curing is required for strength gain, and is dependent upon climatic conditions, including temperature and moisture.
- Traffic disruption can be greater relative to other rehabilitation alternatives.
- The equipment is expensive, and not many contractors may own the equipment.
- There are no standard specifications for in-place recycling.

Three distinct types of CIR are currently being used in the United States. These types, which are briefly discussed below, include the following:<sup>(9)</sup>

- Type 1—Rip/pulverize and compact.
- Type 2—Single Unit Recycler.
- Type 3—Recycling Train.

*Type 1 CIR—Rip/pulverize and compact*

Often referred to as full-depth recycling or reclamation, Type 1 CIR is the oldest and least expensive method of in-place recycling. It is often used when there is little remaining life in the road or when surface defects are caused by problems in the underlying layer. In this process, the existing pavement is reworked to a depth that may vary from 100 to 300 mm. The recycled material provides a good-quality asphalt base layer on which an AC surface course or a surface treatment can be applied.<sup>(9)</sup>

The general procedures for Type 1 CIR are illustrated in figure 3-4. The existing pavement is first ripped and crushed in place by multiple passes of a scarifier or ripper. The crushed material, or RAP, is then windrowed with a grader and may be sprayed with the designated recycling agent. New aggregate may also be added at this point. A motor grader is used to thoroughly mix the new material, which is then spread into place by either the grader or a paver. Following compaction and curing, a surface layer is then applied. In some instances, type 1 CIR may not be appropriate for full-depth AC pavements,

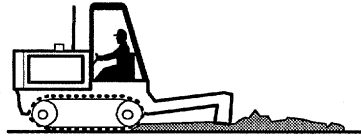

1. Rip and break existing pavement



2. Pulverize existing pavement



3. Windrow Existing Asphalt Bound Materials

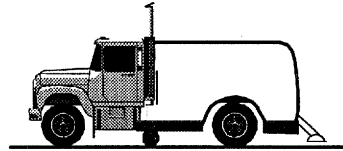

4. Apply Modifier to Windrowed Asphalt Bound Materials

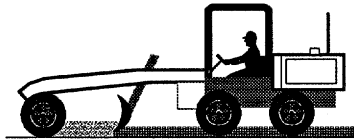

5. Mix with existing and/or new base aggregate material

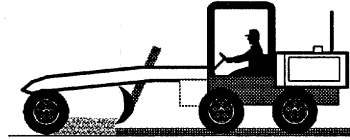

6. Spread upgraded base to specified thickness

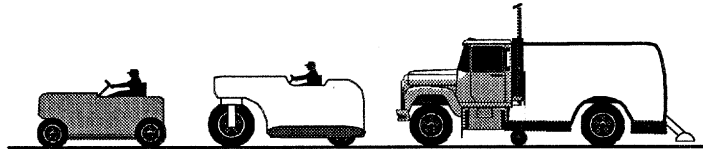

7. Compact, seal and cure

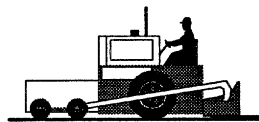

8. Apply wearing surface

Figure 3-4. General sequence of Type 1 CIR operation. <sup>(9)</sup>



especially when asphalt thicknesses are greater than 100 mm. Excessive milling depths are reported to slow production in most cases.<sup>(9)</sup>

*Type 2 CIR—Single unit recycler*

Type 2 CIR is a partial- or full-depth recycling operation that provides a high-quality base or surface course. In comparison to Type 1 CIR, this operation provides better quality control with respect to maintaining a uniform reprocessing depth and to remixing. In addition, Type 2 CIR reduces the recycled material to a smaller and more uniform size. Type 2 CIR is generally limited to a depth of 150 to 200 mm and, as a result, may not be able to treat all pavement defects in a thick, full-depth asphalt pavement.

Type 2 CIR eliminates the need for multiple pieces of equipment and equipment passes for the breaking, crushing, and mixing operations. As shown in figure 3-5, a planer or milling machine is used to perform these operations in a single pass. The new mixture is then either windrowed for spreading by a grader or conveyed to a paver for relaying. Following compaction and curing, a surface layer may or may not be applied. Roughly 1.6 to 3.2 km/day of a standard 3.7-m wide lane can be recycled using this operation.

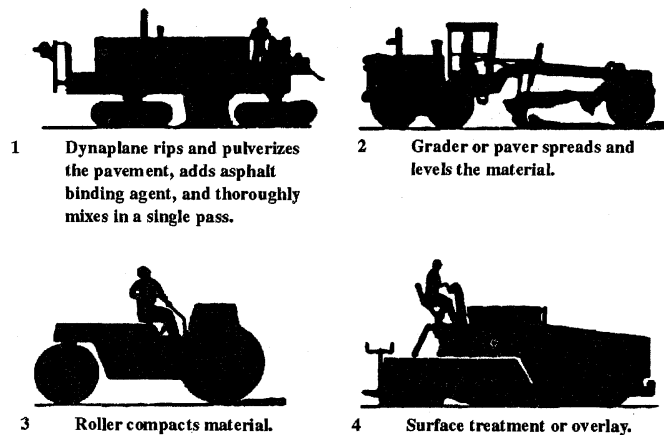

Figure 3-5. General sequence of Type 2 CIR operation.<sup>(9)</sup>

*Type 3 CIR—Recycling train*

Type 3 CIR is the newest and most productive in-place recycling process. Like Type 2 CIR, it is a partial- or full-depth recycling operation that produces a high-quality base or surface course. It differs, however, in the equipment required to carry out the process and, subsequently, in the rate at which the pavement is recycled. For these reasons, it is more appropriate on large recycling jobs.

The process involves the use of large, specialized equipment that work closely together as a recycling train. Figure 3-6 shows a typical recycling train and the flow of material through the individual pieces of equipment.

The train is headed by a milling machine, which grinds off the existing pavement to a depth ideally between 50 and 100 mm. The RAP material is then conveyed to a screening and crushing unit that reduces the material size to less than 30 to 50 mm.



Figure 3-6. Type 3 CIR recycling train.<sup>(9)</sup>

Next, the RAP material is transported to the mixing unit, or traveling pugmill. There it is weighed and mixed with measured amounts of aggregate and recycling agent. The new mixture can be deposited directly into the hopper of a paver or laid down in a windrow for subsequent pick-up by a paver. The paver then spreads the material evenly for compaction by steel-wheeled and/or rubber-tired rollers. Depending on the existing road condition, depth of recycling, terrain, and traffic, the train can recycle 3.2 to 9.7 km/day of a standard 3.7-m wide lane.

### Hot-Mix Recycling

Hot-mix recycling is the process in which all or some portion of the pavement structure is removed, reduced to the desired size, and mixed hot with additional asphalt cement at a central plant. The process normally includes the addition of new aggregate, and may include the addition of a recycling agent.<sup>(4)</sup> The finished product is generally required to meet standard materials specifications and construction requirements for the type of AC mixture being produced (e.g., base, binder, or surface course).<sup>(10)</sup>

In comparison with CIR, hot-mix recycling is a costlier and more labor-intensive operation. Material hauling, hot plant processing, and greater quality control are major contributors to its higher costs. Although there is generally more disruption with hot mix recycling, traffic can be allowed on the recycled pavement much sooner than with CIR because of the shorter curing period. More importantly, the higher level of quality control in the hot-mix recycling process generally results in a more stable and consistent mixture.

The two foremost considerations in selecting hot-mix recycling for a given rehab project are existing pavement condition and cost. As seen in table 3-2, hot-mix recycling is considered a proper remedy for many pavement defects. In general, it can be used to correct mixture deficiencies, to restore pavement smoothness, and to increase the overall strength of the pavement. Because of its higher costs, however, careful comparisons must be made to determine if it is the most cost-effective approach for the combination of defects observed in the existing pavement. This is especially the case for low-volume roads and short rehabilitation projects.

Other matters that must be considered include the suitability of existing materials for recycling and the availability of experienced and properly equipped contractors. In the case of the former, the presence of the following materials may render an existing pavement unsuitable for hot-mix recycling:<sup>(11)</sup>

- More than 10 percent of the pavement material is a seal coat, slurry seal, or cold patch.
- The pavement contains cutback asphalts.
- The pavement contains any coal tars.

Although the availability of experienced and properly equipped contractors has become widespread in recent years, their proximity to the project may be too far for hot-mix recycling to be the most cost-effective rehabilitation strategy.

Because the quality of recycled hot-mix must normally satisfy the requirements of a new AC mixture, a considerable amount of evaluation, testing, and design work is necessary. This often includes the following tasks:

- Reviewing past construction records of the existing pavement.
- Visually assessing the condition of the existing pavement.
- Performing material characterization tests on the stockpiled RAP.
- Formulating a recycled mixture design and determining the proper amounts of new materials (e.g., asphalt, aggregate) to be added to the RAP.
- Performing quality control tests on the recycled mixture to determine if it meets the applicable specifications.

Examples of the design concepts involved in hot-mix recycling can be found in reference 10.

The construction sequence for hot-mix recycling typically consists of the following four activities:

- Full- or partial-depth removal of the pavement.
- Reduction of the RAP to the appropriate size.
- Reprocessing of the RAP through a hot-mix plant with the addition of one or more of the following: virgin aggregate, new asphalt cement, and recycling agent.
- Placement and compaction of the recycled hot-mix as a base, binder, or surface course.

The existing full-depth asphalt pavement is generally removed by milling, although ripping equipment have also been used. With milling, partial- and full-depth pavement removal is possible, and sizing of the RAP is done simultaneously with the pavement removal step. The milling operation is normally performed to an optimum depth of between 50 and 100 mm. And, although single-pass removal to as deep as 200 mm is possible, the operating speed can be greatly reduced and oversized RAP may result, thereby requiring additional sizing.

Complete removal of a full-depth asphalt pavement often requires multiple passes of a milling machine or the use of heavy-duty ripping equipment. While RAP millings are usually reduced to the appropriate size, the RAP produced by ripping equipment must generally undergo additional crushing at the central plant. Central-plant sizing can be performed with conventional, fixed, and portable crushing and screening equipment.<sup>(13)</sup>

Both conventional batch plants and continuous mix (drum-mixer) plants have been used successfully to produce recycled hot-mix.<sup>(4)</sup> Both plant types make use of the heat-transfer method, whereby the RAP is primarily heated through mixing with superheated virgin aggregate. Additional asphalt or recycling agent are also added during the mixing, as called for in the mixture design.

Table 3-2. Guide for selection of AC recycling method.<sup>(12)</sup>

Type of Pavement Distress	Hot-Mix Recycling	Hot In-Place Recycling	Cold In-Place Recycling
Surface Defects			
<i>Raveling</i>	x	x <sup>1</sup>	
<i>Bleeding</i>	x	x <sup>4</sup>	
<i>Slipperiness</i>	x	x <sup>1</sup>	
Deformation			
<i>Corrugations (washboarding)</i>	x	x <sup>4</sup>	
<i>Rutting (shallow)<sup>2</sup></i>	x	x <sup>4</sup>	
<i>Rutting (deep)<sup>3</sup></i>	x		x <sup>5</sup>
Cracking (load associated)			
<i>Alligator</i>	x		x
<i>Longitudinal (wheelpath)</i>	x	x <sup>6</sup>	x
<i>Pavement Edge</i>	x		x
<i>Slippage</i>	x	x <sup>7</sup>	
Cracking (nonload associated)			
<i>Block (shrinkage)</i>	x		x
<i>Longitudinal (joint)</i>	x	x <sup>8</sup>	
<i>Transverse (thermal)</i>	x		x
Reflection Cracking	x		x
Maintenance Patching			
<i>Spray</i>	x <sup>9</sup>		x <sup>9</sup>
<i>Skin</i>	x <sup>9</sup>		x <sup>9</sup>
<i>Pothole</i>	x		x
<i>Deep (hot mix)</i>	x		x
Ride Quality/Roughness			
<i>General Unevenness</i>	x	x	
<i>Depressions (settlement)</i>	x <sup>10</sup>	x <sup>10</sup>	
<i>High Spots (heaving)</i>	x <sup>10</sup>	x <sup>10</sup>	

**Notes:**

- <sup>1</sup> Applicable if the surface course thickness does not exceed 40 mm.
- <sup>2</sup> Rutting is limited to the top 40 to 50 mm of the pavement.
- <sup>3</sup> Rutting originates below the surface course, including base and subgrade.
- <sup>4</sup> May be a temporary correction if entire layer affected not removed or treated by the addition of special admixtures.
- <sup>5</sup> The addition of new aggregate may be required for unstable mixes.
- <sup>6</sup> Applicable if the cracking is limited to the surface course of the pavement.
- <sup>7</sup> Applicable if the treatment is to a depth below the layer where the slippage is occurring.
- <sup>8</sup> Applicable if the cracking is limited to the surface course of the pavement.
- <sup>9</sup> In some instances, spray and skin patches may be removed by cold planing prior to these treatments (consider if very asphalt rich or bleeding).
- <sup>10</sup> May be only a temporary correction if the distress is related to a subgrade problem.

As with conventional hot-mix paving operations, the recycled hot-mix is hauled to the jobsite where it is loaded into the hopper of an asphalt paver for proper laydown. Steel-wheeled and rubber-tired rollers are used to compact the newly laid material to the required density.

### **Resurfacing**

Resurfacing is the process in which an AC or a portland cement concrete (PCC) overlay is placed on the existing pavement to restore serviceability to near original level. AC resurfacing is the most common method of rehabilitating existing pavements, and is the only overlay type to be considered in this manual. The major advantages of AC resurfacing include the wide availability of hot-mix paving contractors and equipment, relatively short disruptions to traffic, and good long-term service. The major disadvantages include the need for careful design and quality control, decreased vertical clearances, potential for reflective cracking, and possible adjustments or level-up work required for adjacent structures (e.g., manholes, curb and gutter, shoulders). In addition, the cost of an overlay can be prohibitive to many local agencies.

AC resurfacing is typically performed to improve the functional or structural performance of a pavement. Functional performance refers to the ability of a pavement to provide a safe, smooth-riding surface for the traveling public. Functional resurfacing generally consists of a thin AC overlay that serves one or more of the following purposes:<sup>(2)</sup>

- Increase skid resistance.
- Improve pavement profile (level up).
- Improve rideability.
- Improve surface drainage.
- Reduce water infiltration.
- Retard environmental deterioration.
- Enhance appearance.

Structural performance refers to the ability of a pavement to withstand traffic and environmental loadings. In contrast with functional resurfacing, structural resurfacing normally involves the use of a thick AC overlay designed to:

- Increase structural capacity of the pavement.
- Reduce the rate of deterioration.

Depending upon the problem in the existing pavement, and on the purpose of the overlay, AC resurfacing may consist of one or more lifts (i.e., paving layers) of material. The lifts may be a part of either the binder course (the structural layer) or the surface course (the top, protective layer), and they generally range from 25 to 200 mm thick. The binder course is sometimes referred to as the

leveling course and the surface course is sometimes referred to as the wearing course.

The material used in each layer can vary in composition. To provide added strength, binder course material typically contains larger sized aggregate and slightly less asphalt cement than surface course material. The smaller sized aggregate and higher asphalt cement content in a surface course material help provide an abrasion-resistant and waterproof surface layer.

AC overlays may be applied in conjunction with recycling operations to provide a protective surface. Such overlays are particularly common with cold-milling (surface removal) and cold in-place recycling (CIR) operations.

To successfully design and construct an AC overlay, a thorough examination must be made of the existing pavement, as detailed in module 2 of this manual. This examination should reveal the prime cause of pavement deterioration so that proper pre-overlay repairs or treatments can be specified and so that an adequate overlay thickness can be determined.

The construction sequence for AC resurfacing consists of the following steps:

- Application of pre-overlay repairs or treatments to the existing pavement.
- Processing of blended aggregate and asphalt cement at a hot-mix asphalt plant to produce a hot, homogeneous asphalt paving mixture.
- Placement and compaction of the hot-mix as a leveling, binder, or surface course.

Pre-overlay repairs or treatments of deteriorated, full-depth asphalt pavement occasionally include one or more of the following:

- Localized patching of potholes or fatigue-cracked (alligatored) areas.
- Level-up patching of rutted wheelpaths.
- Treatment of thermal cracks to delay reflection cracking in the overlay.
- Surface leveling of sags and depressions.
- Cleaning and applying a tack coat to the existing surface to improve bonding between the existing asphalt surface and the AC overlay.

Hot-mix production may take place at either a batch plant or a continuous mix plant. In a batch plant, aggregate is screened into different sizes, weighed to the specified proportions, blended, and heated and dried in a dryer. Next, the aggregate is emptied into a pugmill where it is blended together and mixed with the proper amount (by weight) of heated asphalt cement. The entire batch of hot-mix is then discharged into a haul vehicle.

In a continuous-mix plant, screened and heated aggregate is continuously proportioned and transported to the pugmill. Asphalt cement is then sprayed on the aggregate at a rate that is calibrated with the movement of aggregate. The two materials are continuously mixed in the pugmill and are discharged into a temporary hopper for delivery to the haul vehicle.

After being hauled to the jobsite, the hot-mix is loaded into the hopper of an asphalt paver for proper laydown. Steel-wheeled rollers and rubber-tired rollers are then used to compact the newly laid material to the required density. Achieving the proper density is essential. Insufficient density (compaction) may lead to rutting problems or stripping (from moisture penetrating the surface). Too much compaction of the AC can cause construction cracking and bleeding.

### **Surface Treatment**

Surface treatment is a broad term that embraces several types of asphalt and asphalt-aggregate applications, usually less than 25 mm thick, placed on any kind of roadway surface.<sup>(3)</sup> The general purpose of these applications is to improve or protect the surface characteristics of the roadway. They provide no structural improvement to the pavement.

Although surface treatment techniques have long been used for rehabbing low-volume roads, recent advancements in technology have led to their successful use on higher volume roads and streets. When used in the proper situations, they provide a low-cost, protective surface that extends pavement life and reduces required maintenance expenditures.

The specific functions of surface treatment techniques can be summarized as follows:<sup>(4)</sup>

- Provide a new wearing surface.
- Seal minor cracks in the surface.
- Waterproof the surface.
- Improve skid resistance and surface drainage.
- Slow pavement weathering.
- Improve pavement appearance.
- Provide visual distinction between the mainline pavement and the shoulder.
- Rejuvenate the top 6 mm of an AC surface.

Surface treatment techniques are classified by their composition and by their use. A total of nine techniques are available for use on full-depth asphalt pavements. A description of each of these techniques and the specific functions they serve are provided in the sections below.



### Asphalt Chip Seal

An asphalt chip seal consists of sequential applications of asphalt (asphalt cement, cut-back asphalt, or asphalt emulsion) and stone chips to form a surface layer as thick as 25 mm. The combined application may be applied once (single chip seal) or may be repeated two or three times (double or triple chip seals).

The primary objectives of the asphalt chip seal are to provide a new, durable surface course and to increase skid resistance. Although their past use has typically been on low-volume roads, recent improvements in design and construction have resulted in greater use on higher volume roads.

The construction sequence for a single asphalt chip seal consists of the following four steps:<sup>(6)</sup>

- Clean the existing surface to remove dirt and other loose materials.
- Apply the asphalt material at the specified rate and temperature using a calibrated asphalt distributor.
- Immediately spread the stone chips evenly over the surface at the specified rate using a properly calibrated aggregate spreader.
- Immediately roll the stone chips with a rubber-tired roller to firmly seat them in the asphalt and against the underlying layer.

Depending on the type of asphalt material used and the posted speed limit, the chip-sealed road can be opened to traffic within 0.5 to 2 hours.

### Open-Graded Friction Course

Open-graded friction courses (OGFC), also called plant mix seals or popcorn mixes, are porous surface mixes produced with large amounts of voids (minimum 15 percent) that allow water to drain rapidly through the mix and flow to the side of the road. These mixes are used to improve the friction properties of the surface and also reduce tire spray and the potential for hydroplaning, thereby reducing wet weather accidents. The OGFC also tends to provide a quieter riding surface, as it produces lower tire noise. Typical thicknesses of OGFC are 25 to 50 mm.<sup>(4)</sup>

OGFC contain a more open gradation (i.e., small amount of fines and more particles of one size) than conventional dense graded materials. However, OGFC mixtures are produced and placed in a manner similar to dense-graded hot mixes. A tack coat is needed prior to the placement of the OGFC and compaction is accomplished solely by a static steel-wheeled roller. This is because vibratory rollers can damage the aggregate and rubber-tired rollers tend to pick up the asphalt.

### Rubberized Asphalt Chip Seal

A rubberized asphalt chip seal is a special type of chip seal in which rubber (latex or ground tire rubber) is blended with asphalt cement. This application can be used solely as a stress-absorbing membrane (SAM) or in conjunction with an overlay as a stress-absorbing membrane interlayer (SAMI).

In both applications, the purpose is to reduce the reflection of underlying cracks through the surface layer. The latex or ground rubber tires adds resiliency to the asphalt, which improves bonding with the aggregate and reduces the tackiness and ravelling of the surface. The added resiliency also enables the seal to "bridge" existing cracks better.

The construction of a rubberized asphalt chip seal is similar to the construction of an asphalt chip seal. The major difference is the use of a modified applicator for spraying the thicker rubberized asphalt binder.<sup>(6)</sup>

### Slurry Seal

A slurry seal is a homogeneous mixture of asphalt emulsion, water, fine aggregate, and mineral filler that has a creamy, fluid-like appearance.<sup>(6)</sup> It is effective in sealing surface cracks, waterproofing the pavement surface, and improving skid resistance at speeds below about 65 kph. Three types of slurry seal are available that differ by the size of aggregate used. The type with the finest aggregate is primarily used for sealing purposes, while the type with the largest aggregate is primarily used for improving skid resistance and filling slight depressions.

The slurry seal mixture is produced on-site in a special truck-mounted, traveling mixer. Once mixed, the slurry is dumped into a spreader box attached to the back of the vehicle. The spreader box spreads the slurry onto the cleaned pavement and an attached squeegee smooths the material into a layer between 3 and 6 mm thick. Rolling is not generally necessary and, depending on the weather, traffic can be allowed on the pavement within 2 to 12 hours.

### Micro-Surfacing

Developed in Europe, micro-surfacing is a term used to describe the application of a polymer-modified slurry seal, with latex rubber being the most commonly used polymer. Micro-surfacing materials consist of asphalt and latex mixed with aggregate, fillers, and other additives and is a modification of the slurry and sand seal.<sup>(4)</sup> It has been used as a wearing surface and for rut-filling. Ralumac is probably the most widely known example of this process in the United States.

The construction sequence for micro-surfacing resembles that of slurry seals. A modified traveling plant mixer is used to continuously load materials from haul vehicles and mix them on-site. An adjustable width spreader box is used for resurfacing purposes, while individual drag boxes are used for rut-filling purposes. Rolling is generally not required and the pavement can typically be opened to traffic within 1 hour.

#### Fog Seal

A fog seal is a very light application of an asphalt emulsion (with no aggregate) to an oxidized asphalt surface. The purpose of the application is to rejuvenate the oxidized asphalt and seal fine cracks so that the need for more corrective rehabilitation is postponed for 1 or 2 years.

The treatment is most suitable for low-volume roads that can be closed to traffic for the 4 to 6 hours required for the material to sufficiently set. It is widely used along AC shoulders to help provide a distinct delineation between the mainline pavement and the shoulder. Application involves spraying the material at a specified rate using an asphalt distributor.

#### Sand Seal

A sand seal is a spray application of asphalt emulsion followed by a light covering of sand or screening. This application serves the same function as a fog seal, but provides better surface friction. However, the surface appearance of a sand seal does not provide the delineation that a fog seal does.

The placement of a sand seal is typically 2 to 5 mm thick. Once the sand covering has been applied to the asphalt emulsion, a rubber-tired roller is used to firmly embed the sand in the asphalt. The pavement can be opened to traffic once the seal has sufficiently set (typically about 2 hours).

#### Cape Seal

A cape seal is a combination of both an asphalt chip seal and a slurry seal. The advantage of the cape seal is that a thicker, more durable surface is obtained, and it can be used on higher volume roads.<sup>(4)</sup> The cape seal typically results in a smoother pavement with a more pleasing appearance, and can provide added skid resistance.

The construction process consists of the chip seal being applied first, followed by the application of the slurry seal between 4 and 10 days later.

### Sandwich Seal

A sandwich seal consists of an application of asphalt (asphalt emulsion or asphalt cement), sandwiched between two applications of different sized aggregate. The primary objectives of the sandwich seal are to provide a new wearing course and to increase skid resistance.

Typical sandwich seals are constructed between 6 and 19 mm thick. The construction process consists of the following five steps:

- Cleaning the existing surface.
- Application of the first aggregate at 60 to 80 percent coverage.
- Application of the asphalt material at the specified rate and temperature.
- Application of the second aggregate (smaller size than first aggregate) to sufficiently fill the voids left by the first aggregate.
- Rolling of the aggregate with a rubber-tired roller to firmly seat it in the asphalt.

Depending on the type of asphalt material used, the pavement can generally be reopened to traffic within 2 hours.

### **3. SELECTION OF THE MOST APPROPRIATE REHAB OPTION**

Thus far, course participants have been introduced to the various rehabilitation procedures used to improve the serviceability of full-depth asphalt roadways. In this section, participants will be instructed on the process used to determine the preferred rehab option for a given project.

In the decision-making process for selection of the preferred rehab strategy, the following steps are fundamental:<sup>(14)</sup>

- Determination of the cause of distress(es) or problems of the pavement.
- Development of a candidate list of solutions that will properly address, cure, and/or prevent future occurrences of the problem.
- Selection of the preferred rehabilitation strategy, given economic and other project constraints.

The first step is completed using the pavement evaluation procedures provided in module 2, and is therefore not discussed here.

The second step involves the consideration of other (many noneconomic) factors toward the goal of identifying a few practical options (typically between two and four). These factors largely consist of the following:

- Functional requirements.
- Structural requirements.
- Drainage.
- Local experience and manpower.
- Availability of resources.
- Construction considerations.
- Limited project funding.

To determine which of the resulting practical options is the most cost-effective (and thus the preferred rehabilitation method), a life-cycle cost analysis is recommended. This analysis takes into consideration the various costs and estimated performance of each option over its anticipated life and generates a standard unit of cost by which the options can be compared.

Brief descriptions of the various selection factors and how they affect the different rehab methods are provided in the following sections.

### **Noneconomic Factors**

#### **Functional Requirements**

Frequently, the main objective in a rehabilitation project is to increase the functional adequacy of the pavement (i.e., increase skid resistance and/or ride quality). As a result, some alternatives can be quickly shortlisted for further consideration. These alternatives often include the following:

- Functional AC overlay.
- Asphalt chip seal.
- OGFC.
- Slurry seal.
- Microsurfacing.
- Sand seal.
- Cape seal.
- Sandwich seal.
- Pavement removal.
- Hot-surface recycling.

Further shortlisting can be done given the specific functional improvement desired.

#### **Structural Requirements**

In situations where the major rehabilitation objective is to significantly increase structural capacity, the list of practical alternatives can be narrowed to the following:

- Structural AC overlay.
- CIR (types 1, 2, and 3).
- Hot-mix recycling.
- Pavement removal with thick AC overlay.
- Hot surface recycling with thick AC overlay.

Each of these methods can be used to meet the desired structural requirements. However, only CIR and hot-mix recycling have the capability of fully correcting the structural defects (e.g., alligator cracks and rutting) in the asphalt layers.

### Drainage

If the pavement evaluation reveals a serious drainage problem, immediate consideration must be given to those options that will best remedy the drainage and other problems. Since full-depth asphalt pavements are used to negate the weakening effects of water on the base layer, drainage problems in these structures are generally confined to the surface layer. Here, standing water may be the result of either poor cross-slope (e.g., rutting) or a surface that does not drain well. Practical options for addressing these problems consist of the following:

<u>Poor cross-slope</u>	<u>Non-draining surface</u>	<u>Other methods</u>
Pavement removal	OGFC	Deepen ditches
Hot surface recycling	Asphalt chip seal	Place culverts
Microsurfacing	Hot surface recycling	Clean outlets
Asphalt chip seal		

### Local Experience and Manpower

The availability of local contractors with experience in the various rehabilitation methods is often a major factor in the selection process. Local contractors inexperienced with some methods may simply not be capable of performing those methods or of providing the quality, timeliness, and economics desired of those methods. One option which should be examined in this situation is the added cost associated with retaining outside contractors experienced in the methods that are not practiced locally.

In general, the availability of local contractors experienced in each of the three rehabilitation types is fairly good. Although recycling is not practiced nearly as much as resurfacing and the placement of surface treatments, the availability of local contractors capable of successful recycling operations is steadily growing. Likewise, some of the more specialized surface treatment techniques, such as micro-surfacing and OGFC, are also catching on.

### Resource Requirements

Additional up-front costs can generally be expected if local contractors are improperly equipped or if the necessary materials are not readily available. In the first case, the additional costs stem from greater mobilization and hauling, as an experienced outside contractor must be used. In the second case, the additional costs stem primarily from hauling, as material (usually aggregate) must be shipped in from distant sources.

The availability of recycling equipment and some surface treatment equipment are limited in some areas. Devices such as those used in CIR and microsurfacing operations are still relatively new and, in the case of the former, quite expensive.

The lack of strong and durable local aggregate can be a concern with either of the three general rehabilitation alternatives. Local aggregate that is soft and nondurable will adversely impact performance and must be avoided. Additionally, local aggregate producers may not process aggregate into the sizes or shapes required by particular asphalt-aggregate mixtures. This is occasionally a concern with some of the surface treatment techniques, such as micro-surfacing.

### Construction Considerations

Although there are several construction factors worthy of consideration, the following are among the most common:

- Traffic control requirements.
- Geometric constraints.
- Suitability of existing pavement materials for recycling.

The time period for which a road must be partially or completely shut down can often determine which methods get shortlisted for further consideration and which ones do not. Obviously, the methods that result in the greatest disruptions to traffic will be least desirable by the traveling public. Such disruptions are often tied to material production rates, operational rates of the equipment, and pavement curing times.

Geometric constraints can occasionally limit which alternatives get further consideration. These constraints typically include the following:

- In-the-road manholes.
- Curb and gutter.
- Clearances beneath bridges and overhead signs.
- Utilities.

On occasion, the existing asphalt pavement may be unsuitable for recycling due to the presence of harmful materials or excessive material variability. In the case of the former, considerable amounts of tar, asphalt cutback, and asphalt emulsion in the existing pavement can pose operational problems with air quality or mix design quality. In the case of the latter, several changes in material composition throughout the project can result in excessive reprocessing changes and, possibly, excessive testing requirements.

### **Economic Factors**

#### Limited Project Funding

If the funds available for a particular project are somewhat limited, then it is likely that some of the rehabilitation methods with the highest up-front costs will have to be dropped from consideration. This may, however, result in the dismissal of some of the more cost-effective methods, in which case extra efforts to secure more funding could be justified.

#### Performance Considerations

One important aspect in determining the most cost-effective rehabilitation alternative is the performance of the pavement after it has been rehabilitated. Although performance is defined as the area under a serviceability-time curve (figure 3-2), a commonly used indicator of performance is service life. This is the period of time that a rehabilitated pavement will last before reaching a minimum acceptable serviceability level.

The performance characteristics depend largely on the following factors:

- Climatic conditions.
- Traffic volumes.
- Existing pavement condition.
- Quality of materials.
- Mixture design.
- Construction quality.

Because of these factors, the experiences of agencies with the different rehab methods vary widely. Figure 3-7 shows the expected service lives of a few of the rehabilitation methods based on a 1986 survey of several cities and counties.<sup>(9)</sup> As can be seen, resurfaced pavements are expected to last the longest, followed closely by in-place recycled pavements. Surface treated pavements, however, are generally expected to provide about one-third the life of resurfaced pavements.



**ASPHALT SURFACE MAINTENANCE TECHNIQUES  
EXPECTATION LEVELS (in years)**

183 responses

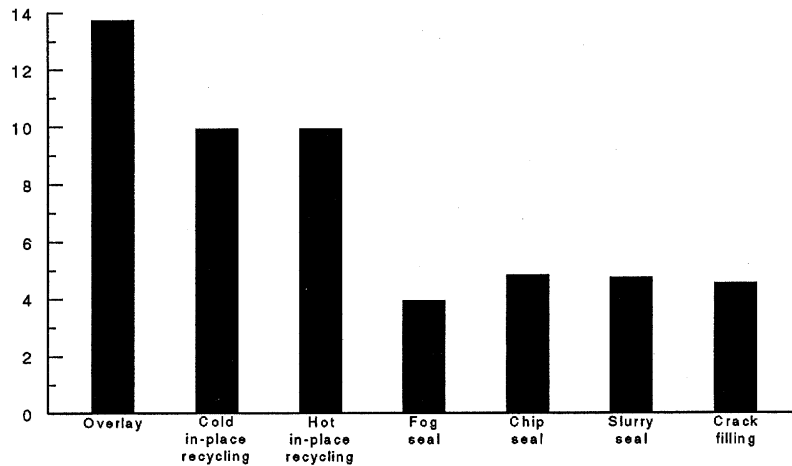

Figure 3-7. Expected life of various rehab methods.<sup>(9)</sup>

Life-Cycle Costs

To determine the most cost-effective rehab option, a fixed analysis period must first be established. This analysis period may range from 5 to 25 years, depending on programmed funding and the desire for long-term planning. A strategy must then be developed for each rehabilitation option such that pavement serviceability remains above a minimum acceptable level over the analysis period. As seen in figure 3-8, a strategy may consist solely of the rehabilitation alternative or may involve the alternative combined with a series of future maintenance or rehabilitation activities.

Once alternative strategies have been developed, the life-cycle costs associated with each strategy can be estimated. These are the projected costs assumed by the local-roads agency and the traveling public during the analysis period. In the case of roadway rehabilitation, the following life-cycle costs should be considered:

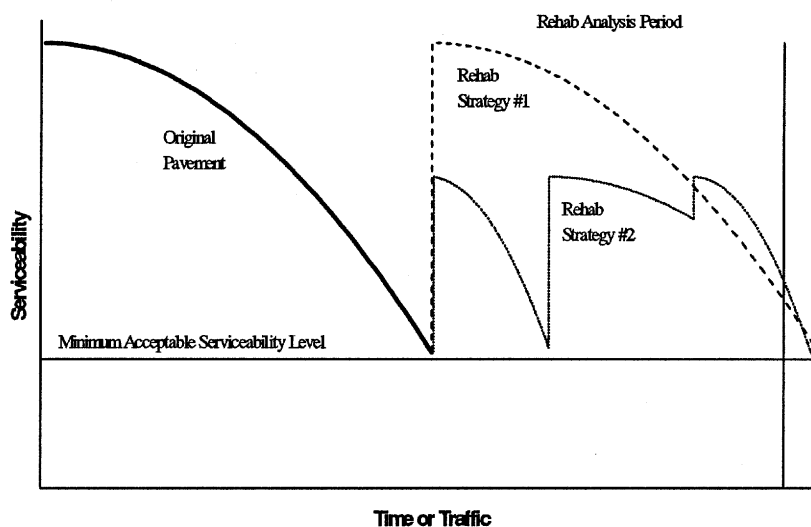

Figure 3-8. Example of different rehab strategies for a given analysis period.

- **Engineering and administrative costs**—The costs of evaluating the existing pavement, selecting the preferred rehab option, designing the rehabilitated pavement, and preparing the necessary plans and specifications for the rehab work.
- **Rehabilitation costs**—The costs associated with initial and future rehabilitation activities intended to restore the pavement to an acceptable serviceability level.
- **Maintenance costs**—The costs associated with maintaining a pavement at or above some predetermined performance level. These costs include both preventive and corrective maintenance costs, but not rehab costs.
- **Salvage value**—The value of the pavement at the end of the life cycle or analysis period.
- **User costs**—The costs assumed by the traveling public in the form of delay costs, increased operating costs, and accidents.

Life-Cycle Cost Analysis

Several methods of economic analysis have been used to compare the cost-effectiveness of different strategies. The more common methods, which are briefly discussed below, require the use of a discount rate to account for the time value of money. The discount rate is used to convert future predicted costs or benefits to their present worth or to uniform annual costs so that the economics of

the different strategies can be compared. The discount rate is commonly taken as the difference between the interest and inflation rates.<sup>(15)</sup> Historically, discount rates in the range of 3 to 5 percent have been common.

- **Present-worth method**—This method involves converting all future costs associated with a particular strategy to present-worth costs. These converted costs and the initial rehab costs are then used to obtain a single, present-worth cost that can be directly compared with the present-worth costs of the other alternatives.
- **Annualized method**—This method involves converting all present and future costs associated with a particular strategy to a uniform annual cost over the analysis period. This uniform annual cost can then be directly compared with the uniform annual costs of the other alternatives. This method is preferred when the estimated service lives of various alternatives are different.
- **Benefit-cost ratio method**—This method involves expressing the ratio of present-worth benefits of a particular strategy to its present-worth costs. Strategies that result in a benefit-cost ratio greater than one are considered economical and the strategy that produces the highest incremental ratio with respect to other strategies is considered the best choice.
- **Rate-of-return method**—This method consists of determining the discount rate at which the cost and benefit for a given strategy are equal. The strategy with the highest first cost that exceeds a minimum acceptable rate of return (specified by the agency) is considered to be the best alternative.

Although the benefit-cost ratio method is used frequently in the highway field, it is occasionally difficult to understand. And, although the rate-of-return method has the distinct advantage of not requiring knowledge of a discount rate, it can be very time-consuming and it has situational flaws.

The present-worth method and the annualized method are the preferred methods of analysis and are therefore presented in this manual. The concepts behind each of these methods are easily understood and the analyses are relatively straightforward to perform.

In the present-worth method, future lump-sum costs and uniform annual costs are converted to present-worth values using the following two equations:

$$PW = F \times \frac{1}{(1+i)^n} \quad (1)$$

where: PW = Present-worth cost.  
F = Future cost at the end of n years.  
i = Discount rate.  
n = number of years.

$$PW = A \times \frac{(1+i)^n - 1}{i(1+i)^n} \quad (2)$$

where: PW = Present-worth cost.  
A = Uniform annual costs for n years.  
i = Discount rate.  
n = number of years.

In the annualized method, present-worth costs are converted to uniform annual costs using the following equation:

$$A = PW \times \frac{i(1+i)^n}{(1+i)^n - 1} \quad (3)$$

where: A = Uniform annual cost over analysis period of n years.  
PW = Present-worth cost.  
i = Discount rate.  
n = number of years in analysis period.

In each case, the costs for each option are determined and the option with the lowest cost represents the most cost-effective solution.

However, because of the other noneconomic factors included, the alternative with the lowest life cycle cost may not be the preferred solution.

Examples of the present-worth method and the annualized method are provided in figures 3-9 and 3-10, respectively.

<b>Comparing Rehab Strategies</b>	
<b>Rehab Strategy A</b>	
Initial cost:	\$100,000
Rehab at 10 years:	\$ 65,000
Salvage value:	\$ 20,000
Estimated service life:	15 years
<b>Rehab Strategy B</b>	
Initial cost:	\$120,000
Maintenance at 5 years:	\$ 12,000
Maintenance at 12 years:	\$ 18,000
Salvage value:	\$ 40,000
Estimated service life:	15 years
Specified Discount Rate:	4 percent
<b>Analysis</b>	
<b>Rehab Strategy A</b>	
PW (initial cost) =	\$100,000
PW (rehab at 10 years) = $65,000 \times [1/(1+0.04)^{10}] =$	+ \$ 30,107
PW (salvage at 15 years) = $20,000 \times [1/(1+0.04)^{15}] =$	- \$ 6,305
<b>Total Present Worth of Rehab Strategy A</b>	<b>\$123,802</b>
<b>Rehab Strategy B</b>	
PW (initial cost) =	\$120,000
PW (maintenance at 5 years) = $12,000 \times [1/(1+0.04)^5] =$	+ \$ 8,167
PW (maintenance at 12 years) = $18,000 \times [1/(1+0.04)^{12}] =$	+ \$ 7,148
PW (salvage at 15 years) = $40,000 \times [1/(1+0.04)^{15}] =$	- \$ 12,609
<b>Total Present Worth of Rehab Strategy B</b>	<b>\$122,706</b>
<b>Based on the given assumptions, rehab strategy B is the more cost-effective strategy.</b>	

Figure 3-9. Example of present-worth method of economic analysis.

<b>Comparing Rehab Strategies</b>	
<b>Rehab Strategy A</b>	
Initial cost:	\$150,000
Maintenance at 10 years:	\$ 25,000
Rehab at 15 years:	\$ 80,000
Salvage value:	\$ 40,000
Estimated service life:	20 years
<b>Rehab Strategy B</b>	
Initial cost:	\$130,000
Maintenance at 5 years:	\$ 15,000
Rehab at 10 years:	\$ 65,000
Salvage value:	\$ 20,000
Estimated service life:	20 years
Specified Discount Rate:	4 percent
<b>Analysis</b>	
<b>Rehab Strategy A</b>	
A (initial cost) = $150,000 \times \frac{[(0.04)(1+0.04)^{20}]}{[(1+0.04)^{20}-1]}$	\$15,278
PW (maintenance at 10 years) = $25,000 \times [1/(1+0.04)^{10}]$	= \$11,580
A (maintenance at 10 years) = $11,580 \times \frac{[(0.04)(1+0.04)^{20}]}{[(1+0.04)^{20}-1]}$	+ \$ 1,179
PW (rehab at 15 years) = $80,000 \times [1/(1+0.04)^{15}]$	= \$25,219
A (rehab at 15 years) = $25,219 \times \frac{[(0.04)(1+0.04)^{20}]}{[(1+0.04)^{20}-1]}$	+ \$ 2,569
PW (salvage at 20 years) = $40,000 \times [1/(1+0.04)^{20}]$	= \$8,582
A (salvage at 20 years) = $8,582 \times \frac{[(0.04)(1+0.04)^{20}]}{[(1+0.04)^{20}-1]}$	- \$ 874
<b>Total Annual Cost of Rehab Strategy A</b>	<b>\$18,152</b>
<b>Rehab Strategy B</b>	
A (initial cost) = $130,000 \times \frac{[(0.04)(1+0.04)^{20}]}{[(1+0.04)^{20}-1]}$	\$13,241
PW (maintenance at 5 years) = $15,000 \times [1/(1+0.04)^5]$	= \$10,209
A (maintenance at 5 years) = $10,209 \times \frac{[(0.04)(1+0.04)^{20}]}{[(1+0.04)^{20}-1]}$	+ \$ 1,039
PW (rehab at 10 years) = $65,000 \times [1/(1+0.04)^{10}]$	= \$30,108
A (rehab at 10 years) = $30,108 \times \frac{[(0.04)(1+0.04)^{20}]}{[(1+0.04)^{20}-1]}$	+ \$ 3,067
PW (salvage at 20 years) = $20,000 \times [1/(1+0.04)^{20}]$	= \$4,291
A (salvage at 20 years) = $4,291 \times \frac{[(0.04)(1+0.04)^{20}]}{[(1+0.04)^{20}-1]}$	- \$ 437
<b>Total Annual Cost of Rehab Strategy B</b>	<b>\$16,910</b>
<b>Based on the given assumptions, rehab strategy B is the more cost-effective strategy.</b>	

Figure 3-10. Example of annualized method of economic analysis.

REFERENCES

1. Huang, Y.H., *Pavement Analysis and Design*, Prentice Hall, Inc., 1993.
2. *Pavement Design: Principles and Practices*, Training Course Manual, National Highway Institute, September 1987.
3. Asphalt Institute, *Asphalt Surface Treatments: Construction Techniques*, Educational Series No. 12 (ES 12), February 1982.
4. *Techniques for Pavement Rehabilitation*, Training Course Manual, National Highway Institute, Federal Highway Administration, Fifth Revision, May 1993.
5. Roberts, F.L., P.S. Kandhal, E.R. Brown, D.Y. Lee, and T.W. Kennedy, *Hot-Mix Asphalt Materials, Mixture Design, and Construction*, First Edition, National Asphalt Pavement Association, Education Foundation, 1991.
6. Heitzman, M.A., *State of the Practice: Design and Construction of Asphalt Paving Materials with Crumb Rubber Modifier*, Report No. FHWA-SA-92-022, Federal Highway Administration, May 1992.
7. *Techniques for Pavement Rehabilitation*, Training Course Manual, National Highway Institute, Federal Highway Administration, Third Revision, October 1987.
8. Epps, J.A., *Cold-Recycled Bituminous Concrete Using Bituminous Materials*, NCHRP Synthesis of Highway Practice 160, National Cooperative Highway Research Program, July 1990.
9. Wood, L.E., T.D. White, and T.B. Nelson, *Current Practice of Cold In-Place Recycling of Asphalt Pavements*, Transportation Research Record 1178, Transportation Research Board, 1988.
10. Asphalt Institute, *Asphalt Hot-Mix Recycling*, Manual Series No. 20 (MS 20), Second Edition, 1986.
11. Asphalt Institute, *The Asphalt Handbook*, Manual Series No. 4 (MS 4), 1988.
12. Asphalt Recycling and Reclaiming Association, *An Overview of Recycling and Reclamation Methods for Asphalt Pavement Rehabilitation*, August 1992.

13. Epps, J.A., D.N. Little, R.J. Holmgreen, and R.L. Terrel, *Guidelines for Recycling Pavement Materials*, NCHRP Report 224, National Cooperative Highway Research Program, September 1980.
14. *AASHTO Guide for Design of Pavement Structures*, American Association of State Highway and Transportation Officials, 1986.
15. Peterson, D.E., *Life-Cycle Cost Analysis of Pavements*, NCHRP Synthesis of Highway Practice 122, National Cooperative Highway Research Program, December 1985.



# MODULE 4

## THICK-LIFT ASPHALT ROADWAYS

### 1. INTRODUCTION

In this manual, thick-lift asphalt roadways are defined as asphalt pavements that have a surface layer greater than 50 mm thick and a granular or soil base layer above the existing subgrade. Figure 4-1 shows a typical thick-lift pavement structure. The asphalt layer in thick-lift pavements can be up to 150 mm thick, and may consist of a specially designed mix placed in a single lift or a traditional asphalt surface or base material placed in several lifts.

One advantage to using a single thick layer is a reduction in mobilization costs for the paving crew and hot mix asphalt plant. Another advantage is the fact that thicker lifts will cool more slowly, allowing material to be placed later in the year with less risk of compaction problems. Disadvantages to using thick single-lift asphalt layers include increased risk of damage to the surface by construction equipment, and the lack of options should soft subgrade or poor drainage areas be discovered during paving.<sup>(1)</sup> Multiple lifts of asphalt can be used to bridge over small, isolated weak areas.

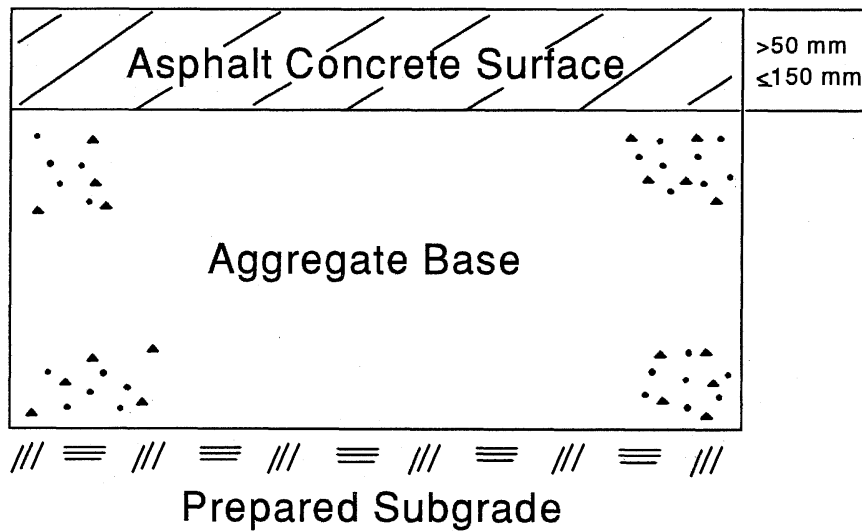

Figure 4-1. Typical thick-lift asphalt roadway cross-section.

The top layer(s) in a thick-lift asphalt road generally consists of asphalt concrete (AC), and may include a surface treatment to improve the surface texture and to seal out moisture. The functions of the AC layer(s) are to provide both a smooth driving surface and a load-carrying layer within the pavement structure.

The second layer, referred to as the granular base course, consists of aggregate material placed on the existing subgrade. This layer serves as a construction platform during the placement of the asphalt concrete layer, and also functions as a load-carrying layer. In most cases, the aggregate base course will consist of a crushed rock material.

The foundation on which the aggregate base course and asphalt concrete layers rest usually consists of the natural soil that exists along the roadway. Occasionally, however, the existing soil may be too soft or unstable to provide an adequate platform for placing the aggregate base course, or would require an excessive amount of aggregate and asphalt concrete to provide adequate protection from traffic. In this case, the deficient soil may be replaced with higher quality soils or may be treated with an additive (e.g., lime, cement) to strengthen or stabilize the soil.

## **2. APPROPRIATE REHAB OPTIONS**

When a roadway is first constructed, it is built to a relatively high level of ride quality, or serviceability. As time goes on, the combined effects of traffic, age, and climate cause the pavement to deteriorate, or decrease in serviceability. The general pattern of pavement deterioration is such that serviceability remains high for a period of time and then begins to drop off fairly quickly, as shown in figure 4-2.

At some point along the serviceability-time curve, a decision must be made to rehabilitate the pavement in order to restore it to a more acceptable serviceability level. Typically, rehabilitation is considered appropriate for pavements ranging in serviceability between poor and good. Reconstruction is often the more cost-effective strategy for pavements having very poor serviceability.

There are essentially three main rehab options available for thick-lift asphalt concrete roadways. These options include the following:

- Recycling.
- Resurfacing.
- Surface treatment.

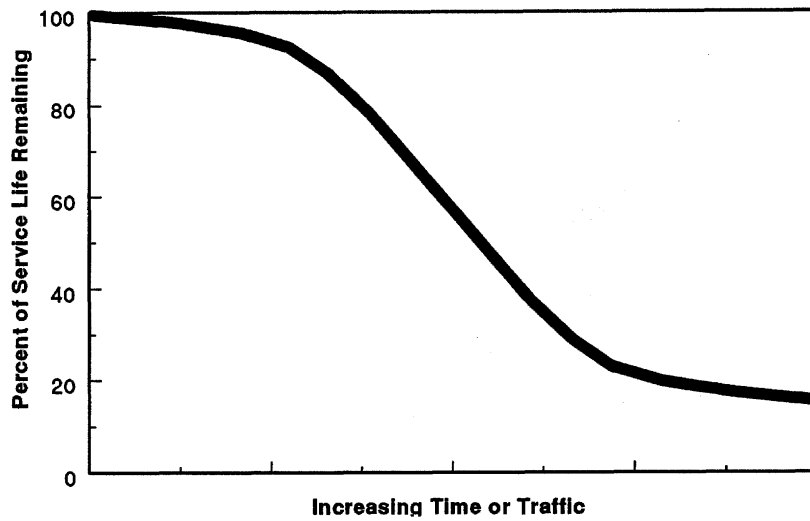

Figure 4-2. Pavement deterioration versus time/traffic.

Descriptions and appropriate uses of these alternatives, as well as the specific applications and procedures available under each alternative, are provided in the following sections.

### Recycling

Recycling refers to any process that utilizes materials from an existing pavement for reuse in the same or other pavements. In the case of the former, the reclaimed materials may be reprocessed immediately through an on-the-spot recycling train or in a relatively short time through a central asphalt plant. In the case of the latter, the reclaimed materials may be reprocessed and then used on a different roadway.

The major advantages of asphalt pavement recycling include reduced costs and the conservation of materials (e.g., asphalt binder, aggregate) and the energy required to process those materials. Additional benefits include eliminating the need for material disposal and, occasionally, preserving roadway geometrics (i.e., eliminating the need for raising manholes, accommodating vertical clearances).

The major disadvantages of asphalt pavement recycling include the possible lack of experienced or properly equipped local contractors and of suitable in-place materials for recycling. The consequence of each of these is usually higher rehabilitation costs.

Various classification schemes have been applied to asphalt pavement recycling operations, based on one or more of the following items:

- Absence/inclusion of heat in the recycling process (cold or hot process).
- Location of material remixing (in-place or at central mixing plant).
- Depth of pavement removal or reworking (surface, surface and base).

One of the more common classification schemes consists of the following three categories:

- Surface recycling.
- Cold-mix recycling.
- Hot-mix recycling.

Surface recycling is a hot or cold, in-place process that targets the top 25 to 50 mm of pavement. Both cold- and hot-mix recycling operations target the surface and a portion or all of the base. However, cold-mix recycling can be done either in-place or at a central plant, while hot-mix recycling is performed at a central plant.

Each recycling category contains several different procedures, with each procedure generally best suited for certain situations. Furthermore, the application of a surface layer (e.g., surface treatment, AC overlay) on top of the recycled layer may be required.

#### Surface Recycling

Surface recycling is the process by which the surface of an asphalt pavement is removed or reworked to a depth of less than 25 to 50 mm. This operation is divided into two basic processes: pavement removal and hot surface recycling. Each process, unique in terms of objectives and the equipment and procedures used, is discussed in further detail below.

Because surface recycling does not affect the base layer and soil foundation, it cannot be seriously considered as a rehab option for pavements containing structural, moisture, or subsurface material problems. Such problems can be addressed by hot-mix and cold-mix recycling operations.

#### *Pavement Removal*

Removal of the top 25 to 50 mm of surface material can be a useful rehab technique by itself or in preparation for resurfacing with AC. Situations that are generally appropriate for pavement removal include the following:<sup>(7)</sup>

- Correction of low- and medium-severity rutting that has developed in the upper layer of asphalt.
- Corrections to areas of bleeding, ravelling, and poor skid-resistance.
- Reestablishing cross-slope for proper surface drainage.
- Removing bumps and, consequently, pavement roughness.
- Reducing or eliminating the need for feathering of a subsequent overlay along gutters or near bridge abutments.
- Improvement of bond between existing asphalt surface and subsequent AC overlay.

Pavement removal is most often accomplished with one of three pieces of equipment. These include:

- Heater-Planer.
- Cold Milling Machine.
- Hot Milling Machine.

The heater-planing operation consists of a mobile heating unit equipped with, or followed by, a blading device. Auxiliary clean-up equipment (e.g., front-end loader and dump truck) are required to remove the bladed material from the pavement.

The heater-planer heats the top fraction of pavement, which is then bladed off and removed for possible reuse as a recycled mix. The heating systems typically used include radiant-heat emitters or open-flame burners, both of which are enclosed by a hood that directs the heat onto the pavement. A diagram of the various construction options available using the heater-planer is shown in figure 4-3.

Surface recycling is often performed with a cold milling machine. The cold milling machine uses carbide-tipped cutter bits mounted on a large revolving drum to grind the pavement surface into small asphalt millings and allows for various depths of removal. The millings are typically picked up by the milling machine and then loaded onto a dump truck using an attached conveyor belt. The millings may be used later as a recycled or unrecycled base course or as a recycled surface course.

Because of the efficiencies of current cold milling devices, hot milling has limited use in the United States. This operation, suitable only for asphalt pavements, is quite similar to cold milling with the exception of the added step of heating the pavement prior to grinding. The greater operational cost of hot milling may be justifiable where high production rates are needed or very cold weather is expected.

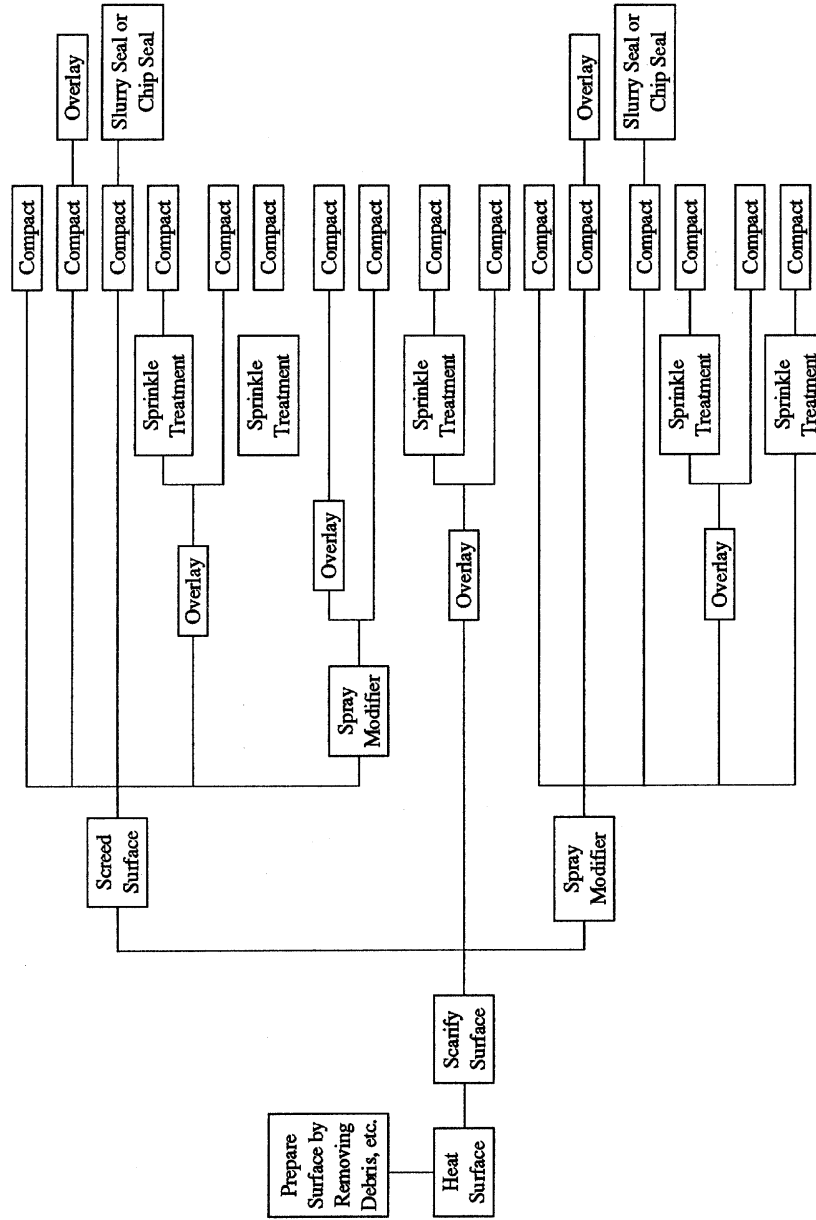

Figure 4-3. Rehab options with heater-planer.<sup>(7)</sup>

Table 4-1 lists the primary objectives for which heater-planing and cold milling are most suitable. Hot milling is typically performed for the same purposes as cold milling. For improvement of skid resistance by the heater-planing method, the heating system may be used in conjunction with a steel-wheeled roller to seat previously spread aggregate chips into the surface.

Table 4-1. Suitable objectives of various surface recycling processes.

Objective	Heater-Planing	Cold-Milling
Remove bumps and reduce pavement roughness	X	X
Reestablish cross-slope	X	X
Removal of low-quality slurry or chip seals	X	
Removal of surface deterioration (e.g., ravelling, bleeding)	X	X
Maintain proper clearances for underpasses, tunnels, and sign bridges	X	X
Improve skid resistance	X	X
Promote bonding with AC overlay		X

#### Hot Surface Recycling

Hot surface recycling is a recycling process whereby the top 25 to 50 mm of asphalt pavement is reworked on the roadway using a heater-scarifier. The process involves heating and scarifying the surface, adding new aggregate or asphalt rejuvenator if required, remixing, and relaying and compacting the material.

The heater-scarifier is a self-contained unit equipped with a heating system and a scarifying attachment. The heating system may be a radiant-heat emitter or an open-flame heater. The scarifying device consists of carbide-tipped steel blades that act as teeth and tear into the heated asphalt. A steel blade or heavy chain is usually attached behind the scarifier to assist in leveling the loosened material. More advanced heater-scarifiers might contain an attached screed, for better spreading and leveling, or an integral spray system, for immediate application of a rejuvenator.

After the surface has been heated and scarified, a rejuvenating agent may be sprayed on the material. If required, new aggregate may also be added. Remixing and relaying is then performed using either the heater-scarifier or by a mixing unit or motor grader that follows the heater-scarifier. Pneumatic rollers or steel-wheeled rollers follow immediately behind the laydown operation and compact the material.

Hot surface recycling is often done for one or more of the following reasons:

- Remove surface defects (e.g., ravelling, bleeding).
- Remove bumps (less than 50 mm) and reduce roughness.
- Reestablish cross-slope.
- Retard reflection cracking.
- Promote bonding with subsequent overlays.
- Improve aesthetics.

Furthermore, by adding new materials, key surface material characteristics can be corrected or improved. For instance, bleeding and ravelling can be corrected by adding proper amounts of aggregate or asphalt rejuvenator. Skid resistance can be improved by incorporating the proper type or amount of aggregate and aged asphalt can be softened for increased life by adding a rejuvenator.

#### Cold-Mix Recycling

Cold-mix recycling is a process in which reclaimed asphalt pavement (RAP) materials are combined with new recycling agent and/or aggregate to produce cold-mix paving materials. This process, which can be done in-place or at a central mixing plant, requires no heat and is performed to a depth greater than 25 to 50 mm. The resulting cold-mix material is most often used as a base course, on which a protective asphalt surface layer is placed.

Cold-mix recycling operations largely involve cold, in-place recycling (CIR) procedures. These procedures have been used for many years, with more widespread use occurring only in the last 20 years. In general, CIR is appropriate for low-volume asphalt roads that are severely cracked and broken, highly rutted, or very rough. It is not recommended for roads with obvious soil foundation problems or with asphalt mixture problems that cannot be adequately corrected with CIR.

The benefits of CIR are numerous and include the following:<sup>(8,9)</sup>

- Significant structural improvements can be achieved without changes in horizontal and vertical geometry.
- Most types and severities of pavement distress can be treated.



- Reflection cracking can be delayed or eliminated.
- Pavement ride quality can be improved.
- Hauling costs can be minimized.
- Pavement profile, crown, and cross-slope can be improved.
- Production rate is high.
- Engineering costs are low.

Among the disadvantages of CIR are the following:<sup>(4, 8)</sup>

- Construction variation is larger for in-place than for central-plant operations (i.e., lower quality control in the field than at the plant).
- Curing is required for strength gain, and is dependent upon climatic conditions, including temperature and moisture.
- Traffic disruption can be greater relative to other rehab alternatives.
- The equipment is expensive, and not many contractors may own the equipment.
- There are no standard specifications for in-place recycling.

Three distinct types of CIR are currently being used in the United States. These types, which are briefly discussed below, include the following:<sup>(9)</sup>

- Type 1—Rip/pulverize and compact.
- Type 2—Single Unit Recycler.
- Type 3—Recycling Train.

#### *Type 1 CIR—Rip/pulverize and compact*

Often referred to as full-depth recycling or reclamation, Type 1 CIR is the oldest and least expensive method of in-place recycling. It is often used when there is little remaining life in the road or when surface defects are caused by problems in the underlying layer. In this process, the existing pavement is reworked to a depth that may vary from 100 to 300 mm. The recycled material provides a good-quality asphalt base layer on which an AC surface course or a surface treatment can be applied.<sup>(9)</sup>

The general procedures for Type 1 CIR are illustrated in figure 4-4. The existing pavement is first ripped and crushed in place by multiple passes of a scarifier or ripper. The crushed material, or RAP, is then windrowed with a grader and may be sprayed with the designated recycling agent. New aggregate may also be added at this point. A motor grader is used to thoroughly mix the new material, which is then spread into place by either the grader or a paver. Following compaction and curing, a surface layer is then applied. In some instances, type 1 CIR may not be appropriate for thick-lift AC pavements, especially when the asphalt thicknesses are greater than 100 mm. Excessive milling depths are reported to slow production in most cases.<sup>(9)</sup>

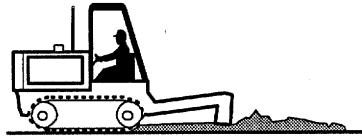

1. Rip and break existing pavement



2. Pulverize existing pavement



3. Windrow Existing Asphalt Bound Materials

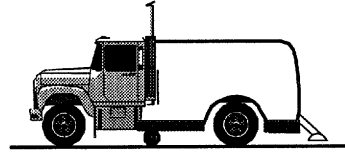

4. Apply Modifier to Windrowed Asphalt Bound Materials

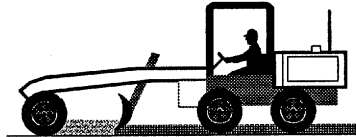

5. Mix with existing and/or new base aggregate material

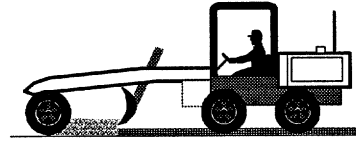

6. Spread upgraded base to specified thickness

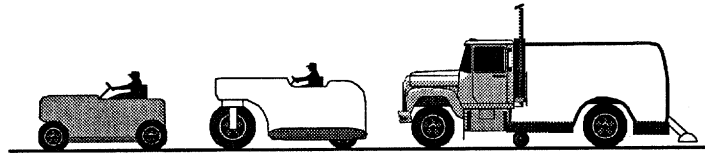

7. Compact, seal and cure



8. Apply wearing surface

Figure 4-4. General sequence of Type 1 CIR operation. <sup>(9)</sup>

*Type 2 CIR—Single unit recycler*

Type 2 CIR is a partial- or full-depth recycling operation that provides a high-quality base or surface course. In comparison to Type 1 CIR, this operation provides better quality control with respect to maintaining a uniform reprocessing depth and to remixing. In addition, Type 2 CIR reduces the recycled material to a smaller and more uniform size. Type 2 CIR is generally limited to a depth of 150 to 200 mm and, as a result, should be able to remove all pavement defects in a typical thick-lift asphalt pavement.

Type 2 CIR eliminates the need for multiple pieces of equipment and equipment passes for the breaking, crushing, and mixing operations. As shown in figure 4-5, a planer or milling machine is used to perform these operations in a single pass. The new mixture is then either windrowed for spreading by a grader or conveyed to a paver for relaying. Following compaction and curing, a surface layer may or may not be applied. Roughly 1.6 to 3.2 km/day of a standard 3.7-m wide lane can be recycled using this operation.

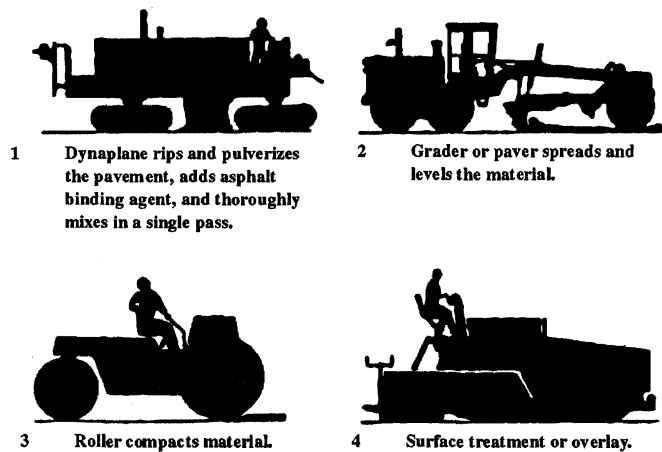

Figure 4-5. General sequence of Type 2 CIR operations.<sup>(9)</sup>

Type 3 CIR—Recycling train

Type 3 CIR is the newest and most productive in-place recycling process. Like Type 2 CIR, it is a partial- or full-depth recycling operation that produces a high-quality base or surface course. It differs, however, in the equipment required to carry out the process and, subsequently, in the rate at which the pavement is recycled. For these reasons, it is more appropriate on large recycling jobs.

The process involves the use of large, specialized equipment that work closely together as a recycling train. Figure 4-6 shows a typical recycling train and the flow of material through the individual pieces of equipment.

The train is headed by a milling machine, which grinds off the existing pavement to a depth ideally between 50 and 100 mm. The RAP material is then conveyed to a screening and crushing unit that reduces the material size to less than 30 to 50 mm.



Figure 4-6. Type 3 CIR recycling train.<sup>(9)</sup>

Next, the RAP material is transported to the mixing unit, or traveling pugmill. There it is weighed and mixed with measured amounts of aggregate and recycling agent. The new mixture can be deposited directly into the hopper of a paver or layed down in a windrow for subsequent pick-up by a paver. The paver then spreads the material evenly for compaction by steel-wheeled and/or rubber-tired rollers. Depending on the existing road condition, depth of recycling, terrain, and traffic, the train can recycle 3.2 to 9.7 km/day of a standard 3.7-m wide lane.

### Hot-Mix Recycling

Hot-mix recycling is the process in which all or some portion of the pavement structure is removed, reduced to the desired size, and mixed hot with additional asphalt cement at a central plant. The process normally includes the addition of new aggregate, and may include the addition of a recycling agent.<sup>(4)</sup> The finished product is generally required to meet standard materials specifications and construction requirements for the type of AC mixture being produced (e.g., base, binder, or surface course).<sup>(10)</sup>

In comparison with CIR, hot-mix recycling is a costlier and more labor-intensive operation. Material hauling, hot plant processing, and greater quality control are major contributors to its higher costs. Although there is generally more disruption with hot mix recycling, traffic can be allowed on the recycled pavement much sooner than with CIR because of the shorter curing period. More importantly, the higher level of quality control in the hot-mix recycling process generally results in a more stable and consistent mixture.

The two foremost considerations in selecting hot-mix recycling for a given rehab project are existing pavement condition and cost. As seen in table 4-2, hot-mix recycling is considered a proper remedy for many pavement defects. In general, it can be used to correct mixture deficiencies, to restore pavement smoothness, and to increase the overall strength of the pavement. Because of its higher costs, however, careful comparisons must be made to determine if it is the most cost-effective approach for the combination of defects observed in the existing pavement. This is especially the case for low-volume roads and short rehab projects.

Other matters that must be considered include the suitability of existing materials for recycling and the availability of experienced and properly equipped contractors. In the case of the former, the presence of the following materials may render an existing pavement unsuitable for hot-mix recycling:<sup>(11)</sup>

- More than 10 percent of the pavement material is a seal coat, slurry seal, or cold patch.
- The pavement contains cutback asphalts.
- The pavement contains any coal tars.

Although the availability of experienced and properly equipped contractors has become widespread in recent years, their proximity to the project may be too far for hot-mix recycling to be the most cost-effective rehab strategy.

Table 4-2. Guide for selection of AC recycling method.<sup>(12)</sup>

Type of pavement distress	Hot-Mix Recycling	Hot In-Place Recycling	Cold In-Place Recycling
Surface Defects			
<i>Raveling</i>	x	x <sup>1</sup>	
<i>Bleeding</i>	x	x <sup>4</sup>	
<i>Slipperiness</i>	x	x <sup>1</sup>	
Deformation			
<i>Corrugations (washboarding)</i>	x	x <sup>4</sup>	
<i>Rutting (shallow)<sup>2</sup></i>	x	x <sup>4</sup>	
<i>Rutting (deep)<sup>3</sup></i>	x		x <sup>5</sup>
Cracking (load associated)			
<i>Alligator</i>	x		x
<i>Longitudinal (wheelpath)</i>	x	x <sup>6</sup>	x
<i>Pavement Edge</i>	x		x
<i>Slippage</i>	x	x <sup>7</sup>	
Cracking (nonload associated)			
<i>Block (shrinkage)</i>	x		x
<i>Longitudinal (joint)</i>	x	x <sup>8</sup>	
<i>Transverse (thermal)</i>	x		x
Reflection Cracking	x		x
Maintenance Patching			
<i>Spray</i>	x <sup>9</sup>		x <sup>9</sup>
<i>Skin</i>	x <sup>9</sup>		x <sup>9</sup>
<i>Pothole</i>	x		x
<i>Deep (hot mix)</i>	x		x
Ride Quality/Roughness			
<i>General Unevenness</i>	x	x	
<i>Depressions (settlement)</i>	x <sup>10</sup>	x <sup>10</sup>	
<i>High Spots (heaving)</i>	x <sup>10</sup>	x <sup>10</sup>	

Notes:

- <sup>1</sup> Applicable if the surface course thickness does not exceed 40 mm.
- <sup>2</sup> Rutting is limited to the top 40 to 50 mm of the pavement.
- <sup>3</sup> Rutting originates below the surface course, including base and subgrade.
- <sup>4</sup> May be a temporary correction if entire layer affected not removed or treated by the addition of special admixtures.
- <sup>5</sup> The addition of new aggregate may be required for unstable mixes.
- <sup>6</sup> Applicable if the cracking is limited to the surface course of the pavement.
- <sup>7</sup> Applicable if the treatment is to a depth below the layer where the slippage is occurring.
- <sup>8</sup> Applicable if the cracking is limited to the surface course of the pavement.
- <sup>9</sup> In some instances, spray and skin patches may be removed by cold planing prior to these treatments (consider if very asphalt rich or bleeding).
- <sup>10</sup> May be only a temporary correction if the distress is related to a subgrade problem.

Because the quality of recycled hot-mix must normally satisfy the requirements of a new AC mixture, a considerable amount of evaluation, testing, and design work is necessary. This often includes the following tasks:

- Reviewing past construction records of the existing pavement.
- Visually assessing the condition of the existing pavement.
- Performing material characterization tests on the stockpiled RAP.
- Formulating a recycled mixture design and determining the proper amounts of new materials (e.g., asphalt, aggregate) to be added to the RAP.
- Performing quality control tests on the recycled mixture to determine if it meets the applicable specifications.

Examples of the design concepts involved in hot-mix recycling can be found in reference 10.

The construction sequence for hot-mix recycling typically consists of the following four activities:

- Full- or partial-depth removal of the pavement.
- Reduction of the RAP to the appropriate size.
- Reprocessing of the RAP through a hot-mix plant with the addition of one or more of the following: virgin aggregate, new asphalt cement, and recycling agent.
- Placement and compaction of the recycled hot-mix as a base, binder, or surface course.

The existing thick-lift asphalt pavement is generally removed by milling, although ripping equipment have also been used. With milling, partial- and full-depth pavement removal is possible, and sizing of the RAP is done simultaneously with the pavement removal step. The milling operation is normally performed to an optimum depth of between 50 and 100 mm. And, although single-pass removal to as deep as 200 mm is possible, the operating speed can be greatly reduced and oversized RAP may result, thereby requiring additional sizing.

Complete removal of a thick-lift asphalt pavement often requires multiple passes of a milling machine or the use of heavy-duty ripping equipment. While RAP millings are usually reduced to the appropriate size, the RAP produced by ripping equipment must generally undergo additional crushing at the central plant. Central-plant sizing can be performed with conventional, fixed, and portable crushing and screening equipment.<sup>(13)</sup>

Both conventional batch plants and continuous mix (drum-mixer) plants have been used successfully to produce recycled hot-mix.<sup>(4)</sup> Both plant types make use of the heat-transfer method, whereby the RAP is primarily heated through mixing with superheated virgin aggregate. Additional asphalt or

recycling agent are also added during the mixing, as called for in the mixture design.

As with conventional hot-mix paving operations, the recycled hot-mix is hauled to the jobsite where it is loaded into the hopper of an asphalt paver for proper laydown. Steel-wheeled and rubber-tired rollers are used to compact the newly laid material to the required density.

### **Resurfacing**

As discussed in module 3, resurfacing in this manual refers to the process in which an AC overlay is placed on the existing pavement to restore serviceability to near original level. The placement of a PCC overlay is another option for thick-lift AC overlays, but this technique is not discussed in this manual.

The major advantages of AC resurfacing include the wide availability of hot-mix paving contractors and equipment, relatively short disruptions to traffic, and good long-term service. The major disadvantages include the need for careful design and quality control, decreased vertical clearances, potential for reflective cracking, and possible adjustments or level-up work required for adjacent structures (e.g., manholes, curb and gutter, shoulders). In addition, the cost of an overlay can be prohibitive to many local agencies.

AC resurfacing is typically performed to improve the functional or structural performance of a pavement. Functional performance refers to the ability of a pavement to provide a safe, smooth-riding surface for the traveling public. Functional resurfacing generally consists of a thin AC overlay that serves one or more of the following purposes:<sup>(2)</sup>

- Increase skid resistance.
- Improve pavement profile (level up).
- Improve rideability.
- Improve surface drainage.
- Reduce water infiltration.
- Retard environmental deterioration.
- Enhance appearance.

Structural performance refers to the ability of a pavement to withstand traffic and environmental loadings. In contrast with functional resurfacing, structural resurfacing normally involves the use of a thick AC overlay designed to:

- Increase structural capacity of the pavement.
- Reduce the rate of deterioration.

Depending upon the problem in the existing pavement, and on the purpose of the overlay, AC resurfacing may consist of one or more lifts (i.e., paving layers) of material. The lifts may be a part of either the binder course (the structural layer) or the surface course (the top, protective layer), and they generally range



from 25 to 200 mm thick. The binder course is sometimes referred to as the leveling course and the binder course is sometimes referred to as the wearing course.

The material used in each layer can vary in composition. To provide added strength, binder course material typically contains larger sized aggregate and slightly less asphalt cement than surface course material. The smaller sized aggregate and higher asphalt cement content in a surface course material help provide an abrasion-resistant and waterproof surface layer.

AC overlays may be applied in conjunction with recycling operations to provide a protective surface. Such overlays are particularly common with cold-milling (surface removal) and cold in-place recycling (CIR) operations.

To successfully design and construct an AC overlay, a thorough examination must be made of the existing pavement, as detailed in module 2 of this manual. This examination should reveal the prime cause of pavement deterioration so that proper pre-overlay repairs or treatments can be specified and so that an adequate overlay thickness can be determined.

The construction sequence for AC resurfacing consists of the following three steps:

- Application of pre-overlay repairs or treatments to the existing pavement.
- Processing of blended aggregate and asphalt cement at a hot-mix asphalt plant to produce a hot, homogeneous asphalt paving mixture.
- Placement and compaction of the hot-mix as a leveling, binder, or surface course.

Pre-overlay repairs or treatments of deteriorated, thick-lift asphalt pavement occasionally include one or more of the following:

- Localized patching of potholes or fatigue-cracked (alligatored) areas.
- Level-up patching of rutted wheelpaths.
- Treatment of thermal cracks to delay reflection cracking in the overlay.
- Surface leveling of sags and depressions.
- Cleaning and the applying a tack coat to the existing surface to improve bonding between the existing asphalt surface and the AC overlay.

Hot-mix production may take place at either a batch plant or a continuous mix plant. In a batch plant, aggregate is screened into different sizes, weighed to the specified proportions, blended, and heated and dried in a dryer. Next, the aggregate is emptied into a pugmill where it is blended together and mixed with the proper amount (by weight) of heated asphalt cement. The entire batch of hot-mix is then discharged into a haul vehicle.

In a continuous-mix plant, screened and heated aggregate is continuously proportioned and transported to the pugmill. Asphalt cement is then sprayed on the aggregate at a rate that is calibrated with the movement of aggregate. The two materials are continuously mixed in the pugmill and are discharged into a temporary hopper for delivery to the haul vehicle.

After being hauled to the jobsite, the hot-mix is loaded into the hopper of an asphalt paver for proper laydown. Steel-wheeled rollers and rubber-tired rollers are then used to compact the newly laid material to the required density. Achieving the proper density is essential. Insufficient density (compaction) may lead to rutting problems or stripping (from moisture penetrating the surface). Too much compaction of the AC can cause construction cracking and bleeding.

#### **Surface Treatment**

Surface treatment is a broad term that embraces several types of asphalt and asphalt-aggregate applications, usually less than 25 mm thick, placed on any kind of roadway surface.<sup>(3)</sup> The general purpose of these applications is to improve or protect the surface characteristics of the roadway. They provide no structural improvement to the pavement.

Although surface treatment techniques have long been used for rehabbing low-volume roads, recent advancements in technology have led to their successful use on higher volume roads and streets. When used in the proper situations, they provide a low-cost, protective surface that extends pavement life and reduces required maintenance expenditures.

The specific functions of surface treatment techniques can be summarized as follows:<sup>(4)</sup>

- Provide a new wearing surface.
- Seal minor cracks in the surface.
- Waterproof the surface.
- Improve skid resistance and surface drainage.
- Slow pavement weathering.
- Improve pavement appearance.
- Provide visual distinction between the mainline pavement and the shoulder.
- Rejuvenate the top 6 mm of an AC surface.

Surface treatment techniques are classified by their composition and by their use. A total of nine techniques are available for use on thick-lift asphalt pavements. A description of each of these techniques and the specific functions they serve are provided in the sections below.

### Asphalt Chip Seal

An asphalt chip seal consists of sequential applications of asphalt (asphalt cement, cut-back asphalt, or asphalt emulsion) and stone chips to form a surface layer as thick as 25 mm. The combined application may be applied once (single chip seal) or may be repeated two or three times (double or triple chip seals).

The primary objectives of the asphalt chip seal are to provide a new, durable surface course and to increase skid resistance. Although their past use has typically been on low-volume roads, recent improvements in design and construction have resulted in greater use on higher volume roads.

The construction sequence for a single asphalt chip seal consists of the following four steps:<sup>(9)</sup>

- Clean the existing surface to remove dirt and other loose materials.
- Apply the asphalt material at the specified rate and temperature using a calibrated asphalt distributor.
- Immediately spread the stone chips evenly over the surface at the specified rate using a properly calibrated aggregate spreader.
- Immediately roll the stone chips with a rubber-tired roller to firmly seat them in the asphalt and against the underlying layer.

Depending on the type of asphalt material used and the posted speed limit, the chip-sealed road can be opened to traffic within 0.5 to 2 hours.

### Open-Graded Friction Course

Open-graded friction courses (OGFC), also called plant mix seals or popcorn mixes, are porous surface mixes produced with large amounts of voids (minimum 15 percent) that allow water to drain rapidly through the mix and flow to the side of the road. These mixes are used to improve the friction properties of the surface and also reduce tire spray and the potential for hydroplaning, thereby reducing wet weather accidents. The OGFC also tends to provide a quieter riding surface, as it produces lower tire noise. Typical thicknesses of OGFC are 25 to 50 mm.<sup>(4)</sup>

OGFC have a more open gradation than dense-graded mixtures. However, OGFC mixtures are produced and placed in a manner similar to dense-graded hot mixes. A tack coat is needed prior to the placement of the OGFC and compaction is accomplished solely by a static steel-wheeled roller. This is because vibratory rollers can damage the aggregate and rubber-tired rollers tend to pick up the asphalt.

### Rubberized Asphalt Chip Seal

A rubberized asphalt chip seal is a special type of chip seal in which rubber (latex or ground tire rubber) is blended with asphalt cement. This application can

be used solely as a stress-absorbing membrane (SAM) or in conjunction with an overlay as a stress-absorbing membrane interlayer (SAMI).

In both applications, the purpose is to reduce the reflection of underlying cracks through the surface layer. The latex or ground rubber tires adds resiliency to the asphalt, which improves bonding with the aggregate and reduces the tackiness and ravelling of the surface. The added resiliency also enables the seal to "bridge" existing cracks better.

The construction of a rubberized asphalt chip seal is similar to the construction of an asphalt chip seal. The major difference is the use of a modified applicator for spraying the thicker rubberized asphalt binder.<sup>(6)</sup>

#### Slurry Seal

A slurry seal is a homogeneous mixture of asphalt emulsion, water, fine aggregate, and mineral filler that has a creamy, fluid-like appearance.<sup>(5)</sup> It is effective in sealing surface cracks, waterproofing the pavement surface, and improving skid resistance at speeds below about 65 kph. Three types of slurry seal are available that differ by the size of aggregate used. The type with the finest aggregate is primarily used for sealing purposes, while the type with the largest aggregate is primarily used for improving skid resistance and filling slight depressions.

The slurry seal mixture is produced on-site in a special truck-mounted, traveling mixer. Once mixed, the slurry is dumped into a spreader box attached to the back of the vehicle. The spreader box spreads the slurry onto the cleaned pavement and an attached squeegee smooths the material into a layer between 3 and 6 mm thick. Rolling is not generally necessary and, depending on the weather, traffic can be allowed on the pavement within 2 to 12 hours.

#### Micro-Surfacing

Developed in Europe, micro-surfacing is a term used to describe the application of a polymer-modified slurry seal, with latex rubber being the most commonly used polymer. Micro-surfacing materials consist of asphalt and latex mixed with aggregate, fillers, and other additives and is a modification of the slurry and sand seal.<sup>(6)</sup> It has been used as a wearing surface and for rut-filling. Ralumac is probably the most widely known example of this process in the United States.

The construction sequence for micro-surfacing resembles that of slurry seals. A modified traveling plant mixer is used to continuously load materials from haul vehicles and mix them on-site. An adjustable width spreader box is used for resurfacing purposes, while individual drag boxes are used for rut-filling purposes. Rolling is generally not required and the pavement can typically be opened to traffic within 1 hour.

### Fog Seal

A fog seal is a very light application of an asphalt emulsion (with no aggregate) to an oxidized asphalt surface. The purpose of the application is to rejuvenate the oxidized asphalt and seal fine cracks so that the need for more corrective rehabilitation is postponed for 1 or 2 years.

The treatment is most suitable for low-volume roads that can be closed to traffic for the 4 to 6 hours required for the material to sufficiently set. It is widely used along AC shoulders to help provide a distinct delineation between the mainline pavement and the shoulder. Application involves spraying the material at a specified rate using an asphalt distributor.

### Sand Seal

A sand seal is a spray application of asphalt emulsion followed by a light covering of sand or screening. This application serves the same function as a fog seal, but provides better surface friction. However, the surface appearance of a sand seal does not provide the delineation that a fog seal does.

The placement of a sand seal is typically 2 to 5 mm thick. Once the sand covering has been applied to the asphalt emulsion, a rubber-tired roller is used to firmly embed the sand in the asphalt. The pavement can be opened to traffic once the seal has sufficiently set (typically about 2 hours).

### Cape Seal

A cape seal is a combination of both an asphalt chip seal and a slurry seal. The advantage of the cape seal is that a thicker, more durable surface is obtained, and it can be used on higher volume roads.<sup>(4)</sup> The cape seal typically results in a smoother pavement with a more pleasing appearance, and can provide added skid resistance.

The construction process consists of the chip seal being applied first, followed by the application of the slurry seal between 4 and 10 days later.

### Sandwich Seal

A sandwich seal consists of an application of asphalt (asphalt emulsion or asphalt cement), sandwiched between two applications of different sized aggregate. The primary objectives of the sandwich seal are to provide a new wearing course and to increase skid resistance.

Typical sandwich seals are constructed between 6 and 19 mm thick. The construction process consists of the following five steps:

- Cleaning the existing surface.
- Application of the first aggregate at 60 to 80 percent coverage.
- Application of the asphalt material at the specified rate and temperature.
- Application of the second aggregate (smaller size than first aggregate) to sufficiently fill the voids left by the first aggregate.
- Rolling of the aggregate with a rubber-tired roller to firmly seat it in the asphalt.

Depending on the type of asphalt material used, the pavement can generally be reopened to traffic within 2 hours.

### **3. SELECTION OF THE MOST APPROPRIATE REHAB OPTION**

Thus far, course participants have been introduced to the various rehabilitation procedures used to improve the serviceability of thick-lift asphalt roadways. In this section, participants will be instructed on the process used to determine the preferred option for a given project.

In the decision-making process for selection of the preferred rehab strategy, the following steps are fundamental:<sup>(14)</sup>

- Determination of the cause of distress(es) or problems of the pavement.
- Development of a candidate list of solutions that will properly address, cure, and/or prevent future occurrences of the problem.
- Selection of the preferred rehabilitation strategy, given economic and other project constraints.

The first step is completed using the pavement evaluation procedures provided in module 2, and is therefore not discussed here.

The second step involves the consideration of other (many noneconomic) factors toward the goal of identifying a few practical options (typically between two and four). These factors largely consist of the following:

- Functional requirements.
- Structural requirements.
- Drainage.
- Local experience and manpower.
- Availability of resources.
- Construction considerations.
- Limited project funding.

To determine which of the resulting practical options is the most cost-effective (and thus the preferred rehab method), a life-cycle cost analysis is recommended. This analysis takes into consideration the various costs and estimated performance of each option over its expected life and generates a standard unit of cost by which the options can be compared.

Brief descriptions of the various selection factors and how they affect the different rehab methods are provided in the following sections.

#### **Noneconomic Factors**

##### Functional Requirements

Frequently, the main objective in a rehabilitation project is to increase the functional adequacy of the pavement (i.e., increase skid resistance and/or ride quality). As a result, some alternatives can be quickly shortlisted for further consideration. These alternatives often include the following:

- Functional AC overlay.
- Asphalt chip seal.
- OGFC.
- Slurry seal.
- Microsurfacing.
- Sand seal.
- Cape seal.
- Sandwich seal.
- Pavement removal.
- Hot-surface recycling.

Further shortlisting can be done given the specific functional improvement desired.

##### Structural Requirements

In situations where the major rehabilitation objective is to significantly increase structural capacity, the list of practical alternatives can be narrowed to the following:

- Structural AC overlay.
- CIR (types 1, 2, and 3).
- Hot-mix recycling.
- Pavement removal with thick AC overlay.
- Hot surface recycling with thick AC overlay.

Each of these methods can be used to meet the desired structural requirements. However, only CIR and hot-mix recycling have the capability of fully correcting the structural defects (e.g., alligator cracks and rutting) in the asphalt layers.

##### Drainage

If the pavement evaluation reveals a serious drainage problem, immediate consideration must be given to those options that will best remedy the drainage and other problems. Thick-lift asphalt pavements are generally not susceptible to weakening effects of water on the subgrade layer. Drainage problems in these

structures are commonly confined to the surface layer. Here, standing water may be the result of either poor cross-slope (e.g., rutting) or a surface that does not drain well. Practical options for addressing these problems consist of the following:

<u>Poor cross-slope</u>	<u>Non-draining surface</u>	<u>Other methods</u>
Pavement removal	OGFC	Deepen ditches
Hot surface recycling	Asphalt chip seal	Place culverts
Microsurfacing	Hot surface recycling	Clean outlets
Asphalt chip seal		

#### Local Experience and Manpower

The availability of local contractors with experience in the various rehab methods is often a major factor in the selection process. Local contractors inexperienced with some rehab methods may simply not be capable of performing those methods or of providing the quality, timeliness, and economics desired of those methods. One option which should be examined in this situation is the added cost associated with retaining outside contractors experienced in the methods that are not practiced locally.

In general, the availability of local contractors experienced in each of the three rehab types is fairly good. Although recycling is not practiced nearly as much as resurfacing and the placement of surface treatments, the availability of local contractors capable of successful recycling operations is steadily growing. Likewise, some of the more specialized surface treatment techniques, such as micro-surfacing and OGFC, are also catching on.

#### Resource Requirements

Additional up-front costs can generally be expected if local contractors are improperly equipped or if the necessary materials are not readily available. In the first case, the additional costs stem from greater mobilization and hauling, as an experienced outside contractor must be used. In the second case, the additional costs stem primarily from hauling, as material (usually aggregate) must be shipped in from distant sources.

The availability of recycling equipment and some surface treatment equipment are limited in some areas. Devices such as those used in CIR and microsurfacing operations are still relatively new and, in the case of the former, quite expensive.

The lack of strong and durable local aggregate can be a concern with either of the three general rehab alternatives. Local aggregate that is soft and nondurable will adversely impact performance and must be avoided. Additionally, local aggregate producers may not process aggregate into the sizes or shapes required by particular asphalt-aggregate mixtures. This is occasionally a concern with some of the surface treatment techniques, such as microsurfacing.



### Construction Considerations

Although there are several construction factors worthy of consideration, the following are among the most common:

- Traffic control requirements.
- Geometric constraints.
- Suitability of existing pavement materials for recycling.

The time period in which a road must be partially or completely shut down can often determine which rehab methods get shortlisted for further consideration and which ones do not. Obviously, the methods that result in the greatest disruptions to traffic will be least desirable by the traveling public. Such disruptions are often tied to material production rates, operational rates of the equipment, and pavement curing times.

Geometric constraints can occasionally limit which alternatives get further consideration. These constraints typically include the following:

- In-the-road manholes.
- Curb and gutter.
- Clearances beneath overhead signs and bridges.
- Utilities.

On occasion, the existing asphalt pavement may be unsuitable for recycling due to the presence of harmful materials or excessive material variability. In the case of the former, considerable amounts of tar, asphalt cutback, and asphalt emulsion in the existing pavement can pose operational problems with air quality or mix design quality. In the case of the latter, several changes in material composition throughout the project can result in excessive reprocessing changes and, possibly, excessive testing requirements.

### **Economic Factors**

#### Limited Project Funding

If the funds available for a particular project are somewhat limited, then it is likely that some of the rehab methods with the highest up-front costs will have to be dropped from consideration. This may, however, result in the dismissal of some of the more cost-effective methods, in which case extra efforts to secure more funding could be justified.

#### Performance Considerations

One important aspect in determining the most cost-effective rehab alternative is the performance of the pavement after it has been rehabilitated. Although performance is defined as the area under a serviceability-time curve (figure 4-2), a commonly used indicator of performance is service life. This is the

period of time that a rehabilitated pavement will last before reaching a minimum acceptable serviceability level.

The performance characteristics of each rehab option depend largely on the following factors:

- Climatic conditions.
- Traffic volumes.
- Existing pavement condition.
- Quality of materials.
- Mixture design.
- Construction quality.

Because of these factors, the experiences of various agencies with the different rehab methods vary widely. Figure 4-7 shows the expected service lives of a few of the rehab methods based on a 1986 survey of several cities and counties.<sup>(9)</sup> As can be seen, resurfaced pavements are expected to last the longest, followed closely by in-place recycled pavements. Surface treated pavements, however, are generally expected to provide about one-third the life of resurfaced pavements.

#### Life-Cycle Costs

To determine the most cost-effective rehab option, a fixed analysis period must first be established. This analysis period may range from 5 to 25 years, depending on programmed funding and the desire for long-term planning. A strategy must then be developed for each rehab option such that pavement serviceability remains above a minimum acceptable level over the analysis period. As seen in figure 4-8, a strategy may consist solely of the rehab alternative or may involve the rehab alternative combined with a series of future maintenance or rehab activities.

Once alternative strategies have been developed, the life-cycle costs associated with each strategy can be estimated. These are the projected costs assumed by the local-roads agency and the traveling public during the analysis period. In the case of roadway rehab, the following life cycle costs should be considered:

- **Engineering and administrative costs**—The costs of evaluating the existing pavement, selecting the preferred rehab option, designing the rehabilitated pavement, and preparing the necessary plans and specifications for the rehab work.
- **Rehab costs**—The costs associated with initial and future rehab activities intended to restore the pavement to an acceptable serviceability level.
- **Maintenance costs**—The costs associated with maintaining a pavement at or above some predetermined performance level. These costs include both preventive and corrective maintenance costs, but not rehab costs.

## ASPHALT SURFACE MAINTENANCE TECHNIQUES EXPECTATION LEVELS (in years)

183 responses

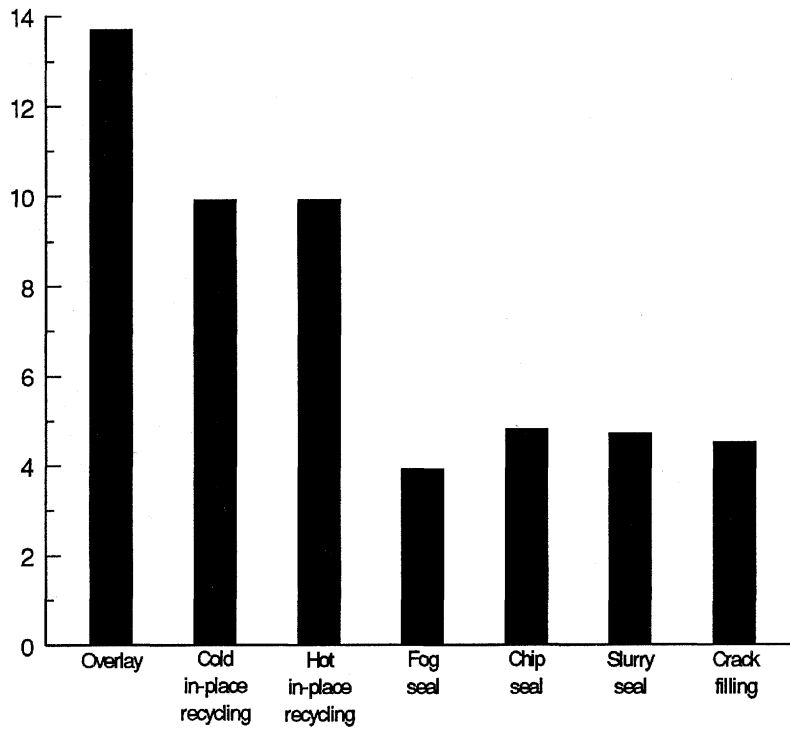

Figure 4-7. Expected life of various rehab methods.<sup>(9)</sup>

- **Salvage value**—The value of the pavement at the end of the life cycle or analysis period.
- **User costs**—The costs assumed by the traveling public in the form of delay costs, increased operating costs, and accidents.

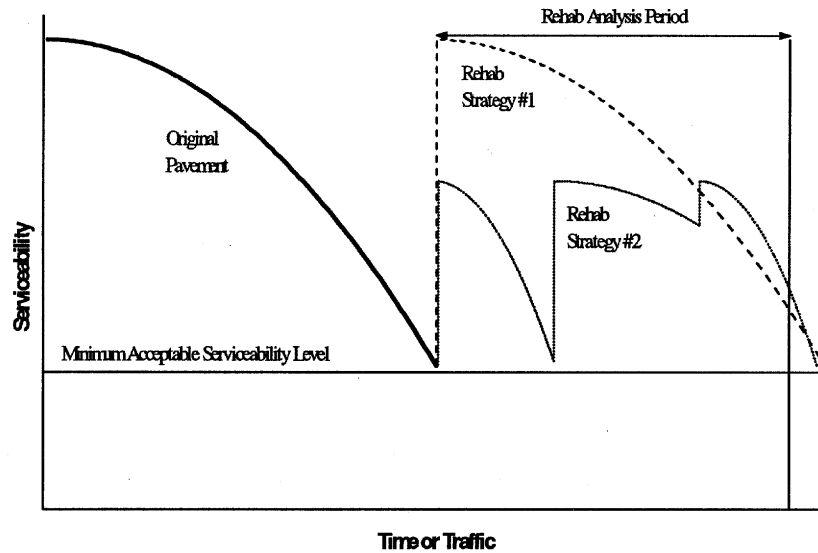

Figure 4-8. Example of different rehab strategies for a given analysis period.

Life-Cycle Cost Analysis

Several methods of economic analysis have been used to compare the cost-effectiveness of different rehab strategies. The more common methods, which are briefly discussed below, require the use of a discount rate to account for the time value of money. The discount rate is used to convert future predicted costs or benefits to their present worth or to uniform annual costs so that the economics of the different strategies can be compared. The discount rate is commonly taken as the difference between the interest and inflation rates.<sup>(15)</sup> Historically, discount rates have been in the range of 3 to 5 percent.

- **Present-worth method**—This method involves converting all future costs associated with a particular strategy to present-worth costs. These converted costs and the initial rehab costs are then summed to obtain a single, present-worth cost that can be directly compared with the present-worth costs of the other alternatives.
- **Annualized method**—This method involves converting all present and future costs associated with a particular strategy to a uniform annual cost over the analysis period. This uniform annual cost can then be directly compared with the uniform annual costs of the other alternatives. This method is preferred when the estimated service lives of various alternatives are different.

- **Benefit-cost ratio method**—This method involves expressing the ratio of present-worth benefits of a particular strategy to its present-worth costs. Strategies that result in a benefit-cost ratio greater than one are considered economical and the strategy that produces the highest incremental ratio with respect to other strategies is considered the best choice.
- **Rate-of-return method**—This method consists of determining the discount rate at which the cost and benefit for a given strategy are equal. The strategy with the highest first cost that exceeds a minimum acceptable rate of return (specified by the agency) is considered to be the best alternative.

Although the benefit-cost ratio method is used frequently in the highway field, it is occasionally difficult to understand. And, although the rate-of-return method has the distinct advantage on not requiring knowledge of a discount rate, it can be very time-consuming and it has situational flaws.

The present-worth method and the annualized method are the preferred methods of analysis and are therefore presented in this manual. The concepts behind each of these methods are easily understood and the analyses are relatively straightforward to perform.

In the present-worth method, future lump-sum costs and uniform annual costs are converted to present-worth values using the following two equations:

$$PW = F \times \frac{1}{(1+i)^n} \quad (1)$$

where: PW = Present-worth cost.  
 F = Future cost at the end of n years.  
 i = Discount rate.  
 n = number of years.

$$PW = A \times \frac{(1+i)^n - 1}{i(1+i)^n} \quad (2)$$

where: PW = Present-worth cost.  
 A = Uniform annual costs for n years.  
 i = Discount rate.  
 n = number of years.

In the annualized method, present-worth costs are converted to uniform annual costs using the following equation:

$$A = PW \times \frac{i(1+i)^n}{(1+i)^n - 1} \quad (3)$$

where: A = Uniform annual cost over analysis period of n years.  
PW = Present-worth cost.  
i = Discount rate.  
n = number of years in analysis period.

In each case, the costs for each option are determined and the option with the lowest cost represents the most cost-effective solution.

Examples of the present-worth method and the annualized method are provided in figures 4-9 and 4-10, respectively.

<b>Comparing Rehab Strategies</b>		
<b>Rehab Strategy A</b>		
Initial cost:		\$150,000
Rehab at 10 years		\$35,000
Salvage value:	\$50,000	
Estimated service life		15 years
<b>Rehab Strategy B</b>		
Initial cost:		\$120,000
Maintenance at 4 years		\$15,000
Maintenance at 8 years:		\$15,000
Maintenance at 12 years:	\$15,000	
Salvage value:	\$1,000	
Estimated service life		15 years
Specified Discount Rate:		4 percent
<b>Analysis</b>		
<b>Rehab Strategy A</b>		
PW (initial cost) =		\$150,000
PW (rehab at 10 years) = $35,000 \times [1/(1+0.04)^{10}] =$		+ \$16,212
PW (salvage at 15 years) = $50,000 \times [1/(1+0.04)^{15}] =$		- <del>\$15,762</del>
<b>Total Present Worth of Rehab Strategy A</b>		<b>\$150,451</b>
<b>Rehab Strategy B</b>		
PW (initial cost) =		\$120,000
PW (maintenance at 4 years) = $15,000 \times [1/(1+0.04)^4] =$		+ \$11,025
PW (maintenance at 5 years) = $15,000 \times [1/(1+0.04)^8] =$		+ \$8,104
PW (maintenance at 12 years) = $15,000 \times [1/(1+0.04)^{12}] =$		+ \$5,957
PW (salvage at 15 years) = $1,000 \times [1/(1+0.04)^{15}] =$		- <del>\$315</del>
<b>Total Present Worth of Rehab Strategy B</b>		<b>\$144,771</b>
<b>Based on the given assumptions, rehab strategy B is the more cost-effective strategy.</b>		

Figure 4-9. Example of present-worth method of economic analysis.

Comparing Rehab Strategies		
<u>Rehab Strategy A</u>		
Initial cost:		\$150,000
Maintenance at 5 years:		\$25,000
Maintenance at 10 years:	\$25,000	
Maintenance at 15 years:	\$25,000	
Salvage value:	\$2,000	
Estimated service life:		20 years
<u>Rehab Strategy B</u>		
Initial cost:		\$200,000
Rehab at 10 years:		\$50,000
Salvage value:	\$40,000	
Estimated service life:		20 years
Specified Discount Rate:		4 percent
<b>Analysis</b>		
<u>Rehab Strategy A</u>		
A (initial cost) = $150,000 \times [(0.04)(1.04)^{20}] / [(1.04)^{20} - 1]$		\$15,278
PW (maint. @ 5 yrs.) = $25,000 \times [1 / (1.04)^5]$		\$17,015
A (maint. @ 5 yrs.) = $17,015 \times [(0.04)(1.04)^{20}] / [(1.04)^{20} - 1]$		+ \$1,733
PW (maint. @ 10 yrs.) = $25,000 \times [1 / (1.04)^{10}]$		\$11,580
A (maint. @ 10 yrs.) = $11,580 \times [(0.04)(1.04)^{20}] / [(1.04)^{20} - 1]$		+ \$1,179
PW (maint. @ 15 yrs.) = $25,000 \times [1 / (1.04)^{15}]$		\$7,881
A (maint. @ 15 yrs.) = $7,881 \times [(0.04)(1.04)^{20}] / [(1.04)^{20} - 1]$		+ \$803
PW (salvage @ 20 yrs.) = $2,000 \times [1 / (1.04)^{20}]$		\$429
A (salvage @ 20 yrs.) = $429 \times [(0.04)(1.04)^{20}] / [(1.04)^{20} - 1]$		- \$44
<b>Total Annual Cost of Rehab Strategy A</b>		<b>\$18,949</b>
<u>Rehab Strategy B</u>		
A (initial cost) = $200,000 \times [(0.04)(1.04)^{20}] / [(1.04)^{20} - 1]$		\$20,370
PW (rehab. @ 10 yrs.) = $50,000 \times [1 / (1.04)^{10}]$		\$23,160
A (rehab. @ 10 yrs.) = $23,160 \times [(0.04)(1.04)^{20}] / [(1.04)^{20} - 1]$		+ \$2,359
PW (salvage @ 20 yrs.) = $40,000 \times [1 / (1.04)^{20}]$		\$8,582
A (salvage @ 20 yrs.) = $8,582 \times [(0.04)(1.04)^{20}] / [(1.04)^{20} - 1]$		- \$874
<b>Total Annual Cost of Rehab Strategy B</b>		<b>\$21,855</b>
<b>Based on the given assumptions, rehab strategy A is the more cost effective.</b>		

Figure 4-10. Example of annualized method of economic analysis.



REFERENCES

1. Eason, J. R., and J. F. Shook, "Design of Hot Mix Asphalt Pavements for Commercial, Industrial, and Residential Areas," National Asphalt Pavement Association Information Series 109, 1991.
2. *Pavement Design: Principles and Practices*, Training Course Manual, National Highway Institute, September 1987.
3. Asphalt Institute, *Asphalt Surface Treatments: Construction Techniques*, Educational Series No. 12 (ES-12), February 1982.
4. *Techniques for Pavement Rehabilitation*, Training Course Manual, National Highway Institute, Federal Highway Administration, Fifth Revision, May 1993.
5. Roberts, F. L., P. S. Kandahl, E. R. Brown, D. Y. Lee, and T. W. Kennedy, *Hot-Mix Asphalt Materials, Mixture Design, and Construction*, First Edition, National Asphalt Pavement Association, Education Foundation, 1991.
6. Heitzman, M. A., *State of the Practice: Design and Construction of Asphalt Paving Materials with Crumb Rubber Modifier*, Report No. FHWA-SA-92-022, Federal Highway Administration, May 1992.
7. *Techniques for Pavement Rehabilitation*, Training Course Manual, National Highway Institute, Federal Highway Administration, Third Revision, October 1987.
8. Epps, J. A., *Cold-Recycled Bituminous Concrete Using Bituminous Materials*, NCHRP Synthesis of Highway Practice 160, National Cooperative Highway Research Program, July 1990.
9. Wood, L. E., T. D. White, and T. B. Nelson, *Current Practice of Cold In-Place Recycling of Asphalt Pavements*, Transportation Research Record 1178, Transportation Research Board, 1988.
10. Asphalt Institute, *Asphalt Hot-Mix Recycling*, Manual Series No. 20 (MS 20), Second Edition, 1986.
11. Asphalt Institute, *The Asphalt Handbook*, Manual Series No. 4 (MS 4), 1988.
12. Asphalt Recycling and Reclaiming Association, *An Overview of Recycling and Reclamation Methods for Asphalt Pavement Rehabilitation*, August 1992.

13. Epps, J. A., D. N. Little, R. J. Holmgreen, and R. L. Terrel, *Guidelines for Recycling Pavement Materials*, NCHRP Report 224, National Cooperative Highway Research Program, September 1980.
14. *AASHTO Guide for Design of Pavement Structures*, American Association of State Highway and Transportation Officials, 1986.
15. Peterson, D. E., *Life-Cycle Cost Analysis of Pavements*, NCHRP Synthesis of Highway Practice 122, National Cooperative Highway Research Program, December 1985.

# MODULE 5

## THIN-LIFT HOT-MIX ASPHALT ROADWAYS

### 1. INTRODUCTION

Thin-lift hot-mix asphalt roadways are defined as having a surface layer less than 50 mm thick with a granular or soil base layer above the existing subgrade. Figure 5-1 shows a typical thin-lift pavement structure. The asphalt layer in thin-lift hot-mix pavements can be up to 50 mm thick. The asphalt layer generally consists of a conventional asphaltic hot-mix surface or base material that is placed on a granular base course.

The primary function of the AC layer in a thin-lift hot-mix asphalt pavement is to provide a smooth and somewhat watertight driving surface. The asphalt layer also provides some load-carrying capacity. The reduction in hot-mix asphalt quantities for these pavements generally makes them less expensive than thick-lift asphalt pavements.

The second layer in a thin-lift hot-mix asphalt pavement, referred to as the granular base course, consists of aggregate material placed on the existing subgrade. This layer serves as a construction platform during the placement of the asphalt concrete layer, and also functions as the primary load-carrying layer. In most cases, the aggregate base course will consist of a crushed rock material.

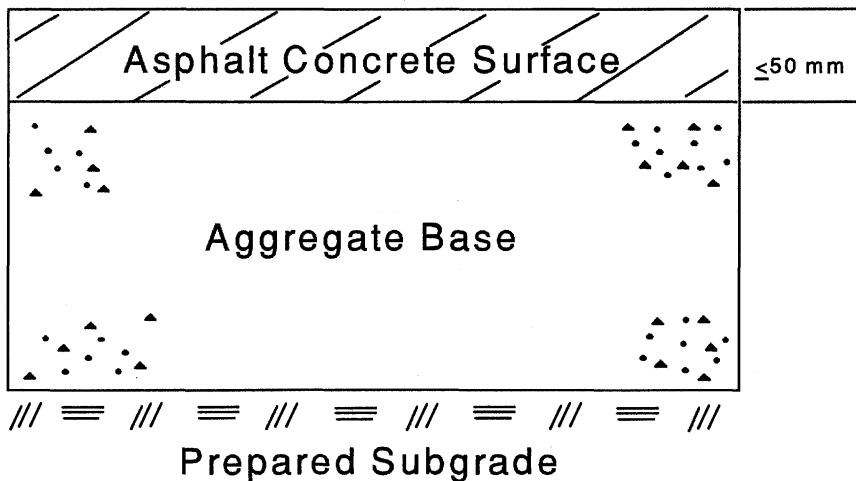

Figure 5-1. Typical thin-lift hot-mix asphalt pavement cross-section.

The foundation on which the aggregate base course and asphalt concrete layers rest usually consists of the natural soil that exists along the roadway. Occasionally, however, the existing soil may be too soft or unstable to provide an adequate platform for placing the aggregate base course, or would require an excessive amount of aggregate and asphalt concrete to provide adequate protection from traffic. In this case, the deficient soil may be replaced with higher quality soils or may be treated with an additive (e.g., lime, cement) to strengthen or stabilize the soil.

Thin-lift hot-mix asphalt pavements are generally used in low-volume situations where there is little justification for stronger pavement sections. Pavements expected to carry more than 100,000 equivalent axle loads over the life of the pavement should have thicker asphalt sections.<sup>(1)</sup>

## **2. APPROPRIATE REHAB OPTIONS**

When a roadway is first constructed, it is built to a relatively high level of ride quality, or serviceability. As time goes on, the combined effects of traffic, age, and climate cause the pavement to deteriorate, or decrease in serviceability. The general pattern of pavement deterioration is such that serviceability remains high for a period of time and then begins to drop off fairly quickly, as shown in figure 5-2.

At some point along the serviceability-time curve, a decision must be made to rehabilitate the pavement in order to restore it to a more acceptable serviceability level. Typically, rehabilitation is considered appropriate for pavements ranging in serviceability between poor and good. Reconstruction is often the more cost-effective strategy for pavements having very poor serviceability.

There are essentially three main options available for thin-lift hot-mix asphalt concrete roadways. These options include the following:

- Recycling
- Resurfacing.
- Surface treatment.

Descriptions and appropriate uses of these options, as well as the specific applications and procedures available under each option, are provided in the following sections.

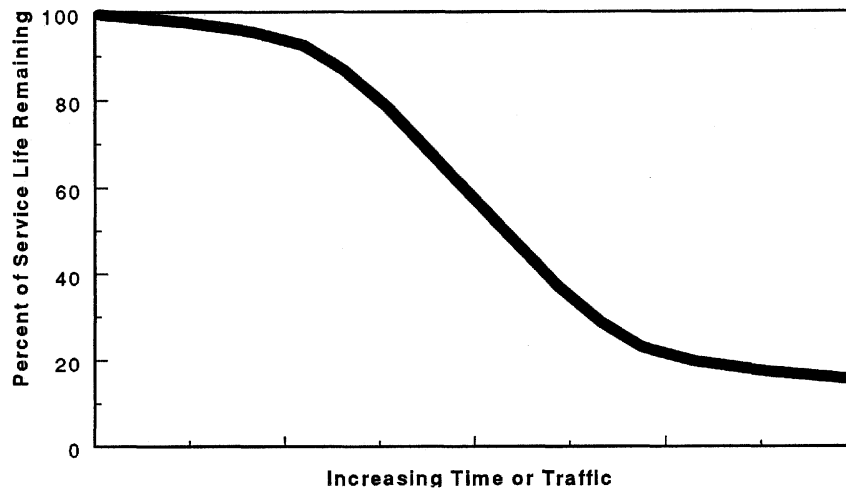

Figure 5-2. Pavement deterioration versus time/traffic.

### Recycling

Recycling refers to any process that utilizes materials from an existing pavement for reuse in the same or other pavements. In the case of the former, the reclaimed materials may be reprocessed immediately through an on-the-spot recycling train or in a relatively short time through a central asphalt plant. In the case of the latter, the reclaimed materials may be reprocessed and then used on a different roadway.

The major advantages of asphalt pavement recycling include reduced costs and the conservation of materials (e.g., asphalt binder, aggregate) and the energy required to process those materials. Additional benefits include eliminating the need for material disposal and, occasionally, preserving roadway geometrics (i.e., eliminating the need for raising manholes, accommodating vertical clearances).

The major disadvantages of asphalt pavement recycling include the possible lack of experienced or properly equipped local contractors and of suitable in-place materials for recycling. The consequence of each of these is usually higher rehabilitation costs.

Various classification schemes have been applied to asphalt pavement recycling operations, based on one or more of the following items:

- Absence/inclusion of heat in the recycling process (cold or hot process).
- Location of material remixing (in-place or at central mixing plant).
- Depth of pavement removal or reworking (surface, surface and base).

One of the more common classification schemes consists of the following three categories:

- Surface recycling.
- Cold-mix recycling.
- Hot-mix recycling.

Surface recycling is a hot or cold, in-place process that targets the top 25 to 50 mm of pavement. Both cold- and hot-mix recycling targets the surface and a portion or all of the base. However, cold-mix recycling can be done either in-place or at a central plant, while hot-mix recycling is performed at a central plant.

Each recycling category contains several different procedures, with each procedure generally best suited for certain situations. Furthermore, the application of a surface layer (e.g., surface treatment, AC overlay) on top of the recycled layer may be required.

### Surface Recycling

Surface recycling is the process by which the surface of an asphalt pavement is removed or reworked to a depth of less than 25 to 50 mm. This operation is divided into two basic processes: pavement removal and hot surface recycling. Each process, unique in terms of objectives and the equipment and procedures used, is discussed in further detail below.

Because surface recycling does not affect the base layer and soil foundation, it cannot be seriously considered as an option for pavements containing structural, moisture, or subsurface material problems. Such problems can be addressed by hot-mix and cold-mix recycling operations.

### *Pavement Removal*

Removal of the top 25 to 50 mm of surface material can be a useful rehab technique by itself or in preparation for resurfacing with AC. Situations that are generally appropriate for pavement removal include the following:<sup>(7)</sup>

- Correction of low- and medium-severity rutting that has developed in the upper layer of asphalt.
- Corrections to areas of bleeding, ravelling, and poor skid-resistance.
- Reestablishing cross-slope for proper surface drainage.
- Removing bumps and, consequently, pavement roughness.
- Reducing or eliminating the need for feathering of a subsequent overlay along gutters or near bridge abutments.
- Improvement of bond between existing asphalt surface and subsequent AC overlay.

Pavement removal for thin-lift hot-mix asphalt pavements is most often accomplished with the following pieces of equipment:

- Cold Milling Machine.
- Hot Milling Machine.

The heater-planing operation described in modules 3 and 4 is not recommended for pavements less than 60 mm thick, and is thus not appropriate for thin-lift hot-mix asphalt pavements.<sup>(7.5)</sup>

Surface recycling is often performed with a cold milling machine. The cold milling machine uses carbide-tipped cutter bits mounted on a large revolving drum to grind the pavement surface into small asphalt millings and allows for various depths of removal. The millings are typically picked up by the milling machine and then loaded onto a dump truck using an attached conveyor belt. The millings may be used later as a recycled or unrecycled base course or as a recycled surface course.

Because of the efficiencies of current cold milling devices, hot milling has seen limited use in the United States. This operation, suitable only for asphalt pavements, is quite similar to cold milling with the exception of an added step of heating the pavement prior to grinding. The greater operational cost of hot milling may be justifiable where high production rates are needed or very cold weather is expected.

Table 5-1 lists the primary objectives for which cold milling is most suitable. Hot milling is typically performed for the same purposes as cold milling.

Table 5-1. Suitable objectives of cold-milling surface recycling process.

Objective	Cold-Milling
Remove bumps and reduce pavement roughness	X
Reestablish cross-slope	X
Removal of low-quality slurry or chip seals	
Removal of surface deterioration (e.g., ravelling, bleeding)	X
Maintain proper clearances for underpasses, tunnels, and sign bridges	X
Improve skid resistance	X
Promote bonding with AC overlay	X

### Cold-Mix Recycling

Cold-mix recycling is a process in which reclaimed asphalt pavement (RAP) materials are combined with new recycling agent and/or aggregate to produce cold-mix paving materials. This process, which can be done in-place or at a central mixing plant, requires no heat and is performed to a depth greater than 25 to 50 mm. The resulting cold-mix material is most often used as a base course, on which a protective asphalt surface layer is placed.

Cold-mix recycling operations largely involve cold, in-place recycling (CIR) procedures. These procedures, used for many years, have more widespread use occurring only in the last 20 years. In general, CIR is appropriate for low-volume asphalt roads that are severely cracked and broken, highly rutted, or very rough. It is not recommended for roads with obvious soil foundation problems or with asphalt mixture problems that cannot be adequately corrected with CIR.

The benefits of CIR are numerous and include the following:<sup>(8,9)</sup>

- Significant structural improvements can be achieved without changes in horizontal and vertical geometry.
- Most types and severities of pavement distress can be treated.
- Reflection cracking can be delayed or eliminated.
- Pavement ride quality can be improved.
- Hauling costs can be minimized.
- Pavement profile, crown, and cross-slope can be improved.
- Production rate is high.
- Engineering costs are low.

Among the disadvantages of CIR are the following:<sup>(4,8)</sup>

- Construction variation is larger for in-place than for central-plant operations (i.e., lower quality control in the field than at the plant).
- Curing is required for strength gain, and is dependent upon climatic conditions, including temperature and moisture.
- Traffic disruption can be greater relative to other rehab alternatives.
- The equipment is expensive, and not many contractors may own the equipment.
- There are no standard specifications for in-place recycling.

Three distinct types of CIR are currently being used in the United States. These types, which are briefly discussed below, include the following:<sup>(9)</sup>

- Type 1—Rip/pulverize and compact.
- Type 2—Single Unit Recycler.
- Type 3—Recycling Train.



*Type 1 CIR—Rip/pulverize and compact*

Often referred to as full-depth recycling or reclamation, Type 1 CIR is the oldest and least expensive method of in-place recycling. It is often used when there is little remaining life in the road or when surface defects are caused by problems in the underlying layer. In this process, the existing pavement is reworked to a depth that may vary from 100 to 300 mm. The recycled material provides a good-quality base layer on which an AC surface course or a surface treatment can be applied.<sup>(9)</sup>

The general procedures for Type 1 CIR are illustrated in figure 5-3. The existing pavement is first ripped and crushed in place by multiple passes of a scarifier or ripper. The crushed material, or RAP, is then windrowed with a grader and may be sprayed with the designated recycling agent. New aggregate may also be added at this point. A motor grader is used to thoroughly mix the new material, which is then spread into place by either the grader or a paver. Following compaction and curing, a surface layer is then applied.

*Type 2 CIR—Single unit recycler*

Type 2 CIR is a partial- or full-depth recycling operation that provides a high-quality base or surface course. In comparison to Type 1 CIR, this operation provides better quality control with respect to maintaining a uniform reprocessing depth and to remixing. In addition, Type 2 CIR reduces the recycled material to a smaller more uniform size. Type 2 CIR is generally limited to a depth of 150 to 200 mm and, as a result, should be able to remove all pavement defects in a typical thick-lift asphalt pavement.

Type 2 CIR eliminates the need for multiple pieces of equipment and equipment passes for the breaking, crushing, and mixing operations. As shown in figure 5-4, a planer or milling machine is used to perform these operations in a single pass. The new mixture is then either windrowed for spreading by a grader or conveyed to a paver for relaying. Following compaction and curing, a surface layer may or may not be applied. Roughly 1.6 to 3.2 km/day of a standard 3.7-m wide lane can be recycled using this operation.

*Type 3 CIR—Recycling train*

Type 3 CIR is the newest and most productive in-place recycling process. Like Type 2 CIR, it is a partial- or full-depth recycling operation that produces a high-quality base or surface course. It differs, however, in the equipment required to carry out the process and, subsequently, in the rate at which the pavement is recycled. For these reasons, it is more appropriate on large recycling jobs.



1. Rip and break existing pavement



2. Pulverize existing pavement

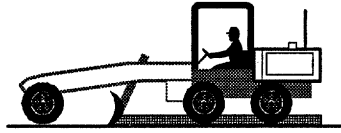

3. Windrow Existing Asphalt Bound Materials

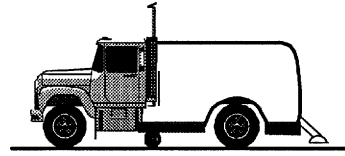

4. Apply Modifier to Windrowed Asphalt Bound Materials

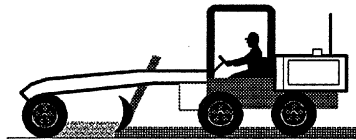

5. Mix with existing and/or new base aggregate material

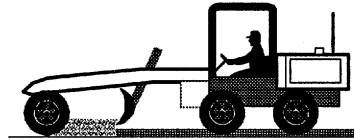

6. Spread upgraded base to specified thickness

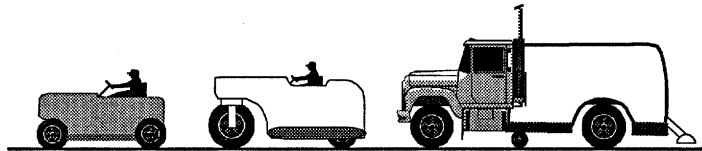

7. Compact, seal and cure



8. Apply wearing surface

Figure 5-3. General sequence of Type 1 CIR operation. <sup>(9)</sup>

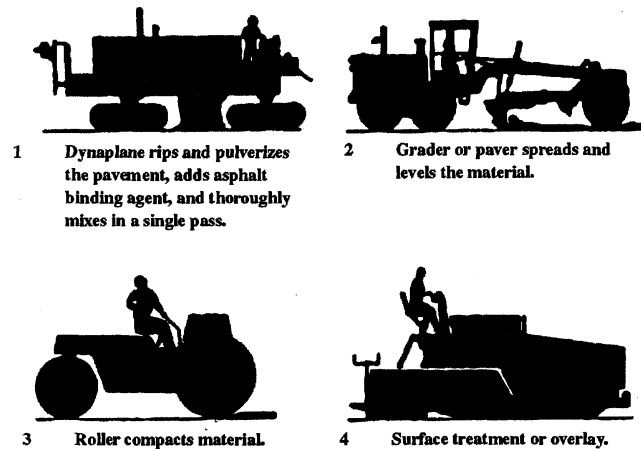

Figure 5-4. General sequence of Type 2 CIR operation.<sup>(9)</sup>

The process involves the use of large, specialized equipment that work closely together as a recycling train. Figure 5-5 shows a typical recycling train and the flow of material through the individual pieces of equipment.

The train is headed by a milling machine, which grinds off the existing pavement to a depth ideally between 50 and 100 mm. The RAP material is then conveyed to a screening and crushing unit that reduces the material size to less than 30 to 50 mm.

Next, the RAP material is transported to the mixing unit, or traveling pugmill. There it is weighed and mixed with measured amounts of aggregate and recycling agent. The new mixture can be deposited directly into the hopper of a paver or layed down in a windrow for subsequent pick-up by a paver. The paver then spreads the material evenly for compaction by steel-wheeled and/or rubber-tired rollers. Depending on the existing road condition, depth of recycling, terrain, and traffic, the train can recycle 3.2 to 9.7 km/day of a standard 3.7-m wide lane.



Figure 5-5. Type 3 CIR recycling train.<sup>(9)</sup>

### Hot-Mix Recycling

Hot-mix recycling is the process in which all or some portion of the pavement structure is removed, reduced to the desired size, and mixed hot with additional asphalt cement at a central plant. The process normally includes the addition of new aggregate, and may include the addition of a recycling agent.<sup>(4)</sup> The finished product is generally required to meet standard materials specifications and construction requirements for the type of AC mixture being produced (e.g., base, binder, or surface course).<sup>(10)</sup>

In comparison with CIR, hot-mix recycling is a costlier and more labor-intensive operation. Material hauling, hot plant processing, and greater quality control are major contributors to its higher costs. Although there is generally more disruption with hot mix recycling, traffic can be allowed on the recycled pavement much sooner than with CIR because of the shorter curing period. More importantly, the higher level of quality control in the hot-mix recycling process generally results in a more stable and consistent mixture.

The two foremost considerations in selecting hot-mix recycling for a given rehab project are existing pavement condition and cost. As seen in table 5-2, hot-mix recycling is considered a proper remedy for many pavement defects. In general, it can be used to correct mixture deficiencies, to restore pavement smoothness, and to increase the overall strength of the pavement. Because of its higher costs, however, careful comparisons must be made to determine if it is the most cost-effective approach for the combination of defects observed in the existing pavement. This is especially the case for low-volume roads and short rehabilitation projects.

Other matters that must be considered include the suitability of existing materials for recycling and the availability of experienced and properly equipped

Table 5-2. Guide for selection of AC recycling method.<sup>(12)</sup>

Type of pavement distress	Hot-Mix Recycling	Hot In-Place Recycling	Cold In-Place Recycling
Surface Defects			
<i>Raveling</i>	x	x <sup>1</sup>	
<i>Bleeding</i>	x	x <sup>4</sup>	
<i>Slipperiness</i>	x	x <sup>1</sup>	
Deformation			
<i>Corrugations (washboarding)</i>	x	x <sup>4</sup>	
<i>Rutting (shallow)<sup>2</sup></i>	x	x <sup>4</sup>	
<i>Rutting (deep)<sup>3</sup></i>	x		x <sup>5</sup>
Cracking (load associated)			
<i>Alligator</i>	x		x
<i>Longitudinal (wheelpath)</i>	x	x <sup>6</sup>	x
<i>Pavement Edge</i>	x		x
<i>Slippage</i>	x	x <sup>7</sup>	
Cracking (nonload associated)			
<i>Block (shrinkage)</i>	x		x
<i>Longitudinal (joint)</i>	x	x <sup>8</sup>	
<i>Transverse (thermal)</i>	x		x
Reflection Cracking	x		x
Maintenance Patching			
<i>Spray</i>	x <sup>9</sup>		x <sup>9</sup>
<i>Skin</i>	x <sup>9</sup>		x <sup>9</sup>
<i>Pothole</i>	x		x
<i>Deep (hot mix)</i>	x		x
Ride Quality/Roughness			
<i>General Unevenness</i>	x	x	
<i>Depressions (settlement)</i>	x <sup>10</sup>	x <sup>10</sup>	
<i>High Spots (heaving)</i>	x <sup>10</sup>	x <sup>10</sup>	

**Notes:**

- <sup>1</sup> Applicable if the surface course thickness does not exceed 40 mm.
- <sup>2</sup> Rutting is limited to the top 40 to 50 mm of the pavement.
- <sup>3</sup> Rutting originates below the surface course, including base and subgrade.
- <sup>4</sup> May be a temporary correction if entire layer affected not removed or treated by the addition of special admixtures.
- <sup>5</sup> The addition of new aggregate may be required for unstable mixes.
- <sup>6</sup> Applicable if the cracking is limited to the surface course of the pavement.
- <sup>7</sup> Applicable if the treatment is to a depth below the layer where the slippage is occurring.
- <sup>8</sup> Applicable if the cracking is limited to the surface course of the pavement.
- <sup>9</sup> In some instances, spray and skin patches may be removed by cold planing prior to these treatments (consider if very asphalt rich or bleeding).
- <sup>10</sup> May be only a temporary correction if the distress is related to a subgrade problem.

contractors. In the case of the former, the presence of the following materials may render an existing pavement unsuitable for hot-mix recycling:<sup>(1)</sup>

- More than 10 percent of the pavement material is a seal coat, slurry seal, or cold patch.
- The pavement contains cutback asphalts.
- The pavement contains any coal tars.

Although the availability of experienced and properly equipped contractors has become widespread in recent years, their proximity to the project may be too far for hot-mix recycling to be the most cost-effective rehabilitation strategy.

Because the quality of recycled hot-mix must normally satisfy the requirements of a new AC mixture, a considerable amount of evaluation, testing, and design work is necessary. This often includes the following tasks:

- Reviewing past construction records of the existing pavement.
- Visually assessing the condition of the existing pavement.
- Performing material characterization tests on the stockpiled RAP.
- Formulating a recycled mixture design and determining the proper amounts of new materials (e.g., asphalt, aggregate) to be added to the RAP.
- Performing quality control tests on the recycled mixture to determine if it meets the applicable specifications.

Examples of the design concepts involved in hot-mix recycling can be found in reference 10.

The construction sequence for hot-mix recycling typically consists of the following four activities:

- Full- or partial-depth removal of the pavement.
- Reduction of the RAP to the appropriate size.
- Reprocessing of the RAP through a hot-mix plant with the addition of one or more of the following: virgin aggregate, new asphalt cement, and recycling agent.
- Placement and compaction of the recycled hot-mix as a base, binder, or surface course.

The existing thin-lift hot-mix asphalt pavement is generally removed by milling, although ripping equipment have also been used. With milling, partial- and full-depth pavement removal is possible, and sizing of the RAP is done simultaneously with the pavement removal step. The milling operation is normally performed to an optimum depth of between 50 and 100 mm. And, although single-pass removal to as deep as 200 mm is possible, the operating

speed can be greatly reduced and oversized RAP may result, thereby requiring additional sizing.

Complete removal of a thin-lift hot-mix asphalt pavement can generally be done with a single pass of a milling machine or the use of ripping equipment. While RAP millings are usually reduced to the appropriate size, the RAP produced by ripping equipment must generally undergo additional crushing at the central plant. Central-plant sizing can be performed with conventional, fixed, and portable crushing and screening equipment.<sup>(13)</sup>

Both conventional batch plants and continuous mix (drum-mixer) plants have been used successfully to produce recycled hot-mix.<sup>(4)</sup> Both plant types make use of the heat-transfer method, whereby the RAP is primarily heated through mixing with superheated virgin aggregate. Additional asphalt or recycling agent are also added during the mixing, as called for in the mixture design.

As with conventional hot-mix paving operations, the recycled hot-mix is hauled to the jobsite where it is loaded into the hopper of an asphalt paver for proper laydown. Steel-wheeled and rubber-tired rollers are used to compact the newly layed material to the required density.

### **Resurfacing**

As discussed in module 3, resurfacing in this manual refers to the process in which an AC overlay is placed on the existing pavement to restore serviceability to near original level. PCC overlays of thin-lift hot-mix asphalt roadways are another option, but are not discussed in this manual.

The major advantages of AC resurfacing include the wide availability of hot-mix paving contractors and equipment, relatively short disruptions to traffic, and good long-term service. The major disadvantages include the need for careful design and quality control, decreased vertical clearances, potential for reflective cracking, and possible adjustments or level-up work required for adjacent structures (e.g., manholes, curb and gutter, shoulders). In addition, the cost of an overlay can be prohibitive to many local agencies.

AC resurfacing is typically performed to improve the functional or structural performance of a pavement. Functional performance refers to the ability of a pavement to provide a safe, smooth-riding surface for the traveling public. Functional resurfacing generally consists of a thin AC overlay that serves one or more of the following purposes:<sup>(2)</sup>

- Increase skid resistance.
- Improve pavement profile (level up).
- Improve rideability.
- Improve surface drainage.
- Reduce water infiltration.
- Retard environmental deterioration.
- Enhance appearance.

Structural performance refers to the ability of a pavement to withstand traffic and environmental loadings. In contrast with functional resurfacing, structural resurfacing normally involves the use of a thick AC overlay designed to:

- Increase structural capacity of the pavement.
- Reduce the rate of deterioration.

Depending upon the problem in the existing pavement, and on the purpose of the overlay, AC resurfacing may consist of one or more lifts (i.e., paving layers) of material. The lifts may be a part of either the binder course (the structural layer) or the surface course (the top, protective layer), and they generally range from 25 to 200 mm thick. The binder course is sometimes referred to as the leveling course, and the surface course is sometimes referred to as the wearing course.

The material used in each layer can vary in composition. To provide added strength, binder course material typically contains larger sized aggregate and slightly less asphalt cement than surface course material. The smaller sized aggregate and higher asphalt cement content in a surface course material help provide an abrasion-resistant and waterproof surface layer.

AC overlays may be applied in conjunction with recycling operations to provide a protective surface. Such overlays are particularly common with cold-milling (surface removal) and cold in-place recycling (CIR) operations.

To successfully design and construct an AC overlay, a thorough examination must be made of the existing pavement, as detailed in module 2 of this manual. This examination should reveal the prime cause of pavement deterioration so that proper pre-overlay repairs or treatments can be specified and so that an adequate overlay thickness can be determined.

The construction sequence for AC resurfacing consists of the following steps:



- Application of pre-overlay repairs or treatments to the existing pavement.
- Processing of blended aggregate and asphalt cement at a hot-mix asphalt plant to produce a hot, homogeneous asphalt paving mixture.
- Placement and compaction of the hot-mix as a leveling, binder, or surface course.

Pre-overlay repairs or treatments of deteriorated, thin-lift hot-mix asphalt pavement occasionally include one or more of the following:

- Localized patching of potholes or fatigue-cracked (alligatored) areas.
- Level-up patching of rutted wheelpaths.
- Treatment of thermal cracks to delay reflection cracking in the overlay.
- Surface leveling of sags and depressions.
- Cleaning and applying tack coat to the existing surface to improve bonding between the existing asphalt surface and the AC overlay.

Hot-mix production may take place at either a batch plant or a continuous mix plant. In a batch plant, blended aggregate is heated and dried in a dryer, screened into different sizes, and then weighed to the specified proportions. Next, the aggregate is emptied into a pugmill where it is blended together and mixed with the proper amount (by weight) of heated asphalt cement. The entire batch of hot-mix is then discharged into a haul vehicle.

In a continuous-mix plant, screened and heated aggregate is continuously proportioned and transported to the pugmill. Asphalt cement is then sprayed on the aggregate at a rate that is calibrated with the movement of aggregate. The two materials are continuously mixed in the pugmill and are discharged into a temporary hopper for delivery to the haul vehicle.

After being hauled to the jobsite, the hot-mix is loaded into the hopper of an asphalt paver for proper laydown. Steel-wheeled rollers and rubber-tired rollers are then used to compact the newly laid material to the required density. Achieving the proper density is essential. Insufficient density (compaction) may lead to rutting problems or stripping (from moisture penetrating the surface). Too much compaction of the AC can cause construction cracking and bleeding.

### **Surface Treatment**

Surface treatment is a broad term that embraces several types of asphalt and asphalt-aggregate applications, usually less than 25 mm thick, placed on any kind of roadway surface.<sup>(9)</sup> The general purpose of these applications is to improve or protect the surface characteristics of the roadway. They provide no structural improvement to the pavement.

Although surface treatment techniques have long been used for rehabbing low-volume roads, recent advancements in technology have led to their successful use on higher volume roads and streets. When used in the proper situations, they provide a low-cost, protective surface that extends pavement life and reduces required maintenance expenditures.

The functions of surface treatment techniques are summarized as follows:<sup>(4)</sup>

- Provide a new wearing surface.
- Seal minor cracks in the surface.
- Waterproof the surface.
- Improve skid resistance and surface drainage.
- Slow pavement weathering.
- Improve pavement appearance.
- Provide visual distinction between the mainline pavement and the shoulder.
- Rejuvenate the top 6 mm of an AC surface.

Surface treatment techniques are classified by their composition and by their use. A total of nine techniques are available for use on thin-lift hot-mix asphalt pavements. A description of each of these techniques and the specific functions they serve are provided in the sections below.

#### Asphalt Chip Seal

An asphalt chip seal consists of sequential applications of asphalt (asphalt cement, cut-back asphalt, or asphalt emulsion) and stone chips to form a surface layer as thick as 25 mm. The combined application may be applied once (single chip seal) or may be repeated two or three times (double or triple chip seals).

The primary objectives of the asphalt chip seal are to provide a new, durable surface course and to increase skid resistance. Although their past use has typically been on low-volume roads, recent improvements in design and construction have resulted in greater use on higher volume roads.

The construction sequence for a single asphalt chip seal consists of the following four steps:<sup>(5)</sup>

- Clean the existing surface to remove dirt and other loose materials.
- Apply the asphalt material at the specified rate and temperature using a calibrated asphalt distributor.
- Immediately spread the stone chips evenly over the surface at the specified rate using a properly calibrated aggregate spreader.
- Immediately roll the stone chips with a rubber-tired roller to firmly seat them in the asphalt and against the underlying layer.

Depending on the type of asphalt material used and the posted speed limit, the chip-sealed road can be opened to traffic within 0.5 to 2 hours.

#### Open-Graded Friction Course

Open-graded friction courses (OGFC), also called plant mix seals or popcorn mixes, are porous surface mixes produced with large amounts of voids (minimum 15 percent) that allow water to drain rapidly through the mix and flow to the side of the road. These mixes are used to improve the friction properties of the surface and also reduce tire spray and the potential for hydroplaning, thereby reducing wet weather accidents. The OGFC also tends to provide a quieter riding surface, as it produces lower tire noise. Typical thicknesses of OGFC are 25 to 50 mm.<sup>(4)</sup>

OGFC contain a more open gradation (i.e. small amount of fines and more particles of one size) than conventional dense-graded materials. However, mixtures are produced and placed in a manner similar to dense-graded hot mixes. A tack coat is needed prior to the placement of the OGFC and compaction is accomplished solely by a static steel-wheeled roller. This is because vibratory rollers can damage the aggregate and rubber-tired rollers tend to pick up the asphalt.

#### Rubberized Asphalt Chip Seal

A rubberized asphalt chip seal is a special type of chip seal in which rubber (latex or ground tire rubber) is blended with asphalt cement. This application can be used solely as a stress-absorbing membrane (SAM) or in conjunction with an overlay as a stress-absorbing membrane interlayer (SAMI).

In both applications, the purpose is to reduce the reflection of underlying cracks through the surface layer. The latex or ground rubber tires adds resiliency to the asphalt, which improves bonding with the aggregate and reduces the tackiness and ravelling of the surface. The added resiliency also enables the seal to "bridge" existing cracks better.

The construction of a rubberized asphalt chip seal is similar to the construction of an asphalt chip seal. The major difference is the use of a modified applicator for spraying the thicker rubberized asphalt binder.<sup>(6)</sup>

#### Slurry Seal

A slurry seal is a homogeneous mixture of asphalt emulsion, water, fine aggregate, and mineral filler that has a creamy, fluid-like appearance.<sup>(5)</sup> It is effective in sealing surface cracks, waterproofing the pavement surface, and improving skid resistance at speeds below about 65 kph. Three types of slurry seal are available that differ by the size of aggregate used. The type with the

finest aggregate is primarily used for sealing purposes, while the type with the largest aggregate is primarily used for improving skid resistance and filling slight depressions.

The slurry seal mixture is produced on-site in a special truck-mounted, traveling mixer. Once mixed, the slurry is dumped into a spreader box attached to the back of the vehicle. The spreader box spreads the slurry onto the cleaned pavement and an attached squeegee smooths the material into a layer between 3 and 6 mm thick. Rolling is not generally necessary and, depending on the weather, traffic can be allowed on the pavement within 2 to 12 hours.

#### Micro-Surfacing

Developed in Europe, micro-surfacing is a term used to describe the application of a polymer-modified slurry seal, with latex rubber being the most commonly used polymer. Micro-surfacing materials consist of asphalt and latex mixed with aggregate, fillers, and other additives and is a modification of the slurry and sand seal.<sup>(4)</sup> It has been used as a wearing surface and for rut-filling. Ralumac is probably the most widely known example of this process in the United States.

The construction sequence for micro-surfacing resembles that of slurry seals. A modified traveling plant mixer is used to continuously load materials from haul vehicles and mix them on-site. An adjustable width spreader box is used for resurfacing purposes, while individual drag boxes are used for rut-filling purposes. Rolling is generally not required and the pavement can typically be opened to traffic within 1 hour.

#### Fog Seal

A fog seal is a very light application of an asphalt emulsion (with no aggregate) to an oxidized asphalt surface. The purpose of the application is to rejuvenate the oxidized asphalt and seal fine cracks so that the need for more corrective rehabilitation is postponed for 1 or 2 years.

The treatment is most suitable for low-volume roads that can be closed to traffic for the 4 to 6 hours required for the material to sufficiently set. It is widely used along AC shoulders to help provide a distinct delineation between the mainline pavement and the shoulder. Application involves spraying the material at a specified rate using an asphalt distributor.

#### Sand Seal

A sand seal is a spray application of asphalt emulsion followed by a light covering of sand or screening. This application serves the same function as a fog

seal, but provides better surface friction. However, the surface appearance of a sand seal does not provide the delineation that a fog seal does.

The placement of a sand seal is typically 2 to 5 mm thick. Once the sand covering has been applied to the asphalt emulsion, a rubber-tired roller is used to firmly embed the sand in the asphalt. The pavement can be opened to traffic once the seal has sufficiently set (typically about 2 hours).

#### Cape Seal

A cape seal is a combination of both an asphalt chip seal and a slurry seal. The advantage of the cape seal is that a thicker, more durable surface is obtained, and it can be used on higher volume roads.<sup>(4)</sup> The cape seal typically results in a smoother pavement with a more pleasing appearance, and can provide added skid resistance.

The construction process consists of the chip seal being applied first, followed by the application of the slurry seal between 4 and 10 days later.

#### Sandwich Seal

A sandwich seal consists of an application of asphalt (asphalt emulsion or asphalt cement), sandwiched between two applications of different sized aggregate. The primary objectives of the sandwich seal are to provide a new wearing course and to increase skid resistance.

Typical sandwich seals are constructed between 6 and 19 mm thick. The construction process consists of the following five steps:

- Cleaning the existing surface.
- Application of the first aggregate at 60 to 80 percent coverage.
- Application of the asphalt material at the specified rate and temperature.
- Application of the second aggregate (smaller size than first aggregate) to sufficiently fill the voids left by the first aggregate.
- Rolling of the aggregate with a rubber-tired roller to firmly seat it in the asphalt.

Depending on the type of asphalt material used, the pavement can generally be reopened to traffic within 2 hours.

### **3. SELECTION OF THE MOST APPROPRIATE REHAB OPTION**

Thus far, course participants have been introduced to the various rehabilitation procedures used to improve the serviceability of thin-lift hot-mix asphalt roadways. In this section, participants will be instructed on the process used to determine the preferred option for a given project.

In the decision-making process for selection of the preferred rehab strategy, the following steps are fundamental:<sup>(14)</sup>

- Determination of the cause of distress(es) or problems of the pavement.
- Development of a candidate list of solutions that will properly address, cure, and/or prevent future occurrences of the problem.
- Selection of the preferred rehabilitation strategy, given economic and other project constraints.

The first step is completed using the pavement evaluation procedures provided in module 2, and is therefore not discussed here.

The second step involves the consideration of other (many noneconomic) factors toward the goal of identifying a few practical options (typically between two and four). These factors largely consist of the following:

- Functional requirements.
- Structural requirements.
- Drainage.
- Local experience and manpower.
- Availability of resources.
- Construction considerations.
- Limited project funding.

To determine which of the resulting practical options is the most cost-effective (and thus the preferred rehabilitation method), a life-cycle cost analysis is recommended. This analysis takes into consideration the various costs and estimated performance of each option over its anticipated service life and generates a standard unit of cost by which the options can be compared.

Brief descriptions of the various selection factors and how they affect the different rehab methods are provided in the following sections.

## **Noneconomic Factors**

### **Functional Requirements**

Frequently, the main objective in a rehabilitation project is to increase the functional adequacy of the pavement (i.e., increase skid resistance and/or ride quality). As a result, some alternatives can be quickly shortlisted for further consideration. These alternatives often include the following:

- Functional AC overlay.
- Asphalt chip seal.
- OGFC.
- Slurry seal.
- Microsurfacing.
- Sand seal.
- Cape seal.
- Sandwich seal.
- Pavement removal.
- Hot-surface recycling.

Further shortlisting can be done given the specific functional improvement desired.

### **Structural Requirements**

In situations where the major rehabilitation objective is to significantly increase structural capacity, the list of practical alternatives can be narrowed to the following:

- Structural AC overlay.
- CIR (types 1, 2, and 3).
- Hot-mix recycling.
- Pavement removal with thick AC overlay.
- Hot surface recycling with thick AC overlay.

Each of these methods can be used to meet the desired structural requirements. However, only CIR and hot-mix recycling have the capability of fully correcting the structural defects (e.g., alligator cracks and rutting) in the asphalt layers.

### **Drainage**

If the pavement evaluation reveals a serious drainage problem, immediate consideration must be given to those options that will best remedy the drainage and other problems. Thin-lift hot-mix asphalt pavements may be susceptible to weakening effects of water on the subgrade layer. Drainage problems in these

structures may also consist of standing water on the pavement surface as a result of either poor cross-slope (e.g., rutting) or a surface that does not drain well. Practical options for addressing these problems consist of the following:

<u>Poor cross-slope</u>	<u>Non-draining surface</u>	<u>Other methods</u>
Pavement removal	OGFC	Deepen ditches
Hot surface recycling	Asphalt chip seal	Place culverts
Micro-surfacing	Hot surface recycling	Clean culverts
Asphalt chip seal		

#### Local Experience and Manpower

The availability of local contractors with experience in the various rehabilitation methods is often a major factor in the selection process. Local contractors inexperienced with some methods may simply not be capable of performing those methods or of providing the quality, timeliness, and economics desired of those methods. One option which should be examined in this situation is the added cost associated with retaining outside contractors experienced in the methods that are not practiced locally.

In general, the availability of local contractors experienced in each of the three rehabilitation types is fairly good. Although recycling is not practiced nearly as much as resurfacing and the placement of surface treatments, the availability of local contractors capable of successful recycling operations is steadily growing. Likewise, some of the more specialized surface treatment techniques, such as micro-surfacing and OGFC, are also catching on.

#### Resource Requirements

Additional up-front costs can generally be expected if local contractors are improperly equipped or if the necessary materials are not readily available. In the first case, the additional costs stem from greater mobilization and hauling, as an experienced outside contractor must be used. In the second case, the additional costs stem primarily from hauling, as material (usually aggregate) must be shipped in from distant sources.

The availability of recycling equipment and some surface treatment equipment are limited in some areas. Devices such as those used in CIR and microsurfacing operations are still relatively new and, in the case of the former, quite expensive.

The lack of strong and durable local aggregate can be a concern with either of the three general rehabilitation alternatives. Local aggregate that is soft and nondurable will adversely impact performance and must be avoided. Additionally, local aggregate producers may not process aggregate into the sizes



or shapes required by particular asphalt-aggregate mixtures. This is occasionally a concern with some of the surface treatment techniques, such as micro-surfacing.

### Construction Considerations

Although there are several construction factors worthy of consideration, the following are among the most common:

- Traffic control requirements.
- Geometric constraints.
- Suitability of existing pavement materials for recycling.

The time period for which a road must be partially or completely shut down can often determine which rehabilitation methods get shortlisted for further consideration and which ones do not. Obviously, the methods that result in the greatest disruptions to traffic will be least desirable by the traveling public. Such disruptions are often tied to material production rates, operational rates of the equipment, and pavement curing times.

Geometric constraints can occasionally limit which alternatives get further consideration. These constraints typically include the following:

- In-the-road manholes.
- Curb and gutter.
- Clearances beneath bridges and overhead signs.
- Utilities.

On occasion, the existing asphalt pavement may be unsuitable for recycling due to the presence of harmful materials or excessive material variability. In the case of the former, considerable amounts of tar, asphalt cutback, and asphalt emulsion in the existing pavement can pose operational problems with air quality or mix design quality. In the case of the latter, several changes in material composition throughout the project can result in excessive reprocessing changes and, possibly, excessive testing requirements.

### **Economic Factors**

#### Limited Project Funding

If the funds available for a particular project are somewhat limited, then it is likely that some of the rehabilitation methods with the highest up-front costs will have to be dropped from consideration. This may, however, result in the dismissal of some of the more cost-effective methods, in which case extra efforts to secure more funding could be justified.

### Performance Considerations

One important aspect in determining the most cost-effective rehabilitation alternative is the performance of the pavement after it has been rehabilitated. Although performance is defined as the area under a serviceability-time curve (figure 5-2), a commonly used indicator of performance is service life. This is the period of time that a rehabilitated pavement will last before reaching a minimum acceptable serviceability level.

The performance characteristics of each option depend largely on the following factors:

- Climatic conditions.
- Traffic volumes.
- Existing pavement condition.
- Quality of materials.
- Mixture design.
- Construction quality.

Because of these factors, the experiences of various agencies with different rehab methods vary widely. Figure 5-6 shows the expected service lives of a few of the rehabilitation methods based on a 1986 survey of several cities and counties.<sup>(9)</sup>

As can be seen, resurfaced pavements are expected to last the longest, followed closely by in-place recycled pavements. However, surface treated pavements are generally expected to provide about one-third the life of resurfaced pavements.

### Life-Cycle Costs

To determine the most cost-effective rehabilitation option, a fixed analysis period must first be established. This analysis period may range from 5 to 25 years, depending on programmed funding and the desire for long-term planning. A strategy must then be developed for each option such that pavement serviceability remains above a minimum acceptable level over the analysis period. As seen in figure 5-7, a strategy may consist solely of the rehab alternative or may involve the rehab alternative combined with a series of future maintenance or rehab activities.

Once alternative strategies have been developed, the life-cycle costs associated with each strategy can be estimated. These are the projected costs assumed by the local-roads agency and the traveling public during the analysis period. In the case of roadway rehabilitation, the following life-cycle costs should be considered:

## ASPHALT SURFACE MAINTENANCE TECHNIQUES EXPECTATION LEVELS (in years)

183 responses

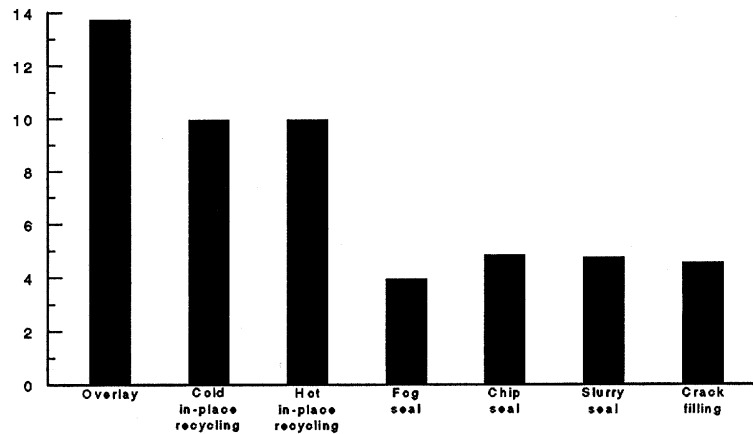

Figure 5-6. Expected life of various rehab methods.<sup>(9)</sup>

- **Engineering and administrative costs**—The costs of evaluating the existing pavement, selecting the preferred option, designing the rehabilitated pavement, and preparing the necessary plans and specifications for the rehabilitation work.
- **Rehabilitation costs**—The costs associated with initial and future rehabilitation activities intended to restore the pavement to an acceptable serviceability level.
- **Maintenance costs**—The costs associated with maintaining a pavement at or above some predetermined performance level. These costs include both preventive and corrective maintenance costs, but not rehabilitation costs.
- **Salvage value**—The value of the pavement at the end of the life cycle or analysis period.
- **User costs**—The costs assumed by the traveling public in the form of delay costs, increased operating costs, and accidents.

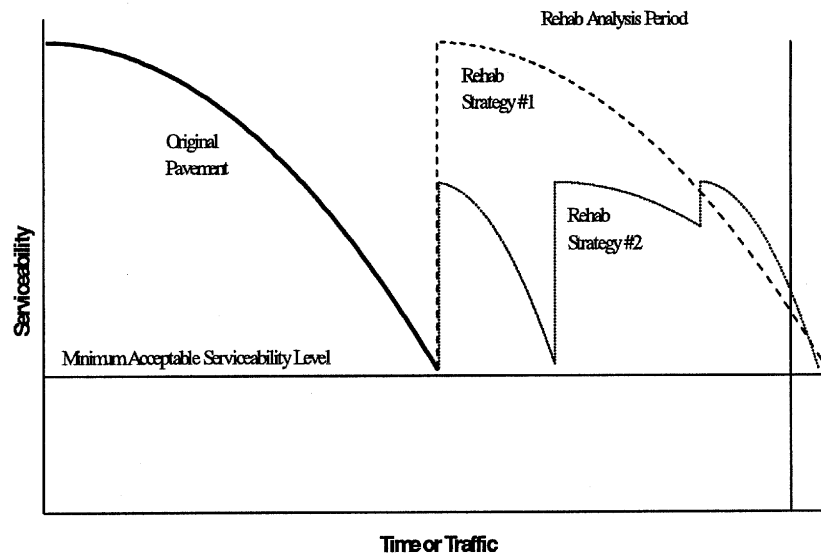

Figure 5-7. Example of different rehab strategies for a given analysis period.

#### Life-Cycle Cost Analysis

Several methods of economic analysis have been used to compare the cost-effectiveness of different rehabilitation strategies. The more common methods, which are briefly discussed below, require the use of a discount rate, which represents the time value of money. The discount rate is used to convert future predicted costs or benefits to their present worth or to uniform annual costs so that the economics of the different strategies can be compared. The discount rate is commonly taken as the difference between the interest and inflation rates.<sup>(15)</sup> Historically, discount rates have been in the range of 3 to 5 percent.

- **Present-worth method**—This method involves converting all future costs associated with a particular strategy to present-worth costs. These converted costs and the initial rehab costs are then summed to obtain a single, present-worth cost that can be directly compared with the present-worth costs of the other alternatives.
- **Annualized method**—This method involves converting all present and future costs associated with a particular strategy to a uniform annual cost over the analysis period. This uniform annual cost can then be directly compared with the uniform annual costs of the other alternatives. This method is preferred when the estimated service lives of various alternatives are different.

- **Benefit-cost ratio method**—This method involves expressing the ratio of present-worth benefits of a particular strategy to its present-worth costs. Strategies that result in a benefit-cost ratio greater than one are considered economical and the strategy that produces the highest incremental ratio with respect to other strategies is considered the best choice.
- **Rate-of-return method**—This method consists of determining the discount rate at which the cost and benefit for a given strategy are equal. The strategy with the highest first cost that exceeds a minimum acceptable rate of return (specified by the agency) is considered to be the best alternative.

Although the benefit-cost ratio method is used frequently in the highway field, it is occasionally difficult to understand. And, although the rate-of-return method has the distinct advantage of not requiring knowledge of a discount rate, it can be very time-consuming and it has situational flaws.

The present-worth method and the annualized method are the preferred methods of analysis and are therefore presented in this manual. The concepts behind each of these methods are easily understood and the analyses are relatively straightforward to perform.

In the present-worth method, future lump-sum costs and uniform annual costs are converted to present-worth values using the following two equations:

$$PW = F \times \frac{1}{(1+i)^n} \quad (1)$$

where: PW = Present-worth cost.  
 F = Future cost at the end of n years.  
 i = Discount rate.  
 n = number of years.

$$PW = A \times \frac{(1+i)^n - 1}{i(1+i)^n} \quad (2)$$

where: PW = Present-worth cost.  
 A = Uniform annual costs for n years.  
 i = Discount rate.  
 n = number of years.

In the annualized method, present-worth costs are converted to uniform annual costs using the following equation:

$$A = PW \times \frac{i(1+i)^n}{(1+i)^n - 1} \quad (3)$$

where: A = Uniform annual cost over analysis period of n years.  
PW = Present-worth cost.  
i = Discount rate.  
n = number of years in analysis period.

In each case, the costs for each option are determined and the option with the lowest cost represents the most cost-effective solution.

However, because of the other noneconomic factors included, the option with the lowest life cycle cost may not be the preferred solution.

Examples of the present-worth method and the annualized method are provided in figures 5-8 and 5-9, respectively.

Comparing Rehab Strategies		
<u>Rehab Strategy A</u>		
Initial cost:		\$150,000
Rehab at 10 years		\$35,000
Salvage value:	\$50,000	
Estimated service life		15 years
<u>Rehab Strategy B</u>		
Initial cost:		\$120,000
Maintenance at 4 years		\$15,000
Maintenance at 8 years:		\$15,000
Maintenance at 12 years:	\$15,000	
Salvage value:	\$1,000	
Estimated service life		15 years
Specified Discount Rate:		4 percent
<b>Analysis</b>		
<u>Rehab Strategy A</u>		
PW (initial cost) =		\$150,000
PW (rehab at 10 years) = $35,000 \times [1/(1+0.04)^{10}] =$		+ \$16,212
PW (salvage at 15 years) = $50,000 \times [1/(1+0.04)^{15}] =$		- \$15,762
<b>Total Present Worth of Rehab Strategy A</b>		<b>\$150,451</b>
<u>Rehab Strategy B</u>		
PW (initial cost) =		\$120,000
PW (maintenance at 4 years) = $15,000 \times [1/(1+0.04)^4] =$		+ \$11,025
PW (maintenance at 5 years) = $15,000 \times [1/(1+0.04)^8] =$		+ \$8,104
PW (maintenance at 12 years) = $15,000 \times [1/(1+0.04)^{12}] =$		+ \$5,957
PW (salvage at 15 years) = $1,000 \times [1/(1+0.04)^{15}] =$		- \$315
<b>Total Present Worth of Rehab Strategy B</b>		<b>\$144,771</b>
<b>Based on the given assumptions, rehab strategy B is the more cost-effective strategy.</b>		

Figure 5-8. Example of present-worth method of economic analysis.

Comparing Rehab Strategies	
<u>Rehab Strategy A</u>	
Initial cost:	\$150,000
Maintenance at 5 years:	\$25,000
Maintenance at 10 years:	\$25,000
Maintenance at 15 years:	\$25,000
Salvage value:	\$2,000
Estimated service life:	20 years
<u>Rehab Strategy B</u>	
Initial cost:	\$200,000
Rehab at 10 years:	\$50,000
Salvage value:	\$40,000
Estimated service life:	20 years
Specified Discount Rate:	4 percent
<b>Analysis</b>	
<u>Rehab Strategy A</u>	
A (initial cost) = $150,000 \times [(0.04)(1.04)^{20}] / [(1.04)^{20} - 1]$ =	\$15,278
PW (maint. @ 5 yrs.) = $25,000 \times [1 / (1.04)^5]$ = \$17,015	
A (maint. @ 5 yrs.) = $17,015 \times [(0.04)(1.04)^{20}] / [(1.04)^{20} - 1]$ =	+ \$1,733
PW (maint. @ 10 yrs.) = $25,000 \times [1 / (1.04)^{10}]$ = \$11,580	
A (maint. @ 10 yrs.) = $11,580 \times [(0.04)(1.04)^{20}] / [(1.04)^{20} - 1]$ =	+ \$1,179
PW (maint. @ 15 yrs.) = $25,000 \times [1 / (1.04)^{15}]$ = \$7,881	
A (maint. @ 15 yrs.) = $7,881 \times [(0.04)(1.04)^{20}] / [(1.04)^{20} - 1]$ =	+ \$803
PW (salvage @ 20 yrs.) = $2,000 \times [1 / (1.04)^{20}]$ = \$429	
A (salvage @ 20 yrs.) = $429 \times [(0.04)(1.04)^{20}] / [(1.04)^{20} - 1]$ =	- \$44
<b>Total Annual Cost of Rehab Strategy A</b>	<b>\$18,949</b>
<u>Rehab Strategy B</u>	
A (initial cost) = $200,000 \times [(0.04)(1.04)^{20}] / [(1.04)^{20} - 1]$ =	\$20,370
PW (rehab. @ 10 yrs.) = $50,000 \times [1 / (1.04)^{10}]$ = \$23,160	
A (rehab. @ 10 yrs.) = $23,160 \times [(0.04)(1.04)^{20}] / [(1.04)^{20} - 1]$ =	+ \$2,359
PW (salvage @ 20 yrs.) = $40,000 \times [1 / (1.04)^{20}]$ = \$8,582	
A (salvage @ 20 yrs.) = $8,582 \times [(0.04)(1.04)^{20}] / [(1.04)^{20} - 1]$ =	- \$874
<b>Total Annual Cost of Rehab Strategy B</b>	<b>\$21,855</b>
<b>Based on the given assumptions, rehab strategy A is the more cost effective.</b>	

Figure 5-9. Example of annualized method of economic analysis.



REFERENCES

1. Asphalt Institute, *Thickness Design of Asphalt Pavements for Highways and Streets*, Manual Series No. 1 (MS-1), February 1991.
2. *Pavement Design: Principles and Practices*, Training Course Manual, National Highway Institute, September 1987.
3. Asphalt Institute, *Asphalt Surface Treatments: Construction Techniques*, Educational Series No. 12 (ES-12), February 1982.
4. *Techniques for Pavement Rehabilitation*, Training Course Manual, National Highway Institute, Federal Highway Administration, Fifth Revision, May 1993.
5. Roberts, F. L., P. S. Kandahl, E. R. Brown, D. Y. Lee, and T. W. Kennedy, *Hot-Mix Asphalt Materials, Mixture Design, and Construction*, First Edition, National Asphalt Pavement Association, Education Foundation, 1991.
6. Heitzman, M. A., *State of the Practice: Design and Construction of Asphalt Paving Materials with Crumb Rubber Modifier*, Report No. FHWA-SA-92-022, Federal Highway Administration, May 1992.
7. *Techniques for Pavement Rehabilitation*, Training Course Manual, National Highway Institute, Federal Highway Administration, Third Revision, October 1987.
- 7.5 Hudson, S. W., B. F. McCullough, and R. F. Carmichael, *Surface Design and Rehabilitation Guidelines for Low-Volume Roads—Final Report*, Report No. FHWA/TS-87-225, Federal Highway Administration, June 1987.
8. Epps, J. A., *Cold-Recycled Bituminous Concrete Using Bituminous Materials*, NCHRP Synthesis of Highway Practice 160, National Cooperative Highway Research Program, July 1990.
9. Wood, L. E., T. D. White, and T. B. Nelson, *Current Practice of Cold In-Place Recycling of Asphalt Pavements*, Transportation Research Record 1178, Transportation Research Board, 1988.
10. Asphalt Institute, *Asphalt Hot-Mix Recycling*, Manual Series No. 20 (MS 20), Second Edition, 1986.
11. Asphalt Institute, *The Asphalt Handbook*, Manual Series No. 4 (MS 4), 1988.

12. Asphalt Recycling and Reclaiming Association, *An Overview of Recycling and Reclamation Methods for Asphalt Pavement Rehabilitation*, August 1992.
13. Epps, J. A., D. N. Little, R. J. Holmgreen, and R. L. Terrel, *Guidelines for Recycling Pavement Materials*, NCHRP Report 224, National Cooperative Highway Research Program, September 1980.
14. *AASHTO Guide for Design of Pavement Structures*, American Association of State Highway and Transportation Officials, 1986.
15. Peterson, D. E., *Life-Cycle Cost Analysis of Pavements*, NCHRP Synthesis of Highway Practice 122, National Cooperative Highway Research Program, December 1985.

# MODULE 6

## THIN-LIFT COLD-MIX ASPHALT ROADWAYS

### 1. INTRODUCTION

Thin-lift cold-mix asphalt roadways are defined as pavements having a cold-mix asphalt surface layer less than 50 mm thick with a granular or soil base layer above the existing subgrade. Figure 6-1 shows a typical thin-lift pavement structure. The asphalt layer in thin-lift cold-mix pavements consists of a conventional emulsified asphaltic cold-mix surface or base material, rather than the conventional hot-mix materials used in thin-lift hot-mix asphalt roadways.

The primary function of the AC layer in a thin-lift cold-mix asphalt pavement is to provide a smooth, somewhat watertight, driving surface. The asphalt layer will also provide some load-carrying capacity.

The second layer in a thin-lift cold-mix asphalt pavement, referred to as the granular base course, consists of aggregate material placed on the existing subgrade. This layer serves as a construction platform during the placement of the asphalt concrete layer, and also functions as the primary load-carrying layer of the pavement. In most cases, the aggregate base course will consist of a crushed rock material.

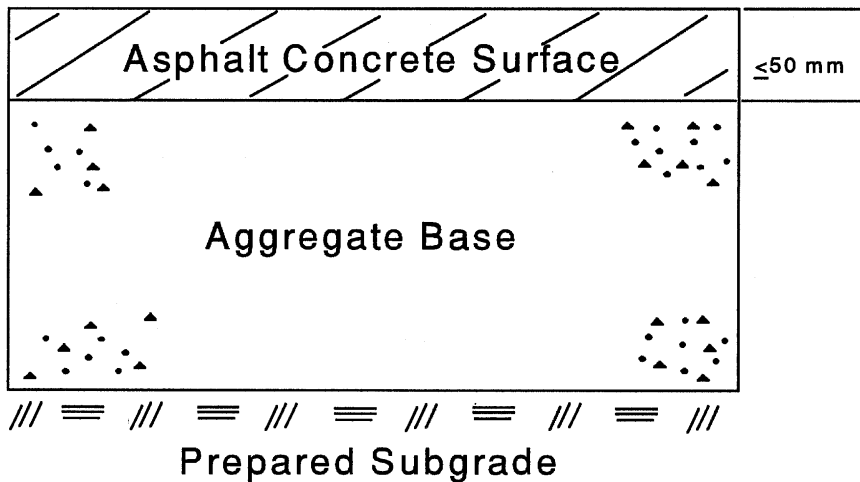

Figure 6-1. Typical thin-lift cold-mix asphalt pavement cross-section.

The foundation on which the aggregate base course and asphalt concrete layers rest usually consists of the natural soil that exists along the roadway. Occasionally, however, the existing soil may be too soft or unstable to provide an adequate platform for placing the aggregate base course, or would require an excessive amount of aggregate and asphalt concrete to provide adequate protection from traffic. In this case, the deficient soil may be replaced with higher quality soils or may be treated with an additive (e.g., lime or cement) to strengthen or stabilize the soil.

Thin-lift cold-mix asphalt pavements are generally used in low-volume situations where there is little justification for stronger pavement sections. Pavements expected to carry more than 100,000 equivalent axle loads over the life of the pavement should have thicker asphalt sections.<sup>(1)</sup>

## 2. APPROPRIATE REHAB OPTIONS

When a roadway is first constructed, it is built to a relatively high level of ride quality, or serviceability. As time goes on, the combined effects of traffic, age, and climate cause the pavement to deteriorate, or decrease in serviceability. The general pattern of pavement deterioration is such that serviceability remains high for a period of time and then begins to drop off fairly quickly, as shown in figure 6-2.

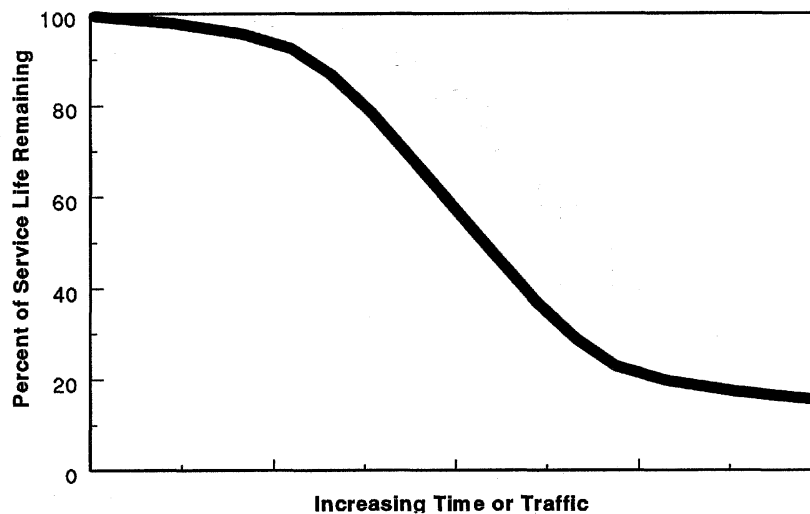

Figure 6-2. Pavement deterioration versus time and/or traffic.

At some point along the serviceability-time curve, a decision must be made to rehabilitate the pavement in order to restore it to a more acceptable serviceability level. Typically, rehabilitation is considered appropriate for pavements ranging in serviceability between poor and good. Reconstruction is often the more cost-effective strategy for pavements having very poor serviceability.

There are essentially three main options available for thin-lift cold-mix asphalt concrete roadways. These options include the following:

- Recycling.
- Resurfacing.
- Surface treatment.

Descriptions and appropriate uses of these options, as well as the specific applications and procedures available under each option, are provided in the following sections.

### **Recycling**

Recycling refers to any process that utilizes materials from an existing pavement for reuse in the same or other pavements. In the case of the former, the reclaimed materials may be reprocessed immediately through an on-the-spot recycling train or in a relatively short time through a central asphalt plant. In the case of the latter, the reclaimed materials may be reprocessed and then used on a different roadway.

The major advantages of asphalt pavement recycling include reduced costs and the conservation of materials (e.g., asphalt binder, aggregate) and the energy required to process those materials. Additional benefits include eliminating the need for material disposal and, occasionally, preserving roadway geometrics (i.e., eliminating the need for raising manholes, accommodating vertical clearances).

The major disadvantages of asphalt pavement recycling include the possible lack of experienced or properly equipped local contractors and of suitable in-place materials for recycling. The consequence of each of these is usually higher rehabilitation costs.

Various classification schemes have been applied to asphalt pavement recycling operations, based on one or more of the following items:

- Absence/inclusion of heat in the recycling process (cold or hot process).
- Location of material remixing (in-place or at central mixing plant).
- Depth of pavement removal or reworking (surface, surface and base).

One of the more common classification schemes consists of the following three categories:

- Surface recycling.
- Cold-mix recycling.
- Hot-mix recycling.

Surface recycling is a hot or cold, in-place process targeting the top 25 to 50 mm of pavement. Both cold- and hot-mix operations target the surface and a portion or all of the base. However, cold-mix recycling can be done either in-place or at a central plant, while hot-mix recycling is performed at a central plant.

Each recycling category contains several different procedures, with each procedure generally best suited for certain situations. Furthermore, the application of a surface layer (e.g., surface treatment, AC overlay) on top of the recycled layer may be required.

#### Surface Recycling

Surface recycling is the process by which the surface of an asphalt pavement is removed or reworked to a depth of less than 25 to 50 mm. This operation is divided into two basic processes: pavement removal and hot surface recycling. Each process, unique in terms of objectives and the equipment and procedures used, is discussed in further detail below.

Because surface recycling does not affect the base layer and soil foundation, it cannot be seriously considered as a rehab option for pavements containing structural, moisture, or subsurface material problems. Such problems can be addressed by hot-mix and cold-mix recycling operations.

#### *Pavement Removal*

Removal of the top 25 to 50 mm of surface material can be a useful rehabilitation technique by itself or in preparation for resurfacing with AC. Situations generally appropriate for pavement removal include the following:<sup>(7)</sup>

- Correction of low- and medium-severity rutting that has developed in the upper layer of asphalt.
- Corrections to areas of bleeding, ravelling, and poor skid-resistance.
- Reestablishing cross-slope for proper surface drainage.
- Removing bumps and, consequently, pavement roughness.
- Reducing or eliminating the need for feathering of a subsequent overlay along gutters or near bridge abutments.
- Improvement of bond between existing asphalt surface and subsequent AC overlay.

Pavement removal for thin-lift cold-mix asphalt pavements is most often accomplished with the following pieces of equipment:

- Cold Milling Machine.
- Hot Milling Machine.

The heater-planing operation described in modules 3 and 4 is not recommended for pavements less than 60 mm thick, and is thus not appropriate for thin-lift cold-mix asphalt pavements.<sup>(6)</sup>

Surface recycling is often performed with a cold milling machine. The cold milling machine uses carbide-tipped cutter bits mounted on a large revolving drum to grind the pavement surface into small asphalt millings and allows for various depths of removal. The millings are typically picked up by the milling machine and then loaded onto a dump truck using an attached conveyor belt. The millings may be used later as a recycled or unrecycled base course or as a recycled surface course.

Because of the efficiencies of current cold milling devices, hot milling has seen limited use in the United States. This operation, suitable only for asphalt pavements, is quite similar to cold milling with the exception of an added step of heating the pavement prior to grinding. The greater operational cost of hot milling may be justifiable where high production rates are needed or very cold weather is expected.

Table 6-1 lists the primary objectives for which cold milling is most suitable. Hot milling is typically performed for the same purposes as cold milling.

Table 6-1. Suitable objectives of cold-milling surface recycling process.

Objective	Cold-Milling
Remove bumps and reduce pavement roughness	X
Reestablish cross-slope	X
Removal of low-quality slurry or chip seals	
Removal of surface deterioration (e.g., ravelling, bleeding)	X
Maintain proper clearances for underpasses, tunnels, and sign bridges	X
Improve skid resistance	X
Promote bonding with AC overlay	X

### Cold-Mix Recycling

Cold-mix recycling is a process in which reclaimed asphalt pavement (RAP) materials are combined with new recycling agent and/or aggregate to produce cold-mix paving materials. This process, which can be done in-place or at a central mixing plant, requires no heat and is performed to a depth greater than 25 to 50 mm. The resulting cold-mix material is most often used as a base course, on which a protective asphalt surface layer is placed.

Cold-mix recycling operations largely involve cold, in-place recycling (CIR) procedures. These procedures, used for many years, have more widespread use occurring in the last 20 years. In general, CIR is appropriate for low-volume asphalt roads that are severely cracked and broken, highly rutted, or very rough. It is not recommended for roads with obvious soil foundation problems or with asphalt mixture problems that cannot be adequately corrected with CIR.

The benefits of CIR are numerous and include the following:<sup>(9,10)</sup>

- Significant structural improvements can be achieved without changes in horizontal and vertical geometry.
- Most types and severities of pavement distress can be treated.
- Reflection cracking can be delayed or eliminated.
- Pavement ride quality can be improved.
- Hauling costs can be minimized.
- Pavement profile, crown, and cross-slope can be improved.
- Production rate is high.
- Engineering costs are low.

Among the disadvantages of CIR are the following:<sup>(4,9)</sup>

- Construction variation is larger for in-place than for central-plant operations (i.e., lower quality control in the field than at the plant).
- Curing is required for strength gain, and is dependent upon climatic conditions, including temperature and moisture.
- Traffic disruption can be greater relative to other alternatives.
- The equipment is expensive, and not many contractors may own the equipment.
- There are no standard specifications for in-place recycling.

Three distinct types of CIR are currently being used in the United States. These types, which are briefly discussed below, include the following:<sup>(10)</sup>

- Type 1—Rip/pulverize and compact.
- Type 2—Single Unit Recycler.
- Type 3—Recycling Train.



*Type 1 CIR—Rip/pulverize and compact*

Often referred to as full-depth recycling or reclamation, Type 1 CIR is the oldest and least expensive method of in-place recycling. It is often used when there is little remaining life in the road or when surface defects are caused by problems in the underlying layer. In this process, the existing pavement is reworked to a depth that may vary from 100 to 300 mm. The recycled material provides a good-quality base layer on which an AC surface course or a surface treatment can be applied.<sup>(10)</sup>

The general procedures for Type 1 CIR are illustrated in figure 6-3. The existing pavement is first ripped and crushed in place by multiple passes of a scarifier or ripper. The crushed material, or RAP, is then windrowed with a grader and may be sprayed with the designated recycling agent. New aggregate may also be added at this point. A motor grader is used to thoroughly mix the new material, which is then spread into place by either the grader or a paver. Following compaction and curing, a surface layer is then applied.

*Type 2 CIR—Single unit recycler*

Type 2 CIR is a partial- or full-depth recycling operation that provides a high-quality base or surface course. In comparison to Type 1 CIR, this operation provides better quality control with respect to maintaining a uniform reprocessing depth and to remixing. In addition, Type 2 CIR reduces the recycled material to a smaller and more uniform size. Type 2 CIR is generally limited to a depth of 150 to 200 mm and, as a result, should be able to remove all pavement defects in a typical thick-lift asphalt pavement.

Type 2 CIR eliminates the need for multiple pieces of equipment and equipment passes for the breaking, crushing, and mixing operations. As shown in figure 6-4, a planer or milling machine is used to perform these operations in a single pass. The new mixture is then either windrowed for spreading by a grader or conveyed to a paver for relaying. Following compaction and curing, a surface layer may or may not be applied. Roughly 1.6 to 3.2 km/day of a standard 3.7-m wide lane can be recycled using this operation.

*Type 3 CIR—Recycling train*

Type 3 CIR is the newest and most productive in-place recycling process. Like Type 2 CIR, it is a partial- or full-depth recycling operation that produces a high-quality base or surface course. It differs, however, in the equipment required to carry out the process and, subsequently, in the rate at which the pavement is recycled. For these reasons, it is more appropriate on large recycling jobs.



1. Rip and break existing pavement



2. Pulverize existing pavement

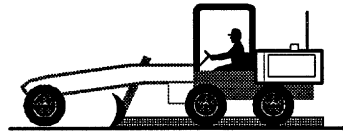

3. Windrow Existing Asphalt Bound Materials

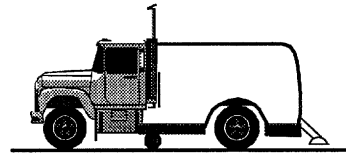

4. Apply Modifier to Windrowed Asphalt Bound Materials

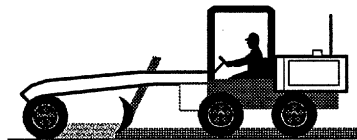

5. Mix with existing and/or new base aggregate material

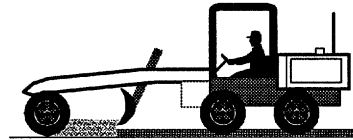

6. Spread upgraded base to specified thickness

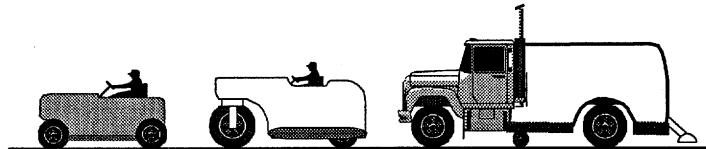

7. Compact, seal and cure

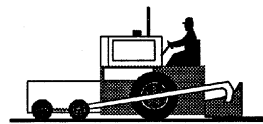

8. Apply wearing surface

Figure 6-3. General sequence of Type 1 CIR operation. <sup>(10)</sup>

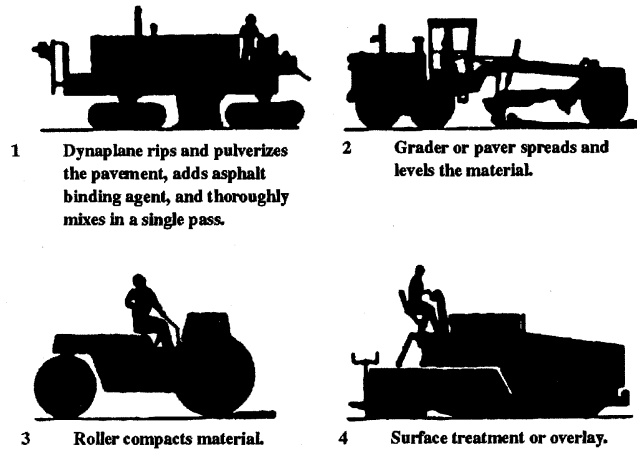

Figure 6-4. General sequence of Type 2 CIR operation.<sup>(10)</sup>

The process involves the use of large, specialized equipment that work closely together as a recycling train. Figure 6-5 shows a typical recycling train and the flow of material through the individual pieces of equipment.

The train is headed by a milling machine, which grinds off the existing pavement to a depth ideally between 50 and 100 mm. The RAP material is then conveyed to a screening and crushing unit that reduces the material size to less than 30 to 50 mm.

Next, the RAP material is transported to the mixing unit, or traveling pugmill. There it is weighed and mixed with measured amounts of aggregate and recycling agent. The new mixture can be deposited directly into the hopper of a paver or laid down in a windrow for subsequent pick-up by a paver. The paver then spreads the material evenly for compaction by steel-wheeled and/or rubber-tired rollers. Depending on the existing road condition, depth of recycling, terrain, and traffic, the train can recycle 3.2 to 9.7 km/day of a standard 3.7-m wide lane.

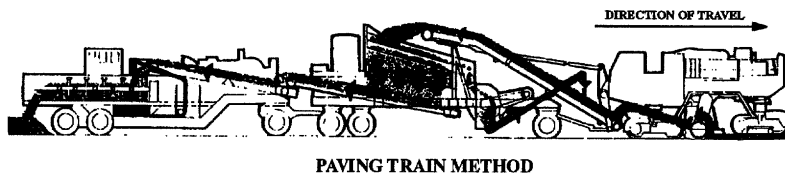

Figure 6-5. Type 3 CIR recycling train.<sup>(10)</sup>

### Hot-Mix Recycling

Hot-mix recycling is the process in which all or some portion of the pavement structure is removed, reduced to the desired size, and mixed hot with additional asphalt cement at a central plant. The process normally includes the addition of new aggregate, and may include the addition of a recycling agent.<sup>(4)</sup> The finished product is generally required to meet standard materials specifications and construction requirements for the type of AC mixture being produced (e.g., base, binder, or surface course).<sup>(11)</sup>

In comparison with CIR, hot-mix recycling is a costlier and more labor-intensive operation. Material hauling, hot plant processing, and greater quality control are major contributors to its higher costs. Although there is generally more disruption with hot mix recycling, traffic can be allowed on the recycled pavement much sooner than with CIR because of the shorter curing period. More importantly, the higher level of quality control in the hot-mix recycling process generally results in a more stable and consistent mixture.

The two foremost considerations in selecting hot-mix recycling for a given rehab project are existing pavement condition and cost. As seen in table 6-2, hot-mix recycling is considered a proper remedy for many defects. In general, it can be used to correct mixture deficiencies, to restore smoothness, and to increase the overall strength of the pavement. Because of its higher costs, however, careful comparisons must be made to determine if it is the most cost-effective approach for the combination of defects observed in the existing pavement. This is especially the case for low-volume roads and short rehabilitation projects.

Table 6-2. Guide for selection of AC recycling method.<sup>(13)</sup>

Type of pavement distress	Hot-Mix Recycling	Hot In-Place Recycling	Cold In-Place Recycling
Surface Defects			
<i>Raveling</i>	x	x <sup>1</sup>	
<i>Bleeding</i>	x	x <sup>4</sup>	
<i>Slipperiness</i>	x	x <sup>1</sup>	
Deformation			
<i>Corrugations (washboarding)</i>	x	x <sup>4</sup>	
<i>Rutting (shallow)<sup>2</sup></i>	x	x <sup>4</sup>	
<i>Rutting (deep)<sup>3</sup></i>	x		x <sup>5</sup>
Cracking (load associated)			
<i>Alligator</i>	x		x
<i>Longitudinal (wheelpath)</i>	x	x <sup>6</sup>	x
<i>Pavement Edge</i>	x		x
<i>Slippage</i>	x	x <sup>7</sup>	
Cracking (nonload associated)			
<i>Block (shrinkage)</i>	x		x
<i>Longitudinal (joint)</i>	x	x <sup>8</sup>	
<i>Transverse (thermal)</i>	x		x
Reflection Cracking	x		x
Maintenance Patching			
<i>Spray</i>	x <sup>9</sup>		x <sup>9</sup>
<i>Skin</i>	x <sup>9</sup>		x <sup>9</sup>
<i>Pothole</i>	x		x
<i>Deep (hot mix)</i>	x		x
Ride Quality/Roughness			
<i>General Unevenness</i>	x	x	
<i>Depressions (settlement)</i>	x <sup>10</sup>	x <sup>10</sup>	
<i>High Spots (heaving)</i>	x <sup>10</sup>	x <sup>10</sup>	

*Notes:*

- <sup>1</sup> Applicable if the surface course thickness does not exceed 40 mm.
- <sup>2</sup> Rutting is limited to the top 40 to 50 mm of the pavement.
- <sup>3</sup> Rutting originates below the surface course, including base and subgrade.
- <sup>4</sup> May be a temporary correction if entire layer affected not removed or treated by the addition of special admixtures.
- <sup>5</sup> The addition of new aggregate may be required for unstable mixes.
- <sup>6</sup> Applicable if the cracking is limited to the surface course of the pavement.
- <sup>7</sup> Applicable if the treatment is to a depth below the layer where the slippage is occurring.
- <sup>8</sup> Applicable if the cracking is limited to the surface course of the pavement.
- <sup>9</sup> In some instances, spray and skin patches may be removed by cold planing prior to these treatments (consider if very asphalt rich or bleeding).
- <sup>10</sup> May be only a temporary correction if the distress is related to a subgrade problem.

Other matters that must be considered include the suitability of existing materials for recycling and the availability of experienced and properly equipped contractors. In the case of the former, the presence of the following materials may render an existing pavement unsuitable for hot-mix recycling:<sup>(12)</sup>

- More than 10 percent of the pavement material is a seal coat, slurry seal, or cold patch.
- The pavement contains cutback asphalts.
- The pavement contains any coal tars.

Although the availability of experienced and properly equipped contractors has become widespread in recent years, their proximity to the project may be too far for hot-mix recycling to be the most cost-effective strategy.

Because the quality of recycled hot-mix must normally satisfy the requirements of a new AC mixture, a considerable amount of evaluation, testing, and design work is necessary. This often includes the following tasks:

- Reviewing past construction records of the existing pavement.
- Visually assessing the condition of the existing pavement.
- Performing material characterization tests on the stockpiled RAP.
- Formulating a recycled mixture design and determining the proper amounts of new materials (e.g., asphalt, aggregate) to be added to the RAP.
- Performing quality control tests on the recycled mixture to determine if it meets the applicable specifications.

Examples of the design concepts involved in hot-mix recycling can be found in reference 11.

The construction sequence for hot-mix recycling typically consists of the following four activities:

- Full- or partial-depth removal of the pavement.
- Reduction of the RAP to the appropriate size.
- Reprocessing of the RAP through a hot-mix plant with the addition of one or more of the following: virgin aggregate, new asphalt cement, and recycling agent.
- Placement and compaction of the recycled hot-mix as a base, binder, or surface course.

The existing thin-lift cold-mix asphalt pavement is generally removed by milling, although ripping equipment have also been used. With milling, partial- and full-depth pavement removal is possible, and sizing of the RAP is done simultaneously with the pavement removal step. The milling operation is

normally performed to an optimum depth of between 50 and 100 mm. And, although single-pass removal to as deep as 200 mm is possible, the operating speed can be greatly reduced and oversized RAP may result, thereby requiring additional sizing.

Complete removal of a thin-lift cold-mix asphalt pavement can generally be done with a single pass of a milling machine or the use of ripping equipment. While RAP millings are usually reduced to the appropriate size, the RAP produced by ripping equipment must generally undergo additional crushing at the central plant. Central-plant sizing can be performed with conventional, fixed, and portable crushing and screening equipment.<sup>(14)</sup>

Both conventional batch plants and continuous mix (drum-mixer) plants have been used successfully to produce recycled hot-mix.<sup>(4)</sup> Both plant types make use of the heat-transfer method, whereby the RAP is primarily heated through mixing with superheated virgin aggregate. Additional asphalt or recycling agent are also added during the mixing, as called for in the mixture design.

As with conventional hot-mix paving operations, the recycled hot-mix is hauled to the jobsite where it is loaded into the hopper of an asphalt paver for proper laydown. Steel-wheeled and rubber-tired rollers are used to compact the newly layed material to the required density.

### **Resurfacing**

As discussed in module 3, resurfacing in this manual refers to the process in which an AC overlay is placed on the existing pavement to restore serviceability to near original level. PCC overlays of thin-lift cold-mix asphalt roadways are not discussed in this manual.

The major advantages of AC resurfacing include the wide availability of hot-mix paving contractors and equipment, relatively short disruptions to traffic, and good long-term service. The major disadvantages include the need for careful design and quality control, decreased vertical clearances, potential for reflective cracking, and possible adjustments or level-up work required for adjacent structures (e.g., manholes, curb and gutter, shoulders). In addition, the cost of an overlay can be prohibitive to many local agencies.

AC resurfacing is typically performed to improve the functional or structural performance of a pavement. Functional performance refers to the ability of a pavement to provide a safe, smooth-riding surface for the traveling public. Functional resurfacing generally consists of a thin AC overlay that serves one or more of the following purposes:<sup>(2)</sup>

- Increase skid resistance.
- Improve pavement profile (level up).
- Improve rideability.
- Improve surface drainage.
- Reduce water infiltration.
- Retard environmental deterioration.
- Enhance appearance.

Structural performance refers to the ability of a pavement to withstand traffic and environmental loadings. In contrast with functional resurfacing, structural resurfacing normally involves the use of a thick AC overlay designed to:

- Increase structural capacity of the pavement.
- Reduce the rate of deterioration.

Depending upon the problem in the existing pavement, and on the purpose of the overlay, AC resurfacing may consist of one or more lifts (i.e., paving layers) of material. The lifts may be a part of either the binder course (the structural layer) or the surface course (the top, protective layer), and they generally range from 25 to 200 mm thick. The binder course is sometimes referred to as the leveling course, and the surface course is sometimes referred to as the wearing course.

The material used in each layer can vary in composition. To provide added strength, binder course material typically contains larger sized aggregate and slightly less asphalt cement than surface course material. The smaller sized aggregate and higher asphalt cement content in a surface course material help provide an abrasion-resistant and waterproof surface layer.

AC overlays may be applied in conjunction with recycling operations to provide a protective surface. Such overlays are particularly common with cold-milling (surface removal) and cold in-place recycling (CIR) operations.

To successfully design and construct an AC overlay, a thorough examination must be made of the existing pavement, as detailed in module 2 of this manual. This examination should reveal the prime cause of pavement deterioration so that proper pre-overlay repairs or treatments can be specified and so that an adequate overlay thickness can be determined.

The construction sequence for AC resurfacing consists of the following three steps:



- Application of pre-overlay repairs or treatments to the existing pavement.
- Processing of blended aggregate and asphalt cement at a hot-mix asphalt plant to produce a hot, homogeneous asphalt paving mixture.
- Placement and compaction of the hot-mix as a leveling, binder, or surface course.

Pre-overlay repairs or treatments of deteriorated, thin-lift cold-mix asphalt pavement occasionally include one or more of the following:

- Localized patching of potholes or fatigue-cracked (alligatored) areas.
- Level-up patching of rutted wheelpaths.
- Treatment of thermal cracks to delay reflection cracking in the overlay.
- Surface leveling of sags and depressions.
- Cleaning the existing surface and the application of a tack coat to improve bonding between the existing asphalt surface and the AC overlay.

Hot-mix production may take place at either a batch plant or a continuous mix plant. In a batch plant, blended aggregate is heated and dried in a dryer, screened into different sizes, and then weighed to the specified proportions. Next, the aggregate is emptied into a pugmill where it is blended together and mixed with the proper amount (by weight) of heated asphalt cement. The entire batch of hot-mix is then discharged into a haul vehicle.

In a continuous-mix plant, screened and heated aggregate is continuously proportioned and transported to the pugmill. Asphalt cement is then sprayed on the aggregate at a rate that is calibrated with the movement of aggregate. The two materials are continuously mixed in the pugmill and are discharged into a temporary hopper for delivery to the haul vehicle.

After being hauled to the jobsite, the hot-mix is loaded into the hopper of an asphalt paver for proper laydown. Steel-wheeled rollers and rubber-tired rollers are then used to compact the newly layed material to the required density. Achieving the proper density is essential. Insufficient density (compaction) may lead to rutting problems or stripping (from moisture penetrating the surface). Too much compaction of the AC can cause construction cracking and bleeding.

### **Surface Treatment**

Surface treatment is a broad term that embraces several types of asphalt and asphalt-aggregate applications, usually less than 25 mm thick, placed on any kind of roadway surface.<sup>(3)</sup> The general purpose of these applications is to improve or

protect the surface characteristics of the roadway. They provide no structural improvement to the pavement.

Although surface treatment techniques have long been used for rehabbing low-volume roads, recent advancements in technology have led to their successful use on higher volume roads and streets. When used in the proper situations, they provide a low-cost, protective surface that extends pavement life and reduces required maintenance expenditures.

The specific functions of surface treatment techniques can be summarized as follows:<sup>(4)</sup>

- Provide a new wearing surface.
- Seal minor cracks in the surface.
- Waterproof the surface.
- Improve skid resistance and surface drainage.
- Slow pavement weathering.
- Improve pavement appearance.
- Provide visual distinction between the mainline pavement and the shoulder.
- Rejuvenate the top 6 mm of an AC surface.

Surface treatment techniques are classified by their composition and by their use. A total of nine techniques are available for use on thin-lift cold-mix asphalt pavements. A description of each of these techniques and the specific functions they serve are provided in the sections below.

#### Asphalt Chip Seal

An asphalt chip seal consists of sequential applications of asphalt (asphalt cement, cut-back asphalt, or asphalt emulsion) and stone chips to form a surface layer as thick as 25 mm. The combined application may be applied once (single chip seal) or may be repeated two or three times (double or triple chip seals).

The primary objectives of the asphalt chip seal are to provide a new, durable surface course and to increase skid resistance. Although their past use has typically been on low-volume roads, recent improvements in design and construction have resulted in greater use on higher volume roads.

The construction sequence for a single asphalt chip seal consists of the following four steps:<sup>(5)</sup>

- Clean the existing surface to remove dirt and other loose materials.
- Apply the asphalt material at the specified rate and temperature using a calibrated asphalt distributor.

- Immediately spread the stone chips evenly over the surface at the specified rate using a properly calibrated aggregate spreader.
- Immediately roll the stone chips with a rubber-tired roller to firmly seat them in the asphalt and against the underlying layer.

Depending on the type of asphalt material used and the posted speed limit, the chip-sealed road can be opened to traffic within 0.5 to 2 hours.

#### Open-Graded Friction Course

Open-graded friction courses (OGFC), also called plant mix seals or popcorn mixes, are porous surface mixes produced with large amounts of voids (minimum 15 percent) that allow water to drain rapidly through the mix and flow to the side of the road. These mixes are used to improve the friction properties of the surface and also reduce tire spray and the potential for hydroplaning, thereby reducing wet weather accidents. The OGFC also tends to provide a quieter riding surface, as it produces lower tire noise. Typical thicknesses of OGFC are 25 to 50 mm.<sup>(4)</sup>

OGFC contain a more open gradation (i.e., small amount of fines and more particles of one size) than conventional dense-graded materials. However, OGFC mixtures are produced and placed in a manner similar to dense-graded hot mixes. A tack coat is needed prior to the placement of the OGFC and compaction is accomplished solely by a static steel-wheeled roller. This is because vibratory rollers can damage the aggregate and rubber-tired rollers tend to pick up the asphalt.

#### Rubberized Asphalt Chip Seal

A rubberized asphalt chip seal is a special type of chip seal in which rubber (latex or ground tire rubber) is blended with asphalt cement. This application can be used solely as a stress-absorbing membrane (SAM) or in conjunction with an overlay as a stress-absorbing membrane interlayer (SAMI).

In both applications, the purpose is to reduce the reflection of underlying cracks through the surface layer. The latex or ground rubber tires adds resiliency to the asphalt, which improves bonding with the aggregate and reduces the tackiness and ravelling of the surface. The added resiliency also enables the seal to "bridge" existing cracks better.

The construction of a rubberized asphalt chip seal is similar to the construction of an asphalt chip seal. The major difference is the use of a modified applicator for spraying the thicker rubberized asphalt binder.<sup>(6)</sup>

### Slurry Seal

A slurry seal is a homogeneous mixture of asphalt emulsion, water, fine aggregate, and mineral filler that has a creamy, fluid-like appearance.<sup>(5)</sup> It is effective in sealing surface cracks, waterproofing the pavement surface, and improving skid resistance at speeds below about 65 kph. Three types of slurry seal are available that differ by the size of aggregate used. The type with the finest aggregate is primarily used for sealing purposes, while the type with the largest aggregate is primarily used for improving skid resistance and filling slight depressions.

The slurry seal mixture is produced on-site in a special truck-mounted, traveling mixer. Once mixed, the slurry is dumped into a spreader box attached to the back of the vehicle. The spreader box spreads the slurry onto the cleaned pavement and an attached squeegee smooths the material into a layer between 3 and 6 mm thick. Rolling is not generally necessary and, depending on the weather, traffic can be allowed on the pavement within 2 to 12 hours.

### Micro-Surfacing

Developed in Europe, micro-surfacing is a term used to describe the application of a polymer-modified slurry seal, with latex rubber being the most commonly used polymer. Micro-surfacing materials consist of asphalt and latex mixed with aggregate, fillers, and other additives and is a modification of the slurry and sand seal.<sup>(4)</sup> It has been used as a wearing surface and for rut-filling. Ralumac is probably the most widely known example of this process in the United States.

The construction sequence for micro-surfacing resembles that of slurry seals. A modified traveling plant mixer is used to continuously load materials from haul vehicles and mix them on-site. An adjustable width spreader box is used for resurfacing purposes, while individual drag boxes are used for rut-filling purposes. Rolling is generally not required and the pavement can typically be opened to traffic within 1 hour.

### Fog Seal

A fog seal is a very light application of an asphalt emulsion (with no aggregate) to an oxidized asphalt surface. The purpose of the application is to rejuvenate the oxidized asphalt and seal fine cracks so that the need for more corrective rehabilitation is postponed for 1 or 2 years.

The treatment is most suitable for low-volume roads that can be closed to traffic for the 4 to 6 hours required for the material to sufficiently set. It is widely used along AC shoulders to help provide a distinct delineation between the

mainline pavement and the shoulder. Application involves spraying the material at a specified rate using an asphalt distributor.

#### Sand Seal

A sand seal is a spray application of asphalt emulsion followed by a light covering of sand or screening. This application serves the same function as a fog seal, but provides better surface friction. However, the surface appearance of a sand seal does not provide the delineation that a fog seal does.

The placement of a sand seal is typically 2 to 5 mm thick. Once the sand covering has been applied to the asphalt emulsion, a rubber-tired roller is used to firmly embed the sand in the asphalt. The pavement can be opened to traffic once the seal has sufficiently set (typically about 2 hours).

#### Cape Seal

A cape seal is a combination of both an asphalt chip seal and a slurry seal. The advantage of the cape seal is that a thicker, more durable surface is obtained, and it can be used on higher volume roads.<sup>(4)</sup> The cape seal typically results in a smoother pavement with a more pleasing appearance, and can provide added skid resistance.

The construction process consists of the chip seal being applied first, followed by the application of the slurry seal between 4 and 10 days later.

#### Sandwich Seal

A sandwich seal consists of an application of asphalt (asphalt emulsion or asphalt cement), sandwiched between two applications of different sized aggregate. The primary objectives of the sandwich seal are to provide a new wearing course and to increase skid resistance.

Typical sandwich seals are constructed between 6 and 19 mm thick. The construction process consists of the following five steps:

- Cleaning the existing surface.
- Application of the first aggregate at 60 to 80 percent coverage.
- Application of the asphalt material at the specified rate and temperature.
- Application of the second aggregate (smaller size than first aggregate) to sufficiently fill the voids left by the first aggregate.
- Rolling of the aggregate with a rubber-tired roller to firmly seat it in the asphalt.

Depending on the type of asphalt material used, the pavement can generally be reopened to traffic within 2 hours.

### **3. SELECTION OF THE MOST APPROPRIATE REHAB OPTION**

Thus far, course participants have been introduced to the various rehabilitation procedures used to improve the serviceability of thin-lift cold-mix asphalt roadways. In this section, participants will be instructed on the process used to determine the preferred option for a given project.

In the decision-making process for selection of the preferred rehab strategy, the following steps are fundamental.<sup>(15)</sup>

- Determination of the cause of distress(es) or problems of the pavement.
- Development of a candidate list of solutions that will properly address, cure, and/or prevent future occurrences of the problem.
- Selection of the preferred rehabilitation strategy, given economic and other project constraints.

The first step is completed using the pavement evaluation procedures provided in module 2, and is therefore not discussed here.

The second step involves the consideration of other (many noneconomic) factors toward the goal of identifying a few practical options (typically between two and four). These factors largely consist of the following:

- Functional requirements.
- Structural requirements.
- Drainage.
- Local experience and manpower.
- Availability of resources.
- Construction considerations.
- Limited project funding.

To determine which of the resulting practical options is the most cost-effective (and thus the preferred rehabilitation method), a life-cycle cost analysis is recommended. This analysis takes into consideration the various costs and estimated performance of each option over its anticipated service life and generates a standard unit of cost by which the options can be compared.

Brief descriptions of the various selection factors and how they affect the different rehab methods are provided in the following sections.

## **Noneconomic Factors**

### Functional Requirements

Frequently, the main objective in a rehabilitation project is to increase the functional adequacy of the pavement (i.e., increase skid resistance and/or ride quality). As a result, some alternatives can be quickly shortlisted for further consideration. These alternatives often include the following:

- Functional AC overlay.
- Asphalt chip seal.
- OGFC.
- Slurry seal.
- Microsurfacing.
- Sand seal.
- Cape seal.
- Sandwich seal.
- Pavement removal.
- Hot-surface recycling.

Further shortlisting can be done given the specific functional improvement desired.

### Structural Requirements

In situations where the major rehabilitation objective is to significantly increase structural capacity, the list of practical alternatives can be narrowed to the following:

- Structural AC overlay.
- CIR (types 1, 2, and 3).
- Hot-mix recycling.
- Pavement removal with thick AC overlay.
- Hot surface recycling with thick AC overlay.

Each of these methods can be used to meet the desired structural requirements. However, only CIR and hot-mix recycling have the capability of fully correcting the structural defects (e.g., alligator cracks and rutting) in the asphalt layers.

### Drainage

If the pavement evaluation reveals a serious drainage problem, immediate consideration must be given to those options that will best remedy the drainage and other problems. Thin-lift cold-mix asphalt pavements may be susceptible to weakening effects of water on the subgrade layer. Drainage problems in these

structures may also consist of standing water on the pavement surface as a result of either poor cross-slope (e.g., rutting) or a surface that does not drain well. Practical options for addressing these problems consist of the following:

<u>Poor cross-slope</u>	<u>Non-draining surface</u>	<u>Other methods</u>
Pavement removal	OGFC	Deepen ditches
Hot surface recycling	Asphalt chip seal	Place culverts
Microsurfacing	Hot surface recycling	Clean outlets
Asphalt chip seal		

#### Local Experience and Manpower

The availability of local contractors with experience in the various rehabilitation methods is often a major factor in the selection process. Local contractors inexperienced with some methods may simply not be capable of performing those methods or of providing the quality, timeliness, and economics desired of those methods. One option which should be examined in this situation is the added cost associated with retaining outside contractors experienced in the methods that are not practiced locally.

In general, the availability of local contractors experienced in each of the three rehabilitation types is fairly good. Although recycling is not practiced nearly as much as resurfacing and the placement of surface treatments, the availability of local contractors capable of successful recycling operations is steadily growing. Likewise, some of the more specialized surface treatment techniques, such as micro-surfacing and OGFC, are also catching on.

#### Resource Requirements

Additional up-front costs can generally be expected if local contractors are improperly equipped or if the necessary materials are not readily available. In the first case, the additional costs stem from greater mobilization and hauling, as an experienced outside contractor must be used. In the second case, the additional costs stem primarily from hauling, as material (usually aggregate) must be shipped in from distant sources.

The availability of recycling equipment and some surface treatment equipment are limited in some areas. Devices such as those used in CIR and microsurfacing operations are still relatively new and, in the case of the former, quite expensive.

The lack of strong and durable local aggregate can be a concern with either of the three general rehabilitation alternatives. Local aggregate that is soft and nondurable will adversely impact performance and must be avoided. Additionally, local aggregate producers may not process aggregate into the sizes



or shapes required by particular asphalt-aggregate mixtures. This is occasionally a concern with some of the surface treatment techniques, such as micro-surfacing.

#### Construction Considerations

Although there are several construction factors worthy of consideration, the following are among the most common:

- Traffic control requirements.
- Geometric constraints.
- Suitability of existing pavement materials for recycling.

The time period for which a road must be partially or completely shut down can often determine which rehabilitation methods get shortlisted for further consideration and which ones do not. Obviously, the methods that result in the greatest disruptions to traffic will be least desirable by the traveling public. Such disruptions are often tied to material production rates, operational rates of the equipment, and pavement curing times.

Geometric constraints can occasionally limit which alternatives get further consideration. These constraints typically include the following:

- In-the-road manholes.
- Curb and gutter.
- Clearances beneath bridges and overhead signs.
- Utilities.

On occasion, the existing asphalt pavement may be unsuitable for recycling due to the presence of harmful materials or excessive material variability. In the case of the former, considerable amounts of tar, asphalt cutback, and asphalt emulsion in the existing pavement can pose operational problems with air quality or mix design quality. In the case of the latter, several changes in material composition throughout the project can result in excessive reprocessing changes and, possibly, excessive testing requirements.

#### **Economic Factors**

##### Limited Project Funding

If the funds available for a particular project are somewhat limited, then it is quite likely that some of the rehabilitation methods with the highest up-front costs will have to be dropped from consideration. This may, however, result in the dismissal of some of the more cost-effective methods, in which case extra efforts to secure more funding could be justified.

### Performance Considerations

One important aspect in determining the most cost-effective rehabilitation alternative is the performance of the pavement after it has been rehabilitated. Although performance is defined as the area under a serviceability-time curve (figure 6-2), a commonly used indicator of performance is service life. This is the period of time that a rehabilitated pavement will last before reaching a minimum acceptable serviceability level.

The performance characteristics of each rehabilitation option depend largely on the following factors:

- Climatic conditions.
- Traffic volumes.
- Existing pavement condition.
- Quality of materials.
- Mixture design.
- Construction quality.

Because of these factors, the experiences of various agencies with the different rehab methods vary widely. Figure 6-6 shows the expected service lives of a few of the rehabilitation methods based on a 1986 survey of several cities and counties.<sup>(10)</sup> As can be seen, resurfaced pavements are expected to last the longest, followed closely by in-place recycled pavements. Surface treated pavements, however, are generally expected to provide about one-third the life of resurfaced pavements.

### Life-Cycle Costs

To determine the most cost-effective rehab option, a fixed analysis period must first be established. This analysis period may range from 5 to 25 years, depending on programmed funding and the desire for long-term planning. A strategy must then be developed for each rehabilitation alternative such that pavement serviceability remains above a minimum acceptable level over the analysis period. As seen in figure 6-7, a strategy may consist solely of the rehabilitation alternative or may involve the option combined with a series of future maintenance or rehabilitation activities.

Once alternative strategies have been developed, the life-cycle costs associated with each strategy can be estimated. These are the projected costs assumed by the local-roads agency and the traveling public during the analysis period. In the case of roadway rehabilitation, the following life-cycle costs should be considered:

## ASPHALT SURFACE MAINTENANCE TECHNIQUES EXPECTATION LEVELS (in years)

183 responses

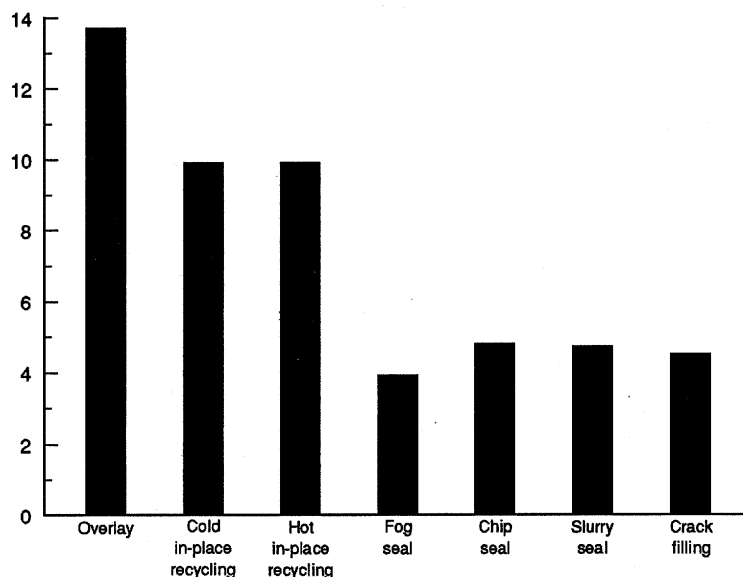

Figure 6-6. Expected life of various rehab methods.<sup>(10)</sup>

- **Engineering and administrative costs**—The costs of evaluating the existing pavement, selecting the preferred rehab option, designing the rehabilitated pavement, and preparing the necessary plans and specifications for the rehab work.
- **Rehabilitation costs**—The costs associated with initial and future rehabilitation activities intended to restore the pavement to an acceptable serviceability level.
- **Maintenance costs**—The costs associated with maintaining a pavement at or above some predetermined performance level. These costs include both preventive and corrective maintenance costs, but not rehab costs.
- **Salvage value**—The value of the pavement at the end of the life cycle or analysis period.
- **User costs**—The costs assumed by the traveling public in the form of delay costs, increased operating costs, and accidents.

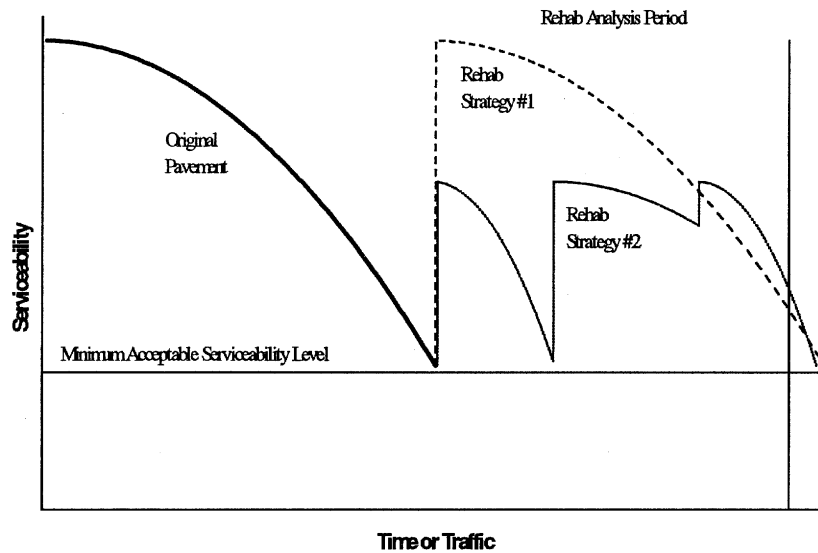

Figure 6-7. Example of different rehab strategies for a given analysis period.

#### Life-Cycle Cost Analysis

Several methods of economic analysis have been used to compare the cost-effectiveness of different rehabilitation strategies. The more common methods, which are briefly discussed below, require the use of a discount rate, which represents the time value of money. The discount rate is used to convert future predicted costs or benefits to their present worth or to uniform annual costs so that the economics of the different strategies can be compared. The discount rate is commonly taken as the difference between the interest and inflation rates.<sup>(16)</sup> Historically, discount rates have typically ranged from 3 to 5 percent.

- **Present-worth method**—This method involves converting all future costs associated with a particular strategy to present-worth costs. These converted costs and the initial rehab costs are then summed to obtain a single, present-worth cost that can be directly compared with the present-worth costs of the other alternatives.
- **Annualized method**—This method involves converting all present and future costs associated with a particular strategy to a uniform annual cost over the analysis period. This uniform annual cost can then be directly compared with the uniform annual costs of the other

alternatives. This method is preferred when the estimated service lives of various alternatives are different.

- **Benefit-cost ratio method**—This method involves expressing the ratio of present-worth benefits of a particular strategy to its present-worth costs. Strategies that result in a benefit-cost ratio greater than one are considered economical and the strategy that produces the highest incremental ratio with respect to other strategies is considered the best choice.
- **Rate-of-return method**—This method consists of determining the discount rate at which the cost and benefit for a given strategy are equal. The strategy with the highest first cost that exceeds a minimum acceptable rate of return (specified by the agency) is considered to be the best alternative.

Although the benefit-cost ratio method is used frequently in the highway field, it is occasionally difficult to understand. And, although the rate-of-return method has the distinct advantage of not requiring knowledge of a discount rate, it can be very time-consuming and it has situational flaws.

The present-worth method and the annualized method are the preferred methods of analysis and are therefore presented in this manual. The concepts behind each of these methods are easily understood and the analyses are relatively straightforward to perform.

In the present-worth method, future lump-sum costs and uniform annual costs are converted to present-worth values using the following two equations:

$$PW = F \times \frac{1}{(1+i)^n} \quad (1)$$

where: PW = Present-worth cost.  
 F = Future cost at the end of n years.  
 i = Discount rate.  
 n = number of years.

$$PW = A \times \frac{(1+i)^n - 1}{i(1+i)^n} \quad (2)$$

where: PW = Present-worth cost.  
 A = Uniform annual costs for n years.  
 i = Discount rate.  
 n = number of years.

In the annualized method, present-worth costs are converted to uniform annual costs using the following equation:

$$A = PW \times \frac{i(1+i)^n}{(1+i)^n - 1} \quad (3)$$

where: A = Uniform annual cost over analysis period of n years.  
PW = Present-worth cost.  
i = Discount rate.  
n = number of years in analysis period.

In each case, the costs for each option are determined and the option with the lowest cost represents the most cost-effective solution.

However, because of the other noneconomic factors included, the option with the lowest life cycle cost may not be the preferred solution.

Examples of the present-worth method and the annualized method are provided in figures 6-8 and 6-9, respectively.

## Comparing Rehab Strategies

Rehab Strategy A

Initial cost:		\$150,000
Rehab at 10 years		\$35,000
Salvage value:	\$50,000	
Estimated service life		15 years

Rehab Strategy B

Initial cost:		\$120,000
Maintenance at 4 years		\$15,000
Maintenance at 8 years:		\$15,000
Maintenance at 12 years:	\$15,000	
Salvage value:	\$1,000	
Estimated service life		15 years

Specified Discount Rate: 4 percent

## Analysis

Rehab Strategy A

PW (initial cost) =	\$150,000
PW (rehab at 10 years) = $35,000 \times [1/(1+0.04)^{10}] =$	+ \$16,212
PW (salvage at 15 years) = $50,000 \times [1/(1+0.04)^{15}] =$	- \$15,762
<b>Total Present Worth of Rehab Strategy A</b>	<b>\$150,451</b>

Rehab Strategy B

PW (initial cost) =	\$120,000
PW (maintenance at 4 years) = $15,000 \times [1/(1+0.04)^4] =$	+ \$11,025
PW (maintenance at 5 years) = $15,000 \times [1/(1+0.04)^8] =$	+ \$8,104
PW (maintenance at 12 years) = $15,000 \times [1/(1+0.04)^{12}] =$	+ \$5,957
PW (salvage at 15 years) = $1,000 \times [1/(1+0.04)^{15}] =$	- \$315
<b>Total Present Worth of Rehab Strategy B</b>	<b>\$144,771</b>

Based on the given assumptions, rehab strategy B is the more cost-effective strategy.

Figure 6-8. Example of present-worth method of economic analysis.

Comparing Rehab Strategies		
<u>Rehab Strategy A</u>		
Initial cost:		\$150,000
Maintenance at 5 years:		\$25,000
Maintenance at 10 years:	\$25,000	
Maintenance at 15 years:	\$25,000	
Salvage value:	\$2,000	
Estimated service life:		20 years
<u>Rehab Strategy B</u>		
Initial cost:		\$200,000
Rehab at 10 years:		\$50,000
Salvage value:	\$40,000	
Estimated service life:		20 years
Specified Discount Rate:		4 percent
Analysis		
<u>Rehab Strategy A</u>		
A (initial cost) = $150,000 \times \{[(.04)(1.04)^{20}] / [(1.04)^{20} - 1]\}$ =		\$15,278
PW (maint. @ 5 yrs.) = $25,000 \times [1 / (1.04)^5]$ = \$17,015		
A (maint. @ 5 yrs.) = $17,015 \times \{[(.04)(1.04)^{20}] / [(1.04)^{20} - 1]\}$ =		+ \$1,733
PW (maint. @ 10 yrs.) = $25,000 \times [1 / (1.04)^{10}]$ = \$11,580		
A (maint. @ 10 yrs.) = $11,580 \times \{[(.04)(1.04)^{20}] / [(1.04)^{20} - 1]\}$ =		+ \$1,179
PW (maint. @ 15 yrs.) = $25,000 \times [1 / (1.04)^{15}]$ = \$7,881		
A (maint. @ 15 yrs.) = $7,881 \times \{[(.04)(1.04)^{20}] / [(1.04)^{20} - 1]\}$ =		+ \$803
PW (salvage @ 20 yrs.) = $2,000 \times [1 / (1.04)^{20}]$ = \$429		
A (salvage @ 20 yrs.) = $429 \times \{[(.04)(1.04)^{20}] / [(1.04)^{20} - 1]\}$ =		- \$44
<b>Total Annual Cost of Rehab Strategy A</b>		<b>\$18,949</b>
<u>Rehab Strategy B</u>		
A (initial cost) = $200,000 \times \{[(.04)(1.04)^{20}] / [(1.04)^{20} - 1]\}$ =		\$20,370
PW (rehab. @ 10 yrs.) = $50,000 \times [1 / (1.04)^{10}]$ = \$23,160		
A (rehab. @ 10 yrs.) = $23,160 \times \{[(.04)(1.04)^{20}] / [(1.04)^{20} - 1]\}$ =		+ \$2,359
PW (salvage @ 20 yrs.) = $40,000 \times [1 / (1.04)^{20}]$ = \$8,582		
A (salvage @ 20 yrs.) = $8,582 \times \{[(.04)(1.04)^{20}] / [(1.04)^{20} - 1]\}$ =		- \$874
<b>Total Annual Cost of Rehab Strategy A</b>		<b>\$21,855</b>
<b>Based on the given assumptions, rehab strategy A is the more cost effective.</b>		

Figure 6-9. Example of annualized method of economic analysis.



REFERENCES

1. Asphalt Institute, *Thickness Design of Asphalt Pavements for Highways and Streets*, Manual Series No. 1 (MS-1), February 1991.
2. *Pavement Design: Principles and Practices*, Training Course Manual, National Highway Institute, September 1987.
3. Asphalt Institute, *Asphalt Surface Treatments: Construction Techniques*, Educational Series No. 12 (ES-12), February 1982.
4. *Techniques for Pavement Rehabilitation*, Training Course Manual, National Highway Institute, Federal Highway Administration, Fifth Revision, May 1993.
5. Roberts, F. L., P. S. Kandahl, E. R. Brown, D. Y. Lee, and T. W. Kennedy, *Hot-Mix Asphalt Materials, Mixture Design, and Construction*, First Edition, National Asphalt Pavement Association, Education Foundation, 1991.
6. Heitzman, M. A., *State of the Practice: Design and Construction of Asphalt Paving Materials with Crumb Rubber Modifier*, Report No. FHWA-SA-92-022, Federal Highway Administration, May 1992.
7. *Techniques for Pavement Rehabilitation*, Training Course Manual, National Highway Institute, Federal Highway Administration, Third Revision, October 1987.
8. Hudson, S. W., B. F. McCullough, and R. F. Carmichael, *Surface Design and Rehabilitation Guidelines for Low-Volume Roads—Final Report*, Report No. FHWA/TS-87-225, Federal Highway Administration, June 1987.
9. Epps, J. A., *Cold-Recycled Bituminous Concrete Using Bituminous Materials*, NCHRP Synthesis of Highway Practice 160, National Cooperative Highway Research Program, July 1990.
10. Wood, L. E., T. D. White, and T. B. Nelson, *Current Practice of Cold In-Place Recycling of Asphalt Pavements*, Transportation Research Record 1178, Transportation Research Board, 1988.
11. Asphalt Institute, *Asphalt Hot-Mix Recycling*, Manual Series No. 20 (MS 20), Second Edition, 1986.
12. Asphalt Institute, *The Asphalt Handbook*, Manual Series No. 4 (MS 4), 1988.

13. Asphalt Recycling and Reclaiming Association, *An Overview of Recycling and Reclamation Methods for Asphalt Pavement Rehabilitation*, August 1992.
14. Epps, J. A., D. N. Little, R. J. Holmgreen, and R. L. Terrel, *Guidelines for Recycling Pavement Materials*, NCHRP Report 224, National Cooperative Highway Research Program, September 1980.
15. *AASHTO Guide for Design of Pavement Structures*, American Association of State Highway and Transportation Officials, 1986.
16. Peterson, D. E., *Life-Cycle Cost Analysis of Pavements*, NCHRP Synthesis of Highway Practice 122, National Cooperative Highway Research Program, December 1985.

# MODULE 7

## SURFACE-TREATED ROADWAYS

### 1. INTRODUCTION

Surface-treated roadways are defined as those pavement structures in which the top layer, or riding surface, consists of a thin application of an asphalt cement or a combination of an asphalt cement and aggregate layer. There are many different types of surface treatments and each of these treatments are placed for a multitude of different reasons. What they have in common is that they are constructed to address a functional and not a structural deficiency of the pavement. Functional deficiencies are those that detract from the pavement's ability to serve the traveling public and include poor skid resistance, rutting or other non-structural wearing of the surface (in some cases), and other safety shortcomings. Because surface treatments address functional deficiencies, they tend to be rather thin. The maximum thickness of surface treated layers is around 25 mm; thin surfaces beyond that thickness are usually referred to as "thin-lift" asphalt overlays.

It is possible to find a surface treatment on any type of pavement, as it is an accepted rehabilitation technique for all types of roads. Thus one may find beneath a surface-treated roadway an AC pavement, a PCC pavement, or even a gravel road or previously applied surface treatment. The following list summarizes some of the common types of surface treatments that are being constructed today.

- Asphalt chip seal.
- Open-graded friction course.
- Rubberized asphalt chip seal.
- Polymer-modified chip seal.
- Slurry seal.
- Micro-surfacing.
- Fog seal.
- Sand seal.
- Cape seal.
- Sandwich seal.

While the appropriate application of each of these different techniques is beyond the scope of this module, the interested reader is encouraged to seek out a number of excellent references on this topic.<sup>(1,2)</sup>

## 2. APPROPRIATE REHAB OPTIONS

It is important to remember that surface-treated pavements themselves are usually already rehabilitated. That is, surface treatments are a type of rehabilitation (or, in some cases, maintenance) that are applied to address deficiencies in existing pavements. The rehabilitation of surface-treated pavements is somewhat more problematic than might be the case with a typical, deteriorated original pavement structure, as surface treatments are constructed with a wide range of materials and admixtures, and the effect of these different materials on subsequent rehabilitations is not widely reported (although it is known that the potential for problems does exist).

In what cases is it appropriate to consider rehabilitating a surface-treated pavement? There are two primary reasons. Recalling that a surface treatment is applied to address a functional deficiency, it is possible that the pavement has begun to exhibit structural defects that need to be corrected. For example, a surface treatment placed on an AC pavement to correct polishing in the wheelpath might begin to show reflective alligator cracking. Similarly, chip seals placed on a gravel roadway might exhibit rutting. These are cases in which repeated traffic loads have caused the pavement to continue to deteriorate and need further rehabilitation.

The other case in which a surface-treated roadway might need rehabilitation is if the surface treatment itself begins to fail. Assuming that the pavement itself is still in sound structural condition, the surface treatment could be peeling off, abrading away, polishing, or weathering. In such cases, the benefits of the functional improvements are lost.

The type of deterioration exhibited by the surface-treated roadway, the type and condition of the underlying pavement, and the desired future service life (both in terms of years and number of traffic loadings) all impact the selection of the appropriate method of rehabilitation. Three appropriate rehabilitation techniques for surface-treated pavements are discussed here: recycling, resurfacing with asphalt concrete, and applying additional surface treatments. This discussion is followed by guidance on selecting an appropriate treatment from among these strategies.

### **Recycling**

Recycling refers to any process that takes materials from an existing pavement for reuse in either the same or other pavements. When reused in the same pavement, the reclaimed materials may be reprocessed immediately through an on-the-spot recycling train, or in a relatively short time through a central asphalt plant. When recycled elsewhere, the reclaimed materials may be reprocessed and then used on a different roadway (or other application).

The major advantages of asphalt pavement recycling include potentially reduced costs, conservation of materials (e.g., asphalt binder, aggregate), and lower energy consumption required to process those materials. Additional benefits include eliminating the need for material disposal and, occasionally, preserving roadway geometrics (e.g., eliminating the need for raising manholes or adjusting curb lines, or accommodating vertical clearances).

Major disadvantages of asphalt pavement recycling include the possible lack of experienced or properly equipped local contractors and a shortage of suitable in-place materials for recycling. The consequence of either of these disadvantages may ultimately be higher rehabilitation costs. Successful recycling also may require more engineering than other rehabilitation techniques, and many of the combinations of recycling methods and surface treatment materials are incompatible.

There are several different ways of classifying recycling operations, but a well accepted differentiation of the most common techniques is based on the following three categories:

- Surface recycling.
- Cold-mix recycling.
- Hot-mix recycling.

Surface recycling is a hot or cold, in-place process that is limited to the top 25 to 50 mm of pavement. Cold-mix recycling can be done either in-place or at a central plant, always includes the surface layer, and may include one or more base layers. Hot-mix recycling also includes the surface, may include one or more base layers, and is performed at a central plant. These techniques are described below in further detail.

#### Surface Recycling

Surface recycling is the process by which the surface of an asphalt pavement is removed or reworked to a depth of less than 25 to 50 mm. This operation is divided into two basic processes: pavement removal and hot surface recycling. Each process is discussed in further detail below. Because surface recycling does not include removal of the base layer or reworking of the foundation, it is not a good rehabilitation option for pavements exhibiting structural, moisture, or subsurface material problems; such problems are better addressed by hot-mix and cold-mix recycling operations. It can also be a difficult process to perform satisfactorily if there is not a higher type material beneath the surface treatment.

*Pavement Removal*

Removal of the top 25 to 50 mm of surface material can be a useful rehabilitation technique by itself or in preparation for resurfacing with AC. Deficiencies that are appropriately addressed by pavement removal include the following.<sup>(9)</sup>

- Low- and medium-severity rutting that can be isolated to the upper surface layer.
- Areas of bleeding, raveling, and poor skid-resistance.
- Inadequate cross-slope for proper surface drainage.
- Where there is a need to reduce or eliminate feathering of a subsequent overlay along gutters or near bridge abutments.
- Improvement of bond between existing asphalt surface and subsequent AC overlay.

Pavement removal is most often accomplished with the following pieces of equipment:

- Cold Milling Machine.
- Hot Milling Machine.

The heater-planing option described in modules 3 and 4 is not recommended on pavements less than 60 mm thick or for pavements with cut-back material, and is thus not generally appropriate for surface-treated roadways.

Surface recycling is often performed with a cold milling machine. Cold milling machines use carbide-tipped bits mounted on a large revolving drum to grind the pavement surface into small asphalt millings; the adjustable drum allows the removal of varying thicknesses of material. The millings are typically transferred from the milling machine into a dump truck by a conveyor belt, and may be used later in either a base course or recycled surface course.

Because of the efficiencies of current cold milling devices, hot milling has seen limited use in the United States. This operation is quite similar to cold milling, except for an added step of heating the pavement prior to milling. The greater operational cost of hot milling may be justifiable where high production rates are needed or very cold weather is expected.

Table 7-1 lists the primary objectives for which cold milling is suitable. Hot milling is typically performed for the same purposes as cold milling.

Table 7-1. Suitability of various surface recycling processes.

Objective	Cold-Milling
Remove bumps and reduce pavement roughness	X
Reestablish cross-slope	X
Removal of low-quality slurry or chip seals	
Removal of surface deterioration (e.g., raveling, bleeding)	X
Maintain proper clearances for underpasses, tunnels, and sign bridges	X
Improve skid resistance	X
Promote bonding with AC overlay	X

### Cold-Mix Recycling

Cold-mix recycling is a process in which reclaimed asphalt pavement (RAP) materials are combined with a lighter fraction of asphalt cement and/or additional aggregate to produce cold-mix paving materials. This process, which can be done in-place or at a central mixing plant, requires no heat and is performed to a depth greater than 25 to 50 mm. The resulting cold-mix material is most often used as a base course, on which a protective asphalt surface layer is placed.

Cold-mix recycling operations largely involve cold, in-place recycling (CIR) procedures. While these procedures have been used for many years, they have seen widespread use only in the last 20 years. In general, CIR is appropriate for low-volume asphalt roads that are severely cracked and broken, highly rutted, or very rough. It is not recommended for roads with obvious soil foundation problems or with asphalt mixture problems that cannot be adequately corrected with CIR.

The benefits of CIR are numerous and include the following:<sup>(4,5)</sup>

- Significant structural improvements can be achieved without changes in horizontal and vertical geometry.
- Most types and severities of pavement distress can be treated.
- Reflection cracking can be delayed or eliminated.

- Pavement ride quality can be improved.
- Hauling costs can be minimized.
- Pavement profile, crown, and cross-slope can be improved.
- Production rate is high.
- Engineering costs are low.

Among the disadvantages of CIR are the following:<sup>(4,6)</sup>

- Construction variation is larger for in-place than for central-plant operations (i.e., lower quality control occurs in the field than at the plant).
- Curing is required for strength gain, and is dependent upon climatic conditions, including temperature and moisture.
- Traffic disruption can be greater relative to other rehabilitation alternatives.
- The equipment is expensive, and not many contractors may own the equipment.
- There are no standard specifications for in-place recycling.

Three distinct types of CIR are currently being used in the United States. They include the following:<sup>(5)</sup>

- Type 1—Rip/pulverize and compact.
- Type 2—Single Unit Recycler.
- Type 3—Recycling Train.

*Type 1 CIR—Rip/pulverize and compact*

Often referred to as full-depth recycling or reclamation, Type 1 CIR is the oldest and least expensive method of in-place recycling. It is often used when there is little remaining life in the road or when surface defects are caused by problems in the underlying layer. In this process, the existing pavement is reworked to a depth that may vary from 100 to 300 mm. The recycled material provides a good-quality asphalt base layer on which an AC surface course or a surface treatment can be applied.<sup>(5)</sup>

The general procedures for Type 1 CIR are illustrated in figure 7-1. The existing pavement is first ripped and crushed in place by multiple passes of a scarifier or ripper. The crushed material, or RAP, is then windrowed with a grader and may be sprayed with the designated recycling agent. New aggregate may also be added at this point. A motor grader is used to thoroughly mix the new material, which is then spread into place by either the grader or a paver. Following compaction and curing, a surface layer is then applied.





1. Rip and break existing pavement

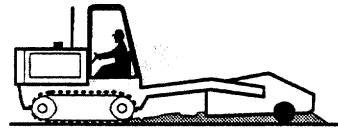

2. Pulverize existing pavement



3. Windrow Existing Asphalt Bound Materials

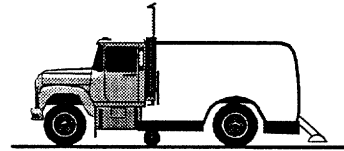

4. Apply Modifier to Windrowed Asphalt Bound Materials

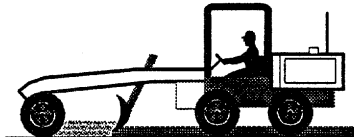

5. Mix with existing and/or new base aggregate material

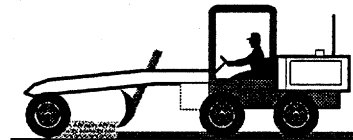

6. Spread upgraded base to specified thickness

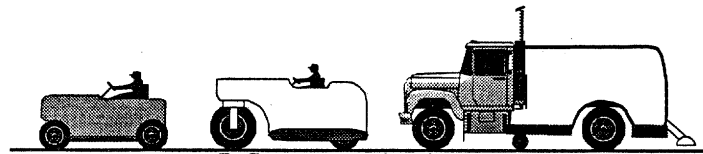

7. Compact, seal and cure



8. Apply wearing surface

Figure 7-1. General sequence of Type 1 CIR operation.<sup>(5)</sup>

Type 2 CIR—Single unit recycler

Type 2 CIR is a partial- or full-depth recycling operation that provides a high-quality base or surface course. In comparison to Type 1 CIR, this operation provides better quality control in that it is possible to maintain a uniform reprocessing depth and achieve better remixing. In addition, Type 2 CIR reduces the recycled material to a smaller more uniform size.

Type 2 CIR eliminates the need for multiple pieces of equipment and equipment passes for the breaking, crushing, and mixing operations. As shown in figure 7-2, a planer or milling machine is used to perform these operations in a single pass. The new mixture is then either windrowed for spreading by a grader or conveyed to a paver for relaying. Following compaction and curing, a surface layer may or may not be applied. Roughly 1.6 to 3.2 km/day of a standard 3.7-m wide lane can be recycled using this operation.

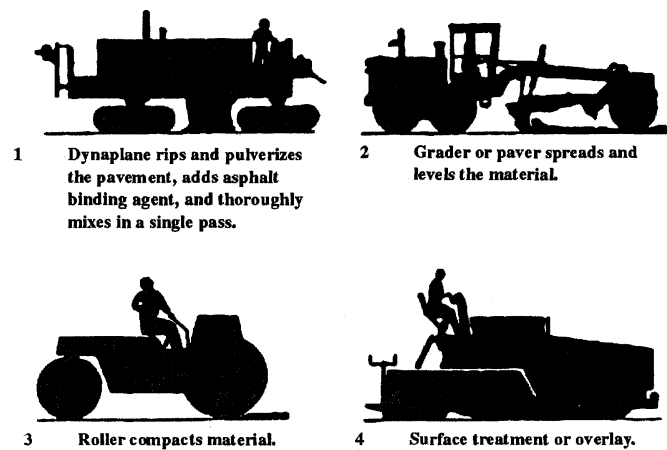

Figure 7-2. General sequence of Type 2 CIR operation.<sup>65</sup>

*Type 3 CIR—Recycling train*

Type 3 CIR is the newest and most productive in-place recycling process. Like Type 2 CIR, it is a partial- or full-depth recycling operation that produces a high-quality base or surface course. It differs, however, in the equipment required to carry out the process and, subsequently, in the rate at which the pavement is recycled. For these reasons, it is more appropriate on large recycling jobs.

The process involves the use of large, specialized pieces of equipment that work closely together as a recycling train. Figure 7-3 shows a typical recycling train and the flow of material through the individual pieces of equipment.

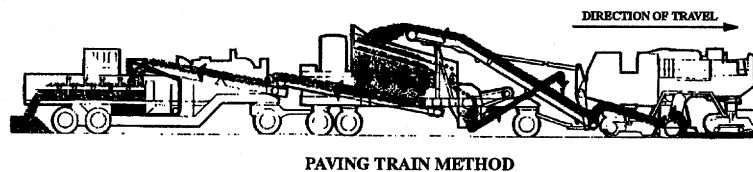

Figure 7-3. Type 3 CIR recycling train.<sup>(5)</sup>

The train is headed by a milling machine, which grinds the existing pavement to a depth ideally between 50 and 100 mm. The RAP material is then conveyed to a screening and crushing unit that reduces the material size to less than 30 to 50 mm.

Next, the RAP material is transported to the mixing unit, or traveling pugmill. There it is weighed and mixed with measured amounts of aggregate and recycling agent. The new mixture can be deposited directly into the hopper of a paver or deposited in a windrow for subsequent pick-up by a paver. The paver then spreads the material evenly for compaction by steel-wheeled and/or rubber-tired rollers. Depending on the existing road condition, depth of

recycling, terrain, and traffic, the train can recycle 3.2 to 9.7 km/day of a standard 3.7-m wide lane.

### Hot-Mix Recycling

Hot-mix recycling is the process in which all or some portion of the pavement structure is removed, reduced to the desired size, and mixed hot with additional asphalt cement at a central plant. The process normally includes the addition of new aggregate, and may include the addition of a recycling agent.<sup>(6)</sup> The finished product is generally required to meet standard materials specifications and construction requirements for the type of AC mixture being produced (e.g., base, binder, or surface course).<sup>(7)</sup>

In comparison with CIR, hot-mix recycling is a costlier and more labor-intensive operation. Material hauling, hot plant processing, and greater quality control are major contributors to its higher costs. Although there is generally more disruption with hot mix recycling, traffic can be allowed on the recycled pavement much sooner than with CIR because of the shorter curing period. More importantly, the higher level of quality control in the hot-mix recycling process generally results in a more stable and consistent mixture.

The two main considerations in selecting hot-mix recycling for a given rehabilitation project are the existing pavement condition and the cost of the rehabilitation. As seen in table 7-2, hot-mix recycling is a proper remedy for many pavement defects. In general, it can be used to correct mixture deficiencies, to restore pavement smoothness, and to increase the overall strength of the pavement. Because of its higher costs, however, careful comparisons must be made to determine if it is the most cost-effective approach for the defects observed in the existing pavement.

Other factors that must be considered include the suitability of existing materials for recycling and the availability of experienced and properly equipped contractors. In the case of the former, the presence of the following materials may make an existing pavement unsuitable for hot-mix recycling.<sup>(8)</sup>

- More than 10 percent of the pavement material is a seal coat, slurry seal, or cold patch.
- The pavement contains cutback asphalts.
- The pavement contains any coal tars.

Although the availability of experienced and properly equipped contractors has become more widespread in recent years, it may still be difficult to locate qualified local contractors able to undertake a successful hot-mix recycling job.

Table 7-2. Guide for selection of AC recycling method.<sup>(9)</sup>

Type of Pavement Distress	Hot-Mix Recycling	Hot In-Place Recycling	Cold In-Place Recycling
Surface Defects			
<i>Raveling</i>	x	x <sup>1</sup>	
<i>Bleeding</i>	x	x <sup>4</sup>	
<i>Slipperiness</i>	x	x <sup>1</sup>	
Deformation			
<i>Corrugations (washboarding)</i>	x	x <sup>4</sup>	
<i>Rutting (shallow)<sup>2</sup></i>	x	x <sup>4</sup>	
<i>Rutting (deep)<sup>3</sup></i>	x		x <sup>5</sup>
Cracking (load associated)			
<i>Alligator</i>	x		x
<i>Longitudinal (wheelpath)</i>	x	x <sup>6</sup>	x
<i>Pavement Edge</i>	x		x
<i>Slippage</i>	x	x <sup>7</sup>	
Cracking (nonload associated)			
<i>Block (shrinkage)</i>	x		x
<i>Longitudinal (joint)</i>	x	x <sup>8</sup>	
<i>Transverse (thermal)</i>	x		x
Reflection Cracking	x		x
Maintenance Patching			
<i>Spray</i>	x <sup>9</sup>		x <sup>9</sup>
<i>Skin</i>	x <sup>9</sup>		x <sup>9</sup>
<i>Pothole</i>	x		x
<i>Deep (hot mix)</i>	x		x
Ride Quality/Roughness			
<i>General Unevenness</i>	x	x	
<i>Depressions (settlement)</i>	x <sup>10</sup>	x <sup>10</sup>	
<i>High Spots (heaving)</i>	x <sup>10</sup>	x <sup>10</sup>	

## Notes:

- <sup>1</sup> Applicable if the surface course thickness does not exceed 40 mm.
- <sup>2</sup> Rutting is limited to the top 40 to 50 mm of the pavement.
- <sup>3</sup> Rutting originates below the surface course, including base and subgrade.
- <sup>4</sup> May be a temporary correction if entire layer affected not removed or treated by the addition of special admixtures.
- <sup>5</sup> The addition of new aggregate may be required for unstable mixes.
- <sup>6</sup> Applicable if the cracking is limited to the surface course of the pavement.
- <sup>7</sup> Applicable if the treatment is to a depth below the layer where the slippage is occurring.
- <sup>8</sup> Applicable if the cracking is limited to the surface course of the pavement.
- <sup>9</sup> In some instances, spray and skin patches may be removed by cold planing prior to these treatments (consider if very asphalt rich or bleeding).
- <sup>10</sup> May be only a temporary correction if the distress is related to a subgrade problem.

Because the quality of recycled hot-mix must normally satisfy the requirements of a new AC mixture, a considerable amount of evaluation, testing, and design work is necessary. This often includes the following tasks:

- Reviewing past construction records of the existing pavement.
- Visually assessing the condition of the existing pavement.
- Performing material characterization tests on the stockpiled RAP.
- Formulating a recycled mix design and determining the proper amounts of new materials (e.g., asphalt, aggregate) to be added to the RAP.
- Performing quality control tests on the recycled mixture to determine if it meets the applicable specifications.

The construction sequence for hot-mix recycling typically consists of the following four activities:

- Full- or partial-depth removal of the pavement.
- Reduction of the RAP to the appropriate size.
- Reprocessing of the RAP through a hot-mix plant with the addition of one or more of the following: virgin aggregate, new asphalt cement, and recycling agent.
- Placement and compaction of the recycled hot-mix as a base, binder, or surface course.

The existing surface-treated roadway is generally removed by milling, although ripping equipment have also been used. With milling, partial- and full-depth pavement removal is possible, and sizing of the RAP is done simultaneously with the pavement removal step. The milling operation is normally performed to an optimum depth of between 50 and 100 mm. Although single-pass removal to as deep as 200 mm is possible, the operating speed can be greatly reduced and oversized RAP may result, thereby requiring additional sizing.

If the surface treated roadway has beneath it a full-depth asphalt pavement, multiple passes of a milling machine or the use of heavy-duty ripping equipment may be required. While RAP millings are usually reduced to the appropriate size, the RAP produced by ripping equipment must generally undergo additional crushing at the central plant. Central-plant sizing can be performed with conventional, fixed, and portable crushing and screening equipment.<sup>(10)</sup>

Both conventional batch plants and continuous mix (drum-mixer) plants have been used successfully to produce recycled hot-mix.<sup>(6)</sup> Both plant types make use of the heat-transfer method, whereby the RAP is primarily heated through mixing with superheated virgin aggregate. Additional asphalt or a recycling agent are also added during the mixing, as called for in the mixture design.

As with conventional hot-mix paving operations, the recycled hot-mix is hauled to the jobsite where it is loaded into the hopper of an asphalt paver for proper laydown. Steel-wheeled and rubber-tired rollers are used to compact the newly laid material to the required density.

#### Feasibility of Recycling Options

Recycling may be an option for surface-treated roadways when there is little or no remaining structural life in the existing pavement and when other measures short of reconstruction will neither address problems in the pavement nor provide the desired future performance. This may be seen when the surface of the pavement exhibits an excessive amount of structural deterioration, such as alligator cracking, deep wheel path rutting, or large deflections under load. When these conditions are present, they usually signify the need for reconstruction of the roadway, and when reconstruction is needed recycling should be considered as an option. The exception to this is when surface recycling techniques are used and it has been determined that the roadway's problems can be successfully addressed without removing the entire pavement.

Recycling surface treated roadways can be as successful as other recycling projects if normal care is taken in their planning and design. The major decisions to make in a recycling project are whether the in-place materials are able to be recycled and where in the new pavement (or elsewhere) they will be used. The least cause for concern arises when the existing pavement is being reworked to serve as a base and entirely virgin material will be placed on top of it as a surface. Special care must be taken, however, when a surface treated roadway is being upgraded to a higher type facility and the new pavement will be built with materials recycled from the old surface. In such cases, the materials used in the mix must be carefully studied to ensure the project's feasibility.

In any recycling project, the existing pavement must be examined to determine if it can be recycled. To begin with, is there sufficient material present to recycle? Care must be taken to identify layer thicknesses so that the materials and their thicknesses are known. Where this is extremely important is in a recycling project, such as surface recycling, that is not reworking all of the structure. Surface treatments are, by their nature, very thin and there is not much material to mill.

The optimal use of a recycled surface treated roadway is in a surface mix, as it already has the high quality materials in it that would help to reduce the overall costs of the project. However, there are many different materials that are used in surface treatments that may not perform well in a recycled surface mix. These include many of the polymer materials that have been added to surface treatments to enhance chip retention as well as the rubber products that have been added to a range of surface treatment mixes to improve their performance.

These (and other) additives obtain their desirable properties during their initial use and their properties will change if they are either reheated or overheated. Some cutbacks and specialized asphalt applications will also not work in any hot recycling process.

Another problem with recycling surface treated roadways is that, over time, the pavement's surface may become quite rich in asphalt. This excess of binder may make it difficult to obtain a satisfactory mix design of the recycled mixture. However, this problem, if it will occur, should be identified during the mix design stage. This is especially critical for any material that will be recycled through an asphalt plant in a hot operation.

### **Resurfacing**

Resurfacing is the process by which an AC or PCC overlay is placed on the existing pavement to restore serviceability to near original levels. AC resurfacing is the most common method of rehabilitating existing pavements, and is the only overlay type considered in this manual. The major advantages of AC resurfacing include the wide availability of hot-mix paving contractors and equipment, relatively short disruptions to traffic during the construction process, and good long-term service. The major disadvantages include the need for careful design and quality control, the resultant decreased vertical clearances, the potential for reflective cracking, and the possible adjustments or level-up work required for adjacent structures (e.g., manholes, curb and gutter, shoulders). In addition, the cost of an overlay can be prohibitive to many local agencies.

AC resurfacing is typically performed to improve the functional or structural performance of a pavement. Functional resurfacing generally consists of a thin AC overlay that serves one or more of the following purposes:<sup>(1)</sup>

- Increases skid resistance.
- Improves pavement profile (levels up).
- Improves rideability.
- Improves surface drainage.
- Reduces water infiltration.
- Retards environmental deterioration.
- Enhances appearance.

In contrast with functional resurfacing, structural resurfacing is the application of a thicker AC overlay. Such overlays are designed to:

- Increase structural capacity of the pavement.
- Reduce the rate of structural deterioration.



Depending upon the condition of the existing pavement and the purpose of the overlay, AC resurfacing may consist of one or more lifts (i.e., paving layers) of material. The lifts may be a part of either the binder course (the structural layer) or the surface course (the top, protective layer), and they generally range from 25 to 200 mm thick. The binder course is sometimes referred to as the leveling course, and the surface course is sometimes referred to as the wearing course.

The material used in each layer can vary in composition. To provide added strength, binder course material typically contains larger sized aggregate and slightly less asphalt cement than surface course material. The smaller sized aggregate and higher asphalt cement content in a surface course material help provide an abrasion-resistant and waterproof surface layer.

AC overlays may be applied in conjunction with recycling operations to provide a protective surface. Such overlays are particularly common with cold-milling (surface removal) and cold in-place recycling (CIR) operations.

The successful design and construction of an AC overlay begins with a thorough examination of the existing pavement, as discussed in module 2 of this manual. The causes of pavement deterioration must be identified so that proper pre-overlay repairs or treatments can be specified and so an adequate overlay thickness can be designed.

The construction sequence for AC resurfacing consists of the following three steps:

- Application of pre-overlay repairs or treatments to the existing pavement.
- Processing of blended aggregate and asphalt cement at a hot-mix asphalt plant to produce a suitable asphalt concrete paving mixture.
- Placement and compaction of the hot-mix as a leveling, binder, or surface course.

Pre-overlay repairs or treatments of deteriorated, surface-treated roadways are needed to help ensure that the overlay will last as long as desired. These treatments include one or more of the following:

- Localized patching of potholes or fatigue-cracked (alligatored) areas.
- Level-up patching of rutted wheelpaths.
- Treatment of thermal cracks to delay reflection cracking in the overlay.
- Surface leveling of sags and depressions.
- Cleaning the existing surface and the application of a tack coat to improve bonding between the existing asphalt surface and the AC overlay.

Hot-mix production may take place at either a batch plant or a continuous mix (drum) plant. In a batch plant, blended aggregate is heated and dried in a dryer, screened into different sizes, and then weighed to the specified proportions. Next, the aggregate is emptied into a pugmill where it is blended together and mixed with the proper amount (by weight) of heated asphalt cement. The entire batch of hot-mix is then discharged into a haul vehicle.

In a continuous-mix plant, screened and heated aggregate is continuously proportioned and transported to the pugmill. Asphalt cement is then sprayed on the aggregate at a rate that is calibrated with the movement of aggregate. The two materials are continuously mixed in the pugmill and are discharged into a temporary silo for transfer to the haul vehicle.

After being hauled to the jobsite, the hot-mix is loaded into the hopper of an asphalt paver for proper laydown. Steel-wheeled rollers and rubber-tired rollers are then used to compact the newly laid material to the required density. Achieving the proper density is essential. Insufficient density (compaction) may lead to rutting problems or stripping (from moisture penetrating the surface). Too much compaction of the AC can cause construction cracking and bleeding.

#### Feasibility of Resurfacing

In general, there are no major problems associated with resurfacing a surface treated roadway. As has already been discussed, however, the condition of the existing surface is important in any rehabilitation project, and AC overlays are no exception. Asphalt concrete overlays must be placed on a uniform surface in order to perform well. Rutting, surface corrugations, or other surface irregularities should either be filled or milled to provide a level surface. Care should be taken with milling, however, as some surface treated pavements may not be thick enough to be milled.

In order to ensure a good bond between the overlay and the existing surface treatment, a tack coat should be applied. If the surface is already rich in asphalt (that is, exhibiting bleeding or areas of streaking), it may be necessary to remove or blot these areas prior to placing the resurfacing. Excess asphalt in the underlying layer may eventually bleed through the new surface. If the surface treatment is loose or raveling, the overlay will not bond well to the surface. Following recommended practices in the construction of the overlay should help to ensure that any problems specific to the surface treatment will not adversely affect the overlay.

#### **Surface Treatments**

As noted at the beginning of this module, surface treatments cover a broad range of pavement surface applications. The term encompasses several types of

asphalt and asphalt-aggregate applications, usually less than 25 mm thick, placed on any kind of roadway surface.<sup>(2)</sup> The general purpose of these applications is to improve or protect the surface characteristics of the roadway; they provide no structural improvement to the pavement.

The specific functions of the different surface treatments can be summarized as follows:<sup>(6)</sup>

- Provide a new wearing surface.
- Seal minor cracks in the surface.
- Waterproof the surface.
- Improve skid resistance and surface drainage.
- Slow pavement weathering.
- Improve pavement appearance.
- Provide visual distinction between the mainline pavement and the shoulder.
- Rejuvenate the top 6 mm of an AC surface.

Surface treatment techniques are classified by their composition and by their use. There are nine common surface treatment techniques that may be used on a surface treated roadway. A description of each of these techniques and the specific functions they serve are provided in the sections below. The feasibility of treating an already surface treated roadway with another application of a surface treatment is discussed later.

#### Asphalt Chip Seal

An asphalt chip seal consists of sequential applications of asphalt (asphalt cement, cut-back asphalt, or asphalt emulsion) and stone chips to form a surface layer as thick as 25 mm. The combined application may be applied once (single chip seal) or may be repeated two or three times (double or triple chip seals). The primary objectives of the asphalt chip seal are to provide a new, durable surface course and to increase skid resistance.

The construction sequence for a single asphalt chip seal consists of the following four steps:<sup>(12)</sup>

- Clean the existing surface to remove dirt and other loose materials.
- Apply the asphalt material at the specified rate and temperature using a calibrated asphalt distributor.
- Immediately spread the stone chips evenly over the surface at the specified rate using a properly calibrated aggregate spreader.
- Immediately roll the stone chips with a rubber-tired roller to firmly seat them in the asphalt and against the underlying layer.

Depending on the type of asphalt material used and the posted speed limit, the chip-sealed road can be opened to traffic within 0.5 to 2 hours.

#### Open-Graded Friction Course

Open-graded friction courses (OGFC), also called plant mix seals or popcorn mixes, are porous surface mixes produced with large amounts of voids (minimum 15 percent) that allow water to drain rapidly through the mix and flow to the side of the road. An open gradation is used for these mixes which means that typically one size stone is used with little fines. These mixes are used to improve the friction properties of the surface and also to reduce tire spray and the potential for hydroplaning, thereby reducing wet weather accidents. The OGFC also tends to provide a quieter riding surface, as it produces lower tire noise. Typical thicknesses of OGFC are 25 to 50 mm.<sup>(6)</sup>

OGFC mixtures are produced and placed in a manner similar to dense-graded hot mixes. A tack coat is needed prior to the placement of the OGFC and compaction is accomplished solely by a static steel-wheeled roller. This is because vibratory rollers can damage the aggregate and rubber-tired rollers tend to pick up the asphalt.

#### Rubberized Asphalt Chip Seal

A rubberized asphalt chip seal is a special type of chip seal in which rubber (latex or ground tire rubber) is blended with asphalt cement. This application can be used solely as a stress-absorbing membrane (SAM) or in conjunction with an overlay as a stress-absorbing membrane interlayer (SAMI).

In both applications, the purpose is to reduce the reflection of underlying cracks through the surface layer. The latex or ground rubber tires adds resiliency to the asphalt, which improves bonding with the aggregate and reduces the tackiness and raveling of the surface. The added resiliency also enables the seal to "bridge" existing cracks better.

The construction of a rubberized asphalt chip seal is similar to the construction of an asphalt chip seal. The major difference is the use of a modified applicator for spraying the thicker rubberized asphalt binder.<sup>(13)</sup>

#### Slurry Seal

A slurry seal is a homogeneous mixture of asphalt emulsion, water, fine aggregate, and mineral filler that has a creamy, fluid-like appearance.<sup>(12)</sup> It is effective in sealing surface cracks, waterproofing the pavement surface, and improving skid resistance at speeds below about 65 kph. Three types of slurry seal are available that differ by the size of aggregate used. The type with the

finest aggregate is primarily used for sealing purposes, while the type with the largest aggregate is primarily used for improving skid resistance and filling slight depressions.

The slurry seal mixture is produced on-site in a special truck-mounted, traveling mixer. Once mixed, the slurry is dumped into a spreader box attached to the back of the vehicle. The spreader box applies the slurry onto the cleaned pavement and an attached squeegee smooths the material into a layer between 3 and 6 mm thick. Rolling is not generally necessary and, depending on the weather, traffic can be allowed on the pavement within 2 to 12 hours.

#### Micro-Surfacing

Developed in Europe, micro-surfacing is a term used to describe the application of a polymer-modified slurry seal, with latex rubber being the most commonly used polymer. Micro-surfacing materials consist of asphalt and latex mixed with aggregate, fillers, and other additives and is a modification of the slurry and sand seal.<sup>(6)</sup> It has been used as a wearing surface and for rut-filling.

The construction sequence for micro-surfacing resembles that of slurry seals. A modified traveling plant mixer is used to continuously load materials from haul vehicles and mix them on-site. An adjustable width spreader box is used for resurfacing purposes, while individual drag boxes are used for rut-filling purposes. Rolling is generally not required and the pavement can usually be opened to traffic within 1 hour.

#### Fog Seal

A fog seal is a very light application of an asphalt emulsion (with no aggregate) to an oxidized asphalt surface. The purpose of the application is to rejuvenate the oxidized asphalt and seal fine cracks so that the need for more corrective rehabilitation is postponed for 1 or 2 years.

This treatment is most suitable for low-volume roads that can be closed to traffic for the 4 to 6 hours required for the material to sufficiently set. It is widely used along AC shoulders to help provide a distinct delineation between the mainline pavement and the shoulder. Application involves spraying the bituminous material at a specified rate using an asphalt distributor.

#### Sand Seal

A sand seal is a spray application of asphalt emulsion followed by a light covering of sand or screening. This application serves the same function as a fog seal, but provides better surface friction. However, the surface appearance of a sand seal does not provide the delineation that a fog seal does.

The placement of a sand seal is typically 2 to 5 mm thick. Once the sand covering has been applied to the asphalt emulsion, a rubber-tired roller is used to firmly embed the sand in the asphalt. The pavement can be opened to traffic once the seal has sufficiently set (typically about 2 hours).

#### Cape Seal

A cape seal is a combination of both an asphalt chip seal and a slurry seal. The advantage of the cape seal over either a conventional chip seal or slurry seal is that a thicker, more durable surface is obtained, and it can be used on higher volume roads.<sup>(6)</sup> The cape seal results in a smoother, more visually pleasing surface, and it also may provide added skid resistance.

The construction of a cape seal consists of the chip seal being applied first, followed by the application of the slurry seal between 4 and 10 days later.

#### Sandwich Seal

A sandwich seal consists of an application of asphalt (asphalt emulsion or asphalt cement), sandwiched between two applications of different sized aggregate. The primary objectives of the sandwich seal are to provide a new wearing course and to increase skid resistance.

Typical sandwich seals are constructed between 6 and 19 mm thick. The construction process consists of the following five steps:

- Clean the existing surface.
- Apply the first aggregate at 60 to 80 percent coverage.
- Apply the asphalt material at the specified rate and temperature.
- Apply the second aggregate (smaller size than first aggregate) to sufficiently fill the voids left by the first aggregate.
- Roll the aggregate with a rubber-tired roller to firmly seat it in the asphalt.

Depending on the type of asphalt material used, the pavement can generally be reopened to traffic within 2 hours.

#### Feasibility of Surface Treatments

Surface treatments are placed to address a functional deficiency of the existing pavement. Such deficiencies are usually related to improving ride, by leveling or smoothing out the surface, or enhancing safety, by providing a more skid resistant surface. Surface treatments also have the benefit of sealing off the structure and reducing further deterioration.

The performance of surface treatments is shorter-lived than other rehabilitation strategies, and the placement of a surface treatment on an already existing surface treated pavement may not last as long as an original placement of a surface treatment. Thus it is important to consider the desired life of the proposed treatment prior to its construction. If the first treatment was placed as a stopgap measure to slow down deterioration, it may be time to consider a more aggressive rehabilitation strategy, such as resurfacing or recycling/reconstruction.

As a general rule, multiple surface treatments will not solve a number of defects that typically develop in pavements over time, such as surface irregularities and structural deficiencies. Any care that is typically taken in the selection of a surface treatment as the appropriate rehabilitation or maintenance strategy originally must also be taken when considering placing a surface treatment over a pre-existing treatment. A detailed distress survey should proceed any selection of a surface treatment as the appropriate rehabilitation strategy. The surveyor should look for weak areas, areas of alligator cracking, potholes and other indicators of structural problems. These must be removed and repaired. Depressions, areas of bleeding, and other surface deficiencies should also be noted and addressed prior to placement of the surface treatment. While it is theoretically possible to place any of these surface treatments on top of an existing surface treatment, they will not all perform uniformly well.

If the pavement surface is at all porous, a higher than normal asphalt application rate will be required. Also, the more uneven the surface, the more chips will be needed. Specific concerns about the application of a surface treatment on top of another relate to the condition of the existing surface treatment and the compatibility of the subsequent treatment with the current one. Furthermore, there may be a greater chance of bleed through, poor chip retention, and so on, depending on the treatment that is selected. Additional precautions related to the use of surface treatments include the following:

- The application of surface treatments is usually limited to when the air temperature is at least 10° C (50° F).
- Surface treatments should not be applied to a wet surface or when rain is imminent.

### 3. SELECTION OF THE MOST APPROPRIATE REHAB OPTION

Thus far, a number of rehabilitation procedures have been presented that can improve the serviceability of surface treated roadways. In this section, a process that can be used to determine the preferred rehabilitation option for a given project is discussed.

In the decision-making process for selecting the preferred rehabilitation strategy, the following steps are fundamental:<sup>(14)</sup>

- Determination of the cause of distress(es) or problems of the pavement.
- Development of a candidate list of solutions that will properly address, cure, and/or prevent future occurrences of the problem.
- Selection of the preferred rehabilitation strategy, given economic and other project constraints.

The first step is completed using the pavement evaluation procedures provided in module 2, and is not discussed here.

The second step involves considering many noneconomic factors, with the goal of identifying a few practical options (typically between two and four). These factors largely consist of the following:

- Functional requirements.
- Structural requirements.
- Drainage.
- Local experience and manpower.
- Availability of resources.
- Construction considerations.
- Limited project funding.

To determine which of the resulting practical options is the most cost-effective (and thus the preferred rehabilitation method), a life-cycle cost analysis is recommended. This analysis takes into consideration the various costs and estimated performance of each option and generates a standard unit of cost by which the options can be compared.

Brief descriptions of the various selection factors and how they affect the different rehabilitation methods are provided in the following sections.

#### **Noneconomic Factors**

##### **Functional Requirements**

Frequently, the main objective in a rehabilitation project is to increase the functional adequacy of the pavement (i.e., increase skid resistance and/or ride quality). As a result, some rehabilitation alternatives can be quickly shortlisted for further consideration. These alternatives might include the following:



- Functional AC overlay.
- Asphalt chip seal.
- OGFC.
- Slurry seal.
- Microsurfacing.
- Sand seal.
- Cape seal.
- Sandwich seal.
- Pavement removal.
- Hot-surface recycling.

Once more specific details about the desired functional improvements are developed, this list can be further reduced.

#### Structural Requirements

In situations where the major objective is to significantly increase structural capacity, the list of practical alternatives can be narrowed to the following:

- Structural AC overlay.
- CIR (types 1, 2, and 3).
- Hot-mix recycling.
- Pavement removal with thick AC overlay.
- Hot surface recycling with thick AC overlay.

Each of these methods can be used to meet the desired structural requirements. However, only CIR and hot-mix recycling have the capability of fully correcting any structural defects (e.g., alligator cracks and rutting) in the asphalt layers.

#### Drainage

If the pavement evaluation reveals a serious drainage problem, consideration must be given to those alternatives that will best address the drainage problems. Surface-treated roadways are not generally used in areas where there is a weakening effect of water on the base layer. Standing water problems may be the result of either poor cross-slope (e.g., rutting) or a surface that drains too slowly. Practical alternatives to these problems include the following:

<u>Poor cross-slope</u>	<u>Slow draining</u>
Pavement removal	OGFC
Hot surface recycling	Asphalt chip seal
Microsurfacing	Hot surface recycling
Asphalt chip seal	

Local Experience and Manpower

The availability of local contractors with experience in the various rehabilitation methods (and, in some cases, the availability of the specialized equipment) is often a major factor in the selection process. Local contractors inexperienced with some rehabilitation methods may simply not be capable of doing the work, or of providing a quality job within the time period and costs that have been budgeted. One option which should be examined in this situation is the added cost associated with retaining outside contractors experienced in the methods that are not practiced locally.

The availability of local contractors experienced in each of the three rehabilitation types is growing. Although recycling is not practiced nearly as much as resurfacing and surface treatments, the availability of local contractors capable of successful recycling operations is steadily growing. Likewise, some of the more specialized surface treatment techniques, such as microsurfacing and OGFC, are also becoming more widely used.

Resource Requirements

Additional initial costs can generally be expected if local contractors are improperly equipped or the necessary materials are not readily available. In the first case, the additional costs stem from greater mobilization and hauling, as an experienced outside contractor must be used. In the second case, the additional costs stem primarily from hauling, as material (usually aggregate) must be shipped in from distant sources.

In some areas, there is limited availability of recycling equipment and some surface treatment equipment. Devices such as those used in CIR and microsurfacing operations are still relatively new and, in the case of the former, quite expensive.

The lack of strong and durable local aggregate can be a concern with either of the three rehabilitation alternatives. Local aggregate that is soft and nondurable will adversely impact performance and must be avoided. Additionally, local aggregate producers may not process aggregate into the sizes or shapes required by particular asphalt-aggregate mixtures. This is occasionally a concern with some of the surface treatment techniques, such as microsurfacing.

Construction Considerations

The following construction factors typically must be considered in selecting the preferred strategy:

- Traffic control requirements.
- Geometric constraints.
- Suitability of existing pavement materials for recycling.

The period that a road must be partially or completely shut down can often determine which rehabilitation methods get shortlisted for further consideration and which ones do not. Obviously, the methods that result in the greatest disruption to traffic will be least desirable to the traveling public. Such disruptions are often tied to material production rates, operational rates of the equipment, and pavement curing times.

Geometric constraints can occasionally limit which alternatives get further consideration. These constraints typically include the following:

- In-the-road manholes.
- Curb and gutter.
- Clearances beneath bridges or overhead signs.
- Utilities.

On occasion, the existing surface treated pavement may be unsuitable for recycling due to the presence of harmful materials or excessive material variability. In the case of the former, considerable amounts of tar, asphalt cutback, and asphalt emulsion in the existing pavement can pose operational problems with air quality or mix design quality. In the case of the latter, several changes in material composition throughout the project can result in excessive reprocessing changes and, possibly, excessive testing requirements.

#### **Economic Factors**

##### Limited Project Funding

If the funds available for a particular project are somewhat limited, then it is likely that some of the rehabilitation methods with the highest initial costs will have to be dropped from consideration. This may, however, result in the dismissal of some of the more cost-effective methods, in which case extra efforts to secure more funding could be justified.

##### Performance Considerations

One important aspect in determining the most cost-effective rehabilitation alternative is the performance of the pavement after it has been rehabilitated. Although performance may be defined as the area under a serviceability-time curve as shown in figure 7-4, a commonly used indicator of performance is service life. This is the period of time that a rehabilitated pavement will last before reaching a minimum acceptable serviceability level.

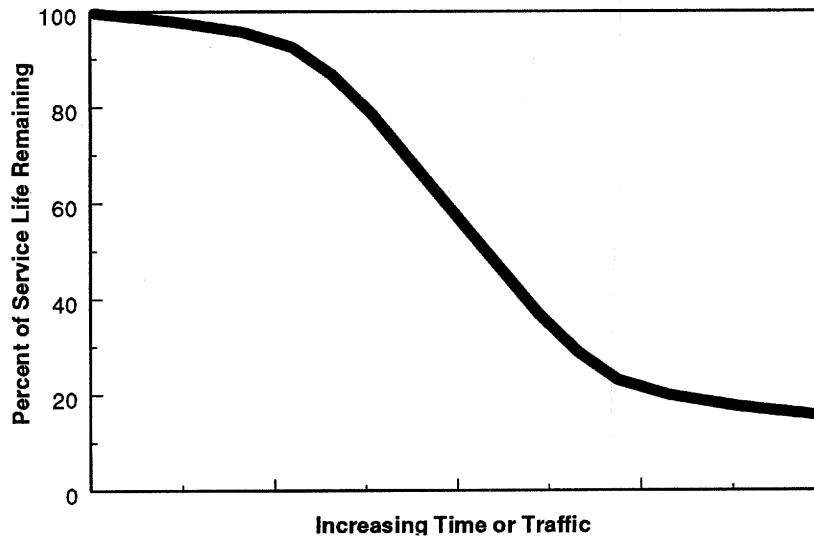

Figure 7-4. Pavement deterioration versus time and/or traffic.

The performance characteristics of each rehabilitation option depend largely on the following factors:

- Climatic conditions.
- Traffic volumes.
- Existing pavement condition.
- Quality of materials.
- Mixture design.
- Construction quality.

Because of these factors, the experiences of various agencies with the different rehabilitation methods vary widely. Figure 7-5 shows the expected service lives of a few of the rehab methods based on a 1986 survey of several cities and counties. As can be seen, resurfaced pavements are expected to last the longest, followed closely by in-place recycled pavements. Surface treated pavements, however, are generally expected to provide about one-third the life of resurfaced pavements. There is no specific information available about the performance of rehabilitation treatments applied to surface treated roadways.

**ASPHALT SURFACE MAINTENANCE TECHNIQUES  
EXPECTATION LEVELS (in years)**

183 responses

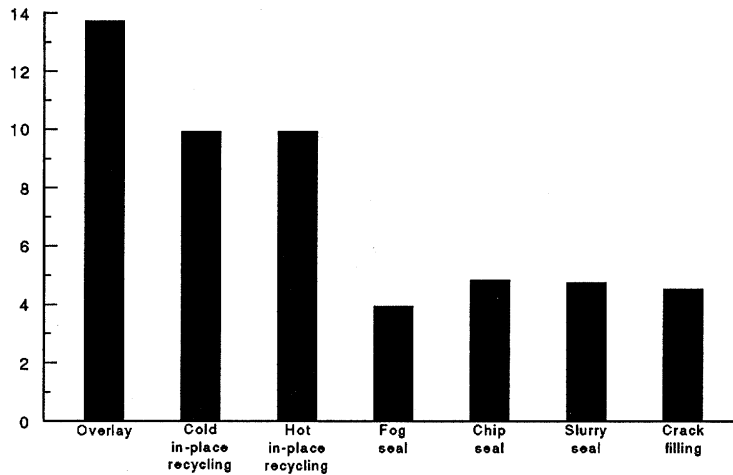

Figure 7-5. Expected life of various rehab methods.<sup>(5)</sup>

Life-Cycle Costs

To determine the most cost-effective rehabilitation option, a fixed analysis period must first be established. This analysis period may range from 5 to 25 years, depending on programmed funding and the desire for long-term planning. A strategy must then be developed for each rehabilitation option so that pavement serviceability remains above a minimum acceptable level over the analysis period. As seen in figure 7-6, a strategy may consist solely of the rehabilitation alternative or may involve the alternative combined with a series of future maintenance or rehabilitation activities

Once alternative strategies have been developed, the life-cycle costs associated with each strategy can be estimated. These are the projected costs assumed by the local-roads agency and the traveling public during the analysis period. In the case of roadway rehabilitation, the following life-cycle costs should be considered:

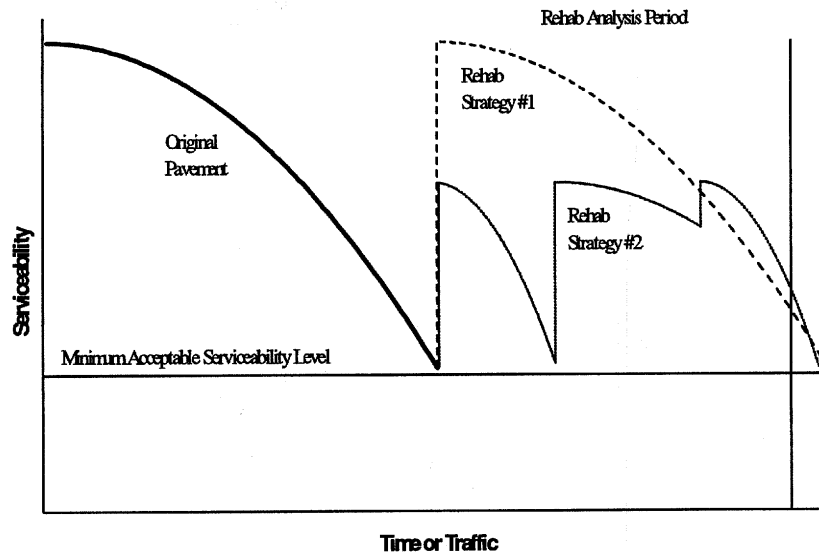

Figure 7-6. Example of different rehab strategies for a given analysis period.

- **Engineering and administrative costs**—The costs of evaluating the existing pavement, selecting the preferred option, designing the rehabilitated pavement, and preparing the necessary plans and specifications for the work.
- **Rehabilitation costs**—The costs associated with initial and future rehabilitation activities intended to restore the pavement to an acceptable serviceability level.
- **Maintenance costs**—The costs associated with maintaining a pavement at or above some predetermined performance level. These costs include both preventive and corrective maintenance costs, but not rehabilitation costs.
- **Salvage value**—The value of the pavement at the end of the life cycle or analysis period.
- **User costs**—The costs assumed by the traveling public in the form of delay costs, increased operating costs, and accidents.

### Life-Cycle Cost Analysis

Several methods of economic analysis have been used to compare the cost-effectiveness of different rehabilitation strategies. The more common methods, which are briefly discussed below, require the use of a discount rate, which represents the time value of money. The discount rate is used to convert future predicted costs or benefits to their present worth or to uniform annual costs so that the economics of the different strategies can be compared.<sup>(15)</sup> The discount rate is commonly taken as the difference between the interest and inflation rates. Historically, discount rates have been in the range of 3 to 5 percent.

- **Present-worth method** — This method involves converting all future costs associated with a particular strategy to present-worth costs. These converted costs and the initial rehabilitation cost are then summed to obtain a single, present-worth cost that can be directly compared with the present-worth costs of the other alternatives.
- **Annualized method** — In this method, all present and future costs associated with a particular strategy are converted to a uniform annual cost over the analysis period. This uniform annual cost can then be directly compared with the uniform annual costs of the other alternatives.
- **Benefit-cost ratio method** — This method involves expressing the ratio of present-worth benefits of a particular strategy to its present-worth costs. Strategies that result in a benefit-cost ratio greater than one are considered economical and the strategy that produces the highest incremental ratio with respect to other strategies is considered the best choice.
- **Rate-of-return method** — In the rate-of-return method, the discount rate at which the cost and benefit for a given strategy are equal is determined. The strategy with the highest first cost that exceeds a minimum acceptable rate of return (specified by the agency) is considered to be the best alternative.

Although the benefit-cost ratio method is used frequently in the highway field, it is occasionally difficult to understand. And, although the rate-of-return method has the distinct advantage on not requiring knowledge of a discount rate, it can be very time-consuming and it has situational flaws.

The present-worth method and the annualized method are the preferred methods of analysis and are therefore presented here. The concepts behind each of these methods are easily understood and the analyses are relatively straightforward to perform.

In the present-worth method, future lump-sum costs and uniform annual costs are converted to present-worth values using the following two equations:

$$PW = F \times \frac{1}{(1+i)^n} \quad \text{Eq. 1}$$

where: PW = Present-worth cost.  
F = Future cost at the end of n years.  
i = Discount rate.  
n = number of years.

$$PW = A \times \frac{(1+i)^n - 1}{i(1+i)^n} \quad \text{Eq. 2}$$

where: PW = Present-worth cost.  
A = Uniform annual costs for n years.  
i = Discount rate.  
n = number of years.

In the annualized method, present-worth costs are converted to uniform annual costs using the following equation:

$$A = PW \times \frac{i(1+i)^n}{(1+i)^n - 1} \quad \text{Eq. 3}$$

where: A = Uniform annual cost over analysis period of n years.  
PW = Present-worth cost.  
i = Discount rate.  
n = number of years in analysis period.

Examples of the present-worth method and the annualized method are provided in figures 7-7 and 7-8, respectively.



Comparing Rehab Strategies		
<u>Rehab Strategy A</u>		
Initial cost:		\$150,000
Rehab at 10 years		\$35,000
Salvage value:	\$50,000	
Estimated service life		15 years
<u>Rehab Strategy B</u>		
Initial cost:		\$120,000
Maintenance at 4 years		\$15,000
Maintenance at 8 years:		\$15,000
Maintenance at 12 years:	\$15,000	
Salvage value:	\$1,000	
Estimated service life		15 years
Specified Discount Rate:		4 percent
<b>Analysis</b>		
<u>Rehab Strategy A</u>		
PW (initial cost) =		\$150,000
PW (rehab at 10 years) = $35,000 \times [1/(1+0.04)^{10}] =$		+ \$16,212
PW (salvage at 15 years) = $50,000 \times [1/(1+0.04)^{15}] =$		- \$15,762
<b>Total Present Worth of Rehab Strategy A</b>		<b>\$150,451</b>
<u>Rehab Strategy B</u>		
PW (initial cost) =		\$120,000
PW (maintenance at 4 years) = $15,000 \times [1/(1+0.04)^4] =$		+ \$11,025
PW (maintenance at 5 years) = $15,000 \times [1/(1+0.04)^8] =$		+ \$8,104
PW (maintenance at 12 years) = $15,000 \times [1/(1+0.04)^{12}] =$		+ \$5,957
PW (salvage at 15 years) = $1,000 \times [1/(1+0.04)^{15}] =$		- \$315
<b>Total Present Worth of Rehab Strategy B</b>		<b>\$144,771</b>
<b>Based on the given assumptions, rehab strategy B is the more cost-effective strategy.</b>		

Figure 7-7. Example of present-worth method of economic analysis.

Comparing Rehab Strategies		
<b>Rehab Strategy A</b>		
Initial cost:		\$150,000
Maintenance at 5 years:		\$25,000
Maintenance at 10 years:	\$25,000	
Maintenance at 15 years:	\$25,000	
Salvage value:	\$2,000	
Estimated service life:		20 years
<b>Rehab Strategy B</b>		
Initial cost:		\$200,000
Rehab at 10 years:		\$50,000
Salvage value:	\$40,000	
Estimated service life:		20 years
Specified Discount Rate:		4 percent
<b>Analysis</b>		
<b>Rehab Strategy A</b>		
A (initial cost) = $150,000 \times \{[(.04)(1.04)^{20}] / [(1.04)^{20} - 1]\}$ =		\$15,278
PW (maint. @ 5 yrs.) = $25,000 \times [1 / (1.04)^5]$ = \$17,015		
A (maint. @ 5 yrs.) = $17,015 \times \{[(.04)(1.04)^{20}] / [(1.04)^{20} - 1]\}$ =		+ \$1,733
PW (maint. @ 10 yrs.) = $25,000 \times [1 / (1.04)^{10}]$ = \$11,580		
A (maint. @ 10 yrs.) = $11,580 \times \{[(.04)(1.04)^{20}] / [(1.04)^{20} - 1]\}$ =		+ \$1,179
PW (maint. @ 15 yrs.) = $25,000 \times [1 / (1.04)^{15}]$ = \$7,881		
A (maint. @ 15 yrs.) = $7,881 \times \{[(.04)(1.04)^{20}] / [(1.04)^{20} - 1]\}$ =		+ \$803
PW (salvage @ 20 yrs.) = $2,000 \times [1 / (1.04)^{20}]$ = \$429		
A (salvage @ 20 yrs.) = $429 \times \{[(.04)(1.04)^{20}] / [(1.04)^{20} - 1]\}$ =		- \$44
<b>Total Annual Cost of Rehab Strategy A</b>		<b>\$18,949</b>
<b>Rehab Strategy B</b>		
A (initial cost) = $200,000 \times \{[(.04)(1.04)^{20}] / [(1.04)^{20} - 1]\}$ =		\$20,370
PW (rehab. @ 10 yrs.) = $50,000 \times [1 / (1.04)^{10}]$ = \$23,160		
A (rehab. @ 10 yrs.) = $23,160 \times \{[(.04)(1.04)^{20}] / [(1.04)^{20} - 1]\}$ =		+ \$2,359
PW (salvage @ 20 yrs.) = $40,000 \times [1 / (1.04)^{20}]$ = \$8,582		
A (salvage @ 20 yrs.) = $8,582 \times \{[(.04)(1.04)^{20}] / [(1.04)^{20} - 1]\}$ =		- \$874
<b>Total Annual Cost of Rehab Strategy B</b>		<b>\$21,855</b>
<b>Based on the given assumptions, rehab strategy A is the more cost effective.</b>		

Figure 7-8. Example of annualized method of economic analysis.

REFERENCES

1. Raza, H., *An Overview of Surface Rehabilitation Techniques for Asphalt Pavements*, Report No. FHWA-PD-92-008, Federal Highway Administration, April 1992.
2. Asphalt Institute, *Asphalt Surface Treatments: Construction Techniques*, Educational Series No. 12 (ES 12), February 1982.
3. *Techniques for Pavement Rehabilitation*, Training Course Manual, National Highway Institute, Federal Highway Administration, Third Revision, October 1987.
4. Epps, J.A., *Cold-Recycled Bituminous Concrete Using Bituminous Materials*, NCHRP Synthesis of Highway Practice 160, National Cooperative Highway Research Program, July 1990.
5. Wood, L.E., T.D. White, and T.B. Nelson, *Current Practice of Cold In-Place Recycling of Asphalt Pavements*, Transportation Research Record 1178, Transportation Research Board, 1988.
6. *Techniques for Pavement Rehabilitation*, Training Course Manual, National Highway Institute, Federal Highway Administration, Fifth Revision, May 1993.
7. Asphalt Institute, *Asphalt Hot-Mix Recycling*, Manual Series No. 20 (MS 20), Second Edition, 1986.
8. Asphalt Institute, *The Asphalt Handbook*, Manual Series No. 4 (MS 4), 1988.
9. Asphalt Recycling and Reclaiming Association, *An Overview of Recycling and Reclamation Methods for Asphalt Pavement Rehabilitation*, August 1992.
10. Epps, J.A., D.N. Little, R.J. Holmgreen, and R.L. Terrel, *Guidelines for Recycling Pavement Materials*, NCHRP Report 224, National Cooperative Highway Research Program, September 1980.
11. *Pavement Design: Principles and Practices*, Training Course Manual, National Highway Institute, September 1987.
12. Roberts, F.L., P.S. Kandhal, E.R. Brown, D.Y. Lee, and T.W. Kennedy, *Hot-Mix Asphalt Materials, Mixture Design, and Construction*, First Edition, National Asphalt Pavement Association, Education Foundation, 1991.

13. Heitzman, M.A., *State of the Practice: Design and Construction of Asphalt Paving Materials with Crumb Rubber Modifier*, Report No. FHWA-SA-92-022, Federal Highway Administration, May 1992.
14. *AASHTO Guide for Design of Pavement Structures*, American Association of State Highway and Transportation Officials, 1986.
15. Peterson, D.E., *Life-Cycle Cost Analysis of Pavements*, NCHRP Synthesis of Highway Practice 122, National Cooperative Highway Research Program, December 1985.

## GLOSSARY

**Alligator Cracking** — A series of interconnecting cracks in an asphalt layer that are caused by repeated traffic loadings. The cracking pattern resembles that of an alligator's skin or chicken wire. The cracks indicate fatigue failure of the asphalt layer. Hence, the term *fatigue cracking* is also used.

**Analysis Period** — The period of time used in making economic comparisons between rehabilitation alternatives. The analysis period should not be confused with the pavement's design life (performance period).

**Asphalt Cement** — A black petroleum based product used as the binder material in most high-quality asphalt pavements. Asphalt cement is a residual of the crude oil distillation process. Asphalt cement is left after the lubricating and fuel oils have been extracted from the crude oil.

**Asphalt Concrete** — A high-quality mixture of aggregate particles embedded in a matrix of asphalt cement that fills the voids between the aggregate particles and binds them together. The mixture is compacted to a uniform, dense state.

**Asphalt Emulsion** — A mixture of asphalt cement, water, and an emulsifying agent. The emulsifying agent acts like a soap and allows the asphalt to be dispersed in the water. The dispersed asphalt can be easily mixed with aggregate or sprayed on a pavement surface. The water and asphalt eventually separate (break) leaving the residual asphalt cement.

**Asphalt Surface Course** — The top layer of an asphalt pavement. Also known as the wearing course.

**Asphalt Surface Treatment** — See *surface treatment*.

**Asphalt-Aggregate Mixture** — A mixture of aggregate particles and either asphalt cement or emulsified asphalt. Asphalt aggregate mixtures range in quality from high-quality asphalt concrete to low-quality cold mix.

**Base Course** — The pavement layer located directly beneath the surface layer. The base layer can consist of an asphalt-aggregate mixture or untreated aggregate (gravel) material. In most instances, the base layer is located directly on the subgrade, unless a subbase layer is used.

**Bleeding** — Excess asphalt binder occurring on the pavement surface. The bleeding may create a shiny, glass-like surface that may be tacky to the touch. Bleeding is usually found in the wheel paths.

**Block Cracking** — A rectangular pattern of cracking in asphalt pavements that is caused by hardening and shrinkage of the asphalt. Block cracking typically occurs at a uniformly-spaced interval.

## GLOSSARY (continued)

**Cold In-Place Recycling (CIR)** — The breaking up, mixing, and reworking of the existing roadway without the application of heat. Cold in-place recycling is typically performed to a depth greater than 50 mm.

**Cold Milling** — The removal of the upper portion (usually 25 to 50 mm) of an AC surface using drum-mounted carbide steel cutting bits.

**Cutback Asphalts** — Asphalt cement that has been diluted through the addition of a petroleum solvent. The solvent softens the asphalt cement and allows it to be easily mixed with aggregates or sprayed on the pavement surface. The solvent eventually evaporates leaving the residual asphalt cement.

**Discount Rate** — The difference between the market rate of interest and the rate of inflation.

**Distress Survey** — An evaluation of a pavement to determine the cause and extent of deterioration.

**Emulsified-Asphalt Aggregate Mixture** — An emulsified asphalt that is combined with aggregate particles, which upon evaporation of the water produces a continuous film of asphalt on the aggregate.

**Fatigue Cracking** — see *alligator cracking*.

**Frost Heave** — Volumetric increase in the soil due to the formation and continuing expansion of ice lenses.

**Functional Condition** — A measure of the pavements ability to provide good ride quality and good skid resistance.

**Heaving** — See *frost heave*.

**Hot-Mix Asphalt Concrete** — See *asphalt concrete*.

**Life-Cycle Costs** — A method used to compare design alternatives based on economic considerations throughout the life of the pavements. Life-cycle costs include initial construction, maintenance, and rehabilitation costs.

**Overlay** — A layer of asphalt material placed over the original pavement or previous overlay to remedy functional or structural deficiencies in the pavement.

**Patch** — A portion of the pavement surface that has been removed and replaced or additional material applied to the pavement after original construction.

## GLOSSARY (continued)

**Performance Period** — The period of time that an initially constructed or rehabilitated pavement structure will perform before reaching its terminal serviceability.

**Polishing** — Wearing away of the surface binder, causing exposure of the coarse aggregate particles. A polished pavement surface is smooth and has little skid resistance.

**Potholes** — Bowl-shaped holes of various sizes in the pavement surface.

**Pumping** — Ejection of loose material and water from under the pavement through joints and cracks, caused by vertical movement of the pavement under traffic loadings.

**Raveling** — Wearing away of the pavement surface caused by the dislodging of aggregate particles and loss of asphalt binder.

**Reconstruction** — Complete removal and replacement of a pavement section with a new design.

**Reflection Cracking** — Cracking that appears on the surface of an overlay above joints and cracks in the underlying pavement layer due to horizontal and vertical movement of these joints and cracks.

**Rehabilitation** — Work undertaken to extend the service life of an existing pavement.

**Rideability** — A measure of the ride quality of a pavement as perceived by its users.

**Restoration** — Work required to return the existing pavement structure to a suitable condition to perform satisfactorily.

**Rubber-Tired Roller** — A piece of asphalt compaction equipment that is equipped with rubber tires. Also known as *pneumatic tired roller*.

**Rutting** — Longitudinal surface depressions in the wheel path caused by plastic movement of the mix, inadequate compaction, or abrasion from studded tires.

**Serviceability** — Ability of a pavement to provide a safe and comfortable ride to its users.

**Settlement** — A depression in an asphalt pavement that is caused by the settling or erosion of the underlying base and subgrade layers.

## GLOSSARY (continued)

**Shoving** — Longitudinal displacement of a localized area of the pavement surface caused by braking or accelerating vehicles.

**Slippage Cracks** — Crescent-shaped cracks occurring in the direction of traffic, generally caused by shoving of the asphalt surface course.

**Steel-Wheeled Roller** — A piece of compaction equipment that contains a large steel drum. The steel drum can be either vibratory or static.

**Stress-Absorbing Membrane Interlayer (SAMI)** — A layer that dissipates movements and stresses at a joint or crack before they create stresses in an overlay. They generally include a spray application of rubber- or polymer-modified asphalt as the stress-relieving material, followed by placing and seating aggregate chips.

**Structural Capacity** — A measure of a pavement's ability to carry repeated traffic loads over time.

**Structural Condition** — The condition of a pavement as it pertains to its ability to support repeated traffic loadings.

**Subbase Course** — The layer or layers of specified material of designed thickness between the base and subgrade to support the base course.

**Subgrade** — The top of a roadbed upon which the pavement structure and the shoulders are constructed.

**Surface Treatment** — Any application applied to an asphalt surface to restore or protect the surface characteristics. Surface treatments may consist of either asphalt (cement, cutback, or emulsion) or an asphalt-aggregate mixture. Surface treatments are typically less than 25 mm thick.





