



# *Alternative Cover Assessment Project Phase I Report*

---

William H. Albright<sup>1</sup>  
Glendon W. Gee<sup>2</sup>  
Glenn V. Wilson<sup>3</sup>  
Michael J. Fayer<sup>2</sup>

---

October 2002

---

Publication No. 41183

Prepared by  
Division of Hydrologic Sciences  
Desert Research Institute  
University and Community College System of Nevada

Prepared for  
U.S. Environmental Protection Agency  
Contract No. 44-0000-2038

<sup>1</sup>Desert Research Institute

<sup>2</sup>Pacific Northwest National Laboratory

<sup>3</sup>U.S. Department of Agriculture, Agriculture Research Service

## EXECUTIVE SUMMARY

The Alternative Cover Assessment Program (ACAP) was initiated in March 1998 by the U. S. Environmental Protection Agency (EPA) to address a growing interest in the use of innovative alternatives to prescribed landfill cover designs. Interest has stemmed from needs to improve cover designs, provide enhanced monitoring capabilities, and lower overall costs of cover systems while maintaining adequate long-term protection of human health and safety. The Desert Research Institute (DRI), with support from the Pacific Northwest National Laboratory (PNNL), was contracted to provide an assessment of sites where alternative landfill covers have been or are currently being tested. In addition, an evaluation of computer codes was conducted to assess current capabilities of hydrologic models to quantify both water balance and performance of landfill covers systems.

Results of the site assessment show that 19 sites have built or tested alternative cover designs. This report provides details of targeted sites including geographic setting, climate, soils, and vegetative conditions as well as alternative landfill cover design and monitoring systems for each site. The report also proposes that a dispersed network of test facilities be established for determining the field performance of various alternative earthen final cover designs. Each of these facilities should include a weather station, a continuous soil water monitoring system for assessing soil water storage, and a lysimeter system designed to directly measure drainage from the cover. General equipment and lysimeter designs for the monitoring network (weather station, soil water monitoring, and lysimeters) were provided to EPA. Data collected from the monitoring network will be used for future model validation purposes.

The modeling assessment section of this report includes a brief description of selected computer codes that have been used for cover design assessments, their capabilities, and limitations. Comparisons are presented for nine codes in terms of their processes and properties. Five of the codes selected: HELP, UNSAT-H, SHAW, EPIC, and HYDRUS-2D are described in detail. Sensitivity tests were conducted for selected hydraulic properties and validation tests on the HELP, EPIC, UNSAT-H, and HYDRUS-2D codes for a humid and a semi-arid site. Sensitivity tests were only conducted on select hydraulic parameters ( $K_s$ , water retention properties, cover thickness, and evaporative depth). Validation tests were conducted using performance data from lysimeter facilities at Hanford, WA (data collected between 1987 and 1993), and Coshocton, OH (data collected between 1985 and 1994).

Of the four codes tested, HELP is the most widely used for landfill design, and is the most user friendly. HELP predictions were highly version dependent but consistently provided the highest estimates of drainage regardless of the version or condition tested. Such predictions can lead to conservative (thicker) cover designs. Three concerns with HELP were (i) a non-realistic response of increased drainage as available water capacity increased, (ii) insensitivity of drainage to thickness of the cover surface layer, (iii) consistent over-prediction of drainage. The over-prediction of drainage was as much as an order of magnitude for the arid site. For water-balance codes such as HELP and EPIC in which evapotranspiration is removed only from an arbitrary evaporative zone, it is critical that the evaporative depth be accurately characterized. Since evaporative depth is a fairly nebulous property that is extremely difficult to characterize, implies that model calibration is needed with these codes.

EPIC was also relatively easy to use, but consistently under-predicted drainage in comparison to the other codes. Drainage was computed to be zero for the arid site using EPIC, while there was measurable drainage computed by the other codes using default weather and soil parameters. In comparison to a measured drainage rate of 30 mm/yr from a Hanford lysimeter, EPIC predicted zero drainage. While UNSAT-H and HYDRUS-2D exhibited the most physically realistic response patterns in the sensitivity tests, they both under-predicted drainage relative to the measured drainage rate at Hanford. However, UNSAT-H was able to closely predict measured drainage rates when hysteresis was included. For the Coshocton lysimeter, all codes were better able to predict the measured drainage than observed for the arid conditions, however, UNSAT-H and HYDRUS-2D exhibited superior ability. This study suggests that the Richards' Equation-based codes (HYDRUS-2D, UNSAT-H) were better able to capture the behavior of alternative earthen covers under both arid and humid conditions than the simple water-balance codes (HELP, EPIC). Numerous recommendations for improvement of each code were developed from these studies. Since a water-balance type model has already been developed specifically for landfill design, further development of EPIC was not recommended. Given the apparent limitations of water-balance approach for alternative covers which function based upon natural (soil-plant-atmosphere continuum) processes in contrasts to compartmental analysis, it was recommended that Richards' equation based codes be adapted for alternative landfill cover designs.

This review indicates that the codes identified as being applied to landfill cover design have limitations and need improvements. Models need to be evaluated against common databases across hydrogeologic regions for confirmation of validity. Data collected from Phase I and the dispersed network will provide the basis for code modifications and validation of these models. Additional testing and modification of codes will be conducted in subsequent phases of ACAP to better represent landfill cover applications.

## **ACKNOWLEDGMENTS**

The United States Environmental Protection Agency (USEPA) provided financial support for this study. The Alternative Cover Assessment Program is managed at the National Risk Management Research Laboratory by Mr. Steven Rock. This report has not been subjected to final USEPA review. Endorsement by USEPA is not implied, and should not be assumed. Each of the sites in described in this report made considerable contributions to this effort. Assistance that has been provided by the site owners and managers is greatly appreciated. Mr. Brian Ogan made considerable contributions toward the review of numerical models while completing his graduate work at the Desert Research Institute in Las Vegas and his help is greatly appreciated.

## CONTENTS

Executive Summary .....	ii
Acknowledgements .....	iv
Figure Legends .....	vii
Table Legends .....	viii
I. Introduction .....	1
A. ACAP Objectives .....	3
B. Report Objectives .....	5
II. Review of Existing Research Sites .....	5
A. Introduction to Site Review .....	5
A.1. Qualitative Methods .....	6
A.2. Indirect Quantitative Methods .....	7
A.3. Direct Quantitative Methods .....	10
B. Site Selection .....	11
C. Research Site Reviews .....	13
Atlanta GA .....	14
Beltsville, MD .....	16
Denver, CO .....	19
Hanford, WA .....	23
Hill AFB UT .....	34
INEEL, ID .....	38
Kalamazoo, MI .....	43
Los Alamos, NM .....	46
Milwaukee, WI .....	54
Nevada Test Site, NV .....	57
Oahu, HI .....	60
Reedsburg, WI .....	63
San Bernardino County, CA .....	65
Sandia National Lab, NM .....	69
Savannah River, SC .....	73
Sheffield, IL .....	77
Sierra Blanca, TX .....	80
Twenty-nine Palms, CA .....	84
Wenatchee, WA .....	87
D. Summary of Site Review .....	90
E. ACAP Dispersed Network Facilities .....	94
III. Numerical Models for Landfill Design and Monitoring .....	101
A. Modeling Introduction .....	101
B. Model Survey and Description .....	106
C. Detailed Code Descriptions .....	113
C.1. HELP .....	113
C.2. HYDRUS-2D .....	123

C.3. EPIC .....	130
C.4. UNSAT-H .....	135
C.5. SHAW .....	140
D. Sensitivity Analysis: Model Comparisons.....	146
E. Validation Tests: Model Comparisons .....	155
F. Code Differences .....	160
G. Model Comparisons Summary .....	163
H. Individual Model Summaries and Recommendations .....	165
H.1 HELP .....	165
H.2 EPIC .....	165
H.3 HYDRUS-2D .....	166
H.4 UNSAT-H .....	168
IV. Conclusions.....	170
V. References.....	175
Appendix A: Sensitivity Analysis Results.....	191

## FIGURE LEGENDS

1.	Locations of landfill cover testing facilities indicated by site number. ....	13
2.	Plan view of proposed 3-lysimeter test facility. ....	98
3.	Detail of proposed lysimeter test facility design. ....	98
4.	Detail of a vadose zone monitoring station. ....	99
5.	Schematic of the soil water retention function(Simunek et al., 1994). ....	136
6.	Schematic of the hydraulic conductivity function (Simunek et al., 1994). ....	136
7.	The effect of varying $\alpha$ while holding n constant. ....	170
8.	The effect of varying n while holding $\alpha$ constant. ....	171
9.	Modeled estimates of drainage using UNSAT-H and HYDRUS-2D with and without simulated evaporation .....	184

## TABLE LEGENDS

1.	Climatic conditions for the landfill cover testing facilities .....	91
2.	Processes and Attributes of the Landfill Cover Codes Identified in the ACAP Survey.....	110
3.	Pertinent Input Parameters and Descriptive Information for Landfill Cover Codes Identified in Survey.....	111
4.	Water retention and hydraulic conductivity parameters provided in the HYDRUS-2D menu (Simunek et al., 1996).....	138
5.	The Effect of Controlling versus the Program Setting, the Initial Condition tested for for HELP Predictions for Cheyenne, WY .....	166
6.	Sensitivity of Drainage Predictions to Saturated Hydraulic Conductivity for Arid Conditions. ....	167
7.	Sensitivity of Drainage Predictions to Saturated Hydraulic Conductivity for Humid Conditions .....	168
8.	Sensitivity of Drainage Predictions to AWC for Arid Conditions.....	169
9.	Sensitivity of Drainage Predictions to AWC for Humid Conditions .....	169
10.	Sensitivity Analysis on HYDRUS-2D Water Retention Parameters .....	171
11.	Sensitivity of Drainage Predictions to Cover Thickness Under Arid Conditions.....	173
12.	Sensitivity of Drainage Predictions to Cover Thickness Under Humid Conditions. ..	174
13.	Sensitivity of HELP to Evaporative Depth and Cover Thickness for Cheyenne, WY.....	175
14.	Code and Version Results Compared to Measured Drainage from a Hanford Lysimeter from 1987 through 1993. ....	179
15.	Code Results Compared to Measured Drainage from a Coshocton Lysimeter from 1985 through 1994.....	180
16.	Drainage predictions by HELP Version 3.01 and 3.07 (DOS) for a Bare Silt Loam, Capillary Barrier Lysimeter at the Hanford Site, Washington. ....	182
17.	Comparison of DOS and VISUAL versions of HELP 3.07 for Buffalo, NY.....	183



## I. INTRODUCTION

The development and implementation of environmentally protective and cost-effective designs for alternative landfill covers are hampered by a number of issues including: 1) lack of field data; 2) absence of rigorously tested models for predicting the hydrologic performance of landfill facilities; and 3) lack of regional or national design guidance that integrates cover design options with the relevant environmental variables. Appropriate designs need to incorporate site-specific information relative to geographic and topographic features, soil types, plant cover, and climatic variables. The diversity in these environmental variables will require a variety of design features to address the hydrologic issues involved in the safe disposal of solid waste.

The design of most landfill covers in the United States has been based on criteria developed by EPA for use in closing either Resource Recovery and Conservation Act (RCRA) Subtitle C (hazardous waste) or Subtitle D (municipal solid waste) landfills. Skahn (1997) reviewed recent work in landfill cover design and noted that two major themes have emerged from the recent studies: 1) there has been an overemphasis on regulatory compliance, which has inhibited innovative and creative cover design. Greater emphasis needs to be placed on how the design will affect cover performance, and 2) there are few published data on field performance of constructed cover systems. Skahn (1997) indicated that EPA would be revising its guidance to enable evaluation and use of alternative cover designs. The guidance will also identify the need to install monitoring systems within the cover to verify performance in preventing drainage from the cover into the landfill.

EPA's current requirement for RCRA Subtitle D landfill covers is detailed in the Code of Federal Regulations (40 CFR Part 258). The regulation calls for:

- An erosion layer that must consist of a minimum of six inches of earthen material that is capable of sustaining native plant growth, and
- An infiltration layer, comprised of a minimum of 18 inches of earthen material that has a saturated hydraulic conductivity less than or equal to the

saturated hydraulic conductivity of any bottom liner system or natural subsoils present, or a hydraulic conductivity no greater than  $1 \times 10^{-5}$  cm/s, whichever is less. In practice, the presence of a geomembrane in a landfill liner infers the presence of a similar geomembrane in the cover system.

Alternative Subtitle D covers can be installed if they can be shown to be equivalent in preventing infiltration and protecting against erosion, and approved by the appropriate state agency with concurrence from EPA.

The EPA requirement for RCRA Subtitle C landfill covers is found in the EPA Code of Federal Regulations (40 CFR 264) concerning final covers on hazardous waste landfills and surface impoundments. A multi-layer cover is required, consisting of:

- A top layer consisting of two components: a) either a vegetated or armored surface or armored-surface component, selected to minimize erosion and promote lateral drainage off the cover, and b) a soil component with a minimum thickness of 24 inches, comprised of topsoil (or fill soil), the surface of which has a slope between 3 and 5%. A soil component of greater thickness may be required to ensure that the underlying low-permeability layer is below the frost zone. Either a soil-drainage layer with a minimum thickness of 12 inches and minimum saturated hydraulic conductivity of  $1 \times 10^{-2}$  cm/s, and a minimum slope of 3%, or a drainage layer consisting of geosynthetic materials with equivalent performance characteristics, and
- A two-component, low-permeability (saturated hydraulic conductivity) layer, lying wholly below the frost zone, consisting of a) a 20-mil-minimum thickness geomembrane and b) a compacted soil component with a minimum thickness of at least 24 inches and a saturated hydraulic conductivity of  $1 \times 10^{-7}$  cm/s. Additional optional layers may be used on a site-specific basis. These layers might include such things as a gas-vent layer to remove gas buildup and a biotic-barrier layer (such as a subsurface layer of coarse gravel or cobble) to limit intrusion depths of animals and plants into the cover.

Alternative covers to the RCRA subtitle D design described above include evapotranspiration (ET) covers and capillary barriers. An ET cover in its simplest form is

a soil cover that is vegetated and has a sufficiently deep soil profile so that infiltrated water is stored until removal by evaporative losses from the soil surface and by plant roots at depth in the profile. A capillary barrier also relies on water removal by ET, but is designed such that water storage near the surface is enhanced to promote the efficient removal of infiltrated water by the ET process. The water storage of a capillary barrier is enhanced because the barrier consists of a fine soil over a coarse soil. Optimization of material types and thickness for capillary barriers is critical to their effective performance. The effectiveness in storing water depends on the hydraulic properties of the soil layers. It can be shown that water storage in soils, such as silt loam, can be increased by strategic placement of a coarse soil at depth in the profile. The use of sands or clays as the fine-soil component in the capillary barrier have proven to be less effective in storing water than silt loams (Stormont and Morris, 1998). Capillary barriers can be thought of as enhanced ET covers. These alternative cover systems work best in semi-arid or arid environments, where high ET rates and low precipitation make possible the removal of all the infiltrated water by ET. However, even in arid environments, there are situations where ET covers and capillary barriers can allow excessive percolation, particularly where the soil used in the cover design has insufficient storage capacity to accommodate winter snowmelt events (Gee et al., 1998).

Permitted RCRA hazardous waste landfills at present must have a cover designed to include a composite impermeable (low permeability) component. If alternatives such as ET or capillary barrier covers can be shown to be effective the EPA may consider their use and provide guidance documentation for application on future landfills (Skahn, 1997). The lack of performance data noted by Skahn (1997) makes difficult the task of comparing the performance of ET covers and capillary barriers against the RCRA (e.g., compacted clay) cover systems. Without these data, EPA will not be able to confirm the expected performance life of the covers and it will be more difficult to bring about regulatory or public acceptance of alternative cover designs.

### **I.A. ACAP Objectives**

The Desert Research Institute, in collaboration with the Pacific Northwest National Laboratory, has contracted with EPA to address questions related to design,

testing, monitoring, and performance predictions for alternative covers for landfills. Under this contract a comprehensive program entitled Alternative Covers Assessment Project (ACAP) has been initiated. The project was scoped in four phases.

- Phase I consists of an initial review of current data collection efforts and numerical modeling capabilities. Existing data collection efforts are to be evaluated for possible inclusion into the program. Currently used models are to be evaluated for features that are appropriate to the evaluation of alternative cover designs.
- Phase II involves the design, construction and operation of a network of cover testing facilities as well as modification of numerical models to better represent alternative cover performance. The testing facilities will be used to document the performance of alternative covers in response to a wide range of environmental variables. These facilities will also provide opportunity for improving methods and tools for alternative cover monitoring.
- Phase III will combine the field results with improved numerical models to predict long-term performance of alternative cover systems at the selected testing sites. Numerical models selected and critically tested for alternative cover evaluation in Phase II will be refined in light of results for the overall field effort and the needs defined by the EPA. Performance predictions will be made for a wide range of expected climatic, geologic and vegetative changes. In addition to these site-specific tasks, data from the dispersed network of cover-testing facilities will be used to extrapolate across geographic, geologic, hydrologic and climatologic boundaries to define requirements for successful alternative landfill cover designs where appropriate.
- Phase IV will provide comprehensive recommendations for development of guidance documentation on alternative cover systems. The documents will synthesize existing information from previous cover tests and all results from the controlled ACAP tests and modeling exercises. Appropriate climate, soil, topography and plant parameter ranges will be specified for optimal

performance or alternative cover systems. The technical basis for regulatory decisions will be provided in the documentation.

### **I.B. Report Objectives**

This report documents activities conducted under Phase I of the ACAP study, describes the assessment of existing sites and the proposed test facilities and equipment requirements for selected ACAP study sites, details the water balance model review and sensitivity tests completed to date and provides references.

## **II. REVIEW OF EXISITING RESEARCH SITES**

### **II. A. Introduction to Site Review**

Earthen final covers are considered cost-effective closure solutions for many waste disposal facilities in the United States. Research conducted to date indicates that earthen covers can provide an effective means to protect the environment. A common view among the research, engineering and regulatory communities, however, is that few field data sets exist that provide direct measurement of the performance of prescriptive or alternative covers (Warren et al., 1994; Skahn, 1997; Nyhan et al., 1997). Those data sets that do exist have not been cataloged to provide a coherent view of the state of cover design.

While many studies have documented parameters related to cover performance, (soil moisture content, precipitation, runoff) these measurements by themselves do not directly address the central issue, namely deep percolation through the cover. In most cases, the collection of soil moisture, runoff, and precipitation data has been performed to meet regulatory performance requirements. Methods that utilize these data to estimate the ability of a cover design to limit the flux of water have inherent uncertainties. The magnitude of these uncertainties frequently exceeds the requirements of adequate protection of the environment from the spread of waste-related contamination. The difficulty in measuring the ability of an engineered cover to limit deep percolation is one aspect of the more general problem of quantifying water balance in any setting, engineered or natural. Methods of determining deep percolation include those based on fixed fractions of annual precipitation, water balance models, soil-water flow models,

environmental tracer models, and lysimetry (Gee and Hillel, 1988; Allison *et al.*, 1994). The performance of individual landfill cover systems has been evaluated by groundwater monitoring methods, and various soil moisture monitoring schemes (Montgomery and Parsons, 1990; Benson *et al.*, 1994; Khire *et al.*, 1997 a,b; Melchior, 1994; Ward and Gee, 1997). Methods that have been used to predict the performance of landfill covers range from qualitative to quantitative.

### **II.A.1. Qualitative Methods**

#### **Groundwater Monitoring and Leachate Collection**

Chemical analysis data from monitoring wells has been used to indicate the presence of deep percolation through a waste facility and into the groundwater system. For an unlined waste site, the time required for a given concentration of contaminant to reach a monitoring well is a function not only of the performance of the cover, but also of the depth of waste, the consolidation and internal drainage from the waste form, the spatial distribution of contaminants within the waste, attenuation of the contaminants by soils beneath the waste, the depth of the vadose zone, lateral distance to the monitoring well, the hydraulic gradient of the phreatic surface, and the spatial distribution of percolation through the cover. Groundwater contamination can also be an indication of problems with engineered features other than the cover, such as run-on control, lateral movement of subsurface flows into the waste, and erosion control. Thus, it is often very difficult to sort out the key processes controlling groundwater contamination and at best this method is only qualitative in predicting drainage rates from cover systems and should be used with caution.

Landfill facilities regularly monitor leachate generation. These data can be used qualitatively to evaluate the effectiveness of covers. However, for reasons similar to groundwater monitoring, quantitative inferences of drainage rates made from such data can be suspect. The accuracy of cover assessments based on leachate generation rates depends on the effectiveness of the liner beneath the leachate collection system. While modern composite liners are known to leak very little (Giroud and Bonaparte, 1989; Gross *et al.*, 1997), older earthen liners are suspect. Unfortunately, most of the landfill

space to be capped in the United States contains earthen liners and thus a substantial fraction of water percolating from a cover may be lost through the liner.

Cover assessments based on leachate generation rates are also biased by storage of water within the waste mass. Storage in the waste mass can result in a delay of a decade or more between the time when water exits the base of the cover and when it reaches the leachate collection system. Thus, only data collected long after closure can be used to assess cover performance. Because of these concerns, other methods including both indirect and direct monitoring methods have been deployed to measure the drainage from cover systems. These methods will be discussed in turn.

## **II.A.2. Indirect Quantitative Methods**

### **Empirical Estimates**

A common method of estimating deep drainage,  $D$ , in the absence of adequate local data is an empirical expression:

$$D = k_1(P - k_2) \quad (1)$$

where  $P$  is precipitation and  $k_1$  and  $k_2$  are empirically determined constants for the area of interest. The use of such methods is fairly common in areas where data are scarce but should be limited to providing initial estimates in regions with high ( $>50$  mm/yr) values of recharge (Allison et al., 1994).

### **Water Mass Balance Methods**

The simplest approach is water-balance modeling. The components of the water budget can be represented by:

$$\text{Inputs-Outputs} = \text{Change in Storage}$$

$$P - ET - R_o - D = \Delta S \quad (2)$$

where  $P$  is precipitation,  $ET$  is evapotranspiration,  $R_o$  is the surface runoff,  $D$  is the drainage out of the profile and  $\Delta S$  is the change in water storage within the soil. The

performance of landfill covers is most often evaluated using drainage as the essential design criterion. Yet drainage is the most difficult component to determine, thus water-balance models estimate  $D$  from knowledge of the other components.  $P$  and  $R_o$  can be measured directly, but often exhibit high spatial variability. These components are particularly difficult to assess under conditions of snow deposition and melting. There have been a number of methods developed for the determination of ET (Levitt, 1996; Czarnecki, 1990; Penman, 1948). These methods for ET perform well in agricultural and humid settings, but have large data requirements and can produce large errors in semi-arid and arid settings.  $\Delta S$  can be calculated from vadose zone instrumentation for monitoring the water content. Methods including time domain reflectometry (TDR) and electrical resistance have significantly improved over the last decade, enabling improvements in water-balance analysis. However, the high degree of spatial variability and uncertainty in scaling small point measurements of water storage to the landfill-scale continues to limit validity.

While these surface processes are fairly well understood for some settings, they are complex and not well understood in most natural, especially semi-arid, environments and the uncertainties in the water balance components can introduce large errors in drainage estimates. Gee and Hillel (1988) assessed the uncertainty in water balance components. They demonstrated that even for the simple case in which  $R$  and  $\Delta S$  are zero on an annual basis,  $D = (P \pm x) - (ET \pm y)$ . If the error associated with  $P$  and  $ET$  is only 5%, the uncertainty in  $D$  is 200% for a condition in which  $P$  and  $ET$  differ by as much as 10%. In reality, error in  $P$  measurements are usually  $>5\%$ , and  $ET$  measurements  $>10\%$ , and under arid conditions  $P$  and  $ET$  often differ by less than 10%. Additionally, errors in  $\Delta S$  by water content measurements can be around 10%, thus, errors in  $D$  by water balance computation can be several hundred percent (Gee and Hillel, 1988).

### **Unsaturated Flow Process Methods**

A common alternative is to use deterministic models that are based upon solution of Richards' equation for transient unsaturated flow conditions. For two-dimensional



transient flow with isotropic hydraulic conductivity [ $K_x = K_z = K(h)$ ], Richards' equation is

$$C(2) Mh/Mt = K(h) [M^2h/Mx^2 + M^2h/Mz^2 + Mh/Mz] \quad (3)$$

where  $C(\theta)$ , the specific water capacity, is the slope of the water retention curve,  $\theta(h)$ . The unsaturated hydraulic conductivity ( $K(\theta)$  or  $K(h)$ ) and water retention  $\theta(h)$  are needed to provide estimates of the flux of water in the unsaturated zone.

The water retention curve is a fundamental soil property that represents the relationship between the water content,  $\theta$ , and the matric head,  $h$ . The water retention function,  $\theta(h)$ , is affected by physical properties of the soil such as texture and structure that affect the pore-size distribution. Water retention data are typically obtained experimentally on undisturbed soil cores. To obtain the  $\theta(h)$  function, water retention data are fit to empirical expressions such as the van Genuchten (1980) water retention model:

$$\theta = \theta_r + [\theta_s - \theta_r] / [1 + (\alpha h)^n]^m \quad (4)$$

where  $h$  is the absolute value of matric head,  $\theta_r$  is the residual water content, and  $\alpha$  ( $\text{cm}^{-1}$ ),  $m$  and  $n$  are fitted parameters. The parameter  $\alpha$  is a measure of the air-entry value ( $h_a$ ), whereas  $m$  and  $n$  are measures of the pore-size distribution. The air-entry value is the pressure head at which air enters the soil and can be approximated by the inverse of  $\alpha$ , i.e.,  $\alpha = 1/h_a$ .

One of the greatest difficulties in predicting unsaturated water flow is determining the  $K(h)$  properties.  $K(h)$  is often described by semi-empirical functions that are based on Pouiselle's law and the pore-size distribution of the soil. One function is the van Genuchten-Mualem model (van Genuchten 1980),

$$K_r = K(h) / K_s = \frac{\{1 - (\alpha h)^n [1 + (\alpha h)^n]^{-m}\}^2}{[1 + (\alpha h)^n]} \quad (5)$$

where  $\alpha$ ,  $n$ , and  $m$  are the same parameters used to describe the water retention curve (Eq. 4) and  $K_s$  is the saturated hydraulic conductivity. The relationship between  $m$  and  $n$  proposed by Mualem (1976) whereby  $m = 1 - 1/n$  is often assumed.

Equations 3 to 5 can be used to estimate the flux of water under unsaturated conditions when the parameters  $\alpha$ ,  $m$ , and  $n$  and the saturated hydraulic conductivity are known, as long as the initial and the boundary conditions are adequately described. While this indirect method of estimating the flux through covers is popular, water fluxes computed using this approach are subject to significant error due to spatial variability and scale effects in the soil hydraulic properties as well as errors made in laboratory measurements of soil properties. There has been a great deal of work in recent years on the determination and modeling of the unsaturated hydraulic properties of soils. Currently, several models predict the flux of water within an unsaturated soil, given adequate knowledge of the soil physical properties and boundary conditions. Determination of the soil physical properties depends on laboratory analysis of relatively small samples and lacks the spatial variability inherent even in a highly engineered environment. Greater difficulties are presented in supplying the atmospheric boundary variables and internal sink terms representing plant root activities. The culmination of these uncertainties led Gee and Hillel (1988) to conclude that the "Darcian approach... is fraught with large potential errors ...often no less than an order of magnitude."

### **II.A.3. Direct Quantitative Methods:**

#### **Lysimeters**

Water-balance lysimeters have often been regarded as the reference instrument for estimation of drainage in irrigated agricultural settings (Allen et al., 1991) and arid and semi-arid sites involving engineered soils (Gee et al., 1992, 1993; Benson et al., 1994; Benson and Khire, 1995). Water-balance lysimeters are typically soil-filled containers buried flush with the soil surface, that allow for some method of collecting drainage. Often these lysimeters can also be used to measure water storage either directly through weighing or by using independent methods (e.g., neutron probe or TDR) to monitor soil water storage. Lysimeters are often expensive to construct, are semi-permanent structures, and must be designed to account for soil physical properties and site-specific

environmental variables. Despite these concerns, Gee and Hillel (1988) concluded that lysimeters provide the most reliable means of measuring percolation, given adequate surface area and long-term monitoring, with precision in drainage "often better than 1 mm/yr."

Measurement of percolation by drainage lysimetry is made possible by the presence of an impermeable geomembrane forming the bottom boundary. The interruption of downward movement of moisture by the geomembrane causes increased moisture content in the soil layer immediately above the membrane. Drainage occurs when the soil above the membrane liner reaches near-saturation. This requirement presents a design problem if roots from surface vegetation are allowed to penetrate to the bottom of the lysimeter. When the downward flux of moisture is impeded by an impermeable membrane and plants are allowed access to the trapped moisture, percolation is reduced which can result in false negatives. This factor can be addressed if the lysimeter is relatively deep and roots are restrained from approaching the bottom liner of the lysimeter. Of all currently available methods, only the use of water-balance lysimeters (over several years, combined with climatic observations, plant community activities, and soil parameters) can provide the data necessary to quantify the performance of landfill covers and to validate and calibrate numerical models for design and evaluation of covers (Khire *et al.*, 1997).

## **II.B. Site Selection**

Those research efforts that have included physical measurement of percolation through the cover are often site-specific in scope and have occasionally neglected measurement of important environmental parameters. These parameters include the variables of climate, plant community activities, soil physical properties, and biointrusion by both animals and plants. Documentation of these variables is important both for extrapolation to other sites and for validation of numerical models. The lack of field-scale tests has hindered both the acceptance of innovative, cost-effective cover designs and the development of numerical models for predicting the performance of alternative landfill facilities. The lack of basic design guidance and numerical tools has resulted in

uncertainties regarding the environmental effectiveness of cover designs and has presented difficulties for site owners, design engineers, and the regulatory community.

In 1998, EPA began an effort to establish design data-base and improve numerical prediction methods for solid waste alternative landfill covers. The initial task of the ACAP was to catalog past and existing research efforts into measurement of cover performance and to describe the current state of numerical prediction methods. The primary criterion for inclusion in this report was direct physical measurement of percolation. The sites described here achieved this measurement in a variety of ways, but all can be generally described as water-balance (i.e., drainage or weighing) lysimeters. Description of relevant environmental variables for each site (precipitation, temperature, plant communities, and hydrogeology) is included where data are available. Description of the testing facility includes physical dimensions, method of drainage and runoff collection, soils instrumentation, and meteorological parameters documented. The cover designs that were (are) tested at these facilities are described in terms of the vertical profile of soils and synthetic layers.

The selection of sites in this report was based on a combination of literature review, contact with regulatory agencies and land managers, and verbal reference. Several research sites operated by branches of the federal government are well known to the landfill cover design community. These sites include the national laboratories at Hanford, Sandia, Los Alamos, Savannah River, and Idaho Falls. The U.S. Department of Energy has conducted cover research at Monticello, UT and the Nevada Test Site, NV. U.S. Department of Defense sites include those at Twentynine Palms, CA, Kaneohe Bay, HI, Rocky Mountain Arsenal near Denver, CO and Hill Air Force Base (AFB) near Ogden, UT. The U. S. Nuclear Regulatory Commission has significant involvement in cover research at Beltsville MD, and Sheffield IL. The Texas Low-Level Radioactive Waste Disposal Authority has a recently constructed site at Sierra Blanca TX. Research efforts relating to municipal waste include the Greater Wenatchee Regional Landfill at Wenatchee, WA, Omega Hills Landfill at Milwaukee, WI, Grede Foundries Landfill at Reedsburg, WI, University of Wisconsin at Madison, Boone County, KY, Sonoma County, CA, Live Oak Landfill at Atlanta, GA, and sites operated by San Bernardino County, CA at Phelan and Millikan. During the course of the literature search for this

report, several sites were identified where measurements relating to cover performance are collected but do not include lysimetry. These sites were not included in this survey due to inadequate measurement of deep percolation. Additionally, there are several sites with drainage lysimeters operated by the Agriculture Research Service of the U.S. Department of Agriculture. The USDA-ARS facilities at Coshocton OH have nearly a 55-year record of water-balance and drainage data. These facilities were not included as they do not mimic cover designs



Figure 1. Location map of landfill cover testing facilities.

### II.C. Research Site Reviews

The following pages of the report includes brief descriptions of the 19 alternative landfill cover research sites identified that directly measure the performance of engineered covers. Although the research sites are more numerous in the western portion of the U.S., Fig. 1, the geographical extent reaches to both coasts and includes research efforts in Hawaii. The areas least covered at present are the south central (TX, OK, KS, MO, LA, AR, MS, AL, TN) and north central (WY, MT, ND, SD, NE, IO, MN) regions.

## Site 1: Atlanta, Georgia (Live Oak Landfill)

Owners of the Live Oak Landfill near Atlanta, GA were interested in a comparison of modeled estimates with actual field measurements of drainage. Since bonding of landfill sites can relate to expected quantities of drainage, the results of the field experiment were expected to have a direct impact on the level of bonding required for the site.

The HELP and UNSAT-H models were used in the comparison. The results were discussed by Khire, *et al.* (1997).

### Point of Contact

Dr. Craig Benson  
Dept. of Civil and Environmental Engineering  
University of Wisconsin, Madison  
2214 Engineering Hall  
1415 Engineering Dr.  
Madison, WI 53706  
608 262-7242  
chbenson@facstaff.wisc.edu

### Climate Factors

Climate data for this report are taken from the Atlanta airport. Annual precipitation at Atlanta averages 125 cm for the 68-year period from 1930 to 1998. Atlanta, Georgia receives an average of 125 cm of precipitation per year, which mostly falls during the months of December through April.

Average monthly precipitation: Atlanta

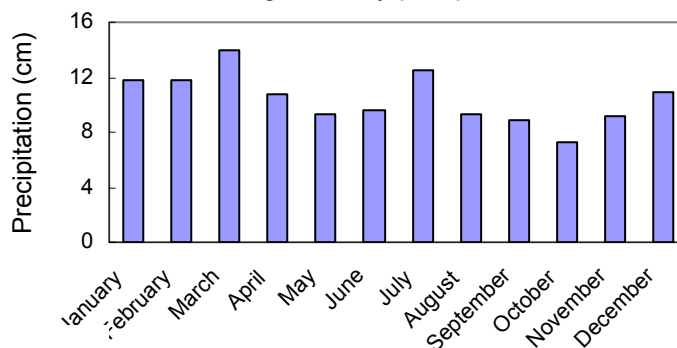

Average monthly temperature: Atlanta

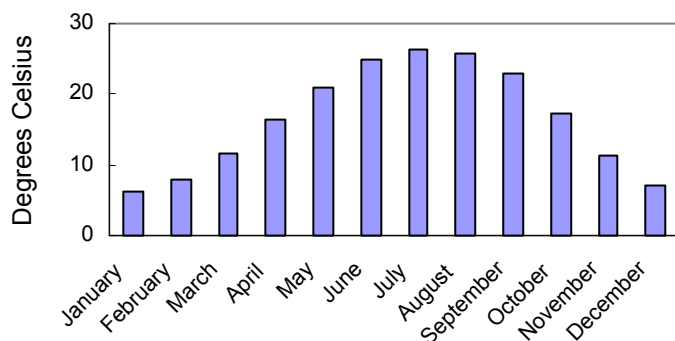

Average monthly values of precipitation range from 7.2 cm to 13.9 cm. Extreme single-day events have recorded as much as 17 cm of rain. Atlanta also receives some snowfall in the winter, with an average annual total snowfall of 5.6 cm. Snow accounts for less than 1% of the average annual precipitation. Atlanta experiences warm temperatures, with an annual mean of 16.5°C. Monthly mean temperatures range from 6.2°C to 26.3°C, and extreme recorded temperatures range from -22°C to 41°C.

## Facility Description

Landfill cover research at Live Oaks is conducted in two large pan-type lysimeters (Benson *et al.*, 1994). The lysimeters are 12.2 m wide by 19.3 m long and are located within 30-m-square test sections of the proposed covers. The lysimeters are lined with a 60-mil HDPE geomembrane and a geocomposite drainage layer. Drainage is routed via a 10-cm PVC pipe to a tipping bucket rain gauge for measurement. Surface runoff is collected with diversion berms and routed via a 10-cm PVC pipe to a tipping bucket rain gauge and dosing siphon for measurement. Soil moisture content is measured with TDR probes. Soil temperature is determined with thermocouples. An on-site meteorological station monitors precipitation, air temperature, solar radiation, wind speed, dew point, and relative humidity.

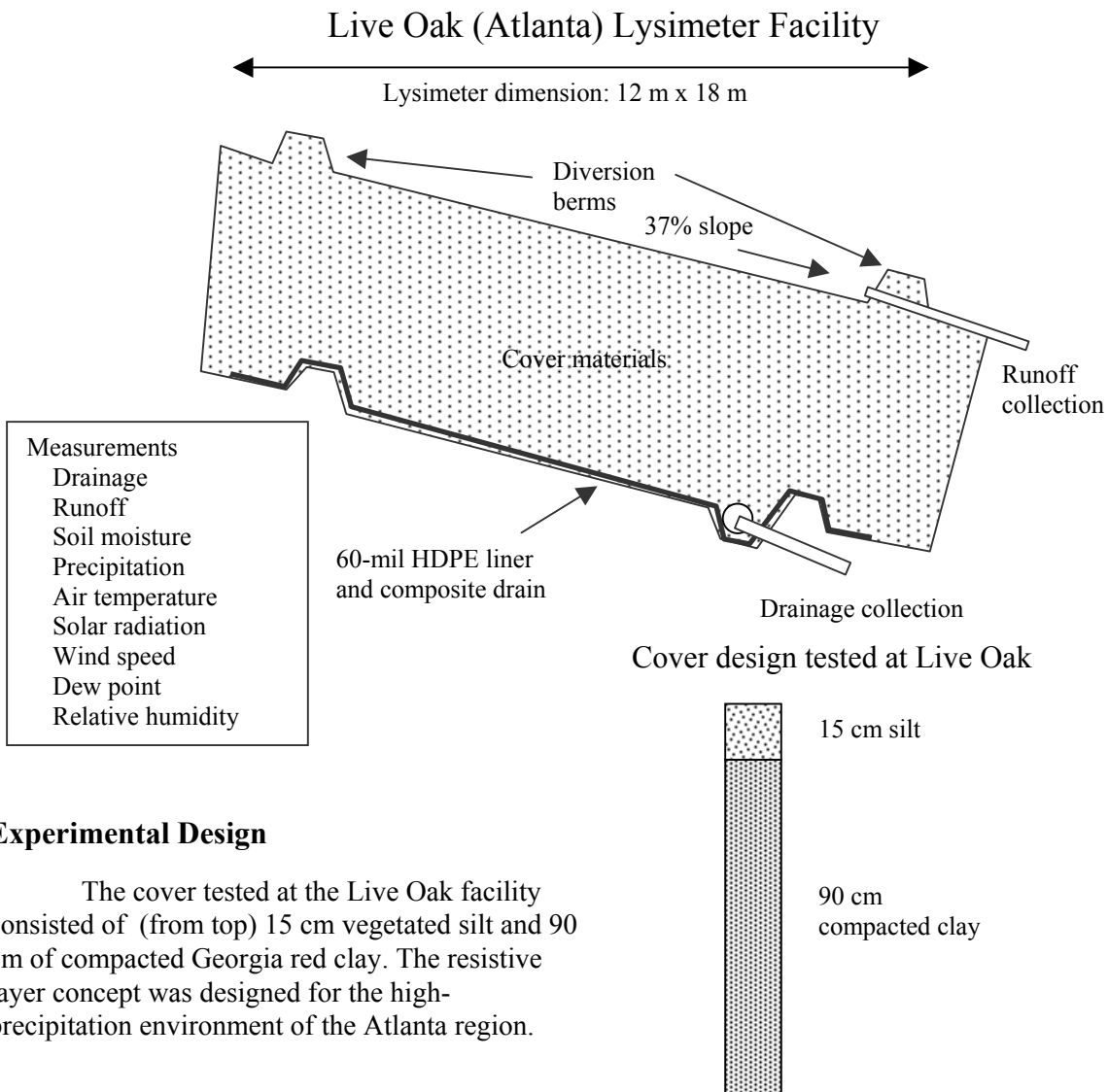

## Experimental Design

The cover tested at the Live Oak facility consisted of (from top) 15 cm vegetated silt and 90 cm of compacted Georgia red clay. The resistive layer concept was designed for the high-precipitation environment of the Atlanta region.

## Site 2: Beltsville, Maryland

The U.S. Nuclear Regulatory Commission (NRC) has recognized the importance of subsidence in landfill cover design. Disruption in subsurface layers can seriously compromise the performance of an engineered cover design. At the Beltsville, MD, facility the NRC has investigated cover designs that limit deep percolation of precipitation and are easily repaired in the case of subsidence damage. The design concept, referred to by the NRC as “bioengineering management,” uses a combination of enhanced runoff and transpiration by plants to effectively control the water balance. Impermeable surface barriers reduce the infiltration of precipitation into the cover soils and plant roots extract the moisture that does penetrate the soil surface.

### Point of Contact

Ed O’Donnell  
U.S. Nuclear Regulatory Commission  
T-9F33  
Washington, D.C. 20555  
301 415-6265  
[EXO@nrc.gov](mailto:EXO@nrc.gov)

### Climate Factors

Climate data for this report are taken from Washington National Airport. The Beltsville, Maryland site receives an average of 100 cm per year of precipitation, which is evenly distributed throughout the year. Average monthly values of precipitation range from 6.6 cm to 10.7 cm. Extreme single-day events have recorded as much as

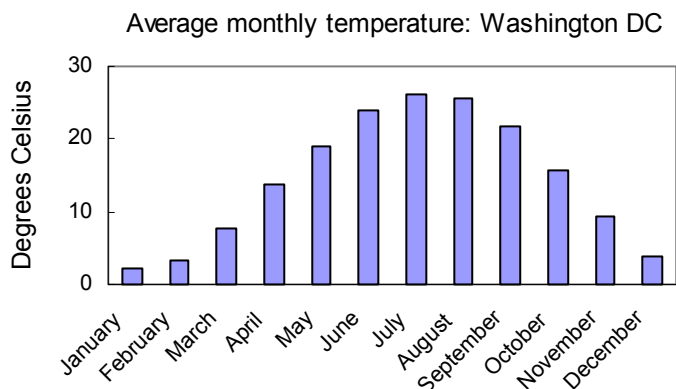
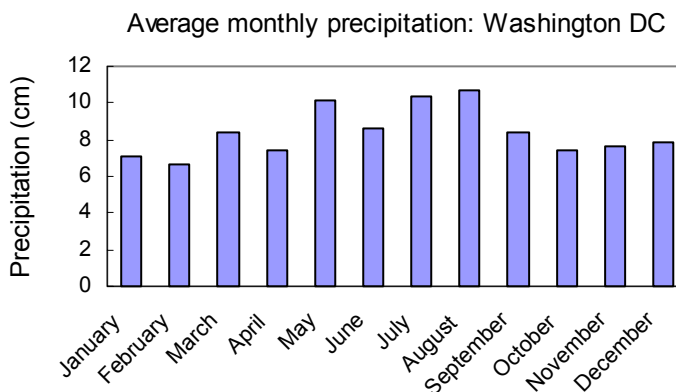

15.5 cm of rain. Beltsville receives snowfall in the winter, with an average annual total snowfall of 45.7 cm. Snow accounts for 5% of the average annual precipitation. Beltsville experiences moderate temperatures, with an annual mean of 14.4°C. Monthly mean temperatures range from 2.2°C to 26.1°C, and extreme recorded temperatures are a low of -20.6°C and a high of 40°C.



## Facility Description

Landfill cover research at the NRS Beltsville facility is conducted in six large lysimeters. The individual units are 13.7 m wide, 21.3 m long, and are 3.1 m deep. The impermeable barrier forming the bottom of the lysimeters consists of four 20-mil layers of vinyl sandwiched between five layers of protective geotextile. Since one intent of the work conducted at Beltsville was to assess the ability of the cover/vegetation system to dewater flooded trenches, the lysimeters did not provide for drainage collection. Measurements at the site included precipitation, runoff, water level in the lysimeter, and soil moisture content by neutron probe. The surface of the cover and all subsurface layers was constructed at a 20 percent slope.

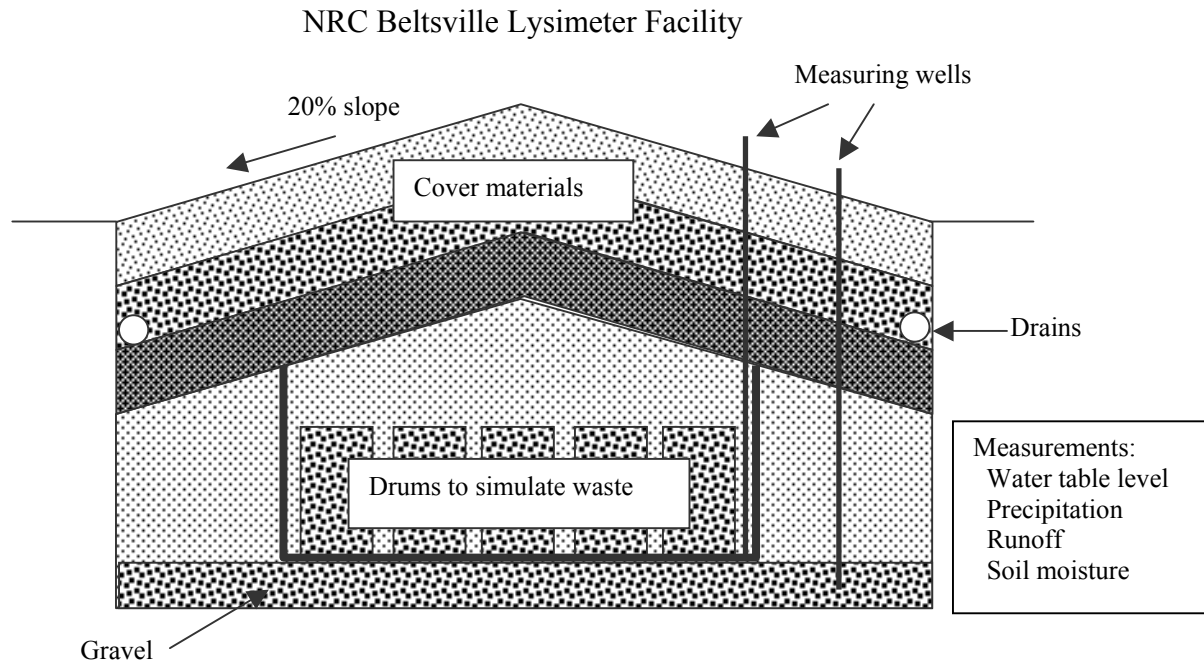

## Experimental Design

The lysimeter facility at Beltsville was designed to test methods of controlling drainage through covers in humid regions (Schulz *et al.*, 1997). Three types of covers have been tested: a resistive layer barrier, a conductive layer barrier, and a bioengineering management system. In each of the cover tests, a layer of gravel-filled, 55-gal drums was placed below the cover materials to simulate waste. This layer was placed over 15 cm of gravel (1.5 cm diameter, washed), which covered the lysimeter membrane.

Two versions of the resistive layer barrier concept were constructed at Beltsville: a rock-armored version and a vegetated surface version. The two covers are identical with the substitution of vegetated topsoil for the rock layer in the armored design. These covers consisted of (from top) 46 cm vegetated topsoil (or 30-35 cm of rock armor), 15 cm of drain (pea) gravel, and 46-61 cm of compacted clay.

The conductive layer concept was combined with a resistive layer at Beltsville. This cover design consisted of (from top) 46 cm of vegetated topsoil, 15 cm pea gravel, 46-61 cm compacted clay, 46 cm of diatomaceous earth, a layer of geotextile, and 15 cm pea gravel.

Two lysimeters were dedicated to testing of the bioengineering concept. The difference between the two was the initial water level in the lysimeters. One started operation with 90 cm of water in the lysimeter, the other contained 190 cm of water. Both covers consisted of 3.8 m of uncharacterized native soil. Placed on top of the soil were alternating panels of aluminum and fiberglass, each 1.2 m wide, to provide increased surface runoff. The space between panels, typically 10 cm, was planted with Pfitzer junipers.

Two lysimeters were constructed as a reference to the bioengineering experiment. These designs were identical to the bioengineering tests except that the surface treatment consisted of fescue grass.

### Cover design tested at the Beltsville lysimeter facility

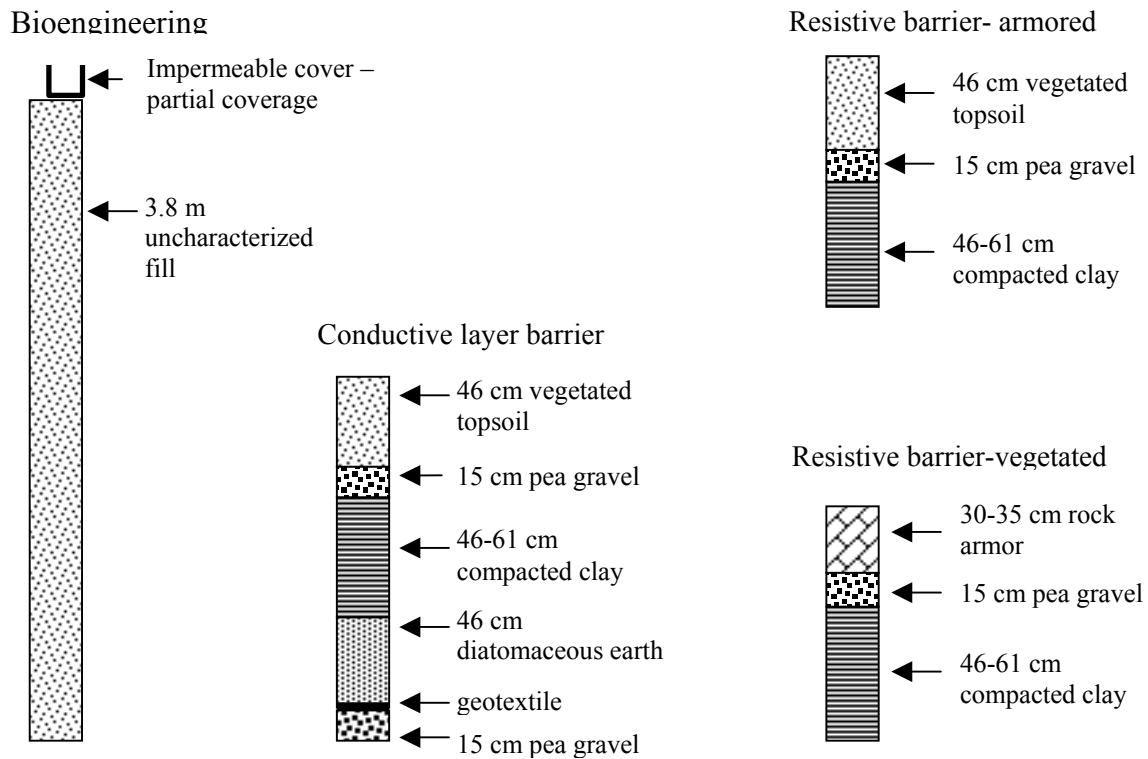

### Results and Discussion

Results from the Beltsville experiments were reported by Schulz *et al.* (1997). The water level in the two reference lysimeters gradually increased over the first year to a level near the surface. At this time, the water was pumped from the lysimeters and this portion of the experiment was terminated. The water levels in the bioengineering lysimeters decreased over two years until saturated conditions in the lysimeters were eliminated.

During seven years of monitoring, the resistive-barrier and conductive-barrier cover designs were quite successful at restricting deep percolation. The grass-covered plot and the conductive-barrier plot allowed no deep percolation. The rock-armored plot allowed the passage of 0.1 cm during one season. Surface runoff from the rock-armored plot and the conductive-barrier plot was substantially higher than from the grass-covered plot.

### Site 3: Denver, Colorado (Rocky Mountain Arsenal)

A test cover facility has been constructed at the U.S. Army's Rocky Mountain Arsenal (RMA) located between downtown Denver and the Denver International Airport (see RMA homepage at [www.pmrma.army.mil](http://www.pmrma.army.mil)). The site is at an elevation of 1,583 m in the high plains region of Colorado. The climate is semi-arid.

The selected remedy outlined in the Record of Decision (ROD) for the RMA includes constructing RCRA-equivalent covers over three sites occupying a total area of almost 200 acres. The ROD specifies that comparative analyses and a field demonstration are required to demonstrate the acceptability of any alternative-type cover that might be proposed. Previous site characterization studies indicate that little or no recharge occurs over RMA areas having suitable, vegetated soils. Based upon this characterization and numerical modeling results, construction of four potential alternatives to prescriptive RCRA Subtitle C covers began in April 1998 as the field demonstration portion of this project. It is expected that performance of the test covers will be monitored for several years.

#### Point of Contact

Mr. Lou Greer  
RVO Representative  
Morrison Knudsen Corp.  
P.O. Box 1717  
Commerce City, CO 80037  
(303) 853-3951  
[lou\\_greer@mk.com](mailto:lou_greer@mk.com)

Dr. George Chadwick  
Project Consultant  
George Chadwick Consulting  
909 Main Ave  
La Grande, OR 97850  
(541) 962-7432  
[dgchadwick@oregontrail.net](mailto:dgchadwick@oregontrail.net)

Dr. Mark Ankeny  
Technical Consultant  
Daniel B. Stephens & Associates, Inc.  
6020 Academy NE, Suite 100  
Albuquerque, NM 87109  
(505) 822-9400  
[mankeny@dbstephens.com](mailto:mankeny@dbstephens.com)

#### Climate Factors

Climate data for this report are taken from Denver Stapleton Airport, which lies about 10 km to the south of the RMA site. The Rocky Mountain Arsenal receives an average of 39.5 cm per year of precipitation, which falls mainly in the months of March-September. Average monthly values of precipitation range from 1.3 cm to 7.9 cm.

Extreme single-day events have recorded as much as 8 cm of rain. RMA receives large amounts of snow in the winter months, with an average annual total snowfall of 186 cm. Snow accounts for 40% of the average annual precipitation. RMA experiences cool temperatures, with an annual mean of 10.2°C. Monthly mean temperatures range from -1.2°C to 22.9°C, extreme recorded temperatures are a low of -31°C and a high of 40°C.

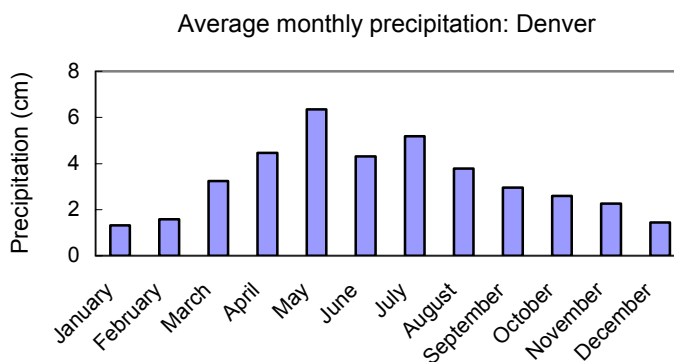

## Hydrogeology

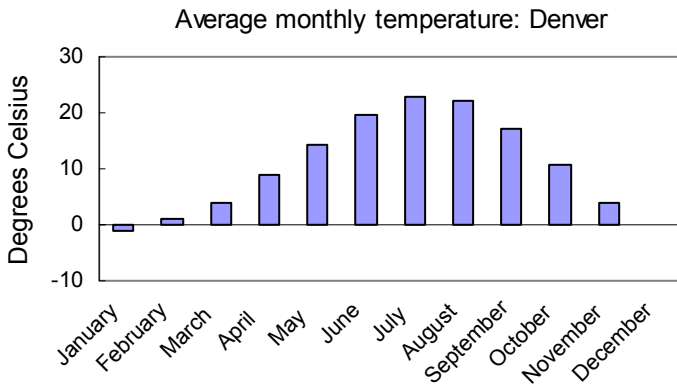

Unconsolidated surficial deposits composed primarily of alluvium and eolian materials cover essentially the entire RMA. The surficial deposits reach a thickness of more than 30 m in some areas, but are more commonly tens of meters thick. The water table beneath most of the RMA is in the surficial deposits, but in some areas is in the underlying Denver Formation, which consists of relatively impermeable claystone, more permeable silty zones, and interbedded permeable sandstone and

fractured lignite. Beneath the test covers, the surficial deposit thickness and depth to the water table are both about 15 m. Soils vary across the RMA, but large amounts of loam, sandy loam, sandy clay loam, and clay loam soils are available for use in cover construction. Beneath the finer-grained soils, an upward movement of water in the near-surface soils is suggested by the soil-water potential profile.

## Plant Parameters

The vegetation selected for use on the test covers consists of native vegetation species from the short-grass prairie. The seed mix used to vegetate the test covers consists of 10 native grass species (composing 95 percent of the seed mix) and 8 native forb species (composing 5 percent of the mix). The mix was composed of 56 percent warm-season species and 44 percent cool-season species to ensure that transpiration occurs during the entire growing season. Other factors considered in species selection included soil texture, height at maturity (to deter prairie dog invasion), suitability for other wildlife, persistence, longevity, drought tolerance, leaf-area index, and seed availability. Roots from the vegetation are expected to explore the entire soil layer thickness of the test covers.

## Facility Description

Vegetated soil cover performance at the Rocky Mountain Arsenal site is being tested in four plots, which vary in either soil type or cover thickness. Each test plot is constructed over a 9.1 m wide by 15.2 m long collection pan consisting of a 60-mil VFPE flexible geomembrane liner placed to collect percolation through the covers. A geocomposite drainage layer consisting of a polyethylene geonet sandwiched between nonwoven geotextiles lies beneath the soil layer. Drainage is conveyed to a measuring device and storage vault. A minimum 2.4 m vegetated soil cover buffer extends beyond the perimeter of each collection pan to minimize edge effects. Surface runoff from each plot is also collected and measured. A sprinkler system provides the capability to help with establishing the vegetation and to augment natural precipitation for testing purposes. Soil moisture conditions within the RMA test covers are measured by TDRs. Natural precipitation adjacent to the covers is measured by a universal rain gauge. Irrigation is measured in six precipitation gauges distributed over each plot. Runoff from each plot drains into a 6.8 m<sup>3</sup> storage tank. Drainage from each lysimeter is measured by a tipping bucket rain gauge, then stored in an HDPE vault for measurement verification.

## Rocky Mountain Arsenal Lysimeter Facility

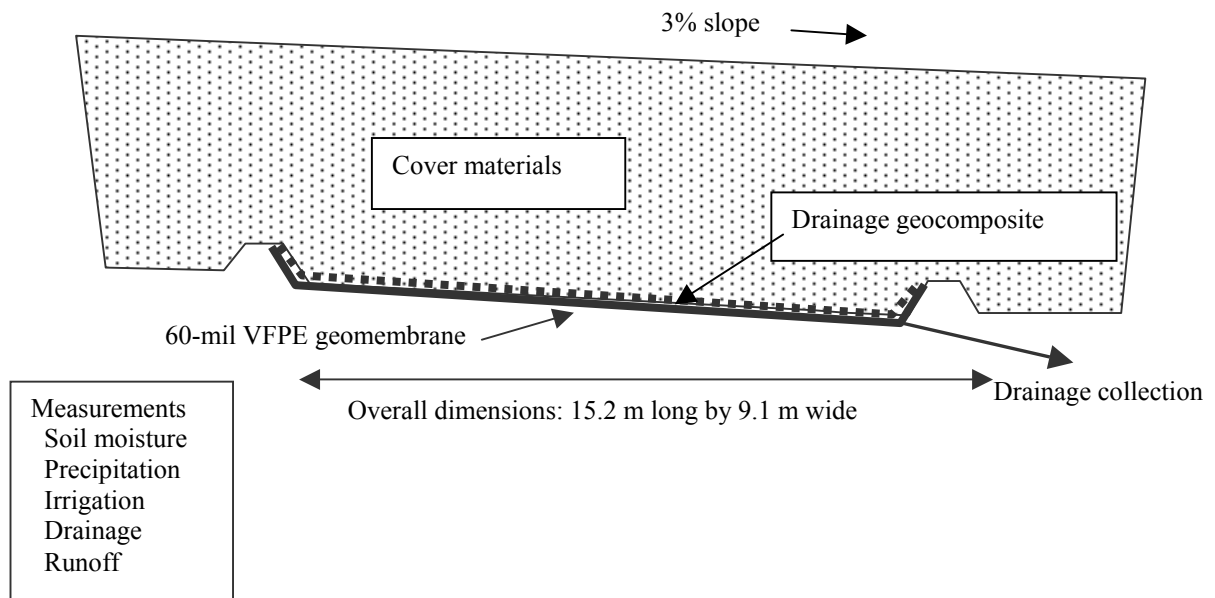

### COVER CONSTRUCTION

The soils in the test covers were placed so as to minimize construction-related compaction. This was done by placing the soils in thick lifts, keeping equipment off the covers until final grade was achieved, and allowing placement only when the soil moisture content did not exceed 10 percent (by weight). After the covers had been constructed to grade, they were ripped deeply to negate compaction that had occurred during placement. Afterwards, the soil amendments were added and tilled into the cover surface and the covers were harrowed and seeded.

### Experimental Design

The RMA test covers were not developed specifically as a research project, but as a demonstration project to show whether any of the four designs would meet the deep percolation performance criterion established for the project. Consequently, the soils being tested are those that are readily available for future use on full-scale cover projects at the RMA and that appear from numerical modeling results to essentially eliminate deep percolation. Due to the nature of the test cover demonstration, a construction specification was developed with cooperation from the U.S. Environmental Protection Agency and Colorado Department of Public Health and Environment, with the intent that it would be the basis for design of full-scale covers if the field demonstration succeeds. Three of the test covers used the same soil specification, and varied only in their soil layer thickness (1.1 m, 1.2 m, and 1.5 m). These soils were intended to test the finer-grained soils available in RMA borrow areas. The specification required that soil samples have a maximum particle size of 5.1 cm, at least 90 percent must pass the #4 sieve, at least 50 percent must pass the #200 sieve, the liquid limit must be less than 40, and the plasticity index must be between 7 and 30. The fourth cover also had a thickness of 1.1 m, but was composed of slightly coarser-grained soils found in the RMA borrow areas. The specification was similar to that mentioned above, except that the percent passing the #200 sieve was required to be between 35 and 50 percent. No topsoil was used on any cover, but organic matter (biosolids) was incorporated into the cover surface at the rate of 40 tons per acre.

## Cover designs at Rocky Mountain Arsenal

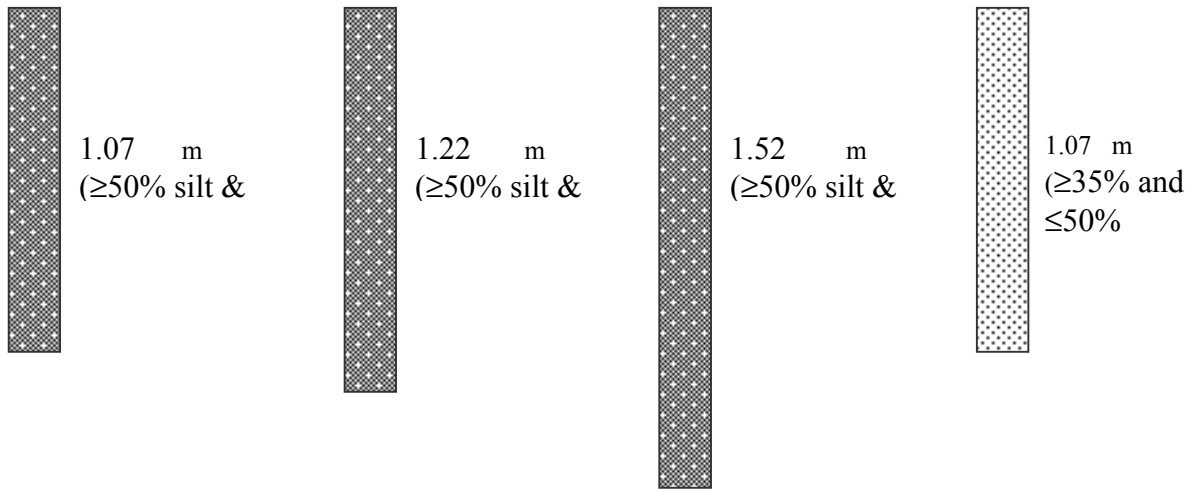

## Results and Discussion

The vegetation had an excellent start during the first growing season. As indicated by the soil moisture monitoring, the wetting front from summer precipitation and irrigation penetrated to depths of approximately 50-80 cm. Percolation from the test covers during the first growing season was negligible.

## Site 4: Hanford, Washington

The U.S. Department of Energy's (DOE) Hanford Site is located in south-central Washington near the town of Richland. The site occupies an area of 1,480 km<sup>2</sup> and ranges in elevation from 120 to 1,200 m (Link *et al.*, 1995). Prototype barrier studies at Hanford are located on the 200 Area Plateau at an elevation of 223 m.

The Hanford Site Permanent Isolation Surface Barrier Development Program was organized to develop the technology necessary to provide long-term surface barrier capabilities for the Hanford Site. The objective of current work being conducted by Pacific Northwest National Laboratory is the development of an isolation barrier to isolate waste from the environment for 1,000 years by limiting deep percolation of water, intrusion of plants, animals, and humans, and erosion by wind and surface water.

Waste containment operations at Hanford have as their primary goal the containment of defense-related radioactive waste.

### Point of Contact

Dr. Glendon W. Gee  
 Battelle  
 Box 999  
 Mail stop K9-33  
 Richland, WA 99352  
 509 372-6096  
 glendon.gee@pnl.gov

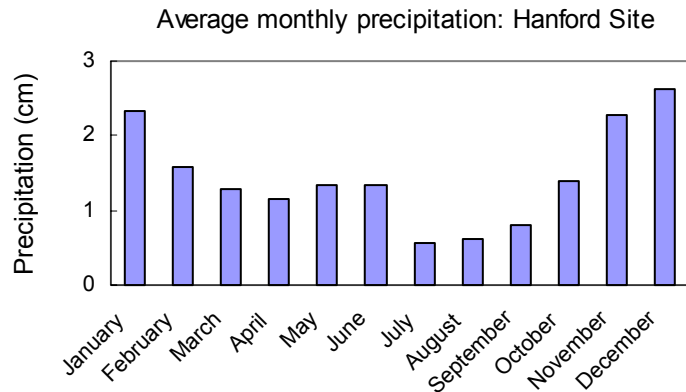

### Climate Factors

Precipitation for the Hanford Site is recorded at the nearby Hanford Meteorological Station and since 1945 has averaged about 160 mm annually, which falls mainly in the months of November-January. Average monthly values of precipitation range from 0.5 cm to 2.54 cm. Summer precipitation events at Hanford can be of high intensity. Two rainfall events in the month of June deposited 14.0 mm and 11.2 mm in 20 minutes and 10 minutes, respectively (Myers and Duranceau, 1994). Hanford receives snowfall in the winter months, with an average annual snowfall of 33.5 cm. Snow accounts for 38% of the average annual precipitation. Hanford experiences extreme temperatures, with an annual mean of 18.9°C. Monthly mean temperatures range from -1°C to 24°C, extreme recorded temperatures are a low of -33.9°C and a high of 46.1°C.

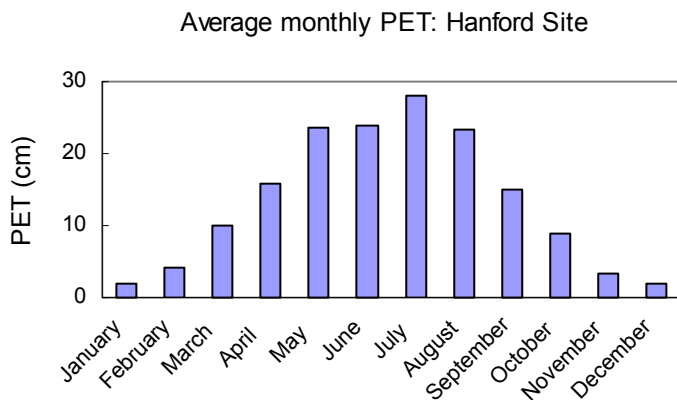

Average monthly RH: Hanford Site

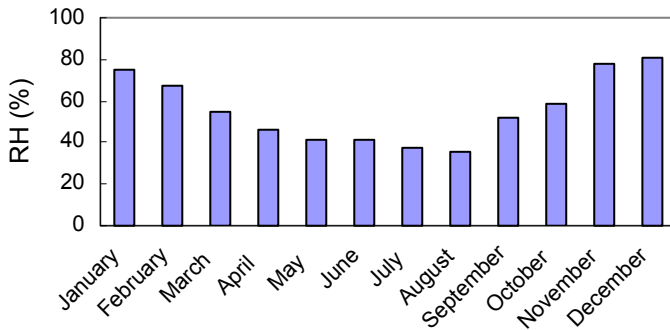

Average monthly temperature: Hanford Site

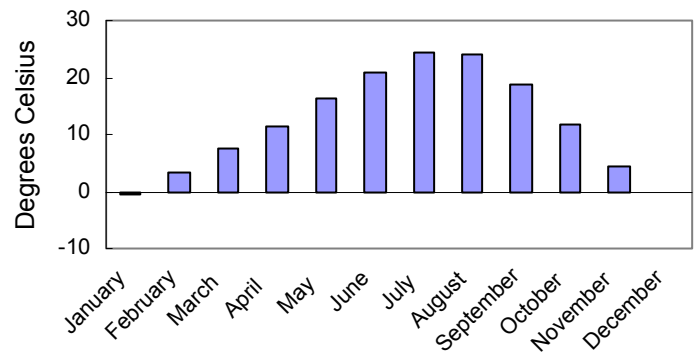

### Plant Parameters

The Hanford Site lies within the sagebrush-bunchgrass vegetation zone described by Daubenmire (1970). As such, the plant community of undisturbed portions of the Hanford Site consists largely of a combination of perennial shrubs and annual grasses. Perennial shrubs typical of the Great Basin include sagebrush (*Artemisia*), rabbitbrush (*Chrysothamnus*), hopsage (*Grayia*), and bitterbrush (*Purshia*). Grasses include cheatgrass (*Bromus tectorum*), Indian ricegrass (*Oryzopsis hymenoides*), Sandberg’s bluegrass (*Poa sandbergii*), Squirreltail grass (*Sitanion hystrix*), and Slender six-weeks (*Vulpia octoflora*). An investigation of the rooting depth of the local plant community indicated root penetration to approximately 2 m.

### Hydrogeology

The geology at the Hanford Site consists of six major stratigraphic sequences. The primary surface features are those of the Hanford Formation, which consists of thick sequences of sediments deposited during a sequence of Pleistocene flood events, the last being dated at about 13,000 years before present.

Soil types typical of the Hanford Site strongly reflect the depositional environment of their occurrence. The Pasco gravels consist of poorly sorted coarse sands and gravels that result from high-energy depositional environments of channels and depositional basins. The Touchet beds are found around the margins of the basin and consist of bedded sequences of graded silt, sand, and gravel that reflect low-energy depositional environments, where slackwater conditions occurred during the flood events.



Depth to groundwater at the Hanford Site ranges from 0 m at the Columbia River to about 135 m on the 200 Area Plateau, where the final cover test facilities are located.

Recharge at the Hanford Site occurs as a function of elevation, predominantly along ephemeral streams. Recharge may range from near zero to large fractions of the annual precipitation (16 cm/yr at the test facility) depending on local variations in soil texture and plant community activities.

## Facility Description

Barrier research at Hanford has involved testing of a number of aspects of barrier design in various testing facilities. Of particular interest to this report are the research efforts that have utilized lysimeters to quantify the effects of various features of barrier design on the water balance of the covers. Lysimeter-based research at Hanford has occurred in three primary facilities: the small-tube lysimeter facility; the field lysimeter test facility; and the prototype surface barrier. This report gives the general features, experimental design, and some discussion of results for each of the three facilities.

### SMALL-TUBE LYSIMETER FACILITY

The small-tube lysimeter facility (STLF) at Hanford was designed to test the influences of different waste cover components on the soil water balance within the covers (Waugh *et al.*, 1991). The low construction and maintenance costs and space requirements of the small tube lysimeters allowed multiple replications and expanded experimental designs without the high costs of field-scale facilities. The STLF began operations in 1988 and continued through the present.

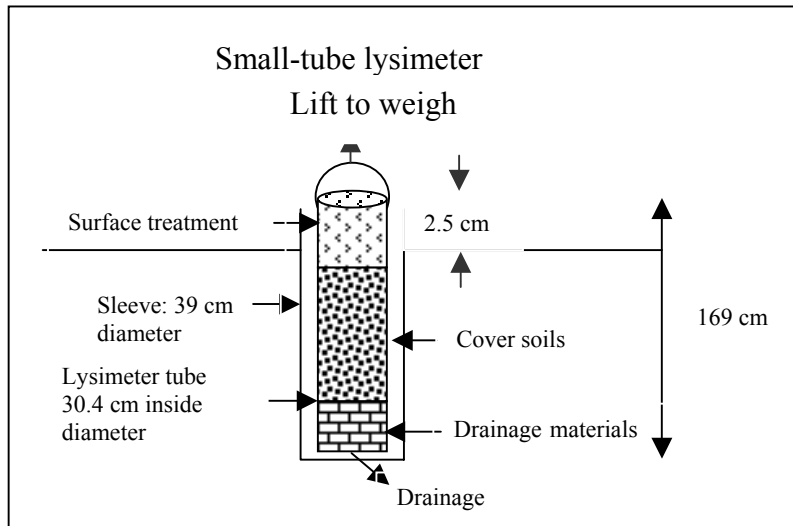

The STLF is located in the 200 Area Plateau and consisted of 105 lysimeters arrayed in 21 rows of 5 each. Lysimeters consisted of sections of plastic pipe 169 cm long and 30.4 cm internal diameter. The bottom of each tube was sealed with a plastic end cap. The tubes were installed with the top extending approximately 2.5 cm above grade. Each tube was fitted with a drain port and a mechanism by which the tube could be weighed.

Water storage changes were determined by weighing with the aid of a crane and load cell. Resolution of the load cell was the equivalent of 1.4 mm water storage.

## Experimental Design

The STLF at Hanford has tested three aspects of waste cover design of interest to this report. The first was the effect of different erosion control surface treatments on the water balance and plant growth characteristics; the second compared different capillary moisture barrier designs; the third compared different low-permeability materials as drainage barriers.

All of the experiments in the small-tube lysimeters were performed on a cover design that incorporated a capillary barrier design. The soil sequence consisted of 150 cm of Warden silt loam overlying a graded sand and gravel filter.

## Erosion Control Experiment

The long-term performance of waste covers depends in part on the resistance of the cover to wind and surface water erosion. In some locations, vegetation alone may be inadequate to prevent loss of soil. Surface armor has been widely used to control erosion and, at Hanford, research efforts were directed to determining the effects of adding gravel as mulch and as an admixture. These treatments were tested both with and without vegetation. Two precipitation treatments were designed with one treatment representing ambient rainfall and the other representing twice the average monthly precipitation.

The gravel admixture treatment consisted of 30% gravel (by weight) (1.0-3.0 cm diameter) mixed uniformly into the top 20 cm of soil. The gravel mulch treatment consisted of the same amount and type of gravel placed on the soil surface. One set of lysimeters received no gravel. The vegetated/non-

Cover designs tested in the erosion control experiment

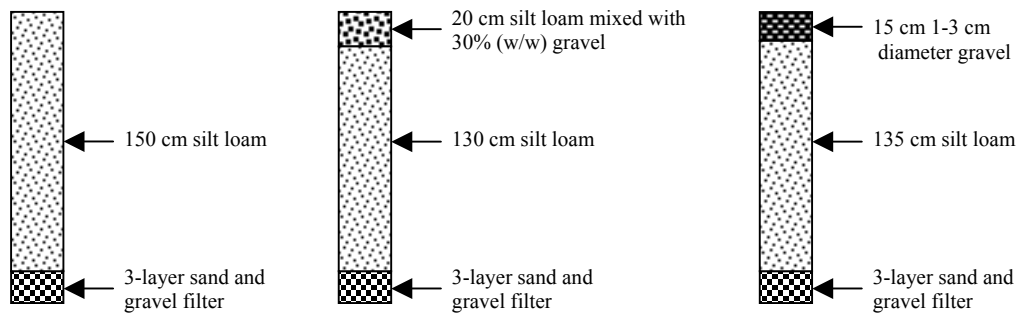

**Variables:** Precipitation: Ambient; 2X average  
Vegetation: Vegetated; Bare

vegetated treatments were performed by seeding with cheatgrass (*Bromus tectorum*) or treating with non-selective herbicides.

## Results and Discussion

After three years of observation, no drainage occurred in lysimeters with soil or gravel admixture surfaces. Except when supplemental irrigation was applied, the amount of ET in the soil and admixture surface treatments exceeded precipitation, resulting in reduced water storage. Supplemental irrigation slightly increased water storage in these treatments. This indicates that in the lysimeters with soil or admixed surfaces, under ambient precipitation, the water input was effectively returned to the atmosphere via evapotranspiration.

The surface treatment study suggests two primary conclusions. First, for Hanford environmental conditions and the soils tested, erosion control can be enhanced by the addition of a significant quantity of gravel as an admixture without negatively altering the drainage or water storage characteristics of the cover design. Second, the addition of the same quantity of gravel as surface

mulch effectively suppressed ET, causing an increase in water storage in the soil profile. At Hanford, this treatment combined with wetter than normal precipitation can result in drainage through the cover.

## CAPILLARY MOISTURE BARRIER EXPERIMENT

Capillary moisture barriers can be located within the soil profile of a waste cover to impede the deep percolation of moisture. Capillary barrier design involves placement of fine-grain soil over coarse-grain soil. The design intent is that moisture reaching the interface will resist the influence of gravity and remain in the lower potential energy environment offered by the fine-grain soil. When effective, capillary barriers retain moisture in the near-surface soils and available to the surface processes of evaporation and transpiration. The capillary barrier effort at the STLF compared the performance of two different capillary barrier configurations (Sackschewsky *et al.*, 1992). One design involved a graded sand filter and the other a bimodal material consisting of a gravel/sand mixture. Both treatments received ambient precipitation along with supplemental irrigation. In both treatments the capillary barrier structure was placed beneath 150 cm of Warden silt loam.

Cover designs tested in the capillary moisture barrier experiment

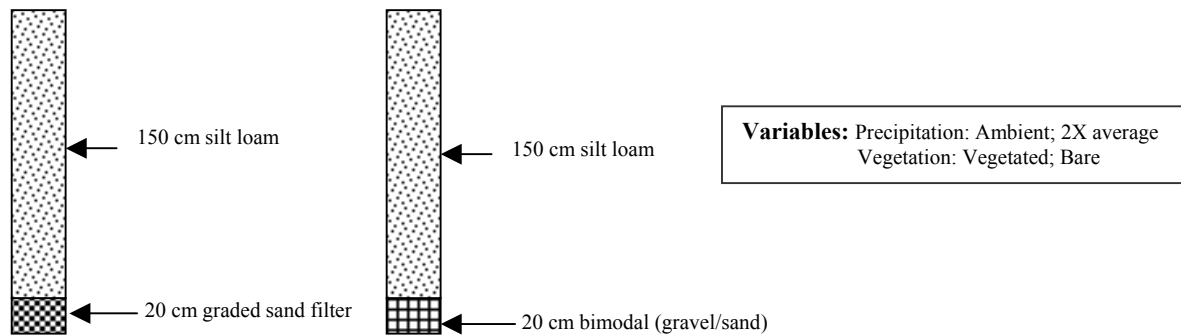

## Results and Discussion

Variations in subsurface capillary barrier design had no effect on the soil water balance over a period of 3.5 years. Both capillary barrier treatments essentially replicated the results obtained in the previously mentioned surface treatment experiment when the surface soil was unamended Warden silt loam.

Since the control treatment in this set of experiments (silt-loam soil over a graded sand filter) produced no drainage even with supplemental irrigation, the effectiveness of the different capillary barrier designs remained essentially untested by the experiment.

## LOW-PERMEABILITY INFILTRATION BARRIERS EXPERIMENT

Waste cover designs that rely on evapotranspiration to restrict deep percolation of moisture often incorporate a low-permeability layer within the cover. As with capillary barriers, the function of the low-permeability layer is to keep moisture available to the surface processes of evaporation and transpiration. The low-permeability experiment at the Hanford STLF placed clay and grout layers

under the Warden silt-loam soil used in the other experiments (Sackschewsky *et al.*, 1992). These lysimeters received supplemental irrigation and none were vegetated.

### Cover designs tested in the low-permeability infiltration barriers experiment

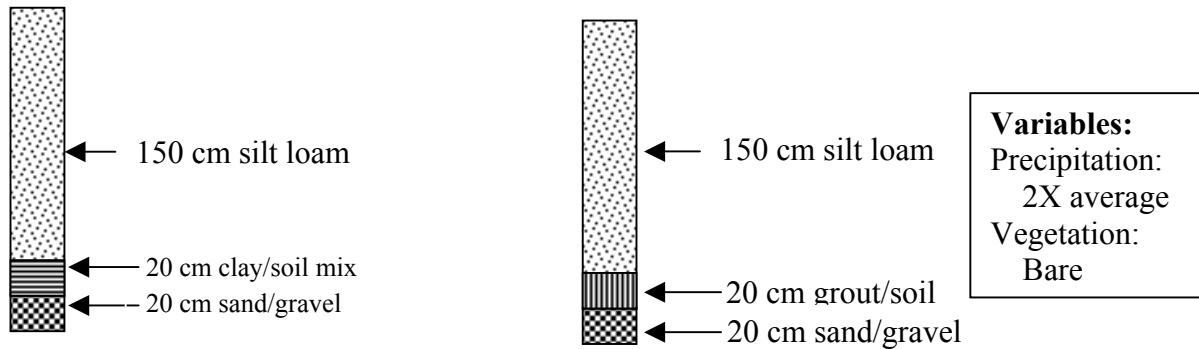

### Results and Discussion

The placement of low-permeability layers in the cover design had no effect on the soil water balance over a period of 3.5 years. As in the case of the capillary barrier experiments at the STLF, the results essentially matched the results obtained with Warden silt loam.

Since the control treatment in this set of experiments (silt-loam soil over a graded sand filter) produced no drainage even with supplemental irrigation, the effectiveness of the different low-permeability designs remained essentially untested by the experiment.

### Hanford Field Lysimeter Test Facility

The Field Lysimeter Test Facility (FLTF) at Hanford was designed to allow precise determinations of the hydrologic performance of various capillary-barrier type cover designs. The FLTF uses a combination of three types of lysimeters, drainage, weighing, and clear-tube, to document hydrologic performance and plant activities in the tested covers. Operations at the FLTF began in 1988 and continue at present.

The FLTF at Hanford is located in the 200-West Area near the Hanford Meteorological Station and consists of 24 lysimeters (14 drainage, 4 weighing, and 6 clear-tube).

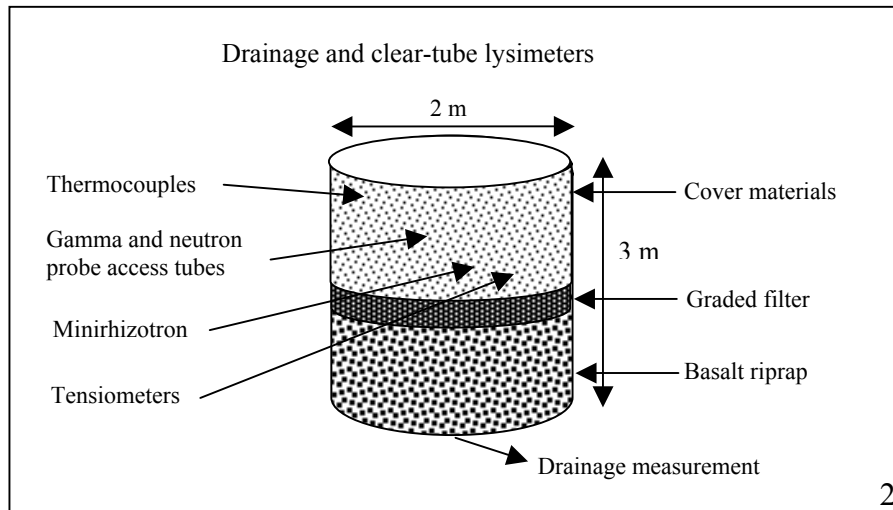

## DRAINAGE LYSIMETERS

Drainage lysimeters are steel cylinders 2 m in diameter and 3 m in length. The 14 drainage lysimeters are positioned in two rows of seven separated by an access passage. All have drain fittings and access ports that allow installation of thermocouples, thermocouple psychrometers, tensiometers, and neutron probes.

## WEIGHING LYSIMETERS

The four rectangular weighing lysimeters are 1.5 m on a side and 1.7 m in depth. Each rests on a 9,000 kg platform scale. Each has a drainage port and, like the drainage lysimeters, is fitted to allow installation of soil instruments including thermocouples,

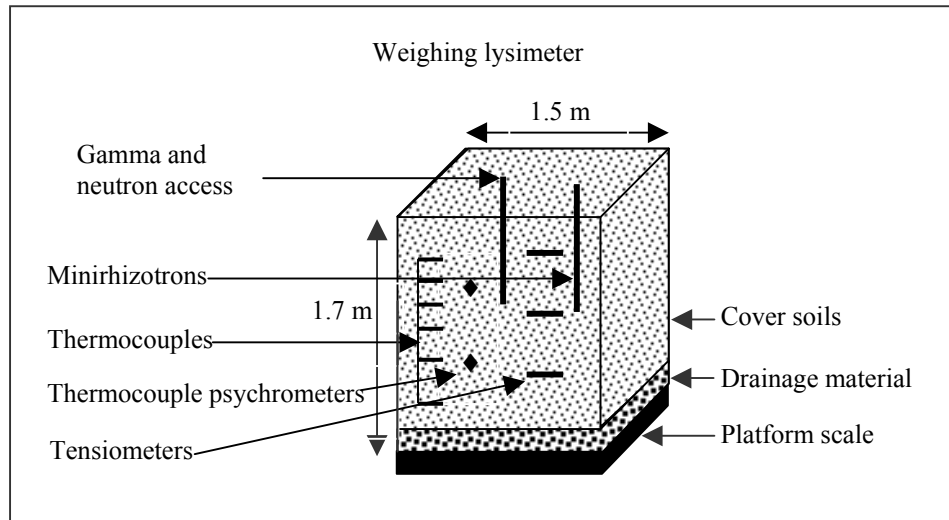

tensiometers, thermocouple psychrometers, and neutron probes. In addition, minirhizotrons (clear glass root observation tubes) were placed in the vegetated lysimeters.

## CLEAR-TUBE LYSIMETERS

The six clear-tube lysimeters are 0.3 m in diameter and 3 m in depth. A drainage port at the bottom allows drainage to be collected and weighed. Instruments in the clear-tube lysimeters include tensiometers, neutron probes, and minirhizotrons.

## Experimental Design

The FLTF at Hanford has tested various combinations of soil, plant and precipitation regimes that represent current and elevated precipitation conditions at Hanford. Supplemental irrigation represented twice the annual average for the first three years of operation. For the next three years, irrigation was increased to represent three times the annual average. Supplemental irrigation was applied twice each month to account for deficits in the natural precipitation. Surface treatments included bare soil, vegetated soil, soil admixed with gravel, vegetated soil admixed with gravel, and bare gravel.

## Cover designs tested in the Field Lysimeter Test Facility

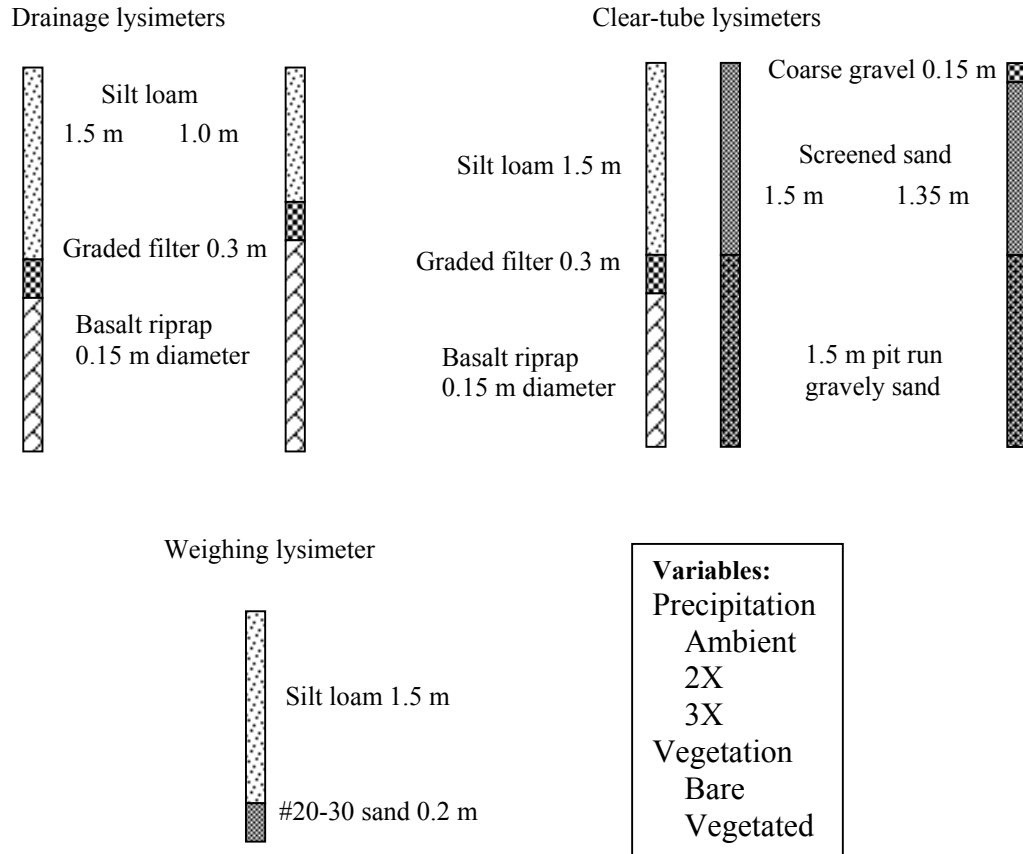

### Cover Description

All of the experiments in the FLTF were performed on a cover design that incorporated versions of a capillary barrier design. In the drainage lysimeters, two depths of silt loam (1.0 m and 1.5 m) were placed over a graded filter consisting of #20-30 sand, #4 sand, pea gravel over 0.1-m-diameter rock. In the weighing lysimeters, 1.5 m silt loam was placed over 0.2 m of #20-30 sand. The clear-tube lysimeters were used to test three soil configurations; (1) 1.5 m silt loam over basalt riprap separated by a filterbed; (2) 1.5 m screened sand over 1.5 m gravely sand; (3) same as (2) but topped with 0.15 m gravel.

### Results and Discussion

In the FLTF lysimeters, drainage did not occur from cover designs that placed silt loam over a capillary barrier except in the most extreme condition tested (Gee *et al.*, 1993). These extreme conditions that resulted in drainage included vegetation-free surface, supplemental irrigation combined with a record winter snowfall. No drainage was noted for the ambient precipitation treatments or the vegetated irrigated treatments. It was noted that the presence of vegetation reduced water storage significantly over lysimeters that were kept free of vegetation.

Drainage was observed from all cover designs that included coarse soils and gravel surfaces. In these treatments, the greatest drainage was noted for bare, gravel-topped sandy soil. Sandy soil with vegetation drained the least. Supplemental irrigation dramatically increased drainage in these treatments.

## **HANFORD PROTOTYPE SURFACE BARRIER**

The Hanford Prototype Surface Barrier (PSB) represents a field-scale test of a cover design intended for extensive use at the DOE facility at Hanford (Ward *et al.*, 1997). Constructed of natural materials, the intent of the PSB is to demonstrate the long-term ability of the cover design to limit waste migration by limiting deep percolation, wind and water erosion, and penetration by burrowing animals and plant roots under ambient and elevated precipitation conditions. Monitoring operations at the PSB began in November of 1994 and continue through the present.

The PSB is located in the 200 East Area of the Hanford Site. The PSB covers an existing waste site and is 2.5 ha (6.9 ac) in size. Collection of drainage water is accomplished by a low-permeability asphalt layer which forms part of the cover design. The asphalt layer is sloped at 2% away from the center of the cover and is divided into 12 collection zones allowing different treatments within the PSB. Each of the 12 collection zones of the PSB is 4 m x 23 m in size. A 6.5-m-square basin lysimeter was installed beneath the asphalt pad of one of the collection basins to monitor drainage through the asphalt.

### **Instruments**

Horizontal neutron probe access tubes allow monitoring of volumetric water content both above and below the asphalt pad. The PSB facility contains 14 water-balance monitoring stations. Each monitoring station allows use of neutron probe, capacitance probe, segmented time domain reflectometry, heat dissipation units, and a precipitation gauge. Drainage out of the collection zones is monitored with use of tipping bucket gauges and dosing siphons. Plant community parameters and burrowing animal activities are monitored.

Rock creep gauges and differential settlement gauges are surveyed using electronic distance measuring equipment to determine movement within the PSB.

### **Experimental Design**

The PSB facility is in the process of testing a proposed cover design under different climatic scenarios. Precipitation treatments include non-irrigated (natural precipitation) and irrigated conditions. Irrigated treatments include the application of three times the long-term annual average as well as extreme events designed to simulate the 1,000-year event. The extreme event irrigation is applied over an 8-hour time frame to test both the drainage response as well as the surface flow response of the cover.

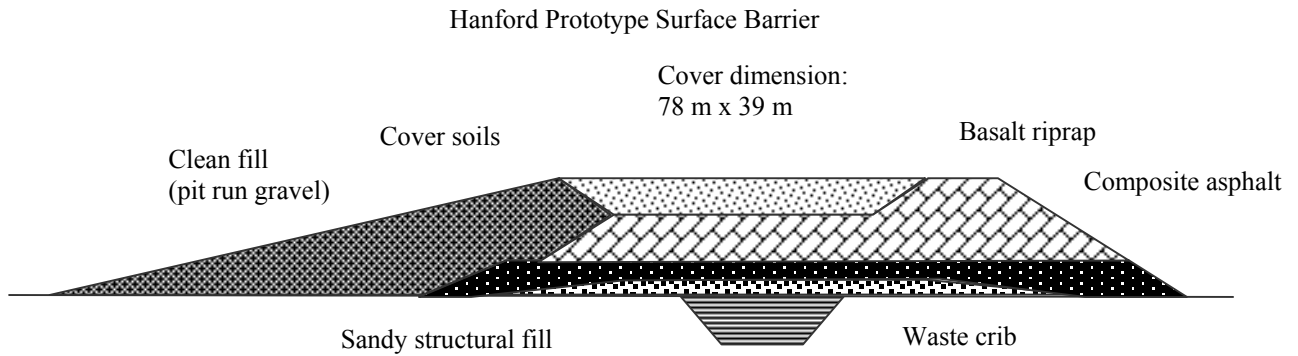

- Measurements:
- Soil moisture
  - Precipitation meters
  - Drainage
  - Matric potential
  - Soil temperature
  - Stability/deflation/subsidence
  - Runoff/sediment yield/moisture content
  - Wind profile/eolian stress
  - Plant cover and plant/animal intrusion

## Cover Description

The PSB was built to test a prototype of the so-called Hanford Barrier. The cover design is comprised of (top to bottom): 1 m of silt loam admixed with 15% (by weight) pea gravel, 1 m silt loam, 0.15 m sand filter, 0.3 m gravel filter, 1.5 m basalt rock riprap, 0.3 m drainage gravel, 0.15 m composite asphalt, 0.1 m top course, sandy soil structural fill, in-situ soil.

## Results and Discussion

During the first two years of observation, the PSB was tested both by above-normal precipitation and additional irrigation. During the 1997 Water Year, natural precipitation amounted to 291.6 mm compared with the long-term average of 160 mm. The irrigated treatments received about three times the long-term average. After two years of observation, significant drainage has occurred in only one of the test plots of the PSB. Following the third 1,000-year storm irrigation, one plot began to drain and continued for seven months. Drainage from the remaining plots has been in very small amounts, generally attributable to condensation in drainage pipes.



### Vertical profile of the Hanford Barrier

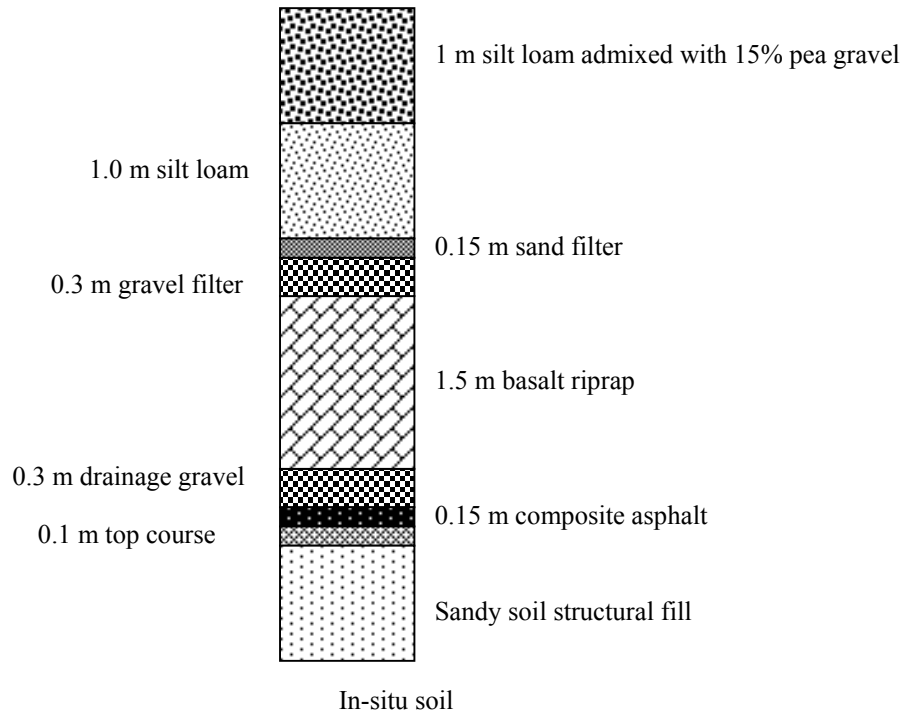

The PSB at Hanford represents the most detailed evaluation of a cover system yet performed. The lack of drainage in all of the collection cells, save one receiving 1,000-year storm supplemental irrigation, is a good indication of the success of the cover design. Although the Hanford cover is far more complex and costly than most applications would warrant, waste cover design in general will benefit from two major accomplishments: (1) the data collected there will be invaluable for the development of improved numerical models, and (2) the design and evaluation system developed at Hanford will serve as a model to others attempting similar activities in other environments.

## SITE 5: Hill AFB, Utah

Hill Air Force Base (HAFB) is located in northeast Utah approximately 10 km south of Ogden. At an elevation of 1,466 m, HAFB lies between the Wasatch Mountains and the Great Salt Lake. Cover development activities at HAFB are intended to address drainage requirements for in-place stabilization of hazardous and mixed wastes.

Cover testing activities at HAFB have included lysimeter-based testing of five different cover designs proposed for use in the high desert environment of northeastern Utah. The cover designs included a “typical” soil monofil, a modified RCRA design, two treatments of a capillary barrier design, and a version of the Hanford cover.

### Point of Contact

Dr. Glendon W. Gee  
Battelle  
Box 999  
Mail stop K9-33  
Richland, WA 99352  
509 372-6096  
[glendon.gee@pnl.gov](mailto:glendon.gee@pnl.gov)

### Climate Factors

Ogden, Utah receives an average of 43.6 cm per year of precipitation, which falls mainly in the months of December-May. Average monthly values of precipitation range from 2.0 cm to 6.50 cm. Extreme single-day events have recorded as much as 6.6 cm of rain. Hill AFB receives snowfall in the winter months, with an average annual total snowfall of 93.9 cm. Snow accounts for 17% of the average annual precipitation. Hill experiences mild temperatures, with an annual mean of 10.4°C. Monthly mean temperatures range from -3°C to 24°C, extreme recorded temperatures are a low of -26.7°C and a high of 39.4°C.

Average monthly precipitation: Ogden

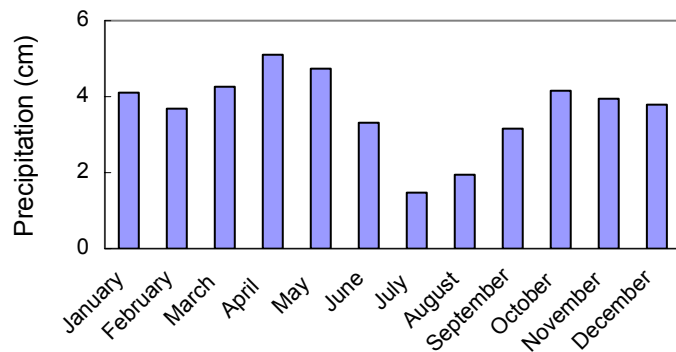

Average monthly temperature: Ogden

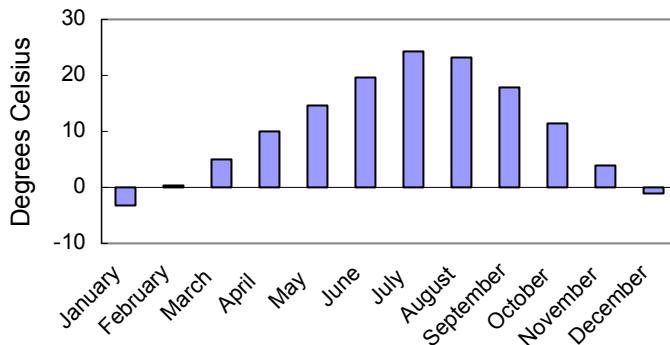

### Plant Parameters

All of these experimental covers at HAFB were seeded with a mixture of native grasses including western wheatgrass (*Pascopyrum smithii*), great basin wild rye (*Leymus cinereus*), streambank wheatgrass (*Elymus lanceolatus*), viva galleta grass

(*Pleuraphis jamesii*), sand dropseed (*Sporobolus cryptandrus*), and sheep fescue (*Festuca ovina*). One of the two capillary barrier tests included two shrub species, rabbitbrush (*Chrysothamnus nauseosus*) and four-winged saltbrush (*Atriplex canescens*), which were introduced as seedlings.

## Hydrogeology

Hill AFB is located on a plateau between the Great Salt Lake and the Weber River Valley. The location was once the site of Pleistocene Lake Bonneville and has the loamy, fine, sandy soils characteristic of a depositional and delta environment. Soils at the site are deep and well drained.

## Facility Description

Landfill cover research at HAFB is being conducted in large pan-type lysimeters (Warren *et al.*, 1997). Five different cover designs are tested at the facility. Four lysimeters were constructed in 1989 to compare and evaluate the performance of a monofil-type design, a modified RCRA design, and two versions of a capillary barrier design (Hakonson *et al.*, 1994). In 1994 another lysimeter was constructed to evaluate a version of the prototype cover design developed for use at the DOE site at Hanford, WA.

### Hill AFB Lysimeter Facility

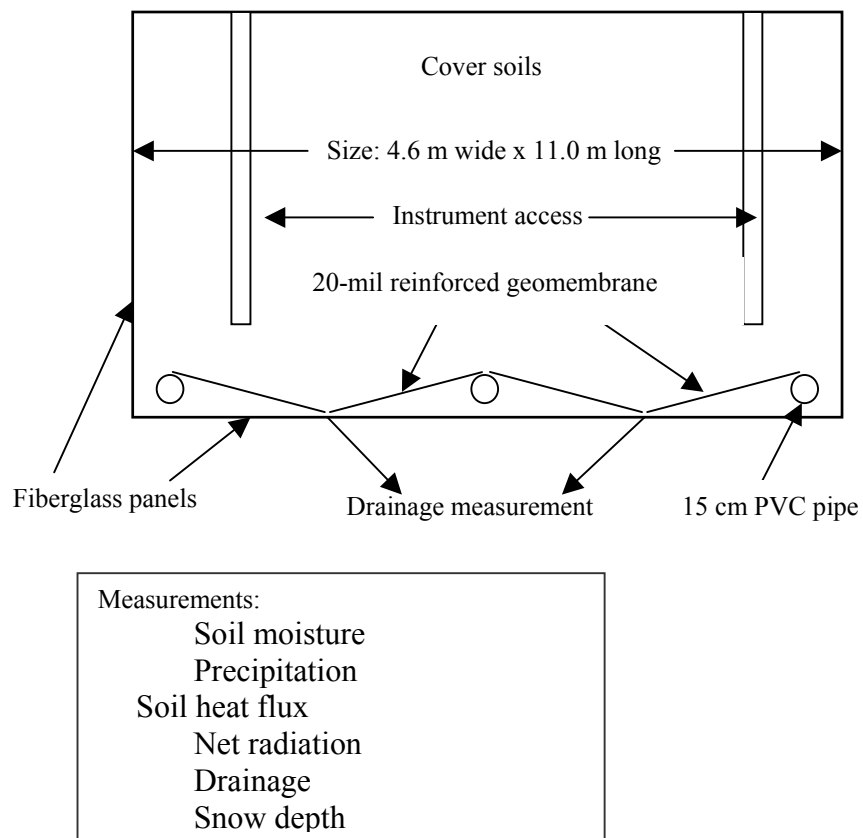

The HAFB lysimeters were constructed of modular swimming pools with dimensions of 5 m x 10 m x 2.8 m deep. Soils placed in the four original lysimeters were sloped to give a 4% slope to the surface and subsurface layers. Soils in the fifth lysimeter were placed with no slope. The fifth

lysimeter was lined with a 20-mil reinforced geomembrane sheet to isolate preferential flow along the side walls of the lysimeter. The lysimeters were instrumented to measure runoff, erosion, lateral flow from the capillary and clay barriers, soil moisture, soil temperature, precipitation, air temperature, and drainage from the lysimeter.

The original four lysimeters were instrumented as follows. Surface runoff was collected in large tanks for measurement of quantity and sediment yield. Drainage through the cover was directed through a tipping bucket rain gauge and into an underground tank. Soil moisture measurements were made with a neutron moisture gauge. Additional measurements included soil temperature, precipitation, air temperature, and snow depth.

The fifth lysimeter was instrumented as follows. Drainage out of the lysimeter is weighed with a top-loading scale. Values for soil moisture are determined at six depths with neutron probe and capacitance. Soil temperature and heat flux are measured with thermopiles and thermocouples. Meteorological parameters are measured with a non-heated tipping bucket rain gauge and a weighing gauge for precipitation, differential black body for net radiation, anemometer for wind speed and sonic distance gauge for snow depth.

### Experimental Design

The lysimeter facility at HAFB provides a direct comparison of multiple cover designs in an environment of moderate precipitation. Tested designs include a simple soil monofil, a resistive

Cover designs tested at the Hill AFB Lysimeter Facility

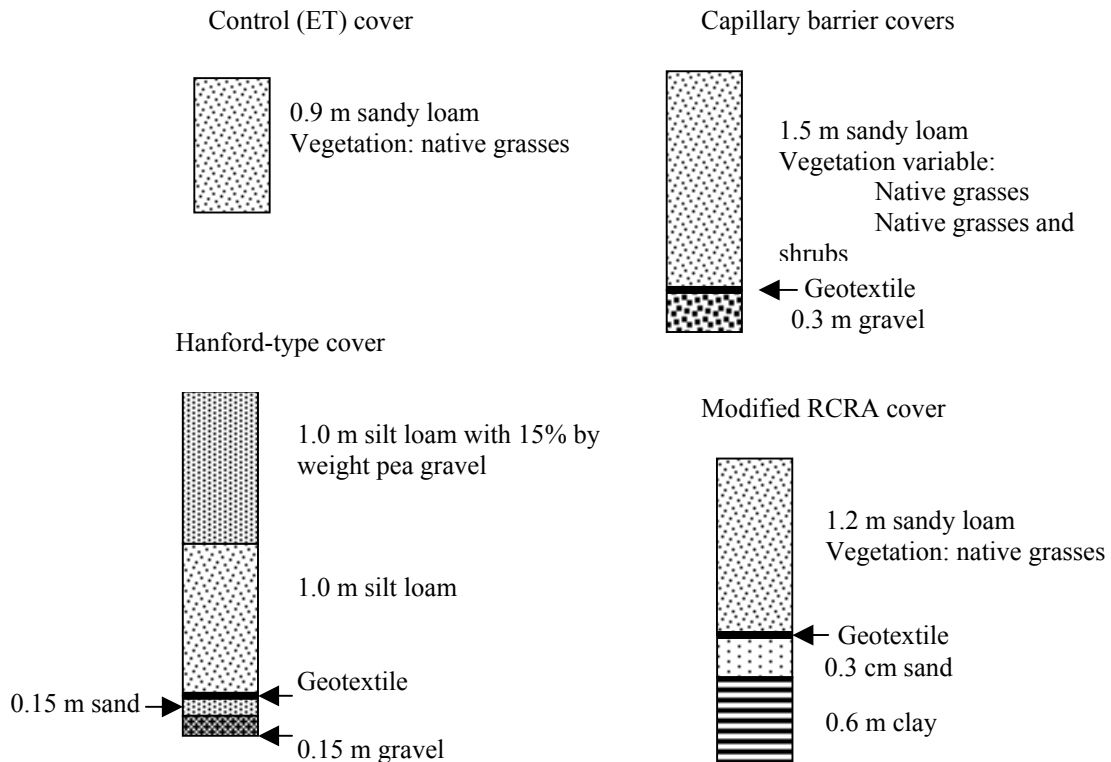

barrier-type RCRA cover, a capillary barrier-type cover with two vegetation treatments, and a version

of the Hanford barrier. The monofil, resistive barrier, and capillary barrier tests utilized a local sandy loam available at HAFB for the surface layers. The Hanford barrier test used a silt loam imported from the Hanford Site in Washington. The monofil cover functioned as a control for the experiments and was simply 0.9 m of the sandy loam compacted to  $1.86 \text{ g cm}^{-1}$ . Laboratory determination of saturated conductivity on undisturbed samples of this soil gave a value of  $5.3 \times 10^{-5} \text{ cm s}^{-1}$ .

The tested RCRA modification consisted of 1.2 m of the sandy loam over 0.3 m of sand drainage layer and 0.6 m clay. Geotextile fabric was placed between the soil and sand layers to prevent downward migration of the soil. The clay layer in this design had a saturated hydraulic conductivity of  $3.4 \times 10^{-6} \text{ cm s}^{-1}$ . In this test, the clay layer had a 4% slope with the intent of laterally diverting water that passed through the sandy loam.

The two capillary barrier tests differed only in the revegetation treatment. Both consisted of 1.5 m of the sandy loam over 0.3 m of approximately 1-cm-diameter gravel. A geotextile fabric was used to separate the loam and gravel. Construction of the covers at a slope of 4% was intended to divert water that percolated through the surface soils to the capillary barrier. Both of the capillary barrier cover tests included approximately 1 cm of gravel mulch applied to the surface to control erosion.

All of these experimental covers were seeded with a mixture of native grasses including western wheatgrass (*Pascopyrum smithii*), great basin wild rye (*Leymus cinereus*), streambank wheatgrass (*Elymus lanceolatus*), viva galleta grass (*Pleuraphis jamesii*), sand dropseed (*Sporobolus cryptandrus*), and sheep fescue (*Festuca ovina*). One of the two capillary barriers tested included two shrub species, rabbitbrush (*Chrysothamnus nauseosus*) and four-winged saltbrush (*Atriplex canescens*), which were introduced as seedlings.

The surface soil of the Hanford cover tested at HAFB consisted of 1.0 m of silt loam admixed with 15% pea gravel for erosion resistance. Another 1.0 m of the silt loam was separated from the underlying 0.15 m sand and 0.15 m gravel by a geotextile to maintain the integrity of the capillary barrier feature. Revegetation was accomplished by transplanting sagebrush and selected bunch grasses.

## Results and Discussion

Monitoring at the HAFB site began with the initial four lysimeters in January 1990. Monitoring of the fifth lysimeter began in 1994. For the 45-month period beginning January 1990, precipitation total was 202 cm with an annual range of 38 to 65 cm (Warren *et al.*, 1997). Snow cover generally persisted from November through February. During the winter of 1991, freezing temperatures were recorded at a depth of 60 cm. Plant cover varied between test plots and species succession was rapid during the study. Surface flows were recorded on all of the original four lysimeters. Soil moisture in the monofil and capillary break covers varied with season. Soil moisture in the RCRA cover increased with time due to accumulation of water in the clay layer, which was nearly saturated at the end of the study. All of the tested covers produced drainage.

Drainage from the control cover began in January 1990 and was followed by both capillary barrier designs later that spring and early summer. The RCRA cover first drained two years into the study. Drainage throughout the study amounted to 41 cm from the control cover, 24 cm and 30 cm from the two capillary barrier designs, and 0.01 cm from the RCRA cover. Most of the percolating water in the RCRA cover was diverted as lateral flow through the sand drainage layer. Warren *et al.* (1997) noted that the critical time for cover performance at HAFB is the time period from February through May when snowmelt rates are high and transpiration is at a minimum. The Hanford cover tested at HAFB has not drained to date (Gee *et al.*, 1998).

## Site 6: Idaho National Engineering and Environmental Laboratory

The Subsurface Disposal Area (SDA) of the Idaho National Engineering and Environmental Laboratory (INEEL) is currently the site for disposal of low-level radioactive waste. Closure plans for the site require a design for final covers for the facilities. The current performance criteria for the site limits net drainage to 1 cm/yr. To support the development of an appropriate cover design, INEEL has investigated alternative covers with the Protective Cap/BioBarrier Experiment and the Engineered Barriers Test Facility (EBTF).

### Point of Contact

Indrek Porro  
Soil Scientist  
Idaho National Engineering  
and Environmental Laboratory  
Lockheed Martin Idaho Technologies Co.  
P.O. Box 1625  
Idaho Falls, ID 83415-2107  
208 526-0906  
ixp@inel.gov

Tim Reynolds  
Environmental Science and Research Inc.  
P.O. Box 51838  
Idaho Falls, ID 83405-1838  
208 525-7055  
reynoldst@esrf.org

### Climate Factors

The Idaho National Engineering Laboratory (INEEL) receives an average of 22.9 cm per year of precipitation, which falls mainly in the months of May-June. Average monthly values of precipitation range from 1.3 cm to 2.8 cm.

Extreme single-day events have recorded as much as 4 cm of rain. INEEL AFB receives large amounts of snowfall in the winter months, with an average annual total snowfall of 87.6 cm. Snow accounts for 40% of the average annual precipitation. INEEL experiences cool temperatures, with an annual mean of 5.6°C. Monthly mean temperatures range from -8.8°C to 20°C, extreme recorded temperatures are a low of -43°C and a high of 38°C.

Average monthly precipitation: INEEL

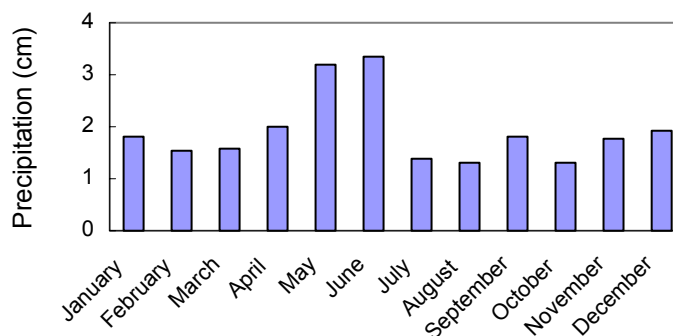

Average monthly temperature: INEEL

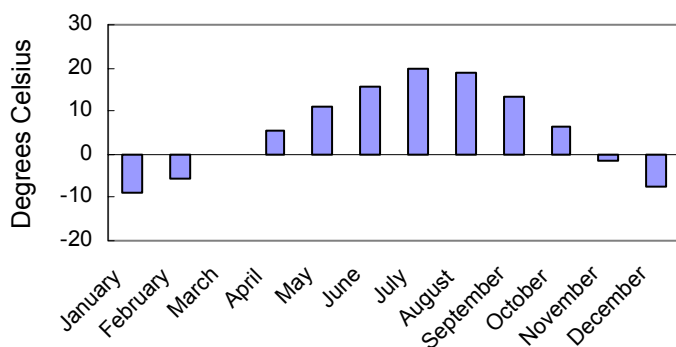

### INEEL Research Facilities

Landfill cover research at INEEL has involved two distinct investigations: the Protective Cap/BioBarrier Experiment (PC/BE) and the Engineered Barrier Test Facility (EBTF). Each is described below.

## Protective Cap/Biobarrier Experiment (PC/BE)

### PC/BE FACILITY DESCRIPTION

Landfill cover research at the PC/BE site has used pan-type lysimeters to evaluate the tested covers (Limbach *et al.*, 1994). A total of 72 plots were constructed to test the various designs under different plant and precipitation treatments. Drainage collection is provided in each test plot by three galvanized steel collection pans. The pans were 1.22 m in diameter, about 0.5 m in depth and were filled with gravel to within 0.1 m of the top of the pan. A layer of geotextile was placed over the gravel to prevent siltation. Drainage from the lysimeter, as well as lateral drainage from subsurface layers, was routed to a tipping bucket rain gauge for measurement. Soil moisture was monitored with neutron probes. TDR probes were installed in one plot for verification of the neutron probe measurements. A meteorological station was installed for measurement of air temperature, wind speed and direction, precipitation, relative humidity, and solar radiation.

INEEL PC/BE Lysimeter Facility

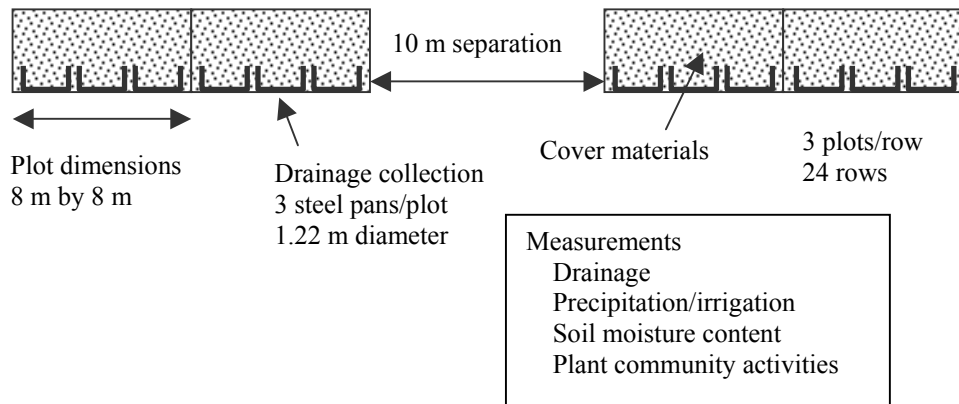

### EXPERIMENTAL DESIGN OF THE PC/BE

The intent of the research effort in the PCBE at INEEL was to compare a RCRA-type cover to three alternative cover designs. The three alternative designs included a thick monolayer design and two capillary barrier designs. The capillary barrier designs were referred to as biobarrier designs. The RCRA design consists of (from top) 1.0 m clay loam, a geomembrane sloped at 3 percent, and 0.6 m clay loam. The two capillary barrier designs differed only in the depth of the capillary break, which consisted of 0.3 m river cobble (10 to 20 cm diameter) placed between 0.1 m layers of gravel (0.5 to 1.5 cm diameter). One capillary barrier design placed the upper surface of the barrier at 0.5 m in depth, the other at 1.0 m in depth. Both capillary barrier designs included native-derived loess above and below the capillary barrier to give the cover a total thickness of 2.5 m.

## Cover designs tested at the INEEL Protective Cap/Biobarrier Experiment

RCRA-type design

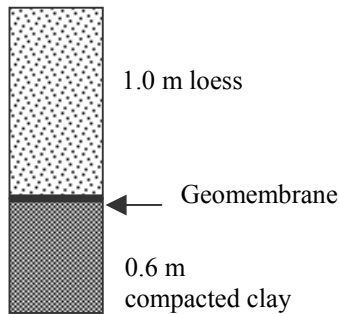

Thick monolayer design

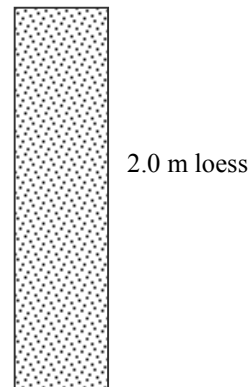

0.5 m biobarrier design

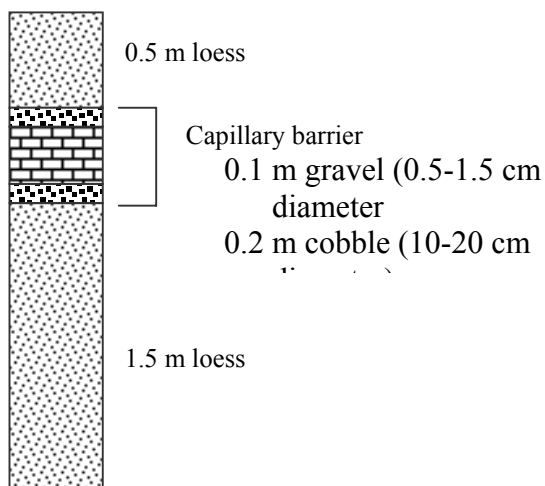

1.0 m biobarrier design

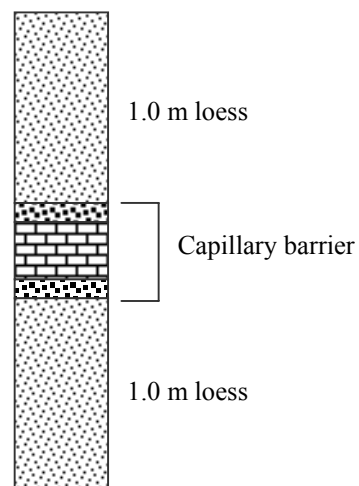

## DISCUSSION OF PC/BE

Anderson *et al.* (1997) reported that all of the cover designs were successful at preventing drainage under ambient and summer irrigation treatments. Under these precipitation/irrigation treatments, most of the capillary barrier covers prevented the movement of moisture through the barrier. Increases in soil moisture were noted near the bottom of the thick monolayer covers, but drainage did not occur.

Under the fall/spring precipitation/irrigation treatment, performance varied. Drainage occurred in all of the thick monolayer covers. Drainage occurred in all of the 0.5-m capillary barrier covers but most of the 1.0-m capillary barriers were successful in preventing drainage. The RCRA-type covers did not produce drainage. Data indicate the removal of water from soil layers below the capillary barrier/biobarrier in most of the covers containing that feature.



Plant cover was higher on all cover designs than is typical under ambient conditions in the area.

## Engineered Barriers Test Facility

### EBTF FACILITY

In April 1996, construction began on the Engineered Barriers Test Facility (EBTF) (Porro and Keck 1998). The EBTF was designed to test the performance of two cover designs and to provide additional data regarding design storm events and materials testing. The EBTF is a concrete structure containing five test plots on either side of an enclosed access area. The structure was constructed above grade with soil bermed on each side. Each test plot is 3 m wide by 3 m long by 3 m deep. Each plot has two floor drains, one in the center and one around the perimeter of the cell. Provisions in the floor and walls of the plots allow instrumentation access to the cover materials. Drainage is measured with a tipping bucket rain gauge and a collection sump equipped with a pressure transducer. TDR and neutron probes are used to measure soil moisture content. Tensiometers, heat dissipation sensors and thermocouple psychrometers are used to measure soil water potential. Soil temperature is measured with thermocouples. Ion exchange resin capsules are placed in the soil to monitor the movement of soil water tracer materials. Precipitation is measured with a tipping bucket rain gauge. Supplemental irrigation is applied with soaker hoses. Subsidence is measured by resting a pipe on opposite walls of the cells and measuring vertical distance to the soil surface.

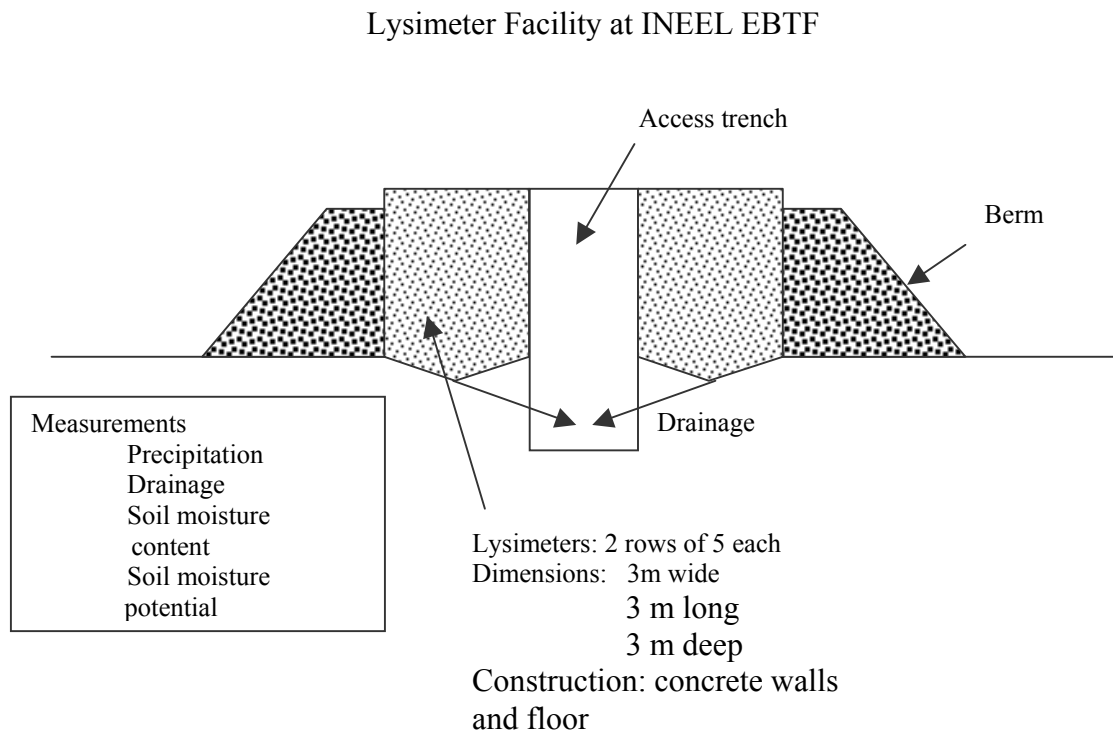

## EXPERIMENTAL DESIGN AT THE EBTF

Four replicates of two cover designs are being tested at the EBTF at INEEL. A thick soil design consists of (from top) 0.15 m of a 75% soil / 25% gravel mixture and 4.85 m of soil identified as Spreading Area B Soil (SAB soil), which is a silt loam. The capillary barrier design consists of (from top) 0.15 m of the soil/gravel mix, 1.45 m of SAB soil, a layer of geotextile fabric, 0.15 m gravel, 0.76 m cobbles, and 2.5 m SAB soil. Both tested cover designs have a total depth of 3 m. Construction plans for the final cover indicate a total depth of 5 m, which will be achieved by adding an additional 2 m of SAB soil to the bottom of the tested design. Revegetation of the plots is planned for 1999. Precipitation treatments include ambient and a twice normal treatment. In addition to the cover tests, two additional plots were constructed, one for in-situ testing of the Spreading Area B cover soil and one for destructive sampling for laboratory determination of soil properties. Water storage properties of the covers were determined by artificial wetting of the soils until drainage occurred.

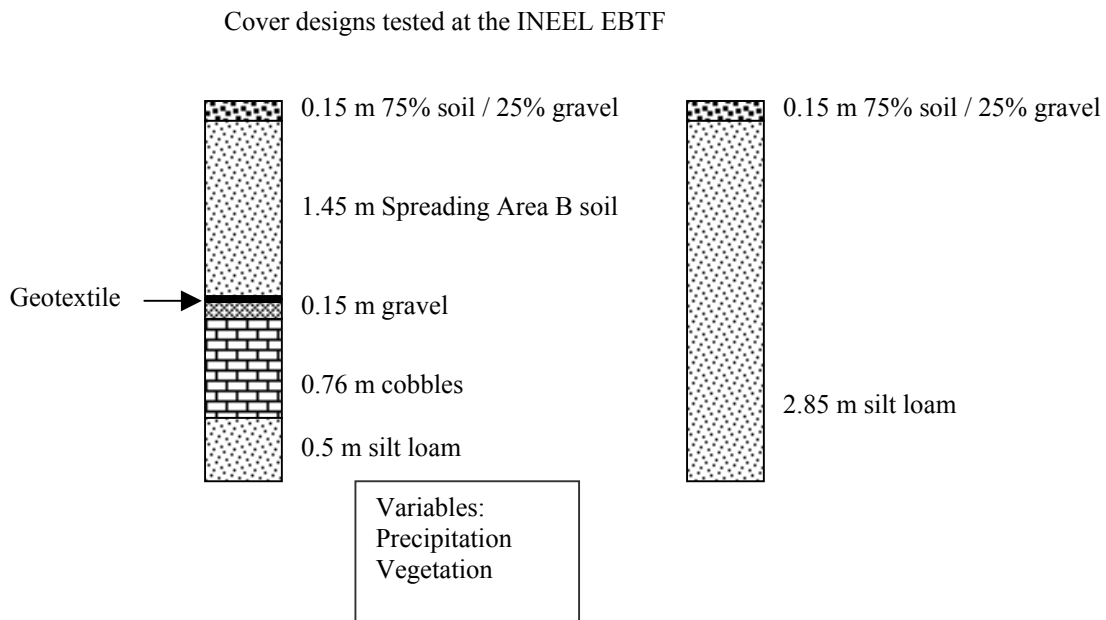

## DISCUSSION OF THE EBTF

Results published in September 1998 (Porro and Keck, 1998) indicate that no water drained from the covers during the period from spring of 1996 (construction) until summer of 1997 (when wetting experiments began). Water stored in the soil profile increased in all covers, partially due to the absence of surface vegetation during this period. The wetting experiment conducted in summer of 1997 resulted in several weeks of drainage. Drainage largely ceased until March of 1998 when thawing of the soil allowed accumulated winter precipitation to drain from the soil. Continued monitoring of the EBTF is planned and the performance of the plots under conditions of surface vegetation will begin in 1999.

## Site 7: Kalamazoo, Michigan (NCASI)

The paper industry produces paper mill sludge as a by-product of paper manufacture. Traditionally disposed of in landfill facilities, the material has properties similar to clays. As such, the paper mill sludge has been proposed as an alternative to clay in applications where a low-permeability material is desired. Beginning in 1984, the National Council for Air and Stream Improvement (NCASI) has pursued a program to determine the suitability of the mill sludge as a substitute for clay barriers in landfill cover applications. NCASI reports at least 14 landfill closures have utilized paper mill sludge as a hydraulic barrier material. These sites range from a 3-acre municipal site to a 30-acre industrial site (NCASI, 1997). An additional 47 sites have used paper mill sludge as an amendment for cover soils. Saturated hydraulic conductivity of the sludge barriers has been reported at values ranging from  $10^{-5}$  to  $10^{-9}$  cm s<sup>-1</sup>.

### Point of Contact

C. Van Maltby  
Senior Research Scientist  
NCASI  
Western Michigan University  
Kalamazoo, MI 49008-3844  
616 387-5128  
van.maltby@wmich.edu

### Climate Factors

Climate data for this report are taken from the Kalamazoo Michigan Airport, which lies approximately 15 km from the NCASI site. Kalamazoo, MI receives an average of 89 cm per year of precipitation, which falls mainly in the

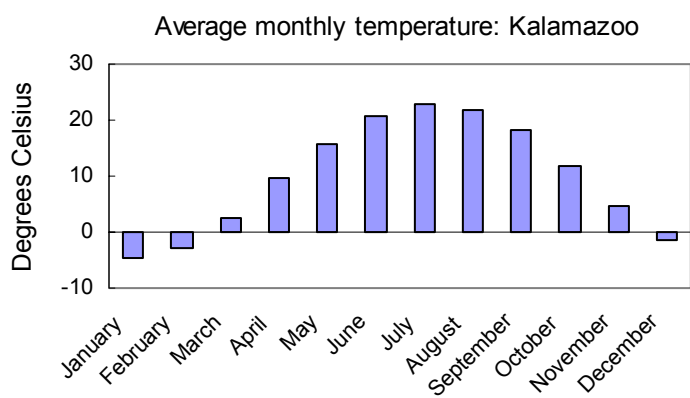
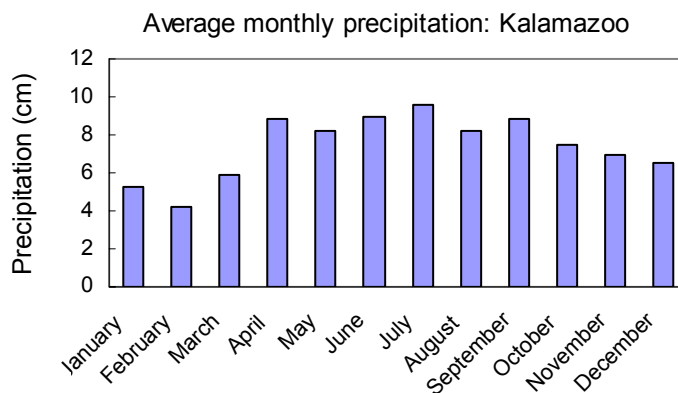

months of April-September. Average monthly values of precipitation range from 4.2 cm to 9.6 cm. Extreme single-day events have recorded as much as 14 cm of rain. NCASI receives large amounts of snowfall in the winter months, with an average annual total snowfall of 71.6 cm. Snow accounts for 31% of the average annual precipitation. Kalamazoo experiences mild temperatures, with an annual mean of 9.9°C. Monthly mean temperatures range from -4.5°C to 23°C, extreme recorded temperatures are a low of -29°C and a high of 39°C.

## Facility Description

Landfill cover research at the NCASI facility is performed in four lysimeters (NCASI, 1997). Lysimeters are square, approximately 8 m on each side. A 30-mil PVC flexible membrane forms the impermeable liner at the bottom of the lysimeters. A 10.2-cm perforated PVC pipe embedded in pea gravel lies immediately above the PVC liner to collect drainage through the cover. Collected water is routed to a collection basin for measurement. Another PVC pipe embedded in pea gravel at the surface of the tested covers collects surface runoff. Piezometers were installed through the covers to measure the saturated depth. Precipitation and air temperature data are collected at the site.

## Experimental Design

The two designs tested at the NCASI facility were of the resistive-barrier variety. The covers were identical in dimensions and differed only in the composition of the barrier layer. Both consisted of (from top) 15 cm of vegetated topsoil, 46 cm of site soil (primarily sand mixed with small amounts of silt and clay), 61 cm of hydraulic barrier, 61 cm of compacted and graded clean sand (NCASI, 1997). The barrier material in two plots was locally obtained clay described as a clay loam material. Barrier material in the other two plots consisted of combined (primary and biological) or primary paper mill wastewater treatment sludge. The sludges were selected to represent a large sector of the paper industry and for their hydraulic properties. The in-situ values for saturated hydraulic conductivity for the sludges were determined to be  $4.4 \times 10^{-7} \text{ cm s}^{-1}$  and  $9.62 \times 10^{-7} \text{ cm s}^{-1}$ .

## Results and Discussion

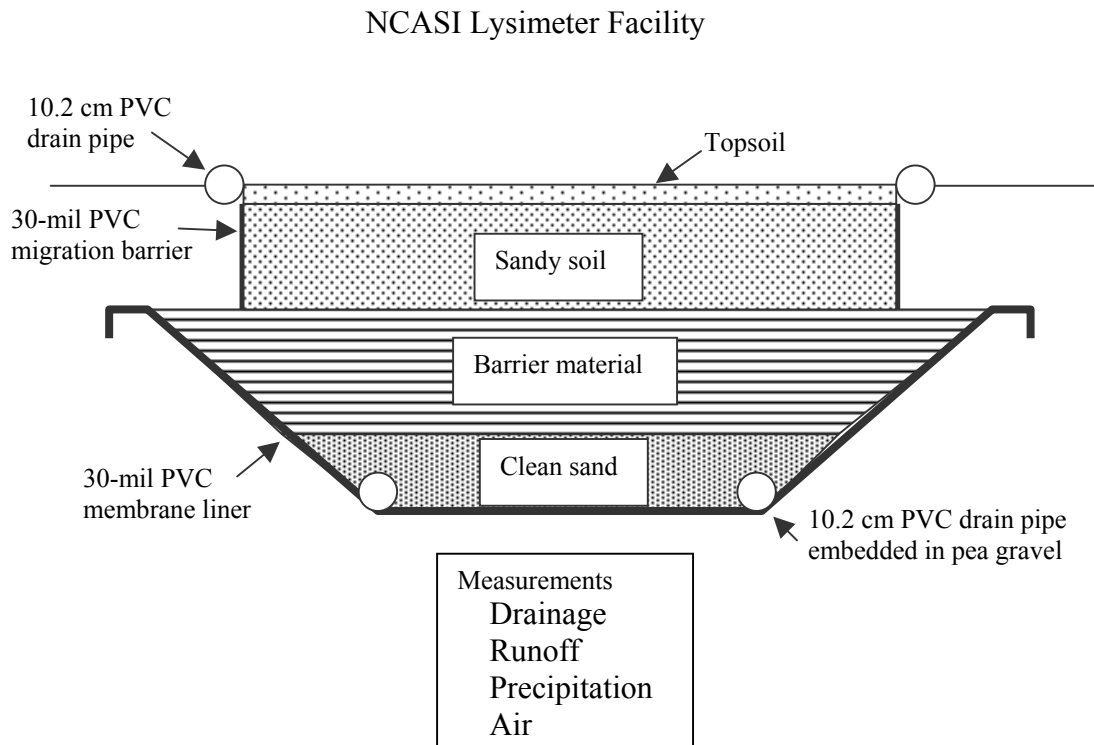

Data collected over eight years of monitoring indicate that the two clay test plots allowed drainage representing 45 percent and 49 percent of precipitation during the monitoring period (NCASI, 1997). The two plots containing the sludge barriers allowed drainage representing 6 percent and 11 percent of precipitation. Total surface runoff from the two sludge barriers exceeded runoff from the clay barrier plots by about a factor of two. Destructive tests at the conclusion of the field study indicate that the sludge suffered no deterioration during the test period. A dye tracer test was performed at the conclusion of the study to evaluate the development of preferential flowpaths. In contrast to the clay barriers, which developed numerous preferential flowpaths, the sludge barriers displayed a single preferential flowpath.

#### Cover designs tested at the NCASI lysimeter facility

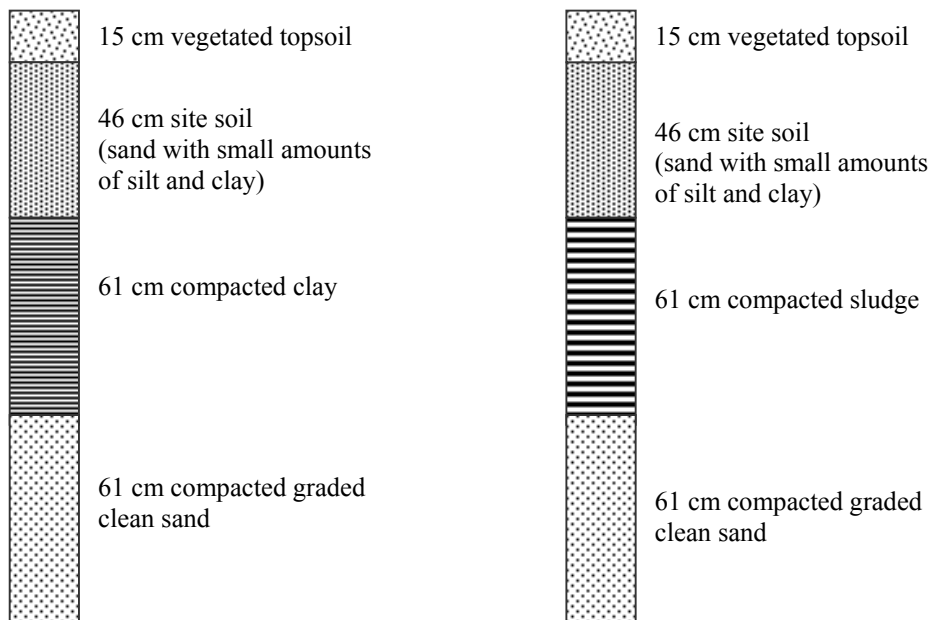

## Site 8: Los Alamos National Laboratory, New Mexico

Los Alamos National Laboratory (LANL) occupies 111 km<sup>2</sup> in north central New Mexico about 40 km northwest of Santa Fe. As the site of weapons development activity, LANL has produced considerable quantities of radioactive and hazardous waste. A program to develop improved shallow land burial technology began in 1981 and continues today. Landfill cover research at LANL has ranged from small-scale, feature specific investigations to large, integrated demonstrations of proposed cover designs. LANL activities have addressed issues of biointrusion, contaminant migration, and water balance of different cover designs. A variety of research facility designs have been developed to address the complex issues of hazardous waste disposal in a high desert environment.

### Point of Contact

John Nyhan  
 Los Alamos  
 National Laboratory  
 EES-15J495  
 Los Alamos, NM  
 87545  
 505 667-3163  
 jwn@lanl.gov

Average monthly precipitation: Los Alamos

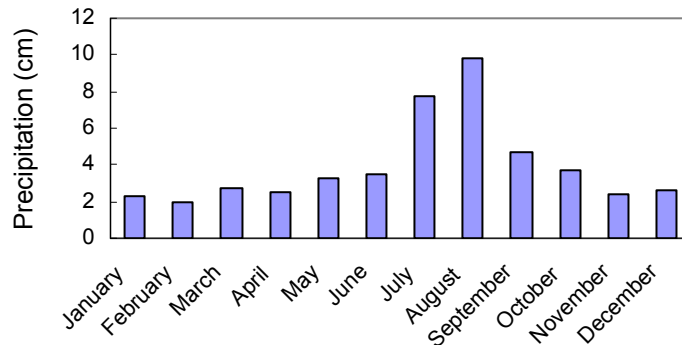

### Climate Factors

Los Alamos National Lab (LANL) receives an average of 47.1 cm precipitation per year, which falls mainly in the months of May-September. Average monthly values of precipitation range from 0.8 cm to 5.8 cm. Extreme single-day events have recorded as much as 6.4 cm of rain. LANL receives snowfall in the winter months, with an average annual total snowfall of 46.5 cm. Snow accounts for 19% of the average annual precipitation. LANL experiences moderate temperatures, with an annual mean of 8.9°C. Monthly mean temperatures range from 1.8°C to 20.1°C, extreme recorded temperatures are a low of -23.3°C and a high of 36.7°C.

Average monthly temperature: Los Alamos

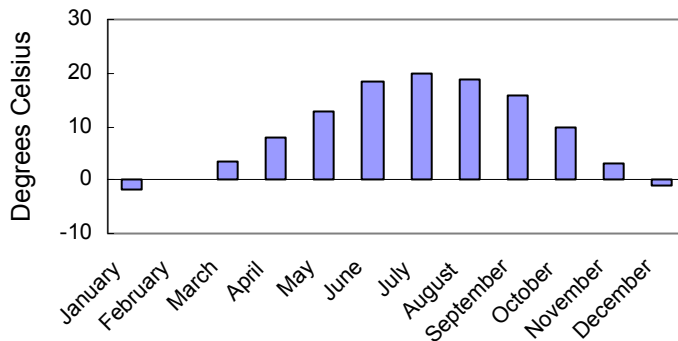

### Facility Description

Landfill cover research at LANL has been conducted on individual components of landfill covers and on integrated cover designs. Of particular interest to the ACAP are the investigations into biointrusion barriers and the field scale tests of cover designs proposed for use at the LANL site.

## Biointrusion Studies

### BIOINTRUSION FACILITIES

Much of the biointrusion barrier work at LANL occurred in the 1980s and is described by Nyhan (1989). The initial plant root intrusion studies were conducted in small PVC lysimeters. The lysimeters, 25 cm in diameter and 183 cm deep, were held in place in a plastic sleeve buried flush with the ground surface. Various combinations of topsoil and barrier material were placed in the lysimeters and were planted with fast-growing, deep-rooted plant species.

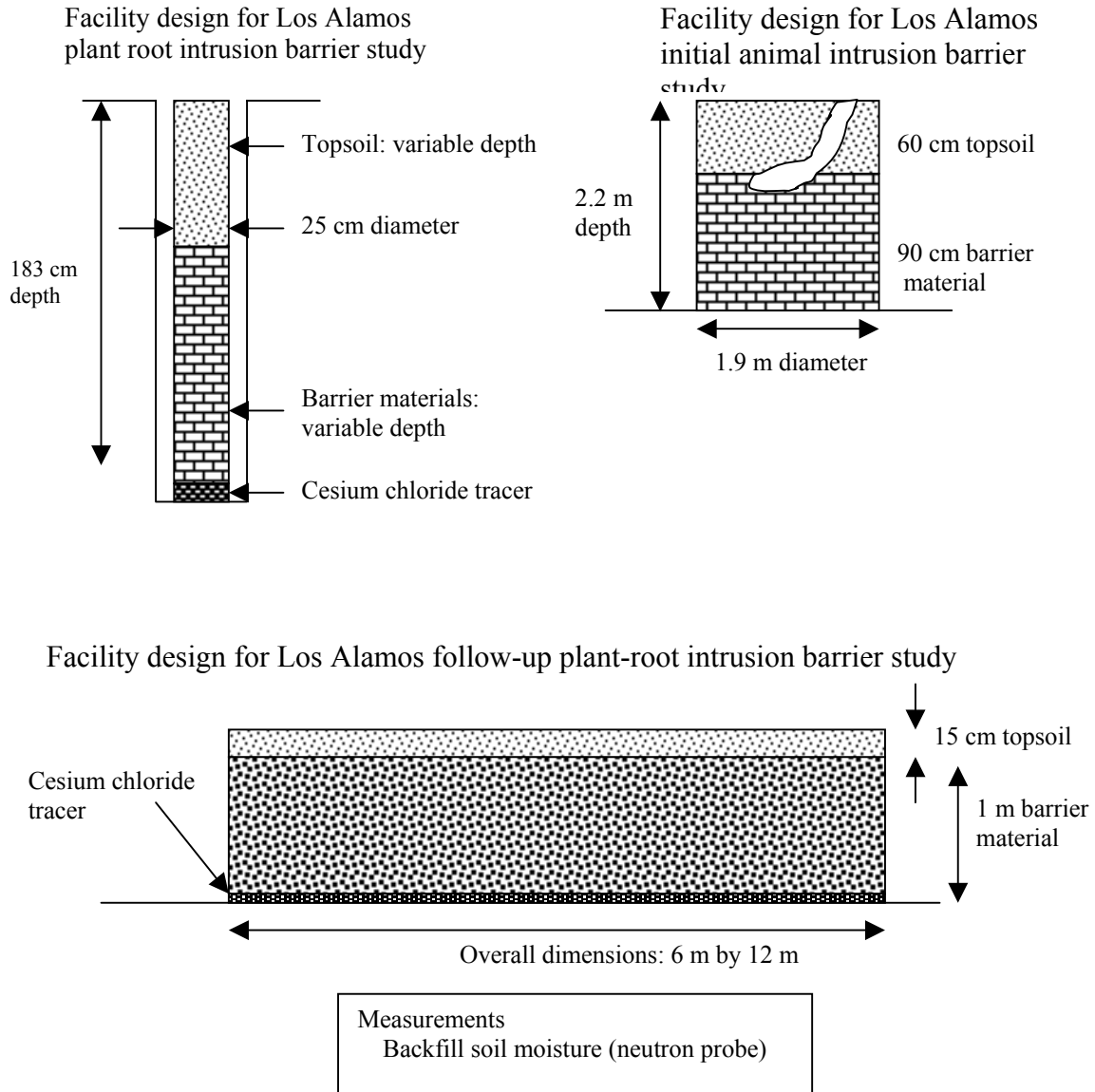

The initial animal intrusion studies were conducted in metal culverts 1.9 m in diameter and 2.2 m deep. The culverts were placed on end and filled with combinations of soil and barrier material. Pocket gophers were introduced to the surface of the soil and maintained in the culvert. After four months, the gopher was removed and the burrows were injected with an expanding foam to provide a

cast of the burrow. The cast was then excavated and examined to provide accurate measure of the burrow dimensions.

Following the preliminary results from the small-scale biointrusion studies, another facility was constructed to test the performance of the cobble/gravel barrier under conditions of extended time frames, field-scale size with ambient precipitation and native vegetation, subsidence, and percolation through the cover. Animal intrusion was not a factor tested in this experiment. Four plots were constructed above grade of galvanized roofing material. The test plots were 6 m wide, 12 m long, and 1.15 m high. The barrier materials were placed on the bottom and covered with 15 cm of topsoil. Neutron gauge access tubes were placed 30 cm under the barrier material and cesium chloride was placed under the barrier material to simulate buried waste available to plant activities.

### Biointrusion Study Experimental Designs

Each lysimeter in the initial plant-root intrusion study was configured with various combinations of topsoil over barrier material. Topsoil depths of 30 and 60 cm were used. Barrier materials used were crushed tuff, bentonite clay, cobble (7.5 to 12-cm diameter), and gravel (1 to 2-cm diameter) over cobble. Clay barriers were 15, 30, and 45 cm in depth. Tuff, cobble and gravel/cobble depths were 30, 60, and 90 cm. The surface of each lysimeter was planted with a fast-growing, deep-rooting

Cover designs tested in the Los Alamos plant-root intrusion barrier study

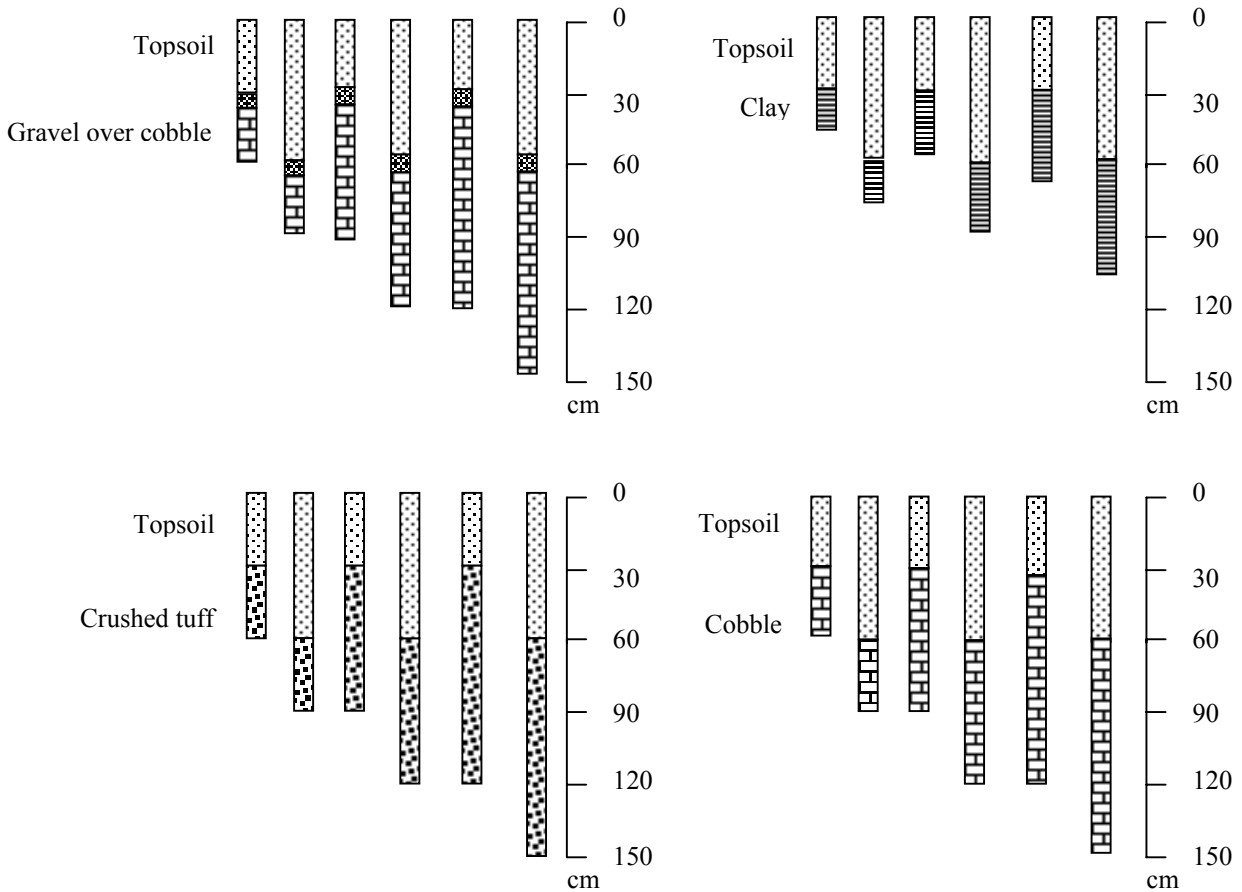



plant species. Plants used were barley (*Hordeum vulgare*), yellow clover (*Melilotus officinalis*), and alfalfa (*Medicago sativa*). Water and fertilizer were added to promote aggressive growth and rooting

Cover designs tested in the initial Los Alamos animal intrusion barrier study

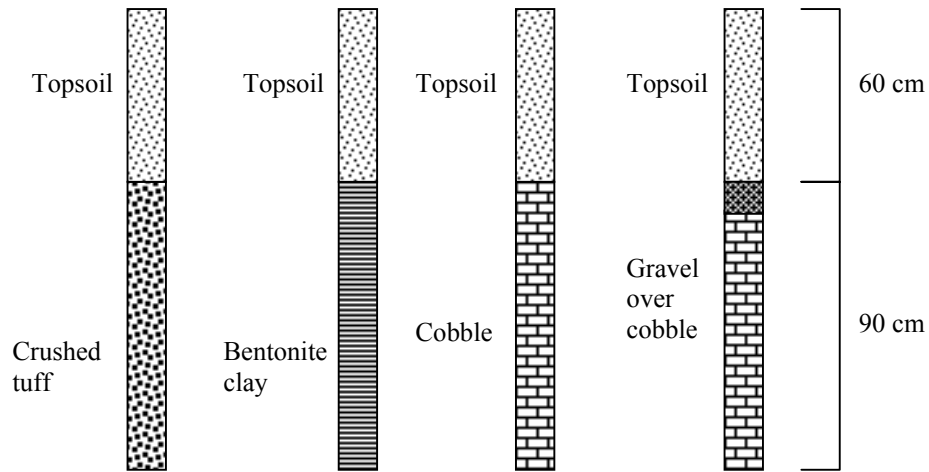

of the plants. Cesium chloride (0.5 g), which is taken up by plant roots, was placed in the bottom of each lysimeter to provide a means of assessing the performance of the root barrier.

The culverts used in the initial animal intrusion study were filled with (from bottom) backfill, 90 cm of one of the barrier materials (crushed tuff, bentonite clay, cobble, cobble/gravel), and topped with 60 cm of topsoil. A single pocket gopher (*Thomomys bottae*) was placed on the soil surface and allowed to conduct burrowing activities for four months. To conclude the study, the gopher was removed and a three-dimensional cast was made of the resulting burrow for accurate measurement of the gopher activities.

Cover designs tested in the follow-up Los Alamos plant-root intrusion barrier study

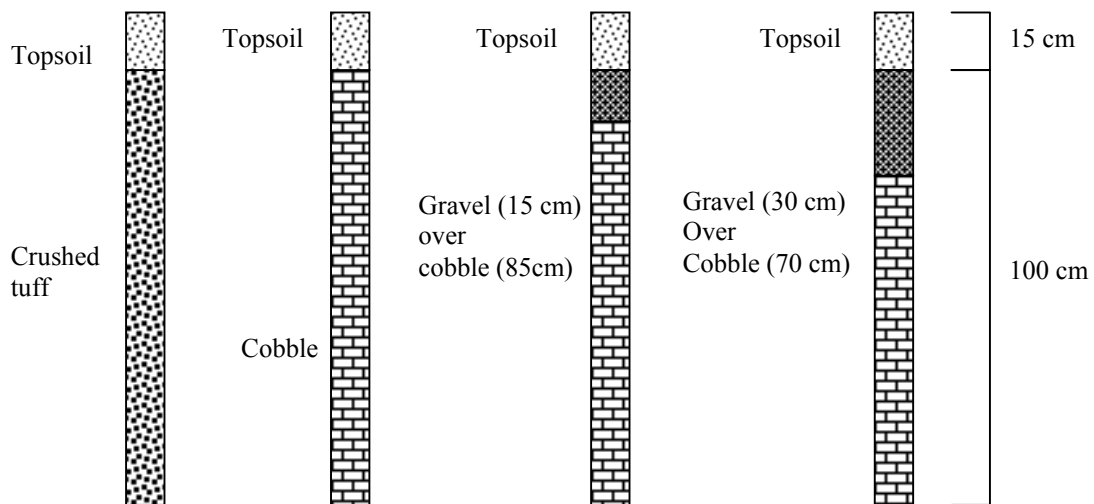

The test plots used in the follow-up study of plant-root intrusion contained 1 m of the four different barrier materials and were covered with only 15 cm of topsoil. The rationale behind the shallow layer of topsoil was to provide a minimum of soil moisture storage, thus encouraging drainage into the underlying backfill. The high probability of drainage promoted rooting activities. The barrier configurations used were 1 m of crushed tuff, 1 m of cobble, 0.15 m of gravel over 0.85 m of cobble, and 0.3 m of gravel over 0.7 m of gravel. As in the initial study, cesium chloride was placed on the surface of the backfill layer to provide indication of root penetration. The soil surface was seeded with a mixture of nine native grass species. The soil surfaces were sloped at 4-5 percent. Data were collected through five growing seasons.

### **Biointrusion Study Discussion**

The initial study of plant-root intrusion indicated that the crushed tuff barrier offered little resistance to root penetration, even in the treatment with the greatest thickness. Barriers constructed of clay, cobble, and cobble/gravel performed better and benefited from increased thickness in both the soil and barrier layers. Examination of the clay barrier following the growing season indicated desiccation of the clay layer and a high concentration of plant roots in the clay layer. The establishment of preferential pathways due to desiccation cracking was a major concern.

The initial study of animal intrusion indicated that the crushed tuff offered little resistance to burrowing activities. The cobble, clay, and gravel/cobble layers all were effective in preventing the establishment of sustainable burrows. The clay used in this experiment was at a high water content and there was some doubt about the performance of the clay material in a desiccated form.

The intermediate-scale investigation of plant-root barriers indicated that the crushed tuff barrier offered little resistance to the penetration of plant roots. The cobble and gravel combinations, however, were quite effective in preventing penetration by roots. Observations at the end of the experiment of the cobble barrier and the 30 cm gravel/70 cm cobble barrier indicated that these barriers were starting to fail. Soil moisture observations in the backfill indicated that moisture contents increased as a result of snowmelt but not as a result of summer thunderstorms.

### **FIELD-SCALE COVER TESTS**

LANL has conducted two different tests of proposed cover designs for landfill facilities. The Integrated Test Plot experiment (ITP) compared a conventional design with a capillary barrier-type design. The Protective Barrier Landfill Cover Demonstration (PBLCD) compared a RCRA-type design to three versions of a capillary barrier-type design.

### **Integrated Test Plot Facility**

Test sections in the ITP were installed in 1984 and were 3.0 m wide by 10.7 m long. Two plots were constructed for each design to be tested. Surface slopes were less than 0.5 percent to reduce runoff. Test plots were lined with 6-mil plastic to collect drainage that was routed via pipes to a collection point. Drainage was routed to a collection tank for measurement. Flow rate measurements were manual using a graduated cylinder and a stopwatch. Soil water measurements were made with neutron probes at four depths and six locations in the tested covers. Plant species composition was estimated along longitudinal transects. Plant biomass was estimated by clipping and drying 10-cm square plots.

## Design of Integrated Test Plot

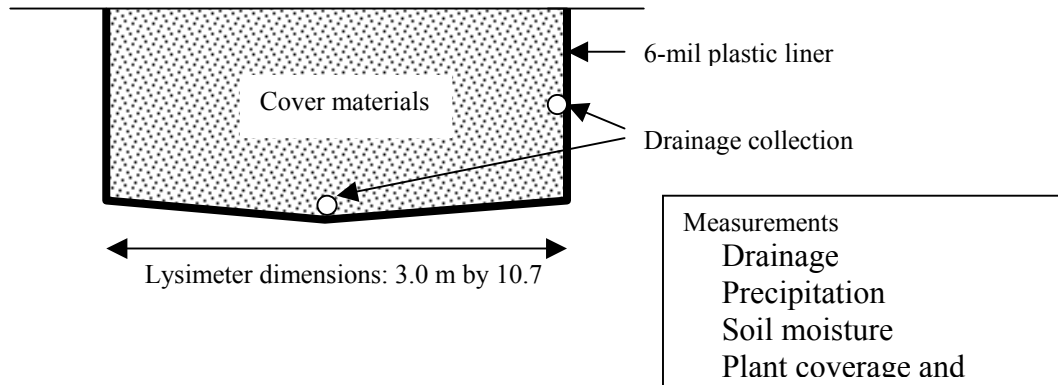

### Integrated Test Plot Experimental Design

The ITP effort compared a “conventional” design with a capillary barrier design. The conventional design consisted of 20 cm of topsoil (Hackroy sandy loam) over 108 cm of crushed tuff backfill. The capillary barrier design consisted of 71 cm of topsoil (Hackroy sandy loam) over 46 cm of gravel (5- to 10-cm diameter). A high conductivity geotextile between the two maintained a sharp interface. This interface sloped at five percent to the side of the test plot providing for lateral movement of water in the upper soil profile. A drain at this level collected water diverted by the capillary barrier.

#### Cover designs tested at the Integrated Test Plot Facility

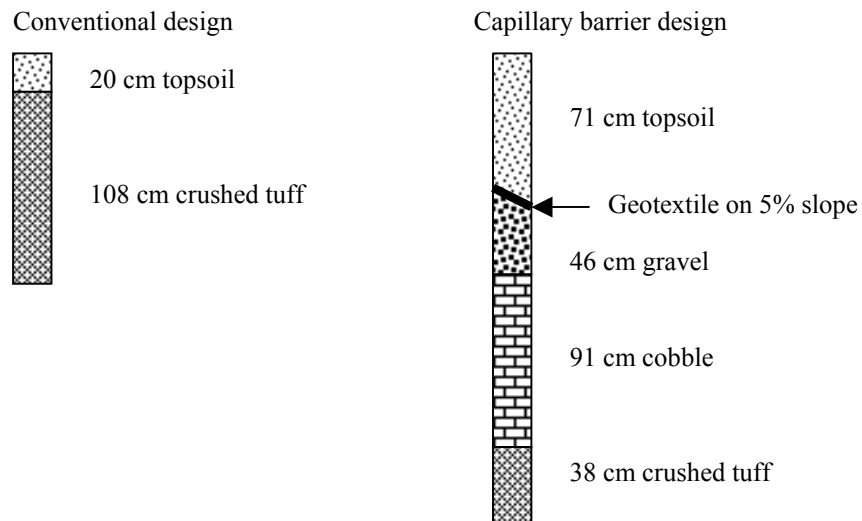

Below the gravel was 91 cm of cobble (10- to 30-cm diameter) over 38 cm of crushed tuff backfill. The surface of both covers consisted of 60 to 70 percent coverage by gravel (<2-cm diameter) and was seeded with blue grama (*Bouteloua gracilis*) and western wheatgrass (*Agropyron smithii*).

### Integrated Test Plot Discussion

All four of the test plots produced drainage during the three years of the study. Evapotranspiration amounted to about 88 percent and 96 percent of precipitation on the plots with conventional and capillary barrier designs, respectively. The capillary barrier design produced drainage over a smaller time frame than the conventional design. Since much of the drainage recorded during the experiment occurred in a record snowfall year, Nyhan *et al.* (1990) speculated that during more typical years, the capillary barrier design would show an even greater relative performance.

### Protective Barrier Landfill Cover Demonstration Facility

Field-scale tests at LANL began in 1991 with the construction of 16 test plots 1m wide by 10 m long. These plots allow testing of four different cover designs on four different slopes. The plots were constructed above ground of metal framing and plywood. Interflow and surface runoff collection systems consist of metal troughs. Collection of infiltrating water is accomplished with four metal pans filled with medium gravel (8-25 mm diameter) overlain with a high conductivity geotextile. The pans are placed 11 cm from the side-walls to minimize sidewall effects. All collected liquid is conveyed to

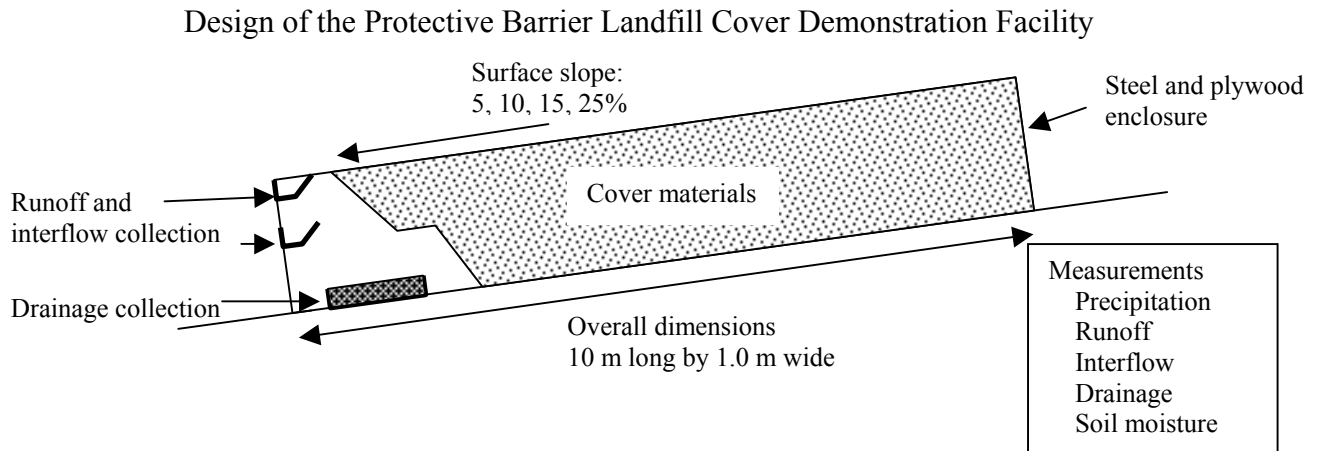

100-liter collection tanks equipped with ultra-sonic liquid level sensors for measurement. Soil moisture is recorded with TDR probes at multiple downslope locations and depths. Eddy flux estimates of evaporation provided an independent check using meteorological data from a nearby site.

### Protective Barrier Landfill Cover Demonstration Experimental Design

Four cover designs at four different slopes are being tested in the Protective Barrier Landfill Cover Demonstration at Los Alamos. Each cover design is being tested at slopes of 5, 10, 15, and 25 percent. All of the tested covers slope in an easterly direction. A conventional design, approximating a design used in waste disposal at Los Alamos, consists of 15 cm of topsoil over 76 cm of crushed tuff. Nyhan *et al.* (1997) describes the crushed tuff as having a saturated hydraulic conductivity of 8.2

$\times 10^{-4} \text{ cm s}^{-1}$ . The loam consisted of a mixture of uncharacterized topsoil, sand, and aged sawdust in a volume ratio of 2:1:1. The first alternative was referred to as the EPA-recommended design and consisted of 61 cm of the same loam, a geotextile layer, 30 cm medium sand, and 61 cm of a clay-tuff mixture (volume ratio of 1:10). Two capillary barrier designs were tested at Los Alamos. The designs were similar, with both having 61 cm of topsoil over 76 cm of fine sand. The difference in the two designs was in the loam layer, with one being the loam used in the other designs and the other being a clay loam. All of the covers were separated from 30 cm of medium gravel in the collection pans by a geotextile.

### Discussion of Protective Barrier Landfill Cover Demonstration

Nyhan *et al.* (1997) reported on the first four years of experimental data. During this time, most of the precipitation at the site was returned to the atmosphere via evaporation for all of the covers. Evaporation increased with increased slope of the cover. Since the covers sloped down to the east this was explained by increased solar radiation. Drainage was highest in the loam capillary barrier design followed by the conventional design, the EPA-recommended design and the clay loam capillary barrier design. Nyhan explained the differing amounts of drainage in terms of the saturated hydraulic conductivity of the soil components of the covers.

### Cover designs tested in the Los Alamos Protective Barrier Landfill Cover Demonstration

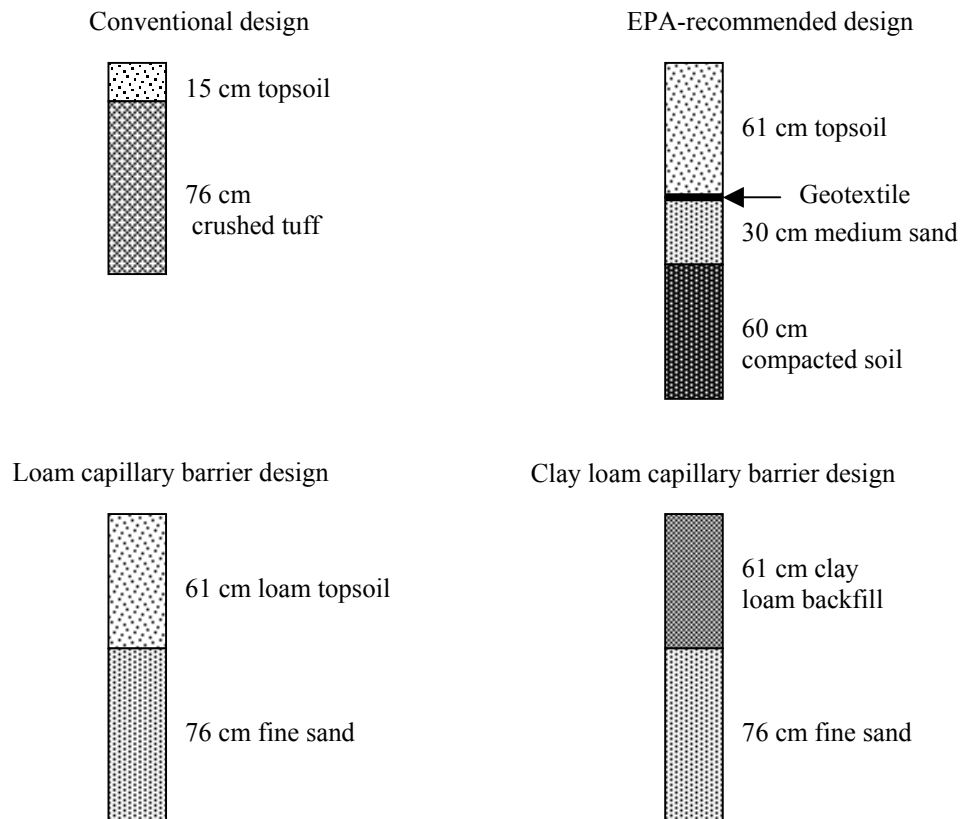

## Site 9: Milwaukee, Wisconsin (Omega Hills Landfill)

The Omega Hills landfill, near Milwaukee, WI, is owned and operated by Waste Management of Wisconsin, Inc. The site covers 83 acres and has recently filled the licensed capacity. A research project has investigated the performance of three cover designs and two vegetation communities.

### Point of Contact

Dr. Craig Benson  
2214 Engineering Hall  
1415 Engineering Dr.  
University of Wisconsin,  
Madison  
Madison, WI 553706  
608 262-7242  
chbenson@facstaff.wisc.edu

### Climate Factors

Precipitation and temperature figures for this report are taken from Milwaukee Airport. Milwaukee, Wisconsin receives an average of 81 cm precipitation per year, which falls mainly in the months of March-September. Average monthly values of precipitation range from 3.6 cm to 9.1 cm. Extreme single-day events have recorded as much as 17.3 cm of rain. Omega Hills receives significant snowfall in the winter months, with an average annual total snowfall of 124 cm. Snow accounts for 15% of the average annual precipitation. Milwaukee experiences moderate temperatures, with an annual mean of 8.3°C. Monthly mean temperatures range from -6.7°C to 21.7°C, extreme recorded temperatures are a low of -30.5°C and a high of 39.4°C.

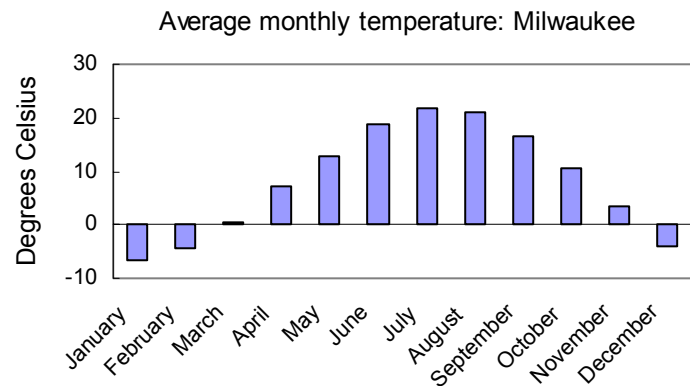
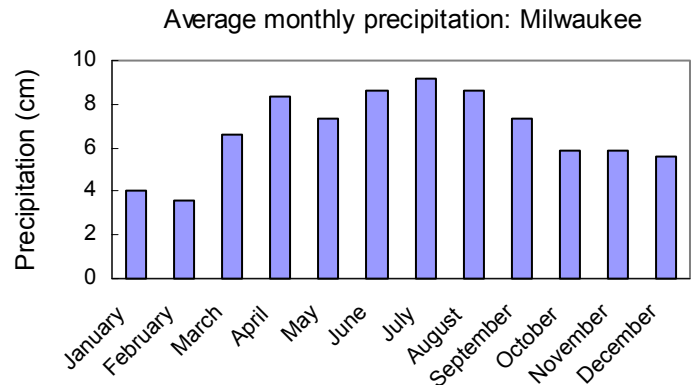

### Facility Description

Landfill cover research at Omega Hills Landfill was conducted in pan-type lysimeters 12 m long by 6 m wide (Montgomery and Parsons, 1990). The impermeable collection pan was a hypalon geomembrane overlain by a geonet and a non-woven geotextile. Runoff, lateral flow, and percolation

were diverted to collection tanks. Measurement was made with electronic pressure transducers. Soil water content and potential were measured with neutron probes and tensiometers equipped with electronic pressure transducers. An on-site weather station provided measurement of meteorological parameters.

### Omega Hills Lysimeter Facility

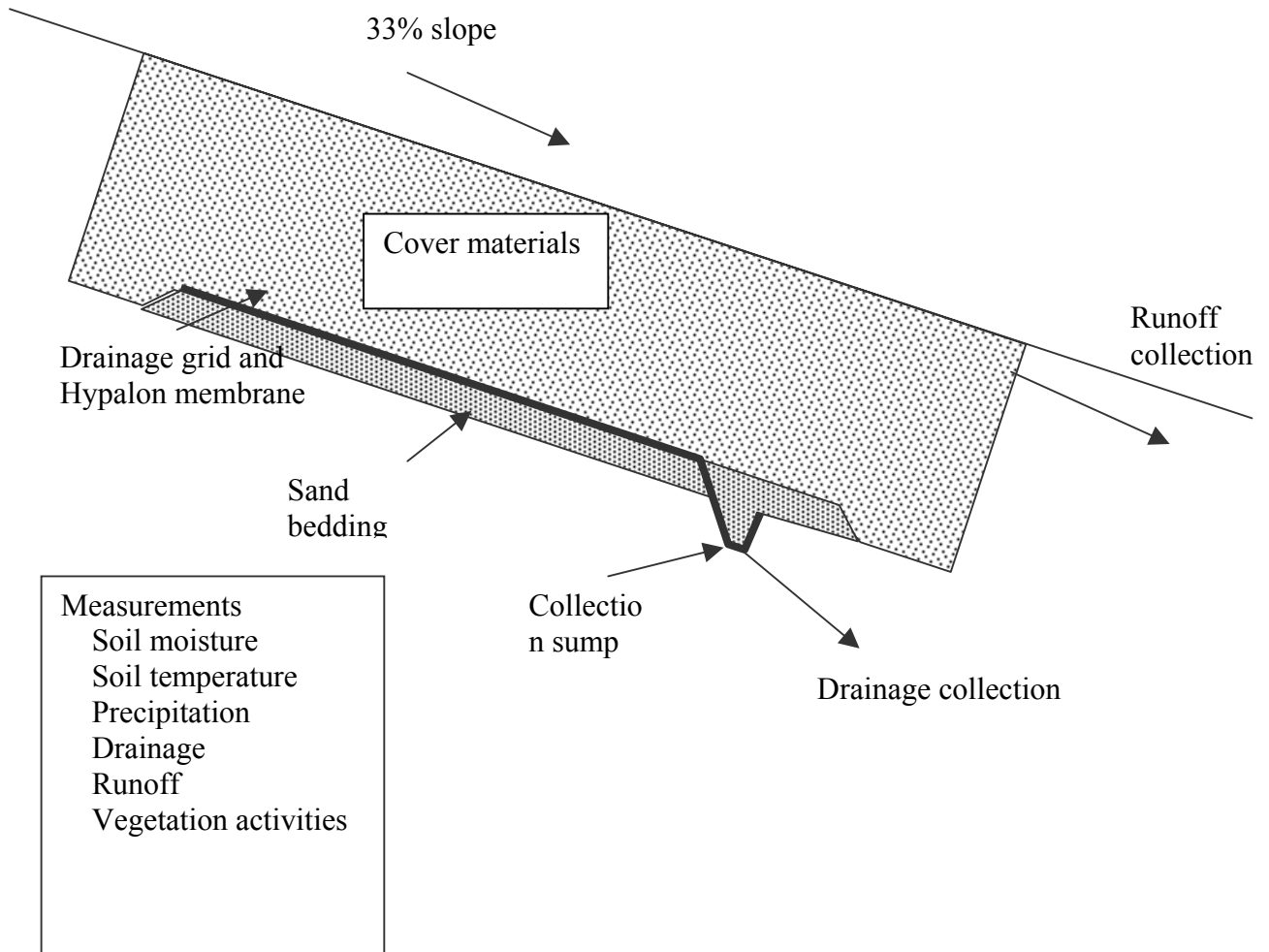

### Experimental Design

The research effort at Omega Hills Landfill evaluated the performance of two resistive barrier and one capillary barrier design. Both resistive barrier designs consisted of 120 cm of compacted, low-plasticity glacial till with a saturated hydraulic conductivity of  $2 \times 10^{-8} \text{ cm s}^{-1}$ . The two designs differ in the thickness of the vegetated topsoil layer. One design included 15 cm of topsoil, which represented the approved design for the site. The other resistive barrier design included 45 cm of

topsoil to test the effect of an increase in topsoil thickness on evapotranspiration. The capillary barrier design consisted of (from top) 15 cm of topsoil, 30 cm compacted glacial till, 30 cm medium uniform graded sand, and 60 cm of compacted glacial till. The presence of the sand layer between layers of compacted clay formed capillary barriers to the movement of water both upward and downward through the cover.

Cover designs tested at Omega Hills Landfill

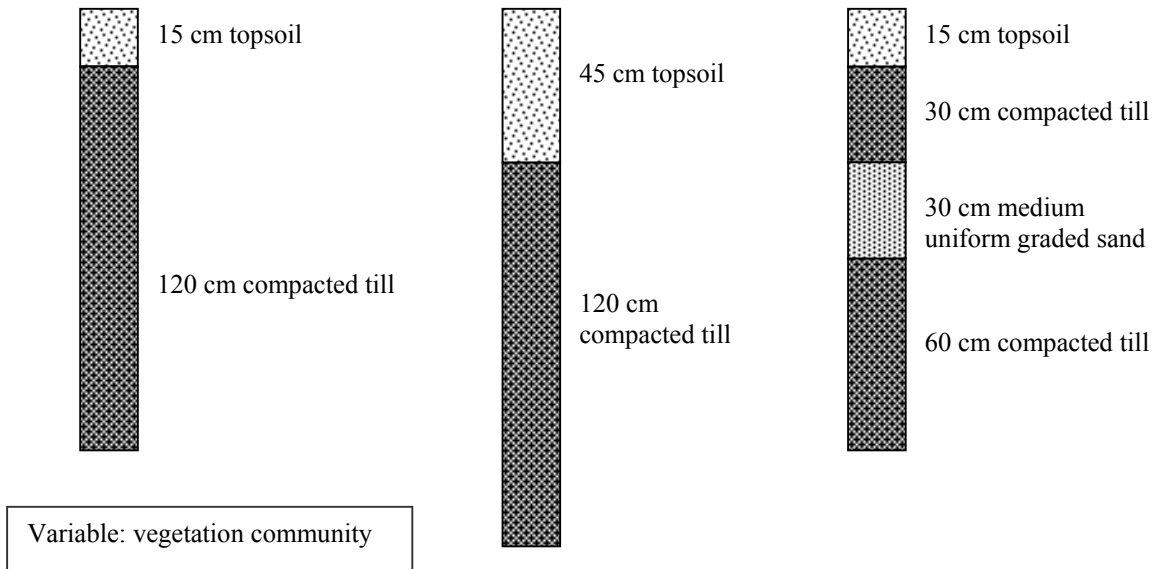

All of the covers were tested with a vegetation treatment that consisted of tall fescue (*Festuca arundinacea*), creeping red fescue (*Festuca rubra*), annual ryegrass (*Lolium Multi-florum*), perennial ryegrass (*Lolium perenne*), and Kentucky bluegrass (*Poa pratense*). An alternate seed mix consisting of smooth brome grass (*Bromus inermis*), birdsfoot trefoil (*Lotus corn-iculatus*), tall fescue (*Festuca arundinacea*), creeping red fescue (*Festuca rubra*), and perennial ryegrass (*Lolium perenne*) was applied to the cover designs that included topsoil over compacted till.

## Results and Discussion

Data were collected at Omega Hills Landfill from 1986 to 1989 (Benson, 1997). During this period, the resistive barrier with the thick layer of topsoil consistently produced more drainage than the resistive barrier with the thin (15 cm) layer of topsoil. The capillary barrier design produced mixed results relative to the other two designs. One year it produced more drainage, one year less, and one year it ranked between the two resistive barrier designs. The capillary barrier design produced considerable lateral flow. A drought in the second year of monitoring resulted in severe desiccation cracking in the compacted clay layer. The exception to this was in the lower clay layer in the capillary barrier design. The upward movement of water was apparently retarded by the inverted capillary barrier.



## Site 10: Nevada Test Site

The Nevada Test Site (NTS) occupies 3,500 km<sup>2</sup> in southern Nevada about 105 km northwest of Las Vegas. Established in 1952, the NTS has served primarily as a proving ground for the testing and development of nuclear weapons. Through 1988, there were approximately 690 announced tests there. Prior to 1963, 84 above-ground tests were conducted at the NTS. Subsequent tests have been below ground. The NTS has been used for other purposes including the disposal of low-level radioactive waste. The Radioactive Waste Management Site (RWMS) occupies 296 ha within Area 5 of the NTS. For many years, the RWMS was used for disposal of low-level radioactive waste. Waste has been stored in a combination of trenches and deep boreholes.

Research efforts at the RWMS have been directed toward characterization of recharge processes that affect the movement of radioactive contaminants derived from a number of activities on the NTS.

### Point of Contact

Dan Levitt  
Bechtel Nevada  
P.O. Box 98521

M/S NLV 081  
Las Vegas, NV  
89193-8521  
702 295-7343

### Climate Factors

Average annual precipitation at the NTS RWMS is approximately 10 cm. Most precipitation comes primarily as rain in two peak seasons, frontal passages during winter and the lesser

convective storms in the summer months. Average monthly values of precipitation range from 1.6 cm to 0.3 cm. Extreme single-day events have recorded as much as 3.0 cm of rain. The NTS

receives some snowfall in the winter months, with an average annual total snowfall of 6.1 cm but only rare trace amounts at the Area 5 RWMS. The NTS experiences extreme temperatures, with an annual mean of 16.1°C. Monthly mean temperatures range from 2.8°C to 29.5°C, extreme recorded temperatures are a low of -15°C and a high of 47.8°C.

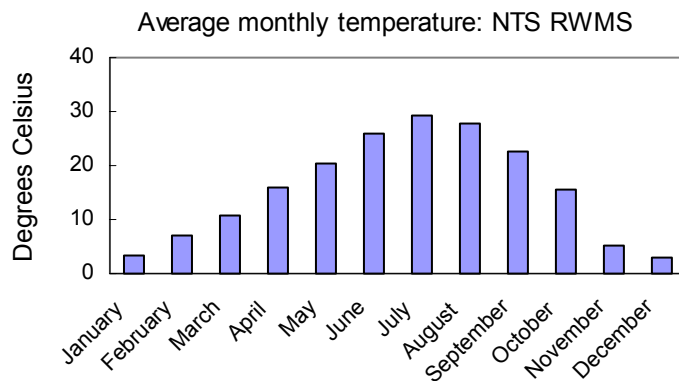
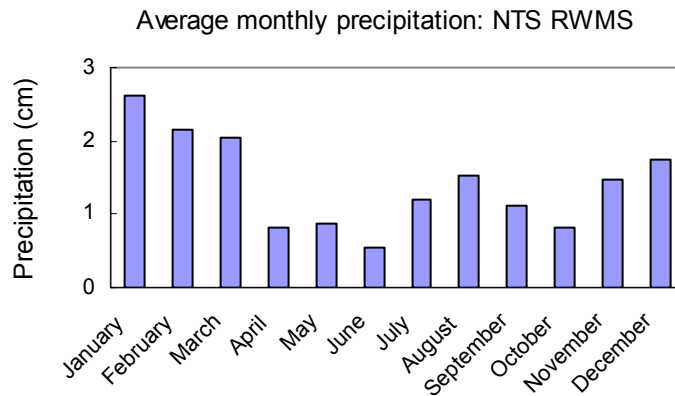

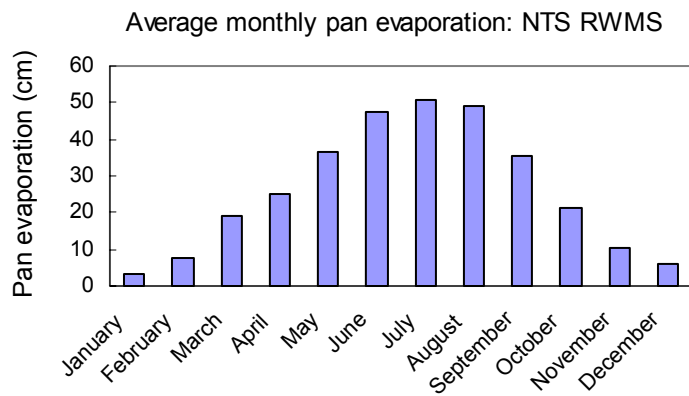

The NTS experiences very hot summers combined with low relative humidity resulting in extremely high values of potential evapotranspiration (PET). PET values for the summer months are much higher than precipitation resulting in low actual values of ET. The estimated pan evaporation is approximately 310 cm. Monthly averages for relative pan evaporation at the NTS are based on data from Magnuson et al. (1992).

## Hydrogeology

The NTS is located within the basin and range physiographic province. Elevations range from 910 m to 2230 m. The Area 5 Radioactive Waste Management Site (RWMS) is located at an elevation of 975 m in the northern part of Frenchman Flat. The RWMS is situated on 300-1200 m of pediment gravels and alluvial deposits derived from the Paleozoic and Tertiary rocks of the surrounding mountains. Depth to water at the RWMS is approximately 250 m.

## Plant Parameters

Vegetation at the RWMS is typical of the Mojave Desert shrub community. Predominate shrub species include creosote bush (*Larrea tridentata*), Ambrosia (*Ambrosia dumosa*), Shockley goldenhead (*Acamptopappus schockleyi*), winterfat (*Ceratoides lanata*), cheese bush (*Hymenoclea salsola*), Pima ratany (*Krameria parvifolia*), and desert thorn (*Lycium andersonii*). Perennial grasses include fluffgrass (*Erioneuron pulchellum*) and Indian ricegrass (*Oryzopsis hymenoides*) (Romney *et al.*, 1973).

## Facility Description

Landfill cover research at the NTS RWMS has been conducted in weighing lysimeters. Two lysimeters began operations in 1994. Lysimeter dimensions were 2 m by 4 m by 2 m deep and were supported on a scale equipped with electronic load cells. Access is provided through an underground entry.

Thermocouple psychrometers and time domain reflectometers (TDR) measure soil moisture conditions at the NTS. TDR probes were placed at depths of 10, 20, 30, 50, 70, 110, 140, and 170 cm. Thermocouple psychrometers were co-located with the TDR probes. Precipitation at the site is measured by a tipping bucket rain gauge.

## Experimental Design

The facility at the NTS was designed to assess the hydrologic performance of the native soil. Soils used in the construction of the lysimeter were removed and stored in lifts and replaced in order to reflect the natural soil profile. Data collected from this experiment are considered relevant to the anticipated performance of a monofill-type cover consisting of native soil. With the low annual precipitation and very high values of PET this type of cover design may be appropriate to the area. The design approach has been encouraged by work by Tyler *et al.* (1996) suggesting that the area has

## Weighing Lysimeter Facility at the NTS

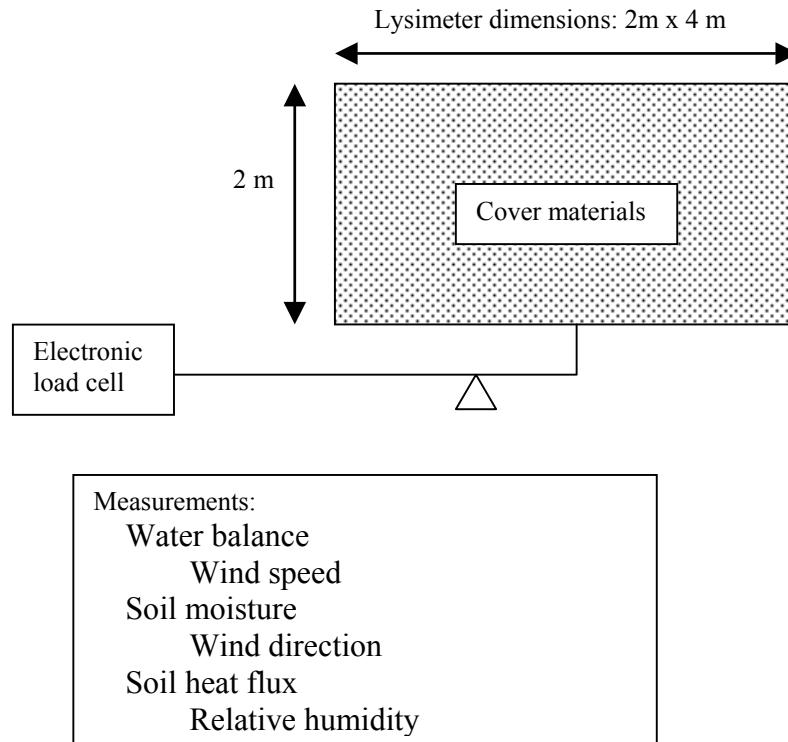

experienced little or no recharge in the last 10,000 years. Treatment variables at the site included one vegetated and one non-vegetated lysimeter. For the vegetated treatment, native shrubs were planted on the soil surface approximating the density of the native vegetation.

### Results and Discussion

Monitoring at the NTS facility began in March 1994 and continues today. Data from the weighing lysimeters indicate that all precipitation is generally removed from the soil profile by evaporation and transpiration (Levitt *et al.*, 1996). Following each winter period, the volumetric water content in the vegetated lysimeter soils returned to a value of approximately three percent while the soil in the bare soil lysimeter returned to a value of approximately six percent. These data suggest that, despite the vast disparity

between precipitation and potential evapotranspiration, the presence of an actively transpiring plant community is important to maintaining water balance in landfill covers.

Cover design tested at the NTS lysimeter facility

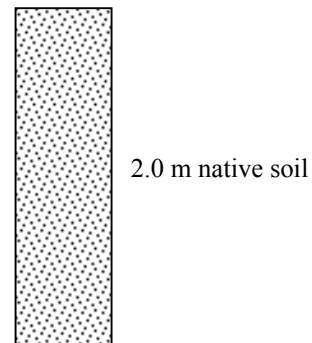

## Site 11: Oahu, Hawaii (Marine Corps Base)

Most landfill cover designs seek to limit deep drainage of water into the underlying waste by means of technologies that prevent the downward movement of the ambient levels of precipitation. Typical among these methods are those that either retain the moisture in the upper layers of soil for eventual return to the atmosphere and those that seek to laterally divert subsurface moisture away from the waste. These technologies are well suited for arid and semi-arid environments where PET exceeds annual precipitation. An alternative concept, one more suited for regions with higher precipitation, is to first reduce the amount of precipitation allowed to penetrate the soil surface. The concept, which is currently being tested at Marine Corps Base Hawaii (MCBH), involves placement of impermeable barriers over much of the cover surface to divert most of the ambient precipitation away from the waste. Plants are expected to control the water that does penetrate the soil surface through transpiration (Hakonson *et al.*, 1997).

### Point of Contact

Bryan Harre  
 Environmental Engineer  
 Naval Facilities Engineering Service Center  
 1100 23<sup>rd</sup> Ave.  
 Port Hueneme, CA 93043  
 805 982-1795  
 bharre@nfesc.navy.mil

### Climate Factors

Oahu, Hawaii receives an average of 193 cm precipitation per year, which falls mainly in the months of November-May. Average monthly values of precipitation range from 9.5 cm

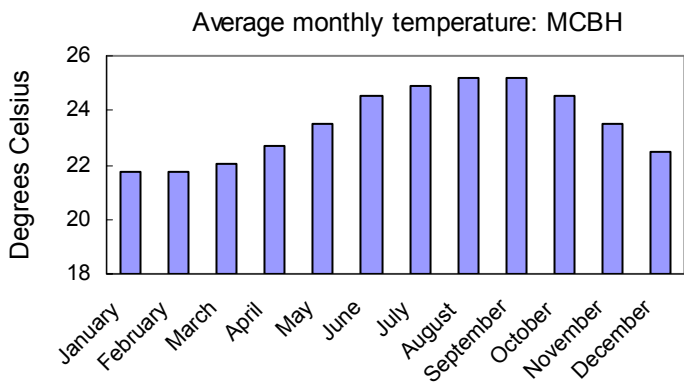
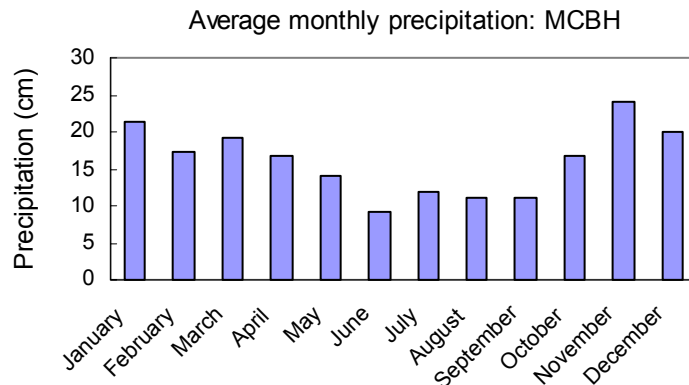

to 24.1 cm. Extreme single-day events have recorded as much as 33 cm of rain. MCBH experiences tropical temperatures, with an annual mean of 23.3°C. Monthly mean temperatures range from 21.7°C to 25.2°C, extreme recorded temperatures are a low of 6.1°C and a high of 33.9°C.

### Facility Description

The lysimeter research facility at MCBH consists of six lysimeters providing replicates of three different designs. Each lysimeter is 6 m

wide by 9 m in length and is lined with 40-mil HDPE for drainage collection. Interception of

precipitation is provided by placement of 12-cm-wide metal rain gutters aligned with the 5 percent slope of the cover surfaces. Plastic pipes collect leachate and runoff, which is conveyed to flowmeters and storage tanks equipped with pressure transducers for measurement. TDR probes are used to measure soil moisture. Sediment is measured in a sediment trap. Precipitation is measured with a tipping bucket gauge.

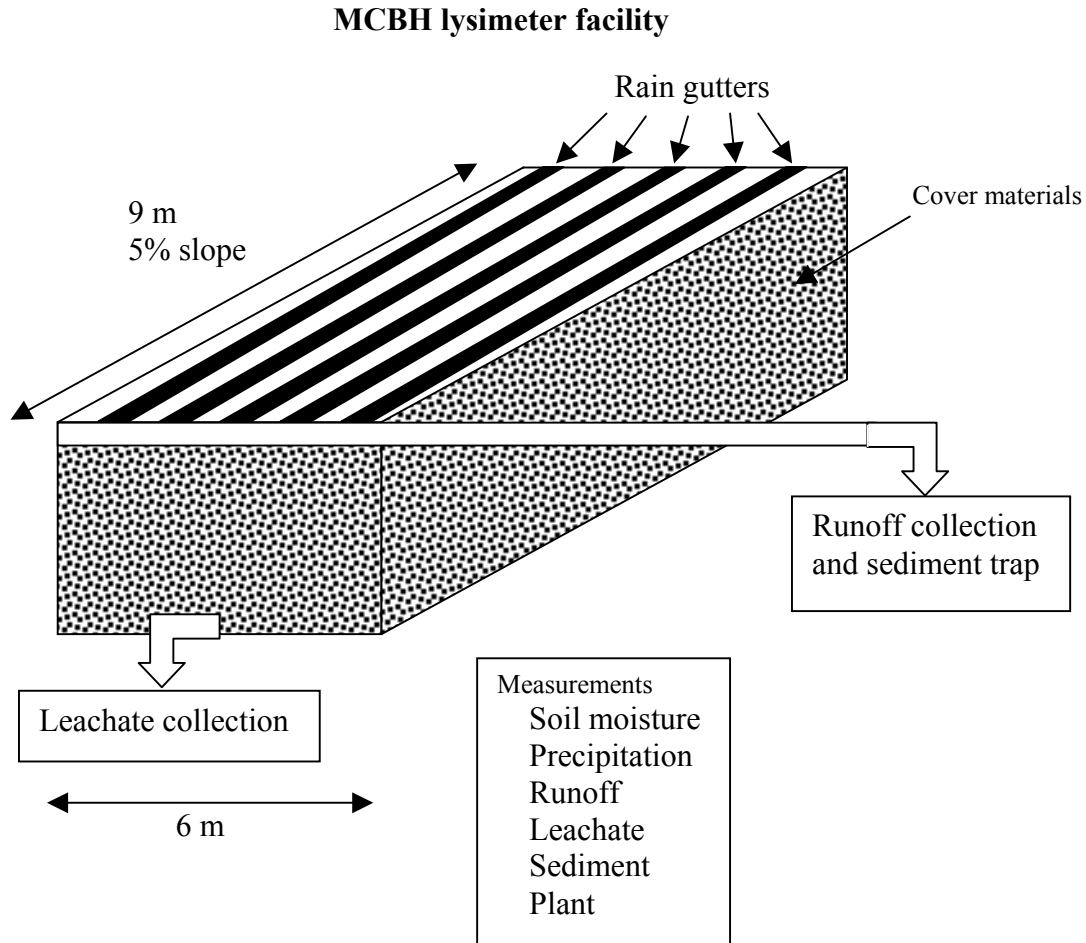

### Experimental Design

The lysimeter facility at the MCBH was designed to test a landfill cover technology in an environment where precipitation exceeds the capacity of the surface processes of evaporation and transpiration to return the moisture to the atmosphere. The concept

## Cover design tested at the MCBH lysimeter facility

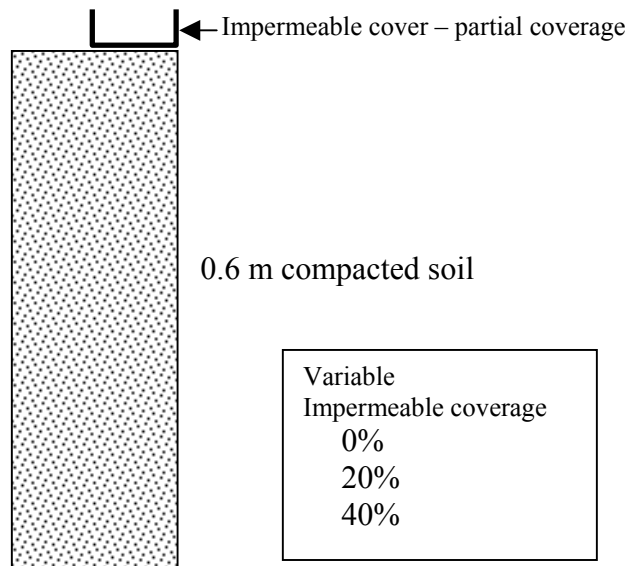

currently being tested at MCBH is to enhance surface runoff to reduce the amount of water that must be partitioned between evapotranspiration and deep percolation. Metal rain gutters, laid directly on the cover surface and aligned with the five percent slope of the cover surface, are used to increase surface runoff and limit the amount of precipitation entering the cover surface. Vegetation, planted between the surface barrier strips, is relied upon to remove precipitation not captured by the rain gutters. Three treatments are being tested: 40 percent surface coverage, 20 percent surface coverage, and a control treatment with no surface coverage. Spaces between rain gutters were planted with a mixture of six species of native grasses and shrubs. Early in the study the vegetation canopy was dominated by one grass specie, *Panicum repens*, with other grass, forb, and shrub species each contributing less that 5 percent of the total coverage. Soil for all treatments consisted of a single non-layered profile compacted to 95 percent of optimum. All plot surfaces have a five percent slope. Surface runoff and deep percolation are measured as well as plant community activities

### Results and Discussion

The landfill cover research currently being conducted at MCBH is an innovative approach to isolating waste in an environment where the surface processes of evaporation and transpiration are not sufficient to prevent significant drainage. Monitoring indicates that, over the first 1.5 years of monitoring, the plots with surface infiltration control generated 2 to 2.5 times more surface runoff than the soil design. The 20 percent cover and the 40 percent cover designs were about equally effective in reducing drainage through the tested covers. The status of soil moisture, vegetation phenology, and duration and intensity of rainfall events determined quantity of runoff.

## Site 12: Reedsburg, Wisconsin (Grede Foundries)

The use of waste foundry sands as the resistive barrier in a cover design has been investigated by the Grede Foundries of Reedsburg, WI. The foundry, which owns and operates a landfill, produces the sands as a waste product. Foundry sand consists of uniform fine sand with about 10 percent sodium bentonite. Compacted, the sands can easily achieve a saturated hydraulic conductivity of less than  $10^{-7}$  cm/sec. In cooperation with the Wisconsin Department of Natural Resources, five cover designs were tested to determine the performance of clay and foundry sand layers with regard to leachate production and desiccation cracking.

### Point of Contact

Jeff Havlena  
 Senior Hydrogeologist  
 Vierbicher Associates, Inc.  
 6200 Mineral Point Rd.  
 Madison, WI 53705  
 608 233-5800  
 JHAV@vierbicher.com

### Climate Factors

Precipitation and temperature figures for this report are taken from Madison Airport. All months of the year receive significant precipitation at Madison. Reedsburg, Wisconsin receives an average of 78.7

cm precipitation per year, which falls mainly in the months of April-September. Average monthly values of precipitation range from 2.8 cm to 9.9 cm. Extreme single-day events have recorded as

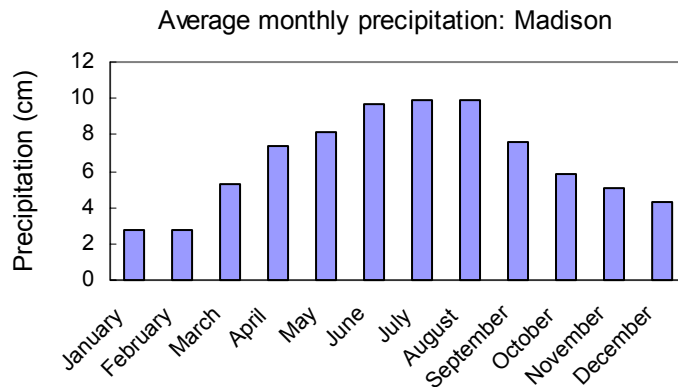

much as 9.9 cm of rain. Snowfall is common during the winter months, and an average total snowfall per year is 107 cm, which accounts for 14% of average annual precipitation. Reedsburg experiences cool temperatures, with an annual mean of 7.8°C. Monthly mean temperatures range from -8.3°C to 22.2°C, extreme recorded temperatures are a low of -38.3°C and a high of 40.0°C.

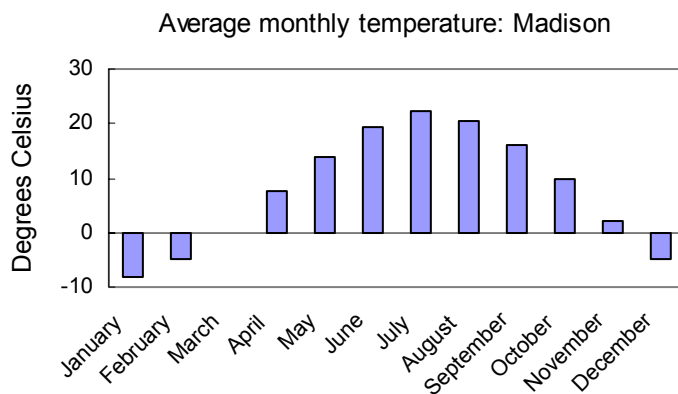

## FACILITY DESCRIPTION

Landfill cover research at the Grede Foundries was conducted in pan-type lysimeters. The drainage lysimeters were formed by placing a gravel drainage layer over a PVC geomembrane (Freber, 1996). Soil moisture and meteorological data were not collected at the site. Drainage was diverted to collection manholes and pumped out for measurement.

### Experimental Design

Five cover designs were tested in the Grede Foundries study (Benson 1997). The previously permitted cover design consisted of 15 cm vegetated topsoil over 60 cm compacted clay (saturated hydraulic conductivity of less than  $10^{-7}$  cm/sec. The cover design required at the outset of the study consisted of (from top) 15 cm topsoil, 90 cm uncompact native soil, and 60 cm compacted clay. The first alternative was identical to the previous design except that the 90cm of native soil was replaced with 90 cm of uncompact foundry sand. The second alternative design is identical to the first alternative except the 60 cm layer of compacted clay was replaced with 90 cm of compacted foundry sand. The third alternative consisted of (from top) 15 cm topsoil, 240 cm uncompact foundry sand, and 150 cm compacted foundry sand.

Each of the cover designs was evaluated with two different vegetation communities.

### Cover Designs Tested at Grede Foundries

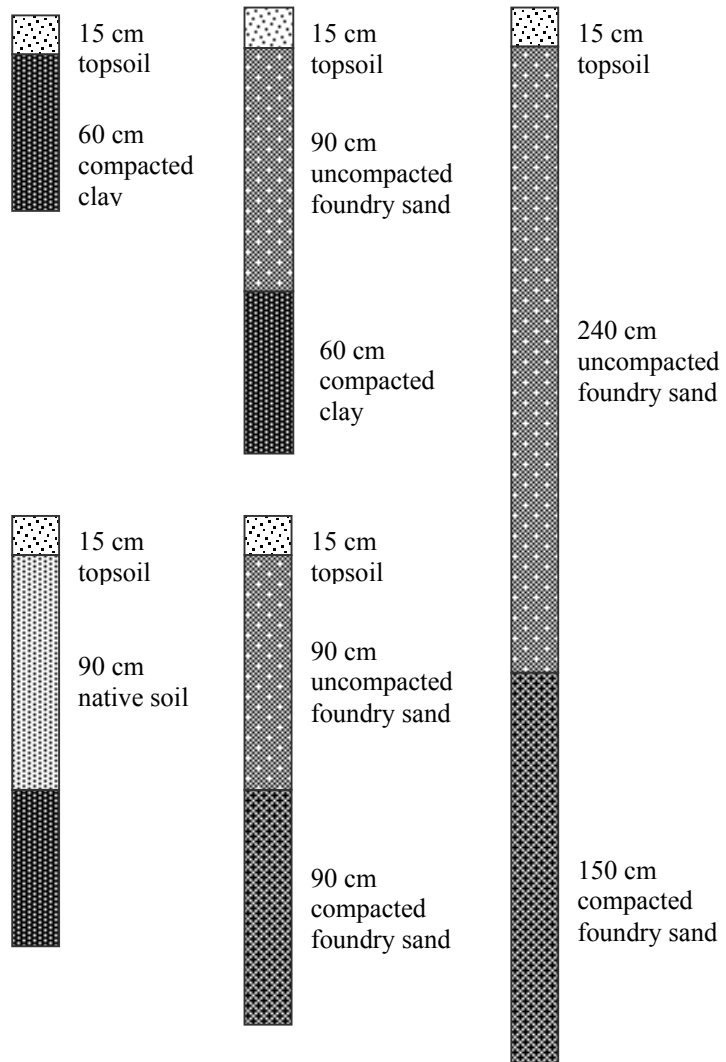

### Results and Discussion

The test sections at the Grede Foundries site have been monitored since 1992. Benson (1997) discussed the results of four years of monitoring data. The different vegetation schemes had no discernible effect on the amount of percolation produced by the various cover designs. When summarized as average annual percolation figures, these data indicate that the covers constructed with clay barriers produced approximately two orders of magnitude more leachate than covers constructed with foundry sand. Within the covers constructed with foundry sand, similar performance was noted.



### Site 13: San Bernardino County, California

San Bernardino County, California, has established cover testing facilities at two county-owned landfill sites. The Phelan Landfill is located in the town of Phelan in the Mojave Desert. The Milliken Landfill is located in the city of Ontario and experiences a somewhat wetter climate than Phelan. Monofill-design covers have been constructed at both sites. Performance monitoring includes drainage lysimeters at both sites.

#### Point of contact

Mr. Gary L. Lass  
GeoLogic Associates  
1360 Valley Vista Dr., Suite 100  
Diamond Bar, CA 91765  
909 860-3448  
garylass@geo-logic.com

#### Climate factors

Climate data for the Phelan site are taken from the Victorville, California, airport, approximately 30 km to the northeast.

Average annual precipitation at Victorville was approximately 14.1 cm for the 50-year period from 1948 to 1998 and comes

primarily as rain during the months of November through March. Extreme precipitation events at Victorville have resulted in over 7.6 cm of rain in a single 24-hour period. Occasional snowfall occurs at Victorville and once reached a depth of 96.5 cm.

Average monthly precipitation: Victorville

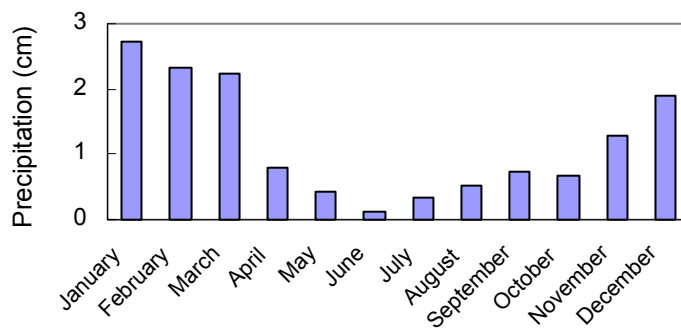

Average monthly temperature: Victorville

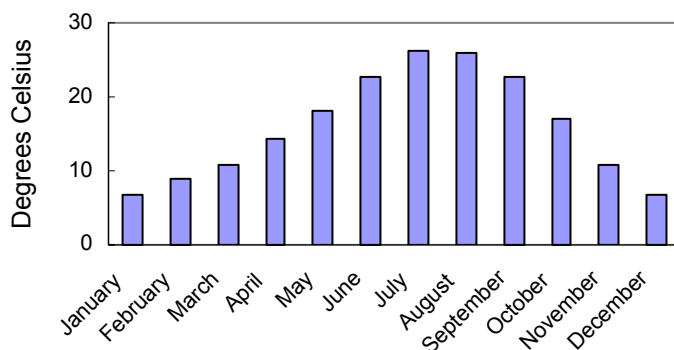

Victorville experiences hot, dry summer and moderate winter temperatures. Mean annual temperature is 15.9°C with monthly mean temperatures ranging from 6.7°C in January to 26.3°C in July. Extreme temperatures have reached 45.0°C and -18.3°C.

Climate data for the Milliken site are taken from California State Polytechnic University at Pomona, approximately 10 km to the west.

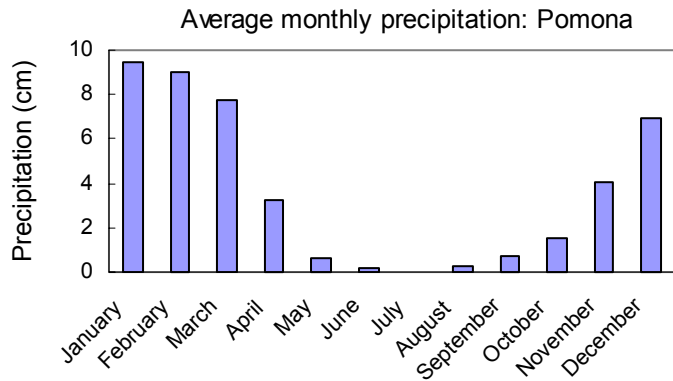

Average annual precipitation at Pomona was approximately 43.8 cm for the 68-year period from 1927 to 1995 and comes primarily as rain between the months of December and March. Extreme precipitation events at Pomona have resulted in over 21.6 cm of rain in a single 24-hour period. Snowfall has been recorded twice at Pomona and has not exceeded 1 cm in depth.

Pomona experiences the moderate temperatures typical of the southern California coastal plain. Mean annual temperature is 16.9°C with monthly mean temperatures ranging from 11.1°C in January to 23.5°C in August. Extreme temperatures have reached 45.0°C and -6.1°C.

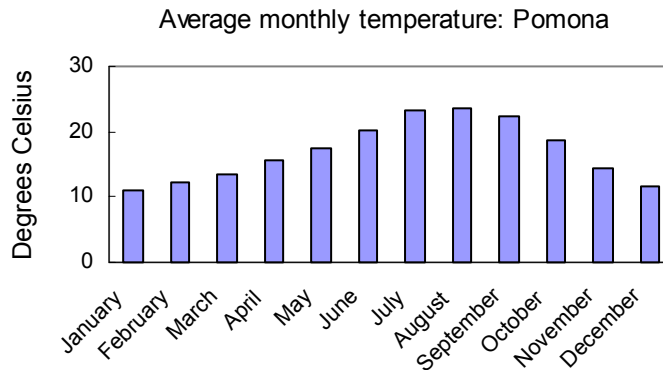

## Facility description

The performance monitoring efforts at Milliken and Phelan consist of several soil moisture monitoring stations in addition to lysimeters for drainage collection. This report will focus on the lysimeters. At both sites, the lysimeters are 0.9 m wide by 15.25 m long. A 40-mil HDPE geomembrane forms the impermeable layer and is overlain with two layers of geo-grid for drainage, and a geotextile. Drainage out of the lysimeters is measured with a tipping bucket gauge with a resolution of 0.025 cm. Each of the San Bernardino County sites have four separate lysimeters located on different portions of the landfill cover. Each lysimeter includes a soil moisture monitoring station consisting of a stack of eight soil moisture capacitance probes. Each site includes three weather stations, which provide a record of air temperature, relative humidity, solar radiation, rainfall and wind speed.

## Experimental design

Both of the San Bernardino landfill sites use a monofill-type design. At Milliken the final cover consists of 1.52 m of soil placed over an existing 0.3-m interim cover. The soils used for the final cover were excavated from nearby and on-site borrow sources and are silty sands. Revegetation of the Milliken site used three seed mixtures: (1) a grass mixture (*Aristida purpurea*, *Vulpia microstachys*, *Hordeum californicum*, *Nassella cernua*, *Elymus multisetus*, *Bromus carinatus*, *Trifolium gracilentum*, and *Lepidium nitidum*), (2) an *Artemisia* mixture (*Artemisia californica*, *Salvia mellifera*, *Salvia apiana*, *Eriogonum fasciculatum*, *Lotus scoparius*, *Vulpia microstachys*, *Hemizonia*

## San Bernardino County lysimeter facility

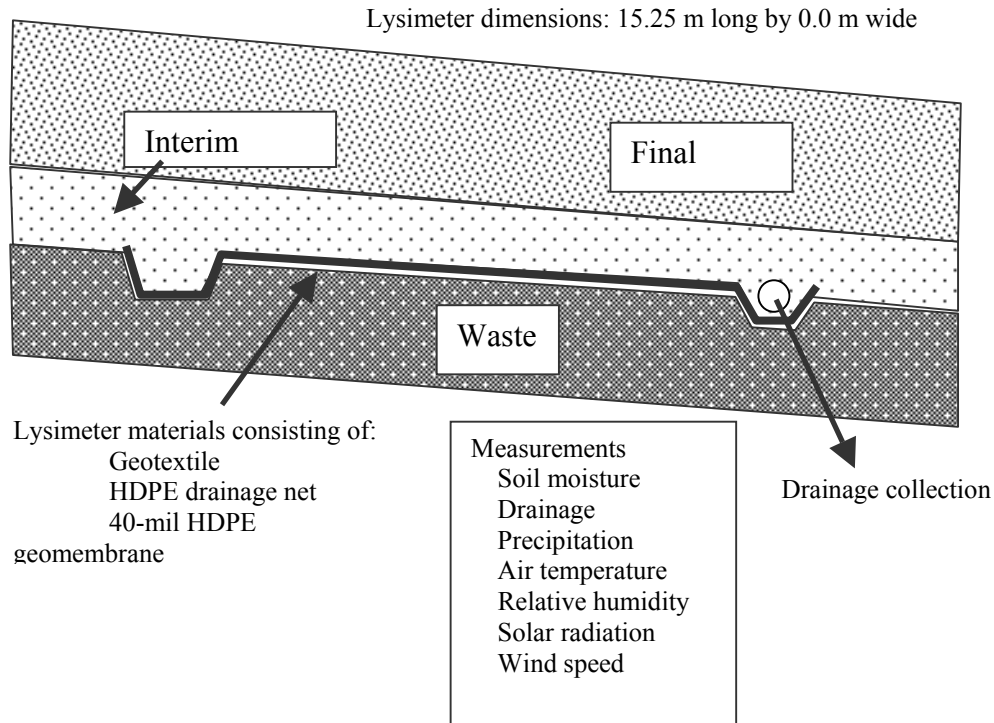

fasciculatum, Lotus purshianus, Ericameria linearifolia), and (3) an Eriogonum mixture (Vulpia microstachys, Eriogonum fasciculatum, Lotus scoparius, Artemisia californica, Encelia californica, Hazardia squarrosus, Eriophyllum confertiflorum, Camissonia bistorta, Eriogonum densifolium).

The cover design at Phelan also consists of a 1.52-m monofill-type design. The soil is a gravelly sand with silt derived from an on-site borrow source. Eleven percent of the soil passes a #200 sieve and three percent is finer than 5-microns. Laboratory analysis of the soil indicated an average value of saturated hydraulic conductivity of  $1.8 \times 10^{-4}$  cm/sec. Revegetation of the Phelan cover was

accomplished with a mixture of native annual grasses and shrubs consisting of Achnatherum hymenoides, Achnatherum speciosa, Aristida ternipes, Atriplex confertifolia, Atriplex polycarpa, Atriplex canescens, Bromus carinatus, Elymus multisetus, Lasthenia californica, Lupinus bicolor, and Vulpia microstachys.

Cover design tested at the San Bernardino County sites



1.52 m locally-derived soil  
 Milliken: silty sands  
 Phelan: gravelly sands with silt

## Results and discussion

Monitoring of the Milliken and Phelan sites has been performed since December 1996 and February 1998, respectively. Multiple weather and soil moisture monitoring sites at each landfill indicate the presence of distinct environmental zones within each site. Lysimeters at both sites recorded significant drainage during the severe winter of 1997-98. Drainage varied with aspect and

soil depth. During July 1998, both sites started recording minor drainage probably not associated with storms of the previous winter. Site personnel attribute the source of this drainage to waste below the cover.

## Site 14: Sandia National Laboratory, New Mexico

Sandia National Laboratory (SNL) is located just outside Albuquerque, New Mexico on Kirtland Air Force Base. SNL is the site of the DOE effort to demonstrate the construction, cost, and performance of alternative landfill covers for arid and semi-arid environments. The overall purpose of the Alternative Landfill Cover Demonstration (ALCD) at SNL is to develop and demonstrate the tools necessary for the design and evaluation of alternative cover designs. Landfill cover research at SNL has been conducted using water balance lysimeters for testing multiple cover designs. Design criteria for the alternative covers tested at SNL include cost, effectiveness at preventing drainage, and ease and reliability of construction.

### Point of Contact

Steve Dwyer  
Sandia National  
Laboratories  
P.O. Box 5800 (MS-0719)  
Albuquerque, NM 87185-  
0719  
505 844-0595  
[sfdwyer@sandia.gov](mailto:sfdwyer@sandia.gov)

### Climate Factors

Average annual precipitation at Albuquerque is approximately 22.1 cm for the 84-year period 1914 to 1998.

Precipitation is greatest during the summer months when convective systems result in thunderstorms. Average monthly values of precipitation range from 1.0 cm to 3.8 cm. Extreme single-day events have recorded as much as 4.9 cm of rain. Some snowfall does occur during the winter months, and an average total snowfall per year is 25.9 cm, which accounts for 12% of average annual precipitation.

Average monthly precipitation: Albuquerque

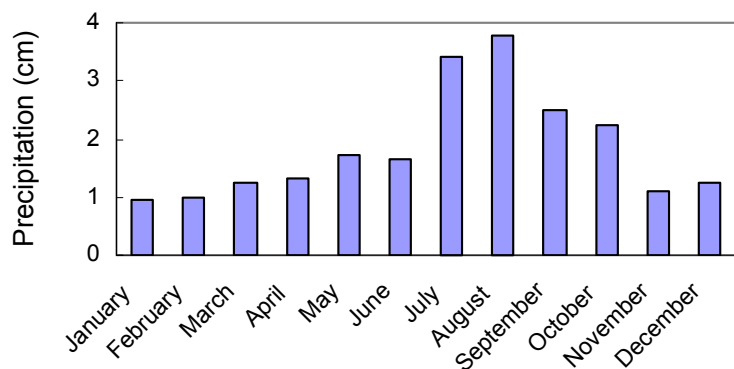

Average monthly temperature: Albuquerque

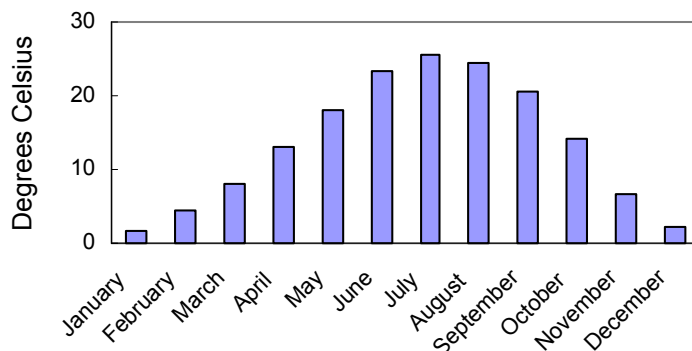

Sandia experiences warm temperatures, with an annual mean of 13.6°C. Monthly mean temperatures range from 1.7°C to 25.6°C, extreme recorded temperatures are a low of -27.2°C and a high of 41.7°C.

### Facility Description

Landfill cover research at SNL is being conducted in large pan-type lysimeters (Dwyer, 1997). Six different cover designs are being evaluated in test plots that are 13 m long by 100 m wide. The size approximates the typical size of hazardous and radioactive waste facilities at DOE facilities. The surface of each test plot is crowned in the middle with a 5% slope extending to each end. The crowned middle of each plot separates ambient precipitation from irrigated treatments. In addition to

the six large lysimeters, SNL is evaluating the performance of a number of surface treatments in a total of 24 lysimeters that measure 10 m by 10 m.

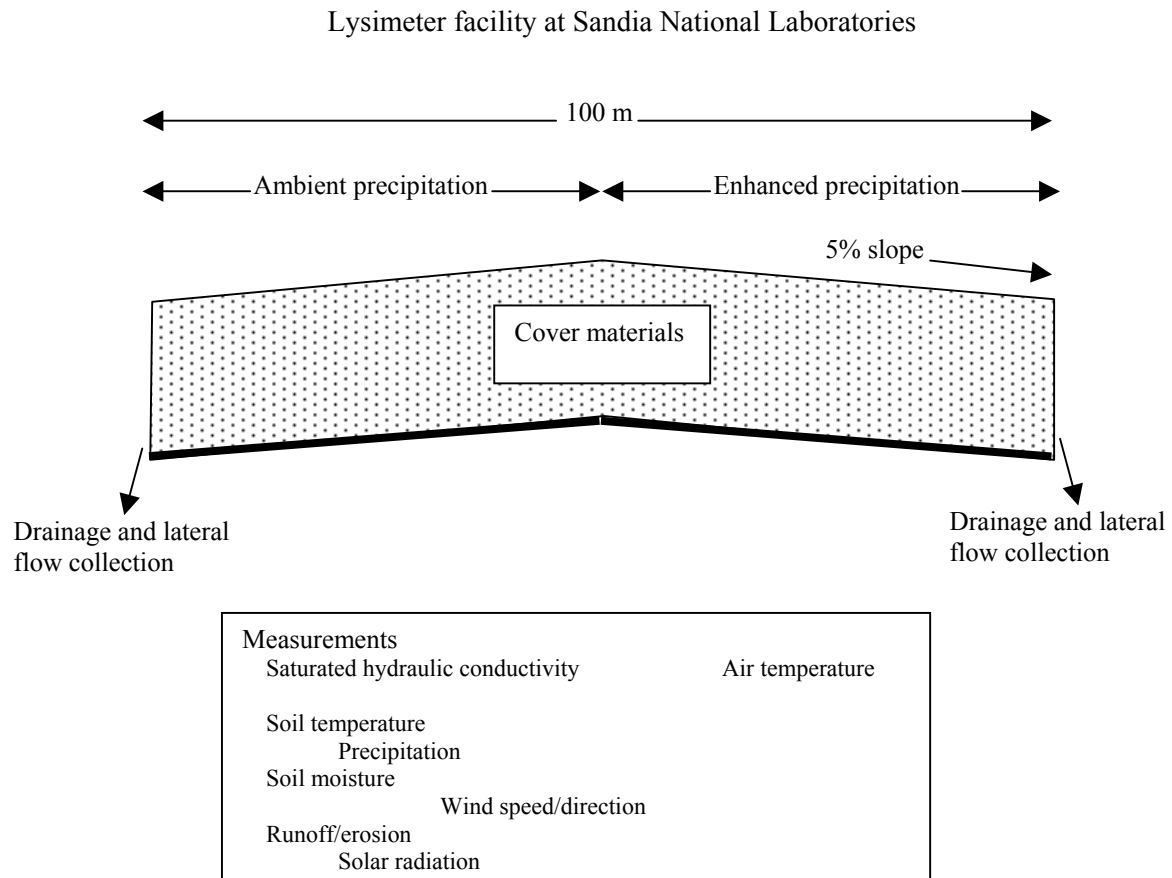

Lysimeters at SNL are constructed in excavated trenches with a geonet placed over a geomembrane to allow for capture of drainage.

The six large lysimeters are instrumented for measurement of surface and sub-surface flows, soil moisture status meteorological parameters and vegetation activities. Soil moisture is measured with TDR probes. Thermocouples are used to measure soil temperature. Surface flows are collected by a gutter system at the bottom of each slope. Sediment is collected in a settling tank and measured. Lateral flows from drainage layers and percolation through the covers is collected by an underdrain system. Measured meteorological parameters include air temperature, precipitation, wind speed, wind direction, relative humidity, and solar radiation. Plant community activities are measured seasonally with use of a point frame. Biomass is measured by clipping, drying, and weighing. Line transects or quadrates are used to measure species composition.

### Experimental Design

The lysimeter facility at SLN provides a direct comparison of multiple covers designed for use in arid and semi-arid environments. Tested designs include a RCRA “D” cover, a RCRA “C” cover, along with four alternative cover designs. The alternative designs include a geosynthetic clay liner (GCL) cover, a capillary barrier cover, an anisotropic barrier cover, and an evapotranspiration soil cover.

The RCRA “D” cover was tested as a baseline design that meets the minimum requirements for sanitary landfills. The tested cover consists of two layers of soil excavated from the test site. A 0.15-m surface layer of topsoil was placed over 0.45 m of compacted native soil. The native soil layer had an in-situ value of saturated hydraulic conductivity of  $4.9 \times 10^{-7}$  cm/sec as measured with a double-ring infiltrometer.

The RCRA “C” cover tested at SNL was designed to meet the minimum requirements for hazardous and mixed waste landfills. The tested cover consisted of three soil layers and two geotextile layers. The bottom 0.6 m consisted of native material amended with sodium bentonite to an in-situ value of saturated hydraulic conductivity of  $7.9 \times 10^{-7}$  cm/sec. This value does not meet the acceptable value of  $1 \times 10^{-7}$  cm/sec required by regulation. The shortcoming was attributed to desiccation cracking. The compacted soil layer was covered with a 40-mil low-density polyethylene geomembrane. Over the geomembrane was placed 0.3 m sand drainage layer covered in turn by a non-woven polyester needle-punched geotextile. The geotextile served to prevent downward migration of the 0.6-m surface layer, which consisted of 0.45 m native fill covered by 0.15 m topsoil.

SNL Alternative Cover I resembles the RCRA “C” design with a GCL used to replace the compacted clay barrier. The GCL was placed under a 40-mil low density polyethylene geomembrane. A 0.3-m sand drainage layer was separated from the overlying 0.6-m surface soil layer by a non-woven polyester needle-punched geotextile. The listed value of saturated hydraulic conductivity for the GCL was  $5 \times 10^{-9}$  cm/sec.

SNL Alternative Cover II is a capillary barrier design consisting of four layers. The capillary barrier was formed by covering 0.3 m of sand with 0.45 m of compacted native soil. A drainage layer was placed over the compacted soil and consisted of 0.22 m pea gravel under 0.15 m sand. The top layer of this design was 0.3 m of topsoil.

SNL Alternative Cover III is an anisotropic barrier design. In this design, lateral movement of water is encouraged by soil layers of different properties and degrees of compaction. This cover consists of four layers starting at the bottom with 0.15 m pea gravel under 0.15 m fine sand. The sand is covered with 0.6 m of moderately compacted native soil. The surface soil consists of 0.15 m topsoil admixed with 25% (by weight) pea gravel.

SNL Alternative Cover IV is an evapotranspiration (ET)-type cover design. The monofil-type design consists of a single, thick, vegetated soil layer. In this design, 0.75 m compacted native soil was covered with 0.15 m topsoil.

The surface of the tested covers was drill seeded with a seed mix used by the New Mexico Highway Department for roadside use.

## **Results and Discussion**

Monitoring at the SNL lysimeter facility began in May 1997. Results of the first year of monitoring were published in September 1998 (Dwyer 1998). The soil profiles in a tested cover require significant time to accurately reflect the influences of the variables of climate and plant activities, therefore, these first-year data should probably be viewed as a qualitative, rather than quantitative, measure of the covers at SNL. Percolation was recorded at all of the tested covers. The RCRA “D” cover leaked the most water followed by (in order) the capillary barrier cover, the GCL cover, the ET cover, the anisotropic cover, and the RCRA “C” cover. The ET cover, the anisotropic barrier cover, and the RCRA “C” cover have, to date, performed well.

Monitoring at the SNL facility is expected to continue for five years.

## Cover designs tested at the SNL lysimeter facility

### RCRA "D" Cover

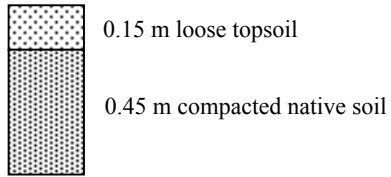

### RCRA "C" Cover

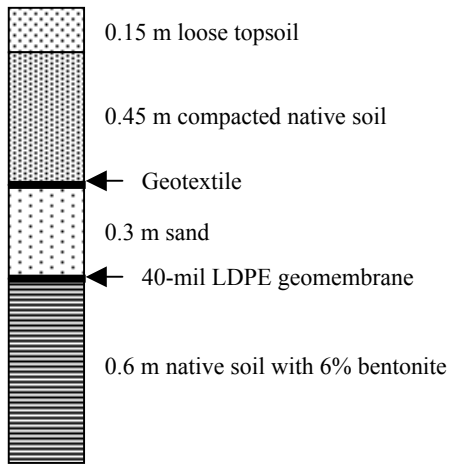

### Anisotropic Barrier Cover

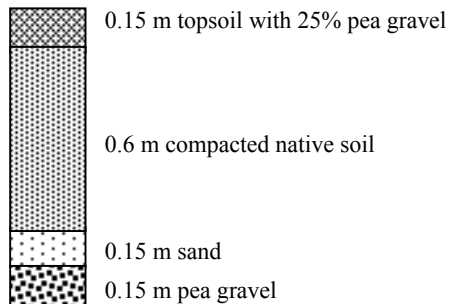

### Evapotranspiration Cover

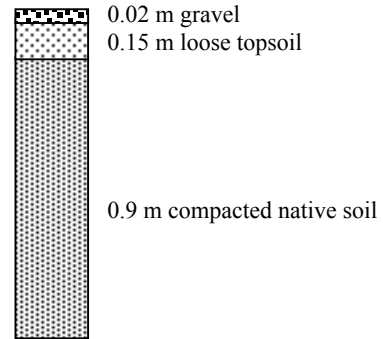

### GCL Cover

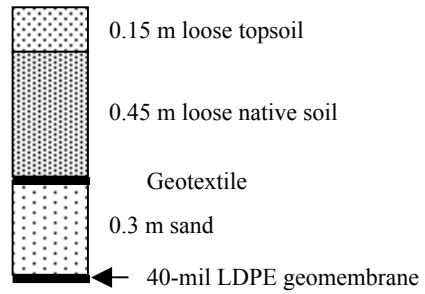

### Capillary Barrier Cover

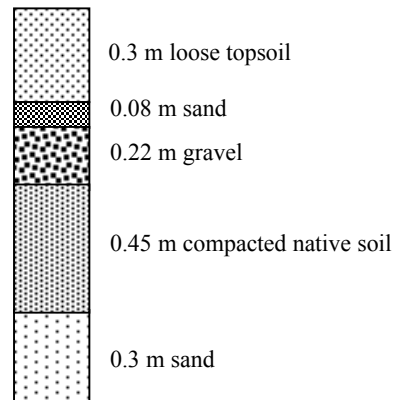



## Site 15: Savannah River, South Carolina

The DOE Savannah River Site (SRS) occupies approximately 800 km<sup>2</sup> in south central South Carolina near the town of Aiken. The site is adjacent to the Savannah River and ranges in elevation from 76 m to 198 m. Defense-related activities for over 40 years have resulted in the production of a variety of hazardous, low-level radioactive, and nonhazardous nonradioactive wastes (Bhutani *et al.*, 1992). Cleanup activities at SRS have identified over 100 sites suspected of containing hazardous materials. Size of the individual sites range from a few square meters to approximately 80 acres. Waste constituents include volatile organic compounds, heavy metals, radionuclides, and nonhazardous building debris and scrap materials. Waste contained in the SRS landfills continues to degrade resulting in a high probability of structural deformation in any cover system.

Cover research at SRS has focused on the development of a cover design that would meet the required hydrologic performance standards in a humid environment with a high probability of subsidence. A composite cover system consisting of geosynthetic barrier materials combined with a variety of soils has been suggested and is currently being tested at SRS.

### Point of Contact

Mike Serrato  
Westinghouse Savannah River Company  
Savannah River Site  
Building 773-42A  
Aiken, SC 29802  
803 725-5200  
michael.serrato@srs.  
gov

### Climate Factors

The Savannah River Site receives an average of 120 cm precipitation per year, which falls evenly distributed throughout the year. Average monthly values of precipitation range from 5.8 cm to 11.4 cm.

Extreme single-day events have recorded as much as 15 cm of rain. Some snowfall does occur during the winter months, and an average total snowfall per year is 2.5 cm, which accounts for < 1% of average annual precipitation. Savannah River experiences warm temperatures, with an annual mean of 18°C. Monthly mean temperatures range from 7.8°C to 27.8°C, extreme recorded temperatures are a low of -18.3°C and a high of 42.2°C.

Average monthly precipitation: Savannah River Site

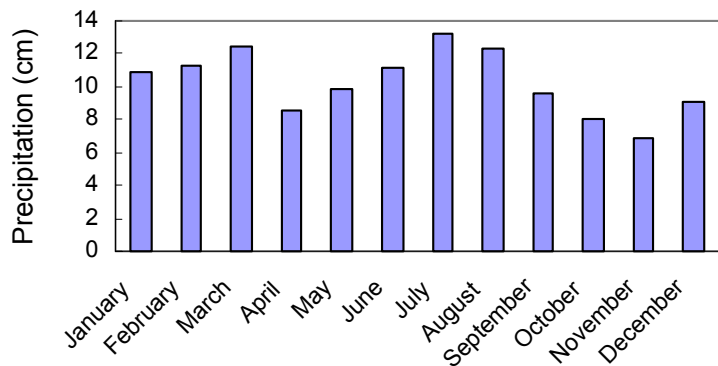

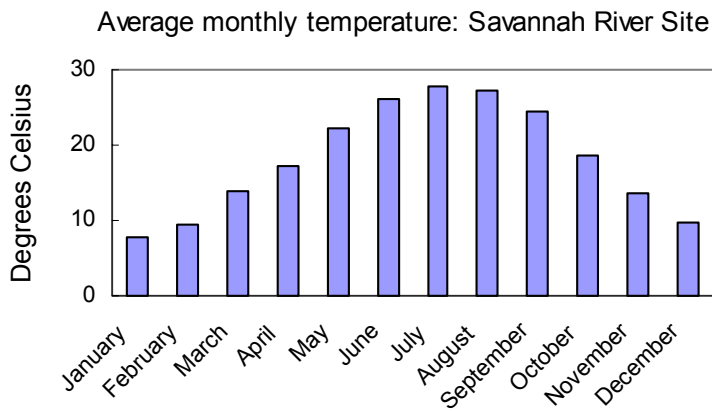

### Plant Parameters

SRS reports indicate that revegetation efforts on landfill operations consist of fertilization and reseeded with grass mixtures recommended by the USDA

Soil Conservation Service.

### Hydrogeology

The SRS lies on the Aiken Plateau portion of the Upper Coastal Plain, approximately 30 km from the transition to the Piedmont Physiographic area. Narrow, steep-sided stream valleys break the interfluvial surface of the Aiken Plateau. The stratigraphic sequence at the SRS consists of fluvial, deltaic, and marine sediments overlying a Precambrian-Paleozoic basement. This sequence forms a system of aquifers and confining layers. Depth to groundwater varies at SRS from less than a meter to approximately 12 m.

### Facility Description

Landfill cover research at the SRS site is being conducted in four test plots configured to allow measurement of hydraulic properties of the tested covers in an in-situ state as well as following induced deformation. One plot served as a control to test the hydraulic properties of a compacted sandy clay soil, while the other three plots included three different GCL products in a cover design otherwise identical to that tested as the control. The test plots are 15.25 m long by 41.5 m wide by 2.4 m deep. The base for the test plots consisted of a loose sand layer that contained a series of access pipes. Evacuation of the sand through the pipes allowed the formation of cavities underlying the cover (Serrato, 1994).

Primary importance was given at SRS to measurements of in-situ values of hydraulic conductivity. Sealed double-ringed infiltrometers were installed for this purpose. In addition, soil moisture status was determined with the use of electrical resistance probes and tensiometers. These instruments were placed immediately above and below the geosynthetic composite layer. Surface surveys, ground-penetrating radar, and horizontal inclinometer probes were used to monitor subsidence and deflection (Serrato, 1994).

## Savannah River Site Test Pad Facility Design

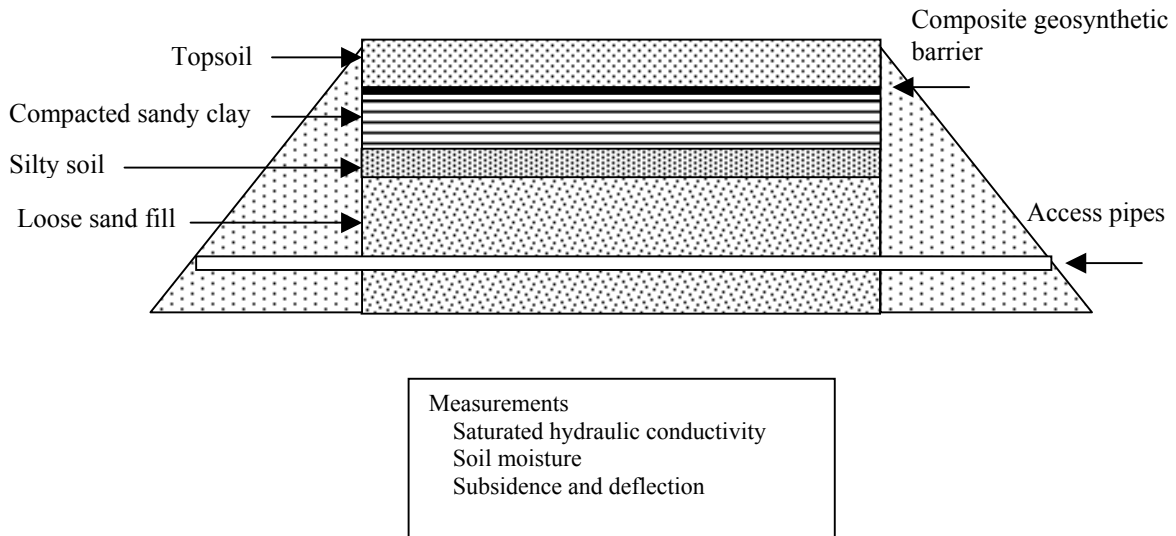

### Experimental Design

The test pad facility at SRS was designed primarily to address issues of hydraulic conductivity before and after induced deformation. The performance of different geosynthetic layers was evaluated in a cover design that included a topsoil layer overlying a sandy clay layer. Each composite geosynthetic layer consisted of a 40-mil HDPE membrane combined with a geosynthetic clay liner (GCL). GCL products from three different manufacturers represented the three geocomposite treatments. Hydraulic conductivity before and after deformation was determined with four instrument stations on each test cover. Instrument stations consisted of sealed double-ring infiltrometers in combination with soil moisture instruments. The soil components of each test pad consisted of (top to bottom): 0.6 m topsoil, 0.6 m compacted sandy clay, 0.3 m silty soil, 1.2 m loose sand. In the cover designs that included the composite geosynthetic layer, these materials were placed between the topsoil and the compacted sandy clay.

### Results and Discussion

Results from the SRS study differ from the other studies reviewed in this document in that structural issues of the cover were of primary importance to the site owner. Much of the final report from the SRS study addresses issues such as the void size each of the covers was able to span prior to collapse. Of interest to hydrologic evaluation of covers was the determination that the sandy clay of the SRS location, compacted with ordinary construction equipment, had a saturated hydraulic conductivity of approximately  $2 \times 10^{-6}$  cm/sec. This value did not meet the EPA recommended value

of  $1 \times 10^{-7}$  cm/sec. In the tests involving the geosynthetic composite component of the cover, it was demonstrated that the cover was capable of spanning a 2-m void without harm to the structural or hydraulic integrity of the cover under both saturated and unsaturated conditions.

Cover design tested at the Savannah River Site Test Pad Facility

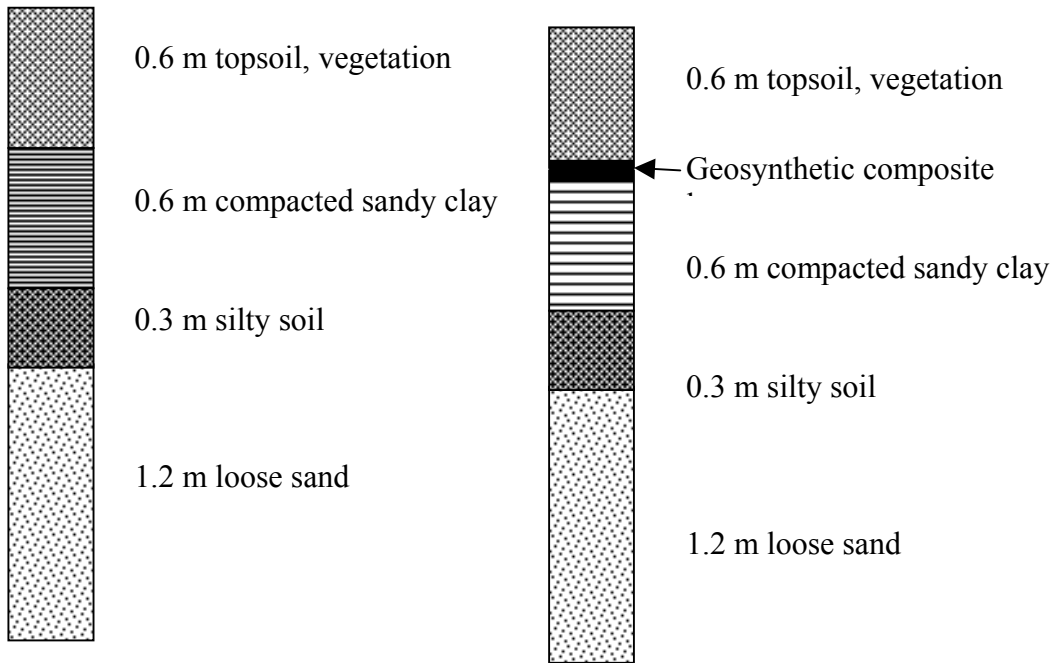

Variable: Induced deformation

## Site 16: Sheffield, Illinois

During the 1960s and 1970s, Sheffield, Illinois, was the site of a low-level radioactive waste disposal facility owned and operated by U.S. Ecology Co. The site received final closure prior to 1980 and is no longer in operation. Landfill cover research was conducted at Sheffield in the early and mid 1980s by the Illinois State Geological Survey for the U.S. Nuclear Regulatory Commission.

### Point of Contact

Ed O'Donnell  
 U.S. Nuclear Regulatory  
 Commission  
 T-9F33  
 Washington, DC 20555  
 301 415-6265

### Climate Factors

Climate details for this report are taken from the weather station at Moline, IL, about 50 km to the west. Sheffield, Illinois receives an average of 94 cm precipitation per year, which falls mainly in the months of March-September.

Average monthly values of precipitation range from 3.6 cm to 12 cm. Extreme single-day events have recorded as much as 15 cm

of rain. Sheffield receives significant snowfall in the winter months, with an average annual total snowfall of 83.8 cm. Snow accounts for 9% of the average annual precipitation. Sheffield experiences moderate temperatures, with an annual mean of 10°C. Monthly mean temperatures range from -6.1°C to 23.9°C, extreme recorded temperatures are a low of -32.8°C and a high of 39.4°C

Average monthly precipitation: Moline

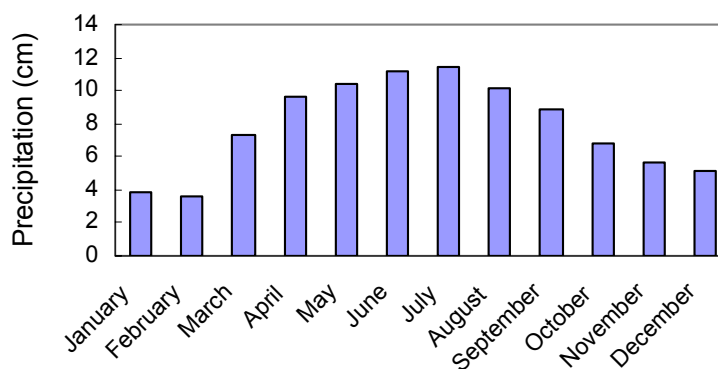

Average monthly temperature: Moline

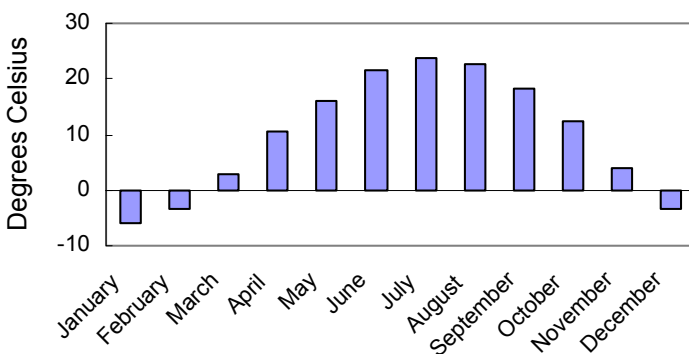

### Facility Design

Landfill cover research at Sheffield has been conducted in four lysimeters located on a 1-ha study site in Bureau County, approximately 250 km north of Champaign, IL. The lysimeters are 6 m wide by 15 m long and are placed in trenches 90 cm deep. The base of each trench slopes 5 percent toward the center and 5 percent along the axis to allow drainage to be collected at one end of the lysimeter. An impermeable barrier at the bottom of the lysimeters is formed by a PVC plastic liner, which is protected above and below by a porous polypropylene geofabric. Perforated drains and a 30-cm-thick layer of pea gravel

provide drainage. Geofabric above the pea gravel maintains separation between the gravel and overlying compacted soil.

Instrumentation of the lysimeters includes tensiometers, soil moisture blocks, neutron moisture probes, and vacuum soil water samplers.

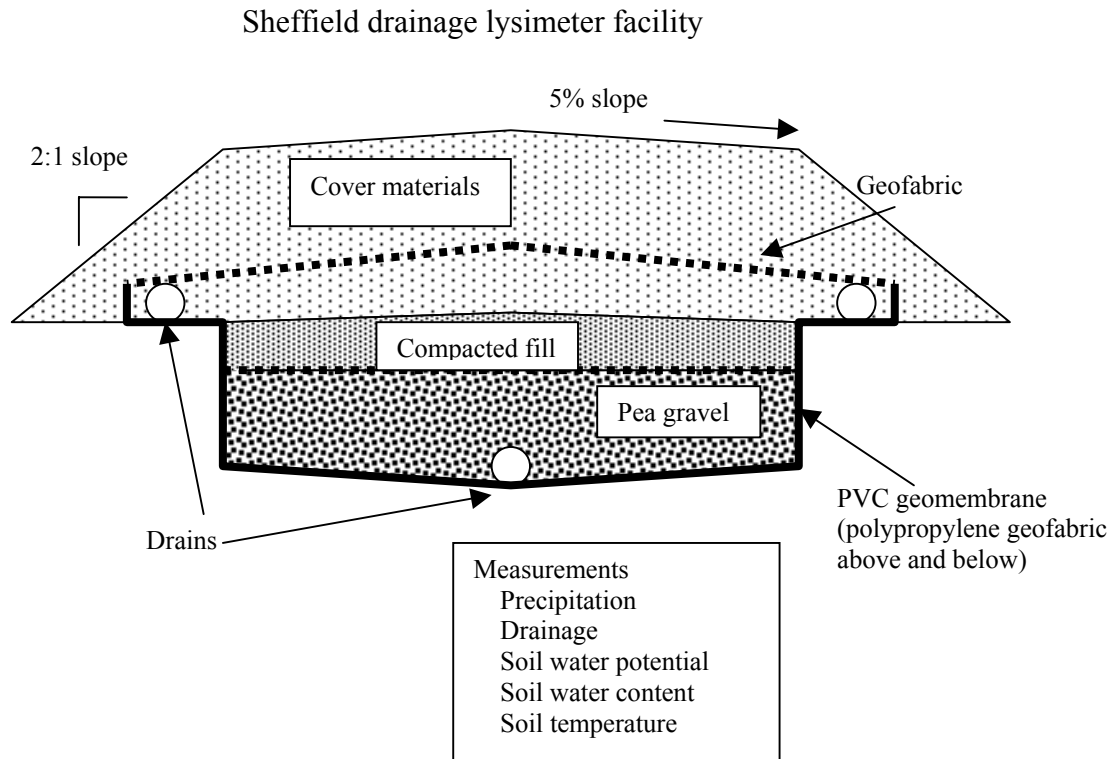

## Experimental Design

Design of the covers utilizes the earthen materials available in the Sheffield area. These materials include Peoria loess, Tiskilwa till and pea gravel in four different design configurations. Each cover is constructed on a base consisting of 30 cm pea gravel for drainage. Geofabric is placed over the pea gravel to separate it from the overlying materials. Cover 1 consists of (from bottom) 60 cm Tiskilwa Till, 60 cm pea gravel, geofabric, 60 cm Tiskilwa Till, and 15 cm topsoil. Cover 2 consists of 60 cm Tiskilwa Till, 60 cm pea gravel, geofabric, 60 cm Peoria loess, and 15 cm topsoil. Cover 3 consists of 60 cm Tiskilwa Till, 30 cm pea gravel, geofabric, 90 cm Peoria loess, and 15 cm topsoil. Cover 4 consists of 60 cm Tiskilwa Till, 1.2 m of compacted Peoria loess, and 15 cm topsoil. All of the layers, including the surface, slope laterally 5 percent from the axis and 5 percent to the north along the length of the cover. All of the covers were seeded with a mixture of grasses including fescue, rye, and timothy. Grasses were chosen for shallow (8-10 cm) rooting depth. Four chemical tracers were applied to the surface of different layers during construction of the covers to allow determination of rates of movement of infiltrating water.

## Results and Discussion

The lysimeters at Sheffield were monitored from construction in the summer of 1983 to the spring of 1986 (Cartwright *et al.*, 1987). During this period, the cover that used compacted Tiskilwa Till as the upper compacted water storage layer outperformed the other three cover designs. Drainage for this cover was estimated to be 0.3 cm per year, or about four percent of the drainage rate for the area. For the covers using loess as the water storage layer, the capillary barrier designs performed better than the design without the capillary barrier. Increasing the thickness of the loess layer resulted in improved performance.

Cover designs tested at the Sheffield lysimeter facility

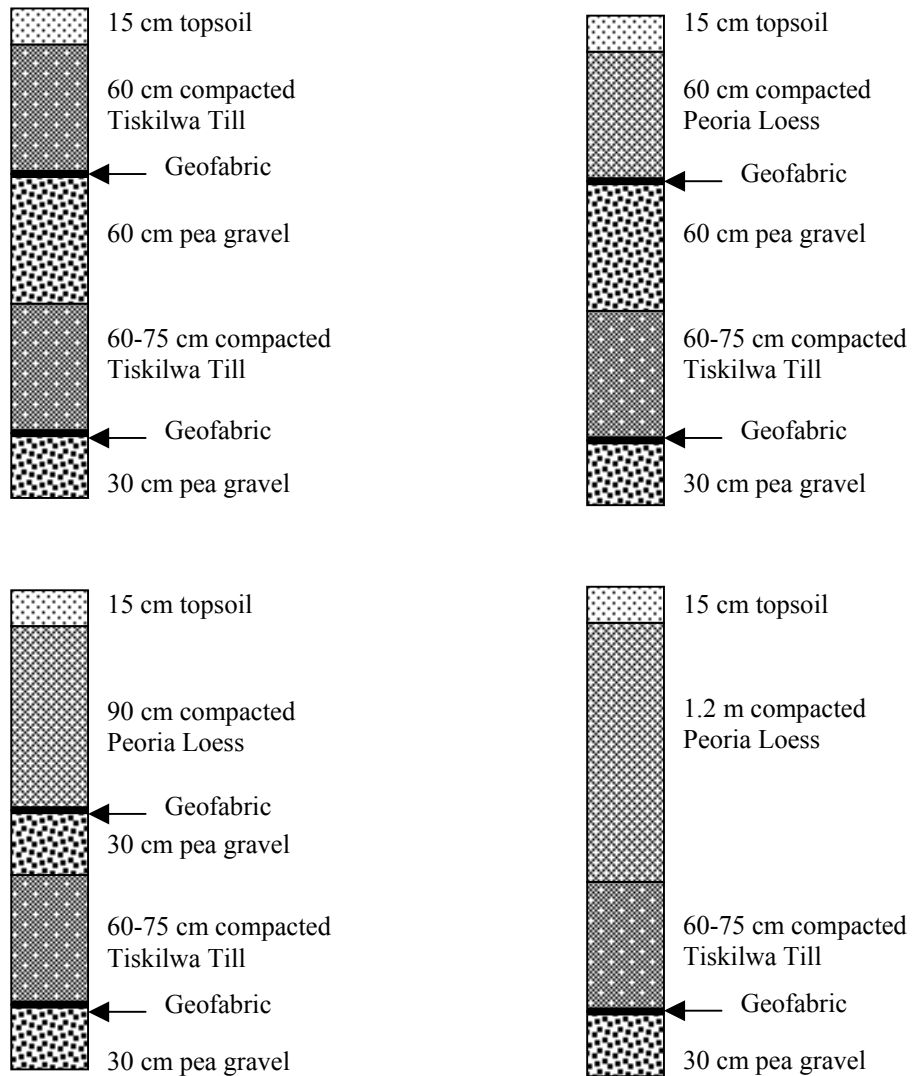

## Site 17: Sierra Blanca, Texas

The Texas Low-Level Radioactive Waste Disposal Authority (TLLRWDA) has established a cover testing facility 10 km east of Sierra Blanca, Texas. Located about 120 km southeast of El Paso, the site is in northwest Eagle Flat basin. Climate of the region can be described as subtropical arid (Scanlon *et al.*, 1997).

The TLLRWDA is currently seeking to license a facility for the disposal of low-level radioactive waste in west Texas. Previous site characterization studies indicate that the Sierra Blanca site is located in a region that experiences very low rates of natural recharge (~1 mm/yr) (Scanlon *et al.*, in press). Current regulations specify that facilities for disposal of radioactive waste must isolate the waste from the accessible environment for 1,000 years. The proposed facility at Sierra Blanca will employ trenches of two sizes: 200 m long x 60 m wide x 11 m deep, and, 140 m long x 34 m wide x 7 m deep. It is anticipated that the two types of trenches will remain open for two and six years, respectively. The waste will be placed in concrete canisters with a design life of 500 years. A prototype engineered barrier has been constructed at the site to evaluate the performance of a proposed final cover. Two drainage-limiting design features will be tested: a capillary-type barrier and an asphalt-based resistive barrier. These designs are being tested at the site as alternatives to traditional clay-rich barriers, which tend to desiccate and crack in arid climates.

### Point of Contact

Dr. Bridget Scanlon  
Bureau of Economic Geology  
University of Texas at Austin  
Univ. Station, Box X  
Austin, TX 78713  
512 471-8241  
bscanlon@begv.utexas.edu

### Climate Factors

Climate data for this report are taken from El Paso. Sierra Blanca, Texas receives an average of 31.7 cm precipitation per year, which falls mainly in the months of July-September. Average monthly values of precipitation range from 0.5 cm to 7 cm. Extreme single-day events have recorded as much as 15 cm of rain. Sierra Blanca receives some snowfall in the winter months, with an average annual total snowfall of 15.2 cm. Snow accounts for 7% of the average annual precipitation. Sierra Blanca experiences warm temperatures, with an annual mean of 17.8°C. Monthly mean temperatures range from 6.7°C to 28.3°C, extreme recorded temperatures are a low of -22°C and a high of 44.4°C.

Average monthly precipitation: El Paso

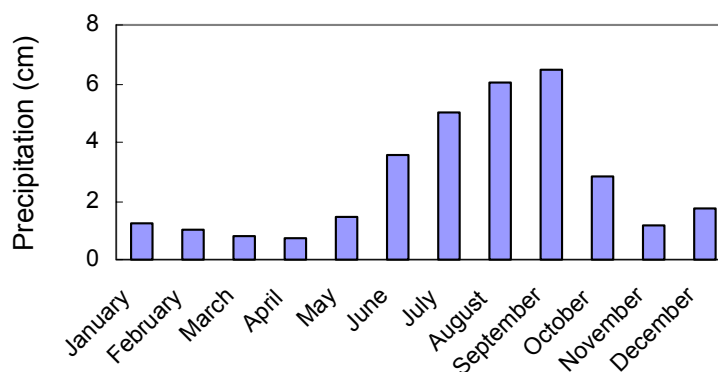

Average monthly temperature: El Paso

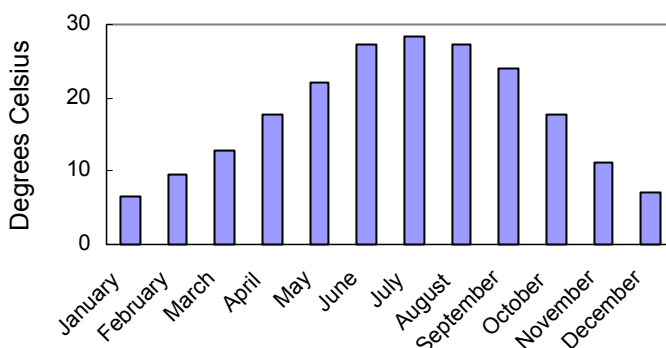



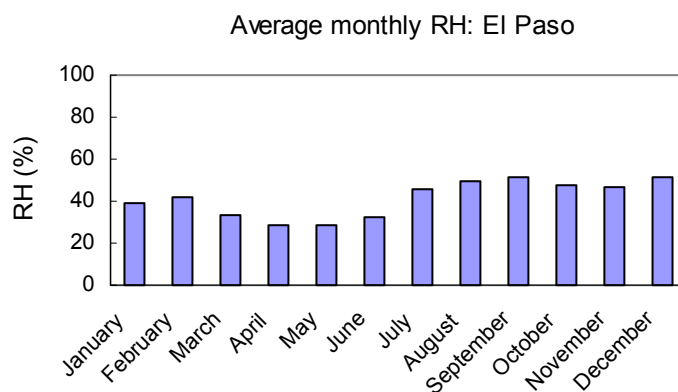

El Paso experiences very hot summers combined with low relative humidity resulting in high values of potential evapotranspiration (PET). PET values for the summer months are much higher than precipitation resulting in low actual values of ET. PET values are not available for the Sierra Blanca area.

## Hydrogeology

The Sierra Blanca site is located in an eolian sand-sheet setting with soils characterized by low water contents. Site characterization detailed 17 soil profiles from 10 m to 25 m in depth with water contents ranging from 7-9% gravimetric. An upward movement of water in the near-surface soils is suggested by a water potential profile that increases with depth. Chloride mass-balance studies indicate the flux of water below 2 m to be about 1 mm yr<sup>-1</sup> (Scanlon *et al.*, in press). Despite several large rainfall events during the site characterization period, neutron probe measurements indicate no flux of water below 0.6 m depth. Groundwater at the site is from 198 to 230 m in depth.

## Plant Parameters

The Sierra Blanca site is located in the Chihuahuan Desert and is characterized as Desert Grassland by the Natural Resource Conservation Service range site descriptions (Schmidt, 1970). Perennial grasses, widely spaced shrubs, and annuals are dominant. Shrubs include mesquite (*Prosopis glandulosa*), yucca (*Yucca elata*), mormon tea (*Ephedra trifurca*), lotebush (*Ziziphus obtusifolia*), and winterfat (*Ceratoides lanata*). Local grasses include black grama (*Bouteloua eriopoda*), blue grama (*Bouteloua gracilis*), sand dropseed (*Sporobolus cryptandrus*), burrograss (*Scleropogon brevifolius*), and threeawns (*Aristida* sp.) (D.B. Wester, Texas Tech. University, 1998, personal communication).

## Facility Description

Landfill cover research at the TLLRWDA site at Sierra Blanca is being conducted in four test plots. The four plots represent a 2 x 2 matrix with the variables being the two cover designs and two precipitation treatments. The tested covers were constructed in a 3-m-deep trench placed over compacted subgrade. A pan lysimeter consisting of a flexible membrane liner was placed below the

cover materials to collect and measure any drainage through the covers. The four test plots are each 15 m square and are separated by a 4-m buffer. In addition to measurement of drainage at the lysimeter perimeter, surface flows and lateral flows within the covers are measured.

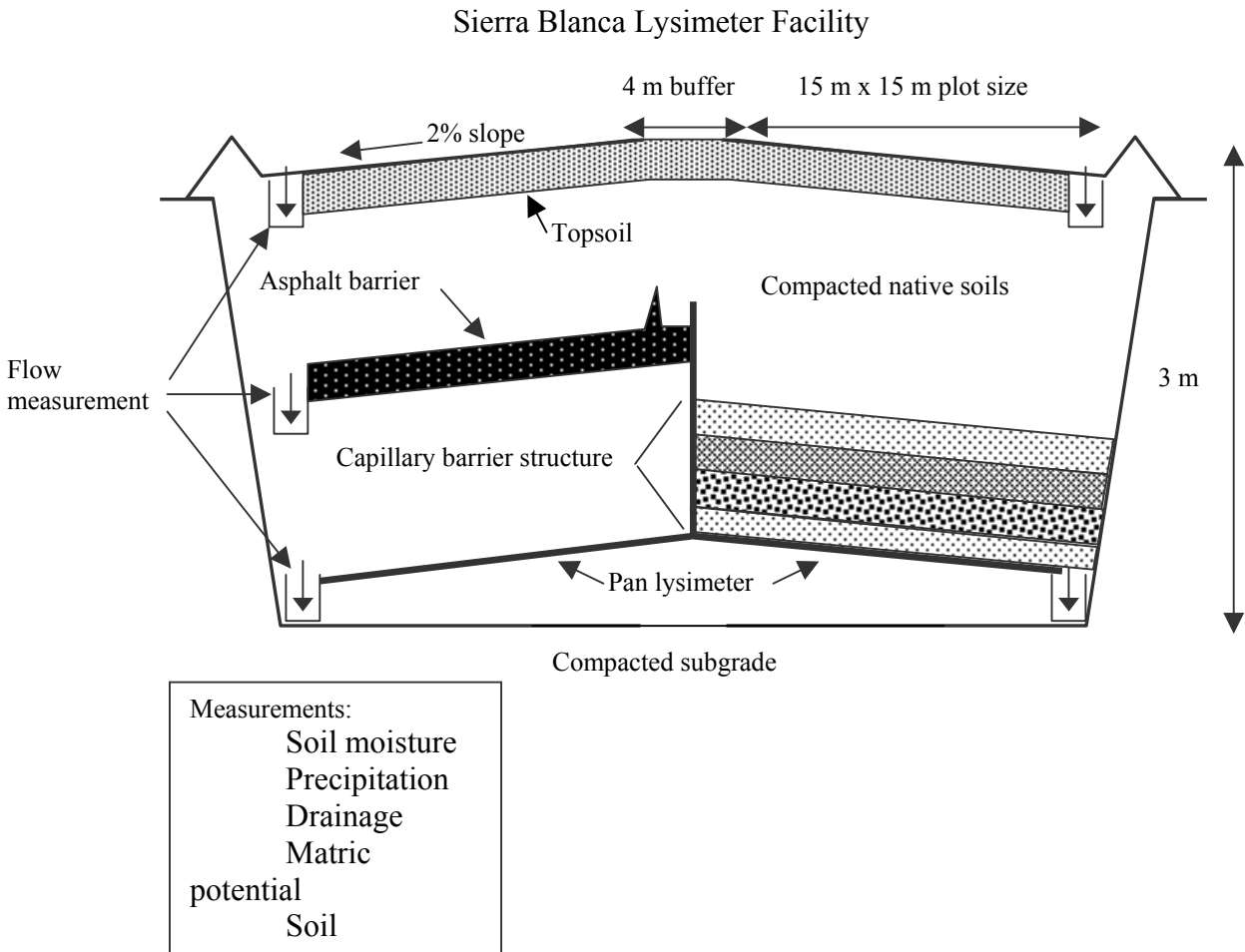

## Instruments

Soil moisture conditions at the Sierra Blanca site are measured by thermocouple psychrometers, heat dissipation, horizontal and vertical neutron probes, and TDR. Soil temperature is monitored by thermistors. Precipitation at each of the four test plots is measured by a rain gauge. Runoff from the plots is drained to a 8.3-m<sup>3</sup> storage tank equipped with a pressure transducer. The pan lysimeter is a sheet of 60-mil polyethylene 10 m x 10 m in size. The lysimeter is inset from the edges of the test plot to prevent the capture of water that did not pass through the 15 m x 15 m cover. Drainage from the lysimeter and lateral drainage from the asphalt barrier is measured by three methods: an infrared drop-counting mechanism, a tipping-bucket rain gauge, and a storage tank with a wire line probe

## Cover Construction

The soils in the test pads were compacted to 90% of the modified Proctor density and 2% wet of optimum. Lifts were about 0.15 m thick and the surface of each was scarified to a depth of 5 cm prior

to placement of the subsequent lift. A smooth roller was used to compact the soils. Where instruments were installed, soils were compacted using a vibratory compactor.

## Experimental Design

The lysimeter facility at Sierra Blanca provides a direct comparison of two cover designs: a resistive barrier and a capillary barrier. Each will be topped with 0.3 m of top soil, vegetated with native grasses with gravel mixed into the top 15-20 cm for erosion control. In the resistive barrier experiment, the topsoil covers 1.0 m of native sediment compacted to achieve a saturated hydraulic conductivity of  $1 \times 10^{-5}$  cm/sec. Below these soils is a geosynthetic clay liner (GCL, bentonite), 5 cm of asphaltic surface, 20 cm of asphaltic concrete and, another 1.5 m of compacted native sediment. In the capillary barrier design, the surface soil covers 1.7 m of compacted native sediments and a sand-gravel filter consisting of 0.3 m sand, 0.3 m gravel, 0.3 m cobble, and 0.15 m sand. The sequence of materials in the filter follows the criteria specified by Cedegren (1989) to prevent migration of the fine material into the coarse material. Ambient and irrigation-enhanced precipitation will be applied to both cover types.

Cover designs tested at the Sierra Blanca Lysimeter Facility

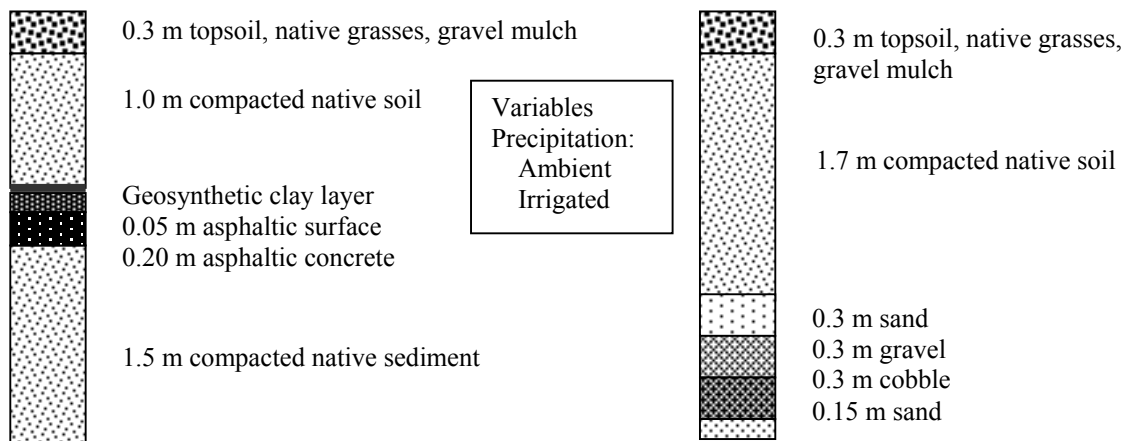

## Results and Discussion

Monitoring of the Sierra Blanca facility began in April 1998. It is anticipated that performance of the tested covers will be monitored for a period of 30 years. The Sierra Blanca site will be an excellent addition to cover research due to the thorough instrumentation, extended period of evaluation, and the testing of multiple cover designs and multiple precipitation treatments.

## Site 18: Twentynine Palms, California

The U. S. Marine Corps Air and Ground Combat Center (MCAGCC) is located in southeastern California near the town of Twentynine Palms. The MCAGCC site occupies approximately 2,419 km<sup>2</sup> and ranges in elevation from 580 m to 1,450 m.

The MCAGCC operates a solid waste landfill facility for disposal of municipal waste. The site is located in an arid upland desert climate with low precipitation and high values for potential evapotranspiration. Since the low-permeability soils required for a prescriptive cover are not locally available, the consulting engineering firm for the site suggested investigation of an alternative cover design for final closure of the landfill (Woodward-Clyde, 1998). The proposed design consisted of approximately 2 m of locally available sandy soils configured as a monofil-type design. The performance of the proposed design was modeled using HELP (U.S. Army Corps of Engineers, 1994). In early 1997, a test pad was constructed on the site of the MCAGCC landfill at an elevation of 670 m to evaluate the field-scale performance of the alternative cover design. Evaluation of the field-scale demonstration is currently in progress.

### Point of Contact

Mr. Clay Longson  
 Officer-in-Charge of Construction  
 Facilities Management Division-Engineering Branch, Bldg. 1130  
 MCAGCC P.O. Box 788106  
 Twentynine Palms, CA  
 92278-8106  
 760 830-7689

### Climate Factors

29 Palms, California receives an average of 10.2 cm precipitation per year, which falls mainly in the months of July-January. Average monthly values of precipitation range from a trace to 1.8 cm. Extreme single-day events have recorded as much as 6.5 cm of rain. 29 Palms receives some snowfall in the winter months, with an average annual total snowfall of 2.54 cm. Snow accounts for 2% of the average annual precipitation. 29 Palms experiences warm temperatures, with an annual mean of 19.5°C. Monthly mean temperatures range from 9.4°C to 31.7°C, extreme recorded temperatures are a low of -9°C and a high of 49°C.

Average monthly precipitation: Twentynine Palms

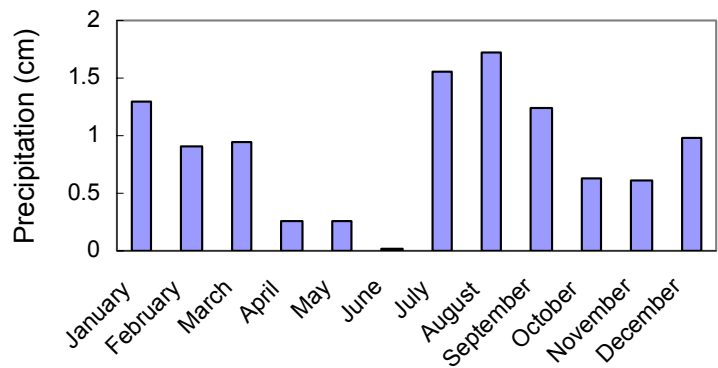

Average monthly RH: Twentynine Palms

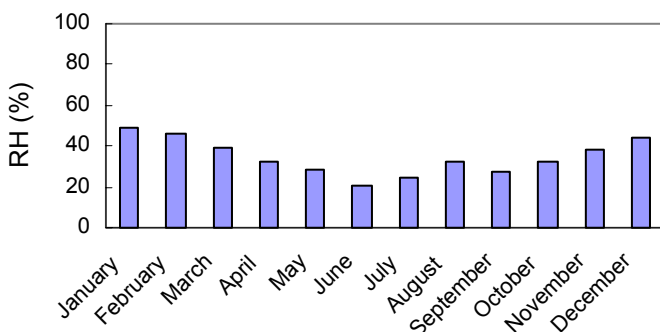

Twentynine Palms experiences very hot summers combined with low relative humidity resulting in high values of potential evapotranspiration (PET). PET values for the summer months are much higher than precipitation resulting in low actual values of ET. PET

values are not available for the Twentynine Palms area.

## Facility Description

Landfill cover research at the Twentynine Palms MCAGCC was initiated with the construction of an alternative cover test pad located at the northern end of the landfill. The alternative cover test pads are 18.25 m wide and extend 91.5 m down the eastern slope of the landfill. Approximately 70 m of the length is located on the upper landfill platform with the other 21 m extending down the easterly side slope. The sloped portion of the test pad will allow for simulation of expected surface flows. The test pad was located on daily cover that was graded and proof-rolled prior to construction. Within the boundary of the test pad, a 5.8 m x 16.1 m area lined with a 40-mil HDPE geomembrane forms a pan-type lysimeter. The geomembrane does not extend to the surface. Rather, the edges of the geomembrane form a 0.16-m-high perimeter berm. A collection pipe extends across the down-slope end of the lysimeter. Drainage collected by the pipe is conveyed to a collection tank adjacent to the lysimeter. Soil instrumentation consists of segmented TDR probes. The probes are arranged in three clusters, each of which includes a shallow and a deep probe. The shallow probe assembly monitors the upper 75 cm in four distinct segments and the deep probe monitors from approximately 60 cm depth to 180 cm in five distinct segments. One TDR cluster is located within the lysimeter perimeter, one outside the perimeter, and one outside the perimeter and on the embankment slope. Additional instrumentation at the test pad includes a tipping bucket rain gauge, solar power supply, and cellular communications equipment.

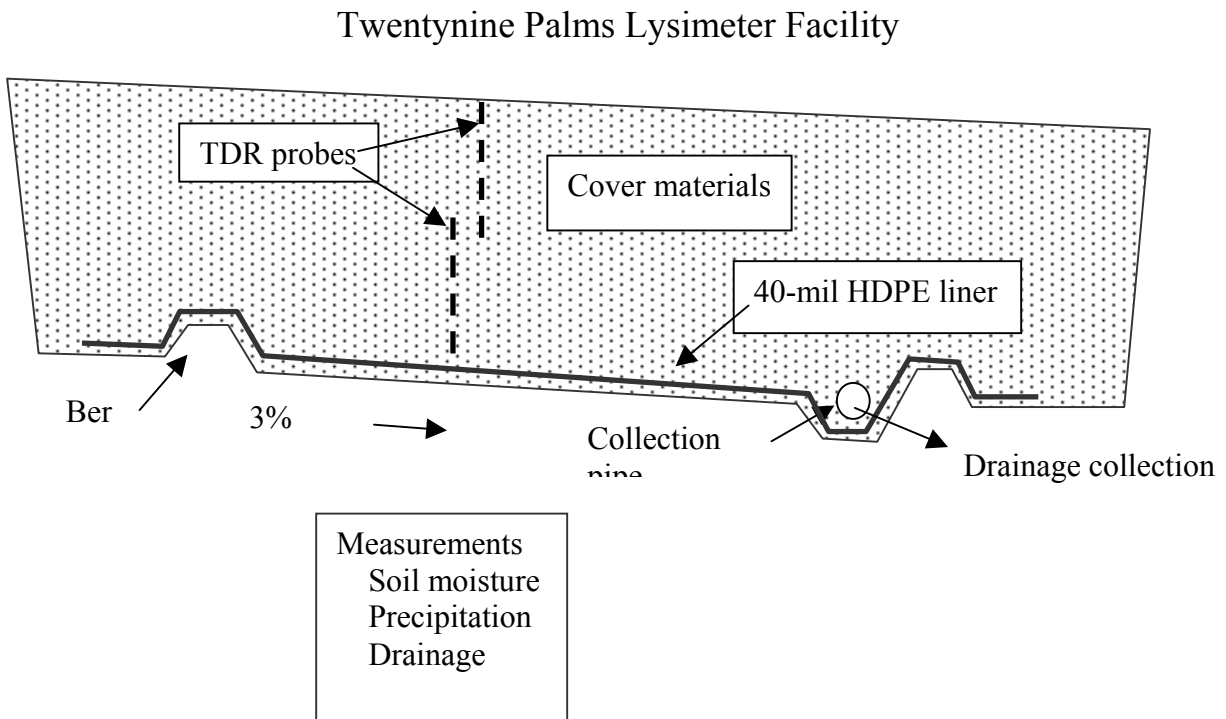

## Cover Construction

The alternative cover test pad was constructed using full-size construction equipment (scrapers, dump trucks, bulldozer). Lift thickness did not exceed 15 cm except for the first lift covering the HDPE membrane, which was placed 60 cm thick to protect the membrane. Some water was added to aid compaction that was achieved with passing loaded scrapers, dump trucks and a bulldozer over the fill.

## Experimental Design

The lysimeter facility at the Twentynine Palms MCAGCC provides a performance evaluation of a monofill-type design applied to a hot desert environment. The absence of locally available fine-grained soils necessitated the use of coarse materials in the cover design. Review of the Woodward-Clyde report indicates that the soils used were poorly graded sand (SP) and poorly graded sand with silt (SP-SM). These soils may not be sufficient to limit drainage in a more humid climate. Preliminary modeling evaluation, however, indicated that these soils, coupled with the low annual precipitation and high values of PET at Twentynine Palms, may prove adequate.

Cover design tested at the Twentynine Palms MCAGCC

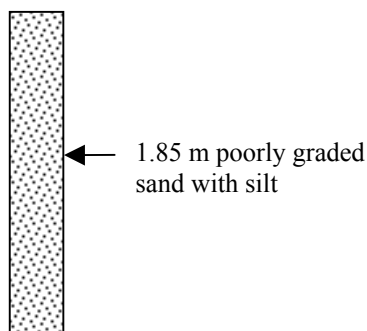

## Results and Discussion

After 14 months of field monitoring, there has been no drainage collected by the lysimeter. Unusual weather conditions have resulted in a number of high-intensity rainfall events including a 3.9-cm event in three hours in September 1997. Increases in soil moisture have been noted to a depth of 30 cm.

The use of coarse-grained materials in a hot, arid environment provides a test of combining the high evapotranspiration rates of an arid environment with a thick, monofil cover design. Engineers at the Twentynine Palms site have provided nearly 2 m of material to meet the expected requirement for water storage within the cover soils. Since monitoring at the site began in the spring of 1997, it is premature to draw conclusions as to the performance of the cover. Reports by Woodward-Clyde do not include mention of re-vegetation efforts or natural re-vegetation. Some evaluation of plant community parameters would add to understanding the performance of the cover.

## Site 19: Wenatchee, Washington

Traditional designs for landfill covers have been termed “resistive barriers” and have relied on the presence of a layer of soil with a low value of hydraulic conductivity to prevent the downward migration of water through the cover. In recent years, covers have been tested that incorporate a sharp discontinuity in pore sizes to limit drainage. This design feature has been termed a “capillary barrier.” The municipal landfill at Wenatchee, Washington has initiated a program to compare the performance of a resistive barrier design to a capillary barrier design.

### Point of Contact

Dr. Craig Benson  
Dept. of Civil and Environmental Engineering  
University of Wisconsin, Madison  
2214 Engineering Hall  
1415 Engineering Dr.  
Madison, WI 53706  
608 262-7242  
chbenson@facstaff.wisc.edu

### Climate Factors

Wenatchee, Washington receives an average of 22.8 cm precipitation per year, which falls mainly in the months of November-February. Average monthly values of precipitation range from 1.0cm to 3.7 cm. Extreme single-day events have recorded as much as 6.9 cm of rain. Wenatchee receives a large amount

Average monthly precipitation: Wenatchee

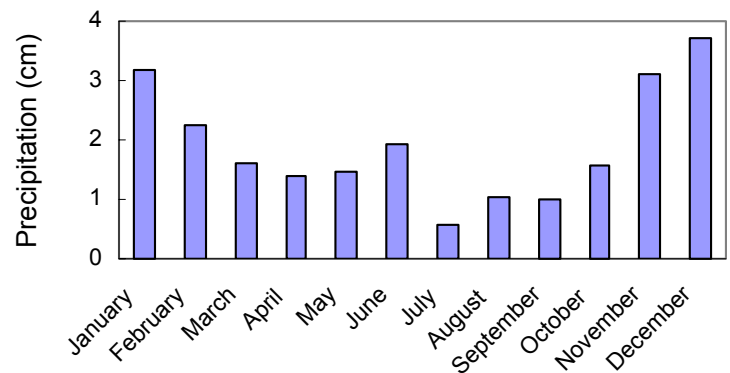

Average monthly temperature: Wenatchee

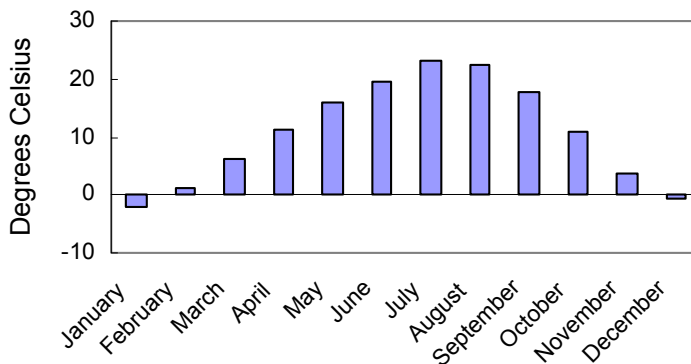

snowfall in the winter months, with an average annual total snowfall of 72.1 cm. Snow accounts for 32% of the average annual precipitation. Wenatchee experiences cool temperatures, with an annual mean of 16.8°C. Monthly mean temperatures range from -2.2°C to 23.2°C, extreme recorded temperatures are a low of -29.3°C and a high of 43.3°C.

## Facility Description

Landfill cover research at Wenatchee is conducted in two large pan-type lysimeters. The lysimeters are 12.2 m wide by 19.3 m long and are located within 30-m-square test sections of the proposed covers. The lysimeters are lined with a 60-mil HDPE geomembrane and a geocomposite drainage layer. Drainage is routed via a 10-cm PVC pipe to a tipping bucket rain gauge for measurement. Surface runoff is collected with diversion berms and routed via a 10-cm PVC pipe to a tipping bucket rain gauge and dosing siphon for measurement. Soil moisture content is measured with TDR probes. Soil temperature is determined with thermocouples. An on-site meteorological station monitors precipitation, air temperature, solar radiation, wind speed, dew point, and relative humidity.

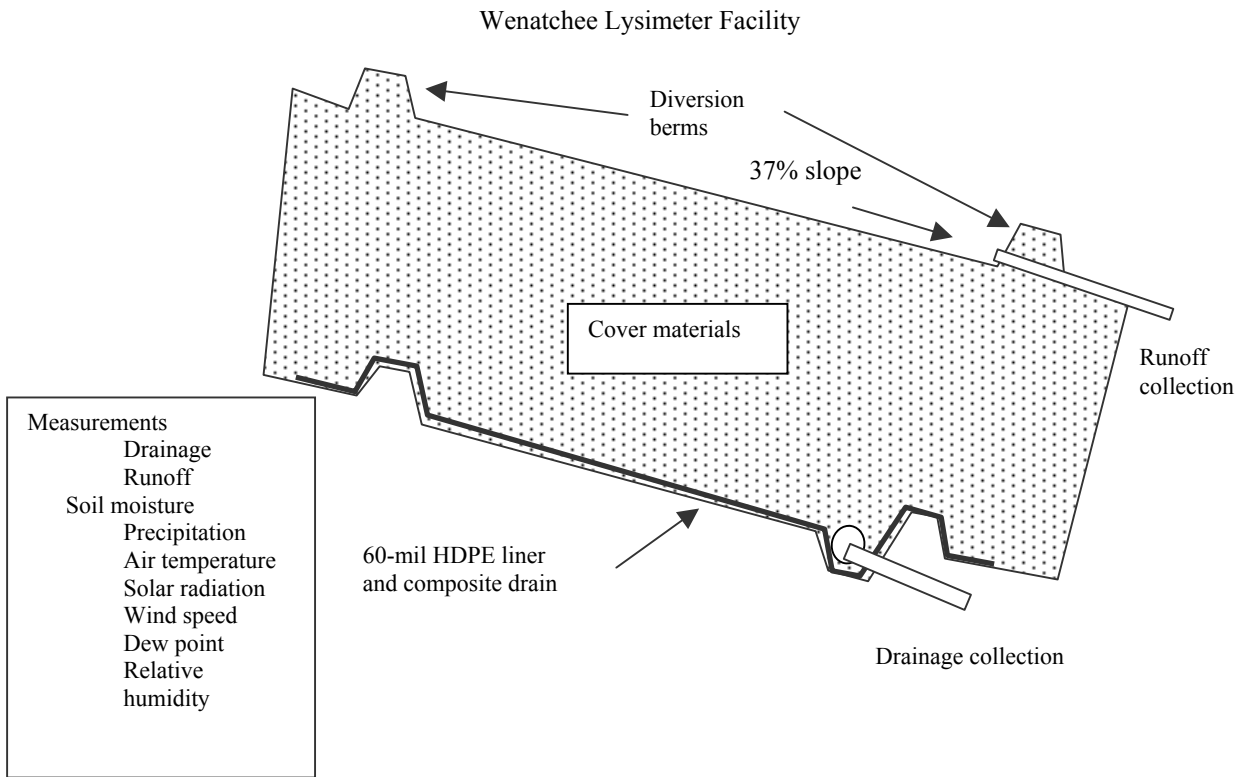

## Experimental Design

The research effort at Wenatchee evaluated two covers. One is essentially a resistive barrier-type design and the other is a capillary barrier design (Khire *et al.*, 1997). The resistive cover consists of (from top) 15 cm uncompacted vegetated silty soil and 60 cm compacted silty clay. Saturated hydraulic conductivity for the surface and subsurface layers was  $4.5 \times 10^{-5}$  cm/sec and  $2.2 \times 10^{-7}$  cm/sec, respectively. The capillary barrier design consists of (from top) 15 cm uncompacted vegetated silty soil and 75 cm of medium uniformly graded sand.



## Cover designs tested at Wenatchee

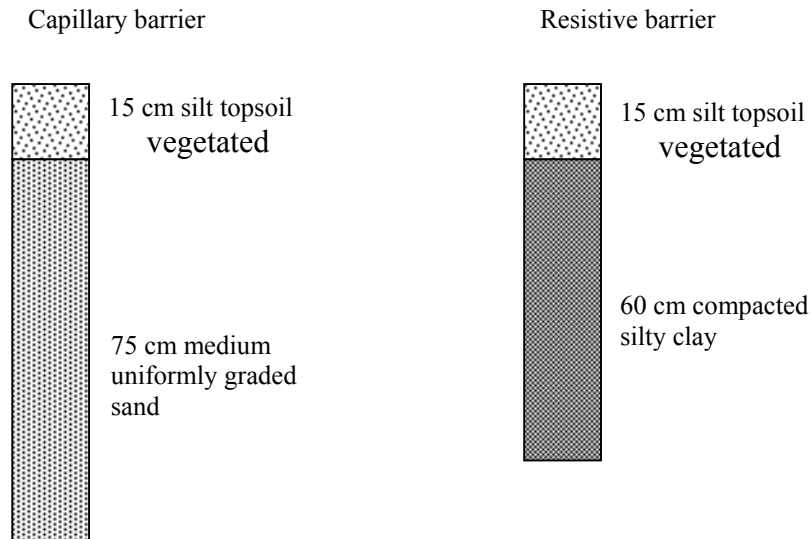

### Results and Discussion

Results following three years of monitoring were reported by Khire *et al.* (1997). The resistive barrier transmitted 3.3 cm of water which amounted to 5.1 percent of precipitation. The capillary barrier transmitted 0.5 cm of water which was equivalent to 0.8 percent of precipitation. Percolation through the resistive barrier increased during the third year of monitoring. This was attributed primarily to desiccation cracking.

## **II.D. Summary of Site Review**

This report briefly describes facilities at 19 sites engaged in testing the performance of landfill covers. The geographical range of the review extends from the east coast to Hawaii. A wide range of climatic conditions are covered, Table 1. Facilities exist in the dry (< 11 cm mean annual precipitation), hot (>16 °C annual mean temperature) conditions of the Nevada Test Site, NV, and Twentynine Palms, CA; and the wet (>120 cm mean annual precipitation), hot (>16 °C mean annual temperature) conditions of Atlanta, GA, Savannah River, SC, and Oahu, HI. Facilities also exist in wet, cold (< 10 °C annual temperature) conditions with high snowfall (> 80 cm annual snowfall) such as Milwaukee, WI and Sheffield, IL; and for relatively dry (<23 cm annual precipitation), cold conditions with high snowfall such as INEEL, ID.

While the climatic conditions may be sufficiently covered, the geological and biological conditions are less represented. The landfill covers tested do cover a wide range of soil textures from coarse-grained materials (NTS, NV), to fine-grained materials (Savanna River, SC;) and loams (Hanford, WA). Given that there are more than 300 groups of soils in the USDA taxonomic scheme with numerous soil types in each, these facilities hardly cover the range in native soils that could be used at a site. Plant species are even more variable than soil types and are only partially represented by these facilities. Given that the function of alternative covers is based upon the synergistic contributions of soil water storage and plant extraction of that moisture, these two features warrant expanding the distribution of facilities.

Table 1. Climatic conditions for the landfill cover testing facilities.

Site # & Name	Mean Annual Precip (cm)	Monthly Precip Range (cm)	High Precip Months	Extreme Precip Event* (cm/24hr)	Mean Annual Snow (cm)	Mean Annual Temp (°C)	Mean Monthly Temp Range (°C)	Extreme Temp (°C)
1. Atlanta, GA	125	7.2-13.9	Dec-April	17/?	5.6	16.5	6.2/26.3	-22/41
2. Beltsville, MD	100	6.6-10.7	Even	15.5/40.6	45.7	14.4	2.2/26.1	-20.6/40.0
3. Denver, CO	39.5	1.3-7.9	Mar-Sept	8.0/61.0	186	10.2	-1.2/22.9	-31/40
4. Hanford, WA	16	0.5-2.54	Nov-Jan	2.8/17.8	33.5	18.9	-1/24	-33.9/46.1
5. Hill AFB, UT	43.6	2.0-6.5	Dec-May	6.6/38.1	93.9	10.4	-3/24	-26.7/39.4
6. INEEL, ID	22.9	1.3-2.8	May-June	4.0/ 25.4	87.6	5.6	-8.8/20.0	-43/38
7. Kalamazoo, MI	89	4.2/9.6	April-Sep	14.0/?	71.6	9.9	-4.5/23.0	-29/39
8. LANL, NM	47.1	.8-5.8	May-Sept	6.4/55.9	46.5	8.9	1.8/20.1	-23.3/36.7
9. Milwaukee, WI	81	3.6-9.1	Mar-Sept	17.3/43.2	124	8.3	-6.7/21.7	-30.5/39.4
10. NTS, NV	10	0.3-1.6	Dec-Mar	3.0/trace	rare	16.1	2.8/29.5	-15/47.8
11. Oahu, HA	193	9.5-24.1	Nov-May	33.0/0.0	0	23.3	21.7/25.2	6.1/33.9
12. Reedsburg, WI	78.7	2.8-9.9	April-Sep	9.9/43.2	107	7.8	-8.3/22.2	-38.3/40.0
13. San Bernardino, CA	14.1	.25-2.8	Dec-Mar	7.6/76.2	4.3	15.9	6.7-26.3	-18.3/45.0
14. SNL, NM	22.1	1.0-3.8	Summer	4.9/22.9	25.9	13.6	1.7/25.6	-27.2/41.7
15. Savannah River, SC	120	5.8-11.4	even	15.0/20.3	2.54	18	7.8/27.8	-18.3/42.2
16. Sheffield, IL	94	3.6/12	Mar-Sept	15.0/40.6	83.8	10	-6.1/23.9	-32.8/39.4
17. Sierra Blanca, TX	31.7	.5/7	Jul-Sept	15.0/38.1	15.2	17.8	6.7/28.3	-22/44.4
18. 29 Palms, CA	10.2	Trace-1.8	Jul-Jan	6.5/22.9	2.54	19.5	9.4/31.7	-9/49
19. Wenatchee, WA	22.8	1.0/3.7	Nov-Feb	6.9/45.7	72.1	16.8	-2.2/23.2	-29.3/43.3

\* maximum 24 hr event for rainfall/snow; snow is reported as depth of snow not in equivalent depth of liquid water.

Each of the 19 facilities includes some form of water balance lysimeter for direct quantitative assessment of cover performance. The presence of a water-balance lysimeter provides a reliable measurement of deep percolation and regulatory requirements are generally met by data collection for multiple years. A number of points can be made regarding the design of final earthen landfill covers to summarize the results of these research efforts,.

- Resistive soil layers fail in a very short time due to the development of preferential flowpaths by the action of desiccation, frost action, and invasion by plant roots. Some research indicates that low-permeability soils that consist of mixtures of expansive clay, such as bentonite, with coarser soil can achieve the low-permeability of the clay while retaining the desirable structural characteristics (lack of shrink/swell) of the coarse material (Albright, 1995; Albrecht, 1996).
- Proper design of a capillary barrier requires careful consideration and understanding of the hydraulic conductivity and the water storage requirements of the upper soil layers. Criteria for evaluating the requirements for water storage have been suggested (Khire, 1995) and need to be rigorously tested in field-scale demonstrations. There is concern about the effects of convergent flow along sloping caps causing preferential flow breakthrough that has not been fully resolved experimentally.
- Monolayer-type barriers can perform within performance requirements given careful consideration of soil physical properties, cover thickness, plant community activities, and amount and seasonality of precipitation. The ability to limit infiltration within certain performance criteria should not, however, be confused with the ability to eliminate infiltration altogether. Performance studies of monolayer-type covers throughout the western US indicate that these covers consistently exhibit drainage. This includes studies at SNL (Dwyer, 1998), PNNL (Gee and Ward, 1997), INEEL (Tim Reynolds, personal communication), Hill AFB (Hakonson et al., 1982), and LANL (Nyhan et al., 1997).

- There are shortcomings in the current state of knowledge of how various cover designs respond to the influences of different physical environments. Documentation of the response of various cover designs to the important environmental influences of a site is very scarce. As the practice of cover design has explored alternatives to the resistive barrier concept, it has become apparent that design features other than saturated hydraulic conductivity and erosion control are very important in reducing deep percolation.
- It has become widely accepted that the activities of the site plant community exert a very large degree of control over the water balance of the cover soils. Plant community data, where they have been collected, typically consist of a list of species involved in revegetation efforts. Usually absent are details about root depth, phenology, species succession, leaf area index, and compatibility of the chosen species with the cover soils.
- There is very little mention of the presence of plant roots at the impermeable lysimeter barrier in the literature for the experimental lysimeter facilities. For the lysimeter to actually collect drainage, a condition of near-saturation must occur in the soil immediately above the membrane barrier. Such water contents are usually much higher than would exist at the same depth in the absence of the membrane. The presence of an enhanced subsurface water supply has the potential to attract the development of plant roots in these soil layers. This, of course, negates the basic purpose of the lysimeter, which is to collect this additional water for physical measurement. The presence of a plant root barrier some distance above the membrane barrier to prevent false negatives is generally lacking in existing field tests.
- Climatic variables, such as episodes of rapid snowmelt, that typically occur when plant activities are dormant, the hydrologic effects of deep layers of frozen soil, and high-intensity storm events have not been adequately investigated. Climatic variables important to cover design are often expressed in terms of daily or annual

average values. Research indicates that in some locations it is short-duration events that contribute most of the recorded percolation.

- Soils used in these cover tests usually have been described in terms of important engineering parameters (USCS classification for example) but often lack description of important hydrologic parameters. The movement and storage of water within a landfill cover are best described by the principles of vadose zone hydrology. Proper design and accurate numerical modeling depend on the ability to predict unsaturated flow, capillarity, and drying characteristics of a soil. Typical engineering classification of soils can give some indication of the unsaturated character of a soil, but additional laboratory and field testing are required to accurately represent the performance of a cover.
- Development of improved numerical prediction methods for alternative landfill cover design will require a standard set of performance data and parameters. The cover test reviews in this report do not provided data sufficient for use in model validation exercises.

One complication in compiling data from these 19 facilities in order to extrapolate across geographic, climatologic, geologic, and biologic conditions is the inconsistency in facility design, i.e. the type and quality of data collected. While all 19 sites include water balance lysimeters each was individually designed and constructed. These differences can significantly impact the quality of data collected, potentially hindering comparisons and conclusions across facilities.

### **II.E. ACAP Dispersed Network Facilities**

The introduction to this report briefly described the four phases of a planned effort to address the need for field data to support advances in alternative landfill cover design and regulation. The central theme of the planned effort is the collection of field data from a number of field testing facilities using a standard lysimeter design. These facilities will be located at disposal sites across the country. The regional study proposed here is unique in its scope. A wide range of efforts will be coordinated to test and verify cover performance data.

These data will be brought into a common database accessible to federal and state agencies for evaluation of alternative covers for specific applications. These data will be used to evaluate the efficacy of numerical models, improve early warning vadose zone monitoring methods, and provide the technical basis for regulatory guidance for alternative cover systems, which could result in substantial cost savings to waste-site operators.

Design, construction, and operation of a dispersed network of cover-testing facilities will allow the testing of various alternative cover designs in a wide range of environmental variables of soils, climate, and plants. Numerical modeling will be used to aid the development of cover designs based on local climate data, local plant community data, and laboratory testing of soil materials intended for use in the test facilities. Construction of the test facilities and collection of field data will follow the design phase.

A dispersed network of testing facilities has significant advantages over laboratory or single-location testing of alternative landfill covers. The application of several climatic regimes to several cover designs will enable the extrapolation across regions of climate and between soil types. The use of an extensively reviewed, standard test facility design will provide for wide acceptance of the field data.

Test facilities will be located at, or near, active disposal sites. At each location, one or more full-scale (in depth) cover designs will be constructed in water-balance lysimeters (Figures 2 through 4). The lysimeters will be 200 m<sup>2</sup> in area, providing a reasonable scale for the evaluation of the proposed cover designs. The primary feature of water-balance lysimeters (direct measurement of drainage) avoids the uncertainties inherent in other methods of estimating percolation.

The ACAP lysimeter consists of a 10-m wide, 20-m long excavated trench filled with a full-scale (in depth) portion of the cover design to be tested. 60-mil, high-density polyethylene (HDPE) will form the bottom, impermeable liner and will extend a small (0.5-1.0 m) distance up the sides. The surface of the lysimeter (200 m<sup>2</sup>) will provide sufficient surface area for evaluation of spatial variability and adequate space for the use of typical construction equipment. The cover materials, which will be variable in depth according to the specific cover design, extend down to a geosynthetic root barrier. This barrier, a non-woven

geotextile impregnated with a root inhibitor, will prevent penetration of roots to the impermeable liner of the facility. Soils between the root barrier and the lysimeter liner will be some combination of interim cover materials and graded fill. For the conceptual design, this depth is not specified and will be designed according to the hydraulic properties of the interim cover to limit capillary rise into the root zone. A geocomposite drain between the soils and the lysimeter liner will provide unimpeded lateral drainage of water. The bottom of the facility will slope (3 to 5 percent) toward the centerline. The primary axis of the lysimeter will be aligned with the natural slope of the setting to allow drainage to collect at one end. Collected water will be conveyed through a boot in the geomembrane to an instrument for measuring flow, such as a tipping bucket rain gauge. This instrument will be located in a manhole for access and maintenance.

Additional instrumentation will be installed in the cover soils within the lysimeters. These instruments, while not necessary for the overall estimate of drainage from the cover being tested, will provide valuable information for the testing program. Data from these instruments are necessary to describe the unsaturated-flow and plant-growth processes regulating the movement of moisture between the soil surface and the geomembrane. The soil water parameters measured will include soil water content, water potential and soil temperature.

The measured water contents will be converted to water storage values, critical to evaluating the capacity of the soil for drainage. The water potential measurements will be used to monitor the energy state of the water which can be used in numerical modeling to predict the point of incipient drainage from the cover. The soil temperature data will be used to document the frost penetration depth and thermal conditions that can affect the flow of water vapor or liquid. Bulk properties of the cover including porosity and density will be documented in the construction phase of the cover as a matter of course. These data will be useful in predicting the volumetric water relationships and gas transport properties of the cover system.

Vadose zone monitoring and biological and climatological observation will provide data concerning the movement of soil moisture, local climate conditions, and plant community



activities. These facilities will be used to test established and emerging technologies for vadose zone monitoring of alternative covers. The lysimeters will be located adjacent to landfill operations or form a portion of a final cover.

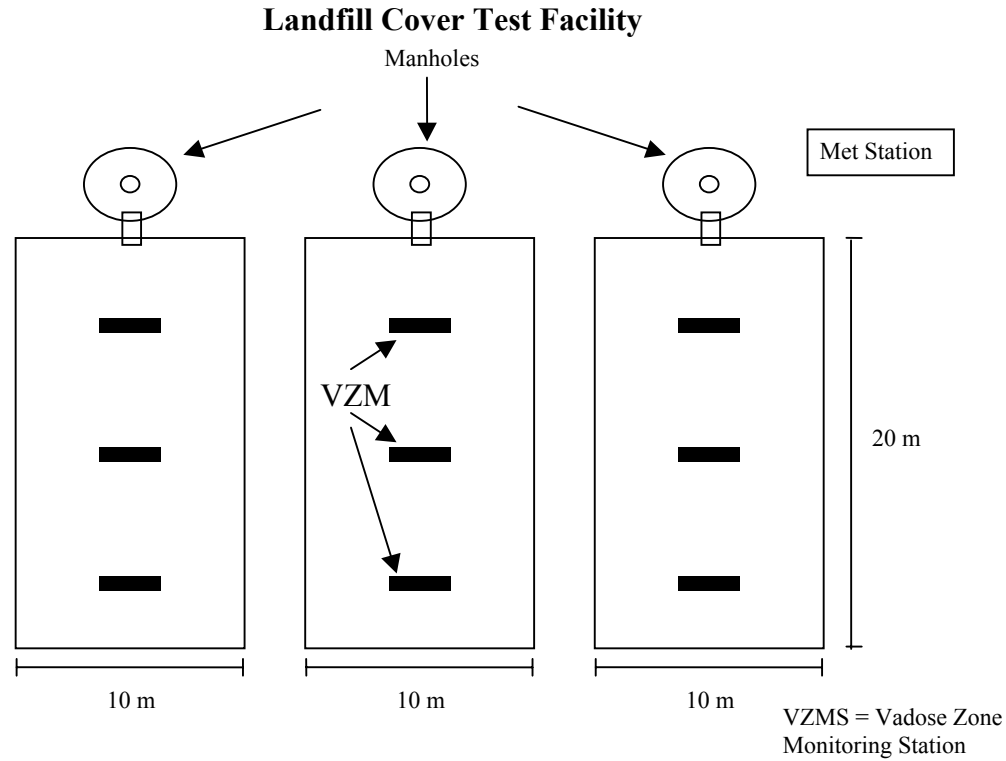

Figure 2. Plan view of proposed 3-lysimeter test facility.

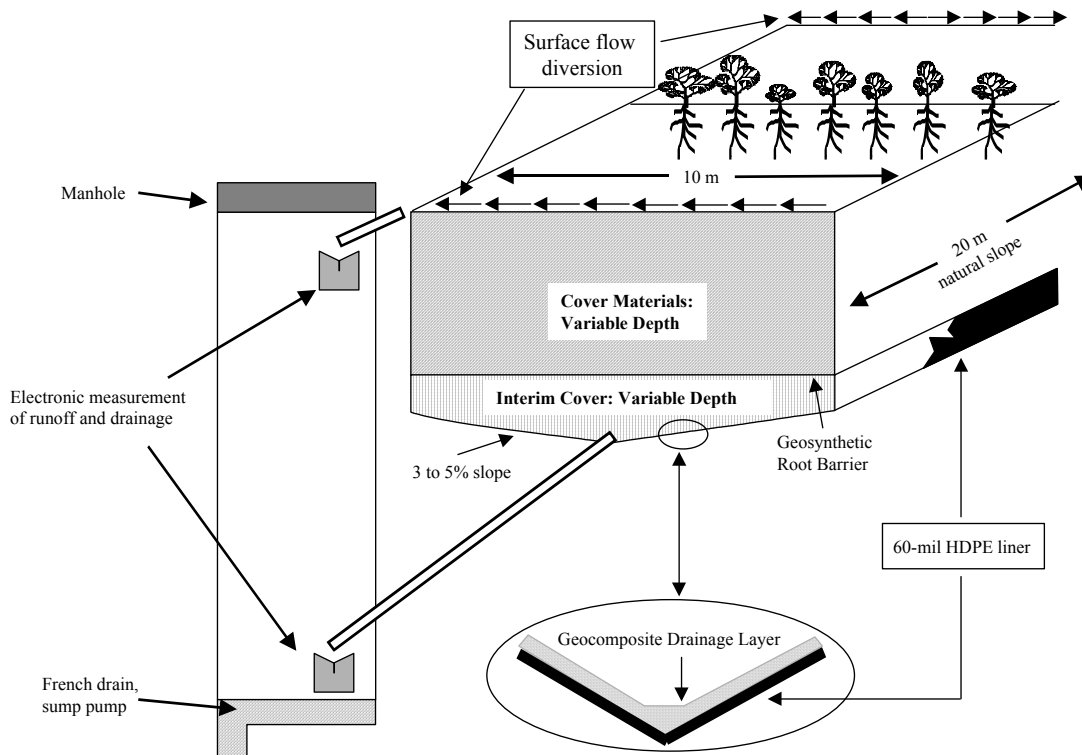

Figure 3 Detail of proposed lysimeter test facility design.

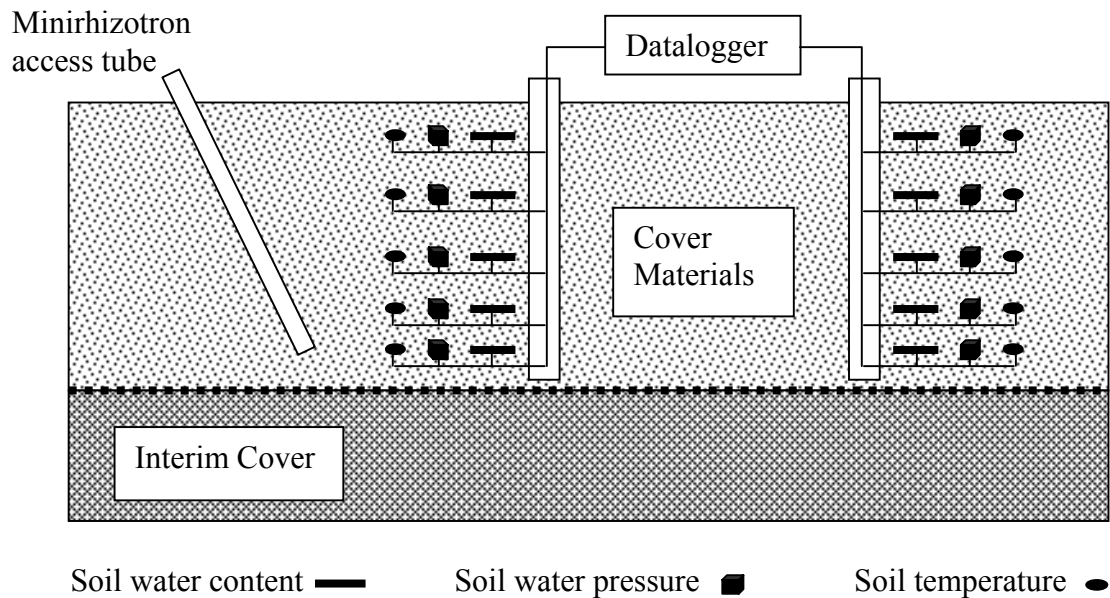

Figure 4. Detail of a vadose zone monitoring station.

### Anticipated Deliverables

The deliverables from this dispersed network of testing facilities integrated with modification and testing of numerical models will be:

- Cost-effective alternative cover designs for the study sites
- Technical basis for establishing guidelines and criteria for the development of alternative cover designs for additional disposal sites
- Improvements in numerical prediction of alternative landfill cover performance
- Improvements in technologies and methods for alternative landfill cover performance monitoring that will enable early warning detection (prior to groundwater impact)
- Presentation of the results in such a manner as to ensure the transfer of the developed technologies to regulators, site owners, and engineering firms

It is also anticipated that the permit process for cost-effective alternative cover designs will benefit from this effort. At each of the cover testing facilities, local regulators will be invited to review and observe the entire process, from site evaluation, to the design of the covers to be tested, to the evaluation of the field test results. Communication between site owners and regulators, as well as increased knowledge and appreciation of alternative cover solutions, will enhance the application of innovative, cost-effective alternative landfill covers. Regulators will benefit from a state-of-the-art treatment of the specific sites that host a cover testing facility.

### **III. NUMERICAL MODELS FOR LANDFILL DESIGN AND MONITORING**

#### **III.A. Modeling Introduction**

As municipal, hazardous, and low-level (radioactive) waste landfills in arid and semi-arid environments prepare to close, cap design and monitoring plans must be established. Numerical models have served as an important tool in cap design, performance or risk assessment, and post-closure monitoring. The Committee on Ground Water Modeling Assessment, CGWMA, was established by the National Research Council to review the accuracy of numerical models, and the degree to which regulatory decisions can be made based upon their long-term predictions (Schwartz et al., 1990). The CGWMA acknowledged that models appear more certain than they really are and that decision makers need to be aware of the assumptions, idealizations, and limitations of the models. It is often forgotten that these numerical models are simply mathematical representations of a conceptual model of the real-world behavior, the conceptual model often being established from limited observations and an incomplete understanding of the real-world processes. Additionally, the numerical models are only as good as the experimental database, which is itself a model of the real world, and supplies the boundary conditions, initial conditions, and parameter values to the numerical model.

Models are inherently imperfect, thus they must not be used as a substitute for data collection (Schwartz et al., 1990), i.e., experimental assessment. The CGWMA concluded that data collection and modeling should be closely linked to provide an adequate representation of site performance. Thus, closure and monitoring plans should be an integration of experimental and numerical assessment. The ACAP was designed with this objective in mind. Task A of Phase I (section II.C) reviewed sources of landfill performance data and identified sites where the construction of additional cover testing facilities would enable the establishment of a dispersed network of cover testing facilities. This dispersed network will provide the necessary experimental foundation across geographical, geological, climatological and biological regions for appropriate selection and application of numerical models.

The stated goals of Task B of Phase I were to describe the range and capabilities of the available numerical models applicable for predicting the hydrologic performance of landfill covers and demonstrate performance of selected models. While the CGWMA recognized that regulatory officials may be reluctant to accept a nonapproved model, they concluded that agencies should not require that specific models be used, nor should a list of approved models be sanctioned (Schwartz et al., 1990). Holding to this philosophy, this report was not intended to approve or disapprove of any specific model, nor does this review qualify in any manner as a sanctioning by this research team or EPA of the codes reviewed. The focus of this report was on identifying and describing numerical models that are currently used to predict the hydrologic performance of landfill covers. Published reports were reviewed to summarize the degree of model verification and validation along with the degree to which these models can be manipulated by parameterization to bias results. In some cases, the body of knowledge was supplemented with additional sensitivity analyses.

Recommendations for future model modifications along with verification, validation, and sensitivity analyses were made.

There are a number of numerical models that have been used to predict the performance of landfill covers. Some have been designed to specifically address landfill facilities and others are general vadose zone models designed to describe the movement of water through soil under unsaturated conditions. Due to incomplete understanding and insufficient databases of the vadose zone, there is general lack of consensus in the research and engineering communities regarding the selection and application of the models to various design and environmental scenarios. Important issues include the complexities of the physical and hydrologic processes of the vadose zone, as well as other processes (plants and climate), and to what degree simplifications can be made.

Given that the vadose zone is the unsaturated zone from the soil surface to the permanent water table, it inherently has the following attributes:

- Consists of multiple phases (air, water, mineralogical, organic, and biological)
- Processes are extremely complex, inter-dependent, and temporally dynamic, and
- Properties are generally highly nonlinear, with substantial spatial and temporal variability.

Holistic, process-integrated models do exist; however, increased complexity of a model may not be advantageous. These models require greater data input and a higher level of user competence, which combined may result in greater uncertainty in the model predictions (Schwartz et al., 1990). A useful model does not need to simulate all the vadose zone processes; it may simulate many processes but to different degrees of simplification. A good example is the representation for water retention and movement in the subsurface. Even with assumed uniform flow, the options include (1) compartmental analysis based upon water balance computations, (2) deterministic analysis based upon physical laws, or (3) stochastic analysis based upon statistical (probabilistic) and analytical solutions.

When a landfill cover is designed based upon a numerical model, regulators would like to have confidence that the model used is appropriate and can be trusted to provide accurate representation of the cover performance. Whether one prefers a water-balance or more physically based deterministic approach, there will be uncertainty in model predictions. There are three general sources of potential error (Brandstetter and Buxton, 1989):

- 1) Conceptual model. The conceptual model from which the numerical model was based may not fully or adequately represent the system processes. A good example is modeling infiltration as uniform movement of a wetting front through a macroporous soil instead of incorporating preferential flow processes into the model. This source of error is particularly common in designing landfill covers due to the assumption that processes governing the behavior of the system at time of construction will represent the long-term behavior. For example, many studies have revealed post-construction changes in the clay barrier layer such as desiccation cracking not only results in changes in the hydraulic properties of the layer ( $K_s$ ) but shifts the processes to a dual-porosity system (Phifer *et*

*al.*, 1995; McBrayer *et al.*, 1997; Montgomery and Parsons, 1990; Khire *et al.*, 1997a,b; Albrecht, 1996; Melchior, 1994). Over the long-term, soil pedogenic processes, (e.g., soil structural development), changes in meteorological conditions (e.g., a shift from a rain to a snow-dominated precipitation regime) and altered plant community dynamics (e.g., fire) can alter the flow processes (Waugh, 1997).

- 2) Numerical computations. Landfill cover computer codes typically incorporate several subroutines for the various processes that must be integrated into the model. These codes potentially create numerical inaccuracies due to coding errors, round-off errors, and subroutine incompatibilities. Models may suffer from convergence errors including numerical oscillations and instabilities.
- 3) Parameters and boundary conditions. All models require operational parameters and deterministic (and certain stochastic) models require initial and boundary conditions be specified. The spatial and temporal variability of the operational parameters may not be properly incorporated into the model, leading to prediction errors. Additionally, many parameters are cross-correlated, e.g.,  $K(h)$  and  $\theta(h)$ , but failure to recognize the impact of this cross-correlation can lead to erroneous results. Even if the operational parameters are properly incorporated, misrepresentation of the boundary and initial conditions can lead to erroneous predictions of cover performance. The decision of how to represent the surface boundary condition (i.e. whether precipitation is incorporated as a yearly average, daily values, or as hourly values) is one common problem in landfill cover modeling that can have a significant impact on drainage estimates (Nofziger *et al.*, 1994a). To alleviate the problem of uncertain initial conditions, some modelers prefer to utilize the results of a preliminary simulation as the initial condition as an alternative to setting the initial condition based upon field measurements.

To address the three sources of error listed above, codes should go through extensive verification, validation, and sensitivity analysis, respectively, before confidence can be placed in their predictions. Numerous modelers recommend that codes be reviewed by experts who are independent of the model developer (Schwartz *et al.*, 1990; Brandstetter and Buxton, 1989; Flavelle, 1989).

Verification is a quantitative evaluation of whether the executable statements in the code make the exact computations required in the mathematical formulas. This is accomplished by comparing the model predictions against exact analytical solutions or, for the case of some water-balance models, against hand calculations. Typically, analytical solutions and hand calculations are only available for very simple conditions, thereby not allowing verification of the full extent of capabilities for which the model was designed. This is particularly true for Richards' equation-based models. This shortcoming can be overcome to some degree by comparison of model predictions to other "verified" codes, a process called "benchmarking." It is important when performing code verification of numerical models that the discretization scheme be consistent between codes and be consistent with the discretization scheme to be used during the model application. Once a code is verified to be numerically sound, if modifications are made later, the code must be tested again for verification (Schwartz *et al.* 1990).

While a code may be numerically sound, i.e., verified, this does not mean that it is “valid” for predicting system behavior. There is a fair amount of ambiguity among the engineering and scientific community as to what constitutes model validation because the term often is confused with verification and calibration. The CGWMA (Schwartz et al., 1990) defined validation as “some measure of the difference between the response of the real world and the response of the simulated system...comparing predictions to observations.” They further state that “results should be compared to well-defined field experiments.” Brandstetter and Buxton (1989) outlined such analysis as “estimates...by a performance model are compared with data from field or laboratory sampling programs that measure the same processes.” One way that predictions (P) and observations (O) can be quantitatively compared is by calculating the root mean square (RMS) as:

$$\text{RMS} = \left[ (1/n) \sum (P_i - O_i)^2 \right]^{0.5} \quad (6)$$

where n is the number of values compared. Even with this method of comparison, what constitutes an adequate match between the prediction and observation is still ill defined. A code may produce a poor match to the observation at a critical point but have a low RMS due to an excellent agreement over other time or spatial locations.

While Flavelle (1989) stated that validation is “accomplished by comparing observed behavior to model predictions based on real input conditions,” herein lies the problem with validation being confused with calibration. Calibration is the adjusting of input parameters until model predictions match the observed response. There are typically multiple combinations of input parameters that provide equally acceptable match to the observed response. Therefore, calibration must be performed by setting the majority of the parameters to measured values and adjusting only the few parameters that lack measurement or have the greatest uncertainty. In the strict sense, validation is the comparison of model solutions to experimental measurements using independent estimates of all parameters (Schwartz et al., 1990). Since it is common with complex processes to have parameters that cannot be directly measured, much less measured independent of the database being used for the comparison, some parameters must be estimated, usually by calibration. Flavelle (1989) called the case in which not all parameters could be provided by real data a “partial validation.”

Does even a perfect match for one test case constitute a valid model for other test cases? The CGWMA concluded that absolute validity of a model could not be obtained since this would require testing over the complete range of conditions. It should be kept in mind, however, that the goal of validation is to, as Hufschmied (1989) put it, “build confidence that the model can correctly predict the site-specific physical phenomena.” This does not mean that a model must provide a perfect match to every observation with all parameters determined independently for users to have confidence in its predictions. One way to improve confidence in a verified model and gain understanding of the processes involved is to perform a sensitivity analysis. Sensitivity analysis is used to determine the effects of systematic variation of parameters on model predictions or, more specifically, the change in a specified model output resulting from a specified change of a single input variable (Nofziger et al., 1994a; McCuen, 1973). This definition is implicitly quantifiable, such that the sensitivity coefficient,  $S_c$ , is defined as:



$$S_c = \frac{\Delta F}{\Delta P} \quad (7)$$

where  $F$  is the output factor and  $P$  is the input parameter. The problem with the use of  $S_c$  is that its value is dependent upon the units and magnitude of the input variable tested. This can be alleviated by using the relative sensitivity coefficient,  $S_r$ :

$$S_r = \left( \frac{\Delta F}{\Delta P} \right) \left( \frac{P_a}{F_a} \right) \quad (8)$$

where  $P_a$  and  $F_a$  are the average parameter and output factors, respectively, used in Eq. 2. This conversion makes  $S_r$  a unitless coefficient, often expressed as a percent, which is invariant to parameter magnitude and thus comparable across parameters.

Sensitivity analysis can reveal numerical errors that were overlooked in the verification test, and it can compare the efficacy of codes (Nofziger et al., 1994a). By providing insight into which parameters cause the greatest variation in predicted behavior, sensitivity analysis can be used to direct site characterization studies and landfill cover monitoring or remediation strategies (Brandstetter and Buxton, 1989; Eisenberg et al., 1989). If a model is found to be sensitive to a highly uncertain parameter, such as  $K(h)$ , sensitivity analysis can be used to guide the site characterization and monitoring necessary to reduce the uncertainty. Gwo et al. (1996a) performed sensitivity analysis on the FEMWATER code to identify the key parameters for waste site monitoring, and to evaluate two remediation strategies, a RCRA cap or French drains, for the Oak Ridge National Laboratory radioactive waste trenches. It should be cautioned that the model sensitivity to parameter variations depends upon the scenario tested (Nofziger et al., 1994b). A model may be highly sensitive to a parameter, such as  $K_s$ , when simulating humid region conditions but found to be relatively insensitive to this same parameter for arid conditions.

Sensitivity analysis can also be used to evaluate the significance of various components of the conceptual model (Brandstetter and Buxton, 1989, Gwo et al., 1996b) on the model prediction. For cases in which databases are incomplete or the processes are so complex that they cannot be quantified nor their parameters measured, sensitivity analysis can be used to gain insight into these processes and properties. Gwo et al. (1995) developed one of the most physically rigorous models of preferential flow, MURF, which is a multi-region flow model based upon solving Richards' equation for three pore regions requiring  $K(h)$  and  $\theta(h)$  functions for each region. MURF was integrated with MURT (Gwo et al., 1996b), a multi-region transport code based upon the advective dispersion equation for each region, which included advective as well as diffusive mass transfer between regions. Gwo et al. (1996b) were able to provide independent parameterization for all variables except the mass transfer coefficient, which they assessed through sensitivity analysis. Sensitivity analysis provided them with insight into the relative importance of the mass transfer parameters. This led to the establishment of research priorities from which they later developed techniques for quantifying the diffusive mass transfer coefficient (Reedy et al., 1996).

Uncertainty analysis must be distinguished from sensitivity analysis discussed above. Despite often being used interchangeably and having a good deal in common, the focus of the two concepts is distinctly different. Recalling that parameter sensitivity can be dependent upon the scenario tested, uncertainty analysis is an attempt to bound the possible scenarios (Brandstetter and Buxton, 1989). While sensitivity analysis focused on the effect of parameters on a system performance, uncertainty analysis is focused on uncertainty of the system. Uncertainty analysis is becoming more common in the landfill regulatory community as long-term performance assessment is required to take into account potential risk to the public by evaluating various release scenarios including climate change.

### **III.B. Survey and Description of Models**

A survey of numerical models currently used in the landfill industry for evaluation of landfill covers was conducted by contacting regulatory agencies, land managers and researchers, and through a literature search. This survey did not include codes used for assessing landfill leachate production on the landfill as a whole, but was specific to cover performance. Provided here is a brief description of these codes, including discussion of process formulation, verification, validation, and sensitivity analysis. Results of additional sensitivity analyses are reported.

An extensive review of models for landfill covers was conducted by Nixon et al. (1997). They compared 13 codes (CREAMS, HSSWDS, HELP, MULTIMED, SOILINER, DRASTIC, HRS, HARM, DPM, RELRISK, NCAPS, RCRSTD, PCLTF) using different degrees of information from 545 landfills based upon reference distributions for a total of 31 parameters (not necessarily 31 for each code). Nixon *et al.* (1997) concluded the following: no two models will give the same assessment, no model has been validated for long-term landfill cover performance, and many existing models could potentially be modified to provide relevant landfill cover performance predictions.

Of the 13 models evaluated, only CREAMS, HELP, and MULTIMED were found by this survey to be commonly used in landfill cover design. Most of the codes reviewed by Nixon et al. (1997) were risk assessment models for landfills as a whole and were therefore not described further in this report. The models identified by this survey that are used specifically for landfill cover design and evaluation were compiled in Table 2, in a format similar to Nixon et al. (1997). More detail on the parameters required by these codes is listed in Table 3.

Of the ten codes listed in this report, HELP is by far the most popular code in use for evaluating landfill covers and it will be discussed in detail later in this report. The TOUGH2 code (Pruess, 1991) was not identified as being used, nor was literature found where it was applied in the landfill industry. Tough2 was developed for multiphase fluid and heat flow prediction and is the code being used for assessment of Yucca Mountain as the nation's high level radioactive waste repository. It is being used, however, to analyze the results of the Alternative Landfill Cover Demonstration (ALCD) study at Sandia (Dwyer, personal communication) and was therefore included. Additionally, the survey did not identify where the CREAMS, SoilCover, and SHAW models were being used in the landfill industry, but they were identified in the literature review as having been used. The SoilCover code

(Geo2000, 1997) was developed by the Unsaturated Soils Group of the University of Saskatchewan specifically for modeling landfill covers. For more information on SoilCover, contact [geo2000@the.link.ca](mailto:geo2000@the.link.ca).

Table 2. Processes and Attributes of the Landfill Cover Codes Identified in the ACAP Survey.

Processes-Attributes	E P I C	C R E A M S	H E L P 3. 0 7	S O I L C O V E R	H Y D R U S 2 D	U N S A T - H	S H A W 2. 3	M U L T I M E D	L E A C H M	T O U G H 2
Mass Balance	X	X	X							
Richards' equation				X	X	X	X	X	X	X
Stochastic Capabilities					X			X		X
Precipitation:	X	X	X	X	X	X	X		X	X
Historical Data			X							
Weather Generation	X	X	X							
Manual input of data required				X	X	X	X		X	X
Potential Evaporation	C		C	C	I	C	C		I	I
Potential Transpiration	C		C	C	I	C	C		I	I
Direchlet (prescribed pressure)				X	X	X	X		X	X
Neuman (prescribed flux)				X	X	X	X		X	X
Cauchy (prescribed gradient)					X	X			X	
Runoff	C	C	C	C	C	C	C		C	
Erosion	C	C								
Vertical Drainage-Percolation	X	X	X	X	X	X	X	X	X	X
Lateral Drainage			X		X					X
Preferential Flow					X					X
Snow Melt	X	X	X	X			X			
Vapor Flow				X		X	X		X	X
Solute Transport			X		X		X	X	X	X
Heat Transfer				X		X	X		X	X
Plant Growth	X	X		X		I	X		X	
Root Growth-distribution	X	X		I	I	I	X		X	
Soil Property menu	X		X	X	X		X	X		
Geomembrane properties			X					X		
Windows Compatible			X	X	X	+	X	X		

+ Windows versions of UNSAT-H, WinUNSATH, are now available.

Table 3. Pertinent input parameters and descriptive information for landfill cover codes identified in survey.

General Category	Specific parameter/attribute	E P I C	C R E A M S	H E L P	S O I L C O V E R	H Y D R O L O G Y	U N S A T U R A T E D	S H A D O W	M U L T I M E D I A	L E A C H M E N T	T O U G H N E S S
General	Time Step	d		d/m/y	Any	Any	Any	Any	y	Any	Any
Physical	Soil Texture	I	I	I	I	I		I	I	X	
Properties	Bulk Density	I	I	I	I			I	I	X	I
	Max # of soil Layers	10		20	8	Any	Any	15		15	Any
	% Organic Matter	I						I			
	Effective Porosity	C									I
	SCS/ Runoff Curve #	I	I	I							
	Soil Albedo	I					I	I			
	Topography/ Slope	I	I	I		I		I	C		I
	Site Elevation	I			I		I	I			
	Initial Soil Temp				I		I	I		I	I
	Maximum Ponding Depth							I			
	Land Area	I		I		C			I		C
Hydraulic	15 bar Wilting Point	I	I	I	I			I		I	
Properties	Field Capacity	I	I	I							
	$\theta(h)$ function parameters				O	VG	BC VG O		BC VG	O	
	Saturated Water Content/Porosity	C	I	I	I	I	I	I		I	I
	$K_s$	I	I	I	I	I	I	I	I	I	I
	$K_h$				C,I	C	C			C	
	Depth to Aquifer	I				I			I	I	
	Initial Water Content/head	I	I	C,I	I	I	I	I	I	I	I
Plant Properties	Pot. Transpiration	C		C	C	I	I	I		I	
	Evaporative Depth	I		I							
	Growing Season Length	C		C	I		I	C		I	
	LAI	I	I	I	C		I	I			
	Leaf Size/Plant Size and Orientation	C						I			
	Root Density	C					I			I	
	Root Depth	I	I		I	I	I	I		I	
	Canopy Albedo						I	I			

Table 3. Pertinent input parameters and descriptive information for landfill cover codes identified in survey (continued).

General Category	Specific parameter/attribute	E P I C	C R E A M S	H E L P	S O I L C O V E R	H Y D R U S- 2 D	U N S A T- H	S H A W	M U L T I M E D	L E A C H M	T O U G H 2
Climatological	Precipitation Time Scale	m	h	D	d	Any	h	d,h	y	any	any
	Precipitation	C	C	C	I	I	I	I	I	I	I
	Potential Evaporation	C	C	C	I	I	I	C		I	
	Relative Humidity	I		I	I		I	I			
	Snow Density and Depth			C				I			
	Air Temperature daily max/min	C		C	I		I	I		I	
	Temperature time scale (Y/M/D/H)	M	m	D	d	any	d	d/h		d	any
	Solar Radiation(Y/M/D/H)	I	I	Y	I		d	d/h			
	Cloud Cover						d				
	Wind Speed	I		Y	I		d	d/h			
	Latitude/Longitude	I		C			I	I			

Where VG signifies a van Genuchten model, BC signifies a Brooks Corey model, O signifies a model other than BC/VG, m = month, D = day, Y = year, H = hour, C signifies that this property is computed while I signifies that the property is inputted. Inputted properties may not be required depending upon the processes included in the simulation.

The three codes that seem to be gaining popularity among consultants are HYDRUS-2D, UNSAT-H, and LEACHM. While survey respondents stated that they were seeing increased use of the LEACHM code, not much information could be obtained on its application to landfill covers. Information on LEACHM can be found at the following web site: <http://www.wiz.uni-kassel.de/kww/irrisoft/drain/leachm.html>.

LEACHM was developed for agricultural use and is very popular among soil scientists. However, the code is no longer supported by the developers and therefore will be less useful in the future as a tool for the regulatory and consulting communities (Dr. Phillipe Baveye, personal communication). Additionally, LEACHM is very similar to UNSAT-H, both being one-dimensional Richards' equation-based codes, thus LEACHM was not selected for detailed description because we feel that its popularity will diminish.

CREAMS (Chemicals, Runoff, and Erosion from Agricultural Management Systems Model), developed by the U.S. Department of Agriculture (Knisel, 1980), was one of the first numerical codes used for performance assessment of landfill covers (Devaurs and Springer, 1988). CREAMS is a water balance model based upon Eq. 2 and uses the Soil Conservation Service (SCS) curve number approach to estimate runoff. It has been used extensively for agricultural scenarios and was not designed for use in landfill cover evaluation. However, it has been used for evaluating landfill cover performance both as a stand-alone code and in combination with HELP. Devaurs and Springer (1988) and Nyhan (1989) were the first to

use CREAMS to evaluate various alternative cover designs. Devaurs and Springer (1988) compared predicted soil-water content distributions with observations from three field experiments at Los Alamos National Laboratory using input parameters recommended in CREAMS. They noted the following shortcomings of applying CREAMS to landfill covers: 1) soil properties of the constructed cover may differ from menu-provided properties, 2) it failed to account for soil-water retention above the drainage layer, 3) it was unable to represent finger flow processes at the soil-rock interface, and 4) it was unable to simulate snowmelt. Nyhan (1990) calibrated CREAMS for  $K_s$ , ET, and leaf area index (LAI) with data from two test plots at LANL. The calibrated  $K_s$  value was nearly three orders of magnitude lower than the laboratory measured values. Even with the calibrated parameters, CREAMS under-predicted drainage and soil water storage by as much as 30 percent each when compared to field measurements. Since the prediction of ET was reasonable, the model was obviously miscalculating runoff. This was attributed to an inability to predict snowmelt. Despite these limitations, CREAMS proved to be a valuable tool for assessing improvements to alternative landfill covers.

Recently, Paige et al. (1996a) presented the calibration and testing of a new decision support model, called PDSS, for the design of alternative covers. PDSS was a combination of the CREAMS and HELP 2.0 models, along with an evaluation module. The PDSS, prototype decision support system, was designed to evaluate the performance of covers selected for trench cap designs (Paige et al., 1996b). The HELP code is used to evaluate the water balance of the covers and the CREAMS code evaluates the soil loss to the cover due to erosion. HELP incorporates aspects of CREAMS, so the CREAMS code will not be included in the detailed model review.

Of the codes identified in the survey, EPIC and HELP appear to be the most comprehensive in processes incorporated (Table 2). EPIC was developed as an agricultural support tool and includes many processes not listed in Table 2 that were considered not pertinent for use in the assessment of landfill covers. These include such processes as fertilization, cattle grazing, pesticide application, crop yields, lagoon and stream parameters, and nitrogen dynamics. For ET covers that rely upon plant processes in addition to soil physical attributes for effective performance, EPIC may be advantageous in that it is the most rigorous of the codes investigated with regards to plant growth processes. However, it does require an extensive list of plant characteristics, many of which are not included in typical landfill site evaluations.

The most important process modeled by codes used for assessing landfill covers is drainage, thus, it was implicitly understood that all the codes identified in the survey could compute vertical drainage. LEACHM, UNSAT-H and SHAW use a finite difference form of Richards' equation as a means of predicting water contents, fluxes, and potentials, while HYDRUS-2D, SoilCover, and TOUGH2 use the finite element form. Information required for either approach includes the soil hydrological characteristics,  $K(h)$  relationships, boundary conditions, and source and sink terms (rainfall, irrigation, evaporation, and transpiration) which are either input or calculated. LEACHM, UNSAT-H, SoilCover, and SHAW solve the one-dimensional Richards' flow equation and can therefore only be used for assessing vertical drainage. However, lateral drainage is an important process, particularly for capillary barrier designs (Nyhan et al., 1997). Of the codes reviewed here,

only HELP, HYDRUS-2D, and TOUGH2 can model lateral flow. Of these, HELP provides a “quasi” two-dimensional drainage process. Many researchers have found that since HELP is not able to fully represent the lateral flow process, it is unable to accurately model capillary barrier designs (Devaurs and Springer, 1988; Paige et al., 1996a). A 2 or 3-dimensional Richards’ equation code such as HYDRUS-2D or TOUGH2 can model this process but their validity for capillary barrier evaluations is yet undetermined.

Another critical process is overland flow, which includes runoff, erosion, and snowmelt processes. While HYDRUS-2D, UNSAT-H, SoilCover, and LEACHM do not calculate overland flow, they do estimate runoff by the difference between precipitation and infiltration. CREAMS is probably the most rigorous of the codes for runoff and erosion, as this was the purpose of its development. Three codes (EPIC, HELP, and SHAW) have similar mathematical basis as CREAMS for modeling runoff and/or erosion. A major weakness that has been identified relative to the performance of landfill covers is the inability to model the impact of snow (Nyhan *et al.*, 1997). The most rigorous code for snowmelt processes is the SHAW model. While it has not received much use by the landfill industry, it should be considered for use in regions where a high percentage of the precipitation is in the form of snow.

This report focused on the modeling of the hydrology of landfill covers, however, several other processes such as contaminant transport, vapor transport and heat transfer are certainly important to landfill cover performance and are often the primary process of interest. The most common of these other process that was included in the codes reviewed is solute transport (HYDRUS-2D, HELP, SHAW, LEACHM, and TOUGH2). The developers of LEACHM (Wagenet and Hutson) state in the user's manual that the code was not intended to be used: (1) with unequal depth increments, (2) to predict runoff water quantity or quality, (3) to simulate response of plants to soil or environmental changes, or predict crop yields, (4) to simulate the transport of immiscible liquids, or (5) to predict solute distributions in situations subject to two- or three-dimensional flux patterns. Only UNSAT-H, SHAW, and TOUGH2 were found to include vapor and heat flow processes. SoilCover includes heat transfer processes as well as oxygen diffusion.

It should be noted that of the codes identified, only HELP was developed specifically for the evaluation of landfill cover designs. Accordingly, there are many advantageous features of HELP for this purpose such as incorporation of geomembrane layers and associated properties. Although TOUGH2 does not require plant parameters, it was the most parameter-intensive code identified in the survey. The data input requirements and complexity of the code is such that it cannot be run on a PC and is not considered by these authors to be suitable for typical landfill cover design applications. EPIC is also a data-intensive code due to the numerous parameters required not pertinent to landfill cover performance (e.g. number of cattle, rates and forms of fertilization) that were not included in Table 3.

The biggest difference in hydraulic property data requirements among the codes largely reflects whether the code is based upon water-balance or Richards’ equation calculations. For either approach, the two most important properties are the ability of the soil to store water, i.e., water retention curve, and the ability to transmit water, i.e., the hydraulic

conductivity. Water-balance models require parameters that characterize the water retention curve, such as the field capacity, wilting point or 15-bar water content, and porosity or saturated water content. From these three parameters, the drainable porosity (saturated water content minus field capacity) and available water-holding capacity (field capacity minus wilting point) can be computed. In contrast, models based on Richards' equation require a function such as the van Genuchten or Brooks and Corey (1966) models to describe the water retention curve. Each of these functions requires several specific input parameters. The van Genuchten (1980) model described in Section II.A requires the saturated water content, residual water content, alpha, n and/or m parameters. The Brooks and Corey (1966) model for water retention is:

$$\begin{aligned} \theta &= \theta_r + [\theta_s - \theta_r][h/h_a]^\lambda & \text{for } h < h_a \\ \theta &= \theta_s & \text{for } h \geq h_a \end{aligned} \quad (9)$$

where  $h_a$  is the air entry value, and  $\lambda$  is the pore-size distribution index. Since Brooks and Corey (BC) (1966) and van Genuchten (VG) (1980) models converge to the same formula for small values (large negative values) of  $h$ , the following approximations can be made:  $h_a = 1/\alpha$ , and  $\lambda = mn$  (Lenhard, *et al.*, 1989). When water retention parameters for the site are not available but water retention data are, these function parameters can be easily obtained. The VG parameters can be obtained by fitting these data using the RETC (RETention Curve) code (van Genuchten, 1980), while BC and Campbell (1974) parameters

$$\Theta_e = \frac{(\theta - \theta_r)}{(\theta_s - \theta_r)} \quad (10)$$

can be obtained graphically. BC parameters can be obtained by plotting  $\ln(\Theta_e)$  vs  $\ln h$ , where

where the intercept will be  $h_a$  and the slope will be the parameter  $\lambda$  for a straight line through these  $\ln$ - $\ln$  data. Parameters for the Campbell model are derived from the plot of  $\ln h$  vs.  $\ln \theta/\theta_s$ . The intercept will be  $h_a$  and the slope will be the parameter  $b$  for a straight line through these  $\ln$ - $\ln$  data.

HYDRUS2D requires parameters for the VG function only, however, a modified form is optional which allows representation of soil as a dual porosity media. SoilCover allows the user to either select water retention data from a menu or input these values for fitting to a modified VG function. UNSAT-H has the greatest flexibility, allowing the user to choose between VG and BC water retention functions, the Haverkamp function as well as polynomial functions to fit water retention data. This flexibility can be useful when site parameters for water retention are limited. LEACHM has the disadvantage of not having water retention function options, and it uses the less popular Campbell (1974) function:

$$\theta = \theta_s \left( \frac{h}{h_a} \right)^{-1/b} \quad \text{for } h < h_a \quad (11)$$



which assumes pressure head to be the dependent variable. Zornberg and Caldwell (1998) used LEACHM to simulate the sensitivity of monolayer covers under southern California climatic conditions to the rooting depth. They assumed values of -4.89 mm and 4.215 for  $h_a$  and  $b$  parameters, respectively, to represent soil properties and an initial volumetric water content of 0.23. They suggested that future studies should evaluate the effect of the water retention parameters and the initial water content.

In summary, ten codes were identified in a survey as being used for landfill-cover evaluation and design. Each code has strengths and weaknesses. Of these, five codes (HELP, HYDRUS-2D, EPIC, UNSAT-H and SHAW) were chosen for more detailed description. Tough2 was not chosen because of its complexity while CREAMS and MULTIMED were not selected due to their process simplicity. SoilCover appears to be an excellent code for landfill design but was not chosen due to its similarity to UNSAT-H, but, in contrast to UNSAT-H, was not identified in the surveyed as currently being used in the U.S. for landfill evaluations. LEACHM was not selected due to reasons discussed earlier.

### **III.C. Detailed Code Descriptions**

#### **III.C.1. HELP (Version 3.07) Code Description**

HELP (Hydrologic Evaluation of Landfill Performance), a quasi-two dimensional hydrologic model of water balance (Schroeder et al. 1994). HELP was developed for the EPA and is accepted or required by many regulatory agencies. Due to regulatory acceptance, cost, availability, extensive documentation and user-friendly reputation, HELP is likely the most widely used water balance model currently used for landfill applications. The model is available for IBM-compatible personal computers. Several versions of HELP are currently available to the public including HELP Version 3.07 and can be downloaded from author's web page, <http://www.wes.army.mil/el/elmodels/helpinfo.html>. A user's guide and a documentation report are available in WordPerfect 5.1™ and Adobe Acrobat™ formats. Excerpts from the web site are placed in quotations. HELP 3.07 has also been made available commercially in a windows-based version, as Visual HELP (Waterloo Hydrologic Inc., 1998). The HELP model calculates water balance for landfills, RCRA (Resource Conservation and Recovery Act of 1976) and CERCLA (Comprehensive Environmental Response, Compensation, and Liability Act of 1980) facilities, and other land disposal systems, including CDFs (Confined Disposal Facilities) for dredged material disposal.

#### **Climate Simulation**

HELP accepts daily weather information. It incorporates the routine developed by the U.S. Department of Agriculture (USDA) as refined by Richardson and Wright (1984). HELP can use historical site data provided by the user or default data taken from the National Oceanographic and Atmospheric Administration (NOAA) database. An option for projecting future site performance is to synthetically generate daily mean values of precipitation, temperature and solar radiation. The generating routine is designed to preserve dependence in time and the seasonal characteristics in actual weather data at a specified location. Default coefficients needed for weather generation are available for up to 183 U. S. cities. Daily precipitation is generated using a Markov-chain two-parameter gamma distribution. A first-

order Markov-chain model is used to generate the occurrence of wet or dry days. Schroeder et al. (1994) provide details of the development of default climatic coefficients for the weather generation.

## **Process Description**

“Daily infiltration into the landfill is determined indirectly from a surface-water balance. Each day, infiltration is assumed to equal the sum of rainfall and snowmelt, minus the sum of runoff, surface storage and surface evaporation. No liquid water is held in surface storage from one day to the next, except in the snow cover. The daily surface-water accounting proceeds as follows. Snowfall and rainfall are added to the surface snow storage, if present, and then snowmelt plus excess storage of rainfall is computed. The total outflow from the snow cover is then treated as rainfall in the absence of a snow cover for the purpose of computing runoff. A rainfall-runoff relationship is used to determine the runoff. Surface evaporation is then computed.

Surface evaporation is not allowed to exceed the sum of surface snow storage and intercepted rainfall. Interception is computed only for rainfall, not for outflow from the snow cover. The snowmelt and rainfall that does not run off or evaporate is assumed to infiltrate into the landfill. Computed infiltration in excess of the storage and drainage capacity of the soil is routed back to the surface and is added to the runoff or held as surface storage.

The first subsurface processes considered are evaporation from the soil and plant transpiration from the evaporative zone of the upper subprofile. These are computed on a daily basis. The evapotranspiration demand is distributed among the seven modeling segments in the evaporative zone.

The other subsurface processes are modeled one subprofile at a time, from top to bottom, using a design dependent time step, varying from 30 minutes to 6 hours.

Unsaturated vertical drainage is computed for each modeling segment starting at the top of the subprofile, proceeding downward to the liner system or bottom of the subprofile. The program performs a water balance on each segment to determine the water storage and drainage for each segment, accounting for infiltration or drainage from above, subsurface inflow, leachate recirculation, moisture content and material characteristics.”

The evaporation coefficient indicates the ease with which water can be drawn through the soil or waste layer by evaporation. The coefficient constrains the amount of water that can be removed via the evaporation process across the entire range of soil types (sands to clays).

“The HELP program imposes upper and lower limits on the evaporation coefficient so as not to yield a capillary flux outside of the range for soils reported by Knisel (1980). If the calculated value of the evaporation coefficient is less than 3.30, then it is set equal to 3.30, and if the evaporation coefficient is greater than 5.50, then it is set equal to 5.50. The user cannot enter the evaporation coefficient independently. Since (the evaporation) equation was developed for soil materials, the HELP program imposes additional checks on the evaporation coefficient based on the relative field capacity and saturated hydraulic conductivity of each soil and waste layer. Relative field capacity is calculated using the following equation:

$$FC_{rel} = \frac{FC - \theta_r}{\phi - \theta_r} \quad (12)$$

where  $FC_{rel}$  = relative field capacity, dimensionless  
 $FC$  = field capacity, vol/vol  
 $\phi$  = total porosity, vol/vol

If the relative field capacity is less than 0.20 (typical of sand), then the evaporation coefficient is set equal to 3.30. Additionally, if the saturated hydraulic conductivity is less than  $5 \times 10^{-6}$  cm/s (the range of compacted clay), the evaporation coefficient is set equal to 3.30.”

Leaf area index (LAI) and evaporative zone depth are parameters used in estimating water losses by evaporation and transpiration. Leaf area index values can be user-defined or taken from the HELP default database that is based on geographical distributions. Evaporative-zone depth is developed from rainfall, temperature and humidity data for climatic regions.

“The estimates for minimum depths are based loosely on literature value (Saxton et al., 1971) and unsaturated flow model results for bare loamy soils (Thompson and Tyler, 1984; Fleenor, 1993), while the maximum depths are for loamy soils with a very good stand of grass, assuming rooting depths will vary regionally with plant species and climate.”

“The HELP code accounts for seasonal variation in leaf area index (LAI) through a general vegetative growth model. The vegetative growth model computes daily values of total and active above-ground biomass based on the maximum LAI value input supplied by the user, daily temperature, solar radiation, mean monthly temperatures and the beginning and ending dates of the growing season.”

The user must supply the estimated maximum LAI and type and quality of vegetative stand. Vegetative growth and phenological development are based on cumulative heat units during the growing season. Growth starts at the beginning of the growing season and continues during the first 75% of the growing season.

“Water is routed downward from one segment to the next using a storage routing procedure, with storage evaluated at the mid-point of each time step. Mid-point routing provides an accurate and efficient simulation of simultaneous incoming and outgoing drainage processes, where the drainage is a function of the average storage during the time step. Mid-point routing tends to produce relatively smooth, gradual changes in flow conditions, avoiding the more abrupt changes that result from applying the full amount of moisture to a segment at the beginning of the time step. The process is smoothed further by using time steps that are shorter than the period of interest. Mid-point routing is based on the following equation of continuity for a segment:”

$$\begin{aligned} \Delta\text{Storage} = & \text{Drainage In} - \text{Drainage Out} - \text{Evapotranspiration} \\ & + \text{Leachate Recirculation} + \text{Subsurface Inflow} \end{aligned} \quad (13)$$

The rainfall-runoff process is modeled using the Soil Conservation Service (SCS) curve-number method (USDA-SCS, 1985) which was developed from rainfall-runoff data for large storms on small watersheds. Empirical relationships developed by the SCS have been used to describe the relationship between precipitation, runoff and retention. Subsequently, curves have been generated that account for the influence of slope, water content, and frozen soils. Runoff was plotted as a function of rainfall on arithmetic graph paper, yielding a curve that becomes asymptotic to a straight line with a 1:1 slope at high rainfall.

“The retention parameter,  $S$ , is transformed into a so-called runoff curve number,  $CN$ , to make interpolating, averaging and weighting operations more nearly linear. The relationship between  $CN$  and  $S$  is:

$$S = \frac{1000}{CN} - 10 \quad (14)$$

$$CN = \frac{1000}{S + 10} \quad (15)$$

The HELP program computes the runoff,  $Q_i$  on day  $i$  based on the net rainfall,  $P_i$ , on this day. The net rainfall is zero when the mean temperature is less than or equal to 32°F; is equal to the precipitation when the mean temperature is above 32 °F and no snow cover is present; or is equal to the outflow from the snow cover when a snow cover is present and the mean temperature is above 32 °F.

The runoff curve number required as input to the HELP program corresponds to antecedent moisture condition II (AMC-II) in the SCS method. AMC-II represents an average soil-moisture condition. The corresponding curve number is denoted  $CN_{II}$ . The HELP user can input a value of  $CN_{II}$  directly, input a curve number and have the program adjust it for surface slope conditions or have the program compute a value based on the vegetative cover type, the default soil type and surface slope conditions.”

HELP uses a regression equation, the KINEROS kinematic runoff and erosion model (Woolhiser, Smith, and Goodrich, 1990) to adjust the AMC-II curve number for default soils and vegetation placed at mild slopes. This is based on hundreds of runoff estimates generated by using different combinations of soil texture class, level of vegetation, slope, slope length, and rainfall depth, duration and temporal distribution.

“When the HELP program predicts frozen conditions to exist, the value of  $CN_{II}$  is increased, resulting in a higher calculated runoff. Knisel et al. (1985) found that this type of curve number adjustment in the CREAMS model resulted in improved predictions of annual runoff for several test watersheds. If the  $CN_{II}$  for unfrozen soil is less than or equal to 80, the  $CN_{II}$  for frozen soil conditions is set at 95. When the unfrozen soil  $CN_{II}$  is greater than 80, the  $CN_{II}$  is reset to be 98 on days when the program has determined the soil to be frozen. This adjustment results in an increase in  $CN_I$  and consequently a decrease in  $S_{mx}$  and  $S'$ . As  $S'$  approaches zero,  $Q$  approaches  $P$ , which causes a decrease in infiltration under frozen soil conditions.”

Drainage is controlled by the unsaturated hydraulic conductivity of the vertical drainage layers. Drainage through vertical percolation layers is calculated based on an assumption of constant unit gradient conditions. The unit head gradient results from the assumption of gravity forces being solely responsible for the driving force. Drainage rates in the vertical percolation layers are computed by use of the modified Brooks-Corey relationships assigned to the soil or waste materials. In contrast, for liner (barrier) layers, the HELP code assumes that the barrier layer materials remain saturated at all times. Percolation is predicted to occur only when there is a positive hydraulic head on top of the barrier layer and is computed via Darcy's law as the product of the saturated conductivity and the estimated hydraulic head gradient.

Drainage through geomembrane liners is also calculated with the HELP code. Geomembranes generally have low but finite hydraulic conductivities. They can also have flaws and pinholes, created during construction of the liner, which can cause elevated drainage rates through an otherwise very low permeability material. Using the description provided by Giroud and Bonaparte (1989), the HELP code calculates the vertical seepage through a geomembrane as a function of the number of pinholes, their estimated size, and the head difference across the membrane. Vapor diffusion through intact geomembranes is expressed as a combination of both advective and diffusive flow. An “equivalent geomembrane hydraulic conductivity” is developed from known or estimated vapor permeability of the geomembrane. The water flux is then computed as the product of the conductivity and hydraulic head difference divided by the membrane thickness. Contact between liner and underlying soil is also considered in the HELP code analysis, and interfacial flow and flow due to construction defects in liner placement are calculated after procedures described by Giroud and Bonaparte (1989). Gradations from excellent to poor contact of the liner are quantified and accounted for in the HELP code.

Lateral drainage recirculation is calculated when appropriate. If water is collected and recirculated, the fraction of the drainage that is removed for recirculation is reported as a

volume input much like rainfall or snow. The method of calculation is to apply the standard vertical routing procedures. Recirculation can be distributed to any non-liner layer. The HELP code also accounts for subsurface inflow if seepage into the landfill is known or can be estimated. If inflow is specified for a liner system that is above the bottom of the landfill, then that inflow is added to the inflow of the first layer above the liner system. Inflow is specified for each layer. The drainage rate out of a subprofile must equal the sum of lateral drainage rate and the leakage rate through the liner system. The subsurface flow is linked to ensure mass balance. A procedure is developed to sum the leakage/percolation volumes for each subprofile for each time step. Daily lateral drainage is partitioned into a removal component and a recirculation component when appropriate. The liner leakage/percolation is assigned as drainage into the next subprofile or out of the landfill. The saturation depths are averaged and reported as daily values.

The model also contains a default soil database of characteristics (hydraulic properties) for 42 types of materials (soils, waste, and geosynthetics). The HELP code requires values for total porosity, field capacity, wilting point and saturated hydraulic conductivity for each layer that is not a liner. Estimates of saturated hydraulic conductivity are required of all liners. Values for these parameters are specified by the user or selected from a list of default values provided by HELP. Soil water storage is computed on a per volume basis. Total porosity is the upper limit of water storage in any given layer and in HELP is equated to the saturated water content. Field capacity is the volumetric water content of a soil after a period of soil wetting followed by prolonged (2-3 days) drainage. In HELP, the default value for field capacity of a given soil layer is assigned the water content at 0.33 bar (0.033 MPa) suction. Wilting point is the lowest volumetric water content achieved by plant transpiration. In HELP, the default value for wilting point is assigned the water content of 15 bars (1.5 MPa) suction. These values are used also to define water storage and relative unsaturated hydraulic conductivity. The HELP code requires that the wilting point be greater than zero but less than the field capacity. Total porosity must be greater than field capacity but less than one.

HELP users can specify the initial water contents of each layer that is not a liner. Soil liners are assumed to remain saturated at all times. If an initial water content is not specified, the code assumes a value near the steady-state value and runs a year of simulation to initialize the water contents closer to steady state. The soil water contents at the end of this simulation year are then substituted as the initial values for the full simulation. The results of the initialization period are not reported in the output.

The HELP code uses the saturated and unsaturated hydraulic conductivity values of the soil and waste layers to compute vertical drainage, lateral drainage and soil-liner percolation. The vapor diffusivity of geomembranes is specified as a saturated hydraulic conductivity to compute leakage through geomembranes by diffusion. For all liners and for saturated soils the liquid water flux rate is computed using Darcy's law, which equates flux to the product of the head gradient and the saturated conductivity. For flux rates through unsaturated soil layers the HELP code (Version 3 and higher) uses the Campbell (1974) modification of the Brooks-Corey (1964) relationship in Eq. (9).

“The HELP program uses a regression equation from Rawls et al. (1982), to calculate the residual water content based upon soil texture. The HELP code solves Eq. (9) for two different capillary pressures simultaneously to determine the bubbling pressure and pore-size distribution index. Hydraulic conductivity is described by the Campbell model:

$$K = K_s \left( \frac{\theta_l}{\theta_s} \right)^{2b+3} \quad (16)$$

where  $K$  is the unsaturated hydraulic conductivity and  $K_s$  is the saturated hydraulic conductivity. The HELP code adjusts the saturated hydraulic conductivities of vegetated soils and waste layers in the top half of the evaporative zone whenever these soils are selected from the default list of soil textures. The adjustment is an empirical function of the leaf area index (LAI) of the vegetated surface. This adjustment is made to account for root channeling due to root penetration.

### **Verification**

The HELP code has evolved from a relatively uncomplicated one-dimensional, water-balance model to a robust quasi-two-dimensional code that handles almost all processes that control drainage into and out of a landfill (Schroeder and Peyton 1987a,b; Peyton and Schroeder 1988; USEPA, 1991; Schroeder et al. 1994a,b). Publication of the documentation and user guides for each HELP code version has been excellent. Not much information, however, is provided on verification testing (Schroeder and Peyton 1987a,b for version 1; Schroeder, 1991 for version 2; Schroeder *et al.*, 1994a,b, for version 3). Sensitivity analysis, which has been substantial, has been used as a means of verification testing. Extensive sensitivity analysis for version 3.04 can be found in Emam (1995).

### **Validation**

More validation testing using landfill conditions has been performed for HELP than any other code identified in the survey. There remains considerable disagreement as to whether it has been validated or invalidated. The approach taken in this report is to identify the conditions under which the code is valid. The first attempt to validate HELP (1.0) with field data was reported by Schroeder and Peyton (1987) for the lateral drainage component of HELP 1.0. Two physical models were made to test what the effects of slope, slope length, hydraulic conductivity of drainage layer, and depth of the saturated layer would have upon the rate of lateral drainage. More than 60 tests were performed using different materials, slopes, and slope lengths. For a steady-state drainage case, the HELP model underpredicted lateral drainage by 30%, and under-predicted lateral drainage in an unsteady state by only 11%. The authors state that the difference in the predicted and actual lateral drainage would not be significant due to the fact that the removal of water from the lateral drainage layer by all other means would be minimal. The model overestimated the amount of increase in lateral drainage with an increase in slope of the lateral drainage layer. The authors' state that although the values of the variables involved in lateral drainage of a cover may be in doubt, the cumulative amount of lateral drainage predicted should be close to the actual amount. This is due to the fact that the depth of saturation will be overpredicted if the drainage rate is

underpredicted, which will balance each other and produce a cumulative lateral drainage amount that is near the actual measured value.

Peyton and Schroeder (1988) validated other components of HELP 1.0 using data from six landfill sites (a total of 17 landfill cells) in Madison, WI; Sonoma CA; and Boone County, KY. Size of the test cells ranged from 0.016 to 9.7 ha (0.04 - 24 acres). Simulation periods were from 2.5 to 8 years. Runoff was overpredicted by the HELP model by 30% for five cells and under-predicted for six cells by an average of 21%. Evapotranspiration (ET) was underestimated by 10%. The model over-predicted the lateral drainage of the uncovered cells by 53% and 6% for the cells covered with a soil liner. Cumulative lateral drainage is very sensitive to the hydraulic conductivity of the cover materials and surface, especially when the value is below  $1 \times 10^{-4}$  cm/s. The authors state that no model can be expected to exactly reproduce field conditions due to spatial variability. However, since the predictions were within the range of field measurements, and calibration to the measured values could produce adequate results, it was concluded that HELP 1.0 was a valuable tool for designing landfills.

Contrasting results were obtained by Khire et al. (1997) who compared HELP 3.0 simulation results with field data from two landfill sites (Atlanta, GA and Wenatchee, WA). HELP 3.0 over-predicted the amount of percolation at both sites even when the input parameters were well defined. The model also significantly underpredicted the actual amount of runoff. However, the model was fairly accurate when predicting ET for the cover; it slightly underpredicted the cumulative ET, which was not anticipated given the deviations in runoff predictions. The model showed that the capillary barrier would have more percolation than the resistive barrier in the system, but the opposite was found by the field measurements. Benson and Pliska (1996) concluded that the HELP code simulated more drainage than measured under arid conditions. This study concluded that a model more capable of computing water balance and determining flow in an unsaturated soil is needed to accurately model landfill covers.

Similar results were obtained by Fayer and Gee (1997) when testing the HELP 2.05 code against lysimeter data at the Hanford Site in Washington state. Data over a six-year period from a non-vegetated field lysimeter were analyzed by the HELP 2.05 model and the UNSAT-H model. The field lysimeter was located on a landfill cover containing 1.5 m of silt loam over sand and gravel. The capillary barrier in this lysimeter was the main feature of the cover to be evaluated. The RMS error for the four UNSAT-H simulations of the water balance in the soils was 23.7 mm. For the HELP simulations, the RMS error for water balance was 97.6 mm. UNSAT-H also predicted drainage within 52% of the actual amount. The HELP code over-predicted the actual amount of runoff by 1,800%. The article states that for the landfill cover in question, hysteresis was the controlling factor in the water budget for the cover. The study showed that the HELP 2.05 model may be inadequate to simulate covers where capillary barriers are in place. HELP 3.01 was used later in the study to see if it provided improved predictions. The new version still could not effectively simulate a capillary barrier in an arid environment. In contrast, Stephens and Coons (1994) found that HELP predicted drainage values at an arid site in New Mexico that were comparable to measured chloride tracer data and to hydraulic properties estimates using Darcy's law.



An attempt at model validation was reported by Ascough et al. (1997), who compared the results of the HELP 2.0 and HELP 3.0 models with field results from test cells in Michigan, Utah, and Delaware. Models were assessed using statistics, including the Nash-Sutcliffe model efficiency, relative error, and absolute relative error. The  $K_s$  and average saturation values used did not reflect field conditions. For example, relative errors for saturation in some of the Michigan test cells exceeded 600 %. For HELP 3.0, the monthly model evaluations were poor, but were improved for annual and cumulative drainage estimates. Ascough et al. (1977) concluded that the HELP 3.0 model should be used for long-term simulations of a landfill system, and not short-term evaluations. For mean annual (as opposed to monthly) drainage predictions, HELP 3.0 performed much better than HELP 2.0.

The work of Berger et al. (1996) further suggested a partial validation. The lateral drainage portion of the HELP 2.0 program was found to be very accurate, but the vertical drainage through soil layers failed due to an inability to model desiccation cracks in these layers. The runoff portion of HELP 2.0 was found inaccurate when given large amounts of precipitation. Since HELP 2.0 models only gravitational forces, capillary barriers may not be modeled correctly as unsaturated flow can be strongly affected by capillary forces. The authors point out that by setting a unit value for hydraulic gradient, the code neglects the capillary forces. The model also does not take into account preferential flow due to such factors as desiccation cracks, which are anticipated to be important to long-term performance that is not reflected in short-term data bases used for validation. They concluded that the model is good for comparing alternative cover designs, but the main factors in the deterioration of the effectiveness of the liner and the aging of the liner system cannot be modeled by HELP 2.0.

Thompson and Tyler (1984) compared two water-balance models, HELP and UNSAT-1D, for a series of climatic conditions ranging from eastern, humid sites to western, semi-arid sites. The model comparison indicated that the two codes predicted similar drainage at humid sites, but for semi-arid sites, the HELP model overpredicted drainage. This was attributed to the inability of HELP to simulate capillary barrier flow in soils and the uncertainty in estimating ET. Similar to all known water-balance codes, the HELP code prediction of ET utilizes methods that are reliable to no more than 10 to 20% of the actual value, particularly for semi-arid and arid sites. As ET decreases, the uncertainties tend to increase. In the absence of runoff, drainage is calculated as the difference between precipitation and ET. Thus, relatively small errors in measurements of precipitation and ET become large estimation errors for drainage (Gee and Hillel 1987). As indicated from the study of Thompson and Tyler (1984), the estimation error in the HELP code generally favors an underestimation of the ET, resulting in an overestimation of the drainage.

From these tests conducted, it appears that the HELP code performs best under humid-site conditions and poorest under arid-site conditions (Thompson and Tyler, 1984; Nichols, 1991; Khire et al., 1997). The recent recommendations by Benson and Pliska (1996) and observations by Fayer and Gee (1997) suggest that HELP must be calibrated for site-specific conditions. Even for well-documented conditions, HELP may overestimate the drainage at arid sites.

## Sensitivity Analysis

As mentioned earlier, extensive sensitivity analysis has been performed on the various HELP versions as verification of the code and to gain insight into the processes. Schroeder (1991) reported the sensitivity analysis of the HELP 2.0 model to numerous design variables for three locations (California, New York, and Louisiana) that provide a range of climatic conditions. This review will focus on the following water-balance variables: drainable porosity (saturated water content minus field capacity), available water capacity (AWC) (equal to field capacity minus wilting point), soil thickness, and evaporative depth. While the hydraulic conductivity of the cover layers may be the most critical single parameter, sensitivity analysis of  $K_s$  was restricted to the barrier and drainage layers without testing the impact of the vegetative layer. Two top soil thicknesses, 46 and 96 cm, were evaluated for all three locations. Three different climate series were simulated by the HELP model weather generator: Shreveport, LA, Schenectady, NY, and Santa Maria, CA. The model determined daily precipitation for each site from 1974-1978. Two different landfill cover systems (a two-layer and a three-layer) were simulated at each site using two different vegetation types and two different soil types. The authors picked evaporative depth based on intuitive observation.

Similar trends were found at each location, with greater runoff and ET for the shallower depth resulting in greater percolation with an increase in soil thickness. This is counter-intuitive, as an increase in soil depth would provide greater storage capacity. However, this finding was explained to be a result of the greater thickness below the evaporative depth allowing larger and longer lasting heads to develop within the thicker profile. The primary importance of the topsoil is the overlap of the evaporative depth and the head in the lateral drainage layer. The greater the overlap of these two layers, the greater the runoff and ET of the system.

Three evaporative depths (10, 25, and 46 cm) were evaluated for three soil textures. As expected, ET increased with increase in evaporative depth and generally resulted in a decrease in lateral and vertical drainage. However, the impact on runoff varied depending upon the timing of precipitation but generally the impact was small. Since water depletions are uniformly removed with depth within a layer, the water content would be higher for greater evaporative depths for a given evaporative demand. Thus, runoff would be higher for the greater evaporative depth, but given equivalent antecedent moisture conditions, increases in the evaporative depth lowers the runoff due to higher infiltration (storage capacity).

Schroeder (personal communication) confirmed that the sensitivity analysis performed for HELP 2.0 on drainable porosity and AWC was made with the acceptable values in units of in/in despite a typographical error in the text for values in cm/cm, which were outside the acceptable range. Only a sandy loam soil was tested, with values of 0.263 and 0.133 cm/cm for field capacity and wilting point, respectively, for the LA and CA conditions. Counter to intuition, as drainable porosity increased from 0.1 to 0.27 cm/cm, the lateral drainage and percolation decreased. In contrast, ET increased for the three-layer design, while for the two-layer design, ET increased but percolation was inconsistent. Schroeder explained the increase in ET to be a result of decreases in unsaturated  $K$  associated with drainable porosity increases that allowed more water to infiltrate and be available for

ET. Drainable porosity is, by definition, that portion of the water storage that moves rapidly due to free drainage. Given that this water is generally unavailable for plant uptake, this explanation does not appear to be technically consistent.

The AWC was varied from 0.07 to 0.2 cm/cm, with drainable porosity held to 0.18 cm/cm for the LA and CA conditions. The model produced expected results with ET increasing, lateral drainage decreasing, and percolation decreasing as AWC increased for the two and three layer designs. While runoff was very small for the three-layer design, and thus not very sensitive, the pattern for runoff was design dependent. Runoff increased for the three-layer but decreased for the two-layer design as AWC increased.

## **Applications**

Paige *et al.* (1996a) tested the HELP model against lysimeter data from Hill Air Force Base, UT where there was a side by side comparison of RCRA-type compacted clay, monofill (control), and capillary barriers. The capillary barriers were not evaluated, since HELP does not adequately address their performance. Paige *et al.* (1996a) concluded that a complete validation of the support system methodology was not possible due to the short duration and limited number of covers in the data base. Paige *et al.* (1996b) also demonstrated how HELP could be calibrated for given site conditions and cover designs. Optimization routines were used to adjust the saturated conductivity and water storage capacity so that the model results matched the measured drainage. As an example, the saturated conductivity was increased by two times the standard deviation of the laboratory-determined values. In addition, the calibration required adjustment of the runoff curve number to match the measured values. It is uncertain how reliable and robust the calibration of the HELP code is for only three years of data. It is anticipated that additional years of data will be required to build credibility into the calibration so that the code can be used in a meaningful way to predict future performance of the test covers.

### **III.C.2. HYDRUS-2D (version 1.0) Code Description**

Statements describing HYDRUS-2D (Simunek *et al.*, 1996) that were obtained directly from the authors' web site ([www.ussl.ars.usda.gov/models/HYDRUS-2D.htm](http://www.ussl.ars.usda.gov/models/HYDRUS-2D.htm)) are provided in quotation marks. "HYDRUS-2D is a Microsoft Windows-based modeling environment for analysis of water flow and solute transport in variably saturated porous media. It includes the two-dimensional finite element model SWMS\_2D for simulating flow and solute transport in variably saturated media. The model is supported by an interactive graphics-based interface for data preprocessing, generation of a structured mesh, and graphic presentation of the results. Optionally, the modeling environment includes a mesh generator for unstructured finite element grids, MESHGEN-2D. This program, based on Delaunay triangulation, is seamlessly integrated in the HYDRUS-2D environment. In the absence of the MESHGEN-2D program, the HYDRUS-2D shell provides an option for automatic construction of simple, structured grids."

## Process Description

“The program 'SWMS\_2D' is a finite element model for simulating two-dimensional water and solute movement in variably saturated media. The program numerically solves the Richards' equation for saturated-unsaturated water flow, and the Fickian-based advection-dispersion equation for solute transport. The flow equation incorporates a sink term to account for water uptake by plant roots”

$$C(\theta)\frac{dh}{dt} = K(h)\left[\frac{d^2h}{dx^2} + \frac{d^2h}{dz^2} + \frac{dh}{dz}\right] - S(h) \quad (17)$$

where  $S(h)$  is the sink term, defined as  $S(h) = a(h) (L_s T_p)/(L_x L_z)$ . Here,  $a(h)$  is the plant water stress function,  $T_p$  is the potential transpiration rate,  $L_s$  is the width of the surface,  $L_x$  is the width of the root zone, and  $L_z$  is the depth of the root zone.

“SWMS\_2D can handle flow regions delineated by irregular boundaries. The flow region itself may be composed of nonuniform soils having an arbitrary degree of local anisotropy. Flow and transport can occur in the vertical plane, the horizontal plane, or in a three-dimensional region exhibiting radial symmetry about the vertical axis.” There are three types of boundary conditions (BC) that are possible with Richards' equation-based models: Dirichlet is a prescribed head, Cauchy is a prescribed flux, and Neumann is a prescribed hydraulic gradient. HYDRUS-2D has the capability to use all three types. “The water flow part of the model can deal with (constant or varying) prescribed head and flux boundaries, as well as boundaries controlled by atmospheric conditions. Soil surface boundary conditions may change during the simulation from prescribed flux to prescribed head type conditions (and vice-versa). The code can also handle a seepage face boundary through which water leaves the saturated part of the flow domain, and free drainage boundary conditions.” There are nine options to choose from in HYDRUS-2D for specifying the BC: no flux, constant pressure, constant flux, variable pressure, variable flux, free drainage, deep drainage, seepage face, and atmospheric. The free-drainage boundary condition is a Neumann-type BC, in which a unit vertical hydraulic gradient is imposed at the boundary. We recommend this be used for the bottom BC when modeling a landfill cap. The atmospheric BC is a Cauchy type, in which the precipitation, potential evaporation, and potential transpiration rates must be specified. The atmospheric BC is recommended for the surface condition when modeling a landfill cap, although one may wish to specify the infiltration rate as a constant or variable flux BC when testing cap performance for an individual precipitation event. For the removal of lateral drainage, either by a tile drain or the lower side slope boundary, the seepage face BC should be used. The seepage face BC assumes that the pressure head is uniformly zero along the face and allows drainage when saturated conditions develop. The flux is set to zero for the unsaturated portion of the seepage face boundary. A seepage face may also be used as the bottom boundary of a landfill cover if one wants to simulate a landfill cover lysimeter that contains a gravel drainage layer at the bottom. Since SWMS\_2D assumes that any excess water on the surface (i.e., precipitation rate > infiltration rate) is immediately removed, HYDRUS-2D cannot model erosion.

“The governing equations are solved using a Galerkin type linear finite element method applied to a network of triangular elements. Integration in time is achieved using an implicit (backwards) finite difference scheme for both saturated and unsaturated conditions. The resulting equations are solved in an iterative fashion, by linearization and subsequent Gaussian elimination for banded matrices, a conjugate gradient method for symmetric matrices, or the ORTHOMIN method for asymmetric matrices. Additional measures are taken to improve solution efficiency in transient problems, including automatic time step adjustment and checking if the Courant and Peclet numbers do not exceed preset levels. The water content term is evaluated using the mass-conservative method proposed by Celia et al. (1990). To minimize numerical oscillations, upstream weighting is included as an option for solving the transport equation.” The ability of a numerical code such as HYDRUS-2D to converge to a stable solution also depends upon the discretization and temporal iteration schemes. Simunek et al. (1996) recommended that the finite element mesh be constructed with close nodal spacing where the hydraulic gradient is expected to be large, such as the soil surface for atmospheric BCs, and near internal source/sinks like tile drains. A closely spaced mesh is particularly needed for coarse-textured soil with high  $n$ -values and small  $\alpha$  values. This principle is also true for layer interfaces where hydraulic properties change sharply and further applies to the time iteration criteria for minimum time steps.

“The unsaturated soil hydraulic properties are described by a set of closed-form equations resembling the 1980 van Genuchten equations. Modifications were made to improve the description of hydraulic properties near saturation.” This improvement was the incorporation of the ability to prescribe an air-entry pressure head,  $h_a$ , and a pressure head,  $h_k$ , for matching the relative hydraulic conductivity function to a measured value below saturation,  $K_k$ , such that:

$$\theta(h) = \theta_r + \frac{\theta_m - \theta_r}{[1 + (\alpha h)^n]^m} \quad \text{for } h < h_s \quad (18)$$

$$\theta(h) = \theta_s \quad \text{for } h \geq h_s \quad (19)$$

and

$$K(h) = K_s K_r(h) \quad \text{for } h < h_k \quad (20)$$

$$K(h) = K_k + (K_s - K_k) \left[ \frac{(h - h_k)}{(h_s - h_k)} \right] \quad \text{for } h_k < h < h_s \quad (21)$$

$$K(h) = K_s \quad \text{for } h \geq h_s. \quad (22)$$

The effect of the prescribed heads,  $h_k$  and  $h_s$ , is illustrated in Figures 5 and 6. This allows the use of a field-saturated water content ( $\theta_s$  in Eq. 19), which is commonly found to be 10-15% lower than the laboratory measured saturated water content ( $\theta_m$  in Eq. 18). It further provides a means of incorporating the effect of macropore flow on the hydraulic properties by making  $K(h)$  a two-region function (Wilson et al., 1992; Mohanty et al., 1997), whereby  $K_s$  represents the hydraulic conductivity when all pores are contributing and  $K_k$  is the hydraulic conductivity after the macropores empty.

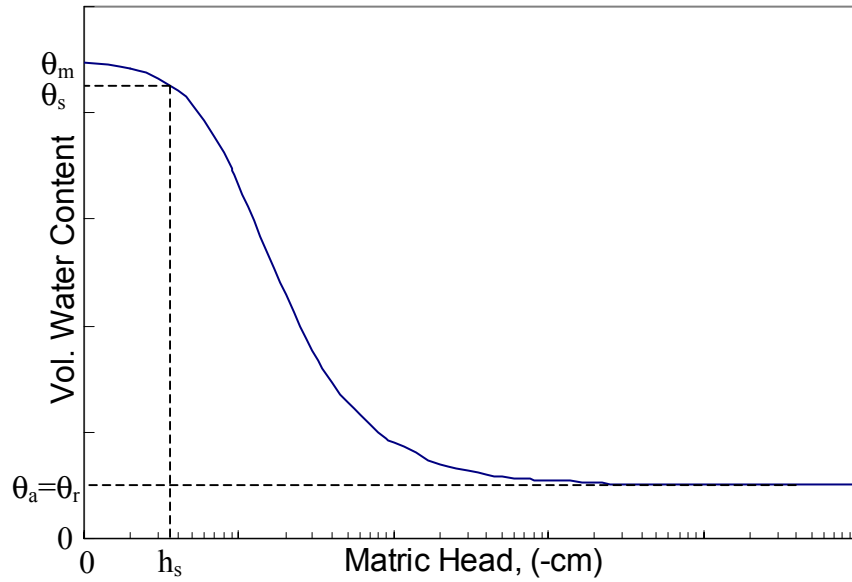

Figure 5. Schematic of the soil water retention function (Simunek et al., 1994).

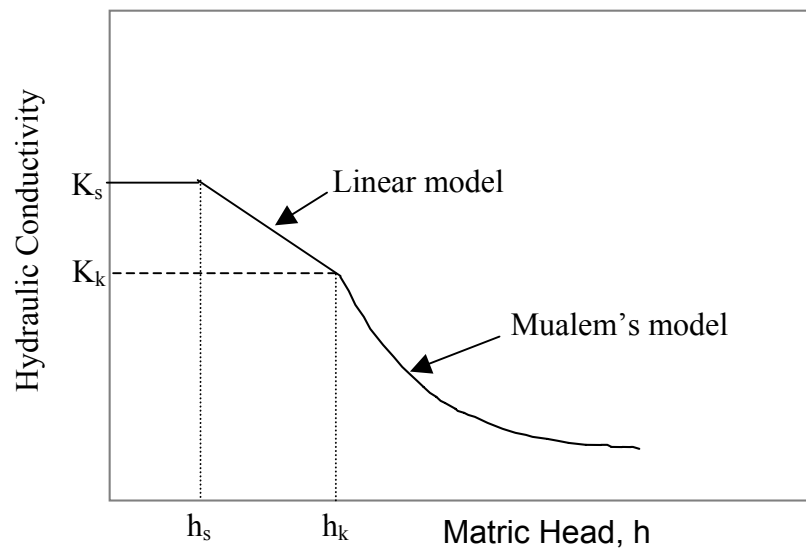

Figure 6. Schematic of the hydraulic conductivity function (Simunek et al., 1994).

“SWMS\_2D implements a scaling procedure to approximate the hydraulic variability in a given area.” Three independent scaling factors may be included which linearly relate the hydraulic conductivity, water content, and pressure head at any location within the site to the measured properties at a reference location. “Included in the program is a small catalog of soil hydraulic properties.” While the soil property catalog was derived from Carsel and Parrish (1988), it should be used with care, as some of the key parameters do not appear to be realistic.

The following general relationships should exist between soil texture and water retention parameters in Eq. (18):

- 1) since porosity is related to bulk density, the finer the texture, the higher the saturated water content,
- 2) clay particles exert greater molecular attraction per surface area than sand, thus the finer the texture, the higher the residual water content,
- 3) since alpha is inversely related to the air entry value, the finer the texture, the lower the alpha value,
- 4) the finer the texture, the more uniform the pore-size distribution, thus the lower the n value, and
- 5) the coarser the texture, the larger the pores, thus the higher the  $K_s$  value.

The HYDRUS-2D catalog values, listed in Table 4, exhibit some deviations from these general trends with values for saturated and residual water contents outside the range of expected values for many of the textures. These parameter values may be input directly instead of selecting from the menu. Additional values for these parameters for various textures may be obtained from Leij et al. (1996) and Romkens et al. (1986).

Table 4. Water retention and hydraulic conductivity parameters provided in the HYDRUS-2D menu (Simunek et al., 1996).

Textural Class	Residual Water Content	Saturated Water Content	alpha (1/cm)	n	$K_s$ (cm/d)
S	0.045	0.43*	.145	2.68	712.8
LS	0.057	.41*	.124	2.28	350.2
SL	0.065	.41	.075	1.89	106.1
L	.078	.43	.036	1.56	25.0
SiL	0.034*	.46	0.016	1.37	6.0**
SCL	0.067*	.45	.02	1.41	10.8
CL	0.10**	.39**	.059*	1.48	31.44*
SiCL	0.095**	.41**	0.019	1.31	6.24
SC	0.089**	.43**	0.010	1.23	1.68
SiC	0.10**	.38**	0.027*	1.23	2.88
C	0.07**	.36**	0.005	1.09	0.48

S=sand, Si=silt, C=clay, L=loam, \* signifies a higher value than expected, and \*\* signifies a lower value than expected

“The Microsoft Windows based Graphics User Interface (GUI) manages the geographical, hydrogeologic and physical inputs required to run SWMS-2D, as well as grid design and editing, parameter allocation, problem execution, and visualization of results. The program includes a set of controls that allow the user to build a flow and transport model and perform graphical analyses on the fly. Both input and output can be examined using areal or cross sectional views, and line graphs. The HYDRUS-2D shell program translates all geometric and parameter data into the SWMS-2D input format. Post-processing is also done in the shell. Areas of interest can be zoomed into, and vertical scale can be enlarged for cross-sectional views. Output graphics include 2D contours (isolines or color spectra) in areal or cross-sectional view for heads, water content, velocity, and concentrations. Included are velocity vector plots, animation of graphic displays for sequential time-steps, and line-graphs for selected boundary or internal sections, and for variable-versus-time plots. The mesh can be displayed with boundaries, and numbering of triangles, edges and points. Observation points can be added anywhere in the grid. Viewing of grid and/or spatially distributed results (pressure head, water content, velocity, or concentration) is facilitated using high resolution color or gray scales.” For processing, HYDRUS-2D requires an “Intel 80386 with math coprocessor, Intel 80486DX, or higher processor, 4 Mb RAM, DOS 5.0 or higher, hard disk with at least 10 Mb free disk space, VGA graphics (SVGA with 256 colors recommended), MS Windows 3.1 or Windows 95.”

## **Verification**

Verification of the HYDRUS-2D code was accomplished by the developers by comparing simulations with both the UNSAT2 (Neuman, 1973) and SWATRE (Belmans et al., 1983) codes. The transport portion of HYDRUS-2D was verified by comparison with an analytical solution for a two-dimensional steady-state groundwater flow problem (Simunek et al., 1996). The comparison with UNSAT2 was made for a one-dimensional infiltration experiment modeled by UNSAT2 (Davis and Neuman, 1983). A homogenous soil column at an initial pressure head of -150 cm was subjected to ponded infiltration at the surface (a constant head BC). The open bottom boundary was modeled as a seepage face BC, and the column sides as no flux BC. Good agreement between UNSAT2 and HYDRUS-2D was observed to demonstrate verification. A more rigorous verification test was made by comparing HYDRUS-2D to SWATRE (Feddes et al., 1978) results for a one-dimensional field profile. The soil profile consisted of two layers with a 30-cm thick root zone. Actual precipitation and potential transpiration rates were used for the atmospheric BC at the surface. The bottom BC was a deep drainage BC with the groundwater level set to 55 cm below the surface and the initial condition was taken to be in equilibrium with the groundwater level. Pressure heads, transpiration rates, and bottom discharge rates showed excellent agreement with SWATRE results to show verification. Gribb and Sewell (1998) further verified the parent code (SWMS\_2D) by making comparisons to a general purpose partial differential equation solver, PDE2D. They found that water volumes in the flow domain were consistent for the four scenarios tested.



## **Validation**

Pohll et al. (1996) coupled SWMS\_2D with an overland flow model to simulate recharge below nuclear subsidence craters. They calibrated the overland flow model by adjusting the catchment area to match field measurements of runoff into the crater and calibrated the crater topography to match the measured pond depths in the crater. Since only the boundary condition on the subsurface flow model was calibrated, comparisons of the simulated to measured moisture profiles serve as a validation test for HYDRUS-2D. They found that the simulated water contents were slightly lower (4%) than measured values and with considerably less variability. They considered the model to be in good agreement with measurements given the apparent vertical heterogeneity of the single vertical profile within a three-dimensional flow field and the approach of simulating the profile as homogenous.

Although water balance models are not able to fully investigate the hydrology of capillary barriers, a Richards' equation-based model can be utilized. Kampf et al. (1998) used HYDRUS-2D to simulate the capillary barrier system of an engineered landfill cover. They investigated the process known as capillary diversion, or the breakthrough point of a capillary barrier where the downward vertical flow through the capillary layer equals the infiltration rate,  $q$ , from the top of the cover. The field measurements of two landfill facilities in Germany were used to compare the simulation results of the HYDRUS-2D model. The HYDRUS-2D model was calibrated using a number of flumes prior to the larger, field-scale experiment. The authors determined that the HYDRUS-2D model could effectively model capillary barriers with fair precision, as long as the model hydraulic parameters are calibrated to the specific site. The authors stress that soil properties taken from cores alone may not be sufficient to accurately characterize the performance of a capillary barrier at a site.

## **Sensitivity Analysis**

Nofziger et al. (1994) performed sensitivity analyses on four widely used vadose zone transport models (RITZ, VIP, CMLS, and HYDRUS) to compare their behavior. HYDRUS is a predecessor of HYDRUS-2D and should behave similarly, since they are both founded upon the SWMS code. Nofziger et al. (1994) stated that of these four models, the HYDRUS model is most suited for detailed use by research scientists. The sensitivity analysis found that the HYDRUS model was particularly sensitive with respect to the amount of pollutant leached, to the partition coefficient, saturated water content, and the van Genuchten  $n$  parameters. For travel time, the model was especially sensitive to the van Genuchten  $n$  parameters, saturated water content, partition coefficient, root water uptake potential, and bulk density. For the pulse width, the model was sensitive to the van Genuchten  $n$  coefficient, bulk density, saturated water content, and dispersivity. All three of these processes were insensitive to the residual water content and diffusion coefficient. Sensitivity of the flow predictions was not addressed.

## **Application**

HYDRUS-2D and its parent code, SWMS\_2D, have been used for a wide range of applications and conditions. Several studies have used HYDRUS-2D to estimate soil hydraulic parameters from multi-step extraction technique (Inoue et al., 1998), transient flow

(Simunek et al., 1998), cone penetrometer data (Kodesova et al., 1998), and disc infiltrometer data (Simunek et al., 1998). Mohanty et al. (1998) used HYDRUS-2D to simulate preferential flow and transport of nitrate to tile drains. Davis et al. (1997) coupled SWMS\_2D with MODFLOW and MT3D for risk-based remediation modeling of contaminated sites.

HYDRUS-2D has been used for risk analysis (Abbaspour et al., 1997) of landfill covers and performance evaluation of landfill covers (Wilson et al., 1998). Abbaspour et al. (1997) included parameter uncertainty in the risk assessment of a landfill in Switzerland using SWMS\_2D to analyze two-dimensional flow and transport. Wilson et al. (1998) used HYDRUS-2D to compare the performance of a monolayer to a subtle-layered ET cover design with regard to the ability of layering to disrupt preferential flowpaths. They ran compaction tests on various particle size fractions of material from the borrow source for a low-level waste repository at the Nevada test Site. They determined the saturated hydraulic conductivity, and water retention characteristics on each size fraction compacted to 83% and 90% maximum dry density. These data were incorporated into HYDRUS-2D to simulate infiltration for a 100-yr, 6-hour storm event for various cover designs. They simulated preferential flow fingering by assigning a  $K_s$  value in a vertical path of nodes that constituted 5% of the cross-sectional area to be four orders of magnitude higher than the remaining nodes. The location of the 5 percent cross-sectional area preferential flow finger was randomly selected for each layer. Based upon the HYDRUS-2D preferential flow analysis, they found that the monolayer cover would need to be 26 percent thicker on average to limit infiltration for the single storm event. However, if subtle layering was incorporated into the cover, the thickness could be reduced by 20 to 60% depending upon the number of layers and their arrangement.

### III.C.3. EPIC Code Description

Note: All items in quotation marks are taken from the internet web site <http://www.brc.tamus.edu/epic/>.

“The Erosion-Productivity Impact Calculator (EPIC) (Williams et al., 1984) model was developed to assess the effect of soil erosion on soil productivity. It was used for that purpose as part of the 1985 RCA (1977 Soil and Water Resources Conservation Act) analysis. Since the RCA application, the model has been expanded and refined to allow simulation of many processes important in agricultural management (Sharpley and Williams, 1990).

EPIC is a continuous simulation model that can be used to determine the effect of management strategies on agricultural production and soil and water resources. The drainage area considered by EPIC is generally a field-sized area, up to 100 ha (weather, soils, and management systems are assumed to be homogeneous). The major components in EPIC are weather simulation, hydrology, erosion-sedimentation, nutrient cycling, pesticide fate, plant growth, soil temperature, tillage, economics, and plant environment control.”

## Process Description

"The runoff portion of the EPIC code uses a modified SCS curve number technique (USDA-SCS, 1972) to determine runoff volumes, and either a modified Rational formula or the SCS TR-55 (USDA-SCS, 1986) method to determine the peak runoff rate. A stochastic element is included in the Rational equation to provide realistic runoff rates using only the daily rainfall and monthly rainfall intensity.

The EPIC percolation component uses a storage routing technique to simulate flow through soil layers. Flow from a soil layer occurs when soil water content exceeds field capacity. Water drains from the layer until the storage returns to field capacity. The reduction in soil water is simulated with the routing equation:

$$SW = (SW_o - FC) \exp(-\Delta t / TT) + FC \quad (23)$$

where  $SW$  and  $SW_o$  are the soil water contents at the end and the start of time interval  $t$  (24 h) and  $TT$  is travel time through layer in h. Travel time through a layer is computed with the linear storage equation

$$TT = (PO - FC) / SC \quad (24)$$

where  $PO$  is the porosity in mm,  $FC$  is field capacity in mm, and  $SC$  is saturated conductivity in  $\text{mm h}^{-1}$ .

"Saturated conductivity may be input or estimated for each soil layer" from an empirical equation based upon the percentage of clay and soil strength factor of the layer. Note that  $FC$  and  $PO$  are not the actual field capacity and porosity provided as model inputs, which have units of vol/vol, but instead,  $FC$  and  $PO$  are these respective values multiplied by the layer thickness.

"Daily percolation can be computed by taking the difference between  $SW$  and  $SW_o$ .

$$O = (SW_o - FC)[1 - \exp(-\Delta t / TT)] \quad (25)$$

where  $O$  is the percolation rate for the layer in  $\text{mm d}^{-1}$ . The routing process is applied from the soil surface layer by layer through the deepest layer. Since the saturated conductivity of some layers may be much lower than that of others, the routing scheme can lead to an impossible situation (porosity of low saturated conductivity layers may be exceeded). For this reason, a back pass is executed from the bottom layer to the surface. If a layer's porosity is exceeded, the excess water is transferred to the layer above. This process continues through the top layer. There is also a provision for upward movement (JF) when a lower layer exceeds field capacity. Movement from a lower layer to an adjoining upper layer is regulated by soil water to field capacity ratios using the equation:

$$JF = (SW_i - FC_i) \left\{ 1 - \exp \left[ 0.05 \left( \frac{SW_{i-1}}{FC_{i-1}} - \frac{SW_i}{FC_i} \right) \right] \right\} \quad (26)$$

Percolation is also affected by freezing temperature. If snow is present, it may be melted on days when the second soil layer temperature exceeds 0 °C."

Snow is melted as an empirical function of the snow pack temperature.

"Melted snow is treated the same as rainfall for estimating runoff volume and percolation, but rainfall energy is set to 0.0 and peak runoff rate is estimated by assuming uniformly distributed rainfall for a 24-h duration.

Water can flow into a frozen layer but is not allowed to percolate from the layer. Lateral subsurface flow in the EPIC model is computed simultaneously with the percolation. The governing equation for lateral flow is:

$$QH_i = (SW_{0i} - FC_i) \left[ 1 - \exp \left( \frac{-24}{TT_H} \right) \right] \quad (27)$$

where QH is the lateral flow rate for soil layer in mm d<sup>-1</sup> and TT<sub>H</sub> is the lateral flow travel time in days. The lateral flow travel time is estimated for each soil layer by using the equation:

$$TT_H = \frac{TT}{S} \quad (28)$$

where S is the land surface slope in m m<sup>-1</sup>.

The water table height is simulated without direct linkage to other soil water processes in the root zone to allow for offsite water effects. The model drives the water table up and down between input values of maximum and minimum depths from the surface. The driving mechanism is a function of rainfall, surface runoff, and potential evaporation.

The model offers four options for estimating potential evaporation: Hargreaves and Samani (1985), Penman (1948), Priestly-Taylor (1972), and Penman-Monteith (Monteith, 1965). The Penman and Penman-Monteith methods require solar radiation, air temperature, wind speed, and relative humidity as input. If wind speed, relative humidity, and solar radiation data are not available, the Hargreaves or Priestly-Taylor methods provide options that give realistic results in most cases. The model computes evaporation from soils and plants separately, as described by Ritchie (1972). Potential soil water evaporation is estimated as a function of potential evaporation and leaf area index (LAI, area of plant leaves relative to the soil surface area). Actual soil water evaporation is estimated by using exponential functions of soil depth and water content. Plant water evaporation (transpiration) is simulated as a linear function of potential evaporation and leaf area index.

The EPIC precipitation model developed by Nicks (1974) is a first-order Markov chain model. Thus, input for the model must include monthly probabilities of receiving precipitation. On any given day, the input must include information as to whether the previous day was dry or wet. A random number (0-1) is generated and compared with the appropriate wet-dry probability. If the random number is less than or equal to the wet-dry probability, precipitation occurs on that day. Random numbers greater than the wet-dry probability give no precipitation. Since the wet-dry state of the first day is established, the process can be repeated for the next day and so on throughout the simulation period.

The temperature model requires monthly means of maximum and minimum temperatures and their standard deviations as inputs. If the standard deviations are not available, the long-term observed extreme monthly minimums and maximums may be substituted. The model estimates standard deviation as 0.25 of the difference between the extreme and the mean for each month.

The EPIC component for water-induced erosion simulates erosion caused by rainfall and runoff and by irrigation (sprinkler and furrow). To simulate rainfall/runoff erosion, EPIC contains six equations: the USLE (Wischmeier and Smith, 1978), the Onstad-Foster modification of the USLE (Onstad and Foster, 1975), the MUSLE (Williams, 1975), two recently developed variations of MUSLE, and a MUSLE structure that accepts input coefficients. Only one of the equations (user specified) interacts with other EPIC components. The six equations are identical except for their energy components. The USLE depends strictly upon rainfall as an indicator of erosive energy. The MUSLE and its variations use only runoff variables to simulate erosion and sediment yield. Runoff variables increased the prediction accuracy, eliminated the need for a delivery ratio (used in the USLE to estimate sediment yield), and enables the equation to give single storm estimates of sediment yields. The USLE gives only annual estimates. The Onstad-Foster equation contains a combination of the USLE and MUSLE energy factors.”

## **Verification**

Initial verification of the EPIC model was conducted by Cooley et al. (1990). Evaporation and percolation at a site in Idaho were predicted by the ERHYM, SPAW, and EPIC models. Cooley et al. (1990) reported enough similarity in the results from all three models to consider EPIC verified.

## **Validation**

Hauser and Shaw (1994) claim that EPIC has been validated with field data for more than 200 sites around the world. Initial validation work on EPIC was done by Jones and Williams (1986). Due to the complex interconnections of EPIC's subcomponents, they were validated separately (Jones and Williams, 1986). The code was tested against annual and monthly precipitation as well as individual precipitation events that caused runoff. The model

was used against a variety of measured data of runoff from Texas, Ohio, Nebraska, Oklahoma, and several other states. The runoff portion of the EPIC model was shown to adequately predict actual measurements and the erosion portion was validated. The weather component, soil and nutrient component, runoff and soil erosion, and crop yields were all found to be accurately predicted by EPIC (Jones and Williams, 1986).

Validation tests of the weather generator in EPIC made by Wallis (1993) for five different locations in Texas contradicted the findings of Jones and Williams (1986). A statistical analysis was performed on the weather submodel (WXGEN), in which it was found to be generally inadequate for predicting weather for the five locations. Since WXGEN was found to be an unreliable weather predictor for a specific location, which would effect most of the model outputs, Wallis (1993) recommended that the weather generator be replaced (Wallis, 1993).

The EPIC model was validated for the crop yield and ground biomass for a site in southern France by Cabelguenne et al. (1990). EPIC was able to simulate yields of five field crops grown in various rotations over a five-year period. The differences in the measured and simulated yields were similar to differences within treatment between similar plots, and even differences within the plot itself. This demonstrated that EPIC was almost as good an indicator of yield as a paired plot measurement in the same experiment.

Cooley et al. (1990) used EPIC to evaluate a shallow clay pan range site. The main importance of this study for landfill covers is the comparison of the water balance data between the 3 models and the measured values. The EPIC model showed only small differences in the soil water balance measured and simulated, and the three models correlated closely to each other. The model did have some difficulty simulating the correct forage yield for the site.

Another validation study was done by Steiner et al. (1990) using EPIC to predict soil moisture, runoff, ET, and crop production for a Bushland, Texas, location. This analysis was done on the growth of wheat and sorghum on a Pullman clay loam. Based on 26 years of data, Steiner et al. (1990) concluded that EPIC was able to satisfactorily predict the soil water balance in a semiarid climate for several different crops (Steiner et al., 1990). The soil water content for the location was underpredicted in the soil profile by an average of 20 mm. The model was, however, able to predict within reason, the ET, annual runoff, crop yield, and growing season soil water depletion at the site. Steiner et al. (1990) state that the model was “generally satisfactory” in predicting the soil water balance at the site over the long-term simulations.

Hauser and Shaw (1994) tested the soil water portion of the EPIC model for four soil types using point measurements of water content. The field water-balance data were from the study by Hauser and Chichester (1989), in which water content was measured with depth to 2.2 m by neutron attenuation between 15 to 28 times each year from 1981 to 1986. Hauser and Shaw (1994) found that the model generally agreed with the measured water contents. They reported that EPIC is likely to over-predict the amount of deep percolation which would make the EPIC model conservative in the modeling of landfill covers. Two things should be kept in mind: (1) the EPIC model prediction for the 1.9 m profile was between 0

and 2 mm, in contrast to the estimate of 0 mm measured for the comparable field soils (differences are too minor to suggest that EPIC is conservative), and (2) deep percolation was not directly measured. The flux was estimated from the point measurements of water content by Hauser and Chichester (1989), which can lend itself to significant underestimates of drainage (Essington et al., 1995). The drainage component of EPIC was, therefore, not able to be validated since direct measurements of flux were not available.

### **Sensitivity Analysis**

An initial sensitivity analysis was performed by Favis-Mortlock and Smith (1990) on the EPIC model. The study found that the model was most sensitive to the SCS curve number, the depth of the root zone, temperature minimums and maximums, and the amount of precipitation. The amount of sensitivity of each of these parameters varied for each scenario tested (Favis-Mortlock and Smith, 1990).

### **Landfill Cover Applications**

Although EPIC was initially intended for agricultural use in determining the impact of soil erosion, it has been adapted to many other uses. The code is well tested and proven in the agricultural industry, but has only been applied to landfill covers in a limited manner. The applicability of the model to the design and comparison of landfill covers is plausible, but the only example identified in the literature search where EPIC was applied to landfill covers was the modeling of an ET cover in east-central Texas by Hauser and Shaw (1994). The EPIC model was chosen because the landfill cover designers believed that the EPIC model simulated the physical processes that affect water movement in the soil simultaneously and realistically. The model uses a water balance approach in its water flow sub-model, which is similar in operation to the HELP code, although it is simpler in design. The authors evaluated nine ET cover designs, from monolayer designs of different soil types to multilayered covers. They concluded from the model that the most effective ET cover for this climate had a thick (1.9 m) soil layer on the surface with a high AWC ( $> 225$  mm). This would allow moisture to be stored near the surface, which is more available for ET, without any water moving out of the cover. In addition to soil profile properties, EPIC showed rooting depth to be an important parameter controlling deep percolation. For overall water balance, the sum of the 100-year average of annual deep percolation, ET, and runoff predictions were within 1 percent of the measured rainfall amount at the east-central Texas site (Hauser and Shaw, 1994).

### **III.C.4. UNSAT-H Code Description**

UNSAT-H is a FORTRAN computer code that simulates the movement of water, vapor, and heat in one-dimensional soil profiles that include the effects of plants. The UNSAT-H model was established in 1986 and since updated (Fayer and Jones 1990). Typical applications include studies of the water-balance behavior of surface covers over shallow land burial waste sites and studies of land disturbance effects on recharge rates. The UNSAT-H computer code is managed by the Hydrology Group at the Pacific Northwest National Laboratory (PNNL), Richland, Washington. Mike Fayer, the point of contact for UNSAT-H, can be reached at (509)-372-6045 or [mike.fayer@pnl.gov](mailto:mike.fayer@pnl.gov). The web page address for

remotely accessing the code for free is [http://etd.pnl.gov:2080/~mj\\_fayer/unsath.htm](http://etd.pnl.gov:2080/~mj_fayer/unsath.htm), but user support is not available.

The UNSAT-H model addresses the processes of infiltration, runoff, soil water and heat flow, deep drainage, evaporation, and plant transpiration. There are two DOS versions of the code available: 2.03 and 2.04, and a WINDOWS version, WinUnsath, which is available from Craig Benson ([chbenson@facstaff.wisc.edu](mailto:chbenson@facstaff.wisc.edu)). Version 2.03, which has been available for several years, uses all single precision REAL variables. Version 2.04, which was made available in July 1998, uses double precision REAL variables to achieve greater accuracy in situations where fluxes are very low. The tradeoff is that output files are twice as large. Version 2.04 also allows the user to modify the PET partitioning equation to more accurately reflect the transpiration rate of plant communities with a low leaf area index.

### **Process Description**

The UNSAT-H model has several options for the boundary conditions. For water flow, the user can specify Dirichlet or Neumann conditions, or a unit gradient condition. For heat flow, the user can specify Dirichlet or Neumann conditions, or a temperature gradient.

The UNSAT-H model simulates infiltration in a two-step process. First, infiltration is set equal to the precipitation rate during each time step. Second, if the surface soil becomes saturated, the solution of that time step is repeated using a Dirichlet boundary condition (with the surface node saturated,  $h = 0$ ). The resulting flux from the surface into the profile is the infiltration rate. The UNSAT-H model does not simulate runoff explicitly. Instead, it equates runoff to the precipitation rate that is in excess of the infiltration rate. There is no provision for runoff.

The UNSAT-H model simulates liquid water flow using Richards' equation, water vapor diffusion using Fick's law, and sensible heat flow using the Fourier equation. Convective air flow is not considered. Options for describing soil water retention include linked polynomials, the Haverkamp function, the Brooks and Corey function, and the van Genuchten function. Options for describing hydraulic conductivity include linked polynomials, the Haverkamp model, the Mualem model, and the Burdine model.

The UNSAT-H model simulates evaporation in two ways. In the isothermal mode, UNSAT-H uses the PET concept. The user supplies either daily values of PET or daily weather data, with which the code calculates daily PET values using the Penman equation. During each time step, the code attempts to apply the potential evaporation rate. If the soil surface dries to or beyond a user-defined matric head limit, the time step is re-solved using a Dirichlet condition at the surface. In this situation, the surface pressure is held constant at the matric head limit and evaporation is set equal to the flux from below. In the thermal mode, UNSAT-H calculates evaporation as a function of the difference in vapor density between the soil and the reference height (the height at which air temperature and wind speed are measured) and the resistance to vapor transport. The resistance to vapor transport is a function of several factors, including air temperature, wind speed, and atmospheric stability.



The UNSAT-H model simulates the effects of plant transpiration using the PET concept. There is no provision to simulate both water and heat flow in a plant canopy. Plant information is supplied to the code to partition the PET into potential evaporation and potential transpiration. The potential transpiration is applied to the root zone using the root distribution to apportion it among the nodes with roots. The withdrawal of water from a particular node is dependent on the matric head of the node. The user provides matric head values that define how the potential transpiration rate applied to a particular node is reduced. Below the minimum value, sometimes known as the wilting point, transpiration is unable to remove any water. When all nodes with roots reach this level of matric head, transpiration is reduced to zero.

The mathematical equations that describe the state and dynamics of the modeled system are written in an implicit finite-difference form. The user must specify an averaging scheme for internodal hydraulic conductivities; choices include arithmetic (and arithmetic-weighted), geometric, and harmonic. Vapor and heat internodal conductances are calculated as arithmetic means. The resulting equations are solved using the modified Picard iteration technique with the Thomas algorithm. The solution strategy is to solve the water flow equations first, then the heat flow equations.

The user controls the spatial detail of the solution by specifying the node spacing via the input file. As configured on the web site, the code allows the user to have up to 250 nodes and five soil types. By editing the parameter file, the user can increase the number of nodes and soil types. The user also controls the temporal domain by specifying the time step size. The minimum time step size should be no less than  $10^{-7}$  hours in single precision mode. The maximum time step size must be no more than 24 hours under any condition, and it should be no more than 1 hour if time-varying evaporation or transpiration is being simulated. The user can control the solution accuracy by specifying an acceptance criterion for the solution to a particular time step. The available criteria are the maximum allowable change in water content per time step, or the maximum allowable mass balance error per time step.

Simulation inputs include number of nodes (up to 250 unless the code is recompiled for more), node depths and associated material types (up to five materials unless the code is recompiled for more), boundary condition choices, output frequencies, and maximum and minimum time step size. Site data include slope, aspect, latitude, elevation, and surface roughness parameters.

The boundary conditions inputs include daily PET values, daily weather conditions (maximum and minimum temperature, average dew point temperature, average wind speed, average humidity, and solar radiation), precipitation (hourly or daily), and lower boundary condition choices (e.g., water and temperature fluxes, variable temperature and matric head, gradients)

The plant parameters includes details about the seasonal variation of leaf area index and maximum rooting depth, root density variations with depth, and soil matric head limits that impact the withdrawal efficiency of plants. UNSAT-H also has a specific function for partitioning PET into evaporation and transpiration for *Bromus tectorum* (cheatgrass).

## Verification

Fayer and Jones (1990) compared UNSAT-H predictions with several known analytic and numerical solutions to specific problems. They successfully matched solutions for infiltration and redistribution for two soil types (a sand and a clay), soil temperature variations in response to an imposed sinusoidal temperature pulse at the surface, and drainage during a one-step pressure test to determine hydraulic properties. Fayer and Jones (1990) contains the theory documentation and user manual for UNSAT-H.

Baca and Magnuson (1990) conducted verifications and benchmark tests of UNSAT-H. In addition to repeating the tests reported by Fayer and Jones (1990), they conducted additional tests that included horizontal infiltration, imposition of a constant heat flux at the surface, infiltration of a stratified vadose zone, and coupled heat and water flow in a field test plot. Baca and Magnuson judged UNSAT-H operationally verified.

## Validation

Fayer et al. (1992) tested the UNSAT-H model using data from a 1.7-m deep lysimeter containing a specific cover design. They found that the model reproduced much of the observed water-balance changes. The largest discrepancies occurred in winter (when evaporation was over-predicted) and summer (when evaporation was under-predicted). Fayer et al. demonstrated the model sensitivity to  $K_s$ , the pore interaction term, PET, and the presence of a snow cover (mimicked by setting PET to zero). When optimal values of these parameters were used in a single simulation, i.e., the calibrated model, the root-mean-square error was reduced by 63% from that determined with the uncalibrated model. Additional simulations were performed that indicated that hysteresis is also important to modeling of covers.

Magnuson (1993) used UNSAT-H simulations to evaluate two landfill cover designs for a disposal facility in Idaho. He examined the sensitivity of UNSAT-H to changes in the hydraulic property parameters of the cover soil and the underlying gravel and cobble layers. In most cases, the changes were factors of 0.5 and 2.0 about the base value. Drainage through this cover during the 10-year simulations was nil, so he used the maximum predicted storage as a surrogate measure of performance, reasoning that drainage was most likely under those conditions when storage was at a maximum. Magnuson found that the hydraulic properties of the surface soil layer had the greatest impact on maximum storage. Changing the  $\theta_s$  by 0.1  $\text{cm}^3/\text{cm}^3$  yielded a similar 10% change in maximum storage. Increasing  $h_a$  of the surface soil decreased maximum storage, whereas increasing the value for the gravel or cobble layers increased maximum storage slightly. Increasing the  $K_s$  value of the surface soil decreased maximum storage. Apparently, precipitation could infiltrate the soil more deeply, but it was easier for evaporation to extract that water later. Changes to the  $K_s$  of the gravel and cobble layers had no discernible effect on maximum storage.

## Sensitivity Analysis

Magnuson (1993) also evaluated the sensitivity to the same parameters for the case where the cover was a single soil material with no layering. For these simulations, drainage

was detectable so it was used as the performance measure. Magnuson found that drainage changed inversely with changes in  $\theta_s$ . For example, as  $\theta_s$  was changed from 0.5 to 0.4, drainage increased by 89% (from 1.36 to 2.58 cm/yr). Changing  $\theta_r$  from 0.007 to 0.056 increased drainage by 36%. Increasing  $h_e$  from 21 to 60 cm reduced drainage by 91%. Magnuson looked at a second soil type and found that the model responses to the parameter changes were inconsistent. For example, increasing the  $K_s$  of the second soil type increased drainage, while increasing the  $K_s$  of the first soil type decreased drainage. The importance of this result is that parameter sensitivities can be dependent on the scenario tested and so should be determined on a case-by-case basis.

Fayer and Gee (1997) used a six-year record of water storage, suction, and drainage data to test UNSAT-H. This comparison was an extension of the work by Fayer et al. (1992). These data were collected from a non-vegetated weighing lysimeter containing 1.5 m of silt loam over sand and gravel. This capillary-barrier configuration was designed to promote water storage in the upper layer for removal by evapotranspiration. Four simulations were conducted with the Richards'-equation-based UNSAT-H: 1) standard parameters, 2) calibrated parameters, 3) heat flow, and 4) hysteresis. The water storage results showed little difference among the four simulations; the root mean square (RMS) errors were all between 23.4 and 23.7 mm. Fayer et al. (1992) reported a RMS error of 8.1 mm for the calibrated simulation during the first 1.5 years. Beyond the calibration period, however, the calibrated model was not much more successful than the other models in predicting total water storage.

The standard parameters, heat flow, and hysteresis simulations had the largest maximum storage difference (75 to 80 mm); the calibrated simulation had the smallest (59.3 mm). This result may be one benefit of the calibration, the goal of which was to match the peak water storage in winter. In contrast, the calibrated simulation had the largest mean and median differences (19.6 and 16.4 mm, respectively). The other simulations had values between -6.0 and 3.0 mm for the 1.65 m profile.

Simulations usually over-predicted suction values, more so in the summer than the winter. The hysteresis simulation gave the best qualitative match of suction data throughout the six-year period. At times, the predictions coincided with the measurements, most importantly during the one and only drainage event observed in six years. The other three simulations predicted suctions that were generally at least a factor of 3 greater than the measured values.

The hysteresis simulation was the only one to predict drainage. The cumulative amount was predicted within 52% of the measured amount and the timing matched the observations. Fayer and Gee (1997) attributed the success of the drainage prediction to the ability to simulate matric head values at the interface. They suggested that soil water matric head is better than water storage as an indicator of conditions at the interface of the silt loam and sand layers that control drainage.

Based on the comparisons, Fayer and Gee (1997) reached several conclusions. First, UNSAT-H can reasonably predict the water-balance components of a capillary barrier-type cover. The predictions improve if the hysteresis phenomenon is included. Second, the inclusion of heat flow has only a minor effect on surface evaporation and vapor flow within

the soil. The impacts of heat flow on snow accumulation and melt and on soil freezing were not evaluated, but Fayer and Gee (1992) speculated that these impacts could be important. Finally, a calibrated model will not necessarily apply well outside of the calibration period. Fayer and Gee (1997) offered suggestions for improving the calibration process: 1) include a more complete conceptual model (e.g., including hysteresis), 2) use multiple performance measures, and 3) calibrate with a period of time sufficiently long to encompass the range of conditions envisioned for the design life of the cover.

### **Application to Landfill Covers**

Khire et al. (1997) applied the UNSAT-H and HELP models to resistive barrier test cells at the Greater Wenatchee Regional Landfill in Washington and the Live Oak Landfill in Georgia. The Wenatchee landfill is in a semi-arid climate; the Live Oak landfill is in a humid climate. The authors tested the models using a three-year record of data that included overland flow, soil water storage, evapotranspiration, and percolation. The results, in the form of time series plots, showed that the models generally mimicked the seasonal trends. The authors stated that the UNSAT-H predictions tended to be more accurate than those using HELP. With respect to UNSAT-H, the authors noted several conceptual features that were important to the Wenatchee site but were not included in the model: snow cover, snow melt, and freezing soil. Based on their experience with simulating these two landfill covers, Khire et al. (1977) suggested that practitioners use a simpler model (e.g., HELP) during the iterative design phase and a more complex model (e.g., UNSAT-H) for final performance assessment.

### **III.C.5. SHAW Code Description**

The Simultaneous Heat and Water Transfer model, SHAW, is a FORTRAN computer code that simulates the movement of water, heat, and solutes within a one-dimensional soil profile that includes the effects of plant cover, dead plant residue and snow. The SHAW model was established in 1989 (Flerchinger and Saxton, 1989a,b). Typical applications include predictions of frost depth, frozen soil runoff, snowmelt, and the effects of management, climate, slope and vegetation on energy and water transfer at the soil-atmosphere interface and temperature and water conditions near the soil surface and within the soil profile.

The SHAW computer code is managed by Northwest Watershed Research Center, which is part of the Agricultural Research Service, an agency of the United States Department of Agriculture. The web page address is <http://ars-boi.ars.pn.usbr.gov/index.html>. Gerald Flerchinger, the point of contact for SHAW, can be reached at (208)-422-0716 or [gflerchi@nwr.c.nwrc.ars.pn.usbr.gov](mailto:gflerchi@nwr.c.nwrc.ars.pn.usbr.gov).

The SHAW model addresses the processes of infiltration, runoff, soil water and heat flow, deep drainage, evaporation, transpiration, soil freezing and thawing, snowmelt, and solute transport. The current version of SHAW is Version 2.3, which was released February, 1997.

The SHAW model simulates infiltration at the end of a time step using a Green-Ampt approach. Precipitation and snowmelt in excess of the interception and infiltration capacity is ponded on the soil surface. If the user-defined maximum ponding depth is exceeded, the excess is considered runoff. The model does not simulate runoff explicitly. Instead, it equates runoff to the precipitation rate that is in excess of the infiltration rate. There is no provision for runoff.

Soil water and heat flow are simulated using Richards' equation for water flow, Fick's law for vapor diffusion, and Fourier's law for conductive heat flow. Movement of both phases is governed by hydraulic and temperature gradients. Convective flow of air is not considered. Water retention can only be described using the Campbell model (Eq. 9). Hydraulic conductivity can only be described with the Burdine model:

$$K(h) = K_s \left( \frac{\theta}{\theta_s} \right)^{2b+3} \quad (29)$$

where  $K_s$  is the saturated hydraulic conductivity, and  $b$  is a fitted pore-size index parameter. The model is capable of simulating the subsurface extraction or addition of water to mimic subsurface irrigation, water seepage into the profile, and water extraction from the profile from roots originating from outside the modeled domain. The status of the model domain does not affect the strength of the sources and sinks except to limit the amount of extractable water to the quantity in the layer in question.

Dirichlet boundary condition is used for drainage and heat flow from the lower boundary. For water flow, the conditions are a time series of either water content or matric head; for heat flow, the conditions are a time series of temperatures. There is also a provision for a unit gradient condition for water flow. There is no provision for a specified flux boundary conditions.

Evaporation is simulated as a function of the difference in vapor density between the soil, plant residue, or snow surface and the reference height (the height at which air temperature and wind speed are measured) and the resistance to vapor transport. The resistance to vapor transport is a function of several factors, including air temperature, wind speed, and atmospheric stability. The SHAW model simulates the effects of a multi-species plant canopy (including standing dead plant material) on heat and water transfer. The user defines the variation in plant size, rooting depth, and leaf area index of each plant species. The plant canopy can be divided into several layers; transfer of water vapor and energy are solved for each layer within the canopy. Heat and water fluxes within the canopy include the effects of solar and long-wave radiation, turbulent transfer of heat and water vapor, and transpiration from plant leaves. Transpiration from plants is linked mechanistically to soil water by flow through the roots and leaves. Within the plant, water flow is controlled mainly by changes in stomatal resistance, which is computed as a function of leaf matric head.

“The model has been shown to accurately simulate frost depth for a wide range of soil, climatic and surface conditions. It is capable of simulating complex wintertime phenomena of freezing effects on moisture and solute migration, solute effects on frost formation, and frozen soil related runoff. Transfer within the soil profile is solved concurrently with the surface energy and mass balance, which includes solar and long-wave radiation exchange, evaporation, and sensible and latent heat transfer.”

SHAW uses a conceptual model of snowpacks that is patterned after the point energy and mass balance model developed by Anderson (1976). The energy balance of the snow includes solar and long-wave radiation exchange, sensible and latent heat transfer at the surface, and vapor transfer within the snowpack. Absorbed solar radiation, corrected for local slope, is based on measured incoming short-wave radiation, with albedo estimated from grain size, which is estimated from snow density. Liquid water is routed through the snowpack using attenuation and lag coefficients. The influence of the metamorphic changes of compaction, settling, and grain size on density and albedo are considered.

Solute transport is simulated using the convection-dispersion equation. The solution considers convection, molecular diffusion, and hydrodynamic dispersion except in the case of infiltration, when only convection is simulated. Adsorption is modeled using a linear adsorption equation. Solute degradation is modeled using a user-defined half life. Solute extraction by plant roots is allowed; it is a function of the volume of water removed by roots and the concentration of the soil solution.

The mathematical equations that describe the state and dynamics of the modeled system are written in an implicit finite-difference form. SHAW allows only one specific formulation of the soil hydraulic property function (i.e., Brooks-Corey and Burdine), thus allowing the equations to be streamlined to facilitate easier solution. The equations are refined further by recasting them in the matric flux potential form. In this formulation, internodal conductivity coefficients are explicitly determined rather than using an averaging scheme. The resulting equations are solved using the Newton-Raphson technique in an iterative manner. The user controls the spatial detail of the solution by specifying the number of nodes via the input file. For example, the user can have up to 20 nodes to represent the soil and up to 10 nodes to represent residue layers. The user also controls the temporal domain by specifying the time step size. Seven time step sizes are available: 1, 2, 3, 4, 6, 8, 12, and 24 hours. The user can control the solution accuracy by specifying an acceptance criterion for the solution to a particular time step.

Simulation options include soil depth, boundary condition choices, output frequencies, number of nodes (from 2 to 20), and time step size. Site data include slope, aspect, latitude, elevation, and surface roughness parameters. The initial conditions inputs include items such as initial snow depth and density, initial soil temperature and water content (or head) profiles, and initial solute content of each layer. The boundary conditions inputs include daily or hourly weather conditions (temperature, wind speed, humidity, precipitation and solar radiation) and values of water content and temperature for the lower boundary condition.

The plant parameter inputs include both plant and residue properties. The species-specific plant information includes coefficients to describe matric head, leaf angle, unstressed stomatal resistance, leaf and root resistance, temperature above which the plant transpires, plant height, biomass, leaf area index, and rooting depth. The user has the option of including seasonal changes in plant height, biomass, leaf area index, and rooting depth. Residue information includes areal coverage, albedo, dry weight, thickness, water content, and resistance to vapor transfer.

There are two user interface options. The user can prepare the text input files and work directly with the SHAW application file. Alternatively, the user can run the user-interface program called ModShell (i.e., Model Shell). ModShell was developed for the SHAW model to facilitate data entry and code use. ModShell helps to create the required input files and run SHAW. It provides information about input parameters and performs range and error checking for input data.

### **Verification**

Verification tests were not identified in the literature search.

### **Validation**

Pierson et al. (1992) simulated near-surface soil temperature and matric head on sagebrush rangelands with three models. Two locations were studied: one beneath a shrub and one in the interspace between plants. The two soil depths were 1 and 30 cm. SHAW was found to give the best overall match to the measured values of temperature. Under the shrub, SHAW-simulated temperatures differed from the measurements by no more than 1.5°C at the 1-cm depth and 0.1°C at the 30-cm depth. In contrast, temperatures simulated for the intershrub space were a maximum of 2.8°C different at 1 cm and 2.4°C at 30 cm.  $R^2$  values ranged from 0.95 to 0.99.

SHAW simulations of soil matric head were not as successful as simulations of temperature. Under shrubs, measured heads predicted by SHAW averaged 18.6 and 3.6 m (less negative) more than the measured values at the 1- and 30-cm depths. In other words, the simulated soil was wetter than measured. In contrast, SHAW-predicted heads for bare ground averaged 15.5 and 27.2 m more than the measured values at the 1- and 30-cm depths. Thus, the simulated interspace soil was drier than measured for bare ground.

Pierson et al. (1992) noted that some simulated responses to precipitation were not reflected in the measurements. They speculated that the response time of the sensors prevented them from observing small precipitation events. The authors also noted that SHAW simulated a spring dry down about one month late under sagebrush. They attributed this to incorrect root extraction or possibly model discretization near the soil surface.

Several validation-type studies have been conducted to test the snow cover energy balance, and soil freezing, thawing, and runoff capabilities of SHAW. Flerchinger et al. (1996) examined the radiative energy balance of snow cover for a site in Minnesota. For the 100 days in which a snow cover was present, they found that SHAW accounted for 55

percent of the variation in net radiation with a mean bias error of  $-16 \text{ W/m}^2$ . Flerchinger et al. (1996) identified the estimated snow albedo as a possible source of error. They adjusted a parameter used to calculate snow albedo and reduced the bias error to  $-12 \text{ W/m}^2$ . An error of  $-12 \text{ W/m}^2$  in net radiation is equivalent to a melt rate of 3 mm/d (if the 12 W were consumed in melting). To quantify the comparisons, Flerchinger et al. (1996) calculated model efficiency to show that model efficiency improved significantly (from 55 to 94%) when the 70 days without a snow cover were included. In their words, “correct timing of initial snow accumulation and complete melt is crucial to the overall radiation energy balance simulation.”

Flerchinger and Seyfried (1997) examined the ability of SHAW to predict frost depth and frozen soil-induced runoff. They compared SHAW simulations with data collected from two shrub sites and two intershrub sites during two winters at the Reynolds Creek Experimental Watershed in Idaho. They found that the soil froze sooner in the intershrub areas and at lower water contents. Later in the winter, when there was a brief melt, the melt water appeared to infiltrate the intershrub areas and run off the shrub-dominated areas. Predicted runoff from the intershrub areas appeared to match the measured runoff. The timing of predicted runoff from the shrub areas did not match the timing of the measured runoff, but total runoff seemed to match by the end of the simulation.

Kennedy and Sharratt (1998) compared predictions of snow cover and frost depth in Alaska and Minnesota using SHAW and three other models. The estimation of snow depth was a weakness identified with all four models. Based on their results, they suggested “that accurate estimation of snow cover is vital to mimicking heat exchange between the soil surface and atmosphere,” thus linking accurate frost penetration predictions with accurate snow cover predictions.

Several validation-type studies have been conducted to assess SHAW's ability to simulate ET and surface energy balance accurately in semiarid watersheds. Flerchinger et al. (1996) compared measured and simulated ET for periods of one and three months in two different years for three plant community types: low sagebrush, big sagebrush, and aspen. They found that SHAW predictions of ET were within 7% of the measured ET in the two different years. Model efficiency for daily simulated net radiation was 0.95 to 0.96. Model efficiency for hourly simulated latent heat ranged from a low of 0.61 for the low sagebrush site to a high of 0.78 for the aspen.

Flerchinger and Pierson (1997) applied SHAW to a two-year record of soil temperature and water content collected at the Reynolds Creek Experimental Watershed in Idaho. In the first year, discrepancies between simulation results and measurements led the authors to calibrate the model. The changes included: 1) varying LAI seasonally, 2) extending the model domain from 2 to 4 m, 3) focusing the majority of the root density in the upper 30 cm of soil, 4) raising the temperature at which sagebrush starts transpiring from 1 to  $7^\circ\text{C}$ , 5) changing the interspace roughness parameter from 12 to 0.5 cm, and 6) changing the critical leaf potential from -100 to -300 m. With the calibrated model, the authors simulated a different year and obtained a much better match with the measurements. Model efficiencies for soil temperature were 0.95 to 0.99 at all depths, in contrast to the uncalibrated simulations, in which the efficiencies at the 100-cm depth were as low as 0.67. Simulated



matric heads generally corresponded to the measured values, more so at the 1-cm versus the 30-cm depth, but the authors did not provide model efficiencies. At the 30-cm depth, the matric heads appeared to be significantly lower than the measurements, indicating much more drying in the simulation than actually occurred. The authors provided neutron probe evidence to suggest that the moisture blocks used in the field may not be entirely dependable. This result highlights the need to have good quality field data and to have as much redundancy as possible.

Flerchinger et al. (1996) tested the ability of the model to simulate the temporal surface energy balance and surface temperatures of different vegetation in a semi-arid watershed. They were interested in ways to link the model with remote sensing information. Two locations were studied within the Walnut Gulch Experimental Watershed in Arizona. One site was dominated by sparse shrub vegetation, the other site by grasses. The authors simulated a 21-day period in 1990 using hourly weather data. Model efficiencies were highest for net radiation (0.98 for both sites) and lowest for evapotranspiration (0.65 and 0.59). Visual comparisons of the time series of energy balance components and temperatures showed that the model tracked changes in the field well. Weaknesses revealed by the comparisons included an under-prediction of nighttime evapotranspiration, an over-prediction of nighttime net radiation, and an over-prediction of soil evaporation following rainfall. Explanations for the discrepancies included uncertainties with the measurements and the observation that variability among the measurements sometimes was as great as the model-measurement differences. The authors concluded, "SHAW can reasonably simulate the surface energy balance and canopy temperatures over diverse vegetation communities, include sparse, heterogeneous plant canopies."

### **Sensitivity Analysis**

Flerchinger (1991) demonstrated the sensitivity of the SHAW model to a suite of 20 parameters using data from the USDA-ARS Reynolds Creek Experimental Watershed in southwest Idaho. He compared frost depths, thaw times, hourly energy fluxes, and frost zone water content for an 80-day period. The parameters were grouped into four categories: initial and boundary conditions, surface heat transfer, thermal conduction, and soil hydraulic properties. Sensitivities arising from parameter interactions were not addressed.

The initial and boundary condition parameters included initial water content, snow depth, air temperature, soil temperature, solar radiation, humidity, and wind speed. By far, the presence and thickness of a snow cover had the greatest impact on the maximum frost depth. Both snow depth and air temperature had significant impacts on time of thaw. Soil temperature had more effect when the lower boundary was close to the freezing front. Variations in solar radiation, humidity, and wind speed had less impact.

The surface heat transfer parameters included slope and aspect, albedo of dry soil, albedo of snow, fraction of surface covered with residue, and the roughness lengths for momentum and heat transfer. Large variations in each of these parameters had minimal impact on the maximum frost depth predictions. A northern aspect delayed the time of thaw by 17 days. The thermal conduction parameters included residue layer thickness, surface residue biomass, thermal conductivity of soil minerals, and bulk density. The model

predictions were most sensitive to residue thickness. Varying the thickness between 0.25 cm and 1.0 cm resulted in a maximum frost depth variation from 76.8 to 68.4 cm. Changing the thermal conductivity from that of quartz to clay reduced the maximum frost depth from 73.7 to 65.1 cm.

The soil hydraulic properties varied included the saturated conductivity, air-entry value, and pore-size index. These parameters did not have a major impact on the maximum frost depth, but they did affect the quantity of water in the frost zone. Higher quantities of water in the frost zone can significantly reduce infiltration and increase surface runoff.

Flerchinger et al. (1996) also conducted some limited sensitivity studies. They found that changing plant resistance by “50 percent had no effect on total ET at one site because the site was very dry and the ET-limiting factor was water availability rather than plant resistance. Where water was not limiting, decreasing plant resistance by 50% increased total ET by 6%. This is further evidence that parameter sensitivities will be simulation dependent.”

### **Application to Landfill Covers**

Flerchinger et al. (1996) used SHAW in conjunction with other models to evaluate the transport of disulfoton from an abandoned landfill in Idaho. The upper 9 m of the landfill consisted of homogeneous loam, with a caliche layer located at a depth of 6.7 m. The landfill was not capped. SHAW was used to estimate the deep drainage flux at the 9-m depth. This flux then served as the upper boundary condition for two-dimensional models of the vadose and saturated zones. SHAW predicted drainage in only a few years of the 100-year period simulated. The average drainage rate was 0.08 mm/year.

### **III.D. Sensitivity Analysis: Model Comparisons**

Sensitivity analyses were conducted on two water balance codes (HELP 3.07-DOS, and EPIC) and two Richards' equation codes (HYDRUS-2D, and UNSAT-H) to augment that reported from the literature and to enable the authors to evaluate these codes from experience. The sensitivity analyses focused on the hydraulic properties, in particular those controlling the ability of the soil to store and conduct water based upon a cover consisting of a single homogeneous layer. The only drainage component evaluated was vertical drainage. Lateral drainage was ignored for all models. Two tests cases were used, 100-yr weather data generated for Cheyenne, WY, as an example of an arid environment with a high proportion of precipitation as snow, and Columbus OH, to represent a humid environment. Columbus was also selected because it was the closest location to Coshocton, OH where lysimeters with long-term drainage data exist for validation testing. There were two complications in making this analysis comparable between codes: (1) EPIC was not able to generate weather data for Cheyenne or Columbus so Laramie, WY and Akron, OH data, respectively, were used and (2) water retention parameters for van Genuchten functions used in HYDRUS-2D and UNSAT-H had to be selected to match the descriptive water-balance parameters used in EPIC and HELP. Additionally, differences existed between the water-balance codes and the Richards' codes in the time scale of weather data. EPIC and HELP used daily weather data for the full 100 years, whereas HYDRUS-2D and UNSAT-H was run for only the first 10 years of the

generated data using monthly average values for the daily weather inputs. For evaluation of HYDRUS-2D and UNSAT-H, the ET values produced by HELP were used as the potential evaporation rate input for each location.

The parameters varied were profile depth, evaporative depth, initial water content (or pressure head), hydraulic conductivity, field capacity, and wilting point (or alpha and n parameters for Eq. 3). Parameters used by HELP and EPIC for the arid and humid sites were:

SCS curve number = 86.8

Maximum LAI = 2.5

slope = 10%

slope length = 45.7 m

growing season start = day 138 and 110, respectively

growing season end = day 273 and 291, respectively

average wind speed = 20.8 km/hr and 14.0 km/hr, respectively

average 1<sup>st</sup> quarter relative humidity = 52% and 69%, respectively

average 2<sup>nd</sup> quarter relative humidity = 54% and 66%, respectively

average 3<sup>rd</sup> quarter relative humidity = 50% and 72%, respectively

average 4<sup>th</sup> quarter relative humidity = 51% and 72%, respectively

The initial water content should have a significant impact on the amount of drainage in the early time periods of the simulations. However, after a few wetting and drying cycles this initial condition will have minimal impact on drainage and thus may not be reflected in the 100-year average drainage rate. The initial water content is usually set at a value measured in the field or estimated based upon the engineered properties of the cover. HELP includes an option to compute an initial condition. This is accomplished by setting the initial water content to the steady-state value and simulating the water balance for the first year of generated weather. The ending water content is then used as the initial condition starting over (repeating) at day one. Using a 61-cm soil cover consisting of silt loam material, which has the maximum available water capacity, the water balance was simulated for prescribed initial water contents of 0.1 and 0.32 and for a value computed by HELP, which equaled 0.177, Table 5. The drainage rate should increase as the initial water content increases due to less available storage capacity. Drainage was impacted as expected when the initial condition was prescribed; the lower prescribed water content (0.1) had a lower 100-yr average drainage rate than the higher prescribed water content (0.32). However, when HELP computed an initial water content value between these prescribed values, the drainage rate was lower than for the 0.10 prescribed value.

While this low drainage rate does not make intuitive sense from the standpoint of water storage capacity, this is likely a result of adjustment of other processes that impact the drainage, such as ET. In addition to the inconsistent response to initial conditions, the relative sensitivity coefficient was low (29.7%). The low sensitivity is due to the combination of being based upon the 100-year average drainage rate and because the silt loam material has the largest storage (available water) capacity of the possible textures. Lowering the available water capacity results in increased sensitivity to the initial condition.

Table 5. The effect of controlling versus the program setting the initial condition for HELP predictions for Cheyenne, WY.

WCi	Depth (cm)	WCs	FC	WP	Ks (cm/s)	D (cm/yr)	Ro (cm/yr)	ET (cm/yr)	Total (cm/yr)
0.1	61	0.45	0.35	0.1	1.0E-04	0.28	0.39	32.66	33.32
0.177	61	0.45	0.35	0.1	1.0E-04	0.26	0.39	32.72	33.38
0.32	61	0.45	0.35	0.1	1.0E-04	0.36	0.39	32.72	33.45

WCi = initial water content, WCs=saturated water content or porosity, FC=field capacity, WP=wilting point, Ks=saturated hydraulic conductivity, D=drainage rate, Ro=runoff rate, and ET=evapotranspiration rate

The hydraulic conductivity was varied by three orders of magnitude to test the impact on vertical drainage for silt loam. Hydraulic conductivity is one of the most variable properties of the soil and may change by several orders of magnitude more than that tested. The authors felt, however, that the patterns observed with three-orders variation would suffice to characterize the model sensitivity. The drainage rates reported for HYDRUS-2D and UNSAT-H are a 10-year average as opposed to a 100-year average for HELP and EPIC. The expected pattern of decreasing drainage with decreased  $K_s$  was not observed for EPIC for arid conditions, as EPIC predicted zero drainage for all hydraulic conductivity values, (Table 6). The total precipitation was slightly lower for Laramie than Cheyenne, which contributed to the lower drainage predictions than observed for the other codes. However, even for HELP, UNSAT-H and HYDRUS-2D, the drainage was extremely low, with the highest drainage rate being less than 3.3% of the total annual precipitation for Cheyenne. The low drainage rates were not only a result of arid climate, but also the high storage capacity of the silt-loam soil. EPIC did predict drainage out of the 61-cm cover under the humid conditions of Akron, OH, (Table 7). These drainage rates were considerably lower than predicted by the other codes, although the annual precipitation between sites was essentially equal. For humid conditions, the maximum drainage predicted by EPIC was only 9.5% of the precipitation, as compared to greater than 22% predicted by the other codes.

For both arid and humid locations, the drainage rate predicted by HELP, UNSAT-H, and HYDRUS-2D decreased as the saturated hydraulic conductivity decreased, (Tables 6 and 7). However, the sensitivity of drainage rates to saturated hydraulic conductivity decreased for the humid conditions with relative sensitivity coefficients of less than 37.5% under humid conditions as compared to greater than 75.4% for arid conditions. This means that accurate determination of  $K_s$  in the site characterization phase of designing alternative covers will be more important for arid conditions. The Richards-based models were particularly more sensitive to  $K_s$  under arid conditions.

For water balance models in particular, the drainage rate should monotonically decrease as available water capacity (AWC) increases. All codes were tested for AWC sensitivity with a 61 cm thick monolayer profile with a  $K_s$  of 1.0E-03 cm/s. While no code predicted steadily decreasing drainage as AWC increased for all conditions, EPIC, UNSAT-H, and HYDRUS-2D gave the most realistic response patterns, Tables 8 and 9. EPIC exhibited high sensitivity to AWC under arid conditions, but this was attributable to the failure to predict drainage under the higher AWC conditions. HELP and UNSAT-H exhibited high sensitivity under arid conditions but low sensitivity under humid conditions, while HYDRUS-2d was sensitive to AWC under both conditions.

Table 6. Sensitivity of drainage predictions to saturated hydraulic conductivity for arid conditions.

Porosity	FC	WP	AWC	Ks (cm/s)	HELP (cm/yr)	EPIC (cm/yr)	UNSAT-H (cm/yr)	HYDRUS (cm/yr)
0.45	0.35	0.10	0.25	1.00E-03	1.09	0.000	0.65	0.236
0.45	0.35	0.10	0.25	1.00E-04	0.28	0.000	0.42	0.074
0.45	0.35	0.10	0.25	1.00E-05	0.12	0.000	0.13	0.000
Sr =					94.2%	Na	75.4%	129.7%

FC = field capacity, WP = wilting point, AWC = available water capacity, Sr = relative sensitivity analysis, Na= not applicable

Table 7. Sensitivity of drainage predictions to saturated hydraulic conductivity for humid conditions.

Porosity	FC	WP	AWC	Ks (cm/s)	HELP (cm/yr)	EPIC (cm/yr)	UNSAT-H (cm/yr)	HYDRUS (cm/yr)
0.45	0.35	0.10	0.25	1.00E-03	20.57	8.97	27.76	27.76
0.45	0.35	0.10	0.25	1.00E-04	15.34	8.92	27.39	27.46
0.45	0.35	0.10	0.25	1.00E-05	10.08	7.92	26.90	25.55
Sr =					37.5%	6.7%	3.0%	4.5%

FC = field capacity, WP = wilting point, AWC = available water capacity, Sr = relative sensitivity analysis, Na= not applicable

Of particular concern was the observation that the expected pattern was not observed for HELP. Under both arid and humid conditions, Tables 8 and 9, the drainage rate predicted by HELP initially decreased as AWC increased from 0.05 to 0.15 then increased as AWC increased. While HELP did predict greater drainage under the humid conditions than arid as expected, the highest drainage rates predicted by HELP occurred with the loam and silt-loam soils, which have the greatest AWC. Under humid conditions, the drainage rate was insensitive to AWC, with a relative sensitivity coefficient of 13%. These results for HELP with regard to water storage are again not technically sound. This analysis was complicated by setting the initial water content equal to the higher value of either 0.1 or the wilting point. Thus, most of the conditions, except the loamy sand (AWC = 0.1), had the full water storage capacity available. The loamy sand was relatively wet with a water content of 0.1 (WP = 0.05) creating a condition where the full storage capacity was not available. This should have caused drainage to increase as AWC was varied from the sandy loam (AWC = 0.05) to the loamy sand (AWC = 0.1). A slight increase was observed under arid conditions for HYDRUS-2D, UNSAT-H, and EPIC but not for HELP.

HYDRUS-2D and UNSAT-H use water retention rather than water-balance parameters. Thus, a separate analysis was conducted for HYDRUS-2D by systematically varying the VG alpha and n parameters based upon the humid conditions of Columbus, OH (Table 10). This analysis was not conducted for UNSAT-H since similar analysis was conducted by Magnuson (1993) as reported earlier. The water retention and hydraulic conductivity properties of soil are cross-correlated such that not only are alpha and n parameters inter-dependent but these are also generally correlated to  $K_s$ . Sensitivity analysis, such as already presented for  $K_s$ , addresses the impact of each parameter independently. Both parameters were varied over their full range of expected values. Alpha was varied from 0.100 to 0.005  $\text{cm}^{-1}$  with n equal to 1.6 (Figure 7), and n was varied from the lowest possible value of 1.01 to 4.0 with alpha set to 0.016  $\text{cm}^{-1}$  (Figure 8).

Table 8. Sensitivity of drainage predictions to awc for arid conditions.

WCi	Porosity	FC	WP	AWC	Ks (cm/s)	HELP (cm/yr)	EPIC (cm/yr)	UNSATH (cm/yr)	HYDRUS (cm/yr)
0.1	0.4	0.15	0.10	0.05	1.00E-03	4.62	0.083	0.88	0.714
0.1	0.4	0.15	0.05	0.10	1.00E-03	0.74	0.122	1.27	0.866
0.25	0.55	0.4	0.25	0.15	1.00E-03	0.87	0.003	0.97	0.584
0.15	0.45	0.35	0.15	0.20	1.00E-03	1.38	0.000	0.62	0.389
0.2	0.55	0.4	0.20	0.20	1.00E-03	0.66	0.000	0.65	0.307
0.1	0.45	0.35	0.10	0.25	1.00E-03	1.09	0.000	0.65	0.236
Sr =						105.5%	275.5%	62.5%	121.7%

WCi = initial water content, FC = field capacity, WP = wilting point, AWC = available water capacity, Sr = relative sensitivity analysis.

Table 9. Sensitivity of drainage predictions to awc for humid conditions.

WCi	Porosity	FC	WP	AWC	Ks (cm/s)	HELP (cm/yr)	EPIC (cm/yr)	UNSATH (cm/yr)	HYDRUS (cm/yr)
0.10	0.4	0.15	0.10	0.05	1.00E-03	19.96	21.11	28.07	37.24
0.10	0.4	0.15	0.05	0.10	1.00E-03	19.10	15.61	27.99	28.65
0.25	0.55	0.40	0.25	0.15	1.00E-03	19.30	11.64	27.99	28.04
0.15	0.45	0.35	0.15	0.20	1.00E-03	21.64	10.23	28.06	25.79
0.20	0.55	0.40	0.20	0.20	1.00E-03	18.82	10.12	27.94	27.81
0.10	0.45	0.35	0.10	0.25	1.00E-03	20.57	8.97	27.76	27.76
Sr =						12.9%	57.2%	15.2%	167.4%

WCi = initial water content, FC = field capacity, WP = wilting point, AWC = available water capacity, Sr = relative sensitivity analysis.

The response to alpha depended on whether the soil was initially wet (pressure head = -100 cm) or extremely dry (pressure head = -23,400 cm) and the time scale for determining this average drainage rate. As expected, drainage rates were more sensitive to water retention parameters at the end of year one than for the 10-year average, (Table 10). The average drainage rate for year one increased as the alpha value decreased under wet initial conditions with high sensitivity coefficients, Sr. However, this average drainage rate was insensitive to alpha under dry initial conditions, with only a slight decrease as alpha decreased.

The impact of the water retention curve slope parameter, n, was more complicated. Again, drainage rates were more sensitive to n for year one than the 10-year average, (Table 10). Under dry initial conditions, the average drainage rate after year one was highest when the water retention curve exhibited limited loss in water with tension, n = 1.01. This is most likely a result of the corresponding gradual decrease in K as h decreased. As n increased, the drainage rate decreased to a minimum at n = 1.5, then increased as n increased to a value of 4.00. Since most soils have n values between 1.0 to 2.0, values that correspond to the range to which drainage rates were most sensitive, care should be taken in determining this parameter for the site. Under wet initial conditions, the response of drainage to changes in n was inconsistent, but generally the opposite of what was observed for dry initial conditions.

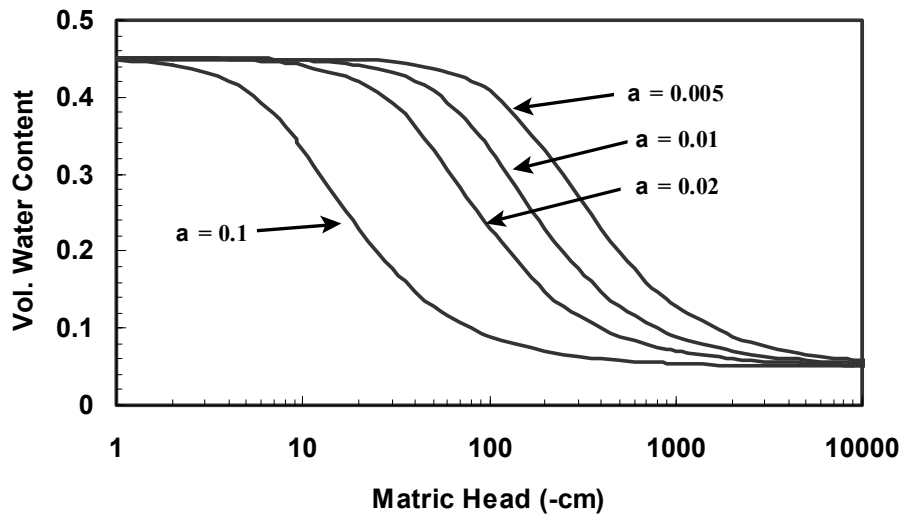

Figure 7. The effect of varying  $\alpha$  while holding  $n$  constant.

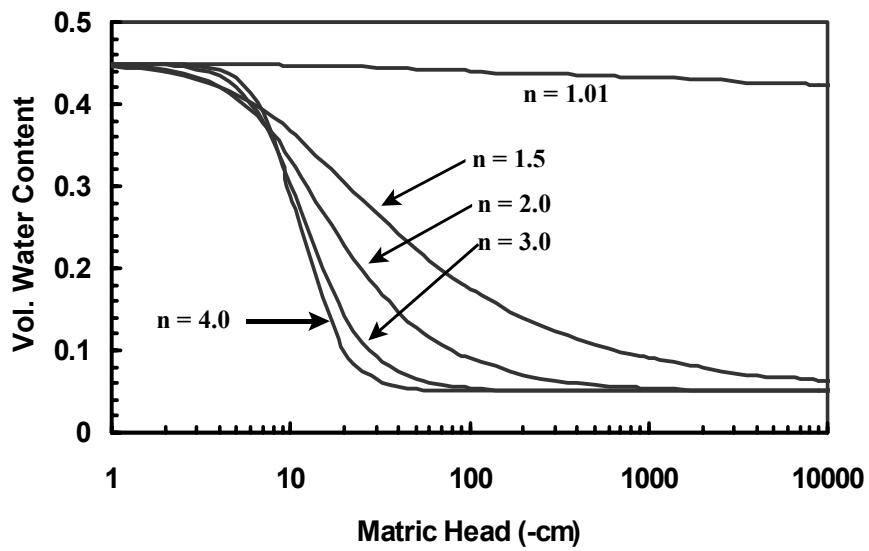

Figure 8. The effect of varying  $n$  while holding  $\alpha$  constant.

Table 10. Sensitivity analysis on HYDRUS-2D water retention parameters.

ho = -23400 cm			ho = -100 cm		
Alpha (1/cm)	Yr 1 Avg. (cm/yr)	10 Yr Avg. (cm/yr)	Alpha (1/cm)	Yr 1 Avg. (cm/yr)	10 Yr Avg. (cm/yr)
0.1000	10.34	27.89	0.1000	14.38	28.30
0.0201	9.45	27.79	0.0201	23.95	29.26
0.0098	8.94	27.71	0.0098	27.71	29.59
0.0051	8.66	27.71	0.0051	30.56	29.90
Sr =	7.5%	0.2%	Sr =	28.8%	2.2%

N	Drainage: Yr 1 (cm/yr)	Avg. Drainage (cm/yr)	N	Drainage: Yr 1 (cm/yr)	Avg. Drainage (cm/yr)
1.01	26.90	37.64	1.01	27.84	37.69
1.5	17.98	36.80	1.5	33.68	38.38
2.0	21.74	37.16	2.0	33.99	38.40
3.0	24.16	37.44	3.0	31.85	38.15
4.0	24.94	37.49	4.0	30.20	38.05
Sr =	35.5%	2.0%	Sr =	17.5%	1.6%

---

ho = initial pressure head. Sr = sensitivity coefficient. S<sub>r</sub> = relative sensitivity analysis

---

The codes were further tested for sensitivity to the depth of the soil profile. Increased depth should increase total storage capacity, an effect comparable to an increase in AWC. HELP and EPIC, however, designate an evaporative zone from which water loss by ET is removed. Although water is not removed directly from the soil below the evaporative depth, this soil is available for water retention and should impact the drainage out of this total soil depth in a physically realistic manner. All codes were tested under an initial condition of water content = 0.10.

EPIC predicted no drainage, while HELP, UNSAT-H and HYDRUS-2D predicted drainage would occur under arid conditions, Table 11. While HELP did show some sensitivity to cover thickness under arid conditions, the inconsistent pattern was not physically realistic. HELP was far more sensitive to evaporative depth than cover thickness. Under humid conditions, Table 12, HELP predictions of drainage were insensitive to cover thickness with relative sensitivity coefficients of only 1%. While EPIC exhibited an appreciable sensitivity in drainage to cover thickness, the pattern was not physically realistic. Since neither provided realistic responses to cover thickness, these results suggest that the cover thickness could be significantly underestimated by HELP and EPIC. Only HYDRUS-2D, and UNSAT-H predicted physically realistic results under both conditions with drainage decreasing as cover thickness increased. These codes were highly sensitive to cover thickness under arid conditions but limited sensitivity under humid conditions.



Table 11. Sensitivity of drainage predictions to cover thickness under arid conditions.

Thick (cm)	Porosity	FC	WP	K <sub>s</sub> (cm/s)	HELP (cm/yr)	EPIC (cm/yr)	UNSATH (cm/yr)	HYDRUS (cm/yr)
30.5	0.45	0.35	0.10	1.00E-03	0.983	0.005	0.86	0.696
61.0	0.45	0.35	0.10	1.00E-03	1.092	0.000	0.65	0.236
91.5	0.45	0.35	0.10	1.00E-03	0.838	0.000	0.44	0.074
122.0	0.45	0.35	0.10	1.00E-03	1.100	0.000	0.24	0.010
Sr =					33.7%	Na	106.7%	253.4%

FC = field capacity, WP = wilting point. S<sub>r</sub> = relative sensitivity analysis, Na = not applicable.

Table 12. Sensitivity of drainage predictions to cover thickness under humid conditions.

Thick (cm)	Porosity	FC	WP	K <sub>s</sub> (cm/s)	HELP (cm/yr)	EPIC (cm/yr)	UNSATH (cm/yr)	HYDRUS (cm/yr)
30.5	0.45	0.35	0.10	1.00E-03	20.52	7.73	28.14	28.24
61.0	0.45	0.35	0.10	1.00E-03	20.57	8.97	27.76	27.76
91.5	0.45	0.35	0.10	1.00E-03	20.37	8.55	27.40	27.36
122.0	0.45	0.35	0.10	1.00E-03	20.47	8.28	27.02	24.94
Sr =					1.0%	17.0%	3.4%	11.3%

FC = field capacity, WP = wilting point. S<sub>r</sub> = relative sensitivity analysis.

Since water lost to ET is removed solely from the portion of the total cover thickness assigned to evaporative depth, sensitivity to the evaporative depth was tested on HELP for the silt-loam soil with a K<sub>s</sub> of 5.2E-04 cm/s under arid conditions (Table 13). HELP was highly sensitive to evaporative depth with an average relative sensitivity coefficient of 278%. The response patterns were also physically realistic, with drainage rate decreasing as evaporative depth increased. However, of concern is the lack of sensitivity in drainage to the portion of the profile below the evaporative depth. Andraski (1997) concluded in a water-balance study under arid conditions that for ET cover to function properly, both the biological component (uptake and transpiration) and the soil component (evaporation and storage) must work synergistically.

It appears that HELP does not fully incorporate the soil water storage component, as drainage is only sensitive to the evaporative depth portion of the cover profile. A further concern is that cover thickness determined by HELP or EPIC will depend not on the soil profile water storage capacity as a whole, but almost exclusively on evaporative depth, which is an extremely difficult parameter to measure. The concept of evaporative depth is dependent upon the plant rooting depth and distribution, which are laborious to directly measure, lack experimental databases, and are not directly correlated to depth of water removal.

### Other Processes:

Information on the associated runoff and ET predictions by these codes can be found in the appendix. Despite the lower precipitation at Laramie than Cheyenne, EPIC predicted higher runoff rates than HELP. This was also true for the humid conditions. Runoff and ET predictions by EPIC were completely insensitive to K<sub>s</sub> variations under arid conditions and only slightly sensitive to K<sub>s</sub> under humid conditions, which brings into question the method by which these processes are modeled. HELP simulations not only exhibited sensitivity of

runoff to  $K_s$  variations for both arid and humid conditions, but the pattern observed of runoff increasing as  $K_s$  decreased was physically realistic. The ET predictions by EPIC were lower than those predicted by HELP for both conditions. ET predicted by HELP increased as  $K$  decreased for the humid condition but was insensitive for the arid condition.

Table 13. Sensitivity of HELP to evaporative depth and cover thickness for Cheyenne, WY.

Evap. Depth (cm)	Thickness (cm)	D (cm/yr)	Ro (cm/yr)	ET (cm/yr)	Total (cm/yr)
15.2	30.48	2.87	0.58	29.90	33.35
	60.96	2.87	0.58	29.92	33.36
	76.2	2.84	0.58	29.95	33.37
25.4	30.48	0.79	0.54	32.03	33.36
	60.96	0.78	0.54	32.03	33.36
27.9	30.48	0.59	0.53	32.23	33.36
	60.96	0.55	0.53	32.28	33.36
	76.2	0.55	0.53	32.28	33.37
30.5	30.48	0.42	0.53	32.42	33.36
	60.96	0.45	0.53	32.39	33.36
	76.2	0.43	0.53	32.40	33.36
	91.44	0.42	0.53	32.42	33.36
	101.6	0.43	0.53	32.41	33.36
	121.92	0.44	0.53	32.39	33.36
61.0	60.96	0.08	0.48	32.80	33.36
	76.2	0.08	0.48	32.80	33.37
	91.44	0.08	0.48	32.80	33.36
	101.6	0.08	0.48	32.80	33.36
	121.92	0.08	0.48	32.80	33.36
76.2	76.2	0.03	0.47	32.86	33.36
	91.44	0.04	0.47	32.86	33.37
	101.6	0.04	0.47	32.86	33.37
	121.92	0.04	0.47	32.86	33.37

D = drainage rate, Ro = runoff rate, and ET = evapotranspiration rate

EPIC provided realistic sensitivities of runoff to AWC for the arid conditions with runoff increasing as AWC decreased. However, the opposite pattern was observed for EPIC under humid conditions. The only response in ET to AWC for EPIC and HELP under arid conditions was for the lowest AWC, which produced the lowest ET rates. The runoff response for HELP to AWC under arid and humid conditions was realistic, while ET was insensitive to AWC under humid conditions.

For EPIC, runoff was clearly sensitive to cover thickness, exhibiting a consistent decrease as thickness increased under arid and humid conditions. In contrast, runoff predictions by HELP were completely insensitive to cover thickness. This was also true for ET predictions by HELP. ET predictions by EPIC were sensitive to cover thickness with a consistent increase in ET as thickness increased as expected.

### **III.E. Validation Test: Model Comparisons**

Validation tests were conducted for UNSAT-H, EPIC, HYDRUS-2D, and several versions of the HELP model using lysimeter drainage data. Validation tests were not made to compare codes against each other but to compare each code to measured drainage. Therefore differences in code capabilities were included in these tests. This analysis was not intended to be a definitive comparison of codes or an evaluation of their validity per se, but was intended to bring the sensitivities discussed into perspective with direct measures of cover performance and to gain further insight into their application. Since the validity of codes depends upon the scenario tested, definitive analysis would require multiple sites with comparable (i.e., standardized) data that span the range of geohydrologic, biologic, and climatic conditions for which alternative covers are to be applied. Such is the long-term objective of ACAP. Hanford, WA and Coshocton OH, lysimeters were chosen for this preliminary analysis as these sites cover a broad range from arid to humid conditions with significant snow accumulation.

The input parameters used for the Hanford lysimeter were those reported by Fayer and Gee (1997) for a non-vegetated, capillary barrier (silt loam over sand) with an evaporative zone depth of 1.6 m. Soil hydraulic property data were identical to that reported by Fayer and Gee (1997) except that the first lateral drainage layer (gravel) beneath the capillary barrier was assigned a hydraulic conductivity of  $1 \times 10^7$  cm/s. In the Fayer and Gee simulations, this value was actually used in contrast to the value reported ( $1 \times 10^{-6}$  cm/s). The wilting point for the silt-loam soil was fixed at 0.0737 cm/cm and the surface was assumed to have a 2 percent slope. The total precipitation (and irrigation) was 2,388 mm (398 mm/yr) for the lysimeter facility for the six-year period (November 1987 through October 1993). Details on the climate data input are available from the Fayer and Gee. HYDRUS-2D was run as a one-dimensional simulation by setting the flow domain to be 1 cm (2 nodes) wide with 825 nodes along each vertical boundary. HYDRUS-2D used the daily precipitation record from the HELP and EPIC input along with the daily PET used for the UNSAT-H input. In contrast, UNSAT-H used only 31 nodes for the vertical profile and used hourly precipitation values.

The results of all HELP versions and the measured drainage for the Hanford lysimeter are reported in Table 14. This analysis suggests that drainage predictions with HELP have improved with each modification (increasing HELP version number). The lower values for

Visual HELP 3.07, relative to the DOS version, are thought to be due to the manner in which both the surface hydraulic conductivity and the ET were calculated for this test case. Despite the improvements, the total drainage for the six year period were an order of magnitude over-predicted. While the HELP predictions did not match the measured drainage rate, the following should be noted: (1) the over-prediction of drainage should result in a conservative approach to landfill closure design, and (2) modifications to the code are progressively improving the validity of the drainage model.

Table 14. Code and version results compared to measured drainage from a Hanford lysimeter from 1987 through 1993.

Code-version	Drainage Rate (cm/yr)	Cumulative Drainage (cm)
HELP 2.05	9.0	53.7
HELP 3.01	8.7	52.2
HELP 3.07 (DOS)	7.2	43.2
HELP 3.07 VISUAL	5.0	30.0
EPIC	0	0
HYDRUS-2D	0	0
UNSAT-H (no hysteresis)	0	0
UNSAT-H (hysteresis)	0.25	1.5
Measured-Lysimeter	0.5	3.0

The UNSAT-H model simulations were run with and without incorporating hysteresis in the hydraulic properties (Fayer and Gee, 1997). Of all the codes tested, UNSAT-H, with hysteresis, provided the closest match to measured drainage. However, when hysteresis was not incorporated into the model, the results from UNSAT-H did not compare well to the measured drainage, as zero drainage was predicted. Despite EPIC and HYDRUS-2D having the same governing equation for drainage as HELP and UNSAT-H, respectively, they predicted essentially no drainage. Given the results of the sensitivity analysis, the lack of drainage predicted by EPIC was expected. The negligible drainage predicted by HYDRUS-2D was consistent with UNSAT-H when hysteresis was not included. HYDRUS-2D was able to handle daily precipitation inputs with the "one-dimensional" simulation. However, the mass balance errors (defined here as the absolute error in water volume divided by the water volume in the flow domain) were significantly larger than for UNSAT-H and substantially more nodes were required, resulting in longer simulation times. The mass-balance errors increased from 2% at the end of 1987 to 22% at the end of 1992, but decreased to 11% by the end of 1993. It appears, for this semi-arid site, that Richards equation based approach is superior if hysteresis is included.

The USDA-ARS operates the North Appalachian Experimental Watershed (NAEW) in Coshocton, Ohio. The NAEW contains multiple instrumented watersheds and lysimeters

for studying various hydrology issues. One of those lysimeters (Y101D) was used to test the HELP3.07, EPIC, UNSAT-H and HYDRUS-2D models. Lysimeter Y101D is a weighing-type lysimeter, with a width of 1.89 m, a length of 4.27 m oriented in the downslope direction, and a depth of 2.44 m. The lysimeter surface is sloped 23.2% (13.1°) to the east. The Y101 lysimeter at Coshocton was chosen because it most closely resembled a monofill alternative design with a grass cover. The soil profile consisted of a fairly uniform A horizon from the surface to 1.5 m with a C horizon extending to the lysimeter bottom at 2.44 m. Hydraulic properties were available for the A horizon (silt loam to loam) but not the C horizon (fractured sandstone). The C horizon properties were estimated by a Neural Network approach (Schaap et al., 1998a) using pedotransfer functions developed by Schaap and Liej (1998b) based upon information on the physical properties of the sandstone (W. Edwards, personal communication). The sandstone was represented as 70% sand, 15% silt and 15% clay with a bulk density of 2.0 g cm<sup>-3</sup>. The hydraulic conductivity of the C horizon is thought to be greater than the A horizon as it does not cause a perched water table to develop. Instead, water freely drains from the profile due to preferential flow through fractures with the water content of the sandstone matrix varying only slightly annually. Therefore, the saturated hydraulic conductivity of the C horizon was assumed to be slightly larger than the A horizon. The following properties were used to describe the lysimeter:

SCS curve number = 58  
 Evaporative zone depth = 1.5 m  
 Maximum LAI = 5.0  
 slope = 23%  
 slope length = 30.5 m  
 growing season start = day 59  
 growing season end = day 334  
 average wind speed = 6.4 km/h  
 average 1<sup>st</sup> quarter relative humidity = 76%  
 average 2<sup>nd</sup> quarter relative humidity = 72%  
 average 3<sup>rd</sup> quarter relative humidity = 79%  
 average 4<sup>th</sup> quarter relative humidity = 77%

	A horizon	C Horizon
Porosity	0.43	0.268
field capacity	0.113	0.11
wilting point	0.008	0.042
$\theta_p$	0.0	0.041
alpha (1/cm)	0.0283	0.0449
n	1.653	1.2567
Ks (cm/d)	28.5	30.0
Initial h (cm) =	-55.5	-55.5
Initial $\theta$ =	0.275	0.2108

HYDRUS-2D was run with the C horizon treated as a dual porosity system with a K(h) value of 0.075 cm/d at the air-entry value of -22.3cm while the other codes treated this material as a single porosity system. Hysteresis was not included in the UNSAT-H simulations, as done for the Hanford case, but isothermal vapor flow was included.

The weather data were derived from the daily Coshocton meteorological data. Drainage and meteorological records were available from 1943 to present, however, due to concerns for data quality, only the 10 year period from 1985 to 1994 was used for the validation test. The meteorological data collection site is about 457 m southeast of the lysimeter at an elevation of about 1,150 (slightly higher than the lysimeter). Relative humidity and air temperature were measured at a height of 1.5 m. Wind speed was measured at a height of 10 m. Maximum and minimum air temperatures, wind speed, and solar radiation were used directly. No attempt was made to adjust the solar radiation for slope and aspect effects (estimated to be less than 5%). For UNSAT-H, average daily relative humidity data were used along with average air temperature to calculate the average daily dewpoint temperature. Measured dewpoint temperatures were available for some years. The estimated values were compared to these measured values and were found to be within 1°C on average. For HELP, EPIC and UNSAT-H, the wind speed, relative humidity, solar radiation, and maximum and minimum air temperature data were used to calculate PET using the Penman Method (Doorenbos and Pruitt 1977). For UNSAT-H and HYDRUS-2D, PET estimates were partitioned into PE (potential evaporation) and PT (potential transpiration) based upon the relationship to LAI proposed by Ritchie and Burnett (1971). Measurements of LAI were not available so the LAI predictions by EPIC were used to partition PET.

The precipitation data consisted of daily amounts without sub-daily intensity information. In lieu of such information, such as hourly precipitation rates, precipitation was applied as daily amounts for HELP, EPIC, and HYDRUS-2d. For UNSAT-H, precipitation was applied at the rate of 1.0 cm/h starting at 0000 h until the day's total precipitation was applied. This method of applying precipitation ignores high intensity storms that might result in runoff. Therefore, less runoff will be predicted, which means that evapotranspiration and drainage will be proportionately greater. Snow and snowmelt were not modeled by any of the codes. Therefore, snowfall was treated as an equivalent rainfall at the time that it occurred.

With the exception of UNSAT-H, default root uptake parameters for grass were used with a uniform root distribution in the rooting zone (0 to 1.5m) throughout the growing season. For UNSAT-H, root density parameters were obtained directly from root length density data for *Agropyron spicatum*, a desert perennial bunchgrass (Mayer et al. 1981). The roots were considered to be at their maximum depth throughout the growing season. The plant water uptake parameters were estimates for agricultural crops (Feddes et al. 1978).

For the Richards' equation based codes, the bottom boundary was represented by a unit hydraulic gradient condition. This condition is generally acceptable when the boundary is well below the deepest plant roots. HYDRUS-2D was run as a one-dimensional simulation by setting the flow domain to be 1 cm (2 nodes) wide with 500 nodes along each vertical boundary. In contrast the node spacing for UNSAT-H started at 0.2 cm at the soil surface and gradually increased with depth. Changes in node spacing from node to node were limited to < 50%. A total of 38 nodes was used. Time step sizes for HYDRUS were allowed to range from  $10^{-20}$  to 0.5 d and for UNSAT-H from  $10^{-10}$  to 0.04 d, depending on the mass balance error.

While the ability of these codes to predict drainage was improved overall for the humid conditions of Coshocton as compared to the semi-arid conditions at Hanford, the

patterns seen previously were repeated. With the exception of year six (1990), HELP 3.07 consistently over-predicted drainage; with the exception of year eight (1992), EPIC consistently under-predicted drainage. These years did in fact represent the extremes for this 10 year period of recorded drainage. While EPIC was by far the best at predicting drainage during the drought year (e.g., year eight), this is not the condition of greatest concern to landfill performance. For the highest drainage year (e.g., year six), all codes under-predicted drainage but HELP gave the closest estimate. As a result, the total drainage over the 10 year period was significantly over-predicted (29%) by HELP and under-predicted (31%) by EPIC. Not only did UNSAT-H provide the most accurate prediction of drainage for the 10 year period (8% over), the yearly total drainage was balanced between over and under-predictions. In contrast, HYDRUS-2D exhibited a tendency to over-predict yearly drainage but was off by only 17% of the total drainage for the 10-year period.

Table 15. Code results compared to measured drainage from a Coshocton lysimeter from 1985 through 1994.

Case	Stat.	Yr1	Yr 2	Yr 3	Yr 4	Yr 5	Yr 6	Yr 7	Yr 8	Yr 9	Yr 10	Total
Measured	D	34.92	31.30	20.55	22.05	30.68	50.66	29.49	6.09	34.74	35.50	296.0
HELP	D	62.82	38.90	25.12	28.49	45.90	47.43	45.03	17.4	30.81	38.55	380.5
	RMS	2.34	0.63	0.33	1.08	0.70	0.96	0.75	0.74	0.89	0.93	
EPIC	D	29.20	23.23	11.07	8.21	25.21	32.41	20.69	6.43	19.83	25.07	201.4
	RMS	0.66	0.34	0.30	0.49	0.47	0.49	0.42	0.30	0.51	0.87	
HYDRUS	D	37.20	34.80	19.90	30.30	34.70	45.10	44.00	22.20	38.10	40.70	347.0
	RMS	0.58	0.23	0.37	0.50	0.55	0.77	0.76	0.67	0.29	0.53	
UNSAT-H	D	62.10	36.62	20.31	22.96	33.86	42.73	28.97	11.26	26.00	33.78	318.6
	RMS	2.19	0.28	0.27	0.35	0.34	0.65	0.43	0.32	0.47	0.43	

RMS is the average of the monthly root mean square errors for the year (cm), D = total drainage for the year (cm)

The RMS (Table 15), as defined in Eq. 6, provides an indication of the accuracy of model predictions. This statistic can be misleading in that the monthly deviation of predicted to measured drainage is averaged for the year. Averaging the monthly deviations over the year incorrectly suggest that EPIC provided the best estimates of drainage over the 10 year period. However, it should be noted that for the 10 year period, HYDRUS-2D and UNSAT-H provided the best estimate 3 and 5 of the years, respectively, while EPIC and HELP 3.07 provided the best estimates only for the two extreme years. The cumulative drainage was best predicted by HYDRUS-2D, Figure 9, for the first six years but eventually this was predicted best by UNSAT-H for the 10 year period. The stair-step pattern of drainage during the spring with zero drainage during the summer and fall months was emulated best by EPIC resulting in low monthly RMS values but because EPIC consistently under-predicted drainage (consistently negative residuals) the cumulative effect was detrimental to drainage prediction. The most erratic predictions were by HELP which frequently had large monthly RMS values (large positive and negative residuals). The initial over-prediction of drainage in the first month by HELP and UNSAT-H suggest that the initial conditions was not well matched to actual conditions, however, this conditions was derived from measured water contents on the lysimeter and this effect was not observed by EPIC or HYDRUS-2D.

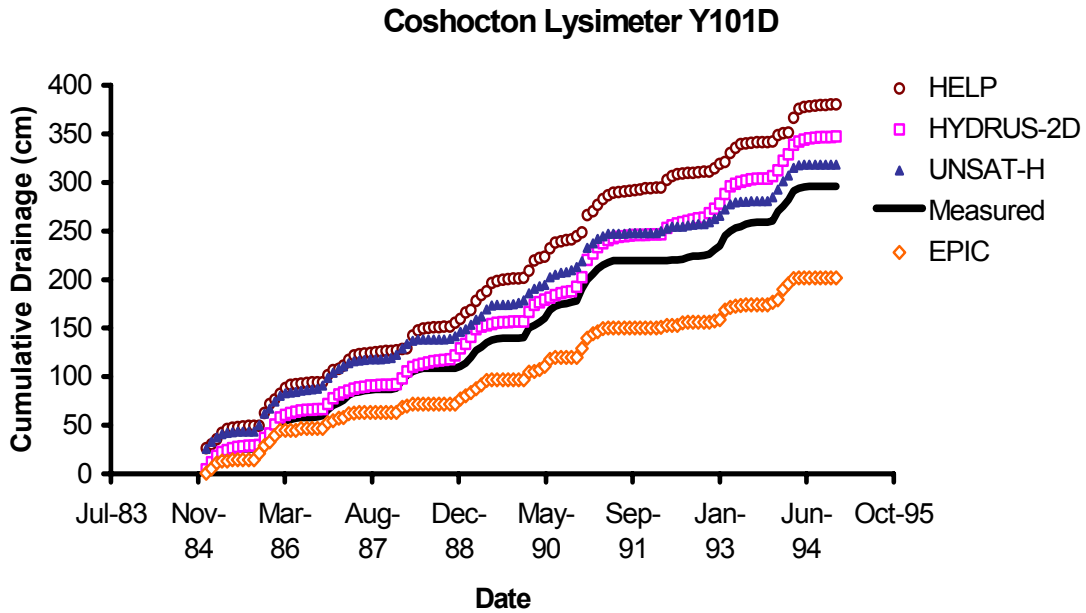

Figure 9. Predicted cumulative drainage compared to the measured drainage for Coshocton, OH.

### III.F. Code Differences

A series of tests were conducted to compare DOS versions and the Window's version of HELP, Visual HELP 3.07 (Waterloo Hydrogeologic, Inc. 1998). Results of the six-year simulations for HELP version 3.01 and 3.07(DOS) for a range of available water contents and initial water contents are shown in Table 16. While both versions of HELP predicted similar trends in drainage in response to AWC, the HELP 3.07 version consistently predicted less drainage than the HELP 3.01 version. Both versions exhibited a decrease in drainage as AWC increased from 0.04 to 0.24, then drainage increased with the subsequent increase in AWC to 0.29 which is not realistic. It is also not clear, why both versions predicted greater drainage, for the two lowest AWC values, with the initial water content at the wilting point than with it set to 0.2127. This is not physically realistic but this observation was reversed to a realistic response as the AWC increased.

Table 16. Drainage predictions by HELP Version 3.01 and 3.07 (DOS) for a bare silt loam, capillary barrier lysimeter at the Hanford Site, Washington. Initial soil water content set either at the Wilting Point or at an arbitrary value of 0.2127.

Case #	FC	AWC	3.01 Wilting Point	3.01 0.2127	3.07 Wilting Point	3.07 0.2127
1	0.1148	0.0411	1915.3	1809.8	1862.5	1789.0
2	0.1648	0.0911	1662.3	1562.1	1659.5	1444.1
3	0.2148	0.1411	257.6	448.9	152.6	333.2
4	0.2648	0.1911	278.5	469.9	159.2	347.7
5	0.3148	0.2411	306.9	496.8	192.7	404.0
6	0.3648	0.2911	326.2	514.3	216.8	426.1



In general, Visual HELP yielded results that were similar to DOS HELP 3.07. Thus, the sensitivity evaluation for DOS HELP, discussed previously, provides an indication of the capabilities of Visual HELP in describing the water balance of a landfill cover at a given site. The major differences were observed when default soil parameter values were changed to input values. In Visual HELP, the code adjusts the saturated hydraulic conductivity of the surface (evaporative zone) in every case when the surface has a vegetative cover. In the DOS version, the code adjusts the saturated conductivity only when default soil parameters are used. This feature of modifying the Ks values as a function of LAI was incorporated into HELP in an attempt to account for impacts of vegetation, e.g. preferential flow, on hydraulic properties.

To illustrate the performance of the two codes under similar test circumstances, the following test cases were run. The codes were tested for drainage through the vertical drainage (top) layer under climatic conditions for Buffalo, NY. The topsoil selected was a fine sandy loam. Default soil parameters were used except where noted. The soil was tested using the default evaporative zone depth, LAI, climate parameters specified for Buffalo. The simulations used identical soil parameters for the surface soil hydraulic conductivity, which was varied by five orders of magnitude. The results of drainage from the two codes for the same test cases are shown in Table 17 and indicate that the two codes performed similarly and yield the same drainage estimates for the cases tested. Differences of 3-4% in drainage may be observed due to rounding procedures and level of precision used in compiling of DOS and WINDOWS applications on a PC that would not be observed when compiled with the double-precision on a mainframe-workstation (Mikhail Gogolev, personal communication). The results from both codes indicate that as the hydraulic conductivity of the surface layer decreased the drainage systematically decreased and runoff (data not shown) increased, correspondingly. When the codes were run without default properties (direct input of hydraulic properties) for the surface layer, the drainage results for the DOS and Visual HELP versions differed by as much as a factor of five (results not shown). The DOS version did not automatically change the hydraulic conductivity as a function of LAI but the Visual HELP version did adjust hydraulic conductivity with the direct input of hydraulic properties.

Table 17. Comparison of DOS and VISUAL versions of HELP 3.07 for Buffalo, NY.

Year	$K_s = 5.2H10^{-4}$		$K_s = 5.2H10^{-6}$		$K_s = 5.2H10^{-7}$		$K_s = 5.2H10^{-8}$		$K_s = 5.2H10^{-9}$	
	DOS	Visual	DOS	Visual	DOS	Visual	DOS	Visual	DOS	Visual
1	25.11	25.01	3.61	3.66	2.49	2.49	0.00	0.00	0.03	0.03
2	20.18	20.17	2.43	2.25	2.00	1.99	0.05	0.05	0.03	0.03
3	16.69	16.64	1.89	2.20	2.02	2.01	0.21	0.22	0.03	0.03
4	20.44	20.38	1.99	1.77	1.97	1.96	0.27	0.27	0.03	0.03
5	19.24	18.82	2.24	1.97	1.98	1.97	0.28	0.28	0.03	0.03
6	23.68	23.29	2.34	2.15	2.38	2.36	0.35	0.35	0.03	0.03
7	24.39	23.57	3.15	3.55	2.36	2.34	0.34	0.34	0.03	0.03
Avg.	21.39	21.13	2.52	2.51	2.17	2.16	0.21	0.22	0.03	0.03

UNSAT-H and HYDRUS-2D were further compared in two simple simulations using identical soil hydraulic properties and variables of precipitation and PET. The hydraulic properties represented a silt loam ( $\alpha = 0.016$ ,  $n = 1.6$ ) at an initial matric head of  $-23400$  cm. The HYDRUS-2D simulation used the 60 cm thick by 20 m long flow domain used in the Cheyenne, WY sensitivity analysis. The UNSAT-H simulation used a one-dimensional domain, also 60 cm thick. The two cases consisted of (1) daily precipitation equal to 0.01 cm/day for 10 years with zero evaporation and transpiration and, (2) the same precipitation input but with daily evaporation equal to 0.005 cm/day and transpiration equal to zero. Despite the fact that both codes use a Richards' equation solution, significant differences in drainage were predicted (Figure 10).

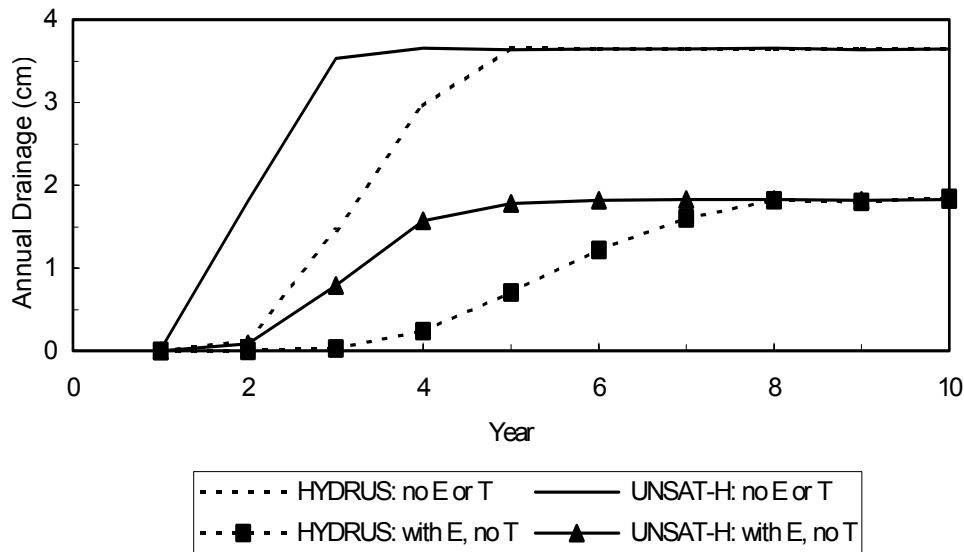

Figure 10. Modeled estimates of drainage using UNSAT-H and HYDRUS-2D with and without simulated evaporation.

Drainage predictions for both codes asymptotically approached a steady-state rate, which was equivalent to the precipitation minus ET rate. However, UNSAT-H reached the limiting rate by the end of the second year of simulation, while HYDRUS-2D required nearly four years of simulation to achieve the same rate. The more dynamic response of UNSAT-H was also seen for the case with evaporation included (Fig. 10). For both cases, the final water contents and matric heads were consistent between these codes. This suggests that the discrepancies are a response to differences in hydraulic conductivity. While both codes used the same function and parameters, there are differences in how these factors are utilized. UNSAT-H computes the  $K(h)$  value from the function at each iteration. In contrast, HYDRUS-2D creates a table of  $K(h)$  values from the function at the beginning of the simulation, then linearly interpolates the required  $K(h)$  values at each iteration from the table. The head intervals for which  $K$  values are computed are not defined by the user, nor are the  $K(h)$  values that are used readily accessible in the output. Given the extremely dry initial condition specified in the simulations, the non-linearity in  $K(h)$  likely led to significant differences between codes. This feature has been modified in the latest version of

HYDRUS2D in which the user can specify the tables' range in h or bypass the table to compute  $K(h)$  at each iteration. While the latest version of HYDRUS-2D was not run on this test case it is expected that by computing  $K(h)$  at each iteration, the results from HYDRUS2D and UNSAT0H would be essentially identical.

### **III.G. Model Comparison Summary**

The four codes selected for additional testing have all received adequate verification, validation, and sensitivity analysis testing. The current independent technical review of these codes suggests the following specific observations:

#### $K_s$ response under arid conditions:

Test case condition: low drainage rates (<3% precipitation)  
HELP: sensitive to  $K_s$  with realistic response patterns  
EPIC: no drainage predicted  
HYDRUS-2D: sensitive to  $K_s$  with realistic response patterns  
UNSAT-H: sensitive to  $K_s$  with realistic response patterns

#### $K_s$ response under humid conditions:

Test case condition: high drainage rate (>30% precipitation)  
Lower sensitivity to  $K_s$  under humid conditions  
Realistic response patterns for all codes

#### AWC response under arid conditions:

HELP: Sensitive to AWC but unrealistic response pattern  
EPIC: Sensitive to AWC but pattern uncertain  
HYDRUS-2D: Sensitive to AWC and realistic response pattern  
UNSAT-H: Sensitive to AWC and realistic response pattern

#### AWC response under humid conditions:

HELP: fairly insensitive and unrealistic response pattern  
EPIC: moderately sensitive and realistic response pattern  
HYDRUS-2D: highly sensitive and realistic response pattern  
UNSAT-H: low sensitivity but realistic response pattern

#### Cover thickness response under arid conditions:

HELP: low sensitivity and unrealistic response pattern  
EPIC: drainage only predicted for thinnest cover  
HYDRUS-2D: highest sensitivity and realistic response  
UNSAT-H: high sensitivity and realistic response

#### Cover thickness response under humid conditions:

Lower sensitivities under humid conditions  
HELP: insensitive and unrealistic response pattern  
EPIC: low sensitivity with unrealistic response pattern

HYDRUS-2D: low sensitivity but with realistic response pattern  
UNSAT-H: low sensitivity but with realistic response pattern

HYDRUS-2D sensitivity to van Genuchten parameters:

Alpha: More sensitive when initially wet  
Response pattern depends upon initial conditions  
n: More sensitive when initially dry  
Inconsistent responses without a pattern

The following general observations were made:

- 1) Sensitivity analysis can be used to guide the characterization and monitoring program.
  - a)  $K_s$  and AWC determination are more important under arid conditions.
  - b) Characterization of van Genuchten alpha parameter is more important under humid conditions.
  - c) For HELP and EPIC, it is critical that the evaporative depth be accurately characterized.
- 2) EPIC appears to under-predict drainage under both arid and humid conditions.
- 3) HELP appears to over-predict drainage under arid and humid conditions.
- 4) HELP and EPIC remove ET only from an evaporative zone, which can lead to insufficient thickness of the surface layer.
- 5) HELP predictions are highly version-dependent, therefore the version number should be stated.
- 6) Richards' equation based codes provide superior prediction of drainage over water-balance based codes for alternative cover designs
- 7) Inclusion of hysteresis appears to be necessary for valid drainage predictions with Richards' equation-based models under arid conditions.

This review indicates that improvements are needed in the models currently being used for landfill cover design and performance monitoring. Models need to be evaluated against common databases across hydrogeologic regions for confirmation of validity. Data collected from Phase I and the dispersed network will provide the basis for code modifications and validation of these models.

## **III.H. Individual Model Summaries and Recommendations**

### **III.H.1 HELP**

Some of the important limitations noted by Schroeder et al. (1994) regarding the HELP model are listed below. The HELP model is designed to simulate water routing or storage in up to 20 layers of soil, waste, and geosynthetics. A limit of five liner systems, either soil, geomembrane or composite liners, can be used. Each layer must be described as being one of four operational types: vertical percolation, lateral drainage, barrier soil liner or geomembrane liner. The model is very specific in how the liners and layer sequences can be placed. The HELP model can be run for a minimum of 1 and a maximum of 100 years.

The vertical drainage routine does not permit capillary rise of water from below the evaporative zone depth. Capillary barriers designed to wick water to the surface or upward into the root (evaporative) zone cannot be modeled directly with HELP. Evapotranspiration (ET) is modeled as a distributed extraction from the evaporative zone depth, which is arbitrarily partitioned into seven segments. It appears that there is a lack of hydrologic connection with the remaining portion of the soil layer. This may be an effective means of modeling drainage for a RCRA-type cover, however, alternative cover design often relies on soil water storage in the total cover thickness. This factor would not be achieved in simulations using HELP. Additionally, the depth of an evaporative zone, which depends upon plant root distributions and soil capillary properties, is an ambiguous property that is not easily characterized or described in the literature.

The HELP code has undergone a series of changes. Consequently, each version of the code will result in different results for a given problem. The most recent version, 3.07, is thought to be the most comprehensive and robust. The major difference between the HELP 2 and 3 versions is the way that the code handles vertical drainage. Reliance entirely on the unsaturated conductivity to predict drainage in version 2 produces an overestimate of drainage, assuming all other changes are ignored. Version 3 was modified to consider the limits of drainage when the soil is below field capacity. No drainage occurs when the soil dries below the wilting point. Version 3 has also been modified to include snowmelt events more rigorously. The major point here is that HELP modeling results are dependent upon the version of the code used, so the version number should be specified in reporting results. The version should also be specified when user-specified input parameters are used so that comparisons and validation tests are meaningful. Future modifications should include improvement of the method by which ET is removed from the surface layer such that the entire layer is hydraulically active. Dependence upon an evaporative depth, which is a speculative property, should be modified. Given the variance among HELP versions and measured rates of drainage, further validation under semi-arid conditions is needed.

### **III.H.2 EPIC**

The EPIC code is incompatible with Windows95 and a PC must be set in DOS mode for the program to run. The EPIC code runs to completion quickly, usually less than 1 minute for a 100-year simulation on a 90 MHz computer. The code was originally designed to determine the effects of soil loss and it is one of the few models that can predict the effects of

soil erosion on percolation through soil layers. The model takes into account both wind and water erosion of the soil. Being an agricultural model, EPIC has a more detailed description of plant processes than do the other models studied in this report, with the possible exception of the SHAW model. This may be the cause of the low drainage estimates predicted by EPIC relative to the other codes tested, but it does not appear to be well matched to the semi-arid conditions that were tested (i.e. Cheyenne, Wyoming and Hanford, Washington) as it yielded results that appeared to under-predict drainage compared to the other codes and the measured data at Hanford and Coshocton .

Future studies on use of the EPIC model in the landfill industry could include a modification of the original code to a more soil-water-specific model. Given the lower prediction of drainage relative to the other codes tested, validation of the EPIC code using directly measured landfill cover drainage data should be made for a variety of climates and soil types. Modification of the code for use in the landfill industry should include adding properties for geomembranes, waste layers, and lateral drainage layers, as well as the removal of many of the unnecessary parameter requirements. The removal of unnecessary features should include livestock parameters, lagoon properties, fertilizer, and pesticide transport. Given the degree of modification necessary to adapt EPIC to landfill cover applications and the lack of conservatism of the drainage predictions, adapting EPIC for cover design may not be warranted. Since the HELP model has been well documented for use on landfill covers and could be modified easier than the EPIC model, the further enhancement of HELP as a consistent water -balance code is recommended in contrast to modifying EPIC.

### **III.H.3 HYDRUS-2D**

HYDRUS-2D offers some advantages over the other codes identified. Landfill covers often consist of sloping layers of soil and the ability to simulate lateral subsurface flow is important to proper prediction. Of the models reviewed, only HYDRUS-2D is suitable for modeling lateral subsurface flow, therefore, the only code that can realistically model capillary barrier processes. It offers the additional advantage of allowing spatial heterogeneity to be incorporated in the description of soil properties. This is accomplished with scaling factors, which convert the reference soil properties supplied for the whole domain to values relevant at each node (spatial location). It also allows the designation of anisotropy in the hydraulic properties. While it is not specifically designed to model preferential flow, this can be included in the landfill cover design simulations through manipulation of the scaling factors, anisotropy, and/or utilizing the dual porosity hydraulic property functions. An important factor that is not permitted in the version tested is hysteresis in hydraulic properties but the latest version has this capability.

One limitation to the use of HYDRUS-2D in landfill cover design applications stems from the development of the code as a general vadose zone hydrology, not an application-specific, code. The IGWMC, which sells the code, has formed an Internet support group, which can be joined by contacting [hydrus2d-request@gale.mines.edu](mailto:hydrus2d-request@gale.mines.edu). Additionally, workshops are periodically held by the U.S. Salinity Laboratory in Riverside, CA.

While the pre- and post-processors added to the original SWMS code make HYDRUS-2D attractive, there are still improvements that need to be made for this code to be a user-friendly option for landfill cover designers. Needed improvements in the input processor include:

- 1) weather generator integrated with the atmospheric boundary condition input file,
- 2) selection of layers and subregions, including:
  - a. the ability to specify layer thickness as opposed to manual selection of nodes,
  - b. an option to designate layers (materials) as subregions instead of inputting each independently, and
  - c. a non-orthogonal manual selector for sloping soils or ability to specify layer slope
- 3) a direct connection between the time variable boundary records (print times selected) and the output to be provided in the ASCII files (such as CUM\_Q.out file),
- 4) geomembrane material properties in the soil property menu, and/or ability to estimate hydraulic properties from soil physical properties
- 5) improvements in the description of the capabilities of the mesh generator. The mesh generator is very powerful but densification of nodes at boundaries or layer interfaces is not user friendly. This could be improved by a tutorial that provides explanations and examples.
- 6) Modification to the way in which  $K(h)$  is computed such that the user can by-pass the interpolation of  $K(h)$  from tables or specify the  $h$  increment in the table of values.

The information provided on-screen during the simulation run-time is of limited value. Explanation of the variables being printed is not provided and interpretation of their significance, why the simulation worked or crashed, is difficult. The relative mass balance (WatBalR) should be interpreted with caution as it expresses mass balance relative to the flux and the change in water content. Under arid conditions (low flux and low change in water content) the WatBalR may be large but the true mass balance adequate. A better approach to interpreting the mass balance is to divide the absolute water mass balance error, WatBalT, by the flow domain area. The bigger limitation with HYDRUS-2D is the difficulty in retrieving the pertinent information. For landfill cover design and performance assessment applications, the output most often needed is the fluxes out of the profile or out of individual layers. This information is provided for the flow domain boundaries at all simulation times in the Cum\_Q.out ASCII file. This file provides the cumulative water fluxes averaged across the boundary, however, caution must be exercised to not misinterpret the data provided due to ambiguity in the variable designations (boundaries identified by flag numbering). Capturing the pertinent information can be laborious for large simulations. Cumulative fluxes from individual layers is not directly provided, however, this information can be interpreted from the flux information provided for individual nodes. Deriving estimates of flux by this method would be a laborious endeavor.

Pre-, and post-processors for HYDRUS-2D can be easily modified to make it user-friendly for landfill cover applications. However, there are mechanistic issues, such as the limited ability to model overland flow and difficulties in handling intermittent precipitation under extremely dry conditions, which need to be addressed. When precipitation is greater than the infiltration capacity, the excess water is immediately removed from the computations. The usefulness of HYDRUS-2D in landfill cover applications would benefit by coupling with a runoff-erosion model. We have found, as have other users, that the code has difficulty using the atmospheric BC when  $PET \gg \text{rainfall}$  or precipitation is intermittent. We had limited success running the code in a two-dimensional domain under conditions of intermittent rainfall followed by extended periods combining a lack of precipitation with high PET. Under these conditions, the water content of the surface became excessively dry and multiple wetting fronts (multiple upward and downward gradients) developed within the profile. This combination of factors, common in the arid and semi-arid portions of the country, caused the model to fail to achieve convergence. The following options may help users apply HYDRUS-2D to landfill cover applications:

- 1) create a finer mesh (reduce nodal spacing)
- 2) use smaller minimum time increments
- 3) increase the iteration criteria
- 4) decrease the hCritA (minimum matric head allowed) value in the Time Variable BC menu.

Options 1 and 2 above are the most technically sound actions but these are made at the expense of increased run time. Nodal spacings of less than 1 cm are often necessary at the surface for arid conditions. While option 3 may enable the code to continue without crashing, the mass-balance errors may suffer. Under option 3, HYDRUS-2D is substantially more sensitive to changes in the iteration criteria for water content than matric head. This is puzzling since the numerical method solves for matric head, from which water content is subsequently interpolated. According to the code developers (Simunek, personal communication), the iteration criterion for water content is only used in the unsaturated domain, while the iteration criterion for pressure head is only used in the saturated domain. Option 4 allows the user to specify the maximum dryness (minimum matric head) allowed at the surface. While it may not seem technically sound to limit the surface dryness, due to the nonlinearity of the water retention function, large (order of magnitude) changes in matric head near the residual water content make trivial differences in water storage capacity. However, since this can invoke large (orders of magnitude) restrictions on  $K(h)$  and the hydraulic gradient, which are causing the failure to infiltrate water or achieve convergence, such an option is a sound approach.

#### **III.H.4 UNSAT-H**

UNSAT-H generally provided the most accurate predictions of drainage and was relatively fast computationally. It has two primary limitations: (i) like HYDRUS-2D, it was developed as a general vadose zone hydrology code and not specifically for landfill cover



design; (ii) it is restricted to 1 dimensional analysis and therefore cannot model lateral flow processes which are critical to capillary barrier designs and runoff-erosion design features.

A common problem encountered was user error due to column specific input. Given the large data input needs for UNSAT-H, a preprocessor is much needed. Improvements include: integration of a weather generator, format-free input structure, incorporation of geomembrane material properties or the ability to estimate hydraulic properties from soil physical properties, and selection of output variables. As for HYDRUS-2D, pre-, and post-processors can be easily modified to make it user-friendly and specific to landfill cover applications.

Mechanistically, the code appeared to be superior to the other codes tested, however, improvements can still be made. As with HYDRUS-2D, when precipitation is greater than the infiltration capacity, the excess water is immediately removed from the computations. While UNSAT-H will not be able to fully represent runoff-erosion processes due to its 1-d nature, landfill cover applications would benefit by coupling with a runoff-erosion model. The following additional modifications should be considered: surface water detention to allow for ponding during precipitation events, and runoff calculations using surface slope that also allows for runoff. The snow hydrology processes could be improved by better representing the freezing-thawing effects on infiltration and in particular a snow melt subroutine could be added to control the surface boundary conditions under snow cover conditions.

## IV. CONCLUSIONS

Alternative covers designs are of increasing interest to EPA and to landfill operators. Alternative covers may provide adequate protection of landfill sites for extended periods of time and at reduced cost. Nineteen sites in the U.S. are described in this report that illustrate either testing or use of alternative covers in their landfill closure activities. These landfill covers range from simple earthen monofills with native grass cover to more complex designs, where multiple soil layers are used to restrict downward movement (drainage) of water into the landfill.

Monitoring of alternative landfill cover sites to ensure that drainage is minimized will require specialized test equipment. A recommended test facility design was developed, which includes a series drainage-type lysimeters, runoff collection systems, and a weather station for a complete water-balance monitoring network. The lysimeters will be used to document water storage and vertical drainage from the landfill cover. The runoff collection and weather station will be used to document the remaining components of the water balance (precipitation and evapotranspiration). The recommended test facility could be constructed as part of the landfill or as a separate test bed adjoining the landfill.

Ten computer codes that are currently being used for landfill cover design were identified and their characteristics described. Four of the ten codes identified, HELP, EPIC, and UNSAT-H, HYDRUS-2D, were subjected to a series of tests, including sensitivity testing to determine which input parameters are most critical to predicting landfill cover drainage. The degree of accuracy (determined by comparison to actual measured results) was not fully determined; however, these same codes were tested for a single humid site and an arid site.

This subset of codes showed varying degrees of sensitivity that we suspect the other codes would also exhibit under similar testing. EPIC, while relatively easy to run and robust, appeared to overestimate the evapotranspiration, especially for semi-arid conditions. Further modifications to EPIC were not recommended since a water-balance type model already exists (HELP) that appeared to provide superior ability to EPIC. HELP is the easiest to run of all codes tested. However, simulations with HELP showed a non-realistic response of increased drainage with increased available water content (increasing field capacity for a fixed wilting point), an insensitivity to total cover thickness, and consistently over-predicted drainage. The fact that the ET function removes water only from the evaporative zone, which is a difficult property to characterize, with limited connection to the rest of the cover surface layer can potentially result in unrealistic estimates of required cover thickness.

Water balance type models (eg. HELP, EPIC) demonstrated several limitations (e.g., process oversimplifications) in testing performance of alternative cover designs, in contrasts to the Richards' equation based codes (UNSAT-H and HYDRUS-2D) which appeared to give the most consistent and physically realistic results. The use of UNSAT-H and HYDRUS-2D by the engineering and regulatory communities will require user-friendly modifications to these codes. HYDRUS-2D had difficulty simulating widely changing surface boundary conditions (highly varying precipitation fluxes) so some modifications are necessary. UNSAT-H provided the closest predictions to measured

drainage and includes a wide variety of processes; however, it is limited to 1-dimensional applications. Some aspects of cover evaluation and design, such as convergence of lateral flow with capillary barriers and surface runoff and erosion control, requires a 2-dimensional code. Despite the increased difficulty of use, a 2-dimensional code is needed for some alternative cover designs. Rather than expand UNSAT-H to 2-dimensions, the existing 2-dimensional code, HYDRUS-2D, or an equivalent model could be modified according to the recommendations in this report for specific application to landfill covers.

It appears that none of the codes tested to date are totally reliable as a water-balance model for landfill cover evaluation. Without field-scale data from a range of climatic, hydrogeologic, and biological conditions, we cannot fully evaluate the validity of the codes across a wide range of physical environments. Additional tests are needed to further evaluate the performance of computer models for the large range of soil, plant, and climatic conditions found within the U.S. It is recommended that on-site data be collected for at least 10 sites where alternative covers will be placed over the next several years. These data collection activities should include measurements of all components of the water balance, including direct drainage measurements. These data can then be used to evaluate performance and confirm the validity of long-term predictions. The continuation of model development for application to landfill cover applications should be enhanced and numerous recommendations for code modifications were included in this report. There is a need to improve these models and make them specific to fulfilling the needs of the landfill site operator. Following extensive validation testing, using data from selected sites from the existing facilities and analysis of the standardized data set developed through the ACAP dispersed network, codes could then be ranked according to their reliability for a wide variety of conditions. Such a task is proposed for subsequent phases of the Alternative Covers Assessment Program.

### **Practical Considerations in Modeling Landfill Covers**

Despite the recognized limitations of models currently employed for landfill cover design and evaluation, there is a strong need by design engineers and the regulatory community for practical guidance given the lack of reliable assessment tools. The use of computer models to predict the performance of landfill covers for design and permitting purposes is pervasive despite their limitations. It is not uncommon to encounter predictions of performance from simulations based on inappropriate assumptions, non-representative input data sets and/or material parameters derived from literature or other non-field sources.

The following section describes features or key elements in current models that need improvement. We make specific recommendations regarding future development of better numerical tools. The business of designing and permitting landfill facilities has a long history, however, and will not wait long for the development of improved methods. The results of the ACAP study are designed to provide needed improvements in the predictive capabilities of numerical codes applied to landfill cover performance. Four issues related to micrometeorological inputs, soil inputs, vegetation inputs and model parameterization are discussed.

*Meteorological input data.* The modeling activities reported as part of this study clearly indicate the direct link between meteorological parameters and predicted flux through a cover. The need for good meteorological records is paramount. Even with good records from a nearby weather station there remain questions about which portion of those records be used to model a proposed cover design. The issue becomes complicated when one considers such factors as seasonality and form (rain or snow) of recorded precipitation. A quite lenient (from a regulatory perspective) approach is to use records from a precipitation year with an annual total that approximates the long-term mean for the site. Even this seemingly simple approach may not be representative of “average” conditions at the site due to seasonality of the precipitation. Most regulators discourage use of average, or mean, meteorological data and require, instead, a more severe test of the cover. A number of approaches have been employed ranging from creation of various synthetic data sets to use of the wettest year in the period of record for multiple years of simulation. Repeating the wettest year simulation for extended time may be overly conservative and could lead to excessive design requirements. One method that is gaining popularity with designers and regulators is to compute running 10-year averages for the entire period of meteorological records and then use the 10-year period with the highest average annual precipitation. This usually includes a combination of wet and dry years. If the record is long enough an analysis with both wet and dry year simulations is warranted. The simulation results can then be used to judge the sensitivity of the modeled flux to variations in precipitation applied to the surface boundary of the model.

*Site-specific soil hydraulic parameters.* A brief review of the results of the sensitivity analyses performed for the Phase 1 ACAP study indicate the importance of the parameters describing the hydraulic character of the soil intended for use in a cover application. Most important are the parameters that describe the ability of the soil to move and store water under the variably saturated conditions prevalent in cover soils. Values for these parameters are properly derived from laboratory (retention) analyses of soil collected from specific borrow sources. Retention analysis of soil samples is expensive relative to some standard geoenvironmental analyses, however, and it is not uncommon for modeling efforts to be undertaken using parameter values from alternative sources. A common approach is to perform a particle size analysis for purposes of soil classification and then use published values for the unsaturated hydraulic properties of that soil type. Given the sensitivity of model predictions to soil parameters and the very wide variation in parameter values (even within a given soil type) this practice should be discouraged. It is imperative that soil parameters be derived from core or field analysis of the specific soil intended for use in a cover.

Adequate description of the hydraulic parameters of a particular soil can only be obtained by representative sampling of a borrow source. Several studies have indicated considerable variation in parameter values (Istok et al. 1994, for example) within a given borrow source. The fact that this variability cannot be captured by a single sample requires analysis of multiple samples. This issue of how many samples are required to characterize a borrow source is further complicated by the fact that different borrow sources will have different degrees of spatial variability. This prevents clear guidance concerning sampling schedules. It is clear that no soil can be adequately characterized by

a single sample and three samples probably represents a minimum for any soil. Use of data from several samples allows two important issues to be addressed in the modeling exercise: (1) variability in flux as a function of specific soil hydraulic parameter value, and (2) the sensitivity of flux to changes in soil parameter values. Both of these issues have direct relevance to predictions of cover performance for design and permitting purposes.

*Site-specific vegetation parameters.* A key to any water balance model is the appropriate representation of the vegetation, since it is largely responsible for water removal from the cover. While assumptions are made that on an annual basis the vegetation is static, this will most likely not be the case and some estimate must be made of the climax vegetation that may exist at some future time on the cover. For alternative covers the burden of performance rest on the vegetation. Little work has been done to assess the longevity of the vegetation an alternative cover site. Phase 3 of the ACAP program has included aspects of vegetation analysis. Specifically, the plant parameters needed in water balance models will be obtained from the field testing program. Three key parameters, root uptake parameters, leaf area index, and percent cover parameters will be obtained empirically and used to calibrate the water balance models.

*Model selection.* Given the variety of computer models available there is understandable uncertainty concerning which model to use for a particular application. All of the codes reviewed in this report have been used to estimate the movement of water in near-surface soils in landfill cover or similar applications. Based on this and other published studies the authors cannot suggest use of a single code to address all cover simulation needs. There are, however, a number of points that can be recognized from the current study. Foremost of these points is that adherence to recognized physical principles is desirable in a computer code. Some computer codes have been created for fairly specific applications and, in the process, have simplified some processes. These codes can be quite limited in their appropriate range of application and can limit the ability of a design engineer to use innovative processes that may not be adequately represented by the code.

Codes that do not accurately represent physical processes can also result in confusing results from sensitivity analyses. This report describes such an analysis that, in the case of one model, did not produce results that make physical sense. For a designer who may attempt to optimize a cover design by performing a sensitivity analysis, such results can add unnecessary complications. For these reasons the authors recommend use of one of the codes based on Richards' equation such as UNSAT-H or HYDUS-2D.

Ultimately a model should be selected based upon appropriate matching of the processes at the specific site that control the behavior of the intended application (i.e., conceptual model) to the code (i.e., numerical model) that best represents those processes. For general environmental problems, the conceptual model for which a numerical model is selected is developed from a site characterization-hydrogeologic investigation. While landfill cover construction arguably involves engineering of the site characteristics, failure to acknowledge the hydrogeologic setting of the landfill can lead to erroneous conceptual models of cover performance. Given the presence of multiple codes and the difficulties in acquiring adequate site description, the selection of a code can be taxing. Instead of a government sanctioning of code(s), practitioners and

regulators need a method or protocol for this selection. The following points should be considered in this selection:

- 1) documentation (such that it can be readily applied without misinterpretation)
- 2) verification testing (is the code numerically sound?)
- 3) validation testing (do the code processes match the site processes?)
- 4) sensitivity analysis (what parameters are the most important to characterize and require care to avoid biased results through manipulation?)
- 5) scientific and technical review independent of the developers (how much trust can be placed in model predictions?)

As discussed above, the success of the modeling will be proper incorporation of climate, soil and plant parameters. The site specific tests being conducted by the ACAP program will provide the key parameters and allow the models to be rigorously tested with qualified water balance data sets.

## V. REFERENCES

- Abbaspour, K.C., R. Schulin, M. Th. van Genuchten and E. Schlappi, 1997. Application of a risk analysis algorithm to a landfill in Switzerland, Proceedings of IAMG'97, V. Pawlowsky-Glahn (Ed.), CIMNE, Barcelona, 911-916.
- Adelman, D.D., and J. Stansbury, 1997. A sensitivity analysis of hazardous waste disposal site climatic and soil design parameters using HELP 3. Proceedings of the International Containment Technology Conference, Feb. 9-12, 1997, St. Petersburg, FL.
- Albrecht, B., 1996. Effects of desiccation on compacted clays, MS Thesis, University of Wisconsin-Madison.
- Albright, W.H., 1995. Physical and hydraulic characteristics of bentonite-amended soil from Area 5, Nevada Test Site. Desert Research Institute Report No. 45137.
- Allen, R.G., T.A. Howell, W.O. Pruitt, I.A. Walter, and M.E. Jensen (ed.) 1991. Lysimeters for evapotranspiration and environmental measurements. p. 444. In Proc. of Symp. Lysimetry, Honolulu, HI. 23-25 July 1991. Am. Soc. Civ. Eng., New York.
- Allison, G.B., G.W. Gee and S.W. Tyler, 1994. Vadose zone techniques for estimating groundwater recharge in arid and semiarid regions. *Soil Sci. Soc. Am. J.* 58:6-14.
- Anderson, E.A., 1976. A point energy and mass balance of a snow cover. NOAA Tech. Rep. NWS 19, U.S. Department of Commerce, National Oceanic and Atmospheric Administration, National Weather Service, Silver Springs, Maryland. 150 p.
- Anderson, J., 1997. Soil-plant cover systems for final closure of solid waste landfills in arid regions. In Landfill Capping in the Semi-Arid West: Problems, Perspectives, and Solutions. (Eds) T.D. Reynolds and R.C. Morris. May 1997, Environ. Sci. and Res. Foundation, Idaho Falls, ID. pp. 27-38.
- Anderson, J.E., T.D. Ratzlaff, E. Duffin, and A. Morris, 1998. Comparisons of four protective cap designs for burial of hazardous waste at the Idaho National Engineering and Environmental Laboratory. In: Environmental Science and Research Foundation, Inc. Annual technical report: Calendar year 1997. T. D. Reynolds and R. W. Warren, Eds. ESRF Report Series No. 27. Environmental Science and Research Foundation, Idaho Falls, ID.
- Andraski, B.J., 1997. Soil-water movement under natural-site and waste-site conditions: A multi-year field study in the Mojave Desert, Nevada. *Water Resour. Res.*, 33:1901-1916.
- Ankeny, M.D., L.M. Coons, N. Majumdar, J. Kelly and M. Miller, 1997. Performance and cost considerations for landfill caps in semiarid climates. In Landfill Capping in the Semi-Arid West: Problems, Perspectives, and Solutions. (Eds.) T.D. Reynolds and R.C. Morris. May 1997, Environ. Sci. and Res. Foundation, Idaho Falls, ID. pp. 243-262.
- Arnold, J.G., J.R. Williams, A.D. Nicks and N.B. Sammons, 1989. SWRRB, a simulator for

water resources in rural basin. Agricultural Research Service, U.S. Department of Agriculture, Texas A&M University Press, College Station, Texas.

- Ascough, J.C. II, H.D. Rector, L.A. Deer-Ascough, and V. Maltby, 1997. Validation of the hydrologic evaluation of landfill performance (HELP) version 3 model for land field test cells in Michigan, Utah, and Delaware. *In* Landfill Capping in the Semi-Arid West: Problems, Perspectives, and Solutions. (Eds) T.D. Reynolds and R.C. Morris. May 1997, Environ. Sci. and Res. Foundation, Idaho Falls, ID. pp.
- Baca, R.G. and S.O. Magnuson, 1990. Independent verification and benchmark testing of the UNSAT-H computer code, Version 2.0. EGG-BEG-8811, EG&G, Idaho, Idaho Falls, Idaho.
- Bear, J., 1979. Hydraulics of Groundwater. McGraw-Hill Inc., USA.
- Belmans, C., J.G. Wesseling and R. A. Feddes, 1983. Simulation model of the water balance of a cropped soil: SWATRE, *J. Hydrol*, 63:271-286.
- Benson, C. H., 1997. A review of alternative landfill cover demonstrations. Environmental Geotechnics Report No. 97-1. Dept. of Civil and Environmental Engineering, University of Wisconsin-Madison.
- Benson, C.H. and Robert J. Pliska, 1996. Final Covers: HELP needs help from the field. *Waste Age*, 27:89-98.
- Benson, C., and M. Khire. 1995. Earthen final covers for landfills in semi-arid and arid climates. Landfill Closures, GSP No. 53 ASCE, R. Dunn and U. Singh, Eds., 201-218.
- Benson, C.H., P.J. Bosscher, D.T. Land, R.J. Pliska, 1994. Monitoring system for hydrologic evaluation of landfill covers. *Geotech, Testing Journal*, 17(2):138-149.
- Benson, C.H., M.V. Khire and P.J. Bosscher, 1993. Final cover hydrologic evaluation: Final report - Phase II. Environmental Geotechnics Report 93-4, 30 Dec. 1993, University of Wisconsin, Madison.
- Berger, K., S. Melchior and G. Miehlich, 1996. Suitability of Hydrologic evaluation of landfill performance (HELP) model of the U.S. Environmental Protection Agency for the simulation of the water balance of landfill cover systems. *Environmental Geology*, 28:181-189.
- Bhutani, J.S., N.P.S. Malik, S.M. Mead, J.T. McMahan and M.G. Serrato, 1992. Closure cap barrier materials evaluation study - Phase I. WSRC-RP-91-1288. Westinghouse Savannah River Company, Aiken, SC.
- Brandstetter, A. and B.E. Buxton, 1989. The role of geostatistical, sensitivity, and uncertainty analysis in performance assessment. *In* Proceedings: Geostatistical, sensitivity, and uncertainty methods for ground-water flow and radionuclide transport modeling. (Ed) Bruce E. Buxton. San Francisco, CA, Sept. 15-17 1987, Battelle Press, Columbus, OH.



- Brooks, R.H. and A.T Corey, 1964. Hydraulic properties of porous media. Hydrology Paper No. 3. Colorado State University. Ft. Collins, Colorado. 27 pp.
- Cabelguenne, M., C.A. Jones, J.R. Marty, P.T. Dyke and J.R. Williams, 1990. Calibration and validation of EPIC for crop rotations in southern France. *Agricultural Systems*, 33(1990) 153-171.
- Campbell, G.S., 1974. A simple method for determining unsaturated hydraulic conductivity from moisture retention data. *Soil Sci.* 117:311-314.
- Carsel, Robert F. and Rudolph S. Parrish, 1988. Developing joint probability distributions of soil water retention characteristics. *Water Resour. Res.*, 24:755-769.
- Cartwright, K., T. H. Larson, B. L. Herzog, T. M. Johnson, K. A. Albrecht, D. L. Moffett, D. A. Keefer and C. J. Stohr, 1987. A study of trench covers to minimize infiltration at waste disposal sites. Illinois State Geological Survey ISGS Circular No. 541. Prepared for U. S. Nuclear Regulatory Commission. NUREG/CR-2478.
- Cedegren, H.R., 1989. Seepage, Drainage, and Flow Nets. John Wiley & Sons.
- Celia, M.A., E.T. Bouloutas and R.L. Zarba, 1990. A general mass-conservative numerical solution for the unsaturated flow equation, *Water Resour. Res.*, 26:1483-1496.
- Cooley, K.R., D.C. Robertson, E.P. Springer, J.R. Williams and C.L. Hanson, 1990. Evaluation of EPIC using a sagebrush range site. Chapter 11, pp. 206-216 In A.N. Sharpley and J.R. Williams (Eds.) EPIC-Erosion/Productivity Impact Calculator: 1. Model Documentation. USDA Tech. Bull. No. 1768, pp. 235.
- Czarnecki, J.B., 1990. Geohydrology and evapotranspiration at Franklin Lake Playa, Inyo County, California. U.S. Geological Survey. Open File Report 90-356.
- Daubenmire, R.F., 1975. Plant succession on abandoned fields, and fire influences, in a steppe area in Southeastern Washington. *Northwest Science* 49:36-48.
- Davis, A., S. Kamp, G. Fennemore, R. Schmidt and M. Keating, 1997. A risk-based approach to soil remediation modeling. *Environ. Science & Technology*, 31:520-525.
- Davis, L.A., and S.P. Neuman, 1983. Documentation and user's guide: UNSAT2 - Variably saturated flow model, Final Report. WWL/TM-1791-1, Water, Waste & Land, Inc., Ft. Collins, Colorado.
- Desert Research Institute, Environmental assessment for operation of Area 5 Radioactive Waste Management Site and proposed mixed waste management unit, Nevada Test Site, Nye County, Nevada.
- Devaurs, M. and E. Springer, 1988. Representing soil moisture in experimental trench cover designs for waste burial with the CREAMS model. *Hazardous Waste & Hazardous*

*Materials*, 5:295-312.

- de Vos, J.A., J. Simunek and P.A.C. Raats, Identification of the hydraulic properties of a layered silt loam, In Characterization and Measurement of the Hydraulic Properties of Unsaturated Porous Media, van Genuchten, M. Th. and F. J. Leij (Eds.), submitted.
- Dwyer S.F., 1997. Alternative landfill cover demonstration. In Landfill Capping in the Semi-Arid West: Problems, Perspectives, and Solutions. (Eds.) T.D. Reynolds and R.C. Morris. May 1997, Environ. Sci. and Res. Foundation, Idaho Falls, ID, pp. 87-108.
- Dwyer, S. F., 1997. Large-scale field study of landfill covers at Sandia National Laboratories. In Landfill Capping in the Semi-Arid West: Problems, Perspectives, and Solutions. Proceedings of the Environmental Science and Research Foundation Conference, May 21-22, 1997. Eds. Reynolds, T. D. and R. C. Morris.
- Dwyer, S.W., 1998. Alternative landfill covers pass the test. *Civil Engineering*, 9/1998, pp. 50-52.
- Edwards, W.M., L.D. Norton and M.J. Shipitalo, 1987. Effect of macroporosity on infiltration into no-till corn watersheds. *EOS Trans. Am. Geophys. Union*, 68:313.
- Eisenberg, N.A., L.D. Rickertsen and C. Voss, 1989. Performance assessment, site characterization, and sensitivity and uncertainty methods: Their necessary association for licensing. In Proceedings: Geostatistical, sensitivity, and uncertainty methods for ground-water flow and radionuclide transport modeling. (Eds.) Bruce E Buxton. San Francisco, CA., Sept. 15-17 1987, Battelle Press, Columbus, OH.
- Essington, M.E., D.D. Tyler and G.V. Wilson, 1995. Fluometuron behavior in long-term tillage plots. *Soil Sci.*, 160:405-414.
- Favis-Mortlock, D.T. and F.R. Smith, 1990. A Sensitivity Analysis of EPIC: A.N. Sharpley and J.R. Williams (Eds.) EPIC-Erosion/Productivity Impact Calculator: 1. Model Documentation. Chapter 9, pp. 178-190 In USDA Tech. Bull. No. 1768. 235pp.
- Fayer, M.J. and G.W. Gee, 1997. Hydrologic modes tests for landfill covers using field data. Landfill Capping in the Semi-Arid West: Problems, Perspectives, and Solutions. (Eds.) T.D. Reynolds and R.C. Morris. May 1997, Environ. Sci. and Res. Foundation, ESRF-019, Idaho Falls, ID. pp.53-68.
- Fayer, M.J., G.W. Gee, M.L. Rockhold, M.D. Freshly and T.B. Walters, 1996. Estimating recharge rates for a groundwater model using GIS. *J. Environ. Qual.*, 25:510-518.
- Fayer, M.J., M.L. Rockhold and M.D. Campbell, 1992. Hydrologic modeling of protective barriers: Comparison of field data and simulation results, *Soil Sci. Soc. of Am. J.*, 56:690-700.
- Fayer, M.J. and G.W. Gee, 1992. Predicted drainage at a semiarid site: Sensitivity to hydraulic property description and vapor flow. In Indirect methods for estimating the hydraulic

- properties of unsaturated soils. M.Th. van Genuchten, F.J. Leij, and L.J. Lund, (Eds.), University of California, Riverside, California.
- Fayer, M.J. and T.L. Jones, 1990. UNSAT-H version 2.0: Unsaturated soil water and heat flow model. PNL-6779, Pacific Northwest Laboratory, Richland, Washington.
- Feddes, R.A., E. Bresler and S.P. Neuman, 1974. Field test of a modified numerical model for water uptake by root systems. *Water Resour. Res.*, 10:1199-1206.
- Flavelle, P.A., 1989. Regulatory perspectives of concept assessment. In Proceedings: Geostatistical, sensitivity and uncertainty methods for ground-water flow and radionuclide transport modeling. (Eds.) Bruce E Buxton. San Francisco, CA., Sept. 15-17 1987, Battelle Press, Columbus, OH.
- Flerchinger, G.N. and F.B. Pierson, 1997. Modeling plant canopy effects on variability of soil temperature and water: Model calibration and validation. *Journal of Arid Environments*, 35: 641-653.
- Flerchinger, G.N. and M.S. Seyfried, 1997. Modeling soil freezing and thawing, and frozen soil runoff with the SHAW model, International Symposium on Physics, Chemistry, and Ecology of Seasonally Frozen Soils, Fairbanks, Alaska, June 10-12, 1997, I.K. Iskandar, E.A. Wright, J.K. Raake, B.S. Sharratt, P.H. Groenevelt and L.D. Hinzman (Eds.) U.S. Army Cold Regions Research and Engineering Laboratory, Hanover, New Hampshire, Special Report 97-10.
- Flerchinger, G.N., J.M. Baker and E.J.A. Spaans, 1996. A test of the radiative energy balance of the SHAW model for snowcover. *Hydrological Processes*, 10: 1359-1367.
- Flerchinger, G.N., Y. Deng and K.A. Gebhardt, 1996. Integrated modeling of disulfoton transport at an abandoned landfill site. *Applied Engineering in Agriculture*, 13: 217-225.
- Flerchinger, G.N., C.L. Hanson and J.R. Wight, 1996. Modeling evapotranspiration and surface energy budgets across a watershed. *Water Resources Research*. 32: 2539-2548.
- Flerchinger, G.N., 1991. Sensitivity of soil freezing simulated by the SHAW model. *Transactions of the ASAE*, 34: 2381-2389.
- Flerchinger, G.N. and K.E. Saxton, 1989a. Simultaneous heat and water model of a freezing snow-residue-soil system. I. Theory and development. *Transactions of the ASAE*, 32: 565-571.
- Flerchinger, G.N. and K.E. Saxton, 1989b. Simultaneous heat and water model of a freezing snow-residue-soil system II. Field verification. *Transactions of the ASAE*, 32: 573-578.
- Freber, B. W., 1996. Beneficial reuse of selected foundry waste material. Presented at the Nineteenth International Madison Waste Conference, Sept. 25-26, 1996. Dept. of Engineering Professional Development, University of Wisconsin-Madison.

- Gee, G.W., A.L. Ward and R.R. Kirkham, 1998. Long-term performance of surface covers estimated with short-term testing. *In* Proceedings of Long-Term Stewardship Workshop LTSM, June 1998, Denver, Colorado. U. S. Department of Energy, Grand Junction Office, Grand Junction, Colorado. pp. 67-81.
- Gee, G.W. and A. Ward, 1997. Still in quest of the perfect cap. *In* Landfill Capping in the Semi-Arid West: Problems, Perspectives, and Solutions. (Eds.) T.D. Reynolds and R.C. Morris. May 1997, Environ. Sci. and Res. Foundation, Idaho Falls, ID. pp. 145-164.
- Gee, G.W., P.J. Wierenga, B.J. Andraski, M.H. Young, M.J. Fayer and M.L. Rockhold, 1994. Variations in water balance and recharge potential at three western desert sites. *Soil Sci. Soc. Am. J.*, 58:63-72.
- Gee, G.W., D.G. Felmy, J.C. Ritter, M.D. Campbell, J.L. Downs, M.J. Fayer, R.R. Kirkham, S.O. Link, 1993. Field lysimeter test facility status report IV: FY 1993. PNL-8911, Pacific Northwest National Laboratory, Richland, WA.
- Gee, G. W., D . G. Felmy, J. C. Ritter, M. D. Campbell, J. L. Downs, M. J. Fayer, R. R. Kirkham and S. O. Link, 1993. Field lysimeter test facility status report IV: FY 1993. PNL-8911, Pacific Northwest National Laboratory, Richland, WA.
- Gee, G.W., M.J. Fayer, M.L. Rockhold and M.D. Campbell, 1992. Variations in recharge at the Hanford site. *Northwest Sci.*, 66:237-250.
- Gee, G.W. and D. Hillel, 1988. Groundwater recharge in arid regions: Review and critique of estimation methods. *J. Hydrol. Process.*, 2:255–266.
- Giroud, J.P. and R. Bonaparte, 1989. Leakage through liners constructed with geomembrane liners - Parts I and II and technical note. *Geotextile and Geomembranes*, 8:27-67, 8:71-111, 8:337-340.
- Gribb, M. M. and G. Sewell, 1998. Solution of ground water flow problems with general purpose and special purpose computer codes. *Ground Water*, 36:366-372.
- Gribb, M.M., J. Simunek and M.F. Leonard, 1998. Development of a cone penetrometer method to determine soil hydraulic properties, *ASCE J. of Geotech. and Geoenviron. Eng.*, 124(9), 820-829.
- Gross, B., R. Bonaparte, and M. Othman. 1997. Inferred performance of surface hydraulic barriers from landfill operational data. *In* Proc. International Containment Technology Conference. St. Petersburg, FL. Feb. 9-12, 1997. 374-380.
- Gwo, J.P., L.E.Toran, M.D. Morris and G.V. Wilson, 1996a. Subsurface stormflow modeling with sensitivity analysis using a latin-hypercube sampling technique. *Ground Water*, 34:811-818.
- Gwo, J.P., P.M. Jardine, G.V. Wilson and G.T. Yeh, 1996b. Using a multiregion model to study

the effects of advective and diffusive mass transfer on local physical nonequilibrium and solute mobility in a structured soil. *Water Resources Research*, 32:561-570.

Gwo, J.P., P.M. Jardine, G.T. Yeh and G.V. Wilson, 1995. MURT user's guide: A hybrid lagrangian-eulerian finite element model of multiple-pore-region solute transport through subsurface media. ORNL/GWPO-015, Environmental Sciences Division Publication No. 4375.

Hakonson, T. E., L. Karr, and B. Harre, 1997. A water balance study of infiltration control landfill cover designs at Marine Corp Base, Hawaii. In Landfill Capping in the Semi-Arid West: Problems, Perspectives, and Solutions. Proceedings of the Environmental Science and Research Foundation Conference, May 21-22, 1997. Reynolds, T. D. and R. C. Morris (eds.)

Hakonson, T.E., K.V. Bostick, G. Trujillo, K.L. Manies, R.W. Warren, L.J. Lane, J.S. Kent and W. Wilson, 1994. Hydrologic evaluation of four landfill cover designs at Hill Air Force Base, Utah. Department of Energy Mixed Waste Landfill Integrated Demonstration Sandia National Laboratories, LAUR-93-4469.

Hakonson T. E., K. V. Bostick, G. Trujillo, K. L. Manies, R. W. Warren, L. J. Land, J. S. Kent, and W. Wilson, 1994. Hydrologic evaluation of four landfill cover designs at Hill AFB, Utah. LAUR-93-4469. Los Alamos National Laboratory, Los Alamos, NM.

Hauser, V.L. and M.A. Shaw, 1994. Water movement through soil-vegetative landfill covers. Presented at the 1994 International Summer Meeting of the ASAE, Paper No. 942176.

Hauser, V.L. and F.W. Chichester, 1989. Water relationships of claypan and constructed soil profiles. *Soil Sci. Soc. Am. J.*, 53:1189-1196.

Hufschmied, P., 1989. Treatment of uncertainties in ground-water flow modeling in the Swiss radioactive waste program. In Proceedings: Geostatistical, Sensitivity, and Uncertainty Methods for Ground-water Flow and Radionuclide Transport Modeling. Bruce E. Buxton (Ed.) San Francisco, CA, Sept. 15-17 1987, Battelle Press, Columbus, OH.

Inoue, M., J. Simunek, J.W. Hopmans and V. Clausnitzer, 1998. In-situ estimation of soil hydraulic functions using a multi-step soil water extraction technique, *Water Resources Research*, 34:1035-1050.

Istok, J. D., D. O. Blout, L. Barker, K. R. Johnejack and D. P. Hammermeister, 1994. Spatial variability in alluvium properties at a low-level nuclear waste site. *Soil Sci. Soc. Of Am. Jour.* 58:1040-1051.

Jones, C. A. and J. R. Williams, 1986. Validation of EPIC. Forum on Erosion Productivity Impact Estimators. U.S. Department of Agriculture, Soil Conservation Service, Assessment and Planning, 1986, p. 15-22.

Kampf, M., T. Holfelder and H. Montenegro, 1998. Inspection and numerical simulations of flow processes in capillary barrier cover systems. In Proceedings: 3<sup>rd</sup> International Conference on Hydrosience and Engineering.

- Kelley, G. E., W. M. Edwards, L. L. Harrold, and J. L. McGuinness, 1975. Soils of the North Appalachian Experimental Watershed. Agricultural Research Service U.S. Dept. of Agriculture. Coshocton, OH.
- Kelley, G. E., W. M. Edwards, L. L. Harrold, and J. L. McGuinness, 1975. Soils of the North Appalachian Experimental Watershed. Agricultural Research Service U.S. Dept. of Agriculture. Coshocton, OH.
- Kennedy I. and B. Sharratt, 1998. Model comparisons to simulate soil frost depth, *Soil Science* 163:636-645.
- Khire, M. V., C. H. Benson and P. J. Bosscher, 1997. Water balance of two earthen landfill caps in a semi-arid climate. In: Proceedings of 1997 International Containment Technology Conference and Exhibition,, St. Petersburg, FL.
- Khire M.V., C.H. Benson and P.J. Bosscher, 1997. Water balance of earthen final covers at humid and semi-arid sites. *J. of Geotech. And Geoenv. Eng., ASCE*, 123:744-754.
- Khire M.V., C.H. Benson and P.J. Bosscher, 1997. Water balance modeling of earthen final covers. *J. of Geotech. and Geoenv. Eng.*, 123:744-754.
- Khire, M., 1995. Field hydrology and water balance modeling of earthen final covers for waste containment, Ph.D. dissertation, University of Wisconsin-Madison.
- Kodesova, R., M.M. Gribb and J. Simunek, 1998. Estimating soil hydraulic properties from transient cone permeameter data. *Soil Science*, 163:436-453.
- Korfiatis, G.P., A.C. Demetrapoulos, E.L. Bourodimos and E.G. Nawy, 1984. Moisture Transport in a Solid Waste Column. *ASCE J. of Env. Eng.*, 110:780-796.
- Korfiatis, G.P., A.C. Demetrapoulos, E.L. Bourodimos and E.G. Nawy, 1984. Flow Characteristics of Landfill Leachate Collection System. *ASCE J. of Env. Eng.*, 112:538-550.
- Kung, K.-J.S., 1990. Preferential flow in a sandy vadose zone: 1. Field observation. *Geoderma*, 46:51-58.
- Lass, G. L., H. Ferriz, and A. Rivera, 1997. Alternative final cover demonstration project at the Milliken Landfill, San Bernardino County, California. Proceedings of the 2<sup>nd</sup> Annual Landfill Symposium of the Solid Waste Association of North America, July 19-20 1997, Sacramento, California.
- Leij, F.J., W.J. Alves, M.Th. Van Genuchten and J.R. Williams, 1996. The UNSODA unsaturated soil hydraulic database, User's Manual version 1.0, EPA/600/R-96/095, Ada, OK.
- Lenhard, R.J., J.C. Parker and S. Mishra, 1989. On the correspondence between Brooks-Corey and van Genuchten models. *J. Irrig. Drain. Eng.*, 115(4): 744-751. Link, S.O., L.L. Cadwell, K.L. Peterson, M.R. Sackschewsky and D.S. Landeen, 1995. The role of plants and animals

- in isolation barriers at Hanford, WA. PNL-10788, Pacific Northwest National Laboratory, Richland, WA.
- Levitt, E. G., C. F. Lohrstorfer, M. J. Sully, and J. M. Ginanni, 1996. An arid zone lysimeter facility for performance assessment and closure investigations at the Nevada Test Site. In Proceedings of Waste Management 1996 Conference, Tucson, AZ.
- Levitt, D.G., M.J. Sully, and C.F. Lohrstorfer, 1996. Modeling evapotranspiration from arid environments: Literature review and preliminary model results. Bechtel Nevada.
- Limbach, W. E., T. D. Ratzlaff, J. E. Anderson, T. D. Reynolds, and J. W. Laundre, 1994. Design and implementation of the Protective Cap/Bio Barrier Experiment at the Idaho National Engineering Laboratory. In: Thirty-third Hanford Symposium of Health and the Environment, G. W. Gee and N. R. Wing, Eds. Nov. 7-11, 1994. Battelle Press, Richland, WA.
- Link, S. O., L. L. Cadwell, K. L. Peterson, M. R. Sackschewsky and D. S. Landeen, 1995. The role of plants and animals in isolation barriers at Hanford, WA. PNL-10788, Pacific Northwest National Laboratory, Richland, WA.
- Magnuson, S.O., S.J. Maheras, H.D. Nguyen, A.S. Rood, J.I. Sipos, M.J. Case, M.A. McKenzie-Carter, and M.E. Donahue. 1992. Radiological performance assessment for the Area 5 Radioactive Waste Management Site at the Nevada Test Site. Revision 1. Idaho National Laboratory, Idaho Falls, ID.
- Magnuson, S.O., 1993. A simulation study of moisture movement in proposed barriers for the Subsurface Disposal Area. INEL, EGG-WM-10974, EG&G Idaho, Idaho Falls, Idaho.
- Martian, P. and S.O. Magnuson, 1994. A simulation study of infiltration into surficial sediments at the Subsurface Disposal Area, Idaho National Engineering Laboratory. EGG-WM-11250, EG&G, Idaho, Idaho Falls, Idaho.
- Martian, P., 1995. UNSAT-H infiltration model calibration at the Subsurface Disposal Area, Idaho National Engineering Laboratory. INEL-95/0596, Lockheed Idaho Technologies Company, Idaho Falls, Idaho.
- McBrayer, M.C., M. Mauldon, E.C. Drumm and G.V. Wilson, 1996. Infiltration tests on fractured compacted clay. *J. Geotech. Eng.*, May 1997:469-473.
- McCuen, R.H., 1973. The role of sensitivity analysis in hydrologic modeling. *J. Hydrology*, 18:37-53.
- Melchior, S. 1997. In situ studies on the performance of landfill caps. *Land Contamination and Reclamation*, 5:209-216.
- Melchior, S., K. Berger, B. Vielhaber and G. Miehlich, 1994. Multilayered landfill covers: Field data on the water balance and liner performance. In: Gee, G.W. and N.R. Wing (Eds). *In-Situ Remediation. Thirty Third Hanford Symposium. On Health and Environment*, 7-11

- November, 1994, Pasco Washington, pp.411-425.
- Miller, C.J. and M. Mishra, 1989. Field verification of HELP model for landfills. *J. Environmental Engineering*, 115:882-887.
- Miller, J.F., R.H. Frederick and R.J. Tracey, 1973. Precipitation-frequency atlas of the Western United States. NOAA Atlas 2, Volume VII-Nevada, U.S. Gov. Printing Office, Washington D.C. Stock Number 0317-00161.
- Mohanty, B.P., R.S. Bowman, J.M.H. Hendrickx, J. Simunek and M.Th. van Genuchten, 1998. Preferential transport of nitrate to a tile drain in an intermittent-flood-irrigated field: Model development and experimental evaluation, *Water Resources Research*, 34:1061-1076.
- Mohanty, B.P., R.S. Bowman, J.M.H. Hendrickx and M.T. van Genuchten, 1997. New piecewise-continuous hydraulic functions for modeling preferential flow in an intermittent flood-irrigated field. *Water Resources Research*, 33:2049-2063.
- Montgomery, R. J. and L. J. Parsons, 1990. The Omega Hills final cover test plot study: Fourth year data summary. Presented at the 22<sup>nd</sup> Mid-Atlantic Industrial Waste Conference, Drexel Uni Rocky Mountain Arsenal Remediation Venture Office, 1998. Final RCRA-equivalent cover demonstration project comparative analysis and field demonstration design scope of work. May 1998.
- Montgomery, R. and L. Parsons, 1990. The Omega Hills final cover test plot study: Four year data summary, Proc. 22<sup>nd</sup> Mid-Atlantic Industrial Waste conference, Technomic, Lancaster, PA, 1-20.
- Mualem, Y., 1976. A new model for predicting the hydraulic conductivity of unsaturated porous media. *Water Resources Research*, 12:513-522.
- Myers, D.R. and D.A. Duranceau, 1994. Prototype Hanford surface barrier: Design basis document. BHI-00007, Bechtel, Hanford, Richland, WA.
- Morrison Knudsen Corporation, 1998. RCRA-equivalent cover demonstration project final design package. January 1998.
- NCASI, 1997. A field-scale study of the use of paper industry sludges in landfill cover systems: final report. Technical Bulletin No. 750. NCASI, Western Michigan University, Kalamazoo, MI.
- Neuman, S.P., 1973. Saturated-unsaturated seepage by finite elements. *J. Hydraul. Div.*, ASCE, 99:2233-2250.
- Neuman, S.P., R.A. Feddes and E. Bresler, 1974. Finite element simulation of flow in saturated-unsaturated soils considering water uptake by plants, Third Annual Report, Project No.A10-SEC-77, Hydraulic Engineering Lab., Technion, Haifa, Israel.
- Nichols, W.E., 1991. Comparative simulations of a two-layer landfill barrier using the HELP



- version 2.0 and UNSAT-H version 2.0 computer codes. PNL-7583, Pacific Northwest Laboratory, Richland, Washington.
- Nixon, W.B., R.J. Murphy and R.I. Stessel, 1997. An empirical approach to the performance assessment of solid waste landfills. *Waste Management & Research*, 15:607-626
- Nofziger, D.L., Jin-Song Chen and C.T. Haan, 1994a. Evaluation of unsaturated/vadose zone models for superfund sites. Robert S. Kerr Environmental Research Laboratory, Ada, OK.
- Nofziger, D.L., Jin-Song Chen and C.T. Haan, 1994b. Evaluation of unsaturated/vadose zone models for superfund sites. EPA/600/R-93/184, CR-818709, Robert S. Kerr Environmental Research Laboratory, ADA, OK.
- Nyhan, J.W., T.G. Schofield and R.H. Starmer, 1997. A water balance study of four landfill cover designs varying in slope for semiarid regions. *J. Environmental Quality*, 16:1385-1392.
- Nyhan, J.W., T.E. Hakonson and B.J. Drennon, 1990. A water balance study of two landfill cover designs for semiarid regions. *J. Environmental Quality*, 19:281-288.
- Nyhan, J. W., 1989. Development of technology for the long-term stabilization and closure of shallow land burial sites in semiarid environments. LA-11283-MS. Los Alamos National Laboratory, Los Alamos, NM.
- Nyhan, J., 1989. Calibration of the CREAMS model for landfill cover designs limiting infiltration of precipitation at waste repositories. *Hazardous Waste & Hazardous Materials*, 7:169-184.
- O'Donnell, E., R. W. Ridky, R. K. Schulz, 1994. Control of water infiltration into near-surface, low-level waste disposal units in humid regions. In: Thirty-third Hanford symposium on health and the environment, G. W. Gee and N. R. Wing, eds.
- Owens, L. B., 1990. Nitrate-nitrogen concentrations in percolate from lysimeters planted to a legume-grass mixture. *J. Environmental Quality*, 19:131-135.
- Paige, G.B., J.J. Stone, L.J. Lane, D.S. Yakowitz and T.E. Hakonson, 1996a. Evaluation of a prototype decision support system for selection trench cap designs. *J. Environmental Quality*, 25:127-135.
- Paige, G.B., J.J. Stone, L.J. Lane and T.E. Hakonson, 1996b. Calibration and testing of simulation models for evaluation of trench cap designs. *J. Environmental Quality*, 25:136-144.
- Penman, H. L., 1963. Vegetation and hydrology. Technical comment # 53. Commonwealth Bureau of Soils, Harpenden, England.
- Penman, H.L., 1948. Natural evaporation from open water, bare soil, and grass: In Proceedings of the Royal Society of London, Biological Sciences Series A, 193:120-146.

- Peyton, R.L. and P.R. Schroeder, 1988. Field verification of HELP model for landfills. *J. Environmental Engineering*, 114:247-269.
- Phifer, M.A., E.C. Drumm and G.V. Wilson, 1994. Effects of post compaction water content variation on saturated conductivity. *Hydraulic Conductivity and Waste Contaminant Transport in Soils*, (Eds.) D.E. Daniel and S.J. Trautwein, Amer. Soc. for Testing of Materials, ASTM STP 1142, pp. 227-254.
- Phifer, M.A., D. Boles, E.C. Drumm and G.V. Wilson, 1995. Comparative response of two barrier soils to post compaction water content variations. ASCE Specialty Conference: Geoenvironment 2000: Characterization, Containment, Remediation and Performance in Environmental Geotechnics. Feb. 22-24, 1995, pp. 519-607.
- Pierson, F.B., G.N. Flerchinger and J.R. Wight, 1992. Simulating near-surface soil temperature and water on sagebrush rangelands: A comparison of models. *Transactions of the ASAE* 35:1449-1455.
- Pohll, G. M., J. J. Warwick and S. W. Tyler, 1996. Coupled surface-subsurface hydrologic model of a nuclear subsidence crater at the Nevada Test Site. *J. of Hydrology*, 186:43-62.
- Porro, E. and K. N. Keck, 1998. Engineered barrier testing at the INEEL Engineered Barriers Test Facility: FY-1997 and FY-1998. INEEL/EXT-98-00964. Idaho National Engineering and Environmental Laboratory, Lockheed Martin Idaho Technologies Co. Idaho Falls, ID 83415.
- Pruess, K., 1991. TOUGH2 - A general-purpose numerical simulator for multiphase fluid and heat flow. LBL -29400, Lawrence Berkeley Laboratory, Berkeley, CA.
- Quarterdeck, 1996. HIJAAK PRO. Quarterdeck Corp., Marina del Rey, CA.
- Reedy, O.C., P.M. Jardine and H.M. Selim, 1997. Quantifying diffusive mass transfer of nonreactive solutes in undisturbed subsurface columns using flow interruption, *Soil Sci. Soc. Am. J.*, 60:1376-1384
- Richardson, C.W. and D.A. Wright, 1984. WGEN: A model for generating daily weather variables. ARS-8 Agricultural Research Service, U.S. Department of Agriculture, 83pp.
- Ritchie, J.T, 1972. A model for predicting evaporation from a row crop with incomplete cover. *Water Resources Research*, 8:1204-1213.
- Ritchie, J.T, and E. Burnett. 1971. Dryland evaporative flux in a subhumid climate, 2. Plant influences. *Agron. J.* 63:56-62.
- Romkens, M.J.M., H.M. Selim, H.D. Scott, R.E. Phillips and F.D. Whisler, 1986. Physical characteristics of soils in the Southern Region: Captina, Gigger, Grenada, Loring, Olivier and Sharkey series. Bulletin 264, Miss. Agric. and Forestry Exp. Sta., Miss. State, MS.
- Romney, E. M., V. Q. Hale, A. Wallace, O. R. Lunt, J. D. Childress, H. Kaaz, G. V. Alexander,

- J. E. Kinnear, and T. L. Ackerman, 1973. Some characteristics of soil and perennial vegetation in Northern Mojave Desert areas of the Nevada Test Site. USAEC Report UCLA, 12-916, p. 340.
- Sackschewsky, M.R., C.J. Kemp and L.L. Cadwell, 1992. Status report for the small-tube lysimeter facility, fiscal year 1992. WHC-EP-0597, Westinghouse Hanford Co., Richland, WA.
- Scanlon, B.R., R.P. Langford and R.S. Goldsmith, in press. Relationship between geomorphic settings and unsaturated flow in an arid setting. *Water Resources Research*.
- Scanlon, B.R., W.F. Mullican III, R.C. Reedy and E.S. Angle, 1997. Prototype engineered barrier designs for low-level radioactive waste disposal in Texas. In Landfill Capping in the Semi-Arid West: Problems, Perspectives and Solutions. Proceedings of the Environmental Science and Research Foundation Conference, May 21-22, 1997. (Eds.) T.D. Reynolds and R. C. Morris.
- Schaap, M.G., F.J. Leij, and M.Th. van Genuchten. 1998. Neural network analysis for hierarchical prediction of soil water retention and saturated hydraulic conductivity. *Soil Sci. Soc. Am. J.* 62:847-855.
- Schaap, M.G., and F.J. Leij, 1998b. Database related accuracy and uncertainty of pedotransfer functions. *Soil Science* 163:765-779.
- Schmidt, R. H., Jr., 1970. A climatic delineation of the "real" Chihuahuan desert. *J. Arid Env.* 2:243-250.
- Schroeder, P.R., C.M. Lloyd, P.A. Zappi and N.M. Aziz, 1994. The Hydrologic Evaluation of Landfill Performance (HELP) Model, User's Guide for Version 3. EPA/600/R-94/168a
- Schroeder, P.R., T.S. Dozier, P.A. Zappi, B.M. McEnroe, J.W. Sjostrom and R.L. Peyton, 1994. The Hydrologic Evaluation of Landfill Performance (HELP) Model. Engineering Documentation for Version 3. EPA/600/R-94/168b,
- Schroeder, P.R. and R.L. Peyton, 1987a. Verification of the hydrologic evaluation of landfill performance (HELP) model using field data. EPA 600/2-87-050. U.S. Environmental Protection Agency, Cincinnati, OH.
- Schroeder, P.R. and R.L. Peyton, 1987b. Verification of the lateral drainage component of the HELP model using physical models. Hazardous waste Engineering Research Laboratory Office of Research and Development U.S. Environmental Protection Agency, Cincinnati, OH.
- Schulz, R. K., R. W. Rickey, and E. O'Donnell, 1997. Control of water infiltration into near surface low-level waste disposal units. U.S. Nuclear Regulatory Commission, NUREG/CR-4918. Wester, D. B. Texas Tech University. Personal communication. Oct. 1998.
- Schwartz, F.W., C.B. Andrews, D.L. Freyberg, C.T. Kincaid, L.F. Konikow, C.R. McKee, D.B.

- McLaughlin, J.W. Mercer, E.J. Quinn, P.S.C. Rao, B.E. Rittmann, D.D. Runnells, P.K.M van der Heijde, W.J. Walsh, 1990. Ground water models scientific and regulatory applications. National Academy Press, Washington, D.C.
- Serrato, M.G., 1994. Bentonite mat demonstration: Field performance evaluation of an alternative geosynthetic composite cover system. *In* Thirty-Third Hanford Symposium of Health and the Environment. G. W. Gee and N. R. Wind, (Eds).
- Serrato, M.G., 1994. Bentonite mat demonstration, final report. WSRC-TR-94-0618. Westinghouse Savannah River Company, Aiken, SC.
- Simunek, J., M.Th. van Genuchten, M.M. Gribb and J.W. Hopmans, 1998. Parameter estimation of unsaturated soil hydraulic properties from transient flow processes, *Soil & Tillage Research*, 47/1-2, Special issue "State of the art in soil physics and in soil technology of anthropic soils", pp. 27-36.
- Simunek, J., R. Angulo-Jaramillo, M. Schaap, J.-P. Vandervaere and M.Th. van Genuchten, Using an inverse method to estimate the hydraulic properties of crusted soils from tension disc infiltrometer data, *Geoderma*.
- Simunek, J., M. Sejna and M.Th. van Genuchten, 1996. HYDRUS-2D: Simulating water flow and solute transport in two-dimensional variably saturated media. International Groundwater Modeling Center, Colorado School of Mines, Golden, CO.
- Skahn, K., 1997. EPA's performance, monitoring, and maintenance requirements for landfill caps. *In* Landfill Capping in the Semi-Arid West: Problems, Perspectives, and Solutions. (Eds) T.D. Reynolds and R.C. Morris. May 1997, Environ. Sci. and Res. Foundation, Idaho Falls, ID. pp. 19-26.
- Steiner, J.L., J.R. Williams and O.R. Jones, 1990. Evaluation of EPIC using a dryland wheat-sorghum-fallow crop rotation. *In* A.N. Sharpley and J.R. Williams (Eds.) EPIC-Erosion/Productivity Impact Calculator: 1. Model Documentation. Chapter 10, pp. 191-205 U.S. Department of Agriculture Tech. Bull. No. 1768. Pp. 235.
- Stephens, D.B. and L.M. Coons, 1994. Landfill performance assessment at a semiarid site: Modeling and validation. *Ground Water Monitoring Review*, 14:101-109.
- Stone, W.A., J.M. Thorp, O.P. Gifford and D.J. Hoitink, 1983. Climatological summary for the Hanford area. PNL-4622, Pacific Northwest National Laboratory, Richland, WA.
- Stormont, J.C. and C. E. Morris, 1998. Method to estimate water storage capacity of capillary barriers. *J. Geotech. Geoenviron. Engr.*, 124:297-302.
- Therrien, R., E.A. Sudicky and R.G. McLaren, 1994. User's Guide for FRAC3DVS: An Efficient Simulator for Three-dimensional, Saturated-Unsaturated Groundwater Flow and Chain Decay Solute Transport in Porous or Discretely Fractured Porous Formations. University of Waterloo, Ontario, Canada.

- Thompson, F.L. and S.W. Tyler, 1984. Comparison of two groundwater flow models-UNSAT1D and HELP. EPRI CS-3695. Electric Power Research Institute, Palo Alto, CA. 71 pp.
- Tyler, S. W., J. B. Chapman, S. H. Conrad, D. P. Hammermeister, D. O. Blout, J. J. Miller, M. J. Sully and J. M. Ginanni, 1996. Soil-water flux in the southern Great Basin, United States: Temporal and spatial variations over the last 120,000 years. *Water Resources Research*. 32:1481-1499.
- U.S. Army Corps of Engineers, 1994. The Hydrological Evaluation of Landfill Performance (HELP) Model, Version 3.03.
- U.S. Department of Agriculture, 1985. National Engineering Handbook, Section 4, Hydrology. U. S. Department of Agriculture, Soil Conservation Service. U.S. Government Printing Office, Washington, D. C.
- U.S. Environmental Protection Agency, 1983. Standards for the disposal of uranium mill tailings, 40 CFR 192, Washington, DC.
- U.S. Nuclear Regulatory Commission, 1989. Calculation of radon flux attenuation by earthen uranium mill tailings covers, Regulatory Guide 3.64 (Task WM 503-4), U.S. Nuclear Regulatory Commission, Washington, DC.
- van Genuchten, M.Th., 1980. A closed-form equation for predicting the hydraulic conductivity of unsaturated soils. *Soil Sci. Soc. Am. J.*, 44:892-898.
- Wallis, T.W.R., 1993. A comparison between weather simulated within the erosion/productivity impact calculator (EPIC) and observed data. *International Journal of Environmental Studies*, 1993, 45:1-12.
- Ward, A.L. and G.W. Gee, 1997. Performance evaluation of a field-scale surface barrier. *J. Environmental Quality*, 26:694-705.
- Ward A.L., G.W. Gee and S.O. Link, 1997. Hanford prototype-barrier status report: FY 1997. PNNL-11789, Pacific Northwest National Laboratory, Richland, WA.
- Warren, R.W., T.E. Hakonson and K.V. Bostick, 1997. The hydrologic evaluation of four cover designs for hazardous waste landfills. In Landfill Capping in the Semi-Arid West: Problems, Perspectives and Solutions. Proceedings of the Environmental Science and Research Foundation Conference, May 21-22, 1997. T.D. Reynolds and R. C. Morris, (eds.)
- Warren, T.W., T.E. Hakonson and G. Trujillo, 1994. Water balance relationships in four alternative cover designs for radioactive and mixed waste landfills. LA-UR-94-2664, Los Alamos National Laboratory.
- Waugh, W. J. and G. N. Richardson, 1995. Ecology, design, and long-term performance of waste-site covers: Applications at a uranium mill tailings site. Presented at the National Academy of Sciences Workshop, Barriers for Long-Term Isolation, August 13, 1995. Denver, CO.

- Waugh, W.J., M.E. Thiede, L.L. Cadwell, G.W. Gee, H.D. Freeman, M.R. Sackschewsky and J.F. Relyea, 1991. Small lysimeters for documenting arid site water balance. In Lysimeters for Evapotranspiration and Environmental Measurements. In Proceedings of the ASCE International Symposium on Lysimetry. July 23-25, 1991. Allen, R. G. et al. (eds.).
- Waterloo Hydrogeologic, Inc., 1998. Visual HELP User's Manual. Waterloo Hydrologic, Inc. Waterloo, Ontario, Canada. 131pp.
- Waugh, W.J, 1997. Summary of the Subsurface Contaminant Focus Area Workshop on Long-Term Performance of Landfill Covers. Park City, Utah, June 26, 1996, Roy F. Weston, Inc., Grand Junction, CO.
- Williams, J.R., C.A. Jones and P.T. Dyke, 1984a. The EPIC model and its application (pp. 111-121). In Proc. ICRISAT-IBSNAT-SYSS Symp. on Minimum Data Sets for Agrotechnology Transfer, March 1983. Hyderabad, India.
- Williams, J.R., C.A. Jones and P.T. Dyke, 1984b. A modeling approach to determining the relationship between erosion and soil productivity. *Trans. ASAE*, 27:129-144.
- Wilson, G.V., M. Henley and B. Valceschini, 1998. Numerical evaluation of monofill and subtle-layered evapotranspiration (ET) landfill caps. Desert Research Institute Publication No. 45159.
- Wilson, G.V., P.M. Jardine and J.P. Gwo, 1992. Modeling the hydraulic properties of a multiregion soil. *Soil Sci. Soc. Am. J.*, 56:1731-1737.
- Woodward-Clyde, 1998. Moisture monitoring system test pad- landfill no. 2. Marine Corps Air and Ground Combat Center, Twentynine Palms, CA. Prepared for Facilities Management Division, MCAGCC, Twentynine Palms, CA.
- Zornberg, J.G., and J.A. Caldwell. 1998. Design of monocovers for landfills in arid locations. IN: Proceedings of the Third International Congress on Environmental Geotechnics. (Ed) P.S. Seco e Pinto, Environmental Geotechnics, Balkema, Rotterdam, ISBN 90 5809 006X, pp. 169-174.

## **Appendix A: Sensitivity Analysis Results**

Table 1. Sensitivity of HELP to Hydraulic Properties for Cheyenne, WY.

WCo	Thickness (m)	Wcs	FC	WP	Ks (cm/s)	D (cm/yr)	Ro (cm/yr)	ET (cm/yr)	Total (cm/yr)
0.1	0.61	0.45	0.35	0.1	1.0E-03	1.09	0.36	31.83	33.27
0.1	0.61	0.45	0.35	0.1	1.0E-04	0.28	0.38	32.74	33.40
0.1	0.61	0.45	0.35	0.1	1.0E-05	0.13	0.53	32.64	33.30
0.1	0.61	0.4	0.15	0.05	1.0E-03	0.74	0.41	32.21	33.35
0.1	0.61	0.4	0.15	0.1	1.0E-03	4.62	0.56	28.17	33.35
0.15	0.61	0.45	0.35	0.15	1.0E-03	1.37	0.38	31.60	33.32
0.1	0.61	0.45	0.35	0.1	1.0E-03	1.09	0.36	31.83	33.27
0.2	0.61	0.55	0.4	0.2	1.0E-03	0.66	0.38	32.31	33.32
0.25	0.61	0.55	0.4	0.25	1.0E-03	0.86	0.41	32.05	33.32
0.1	0.30	0.45	0.35	0.1	1.0E-03	0.99	0.36	32.03	33.38
0.1	0.61	0.45	0.35	0.1	1.0E-03	1.09	0.36	31.83	33.27
0.1	0.91	0.45	0.35	0.1	1.0E-03	0.84	0.36	32.05	33.25
0.1	1.22	0.45	0.35	0.1	1.0E-03	1.09	0.36	31.85	33.30

Wco = initial water content, Wcs = saturated water content or porosity, FC = field capacity, WP = wilting point, Ks = saturated hydraulic conductivity, D = drainage rate, Ro = runoff rate, and ET = evapotranspiration rate



Table 2. Sensitivity of HELP to Hydraulic Properties for Columbus, OH.

WCo	Thickness (m)	WCs	FC	WP	Ks (cm/s)	D (cm/yr)	Ro (cm/yr)	ET (cm/yr)	Total (cm/yr)
0.1	0.61	0.45	0.35	0.1	1.0E-03	20.57	11.38	60.96	92.91
0.1	0.61	0.45	0.35	0.1	1.0E-04	15.34	12.78	64.74	92.86
0.1	0.61	0.45	0.35	0.1	1.0E-05	10.08	16.64	66.07	92.76
0.1	0.61	0.4	0.15	0.05	1.0E-03	19.10	12.40	61.47	92.96
0.1	0.61	0.4	0.15	0.1	1.0E-03	19.96	14.91	57.99	92.86
0.15	0.61	0.45	0.35	0.15	1.0E-03	21.64	11.89	59.39	92.91
0.1	0.61	0.45	0.35	0.1	1.0E-03	20.57	11.38	60.96	92.91
0.2	0.61	0.55	0.4	0.2	1.0E-03	18.82	11.91	62.15	92.89
0.25	0.61	0.55	0.4	0.25	1.0E-03	19.30	12.73	60.88	92.91
0.1	0.30	0.45	0.35	0.1	1.0E-03	20.52	11.38	61.06	92.96
0.1	0.61	0.45	0.35	0.1	1.0E-03	20.57	11.38	60.96	92.91
0.1	0.91	0.45	0.35	0.1	1.0E-03	20.37	11.38	61.01	92.76
0.1	1.22	0.45	0.35	0.1	1.0E-03	20.47	11.38	60.96	92.81

Wco = initial water content, Wcs = saturated water content or porosity, FC = field capacity, WP = wilting point, Ks = saturated hydraulic conductivity, D = drainage rate, Ro = runoff rate, and ET = evapotranspiration rate

Table 3. Sensitivity of EPIC to Hydraulic Properties for Laramie, WY.

WCo	Thickness (m)	Wcs	FC	WP	Ks (cm/s)	D (cm/yr)	Ro (cm/yr)	ET (cm/yr)	Total (cm/yr)
0.1	0.61	0.45	0.35	0.1	1.0E-03	0.00	1.83	23.67	25.50
0.1	0.61	0.45	0.35	0.1	1.0E-04	0.00	1.83	23.67	25.50
0.1	0.61	0.45	0.35	0.1	1.0E-05	0.00	1.83	23.67	25.50
0.1	0.61	0.4	0.15	0.05	1.0E-03	0.12	2.36	23.01	25.50
0.1	0.61	0.4	0.15	0.1	1.0E-03	0.08	2.45	22.19	24.73
0.15	0.61	0.45	0.35	0.15	1.0E-03	0.00	1.94	23.59	25.53
0.1	0.61	0.45	0.35	0.1	1.0E-03	0.00	1.83	23.67	25.50
0.2	0.61	0.55	0.4	0.2	1.0E-03	0.00	1.83	23.71	25.54
0.25	0.61	0.55	0.4	0.25	1.0E-03	0.00	1.95	23.59	25.54
0.1	0.30	0.45	0.35	0.1	1.0E-03	0.01	3.35	22.18	25.54
0.1	0.61	0.45	0.35	0.1	1.0E-03	0.00	1.83	23.67	25.50
0.1	0.91	0.45	0.35	0.1	1.0E-03	0.00	0.96	24.53	25.49
0.1	1.2192	0.45	0.35	0.1	1.0E-03	0.00	0.96	24.53	25.49

Wco = initial water content, Wcs = saturated water content or porosity, FC = field capacity, WP = wilting point, Ks = saturated hydraulic conductivity, D = drainage rate, Ro = runoff rate, and ET = evapotranspiration rate

Table 4. Sensitivity of EPIC to Hydraulic Properties for Akron, OH.

WCo	Thickness (m)	Wcs	FC	WP	Ks (cm/s)	D (cm/yr)	Ro (cm/yr)	ET (cm/yr)	Total (cm/yr)
0.1	0.61	0.45	0.35	0.1	1.0E-03	8.97	28.62	52.05	89.65
0.1	0.61	0.45	0.35	0.1	1.0E-04	8.92	28.64	52.09	89.65
0.1	0.61	0.45	0.35	0.1	1.0E-05	7.92	28.85	52.96	89.73
0.1	0.61	0.4	0.15	0.05	1.0E-03	15.61	26.59	47.80	90.00
0.1	0.61	0.4	0.15	0.1	1.0E-03	21.12	24.38	44.96	90.46
0.15	0.61	0.45	0.35	0.15	1.0E-03	10.23	28.02	51.27	89.52
0.1	0.61	0.45	0.35	0.1	1.0E-03	8.97	28.62	52.05	89.65
0.2	0.61	0.55	0.4	0.2	1.0E-03	10.12	27.12	52.35	89.59
0.25	0.61	0.55	0.4	0.25	1.0E-03	11.64	26.55	51.23	89.42
0.1	0.30	0.45	0.35	0.1	1.0E-03	7.73	31.54	51.05	90.32
0.1	0.61	0.45	0.35	0.1	1.0E-03	8.97	28.62	52.05	89.65
0.1	0.91	0.45	0.35	0.1	1.0E-03	8.54	26.94	55.06	90.55
0.1	1.2192	0.45	0.35	0.1	1.0E-03	8.28	22.96	58.75	89.99

Wco = initial water content, Wcs = saturated water content or porosity, FC = field capacity, WP = wilting point, Ks = saturated hydraulic conductivity, D = drainage rate, Ro = runoff rate, and ET = evapotranspiration rate