



U.S. Department
of Transportation

**Federal Highway
Administration**

Publication No. FHWA-SA-91-048

August 1993

COM624P—

Laterally Loaded Pile Analysis Program for the Microcomputer

Version 2.0

Office of Engineering
Office of Technology Applications

400 Seventh Street, SW.
Washington, D.C. 20590



Innovation Through Partnerships

NOTICE

This document is disseminated under the sponsorship of the Department of Transportation in the interest of **information** exchange. The United States Government assumes no liability for its contents or use thereof. The United States Government does not endorse products or manufacturers. Trademarks or manufacturers' names appear herein only because they are considered essential to the object of this document.

1. Report No. FHWA-SA-91-048	2. Government Accession No.	3. Recipient's Catalog No.	
4. Title and Subtitle COM624P—LATERALLY LOADED PILE ANALYSIS PROGRAM FOR THE MICROCOMPUTER, VERSION 2.0		5. Report Date June 1993	
		6. Performing Organization Code	
		8. Performing Organization Report No.	
7. Author(s) Shih-Tower Wang and Lymon C. Reese		10. Work Unit No. (TRAVIS)	
9. Performing Organization Name and Address Ensoft, Inc. P.O. Box 180348 Austin, TX 78718		11. Contract or Grant No. DTFH61-88-C-00101	
		13. Type of Report and Period Covered Final Report	
12. Sponsoring Agency Name and Address U.S. DOT, Federal Highway Administration Office of Technology Applications 400 Seventh Street, SW. Washington, D.C.		14. Sponsoring Agency Code	
		15. Supplementary Notes FHWA Contracting Officer's Technical Representative: Chien-Tan Chang, HTA-21 Technical Consultants: Richard Cheney, Jerry DiMaggio, and Chris Dumas (HNG-31)	
16. Abstract Computer Program COM624P has been developed for use in the analysis of stresses and deflection of piles or drilled shafts under lateral loads. The program is especially written for highway engineers who wish to run the analysis on microcomputers. The technology on which the program is based is the widely-used p-y curve method. The program solves the equations giving pile deflection, rotation, bending moment, and shear by using iterative procedures because of the nonlinear response of the soil. The program provides a user-friendly/menu-driven input and a graphics output in microcomputer environment. The version of the Program COM624P for the microcomputer was developed in 1989. Several new features were included in the program such as: generating p-y curves for rock, capability of analysis of piles in sloping ground, improved solution for multi-layered soils, and a variety of boundary conditions at the pile head for selection. The current version of COM624P (version 2.0) includes more improvements, and a subroutine has been added to compute the ultimate bending capacity and the flexural rigidity of piles. The user documentation provides detailed information to enable the user to employ the program conveniently and effectively. The documentation consists of three parts—Part I, Users Guide; Part II, Engineering Background; Part III, Systems Maintenance.			
17. Key Words Piles, lateral loading, analysis, design, soil response, p-y method, deflection, bending, static loading, cyclic loading, difference-equation methods, microcomputer program		18. Distribution Statement No restrictions. This document is available to the public from the National Technical Information Service, Springfield, Virginia 22161	
19. Security Classif. (of this report) Unclassified	20. Security Classif. (of this page) Unclassified	21. No. of Pages 504	22. Price

METRIC CONVERSION FACTORS

APPROXIMATE CONVERSIONS FROM METRIC MEASURES

SYMBOL	WHEN YOU KNOW	MULTIPLY BY	TO FIND	SYMBOL
<u>LENGTH</u>				
in	inches	2.5	centimeters	cm
ft	feet	30	centimeters	cm
yd	yards	0.9	meters	m
mi	miles	1.6	kilometers	km
mm	millimeters	0.04	inches	in
cm	centimeters	0.4	inches	in
m	meters	3.3	feet	ft
m	meters	1.1	yards	yd
km	kilometers	0.6	miles	mi
<u>AREA</u>				
sq in	square inches	6.5	square centimeters	cm ²
sq ft	square feet	0.09	square meters	m ²
sq yd	square yards	0.6	square meters	m ²
sq mi	square miles	2.6	square kilometers	km ²
	acres	0.4	hectares	ha
cm ²	square centimeters	0.16	square inches	sq in
m ²	square meters	1.2	square yards	sq yd
km ²	square kilometers	0.4	square miles	sq mi
ha	hectares (10,000 m ²)	2.5	acres	
<u>MASS (weight)</u>				
oz	ounces	28	grams	g
lb	pounds	0.45	kilograms	kg
t	short tons (2000 lb)	0.9	tonnes	T
g	grams	0.035	ounces	oz
kg	kilograms	2.2	pounds	lb
T	tonnes (1000 kg)	1.1	short tons	

APPROXIMATE CONVERSIONS FROM METRIC MEASURES, Continued

SYMBOL	WHEN YOU KNOW	MULTIPLY BY	TO FIND	SYMBOL
<u>VOLUME</u>				
tsp	teaspoons	5	milliliters	ml
tbsp	tablespoons	15	milliliters	ml
fl oz	fluid ounces	30	milliliters	ml
c	cups	0.24	liters	l
pt	pints	0.47	liters	l
qt	quarts	0.95	liters	l
gal	gallons	3.8	liters	l
cu ft	cubic feet	0.03	cubic meters	m ³
cu yd	cubic yards	0.76	cubic meters	m ³
ml	milliliters	8.03	fluid ounces	fl oz
l	liters	2.1	pints	pt
l	liters	1.06	quarts	qt
l	liters	0.26	gallons	gal
m ³	cubic meters	36	cubic feet	cu ft
m ³	cubic meters	1.3	cubic yards	cu yd

TEMPERATURE (exact)

°F	Fahrenheit temperature	5/9	Celsius temperature	°C
°C	Celsius temperature	9/5	Fahrenheit temperature	°F
		(after subtracting 32)		
		(then add 32)		

FOREWORD

The technology on which COM624P is based has been widely used for many years for the design of a variety of applications of piles that must resist lateral load. While the program is based on sound principles of engineering and has proven to be useful in many engineering offices, research is continuing on several aspects of the behavior of piles under lateral loading. The first development of Program COM624 for microcomputers was initiated in 1989, sponsored by the Federal Highway Administration. The PC version was primarily based on the existing program COM624, which was developed at The University of Texas at Austin. The updated information and user-friendly features were periodically added into Program COM624P. The current version of COM624P (Version 2.0) includes a subroutine to compute the ultimate bending capacity of a pile and the variation of flexural rigidity. It provides an option to use internally-generated flexural rigidity of cracked sections in computation of the pile deflection. An additional improvement is the incorporation of screen windows and pull-down menus for ease in learning and operation.

The design of piles involves a large number of judgments on the part of the engineer, and COM624P should be of significant assistance. The engineer must be assured that the technology on which the program is based, particularly the information on soil response, is applicable to a particular design, that the program has been used properly, and that the results have been verified. The design of piles under lateral load requires the direct participation of an experienced engineer and, on occasions, the engineer may decide that a full-scale field test is needed. Thus, no warranty can be stated implicitly or implied by the authors that any particular design made with the assistance of COM624P is without fault.

TABLE OF CONTENTS

	<u>Page</u>
LISTING OF FIGURES	xiii
LISTING OF TABLES	xvii
PART I: USERS GUIDE	
CHAPTER 1. GENERAL	1
PURPOSE OF THE USERS GUIDE	1
PROJECT REFERENCES	1
SECURITY	2
CHAPTER 2. SYSTEM SUMMARY AND PROGRAM STRUCTURE	3
SYSTEM APPLICATION	3
SYSTEM COMPONENTS	3
SYSTEM PROCESSING	4
SYSTEM CONFIGURATION	5
MAIN PROGRAM STRUCTURE	7
CHAPTER 3. GUIDE FOR EXECUTION OF COM624P ON A MICROCOMPUTER	15
INTRODUCTION	15
BACKING UP AND RESTORING ORIGINAL DISKETTE	15
GUIDE FOR INSTALLATION OF CONFIGURATION FILE	16
Control Parameters	17
Graphics Driver and Mode	18
Video Attributes	20
Acceptance of Changes	20
MENU STRUCTURE	21
GUIDE FOR USING MAINMENU	23
GUIDE FOR USING INPUT MENU	25
Input Menu Options	25
File Submenu	26
Analysis Submenu	29
MULT Submenu	41
Options Submenu	49
File-Library File	50
Guide to Data-Entry	54
Worksheet Commands	57
Basic Worksheet Commands	57
Cell-Edit Commands	61
Worksheet-Edit Commands	63
GUIDE FOR RUNNING MAIN PROGRAM (COM624P)	67

TABLE OF CONTENTS (Continued)

	<u>Page</u>
GUIDE FOR OPERATING GRAPHICS POSTPROCESSOR (C624VIEW)	68
Graphics Menu	69
File Menu	71
View Menu	73
Plot Submenu	83
Options	87
CHAPTER 4. INPUT INFORMATION AND DATA STRUCTURE	89
INTRODUCTION	89
GENERAL REMARKS	89
SELECTION OF BOUNDARY CONDITIONS AT PILE HEAD	95
Case 1. Pile Head is Free to Rotate	95
Case 2. Pile Head is Fixed Against Rotation....	95
Case 3. Pile Head is Restrained Against Rotation	96
Case 4. Pile Head Deflection is Restrained	
Against Lateral Movement	96
ITERATIONS OF COMPUTATIONS USING CRACKED/UNCRAKED	
EI GENERATED INTERNALLY BY SUBROUTINE PMEIX.....	96
CHAPTER 5. EXAMPLE STUDIES	99
INTRODUCTION	99
EXAMPLE 1, PILES IN A SINGLE LAYER OF SOIL	101
EXAMPLE 2, CONCRETE PILES IN LAYERED SOIL WITH	
DISTRIBUTED LOAD	133
EXAMPLE 3, PILES IN A SLOPING ABUTMENT	161
EXAMPLE 4, USER INPUT p-y CURVES	189
EXAMPLE 5, COMPUTE ULTIMATE BENDING MOMENT FOR	
BORED PILES	217
EXAMPLE 6, ANALYSES RELATED TO DESIGN OF	
CONCRETE PILES	241

PART II: BACKGROUND

CHAPTER 1. INTRODUCTION	283
NATURE OF THE PROBLEM	283
Definition of Soil Response	284
Definition of Soil Modulus	284
DESIGN BY FACTORING THE LOAD	288
NATURE OF LOADING	289
Static Loading	289
Cyclic Loading	290
Sustained Loading	290
Dynamic or Seismic Loading	291
INTERACTION OF THE PILES WITH THE SUPERSTRUCTURE	292
INFLUENCE OF PILE LENGTH	293
PILE GROUPS UNDER LATERAL LOADING	294
VERIFICATION OF ACCURACY OF THE COMPUTER OUTPUT	295
CHAPTER 2. BASIC THEORY OF COMPUTATION	297
THE DIFFERENTIAL EQUATION	297
SOLUTION TO THE GOVERNING DIFFERENTIAL EQUATION	302
CHAPTER 3. SOIL RESPONSE CURVES (p-y CURVES)	315
INTRODUCTION	315
USE OF SOIL MODELS TO DETERMINE SOIL BEHAVIOR	316
Soil Models for Saturated Clay	316
Soil Models for Sand	318
RECOMMENDATIONS FOR p-y CURVES FOR CLAYS	323
Response of Soft Clay below the Water Table	323
Field Experiments	323
Recommendations for Computing p-y Curves	324
Recommended Soil Tests	327
Response of Stiff Clay below the Water Surface	328
Field Experiments	328
Recommendations for Computing p-y Curves	328
Recommended Soil Tests	335
Response of Stiff Clay above the Water Table	336
Field Experiments	336
Recommendations for Computing p-y Curves	336
Recommended Soil Tests	340
RECOMMENDATIONS FOR p-y CURVES FOR SAND	340
Response of Sand below the Water Table	340
Field Experiments	340
Recommendations for Computing p-y Curves	341
Recommended Soil Tests	347
Response of Sand above the Water Table	347

TABLE OF CONTENTS (Continued)

	Page
RECOMMENDATIONS FOR p-y CURVES FOR VUGGY LIMESTONE ...	348
Field Experiments	348
Recommendations for Computing p-y Curves	349
RECOMMENDATIONS FOR p-y CURVES FOR LAYERED SOIL	351
Method of Georgiadis	351
Example p-y Curves	352
MODIFICATIONS TO p-y CURVES FOR SLOPING GROUND	357
Introduction	357
Equations for Ultimate Resistance in Clay	357
Equations for Ultimate Resistance in Sand	360
CHAPTER 4. COMPUTATION OF ULTIMATE MOMENT AND FLEXURAL RIGIDITY OF PILE	363
INTRODUCTION	363
Application	363
Significant Assumptions	364
STRESS-STRAIN CURVES FOR CONCRETE AND STEEL	364
CROSS SECTIONS THAT CAN BE ANALYZED	368
COMPUTATION PROCEDURE	368
EXAMPLE CALCULATION BY HAND	374
CHAPTER 5. VERIFICATION OF ACCURACY OF SOLUTION	379
SIGNIFICANT FIGURES	380
SELECTION OF NUMBER OF INCREMENTS	380
CHECKING AGAINST EXAMPLE PROBLEMS	381
CHECK OF ECHO-PRINT	383
CHECK OF SOIL RESISTANCE	383
CHECK OF MECHANICS	384
Check of Results of Analysis of Buckling Load...	384
Check of Values of Shear and Bending Moment	384
Check of Deflection	385
Relationships Between Computed Values	385
CHECK BY IMPLEMENTING APPROXIMATE METHODS OF ANALYSIS	387
CHECK BY AN ASSOCIATE OR A COLLEAGUE	387
CONCLUDING COMMENT	388
CHAPTER 6. FULL-SCALE TESTING OF PILES.....	389
INTRODUCTION	389
SELECTION OF TEST SITE.....	390
INVESTIGATION OF SOIL PROPERTIES.....	391
SELECTION OF TEST PILE.....	392
INSTALLATION OF TEST PILE.....	393

TABLE OF CONTENTS (Continued)

	Page
TESTING PROCEDURES	394
TESTING PILE WITH NO INTERNAL INSTRUMENTATION	397
Preliminary Computations.....	398
Obtaining Stiffness of Test Pile.....	398
Pile Installation.....	399
Loading Arrangement.....	399
Instrumentation.....	403
Interpretation of Data.....	405
Example Computations.....	405
TESTING PILE WITH INTERNAL INSTRUMENTATION	408
Preliminary Computations.....	408
Instrumentation.....	409
Analysis of Data and Correlations with Theory...	410
Review of Three Experiments Using Piles with Internal Instrumentation.....	411
CONCLUDING COMMENTS.....	413
CHAPTER 7. SUGGESTIONS FOR DESIGN	417
SELECTING AN APPROPRIATE MODEL FOR A PILE	418
STUDY OF INFLUENCE OF VARIOUS PARAMETERS	419
CASE STUDIES	420
FIELD TESTS	420
TECHNICAL ADVANCES	421

TABLE OF CONTENTS (Continued)

	<u>Page</u>
PART III: SYSTEM MAINTENANCE MANUAL	
CHAPTER 1. GENERAL	425
CHAPTER 2. SYSTEM DESCRIPTION	427
SYSTEM APPLICATION	427
SYSTEM ENVIRONMENT	427
Hardware Requirements	427
Software Requirements	427
COMMUNICATIONS	429
INTERFACES	429
SECURITY	429
REFERENCES	
REFERENCES	433
APPENDICES	
APPENDIX A. LINE-BY-LINE INPUT GUIDE FOR BATCH FILE	437
APPENDIX B. DESIGN PROCEDURE FOR Laterally Loaded DEEP FOUNDATION USING COM624P VERSION 2.....	451
APPENDIX C. DESIGN OF DRILLED SHAFTS FOR LATERAL LOADS USING COM624P VERSION 2, ABUTMENT FOUNDATION DESIGN, A CASE STUDY EXAMPLE	461

LISTING OF FIGURES

PART I

Figure	Title	Page
2.1	System Flow Chart	6
2.2	The Flow Chart of Main Program COM624P	8
3.1	Main Menu Structure of COM624P	22
3.2	Data-Entry Worksheet.....	55
4.1	Coordinate System	90
4.2	Sign Conventions	91
4.3	Bending Moment and Flexural Rigidity versus Depth for a Laterally-Loaded Pile	98
5.1	Data for Example 2.....	134
5.2	Data for Example 3.....	162
5.3	Pile-Head Deflection y_t versus Slope Angle	163
5.4	Data for Example 4.....	190

PART II

1.1	Definition of p and y (after Reese, 1983)	285
1.2	Concept of Determination of Soil Modulus as a Function of Distance Along Pile	287
1.3	Influence of Pile Penetration on Groundline Deflection	294
2.1	Element for Beam-Column (after Hetenyi, 1946)	298
2.2	Sign Conventions	301
2.3	Form of the Results Obtained from a Complete Solution	301
2.4	Representation of Deflected Pile	303

LISTING OF FIGURES (Continued)

Figure	Title	Page
2.5	Points at Bottom of Pile	305
2.6	Points at Top of Pile	308
2.7	Case 1 of Boundary Conditions at Top of Pile.....	309
2.8	Case 2 of Boundary Conditions at Top of Pile.....	311
2.9	Case 3 of Boundary Conditions at Top of Pile.....	313
2.10	Case 4 of Boundary Conditions at Top of Pile.....	314
3.1	Assumed Passive Wedge-Type Failure for Clay: (a) Shape of Wedge (b) Forces Acting on Wedge (After Reese, 1958)	317
3.2	Assumed Lateral Flow-Around Type of Failure for Clay: (a) Section through Pile (b) Mohr-Coulomb Diagram (c) Forces Acting on Pile 4.5	319
3.3	Assumed Passive Wedge-Type Failure: (a) General Shape of Wedge (b) Forces of Wedge (c) Forces on Pile (After Reese, et al, 1974)	320
3.4	Assumed Mode of Soil Failure by Lateral Flow Around the Pile: (a) Section through the Pile (b) Mohr-Coulomb Diagram Representing States of Stress of Soil Flowing Around a Pile	322
3.5	Characteristic Shapes of the p-y Curves for Soft Clay below Water Surface: (a) Static Loading (b) Cyclic Loading (After Matlock, 1970)	325
3.6	Characteristic Shape of p-y Curve for Static Loading in Stiff Clay below the Water Surface (After Reese, et al, 1975)	329
3.7	Values of Constants A_S and A_C (After Reese, et al, 1975)	330

LISTING OF FIGURES (Continued)

<u>Figure</u>	<u>Title</u>	<u>Page</u>
3.8	Characteristic Shape of p-y Curve for Cyclic Loading in Stiff Clay below Water Surface (After Reese, et al, 1975)	334
3.9	Characteristic Shape of p-y Curve for Static Loading in Stiff Clay Above Water Surface (After Welch and Reese, 1972)	337
3.10	Characteristic Shape of p-y Curve for Cyclic Loading in Stiff Clay Above the Water Surface (After Welch and Reese, 1972)	339
3.11	Characteristic Shape of a Family of p-y Curves for Static and Cyclic Loading in Sand (After Reese, et al, 1974)	342
3.12	Values of Coefficients \bar{A}_c and \bar{A}_s (After Reese, et al, 1974)	344
3.13	Values of Coefficient B for Soil Resistance versus Depth (After Reese, et al, 1974)	345
3.14	Recommended p-y Curve for Design of Drilled Shafts in Vuggy Limestone (After Reese and Nyman, 1978)	350
3.15	Example Problem for Soil Response for Layered Soils	353
3.16	Example p-y Curves for Layered Soils	354
3.17	Equivalent Depths of Overlying Soil for use in Computing p-y Curves for a Layered System.....	356
3.18	Pile Installed in Sloping Ground	359
4.1	Stress-Strain Curve for Concrete	365
4.2	Stress-Strain (α - ϵ) Curve for Steel	367
4.3	Element from a Beam with an Unloaded Shape of abcd	370
4.4	Cross Section of a Beam for Example Problem.....	375

LISTING OF FIGURES (Continued)

Figure	Title	Page
5.1	Influence of Length of Increment on Pile-Head Deflection and Maximum Bending Moment	382
5.2	Plot of Soil Resistance for Example 1, Lateral Load of 20,000 Pounds	386
6.1	Testing of a Drilled Shaft under Lateral Loading, Los Angeles	389
6.2	Two-pile Test Arrangement for Two-Way Loading....	401
6.3	Two-pile Test Arrangement with One-Way Loading...	401
6.4	Schematic Drawing of Deflection-Measuring System.	403
6.5	Device for Measuring Pile-Head Rotation	404
6.6	Information for Analysis of Test at St. Gabriel..	406
6.7	Comparison of Measured and Computed Results for St. Gabriel Test	407
6.8	Effect of Repeated Loading on p-y Curves	414

PART III

2.1	The Interrelationships of the Major Components of the System	428
-----	--	-----

LISTING OF TABLES

PART I

Table	Title	Page
3.1	Driver Information for Graphics Adapters and Printers	69

PART II

3.1	Representative Values of e_{50}	324
3.2	Representative Values of k for Stiff Clays.....	331
3.3	Representative Values of e_{50} for Stiff Clays.....	331
3.4	Representative Values of k for Submerged Sand (Static and Cyclic Loading)	346
3.5	Representative Values of k for Sand Above Water Table (Static and Cyclic Loading).....	346

COM624P
LATERALLY LOADED PILE ANALYSIS PROGRAM
FOR THE MICROCOMPUTER
Version 2.0

Part I: USERS GUIDE

CHAPTER 1. GENERAL

The documentation for Computer Program COM624P consists of three documents: Part I, Users Guide; Part II, Engineering Background; and Part III, Systems Maintenance.

PURPOSE OF THE USERS GUIDE

The purpose of Part I of COM624P is to provide detailed information to enable the user to employ the program conveniently and effectively. The project was conducted under Contract DTHF61-88-C-00101 from 1988-1989. The information is presented as follows: Chapter 1 introduces the Users Guide and provides system background; Chapter 2 summarizes the system in general; Chapter 3 provides a step-by-step operating procedure; Chapter 4 presents input information, names of variables, and data structure for the input files; and Chapter 5 presents input and output for examples that were studied.

PROJECT REFERENCES

The technology on which the program is based has been widely used for many years for the analysis of a variety of piles subjected to lateral loads. The existing program, COM624, was developed at the The University of Texas at Austin and has been used on main-frame computers for several years. The project is to upgrade COM624 and to develop a user-friendly version for running on IBM XT's, AT's, and compatible microcomputers. The first version of Program COM624P (Version 1.0) has been used and distributed by FHWA since 1990. Because of a number of inquiries by design engineers about the ultimate capacity of a pile in bending, a subroutine has been added to the current version (2.0) to compute the ultimate capacity in bending and the variation of flexural rigidity with applied moment.

The information shown in the three parts of the documentation is limited to that needed for the operation of the computer program and to a brief introduction of the method of analysis. The user is referred to two documents published by the Federal Highway Administration for a relatively complete treatment of the topic. The first one is entitled "Behavior of Piles and Pile Groups under Lateral Load" (FHWA/RD-85/106). The second one is entitled "Handbook on Design of Piles and Drilled Shafts Under Lateral Load" (FHWA-IP-84-11).

SECURITY

This project is conducted under the sponsorship of the United States Department of Transportation. Under the United States Copyright Act of 1976, no part of this document or accompanying software may be reproduced, translated, or distributed without the prior approval of the Department of Transportation.

No warranty, expressed or implied, is offered either by FHWA or Ensoft, Inc., as to the accuracy of results from the program. The program should not be used for design unless caution is exercised in interpreting the results, and independent calculations are available to verify the general correctness of the results. The user is assumed to be knowledgeable of the information in the documentation that accompanies the diskettes. The user is assumed to recognize that the input parameters can have a significant effect on the solution and must be chosen carefully.

CHAPTER 2. SYSTEM SUMMARY AND PROGRAM STRUCTURE

SYSTEM APPLICATION

The design of driven piles and drilled shafts under lateral loading is an important problem and one that is encountered frequently in highway design. The principal use of piles or drilled shafts in highway structures is for the support of bridges, either to span water courses or to serve in interchanges. Other applications using laterally-loaded piles on highways can be seen in bridge abutments, overhead signs, pile-supported retaining walls, and pile-stabilized slopes.

Computer program COM624P is used to analyze the behavior of piles or drilled shafts which are subjected to lateral loads. The method of analysis implemented in COM624P is the so-called p-y method. The theoretical background about the p-y method of analysis is described in Part II of this document. The digital computer allows the deflected shape (lateral deflection) of a pile to be computed rapidly and accurately by iteration even though the soil reaction against the pile is a nonlinear function of pile deflection. After the deflection is determined, the shear, bending moment, and soil resistance along the pile can be computed thereafter. With the availability of microcomputers, this program makes it possible for highway engineers to employ the rational p-y method for analysis of laterally-loaded piles and drilled shafts.

SYSTEM COMPONENTS

The package sent with COM624P, in general, contains three 5.25-inch double-sided, double-density floppy diskettes. The first diskette contains the main program of COM624P.EXE and six sample-data files: Example.IN1 through Example.IN6. The engineer may use the sample data to run COM624P and check the solutions

presented in Chapter 5. If there are significant discrepancies, the user should report to FHWA immediately.

The second diskette contains the screen-editing files. The files stored in this diskette are: C624EDIT.EXE., C624EDIT.HLP, C624EDIT.CFG, PILEDATA.LIB, and INSTVIEW.EXE. The engineer may use a preprocessor program named C624EDIT.EXE to create a new data file, retrieve, and edit an existing data file.

The third diskette contains the graphics package. The files stored in the diskette are C624VIEW.EXE., C624EDIT.CFG, INSTVIEW.EXE, and EXAM1.PLT. The main graphics program is named C624VIEW.EXE. The user may execute this program and assign the data created by COM624P for graphics display.

SYSTEM PROCESSING

The system consists of three modules as described earlier. To process the system, the user starts to load the Menu and selects the preprocessor program C624EDIT.EXE to create an input-data file. C624EDIT can also be used to retrieve an existing data file and to edit the data entry. After the data file has been created or corrected, the user should save the data file using the SAVE command.

The second step of processing the system is to call the main program COM624P. COM624P will process the data file that contains the user's input data, and will create a text-output file and a graphics-output file. The user may view the output data on the monitor or print the output file to get a hard copy. If the user prefers to have a graphics display, then the program C624VIEW should be viewed. C624VIEW will display the graphics based on the computed results, and the user can get a hard copy of graphics from the installed HP plotter or dot-matrix printer. A flow chart

depicting data flow and showing the relationships of each module is presented in Fig. 2.1.

SYSTEM CONFIGURATION

Program COM624P was developed for the IBM-XT and IBM-AT or for any microcomputer that is compatible with the IBM. The program has been checked for conformance with ANSI FORTRAN77. The Fortran Compiler from Microsoft, Inc., was used to compile the source code and create the execution file.

The word length is important for convergence to a solution of the nonlinear equations employed by this program. Therefore, a double-precision real value, occupying 8 bytes of storage, was used in the Fortran Code. The precision is approximately 15 decimal digits. If a value has more digits, only the first 15 are significant.

The program requires at least 256k of RAM memory. The math coprocessor is highly recommended but is not required. If a high-speed, floating-point math coprocessor is installed, the execution time for a normal problem is less than one minute. However, it can take 3 to 7 minutes for the same problem, depending on the type of microcomputer, if the math coprocessor is absent. The operating system that is required to run the program should be MS-DOS 2.1 or a later version.

The preprocessor for input data, C624EDIT, and the post-processor for graphics display, C624VIEW, were developed in the Pascal language to utilize fully the screen-control function provided by most microcomputers. Two peripheral devices are required to run C624VIEW. One is a graphics adapter which can change the screen to the graphics mode for plotting output. Currently, the program supports the following graphics adapters:

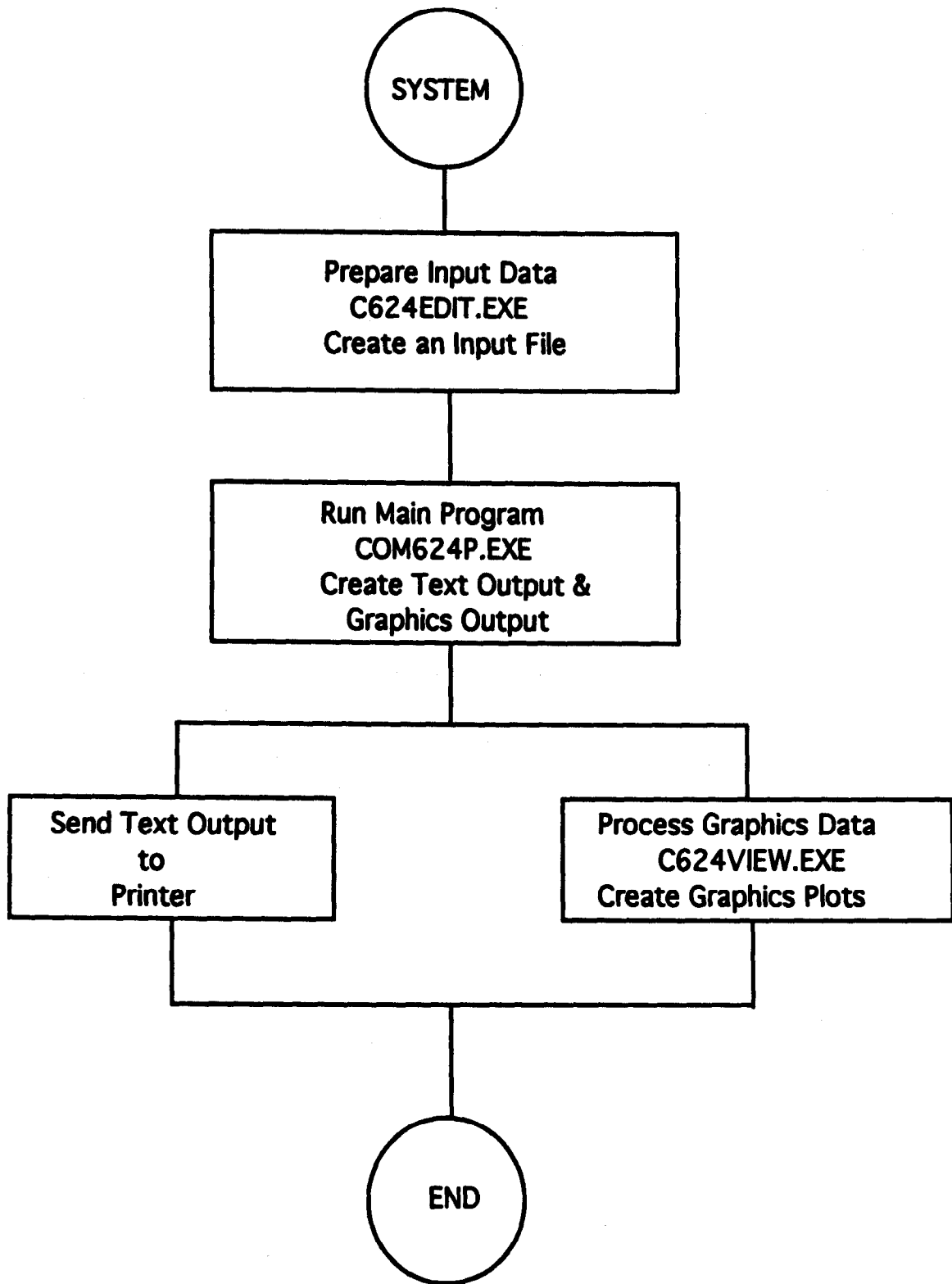

CGA - IBM Color-Graphics Adapter Driver
EGA - IBM Enhanced-Graphics Adapter Driver
VGA - Video Graphics Array Adapter
HERC - Hercules Driver
AT&T - AT&T 400 Line Driver

The other peripheral equipment is a printer or plotter for hard copies of graphics. The program supports HP plotters; the IBM proprinter; Epson MX, FX, LX, LQ or Epson compatible printers including Okidata, Panasonic, and Star printers.

MAIN PROGRAM STRUCTURE

The structure of the main program COM624P is shown in the flow diagram Fig. 2.2. The function of each subprogram is described in the following listing.

1. Main Program

Function: the main program COM624P inputs and outputs a small amount of data, but mainly controls the flow of logic by calling appropriate subroutines.

Calls: UNITSS, NODEM INPT, OPIN, NODE, FLXRIG, DEFLEC, ESCALL, DISTR, MCALC, OPCHK, EQUIL, PYGEN, PMEIX

2. UNITSS

Function: to store table headings.

Called

From: COM624P

Calls: none

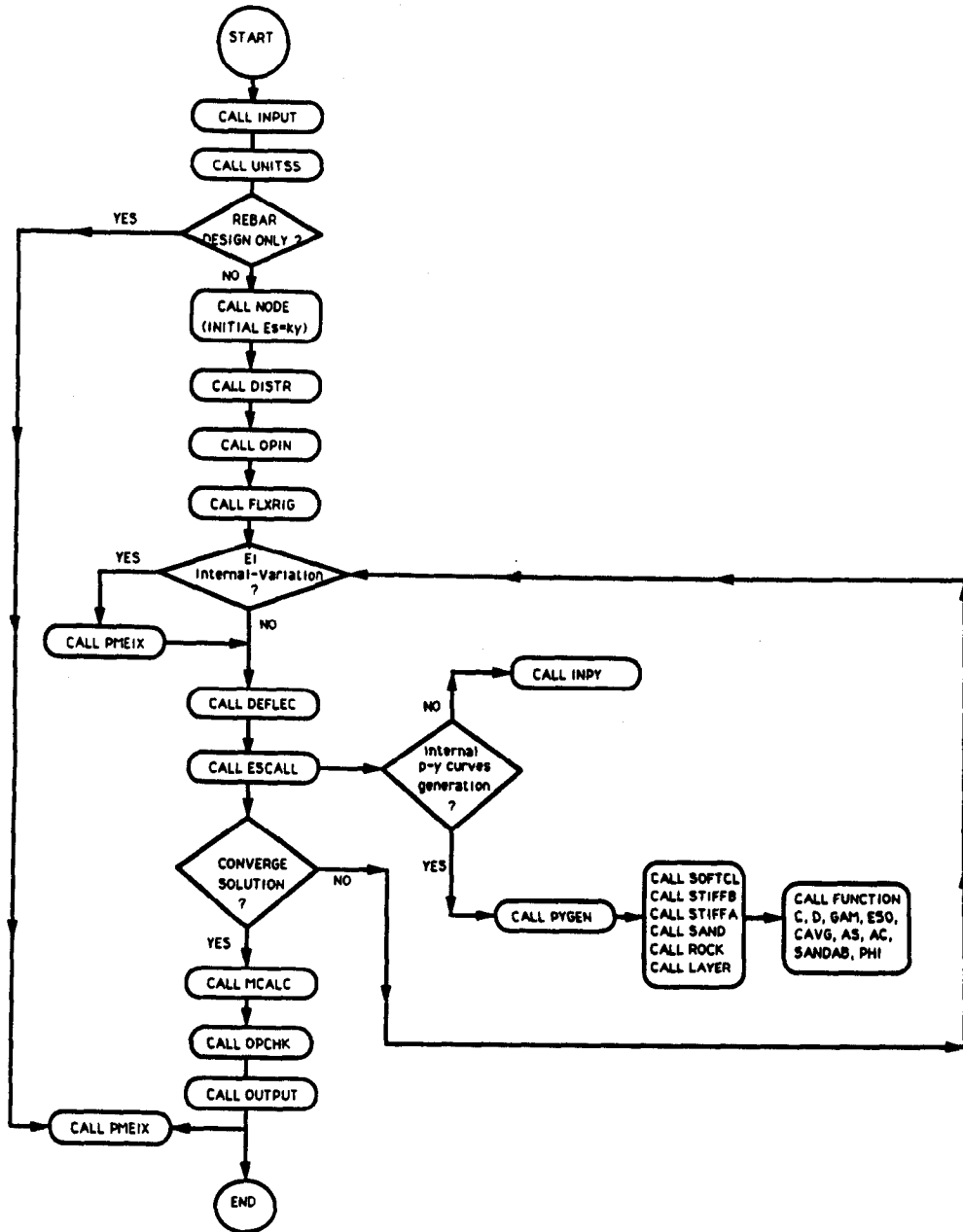

Figure 2.2. The flow chart of Main Program COM624P.

3. INPT

Function: this subroutine reads most of the technical data for the problem.

Called

From: COM624P

Calls: none

4. OPIN

Function: this subroutine outputs the data for a problem.

Called

From: COM624P

Calls: none

5. NODE

Function: this subroutine (1) calculates the coordinate for each node, (2) calculates the number of the node at the top and bottom of each layer of soil, and (3) initializes the array of soil moduli.

Called

From: COM624P

Calls: none

6. FLXRIG

Function: this subroutine calculates the flexural rigidity of the pile at each node.

Called

From: COM624P

Calls: none

7. DEFLEC

Function: subroutine DEFLEC calculates deflection at all points along the pile.

Called

By: COM624P

Calls: none

8. DISTR

Function: this subroutine calculates distributed load relevant to each node.

Called

By: COM624P

Calls: none

9. MCALC

Function: this subroutine computes the moment, soil reaction, and combined stress in the pile at each node along the pile.

Called

By: COM624P

Calls: FUNCTION D

10. OPCHK

Function: this routine calculates the imbalance in force and moment at a node.

Called

By: COM624P

Calls: none

11. OUTPT

Function: subroutine OUTPT prints the information from final solution, including a table of depth, deflection, moment, maximum combined stress in the pile, distributed load, soil modulus, and flexural rigidity.

Called

By: COM624P

Calls: none

12. EQUIL

Function: this subroutine (1) computes boundary conditions and prints them to facilitate checking and (2) computes and prints overall force and moment imbalance.

Called

By: COM624P

Calls: none

13. INPY

Function: this subroutine computes values of soil modulus from input p-y curves.

Called

By: ESCALL

Calls: none

14. FUNCTIONS C, D, GAM, E50, CAVG, AS, AC, SANDAB, PHI

Functions: these function subroutines do the following:

FUNCTION C computes the value of cohesion at any depth by linear interpolation from input data.

FUNCTION D computes the pile diameter at any depth.

FUNCTION GAM computes the average effective unit weight of soil above a point.

FUNCTION E50 computes the ϵ_{50} (strain at a stress ratio of 50 percent) by linear interpolation from input data.

FUNCTION CAVG computes the average shear strength of soil above a point.

FUNCTION AS computes the coefficient A_s for stiff clay below the water table.

FUNCTION AC computes the coefficient A_c for stiff clay below the water table.

FUNCTION SANDAB computes coefficients A and B for sand.

FUNCTION PHI computes angle of internal friction at any depth.

Called

By: these functions are called in the subroutines that generate p-y curves (SOFTCL, STIFFA, STIFFB, and SAND).

Calls: none

15. PYGEN

Function: this subroutine reads information needed to generate p-y curves, stores data for each layer, and calls ESCALL to generate p-y curves.

Called

By: COM624P

Calls: ESCALL

16. ESCALL

Function: subroutine ESCALL calls the appropriate subroutine for calculation of soil modulus or generation of p-y curves for verification purposes.

Called

By: COM624P, PYGEN

Calls: SOFTCL, STIFFB, STIFFA, SAND, INPY

17. SOFTCL

Function: this subroutine generates p-y curves for output verification and calculates secant soil modulus at all nodes in soil with KSOIL = 1 (internally-generated p-y curves in soft clay with Matlock's (1970) recommendations).

Called
By: ESCALL

Calls: Functions D, C, GAM, E50

18. STIFFB

Function: this subroutine generates p-y curves for verification of output and calculates secant soil modulus at all relevant nodes where KSOIL = 2 (stiff clay below the water table with criteria by Reese et al., 1975).

Called
By: ESCALL

Calls: Functions D, C, CAVG, GAM, E50, AS, AC

19. SAND

Function: this subroutine generates p-y curves for verification of output and calculates secant soil modulus at all relevant nodes where KSOIL = 4 (internally-generated p-y curves in sand with criteria by Reese et al., 1974).

Called
By: ESCALL

Calls: Functions D, GAM, PHI

20. STIFFA

Function: this subroutine generates p-y curves for verification of output and calculates secant soil modulus at all relevant nodes when KSOIL = 3.

Called

By: ESCALL

Calls: Functions D, C, CAVG, GAM, and E50

21. ROCK

Function: this subroutine generates p-y curves for verification of output and calculates secant soil modulus at all relevant nodes where KSOIL = 6 (internally-generated p-y curves in rock with limestone criteria by Reese and Nyman, 1978).

Called

By: ESCALL

Calls: Functions, D, C, CAVG, GAM, E50

22. LAYERS

Function: this subroutine calculates the equivalent thickness of soil layers for use in the theory for the behavior of layered soil.

Called

By: SOFTCL, STIFFB, STIFFA SAND

Calls: none.

23. PMEIX

Function: this subroutine calculates the ultimate bending capacity and variation of flexural rigidity based on given data on cross section.

Called

By: COM624P

Calls: SETUP, CSTRES, STEELP, SHELLP, SHELLM, COREP, COREM.

CHAPTER 3. GUIDE FOR EXECUTION OF COM624P ON A MICROCOMPUTER

INTRODUCTION

COM624P was written with user-friendly features such as menu input, free-field format, and screen editing. The output can be sent to printers for hard-copy or sent to plotters for display of graphics. This section describes the step-by-step procedures to operate the system.

Operation of COM624P consists of three steps. The first step is the creation of input-data files using the user friendly input menus or an ASCII input batch file using a text editor. After an input file has been created execute the program by selecting the "Run" menu or typing COM624P.EXE for batch file execution. The procedures for each step are described in the following paragraphs.

BACKING UP AND RESTORING ORIGINAL DISKETTE

The user is assumed to have basic knowledge on how to use the operating system (DOS) for selected microcomputers. Before operating, a backup copy should be made for each original diskette and the original diskettes should be stored in a safe place.

To make a backup of the entire diskette, the user can use the following steps:

1. Format a regular blank floppy diskette using the FORMAT command on the DOS operation system.

2. Insert the original diskette in Drive A, and the formatted diskette in Drive B, then enter the following:

```
A:> COPY A:*. * B: <CR>
```

(Note: <CR> represents the enter or return key)

3. If the user has a hard disk installed in the computer, use the following instructions to create a COM624P directory and save all the files onto the hard disk:

```
C:> MD COM624P <CR>
```

(Note: create a directory)

```
C:> CD COM624P <CR>
```

(Note: change main directory to COM624P directory)

```
C:\COM624P>COPY A:*. * <CR>
```

(Note: copy files from the original diskette in Drive A to the hard disk in Drive C)

GUIDE FOR INSTALLATION OF CONFIGURATION FILE

The program named INSTVIEW.EXE is used to create the configuration file used for video attributes and graphics drivers. The file produced by INSTVIEW is named C624EDIT.CFG. The configuration file must be kept on the same disk directory that contains C624EDIT.EXE and C624VIEW.EXE.

If these files are on Drive C, then enter the following:

```
C:\COM624P>INSTVIEW.EXE <CR>
```

INSTVIEW will begin and will ask the user to make selections regarding units of data, graphics hardware, Graphics Mode, and video attributes. The following sections discuss the information requested by INSTVIEW.

Control Parameters

The first input screen presented by INSTVIEW is the values for control parameters denoted by COM624P. The default values are provided as shown in the following. The user can change the preset values, if it is necessary. For example, an input value of 2 for units will cause COM624P to display SI units instead of English units. When the user is satisfied with the selection, the F8 key should be pressed to continue to the selection of the graphics driver and Graphics Mode.

```

                                C624EDIT Configuration File Editor

Units, 1 = lbs&inch, 2 = metric, 3 = other           1
p-y Curve Criteria: 0 = cyclic, 1 = static           1
Print full pile response: 0 = off, 1 = on            1
Print p-y curves: 0 = off, 1 = on .....            1
Iterations Limit for Analysis .....                100
Convergence tolerance for pile analysis ... 0.000100
Back-up data files: 0 = off, 1 = on .....           1
File Property Library Path & Name ..... B:PILEDATA.LIB

A 1:DEF:Num           1

: Move Cell — ? : Help — F2 : Edit Cell — F8 : Continue —
```

Graphics Driver and Mode

The second input screen presented by INSTVIEW is the menu from which the graphics driver is selected. The graphics drivers that are supported are:

- (1) CGA
- (2) MCGA
- (3) EGA (256K memory version)
- (4) EGA (64K memory version)
- (5) EGA driving monochrome monitors
- (6) VGA
- (7) IBM 8514
- (8) AT&T
- (9) Hercules monochrome
- (10) IBM PC3270

Graphics Drivers

- (1) Color Graphics Adapter (CGA)
 - (2) MCGA
 - (3) 16 Color Enhanced Graphics Adapter
 - (4) 4-Color Enhanced Graphics Adapter
 - (5) EGA driving Monochrome Display
 - (6) IBM-8514 Graphics Card
 - (7) Hercules Monochrome Graphics Adapter
 - (8) AT&T 400-Line Graphics Adapter
 - (9) Virtual Graphics Array (VGA)
 - (10) IBM PC3270 Graphics

 - (11) Accept this selection
- Current Selection is VGA
- Enter new selection: 11

All of the above graphics drivers, with the exception of the IBM PC3270 and Hercules monochrome, can be driven in a variety of modes. After the graphics driver has been selected, a third input

screen is presented for the selection of the Graphics Mode. The Graphics Mode controls the combination of pixel densities and colors used by COM624P.

```

                                Graphics Modes for VGA

(1) 640x200 16-Color
(2) 640x350 16-Color
(3) 640x480 16-Color

(4) Accept this selection

Current Selection is (3)

Enter new selection: 4

```

The next screen is to specify plotting-control values and the printing device in the system, as shown below. It should be noted that all the printer output will be sent to port LPT1. If the setup in the system is different, the user can use DOS MODE command to redirect the printer port.

```

                                Optional Plotting Control Values

Axis Title Character Size (IN) ..... 0.15000
Plotting Symbol Size (IN) ..... 0.15000
Plotter Pen Number for Axis Titles ..... 1
Plotter Pen Number for Axis and Borders ..... 1
Plotter Pen Number for Data Line & Symbols .. 1
Type of Printer Used for Screen Dump ..... 2
Codes for printers: 1 = Epson MX, FX
                   2 = Epson LQ
                   3 = Toshiba 24-pin
                   4 = HP LaserJet and DeskJet
                   5 = HP InkJet
                   6 = IBM Proprinter
                   7 = IBM Proprinter24

All printer output is sent to LPT1.
To redirect LPT1 to COM1 use the DOS MODE command.

A 1:DEF:Num          0.15000
----- : Move Cell --- ? : Help --- F2 : Edit Cell --- F8 : Continue ---|

```

Video Attributes

The final input screen presented by INSTVIEW is the interactive selection of the video attributes used in the screen menus. The user may use this feature to customize the colors used by Menu to suit his or her personal tastes. Five video attributes may be selected. They are the color schemes used on Menu backgrounds, the highlighted letter choices, the current Menu selections and the data-entry cells (both active and inactive). This interactive section shows an example of the current selections so that the user can appraise the selections and avoid confusing combinations of color. Users running the program on systems with monochrome monitors have a smaller range of selections, but still have a wide variety of possible selections.

Selections for the video attributes are made by moving the box to the desired combination of letter color and background color, then by pressing the appropriate Function Key (Keys F1 through F5). The user may change any of the selections as desired. The user then presses the Escape Key when satisfied with the current selections for the video attributes.

Acceptance of Changes

The last step of the installation process is for the user to indicate acceptance of the current configuration for COM624P. If the user is satisfied, 'Y' or 'y' should be entered for yes. If a 'yes' response is given, COM624P will write the new version of C624EDIT to the current directory and indicate that it has been changed. If the user enters an answer other than 'yes', the program exits without saving a new configuration file.

MENU STRUCTURE

COM624P, Version 2.0, uses the window feature and pull-down-menu interface for easy learning and operation. Figure 3.1 shows the complete structure of COM624P's Main Menu and its successive pull-down menus.

The main function of the File Menu is for assigning files for input, output, and graphical data. The "Input" Menu will call up Module C624EDIT which consists of four sub-menus. The sub-menu named "Analysis" in C624EDIT is for entering data that are needed for computation of a pile under lateral loading. The sub-menu named "Mult" is for entering data that are needed for computing the ultimate bending moment and EI-values for the selected-pile section. Because Module C624EDIT also can be used as a stand-alone program, the "File" sub-menu is provided for reading and saving of the data files. The "Option" sub-menu mainly provides the user an easy way for changing parameters on configuration.

The "Run" Menu will call up Module COM624P for execution, using the specified files for input and output. The "Graphics" Menu will call up Module C624VIEW, which consists of four sub-menus. The sub-menu "File" under the Graphics Menu is needed only if the Module C624VIEW is used as a stand-alone program. If a file name for graphical data has been given earlier, the program will automatically use that file for producing graphical results. The sub-menu named "View" is for generating graphics on the screen for preview. The sub-menu named "Plot" is for generating HP-GL plotting files for high-quality pen plotters. The sub-menu "Option" is provided for changing the parameters on configuration. The detailed discussion of each menu will be presented later in this chapter.

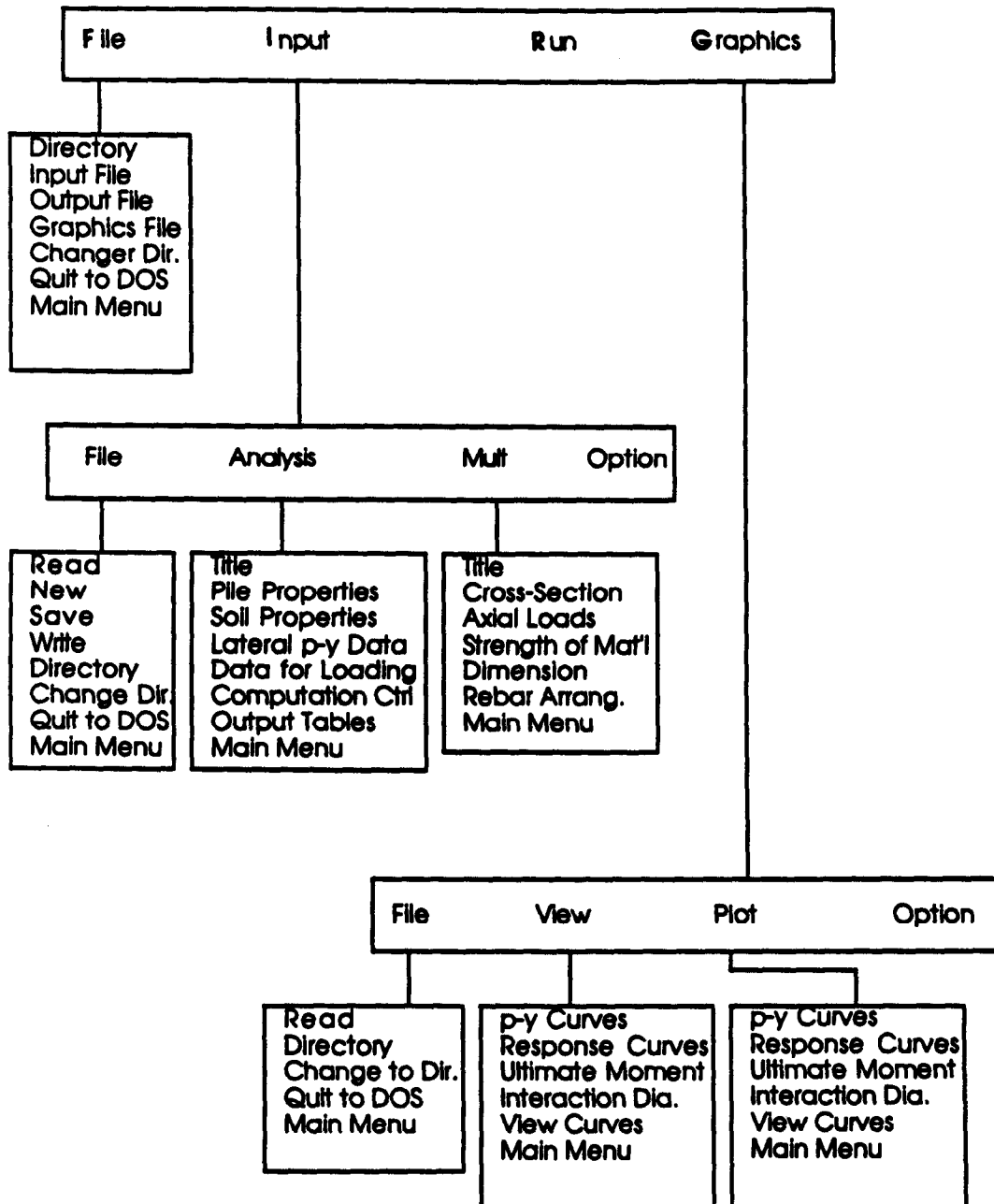

Figure 3.1. Main menu structure of COM624P.

GUIDE FOR USING MAINMENU

The MAINMENU.BAT file is a special batch file that will integrate all the modules needed for operation of COM624P in the DOS environment. The shell process was used so that the computer will automatically transfer control to the appropriate module, based on the given command.

To initiate the program, the user enters

```
C:\COM624P>MAINMENU <CR>
```

The program will quickly bring up the Main Menu on the screen. The Main Menu has four choices: File, Input, Run, and Graphics.

File Input Run Graphics

This program is developed especially for Design and analysis of piles under lateral loading. The current version is 2.0

The selection of the FILE menu allows the user to access a pull-down menu for file operations such as assigning input file, output file, and graphics file, reading in an existing file, creating a new data file, checking files in the directory, and similar operations.

The selection of INPUT menu allows the user to access Program C624EDIT to create a data file or to edit an existing data file.

The selection of the RUN menu allows the user to execute the program with the specified input and output files.

The selection of the GRAPHICS menu allows the user to view the soil and pile response curves directly on the screen. The system must have graphics adapters such as CGA, EGA, VGA, or monographics adapter in order to view the graphics.

F1-Help Alt-X-Exit

Once the Main Menu has been called, an item can be selected by pressing the key corresponding to the first letter in the name of the menu. The arrow keys can also be used to move the highlight bar and Enter can be pressed when the bar is at the appropriate command.

The selection of the File Menu allows the user to access a pull-down menu for file operations such as assigning an input file, output file, and graphics file, reading an existing file, creating a new data file, checking files in the directory, and similar operations.

The selection of the Input Menu changes the screen from the Main Menu to the Input Menu as shown in Figure 3.1. The selection of the Run Menu allows the user to execute the program with the specified files for input and output. The selection of the Graphics Menu changes the screen from the Main Menu to the Graphics Menu as shown in Fig. 3.1.

The first step is to select the File Menu. Once the File Menu has been pulled down, the hot keys for the Up arrow and the Down arrow can be used to highlight the desired command.

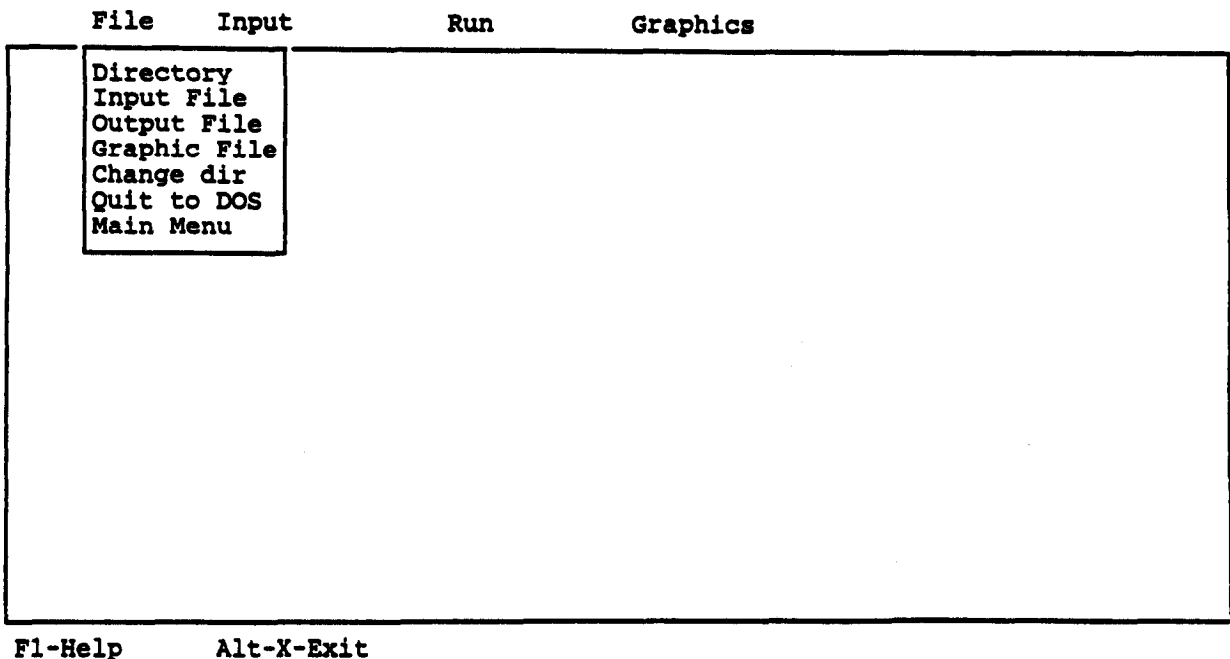

The user needs to specify a Input, Output, and Graphics file before selecting the Input, Run or Graphics Menu.

File	Input	Run	Graphics
Directory	Read File Name _____		
EXAMPLE.IN1			
Change dir			
Quit to DOS			
Main Menu			

F1-Help Alt-X-Exit

GUIDE FOR USING INPUT MENU

Input Menu Options

Once you select the "INPUT" from the Main Menu, the Input Menu will be shown on the screen as in the following.

File	Analysis	Mult	Option
C624EDIT 2.0, Edit Variables:			
This program is a preprocessor developed especially for users for preparation of input for the computer program COM624P. The main menu for this program is displayed as a bar at the top row of the screen. The main menu has four choices: FILE, ANALYSIS, MULT, and OPTION.			
The selection of the FILE menu allows the user to access a pull-down menu for file operations such as reading in an existing file, creating a new data file, checking files in the directory, and similar operations. The selection of the ANALYSIS menu allows the user to enter required data for computing the response of the pile and soil, such as distributions of deflection, bending moment, shear, and soil resistance as a function of length along the pile. The selection of the MULT menu allows the user to enter data of a selected pile size for computing the ultimate bending moment and other design-related information. The OPTION menu is used for screen setting and it may not be needed for most computer systems.			

F1-Help Alt-X-Exit

The Input Menu has four submenus: File, Analysis, MULT, and Option. The four menus allow the user to access file operations, data editing, control of variables in the analysis, and program options. If help is needed for data entry, the FI key is pressed to access the help files.

The user can move from one choice to another by using either the arrow keys or by typing the highlighted letter of the choice. Thus, if the File selection is currently highlighted (and the File pull-down menu is not shown), one may move to the Analysis selection by either typing the right-arrow key twice or by typing 'A' or 'a' for Analysis.

File Submenu

The File Submenu presented under the "Input" menu provides additional access to the commands for the control of input files. This menu controls reading of input files, creation of new input files, saving of files, examining the contents of any subdirectory, changing of directories, and exiting the program at the conclusion of use.

If the user has already specified the file name for the input data under the Main Menu, they need not give the file name here; however, if the input file was not specified previously, the selection of "File" will allow you to enter the file name again. To access the file menu, you need to move the highlighted bar to the "File" and press <Enter>. The options under the File submenu will be shown on the screen as the following.

The File pull-down menu commands are:

Read -	to read data files,
New -	to create a new data file,
Save -	to save the current data as a disk file,

Directory - to display disk directories,
Change Dir - to switch subdirectories,
Exit to Dos - to leave the program, and
Main - to return to the Main Menu.

File	Analysis	Mult	Option
Read New Save Directory Change dir Quit to DOS Main Menu			

F1-Help Alt-X-Exit

For example, to retrieve an existing input file named EXAMPLE.IN6, you can move the cursor to highlight "Read" on the submenu and press <Enter>. The screen will have a window for the user to enter the file name as shown below.

File	Analysis	Mult	Option
Read New			
New File Name			
EXAMPLE.IN6			
Change dir Quit to DOS Main Menu			

F1-Help Alt-X-Exit

Once the input file is found, the program will read line by line from the file and the data will be echoed on the screen.

File	Analysis	Mult	Option		
Reading EXAMPLE.IN6					
Line #10:	30.0000	30.0000	14906.0000	707.0000	
Line #10:	160.0000	30.0000	47813.0000	707.0000	
Line #11:	1 4	0.0000	360.0000	90.0000	
Line #12:	0.0000	0.06900			
Line #12:	360.0000	0.06900			
Line #13:	0.0000	0.0000	38.0000	0.00000	
Line #13:	360.0000	0.0000	38.0000	0.00000	
Line #17:	4				
Line #18:	20.0000				
Line #18:	60.0000				
Line #18:	100.0000				
Line #18:	150.0000				
Line #19:	1				
Line #20:	1 60000.0000	0.0000	50000.0000		
Line #21:	2 1				
Line #22:	50000.00				
Line #23:	3500.00	60000.00	0.00	29000000.00	
Line #24:	0.00	30.00	0.00	0.00	0.00
Line #25:	8 12	0	3.0000		
Press any key to continue					

F1-Help Alt-X-Exit

If there is an error in retrieving data, a message will be given on the screen. The user should note the cause of the error and press the <Enter> key to continue. Most of the errors have to do with the format of input data. The user should check the line number and make the correction later on the Edit screen.

After the editing of the input data is completed, the user needs to save the new data by moving the cursor to "Save" and pressing <Enter> after the "Save" was highlighted. A window will allow the user to give a file name for the new data as shown in the following.

The user can press "M" and then <Enter> to return to the initial Input Menu.

File	Analysis	Mult	Option
Read New Save			
Save File Name		EXAMPLE.IN7	
Main Menu			

F1-Help Alt-X-Exit

Analysis Submenu

The Analysis Submenu opens access to edit the various data groups defining the problem. Variables that may be edited through this submenu are title for the problem, pile properties, soil properties, load-transfer data, data for loading, computation control and output format.

File	Analysis	Mult	Option
	Title File Properties Soil Properties Lateral p-y Data Data for Loading Computation Control Output Tables Main Menu		

F1-Help Alt-X-Exit

The Analysis pull-down menu commands are:

- Title* - to edit the program title,
- Pile Properties* - to edit the pile properties (length, diameter, cross-sectional area, and EI),
- Soil Properties* - to edit the soil properties (layers, strength parameters, unit weights, etc.),
- Load-Transfer* - to edit the user-specified p-y curves,
- Data for Loading* - to edit loads at the top of the pile and the distributed load,
- Computation Control* - to select the tolerance and iteration numbers for computation,
- Output Tables* - to select options for printing output data, and
- Main* - to return to Main Menu.

The user can select any one of the items shown in the Analysis submenu to review, create, or change the data. Some of the variables for input may use an abbreviated name because of the limited space available on the editing window. However, all variables will have a full, detailed explanation in the help file. It should also be noted that all the x-coordinates described by the program are based on the origin which is set at the top of the pile. If help is needed for data entry, the user can press the "F1" key to access the help file, and press the "F8" to return to the edit screen.

The screens that are used to create data for EXAMPLE.IN6 are presented in the following to illustrate the usage of the Analysis submenu.

File Analysis Mult Option

C624EDIT 2.0, Edit Variables:

This program is a preprocessor developed especially for users for preparation of input for the computer program COM624P. The main menu for this program is displayed as a bar at the top row of the screen. The main menu has four choices: FILE, ANALYSIS, MULT, and OPTION.

The selection of the FILE menu allows the user to access a pull-down menu for file operations such as reading in an existing file, creating a new data file, checking files in the directory, and similar operations. The selection of the ANALYSIS menu allows the user to enter required data for computing the response of the pile and soil, such as distributions of deflection, bending moment, shear, and soil resistance as a function of length along the pile. The selection of the MULT menu allows the user to enter data of a selected pile size for computing the ultimate bending moment and other design-related information. The OPTION menu is used for screen setting and it may not be needed for most computer systems.

F1-Help Alt-X-Exit

File Analysis Mult Option

Title ←
File Properties
Soil Properties
Lateral p-y Data
Data for Loading
Computation Control
Output Tables
Main Menu

F1-Help Alt-X-Exit

Move the cursor to "Title", then press <Enter> key; the following screen will appear.

Enter title for this data file (up to 72 characters long)

EXAMPLE 6 ANALYSES RELATED TO DESIGN OF CONCRETE PILES

A 1:DEF:Lab EXAMPLE 6 ANALYSES RELATED TO DESIGN OF CONCRETE PILES

— : Move Cell — ? : Help — / : Edit Screen — F8 : Continue —
 F1-Help Alt-X-Exit

Press Command Key: [F8].

Title
 Pile Properties ←
 Soil Properties
 Lateral p-y Data
 Data for Loading
 Computation Control
 Output Tables
 Main Menu

F1-Help Alt-X-Exit

Move the cursor to "Pile Properties", then press <Enter> key;
 the following screen will appear.

Editing File Dimensions

Number of increments (<= 300)	100
Distance from top of pile to ground surface - inches	0.0
Length of pile	360.00
Pile modulus	3200000
Slope of ground surface (degrees)	0.0000

A 1:DEF:Num 100

_____ : Move Cell _____ ? : Help _____ / : Edit Screen _____ F8 : Continue _____
 F1-Help Alt-X-Exit

Press Command Key: [F8].

Editing File Section Properties

Section #	Top Depth inches	Diameter inches	Mom. of Inert. inches**4	Area inches ²
1	0.00	30.000	47813.0000	707.0000
2	30.00	30.000	14906.0000	707.0000
3	160.00	30.000	47813.0000	707.0000
4				
5				
6				
7				
8				
9				
10				

To access pile property library leave pile diameter blank.

A 1:DEF:Num 0.00000

_____ : Move Cell _____ ? : Help _____ / : Edit Screen _____ F8 : Continue _____
 F1-Help Alt-X-Exit

Press Command Key [F1] or "?" for help, the screen on next page will appear.

Help Topics

<p>Mult MENU</p> <ul style="list-style-type: none"> Mult - Shape and Axial Loads Mult - Rebar & Concrete Strength Mult - Section Dimension Mult - Rebar Arrangement <p>EDIT MENU</p> <ul style="list-style-type: none"> Edit - Title Edit - Pile Properties ← Edit - Soil Properties Edit - Soil - p-y Criteria Edit - Soil - k for Clays Edit - Soil - k for Sands Edit - Soil - E50 Edit - Soil - p-y Multipliers Edit - Soil - Unit Weights Edit - Lat. Load Trans. Edit - Data for Loading 	<ul style="list-style-type: none"> Edit - Computation Control Edit - Output Tables <p>FILE MENU</p> <ul style="list-style-type: none"> File - Read File - New File - Save File - Write File - Directory File - Change Directory File - Exit to DOS <p>MAIN MENU</p> <ul style="list-style-type: none"> Main - Pull-down Menus Main - Hot Keys <p>OPTIONS MENU</p> <ul style="list-style-type: none"> Options - Units Options - Pile Property Library Options - Save Config. File Options - Auto-backup
---	---

F1-Help Alt-X-Exit

Move the cursor to "Pile Properties" and press <Enter>; the following screen will appear.

The maximum number of increments allowed into which the pile is divided is 300. Typically the user will have selected the number of increments to be equal to some multiple of the overall pile length, so that the output values are calculated uniformly with depth.

Piles can have several different segments but each one is treated as a uniform cross section. For taper piles, the program allows the user to use up to 10 uniform segments to model the properties. "Top Depth" shown in Editing Pile Section Properties is the x-coord. (depth below the top of pile) of the top of a segment of pile with uniform cross section.

For frequent designers if the pile diameter is set equal to zero, the user gains access to a library file defining pile properties. The pile property library is created separately by the user for his own use. If the units of the data in the pile property library are different from those set inside C624EDIT, a units conversion is performed

_____ F1 : Help Index _____ PageUp PageDown _____ F8 : Return _____

F1-Help Alt-X-Exit

Press Command Key [F8] to return to the Edit Menu.

Editing File Section Properties

Section #	Top Depth inches	Diameter inches	Mom. of Inert. inches**4	Area inches ²
1	0.00	30.000	47813.0000	707.0000
2	30.00	30.000	14906.0000	707.0000
3	160.00	30.000	47813.0000	707.0000
4				
5				
6				
7				
8				
9				
10				

To access pile property library leave pile diameter blank.

A 1:DEF:Num 0.00000

_____ : Move Cell _____ ? : Help _____ / : Edit Screen _____ F8 : Continue _____
 F1-Help Alt-X-Exit

Press Command Key: [F8].

- Title
- File Properties
- Soil Properties ←
- Lateral p-y Data
- Data for Loading
- Computation Control
- Output Tables
- Main Menu

F1-Help Alt-X-Exit

Move the cursor to "Soil Properties", then press <Enter>; the following screen will appear.

File

Analysis

Mult

Option

EXAMPLE.IN6

Editing Shear Strength Information

Layer #	Depth inches	c psi	ϕ deg.	E50 @ 50% of c
1	0.00	0.000	38.00	0.0000
2	360.00	0.000	38.00	0.0000
3	360.00	10.000	0.00	0.0050
4	540.00	10.000	0.00	0.0050
5				
6				
7				
8				
9				
10				

A 4:DEF:Num 540.00000

_____ : Move Cell _____ ? : Help _____ / : Edit Screen _____ F8 : Continue _____
F1-Help Alt-X-Exit

Press Command Key [F8].

File

Analysis

Mult

Option

- Title
- PILE Properties
- Soil Properties
- Lateral p-y Data
- Data for Loading ←
- Computation Control
- Output Tables
- Main Menu

F1-Help Alt-X-Exit

Move the cursor to "Data for Loading", then press <Enter>; the following screen will appear.

Editing Loading Information

```
Distributed lateral loading (y/n) ? ..... n
Is loading cyclic (y/n) ? ..... n
Boundary condition code (KBC) ..... 1
```

```
KBC = 1 for shear and moment (free head)
KBC = 2 for shear and slope (fixed head)
KBC = 3 for shear and rotational restraint (partially fixed)
KBC = 4 for deflection and moment
```

A 1:DEF:Lab n

_____ : Move Cell _____ ? : Help _____ / : Edit Screen _____ F8 : Continue _____
 F1-Help Alt-X-Exit

Press Command Key [F8] to continue.

Editing File-head Loading

KOP	Shear pounds	Moment in-lbs	Axial Load pounds
1	20000.00	0.000	50000.00
1	40000.00	0.000	50000.00

```
KOP=0 if only a summary output for this load to be printed
=1 if complete output is desired for this load
```

A 1:DEF:Num 1

_____ : Move Cell _____ ? : Help _____ / : Edit Screen _____ F8 : Continue _____
 F1-Help Alt-X-Exit

Press Command Key [F8].

File Analysis Mult Option

Title
File Properties
Soil Properties
Lateral p-y Data
Data for Loading
Computation Control ←
Output Tables
Main Menu

F1-Help Alt-X-Exit

Move the cursor to "Computation Control", then press <Enter>; the following screen will appear.

File Analysis Mult Option EXAMPLE.IN6

1. Maximum number of iterations allowed for analysis : 100
2. Tolerance on solution convergence, inches : 0.000010
3. Value of deflection considered to be excessive, inches : 147.0000
4. Computation using internally-generated cracked EI (Y/N : N

Note: If the above answer is Y, remeber to enter the same axial load and other parameters such as arrangement of rebar, concrete and rebar strength in the "MULT" menu later.

A 1:DEF:Num 100

_____ : Move Cell _____ ? : Help _____ / : Edit Screen _____ F8 : Continue _____
F1-Help Alt-X-Exit

Press Command Key [F8] (if needed, press the [F-1] key to access the Help File for an explanation of cracked/uncracked EI).

File Analysis Mult Option

	<p>Title File Properties Soil Properties Lateral p-y Data Data for Loading Computation Control Output Tables ← Main Menu</p>	
--	--	--

F1-Help Alt-X-Exit

Move the cursor to "Output Tables," then press <Enter>; the following screen will appear.

File Analysis Mult Option EXAMPLE.IN6

Output Printing Options	
*** Lateral Load Analysis ***	
Printing Increment (1 for every node, 2 for every other node, etc)	1
Print deflection, moment, shear over full length of pile (y/n)	Y
Print p-y curves for verification	Y
A 1:DEF:Num 1	
_____ : Move Cell _____ ? : Help _____ / : Edit Screen _____ F8 : Continue _____	

F1-Help Alt-X-Exit

Press Command Key: [F8].

MULT Submenu

The MULT Submenu opens access to the editing commands for ultimate-bending moment computation. Variables edited through this menu are the title for computation, cross-sectional shape, axial loads, strength of materials, dimensions of cross section, and rebar measurement. The user can pull down the MULT submenu by moving the highlighted bar to "MULT" and press <Enter> after the initial Input Menu is returned to the screen as shown below.

File	Analysis	Mult	Option	EXAMPLE.IN6
		Title Cross Section Shape Axial Loads Strength of Materials Dimension of Cross Section Rebar Arrangement Main Menu		

F1-Help Alt-X-Exit

The MULT pull-down menu commands are:

- Title* - to edit the program title,
- Cross-section Shape* - to select the shape of the cross section,
- Axial Loads* - to enter the values of axial loads that are considered,
- Strength of Materials* - to enter the yield strength and the elastic modulus,
- Dimension of Cross Section* - to enter the dimensions for specified cross section,
- Rebar Arrangement* - to enter the rebar size, rebar number and arrangement, and
- Main* - to return to Main Menu.

If the user would like to compute the ultimate bending moment of the pile or ask the program to generate cracked/uncracked bending stiffness used for deflection computation, input data should be provided for each item under the MULT submenu. If cracked EI is chosen for the computation, the axial load entered in the "Data for Loading" submenu of the "Analysis" menu should be consistent with the axial load used in the "Mult" submenu for each case. If help is needed for data entry, the user can press "F1" key to access the help file and then press the "F8" key to return to the previous screen.

The screens that are needed to create data for EXAMPLE.IN6 are presented in the following screens to illustrate the usage of the MULT menu.

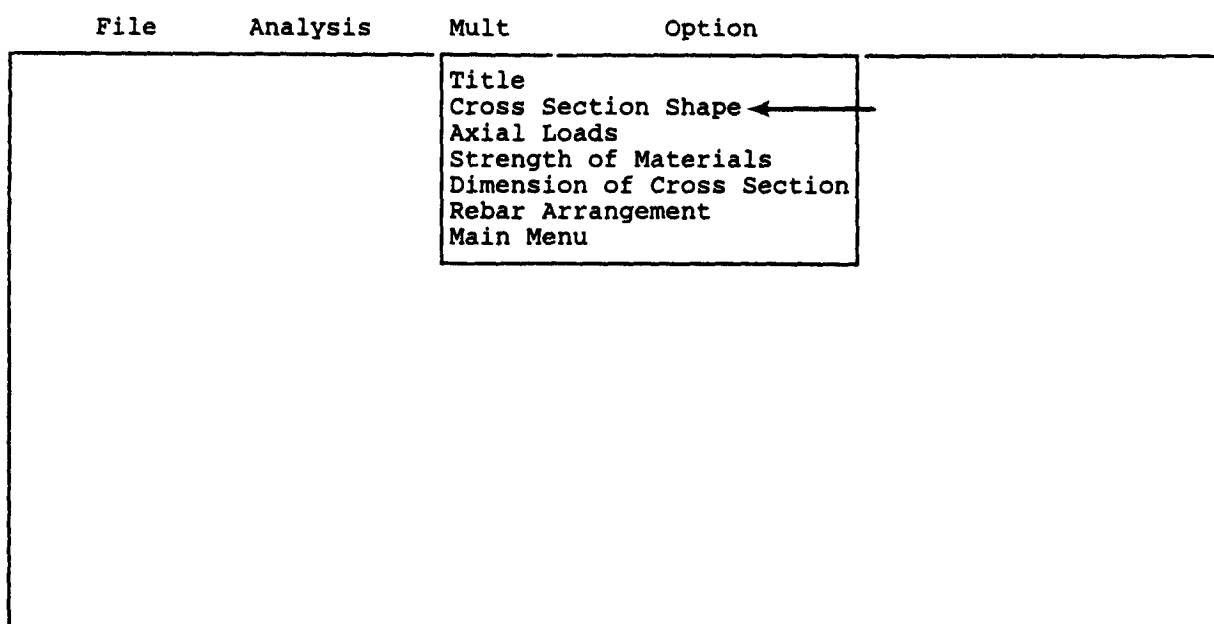

F1-Help Alt-X-Exit
Press Command Key: [C].

Identification number of the shape of cross section
of the pile:

- 1: Rectangular or square;
- 2: Circular (without shell or core);
- 3: Circular (with shell but without core);
- 4: Circular (with shell and core);
- 5: Circular steel pipe;

Enter the number: 2

A 1:DEF:Num 2

_____ : Move Cell — ? : Help — / : Edit Screen — F8 : Continue — |
F1-Help Alt-X-Exit

Press Command Key: [F8]

Title
Cross Section Shape
Axial Loads ←
Strength of Materials
Dimension of Cross Section
Rebar Arrangement
Main Menu

F1-Help Alt-X-Exit

Press Command Key: [A]

Enter axial loads for cross section design:

Point	Loads pounds
1	50000.00
2	
3	
4	
5	
6	
7	
8	
9	
10	

If the cracked EI will be used in computation of the pile deflection, the field will show the same axial load given in the "Analysis" menu.

A 1:DEF:Num 50000.00000

— : Move Cell — ? : Help — / : Edit Screen — F8 : Continue —
F1-Help Alt-X-Exit

Press Command Key: [F8]

Title
Cross Section Shape
Axial Loads
Strength of Materials ←
Dimension of Cross Section
Rebar Arrangement
Main Menu

F1-Help Alt-X-Exit

press Command Key: [S]

Enter strength parameters of materials

Cylinder strength of concrete	psi	3500.00000
Yield strength of reinforcement	psi	60000.00000
Yield strength of shell or core	psi	0.00000
Modulus of elasticity of steel	psi	29000000.00000

A 1:DEF:Num 3500.00000000

_____ : Move Cell — ? : Help — / : Edit Screen — F8 : Continue — |
F1-Help Alt-X-Exit

Press Command Key: [F8]

Title
Cross Section Shape
Axial Loads
Strength of Materials
Dimension of Cross Section ←
Rebar Arrangement
Main Menu

F1-Help Alt-X-Exit

Press Command Key: [D]

Enter cross-section dimension

Width of section (rectangular section only) inches	0.00000
Depth of section (rectangular section only) inches	0.00000
Outer diameter (circular section only) inches	30.00000
Outer diameter of core (circular section only) inches	0.00000
Thickness of shell (circular section only) inches	0.00000
Thickness of core (circular section only) inches	0.00000

A 1:DEF:Num 0.00000000

_____ : Move Cell _____ ? : Help _____ / : Edit Screen _____ F8 : Continue _____
F1-Help Alt-X-Exit

Press Command Key: [F8]

Title
Cross Section Shape
Axial Loads
Strength of Materials
Dimension of Cross Section
Rebar Arrangement ←
Main Menu

F1-Help Alt-X-Exit

Press Command Key: [R]

Rebar Arrangement

Size of the rebar (enter the bar number, 3, 5, 8, 9...)	8
Number of reinforcing bars	12
Number of rows of reinforcing bars (rectangular section only)	0
Cover of rebar (from center of rebar to outer edge of concrete) inches	3.0000

A 1:DEF:Num 8

_____ : Move Cell — ? : Help — / : Edit Screen — F8 : Continue — |
 F1-Help Alt-X-Exit

Press Command Key: [F8]

Title
Cross Section Shape
Axial Loads
Strength of Materials
Dimension of Cross Section
Rebar Arrangement
Main Menu ←

F1-Help Alt-X-Exit

Press Command Key: [M]

File Analysis Mult Option

C624EDIT 2.0, Edit Variables:

This program is a preprocessor developed especially for users for preparation of input for the computer program COM624P. The main menu for this program is displayed as a bar at the top row of the screen. The main menu has four choices: FILE, ANALYSIS, MULT, and OPTION.

The selection of the FILE menu allows the user to access a pull-down menu for file operations such as reading in an existing file, creating a new data file, checking files in the directory, and similar operations. The selection of the ANALYSIS menu allows the user to enter required data for computing the response of the pile and soil, such as distributions of deflection, bending moment, shear, and soil resistance as a function of length along the pile. The selection of the MULT menu allows the user to enter data of a selected pile size for computing the ultimate bending moment and other design-related information. The OPTION menu is used for screen setting and it may not be needed for most computer systems.

F1-Help Alt-X-Exit

Press Command Key: [F]

File Analysis Mult Option

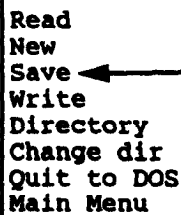

Read
New
Save
Write
Directory
Change dir
Quit to DOS
Main Menu

F1-Help Alt-X-Exit

Press Command Key: [S]

Options Submenu

The Options Submenu provides a path for the user to the commands that control where C624EDIT looks for a library file, for pile properties, and to save the current Analysis variables in the configuration file. The procedure for accessing the Options pull-down menu is no different than for the other menus. The user can move the cursor to "Options" and press <Enter>. The following information will be shown on your screen.

File	Analysis	Mult	Option
			Units pounds & inches Library Directory Save Configuration file Auto Backup On Main Menu

F1-Help Alt-X-Exit

The Options pull-down menu commands are:

- Units* - to select units for computation,
- Library Directory* - to change the name of the subdirectory containing the pile-properties library,
- Save Configuration File* - to save the current values of the Analysis and Options variables to the configuration file,
- Auto Backup* - a toggle switch to enable the automatic backing up of any file read by C624EDIT.EXE, so that the file may be saved under its original name. The backup-file name will be the original file name with a file extension of "BAK," and
- Main* - to return to the Main Menu.

COM624P can perform calculations in pounds and inches (Option 1), kilonewtons and meters (Option 2), or any consistent set on units (Option 3) for force and length. The user should take care that all input values are entered in consistent units. The following screen will illustrate how to select the units that the user requires.

File	Analysis	Mult	Option
			Units force & length
			Library D
			Save Conf 1 for pounds & inches
			Auto Back 2 for kN & meters
			Main Menu 3 for force & length
			Units = 1

F1-Help Alt-X-Exit

Pile-Library File

In many cases, a user may want to try several different sizes of piles, which can be a standard steel section or a non-standard reinforced concrete section, for the preliminary studies. The pile-library file is a data-base file in which the user can store data for most commonly-used pile sections. This file will be automatically loaded into the computer memory each time the user calls the Input Menu.

The pile-library file is associated with the section for editing pile properties in Module C624EDIT. The pile-library data will be presented on the screen for selection if the user leaves

blank the entry fields for pile diameter, moment of inertia, and area during the editing process.

The name of the file under which C624EDIT looks for the pile property library can have up to 42 characters. The user should be sure to enter the full name of the pile property library file, including the disk drive letter and path. The following screens will illustrate how to select the new pile property library.

File Analysis Mult Option

Editing File Section Properties

Section #	Top Depth inches	Diameter inches	Mom. of Inert. inches**4	Area inches ²
1	0.00			
2	240.00			
3				
4				
5				
6				
7				
8				
9				
10				

To access pile property library leave pile diameter blank.

A 2:DEF:Num 240.00000

_____ : Move Cell _____ ? : Help _____ / : Edit Screen _____ F8 : Continue _____
F1-Help Alt-X-Exit

Leave blank for all fields except for "Top Depth", then press [F8] key.

File Analysis Mult Option

File Section 1 - Top Depth = 0.00 inches

Select Appropriate File Type

HP 14x117, Axis X-X
HP 14x117 Axis Y-Y
HP 14x102, Axis X-X ←
HP 14x102, Axis Y-Y
HP 14x89, Axis X-X
HP 14x89, Axis Y-Y
HP 14x73, Axis X-X
HP 14x73, Axis Y-Y
HP 12x74, Axis X-X
HP 12x74, Axis Y-Y

FX = A FY = 3 Page = 0 Library entry 3

F1-Help Alt-X-Exit

Move the cursor to the selection for the first pile segment, then press <Enter>.

File Analysis Mult Option

File Section 2 - Top Depth = 240.00 inches

Select Appropriate File Type

HP 14x117, Axis X-X
HP 14x117 Axis Y-Y
HP 14x102, Axis X-X
HP 14x102, Axis Y-Y
HP 14x89, Axis X-X
HP 14x89, Axis Y-Y
HP 14x73, Axis X-X ←
HP 14x73, Axis Y-Y
HP 12x74, Axis X-X
HP 12x74, Axis Y-Y

FX = A FY = 7 Page = 0 Library entry 7

F1-Help Alt-X-Exit

Move the cursor to the selection for the second segment, then press <Enter>.

File Analysis Mult Option

Editing File Section Properties

Section #	Top Depth inches	Diameter inches	Mom. of Inert. inches**4	Area inches ²
1	0.00	14.030	1050.0000	30.0000
2	240.00	13.640	734.0000	21.5000
3				
4				
5				
6				
7				
8				
9				
10				

To access pile property library leave pile diameter blank.

A 1:DEF:Num 0.00000

_____ : Move Cell _____ ? : Help _____ / : Edit Screen _____ F8 : Continue _____
F1-Help Alt-X-Exit

The selection from the pile-library is shown on the above screen.

The format for pile-library data is quite straightforward. There are two lines of input reserved for each size of pile. The first line is used for the description of the pile section such as "HP 14 x 73, Y-Y Axis". The second line consists of five entry fields. The first entry is the I.D. for units. For English Units "1" is entered, and "2" is entered for S.I. units. The second entry on Line 2 is the diameter or width of the section perpendicular to the direction of loading. The third entry on Line 2 is the value of the moment of inertia. The fourth entry on Line 2 is the cross-sectional area. The last entry is the modulus of elasticity for the section. The free-field format is used for the entry. The user can use any text editor to add or delete the data in the pile-library file.

Guide to Data-Entry

When a selection is made from the Analysis or Mult Submenus, a data-entry-worksheet display appears on the screen. The data that have been entered are shown in a spreadsheet-type arrangement.

The data-entry worksheet screen, as shown in Fig. 3.2, contains three main sections:

1. The top line of the screen display is the Main Menu with 'Edit' highlighted.
2. The data-entry worksheet section consists of two boxes, a large box about 18 lines high followed by a small box about two lines high.
3. The bottom two lines of the display contain a guide to some of the 'key assignments' for commands to use with the data-entry worksheet.

File Analysis Mult Option EXAMPLE.IN6 ← Top Line

Editing Shear Strength Information

Layer #	Depth inches	c psi	ϕ deg.	E50 @ 50% of c
1	0.00	0.000	38.00	0.0000
2	360.00	0.000	38.00	0.0000
3				
4				
5				
6				
7				
8				
9				
10				

A 1:DEF:Num 0.00000 ← Small box for data entry

← Key Assignment

 : Move Cell — ? : Help — / : Edit Screen — F8 : Continue — |
F1-Help Alt-X-Exit

Figure 3.2. Data-entry worksheet.

The data-entry worksheet, Section 2, is the most important part of the display, and the section where all of the data-entry operations will take place.

The upper, and largest, box of the worksheet section of the screen display contains the data that have been entered. These data are in a spreadsheet-type arrangement; that is, in columns, designated alphabetically from left to right, and in rows, designated numerically from top to bottom. A location, designated by a column letter and a row number, is called a cell and each item of data is stored in one of these cells. By using the cursor-movement commands, a highlight can be moved in any direction from the upper left cell to the lower right cell. The highlighted cell is called the 'working cell'. A cell must be highlighted - the working cell - for data to be entered or edited. The data in an existing file, shown on the worksheet, can be manipulated to some extent by using the Worksheet Edit commands that will be described later.

The lower box of the worksheet section of the display is where data are entered into the working cell, or the existing data is edited. This box has two lines. The upper line shows the following information for the working cell:

Location - column letter and row number,
Status - UND means the cell is not defined as a part of
the data and DEF means the cell has been
defined to contain data, and
Data - the data type [Num for numeric and Lab(label)
for alphanumeric] followed by the existing
data in the cell.

The bottom line of the lower box is the 'Entry Line' where data entry or data editing are done. A blinking cursor is shown on this line. Data are typed by moving the cursor to the right. Only the Backspace key, however, may be used for corrections to

the typed data; the Backspace key is used to move the cursor back (without canceling the typed symbols) to where a correction is to be made, and then the correct data are overtyped. The Enter (Return) key is used to accept edited data as the data in the working cell.

If the information in the working cell requires editing, two methods may be used. The simplest way is merely to reenter the data. The other way is to enter the Cell Edit Mode by pressing the F2 key. Editing in this mode will be explained later. The key assignments in the bottom two lines of the display, Section 3, change to show Cell Edit commands. These commands are used to make the desired modifications to the data in a cell. Pressing Enter (Return) will exit the Edit Mode and also replace the existing data in the working cell with the edited data.

Worksheet Commands

There are three sets of commands to be used with a data-entry worksheet. These are the Basic Worksheet Commands, the Cell Edit Commands, and the Worksheet Edit Commands. The Basic Worksheet Commands are in effect when a data-entry worksheet is entered. The other two sets of commands are invoked from the Basic Worksheet Commands. A key assignment in the form of '^ (key)' may be found in the command sets. To obtain this key assignment, the 'Cntl' and the second key are pressed at the same time. For example, ^A is obtained by pressing <Cntl> and <A> at the same time. The key assignments for the various sets of commands are given in the following paragraphs.

Basic Worksheet Commands

These commands are in effect when a display of a data-entry worksheet is on the screen, except when either of the other two

command sets has been invoked and is in use. The key assignments for some, but not all, of these commands are shown in the bottom two lines, Section 3, of the screen display. The key assignments for the commands in this set are as follows:

<u>Key Assignment</u>	<u>Action</u>
Left Arrow	Move highlight one cell to the left
Right Arrow	Move highlight one cell to the right
Up Arrow	Move highlight up one cell
Down Arrow	Move highlight down one cell
Page Up	Move up one page (if more than one page)
Page Down	Move down one page (if more than one page)
F2	Enter Cell-Edit Mode
Return (Enter)	Accept data entered or edited, exit Cell-Edit Mode
/	Enter Worksheet-Edit Mode
F8	Return to Edit Menu or move to next worksheet for current menu item
End	Return to Main Menu
? or F1	Enter Help Mode

The preceding commands are all self-explanatory except for "F2" - Enter Cell - Edit Mode and "/" - Enter Worksheet - Edit Mode, which will be described in detail in the next two sections.

The following screens illustrate the procedures for calling the help file during data entry. It should be noted that the help file is a simple text file to which the user can add his/her own comments or notes at desirable locations. The user can open the help file named C624EDID.HLP by using any available text editor. The help file, however, always needs to stay in the same file directory with C624EDIT.EXE.

File	Analysis	Mult	Option	EXAMPLE.IN6
Editing Shear Strength Information				
Layer #	Depth inches	c psi	ϕ deg.	E50 @ 50% of c
1	0.00	0.000	38.00	0.0000
2	360.00	0.000	38.00	0.0000
3				
4				
5				
6				
7				
8				
9				
10				
A 1:DEF:Num 0.00000				
_____ : Move Cell _____ ? : Help _____ / : Edit Screen _____ F8 : Continue _____ F1-Help Alt-X-Exit				

The help topics will be shown on the screen once the "F1" or "?" keys have been pressed. You can move the cursor to the desired topics and press <Enter> to bring the help instruction on to the screen.

File Analysis Mult Option

Help Topics

Mult MENU	Edit - Computation Control
Mult - Shape and Axial Loads	Edit - Output Tables
Mult - Rebar & Concrete Strength	FILE MENU
Mult - Section Dimension	File - Read
Mult - Rebar Arrangement	File - New
EDIT MENU	File - Save
Edit - Title	File - Write
Edit - File Properties	File - Directory
Edit - Soil Properties	File - Change Directory
Edit - Soil - p-y Criteria	File - Exit to DOS
Edit - Soil - k for Clays	MAIN MENU
Edit - Soil - k for Sands	Main - Pull-down Menus
Edit - Soil - E50 ←	Main - Hot Keys
Edit - Soil - p-y Multipliers	OPTIONS MENU
Edit - Soil - Unit Weights	Options - Units
Edit - Lat. Load Trans.	Options - File Property Library
Edit - Data for Loading	Options - Save Config. File
	Options - Auto-backup

F1-Help Alt-X-Exit

Move the cursor to the "E50", then press <Enter>.

File Analysis Mult Option EXAMPLE.IN6

Soil Strain Parameter E50

Soft Clay,	c = 1.74 to 3.47 psi	E50 = 0.02
	250 to 500 psf	
	12 to 24 KPa	
Medium Clay,	c = 3.47 to 6.94 psi	E50 = 0.01
	500 to 1000 psf	
	24 to 48 KPa	
Stiff Clay,	c = 6.94 to 13.9 psi	E50 = 0.007
	1000 to 2000 psf	
	48 to 96 KPa	
Very Stiff Clay,	c = 13.9 to 27.8 psi	E50 = 0.005
	2000 to 4000 psf	
	96 to 192 KPa	

F1 : Help Index PageUp PageDown F8 : Return

F1-Help Alt-X-Exit

Press Command Key [F8] to return.

Cell-Edit Commands

The Cell-Edit Mode is used to make changes and additions to the data in the working cell, and is entered by typing the F2 key. When this key is pressed, a highlighted bar will appear on the line between the two worksheet boxes as shown in the following.

```
File      Analysis      Mult      Option      EXAMPLE.IN6

Enter title for this data file (up to 72 characters long)
EXAMPLE 6 ANALYSES RELATED TO DESIGN OF CONCRETE PILES

----- Edit Mode ----- Overwrite -----
A 1:DEF:Lab EXAMPLE 6 ANALYSES RELATED TO DESIGN OF CONCRETE PILES
EXAMPLE 6 ANALYSES RELATED TO DESIGN OF CONCRETE PILES
^A ^F : Move Cursor ----- Insert/Delete/^G -----
F1-Help      Alt-X-Exit
```

The highlighted bar contains 'Edit Mode' and an indication that the data entry is in the 'Insert' or the 'Overwrite' condition. Two general types of commands are available, cursor-movement commands and data-change commands. The key assignments for the Cell-Edit Mode are displayed in the bottom two lines, Section 3, of the screen.

Key Assignment

Action

Left Arrow

Move cursor on the entry line to the left

Right Arrow	Move cursor on the entry line to the right
^A	Move cursor to beginning of the entry line
^F	Move cursor to end of the entry line
Insert	Toggles between 'Insert' and 'Overtyping' for data entry
Del	Deletes character to the left of the cursor
^G	Deletes character at the cursor
Return (Enter)	Accepts data on the entry line and exits Cell-Edit Mode

The following screens illustrate how to use the above commands for changing the data.

File	Analysis	Mult	Option	EXAMPLE.IN6
Enter title for this data file (up to 72 characters long)				
EXAMPLE 6 ANALYSES RELATED TO DESIGN OF CONCRETE PILES				
Edit Mode		Insert On		
A 1:DEF:Lab EXAMPLE 6 ANALYSES RELATED TO DESIGN OF CONCRETE PILES				
EXAMPLE 6 ANALYSES RELATED TO DESIGN OF REINFORCED CONCRETE PILES				
^A ^F : Move Cursor		Insert/Delete/^G		
F1-Help	Alt-X-Exit			

Press the "Ins" key to change to insert mode for the edited cell, then add the word "Reinforced" before the word "Concrete" as shown in the next screen.

Enter title for this data file (up to 72 characters long)
 EXAMPLE 6 ANALYSES RELATED TO DESIGN OF REINFORCED CONCRETE PILES

A 1:DEF:Lab EXAMPLE 6 ANALYSES RELATED TO DESIGN OF REINFORCED CONCRETE PILES

_____ : Move Cell _____ ? : Help _____ / : Edit Screen _____ F8 : Continue _____
 F1-Help Alt-X-Exit

Worksheet-Edit Commands

The Worksheet-Edit Mode is used to manipulate entire lines of data in the worksheet. It is invoked by typing '/' from the Basic-Worksheet-Command list. When the '/' is typed, a highlighted bar appears on the line between the two worksheet boxes, and a list of possible operations appears in the highlighted bar as shown in the following.

Editing File Section Properties

Section #	Top Depth inches	Diameter inches	Mom. of Inert. inches**4	Area inches ²
1	0.00	30.000	47813.0000	707.0000
2	30.00	30.000	14906.0000	707.0000
3	160.00	30.000	47813.0000	707.0000
5				
6				
7				
8				
9				
10				

To access pile property library leave pile diameter blank.

Blank Copy Delete Exchange Insert Move

A 1:DEF:Num 0.00000
 /

_____ : Move Cell _____ ? : Help _____ / : Edit Screen _____ F8 : Continue _____
 F1-Help Alt-X-Exit

A '/' also appears on the entry line of the lower box. To complete the command, the first letter of the choice from the list of possible operations is typed on the entry line; in addition, some answers to prompts on the entry line may have to be typed. After the selected operation is complete, the program returns to the Basic-Worksheet-Command Mode. The following operations are available:

<u>Key</u> <u>Assignment</u>	<u>Action</u>
/B(lank)	Erase current row and set all cells on the row to UND (undefined) status
/C(opy)	Copies contents of first row specified to second row specified
/D(elete)	Deletes current row and moves up following rows
/E(xchange)	Exchanges contents between first row specified and second row specified
/I(nsert)	Inserts blank row where specified and moves following rows down
/M(ove)	Moves contents of first row specified to second row specified and adjusts contents of intermediate rows so no data are lost
ESC(ape)	Exits Worksheet-Edit Mode without performing any operation

The following screens are presented to illustrate the procedures for copying and deleting one row of data. For copying data, type "C" in the lower box of the edit screen, then tell the program to copy data from Row 2 to Row 4 as shown below.

```

                                Editing File Section Properties

Section  Top Depth  Diameter  Mom. of Inert.  Area
#        inches    inches    inches**4      inches2
1         0.00     30.000   47813.0000     707.0000
2         30.00     30.000   14906.0000     707.0000
3        160.00     30.000   47813.0000     707.0000
4
5
6
7
8
9
10

To access pile property library leave pile diameter blank.

_____ Blank Copy Delete Exchange Insert Move _____
A 1:DEF:Num 0.00000
Copy from row 2 to row 4 ←
_____ : Move Cell _____ ? : Help _____ / : Edit Screen_____ F8 : Continue _____
F1-Help            Alt-X-Exit
    
```

Press <Enter> after the command is given, you will see the data from Row 2 are also presented in Row 4.

```

                                Editing File Section Properties

Section  Top Depth  Diameter  Mom. of Inert.  Area
#        inches    inches    inches**4      inches2
1         0.00     30.000   47813.0000     707.0000
2         30.00     30.000   14906.0000     707.0000
3        160.00     30.000   47813.0000     707.0000
4         30.00     30.000   14906.0000     707.0000
5
6
7
8
9
10

To access pile property library leave pile diameter blank.

_____ : Move Cell _____ ? : Help _____ / : Edit Screen_____ F8 : Continue _____
F1-Help            Alt-X-Exit
    
```

If the user decides to erase Row 4, the user need to press the "/" key first, then type "D" in the lower box of the edit screen. The screen will ask the user to specify a row number as shown below.

```

File      Analysis  Mult      Option      EXAMPLE.IN6

Editing File Section Properties

Section  Top Depth  Diameter  Mom. of Inert.  Area
#        inches   inches    inches**4      inches²
1         0.00    30.000    47813.0000     707.0000
2         30.00    30.000    14906.0000     707.0000
3        160.00    30.000    47813.0000     707.0000
4         30.00    30.000    14906.0000     707.0000
5
6
7
8
9
10

To access pile property library leave pile diameter blank.

Blank Copy Delete Exchange Insert Move
A 1:DEF:Num 0.00000
Delete row: 4 ←
: Move Cell — ? : Help — / : Edit Screen — F8 : Continue —
F1-Help      Alt-X-Exit
  
```

Press the <Enter> key, the user will find data on Row 4 are removed as presented in the following screen.

```

File      Analysis  Mult      Option      EXAMPLE.IN6

Editing File Section Properties

Section  Top Depth  Diameter  Mom. of Inert.  Area
#        inches   inches    inches**4      inches²
1         0.00    30.000    47813.0000     707.0000
2         30.00    30.000    14906.0000     707.0000
3        160.00    30.000    47813.0000     707.0000
4
5
6
7
8
9
10

To access pile property library leave pile diameter blank.

A 1:DEF:Num 0.00000
: Move Cell — ? : Help — / : Edit Screen — F8 : Continue —
F1-Help      Alt-X-Exit
  
```

GUIDE FOR RUNNING MAIN PROGRAM (COM624P)

After an input file has been created and saved on the same directory, press the <ALT> and <X> keys simultaneously to exit the Input screen and return to the original Main Menu as shown below. To execute the program, the user should move the cursor to "Run" as shown on the top of the screen and press <Enter>. A normal run will end in less than one minute if a math-coprocessor is installed. The text output and graphics data will be created and saved to the previously specified files, respectively. If an unexpected result is encountered, the program will stop running and an error message will be shown on the screen. Then, the user should check the input data carefully. If Module COM624P is used as a stand-alone program, make sure to erase the file named "COMFILE.DAT" if it exists in the same directory. This file is a temporary file to be used for the shell process.

File Input Run ← Graphics

This program is developed especially for Design and analysis of piles under lateral loading. The current version is 2.0

The selection of the FILE menu allows the user to access a pull-down menu for file operations such as assigning input file, output file, and graphics file, reading in an existing file, creating a new data file, checking files in the directory, and similar operations.

The selection of INPUT menu allows the user to access Program C624EDIT to create a data file or to edit an existing data file.

The selection of the RUN menu allows the user to execute the program with the specified input and output files.

The selection of the GRAPHICS menu allows the user to view the soil and pile response curves directly on the screen. The system must have graphics adapters such as CGA, EGA, VGA, or monographics adapter in order to view the graphics.

F1-Help

Alt-X-Exit

GUIDE FOR OPERATING GRAPHICS POSTPROCESSOR (C624VIEW)

After a successful run, the graphics data will be saved to the specified file. The user can move the cursor to "Graphics" shown on the top of the Main Menu and press <Enter> to open the graphics window.

File Input Run Graphics ←

This program is developed especially for Design and analysis of piles under lateral loading. The current version is 2.0

The selection of the FILE menu allows the user to access a pull-down menu for file operations such as assigning input file, output file, and graphics file, reading in an existing file, creating a new data file, checking files in the directory, and similar operations.

The selection of INPUT menu allows the user to access Program C624EDIT to create a data file or to edit an existing data file.

The selection of the RUN menu allows the user to execute the program with the specified input and output files.

The selection of the GRAPHICS menu allows the user to view the soil and pile response curves directly on the screen. The system must have graphics adapters such as CGA, EGA, VGA, or monographics adapter in order to view the graphics.

F1-Help Alt-X-Exit

The graphics window with pull-down menu is designed for C624VIEW. The configuration file, C624EDIT.CFG, must be on the same disk directory that contains C624VIEW.EXE. If there is no plot shown on the screen after the graphics data have been read in, the user may need to again run the installation program INSTVIEW.EXE, described in a previous section, to specify the correct screen driver for the program. The detailed procedures for using C624VIEW to obtain graphics will be presented in the following section.

The driver supports the IBM color-graphics adapter (CGA), IBM enhanced color-graphics adapter (EGA), Hercules graphics boards and video-graphics array (VGA). The graphics adapters and

printers supported by this graphics package are listed in Table 3.1. The distributor will not be responsible for modifying the software for use on any graphics adapter or printer not listed or not compatible to those listed in Table 3.1. The graphics program is easy to use and the procedures will be illustrated in this section.

TABLE 3.1. DRIVER INFORMATION FOR GRAPHICS ADAPTERS AND PRINTERS

GRAPHICS ADAPTERS
IBM Color-Graphics Adapter (CGA)
IBM Enhanced-Graphics Adapter (EGA)
IBM PC3270
Hercules Monochrome
AT&T Indigenous Graphics Board
IBM Video-Graphics Array (VGA)
PRINTERS
Epson MX, FX, LX-80, 100, Okidata, Panasonic, and Star Gemini
Epson LQ
IBM Proprinter
Hewlett Packard Laser Jet and Desk Jet
Hewlett Packard Pen Plotter

Graphics Menu

The Graphics Menu is displayed on the top line of the screen. This menu has four submenus: File, Select, View, and Options. Any of these selections may be chosen by highlighting the selection using the cursor keys or by typing the first letter of the selection ("V" for View, etc.)

When the Graphics Menu is active, a status report is displayed on the screen below the Main Menu. This report shows the number and size of any data sets stored currently in the microcomputer's memory and indicates what data sets are currently selected for viewing.

File View Plot Options

```
C624VIEW Version 2.0, Graphics Data:
Number of p-y curves: NumPYcurve = 4
Number of load-response curves: NumCurves = 2
Number of point on load-response curves: Npts = 99
Units are Pounds & Inches
p-y Curves selected for viewing

Response Curves selected for viewing

277520 bytes available
Largest block contains 277520 bytes

The graphics data file is PLOTDATA
```

Alt-X Exit

File Menu

The File Menu is used to read files of graphics data, show the current subdirectory, change the logged subdirectory, or quit the program and return to the disk-operating system. The selections in the File Menu are:

Read - to enter the name of the file to be read. If the file does not exist or is empty, a diagnostic message is displayed,

Directory - to display the directory of the current subdirectory,

Change Dir - to change the logged subdirectory,

Quit - to quit UPVIEW and return to DOS, and

Main Menu - to return to the Main Menu.

If the user has already specified in the Main Menu the file name for the graphics data, the program will automatically read and display it on the screen. However, if the user would like to view the graphics under other file names, then the user can move the cursor to "Read" and type the new file name as shown below.

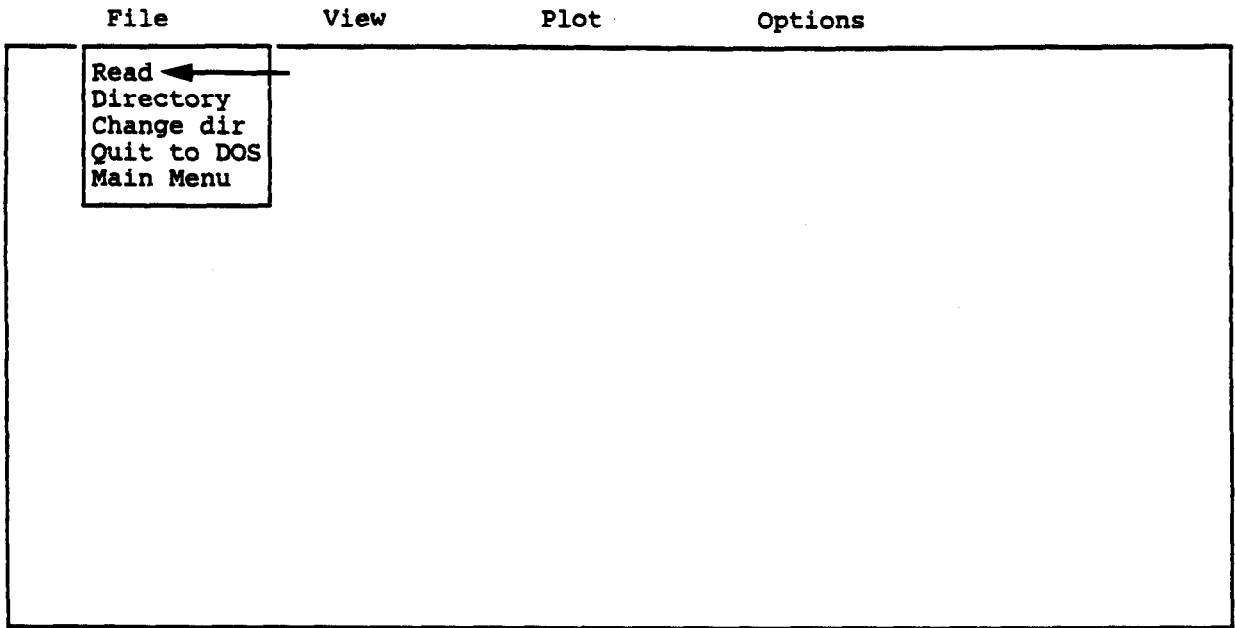

Alt-X Exit

Move the cursor to the "Read", then press <Enter>.

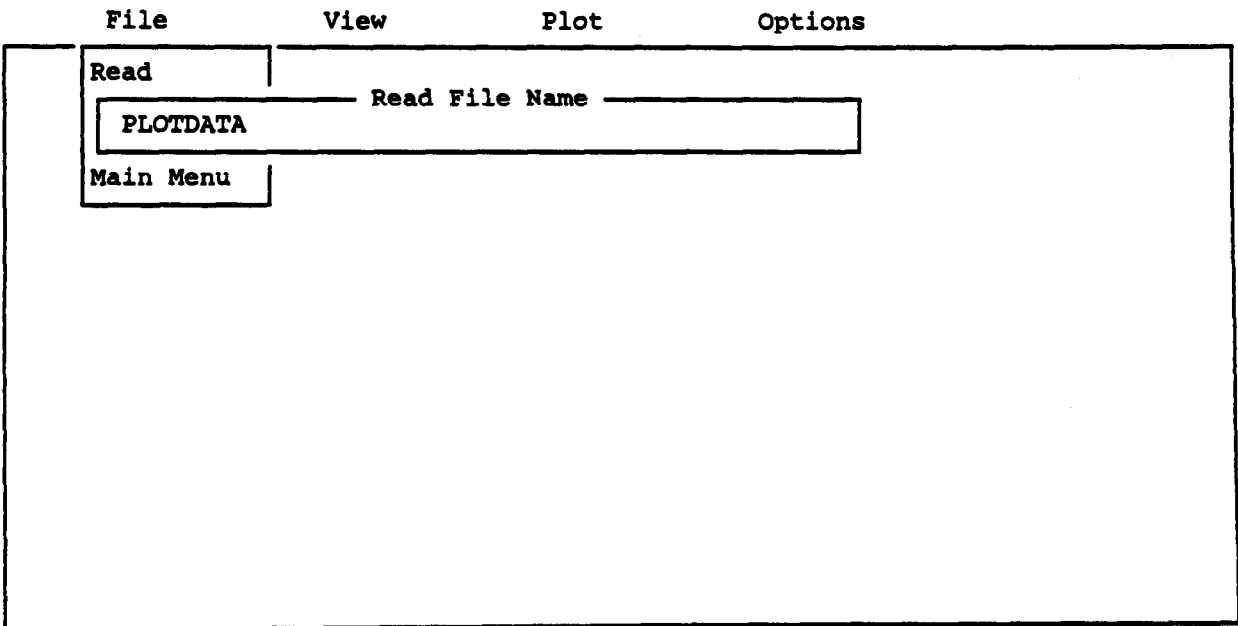

Alt-X Exit

View Menu

The View Menu is used to select the data sets to view under the View option. The selections on the View Menu are:

p-y Curves - to select individual p-y curves for viewing. To select a p-y curve, the user tabs down to the desired curve using the cursor keys, then presses the space bar. An asterisk will mark any p-y curve to be displayed. Pressing the space bar a second time will turn off the selection. Finally, F8 is pressed to return to the Select Menu.

Response Curves - to select individual curves for viewing that show the response of the pile. Pile-response curves are selected in the same manner as p-y curves,

Ultimate-Moment Curves - to select curves of moment versus curvature or curves of flexural rigidity (EI) versus moment for different axial-loading cases.

Interaction Diagram - to select the interaction diagram (ultimate moment vs. axial load). In order to view the diagram, the user must have selected at least three different axial loads for computation.

View Curves - to display the selected curves and to dump the graphics on the screen, and

Main Menu - to return to the Main Menu.

The user can type "V" or move the cursor to "View," then press the <Enter> key to pull down the View Menu.

The p-y curves are displayed first (if selected), followed by the pile-response curves for deflection, moment, shear, and soil reaction, and followed by the moment-curvature curve, the EI-moment curve, and the interaction diagram. The user clears the display by pressing the <Enter> key.

File	View	Plot	Options
	p-y Curves Response Curves Ultimate Moment Interaction Diagram View Curves Main Menu		

Alt-X Exit

A dump of the graphics from the screen is possible to any Epson dot-matrix, IBM or HP laser jet, or any compatible printing device. The dump is triggered by pressing the Control and "P" keys simultaneously. The user can specify the type of printer during installation or specify the printer in the Options submenu. If no printer is connected or is turned off, the program will lock until the printer is made available.

The following screens will illustrate the procedures to view each graphic. Be sure to follow the instructional commands which are printed directly below each screen for practice.

File

View

Plot

Options

p-y Curves ←
Response Curves
Ultimate Moment
Interactive Diagram
View Curves
Main Menu

Alt-X Exit

Press Command Key: [P].

File

View

Plot

Options

Selection of p-y Curves for Viewing

	Number	Depth
ON	1	20.00
ON	2	60.00
ON	3	100.00
ON	4	150.00

Toggle Viewing of Curves ON/off Using Space Bar ←

F8 : Continue

Alt-X Exit

Press Command Key: [F8].

File	View	Plot	Options
	<p>p-y Curves Response Curves ← Ultimate Moment Interactive Diagram View Curves Main Menu</p>		

Alt-X Exit
 Press Command Key: [R].

File	View	Plot	Options	
Selection of Response Curves for Viewing				
Number	Deflection	Moment	Shear	Soil Reaction
1	ON	ON	off	off
Toggle Viewing of Curves ON/off Using Space Bar ←				
F8 : Continue				

Alt-X Exit
 Press Command Key: [F8].

File	View	Plot	Options
	<p>p-y Curves Response Curves Ultimate Moment ← Interactive Diagram View Curves Main Menu</p>		

Alt-X Exit
 Press Command Key: [U].

File	View	Plot	Options
Selection of Moment, Curvature and EI Curves for Viewing			
Number	Moment vs Curvature	EI vs Moment	
1	ON	ON	
2	off	off	
3	off	off	
Toggle Viewing of Curves ON/off Using Space Bar			
F8 : Continue			

Alt-X Exit
 Press Command Key: [F8].

File

View

Plot

Options

p-y Curves
Response Curves
Ultimate Moment
Interactive Diagram
View Curves
Main Menu

Alt-X Exit

Press Command Key: [I].

File

View

Plot

Options

Selection of Curves Under Various Axial Loads for Viewing

	Number	Axial Load
ON	1	0.00
ON	2	100.00
ON	3	1000.00

Toggle Viewing of Curves ON/off Using Space Bar

F8 : Continue

Alt-X Exit

Press Command key: [F8].

File

View

Plot

Options

p-y Curves
Response Curves
Ultimate Moment
Interactive Diagram
View Curves ←
Main Menu

Alt-X Exit

Press Command Key: [V].

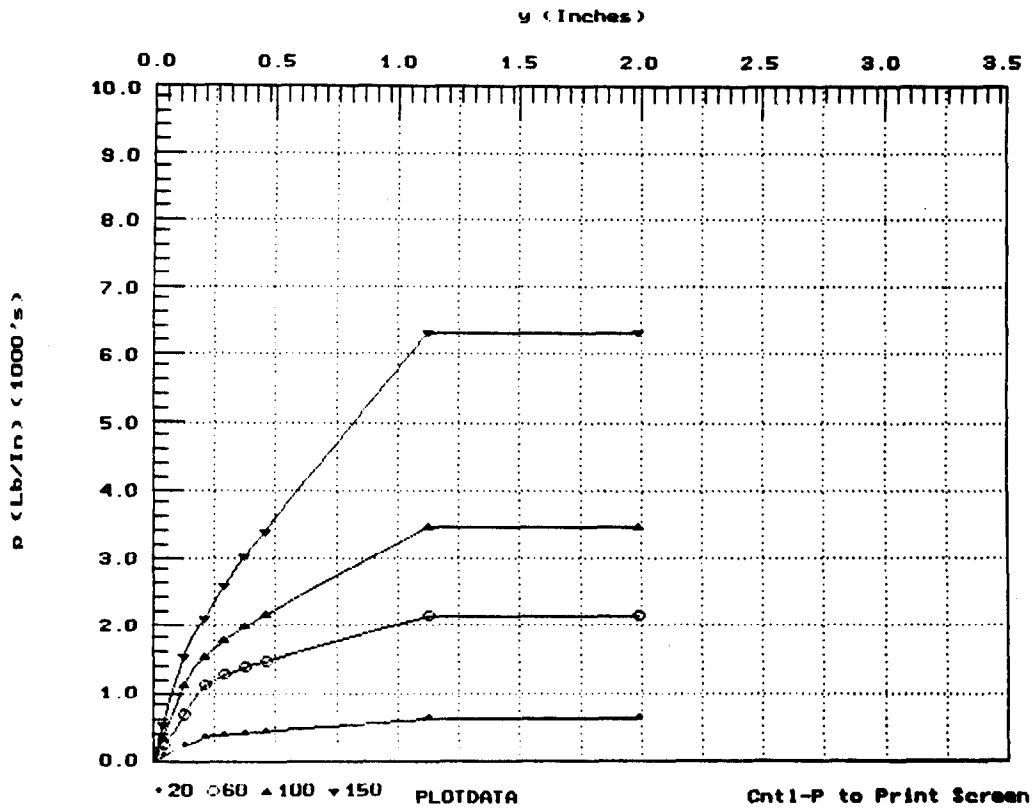

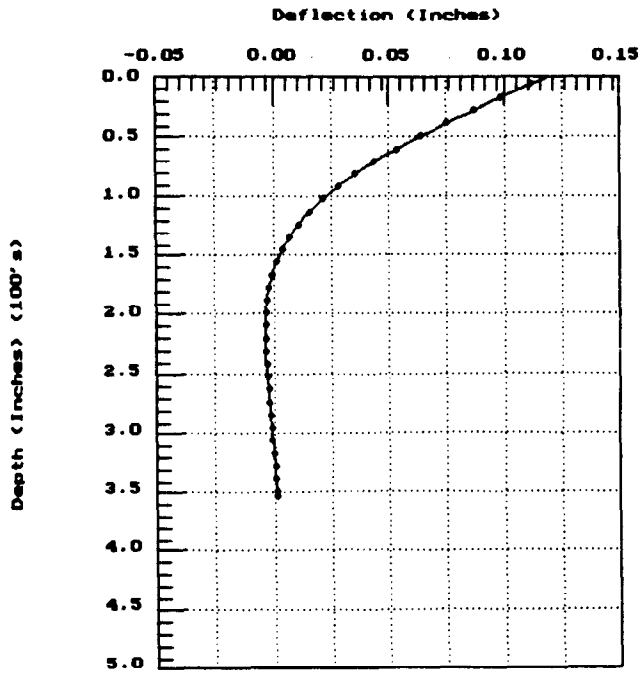

PLOTDATA

Cntl-P to Print Screen

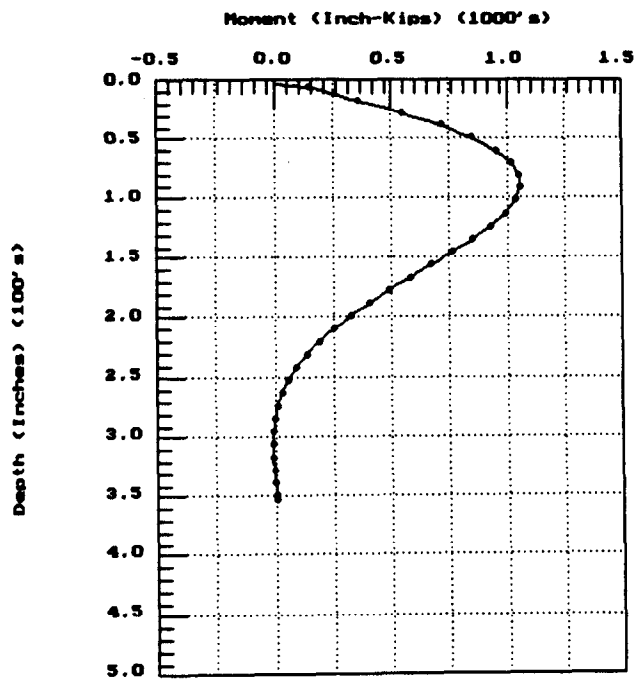

PLOTDATA

Cntl-P to Print Screen

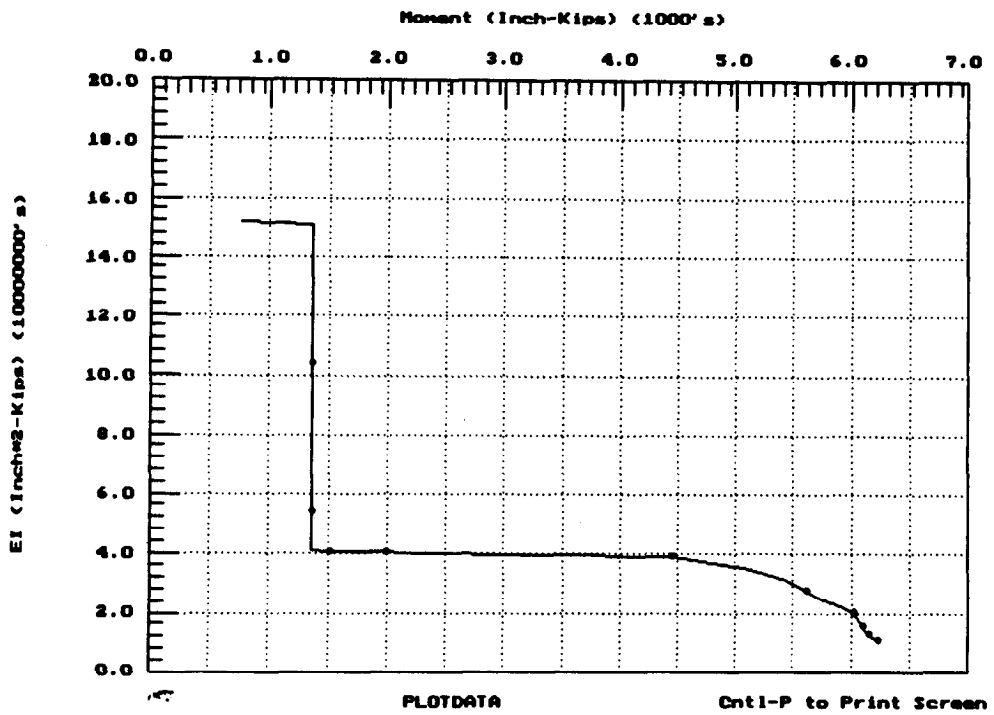
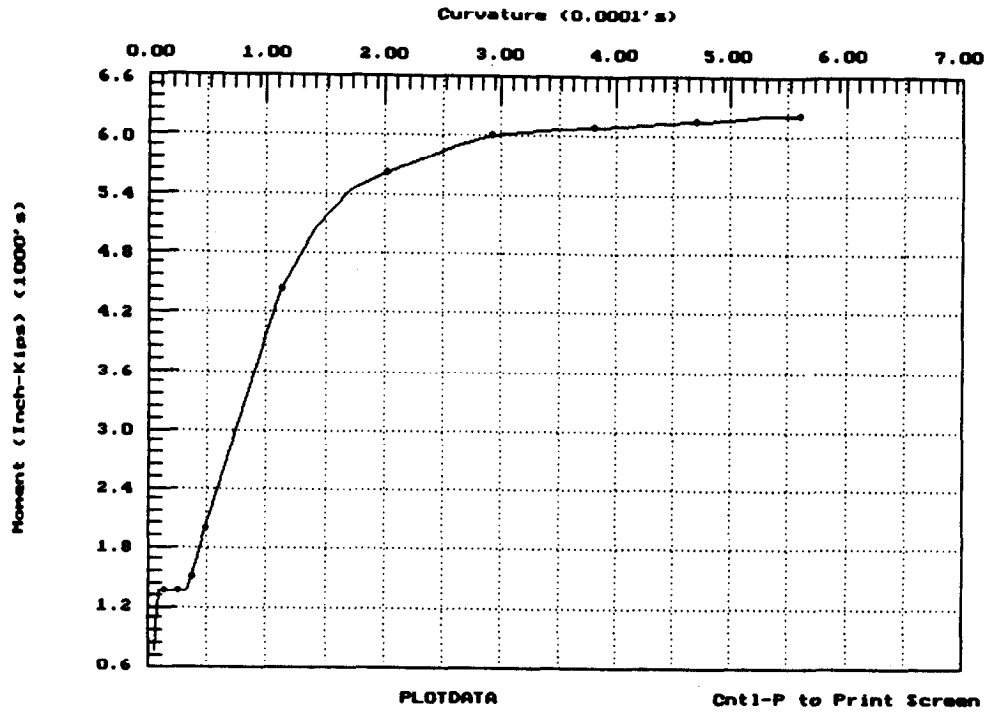

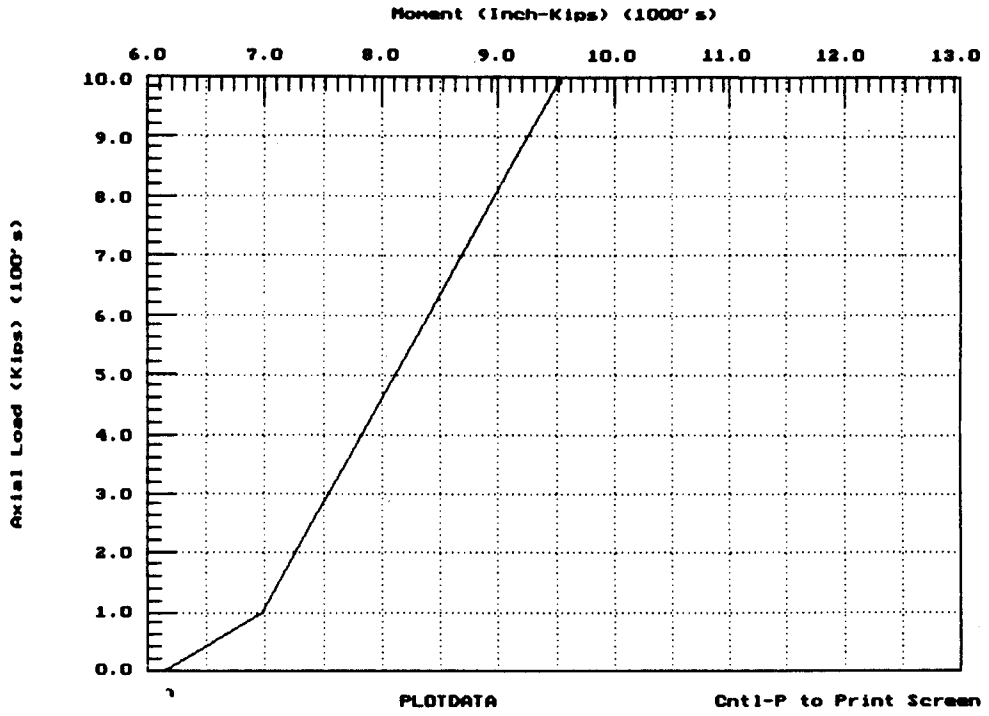

Plot Submenu

The Plot Submenu is used to select the sets of data and to prepare the files on graphics for HP-plotters or plotter emulators. The selections in the Plot Menu are:

p-y Curves - to select individual p-y curves for viewing. To select a p-y curve, the user tabs down to the desired curve using the cursor keys, then presses the space bar. An asterisk will mark any p-y curve to be displayed. If the space bar is pressed a second time, the selection will be eliminated. Returning to the Select Menu is accomplished by pressing F8.

Response Curves - to select individual curves for viewing on the response of the pile. The curves are selected in the same manner as the p-y curves,

Ultimate-Moment Curves - to select curves of moment vs curvature or flexural rigidity (EI) vs moment for different axial-loading cases.

Interaction Diagram - to select the interaction diagram (ultimate moment vs axial load). To view the interaction diagram, at least three different axial loads must have been used in the computations.

Generate Plots - to prepare the HD-LG-plot files and to select the pen speed, and

Main Menu - to return to the Main Menu.

The pull-down menu shown below can be opened by pressing "P" or moving the highlighted cursor to "Plot" followed by the <Enter> key. The following screen will be presented to illustrate the procedures to create a HP-GL-PLOT file to send to the pen plotter.

File View Plot Options

p-y Curves
Response Curves ←
Ultimate Moment
Interaction Diagram
Generate Plots
Main Menu

Alt-X Exit

Press Command Key: [R].

File View Plot Options

Selection of Response Curves for Plotting

Number	Deflection	Moment	Shear	Soil Reaction
1	ON	ON	off	off

Toggle Plotting of Curves ON/off Using Space Bar ←

F8 : Continue

Alt-X Exit

Press Command Key: [F8].

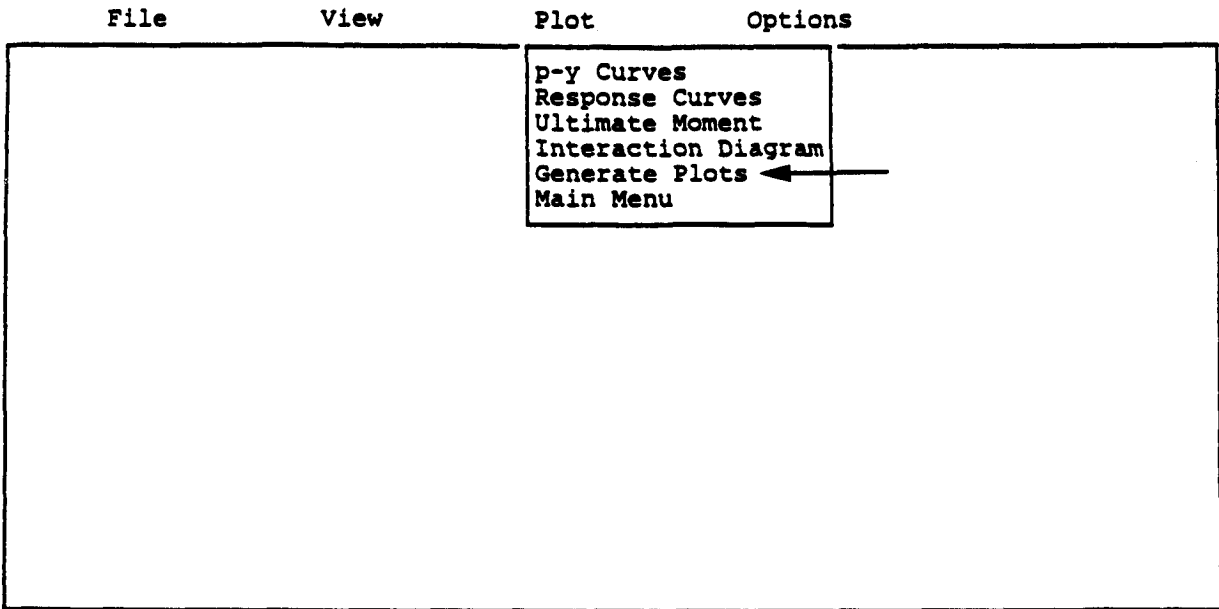

Alt-X Exit

Press Command Key: [G].

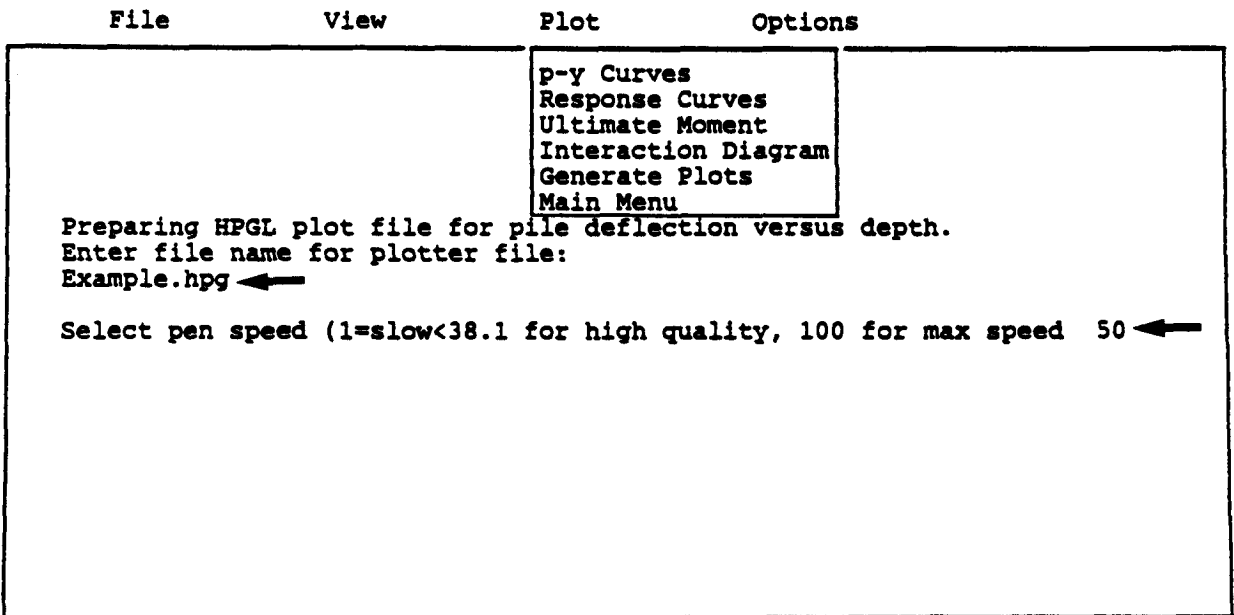

Alt-X Exit

Press Command Key: [Enter].

File View Plot Options

C624VIEW Version 2.0, Graphics Data:

Number of p-y curves: NumPYcurve = 0

Number of load-response curves: NumCurves = 0

Number of point on load-response curves: Npts = 0

Units are Pounds & Inches

p-y Curves selected for viewing

Response Curves selected for viewing

212416 bytes available

Largest block contains 212416 bytes

The graphics data file is D:PLOTDATA

Alt-X Exit

Press Command Key: [ALT] [X].

After the HP-GL-plot files have been created, the user can exit (Alt-x) to DOS and use the following DOS commands to get hard copies from the HP-plotter.

```
C:> MODE COM1:9600,N,7,1,P <CR>
      (For DOS 4.01 or higher, using the following
      MODE COM1:9600,N,7,1,B <CR>)
```

```
C:> Print (HP-GL File-Name) <CR>
```

Some parameters used in the Mode command may vary with the set-up of the hardware. The user should refer to the DOS Manual for proper changes.

Options

The Options selection of the Main Menu is used for several options relating to the display of data on the screen. The user can move the cursor to "Options" followed by the <Enter> key to open the first window as shown below.

File	View	Plot	Options ←
------	------	------	-----------

Optional Plotting Control Values - Screen 1 of 2

Symbol plotting increment.....	3
Upper y-value for p-y curves (in).....	2.000
Limiting depth for response curve plots (in).	600.000
Plotter X-coordinate for origin (in).....	1.750
Plotter Y-coordinate for origin (in).....	1.500
Plotter X-axis length (in).....	8.000
Plotter Y-axis length (in).....	5.000

Symbol plotting increment is 0 for no symbols, 1 for every symbol, 2 for every 2nd point, 3 for every 3rd point, and so on.

A 3:DEF:Num 6.0000000000E+02

: Move Cell — ? : Help — F2 : Edit Cell — F8 : Continue —

Alt-X Exit

The first optional value is the increment used to mark individual data sets with unique symbols. Any value of increment may be used, including zero for no symbols at all. A legend defining the symbols used by UPVIEW is displayed on each graph.

The second optional value is the value of depth below which no response of the pile is displayed. The program will normally allow the user to view the curves showing the response of the pile over the full length of the pile. By setting the length to something less than the full length of the pile, the user may zoom in on the area where the response is most often critical.

The third optional value is the y-value above which no p-y data are displayed. This allows the user to zoom in on the p-y values near the origin to examine the initial stiffness of the p-y curves. The other options are for the format used by the pen plotter. The most important option shown on the second window is the selection of a printing device. The printer may already be specified in the configuration file; however, the user may make a change here. The code for printers must be set before the command for "screen dump" can be sent.

File View Plot Options

Optional Plotting Control Values - Screen 2 of 2

Axis Title Character Size (in)	0.15000
Plotting Symbol Size (in)	0.15000
Plotter Pen Number for Axis Titles	1
Plotter Pen Number for Axis and Borders	1
Plotter Pen Number for Data Line & Symbols ..	1
Type of Printer Used for Screen Dump	2

Codes for printers: 1 = Epson MX, FX
 2 = Epson LQ
 3 = Toshiba 24-pin
 4 = HP LaserJet and DeskJet
 5 = HP InkJet
 6 = IBM Proprinter
 7 = IBM Proprinter24.

All printer output is sent to LPT1.
 To redirect LPT1 to COM1 use the DOS MODE command.

A 1:DEF:Num 1.5000000000E-01

_____ : Move Cell — ? : Help — F2 : Edit Cell — F8 : Continue — |
 Alt-X Exit

CHAPTER 4. INPUT INFORMATION AND DATA STRUCTURE

INTRODUCTION

A user-friendly, menu-input, preprocessor C624EDIT was developed to create and edit input data for the computer program COM624P. C624EDIT is a full-screen editor and has an option to save and retrieve data files.

The user can also prepare an input file by following the line-by-line input guide with any available text editor. The structure of input data is presented in this chapter. It should be noted that all the data entry is free-field format with a maximum of 80 characters per line. Therefore, numerical data may be entered in fixed, floating-point, or exponential format as desired. A blank space is needed to separate two variables in the same line. The sequence of the line-by-line input format is presented in Appendix A.

GENERAL REMARKS

Data input is based on a coordinate system in which the pile head (top of pile) is the origin and the positive x-direction is downward (Fig. 4.1). The ground surface need not be at the elevation of the pile head. Sign conventions are shown in Fig. 4.2.

Any convenient and consistent units of force and length can be used. The program is set up to label the output in one of three ways.

1. The user can designate that English units of inches and pounds will be used, and output will be labeled accordingly.

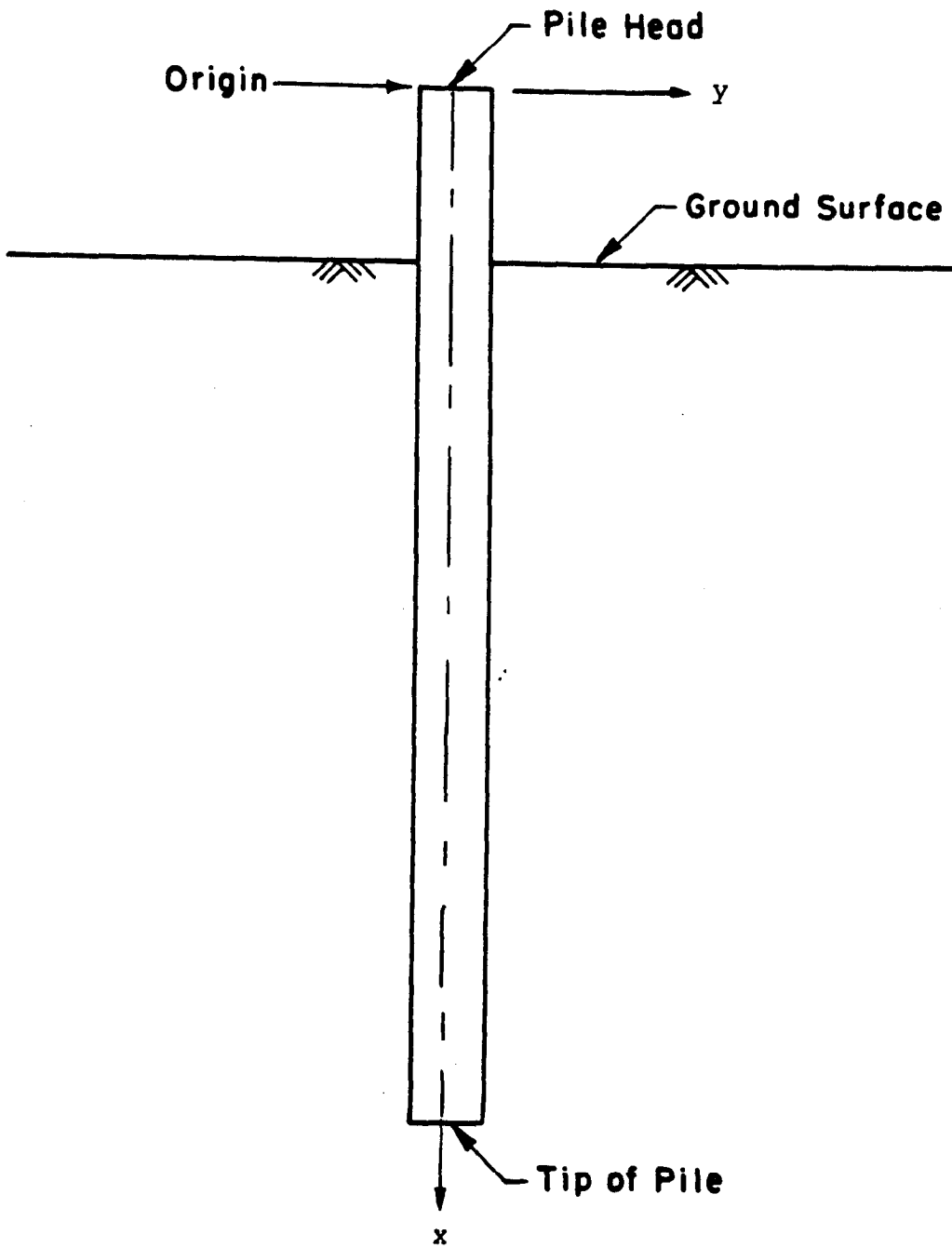

Figure 4.1. Coordinate system.

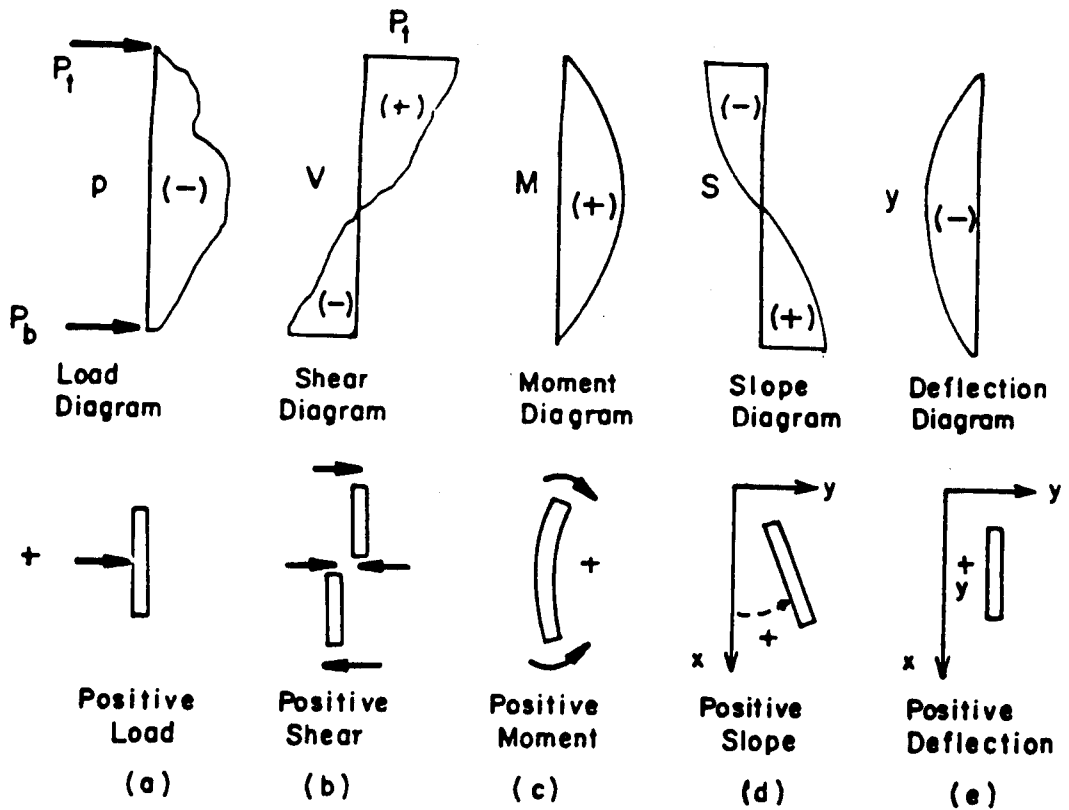

Figure 4.2. Sign conventions.

2. The user can specify that SI units of kilonewtons and meters will be used, and output will be labeled accordingly.

3. The user can use any other consistent units (the computer does not need to know which ones) of force and length, and output will be labeled in terms of forces and lengths (F and L).

Several default values may be used in data input. Where the user desires to use a default value, the input should be left blank for the relevant variable.

(In this section, the symbol "O" denotes a capital letter O; the symbol "Ø" denotes the number zero.)

The following steps are recommended for preparation of input of data.

1. Decide which units will be used for force and length.

2. Decide into how many increments the pile is to be divided. Up to 300 increments are allowed. Be sure to satisfy yourself that an adequate number of increments have been used to obtain a satisfactory solution. Some trials will be helpful as discussed in Part II on verification of results.

3. Decide whether p-y curves will be input or whether they will be generated internally. If they are to be input, pick the depth for each curve, pick the number of points to be input for each depth, and tabulate the data. Up to 30 p-y curves are allowed.

4. If p-y curves are to be generated internally, divide the soil profile into from one to nine layers; decide which of the following p-y criteria will be used for each layer:

- Matlock's (1970) criteria for soft clay;
- Reese et al.'s (1975) criteria for stiff clay below the water table;
- Welch and Reese's (1972) criteria for stiff clay above the water table;
- Reese et al.'s (1974) criteria for sand; and/or
- Reese and Nyman's (1978) criteria for limestone.

Estimate undrained shear strength c and strain at 50 percent stress level ϵ_{50} for clay layers; estimate the angle of internal friction ϕ for sand; and estimate the slope k of a plot of maximum soil modulus E_s versus depth x for all strata. Be sure to read the background on any criteria that are used so that their basis and limitations are thoroughly understood.

5. Select the length of the pile, the modulus of elasticity of the pile material, and the x-coordinate of the ground surface (x is equal to zero at the top of the pile).

6. Divide the pile into from one to 10 segments with uniform cross-section. For each segment, tabulate the x-coordinate of the top of the segment, the diameter of the segment, the moment of inertia, and the pile cross-section area.

7. If there are any distributed lateral loads on the pile, tabulate up to 10 points on a plot of distributed load versus depth below top of pile.

8. Tabulate up to 10 points on a plot of effective unit weight of soil versus depth. This step is not necessary if no p-y curves are generated internally.

9. Tabulate up to 10 points on plots of c , ϕ , and ϵ_{50} versus x . Skip this step if no p-y curves will be generated internally.

10. If p-y curves are generated internally in the program, tabulate any depths for which p-y curves are to be printed. Ordinarily, a few curves are printed for the purpose of verification.

11. Determine the loads to be applied to the top of the pile:

- A. lateral load at pile head or lateral deflection at pile head;
- B. second boundary condition at pile head, which can be either,
 - i. moment (M_t),
 - ii. slope (S_t),
 - iii. rotational restraint (M_t/S_t); and
- C. axial load (assumed to be uniform over full length of pile).

Up to 20 loading combinations can be input for each problem, e.g., to generate a load-deflection curve.

SELECTION OF BOUNDARY CONDITIONS AT PILE HEAD

Four types of boundary conditions for the pile-head connection are implemented in Program COM624P. These are designated as Cases 1 through 4. The detailed information for modeling these boundary conditions is described in Chapter 2 of Part II of this manual.

Case 1. Pile Head is Free to Rotate (KBC=1)

The lateral load (P_t), the bending moment (M_t), and the axial load (P_x) at the top of the pile are known. No rotational restraint will be provided by the superstructure, and the rotation at the top of the pile will depend only on the flexural rigidity of the pile itself. If the above conditions are met, the user can select this boundary condition for analysis. A typical example is a pile that is used to support an overhead sign.

Case 2. Pile Head is Fixed Against Rotation (KBC=2)

Frequently, the pile head is embedded into a monolithic reinforced-concrete cap. Conceptually, if the flexural rigidity of the pile cap is much stronger than that of a connected pile, the rotation angle between the pile head and the monolithic cap is unchanged with or without lateral bending. For such a case, the pile-head connection is defined as completely fixed and the rotation of the pile head within the monolithic concrete cap is assumed to be zero, in which case the slope (S_t) is set to zero. However, if a small rotation at the pile-head connection is allowed, the user can specify the slope (in radians) for the computation. To apply the boundary condition in Case 2, the lateral load (P_t), the slope or rotation (S_t) at the pile head, and the axial load (P_x) should be given.

Case 3. Pile Head is Restrained Against Rotation (KBC=3)

The connection between the pile and the superstructure, such as a steel frame, may not be always a perfectly rigid joint. If the magnitude of the restraint between the pile and superstructure can be estimated, and can be further expressed with a function of M_t/S_t (M_t and S_t are the bending moment and the slope angle at the pile head, respectively), the elastically-restrained boundary condition can be selected for use in Program COM624P. The elastic restraint M_t/S_t is largely affected by the stiffness of superstructures. The superstructures are different in many ways; therefore, the elastic restraint at each joint needs to be studied by using a sound structural theory. If there is a nonlinear relationship between M_t and S_t , iteration may be required to achieve compatibility. To apply this boundary condition, the lateral load (P_t), the elastic restraint (M_t/S_t), and the axial load (P_x), at the top of the pile must be known.

Case 4. Pile Head Deflection is Restrained Against Lateral Movement (KBC=4)

If the pile-head deflection (y_t), the bending moment (M_t), and the axial load (P_x) at the top of the pile are given, then the user can use the boundary conditions in Case 4 for computation. The deflection of the pile head can be restrained in either direction. The reaction force at the pile head (restrained point) will be one of the outputs of the program. This boundary condition can be applied to piles which support a bridge abutment that has zero or a very small allowable movement.

ITERATIONS OF COMPUTATIONS USING CRACKED/UNCRACKED EI GENERATED INTERNALLY BY SUBROUTINE PMEIX

A new feature of the second version of Program COM624P is that the program will use a more rigorous approach to control the

use of cracked and uncracked EI values during computation. The subroutine PMEIX will compute the ultimate bending moment for the selected section. For reinforced concrete sections, it will compute the EI values for uncracked sections and for cracked sections. The user can manually input different EI values for several sections after examining the computer curve for bending moment and finding the length over which the moment distribution to the cracked-section conditions will exist. Two or three iterations may be required to achieve satisfactory results. Program COM624P provides an option for the user to request the computer to select values of EI internally for cracked or uncracked sections for use in the iterations.

Figure 4.3 shows the variation of bending moment and associated cracked/uncracked EI values. As it may be seen, only the upper portion of the pile will be subjected to a large moment. Because the upper portion of the pile needs greater stiffness, the reinforcing steel can be enhanced only for that portion in order to reduce the pile deflection.

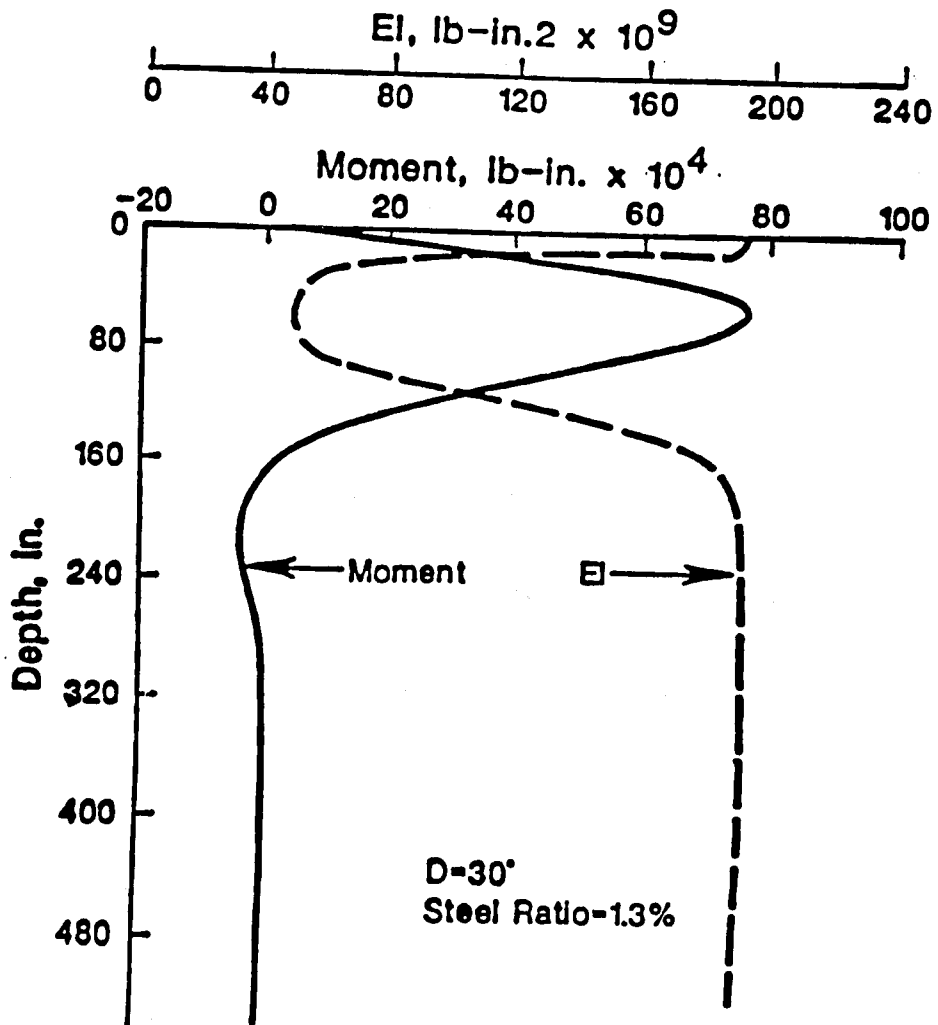

Figure 4.3. Bending moment and flexural rigidity versus depth for a laterally-loaded pile.

CHAPTER 5. EXAMPLE STUDIES

INTRODUCTION

This chapter presents six examples that were studied by use of COM624P. The first example is for a 14HP89 steel pile embedded in a single-layer deposit. The second example is for a reinforced-concrete pile embedded in a multi-layer deposit. The third example is for a pile embedded in a sloping abutment. The fourth example is to illustrate the use of p-y curves entered by the user. Examples 5 and 6 are included to illustrate the cases in which the ultimate bending moment and design of reinforcement are required.

The examples that follow are intended to demonstrate the capability of the computer program and are not intended to be a complete presentation of the design process. The publication (FHWA-IP-84-11) entitled "Handbook on Design of Piles and Drilled Shafts under Lateral Load" is highly recommended for engineers seeking guidelines for design. There are a number of factors that must be considered in design before and after the computer execution.

A general procedure on proper use of the program was developed by Christopher Dumas of FHWA during the design review and analysis of a case study for pile-supported abutment. The guidelines and procedures are presented in Appendix B.

The program gives output as follows:

- Echo-print of input data,
- Generated p-y curves,

Listing of pile deflection, bending moment, shear, soil resistance, and flexural rigidity along the length of the pile,

Summary results of pile-head deflection, maximum bending moment, and maximum shear force for various loading conditions, and

Listing of bending moment, EI, neutral axis, and concrete strain at each curvature.

From the variety of output that can be generated, the user should be able to get all the needed information on the response of a pile.

EXAMPLE 1, PILES IN A SINGLE LAYER OF SOIL

A 14HP89 H-pile is used for the foundation of a bridge abutment. The width of the steel section is 14.7 in and the length of the pile is 25 feet. The soil deposit is a uniform stiff clay above the water table. The undrained cohesive strength is 14 lb/sq in, the total unit weight is 0.069 lb/cu in, and the ϵ_{50} is 0.007. The value of soil modulus (k) is assumed for 400/lb/cu inch. The user can estimate the value of k based on Table 3.2 in Part II of this manual if k-values were not measured for soils. The axial load is 39 kips and lateral loads at the pile head are 40 kips and 20 kips respectively. The pile head is assumed to be free to rotate.

This example was used by the Design Handbook (FHWA-IP-84-11) in Section 3.5, Page 75. In regard to the aspects of design, thorough discussions have been given in the handbook. The users are encouraged to read that section. The strong axis of the pile ($I_x - 904 \text{ in}^4$) will be used to resist the lateral load. Therefore, the width (14.7 in) of the flange was used as the equivalent diameter for the input required by Program COM624P.

The input file created by C624EDIT is presented on the next page followed by a listing of the output data. The computed maximum bending moment on the pile is less than the yield moment ($5.84 \times 10^3 \text{ in-kip}$) of the section. In this example the user can increase the lateral load until the ultimate bending moment is reached. The service load can be selected by dividing the maximum lateral load, which creates the ultimate bending moment, with a load factor. The load factor can be 2 to 2.5 depending on the importance of the structure. The deflection under the service load also needs to be satisfied by the design specifications. The graphics display of p-y curves, pile-deflection curves, and bending moment curves are also presented for verification.

The input and output data are shown in the following pages.

INPUT SCREENS FOR EXAMPLE 1

File ← Analysis Mult Option

C624EDIT 2.0, Edit Variables:

This program is a preprocessor developed especially for users for preparation of input for the computer program COM624P. The main menu for this program is displayed as a bar at the top row of the screen. The main menu has four choices: FILE, ANALYSIS, MULT, and OPTION.

The selection of the FILE menu allows the user to access a pull-down menu for file operations such as reading in an existing file, creating a new data file, checking files in the directory, and similar operations. The selection of the ANALYSIS menu allows the user to enter required data for computing the response of the pile and soil, such as distributions of deflection, bending moment, shear, and soil resistance as a function of length along the pile. The selection of the MULT menu allows the user to enter data of a selected pile size for computing the ultimate bending moment and other design-related information. The OPTION menu is used for screen setting and it may not be needed for most computer systems.

F1-Help Alt-X-Exit

File Analysis Mult Option

Read
New ←
Save
Directory
Change dir
Quit to DOS
Main Menu

F1-Help Alt-X-Exit

File Analysis Mult Option EXAMPLE.IN1

Read New	
	New File Name
	EXAMPLE.IN1
Change dir Quit to DOS Main Menu	

F1-Help Alt-X-Exit

File Analysis ← Mult Option

C624EDIT 2.0, Edit Variables:

This program is a preprocessor developed especially for users for preparation of input for the computer program COM624P. The main menu for this program is displayed as a bar at the top row of the screen. The main menu has four choices: FILE, ANALYSIS, MULT, and OPTION.

The selection of the FILE menu allows the user to access a pull-down menu for file operations such as reading in an existing file, creating a new data file, checking files in the directory, and similar operations. The selection of the ANALYSIS menu allows the user to enter required data for computing the response of the pile and soil, such as distributions of deflection, bending moment, shear, and soil resistance as a function of length along the pile. The selection of the MULT menu allows the user to enter data of a selected pile size for computing the ultimate bending moment and other design-related information. The OPTION menu is used for screen setting and it may not be needed for most computer systems.

F1-Help Alt-X-Exit

File Analysis Mult Option

Title ←
File Properties
Soil Properties
Lateral p-y Data
Data for Loading
Computation Control
Output Tables
Main Menu

F1-Help Alt-X-Exit

File Analysis Mult Option EXAMPLE.IN1

Enter title for this data file (up to 72 characters long)

EXAMPLE 1 PILES IN A SINGLE LAYER OF SOIL

A 1:DEF:Lab EXAMPLE 1 PILES IN A SINGLE LAYER OF SOIL

_____ : Move Cell — ? : Help — / : Edit Screen — F8 : Continue — |
F1-Help Alt-X-Exit

File Analysis Mult Option

Title
Pile Properties ←
Soil Properties
Lateral p-y Data
Data for Loading
Computation Control
Output Tables
Main Menu

F1-Help Alt-X-Exit

File Analysis Mult Option EXAMPLE.IN1

Editing Pile Dimensions

Number of increments (<= 300)	120
Distance from top of pile to ground surface - inches	0.0
Length of pile	300.00
Pile modulus	29000000
Slope of ground surface (degrees)	0.0000

A 1:DEF:Num 120

_____ : Move Cell _____ ? : Help _____ / : Edit Screen _____ F8 : Continue _____
F1-Help Alt-X-Exit

File

Analysis

Mult

Option

EXAMPLE.IN1

Editing Pile Section Properties

Section #	Top Depth inches	Diameter inches	Mom. of Inert. inches**4	Area inches ²
1	0.00	14.700	904.0000	26.1000
2				
3				
4				
5				
6				
7				
8				
9				
10				

To access pile property library leave pile diameter blank.

A 1:DEF:Num 0.00000

_____ : Move Cell _____ ? : Help _____ / : Edit Screen _____ F8 : Continue _____
F1-Help Alt-X-Exit

File

Analysis

Mult

Option

- Title
- Pile Properties
- Soil Properties ←
- Lateral p-y Data
- Data for Loading
- Computation Control
- Output Tables
- Main Menu

F1-Help

Alt-X-Exit

Editing Soil Layer Information

Layer #	Criteria #	X-top inches	X-bot inches	k lb/in3
1	3	0.00	360.00	400.00
2				
3				
4				
5				
6				
7				
8				
9				
10				

p-y Curve Criteria

- | | |
|-----------------------------------|----------------------------------|
| #1 = Soft Clay Criteria | #3 = Stiff Clay Above Watertable |
| #2 = Stiff Clay Below Watertable | #4 = Sand |
| #5 = Interp. Between Input Curves | #6 = Vuggy Limestone |

A 1:DEF:Num 3

_____ : Move Cell _____ ? : Help _____ / : Edit Screen _____ F8 : Continue _____
 F1-Help Alt-X-Exit

Editing Effective Unit Weight Information

Point #	Depth inches	Unit Weight lb/in3
1	0.00	0.069
2	360.00	0.069
3		
4		
5		
6		
7		
8		
9		
10		

A 1:DEF:Num 0.00000

_____ : Move Cell _____ ? : Help _____ / : Edit Screen _____ F8 : Continue _____
 F1-Help Alt-X-Exit

Editing Shear Strength Information

Layer #	Depth inches	c psi	φ deg.	E50 @ 50% of c
1	0.00	14.000	0.00	0.0070
2	360.00	14.000	0.00	0.0070
3				
4				
5				
6				
7				
8				
9				
10				

A 1:DEF:Num 0.00000

_____ : Move Cell _____ ? : Help _____ / : Edit Screen _____ F8 : Continue _____
 F1-Help Alt-X-Exit

	Title File Properties Soil Properties Lateral p-y Data Data for Loading ← Computation Control Output Tables Main Menu	
--	--	--

F1-Help Alt-X-Exit

Editing Loading Information

Distributed lateral loading (y/n) ? n
 Is loading cyclic (y/n) ? n
 Boundary condition code (KBC) 1

KBC = 1 for shear and moment
 KBC = 2 for shear and slope
 KBC = 3 for shear and rotational restraint
 KBC = 4 for deflection and moment

A 1:DEF:Lab n

_____ : Move Cell _____ ? : Help _____ / : Edit Screen _____ F8 : Continue _____
 F1-Help Alt-X-Exit

Editing File-head Loading

KOP	Shear pounds	Moment in-lbs	Axial Load pounds
1	20000.00	0.000	39000.00
1	40000.00	0.000	39000.00

KOP=0 if only a summary output for this load is to be printed
 =1 if complete output is desired for this load

A 1:DEF:Num 1

_____ : Move Cell _____ ? : Help _____ / : Edit Screen _____ F8 : Continue _____
 F1-Help Alt-X-Exit

File	Analysis	Mult	Option
	Title File Properties Soil Properties Lateral p-y Data Data for Loading Computation Control ← Output Tables Main Menu		

F1-Help Alt-X-Exit

File	Analysis	Mult	Option	EXAMPLE.IN1
Maximum number of iterations allowed for analysis : 100 Tolerance on solution convergence, inches : 0.000010 Value of deflection considered to be excessive, inches : 147.0000 Computation using internal-generated cracked/uncracked EI: N				
A 1:DEF:Num 100				
_____ : Move Cell _____ ? : Help _____ / : Edit Screen _____ F8 : Continue _____				

F1-Help Alt-X-Exit

File Analysis Mult Option

Title
Pile Properties
Soil Properties
Lateral p-y Data
Data for Loading
Computation Control
Output Tables ←
Main Menu

F1-Help Alt-X-Exit

File Analysis Mult Option EXAMPLE.IN1

Output Printing Options

*** Lateral Load Analysis ***

Printing Increment (1 for every node, 2 for every other node, etc)	2
Print deflection, moment, shear over full length of pile (y/n)	Y
Print p-y curves for verification	Y

A 1:DEF:Num 2

_____ : Move Cell — ? : Help — / : Edit Screen — F8 : Continue —
F1-Help Alt-X-Exit

Enter depths for which p-y curves are to be calculated for verification:

Point	Depth inches
1	20.00
2	60.00
3	100.00
4	150.00
5	
6	
7	
8	
9	
10	

A 1:DEF:Num 20.00000

_____ : Move Cell _____ ? : Help _____ / : Edit Screen _____ F8 : Continue _____
F1-Help Alt-X-Exit

- Title
- File Properties
- Soil Properties
- Lateral p-y Data
- Data for Loading
- Computation Control
- Output Tables
- Main Menu ←

F1-Help Alt-X-Exit

File Analysis Mult Option EXAMPLE.IN1

Read
New
Save ←
Write
Directory
Change dir
Quit to DOS
Main Menu

F1-Help Alt-X-Exit

File Analysis Mult Option EXAMPLE.IN1

Read
New
Save

Quit to DOS
Main Menu

Save File Name
EXAMPLE.IN1

F1-Help Alt-X-Exit

OUTPUT RESULTS FOR EXAMPLE 1

EXAMPLE 1 PILES IN A SINGLE LAYER OF SOIL

UNITS--ENGL

PILE DEFLECTION, BENDING MOMENT, SHEAR & SOIL RESISTANCE

I N P U T I N F O R M A T I O N

THE LOADING IS STATIC

PILE GEOMETRY AND PROPERTIES

PILE LENGTH	=	300.00	IN
MODULUS OF ELASTICITY OF PILE	=	.290E+05	KIP/IN**2
1 SECTION(S)			
X	DIAMETER	MOMENT OF	AREA
IN	IN	INERTIA	IN**2
.00		IN**4	
300.00	14.700	.904E+03	.261E+02

SOILS INFORMATION

X-COORDINATE AT THE GROUND SURFACE = .00 IN
SLOPE ANGLE AT THE GROUND SURFACE = .00 DEG.

1 LAYER(S) OF SOIL

LAYER 1
THE LAYER IS A STIFF CLAY ABOVE THE WATER TABLE
X AT THE TOP OF THE LAYER = .00 IN
X AT THE BOTTOM OF THE LAYER = 360.00 IN
VARIATION OF SOIL MODULUS, k = .400E+03 LBS/IN**3

DISTRIBUTION OF EFFECTIVE UNIT WEIGHT WITH DEPTH
2 POINTS

X, IN	WEIGHT, LBS/IN**3
.00	.69E-01
360.00	.69E-01

DISTRIBUTION OF STRENGTH PARAMETERS WITH DEPTH
2 POINTS

X, IN	C, LBS/IN**2	PHI, DEGREES	E50
.00	.140E+02	.000	.700E-02
360.00	.140E+02	.000	.700E-02

FINITE DIFFERENCE PARAMETERS

NUMBER OF PILE INCREMENTS	=	120
TOLERANCE ON DETERMINATION OF DEFLECTIONS	=	.100E-04 IN
MAXIMUM NUMBER OF ITERATIONS ALLOWED FOR PILE ANALYSIS	=	100
MAXIMUM ALLOWABLE DEFLECTION	=	.15E+03 IN

INPUT CODES

OUTPT	=	1
KCYCL	=	1
KBC	=	1
KPYOP	=	1
INC	=	2

EXAMPLE 1 PILES IN A SINGLE LAYER OF SOIL

UNITS--ENGL

OUTPUT INFORMATION

GENERATED P-Y CURVES

THE NUMBER OF CURVE IS	=	4
THE NUMBER OF POINTS ON EACH CURVE	=	17

DEPTH BELOW GS IN	DIAM IN	C LBS/IN**2	CAVG LBS/IN**2	GAMMA LBS/IN**3	E50
20.00	14.700	.1E+02	.1E+02	.7E-01	.700E-02
		Y		P	
		IN		LBS/IN	
		.000		.000	
		.274		395.168	
		.549		469.936	
		.823		520.070	
		1.098		558.852	
		1.372		590.914	
		1.646		618.471	
		1.921		642.771	
		2.195		664.590	
		2.470		684.451	
		2.744		702.719	
		3.018		719.664	
		3.293		735.490	
		3.567		750.356	
		3.842		764.387	
		4.116		777.686	
		5.145		777.686	

DEPTH BELOW GS IN	DIAM IN	C LBS/IN**2	CAVG LBS/IN**2	GAMMA LBS/IN**3	E50
60.00	14.700	.1E+02	.1E+02	.7E-01	.700E-02
		Y		P	
		IN		LBS/IN	
		.000		.000	
		.274		558.061	
		.549		663.650	
		.823		734.449	
		1.098		789.217	
		1.372		834.496	
		1.646		873.412	
		1.921		907.729	
		2.195		938.543	
		2.470		966.590	
		2.744		992.388	
		3.018		1016.318	
		3.293		1038.668	
		3.567		1059.662	
		3.842		1079.477	
		4.116		1098.258	
		5.145		1098.258	

DEPTH BELOW GS IN	DIAM IN	C LBS/IN**2	CAVG LBS/IN**2	GAMMA LBS/IN**3	E50
100.00	14.700	.1E+02	.1E+02	.7E-01	.700E-02

Y IN	P LBS/IN
.000	.000
.274	720.954
.549	857.364
.823	948.829
1.098	1019.583
1.372	1078.078
1.646	1128.354
1.921	1172.687
2.195	1212.495
2.470	1248.729
2.744	1282.058
3.018	1312.973
3.293	1341.847
3.567	1368.968
3.842	1394.568
4.116	1418.830
5.145	1418.830

DEPTH BELOW GS IN	DIAM IN	C LBS/IN**2	CAVG LBS/IN**2	GAMMA LBS/IN**3	E50
150.00	14.700	.1E+02	.1E+02	.7E-01	.700E-02

Y IN	P LBS/IN
.000	.000
.274	924.570
.549	1099.506
.823	1216.803
1.098	1307.540
1.372	1382.555
1.646	1447.031
1.921	1503.885
2.195	1554.936
2.470	1601.403
2.744	1644.145
3.018	1683.791
3.293	1720.819
3.567	1755.601
3.842	1788.430
4.116	1819.545
5.145	1819.545

----- *** -----

PILE LOADING CONDITION

LATERAL LOAD AT PILE HEAD = .200E+02 KIP
 APPLIED MOMENT AT PILE HEAD = .000E+00 IN-KIP
 AXIAL LOAD AT PILE HEAD = .390E+02 KIP

X	DEFLECTION		MOMENT	TOTAL STRESS	SHEAR	SOIL RESIST	FLEXURAL RIGIDITY
	IN	IN	IN-KIP	LBS/IN**2	KIP	LBS/IN	KIP-IN**2
0.00	.145E+00	.000E+00	.149E+04	.201E+02	.267E+03	.262E+08	
5.00	.134E+00	.971E+02	.228E+04	.186E+02	.279E+03	.262E+08	
10.00	.123E+00	.187E+03	.302E+04	.172E+02	.290E+03	.262E+08	
15.00	.112E+00	.270E+03	.369E+04	.157E+02	.299E+03	.262E+08	
20.00	.101E+00	.345E+03	.430E+04	.142E+02	.308E+03	.262E+08	
25.00	.910E-01	.413E+03	.485E+04	.127E+02	.315E+03	.262E+08	
30.00	.812E-01	.473E+03	.534E+04	.111E+02	.321E+03	.262E+08	
35.00	.718E-01	.524E+03	.576E+04	.945E+01	.326E+03	.262E+08	
40.00	.629E-01	.568E+03	.611E+04	.781E+01	.330E+03	.262E+08	
45.00	.546E-01	.603E+03	.640E+04	.615E+01	.332E+03	.262E+08	
50.00	.468E-01	.630E+03	.662E+04	.449E+01	.332E+03	.262E+08	
55.00	.396E-01	.649E+03	.677E+04	.283E+01	.332E+03	.262E+08	
60.00	.331E-01	.659E+03	.685E+04	.118E+01	.329E+03	.262E+08	
65.00	.272E-01	.661E+03	.687E+04	-.456E+00	.325E+03	.262E+08	
70.00	.219E-01	.655E+03	.682E+04	-.206E+01	.318E+03	.262E+08	
75.00	.172E-01	.641E+03	.670E+04	-.364E+01	.310E+03	.262E+08	
80.00	.132E-01	.619E+03	.652E+04	-.516E+01	.299E+03	.262E+08	
85.00	.972E-02	.589E+03	.629E+04	-.663E+01	.286E+03	.262E+08	
90.00	.682E-02	.553E+03	.599E+04	-.802E+01	.270E+03	.262E+08	
95.00	.444E-02	.509E+03	.564E+04	-.932E+01	.250E+03	.262E+08	
100.00	.255E-02	.460E+03	.523E+04	-.105E+02	.224E+03	.262E+08	
105.00	.110E-02	.405E+03	.479E+04	-.115E+02	.187E+03	.262E+08	
110.00	.367E-04	.345E+03	.430E+04	-.123E+02	.805E+02	.262E+08	
115.00	-.700E-03	.284E+03	.380E+04	-.118E+02	-.176E+03	.262E+08	
120.00	-.117E-02	.227E+03	.334E+04	-.108E+02	-.205E+03	.262E+08	
125.00	-.141E-02	.176E+03	.292E+04	-.978E+01	-.221E+03	.262E+08	
130.00	-.150E-02	.130E+03	.255E+04	-.865E+01	-.229E+03	.262E+08	
135.00	-.145E-02	.892E+02	.222E+04	-.750E+01	-.233E+03	.262E+08	
140.00	-.132E-02	.546E+02	.194E+04	-.633E+01	-.233E+03	.262E+08	
145.00	-.114E-02	.259E+02	.170E+04	-.517E+01	-.230E+03	.262E+08	
150.00	-.938E-03	.287E+01	.152E+04	-.404E+01	-.224E+03	.262E+08	
155.00	-.729E-03	-.146E+02	.161E+04	-.295E+01	-.214E+03	.262E+08	
160.00	-.533E-03	-.267E+02	.171E+04	-.192E+01	-.198E+03	.262E+08	
165.00	-.363E-03	-.339E+02	.177E+04	-.974E+00	-.180E+03	.262E+08	
170.00	-.225E-03	-.366E+02	.179E+04	-.127E+00	-.159E+03	.262E+08	
175.00	-.121E-03	-.353E+02	.178E+04	.613E+00	-.136E+03	.262E+08	
180.00	-.511E-04	-.306E+02	.174E+04	.123E+01	-.110E+03	.262E+08	
185.00	-.993E-05	-.232E+02	.168E+04	.170E+01	-.729E+02	.262E+08	

190.00	.925E-05	-.145E+02	.161E+04	.158E+01	.718E+02	.262E+08
195.00	.145E-04	-.755E+01	.156E+04	.120E+01	.803E+02	.262E+08
200.00	.124E-04	-.257E+01	.152E+04	.801E+00	.772E+02	.262E+08
205.00	.772E-05	.499E+00	.150E+04	.437E+00	.686E+02	.262E+08
210.00	.343E-05	.186E+01	.151E+04	.125E+00	.560E+02	.262E+08
215.00	.840E-06	.184E+01	.151E+04	-.113E+00	.394E+02	.262E+08
220.00	-.529E-07	.857E+00	.150E+04	-.207E+00	-.196E+02	.262E+08
225.00	-.981E-07	.101E+00	.150E+04	-.921E-01	-.230E+02	.262E+08
230.00	-.127E-07	-.967E-01	.150E+04	.136E-02	-.139E+02	.262E+08
235.00	.602E-09	-.502E-02	.149E+04	.107E-01	.654E+01	.262E+08
240.00	-.181E-13	.274E-04	.149E+04	-.494E-03	-.512E+00	.262E+08
245.00	.289E-18	-.452E-09	.149E+04	.150E-07	.157E-04	.262E+08
250.00	-.460E-23	.746E-14	.149E+04	-.239E-12	-.250E-09	.262E+08
255.00	.732E-28	-.123E-18	.149E+04	.381E-17	.396E-14	.262E+08
260.00	-.116E-32	.203E-23	.149E+04	-.606E-22	-.629E-19	.262E+08
265.00	.185E-37	-.334E-28	.149E+04	-.133E-28	.996E-24	.262E+08
270.00	-.293E-42	.550E-33	.149E+04	.219E-33	-.157E-28	.262E+08
275.00	.464E-47	-.905E-38	.149E+04	-.361E-38	.249E-33	.262E+08
280.00	-.733E-52	.149E-42	.149E+04	.593E-43	-.393E-38	.262E+08
285.00	.116E-56	-.245E-47	.149E+04	-.976E-48	.618E-43	.262E+08
290.00	-.183E-61	.403E-52	.149E+04	.161E-52	-.973E-48	.262E+08
295.00	.288E-66	-.663E-57	.149E+04	-.264E-57	.153E-52	.262E+08
300.00	-.924E-71	.000E+00	.149E+04	.000E+00	-.489E-57	.262E+08

COMPUTED LATERAL FORCE AT PILE HEAD = .20000E+02 KIP
 COMPUTED MOMENT AT PILE HEAD = .00000E+00 IN-KIP
 COMPUTED SLOPE AT PILE HEAD = -.22178E-02

 THE OVERALL MOMENT IMBALANCE = .103E-09 IN-KIP
 THE OVERALL LATERAL FORCE IMBALANCE = .612E-08 LBS

OUTPUT SUMMARY

FILE HEAD DEFLECTION = .145E+00 IN
 MAXIMUM BENDING MOMENT = .661E+03 IN-KIP
 MAXIMUM TOTAL STRESS = .687E+04 LBS/IN**2

 NO. OF ITERATIONS = 20
 MAXIMUM DEFLECTION ERROR = .949E-05 IN

----- *** -----

FILE LOADING CONDITION

LATERAL LOAD AT PILE HEAD = .400E+02 KIP
 APPLIED MOMENT AT PILE HEAD = .000E+00 IN-KIP
 AXIAL LOAD AT PILE HEAD = .390E+02 KIP

X	DEFLECTION	MOMENT	TOTAL STRESS	SHEAR	SOIL RESIST	FLEXURAL RIGIDITY
IN	IN	IN-KIP	LBS/IN**2	KIP	LBS/IN	KIP-IN**2
*****	*****	*****	*****	*****	*****	*****
.00	.623E+00	.000E+00	.149E+04	.403E+02	.385E+03	.262E+08
5.00	.586E+00	.197E+03	.309E+04	.380E+02	.404E+03	.262E+08
10.00	.549E+00	.383E+03	.461E+04	.360E+02	.422E+03	.262E+08
15.00	.512E+00	.559E+03	.604E+04	.338E+02	.438E+03	.262E+08
20.00	.476E+00	.724E+03	.738E+04	.316E+02	.454E+03	.262E+08
25.00	.441E+00	.878E+03	.863E+04	.293E+02	.468E+03	.262E+08
30.00	.406E+00	.102E+04	.978E+04	.269E+02	.481E+03	.262E+08
35.00	.372E+00	.115E+04	.108E+05	.245E+02	.492E+03	.262E+08
40.00	.340E+00	.127E+04	.118E+05	.220E+02	.503E+03	.262E+08
45.00	.308E+00	.137E+04	.126E+05	.195E+02	.512E+03	.262E+08
50.00	.278E+00	.146E+04	.134E+05	.169E+02	.519E+03	.262E+08
55.00	.250E+00	.154E+04	.140E+05	.143E+02	.525E+03	.262E+08
60.00	.223E+00	.161E+04	.146E+05	.116E+02	.530E+03	.262E+08
65.00	.197E+00	.166E+04	.150E+05	.897E+01	.532E+03	.262E+08
70.00	.173E+00	.170E+04	.153E+05	.630E+01	.533E+03	.262E+08
75.00	.150E+00	.173E+04	.155E+05	.364E+01	.533E+03	.262E+08
80.00	.130E+00	.174E+04	.156E+05	.978E+00	.530E+03	.262E+08
85.00	.111E+00	.174E+04	.156E+05	-.166E+01	.526E+03	.262E+08
90.00	.931E-01	.172E+04	.155E+05	-.428E+01	.519E+03	.262E+08
95.00	.772E-01	.170E+04	.153E+05	-.685E+01	.510E+03	.262E+08
100.00	.630E-01	.166E+04	.150E+05	-.937E+01	.499E+03	.262E+08
105.00	.504E-01	.160E+04	.145E+05	-.118E+02	.485E+03	.262E+08
110.00	.392E-01	.154E+04	.140E+05	-.142E+02	.468E+03	.262E+08
115.00	.296E-01	.146E+04	.134E+05	-.165E+02	.448E+03	.262E+08
120.00	.213E-01	.137E+04	.127E+05	-.187E+02	.424E+03	.262E+08
125.00	.144E-01	.128E+04	.119E+05	-.207E+02	.394E+03	.262E+08
130.00	.867E-02	.117E+04	.110E+05	-.226E+02	.355E+03	.262E+08
135.00	.405E-02	.105E+04	.100E+05	-.243E+02	.301E+03	.262E+08
140.00	.432E-03	.925E+03	.902E+04	-.255E+02	.176E+03	.262E+08
145.00	-.230E-02	.798E+03	.798E+04	-.248E+02	-.274E+03	.262E+08
150.00	-.428E-02	.678E+03	.700E+04	-.233E+02	-.327E+03	.262E+08
155.00	-.560E-02	.565E+03	.609E+04	-.216E+02	-.356E+03	.262E+08
160.00	-.639E-02	.462E+03	.525E+04	-.198E+02	-.368E+03	.262E+08
165.00	-.674E-02	.367E+03	.448E+04	-.180E+02	-.373E+03	.262E+08
170.00	-.673E-02	.282E+03	.379E+04	-.161E+02	-.373E+03	.262E+08
175.00	-.646E-02	.206E+03	.317E+04	-.142E+02	-.369E+03	.262E+08
180.00	-.599E-02	.140E+03	.263E+04	-.124E+02	-.362E+03	.262E+08
185.00	-.538E-02	.822E+02	.216E+04	-.106E+02	-.352E+03	.262E+08
190.00	-.470E-02	.334E+02	.177E+04	-.889E+01	-.340E+03	.262E+08

195.00	-.398E-02	-.682E+01	.155E+04	-.722E+01	-.327E+03	.262E+08
200.00	-.327E-02	-.389E+02	.181E+04	-.563E+01	-.311E+03	.262E+08
205.00	-.260E-02	-.632E+02	.201E+04	-.412E+01	-.294E+03	.262E+08
210.00	-.198E-02	-.802E+02	.215E+04	-.269E+01	-.274E+03	.262E+08
215.00	-.145E-02	-.904E+02	.223E+04	-.137E+01	-.254E+03	.262E+08
220.00	-.994E-03	-.942E+02	.226E+04	-.163E+00	-.231E+03	.262E+08
225.00	-.631E-03	-.922E+02	.224E+04	.930E+00	-.206E+03	.262E+08
230.00	-.356E-03	-.850E+02	.219E+04	.189E+01	-.179E+03	.262E+08
235.00	-.162E-03	-.735E+02	.209E+04	.271E+01	-.147E+03	.262E+08
240.00	-.379E-04	-.582E+02	.197E+04	.334E+01	-.102E+03	.262E+08
245.00	.311E-04	-.413E+02	.183E+04	.320E+01	.969E+02	.262E+08
250.00	.606E-04	-.266E+02	.171E+04	.266E+01	.115E+03	.262E+08
255.00	.646E-04	-.147E+02	.161E+04	.207E+01	.116E+03	.262E+08
260.00	.543E-04	-.580E+01	.154E+04	.150E+01	.111E+03	.262E+08
265.00	.384E-04	.332E+00	.150E+04	.962E+00	.102E+03	.262E+08
270.00	.226E-04	.390E+01	.153E+04	.479E+00	.895E+02	.262E+08
275.00	.104E-04	.521E+01	.154E+04	.657E-01	.737E+02	.262E+08
280.00	.310E-05	.466E+01	.153E+04	-.260E+00	.544E+02	.262E+08
285.00	.128E-06	.275E+01	.152E+04	-.459E+00	.266E+02	.262E+08
290.00	-.245E-06	.580E+00	.150E+04	-.332E+00	-.254E+02	.262E+08
295.00	-.153E-08	-.446E+00	.150E+04	.219E-01	.329E+01	.262E+08
300.00	.538E-13	.000E+00	.149E+04	.000E+00	-.517E-01	.262E+08

COMPUTED LATERAL FORCE AT PILE HEAD = .40000E+02 KIP
 COMPUTED MOMENT AT PILE HEAD = .00000E+00 IN-KIP
 COMPUTED SLOPE AT PILE HEAD = -.74502E-02

THE OVERALL MOMENT IMBALANCE = -.278E-07 IN-KIP
 THE OVERALL LATERAL FORCE IMBALANCE = .563E-06 LBS

OUTPUT SUMMARY

PILE HEAD DEFLECTION = .623E+00 IN
 MAXIMUM BENDING MOMENT = .174E+04 IN-KIP
 MAXIMUM TOTAL STRESS = .156E+05 LBS/IN**2

NO. OF ITERATIONS = 27
 MAXIMUM DEFLECTION ERROR = .880E-05 IN

S U M M A R Y T A B L E

LATERAL LOAD (KIP)	BOUNDARY CONDITION BC2	AXIAL LOAD (KIP)	YT (IN)	ST (IN/IN)	MAX. MOMENT (IN-KIP)	MAX. STRESS (LBS/IN**2)
.200E+02	.000E+00	.390E+02	.145E+00	-.222E-02	.661E+03	.687E+04
.400E+02	.000E+00	.390E+02	.623E+00	-.745E-02	.174E+04	.156E+05

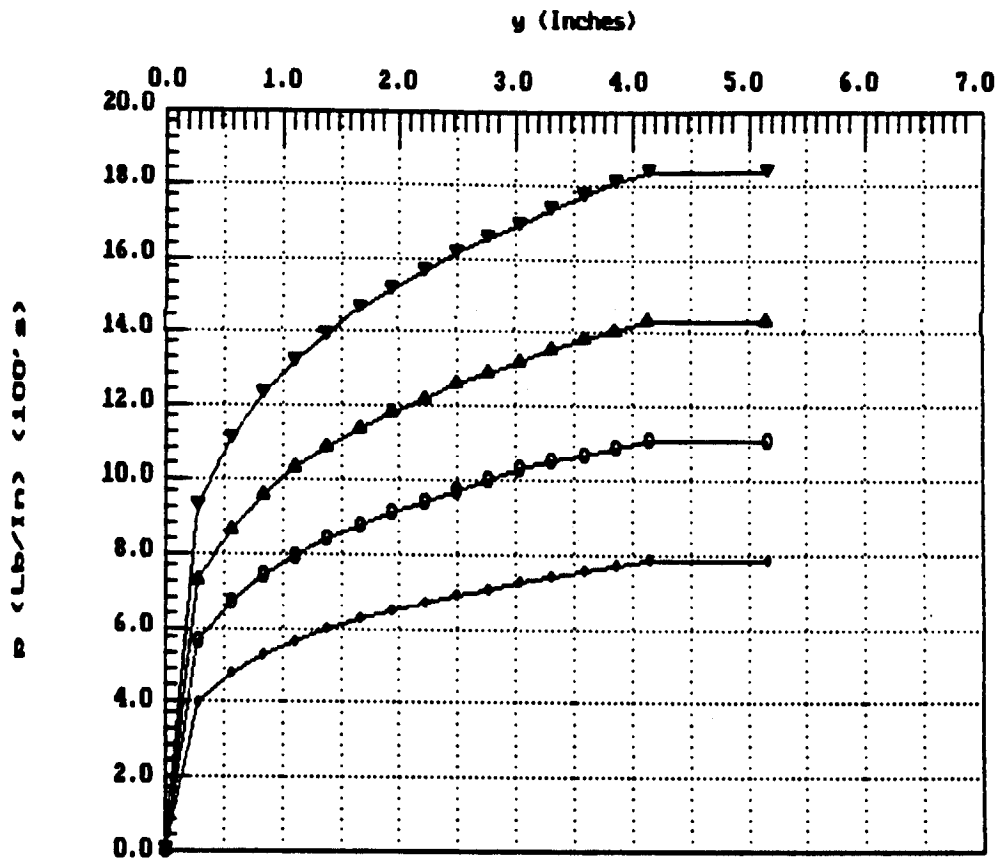

- Depth
- 20 inches
 - 60 inches
 - ▲ 100 inches
 - ▼ 150 inches

p-y Curves.

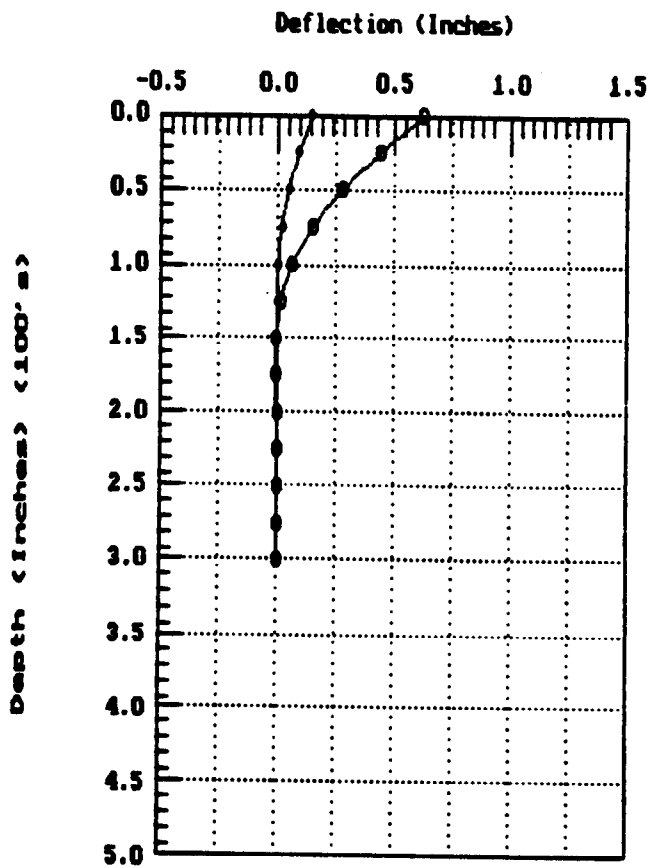

• 1
 ◻ 2

Pile Deflection vs. Depth.

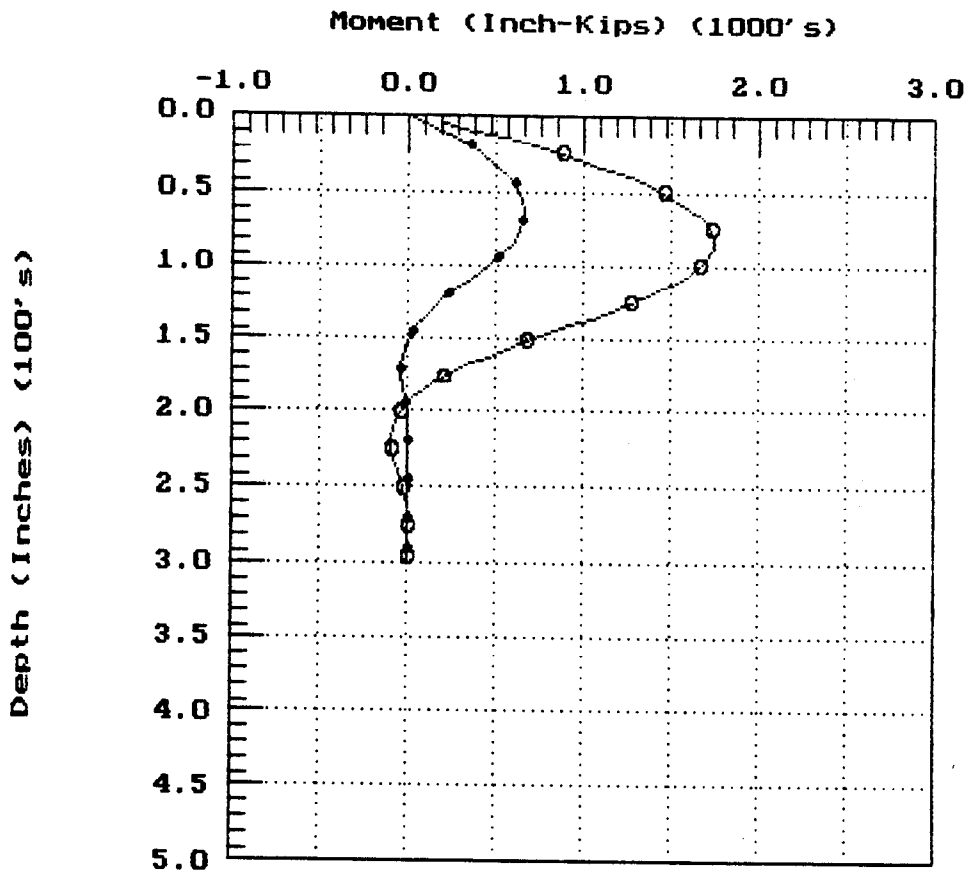

Bending Moment vs. Depth.

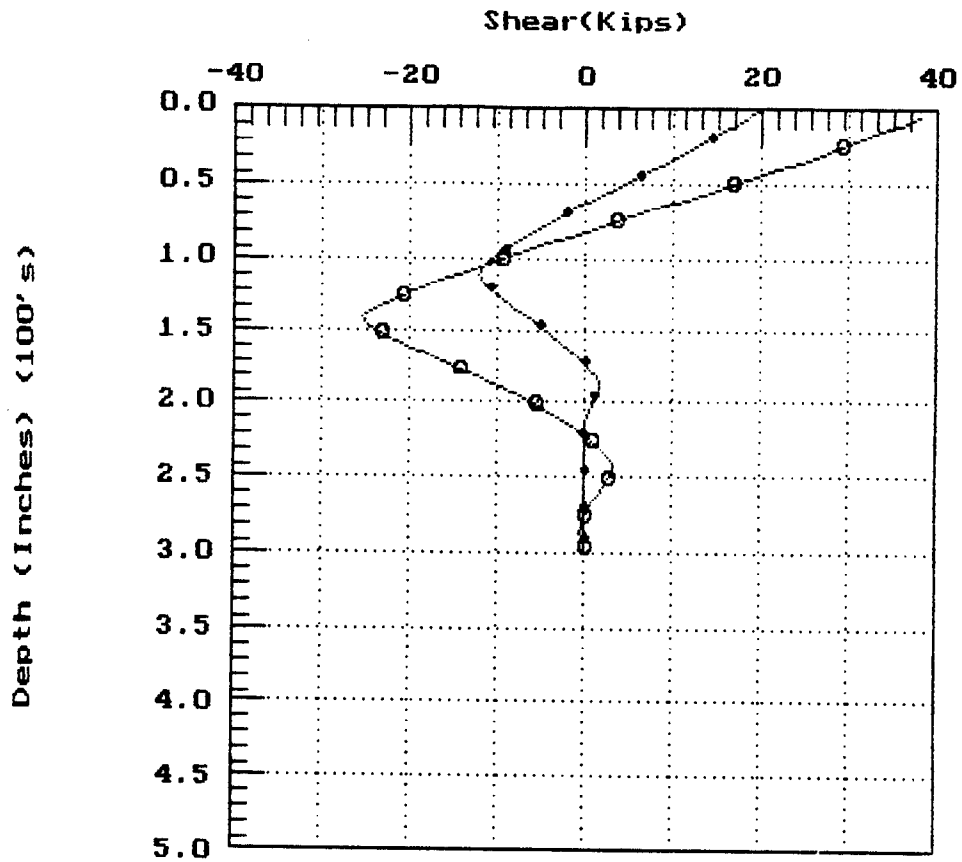

Shearing Force vs. Depth.

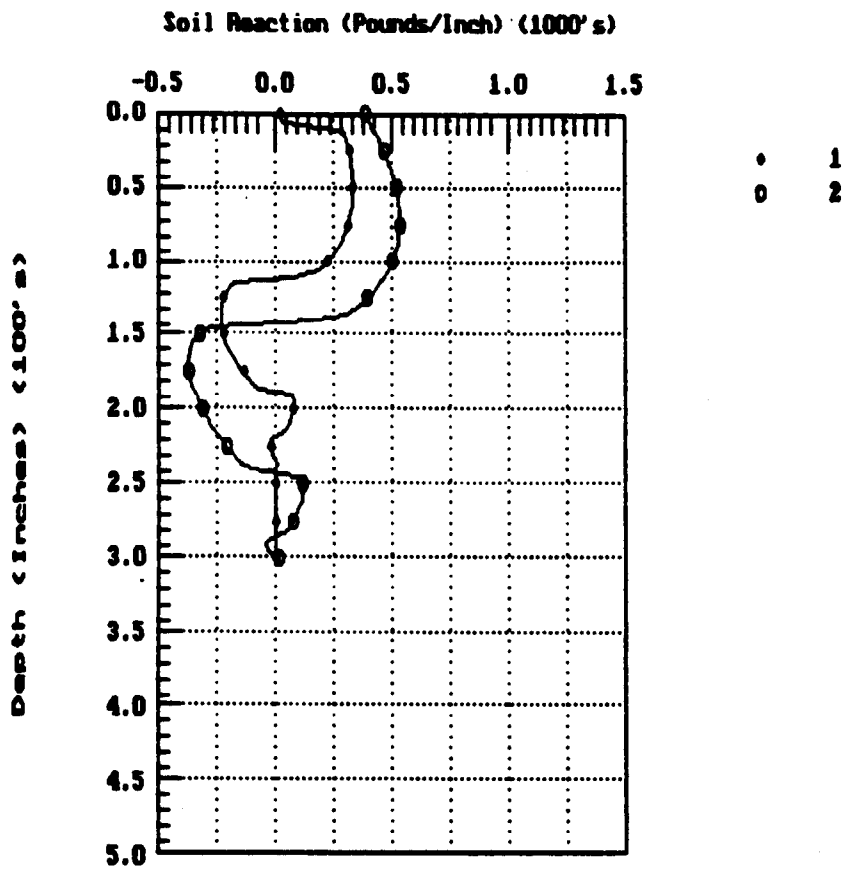

Soil Reaction vs. Depth.

EXAMPLE 2, CONCRETE PILES IN LAYERED SOIL WITH DISTRIBUTED LOAD

This example is included to illustrate a common case in which a 36-in diameter, reinforced-concrete pile is subjected to both horizontal and vertical forces at the top of the pile. Distributed loads are also specified near the top portion of the pile. The soil deposit is not uniform and, as shown in Fig. 5.1, five different layers are encountered in this example.

The recommendations for p-y curves for layered soils are presented in Chapter 3 of Part II of this manual. The computer will calculate the equivalent thickness for each layer. If the user wants to check the p-y curves generated by the computer, the equivalent thickness should be taken into account. The p-y curves for rock at the fifth layer were generated internally by the computer. The only parameter that is needed for rock is the shear strength. The modulus k and ϵ_{50} are only used for the initial condition. It should be noted that the shear strength is half of the uniaxial compression strength reported for most rock specimens.

Layered-soil is commonly encountered in routine design. It should be noted that there may be some uncertainty regarding the theory used for conversion of layered soils. If soil layers do not change their natural properties dramatically (for example, sandy layers with differing angles of friction) then the best approach for modeling the soil response is to use a lower number of layers. However, care must be taken to characterize in detail the strength variation profile in the input data.

The input and output data are shown in the following pages.

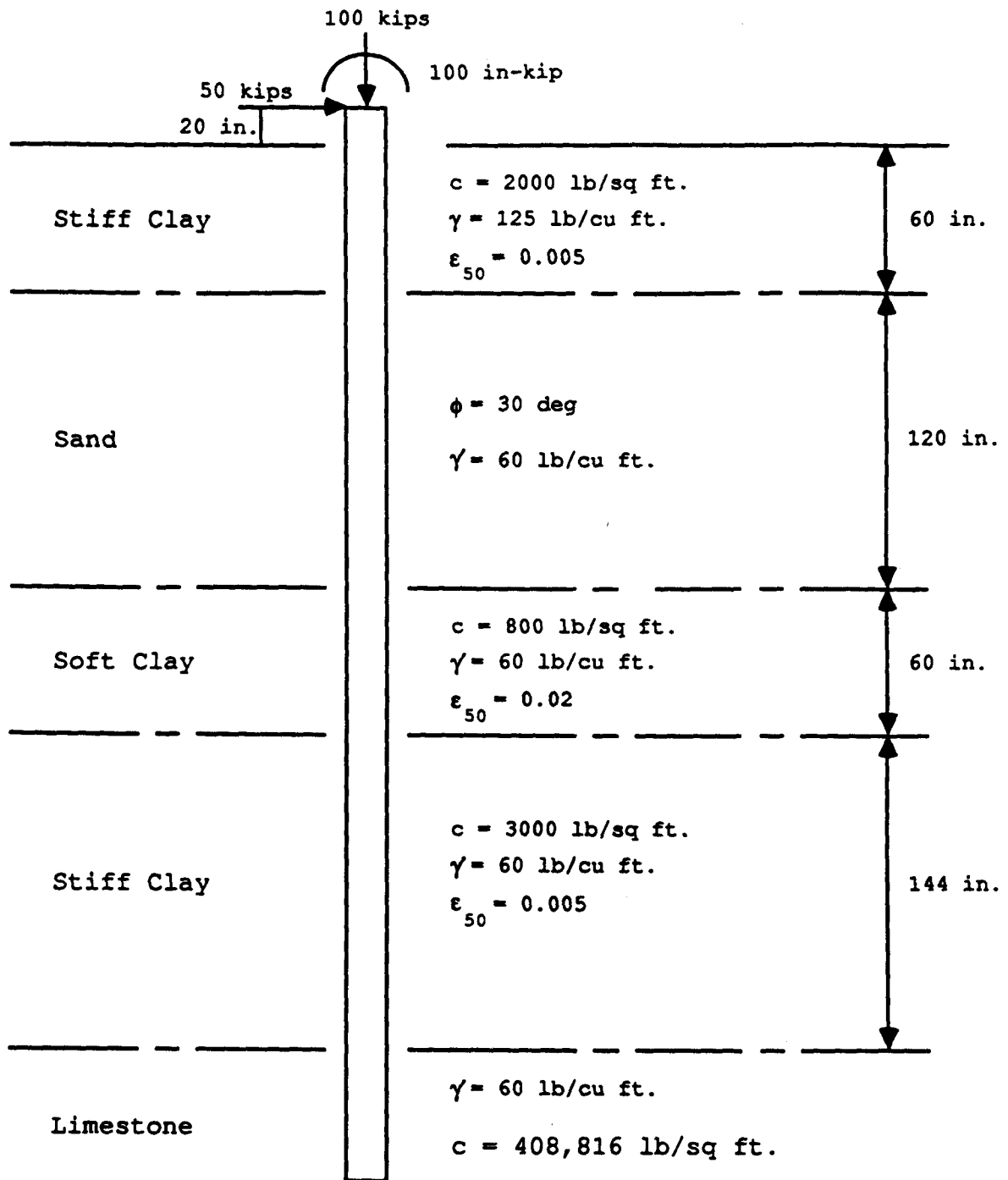

Pile Length = 500 in.
 Pile Diameter = 36 in.
 Modulus of Elasticity = $3.1 \times 10^6 \text{ lb/sq in.}$

Figure 5.1. Data for Example 2.

INPUT SCREENS FOR EXAMPLE 2

File ← Analysis Mult Option

C624EDIT 2.0, Edit Variables:

This program is a preprocessor developed especially for users for preparation of input for the computer program COM624P. The main menu for this program is displayed as a bar at the top row of the screen. The main menu has four choices: FILE, ANALYSIS, MULT, and OPTION.

The selection of the FILE menu allows the user to access a pull-down menu for file operations such as reading in an existing file, creating a new data file, checking files in the directory, and similar operations. The selection of the ANALYSIS menu allows the user to enter required data for computing the response of the pile and soil, such as distributions of deflection, bending moment, shear, and soil resistance as a function of length along the pile. The selection of the MULT menu allows the user to enter data of a selected pile size for computing the ultimate bending moment and other design-related information. The OPTION menu is used for screen setting and it may not be needed for most computer systems.

F1-Help Alt-X-Exit

File Analysis Mult Option

Read
New ←
Save
Write
Directory
Change dir
Quit to DOS
Main Menu

F1-Help Alt-X-Exit

File Analysis Mult Option

Read New	
	New File Name _____
	EXAMPLE.IN2
Change dir Quit to DOS Main Menu	

F1-Help Alt-X-Exit

File Analysis Mult Option

Read New Save Directory Change dir Quit to DOS Main Menu ←	
--	--

F1-Help Alt-X-Exit

File Analysis ← Mult Option

C624EDIT 2.0, Edit Variables:

This program is a preprocessor developed especially for users for preparation of input for the computer program COM624P. The main menu for this program is displayed as a bar at the top row of the screen. The main menu has four choices: FILE, ANALYSIS, MULT, and OPTION.

The selection of the FILE menu allows the user to access a pull-down menu for file operations such as reading in an existing file, creating a new data file, checking files in the directory, and similar operations. The selection of the ANALYSIS menu allows the user to enter required data for computing the response of the pile and soil, such as distributions of deflection, bending moment, shear, and soil resistance as a function of length along the pile. The selection of the MULT menu allows the user to enter data of a selected pile size for computing the ultimate bending moment and other design-related information. The OPTION menu is used for screen setting and it may not be needed for most computer systems.

F1-Help Alt-X-Exit

File Analysis Mult Option

Title ←
File Properties
Soil Properties
Lateral p-y Data
Data for Loading
Computation Control
Output Tables
Main Menu

F1-Help Alt-X-Exit

File

Analysis

Mult

Option

EXAMPLE.IN2

Enter title for this data file (up to 72 characters long)

EXAMPLE 2 CONCRETE PILES IN LAYERED SOIL WITH DISTRIBUTED LOADS

A 1:DEF:Lab EXAMPLE 2 CONCRETE PILES IN LAYERED SOIL WITH DISTRIBUTED LOADS

_____ : Move Cell _____ ? : Help _____ / : Edit Screen_____ F8 : Continue _____
F1-Help Alt-X-Exit

File

Analysis

Mult

Option

Title
File Properties ←
Soil Properties
Lateral p-y Data
Data for Loading
Computation Control
Output Tables
Main Menu

F1-Help

Alt-X-Exit

Editing Pile Dimensions

Number of increments (<= 300)	100
Distance from top of pile to ground surface - inches	20.0
Length of pile	500.00
Pile modulus	3100000
Slope of ground surface (degrees)	0.0000

A 1:DEF:Num 100

_____ : Move Cell _____ ? : Help _____ / : Edit Screen _____ F8 : Continue _____
 F1-Help Alt-X-Exit

Editing Pile Section Properties

Section #	Top Depth inches	Diameter inches	Mom. of Inert. inches**4	Area inches ²
1	0.00	36.000	82500.0000	1080.0000
2	300.00	36.000	61500.0000	1080.0000
3				
4				
5				
6				
7				
8				
9				
10				

To access pile property library leave pile diameter blank.

A 1:DEF:Num 0.00000

_____ : Move Cell _____ ? : Help _____ / : Edit Screen _____ F8 : Continue _____
 F1-Help Alt-X-Exit

File Analysis Mult Option

	Title File Properties ← Soil Properties Lateral p-y Data Data for Loading Computation Control Output Tables Main Menu	
--	--	--

F1-Help Alt-X-Exit

File Analysis Mult Option EXAMPLE.IN2

Editing Soil Layer Information				
Layer #	Criteria #	X-top inches	X-bot inches	k lb/in3
1	3	20.00	80.00	1000.00
2	4	80.00	200.00	60.00
3	1	200.00	260.00	200.00
4	3	260.00	404.00	1200.00
5	6	404.00	600.00	2000.00
6				
7				
8				
9				
10				
p-y Curve Criteria				
#1 = Soft Clay Criteria		#3 = Stiff Clay Above Watertable		
#2 = Stiff Clay Below Watertable		#4 = Sand		
#5 = Interp. Between Input Curves		#6 = Vuggy Limestone		
A 1:DEF:Num 3				
_____ : Move Cell _____ ? : Help _____ / : Edit Screen _____ F8 : Continue _____				

F1-Help Alt-X-Exit

Editing Effective Unit Weight Information

Point #	Depth inches	Unit Weight lb/in3
1	20.00	0.072
2	80.00	0.072
3	80.00	0.035
4	600.00	0.035
5		
6		
7		
8		
9		
10		

A 1:DEF:Num 20.00000

_____ : Move Cell _____ ? : Help _____ / : Edit Screen _____ F8 : Continue _____
 F1-Help Alt-X-Exit

Editing Shear Strength Information

Layer #	Depth inches	c psi	φ deg.	E50 @ 50% of c
1	20.00	13.900	0.00	0.0050
2	80.00	13.900	0.00	0.0050
3	80.00	0.000	30.00	0.0000
4	200.00	0.000	30.00	0.0000
5	200.00	5.560	0.00	0.0200
6	260.00	5.560	0.00	0.0200
7	260.00	20.800	0.00	0.0050
8	404.00	20.800	0.00	0.0050
9	404.00	2839.000	0.00	0.0010
10	600.00	2839.000	0.00	0.0010

A 1:DEF:Num 20.00000

_____ : Move Cell _____ ? : Help _____ / : Edit Screen _____ F8 : Continue _____
 F1-Help Alt-X-Exit

File Analysis Mult Option

Title
Pile Properties
Soil Properties
Lateral p-y Data
Data for Loading ←
Computation Control
Output Tables
Main Menu

F1-Help Alt-X-Exit

File Analysis Mult Option EXAMPLE.IN2

Editing Loading Information

Distributed lateral loading (y/n) ? y
Is loading cyclic (y/n) ? n
Boundary condition code (KBC) 1

KBC = 1 for shear and moment
KBC = 2 for shear and slope
KBC = 3 for shear and rotational restraint
KBC = 4 for deflection and moment

A 1:DEF:Lab y

_____ : Move Cell _____ ? : Help _____ / : Edit Screen _____ F8 : Continue _____
F1-Help Alt-X-Exit

Editing Distributed Loading on Pile

Point #	Depth inches	Loading pounds/inches
1		
2	0.00	50.00
3	10.00	100.00
4		
5		
6		
7		
8		
9		
10		

A 1:DEF:Num 0.00000

_____ : Move Cell _____ ? : Help _____ / : Edit Screen _____ F8 : Continue _____
 F1-Help Alt-X-Exit

Editing File-head Loading

KOP	Shear pounds	Moment in-lbs	Axial Load pounds
1	50000.00	100000.000	100000.00

KOP=0 if only a summary output for this load is to be printed
 =1 if complete output is desired for this load

A 1:DEF:Num 1

_____ : Move Cell _____ ? : Help _____ / : Edit Screen _____ F8 : Continue _____
 F1-Help Alt-X-Exit

File Analysis Mult Option

Title
Pile Properties
Soil Properties
Lateral p-y Data
Data for Loading
Computation Control ←
Output Tables
Main Menu

F1-Help Alt-X-Exit

File Analysis Mult Option EXAMPLE.IN2

Maximum number of iterations allowed for analysis : 100
Tolerance on solution convergence, inches : 0.000010
Value of deflection considered to be excessive, inches : 360.0000
Computation using internal-generated cracked/uncracked EI: N

A 1:DEF:Num 100

— : Move Cell — ? : Help — / : Edit Screen — F8 : Continue —

F1-Help Alt-X-Exit

File Analysis Mult Option

Title
File Properties
Soil Properties
Lateral p-y Data
Data for Loading
Computation Control
Output Tables ←
Main Menu

F1-Help Alt-X-Exit

File Analysis Mult Option B:EXAMPLE.IN2

Output Printing Options

*** Lateral Load Analysis ***

Printing Increment (1 for every node, 2 for every other node, etc)	2
Print deflection, moment, shear over full length of pile (y/n)	Y
Print p-y curves for verification	Y

A 1:DEF:Num 2

_____ : Move Cell _____ ? : Help _____ / : Edit Screen _____ F8 : Continue _____

F1-Help Alt-X-Exit

File

Analysis

Mult

Option

B:EXAMPLE.IN2

Enter depths for which p-y curves are to be calculated for verification:

Point	Depth inches
1	60.00
2	120.00
3	240.00
4	360.00
5	
6	
7	
8	
9	
10	

A 1:DEF:Num 60.00000

_____ : Move Cell _____ ? : Help _____ / : Edit Screen _____ F8 : Continue _____
F1-Help Alt-X-Exit

File

Analysis

Mult

Option

Title
Pile Properties
Soil Properties
Lateral p-y Data
Data for Loading
Computation Control
Output Tables
Main Menu ←

F1-Help

Alt-X-Exit

File ← Analysis Mult Option

C624EDIT 2.0, Edit Variables:

This program is a preprocessor developed especially for users for preparation of input for the computer program COM624P. The main menu for this program is displayed as a bar at the top row of the screen. The main menu has four choices: FILE, ANALYSIS, MULT, and OPTION.

The selection of the FILE menu allows the user to access a pull-down menu for file operations such as reading in an existing file, creating a new data file, checking files in the directory, and similar operations. The selection of the ANALYSIS menu allows the user to enter required data for computing the response of the pile and soil, such as distributions of deflection, bending moment, shear, and soil resistance as a function of length along the pile. The selection of the MULT menu allows the user to enter data of a selected pile size for computing the ultimate bending moment and other design-related information. The OPTION menu is used for screen setting and it may not be needed for most computer systems.

F1-Help Alt-X-Exit

File Analysis Mult Option

Read
New
Save ←
Directory
Change dir
Quit to DOS
Main Menu

F1-Help Alt-X-Exit

File

Analysis

Mult

Option

B:EXAMPLE.IN2

Read
New
Save

Save File Name

EXAMPLE.IN2

Main Menu

F1-Help

Alt-X-Exit

OUTPUT RESULTS FOR EXAMPLE 2

EXAMPLE 2 CONCRETE PILES IN LAYERED SOIL WITH DISTRIBUTED LOADS

UNITS--ENGL

FILE DEFLECTION, BENDING MOMENT, SHEAR & SOIL RESISTANCE

I N P U T I N F O R M A T I O N

DISTRIBUTED LOAD CURVE 3 POINTS
 X, IN LOAD, LBS/IN
 .00 .500E+02
 10.00 .100E+03
 20.00 .200E+03

THE LOADING IS STATIC

PILE GEOMETRY AND PROPERTIES

PILE LENGTH = 500.00 IN
MODULUS OF ELASTICITY OF PILE = .310E+04 KIP/IN**2
 2 SECTION(S)

X	DIAMETER	MOMENT OF INERTIA	AREA
IN	IN	IN**4	IN**2
.00	36.000	.825E+05	.108E+04
300.00	36.000	.615E+05	.108E+04
500.00			

SOILS INFORMATION

X-COORDINATE AT THE GROUND SURFACE = 20.00 IN

SLOPE ANGLE AT THE GROUND SURFACE = .00 DEG.

5 LAYER(S) OF SOIL

LAYER 1

THE LAYER IS A STIFF CLAY ABOVE THE WATER TABLE
 X AT THE TOP OF THE LAYER = 20.00 IN
 X AT THE BOTTOM OF THE LAYER = 80.00 IN
 VARIATION OF SOIL MODULUS, k = .100E+04 LBS/IN**3

LAYER 2

THE LAYER IS A SAND
 X AT THE TOP OF THE LAYER = 80.00 IN
 X AT THE BOTTOM OF THE LAYER = 200.00 IN
 VARIATION OF SOIL MODULUS, k = .600E+02 LBS/IN**3

LAYER 3

THE LAYER IS A SOFT CLAY
 X AT THE TOP OF THE LAYER = 200.00 IN
 X AT THE BOTTOM OF THE LAYER = 260.00 IN
 VARIATION OF SOIL MODULUS, k = .200E+03 LBS/IN**3

LAYER 4

THE LAYER IS A STIFF CLAY ABOVE THE WATER TABLE
 X AT THE TOP OF THE LAYER = 260.00 IN
 X AT THE BOTTOM OF THE LAYER = 404.00 IN
 VARIATION OF SOIL MODULUS, k = .120E+04 LBS/IN**3

LAYER 5

THE LAYER IS A ROCK
 X AT THE TOP OF THE LAYER = 404.00 IN
 X AT THE BOTTOM OF THE LAYER = 600.00 IN
 VARIATION OF SOIL MODULUS, k = .200E+04 LBS/IN**3

DISTRIBUTION OF EFFECTIVE UNIT WEIGHT WITH DEPTH
 4 POINTS

X, IN	WEIGHT, LBS/IN**3
20.00	.72E-01
80.00	.72E-01
80.00	.35E-01
600.00	.35E-01

DISTRIBUTION OF STRENGTH PARAMETERS WITH DEPTH
 10 POINTS

X, IN	C, LBS/IN**2	PHI, DEGREES	E50
20.00	.139E+02	.000	.500E-02
80.00	.139E+02	.000	.500E-02
80.00	.000E+00	30.000	-----
200.00	.000E+00	30.000	-----
200.00	.556E+01	.000	.200E-01
260.00	.556E+01	.000	.200E-01

260.00	.208E+02	.000	.500E-02
404.00	.208E+02	.000	.500E-02
404.00	.284E+04	.000	.100E-02
600.00	.284E+04	.000	.100E-02

FINITE DIFFERENCE PARAMETERS

NUMBER OF PILE INCREMENTS	=	100
TOLERANCE ON DETERMINATION OF DEFLECTIONS	=	.100E-04 IN
MAXIMUM NUMBER OF ITERATIONS ALLOWED FOR PILE ANALYSIS	=	100
MAXIMUM ALLOWABLE DEFLECTION	=	.36E+03 IN

INPUT CODES

OUTPT	=	1
KCYCL	=	1
KBC	=	1
KPYOP	=	1
INC	=	2

EXAMPLE 2 CONCRETE PILES IN LAYERED SOIL WITH DISTRIBUTED LOADS

UNITS--ENGL

OUTPUT INFORMATION

GENERATED P-Y CURVES

THE NUMBER OF CURVE IS	=	4
THE NUMBER OF POINTS ON EACH CURVE	=	17

DEPTH BELOW GS IN	DIAM IN	C LBS/IN**2	CAVG LBS/IN**2	GAMMA LBS/IN**3	E50
40.00	36.000	.1E+02	.1E+02	.7E-01	.500E-02
		Y		P	
		IN		LBS/IN	
		.000		.000	
		.480		956.753	
		.960		1137.777	

1.440	1259.158
1.920	1353.053
2.400	1430.679
2.880	1497.399
3.360	1556.232
3.840	1609.060
4.320	1657.145
4.800	1701.374
5.280	1742.401
5.760	1780.718
6.240	1816.710
6.720	1850.682
7.200	1882.880
9.000	1882.880

DEPTH BELOW GS IN	DIAM IN	PHI	GAMMA LBS/IN**3	A	B
100.00	36.00	30.0	.6E-01	1.14	.78

Y IN	P LBS/IN
.000	.000
.050	370.940
.100	741.881
.150	1093.652
.200	1216.369
.250	1320.962
.300	1413.062
.350	1495.924
.400	1571.620
.450	1641.561
.500	1706.759
.550	1767.966
.600	1825.758
1.350	2669.421
37.350	2669.421
73.350	2669.421
109.350	2669.421

DEPTH BELOW GS IN	DIAM IN	C LBS/IN**2	GAMMA LBS/IN**3	E50
220.00	36.000	.6E+01	.5E-01	.200E-01

Y, IN	P, LBS/IN
.000	.000
.014	180.144
.450	567.418
.900	714.902
1.350	818.358
1.800	900.720

2.250	970.271
2.700	1031.067
3.150	1085.432
3.600	1134.836
4.050	1180.277
4.500	1222.465
4.950	1261.926
5.400	1299.063
14.400	1801.440
27.000	1801.440
36.000	1801.440

DEPTH BELOW GS IN	DIAM IN	C LBS/IN**2	CAVG LBS/IN**2	GAMMA LBS/IN**3	E50
340.00	36.000	.2E+02	.2E+02	.4E-01	.500E-02
		Y		P	
		IN		LBS/IN	
		.000		.000	
		.480		2789.525	
		.960		3317.323	
		1.440		3671.222	
		1.920		3944.985	
		2.400		4171.313	
		2.880		4365.843	
		3.360		4537.376	
		3.840		4691.404	
		4.320		4831.600	
		4.800		4960.555	
		5.280		5080.173	
		5.760		5191.892	
		6.240		5296.831	
		6.720		5395.880	
		7.200		5489.757	
		9.000		5489.757	

----- *** -----

PILE LOADING CONDITION

LATERAL LOAD AT PILE HEAD = .500E+02 KIP
 APPLIED MOMENT AT PILE HEAD = .100E+03 IN-KIP
 AXIAL LOAD AT PILE HEAD = .100E+03 KIP

DISTRIBUTED LOAD CURVE 3 POINTS

X, IN	LOAD, LBS/IN
.00	.500E+02
10.00	.100E+03
20.00	.200E+03

X	DEFLECTION	MOMENT	TOTAL STRESS	SHEAR	SOIL RESIST	FLEXURAL RIGIDITY
IN	IN	IN-KIP	LBS/IN**2	KIP	LBS/IN	KIP-IN**2
.00	.251E+00	.100E+03	.114E+03	.502E+02	.000E+00	.256E+09
10.00	.230E+00	.605E+03	.225E+03	.507E+02	.000E+00	.256E+09
20.00	.209E+00	.112E+04	.337E+03	.507E+02	.620E+03	.256E+09
30.00	.189E+00	.160E+04	.442E+03	.449E+02	.643E+03	.256E+09
40.00	.170E+00	.202E+04	.534E+03	.384E+02	.663E+03	.256E+09
50.00	.151E+00	.237E+04	.611E+03	.316E+02	.680E+03	.256E+09
60.00	.133E+00	.266E+04	.673E+03	.248E+02	.695E+03	.256E+09
70.00	.117E+00	.287E+04	.719E+03	.178E+02	.706E+03	.256E+09
80.00	.101E+00	.302E+04	.751E+03	.112E+02	.507E+03	.256E+09
90.00	.865E-01	.310E+04	.770E+03	.621E+01	.486E+03	.256E+09
100.00	.733E-01	.314E+04	.778E+03	.149E+01	.456E+03	.256E+09
110.00	.613E-01	.314E+04	.777E+03	-.288E+01	.418E+03	.256E+09
120.00	.505E-01	.309E+04	.767E+03	-.684E+01	.375E+03	.256E+09
130.00	.409E-01	.300E+04	.748E+03	-.104E+02	.328E+03	.256E+09
140.00	.325E-01	.289E+04	.722E+03	-.134E+02	.281E+03	.256E+09
150.00	.253E-01	.274E+04	.690E+03	-.160E+02	.233E+03	.256E+09
160.00	.191E-01	.257E+04	.653E+03	-.181E+02	.187E+03	.256E+09
170.00	.139E-01	.238E+04	.612E+03	-.197E+02	.145E+03	.256E+09
180.00	.965E-02	.218E+04	.567E+03	-.210E+02	.106E+03	.256E+09
190.00	.624E-02	.196E+04	.520E+03	-.219E+02	.725E+02	.256E+09
200.00	.360E-02	.174E+04	.472E+03	-.226E+02	.113E+03	.256E+09
210.00	.164E-02	.151E+04	.422E+03	-.236E+02	.872E+02	.256E+09
220.00	.263E-03	.127E+04	.369E+03	-.243E+02	.475E+02	.256E+09
230.00	-.614E-03	.102E+04	.316E+03	-.241E+02	-.629E+02	.256E+09
240.00	-.109E-02	.787E+03	.264E+03	-.234E+02	-.762E+02	.256E+09
250.00	-.126E-02	.558E+03	.214E+03	-.226E+02	-.799E+02	.256E+09
260.00	-.121E-02	.336E+03	.166E+03	-.208E+02	-.482E+03	.256E+09
270.00	-.102E-02	.152E+03	.126E+03	-.160E+02	-.476E+03	.256E+09
280.00	-.781E-03	.161E+02	.961E+02	-.113E+02	-.457E+03	.256E+09
290.00	-.530E-03	-.744E+02	.109E+03	-.688E+01	-.425E+03	.256E+09
300.00	-.308E-03	-.122E+03	.119E+03	-.283E+01	-.380E+03	.223E+09
310.00	-.140E-03	-.132E+03	.131E+03	.690E+00	-.320E+03	.191E+09
320.00	-.400E-04	-.110E+03	.125E+03	.352E+01	-.239E+03	.191E+09
330.00	.261E-05	-.643E+02	.111E+03	.479E+01	.129E+03	.191E+09
340.00	.111E-04	-.235E+02	.995E+02	.321E+01	.184E+03	.191E+09
350.00	.669E-05	-.167E+00	.926E+02	.149E+01	.165E+03	.191E+09
360.00	.166E-05	.711E+01	.947E+02	.822E-01	.119E+03	.191E+09
370.00	-.132E-07	.296E+01	.935E+02	-.533E+00	-.363E+02	.191E+09

380.00	-.206E-07	-.184E+00	.926E+02	-.894E-01	-.425E+02	.191E+09
390.00	.262E-10	-.731E-03	.926E+02	.156E-01	.866E+01	.191E+09
400.00	-.704E-16	.153E-08	.926E+02	-.200E-04	-.112E-01	.191E+09
410.00	-.467E-15	.763E-09	.926E+02	-.650E-10	-.414E-08	.191E+09
420.00	-.455E-15	.249E-09	.926E+02	-.380E-10	-.405E-08	.191E+09
430.00	-.304E-15	-.110E-10	.926E+02	-.162E-10	-.271E-08	.191E+09
440.00	-.153E-15	-.984E-10	.926E+02	-.339E-11	-.137E-08	.191E+09
450.00	-.505E-16	-.971E-10	.926E+02	.219E-11	-.455E-09	.191E+09
460.00	.188E-17	-.653E-10	.926E+02	.342E-11	.138E-10	.191E+09
470.00	.200E-16	-.334E-10	.926E+02	.271E-11	.177E-09	.191E+09
480.00	.202E-16	-.122E-10	.926E+02	.153E-11	.180E-09	.191E+09
490.00	.137E-16	-.221E-11	.926E+02	.554E-12	.123E-09	.191E+09
500.00	.578E-17	.000E+00	.926E+02	.000E+00	.525E-10	.191E+09

COMPUTED LATERAL FORCE AT PILE HEAD = .50000E+02 KIP
 COMPUTED MOMENT AT PILE HEAD = .10000E+03 IN-KIP
 COMPUTED SLOPE AT PILE HEAD = -.20834E-02

THE OVERALL MOMENT IMBALANCE = .756E-09 IN-KIP
 THE OVERALL LATERAL FORCE IMBALANCE = .152E-06 LBS

OUTPUT SUMMARY

PILE HEAD DEFLECTION = .251E+00 IN
 MAXIMUM BENDING MOMENT = .315E+04 IN-KIP
 MAXIMUM TOTAL STRESS = .779E+03 LBS/IN**2

NO. OF ITERATIONS = 14
 MAXIMUM DEFLECTION ERROR = .499E-05 IN

S U M M A R Y T A B L E

LATERAL LOAD (KIP)	BOUNDARY CONDITION BC2	AXIAL LOAD (KIP)	YT (IN)	ST (IN/IN)	MAX. MOMENT (IN-KIP)	MAX. STRESS (LBS/IN**2)
.500E+02	.100E+03	.100E+03	.251E+00	-.208E-02	.315E+04	.779E+03

EXAMPLE 3, PILES IN A SLOPING ABUTMENT

The third example is illustrated in Fig. 5.2 and is included to show the use of the program for analysis of a 36-O.D. drilled shaft in a sloping abutment. The pile length is 500 in and the diameter is 36 inches. The soil stratum is a medium-dense sand layer underlaid by a stiff clay. The slope of the abutment is 20 degree from a horizontal surface.

The input and the output are shown in the following pages. The deflection at the pile head for this case is 0.402 in, which is about 20 percent higher than that (0.335 in) if the ground were a flat plane. A parametric study, with different slope angles in each run, indicates that the deflection of piles increases with an increase in the slope angle (Fig. 5.3).

It should be noted that the slope angle cannot be greater than the internal friction angle ϕ if the soil in the slope is cohesionless material. If a slope has a factor of safety below the standard requirement, it may create a driving force instead of a resisting force on the pile. For such a situation, analyses for slope stability with piles in place should be conducted. If a driving force from the slope is possible, the user should input the driving force as a distributed load on the pile in making the design.

The input and output data are shown in the following pages.

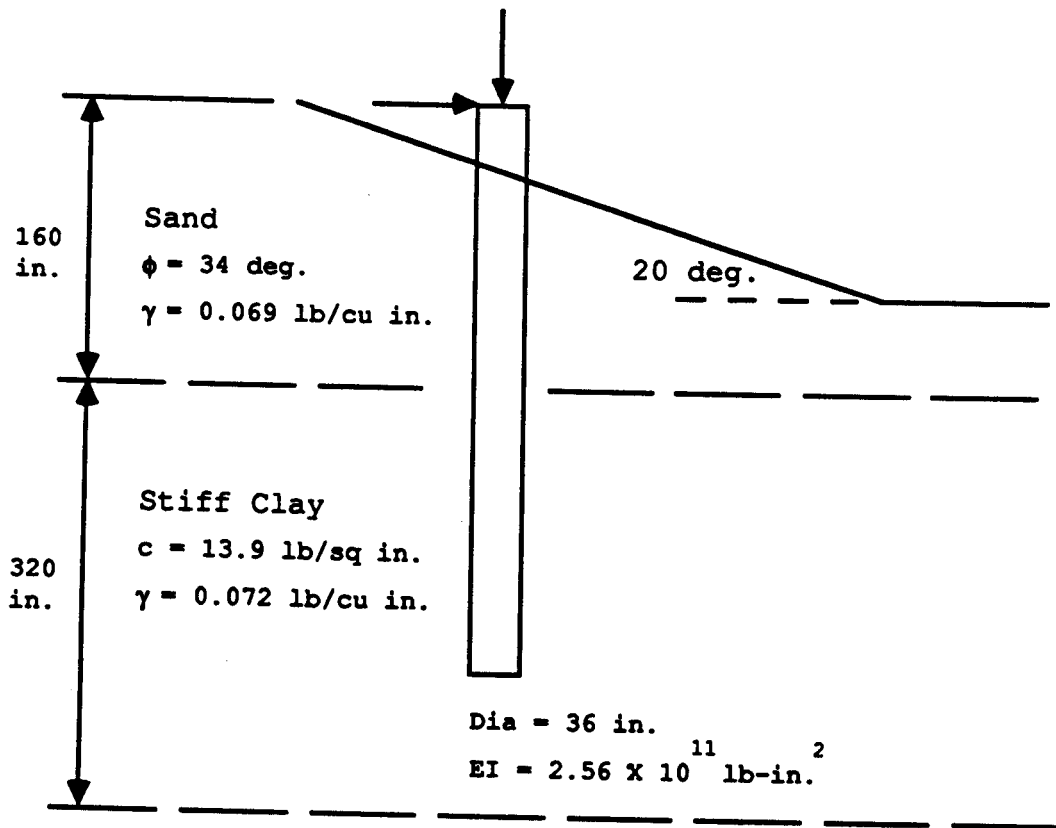

Figure 5.2. Data for Example 3.

Yt Versus Slope Angle

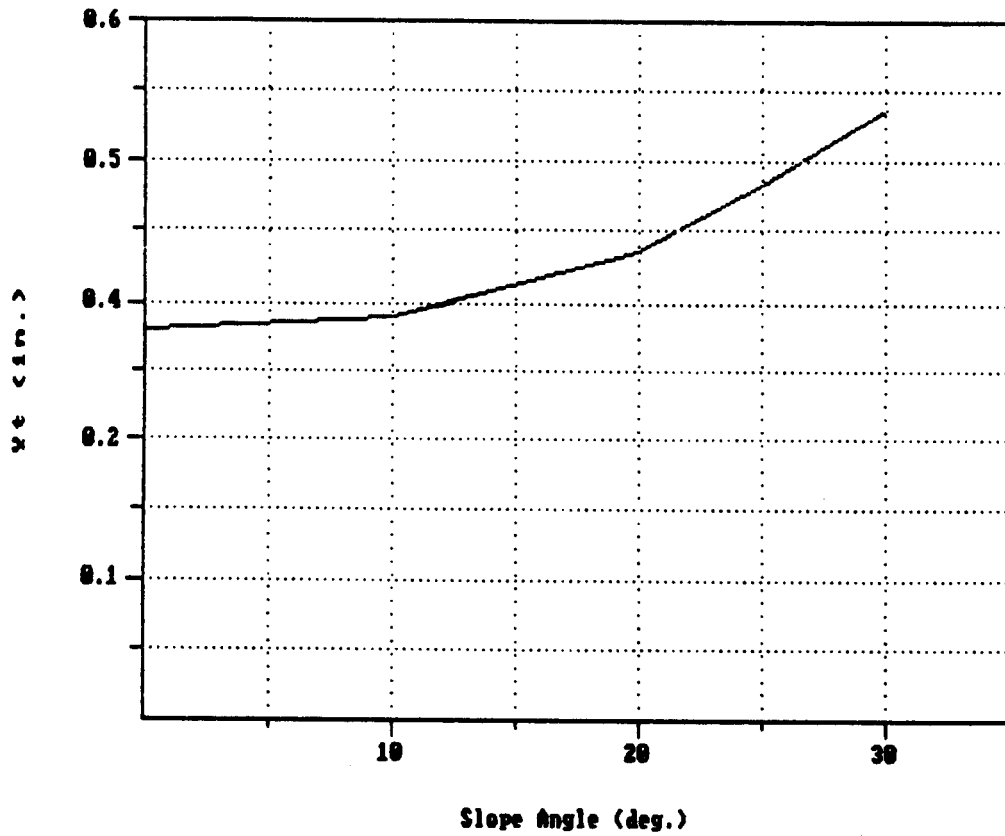

Figure 5.3. Pile-head deflection y_t versus slope angle.

INPUT SCREENS FOR EXAMPLE 3

File ← Analysis Mult Option

C624EDIT 2.0, Edit Variables:

This program is a preprocessor developed especially for users for preparation of input for the computer program COM624P. The main menu for this program is displayed as a bar at the top row of the screen. The main menu has four choices: FILE, ANALYSIS, MULT, and OPTION.

The selection of the FILE menu allows the user to access a pull-down menu for file operations such as reading in an existing file, creating a new data file, checking files in the directory, and similar operations. The selection of the ANALYSIS menu allows the user to enter required data for computing the response of the pile and soil, such as distributions of deflection, bending moment, shear, and soil resistance as a function of length along the pile. The selection of the MULT menu allows the user to enter data of a selected pile size for computing the ultimate bending moment and other design-related information. The OPTION menu is used for screen setting and it may not be needed for most computer systems.

F1-Help Alt-X-Exit

File Analysis Mult Option

Read
New ←
Save
Directory
Change dir
Quit to DOS
Main Menu

F1-Help Alt-X-Exit

File Analysis Mult Option

Read
New

EXAMPLE.IN3

New File Name

Change dir
Quit to DOS
Main Menu

F1-Help

Alt-X-Exit

File Analysis Mult Option

Read
New
Save
Directory
Change dir
Quit to DOS
Main Menu ←

F1-Help

Alt-X-Exit

File Analysis Mult Option

C624EDIT 2.0, Edit Variables:

This program is a preprocessor developed especially for users for preparation of input for the computer program COM624P. The main menu for this program is displayed as a bar at the top row of the screen. The main menu has four choices: FILE, ANALYSIS, MULT, and OPTION.

The selection of the FILE menu allows the user to access a pull-down menu for file operations such as reading in an existing file, creating a new data file, checking files in the directory, and similar operations. The selection of the ANALYSIS menu allows the user to enter required data for computing the response of the pile and soil, such as distributions of deflection, bending moment, shear, and soil resistance as a function of length along the pile. The selection of the MULT menu allows the user to enter data of a selected pile size for computing the ultimate bending moment and other design-related information. The OPTION menu is used for screen setting and it may not be needed for most computer systems.

F1-Help Alt-X-Exit

File Analysis Mult Option

Title ←
File Properties
Soil Properties
Lateral p-y Data
Data for Loading
Computation Control
Output Tables
Main Menu

F1-Help Alt-X-Exit

File

Analysis

Mult

Option

EXAMPLE.IN3

Enter title for this data file (up to 72 characters long)

EXAMPLE 3 PILES IN A SLOPING ABUTMENT

A 1:DEF:Lab EXAMPLE 3 PILES IN A SLOPING ABUTMENT

_____ : Move Cell — ? : Help — / : Edit Screen — F8 : Continue —
F1-Help Alt-X-Exit

File

Analysis

Mult

Option

Title
File Properties ←
Soil Properties
Lateral p-y Data
Data for Loading
Computation Control
Output Tables
Main Menu

F1-Help

Alt-X-Exit

Editing Pile Dimensions

Number of increments (<= 300)	100
Distance from top of pile to ground surface - inches	20.0
Length of pile	400.00
inches	
Pile modulus	3100000
psi	
Slope of ground surface (degrees)	20.0000

\ 1:DEF:Num 100

— : Move Cell — ? : Help — / : Edit Screen — F8 : Continue —
'1-Help Alt-X-Exit

File

Analysis

Mult

Option

EXAMPLE.IN3

Editing File Section Properties

Section #	Top Depth inches	Diameter inches	Mom. of Inert. inches**4	Area inches ²
1	0.00	36.000	82500.0000	1080.0000
2				
3				
4				
5				
6				
7				
8				
9				
10				

To access pile property library leave pile diameter blank.

1:DEF:Num 0.00000

: Move Cell — ? : Help — / : Edit Screen — F8 : Continue —
F1-Help Alt-X-Exit

File

Analysis

Mult

Option

- Title
- File Properties
- Soil Properties ←
- Lateral p-y Data
- Data for Loading
- Computation Control
- Output Tables
- Main Menu

F1-Help

Alt-X-Exit

Editing Soil Layer Information

Layer #	Criteria #	X-top inches	X-bot inches	k lb/in3
1	4	20.00	180.00	60.00
2	3	180.00	500.00	1000.00
3				
4				
5				
6				
7				
8				
9				
10				

p-y Curve Criteria

- #1 = Soft Clay Criteria
- #2 = Stiff Clay Below Watertable
- #3 = Stiff Clay Above Watertable
- #4 = Sand
- #5 = Interp. Between Input Curves
- #6 = Vuggy Limestone

A 1:DEF:Num 4

: Move Cell — ? : Help — / : Edit Screen — F8 : Continue —
 F1-Help Alt-X-Exit

Editing Effective Unit Weight Information

Point #	Depth inches	Unit Weight lb/in3
1	20.00	0.069
2	180.00	0.069
3	180.00	0.072
4	500.00	0.072
5		
6		
7		
8		
9		
10		

A 1:DEF:Num 20.00000

: Move Cell — ? : Help — / : Edit Screen — F8 : Continue —
 F1-Help Alt-X-Exit

File

Analysis

Mult

Option

EXAMPLE.IN3

Editing Shear Strength Information

Layer #	Depth inches	c psi	ϕ deg.	E50 @ 50% of c
1	20.00	0.000	34.00	0.0000
2	180.00	0.000	34.00	0.0000
3	180.00	13.900	0.00	0.0050
4	500.00	13.900	0.00	0.0050
5				
6				
7				
8				
9				
10				

A 1:DEF:Num 20.00000

_____ : Move Cell _____ ? : Help _____ / : Edit Screen _____ F8 : Continue _____
F1-Help Alt-X-Exit

File

Analysis

Mult

Option

- Title
- File Properties
- Soil Properties
- Lateral p-y Data
- Data for Loading ←
- Computation Control
- Output Tables
- Main Menu

F1-Help

Alt-X-Exit

Editing Loading Information

Distributed lateral loading (y/n) ? n
 Is loading cyclic (y/n) ? n
 Boundary condition code (KBC) 1

KBC = 1 for shear and moment (free head)
 KBC = 2 for shear and slope (fixed head)
 KBC = 3 for shear and rotational restraint (partially fixed)
 KBC = 4 for deflection and moment

A 1:DEF:Lab n

_____ : Move Cell _____ ? : Help _____ / : Edit Screen _____ F8 : Continue _____
 F1-Help Alt-X-Exit

Editing File-head Loading

KOP	Shear pounds	Moment in-lbs	Axial Load pounds
1	40000.00	600000.000	200000.00

KOP=0 if only a summary output for this load is to be printed
 =1 if complete output is desired for this load

A 1:DEF:Num 1

_____ : Move Cell _____ ? : Help _____ / : Edit Screen _____ F8 : Continue _____
 F1-Help Alt-X-Exit

File Analysis Mult Option

Title
File Properties
Soil Properties
Lateral p-y Data
Data for Loading
Computation Control ←
Output Tables
Main Menu

F1-Help Alt-X-Exit

File Analysis Mult Option EXAMPLE.IN3

Maximum number of iterations allowed for analysis : 100
Tolerance on solution convergence, inches : 0.000010
Value of deflection considered to be excessive, inches : 360.0000
Computation using internal-generated cracked/uncracked EI: N

A 1:DEF:Num 100

_____ : Move Cell — ? : Help — / : Edit Screen — F8 : Continue — |
F1-Help Alt-X-Exit

File Analysis Mult Option

Title
File Properties
Soil Properties
Lateral p-y Data
Data for Loading
Computation Control
Output Tables ←
Main Menu

F1-Help Alt-X-Exit

File Analysis Mult Option EXAMPLE.IN3

Output Printing Options

*** Lateral Load Analysis ***

Printing Increment (1 for every node, 2 for every other node, etc)	2
Print deflection, moment, shear over full length of pile (y/n)	Y
Print p-y curves for verification	Y

A 1:DEF:Num 2

_____ : Move Cell _____ ? : Help _____ / : Edit Screen _____ F8 : Continue _____

F1-Help Alt-X-Exit

File

Analysis

Mult

Option

EXAMPLE.IN3

Enter depths for which p-y curves are to be calculated for verification:

Point	Depth inches
1	50.00
2	
3	
4	
5	
6	
7	
8	
9	
10	

A 1:DEF:Num 50.00000

_____ : Move Cell _____ ? : Help _____ / : Edit Screen _____ F8 : Continue _____
F1-Help Alt-X-Exit

File

Analysis

Mult

Option

Title
File Properties
Soil Properties
Lateral p-y Data
Data for Loading
Computation Control
Output Tables
Main Menu ←

F1-Help

Alt-X-Exit

File ← Analysis Mult Option

C624EDIT 2.0, Edit Variables:

This program is a preprocessor developed especially for users for preparation of input for the computer program COM624P. The main menu for this program is displayed as a bar at the top row of the screen. The main menu has four choices: FILE, ANALYSIS, MULT, and OPTION.

The selection of the FILE menu allows the user to access a pull-down menu for file operations such as reading in an existing file, creating a new data file, checking files in the directory, and similar operations. The selection of the ANALYSIS menu allows the user to enter required data for computing the response of the pile and soil, such as distributions of deflection, bending moment, shear, and soil resistance as a function of length along the pile. The selection of the MULT menu allows the user to enter data of a selected pile size for computing the ultimate bending moment and other design-related information. The OPTION menu is used for screen setting and it may not be needed for most computer systems.

F1-Help Alt-X-Exit

File Analysis Mult Option

Read
New
Save ←
Directory
Change dir
Quit to DOS
Main Menu

F1-Help Alt-X-Exit

File

Analysis

Mult

Option

EXAMPLE.IN3

Read
New
Save

Save File Name

EXAMPLE.IN3

Quit to DOS
Main Menu

F1-Help

Alt-X-Exit

OUTPUT RESULTS FOR EXAMPLE 3

EXAMPLE 3 PILES IN A SLOPING ABUTMENT

UNITS--ENGL

PILE DEFLECTION, BENDING MOMENT, SHEAR & SOIL RESISTANCE

I N P U T I N F O R M A T I O N

THE LOADING IS STATIC

PILE GEOMETRY AND PROPERTIES

PILE LENGTH = 400.00 IN
MODULUS OF ELASTICITY OF PILE = .310E+04 KIP/IN**2
1 SECTION(S)

X	DIAMETER	MOMENT OF INERTIA	AREA
IN	IN	IN**4	IN**2
.00	36.000	.825E+05	.108E+04
400.00			

SOILS INFORMATION

X-COORDINATE AT THE GROUND SURFACE = 20.00 IN
SLOPE ANGLE AT THE GROUND SURFACE = 20.00 DEG.

2 LAYER(S) OF SOIL

LAYER 1

THE LAYER IS A SAND

X AT THE TOP OF THE LAYER = 20.00 IN
X AT THE BOTTOM OF THE LAYER = 180.00 IN
VARIATION OF SOIL MODULUS, k = .600E+02 LBS/IN**3

LAYER 2
 THE LAYER IS A STIFF CLAY ABOVE THE WATER TABLE
 X AT THE TOP OF THE LAYER = 180.00 IN
 X AT THE BOTTOM OF THE LAYER = 500.00 IN
 VARIATION OF SOIL MODULUS, k = .100E+04 LBS/IN**3

DISTRIBUTION OF EFFECTIVE UNIT WEIGHT WITH DEPTH
 4 POINTS

X, IN	WEIGHT, LBS/IN**3
20.00	.69E-01
180.00	.69E-01
180.00	.72E-01
500.00	.72E-01

DISTRIBUTION OF STRENGTH PARAMETERS WITH DEPTH
 4 POINTS

X, IN	C, LBS/IN**2	PHI, DEGREES	E50
20.00	.000E+00	34.000	-----
180.00	.000E+00	34.000	-----
180.00	.139E+02	.000	.500E-02
500.00	.139E+02	.000	.500E-02

FINITE DIFFERENCE PARAMETERS

NUMBER OF PILE INCREMENTS	=	100
TOLERANCE ON DETERMINATION OF DEFLECTIONS	=	.100E-04 IN
MAXIMUM NUMBER OF ITERATIONS ALLOWED FOR PILE ANALYSIS	=	100
MAXIMUM ALLOWABLE DEFLECTION	=	.36E+03 IN

INPUT CODES

OUTPT	=	1
KCYCL	=	1
KBC	=	1
KPYOP	=	1
INC	=	2

EXAMPLE 3 PILES IN A SLOPING ABUTMENT

UNITS--ENGL

OUTPUT INFORMATION

GENERATED P-Y CURVES

THE NUMBER OF CURVE IS = 1

THE NUMBER OF POINTS ON EACH CURVE = 17

DEPTH BELOW GS IN	DIAM IN	PHI	GAMMA LBS/IN**3	A	B
30.00	36.00	34.0	.7E-01	2.23	1.64
		Y IN		P LBS/IN	
		.000		.000	
		.050		90.000	
		.100		180.000	
		.150		228.027	
		.200		247.984	
		.250		264.660	
		.300		279.114	
		.350		291.948	
		.400		303.543	
		.450		314.151	
		.500		323.954	
		.550		333.085	
		.600		341.646	
		1.350		466.197	
		37.350		466.197	
		73.350		466.197	
		109.350		466.197	

----- *** -----

PILE LOADING CONDITION

LATERAL LOAD AT PILE HEAD = .400E+02 KIP
 APPLIED MOMENT AT PILE HEAD = .600E+03 IN-KIP
 AXIAL LOAD AT PILE HEAD = .200E+03 KIP

X	DEFLECTION	MOMENT	TOTAL STRESS	SHEAR	SOIL RESIST	FLEXURAL RIGIDITY
IN	IN	IN-KIP	LBS/IN**2	KIP	LBS/IN	KIP-IN**2
*****	*****	*****	*****	*****	*****	*****
.00	.403E+00	.600E+03	.316E+03	.406E+02	.000E+00	.256E+09
8.00	.379E+00	.925E+03	.387E+03	.400E+02	.000E+00	.256E+09
16.00	.355E+00	.125E+04	.458E+03	.400E+02	.000E+00	.256E+09
24.00	.332E+00	.157E+04	.529E+03	.399E+02	.335E+02	.256E+09
32.00	.308E+00	.190E+04	.599E+03	.394E+02	.105E+03	.256E+09
40.00	.286E+00	.221E+04	.668E+03	.383E+02	.177E+03	.256E+09
48.00	.264E+00	.252E+04	.734E+03	.365E+02	.250E+03	.256E+09
56.00	.242E+00	.280E+04	.797E+03	.343E+02	.317E+03	.256E+09
64.00	.222E+00	.307E+04	.856E+03	.315E+02	.378E+03	.256E+09
72.00	.202E+00	.332E+04	.909E+03	.283E+02	.428E+03	.256E+09
80.00	.183E+00	.353E+04	.956E+03	.247E+02	.471E+03	.256E+09
88.00	.164E+00	.372E+04	.996E+03	.208E+02	.503E+03	.256E+09
96.00	.147E+00	.387E+04	.103E+04	.166E+02	.525E+03	.256E+09
104.00	.131E+00	.399E+04	.106E+04	.124E+02	.538E+03	.256E+09
112.00	.116E+00	.407E+04	.107E+04	.807E+01	.537E+03	.256E+09
120.00	.101E+00	.412E+04	.109E+04	.383E+01	.522E+03	.256E+09
128.00	.879E-01	.414E+04	.109E+04	-.236E+00	.492E+03	.256E+09
136.00	.757E-01	.413E+04	.109E+04	-.407E+01	.465E+03	.256E+09
144.00	.645E-01	.408E+04	.108E+04	-.763E+01	.425E+03	.256E+09
152.00	.543E-01	.401E+04	.106E+04	-.108E+02	.375E+03	.256E+09
160.00	.451E-01	.391E+04	.104E+04	-.136E+02	.317E+03	.256E+09
168.00	.369E-01	.380E+04	.101E+04	-.159E+02	.277E+03	.256E+09
176.00	.297E-01	.366E+04	.984E+03	-.181E+02	.257E+03	.256E+09
184.00	.233E-01	.351E+04	.950E+03	-.212E+02	.426E+03	.256E+09
192.00	.179E-01	.333E+04	.911E+03	-.245E+02	.411E+03	.256E+09
200.00	.132E-01	.312E+04	.865E+03	-.277E+02	.392E+03	.256E+09
208.00	.937E-02	.288E+04	.814E+03	-.308E+02	.371E+03	.256E+09
216.00	.624E-02	.263E+04	.758E+03	-.337E+02	.344E+03	.256E+09
224.00	.376E-02	.235E+04	.697E+03	-.363E+02	.312E+03	.256E+09
232.00	.188E-02	.205E+04	.632E+03	-.386E+02	.269E+03	.256E+09
240.00	.502E-03	.173E+04	.563E+03	-.405E+02	.198E+03	.256E+09
248.00	-.440E-03	.141E+04	.492E+03	-.395E+02	-.399E+03	.256E+09
256.00	-.103E-02	.110E+04	.426E+03	-.359E+02	-.493E+03	.256E+09
264.00	-.134E-02	.833E+03	.367E+03	-.318E+02	-.527E+03	.256E+09
272.00	-.145E-02	.596E+03	.315E+03	-.275E+02	-.536E+03	.256E+09
280.00	-.140E-02	.393E+03	.271E+03	-.232E+02	-.532E+03	.256E+09
288.00	-.126E-02	.224E+03	.234E+03	-.190E+02	-.518E+03	.256E+09
296.00	-.106E-02	.876E+02	.204E+03	-.150E+02	-.496E+03	.256E+09
304.00	-.835E-03	-.167E+02	.189E+03	-.111E+02	-.468E+03	.256E+09
312.00	-.616E-03	-.911E+02	.205E+03	-.753E+01	-.433E+03	.256E+09
320.00	-.419E-03	-.138E+03	.215E+03	-.423E+01	-.394E+03	.256E+09
328.00	-.257E-03	-.159E+03	.220E+03	-.126E+01	-.348E+03	.256E+09
336.00	-.133E-03	-.159E+03	.220E+03	.131E+01	-.296E+03	.256E+09
344.00	-.497E-04	-.139E+03	.216E+03	.342E+01	-.231E+03	.256E+09
352.00	-.698E-06	-.105E+03	.208E+03	.478E+01	-.808E+02	.256E+09
360.00	.220E-04	-.677E+02	.200E+03	.424E+01	.126E+03	.256E+09
368.00	.277E-04	-.379E+02	.193E+03	.319E+01	.136E+03	.256E+09

376.00	.237E-04	-.168E+02	.189E+03	.211E+01	.133E+03	.256E+09
384.00	.154E-04	-.408E+01	.186E+03	.109E+01	.122E+03	.256E+09
392.00	.599E-05	.902E+00	.185E+03	.207E+00	.982E+02	.256E+09
400.00	-.332E-05	.000E+00	.185E+03	.000E+00	-.116E+03	.256E+09

COMPUTED LATERAL FORCE AT PILE HEAD	=	.40000E+02 KIP
COMPUTED MOMENT AT PILE HEAD	=	.60000E+03 IN-KIP
COMPUTED SLOPE AT PILE HEAD	=	-.30108E-02

THE OVERALL MOMENT IMBALANCE	=	.996E-07 IN-KIP
THE OVERALL LATERAL FORCE IMBALANCE	=	-.174E-05 LBS

OUTPUT SUMMARY

PILE HEAD DEFLECTION	=	.403E+00 IN
MAXIMUM BENDING MOMENT	=	.414E+04 IN-KIP
MAXIMUM TOTAL STRESS	=	.109E+04 LBS/IN**2

NO. OF ITERATIONS	=	18
MAXIMUM DEFLECTION ERROR	=	.809E-05 IN

S U M M A R Y T A B L E

LATERAL LOAD (KIP)	BOUNDARY CONDITION BC2	AXIAL LOAD (KIP)	YT (IN)	ST (IN/IN)	MAX. MOMENT (IN-KIP)	MAX. STRESS (LBS/IN**2)
.400E+02	.600E+03	.200E+03	.403E+00	-.301E-02	.414E+04	.109E+04

EXAMPLE 4, USER INPUT p-y CURVES

This example is included to illustrate a case in which the p-y curves are specified externally by the user. The head of the pile will be assumed to be unrestrained against rotation (free-head case) with no moment. A lateral load of 5 kips will be used to generate data for preparing a load-deflection curve. The p-y curves shown in Fig. 5.4 will be used. The output for every other mode is shown on the following pages.

The program interpolates linearly between points on a p-y curve and between p-y curves. In this example, the deepest p-y curve is given at 188 inches. For any nodes that extend below the depth of the deepest p-y curve, the program uses the deepest p-y curve for computation.

The input and output data are shown on the following pages.

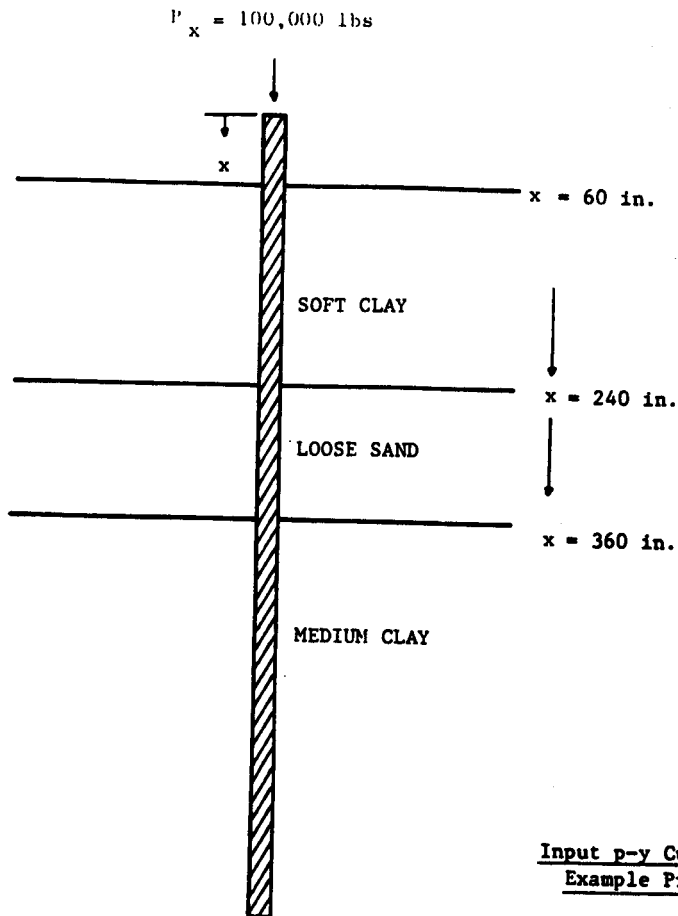

Input p-y Curves for
Example Problem 4

File Properties:

- * 16" O.D. Pipe Pile
- * $E = 29 \times 10^6 \text{ psi}$
- * $I = 1047 \text{ in.}^4$ between $x = 0$
and $x = 180 \text{ in.}$
- * $I = 720 \text{ in.}^4$ between $x = 180$
and $x = 720 \text{ in.}$
- * Length = 720 in.

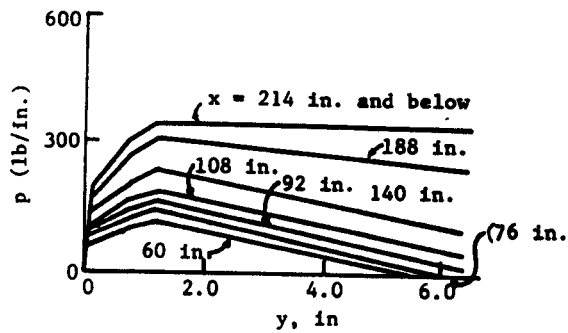

Figure 5.4. Data for Example 4.

INPUT SCREENS FOR EXAMPLE 4

File ← Analysis Mult Option

C624EDIT 2.0, Edit Variables:

This program is a preprocessor developed especially for users for preparation of input for the computer program COM624P. The main menu for this program is displayed as a bar at the top row of the screen. The main menu has four choices: FILE, ANALYSIS, MULT, and OPTION.

The selection of the FILE menu allows the user to access a pull-down menu for file operations such as reading in an existing file, creating a new data file, checking files in the directory, and similar operations. The selection of the ANALYSIS menu allows the user to enter required data for computing the response of the pile and soil, such as distributions of deflection, bending moment, shear, and soil resistance as a function of length along the pile. The selection of the MULT menu allows the user to enter data of a selected pile size for computing the ultimate bending moment and other design-related information. The OPTION menu is used for screen setting and it may not be needed for most computer systems.

F1-Help Alt-X-Exit

File Analysis Mult Option

Read
New ←
Save
Directory
Change dir
Quit to DOS
Main Menu

F1-Help Alt-X-Exit

File Analysis Mult Option

Read New	
	New File Name <input type="text"/>
Change dir Quit to DOS Main Menu	

F1-Help Alt-X-Exit

File Analysis Mult Option

Read New Save Directory Change dir Quit to DOS Main Menu ←	
--	--

F1-Help Alt-X-Exit

File Analysis Mult Option

	<p>Title ← File Properties Soil Properties Lateral p-y Data Data for Loading Computation Control Output Tables Main Menu</p>	
--	--	--

F1-Help Alt-X-Exit

File Analysis Mult Option EXAMPLE.IN4

<p>Enter title for this data file (up to 72 characters long) EXAMPLE NO 4 USER INPUT P-Y CURVES</p>	
---	--

A 1:DEF:Lab EXAMPLE NO 4 USER INPUT P-Y CURVES

_____ : Move Cell — ? : Help — / : Edit Screen — F8 : Continue —
F1-Help Alt-X-Exit

File Analysis Mult Option

Title
File Properties ←
Soil Properties
Lateral p-y Data
Data for Loading
Computation Control
Output Tables
Main Menu

F1-Help Alt-X-Exit

File Analysis Mult Option EXAMPLE.IN4

Editing Pile Dimensions

Number of increments (<= 300)	120
Distance from top of pile to ground surface - inches	60.0
Length of pile	inches 720.00
Pile modulus	psi 29000000
Slope of ground surface (degrees)	0.0000

A 1:DEF:Num. 120

_____ : Move Cell _____ ? : Help _____ / : Edit Screen _____ F8 : Continue _____
F1-Help Alt-X-Exit

Editing File Section Properties

Section #	Top Depth inches	Diameter inches	Mom. of Inert. inches**4	Area inches ²
1	0.00	16.000	1050.0000	35.9000
2	180.00	16.000	720.0000	23.9000
3				
4				
5				
6				
7				
8				
9				
10				

To access pile property library leave pile diameter blank.

A 1:DEF:Num 0.00000

— : Move Cell — ? : Help — / : Edit Screen — F8 : Continue —
 F1-Help Alt-X-Exit

Title
File Properties
Soil Properties ←
Lateral p-y Data
Data for Loading
Computation Control
Output Tables
Main Menu

F1-Help

Alt-X-Exit

File

Analysis

Mult

Option

EXAMPLE.IN4

Editing Soil Layer Information

Layer #	Criteria #	X-top inches	X-bot inches	k lb/in ³
1	5	60.00	720.00	50.00
2				
3				
4				
5				
6				
7				
8				
9				
10				

p-y Curve Criteria

- #1 = Soft Clay Criteria
- #2 = Stiff Clay Below Watertable
- #3 = Stiff Clay Above Watertable
- #4 = Sand
- #5 = Interp. Between Input Curves
- #6 = Vuggy Limestone

A 1:DEF:Num 5

: Move Cell — ? : Help — / : Edit Screen — F8 : Continue —
 F1-Help Alt-X-Exit

File Analysis Mult Option

Title
 Pile Properties
 Soil Properties
 Lateral p-y Data ←
 Data for Loading
 Computation Control
 Output Tables
 Main Menu

F1-Help Alt-X-Exit

File Analysis Mult Option EXAMPLE.IN4

Editing Load-Transfer Data

Depth of Input p-y Curves

Point #	Depth inches
1	60.00000
2	76.00000
3	92.00000
4	108.00000
5	140.00000
6	188.00000
7	214.00000
8	
9	
10	

A 1:DEF:Num 60.00000000

_____ : Move Cell _____ ? : Help _____ / : Edit Screen _____ F8 : Continue _____

F1-Help Alt-X-Exit

File

Analysis

Mult

Option

EXAMPLE.IN4

Editing Load-Transfer Data

p-y Curve #1 of 7 at 60.00 inches

Point #	Deflection inches	Soil Resistance pounds/inches
1	0.00000	0.00000
2	0.20000	66.10000
3	0.40000	83.20000
4	0.80000	105.00000
5	1.20000	120.00000
6	6.00000	0.00000
7		
8		
9		
10		

A 1:DEF:Num 0.00000000

: Move Cell — ? : Help — / : Edit Screen — F8 : Continue —
F1-Help Alt-X-Exit

File

Analysis

Mult

Option

EXAMPLE.IN4

Editing Load-Transfer Data

p-y Curve #2 of 7 at 76.00 inches

Point #	Deflection inches	Soil Resistance pounds/inches
1	0.00000	0.00000
2	0.20000	79.80000
3	0.40000	100.00000
4	0.80000	127.00000
5	1.20000	145.00000
6	6.00000	15.00000
7		
8		
9		
10		

A 1:DEF:Num 0.00000000

: Move Cell — ? : Help — / : Edit Screen — F8 : Continue —
F1-Help Alt-X-Exit

Editing Load-Transfer Data

p-y Curve #3 of 7 at 92.00 inches

Point #	Deflection inches	Soil Resistance pounds/inches
1	0.00000	0.00000
2	0.20000	93.30000
3	0.40000	117.00000
4	0.80000	148.00000
5	1.20000	169.00000
6	6.00000	34.00000
7		
8		
9		
10		

A 1:DEF:Num 0.00000000

_____ : Move Cell _____ ? : Help _____ / : Edit Screen _____ F8 : Continue _____
 F1-Help Alt-X-Exit

Editing Load-Transfer Data

p-y Curve #4 of 7 at 108.00 inches

Point #	Deflection inches	Soil Resistance pounds/inches
1	0.00000	0.00000
2	0.20000	107.00000
3	0.40000	135.00000
4	0.80000	170.00000
5	1.20000	194.00000
6	6.00000	61.00000
7		
8		
9		
10		

A 1:DEF:Num 0.00000000

_____ : Move Cell _____ ? : Help _____ / : Edit Screen _____ F8 : Continue _____
 F1-Help Alt-X-Exit

Editing Load-Transfer Data

p-y Curve #5 of 7 at 140.00 inches

Point #	Deflection inches	Soil Resistance pounds/inches
1	0.00000	0.00000
2	0.20000	134.00000
3	0.40000	169.00000
4	0.80000	213.00000
5	1.20000	243.00000
6	6.00000	123.00000
7		
8		
9		
10		

A 1:DEF:Num 0.00000000

_____ : Move Cell _____ ? : Help _____ / : Edit Screen _____ F8 : Continue _____
 F1-Help Alt-X-Exit

Editing Load-Transfer Data

p-y Curve #6 of 7 at 188.00 inches

Point #	Deflection inches	Soil Resistance pounds/inches
1	0.00000	0.00000
2	0.20000	175.00000
3	0.40000	221.00000
4	0.80000	278.00000
5	1.20000	318.00000
6	6.00000	264.00000
7		
8		
9		
10		

A 1:DEF:Num 0.00000000

_____ : Move Cell _____ ? : Help _____ / : Edit Screen _____ F8 : Continue _____
 F1-Help Alt-X-Exit

Editing Load-Transfer Data

p-y Curve #7 of 7 at 214.00 inches

Point #	Deflection inches	Soil Resistance pounds/inches
1	0.00000	0.00000
2	0.20000	198.00000
3	0.40000	250.00000
4	0.80000	315.00000
5	1.20000	360.00000
6	6.00000	360.00000
7		
8		
9		
10		

A 1:DEF:Num 0.00000000

_____ : Move Cell _____ ? : Help _____ / : Edit Screen _____ F8 : Continue _____
 F1-Help Alt-X-Exit

- Title
- File Properties
- Soil Properties
- Lateral p-y Data
- Data for Loading ←
- Computation Control
- Output Tables
- Main Menu

F1-Help Alt-X-Exit

Editing Loading Information

Distributed lateral loading (y/n) ? n
 Is loading cyclic (y/n) ? n
 Boundary condition code (KBC) 1

KBC = 1 for shear and moment (free head)
 KBC = 2 for shear and slope (fixed head)
 KBC = 3 for shear and rotational restraint (partially fixed)
 KBC = 4 for deflection and moment

A 1:DEF:Lab n

_____ : Move Cell _____ ? : Help _____ / : Edit Screen _____ F8 : Continue _____
 F1-Help Alt-X-Exit

Editing Pile-head Loading

KOP	Shear pounds	Moment in-lbs	Axial Load pounds
1	5000.00	0.000	100000.00

KOP=0 if only a summary output for this load is to be printed
 =1 if complete output is desired for this load

A 1:DEF:Num 1

_____ : Move Cell _____ ? : Help _____ / : Edit Screen _____ F8 : Continue _____
 F1-Help Alt-X-Exit

File Analysis Mult Option

	<p>Title File Properties Soil Properties Lateral p-y Data Data for Loading Computation Control ← Output Tables Main Menu</p>	
--	--	--

F1-Help Alt-X-Exit

File Analysis Mult Option EXAMPLE.IN4

<p>Maximum number of iterations allowed for analysis : 100 Tolerance on solution convergence, inches : 0.000100 Value of deflection considered to be excessive, inches : 100.0000 Computation using internal-generated cracked/uncracked EI: N</p>	
--	--

A 1:DEF:Num 100

_____ : Move Cell _____ ? : Help _____ / : Edit Screen _____ F8 : Continue _____

F1-Help Alt-X-Exit

File Analysis Mult Option

Title
File Properties
Soil Properties
Lateral p-y Data
Data for Loading
Computation Control
Output Tables ←
Main Menu

F1-Help Alt-X-Exit

File Analysis Mult Option EXAMPLE.IN4

Output Printing Options

*** Lateral Load Analysis ***

Printing Increment (1 for every node, 2 for every other node, etc) 3
Print deflection, moment, shear over full length of pile (y/n) Y
Print p-y curves for verification N

A 1:DEF:Num 3

_____ : Move Cell _____ ? : Help _____ / : Edit Screen _____ F8 : Continue _____
F1-Help Alt-X-Exit

File Analysis Mult Option

Title
File Properties
Soil Properties
Lateral p-y Data
Data for Loading
Computation Control
Output Tables
Main Menu ←

F1-Help Alt-X-Exit

File Analysis Mult Option

C624EDIT 2.0, Edit Variables:

This program is a preprocessor developed especially for users for preparation of input for the computer program COM624P. The main menu for this program is displayed as a bar at the top row of the screen. The main menu has four choices: FILE, ANALYSIS, MULT, and OPTION.

The selection of the FILE menu allows the user to access a pull-down menu for file operations such as reading in an existing file, creating a new data file, checking files in the directory, and similar operations. The selection of the ANALYSIS menu allows the user to enter required data for computing the response of the pile and soil, such as distributions of deflection, bending moment, shear, and soil resistance as a function of length along the pile. The selection of the MULT menu allows the user to enter data of a selected pile size for computing the ultimate bending moment and other design-related information. The OPTION menu is used for screen setting and it may not be needed for most computer systems.

F1-Help Alt-X-Exit

File Analysis Mult Option

Read
New
Save ←
Directory
Change dir
Quit to DOS
Main Menu

F1-Help Alt-X-Exit

File Analysis Mult Option EXAMPLE.IN4

Read
New
Save

EXAMPLE.IN4 Save File Name

Main Menu

F1-Help Alt-X-Exit

OUTPUT RESULTS FOR EXAMPLE 4

EXAMPLE NO 4 USER INPUT P-Y CURVES

UNITS--ENGL

PILE DEFLECTION, BENDING MOMENT, SHEAR & SOIL RESISTANCE

I N P U T I N F O R M A T I O N

THE LOADING IS STATIC

PILE GEOMETRY AND PROPERTIES

PILE LENGTH = 720.00 IN
MODULUS OF ELASTICITY OF PILE = .290E+05 KIP/IN**2
2 SECTION(S)

X	DIAMETER	MOMENT OF INERTIA	AREA
IN	IN	IN**4	IN**2
.00	16.000	.105E+04	.359E+02
180.00	16.000	.720E+03	.239E+02
720.00			

SOILS INFORMATION

X-COORDINATE AT THE GROUND SURFACE = 60.00 IN
SLOPE ANGLE AT THE GROUND SURFACE = .00 DEG.

1 LAYER(S) OF SOIL

LAYER 1
THE LAYER RESPONSE IS DEFINED BY INPUT P-Y CURVES
X AT THE TOP OF THE LAYER = 60.00 IN

X AT THE BOTTOM OF THE LAYER = 720.00 IN
 VARIATION OF SOIL MODULUS, k = .500E+02 LBS/IN**3

INPUT P-Y CURVES 7 CURVES, 6 POINTS ON EACH

X, IN	Y, IN	P, LBS/IN
60.00	.00	.00
	.20	66.10
	.40	83.20
	.80	105.00
	1.20	120.00
	6.00	.00
	76.00	.00
.20		79.80
.40		100.00
.80		127.00
1.20		145.00
6.00		15.00
92.00		.00
	.20	93.30
	.40	117.00
	.80	148.00
	1.20	169.00
	6.00	34.00
	108.00	.00
.20		107.00
.40		135.00
.80		170.00
1.20		194.00
6.00		61.00
140.00		.00
	.20	134.00
	.40	169.00
	.80	213.00
	1.20	243.00
	6.00	123.00
	188.00	.00
.20		175.00
.40		221.00
.80		278.00

	1.20	318.00
	6.00	264.00
X, IN	Y, IN	P, LBS/IN
214.00	.00	.00
	.20	198.00
	.40	250.00
	.80	315.00
	1.20	360.00
	6.00	360.00

FINITE DIFFERENCE PARAMETERS

NUMBER OF PILE INCREMENTS = 120
TOLERANCE ON DETERMINATION OF DEFLECTIONS = .100E-03 IN
MAXIMUM NUMBER OF ITERATIONS ALLOWED FOR PILE ANALYSIS = 100
MAXIMUM ALLOWABLE DEFLECTION = .10E+03 IN

INPUT CODES

OUTPT = 1
KCYCL = 1
KBC = 1
KPYOP = 0
INC = 3

EXAMPLE NO 4 USER INPUT P-Y CURVES

UNITS--ENGL

OUTPUT INFORMATION

----- *** -----

PILE LOADING CONDITION

LATERAL LOAD AT PILE HEAD = .500E+01 KIP
APPLIED MOMENT AT PILE HEAD = .000E+00 IN-KIP
AXIAL LOAD AT PILE HEAD = .100E+03 KIP

X DEFLECTION		MOMENT	TOTAL STRESS	SHEAR	SOIL RESIST	FLEXURAL RIGIDITY
IN	IN	IN-KIP	LBS/IN**2	KIP	LBS/IN	KIP-IN**2
****	*****	*****	*****	*****	*****	*****
.00	.453E+00	.000E+00	.279E+04	.532E+01	.000E+00	.305E+08
18.00	.396E+00	.957E+02	.351E+04	.500E+01	.000E+00	.305E+08
36.00	.340E+00	.191E+03	.424E+04	.500E+01	.000E+00	.305E+08
54.00	.286E+00	.287E+03	.497E+04	.500E+01	.000E+00	.305E+08
72.00	.235E+00	.374E+03	.563E+04	.387E+01	.798E+02	.305E+08
90.00	.188E+00	.435E+03	.610E+04	.235E+01	.862E+02	.305E+08
108.00	.146E+00	.468E+03	.635E+04	.869E+00	.780E+02	.305E+08
126.00	.109E+00	.475E+03	.640E+04	-.435E+00	.663E+02	.305E+08
144.00	.762E-01	.460E+03	.629E+04	-.151E+01	.524E+02	.305E+08
162.00	.488E-01	.428E+03	.605E+04	-.231E+01	.373E+02	.305E+08
180.00	.259E-01	.384E+03	.571E+04	-.284E+01	.218E+02	.257E+08
198.00	.795E-02	.331E+03	.787E+04	-.310E+01	.730E+01	.209E+08
216.00	-.488E-02	.276E+03	.725E+04	-.312E+01	.484E+01	.209E+08
234.00	-.134E-01	.222E+03	.665E+04	-.295E+01	.133E+02	.209E+08
252.00	-.185E-01	.172E+03	.609E+04	-.267E+01	.183E+02	.209E+08
270.00	-.209E-01	.127E+03	.560E+04	-.231E+01	.207E+02	.209E+08
288.00	-.214E-01	.890E+02	.517E+04	-.193E+01	.212E+02	.209E+08
306.00	-.204E-01	.576E+02	.482E+04	-.156E+01	.202E+02	.209E+08
324.00	-.186E-01	.325E+02	.455E+04	-.121E+01	.184E+02	.209E+08
342.00	-.162E-01	.134E+02	.433E+04	-.898E+00	.161E+02	.209E+08
360.00	-.137E-01	-.516E+00	.419E+04	-.632E+00	.135E+02	.209E+08
378.00	-.111E-01	-.101E+02	.430E+04	-.411E+00	.110E+02	.209E+08
396.00	-.866E-02	-.161E+02	.436E+04	-.236E+00	.858E+01	.209E+08
414.00	-.649E-02	-.192E+02	.440E+04	-.101E+00	.642E+01	.209E+08
432.00	-.461E-02	-.203E+02	.441E+04	-.256E-02	.457E+01	.209E+08
450.00	-.305E-02	-.198E+02	.440E+04	.653E-01	.302E+01	.209E+08
468.00	-.179E-02	-.184E+02	.439E+04	.108E+00	.177E+01	.209E+08
486.00	-.820E-03	-.163E+02	.437E+04	.131E+00	.811E+00	.209E+08
504.00	-.993E-04	-.139E+02	.434E+04	.139E+00	.981E-01	.209E+08
522.00	.406E-03	-.115E+02	.431E+04	.136E+00	.402E+00	.209E+08
540.00	.732E-03	-.913E+01	.429E+04	.126E+00	.725E+00	.209E+08
558.00	.917E-03	-.702E+01	.426E+04	.111E+00	.908E+00	.209E+08
576.00	.993E-03	-.519E+01	.424E+04	.935E-01	.983E+00	.209E+08
594.00	.987E-03	-.366E+01	.422E+04	.758E-01	.977E+00	.209E+08
612.00	.925E-03	-.245E+01	.421E+04	.587E-01	.916E+00	.209E+08
630.00	.824E-03	-.153E+01	.420E+04	.431E-01	.816E+00	.209E+08
648.00	.699E-03	-.866E+00	.419E+04	.295E-01	.692E+00	.209E+08
666.00	.561E-03	-.427E+00	.419E+04	.182E-01	.555E+00	.209E+08
684.00	.415E-03	-.168E+00	.419E+04	.952E-02	.411E+00	.209E+08
702.00	.267E-03	-.410E-01	.418E+04	.344E-02	.265E+00	.209E+08
720.00	.118E-03	.000E+00	.418E+04	.000E+00	.117E+00	.209E+08

COMPUTED LATERAL FORCE AT PILE HEAD = .50000E+01 KIP

COMPUTED MOMENT AT PILE HEAD = .00000E+00 IN-KIP
 COMPUTED SLOPE AT PILE HEAD = -.31736E-02

 THE OVERALL MOMENT IMBALANCE = -.162E-08 IN-KIP
 THE OVERALL LATERAL FORCE IMBALANCE = .117E-07 LBS

OUTPUT SUMMARY

PILE HEAD DEFLECTION = .453E+00 IN
 MAXIMUM BENDING MOMENT = .475E+03 IN-KIP
 MAXIMUM TOTAL STRESS = .826E+04 LBS/IN**2

 NO. OF ITERATIONS = 6
 MAXIMUM DEFLECTION ERROR = .881E-04 IN

S U M M A R Y T A B L E

LATERAL LOAD (KIP)	BOUNDARY CONDITION BC2	AXIAL LOAD (KIP)	YT (IN)	ST (IN/IN)	MAX. MOMENT (IN-KIP)	MAX. STRESS (LBS/IN**2)
.500E+01	.000E+00	.100E+03	.453E+00	-.317E-02	.475E+03	.826E+04

EXAMPLE 5, COMPUTE ULTIMATE BENDING MOMENT FOR BORED PILES

Example 5 is included to illustrate the functions of Program COM624P for computing the ultimate bending moment and an interaction diagram. A total of eight axial loads are specified for the program to compute the ultimate bending moment at each axial load and to construct the interaction diagram (ultimate bending moment versus axial load). Only the tables of output for axial load of 0 kips, 100 kips, and 500 kips are shown in the following pages.

The ultimate bending moment of a reinforced-concrete section is taken at a maximum strain of concrete of 0.003 based on the ACI code. It should be noted that the flexural rigidity (EI), corresponding to the ultimate bending moment, is significantly lower than that of the uncracked EI value. Therefore, the user should also pay attention to the variation of EI versus moment as shown in the first two columns in the output summary. In general, the moment distribution is not much affected by the EI used in the computation. However, if the deflection is more critical for the design, then careful interpretation of EI should be done.

Three ranges of EI magnitude can be found in the output. The first range of EI magnitude is associated with the uncracked stage. The concrete is uncracked and the EI is more-or-less constant and is equal to the calculated EI for the gross section. The second range of EI magnitude is for the cracked stage. A significant decrease in the EI value takes place as cracks continue propagating. The third range of EI magnitude is for the cracked and large strain stage. The EI value is further reduced because the stress-strain curve as shown in Fig. 4.1 of Part II of this manual is softened at large strain.

The input and output data are shown in the following pages.

INPUT SCREENS FOR EXAMPLE 5

File ← Analysis Mult Option

C624EDIT 2.0, Edit Variables:

This program is a preprocessor developed especially for users for preparation of input for the computer program COM624P. The main menu for this program is displayed as a bar at the top row of the screen. The main menu has four choices: FILE, ANALYSIS, MULT, and OPTION.

The selection of the FILE menu allows the user to access a pull-down menu for file operations such as reading in an existing file, creating a new data file, checking files in the directory, and similar operations. The selection of the ANALYSIS menu allows the user to enter required data for computing the response of the pile and soil, such as distributions of deflection, bending moment, shear, and soil resistance as a function of length along the pile. The selection of the MULT menu allows the user to enter data of a selected pile size for computing the ultimate bending moment and other design-related information. The OPTION menu is used for screen setting and it may not be needed for most computer systems.

F1-Help Alt-X-Exit

File Analysis Mult Option

Read
New ←
Save
Directory
Change dir
Quit to DOS
Main Menu

F1-Help Alt-X-Exit

File Analysis Mult Option

Read New	
	New File Name
	EXAMPLE.IN5
Change dir Quit to DOS Main Menu	

F1-Help Alt-X-Exit

File Analysis Mult Option

Read New Save Directory Change dir Quit to DOS Main Menu ←	
--	--

F1-Help Alt-X-Exit

File Analysis Mult ← Option

C624EDIT 2.0, Edit Variables:

This program is a preprocessor developed especially for users for preparation of input for the computer program COM624P. The main menu for this program is displayed as a bar at the top row of the screen. The main menu has four choices: FILE, ANALYSIS, MULT, and OPTION.

The selection of the FILE menu allows the user to access a pull-down menu for file operations such as reading in an existing file, creating a new data file, checking files in the directory, and similar operations. The selection of the ANALYSIS menu allows the user to enter required data for computing the response of the pile and soil, such as distributions of deflection, bending moment, shear, and soil resistance as a function of length along the pile. The selection of the MULT menu allows the user to enter data of a selected pile size for computing the ultimate bending moment and other design-related information. The OPTION menu is used for screen setting and it may not be needed for most computer systems.

F1-Help Alt-X-Exit

File Analysis Mult Option

Title ←
Cross Section Shape
Axial Loads
Strength of Materials
Dimension of Cross Section
Rebar Arrangement
Main Menu

F1-Help Alt-X-Exit

File

Analysis

Mult

Option

EXAMPLE.IN5

Enter title for this data file (up to 72 characters long)

EXAMPLE 5 COMPUTE ULTIMATE BENDING MOMENT FOR BORED PILES

A 1:DEF:Lab EXAMPLE 5 COMPUTE ULTIMATE BENDING MOMENT FOR BORED PILES

_____ : Move Cell _____ ? : Help _____ / : Edit Screen _____ F8 : Continue _____
F1-Help Alt-X-Exit

File

Analysis

Mult

Option

Title
Cross Section Shape ←
Axial Loads
Strength of Materials
Dimension of Cross Section
Rebar Arrangement
Main Menu

F1-Help

Alt-X-Exit

Identification number of the shape of cross section
of the pile:

- 1: Rectangular or square;
- 2: Circular (without shell or core);
- 3: Circular (with shell but without core);
- 4: Circular (with shell and core);
- 5: Circular steel pipe;

Enter the number: 2

A 1:DEF:Num 2

_____ : Move Cell _____ ? : Help _____ / : Edit Screen _____ F8 : Continue _____
F1-Help Alt-X-Exit

Title
Cross Section Shape
Axial Loads ←
Strength of Materials
Dimension of Cross Section
Rebar Arrangement
Main Menu

F1-Help

Alt-X-Exit

File

Analysis

Mult

Option

EXAMPLE.IN5

Enter axial loads for cross section design:

Point	Loads pounds
1	0.00
2	10000.00
3	100000.00
4	500000.00
5	750000.00
6	1000000.00
7	1500000.00
8	2000000.00
9	
10	

A 1:DEF:Num 0.00000

_____ : Move Cell _____ ? : Help _____ / : Edit Screen _____ F8 : Continue _____
F1-Help Alt-X-Exit

File

Analysis

Mult

Option

Title
Cross Section Shape
Axial Loads
Strength of Materials ←
Dimension of Cross Section
Rebar Arrangement
Main Menu

F1-Help

Alt-X-Exit

Enter strength parameters of materials

Cylinder strength of concrete psi	4000.00000
Yield strength of reinforcement psi	60000.00000
Yield strength of shell or core psi	0.00000
Modulus of elasticity of steel psi	29000000.00000

A 1:DEF:Num 4000.00000000

_____ : Move Cell _____ ? : Help _____ / : Edit Screen _____ F8 : Continue _____
F1-Help Alt-X-Exit

- Title
- Cross Section Shape
- Axial Loads
- Strength of Materials
- Dimension of Cross Section ←
- Rebar Arrangement
- Main Menu

F1-Help Alt-X-Exit

File

Analysis

Mult

Option

EXAMPLE.IN5

Enter cross-section dimension

Width of section (rectangular section only) inches	0.00000
Depth of section (rectangular section only) inches	0.00000
Outer diameter (circular section only) inches	30.00000
Outer diameter of core (circular section only) inches	0.00000
Thickness of shell (circular section only) inches	0.00000
Thickness of core (circular section only) inches	0.00000

A 1:DEF:Num 0.00000000

_____ : Move Cell _____ ? : Help _____ / : Edit Screen _____ F8 : Continue _____
F1-Help Alt-X-Exit

File

Analysis

Mult

Option

Title
Cross Section Shape
Axial Loads
Strength of Materials
Dimension of Cross Section
Rebar Arrangement ←
Main Menu

F1-Help

Alt-X-Exit

File

Analysis

Mult

Option

B:EXAMPLE.IN5

Rebar Arrangement

Size of the rebar (enter the bar number, 3, 5, 8, 9...)	8
Number of reinforcing bars	12
Number of rows of reinforcing bars (rectangular section only)	0
Cover of rebar (from center of rebar to outer edge of concrete) inches	3.0000

A 1:DEF:Num 8

_____ : Move Cell — ? : Help — / : Edit Screen — F8 : Continue — |

F1-Help Alt-X-Exit

File

Analysis

Mult

Option

Title
Cross Section Shape
Axial Loads
Strength of Materials
Dimension of Cross Section
Rebar Arrangement
Main Menu ←

F1-Help

Alt-X-Exit

File ← Analysis Mult Option

C624EDIT 2.0, Edit Variables:

This program is a preprocessor developed especially for users for preparation of input for the computer program COM624P. The main menu for this program is displayed as a bar at the top row of the screen. The main menu has four choices: FILE, ANALYSIS, MULT, and OPTION.

The selection of the FILE menu allows the user to access a pull-down menu for file operations such as reading in an existing file, creating a new data file, checking files in the directory, and similar operations. The selection of the ANALYSIS menu allows the user to enter required data for computing the response of the pile and soil, such as distributions of deflection, bending moment, shear, and soil resistance as a function of length along the pile. The selection of the MULT menu allows the user to enter data of a selected pile size for computing the ultimate bending moment and other design-related information. The OPTION menu is used for screen setting and it may not be needed for most computer systems.

F1-Help Alt-X-Exit

File Analysis Mult Option

Read
New
Save ←
Directory
Change dir
Quit to DOS
Main Menu

F1-Help Alt-X-Exit

File

Analysis

Mult

Option

EXAMPLE.IN5

Read
New
Save

Save File Name

EXAMPLE.IN5

Quit to DOS
Main Menu

F1-Help

Alt-X-Exit

OUTPUT RESULTS FOR EXAMPLE 5

EXAMPLE 5 COMPUTE ULTIMATE BENDING MOMENT FOR BORED PILES

 ULTIMATE BENDING RESISTANCE AND FLEXURAL RIGIDITY

DIAMETER = 30.00 IN

CONCRETE COMPRESSIVE STRENGTH = 4.000000 KIP/IN**2

REBAR YIELD STRENGTH = 60.000000 KIP/IN**2

MODULUS OF ELASTICITY OF STEEL = 29000.000000 KIP/IN**2

NUMBER OF REINFORCING BARS = 12

NUMBER OF ROWS OF REINFORCING BARS = 7

COVER THICKNESS = 3.000 IN

SQUASH LOAD CAPACITY = 2939.89 KIPS

ROW NUMBER	AREA OF REINFORCEMENT IN**2	DISTANCE TO CENTROIDAL AXIS IN
1	.790000	12.0000
2	1.580000	10.3923
3	1.580000	6.0000
4	1.580000	.0000
5	1.580000	-6.0000
6	1.580000	-10.3923
7	.790000	-12.0000

OUTPUT RESULTS FOR AN AXIAL LOAD = .00 KIPS

MOMENT IN-KIP	EI KIP-IN**2	PHI 1/IN	MAX STR IN/IN	N AXIS IN
164.369	.16437E+09	.000001	.00002	15.0477
813.938	.16279E+09	.000005	.00008	15.0473
1450.856	.16121E+09	.000009	.00014	15.0470
1450.856	.11160E+09	.000013	.00011	8.2641
1450.856	.85344E+08	.000017	.00014	8.2758
1450.856	.69088E+08	.000021	.00017	8.2877
1450.856	.58034E+08	.000025	.00021	8.2998
1450.856	.50030E+08	.000029	.00024	8.3120
1450.856	.43965E+08	.000033	.00027	8.3241
1542.059	.41677E+08	.000037	.00031	8.3367

1706.145	.41613E+08	.000041	.00034	8.3490
1869.770	.41550E+08	.000045	.00038	8.3619
2032.827	.41486E+08	.000049	.00041	8.3747
2195.364	.41422E+08	.000053	.00044	8.3877
3396.051	.40916E+08	.000083	.00070	8.4898
4557.698	.40334E+08	.000113	.00097	8.5752
5181.602	.36235E+08	.000143	.00120	8.4079
5551.161	.32088E+08	.000173	.00141	8.1675
5731.058	.28232E+08	.000203	.00161	7.9192
5896.307	.25306E+08	.000233	.00180	7.7198
6051.316	.23009E+08	.000263	.00199	7.5807
6143.448	.20967E+08	.000293	.00218	7.4550
6173.590	.19113E+08	.000323	.00235	7.2786
6201.067	.17567E+08	.000353	.00252	7.1394
6226.547	.16257E+08	.000383	.00269	7.0284
6253.610	.15142E+08	.000413	.00288	6.9714
6274.235	.14163E+08	.000443	.00305	6.8853
6293.935	.13306E+08	.000473	.00322	6.8144
6312.940	.12551E+08	.000503	.00340	6.7549
6331.056	.11878E+08	.000533	.00357	6.7038
6348.535	.11276E+08	.000563	.00375	6.6613
6359.241	.10724E+08	.000593	.00394	6.6402

THE ULTIMATE BENDING MOMENT AT A CONCRETE STRAIN OF 0.003 IS : .627E+04 IN-KIP

OUTPUT RESULTS FOR AN AXIAL LOAD = 100.00 KIPS

MOMENT IN-KIP	EI KIP-IN**2	PHI 1/IN	MAX STR IN/IN	N AXIS IN
162.006	.16201E+09	.000001	.00005	50.6153
808.512	.16170E+09	.000005	.00011	22.2220
1444.742	.16053E+09	.000009	.00017	19.0790
1444.742	.11113E+09	.000013	.00019	14.9310
1444.742	.84985E+08	.000017	.00023	13.6948
1520.720	.72415E+08	.000021	.00027	12.8775
1691.928	.67677E+08	.000025	.00031	12.2856
1860.528	.64156E+08	.000029	.00034	11.8438
2028.040	.61456E+08	.000033	.00038	11.5001
2191.405	.59227E+08	.000037	.00042	11.2183
2355.083	.57441E+08	.000041	.00045	10.9999
2517.698	.55949E+08	.000045	.00049	10.8075
2678.916	.54672E+08	.000049	.00052	10.6459
2839.518	.53576E+08	.000053	.00056	10.5106
4022.045	.48458E+08	.000083	.00083	9.9455
5163.315	.45693E+08	.000113	.00110	9.7123

5932.108	.41483E+08	.000143	.00135	9.4648
6379.425	.36875E+08	.000173	.00159	9.1707
6569.130	.32360E+08	.000203	.00180	8.8503
6723.582	.28857E+08	.000233	.00200	8.5933
6868.083	.26114E+08	.000263	.00222	8.4326
6997.694	.23883E+08	.000293	.00243	8.2930
7067.918	.21882E+08	.000323	.00263	8.1401
7081.734	.20062E+08	.000353	.00282	8.0000
7120.547	.18592E+08	.000383	.00302	7.8743
7140.321	.17289E+08	.000413	.00320	7.7537
7158.454	.16159E+08	.000443	.00339	7.6537
7168.455	.15155E+08	.000473	.00359	7.5871
7176.483	.14267E+08	.000503	.00379	7.5333
7176.483	.13464E+08	.000533	.00400	7.4999

THE ULTIMATE BENDING MOMENT AT A CONCRETE STRAIN OF 0.003
IS : .712E+04 IN-KIP

OUTPUT RESULTS FOR AN AXIAL LOAD = 500.00 KIPS

MOMENT IN-KIP	EI KIP-IN**2	PHI 1/IN	MAX STR IN/IN	N AXIS IN
150.462	.15046E+09	.000001	.00020	*****
752.095	.15042E+09	.000005	.00026	52.0128
1353.050	.15034E+09	.000009	.00032	35.6773
1953.446	.15027E+09	.000013	.00038	29.4320
2549.110	.14995E+09	.000017	.00044	26.1480
3137.984	.14943E+09	.000021	.00051	24.1300
3243.175	.12973E+09	.000025	.00055	22.0952
3542.862	.12217E+09	.000029	.00060	20.8238
3808.285	.11540E+09	.000033	.00065	19.8069
4051.712	.10951E+09	.000037	.00070	18.9774
4273.498	.10423E+09	.000041	.00075	18.2747
4482.946	.99621E+08	.000045	.00080	17.6794
4682.184	.95555E+08	.000049	.00084	17.1674
4873.092	.91945E+08	.000053	.00089	16.7220
6133.245	.73895E+08	.000083	.00121	14.6076
7229.911	.63982E+08	.000113	.00153	13.5570
8225.903	.57524E+08	.000143	.00186	12.9841
8857.891	.51202E+08	.000173	.00217	12.5170
9201.317	.45327E+08	.000203	.00246	12.1343
9481.273	.40692E+08	.000233	.00276	11.8621
9562.766	.36360E+08	.000263	.00305	11.5895
9637.997	.32894E+08	.000293	.00334	11.4096
9678.995	.29966E+08	.000323	.00364	11.2737
9692.204	.27457E+08	.000353	.00396	11.2071

THE ULTIMATE BENDING MOMENT AT A CONCRETE STRAIN OF 0.003
IS : .955E+04 IN-KIP

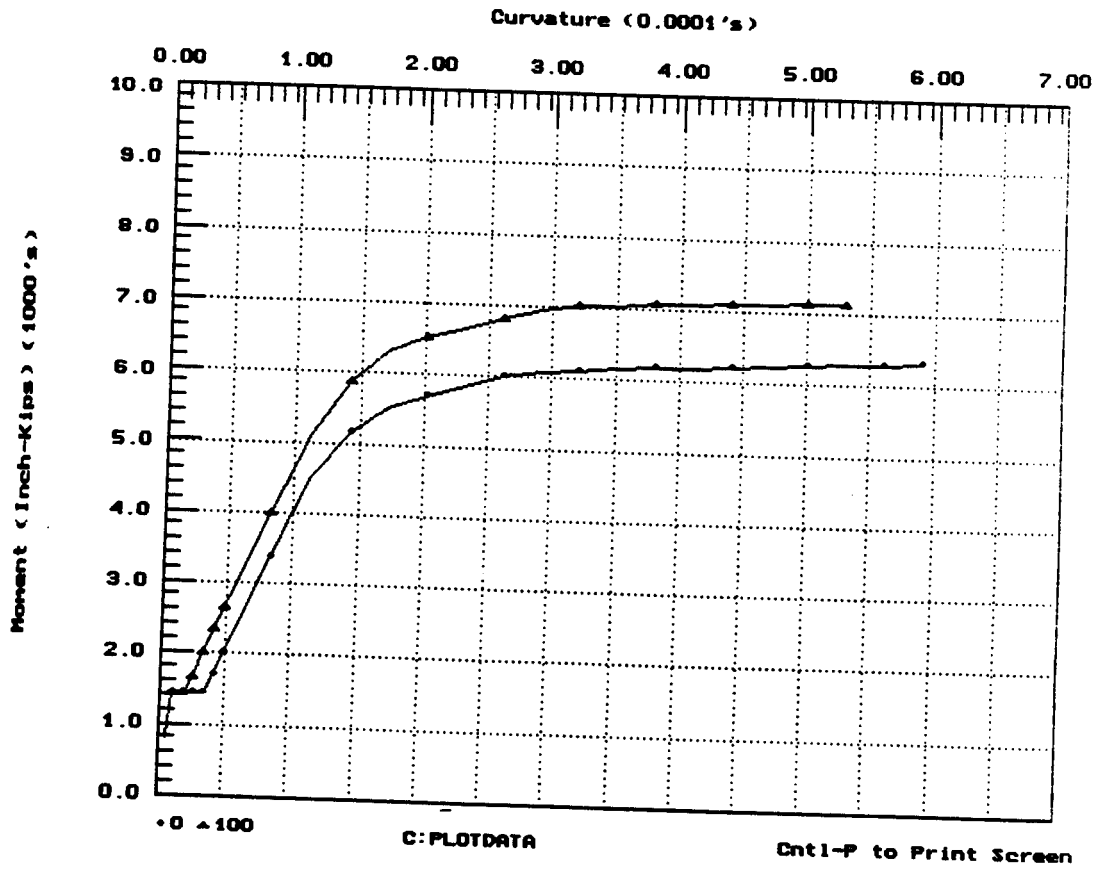

Bending Moment vs. Curvature

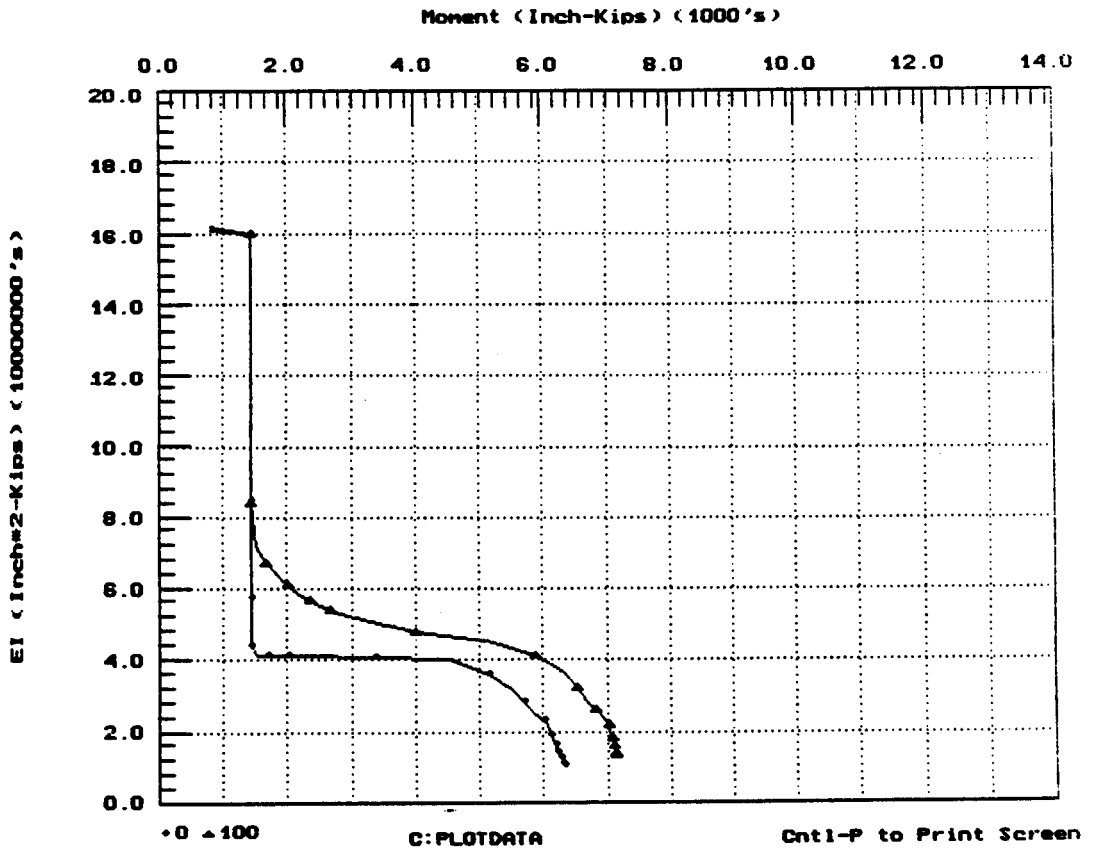

EI vs. Bending Moment

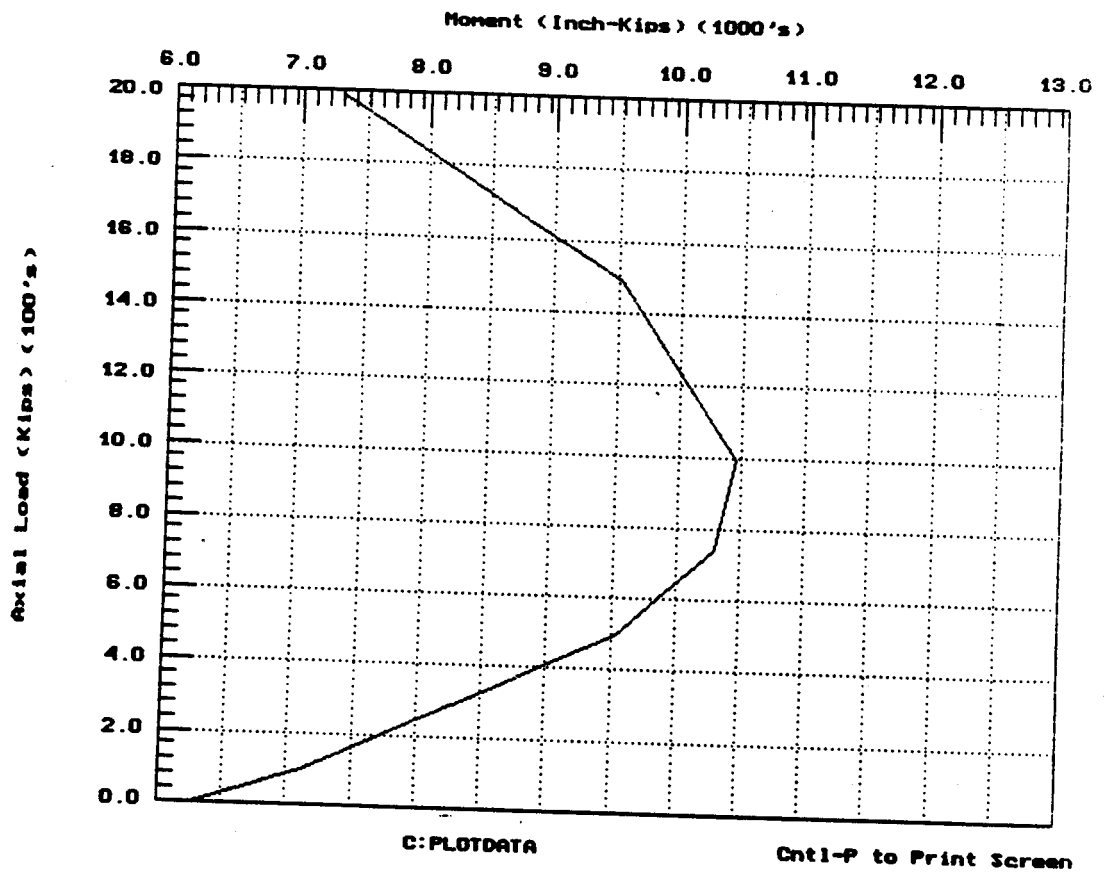

Interaction Diagram

EXAMPLE 6, ANALYSES RELATED TO DESIGN OF CONCRETE PILES

This example is presented to illustrate the capability of Program COM624P to perform analyses that can yield results of direct benefit to the designer of a reinforced-concrete pile. The pile is 30-inches in diameter and 30 ft in length. The pile is embedded in a uniform dense sand with an internal friction angle of 38 degrees. In general, with input information provided for reinforcement in the same data file, the program will compute the ultimate bending moment as the first step. Loadings and preliminary data on piles are selected, and the program yields values of pile deflection, moment, shear, and soil resistance as the second step.

The user can then compare the maximum bending moment computed in the second step with the ultimate bending moment in the first step for an allowable factor of safety. The properties of the pile can then be changed, if necessary or desirable, and further computations made to achieve the final selection of the properties of the pile.

As described in Example 5, the EI values used for each pile have a significant effect on the deflection of the pile. The relationship between moment and EI is computed during the first step. Therefore, the user can ask the program to take the moment-EI variation directly into the computation. The user may also manually input the justified EI values for different sections, based on the curve of bending moment versus depth obtained earlier. In this example, the option for automatic iterations using internally-generated, cracked/uncracked EI values was given to the computer for the final solution.

The procedure that is illustrated is, of course, only one aspect of the design of a pile but it is certainly an important one.

The input and output data are shown on the following pages.

INPUT SCREENS FOR EXAMPLE 6

File ← Analysis Mult Option

C624EDIT 2.0, Edit Variables:

This program is a preprocessor developed especially for users for preparation of input for the computer program COM624P. The main menu for this program is displayed as a bar at the top row of the screen. The main menu has four choices: FILE, ANALYSIS, MULT, and OPTION.

The selection of the FILE menu allows the user to access a pull-down menu for file operations such as reading in an existing file, creating a new data file, checking files in the directory, and similar operations. The selection of the ANALYSIS menu allows the user to enter required data for computing the response of the pile and soil, such as distributions of deflection, bending moment, shear, and soil resistance as a function of length along the pile. The selection of the MULT menu allows the user to enter data of a selected pile size for computing the ultimate bending moment and other design-related information. The OPTION menu is used for screen setting and it may not be needed for most computer systems.

F1-Help Alt-X-Exit

File Analysis Mult Option

Read
New ←
Save
Directory
Change dir
Quit to DOS
Main Menu

F1-Help Alt-X-Exit

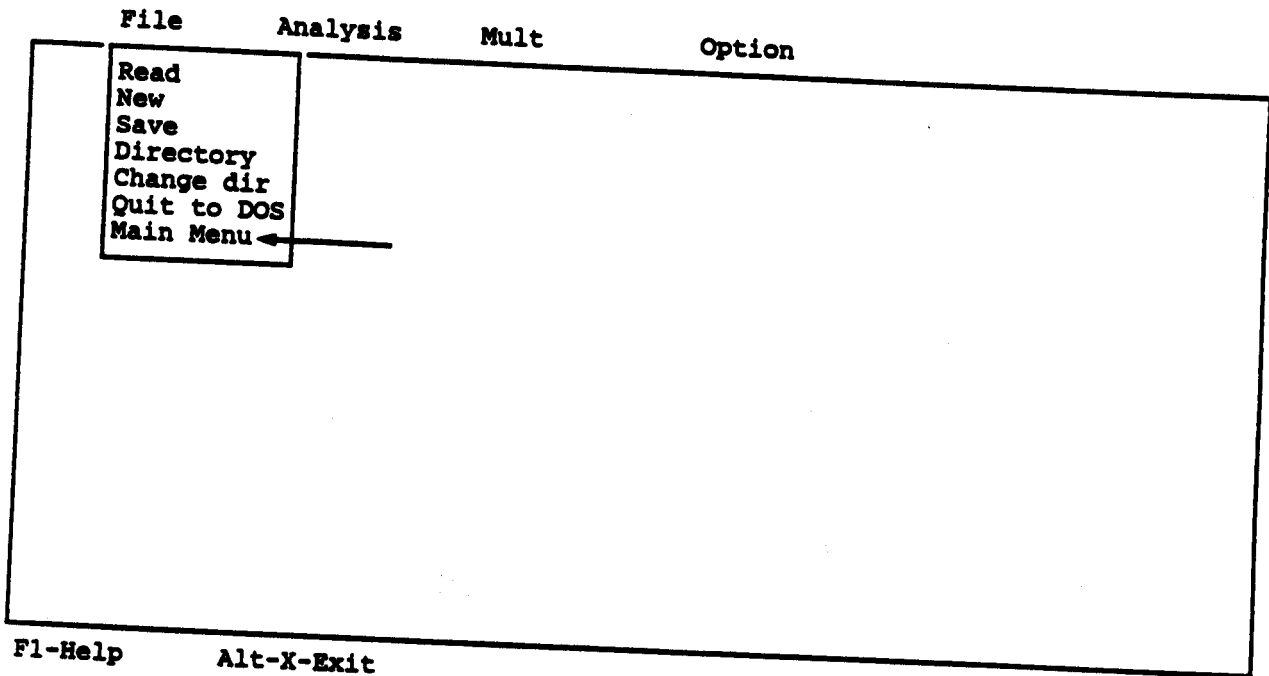
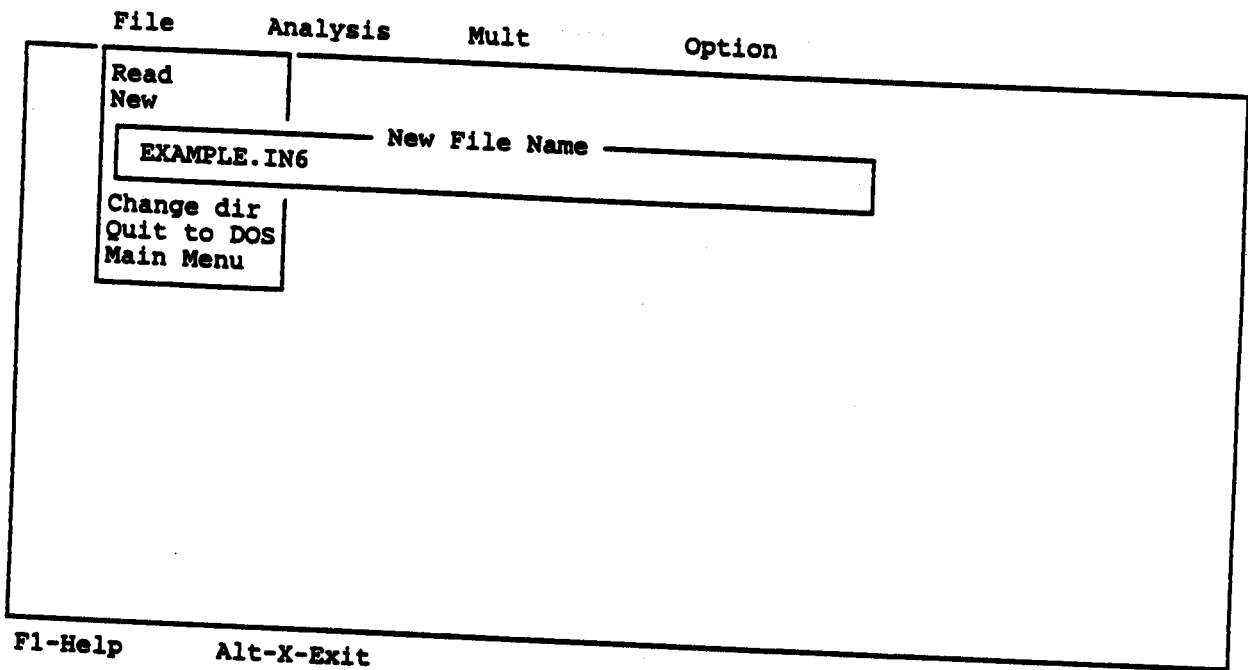

File	Analysis	Mult	Option
	Title ← Pile Properties Soil Properties Lateral p-y Data Data for Loading Computation Control Output Tables Main Menu		

F1-Help Alt-X-Exit

File	Analysis	Mult	Option	EXAMPLE.IN6
Enter title for this data file (up to 72 characters long) EXAMPLE 6 ANALYSES RELATED TO DESIGN OF CONCRETE PILES				

A 1:DEF:Lab EXAMPLE 6 ANALYSES RELATED TO DESIGN OF CONCRETE PILES

_____ : Move Cell _____ ? : Help _____ / : Edit Screen _____ F8 : Continue _____

F1-Help Alt-X-Exit

File Analysis Mult Option

Title
 File Properties ←
 Soil Properties
 Lateral p-y Data
 Data for Loading
 Computation Control
 Output Tables
 Main Menu

F1-Help Alt-X-Exit

File Analysis Mult Option EXAMPLE.IN6

Editing Pile Dimensions

Number of increments (<= 300)	100
Distance from top of pile to ground surface - inches	0.0
Length of pile	360.00
File modulus	3200000
Slope of ground surface (degrees)	0.0000

A 1:DEF:Num 100

_____ : Move Cell _____ ? : Help _____ / : Edit Screen _____ F8 : Continue _____

F1-Help Alt-X-Exit

Editing Pile Section Properties

Section #	Top Depth inches	Diameter inches	Mom. of Inert. inches**4	Area inches ²
1	0.00	30.000	39761.0000	707.0000
2				
3				
4				
5				
6				
7				
8				
9				
10				

To access pile property library leave pile diameter blank.

A 1:DEF:Num 0.00000

_____ : Move Cell _____ ? : Help _____ / : Edit Screen _____ F8 : Continue _____
 F1-Help Alt-X-Exit

- Title
- Pile Properties
- Soil Properties ←
- Lateral p-y Data
- Data for Loading
- Computation Control
- Output Tables
- Main Menu

F1-Help Alt-X-Exit

EXAMPLE.IN6

File	Analysis	Mult	Option	
Editing Soil Layer Information				
Layer #	Criteria #	X-top inches	X-bot inches	k lb/in3
1	4	0.00	360.00	90.00
2	3	360.00	540.00	500.00
3				
4				
5				
6				
7				
8				
9				
10				

P-Y Curve Criteria

#1 = Soft Clay Criteria	#3 = Stiff Clay Above Watertable
#2 = Stiff Clay Below Watertable	#4 = Sand
#5 = Interp. Between Input Curves	#6 = Vuggy Limestone

A 1:DEF:Num 4

_____ : Move Cell _____ ? : Help _____ / : Edit Screen _____ F8 : Continue _____
 F1-Help Alt-X-Exit

EXAMPLE.IN6

File	Analysis	Mult	Option
Editing Effective Unit Weight Information			
Point #	Depth inches	Unit Weight lb/in3	
1	0.00	0.069	
2	360.00	0.069	
3	360.00	0.034	
4	540.00	0.034	
5			
6			
7			
8			
9			
10			

A 1:DEF:Num 0.00000

_____ : Move Cell _____ ? : Help _____ / : Edit Screen _____ F8 : Continue _____
 F1-Help Alt-X-Exit

File

Analysis

Mult

Option

EXAMPLE.IN6

Editing Shear Strength Information

Layer #	Depth inches	c psi	ϕ deg.	E50 @ 50% of c
1	0.00	0.000	38.00	0.0000
2	360.00	0.000	38.00	0.0000
3	360.00	10.000	0.00	0.0050
4	540.00	10.000	0.00	0.0050
5				
6				
7				
8				
9				
10				

A 1:DEF:Num 0.00000

_____ : Move Cell _____ ? : Help _____ / : Edit Screen _____ F8 : Continue _____
F1-Help Alt-X-Exit

File

Analysis

Mult

Option

- Title
- File Properties
- Soil Properties
- Lateral p-y Data
- Data for Loading ←
- Computation Control
- Output Tables
- Main Menu

F1-Help

Alt-X-Exit

Editing Loading Information

Distributed lateral loading (y/n) ? n
 Is loading cyclic (y/n) ? n
 Boundary condition code (KBC) 1

KBC = 1 for shear and moment (free head)
 KBC = 2 for shear and slope (fixed head)
 KBC = 3 for shear and rotational restraint (partially fixed)
 KBC = 4 for deflection and moment

A 1:DEF:Lab n

_____ : Move Cell _____ ? : Help _____ / : Edit Screen _____ F8 : Continue _____
 F1-Help Alt-X-Exit

Editing Pile-head Loading

KOP	Shear pounds	Moment in-lbs	Axial Load pounds
1	20000.00	0.000	50000.00
1	40000.00	0.000	50000.00

KOP=0 if only a summary output for this load is to be printed
 =1 if complete output is desired for this load

A 1:DEF:Num 1

_____ : Move Cell _____ ? : Help _____ / : Edit Screen _____ F8 : Continue _____
 F1-Help Alt-X-Exit

File Analysis Mult Option

Title
File Properties
Soil Properties
Lateral p-y Data
Data for Loading
Computation Control ←
Output Tables
Main Menu

F1-Help Alt-X-Exit

File Analysis Mult Option EXAMPLE.IN6

1. Maximum number of iterations allowed for analysis : 100
2. Tolerance on solution convergence, inches : 0.000010
3. Value of deflection considered to be excessive, inches : 147.0000
4. Computation using internally-generated cracked EI (Y/N : N

Note: If the above answer is Y, remeber to enter the same axial load and other parameters such as arrangement of rebar, concrete and rebar strength in the "MULT" menu later.

A 1:DEF:Num 100

_____ : Move Cell _____ ? : Help _____ / : Edit Screen _____ F8 : Continue _____
F1-Help Alt-X-Exit

File	Analysis	Mult	Option
	Title Pile Properties Soil Properties Lateral p-y Data Data for Loading Computation Control Output Tables ← Main Menu		

F1-Help Alt-X-Exit

File	Analysis	Mult	Option	EXAMPLE.IN6
Output Printing Options				
*** Lateral Load Analysis ***				
	Printing Increment (1 for every node, 2 for every other node, etc)			1
	Print deflection, moment, shear over full length of pile (y/n)			Y
	Print p-y curves for verification			Y
A 1:DEF:Num 1				
: Move Cell — ? : Help — / : Edit Screen — F8 : Continue —				

F1-Help Alt-X-Exit

File

Analysis

Mult

Option

EXAMPLE.IN6

Enter depths for which p-y curves are to be calculated for verification:

Point	Depth inches
1	20.00
2	60.00
3	100.00
4	150.00
5	
6	
7	
8	
9	
10	

A 1:DEF:Num 20.00000

_____ : Move Cell _____ ? : Help _____ / : Edit Screen _____ F8 : Continue _____
F1-Help Alt-X-Exit

File

Analysis

Mult

Option

Title
Cross Section Shape ←
Axial Loads
Strength of Materials
Dimension of Cross Section
Rebar Arrangement
Main Menu

F1-Help

Alt-X-Exit

Identification number of the shape of cross section of the pile:

- 1: Rectangular or square;
- 2: Circular (without shell or core);
- 3: Circular (with shell but without core);
- 4: Circular (with shell and core);
- 5: Circular steel pipe;

Enter the number: 2

A 1:DEF:Num 2

_____ : Move Cell _____ ? : Help _____ / : Edit Screen _____ F8 : Continue _____
F1-Help Alt-X-Exit

Title
Cross Section Shape
Axial Loads ←
Strength of Materials
Dimension of Cross Section
Rebar Arrangement
Main Menu

F1-Help Alt-X-Exit

Enter axial loads for cross section design:

Point	Loads pounds
1	50000.00
2	
3	
4	
5	
6	
7	
8	
9	
10	

A 1:DEF:Num 50000.00000

_____ : Move Cell _____ ? : Help _____ / : Edit Screen _____ F8 : Continue _____
F1-Help Alt-X-Exit

Title
Cross Section Shape
Axial Loads
Strength of Materials ←
Dimension of Cross Section
Rebar Arrangement
Main Menu

F1-Help

Alt-X-Exit

File

Analysis

Mult

Option

EXAMPLE.IN6

Enter strength parameters of materials

Cylinder strength of concrete psi	3500.00000
Yield strength of reinforcement psi	60000.00000
Yield strength of shell or core psi	0.00000
Modulus of elasticity of steel psi	29000000.00000

A 1:DEF:Num 3500.00000000

_____ : Move Cell _____ ? : Help _____ / : Edit Screen _____ F8 : Continue _____
F1-Help Alt-X-Exit

File

Analysis

Mult

Option

Title	
Cross Section Shape	
Axial Loads	
Strength of Materials	
Dimension of Cross Section	←
Rebar Arrangement	
Main Menu	

F1-Help Alt-X-Exit

Enter cross-section dimension

Width of section (rectangular section only) inches	0.00000
Depth of section (rectangular section only) inches	0.00000
Outer diameter (circular section only) inches	30.00000
Outer diameter of core (circular section only) inches	0.00000
Thickness of shell (circular section only) inches	0.00000
Thickness of core (circular section only) inches	0.00000

A 1:DEF:Num 0.00000000

_____ : Move Cell _____ ? : Help _____ / : Edit Screen _____ F8 : Continue _____
F1-Help Alt-X-Exit

Title
Cross Section Shape
Axial Loads
Strength of Materials
Dimension of Cross Section
Rebar Arrangement ←
Main Menu

F1-Help Alt-X-Exit

File

Analysis

Mult

Option

EXAMPLE.IN6

Rebar Arrangement

Size of the rebar (enter the bar number, 3, 5, 8, 9...)	8
Number of reinforcing bars	12
Number of rows of reinforcing bars (rectangular section only)	0
Cover of rebar (from center of rebar to outer edge of concrete) inches	3.0000

A 1:DEF:Num 8

_____ : Move Cell _____ ? : Help _____ / : Edit Screen _____ F8 : Continue _____
 F1-Help Alt-X-Exit

File

Analysis

Mult

Option

EXAMPLE.IN6

Title
Cross Section Shape
Axial Loads
Strength of Materials
Dimension of Cross Section
Rebar Arrangement
Main Menu ←

F1-Help Alt-X-Exit

File ← Analysis Mult Option

C624EDIT 2.0, Edit Variables:

This program is a preprocessor developed especially for users for preparation of input for the computer program COM624P. The main menu for this program is displayed as a bar at the top row of the screen. The main menu has four choices: FILE, ANALYSIS, MULT, and OPTION.

The selection of the FILE menu allows the user to access a pull-down menu for file operations such as reading in an existing file, creating a new data file, checking files in the directory, and similar operations. The selection of the ANALYSIS menu allows the user to enter required data for computing the response of the pile and soil, such as distributions of deflection, bending moment, shear, and soil resistance as a function of length along the pile. The selection of the MULT menu allows the user to enter data of a selected pile size for computing the ultimate bending moment and other design-related information. The OPTION menu is used for screen setting and it may not be needed for most computer systems.

F1-Help Alt-X-Exit

File Analysis Mult Option

Read
New
Save ←
Directory
Change dir
Quit to DOS
Main Menu

F1-Help Alt-X-Exit

File

Analysis

Mult

Option

EXAMPLE.IN6

Read
New
Save

Save File Name

EXAMPLE.IN6

Quit to DOS
Main Menu

F1-Help

Alt-X-Exit

OUTPUT RESULTS FOR EXAMPLE 6

EXAMPLE 6 ANALYSES RELATED TO DESIGN OF CONCRETE PILES

 ULTIMATE BENDING RESISTANCE AND FLEXURAL RIGIDITY

DIAMETER = 30.00 IN
 CONCRETE COMPRESSIVE STRENGTH = 3.500000 KIP/IN**2
 REBAR YIELD STRENGTH = 60.000000 KIP/IN**2
 MODULUS OF ELASTICITY OF STEEL = 29000.000000 KIP/IN**2
 NUMBER OF REINFORCING BARS = 12
 NUMBER OF ROWS OF REINFORCING BARS = 7
 COVER THICKNESS = 3.000 IN
 SQUASH LOAD CAPACITY = 2643.50 KIP

ROW NUMBER	AREA OF REINFORCEMENT IN**2	DISTANCE TO CENTROIDAL AXIS IN
1	.790000	12.0000
2	1.580000	10.3923
3	1.580000	6.0000
4	1.580000	.0000
5	1.580000	-6.0000
6	1.580000	-10.3923
7	.790000	-12.0000

OUTPUT RESULTS FOR AN AXIAL LOAD = 50.00 KIP

MOMENT IN-KIP	EI KIP-IN**2	PHI 1/IN	MAX STR IN/IN	N AXIS IN
153.941	.15394E+09	.000001	.00003	33.870
765.633	.15313E+09	.000005	.00009	18.860
1364.857	.15165E+09	.000009	.00015	17.192
1364.857	.10499E+09	.000013	.00016	12.334
1364.857	.80286E+08	.000017	.00020	11.553
1364.857	.64993E+08	.000021	.00023	11.048
1364.857	.54594E+08	.000025	.00027	10.696
1517.223	.52318E+08	.000029	.00030	10.444

1678.489	.50863E+08	.000033	.00034	10.238
1839.116	.49706E+08	.000037	.00037	10.079
1999.618	.48771E+08	.000041	.00041	9.965
2158.825	.47974E+08	.000045	.00044	9.859
2317.381	.47293E+08	.000049	.00048	9.772
2475.348	.46705E+08	.000053	.00051	9.701
3639.372	.43848E+08	.000083	.00078	9.441
4762.959	.42150E+08	.000113	.00106	9.375
5467.619	.38235E+08	.000143	.00131	9.170
5896.697	.34085E+08	.000173	.00155	8.955
6057.286	.29839E+08	.000203	.00175	8.636
6206.912	.26639E+08	.000233	.00197	8.437
6340.834	.24110E+08	.000263	.00218	8.274
6466.427	.22070E+08	.000293	.00239	8.161
6519.455	.20184E+08	.000323	.00259	8.011
6547.419	.18548E+08	.000353	.00278	7.887
6568.075	.17149E+08	.000383	.00297	7.753
6587.674	.15951E+08	.000413	.00316	7.644
6606.533	.14913E+08	.000443	.00335	7.552
6606.533	.13967E+08	.000473	.00355	7.500
6631.914	.13185E+08	.000503	.00376	7.480
6639.605	.12457E+08	.000533	.00396	7.434

THE ULTIMATE BENDING MOMENT AT A CONCRETE STRAIN OF 0.003
IS : .657E+04 IN-KIP

EXAMPLE 6 ANALYSES RELATED TO DESIGN OF CONCRETE PILES

UNITS--ENGL

PILE DEFLECTION, BENDING MOMENT, SHEAR & SOIL RESISTANCE

INPUT INFORMATION

THE LOADING IS STATIC

PILE GEOMETRY AND PROPERTIES

PILE LENGTH = 360.00 IN
 MODULUS OF ELASTICITY OF PILE = .320E+04 KIP/IN**2
 1 SECTION(S)

X	DIAMETER	MOMENT OF INERTIA	AREA
IN	IN	IN**4	IN**2
360.00	30.000	.398E+05	.707E+03

SOILS INFORMATION

X-COORDINATE AT THE GROUND SURFACE = .00 IN
 SLOPE ANGLE AT THE GROUND SURFACE = .00 DEG.

2 LAYER(S) OF SOIL

LAYER 1

THE LAYER IS A SAND

X AT THE TOP OF THE LAYER = .00 IN
 X AT THE BOTTOM OF THE LAYER = 360.00 IN
 VARIATION OF SOIL MODULUS, k = .900E+02 LBS/IN**3

LAYER 2

THE LAYER IS A STIFF CLAY ABOVE THE WATER TABLE

X AT THE TOP OF THE LAYER = 360.00 IN
 X AT THE BOTTOM OF THE LAYER = 540.00 IN
 VARIATION OF SOIL MODULUS, k = .500E+03 LBS/IN**3

DISTRIBUTION OF EFFECTIVE UNIT WEIGHT WITH DEPTH
 4 POINTS

X, IN	WEIGHT, LBS/IN**3
.00	.69E-01
360.00	.69E-01
360.00	.34E-01
540.00	.34E-01

DISTRIBUTION OF STRENGTH PARAMETERS WITH DEPTH
 4 POINTS

X, IN	C, LBS/IN**2	PHI, DEGREES	E50
.00	.000E+00	38.000	-----
360.00	.000E+00	38.000	-----
360.00	.100E+02	.000	.500E-02
540.00	.100E+02	.000	.500E-02

FINITE DIFFERENCE PARAMETERS
 NUMBER OF PILE INCREMENTS = 100
 TOLERANCE ON DETERMINATION OF DEFLECTIONS = .100E-04 IN
 MAXIMUM NUMBER OF ITERATIONS ALLOWED FOR PILE ANALYSIS = 100
 MAXIMUM ALLOWABLE DEFLECTION = .15E+03 IN

INPUT CODES
 OUTPT = 1
 KCYCL = 1
 KBC = 1
 KPYOP = 1
 INC = 1

EXAMPLE 6 ANALYSES RELATED TO DESIGN OF CONCRETE PILES

UNITS--ENGL

OUTPUT INFORMATION

GENERATED P-Y CURVES

THE NUMBER OF CURVE IS = 4
 THE NUMBER OF POINTS ON EACH CURVE = 17

DEPTH BELOW GS IN	DIAM IN	PHI	GAMMA LBS/IN**3	A	B
20.00	30.00	38.0	.7E-01	2.36	1.73
	Y IN		P LBS/IN		
	.000		.000		
	.042		75.000		
	.083		150.000		
	.125		225.000		
	.167		300.000		
	.208		365.158		
	.250		384.822		
	.292		402.273		
	.333		418.027		
	.375		432.435		
	.417		445.743		
	.458		458.134		
	.500		469.747		
	1.125		638.676		
	31.125		638.676		
	61.125		638.676		
	91.125		638.676		

DEPTH BELOW GS IN	DIAM IN	PHI	GAMMA LBS/IN**3	A	B
60.00	30.00	38.0	.7E-01	1.48	1.05

Y IN	P LBS/IN
.000	.000
.042	225.000
.083	450.000
.125	675.000
.167	900.000
.208	1125.000
.250	1216.512
.292	1279.527
.333	1336.746
.375	1389.336
.417	1438.131
.458	1483.745
.500	1526.650
1.125	2151.850
31.125	2151.850
61.125	2151.850
91.125	2151.850

DEPTH BELOW GS IN	DIAM IN	PHI	GAMMA LBS/IN**3	A	B
100.00	30.00	38.0	.7E-01	1.01	.65

Y IN	P LBS/IN
.000	.000
.042	375.000
.083	750.000
.125	1125.000
.167	1401.127
.208	1545.320
.250	1674.083
.292	1791.286
.333	1899.424
.375	2000.215
.417	2094.899
.458	2184.406
.500	2269.455
1.125	3514.745
31.125	3514.745
61.125	3514.745
91.125	3514.745

DEPTH BELOW GS IN	DIAM IN	PHI	GAMMA LBS/IN**3	A	B
----------------------	------------	-----	--------------------	---	---

150.00 30.00 38.0 .7E-01 .88 .50

Y IN	P LBS/IN
.000	.000
.042	562.500
.083	1125.000
.125	1558.341
.167	1856.202
.208	2125.918
.250	2375.137
.292	2608.509
.333	2829.120
.375	3039.150
.417	3240.206
.458	3433.519
.500	3620.052
1.125	6371.292
31.125	6371.292
61.125	6371.292
91.125	6371.292

----- *** -----

FILE LOADING CONDITION

LATERAL LOAD AT PILE HEAD = .200E+02 KIP
 APPLIED MOMENT AT PILE HEAD = .000E+00 IN-KIP
 AXIAL LOAD AT PILE HEAD = .500E+02 KIP

X	DEFLECTION IN	MOMENT IN-KIP	TOTAL STRESS LBS/IN**2	SHEAR KIP	SOIL RESIST LBS/IN	FLEXURAL RIGIDITY KIP-IN**2
*****	*****	*****	*****	*****	*****	*****
.00	.110E+00	.000E+00	.707E+02	.201E+02	.000E+00	.153E+09
3.60	.106E+00	.000E+00	.707E+02	.200E+02	.345E+02	.153E+09
7.20	.103E+00	.144E+03	.125E+03	.198E+02	.665E+02	.153E+09
10.80	.989E-01	.215E+03	.152E+03	.195E+02	.961E+02	.153E+09
14.40	.951E-01	.284E+03	.178E+03	.191E+02	.123E+03	.153E+09
18.00	.914E-01	.352E+03	.204E+03	.186E+02	.148E+03	.153E+09
21.60	.877E-01	.419E+03	.229E+03	.180E+02	.171E+03	.153E+09
25.20	.841E-01	.482E+03	.253E+03	.174E+02	.191E+03	.153E+09

28.80	.805E-01	.544E+03	.276E+03	.166E+02	.209E+03	.153E+09
32.40	.769E-01	.603E+03	.298E+03	.159E+02	.224E+03	.153E+09
36.00	.734E-01	.658E+03	.319E+03	.150E+02	.238E+03	.153E+09
39.60	.700E-01	.711E+03	.339E+03	.141E+02	.249E+03	.153E+09
43.20	.666E-01	.761E+03	.358E+03	.132E+02	.259E+03	.153E+09
46.80	.633E-01	.807E+03	.375E+03	.123E+02	.266E+03	.153E+09
50.40	.600E-01	.849E+03	.391E+03	.113E+02	.272E+03	.153E+09
54.00	.568E-01	.889E+03	.406E+03	.103E+02	.276E+03	.153E+09
57.60	.537E-01	.924E+03	.419E+03	.933E+01	.278E+03	.153E+09
61.20	.507E-01	.956E+03	.431E+03	.833E+01	.279E+03	.153E+09
64.80	.477E-01	.984E+03	.442E+03	.733E+01	.278E+03	.153E+09
68.40	.448E-01	.101E+04	.451E+03	.633E+01	.276E+03	.153E+09
72.00	.421E-01	.103E+04	.459E+03	.534E+01	.273E+03	.152E+09
75.60	.394E-01	.105E+04	.466E+03	.437E+01	.268E+03	.152E+09
79.20	.368E-01	.106E+04	.471E+03	.342E+01	.262E+03	.152E+09
82.80	.343E-01	.107E+04	.475E+03	.248E+01	.255E+03	.152E+09
86.40	.318E-01	.108E+04	.478E+03	.158E+01	.247E+03	.152E+09
90.00	.295E-01	.108E+04	.480E+03	.704E+00	.239E+03	.152E+09
93.60	.273E-01	.109E+04	.480E+03	-.139E+00	.230E+03	.152E+09
97.20	.251E-01	.108E+04	.480E+03	-.948E+00	.220E+03	.152E+09
100.80	.231E-01	.108E+04	.478E+03	-.172E+01	.209E+03	.152E+09
104.40	.211E-01	.107E+04	.475E+03	-.245E+01	.198E+03	.152E+09
108.00	.192E-01	.106E+04	.471E+03	-.315E+01	.187E+03	.152E+09
111.60	.174E-01	.105E+04	.466E+03	-.380E+01	.175E+03	.152E+09
115.20	.157E-01	.103E+04	.461E+03	-.441E+01	.163E+03	.152E+09
118.80	.141E-01	.102E+04	.455E+03	-.497E+01	.151E+03	.153E+09
122.40	.126E-01	.999E+03	.447E+03	-.550E+01	.139E+03	.153E+09
126.00	.112E-01	.978E+03	.440E+03	-.597E+01	.127E+03	.153E+09
129.60	.984E-02	.956E+03	.431E+03	-.641E+01	.115E+03	.153E+09
133.20	.857E-02	.932E+03	.422E+03	-.680E+01	.103E+03	.153E+09
136.80	.738E-02	.907E+03	.413E+03	-.715E+01	.909E+02	.153E+09
140.40	.627E-02	.881E+03	.403E+03	-.745E+01	.792E+02	.153E+09
144.00	.523E-02	.853E+03	.393E+03	-.772E+01	.678E+02	.153E+09
147.60	.426E-02	.825E+03	.382E+03	-.794E+01	.566E+02	.153E+09
151.20	.337E-02	.796E+03	.371E+03	-.813E+01	.458E+02	.153E+09
154.80	.254E-02	.767E+03	.360E+03	-.827E+01	.354E+02	.153E+09
158.40	.177E-02	.737E+03	.349E+03	-.838E+01	.253E+02	.153E+09
162.00	.107E-02	.706E+03	.337E+03	-.846E+01	.156E+02	.153E+09
165.60	.430E-03	.676E+03	.326E+03	-.850E+01	.641E+01	.153E+09
169.20	-.154E-03	.645E+03	.314E+03	-.850E+01	-.235E+01	.153E+09
172.80	-.684E-03	.615E+03	.303E+03	-.848E+01	-.106E+02	.153E+09
176.40	-.116E-02	.584E+03	.291E+03	-.843E+01	-.184E+02	.153E+09
180.00	-.159E-02	.554E+03	.280E+03	-.835E+01	-.258E+02	.153E+09
183.60	-.197E-02	.524E+03	.268E+03	-.824E+01	-.326E+02	.153E+09
187.20	-.231E-02	.495E+03	.257E+03	-.811E+01	-.389E+02	.153E+09
190.80	-.260E-02	.466E+03	.246E+03	-.796E+01	-.447E+02	.153E+09
194.40	-.286E-02	.437E+03	.236E+03	-.779E+01	-.500E+02	.153E+09
198.00	-.308E-02	.410E+03	.225E+03	-.760E+01	-.549E+02	.153E+09
201.60	-.326E-02	.383E+03	.215E+03	-.740E+01	-.592E+02	.153E+09
205.20	-.342E-02	.357E+03	.205E+03	-.718E+01	-.631E+02	.153E+09
208.80	-.354E-02	.331E+03	.196E+03	-.695E+01	-.665E+02	.153E+09
212.40	-.363E-02	.307E+03	.186E+03	-.670E+01	-.694E+02	.153E+09

216.00	-.370E-02	.283E+03	.177E+03	-.645E+01	-.719E+02	.153E+09
219.60	-.374E-02	.260E+03	.169E+03	-.618E+01	-.740E+02	.153E+09
223.20	-.376E-02	.238E+03	.161E+03	-.592E+01	-.756E+02	.153E+09
226.80	-.376E-02	.218E+03	.153E+03	-.564E+01	-.769E+02	.153E+09
230.40	-.375E-02	.198E+03	.145E+03	-.536E+01	-.777E+02	.153E+09
234.00	-.371E-02	.179E+03	.138E+03	-.508E+01	-.782E+02	.153E+09
237.60	-.367E-02	.161E+03	.131E+03	-.480E+01	-.784E+02	.153E+09
241.20	-.360E-02	.144E+03	.125E+03	-.452E+01	-.782E+02	.153E+09
244.80	-.353E-02	.129E+03	.119E+03	-.424E+01	-.777E+02	.153E+09
248.40	-.344E-02	.114E+03	.114E+03	-.396E+01	-.770E+02	.153E+09
252.00	-.335E-02	.100E+03	.108E+03	-.368E+01	-.759E+02	.153E+09
255.60	-.324E-02	.873E+02	.104E+03	-.341E+01	-.746E+02	.153E+09
259.20	-.313E-02	.755E+02	.992E+02	-.315E+01	-.731E+02	.153E+09
262.80	-.302E-02	.646E+02	.951E+02	-.289E+01	-.713E+02	.153E+09
266.40	-.289E-02	.547E+02	.913E+02	-.263E+01	-.694E+02	.153E+09
270.00	-.277E-02	.456E+02	.879E+02	-.239E+01	-.672E+02	.153E+09
273.60	-.263E-02	.375E+02	.849E+02	-.215E+01	-.649E+02	.153E+09
277.20	-.250E-02	.301E+02	.821E+02	-.192E+01	-.624E+02	.153E+09
280.80	-.236E-02	.236E+02	.796E+02	-.170E+01	-.597E+02	.153E+09
284.40	-.222E-02	.179E+02	.775E+02	-.149E+01	-.569E+02	.153E+09
288.00	-.208E-02	.129E+02	.756E+02	-.129E+01	-.540E+02	.153E+09
291.60	-.194E-02	.857E+01	.740E+02	-.110E+01	-.510E+02	.153E+09
295.20	-.180E-02	.492E+01	.726E+02	-.925E+00	-.478E+02	.153E+09
298.80	-.166E-02	.190E+01	.714E+02	-.758E+00	-.445E+02	.153E+09
302.40	-.151E-02	-.552E+00	.709E+02	-.604E+00	-.412E+02	.153E+09
306.00	-.137E-02	-.247E+01	.717E+02	-.462E+00	-.378E+02	.153E+09
309.60	-.123E-02	-.389E+01	.722E+02	-.332E+00	-.342E+02	.153E+09
313.20	-.109E-02	-.487E+01	.726E+02	-.216E+00	-.306E+02	.153E+09
316.80	-.944E-03	-.546E+01	.728E+02	-.112E+00	-.269E+02	.153E+09
320.40	-.802E-03	-.570E+01	.729E+02	-.222E-01	-.231E+02	.153E+09
324.00	-.661E-03	-.563E+01	.728E+02	.542E-01	-.193E+02	.153E+09
327.60	-.521E-03	-.532E+01	.727E+02	.117E+00	-.154E+02	.153E+09
331.20	-.381E-03	-.481E+01	.725E+02	.165E+00	-.113E+02	.153E+09
334.80	-.241E-03	-.415E+01	.723E+02	.198E+00	-.726E+01	.153E+09
338.40	-.102E-03	-.340E+01	.720E+02	.217E+00	-.310E+01	.153E+09
342.00	.374E-04	-.260E+01	.717E+02	.220E+00	.115E+01	.153E+09
345.60	.176E-03	-.183E+01	.714E+02	.208E+00	.548E+01	.153E+09
349.20	.315E-03	-.112E+01	.711E+02	.181E+00	.990E+01	.153E+09
352.80	.453E-03	-.539E+00	.709E+02	.137E+00	.144E+02	.153E+09
356.40	.592E-03	.000E+00	.707E+02	.000E+00	.190E+02	.153E+09
360.00	.730E-03	.000E+00	.707E+02	.000E+00	.237E+02	.153E+09

COMPUTED LATERAL FORCE AT PILE HEAD	=	.20000E+02 KIP
COMPUTED MOMENT AT PILE HEAD	=	.00000E+00 IN-KIP
COMPUTED SLOPE AT PILE HEAD	=	-.10473E-02
THE OVERALL MOMENT IMBALANCE	=	-.813E-08 IN-KIP
THE OVERALL LATERAL FORCE IMBALANCE	=	.129E-06 LBS

OUTPUT SUMMARY

FILE HEAD DEFLECTION = .110E+00 IN
 MAXIMUM BENDING MOMENT = .112E+04 IN-KIP
 MAXIMUM TOTAL STRESS = .493E+03 LBS/IN**2

NO. OF ITERATIONS = 6
 MAXIMUM DEFLECTION ERROR = .461E-07 IN

----- *** -----

PILE LOADING CONDITION

LATERAL LOAD AT PILE HEAD = .400E+02 KIP
 APPLIED MOMENT AT PILE HEAD = .000E+00 IN-KIP
 AXIAL LOAD AT PILE HEAD = .500E+02 KIP

X	DEFLECTION	MOMENT	TOTAL	SHEAR	SOIL	FLEXURAL
IN	IN	IN-KIP	STRESS	KIP	RESIST	RIGIDITY
*****	*****	*****	LBS/IN**2	*****	LBS/IN	KIP-IN**2
*****	*****	*****	*****	*****	*****	*****
.00	.337E+00	.000E+00	.707E+02	.402E+02	.000E+00	.153E+09
3.60	.323E+00	.000E+00	.707E+02	.401E+02	.608E+02	.153E+09
7.20	.309E+00	.289E+03	.180E+03	.396E+02	.128E+03	.153E+09
10.80	.296E+00	.431E+03	.233E+03	.390E+02	.199E+03	.153E+09
14.40	.282E+00	.570E+03	.286E+03	.381E+02	.272E+03	.153E+09
18.00	.269E+00	.707E+03	.337E+03	.370E+02	.348E+03	.153E+09
21.60	.255E+00	.838E+03	.387E+03	.356E+02	.423E+03	.153E+09
25.20	.242E+00	.964E+03	.435E+03	.340E+02	.497E+03	.153E+09
28.80	.228E+00	.108E+04	.480E+03	.320E+02	.568E+03	.152E+09
32.40	.215E+00	.120E+04	.522E+03	.299E+02	.628E+03	.152E+09
36.00	.202E+00	.130E+04	.561E+03	.276E+02	.655E+03	.152E+09
39.60	.189E+00	.140E+04	.597E+03	.252E+02	.674E+03	.541E+08
43.20	.176E+00	.148E+04	.630E+03	.227E+02	.686E+03	.528E+08
46.80	.164E+00	.156E+04	.660E+03	.203E+02	.691E+03	.519E+08
50.40	.152E+00	.163E+04	.686E+03	.178E+02	.690E+03	.513E+08
54.00	.141E+00	.169E+04	.708E+03	.153E+02	.684E+03	.508E+08
57.60	.130E+00	.174E+04	.728E+03	.129E+02	.672E+03	.504E+08
61.20	.119E+00	.178E+04	.744E+03	.105E+02	.655E+03	.501E+08
64.80	.109E+00	.182E+04	.757E+03	.815E+01	.634E+03	.498E+08
68.40	.991E-01	.184E+04	.766E+03	.591E+01	.610E+03	.496E+08
72.00	.899E-01	.186E+04	.773E+03	.377E+01	.582E+03	.495E+08

75.60	.811E-01	.187E+04	.777E+03	.172E+01	.552E+03	.495E+08
79.20	.729E-01	.187E+04	.778E+03	-.205E+00	.520E+03	.494E+08
82.80	.651E-01	.187E+04	.777E+03	-.201E+01	.485E+03	.495E+08
86.40	.579E-01	.186E+04	.773E+03	-.370E+01	.450E+03	.495E+08
90.00	.511E-01	.185E+04	.767E+03	-.525E+01	.414E+03	.496E+08
93.60	.448E-01	.182E+04	.759E+03	-.668E+01	.378E+03	.497E+08
97.20	.390E-01	.180E+04	.749E+03	-.797E+01	.341E+03	.499E+08
100.80	.337E-01	.177E+04	.737E+03	-.914E+01	.305E+03	.501E+08
104.40	.288E-01	.173E+04	.724E+03	-.102E+02	.270E+03	.503E+08
108.00	.243E-01	.169E+04	.710E+03	-.111E+02	.236E+03	.506E+08
111.60	.203E-01	.165E+04	.694E+03	-.119E+02	.204E+03	.509E+08
115.20	.167E-01	.161E+04	.678E+03	-.126E+02	.173E+03	.513E+08
118.80	.135E-01	.156E+04	.660E+03	-.131E+02	.145E+03	.517E+08
122.40	.108E-01	.151E+04	.642E+03	-.136E+02	.119E+03	.521E+08
126.00	.835E-02	.147E+04	.624E+03	-.140E+02	.946E+02	.527E+08
129.60	.629E-02	.141E+04	.604E+03	-.143E+02	.734E+02	.534E+08
133.20	.458E-02	.136E+04	.585E+03	-.145E+02	.550E+02	.542E+08
136.80	.320E-02	.131E+04	.565E+03	-.147E+02	.394E+02	.152E+09
140.40	.193E-02	.126E+04	.545E+03	-.148E+02	.244E+02	.152E+09
144.00	.765E-03	.120E+04	.525E+03	-.149E+02	.991E+01	.152E+09
147.60	-.297E-03	.115E+04	.505E+03	-.149E+02	-.395E+01	.152E+09
151.20	-.126E-02	.110E+04	.484E+03	-.148E+02	-.172E+02	.152E+09
154.80	-.213E-02	.104E+04	.464E+03	-.148E+02	-.297E+02	.152E+09
158.40	-.291E-02	.990E+03	.444E+03	-.146E+02	-.415E+02	.152E+09
162.00	-.361E-02	.938E+03	.425E+03	-.145E+02	-.526E+02	.153E+09
165.60	-.423E-02	.886E+03	.405E+03	-.142E+02	-.630E+02	.153E+09
169.20	-.477E-02	.835E+03	.386E+03	-.140E+02	-.727E+02	.153E+09
172.80	-.524E-02	.786E+03	.367E+03	-.137E+02	-.815E+02	.153E+09
176.40	-.565E-02	.737E+03	.349E+03	-.134E+02	-.897E+02	.153E+09
180.00	-.599E-02	.689E+03	.331E+03	-.131E+02	-.971E+02	.153E+09
183.60	-.628E-02	.643E+03	.313E+03	-.127E+02	-.104E+03	.153E+09
187.20	-.651E-02	.597E+03	.296E+03	-.123E+02	-.110E+03	.153E+09
190.80	-.669E-02	.554E+03	.280E+03	-.119E+02	-.115E+03	.153E+09
194.40	-.682E-02	.512E+03	.264E+03	-.115E+02	-.119E+03	.153E+09
198.00	-.691E-02	.471E+03	.248E+03	-.111E+02	-.123E+03	.153E+09
201.60	-.696E-02	.432E+03	.234E+03	-.106E+02	-.126E+03	.153E+09
205.20	-.697E-02	.394E+03	.219E+03	-.102E+02	-.129E+03	.153E+09
208.80	-.695E-02	.359E+03	.206E+03	-.970E+01	-.131E+03	.153E+09
212.40	-.690E-02	.324E+03	.193E+03	-.923E+01	-.132E+03	.153E+09
216.00	-.682E-02	.292E+03	.181E+03	-.875E+01	-.133E+03	.153E+09
219.60	-.672E-02	.261E+03	.169E+03	-.827E+01	-.133E+03	.153E+09
223.20	-.660E-02	.233E+03	.158E+03	-.780E+01	-.132E+03	.153E+09
226.80	-.645E-02	.205E+03	.148E+03	-.732E+01	-.132E+03	.153E+09
230.40	-.629E-02	.180E+03	.139E+03	-.685E+01	-.130E+03	.153E+09
234.00	-.611E-02	.156E+03	.130E+03	-.638E+01	-.129E+03	.153E+09
237.60	-.592E-02	.134E+03	.121E+03	-.592E+01	-.127E+03	.153E+09
241.20	-.572E-02	.113E+03	.113E+03	-.547E+01	-.124E+03	.153E+09
244.80	-.551E-02	.944E+02	.106E+03	-.503E+01	-.121E+03	.153E+09
248.40	-.529E-02	.770E+02	.998E+02	-.460E+01	-.118E+03	.153E+09
252.00	-.506E-02	.612E+02	.938E+02	-.418E+01	-.115E+03	.153E+09
255.60	-.483E-02	.469E+02	.884E+02	-.377E+01	-.111E+03	.153E+09
259.20	-.460E-02	.340E+02	.836E+02	-.338E+01	-.107E+03	.153E+09

262.80	-.436E-02	.225E+02	.792E+02	-.300E+01	-.103E+03	.153E+09
266.40	-.412E-02	.124E+02	.754E+02	-.264E+01	-.988E+02	.153E+09
270.00	-.388E-02	.353E+01	.721E+02	-.229E+01	-.943E+02	.153E+09
273.60	-.364E-02	-.412E+01	.723E+02	-.196E+01	-.896E+02	.153E+09
277.20	-.340E-02	-.106E+02	.747E+02	-.165E+01	-.848E+02	.153E+09
280.80	-.316E-02	-.160E+02	.768E+02	-.135E+01	-.798E+02	.153E+09
284.40	-.292E-02	-.203E+02	.784E+02	-.107E+01	-.747E+02	.153E+09
288.00	-.268E-02	-.237E+02	.797E+02	-.812E+00	-.695E+02	.153E+09
291.60	-.245E-02	-.262E+02	.806E+02	-.571E+00	-.642E+02	.153E+09
295.20	-.222E-02	-.279E+02	.812E+02	-.349E+00	-.589E+02	.153E+09
298.80	-.199E-02	-.287E+02	.816E+02	-.147E+00	-.534E+02	.153E+09
302.40	-.176E-02	-.289E+02	.816E+02	.348E-01	-.478E+02	.153E+09
306.00	-.153E-02	-.285E+02	.815E+02	.197E+00	-.422E+02	.153E+09
309.60	-.131E-02	-.276E+02	.811E+02	.339E+00	-.365E+02	.153E+09
313.20	-.109E-02	-.261E+02	.806E+02	.459E+00	-.307E+02	.153E+09
316.80	-.871E-03	-.243E+02	.799E+02	.559E+00	-.248E+02	.153E+09
320.40	-.654E-03	-.221E+02	.791E+02	.638E+00	-.189E+02	.153E+09
324.00	-.440E-03	-.197E+02	.782E+02	.695E+00	-.128E+02	.153E+09
327.60	-.227E-03	-.171E+02	.772E+02	.730E+00	-.670E+01	.153E+09
331.20	-.161E-04	-.145E+02	.762E+02	.743E+00	-.480E+00	.153E+09
334.80	.194E-03	-.118E+02	.752E+02	.734E+00	.584E+01	.153E+09
338.40	.403E-03	-.919E+01	.742E+02	.701E+00	.123E+02	.153E+09
342.00	.611E-03	-.676E+01	.733E+02	.645E+00	.188E+02	.153E+09
345.60	.819E-03	-.457E+01	.724E+02	.565E+00	.255E+02	.153E+09
349.20	.103E-02	-.271E+01	.717E+02	.461E+00	.323E+02	.153E+09
352.80	.123E-02	-.127E+01	.712E+02	.333E+00	.392E+02	.153E+09
356.40	.144E-02	.000E+00	.707E+02	.000E+00	.462E+02	.153E+09
360.00	.165E-02	.000E+00	.707E+02	.000E+00	.534E+02	.153E+09

COMPUTED LATERAL FORCE AT PILE HEAD = .40000E+02 KIP
 COMPUTED MOMENT AT PILE HEAD = .00000E+00 IN-KIP
 COMPUTED SLOPE AT PILE HEAD = -.37926E-02

THE OVERALL MOMENT IMBALANCE = .519E-08 IN-KIP
 THE OVERALL LATERAL FORCE IMBALANCE = .885E-07 LBS

OUTPUT SUMMARY

PILE HEAD DEFLECTION = .337E+00 IN
 MAXIMUM BENDING MOMENT = .217E+04 IN-KIP
 MAXIMUM TOTAL STRESS = .890E+03 LBS/IN**2

NO. OF ITERATIONS = 13
 MAXIMUM DEFLECTION ERROR = .435E-05 IN

SUMMARY TABLE

LATERAL LOAD (KIP)	BOUNDARY CONDITION BC2	AXIAL LOAD (KIP)	YT (IN)	ST (IN/IN)	MAX. MOMENT (IN-KIP)	MAX. STRESS (LBS/IN**2)
.200E+02	.000E+00	.500E+02	.110E+00	-.105E-02	.112E+04	.493E+03
.400E+02	.000E+00	.500E+02	.337E+00	-.379E-02	.217E+04	.890E+03

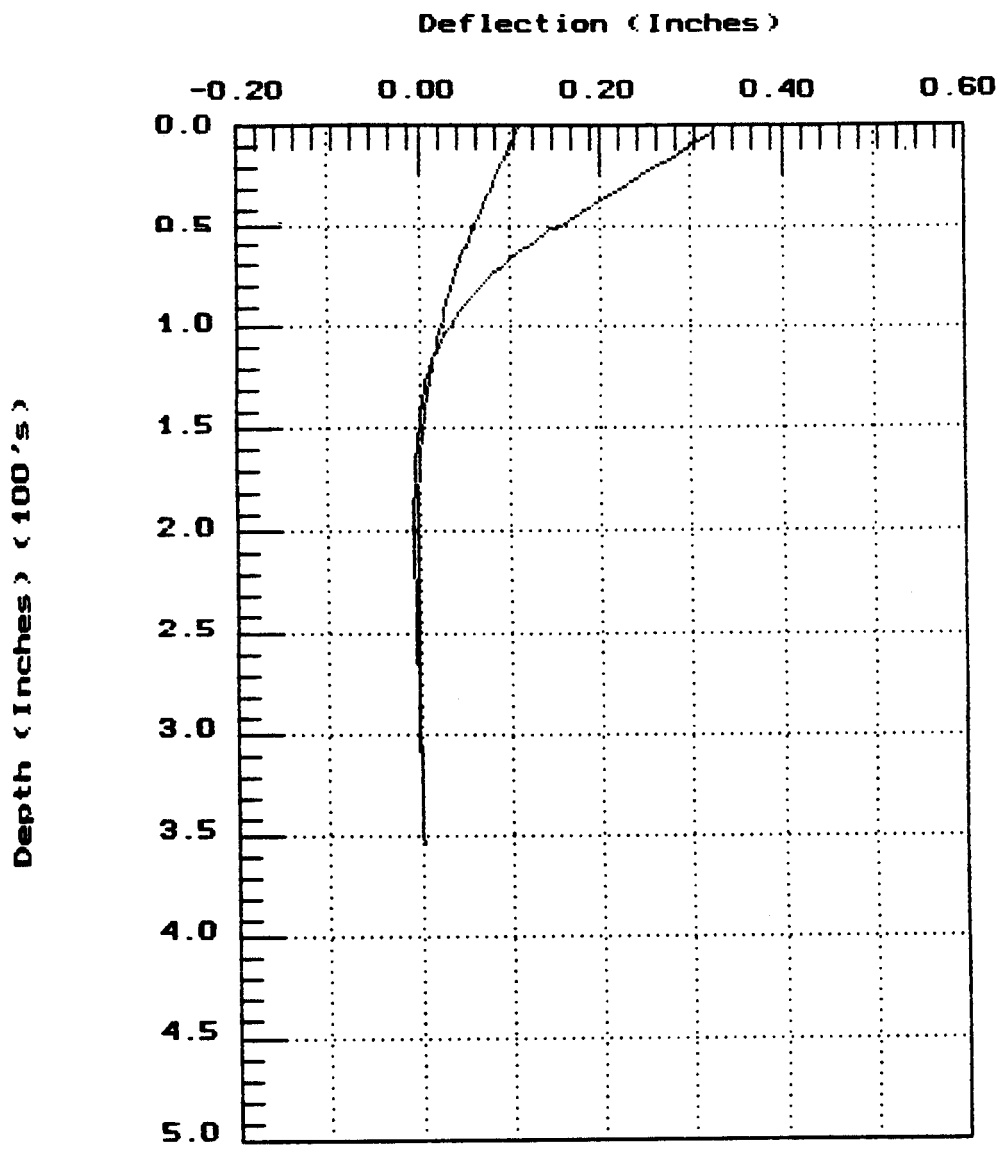

Deflection vs. Depth

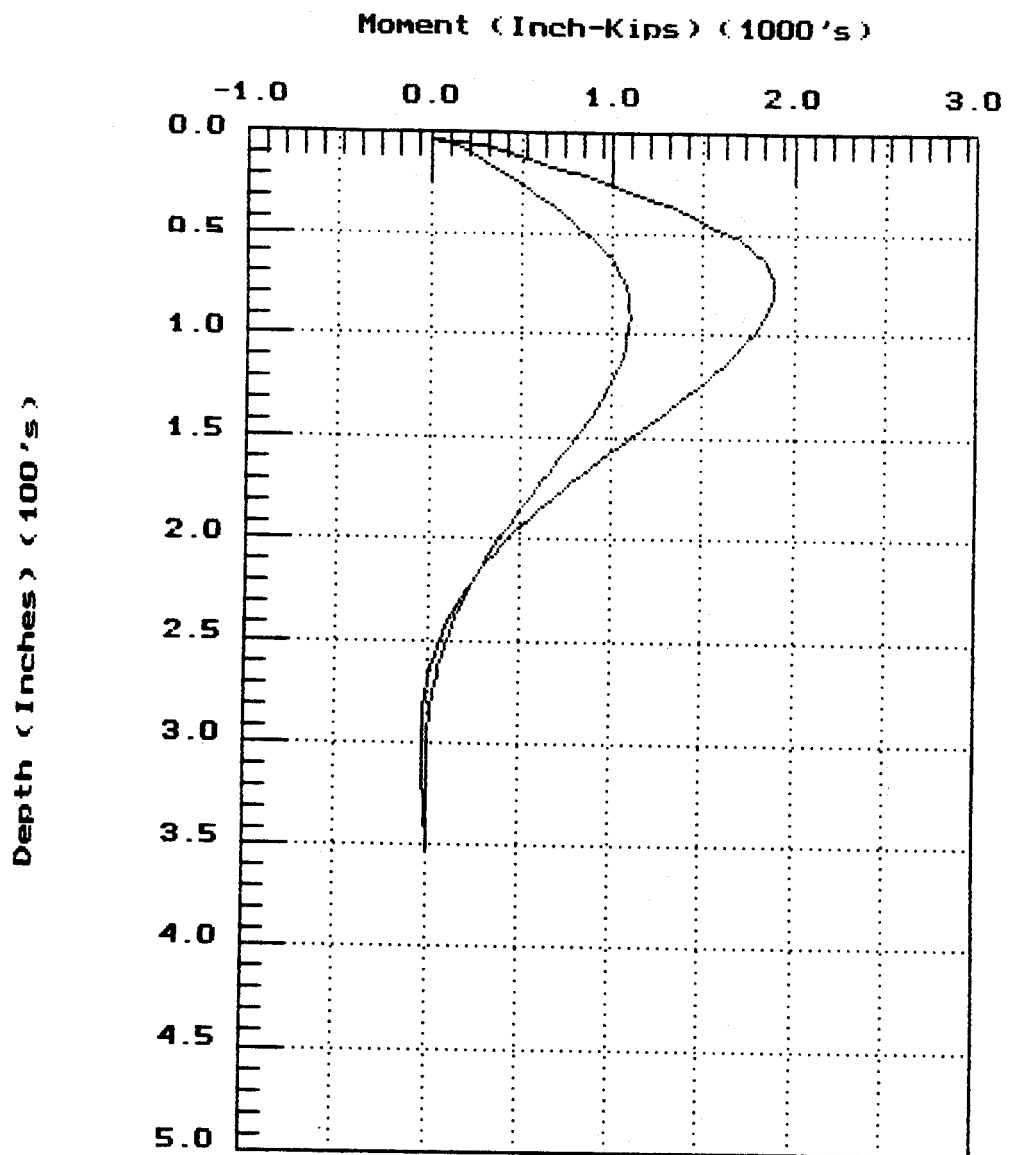

Bending Moment vs. Depth

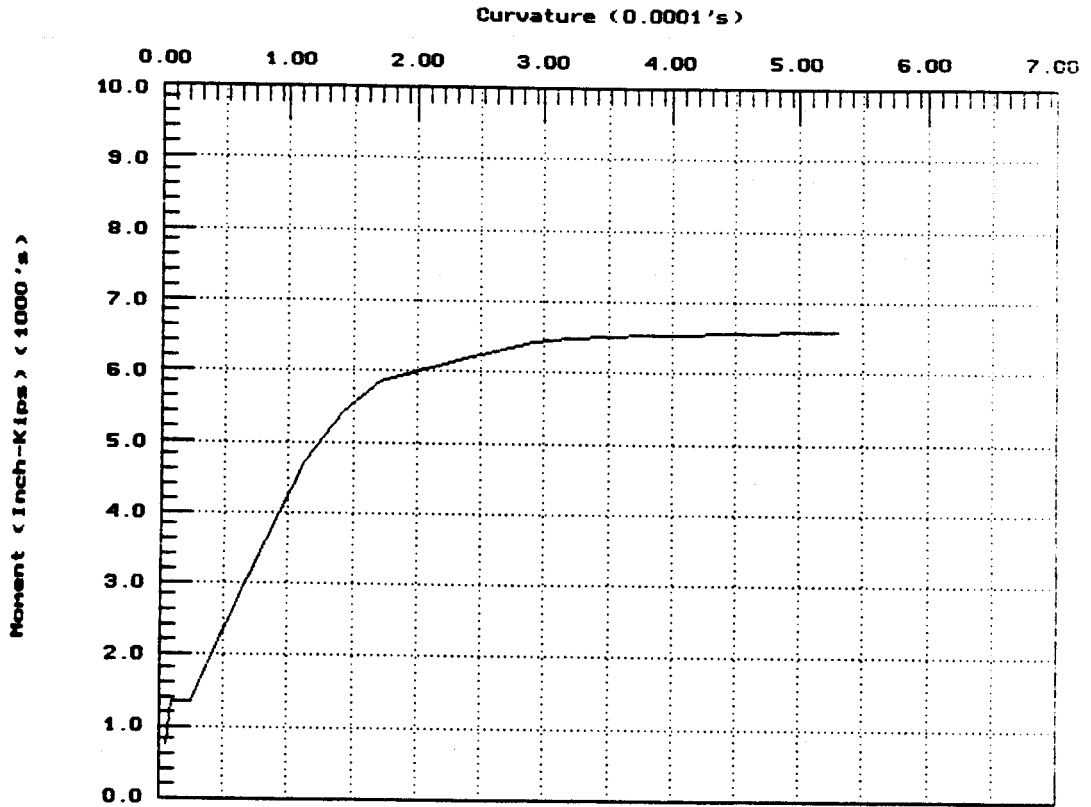

Bending Moment vs. Curvature

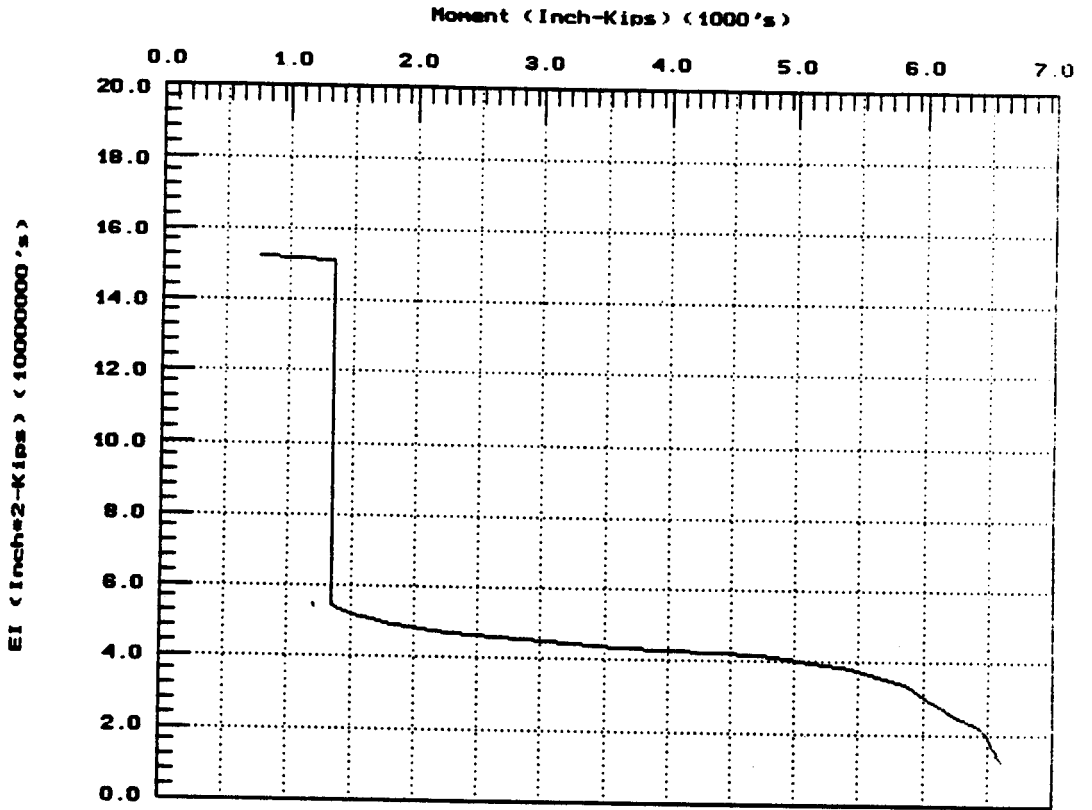

EI vs. Bending Moment

COM624P
LATERALLY LOADED PILE ANALYSIS PROGRAM
FOR THE MICROCOMPUTER
Version 2.0

Part II: Background

CHAPTER 1. INTRODUCTION

The documentation for Computer Program COM624P consists of three documents: Part I, Users Guide; Part II Engineering Background; and Part III, Systems Maintenance.

The information shown in this document is limited to that needed for the operation of the computer program and to a brief introduction of the nature of the method of analysis. The user is referred to two documents published by the Federal Highway Administration for a relatively complete treatment of the topic (FHWA-IP-84-11 and FHWA/RD-85/106). A study of those publications and some of the papers that are cited therein will be necessary for the engineer to make proper use of COM624P. This program does not provide an "automatic" solution to the problem of the pile under lateral loading; rather, decisions of an experienced engineer are required in the selection of appropriate input and in the analysis of output of the program.

NATURE OF THE PROBLEM

The analysis of a pile under lateral loading is a problem in soil-structure interaction; that is, the deflection of the pile is dependent on the soil response and the soil response is a function of pile deflection. Thus, the problem cannot be solved by the equations of static equilibrium, but a differential equation must be solved to obtain the deflection of the pile. Iteration must be employed because the soil response is a nonlinear function of pile deflection and of position along the length of the pile.

Definition of Soil Response

The definition of soil response is given in Fig. 1.1. Figure 1.1a is an elevation view of a section of a pile with the depth identified at which the soil response is investigated. Figure 1.1b gives the distribution of unit stresses around the pile after its installation and before load is applied; if the pile has been installed without bending, there is no unbalanced force acting. If the pile is caused to deflect through a distance y_1 (exaggerated here for clarity of presentation), the unit stresses may be as shown in Fig. 1.1c. The unit stress has decreased on the back side of the pile and has increased on the front side. The unbalanced force is now p_1 , in units of force per unit of length along the pile, and can be found by integrating the unit stresses.

A nonlinear relationship exists between p and y because, at some deflection y , the soil response p will reach a limit and remain constant, or perhaps decrease, with further deflection. The nonlinear curve relating the soil response and the pile deflection is termed a p - y curve. A family of p - y curves can be generated by methods discussed later and it is evident that the curves can vary in any arbitrary manner along the length of the pile.

Definition of Soil Modulus

The soil modulus, as employed in the solution of the laterally-loaded pile, is defined as p divided by y , has the units of force per length squared, and is given the symbol E_s . Thus, E_s can be characterized as a nonlinear spring whose stiffness is largest with small deflection and decreases as the deflection of the pile increases.

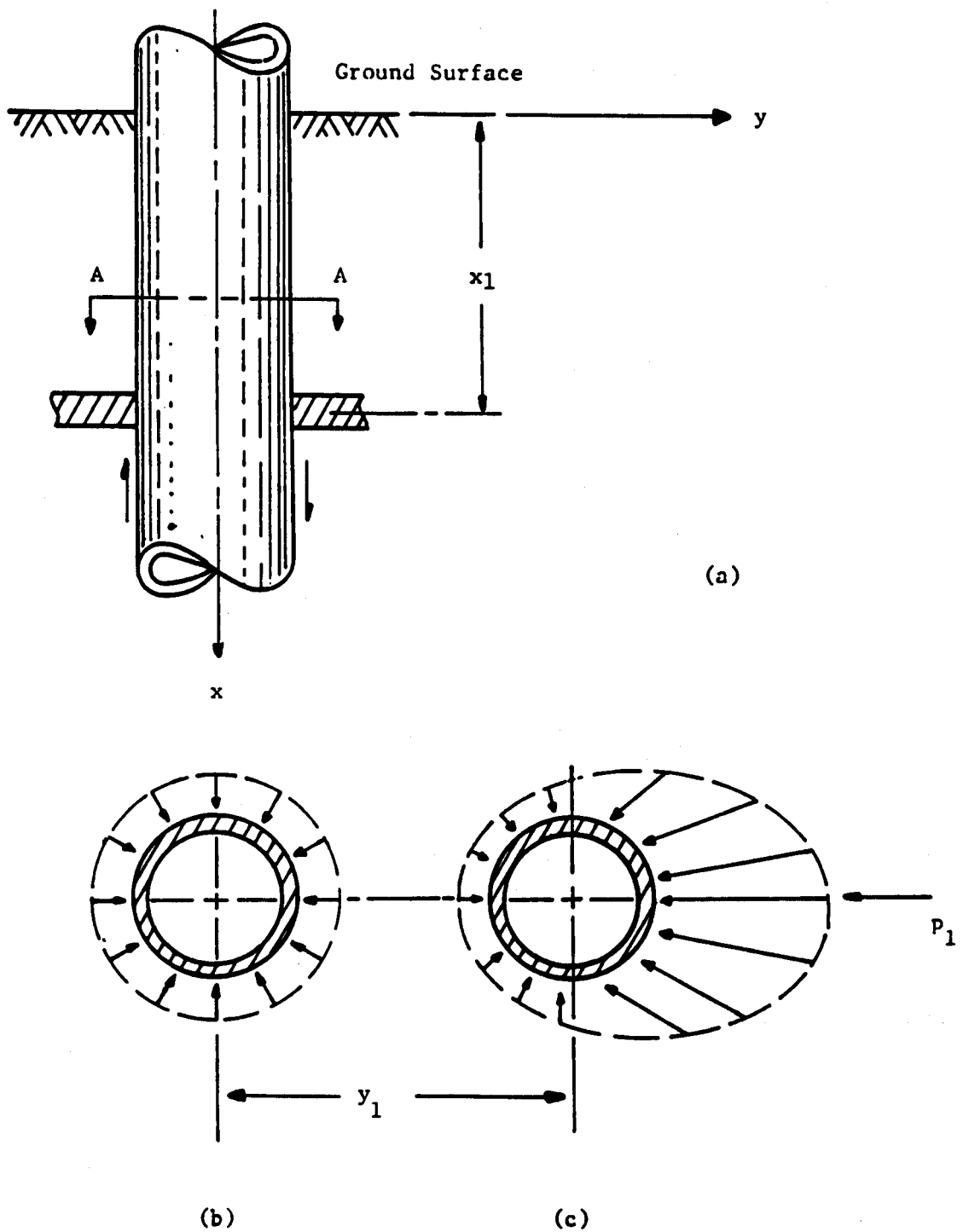

Figure 1.1. Definition of p and y (after Reese, 1983).

The left-hand portion of Fig. 1.2 shows the upper portion of a pile with three p-y curves in conceptual form. The curves are plotted in the second and fourth quadrants because the soil response is opposite in sign to pile deflection. The pile is assumed to be subjected to a lateral load P_t at its top. Dashed lines are drawn to show the possible deflection of the pile under two different loadings with the curvature in the deflection being ignored for ease in presentation. For each of the p-y curves, dotted lines are drawn to the intersection of the deflection with the p-y curve. The slope of these dotted lines indicates the magnitude of the soil modulus E_s at each of the particular points along the pile and at each particular deflection of the pile.

The right-hand portion of the sketch shows a plot of E_s as a function of distance x along the pile. As may be seen, E_s is some arbitrary function of x and y for any particular lateral load P_t at the top of the pile. The figure suggests that: a solution of the problem cannot in general be based on some presumed variation of E_s as a function of x ; that E_s is not a property of the soil but is merely a fitting function to be determined; that the ability to formulate p-y curves is essential to a solution; that iteration will invariably be necessary; and that a computer program is essential.

A method of analysis employed in some engineering offices starts with the selection of a depth below the groundline at which the pile is assumed to be fixed against rotation. No soil is assumed to exist along the pile above that point; thus, the pile in soil is replaced by a cantilever beam, and solving for deflection and bending moment proceeds by using the ordinary equations of mechanics. If, by chance, the depth to the point of fixity was selected correctly, the computed maximum bending moment would agree with the actual maximum moment, but the distribution of bending moment along the pile would certainly be incorrect.

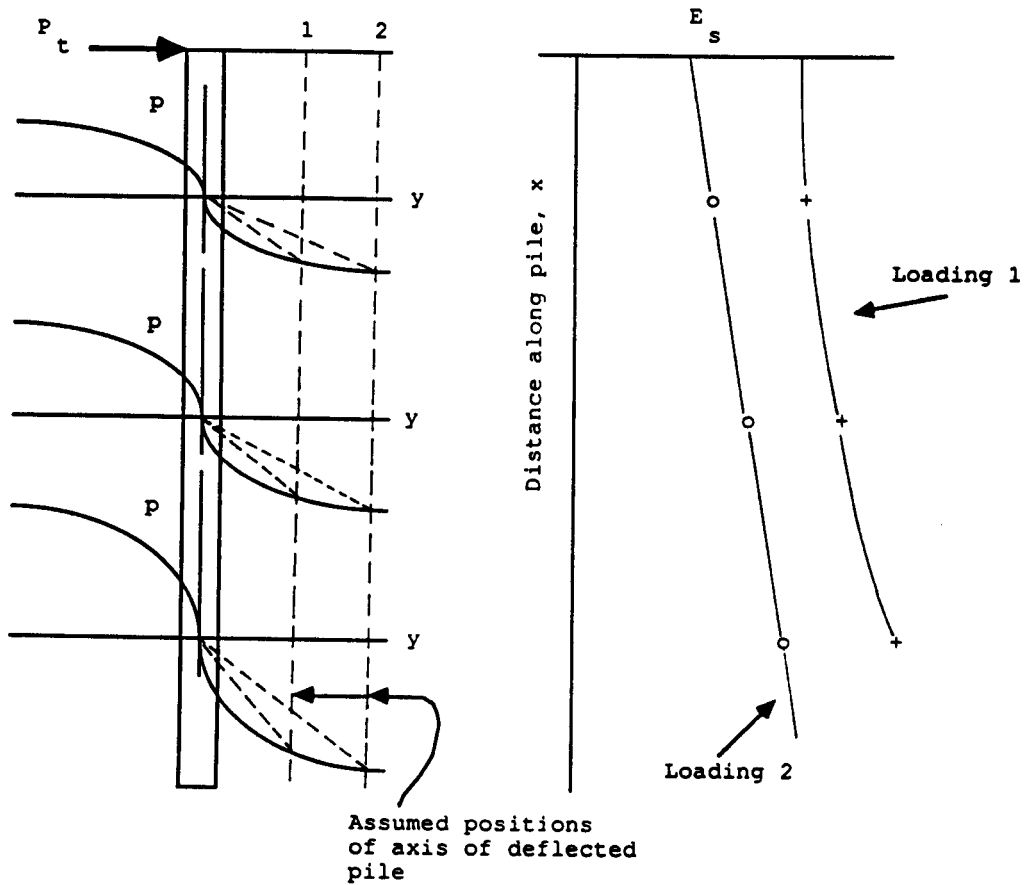

Figure 1.2. Concept of determination of soil modulus as a function of distance along pile.

Furthermore, the selection of a point of fixity (such that both the maximum deflection and the maximum bending both were computed correctly) would be a virtual impossibility. Thus, no guidelines can be developed for selecting a point of fixity that would allow the response of a pile to be computed accurately. This discussion is for the purpose of reinforcing the desirability of using the p-y method of analysis as presented herein.

DESIGN BY FACTORING THE LOAD

A pile under lateral load, and some amount of axial load as well, must be selected so that it has an appropriate factor of safety against collapse due to bending and against excessive deflection. If a curve were to be developed for bending moment or deflection, the curve would be nonlinear with respect to the lateral load. Thus, the preferred method of design of the pile is to find the factored load that will cause the pile to "fail." The factor is selected so as to provide an appropriate factor of safety with respect to load. If the allowable-stress approach is used, the load that produced the allowable stress could be increased only a small percentage and failure might occur because of the response of the nonlinear p-y curves.

The load-factor approach requires that the cross section of the pile be analyzed to determine the ultimate moment that will cause the development of a plastic hinge. Such values are tabulated for structural shapes, and computer programs are available to analyze composite sections, such as a reinforced-concrete section. The determination of some magnitude of deflection that will cause a failure is less straightforward. There may be some structures that are sensitive to deflection for a site-specific reason, and the load-factor method can be used to reduce the load that results in excessive deflection to a safe lateral load.

Another type of failure can be investigated by COM624P. The equation that is programmed and described later defines the behavior of a beam-column so that one of the input parameters is axial load. Some piles may extend some distance above the groundline so that buckling may be a problem. The failure of the pile in buckling can be investigated by holding the factored lateral load constant and by increasing the axial load in increments until the deflection becomes excessive. It is important that the axial load be increased in small increments because the procedure that is employed behaves erratically at loads above the buckling load.

NATURE OF LOADING

In respect to lateral loading, four kinds of loads are encountered in practice: short-term, repeated, sustained, and seismic or dynamic. The engineer must select the soil-response curves to be used in a particular design by giving careful consideration to the nature of the loading.

Static Loading

Short-term or static loading is frequently employed in a field test in order to obtain the response of a soil that can be correlated with the engineering properties of the soil. The p-y curves for static loading, thus, are a sort of "backbone" response by which the response of a pile to other sorts of loading can be judged. In some instances, the static p-y curves can be used in design. Methods of predicting p-y curves for static loading are presented later.

Cyclic Loading

Many structures are subjected to cyclic or repeated lateral loads. Wind gusts are an example. Other examples are traffic loads on curved bridges, braking loads, current and wave loads, and ice loads. The p-y curves that are proposed for cyclic loading are presented in a later section of this report. The proposals are strongly based on field experiments. Only a limited number of such experiments have been performed and the judgment of an experienced engineer is needed in ascertaining the magnitude of the load factor that is appropriate. In some instances, field load tests at the specific site are indicated.

Sustained Loading

Retaining walls, bulkheads, and bridge abutments are subjected to sustained loading. A pile in granular soil or heavily overconsolidated clay can be expected to undergo only a small amount of additional deflection, or perhaps none, depending on the magnitude of the unit stresses that exist around the pile. On the other hand, if the pile is installed in normally consolidated or lightly overconsolidated clay, the time-related deflection due to consolidation and creep may be significant. In concept, an analysis could be accomplished by stretching the y-values on the p-y curves an amount to accommodate the time-related displacement. However, no analytical method has been proposed for making the adjustments in the p-y curves.

The procedure that is suggested is to refer to any information that may be found in the technical literature; for example to the papers by Neukirchner and Nixon (1987), and Neukirchner (1987). Also, the computer program can be utilized to obtain an estimate under the working load of the lateral stresses against the soil. The theory of consolidation can be employed to gain some insight

into the possible additional, time-related deflection of the pile. In this connection, some consideration must be given to the time-related changes in the soil stresses.

An alternative procedure in important cases is to install a test pile and subject it to sustained loading. The length of time the load can be maintained would be limited, of course; however, the additional deflection will decay exponentially so that it would be possible to make an extrapolation to estimate the final amount of additional deflection.

Dynamic or Seismic Loading

There may be instances in the design of piles where the lateral loading arises from vibration as from oscillating machinery. Because the deflections of a pile would, in general, be quite small due to the vibration, a constant value of soil modulus as a function of deflection could be selected. The reader is referred to technical literature on soil dynamics for guidance. With regard to the response of the pile, inertia effects cannot be ignored as is possible with static or with most cyclic loads.

A discussion of the design of a pile to sustain lateral loading that could be generated by an earthquake is beyond the scope of this report. The design may be made by a pseudo-static method or, if a rational method is to be employed, the analysis would start with an estimation of the free-field motion of the surface soils at the site.

INTERACTION OF THE PILES WITH THE SUPERSTRUCTURE

As shown later, the user of the program can select a variety of sets of boundary conditions at the top of the pile. The conditions of equilibrium and compatibility are satisfied by the appropriate selection. If a pile extends upward to support a road sign, the two boundary conditions consist of a shear and a moment. If a pile extends upward to form a part of the superstructure, the two boundary conditions consist of a shear and a rotational restraint. In order to select the proper magnitude of the rotational restraint, iteration between the pile foundation and the superstructure is usually necessary.

If a pile extends upward and is embedded in a concrete mat such as the base of a retaining wall, an acceptable solution in some cases is to assume that the pile head is fully fixed against rotation. The second boundary condition, the shear, may be selected by dividing the total lateral load of the wall by the number of piles. There may be occasions when the deflection at the pile head is one of the known boundary conditions. For example, a bridge may be constructed in such a way that the lateral deflection of the pile head is limited to a known amount.

In any case, the engineer must make a careful study of the manner in which the piles interact with the entire structure so that the proper input to the program can be selected. A number of trials may be necessary on occasion.

INFLUENCE OF PILE LENGTH

The length of the pile that is employed in the analyses by computer is an important consideration. An examination of the output for the solution of the behavior of a long pile will show that the deflection oscillates back and forth about the axis of the lower portion of the pile so that there are a large number of points of zero deflection. If the length of the pile is arbitrarily shortened so that there are only two or three points of zero deflection, a comparison of the two sets of results will show that there is no difference in the groundline deflection or in the magnitude of the maximum moment. As a matter of fact, there is no discernible difference in the two solutions for the portion of the pile above the first point of zero deflection. Therefore, the engineer may wish to shorten the length of a pile that is being analyzed in order to save computer time. This can be done by examining the results of the first run to discover the number of points of zero deflection. The length of the pile can then be shortened so that there are two or three points of zero deflection.

On the other hand, if the total length of a pile is not selected on the basis of axial loading but only on lateral loading, it will be desirable to make a series of computer runs with variation in the penetration of the pile. As shown in Fig. 1.3, a critical penetration will be found. At penetrations less than the critical, the top of the pile will experience additional deflection because the bottom of the pile is deflecting. The pile is undergoing a "fence-posting" action, a condition that is generally undesirable.

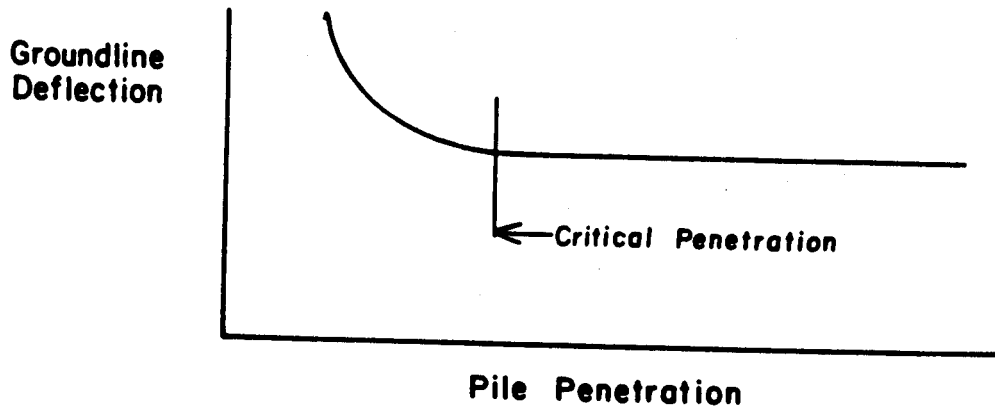

Figure 1.3. Influence of pile penetration on groundline deflection.

PILE GROUPS UNDER LATERAL LOADING

Single piles can be employed to support an overhead sign but most piles are installed in groups. Two problems must be addressed with respect to pile groups: the loss of efficiency due to close spacing, and the distribution of the load from the superstructure to each of the supporting piles.

The second of these problems can be solved rationally if the three nonlinear stiffnesses at the pile head; for axial load, for lateral load, and for moment; can be defined. The result is the vertical displacement, lateral displacement, and rotation of the superstructure and the corresponding movements at each of the pile heads. The response of each of the piles is computed. The solution is as accurate as the pile head stiffnesses can be determined.

The problem of the interaction between groups of closely spaced piles cannot be solved with the same assurance as can the one described above. The theory of elasticity has been employed to develop interaction factors, but experiments have shown that

these factors can be seriously in error. Other methods have been suggested but research has not yet developed sufficient information to allow an engineer to make a confident prediction. The behavior of piles in groups is discussed in the two FHWA publications on laterally loaded piles mentioned earlier (FHWA, 1984; FHWA, 1986).

VERIFICATION OF ACCURACY OF THE COMPUTER OUTPUT

Chapter 5 of this report is concerned in some detail with the verification of the results of the computations. An important consideration is that the results should be considered as questionable until the engineer has done an independent study, however brief, to verify the solution.

The computer will produce results in a short period of time that would take weeks, or much longer, with the calculator. Deflection, rotation, bending moment, shear, and soil resistance are given point by point along the length of a pile, and the equations of equilibrium and compatibility are automatically satisfied. A series of loads can be input and the computer will rapidly produce pile-head deflection and maximum bending moment as a function of load. If desired, the results can be readily displayed in graphical form.

The versatility and utility of the computer program are so impressive that it is difficult not to accept the results as correct; however, the engineer is well advised to question the results and to adopt some routine means for verification. The methods that are indicated in Chapter 5 should prove helpful and the engineer may devise other methods that are applicable to local situations.

CHAPTER 2. BASIC THEORY OF COMPUTATION

THE DIFFERENTIAL EQUATION

The standard differential equation for the deflection of a beam as presented in textbooks on mechanics provides the basis for the analysis of most of the cases of piles under lateral loading. The only adjustment that is needed to the basic equation is to replace the distributed load p with the soil modulus E_s times the pile deflection y (with a negative sign).

However, if the axial load is relatively large or if an unsupported portion of the pile extends above the groundline, the inclusion of the effect of the axial load in the differential equation is necessary. The beam-column equation that is derived can be used to investigate buckling and, for cases where the axial load is applied at the groundline, will allow the additional lateral deflection due to axial loading to be computed.

The derivation of the beam-column was done by Hetenyi (1946). The pile is assumed to be replaced by a bar and a segment, bounded by two horizontals a distance of dx apart, has been cut from the bar as shown in Fig. 2.1. The segment has been displaced due to lateral loading and a pair of vertical compressive forces P_x are acting at the center of gravity of the end cross sections of the bar.

The equilibrium of moments (ignoring second-order terms) leads to the equation:

$$(M + dM) - M + P_x dy - V_v dx = 0 \quad (2.1)$$

or

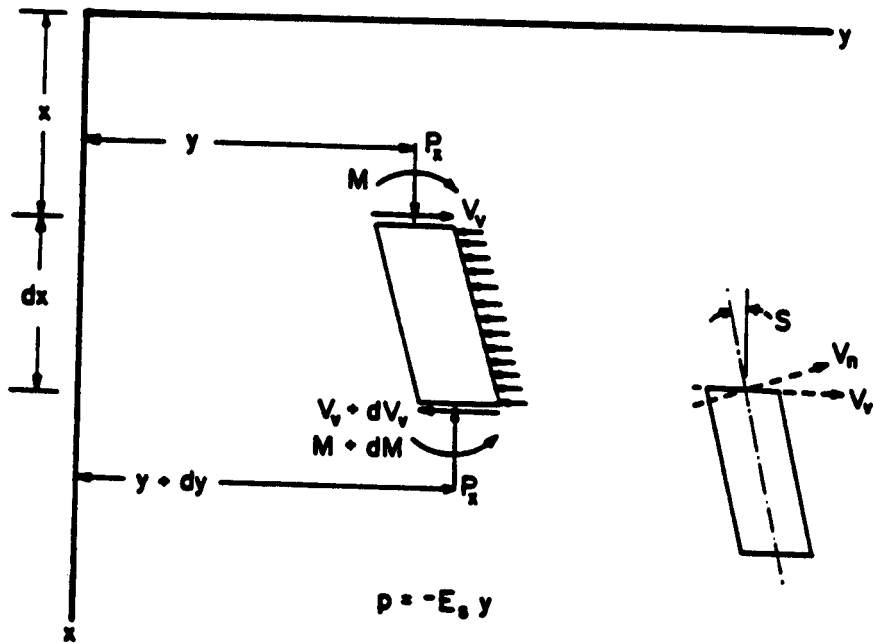

Figure 2.1. Element for beam-column (after Hetenyi, 1946).

$$\frac{dM}{dx} + P_x \frac{dy}{dx} - V_v = 0. \quad (2.2)$$

Differentiating Eq. 2.2 with respect to x , the following equation is obtained:

$$\frac{d^2M}{dx^2} + P_x \frac{d^2y}{dx^2} - \frac{dV_v}{dx} = 0. \quad (2.3)$$

The following identities are noted:

$$\frac{d^2M}{dx^2} = EI \frac{d^4y}{dx^4}, \quad (2.4)$$

$$\frac{dV_v}{dx} = p, \text{ and} \quad (2.5)$$

$$p = -E_s y. \quad (2.6)$$

And making the indicated substitutions, Eq. 2.3 becomes:

$$EI \frac{d^4y}{dx^4} + P_x \frac{d^2y}{dx^2} + E_s y = 0. \quad (2.7)$$

The direction of the shearing force V_v is shown in Fig. 2.1. The shearing force in the plane normal to the deflection line can be obtained as:

$$V_n = V_v \cos S - P_x \sin S. \quad (2.8)$$

Because S is usually small, $\cos S = 1$ and $\sin S = \tan S = \frac{dy}{dx}$.

Thus, Eq. 2.9 is obtained:

$$V_n = V_v - P_x \frac{dy}{dx}. \quad (2.9)$$

V_n will mostly be used in computations but V_v can be computed from Eq. 2.9 where dy/dx is equal to the rotation S .

The following assumptions are made in deriving the differential equation:

- the pile has a longitudinal plane of symmetry; loads and reactions lie in that plane,
- the modulus of elasticity of the pile material is the same for tension and compression,
- transverse deflections of the pile are small,
- the pile is not subjected to dynamic loading, and
- deflections due to shearing stresses are negligible.

The sign conventions that are employed are shown in Fig. 2.2. For ease of understanding, the sign conventions are presented for a beam that is oriented like a pile. A solution of the differential equation yields values of y as a function of x . A family of curves can then be obtained as shown in Fig. 2.3 by using the following basic equations:

$$EI \frac{d^3y}{dx^3} = v \quad (2.10)$$

$$EI \frac{d^2y}{dx^2} = M, \text{ and} \quad (2.11)$$

$$\frac{dy}{dx} = S, \quad (2.12)$$

where

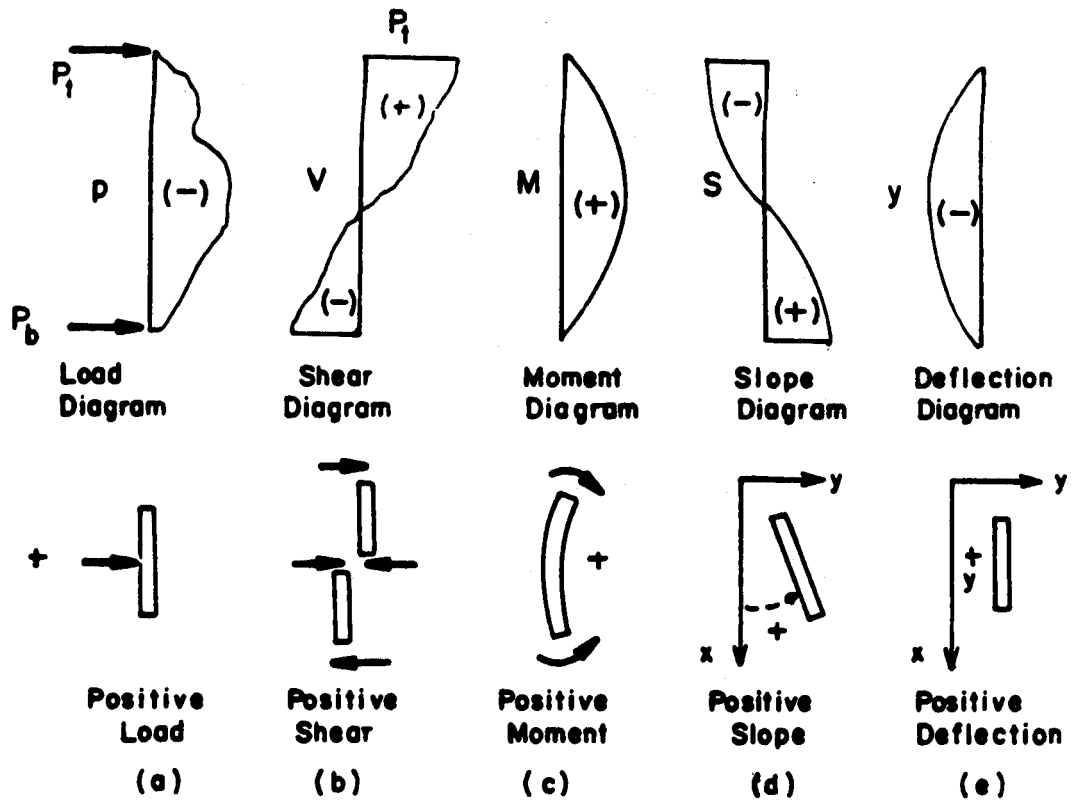

Figure 2.2. Sign conventions.

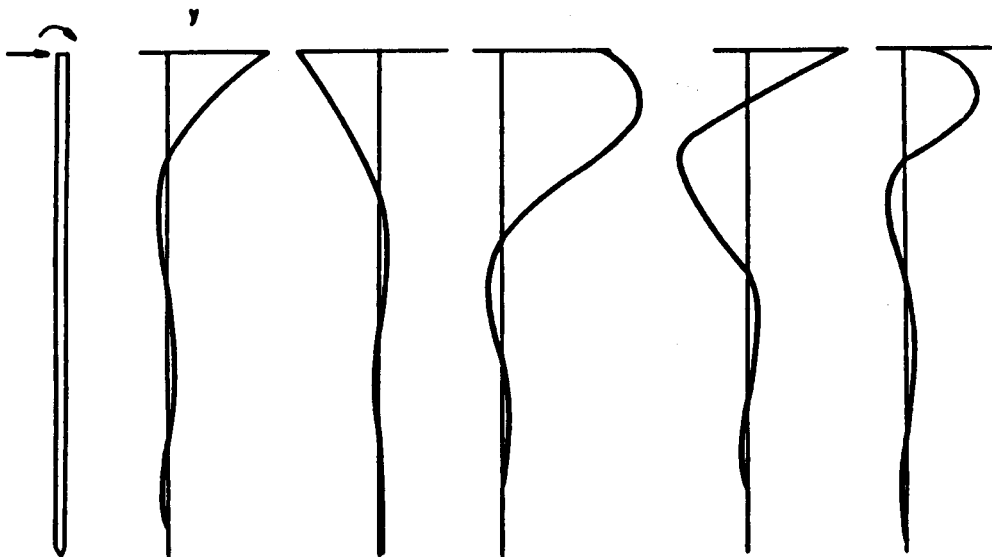

Figure 2.3. Form of the results obtained from a complete solution.

V = shear,
 M = bending moment of the pile, and
 S = slope of the elastic curve.

SOLUTION TO THE GOVERNING DIFFERENTIAL EQUATION

Equation 2.7 is rewritten and shown as Eq. 2.13. The term W , which is exactly similar to p , is added to allow a distributed load to be placed along the pile as, for example, when the pile extends above the groundline and is subjected to a distributed load from water currents or wind. The term k is substituted for E_s for ease in writing the equations.

$$\frac{d^2M}{dx^2} + P_x \frac{d^2y}{dx^2} + ky - W = 0 \quad (2.13)$$

Equation 2.13 can be solved readily by using finite-difference techniques. The deflection of the pile by finite deflections is shown in Fig. 2.4. The finite difference expressions for the first two terms of Eq. 2.13 at point m are:

$$\left(\frac{d^2M}{dx^2}\right)_m = \left[y_{m-2} R_{m-1} + y_{m-1} (-2R_m - 2R_{m-1}) \right. \\ \left. + y_m (4R_m + R_{m-1} + R_{m+1}) \right. \\ \left. + y_{m+1} (-2R_m - 2R_{m+1}) + y_{m+2} R_{m+1} \right] \frac{1}{h^4}, \quad (2.14)$$

$$P_x \left(\frac{d^2y}{dx^2}\right)_m = \frac{P_x (y_{m-1} - 2y_m + y_{m+1})}{h^2}, \quad (2.15)$$

where

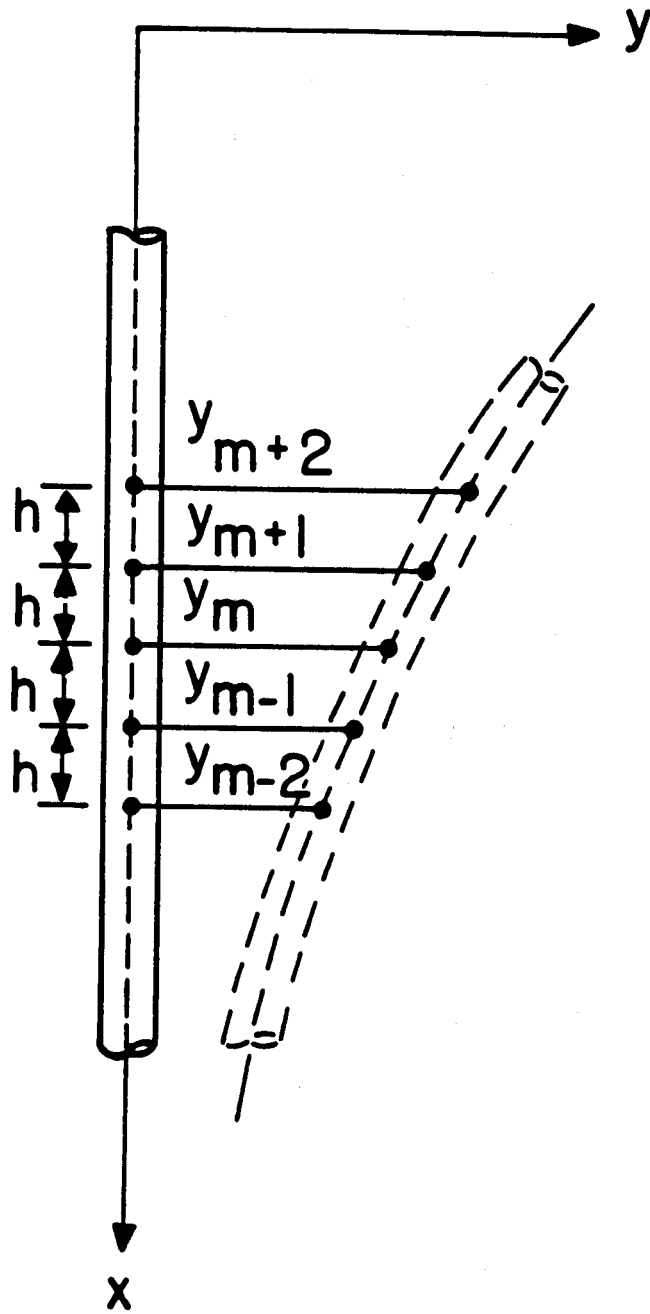

Figure 2.4. Representation of deflected pile.

R_m = flexural rigidity at point (m), that is,

$$R_m = E_m I_m. \quad (2.16)$$

Equations 2.14 and 2.15 are substituted for terms in Eq. 2.13 and the resulting equation for Point m along the pile and Eq. 2.17 results.

$$\begin{aligned} & Y_{m-2} R_{m-1} + Y_{m-1} (-2R_{m-1} - 2R_m + P_x h^2) + Y_m (R_{m-1} + 4R_m \\ & + R_{m+1} - 2P_x h^2 + k_m h^4) + Y_{m+1} (-2R_m - 2R_{m+1} + P_x h^2) \\ & + Y_{m+2} R_{m+1} - W_m h^4 = 0. \end{aligned} \quad (2.17)$$

The axial force P_x which produces compression is assumed to be positive. Also, P_x acts through the axis of the pile; thus, P_x causes no moment at the top of the pile.

Applying the boundary conditions at the bottom of the pile, the solution to the differential equation in difference form can proceed (Gleser, 1953).

Using the notation shown in Fig. 2.5, the two boundary conditions at the bottom of the pile (point 0) are zero bending moment,

$$\left(\frac{d^2 y}{dx^2} \right)_0 = 0, \quad (2.18)$$

and zero shear,

$$R_0 \left(\frac{d^3 y}{dx^3} \right)_0 + P_x \left(\frac{dy}{dx} \right)_0 = 0. \quad (2.19)$$

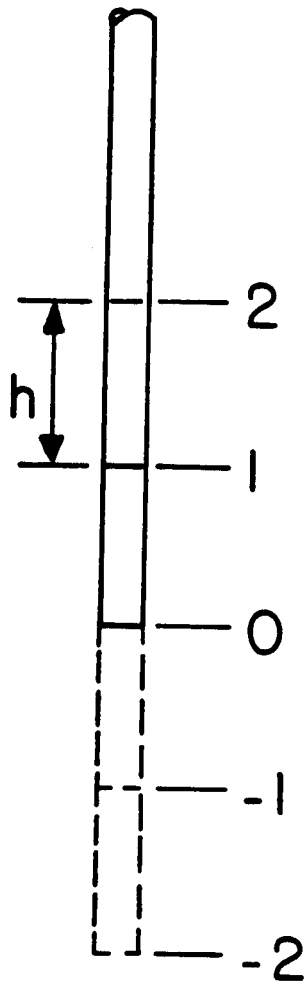

Figure 2.5. Points at bottom of pile.

For simplicity it is assumed that:

$$R_{-1} = R_0 = R_1. \quad (2.20)$$

These boundary conditions are, in finite difference form,

$$y_{-1} - 2y_0 + y_1 = 0, \text{ and} \quad (2.21)$$

$$y_{-2} = y_{-1} \left(2 - \frac{P_x h^2}{R_0} \right) - y_1 \left(2 - \frac{P_x h^2}{R_0} \right) + y_2, \quad (2.22)$$

respectively. Substituting these boundary conditions in finite difference form in Eq. 2.17 where m is equal to zero, and rearranging terms, results in the following equations:

$$y_0 = a_0 y_1 - b_0 y_2 + d_0, \quad (2.23)$$

$$a_0 = \frac{2R_0 + 2R_1 - 2P_x h^2}{R_0 + R_1 + k_0 h^4 - 2P_x h^2}, \quad (2.24)$$

$$b_0 = \frac{R_0 + R_1}{R_0 + R_1 + k_0 h^4 - 2P_x h^2}, \text{ and} \quad (2.25)$$

$$d_0 = \frac{w_0 h^4}{R_0 + R_1 + k_0 h^4 - 2P_x h^2}. \quad (2.26)$$

Equation 2.17 can be expressed for all values of m other than 0 and the top of the pile by the following relationships:

$$y_m = a_m y_{m+1} - b_m y_{m+2} + d_m, \quad (2.27)$$

$$a_m = \frac{-2b_{m-1}R_{m-1} + a_{m-2}b_{m-1}R_{m-1} + 2R_m - 2b_{m-1}R_m + 2R_{m+1} - P_x h^2 (1 - b_{m-1})}{c_m}, \quad (2.28)$$

$$b_m = \frac{R_{m+1}}{c_m}, \text{ and} \quad (2.29)$$

$$d_m = \frac{W_m h^4 - d_{m-1} (a_{m-2}R_{m-1} - 2R_{m-1} - 2R_m + P_x h^2) - d_{m-2}R_{m-1}}{c_m}. \quad (2.30)$$

where

$$c_m = R_{m-1} - 2a_{m-1}R_{m-1} - b_{m-2}R_{m-1} + a_{m-2}a_{m-1}R_{m-1} \\ + 4R_m - 2a_{m-1}R_m + R_{m+1} + k_m h^4 - P_x h^2 (2 - a_{m-1}) \quad (2.31)$$

The top of the pile ($m=t$) is shown in Fig. 2.6. Four sets of boundary conditions are considered. These are designated as Cases 1 through 4.

1. The lateral load (P_t) and the moment (M_t) at the top of the pile are known.
2. The lateral load (P_t) and the slope of the elastic curve (S_t) at the top of the pile are known.
3. The lateral load (P_t) and the rotational-restraint constant (M_t/S_t) at the top of the pile are known.
4. The moment (M_t) and the deflection (y_t) at the top of the pile are known.

For convenience in establishing expressions for these boundary conditions, the following constants are defined:

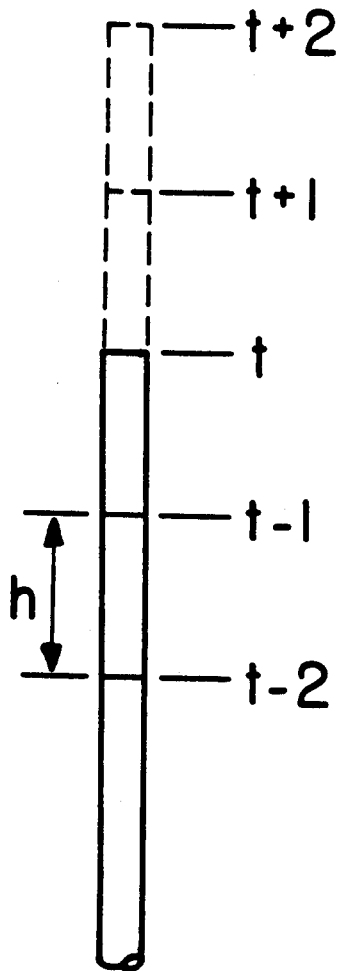

Figure 2.6. Points at top of pile.

$$J_1 = 2hS_t, \quad (2.32)$$

$$J_2 = \frac{M_t h^2}{R_t}, \quad (2.33)$$

$$J_3 = \frac{2P_t h^3}{R_t}, \quad (2.34)$$

$$J_4 = \frac{h}{2R_t} \frac{M_t}{S_t}, \text{ and} \quad (2.35)$$

$$E = \frac{-P_x h^2}{R_t}. \quad (2.36)$$

The boundary conditions for Case 1 are shown by the sketches in Fig. 2.7. The difference equations for the top of the pile are as shown in Eqs. 2.37 and 2.38.

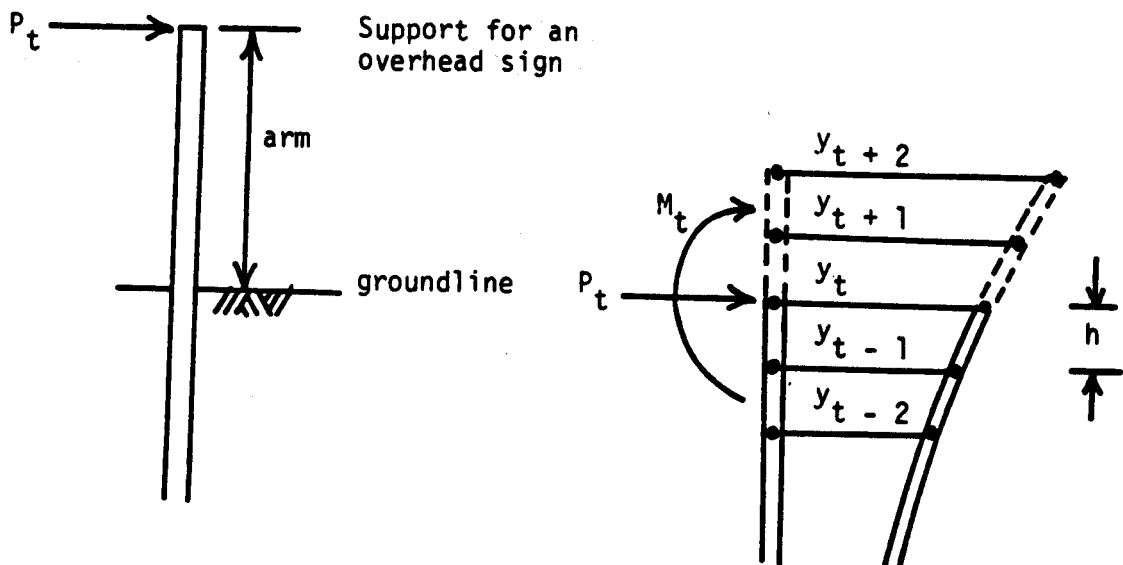

Note: P_t and M_t are known; they are shown in the positive sense in the sketches.

Figure 2.7. Case 1 of boundary conditions at top of pile.

$$\frac{R_t}{2h^3} (y_{t-2} - 2y_{t-1} + 2y_{t+1} - y_{t+2}) + \frac{P_x}{2h} (y_{t-1} - y_{t+1}) = P_t, \text{ and} \quad (2.37)$$

$$\frac{R_t}{h^2} (y_{t-1} - 2y_t + y_{t+1}) = M_t. \quad (2.38)$$

After substitutions the difference equations for the deflection at the top of the pile and at the two imaginary points above the top of the pile are:

$$y_t = \frac{Q_2}{Q_1}, \quad (2.39)$$

$$y_{t+1} = \frac{J_2 + G_1 y_t - d_{t-1}}{G_2}, \text{ and} \quad (2.40)$$

$$y_{t+2} = \frac{a_t y_{t+1} - y_t + d_t}{b_t}, \quad (2.41)$$

where

$$Q_1 = H_1 + \frac{G_1 H_2}{G_2} + \left(1 - a_t \frac{G_1}{G_2}\right) \frac{1}{b_t}, \quad (2.42)$$

$$Q_2 = J_3 + \frac{a_t (J_2 - d_{t-1})}{b_t G_2} + \frac{H_2 (d_{t-1} - J_2)}{G_2} + \frac{d_t}{b_t} + d_{t-1} (2 + E - a_{t-2}) - d_{t-2}, \quad (2.43)$$

$$G_1 = 2 - a_{t-1}, \quad (2.44)$$

$$G_2 = 1 - b_{t-1}, \quad (2.45)$$

$$H_1 = -2a_{t-1} - Ea_{t-1} - b_{t-2} + a_{t-1}a_{t-2}, \text{ and} \quad (2.46)$$

$$H_2 = -a_{t-2}b_{t-1} + 2b_{t-1} + 2 + E(1 + b_{t-1}). \quad (2.47)$$

The boundary conditions for Case 2 are shown by the sketches in Fig. 2.8. The difference equations for the boundary conditions are given by Eq. 2.37 given earlier and Eq. 2.48 shown below.

$$Y_{t-1} - Y_{t+1} = J_1 \quad (2.48)$$

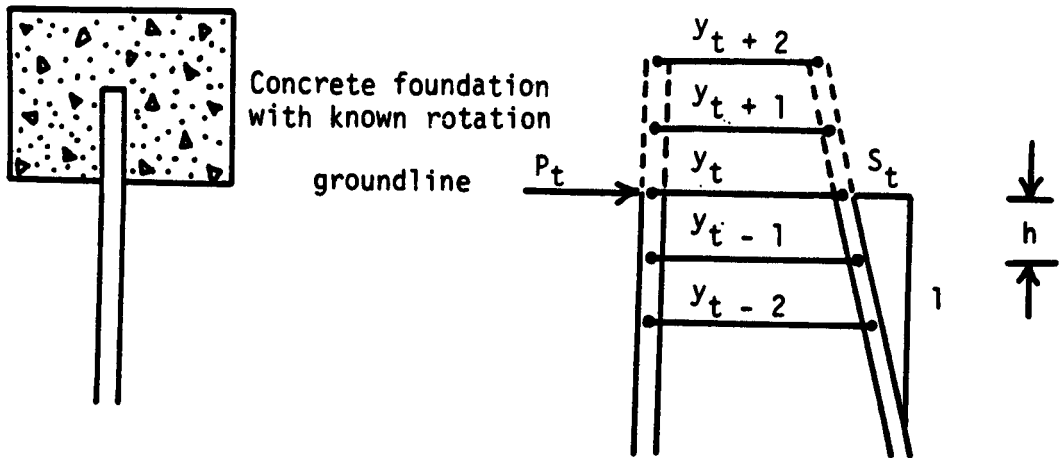

Note: P_t and S_t are known; they are shown in the positive sense.

Figure 2.8. Case 2 of boundary conditions at top of pile.

The resulting difference equations for the deflections at the three points at the top of the pile are:

$$y_t = \frac{Q_4}{Q_3'} \quad (2.49)$$

$$y_{t+1} = \frac{a_{t-1}y_t - J_1 + d_{t-1}}{G_4}, \text{ and} \quad (2.50)$$

$$y_{t+2} = \frac{a_t y_{t+1} - y_t + d_t}{b_t}, \quad (2.51)$$

where

$$Q_3 = H_1 + \frac{H_2 a_{t-1}}{G_4} - \frac{a_t a_{t-1}}{b_t G_4} + \frac{1}{b_t}, \quad (2.52)$$

$$Q_4 = J_3 + \frac{J_1 H_2}{G_4} - \frac{a_t (J_1 - d_{t-1}) - G_4 d_t + b_t d_{t-1} H_2}{b_t G_4} + d_{t-1} (2 + E - a_{t-2}) - d_{t-2}, \text{ and} \quad (2.53)$$

$$G_4 = 1 + b_{t-1}. \quad (2.54)$$

and the other constants are as previously defined.

The boundary conditions for Case 3 are shown by the sketches in Fig. 2.9. The difference equations for the boundary conditions are Eq. 2.37 given earlier and Eq. 2.55 shown below.

$$\frac{y_{t-1} - 2y_t + y_{t+1}}{y_{t-1} - y_{t+1}} = J_4 \quad (2.55)$$

The resulting difference equations for the deflections at the three points at the top of the pile are:

$$y_t = \frac{J_3 - \frac{a_t d_{t-1} (1 - J_4)}{b_t (G_2 + J_4 G_4)} + \frac{d_t}{b_t} + d_{t-1} (2 + E - a_{t-2}) - d_{t-2} + \frac{d_{t-1} H_2 (1 - J_4)}{G_2 + J_4 G_4}}{H_1 + H_2 H_3 - \frac{a_t}{b_t} H_3 + \frac{1}{b_t}}, \quad (2.56)$$

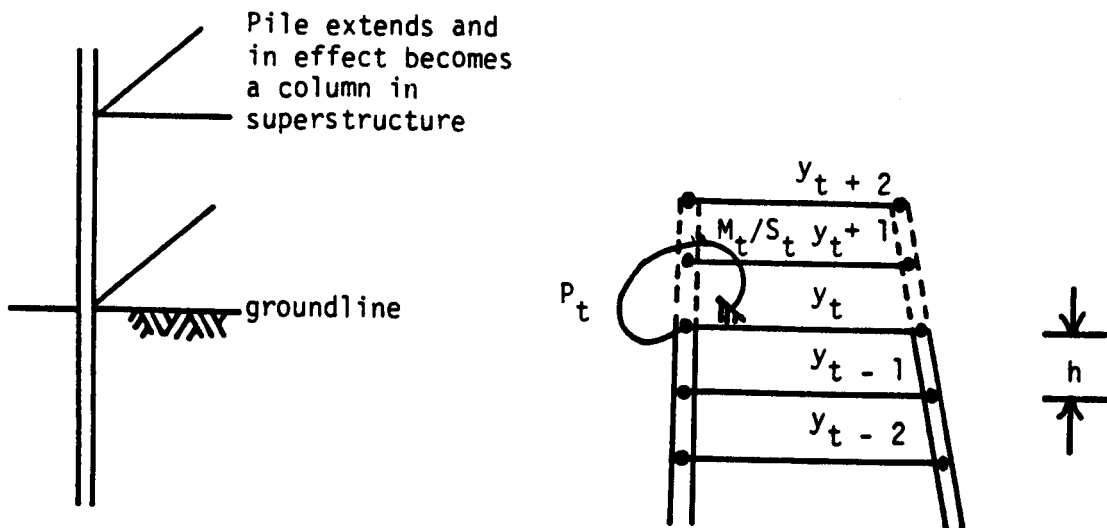

Note: P_t and M_t/S_t are known; they are shown in the positive sense in the sketches

Figure 2.9. Case 3 of boundary conditions at top of pile.

$$y_{t+1} = \frac{y_t (G_1 + J_4 a_{t-1}) - d_{t-1} (1 - J_4)}{G_2 + J_4 G_4} = H_3 y_t - \frac{d_{t-1} (1 - J_4)}{G_2 + J_4 G_4}, \text{ and} \quad (2.57)$$

$$y_{t+2} = \frac{1}{b_t} (a_t y_{t+1} - y_t + d_t), \quad (2.58)$$

where

$$H_3 = \frac{G_1 + J_4 a_{t-1}}{G_2 + J_4 G_4}. \quad (2.59)$$

The other constants have been previously defined.

The boundary conditions for Case 4 are shown by the sketches in Fig. 2.10. The difference equations are given by Eq. 2.38 given earlier and by Eq. 2.60 given below.

$$Y_t = y_t \quad (2.60)$$

Using the above equations with a family of p-y curves, iteration is carried out until the solution converges to appropriate values of k at all points along the pile. Thus, the behavior of a pile under lateral load may be obtained by using COM624P.

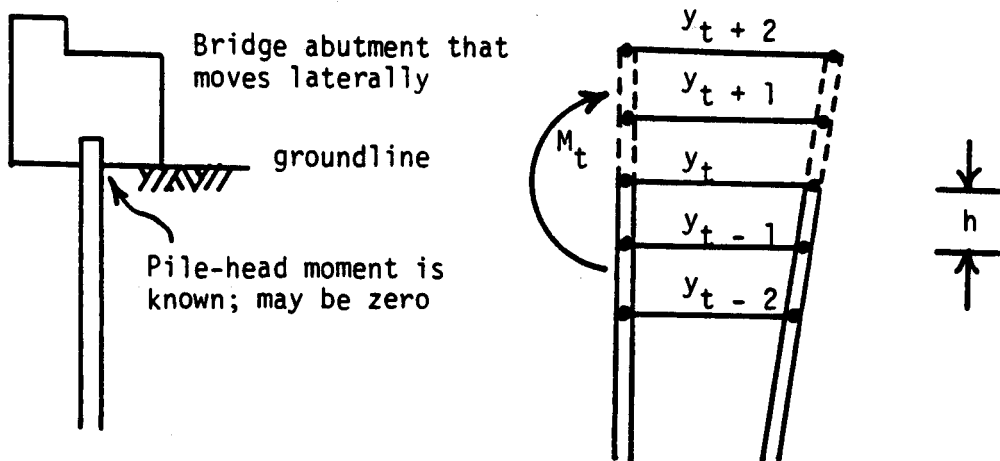

Note: M_t and Y_t are known; they are shown in the positive sense in the sketches

Figure 2.10. Case 4 of boundary conditions at top of pile.

CHAPTER 3. SOIL RESPONSE CURVES (p-y CURVES)

INTRODUCTION

As noted earlier, the soil response is characterized as a set of discrete mechanisms such that the soil response at a point is not dependent on pile deflection elsewhere, thus, a continuum is not perfectly modeled. However, the recommendations for predicting p-y curves, as presented herein, are based on full-scale experiments in which the continuum effect was explicitly implemented. Furthermore, a small amount of unpublished experimental data suggests that the soil response at a point is unaffected by those changes in deflected shape that can be achieved by altering the rotational restraint at the pile head by any practical amount.

The three factors that have the most influence on a p-y curve are the soil properties, the pile geometry, and the nature of loading. The correlations that have been developed for predicting soil response have been based on the best estimate of the properties of the in-situ soil with no adjustment for the effects on soil properties of the method of installation. The logic supporting this approach is that the effects of pile installation on soil properties are principally confined to a zone of soil close to the pile wall, while a mass of soil of several diameters from the pile is stressed as lateral deflection occurs. There are instances, of course, where the method of pile installation must be considered; for example, if a pile is jettied into place, a considerable volume of soil could be removed with a significant effect on the soil response.

The principal dimension of a pile affecting the soil response is its diameter. All of the recommendations for developing p-y

curves include a term for the diameter of the pile; if the cross section of the pile is not circular, the width of the pile perpendicular to the direction of loading is usually taken as the diameter.

USE OF SOIL MODELS TO DETERMINE SOIL BEHAVIOR

Some writers have made use of the theory of elasticity to develop expressions for p as a function of y , but the approach has been of limited use. Soil behavior can be modeled by the theory of elasticity only for very small strains. The limit-equilibrium approach applies at large strains and is employed herein to develop some useful expressions.

Soil Models for Saturated Clay

The assumed model for estimating the ultimate soil resistance near the ground surface is shown in Fig. 3.1 (Reese, 1958). The force F_p is

$$F_p = c_a b H [\tan \alpha + (1+K) \cot \alpha] + \frac{1}{2} \gamma b H^2 + c_a H^2 \sec \alpha \quad (3.1)$$

where

c_a = average drained shear strength,

K = a reduction factor to be multiplied by c_a to yield the average sliding stress between the pile and the stiff clay, and

γ = average unit weight of soil.

(the other terms are defined in the figure)

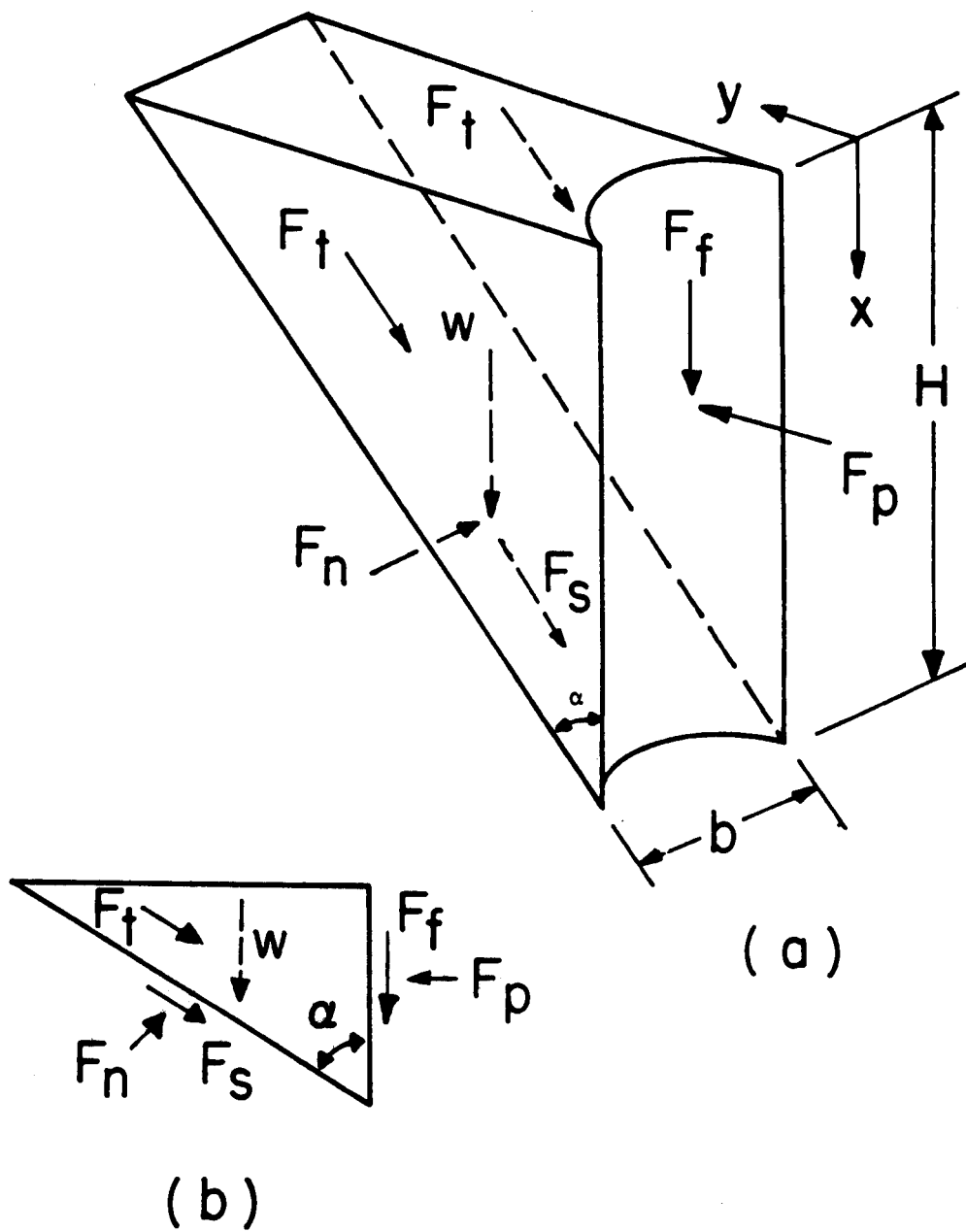

Figure 3.1. Assumed passive wedge-type failure for clay:
 (a) shape of wedge (b) forces acting on wedge
 (after Reese, 1958).

The angle α is taken as 45 degrees and K is assumed equal to zero. Differentiation of the resulting expression with respect to H yields an expression for the ultimate soil resistance as follows.

$$(p_u)_{ca} = 2c_a b + \gamma b H + 2.83 c_a H \quad (3.2)$$

It can be reasoned that at some distance below the ground surface the soil must flow around the deflected pile. The model for such movement is shown in Fig. 3.2a. If it is assumed that blocks 1, 2, 4, and 5 fail by shear and that block 3 develops resistance by sliding, the stress conditions are represented by Fig. 3.2b. By examining a free body of a section of the pile, Fig. 3.2c, one can conclude that:

$$(p_u)_{cb} = 11cb. \quad (3.3)$$

Equations 3.2 and 3.3 are, of course, approximate but they do indicate the general form of the expressions that give the ultimate soil resistance along the pile. The equations can be solved simultaneously to find the depth at which the failure would change from the wedge-type to the flow-around type.

Soil Models for Sand

The soil model for computing the ultimate resistance near the ground surface is shown in Fig. 3.3a (Reese, Cox, and Koop, 1974). The total lateral force F_{pt} (Fig. 3.3c) may be computed by subtracting the active force F_a , computed using Rankine theory, from the passive force F_p , computed from the model. The force F_p is computed by assuming that the Mohr-Coulomb failure condition is satisfied on planes ADE, BCF, and AEFB. The directions of the forces are shown in Fig. 3.3b. No frictional force is assumed to

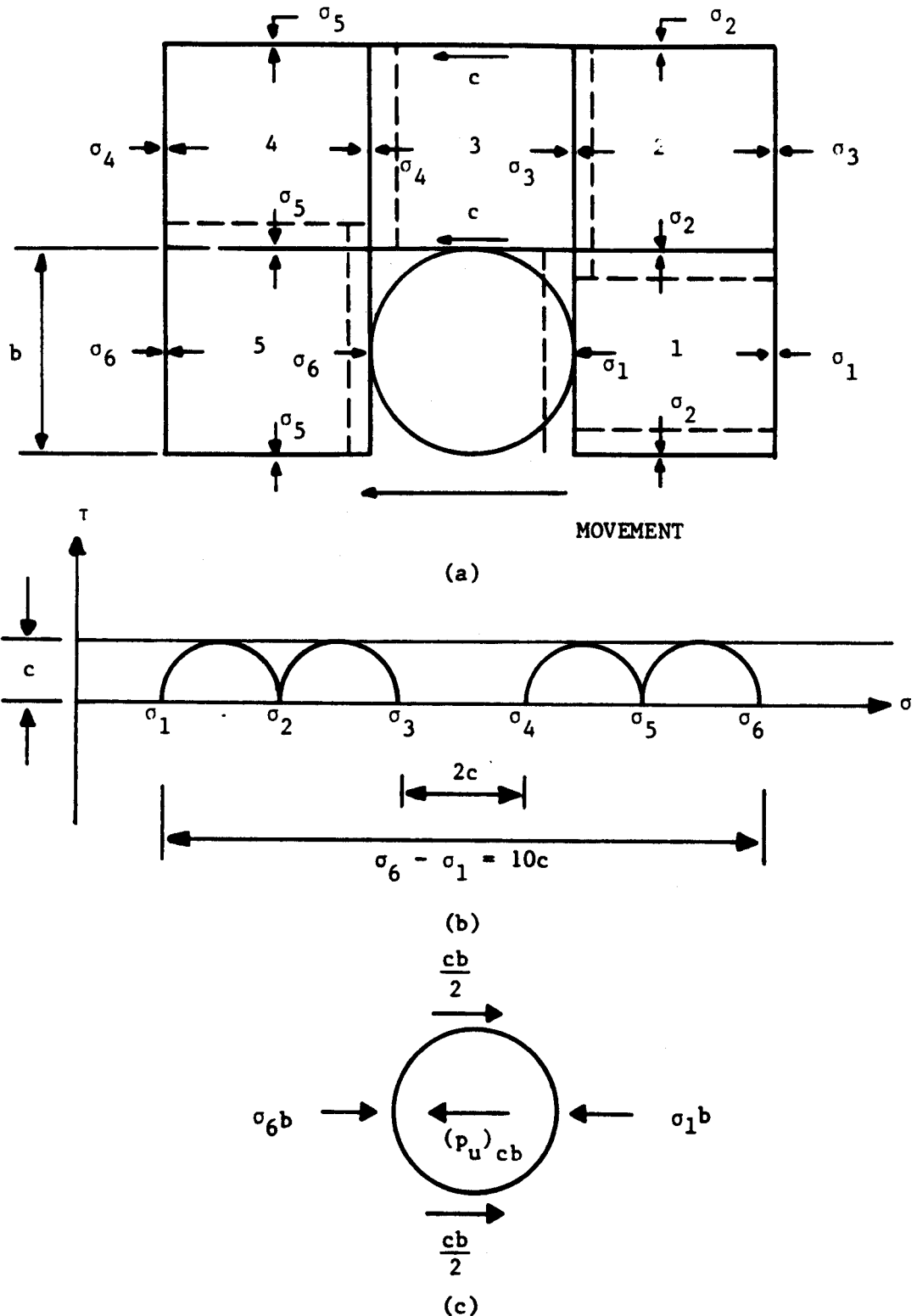

Figure 3.2. Assumed lateral flow-around type of failure for clay:
 (a) section through pile (b) Mohr-Coulomb diagram
 (c) forces acting on Pile 4.5.

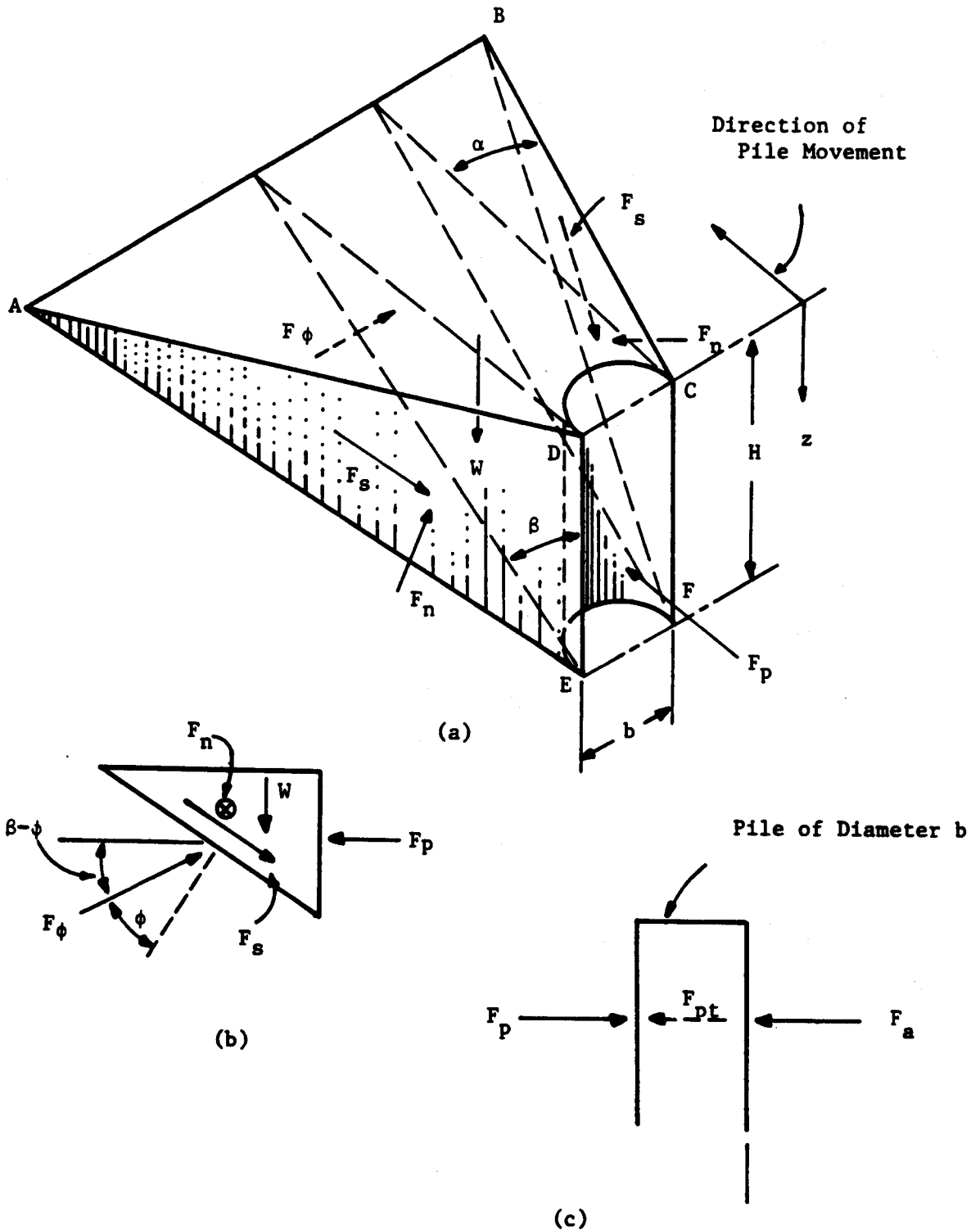

Figure 3.3. Assumed passive wedge-type failure:
 (a) general shape of wedge (b) forces of wedge (c) forces on pile
 (after Reese, et al, 1974).

be acting on the face of the pile. The equation for F_{pt} is as follows:

$$F_{pt} = \gamma H^2 \left[\frac{K_0 H \tan \phi \sin \beta}{3 \tan (\beta - \phi) \cos \alpha} + \frac{\tan \beta}{\tan (\beta - \phi)} \left(\frac{b}{2} + \frac{H}{3} \tan \beta \tan \alpha \right) + \frac{K_0 H \tan \beta}{3} (\tan \phi \sin \beta - \tan \alpha) - \frac{K_a b}{2} \right] \quad (3.4)$$

where

K_0 = coefficient of earth pressure at-rest, and

K_a = minimum coefficient of active earth pressure.

The ultimate soil resistance per unit length of the pile is obtained by differentiating Eq. 3.4.

$$(P_u)_{sa} = \gamma H \left[\frac{K_0 H \tan \phi \sin \beta}{\tan (\beta - \phi) \cos \alpha} + \frac{\tan \beta}{\tan (\beta - \phi)} (b + H \tan \beta \tan \alpha) + K_0 H \tan \beta (\tan \phi \sin \beta - \tan \alpha) - K_a b \right] \quad (3.5)$$

Bowman (1958) suggested values of α from $\phi/3$ to $\phi/2$ for loose sand and up to ϕ for dense sand. The value of β is approximated as follows:

$$\beta = 45 + \frac{\phi}{2} \quad (3.6)$$

The model for computing the ultimate soil resistance at some distance below the ground surface is shown in Fig. 3.4a. The stress σ_1 , at the back of the pile must be equal to or larger than the minimum active earth pressure; if not, the soil could fail by

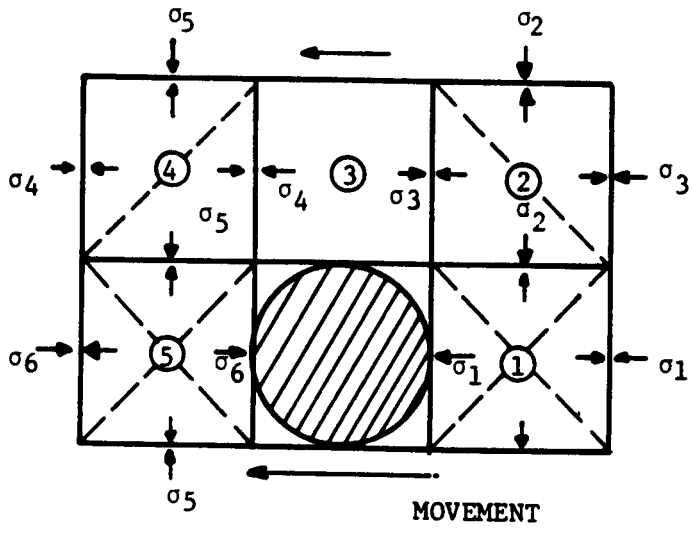

(a)

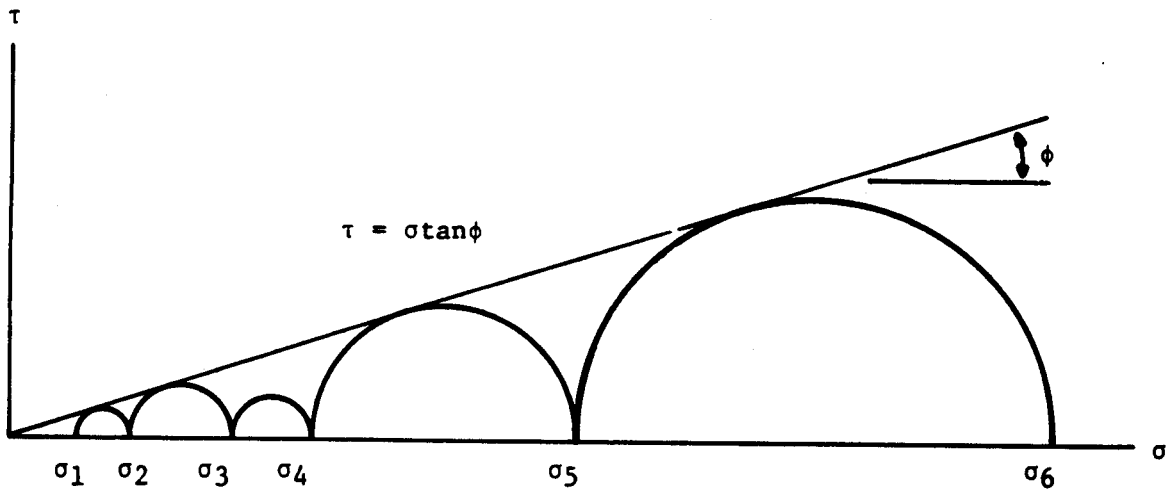

(b)

Figure 3.4. Assumed mode of soil failure by lateral flow around the pile: (a) section through the pile (b) Mohr-Coulomb diagram representing states of stress of soil flowing around a pile.

slumping. This assumption is based on two-dimensional behavior, of course, and is subject to some uncertainty. However, the assumption should be adequate for the present purpose. Assuming the states of stress shown in Fig. 3.4b, the ultimate soil resistance for horizontal flow around the pile is

$$(p_u)_{sb} = K_a b \gamma H (\tan^8 \beta - 1) + K_o b \gamma H \tan \phi \tan^4 \beta. \quad (3.7)$$

As in the case for clay, Eqs. 3.6 and 3.7 are quite approximate but they serve a useful purpose in indicating the form, if not the magnitude, of the ultimate soil resistance. The two equations can be solved simultaneously to find the approximate depth at which the soil failure changes from the wedge type to the flow-around type.

RECOMMENDATIONS FOR p-y CURVES FOR CLAYS

Three major experimental programs were performed for piles in clays to yield the criteria which follow. In each case the piles were subjected to short-term static loads and to repeated (cyclic) loads. The experimental program is described briefly in the paragraphs that follow; a step-by-step procedure is given for computing the p-y curves, recommendations are given for obtaining the necessary data on soil properties, and example curves are presented.

Response of Soft Clay below the Water Table

Field Experiments

Matlock (1970) performed lateral load tests employing a steel pipe pile that was 12.75 inches in diameter and 42 ft long. It was driven into clays near Lake Austin that had a shear strength

of about 800 lb/ft². The pile was recovered, taken to Sabine Pass, Texas, and driven into clay with a shear strength that averaged about 300 lb/ft² in the significant upper zone.

Recommendations for Computing p-y Curves

The following procedure is for short-term static loading and is illustrated by Fig. 3.5a.

1. Obtain the best possible estimate of the variation of undrained shear strength c and submerged unit weight γ' with depth. Also obtain the values of ϵ_{50} , the strain corresponding to one-half the maximum principal stress difference. If no stress-strain curves are available, typical values of ϵ_{50} are given in the following table.

TABLE 3.1. REPRESENTATIVE VALUES OF ϵ_{50}

Consistency of Clay	ϵ_{50}
Soft	0.020
Medium	0.010
Stiff	0.005

2. Compute the ultimate soil resistance per unit length of pile, using the smaller of the values given by the equations below.

$$p_u = \left[3 + \frac{\gamma'}{c} x + \frac{J}{b} x \right] cb \quad (3.8)$$

$$p_u = 9cb \quad (3.9)$$

where

γ' = average effective unit weight from ground surface to p-y curve,

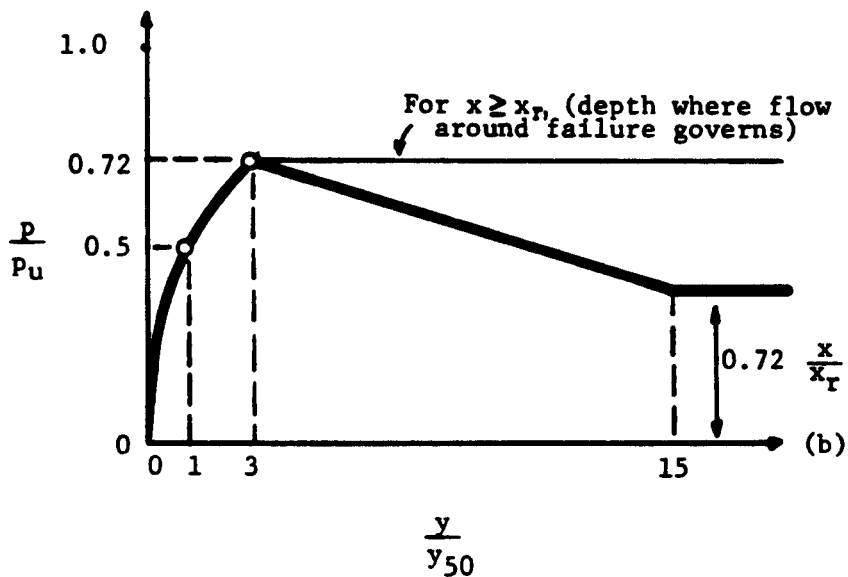
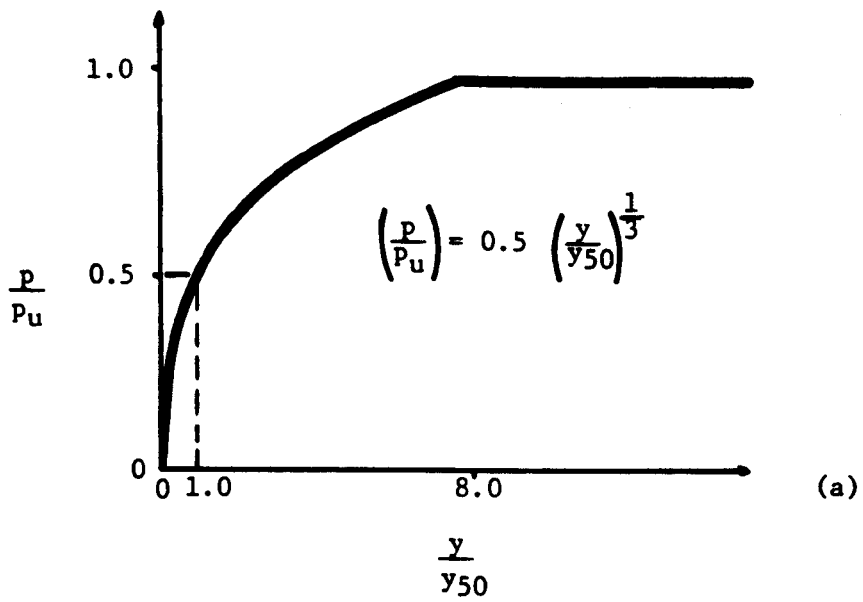

Figure 3.5. Characteristic shapes of the p-y curves for soft clay below water surface: (a) static loading (b) cyclic loading (after Matlock, 1970).

x = depth from ground surface to p-y curve,

c = shear strength at depth x , and

b = width of pile.

Matlock (1970) stated that the value of J was determined experimentally to be 0.5 for a soft clay and about 0.25 for a medium clay. A value of 0.5 is frequently used for J . The value of p_u is computed at each depth where a p-y curve is desired, based on shear strength at that depth.

3. Compute the deflection, y_{50} , at one-half the ultimate soil resistance from the following equation:

$$y_{50} = 2.5 \epsilon_{50} b. \quad (3.10)$$

4. Points describing the p-y curve are now computed from the following relationship.

$$\frac{p}{p_u} = 0.5 \left(\frac{y}{y_{50}} \right)^{\frac{1}{3}} \quad (3.11)$$

The value of p remains constant beyond $y = 8y_{50}$.

The following procedure is for cyclic loading and is illustrated in Fig. 3.5b.

1. Construct the p-y curve in the same manner as for short-term static loading for values of p less than $0.72p_u$.
2. Solve Eqs. 3.8 and 3.9 simultaneously to find the depth, x_r , where the transition occurs. If the unit weight and shear strength are constant in the upper zone, then

$$x_r = \frac{6cb}{(\gamma_b + Jc)} \quad (3.12)$$

If the unit weight and shear strength vary with depth, the value of x_r should be computed with the soil properties at the depth where the p-y curve is desired.

3. If the depth to the p-y curve is greater than or equal to x_r , then p is equal to $0.72p_u$ for all values of y greater than $3y_{50}$.
4. If the depth to the p-y curve is less than x_r , then the value of p decreases from $0.72p_u$ at $y = 3y_{50}$ to the value given by the following expression at $y = 15y_{50}$.

$$p = 0.72p_u \left(\frac{x}{x_r} \right) \quad (3.13)$$

The value of p remains constant beyond $y = 15y_{50}$.

Recommended Soil Tests

For determining the various shear strengths of the soil required in the p-y construction, Matlock (1970) recommended the following tests in order of preference:

1. in-situ vane-shear tests with parallel sampling for soil identification,
2. unconsolidated-undrained triaxial compression tests having a confining stress equal to the overburden pressure with c being defined as half the total maximum principal-stress difference,
3. miniature vane tests of samples in tubes, and
4. unconfined compression tests.

Tests must also be performed to determine the unit weight of the soil.

Response of Stiff Clay below the Water Surface

Field Experiments

Reese, Cox, and Koop (1975) performed lateral-load tests employing steel-pipe piles that were 24 inches in diameter and 50 ft long. The piles were driven into stiff clay at a site near Manor, Texas. The clay had an undrained shear strength ranging from about 1 ton/ft² at the ground surface to about 3 ton/ft² at a depth of 12 feet.

Recommendations for Computing p-y Curves

The following procedure is for short-term static loading and is illustrated by Fig. 3.6.

1. Obtain values for undrained soil shear strength c , soil submerged unit weight γ' , and pile diameter b .
2. Compute the average undrained soil shear strength c_a over the depth x .
3. Compute the ultimate soil resistance per unit length of pile, using the smaller of the values given by the equations below:

$$P_{ct} = 2c_a b + \gamma' b x + 2.83 c_a x, \text{ and} \quad (3.14)$$

$$P_{cd} = 11cb. \quad (3.15)$$

4. Choose the appropriate value of A_s from Fig. 3.7 for the particular nondimensional depth.

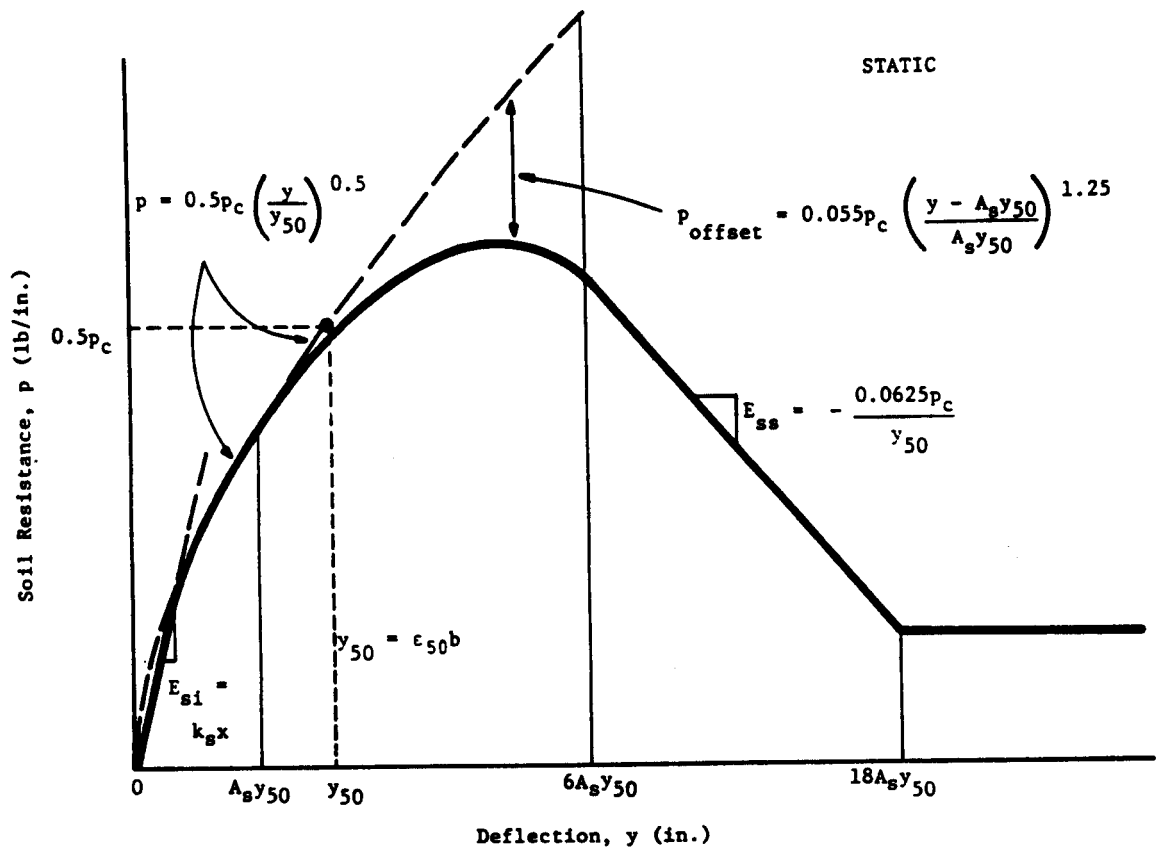

Figure 3.6. Characteristic shape of p - y curve for static loading in stiff clay below the water surface (after Reese, et al, 1975).

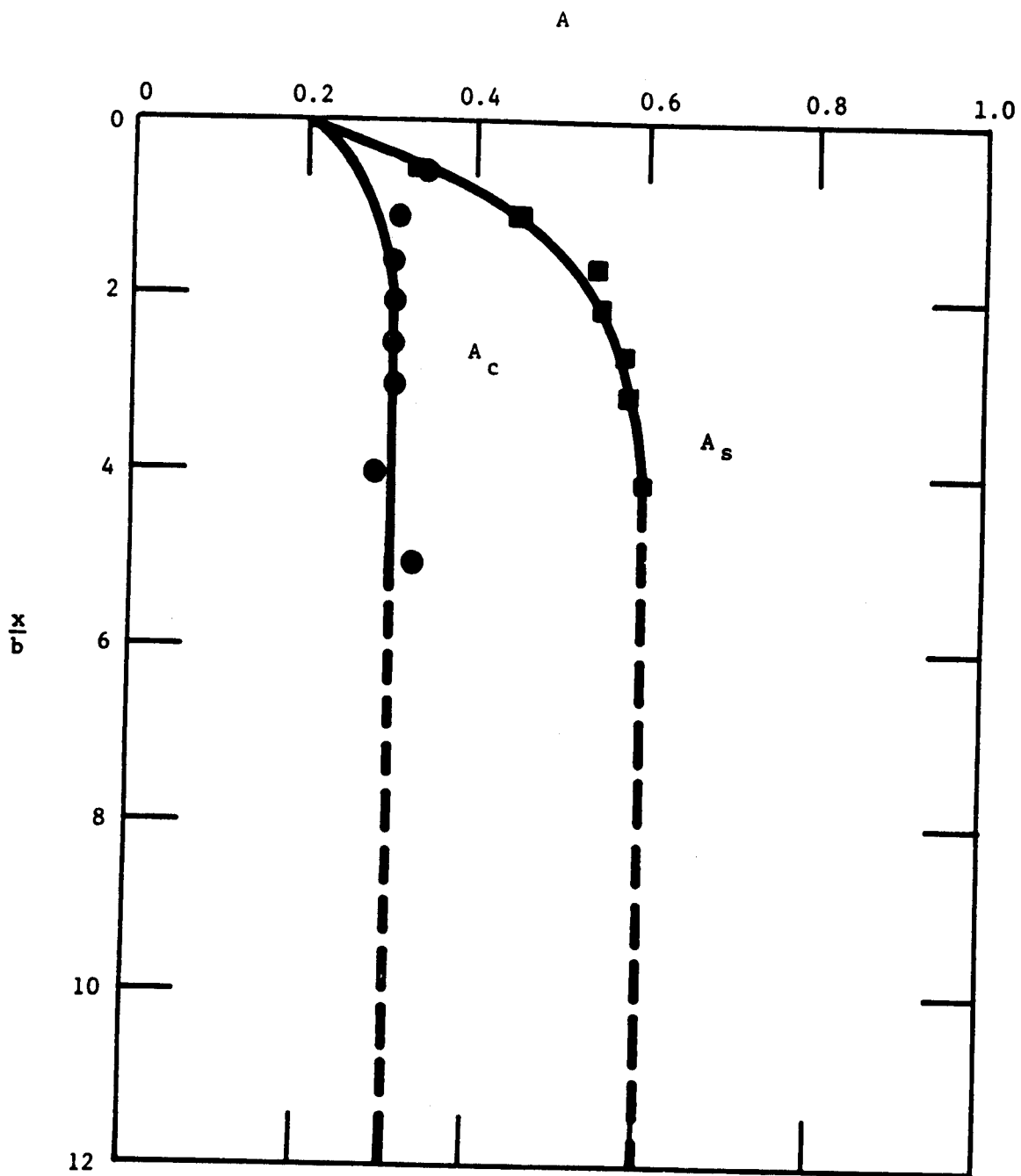

Figure 3.7. Values of constants A_S and A_C (after Reese, et al, 1975).

5. Establish the initial straight-line portion of the p-y curve,

$$p = (kx)y \quad (3.16)$$

Use the appropriate value of k_s or k_c from Table 3.2 for k .

TABLE 3.2. REPRESENTATIVE VALUES OF k FOR STIFF CLAYS

	Average Undrained Shear Strength* ton/ft ²		
	<u>0.5-1</u>	<u>1-2</u>	<u>2.4</u>
k_s (Static) lb/in ³	500	1000	2000
k_c (Cyclic) lb/in ³	200	400	800

*The average shear strength should be computed from the shear strength of the soil to a depth of 5 pile diameters. It should be defined as half the total maximum principal stress difference in an unconsolidated undrained triaxial test.

6. Compute the following:

$$y_{50} = \epsilon_{50}b \quad (3.17)$$

Use an appropriate value of ϵ_{50} from results of laboratory tests or, in the absence of laboratory tests, from Table 3.3.

TABLE 3.3. REPRESENTATIVE VALUES OF ϵ_{50} FOR STIFF CLAYS

	Average Undrained Shear Strength ton/ft ²		
	<u>0.5-1</u>	<u>1-2</u>	<u>2.4</u>
ϵ_{50} (in/in)	0.007	0.005	0.004

7. Establish the first parabolic portion of the p-y curve, using the following equation and obtaining p_c from Eqs. 3.14 or 3.15.

$$p = 0.5p_c \left(\frac{y}{y_{50}} \right)^{0.5} \quad (3.18)$$

Equation 3.18 should define the portion of the p-y curve from the point of the intersection with Eq. 3.16 to a point where y is equal to $A_s y_{50}$ (see note in Step 10).

8. Establish the second parabolic portion of the p-y curve,

$$p = 0.5p_c \left(\frac{y}{y_{50}} \right)^{0.5} - 0.055p_c \left(\frac{y - A_s y_{50}}{A_s y_{50}} \right)^{1.25} \quad (3.19)$$

Equation 3.19 should define the portion of the p-y curve from the point where y is equal to $A_s y_{50}$ to a point where y is equal to $6A_s y_{50}$ (see note in Step 10).

9. Establish the next straight-line portion of the p-y curve,

$$p = 0.5p_c (6A_s)^{0.5} - 0.411p_c - \frac{0.0625}{y_{50}} p_c (y - 6A_s y_{50}) \quad (3.20)$$

Equation 3.20 should define the portion of the p-y curve from the point where y is equal to $6A_s y_{50}$ to a point where y is equal to $18A_s y_{50}$ (see note in Step 10).

10. Establish the final straight-line portion of the p-y curve,

$$p = 0.5p_c (6A_s)^{0.5} - 0.411p_c - 0.75p_c A_s, \text{ or} \quad (3.21)$$

$$p = p_c (1.225\sqrt{A_s} - 0.75A_s - 0.411) \quad (3.22)$$

Equation 3.22 should define the portion of the p-y curve from the point where y is equal to $18A_s y_{50}$ and for all larger values of y (see following note).

Note: The step-by-step procedure is outlined, and Fig. 3.6 is drawn, as if there is an intersection between Eqs. 3.16 and 3.18. However, there may be no intersection of Eq. 3.16 with any of the other equations defining the p-y curve. Equation 3.16 defines the p-y curve until it intersects with one of the other equations or, if no intersection occurs, Eq. 3.16 defines the complete p-y curve.

The following procedure is for cyclic loading and is illustrated in Fig. 3.8.

1. Steps 1, 2, 3, 5, and 6 are the same as for the static case.
4. Choose the appropriate value of A_c from Fig. 3.7 for the particular nondimensional depth.

Compute the following:

$$y_p = 4.1 A_c y_{50}. \quad (3.23)$$

7. Establish the parabolic portion of the p-y curve,

$$p = A_c p_c \left[1 - \left| \frac{y - 0.45 y_p}{0.45 y_p} \right|^{2.5} \right]. \quad (3.24)$$

Equation 3.24 should define the portion of the p-y curve from the point of the intersection with Eq. 3.16 to where y is equal to $0.6y_p$ (see note in step 9).

8. Establish the next straight-line portion of the p-y curve,

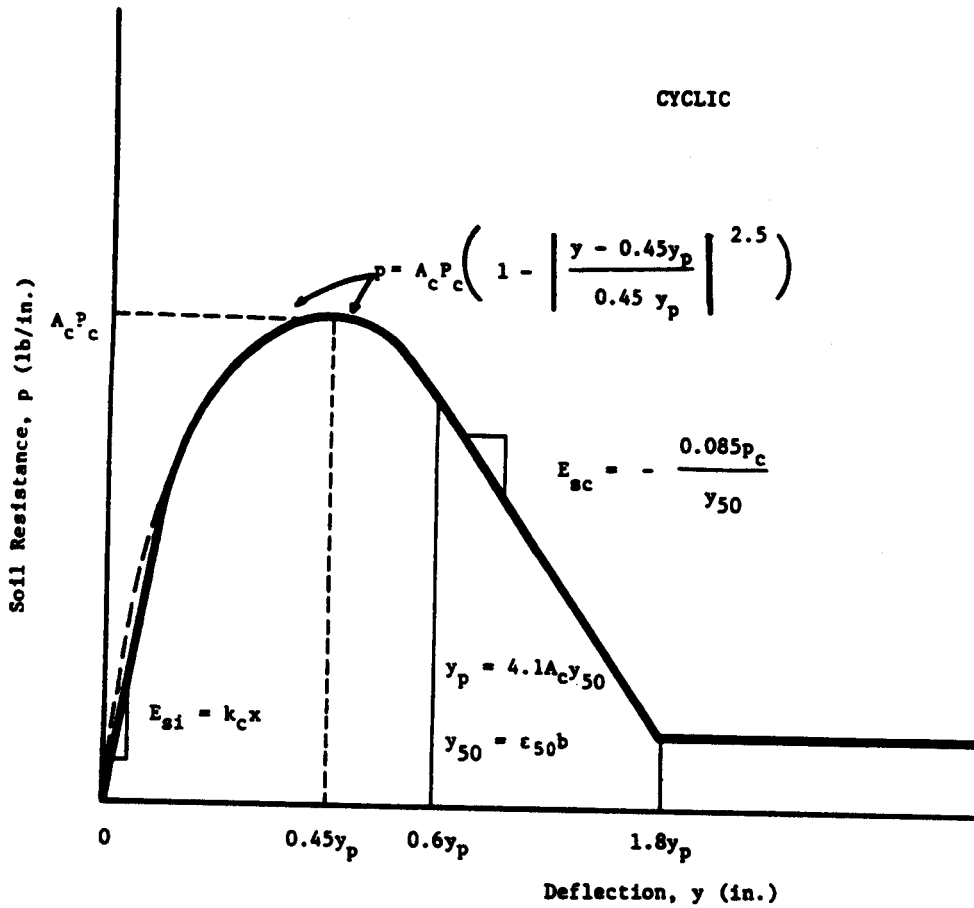

Figure 3.8. Characteristic shape of p - y curve for cyclic loading in stiff clay below water surface (after Reese, et al, 1975).

$$p = 0.936 A_c p_c - \frac{0.085}{y_{50}} p_c (y - 0.6 y_p) . \quad (3.25)$$

Equation 3.25 should define the portion of the p-y curve from the point where y is equal to $0.6y_p$ to the point where y is equal to $1.8y_p$ (see note in step 9).

9. Establish the final straight-line portion of the p-y curve,

$$p = 0.936 A_c p_c - \frac{0.102}{y_{50}} p_c y_p . \quad (3.26)$$

Equation 3.26 should define the portion of the p-y curve from the point where y is equal to $1.8y_p$ and for all larger values of y (see following note).

Note: The step-by-step procedure is outlined, and Fig. 3.8 is drawn, as if there is an intersection between Eq. 3.16 and 3.24. However, there may be no intersection of those two equations and there may be no intersection of Eq. 3.16 with any of the other equations defining the p-y curve. If there is no intersection, the equation should be employed that gives the smallest value of p for any value of y.

Recommended Soil Tests

Triaxial compression tests of the unconsolidated-undrained type with confining pressures conforming to in-situ pressures are recommended for determining the shear strength of the soil. The value of ϵ_{50} should be taken as the strain during the test corresponding to the stress equal to half the maximum total principal stress difference. The shear strength, c, should be interpreted as one-half of the maximum total-stress difference. Values obtained from the triaxial tests might be somewhat conservative but would represent more realistic strength values than other tests. The unit weight of the soil must be determined.

Response of Stiff Clay above the Water Table

Field Experiments

A lateral load test was performed at a site in Houston where the foundation was a drilled shaft, 36 ins in diameter. A 10-inch diameter pipe, instrumented at intervals along its length with electrical-resistance-strain gages, was positioned along the axis of the shaft before concrete was placed. The embedded length of the shaft was 42 feet. The average undrained shear strength of the clay in the upper 20 ft was approximately 2,200 lbs/ft². The experiments and their interpretation are discussed in detail by Welch and Reese (1972) and Reese and Welch (1975).

Recommendations for Computing p-y Curves

The following procedure is for short-term static loading and is illustrated in Fig. 3.9.

1. Obtain values for undrained shear strength c , soil unit weight γ , and pile diameter b . Also obtain the values of ϵ_{50} from stress-strain curves. If no stress-strain curves are available, use a value from ϵ_{50} of 0.010 or 0.005 as given in Table 3.1, the larger value being more conservative.
2. Compute the ultimate soil resistance per unit length of shaft, p_u , using the smaller of the values given by Eqs. 3.8 and 3.9. (In the use of Eq. 3.8 the shear strength is taken as the average from the ground surface to the depth being considered and J is taken as 0.5. The unit weight of the soil should reflect the position of the water table.)
3. Compute the deflection, y_{50} , at one-half the ultimate soil resistance from Eq. 3.10.

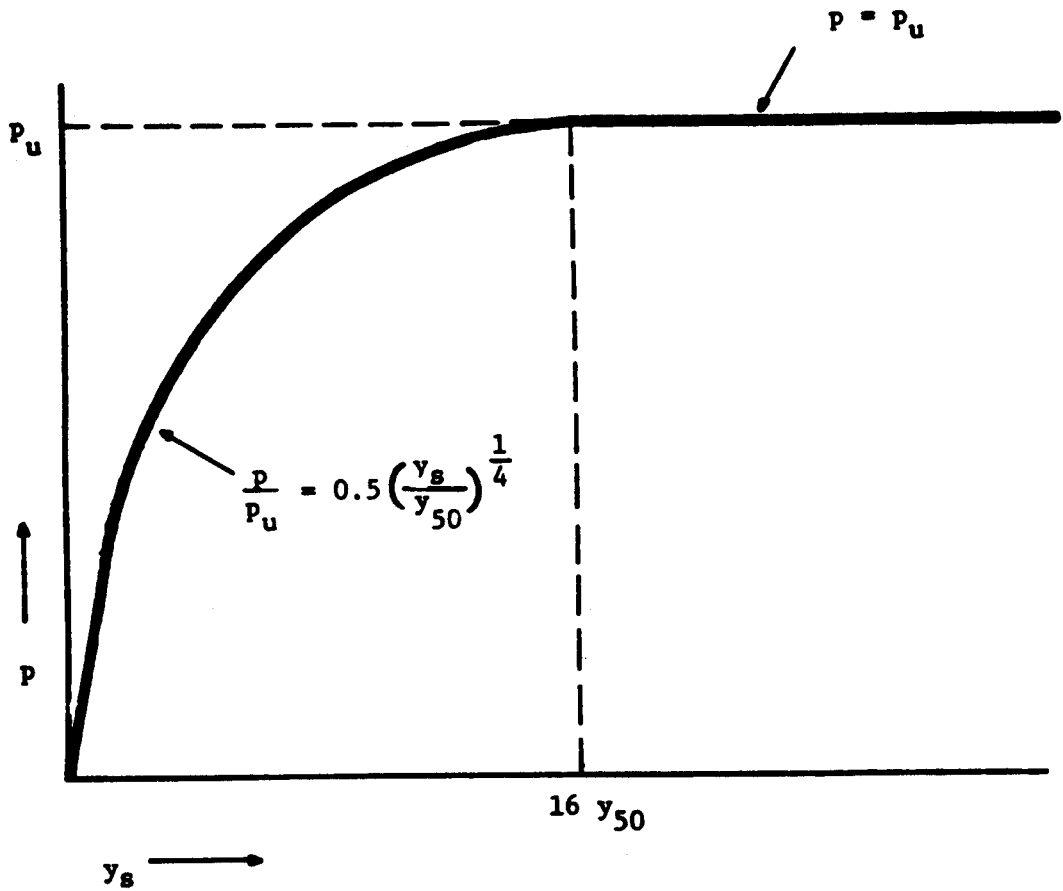

Figure 3.9. Characteristic shape of p-y curve for static loading in stiff clay above water surface (after Welch and Reese, 1972).

4. Points describing the p-y curve may be computed from the relationship below.

$$\frac{p}{p_u} = 0.5 \left(\frac{y}{y_{50}} \right)^{\frac{1}{4}} \quad (3.27)$$

5. Beyond $y = 16y_{50}$, p is equal to p_u for all values of y.

The following procedure is for cyclic loading and is illustrated in Fig. 3.10.

1. Determine the p-y curve for short-term static loading by the procedure previously given.
2. Determine the number of times the design lateral load will be applied to the pile.
3. For several values of p/p_u obtain the value of C, the parameter describing the effect of repeated loading on deformation, from a relationship developed by laboratory tests, (Welch and Reese, 1972), or in the absence of tests, from the following equation.

$$C = 9.6 \left(\frac{p}{p_u} \right)^4 \quad (3.28)$$

4. At the value of p corresponding to the values of p/p_u selected in step 3, compute new values of y for cyclic loading from the following equation.

$$y_c = y_s + y_{50} \cdot C \cdot \log N \quad (3.29)$$

where

y_c = deflection under N-cycles of load,

y_s = deflection under short-term static load,

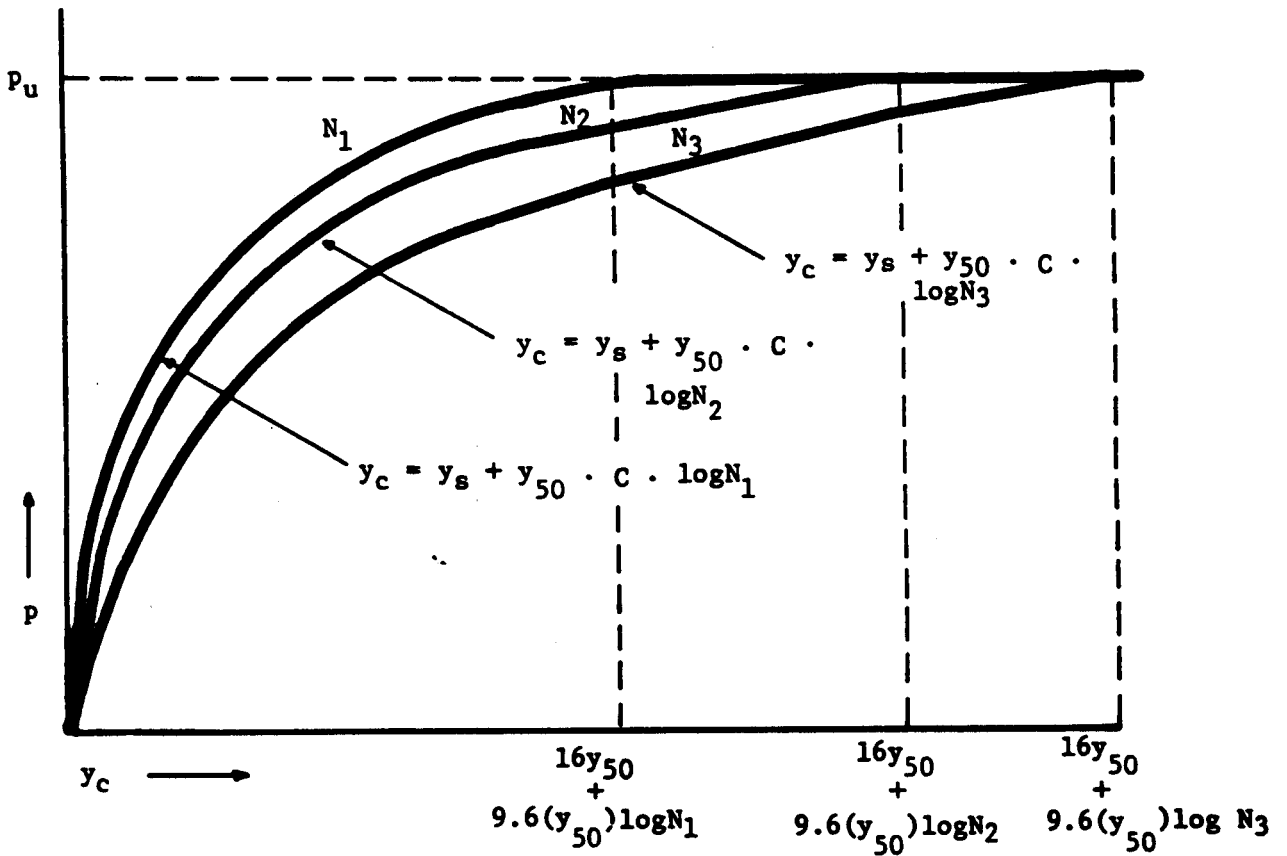

Figure 3.10. Characteristic shape of p-y curve for cyclic loading in stiff clay above water surface (after Welch and Reese, 1972).

Y_{50} = deflection under short-term static load at one-half the ultimate resistance, and

N = number of cycles of load application.

5. The p-y curve defines the soil response after N-cycles of load.

Recommended Soil Tests

Triaxial compression tests of the unconsolidated-undrained type with confining stresses equal to the overburden pressures at the elevations from which the samples were taken are recommended to determine the shear strength. The value of ϵ_{50} should be taken as the strain during the test corresponding to the stress equal to half the maximum total principal stress difference. The undrained shear strength, c , should be defined as one-half the maximum total-principal-stress difference. The unit weight of the soil must also be determined.

RECOMMENDATIONS FOR p-y CURVES FOR SAND

As shown below, a major experimental program was conducted on the behavior of laterally loaded piles in sand below the water table. The results can be extended to sand above the water table.

Response of Sand below the Water Table

Field Experiments

An extensive series of tests was performed at a site on Mustang Island, near Corpus Christi (Cox, Reese, and Grubbs, 1974). Two steel pipe piles, 24 ins in diameter, were driven into sand in a manner to simulate the driving of an open-ended pipe,

pipe, and were subjected to lateral loading. The embedded length of the piles was 69 feet. One of the piles was subjected to short-term loading and the other to repeated loading.

The soil at the site was a uniformly graded, fine sand with an angle of internal friction of 39 degrees. The submerged unit weight was 66 lb/ft³. The water surface was maintained a few inches above the mudline throughout the test program.

Recommendations for Computing p-y Curves

The following procedure is for short-term static loading and for cyclic loading and is illustrated in Fig. 3.11 (Reese, Cox, and Koop, 1974).

1. Obtain values for the angle of internal friction ϕ , the soil unit weight γ , and pile diameter b .
2. Make the following preliminary computations.

$$\alpha = \frac{\phi}{2}; \quad \beta = 45 + \frac{\phi}{2}; \quad K_O = 0.4; \quad \text{and} \quad K_a = \tan^2 \left(45 - \frac{\phi}{2} \right) \quad (3.30)$$

3. Compute the ultimate soil resistance per unit length of pile using the smaller of the values given by the equations below.

$$P_{st} = \gamma x \left[\frac{K_O x \tan \phi \sin \beta}{\tan(\beta - \phi) \cos \alpha} + \frac{\tan \beta}{\tan(\beta - \phi)} (b + x \tan \beta \tan \alpha) + K_O x \tan \beta (\tan \phi \sin \beta - \tan \alpha) - K_a b \right]. \quad (3.31)$$

$$P_{sd} = K_a b \gamma x (\tan^8 \beta - 1) + K_O b \gamma x \tan \phi \tan^4 \beta. \quad (3.32)$$

For the sand below the water table, the submerged unit weight γ' should be used.

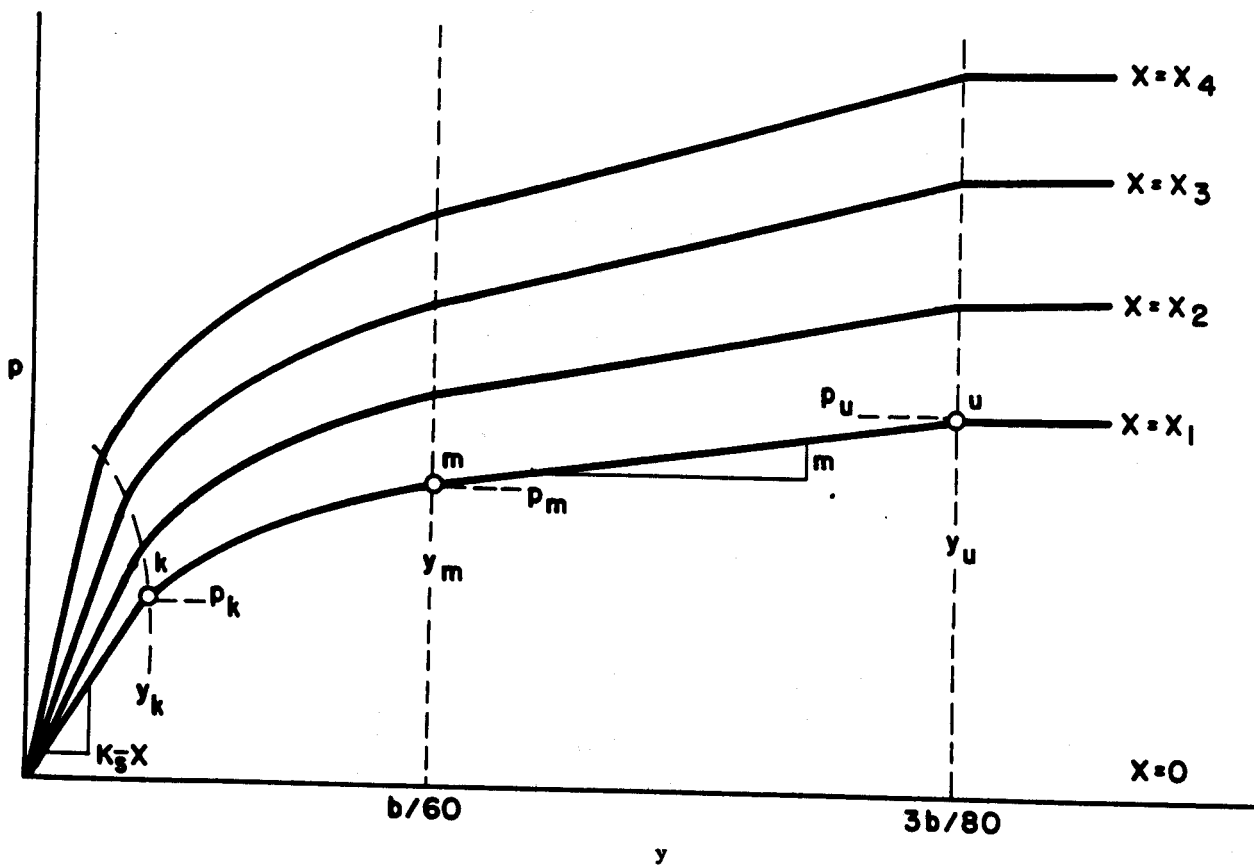

Figure 3.11. Characteristic shape of a family of p - y curves for static and cyclic loading in sand (after Reese, et al, 1974).

4. In making the computations in Step 3, find the depth x_t at which there is an intersection at Eqs. 3.31 and 3.32. Above this depth use Eq. 3.31. Below this depth use Eq. 3.32.
5. Select a depth at which a p-y curve is desired.
6. Establish y_u as $3b/80$. Compute p_u by the following equation:

$$p_u = \bar{A}_s p_s \text{ or } p_u = \bar{A}_c p_s. \quad (3.33)$$

Use the appropriate value of \bar{A}_s or \bar{A}_c from Fig. 3.12 for the particular nondimensional depth, and for either the static or cyclic case. Use the appropriate equation for p_s , Eq. 3.31 or Eq. 3.32, by referring to the computation in step 4.

7. Establish y_m as $b/60$. Compute p_m by the following equation:

$$p_m = B_s p_s \text{ or } p_m = B_c p_s. \quad (3.34)$$

Use the appropriate value of B_s or B_c from Fig. 3.13 for the particular nondimensional depth, and for either the static or cyclic case. Use the appropriate equation for p_s . The two straight-line portions of the p-y curve, beyond the point where y is equal to $b/60$, can now be established.

8. Establish the initial straight-line portion of the p-y curve,

$$p = (kx)y. \quad (3.35)$$

Use the appropriate value of k from Tables 3.4 or 3.5.

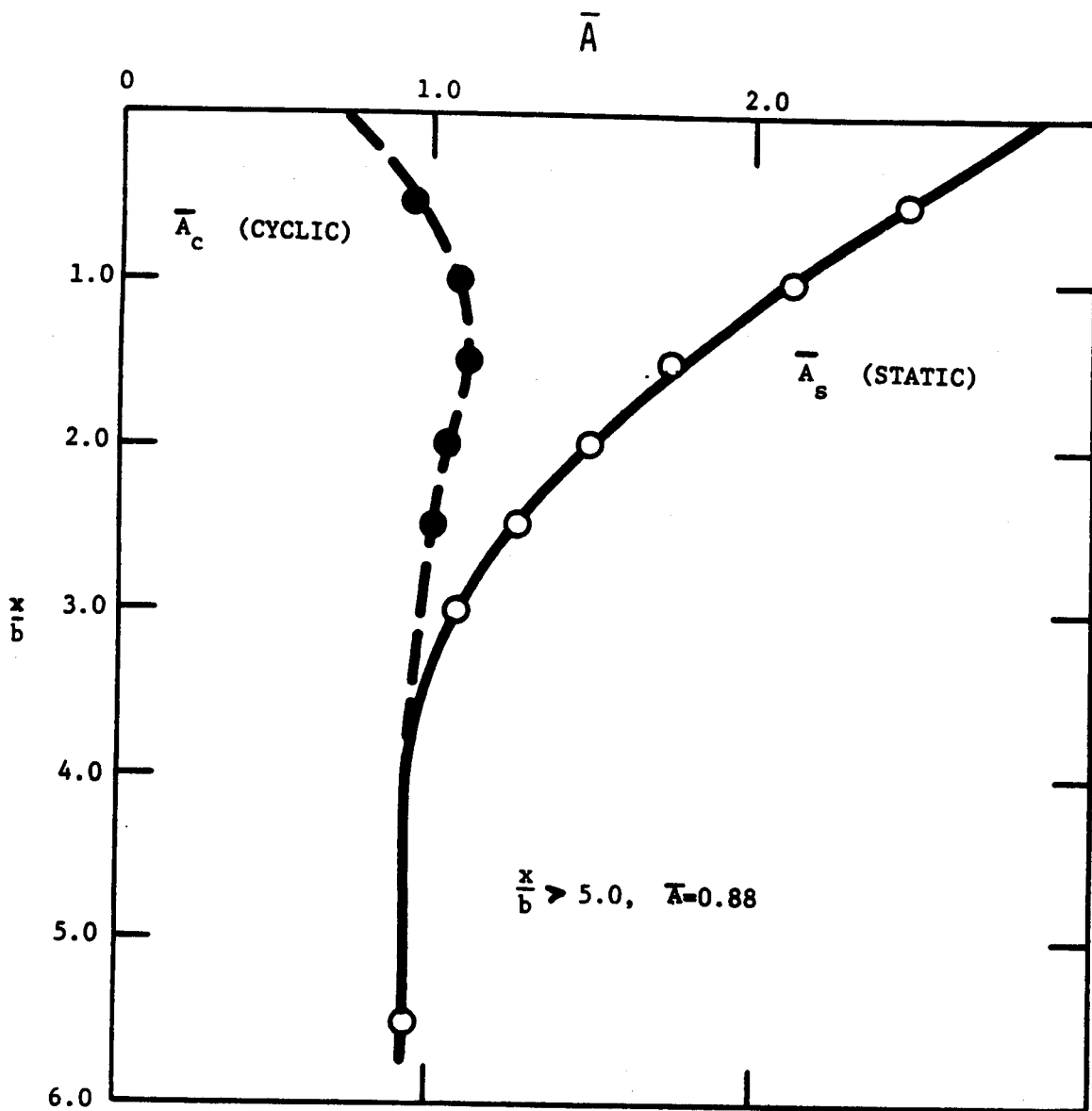

Figure 3.12. Values of coefficients \bar{A}_c and \bar{A}_s (after Reese, et al, 1974).

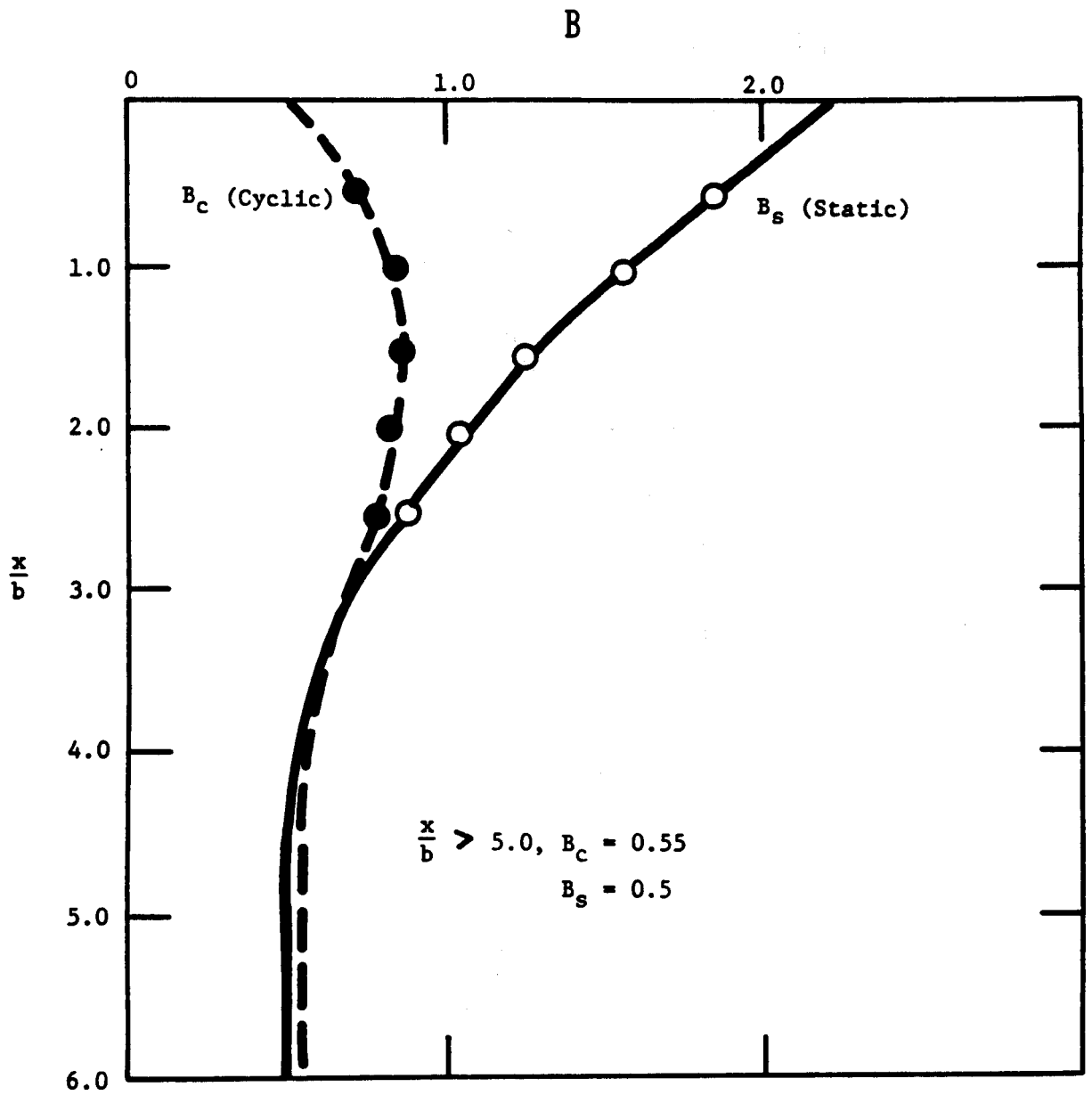

Figure 3.13. Values of coefficient B for soil resistance versus depth (after Reese, et al, 1974).

TABLE 3.4. REPRESENTATIVE VALUES OF k FOR SUBMERGED SAND
(Static and Cyclic Loading)

Relative Density	Loose	Medium	Dense
Recommended k (lb/in ³)	20	60	125

TABLE 3.5. REPRESENTATIVE VALUES OF k FOR SAND ABOVE WATER TABLE
(Static and Cyclic Loading)

Relative Density	Loose	Medium	Dense
Recommended k (lb/in ³)	25	90	225

9. Establish the parabolic section of the p-y curve,

$$p = \bar{C} y^{1/n}. \quad (3.36)$$

Fit the parabola between points k and m as follows:

- a. Get the slope of line between points m and u by,

$$m = \frac{P_u - P_m}{Y_u - Y_m}. \quad (3.37)$$

- b. Obtain the power of the parabolic section by,

$$n = \frac{P_m}{m Y_m}. \quad (3.38)$$

- c. Obtain the coefficient \bar{C} as follows:

$$\bar{C} = \frac{P_m}{Y_m^{1/n}}. \quad (3.39)$$

d. Determine point k as,

$$y_k = \left(\frac{\bar{C}}{kx} \right)^{n/n-1} \quad (3.40)$$

e. Compute appropriate number of points on the parabola by using Eq. 3.36.

Note: The step-by-step procedure is outlined, and Fig. 3.11 is drawn, as if there is an intersection between the initial straight-line portion of the p-y curve and the parabolic portion of the curve at point k. However, in some instances there may be no intersection with the parabola. Equation 3.35 defines the p-y curve until there is an intersection with another branch of the p-y curve or if no intersection occurs, Eq. 3.35 defines the complete p-y curve. This completes the development of the p-y curve for the desired depth. Any number of curves can be developed by repeating the above steps for each desired depth.

Recommended Soil Tests

Triaxial compression tests are recommended for obtaining the angle of internal friction of the sand. Confining pressures should be used which are close or equal to those at the depths being considered in the analysis. Tests must be performed to determine the unit weight of the sand.

Response of Sand above the Water Table

The procedure in the previous section can be used for sand above the water table if appropriate adjustments are made in the unit weight and angle of internal friction of the sand. Some small-scale experiments were performed by Parker and Reese (1971) and recommendations for p-y curves for dry sand were developed from the experiments. The results from the Parker and Reese

experiments should be useful as a check of solutions made using results from the test program using full-scale piles.

RECOMMENDATIONS FOR p-y CURVES FOR VUGGY LIMESTONE

Field Experiments

Very little information is available on the behavior of piles that have been installed in rock. Some other type of foundation would normally be used. However, a study was made of the behavior of an instrumented drilled shaft that was installed in vuggy limestone in the Florida Keys (Reese and Nyman, 1978). The test was performed for the purpose of gaining information for the design of foundations for highway bridges.

Difficulty was encountered in obtaining properties of the intact rock. Cores broke during excavation and penetrometer tests were misleading (because of the vugs) or could not be run. Tests were made on two cores from the site. The small discontinuities in the outside surface of the specimens were covered with a thin layer of gypsum cement in an effort to minimize stress concentrations. The ends of the specimens were cut with a rock saw and lapped flat and parallel. The specimens were 5.88 ins in diameter and with heights of 11.88 ins for Specimen 1 and 10.44 ins for Specimen 2. The undrained shear strength of the specimens were taken as one-half the unconfined compressive strength and were 17.4 and 13.6 T/sq ft for Specimens 1 and 2, respectively.

The rock at the site was also investigated by in-situ-grout-plug tests under the direction of Dr. John Schmertmann (1977). A 5.5-inch diameter hole was drilled into the limestone, a high strength steel bar was placed to the bottom of the hole, and a grout plug was cast over the lower end of the bar. The bar was

pulled until failure occurred and the grout was examined to see that failure occurred at the interface of the grout and limestone. Tests were performed at three borings and the following results were obtained, in T/sq ft; depth into limestone from 2.5 to 5 ft, 23.8, 13.7, and 12.0; depth into limestone from 8 to 10 ft, 18.2, 21.7, and 26.5; depth into limestone from 18 to 20 ft, 13.7 and 10.7. The average of the eight tests was 16.3 T/sq feet. However, the rock was stronger in the zone where the deflections of the drilled shaft were most significant and a shear strength of 18 T/sq ft was selected for correlation.

The drilled shaft was 48 inches in diameter and penetrated 43.7 ft into the limestone. The overburden of fill was 14 ft thick and was cased. The load was applied about 11.5 ft above the limestone. A maximum horizontal load of 75 tons was applied to the drilled shaft. The maximum deflection at the point of load application was 0.71 in and at the top of the rock (bottom of casing) it was 0.0213 inch. While the curve of load versus deflection was nonlinear, there was no indication of failure of the rock.

Recommendations for Computing p-y Curves

A single p-y curve, shown in Fig. 3.14, was proposed for the design of piles under lateral loading in the Florida Keys. Data are insufficient to indicate a family of curves to reflect any increased resistance of the rock.

As shown in the figure, load tests are recommended if deflection of the rock (and pile) are greater than $0.0004b$ and brittle fracture is assumed if the lateral stress (force per unit length) against the rock becomes greater than the diameter times the shear strength s_u of the rock.

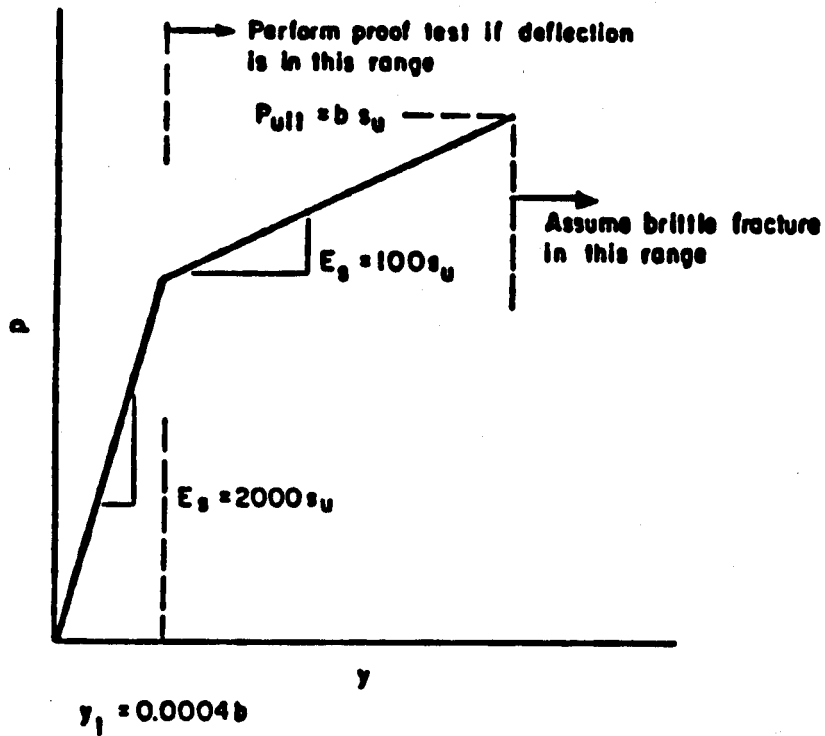

Figure 3.14. Recommended p-y curve for design of drilled shafts in vuggy limestone (after Reese and Nyman, 1978).

The p-y curve shown in Fig. 3.14 should be employed with considerable caution because of the limited amount of experimental data and because of the great variability in rock. The behavior of rock at a site could be very well controlled by joints, cracks, and secondary structure of rock and not by the strength of intact specimens.

RECOMMENDATIONS FOR p-y CURVES FOR LAYERED SOIL

There are numerous cases where the soil near the ground surface is not homogeneous but is layered. If the layers are in the zone where the soil would move up and out as a wedge, some modification is plainly needed in order to compute the ultimate soil resistance p_u , and consequently modifications are needed in the p-y curves.

The problem of the layered soil has been given intensive study by Allen (1985); however, Allen's formulations require the use of several computer codes. Integrating the methods of Allen with the methods shown herein must be delayed until a later date when his research can be put in a readily usable form.

Method of Georgiadis

The proposal of Georgiadis (1983) was selected for the purposes of the computer code that is presented here. The method is based on the determination of the "equivalent" depth of all the layers existing below the upper layer. The p-y curves of the upper layer are determined according to the methods presented herein for homogeneous soils. To compute the p-y curves of the second layer, the equivalent depth H_2 to the top of the second layer has to be determined by summing the ultimate resistances of

the upper layer and equating that value to the summation as if the upper layer had been composed of the same material as in the second layer. The values of p_u are computed according to the equations given earlier. Thus, the following two equations are solved simultaneously for H_2 :

$$F_1 = \int_0^{H_1} p_{u1} dH, \text{ and} \quad (3.41)$$

$$F_1 = \int_0^{H_2} p_{u2} dH. \quad (3.42)$$

The equivalent thickness H_2 of the upper layer along with the soil properties of the second layer, are used to compute the p-y curves for the second layer.

The concepts presented above can be used to get the equivalent thickness of two or more dissimilar layers of soil overlying the layer for whom the p-y curves are desired.

Example p-y Curves

The example problem to demonstrate the manner in which the computer program deals with layered soils is shown in Fig. 3.15. As seen in the sketch, a pile with a diameter of 24 ins is embedded in soil consisting of an upper layer of soft clay, overlying a layer of loose sand, which in turn overlays a layer of stiff clay. The water table is at the ground surface and the loading is assumed to be static.

Four p-y curves for the case of layered soil are shown in Fig. 3.16. The curve at a depth of 36 ins falls in the upper zone of soft clay; the curve for the depth of 72 ins falls in the sand

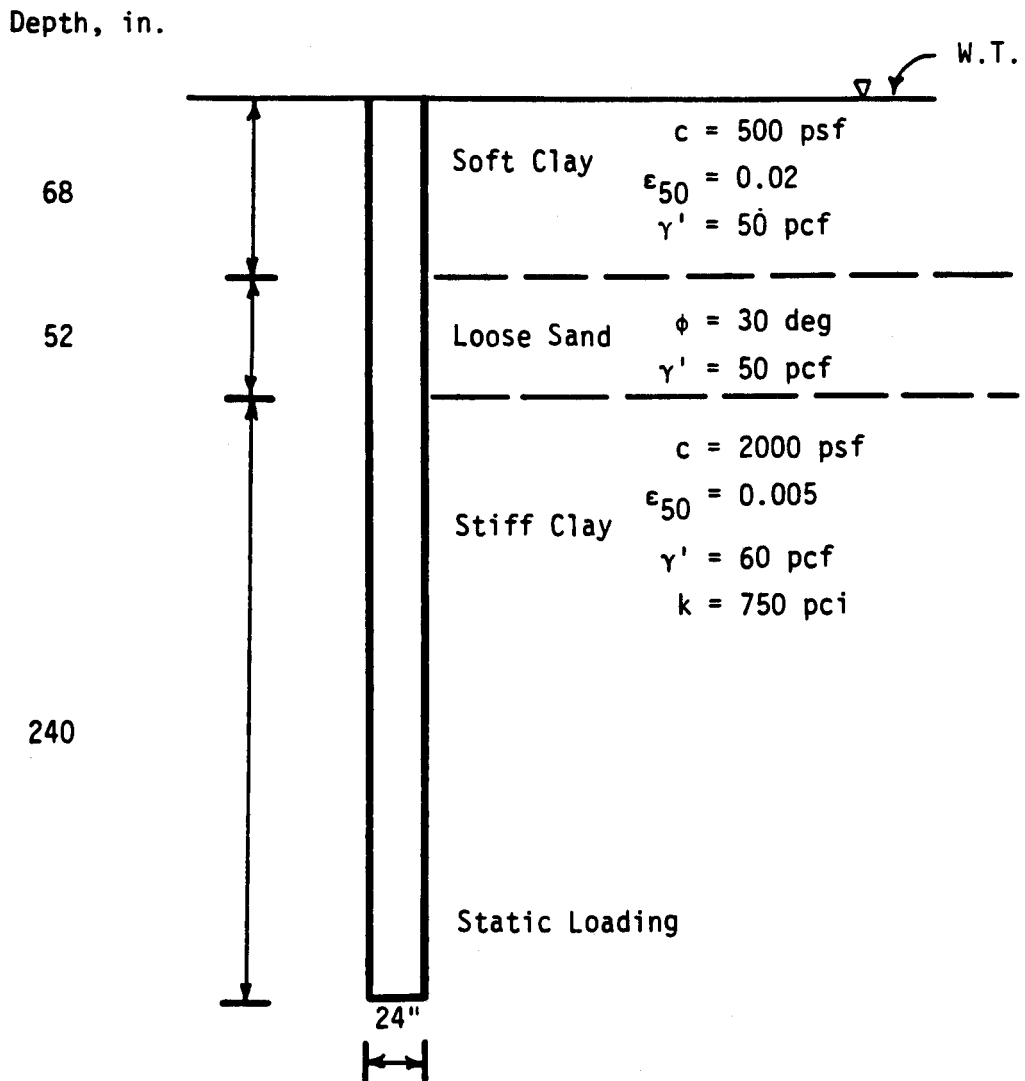

Figure 3.15. Example problem for soil response for layered soils.

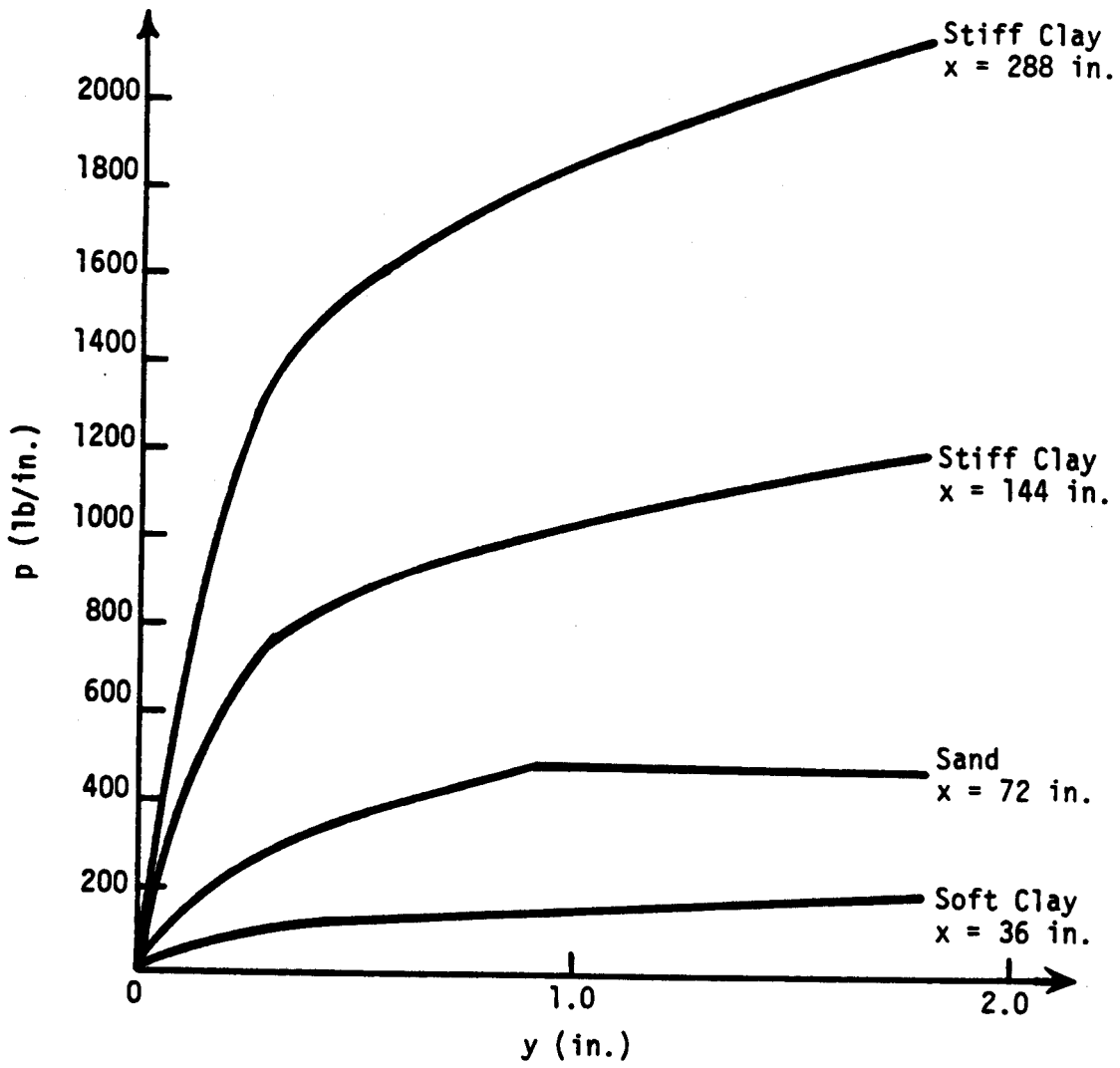

Figure 3.16. Example p - y curves for layered soils.

just below the soft clay; and the curve for depths of 144 ins and 228 ins in the lower zone of stiff clay.

Following the procedure suggested by Georgiadis (1983), the p-y curve for soft clay can be computed as if the profile consists altogether of that soil. When dealing with the sand, an equivalent depth of sand is found such that the value of the sum of the ultimate soil resistance for the equivalent sand and the soft clay are equal at the interface. The equivalent depth of loose sand to substitute for the effect of the clay was computed to be 74 inches. Thus, 68 ins of soft clay is replaced by 74 ins of loose sand, and point B that defines the position of the p-y curve in the sand is 78 ins below the assumed ground surface that the actual depth of 72 inches. Figure 3.17 shows a plot of the sum of the ultimate soil resistances with the equivalent thickness of the soft clay layer (computed as H_2 by use of Eqs. 3.41 and 3.42) as shown as XEQ.

An equivalent depth of stiff clay was found such that the sum of the ultimate soil resistance for the stiff clay is equal to the sum of the ultimate soil resistance of the loose sand and soft clay. That equivalent depth was found to be 45 ins and is indicated in Fig. 3.17. Thus, the depths to the two p-y curves in the stiff clay are assumed to be 69 ins and 213 ins rather than the actual depths of 144 ins and 288 ins (the actual thickness of 120 ins of the two upper-layers was reduced to 45 ins, a reduction of 75 inches.)

Another point of considerable interest is that the presence of no free water was used for the stiff clay in the recommendations for p-y curves for stiff clay. This decision is based on the assumption that the sand above the stiff clay can move downward and fill any gap that develops between the clay and

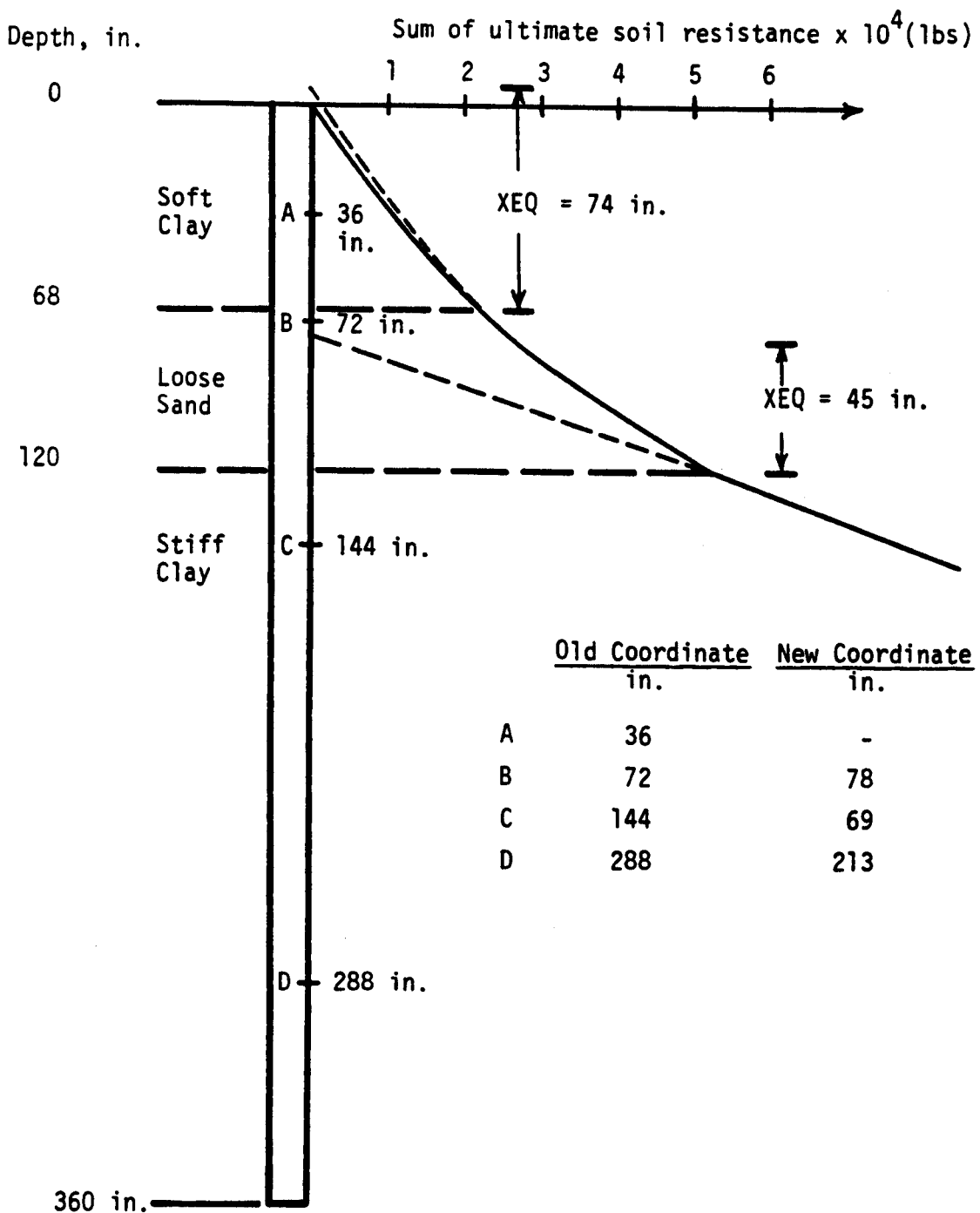

Figure 3.17. Equivalent depths of overlying soil for use in computing p-y curves for a layered system.

the pile. Furthermore, in the stiff-clay experiment where free water was present, the free water moved upward along the face of the pile with each cycle of loading. The presence of soft clay and sand to a depth of 10 ft above the stiff clay is believed to suppress the hydraulic action of free water even though the sand did not serve to close the potential gaps in the stiff clay.

MODIFICATIONS TO p-y CURVES FOR SLOPING GROUND

Introduction

The recommendations for p-y curves presented to this point are developed for a horizontal ground surface. In order to allow designs to be made if a pile is installed on a slope, modifications must be made in the p-y curves. The modifications involve revisions in the manner in which the ultimate soil resistance is computed. In this regard, the assumption is made that the flow-around failure will not be influenced by sloping ground; therefore, only the equations for the wedge-type failure need modification.

The solutions presented herein are entirely analytical and must be considered as preliminary. Additional modifications may be indicated if it is possible to implement an extensive laboratory and field study.

Equations for Ultimate Resistance in Clay

The ultimate soil resistance near the ground surface for saturated clay where the pile was installed in ground with a horizontal slope was derived by Reese (1958) and was shown in Eq. 3.2.

$$(P_u)_{ca} = 2c_a b + \gamma b H + 2.83 c_a H \quad (3.2)$$

If the ground surface has a slope angle θ as shown in Fig. 3.18, the soil resistance in the front of the pile, following the Reese approach is:

$$(P_u)_{ca} = (2c_a b + \gamma b H + 2.83 c_a H) \frac{1}{1 + \tan \theta} \quad (3.43)$$

The soil resistance in the back of the pile is:

$$(P_u)_{ca} = (2c_a b + \gamma b H + 2.83 c_a H) \frac{\cos \theta}{\sqrt{2} \cos (45^\circ + \theta)} \quad (3.44)$$

where

$(P_u)_{ca}$ = ultimate soil resistance near ground surface,

c_a = average undrained shear strength,

b = pile diameter,

γ = average unit weight of soil,

H = depth from ground surface to point along pile where soil resistance is computed, and

θ = angle of slope as measured from the horizontal.

A comparison of Eqs. 3.43 and 3.44 shows that the equations are identical except for the terms at the right side of the

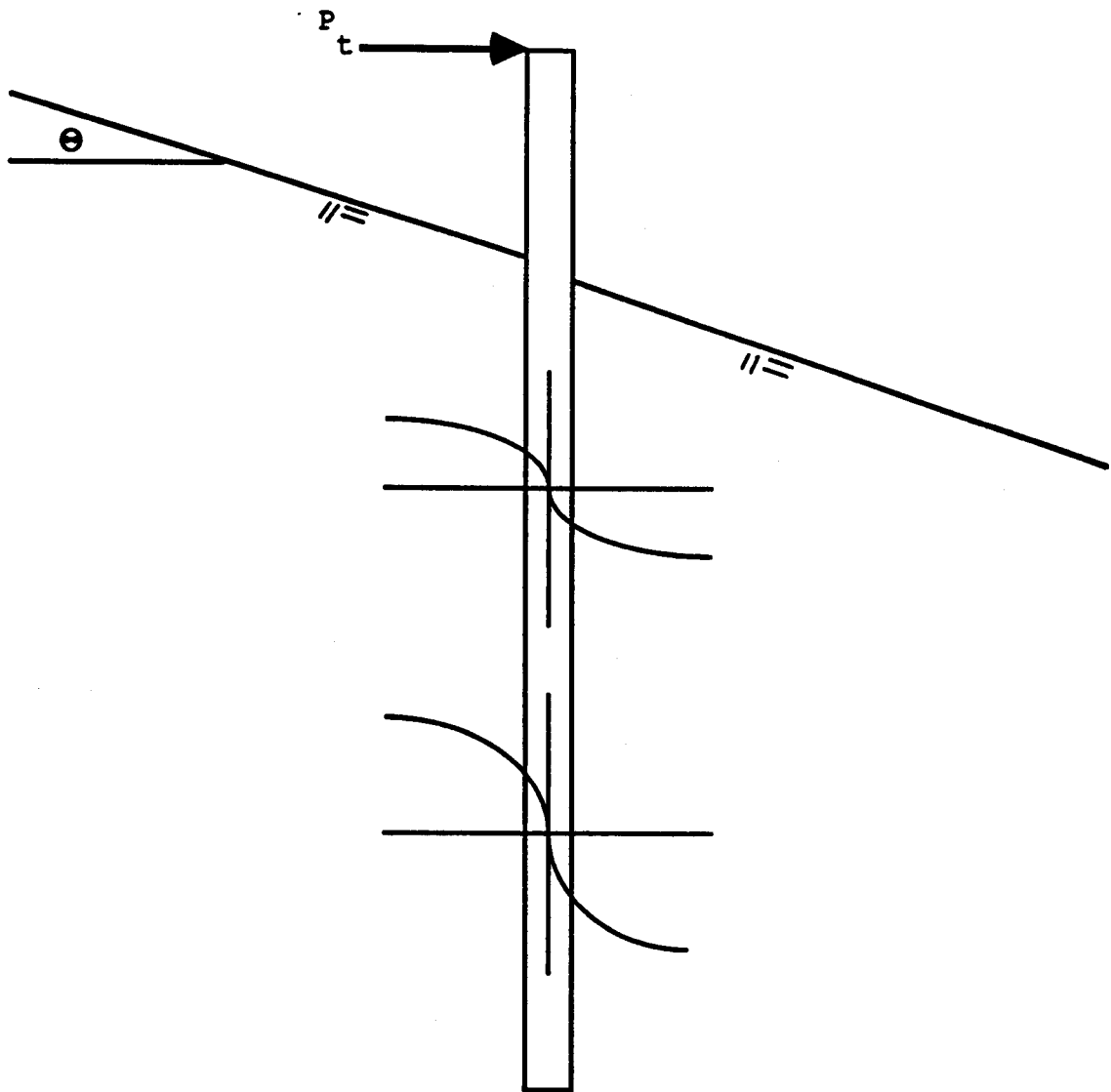

Figure 3.18. Pile installed in sloping ground.

parenthesis. If θ is equal to zero, the equations become equal to the original equation.

Equations for Ultimate Resistance in Sand

The ultimate soil resistance near the ground surface for sand where the pile was installed in ground with a horizontal slope is:

$$(P_u)_{sa} = \gamma H \left[\frac{K_o H \tan \phi \sin \beta}{\tan(\beta - \phi) \cos \alpha} + \frac{\tan \beta}{\tan(\beta - \phi)} (b + H \tan \beta \tan \alpha) + K_o H \tan \beta (\tan \phi \sin \beta - \tan \alpha) - K_a b \right]. \quad (3.5)$$

If the ground surface has a slope angle θ , the ultimate soil resistance in the front of the pile is:

$$(P_u)_{sa} = \gamma H \left[\frac{K_o H \tan \phi \sin \beta}{\tan(\beta - \phi) \cos \alpha} \left(4D_1^3 - 3D_1^2 + 1 \right) + \frac{\tan \beta}{\tan(\beta - \phi)} \left(bD_2 + H \tan \beta \tan \alpha D_2^2 \right) + K_o H \tan \beta (\tan \phi \sin \beta - \tan \alpha) \left(4D_1^3 - 3D_1^2 + 1 \right) - K_a b \right]. \quad (3.45)$$

where

$$D_1 = \frac{\tan \beta \tan \theta}{\tan \beta \tan \theta + 1}, \quad (3.46)$$

$$D_2 = 1 - D_1, \text{ and} \quad (3.47)$$

$$K_a = \cos\beta \frac{\cos\beta - \sqrt{\cos^2\beta - \cos^2\phi}}{\cos\beta + \sqrt{\cos^2\beta - \cos^2\phi}}. \quad (3.48)$$

(β is defined in Fig. 3.3)

The ultimate soil resistance in the back of the pile is:

$$\begin{aligned} (P_u)_{sa} = \gamma H \left[\frac{K_o H \tan\phi \sin\beta}{\tan(\beta-\phi) \cos\alpha} \left(4D_3^3 - 3D_3^2 + 1 \right) + \right. \\ \left. \frac{\tan\beta}{\tan(\beta-\phi)} \left(bD_4 + H \tan\beta \tan\alpha D_4^2 \right) + \right. \\ \left. K_o H \tan\beta (\tan\phi \sin\beta - \tan\alpha) \left(4D_3^3 - 3D_3^2 + 1 \right) - K_a b \right] \end{aligned} \quad (3.49)$$

where

$$D_3 = \frac{\tan\beta \tan\theta}{1 - \tan\beta \tan\theta}, \text{ and} \quad (3.50)$$

$$D_4 = 1 + D_3. \quad (3.51)$$

CHAPTER 4. COMPUTATION OF ULTIMATE MOMENT AND FLEXURAL RIGIDITY OF PILE

INTRODUCTION

Application

The designer of piles under lateral loading must usually make computations to ascertain that three factors are within tolerable limits: combined stress (including bending stress), shear stress, and pile-head deflection. The flexural rigidity of the pile (bending stiffness) is an important parameter that influences the computations (Reese and Wang, 1988).

In general, the flexural rigidity of reinforced concrete with a specified cross section varies nonlinearly with the applied bending moment, and a constant EI employed in the p-y analysis for a concrete pile will result in some degree of inaccuracy in the computation.

Because the response of a pile is nonlinear with respect to load (the soil has a nonlinear response), the load-factor approach is recommended. Therefore, the ultimate bending moment of a reinforced-concrete member, and of any other type of section being analyzed, is needed.

The code PMEIX has been developed to yield the ultimate-moment capacity of a reinforced-concrete or steel-pipe pile and to give the bending stiffness of such piles as a function of applied moment. With this information the designer can make a correct judgement in the selection of a representative EI value in accordance with the loading range and can compute the ultimate lateral load for a given cross-section.

Significant Assumptions

The program solves for the behavior of a slice from a pile or from a beam-column. It is of interest to note that the EI of the concrete member will experience a significant change when cracking occurs. In the coding used herein, the assumption is made that the tensile strength of concrete is minimal and that cracking will be closely spaced when it appears. Actually, such cracks will initially be spaced at some distance apart and the change in the EI will not be so drastic. In respect to the cracking of concrete, therefore, the EI for a beam will change more gradually than is given by the coding.

The ultimate bending moment of a reinforced-concrete section is taken at a maximum strain of concrete of 0.003 and is not affected by the crack spacing. The ultimate bending moment for steel, because of the large amount of deformation of steel when stressed to beyond the proportional limit, is taken at a maximum strain of 0.015 which is five times that of concrete.

STRESS-STRAIN CURVES FOR CONCRETE AND STEEL

Any number of models can be used for the stress-strain curves for concrete and steel. For the purposes of the computations presented herein, some relatively simple curves are used.

Figure 4.1 shows the stress-strain curve for concrete. The following equations apply to the branches of the curve. The value of f'_c is specified by the engineer; the other symbols are defined below or in the figure.

$$f''_c = 0.85 f'_c \quad (4.1)$$

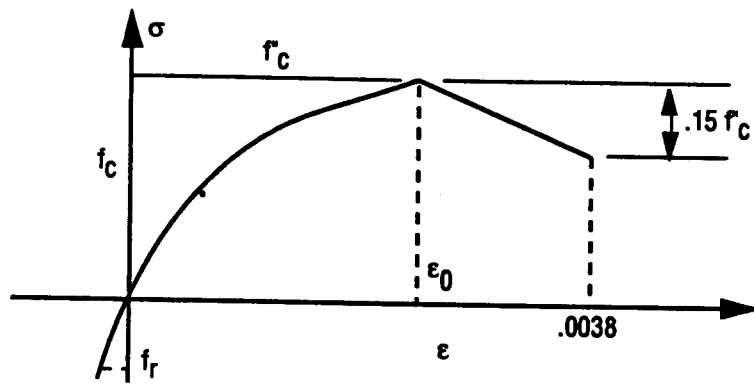

Figure 4.1. Stress-strain curve for concrete.

$$f_c = f''_c \left[2 \frac{\epsilon}{\epsilon_0} - \left(\frac{\epsilon}{\epsilon_0} \right)^2 \right] \quad (4.2)$$

$$f_r = 7.5 (f'_c)^{0.5} \quad (4.3)$$

$$E_c = 57,000 (f'_c)^{0.5} \quad (4.4)$$

$$\epsilon_0 = 1.7 \frac{f'_c}{E_c} \quad (4.5)$$

where

E_c = initial modulus of the concrete and the units of E_c , f_r and f'_c are psi.

Figure 4.2 shows the stress-strain (σ - ϵ) curve for steel and, as may be seen, there is no limit to the amount of plastic deformation. The curves for tension and compression are identical. The yield strength of the steel f_y is selected according to the material being used, and the following equations apply.

$$\epsilon_y = \frac{f_y}{E_s} \quad (4.6)$$

$$E_s = 29,000,000 \text{ psi.} \quad (4.7)$$

The models and the equations shown here are employed in the derivations that are shown subsequently.

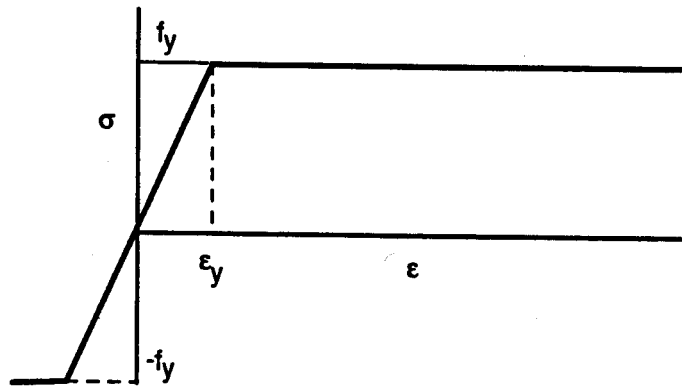

Figure 4.2. Stress-strain (σ - ϵ) curve for steel.

CROSS SECTIONS THAT CAN BE ANALYZED

The following types of cross sections can be analyzed:

1. square or rectangular, reinforced concrete,
2. circular, reinforced concrete,
3. circular, reinforced concrete, with steel tubular shell around concrete,
4. circular, reinforced concrete, with steel tubular shell and tubular core, and
5. circular, steel tubular shell

The output consists of a set of values for M versus EI for different axial loads ranging from zero to the axial-load capacity for the column. The number of load cases in one run is limited to 10.

COMPUTATION PROCEDURE

The flexural behavior of a structural element such as a beam, column, or a pile subjected to bending is dependent upon its flexural rigidity, EI , where E is the modulus of elasticity of the material of which it is made and I is the moment of inertia of the cross section about the axis of bending. In some instances the values of E and I remain constant for all ranges of stresses to which the member is subjected, but there are situations where both E and I vary with changes in stress conditions.

This variation is most pronounced in reinforced concrete members. Because of nonlinearity in stress-strain relationships, the value of E varies; and because the concrete in the tensile zone below the neutral axis becomes ineffective due to cracking, the value of I is reduced. When a member is made up of a composite cross section there is no way to calculate directly the value of E for the member as a whole. Reinforced concrete is a composite material; other examples are concrete encased in a steel tube or a steel section encased in concrete.

An element from a beam with an unloaded shape of $abcd$ is shown by the dashed lines in Fig. 4.3. The beam is subjected to pure bending and the element changes in shape as shown by the solid lines. The relative rotation of the sides of the element is given by the small angle $d\theta$ and the radius of curvature of the elastic element is signified by the length ρ . The unit strain ϵ_x along the length of the beam is given by Eq. 4.8.

$$\epsilon_x = \frac{\Delta}{dx} \quad (4.8)$$

where

Δ = deformation at any distance from the neutral axis, and

dx = length of the element.

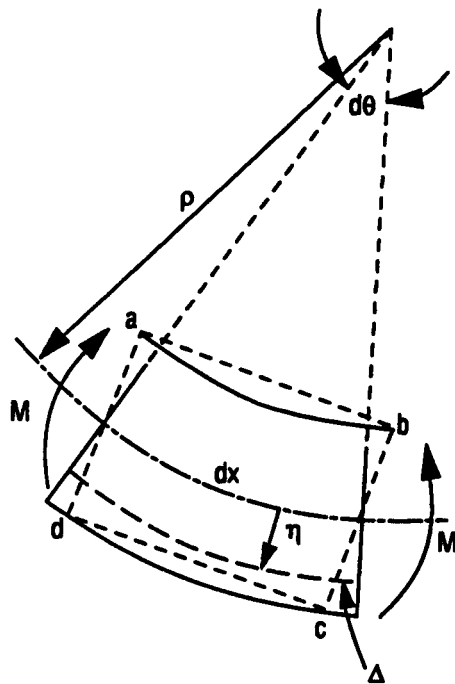

Figure 4.3. Element from a beam with an unloaded shape of $abcd$.

From similar triangles

$$\frac{\rho}{dx} = \frac{\eta}{\Delta} \quad (4.9)$$

where

η = distance from neutral axis.

Equation 4.10 is obtained from Eqs. 4.8 and 4.9, as follows:

$$\epsilon_x = \frac{\eta}{\rho} \quad (4.10)$$

From Hooke's law

$$\epsilon_x = \frac{\sigma_x}{E} \quad (4.11)$$

where

σ_x = unit stress along the length of the beam, and

E = Young's modulus.

Therefore

$$\sigma_x = \frac{E\eta}{\rho} \quad (4.12)$$

From beam theory

$$\sigma_x = \frac{M\eta}{I} \quad (4.13)$$

where

M = applied moment, and

I = moment of inertia of the section.

From Eqs. 4.12 and 4.13

$$\frac{M\eta}{I} = \frac{E\eta}{\rho} \quad (4.14)$$

Rewriting Eq. 4.14

$$\frac{M}{EI} = \frac{1}{\rho} \quad (4.15)$$

Continuing with the derivation, it can be seen that $dx = \rho d\theta$ and

$$\frac{1}{\rho} = \frac{d\theta}{dx} \quad (4.16)$$

For convenience, the symbol ϕ is substituted for $\frac{d\theta}{dx}$; therefore, from this substitution and Eqs. 4.15 and 4.16, the following equation is found.

$$EI = \frac{M}{\phi} \quad (4.17)$$

Also, because $\Delta = \eta d\theta$ and $\epsilon_x = \frac{\Delta}{dx}$ then,

$$\epsilon_x = \phi \eta \quad (4.18)$$

The computation for a reinforced-concrete section, or a section consisting partly or entirely of a pile, proceeds by selecting a value of ϕ and estimating the position of the neutral axis. The strain at points along the depth of the beam can be

computed by use of Eq. 4.18, which in turn will lead to the forces in the concrete and steel. In this step, assumptions are made that the stress-strain curves for concrete and steel are as shown in Figs. 4.1 and 4.2.

With the magnitude of the forces, both tension and compression, the equilibrium of the section can be checked, taking into account the external compressive loading. If the section is not in equilibrium, a revised position of the neutral axis is selected and iterations proceed until the neutral axis is found.

The bending moment is found from the forces in the concrete and steel by taking moments about the centroidal axis of the section. Thus, the externally-applied, axial load does not enter the equations. Then, the value of EI is found from Eq. 4.10. The maximum strain is tabulated and the solution proceeds by incrementing the value of ϕ . The computations continue until the maximum strain selected for failure, in the concrete or in a steel pipe, is reached or exceeded. Thus, the ultimate moment that can be sustained by the section can be found.

EXAMPLE CALCULATION BY HAND

Figure 4.4 shows the cross section of a beam subjected to bending moment. The axial load is 200 kips, $\phi = .0001 \text{ in}^{-1}$, $E_c = 4,000 \text{ kip/sq in}$, and $E_s = 30,000 \text{ kips/sq inches}$. The value of M and EI are to be found.

Step 1

As the first step, the position of the neutral axis should be determined by trial, such that the net force on the cross section equals the applied load of 200 kips. Concrete below the neutral axis will be neglected if the tensile stress in the concrete is high enough to cause the concrete to crack. A linear stress-strain relationship will be assumed here for simplicity.

Strains:

At top fiber of concrete: $(.0001)(9.2) = .00092$

1st row of bars:	$(.0001)(6.2) = .00062$
2nd row of bars:	$(.0001)(1.8) = .00018$
3rd row of bars:	$(.0001)(9.8) = .00098$
4th row of bars:	$(.0001)(17.8) = .00178$

Forces:

Concrete: $[(.00092)(4000/2)][(20)(9.2)] = 338 \text{ kips comp}$

1st row of bars:	44 kips comp
2nd row of bars:	8 kips tension
3rd row of bars:	46 kips tension
4th row of bars:	127 kips tension

Net forces = 201 kips - OK

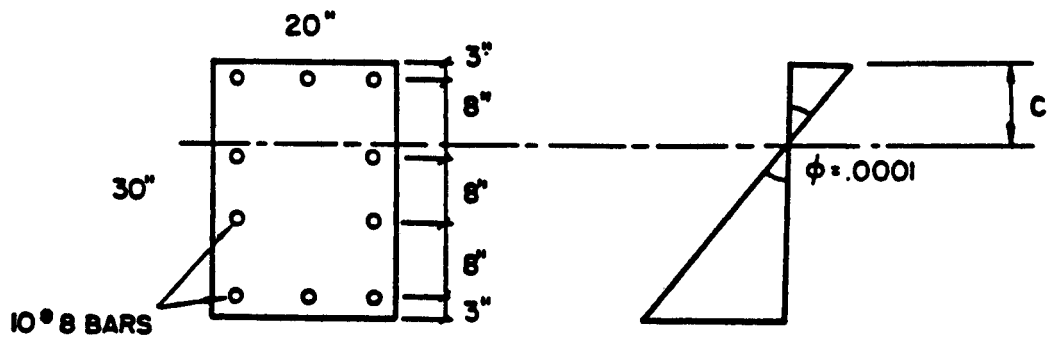

Figure 4.4. Cross section of a beam for example problem.

Step 2

The bending moment due to all these forces about the centroidal axis of the cross section now is to be found. Clockwise moments are taken as positive.

Moment due to compression in concrete

$$= 338 \left(15 - \frac{9.2}{3}\right)$$

$$= +4,033 \text{ in-kips.}$$

Trial 1

$c = 9$ inches.

Strains:

At top fiber of concrete $(.0001)(9) = .0009$

1st row of bars: $(.0001)(6) = .0006$

2nd row of bars: $(.0001)(2) = .0002$

3rd row of bars: $(.0001)(10) = .001$

4th row of bars: $(.0001)(18) = .00018$

Forces (stress x area):

Concrete: $[(.0009)(4000/2)] [(20)(9.0)] = 324 \text{ kips comp}$

1st row of bars: $(.0006)(30,000)(3)(.79)$

$= 43 \text{ kips comp}$

2nd row of bars: $(.0002)(30,000)(2)(.79)$

$= 9 \text{ kips tension}$

3rd row of bars: $(.001)(30,000)(2)(.79)$

$= 47 \text{ kips tension}$

4th row of bars: $(.0018)(30,000)(2)(.79)$

$= 128 \text{ kips tension}$

Net forces = 183 kips comp - no good

Trial 2

$c = 9.2$ inches.

Moment due to compression in Row 1 bars	= (44)(12) = +528 in-kips
Moment due to tension in Row 2 bars	= (8)(4) = -32 in-kips
Moment due to tension in Row 3 bars	= (46)(4) = +184 in-kips
Moment due to tension in Row 4 bars	= (127)(12) = +1524 in-kips
Net moment M	= +6237 in-kips

The net moment from the computer solution is 6169 in-kips. The discrepancy between hard calculation and computer solution can be further reduced if more trials by hand calculations can be done.

$$EI = M/\phi = 6237/.0001 = 62,370,000 \text{ kips-sq inches.}$$

The above method, though simple in cases like rectangular cross sections, becomes tedious when cross sections with varying widths are considered. Further, because the actual stress-strain relationship of concrete is a nonlinear function, for a circular cross section, the computation of forces will involve double integration, one for the area and one for the stress. This is not feasible by hand calculations. However, with the aid of the high-speed digital computer, the solution has been made possible for these complicated cases.

CHAPTER 5. VERIFICATION OF ACCURACY OF SOLUTION

The accuracy of the output of any computer run must be verified because of a compelling and urgent reason. An error in the output could lead to an incorrect design with unforeseen and undesirable results. Incidents can be cited with regard to placing too much reliance on the accuracy of any output. In another context, the late Dr. Karl Terzaghi wrote about his early experiences as an engineer in Russia. He looked at the plans for a major building and by his experience he knew that some reinforced-concrete beams were too small. As noted earlier, the analysis of a pile under lateral loading, or lateral and axial loading, requires the full attention of an experienced engineer.

Verification is necessary for several reasons: the input boundary conditions and soil properties could be in error; the particular computer could be operating with an inadequate word length; some problem could exist with the operating system of the computer; the number of increments into which the pile is divided could be improper; and, finally, there could be a "bug" in the computer program itself. Some teachers of methods of coding the solution to engineering problems have stated the following truism, "It is impossible to write a computer code of any length without an error."

With regard to the accuracy of the coding of COM624P, several comments can be made: the code was written by a programmer with extensive experience in writing codes and with an excellent educational background in mechanics, many parts of the code have been tested against existing codes, the program was checked thoroughly before any release, and the program will have been used by a number of beta sites before any general release. Furthermore, by agreement with FHWA, ENSOFT will answer questions with the view of maintaining the code for a considerable period of time.

Nevertheless, the verification of the output for any problem should be viewed as an integral part of using the program.

The verification may be accomplished by one of the methods given herein or, preferably, by means devised specifically by the engineer for the particular problem that is being addressed. The following sections of this chapter present specific suggestions for verification.

SIGNIFICANT FIGURES

The solution of the differential equation is done numerically by use of difference equations as presented in Chapter 2. The differences between deflections at adjacent points will disappear unless a sufficient number of significant figures are carried in the computations. COM624P is written in double-precision arithmetic and, using IBM PC's XT and AT, the word length for computations is 64 bits, resulting in 15 significant figures.

The first step to be taken by the user of COM624P is to investigate the operating system of the particular computer being used to make sure that a sufficient number of significant figures is being used in the computations. Also, the identical problems can be run that are solved in Part I, Chapter 5, and the output can be compared in detail.

SELECTION OF NUMBER OF INCREMENTS

A fundamental aspect of the solution of the differential equation by difference techniques, as shown in Chapter 2, is the selection of the number of increments into which the pile is divided, or, in effect, the selection of the length of an increment. The length of the pile that is to be sub-divided is the embedded length plus the portion above the groundline.

The first step in the selection of the increment is to eliminate the lower portion of a pile where there may be several points of zero deflection. As discussed earlier, the groundline deflection and the maximum bending moment are unaffected if the length of a pile extends so that there are at least two points of zero deflection at the bottom of the pile.

With the length of the pile adjusted so that there is not a large number of points of zero deflection, the engineer may wish to make a few runs with a relatively large lateral loading with the pile subdivided into different numbers of increments. The results for an example of such a study are shown in Fig. 5.1 where computed values of groundline deflection and maximum bending moment are plotted. Serious errors were introduced when the number of increments was less than 50, and virtually the same results were obtained if the number of increments was 100 or more. Because of the nonlinearity of the problem and because of the number of parameters that are involved, the selection of an appropriate number of increments cannot easily be made automatic. The engineer-user should study a number of the kinds of problems that are usually encountered in the local practice and make enough studies of the sort shown in Fig. 5.1 to be assured of introducing no errors due to too few increments.

CHECKING AGAINST EXAMPLE PROBLEMS

Six examples of computer output are presented in Part I, Chapter 5. The engineer may wish to code one or more of those problems for the particular computer being used. If agreement is not obtained between the outputs, the operating system of the local computer needs to be evaluated; it may be necessary to make use of another computer.

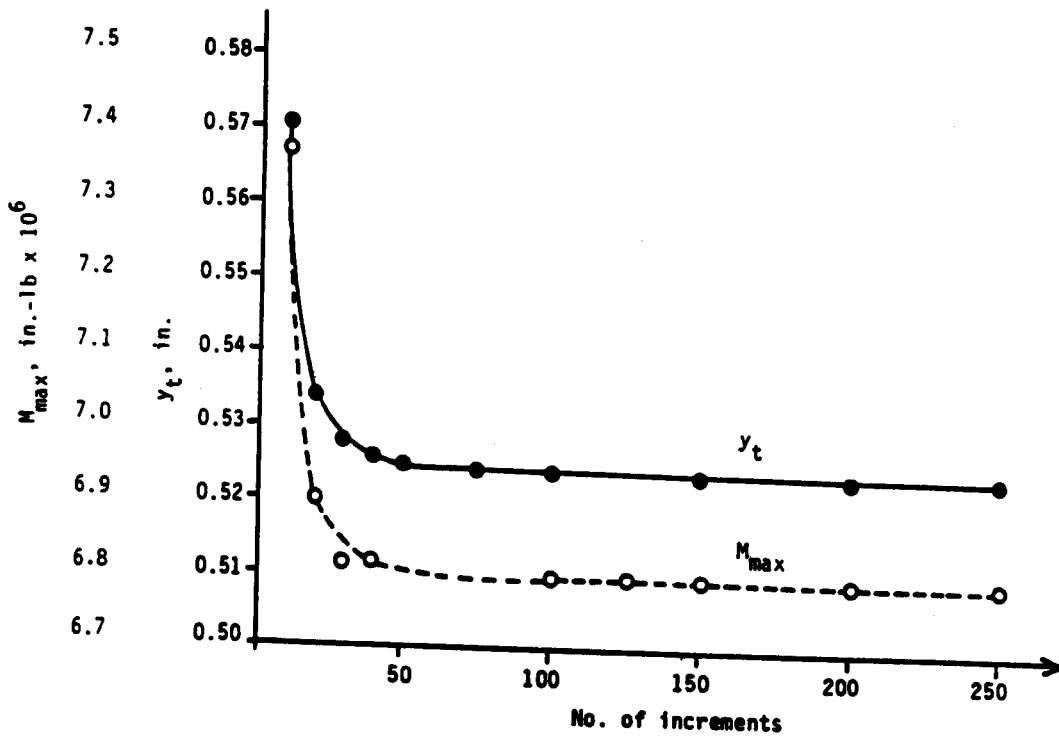

Figure 5.1. Influence of length of increment on pile-head deflection and maximum bending moment.

CHECK OF ECHO-PRINT

The code for COM624P is written so that there is an echo-print of the input data. A careful check of the echo-print to see that the coding was correct is necessary for each computer run.

CHECK OF SOIL RESISTANCE

The engineer-user has the option of asking that p-y curves be printed for various positions along the length of the pile. As COM624P is being implemented and on occasion thereafter, the user may have some p-y curves printed for the purpose of checking. The first step is to check one or more of the curves against the recommendations shown in Chapter 3. The computations may be tedious but the assurance of accurate computations is necessary.

The next step in the check is to read off the tabulated value of deflection from a table of output for one of the p-y curves. With that value of deflection as an argument, the p-y curve is consulted and the soil resistance corresponding to the deflection is interpolated. The soil resistance should agree closely with the value tabulated in the output. In this connection, the point should be made that the equations for the p-y curves are employed for every point that a soil resistance is needed as the computer is doing the internal computations; however, the soil resistances that are output for a p-y curve are for discrete deflections. Therefore, the interpolation mentioned above could be very slightly in error.

The procedures of verification with respect to a specific computer run will be implemented with respect to Example 1 in Part I, Chapter 5. With regard to the p-y curves, the values of ultimate resistance will be computed for the four curves that are tabulated; the values were computed by calculator to be 778, 1098, 1419, and 1820 lb/in. These values agree with the values that are

tabulated. The deflection was checked at which the soil resistance became constant, or 16 y50. The value of y50 was computed to be 0.257 in and 16 y50 was computed to be 4.12 inches. This value agrees with the tabulated values.

Next, a check will be made to determine whether or not an appropriate value of soil resistance was computed. The p-y curve at a depth of 20 ins and the run for a lateral load of 20,000 lbs were selected. The deflection at a value of x of 20 ins was 0.101 inch. Employing the equation for the early part of the p-y curve: $p = (0.5) (778) (0.101/0.257) 0.25 = 308$ lbs/inches. This value agrees with the value shown in the output for a depth of 20 inches.

CHECK OF MECHANICS

Check of Results of Analysis of Buckling Load

As noted earlier, the computation of the buckling load does not involve the solution of an eigenvalue problem, but is accomplished by incrementing the axial load until there is excessive deflection. The computer output can be examined and a point below the groundline can be found where the moment is zero. This point can be selected as a hinge and the Euler equation can be used to check the buckling load for the column that consists of that portion of the pile from the assumed hinge and above.

Check of Values of Shear and Bending Moment

A plot can be made by hand or with the computer of the values of soil resistance that are computed for a particular run. The boundary conditions can be used and the shear can be computed point-by-point along the pile. The values of shear computed in this way should agree closely with the values that are tabulated. Also, the area under the p-x curve can be integrated approximately

to obtain a concentrated load that is equivalent to the distributed load. The equilibrium of the pile in shear can then be checked. If the pile is subjected to an axial load, the computation will have some error, but the engineer can reach a reasonable conclusion about the accuracy of the computer results.

A check of the results for Example 1 with a lateral load of 20,000 lbs is continued by making a plot of the soil resistance, as shown in Fig. 5.2. The concentrated loads with their estimated line of action are shown in the figure. The concentrated loads were found by counting squares. The lines of action were "eyeballed." The out-of-balance of the shear is 1,800 lbs; a satisfactory solution in consideration of the method and that the effect of axial loading is ignored. The out-of-balance of the moment, if moments are taken about the top of the pile, is only 9,200 ins-lbs; again, a satisfactory solution.

Check of Deflection

An examination of the tabulation of the values of deflection for the output being studied shows that a zero slope occurred at a value of x of about 130 inches. A plot of the moment diagram to a depth of 130 ins was made, not shown here, and the second area-moment proposition was employed to compute the deflection at the top of the pile. A value of 0.15 in was computed, which agrees well with the value from COM624P.

Relationships Between Computed Values

The tabulated results from the computer of the graphical results can be checked to see that the equations of mechanics are satisfied at significant points. The following checks can be made: the shear must have maximum values where the values of soil resistance are zero, the moment must have maximum values where the

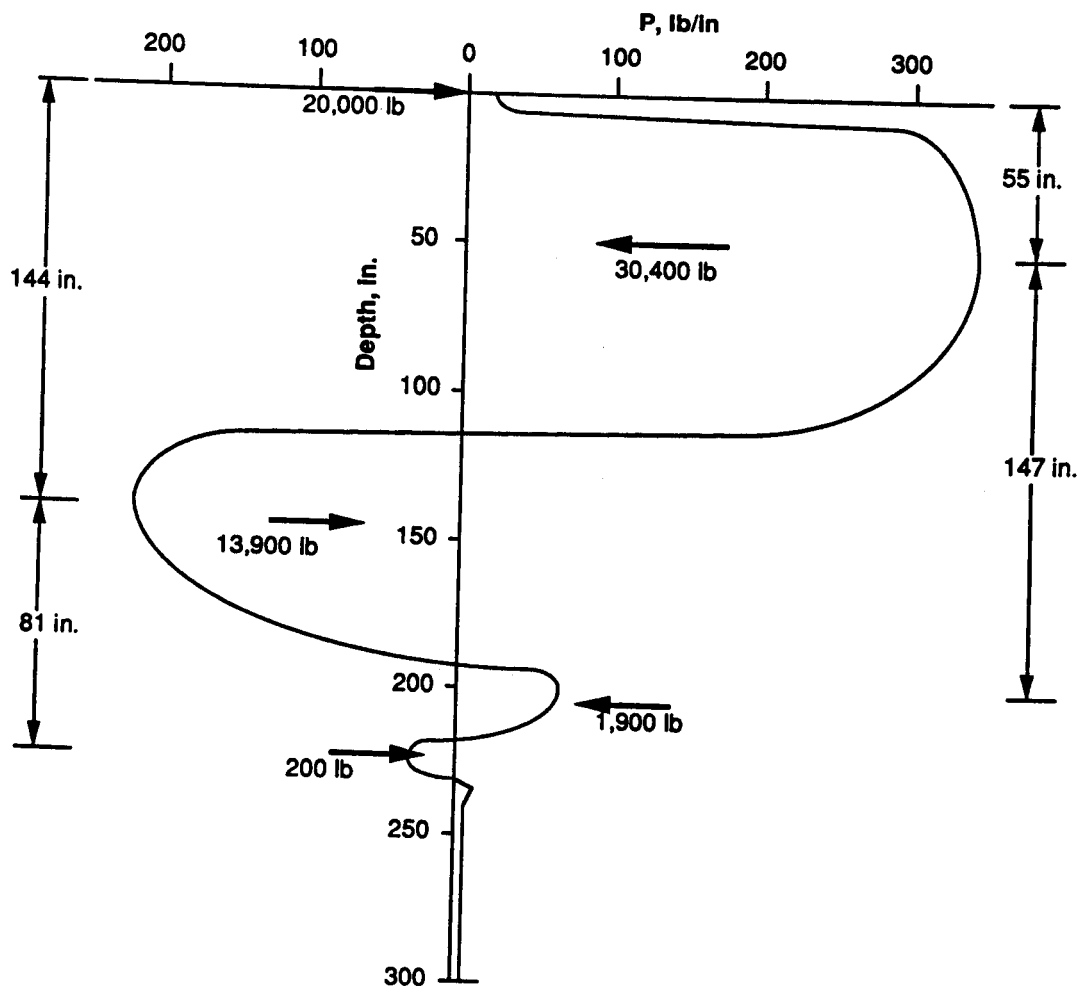

Figure 5.2. Plot of soil resistance for Example 1, lateral load of 20,000 pounds.

values of shear are zero, and the soil resistance must be zero where the deflection is zero.

An examination of the output for Example 1 in Part I, Chapter 5 shows that the checks that are indicated are satisfied.

CHECK BY IMPLEMENTING APPROXIMATE METHODS OF ANALYSIS

The two publications on laterally loaded piles sponsored by FHWA (FHWA, 1984; FHWA, 1986) contain sections on two methods of analysis that yield approximate results. The methods proposed by Broms, (1964a, 1964b, 1965), allow for the computation of the load at which the pile will develop a plastic hinge; then the load can be compared to the comparable load obtained by the computer. The method is based on the equations of static equilibrium and it is approximate; nevertheless, the engineer can obtain a crude evaluation of the accuracy of the computer solution.

The second method of analysis can provide a much closer check of the computer results. With the p-y curves that are either tabulated or presented in graphical form by COM624P, the engineer can use nondimensional curves and check the results of the computer for any particular run. The bending stiffness of the pile should be taken as that for the upper section, the boundary conditions should be used as the lateral loading on the pile at the groundline, and axial loading must be ignored. Even with the approximations that are made in the nondimensional method, the agreement with the computer solutions should be fair to good.

CHECK BY AN ASSOCIATE OR A COLLEAGUE

One of the emerging methods of verification of engineering studies is peer review. Such a technique should be advantageous with respect to the verification of the results of computations

with COM624P. If such a procedure were to be implemented, the review should probably be delayed until the computations had been completed for a particular design.

CONCLUDING COMMENT

The use of a calculator to make checks of the output of the computer program is a time-consuming and tedious process. However, such a procedure pays dividends in preventing errors and will give the engineer an excellent understanding of the computational process that is employed in the program. However, after the engineer gains some experience in analyzing the types of piles in the kinds of soils that are usually encountered in the local practice, the correctness of a computer run can readily be judged on the basis of past experience. Some serious checking is advised, however, when a new situation is encountered.

CHAPTER 6. FULL-SCALE TESTING OF PILES

INTRODUCTION

The testing of piles in the field under axial loading is a well-established practice and has been common since piles were first used. The testing of piles under lateral loading is less frequent, perhaps because the means of establishing failure of a pile under lateral load has not become common knowledge. However, with the availability of the technology presented herein, there are benefits to be gained from the performance of full-scale tests of piles under lateral loading. The photograph in Fig. 6.1 is of a test of a drilled shaft at Los Angeles. The testing arrangement is as described later in this chapter.



Figure 6.1. Testing of a drilled shaft under lateral loading, Los Angeles.

There are two general reasons for performing tests of piles in the field under axial loading: to prove a particular design, and to gain information to allow for a redesign (Reese, 1978). These reasons are valid for the test of a pile under lateral

loading. Thirdly, in some cases a valuable contribution to the technical literature can be made.

With regard to a proof test of a pile under lateral load, the procedure is not straightforward, because the response of the pile under lateral load is affected strongly by the way the pile is connected to the superstructure. A single-pile foundation for an overhead sign, for example, will be subjected to a shear and a moment. The exact simulation of the pile-head conditions for the sign structure and for a particular kind of loading is impractical if not impossible; therefore, analytical procedures must be employed to interpret the results of virtually any lateral-load test. Such analytical procedures are presented later in this chapter. A standard test is described where no internal instrumentation is used in the pile and where only a relatively small amount of instrumentation is used above the groundline. The standard test can be employed to prove any given design and, in some instances, the standard test can provide information for redesign.

Some information is given on a comprehensive testing program where a pile is instrumented internally for the measurement of bending moment along its length. Precise information on soil response at a particular site can be gained from such a testing program, design information will be specific and valuable, and a contribution to the technical literature can be made. The comprehensive program is expensive and advisable when the benefits are worth the cost.

SELECTION OF TEST SITE

Site selection is simplified if a test is to be performed in connection with the design of a particular structure. However, even in such a case, care should be taken in selecting the precise

location of the test pile. In general, the test location should be where the soil profile reveals the weakest condition. In evaluating a soil profile, the soils from the ground surface to a depth equal to five to ten pile diameters are of principal importance. If designed on the basis of the results from the weakest soil, the piles at other places on the construction site should behave more favorably than the test pile.

The selection of a site where a fully instrumented pile is to be tested is usually difficult. The principal aim of such a test is to obtain experimental p-y curves that can be employed in developing predictions of soil response. Thus, the soil at the site must be relatively homogeneous and representative of a type of soil for which predictive equations are needed. For many of the past experiments, the finding of a suitable site was a major problem.

After a site has been selected, attention must be given to the moisture content of the near-surface soils. If cohesive soils exist at the site and are partially saturated, steps may be taken to saturate the soils. If the cohesive soils will be submerged during the life of the structure, the site should be flooded during the testing period.

The position of the water table and the moisture content are also important if the soil at the test site is granular. Partial saturation of sand will result in an apparent cohesion that will not be present if the sand dries or if it becomes submerged.

INVESTIGATION OF SOIL PROPERTIES

The recommendations for obtaining soil properties should be consulted when obtaining data on soils for use in analyzing the

results of the lateral-load experiments. Those recommendations make use of the soil parameters of significance.

For cohesive soils, high-quality tube samples should be obtained and laboratory tests should be performed. The Standard Penetration Test is the principal investigative technique for cohesionless soils, but the static-cone-penetrometer test is also recommended.

In performing the soil investigation, careful attention should be given to the near-surface soils, a zone that is frequently given little attention for design of piles under axial loading. As noted previously, the soil strata within a few diameters of the ground surface provide the principal support for a laterally-loaded pile.

SELECTION OF TEST PILE

If a lateral load test is being performed to confirm the design at a particular site, the diameter, stiffness, and length of the test pile should be as close as possible to similar properties of the piles proposed for production. Because the purpose of the test is to obtain information on soil response, consideration should be given to increasing the stiffness and bending-moment capacity of the test pile in order to allow the test pile to be deflected as far as possible. The increased load that will be necessary will usually cause no significant problem.

The length of the test pile must be considered with care. As shown in Fig. 5.1, the deflection of a pile will be significantly greater if it is in the "short" pile range. Tests of these short piles could be hard to interpret because a small change in the pile penetration could cause a large change in the ground-line deflection.

The selection of the test pile for the case of complete instrumentation involves a considerable amount of preliminary analysis. Factors to be considered are: the pile diameter for which the soil response is desired, the soil conditions, the kind of instrumentation to be employed for determining bending moment along the length of the pile, the method of installing instrumentation in the pile, the magnitude of the desired ground-line deflection, and the nature of the loading.

INSTALLATION OF TEST PILE

For cases where information is desired on pile response at a particular site, the installation of the test pile should agree as closely as possible to the procedure proposed for the production piles. The response of a pile to load is affected considerably by the installation procedure; thus, the detailed procedure used for pile placement is important.

For the case of a test pile in cohesive soil, the placing of the pile can cause excess porewater pressures to occur. As a rule, these porewater pressures should have dissipated before testing begins; therefore, the use of piezometers at the test site may be important.

The installation of a pile that has been instrumented for the measurement of bending moment along the length of the pile must consider the possible damage of the instrumentation due to pile driving or other installation effects. The instrumentation must be especially rugged where the pile is to be installed by an impact hammer and where hard driving is expected. However, the installation must be such that it is consistent with methods used in practice. In no case would jetting be allowed with wash water flowing up and along the outside of the test pile.

The influence of the installation procedures on the soil properties should be investigated if possible. However, almost any testing technique prior to the loading would cause soil disturbance and would be undesirable. Some non-intrusive methods are available, based on the use of dynamic methods, that can be considered.

Testing of the near-surface soils close to the pile wall at the completion of the load tests is useful and can be done without any undesirable effects. The kinds of tests that are desirable are indicated where criteria for p-y curves are discussed. In general, laboratory tests of undisturbed samples are recommended.

TESTING PROCEDURES

Excellent guidance for the procedures for testing a pile under lateral loading is given by the ASTM Standard D 3966-81, "Standard Method of Testing Piles Under Lateral Loads." Some general comments on the ASTM standard are given in this section, and detailed recommendations are given in the following sections.

For the standard test as well as for the instrumented test, two principles should guide the testing procedure: (1) the loading (static, repeated, sustained, or dynamic) should be consistent with that expected for the production piles and (2) the testing arrangement should be such that deflection, rotation, bending moment, and shear at the groundline (or at the point of load application) are measured or can be computed.

With regard to loading, even though static (short-term) loading is seldom encountered in practice, the soil response from that loading is usually desirable so that correlations can be made with soil properties. The combination of static and repeated

loading may be desirable. A load can be applied, readings taken, and the same load can be reapplied a number of times with readings taken after specific numbers of cycles. Then, a larger load is applied and the procedure repeated. The assumption is made that the readings for the first application at a larger load are unaffected by the repetitions of a smaller load. While that important assumption may not be strictly true, errors are on the conservative side.

Sustained loads will probably have little influence on the behavior of granular materials or on overconsolidated clays if the computed values of soil stresses are well below ultimate. If a pile is installed in soft, inorganic clay or other compressible soil, sustained loading would obviously influence the soil response. In general, loads would have to be maintained for a long period of time and a special testing program would have to be designed. However, data can be obtained in a period of several days or a few weeks that can allow extrapolation to results for a long period.

The application of a dynamic load to a single pile is feasible and desirable if the production piles sustain such loads. The loading equipment and instrumentation for such a testing program would have to be designed to yield results that would be relevant to a particular application, and a special study would be required. The design of piles to withstand the effects of an earthquake involves several levels of computation. Soil-response curves must include an inertia effect and the free-field motion of the earth must be estimated. Therefore, p-y curves that are determined from the tests described herein have only a limited application to the earthquake problem. No method is currently available for performing field tests of piles to gain information on soil response that can be used directly in design of piles to sustain seismic loadings.

The testing of battered piles is mentioned in ASTM D 3966-81 (also see FHWA-IP-84-11, Appendix 8). The analysis of a pile group, some of which are batter piles, is discussed in the technical literature. In such analyses, information is required on the behavior of battered piles under a load that is normal to the axis of the pile. Unless the batter is large, the behavior of battered and vertical piles under this normal load (lateral load) is similar. For large batter, an approximate solution is given in FHWA-IP-84-11 (page 300).

The testing of pile groups, also mentioned in D 3966-81, is desirable but is expensive in time, material, and instrumentation. If a large-scale test of a group of piles is proposed, detailed analyses should precede the design of the test in order that measurements can be made that will provide critical information. Such analyses may reveal the desirability of internal instrumentation to measure bending moment in each of the piles.

The analysis of test results is not covered in D 3966-81. The argument can be made, as presented earlier in this chapter, that test results can fail to reveal critical information unless combined with analytical methods. The next section of this chapter suggests procedures that demonstrate the close connection between testing and analysis. A testing program should not be initiated unless preceded and followed by analytical studies.

The ASTM standard mentions methods of dealing with the lateral soil resistance against a pile cap. A conservative procedure, and one that is consistent with reality in many instances, is to assume that there is no soil resistance either against the sides or the bottom of the cap. A small amount of settlement would eliminate the bottom resistance, and shrinkage would eliminate the side resistance. Therefore, it is recommended

that a pile cap not be used in the testing program or, if used, that the cap not be placed against the soil.

ASTM D 3966-81 gives a number of procedures for applying load and for measuring movements. Some details, generally consistent with the ASTM standard, about methods that have been found to be satisfactory are given in the next section. With regard to a loading schedule, ASTM indicates that loading should be applied in increments to a maximum of 200 to 250 percent of the design load. However, it is rarely possible to perform a test with the rotational restraint at the pile-head exactly the same as for production piles; thus, an alternate suggestion is made that the loading be continued in increments until the pile actually fails due to the development of a plastic hinge. Or, the loading can be continued until the bending stress becomes equal to a certain percentage of the ultimate, as indicated by computations.

The sections in D 3966-81 on safety requirements and report presentation are worthy of careful consideration. Safety is an important concern in load testing and safety meetings prior to any load test should be held. The detailed list in the section on reporting is useful and indicates most of the items that should be addressed in preparing a report.

TESTING PILE WITH NO INTERNAL INSTRUMENTATION

A step-by-step procedure is given in the following paragraphs for the testing of a pile or piles with no internal instrumentation, termed the standard test because of its simplicity and ease of performance. The test program is initiated with a study to indicate the economic advantages of the experiment. It is presumed that a careful subsurface investigation with laboratory testing has been carried out and

that soil properties are well known. The soil properties near the ground surface are especially important.

Preliminary Computations

After the type and size of pile has been selected for testing, preliminary computations should be made using the computer code described herein. The computations should anticipate that the pile head should be free to rotate and that the shear should be applied near the ground surface. Analyses should be done using p-y curves for both static and repeated loading. Curves showing pile-head deflection and pile-head rotation should be developed for a range of loading up to the point where the ultimate moment is developed.

Computations should be done with parameters varied, and the length of the test pile and its bending stiffness should be selected on the basis of the computations.

Obtaining Stiffness of Test Pile

The bending stiffness of the test pile or piles can be found by computation, but it is preferable to obtain the stiffness experimentally. If the pile consists of a pipe or some other prefabricated section, rather than a cast-in-place pile, it is possible to support the pile near its ends in the laboratory and load it as a beam. The stiffness of the pile can be computed from the deflection.

For a cast-in-place section, or for a prefabricated section as well, several feet of soil around the pile can be excavated after the primary testing program is completed. The pile can be reloaded and deflections can be measured at several points along the exposed portion of the pile. If this latter procedure is to

be employed, the lateral loading should have been stopped before the pile was damaged.

The stiffness of drilled shafts and other reinforced-concrete sections will vary with bending moment. Some information on this variation can be obtained from the field measurements described above. That information, along with the use of the code for PMEIX, should provide engineers with adequate data on stiffness of reinforced-concrete sections.

Pile Installation

As noted earlier, the installation of a test pile should be done in the same manner as for the production piles. Small amounts of accidental batter will have little influence on the performance of a pile under lateral load. Care should be exercised in installation that the near-surface soils have the same properties as for the production piles.

Loading Arrangement

A wide variety of arrangements for the test pile and the reaction system are possible. The arrangement to be selected is the one that has the greatest advantage for the particular design. There are some advantages, however, in testing two piles simultaneously as shown in Fig. 2 of D 3966-81. A reaction system must be supplied; thus, a second pile can supply that need. Furthermore, and more importantly, a comparison of the results of two tests performed simultaneously will give the designer some idea of the natural variations that can be expected in pile performance. It is important to note, however, that spacing between the two piles should be such that the pile-soil-pile interaction is negligible.

Drawings of two two-pile arrangements are shown in Figs. 6.2 and 6.3. In both instances the pile head is free to rotate and the loads are applied as near the ground surface as convenient. In both instances free water should be maintained above the ground surface, if that situation can exist during the life of the structure.

The details of a system where the piles can be shoved apart or pulled together are shown in Fig. 6.2. This two-way loading is important if the production piles can be loaded in that manner. The lateral loading on a pile will be predominantly in one direction, termed the forward direction here. If the loading is repeated or cyclic, a smaller load in the reverse direction could conceivably cause the soil response to be different than if the load is applied only in the forward direction. As noted earlier, it is important that the shear and moment be known at the ground line; therefore, the loading arrangement should be designed as shown so that shear only is applied at the point of application of load.

Figure 6.3 shows the details of a second arrangement for testing two piles simultaneously. In this case, however, the load can be applied in only one direction. A single bar of high-strength steel that passes along the diameter of each of the piles is employed in the arrangement shown in Fig. 6.3. Two high-strength bars are utilized in the arrangement shown in Fig. 6.3. Not shown in the sketches are the means to support the ram and load cell that extend horizontally from the pile. Care must be taken in employing the arrangement shown in either Figs. 6.3a or 6.3b to ensure that the loading and measuring systems will be stable under the applied loads.

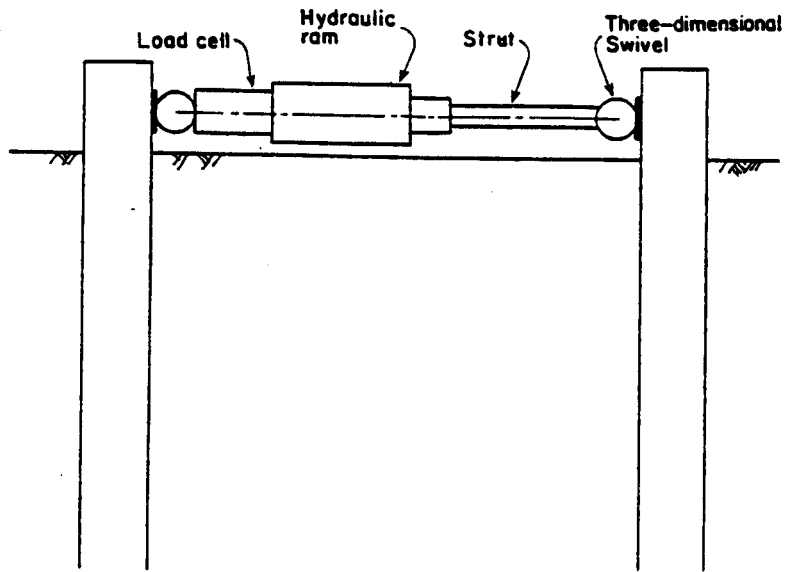
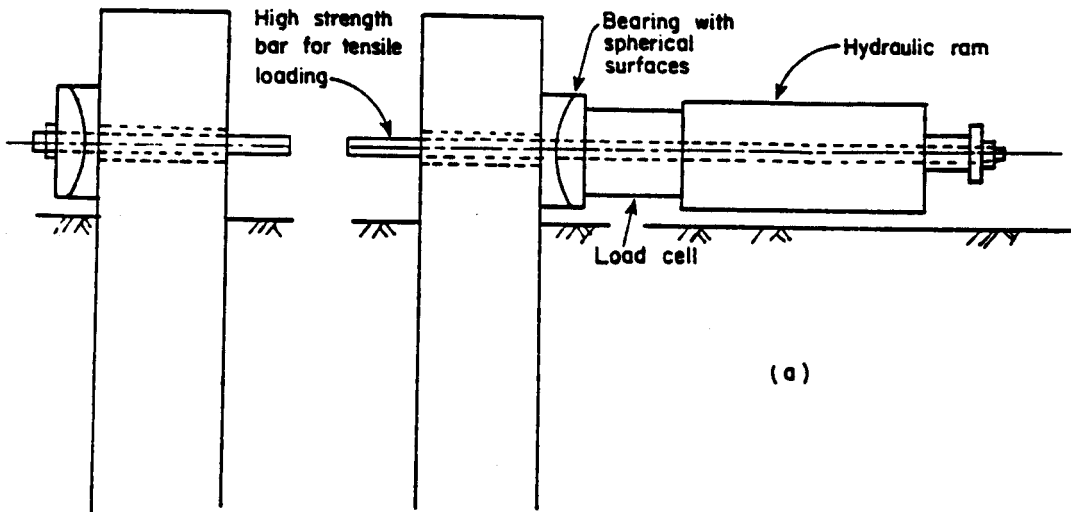
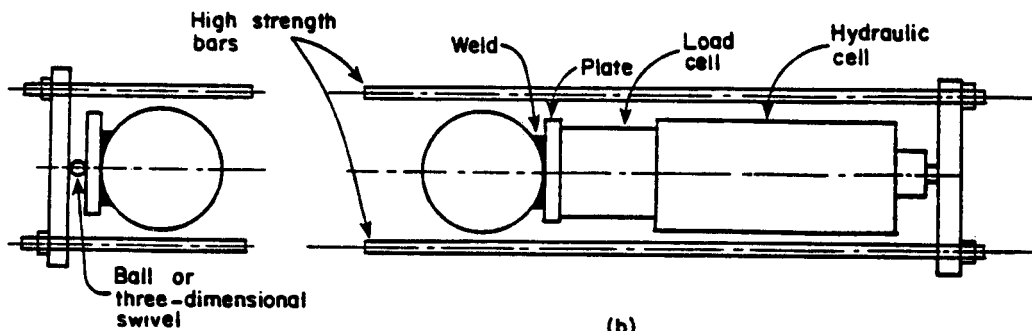

Figure 6.2. Two-pile test arrangement for two-way loading.



(a)



(b)

Figure 6.3. Two-pile test arrangement with one-way loading.

The most convenient way to apply the lateral load is to employ a hydraulic ram with hydraulic pressure developed by an air-operated or electricity-operated pump. The capacity of a ram is computed by multiplying the piston area by the maximum pressure. Some rams, of course, are double acting and can apply a forward or reverse load on the test pile or piles. The preliminary computations should ensure that the capacity and the travel of the piston are ample.

If the rate of loading is important (and it may be if the test is in clay soils beneath water, and erosion at the pile face is important), the maximum rate of flow of the pump is important along with the volume required per inch of stroke of the ram. The seals on the pump and on the ram, along with hydraulic lines and connections, must be checked ahead of time and spare parts should be available.

High pressures in the operating system constitute a safety problem and can cause operating difficulties. On some projects, the use of an automatic controller for the hydraulic system is justified. A backup control must be available to allow the override of the automatic system in case of malfunction. On at least one important project the malfunction of the hydraulic system caused a large monetary loss.

The loading system shown in Fig. 6.3 will ensure that no eccentricity will be applied to the load cell and the hydraulic ram. If the two-bar system shown in Fig. 6.3(b) is employed, it should be even simpler to achieve concentric loading. However, the system shown in Fig. 6.2 will require that the load cell and the ram be connected rigidly and that bearings be placed at the face of each of the piles so that no eccentric loading is applied to the ram or to the load cell. The arrangement shown in Fig. 6.2

may require that the points of load application be adjustable in order to prevent torsional loading of the piles.

Instrumentation

A simple system for obtaining the deflection and rotation of the pile head is shown in Fig. 6.4. The slope or rotation of the portion of the pile above the point of load application can be found by knowing the gauge readings and the distance between them. The same data will yield the deflection at the point of load application. In the test shown in Fig. 6.1, a casing was attached to the rebar cage prior to concreting and a slope indicator was used to measure the slope (or rotation) of the drilled shaft over its full length.

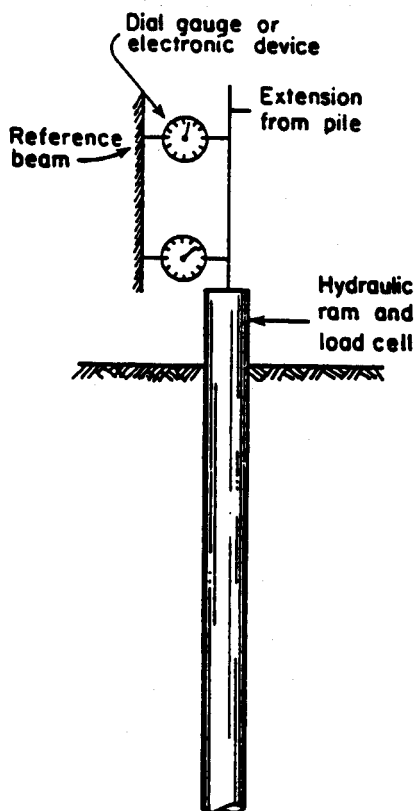

Figure 6.4. Schematic drawing of deflection-measuring system.

An alternate or redundant method of obtaining the pile-head rotation is shown in Fig. 6.5. A sensitive bubble for leveling a bar is attached as shown. A micrometer is fixed to one end of the bar and a hardened point to the other. A sturdy bracket is attached to the pile, or to an extension of the pile, at a convenient distance above the point of load application. Readings of the micrometer when the instrument is carefully leveled for each load will allow pile-head rotation to be computed.

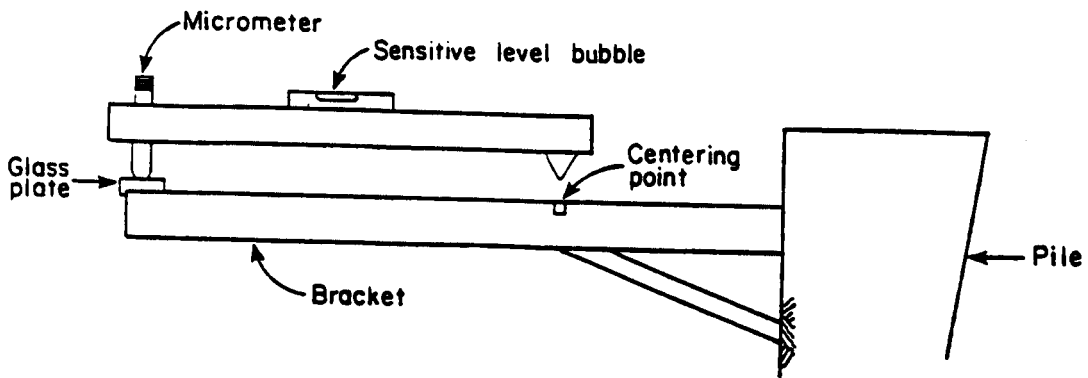

Figure 6.5. Device for measuring pile-head rotation.

Electronic load cells are available for routine purchase. These cells can be used with a minimum of difficulty and can be read with a high-speed data-acquisition system, if desired.

The motion of the pile head can be measured with dial gauges, but a more convenient way is to employ electronic gauges. In either case, gauges with sufficient travel should be obtained or difficulty will be encountered during the test program. Two types of electronic motion transducers are in common use: linear potentiometers or LVDT's (linear variable differential transformers). The LVDT may have a longer life than the differential potentiometers; in either case the motion transducer should be attached so that there is no binding as the motion rod moves in and out.

Two other comments about instrumentation are important. The verification of the output of each instrument should be an important step in the testing program. Also, the instruments should be checked for temperature sensitivity. In some cases it may be necessary to perform tests at night or to protect the various instruments from all but minor changes in temperature.

Interpretation of Data

The interpretation of data from a test of an uninstrumented piles is a straightforward process. Plots are made of deflection versus applied load and rotation versus applied load (for the ground line or for the point of load application). Computer Program COM624P is then used, and computations of pile-head deflection and rotation are made for the same loads that were used for the field test. The results are plotted against the field results. If the results do not agree, the soil parameters (probably the shear strength of clay and angle of internal friction of sand) are changed by trial to bring the computed and experimental results into agreement. (Most of the interpretation will be done in the office; however, it is desirable to do some plotting in the field as a means of checking the validity of the data that are being taken).

The soil parameters as modified are then used in making a design for the site. An appropriate factor of safety, normally introduced as a load factor to increase the working load, is employed, taking into account all of the relevant considerations.

Example Computations

The test selected for study was performed by Capozzoli (1968) near St. Gabriel, Louisiana. The pile and soil properties are shown in Fig. 6.6. The loading was short term. The soil at the

site was a soft-to-medium, intact, silty clay. The natural moisture content of the clay varied from 35 to 46 percent in the upper 10 ft of soil. The undrained shear strength, shown in Fig. 6.6, was obtained from triaxial tests. The unit weight of the soil was 110 lb/ft³ above the water table and 48 lb/ft³ below the water table.

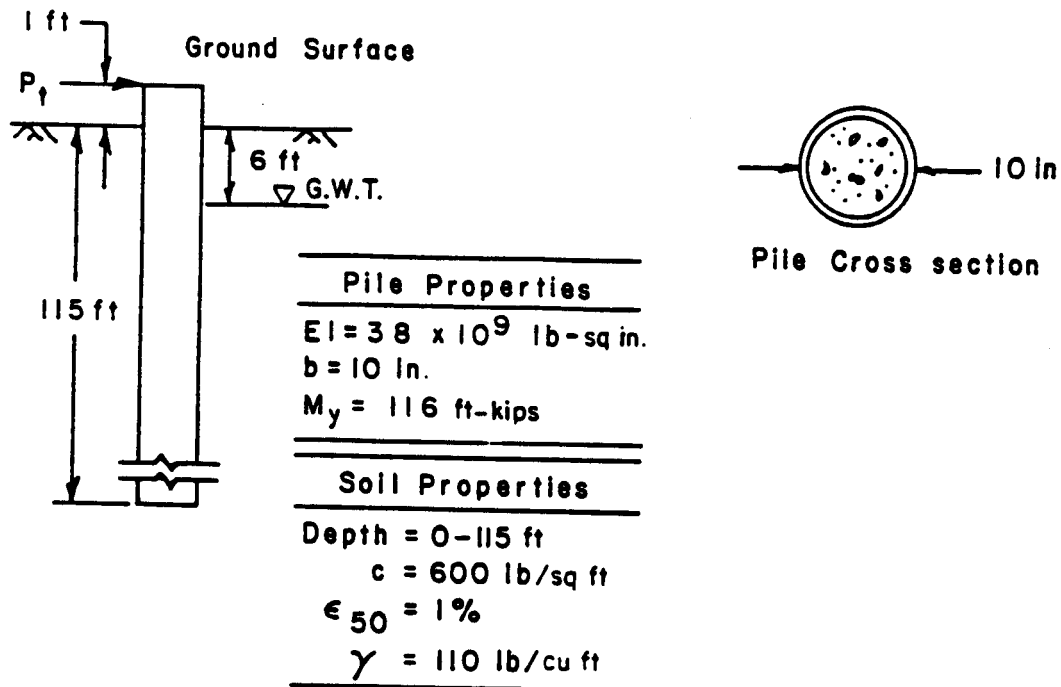

Figure 6.6. Information for analysis of test at St. Gabriel.

The results from the field experiment and computed results are shown in Fig. 6.7. The experimental results are shown by the open circles; the results from Computer Program COM624P with the reported shear strength of 600 lb/ft² and with an ϵ_{50} of 1.0 percent are shown by the solid line. The soil properties were varied by trial and the best fit to the experimental results was found for an undrained strength of 887 lb/ft² and an ϵ_{50} of 0.9 percent. These values of the modified soil properties should be used in design computations for the production piles if the production piles are to be identical with the one employed in the load test.

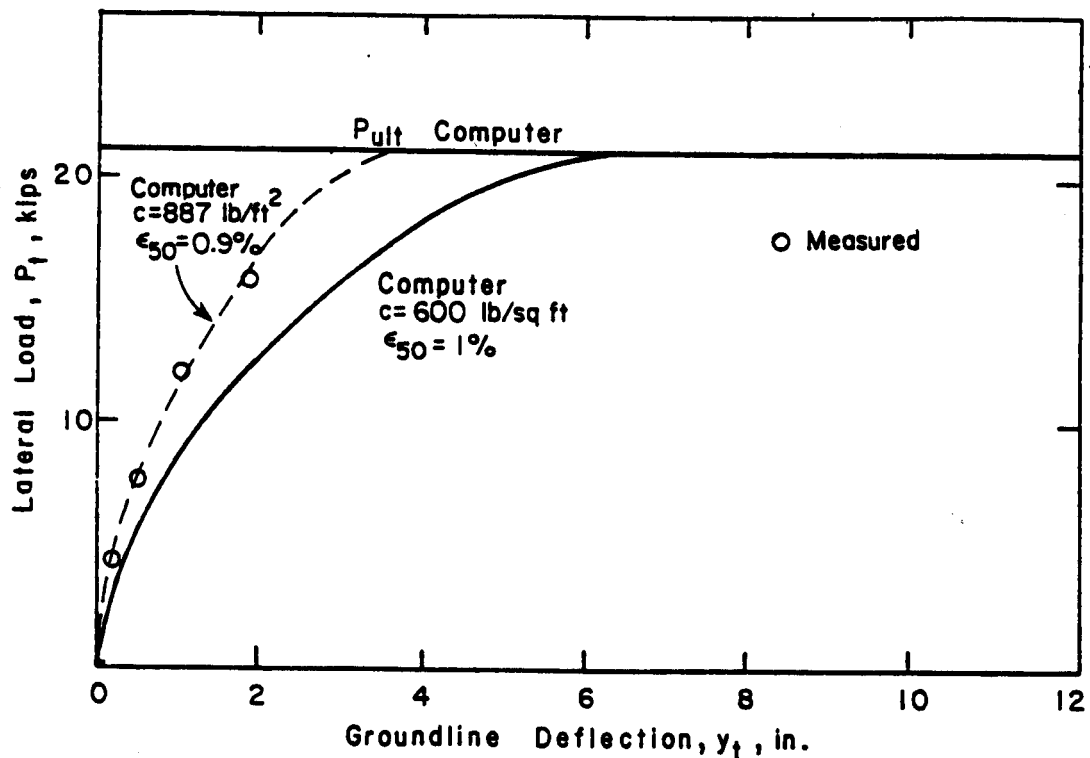

Figure 6.7. Comparison of measured and computed results for St. Gabriel Test.

Computer Program PMEIX was employed and an ultimate bending moment for the section in Fig. 6.6 was computed to be 1392 in-kips. In making the design computations with the modified soil properties, the computed maximum bending moment should be no greater than the ultimate moment (1392 in-kips) divided by an appropriate factor of safety. In computing the maximum bending moment, the rotational restraint at the pile head must be estimated as accurately as possible. If it is assumed that the pile will be unrestrained against rotation and that the load is applied one ft above the ground line, a load of 21 kips will cause the ultimate bending moment to develop. The deflection of the pile must be considered because deflection can control some designs rather than the design being controlled by the bending resistance of the section.

Two other factors must also be considered in design. These are: the nature of the loading and the spacing of the piles. The experiment employed short-term loading; if the loading on the production piles is to be different, an appropriate adjustment must be made in the p-y curves. Also, if the production piles are to be in a closely-spaced group, consideration must be given to pile-soil-pile interaction.

TESTING PILE WITH INTERNAL INSTRUMENTATION

The performance of experiments with piles that are instrumented internally for the measurement of bending moment along the length of the pile is highly desirable. The results of experiments that are carefully performed will allow experimental p-y curves to be developed; thus, significant information can be added to the technical literature. In addition, of course, excellent data will be available to guide the design of piles at the test site. However, the performance of experiments with piles that have internal instrumentation is expensive, both in labor and materials. In addition, instrumentation specialists with excellent skills are required. Therefore, a detailed cost-benefit study should be undertaken before such a test program is begun.

Preliminary Computations

If a major experiment with a pile with internal instrumentation is to be undertaken, the preliminary computations should be exhaustive. Assuming that the test site and the pile geometry have been selected and that soil properties are known, computations must be performed to get the best possible estimate of the response of the pile. On the basis of these computations, the nature of the loading system is decided upon and a detailed design of the system is made.

The preliminary computations also allow the selection of the kind of internal instrumentation that is to be employed and a detailed design of the instrumentation is then made. Electrical-resistance strain gauges are frequently employed to read strains in the pile material. The test pile can be calibrated by supporting the pile as a beam, applying known measurements at positions of strain gauges, and reading the output of each gauging point. If a drilled shaft is employed in the test, an instrumented pipe can be cast along the axis of the shaft and calibration can be done after the test is over by removing soil around the pile to as great a depth as possible and reloading the pile (Welch and Reese, 1972).

Further computations must be carried out to ensure that the pile is not damaged if it is to be installed by driving. Diligence in planning and in performing preliminary computations can do much to ensure the success of the expensive instrument.

Instrumentation

The instrumentation that is placed above the ground is similar, if not identical, to that described for the pile with no instrumentation. While the principal item of internal instrumentation pertains to a direct determination of bending moment from point to point along the pile, the use of a slope indicator from which deflections can be obtained is sometimes desirable. If space allows and if the loading schedule that is proposed will allow a slope indicator to be used, the installation of slope-indicator casing may be warranted.

As noted above, the use of strain gauges to enable bending moments to be obtained is a common practice. However, innovative techniques are being developed regularly, and the selection and

installation of the internal instrumentation should follow a careful study of available methods.

Some investigators have made measurements of ground-surface movements during the lateral loading of a pile. The placing of markers on a grid pattern around the test pile and the measurement of the movement of those markers are time-consuming and cumbersome. The use of photographic techniques to obtain ground-surface movements has much to recommend it.

Analysis of Data and Correlations with Theory

The principal analytical technique is to perform two integrations of the bending moment curves and two differentiations. The boundary conditions at the head of the pile must be employed in the analysis. The integrations yield the pile deflections; with reasonably good moment curves and with good measurements of the boundary conditions at the pile head, an accurate family of curves giving deflection of the pile as a function of depth can be obtained.

The two differentiations are another matter. Errors in the moment values are accentuated. Therefore, it is usually necessary to employ curve-fitting techniques and obtain analytical expressions for selected portions of the moment curves. If the differentiations can be carried out successfully, the result will be a family of curves showing soil resistance as a function of depth. Specific depths can be selected and cross-plotting will yield a family of p-y curves.

An additional step in the analytical process is to employ the principles of soil mechanics and of elasticity to develop predictive equations for pile response. Ideally, the predictive equations should agree with the experimental results at the test

site and should further serve to predict the behavior of piles of different geometry at the test site and at other sites where the soils are similar. The predictive equations will be valid, of course, only for the kind of loading employed at the test site.

Review of Three Experiments Using Piles with Internal Instrumentation

Matlock (1970) performed experiments near Austin, Texas, and near Sabine, Texas, in soft to medium clay. The pile was a steel pipe, 12.75 ins in diameter. Thirty-five pairs of electrical-resistance strain gauges were installed in the interior of the pipe. The gauges were spaced 6 ins apart near the top of the embedded portion with wider spacings being used below. The embedded portion of the pile was 45 ft long. The pipe was split along a diameter, the gauges were installed, and the two halves were welded together.

The pile was calibrated prior to driving so that extremely accurate determinations of bending moment could be made. The experimental p-y curves that were obtained from the testing program form the basis of recommendations that are widely used for design of piles in soft clay under lateral loading.

Cox, Reese, and Grubbs (1974) performed experiments in sand near Corpus Christi, Texas. The piles were steel pipes, 24 ins in diameter. Forty electrical-resistance strain gauges were installed in each of the two piles by placing the piles horizontally and by working from a trolley. Two piles were driven at the same site; one pile was tested under static loading and the other under cyclic loading. The embedded length of each pile was 69 feet.

The piles were calibrated in the laboratory prior to installation. The experimental p-y curves that were obtained from the testing program form the basis of recommendations that are widely used for the design of piles in sand under lateral loading.

Welch and Reese (1972) conducted a test of an instrumented drilled shaft with a nominal diameter of 30 in, a total length of 44 ft, and a penetration of 42 feet. The soil at the site was an overconsolidated clay with an average undrained shear strength in the upper 20 ft of approximately 2,200 lb/ft². Average values of liquid limit and plastic limit were 70 and 20, respectively. The water table was at a depth of 18 feet.

A steel pipe, with an outside diameter of 10.75 in and with a wall thickness of 0.25 in, was split longitudinally and strain-gauge rosettes were installed on each half to form a full bridge at 28 points along the drilled shaft. Twenty-three gauge points were at spacings of 15 in from the top and there were 5 spaces at 30 in near the bottom.

The lateral loads were applied at the groundline and in one direction only. Readings were taken after 1, 2, 5, 10, 15, and 20 applications of load. Readings were taken with a data logger of the gauges at the top of the drilled shaft and of all of the gauges for the measurement of bending moment. After the loadings were completed, an excavation to a depth of 20 ft was made around the drilled shaft and a loading was made to obtain data for determination of the as-built values of bending stiffness (EI), as well as calibrations for each of the gauge points so that strain-gauge readings could be converted directly into bending moment.

Curves for each of the applied loads were plotted to show bending moment as a function of depth. A study of curve-fitting techniques was done and the result indicated that the best results

could be obtained with least-squares using a 7-degree polynomial. The values of deflection (y) and soil resistance (p) were obtained at various points along the drilled shaft by using the following equations.

$$y = \iint (M/EI) dx \quad 6.1$$

$$p = \frac{d^2M}{dx^2} \quad 6.2$$

The resulting p-y curves for the depth of 37.5 in below the groundline are shown in Fig. 6.8. The curves illustrate the effect of cyclic loading. The soil resistance is decreased or the deflections are increased with cyclic loading. The authors decided to take cyclic loading into account by increasing the computed deflection for static loading by an increment that takes into account the stress level and the number of cycles (Welch and Reese, 1972). The resulting equations are implemented in the recommendations for p-y curves that are shown earlier in this document.

CONCLUDING COMMENTS

Only a brief presentation is possible concerning the details of a program of testing of piles under lateral load. The brevity of the presentation is consistent with the purposes of this document and is not meant to detract from the importance of the topic.

Simple, inexpensive experiments can be performed with piles with no internal instrumentation and data of great value can be obtained concerning the response of a pile at a particular site.

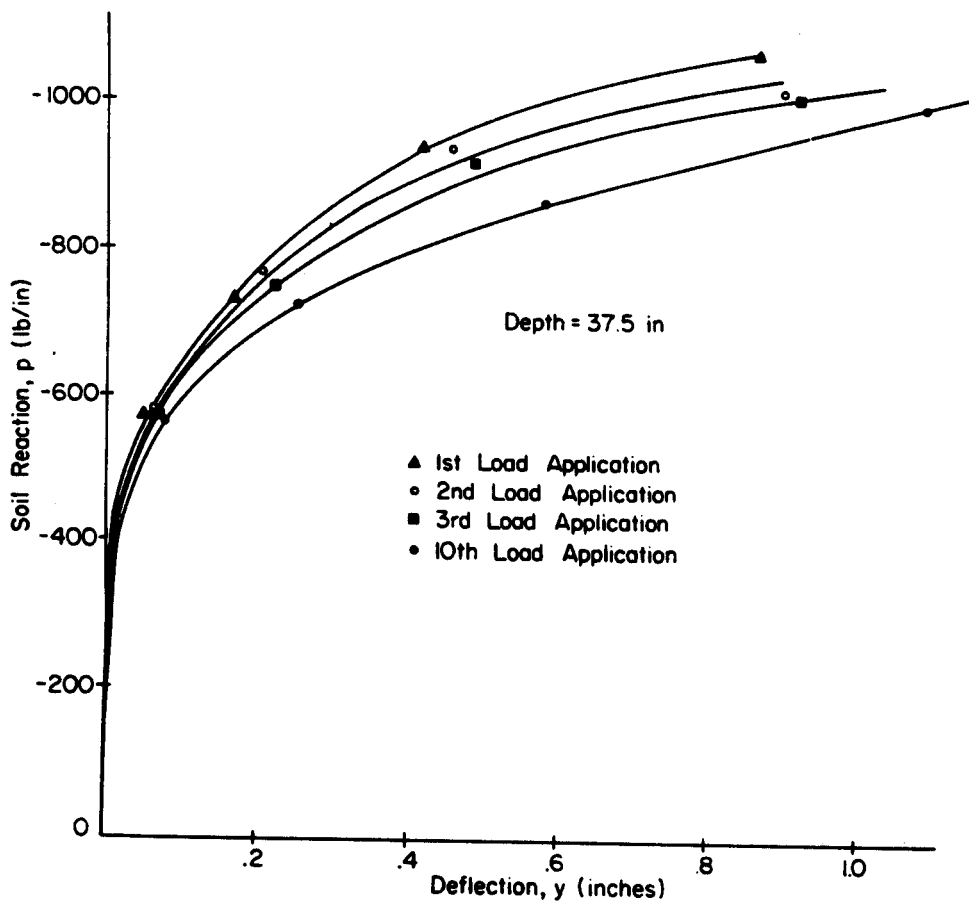

Figure 6.8. Effect of repeated loading on p-y curves.

The performance of tests of piles with internal instrumentation can well be justified at the site of a major project, especially if the current methods of predicting p-y curves are not exactly applicable to the soil, pile, and loading to be employed at the site. In addition to getting data for the design of a particular project, data will be obtained for use at similar sites. Also, a contribution can be made to the engineering profession.

Redundancy in load-measuring and deflection-measuring systems is good practice. Rams can be calibrated as a means of checking readings from load cells. Stretched wires or surveying instruments can be employed to check deflection. Such redundancy can be extremely useful in case of the failure of a primary system of measurement.

The available data are insufficient to allow a comment to be made that all field tests of piles under lateral loading are cost effective. However, the tests that have been performed appear to have saved money on specific projects. The tests of instrumented piles have paid for themselves many times over. The investigation of the benefits from performing field tests of piles under lateral loading for a specific project is strongly advised.

CHAPTER 7. SUGGESTIONS FOR DESIGN

A conference on deep foundations several years ago was opened by an address by Dr. Ralph B. Peck (1967). He gave factors that related to a successful design: loading, soil conditions, theory, tolerance to differential movement, and quality of construction. Dr. Peck concluded his address by saying that very few problems with foundations could be attributed to inadequacy of theory but that most of them were due to misjudgment of loading or of soil conditions or to construction defects. The computer program COM624P might fit into the category of theory in Dr. Peck's list; however, it will be exceedingly difficult to design a pile properly to sustain lateral loading without a suitable analytical tool. The point that there are many important aspects of design in addition to analysis is well taken.

There is a movement in several countries to design on the basis of "limit states" and "partial safety factors." The concept of limit states is to identify all of the reasons that a particular design could fail to perform its assigned function during the life of the structure; in other words, reasons that would limit the usefulness of the construction. Partial safety factors are employed to find a global safety factor for a component of a structure, say a pile. A partial factor would be applied to loads, soil properties, theory, construction, and so on, in consideration of the engineer's evaluation of how well each of the items could be evaluated. The two concepts are used rarely in the United States but the engineer brings experience, training, and judgment to bear rather than using a formalized approach to the selection of the factor of safety. Such attributes of the engineer are essential with respect to the design of piles under lateral loading.

SELECTING AN APPROPRIATE MODEL FOR A PILE

As noted earlier, two aspects of the response of a pile must be considered in design: the development of a plastic hinge, or hinges, along the length of the pile; and excessive deflection. In both instances, the pile must be modeled properly. As an example, a pile is considered that is attached to the superstructure at some distance above the groundline. In many instances, the pile head is neither free to rotate nor fully fixed against rotation but is somewhere in between. In some instances, the determination of the degree of rotational restraint is difficult. Then, some parametric studies can be done with the rotational restraint varied. The computer output usually will allow the engineer to decide whether or not to proceed with an uncertain pile-head condition or to design one with a predictable amount of rotational restraint.

With regard to the axial load and bending moment that will result in the formation of a plastic hinge, formulas are available for steel piles. However, a computer program is desirable for the determination of the ultimate moment for a reinforced-concrete pile. The bending stiffness, EI , of the reinforced-concrete pile will vary with the loading. Thus, the output from the computer will enable the engineer to select the EI to agree with the bending moment when modeling the pile.

The axial load that acts on a pile subjected to lateral load usually has only a small effect on the bending moment; therefore, the assumption is made that the axial load is constant over the length of the pile being analyzed by COM624P. Any error resulting from that assumption is thought to be extremely small. In almost all instances the reduction in axial load from the groundline to the point of maximum bending moment will be negligible.

If the above assumption is valid, the behavior of a pile under axial load and under lateral load can be solved independently. However, in computing axial load of a pile in clay by use of soil properties, the engineer could decide to eliminate the clay from the first point of zero lateral deflection to the groundline in computing the axial load. The clay can be molded away by lateral deflection and lose at least some of its ability to transfer axial load.

STUDY OF INFLUENCE OF VARIOUS PARAMETERS

A number of suggestions have been made in previous sections about the desirability of varying certain parameters in the input and observing their influence. The engineer-user is urged to extend the procedure to most of the factors that must be input. The results of some such studies are given elsewhere (FHWA/RD-85/106, pp. 197-210) but the studies are more meaningful if done for local subsurface conditions and for the piles that are more commonly used in practice.

The parametric studies are especially useful with respect to the properties of the soil. An informative set of computations is to put the maximum and minimum values of soil strength that could be reasonably expected at a given site, and obtain upper-bound and lower-bound solutions. Such a study would give excellent guidance on the benefits of a comprehensive study of the subsurface conditions. In connection with the study of the influence of soil properties, the shear strength and other relevant properties should be varied with depth. Contrary to the need for piles under axial loading, the properties of the near-surface soils are very significant. Studies of this sort could lead to a change in the way that soils are sampled and tested when a pile under lateral loading is to be designed.

CASE STUDIES

An exercise that is of considerable use is to compare results from analysis with those for experiments. Some offices have a number of such cases in the engineering files and the technical literature contains a number of reports on lateral-load tests. One of the difficulties in making such comparisons is that the results of the experiments are frequently incomplete. Typical data that are missing are the point of application of the lateral load and the bending stiffness of the test pile.

Comparisons of the results from analysis and from experiments have been reported (FHWA/RD-85/106, pp. 211-244). Reference to these studies and to those made by the user-engineer will provide valuable information of the accuracy that can be expected from COM624P.

FIELD TESTS

Upper-bound and lower-bound studies and case studies will provide an excellent background for making a decision about the desirability of running a field test at the construction site. A full-scale test of the proposed production piles might be necessary at locations where a number of piles are to be installed and where the lateral loading is significant. Procedures for such tests are given in some standards; however, one feature in some such recommendations is inappropriate. That is, it is virtually impossible in most cases to provide the rotational restraint at the pile head that will exist in the structure to be constructed. Therefore, the testing program should be aimed at determining the response of the soil (FHWA, 1984, pp. 176-178) The response so obtained can be used to design piles of various diameters and with various bending stiffnesses.

A desirable testing technique is to test two identical piles simultaneously by jacking them apart or pulling them together (FHWA, 1984, pp. 169-175). The difference in the response of the two piles will give the engineer some idea of the amount of variability that could be expected with the production piles.

TECHNICAL ADVANCES

The engineer-user of COM624P may wish to search the new technical literature for articles on piles under lateral loading. Of particular interest will be articles that deal with the testing of fully instrumented piles to obtain p-y curves and articles on the response of pile groups to lateral loading. Research is underway in the United States and in many foreign countries on lateral loading of piles, and there undoubtedly will be a number of advances in the state-of-the-art from time to time.

COM624P
LATERALLY LOADED PILE ANALYSIS PROGRAM
FOR THE MICROCOMPUTER
Version 2.0

Part III: System Maintenance Manual

CHAPTER 1. GENERAL

The documentation for Computer Program COM624P consists of three documents: Part I, Users Guide; Part II Engineering Background; and Part III, Systems Maintenance.

The necessity of maintaining a computer program, regardless of its length and simplicity, is essential and procedures for the maintenance must be clear. Maintenance assures the user that the program is operating satisfactorily and that information can be obtained about the program when necessary. As a part of the maintenance, the user should be able to obtain a rapid response to questions as they arise.

The expected use of COM624P in the solution of problems in foundation engineering imposes some special requirements regarding the maintenance of the program. It is expected that copies of the program will be distributed to one or more offices of the departments of highways of the States, and possibly to other transportation agencies in the States. The components of the program to be distributed are the user guide, and floppy disks with an executable object code, example problems, and graphics capabilities. The object codes are to be permanently identified as being distributed to a particular engineering office.

The source code will remain at an appropriate office in the Federal Highway Administration where the maintenance of COM624P will reside. After the initial period when ENSOFT will maintain the program according to the terms of the contract, it is expected that FHWA will assign maintenance responsibilities to two persons: a geotechnical engineer, and a computer programmer. However, only minimal questions are expected to arise that must be answered.

The terms of the contract for Version I require that ENSOFT provide technical assistance for 18 months from the date the program was submitted to June of 1990. The principal activities related to the maintenance of COM624P were handled by ENSOFT during that period. It is expected that many of the users will receive Version 2.0 of the program and that FHWA staff, along with the assistance of Ensoft, will help to address most of the questions that are expected to arise from the users in 1993.

The USERS GUIDE was prepared in a manner to allow almost all of the questions that arise on the part of the user to be answered by referring to the document. In this connection, some of the material that might be normally placed in the SYSTEM MAINTENANCE MANUAL is included in the USERS GUIDE. The experience of ENSOFT with similar programs has led to the careful selection of material so that the user can use COM624P with assurance.

CHAPTER 2. SYSTEM DESCRIPTION

SYSTEM APPLICATION

The program computes deflection, shear, bending moment, and soil response with respect to depth for a laterally-loaded pile in nonlinear soils. There are three major components of this software for the microcomputer for the analysis of laterally-loaded piles. The system consists of a menu-input preprocessor (C624EDIT), a main program for the analyses (COM624P), and a postprocessor for display of graphics (C624VIEW). A flowchart showing the interrelationships of the major components of the system is provided in Fig. 2.1.

SYSTEM ENVIRONMENT

Hardware Requirements

The system was developed for the IBM-XT and the IBM-AT machines or for any other microcomputer that is compatible with those IBM machines. The microcomputer should have at least 256k of RAM memory. A high-speed, floating-point math coprocessor is highly recommended but it is not required.

Two peripheral devices are required for the display of graphics: a graphics adapter and a graphics printer. The specific graphics adapters and printers supported by the system are described in Chapter 3 of the USERS GUIDE.

Software Requirements

The operating system that is required to run the program is MS-DOS 2.1 or a later version. The main program is written in FORTRAN language with double-precision arithmetic. A FORTRAN

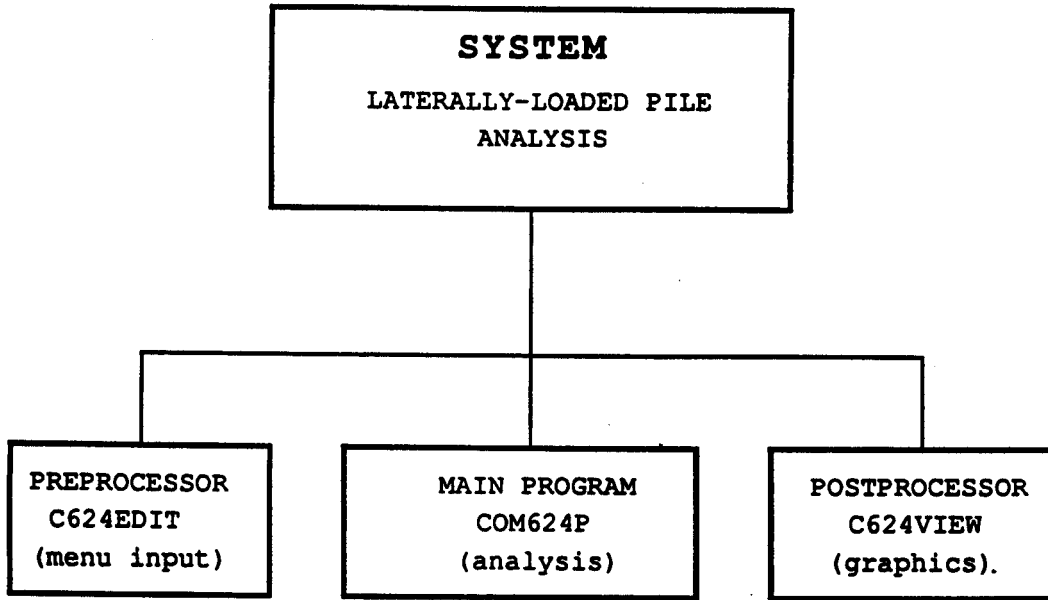

Figure 2.1. The interrelationships of the major components of the system.

compiler in compliance with ANSI FORTRAN 77 is required to compile the program if any modifications are made in the future.

The preprocessor and the postprocessor are written in PASCAL language to utilize fully the screen functions. A TURBO PASCAL compiler from Borland International should be used to recompile these two programs if any upgrade is required in the future.

COMMUNICATIONS

No requirements are necessary.

INTERFACES

No requirements are necessary.

SECURITY

No data base is included and no security is required. Security of the source code that is supplied should be maintained by FHWA.

COM624P
LATERALLY LOADED PILE ANALYSIS PROGRAM
FOR THE MICROCOMPUTER
Version 2.0

References

REFERENCES

- Allen, J. D., "p-y Curves in Layered Soils," Unpublished Dissertation, College of Engineering, The University of Texas at Austin, May, 1985.
- American Society for Testing and Materials, D3966-83, "Piles Under Lateral Load, Method of Testing," Annual Book of ASTM Standards.
- Bowman, E. R., "Investigation of the Lateral Resistance to Movement of a Plate in Cohesionless Soil," Unpublished Thesis, College of Engineering, The University of Texas at Austin, January, 1958
- Broms, B. B., "Design of Laterally Loaded Piles," Journal of the Soil Mechanics and Foundations Division, American Society of Civil Engineers, Vol. 91, No. SM3, May 1965, pp. 79-99.
- Broms, B. B., "Lateral Resistance of Piles in Cohesion Soils," Journal of the Soil Mechanics and Foundations Division, American Society of Civil Engineers, Vol. 90, No. SM2, March 1964a, pp. 27-63.
- Broms, B. B., "Lateral Resistance of Piles in Cohesionless Soils," Journal of the Soil Mechanics and Foundations Division, American Society of Civil Engineers, Vol. 90, No. SM3, May 1964b, pp. 123-156.
- Cox, W. R., L. C. Reese, and B. R. Grubbs, "Field Testing of Laterally Loaded Piles in Sand," Proceedings, Offshore Technology Conference, Paper No. 2079, Houston, Texas, May, 1974.
- Federal Highway Administration, "Handbook on Design of Piles and Drilled Shafts Under Lateral Load," Report No. FHWA-IP-84-11, July 1984, 360 pages.
- Federal Highway Administration, "Behavior of Piles and Pile Groups Under Lateral Loading," Report No. FHWA/RD-85/106, March 1986, 393 pages.
- Georgiadis, M., "Development of p-y Curves for Layered Soils," Proceedings, Geotechnical Practice in Offshore Engineering, American Society of Civil Engineers, April, 1983, pp. 536-545.

- Gleser, S. M., "Lateral Load Tests on Vertical Fixed-Head and Free-Head Piles," Symposium on Lateral Load Tests on Piles, ASTM Special Technical Publication No. 154, pp. 75-101.
- Hetenyi, M., Beams on Elastic Foundation, The University of Michigan Press, Ann Arbor, Michigan, 1946.
- Matlock, H., "Correlations for Design of Laterally Loaded Piles in Soft Clay," Paper No. OTC 1204, Proceedings, Second Annual Offshore Technology Conference, Houston, Texas, Vol. 1, 1970, pp. 577-594.
- Neukirchner, R. J., "Analysis of Laterally-Loaded Piles in Permafrost" Journal of Geotechnical Engineering Division, American Society of Civil Engineers, Vol. 113, No. 1, January, 1987, pp. 15-29.
- Neukirchner, R. J. and J. F. Nixon, "Behavior of Laterally-Loaded Piles in Permafrost," Journal of Geotechnical Engineering Division, American Society of Civil Engineers, Vol. 113, No. 1, January, 1987, pp. 1-14.
- Parker, F., Jr., and L. C. Reese, "Lateral Pile-Soil Interaction Curves for Sand," Proceedings, The International Symposium on the Engineering Properties of Sea-Floor Soils and Their Geophysical Identification, The University of Washington, Seattle, Washington, July, 1971.
- Peck, R. B., "Bearing Capacity and Settlement: Certainties and Uncertainties," Proceedings of a Symposium, Bearing Capacity and Settlement of Foundations, School of Engineering, Duke University, Durham, North Carolina, 1967, pp. 3-8.
- Reese, L. C., Discussion of "Soil Modulus for Laterally Loaded Piles," by Bramlette McClelland and John A. Focht, Jr., Transactions, American Society of Civil Engineers, Vol. 123, 1958, pp. 1071.
- Reese, L. C., "Behavior of Piles and Pile Groups Under Lateral Load," a manual prepared for U. S. Department of Transportation, Federal Highway Administration, Office of Research, Washington, D. C., 1983.
- Reese, L. C., W. R. Cox, and F. D. Koop, "Analysis of Laterally Loaded Piles in Sand," Paper No. OTC 2080, Proceedings, Fifth Annual Offshore Technology Conference, Houston, Texas, 1974 (GESA Report No. D-75-9).

- Reese, L. C., W. R. Cox, and F. D. Koop, "Field Testing and Analysis of Laterally Loaded Piles in Stiff Clay," Paper No. OTC 2312, Proceedings, Seventh Offshore Technology Conference, Houston, Texas, 1975.
- Reese, L. C. and K. J. Nyman, "Field Load Tests of Instrumented Drilled Shafts at Islamorada, Florida," a report to Girdler Foundation and Exploration Corporation, Clearwater, Florida, February, 1978.
- Reese, L. C. and R. C. Welch, "Lateral Loading of Deep Foundations in Stiff Clay," Journal of the Geotechnical Engineering Division, American Society of Civil Engineers, Vol. 101, No. GT7, Proceedings Paper 11456, 1975, pp. 633-649 (GESA Report No. D-74-10).
- Schmertmann, J. H., "Report on Development of a Keys Limerock Shear Test for Drilled Shaft Design," a report to Girdler Foundation and Exploration Company, Clearwater, Florida, December, 1977.
- Wang, S. and L. C. Reese, "The Effect of Nonlinear Flexural Rigidity on the Behavior of Concrete Piles under Lateral Load." Texas Civil Engineer, 58(5), 17-22, 1988.
- Welch, R. C. and L. C. Reese, "Lateral Loaded Behavior of Drilled Shafts," Research Report No. 3-5-65-99, conducted for Texas Highway Department and U.S. Department of Transportation, Federal Highway Administration, Bureau of Public Roads by Center for Highway Research, The University of Texas at Austin, May, 1972.

APPENDIX A
LINE-BY-LINE INPUT GUIDE FOR BATCH FILE

LINE-BY-LINE INPUT GUIDE FOR BATCH FILE

The free-field format is used for all the data entry. Each line can have a maximum of 80 characters. The variables can be separated by either a space or a comma. It is recommended that the user follow the line arrangement described later in entering the data.

1. Title Line

Number of lines: 1

Explanation:

Any characters, including blanks, are allowed in this descriptive title. However, do not type the word END in columns 1 through 3 as end is used to indicate the end of the data input.

2. Units and Computation Selection Line

Variables: ISYSTEM, NCOM, MEI

Number of lines: 1

Explanation:

ISYSTEM = 1 if English units of pounds and inches are to be used,
= 2 if SI units of kilonewtons and meters are to be used, and
= 3 if some other consistent set of units for force and length are to be used (the program will not try to determine which set of units is used but will indicate units on output by F for force and L for length, e.g., stress would be F/L^{**2}).

NCOM = 1 for analysis of piles under lateral loading,
= 2 for computation of ultimate bending moment,
= 3 for both analyses,

If NCOM = 1, omit input lines 21 to 26,
If NCOM = 2, omit input lines 3 through 20,

MEI = 0 for no internal variation of EI employed in computation,
= 1 for using the internal variation of EI generated by the program during computation, and
If NCOM = 1 or 2, set MEI = 0.

3. Input Control Line

Variables: NI, NL, NDIAM, NW

Number of lines: 1

Explanation:

- NI = number of increments into which the pile is divided (maximum is 300),
NL = number of layers of soil (maximum is 9),
NDIAM = number of segments of pile with different diameter, area, or moment of inertia (maximum is 10), and
NW = number of points on plot of distributed lateral load on the pile versus depth (minimum is 0, maximum is 10).

Set NW = 0 if there are no distributed loads on the pile.

4. Input Control Line

Variables: NG1, NSTR, NPY

Number of lines: 1

Explanation:

- NG1 = number of points on plot of effective unit weight versus depth (minimum = 2, maximum = 10),
NSTR = number of points on input curves of strength parameters (c , ϕ , ϵ_{50}) versus depth (minimum = 2, maximum = 10), and
NPY = number of input p-y curves (minimum = 0, maximum = 30).

Set NG1 = 0 and NSTR = 0 if all p-y curves are to be input by the user (if no p-y curves are to be generated internally).

5. Geometry Line

Variables: LENGTH, EPILE, XGS, SLOPE

Number of lines: 1

Explanation:

- LENGTH = length of pile (L),
EPILE = modulus of elasticity of pile (F/L^2),

XGS = depth below top of pile to ground surface (L), and
SLOPE = slope angle of ground surface to horizontal plane
(degrees).

6. Output Control Line

Variables: KPYOP, INC

Number of lines: 1

Explanation:

KPYOP = \emptyset if no p-y curves are to be generated and printed
for verification purposes,
= 1 if p-y curves are to be generated and printed
for verification (see 17 and 18 for input of depths
at which p-y curves will be generated and printed),
INC = increment used in printing output,
= 1 to print values at every node,
= 2 to print values at every second node, and
= 3 to print values at every third node,
etc. (up to NI + 1).

7. Analysis Control Line

Variables: KBC, KOUTPT, KCYCL, RCYCL

Number of lines: 1

Explanation:

KBC = code to control boundary condition at top of pile,
= 1 for a free head (user specifies shear P_t and
moment M_t at the pile head),
= 2 for specified shear P_t and slope S_t at the pile
head ($S_t = \emptyset$ for a fixed-head pile),
= 3 for a specified shear P_t and rotational restraint
 M_t/S_t at the pile head,
= 4 for a specified deflection y_t and moment at the
pile head,
KOUTPT = \emptyset if data are to be printed only to depth where
moment first changes sign,
= 1 if data are to be printed for full length of
pile,
= 2 for extra output to help with debugging,
KCYCL = \emptyset for cyclic loading,
= 1 for static loading, and
RCYCL = number of cycles of loading (need only for p-y
curves generated with criteria for stiff clay
above the water table).

8. Run Control Line

Variables: MAXIT, YTOL, EXDEFL

Number of lines: 1

Explanation:

MAXIT = maximum number of iterations allowed for analysis of single set of loads,
YTOL = tolerance (L) on solution convergence. When the maximum change in deflection at any node for successive iterations is less than YTOL, iteration stops, and
EXDEFL = value of deflection of pile head (L) that is considered grossly excessive and which stops the run.

9. Distributed Loads

Omit if NW = 0

Variables: XW(I), WW(I)

Number of lines: NW

Explanation:

XW = depth (L) below top of pile to a point where distributed load is specified, and
WW = distributed lateral load (F/L) on pile.

The program uses linear interpolation between points on the WW-XW curve to determine the distributed load at every node. For best results, points on the WW-XW curve should fall on the pile-node points. Wherever no distributed load is specified, it is assumed to be zero. Data must be arranged with ascending values of XW.

10. Pile Properties Line

Variables: XDIAM(I), DIAM(I), MINERT(I), AREA(I)

Number of lines: NDIAM

Explanation:

XDIAM = x-coordinate (depth below top of pile) of the top of a segment of pile with uniform cross-section (L). The first depth (XDIAM (1)) must equal 0.0,

DIAM = diameter of pile corresponding to XDAIM (L). For non-circular cross sections, use of minimum width will produce conservative results,
 MINERT = moment of inertia of pile cross sections (L^4), and
 AREA = cross-sectional area of pile (L^2). If left blank, program will compute area assuming a pipe section.

Data must be arranged with ascending values of XDAIM. Note that at a depth between XDIAM(I) and XDIAM(I + 1), the pile properties associated with XDIAM(I) will be used. For a pile with uniform cross section, just one pile property value is needed. The last value of XDIAM need not be greater than or equal to the length of pile.

11. Soil Profile Line

Variables: LAYER, KSOIL, XTOP, XBOT, K

Number of Lines: NL

Explanation:

LAYER(I) = Layer identification number (use 1 for the top layer, 2 for the second layer, etc.),
 KSOIL = code to control the type of p-y curves that will be used for L-th layer,
 = 1 to have p-y curves computed internally using Matlock's (1970) criteria for soft clay,
 = 2 to have p-y curves computed internally using Reese et al.'s (1975) criteria for stiff clay below the water table,
 = 3 to have p-y curves computed internally using Welch and Reese's (1972) criteria for stiff clay above the water table,
 = 4 to have p-y curves computed internally using Reese et al.'s (1974) criteria for sand,
 = 5 to use linear interpolation between input p-y curves,
 = 6 to have p-y curves computed internally using Reese and Nyman's (1978) limestone criteria,
 XTOP(I) = x-coordinate of top of layer (L),
 XBOT(I) = x-coordinate of bottom of layer (L), and
 K(I) = constant (F/L^3) in equation $E_s = kx$. This is used
 (1) to define initial soil moduli for the first iteration and (2) to determine initial slope of p-y curve where
 KSOIL = 2 and 4.

Arrange data in ascending order of LAYER(I).

12. Unit Weight Line

Variables: XG1(I), GAM1(I)

Number of lines: NG1

Explanation:

XG1 = depth below top of pile to point where effective unit weight of soil is specified (L), and
GAM1 = effective unit weight of soil (F/L^3) corresponding to XG1.

The first depth (XG1(1)) must not be greater than the x-coordinate of the ground surface and the last depth (XG1(NG1)) must not be less than the length of the pile. The program interpolates linearly between points on the XG1 - GAM1 curve to determine effective unit weight of soil at a particular depth. The data must be arranged with ascending values of XG1.

13. Strength Parameter Line

Omit this line if NSTR = 0.

Variables: XSTR(I), C1(I), PHI1(I), EE50(I)

Number of lines: NSTR

Explanation:

XSTR = x-coordinate (depth below top of pile) for which c, ϕ , and ϵ_{50} are specified (L),
C1 = undrained shear strength of soil (F/L^2) corresponding to XSTR,
PHI1 = angle of internal friction (ϕ , in degrees) corresponding to XSTR, and
EE50 = strain at 50 percent stress level (ϵ_{50} , dimensionless) corresponding to XSTR.

The program uses linear interpolation to find c, ϕ , and ϵ_{50} at points between input XSTR's. XSTR(1) should not be greater than the x-coordinate of the ground surface and XSTR(NSTR) should not be less than the length of the pile. Arrange data with ascending values of XSTR. For clay layers (KSOIL = 1, 2, 3, or 6), PHI1 will not be used and may be left blank. For sand layers (KSOIL = 4), C1 and EE50 are not used and may be left blank.

14. Control Line for Input of p-y Curves

Omit this line if NPY = 0

Number of lines: 1

Explanation:

NPPY = number of points on input p-y curves (minimum = 2, maximum = 30).

15. Line for Depth of p-y Curve

Omit this line if NPY = 0

Variables: XPY(I)

Number of lines: 1

Explanation:

XPY = x-coordinate (depth below top of pile) to an input p-y curve (L).

Data must be arranged in ascending order of XPY. Input XPY, then data to define the associated p-y curve (see next line), then the next XPY, etc.

16. Data Line for p-y Curve

Omit if NPY = 0

Number of lines: NPY * NPPY

Explanation:

YP = deflection (L) of a point on a p-y curve, and

PP = soil resistance (F/L corresponding to YP).

Data must be arranged in ascending order of YP. Sequence of input is as follows:

```
DO 30 I=1, NPY
  READ (5,10), XPY(I)
10  FORMAT (D10.3)
  READ (5,20), (YP(I,J), PP(I,J), J=1, NPPY)
20  FORMAT (2D10.3)
30  CONTINUE
```

The program interpolates linearly between points on a p-y curve and between p-y curves. The program uses the deepest p-y curve available for any nodes that extend below the depth of the deepest p-y curve.

17. Control Line for Output of Internally-Generated p-y Curves

Omit this line if KPYOP = 0

Variable: NN

Number of lines: 1

Explanation:

NN = number of depths for which internally-generated p-y curves are to be printed (maximum = 305).

Internally-generated p-y curves may be computed for selected depths and printed for verification purposes. In the analysis of pile response, a separate p-y curve is calculated at every node. Therefore, the number of p-y curves printed will have no effect on the solution.

18. Control Line for Depths at Which Internally-Generated p-y Curves are to be Printed

Omit this line if KPYOP = 0.

Number of lines: NN

Explanation:

XN = x - coordinate (L) at which internally-generated p-y curves are to be generated and printed.

19. Input of Number of Loading Conditions

Variables: LOAD

Number of lines: 1

Explanation:

Number of different loading conditions involved in one computer run (maximum = 20)

20. Line to Establish Loads on Pile Head

Variables: KOP, PT, BC2, PX

Number of lines: between 1 and 20

Explanation:

- KOP = 0 if only the pile head deflection, pile-head slope, maximum bending moment, and maximum combined stress are to be printed for the associated loads,
= 1 if complete output is desired for the associated loads,
- PT = lateral load (F) at top of pile if KBC = 1, 2, or 3,
lateral deflection (L) at top of pile if KBC = 4,
- BC2 = value of second boundary condition,
= moment (F-L) at top of pile if KBC = 1 or 4,
= slope (dimensionless) at top of pile if KBC = 2,
= rotational stiffness (F-L), or moment divided by slope, if KBC = 3, and
- PX = axial load (F) on pile (assumed to be uniform over whole length of pile).

21. Cross-Sectional Shape and Number of Axial Loads

Variables: ID, NP

Number of lines: 1

Explanation:

- ID = identification number of the shape of cross section of column/pile:
1. rectangular or square,
 2. circular (without shell or core),
 3. circular (with shell but without core),
 4. circular (with shell and core or without shell and core, and
 5. circular steel pipe.
- NP = number of axial loads.

22. Axial Loads

Variables: P(I)

Number of lines: NP

Explanation:

P = axial load (kN). The total number of axial loads per run is limited to 10

23. Material Strength Parameters

Variables: FC, BARFY, TUBEFY, ET

Number of lines: 1

Explanation:

FC = cylinder strength of concrete (kPa)
(Ø if ID is 5),
BARFY = yield strength of reinforcement (kPa)
(Ø if ID is 5),
TUBEFY = yield strength of shell or core (kPa)
(Ø if ID is 1 or 2), and
ET = modulus of elasticity of steel (kPa).

24. Cross-Sectional Dimension

Variables: WIDTH, OD, DT, T, TT

Number of lines: 1

Explanation:

WIDTH = width of section if rectangular (m)
(Ø if circular),
OD = outer diameter if circular, or depth of section if
rectangular (m),
DT = outer diameter of core (m)
(Ø if ID is not 4),
T = thickness of shell (m).
(Ø if ID is 1 or 2), and
TT = thickness of core (m)
(Ø if ID is not 4).

25. Rebar Arrangement

(Skip this line if ID is 5)

Variables: NSIZE, NBARS, NROWS, COVER

Number of lines: 1

Explanation:

NSIZE = size number of rebars proposed to use.
Enter number as 3, 4, 5, 6, 7,14,

NBARS = number of reinforcing bars,
NROWS = number of rows of reinforcing bars,
 (a number not exceeding 50), and,
COVER = cover of rebar, from center of rebar to outer edge
 of concrete (m).

26. Area of Reinforcing in a Row

(Skip this line if ID is >1)

Variables: XS(I), AS(I)

Number of lines: NP

Explanation:

XS(I) = distance of row from centroidal axis, starting
 from top row (m),

AS(I) = area of reinforcing in a row (m²),

AS(1) = if for the top row (m²), and

AS(2) = if for the second row from the top (m²), etc.

 The total number of values should not exceed 50.

Generally, rebars will be equally distributed in a circular cross section. If this is the case, the program will compute the required information internally, based on the data provided in the previous line. The user needs to input data only if the shape of the section is square or rectangular.

APPENDIX B

**DESIGN PROCEDURE FOR LATERALLY LOADED
DEEP FOUNDATIONS USING
COM624P VERSION 2**

by
Christopher Dumas, P. E.
Hydraulics & Geotech Branch
FHWA Headquarters Bridge Division



DESIGN PROCEDURE FOR LATERALLY LOADED DEEP FOUNDATIONS USING COM624P VERSION 2

The computer program COM624P is an excellent tool for designing laterally loaded deep foundations. However, currently, there is little guidance available in either the Users manual, or other publications, on its proper use as an analysis tool. A general procedure on the program's proper use was developed during the design review and analysis of the case study abutment foundation (Appendix C). This procedure is a synthesis of the FHWA manual "Handbook on Design of Piles and Drilled Shafts Under Lateral Loads," the COM624P Users Manual, and phone conversations with Dr. Shin Tower Wang of Ensoft. The method is flexible and may be modified to fit specific situations. The general procedure is broken into six major tasks:

- TASK I.** Identify the loading combinations to be analyzed and project serviceability criteria.
- TASK II.** Determine a preliminary shaft/pile size and foundation configuration.
- TASK III.** Based on ultimate moment capacity criteria, determine if the shaft/pile is structurally acceptable.
- TASK IV.** Determine if the shaft/pile is acceptable based on allowable service load deflection criteria.
- TASK V.** Determine minimum shaft/pile depth required for axial capacity.
- TASK VI.** Based on the analysis results from TASKS I through V, choose the final foundation configuration, shaft/pile diameter, and shaft/pile length.



TASK I: Identify the loading combinations to be analyzed.

Identify design loading requirements (axial, lateral and bending moments) and performance criteria for routine AASHTO loading combinations (Table 3.22.1A), and special design events such as ship impact and seismic loading. It is essential the foundation designer be positive as to whether the supplied combination loads are load factor design (LFD) values or service load values.

Each set of load combinations should be evaluated separately since combinations, load type (static, cyclic, or dynamic) and performance criteria (safety factor or deflection limit) will modify the loads used in the analysis and interpretations of the results. This is a critical step in overall design process. Inappropriate designs have resulted from designers applying incorrect load magnitudes, "piggybacking load combinations" (applying the largest axial, lateral and bending moments from different combinations simultaneously), and applying inappropriate performance criteria. This information should be supplied by the structural engineer.

- i. For each critical loading combination, determine the bending moments, lateral loads, and axial loads for analysis. Be careful to determine if the applied loads are Load Factor Design (LFD) values or are Service Load values.



TASK II: Determine a preliminary shaft/pile size and foundation configuration.

- i. Determine a preliminary foundation configuration using AASHTO¹ guidance on spacing and group reduction factors. The AASHTO guidelines are believed to be conservative, but currently there is insufficient evidence or implementation guidance for adopting other methods. Therefore, engineering judgment should be applied cautiously when considering any modification of the AASHTO reduction factors and spacing requirements.

TASK III: Based on ultimate moment capacity criteria, determine if the shaft/pile is structurally acceptable.

- i. Determine the ultimate shaft/pile loads:

Factor of Safety x Service Loads (bending moments, axial loads, and lateral loads) or the Load Factor Design values.
- ii. Determine a preliminary shaft/pile reinforcement configuration (Drilled Shafts Only).

¹AASHTO "Standard Specifications for Highway Bridges," 1992.



- iii. Determine the maximum applied bending moments (computed by COM624P subroutine of COM624P version 2 program) and maximum ultimate moment capacity (computed by the PMEIX subroutine of COM624P version 2 program) for both a free head condition (KBC=1) and a fixed head condition (KBC=2). The designer may analyze only one pile head condition if they are confident the pile head is 100% free or 100% fixed. In most cases, it is recommended the designer start with a free head condition and then perform a fixed head analysis. This will provide the designer with a maximum and minimum range of deflections and moments.
- ⊗ For both the free head and fixed head conditions, execute COM624P version 2 using the ultimate axial loads from step i in both the "Data for Loading" submenu of the "Analysis" menu, and "Axial loads" submenu of the "Mult" menu. Do not input design loads in the "Data for Loading" submenu. The axial loads must match. The shaft/pile should be as long as possible for the given soils information.
- iv. Determine if the shaft/pile is acceptable based on ultimate moment capacity criteria. For both the free head and fixed head conditions, perform the following:
- ⊗ Review the text and graphical output. For the ultimate axial load input in step iii, compare the computed maximum applied bending moment (COM624P subroutine) in the shaft/pile and the maximum ultimate moment capacity (PMEIX ultimate capacity subroutine) of the shaft/pile.



- ⊗ If the computed maximum bending moment in the shaft/pile is larger than the maximum ultimate moment capacity of the shaft/pile, then either: a) modify the reinforcement (shafts only); or b) increase the shaft/pile diameter and return to Task II.
 - ⊗ If no run time error messages flash on the screen and the program terminates without generating complete graphical or text output, the computed deflections are excessive and the program was terminated. Increase the shaft/pile diameter and return to TASK II.
-

TASK IV: Determine if the shaft/pile is acceptable based on allowable service load deflection criteria.

- i. Determine the maximum shaft/pile deflection for a free head condition ($KBC=1$). The designer may skip to step iv for a 100% fixed head condition.
 - ⊗ Execute COM624P version 2 using the internal-generated cracked/uncracked EI option in the "Computational control" submenu of the "Analysis" menu. Use the service load axial values in both the "Data for Loading" submenu of the "Analysis" menu, and the "Axial loads" submenu of the "Mult" menu. The axial loads must match. Again, make the shaft/pile as long as possible for the given soils information.
- ii. Determine if shaft/pile is acceptable based on free head deflection criteria.



- ⊗ Review the graphics results (Graphics Menu) and text output to determine the maximum deflection. Based on the designer estimate of shaft/pile head fixity, determine if the deflections are acceptable. For example, if a shaft/pile has a computed maximum free head deflection of 1½ inches and a maximum allowable deflection is 1 inch, the following decisions could be made based on the estimated shaft/pile head fixity:
 - ◆ *Designer estimate of 0% shaft/pile head fixity.*

1 ½ inches of deflection. No good. Increase the shaft/pile diameter and return to TASK II.
 - ◆ *Design assumption of a 50% shaft/pile head fixity.*

Continue analysis.
- iii. Determine preliminary maximum shaft/pile depth.
 - ⊗ Review graphical plot of shaft/pile moment versus depth. Locate the depth where the moment plot crosses the zero moment line for the second time (second point of contraflexure). This depth will negate the influence of depth on the shaft/pile deflection and is therefore a good first estimate of minimum depth. The depth can be refined later after the minimum shaft/pile size, foundation configuration, and minimum depth for axial capacity have been determined.
- iv. Repeat steps i through iii for a fixed shaft/pile head condition (KBC=2). The designer may skip this step for a 100% free head condition.



- v. Determine if shaft/pile is acceptable based on the range of deflections (free head and fixed head).
- ⊗ Based on the designer estimate of shaft/pile head fixity, determine if the deflections are acceptable. For example, a shaft/pile has a computed free head deflection of 2 inches, a computed fixed deflection of 1/2 inch, and maximum allowable deflection of 1 inch. The following decisions could be made based on the estimated shaft/pile head fixity:
 - ◆ *Designer estimate of 25% shaft/pile head fixity*

No good. Increase the shaft/pile diameter and return to TASK II.
 - ◆ *Designer estimate of 50% shaft/pile head fixity*

Marginal. Depending on the designers confidence in the soils data, Continue analyses or increase the shaft/pile diameter and return to TASK II.
 - ◆ *Designer estimate of 75% (or higher) shaft/pile head fixity.*

Continue analysis.

TASK V: Determine minimum shaft/pile depth required for axial capacity.

- ⊗ If large lateral deflections are expected, use the COM624P deflection plot to determine the portion of the top of the shaft/pile where skin resistance should be ignored.



TASK VI: Based on the analysis results from TASK I through V above, choose the final foundation configuration and shaft/pile diameter.

i. Determine final shaft/pile depth.

- ⊗ If the minimum depth required for axial capacity is less than the depth determined in TASK IV, the final shaft/pile depth could be refined.

Repeat TASK IV with shorter shaft/pile lengths. The COM624P manual recommends the shaft/pile extend at a minimum to the depth where the deflection plot crosses the zero line a second time. If this results in unacceptable deflection, try again with the shaft/pile five feet deeper. Repeat until an optimum depth is found.

ii. Determine the final foundation configuration.

APPENDIX C

**DESIGN OF DRILLED SHAFTS FOR LATERAL LOADS
USING COM624P VERSION 2**

**ABUTMENT FOUNDATION DESIGN
A CASE STUDY EXAMPLE**

Presented to the Eighteenth Northwest Geotechnical Workshop
Rapid City South Dakota on September 18, 1992

by

Christopher Dumas, P. E.
Hydraulics & Geotech Branch
FHWA Headquarters Bridge Division



**DESIGN OF DRILLED SHAFTS FOR
LATERAL LOADS USING
COM624P VERSION 2**

ABUTMENT FOUNDATION DESIGN

A CASE STUDY EXAMPLE

Presented to the Eighteenth Northwest Geotechnical Workshop
Rapid City South Dakota on September 18, 1992

by

Christopher Dumas, P.E.
Hydraulics & Geotech Branch
FHWA Headquarters Bridge Division



USING COM624P VERSION 2 AS A DESIGN TOOL

ABUTMENT FOUNDATION DESIGN

A CASE STUDY EXAMPLE

The computer program COM624P is an excellent tool for designing laterally loaded deep foundations. However, currently, there is little guidance available in either the Users manual, or other publications, on its proper use as an analysis tool. A general procedure on the program's proper use was developed during the design review and analysis of the case study abutment foundation. This procedure is a synthesis of the FHWA manual "Handbook on Design of Piles and Drilled Shafts Under Lateral Loads," the COM624P Users Manual, and phone conversations with Dr. Shin Tower Wang of Ensoft. The method is flexible and may be modified to fit specific situations.

The general procedure is broken into six major tasks:

- TASK I. Identify the loading combinations to be analyzed and project serviceability criteria.
 - TASK II. Determine a preliminary shaft/pile size and foundation configuration.
 - TASK III. Based on ultimate moment capacity criteria, determine if the shaft/pile is structurally acceptable.
 - TASK IV. Determine if the shaft/pile is acceptable based on allowable service load deflection criteria.
 - TASK V. Determine minimum shaft/pile depth required for axial capacity.
 - TASK VI. Based on the analysis results from TASK I through V, choose the final foundation configuration, shaft/pile diameter, and shaft/pile length.
-
-



TASK I: Identify the loading combinations to be analyzed.

The submitted abutment design section and loads are shown below in Figure 1.

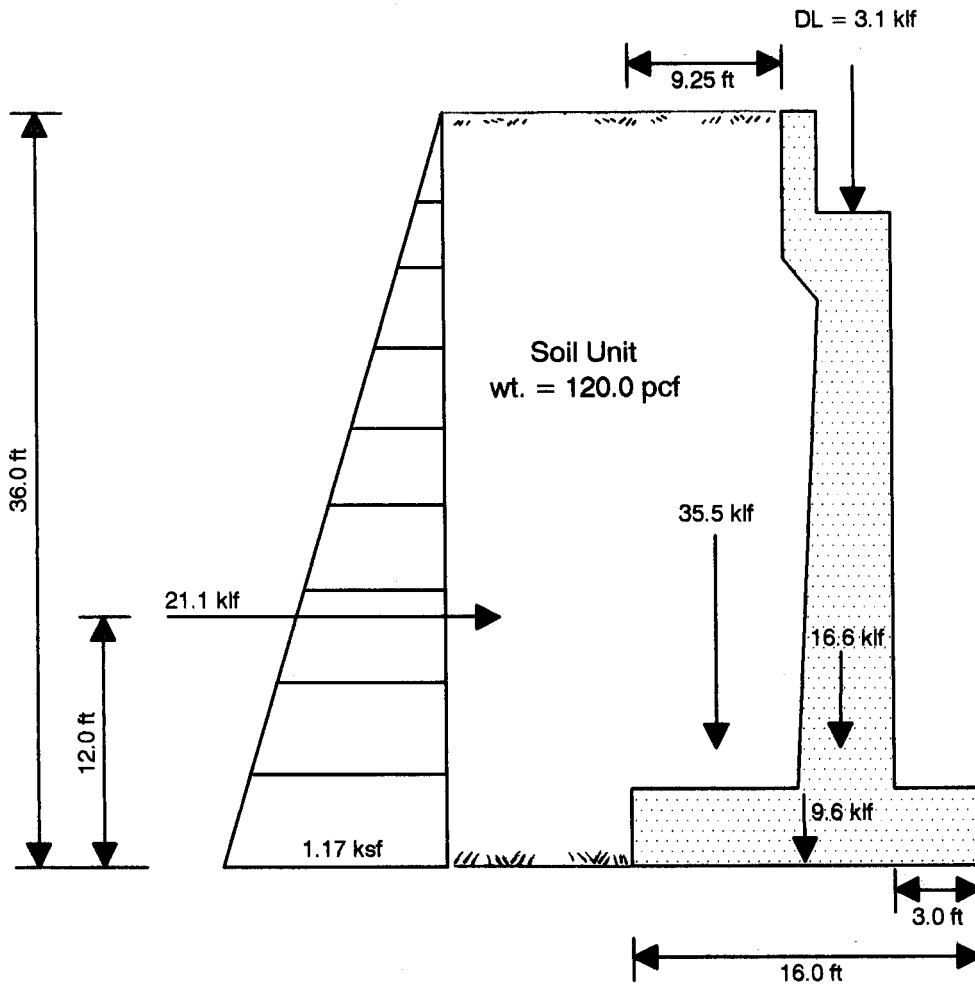

$$\sum P_{D.L.} = 64.8 \text{ klf}$$

$$\sum L_{D.L.} = 21.1 \text{ klf}$$

Figure 1 - Submitted Design Section and Applied Loads.



TASK II: Determine a preliminary shaft/pile size and foundation configuration.

The submitted foundation configuration is shown below in Figure 2.

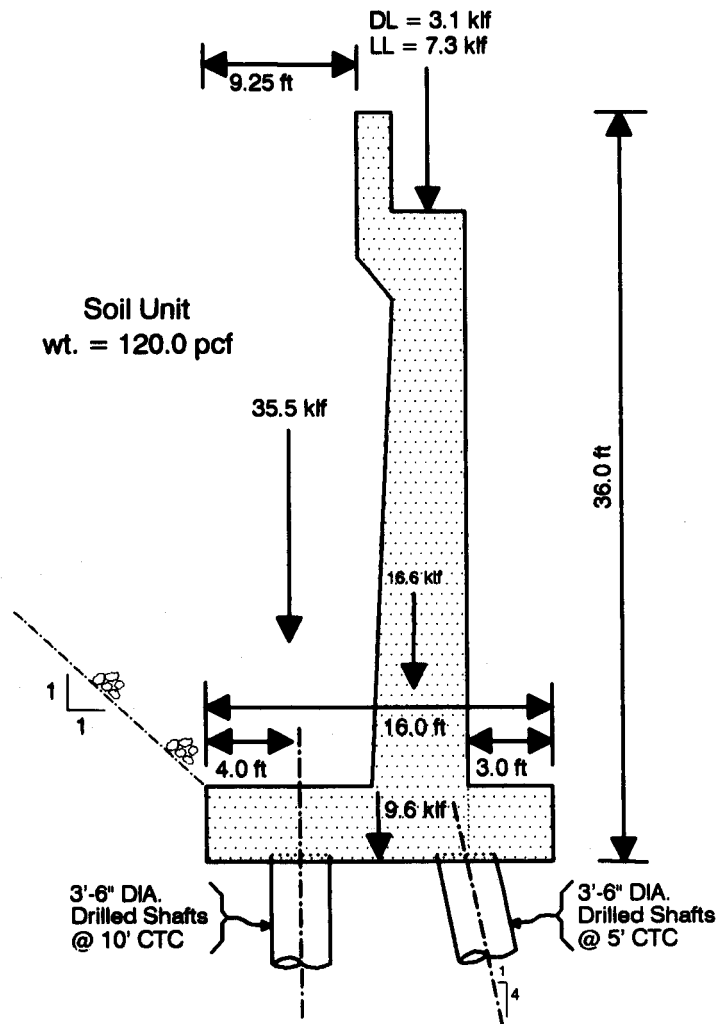

Figure 2 - Submitted Foundation Configuration.



- i. Determine a preliminary foundation configuration using AASHTO guidance on shaft spacing and group reduction factors. The AASHTO guidelines are generally considered conservative, but currently there is insufficient verification of how to apply other methods. Therefore, engineering judgment should be applied cautiously when modifying the AASHTO pile reduction factors and spacing requirements.

A.A.S.H.T.O "STANDARD SPECIFICATIONS FOR HIGHWAY BRIDGES," 1992

4.6.1.6 BATTER SHAFTS

"The use of battered shafts to increase the lateral capacity of foundations is not recommended due to their difficulty of construction and high cost. Instead, consideration should first be given to increasing the shaft diameter to obtain the required lateral capacity."

4.6.5.6.1.4 GROUP ACTION

Minimum center-to-center (CTC) shaft spacing of 2.5 diameters in the direction normal to the lateral load.

AASHTO GENERAL GUIDE FOR THE EFFECTS OF GROUP ACTION FOR IN-LINE LOADING CTC < 8B (NON-DISPLACEMENT PILING)

CTC Shaft Spacing for In-line Loading	Ratio of Lateral Resistance of Shaft in Group to Single Shaft
8B 8 x 3.5' = 28'	1.00
6B 6 x 3.5' = 21'	0.70
4B 4 x 3.5' = 14'	0.40
3B 3 x 3.5' = 10.5'	0.25

Based on this AASHTO criteria, the submitted in-line of loading shaft spacing (Figure 2) of 2.0B (7'CTC, 3.5' clear) reduces the lateral resistance of the back row to nearly zero. In addition, the front row spacing of 1.4B (5' CTC) does not comply with the AASHTO minimum guide of 2.5B. Therefore, the submitted spacing configuration is not acceptable.

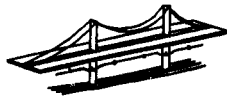

TRY A SINGLE ROW OF 3.5'Ø SHAFTS WITH A CTC SPACING OF 2.5B (9') WITH THE SHAFT ROW & AT THE VERTICAL FORCE RESULTANT (NO MOMENT AT THE PILE HEAD).

TASK III: Based on ultimate moment capacity criteria, determine if the shaft/pile is structurally acceptable.

i. Determine the ultimate shaft/pile loads:

Factor of Safety x Service Loads (bending moments, axial loads, and lateral loads) or the Load Factor Design Values.

Single row of 3.5'Ø shafts with a CTC spacing of 2.5B (9') and F.S.= 2.0

$$P = (64.8 \text{ klf} * 9') * (2.0) = 1,160 \text{ kips}$$

$$L = (21.1 \text{ klf} * 9') * (2.0) = 380 \text{ kips}$$

ii. Determine a preliminary shaft/pile reinforcement configuration (Drilled Shafts Only).

$$f'c = 4,000 \text{ psi} \quad 14\text{-}\#9 \text{ bars}$$

iii. Determine the maximum applied bending moments (computed by the main subroutine of COM624P version 2 program) and maximum ultimate moment capacity (computed by the PMEIX subroutine of COM624P version 2 program) for both a free head condition (KBC=1) and a fixed head condition (KBC=2). The designer may analyze only one pile head condition if they are confident the pile head is 100% free or 100% fixed. In most cases, it is recommended the designer start with a free head condition and then

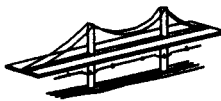

perform a fixed head analysis. This will provide the designer with a maximum and minimum range of deflections and moments.

- * For both the free head and fixed head conditions, execute COM624P version 2 using the ultimate loads from step 3 in both the "Data for Loading" submenu of the "Analysis" menu, and "Axial loads" submenu of the "Mult" menu. Do not input design loads (service loads) in the "Data for Loading" submenu. The axial loads must be the same. To negate the effects of shaft length on deflection and moment magnitudes, the shaft/pile should be as long as possible for the given soils information.

The case study soil stratigraphy is shown in Figure 3.

- iv. Determine if the shaft/pile is acceptable based on ultimate moment capacity criteria. For both the free head and fixed head conditions, perform the following:
 - * Review the text and graphical output. For the ultimate axial load input in step iii, compare the computed maximum applied bending moment (COM624P subroutine) in the shaft/pile and the maximum ultimate moment capacity (PMEIX ultimate capacity subroutine) of the shaft/pile.
 - * If the computed maximum bending moment in the shaft/pile is larger than the maximum ultimate moment capacity of the shaft/pile, then either: a) modify the reinforcement (shafts only); or b) increase the shaft/pile diameter and return to Task II.
 - * If no run time error messages flash on the screen and the program terminates without generating complete graphical or text output, the computed deflections are excessive and the program was terminated. Increase the shaft/pile diameter and return to TASK II.

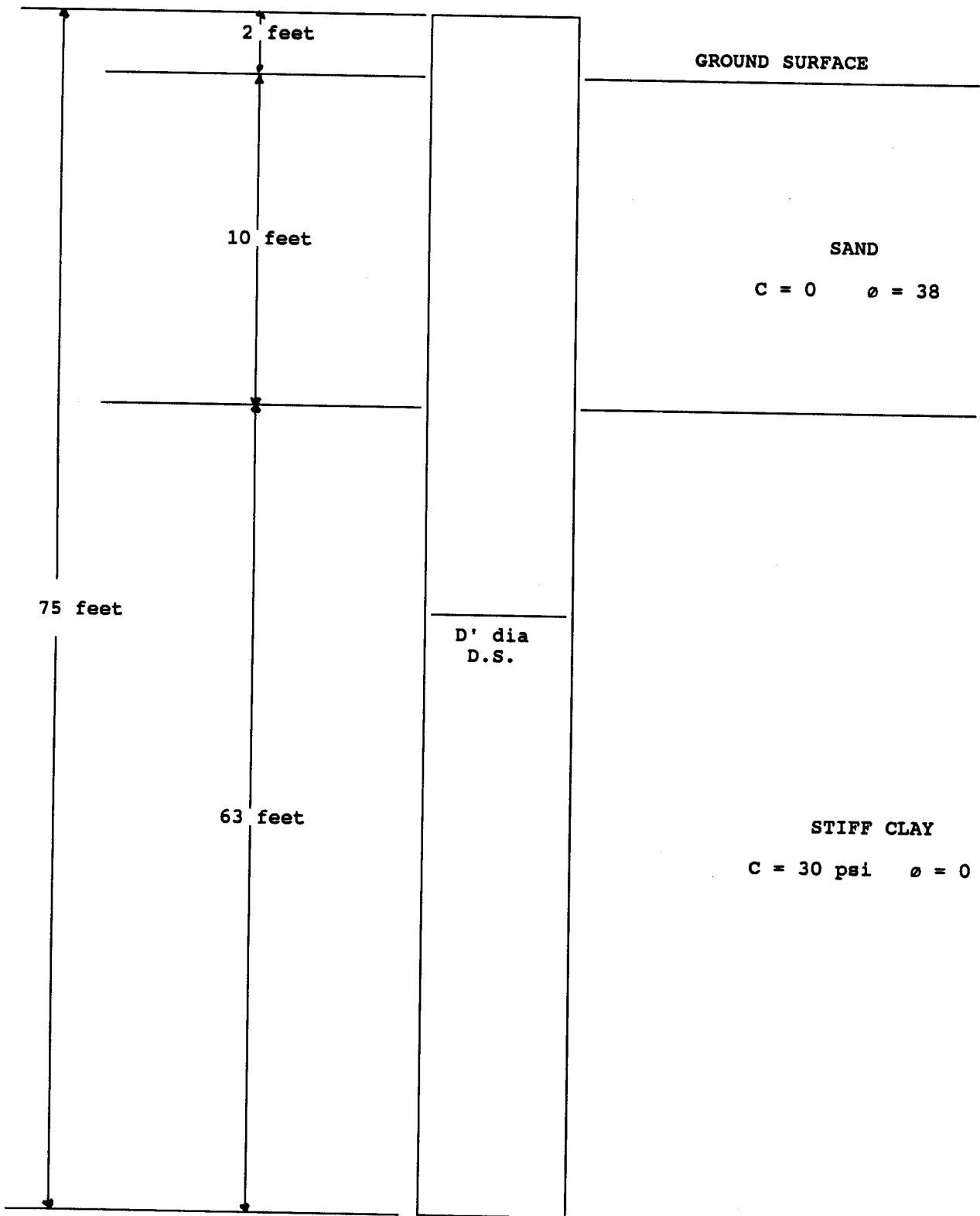

Figure 3 - Case Study Soil Stratigraphy



CHECK FREE HEAD CONDITION

COM624P VERSION 2 - RUN #1

**BRIDGE ABUTMENT - 42 INCH DIA SHAFTS @ 9' CTC
FREE HEAD CONDITION AND FULL GROSS SECTION
ULTIMATE LOADING (F.S.= 2)**

Maximum Bending Moment computed by the main program of COM624P version 2 program = 44,700 k-in.

Plots of computed deflections and moments versus depth are shown in Figures 4 & 5 respectively.

Maximum Ultimate Bending Moment Capacity computed by the PMEIX subroutine of COM624P version 2 = 25,100 k-in

PMEIX computed Interaction Diagram is shown in Figure 6.

44,700 k-in \gg 25,100 k-in **NO GOOD. RETURN TO TASK II**

NOTE: "Full Gross Section" refers to the Shaft EI value used in this COM624P run - E.I. for a full uncracked section. Since this will not allow the shaft to crack, the results will be conservative (larger moments).

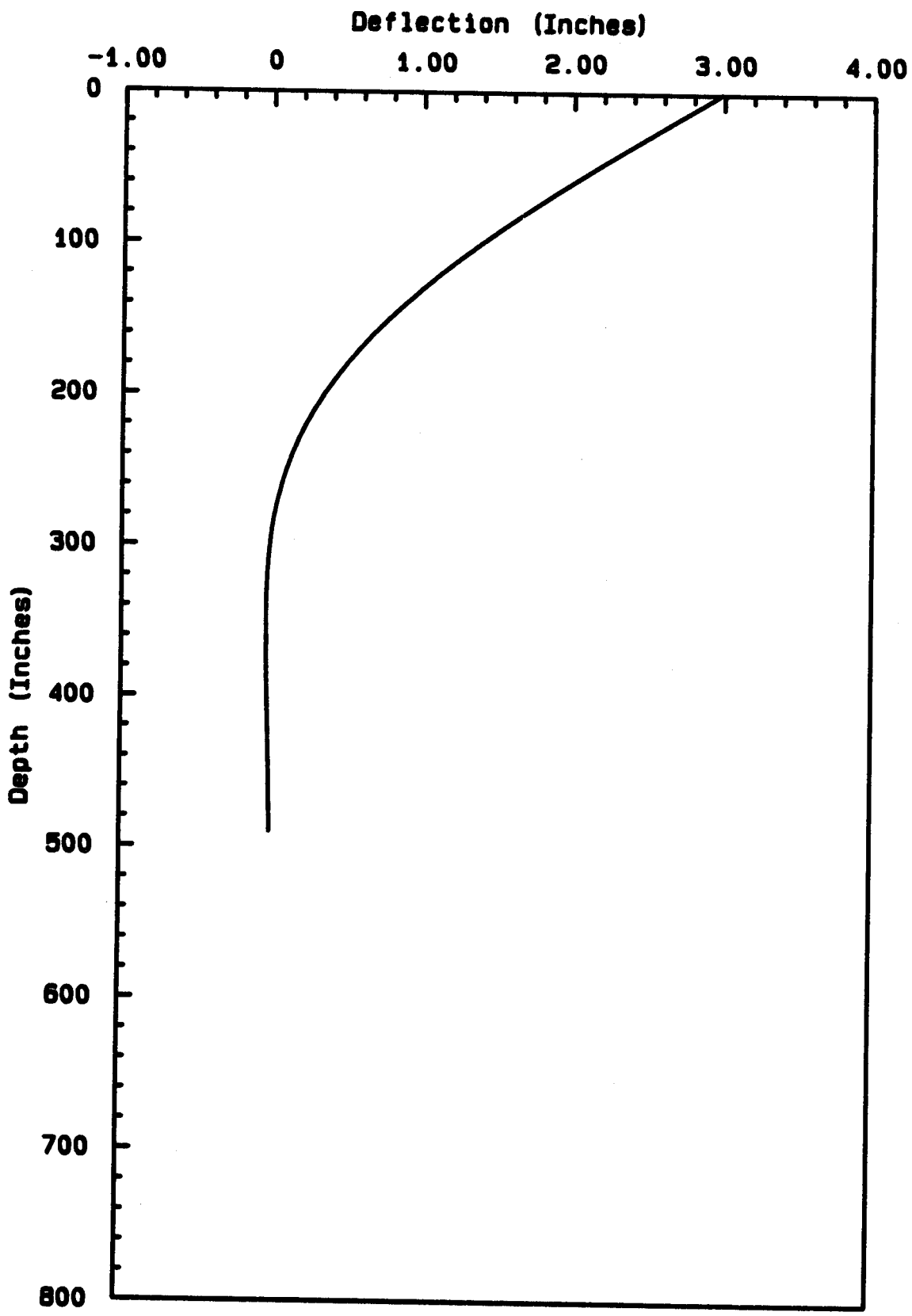

Figure 4 - COM624P computed deflection versus depth for a 42" diameter shaft with ultimate loads and free head condition.

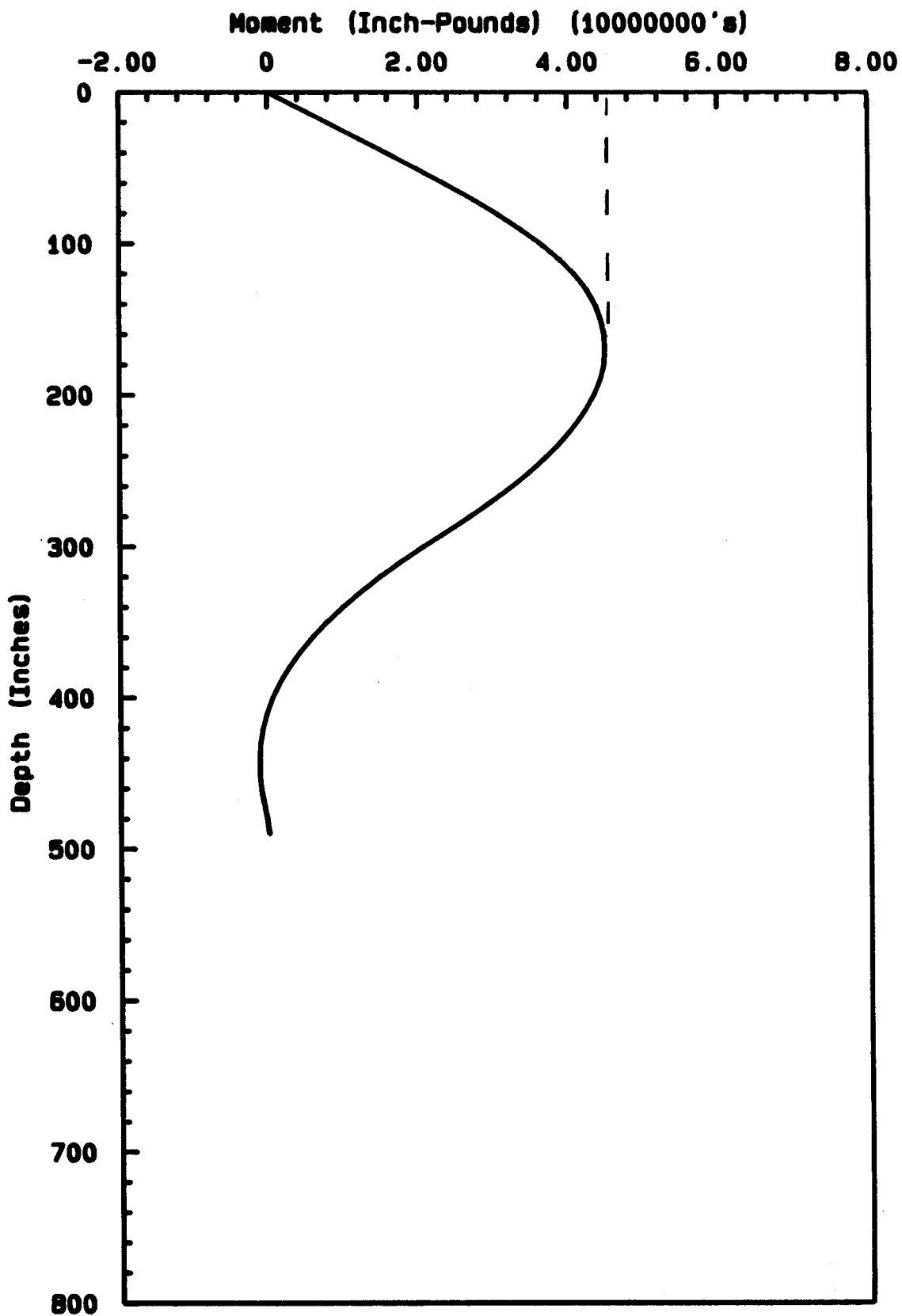

Figure 5 - COM624P computed moment versus depth for a 42" diameter shaft with ultimate loads and free head condition.

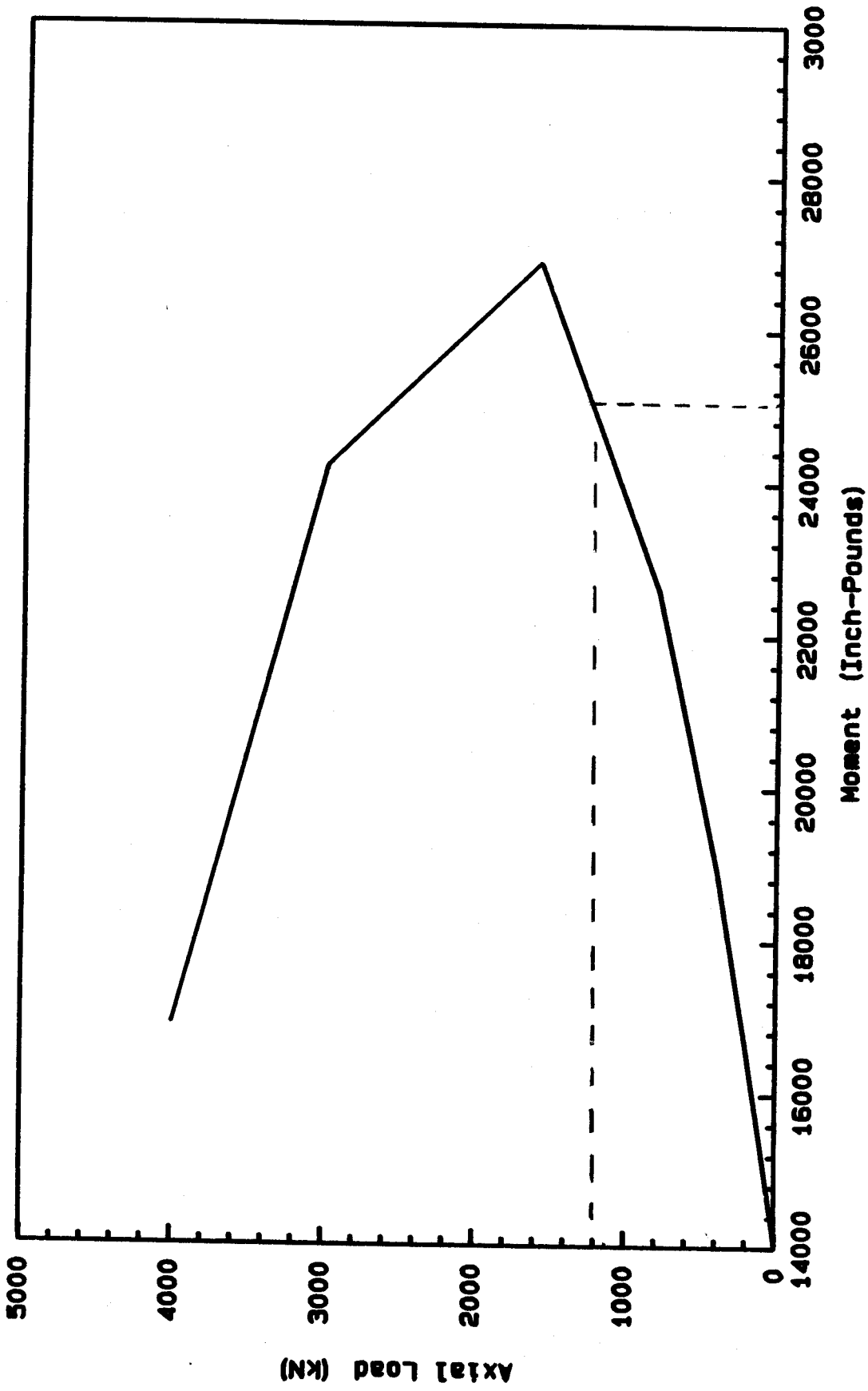

Figure 6 - PMEIX computed Interaction Diagram for a 42" diameter shaft with an ultimate axial load of 1,160 kips



**TRY SINGLE ROW OF 5' Ø SHAFTS
CENTERLINE ON THE VERTICAL FORCE RESULTANT (NO MOMENT AT THE PILE HEAD)
AND SPACED AT 12' CTC (2.5B).**

Check the ultimate capacity (F.S. = 2)

$$P = (64.8 \text{ klf} * 12') \times (2.0) = 1,560 \text{ kips}$$

$$L = (21.1 \text{ klf} * 12') \times (2.0) = 506 \text{ kips}$$

$$f'c = 4,000 \text{ psi} \quad 28\text{-}\#10 \text{ bars}$$

CHECK FREE HEAD CONDITION

COM624P VERSION 2 - RUN #2
**BRIDGE ABUTMENT - 60" DIA SHAFTS @ 12' CTC
FREE HEAD CONDITION AND FULL GROSS SECTION
ULTIMATE LOADING (F.S. = 2)**

Maximum Bending Moment computed by the main program of COM624P version 2 program = 65,300 k-in.

Plots of computed deflections and moments versus depth are shown in Figures 7 & 8 respectively.

Maximum Ultimate Bending Moment Capacity computed by the PMEIX subroutine of COM624P version 2 = 74,000 k-in

PMEIX computed Interaction Diagram is shown in Figure 9.

65,300 k-in < 74,000 k-in OK ✓

NOTE: "Full Gross Section" refers to the Shaft EI value used in this COM624P run - E.I. for a full uncracked section.

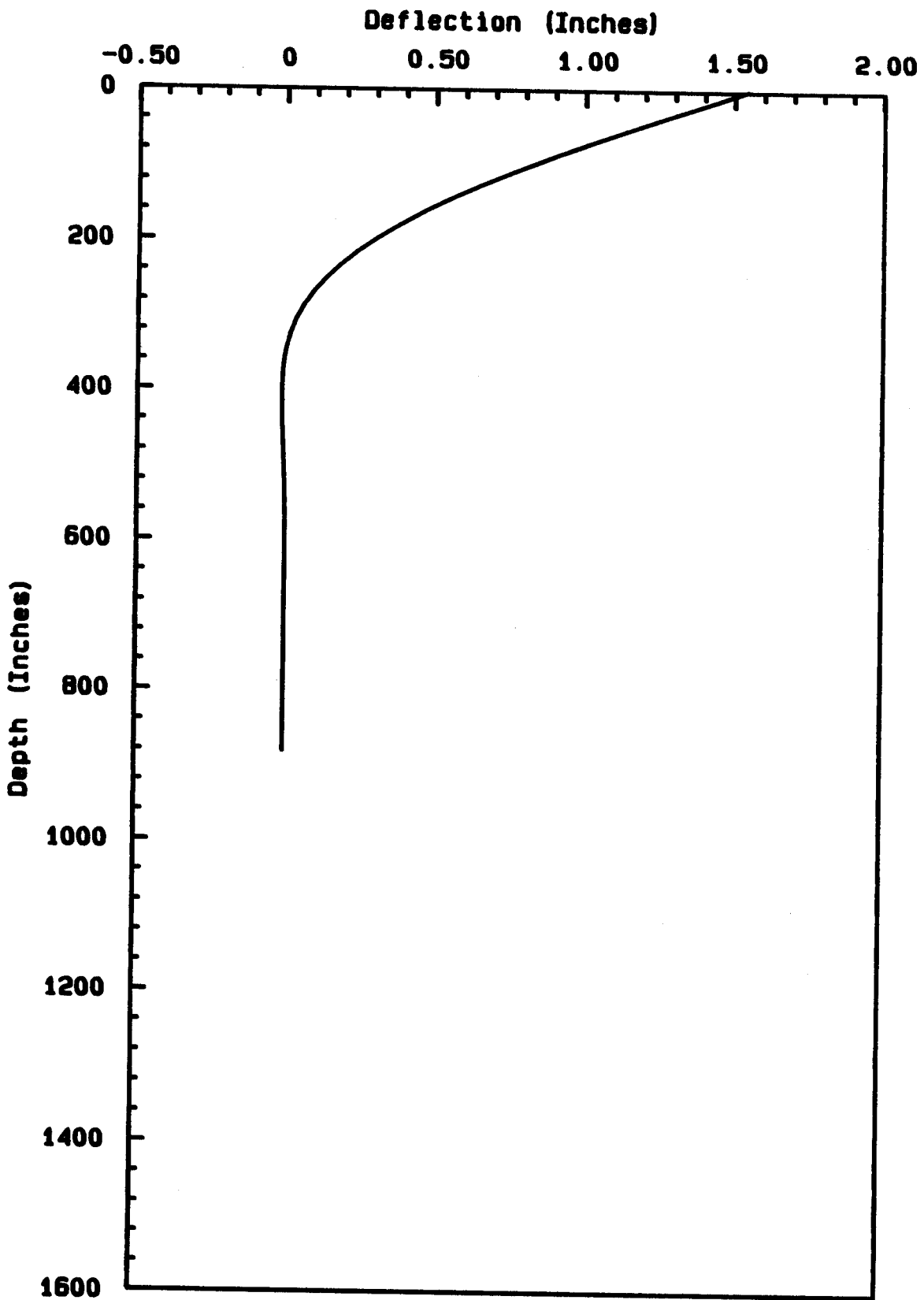

Figure 7 - COM624P computed deflection versus depth for a 60" diameter shaft with ultimate loads and free head condition.

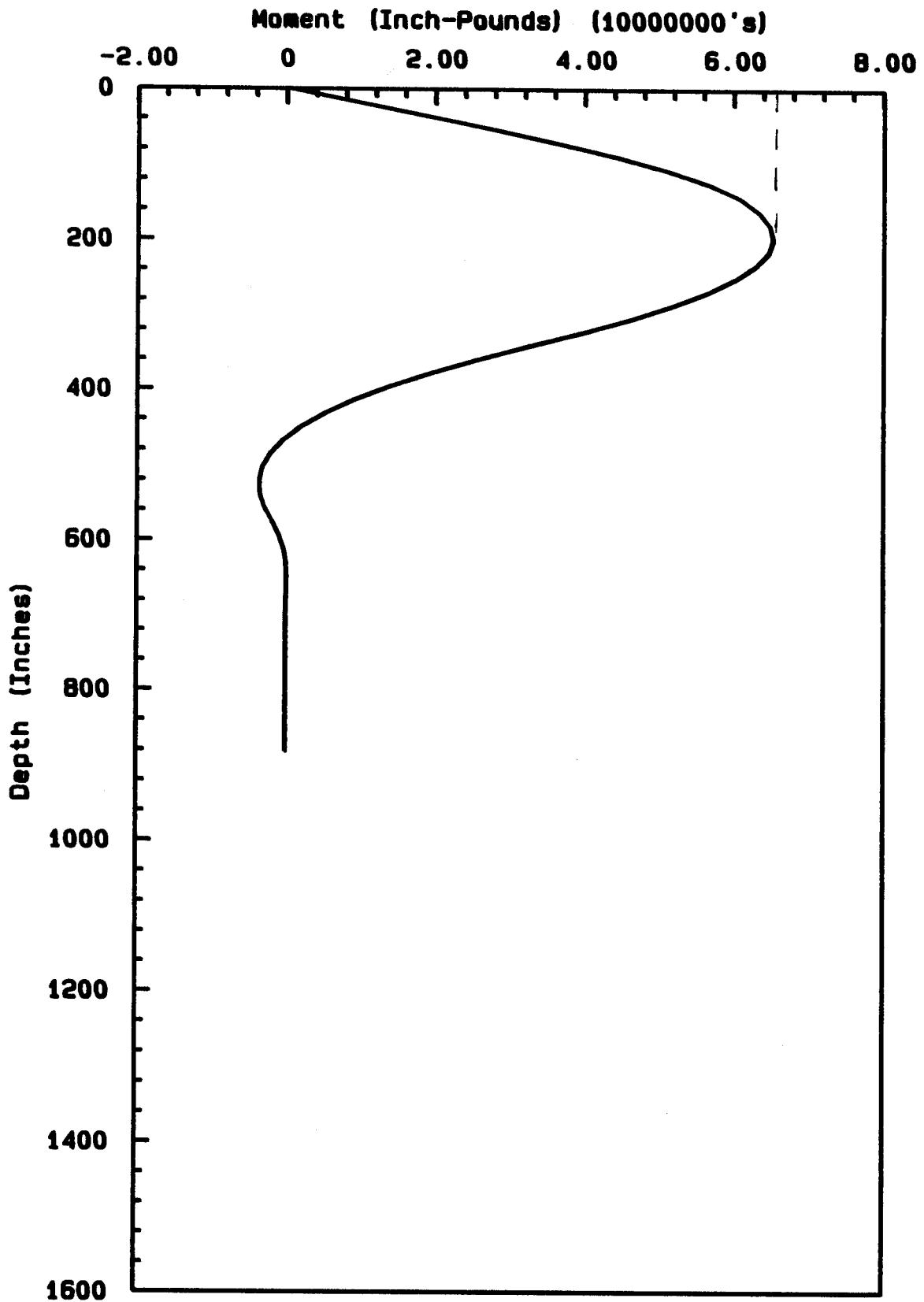

Figure 8 - COM624P computed moment versus depth for a 60" diameter shaft with ultimate loads and free head condition.

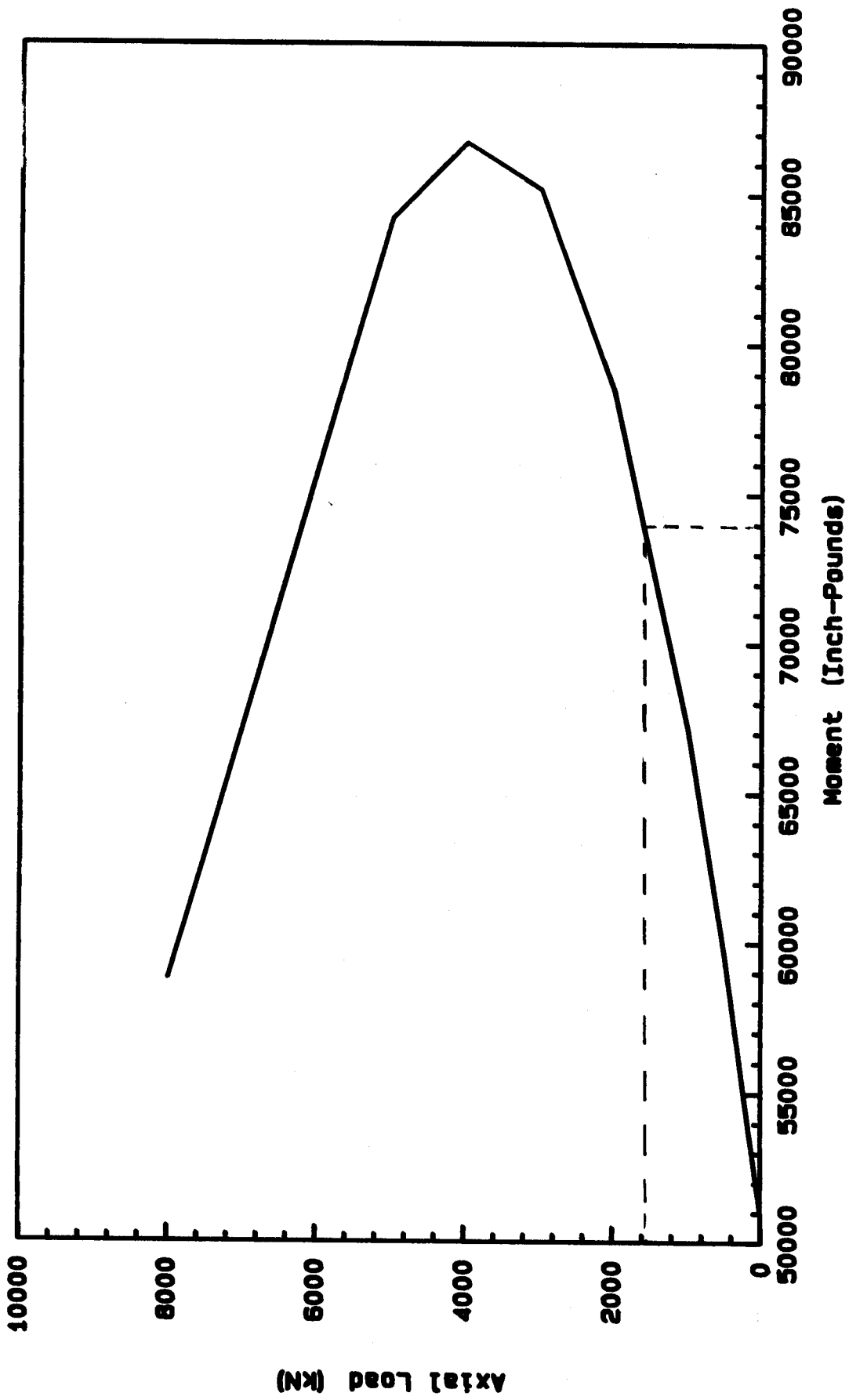

Figure 9 - PMEIX computed Interaction Diagram for a 60" diameter shaft with an ultimate axial load of 1,560 kips



CHECK FIXED HEAD CONDITION

COM624P VERSION 2 - RUN #3
BRIDGE ABUTMENT - 60" DIA SHAFTS @ 12' CTC
FIXED HEAD CONDITION AND FULL GROSS SECTION
ULTIMATE LOADING (F.S. = 2)

Maximum Bending Moment computed by the main program of COM624P version 2 program = 59,000 k-in.

59,000 k-in < 74,000 k-in OK ✓

TASK IV: Determine if the shaft/pile is acceptable based on allowable service load deflection criteria.

- i. Determine the maximum shaft/pile deflection for a free head condition (KBC=1). The designer may skip to step iv for a 100% fixed head condition.
- * Execute COM624P version 2 using the internally generated cracked/uncracked EI option in the "Computational control" submenu of the "Analysis" menu. Use the service load values in both the "Data for Loading" submenu of the "Analysis" menu, and the "Axial loads" submenu of the "Mult" menu. The axial loads must be the same. Again, make the shaft/pile as long as possible for the given soils information.

NOTE: internally generated cracked/uncracked EI option refers to the automatic variation of EI with stress along the shaft length. When stresses are high, the shaft cracks, deflections increase, and stresses migrate downward. Therefore, this option provides superior pile-soil interaction modeling and computed deflection magnitudes.



Service Loads

$$P = (64.8 \text{ klf} * 12') = 778 \text{ kips}$$
$$L = (21.13 \text{ klf} * 12') = 253 \text{ kips}$$
$$f'c = 4,000 \text{ psi} \quad 28\text{-}\#10 \text{ bars}$$

CHECK FREE HEAD CONDITION

COM624P VERSION 2 - RUN #4

BRIDGE ABUTMENT - 60 INCH DIA SHAFTS @ 12' CTC

FREE HEAD CONDITION AND CRACKED SECTION

SERVICE LOADS

Maximum pile head deflection calculated by the main program of COM624P version 2 = 0.667 inch

Plots of computed deflections and moments versus depth are shown in Figures 10 & 11 respectively.

ii. Determine if shaft/pile is acceptable based on free head deflection criteria.

- * Review the graphics results (Graphics Menu) and text output to determine the maximum deflection. Based on the designer estimate of shaft/pile head fixity, determine if the deflections are acceptable.

MAXIMUM PILE HEAD DEFLECTION w/FREE HEAD = 0.667 INCH

0.677 INCH < 1.0 INCH MAXIMUM ALLOWABLE - OK ✓

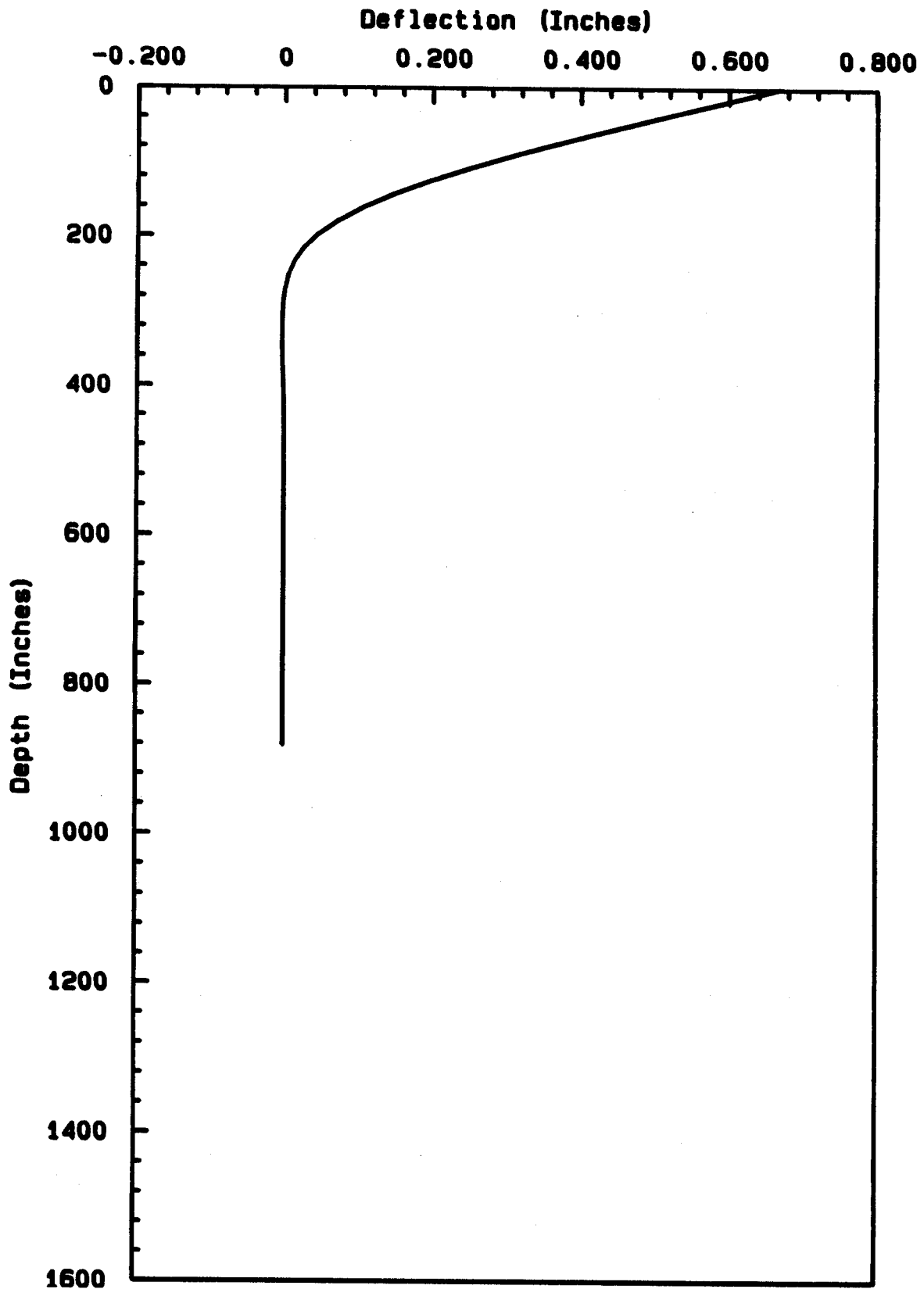

Figure 10 - COM624P computed deflection versus depth for a 60" diameter shaft with service loads and free head condition.

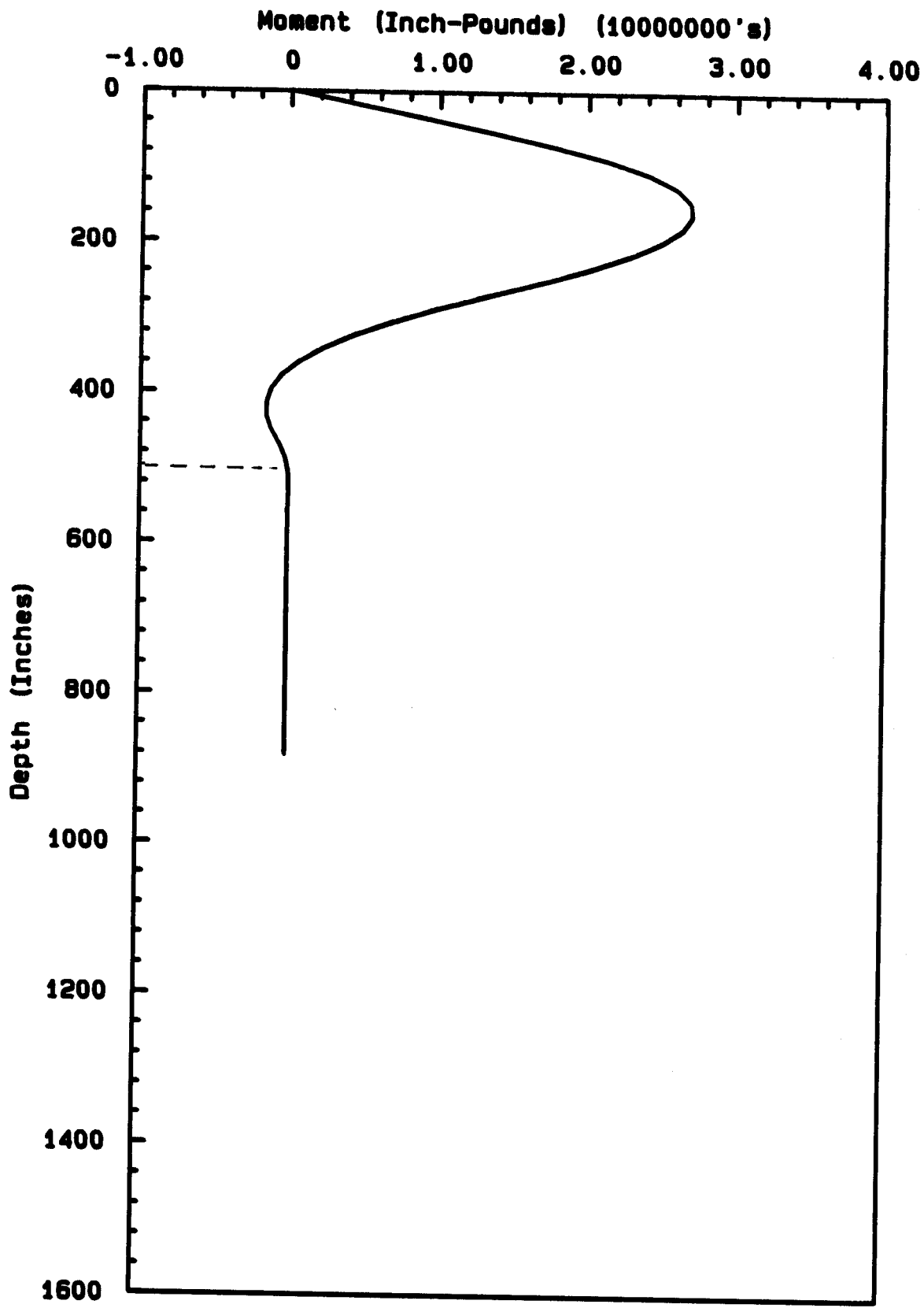

Figure 11 - COM624P computed moment versus depth for a 60" diameter shaft with service loads and free head condition.



iii. Determine preliminary maximum shaft/pile depth.

- * Review graphical plot of shaft/pile moment versus depth. Locate the depth where the moment plot crosses the zero moment line for the second time (second point of contraflexure). This depth will negate the influence of depth on the shaft/pile deflection and is therefore a good first estimate of minimum depth. The depth can be refined later after the minimum shaft/pile size, foundation configuration, and minimum depth for axial capacity have been determined.

Review of Figure 11 moment versus depth plot shows the moment crossing the zero line a second time at 500 inches.

PRELIMINARY SHAFT DEPTH = 42'

iv. Repeat steps i through iii for a fixed shaft/pile head condition (KBC=2). The designer may skip this step for a 100% free head condition.

CHECK FIXED HEAD CONDITION

COM624P VERSION 2 - RUN #5

BRIDGE ABUTMENT - 60" DIA SHAFTS @ 12' CTC

FIXED HEAD CONDITION AND CRACKED SECTION

SERVICE LOADS

Maximum pile head deflection calculated by the main program of COM624P version 2 = 0.172"

A plot of computed deflections versus depth is shown in Figure 12.

MAXIMUM PILE HEAD DEFLECTION = 0.172"

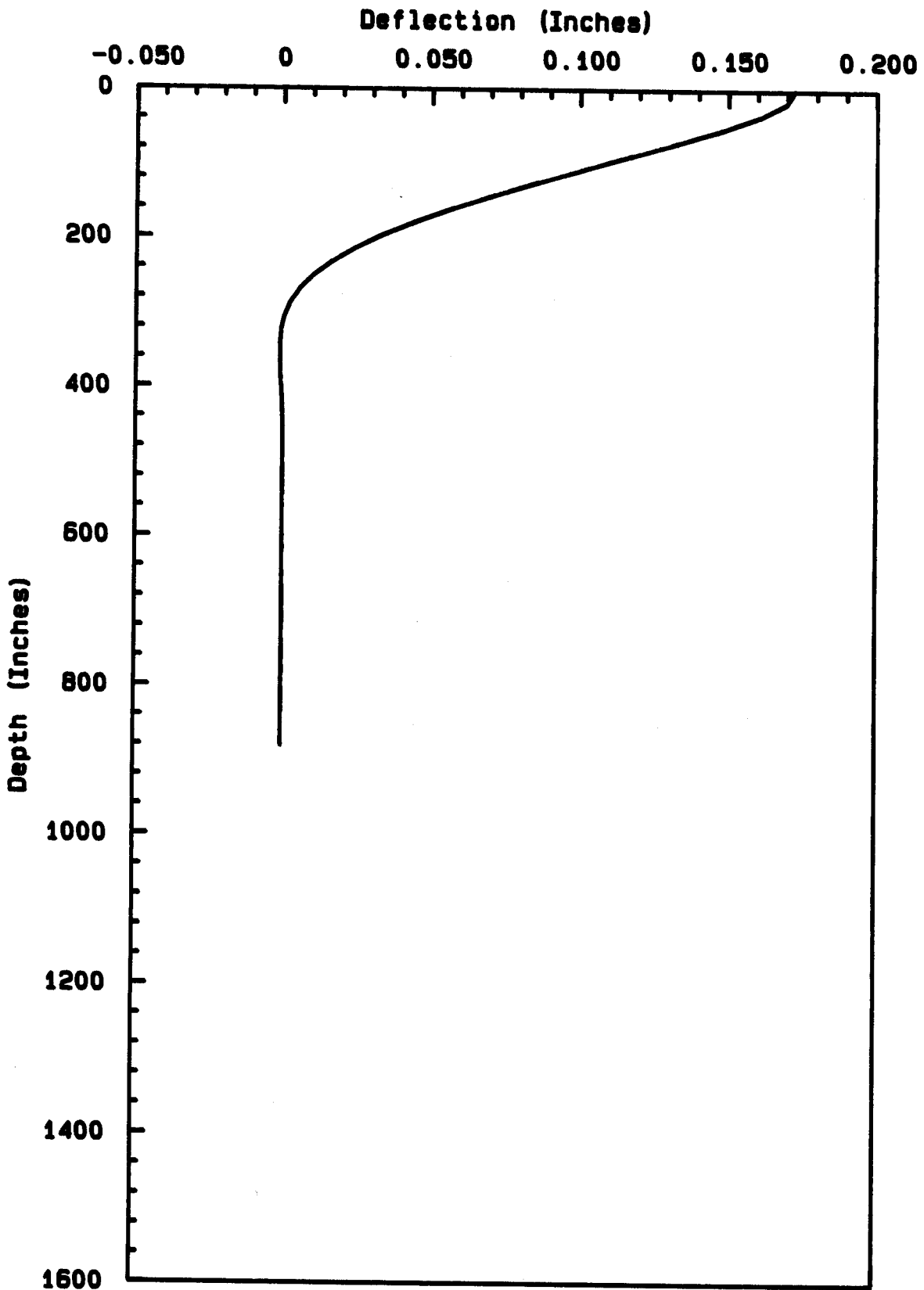

Figure 12 - COM624P computed deflection versus depth for a 60" diameter shaft with service loads and fixed head condition.



- v. Determine if shaft/pile is acceptable based on the range of deflections (free head and fixed head).

**SUMMARY OF COM624P LATERAL LOAD ANALYSIS RESULTS
BRIDGE ABUTMENT - 60" DIAMETER SHAFT @ 12' CTC:**

Ultimate Load (F.S.= 2): P = 1,560 kips L = 506 kips
Service Load: P = 778 kips L = 253 kips
Shaft Materials: f'c = 4,000 psi 28-#10 bars

Maximum Service Load Deflection - 0.667" (Free Head)

Minimum Service Load Deflection - 0.172" (Fixed Head)

Minimum Shaft Length - 42.0 feet

Estimated % shaft head fixity = 0-10%

0.172" to 0.667" < 1.0" MAXIMUM ALLOWABLE - OK ✓

TASK V: Determine minimum shaft/pile depth required for axial capacity.

- * If large lateral deflections are expected, use the COM624P deflection plot to determine the portion of the top of the shaft/pile where skin resistance should be ignored.



CHECK AXIAL LOAD CAPACITY FOR A 5'Ø SHAFT:

$$P_{D.L.} = (64.8 \text{ klf} * 12') = 778 \text{ kips}$$

$$P_{L.L.} = (7.1 \text{ KLF} * 12') = 85 \text{ kips}$$

$$\text{TOTAL} = 433 \text{ TONS}$$

ANALYSIS PERFORMED WITH ENSOFT COMPUTER PROGRAM SHAFT1

AXIAL CAPACITY OF DRILLED SHAFTS

SUMMARY OF RESULTS FOR THE DESIGN LOAD OF 433 TONS (F.S.= 2)

SHAFT DIAMETER	MINIMUM EMBEDMENT FOR 433 TONS
3.5'	75'
4.0'	63'
4.5'	54'
5.0'	46'
5.5'	39'
6.0'	33'
6.5'	34'
7.0'	30'

MINIMUM EMBEDMENT FOR A 5'Ø TO MEET LATERAL LOAD REQUIREMENTS IS 42'.

MINIMUM EMBEDMENT FOR A 5'Ø TO MEET AXIAL LOAD REQUIREMENTS IS 46'.

5' Ø SHAFT IS AN EFFICIENT SIZE ✓



TASK VI: Based on the analysis results from TASKS I through V, choose the final foundation configuration and shaft/pile diameter.

i. Determine final shaft/pile depth.

- * If the minimum depth required for axial capacity is less than the depth determined in TASK IV, the final shaft/pile depth could be refined.

MINIMUM REQUIRED AXIAL DEPTH OF 46' > MAXIMUM REQUIRED LATERAL DEPTH OF 42'

OK ✓ No refinement necessary

USE

**A SINGLE ROW OF 5' DIAMETER SHAFTS @ 12'
CTC**

**CENTERLINE OF SHAFT ROW AT THE VERTICAL
FORCE RESULTANT (NO MOMENT)**

**MINIMUM OF 28 - #10 BARS FOR SHAFT
REINFORCEMENT**

MINIMUM OF DEPTH OF EMBEDMENT - 46'

