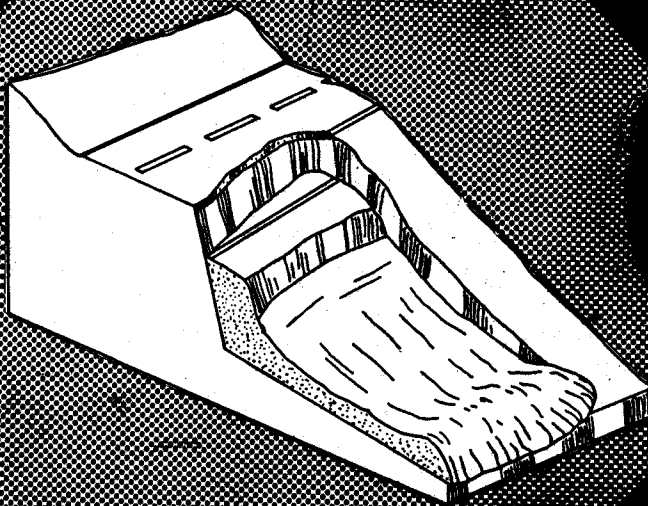


# HIGHWAY SLOPE MAINTENANCE AND SLIDE RESTORATION WORKSHOP

**PARTICIPANT MANUAL**



U.S. Department  
of Transportation

**Federal Highway  
Administration**

Report No. FHWA-RT-88-040  
December 1988

## **FOREWORD**

**The Kentucky Transportation Center at the University of Kentucky is pleased to have had the opportunity to develop the document, which is the course manual for a workshop on Slope Maintenance and Slide Restoration for Highways. The purpose of this manual is to provide reference material and a training aid to first level road maintenance supervisors who, in most cases, are not engineering graduates. These supervisors are often called upon, however, to make quick technical decisions in emergency situations that demand a high level of expertise. We have attempted to provide this technical information in non-technical language.**

**Additional copies of the report can be obtained from the Office of Implementation, Engineering and Highway Operations Implementation Division , 6300 Georgetown Pike, McLean, Virginia 22101, Phone (703) 285-2346.**

## **NOTICE**

**The contents of this report reflect the views of the authors who are responsible for the facts and accuracy of the data presented herein. The contents do not necessarily reflect the official views or policies of the Department of Transportation, the Federal Highway Administration, The Kentucky Transportation Center, nor the University of Kentucky. This report does not constitute a standard, specification, or regulation. The inclusion of manufacturer names and tradenames are for identification purposes and are not to be considered as endorsements.**

1. Report No. <b>FHWA-RT-88-040</b>		2. Government Accession No.		3. Recipient's Catalog No.	
4. Title and Subtitle <b>Slope Maintenance and Slide Restoration</b>				5. Report Date <b>December 1988</b>	
				6. Performing Organization Code	
7. Author(s) <b>Tommy C. Hopkins; David L. Allen; Robert C. Deen; and Calvin G. Grayson</b>				8. Performing Organization Report No.	
				9. Performing Organization Name and Address The University of Kentucky Transportation Center College of Engineering, University of Kentucky 533 South Limestone Lexington, Kentucky 40506-0043	
12. Sponsoring Agency Name and Address Federal Highway Administration Office of Implementation 6300 Georgetown Pike McLean, Virginia 22101-2296				10. Work Unit No. (TRAIS) <b>HHI-20-06-88-52</b>	
				11. Contract or Grant No.	
15. Supplementary Notes  <b>FHWA Contracting Officer's Technical Representative - Chien-Tan Chang, HRT-10</b>				13. Type of Report and Period Covered <b>Final Report August 28, 1987 to December 31, 1988</b>	
				14. Sponsoring Agency Code	
16. Abstract  Each year U.S. highway agencies spend millions of dollars in maintaining highway embankments, slopes, and other earth structures as well as removing rock falls and soil debris from roadways and repairing landslides. Activities from maintaining highway slopes and restoring landslides often cause traffic slow down and stoppage that creates serious safety hazards and consumes significant highway maintenance and construction funds. In addition, economic losses due to the inconvenience to the traveling public is often immeasurable.  During 1984 and 1985, as part of a continuing project to evaluate and improve maintenance activities, a study on slope maintenance and slide restoration was undertaken by the Federal Highway Administration (FHWA), Office of Implementation. This joint effort by engineers from the FHWA and six state highway agencies (that is, California, Kentucky, Oregon, Pennsylvania, Texas, and Wyoming) developed guidelines for slope maintenance and slide restoration. These guidelines reflect the collective experience of the six state highway agencies and are documented in FHWA report (TS-85-231) entitled "Guidelines for Slope Maintenance and Slide Restoration."  This technical note was developed and based on the above report for use by Technology Transfer Centers funded through the Rural Technical Assistance Program of the Federal Highway Administration in conducting training of the subject title.  This manual represents one of the many contributions of Dr. Robert C. Deen to the transportation research and education community. Dr. Deen died on March 25, 1988, while completing the editing of this manual.					
17. Key Words Slope Restoration Slide Highway Soil Mechanics Maintenance			18. Distribution Statement No restriction. Copies of this report are available from the Office of Implementation, Engineering and Highway Operations Implementation Division, 6300 Georgetown Pike, McLean, Virginia 22101, Phone (703) 285-2346.		
19. Security Classif. (of this report) <b>Unclassified</b>		20. Security Classif. (of this page) <b>Unclassified</b>		21. No. of Pages <b>300</b>	22. Price

# METRIC (SI\*) CONVERSION FACTORS

## APPROXIMATE CONVERSIONS TO SI UNITS

Symbol	When You Know	Multiply By	To Find	Symbol
--------	---------------	-------------	---------	--------

### LENGTH

in	inches	2.54	millimetres	mm
ft	feet	0.3048	metres	m
yd	yards	0.914	metres	m
mi	miles	1.61	kilometres	km

### AREA

in <sup>2</sup>	square inches	645.2	millimetres squared	mm <sup>2</sup>
ft <sup>2</sup>	square feet	0.0929	metres squared	m <sup>2</sup>
yd <sup>2</sup>	square yards	0.836	metres squared	m <sup>2</sup>
mi <sup>2</sup>	square miles	2.59	kilometres squared	km <sup>2</sup>
ac	acres	0.395	hectares	ha

### MASS (weight)

oz	ounces	28.35	grams	g
lb	pounds	0.454	kilograms	kg
T	short tons (2000 lb)	0.907	megagrams	Mg

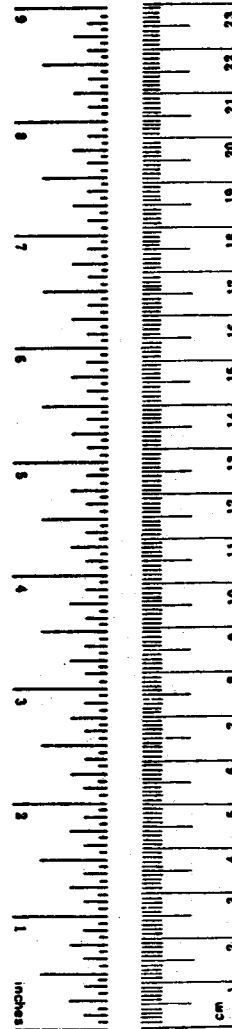
### VOLUME

fl oz	fluid ounces	29.57	millilitres	mL
gal	gallons	3.785	litres	L
ft <sup>3</sup>	cubic feet	0.0328	metres cubed	m <sup>3</sup>
yd <sup>3</sup>	cubic yards	0.0765	metres cubed	m <sup>3</sup>

NOTE: Volumes greater than 1000 L shall be shown in m<sup>3</sup>.

### TEMPERATURE (exact)

°F	Fahrenheit temperature	5/9 (after subtracting 32)	Celsius temperature	°C
----	------------------------	----------------------------	---------------------	----



## APPROXIMATE CONVERSIONS TO SI UNITS

Symbol	When You Know	Multiply By	To Find	Symbol
--------	---------------	-------------	---------	--------

### LENGTH

mm	millimetres	0.039	inches	in
m	metres	3.28	feet	ft
m	metres	1.09	yards	yd
km	kilometres	0.621	miles	mi

### AREA

mm <sup>2</sup>	millimetres squared	0.0016	square inches	in <sup>2</sup>
m <sup>2</sup>	metres squared	10.764	square feet	ft <sup>2</sup>
km <sup>2</sup>	kilometres squared	0.39	square miles	mi <sup>2</sup>
ha	hectares (10 000 m <sup>2</sup> )	2.53	acres	ac

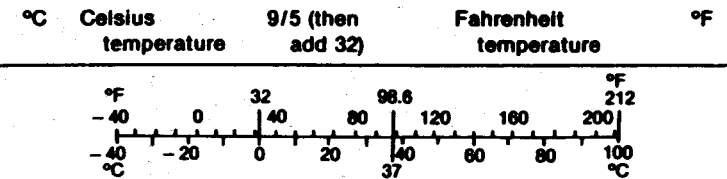
### MASS (weight)

g	grams	0.0353	ounces	oz
kg	kilograms	2.205	pounds	lb
Mg	megagrams (1 000 kg)	1.103	short tons	T

### VOLUME

mL	millilitres	0.034	fluid ounces	fl oz
L	litres	0.264	gallons	gal
m <sup>3</sup>	metres cubed	35.315	cubic feet	ft <sup>3</sup>
m <sup>3</sup>	metres cubed	1.308	cubic yards	yd <sup>3</sup>

### TEMPERATURE (exact)



These factors conform to the requirement of FHWA Order 5190.1A.

\* SI is the symbol for the International System of Measurements

## TABLE OF CONTENTS

## NOTES

I. INTRODUCTION .....	1
I.A. BACKGROUND .....	1
I.B. PURPOSE .....	10
I.C. SCOPE .....	10
II. SLOPE MOVEMENTS/PROCESSES .....	13
II.A. WHY AND HOW SLOPES FAIL .....	13
II.B. EXAMPLES OF MOVEMENTS ON SLOPES	15
II.C. CAUSES OF SLOPE MOVEMENTS .....	21
III. RECOGNITION AND IDENTIFICATION .....	24
III.A. TERRAIN .....	24
III.B. SIGNS OF MOVEMENT .....	35
III.C. INSTRUMENTATION .....	46
III.D. SOIL/ROCK IDENTIFICATION .....	50
IV. MAINTENANCE PRACTICES .....	56
IV.A. INVENTORY OF SLOPE PROBLEMS .....	56
IV.B. SLOPE MAINTENANCE .....	64
IV.C. DRAINAGE MAINTENANCE .....	74
IV.D. ROAD SURFACE MAINTENANCE .....	82
IV.E. UTILITIES CONSTRUCTION .....	83
V. STABILIZATION METHODS .....	85
V.A. BASIC APPROACHES .....	96
V.B. REPAIR METHODS .....	98
V.C. ECONOMICS OF REPAIR METHODS .....	197
VI. LEGAL LIABILITIES .....	204
VI.A. SAFETY .....	204
VI.B. LEGAL ASPECTS OF SLOPE MOVEMENTS	204
VI.C. RISK MANAGEMENT .....	209
BIBLIOGRAPHY .....	211
APPENDIX A .....	217
APPENDIX B .....	251
APPENDIX C .....	265
APPENDIX D .....	289
APPENDIX E .....	299

(This space is for notes)



# I. INTRODUCTION

## I.A. BACKGROUND

## NOTES

### Slide Problem

The maintenance of slopes and the restoration and correction of slides on highways has been identified by a number of agencies as a major and continuing problem involving considerable expenditures of funds. Each year, highway agencies in the United States spend millions of dollars in maintaining highway embankments, slopes, and other earth structures; removing rock falls and debris from roadways; and repairing landslides. Such activities often cause restrictions and sometimes disruptions of traffic flow, creating serious safety hazards and resulting in economic losses due to the inconvenience to the traveling public. Maintenance crews must take corrective action to return slopes to a usable and stable condition, to restore the facility to normal operating conditions, and to minimize hazards to the traveling public. Various routine activities may minimize the potential of slope failures.

Major and catastrophic failures of earth slopes are frequent occurrences around the world. These failures are often related to natural phenomena such as earthquakes and floods or to insufficiencies in design elements of major construction projects. Major slope failures "make the news" because of their sizes and quantities of material involved or because of significant losses and injuries to life and property. Failures lead to formation of investigative teams to study the probable causes of the failures and to identify corrective measures to restore the slopes to their original function and to minimize possible reoccurrences.

Investigations of such failures may involve sophisticated and highly theoretical analyses by geotechnical engineers, as well as experts from other disciplines.

The extent to which slope failures impact upon highway agencies in this country is not fully known. There is no doubt that large slope failures, which are reported in the newspapers and on television and radio news programs, are major items in highway budgets. Major slope failures often cost millions of dollars to restore the highway facility to a safe and usable condition. These failures significantly affect the highway budget.

User costs are often immeasurable. Direct costs to highway agencies related to slope maintenance and slide restoration may not be accurately reflected in maintenance records. This is largely due to procedures currently used for allocating costs to various and numerous maintenance activities. The repair of a roadway surface due to settlement may be charged to asphalt patching when in fact the settlement is a result of movement of materials within the embankment or cut slopes. Tracking costs for maintenance and restoration of slopes as well as user costs associated with such failures is extremely difficult.

There are several thousands of miles of roadway under the jurisdictions of various State and local highway agencies in the United States. In many jurisdictions, large numbers of slope failures, some of which may not require any significant maintenance attention while others must be given attention to maintain the facility in a safe and operating condition, are common occurrences. Since most highway agencies do not maintain an inventory of slope failures, it is almost impossible to develop a reliable measure of the



problem of slope failures. It is understood, however, that the problem is significant.

This workshop is based in large part upon the Federal Highway Administration's report entitled "Guidelines for Slope Maintenance and Slide Restoration", FHWA-TS-85-231. That report is the result of efforts by personnel from state highway agencies in California, Kentucky, Pennsylvania, Oregon, Texas, and Wyoming. Additional information and discussions have been added where appropriate.

### **Economics of Slope Movements**

Not only are records relating to the number of slope failures inadequate and sparse, information relative to the expenditures to remedy slope failures is also generally unknown. Expenditures of time, personnel, equipment, and materials to correct and remedy slope problems are not maintained by most highway agencies. Even if such a cost-accounting system were in place in a highway agency, the problem of assigning ALL costs associated with the maintenance of a slope is extremely difficult. Many activities are often more directly related (from a cost-accounting point of view) to other aspects of highway maintenance, such as guardrail maintenance, drainage maintenance, etc.; while in many cases, maintenance activities on those elements of the highway are to correct problems due directly or indirectly to a slope failure.

The magnitude of the slope maintenance problem faced by the maintenance supervisor is unknown but is estimated to be extremely large. The geotechnical engineer in Indiana

estimated an expenditure of \$960,000 annually over the past seven years on minor landslides and erosion control areas. In Missouri, approximately \$550,000 (0.3 percent of the maintenance budget) was expended. Another \$1.1 million from construction monies was spent. In Ohio, the annual cost of repair of minor slips and slides is over \$1 million (approximately one percent of the total maintenance budget).

In addition to the cost of maintenance in terms of personnel, equipment, and materials mentioned above, there are other social and economic costs to the highway agency as well as the general public. It is obvious to most that there is destruction of public property when a highway slope fails. Not only is the slope itself damaged, but other adjacent elements of the highway also may be affected in a negative manner. In some situations, private property also may be subjected to damage as a result of the failure of a slope on a highway and may result in a financial burden on the property owner. Often, when a slope fails and maintenance activities require closure or restriction of traffic flow in order to restore the slope to a safe and operable condition, there are significant inconveniences and user costs such as delays and increased vehicular costs.

### **Role of Maintenance**

The role of maintenance is to control the natural deterioration of a highway facility. With regard to the deterioration of a highway slope, some basic functions of maintenance are as follows:

- o Insure the safe passage of motorists and keep the road open if possible,
- o Perform routine slope maintenance,

- o Implement temporary measures in an attempt to halt, or delay, the deterioration of the slope,
- o Monitor and report the deterioration of the highway slope, and
- o Perform slide restoration on small slides.

The deterioration of a highway slope based on costs may be assigned to one of the following categories:

- o Routine maintenance -- At this stage only routine maintenance is needed. The slope problem is only minor. For example, the problem may involve the removal for the first time of small quantities of rock or soil debris which has fallen onto the roadway or the roadway has settled or sagged and required patching for the first time. Other routine actions might include clearing of a blocked drainage ditch, sealing cracks, or repairing slope erosion and re-establishing vegetation.
- o Extraordinary Maintenance -- The deterioration has reached a stage where the slope problem continues to reoccur and extraordinary and temporary measures and costs are incurred to halt or delay the slope movement and maintain traffic flow until more permanent slide restoration measures are imposed. As an example, slope movements of a particular highway may have reached a stage where more than one patching has been performed, pavement cracks have been sealed on several occasions, and the guardrail has been repaired on different occasions. Another example might include a situation where large rock debris has fallen onto the highway on different occasions and required expensive removal.
- o Slide Restoration -- When the deterioration of the slope has reached a condition where routine and extraordinary

maintenance costs approach or represent a sizable portion of the costs of restoring the highway section to its original condition, or to a condition better than the original condition, then remedial repairs should be implemented. However, corrective actions may be taken in cases where a real danger threatens the traveling public, although extraordinary costs may not be involved. At this stage, the highway slope has failed or moved to such a state that the situation poses a real danger to the traveling public. At this stage, the traffic lanes may have to be closed or the roadway may have to be completely closed.

Each agency or locality should develop an accounting system that monitors maintenance costs of a given section which is experiencing slope problems.

Routine maintenance is the responsibility of the maintenance supervisor. Also, he usually will be involved in performing extraordinary maintenance. Extraordinary maintenance may normally be performed under the guidance of the maintenance engineer. With regard to performing slide restoration, the maintenance supervisor may or may not be directly involved. Whether the maintenance supervisor becomes directly involved and assumes the responsibility of slide restoration depends on the following factors:

- o The skills and capabilities of maintenance personnel and available equipment,
- o Whether or not the maintenance supervisor feels he is knowledgeable enough of the problem,
- o Prohibitive cost of implementing a slide stabilization method, and
- o The size of the slide and the depth and position of the failure plane or surface of sliding.

Each of these factors must be considered in making a decision on slide restoration.

To aid the maintenance supervisor in making this decision, it is useful to classify the slide problem according to the size of the fill. For example, the height of the fill, as measured from the toe of the fill to the top of the shoulder, may be classified according to one of the following categories:

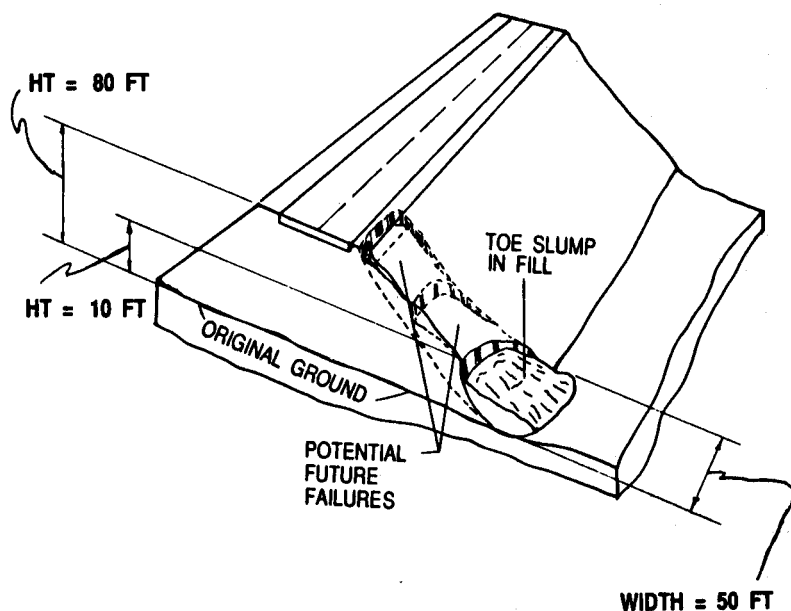
- o small fill -- 20 feet or less
- o medium fill -- 20 to 50 feet
- o large fill -- greater than 50 feet

In many instances, from a viewpoint of available maintenance equipment and materials' handling capabilities, slides that occur in fills measuring less than about 20 feet could probably be repaired by many maintenance supervisors and crews. However, there are situations where the maintenance supervisor may not be able to handle a small slide because of budgetary limitation. For example, suppose that the supervisor has determined that a particular stabilization method can be applied. Suppose that the technique cost 200 dollars per linear foot (as measured parallel to centerline). Although the slide may only be 20 feet in height, the slide may be 500 feet in length (parallel to centerline). The total cost to repair the slide is (500 feet x 200 dollars/ft) equal to 100,000 dollars. If the maintenance supervisor's total yearly budget is only 400,000 dollars, then slide restoration may not be feasible. In terms of budgetary restraints the slide restoration may represent a major investment. However, suppose the slide is only 200 feet in width. The cost, in this case, to repair

the slide is 40,000 dollars. Hence, the supervisor may feel that he can repair the slide with his forces. It is suggested that a small slide may be defined as one that is less than 20 feet in height and the cost to repair the slide is less than an amount to be determined by the maintenance supervisor. The maximum amount to be spent at a particular location should be determined by the maintenance engineer, geotechnical engineer and maintenance supervisors. For example, it may be predetermined by maintenance supervisors, maintenance engineers, and geotechnical engineers of a given locality that the maintenance supervisor will not spend more than 25,000 dollars to repair a slide. At another locality, the value may be fixed at 50,000 dollars. If the amount of slide restoration exceeds this predetermined value, then the geotechnical staff should be contacted. In the case of county or city maintenance supervisors, the local political unit should be contacted and given the necessary information concerning the cost of slide restoration. The local political unit should seek the advice and assistance of a consulting geotechnical engineer.

Slides in medium and large embankments may or may not be repaired by the maintenance supervisor. For example, deep-seated failures (greater than a height of about 20 feet) need to be examined by a geotechnical engineer as well as the maintenance engineer. In a deep-seated failure, the failure plane is located several feet, or several tens of feet, below the surface of the fill. Slides of this size will probably require a major investigation and analysis to determine the most appropriate repair method. However, if the slide is less than about 20 feet in height, although the fill height is greater than 20 feet, the maintenance

supervisor and crew may still be capable of repairing the slide. For example, suppose an embankment measures 80 feet in height; a failure measuring 10 feet in height and 50 feet in width occurs at the toe of the fill. Although the fill is classified as large, the maintenance crew could probably repair this failure based on the advice of the geotechnical and maintenance engineer. It is good policy to seek the advice of the geotechnical and maintenance engineers before implementing a slide restoration method. By working with and seeking the advice of the geotechnical engineer who is familiar with local conditions and the types of slides that occur in a locality, pre-engineered restoration methods may be developed for many small slides. Hence, the maintenance supervisor may be able to repair many small slides without needing the assistance of the geotechnical engineer in every case.



*Toe slump in a large highway embankment*

## **II.B. PURPOSE**

This workshop, and accompanying manual, is intended to provide guidelines for state, county, and city maintenance supervisors who are responsible on a daily basis for making decisions related to the maintenance of slopes and slide restoration.

## **II.C. SCOPE**

This workshop and manual discuss the maintenance of slopes and methods of restoring slides. Features and problems that may be detected and addressed by typical highway maintenance crews are emphasized. Topics to be discussed are as follows:

- o Slope Movements and Processes -- Different types of highway slope movements and why slopes move in certain ways are discussed in simple terms.
- o Recognition and Identification -- The many features that may indicate slope problems and the need for preventive maintenance are described.
- o Maintenance Practices -- Maintenance practices that may aid in minimizing slope problems are described. Practices that should be performed and avoided are emphasized.
- o Stabilization Methods -- Various methods of repairing, protecting, and restoring, or reinstatement, of highway slopes are discussed.
- o Legal Liabilities -- a brief discussion of legal liabilities and safety measures are described.

All cases, sketches, and photographs (in the oral presentation) are used to illustrate concepts. Slope stability and remedial design analysis of highway slopes are



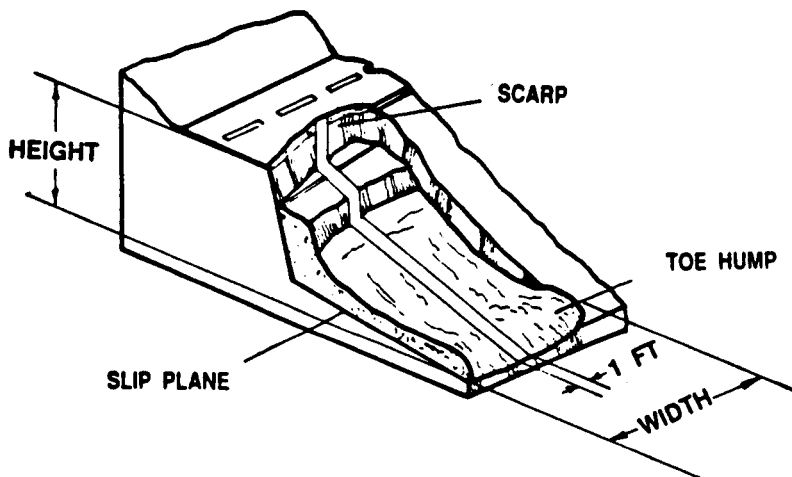
EXCLUDED from this workshop. In slide problems requiring these types of analyses, the maintenance supervisor should contact the maintenance engineer and the geotechnical staff (or geotechnical consulting engineer).

Even though this workshop is not directed towards review of major slope failures, sketches and photographs of selected examples of major failures may be used to illustrate certain engineering and maintenance problems and strategies. The emphasis of this short course is upon those more commonly occurring minor slope failures to which the first-line maintenance supervisor must give attention. However, maintenance crews may aid in preventing major slope failures by being alert and identifying early signs of distress that foretell major slope movements. Some early preventive maintenance activities may minimize the development of major slides from what appear to be only minor problems. Very often, the maintenance supervisor is not in a position nor has resources available to call upon investigative teams of geotechnical engineers and others to study and evaluate the situation. The maintenance crew must respond immediately and make decisions regarding slope movements and maintenance activities.

A number of sketches and tables summarizing many of the features that foretell problems with slopes and some of the actions that may be taken to minimize those problems are shown in APPENDIX A. These few pages might be removed from the manual and carried in maintenance vehicles for ready and quick reference. In APPENDIX B, suggested slide and culvert inventory forms are presented. Also, as an appendix (C) to this manual, some aspects of

slope stability analysis and slope design are presented for those who might want to review this subject.

It should be noted that terms used to describe slope conditions may differ from one part of the country to another. Terms and illustrations in this manual are common but may not be universally used. Sketches are included to picture characteristics being defined or illustrated. Local terminology should be used to identify those situations and circumstances. It is extremely important that the language used to communicate with others be familiar to them so there is a definite understanding of conditions being described. As an example, the plane or zone separating unstable (moving) soil or rock from stable material on a slope may be referred to as the "failure plane," the "slip plane," the "sliding plane", or the "shear surface." These different terms all refer to the plane or zone along which movement occurs.

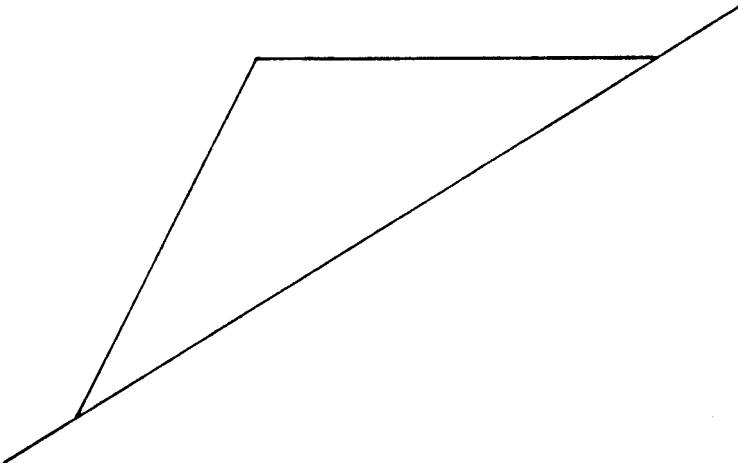


*Failure plane or slip surface of a highway slope failure*

## II. SLOPE MOVEMENTS/PROCESSES

### II.A. WHY AND HOW SLOPES FAIL

Any object or material placed on a slope will have a tendency to move down that slope. This tendency towards downhill movement, in a large part, is a result of the action of gravity. Gravity is a force that tends to draw out bodies or objects of the earth's sphere toward the center of the earth.



*Material placed on a slope*

All objects and materials placed on a slope do not necessarily move downward, however. There are other forces, acting in opposition to the force of gravity, that tend to hold the object or material in place upon the slope. These resisting forces often may be considered in terms of the strength of the particular material on the slope. If the resisting forces due to the strength of the material are greater than the force of gravity acting upon the material, the slope will remain stable and the material will not move. If the driving or gravity forces acting upon the material are

greater than the resisting forces provided by the strength of the material or some kind of retaining structure, then the material will move downward.

Materials on slopes that are of concern to highway agencies and their maintenance crews are soil and rock. Many slopes are composed entirely of soil or entirely of rock while other slopes may contain various mixtures of soil and rock.

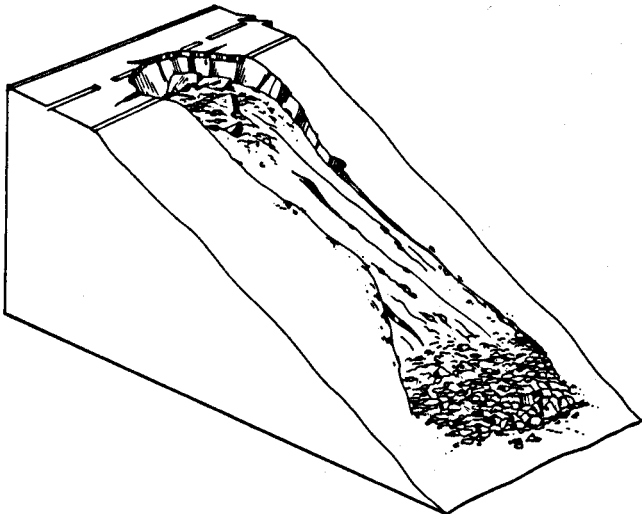
Soils often fail along distinctive surfaces that may be observed and/or estimated by field inspections. Many soil slope failures have been observed to occur along a surface approximated by a circular arc. Other slopes have been observed to fail along a series of circular arcs. Also, many soil slope failures have been observed to occur along a surface consisting of a series of planes. Theories have been developed that may be used to analyze slope failures along some well defined geometric shape such as the circular arc or a plane. When the water content of the soil is very high, the soil may move downward. Downward movements of soils on slopes may occur very gradually and extend over a number of years. Other soil slopes have been observed to have failed rapidly and as a result might create sudden catastrophic situations for the driving public and adjacent property owners.

Slopes consisting primarily of rock do not have distinctive failure surfaces. The failure is a result of fragments breaking from the rock mass and falling or rolling down slope. Rock slope failures more typically are very rapid and occur over a short period of time.

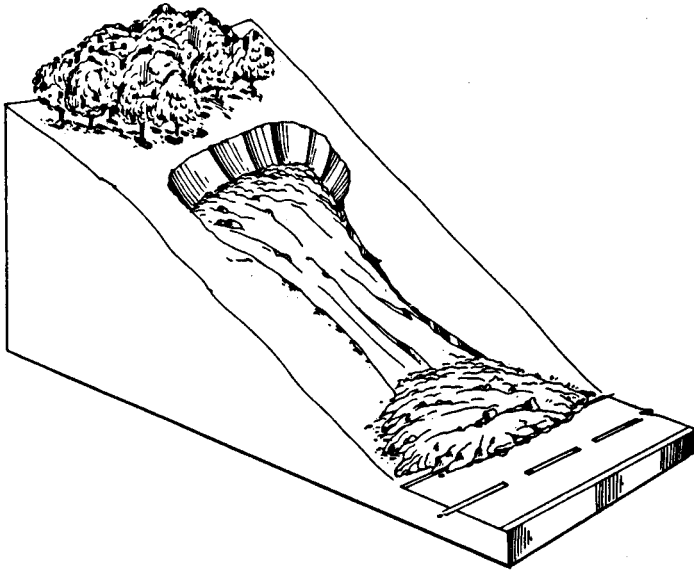
## II.B. EXAMPLES OF MOVEMENTS ON SLOPES

Landslides can usually be classified into one of several general categories. Included here are sketches that help to identify those categories.

**MUDFLOW** (above or below the roadway). This type is usually a shallow failure involving mostly surface soils. Mudflows consist of highly saturated soils that simply flow (like water) downward. The flowing mass is saturated with water and most often occurs without warning during or after very heavy rainstorms or when snowmelt occurs. Mudflows frequently occur in soils that are sandy and silty with or without small amounts of clays. They oftentimes occur in steep slopes.

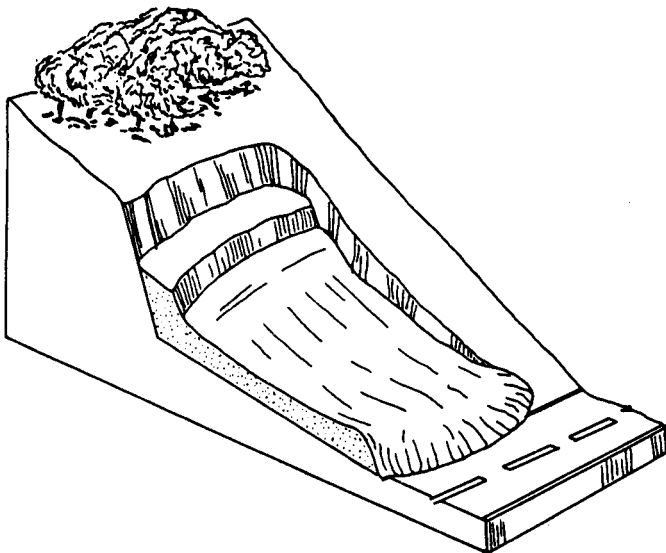


*Mudflow slide below roadway*

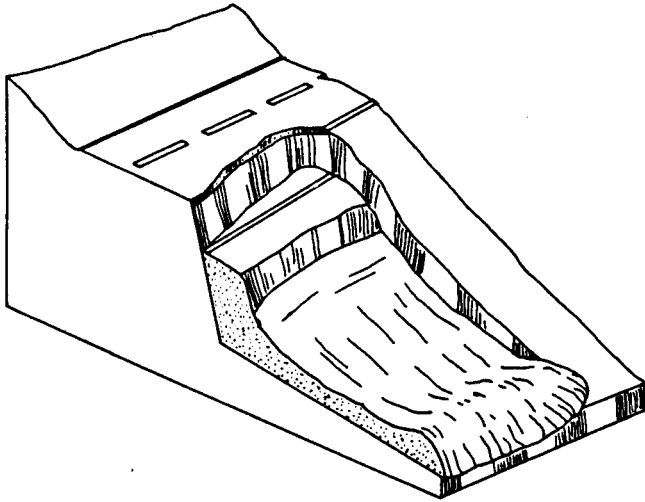


*Mudflow slide above roadway*

**WEDGE** (above or below the roadway). This type is usually larger than a mudflow and the failure plane is wedge shaped. Wedge-shaped slides usually occur along a distinctive failure plane. Usually the failure plane in the middle and lower portion of the slide is a soft clay layer of low strength or a silt layer sandwiched in between two clay layers. The failure mass of soil oftentimes slides along bedrock.

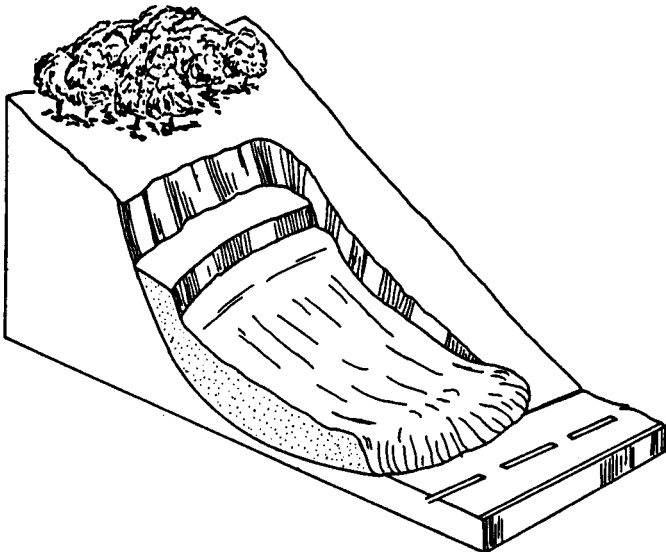


*Wedge-type slide above roadway*

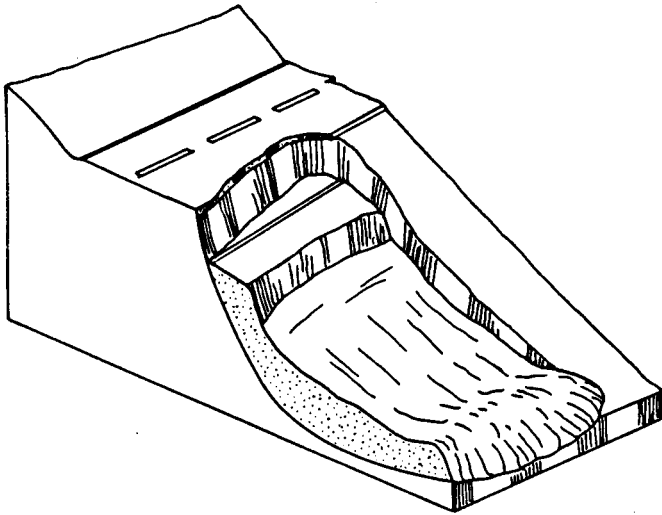


*Wedge-type slide below roadway*

**ROTATIONAL** (above or below the roadway). This type is similar to a wedge failure except the failure surface is more circular. Rotational slides usually occur in fairly homogeneous materials. The failure plane is usually circular and deep, and the mass of soil fails as a unit, although several scraps may be observed in the upper portions of the slide. Rotational slides may occur in the fill or in the fill and foundation soils (subsurface failure).

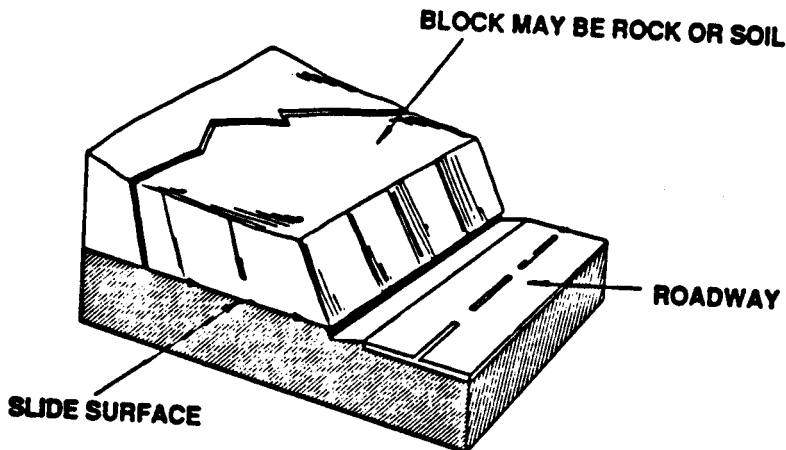


*Rotational slide above roadway*



*Rotational slide below roadway*

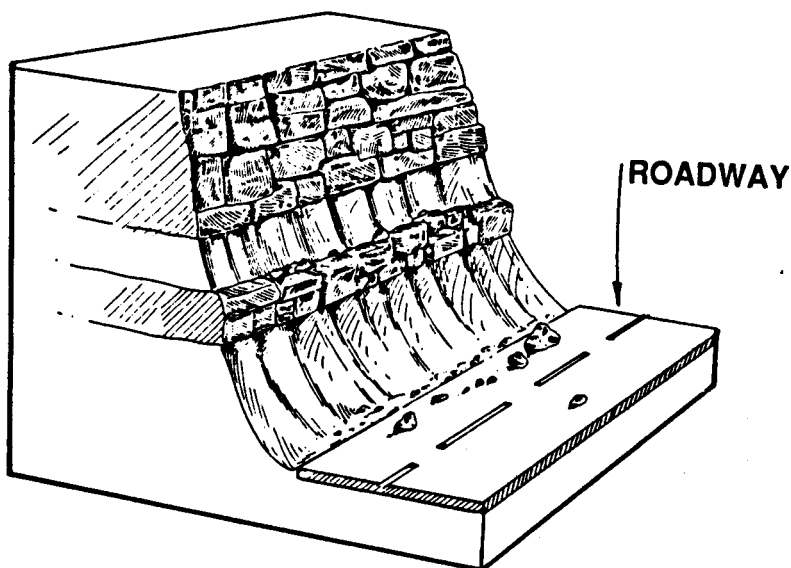
**BLOCKSLIDE ABOVE ROAD.** This type usually consists of a massive block of soil or rock moving as a unit. Blockslides usually occur along a distinctive failure plane, or natural joints in rocks or soils. The failure plane usually consists of weak materials or joints. A blockslide may fail as a single unit of material or numerous units may fail at different times. These types of slides are extremely dangerous because they fail instantaneously without any warning.



*Blockslide above roadway*

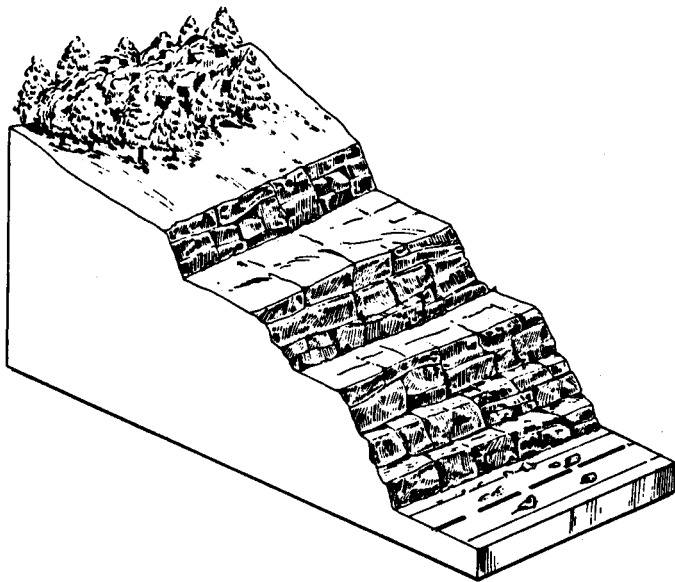


**ROCKFALL FROM DIFFERENTIAL WEATHERING.** This type usually consists of large boulders falling onto the roadway. These boulders are mostly competent (hard) rock underlain by rocks that weather more quickly. This causes the competent rock to lose support and fall onto the roadway.



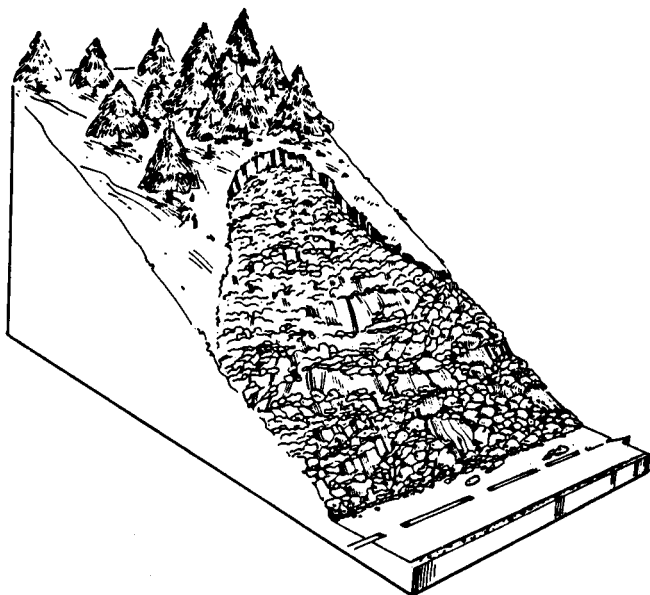
*Rockfall from differential weathering*

**ROCKFALL FROM MASSIVE ROCK SLOPES.** This consists of rock debris that falls from rock slopes that are close to the roadway. Rockfall from massive slopes occurs as a result of rock weathering, rainfall, snowmelt, and freezing and thawing. Very often the massive rock is jointed. Water gets into the joints and exerts a force against the rock, causing chunks of rock to fall. Alternately, the water freezes in the joints. When water freezes to ice it expands and forces chunks of rock to fall. Water also seeps along the joints eroding contact points between pieces and causing rockfalls.



*Rockfall from a massive rock slope*

**ROCKFALL FROM TALUS SLOPES.** This type consists of a mass of highly weathered boulders and some fine materials that move onto the roadway. This type of material is prone to failure because of groundwater seepage and seepage into the talus pile from rainfall and snowmelt.



*Rockfall from a talus slope*

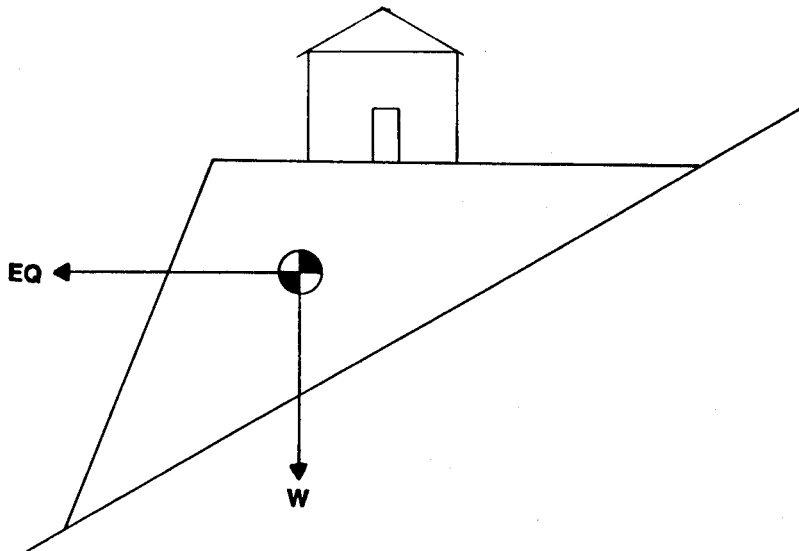
The above sketches are repeated in APPENDIX A. Details have been added in an attempt to indicate those characteristics that are significant in identifying the type of movement as well as suggesting the nature of the problem. Included with the sketches are features to look for in observing the slide area as well as the meaning of those particular features. Also contained in the APPENDIX A are various courses of actions available to a maintenance crew to remedy problems that have been observed. Additionally, certain courses of action have been indicated that should be a part of routine and day-to-day maintenance activities in order to minimize problems.

## **II.C. CAUSES OF SLOPE MOVEMENTS**

Earth materials on a slope become unstable and tend to move downward either when the driving forces of gravity (or other external loads or forces) increase or when the strength (resisting force) of the material is reduced so that the resisting forces are decreased. It is the relative relationship of the driving forces to the resisting forces that is of importance in analyzing the stability of a slope and to select various alternative corrective actions that may be applied to bring these two forces into proper relationship to one another.

Even though the action of gravity is constant at a particular site, the driving forces acting upon the earth material in a slope may be changed and altered in a number of ways. When a building or highway pavement or a railroad track is placed on or at the top of a slope, the loads imposed by those structures and traffic add to the forces of gravity tending to move the material downward.

In some parts of the country, liquefaction resulting from vibrations due to vehicular loads and earthquake forces may induce what is referred to as a quick condition and greatly reduce the shear strength of the material because of unusually high increases in pore pressures. In those areas of the country subject to earthquakes, liquefaction may be a potentially serious problem that should be evaluated. When a mass of soil liquefies, it is changed into a liquid.



***Forces of earthquake and gravity acting on a slope***

Side casting of material over the shoulder of a highway slope also increases the forces tending to move the material downhill. Side casting, therefore, cannot be used alone to restore the grade and profile of a pavement deformed by a slope movement. Care also must be used in storing or disposing of soil and rock accumulated when cleaning ditches or slopes. Rather than sidecasting these materials at the top of the slope, it is much better to place the wasted materials at the toe of the slope. By placing the materials at the toe, the stability of the slope is increased.

Driving forces also may be increased by the addition of significant amounts of water to the soil as a result of rainfalls or floods. Rather than changing the driving forces that tend to move material downward, the stability of the slope may be altered by either reducing or increasing the resisting forces (shear strength of the soils). Soils are generally sensitive to the water content and their strengths may be altered significantly by controlling or not controlling the presence of water in and around the slope area. Theories explaining the strength of soils show that when pressures in the water contained in the pores or voids of the soil increase, the strength of the soil decreases accordingly. Water added to the material on the slope as a result of a rainfall not only increases the weight and therefore the driving forces acting on the slope but also may increase pore pressures and therefore decrease the shear strength of the material. In addition to rainfall, pore pressures in soils also may be increased as a result of saturation of the soil mass because of damming of surface or subsurface drainage. These changes on conditions associated with water emphasize the need to control water flow and drainage in and around a slope. It is important that as much water (surface and subsurface) as possible be diverted from the area. Provisions should be made to remove or drain water that gets into the earth slope as quickly as possible.

Forces tending to move the material down the slope may be increased as a result of the removal of earth material near the toe of the slope by erosion or undercutting. This, in effect, increases the angle of the slope and therefore brings the force of gravity more into play.

Some soils are subject to large deformations or changes in dimensions under their own weight or under constant loading. The strength of a soil may be greatly reduced if the material is deformed and strained to very large degrees. On rock slopes, in particular, many materials have a tendency to degrade and weather when exposed to the actions of wind and rain. Many shales, for example, have a high susceptibility to weathering. They degrade to clays which have a much lower strength than the shale.

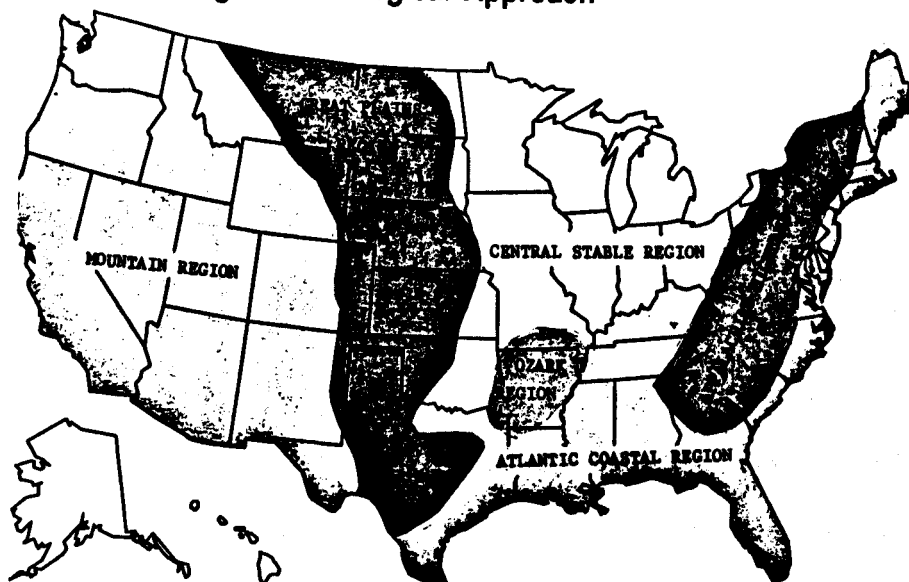
A slope is stable when the resisting forces (shear-strength of soils or rock) are greater than the driving forces (gravity, external loads, sidecasted materials at top of slope, water loads and seepage forces, etc., I). A slope is unstable when the resisting forces are less than the driving forces.

### III. RECOGNITION AND IDENTIFICATION

#### III.A. TERRAIN

Landform and geology make some areas more prone to slides than other areas. These areas should be identified and cataloged.

##### III.A.1. Regional/Geological Approach



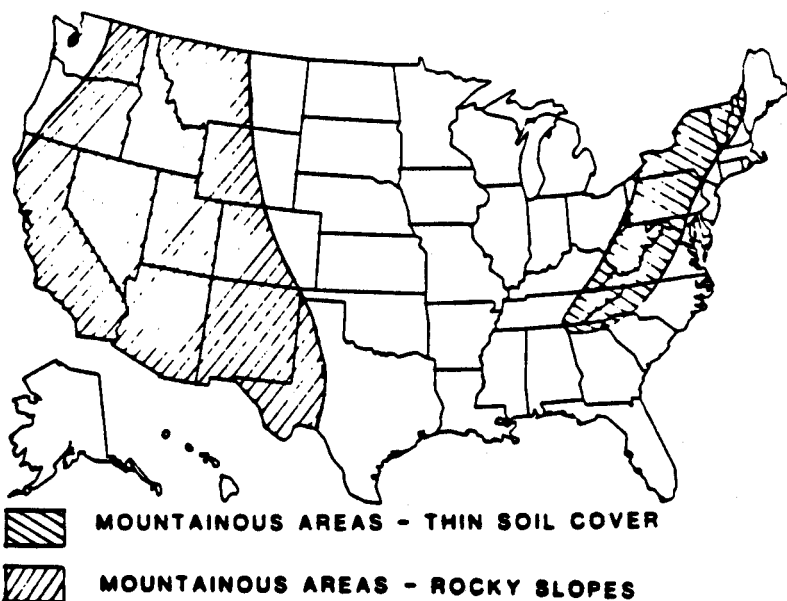
*Major geological and physiographical regions of the contiguous United States*

### III.A.1.a. Areas of Clay Shales

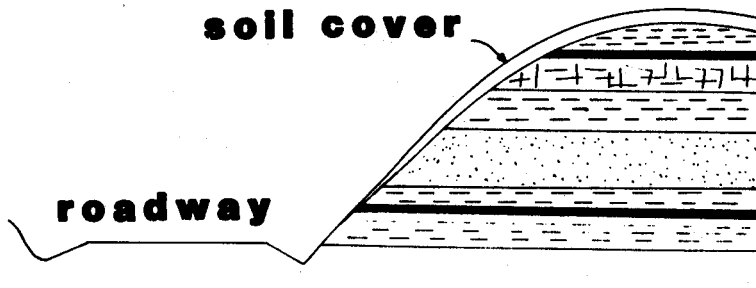
Certain rocks appear to be sound and durable when first excavated. However, because of the high clay content of these rocks, they breakdown into soil-like material when exposed to air and water. These rocks are referred to as clay shales.

Clay shales generally weather to weak clays that are susceptible to water, freezing, swelling, and creep (slow, long-term movements). This causes embankments to slump (dips in pavement), bridge approaches to need patching, and complete embankment failures. These areas are particularly widespread in many portions of the country.

### III.A.1.b. Steep Natural Slopes with Thin Soil Covers



*Major areas of the contiguous United States containing rocky slopes and thin soil covers*



*Thin soil covers on steep natural slopes*

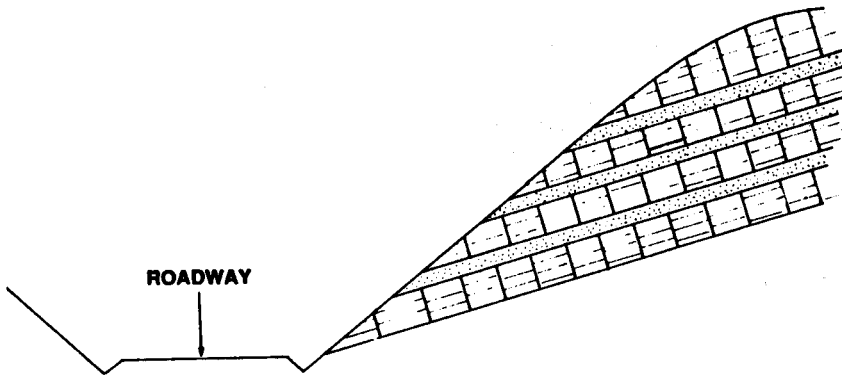
### **III.A.1.c. Mountainous Areas with Highly Weathered Rocky Slopes**

In mountainous areas where deep cuts must be made, high rock faces may be a problem. The action of rain dissolving rock, particularly shale seams, and freezing of water in crevices in the rock may loosen fragments or boulders. In western states where there may be little or no soil cover, rock debris slides are common.

### **III.A.1.d. Areas with Particularly Troublesome Geologic or Soil Formations**

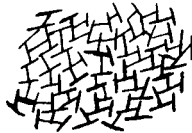
Some geologic formations may, by nature, present conditions that are landslide prone. If the formation has weak soil or rock layers interbedded with competent (strong, brittle) rock, slides often will occur along those weak layers. Some formations have rock that are very susceptible to breakdown during weathering, producing much debris. The chemical composition of rock and the reaction of that rock with ground water may be an important factor in the behavior of a formation. Rocks that have higher porosities will permit more water into the stone and will be more susceptible to freezing.





***Geologic beds sloping toward roadway***

Some soils are susceptible to vibration, because of the arrangement of their particles. When these soils are subjected to vibration, the structure of their particle arrangement collapses (similar to a "house of cards") and a landslide results.



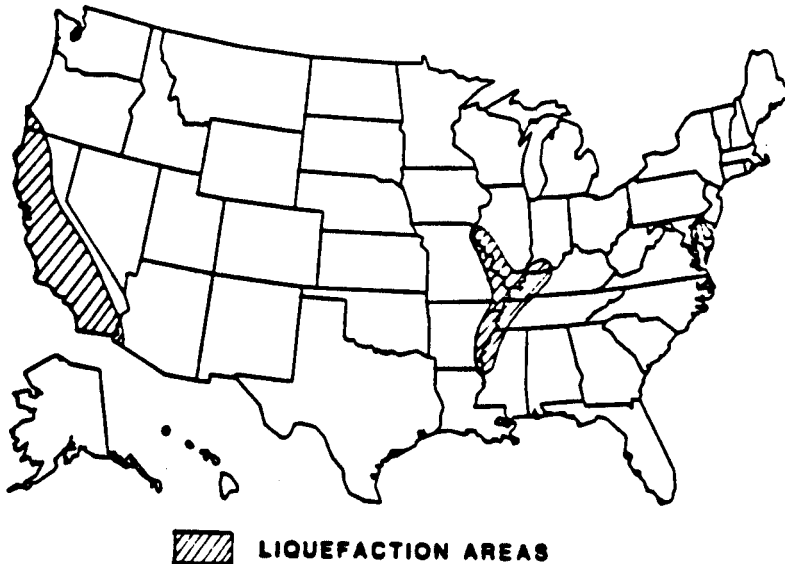
**HOUSE OF CARDS ARRANGEMENT (UNDISTURBED)**



**HOUSE OF CARDS ARRANGEMENT (DISTURBED)**

***Two types of soil particle arrangements***

Other areas have soils subject to flowing like water (liquefaction). When these soils have a large amount of water in them and are vibrated by an earthquake or blasting, water pressure (pore pressure) builds up in the soil, and the soil loses all or most of its strength. As a result, a landslide occurs.



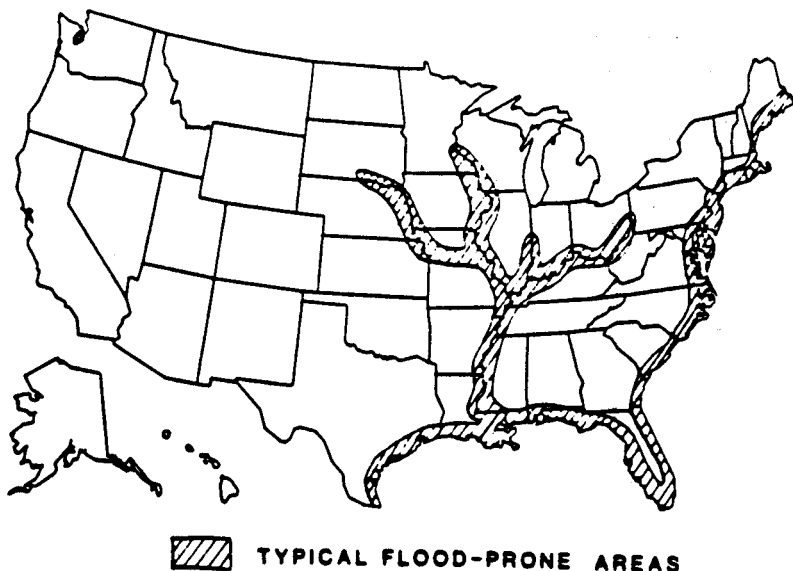
***Areas in the contiguous United States susceptible to liquefaction***

Some soil areas are subject to erosion. River banks, the toes of hills, the toes of embankments, and steep hillsides are particularly susceptible to erosion. Deep gullies may result from flowing water. Erosion removes support from the toe of man-made or natural structures or landforms, and landslides will result.

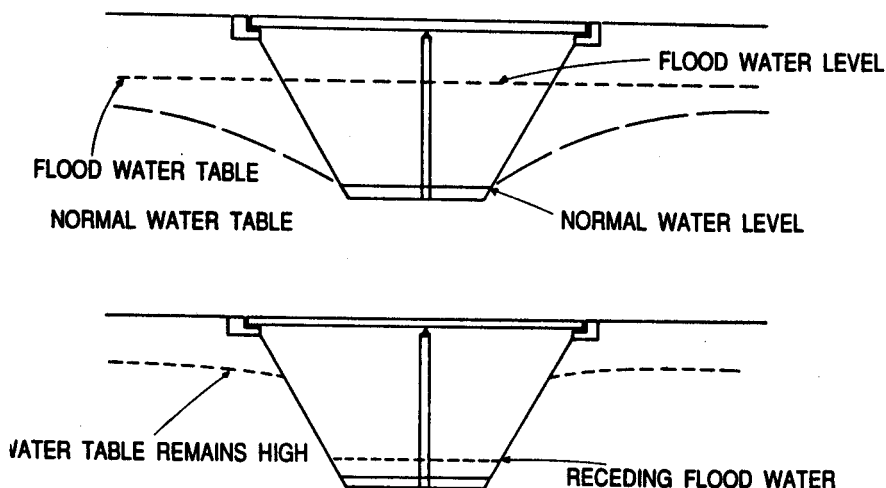
**III.A.1.e. Flood-Prone Areas**

Areas subject to frequent flooding are prone to landslides. One landslide mechanism in flooded areas is erosion from rapidly flowing water. A second mechanism is from a condition known as "rapid drawdown", which results when

the soils become saturated during periods when water levels are high. As flood waters rapidly recede, the soils do not drain as quickly as the water level falls; therefore, the soils remain nearly saturated with a consequent loss of strength, and a landslide results.



***Typical flood-prone areas of the contiguous United States***



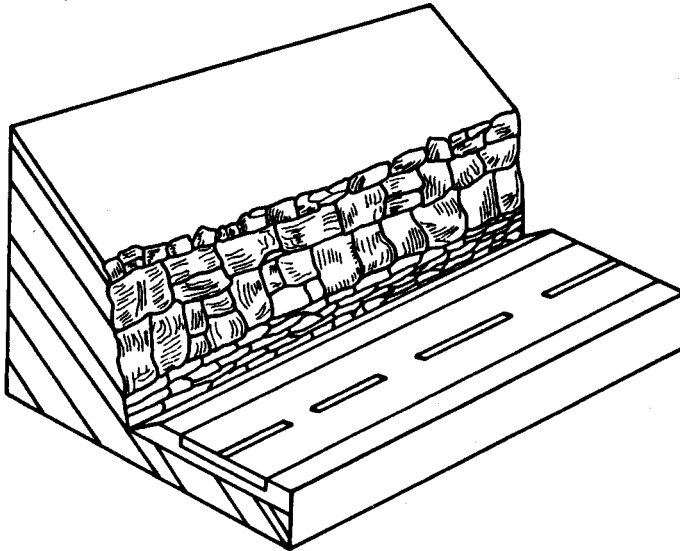
***Illustration of the principle of rapid drawdown***

### III.A.2. VULNERABLE LOCATIONS

Some sites are vulnerable to landslides because of conditions existing at a particular locale. Often these conditions are related to the geometry of the location, to prevailing drainage patterns, or to a very localized geologic or soil condition.

#### III.A.2.a. Undercutting Rock Slopes Where Bending Planes Dip toward Roadway

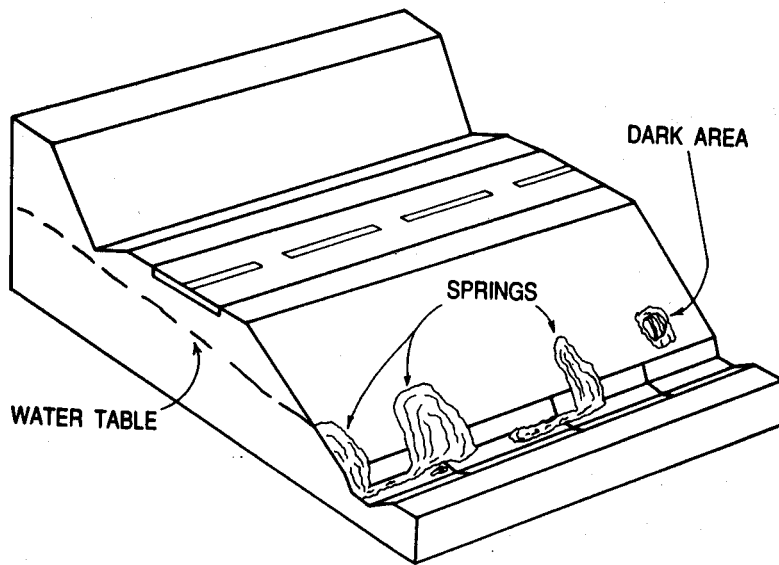
When bedding planes of a geologic formation dip into the roadway, undercutting that formation in such a way to produce an unsupported toe will often cause slippage along weakened planes in the formation.



*Sliding along dipping bedding planes undercut at toe of rock slope*

#### III.A.2.b. Naturally Occurring Springs

Springs located at toes of embankments may soften the soil, causing it to lose strength and allowing the embankment to fail. If springs occur at the toe of a cut slope, on the uphill side of an embankment, the side-hill embankment may become saturated and eventually cause the embankment to fail.



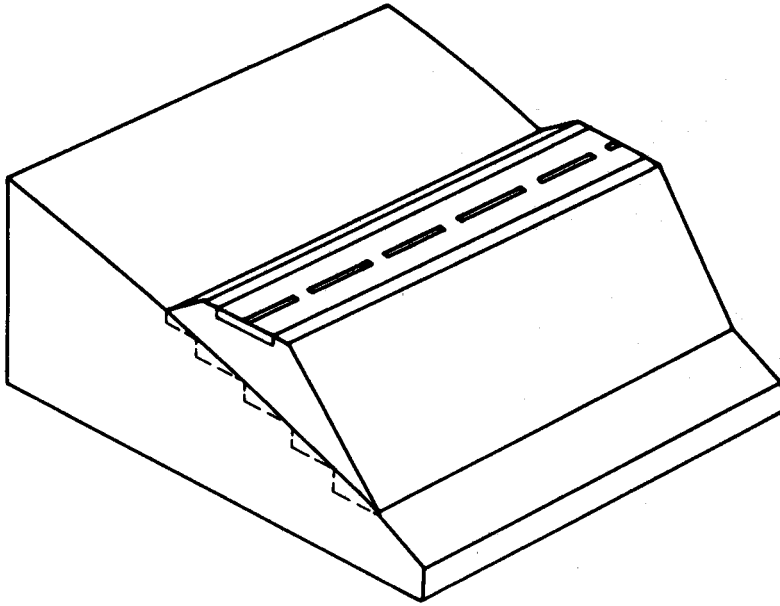
*Naturally occurring springs on highway slopes*

### **III.A.2.c. Side-Hill Cut-and-Fill Sections**

Side-hill cut-and-fill sections are particularly prone to landslides. The toe of the cut slope on the uphill side is subject to erosion and loss of toe support (undercutting). The side-hill fill portion of a cut-and-fill section may be weakened by ground-water saturation. Also, if the interface between the original ground and the fill material is not constructed (benched), failure of the fill may occur along that plane.

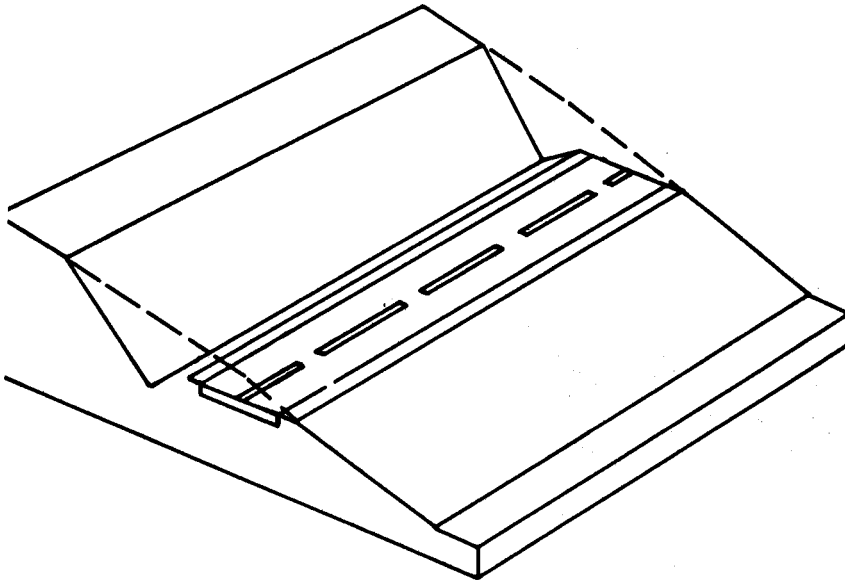
### **III.A.2.d. Side-Hill Fill Sections**

(See III.A.2.c.)

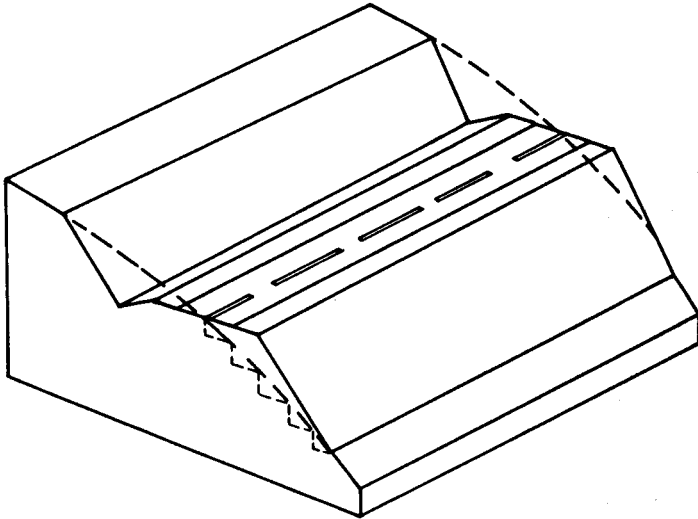


***Benching of natural ground under a side-hill fill section***

**III.A.2.e. Cut Slopes**  
(See III.A.2.c)



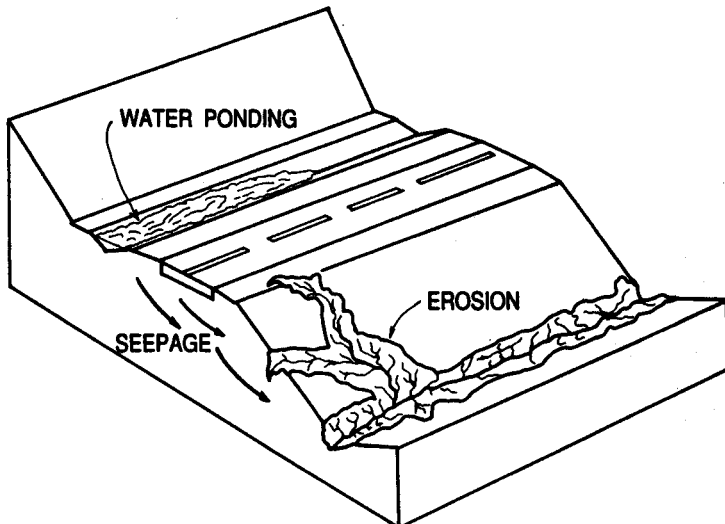
***Cut slope***



***Cut slope***

### **III.A.2.f. Poorly Drained Locations**

Drainage is one of the most important factors involving landslides. Subsurface water may saturate and weaken the soils of embankments, foundations, and natural soils. The result is often a landslide. Surface water, if not properly drained away from the earth structure, also may saturate the soil or infiltrate rock structures.

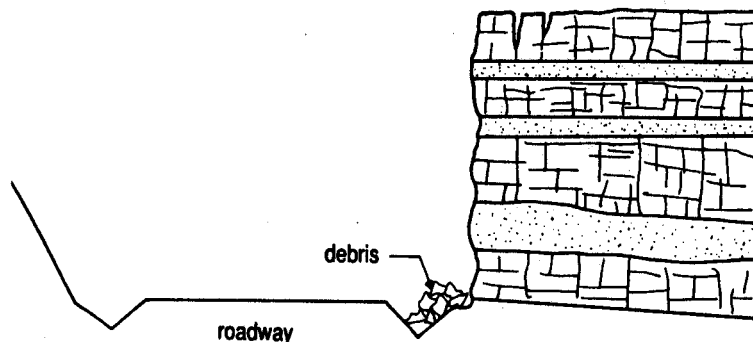


***Poorly drained highway locations***

### III.A.2.g. Vertical or Nearly Vertical

#### Rock Faces near Roadway

These locations are always a hazard. Because of the proximity of the rock face to the roadway, rock debris is nearly always present. Ditches are usually clogged, and debris often will fall onto the driving surface. Many rock falls are due to weathering, either from freezing and thawing or from differences in the rate of weathering between soft soil or rock layers and competent (strong) rock layers.

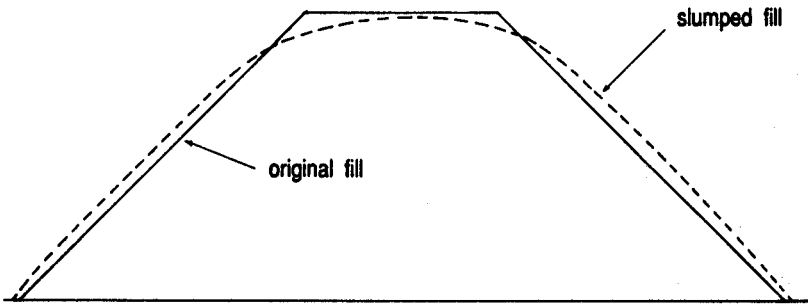


*Falling debris from vertical or nearly vertical faces near roadway*

### III.A.2.h. Very High Fills

When highway embankments or fills are over approximately 20 feet in height, the embankment will creep or slump under its own weight. This happens over a very long period of time (10 to 20 years). Usually the sides of the embankment develop a noticeable bulge. The surface of the roadway may have a slight "dip".





*Settlement of very high highway fills*

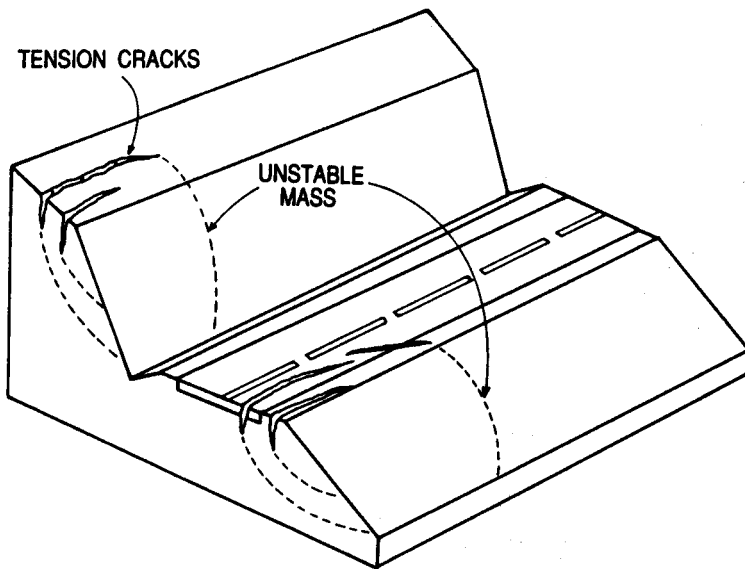
### **III.B. SIGNS OF MOVEMENT**

Most landslides do not occur without some advance warning. Maintenance personnel should be trained to look for these signs. If a slide is discovered in the early stages, steps often may be taken to prevent further movement, prevent major failure, and save the cost of extensive repair.

One of the early tasks of the maintenance supervisor is to determine the location of the failure or slip plane so as to assess the extent (horizontally and vertically) of the unstable mass. Attempts to identify the source of the problem and mode of failure are important since the corrective action must be related to eliminating the source of the trouble.

#### **III.B.1. Tension Cracks in Roadway or on Slopes above Roadway**

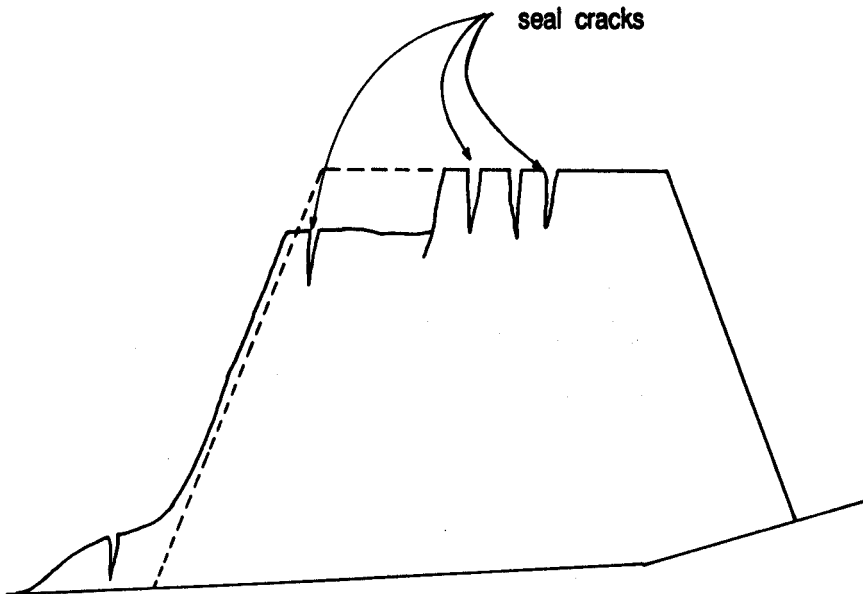
Soil is very weak in tension and it only takes a small amount of movement at the top of a slope before the soil "breaks" and a crack forms. Tension cracks in the roadway indicate movement has started. These cracks permit water to enter and further soften material along the failure plane as well as add additional water pressure to the moving mass. Tension cracks above the roadway indicate the natural slope or cut slope is in the early stages of movement.



***Development of tension cracks at the top of the roadway slope or cut slope***

### **III.B.2. Escarpments in or above Roadway**

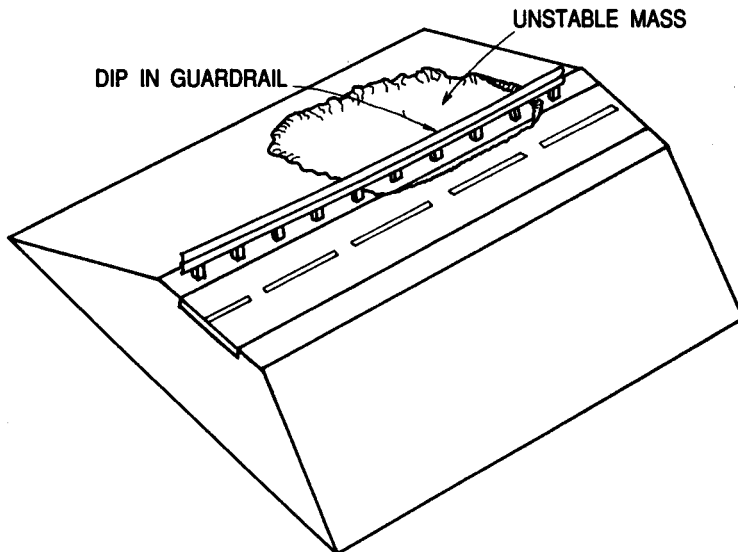
Escarpments indicate that the mass of soil or rock has already failed and moved. Some landslides will have more than one escarpment, as the soil mass often has a tendency to move in "blocks".



***Development of escarpments in or above roadway***

### III.B.3. Sunken Guardrail

Guardrails are installed to match the grade of the roadway. If there is an obvious dip in the guardrail, but none is observed in the roadway, this probably indicates that shallow movement is occurring within the embankment and involves only the shoulder but not the driving lanes. However, if there also is an obvious dip in the roadway, this would indicate a major portion of the embankment is involved in the movement. Dips in the guardrail at bridge approaches indicate that the approach embankment and/or foundation have settled or that the embankment is creeping.



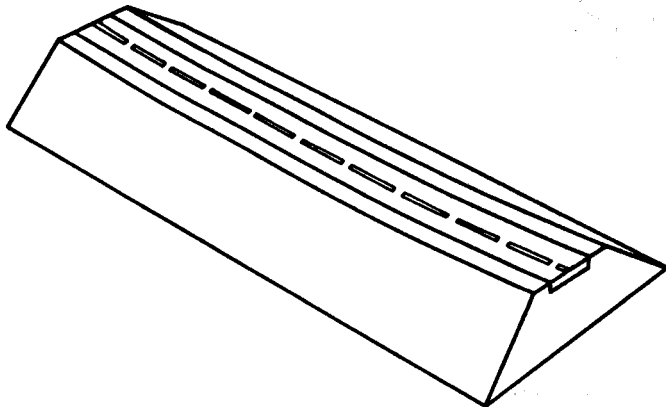
#### *Dip in guardrail*

### III.B.4. Dips In Grade

For long and high embankments, dips in the grade usually involve all driving lanes. This type of movement may be associated with slumping or creeping of the embankment under its own weight.

Dips in grade also may be associated with culverts located under large fills. In many cases, these dips may be

attributed to settlement of the backfill around the culvert and are not related to slump or creep.



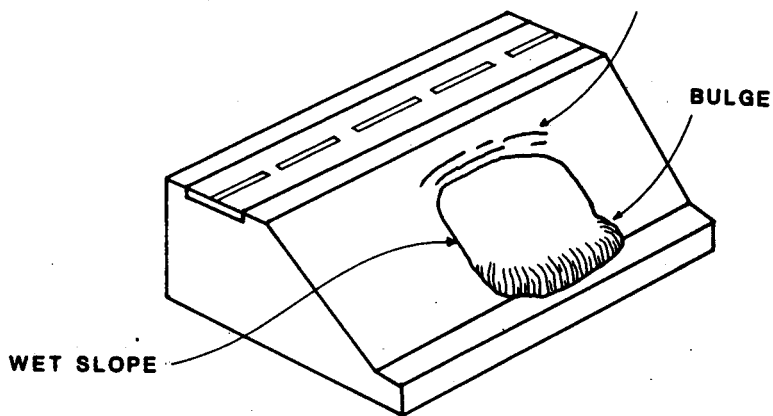
***Dip in highway grade***

**III.B.5. Debris on Roadway**

Debris of soil or rock on the roadway may indicate an unstable slope above the roadway. This debris could be the forerunner of a massive rockfall or slide. A continuing problem at a particular site would require maintenance personnel to take measures to protect the motoring public.

**III.B.6. Bulges above, on, or below Roadway**

Most slides in soil masses will have a bulge at the toe of the slide where the sliding mass has accumulated and "piles up". This bulge indicates considerable movement already has occurred and that movement will probably continue until complete failure occurs.

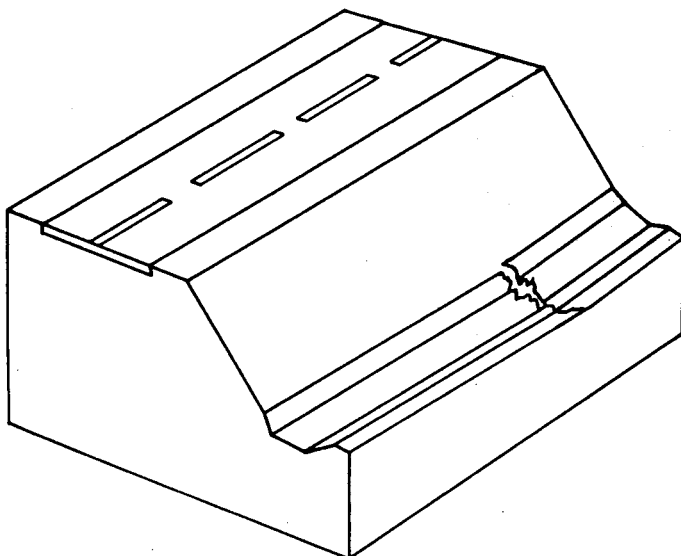


***Bulges above, on, or below highway roadway***

### **III.B.7. Poor Drainage (Surface Water)**

o **Blocked Culverts:** A culvert that does not permit water to flow properly may cause water to pond next to the toe of embankments. This condition will facilitate saturation of the embankment toe, cause the soil to lose strength and hinder the ability of the soil at the toe to resist the weight of the soil higher on the slope. Consequently, a landslide may result.

o **Broken Paved Ditches:** Paved ditches that are broken permit surface water to flow under the remaining portion of the ditch. This may erode the embankment or it may permit surface water to saturate portions of the embankment.

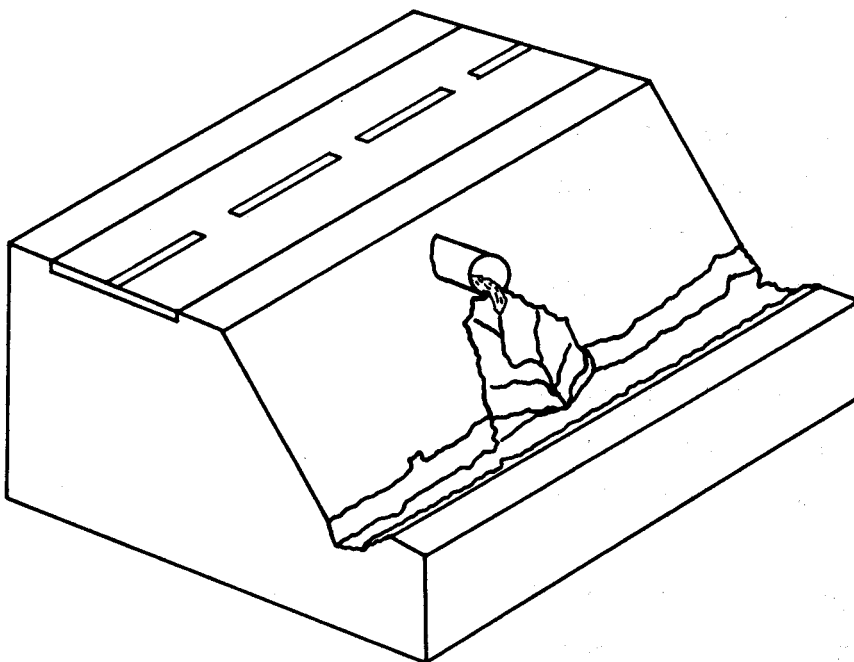


***Broken paved ditch***

**o Water Ponding above, below, on, and in Median of Roadway:** Ponding water is always an undesirable source of saturating water. Water ponding above the roadway may cause a cut slope to become saturated and slide onto the roadway. Water ponding in a ditch or in a median may saturate the entire embankment or further saturate a weakened failure plane in an embankment. Water ponding at the toe of the embankment will weaken the toe and may cause a landslide.

**o Drainage Structures Discharging onto Slopes:**

Pipes, culverts, ditches, or other drainage structures that permit water to flow onto an unprotected embankment slope may be a major factor in causing landslides. Water from these structures may saturate a soil structure or severely erode the slope.

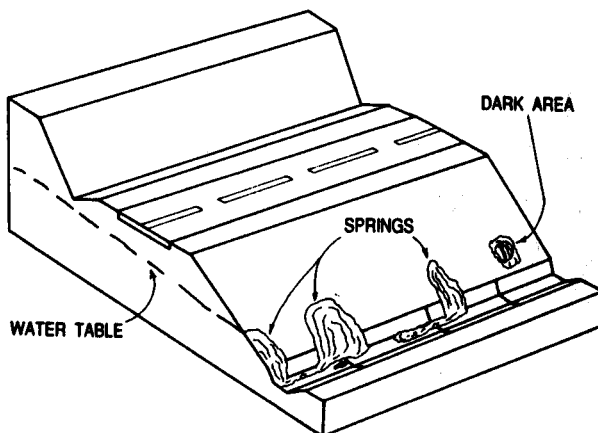


*Slope erosion caused by discharge from drainage structure*

### III.B.8. Poor Drainage (Subsurface Water)

#### o Springs on or at Toes of Slopes:

Springs indicate the presence of the ground-water table as it intercepts the ground surface. Springs also may indicate where water from a water-bearing rock formation has saturated a portion of an embankment or cut slope. Areas around springs will be particularly vulnerable to landslides.



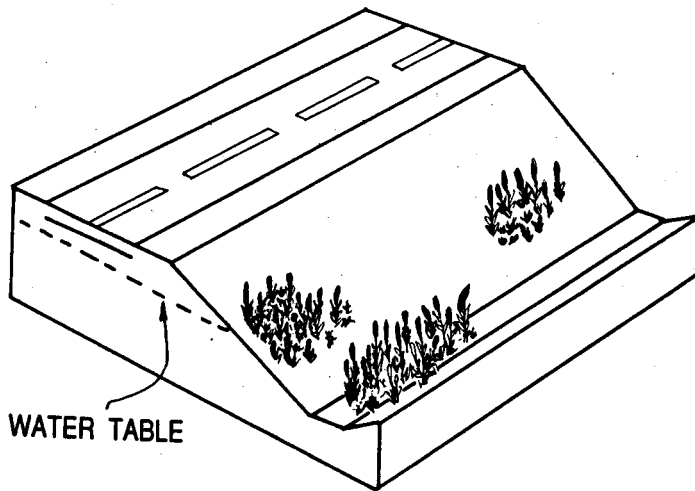
#### *Indications of the presence of ground water table by springs near toe of slope*

o **Light and Dark Areas on Slopes:** Differences in color may indicate distinct differences in the amount of water from one area of the slope to another. Again, areas containing the greater amounts of water will be more vulnerable to landslides.

o **Soft or Muddy Areas on Slopes:** Although no free or flowing water may be present, a soft or muddy area on a slope could indicate an area that is saturated and is subject to movement.

o **Vegetation:** The type or condition of vegetation growing on slopes may indicate the presence of subsurface water. Cattails or willow trees are particularly good plants to warn maintenance personnel of subsurface water. Grassy areas

of a slope that stay green in dry seasons are sometimes indications of subsurface water.



*Cattails or willow trees warn of subsurface seepage*

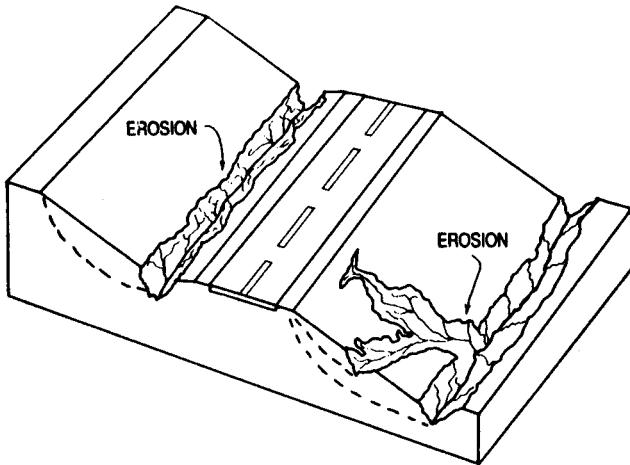
### III.B.9. Erosion

o **Toe of Embankment Slopes:** Surface water from paved ditches or other drainage structures may erode the toe of an embankment, removing supporting soil and causing a landslide.

o **Toe of Cut Slopes:** Rapidly flowing water in drainage ditches often cause severe erosion at the toe of cut slopes. Also, poor practices when cleaning ditches may undercut the toe of cut slopes and cause landslides.

o **On Slopes of Embankments:** Surface water from broken paved ditches or other drainage structures often is the source of this erosion. Poor maintenance practices are usually the cause of this type of erosion.

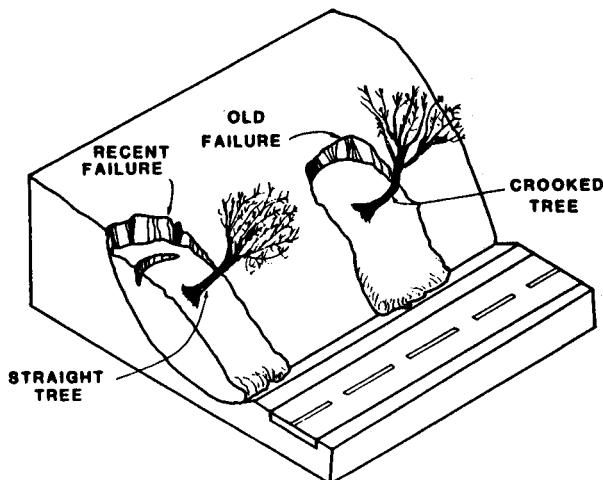




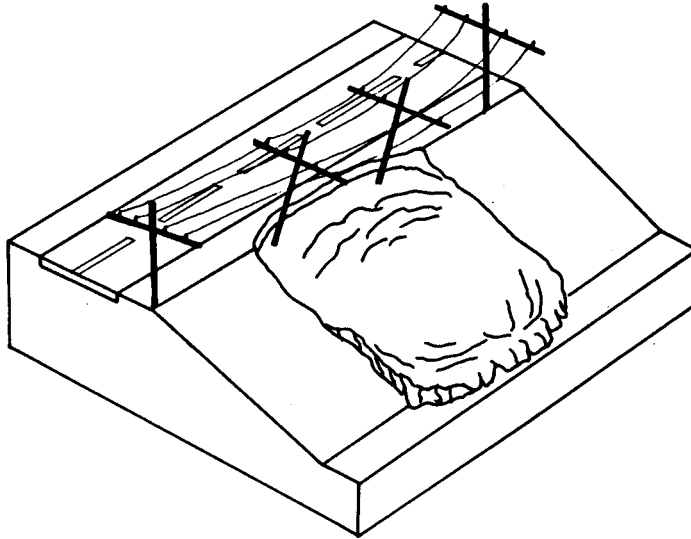
***Erosion of toe of cut slope and toe of fill***

### **III.B.10. Changes in Features**

More subtle signs of earth movements may include trees that are tilted from vertical. Tilted trees at the toe of a slope that are now growing vertically indicate an old landslide that moved many years previously. However, the movement has stopped and the tree is now growing vertically again. A tree growing in a continuous gentle curve may indicate a very gradual and slow creeping movement. Telephone poles and fences that have sunk or are tilted out of alignment are also good indicators of earth movement.



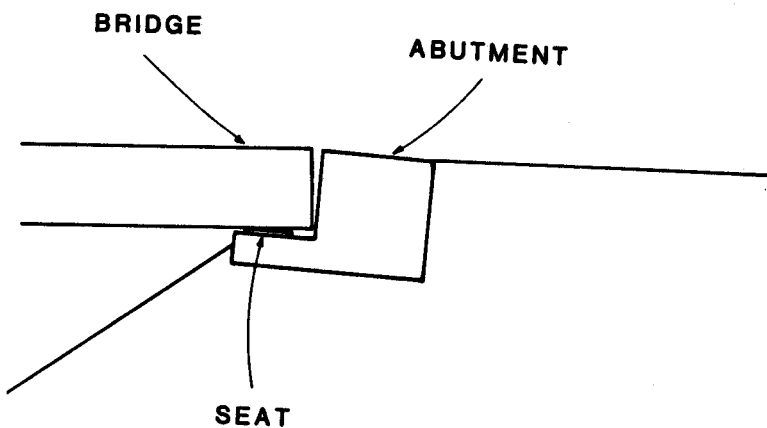
***Tilted or curved trees***



*Leaning telephone poles*

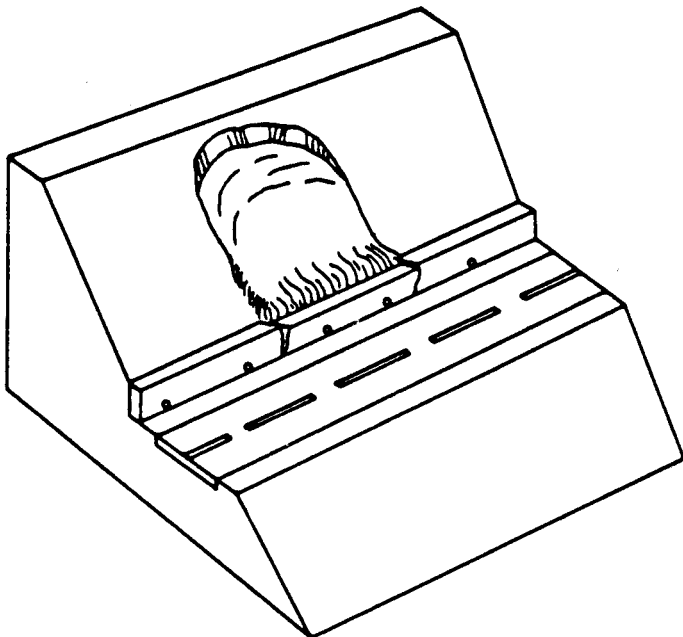
### III.B.11. Changes in Structures

o **Bridges:** Bridge abutments that tilt in relation to the bridge beams or abutments that move toward the ends of the bridge beams indicate that the approach embankment is moving or creeping toward the bridge. Settlement of bridge approach pavement slabs indicates that the approach embankment is settling or slumping.



*Tilted bridge abutments*

**o Retaining Walls:** Retaining walls are structures used to hold back soil slopes. However, if the soil continues to move excessively, the wall will tilt from the vertical and in severe cases will actually overturn. Cracks in retaining walls also may be evidence of soil movement behind the wall.



*Cracks in retaining wall or tilted retaining wall*

**o Buildings:** Buildings located in slide areas may provide evidence of earth movements. The most notable evidence are cracks in foundations or in masonry walls. Buildings also may rise or fall in elevation, depending on their locations in the slide area.

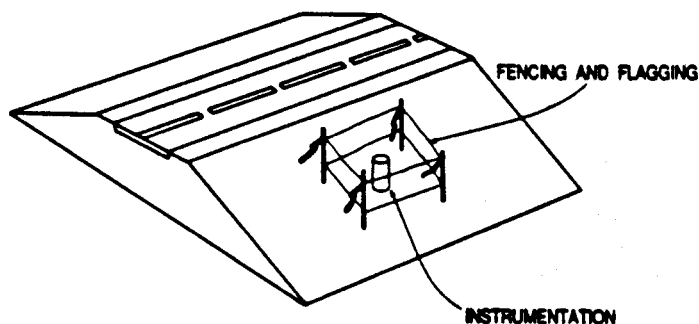
### **III.B.12. Examine Adjacent Development (logging, mining, etc.) for Changes that Affect the Roadway and Slope**

Development along highway rights of way may change topography, drainage patterns, soil conditions, and any

number of other factors that are significant to landslides. Any new development or changes adjacent to the roadway should be cataloged and carefully observed over a period of time by maintenance personnel.

### III.C. INSTRUMENTATION

Various instruments and methods may be used to determine the size of a landslide, how rapid it is moving, the depth of failure plane, the direction of movement, the location of ground water in the slide, and the water pressure in the unstable slide material. It is critical that instrumentation that is installed in a slide be carefully protected from damage. Often instrumentation must provide months or even years of data; and if they are destroyed, then valuable data may be lost. Instruments may be protected by stakes, flagging, fence posts, or any other appropriate means. Maintenance and/or construction personnel should be fully informed about the location, purpose, and operation of instrumentation.

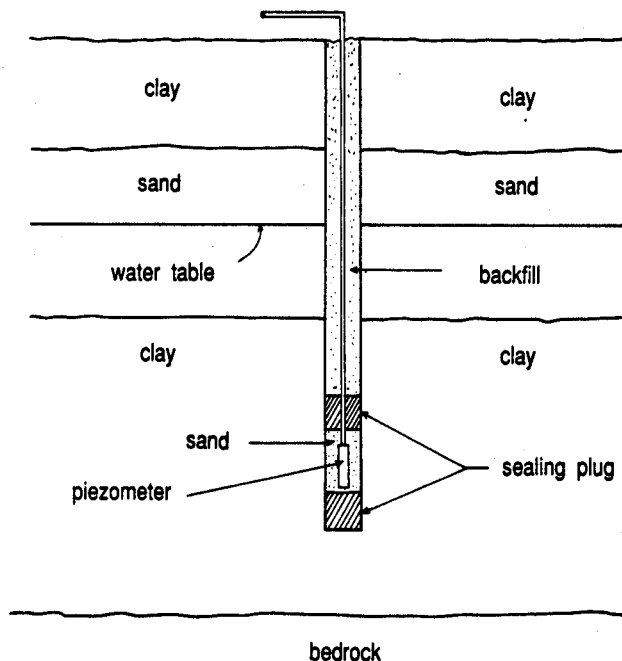


#### *Protection of geotechnical field instrumentation*

##### III.C.1. Piezometers

Piezometers are used to measure water pressure in the soil. It is important to know the fluid pressure in the soil. Higher water pressure reduces the strength of soils, thereby

making the earth slope less resistant to sliding. Piezometers usually are installed with a drill rig at some predetermined depth. The drill hole is sealed below and above the depth at which the piezometer is installed. This permits the piezometer to measure water pressure only at the desired depth. Pressure tubes are run from the piezometer to the surface. Pressure readings are taken periodically as the need arises.



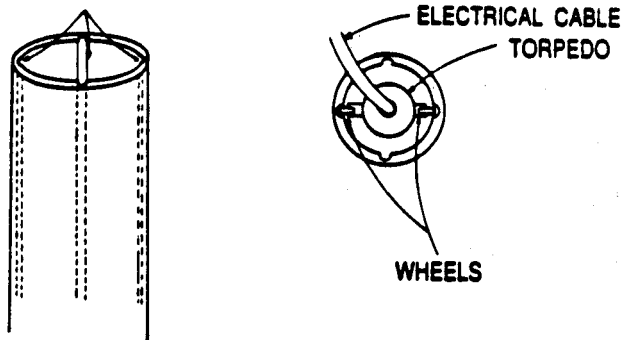
***Typical cross section of piezometer installation***

Observation wells are utilized to obtain information about the free water table in the subsurface. These wells are formed by installing a standpipe (may consist of downspout) in drilled or augered holes. After sufficient time is allowed for the water level in the standpipe to reach equilibrium, the elevation of the water table is determined by lowering a measuring device (stringline, chain, etc.) to the water surface.

### III.C.2. Slope Inclinometers

A drill rig also is used to install slope inclinometers. A hole is augered through the moving landslide mass and usually 5 to 10 feet into stable soil or bedrock. A special hollow plastic casing is installed in the entire length of the hole and the hole is backfilled with gravel, sand, or grout. The bottom portion of the casing (5 to 10 feet) is located in stable soil or bedrock so that it cannot move. The upper portion of casing is free to move as the landslide moves. The casing has vertical grooves on the interior wall in which an electronic "torpedo" rides. The torpedo measures the deviation of the casing from the vertical at various depths in the hole. If the landslide is still moving, the casing will also move. Periodic readings will indicate if the slide is moving, the depth at which it is moving, and the rate of movement.

INTERIOR GROOVES FOR TORPEDO WHEELS

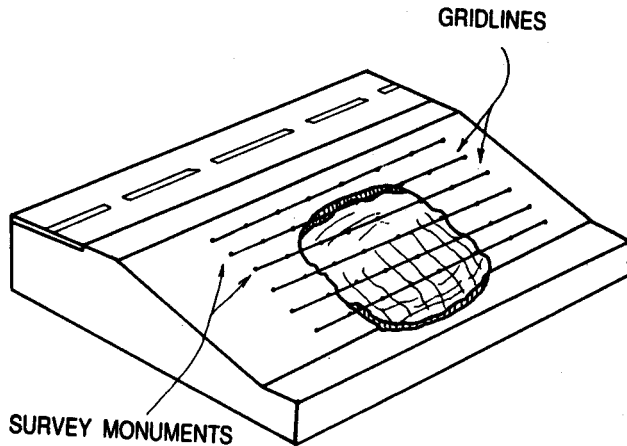


*Side view and top view of slope inclinometers*

### III.C.3. Ground Surveys

Establishing a series of survey monuments in the vicinity of a slide is very helpful in determining surface movements in the unstable area. A series, network, or gridwork of hubs, stakes, or iron pins may be precisely located and elevations and alignments taken on each monument. Subsequent periodic surveys reveal the relative horizontal movement of

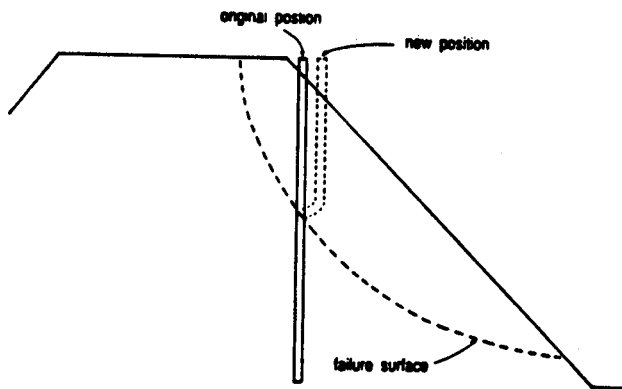
the monuments to each other as well as any elevation changes. This information defines or indicates the aerial extent of a slide and the rate at which it is moving.



*Tracking slope surface movements using survey monuments placed in a pattern of gridlines*

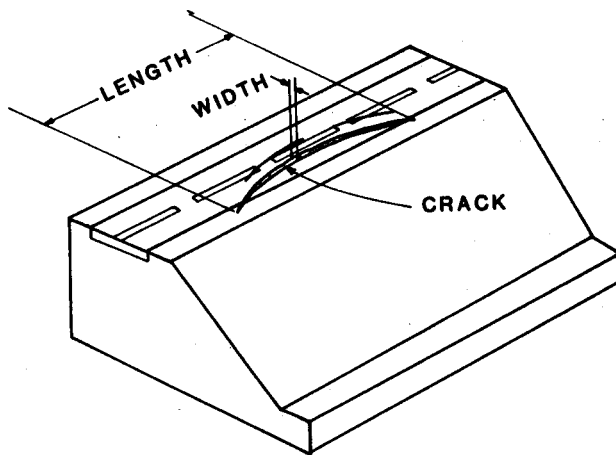
#### III.C.4. Simple Methods

Drain tile or downspout may be installed in a landslide instead of slope inclinometers. By lowering a rope or tape in the tile until the rope or tape can go no further because the tile or downspout has closed off, an indication of the location of the failure plane may be obtained. Unlike slope inclinometers, these methods will not yield the rate of movement.



*Cross-sectional view of movement of drain tile or downspout*

If cracks are present in a slide, one may obtain information about the rate and growth of a slide by measuring the length and width of cracks.



*Measuring the width, length, and growth of cracks in the pavement or slope*

### III.D. SOIL/ROCK IDENTIFICATION AND PROPERTIES

The mechanical and engineering behavior of soil and rock have a tremendous influence on the probability of a landslide occurring at a particular site. These properties will influence the size, shape, and rate of movement of a soil or rock mass.

Discussions presented in this subsection are primarily for information and for a complete coverage of the topic of slope stability. However, it is important that maintenance crews have an elementary background and understanding of the properties and characteristics of soils and rocks. It is these materials (i.e., soil and rock) from which slopes are made. An appreciation of the characteristics and properties of soils and rocks will assist in determining the extent of an unstable mass and in evaluating possible causes and potential remedies.

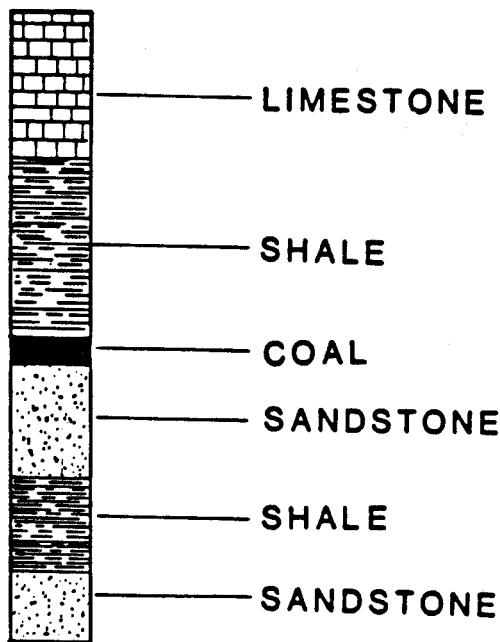


### III.D.1. Soil

Soil consists of individual particles that usually are not compacted very tightly (not consolidated). In addition, the particles usually are not cemented very well and can easily be broken apart. Some soils are the result of weathering of rock. Some are the result of deposits at the bottoms of oceans, lakes, and rivers. Other soils are the result of deposits of fine particles that have been carried by wind and some soils are the result of glaciers that have melted, leaving the debris carried by the glacier to become soil.

#### III.D.1.a. Geologic Formation

Knowing the geologic formation from which soil was formed may yield much information about the behavior of the soil. Marine-deposited soils, residual soils (from the weathering of rock in place), glacial soils, and wind-blown soils behave differently because of their different geologic origins. The types of minerals in a formation are important to behavior.



*Cross-sectional view of a typical geological formation*

More specifically, the types of clay minerals present in a geologic formation may have a strong influence on the landslide behavior of a soil. Some clay minerals absorb more water than other types. Those clays that absorb more water are more likely to cause landslides than those that absorb less water.

### **III.D.1.b. Basic Characteristics**

**o Particle-size Distribution:** Sizes of soil particles range from large boulders and coarse gravels to particles smaller than the naked eye can see (clay sizes). Between these two extremes are fine gravels, coarse sands, sands, fine sands, and silts, in descending order of size. Coarse-grained soils usually are less likely to present landslide-related problems; whereas silts and clays are much more prone to landslides.

In most cases, a very general classification of a soil may be made visually by the following rules-of-thumb:

**o Gravels** -- Very large particle sizes, all or nearly all of which are large rock fragments clearly visible to the eye.

**o Sands** -- Much smaller particle sizes, but still clearly visible to the eye. The particles will not stick together but will pour loosely when dry.

**o Silts** -- Particle sizes are much smaller than sands. The particles are visible to the eye only with difficulty. The soil feels slightly gritty. A small lump will crush easily between the fingers.

**o Clays** -- Particles cannot be seen with the naked eye. Soil feels sticky when wet and can be easily molded between the fingers. When dry, a small lump can be crushed between the fingers only with great difficulty.

Generally water flows more rapidly through gravels and sands than through silts and clays, which tend to hold water. The behavior of silts and clays is more sensitive to changes in water content. If gravels and sands contain more than about 20 percent passing the No.-200 sieve, flow of water is significantly reduced. As a general rule of thumb, gravels and sands have greater strengths than silts and clays.

**o Plastic Behavior:** The engineering behavior of clay soils is influenced by the amount of water in the soil. If a particular clay contains a large amount of water, it will act more as a liquid and will flow easily under a small disturbance. If water is removed from that soil by drying or drainage, the soil eventually ceases to act as a liquid and begins to act more as a highly plastic material. The water content at which this occurs is known as the liquid limit. If more water is removed from the soil, the soil eventually ceases to act as a plastic, and it will act as a semi-solid. The water content at which this occurs is called the plastic limit. These limits are determined in the laboratory using standardized procedures. The greater the range of plasticity of a clay soil, the more apt it will be to lead to landslide- related problems.

above liquid limit —  
soil acts as a liquid



above plastic limit —  
soil acts as a plastic

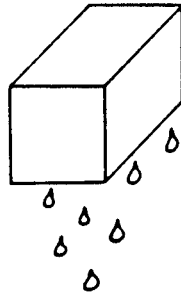


below plastic limit —  
soil acts as a solid



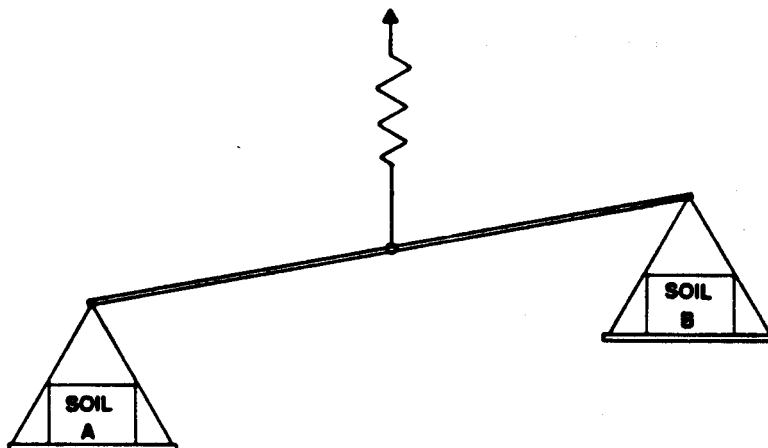
***Sketch illustrating the definitions of atterberg limits***

**o Natural Water Content:** This is defined as the weight of the water in the soil divided by the weight of the dry soil (expressed as a percentage). It is important for the natural water content of clays be kept at or below the plastic limit. This minimizes the possibilities of landslides.



*Natural water content illustration*

**o Unit Weight:** The unit weight is defined as the weight of the soil per unit of volume (for example, 100 pounds of soil per cubic foot of volume). The unit weight of a soil is controlled by the weight of the minerals that comprise the soil particles and by how closely the soil particles are packed. Usually, the denser the soil (higher unit weight), the more likely it is to withstand movements that are associated with landslides.



*Illustration of the unit weight of soil*

## **III.D.2. Rock**

### **III.D.2.a. Geologic Formation**

As with soil, much information may be gained about rock if its geologic formation is known. Information about the bedding planes, such as how steeply and in what direction the beds dip and thickness of bedding, is important in understanding slides in rock formations. Information on the type of rock, its mineral composition, how it was deposited, and how it weathers is important.

### **III.D.2.b. Basic Characteristics**

- o Unit Weight:** The unit weight of rock is important in determining the forces that initiate a slide.
- o Slake Durability:** Many rocks (most notably shales) have a tendency to degrade or breakdown when subjected to water and mechanical manipulation (this includes working with bulldozers, hauling in trucks, and working with compaction equipment). Shales will degrade to clays. A laboratory test known as the slake-durability test is used to determine this characteristic. A shale having a slake-durability index of less than 90 is usually considered a poor shale and could present landslide problems if used in embankments.
- o Freeze-Thaw Durability** Freeze-thaw durability is an important factor in determining the probability of slides in a rock formation. Obviously, the greater the resistance of rock to degradation from freezing and thawing the less likely rockfalls or slides are to occur.

### **III.D.2.c. Shear Strength Properties**

In general, there are two laboratory tests used to determine the shear strength properties of rock. These are the triaxial

compression test and the unconfined compression test. The basic testing procedures are the same as for soil, except that loads are much higher in the case of rock.

#### **III.D.2.d. Other Characteristics**

Results of strength tests on rock may sometimes be misleading. Intact rock specimens are tested in the laboratory and, consequently, the shear strengths are for unfractured rock. In the field, most rock deposits are crisscrossed with many cracks, fissures, solution channels, joints, and bedding planes. These features are planes of weakness that often control the behavior of the rock mass. In nearly every case when a slide or slope failure occurs in rock, failure will be through these weak zones.

## **IV. MAINTENANCE PRACTICES**

### **IV.A. INVENTORY OF SLOPE PROBLEMS**

#### **IV.A.1. Methodology**

Maintenance supervisors, or other designated personnel, should establish and maintain an inventory of all highway slides, slipouts, rockfalls, and sections of highway showing distress. Distress signs, or preslide symptoms, are shown in APPENDIX A for several typical highway slides. Also, any drainage facilities located near or within the distressed section of highway or slide should be inspected. The purpose of the highway inventory is to provide information so that an evaluation of a particular fill or cut slope can be made. Benefits of an inventory program of slides are as follows:

- o Aids in identifying potential slide areas.
- o Aids in defining the scope of a potential highway slide.
- o Aids in determining the cause(s) of the highway slide.
- o Traces the progression of a potential slide from year to year.
- o Provides vital information for establishing a priority program for allocating monies and repairs.
- o Provides vital and historical data for the geotechnical staff (or consulting engineer) to review in cases involving medium and large slides, or slides that may require the attention of the geotechnical engineer.
- o Provides a means of "opening up" communication among maintenance supervisors, maintenance engineers, and geotechnical engineers.
- o Aids in establishing future budgetary requirements.
- o Aids in establishing an appropriate course of action.

It is recommended that the maintenance slide inventory and maintenance records be reviewed periodically by the geotechnical engineering staff or consulting engineer. In cases where city and local officials may not have access to the state's geotechnical staff, it is recommended that consideration be given to retaining a geotechnical consulting engineer. City and county officials should consider using a geotechnical consulting engineer that is knowledgeable in slide problems to conduct and help establish the slide inventory system. This review should be a joint effort undertaken by the maintenance supervisors, maintenance engineers, and geotechnical engineers.

By conducting a joint review, slides or potential slides that need the attention and further study by the geotechnical staff may be identified. Also, the joint review affords an

opportunity to the maintenance engineer and supervisor to obtain the opinions of the geotechnical engineers regarding repairs or further studies that may be considered for a particular small slide. In certain localities, such as mountainous areas or areas prone to sliding, establishing an inventory of slides may represent a large undertaking since there may be numerous problems and sites. Establishing the inventory system may require a temporary reallocation of personnel.

Maintenance records and costs should be used as major factors in establishing a slide inventory system. Maintenance records may be used effectively by identifying:

- o Areas of numerous overlays or patching,
- o Areas of pavement cracking, and
- o Locations of previous slope repairs.

Present maintenance accounting systems within a locality should be tailored, or revised, to trace maintenance costs of slides or potential slides.

During the initial stages of developing the slide inventory system, the three identified areas listed above should, perhaps, be inspected first. Later, as time permits, the inventory could be expanded to include

- o All fill and cut slopes greater than certain critical steepness and height (officials of each locality should establish the critical parameters -- it is suggested that all fills larger than 50 feet and slopes of 2 horizontal to 1 vertical or less be inspected periodically.),,
- o All surface and subsurface drainage features, and
- o All known slides and slipouts, or suspected areas that may be prone to sliding.



Inspections of particular sites should include a written record and notes of any abnormal conditions. **The purpose of site inspections is to determine or classify the condition of a highway fill or cut slope.** Site inspections are best performed during periods when foliage of trees, bushes, etc., has fallen. Ground conditions are better viewed during periods when leaves have fallen and other foliage is dormant. Suggested guidelines for classifying the conditions of an inspected site might consist of the following:

o **VERY SERIOUS** -- Immediate repairs are necessary to restore the roadway to a safe condition. Examples of a "very serious" condition might include dropping of traffic lanes, or shoulder, or massive rocks have fallen onto the roadway which would impede and pose a danger to the normal flow of traffic. Such conditions require an immediate investigation to determine the causes, evaluate future dangers to motorists, and develop a method of repair or protection. This situation should be brought to the attention of the maintenance engineer and geotechnical staff, or consulting engineer immediately.

o **SERIOUS** -- Investigation is needed to determine the cause of the distress and of repairs the type that may be needed. Examples might include a pavement located on a fill section that has settled several inches and has required numerous overlays, or patching, or cracks in the pavement have been filled on numerous occasions. Another example may include frequent rock falls onto the roadway. The situation should be discussed with the maintenance engineer and geotechnical staff or consulting engineer.

o **MEDIUM** -- The potential that a problem may become serious or very serious exists. A limited investigation is

needed and follow-up inspections are needed. The situation should be closely monitored. Examples of this situation might include minor settlement of the roadway (less than or about 2 inches), slight settlement of the guardrail, or small amounts of debris are discovered on the roadway.

o **MINOR** -- Some maintenance repairs may be needed.

#### **IV.A.2. Survey Form**

To aid the inspector in gathering physical distress data, sample slide and culvert inventory forms are presented in APPENDIX B. Some items that should be included on or with the survey form are as follows:

o **Location** -- district, county, route, etc.

o **Type of slide** -- rockfill, mud flow, rotational, etc. (see APPENDIX A for typical failures).

o **Contributing factors** -- Subsurface drainage, side casted material, etc.

#### **o Inspection data**

- rate of movement,
- effect on roadway,
- utilities affected,
- adjacent properties involved,
- maintenance activity,
- discharge from drains,
- size of slide.
  - \* width.
  - \* height (toe of fill to top of fill or toe of cut slope to top of cut slope).
- classification of size of slide
  - \* small,
  - \* medium,
  - \* large.

- o Additional notes/sketches**
- o Photographs**
- o Cross-sectional sheet**
- o Estimated repair method**
- o Estimated repair cost**
- o Follow-up report (if corrected)**

Useful items to have on hand when an inspection is made are as follows:

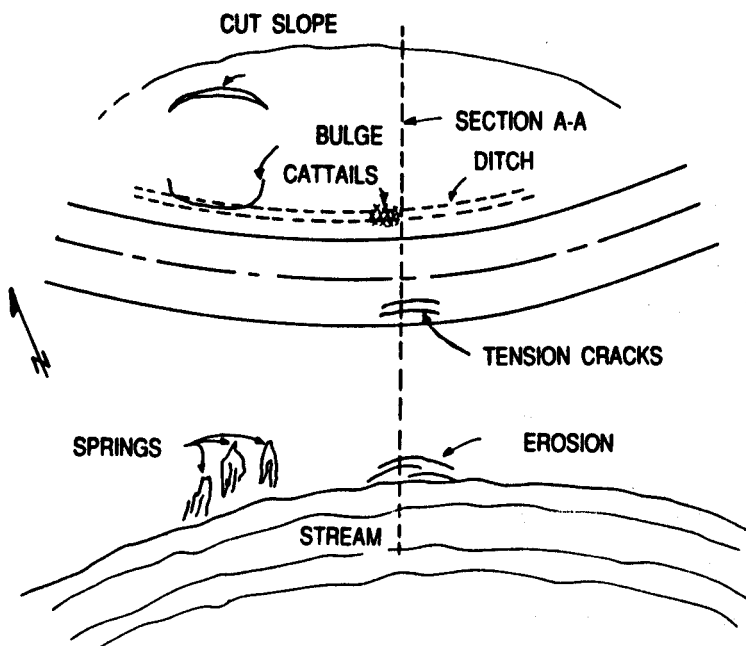
**o Sketch pad or notebook** -- a sketch(s) of the site should be prepared showing such features and distressed signs (see APPENDIX A) as:

- alignment of guardrail posts, sign posts, poles, fences, and trees,
- cracking of the fill or cracking at the top of a cut slope,
- settlement of the fill and roadway,
- drainage (surface and subsurface structures, such as culverts, etc.),
- sloughing,
- seepage, spring areas, and ponding,
- other distress signs,
- date of sketch,
- sketched by (name) and telephone number,
- district, county, route, mile post, or station number (if available) or automobile mileage from a known landmark,
- north arrow.

**o Camera** -- Obtain 35mm colored photographs or slides of the slide or distressed section. Photograph an over-all view of the site, toe of the fill, roadway, and other physical distress signs. If photographs are used, then have the photographs developed to a size measuring 4 inches by 6

inches (Note: photographs measuring 3 inches x 5 inches are usually too small to view details of physical distress signs). Some consideration might be given to using only 35mm colored slides, since these would be convenient to engineer. Photographs or slides should be mounted and dated in plastic mount holders which may be obtained from any photographic supply company. In emergency situations, Polaroid photographs, or comparable photographs, are useful since photographs may be obtained immediately. Combine the plastic mounted photographs or slides with other inventory data.

o **Cloth tape and hand level** -- These items can be used to obtain a cross section(s) of the distressed fill as it exists at the time of the inspection. Cross sections of the distressed fill or cut slope may give important clues as to the type and cause of failure that may be occurring. For example, as shown in the sketch below, the toe of the fill has eroded (tension cracks and springs are indicated on the cross section). Distress signs should be located on the



***Illustration of a sample sketch to include in the slide inventory***

sketch (measured from a known reference point such as a guardrail, culvert, etc.). Also, the distance from the toe of the slope to right of way (if it is known) or from the top of the cut to right of way should be indicated on the cross section. In some cases, the right of way may be determined by talking to adjacent property owners or checking courthouse records. If no physical evidence such as a fence is evident during the inspection, then make a note that right of way is unknown. As shown in the sketch, the presence of cattails and green grass in the lower portion of the fill may indicate that subsurface water (ground water) is intersecting in the lower portion of the slope. This condition represents an important cause of the slide.

o **Compass** -- Used to determine north arrow for sketch.

Once the above information is obtained and reviewed, recommendations on a course of action should be indicated on the inventory form. Suggested categories of recommended actions might include:

o No maintenance is needed; follow-up survey should be made.

o Only maintenance repairs are needed (specify).

o Maintenance repairs are needed (specify); behavior should be monitored and other action taken if problem worsens.

o Behavior should be monitored; geotechnical action needed; maintenance forces could probably perform needed action; borings or soundings may be needed to define bedrock. Stabilization method should be implemented.

o Behavior should be monitored; geotechnical action needed; slide probably too large for maintenance forces to implement stabilization method; field instrumentation needed

to monitor movement.

- o Emergency maintenance repairs are needed; maintenance and geotechnical engineers need to be contacted immediately.

- o Other recommendations and comments.

If the slide is classified as medium or large, or if the slide is such size that the maintenance supervisor and crew cannot perform the necessary corrections, then the geotechnical engineer may be required to analyze the conditions of a site.

Each state or locality should give consideration to computerizing the slide inventory and inspection data. The sample forms in APPENDIX B could easily be modified and adapted for the computer. Computer formats could be developed for the sample inventory form in APPENDIX B by each state or locality. By developing a computer inventory system, data can be manipulated so that distressed sections of a highway may be easily identified. Also, a computer inventory system would aid maintenance personnel in establishing priorities and deciding which highway sections should receive the most attention. Each state (where slides are a major problem) should consider establishing a slide control center for the purpose of monitoring and reviewing the data. These data would aid in defining the magnitude and scope of the slide problems within each state. These data may be useful for obtaining increased funding for maintenance activities in the future.

#### **IV.B. SLOPE MAINTENANCE**

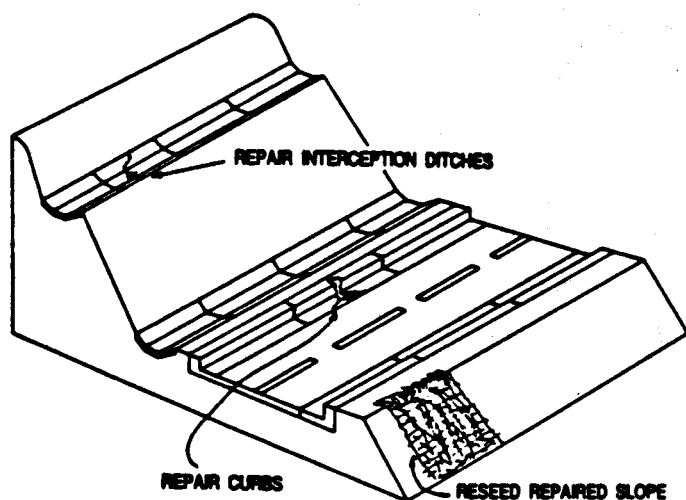
Many landslides can be prevented or minimized by careful and knowledgeable maintenance practices. If maintenance

personnel are familiar with the factors that cause or worsen slides, more responsive and effective maintenance efforts will reduce costs to the maintenance agency and inconvenience to the public.

#### **IV.B.1. Surface Maintenance**

##### **IV.B.1.a. Erosion**

- o Regularly inspect erosion-control elements. These include ditch checks, all paved ditches, pipe and culvert headwalls, slope paving, rip-rap, and all vegetation.
- o Maintain interception ditches. This will prevent rapidly flowing surface water from running over fragile slopes.
- o Slopes should be reseeded immediately after repairs. When reseeding, straw or some form of netting should be used to help hold the soil and seed in place until sod is established.
- o Curbs, dikes, or berms that are not properly maintained may permit surface water to erode soil slopes. These should be repaired and maintained in proper working order.

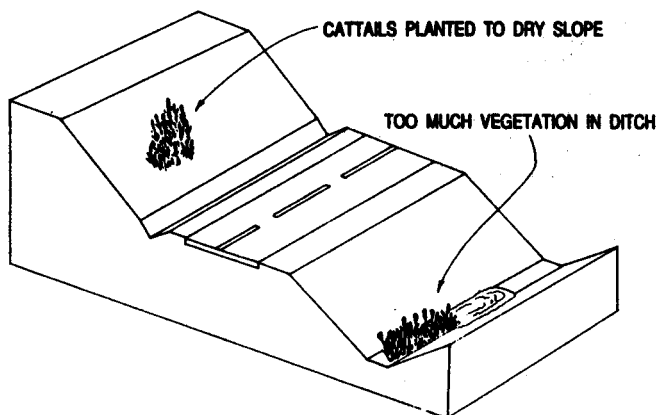


***Surface maintenance repairs***

#### IV.B.1.b. Vegetation

o Vegetation is one of the better means of controlling erosion. In addition, sod, trees, and shrubs help to beautify the right of way, providing a greenbelt along the highway. Grass roots hold the soil in place, preventing it from being transported by moving water. Root systems of trees and shrubs not only hold the soil in place but also help to reinforce the slope.

o Vegetation in drainage ditches should be controlled. The vegetation should not be so heavy that the ditch becomes clogged and water collects behind the vegetation. However, if the ditch is unpaved, enough grass should be in the flowline to prevent erosion.



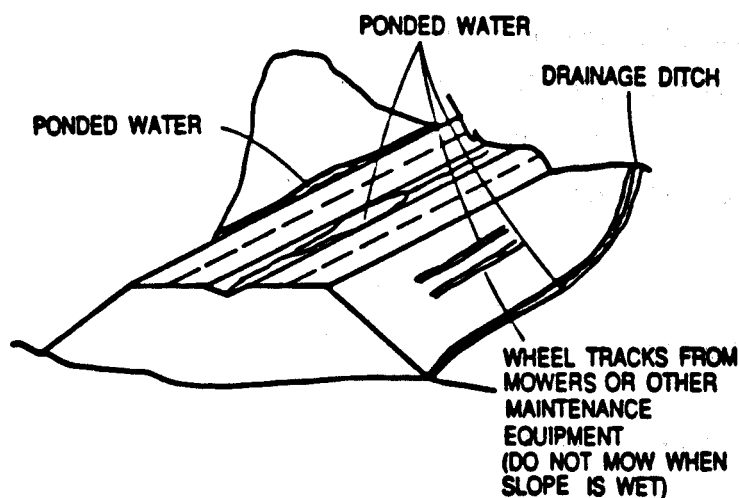
***Areas on slopes where vegetation may be useful or should be controlled***

o In some cases, water-loving plants (grass, willow trees, cattails) may be planted in wet areas to absorb the excess moisture in plant growth, thereby reducing the likelihood of a landslide.

o Although noxious weeds may be a problem in some areas, it is advisable not to spray vegetation in locations that are prone to slides.



o Special care should be given to sodded slopes. In dry seasons, the grass should not be cut too short and scalping of the ground should be avoided. Where possible, sod should be watered in the dry season. When wet and soft, do not put mowers on the slopes. Resulting ruts allow water to stand and infiltrate into the earth material. This tends to reduce the strength of the soil. For particularly troublesome slopes, the sod should be fertilized in the proper season.



*Areas of the slope where water may pond*

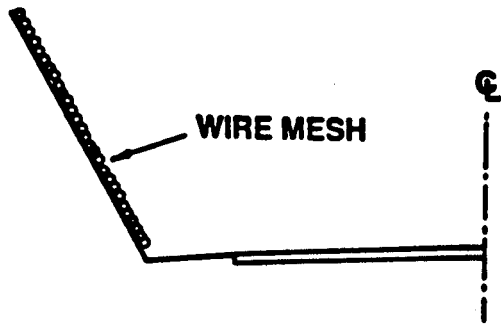
#### IV.B.1.c. Rockfall

o When rock faces are close to the roadway, there is a danger of weathered rock falling onto the roadway. These faces should be inspected regularly and probably should be scaled periodically.

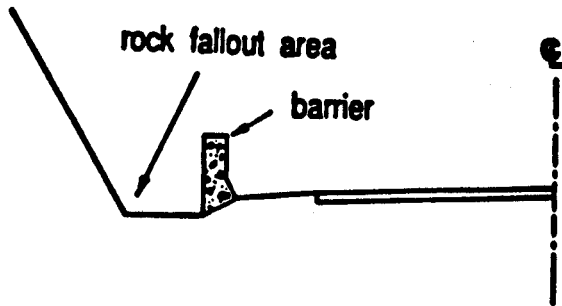
o Where there is space between the roadway and rock face, rockfall barriers may be placed to prevent debris from encroaching onto the driving lanes. Where little space is available, screens may be placed over the rock face to prevent rock from falling onto the driving lane.

o All fallen rock should be removed immediately.

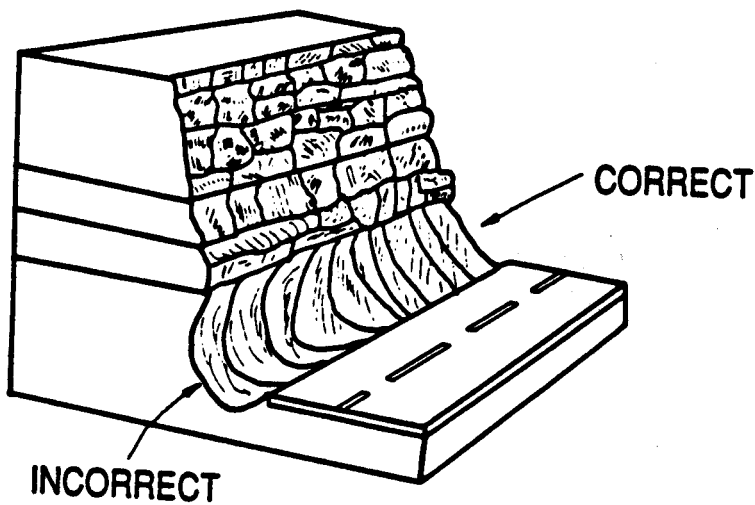
o It is very important not to undercut rock slopes when ditches are being cleaned.



*Use of wire mesh on slope to protect roadway*



*Use of barriers to protect roadway from falling rock*



*Correct and incorrect methods of sloping the toe of a cut slope above a ditchline*

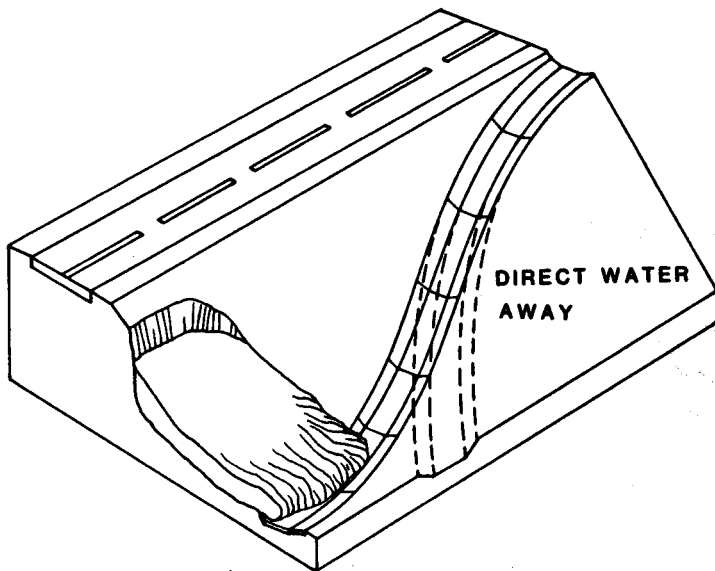
#### **IV.B.1.d. Irrigation**

- o If vegetation on the right of way is being watered, be certain there are not leaks or other damage that might allow excess water to saturate a localized area of the slope.
- o Water the vegetation only to the point to maintain proper growth. Excessive watering may saturate the entire slope.

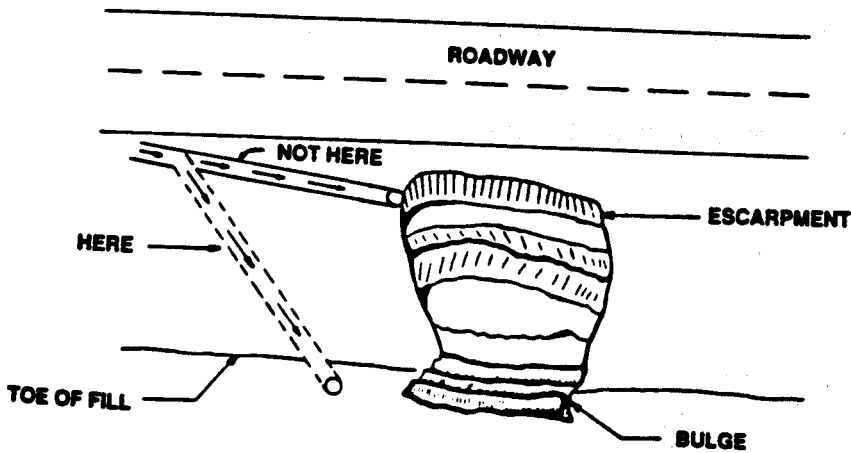
#### **IV.B.2. Small Slide Maintenance**

When a small slide has occurred, maintenance personnel can do a number of things to prevent the slide from becoming worse, or to slow or stop slide movement. These are as follows:

- o Always direct surface waters away from the slide area. This can be done using pipes or paved ditches.

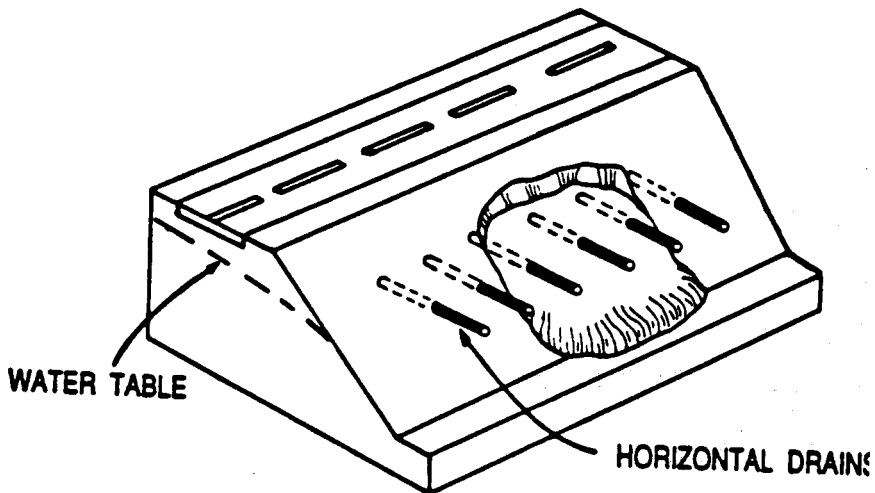


***Method of directing water away from the slide area***



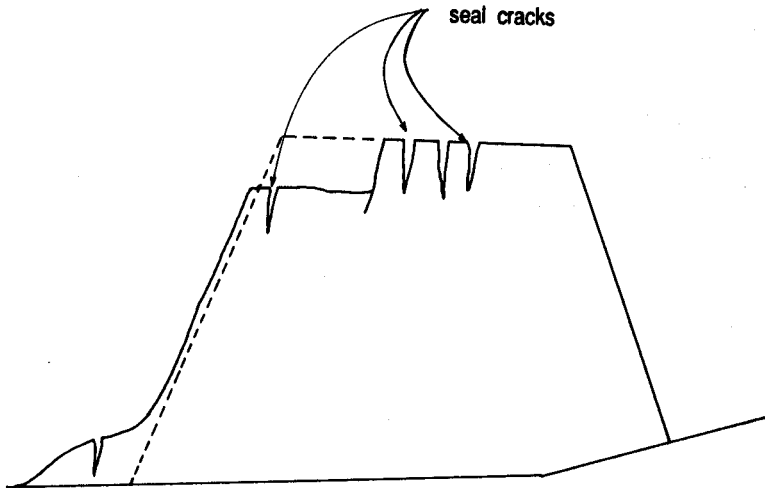
*Realignment of drainage pipe to divert drainage from the slide area*

o If there is excess water in the slide area, providing some mode of drainage would be beneficial. Horizontal drains are helpful, in many cases, where subsurface water is a problem. Ditches and pipes are best for draining ponded surface water.



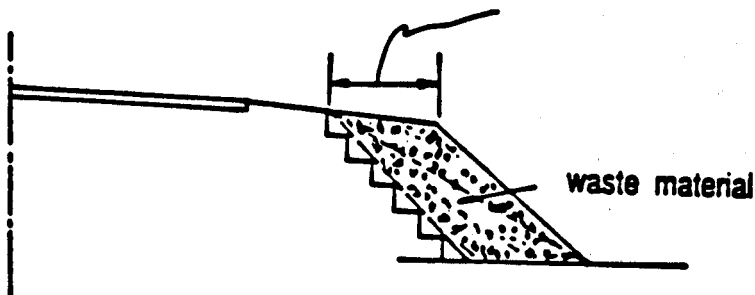
*Control of subsurface seepage using horizontal drains*

- o Establishing vegetation will help to absorb some excess water and prevent erosion.
- o All surface cracks should be sealed to prevent water from saturating the slope.



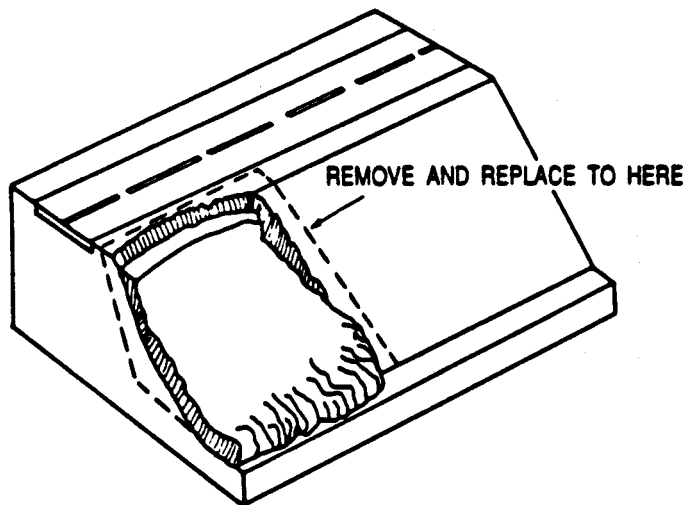
***Sealing of cracks to prevent infiltration of surface water into fill***

- o If material and right of way are available, the side slope of a small slide could be flattened. This will provide more side support.



***Flattening a side slope to repair a highway slope failure***

- o Materials that are very weak or are susceptible to water (hard to dry) should be removed, if possible, and replaced with a material having a higher shear strength.

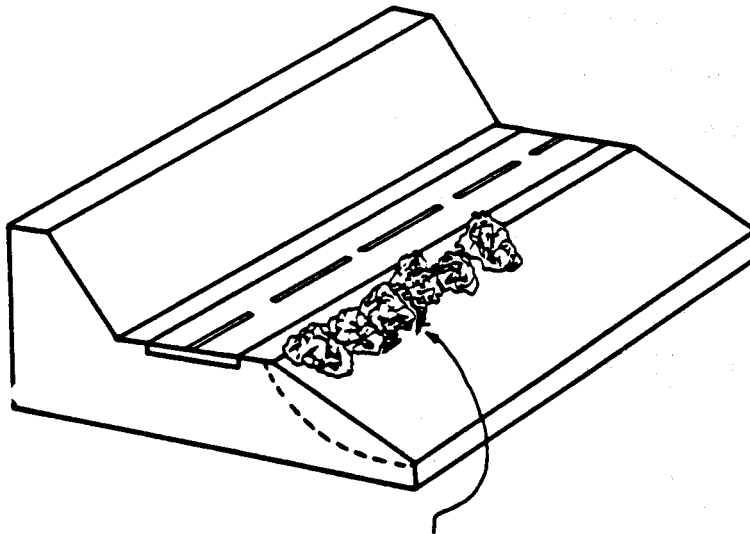


***Replacing weak materials with strong materials to repair a highway slope failure***

- o The movement of all known slides or unstable areas should be regularly monitored. This will help to determine if maintenance efforts are working.

There are a number of things maintenance personnel should avoid when performing maintenance work on small landslides. These are as follows:

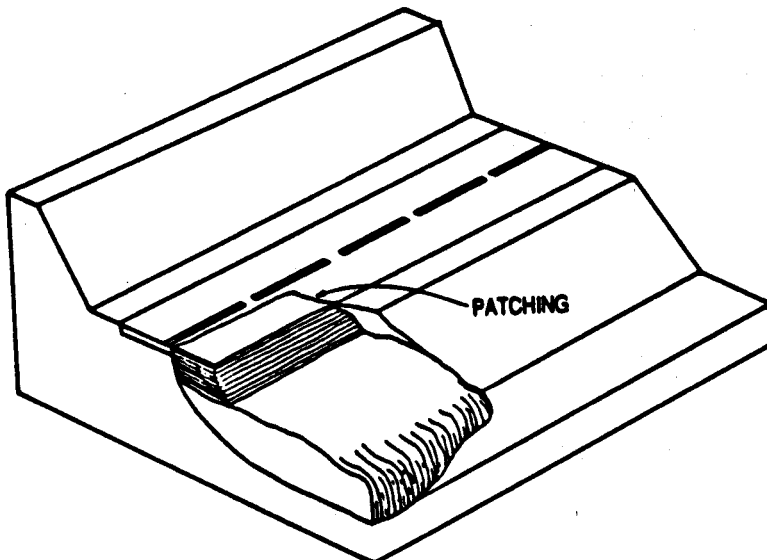
- o Do not excavate the toe of a slope.
- o Do not remove any lateral support for a slope or embankment.
- o Do not perform any type of excavation or earth work that would permit water to pond in the slope area.
- o Do not load the top of the fill (side casting). This will add a driving force to the slide.



**DO NOT DUMP WASTE MATERIAL HERE**

***The poor practice of sidecasting or dumping waste material at the top of a slope***

- o Do not block any drainage structure, including ditches, pipes, or culverts.
- o If a slide continually causes the driving surface to sink or settle, frequent patching of the surface will only add more weight to the slide. This practice should be avoided and the slide should be properly repaired.



***Continuous patching of a section of highway pavement***

## IV.C. DRAINAGE MAINTENANCE

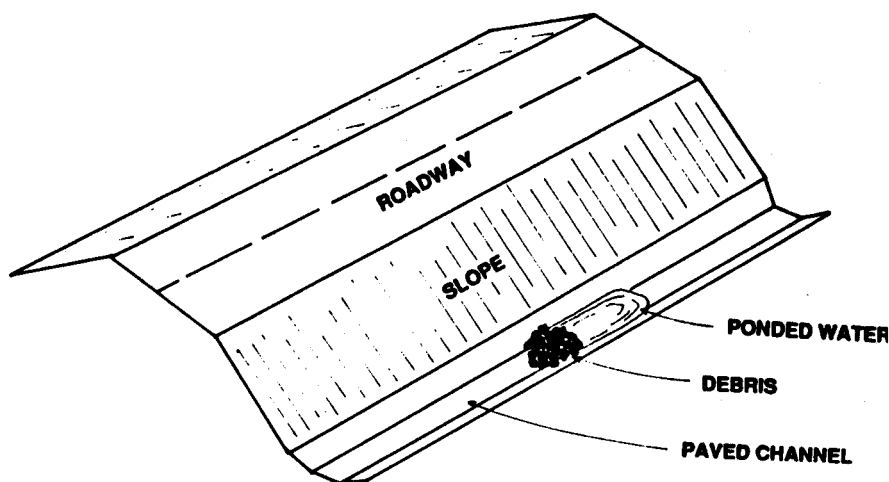
Proper drainage of surface and subsurface water is one of the most important aspects of maintaining stable slopes.

### IV.C.1. Surface Maintenance

Proper management of surface water will greatly assist in the prevention of landslides.

#### IV.C.1.a. Maintaining Surface Runoff

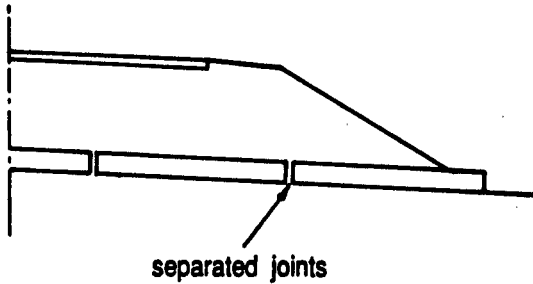
- o Always divert water from a slide area or an unstable slope. This will help to prevent erosion and saturation of the slope.
- o Always keep pipes and drainage channels free of dirt, debris, and vegetation.



#### *Blocked drainage and ponding in drainage channel*

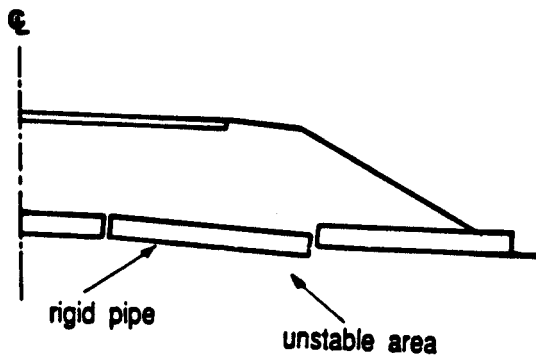
- o If any joints have separated in a drainage pipe, they should be repaired immediately. This will prevent saturation of the slope or embankment and also minimize erosion around the pipe.





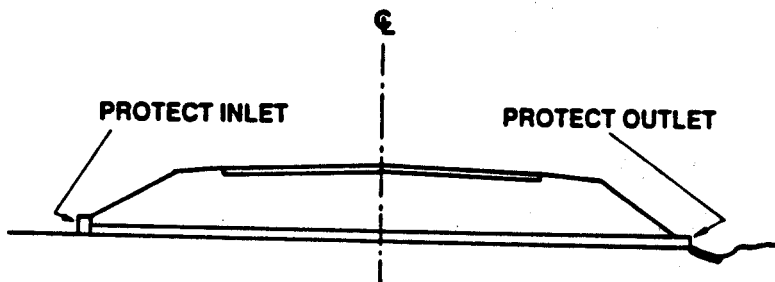
***Pipe with separated joints***

o Do not use rigid pipe in a landslide or an unstable area. A rigid pipe cannot accommodate the movement that is occurring in the area without separating at the joints.



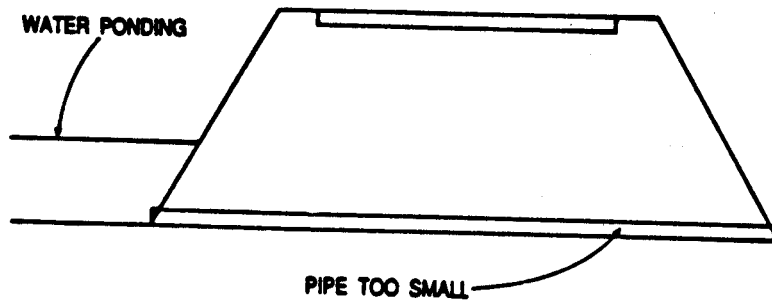
***Rigid pipe in unstable area***

o Do not allow erosion to occur around the ends of pipes. Always use head walls and slope protection on the inlets and outlets of pipe. This will help to prevent erosion around the pipe.



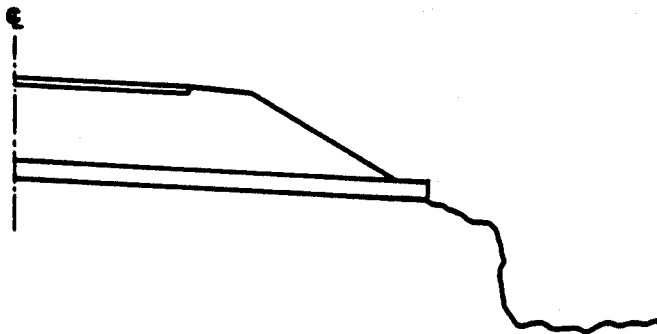
***Inlet and outlet protection of pipes***

o Always use the proper pipe for the job. Do not use a pipe that is too small and will cause water to back up. Always use flexible pipe in an area where movement is occurring. In areas where the water is acidic, use only pipe that is not affected by acid.



*Ponding water caused by inadequate pipe size*

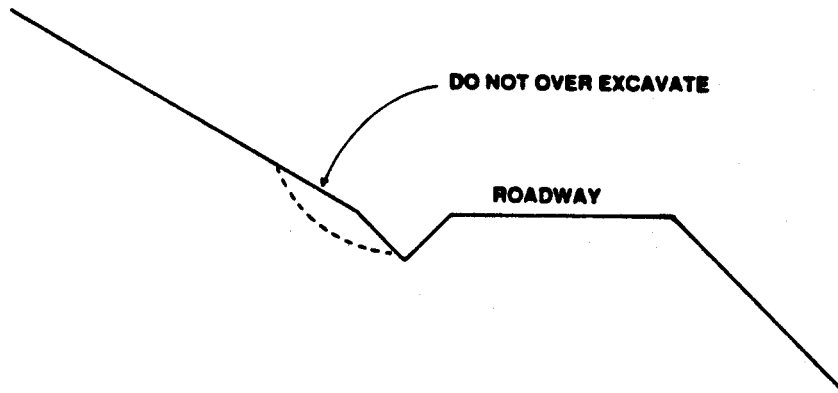
o Do not permit drainage pipes to terminate too short, allowing water to discharge onto the slope. Again, erosion or saturation of the slope could result.



*Water flowing onto slope because pipe is too short*

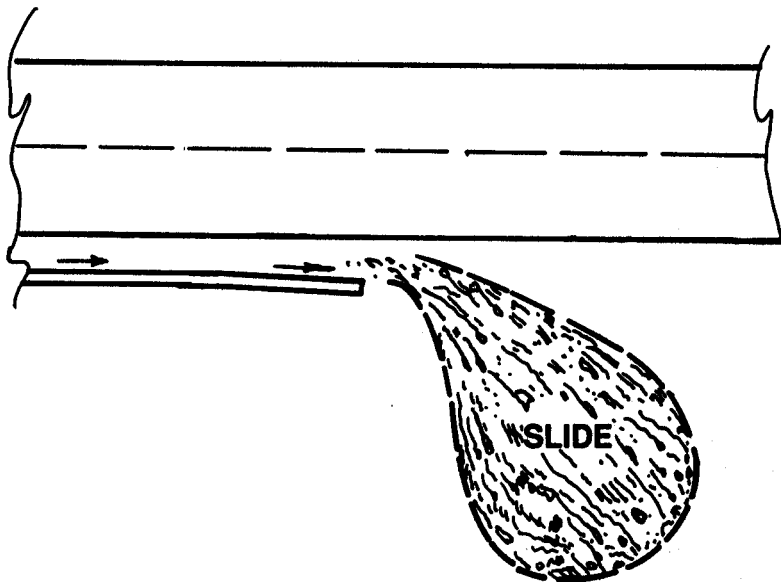
#### IV.C.1.b. Maintaining Surface Drainage

o Do not over excavate ditches. This may remove toe support of an embankment or cut slope. This also may permit water to pond in the ditch, and this water may saturate the embankment.



*Over excavation of highway slope*

o Do not divert water toward the slide or slope.



*Water diverted to slope*

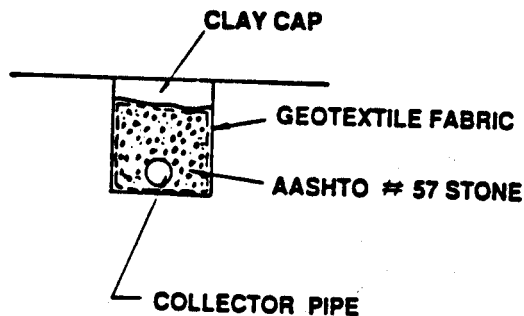
## IV.C.2. Subsurface Drainage Systems

All subsurface drainage systems in landslide areas must be maintained.

### IV.C.2.a. Do's

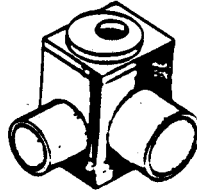
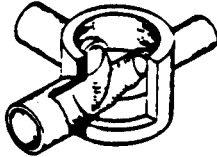
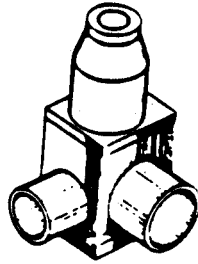
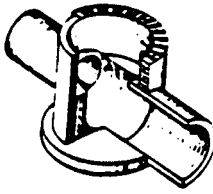
The following is a list of items that should be done to maintain subsurface drainage:

- o Geotextiles should be used around all drainage gravel. This prevents fine clays and silts from filling the void spaces in the gravel, resulting in clogging of the gravel.



### *Recommended method of constructing drainage gravel*

- o All drainage systems should be cleaned on a regular basis.
- o Flexible pipes should be used in all collector systems.
- o Pavement edge drains should be used in slide areas. These drains help to collect surface water that gets into the pavement structure through cracks in the surface and through paving joints.
- o Access should be provided to all drainage systems in order to maintain and clean them.
- o All large pipes should have cleanouts installed at regular intervals.



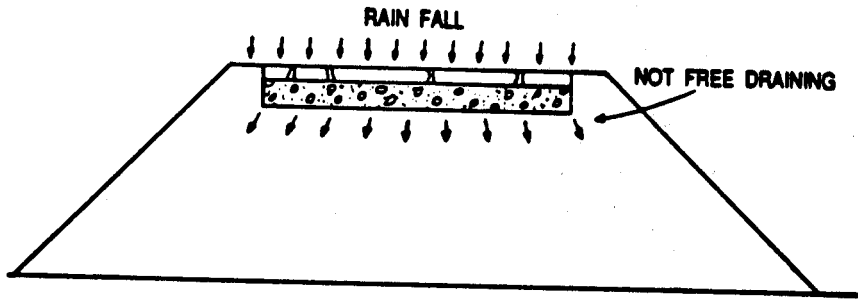
### ***Large pipe cleanouts***

- o All non-functioning systems should be carefully evaluated for proper repair and repairs should be made as quickly as possible.
- o All utility installations should be monitored to insure that damage does not occur to existing subsurface drainage systems.

### **IV.C.2.b. Don'ts**

A number of things should not be permitted when maintaining subsurface drainage. These are as follows:

- o **Do not** use any features on any subsurface system that would hinder or prevent maintenance activity.
- o **Do not** use rigid collectors on subsurface drainage systems.
- o **Do not** construct a structure with a granular backfill that will not drain (bathtub design). This type of structure will only serve to saturate the embankment.



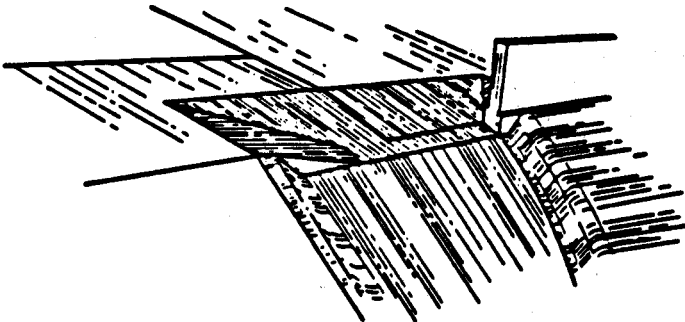
***Bathtub drainage condition caused by poor drainage material***

### **IV.C.3. Structures**

#### **IV.C.3.a. Do's**

Maintenance personnel should remember the following items when performing maintenance work around highway structures.

- o Provide drainage for bridge ends. This will prevent erosion around bridge abutments and will minimize high pore waterpressures behind abutment walls.



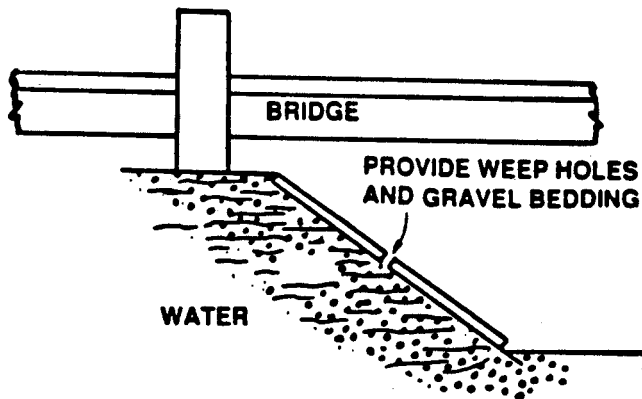
***Bridge end drainage***

- o Be certain that filtration materials behind abutment walls and retaining walls are performing properly. These filtration materials help to minimize high pore pressures.
- o Maintain all drainage structures such as pumping stations, diversion structures, siphons, and irrigation systems.
- o Be certain that expansion joints at bridge ends are maintained and that they are performing properly.

#### IV.C.3.b. Don'ts

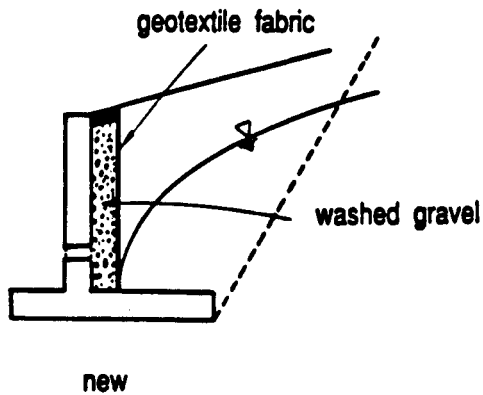
The following items should not be permitted when maintaining highway structures:

- o **Do not** permit the use of rigid slope paving where water may get behind it. This could produce high pore pressures or cause frost heaving in the winter.



#### *Weep holes in rigid slope paving*

- o **Do not** permit water to be channeled behind headwalls, abutments, or retaining walls. This will cause high pore pressures behind these structures. Be certain that filtration materials behind abutment walls and retaining walls are performing properly. These filtration materials help to minimize high pore pressures.

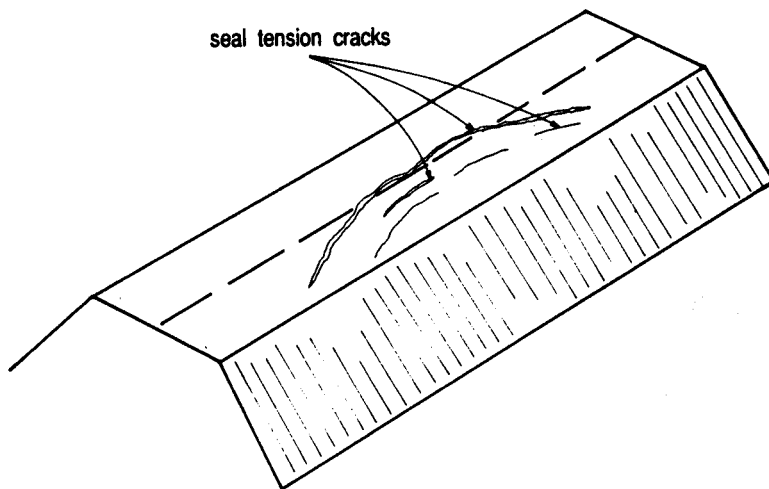


***Drainage behind retaining walls***

**IV.D. ROAD SURFACE MAINTENANCE**

**IV.D.1. Crack Sealing**

Seal all surface joints, cracks, and edges that have a potential to permit water to enter the subgrade or embankment.

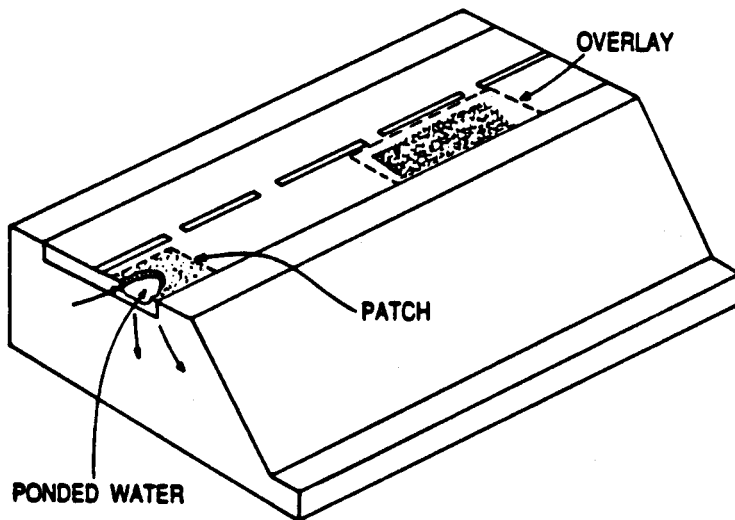


***Sealing of pavement and slope cracks***

**IV.D.2. Patching**

All potholes and uneven settlement should be patched to prevent standing water that could saturate the subgrade.





### ***Patching of potholes and areas of uneven settlement***

#### **IV.D.3. Overlays**

Overlays (covers entire pavement surface) should be considered when the pavement has many cracks from fatigue or temperature changes.

### **IV.E. UTILITIES CONSTRUCTION**

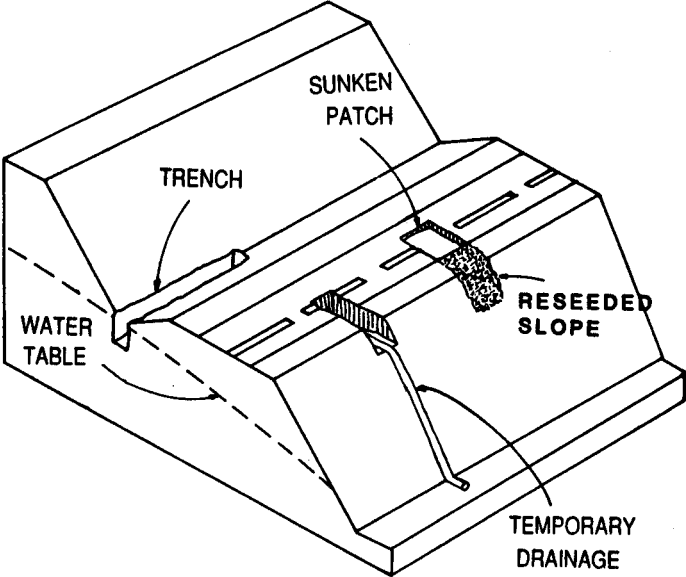
**IV.E.1.** Make certain subsurface drainage is not disturbed by installation of utilities.

**IV.E.2.** Excavation should not be permitted to cause instability in an adjacent slope.

**IV.E.3.** Backfill should be properly compacted to be certain settlement does not occur. Settlement would permit water to pond.

**IV.E.4.** All trenches left open for any period of time should have drainage provided to prevent water from standing in the excavation and saturating the surrounding soil.

**IV.E.5.**All vegetation should be restored to excavated slopes to prevent erosion.



***Reseeded areas of slope repairs***

## V. STABILIZATION METHODS

To aid the maintenance supervisor, this portion of the manual (and workshop) includes a description and discussion on the various methods that may be used to stabilize a slope failure or to provide a slope protection system. The purpose of stabilization is to restore the highway section to an original condition (or in some cases, to restore the section to a condition that is better than the original condition).

It should be noted that the same principles used to repair large slides are generally applicable to repairing small slope failures. Also, it is important to understand that there are several different ways of repairing a small slope failure. Each case must be examined to determine the most economical and appropriate method.

This section has been divided into three parts:

- o Basic approaches -- A discussion of the fundamental approaches and basic concepts involved in stabilization and protection methods.
- o Repair methods -- The various repair methods that may be used to stabilize/protect a slope are described. The type and mode of failure where the method could be applied are indicated.
- o Slide economics -- A quick method of estimating the costs of several repair methods is described.

When a highway slope fails, or rock debris falls onto the highway, the maintenance supervisor must decide on a

course of action. Suggested general steps involved in reacting to a slope failure include the following:

- o **ALWAYS EVALUATE THE SAFETY OF THE SLIDE -- DON'T ASSUME THAT THE SLIDE IS SAFE** (when there is doubt, especially in medium and large slopes, contact the geotechnical engineer).
- o Obtain preliminary information (use the inventory form in the APPENDIX B -- this form serves as a checklist of items that the supervisor should observe during inspection of the failure. **GATHER ESSENTIAL DATA BEFORE TAKING ACTION.**
- o Monitor the slide and record location (notify responsible person).
- o Select a repair/protection method -- **IN MEDIUM AND LARGE SLOPES**, or if there is uncertainty about conditions of a small slide, seek advice from the maintenance and geotechnical engineer.
- o Inspect repaired/protected slope periodically.

A more detailed description of each of the above steps is described in the APPENDIX B. Since a slope has failed, the maintenance engineer must decide if it is necessary to contact the state's geotechnical staff or a consulting engineer or if he should proceed and select a method of stabilization. With regard to this decision, the course of action will depend on:

- o The experience and capabilities of the supervisor in dealing with slope failures of a similar nature
- o The size of the fill, depth of the failure plane, and size of the slide
- o The type and mode of failure.

Strict rules cannot be formulated for making this decision. However, some general guidelines are suggested and discussed below.

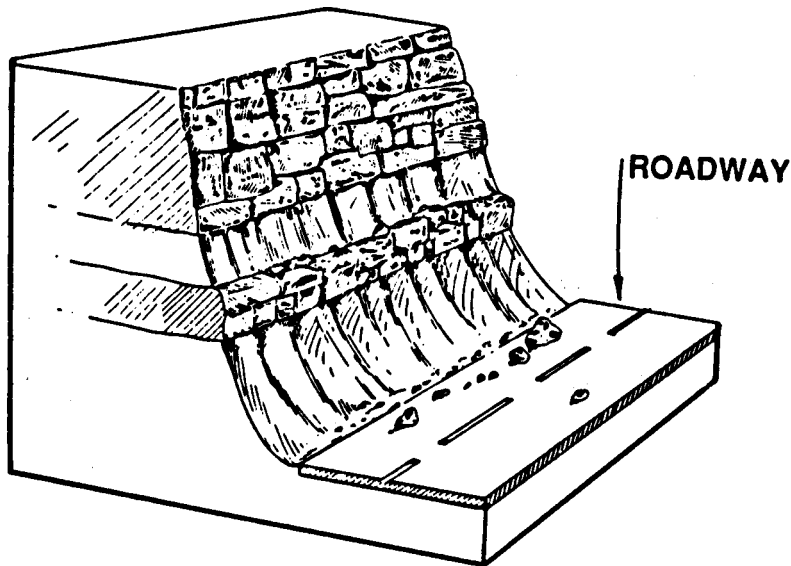
Experience is obviously developed and obtained over a period of time by dealing with different types of slope failures and finding satisfactory solutions, that is, selecting a slope stabilization method that works for similar types of slope failures. The geotechnical staff, maintenance engineer, or consulting engineer should aid the maintenance supervisor in this sense by helping them (with the information in this manual and knowledge of local conditions) to identify situations and showing them that certain methods of stabilization could be applied to similar situations.

The size of slide involved, depth of the failure plane, size of fill, and type of slide are significant factors in deciding on a course of action. The following steps are suggested:

o Determine type and mode of failure (review section in APPENDIX A entitled " Typical Slides on Highways").

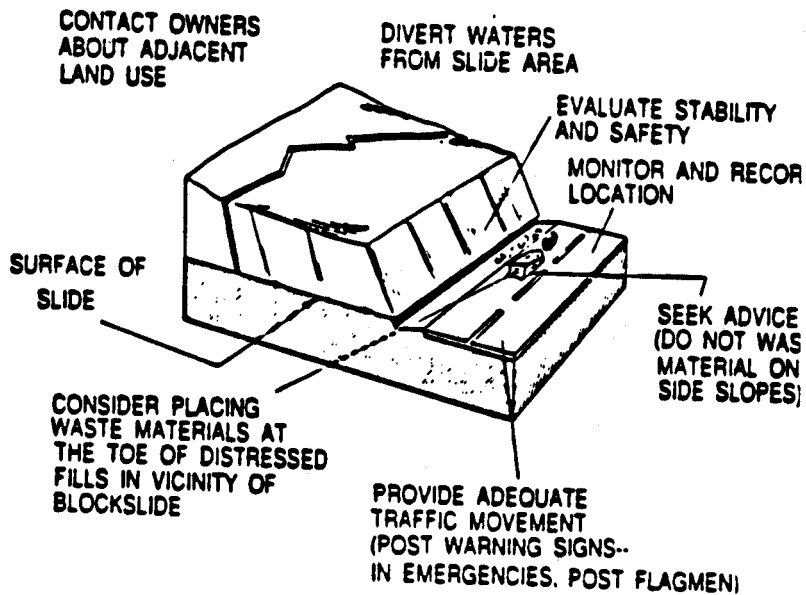
These are as follows:

- Small debris falls from cut slopes -- Seek advice and assistance from the maintenance engineer, geotechnical engineer and geologist. Stabilization/protection methods are described in Section V.B.7.



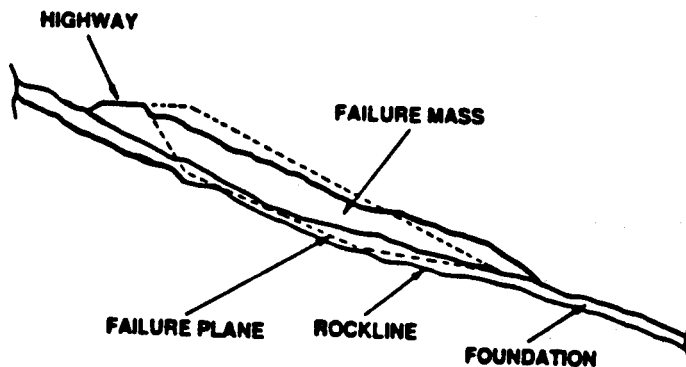
**Rockfall from differential weathering**

- Large, massive rockfall from cut slopes - Seek advice and assistance from the maintenance engineer, geotechnical engineer and geologist. Stabilization/protection methods are described in Section V.B.7.



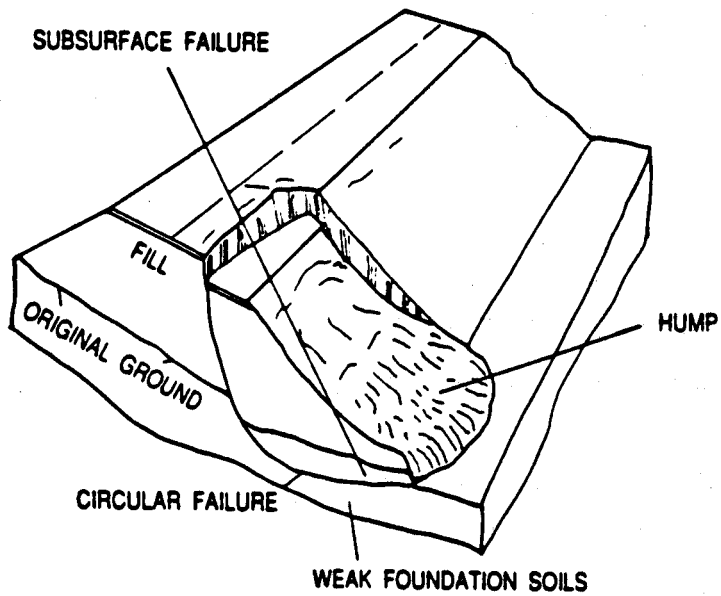
**Example of recommended actions by maintenance supervisor for a blockside ( for other typical slope failures, see APPENDIX A.)**

- Long, shallow failures -- Seek advice and assistance from the maintenance and geotechnical engineers if the slide is greater than about 20 feet in height or if there is some uncertainty about the slide and method of repair. Usually the failure plane or surface of sliding occurs at the interface of soil and rock line. Fill and foundation soils slide along the top of the bedrock. Stabilization methods are described in Section V.B.3. Generally, these methods are expensive.

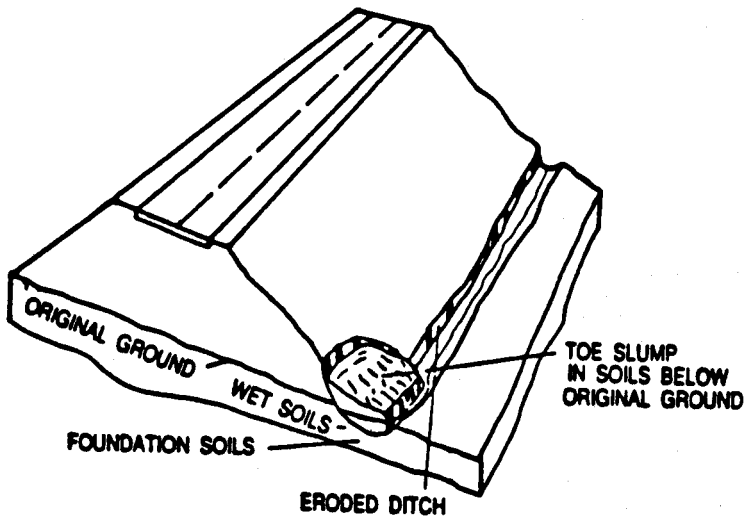


*Long shallow highway slope failure*

- Subsurface failure in fill and supporting foundation soils (deep-seated, rotational and wedge-shaped failures) -- Seek advice and assistance from the maintenance and geotechnical engineers. Subsurface failure is the condition where weak soils below original ground cannot support the weight of the fill. Some types of subsurface failures are illustrated below. This type of failure is characterized by a "hump" at the toe of the slope.



*Subsurface failure in weak foundation soils and fill*



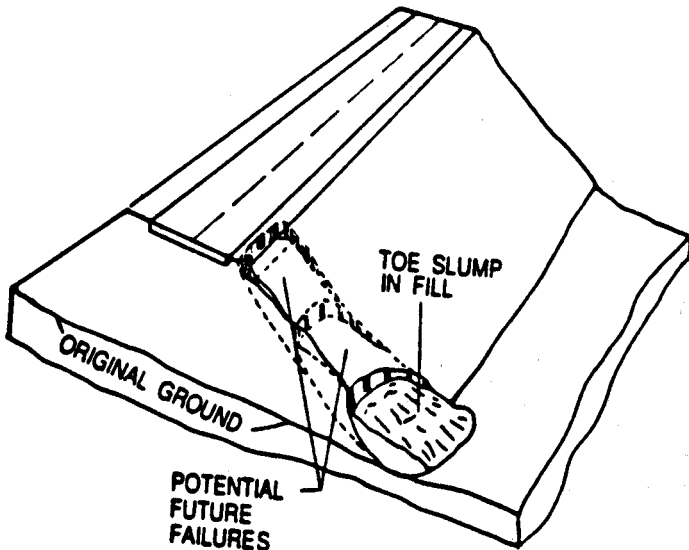
*Toe slump in large fill and soils below original ground*



If the slide is still in an active state, that is, complete collapse has not occurred, rows of survey stakes placed parallel to centerline can be useful in determining if a subsurface failure is occurring.

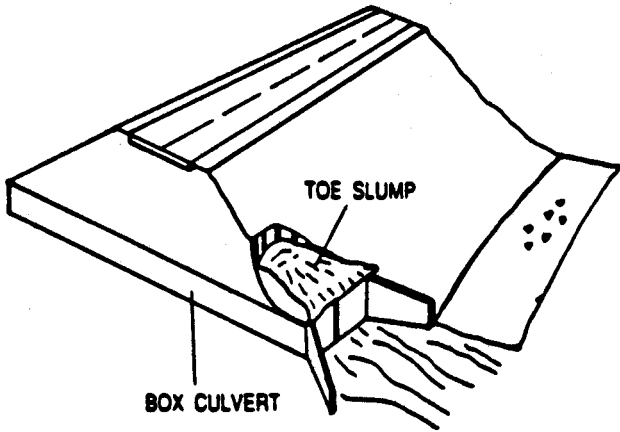
In small slides and small fills or cut slopes (less than about 20 feet), the maintenance supervisor may be able to construct a stabilization method based on the advice and direction of the geotechnical engineer. Some methods of repair that might be considered are discussed in sections V.B.1.a, b, and c; section V.B.3 (in particular section V.B.3.h); and methods in section V.B.4 in combination with methods in section V.B.2.

- Small rotational toe failures of the slope -- These types of slips are illustrated below. These types of failure need immediate attention.

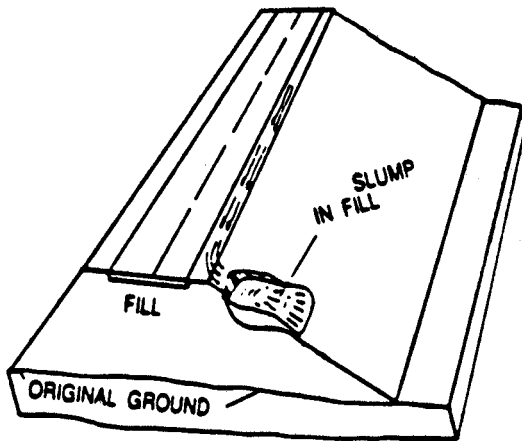


***Toe slump and potential slumps in fill***

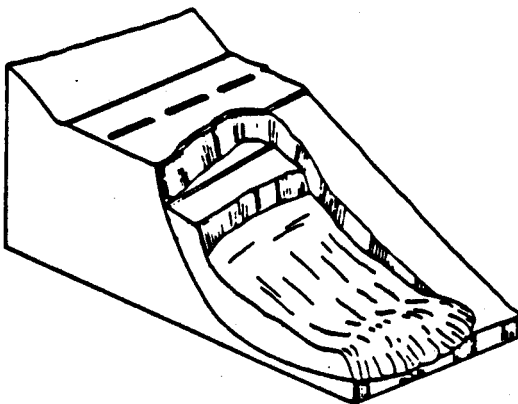
Toe slumps may eventually lead to large-scale failures because the failure plane eventually



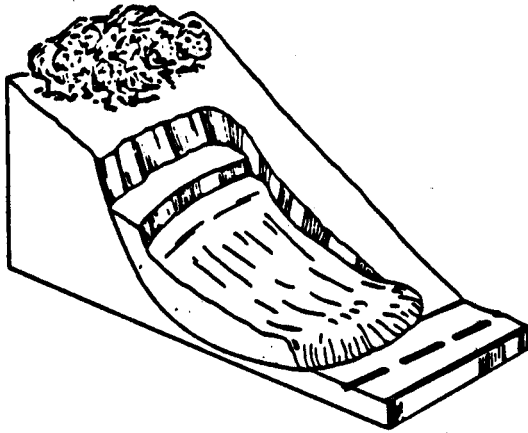
***Toe slump in fill above reinforced concrete culvert***



***Slump in upper portion of fill***



***Rotational slide below roadway***

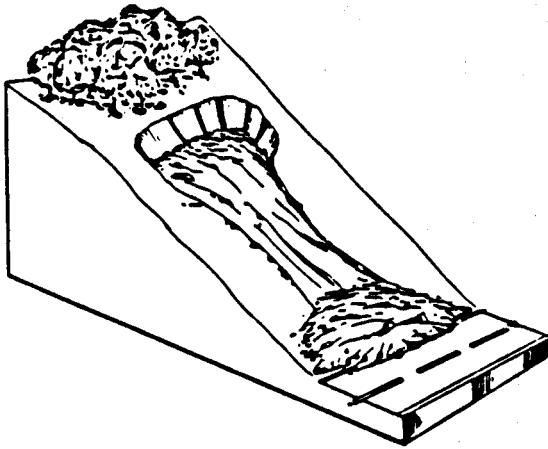


### ***Rotational slide above roadway***

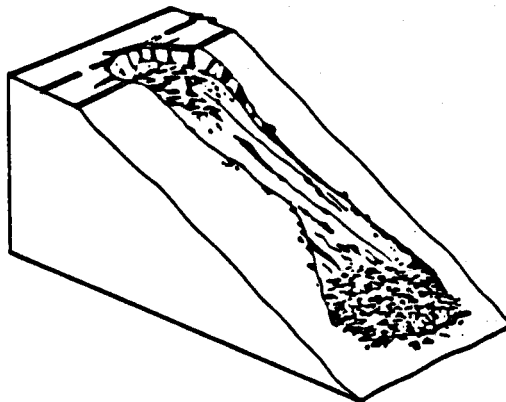
progresses up the slope and affects the outer traffic lane. Oftentimes the toe slump occurs in the fill material, that is, the failure plane passes through the soil that was placed when the fill was constructed. However, as shown above, a portion of the failure plane may pass through weak foundation soils. If the toe slump and slide are small (less than about 20 feet) and the maintenance supervisor feels knowledgeable enough of the situation, then a repair method might be selected and implemented. If there is doubt, then seek advice and assistance from the geotechnical engineer. If the toe slump occurs in a medium (20-50 feet) or large fill (greater than 50 feet), notify the geotechnical engineer and get advice. Some methods of repair that may be considered are discussed in sections V.B.1.a, b. and c; section V.B.2; and section V.B.3.h.

- Surface, or fill slides (mudflows) -- Surface slides occur in cohesive soils (clays and silty clays) that were used to construct the fill. Usually this type of failure is about 2 to 5 feet deep and appears some 5 to 10 years after construction of the slope. This type

of failure is a mudflow and is caused by plastic flow of the soil. This type of failure occurs after many wetting and drying cycles and is usually most prominent in soils that have a liquid limit and plastic limit equal to or greater than 50 and 30 percent, respectively. During dry periods, cracks open up. The soils are very plastic, sticky, and have a high clay content. The clays tend to swell when exposed to water. During wet periods the open cracks provide pathways for water to infiltrate into the slope.



***Mudflow slide below roadway***



***Mudflow slide above roadway***

As the water content approaches the liquid limit of the soil (the soils swell and increase in volume), there is a loss of strength. Once this occurs, the soils flow.

Movement progresses up the slope until the outer traffic lane is affected. Usually, the maintenance supervisor assumes the responsibility of repairing the slope. However, if the fill slope is greater than about 20 feet, the supervisor should seek advice from the geotechnical engineer because the cost of repairing the slide may represent a sizable portion of his maintenance budget. (see decision chart in Appendix E concerning surface slides -- mudflows -- and subsurface failures.

- o Study drainage of fill, roadway, slope and structure (see section V.B.2).
- o Summarize and review inventory data.
- o Select slide stabilization method (section V).
- o Perform cost comparisons of selected stabilization methods (quick cost estimates of some methods can be obtained from the information described in section V.C.).

In fills involving medium and large slides, or subsurface failures, the geotechnical engineer will perform the following:

- o Determine the depth of failure -- slope inclinometers may be installed to determine depth to failure plane.
- o Determine depth of water table -- water observation wells or piezometers may be installed.
- o Sample failed materials.
- o Determine strength of materials.

- o Classify soil from Atterberg Limits and particle-size tests; determine natural water contents.
- o Obtain cross sections; define site geometry.
- o Review geology of site and other historical documents pertaining to the site.
- o Perform stability analysis of failed slope and check the stability of repair method selected for correction.
- o Compare costs of selected method and select a method having the lowest cost.

## **V.A. BASIC APPROACHES**

### **V.A.1. Modify Slope Profile**

The slope may be altered so the driving forces tending to cause failure are decreased or the resisting forces tending to stabilize the slope are increased. For example, removing the top portion of a fill decreases driving forces. Placing a soil mass at the toe of the failure increases the resisting forces.

### **V.A.2. Control Drainage and Seepage**

Water is the primary cause of most highway slope failures. Methods of stabilizing a slope failure are usually combined with methods of controlling water in the failed area.

The strength of soil or rock consists of two parts: a cohesive part and a frictional part. Cohesion is that part of strength that binds soil or rock particles together. The frictional part occurs when one part of the soil mass slides past another part of the mass. These two parts of the strength of soils and rock resist failure.

Water affects strength of soil or rock by reducing the cohesion (softening) and by reducing the frictional strength

component. Soil or rock softening usually occurs when it is exposed to water over a prolonged period. If water rises or seeps into a highway fill or cut slope, the strength of the soil or rock is lowered. Conversely, if water is lowered or removed, the strength is increased. Controlling surface drainage and subsurface seepage are essential remedial actions in highway slope failures.

When a slide occurs on a highway slope, the cohesive component of strength is essentially reduced to zero along the failure plane. Also, there may be a reduction in the frictional component. Hence, on the failure plane, the strength of the soil or rock is reduced, although the strength of the material above and below the failure plane usually may be much greater. Therefore, a slope that once stood on a 2 horizontal to 1 vertical slope may not remain the same or stand for a long period of time.

### **V.A.3. Construction of Stabilizing Structures**

The purpose of stabilizing structures is to increase forces resisting failure. This is usually done by placing a mass of earth or a retaining structure at the toe of the slide.

### **V.A.4. Removal and Replacement**

The entire unstable mass or a portion of the slide (normally the top portion) may be removed and replaced with a more suitable or stronger material. By replacing the weakened material with a stronger material (such as stone or gravel), the forces resisting slope movement are increased. A portion of the excavated slope may not be replaced. The driving forces tending to move the slope downhill may be reduced by removing the upper portion of the unstable mass and replacing it with lightweight material.

### **V.A.5. Relocation/Avoid Problem**

In some circumstances, the solution to a particularly troublesome slide problem may involve relocating the highway into a more stable situation. This approach avoids the problem area.

## **V.B. REPAIR METHODS**

### **V.B.1. Modify Slope Profile**

Reshaping the slope to increase its stability may be accomplished by several methods. Methods commonly used are as follows:

- o Flatten slope.
- o Soil and rock berms at toe of slope.
- o Shear trenches.
- o Benching.
- o Excavation

#### **V.B.1.a. Flatten Slope**

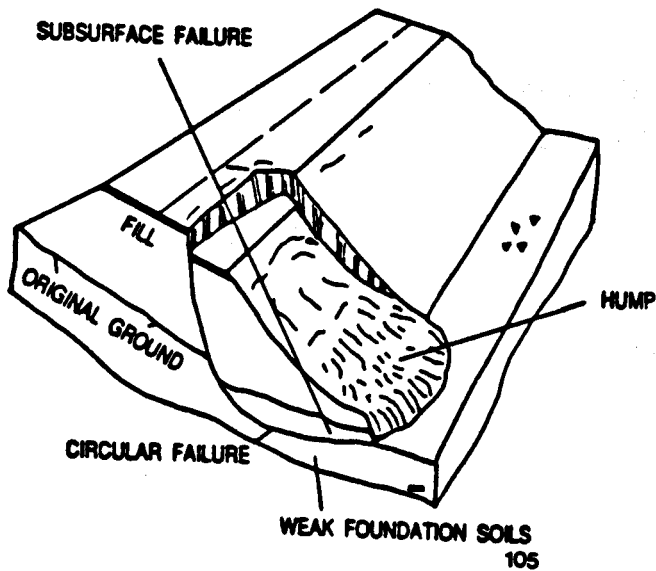
Regrading and flattening the slope of a highway fill or cut slope is a primary and economical method used to repair small failures. This is a common and reliable method of correcting a slide. In the case of a highway fill slip, this method usually causes minimal disturbance to the existing pavement and fill. In the case of a cut, generally sufficient material may be removed to permit the passage of traffic. Remember that proper signing is essential for the safety of the traveling public as well as the maintenance crew.

Slope flattening often is easier to construct and less expensive than other remedial methods. However, if

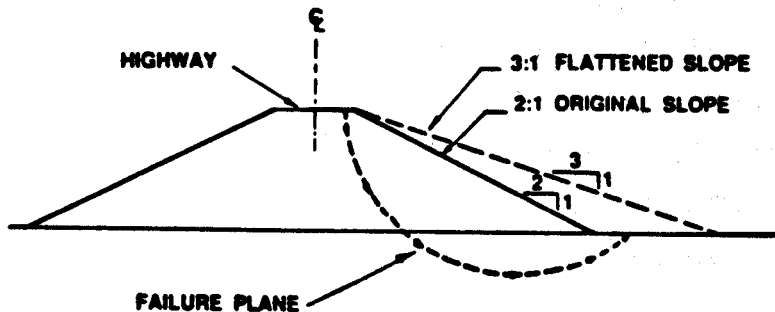


additional right of way is required, the cost may be prohibitive. Also, the time delay to acquire the right of way may contribute to an aggravation of the instability. When a cut slope or the slope of the original ground under a fill is very steep, it may be impractical to flatten the slope.

Slope flattening is normally used to correct deep rotational failures in clayey soils.



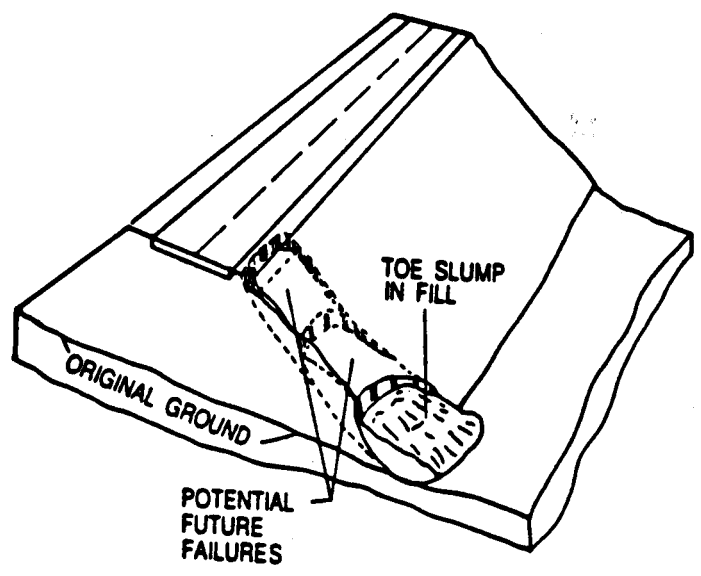
***Deep-seated, rotational failure***



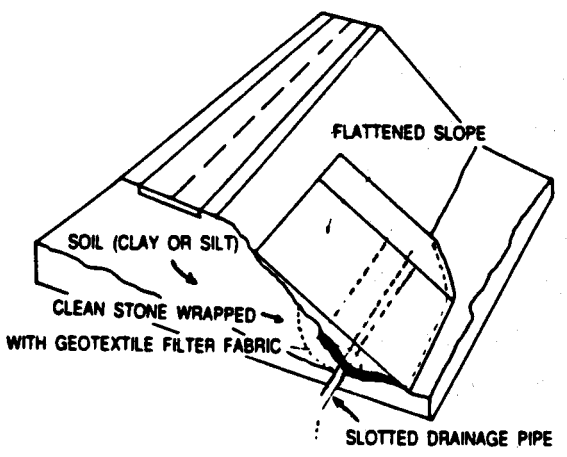
***Cross section illustrating the concept of flattening a highway slope***

Typically, the failed slope is regraded so the new slope is 3 or 4 horizontal to 1 vertical. Do not regrade the slope to the old slope -- this usually is not a permanent solution. Since the slope failed, regrading to the same slope will usually insure that failure will occur again. Since failure occurred, the soil in the failure zone is weaker than the soil above and below the failure plane.

Slope flattening may also be used to repair small toe failures in the fill as illustrated below.

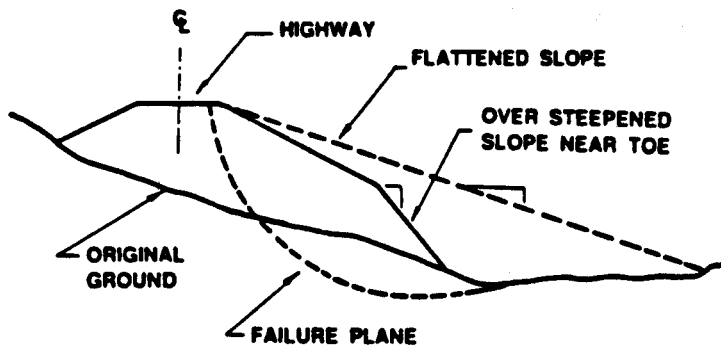


*Toe slump in fill*



*Using a flattened slope to correct a toe slump*

Slope flattening also is useful for repairing small slides where the slope in the toe area is steep (2 horizontal to 1 vertical or steeper). The over steepened slope may be the result of erosion or may have been constructed originally.

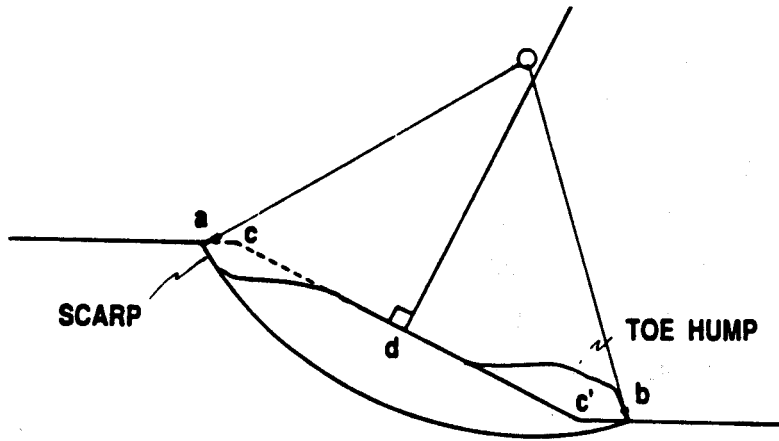


***Over steepened slope near toe of highway slope and use of a flattened slope***

An approximate method for estimating the flattened slope based on the original steeper slope is given in APPENDIX C.

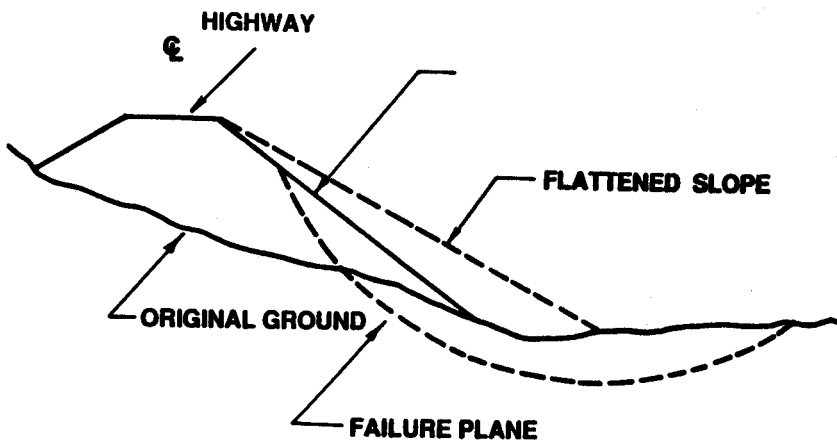
Basic steps for flattening slopes are as follows:

o Obtain slope profile when feasible. Locate the failure scarp at the top of the failed mass (point a), and the bulge on the slope at the toe of the failed mass (point b), when the slope profile is obtained. On a plotted cross section, sketch a circular arc through these two points, and any others known or estimated on the failure surface. It is this arc that approximates the location of the failure plane. The circular failure arc that passes through these two points (a and b in the sketch below) is located by trial and error using a compass. The center of the circle is moved around and the radius of the circle is varied until a circle is located that passes through the two failure points.



***Method of approximating the failure plane and size of slide***

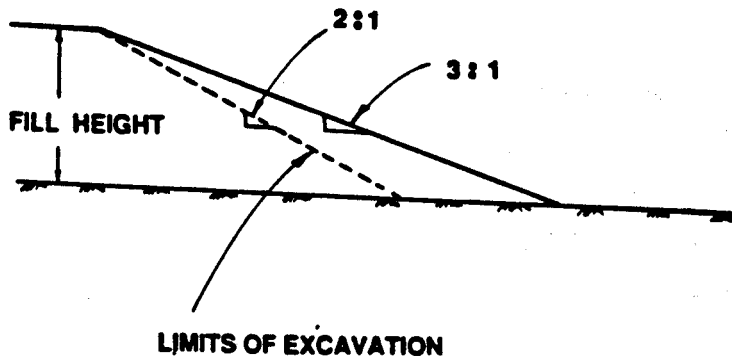
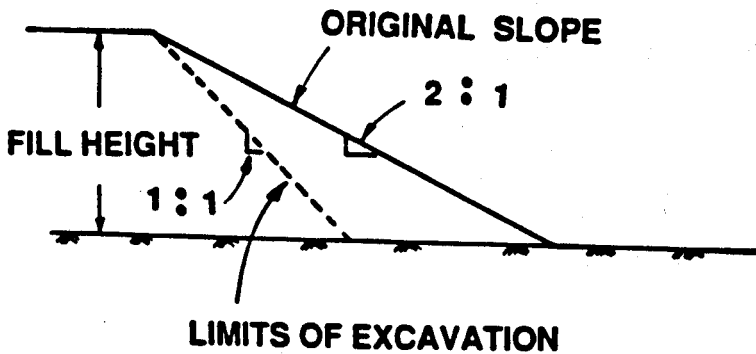
o Divide the slope line segment  $cc'$  into two equal parts. Construct a perpendicular line at point  $d$ . Usually, the center of the failure circle that passes through points  $a$  and  $b$  is located slightly above the line perpendicular to the slope. Determine flattened slope. Generally, a 3 or 4 horizontal to 1 vertical slope may be used. Use the flatter slopes for the more clayey or silty slopes. Make sure the flattened slope covers the toe area of the failed slope. When the material of the flattened slope is placed as shown in the sketch, most of the additional weight is to the left of the vertical line through the center of the circular failure arc. This adds to the driving forces and will not stabilize the unstable slope.



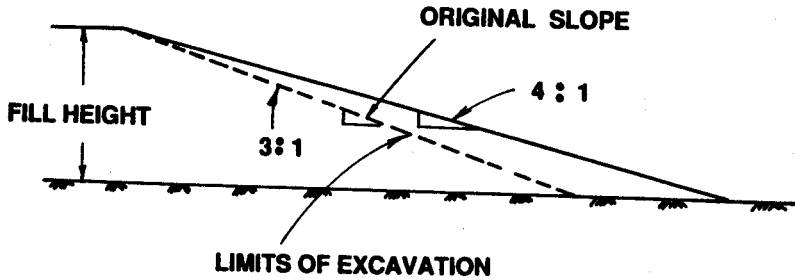
***incorrect application of a flattened slope***

o Look on site (within right of way) for suitable borrow material. Clean, durable stone, such as limestone, sandstone or washed bank gravel, is preferred. However, if these higher quality materials are not available, use what is available, except for organic soils. Waste materials from other slope failures, ditch cleaning, slope cleaning, etc. may be used. It is good policy during ditch and slope cleaning to stockpile waste materials for future use. Stockpiles might be located close to highway sections showing distress as determined from the inventory. Alternately, at fill sections showing distress, the waste materials could be placed at the toes of the distressed fills.

o Remove failed material partially or completely (cut slightly below the failure plane to remove as much soil as possible). Suggested limits of excavation are shown in the sketches.



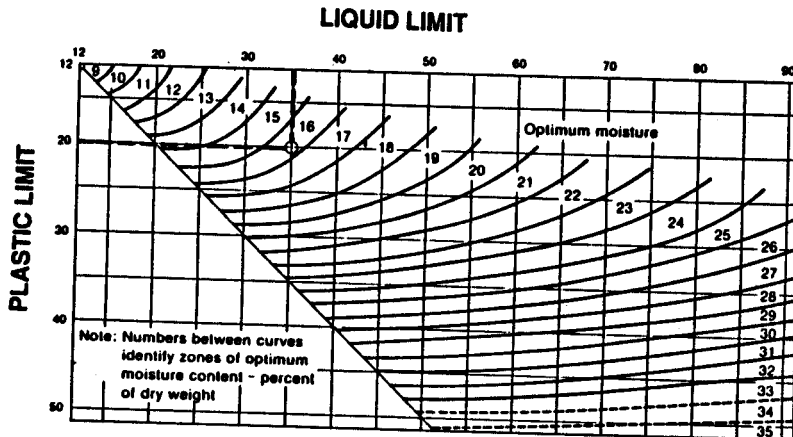
*Suggested limits of excavation for various slopes*



***Suggested limits of excavation for various slopes***

Be extremely cautious when removing failed material -- this operation may lead to a larger failure. Work quickly and around the clock if necessary to place material back at the toe of the failure. If practical, do not remove more than about 50 to 100 linear feet of the failed material at a time (this is about the minimum distance that equipment can operate). Replace the material immediately.

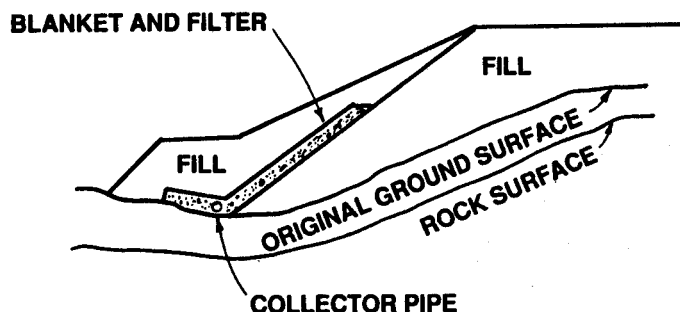
o If the material removed is wet (equipment sinks into the soil), then dry the material by grading back and forth until the water content is about equal to the plastic limit. Alternately, the optimum water content may be estimated using the liquid and plastic limits of the wet soil and the accompanying graph. (Adding a small amount of hydrated



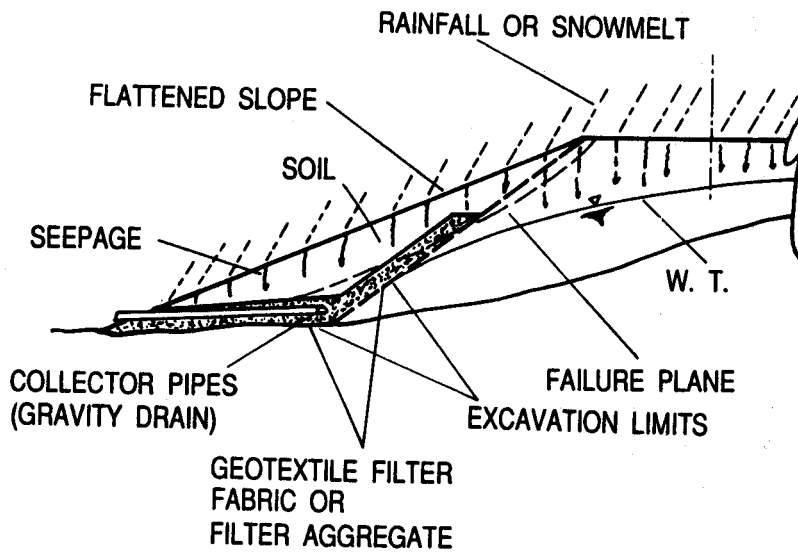
***Chart for estimating the optimum water content of a soil***

or quick lime when available can aid in drying the soil and improve workability. This is effective mainly in clayey soils. If the soil sticks to your hands, then most likely lime will work. Use two to six percent lime by weight of failed mass. The soil also may be dried using a plow or disc.)

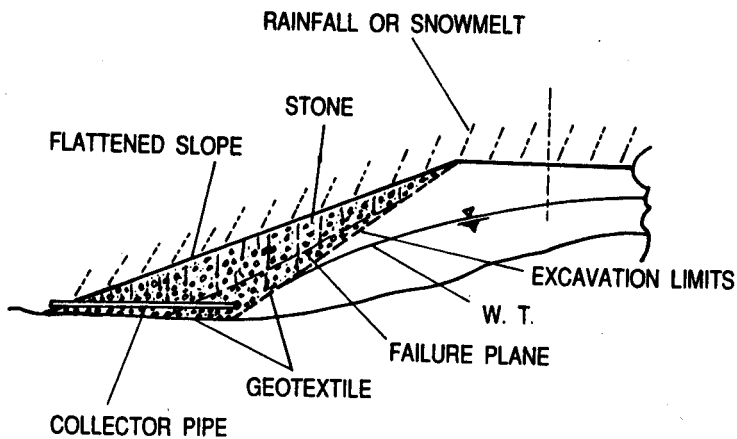
o Place a drainage blanket on the lower portion of the distressed area when soil is used to construct the flattened slope. A drainage blanket is a relatively thin course of free-draining material (sound, clean, non-degradable rock), and is usually 1 to 3 feet thick. The blanket is relatively permeable and drains water that may enter the slope area. The drainage blanket (and slotted PVC or perforated collector pipes) intercepts ground-water seepage before it enters the slope zone and drains the water that might infiltrate the slope from rainfall and snowmelt runoff. The drainage blanket should be protected from clogging by enclosing it with a geotextile filter fabric, or by designing the blanket as a filter. If the flattened slope is constructed entirely of clean stone (on fines), the drainage blanket may be omitted. However, geotextile fabric or filter aggregate should be placed against the excavated soil slope before placing the stone.



*Drainage blanket under a flattened slope*



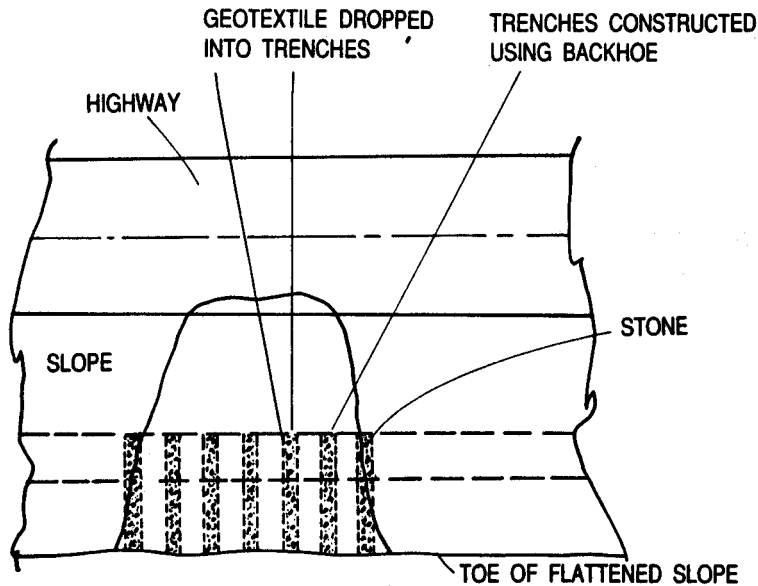
***Use of a drainage blanket under a flattened slope to control surface seepage from rainfall and snowmelt and ground water seepage***



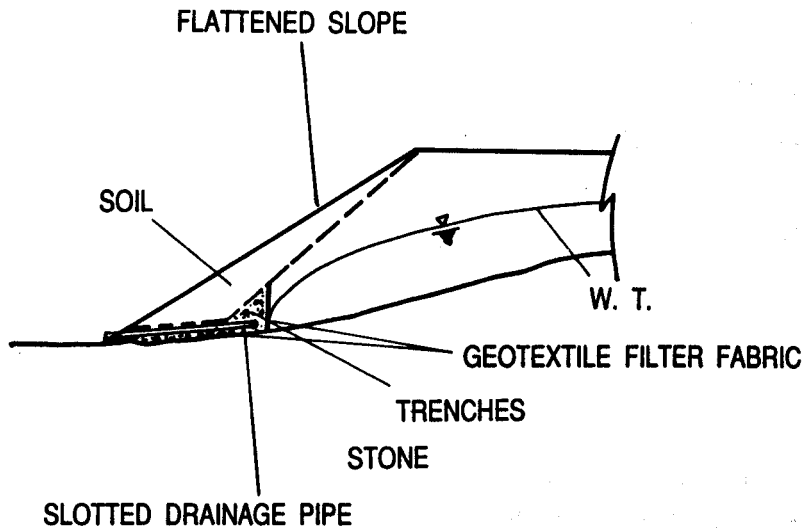
***Use of geotextile filter fabric and slotted pipe to prevent infiltration of soil into flattened slope constructed of stone***



Another scheme of internal drainage is shown in the sketches below. After excavating the unstable material, trenches are dug (using a backhoe) into the slope at approximately 5-foot intervals. The sides and bottom of the trench are lined with geotextiles before backfilling with free-draining stone. Geotextile fabric is placed on top of the



*Plan view of scheme using stone-filled trenches*



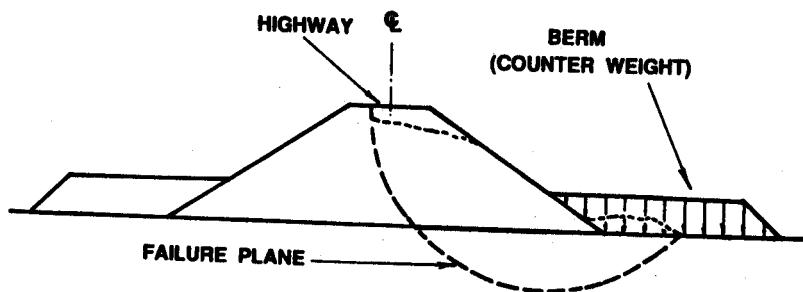
*Cross-sectional view of internal drainage scheme of stone-filled trenches*

stone before placing soil on the slope.

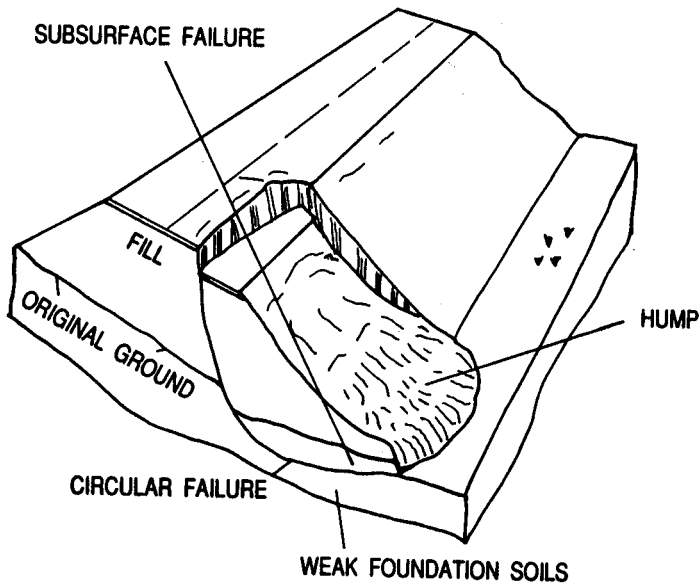
- o Regrade and place the flattened slope against the drainage blanket and distressed area.
- o Reseed the flattened slope (if soil is used).
- o Inspect repaired slope periodically to monitor performance.

### V.B.1.b. Earth and Rock Berms

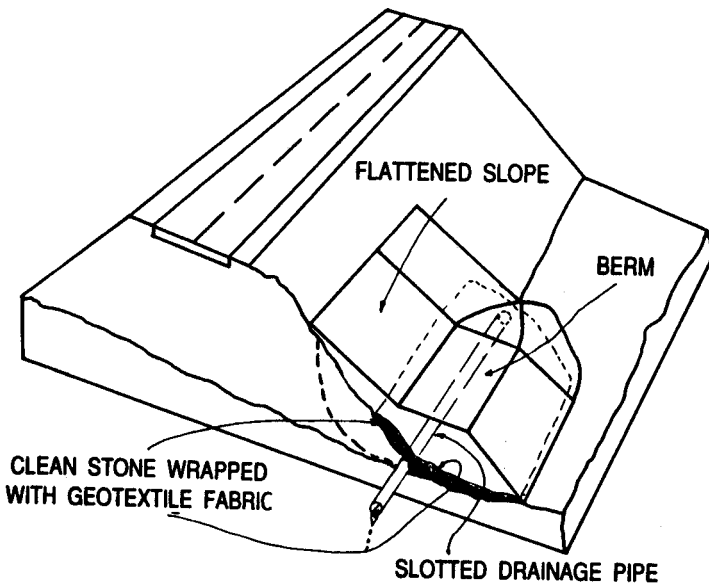
Earth and rock berms are used to provide a counterweight in the toe area of a failed slope. Berms usually are applied to correct deep rotational failures (which usually occur in cohesive soils -- clays and silty clays). Also, berms are used to repair small slides where the toe area of a slope may be over steepened as a result of erosion or poor construction. Small toe failures, a condition that may lead to larger failures, may be corrected by earth and rock berms.



*Use of earth and rock berms as a counterweight in the toe area of a failed slope*



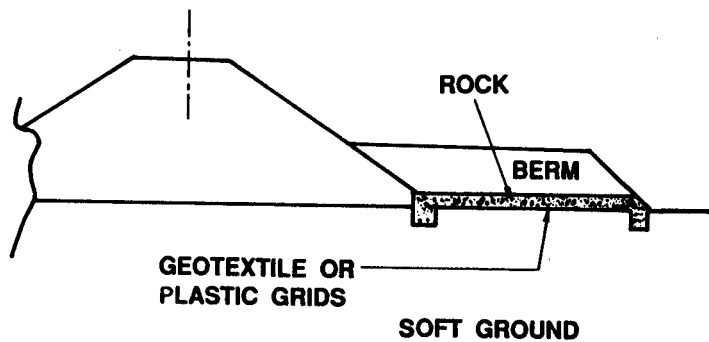
***Deep-seated, rotational failure***



***Important components of a berm***

Typically, the volume of the berm should be approximately 1/4 to 1/2 of the unstable soil mass and should extend beyond the toe area of the failure. Caution should be exercised in placement of the berm. It should not be positioned in a manner that would increase the driving forces on the failure mass.

Steps involved in constructing the berm are essentially the same as those in constructing flattened slopes. Nondegradable rock is preferred for constructing berms. However, almost any type of soil or rock (including shales) may be used. Caution should be exercised when the berm must be constructed on soft soils since there is the danger a failure may occur in the berm. In this case, a high-strength geotextile fabric might be considered and placed on the soft ground as shown in the scheme in the accompanying sketch.

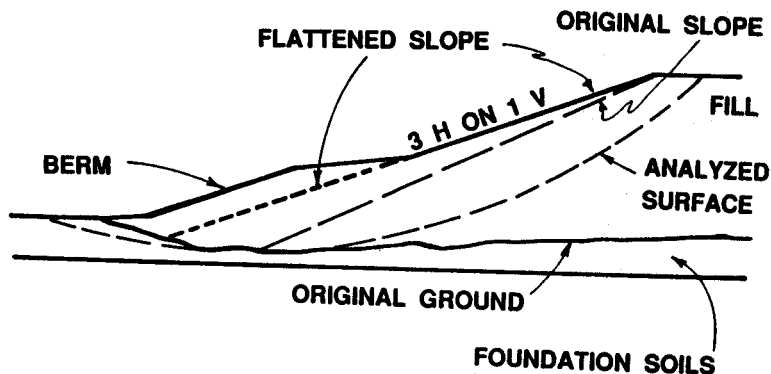


***Suggested approach for constructing a berm on a soft foundation***

The factor of safety of a flattened slope with a berm is usually higher than that of a flattened slope without a berm.

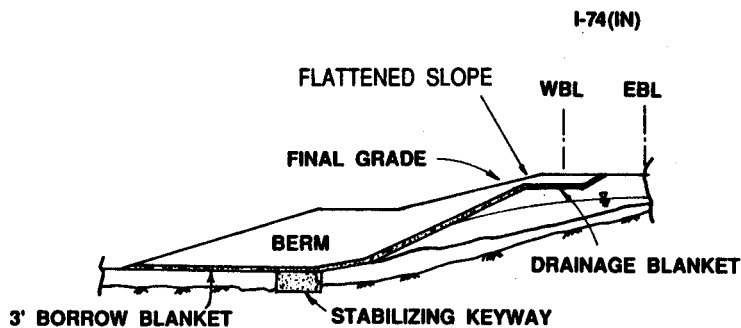
3H: 1V FLATTENED SLOPE : F=1.2

3H : 1V FLATTENED SLOPE WITH BERM : F=1.5



***Comparison of the stabilities of a flattened slope and a berm coupled with a flattened slope***

A flattened slope with a berm is a good remedial combination.

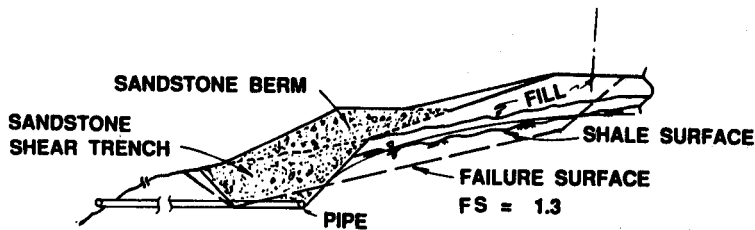


### *Flattened slope and berm*

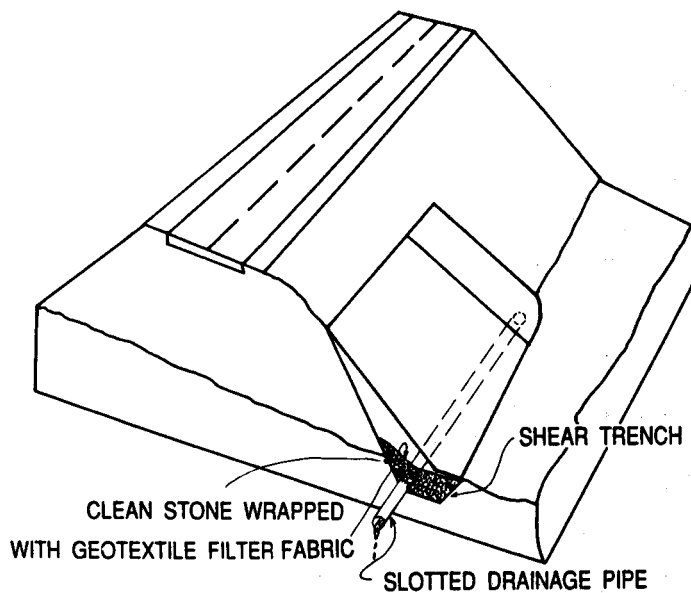
#### **V.B.1.c. Shear Trenches**

Shear trenches or shear keys provide increased shearing resistance to failure and also may serve as a subsurface drain. A shear trench is frequently a good supplement to flattened slopes and berms. Shear trenches should extend the entire length of the failure, and should be keyed into rock. Coarse nondegradable rock should be used to backfill the shear trench. The rock should be compacted in place (maximum lift thickness of 2 feet). When stone is used, a crawler tractor may be used for compaction. The rock fill should not have more than five percent passing the No.-200 sieve when used as a drainage course. Sandstone, limestone, and washed river or bank gravel are good backfill materials.

Recommended designs of a shear trench and shear key are shown in the sketches. Trench back slopes may usually



***Stability principle of a shear trench***

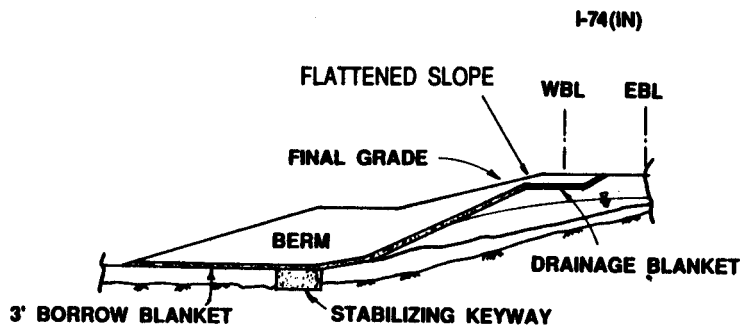


***Important components of a shear trench***

be constructed between 1 to 1.5 vertical to 1 horizontal. Since excavation of the trench may be near the toe of the failure, stability of the standing embankment is critical. It is best to construct shear trenches during the dry season of the year. Excavation of the trench should not be performed in segments exceeding about 50 feet. Immediately backfill each 50-foot segment before excavating

the next 50-foot segment. Be prepared to work continuously until finished. As soon as a 50-foot segment is excavated, have the stone trucks ready to back-fill. Shear trenches up to about 30 feet deep have been constructed economically. Generally, for small slides, trenches of 5 to 10 feet might be used.

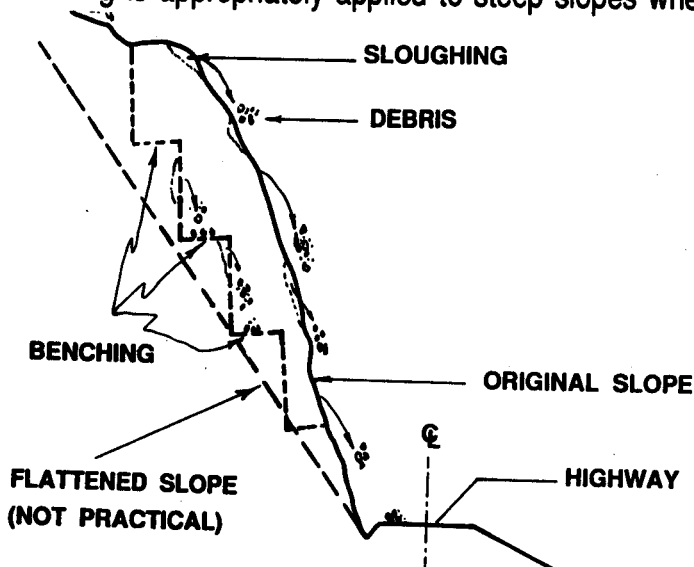
Another form of a shear trench is shown in the sketch below. In this scheme, a stabilizing keyway, which is excavated into rock, is placed under a berm. The keyway is backfilled with good, durable rock of high strength.



*Use of a keyway shear trench combined with a flattened slope and berm to stabilize a slope failure*

### V.B.1.d. Benching

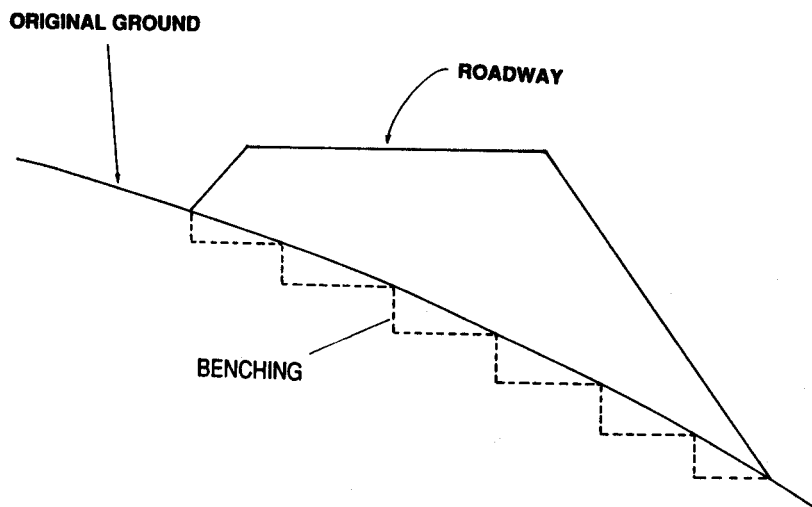
Benching is appropriately applied to steep slopes where



*Benching of a problem slope*

flattening is difficult and sloughing occurs as shown in the sketch. Benching helps to control erosion and catch debris of small slides. Slope benches so that runoff is collected and conveyed from the slide area.

Benching also is used where slope flattening or berms are used. Recommended general design considerations are shown in the sketch. It is a good practice to place a drainage blanket (1 to 2 feet thick for small slides) on top of the benched slope before backfilling. If the stone is exposed to clay or silts, then it should be wrapped in a geotextile fabric. Also, installing PVC slotted pipe in the drainage blanket is good practice. The pipe should be sloped (approximately two percent grade) to convey water away from the slide area.



***Benching of original ground under a highway embankment***



### **V.B.1.e. Overall Considerations**

When using slope flattening, berms, benching, and shear trenches, certain economic and feasibility factors must be considered:

**Right of Way:** Do not encroach onto adjacent property with the flattened slope or berm. The supervisor should be aware of property lines near the slide to avoid litigation. Property lines of distressed highway sections should be determined before the section fails when possible. An inventory system can be used effectively to identify potential slide locations. Property lines may be studied before the slide occurs.

**Topography of Site:** There may be cases where slope flattening and berm construction are not feasible because of the rough topography of the site. The toe of the highway slide or top of the cut slope may not be readily accessible. The feasibility of using slope flattening and accessibility of equipment for distressed highway sections should be studied in advance when possible.

**Availability of Suitable Borrow Materials:** When possible, use coarse (nondegradable) rock fill. Nondegradable stone does not break down when exposed to air, water, and freezing and thawing. Limestone, hard sandstone, sand, washed river and bank gravel are examples of suitable borrow materials. Clay shale is not suitable since it degrades when exposed to water. Consult a geotechnical engineer about local aggregates that are considered nondegradable. However, good rock fill may not be available or is uneconomical at many slides. Usually, materials at the site will be used. All materials

should be compacted. Study the sites identified in the slide inventory and identify suitable borrow materials and haul distances -- plan ahead.

**Available Personnel and Equipment:** Learn the capabilities of your personnel and equipment. Ask yourself, "If this highway section failed, is the necessary equipment and skilled personnel available to repair the failure?" Discuss the problem with your personnel and explore ways a potential slide identified during the inventory might be repaired. Trust the instincts of the employee on the bulldozer. He will know when a particular operation is unsafe. If the job appears too large, contact a higher authority or a knowledgeable contractor and/or geotechnical engineer. If an engineer and/or contractor is contacted, obtain a reference list of landslide repairs he has managed or designed. Make sure the engineer and contractor have experience in landslide repairs.

**Budgetary Constraints:** Many budgets are usually not prepared with the notion of repairing a highway failure. Do not attempt to spend \$350,000 on a slide when the maintenance budget may be only \$1 or \$2 million per year. Use of the inventory system will permit some preplanning so that some small slides may be corrected and remedial actions taken to minimize failures.

### **V.B.2. Drainage**

Surface drainage and subsurface seepage into highway fills and cuts are a major cause of highway failures. Control of surface and subsurface seepage is essential to prevent or halt failures. Drainage methods should be used early in the

treatment of failures or distressed highway sections. A variety of surface and subsurface methods may be used:

### **SURFACE WATER DRAINAGE MEASURES**

- Surface ditches
- Divert surface waters
- Seal joints, cracks, fissures
- Regrade slope to eliminate ponding
- Pave surface of slope
- Seeding

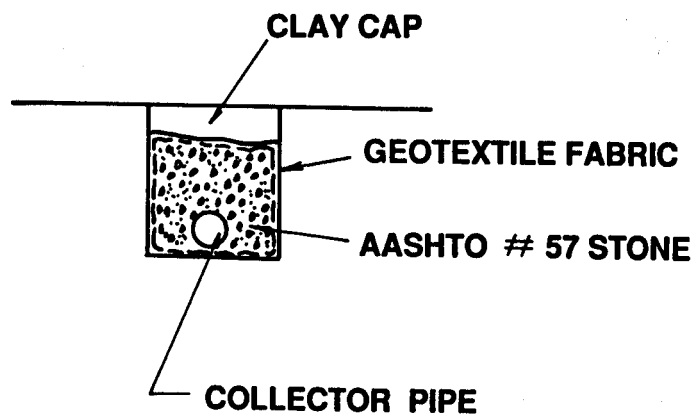
### **SUBSURFACE DRAINAGE MEASURES**

- Horizontal drains
- Drainage blankets
- Cutoff walls
- Vertical well points
- Seepage tunnels

#### **V.B.2.a. Surface Waters**

**Construct Surface Ditches:** Open surface ditches may be used to reduce ponding and to control runoff within the distressed area. Open ditches also may be used to surround a slide area to prevent the entry of water into the unstable mass. Be cautious of using open ditches within the slide or distressed area. This could aggravate the situation and contribute to further distress. Study the situation carefully and be sure water is conveyed to a point outside the distressed area. Surface ditching may be as simple as cutting or making an unlined channel to constructing a channel lined with clay, rock, or plastic. Surface treatment may include surface drains and other surface repairs.

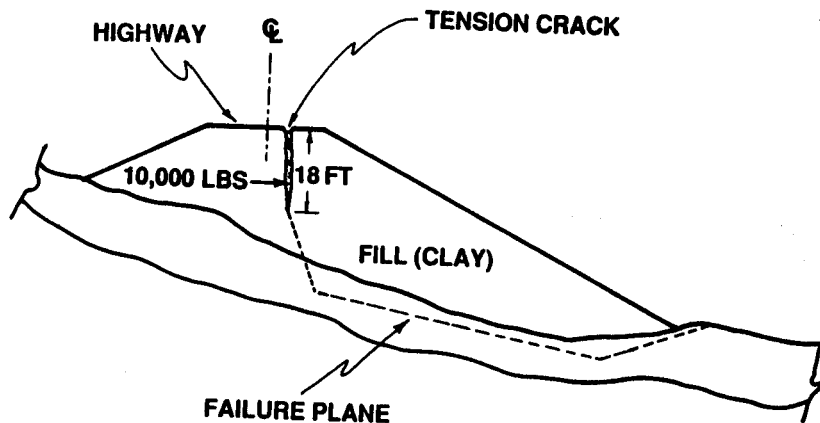
**Divert Surface Waters:** Small streams of surface water running into the distressed area or onto the failed slope may be diverted by cutting an open drainage ditch around the head of the slide so that runoff is diverted away from the slide. Also, a drainage ditch lined with stone, filter fabric (geotextile), and slotted drainage pipe (shown in the sketch) may be used to intercept subsurface seepage and convey it away from the distressed area. As shown in the sketch, the stone is completely wrapped with geotextile. The drainage or filter fabric allows water to pass into the stone, but it blocks the movement of small soil particles into the stone. As a result, the stone drainage blanket does not become clogged by small soil particles.



***Geotextile filter fabric around drainage gravel***

**Seal Joints, Cracks, and Fissures:** Surface water flowing into an open crack may significantly affect the stability of a highway slope failure in progress (shown in the sketch). Tension cracks develop at the head of slopes because soil cannot withstand large tensile forces (tending to pull soil apart) over a period of time. Tension cracks may extend several feet into the fill. As shown in the sketch, for a

tension crack measuring 18 feet deep and filled with water, a force of about 10,000 pounds acts against the potential failure mass. This force would be large enough to cause complete failure in many cases. Therefore, it is essential to seal all joints, cracks, and fissures observed in a distressed area. In emergency situations, use plastic sheeting to cover open cracks and joints until the maintenance crew can provide a more permanent solution. Position the plastic sheeting so runoff is conveyed away from the cracks. Cracks may be filled and sealed with asphalt or fat clay. The repaired cracks should be inspected periodically and repaired again if necessary. Reopening of a repaired crack is a sign that movement of the slope is continuing.

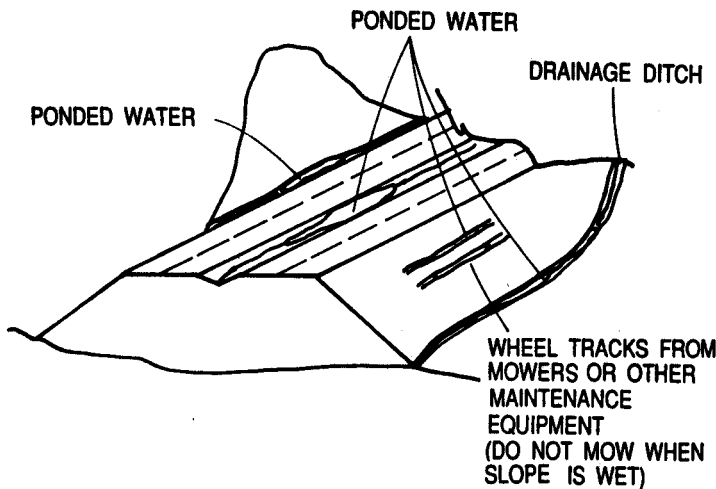


*Illustration of the large force exerted against a potential failure mass caused by a tension crack filled with water*

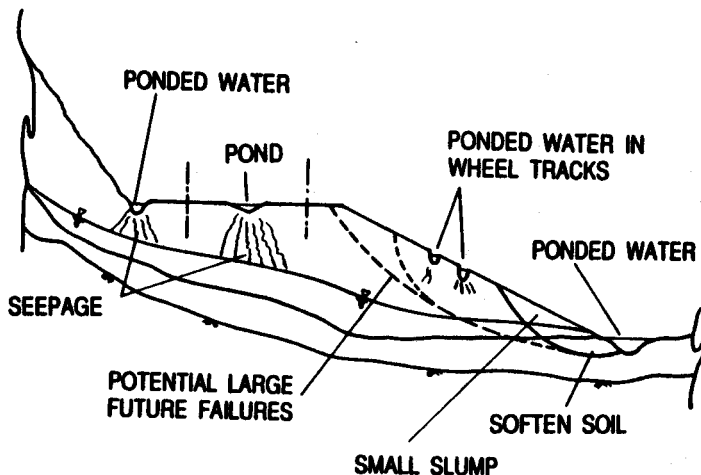
**Regrade Slope to Minimize Ponding:** Ponding of water on any part of a highway slope should be eliminated. Ponding of water on the slope reduces the available strength of the soil or rock, since ponded water eventually

seeps into the slope. Ponding may often be eliminated by regrading the slope. Four particular areas on the slopes of highways that should be constantly watched are as follows:

- o Ponding of water on top of the slope, such as in depressed medians of separated highways.
- o Ponding of water in the drainage ditch that parallels the roadway.
- o Ponding of water along the toe of a highway fill.
- o Ponding of water in ruts left by mowing equipment operating on wet, soft slopes.



***Areas on slope where ponding water may occur***



***Cross-sectional view of ponded waters on a slope and potential problems that may develop***

The toes of highway fills are highly vulnerable to ponding. High concentration of stresses occur in the toe area and anything that disturbs that area may cause complete failure. Ponding saturates the soils and reduces strength available to resist failure (prolonged soaking softens clay soils. As clay soils absorb water and swell, a gradual decrease in the cohesive component of strength occurs). A high water table (top of pond) reduces the frictional component of strength.

Ponding commonly occurs in depressed medians and at toes of fills. Ponding of water at the toes of highway fills, for example, was a common occurrence along a stretch of I 71 in Kentucky (between Louisville, Kentucky, and Cincinnati, Ohio). Many small failures were observed along this stretch of interstate. The small failures would eventually lead to major failures.

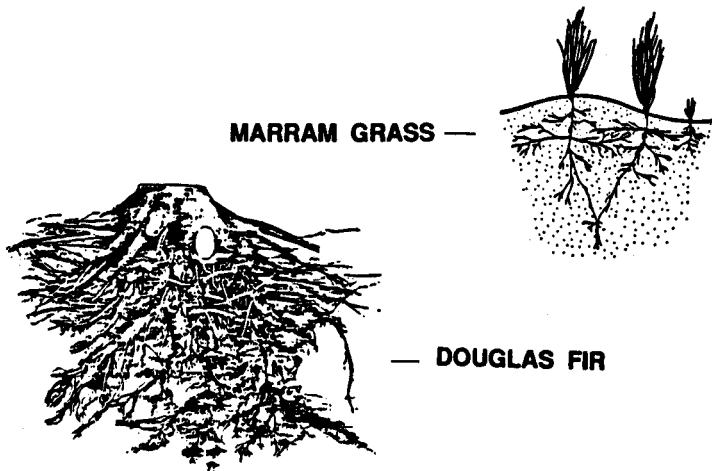
Ponding may be eliminated in many cases by regrading the slope. This action may require placing additional material in the ponded area and building additional ditches. Do not allow mowing equipment on the slope when the soils are wet.

**Pave Surface of Slope:** Paving is another surface treatment that is applied in critical locations to control erosion and to collect, control, and redirect surface seepage or runoff. This method is used to prevent runoff from entering the unstable mass or to convey water from the unstable mass.

**Seeding:** Vegetation may be used to control erosion of unstable masses. This method provides a protective

surface on the slope and is used as a means of lining ditches. Roots of plants and grasses absorb moisture and aid in preventing infiltration of water into the unstable mass. Seeding and the establishment of vegetation always should be used in the reconstruction of slope failures. In some cut slopes, seeding may not be practical because of the steepness and nature of the materials on the slope. On fill slopes, vegetation also serves another purpose -- the prevention of small shallow slides. Roots form a matrix or a mat that hold soil particles in place. This matting helps resist failure and aids in holding the top few feet of soil in place. Roots of vegetation generally increase the strength of soil. Consult a geotechnical engineer or plant pathologist in the local area for a list of native plants and grasses that form a thick mat of roots, absorb water, and are adaptable to the local climate.

## VEGETATION

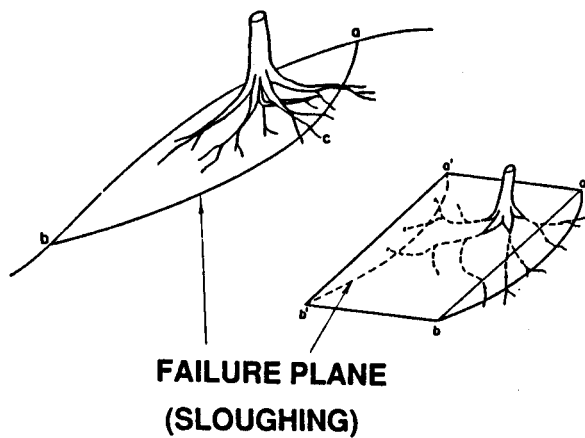


### *Roots of vegetation*

Subsurface seepage areas may be detected by observing "green areas" on the face of highway fill or cut slopes during dry periods. It is best to view the slope at a distance to detect different colorations of vegetation on the



slope. These areas should be staked or flagged for future reference and treatment, and noted in the slide inventory file.



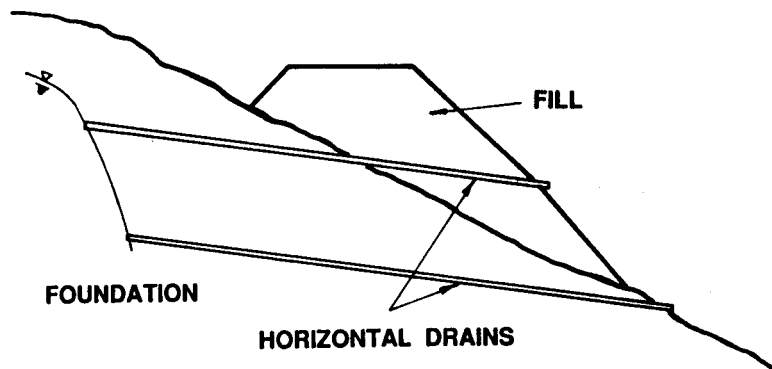
***Prevention of shallow sloughing of a slope using roots of vegetation***

#### **V.B.2.b. Subsurface Waters**

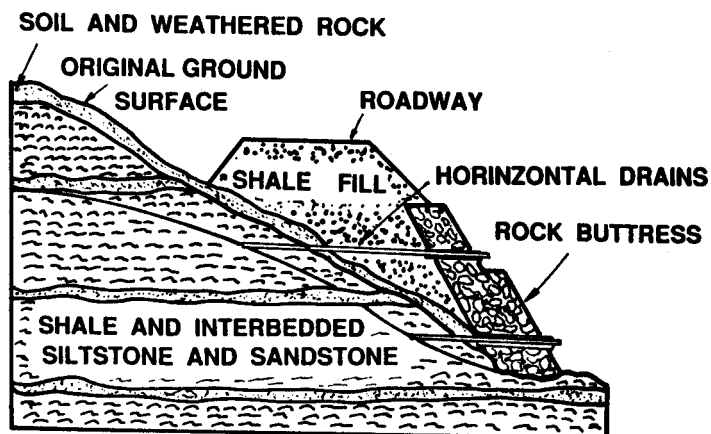
**Horizontal Drains:** Horizontal drains are a good early treatment to intercept subsurface seepage at side-hill highway fill and cut slopes. This technique often is the most economical drainage measure. The method is appropriately applied at sites where deep failure has occurred and is very useful in intercepting pervious water-bearing strata before the water reaches the failure mass. This method lowers the water table in the slide mass (or intercepts the seepage before it enters the slide mass) and therefore increases shear strength.

Installation of horizontal drains usually consists of inserting a slotted PVC pipe or perforated metal pipe, measuring about 1.5 to 2.0 inches in diameter, into cased horizontally drilled holes. Special drilling equipment is used for this purpose. The pipe is usually placed on a 3 to 20 percent grade to allow gravity drainage. The casing prevents

collapse of the hole. An example of the use of horizontal drains to repair a landslide is shown in the sketch.



***Horizontal drains***



**EMBANKMENT REPAIR  
I 75 (TN)**

***Repair of embankment using horizontal drains and a rock buttress***

In smaller slides, cased water observation wells should be installed in the distressed area as a minimal measure before installing horizontal drains. These wells aid in

locating the ground-water table. Casing for observation wells may be slotted PVC pipe or perforated metal (galvanized) pipe (e.g., downspout). Several holes are drilled into the downspout. The casing prevents collapse of the hole and the slots and holes in the casing allow water to enter. The use and cost of installing horizontal drains is wasted if the ground-water table is below the distressed area. Observation wells should be monitored over a period of time (several days or even weeks), when possible, to establish the ground-water level. On highway fill or cut slopes where "green areas" of vegetation, in contrast to lighter areas of vegetation, have been observed, installation of horizontal drains may be a good possibility. Hence, the slide inventory may prove valuable in selecting sites for applying horizontal drains.

Horizontal drains usually are positioned in the lower portion of the slope and below the toe of the slope in natural ground. Frequently, drains are installed in rows. In difficult terrain, they may be installed in a fan-shaped pattern. Usually, at least two rows of drains are needed to be effective. To prevent clogging by fine materials and roots, the drains are wrapped with a geotextile filter fabric and the last 15 to 20 feet of the pipe (near the ground surface) is left unslotted.

Routine maintenance and monitoring of horizontal drains should be performed periodically. Discharge rates should be measured. Also, wells and piezometers should be monitored to determine if the horizontal wells are effective in lowering the ground-water table.

In large slides, it is good practice to perform subsurface exploration so that:

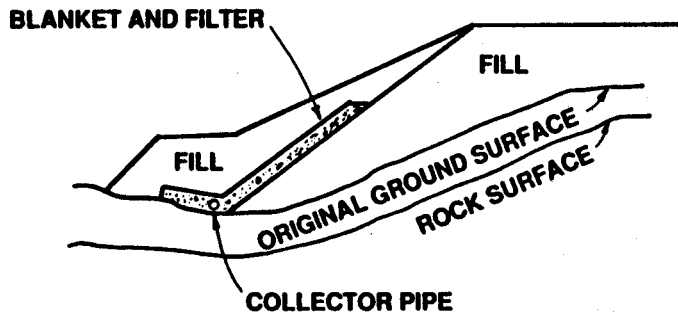
- o Embankment conditions may be defined.
- o Foundation conditions may be defined.
- o Ground-water levels may be defined.
- o Piezometers or cased water observation wells may be installed.

**Drainage Blanket:** Drainage blankets are used to collect and control subsurface or ground-water seepage. Drainage blankets also control and collect surface seepage that infiltrates from rainfall and snowmelt runoff. The blanket consists of pervious drainage material. Sound, durable rock fill (such as washed river or bank gravel, limestone, or hard sandstone gravel) should be used to construct the blanket. To be most effective, the rock fill should not contain fines (zero percent passing the No.-200 sieve). Consult a geotechnical engineer for information on good drainage materials.

Drainage blankets normally should not be placed directly on clayey or silty clay soils. Fines from these soils will eventually infiltrate into the rock fill and clog the drainage paths. Small amounts of fines, as low as five percent passing the No.-200 sieve, may significantly reduce the permeability or capacity of the drainage blanket to convey water. Geotextile fabric or filter aggregate, such as concrete sand or similar material, may be used as a filter against many fine-grained silty and clayey soils. Asphalt sands may be used as a filter against silt-sized soils (nonplastic).

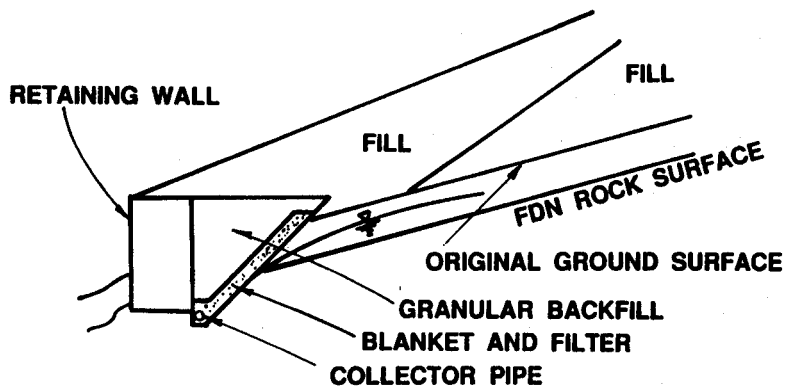
Typical applications of drainage blankets are as follows:

o Drainage blanket placed beneath reconstructed fill.



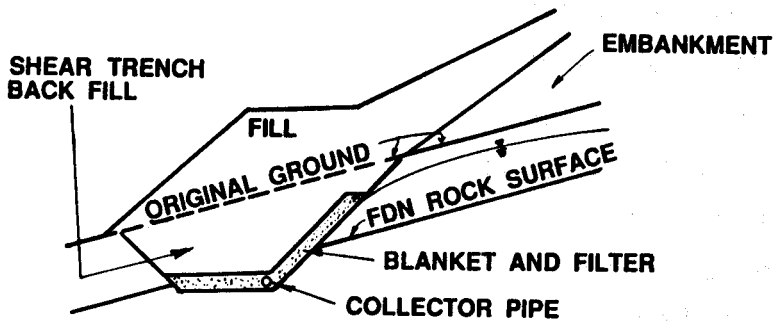
***Drainage blanket under flattened slope and berm***

o Drainage blanket placed beneath flattened slope or berm.



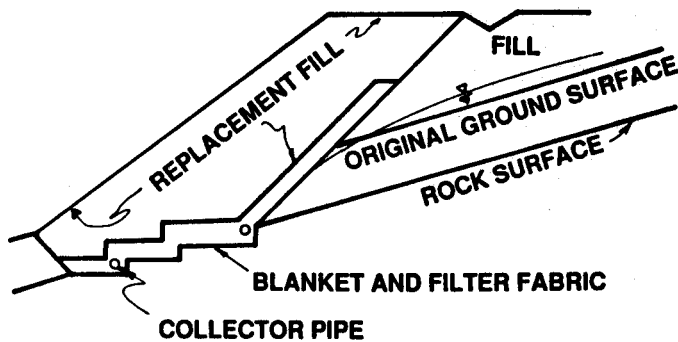
***Drainage blanket under backfill behind retaining wall***

o Drainage blanket placed beneath shear trench backfill.



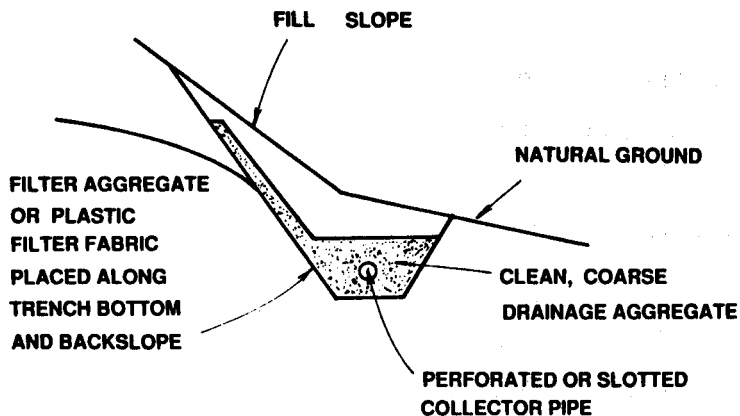
***Drainage blanket beneath shear trench backfill***

o Drainage blanket placed beneath backfill behind a retaining wall.



***Drainage blanket under reconstructed fill***

o Drainage blanket placed as an interceptor trench-filled toe drain.



***Drainage blanket placed as an interceptor toe trench drain***

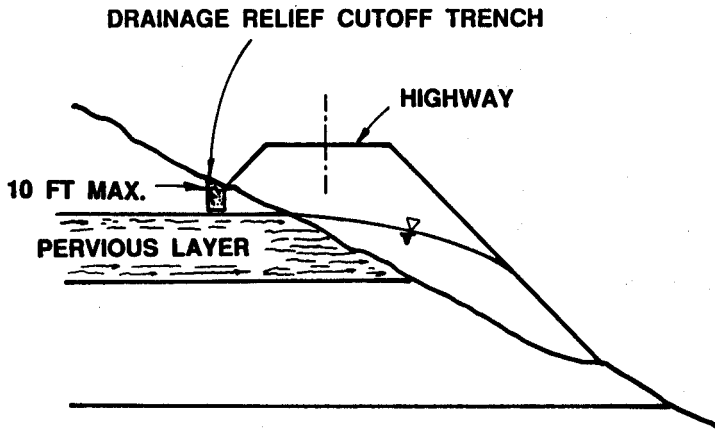
Thickness of the drainage blanket should be a minimum of 1 foot when the blanket is placed on fine-grained soils. A thickness of 3 feet is preferred. For small slides, the blanket may be thinner (1 to 2 feet thick). When the fill consists of sound durable rock or clean sand, the blanket may be eliminated or reduced in thickness. Filter aggregate or filter fabric should always be placed between the fill soil and drainage blanket. Perforated or slotted pipe should be embedded in the drainage blanket to convey water from the distressed area.

**Cutoff Wall:** Cutoff walls are used to control seepage and often are used with hydraulic structures such as earth dams. The intent of cutoff walls is to decrease the quantity of seepage or increase the flow quantity (but reduce pore pressures) by providing drainage relief structures. Methods used include the following:

- o Sheet-pile cutoff wall.
- o Compacted barrier of impervious soil.
- o Grouted or injected cutoff.
- o Slurry trench.
- o Impervious mixed in-place walls.
- o Drainage relief trenches.

The first five methods have limited application for correcting highway slides, particularly when applied to smaller slides.

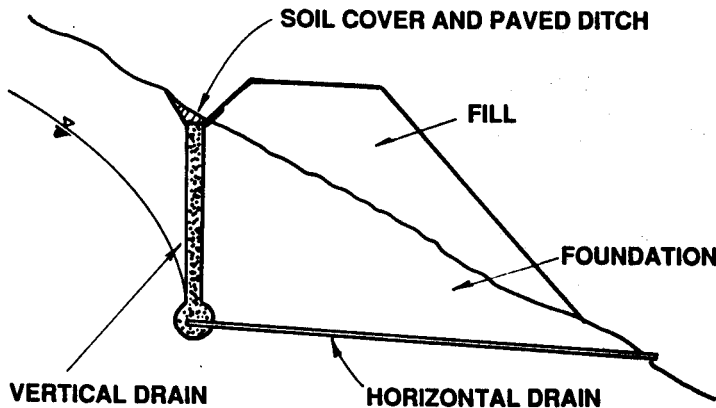
Drainage relief cutoff trenches are sometimes used to intercept subsurface seepage before it enters highway fills. However, based on past experience, interceptor drainage trenches, when used at the uphill side of fills, are ineffective because of their shallow depth. Usually, the maximum



***Drainage relief cutoff trenches***

depth of a drainage trench that can be constructed economically is about 10 feet. This depth often is too shallow to intercept seepage before it enters the fill. Careful study of site conditions and geometry should be made before using drainage trenches on the uphill side. Use of this technique should be limited to very shallow highway failures and failures in cut slopes. Drainage trenches are more effectively applied at the toe of fills.

**Vertical Drain Wells and Well Points:** Vertical drainage wells are sometimes used on the up slope side of highway fills to intercept subsurface seepage before it enters the



***Vertical drain wells with belled bottoms as a means of controlling subsurface seepage***



highway fill. Vertical drains are more effective than drainage cutoff trenches because they can be extended to greater depths. The vertical wells are either pumped directly or joined with horizontal drains. Pumping should be considered a temporary control measure because of the high expense. Well points (vertical drainage) are sometimes installed at slide locations when making repairs. For example, well points might be used to lower the ground-water table when constructing shear trenches and aid in maintaining stability.

Typical features of pumped vertical well points when placed upslope are as follows:

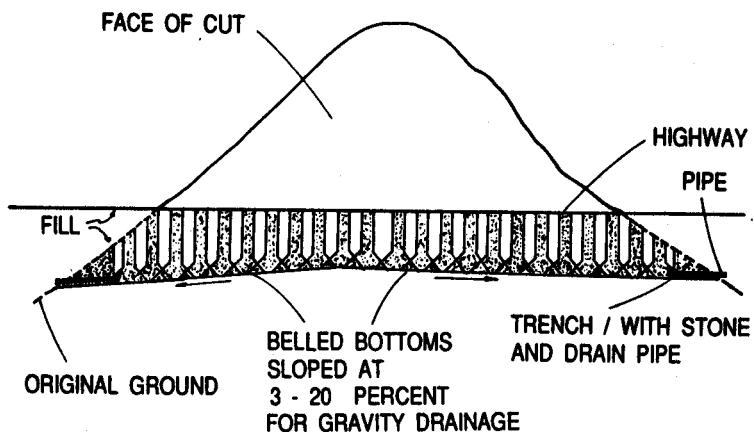
- o Well diameters are 6 to 12 inches.
- o Vertical wells are spaced on 20- to 30-foot centers.
- o Sound, clean durable rock (no fines) are used to backfill.

Typical features of vertical drains joined by horizontal drains are as follows:

- o Vertical drains are placed up slope of the fill on 4- to 5-foot centers.
- o Diameter of vertical drain should be about 2 to 3 feet (Drill rigs normally used for installing caissons or drilled-in piers for building foundations are available in most areas to install these drains.).
- o Bottoms of vertical drains are belled using a special belling drill tool so the drains are interconnected at the bottom.
- o Horizontal drains are connected to the vertical drains to provide gravity drainage.

- o When vertical drains are not interconnected, interception of the vertical drains with horizontal drains is difficult at horizontal distances in excess of about 100 feet. Greater lengths of horizontal drains may be used when the bottoms of the vertical drains are connected.
- o For every ten vertical wells, two to four horizontal wells are needed to drain effectively.
- o Vertical holes usually are backfilled with sand. For nonplastic soils, asphaltic concrete or comparable sands may be used. For silty and clayey soils, concrete sand is satisfactory.
- o Vertical observation water wells (perforated pipe or slotted PVC) are installed during installation to monitor ground-water levels and to determine the effectiveness of the drainage system.

In some situations (as in cut-fill transitions), interconnected, belled bottoms of the vertical drains may be sloped to induce gravity flow to remove the water as shown in the sketch. A careful study of the site (possibly by a geotechnical engineer) is required to design an effective drainage system.



***Vertical drains as a means of controlling subsurface seepage***

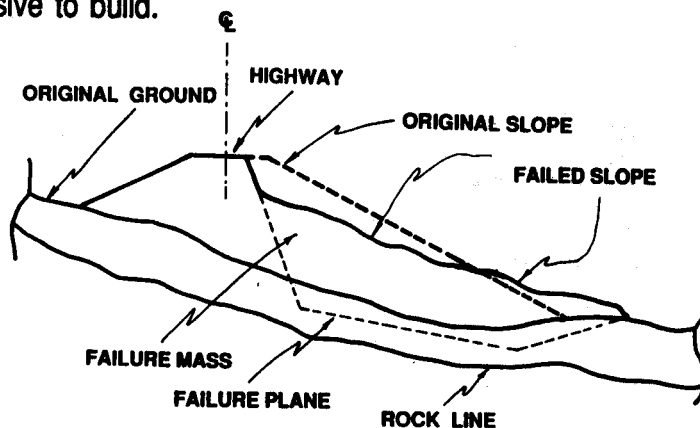
**Seepage Tunnels:** Seepage tunnels are used to correct large slides and in cases where major structures are threatened. This method is not applied to small slide corrections.

### V.B.3. Retaining Structures

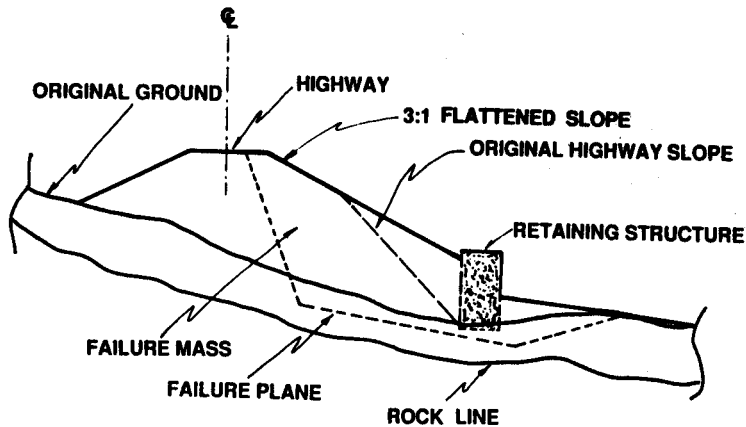
Retaining structures are used to correct highway failures by increasing the forces tending to resist failure. Generally, the retaining structure is placed at the toe of the distressed area or slope failure. Types of structures used in highway slide corrections include:

- o Concrete walls.
- o Earth and rock buttresses.
- o Crib walls.
- o Gabion walls.
- o Piles and caissons (drilled into rock).
- o Tiedback walls.
- o Tied piles.
- o Reinforced slopes.

Retaining structures frequently are misused because the failure mass may be several times larger than the wedge of soil retained by the structure. Also, retaining structures are expensive to build.

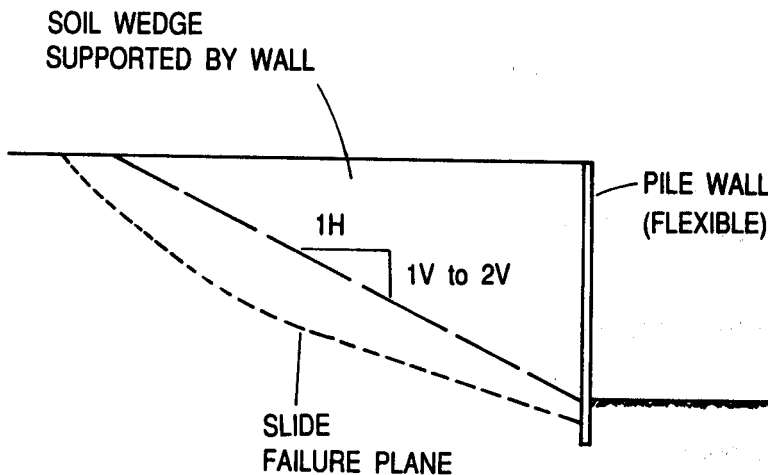


***Sliding wedge slope failure***



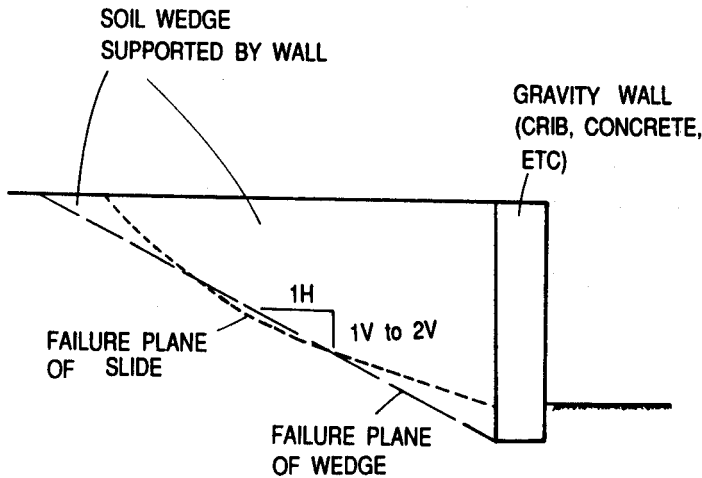
***Misuse of a retaining structure***

To be effective, the wedge of soil supported by the wall should be similar or larger in size to that of the failed mass. Typically, the slope of the supported wedge ranges from about 1 horizontal to 1 to 2 vertical. If the failure



***Comparison of soil wedge supported by a retaining wall and the sliding failure mass***

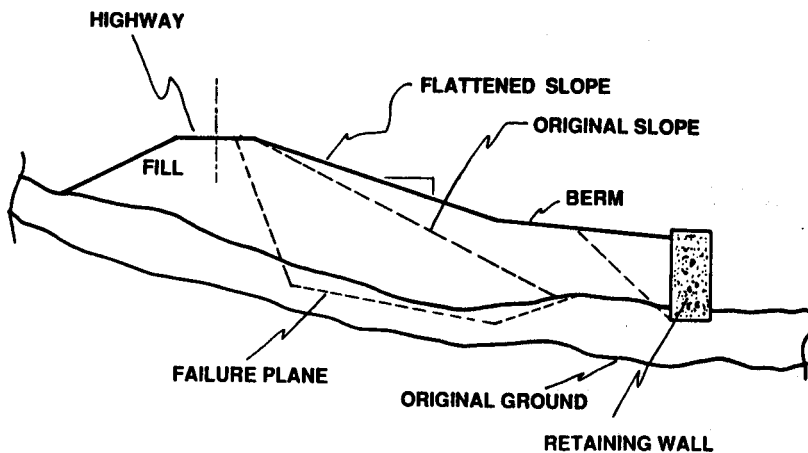
mass is much larger than the wedge of soil that the wall can potentially retain, a tieback system or some other method of stabilization may be required. As shown in the sketch, the supported mass (wedge) may be increased by increasing the depth of the wall.



***Soil wedge supported by wall in relation to depth of wall***

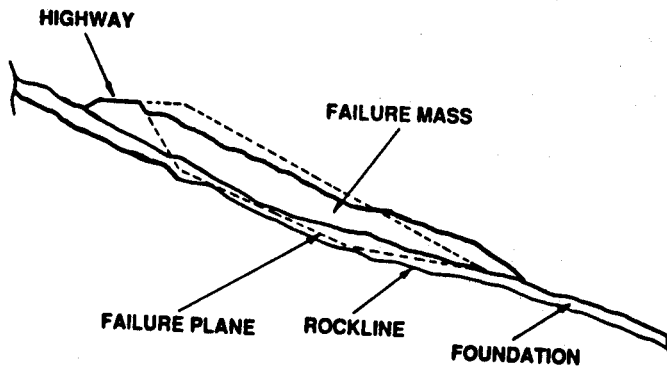
Some potential applications of retaining structures are as follows:

- o Small slides with small dimension in direction of movement.
- o Slides with steep toe slopes.
- o Backward extension of failure into larger mass not likely.
- o Used primarily to support slope flattening and berm fills.

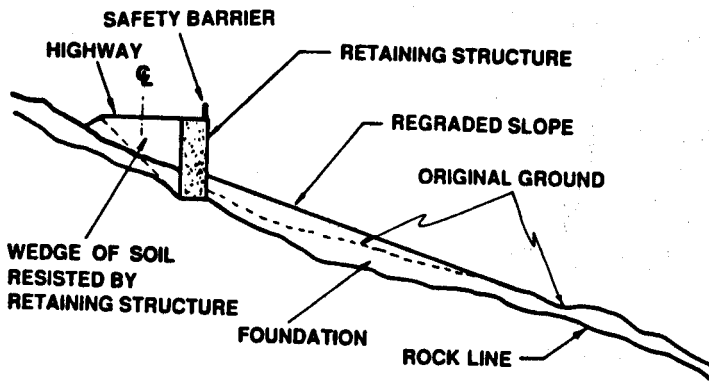


***Application of a retaining structure at the end of a berm and flattened slope***

- o Used where right of way and/or borrow material is limited.
- o Long shallow slides.



***Long shallow highway slope failure***

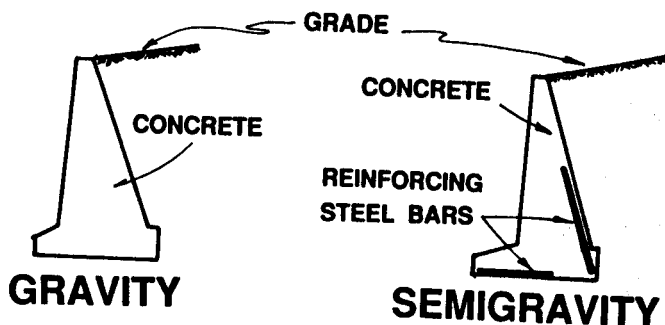


***Application of a retaining structure to repair a long shallow highway slope failure***

### V.B.3.a. Concrete Walls

Because of foundation requirements and construction costs, concrete walls may have limited application in repairing highway failures. Concrete walls are susceptible to cracking as a result of differential settlement (i.e., one point of the wall settles more than another). Other types of structures usually can be constructed at less expense. Types of concrete retaining walls include the following:

- o Gravity concrete wall -- mass of concrete resists overturning and sliding caused by the retained wedge. Steel reinforcement (except for some steel to counteract wall expansion due to fluctuations in temperature) usually is not used.
- o Semi-gravity concrete wall -- mass of concrete, reinforced with steel bars, resists overturning and sliding caused by the retained wedge. Generally, the semi-gravity wall is slightly thinner than the gravity concrete wall

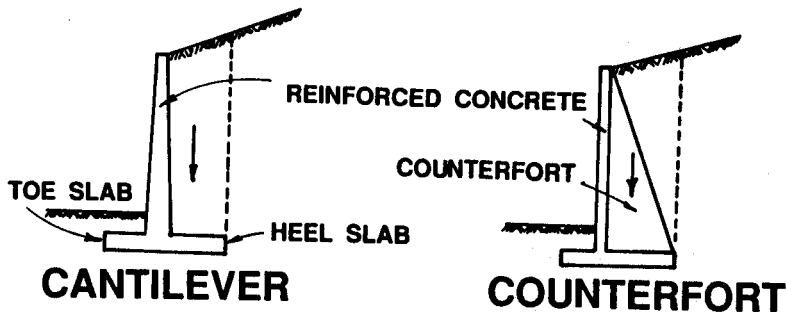


#### *Gravity and semigravity retaining structures*

- o Cantilever concrete wall -- in this design, the footing width in front and back of the wall are sufficiently wide so the columns of soils in front and back of the wall rest on the concrete footing and aid in resisting failure and maintaining stability. Reinforcement is used to hold the concrete

together and stiffen the wall. This type of wall is much thinner than the gravity and semi-gravity walls.

o Counterfort concrete -- this design is essentially the same as the cantilever wall except counterforts are used to strengthen the wall. The concrete counterfort wall is slightly thinner than cantilever walls and is reinforced with steel bars.



#### *Cantilever and counterfort retaining structures*

Positive drainage behind concrete walls is essential to maintain stability. Weep holes and/or drainage blankets should be used. Retaining walls should be inspected periodically.

Portable, precast concrete walls may be used effectively to repair small highway slides. In one locality, county officials use portable, precast concrete wall units to correct many failures. These failures basically are less than about 10 feet in height and are caused by the erosion of the toes of the highway fills by streams. Each precast concrete wall unit measures 8 feet in length and 4 feet in height. The base of each concrete unit measures 1 foot. The width at the top of the unit is 6 inches. Steel reinforcement bars and hooks (for lifting) are included when the concrete is poured into a specially designed concrete form. The

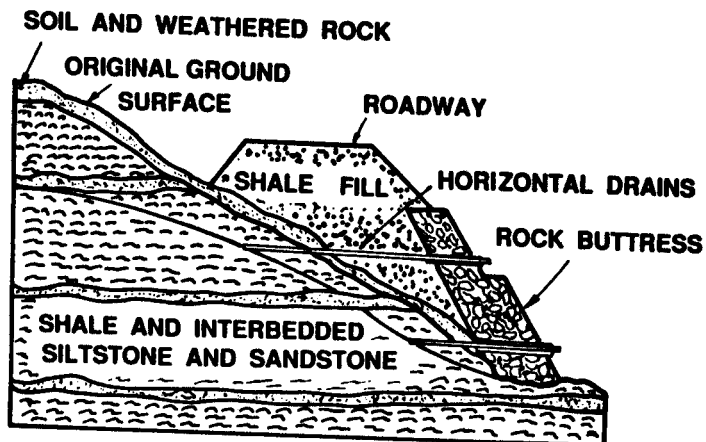


precast concrete units are poured at the concrete plant and stored until they are needed. The length of the concrete units are limited to 8 feet so that they will fit in a dump truck. A large rubber-tired backhoe is used to load the units into a dump truck and unload and place the units at a particular slide location. The rubber-tired backhoe is also used to excavate a portion of the slide and shape the area of the slide before placing the portable concrete wall units. After the concrete units are placed, they are tied together using reinforcement bars that are originally placed during precasting. About 2 feet of a reinforcing bar protrudes from each end (backside) of the wall unit. The protruding bar of one unit is threaded through an "eye" bolt (placed during precasting) of an adjacent unit. The wall units are anchored using precast concrete anchor blocks. The protruding reinforcing bars of the anchor blocks and wall units are tied or bolted together. The anchor blocks are placed behind the wall at a height of one-third of the height of the wall from the bottom of the wall. The walls are backfilled with material from the streambed so that it is not necessary to import backfill materials. The wall units are sometimes double-stacked or a gabion wall may be constructed on top of the wall units. Occasionally, the wall units fail. In this case the wall units are lifted, placed back to the original position, and backfilled. Generally, a small slide can be corrected in less than 4 or 5 hours using a 3 or 4 man crew.

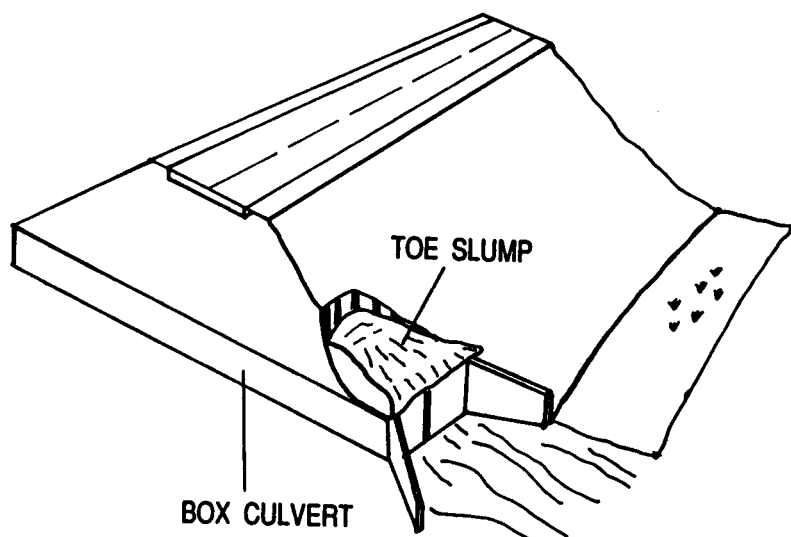
#### **V.B.3.b. Earth and Rock Buttresses**

Earth or rock buttresses are used to reinforce the toe area of the slope as shown in the sketch. To be effective, the volume of the buttress should be  $1/4$  to  $1/2$  the volume of

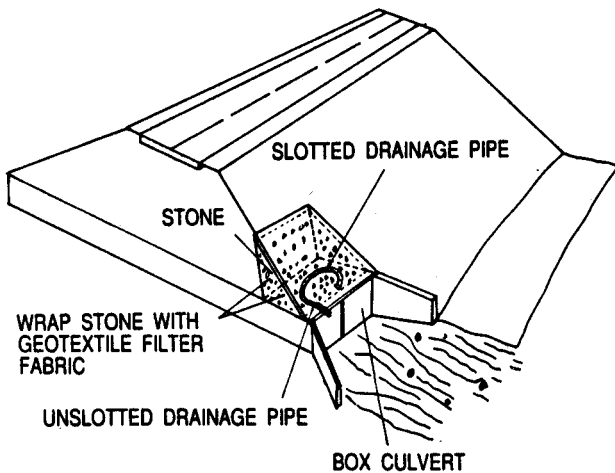
the slide mass. The buttress should extend 5 to 10 feet below the failure zone to provide an adequate shear key. By using nondegradable rock fill (no fines passing the No.-200 sieve), slopes of rock buttresses may be constructed as steep as approximately 1 horizontal to 1 vertical (provided water is intercepted by the rock buttress



*Rock buttress used to repair a highway slope failure*

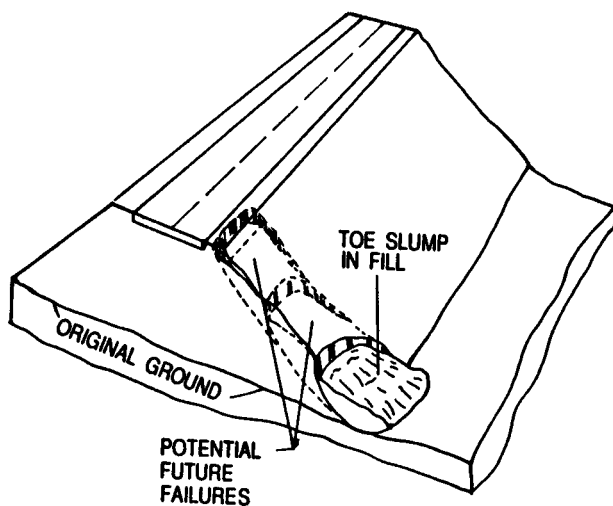


*Toe slump in fill over a reinforced box culvert*

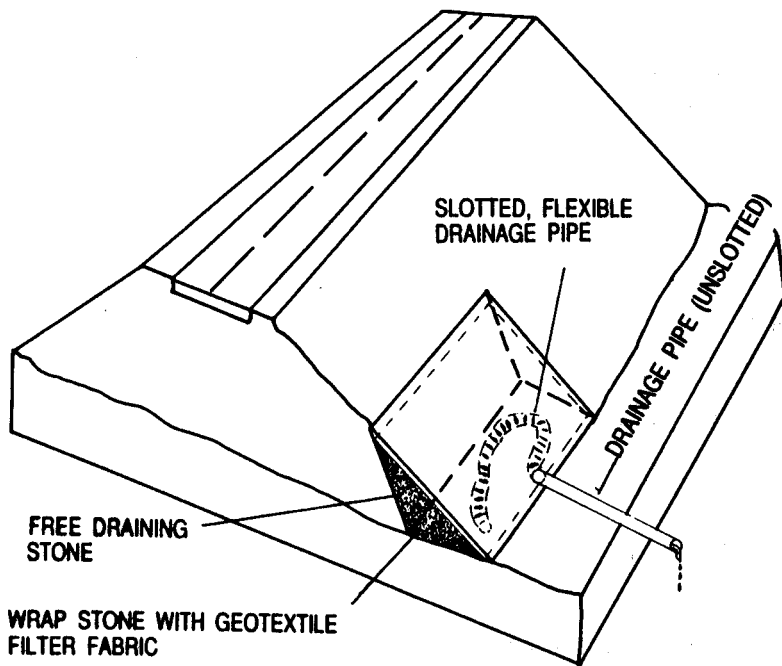


***Repair of a toe slump over a box culvert using a rock buttress***

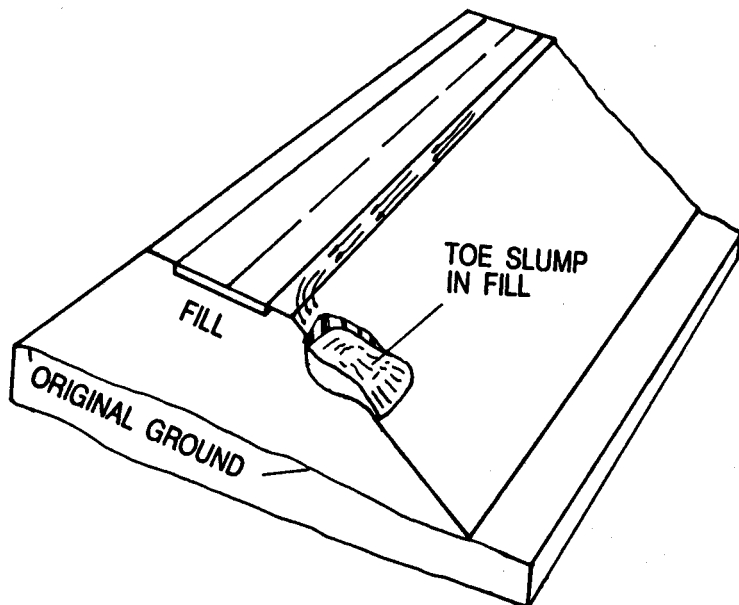
or by a drainage blanket before it enters the buttress). Slopes of earth or soil buttresses (mixtures of soil and rock) should not be greater than about 2 horizontal to 1 vertical. The amount of fines (percentage passing the No.- 200 sieve) in the mixture should be limited to a maximum of about 20 percent.



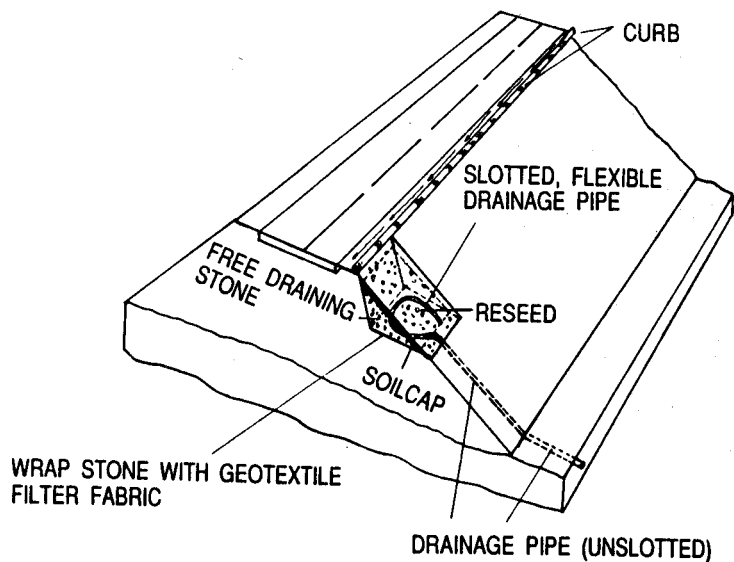
***Slump in fill near toe of slope***



*Repair of toe slump using a rock buttress*



*Slump in fill near top of slope*

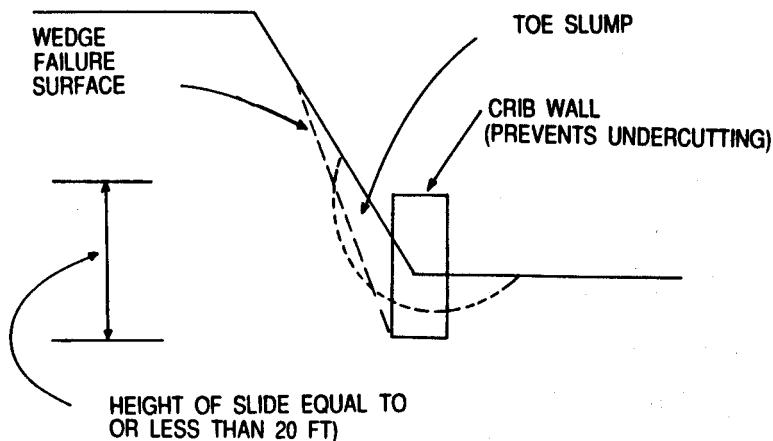


***Repair of a slump near the top of a slope using a rock buttress***

If fill material of the failed slope contains fine-grained soil, then filter aggregate or geotextile filter fabric should be placed next to the fill material before placing the rock or earth buttress. Generally, a drainage blanket should be placed on the filter fabric to intercept the ground-water table as shown in the sketch. The drainage blanket should be 2 to 3 feet thick and should be constructed of sound and clean (no fines) nondegradable rock.

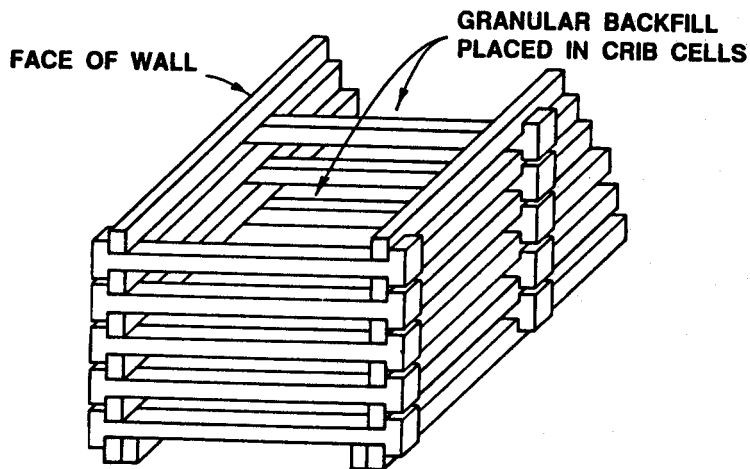
**V.B.3.c. Crib Walls**

Crib walls are suitable for repairing small slides (approximately 20 feet or less in height) and for preventing the undercutting of the toe of slopes. Crib walls are more versatile than rigid retaining walls because they can withstand fairly large vertical and lateral movements (also differential movements) and not lose stability.



***Use of a crib wall prevent undercutting of toe of slope***

Components of a crib wall consist of a series of interconnected cells usually 8 to 12 feet square. The cells (headers and stretchers) usually are constructed of wood (old railroad ties and treated timber have been used in



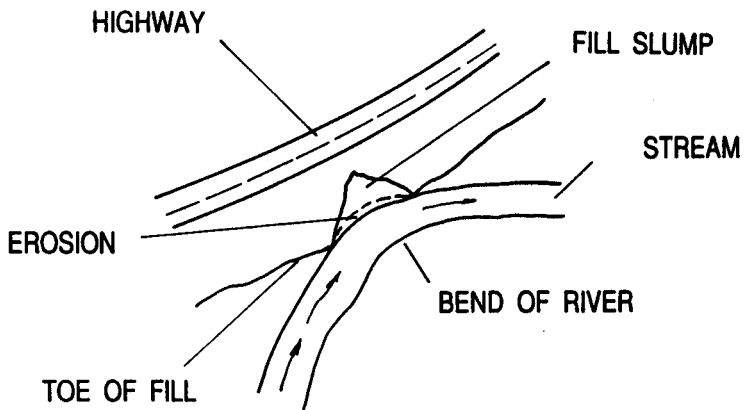
***Components of a crib retaining wall***

small slide repair), metal, and precast reinforced concrete struts. Backfill consists of granular materials (smaller than about 12 inches) such as crushed stone or sand. As the wall is constructed, the backfill should be compacted in thin lifts (6 to 12 inches). Space between stretchers should be limited to a maximum of 8 inches to retain the backfill.

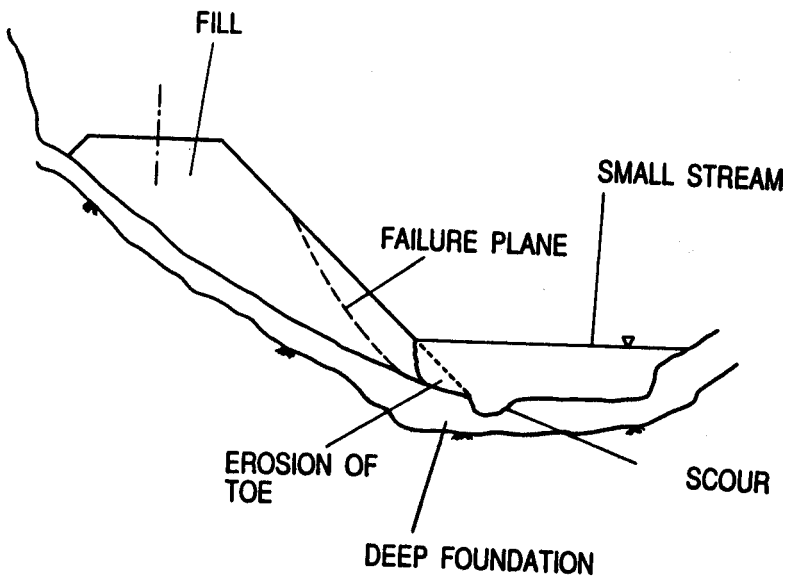
Crib walls should be battered toward the supported fill when the height of the wall exceeds 12 feet. Slope of the batter should be 1 horizontal to 6 vertical. Additionally, lower cribs should be placed behind the wall (for added support) when the wall is battered. The additional lower cribs also enlarge the wedge of soil that can be retained by the wall. Approximately 10 to 20 percent of the wall height should be placed below finished grade at the toe. When the backfill behind the wall consists of fine-grained soils or contains significant fines, filter fabric should be placed on the fine-grained soils (clays and silts) behind the wall to prevent clogging of the backfill. The top of the wall should rise above the backfill so that loose fine material does not wash over the wall and into the backfill. This condition would clog the crib-wall backfill. Whenever practical, the wall should be placed on firm rock, or, when this cannot be achieved, the wall should be placed on compacted fill or the natural soil (if firm). It may be desirable to construct a granular working platform at the start of construction of the crib wall. A granular drainage blanket (with collector pipe(s)) consisting of clean nondegradable rock should be placed behind the wall.

#### **V.B.3.d. Gabion Walls**

Gabion walls are effective in situations where erosion control is important and should be considered as part of designs involving berms or flattened slopes adjacent to rivers and streams when waters from flooding may seep into the slope. Gabion walls are economical up to a height of about 20 feet. At greater heights, other wall systems may be more economical. A Gabion wall is a gravity type of structure. The Gabion wall is a flexible type of wall and

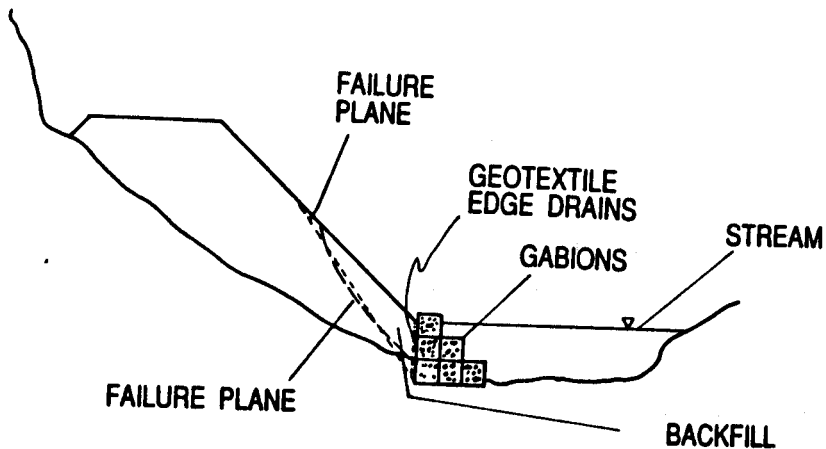


*Plan view of stream erosion at the toe of a highway fill*

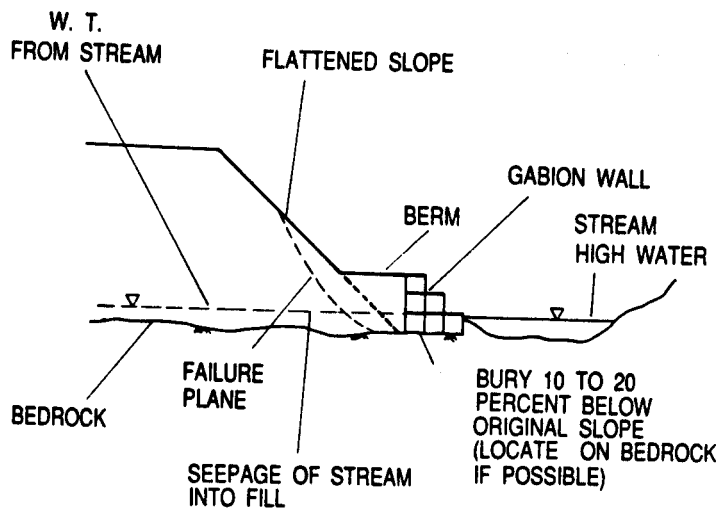


*Toe erosion of a highway slope adjacent to a stream*





*Portion of gabion wall buried below original ground*

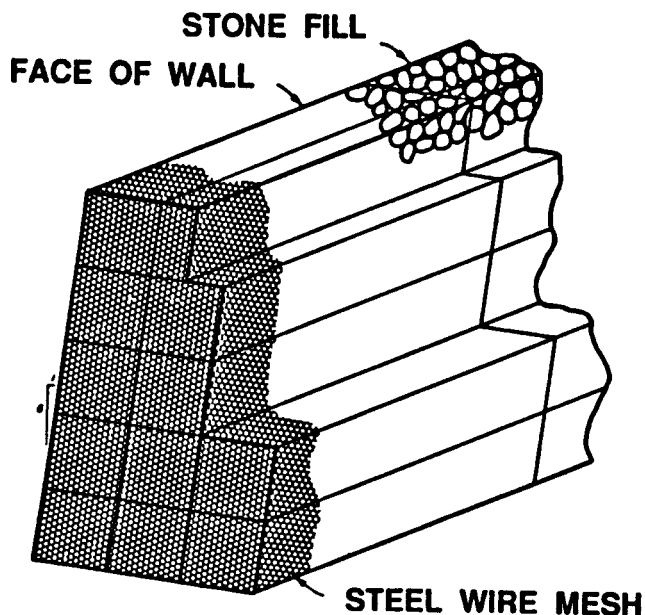


*Use of a gabion wall to prevent erosion of toe of highway fill*

can withstand some vertical and horizontal movements without failing. Other advantages include:

- o foundation footings are not required.
- o unaffected by frost heave.
- o self-draining.
- o easy to erect.

The gabion wall consists of interconnected wire mesh containers filled with nondegradable rock (see the sketch). Typically, the wire mesh is 11-gauge galvanized or coated (plastic) steel wire to minimize corrosion and it is woven in a hexagonal pattern. Openings are about 3 to 4 inches. Typical lengths of gabion containers are 3, 6, 9, and 12

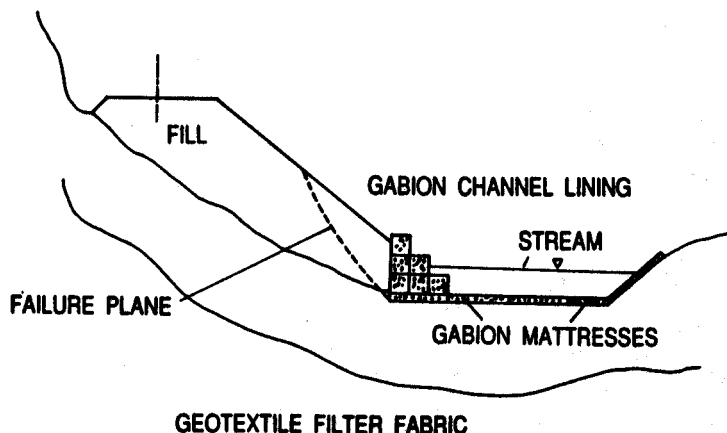


#### ***Components of a gabion retaining wall***

feet. Ends of the gabion containers typically measure 1, 1.5, and 3 feet (square). Gabion containers are backfilled with nondegradable stone (stone size must be greater than the openings of the container). Generally, the size of stone used ranges from 4 to 8 inches. The zinc coating should conform to ASTM (American Society for Testing Materials) 641-71 and to U.S. Federal Specification LL-W-461H finish 5-class 3. Construction of the gabion consists of placing the containers next to and on top of each other. The containers are joined together at all contact surfaces using 13-gauge steel wire. The gabion wall should be battered on a slope of 1 horizontal to 6 vertical. About 10 to 20

percent of the gabion wall height should be located below final grade at the toe of the slope. The wall should be founded on firm rock, silty soil, or compacted fill. A geotextile filter fabric should be placed behind the wall when the backfill consists of fine-grained soils.

Erosion of the toes of slopes along streams is a frequent occurrence. This situation often occurs at sharp bends in the stream. The bottom of the gabion wall should be founded on bedrock to minimize undercutting. For narrow streams, the gabions might be extended across the bottom to reduce erosion and undercutting. Gabions may be used to line the entire channel throughout the distressed area.



***Lining channel of stream with gabion mattresses to prevent streambed erosion***

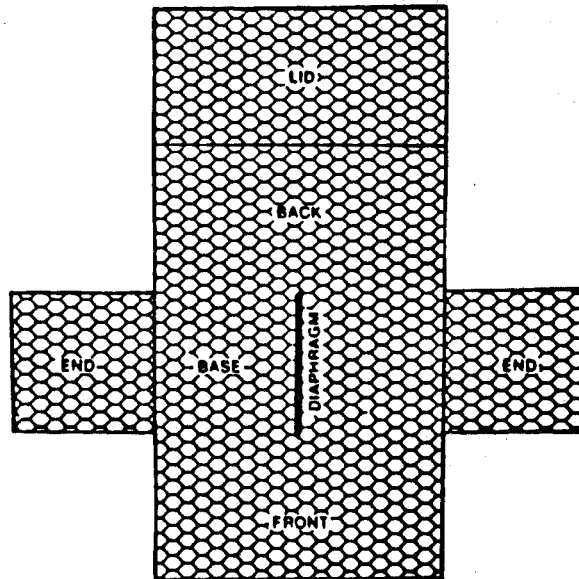
Using gabion walls, as a method of stabilizing small highway slides, is a technique that many maintenance

in a given locality. A wealth of design and construction information is available from manufacturer's literature. Gabions are supplied folded flat and tied in pairs for ease of handling.

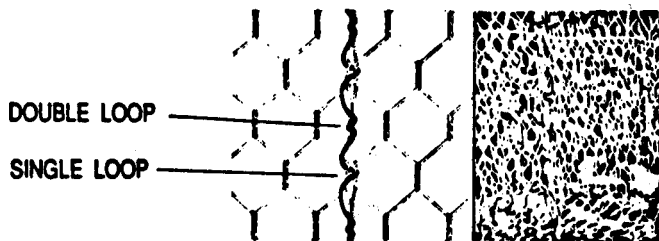
Steps in erecting a gabion wall consist of the following:

o Assembly.

- Remove flat gabion and stampout kinks.
- Fold front and back panels to a right angle by stepping on the base along the crease. Fold up the end panels and then fasten to the front and back panels using wire projecting from the upper corners of each panel.



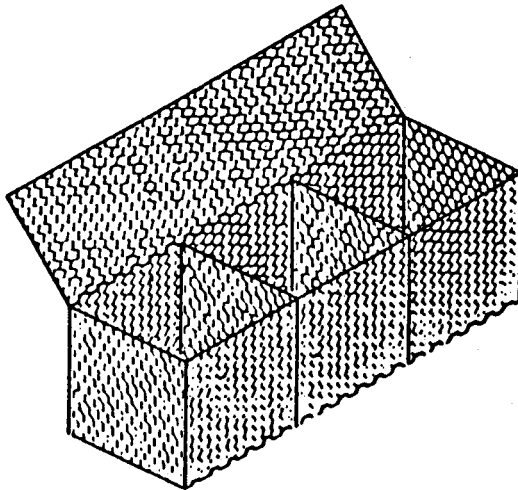
**Flat gabion**



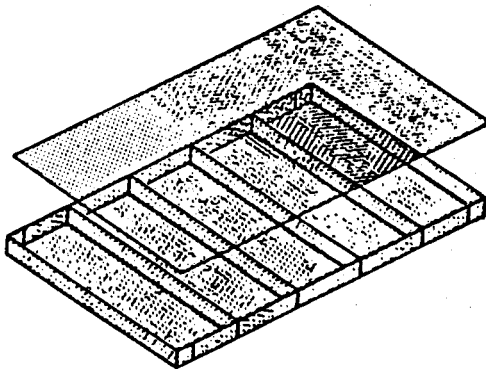
**Method of looping lacing wire**

- Lace all vertical edges of ends and diaphragms.

To lace, cut a length of lacing wire about 1 1/2 times the distance to be laced (the length should not exceed 5 feet). Loop and twist wire at the corner and lace with single and double loops at about five (5) inch intervals. Fasten the other lacing end by looping and twisting.



***Typical gabion baskets***

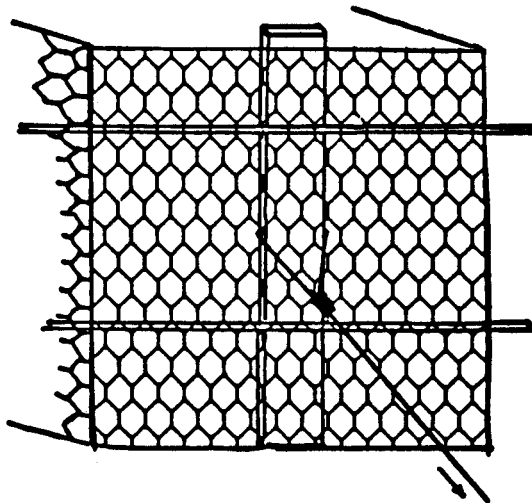


***Gabion mattress***

o Installation.

- Smooth ground surface (when possible locate first row of gabions on bedrock when possible. If this is not feasible, locate on natural ground or a compacted layer of hard, durable rock)

- To facilitate backfilling, place gabions at the site front to front and back to back (Note: sub-assemblies can be constructed at the maintenance yard--the number of gabions assembled at the yard depends on the number that can be handled at one time. These sub-assemblies could be constructed during slack periods and kept on hand for future use).
- Lace all contact surfaces of the gabions. The base of the empty gabions that are placed on top of a backfilled row must be laced.
- Stretch a row of empty gabions by backfilling the first gabion on one end and using a come-a-long at the other (applies to 3-foot high gabions). Inspect all corners during stretching and relace any openings between edges or corners. Continue stretching during the placement of stone.



***Stretching a gabion basket using a come-a-long***

**o Filling**

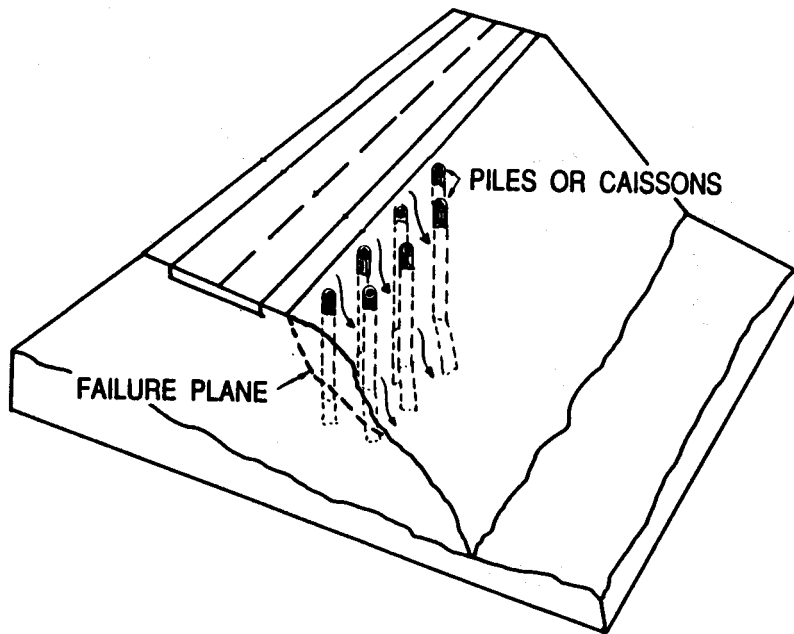
- Fill gabion with hard, durable rock that has been graded between 4 to 8 inches.
  - Mechanical filling is desirable and is usually used.
- Filling of the gabion may be performed by using earth

handling equipment such as a payload, gradall, crane, conveyor, or modified bucket.

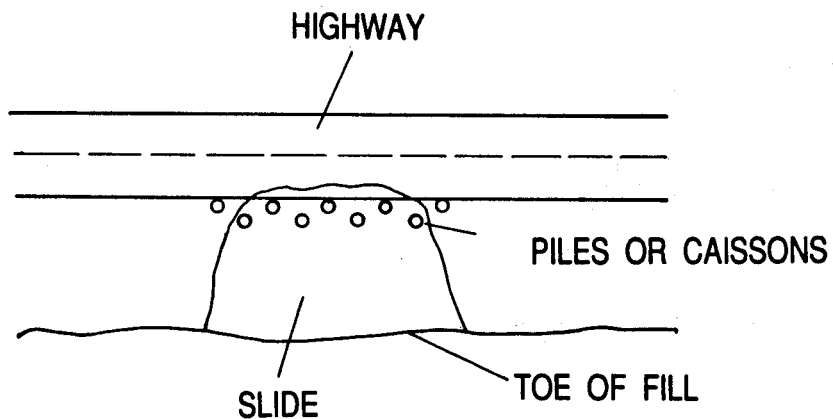
- To prevent damage to the top edges of the diaphragms and end panels, place rebars along the top edges of each mesh panel and lace the rebars to prevent movement. Alternatively, pliable metal may be bent and placed over the vertical panels to deflect the stone as it is placed.
- Dump the stone when the bucket is at its lowest distance.
- Place the stone in one-foot lifts. After each lift, two connecting wires should be placed between each lift in each cell of all exposed faces.
- Be sure to lid mesh be stretched tight when wiring the gabion is wired closed to prevent movement of the fill.
- During filling, some hand labor may be needed to prevent large voids in the backfill by adjusting the stone fill.

### **V.B.3.e. Piles/Caissons**

Piles and caissons (or drilled shafts), placed in rows to form a pile or caisson retaining wall and to provide lateral restraint, have commonly been used by maintenance personnel to repair highway slides. Piles may be driven or pushed into place or piles may be placed in drilled holes. Caissons are constructed by drilling a hole 2 to 3 feet in diameter, installing reinforcing steel (an H-pile or steel cage), and backfilling with concrete. This method can be applied rapidly and is frequently used in the early treatment of a highway slope failure. This method of slide correction frequently has been misapplied to large slides. Either a single row or several rows may be used to form the wall.



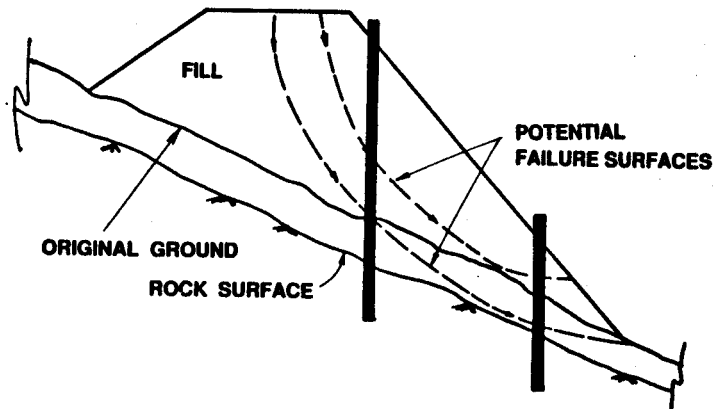
*Use of piles or caissons as a retaining wall*



*Plan view of rows of piles or caissons*

Pile or caisson walls frequently are placed or installed along the shoulder of the fill; sometimes pile walls may be installed along the toe of the fill.

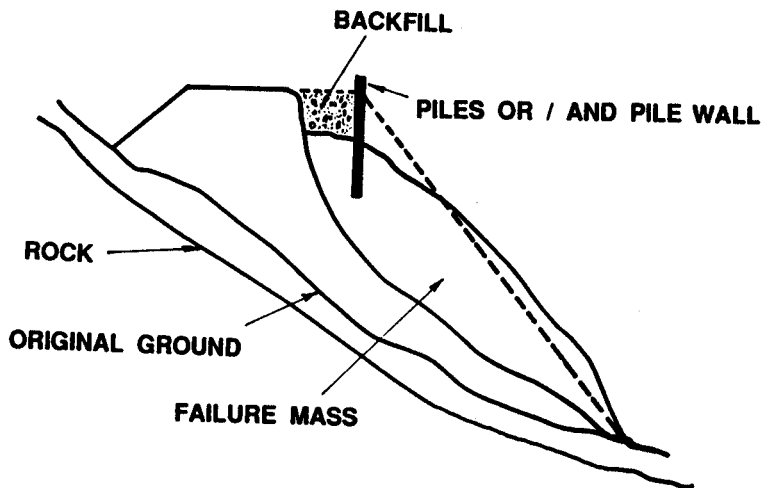




***One pattern of installing piles***

There are numerous documented cases of pile-wall failures.

A common practice of maintenance crews in repairing failed slopes consists of the following (see the sketch):



***Common practice used in an attempt to repair a highway slope failure***

o Piles -- timber piles, old telephone poles, or old railroad rails -- are installed (usually driven) adjacent to the shoulder of the distressed area.

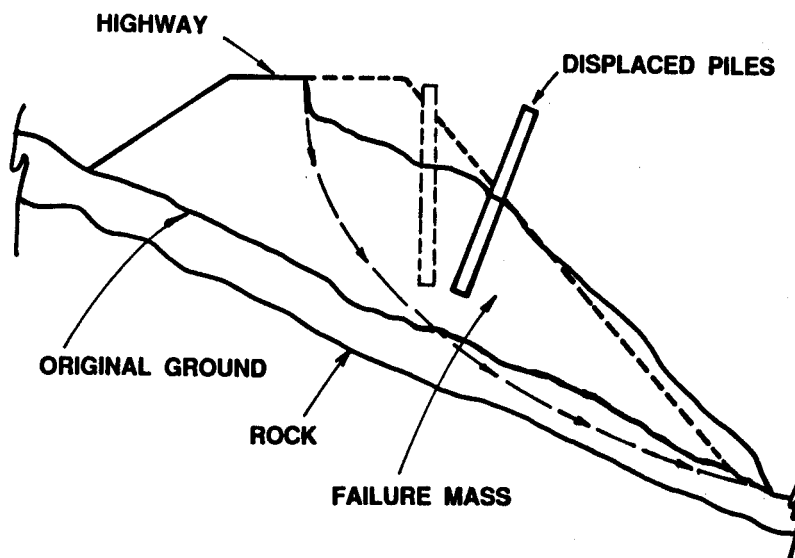
o Wood planks, steel guardrail, rails, or precast concrete panels are installed against the exposed piling to form a retaining wall.

o Backfill is placed behind the wall to extend the shoulder.

Although this action may be necessary, the added fill increases the driving forces tending to cause failure, and in many instances, this solution is only temporary. In an active slide, additional material must be added periodically to maintain grade elevation of the shoulder behind the retaining wall, and this action increases the driving forces.

Pile and caisson retaining walls generally are not effective in controlling large failures because of the following factors:

o The pile or caisson does not extend below the failure surface.



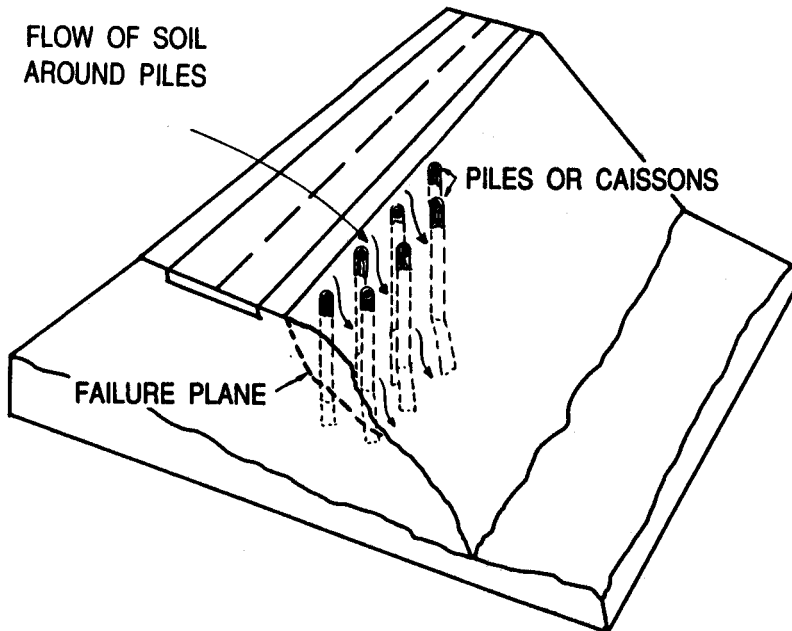
***Failure of piles to intercept failure plane***

o The wedge of soil resisted by the pile or caisson wall is much smaller than the failure mass of soil (as a result, the failure mass passes below the pile wall, or shears or bends

the pile wall since the driving forces of the failure mass are much greater than the resisting forces of the wall).

o This method does not control subsurface seepage.

o Cohesive soils (clays) may flow around and through openings between the piles or caissons. Cohesive soils in the plastic range do not mobilize the arching effect sufficiently to minimize this flow. The flow-through problem is very pronounced for soils having a plasticity index greater than 30 and a liquid limit greater than 50.



*Flow of soil around piles*

o The pile wall, by nature, is a flexible structure and may bend as the slope moves.

Detailed cost analyses should be performed when a pile wall system is considered as a repair method. Although successes of the method have been recorded, there are many unsuccessful applications on record. On an individual case-by-case basis, the repair method may appear to be economical. Considering the probabilities of failure, however, it does not take many unsuccessful applications to negate any cost savings that may be realized on a particular slide repair.

The advice of the geotechnical staff or a geotechnical consulting engineer experienced in landslide repair should be obtained when possible before installing pile walls. In large slides, detailed subsurface exploration and design analyses must be conducted before pile walls are recommended.

However, in small shallow slides or as a temporary measure, pile or caisson walls may be effective when the depth to competent (firm) rock or stable material is about 20 feet or less. Critical factors that must be considered when piles are used are as follows:

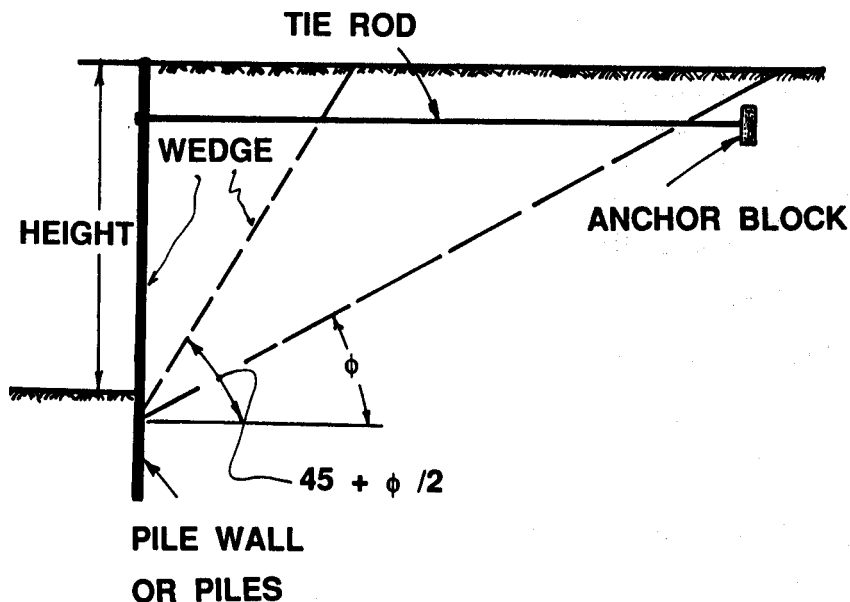
- o Pile spacing (if piles are spaced too far apart soil may flow between piles).
- o Pile bending strength (if piles are flexible, then the pile row may bend as the soil mass moves).
- o Pile depth (if the tips of the piles are not located below the failure plane of the slide, the entire pile wall will move with the slide).
- o Pile anchorage (pile wall may be very flexible without anchorage of the wall and the pile wall may distort or move as the failure mass moves).

When piles or caissons are used in repairing small slides or as a temporary measure, the following approximate guidelines are suggested:

- o Spacing between individual piles should be less than 3 feet.
- o Pile or caisson should be anchored into competent bedrock and extend across the failure plane. Competent bedrock consists of unweathered and unbroken rock.
- o The size of the failure mass should not be much larger than a wedge of soil (theoretical mass) with a failure plane rising at a slope of about 1 horizontal to 1 vertical.
  - o About 1/4 to 1/3 of the total pile length should be anchored into stable bedrock or soil. If the pile is anchored into stable soil, about 1/3 of the total pile length should extend below the failure surface.
- o If the piling is fixed at the slip surface (anchored in stable rock), about one pile per 100 cubic yards of moving mass is needed -- maximum depth of the moving soil is 12 to 15 feet.
- o If the piling is anchored into stable soil below the slip surface, about one pile per 50 cubic yards of moving mass is needed -- maximum depth of the moving soil is 10 to 12 feet.
- o When piles are used, the primary consideration should be to use steel piles placed into predrilled holes and backfilled with concrete (a less expensive method used successfully by the Kentucky Department of Highways for temporary support or in treating shallow slides consists of placing railroad rails in predrilled holes and backfilling with concrete, sand, or pea gravel. Spacing of the piles is

less than 3 feet and the method is used when the depth to firm bed rock is less than 20 feet. The design procedure is shown in APPENDIX D).

o Pile walls may be made more effective by anchoring into firm bedrock and/or by using anchor blocks. The anchor



*Using blocks to anchor the tops of piles or pile wall*

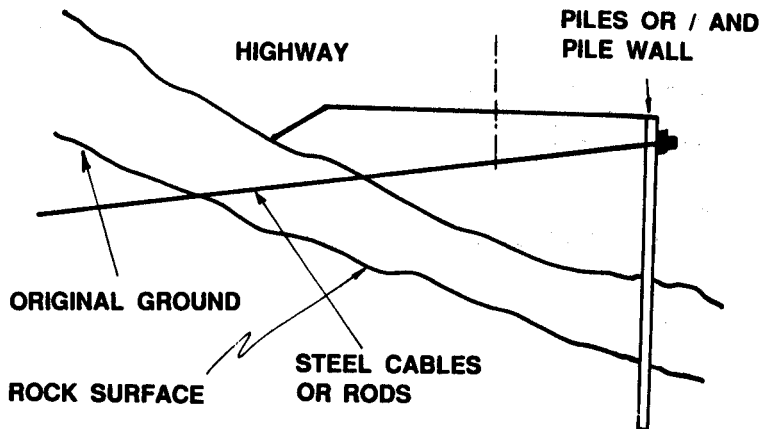
block should be positioned as shown in the sketch to develop full resistance. For  $\phi$  ranging from 18 to 38 degrees and assuming a wall height of 20 feet, the distance from the face of the wall to the anchor block ranges from 68 to 26 feet. The distance x between the wall and the anchor may be estimated from

$$x = y / \tan \phi$$

where y = height of wall and

$\phi$  = angle of internal friction of the soil.

Another scheme, as shown in the sketch below, for anchoring the tops of piles makes use of drilled-in steel cables or rods.

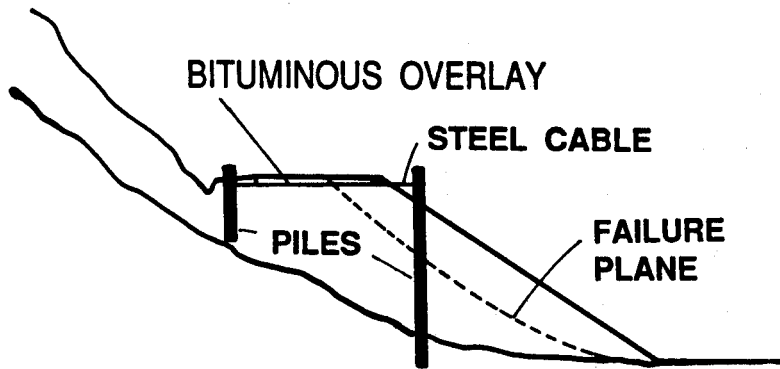


***One approach of anchoring the tops of piles using cables or rods***

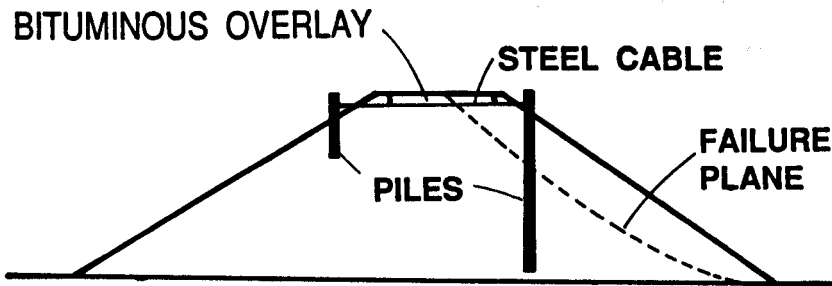
Seek the advice of geotechnical engineers when considering a tiedback wall. A detailed subsurface investigation is desirable. A number of specialty companies provide design/ construct services. Rely on the advice of a geotechnical engineer as to the applicability of tiedback walls. Obtain bids from two or more of those specialty companies.

**V.B.3.f. Tied Piles**

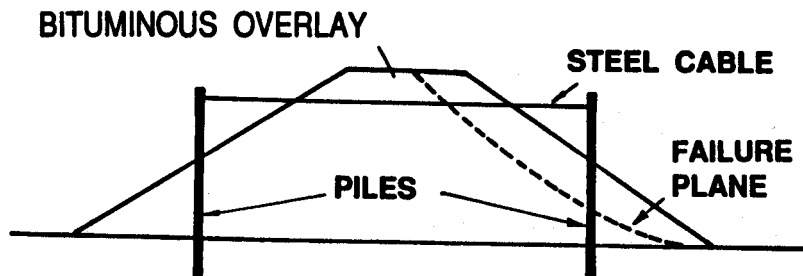
When piles are used as a retaining structure, they should be anchored by cables to firm bedrock or to concrete anchor blocks buried upslope from the landslide. The sketches show schemes for tied piles or pile walls. Anchoring the piles or walls increases the resisting capacity of the structure.



*Anchoring the tops of piles at side-hill fill location*



*Anchoring the tops of piles at a built-up fill location*



*Anchoring the tops of piles at a built-up fill*

### V.B.3.g. Tiedback Walls

Ground anchors, or tiebacks, are structural elements (rods) that are anchored into soil or rock and that act to restrain a



wall retaining an earth mass. Hence, this type of wall is referred to as a "tiedback" or "anchored" wall (see the sketch). This method may be applied to walls higher than 20 feet. To use this method to correct large slides, a thorough subsurface exploration and design analyses should be made. Tiedback walls have been used for over 40 years in Europe where they were introduced. This technique was introduced in the United States several years ago, but only recently has it gained some usage in highway slide restoration. Permanent tiedback walls should not be used when the liquid limit of the soil is greater than 50 or when the liquidity index is greater than 0.2. Liquidity index (LI) is defined as

$$LI = (w - PL) / PI$$

where  $w$  = natural water content,

$PL$  = plastic limit, and

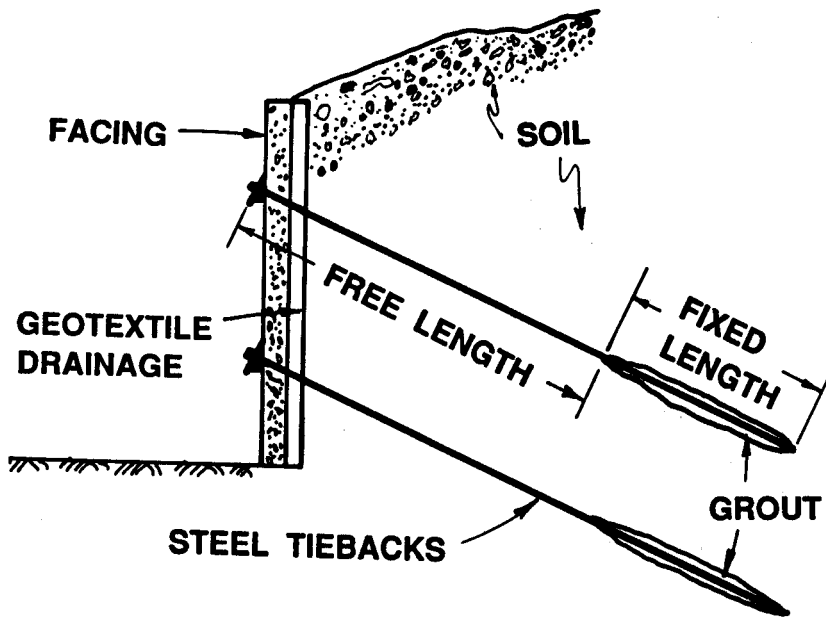
$PI$  = plasticity index.

Also, tiedback walls should not be used when the soils are organic.

Major components of a tiedback wall are as follows:

- o Soldier piles -- steel piles and lagging, sheet piling, cast-in-place diaphragm walls, etc.
- o Prestressing steel -- single or multiple strands of wires, strands, or bars.
- + bonded length -- the portion of the prestressing steel fixed in the primary grout.
- + unbonded length -- the portion of the prestressing steel not fixed or not bonded.

- o Anchorage -- a plate and threaded nut (anchor head) that permits prestressing the steel. This is mounted on the face of the wall.
- o Grout -- a portland cement based mixture.

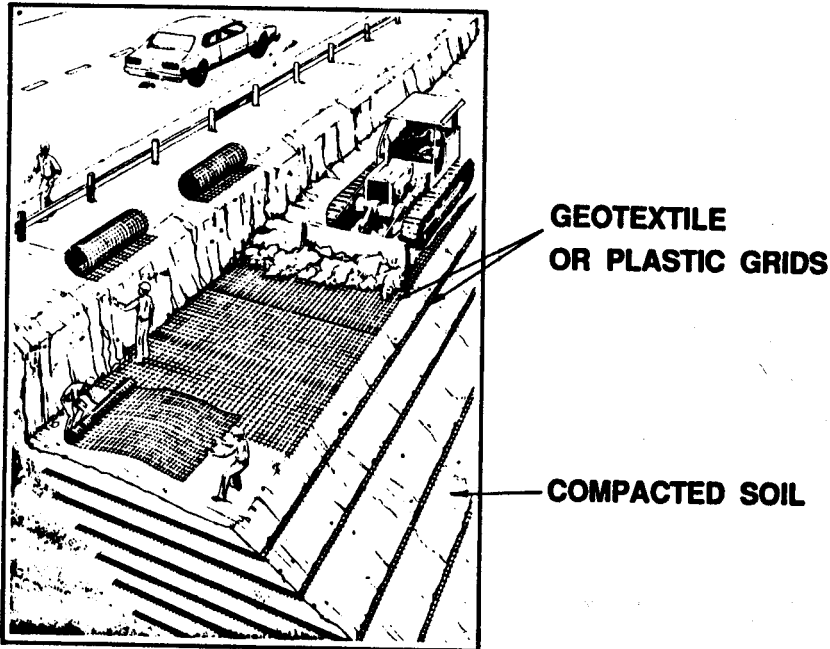


***Components of a tied-back wall***

The wall and tiebacks are installed as excavation proceeds downward. Generally, tiedback walls are less expensive than concrete walls. It is also important that positive drainage be provided.

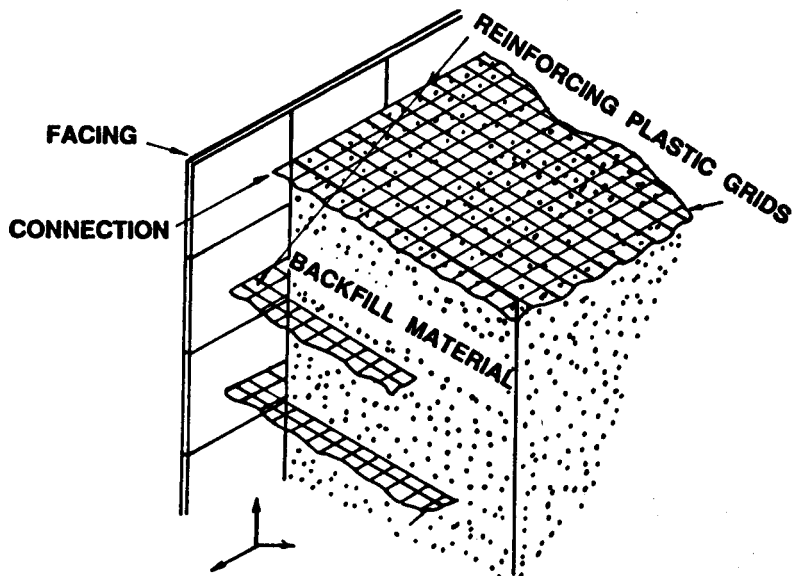
**V.B.3.h. Reinforced Slopes/Walls**

Failed highway slopes may be reconstructed reasonably inexpensively using a reinforcing material and the failed soil of the highway slip. The slope or wall is reconstructed by alternating layers of soil and reinforcing material as shown in the sketches.

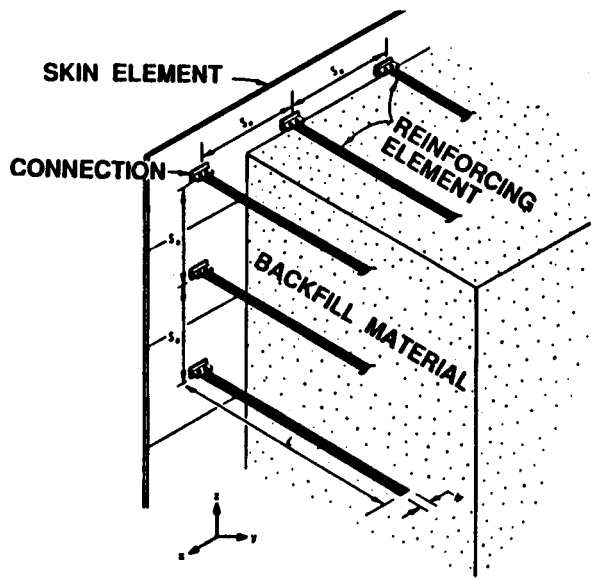


*Installation of geotextiles or plastic grids to reinforce a highway slope*

Major components of reinforced soil walls consist of the following (see the sketch):



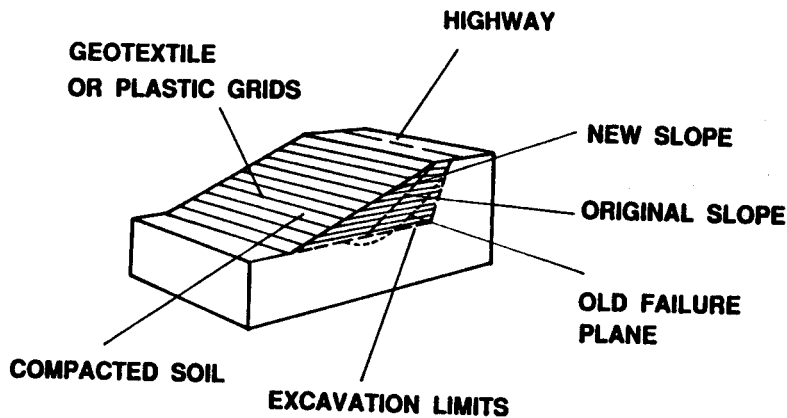
*Major components of a reinforced soil wall*



***Major components of a reinforced earth wall***

- o Backfill material (granular material such as sand and gravel with less than 15 percent passing the No.-200 sieve).
- o Reinforcement strips (thin, wide, long strips of galvanized steel, fiberglass, etc. that have high tensile strength and a rough surface). (Another type of reinforcement is a high-strength plastic (polymer) sheeting. The strips are regularly spaced in the horizontal and vertical directions.
- o Skin or facing units (metal plates, reinforced concrete panels, geotextiles etc.).

To be effective, reinforcement should be placed across the old failure plane of slope failures when possible, or, as shown in the sketch, the reconstructed reinforced slope is slightly flattened (made flatter than the original slope).

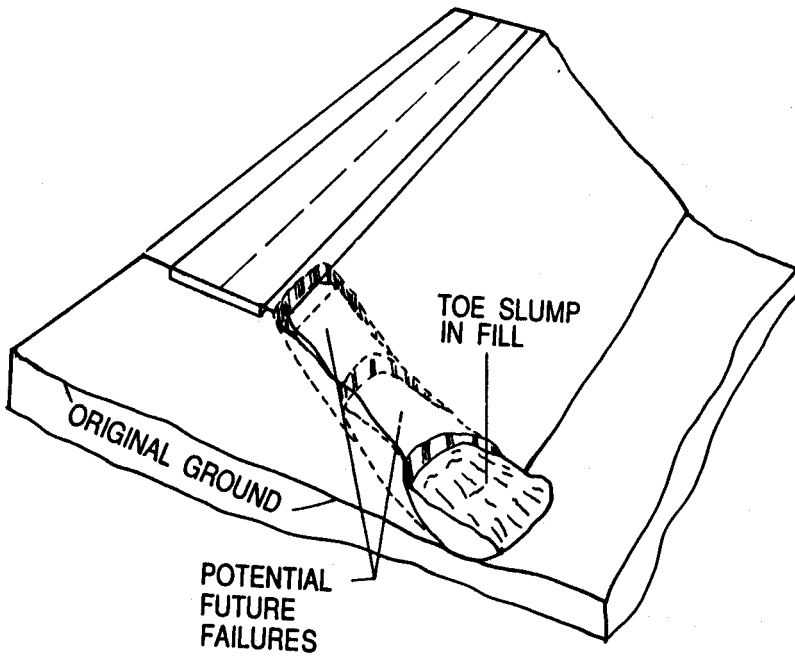


*View of alternating layers of geotextile fabric and compacted soil layers*

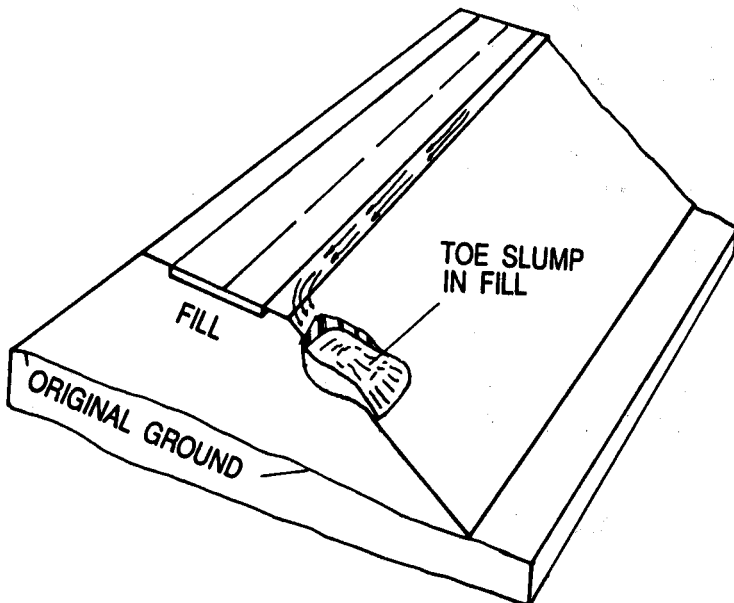
However, the reinforced slope does not have to be as flat as an unreinforced slope. The flattened reinforced slope should extend beyond the toe of the failed mass. The concept of reinforcing the reconstructed slope involves increasing the resisting strength along the failure plane or forcing a potential failure plane to extend deeper into the soil. By forcing the failure plane deeper, the length of the failure is extended and the factor of safety is usually increased (when compared to the original failure surface and the factor of safety of the old failure plane).

In repairing small landslides, reinforced slopes should be considered as an alternative to other more conventional methods. Two areas where reinforced slopes should be considered in repairing highway fill slips include:

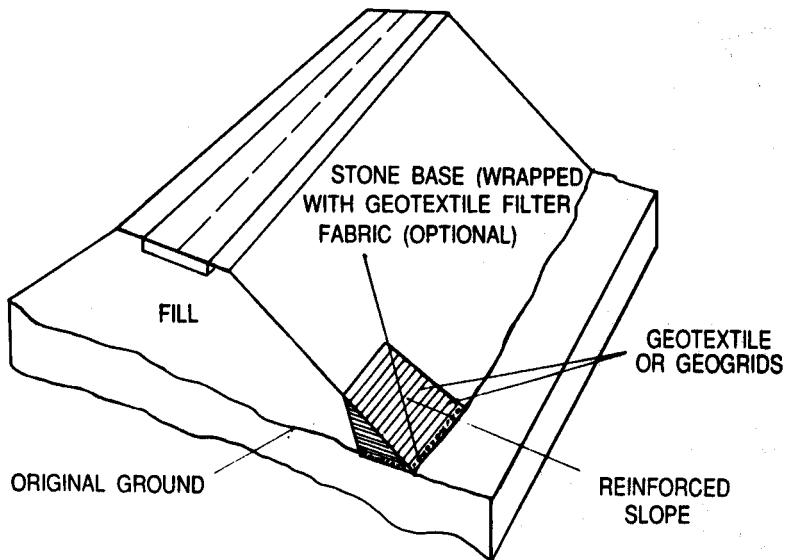
- o Reconstructing fill slopes.
- o Retaining structures.



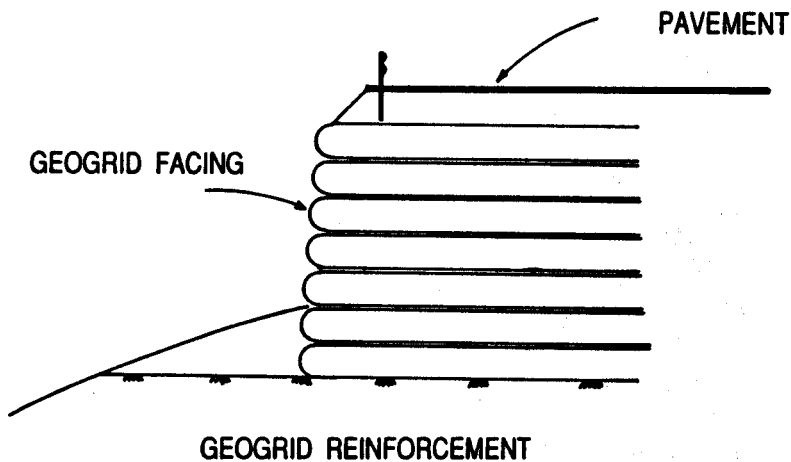
*Toe slump in fill*



*Toe slump in fill*



***Repair of a toe slump using a reinforced slope***



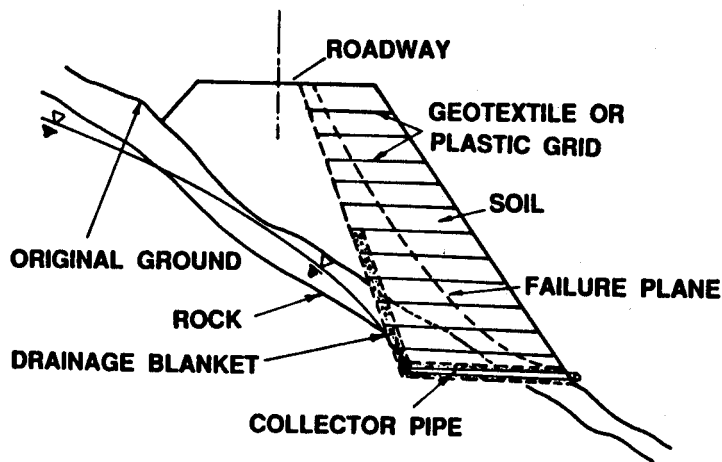
***Reinforced retaining wall***

Advantages of reinforced walls and slopes are as follows:

- o On-site and failed (unstable) materials usually may be used.
- o Space may be saved when right of way or other conditions are restricted.
- o Fill requirements may be reduced when compared to unreinforced slopes.

- o Provides an economical alternative and may be less expensive than other conventional methods.
- o Provides a means of building over weak foundations.
- o Tolerates large horizontal and vertical movements.

This small slide, as shown in the sketch below, illustrates a situation frequently encountered by maintenance. This is a



### ***Reinforced slope***

case where a reinforced slope could be rebuilt using a reinforced slope. The sliding material is excavated to firm strata. Next a drainage blanket is placed, then the reconstructed slope is reinforced with geotextiles or plastic grids.

Steps involved in reconstructing a failed slope or retaining wall are as follows:

- o Obtain cross section of old slope.
- o Remove the failed material.
- o Determine geometry and dimensions of reconstructed slope or wall (plot a cross section).



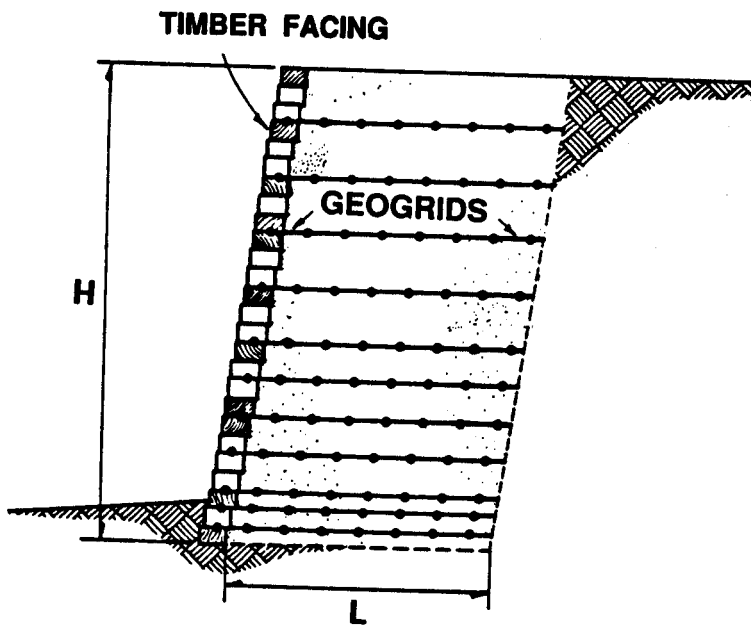
- o Perform natural water content tests, liquid and plastic limit tests, and particle-size distribution tests. To obtain these soil test data, it may be necessary to contract with a geotechnical testing laboratory. These data are used to obtain engineering classifications of the materials, and to obtain an indication of performance.
- o Dry the material to a water content less than the plastic limit and then determine the water content of soil. If the liquid limit and plastic limit are known, the optimum water content of the soil may be estimated. In this case, dry the material to the water content estimated from the sketch in V.B.1.a. If the plasticity index is greater than about 12 percent (or if test values are not available and the soils are "sticky" and cling to your hands), then the addition of three to six percent (by dry weight of soil) of hydrated or quick lime will aid in drying the material and improve workability of clay soils.
- o Determine excavation limits -- see the sketches in Section V.B.1.a.
- o Place layer of reinforcing material at bottom of excavation.
- o Place a layer of compacted soil on top of the reinforcing material. Suggested loose lift thickness is 6-12 inches. The soil should be compacted to 95 percent of standard compaction (ASTM D 698 or AASHTO T 99 or your state specification).
- o Place another layer of reinforcing material on top of the compacted layer and follow with another layer of compacted soil. This sequence is continued until the top of the embankment is reached. The thickness of the compacted soil layer between layers of reinforcing materials typically may range from 0.75 to 2 feet. Thickness of each

compacted layer depends on the type of soil and other conditions, such as available equipment, etc.

With regard to reinforced walls, wall heights used in the highway industry are typically in range of 20 to 50 feet. However, reinforced soil walls have been constructed as high as 85 feet.

Examples of various retaining-wall systems using engineered reinforcement materials are as follows:

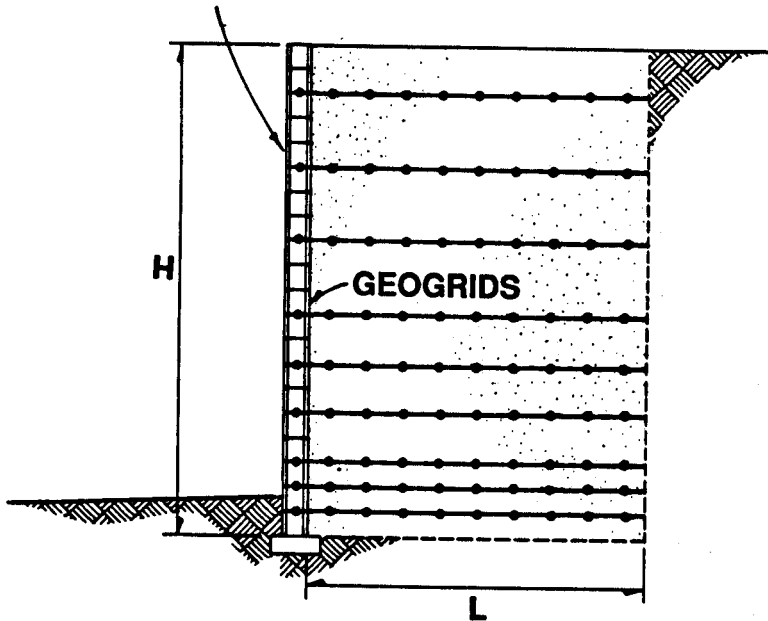
- o Wrap-around wall.
- o Timber-faced wall.



*Use of timber facing to protect geotextile material*

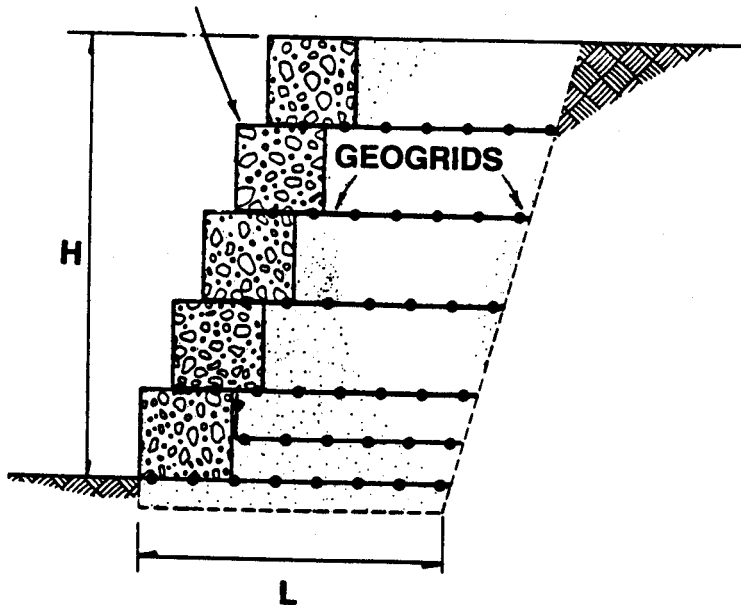
- o Masonry wall.
- o Gabion wall.

**MASONRY FACING**



*Use of masonry facing to protect geotextile material*

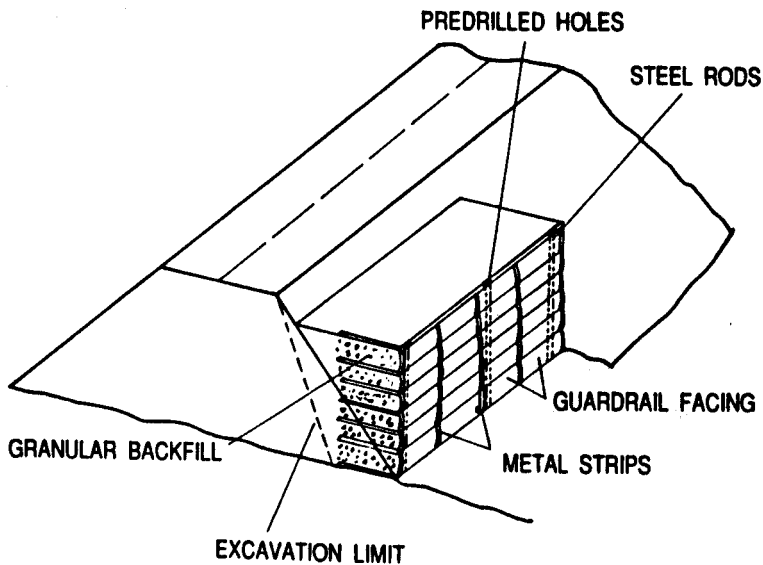
**GABION FACING**



*Use of gabion facing to protect geotextile material*

Types of materials that may be used to reinforce slopes and walls are as follows:

- o Engineered plastic grid system.
- o Engineered geotextile.
- o Engineered metal strips.
- o Fencing.
- o Guardrails.
- o Concrete reinforcing mesh.
- o Others (use your imagination).



#### ***Repair of a slope failure using recycled guardrail***

#### **VI.B.4. Stabilization -- Methods of Increasing Shear Strength**

There are various methods of stabilization that may be used to increase the shear strength of soils. These methods may be broadly divided into groups as follows:

- o Mechanical stabilization.
  - Compaction
  - Densification and drainage
- o Chemical stabilization.
  - Lime stabilization
  - Lime-fly ash stabilization
  - Fly-ash stabilization
  - Cement stabilization
  - Asphalt stabilization
  - Waste by-products[AFBC (atmospheric fluidized bed combustion waste), kiln dust, etc.]
  - Freezing
  - Electroosmosis

#### VI.B.4.a. Mechanical Stabilization

**Compaction:** Compaction is a means of reducing the volume of a soil mass by application of loads, such as rolling, tamping, or vibration. When a soil is compacted, air is expelled from the soil mass without significantly changing the amount of water in the soil.

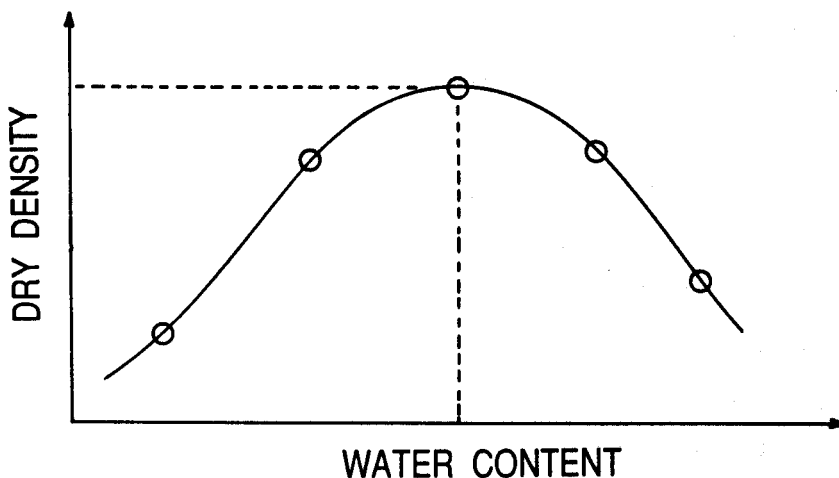
When a soil is compacted, the following changes generally occur:

- o strength increases.
  - + clays (cohesive strength component increases)
  - + sands, gravels (frictional strength component increases)
- o density increases.
- o permeability (movement of water through soil) decreases.
- o compressibility decreases.
- o swell potential increases.
- o shrinkage decreases.

Compaction is generally used in most all methods for repair of highway slips. When considering compaction, materials are broadly divided into two classes:

- o Cohesive soils (soils that contain relatively large amounts of clays and silts). When these soils are compacted, they essentially become impermeable. Cohesive soils include clays, silts, and silty or clayey sands or gravels.
- o Cohesionless soils (clean sands and gravels - - when compacted, these soils remain permeable).

For a given compactive effort, cohesive soils (fine-grained or dirty coarse-grained soils), have an optimum water content and maximum dry density. This point occurs at the top of the dry density-water content curve as shown by the dashed lines in the sketch below. Cohesive soils are compacted in most highway projects according to a certain standard procedure. This is referred to as standard compaction (AASHTO T 99 or ASTM D 698). The dry density of cohesive soil is significantly affected by and sensitive to moisture content when compacted. As the water



***Relationship between dry density and water content of cohesive soils***

content increases, the dry density increases to a maximum value and decreases thereafter for the same compactive effort.

Cohesionless, or coarse-grained, soils are not significantly affected by compaction moisture. Cohesionless soils that are insensitive to compaction moisture are soils with less than 4 percent passing the No. 200 sieve for well-graded soils, or with less than 8 percent for uniform gradation. A more complex laboratory procedure is used to define the compactive state of sands and gravels.

A variety of equipment is available for compacting soils. The type of soil to be compacted should be matched with the proper compaction equipment. The intended purpose of the compacted fill also may be a factor in selecting compaction equipment. Some important compaction equipment and the general types of soils most suitable for compacting with that equipment are summarized below:

**o Sheepsfoot Roller**

Use to compact fine-grained soils or dirty coarse-grained soils with more than 20 percent passing the No. 200 sieve. Need 4 to 6 passes for fine-grained soils and 6 to 8 passes for coarse-grained soils; Compacted lift thickness should be 6 inches.

**o Rubber-Tire Rollers fine-grained soils**

+ use for clean, coarse-grained soils with 4 to 8 percent passing the No. 200 sieve. Need 3 to 5 passes; compacted lift thickness is 10 inches.

+ use for fine-grained soils or well-graded dirty coarse-grained soils with more than 8 percent passing the No. 200 sieve. Need 4 to 6 passes; compacted lift thickness is 6 to 8 inches.

**o Smooth-Wheel Rollers**

Use for fine-grained soils. Need 6 to 8 passes; compacted lift thickness should be 6 to 8 inches. Not suitable for clean, well-graded sands or silty uniform sands.

**o Vibrating Baseplate Compactors, Vibratory Compactors**

Use for coarse-grained soils with less than about 12 percent passing the No. 200 sieve. This compactor is best suited for materials with 4 to 8 percent passing the No. 200 sieve, placed thoroughly wet. Need 3 passes; compacted lift thickness should be 8 to 10 inches.

**o Crawler Tractor**

Use for coarse-grained soils with less than 4 to 8 percent passing the No. 200 sieve, placed thoroughly wet. Need 3 to 4 passes; compacted lift thickness should be 10 to 12 inches.

**o Power Tamper or Rammer**

Use in situations where access is difficult. Need two passes; compacted lift thickness should be 4 to 6 inches.

**Densification and Drainage:** Various methods of densification and drainage are used in many situations to stabilize soils; usually these methods are very specialized, requiring expert advice. These methods include:



- o Surface Compaction -- discussed under VI.B.3.c.
- o Vibration -- deep deposits. Discussed under VI.B.3.c.
- o Blasting of deep deposits -- applicable to clean coarse-grained soils.
- o Pile driving -- applicable to loose, deep deposits of coarse-grained soils or sandy silts.
- o Drainage by pumping -- see VI.B.3.
- o Drainage by gravity -- may be applied to a wide range of soils and conditions.
- o Reduction in excess pore pressures -- vertical sand drains are an example. This technique is applied to soft compressible soils to accelerate consolidation settlement. Material densifies as it is loaded.
- o Electroosmosis -- applicable to fine-grained soils. Sets of anodes and well-point holes are driven into soil and an electrical potential is imposed between them. This is a highly specialized method requiring expert advice.
- o Desiccation by transpiration -- applicable to all soil types. Slopes are planted with vegetation. Roots absorb water and reduce water content of soils. Capillary stresses are created by transpiration, which creates a thin skin of stiff material.
- o Dynamic Compaction -- compaction is achieved by dropping a large weight; soils are compacted by impact.
- o Vibrofloatation - a patented process for obtaining high densities in sandy soils. A special probe is jettied into the layer to be compacted. By vibration and saturation, a quick condition is created in the sand adjacent to the probe. The sand a short distance from the probe is densified and additional

sand is carried to the probe by water jets. As the probe is withdrawn, additional sand is added.

#### **VI.B.4.b Chemical Stabilization**

Chemical stabilization is the altering of soil properties by adding certain chemical additives to the soil. Addition of chemicals to soils creates a cementing action, in some cases, that binds soil particles together and increases strength. As a means of repairing small slides, chemical stabilization might be considered in the following situations:

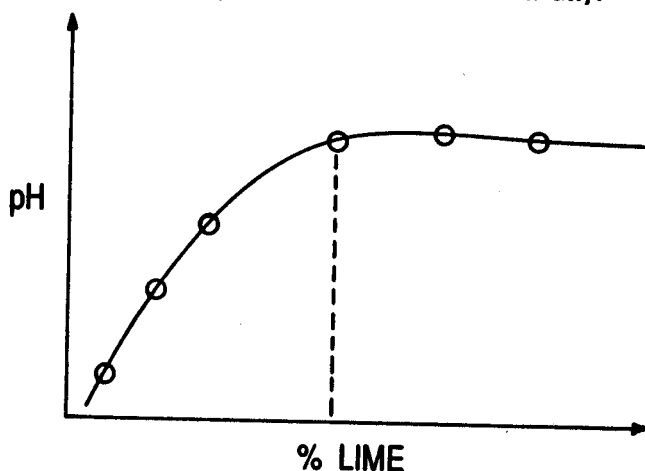
- o Working platform at toe of slope -- In this situation, a chemical additive such as hydrated lime or quicklime may be used to dry wet soils at the toe of the slide. A working platform is constructed using the in-place wet soils.
- o Flattened slope and/or berm built entirely or partially of soil-chemical mixture -- Depending on the position of the failure plane, the soil-chemical mixture could be placed in the lower portion of the reconstructed slope or the entire slope could be reconstructed with soil-lime mixtures.
- o Foundation for retaining structure -- In situations where firm bedrock may not be accessible and granular material is not readily available, a firm foundation for a retaining wall could be constructed using clayey soil-chemical mixtures.

Before using chemical stabilization, the maintenance supervisor should consult with the maintenance engineer and geotechnical engineer. Various chemical additives may be used:

**Lime Stabilization:** Lime includes all classes of lime and hydrated lime. Lime is usually applicable to medium-, moderately fine-, to fine-grained soils (clays and clayey type soils). To be effective, the plasticity index of the soil should be greater than or equal to 10 or 12 percent. As a general guideline, soils that classify as A-4 through A-7 according to the AASHTO classification system (or CH, CL, MH, ML, SC, SM, GC, GM, SW-SC, SP-SC, SM-SC, GW-GC, GP- GC, or GM-GC according to the Unified Classification System) are potentially susceptible to stabilization with lime.

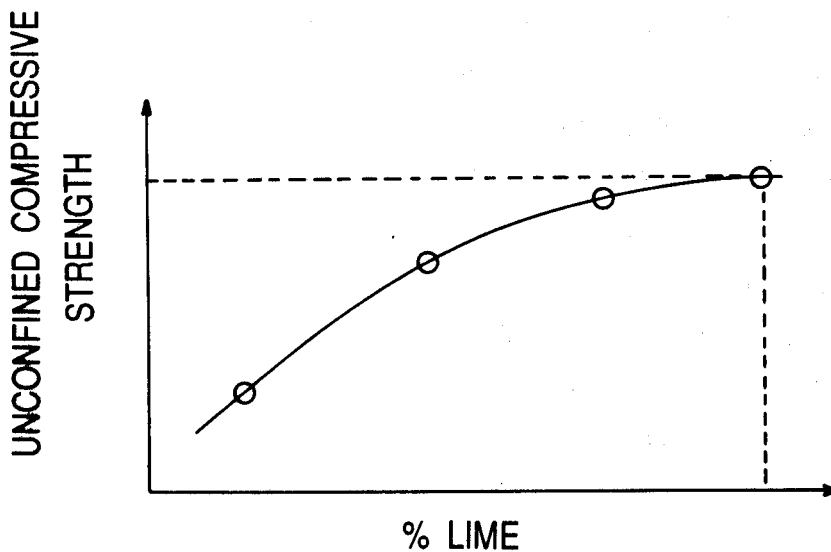
Percent of lime (based on dry weight of soil) ranges approximately from three to eight percent. The percent of lime to add to a clay soil may be determined (approximated) by various methods:

o pH tests -- Soil specimens are mixed with different percentages (by dry weight of soil) of lime. The pH value of each soil- lime mixture is determined and plotted as shown in the sketch. The point at which the pH value does not increase significantly with additional amounts of lime is the optimum percent of lime to add to the soil. These tests usually may be performed in less than a day.



*Relationship between pH and percent of hydrated lime*

o Unconfined compression triaxial tests -- Soil specimens are molded using different percentages of lime. The specimens are cured either 7 or 14 days (a 14-day curing period is preferred). Unconfined compression strengths are plotted as a function of the percentages of lime. The optimum lime content is that percentage at which there is no significant increase of shear strength (as shown in the sketch). This method is a more desirable procedure for determining the percentage of lime to use for a given soil. Generally, about one percent of lime is added to the optimum percent to account for losses of lime during mixing in the field.



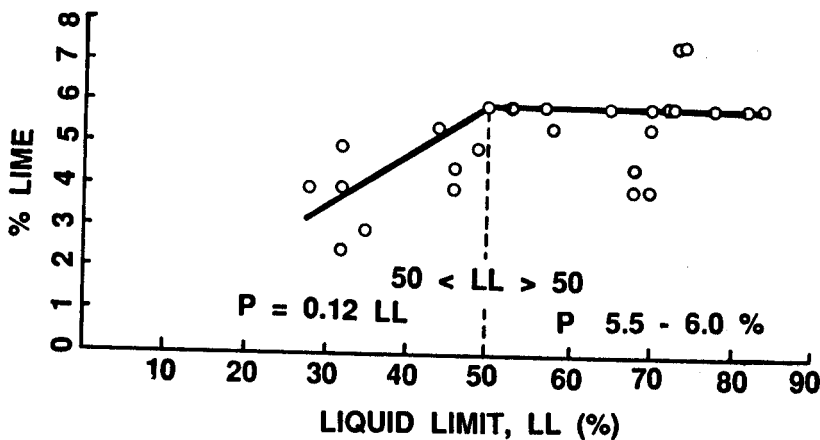
*Unconfined compressive strength as a function of percent of hydrated lime*

- o National Lime Association method.
- o Liquid limit tests -- If the liquid limit (LL) of the soil is known, then a quick estimate of the percentage of lime to add may be obtained as shown in the sketch. If the liquid limit is less than about 50 percent, then the optimum percent of lime may be approximated by

$P = \text{percent lime} = 0.12 \text{ LL}$ .

If the liquid limit is greater than 50 percent, the percent of lime usually required for stabilization is about 5.5 to 6 percent. These are only approximate values, but for small slide repairs, the numbers may be sufficient for quick estimates.

Hydrated lime or quicklime (not agricultural lime) is especially applicable to situations where clayey soils of failed slopes are saturated and wet. In cases where berms or flattened slopes may be used and the foundation soils and the failed soils are wet, the addition of three to eight percent lime aids in drying the wet soils quickly. Lime accelerates the disintegration (or breakup) of clay clods during mixing, makes the clayey soil friable, improves workability, and aids compaction. In wet situations, soil-lime mixtures provide a good working platform for equipment so that slide repairs may continue even during wet weather. Since the strength of a soil-lime mixture is generally much larger than the soil without lime (the addition of lime mainly



*Percent of hydrated lime as a function of liquid limit*

increases the cohesive strength component), soil-lime mixtures could be used in a variety of ways with other repair methods.

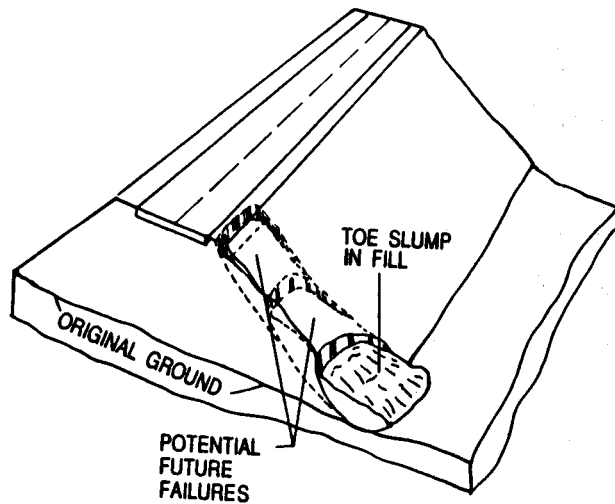
General steps in lime stabilization are as follows:

- o Determine percentage of lime -- For quick estimates on small slides, use the sketch (or see chart in the National Lime Association method) to determine number of pounds of lime per square yard per inch of depth).
- o Scarify and pulverize soil -- Grader- scarifier and/or disc harrow may be used for initial scarification and pulverization.
- o Spread lime -- Special mechanical spreaders (tailgate type) or bags of lime may be spaced across the lift (see literature from the National Lime Association for bag spacing and other construction details). Lime may be spread either dry or in slurry form. Granular quicklime may be spread by dump trucks.
- o Water -- Water is spread on the layer of lime using a water truck (if necessary).
- o Mixing -- Rotary mixing is the preferred method. On small jobs, blade mixing or disc harrow mixing may be more practicable.
- o Curing or mellowing period -- Lime-soil mixtures should cure from 0 to 48 hours. The curing period aids in breaking down clods of clay.
- o Final mixing and pulverization -- Grader- scarifier is used to loosen layer and rotary mixer is used to perform final mixing. In small repairs, a disc harrow might be used for mixing. Rotary mixing is the preferred method.
- o Compaction -- The lift of soil-lime mixture (usually 6

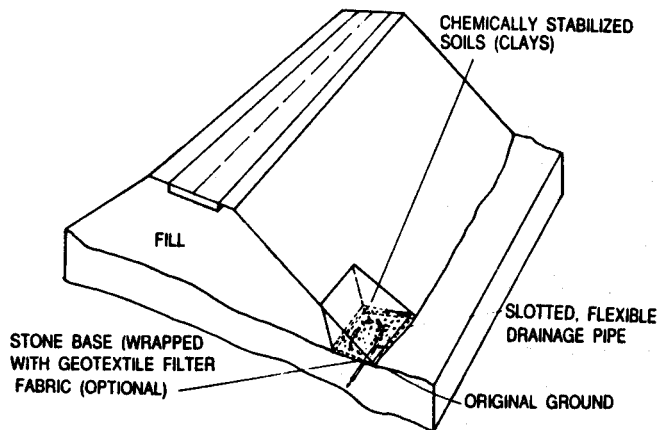
inches) should be compacted to 95 percent (or 98 percent) of standard density (ASSHTO T 99 or ASTM D 698).

o Soil-lime mixtures may be compacted using a sheepfoot roller for initial compaction. Final compaction is achieved using a vibratory steel roller. In small slide repairs, a sheepfoot roller may be sufficient to compact the mixture.

o Final curing -- The compacted soil-lime mixture should be cured (moist or membrane curing) for a minimum of 7 days. This mainly applies to cases where a working platform or haul road is being built.



***Toe slump in fill***



***Repair of a toe slump using chemically stabilized soils***

**Fly-Ash and Lime-Fly Ash Stabilization:** Fly ash is a by-product or waste product produced when coal is burned. Millions of tons per year of fly ash are produced throughout the country by coal-burning utilities. Generally, when used alone, fly ash is not appropriate for use with fine-grained soils (particle sizes are usually larger than the voids in fine-grained soils). Fly ashes usually are used to act as pozzolans (binders) or as fillers to reduce voids in natural or blended aggregates (some fly ashes from power plants burning coal from the west are high in calcium oxide and may be used with fine-grained soils).

Fly ash is normally combined with lime or cement. Silts are generally considered to be the most suitable fine-grained soil for lime-fly ash treatment. Lime-fly ash treatment has been applied successfully to such aggregate types as sands, gravels, crushed stone, and slag.

Steps in constructing lime-fly ash stabilized soils are similar to those described under Section VI.B.4.b. (Lime Stabilization). Generally, 10 to 20 percent fly ash is used in lime-fly ash mixtures. Appropriate applications to small slide repairs are similar to those of soil-lime mixtures.

**Cement Stabilization:** As noted by the Portland Cement Association, all soils may be stabilized with cement. However, granular soils are generally more suitable. A US Air Force criterion specifies that the plasticity index should be less than 30 percent for sandy materials. For fine-grained soils, the plasticity index should be less than 20 percent and the liquid limit should be less than 40 percent for proper mixing of the cement stabilizer. In fact



clays, clay clods are difficult to break down and may pose a problem in mixing with cement because of the relatively fast set of cement. Criteria from the Federal Highway Administration indicate that cement should be applied to soils having less than 35 percent passing the No.-200 sieve and the plasticity index should be less than 20 percent. This implies that soils that classify as A-2 and A-3 (AASHTO classification) are more suitable for cement stabilization. Cement should not be applied to plastic clays without careful study of construction details.

Steps involved in constructing soil-cement stabilized soils are similar to those described in section VI.B.4.b. (Lime Stabilization).

**Bituminous Stabilization:** Soils suitable for bituminous or asphalt stabilization (guidelines offered by the Asphalt Institute) are as follows:

- o Percent passing the No.-200 sieve is less than 25.
- o Plasticity index is less than 6.
- o Sand equivalent is less than 25.

Generally, soils that classify as A-1-2, A-1-6, A-2-4, A-2-6, A-3, A-4, and low plasticity A-6 soils are suitable for asphalt treatment. Guidelines for selecting the percent of asphalt cement and construction procedures are described elsewhere. Construction is similar to lime and cement stabilization. Some applications to small slide repairs are described under VI.B.4.b. (Lime Stabilization).

**Combination Stabilizers:** Various combinations of stabilizers may be used. These include lime-fly ash, lime-cement, cement-fly ash, and lime- asphalt. Generally, soils classified as A-6 and A-7 and certain A-4 and A-5 soils may be treated economically with lime-cement and lime-asphalt. A knowledgeable geotechnical engineer should be consulted before attempting to use chemical stabilizers. If there is successful local experience in applying a chemical stabilizer for certain types of soils, then it might be permissible to rely on this experience.

**Other Chemical Stabilization:** Certain other types of by-products are under study as soil stabilizers or for improving engineering properties of in situ soils. Such products as AFBC (by-product of new oil- or coal-burning technology -- the process is referred to as Atmospheric Fluidized Bed Combustion) and kiln dust (by-product of concrete industry) are currently being studied relative to possible application as chemical stabilizers. These products should not be used without careful study and/or consulting a knowledgeable geotechnical engineer. For example, AFBC is subject to large swelling when mixed with soil.

#### **VI.B.5. Rockfall Remedial and Mitigation Measures**

Rockfalls and cut slope failures are prevalent along many highways. Many cuts have been made along highways without the benefit of geologic and geotechnical investigations. A primary cause of cut slope failures is rainfall and ground- water flow. Repair methods and mitigation measures generally may be classified into three broad groups:

- o slope stabilization.
- o protection methods.
- o warning methods.

#### **VI.B.5.a. Slope Stabilization**

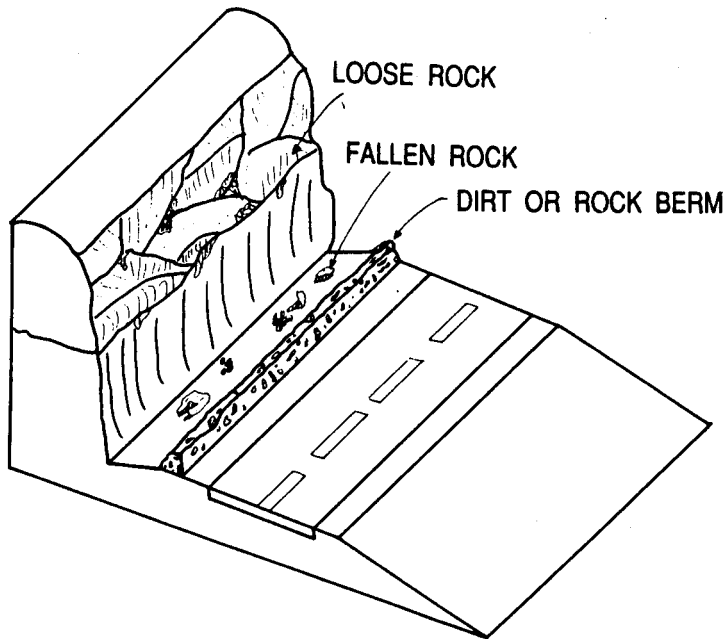
Rock slope stabilization is an attempt to prevent rocks from moving down the slope onto the roadway. Methods include:

- o Excavation -- Complete removal or partial unloading of the failed mass.
- o Drainage -- See Section VI.B.2.
- o Shotcrete -- pneumatically applied concrete (maximum aggregate size is 3/4 inch). Wire mesh is used for reinforcement and rock dowels or bolts anchor the shotcrete.
- o Support and Reinforcement Systems -- These are various systems such as concrete buttresses, rock bolts, etc.

#### **VI.B.5.b. Protection Methods**

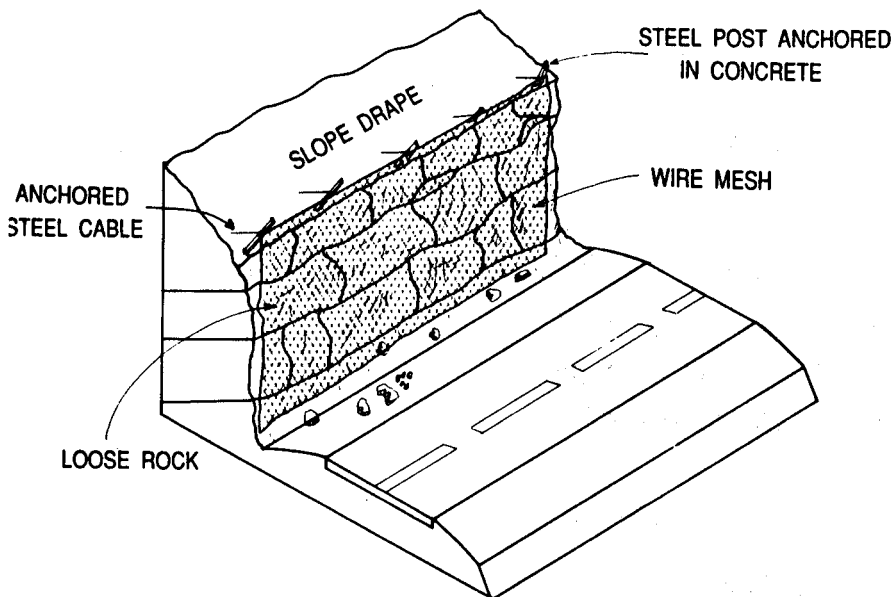
Methods include the following:

- o Relocation -- The highway is realigned to avoid the slide.
- o Intercepting Sloped Ditches and Berms -- Sloped ditches and berms are constructed to catch falling rock and prevent it from entering the highway. The ditch must be cleaned periodically.
- o Wire Blankets -- Wire mesh is draped over the slope and fastened at the top of the slope with pins and/or cables. This method is used to control small rock and raveling slopes and requires periodical cleanup of debris.



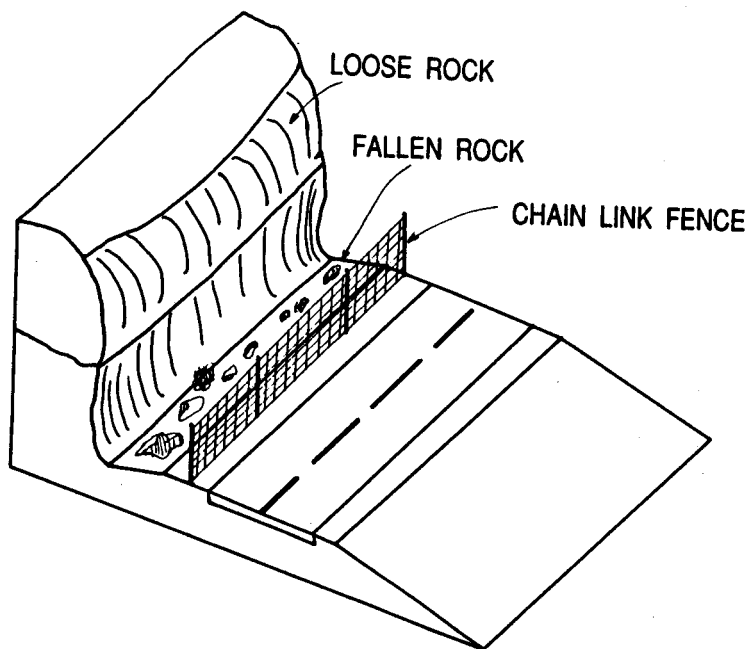
***Protection of roadway using a drop area and dirt or rock berm***

o Wire Mesh Catch Fences and Catch Nets -- Chain link fence or gabion wire fence is placed between the shoulder of the highway and the toe of the slope (right-of-way



***Control of falling rock by draping wire mesh over a rock slope***

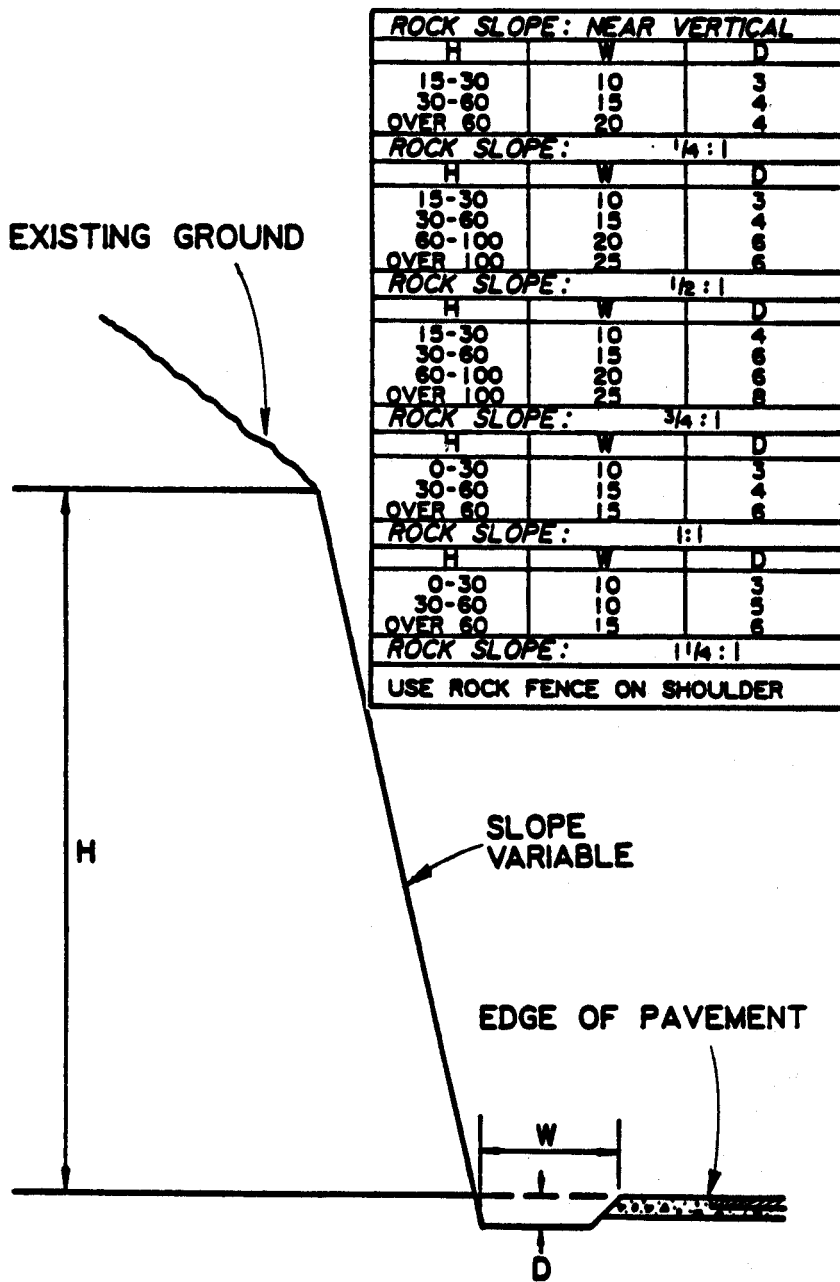
fencing is often used since it is usually readily available). Periodic cleanup of rock debris is required. Catch fences are used to arrest rocks up to 2 feet in diameter.



***Protection of roadway using a chain link fence***

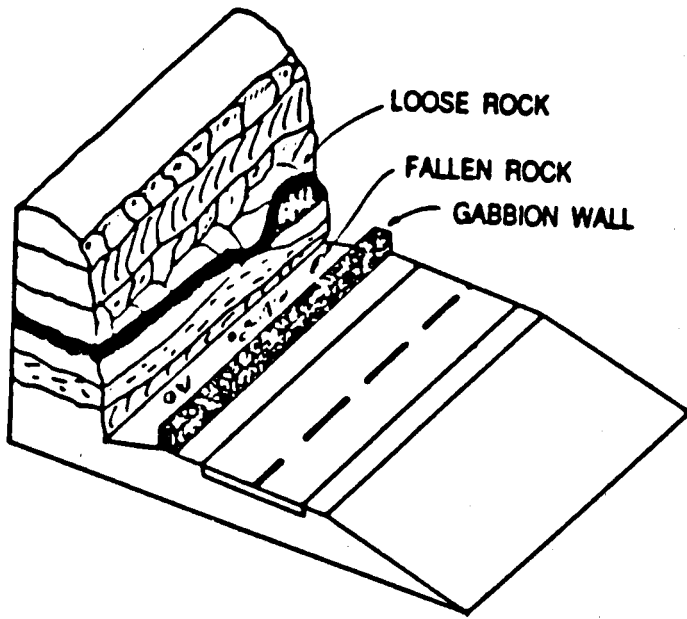
o Shaped Catchment Ditches -- This method is useful in catching and controlling large falling rock (see table and sketch). The guidelines in the table are useful in designing new slopes. They are also useful in checking old highway cut slopes.

o Catch Walls -- This method is used to stop rocks from entering the highway and to provide storage. Catch walls are constructed of reinforced concrete, gabions, rails and ties, posts and cables, I-beams, and timbers and posts.

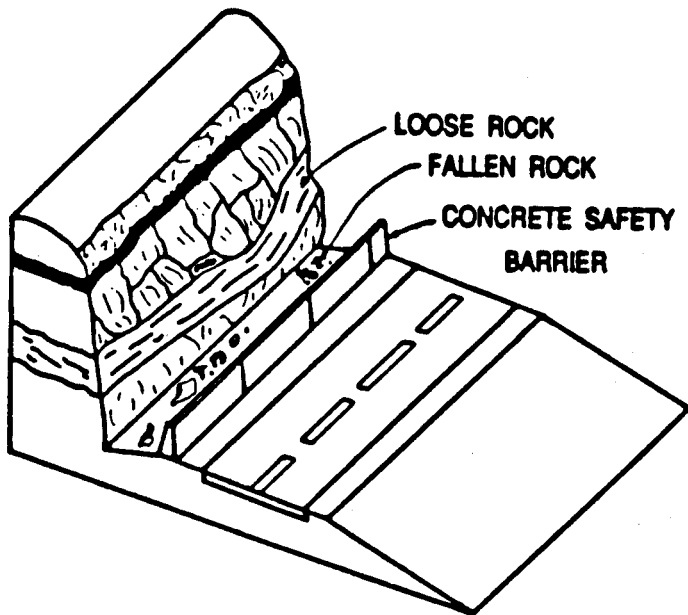


**Shaped catchment ditches using the Ritchie criteria**

- o Rock Sheds --This is a positive, but expensive, solution for rockfall problems. The shed is a roof that provides a sloping surface so that rocks pass over the roadway.
- o Tunnels -- A tunnel is used to avoid all rockfall problems and is an expensive solution. In certain situations, a tunnel may be the only solution.



*Protection of roadway using a gabion wall*



*Protection of roadway using a concrete safety barrier*

### **VI.B.5.c. Warning Methods**

Warning methods consist of the following:

- o Patrols -- Rock patrols are used to remove rock after it has reached the roadway. This method does not solve the problem.
- o Electric Fences and Wires -- This method has been used primarily by railroad companies. It is a warning system that stops a train automatically. This method is not feasible for use on highways.
- o Signs -- Signs are used to warn motorists of falling and fallen rock. This method does not solve the rockfall problem.
- o Surveying or Monitoring Methods -- A variety of techniques may be used to monitor the downward movement of rock. However, since rock landslides occur instantaneously, these methods are not too practical. Additionally, this method does not solve the problem.

### **VI.B.6. Removal and Replacement**

In certain instances, unstable materials may be completely or partially removed and replaced with more appropriate material. Usually, when partial removal is used, the top portion of the slide is removed and replaced with lightweight materials. This approach decreases driving forces. Generally, unit weights of embankment or fill materials range from 100 to 130 pounds per cubic foot. By replacing the top portion of the embankment with lighter materials with smaller unit weights, the forces (weights)tending to cause failure are reduced. Some lightweight materials that are used for replacement include the following:



o **Lightweight aggregate** (such as expanded shale) -- Expanded shale aggregate is a manufactured product made by heating certain types of shales to about 2,000 degrees Fahrenheit. The unit weight of the aggregate is about 50 to 90 pounds per cubic foot -- about half to three quarters of the unit weight of compacted soil. Use of this material is probably restricted to areas or locations close to sources. Haul distances would be a major factor in using this type of material for replacement.

o **Elastizell** -- Elastizell is an engineered lightweight concrete manufactured in various classes by the Elastizell Corporation of America. Unit weights range from 18 to 80 pounds per cubic foot. This material can be batched, mixed, and placed at the job site with specialized equipment.

o **Sawdust** -- Where a slide is located close to sources of sawdust, this material may be considered as a replacement alternative. Compacted sawdust fill weighs about 40 pounds per cubic foot. However, moisture penetration may eventually cause sawdust to rot. Good drainage in the slide area should accompany the use of sawdust. Also, the fill should, preferably, be encapsulated with asphalt or clay to minimize water penetration. This method, in areas where the material is economical and readily available, could aid in halting a potential failure.

o **Cinders** -- Cinders are produced when coal or wood is burned or partly burned. However, burning does reduce the coal or wood to ashes. Cinders are usually light weight and have high strength. They should be considered as a replacement material for the top portion of a slide and where sources of this material are located near the slide.

### **VI.B.7. Relocation/Avoid Problem**

In certain landslide situations, the only feasible solution may be to relocate the highway to avoid the problem. Relocation usually involves an alignment change. The manner in which the alignment is changed depends on geometrical standards of the highway and geometry of the site. For example, relocation of a section of interstate highway (or comparable roadway) would generally be very costly. Relocation of a section of interstate highway, if this is the only solution, probably would be done because of the high standards of this roadway and/or high traffic volumes. Relocation of an interstate may involve extensive realignment and costs. To construct the relocated section to geometrical standards lower than interstate standards would not be acceptable. In rural areas, however, for low-volume roads, relocating the highway with decreased geometrical standards might be an economical solution.

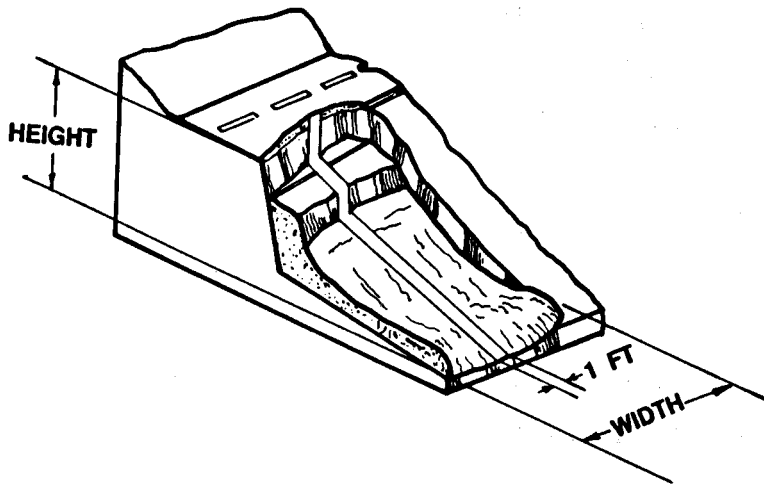
A typical situation on rural low-volume roads that often occurs is an embankment slip that completely destroys the roadway. The only immediately available solution to the maintenance crew is to build a detour (up slope of the failure) around the failure to allow traffic to pass the slide area. A sharp curve must be built into the alignment. This may be a dangerous practice if the toe of the cut slope must be excavated to construct the detour -- this action may activate a large failure in the cut slope. A permanent solution may involve spending several thousand dollars, which may be a large percentage of the maintenance unit's total annual budget. Consequently, the only economical solution may be to build around or over the slide, or to direct traffic over alternate routes.

## VI.C. ECONOMICS OF REPAIR METHODS

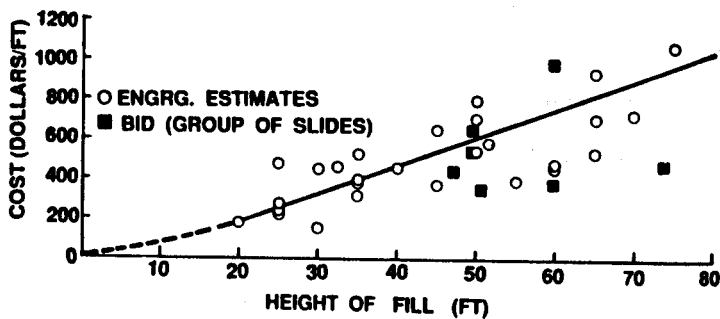
One of the first questions asked by administrators and others when a highway slide occurs or when a section of highway shows distress is, "What will it cost to repair this slide?" or "What's the bottom line?" Preliminary cost estimates are needed and necessary to determine whether or not the maintenance unit has the necessary equipment and budget to repair the slide or if outside help is needed. Additionally, a cost estimate is needed if the repair work is let to contract. Such estimates may be used to judge the reasonableness of bids by contractors. In certain instances, the magnitude of the cost of the repair will dictate the remedial method or may result in taking no major action. Hence, preliminary cost estimates are needed to determine the most appropriate response to the highway failure.

When a flattened slope or berm is considered as a means of repairing a slide, the accompanying sketch may be used to obtain a quick cost estimate. The data in this sketch were compiled from records (and reports) of the Kentucky Department of Highways. The data represent both engineering estimates and actual bids on some sixty highway fill failures (and distressed fills) on a stretch of 175 between Lexington, Kentucky, and Cincinnati, Ohio. In the sketch, the cost per linear foot (parallel to centerline) of the berm and/or flattened slope is shown as a function of the height of fill, as measured from the toe of the slope to the top of the fill. Circled points represent engineering cost estimates; square (darkened) points are actual bid prices. Each square point represents a group of slides. Although considerable scatter is present, there is a reasonable trend between the cost per foot and height of fill (the trend line is

based on a linear regression analysis).



*Dimensions of a slope failure required to estimate slope repair costs*



*Repair cost of berm and / or flattened slope per linear foot of slope failure and height of fill ( or height of slope failure )*

To illustrate how this approach may work, consider the following example:

Given: Height of fill = 20 feet

Width of highway slide = 200 feet

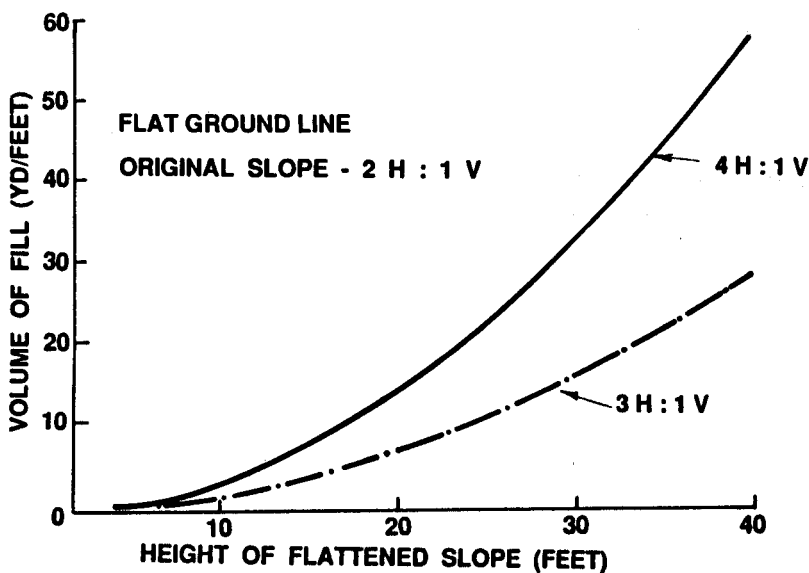
Determine: Estimated cost of flattened slope and(or) berm

Solution:

Enter the sketch at 20 feet and move vertically upward until the trend line is intercepted. From that point move left horizontally until the y-axis is intercepted at \$175 per foot.

$$\begin{aligned}\text{Estimated cost} &= (\$175/\text{ft of slide}) \times 200 \text{ ft} \\ &= \$35,000\end{aligned}$$

Another approach to obtain a quick estimate for a flattened slope, the yardage required to flatten the slope (assuming the original slope is 2 horizontal to 1 vertical) to 3 horizontal to 1 vertical and 4 horizontal to 1 vertical are shown in the accompanying sketch as a function of the height of fill (measured from the toe of fill to the top of the fill). For the 3:1 flattened slope and for a fill height of 250 feet, the volume of additional soil required is 7.4 yd<sup>3</sup> per foot of slide (width). For a 4:1 flattened slope, the volume is 14.8 yd<sup>3</sup> per foot of slide. If the cost per cubic yard of soil



*Volume of fill in cubic yards as a function of height of 3H:1V and 4H:1V flattened slopes*

(in place) is known in a given locality, then the estimated cost may be calculated. For example, assume the cost is \$7.00 per cubic yard. Then, for a 3:1 slope,

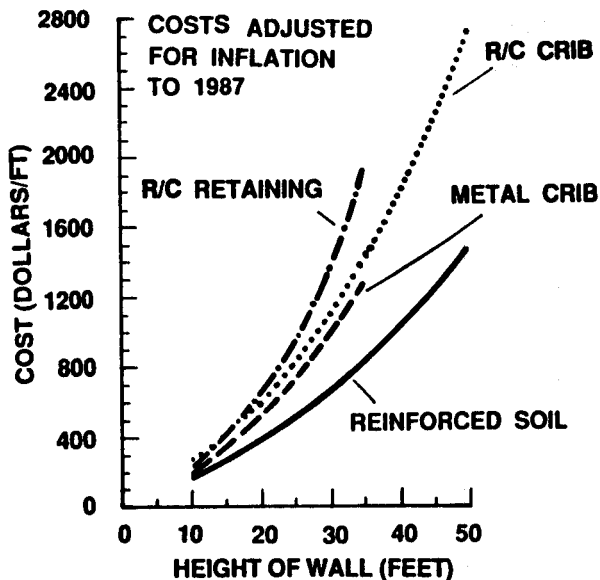
$$\begin{aligned} \text{Est Cost} &= (7.4 \text{ yd}^3/\text{ft of slide}) \times 200 \text{ ft} \\ &\quad \times \$7/\text{yd}^3 \qquad \qquad \qquad = \$10,360 \end{aligned}$$

and for a 4:1 flattened slope,

$$\begin{aligned} \text{Est Cost} &= (14.8 \text{ yd}^3/\text{ft of slide}) \times 200 \text{ ft} \\ &\quad \times \$7/\text{yd}^3 \qquad \qquad \qquad = \$20,720 \end{aligned}$$

These estimates do not include expenditures for replacing guardrail, drainage stone, and other material and labor costs).

When other repair methods are considered, cost data compiled by the California Department of Transportation (in cooperation with the Federal Highway Administration) may be useful. The accompanying data, compiled in 1981, pertains to four different wall systems: reinforced concrete wall, reinforced soil wall (geotextiles), reinforced concrete crib wall, and metal crib wall. Since the data were published in 1981 (and costs have risen since that date), those data were adjusted for inflation to 1987 using a construction index (construction indices were provided by the Kentucky Department of Highways). In the sketch, the cost per running foot of wall is shown as a function of the height of wall.



*Estimated cost of various types of retaining structures per linear foot of wall as a function of wall height*

Using the example above and unit costs from the graph, estimated repair costs are as follows:

$$\begin{aligned} \text{Est Cost (Reinforced Concrete Wall)} &= (\$660/\text{ft} \\ &\text{of slide}) \times 200 \text{ ft} \\ &= \$132,000 \end{aligned}$$

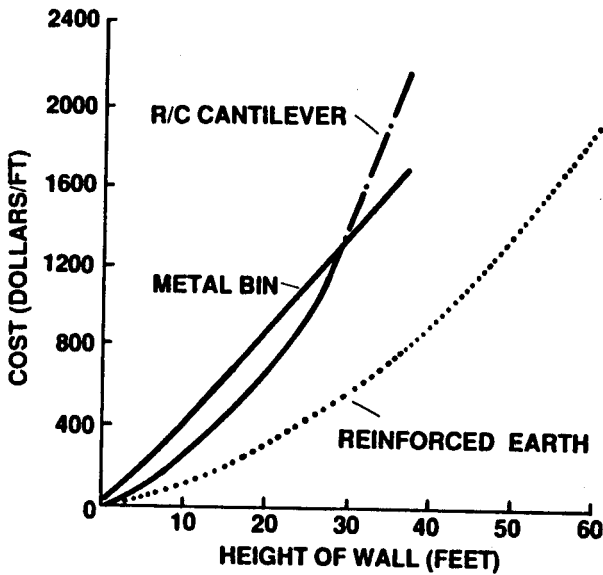
$$\begin{aligned} \text{Est Cost (Reinforced Concrete Crib Wall)} &= (\$590/\text{ft of slide}) \times 200 \text{ ft} \\ &= \$118,000 \end{aligned}$$

$$\begin{aligned} \text{Est Cost (Metal Crib Wall)} &= (\$520/\text{ft of slide}) \times 200 \text{ ft} \\ &= \$104,000 \end{aligned}$$

$$\begin{aligned} \text{Est Cost (Reinforced Soil Wall)} &= (\$380/\text{ft of slide}) \times 200 \\ &= \$76,000 \end{aligned}$$

Cost data for another part of the country also are shown in the accompanying sketch. Those data also have been adjusted for inflation. Based on those data, cost estimates are as follows:

### COMPARATIVE COST ESTIMATES



*Estimated costs of various types of retaining structures per linear foot of wall as a function of wall height*

$$\begin{aligned}
 &\text{Est Cost (Reinforced Concrete Wall)} \\
 &= (\$710/\text{ft of slide}) \times 200 \text{ ft} \\
 &= \$142,000
 \end{aligned}$$

$$\begin{aligned}
 &\text{Est Cost (Metal Crib Wall)} \\
 &= (\$940/\text{ft of slide}) \times 200 \text{ ft} \\
 &= \$188,000
 \end{aligned}$$



Est Cost (Reinforced Earth Wall)

= (\$350/ft of slide) x 200 ft

= \$72,000

The cost of railroad rail pilings for slides that are 20 feet or less in height is approximately \$175 to 250 per foot of slide. On this basis, the estimated cost for the example above is as follows:

Est Cost (Rail Piling)

= (\$175/ft of slide x 200 ft)

= \$35,000

or

Est Cost

= (\$250/ft of slide)

= \$50,000

The cost estimates shown above are not, necessarily, intended to show that one method of repair is superior to another method. It should be recognized, however, that construction costs will vary from one section of the country to another. Moreover, each slope failure must be carefully studied to determine the most suitable and economical remedy. For example, in some situations, a retaining wall may be the better solution. In the situation shown in the accompanying sketch, slope flattening may not be practicable because of steeply sloping original ground below the toe of the fill. Slope flattening also might require buying additional right of way. The graphs described above are intended to provide a "quick response" to the question, "What's the bottom line?" More detailed cost estimates should be made.

## **VI. LEGAL LIABILITIES**

### **VI.A. Safety**

Safety is an important factor in all roadway improvements; in design, construction, and maintenance. Every effort should be made to eliminate and reduce landslide hazards. Many studies have shown that most damaging landslides are human related. Thus, as indicated previously, the potential for hazard may be reduced by introduction of countermeasures such as improved grading procedures, land use controls, and drainage or runoff controls.

In one state, approximately 80 percent of the landslides have been caused by human activity. In another state, a study revealed that more than 90 percent of the landslides were related to human activities. We believe that this course has shown that slope movements can be reduced by 90 percent or more through a combination of measures involving adequate geologic investigations, good engineering practice, and effective enforcement of legal restraints on land use.

### **VI.B. Legal Aspects of Slope Movements**

Although the number of legal cases resulting from property damage due to landslides has been increasing over the years, few legal precedences have been established to guide the courts in determining responsibility for these landslides or in assessing the damages caused by them. This lack of specific laws and legal decisions is perhaps due to two main factors: 1) cases that involve private

companies are settled out of court and 2) most cases against state or federal agencies are settled out of court or the public agency exercises its sovereign right to refuse to consent to be sued. It is most important that those who undertake activities that involve the use of slopes have an understanding of the legal implications of that use.

Since most litigation involving landslides relates to construction and maintenance of public roads, we will assume that a public agency is a defendant. It should also be understood that when liability for a landslide is discussed, it must be assumed that a landslide has caused personal injury and/or property damage thus enabling an action against a public agency. The legally protected interest of the injured party may be his or her personal property, real estate, or physical well being. It should also be assumed that the public agency is in some way responsible for the landslide. Responsibility or liability may be related to construction or maintenance operations that create or activate a landslide on public property.

There have been numerous cases in which private property has been damaged and/or personal injury has resulted from landslides on public highways in the United States. In those instances, liability of the public agency having jurisdiction over the highway has varied from state to state. Some states prohibit suits against public agencies through sovereign immunity. Other states have established statutory provisions under which recovery may be realized. Such statutes generally delineate specific duties and responsibilities of public agencies, specific circumstances of the slope failure, procedural requirements for bringing action against a public agency, and specific defenses available to

the public agency.

While it is true that states and the federal government, as owners, may invoke the protection of sovereign immunity, there are many indications that this sheltered position will not survive. Recently, numerous agencies have lost the right of sovereign immunity. While in some states, employees of governmental bodies appear to be held harmless from legal action, there are indications it is possible to bring personal suits against such employees for negligence.

With regard to landslides, it should be understood that the legal rights of private citizens against public agencies are divided into two categories: **1) a property owner's rights and response to the invasion of the property by sliding material or interference with the lateral support of the property by construction or maintenance of a public way and 2) a highway travelers rights in tort against a public agency for injury sustained from a landslide that resulted in part from the negligent construction or maintenance of a public way.**

#### **VI.B.1. Landslide Encroachment onto Adjacent Property**

When a landslide results in damage to property either by invasion of the property or loss of its lateral support, the liability of a public agency is not necessarily based on statutes. Under the Fifth Amendment to the United States Constitution, just compensation must be paid when public works or other governmental activities result in the taking of

private property. That concept can be extended to the damaging of property as a result of an action of a public agency. The owner of the property may bring an action known as an inverse condemnation suit to recover damages. Courts have held that a state or local government cannot take or damage private property for public use without just compensation.

In studying several cases, it may be concluded that if public works activities result in the creation of a landslide or the reactivation of an old landslide that causes damage to private property, the public agency is liable for the full extent of such damage. If the particular governmental agency has such a constitutional provision, even in jurisdictions that do not have a provision relating directly to damage of private property, the courts have tended to find that the damage that results to private property constitutes a taking for which just compensation must be paid.

## **VI.B.2. Injuries Sustained from a Landslide**

Although the courts have made it clear that a public agency is not an insurer of the safety of persons using its highways, in certain circumstances travelers are protected by law from landslides. In general, the public agency will not be held liable for injuries if it can be shown that the acts or omissions that created the dangerous condition were reasonable or that the action taken to protect against such injuries or the failure to take such action was reasonable. The reasonableness of action or inaction is determined by considering the time and opportunity that the public employees had to take the action by weighing the

probability and gravity of potential injury to persons foreseeably exposed to the risk of injury against the practicality and cost of protecting against such injury.

Some states have statutes that impose liability for the dangerous condition of public property. In those states, the injured person must prove that the public property was in a dangerous condition at the time of the injury and that the injury resulted from that dangerous condition. This dangerous condition must be the result of negligence, a wrongful act, or failure of an employee of the public agency to act within the scope of his or her employment. The public agency must have had notice of this dangerous condition in sufficient time prior to the injury to have taken measures to protect against it. Thus, liability depends upon whether circumstance and conditions were such that the danger was reasonably foreseeable in the exercise of ordinary care and if so, whether reasonable measures were taken by the public agency to prevent injury.

A public agency, since it is not an insurer of the safety of the travelers on its highways, need only to maintain highways in a reasonably safe condition for ordinary travel under ordinary conditions or under such conditions as should be reasonably expected.

Foreseeability has been held as a necessary element of contributory negligence. It must be shown that a reasonable person would have foreseen the exact consequences of negligence. The doctrine of contributory negligence has been replaced by comparative negligence in many states. Under comparative negligence doctrines, negligence is measured in terms of percentage. Any

damages allocated are diminished in proportion to the amount of negligence assigned to the plaintiff.

### **VI.C. Risk Management**

Risk management recognizes the likelihood of lawsuits resulting from slides which cause human and/or property damage. To prevent or minimize this type of litigation and to help defend lawsuits, it is suggested that the following steps be followed:

1. Establish a regular record for inventorying and inspecting highways under your agencies responsibility.
2. Record all inspections and notice of change of any slide areas.
3. After noticing movement in a potential slide area, make regular inspections using inspection forms and diaries.
4. Document your actions relative to corrective measures taken after the inspection.
5. After identifying slide movement, take photographs during each inspection.
6. Erect warning signs at sites which cannot immediately be repaired.
7. Take routine corrective maintenance actions as soon as possible to improve safety at the site.

8. If routine maintenance does not provide a safe travel way for the public, program a design project immediately for reconstruction and/or rehabilitation.

9. The most important aspect...keep good maintenance records.

As stated earlier, while providing transportation services, the governmental agency is not the absolute insurer of the safety of a highway user. The total resources of any government are limited and it would not be realistic to expect that the bulk of all funding be devoted to keeping the roads in an absolutely sound and safe condition. However, the courts have consistently held that governments are required to maintain streets and roads in a reasonably safe manner.

Your attention is called to a book that was published in 1985. The title of the book is **"Killer Roads from Crash to Verdict."** Most county engineers live in terror because of it. This book was written by attorneys for attorneys. It is considered to be a "how to sue" book. It therefore behooves all governmental agencies and their employees to establish a standard of care for a given maintenance activity. It is also important that all employees seek to achieve a reasonable level of performance.

It should be understood that the function of governmental agencies is to provide security and services for its citizens. Transportation is one of the services which governmental officials and employees are charged with providing. The goal of transportation should be the safe and efficient movement of people and goods within reasonable physical constraint.



## BIBLIOGRAPHY

- Allen, D. L.; Meade, B. W.; and Hopkins, T. C.; *Performance Monitoring of a Highway Tieback Wall, University of Kentucky Transportation Center, College of Engineering, Report UKTRP-86-17, July 1986.*
- Allen, D. L.; Meade, B. W.; and Hopkins, T. C.; *Analysis of Movements on Bridge Approaches: A Case Study (Bridge over Chesapeake Avenue on Interstate 71 in Campbell County, Kentucky), Report UKTRP-85-10, University of Kentucky Transportation Center, College of Engineering, University of Kentucky, April 1985.*
- Allen, D. L.; and Russ, R. L.; *Loads on Box Culverts under High Embankments: Analysis and Design Considerations, Report No. 491 Kentucky Department of Transportation, Division of Research, January 1978.*
- Allen, D. L.; *The Creep Response of Cohesive Soils: A Method of Design Using Rheological Strength Parameters, Report No. 382 Kentucky Department of Transportation, Division of Research, December 1973.*
- Allen, D. L.; *A Survey of the States on Problems Related to Bridge Approaches, University of Kentucky Transportation Center, College of Engineering, Report UKTRP-85-25, October 1985.*
- Allen, D. L.; *A Review and Analysis of Pile Design, University of Kentucky Transportation Center, College of Engineering, Report UKTRP, December 1984.*
- American Geologic Institute; *Glossary of Geology, Third Printing, Falls Church, Va., 1974.* Huang, W. T.; *Petrology, McGraw-Hill Book Company, 1962.*
- Bailey, W. A.; and Christian, J. T.; *A Problem-Oriented Language for Slope Stability Analysis -- User's Manual, Soil Mechanics Publication 1969, Department of Civil Engineering, Massachusetts Institute of Technology, April 1969.*
- Bishop, A. W.; "The Use of the Slip Circle in the Stability Analysis of Slopes," *European Conference on Stability of Earth Slopes, Stockholm Sweden, 1954.*
- Bishop, A. W.; and Henkel, D. J.; *The Triaxial Test, Edward Arnold (Publishers) LTD, London, England, 1964.*
- Bishop, A. W. and Bjerrum, L.; "The Relevance of the Triaxial Test to the Solution of Stability Problems," *Research Conference on Shear Strength of Cohesive Soils, American Society of Civil Engineers, University of Colorado, Boulder Colorado, June 1960.*
- Bishop, C. S.; Armour, D. W.; and Hopkins, T. C.; "Design of Highway Embankments on Unstable Natural slopes," *Proceedings, Ohio River Valley Soils Seminar.*
- Bjerrum, L.; "Embankments on Soft Ground," *Proceedings, Specialty Conference of Earth and Earth-Supported Structures, American Society of Civil Engineers, Purdue University, Vol 1, June 1972.*
- Bjerrum, L.; "Problems of Soil Mechanics and Construction on Soft Clays and Structurally Unstable Soils (Collapsible, Expansive, and Others)," *Proceedings of the Eighth International Conference on Soil Mechanics and Foundation Engineering, Vol 3, page 111, Moscow, USSR, 1973.*
- Bjerrum, L.; *Progressive Failure in Slopes in Overconsolidated Plastic Clay and Clay Shales, Journal of the Soil Mechanics and Foundations Division, Vol 93, SM5, ASCE, September 1967.*
- Bowles, J. E.; *Engineering Properties of Soils and Their Measurements, McGraw-Hill Book Company, New York 1970.*
- Bragg, G. H., Jr.; and Zeigler, T. W.; *Design and Construction of Compacted Shale Embankments, Vol 2 (Evaluation and Remedial Treatment of Compacted Shale Embankments), Report No. FHWA-RD-75-62, Federal Highway Administration, Washington, D. C., August 1975.*
- Chapman, D. R.; *Shale Classification Tests and Systems: A Comparative Study, Purdue University, West Lafayette, Indiana, June 1975.*
- Chellis, R. D.; *Pile Foundations - Theory, Design and Practice, McGraw-Hill Book Company, Inc.,*

New York, N.Y.

Cheney, R. S.; and Chassie, R. G.; "Soils and Foundation Workshop," U.S. Department of Transportation, Federal Highway Administration, Washington, D.C., November 1982.

Chirapunta, S. and Duncan, J. M.; "The Role of Fill Strength in the Stability of Embankments on Soft Clay Foundations," Prepared for Office, Chief of Engineers, U. S. Army, Washington, D. C. 20314, Monitored by Soils and Pavement Laboratory, U. s. Army Engineer Waterways Experiment Station, P.O. Box 632, Vicksburg, Miss. 39180, Contract S-76-6, College of Engineering, University of California, Berkeley, California 94720, June 1976.

Chowdhury, R. N.; *Slope Analysis*, Elsevier Scientific Publishing Company, New York 1978.

Daehn, W. W. and Hilf, J. W.; "Implications of Pore Pressures in Design and Construction of Rolled Earth Dams," *International Congress on Large Dams, New Delhi, Transactions, Vol 1, 1951.*

D'Appolonia, E.; Alperstein, R.; and D'Appolonia, D. J.; "Behavior of a Colluvial Slope," *Journal of the Soil Mechanics and Foundation Division, American Society of Civil Engineers, Vol. 93, No. SM4, July 1967.*

Deen, R. C.; and Havens, J. H.; *Landslides in Kentucky, Research Report 266, Division of Research, Kentucky Department of Highways, September 1968 (presented to a Landslide).*

Deen, R. C.; *The Need for a Schema for the Classification of Transitional (shale) Materials, Geotechnical Testing Journal for Testing and Materials, Vol. 4, No. 1, March 1981.*

Deo, P.; *Shales as Embankment Materials, Report No. 45, Joint Highway Research project, Purdue University and Indiana Highway Commission, West Lafayette, December 1972.*

Department of the Navy, *Design Manual, Soil Mechanics, Foundations, and Earth Structures, NAVFAC DM-7, March 1971.*

Driscoll, D. D.; *Retaining Wall Design Guide,*

*USDA Forest Service, Region 6, 1979.*

Drnevich V. P.; Hopkins, T. C.; and Hale, S. S.; "Design of Oil Shale Disposal Embankments," *Department of Civil Engineering, University of Kentucky, Soil Mechanics Series No. 31, September 1982 (also Proceedings, 1982 Eastern Oil Shale Symposium, October 11-13, 1982, Lexington, Kentucky).*

Drnevich, V. P.; Hopkins, T. C.; and Hale, S. S.; "Design of Oil shale disposal Embankments," *Proceedings, 1982 Eastern Oil Shale symposium, October 11-13, 1982, Lexington, Kentucky (also, Soil Mechanics Series No. 31, September 1982, Department of Civil engineering, University of Kentucky).*

Eades, J. L.; and Grim, R. E.; "A Quick Test to Determine Lime Requirements for Lime Stabilization", *Highway Research Board, Research Record 139, 1966.*

*Earth Manual, U. S. Bureau of Reclamation, Denver, Colo.*

Epps, J. A.; Dunlap, W. A.; and Galtway, B. M.; "Basis for the Development of a Soil Stabilization Index System," *U. S. Air Force Contract No. F29601-90-C-0008, Air Force Weapons Laboratory, Texas A & M University, November 1970.*

*FHWA Rockfall Mitigation Seminar, Portland, Oregon, August 1987.*

*Geotechnical Manual, Division of Materials, Kentucky Department of Transportation, February 1978.*

*Geotechnical Section, Division of Materials, Kentucky Department of Transportation, Bureau of Highways, various landslide staff reports - Numbered L-7-75, L-3-75, L-8-74, L-5-76, L-16-75, L-20-75, L-11-75, L-8-75, L-15-75, L-12-76, L-6-74, M-7-74, L-22-76, L-13-76, L-18-75, L-5-75, L-1-77, and L-5-74, Frankfort, Kentucky.*

Girdler, H. F.; and Hopkins, T. C.; *Stability Analysis of Slide at M.P 152.7, Report No. 372, Kentucky Department of Highways, Division of Research, 1973.*

- Gorman, C. T.; Hopkins, T. C.; and Drnevich, V. P.; "In Situ Shear Strength Parameters by Dutch Cone Penetration Tests," Division of Research, Kentucky Department of Transportation, September 1973 (also presented to the European Symposium on Penetration Testing, Stockholm, Sweden, June 1974).
- Gray, R. E.; Guinnee, J. W.; Hampton, D.; and Deen, R. C.; *Subgrades, Foundations, Embankments, and Cut Slopes*, Van Nostrand Reinhold Company, 1975.
- Hagerty, D. J.; Palmer, M. W.; Tockstein, C. D.; and Deen, R. C. *Rock Evaluation for Engineered Facilities, Record 548, Transportation Research Record, 1975.*
- Harr, M. E.; and Deen, R. C.; *Analysis of Seepage Problems, Journal of the Soil Mechanics and Foundations Divisions, American Society of Civil Engineers, Paper 2971, Vol. 87, No. SM-5, October 1961.*
- Haston, J. S.; and Wohlgemuth, S. K.; "Experiences in the Selection of the Optimum Lime Content for Soil Stabilization," Paper presented at the 1985 Spring Meeting of the Texas Section of the American Society of Civil Engineers.
- Henkel, D. J. and Skempton, A. W.; "A Landslide at Jackfield, Shropshire, in a Heavy Over-Consolidated Clay," *Geotechnique, Vol 5, No. 2, 1955.*
- Highway Research Board, *Landslides and Engineering Practice, Special Report 19, Publication 544, by Committee on Landslide Investigations and edited by Edwin B. Eckel, Washington, D. C., 1958.*
- Hirschfield, R. C.; and Polous, S. J.; *Embankment-Dam Engineering, Casagrande Volume, John Wiley and Sons, New York, 1973.*
- Hopkins, T. C.; *Long-Term Movements of Highway Bridge Approach Embankments and Pavements, UKTRP-85-12 University of Kentucky Transportation Center, College of Engineering, April 1985.*
- Hopkins, T. C.; and Yoder, S. M.; *Remedial Stability Analysis of Unstable, Eastern Approach Embankment, Bluegrass Parkway Bridges over Chaplin River, Report No. 370, Kentucky Department of Transportation, Division of Research, 1973.*
- Hopkins, T. C.; Allen, D. L.; Deen, R. C.; *Uncertainty of Slope Stability Analysis, Kentucky Department of Transportation, Division of Research, 1976.*
- Hopkins, T. C.; and Allen, D. L.; *Investigation of a Side-Hill Embankment Slope Failure on I 64, Bath County, Milepost 118, Division of Research, Kentucky Department of Highways, 1971.*
- Hopkins, T. C.; *Unstable embankment, US 119, Research Report 334, Division of Research, Kentucky Department of Highways, July 1972.*
- Hopkins, T. C.; *Settlement of Highway Bridge Approaches and Embankment Foundations, Bluegrass Parkway Bridges over Chaplin river, Research Report 356, Division of Research, Kentucky Department of Highways, February.*
- Hopkins, T. C.; *Stability of a Side-Hill Embankment, I 64 Lexington-Catlettsburg Road, Research Report 363, Division of Research, Kentucky Department of Transportation, April 1973.*
- Hopkins, T. C.; "Settlement of Highway Bridge Approaches and Embankment Foundations," *Division of Research, Kentucky Department of Highways, February 1968.*
- Hopkins, T. C.; "The Bump at the End of the Bridge," *Division of Research, Kentucky Department of Highways, 1969.*
- Hopkins, T. C.; and Dean, R. C.; "The Bump at the End of the Bridge," *Record 302, Highway Research Board, 1970.*
- Hopkins, T. C.; and Scott, G. D.; "Estimated and Observed Settlements of Bridge Approaches," *Record 302, Highway Research Board, 1970.*
- Hopkins, T. C.; and Deen, R. C.; "Mercury-Filled Settlement Gage," *457, Highway Research Board, 1973.*
- Hopkins, T. C.; and Deen, R. C.; "Identification of Shales," *Geotechnical Testing Journal, ASTM,*

Vol 7, March-December, 1983.

Hopkins, T. C.; Allen, D. L.; and Deen, R. C.; *Effects of Water on Slope Stability, Report No. 435, Division of Research, Kentucky Department of Transportation, October 1975.*

Hopkins, T. C.; "A Generalized Slope Stability Method and Computer Program, User's Guide to HOPK-I," UKTRP-86-2 Kentucky Transportation Research Program, University of Kentucky, January 1986.

Hopkins, T. C.; Hughes, R. D.; Allen D. L.; "Geotechnical, Hydrologic, and Hydraulic Investigation of Mill Creek Dam -- Phase II" Transportation Research Program, University of Kentucky, UKTRP-84-14, Lexington, Kentucky, July 1983.

Hopkins, T. C.; "Identification of Kentucky Shales", University of Kentucky Transportation Center, College of Engineering, Research Report 81-16, August 1981.

Hopkins, T. C.; "Shear Strengths of Compacted Shales", University of Kentucky Transportation Center, College of Engineering, Research Report 88-1, January 1988.

Hopkins, T. C.; and Allen, D. L.; "Lime Stabilization of Pavement Subgrade Soils of Section AA-19 of the Alexandria-Ashland Highway, Research Report 86-24, University of Kentucky Transportation Center, October 1986.

Hopkins, T. C.; "Lime Stabilization of Kentucky Soils", University of Kentucky Transportation Center, College of Engineering, Oral presentation to the National Lime Conference, Lexington, Kentucky, October 1987.

Hopkins, T. C.; and Yoder, S. M.; *Slope Stability Analysis: A Computerized Solution of Bishop's Simplified Method of Analysis, Report No. 358, Kentucky Department of Highways, Division of Research, 1973.*

Hopkins, T. C.; *Relationship Between Kentucky CBR and Slake - Durability, University of Kentucky Transportation Center, College of Engineering, August 1984.*

Hopkins, T. C.; *Design of embankments on Soft*

*Clay Foundations, Presentation to the 1984 Southeastern Dam Safety Conference, Knoxville, Tennessee, April 1984.*

Hopkins, T. C.; "Relationship Between Kentucky CBR and Slake Durability", Research Report 84-24, University of Kentucky Transportation Center, College of Engineering, August 1984.

Hopkins, T. C.; and Sharpe, G. W.; "Unstable Subgrade, I65, Hardin County (I65-5(17)92; FSP 047-0065-091-094-0396," University of Kentucky Transportation Center, College of Engineering, Research Report 85-9, March 1985.

Hughes, R. D.; and Allen, D. L.; *Workshop on Roadway and Street Drainage, University of Kentucky Transportation Center, College of Engineering, UKTRP, January 1986.*

Janbu, N.; "Application of Composite Slip Surface for Stability Analysis," European Conference on Stability of Earth Slopes, Stockholm, Sweden, 1954.

Johnson, S. J.; "Analysis and Design Relating to Embankments (A State-of-the-Art Review)," U.S. Army Engineer Waterways Experiment Station, Vicksburg, Mississippi, July 1974. (Also, Proceedings, Conference on Analysis and Design in Geotechnical Engineering, American Society of Civil Engineers, Austin, Texas, Vol II, June 9-12, 1974.

Kentucky Department of Highways, *Standard Specifications for Road and Bridge Construction, Frankfort, Kentucky, 1965.*

Klinedinst, G.; Munoz, A.; and Niessner, C. W.; *Guidelines for Slope Maintenance and Slide Restoration, Report No. FHWA-TS-85-231, U.S. Department of Transportation, Federal Highway Administration, April 1986.*

Ladd, C. C.; and Foott R.; "New Design Procedure for Stability of Soft Clays," American Society of Civil Engineers, *Journal of the Geotechnical Engineering Division, Vol. 100, No. GT7, July 1974.*

Lambe, T. W.; "Soil Parameters for Predicting Deformations and Stability", Session I, General Report, Seventh International Conference on Soil Mechanics and Foundation Engineering, Mexico,

1969.

Lambe, T. W.; and Whitman, R. V.; *Soil Mechanics*, Wiley, 1969.

Lambe, T. W.; *Soil Testing for Engineers*, John Wiley & sons, Inc., New York, N.Y.

Lambe, T. W.; "Soil Parameters for Predicting Deformations and Stability," Session I, General Report, Seventh International Conference on Soil Mechanics and Foundation Engineering, Mexico City, 1969.

Lutton, R. J.; *Design and Construction of Compacted Shale Embankments*, U.S. Army Engineers Waterways Experiment Station, Vol. 3, Report No. FHWA-RD-77-1, Prepared for Federal Highway Administration, U.S. Dept. of Transportation, Washington, D. C., February 1977.

Mathis, H. A.; and Gray, E.; "Soil Engineering Report, Breathitt County, S 364(4), sp 13-67 10L, Boonesville-Jackson Ky 30, Station 0+00-131+00," Division of Materials, Soils Section, Kentucky Department of Highways, September 6, 1972.

Morgenstern, N. R.; and Eigenbrod, K. D.; *Classification of Argillaceous Soils and Rocks*, Journal of the Geotechnical Engineering Division, ASCE, Vol. 100, No. GT10, October 1974.

Morgenstern, N. R. and Price, V. E., "The Analysis of the Stability of General Slip Surface," *Geotechnique*, Vol. 15, No. 1, 1965.

McCauley, M. L.; Works, B. W.; and Naramore, S. A.; *Rockfall Mitigation FHWA/ca/TL-85-12*, Calif. DoT, in cooperation with U.S. DoT, FHWA, Sacramento, Calif., Sept, 1985.

McNulty, E. G.; Gorman, C. T.; and Hopkins, T. C.; *Analysis of Time-Dependent Consolidation Data*, Preprint 3280, ASCE Spring Convention and Exhibit, April 24-28, 1978.

Munoz, A.; *Guidelines on Maintenance and Reconstruction on Embankment Slopes, Region 6*, Federal Highway Administration, April 1983.

National Lime Association, "Lime Stabilization

*Construction Manual*," Bulletin 326, Ninth Edition, Arlington, Virginia, 1987.

Noble, D. F.; *Accelerated Weathering of Tough Shales, Final Report, VHTRC 78-R20*, Virginia Highway and Transportation Research Council, Charlottesville, Virginia, October 1977.

Peck, R. B. and Lowe III, J.; "Shear Strength of Undisturbed Cohesive Soils," Moderator's Report, Session 4, Research Conference on Shear Strength of Cohesive Soils, American Society of Civil Engineers, University of Colorado, Boulder, Colorado, June 1960.

Peterson, R.; Jasper, J. L.; Rivard, P. J.; and Iverson, N. L.; "Limitations of Laboratory Shear Strength in Evaluating Stability of Highly Plastic Clays," *Proceedings, Research Conference on Shear Strength of Cohesive Soils*, Boulder, Colorado, American Society of Civil Engineers, June 1960.

Royster, D. C.; *Landslide Remedial Measures*, Tennessee Department of Transportation, September 1982.

Saltzman, U.; *Rock Quality Determination for Large-Size Stone Used in Protective Blankets*, Ph.D. Thesis, Purdue University, May 1975.

Scott, G. D.; and Deen, R. C.; *Proposed Remedial Design for Unstable Highway Embankment Foundation*, Research Report 234, Division of Research, Kentucky Department of Highways, April 1966.

Sehuster, R. L.; and Krizek, R. J.; *Landslides Analysis and Control*, Transportation Research Board, National Academy of Sciences, Special Report 176, Washington, D. C., 1978.

Shamburger, J. H.; Patrick, D. M.; and Lutton, R. J.; *Design and Construction of Compacted Shale Embankments, Vol 1 (Survey of Problem Areas and Current Practices)* Report No. FHWA-RD-75-61, Federal Highway Administration, Washington, D. C., August 1975.

Shamburger, J. H.; Patrick, D. M.; and Lutton, R. J.; "Design and Construction of Compacted Shale Embankments," Vol 4, Report FHWA-RD-75-61, Federal Highway Administration, August 1975.

Skempton, A. W.; *Long-Term Stability of Clay Slopes, Geotechnique, Vol. 14, No. 2, 1964.*

Skempton, A. W.; "The Pore Pressure Coefficients A and B," *Geotechnique, Vol. 4, No. 4, 1954.*

Skempton, A. W.; and Hutchinson, J.; "Stability of Natural Slopes and Embankment Foundations," *State-of-the-Art Report, Proceedings, Seventh International Conference on Soil Mechanics and Foundation Engineering, Mexico City, 1969.*

Smith, D. D.; *The Effectiveness of Horizontal Drains, 1978.*

Southgate, H. F.; *I 75, Kenton County Slide, Research Report 267, Division of Research, Kentucky Department of Highways, September 1968.*

Spencer, E.; "A Method of Analysis of the Stability of Embankments Assuming Inter-Slice Forces," *Geotechnique, Vol 17, No. 1, 1967.*

Spencer, E.; "Thrust Line Criterion in Embankment Stability Analysis," *Geotechnique, Vo. 23, No. 1, 1973.*

*Standard Specifications for Road and Bridge Construction, Bureau of Highways, Kentucky Department of Transportation, Edition of 1979, Frankfort, Kentucky.*

Taylor, D. W.; *Soil Mechanics, John Wiley & Sons, Inc., London, England, fourth edition 1950.*

Terrel, R. L.; Epps, J. A.; Barenberg, E. J.; Mitchell, J. K.; Thompson, M. R.; "Soil Stabilization in Pavement Structures Users Manual," *FHWA-IP-80-2, U.S. Department Transportation, Federal Highway Administration, 1979.*

*Volume 1 - Pavement Design and Construction*

*Consideration*

*Volume 2 - Mixture Design Considerations*

Terzaghi, K. and Peck, R. B; *Soil Mechanics in Engineering Practice, Wiley, 1948.*

Tschebotarioff, G. P.; "Bridge Abutments on Piles Driven through Plastic Clay," *Design and Installation of Pile Foundations and Cellular Structures, Edited by Hsai-Yan Fang and Thomas D. Dismuke, Envo Publishing Co., 1970.*

Tschebotarioff, G. P.; *Foundations, Retaining and Earth Structures, McCraw Hill Book Company, Second Edition, New York, 1973.*

Whitman, R. V. and Bailey, W. A.; "Use of Computers for Slope Stability Analysis," *Journal of the Soil Mechanics and Foundations Division, American Society of Civil Engineers, Vol 93, No. SM4, July 1967.*

Wright, S. G.; "A Study of Slope Stability and Undrained Shear Strength of Clay Shales, a dissertation submitted in partial satisfaction of the requirements for the Degree of Doctor of Philosophy, University of California, Berkely, 1969 (also, *Proceedings, Conference on Analysis and Design in Geotechnical Engineering, American Society of Civil Engineers, Vol II, Austin, Texas, June 9-12, 1973.*

Winterkorn, H. F.; and Hsai-Yang Fang; *Foundation Engineering Handbook, Van Nostrand Reinhold Company, New York, 1975.*

*U.S. Department of Transportation, Federal Highway Administration; Introduction to Drilled Shafts, Pilot Course, Region-4, 1985.*

Vanikar, N.S.; *U.S. Department of Transportation, Federal Highway Administration; Manual on Design and Construction of Driven Pile Foundations, FHWA-DP-66-1, April 1985.*

**APPENDIX A**

**SLIDE AND ROCKFALL FEATURES**

- A. Preslide Symptoms**
- B. Features**

## TYPICAL SLIDES ON HIGHWAYS

Many different types of slides occur along highways. In a given situation, the maintenance crew, maintenance supervisor, or geotechnical engineer must decide on a course of action to follow to repair or protect the roadway. A general recommended course of action consists of the following:

**o ALWAYS EVALUATE THE SAFETY OF THE SLIDE -- DO NOT ASSUME THE SLIDE IS SAFE.**

- Are houses above or/and below the slide threaten or in danger? Notify house owners and/or landowners if the slide threatens life or property. Be prepared to evacuate people that may be threatened.

- Are motorists traveling the distressed section of roadway in danger? Post signs to warn motorists of the danger. IN EMERGENCY SITUATIONS (portions or all of the roadway has completely failed or a soil or rock slide has moved or threaten to fall onto the roadway) POST FLAGMEN TO WARN MOTORISTS. If failure appears imminent be prepared to close the roadway, built detours, or/and select alternate routes.

**o OBTAIN PRELIMINARY INFORMATION --** Use the slide/inventory form to identify location, type of slide size, number of times the section has been patched, etc. This information will be invaluable to a geotechnical engineer if he is required to investigate the slide.

**o MONITOR THE SLIDE --** Any distressed section of highway should be watched closely. Widening cracks, falling rocks occurring often, a section of roadway that



requires periodic patching are signs that the section may eventually fail. Its normal to patch a section once because fills settle after construction. Generally, settlement of fills decrease with increasing time. However, sections of highway that requires periodic patching are usually settling more than normal and probably indicates that failure will eventually occur. Any section of highway that has been patched more than once should be included on the slide inventory list and the causes of the settlement should be investigated.

**o DETERMINE A REPAIR/PROTECTION METHOD --**

Based on the methods described in Section IV, decide on an appropriate repair and/or protection method.

Quick estimates may be obtained from the data shown in Section V under REPAIR ECONOMICS. These cost estimates will aid the supervisor/maintenance crew in deciding whether the geotechnical staff or consultant should be contacted. More detailed cost estimates based on local conditions should be made before implementation of the plan. Whichever approach is used, the supervisor must decide whether he has the resources to implement a repair method(s). If the supervisor decides that the job is too large and/or too expensive, then he should contact the geotechnical staff or a geotechnical consultant for assistance.

**o IMPLEMENT REPAIR/PROTECTION METHOD --**

The supervisor should monitor the progress of work carefully whether his crew performs the work or the work is performed by a contractor. IT'S GOOD PRACTICE TO PHOTOGRAPH IMPORTANT STAGES OF THE WORK.

**o INSPECT REPAIRED HIGHWAY SECTION**

**PERIODICALLY --** After the work has been completed,

periodical inspections should be made to be sure that the method has been successful. Use the slide/inventory form when making the inspections and as updates to the original slide/inventory forms. These inspections may reveal that the work was unsuccessful. **DON'T ASSUME THAT THE SLIDE HAS BEEN REPAIRED JUST BECAUSE A GEOTECHNICAL ENGINEER AND/OR CONTRACTOR PERFORMED THE WORK.**

To aid the maintenance supervisor and crew members, several typical highway slide situations frequently encountered along roadways are described below. For each situation, preslide features and the suggested actions to be followed by the maintenance supervisor and crew are shown.

## **Preslide Symptoms**

# SETTLEMENT OF ROADWAY, SHOULDER, GUARDRAIL, OR ADJACENT AREAS SUCH AS WALLS, FENCES, OR RAILS

<u>THINGS TO LOOK FOR</u>	<u>SIGNIFICANCE OF OBSERVED FEATURE</u>	<u>COURSE OF ACTION</u>	<u>THINGS TO AVOID</u>
A. Surface Cracking in Surrounding Areas	<ul style="list-style-type: none"> <li>o Allows water infiltration.</li> <li>o May outline limits of distress.</li> <li>o May indicate potential major movement.</li> </ul>	<ul style="list-style-type: none"> <li>o Investigate cause of cracking.</li> <li>o Record size, location, &amp; extent; periodically monitor.</li> <li>o Consider sealing cracks.</li> <li>o Monitor for roadway movement with pins and record.</li> <li>o If movement continues, seek help.</li> </ul>	<ul style="list-style-type: none"> <li>o Avoid loading of distressed area.</li> </ul>
B. Blocked, Leaking, or Otherwise Malfunctioning Drainage or Septic Systems Outside R/W	<ul style="list-style-type: none"> <li>o May add water to the problem area.</li> <li>o May be the cause of the problems.</li> <li>o May cause future problem.</li> </ul>	<ul style="list-style-type: none"> <li>o Investigate cause.</li> <li>o Properly drain.</li> <li>o Redirect water if practical.</li> <li>o Seek advice.</li> <li>o Reconstruct or protect eroded area if practical.</li> </ul>	<ul style="list-style-type: none"> <li>o Do not direct water towards problem area.</li> <li>o Do not over excavate when cleaning drainage.</li> </ul>
C. Erosion by Natural Drainage (Including stream flow, springs, lakes, and channel changes)	<ul style="list-style-type: none"> <li>o May be the cause of distress.</li> <li>o May reoccur or progress to travel unless altered.</li> <li>o May be adding water to distressed area.</li> <li>o Constructed side slopes may be too steep.</li> </ul>	<ul style="list-style-type: none"> <li>o Monitor &amp; record changes in distress.</li> <li>o Monitor &amp; record changes in water volume, color, or level.</li> </ul>	<ul style="list-style-type: none"> <li>o Avoid sudden change in water levels where controllable.</li> <li>o Avoid blocking natural drainage courses or springs.</li> </ul>
D. Slope Bulging or Movement	<ul style="list-style-type: none"> <li>o May indicate location of movement.</li> <li>o May indicate swelling soils.</li> <li>o May indicate frost heave areas.</li> </ul>	<ul style="list-style-type: none"> <li>o Monitor &amp; record locations, changes in size or shape.</li> <li>o Be prepared to close road if changing rapidly.</li> <li>o If movement continues, seek help.</li> </ul>	<ul style="list-style-type: none"> <li>o Do not disturb until stability evaluated.</li> <li>o Avoid loading distressed area.</li> <li>o Do not remove shrubs, bushes, grasses, etc.</li> </ul>
E. Wasting of Materials on Slope (side casting)	<ul style="list-style-type: none"> <li>o May cause settlement.</li> <li>o May block natural or designed drainage.</li> <li>o May cause moisture to collect, i.e., snow melt or rainfall.</li> </ul>	<ul style="list-style-type: none"> <li>o Remove existing waste material if practical.</li> <li>o Properly drain.</li> <li>o Use designated waste areas.</li> </ul>	<ul style="list-style-type: none"> <li>o Avoid wasting or stock piling material at this location.</li> </ul>
F. Adjacent Land Use Changes, Construction, Mining, Logging, etc.	<ul style="list-style-type: none"> <li>o May be cause of distress.</li> <li>o Changes from agricultural to industrial or commercial to urban may cause increased runoff.</li> </ul>	<ul style="list-style-type: none"> <li>o Investigate activities and contact supervisor, and/or owner.</li> </ul>	<ul style="list-style-type: none"> <li>o Do not grant access or permits within the distressed area.</li> </ul>
G. Vegetation Changes Such As Tilting, Dying, New Cat Tails, New Green Areas	<ul style="list-style-type: none"> <li>o May indicate movement and outline limits of distress area.</li> <li>o May indicate changed drainage conditions, surface or subsurface.</li> </ul>	<ul style="list-style-type: none"> <li>o Investigate cause; monitor &amp; record changes.</li> <li>o Consider horizontal or underdrains.</li> </ul>	<ul style="list-style-type: none"> <li>o Avoid directing water into distressed area.</li> <li>o Do not remove vegetation unless a hazard to travelling public.</li> </ul>

Note: 1) Always evaluate safety first, don't assume it's safe.  
2) Do not raise roadway until settlement cause has been evaluated.

# DEBRIS ON ROADWAY

## THINGS TO LOOK FOR

### A. Surface Cracking In Surrounding Areas

## SIGNIFICANCE OF OBSERVED FEATURE

- o Allows water infiltration.
- o May outline limits of distress.
- o May indicate potential major movement.

## COURSE OF ACTION

- o Investigate cause of cracking.
- o Record size, location, & extent; periodically monitor.
- o Consider sealing cracks.
- o Monitor for roadway movement with pins and record.
- o If movement continues, seek help.

## THINGS TO AVOID

- o Avoid loading of distressed area.

### B. Blocked, Leaking or Otherwise Defective Septic Systems Outside R/W

- o May add water to the problem area.
- o May be the cause of the problems.
- o May cause future problem.

- o Investigate cause.
- o Properly drain.
- o Redirect water if practical.
- o Seek advice.
- o Reconstruct or protect eroded area if practical.

- o Do not direct water towards problem area.
- o Do not over excavate when cleaning drainage.

### C. Erosion by Natural Drainage (Including stream flow, springs, lakes, and channel changes)

- o May be the cause of distress.
- o Unless altered, may reoccur or progress to travel way.
- o May be adding water to distressed area.
- o Constructed side slopes may be too steep.

- o Monitor & record changes in distress.
- o Monitor & record changes in water volume, color, or level.

- o Avoid sudden change in water levels where controllable.
- o Avoid blocking natural drainage courses or springs.

### D. Bulging or Slope Movement

- o May indicate location of movement.
- o May indicate swelling soils.
- o May indicate frost heave areas.

- o Monitor & record locations, changes in size or shape.
- o Be prepared to close road if changing rapidly.
- o If movement continues, seek help.

- o Do not disturb until stability evaluated.
- o Avoid loading distressed area.
- o Do not remove shrubs, bushes, grasses, etc.

### E. Tilting Features Such as Trees, Poles, Fences Walls, or Rails

- o May indicate additional distress.
- o May indicate changed drainage surface or subsurface.
- o May be source of future debris.
- o May indicate larger area of distress.

- o Investigate cause; monitor & record changes.
- o Consider horizontal or underdrains.

- o Avoid directing water into distressed area.
- o Do not remove vegetation unless a hazard to travelling public.

### F. Adjacent Land Use Changes, Construction, Mining, Logging, etc.

- o May be cause of distress.
- o Changes from agricultural to industrial, or commercial to urban may cause increased runoff.
- o May indicate changed drainage.
- o Debris may come from equipment disturbance.

- o Contact supervisor and/or owner.
- o Consider restraining structures, berms, fences, K-rail, etc.
- o Consider rerouting traffic.
- o Drain properly.

- o Do not block drainage with retaining structures.

Note: 1) Always evaluate safety first, don't assume it's safe.  
2) Determine type of debris - rock, rock and soil, etc. - to help establish source; look for more loose debris before cleaning up roadway.

# TILTING FEATURES: TREES, POLES, FENCES, WALLS, OR RAILS

<u>THINGS TO LOOK FOR</u>	<u>SIGNIFICANCE OF OBSERVED FEATURE</u>	<u>COURSE OF ACTION</u>	<u>THINGS TO AVOID</u>
A. Surface Cracking in Surrounding Areas	<ul style="list-style-type: none"> <li>o Allows water infiltration.</li> <li>o May outline limits of distress.</li> <li>o May indicate potential major movement.</li> </ul>	<ul style="list-style-type: none"> <li>o Investigate cause of cracking.</li> <li>o Record size, location, &amp; extent; periodically monitor.</li> <li>o Consider sealing cracks.</li> <li>o Monitor for roadway movement with pins and record.</li> <li>o If movement continues, seek help.</li> </ul>	<ul style="list-style-type: none"> <li>o Avoid loading of distressed area.</li> </ul>
B. Blocked, Leaking or Otherwise Malfunctioning Drainage; Septic Systems Outside R/W	<ul style="list-style-type: none"> <li>o May add water to the problem area.</li> <li>o May be the cause of the problems.</li> <li>o May cause future problem.</li> </ul>	<ul style="list-style-type: none"> <li>o Investigate cause.</li> <li>o Properly drain.</li> <li>o Redirect water if practical.</li> <li>o Seek advice.</li> <li>o Reconstruct or protect eroded area if practical.</li> </ul>	<ul style="list-style-type: none"> <li>o Do not direct water towards problem area.</li> <li>o Do not over excavate when cleaning drainage.</li> </ul>
C. Erosion by Natural Drainage (Including stream flow, springs, lakes, and channel changes)	<ul style="list-style-type: none"> <li>o May be the cause of distress.</li> <li>o Unless altered may reoccur or progress to travel way.</li> <li>o May be adding water to distressed area.</li> <li>o Constructed side slopes may be too steep.</li> </ul>	<ul style="list-style-type: none"> <li>o Monitor &amp; record changes in distress.</li> <li>o Monitor &amp; record changes in water volume, color, or level.</li> </ul>	<ul style="list-style-type: none"> <li>o Avoid sudden change in water levels where controllable.</li> <li>o Avoid blocking natural drainage courses or springs.</li> <li>o Avoid removal of beneficial vegetation.</li> </ul>
D. Bulging or Slope Movement	<ul style="list-style-type: none"> <li>o May indicate location of movement.</li> <li>o May indicate swelling soils.</li> <li>o May indicate frost heave areas.</li> </ul>	<ul style="list-style-type: none"> <li>o Monitor &amp; record locations, changes in size or shape.</li> <li>o Be prepared to close road if changing rapidly.</li> <li>o If movement continues, seek help.</li> </ul>	<ul style="list-style-type: none"> <li>o Do not disturb until stability evaluated.</li> <li>o Avoid loading distressed area.</li> <li>o Do not remove shrubs, bushes, grasses, etc.</li> </ul>
E. Wasting of Materials on Slope (side casting)	<ul style="list-style-type: none"> <li>o May be causing settlement.</li> <li>o May block natural or designed drainage.</li> <li>o May cause moisture to collect, i.e., snow melt or rainfall collection.</li> </ul>	<ul style="list-style-type: none"> <li>o Remove existing waste material if practical.</li> <li>o Properly drain.</li> <li>o Use designated waste areas.</li> </ul>	<ul style="list-style-type: none"> <li>o Avoid wasting or stock piling material at this location.</li> </ul>
F. Adjacent Land Use Changes, Construction, Mining, Logging, etc.	<ul style="list-style-type: none"> <li>o May be cause of distress.</li> <li>o Changes from agricultural to industrial or commercial to urban may cause increased runoff.</li> </ul>	<ul style="list-style-type: none"> <li>o Investigate activities and contact supervisor, and/or owner.</li> </ul>	<ul style="list-style-type: none"> <li>o Do not grant access or permits within the distressed area.</li> </ul>

Note: 1) Always evaluate safety first, don't assume it's safe.  
2) Consider removing only those features hazardous to travelling public.

# UPLIFTING OF ROADWAYS

## THINGS TO LOOK FOR

### A. Surface Cracking in Surrounding Areas

## SIGNIFICANCE OF OBSERVED FEATURE

- o Allows water infiltration.
- o May outline limits of distress.
- o May indicate potential major movement.

## COURSE OF ACTION

- o Investigate cause of cracking.
- o Record size, location, & extent; periodically monitor.
- o Consider sealing cracks.
- o Monitor for roadway movement with pins and record.
- o If movement continues, seek help.

## THINGS TO AVOID

- o Avoid loading of distressed area.

### B. Blocked, Leaking or Otherwise Malfunctioning Drainage or Septic Systems Outside R/W

- o May add water to the problem area.
- o May be the cause of the problems.
- o May cause future problem.

- o Investigate cause.
- o Properly drain.
- o Redirect water if practical.
- o Seek advice.
- o Reconstruct or protect eroded area if practical.

- o Do not direct water towards problem area.
- o Do not over excavate when cleaning drainage.

### C. Tilting Features Such as Trees, Poles, Fences Walls, or Rails

- o May indicate movements and outline limits of distress area.
- o May indicate changed drainage conditions, surface or subsurface.
- o May indicate overloading of adjacent areas.

- o Investigate cause; monitor & record changes.
- o Consider horizontal or underdrains.
- o Remove material causing adjacent overload if practical.

- o Avoid directing water into distressed area.
- o Do not remove vegetation unless a hazard to travelling public.

### D. Bulging or Slope Movement

- o May indicate location of movement.
- o May indicate swelling soils.
- o May indicate frost heave areas.

- o Monitor & record locations, changes in size or shape.
- o Be prepared to close road if changing rapidly.
- o If movement continues, seek help.

- o Do not disturb until stability evaluated.
- o Avoid loading distressed area.
- o Do not remove shrubs, bushes, grasses, etc.

### E. Debris on Roadway

- o May indicate erosion or freeze-thaw action.
- o May indicate slope failure above road.
- o May indicate near future movement and debris.
- o May indicate ongoing work above roadway.

- o Remove debris from roadway.
- o Investigate cause; monitor & record.
- o Reestablish vegetation.
- o Drain properly.
- o Consider retaining structures, i.e., fences, berms, etc.
- o If debris continues, seek help.

- o Remove only as necessary.
- o Do not undercut slope to increase storage area.
- o Do not waste material on slopes (side cast).

### F. Adjacent Land Use Changes, Construction, Mining, Logging, etc.

- o May be cause of distress.
- o Changes from agricultural to industrial or commercial to urban may cause increased runoff.

- o Consider ramping over uplift or rerouting traffic.
- o Contact supervisor and/or owner.

- o Avoid overloading when ramping over--additional sliding may result.

Note: 1) Always evaluate safety first, don't assume it's safe.  
 2) May be toe of a slide up slope from roadway.  
 Consider ramping over, do not cut until evaluated.

# CRACKING OF PAYEMENT, SHOULDERS, DITCHES, OR ADJACENT AREAS

<u>THINGS TO LOOK FOR</u>	<u>SIGNIFICANCE OF OBSERVED FEATURE</u>	<u>COURSE OF ACTION</u>	<u>THINGS TO AVOID</u>
A. Blocked, Leaking or Otherwise Malfunctioning Drainage; Septic Systems Outside R/M	<ul style="list-style-type: none"> <li>o May add water to the problem area.</li> <li>o May be the cause of the problems.</li> <li>o May cause future problem.</li> </ul>	<ul style="list-style-type: none"> <li>o Investigate cause.</li> <li>o Properly drain.</li> <li>o Redirect water if practical.</li> <li>o Seek advice.</li> <li>o Reconstruct or protect eroded area if practical.</li> </ul>	<ul style="list-style-type: none"> <li>o Do not direct water towards problem area.</li> <li>o Do not overexcavate when clearing drainage.</li> </ul>
B. Slope Cracking	<ul style="list-style-type: none"> <li>o May outline distress limits.</li> <li>o May be first indication of major movements.</li> <li>o May be removing roadway support causing cracking.</li> </ul>	<ul style="list-style-type: none"> <li>o Investigate cause of cracking.</li> <li>o Record size, location, &amp; extent; periodically monitor.</li> <li>o Consider sealing cracks.</li> <li>o Monitor for roadway movement with pins and record.</li> <li>o If movement continues, seek help.</li> </ul>	<ul style="list-style-type: none"> <li>o Avoid directing water to distressed areas.</li> <li>o Avoid removing vegetation; shrubs, brushes, grasses, etc.</li> <li>o Avoid dumping waste material in distressed area.</li> </ul>
C. Erosion by Natural Drainage (Including stream flow, springs, lakes, and channel changes)	<ul style="list-style-type: none"> <li>o May indicate deteriorated pipes or structures.</li> <li>o May indicate new springs or drainages.</li> </ul>	<ul style="list-style-type: none"> <li>o Repair erosion, if practical.</li> <li>o Properly drain.</li> <li>o Be prepared to close road if changing rapidly.</li> <li>o If movement continues, seek help.</li> </ul>	<ul style="list-style-type: none"> <li>o Avoid sudden change in water levels where controllable.</li> <li>o Avoid blocking natural drainage courses or springs.</li> <li>o Avoid removal of beneficial vegetation.</li> </ul>
D. Bulging or Slope Movement	<ul style="list-style-type: none"> <li>o May indicate location of movement.</li> <li>o May indicate swelling soils.</li> <li>o May indicate frost heave areas.</li> </ul>	<ul style="list-style-type: none"> <li>o Monitor &amp; record locations, and changes in size or shape.</li> <li>o Be prepared to close road if changing rapidly.</li> <li>o If movement continues, seek help.</li> </ul>	<ul style="list-style-type: none"> <li>o Do not disturb until stability evaluated.</li> <li>o Avoid loading distressed area.</li> <li>o Do not remove shrubs, grasses, etc.</li> </ul>
E. Wasting of Materials on Slope (side casting)	<ul style="list-style-type: none"> <li>o May be causing settlement.</li> <li>o May block natural or designed drainage.</li> <li>o May cause moisture to collect, i.e., snow melt or rainfall collection.</li> </ul>	<ul style="list-style-type: none"> <li>o Remove existing waste material if practical.</li> <li>o Properly drain.</li> <li>o Use designated waste areas.</li> </ul>	<ul style="list-style-type: none"> <li>o Avoid piling material at this location.</li> </ul>
F. Tilting Features Such as Trees, Poles, Fences, Walls, or Rails	<ul style="list-style-type: none"> <li>o May indicate additional distress.</li> <li>o May indicate changed drainage surface or subsurface.</li> </ul>	<ul style="list-style-type: none"> <li>o Evaluate cause of tilting.</li> <li>o Consider horizontal or underdrains.</li> </ul>	<ul style="list-style-type: none"> <li>o Avoid directing water into distressed area.</li> <li>o Do not remove vegetation unless a hazard to traveling public.</li> </ul>

Note: 1) Always evaluate safety first, don't assume it's safe.  
 2) Consider: Monitoring cracks for movement, sealing to keep water out.  
 3) Rapidly changing cracks may indicate imminent future movement of a larger extent.



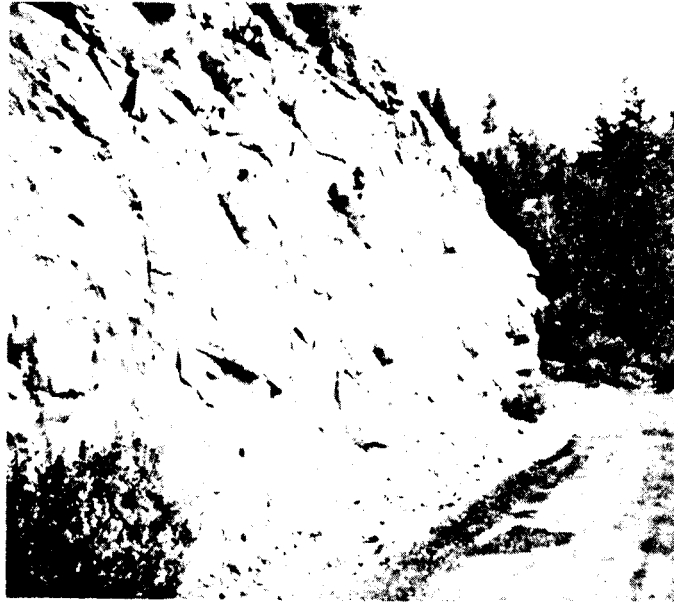
# CHANGES IN DRAINAGE

<u>THINGS TO LOOK FOR</u>	<u>SIGNIFICANCE OF OBSERVED FEATURE</u>	<u>COURSE OF ACTION</u>	<u>THINGS TO AVOID</u>
A. Blocked Drainage--Culverts, Entrances, Outlets or Inside, Ditches; Underdrains, Horizontal Drains, Natural Drains, Creeks, Gulleys, Springs	<ul style="list-style-type: none"> <li>o May add water to the problem area.</li> <li>o May be the cause of the problems.</li> <li>o May cause future problem.</li> </ul>	<ul style="list-style-type: none"> <li>o Investigate cause, and correct drainage.</li> </ul>	<ul style="list-style-type: none"> <li>o Do not direct water into distress area.</li> <li>o Do not overexcavate when cleaning drainage.</li> </ul>
B. Leaking Drainage - Pipe Separation Lined Ditch Joints, Septic Systems Outside R/W	<ul style="list-style-type: none"> <li>o May be adding water to problem area.</li> <li>o May cause future distress.</li> </ul>	<ul style="list-style-type: none"> <li>o Investigate cause, and correct drainage.</li> </ul>	<ul style="list-style-type: none"> <li>o Do not reroute where additional distress will result.</li> </ul>
C. Rerouted Drainage	<ul style="list-style-type: none"> <li>o May add water to problem.</li> <li>o May cause additional distress.</li> </ul>	<ul style="list-style-type: none"> <li>o Evaluate new route; correct if necessary.</li> </ul>	<ul style="list-style-type: none"> <li>o Do not direct water into distress areas.</li> </ul>
D. Raised or Lowered Roadway Shoulder, Guard Rail, or Adjacent Areas Such as Walls, Fences, Poles, or Rails	<ul style="list-style-type: none"> <li>o May block drainage.</li> <li>o May separate drain pipe.</li> </ul>	<ul style="list-style-type: none"> <li>o Investigate cause; monitor &amp; record.</li> <li>o Drain properly.</li> <li>o Consider traffic realignment.</li> </ul>	<ul style="list-style-type: none"> <li>o Do not cut or fill grade until cause evaluated.</li> </ul>
E. Surface Cracking in Surrounding Areas	<ul style="list-style-type: none"> <li>o Allows water infiltration.</li> <li>o May outline limits of distress.</li> <li>o May indicate potential major movement.</li> </ul>	<ul style="list-style-type: none"> <li>o Investigate cause of cracking.</li> <li>o Record size, location, &amp; extent; periodically monitor.</li> <li>o Consider sealing cracks.</li> <li>o Monitor for roadway movement with pins and record.</li> <li>o If movement continues, seek help.</li> </ul>	<ul style="list-style-type: none"> <li>o Avoid loading of distressed area.</li> </ul>
F. Vegetation Changes Such As: Tilting, Dying, New Green Areas, New Cat Tail Locations	<ul style="list-style-type: none"> <li>o May indicate slope movement.</li> <li>o May indicate changed drainage conditions, surface or subsurface.</li> </ul>	<ul style="list-style-type: none"> <li>o Investigate cause; monitor &amp; record changes.</li> <li>o Consider horizontal or underdrains.</li> </ul>	<ul style="list-style-type: none"> <li>o Avoid directing water into distressed area.</li> <li>o Do not remove vegetation unless a hazard to travelling public.</li> </ul>
G. Bulging or Slope Movement	<ul style="list-style-type: none"> <li>o May indicate location of distress.</li> <li>o May indicate swelling soils.</li> <li>o May indicate frost heave areas.</li> </ul>	<ul style="list-style-type: none"> <li>o Monitor &amp; record locations, and changes in size or shape.</li> <li>o Be prepared to close road if changing rapidly.</li> <li>o If movement continues, seek help.</li> </ul>	<ul style="list-style-type: none"> <li>o Do not disturb until stability evaluated.</li> <li>o Avoid loading distressed area.</li> <li>o Do not remove shrubs, bushes, grasses, etc.</li> </ul>
H. Adjacent Land Use Changes, Construction, Mining, Logging, etc.	<ul style="list-style-type: none"> <li>o May be cause of distress.</li> <li>o Agricultural to industrial or commercial to urban--increased runoff.</li> </ul>	<ul style="list-style-type: none"> <li>o Investigate activities &amp; notify supervisor, and/or owner.</li> </ul>	<ul style="list-style-type: none"> <li>o Do not grant access or permits within the distressed area.</li> </ul>
I. Springs - New, Discolored or Changed Volume	<ul style="list-style-type: none"> <li>o May develop from changed drainage.</li> </ul>	<ul style="list-style-type: none"> <li>o Drain properly.</li> </ul>	<ul style="list-style-type: none"> <li>o Avoid wasting in drainages or spring areas.</li> </ul>

Note: 1) Always evaluate safety first, don't assume it's safe.  
 2) Avoid ponding of water.



## **Features**

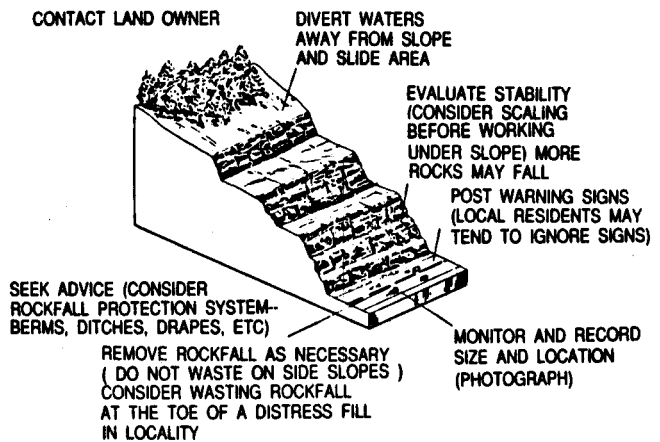
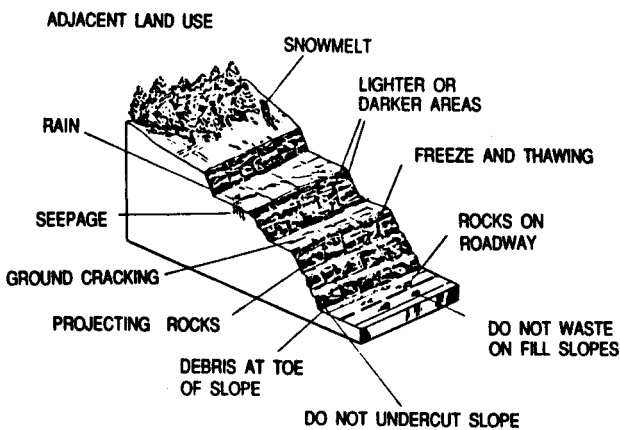


**ROCKFALL FROM MASSIVE ROCK SLOPES  
(PRESLIDE AND SLIDE CONDITIONS)**

Rockfall from massive rock slopes occurs as a result of rock weathering, rainfall, snowmelt, and freezing and thawing. Very often the massive rock cut is jointed. Falling rocks range in sizes. Water seeps along the joints eroding contact points between pieces and causing falls. Also, the water in the joints freezes and thaws which widens the joints and causes pieces of rock to fall. Distress signs are shown in the sketch below and in the accompanying table.

**ROCKFALL FROM MASSIVE ROCK SLOPES --  
MAINTENANCE SUPERVISOR AND CREW'S  
ACTIONS**

Rock falls should receive careful and immediate attention since the debris on the roadway may cause serious accidents by motorist either hitting the debris or attempting to avoid hitting the debris and to minimize future uncontrolled rockfall. The supervisor should consider scaling the slope before working under. DO NOT leave equipment parked under the slope. If it appears that more rockfall may occur in the future (SEEK ADVICE from the geotechnical staff or consultant and/or geologist if you are not sure), or if rock falls occur a second time, consider constructing a slope protection method such as berms, slope drapes, catchment fence, and etc. Suggested actions by the maintenance supervisor and crew to follow are shown in the sketch below and the accompanying table.



# ROCKFALL FROM MASSIVE ROCK SLOPES

## THINGS TO LOOK FOR

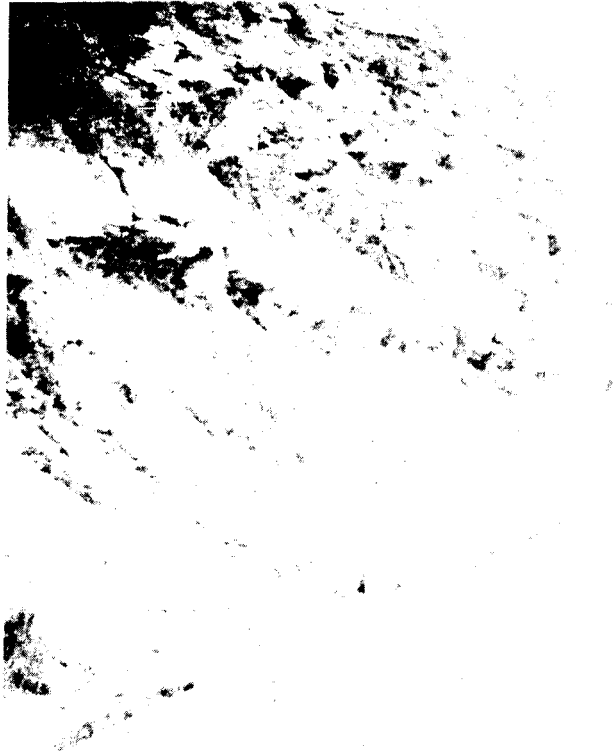
## SIGNIFICANCE OF OBSERVED FEATURE

## COURSE OF ACTION

## THINGS TO AVOID

<p>A. Individual rocks or groups of rock on roadway.</p>	<ul style="list-style-type: none"> <li>o More debris may fall in future.</li> </ul>	<ul style="list-style-type: none"> <li>o Consider scaling prior to working under slope, or to minimize future uncontrolled rockfall.</li> <li>o Remove rockfall as necessary.</li> </ul>	<ul style="list-style-type: none"> <li>o Avoid wasting rockfall on fill slopes.</li> <li>o Avoid undercutting slope when cleaning ditch or to increase storage area.</li> </ul>
<p>B. Debris at toe of slope, or on slope.</p>	<ul style="list-style-type: none"> <li>o Expect more debris.</li> </ul>	<ul style="list-style-type: none"> <li>o Consider scaling prior to working under slope, or to minimize future uncontrolled rockfall.</li> <li>o Remove rockfall as necessary.</li> </ul>	<ul style="list-style-type: none"> <li>o Avoid wasting rockfall on fill slopes.</li> <li>o Avoid undercutting slope when cleaning ditch or to increase storage area.</li> </ul>
<p>C. Irregular slope surfaces with projecting rocks. Rocks being exposed more and more.</p>	<ul style="list-style-type: none"> <li>o Expect additional rockfall.</li> <li>o Rock exposures may indicate the beginning of a slide.</li> </ul>	<ul style="list-style-type: none"> <li>o Consider scaling prior to working under slope, or to minimize future uncontrolled rockfall.</li> <li>o Remove rockfall as necessary.</li> </ul>	<ul style="list-style-type: none"> <li>o Avoid wasting rockfall on fill slopes.</li> <li>o Avoid undercutting slope when cleaning ditch or to increase storage area.</li> </ul>
<p>D. Lighter or darker areas on slope.</p>	<ul style="list-style-type: none"> <li>o May be source of rockfall.</li> </ul>	<ul style="list-style-type: none"> <li>o Consider scaling prior to working under slope, or to minimize future uncontrolled rockfall.</li> <li>o Remove rockfall as necessary.</li> </ul>	<ul style="list-style-type: none"> <li>o Avoid wasting rockfall on fill slopes.</li> <li>o Avoid undercutting slope when cleaning ditch or to increase storage area.</li> </ul>
<p>E. Ground cracking around rock source area.</p>	<ul style="list-style-type: none"> <li>o May outline disturbed areas which may yield future rockfall.</li> </ul>	<ul style="list-style-type: none"> <li>o Monitor &amp; record size, location.</li> </ul>	<ul style="list-style-type: none"> <li>o Do not obliterate.</li> </ul>
<p>F. Adjacent land use changes logging, construction, mining, etc.</p>	<ul style="list-style-type: none"> <li>o May be source of rockfall.</li> <li>o Expect additional rockfall until use changes.</li> </ul>	<ul style="list-style-type: none"> <li>o Contact your supervisor and/or land owner.</li> </ul>	

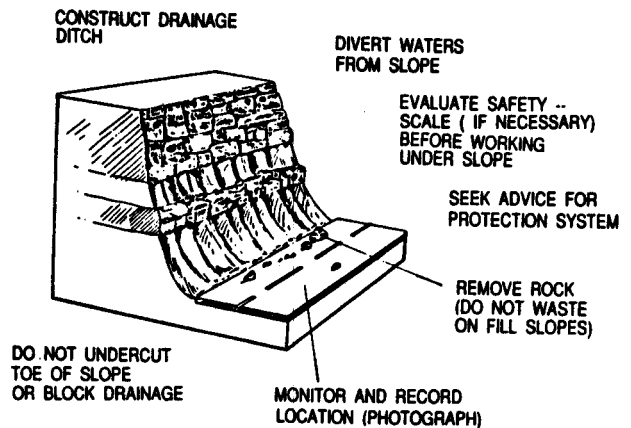
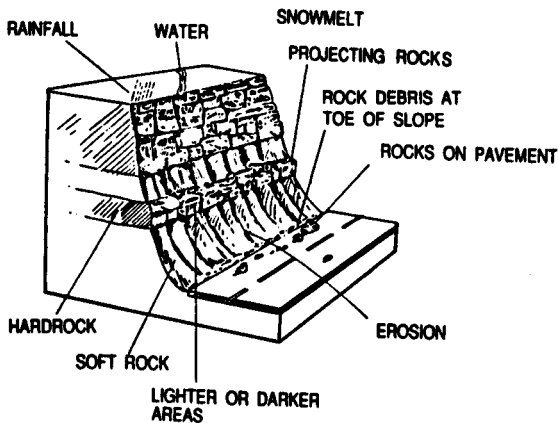
Note: 1) Always evaluate safety first, don't assume it safe.  
 2) Consider rockfall protection system: berms, ditches, fences, slope drapes, bolting, widening at grade, etc.



**ROCKFALL FROM DIFFERENTIAL WEATHERING --**

This situation develops when a harder rock is located on top of a softer rock. The softer rock (such as a clay shale) weathers or/and erodes much faster than the harder rocks (such as sandstone, limestone). The harder rocks project out over the softer rock and, as the support of the softer rock is lost, the harder rock eventually falls as shown in the sketch below. Light areas, in contrast to dark areas, on the slope indicate that observed fallen rock came from the slope and indicates that more rock may fall in the future.

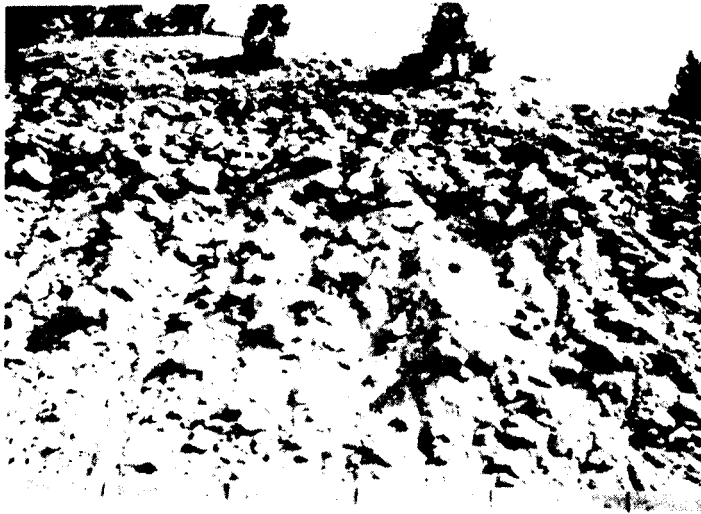
General actions that the maintenance supervisor and crew may follow for rockfall from differential weathering is shown in the sketch below and accompanying table.



## ROCKFALL FROM DIFFERENTIAL WEATHERING

<u>THINGS TO LOOK FOR</u>	<u>SIGNIFICANCE OF OBSERVED FEATURE</u>	<u>COURSE OF ACTION</u>	<u>THINGS TO AVOID</u>
A. Individual rocks or groups of rock on roadway.	<ul style="list-style-type: none"> <li>o More debris may fall in future.</li> </ul>	<ul style="list-style-type: none"> <li>o Consider scaling prior to working under slope, or to minimize future uncontrolled rockfall.</li> <li>o Remove rockfall as necessary.</li> </ul>	<ul style="list-style-type: none"> <li>o Avoid wasting rockfall on fill slopes.</li> <li>o Avoid undercutting slope when cleaning ditch or to increase storage area.</li> </ul>
B. Debris at toe of slope, or on slope.	<ul style="list-style-type: none"> <li>o More debris may fall in future.</li> </ul>	<ul style="list-style-type: none"> <li>o Consider scaling prior to working under slope, or to minimize future uncontrolled rockfall.</li> <li>o Remove rockfall as necessary.</li> </ul>	<ul style="list-style-type: none"> <li>o Avoid wasting rockfall on fill slopes.</li> <li>o Avoid undercutting slope when cleaning ditch or to increase storage area.</li> </ul>
C. Irregular surfaces projecting or over hanging rocks.	<ul style="list-style-type: none"> <li>o More debris may fall in future.</li> </ul>	<ul style="list-style-type: none"> <li>o Consider scaling prior to working under slope, or to minimize future uncontrolled rockfall.</li> <li>o Remove rockfall as necessary.</li> </ul>	<ul style="list-style-type: none"> <li>o Avoid wasting rockfall on fill slopes.</li> <li>o Avoid undercutting slope when cleaning ditch or to increase storage area.</li> </ul>
D. Lighter or darker areas on slope.	<ul style="list-style-type: none"> <li>o More debris may fall in future.</li> <li>o May indicate sources of debris and may establish rate of erosion or weathering.</li> </ul>	<ul style="list-style-type: none"> <li>o Consider scaling prior to working under slope, or to minimize future uncontrolled rockfall.</li> <li>o Remove rockfall as necessary.</li> </ul>	<ul style="list-style-type: none"> <li>o Avoid wasting rockfall on fill slopes.</li> <li>o Avoid undercutting slope when cleaning ditch or to increase storage area.</li> </ul>
E. Erosion	<ul style="list-style-type: none"> <li>o More debris may fall in future.</li> <li>o Soft areas of slope may be eroding leaving the rocks to fall down slope.</li> <li>o May result from inadequate or nonfunctioning drainage system.</li> </ul>	<ul style="list-style-type: none"> <li>o Remove rockfall as necessary.</li> <li>o Repair or improve drainage.</li> <li>o Seek advice for slope protection.</li> </ul>	<ul style="list-style-type: none"> <li>o Avoid wasting rockfall on fill slopes.</li> <li>o Avoid undercutting slope when cleaning ditch or to increase storage area.</li> <li>o Do not block drainage.</li> </ul>

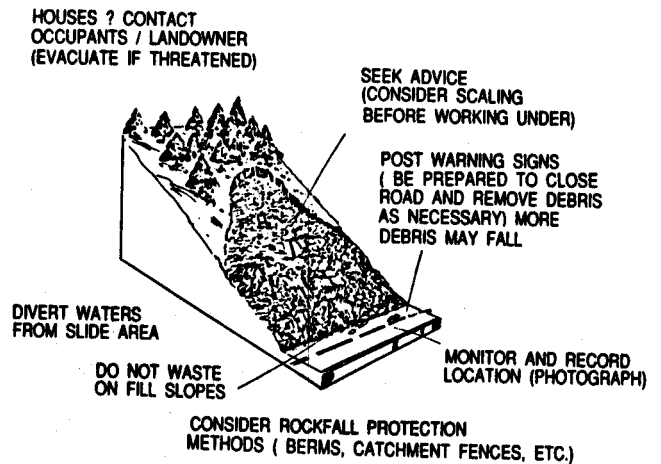
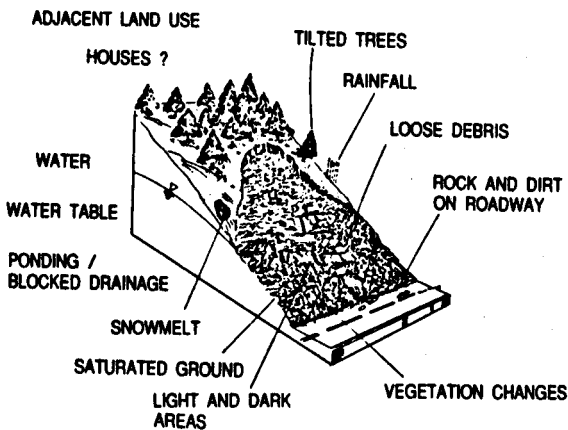
Note: 1) Always evaluate safety first, don't assume it safe.  
 2) Consider rockfall protection system: berms, ditches, fences, slope drapes, bolting, widening at grade, etc.



**ROCKFALL FROM A TALUS SLOPE (PRESLIDE AND SLIDE CONDITIONS)**

Talus is a pile of rock or boulder debris or fragments on a slope below a rock face. This type of material above the highway is prone to failure because of groundwater seepage and seepage into the talus pile from rainfall and snowmelt. Distress signs are shown in the sketch below and the accompanying table.

**ROCKFALL FROM A TALUS SLOPE -- MAINTENANCE SUPERVISOR AND CREW'S ACTIONS**





# ROCKFALL FROM A TALUS SLOPE

<u>THINGS TO LOOK FOR</u>	<u>SIGNIFICANCE OF OBSERVED FEATURE</u>	<u>COURSE OF ACTION</u>	<u>THINGS TO AVOID</u>
A. Rock and dirt piled on roadway.	<ul style="list-style-type: none"> <li>o May indicate instability. Rockfall may be warning of larger slide.</li> <li>o More debris may fall in future.</li> </ul>	<ul style="list-style-type: none"> <li>o Monitor &amp; record location.</li> <li>o Be prepared to close road and remove rockfall as necessary.</li> <li>o Properly drain.</li> <li>o Seek advice.</li> </ul>	<ul style="list-style-type: none"> <li>o Avoid wasting material on fill slopes.</li> <li>o Avoid undercutting slope when cleaning ditch or to increase storage area.</li> <li>o Don't block drainage.</li> </ul>
B. Loose debris on slope.	<ul style="list-style-type: none"> <li>o May indicate instability. Rockfall may be warning of larger slide.</li> <li>o More debris may fall in future.</li> <li>o Could be sources of rockfall.</li> </ul>	<ul style="list-style-type: none"> <li>o Monitor &amp; record location.</li> <li>o Be prepared to close road and remove rockfall as necessary.</li> <li>o Consider scaling prior to working under slope, or to minimize future uncontrolled rockfall.</li> <li>o Seek advice.</li> </ul>	<ul style="list-style-type: none"> <li>o Avoid wasting material on fill slopes.</li> <li>o Avoid undercutting slope when cleaning ditch or to increase storage area.</li> <li>o Don't block drainage.</li> </ul>
C. Lighter or darker areas on slope.	<ul style="list-style-type: none"> <li>o May indicate instability. Rockfall may be warning of larger slide.</li> <li>o More debris may fall in future.</li> <li>o Could be sources of rockfall.</li> <li>o May indicate changed water conditions.</li> </ul>	<ul style="list-style-type: none"> <li>o Monitor &amp; record location.</li> <li>o Properly drain.</li> </ul>	
D. Tilted features, such as trees, poles, fences, walls	<ul style="list-style-type: none"> <li>o May indicate instability. Rockfall may be warning of larger slide.</li> <li>o More debris may fall in future.</li> </ul>	<ul style="list-style-type: none"> <li>o Monitor &amp; record location.</li> <li>o Consider scaling prior to working under slope, or to minimize future uncontrolled rockfall.</li> </ul>	<ul style="list-style-type: none"> <li>o Don't block drainage.</li> </ul>
E. Springs & vegetation changes.	<ul style="list-style-type: none"> <li>o May indicate instability. Rockfall may be warning of larger slide.</li> <li>o More debris may fall in future.</li> <li>o May indicate changed water conditions.</li> <li>o May cause instability.</li> </ul>	<ul style="list-style-type: none"> <li>o Monitor &amp; record location.</li> <li>o Properly drain.</li> <li>o Seek advice.</li> </ul>	<ul style="list-style-type: none"> <li>o Don't block drainage.</li> </ul>
F. Blocked drainage or changes in drainage.	<ul style="list-style-type: none"> <li>o May indicate instability. Rockfall may be warning of larger slide.</li> <li>o More debris may fall in future.</li> <li>o May cause instability.</li> </ul>	<ul style="list-style-type: none"> <li>o Monitor &amp; record location.</li> <li>o Be prepared to close road and remove rockfall as necessary.</li> <li>o Properly drain.</li> <li>o Seek advice.</li> </ul>	<ul style="list-style-type: none"> <li>o Avoid wasting material on fill slopes.</li> <li>o Avoid undercutting slope when cleaning ditch or to increase storage area.</li> </ul>
G. Adjacent land use changes logging, mining, construction, etc.	<ul style="list-style-type: none"> <li>o May indicate instability. Rockfall may be warning of larger slide.</li> <li>o More debris may fall in future.</li> <li>o Could be sources of rockfall.</li> <li>o May cause instability.</li> </ul>	<ul style="list-style-type: none"> <li>o Monitor &amp; record location.</li> <li>o Be prepared to close road and remove rockfall as necessary.</li> <li>o Properly drain.</li> <li>o Contact your supervisor and/or land owner.</li> </ul>	<ul style="list-style-type: none"> <li>o Avoid wasting material on fill slopes.</li> <li>o Avoid undercutting slope when cleaning ditch or to increase storage area.</li> <li>o Don't block drainage.</li> </ul>

Note: 1) Always evaluate safety first, don't assume it safe.  
 2) Consider rockfall protection system: berms, ditches, fences, slope drapes, bolting, widening at grade, etc.



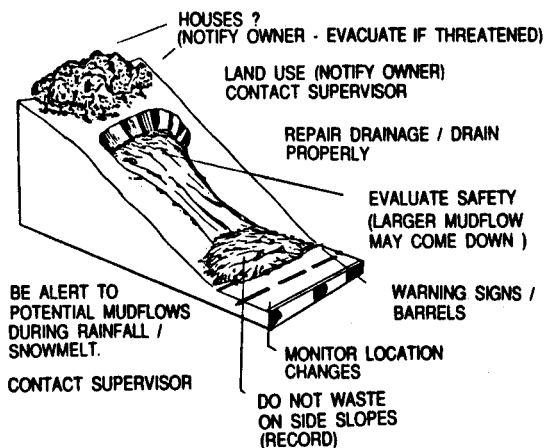
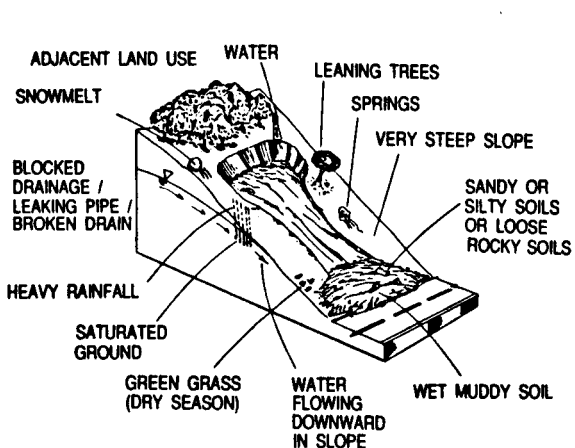
**TYPE A SLIDE ABOVE ROAD-MUDFLOW (PRESIDE AND SLIDE CONDITIONS)**

Mudflows consist of highly saturated soils that simply flow (like water) down slopes. Mudflows most often occur without warning during or shortly after very heavy rainstorms or when snowmelt occurs. The flowing mass is completely saturated with water. Mudflows oftentimes occur in soils that are sandy and silty with or without small amounts of clays and are located on steep slopes. Conditions to look for are shown in the sketch.

**TYPE A SLIDE ABOVE ROAD -- MUDFLOW -- MAINTENANCE SUPERVISOR AND CREW'S ACTIONS**

Suggested actions for the maintenance supervisor and crew to follow in reacting to a mudflow above the road are described in the sketch and accompanying table.

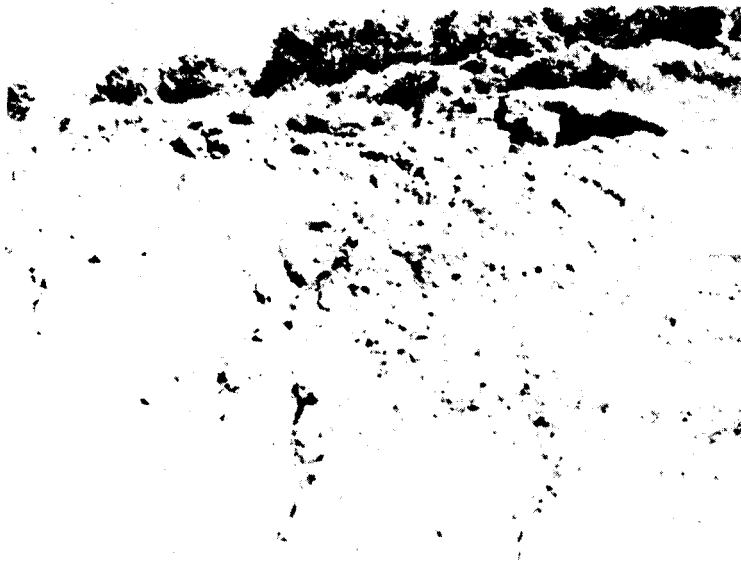
Actions to be followed by the maintenance supervisor and crew for mudflow conditions are summarized below in the sketch and accompanying table.



# TYPE A SLIDE ABOVE ROAD MUDFLOW

<u>THINGS TO LOOK FOR</u>	<u>SIGNIFICANCE OF OBSERVED FEATURE</u>	<u>COURSE OF ACTION</u>	<u>THINGS TO AVOID</u>
A. Wet muddy soil mass with or without rock and/or vegetation flowing onto the roadway.	<ul style="list-style-type: none"> <li>o May be a large unstable mass still to come down.</li> </ul>	<ul style="list-style-type: none"> <li>o Monitor and record location.</li> <li>o Drain properly.</li> </ul>	<ul style="list-style-type: none"> <li>o Stay out from under until stability evaluated.</li> <li>o Avoid wasting flow material on fill slopes.</li> </ul>
B. Bulging or surface waves.	<ul style="list-style-type: none"> <li>o May be a large unstable mass still to come down.</li> <li>o May indicate saturated mass that will become a liquid flow.</li> <li>o May indicate further water sources or outlets.</li> <li>o May indicate a larger possible failure area.</li> </ul>	<ul style="list-style-type: none"> <li>o Monitor and record location.</li> <li>o Monitor for changes. If rapidly changing, evacuate area beneath; be prepared to close road.</li> <li>o Drain properly.</li> </ul>	<ul style="list-style-type: none"> <li>o Stay out from under until stability evaluated.</li> <li>o Do not disturb until stability evaluated.</li> </ul>
C. Blocked drainage.	<ul style="list-style-type: none"> <li>o May be causing bulging.</li> <li>o May make mass soupy, allowing it to flow downhill.</li> <li>o May be contributing water and thus to loss of stability.</li> </ul>	<ul style="list-style-type: none"> <li>o Monitor and record location.</li> <li>o Drain properly.</li> </ul>	
D. Springs.	<ul style="list-style-type: none"> <li>o May be a large unstable mass still to come down.</li> <li>o May indicate saturated mass that will become a liquid flow.</li> <li>o May be causing bulging.</li> <li>o May make mass soupy, allowing it to flow downhill.</li> <li>o May indicate a larger possible failure area.</li> </ul>	<ul style="list-style-type: none"> <li>o Monitor and record location.</li> <li>o Monitor for changes. If rapidly changing, evacuate area beneath, be prepared to close road.</li> <li>o Drain properly.</li> </ul>	
E. Green grass during inappropriate time of year.	<ul style="list-style-type: none"> <li>o May be a large unstable mass still to come down.</li> <li>o May indicate saturated mass that will become a liquid flow.</li> <li>o May indicate further water sources or outlets.</li> <li>o May indicate a larger possible failure area.</li> </ul>	<ul style="list-style-type: none"> <li>o Monitor and record location.</li> </ul>	
F. Adjacent land use changes Logging, Mining, Construction etc.	<ul style="list-style-type: none"> <li>o May be a large unstable mass still to come down.</li> <li>o May be cause of bulging.</li> <li>o May make mass soupy allowing it to flow downhill.</li> <li>o May be contributing water and to loss of stability.</li> </ul>	<ul style="list-style-type: none"> <li>o Monitor and record location.</li> <li>o Monitor for changes. If rapidly changing, evacuate area beneath, be prepared to close road.</li> <li>o Drain properly.</li> <li>o Contact your supervisor and/or land owner.</li> </ul>	<ul style="list-style-type: none"> <li>o Stay out from under until stability evaluated.</li> <li>o Avoid wasting flow material on fill slopes.</li> </ul>
G. Tilted features, such as trees, poles, walls, fences	<ul style="list-style-type: none"> <li>o May be a large unstable mass still to come down.</li> <li>o May indicate saturated mass that will become a liquid flow.</li> <li>o May indicate further water sources or outlets.</li> <li>o May be contributing water and to loss of stability.</li> <li>o May indicate a larger possible failure area.</li> </ul>	<ul style="list-style-type: none"> <li>o Monitor and record location.</li> <li>o Monitor for changes. If rapidly changing, evacuate area beneath, be prepared to close road.</li> </ul>	<ul style="list-style-type: none"> <li>o Stay out from under until stability evaluated.</li> <li>o Avoid wasting flow material on fill slopes.</li> </ul>

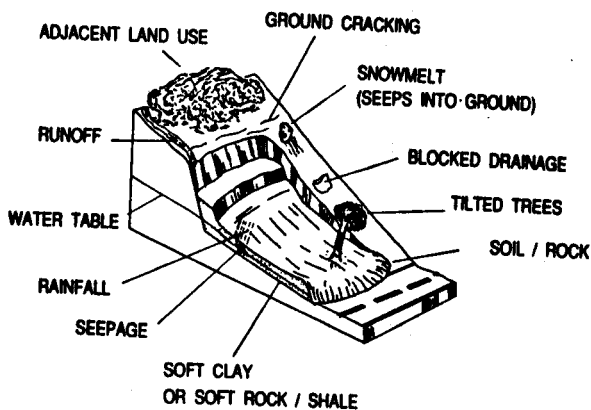
Note: 1) Always evaluate safety first, don't assume it safe.  
2) Be prepared for additional material on roadway.



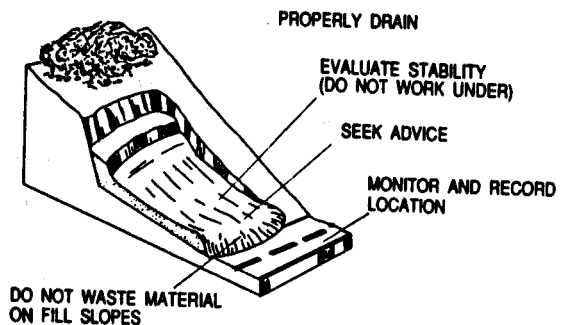
**TYPE B SLIDE ABOVE ROAD-WEDGE**

Wedge-shaped slides usually occur along a distinctive failure plane. usually the failure plane in the middle and lower portion of the slide is a soft clay of low strength or a silt layer sandwiched between two clay layers. The failure plane may also be along the bed rock surface.

**TYPE B SLIDE ABOVE ROAD -- WEDGE --  
MAINTENANCE SUPERVISOR AND CREW'S  
ACTIONS**



HOUSES ? CONTACT  
OCCUPANTS / OWNERS -  
EVACUATE IF THREATENED



## TYPE B SLIDE ABOVE ROAD WEDGE

<u>THINGS TO LOOK FOR</u>	<u>SIGNIFICANCE OF OBSERVED FEATURE</u>	<u>COURSE OF ACTION</u>	<u>THINGS TO AVOID</u>
A. Soil and/or rock and/or vegetation on roadway.	<ul style="list-style-type: none"> <li>o May result from inadequate or non-functioning drainage systems.</li> </ul>	<ul style="list-style-type: none"> <li>o Monitor and record location.</li> <li>o Seek advice.</li> </ul>	<ul style="list-style-type: none"> <li>o Avoid wasting material on fill slopes.</li> <li>o Do not work under until stability evaluated.</li> </ul>
B. Ground cracking in surrounding area.	<ul style="list-style-type: none"> <li>o May indicate additional unstable area.</li> <li>o May be contributing water and to loss of stability.</li> <li>o May result from inadequate or non-functioning drainage systems.</li> </ul>	<ul style="list-style-type: none"> <li>o Monitor and record location.</li> <li>o Properly drain.</li> <li>o Seek advice.</li> </ul>	<ul style="list-style-type: none"> <li>o Do not work under until stability evaluated.</li> </ul>
C. Tilted features, such as trees, poles, walls, fences	<ul style="list-style-type: none"> <li>o May indicate additional unstable area.</li> <li>o May result from inadequate or non-functioning drainage systems.</li> </ul>	<ul style="list-style-type: none"> <li>o Monitor and record location.</li> <li>o Consider removing tilted trees.</li> </ul>	<ul style="list-style-type: none"> <li>o Do not work under until stability evaluated.</li> </ul>
D. Springs	<ul style="list-style-type: none"> <li>o May be cause of slide and/or make problem worse.</li> <li>o May be contributing water and thus to loss of stability.</li> <li>o May result from inadequate or non-functioning drainage systems.</li> </ul>	<ul style="list-style-type: none"> <li>o Monitor and record location.</li> <li>o Properly drain.</li> <li>o Seek advice.</li> </ul>	
E. Blocked drainage.	<ul style="list-style-type: none"> <li>o May be cause of slide and/or make problem worse.</li> </ul>	<ul style="list-style-type: none"> <li>o Monitor and record location.</li> <li>o Properly drain.</li> </ul>	<ul style="list-style-type: none"> <li>o Avoid wasting material on fill slopes.</li> </ul>
F. Adjacent land use changes, i.e., logging, mining, construction, etc.	<ul style="list-style-type: none"> <li>o May be cause of slide and/or make problem worse.</li> <li>o May be contributing water and thus to loss of stability.</li> </ul>	<ul style="list-style-type: none"> <li>o Monitor and record location.</li> <li>o Properly drain.</li> <li>o Contact supervisor and/or land owner.</li> </ul>	<ul style="list-style-type: none"> <li>o Avoid wasting material on fill slopes.</li> <li>o Do not work under until stability evaluated.</li> </ul>

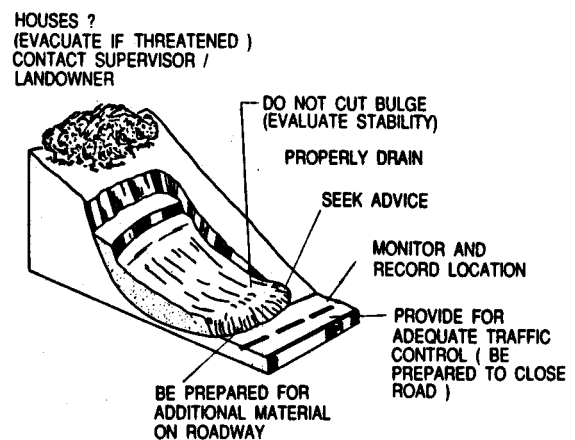
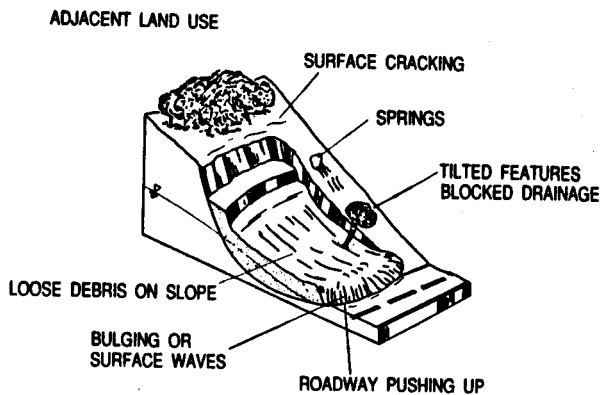
Note: 1) Always evaluate safety first, don't assume it safe.  
2) Be prepared for additional material on roadway.



**TYPE C SLIDE ABOVE ROAD -- ROTATIONAL (PRESLIDE AND SLIDE FEATURES)**

Rotational slides usually occur in fairly homogeneous materials. The failure plane is essentially circular and deep, and the mass of soil fails as a unit, although several scarps may be observed in the upper portions of the slide. The slide may occur in the fill or in the fill and foundation soils. Usually when the failure occurs in the fill and foundation, the soils of the fill and foundation have similar properties. Preslide and slide conditions are shown in the sketch and the accompanying table.

**TYPE C SLIDE ABOVE ROAD -- ROTATIONAL -- MAINTENANCE SUPERVISOR AND CREW'S ACTIONS**



# TYPE C SLIDE ABOVE ROAD ROTATIONAL

<u>THINGS TO LOOK FOR</u>	<u>SIGNIFICANCE OF OBSERVED FEATURE</u>	<u>COURSE OF ACTION</u>	<u>THINGS TO AVOID</u>
A. Roadway pushing up. Pavement elevation rising.	<ul style="list-style-type: none"> <li>o May indicate unstable slope above roadway.</li> <li>o May indicate additional unstable area.</li> </ul>	<ul style="list-style-type: none"> <li>o Monitor and record locations and changes. If moving rapidly, be prepared to close road.</li> <li>o Properly drain.</li> <li>o Provide for adequate traffic movement.</li> <li>o Seek advice.</li> </ul>	<ul style="list-style-type: none"> <li>o Avoid cutting push up, consider ramping over.</li> </ul>
B. Surface cracking - in surrounding area.	<ul style="list-style-type: none"> <li>o May indicate unstable slope above roadway.</li> <li>o May indicate additional unstable area.</li> <li>o May contribute water and to loss of stability.</li> </ul>	<ul style="list-style-type: none"> <li>o Monitor and record locations and changes. If moving rapidly, be prepared to close road.</li> <li>o Properly drain.</li> <li>o Provide for adequate traffic movement.</li> <li>o Seek advice.</li> </ul>	<ul style="list-style-type: none"> <li>o Avoid disturbing until stability evaluated.</li> </ul>
C. Springs.	<ul style="list-style-type: none"> <li>o May indicate unstable slope above roadway.</li> <li>o May indicate additional unstable area.</li> <li>o May contribute water and to loss of stability.</li> </ul>	<ul style="list-style-type: none"> <li>o Monitor and record locations and changes. If moving rapidly, be prepared to close road.</li> <li>o Properly drain.</li> <li>o Seek advice.</li> </ul>	<ul style="list-style-type: none"> <li>o Avoid disturbing until stability evaluated.</li> </ul>
D. Bulging or surface waves in slope.	<ul style="list-style-type: none"> <li>o May indicate unstable slope above roadway.</li> <li>o May indicate additional unstable area.</li> </ul>	<ul style="list-style-type: none"> <li>o Monitor and record locations and changes. If moving rapidly, be prepared to close road.</li> <li>o Properly drain.</li> <li>o Provide for adequate traffic movement.</li> </ul>	
E. Tilted features, such as trees, poles, walls, fences	<ul style="list-style-type: none"> <li>o May indicate unstable slope above roadway.</li> <li>o May indicate additional unstable area.</li> <li>o May contribute water and to loss of stability.</li> </ul>	<ul style="list-style-type: none"> <li>o Monitor and record locations and changes. If moving rapidly, be prepared to close road.</li> <li>o Properly drain.</li> <li>o Seek advice.</li> </ul>	
F. Blocked drainage, etc.	<ul style="list-style-type: none"> <li>o May indicate unstable slope above roadway.</li> <li>o May be cause of distress.</li> <li>o May contribute water and to loss of stability.</li> </ul>	<ul style="list-style-type: none"> <li>o Monitor and record locations and changes. If moving rapidly, be prepared to close road.</li> <li>o Properly drain.</li> <li>o Provide for adequate traffic movement.</li> <li>o Seek advice.</li> </ul>	
G. Adjacent land use changes, i.e., logging, mining, construction, etc.	<ul style="list-style-type: none"> <li>o May be cause of distress.</li> </ul>	<ul style="list-style-type: none"> <li>o Contact supervisor and/or land owner.</li> </ul>	
H. Loose debris on slope.	<ul style="list-style-type: none"> <li>o May indicate unstable slope above roadway.</li> <li>o May indicate additional unstable area.</li> </ul>	<ul style="list-style-type: none"> <li>o Monitor and record locations and changes. If moving rapidly, be prepared to close road.</li> </ul>	<ul style="list-style-type: none"> <li>o Avoid disturbing until stability evaluated.</li> </ul>

Note: 1) Always evaluate safety first, don't assume it safe.  
2) Be prepared for additional material on roadway.

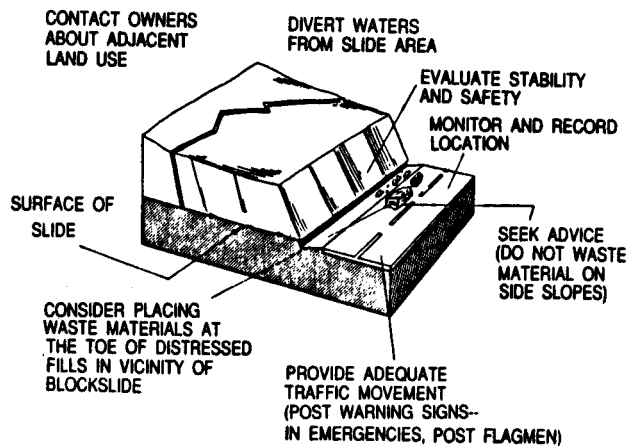
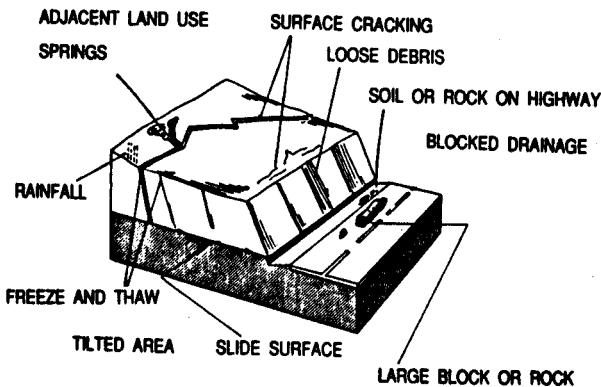


**TYPE D SLIDE ABOVE ROAD --  
BLOCKSLIDE--PRESLIDE AND SLIDE CONDITIONS**

Blockslides usually occur along a distinctive failure plane, or natural joints in rocks or soils. The failure planes usually consist of weak materials or joints. Blockslides may consist of large, massive units. A blockslide may fail as single unit of material or numerous units may fail at different times. These types of slides are usually extremely dangerous because they fail instantaneously without any warning.

**TYPE D SLIDE ABOVE ROAD -- BLOCKSLIDE --  
MAINTENANCE SUPERVISOR AND CREW'S  
ACTIONS**

The maintenance supervisor and crew should generally seek advice from the geotechnical staff or geotechnical consulting engineer when dealing with blockslides. DO NOT ASSUME BLOCKSLIDES ARE SAFE. ALWAYS EVALUATE STABILITY BEFORE WORKING PERSONNEL AND EQUIPMENT UNDER BLOCKSLIDE SLOPES. Suggested actions for the maintenance crew to follow in reacting to a blockslide are shown in the sketch below and detailed in the accompanying table.

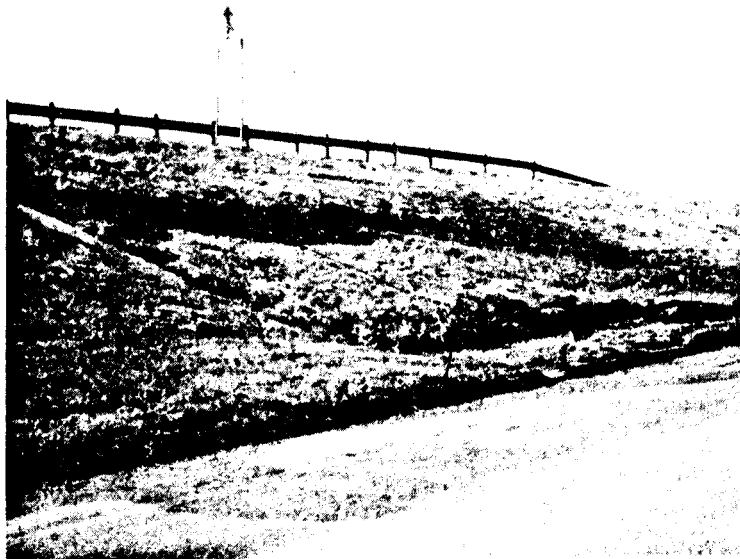




## TYPE D SLIDE ABOVE ROAD BLOCK SLIDE

<u>THINGS TO LOOK FOR</u>	<u>SIGNIFICANCE OF OBSERVED FEATURE</u>	<u>COURSE OF ACTION</u>	<u>THINGS TO AVOID</u>
A. Soil and/or rock on roadway.	o May indicate extensive distress.	o Monitor and record location. o Provide for adequate traffic movement. o Seek advice.	o Avoid working under until stability evaluated. o Avoid wasting material on fill slopes. o Avoid undercutting the slope during removal or ditch cleaning.
B. Springs	o May be cause of sliding.	o Monitor and record location. o Properly drain.	
C. Blocked drainage.	o May be cause of sliding.	o Monitor and record location. o Properly drain. o Provide for adequate traffic movement.	o Avoid wasting material on fill slopes. o Avoid undercutting the slope during removal or ditch cleaning.
D. Adjacent land use changes, i.e., logging, mining, construction, etc.	o May be cause of sliding.	o Monitor and record location. o Properly drain. o Provide for adequate traffic movement.	
E. Loose debris on remaining slope.	o May indicate extensive distress. o May indicate limits of distress.	o Monitor and record location. o Consider scaling. o Provide for adequate traffic movement.	o Avoid working under until stability evaluated. o Avoid wasting material on fill slopes.
F. Surface cracking in surrounding area.	o May indicate extensive distress. o May indicate limits of distress.	o Monitor and record location. o Properly drain. o Seek advice.	
G. Tilted features, such as trees, poles, walls, fences, etc.	o May indicate extensive distress. o May indicate limits of distress.	o Monitor and record location. o Provide for adequate traffic movement.	o Avoiding working under until stability evaluated. o Avoid undercutting the slope during removal or ditch cleaning.

Note: 1) Always evaluate safety first, don't assume it safe.  
2) Be prepared for additional material on roadway.

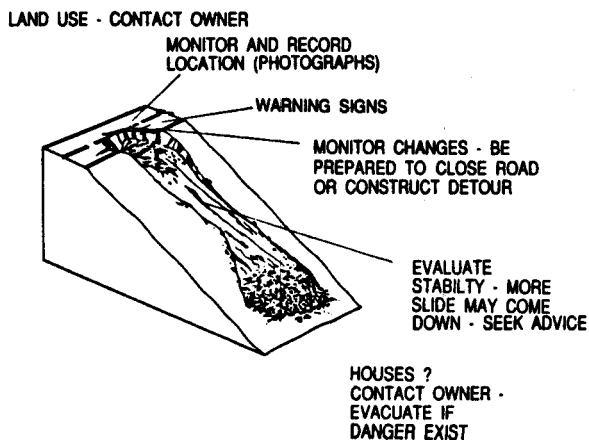
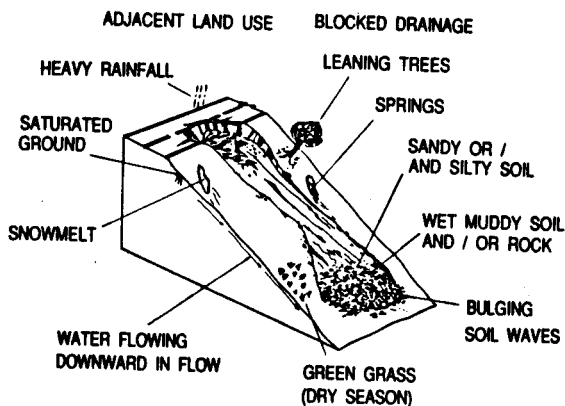


**TYPE A SLIDE BELOW ROAD -- MUDFLOW --  
PRESLIDE AND SLIDE CONDITIONS**

Comments concerning mudflows are the same as described in the discussion on TYPE A slide above the road -- mudflows. Distress signs are shown in the sketch below.

**TYPE A SLIDE BELOW ROAD -- MUDFLOW --  
MAINTENANCE SUPERVISOR AND CREWS  
ACTIONS**

Suggested actions for the maintenance supervisor and crew to follow in reacting to a mudflow below the roadway are shown in the sketch below and accompanying table.



# TYPE A SLIDE BELOW ROAD MUDFLOW

## THINGS TO LOOK FOR

A. Wet muddy soil mass with or without rock and/or vegetation - moving downslope.

B. Bulging or surface waves.

C. Blocked drainage.

D. Springs.

E. Green grass during inappropriate time of year.

F. Adjacent land use changes, i.e., Logging, Mining, Construction etc.

G. Tilted features, such as trees, poles, walls, fences etc.

## SIGNIFICANCE OF OBSERVED FEATURE

- o May progress up slope to roadway.
- o May progress up slope to roadway.
- o May indicate saturated mass that will become a liquid flow.
- o May indicate further water sources or outlets.
- o May indicate a larger possible failure area.
- o May make mass soupy, allowing it to flow downhill.
- o May be contributing water and thus to loss of stability.
- o May be causing bulging.
- o May indicate saturated mass that will become a liquid flow.
- o May make mass soupy, allowing it to flow downhill.
- o May indicate a larger possible failure area.
- o May be contributing water and thus to loss of stability.
- o May be causing bulging.
- o May indicate saturated mass that will become a liquid flow.
- o May indicate further water sources or outlets.
- o May indicate a larger possible failure area.
- o May make mass soupy, allowing it to flow downhill.
- o May be cause of bulging or flow.
- o May progress up slope to roadway.
- o May indicate saturated mass that will become a liquid flow.
- o May indicate further water sources or outlets.
- o May indicate a larger possible failure area.
- o My be contributing water and thus to loss of stability.

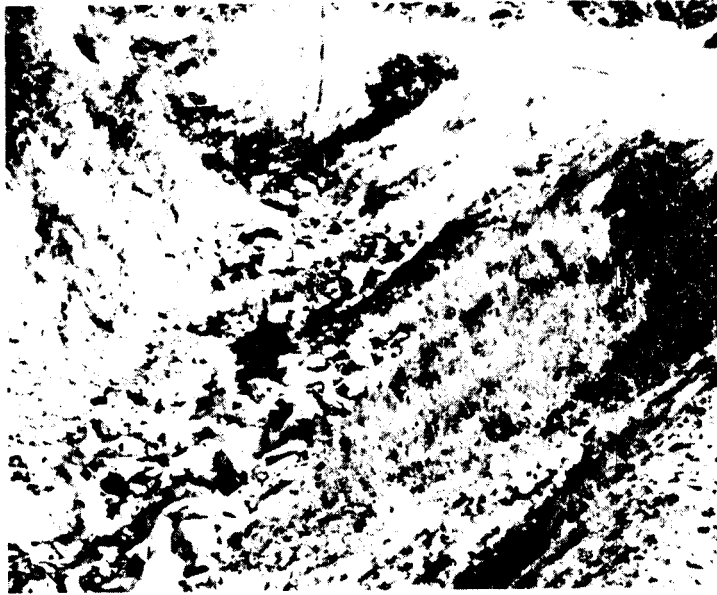
## COURSE OF ACTION

- o Monitor and record location.
- o Monitor for changes. If rapidly changing, evacuate area beneath; be prepared to close road.
- o Monitor and record location.
- o Monitor for changes. If rapidly changing, evacuate area beneath; be prepared to close road.
- o Drain properly.
- o Monitor and record location.
- o Drain properly.
- o Monitor and record location.
- o Monitor for changes. If rapidly changing, evacuate area beneath; be prepared to close road.
- o Drain properly.
- o Monitor and record location.
- o Drain properly.
- o Monitor and record location.
- o Drain properly.
- o Contact your supervisor and/or land owner.
- o Monitor and record location.
- o Monitor for changes. If rapidly changing, evacuate area beneath; be prepared to close road.

## THINGS TO AVOID

- o Stay out from under until stability evaluated.
- o Do not disturb until stability evaluated.
- o Stay out from under until stability evaluated.
- o Do not disturb until stability evaluated.
- o Stay out from under until stability evaluated.

Note: 1) Always evaluate safety first, don't assume it safe.  
2) Be prepared to re-route or otherwise provide for traffic when roadway drops.

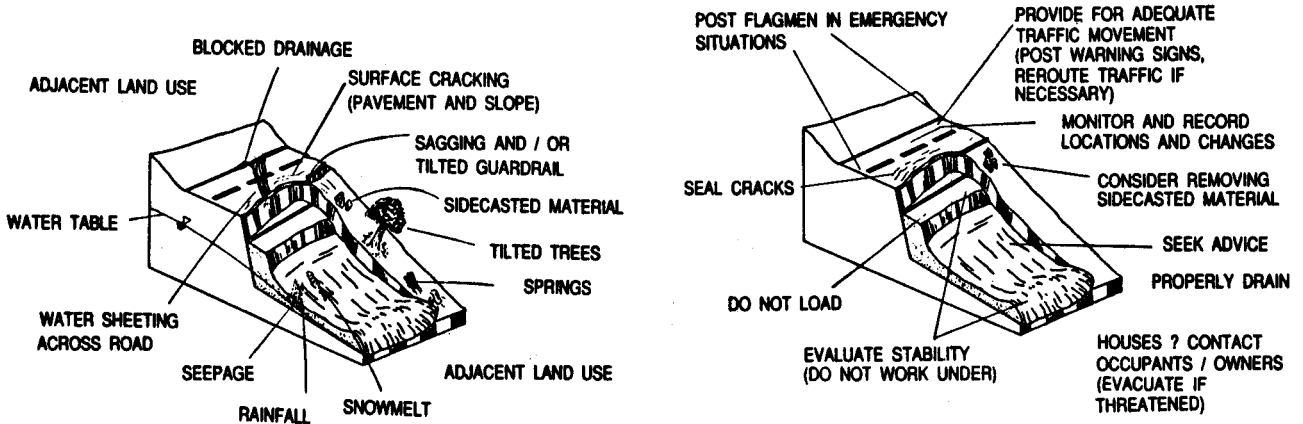


**TYPE B SLIDE BELOW ROAD-WEDGE**

Wedge-shaped slides usually occur along a distinctive failure, or sliding plane in the middle and lower portions of the slide. Typically, the sliding plane is along a soft clay layer, or along the interface of rock and soil, or it may be along a silt layer that is sandwiched between two clay layers. Preslide and slide distress signs are graphically illustrated below and described in the accompanying table.

**TYPE B SLIDE BELOW ROAD -- WEDGE -- MAINTENANCE SUPERVISOR AND CREW'S ACTIONS**

Suggested actions for the maintenance supervisor and crew to follow in reacting to a wedge failure below the roadway are shown in the sketch below and the accompanying table.



## TYPE B SLIDE BELOW ROAD WEDGE

<u>THINGS TO LOOK FOR</u>	<u>SIGNIFICANCE OF OBSERVED FEATURE</u>	<u>COURSE OF ACTION</u>	<u>THINGS TO AVOID</u>
A. Roadway and/or guardrail dropped.	<ul style="list-style-type: none"> <li>o May result from inadequate or non-functioning drainage systems.</li> </ul>	<ul style="list-style-type: none"> <li>o Monitor and record locations and changes.</li> <li>o Provide for adequate traffic movement.</li> <li>o Seek advice.</li> </ul>	<ul style="list-style-type: none"> <li>o Do not work under until stability evaluated.</li> <li>o Avoid loading the distressed area until evaluated.</li> </ul>
B. Surface cracking - in surrounding area.	<ul style="list-style-type: none"> <li>o May indicate additional unstable area.</li> <li>o May be contributing water and thus to loss of stability.</li> <li>o May result from inadequate or non-functioning drainage systems.</li> </ul>	<ul style="list-style-type: none"> <li>o Monitor and record locations and changes.</li> <li>o Properly drain.</li> <li>o Provide for adequate traffic movement.</li> <li>o Consider sealing cracks.</li> <li>o Seek advice.</li> </ul>	<ul style="list-style-type: none"> <li>o Do not work under until stability evaluated.</li> <li>o Avoid loading the distressed area until evaluated.</li> </ul>
C. Tilted features, i.e., trees, poles, walls, fences, etc.	<ul style="list-style-type: none"> <li>o May indicate additional unstable area.</li> <li>o May result from inadequate or non-functioning drainage systems.</li> </ul>	<ul style="list-style-type: none"> <li>o Monitor and record locations and changes.</li> </ul>	
D. Springs	<ul style="list-style-type: none"> <li>o May be cause of slide and/or make problem worse.</li> <li>o May be contributing water and thus to loss of stability.</li> <li>o May result from inadequate or non-functioning drainage systems.</li> </ul>	<ul style="list-style-type: none"> <li>o Monitor and record locations and changes.</li> <li>o Properly drain.</li> <li>o Seek advice.</li> </ul>	
E. Blocked drainage.	<ul style="list-style-type: none"> <li>o May be cause of slide and/or make problem worse.</li> </ul>	<ul style="list-style-type: none"> <li>o Monitor and record locations and changes.</li> <li>o Properly drain.</li> <li>o Provide for adequate traffic movement.</li> </ul>	
F. Adjacent land use changes, i.e., logging, mining, construction, etc.	<ul style="list-style-type: none"> <li>o May be cause of slide and/or make problem worse.</li> <li>o May be contributing water and thus to loss of stability.</li> </ul>	<ul style="list-style-type: none"> <li>o Monitor and record locations and changes.</li> <li>o Contact supervisor and/or land owner.</li> </ul>	
G. Improper material wasting. (side casting)	<ul style="list-style-type: none"> <li>o May be cause of slide and/or make problem worse.</li> </ul>	<ul style="list-style-type: none"> <li>o Monitor and record locations and changes.</li> <li>o Seek advice.</li> <li>o Consider removing waste material where practical.</li> </ul>	<ul style="list-style-type: none"> <li>o Do not waste additional material in vicinity.</li> </ul>

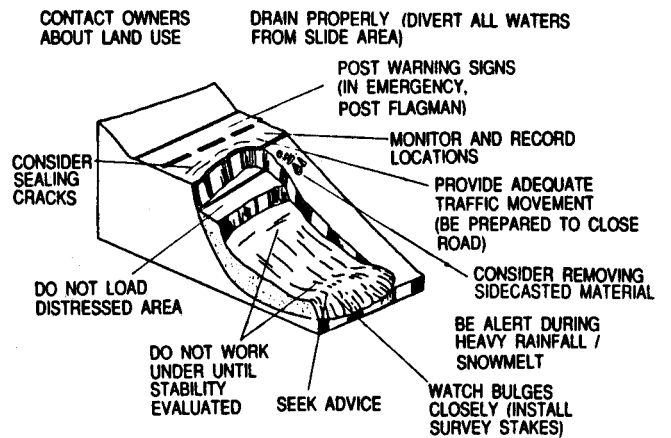
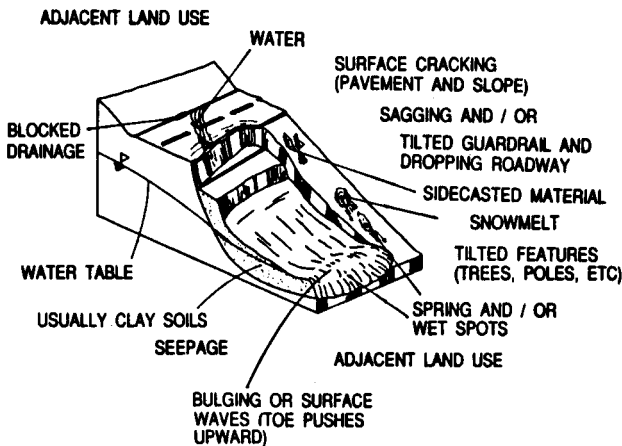
Note: 1) Always evaluate safety first, don't assume it safe.  
 2) Be prepared to re-route or otherwise provide for traffic when roadway drops.



**TYPE C SLIDE BELOW ROAD -- ROTATIONAL  
(PRESLIDE AND SLIDE CONDITIONS)**

**TYPE C SLIDE BELOW ROAD -- ROTATIONAL  
(PRESLIDE AND SLIDE CONDITIONS)**

Rotational slides usually occur in fairly homogenous materials. The failure plane is essentially circular and deep, and the mass of soil fails as a unit, although several scarps may be observed in the upper portions of the slide. The slide may occur in the fill or in the fill and foundation soils. Usually when the failure occurs in the fill and foundation soils, the soils of the fill and foundation have similar properties. Preslide and slide conditions are shown in the sketch below and the accompanying table.



## TYPE C SLIDE BELOW ROAD ROTATIONAL

<u>THINGS TO LOOK FOR</u>	<u>SIGNIFICANCE OF OBSERVED FEATURE</u>	<u>COURSE OF ACTION</u>	<u>THINGS TO AVOID</u>
A. Roadway dropping and/or guardrail dropped.	<ul style="list-style-type: none"> <li>o May indicate extensive instability.</li> <li>o Allows water infiltration.</li> </ul>	<ul style="list-style-type: none"> <li>o Monitor and record locations.</li> <li>o Be prepared to close road.</li> <li>o Properly drain.</li> <li>o Provide for adequate traffic movement.</li> <li>o Seek advice.</li> </ul>	<ul style="list-style-type: none"> <li>o Avoid loading distressed area until evaluated.</li> </ul>
B. Surface cracking in surrounding area.	<ul style="list-style-type: none"> <li>o May indicate extensive instability.</li> <li>o Allows water infiltration.</li> <li>o May indicate additional movement.</li> </ul>	<ul style="list-style-type: none"> <li>o Monitor and record locations.</li> <li>o Properly drain.</li> <li>o Consider sealing cracks.</li> </ul>	<ul style="list-style-type: none"> <li>o Avoid loading distressed until evaluated.</li> </ul>
C. Spring or wet spots.	<ul style="list-style-type: none"> <li>o May be cause of dropping.</li> </ul>	<ul style="list-style-type: none"> <li>o Monitor and record locations.</li> </ul>	<ul style="list-style-type: none"> <li>o Do <u>not</u> block outlet.</li> </ul>
D. Bulging or surface waves in slope below roadway.	<ul style="list-style-type: none"> <li>o May indicate extensive instability.</li> </ul>	<ul style="list-style-type: none"> <li>o Monitor and record locations.</li> <li>o Seek advice.</li> </ul>	<ul style="list-style-type: none"> <li>o Avoid loading distressed area until evaluated.</li> </ul>
E. Tilted features, such as trees, poles, walls, fences	<ul style="list-style-type: none"> <li>o May be cause of dropping.</li> <li>o May add water to problem area.</li> </ul>	<ul style="list-style-type: none"> <li>o Monitor and record locations.</li> <li>o Seek advice.</li> </ul>	
F. Blocked drainage.	<ul style="list-style-type: none"> <li>o May indicate extensive instability.</li> <li>o May indicate additional movement.</li> <li>o May be cause of problem.</li> </ul>	<ul style="list-style-type: none"> <li>o Monitor and record locations.</li> <li>o Seek advice.</li> <li>o Properly drain.</li> </ul>	<ul style="list-style-type: none"> <li>o Avoid loading distressed area until evaluated.</li> </ul>
G. Improper material wasting (cast casting).	<ul style="list-style-type: none"> <li>o Allows water infiltration.</li> <li>o May be cause of dropping.</li> <li>o May add water to problem area, snow melt, or rainfall collection.</li> </ul>	<ul style="list-style-type: none"> <li>o Monitor and record locations.</li> <li>o Properly drain.</li> <li>o Consider removing waste material</li> </ul>	<ul style="list-style-type: none"> <li>o Do <u>not</u> waste additional material in vicinity.</li> </ul>
H. Pushup at toe or below fill; bulge in toe of fill.	<ul style="list-style-type: none"> <li>o May indicate extensive ability.</li> <li>o May indicate additional movement.</li> </ul>	<ul style="list-style-type: none"> <li>o Monitor and record locations.</li> <li>o Provide for adequate traffic movement.</li> <li>o Seek advice.</li> </ul>	

Note: 1) Always evaluate safety first, don't assume it safe.  
 2) Be prepared to re-route or otherwise provide for traffic when roadway drops.





## **APPENDIX B**

**SLIDE INVENTORY / INSPECTION REPORT**

**CULVERT INVENTORY / INSPECTION REPORT**

# SLIDE INVENTORY/INSPECTION REPORT

**I. District**

\_\_\_\_\_

**County**

\_\_\_\_\_

**Route**

\_\_\_\_\_

**Milepost/Station**

\_\_\_\_\_

**Location**

\_\_\_\_\_

**Date Discovered**

\_\_\_\_\_

**AADT (Average Annual  
Daily Traffic)**

\_\_\_\_\_

**Date of Inspection**

\_\_\_\_\_

**Is this an Update?**

**Assigned Number of Slide**

\_\_\_\_\_

**Mileage and Direction**

\_\_\_\_\_

**from a known landmark**

\_\_\_\_\_

\_\_\_\_\_

**II. Type of Slide (circle)**

**A. Rockfall**

- 1) Massive Rock Slope
- 2) Differential Weathering
- 3) Talus

**B. Slide Above Roadway**

- 1) Mud Flow
- 2) Wedge
- 3) Rotational
- 4) Blockslide

**C. Slide Below Roadway**

- 1) Mud Flow
- 2) Wedge
- 3) Rotational

**III. Contributing Factors (circle)**

A. Subsurface Drainage

B. Surface Drainage

C. Broken Drainage Structures

D. Blocked Drainage Structures

E. Flooding/Washouts

F. Overloading Head of Slide

G. Removal of Toe

H. Saturated Material

I. Other: \_\_\_\_\_

J. \_\_\_\_\_

K. \_\_\_\_\_

L. \_\_\_\_\_

**IV. Inspection Date (circle)**

**A. Rate of Movement**

1. Inactive
2. Only After Flooding
3. Only Wet Seasons
4. Intermittent
5. Continuous--Slow
6. Continuous--Moderate
7. Continuous--Rapid
8. Not Sure

**B. Effect on Roadway**

1. Only Cut Slope
2. Only Fill Slope
3. Ditchline Affected
4. Culvert Pipe Affected
5. Box Culvert Affected
6. Bridge Affected
7. Shoulder Affected
8. Travel Lane Pavement Affected
9. Length of Slide Along Roadway (Feet)
10. Special Signing Required
11. Special Signing in Place
12. Not Sure

**C. Utilities Affected**

1. None Observed or Known
2. Gas Line \_\_\_\_\_ Size (If Known)
3. Water Line \_\_\_\_\_ Size (If Known)
4. Sewer Line \_\_\_\_\_ Size (If Known)
5. Telephone
  - a) Overhead
  - b) Underground
6. Electric
  - a) Overhead
  - b) Underground
7. Cable TV
8. Oil Pipeline
9. Other \_\_ (List) \_\_
10. \_\_\_\_\_
11. \_\_\_\_\_

**D. Adjacent Properties Involved (circle)**

1. Vacant Land
2. Residences
3. Businesses
4. Other Improvements \_\_ (List) \_\_
5. \_\_\_\_\_
6. \_\_\_\_\_

**E. Maintenance Activity (circle)**

1. None Required
2. Yearly
3. Monthly
4. Weekly
5. Daily
6. Road Closed
  - a) Permanent
  - b) Temporary (No. Times/Year)

**V. CLASSIFICATION OF SITE CONDITIONS (circle)**

- A. Very Serious
- B. Serious
- C. Medium
- D. Minor

**VI. RECOMMENDED ACTIONS (circle)**

1. Maintenance not needed; follow-up survey needed  
\_\_\_yes \_\_\_no
2. Maintenance repairs needed (specify)
3. Maintenance repairs needed (specify); monitor behavior; take action if problem worsens.
4. Geotechnical action needed; repair by maintenance forces; monitor behavior.
5. Geotechnical action needed; monitor behavior; slide repair too large for maintenance forces; corrective action needed.
6. Emergency maintenance repairs needed; contact maintenance and geotechnical engineer.

7. Not sure; contact maintenance and/or geotechnical engineer.

8. Other recommendations.

**VII. CROSS SECTION SHEETS(s)**



## VIII. PHOTOGRAPHS

## IX. NOTES/SKETCHES

## **X. ESTIMATED COSTS OF REPAIRS**

### **A. Temporary/Protective Methods**

## B. Permanent Method

Example

CULVERT INVENTORY/INSPECTION REPORT

District \_\_\_\_\_

County Lincoln

Route 20

---

Mile Point	culvert Size	Culvert Type	Culvert Length	Date Inspected/B	Comments
2.7	18"	B.C.C.M.P	36'	1/15/85 CHB	Outlet Channel Blocked
3.9	10 x 10	R.C.B.C	60'	1/15/85 CHB	Good Condition
5.7	36"	R.C.P	40'	1/15/85 CHB	Joints Separated
10.3	17 x 13	C.A.P	36'	1/15/85 CHP	1/2 Silted

---



## **APPENDIX C**

### **SLOPE DESIGN AND ANALYSIS**

## SLOPE DESIGN AND ANALYSIS

This appendix is included in this manual to provide an elementary overview of the factors and techniques of a slope stability analysis and design. It is recognized that maintenance crews generally do not have the expertise to conduct such analyses, it is important to have a very general understanding of the process and phenomenon so that they may perform their tasks more effectively.

Accurately predicting the stability of highway fill and cut slopes is difficult because of the complex nature of soils and geology at a given site. Design of a stable slope requires that complex conditions be idealized, or simplified. There are more unknown than known conditions at a given site and for a given method of analysis. It would be impractical to determine all conditions at a site. For example, the strength of the soil or rock may be defined from laboratory tests and this strength may be representative of the soil or rock at the time of construction. However, after several years, site conditions may change and the strength of the soil and rock may change. Predicting changing conditions at a site and changes in strength are difficult. Using a sophisticated computer program and complex mathematical model is useless unless some experience and judgment are applied to defining possible ranges in the strength of the soil and rock over the life of the slope. The analysis is only as accurate as the data used in the computer program. Unfortunately, it is far easier to analyze a slope after failure and develop a



remedial solution than to initially design the slope against failure. Nevertheless, since highway fill and cut slopes usually cost several thousands of dollars, the initial design of these structures, as well as analyzing the stability of distressed highway fill and cut slopes, is essential even though conditions of a given site are complex. Using various methods of analyses helps build a base of experience that improves engineering judgment. However, not all landslides (for example, mud slides) lend themselves to analysis.

Key elements needed to predict the stability of a slope are as follows:

- o Preliminary Slope Design
- o Analysis Methods
- o Factors (Parameters)
  - +Geometry
  - +Material Parameters
  - +Definition of Factor of Safety

## **A. PRELIMINARY SLOPE DESIGN**

Various methods are available for selecting preliminary slope designs. Selection of preliminary designs serves at least two purposes:

- o During planning stages of new slopes as well as failed slopes, the methods yield quick information regarding right-of-way requirements.
- o Slopes defined by simple analysis provide a good starting point for more sophisticated analyses.

Two methods for selecting preliminary designs of slopes are

o Table of Designs

o Infinite Slope Method

If the classification or type of soil or rock is known, then a preliminary slope may be selected from the table below. Side slopes listed in the table assume surface or subsurface waters may infiltrate the fill and saturate it. When the fill height of the embankment is greater than 50 feet, when the embankment is constructed of low-strength soils, or when poor foundation conditions are suspected, the stability of the fill should be investigated using methods of soil mechanics. Some agencies conduct detailed subsurface exploration and stability analyses for all highway fills over about 25 or 30 feet.

SUGGESTED EMBANKMENT SLOPES FOR DIFFERENT TYPES OF SOILS

AASHTO SOIL CLASSIFICATION	UNIFIED SOIL CLASSIFICATION	FILL HEIGHT (Feet)	Side Slope	DESIRED COMPACTION (% OF MAX DRY DENSITY)
A1	GW, GP, SW (Some GM or SM)	N.C.*	2 to 1	95 - 100
A3	SP	N.C.	2 to 1	95 - 100
A-2-4 A-2-5	Most GM and SM	<50	3 to 1	95 - 100
A-2-6 or 7	GC or SC	<50	3 to 1	95 - 100
A-4, A-5	ML, MH	<50	3 to 1	95 - 100
A-6, A-7	CL, MH	<50	3 to 1 or 4 to 1	95 - 100

\*N.C. -- Not critical

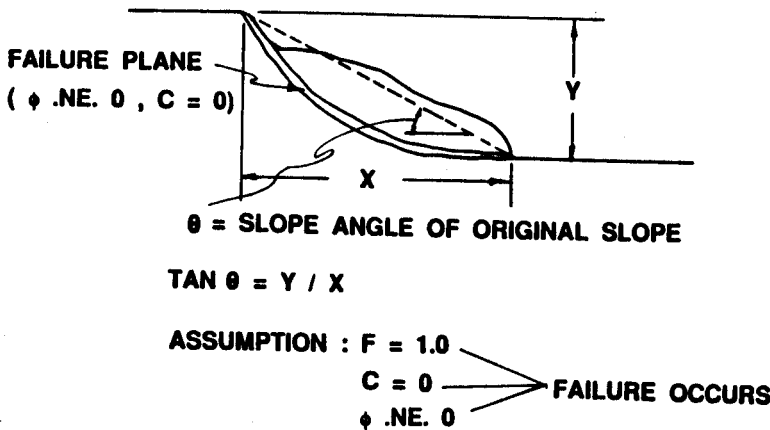
As the name implies in the infinite slope approach, the slope is assumed to be infinitely long and the factor of

safety (F) is defined as

$$F = \tan \Phi / \tan \theta$$

in which  $\Phi$  = frictional component of strength and  
 $\theta$  = angle of the slope.

In the formula above, it is assumed that no water is in the slope. Also, if the value of  $\theta$  is less than the angle of the slope, then the factor of safety is less than one; that is, the slope is unstable. This simple analysis ignores the



***Slope parameters***

cohesive component of strength. Two other useful cases, which assume ground-water flow in the slope, are as follows:

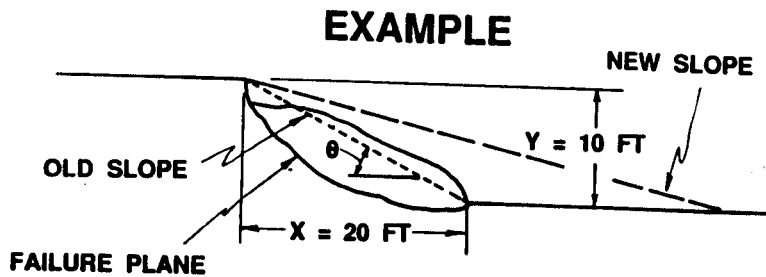
$$F = 0.5 \tan \Phi / \tan \theta .$$

This expression assumes that flow of water occurs

throughout the slope. In the expression below, the assumption is made that flow of water is located one-half the distance between the slope surface and failure plane and

$$F = 0.75 \tan \phi / \tan \theta .$$

To illustrate the use of the above equations, the following example is given:



**FAILURE MASS HALF FILLED WITH WATER**

$$F = 1.5$$

$$\begin{aligned} \text{TAN } \theta &= Y / X \\ &= 10 / 20 \\ &= 0.5 \end{aligned}$$

**Example problem**

Given:  $\Phi$  = strength of soil = 30 degrees

F = 1.5 (assumed for design purposes)

Determine: Angle of slope for following flow conditions:

1. No water in slope.
2. Potential failure mass half filled with water.
3. Flow occurs throughout failure mass.

Solution:

1.  $\tan \Theta = \tan \Phi / F$

$$\tan \Theta = 0.5 / 1.5 = 1 / 3 \text{ or}$$

Slope = 1 horizontal to 3 vertical

2.  $\tan \Theta = (0.75)(0.5) / 1.5 = 1 / 4 \text{ or}$

Slope = 1 horizontal to 4 vertical

3.  $\tan \Theta = (0.5)(0.5) / 1.5 = 1 / 6 \text{ or}$

Slope = 1 horizontal to 6 vertical

Since the cohesive portion of strength is ignored in these analyses, the results are conservative.

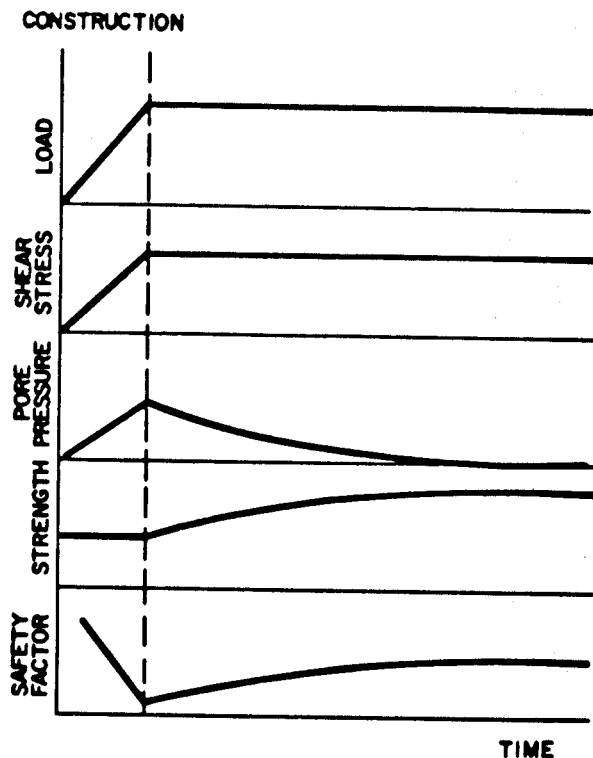
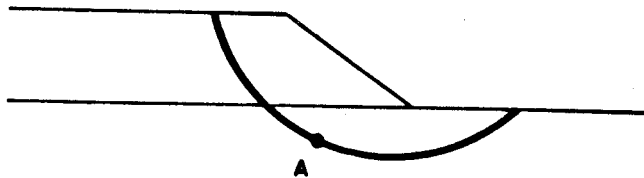
## **B. ANALYSIS METHODS**

Two methods of analysis (total stress analysis and effective stress analysis), are used in designing highway fill and cut slopes. Two limiting conditions occurring during the design life of highway fill and cut slopes are investigated. These limiting conditions are referred to as the end-of-construction state and the long-term state of the fill slope or cut slope. Geotechnical engineers are concerned about the stability during construction and as well as a long time (several years) after construction.

### **B.1. Total Stress Analysis**

The total stress approach is used to study the end-of-construction (short-term) state of highway fill and cut slopes in soil. In the construction of a highway embankment over a clay or silty clay foundation, the end-of-construction condition is considered to be the most critical; that is, it is the condition when the embankment is more likely to fail. Excess pore pressures in the foundation caused by the load of the fill reach a maximum at the end of construction and the factor of safety decreases (ideally) to its lowest value during the life of the structure. After construction, excess pore pressures in the foundation dissipate and the factor of safety increases.

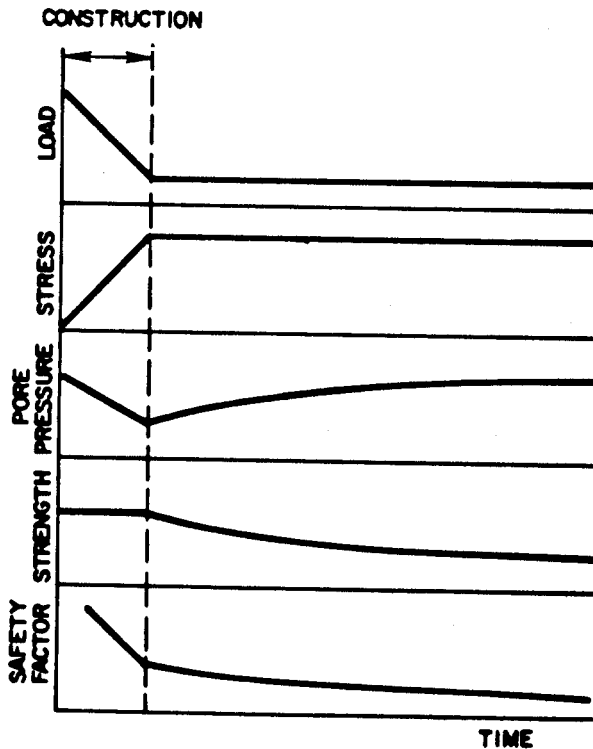
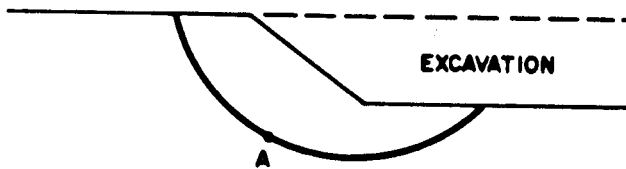
When a cut slope is made in clay or silty clay, the long-term state is the most critical case. In this state, the maximum pore water pressures occur a long time after the cut is made. The factor of safety gradually decreases over a long time as the pore-water pressure increases. During or at the end of construction, pore pressures are small and the factor of safety is relatively large compared to the



*Long-term factor of safety of a highway embankment on a clayey foundation as a function of time*

condition of the slope after a long time when pore pressures have increased and the factor of safety is reduced. However, geotechnical engineers may use the total stress analysis to forecast stability when temporary cut slopes are made. For example, during construction of shear trenches, the total stress analysis is used to predict stability of trench backslopes. The long-term state may be the most critical case, but the geotechnical engineer knows the trench will be backfilled as quickly as practical. Another example involves construction of flattened slopes. The failed materials and some "fresh" material may be excavated to a slope that is steeper than the original slope. However, this is a temporary condition. In this case, the

engineer will make sure that backfilling for the flattened slope starts as soon as possible after the temporary cut is



*Long-term factor of safety of a highway cut section as function of time*

made. He will use results of the total stress analysis as a guide to determine the limits of excavation for the flattened slope construction. However, the geotechnical engineer would not use the total stress analysis to predict the long-term (several years after construction) stability of the cut section.

## B.2. Effective Stress Analysis

One of the more important principles in soil, or



geotechnical, engineering is as follows:

$$\text{Strength of Soil} = \text{Cohesion} + (\text{Total Stress} - \text{Pore-Water Pressure}) \times \tan \phi$$

Hence, if water rises in a fill, the right side of the equation decreases since the term (total stress - pore-water pressure) decreases. If the water table in a fill or cut slope is lowered, the strength increases (up to a point) because the term (total stress - pore-water pressure) increases. The total stress in the equation is the stress on the failure plane due to the weight of material above the failure plane. This is the reason that the geotechnical engineer first looks for means to drain the fill or cut slope when distress occurs.

This principle forms the basis for another method of analysis -- the effective stress analysis. In designing fills on clay or silty clay foundations, both the total stress and effective stress analyses may be performed. If the factor of safety from the total stress analysis is low (less than about 1.30), then an effective stress analysis may be performed to determine the long-term factor of safety. In this analysis, a knowledge of the pore pressures in the foundation at any time must be known or estimated. Usually for fills on clay foundations, the time when no excess pore-water pressures occur is the state used in the analysis -- that is, the excess pore pressures due to fill loading have dissipated and the only pore pressures in the foundation are those that existed (water table) before construction. Pore pressures existing before construction eventually equal pore pressures a long time after construction. Using these pore pressures, an effective stress analysis is performed to determine the long-term

stability of the fill. If the factor of safety is adequate, then the design may be accepted, although the factor of safety obtained from the end-of- construction may be below the design factor of safety.

In cut (soil) slopes, estimates of the future equilibrium position of the ground-water table in the slope are made. Using this water table, effective stress analyses are performed to examine the long-term stability.

If the slope is side-hill fill constructed of clays or silty clay soils, the fill soil may create a "damning" effect, which causes the ground-water table to slowly rise and infiltrate into the fill. As the water table rises into the fill, the shear strength slowly decreases. As this occurs, the factor of safety (stability) decreases. Many highway slope failures have occurred as a result of this phenomenon.

### **B.3. Approaches**

A number of methods are available for calculating the factor of safety against failure and determining the stability of a highway fill or cut slope. These methods may be divided into two broad categories as follows:

- o Slopes based on past experience and
- o Mathematical models (equilibrium equations).

For the first category, slopes of different types of soils based on past experience are shown in the table in Section A.

Numerous mathematical models (or equations) have been developed for computing the factor of safety and

determining the stability of slopes. Most of these methods have been programmed for the computer. In these methods, the geotechnical engineer attempts to represent the actual mechanics of a landslide by a mathematical model. The fundamental problem is there are too many unknown quantities in the mathematical expressions. Consequently, to solve the expressions, assumptions must be made. This situation has led to a number of mathematical models that attempt to describe the slope stability problem and provide computer programs for solving for the factor of safety.

Mathematical methods may be classified into two classes:

- o Force Equilibrium Methods -- Vertical and horizontal force equations used; moment equation is not used. Generally, these methods are not considered to be accurate, although they often are used. Usually, these methods are used to analyze non-circular failure planes.

- o Force/Moment Methods -- Both vertical and horizontal force equations as well as the moment equations are used.

In developing the expressions for slope stability analysis, the failure mass is divided into vertical slices. Although there are numerous methods available for determining stability, the following (methods of slices) generally are recognized as the more accurate or "so-called" accurate methods. Generally, mathematical stability models are named after the individual(s) who developed the methods:

- o **Bishop** -- This model is limited to circular failure planes. This is a good utility model and numerous slope stability computer programs have been developed based on this model. This model will not handle failure planes of an irregular shape.

o **Morgenstern-Price** -- This model is considered to be one of the "most accurate" mathematical stability methods. However, each solution obtained from this method must be reviewed to determine if the solution meets certain physical criteria. Solutions for both circular and non- circular failure planes can be obtained. When searching and trying to find the most critical shear surface (hundreds of shear surfaces may be tried in the analysis), this method is not practical (requires too much computer time). This method is usually reserved for research purposes.

o **Spencer** -- The comments for the Morgenstern and Price model apply to this model.

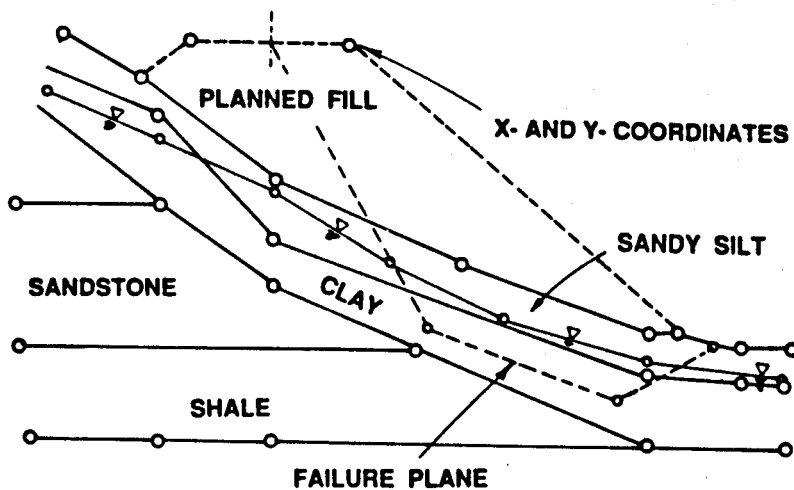
o **Janbu** -- This model analyzes circular and non-circular failure planes (shear surfaces). Problems sometimes are encountered in analyzing deep failure planes and factors of safety cannot be computed. A simplified version of this method is sometimes used in some computer programs to analyze wedge-shaped or non- circular failure planes.

o **Hardin** -- Another recently developed model is capable of analyzing circular and non- circular failure planes. To date, this model has been confined to research.

o **Hopkins** -- Another model analyzes circular and non-circular shear surfaces. This method and computer program is geared to practioners and gives results that are within about 0.5 to 3 percent of solutions obtained from the Morgenstern-Price model for both circular and non-circular failures.

The Bishop model is the most widely used method in practice, and many computer programs are available based on this model. However, this model does not analyze non-circular failure planes. Consequently, many computer programs use at least two models -- one model (usually

# IDEALIZED CROSS SECTION



*Idealized cross section of a highway embankment and foundation*

Bishop) to analyze circular failure planes and another model (usually a force equilibrium method) to analyze non-circular failure planes. Computer programs often may contain several models. Alternatively, the problem may be solved with different computer programs based on different models. The geotechnical engineer may use two or more slope stability computer programs to solve a given problem.

A rapid method of obtaining the factor of safety makes use of stability charts devised for particular problems, specific geometries, and specific pore-water pressure conditions. The various charts usually are based on specific mathematical models. For example, Taylor's stability chart may be used to determine of factor of safety for clay slopes (one material only) based on total stress analysis. This chart expresses the stability number  $N_s$  and friction number  $N_f$  as a function of the slope angle.

Bishop and Morgenstern developed stability charts for effective stress analysis.

After establishing surface and subsurface conditions at a site, a slope stability analysis is performed to determine the factor of safety of the planned highway fill or cut slope or of a distressed slope. The factor of safety is classically defined as

$$F = \text{Factor of Safety} \\ = \text{Resisting Forces} / \text{Driving Forces.}$$

The resisting force is the strength available to resist driving forces. This strength is due to the cohesive and frictional parameters. The driving force is the weight of soils (and external loads) tending to move the slope downward. In mathematical models, the strength(s) is defined as

$$S = c / F + (\text{total stress} - \text{pore-water} \\ \text{pressure}) \times \tan \Phi / F$$

where  $c$  = effective cohesion component and  
 $\Phi$  = effective frictional component.

If the factor of safety obtained from the analysis is less than 1.0, the slope is considered (theoretically) unsafe. If the factor of safety is equal to or greater than 1.0, the slope is theoretically safe. However, in the design of highway fill and cut slopes, the long-term factor of safety should be 1.5 or greater (to avoid creep movements that eventually may lead to failure after several years). During construction of highway slopes, a temporary factor of safety as low as 1.4 to 1.2 may be acceptable if the long-term factor of safety is equal to or greater than 1.5.

## C. FACTORS (PARAMETERS)

To perform a slope stability analysis, several factors must be established or defined:

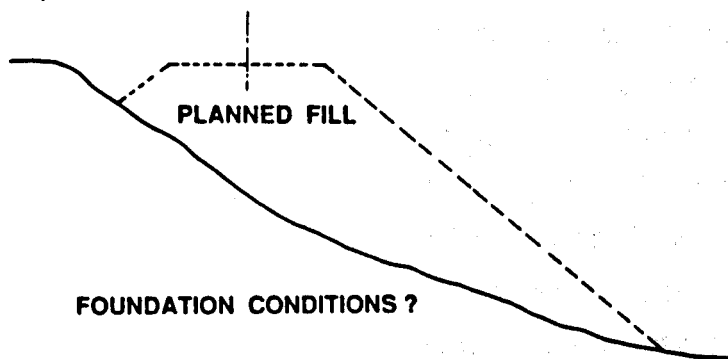
- o Geometry of the slope and site and
- o Material properties.

### C.1. Site Geometry

The geometry of the site may be established using:

o **Ground Sketches** -- In active slides, sketches may be made of cracks, scarps, etc., which may be used to establish the pattern of failure. In new designs, ground sketches of visual conditions, such as springs and seeps, aids and alerts the geotechnical engineer to possible problems at a given site.

o **Optical Surveys** -- Optical surveys are used to obtain accurate geometry of the site. In active or distressed slopes, the survey will locate accurately scarps, seeps, springs, cracks, etc. Using these data, cross sections of the site are obtained. Reasonably accurate cross sections of small failures may be obtained using a hand level and cloth tape.



*Surface geometry of a planned fill defined by optical surveys*

o **Aerial Surveys** -- Aerial surveys (photographs taken from airplanes at low altitudes) may be used effectively in defining reasonably accurate geometry of a site (when the necessary equipment is available for plotting contour maps). Contour maps (resolution 1 to 2 feet) can be prepared and are suitable for developing cross sections of active landslides. This is a useful technique where there may be a rush to develop remedial plans. Also, aerial surveys are useful in spotting adverse features (drainage patterns, etc.) that may be contributing to the landslide movement.

Cross sections and plan views of a site define only the geometry of the surface. Parameters such as the height of the slope, steepness of the slope, slope of the original ground, seepage and spring locations, and external forces such as bodies of water resting against the slope or buildings or highways are obtained from cross sections of the site (and ground sketches and optical surveys).

## **C.2. Material Properties**

Subsurface exploration must be performed to obtain vital information regarding foundation conditions. The particular site must be drilled to define such parameters as the slope of the bedrock, the number and types of soil and rock layers, the thicknesses of the layers, and the location of the water table. During drilling, samples of soil (undisturbed and bag samples) are obtained for laboratory testing and analysis. To accurately define a water table from observation wells, readings must be obtained over several days -- and sometimes weeks. Readings should be plotted as a function of time to determine when the water level in the well has reached equilibrium.

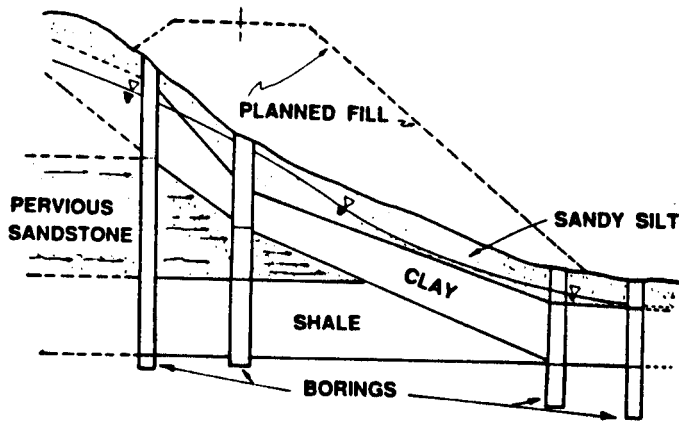


**o Cohesion:** This is the component of shear strength that fine-grained soils (silts and clays) have. Cohesion is the component of strength that makes a clay soil appear to be "sticky". It is the "glue" that holds the soil together. It is this component that causes hard lumps or clods to form. Cohesion is the result of electrical charges between soil particles, chemical reactions between soil particles, surface tension on water trapped in the voids between soil particles, and other (not fully understood) forces.

**o Internal Friction Angle:** The second component of shear strength is the force that results when soil particles move relative to each other. These forces are frictional in nature. The internal friction angle may be compared in general terms to the coefficient of friction between soil particles. Although all soils exhibit some frictional component of shear strength, coarse-grained soils (sands and gravels) have the higher porportion of this component.

**o Peak Strength:** When a soil specimen is tested to determine its shear strength, the specimen will yield as the load increases. At some point, the specimen will fail (crack or collapse) and the load needed to continue testing the specimen will decrease. The point at which the maximum load occurred is defined as the peak strength.

**o Residual Strength:** If a soil specimen is tested to failure, and the magnitude of load decreases after the peak is reached, a minimum load will be reached in many cases. This minimum value is defined as the residual strength. After a landslide has occurred, it is probable, in many cases, the soil in the failure zone has reached its residual strength.



***Idealized cross section of a highway embankment and foundation***

Samples obtained from the drilling program are subjected to a variety of both simple and complex laboratory tests. Four vital pieces of information are needed with regard to soils and rocks:

- o Unit weight of soils and rocks in each layer,
- o Permeability and drainability of soils and rocks in each layer,
- o Water (pore) pressures,
- o Shear strength of each layer.

Unit weights of the soils and rocks are used to determine forces acting on the potential failure planes. The permeability and drainability aid in determining the applicable method of analysis -- total stress or effective stress. For example, if a foundation of sand is loaded rapidly (with fill), the water will drain from the sand almost instantly and excess pore pressures (pressures above those that existed prior to loading) do not develop. However, if a clay foundation is loaded rapidly, the water in the foundation cannot drain rapidly, and high excess pore

pressures buildup and decreases the strength available to resist failure. Pore pressures must be known when effective stress analyses are performed.

Pore-water pressures may be determined from

- o Laboratory Tests -- Values obtained from triaxial tests are sometimes used to estimate field pore pressures.

- o Field Tests

- + Piezometers, or porous elements, are installed in the field in a particular layer(s) to determine pore-water pressure during fill loading. These values may be used in an effective stress analysis to check the stability during fill loading.

- + Observation wells consist of perforated or slotted pipe installed in holes bored during the subsurface exploration program. Water levels in the wells are monitored to determine ground-water levels in the foundation. These values are used in effective stress analyses.

## **C.2. Shear Strength**

An important factor in landslides is the strength of the earth material in the slide area. In general terms, the resistance of a soil or rock to the force applied to the soil that causes the soil to "fail" and large movements to occur can be defined as the shear strength. Geotechnical engineers usually consider two components of shear strength: cohesion (usually identified by the symbol  $c$ ) and the angle of internal friction (identified by the symbol  $\phi$ ).

### **C.3. Shear Strength Tests**

A variety of methods are used to define the strength of the foundation soils and rocks as well as the strength of the highway fill or soils and rocks in the cut slope. These methods may be divided broadly into three groups:

- o Laboratory methods,
- o Field test methods, and
- o Empirical methods.

#### **C.3.1. Laboratory Methods**

##### **C.3.1.a. Triaxial Test**

A cylindrical specimen is placed in a pressure chamber and the chamber is pressurized to a predetermined level. The chamber pressure places a uniform pressure on the soil specimen. The specimen is tested to failure and the load is recorded as a function of the specimen deformation. Usually a series of three tests is performed. From these data, the internal friction angle and the cohesion of the soil can be determined.

- o **Unconsolidated-Undrained** -- This method is used to define the cohesive component of strength (the frictional component of strength is zero if the soil specimen is saturated). This value is used in total stress analyses.
- o **Consolidated-Drained** -- This method is used to define the cohesive and frictional strength components (the test is run very slowly). The parameters obtained are referred to as effective cohesive strength component and effective frictional component of strength. These parameters are

used to perform effective stress analyses.

**o Consolidated-Undrained with Pore-Pressure Measurements** -- Effective cohesive and frictional strength components are obtained. This is another means of obtaining these parameters and is the method usually used in practice.

#### **C.3.1.b. Direct Shear Test**

In a direct shear test, a constant vertical force is placed on a soil specimen, and at the same time, one half of the specimen is pulled relative to the other half. The peak force necessary to pull the specimen under a particular vertical force is recorded. As in the case of the triaxial test, a series of tests (usually three) is performed. Cohesion and the internal friction angle are determined from the data.

This is another method of obtaining effective stress parameters and, when it is run in a cyclic pattern (back and forth), residual stress parameters also are obtained.

#### **C.3.1.c. Unconfined Compression Test**

A cylindrical specimen is placed in a compression machine. It is then loaded to failure. The maximum load is defined as the unconfined compressive strength.

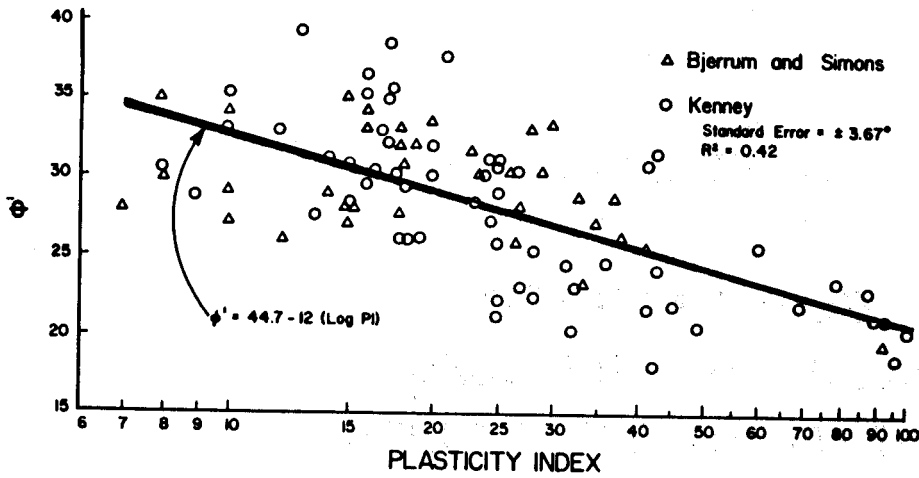
#### **C.3.2. Field Methods**

Field methods of defining shear strength include Dutch cone and standard penetration tests. Values obtained from these tests have been related empirically to shear strength.

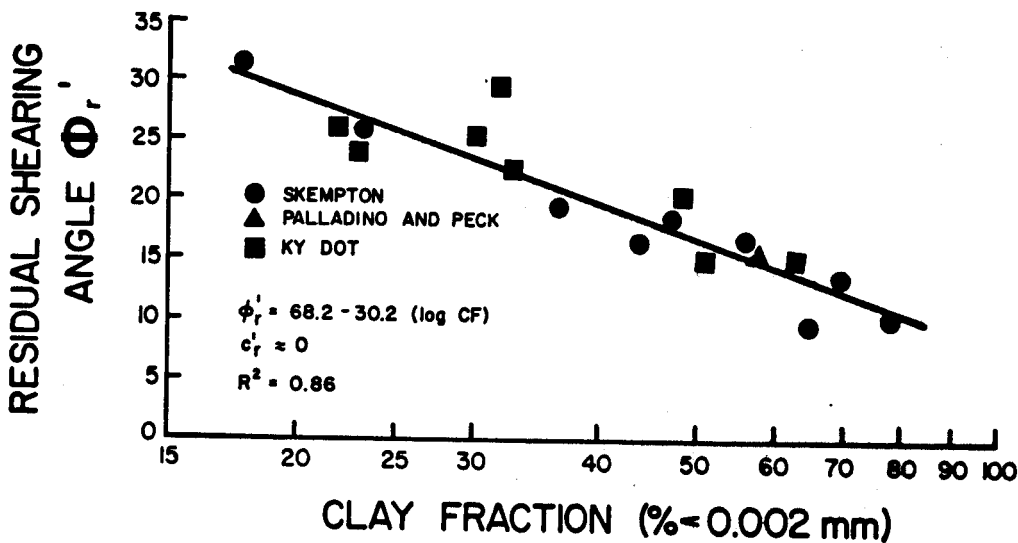
#### **C.3.3. Empirical Methods**

Shear strength also has been related to simple laboratory

index tests. For example, the frictional strength component is related to the plasticity index of a soil as shown in the sketch below. Also, the residual frictional shear strength component is related (empirically) to the percent passing the No.-200 sieve (clay fraction) as shown below. This relationship is useful for estimating the frictional strength component of soils in an active failure plane.



*Peak effective stress value of the angle of internal friction as a function of plasticity index*



*Residual angle of internal friction as a function clay fraction (percent finer than .002 mm)*

**APPENDIX D**

**GUIDELINES FOR  
RAILROAD RAILS USED  
AS RETAINING STRUCTURES**

**Department of Highways  
Kentucky Transportation Cabinet**

## GUIDELINES FOR RAILROAD RAILS USED AS RETAINING STRUCTURES

### INTRODUCTION

Railroad rails have been used for years on maintenance projects involving landslides along roadway shoulders. The results have been variable. Probably a major portion of the problems with the use of rail piles has been the lack of standardized design and construction procedures. The variables of rail size, rail spacing, maximum length and embedment required for maximum efficiency have not been addressed previously and guidelines have not been available.

It has been found from engineering experience and analysis that laterally loaded piles operate in the optimum fashion when they are socketed at least a minimum length into stable material and are not allowed to become overstressed. Generally, rails in use as piling have been driven to refusal which may not always be satisfactory for complete embedment. Also, too large a space between the piles will not allow the soil to "arch", thus the soil will slide through them. Rails used at too great a depth will become overstressed and fail.

The fact that rail piles can be used effectively has motivated the development of guidelines for their use and installation. The guidelines are an effort to assist maintenance engineering in their choice of where to use rail piles and how to design for soil arch, spacing, and how to correctly install them. In addition, the guidelines will be useful in establishing how large a landslide problem may be corrected by means of rail piling.

### GENERAL GUIDELINES CONCERNING THE USE OF RAILS AS PILING . . .

- A. Railroad rail piling is intended for use on landslides affecting roadway shoulders and a limited amount of the driving lanes only.
- B. If the distance from the shoulder to the furthest depressions and/or cracking of the pavement is greater than the depth to solid rock, the use of rails is not practical.
- C. The depth of unstable soil must be less than 18 feet. The unstable soil must be underlain by rock or a firm stable soil. The determination of depth should be made by auger borings.
- D. The slopes beneath the supported sections must not be subject to erosion by stream flow. Suitable erosion control must be established on the slope if the pile design is to be implemented.



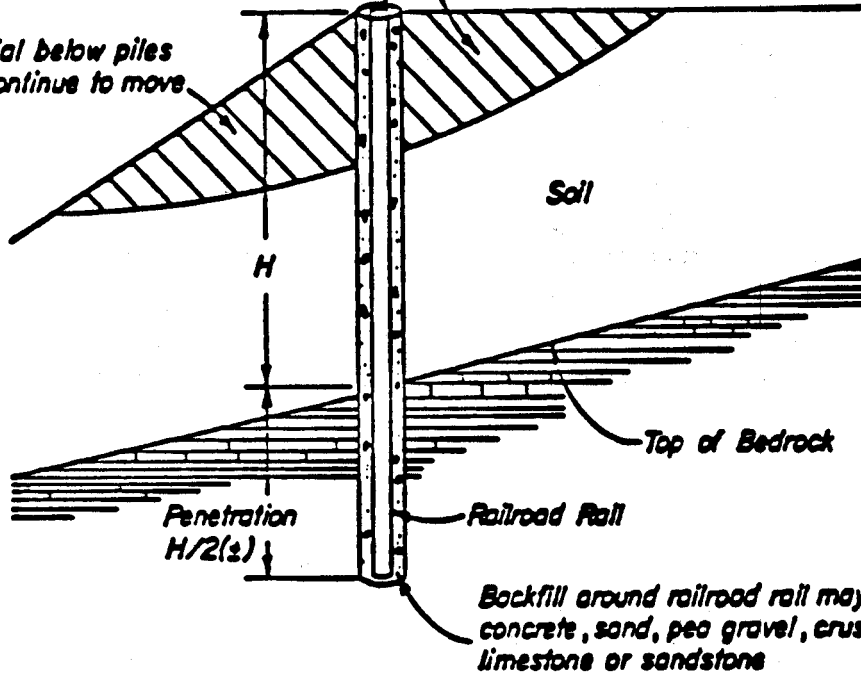
- E. In order for the rails to work most efficiently they should be installed in drilled sockets in the rock or stable material under the landslide. The minimum length of embedment into solid rock shall be no less than one-half the free end length, the depth from the ground surface to auger refusal. This is to assure proper fixation of the rail. See figure 1 for a diagram of a rail installation.
- F. Depth of the drill hole and socket should be slightly greater than the length of rail to be installed. This is to insure that required embedment is obtained. Debris falling into the hole will fill up a portion of the bottom and prevent the rail from reaching the true bottom of the hole. Also, if the rail does not extend above the ground surface, the shoulder can be repaved and returned to use for traffic.
- G. The maximum effective spacing from edge to edge of the holes is three feet. This is to insure that the soil will not flow between the piles.
- H. When the required spacing for rails is less than two feet, additional rows of rails should be used. If a spacing of one and one half feet were required, two rows of railing with rails on three foot centers would be used. The rows would be staggered to obtain the required spacing. The spacing between the rows of rails should be kept as close as is practical. A spacing between the rows of two feet or less is desirable in order to make the group of piles behave as a unit in retaining the sliding mass. See figure 2 for a diagram showing rail spacings and staggering in the rows.
- I. Care must be taken to insure that the flanges on the rails are positioned perpendicular to the direction of the landslide. This is to utilize the full strength of the rail cross section.
- J. After the rail is installed, the hole is to be backfilled with concrete, sand, peagravel, or crushed limestone or sandstone as availability and economics dictate. Care is to be taken to insure adequate backfilling. The backfill material is to be shoveled or dropped in small amounts to avoid bridging between the rail and the sides of the hole. If bridging occurs, empty pockets result down in the hole and the rail will not be able to resist any landslide movement until settlement of backfill takes place.
- K. When backfilling behind the rails, care should be taken to obtain compaction of the backfill. Every precaution should be taken to see that the rails are not damaged during the backfilling operation. Light weight fill material such as sawdust or flyash should be used when possible.

**Typical Section Depicting Installation of  
Railroad Rail Placed in Drilled Socket  
for Landslide Correction**

*If concrete is used as the backfill material, guardrail post may be inserted in fresh concrete*

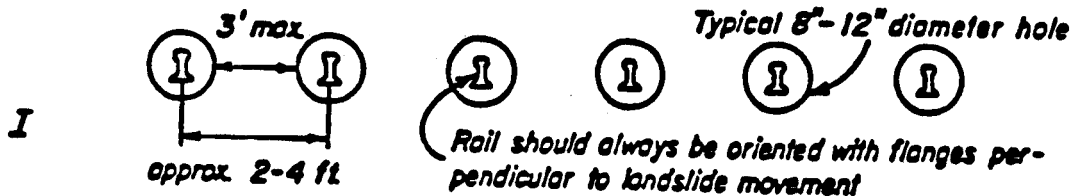
*Newly Compacted Fill, usually select, granular, free draining material*

*Material below piles may continue to move*

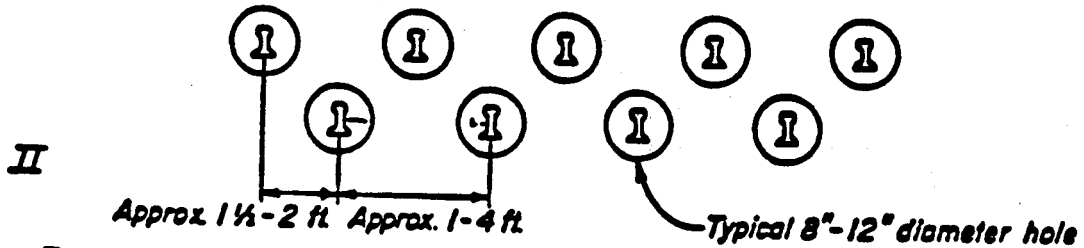


**Fig. 1**

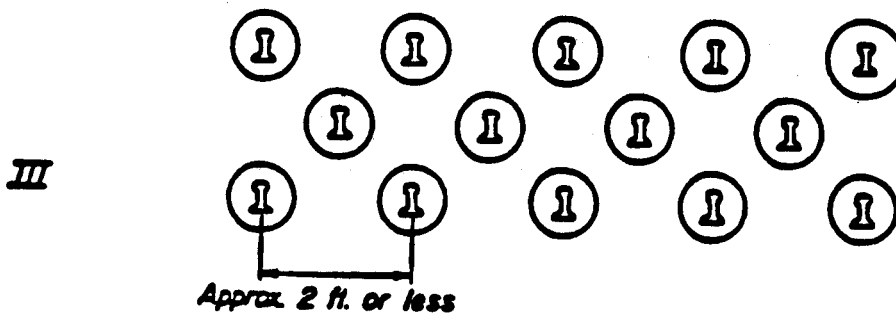
## Alternate Schemes for Installing Railroad Rails placed in drilled sockets



*One row may be used when the effective spacing varies from approximately 2-4 ft.*



*Two rows should be used when the effective spacing varies from 1½ ft - 2 ft. The rails in each row would be spaced from 1ft-4ft. This plan may also be used when effective spacing of ½ ft. or less is specified by inserting more than one rail in each hole.*



*Three rows may be used when the effective spacing is very close, say ½ ft. The rails in each row would be spaced approx. 2 ft. apart.*

**Fig. 2**

### Example Problem #1

Given: A stockpile of railroad rails with a nominal weight of 90 pounds and 140 pounds per yard of length. A roadway shoulder slide develops in which it is found that the depth to rock is 12 feet at the shoulder. Find the spacing requirements for the rails for each size.

#### Procedure:

1. Go to the corresponding design chart for the rail weight.
2. Find the depth to rock along the bottom of the rail weight.
3. Go straight up from that depth until the curve is intersected.
4. Go straight across to the vertical line at the left to read the spacing.
5. Specify the depth of embedment at least one-half the depth to rock.

#### Answers:

1. For a 90 lb/yd rail:

A single row spaced at 1.5 feet or a double row at 3 feet evenly spaced and staggered. Embedment is at least 6 feet into rock.

2. For a 140 lb/yd rail:

A single row spaced at 3 feet on a double row at 6 feet evenly spaced and staggered. Embedment is at least 6 feet into the rock.

### Example Problem #2

Given: A shoulder landslide develops in which the depth to rock is found to be 16 feet. Specify a design for correction using rail piling.

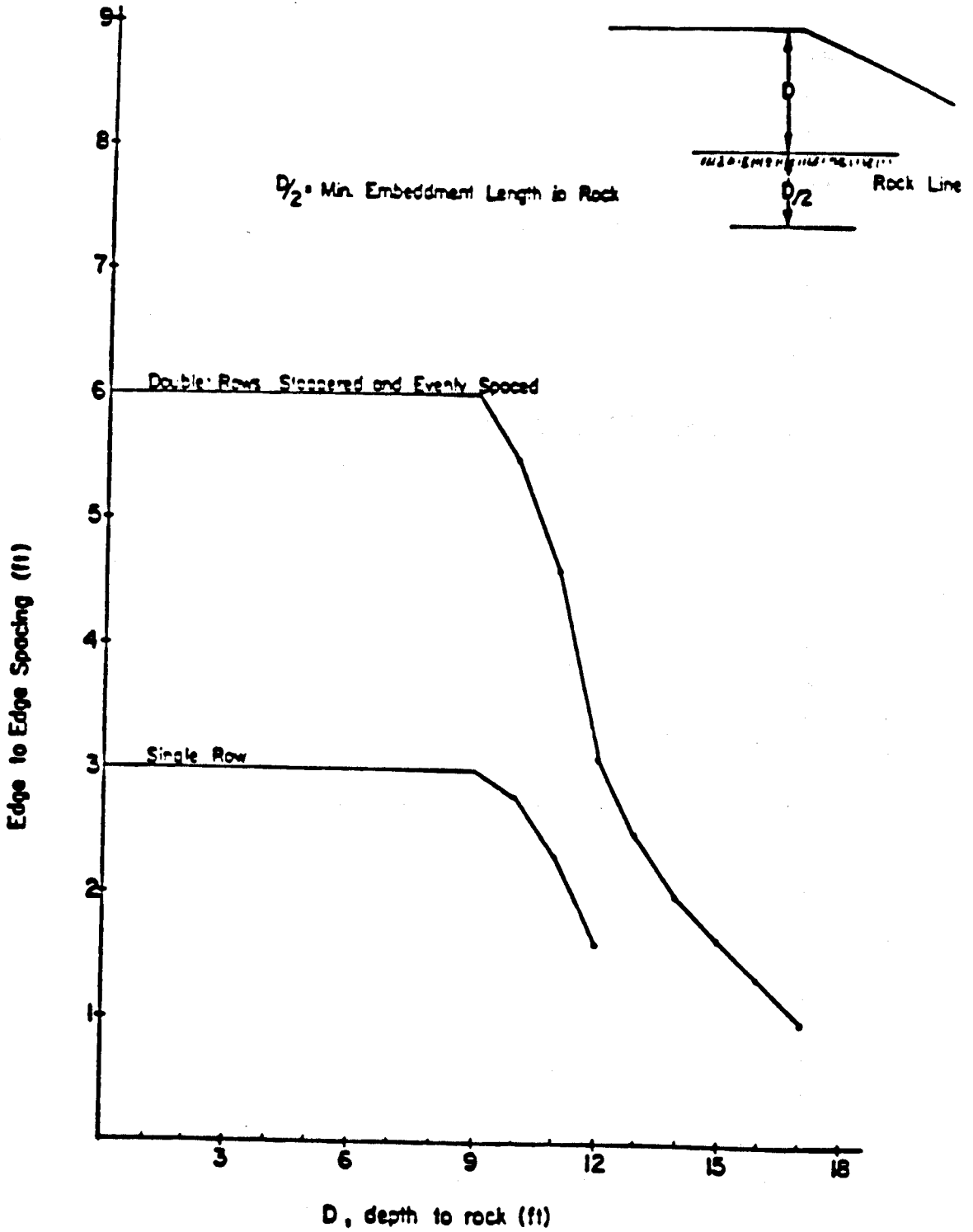
Procedure:

1. Find the depth to rock on the bottom line of any chart.
2. Go straight up from that point until the curve is intersected. If the curve is not intersected, then try the next larger size. Repeat if necessary until the curve can be intersected.
3. Go straight across to read the edge to edge spacing.
4. Specify the depth of rail embeddment of no less than one-half the depth to rock.

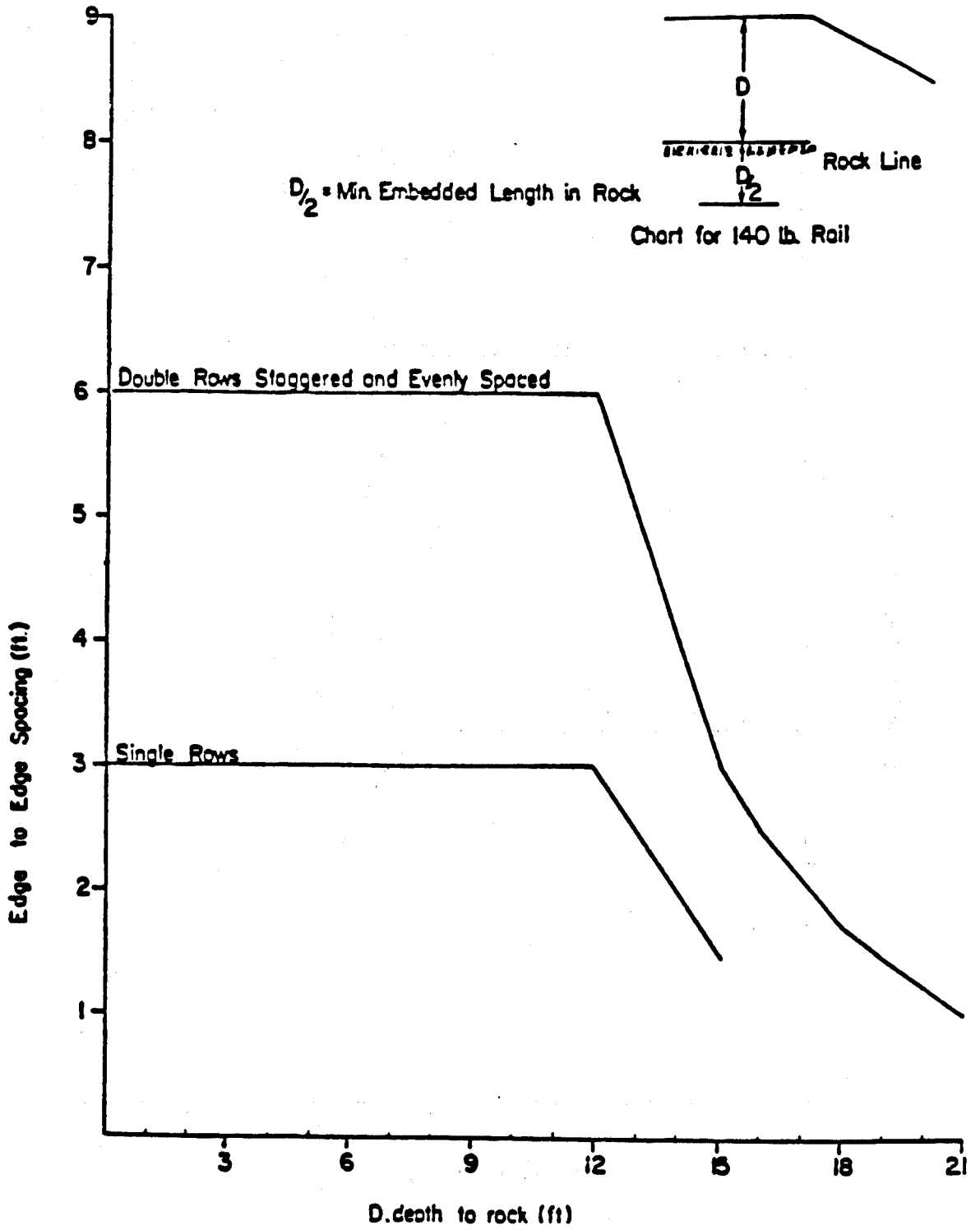
An Example Answer:

- A. Two rows of 90 lb/yd rails, evenly spaced and staggered, at 1.5 feet edge to edge. Embeddment length is no less than 8 feet into rock.
- B. Two rows of 140 lb/yd rails, evenly spaced and staggered, at 2.5 feet edge to edge. Embeddment length is no less than 8 feet into rock.
- C. Any other size rail which shows a point on its design curves for the specified depth. The two sizes above are just for example and are not the only sizes to be specified.

### Design Chart for 90 lb./yd. Rail



# Design Chart for 140 lb./yd Rail







**APPENDIX E**  
**DECISION FLOW CHART**

DECISION FLOW CHART

