

## Evolutionary Analysis

Fiona Brinkman  
Simon Fraser University,  
Greater Vancouver, BC, Canada

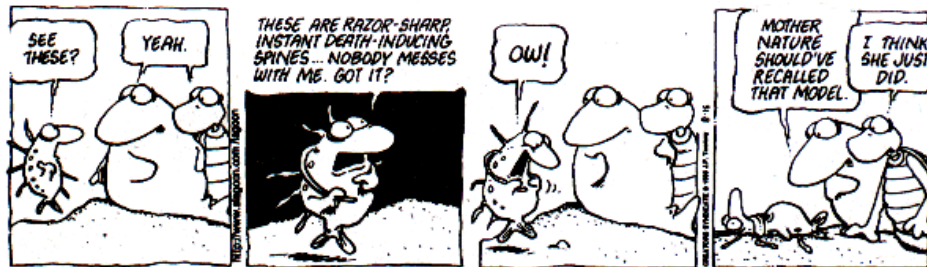

## Why care about Evolutionary Analysis?

What do

- BLAST
- Protein motif searching
- Protein threading
- Multiple sequence alignment

Have in common?

## **Why care about Evolutionary Analysis?**

Gene family identification

Gene discovery – inferring gene function, gene annotation

Origins of a genetic disease, characterization of polymorphisms

## **Why care about Evolutionary Analysis?**

Koski LB, Golding GB

The closest BLAST hit is often not the nearest neighbor.

J Mol Evol. 2001 Jun;52(6):540-2.

## Evolutionary Analysis: Key Concepts

- Foundation of most bioinformatic analyses: Evolutionary theory
- Unique versus non-unique characters
- Sequence alignments are important!
- Fundamentals of phylogenetics and interpreting phylogenetic trees (with cautionary notes)
- Overview of some common phylogenetic methods
- Appreciate the need for new algorithms

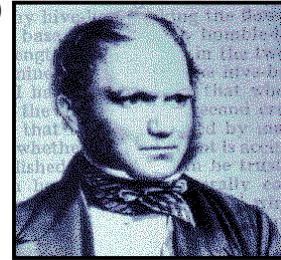

## 18th and 19th centuries: The evolution of a theory

- Earth erosion, sediment deposition, strata – present earth conditions provide keys to the past

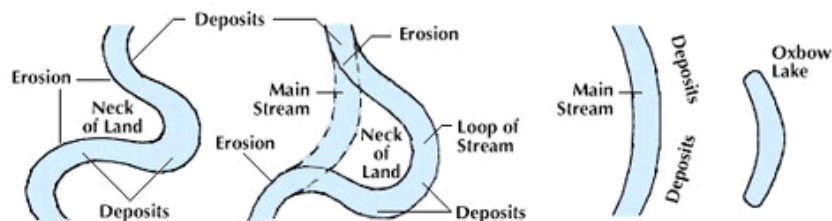
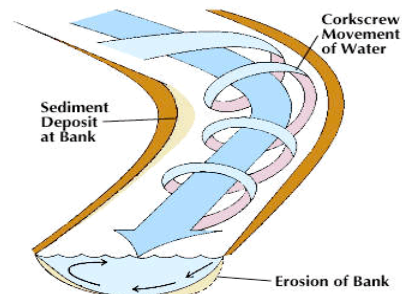

## 18th and 19th centuries: The evolution of a theory

- Discoveries of fossils accumulated
  - Remains of unknown but still living species that are elsewhere on the planet?
  - Cuvier (circa 1800): the deeper the strata, the less similar fossils were to existing species

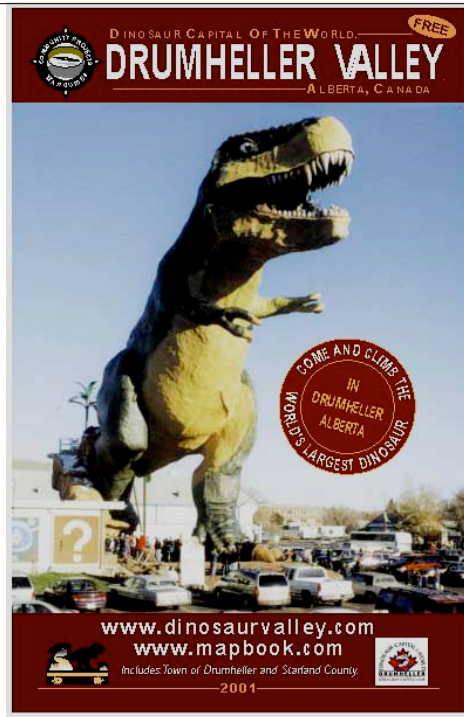

## Darwin: "Origin of the species"

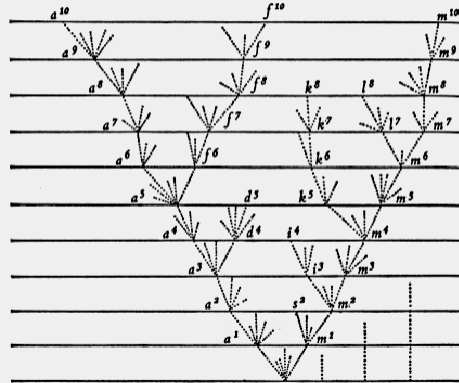

## Part of Darwin's Theory

- The world is not constant, but changing
- All organisms are derived from common ancestors by a process of branching.

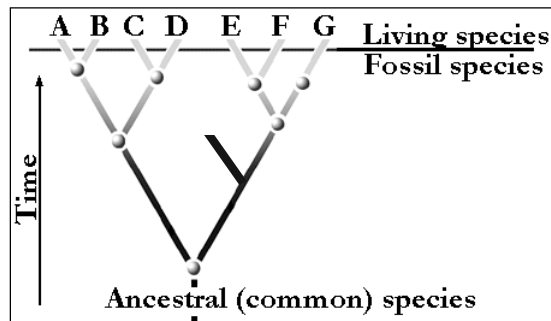

## Part of Darwin's Theory

- This explained...
  - Fossil record
  - Similarities of organisms classified together (shared traits inherited from common ancestor)
  - Similar species in the same geographic region

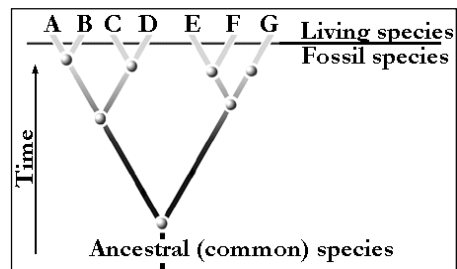

- Morphological character-based analysis

## What is evolution?

- Think – Pair – Share!
- Come up with a definition of evolution that is 6 words or less. Bonus points for 2-3 words!

## Characters

- Heritable changes in features (morphology, DNA sequence etc...)
- The more similar characters you have, the more related you are
- However..... characters can be unique and non-unique

## Evolution and characters

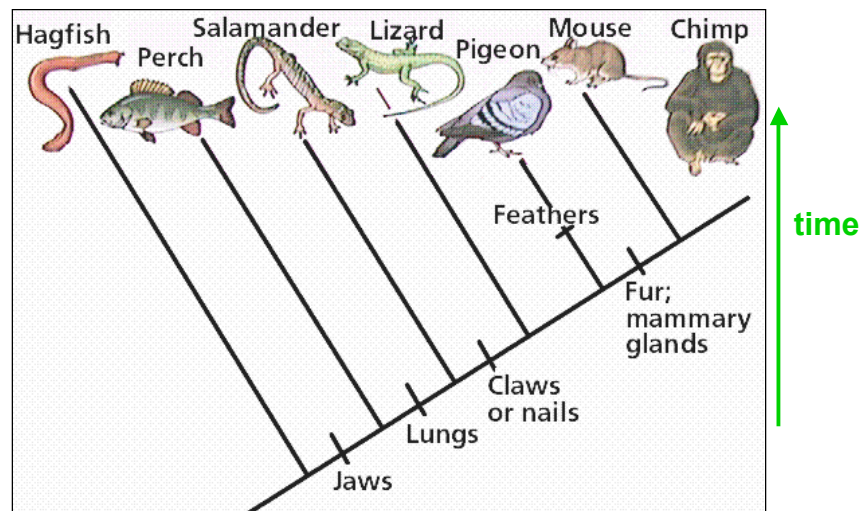

## A Unique Character: Hair for Mammals

- Hair evolved only once and is “unreversed”
- Presence of hair → strong indication that organism is a mammal

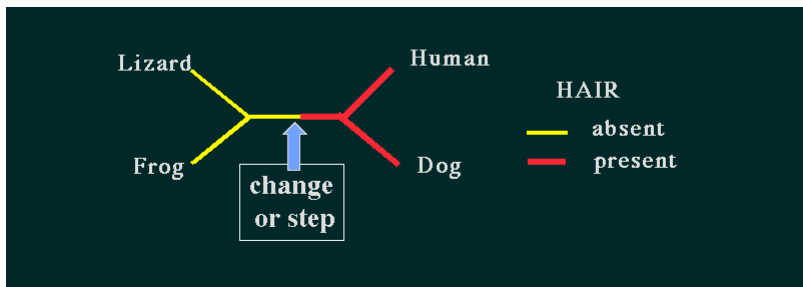

## Homoplasy: The formation of tails

- Tails evolved independently in the ancestors of frogs and humans
- Presence of a tail → no useful conclusions

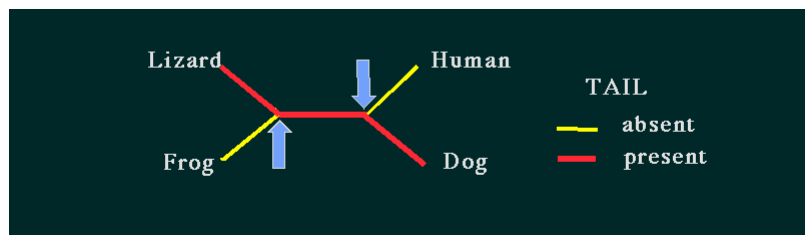



## Unique and non-unique characters

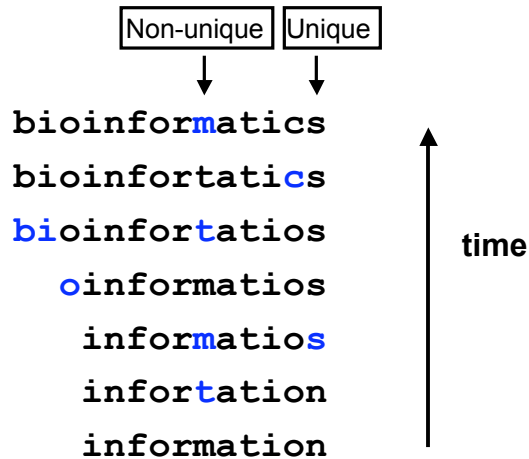

## Unique and non-unique characters

Example: Sequence analysis of functionally similar transporters

*All share the same deleted sequence region, which is not found in any other transporter examined to date*

→ Unique character?

→ Further investigate for possible functional significance, or use for classification

## Unique and non-unique characters

Example: Sequence analysis of functionally similar transporters

*All have isoleucine at the third position in the sequence, however some other transporters have isoleucine there too, while some other transporters have leucine at that position*

→Non-unique.

→Changes from I → L → I are common (see BLOSUM OR PAM matrices). Not a high priority for further analysis of significance and not useful for classification.

## Classification according to characters – more characters can be good

	Colour	Skin	Cost
<b>Beef</b>	red	no	\$\$\$
<b>Duck</b>	red	yes	\$\$\$
<b>Pork</b>	white	no	\$\$
<b>Chicken</b>	white	yes	\$
<b>Tofu</b>	white	sometimes	\$

Chicken most similar to Tofu?

## Classification according to characters

	<b>Colour</b>	<b>Skin</b>	<b>Cost</b>	<b>Legs</b>
<b>Beef</b>	red	no	\$\$\$	four
<b>Duck</b>	red	yes	\$\$\$	two
<b>Pork</b>	white	no	\$\$	four
<b>Chicken</b>	white	yes	\$	two
<b>Tofu</b>	white	sometimes	\$	none

## Classification according to characters – increasing the number of characters

	<b>Colour</b>	<b>Skin</b>	<b>Cost</b>	<b>Legs</b>	<b>Feathers</b>	<b>Hair</b>
<b>Beef</b>	red	no	\$\$\$	four	no	yes
<b>Duck</b>	red	yes	\$\$\$	two	yes	no
<b>Pork</b>	white	no	\$\$	four	no	yes
<b>Chicken</b>	white	yes	\$	two	yes	no
<b>Tofu</b>	white	sometimes	\$	none	no	no

Chicken most similar to Duck?

## Evolution and characters – the importance of comparing characters with common origins (homologous)

bioinformatics  
bioinformatics  
bioinformatios  
oinformatios  
informatios  
information  
information

↑ time

## Evolution and characters

bioinformatics  
bioinformatics  
bioinformatios  
--oinformatios  
---informatios  
---information  
---information

↑ time

- Gaps represent non-homologous positions in the sequence.
- They reflect the occurrence of insertions/deletions or other rearrangements during the evolutionary process.

## Multiple Sequence Alignment

```
VTISCTGSSSNIGAG-NHVRWYQQLPG
VTISCTGTSSNIGS--ITVNWYQQLPG
LRLSCSSSGFIFSS--YAMYWVRQAPG
LSLTCTVSGTSEFDD--YYSTWVRQPPG
PEVTCVVVDVSHEDPQVKFNWYVDG--
ATLVCLISDFYPGA--VTVAWKADS--
AALGCLVKDYFPEP--VTVSWNSG---
VSLTCLVKGFPYPSD--IAVEWESNG--
```

The sole purpose of multiple sequence alignments is to place *homologous positions of homologous sequences* into the same column.

## Multiple sequence alignments and phylogenetic analysis

- First step in any phylogenetic analysis
- Phylogenetic analysis only as good as the alignment

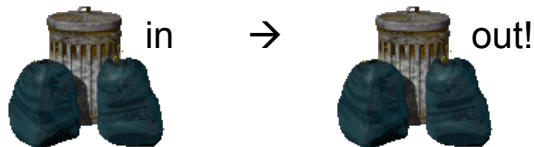

## Clustal: Adding evolutionary theory to multiple sequence alignment

Thompson, J.D., Higgins, D.G. and Gibson, T.J. (1994)  
CLUSTAL W: improving the sensitivity of progressive multiple sequence alignment through sequence weighting, positions-specific gap penalties and weight matrix choice. *Nucleic Acids Research*, 22:4673-4680.

### (A) Pairwise Alignment

Example - 4 sequences  $S_1, S_2, S_3, S_4$

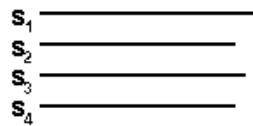

6 pairwise comparisons  
then cluster analysis

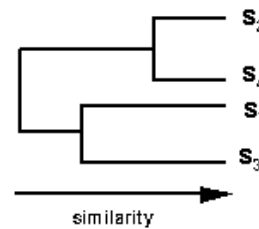

### (B) Multiple alignment following the tree from A

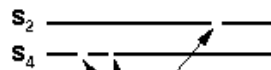

align most similar pair

Gaps to optimize alignment

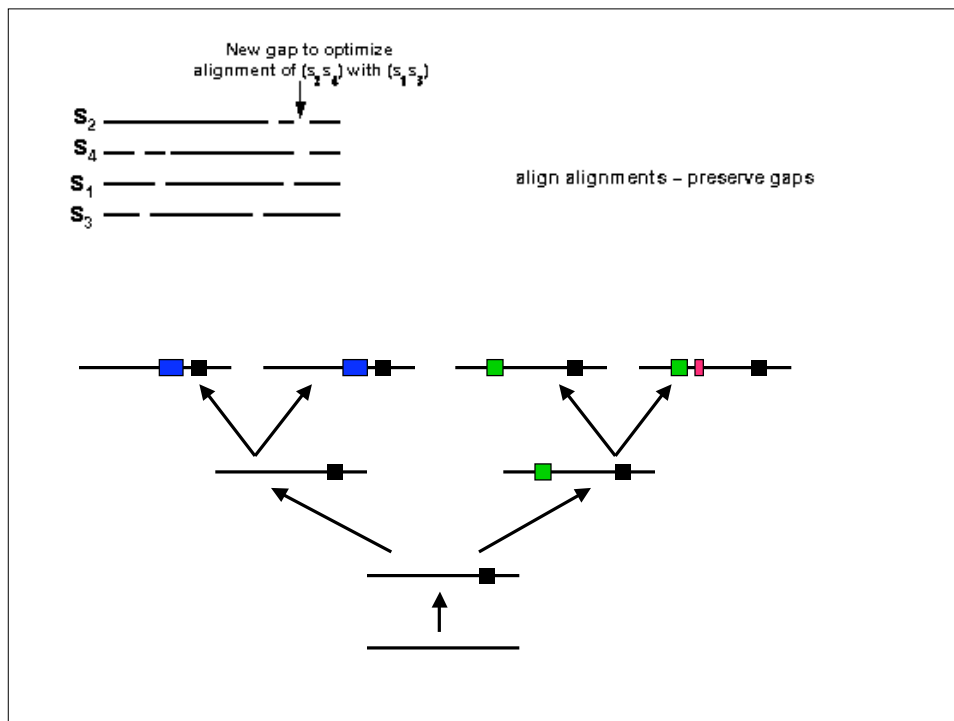
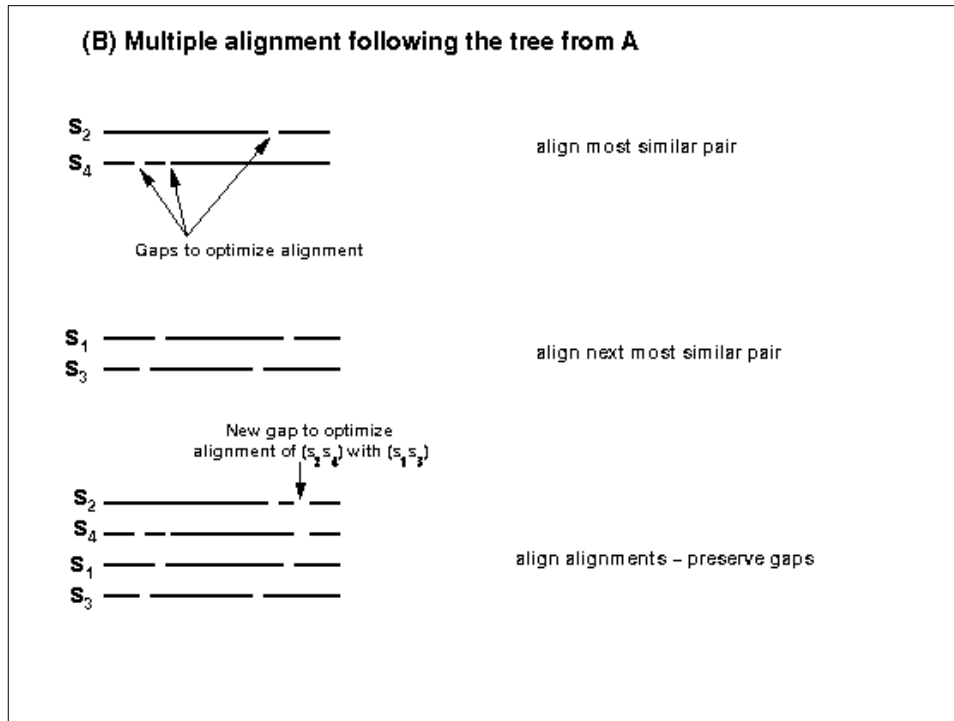

## Clustal: Incorporating Biology into Sequence Alignment Algorithms

- Matrices varied at different alignment stages according to the divergence of the sequences
- Gap penalties differ for hydrophilic regions to encourage new gaps in potential loop regions
- Gapped positions in early alignments - reduced gap penalties to encourage the opening up of new gaps at these positions

## Standard multiple sequence alignment approach (first step for phylogenetic analysis)

- Be as sure as possible that the sequences included are homologous
- Know as much as possible about the gene/protein in question before trying to create an alignment (secondary structure etc..)
- Start with an automated alignment: preferably one that utilizes some evolutionary theory such as Clustal



- Examine alignment:
  - Are you confident that aligned residues/bases evolved from a common ancestor?
  - Are domains of the proteins/predicted secondary structures, etc. aligning correctly?

→ No? May need to edit sequences and redo...

---

---

→ Yes? Move on!
- Note indels (insertions and deletions)
  - Possible insights into functionally important regions...

- Use alignment as a based for subsequent analyses (identify consensus or other pattern recognition, for PSSM, HMM construction, phylogenetic analysis, etc..)
- Remove unreliably aligned regions for phylogenetic analysis

```
ILPITSPSKEGYESGKAPDEFSSGG
ILPEH--IKDDGELGAAPHSFSTAG
VLPLD-----S--AGRPADSFSAAAG
VLPVDR-----DGQARDEYT-VG
VLPVDN-----KGEARDEYT-VG
LLPYDD-----QGRPQDDYSRAG
GIVSRSG---SNFDGEPKDSYGKVG
```

Delete?

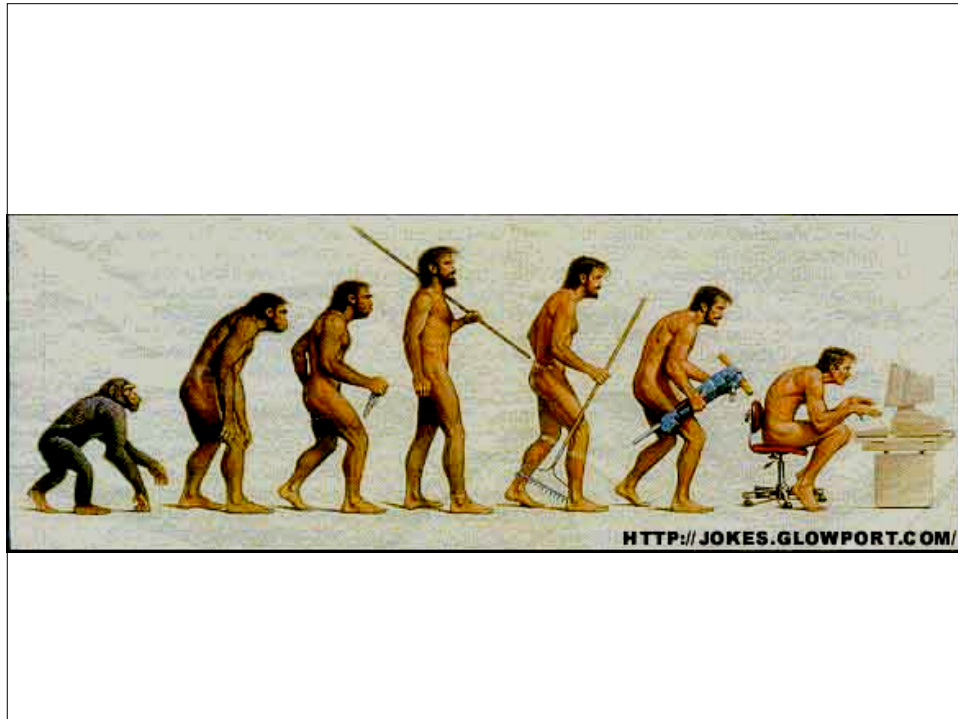

## A phylogenetic tree

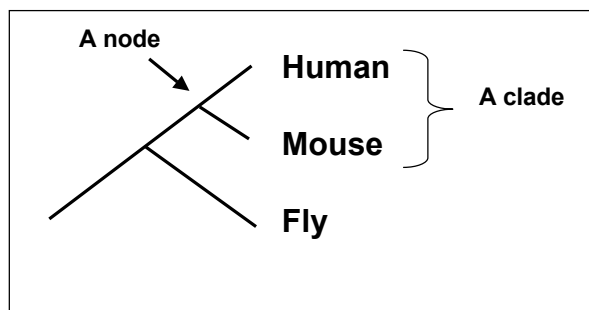

**taxon** -- Any named group of organisms -- evolutionary theory not necessarily involved.

**clade** -- A monophyletic **taxon** (evolutionary theory utilized)

## A phylogenetic tree with branch lengths

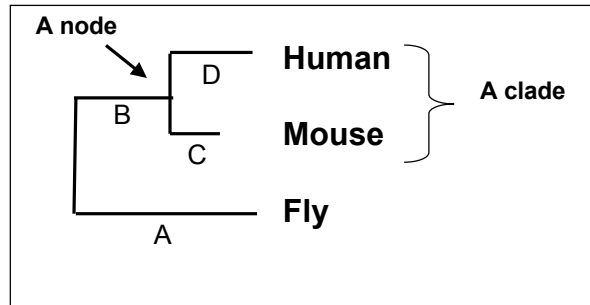

**Branch length can be significant...**

**In this case the analysis suggests that the mouse sequence/taxon is slightly more similar to fly than human is to fly**

**(i.e. sum of branches  $A+B+C$  is less than sum of  $A+B+D$ )**

## Phylogenetic analysis

- **Organismal relationships**
- **Gene/Protein relationships**

## Organismal relationships

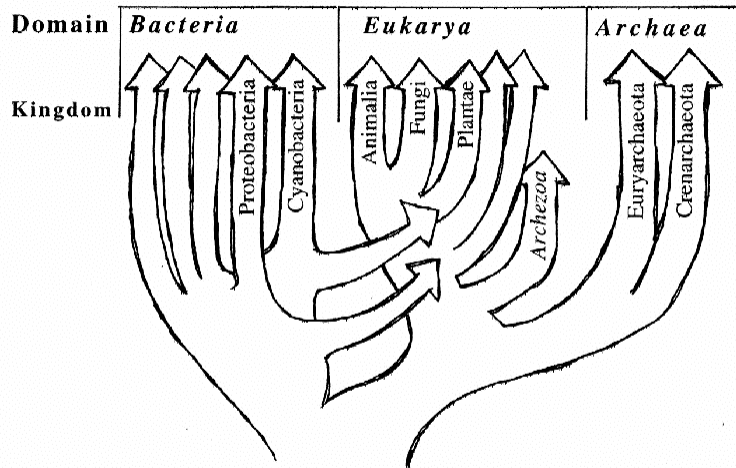
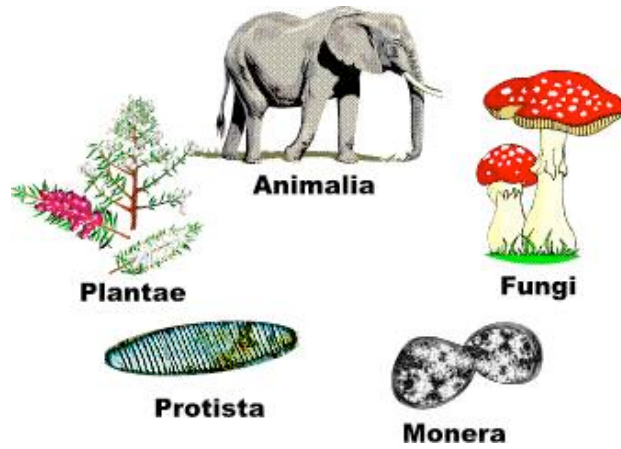

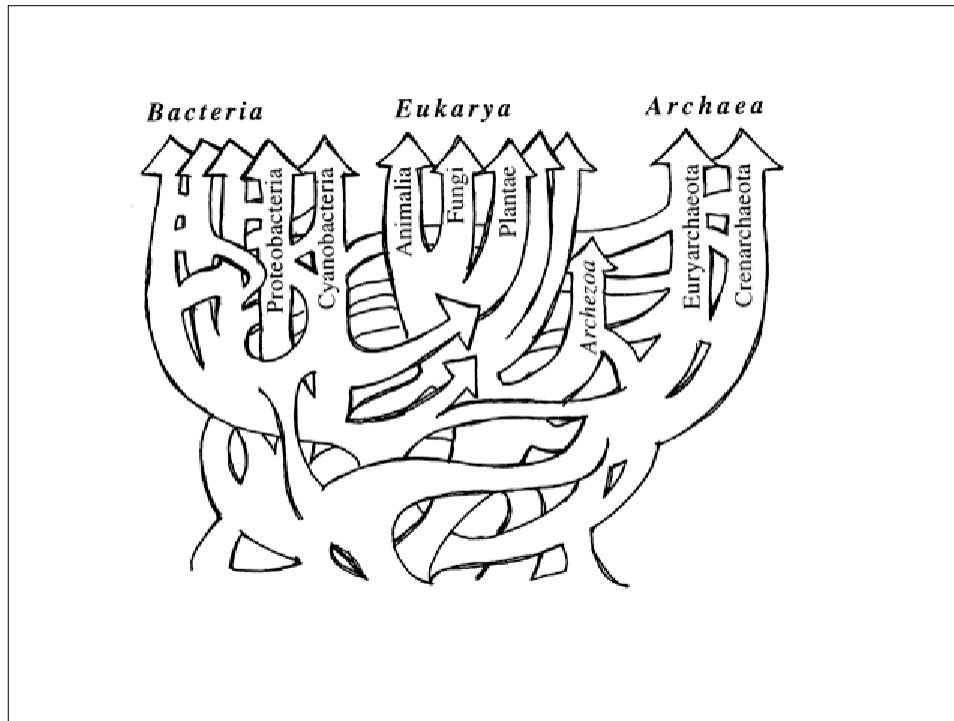

## Improving our understanding of organismal relationships

**Realization that rates of change are not constant**



## Improving our understanding of organismal relationships

**Better appreciation for what sequences may be suitable for analysis of different degrees of divergence**

**For the tree of life:**

**rRNA genes**



**Multiple genes**



**“Whole genome” datasets of genes**



**rRNA genes and multiple suitable genes**

## Gene/Protein Relationships

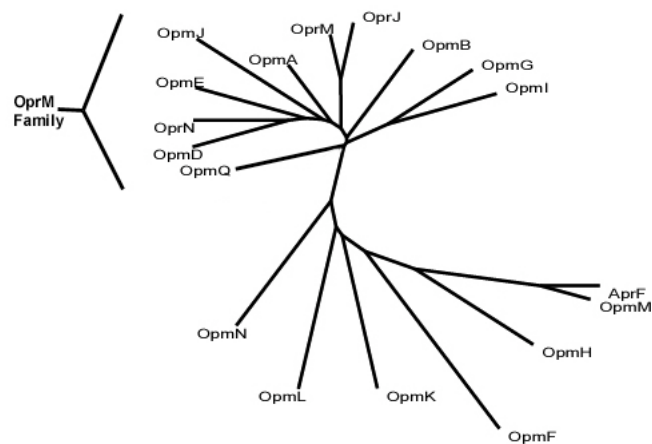

**Homolog, ortholog, paralog??**

## Homologs

**Have common origins but may or may not have common activity.**

**Homologous or not?: *Often* determined by arbitrary threshold level of similarity determined by alignment**

## Homologs

**...have common ancestry, but the way they are related can vary (i.e. the reasons they have diverged into different sequences can vary)**

- **orthologs** - Homologs produced *only* by speciation. They *tend* to have similar function.
- **paralogs** - Homologs produced by gene duplication. They *tend* to have differing functions.
- **xenologs** -- Homologs resulting from horizontal gene transfer between two organisms.

### Orthologous or paralogous homologs

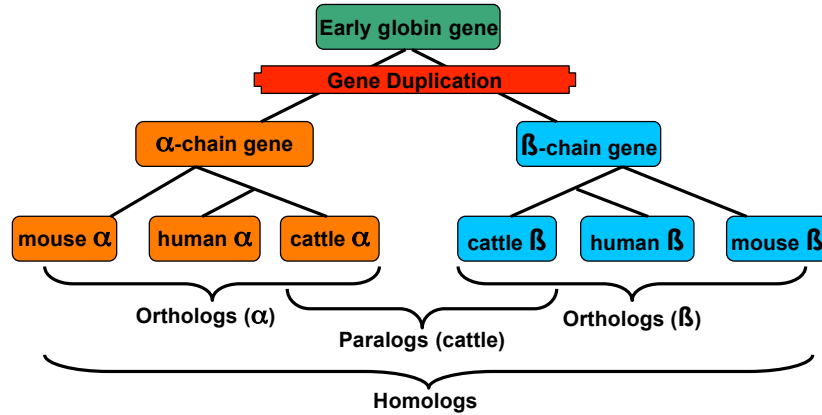

Orthologs – diverged only after speciation – *tend to have similar function*  
 Paralogs – diverged after gene duplication – *some functional divergence occurs*  
*Therefore, for linking similar genes between species, or performing “annotation transfer”, identify orthologs*

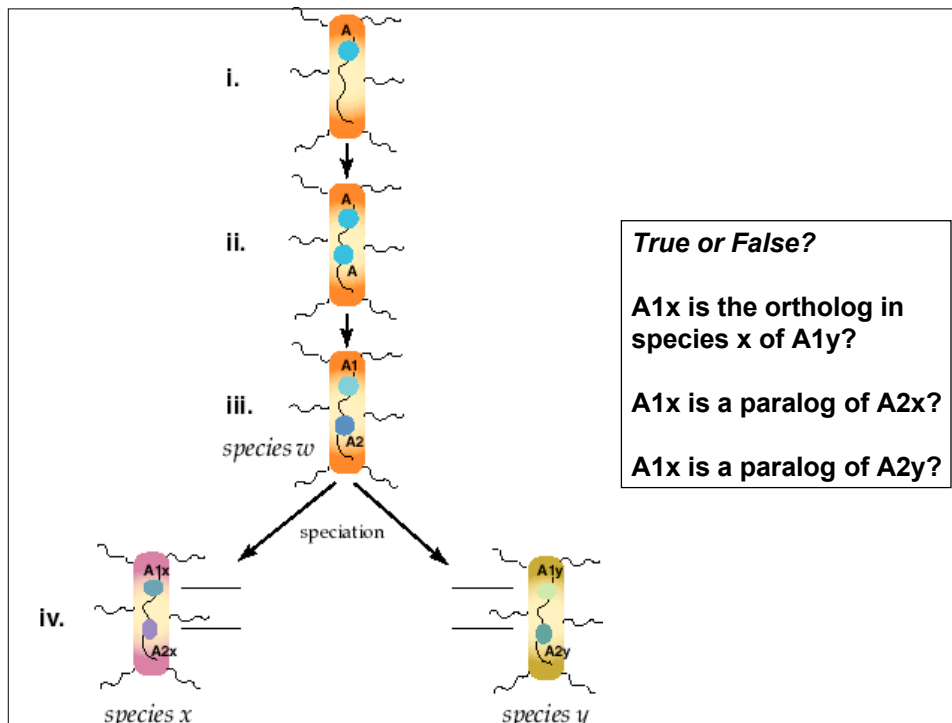

**True or False?**  
 A1x is the ortholog in species x of A1y?  
 A1x is a paralog of A2x?  
 A1x is a paralog of A2y?



## Identifying Gene/Protein Relationships from Phylogenetic trees

- **orthologs** - Homologs produced only by speciation.  
*ID: Gene phylogeny matches organismal phylogeny.*
- **paralogs** - Homologs produced by gene duplication.  
*ID: Multiple copies of homologs in a given species, or genes more/less related than expected by organismal phylogeny.*
- **xenologs** -- Homologs resulting from horizontal gene transfer between two organisms.  
*ID: Gene phylogeny does not match organismal phylogeny in a tree where most genes do match organismal phylogeny well.*

## What are the probable orthologs and paralogs of the fly genes BKA and WOOT?

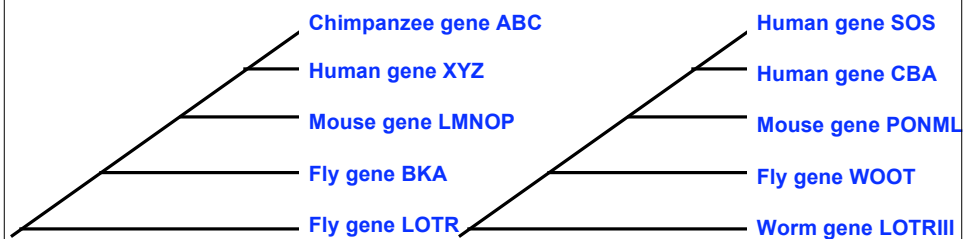
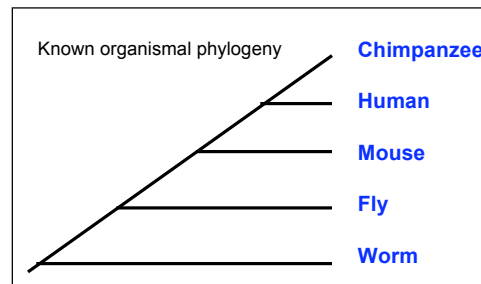

## High Throughput Gene Orthology: How to detect?

- Most common high throughput computational method: Identify reciprocal best BLAST hits (EGO, COGs,...)

### Example Problem:

- If making comparisons between human and bovine, for example, the bovine gene dataset is still quite incomplete
- Therefore, current best hit may be a paralog now and the true ortholog not yet sequenced

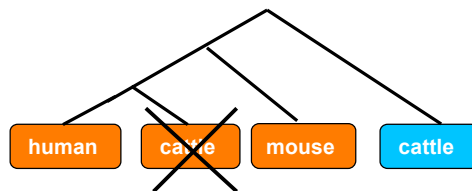

## Can we improve orthology analysis for linking functionally similar genes?

- One solution: Phylogenetic analysis of all putative human-bovine orthologs, using mouse as an outgroup
- Assumption:
  - Mouse and Human gene datasets are more complete, with more true orthologs identified

Expect (organismal phylogeny):

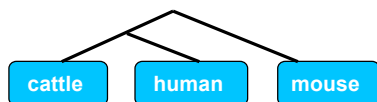

Reject:

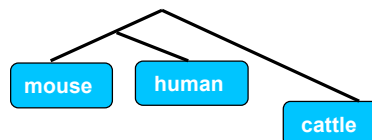

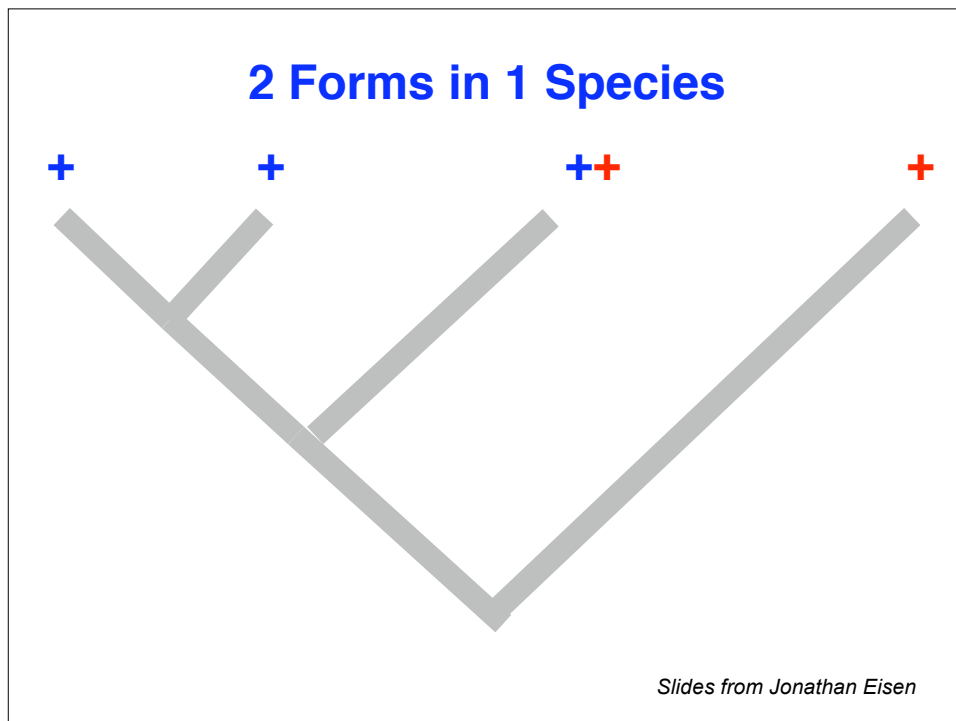
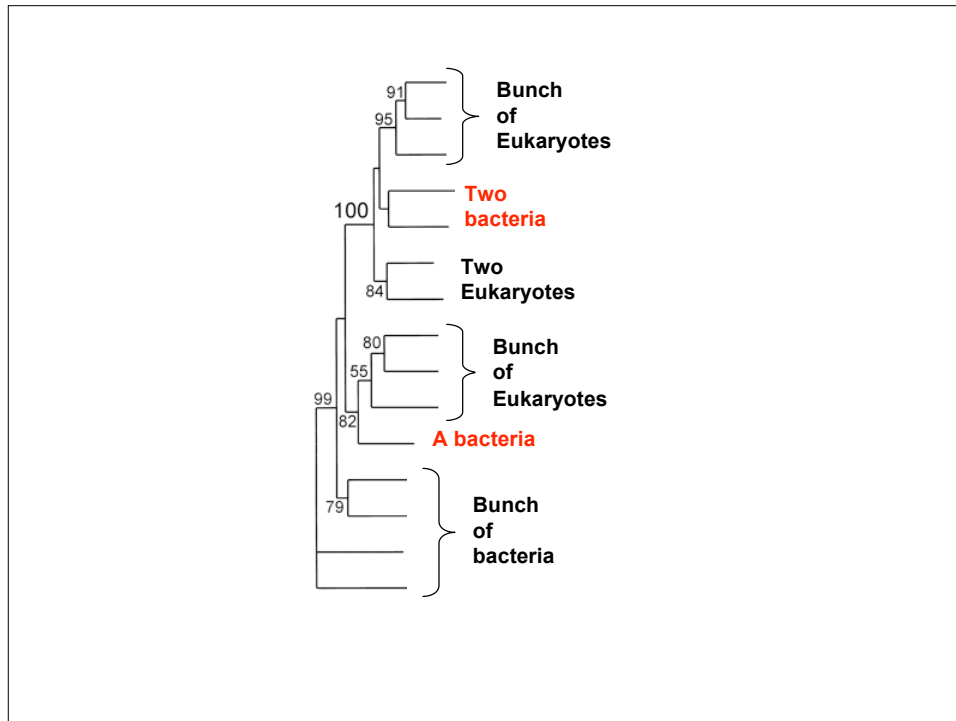

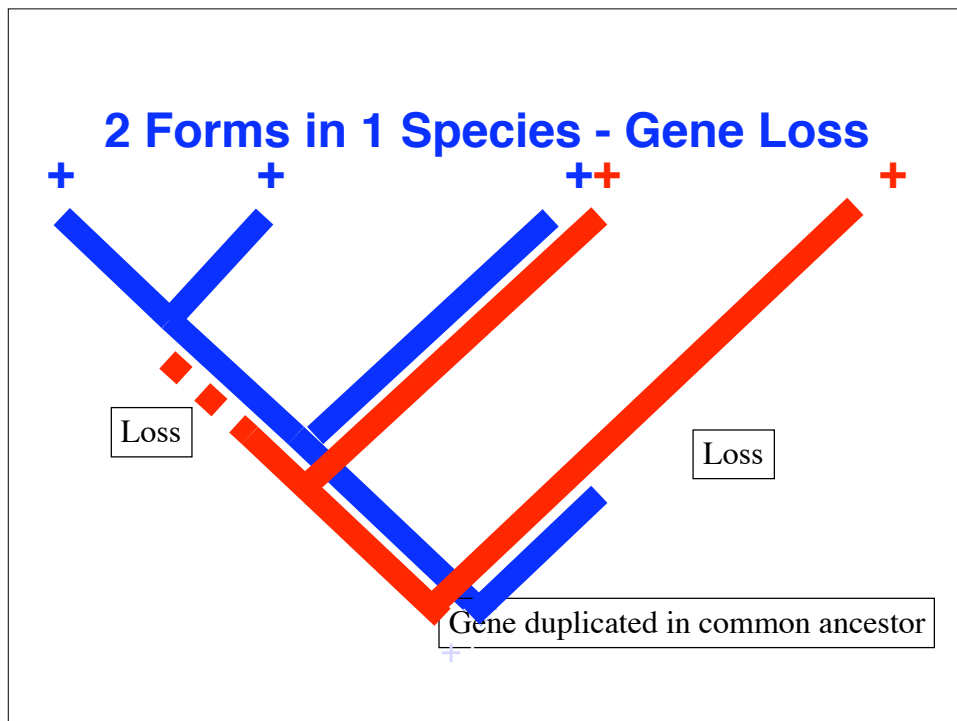
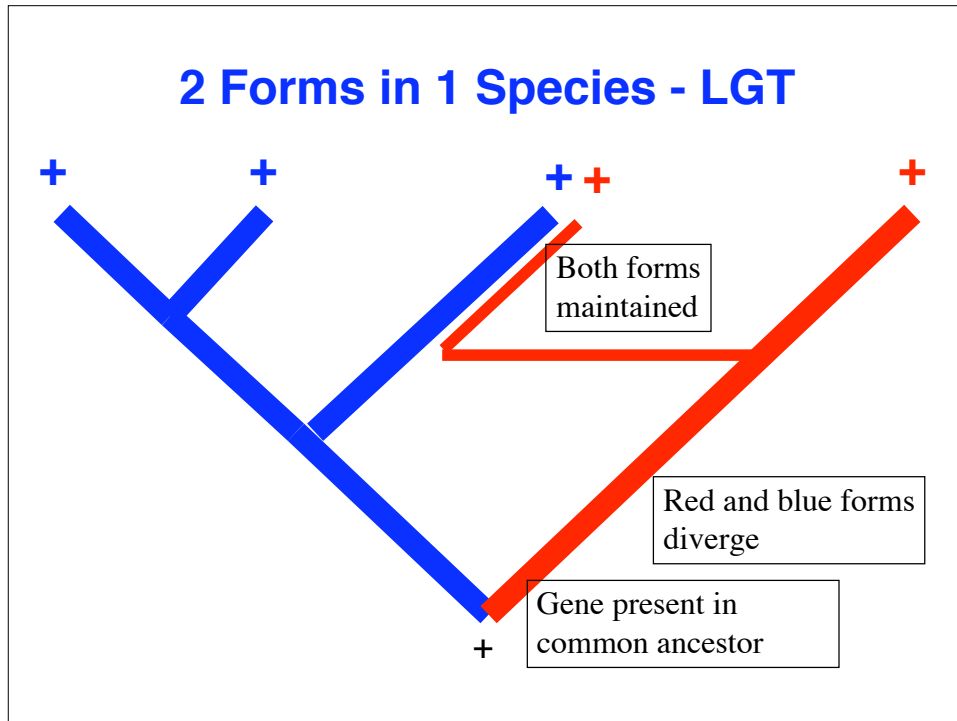

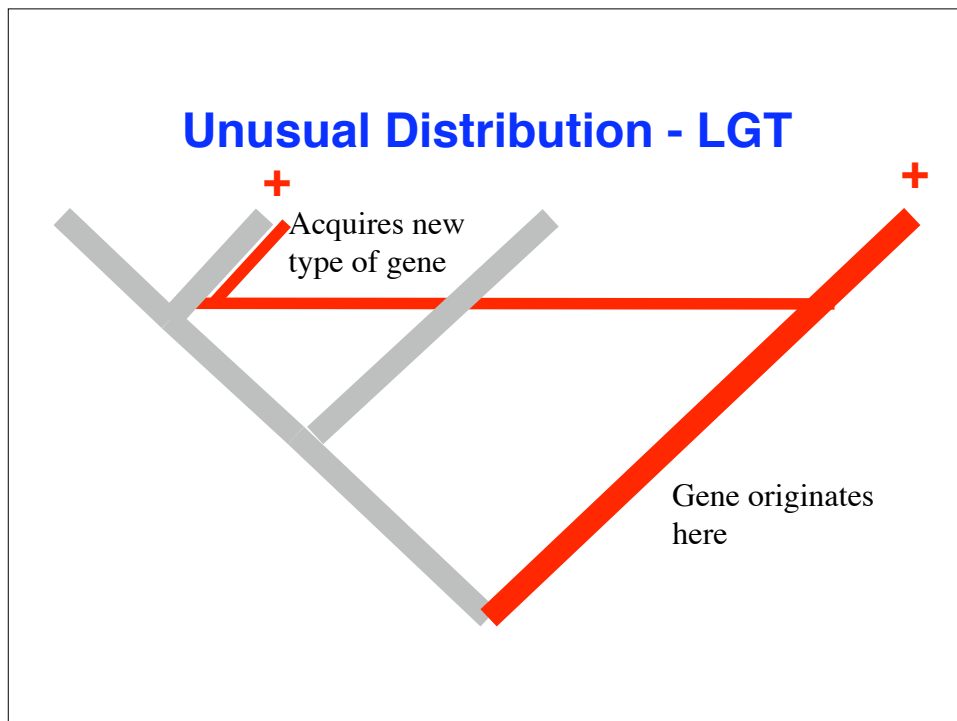
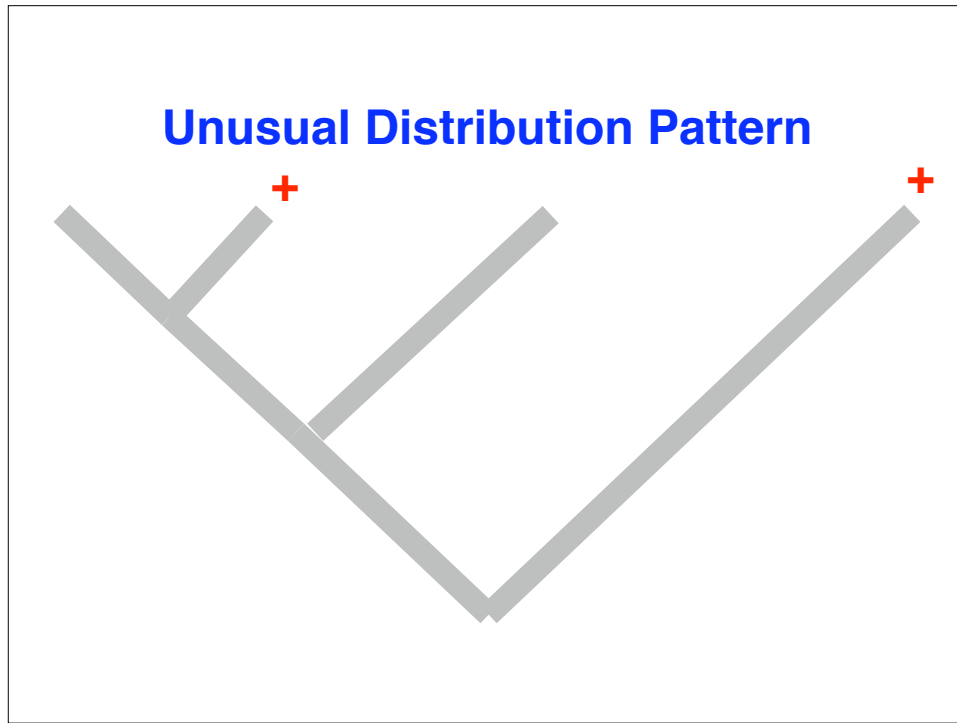

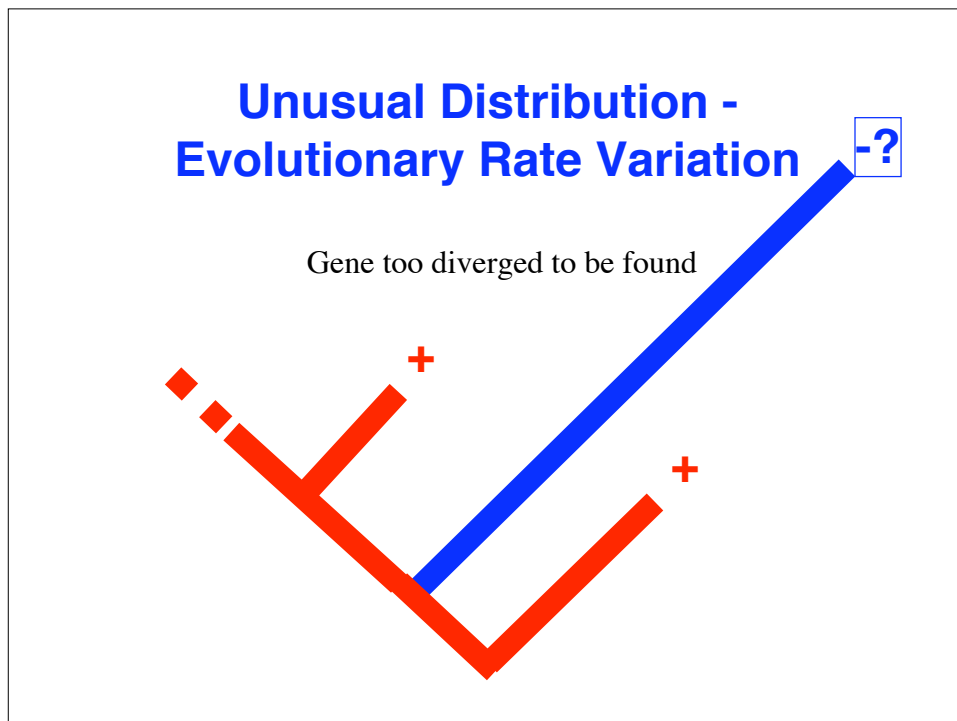
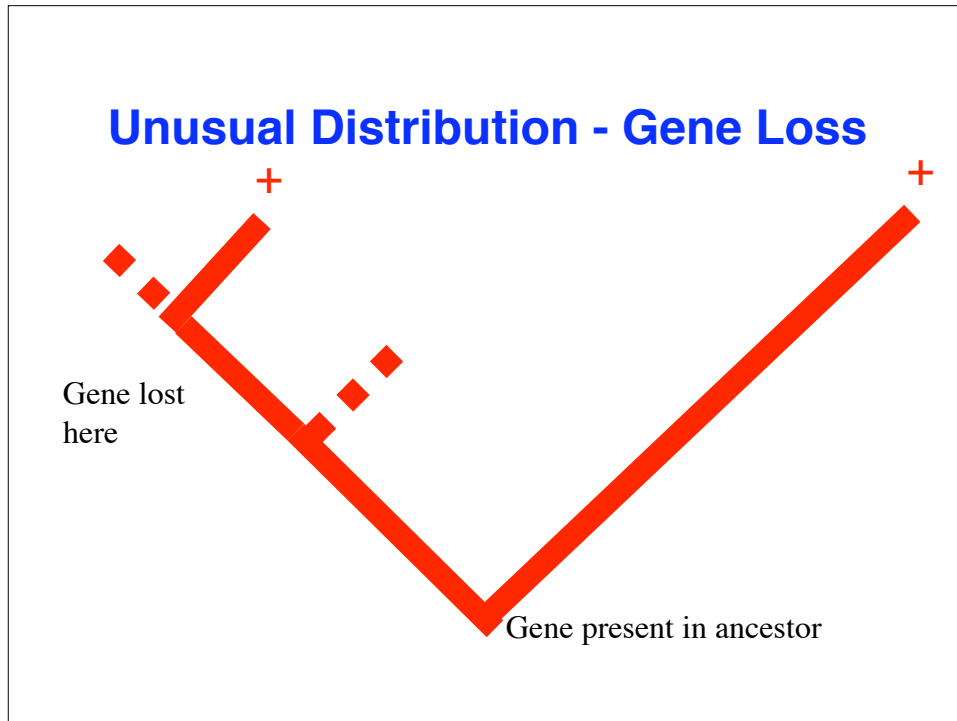

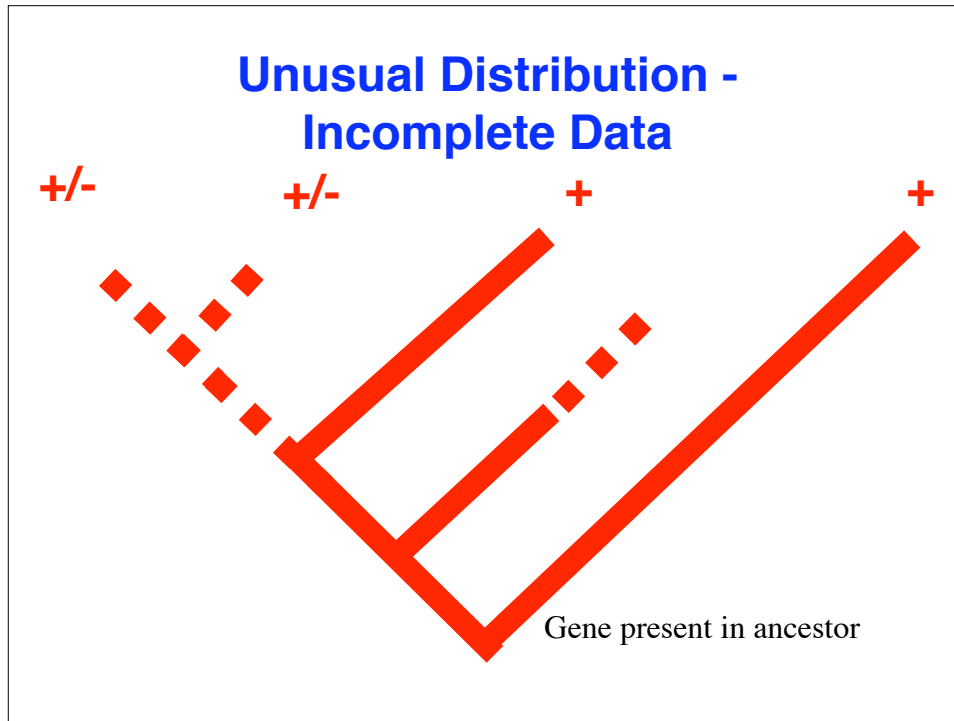

## Hope for the future

**Better sampling of all the species in our world**

### **2004: Environmental genomics sampling takes centre stage**

Tyson et al (2004) Community structure and metabolism through reconstruction of microbial genomes from the environment. *Nature*, 428, 37-43.

Venter et al (2004) Environmental genome shotgun sequencing of the Sargasso Sea. *Science*, 304, 66-74.

**TRUE!** by Daryl Cagle

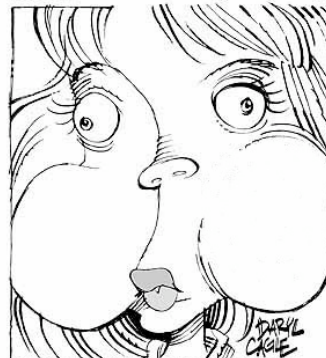

Source: LA Times quoting Dr. Socransky of Forsyth Dental Center in Boston.  
The number of bacteria living in your mouth can easily exceed the number of people who live on the Earth.

“So..... how do we construct a phylogenetic tree??”

Most common methods

- Parsimony
- Neighbor-joining
- Maximum Likelihood



## Parsimony

- “Shortest-way-from-A-to-B” method
- The tree implying the least number of changes in character states (most parsimonious) is the best.
- Note:
  - May get more than one tree
  - No branch lengths
  - Uses all character data

## Neighbor-joining (and other distance matrix methods)

- “speedy-and-popular” method
- distance matrix constructed
- distance estimates the total branch length between a given two species/genes/proteins
- Neighbor-joining approach: Pairing those sequences that are the most alike and using that pair to join to next closest sequence.

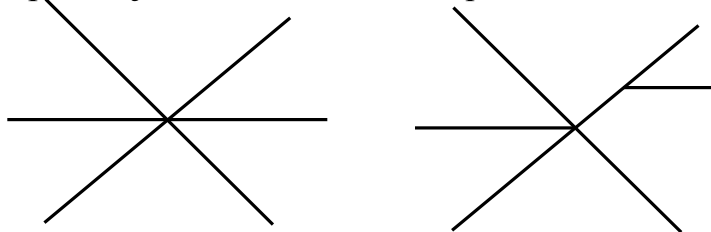

## Maximum Likelihood

- “Inside-out” approach
- produces trees and then sees if the data could generate that tree.
- gives an estimation of the likelihood of a particular tree, given a certain model of nucleotide substitution.
- Notes:
  - All sequence info (including gaps) is used
  - Based on a specific model of evolution – gives probability
  - Verrrrrrrrrry slow (unless topology of tree is known)

## How reliable is a result?

- **Non-parametric bootstrapping**
  - analysis of a sample of (eg. 100 or 1000) randomly perturbed data sets.
  - perturbation: random resampling with replacement, (some characters are represented more than once, some appear once, and some are deleted)
  - perturbed data analysed like real data
  - number of times that each grouping of species/genes/proteins appears in the resulting profile of cladograms is taken as an index of relative support for that grouping

## Bootstrapping

The number of times a particular branch is formed in the tree (out of the X times the analysis is done) can be used to estimate its probability, which can be indicated on a consensus tree

*High bootstrap values don't mean that your tree is the true tree!*

*Alignment and evolutionary assumptions are key*

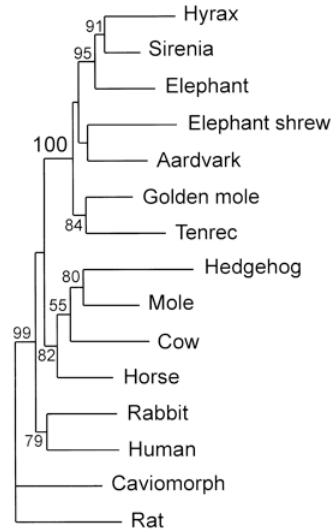

## Parametric Bootstrapping

Data are simulated according to the hypothesis being tested.

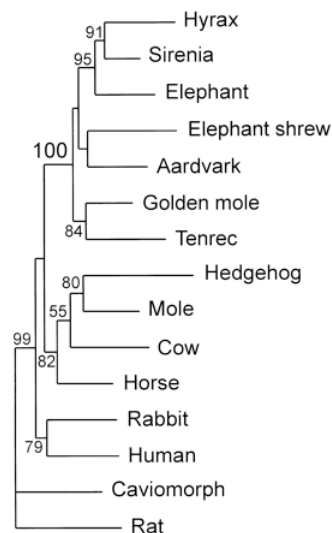

## Phylogenetics – More info

Li, Wen-Hsiung. 1997. Molecular evolution Sunderland, Mass. Sinauer Associates.

- a good starting book, clearly describing the basis of molecular evolution theory. It is a 1997 book, so is starting to get a bit out of date.

Nei, Masatoshi & Kumar, Sudhir. 2000. Molecular evolution and phylogenetics Oxford ; New York. Oxford University Press.

- a relatively new book, by two very well respected researchers in the field. A bit more in-depth than the previous book, but very useful.

## Phylogenetic Tree Construction: Examples of Common Software

### **PHYLIP**

<http://evolution.genetics.washington.edu/phylip.html>

### **PAUP**

<http://paup.csit.fsu.edu/>

### **MEGA 2.1**

[www.megasoftware.net/](http://www.megasoftware.net/)

### **TREEVIEW**

<http://taxonomy.zoology.gla.ac.uk/rod/treeview.html>

### ***Extensive list of software***

<http://evolution.genetics.washington.edu/phylip/software.html>

## Challenges

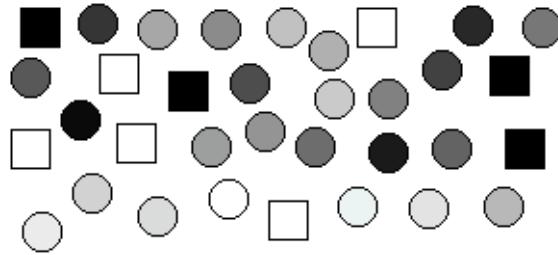

**How do we classify?**

## Computational Challenges

- Need to incorporate more evolutionary theory into the multiple sequence alignment and phylogenetic algorithms used in phylogenetic analysis
- Phylogenetic analyses are computationally intensive – great way to benchmark your CPU speed!

## More Challenges

- *Increasing the sampling of our genetic world*
- More accurately differentiating orthologs, paralogs, and horizontally acquired genes
- How frequent is gene loss, gene duplication, and horizontal gene transfer in genome evolution?
- To what degree can we predict protein/gene function using phylogenetic analysis?

**Remember:**  
**Evolutionary theory is evolving...**



"I've only just bought this bronze stuff and you're telling me I ought to upgrade to iron?"