



U.S. Department
of Transportation
**Pipeline and
Hazardous Materials
Safety Administration**

RADIOACTIVE MATERIAL



December 08

Regulations Review

Note: This document is for general guidance only and must not be used to determine compliance with 49 CFR Parts 100-185.

This page intentionally left blank.

TABLE OF CONTENTS

I. INTRODUCTION.....	1
II. BACKGROUND.....	2
A. Uses of Radioactive Material.....	2
B. Review of Radioactivity and Radiation.....	2
C. Radiation Protection Principles.....	3
D. SI and Customary Radiological Units.....	4
E. Radiation Exposures and Biological Effects.....	4
III. TRANSPORT SAFETY REGULATIONS.....	6
A. International Regulations.....	6
1. United Nations.....	6
2. International Atomic Energy Agency.....	7
3. International Maritime Organization.....	7
4. International Civil Aviation Organization.....	7
B. Federal Regulations.....	8
1. Department of Transportation.....	8
2. Nuclear Regulatory Commission.....	11
3. Transportation Security Administration.....	12
4. United States Postal Service.....	12
IV. RADIOACTIVE MATERIALS TERMINOLOGY.....	14
A. Radioactive Material.....	14
B. Special Form Radioactive Material.....	14
C. Normal Form Radioactive Material.....	17
D. A ₁ and A ₂ Quantity Limits.....	17
E. Excepted Quantities.....	19
F. Highway Route Controlled Quantities (HRCQ).....	21
G. Low Specific Activity (LSA) Material.....	22
H. Surface Contaminated Objects (SCO).....	23
I. Fissile Material.....	25
J. Radioactive Materials Not Covered by the HMR.....	26
V. CATEGORIES OF RADIOACTIVE MATERIALS	
PACKAGES.....	27
A. General Packaging Requirements.....	28

TABLE OF CONTENTS

B. Excepted Packages	28
C. Industrial Packages (Type IP-1, IP-2, IP-3)	30
D. Type A Packages	31
E. Type B Packages	36
F. Fissile Radioactive Material Packages	41
G. Packages Containing Uranium Hexafluoride	43
VI. TRANSPORT CONTROLS	44
A. Transport Index (TI)	44
B. Criticality Safety Index (CSI)	48
C. Package Radiation Limits	50
D. Contamination Limits and Contamination Surveys	54
VII. SHIPMENTS OF LOW SPECIFIC ACTIVITY (LSA) MATERIALS AND SURFACE CONTAMINATED OBJECTS (SCO)	56
A. Transport Requirements for LSA Materials and SCO	56
B. Packages for LSA Materials and SCO	57
1. Unpackaged LSA Material and SCO	57
2. Excepted Packages of LSA Material and SCO	57
3. Industrial Packages of LSA Material and SCO	58
4. Type A Packages for LSA Material and SCO	58
5. Type B Packages for LSA and SCO	59
6. Packages for Exclusive Use Transport of Liquid LSA-I	59
7. Typical Packages for Radioactive Waste Shipped as LSA or SCO	59
VIII. HAZMAT COMMUNICATIONS AND RELATED REQUIREMENTS	61
A. Hazardous Materials Table	61
B. Proper Shipping Names for Radioactive Materials	61
C. Shipping Paper Requirements	63
1. Basic Shipping Paper Requirements	63
2. Additional Shipping Paper Description for Radioactive Material	64
3. Other Information and Examples of Shipping Papers Entries	65
4. 95% Rule for Mixtures	67
5. Documentation for Excepted Packages	69
6. Shipper's Certification	69
D. Marking Requirements	70

TABLE OF CONTENTS

1. Basic Marking Requirements.....	70
2. Marking Requirement for Liquids	71
3. Marking Requirements for Radioactive Materials.....	71
4. Marking of Bulk Radioactive Material Packages	72
E. Labeling Requirements	73
F. Placarding Requirements	77
G. Emergency Response Information Requirements.....	78
1. Required Information.....	79
2. Emergency Response Telephone Number	79
3. Emergency Response Guidebook	80
H. Training Requirements	81
1. General Awareness/Familiarization Training.....	82
2. Function-Specific Training	82
3. Safety Training	82
4. Security Awareness Training.....	82
5. In-Depth Security Training	83
6. Testing and Record Keeping.....	83
I. Security Requirements	83
J. Incident Reporting Requirements	84
IX. QUALITY ASSURANCE.....	85
A. Prior to First Use.....	85
B. Prior to Each Use	85
C. NRC QA Requirements	86
X. OVERVIEW OF NRC'S 10 CFR TRANSPORT-RELATED REQUIREMENTS.....	87
A. 10 CFR PART 71	87
B. 10 CFR PART 20.....	88
1. Procedures for Receiving and Opening Packages	88
2. Control Of Access To High Radiation Areas Containing Radioactive Material Packages	89
3. Requirements for Transfers of Low-Level Radioactive Waste	89
C. Notification Requirements.....	90
D. NRC Requirements for Radioactive Materials in Quantities of Concern.....	90

TABLE OF CONTENTS

XI. OTHER REQUIREMENTS	91
A. Carrier Requirements	91
B. Registration Requirements	92
C. Motor Carrier Safety Requirements	93
1. Commercial Driver's License.....	93
2. Hazardous Materials Safety Permits	94
3. Highway Routing Requirements	95
D. Radioactive Material Shipments By Air	96
XII. DOT AND NRC ENFORCEMENT POLICIES	97
APPENDIX A INTERNATIONAL SYSTEM OF UNITS (SI) FOR RADIOACTIVE MATERIALS IN TRANSPORTATION	A-1

TABLE OF CONTENTS

List of Figures

Figure 1 - Radiation Doses in Perspective	5
Figure 2 - NRC Agreement States.....	12
Figure 3 - “Special Form” Radioactive Material	16
Figure 4 - “Normal Form” Radioactive Material	17
Figure 5 - Material Quantity Categories	22
Figure 6 - Example Excepted Package.....	29
Figure 7 - Industrial Packages (IP).....	31
Figure 8 - Type A Packaging Tests.....	33
Figure 9 - Typical Type A Packaging Configurations	35
Figure 10 - Type B Hypothetical Accident Conditions.....	38
Figure 11 - Example Type B Packages	40
Figure 12 - Fissile Radioactive Material Packaging	42
Figure 13 - Transport Index.....	45
Figure 14 - Package Radiation Limits for Non-Exclusive Use Shipments	50
Figure 15 - Allowable Dose Rates for an Exclusive Use Shipment.....	52
Figure 16 - Allowable Dose Rates for an Exclusive Use Shipment in a Closed Transport Vehicle.....	52
Figure 17 - Typical Packages for LSA Materials and SCO	60
Figure 18 - Package Orientation Marking for Liquid Packages.....	71
Figure 19 - Trefoil Symbol.....	72
Figure 20 - ICAO Excepted Package Label	73
Figure 21 - Radioactive Material Labels.....	75
Figure 22 - Fissile Label.....	76
Figure 23 - Empty Label	76
Figure 24 - Vehicle Radioactive Placard.....	77
Figure 25 - HRCQ Placard	78

TABLE OF CONTENTS

List of Tables

Table 1 - Type A Package Quantity Limits for Selected Radionuclides.....	18
Table 2 - Activity Limits for Limited Quantities, Instruments, and Articles.....	20
Table 3 - Contamination Limits for SCOs	24
Table 4 - TI Limits for Freight Containers and Conveyances on Vessels	47
Table 5 - CSI Limits for Freight Containers and Conveyances on Vessels.....	49
Table 6 - Radiation Level Limitations	53
Table 7 - Non-Fixed External Radioactive Contamination Limits for Packages.....	54
Table 8 - Non-Fixed External Radioactive Contamination <i>Wipe</i> Limits for Packages *	54
Table 9 - Industrial Package Integrity Requirements for LSA Material and SCO.....	58
Table 10 - Radioactive Materials Proper Shipping Names and Identification Numbers	62
Table 11 - Label Category Based on TI and Surface Radiation Level.....	74

I. INTRODUCTION

This review provides guidance on the Department of Transportation (DOT) Hazardous Materials Regulations (HMR) contained in Title 49, Code of Federal Regulations (49 CFR) Parts 171-185, which govern the packaging and shipment of radioactive material. These materials have an excellent safety record when packaged, labeled, marked and transported in accordance with these regulations.

This review serves as a reference document and is not an official interpretation or restatement of the regulations. This review of the radioactive material regulations was designed as a guidance document and should not be used without simultaneous reference to all applicable and current regulations pertaining to the transportation of radioactive material. **Users of this review are strongly encouraged to obtain the latest copy of the HMR** from the Government Printing Office (<http://bookstore.gpo.gov>). Amendments to the HMR are published in the Federal Register (<http://www.gpoaccess.gov/fr/index.html>). The current HMR may be found at: <http://www.gpoaccess.gov/cfr/index.html>.

Additional information on DOT's hazardous materials transportation regulations and programs may be found at <http://hazmat.dot.gov>.

The first version of this document was issued in 1972, with subsequent revisions issued in 1974, 1976, 1977, 1980, 1983, and 1998. This version updates the contents to be consistent with changes in the regulations since the last edition. These changes include those made in rulemaking RSPA-99-6283 (HM-230) to be compatible with changes contained in the International Atomic Energy Agency (IAEA) publication, "IAEA Safety Standards Series: Regulations for the Safe Transport of Radioactive Material," 1996 Edition, No. TS-R-1.

This document may be reproduced without further permission from DOT, subject to the following:

The name and the seal of the U.S. Department of Transportation may not be reproduced unless that copy accurately reproduces the entire content (text and format) of this document without modification. In addition, the publisher's full name and address must be displayed on the cover of each copy.

Comments, suggestions, corrections or requests for additional training aids should be mailed to: U.S. Department of Transportation, Office of Hazardous Materials Initiatives and Training, PHH-50, 1200 New Jersey Avenue, SE, Washington, DC 20590.

II. BACKGROUND

A. Uses of Radioactive Material

Radioactive materials are used for a wide range of purposes, including the generation of electric power, research, manufacturing, industrial processes, and medical diagnosis and therapy. Industrial applications of radioactive material include inspection and gauging operations such as examining the integrity of welded joints or measuring the thickness of paper as it is produced. Sealed radioactive sources are also used extensively in oil and gas exploration drilling operations and to check the compactness of roadbeds during paving operations. Every major hospital in the United States has a nuclear medicine department in which radionuclides are used to diagnose and treat a wide variety of diseases.

Millions of radioactive materials packages are shipped annually in the United States; a large percentage of these are radiopharmaceutical shipments. To date, there have been no known deaths or injuries to transport workers, emergency services personnel, or the general public as a result of the radioactive nature of materials in transport. This safety record can be attributed to the proper packaging of radioactive material and the effectiveness of the transportation safety standards and regulations.

B. Review of Radioactivity and Radiation

If there are too few neutrons or too many neutrons in the nucleus of an atom, the atom is unstable. Such an unstable atom will try to become more stable by emitting energy in the form of radiation, and it is said to be radioactive. When it emits radiation to become more stable, it is said to disintegrate or decay.

Each radioactive isotope has a specific known time in which half of the atoms will decay, called the “half-life,” measured in years, days, hours, minutes or seconds. The activity of a radioactive material is the number of decays per unit of time measured in becquerels (Bq) (or curies (Ci)). The activity per unit mass is called the “specific activity,” often measured in becquerels (or curies) per gram.

When an isotope decays, one or more of the following may be emitted:

- A particle consisting of two neutrons and two protons, called an alpha particle (α -radiation),
- Electrons or positrons, called beta particles (β -radiation),
- Electromagnetic energy in the form of gamma radiation (γ -radiation) or X-rays, and/or
- Neutrons.

Alpha radiation consists of high-energy particles that are relatively large, heavy, and only travel a short distance. Alpha particles lose their energy very rapidly, have a low penetrating ability and a short range of travel - only a few inches in air. Because of the alpha particle's short range and limited penetrating ability, external shielding is not required. A few inches of air, a sheet of paper, or the dead (outer) layer of skin that surrounds our bodies easily stops alpha particles. Alpha radiation poses minimal biological hazard outside the body. The greatest hazard from alpha-emitting material occurs when the material is inhaled, ingested, or absorbed through open wounds. Once inside the body, the alpha radiation can cause harm to individual cells or organs. Common alpha emitters transported include smoke detectors containing americium-241.

Beta radiation consists of particles that are smaller, lighter, and travel farther than alpha radiation. Beta radiation is more penetrating than alpha radiation. The range of penetration in human tissue is less than ¼ inch. In air, beta radiation can travel several feet. Beta radiation may be blocked or shielded by plastic, aluminum, thick cardboard, several layers of clothing or the walls of a building. Outside the body, beta radiation constitutes only a slight hazard. Because beta radiation penetrates only a fraction of an inch into living skin tissue, it does not reach the major organs of the body. However, exposure to high levels of beta radiation can cause damage to the skin and eyes. Internally, beta radiation is less hazardous than alpha radiation because beta particles travel farther than alpha particles and, as a result, the energy deposited by the beta radiation is spread out over a larger area. This causes less harm to individual cells or organs. Common beta emitters transported include medical isotopes such as iodine-131, carbon-14, tritium (H-3), and sulfur-35.

Gamma radiation frequently accompanies the emission of alpha and beta radiation. Gamma radiation, like X-rays, is electromagnetic radiation. This means that it does not consist of particles like alpha and beta radiation but, rather, waves of energy that have no mass and no electrical charge. Because they have no mass and no electrical charge, they are able to travel great distances and require dense material for shielding. Gamma radiation poses a hazard to the entire body because it can easily penetrate human tissue. Lead, steel, and concrete are commonly used to shield gamma radiation. Common gamma emitters transported include radiography sources such as cobalt-60 and iridium-192.

Neutron radiation can travel great distances and is highly penetrating like gamma radiation. Thus, neutron radiation is an external and internal hazard. It is best shielded with material having a high hydrogen content (e.g., water, plastic). The ease with which neutrons can be shielded and detected depends on their energy; fast neutrons can be shielded by hydrogenous material while cadmium or boron can be used to shield slow thermal neutrons. In transportation situations, neutron radiation is not commonly encountered. Neutron emitters transported include californium-252 and spent nuclear fuel.

C. Radiation Protection Principles

A key principle of radiation protection is the minimization of dose. The external dose received is the product of the dose rate and the time exposed. Dose from external radiation can be reduced by either:

- reducing the activity of the source,
- increasing shielding around the source
- increasing the distance from the source, or
- reducing the time spent near the source.

Transport packages provide distance and shielding from the contained material, as needed to maintain safe dose rates at the surface of the package. Transport packages also provide for containment of the radioactive material. If the containment is breached, the material can contaminate objects and potentially be inhaled or ingested by people. Contamination can be either fixed or removable. Removable, or non-fixed contamination, is contamination that is deposited on the surface of objects or personnel that can readily be picked up or wiped up by physical or mechanical means during a survey or through decontamination efforts. Fixed contamination is bound to the contaminated surface and not easily removed and so presents primarily a radiation hazard and not a contamination hazard.

D. SI and Customary Radiological Units

To ensure compatibility with international transportation standards, units of measure in the HMR are expressed using International System of Units (SI) units. U.S. standard or customary units, which appear in parentheses following the SI units, are for informational purposes only and are not intended to be the regulatory standard. Shipping papers and labels must use the International System of Units (SI) units, which may be followed by customary units in parentheses.

The basic SI unit for quantity of radioactive material is the becquerel (Bq), and the customary unit is the curie (Ci). One becquerel is equivalent to one atom decaying (or disintegrating) each second. A curie (Ci), originally defined as the activity of 1.0 g of radium, is equal to 3.7×10^{10} Bq.

For radiation levels, or dose rates, the basic SI unit is the sievert per hour (Sv/h), and the customary unit is rem per hour (rem/h). The information in Appendix A may be useful in converting values between SI Units and customary units.

E. Radiation Exposures and Biological Effects

The average annual radiation exposure from natural sources to an individual in the United States is about 3 millisieverts (mSv) (equivalent to 300 millirem (mrem)); however, levels of background radiation vary greatly from one location to the next. Radon gas accounts for two-thirds of this exposure, while cosmic, terrestrial, and internal radiation account for the remaining third. Man-made sources of radiation from medical, commercial, and industrial activities contribute about another 0.6 mSv (60 mrem) annually, with diagnostic medical procedures accounting for about 0.4 mSv (40 mrem) of this. Consumer products such as tobacco, fertilizer, welding rods, gas mantles, luminous watch dials, and smoke detectors contribute another 0.1 mSv (10 mrem) to annual radiation exposure.

Radiation is known to be carcinogenic at high doses. The association between radiation exposure and the development of cancer is mostly based on populations exposed to high levels of radiation. Currently there are no data to unequivocally establish the occurrence of cancer following exposure to low doses and dose rates, i.e., those below about 100 mSv (10,000 mrem). However, it is conservatively assumed that any amount of radiation exposure may pose some risk for causing cancer and hereditary effects, and that the risk is higher for higher radiation exposures.

The following figure provides some radiation doses in perspective.

Figure 1 – Radiation Doses In Perspective
(in millirem)

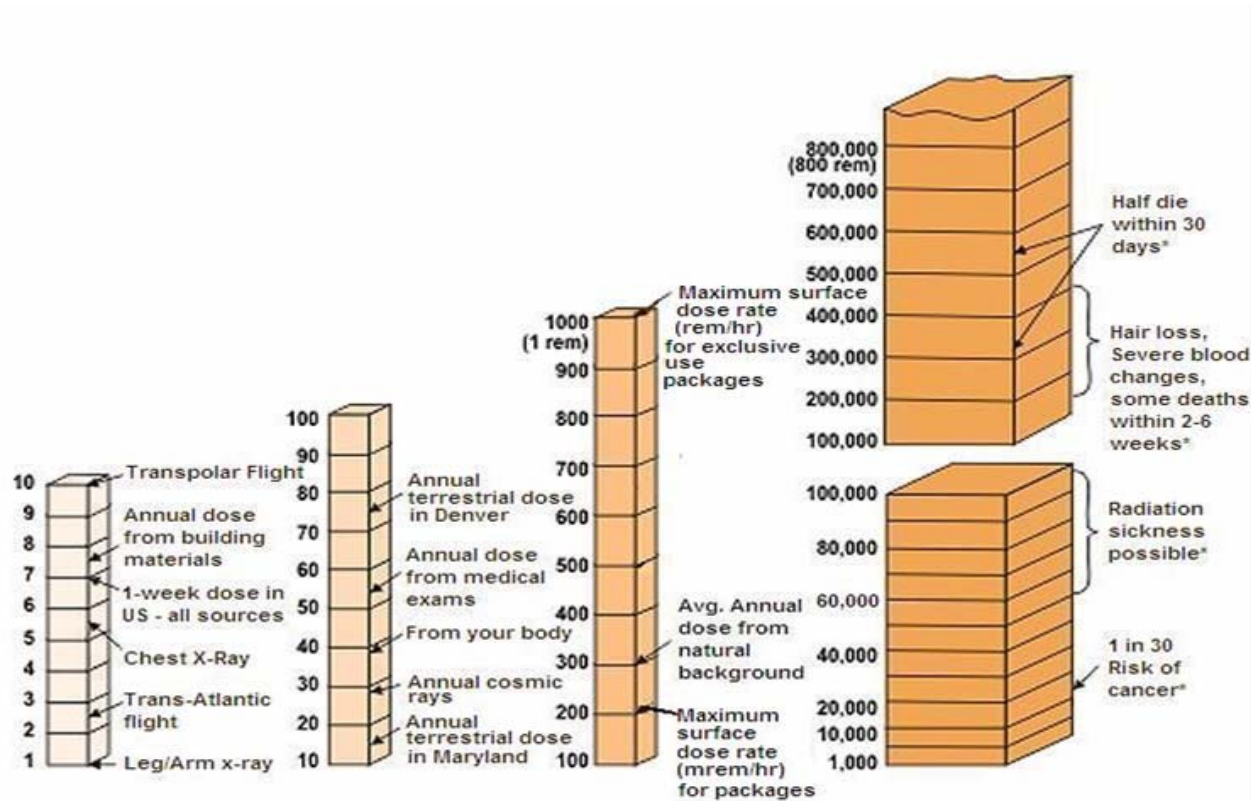

* Doses received over short time period (hours to days) at high dose rates are "acute" doses.

III. TRANSPORT SAFETY REGULATIONS

A. International Regulations

There are a number of international bodies and organizations which deal with the transportation of radioactive material. The majority of these international bodies are sanctioned by or affiliated with the United Nations (UN). These agencies write regulations and recommend their adoption by member states as a basis for national regulations. Additional information on international standards may be found at: <http://hazmat.dot.gov/regs/intl/intstandards.htm>. A list of suppliers of these documents may be found at: <http://hazmat.dot.gov/regs/intl/interpub.htm>.

1. United Nations

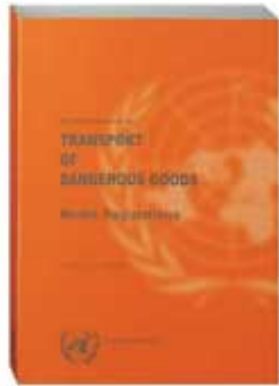

The United States participates as a member of the United Nations (UN) Committee of Experts on the Transportation of Dangerous Goods which produces the “Recommendations on the Transport of Dangerous Goods - Model Regulations” commonly referred to as the UN “Orange Book.” The Model Regulations cover principles of classification and definition of classes, lists of the principal dangerous goods, general packing requirements, testing procedures, marking, labeling or placarding, and transport documents. There are, in addition, special requirements related to particular classes of goods, including performance standards for packaging. Although only recommendations, the Model Regulations are written in the mandatory sense (i.e., the word “shall” is used rather than “should”) in order to facilitate direct use of the Model Regulations as a basis for national and international transport regulations.

The United Nations Economic Commission for Europe (UNECE) publishes “European Agreement Concerning the International Carriage of Dangerous Goods by Road” (ADR). The UNECE also coordinates the ADR with the “Regulations Concerning the International Carriage of Dangerous Goods by Rail” (RID) (produced by the Intergovernmental Organisation for International Carriage by Rail) which regulate rail shipments in Europe.

2. International Atomic Energy Agency

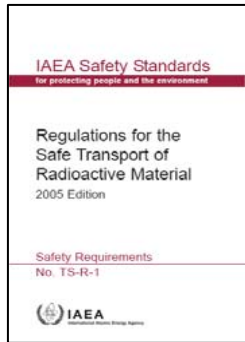

Beginning in the 1950s, there was an effort to develop an international consensus on how radioactive materials should be transported. The initial effort relied heavily on the standards used in the United States, which at that time were found in the Bureau of Explosives regulations. The first publication of the international standards was the 1961 edition of Regulations for the Safe Transport of Radioactive Materials, Safety Series No. 6, issued by the International Atomic Energy Agency (IAEA). The 1967 edition of Safety Series No. 6 was adopted into the domestic regulations in 1968. Since that time, the United States has continued to incorporate these standards (with certain exceptions) into its domestic regulations.

3. International Maritime Organization



The International Maritime Organization (IMO) implements the UN recommendations in the International Maritime Dangerous Goods (IMDG) Code. The IMDG Code contains regulations applicable to the transport of dangerous goods by sea. If all or part of a shipment of hazardous materials is made by vessel to, from, or within the United States, the HMR allow the shipment to be made in accordance with the IMDG Code, provided certain additional provisions are satisfied. These additional provisions are found in 49 CFR, §§ 171.22, 171.23, and 171.25.

4. International Civil Aviation Organization



The International Civil Aviation Organization’s “Technical Instructions on the Safe Transport of Dangerous Goods by Air” (ICAO TI) establishes requirements necessary to ensure hazardous materials are safely transported in aircraft while providing a level of safety that protects the aircraft and its occupants from undue risk. The ICAO TI is based on the UN Recommendations on the Transport of Dangerous Goods and the International Atomic Energy Agency Regulations for the Safe Transport of Radioactive Material.

Virtually all shipments of hazardous materials transported internationally by air, as well as most domestic U.S. shipments, are transported in accordance with the ICAO TI. The U.S. Hazardous Materials Regulations authorize transport in accordance with the ICAO TI provided all of the conditions of 49 CFR §§ 171.22, 171.23, and 171.24 are met. Note that shipments made in accordance with the ICAO TI remain subject to Part 175 of the HMR and the emergency response information provisions of Subpart G of Part 172.

Air carriers have adopted their own regulations through the International Air Transportation Association (IATA). These IATA dangerous goods regulations are based on the ICAO TI, but they are generally more restrictive in certain operational respects. Most domestic carriers have chosen to only accept shipments prepared under the ICAO TI as implemented by the IATA.

B. Federal Regulations

The regulations of the United States of America concerning the transportation of radioactive materials are published by four agencies: DOT, the Nuclear Regulatory Commission (NRC), the Transportation Security Administration (TSA), and the United States Postal Service (USPS).

1. Department of Transportation



The Secretary of the Department of Transportation has the authority to regulate the transportation of hazardous materials per the Hazardous Materials Transportation Act (HMTA), as amended and codified in 49 U.S.C. 5101 et seq. The Secretary is authorized to issue regulations to implement the requirements of the statute.

DOT's Pipeline and Hazardous Materials Safety Administration (PHMSA) (formerly the Research and Special Programs Administration (RSPA)) has been delegated the responsibility for the hazardous materials regulations, which are contained in 49 CFR Parts 100-185.

The hazardous materials regulations have changed significantly over the last several years. These changes include the harmonization of the United State's hazardous materials regulations with international standards, extension of the applicability of the hazardous materials regulations to all intrastate shipments of hazardous materials by highway, and the introduction of additional security requirements.

The hazardous materials regulations are applicable to the transportation of hazardous materials in commerce and apply to the following activities:

- Transport by interstate, intrastate, and foreign carriers by rail car, aircraft, motor vehicle and vessel.
- Shipper's pre-transportation activities to present for shipment a hazardous material in a package, container, rail car, aircraft, motor vehicle or vessel with accompanying marking, labeling, placarding and shipping papers.
- The manufacture, fabrication, marking, maintenance, reconditioning, repairing or testing of a package or container which is represented, marked, certified or sold for use in the transportation of hazardous materials.

The HMR defines nine Classes of hazardous materials. Radioactive material is Class 7.

The Parts of the HMR are as follows:

- 49 CFR 171 General information, regulations, and definitions
- 49 CFR 172 Hazardous materials table, special provisions, hazardous materials communications, emergency response information, and training requirements
- 49 CFR 173 Shippers-general requirements for shipments and packagings
- 49 CFR 174 Carriage by rail
- 49 CFR 175 Carriage by aircraft
- 49 CFR 176 Carriage by vessel
- 49 CFR 177 Carriage by public highway
- 49 CFR 178 Specifications for packagings
- 49 CFR 179 Specifications for tank cars
- 49 CFR 180 Continuing qualification and maintenance of packagings

Sections of the HMR specific to radioactive materials are:

- 49 CFR 173, Subpart I (§§ 173.401 – 173.477) Class 7 (Radioactive) Materials
- 49 CFR 174, Subpart K (§§ 174.700 – 174.750) Detailed Requirements for Class 7 (Radioactive) Materials
- 49 CFR 175, Subpart C, (§§ 175.700 – 175.706) Specific Regulations Applicable According to Classification of Material
- 49 CFR 176, Subpart M (§§ 176.700 – 176.720) Detailed Requirements for Radioactive Materials
- 49 CFR 177, Subpart B, (§§ 177.842) Class 7 (Radioactive) Material
- 49 CFR 178, Subpart K (§§ 178.350 – 178.360) Specifications for Packagings for Class 7 (Radioactive) Materials

DOT's Federal Motor Carrier Safety Administration (FMCSA) has additional requirements for transporting radioactive materials by highway. FMSCA provides routing requirements for motor carriers and drivers who transport radioactive material in 49 CFR Part 397, Subpart D. FMCSA also requires motor carriers to obtain a Hazardous Materials Safety Permit (HMSP) prior to transporting certain highly hazardous materials, including a highway route controlled quantity of radioactive material (see 49 CFR 385, Subpart E).

2. Nuclear Regulatory Commission

Under the Atomic Energy Act of 1954, as amended, the NRC also has responsibility for safety in the possession, use and transfer (including transport) of by-product, source, and special nuclear materials, i.e., “licensed material.” Due to this overlap in statutory authorities of NRC and DOT, the two Agencies signed a 1979 Memorandum of Understanding (MOU) with regard to regulation of the transport of radioactive material. The principal objective of the MOU was to avoid conflicting and duplicative regulations and to clearly delineate the areas in which each Agency establishes regulations.

Except for certain small quantities and specific products, a license is required from the NRC for possession and use of licensed materials. The NRC has promulgated, in 10 CFR Part 71, requirements which must be met by licensees for packaging used to deliver certain types of licensed material to a carrier for transport if fissile material or quantities exceeding Type A are involved. NRC also assists and advises DOT in the establishment of both national and international safety standards and in the review and evaluation of packaging designs. In 1979, NRC adopted by reference (10 CFR § 71.5) portions of the DOT regulations, enabling NRC to inspect its licensees for compliance with DOT regulations applicable to shipper/licensees and to take enforcement actions on violations.

Many states have entered into formal agreements with the NRC whereby the NRC transfers to states the regulatory authority over licensed by-product, source, and less than critical quantities of special nuclear material (fissile materials). These 35 Agreement States (and 3 states that have filed intent to become Agreement States) are illustrated in Figure 2.

**Figure 2 – NRC Agreement States
(Source: Nuclear Regulatory Commission)**

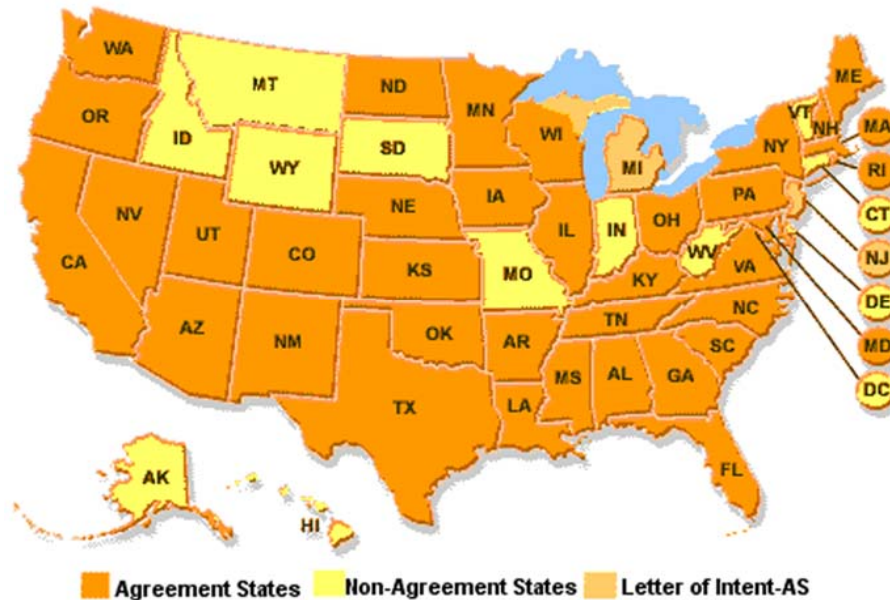

3. Transportation Security Administration

Under the Aviation and Transportation Security Act (ATSA), Public Law 107-71, 115 Stat. 597 (November 19, 2001), and delegated authority from the Secretary of Homeland Security (DHS), the Assistant Secretary of DHS for the Transportation Security Administration (TSA) has broad responsibility and authority for “security in all modes of transportation”. TSA’s authority with respect to transportation security is comprehensive and supported with specific powers related to the development and enforcement of regulations, security directives, security plans, and other requirements. On September 28, 2004, DOT and DHS signed a Memorandum of Understanding (MOU) on Roles and Responsibilities and on August 7, 2006, PHMSA and TSA signed an annex to the MOU. The MOU recognizes that DHS has primary responsibility for security in all modes of transportation.

4. United States Postal Service

The carriage of U.S. mail by the Postal Service (USPS) is not subject to the HMR as commercial carriers are. However, for legal and safety reasons, the postal mailing standards for hazardous materials not only closely adhere to the HMR, but also include many additional limitations and prohibitions. Radioactive materials are prohibited in domestic mail via air

transportation. Quantities of radioactive material in excess of those authorized in USPS Publication 52, “Hazardous, Restricted, or Perishable Mail” are prohibited in surface mail. For international mail, the standards in Section 135.6 of the “Mailing Standards of the United States Postal Service, International Mail Manual” apply.

IV. RADIOACTIVE MATERIALS TERMINOLOGY

This section explains the various terms used to define and categorize radioactive materials in the HMR. The regulatory definitions for these terms and other terms specific to radioactive materials transportation may be found in § 173.403; other terms used throughout the HMR are defined in § 171.8.

A. Radioactive Material

Prior to 2004, the HMR used a specific activity threshold of 70 Bq/g (0.002 µCi/g) for defining a material as radioactive for purposes of transportation, and material was not subject to the requirements of the HMR if its specific activity was equal to or below that value. In 2004, the HMR was revised and the single activity concentration threshold of 70 Bq/g was replaced with radionuclide-specific values. In addition, the 2004 revision established threshold values for the total activity in a consignment, below which the risk is so small that the material could be transported without being subject to transportation regulatory requirements (“consignment” means a package or group of packages or load of radioactive material offered by a person for transport in the same shipment). To be considered a radioactive material under the HMR, the material must exceed **both** the nuclide specific exemption concentration limit **and** the consignment exemption activity limit.

These nuclide specific values are given in § 173.436. Those nuclides shown with a reference to footnote (b) have the activity of their daughters included, and therefore, shippers need only compare the activity and activity concentration of the parent nuclide to the exemption value. If the daughter products are not included, or if other radionuclides are present, the mixture of nuclides must be evaluated using the equations in §§ 173.433(d)(6) and (7) to determine if the material is radioactive material under the HMR. (Some materials which may be exempt from regulation during transportation still might be subject to licensing requirements of NRC, or an Agreement State with respect to use, possession, materials control or waste disposal; or they may be subject to EPA requirements as a hazardous substance or hazardous waste.)

For example, using § 173.436, it can be seen that ²⁴¹Am has a concentration exemption value of 1 Bq/gram (g) and a consignment activity exemption value of 10,000 Bq. Therefore, a material containing ²⁴¹Am would be regulated as radioactive material if it is shipped with more than 10,000 Bq in a single consignment **and** in a concentration greater than 1 Bq/g.

B. Special Form Radioactive Material

Special form materials are those materials which, if released from a package, would present a hazard due to direct external radiation only. Usually, due to the high physical integrity of a special form material, radioactive material contamination is not expected even under severe accident conditions. Therefore, larger quantities can typically be shipped in any given package than

if the material were not special form (i.e., “normal form”). This high physical integrity is occasionally the result of inherent natural properties of the material, such as its being in an indispersible solid form. Most often, however, it is an acquired characteristic, resulting from being welded (encapsulated) into an extremely durable metal capsule.

Special form sources must have at least one external physical dimension which exceeds 5 mm (0.197”). The minimum dimension requirement makes the capsule easier to see and recover in the event of its release from the package during an accident. Special form encapsulations are required to be constructed in a manner that they can only be opened by destroying the capsule. This requirement prevents the inadvertent loosening or opening of the capsule, either during transport or following an accident.

The testing requirements for determination of whether radioactive materials qualify as “special form” are found in § 173.469, which describes tests for high temperature, impact, percussion, bending, and leakage. (An encapsulated sealed source need not be subjected to the impact and percussion tests of § 173.469(b)(1) and (2), provided that it satisfies the Class 4 impact test prescribed in International Standards Organization (ISO) document ISO 2919, Sealed Radioactive Sources Classification. Also, it need not be subjected to the heat test listed in § 173.469(b)(4) if it satisfies the Class 6 temperature test specified in ISO 2919.)

For the purposes of import or export, a shipper must furnish the carrier and the foreign consignee a Certificate of Competent Authority for the special form material. For domestic shipments, the DOT does not require special form certificates when offering the material as special form. However, the shipper must have evidence that the source, if offered as special form radioactive material, meets the special form standards. Such evidence must be maintained on file by the shipper for at least one year after shipment in accordance with § 173.476(a).

A special form certificate issued by the DOT or by a foreign competent authority is acceptable evidence of a source being special form. Special form source manufacturers or suppliers often provide customers with special form Certificates of Competent Authority. The requirements for certification of special form sources are listed in § 173.476.

Figure 3 displays several typical special form radioactive material sources.

Figure 3- “Special Form” Radioactive Material



Figure A - Neutron Source

(showing empty inner and outer capsules with plugs to be welded for sealing)

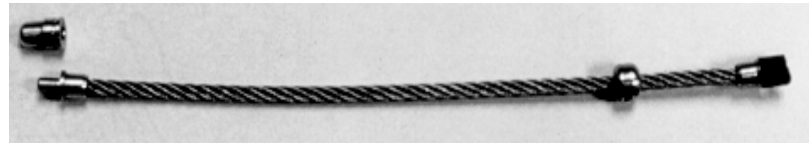

Figure B - Industrial Radiography Source

(with 15 cm connector cable “pigtail”)

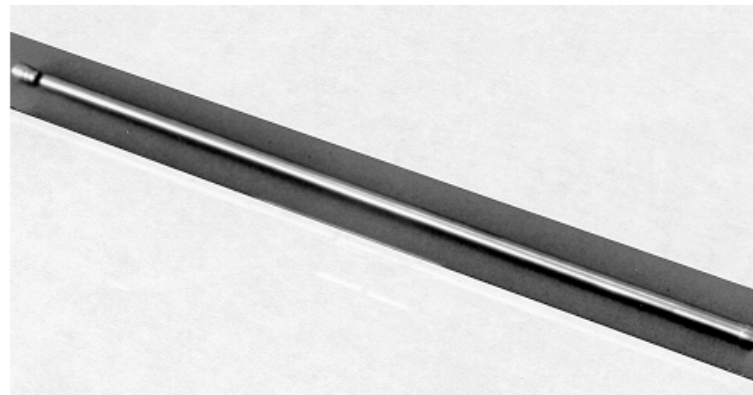

Figure C - Industrial Radiography Source Sterilizer/Process Irradiator Source

C. Normal Form Radioactive Material

Normal form radioactive material means a radioactive material which does not qualify as a “special form material”. Illustrated in Figure 4 are typical physical forms for normal form radioactive material.

Figure 4- “Normal Form” Radioactive Material

Normal Form Materials may be solid, liquid, or gaseous and include any material which has not been qualified as Special form.

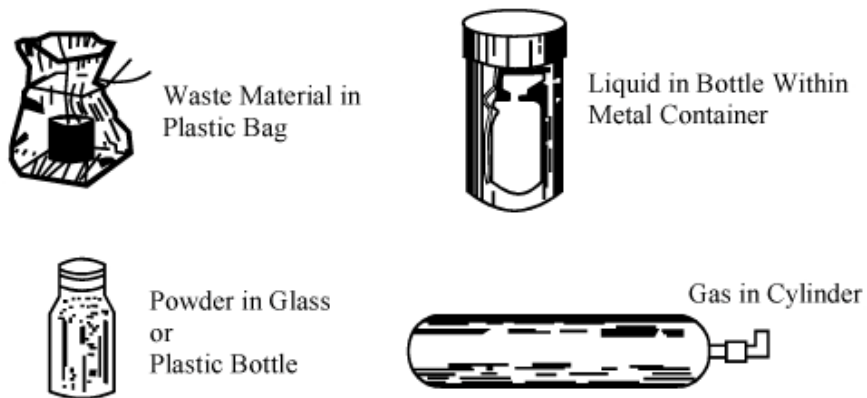

D. A₁ and A₂ Quantity Limits

A₁ and A₂ are quantities of radioactivity which are used in the regulations to determine such things as the type of packaging necessary for a particular radioactive material shipment. Each radionuclide is assigned an A₁ and an A₂ value. **A₁** applies to **special form** and **A₂** applies to **normal form** material; A₁ is the maximum activity of special form material that is permitted in a type of package called a Type A package, and A₂ is the maximum activity of normal form radioactive material that is permitted in a Type A package.

A₁ and A₂ values have been determined for most common radionuclides and are listed in the table in § 173.435 (instructions are provided in § 173.433 for unlisted radionuclides and § 173.433(d) details how to determine Type A quantities for mixtures of radionuclides). For each radionuclide, both the A₁ value for materials in special form and the A₂ value for materials in normal form are listed in terabecquerels (TBq) and curies (Ci) (the values in curies are approximate and for information only; the regulatory standard units are terabecquerels, equal to 10¹² becquerels). Table 1 gives examples of A₁ and A₂ values for a number of typical radionuclides.

Table 1 - Type A Package Quantity Limits for Selected Radionuclides

<u>Symbol of radionuclide</u>	<u>Element and Atomic number</u>	<u>A₁ TBq (Ci)</u> <u>(Special Form)</u>	<u>A₂ TBq (Ci)</u> <u>(Normal Form)</u>
¹⁴ C	Carbon (6)	40 (1100)	3 (81)
¹³⁷ Cs	Cesium (55)	2 (54)	0.6 (16)
²²⁶ Ra	Radium (88)	0.2 (5.4)	0.003 (0.081)
⁶⁰ Co	Cobalt (27)	0.4 (11)	0.4 (11)
¹⁹² Ir	Iridium (77)	1 (27)	0.6 (16)
Thorium (Natural)	Thorium (90)	Unlimited	Unlimited
Uranium (Natural)	Uranium (92)	Unlimited	Unlimited
Uranium (Enriched 20% or less and unirradiated)	Uranium (92)	Unlimited	Unlimited
⁹⁹ Mo	Molybdenum (42)	1 (27)	0.6 (16) {0.74 TBq (20 Ci) for domestic shipments }

The A₁ and A₂ values are used in the regulations as a normalized measurement of radiological risk for all radionuclides. Their uses go beyond the activity limits for Type A packages. Other uses involving large multiples of A₁ or A₂ or different fractions of A₁ or A₂ include the following:

- Special routing of packages with large quantities,
- Total activity in packages and conveyances,
- Designating the limits for packages excepted from most requirements, and
- Designating the specific activity of a contaminated material and associated packaging.

The derivation of the A₁ and A₂ values in the IAEA regulations is based on a series of dosimetric models. The limiting value for A₁ results from the worst case assumptions of external direct γ radiation levels from an unshielded source at a certain distance. Generally, the A₁ value for a radionuclide is the quantity of that radionuclide that will result in a dose rate of 0.1 Sv/h (10 rem/h) at a distance of 1 meter. The A₂ value, however, is based on the applicability of the most conservative worst case value for five different scenarios, which include the A₁ scenario plus external β radiation to skin, inhalation, ingestion, and external γ radiation from immersion in a gaseous cloud of material released from a breached package.

As a result of a limitation established by the IAEA, no radionuclides have been assigned A_1 or A_2 values greater than 40 TBq (1,080 Ci). However, based on their low specific activity and low toxicity, some radionuclides have been assigned “unlimited” A_1 and A_2 values.

E. Excepted Quantities

When a small fraction of the A_1 or A_2 activity is being shipped, some shipments are excepted from some of the requirements of the HMR and can be shipped in an “excepted package” (see Section V.B). The following types of materials may be eligible for such exceptions:

- limited quantity of radioactive material
- radioactive instruments or articles
- articles manufactured from natural or depleted uranium or natural thorium
- empty packagings.

A “limited quantity of radioactive material” is a quantity of radioactive material that does not exceed the material's package limits specified in § 173.425 (see Table 2) and conforms to the requirements specified in § 173.421.

“Radioactive instruments or articles” are manufactured items such as instruments, clocks, electronic tubes, gauges, smoke detectors, electronic apparatus or similar devices having radioactive material in gaseous or non-dispersible solid form as a component part. Allowance is made for the additional protection provided by the structure of the instrument or article and they are considered excepted quantities if they do not exceed the limits in § 173.425 (see Table 2) and conform to the requirements specified in § 173.424. As shown in Table 2, there are two sets of limits: one for the item and another for the package.

Table 2 - Activity Limits for Limited Quantities, Instruments, and Articles

Nature of contents	Instruments and articles		Limited quantity package limits ¹
	Limits for each instrument or article ¹	Package Limits ¹	
Solids:			
Special Form	$10^{-2} A_1$	A_1	$10^{-3} A_1$
Normal Form	$10^{-2} A_2$	A_2	$10^{-3} A_2$
Liquids:			
Tritiated water:			
<0.0037 TBq/L (0.1 Ci/L)			37 TBq (1,000 Ci)
0.0037 TBq to 0.037 TBq/L (0.1 Ci to 1.0 Ci/L)			3.7 TBq (100 Ci)
>0.037 TBq/L (1.0 Ci/L)			0.037 TBq (1.0 Ci)
Other Liquids	$10^{-3} A_2$	$10^{-1} A_2$	$10^{-4} A_2$
Gases:			
Tritium²	$2 \times 10^{-2} A_2$	$2 \times 10^{-1} A_2$	$2 \times 10^{-2} A_2$
Special Form	$10^{-3} A_1$	$10^{-2} A_1$	$10^{-3} A_1$
Normal Form	$10^{-3} A_2$	$10^{-2} A_2$	$10^{-3} A_2$

¹For mixtures of radionuclides see § 173.433(d).

²These values also apply to tritium in activated luminous paint and tritium adsorbed on solid carriers.

A manufactured article in which the sole radioactive material is natural uranium, unirradiated depleted uranium, or natural thorium may be transported in any quantity in an excepted package. This is under the condition that the outer surface of the uranium or thorium is enclosed in an inactive sheath of metal or some other durable protective material as stated in § 173.426.

The empty packaging provisions in § 173.428 provide exceptions for a radioactive material packaging which has been emptied of its radioactive contents as far as practicable, but still contains residual radioactivity. The residual radioactivity limit on internal contamination is 100 times the removable (non-fixed) contamination limits for exterior package surfaces. Wipe contamination sampling techniques are often not practical or feasible for the interior of the containment system of some radioactive material packages; if total (fixed and non-fixed) can be measured, and is below the limit, then the non-fixed component would be below the limit. If it cannot be demonstrated that the non-fixed contamination is less than 100 times the limits in § 173.443, the empty classification cannot be used.”

F. Highway Route Controlled Quantities (HRCQ)

“Highway route controlled quantity” is defined as a quantity of radioactive material within a single package which exceeds:

- 3,000 times the A_1 value of the radionuclides for special form material or 3,000 times the A_2 value of the radionuclides for normal form material; or
- 1,000 TBq (27,000 curies), whichever is less.

For example, consider a package which contains 777 TBq of cobalt-60 in special form. The A_1 value for cobalt-60 is 0.4 TBq. Since 3,000 times 0.4 TBq = 1,200 TBq and this is greater than 1,000 TBq, the 777 TBq quantity should be compared to 1,000 TBq. Since the amount in the package does not exceed 1,000 TBq, the amount in the package is not an HRCQ.

It is important to note that HRCQ shipments can be made by all modes of transport, not just by highway. If a package contains a quantity in excess of the HRCQ definition, it is an HRCQ shipment, regardless of the mode used.

There are specific requirements for the highway routing of HRCQ shipments as discussed in Section XI of this document. In addition, § 173.22(c) requires shippers of highway route controlled quantities to notify the consignee of the expected arrival date and any special loading/unloading requirements.

Figure 5 illustrates HRCQ in relation to the other categories of radioactive materials discussed previously.

Figure 5 - Material Quantity Categories

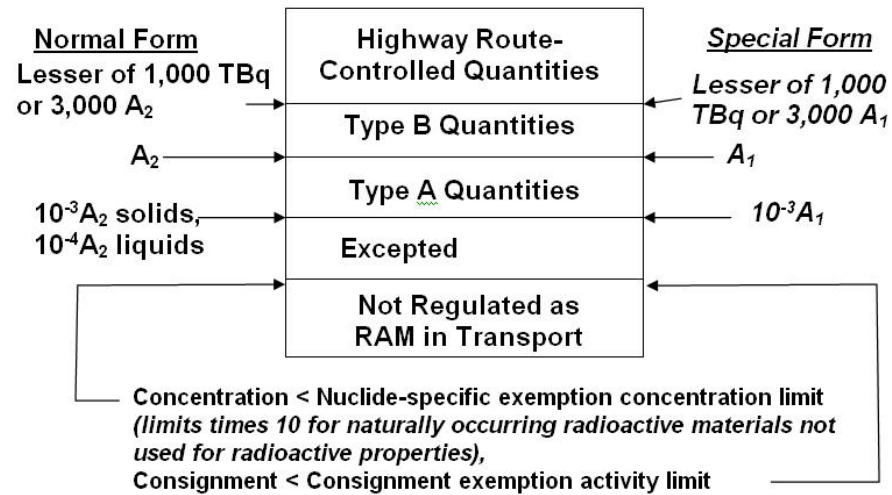

G. Low Specific Activity (LSA) Material

Low specific activity (LSA) material is radioactive material that has a low activity per unit mass (specific activity). LSA material is divided into three groups of increasing specific activities: LSA-I, LSA-II, and LSA-III. Most LSA materials have a characteristic of presenting limited radiation hazard, because of their relatively low concentration of radioactivity. When the specific activity of an LSA material is computed, the radioactivity is divided by the mass of material in which the radioactivity is distributed; the mass of the packaging that may surround the LSA is excluded from the calculation.

LSA-I generally consists of unirradiated natural or depleted uranium and thorium compounds and processing ores, other radionuclides with unlimited A_2 values, or material with a specific activity not exceeding 30 times the exempt concentration. The radioactive concentration is such that a person cannot physically breathe or ingest enough of the material to give significant radiation exposures.

LSA-II material includes material for which the average specific activity does not exceed $10^{-4} A_2/g$ for solids and gases and $10^{-5} A_2/g$ for liquids. The activity must be distributed throughout the material. For water with tritium, the concentration limit is 0.8 TBq/L.

LSA-III material consists of solids in which radioactive material is distributed throughout, or is essentially uniformly distributed in a solid binding agent such as concrete, bitumen, or ceramic. It must be relatively insoluble with a leach rate of 0.1 A₂, or less, per week and have a specific activity not exceeding 2 x 10⁻³ A₂/g. Test requirements for LSA-III material are given in § 173.468.

The quantity of LSA material in a single package must be restricted so that the external radiation level from the unshielded material does not exceed 10 mSv/h (1 rem/h) at 3 meters from the unshielded material.

The definitions of LSA-I, LSA-II, and LSA-III all use the term “*distributed throughout*”. The definition of LSA-III also uses “*essentially uniformly distributed*”. “*Distributed throughout*” means that the activity should not be localized in small portions of the volume of the material, but there may be some degree of non-homogeneity. In LSA-III, “*essentially uniformly distributed*” in a solid compact binding agent indicates a greater degree of homogeneity. While not defined in the regulations, activity *distributed throughout* should not vary by more than a factor of 10 and activity *essentially uniformly distributed* should not vary by more than a factor of 3.

Further information on shipment of LSA materials is provided in Section VII of this document.

H. Surface Contaminated Objects (SCO)

A surface contaminated object (SCO) is a solid object which is not itself radioactive but which has *radioactive material* distributed on its surfaces (rather than distributed within the material as for LSA materials). There are two categories of SCO, and SCO-II allows for higher contamination levels than SCO-I. The limits for the categories are shown in Table 3.

Table 3 - Contamination Limits for SCOs

Contamination Type	Limits in Bq/cm ² *		Limits in μCi/cm ² *	
	SCO-I	SCO-II	SCO-I	SCO-II
On Accessible Surfaces				
Non-fixed, most α	0.4	40	10 ⁻⁵	10 ⁻³
Non-fixed, β, γ, low-toxicity α**	4.0	400	10 ⁻⁴	10 ⁻²
Fixed, most α	4 x 10 ³	8 x 10 ⁴	0.1	2.0
Fixed, β, γ, low-toxicity α**	4 x 10 ⁴	8 x 10 ⁵	1.0	20
On Inaccessible Surfaces				
Fixed + non-fixed, most α	4 x 10 ³	8 x 10 ⁴	0.1	2.0
Fixed + non-fixed, β, γ, low-toxicity α**	4 x 10 ⁴	8 x 10 ⁵	1.0	20

* Contamination values are to be averaged over 300 cm², or the area of the surface if it is less than 300 cm².

** Low toxicity alpha emitters means natural uranium; depleted uranium; natural thorium; uranium-235 or uranium-238; thorium-232; thorium-228 and thorium-230 when contained in ores or physical and chemical concentrates; and alpha emitters with a half-life of less than 10 days.

SCO-II limits exceed SCO-I limits by a factor of twenty, except for non-fixed contamination on accessible surfaces of objects, in which case, the SCO-II limits exceed SCO-I by a factor of 100. For both SCO-I and SCO-II, the beta, gamma and low-toxicity alpha limits are a factor of ten greater than the limits for other alpha contamination. For inaccessible surfaces of both SCO-I and SCO-II, the total fixed plus non-fixed contamination limits are the same as the fixed contamination limits on accessible surfaces of both SCO-I and SCO-II.

The quantity of SCO in a single package must be restricted so that the external radiation level from the unshielded material does not exceed 10 mSv/h (1 rem/h) at 3 meters from the unshielded material.

The definition of SCO uses several terms which must be understood to properly categorize an item as an SCO. These terms are: *contamination, fixed radioactive contamination, non-fixed radioactive contamination, accessible surfaces, and inaccessible surfaces.*

Contamination means the presence of a radioactive substance on a surface in quantities in excess of 0.4 Bq/cm² for beta and gamma emitters and low toxicity alpha emitters or 0.04 Bq/cm² for all other alpha emitters. Contamination exists in two phases:

- *Fixed radioactive contamination* means radioactive contamination that cannot be removed from a surface during normal conditions of transport.
- *Non-fixed radioactive contamination* means radioactive contamination that can be removed from a surface during normal conditions of transport.

An *accessible surface* is any surface which can readily be wiped by hand, using standard radiation-measuring techniques; any other surface is an *inaccessible surface*. Examples of *inaccessible surfaces* are:

- Inner surfaces of pipes the ends of which have been securely closed with end plugs or caps;
- Inner surfaces of equipment which are suitably blanked off or formally closed;
- Interiors of glove boxes with access ports blanked off.

A solid object which is not radioactive that has contamination on its surface is not an SCO unless the contamination is in sufficient quantity to meet the definition of radioactive material. The radioactive material definition given in §173.403 notes that to be considered radioactive material, the material must exceed both the nuclide specific exemption concentration limit and the consignment exemption activity limits. Thus, if the total activity of the contamination on the surface of items in a consignment does not meet the consignment limit needed to meet the definition of radioactive material, those items, while slightly contaminated, would not be considered to be SCO.

Problems in determining the proper classification for an object with surface contamination may involve methods of measuring the non-fixed and fixed contamination and determining whether the surfaces should be considered accessible or inaccessible. The joint DOT/NRC document “Categorizing and Transporting Low Specific Activity Materials and Surface Contaminated Objects” (NUREG-1608) provides guidance on these issues (available online at http://www.rampac.energy.gov/NRCinfo/NUREG_1608.pdf).

Further information on shipment of SCO materials is provided in Section VII.

I. Fissile Material

Fissile material is material that has the capability of undergoing nuclear fission with the potential to produce a criticality event which would result in significant releases of radiation and heat. Thus, fissile material requires additional package design considerations and controls to assure nuclear criticality safety during transport. Fissile material is defined as plutonium-239, plutonium-241, uranium-233, uranium-235, or any combination of these radionuclides. The definition

applies to the nuclides themselves and not the material containing them. For example, fissile mass restrictions in the regulations apply to the mass of uranium-235 and not to the mass of uranium metal containing the uranium-235. While there are other nuclides that are fissionable, the HMR only regulates as fissile material those materials that are capable of having a sustained criticality by accumulation of mass alone. Therefore, the fissile material definition does not apply to unirradiated natural uranium and unirradiated depleted uranium, or to natural uranium or depleted uranium that has been irradiated in thermal reactors only.

Certain quantities and configurations of fissile material cannot become critical under any circumstances associated with transportation. To allow for this, there are several exceptions to the fissile material requirements in the HMR. Generally, the exceptions are for small quantities. If fissile material meets the requirements of § 173.453, it is excepted from the packaging and controls that are required for fissile materials. Paragraphs (a)-(f) of § 173.453 are independent, and only one paragraph needs to be met to take the fissile exception.

J. Radioactive Materials Not Covered by the HMR

There are several categories of radioactive material that are not subject to the HMR, as follows (see § 173.401):

- Materials that are not in transportation,
- Materials that have been implanted or incorporated into, and are still in, a person or live animal for diagnosis or treatment,
- Material that is an integral part of the means of transport,
- Natural material and ores containing naturally occurring radionuclides which are not intended to be processed for use of these radionuclides, provided the activity concentration of the material does not exceed 10 times the values specified in § 173.436.

Materials not in transport may be covered by other regulations, but are not subject to transportation regulations. § 171.1 explains the applicability of the HMR to persons and functions. The HMR apply to the transportation of hazardous materials in commerce, the manufacture and maintenance of packagings used for such transportation, pre-transportation functions (such as filling a package, marking, labeling, and shipping paper preparation), and transportation functions. Movement of materials within facility boundaries where public access is restricted is not subject to the HMR.

Material that is an integral part of the means of transport refers to such items as thoriated metallic engine parts, depleted uranium counterweights, tritium exit signs, and similar items containing radioactive material which are an integral part of, and are routinely used in the normal operation of a transport vehicle.

The radioactive material transport regulations are intended to apply to natural materials or ores that form part of the nuclear fuel cycle, or that will be processed in order to utilize their radioactive properties. They do not apply to other natural materials or ores that may contain small amounts of naturally occurring radionuclides, when those materials or ores are to be used because of some other physical or chemical characteristics, provided that their activity concentrations do not exceed 10 times the exemption values given in the table in § 173.436. Examples of such natural occurring radioactive materials (NORM) are cement, coal, fertilizers, non-radioactive metals, gypsum, and residues from mining and smelting processes.

V. CATEGORIES OF RADIOACTIVE MATERIALS PACKAGES

In the HMR, “package” means the packaging together with its radioactive contents as presented for transportation. For radioactive materials, “packaging” means the assembly of components necessary to ensure compliance with the packaging requirements of the HMR. The packaging may consist of one or more receptacles, absorbent materials, spacing structures, thermal insulation, radiation shielding, service equipment for filling, emptying, venting and pressure relief, and devices for cooling or absorbing mechanical shocks. The conveyance, tie-down system, and auxiliary equipment may sometimes be designated as part of the packaging.

Fundamental to a good understanding of radioactive material transportation safety and packaging requirements is the basic premise that:

Safety in transporting radioactive material primarily depends upon the use of the proper packaging for the type, quantity, and form of the radioactive material to be transported. In addition, packaging design is performance oriented, with the packaging integrity being dictated by the hazards of the radioactive content.

That is, proper packaging is the primary means of providing safety, and contents which present higher hazards are to be contained in stronger packagings.

The following categories of radioactive material packages are defined in the HMR:

- Excepted packages
- Industrial packages (IP-1, IP-2, IP-3)
- Type A packages
- Type B packages
- Fissile material packages
- Packages containing uranium hexafluoride

Each of these is discussed below.

A. General Packaging Requirements

Unless excepted, all packages are subject to applicable general requirements in 49 CFR Part 173, Subparts A and B. General requirements for packagings and packages may be found in § 173.24, additional requirements for non-bulk packagings and packages are given in § 173.24a and requirements for bulk packagings are given in § 173.24b. Radioactive materials packages are also subject to § 173.410, “General Design Requirements.”

An example of a requirement that is applicable to all packages is the performance capability requirement for vibration in §§ 173.24a (a)(5) and 173.410(f). Packages do not require vibration-testing in a laboratory. Demonstrating compliance by methods other than testing is allowed in § 173.461(a)(4). The DOT has provided letters of interpretation that the vibration requirement in § 178.608 is a performance capability requirement that may be reasonably satisfied by documented evidence that packages of a particular design have been transported extensively without failure.

B. Excepted Packages

As described in Section IV.E of this document, packages containing excepted quantities of materials (limited quantity of radioactive material, radioactive instruments or articles, articles manufactured from natural or depleted uranium or natural thorium, and empty packagings) are excepted from some requirements of the HMR.

Excepted packages are not required to be tested or designed to survive any transportation accidents, and it is assumed that under accident conditions all the contents could be potentially released. Therefore, the total activity and maximum allowable dose rates associated with these packages are significantly lower than those allowed for other packages. By severely limiting the contents, excepted packages provide a standard of safety comparable to that of more robust packages.

Excepted packages are excepted from specification packaging, marking (except for the UN identification number marking), labeling, and shipping paper requirements. However, they are not exempt from regulation during transportation as would materials not meeting the definition of “radioactive material” for purposes of transportation. In addition to the general packaging requirements for all hazardous material packaging, excepted packaging must meet the general requirements for radioactive material packaging in § 173.410.

Excepted packages must meet the following:

- The general design requirements cited above;
- The outside of each package must be marked with the four digit UN identification number for the material preceded by the letters **UN**, as shown in column (4) of the Hazardous Materials Table in § 172.101;

- Non-fixed contamination limits on package surfaces must not exceed the limits of § 173.443(a);
- The radiation level at any point on the surface of the package must not exceed 0.005 mSv/h (0.5 mrem/h);
- For limited quantities, the outside of the inner packaging, or if there is no inner packaging, the outside of the package itself must bear the marking “**Radioactive**”;
- An “**Empty**” label is required on empty packagings;
- For instruments or articles, the radiation level at four inches from any point on the surface of the unpackaged instrument or article shall not exceed 0.1 mSv/h (10 mrem/h).

The specific sections of 49 CFR for the various categories of excepted radioactive packages are:

- § 173.421 Excepted packages for limited quantities of Class 7 (radioactive) materials
- § 173.422 Additional requirements for excepted packages containing Class 7 (radioactive) materials
- § 173.423 Requirements for multiple hazard limited quantity Class 7 (radioactive) materials
- § 173.424 Excepted packages for radioactive instruments and articles
- § 173.426 Excepted packages for articles containing natural uranium or thorium
- § 173.428 Empty Class 7 (radioactive) materials packaging.

Figure 6 shows an example of an excepted packaging and its contents.

Figure 6 - Example Excepted Package



C. Industrial Packages (Type IP-1, IP-2, IP-3)

“Industrial packagings” (IP) may be used for materials with sufficiently limited specific activity (LSA materials) and certain SCO. There are three categories of IP: IP-1, IP-2, and IP-3. The requirements for each IP category are given in § 173.411. IP-1 packagings must meet the general packaging requirements of § 173.410 and are, therefore, equivalent in design requirements to excepted packagings.

IP-2 packagings must also meet the general design requirements and, when subjected to the free drop and stacking (compressive load) tests specified in § 173.465(c) and (d) or evaluated against these tests by any of the authorized methods of § 173.461(a), each IP-2 must prevent the following:

- Loss or dispersal of the radioactive contents
- Any significant increase in the radiation levels recorded or calculated at the external surfaces for the condition before the test.

IP-3 packaging must meet the requirements of an IP-1 and IP-2 and must also meet the requirements specified in § 173.412(a)-(j). IP-3 packagings are, therefore, identical to Type A packagings authorized for solid Type A quantities of radioactive materials.

The following types of packagings may be *used as* IP-2 and IP-3 packages if they meet requirements for an IP-1 and the cited requirements, including containment and shielding requirements (they do not need to meet the other IP-2 and IP-3 requirements):

- Tank containers meeting the requirements of § 173.411 (b)(4)
- Other tanks meeting the requirements of § 173.411(b)(5)
- Freight containers (for solid materials only) that are built to the ISO 1496-1 standards meeting the requirements in § 173.411 (b)(6)
- Metal intermediate bulk containers meeting the requirements in § 173.411 (b)(7).

Shippers of any IP-2 and IP-3 packages must maintain the packaging documentation on file for one year after shipment that shows, by test results or analysis, that the packaging met the IP-2 or IP-3 criteria.

Figure 7 shows two examples of IP packages.

Figure 7 - Industrial Packages (IP)



Figure A – An IP-1 Package



Figure B - An IP-2 Package

D. Type A Packages

Type A packages are required to maintain their integrity under conditions of normal transport. However, it is assumed that a Type A package may be damaged in a severe accident and could then release some of its contents. Therefore, the maximum amount of radioactivity that can be transported in such packages is limited to Type A quantities (A_1 for special form materials, A_2 for normal form materials).

Type A packaging must comply with the applicable general packaging requirements of §§ 173.24, 173.24a (non-bulk) or § 173.24b (bulk), and § 173.410, and the additional requirements of § 173.412, and § 173.415. These packagings must prevent the loss or dispersal of the radioactive contents and maintain the radiation shielding properties during normal conditions of transportation, which include rough handling conditions, for which tests are specified in § 173.465. These rough handling conditions include: falling from a transport vehicle or handling equipment; being struck by irregularly shaped freight or other packages with sharp corners; sitting on an uncovered loading dock during inclement weather; and having heavy freight loaded on top of the package. The packaging, with contents, must be

capable of withstanding the water spray, free drop, stacking and penetration tests described below. One prototype may be used for all tests if the requirements of § 173.465(b) are met. The water spray test must precede each test or test sequence.

The tests that simulate the types of damage that could result from these conditions are:

- **Water Spray Test**, which simulates the package having been left in rain at a rate of about 2 inches/h for a period of at least one hour, followed by;
- **Free Drop Test** of 1- 4 feet (depending on the package mass, with 4 feet for packages under 11,000 pounds) onto a hard surface, in a most damaging orientation - simulating falling off a vehicle or loading platform (there are additional requirements for fiberboard, wood, and fissile material packages),
- **Stacking Test** equal to a force of at least 5 times the weight of the package for at least 24 hours - simulating the damp package being at the bottom of a stack of packages, and
- **Penetration Test** with a 13.2 pound, 1.25 inch diameter steel rod being dropped at least 3.3 feet onto the damp package - simulating a loose object hitting the package.

The performance requirements for Type A packages containing liquids and gases are more stringent than the requirements for solids, because of the greater potential for materials spreading if the package containment system fails. The more stringent requirements relate to containment, and the height in the drop (30 feet) and puncture (5.5 feet) tests, and are found in § 173.412 (k) and § 173.466.

Figure 8 illustrates the Type A packaging tests.

Figure 8 - Type A Packaging Tests



WATER

Water spray for 1 hour to simulate rainfall of 2 inches per hour.



DROP

Free drop test onto a flat, hard surface.



COMPRESSION

Stacking test of at least 5 times the weight of the package. This test is conducted for at least 24 hours.

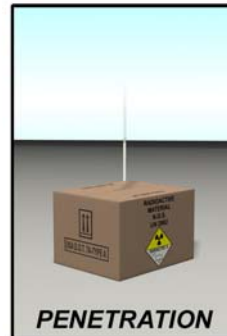

PENETRATION

Penetration test by dropping a 13-pound, 1.25-inch diameter bar vertically onto the package from a height of 3.3 feet.

Essentially, the only authorized Type A package in the DOT regulations is the DOT specification 7A (see § 178.350), which is based totally on performance test conditions rather than on hardware or design requirements. This provides the package designer with maximum latitude in the use of engineering creativity to produce optimally useful and economic designs. Using any of the methods authorized in § 173.461, each shipper of a DOT-7A package must determine if the design meets the performance requirements in §§ 173.412 and 173.465, and then must document and maintain this evaluation or “self-certification” on file for at least one year after the latest shipment, per § 173.415(a). Consequently, each design must be specifically certified as meeting the DOT-7A requirements. Each time the *contents or packaging components* change, the performance capability of the modified package must be re-evaluated with respect to the requirements before the Type A designation may be assigned.

Shippers are cautioned that often, additional documentation beyond that provided by the packaging supplier is needed to fulfill all of the requirements for a particular shipment; most importantly that the contents to be shipped have been evaluated for compatibility with the packaging and that their characteristics have been bounded by the simulated contents used in qualification testing (see § 173.461). To satisfy the documentation requirements of § 173.415(a), each shipper must maintain complete documentation of tests and an engineering evaluation or comparative data showing that the construction methods, packaging design, and materials of construction comply with the 7A specification. It is recommended that the documentation identify each requirement and state how each is met. The statements can contain references to supporting documentation, such as engineering evaluations. The documentation shall be provided to DOT upon request.

DOT-7A designs do **not** require the approval of either DOT or NRC, for domestic shipment or for international transportation of non-fissile radioactive material. Type A quantities may also be shipped in certified fissile or Type B packaging or in foreign-made Type A packaging which meets IAEA TS-R-1 requirements. If foreign-made packages are to be used for domestic shipments, the domestic shipper must obtain and maintain on file the applicable Type A evaluation and documentation performed by the foreign package designer.

Each packaging built to DOT Specification 7A Type A must be marked on the outside as “**USA DOT 7A Type A**” and also in accordance with the marking requirements in § 178.3. Section 178.350 (c) requires that the package also be marked with the name and address of the person certifying that the package (including the contents) meets the applicable requirements. This may be the shipper, if the packaging supplier has not tested for contents comparable to what is being shipped.

Figure 9 illustrates several representative Type A packaging configurations.

Figure 9 - Typical Type A Packaging Configurations

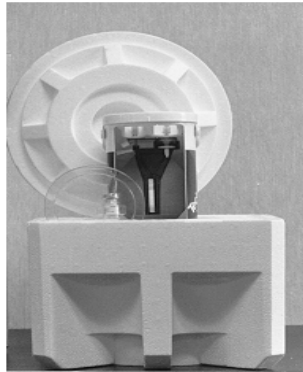

Figure A - Molybdenum 99 Generator
(Cutaway shows outer carton, foam spacer, shielding, ion column, and tubing for saline solution)

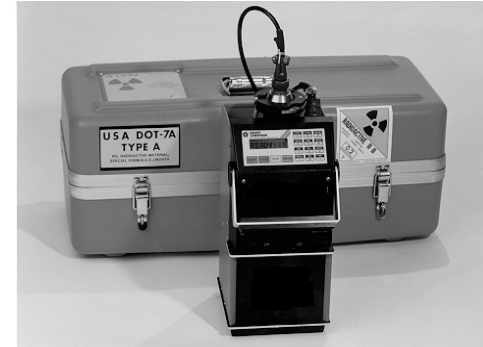

Figure B - Moisture Density Gauge & Carrying Case



Figure C - 55 Gallon Steel Drum



Figure D - Components of a Type A Package for Isotopes

E. Type B Packages

Type B packages must meet the general packaging and performance standards for Type A packages and additionally must have the ability to survive serious accident damage tests (hypothetical accident conditions). After testing, there may be only a very limited loss of shielding capability and no loss of containment, as measured by leak-rate testing of the containment system of the package.

Most domestic Type B packages are fabricated to designs certified by the NRC. Each design is approved under a NRC certificate of compliance and general license issued pursuant to 10 CFR 71.17. DOT authorizes use of NRC-approved Type B packages in § 173.416(a) and the standard requirements applicable to their use are in § 173.471. In addition, numerous Type B packages are approved by the U.S. Department of Energy (DOE) under the authority provided by DOT in § 173.7(d). Many of these DOE-certified packages are also certified by the NRC.

Type B Packages of foreign origin which meet the applicable requirements of TS-R-1, and for which the foreign competent authority certificate has been revalidated by DOT pursuant to § 173.473, are authorized only for export shipments from, import shipments into, and shipments traveling through the U.S. For purely domestic shipments of such packages, NRC certification of the package must be obtained.

The performance criteria which the package designer must use to assess a Type B package design against the established hypothetical accident conditions are prescribed in 10 CFR 71.73 of the NRC regulations and include the following tests, which are to be done sequentially (except the immersion test for all packages which may be done on a separate specimen):

- **Free Drop:** A 9 m (30 ft) free fall of the test package onto an unyielding surface in a position for which maximum damage is expected;
- **Crush:** For packages with mass not greater than 500 kg (1,100 lb), overall density not greater than 1,000 kg/m³ (62.4 lb/ft³) and for normal form non-fissile material, contents greater than 1,000 A₂ - subjecting the test specimen to a dynamic crush test by positioning the specimen on a flat unyielding horizontal surface so as to suffer maximum damage by the drop of a 500 kg (1,100 lb) steel plate mass from 9 meters (30 ft) onto the test package;
- **Puncture:** A puncture test as a free drop of the test package from a height of 1 m (40 in) onto a 15 cm (6 in) diameter vertical steel peg which has a length as to cause maximum damage to the package, at least 20 cm (8 in) long;
- **Thermal:** Exposure to a fully engulfing thermal environment of at least 800°C (1,475°F) for 30 minutes;
- **Immersion – fissile material:** For fissile packages where water in-leakage is not assumed in the criticality analysis, immersion of the test package under a head of water of at least 0.9 meters (3 ft) in the attitude for which maximum leakage is expected; and

- **Immersion – all packages:** Water immersion of the test package under at least 15 meters (50 ft) depth. In addition, packages containing more than 10^5 A₂ must be designed to withstand an external water pressure of 2 MPa (290 psi) for a period of not less than one hour without collapse, buckling, or in-leakage of water (see 10 CFR § 71.61).

Figure 10 illustrates the hypothetical accident conditions for Type B packages except for the crush test and the fissile material package immersion test.

Figure 10 - Type B Hypothetical Accident Conditions



FREE DROP
A 30-foot free drop onto a flat, essentially unyielding surface so that the package's weakest point is struck.

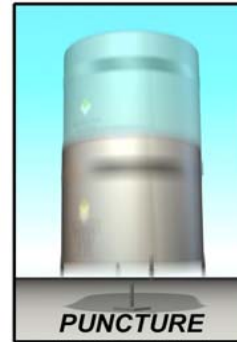

PUNCTURE
A 40-inch free drop onto a 6-inch diameter steel rod at least 8 inches long, striking the package at its most vulnerable spot.



THERMAL
Exposure of the entire package to 1475°F for 30 minutes.

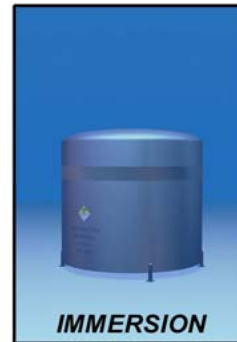

IMMERSION
Immersion of the package under 50 feet of water for at least 8 hours.

Certified Type B packagings are designated as Type B(U), or Type B(M). The (U) designation indicates a design requiring only unilateral approval—approval by the country of origin only. The receiving country does not need to review these designs, but in general, they will revalidate the certification. The (M) indicates a design requiring multilateral approval, i.e., approval by all countries into or through which the package is transported. A Type B(U) and a Type B(M) package are identical except that a Type B(M) package design has a maximum normal operating pressure greater than 700 kiloPascal or a pressure-relief device that allows the release of radioactive material to the environment under the hypothetical accident condition tests. Certificates of Type B packaging that are authorized for fissile materials have an “F” in the identification, e.g., USA/9126/B(U)F-85.

Type B(U) and B(M) package designs without a -85 or -96 at the end of their designation were approved to the 1973 IAEA regulations and were approved prior to April 1, 1996. Package designs with the -85 designation were approved after April 1, 1996, and meet the 1985 IAEA regulations. Package designs with -96 designations meet the 1996 IAEA regulations. Use or fabrication of package designs without the -96 designation is restricted in 10 CFR § 71.19.

Type B Packages cover a wide range of physical sizes, from small radiographic devices to large waste casks and spent nuclear fuel casks.

Figure 11 provides illustrations of several Type B Packages.

Figure 11 - Example Type B Packages



Figure A - RH-TRU 72B Cask



Figure B - CNS 10-160B



Figure C - 3 TRUPACT-II Packages

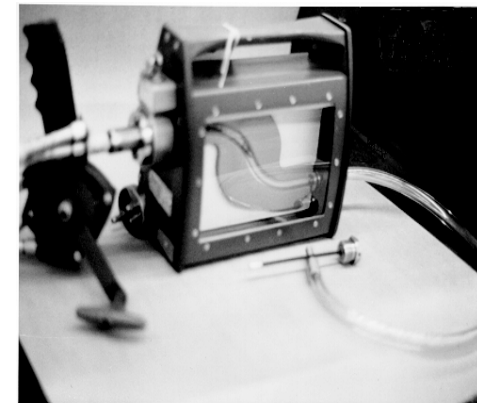

Figure D - Industrial Radiography Exposure Device (cutaway shows "S" tube for source in the shielding material)

F. Fissile Radioactive Material Packages

As discussed in Section IV.I, fissile material is defined as plutonium-239, plutonium-241, uranium-233, uranium-235, or any combination of these radionuclides. Authorized fissile material packages are provided in § 173.417; acceptable Type A packages are listed in paragraph (a) and acceptable Type B packages are listed in paragraph (b) (paragraph (c) provides the DOT Specification Type A and Type B packages that are being phased out after October 1, 2008).

All Type A and Type B fissile packages are certified by the NRC as indicated in § 173.417(a)(4) and (b)(3) or by DOE pursuant to the authority of § 173.7(d). Fissile packages of foreign origin are subject to the same DOT requirements as non-fissile Type B packages, and they must be revalidated by the DOT before they can be used for import or export of shipments.

When the DOT Specification 7A, Type A package is used for fissile material contents, the package must have been evaluated for the additional drop test from a height of 1 foot on each corner, or in the case of cylindrical packages, onto each of the quarters of each rim (see § 172.465(b)(2)).

In addition to the accident condition tests for Type B packaging, fissile material packaging designs for air transport must remain subcritical after being subjected to enhanced puncture, thermal, and drop tests in addition to the 10 CFR § 71.73 free drop and crush tests. These additional requirements are stated in 10 CFR § 71.55(f). In addition, 10 CFR §§ 71.74 and 71.88 address additional requirements for shipments of plutonium by air.

Figure 12 illustrates some typical packages used in the transportation of fissile radioactive material.

Figure 12 - Fissile Radioactive Material Packaging

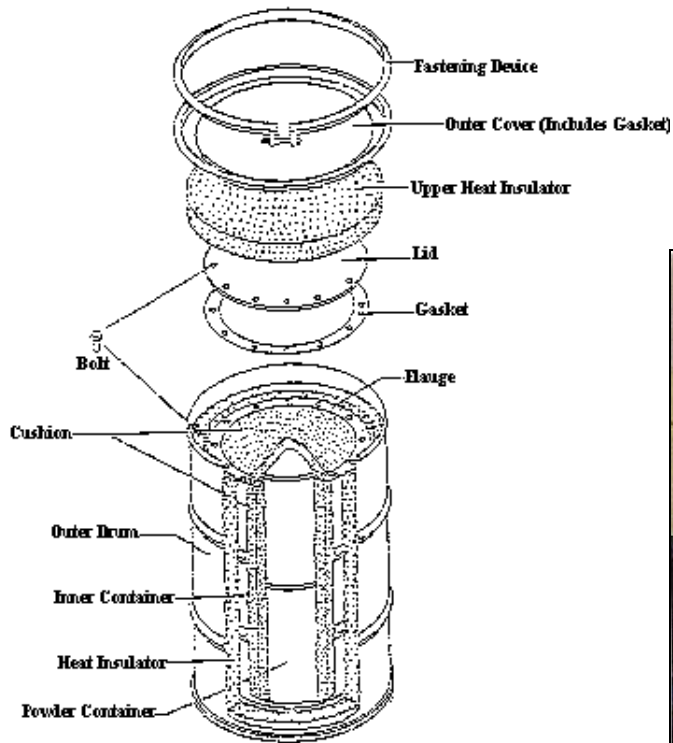

Figure A - Type A Drum for UO_2



Figure B - Power Reactor Spent Fuel

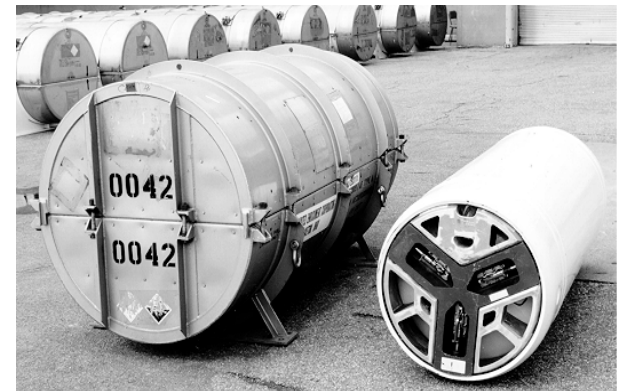

Figure C - Uranium Hexafluoride (UF_6) Overpack and Bare 30" Cylinder

G. Packages Containing Uranium Hexafluoride

Uranium hexafluoride (UF₆) is a radioactive material having a significant chemical hazard. During transportation, UF₆ exists as a crystalline solid and is shipped in metal cylinders at slightly reduced atmospheric pressure. The material presents hazards due to its radioactivity, as well as its corrosivity; breach of a cylinder of solid UF₆ would result in a reaction product of the material with the moisture in the air to produce highly corrosive hydrogen fluoride gas along with moderately radioactive uranyl fluoride solid particulates. Under the HMR, the radioactive nature of the material takes precedence, and the chemical hazard is treated as a subsidiary risk.

Depending on the degree of enrichment and the amount of fissile U present, UF₆ may be transported in excepted, industrial, Type A, or fissile packaging. The packaging requirements for UF₆, both fissile and LSA, are in § 173.420. This section contains references to American National Standards Institute (ANSI) Standard N14.1, *Nuclear Materials - Uranium Hexafluoride - Packaging for Transport*, and to ASME Code. All UF₆ cylinders with greater than 100g of UF₆ must comply with the provisions in § 173.420 that require each UF₆ package be designed to withstand:

- A hydraulic test at internal pressure of 200 lb per square inch without leakage.
- The free drop test in § 173.465(c) without loss or dispersal of the UF₆.
- The thermal test in 10 CFR § 71.73(c)(4) without rupture of the containment.

These tests do not have to be conducted sequentially or on the same package.

In addition to the provisions in § 173.420, UF₆ shipments are subject to the provisions in either § 173.427 or § 173.417. UF₆ that is enriched to not more than 1% is considered non-fissile, since it will meet the fissile exemption in § 173.453(d); as such, it can be shipped using the LSA shipping provisions in § 173.427. UF₆ that is enriched to more than 1% must be shipped in the authorized Type A or Type B fissile packages that are referenced in § 173.417(a)(2) and (3) and in § 173.417(b)(3).

The quantity limits for shipment of enriched (fissile) UF₆ in the form of residual “heels” of material in “empty” cylinders are provided in § 173.417(a)(2).

The quantity limits for fissile UF₆ in metal cylinders overpacked in DOT Specification 20PF and 21PF protective overpacks are contained in § 173.417(b)(3) or in the certificates for NRC-certified UF₆ packages. The specifications for the DOT overpacks are provided in

§ 178.356 (Specification 20PF) and § 178.358 (Specification 21PF). Handling procedures and packaging criteria for the overpacks must be in accordance with the United States Enrichment Corporation (USEC) Report USEC-651, *Good Handling Practices for Uranium Hexafluoride*.

VI. TRANSPORT CONTROLS

While proper packaging is the primary means of providing safety, transport controls provide additional levels of safety in the transport of radioactive materials. These controls include use of a transport index (TI), a criticality safety index (CSI) for fissile materials, dose rate limits, contamination limits, exclusive use provisions, and use of closed transport vehicles.

Exclusive use means sole use by a single consignor of a conveyance for which all initial, intermediate, and final loading and unloading are carried out in accordance with the direction of the consignor or consignee. The consignor and the carrier must ensure that any loading or unloading is performed by personnel having radiological training and resources appropriate for safe handling of the consignment. The consignor must provide to the initial carrier specific written instructions for maintenance of exclusive use shipment controls, including the vehicle survey requirement of § 173.443 (c) as applicable, and include these instructions with the shipping paper information provided to the carrier by the consignor.

A. Transport Index (TI)

The dose rates associated with radioactive material shipments are controlled, in part, by the transport index, often called the TI. The TI is a dimensionless number that restricts the number of radioactive material packages that can be safely accumulated on a conveyance or in a storage area. By definition, the transport index is determined by multiplying the maximum radiation level in millisieverts (mSv) per hour at 1 m (3.3 ft) from the external surface of the package by 100 (equivalent to the maximum radiation level in millirem per hour at 1 m (3.3 ft)). The TI is rounded up to the nearest tenth (except a TI between 0.0 and 0.05 may be taken as zero) and is shown, without units, as the TI on shipping papers and radioactive material labels. Figure 13 illustrates the measurement of a package TI.

Figure 13 - Transport Index

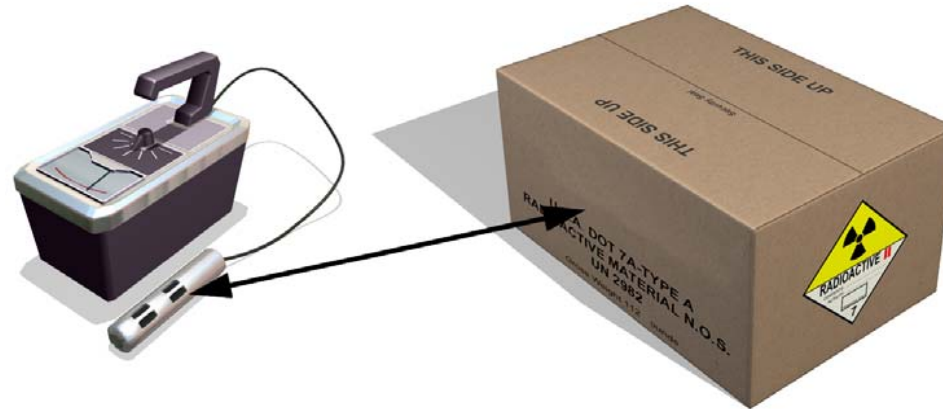

For non-exclusive use shipments, the TI from a single package can not exceed 10.

Conveyance limits on the sum of package transport indices are given in § 173.441(d) and are as follows:

1. Except for shipments by cargo aircraft only or by seagoing vessel, the sum of TIs for a non-exclusive use shipment may not exceed 50.
2. Where a consignment is transported under exclusive use, there is no limit on the sum of the TIs aboard a single conveyance.
3. Provisions for shipments of radioactive materials by air are described in §§ 175.700 - 175.705 and include:
 - a. On a passenger-carrying aircraft—
 - i. Each single package on the aircraft has a TI no greater than 3.0;
 - ii. The combined TI of all the packages on the aircraft must be no greater than 50.
 - b. On a cargo aircraft—
 - i. Each single package on the aircraft has a TI no greater than 10.0.
 - ii. The combined TI of all the packages on the aircraft is no greater than 200.
4. Provisions for shipment of radioactive materials by vessel are described in §§ 176.700 - 176.720 and include the requirement that the sum of the TIs for all packages on board a vessel may not exceed the limits specified in Table 4 (this table does not apply to consignments of LSA-I material).

Packages must be stowed at prescribed distances from areas occupied by persons, based on tables of cumulative TI versus separation distance found in DOT carrier regulations as follows:

- Rail § 174.700
- Air §§ 175.701 – 175.702
- Water § 176.708
- Highway § 177.842

There is a limit of a total TI of 50 for each group of packages in a single spot in storage incident to transportation (with each group of packages at least 6 m (20 ft) from other groups of radioactive packages).

The TI limits for freight containers and conveyances on vessels are listed in Table 4.

Table 4 - TI Limits for Freight Containers and Conveyances on Vessels

Type of freight container or conveyance	Limit on total sum of transport indices in a single freight container or aboard a conveyance	
	Not under exclusive use	Under exclusive use
I. Freight container - small	50	N/A
II. Freight container - large	50	No limit
III. Vessel: ^{a,b}		
1. Hold, compartment or defined deck area:		
i. Packages, overpacks, small freight containers.	50	No limit
ii. Large freight containers.	200	No limit
2. Total vessel:		
i. Packages, overpacks, small freight containers.	200	No limit
ii. Large freight containers.	No limit	No limit

NOTES:

^a For vessels, the requirements in both 1 and 2 must be fulfilled.

^b Packages or overpacks transported in or on a vehicle which are offered for transport in accordance with the provisions of § 173.441(b) (exclusive use) may be transported by vessels provided that they are not removed from the vehicle at any time while on board the vessel.

B. Criticality Safety Index (CSI)

In addition to a transport index, packages containing fissile material (those not excepted under § 173.453) must be assigned a criticality safety index (CSI). Like the TI, the CSI is a dimensionless number, rounded up to the next tenth, which is used to provide control over the accumulation of packages, overpacks or freight containers. The CSI for packages containing fissile material is determined in accordance with the instructions provided in 10 CFR §§ 71.22, 71.23, and 71.59; it is determined from the grams of fissile material (plutonium-239, plutonium-241, uranium-233, uranium-235) present in the package. The CSI for an overpack, freight container, or consignment containing fissile material packages is the arithmetic sum of the criticality safety indices of all the fissile material packages contained within the overpack, freight container, or consignment.

Except for consignments under exclusive use, the CSI of any package or overpack may not exceed 50; a fissile material package with CSI greater than 50 must be transported by exclusive use. For non-exclusive use shipments of fissile material packages, except on vessels, the total sum of CSIs in a freight container or on a conveyance may not exceed 50, for exclusive use shipments the total sum of CSIs may not exceed 100. In temporary storage during transportation, the total CSI in any storage location must not exceed 50. Groups of such packages must be spaced at least 6 m (20 ft) apart.

Mixing of fissile material packages with other types of Class 7 (radioactive) materials in any conveyance or storage location is authorized only if the TI of any single package does not exceed 10, the CSI of any single package does not exceed 50, and the radiation level restrictions of § 173.441 and the specific requirements for the transportation of fissile material packages in § 173.457 are satisfied.

Provisions for shipment of radioactive materials by vessel are described in §§ 176.700 – 176.720 and include the requirement that the sum of the CSIs for all packages radioactive materials on board a vessel may not exceed the limits specified in Table 5 (this table does not apply to consignments of LSA-I material).

Table 5 - CSI Limits for Freight Containers and Conveyances on Vessels

Type of freight container or conveyance	Limit on total sum of criticality safety indices in a single freight container or aboard a conveyance	
	Not under exclusive use	Under exclusive use
I. Freight container - small	50	N/A
II. Freight container - large	50	100
III. Vessel: ^{a,b}		
1. Hold, compartment or defined deck area:		
i. Packages, overpacks, small freight containers.	50	100
ii. Large freight containers.	50	100
2. Total vessel:		
i. Packages, overpacks, small freight containers.	200	200
ii. Large freight containers.	No limit ^c	No limit ^d

NOTES:

^a For vessels, the requirements in both 1 and 2 must be fulfilled.

^b Packages or overpacks transported in or on a vehicle which are offered for transport in accordance with the provisions of § 173.441(b) (exclusive use) may be transported by vessels provided that they are not removed from the vehicle at any time while on board the vessel. In that case, the entries under the heading “under exclusive use” apply.

^c The consignment must be handled and stowed such that the total sum of CSIs in any group does not exceed 50, and such that each group is handled and stowed so that the groups are separated from each other by at least 6 m (20 ft).

^d The consignment must be handled and stowed such that the total sum of CSIs in any group does not exceed 100, and such that each group is handled and stowed so that the groups are separated from each other by at least 6 m (20 ft). The intervening space between groups may be occupied by other cargo.

C. Package Radiation Limits

The limits on radiation levels of a package offered for transportation are found in § 173.441. (The dose limits for excepted packages are located in §§ 173.421, 424, 426, and 428; at 0.005 mSv/h (0.5 mrem/h) these limits are significantly lower than what is allowed for other radioactive material packages.)

For non-excepted packaging, packages are restricted to surface readings not exceeding 2 mSv/h (200 mrem/h) and a transport index (TI) that does not exceed 10 as shown in Figure 14. These limits apply for non-exclusive use shipments and help to ensure that transport personnel do not receive significant doses, even when frequently handling a large number of packages.

Figure 14- Package Radiation Limits for Non-Exclusive Use Shipments

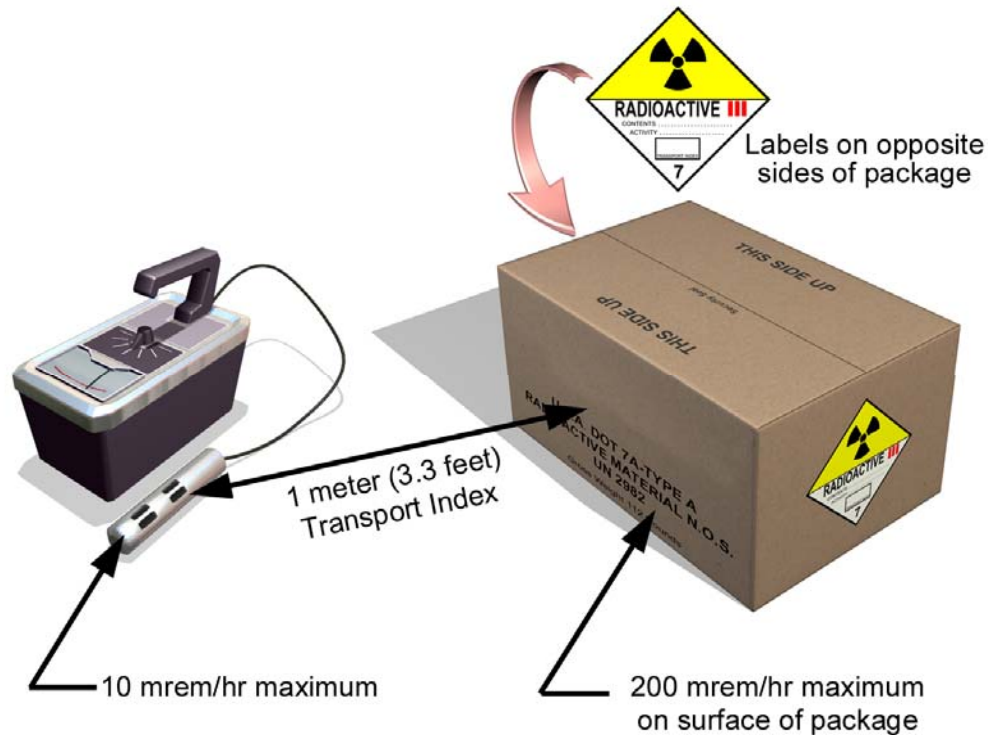

Packages may be shipped with higher dose rates if they are placed under additional controls. For packages with surface readings under 2 mSv/h (200 mrem/h), but with a TI exceeding 10, the shipment may be placed under exclusive use. Packages having a surface reading over 2 mSv/h (200 mrem/h), up to as high as 10 mSv/h (1,000 mrem/h), must not only be placed under exclusive use but also must be shipped in a closed transport vehicle with the package secured in place with no loading or unloading operations between the beginning and end of the transportation. (A “closed transport vehicle” includes not only closed trailers and vans, but also arrangements where personnel barriers to limit access are placed around large packages carried on flat bed trailers.)

For exclusive use shipments, the vehicle radiation levels must not exceed the following during transportation:

- 2 mSv/h (200 mrem/h) at any point on the outer surfaces of the vehicle;
- 0.1 mSv/h (10 mrem/h) at any point 2 m (6.6 feet) from the outer lateral surfaces of the vehicle (excluding the top and underside of the vehicle);
- 0.02 mSv/h (2 mrem/h) in any normally occupied space, (this does not apply to carriers if they operate under the provisions of a State or federally-regulated radiation protection program and if personnel under their control who are in such an occupied space wear radiation dosimetry devices).

Figures 15 and 16 illustrate the allowable dose rates for exclusive use shipments.

Figure 15 - Allowable Dose Rates for an Exclusive Use Shipment

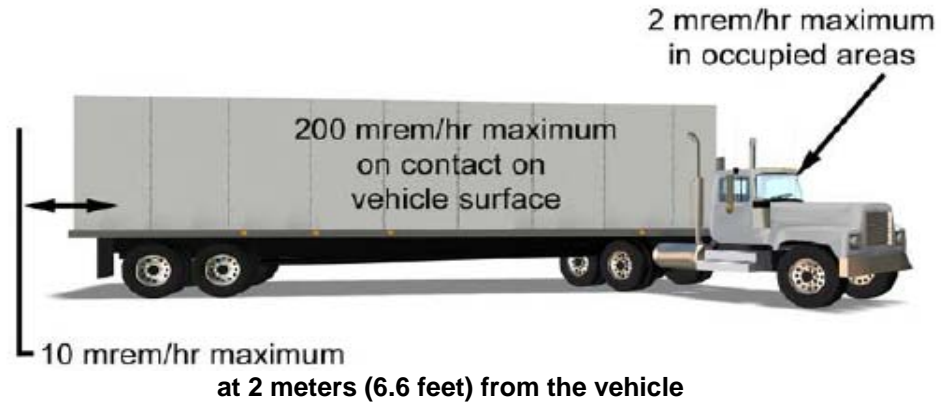

Figure 16- Allowable Dose Rates for an Exclusive Use Shipment in a Closed Transport Vehicle

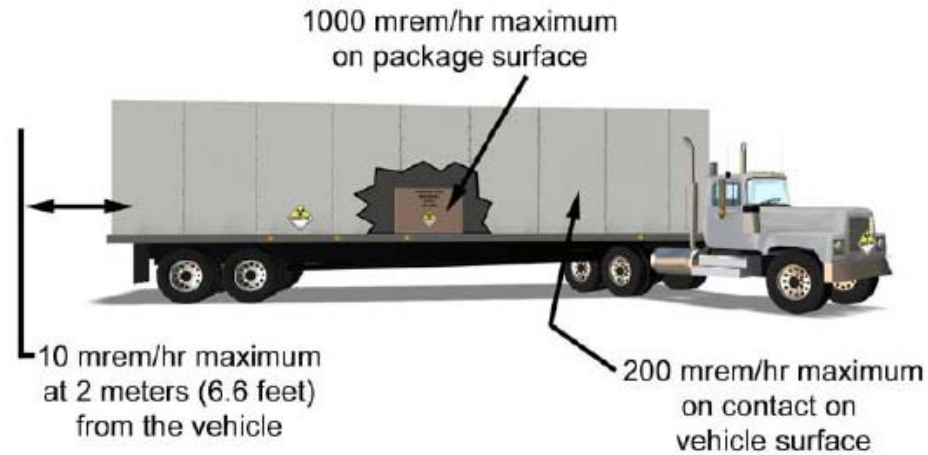

Table 6 summarizes the radiation level limits packages and transport vehicles in various configurations.

Table 6 - Radiation Level Limitations

Package and Vehicle Radiation Level Limits (§ 173.441) ¹				
		Nonexclusive Use Shipment	Exclusive Use Shipment	
		Open or Closed Transport Vehicle	Open (flat-bed)	Closed Transport Vehicle
Package Limits:	External Surface	2 mSv/h (200 mrem/h)	2 mSv/h (200 mrem/h)	10 mSv/h (1000 mrem/h)
	Transport Index (TI) ²	10	No limit	
	Criticality Safety Index (CSI) ⁵	50	No limit	
Transport Vehicle Limits (highway and rail):	Any point on the outer surface	N/A	N/A	2 mSv/h (200 mrem/h)
	Vertical planes projected from outer edges		2 mSv/h (200 mrem/h)	N/A
	Top of		Load: 2 mSv/h (200 mrem/h)	Vehicle: 2 mSv/h (200 mrem/h)
	2 meters from		Vertical Planes: 0.1 mSv/h (10 mrem/h)	Outer Lateral Surfaces: 0.1 mSv/h (10 mrem/h)
	Underside		2 mSv/h (200 mrem/h)	
	Occupied position	N/A ³	0.02 mSv/h (2 mrem/h) ⁴	
	Sum of package TIs	50	No limit	
	Sum of package CSIs ^{5,6}	50	100	

¹ The limits in this table do not apply to excepted packages. [§§ 173.421, 173.424, 173.426, and 173.428]
² The dimensionless number equivalent to maximum radiation level at 1 meter (3.3 feet) from the exterior package surface is in mrem/h rounded up to the next tenth. [§ 173.403]
³ No dose limit is specified, but separation distances apply to packages with RADIOACTIVE YELLOW-II, RADIOACTIVE YELLOW-III, or CSI labels. (§ 177.842)
⁴ Does not apply to carriers if operating under a state or federally-regulated radiation protection program and if personnel wear radiation dosimetry devices. [§ 173.441(b)(4)]
⁵ These provisions do not apply to shipment by vessel. See § 176.700–720 for the vessel requirements.
⁶ The number of packages containing fissile material stored in transit in any one storage area must be limited so that the total sum of the CSIs is ≤50 and such groups of packages must be spaced at least 6 meters (20 feet) from other such groups. [§§ 173.457 and 173.459]

D. Contamination Limits and Contamination Surveys

Removable, or non-fixed, contamination on the surface of radioactive material packages must be kept as low as reasonably achievable. The maximum removable surface contamination limits are stated in § 173.443 and are shown in Table 7.

Table 7 - Non-Fixed External Radioactive Contamination Limits for Packages

Contaminant	Maximum permissible limits		
	Bq/cm ²	μCi/cm ²	dpm/cm ²
Beta and gamma emitters and low toxicity alpha emitters	4	10 ⁻⁴	220
All other alpha emitting radionuclides	0.4	10 ⁻⁵	22

These levels are the surface limits for removable contamination. Usually, smears are used to assess the removable contamination levels. It is assumed that the smear technique has 10% efficiency. Therefore, shippers should multiply the smear data by 10 before comparing it to the limits. Taking account of this factor, the limits based on wipe data are as shown in Table 8.

Table 8 - Non-Fixed External Radioactive Contamination *Wipe* Limits for Packages

Contaminant	Maximum permissible <i>wipe</i> limits		
	Bq/cm ²	μCi/cm ²	dpm/cm ²
Beta and gamma emitters and low toxicity alpha emitters	0.4	10 ⁻⁵	22
All other alpha emitting radionuclides	0.04	10 ⁻⁶	2.2

* Assuming 10% smear efficiency

In addition, since smears are to be done over 300 cm², shippers should be careful to ensure that they convert to /cm² before making comparisons between the smear data and the values in the table. Techniques other than smears may be used to assess the removable contamination if they have equal or greater efficiency.

The contamination limits cited above apply to all non-exclusive use shipments of radioactive material packages. For packages shipped as exclusive use shipments by rail or highway, the contamination levels must not exceed the Table 7 limits at the beginning of transport, but may increase up to 10 times the limits during transport. This provision allows for the phenomenon of weeping (or leaching) whereby under certain conditions, packages will have fixed contamination that will migrate, or weep, to the outer surface and become removable.

If non-fixed surface contamination levels on packages in an exclusive use vehicle have risen during transportation above the Table 7 limits, the transport vehicle must be surveyed with appropriate radiation detection instruments after each use. It shall not be returned to service until the external radiation on the surface is below 0.005 mSv per hour (0.5 mrem per hour) and the removable surface contamination is below the limits of Table 7 (see §§ 177.843 and 174.715). These requirements do not apply to any vehicle used solely for transporting Class 7 (radioactive) material if a survey of the interior surface shows that the radiation dose rate does not exceed 0.1 mSv per hour (10 mrem per hour) at the interior surface or 0.02 mSv per hour (2 mrem per hour) at 1 meter (3.3 feet) from any interior surface. These vehicles must be stenciled with the words “For Radioactive Materials Use Only” in lettering at least 7.6 cm (3 inches) high in a conspicuous place, on both sides of the exterior of the vehicle. These vehicles must be kept closed at all times other than loading and unloading. The vehicles do not have to be decontaminated to the Table 7 limits until they are released back to general service.

VII. SHIPMENTS OF LOW SPECIFIC ACTIVITY (LSA) MATERIALS AND SURFACE CONTAMINATED OBJECTS (SCO)

As described in Section IV, low specific activity (LSA) material is radioactive material that has a low activity per unit mass (specific activity) and surface contaminated objects (SCO) are solid objects which are not themselves radioactive but which have radioactive material distributed on their surfaces. LSA implies *activity within* a material, while SCO implies *activity on* a material.

Low Specific Activity (LSA) material and Surface Contaminated Objects (SCO) are extremely important radioactive material classifications with respect to shipments of low-to-medium level radioactive waste materials. The majority of shipments of such wastes originating from the nuclear fuel cycle facilities, and from all kinds of industrial, medical, research and academic communities are in the form of varying types of LSA materials. The SCO category addresses solid wastes generated in the form of non-radioactive contaminated materials originating from cleanup, remediation and decontamination activities.

A. Transport Requirements for LSA Materials and SCO

Transport requirements specific to LSA materials and SCO may be found in § 173.427.

The quantity of LSA material or SCO in a single package must be restricted so that the external radiation level from the unshielded material does not exceed 10 mSv/h (1 rem/h) at 3 meters from the unshielded material. Compliance with this requirement does not allow taking credit for shielding provided by the packaging; the inherent property of the material must be limited so that even without any shielding, the dose rate would not exceed the limit. If the external radiation level from the unshielded material exceeds 10 mSv/h at 3 meters, the material may not be considered LSA or SCO, and it will require Type B packaging.

There are restrictions on the total activity of all SCO and some LSA transported in a conveyance. An activity restriction of 100 A₂ per conveyance applies to all SCOs and to LSA-II and LSA-III materials that are combustible solids or are in liquid or gaseous form.

LSA materials and SCO must be either non-fissile or fissile-excepted under § 173.453.

Packages of SCO and LSA materials must meet the contamination control limits in § 173.443 and the dose limits in § 173.441 discussed in Section VI.C and VI.D above.

Domestic shipments containing less than an A₂ quantity that are conducted as exclusive use are excepted from the marking and labeling requirements in 49 CFR Part 172. However, packages and unpackaged materials must be marked with “RADIOACTIVE—LSA” or “RADIOACTIVE—SCO”, as appropriate and with “RQ” if the materials contain a hazardous substance. Unless the material is unconcentrated uranium or thorium ores, placards are required for exclusive use shipments of LSA and SCO shipped in excepted packaging under § 173.427(b)(4); liquid LSA-I material; or unpackaged LSA material or SCO.

B. Packages for LSA Materials and SCO

LSA materials and SCO may be shipped in a variety of package types, depending on their characteristics and the method of shipment.

1. Unpackaged LSA Material and SCO

LSA material and SCO in groups LSA-I and SCO-I may be transported “unpackaged”, that is, the material may be shipped without packaging within a freight container, tank, intermediate bulk container or closed conveyance, under the following conditions (see § 173.427(c)):

- The material must be transported in a manner that ensures no release of contents from the conveyance and no loss of shielding under normal conditions of transport.
- Except for SCO-I material with specified low contamination levels, the shipment must be exclusive use. The conveyance must be surveyed and decontaminated, if necessary, in accordance with § 173.443(c), prior to unrestricted release of the conveyance.
- For SCO-I material with removable contamination above specified limits, measures must be taken to ensure that the radioactive material is not released inside the conveyance or to the environment.

2. Excepted Packages of LSA Material and SCO

For domestic transportation only, excepted packaging is authorized when the LSA material or SCO is transported in an exclusive use vehicle and does not exceed an A₂ quantity in each package. The packaging must meet the “General Design Requirements” of §§ 173.410, 173.24 and 173.24a.

3. Industrial Packages of LSA Material and SCO

Various industrial packages may be used for LSA materials or SCO based on the potential radiological hazard of the material to be transported. LSA-I materials can be shipped in IP-1 packagings, LSA-II and LSA-III materials require more durable IP-2 and IP-3 packagings. LSA material in liquid form requires more durable IP packaging than solid LSA material. Similarly, non-exclusive use shipments do not have the controls during transport that may exist for exclusive use shipments; thus non-exclusive use LSA requires packagings of a greater integrity than are required for exclusive use shipments. The categories of IP packages required for different LSA and SCO materials shipped under different transportation conditions are illustrated in Table 9.

Table 9 - Industrial Package Integrity Requirements for LSA Material and SCO

Contents	Industrial Packaging Type	
	Exclusive Use Shipment	Non-Exclusive Use Shipment
1. LSA-I:		
Solid	IP-1	IP-1
Liquid	IP-1	IP-2
2. LSA-II:		
Solid	IP-2	IP-2
Liquid	IP-2	IP-3
3. LSA-III	IP-2	IP-3
4. SCO-I	IP-1	IP-1
5. SCO-II	IP-2	IP-2

4. Type A Packages for LSA Material and SCO

For domestic transportation only, DOT-7A Type A packaging may be used.

5. Type B Packages for LSA and SCO

Type B packages are usually used for materials other than LSA and SCO. However, they may be used if the radioactivity and physical form of the LSA or SCO to be shipped are such that it can be considered one of the authorized contents for a particular Type B package.

6. Packages for Exclusive Use Transport of Liquid LSA-I

Exclusive use transport of liquid LSA-I must be done, in either:

- Specification 103CW, 111A60W7 tank cars. Bottom openings in tanks are prohibited; or
- Specification MC 310, MC 311, MC 312, MC 331 or DOT 412 cargo tank motor vehicles. Bottom outlets are not authorized. Trailer-on-flat-car service is not authorized.

7. Typical Packages for Radioactive Waste Shipped as LSA or SCO

Figure 17 shows typical packaging and shipping configurations for materials classified as LSA materials or SCO.

Figure 17 - Typical Packages for LSA Materials and SCO



Figure A - Intermodal Container

Depending on the contents or other packaging, it may be a conveyance, bulk packaging, excepted, or IP packaging.



Figure B - Steel Drum Depending on content and inner packaging, it may be a Type A, IP-1, -2, or -3.



Figure C - Shielded LSA Cask
Type A, IP-2 and IP-3.



Figure D - Metal Box
Type A or IP

VIII. HAZMAT COMMUNICATIONS AND RELATED REQUIREMENTS

Shippers have the greatest responsibility for compliance with the communication requirements of Part 172 of 49 CFR, but carriers are also subject to some of the requirements. Safe transportation of radioactive material requires correct communication of the specific hazards of the materials. Generally, an essential part of the total system for providing safety in transport of radioactive material is the requirement for communication of information on the specific hazards of the materials. The communication requirements of 49 CFR Part 172 are designed to complement the basic safety requirements for package activity limitation and package integrity. Historically, Part 172 has addressed the conventional communication requirements, such as, proper shipping papers, package marking, package labeling, and vehicle placarding. In recent years, additional subparts have been added to Part 172 to address emergency response information, hazmat employee training, and security plans.

A. Hazardous Materials Table

Subpart A of Part 172 describes the applicability of the regulations to shippers and carriers. Subpart B contains the hazardous materials table. The Hazardous Materials Table (HMT) in § 172.101 classifies those materials which DOT has designated as hazardous materials for purposes of transportation. The HMT prescribes the requirements for shipping papers, marking, and labeling applicable to the shipment and transportation of those hazardous materials. For each listed material, the table identifies the hazard class, the UN identification number, and gives the proper shipping name or directs the user to the proper shipping name. In addition, the HMT specifies or references other regulatory requirements pertaining to labeling, packaging, and quantity limits aboard aircraft and stowage of hazardous materials aboard vessels.

Before using the HMT, shippers should be familiar with the ground rules which explain the information in the ten columns of the table, and the explanatory symbols (see §§ 172.101(a)-(l) that precede the HMT). The information in the paragraphs preceding the HMT provides extensive information related to the proper use of the table and the information in the table.

B. Proper Shipping Names for Radioactive Materials

The list of proper shipping names for radioactive material, along with their UN identification numbers as shown in the HMT, is given in Table 10.

Table 10 - Radioactive Material Proper Shipping Names and Identification Numbers

Hazardous materials description and proper shipping names	Identification Numbers
Radioactive material, excepted package-articles manufactured from natural uranium <i>or</i> depleted uranium <i>or</i> natural thorium.	UN2909
Radioactive material, excepted package-empty packaging.	UN2908
Radioactive material, excepted package-instruments <i>or</i> articles.	UN2911
Radioactive material, excepted package-limited quantity of material.	UN2910
Radioactive material, low specific activity (LSA-I) <i>non fissile or fissile-excepted.</i>	UN2912
Radioactive material, low specific activity (LSA-II) <i>non fissile or fissile-excepted.</i>	UN3321
Radioactive material, low specific activity (LSA-III) <i>non fissile or fissile excepted.</i>	UN3322
Radioactive material, surface contaminated objects (SCO-I <i>or</i> SCO-II) <i>non fissile or fissile-excepted.</i>	UN2913
Radioactive material, transported under special arrangement <i>non fissile or fissile excepted.</i>	UN2919
Radioactive material, transported under special arrangement, fissile.	UN3331
Radioactive material, Type A package, fissile <i>non-special form.</i>	UN3327
Radioactive material, Type A package <i>non-special form non fissile or fissile-excepted.</i>	UN2915
Radioactive material, Type A package, special form <i>non fissile or fissile-excepted.</i>	UN3332
Radioactive material, Type A package, special form, fissile.	UN3333
Radioactive material, Type B(M) package, fissile.	UN3329
Radioactive material, Type B(M) package <i>non fissile or fissile- excepted.</i>	UN2917
Radioactive material, Type B(U) package, fissile.	UN3328
Radioactive material, Type B(U) package <i>non fissile or fissile-excepted.</i>	UN2916
Radioactive material, uranium hexafluoride <i>non fissile or fissile-excepted.</i>	UN2978
Radioactive material, uranium hexafluoride, fissile.	UN2977

These proper shipping names have been harmonized with those used internationally; there are no longer any generic proper shipping names for radioactive material with the phrase “not otherwise specified (n.o.s).” Most of the proper shipping names are based on the type of package used for the shipment. If the packaging type matches the contents, this is straightforward. However, if the shipper uses a higher-rated package than required for the contents, then either the package markings may be left as is and the proper shipping name consistent with that *packaging* is used, or the proper shipping name based on the *contents* is used, in which case the packaging markings are altered to be consistent.

C. Shipping Paper Requirements

As with other hazardous materials shipments, certain essential elements of information must be included on shipping papers. The availability of a complete and correct shipping paper description for a hazardous material shipment is vital not only to the carrier and the consignee, but also to emergency response personnel in the event of an incident.

1. Basic Shipping Paper Requirements

The shipping paper description must basically include the following:

- The basic shipping description, which consists of;
 - The UN Identification number from Column (4) of the § 172.101 table;
 - The proper shipping name from Column (2) of the § 172.101 table;
 - The UN hazard class or division - radioactive material is hazard class 7;
- The net quantity of material by mass, volume, or for Class 7 materials, activity. *NOTE: For most radioactive material, it is not required to list the weight or volume, since the additional requirements of § 172.203(d) provide better information, i.e., the radioactivity content in becquerels (curies). A listing of weight or volume is usually needed only with respect to establishing freight charges;*
- The letters “RQ”, if the shipment is a “hazardous substance”, either before or after, the basic description [see § 172.101, Appendix A, Table 2 for RQ values of radionuclides].
- Emergency response telephone number as prescribed in Subpart G, Part 172.

A shipping paper may contain additional information concerning the material, provided it is not inconsistent with, and does not cause confusion with, the basic description. Unless otherwise specified, the additional information must be placed after the required basic description.

2. Additional Shipping Paper Description for Radioactive Material

Section 172.203(d) details the additional shipping paper description for radioactive material, and this information, as appropriate, follows the basic description:

- The name of each radionuclide in the material as listed in § 173.435. Abbreviations, e.g., “⁹⁹Mo,” are authorized;
- For mixtures of radionuclides, only the radionuclides that constitute 95% of the hazard of the mixture as described in § 173.433(g) need be listed on shipping papers and package labels (see Section VIII.C.4 of this document).
- A description of the physical and chemical form of the material, if the material is not in special form (generic chemical description is acceptable for chemical form).
- The activity contained in each package of the shipment in terms of the appropriate SI units (e.g., Becquerels (Bq), Terabecquerels (TBq), etc.). The activity may also be stated in appropriate customary units (curies (Ci), millicuries (mCi), microcuries (uCi), etc.) in parentheses following the SI units. Abbreviations are authorized. (The weight in grams or kilograms of fissile radionuclides may be inserted *instead* of activity units, except for plutonium-239 and plutonium-241. For plutonium-239 and plutonium-241, the weight in grams of fissile radionuclides may be inserted in *addition* to the activity units.)
- The category of label applied to each package in the shipment. For example: “RADIOACTIVE WHITE-I.”
- The transport index assigned to each package in the shipment bearing RADIOACTIVE YELLOW-II or RADIOACTIVE YELLOW-III labels.
- For a package containing fissile material:
 - The words “Fissile Excepted” if the package is excepted pursuant to § 173.453; or otherwise
 - The criticality safety index for that package.
- For a package approved by the U.S. Department of Energy (DOE) or U.S. Nuclear Regulatory Commission (NRC), a notation of the package identification marking as prescribed in the applicable DOE or NRC approval (see § 173.471).
- For an export shipment or a shipment in a foreign-made package, a notation of the package identification marking as prescribed in the applicable International Atomic Energy Agency (IAEA) Certificate of Competent Authority which has been issued for the package (see § 173.473).

- For a shipment required to be consigned as exclusive use:
 - An indication that the shipment is consigned as exclusive use; or
 - If all the descriptions on the shipping paper are consigned as exclusive use, then the statement “Exclusive Use Shipment” may be entered only once on the shipping paper in a clearly visible location.
- For the shipment of a package containing a highway route controlled quantity of Class 7 (radioactive) materials the words “Highway route controlled quantity” or “HRCQ” must be entered in association with the basic description.

3. Other Information and Examples of Shipping Papers Entries

As indicated above, a great deal of specific information is required on shipping papers for radioactive material. While there is no precise prescription for the shipping paper format, the first three entries of the basic description must be in a specific order. In a final rule published under Docket HM-215I on December 29, 2006, DOT established new requirements for shipping descriptions on shipping papers. Previously, the basic description of a hazardous material consisted of the proper shipping name, hazard class, ID number and packing group (packing group is not applicable to Class 7), in that order. The HMR had also authorized an alternative description sequence, which lists the identification number first, followed by the proper shipping name, hazard class, and packing group (not applicable to Class 7). Beginning January 1, 2007, the alternative shipping description sequence became mandatory on shipping documents prepared in accordance with the ICAO Technical Instructions and the IMDG Code. The older sequence can be used until January 1, 2013 on other shipments; thereafter all shipping descriptions of a hazardous material must be indicated on a shipping paper in the following manner (as described earlier):

- Identification (ID) number listed first, followed by
- the proper shipping name,
- hazard class, and
- packing group (not applicable to Class 7).

Other descriptive information is allowed, such as the functional description of the product or the applicable regulatory citation under which the shipment is offered. This additional description must not confuse or detract from the required description. The following are some example entries of different ways shipments can be described on shipping papers:

Example 1:

One (1) box UN 2916, Radioactive material Type B(U) package, 7, RQ, 22.7 kg Gross, Iridium - 192, Special Form, 2.2 TBq Radioactive Yellow-II, Transport Index 0.6 USA/9033/B(U), In emergency, contact: 1-800-000-0000.

Example 2:

One (1) box UN 2915, Radioactive material Type A package, Class 7(8), 7.8 kg gross, ⁶⁰Cobalt, 0.01 GBq, liquid, cobalt in 50 ml 5% hydrochloric acid solution, Radioactive Yellow-III and Corrosive labels applied, TI= 1.8, Emergency contact: 1-800-000-0000.

Example 3:

One (1) box UN2915, Radioactive material Type A package, 7(5.1), 10 kg net, Thorium natural, as powdered solid thorium nitrate 48 MBq (1.3 mCi), Radioactive Yellow-II and 5.1 labels, TI 0.1 DOT Spec. 7A, Cargo aircraft only, In emergency contact: 1-800-000-0000.

NOTE: Although this material is LSA-I, as an oxidizer, it must be packaged and shown on the shipping papers in accordance with the specific packaging requirements of Section 173.419, with air shipment limited to not more than 11.3 kg.

Example 4:

Three (3) drums UN 3321, Radioactive material low specific activity (LSA-II), 7, 363kg ea., ¹³⁷Cs, ⁶⁰Co and ⁹⁰Sr, Solid, elemental and inorganic salts in non-compacted solid debris and waste

Drum No.	Activity (MBq)
731	1.5
680	0.57
541	0.18

See attached Radwaste Manifest XZ 00052, Exclusive-use shipment. In emergency, contact (24-hour) 1-800-000-0000.

NOTE: This is an example of a shipment under § 173.427(b)(4).

Example 5:

(3) boxes

UN 2915, Radioactive material Type A package, 7,
Box No.1, catalytic specimen, ³⁵S, 2.6 GBq
solid, powdered metal oxide matrix,
Radioactive White-I label, 60 lb

Box No.2, Tagged solvent, ³⁰Cl, 0.11 GBq
liquid, nonflammable organic
Radioactive White-I label, 50 lb

Box No. 3, converter element, ⁵⁹Fe and ⁵⁵Fe
1.1 GBq and 0.74 GBq, solid, steel part
Radioactive Yellow-III label, TI 1.6, 80 lb

NOTE: This is an example of how one basic entry can be used along with three different packages. Detailed information is given on the content, labels, and TI of each package.

Example 6:

4 cyl.

UN 2977, Radioactive material uranium hexafluoride fissile, 7(8),
Total Gross Wt. 18,795 kg

Solid Uranium Hexafluoride (UF₆) contained in four Model 30B steel cylinders, each enclosed in a Model UX-30 protective overpack, Each cylinder contains 2,277 kg of UF₆, 63 kg ²³⁵U (629 MBq) 5.0 % ²³⁵U enrichment
NRC Certificate USA/9196/AF, Type A

Radioactive Yellow-III labels, TI=5.0/package, CSI=5.0/package.

Radioactive and Corrosive placards and orange 2977 UN panel applied.

24-hour Emergency Telephone No.: contact 1-888-888-8888.

4. 95% Rule for Mixtures

The “95% Rule” for listing mixtures of radionuclides on shipping papers and labels is given in § 173.435(g), which states, “For mixtures of radionuclides, the radionuclides (*n*) that must be shown on shipping papers and labels in accordance with §§ 172.203 and 172.403 of this subchapter, respectively, must be determined on the basis of the following formula:

$$\sum_{i=1}^n \frac{a_{(i)}}{A_{(i)}} \geq 0.95 \sum_{i=1}^{n+m} \frac{a_{(i)}}{A_{(i)}}$$

Where:

$n+m$ represents all the radionuclides in the mixture
 m are the radionuclides that do not need to be considered
 $a_{(i)}$ is the activity of radionuclide i in the mixture; and
 $A_{(i)}$ is the A_1 or A_2 value as appropriate for radionuclide i .

For example, consider a shipment of radionuclides in normal form where the contents of the package are as follows: 0.3 TBq of Co-60, 0.0002 TBq of Sr-90, 0.018 TBq of Cs-137, 0.016 TBq of I-131, and 0.011 TBq of Sr-89. The summation terms are as follows:

Isotope	Activity [TBq]	A_2 [TBq]	Contribution = $\frac{a_{(i)}}{A_{(i)}}$
Co-60	0.3	0.4	$= \frac{0.3}{0.4} = 0.75$
Sr-90	0.0002	0.3	$= \frac{0.0002}{0.3} = 6.7E-4$
Cs-137	0.018	0.6	$= \frac{0.018}{0.6} = 0.03$
I-131	0.016	0.7	$= \frac{0.016}{0.7} = 0.023$
Sr-89	0.011	0.6	$= \frac{0.011}{0.6} = 0.183$

The summation of each contribution is 0.987 and 95% of this value is 0.937; so it is necessary to list the largest radionuclide quantities until a contribution level of 0.937 is reached. Co-60 and Sr-89 are the 2 largest contributors, and the summation of their contributions is 0.933, so the next largest contributor is needed to reach the 95% value of 0.937, and that radionuclide is Cs-137.

Thus, the radionuclides that will need to be listed as “contents” on the shipping paper and label are: Co-60, Sr-89 and Cs-137. Note that the 95% Rule does not always list the radionuclides with the highest activity values, as the rule is dependent on the relative ratio of activity to A_1/A_2 values for each radionuclide.

5. Documentation for Excepted Packages

As noted in Section V.B, packages shipped according to the exceptions provided in §§ 173.421, 173.424, 173.426 and 173.428 (for limited quantity, instruments or articles, articles manufactured from natural or depleted U or natural Th, and empty radioactive material packaging) are excepted from the detailed shipping paper description requirements. With the addition of the requirement to mark these excepted packages, certification statements are no longer required. (However, a shipping paper is required if the radioactive material in the excepted package meets the definition of a hazardous substance or hazardous waste (as defined in § 171.8)).

Although shipping papers are not required for these excepted packages (with UN identification numbers 2908, 2909, 2910, and 2911), they are not forbidden. In addition, when shipping excepted packages by air, a prescribed statement on an airbill is required by ICAO and IATA regulations.

6. Shipper's Certification

Unless excepted, a shipping paper must include a certification statement, signed by the person offering the package for transport. The certification must appear on the paper that lists the required shipping description.

The following statement listed in § 172.204(a)(1) (or an alternate statement listed in §172.204(a)(2)) must be used for all hazardous materials shipments except for those by air:

“This is to certify that the above-named materials are properly classified, described, packaged, marked, and labeled, and are in proper condition for transportation according to the applicable regulations of the Department of Transportation.”

For air transportation, the following language may be included on shipping papers in place of the above statement:

“I hereby certify that the contents of this consignment are fully and accurately described above by proper shipping name and are classified, packed, marked, and labeled, and in proper condition for carriage by air according to applicable national governmental regulations.”

The requirements and limitations for carriage of radioactive materials aboard aircraft are prescribed in §§ 175.75(a)(3) and 175.700 through § 175.705. The following statement, with deletion marking, is required for all hazardous material (including radioactive material) shipments by air:

“This shipment is within the limitations for passenger carrying/cargo aircraft only (delete non-applicable).”

D. Marking Requirements

General marking requirements for all hazardous materials are provided in §§ 172.301 and 172.302. Specific requirements for Class 7 materials are located in § 172.310.

1. Basic Marking Requirements

Marking for non-bulk hazardous material packaging includes the following (some exceptions apply):

- Proper shipping name
- UN ID number (required on ALL packages, including excepted and empty)
- Name and address of the consignee or consignor
- RQ, if a “hazardous substance”
- DOT-SP Number, if shipped under a DOT Special Permit.

All required markings must be durable, in English, and displayed in a manner so as to not obscure them or reduce their effectiveness. Markings may either be printed on the surface of the package itself or on a label, tag, or sign (see § 172.304).

2. Marking Requirement for Liquids

Each non-bulk combination package with inner packaging containing liquid hazardous materials must be marked with arrows on two opposite sides to indicate the upward position of the inside packaging (see Figure 18). Such marking must be on two opposite sides, with the double arrows in the symbol pointing in the correct upright direction. Arrows for any other purpose may not be displayed on a package containing a liquid hazardous material. There are some exceptions to this rule (see § 172.312(c)). These exceptions include Class 7 radioactive material in Type A, IP-2, IP-3, Type B(U), or Type B(M) packages and non-bulk packages with hermetically sealed inner packagings.

Figure 18 - Package Orientation Marking for Liquid Packages

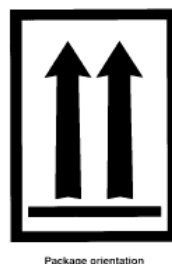

3. Marking Requirements for Radioactive Materials

In addition to the above markings, radioactive materials are subject to the following package marking requirements (see §§ 172.310, 173.471(b), 173.472(c), 173.473(b), and 178.350):

- Gross weight if > 50 kg (110 lb)
- “TYPE IP-1”, “TYPE IP-2”, “TYPE IP-3”, “TYPE A” “TYPE B(U)”, or “TYPE B(M),” as appropriate to the package
- For each IP-1, IP-2, IP-3, or Type A package, the code for the country of origin of design (e.g., “USA”)
- For each DOT 7A Type A packaging:
 - “USA DOT 7A Type A”
 - Name of packaging manufacturer (the person certifying that the package meets all requirements for a Type A package)

- For Type B packages, the trefoil radiation symbol (see Figure 19) - resistant to the effects of fire and water, plainly marked by embossing, stamping or other means resistant to the effects of fire and water (not on a sticky label)
- For Type B and fissile material packages, the applicable DOT, NRC or DOE package certificate ID number, as specified in the relevant certificate, e.g., USA/9166/B(U)-85
- Exclusive use domestic transportation of LSA materials and SCO is excepted from other marking requirements but must be stenciled or marked as “RADIOACTIVE – LSA” or “RADIOACTIVE – SCO,” as appropriate
- Excepted packages are excepted from other marking requirements but must be marked with the UN identification number for the material.

Figure 19- Trefoil Symbol

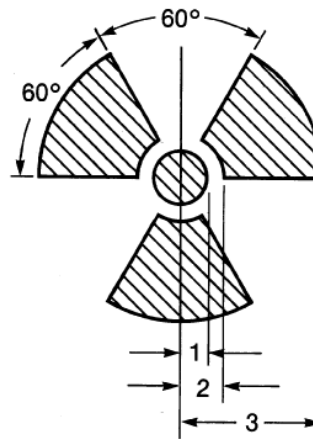

{1=Radius of Circle (Minimum dimensions 4 mm (0.16 inch) for markings and labels, 12.5 mm (0.5 inch) for placards), 2=1.5* Radius, 3= 5* Radius for markings and labels,= 4.5*Radius for placards.}

4. Marking of Bulk Radioactive Material Packages

Bulk packaging for a hazardous material is defined in § 171.8. The concept of bulk packaging reflected in that definition is that the packaging may involve the vehicle itself, such as a freight container or other large closed receptacle in which the hazardous material is loaded with no intermediate form of containment. Traditionally, the DOT has viewed Type A and Type B radioactive material packaging as non-bulk packaging.

Bulk radioactive material packaging is, therefore, most likely to involve conveyances such as the following:

- Tightly closed trucks/vans or railcars containing contaminated soils and debris
- Large bins or freight containers for solids
- Tanks containing slurries or other liquid waste.

For such shipments, the bulk packaging must be marked on its exterior with the applicable UN hazard ID number (see § 172.302). When required for radioactive material, this ID number must be placed on either an orange rectangular panel adjacent to the required radioactive placard (see § 172.332.) or on a plain white square-on-point display configuration having the same outside dimensions as a placard (see § 172.336(b)). According to § 172.334(a), the ID number may not be placed on the radioactive placard in lieu of the word *Radioactive* for domestic shipments; however, this prohibition does not exist in the international (IAEA and IMO) regulations.

E. Labeling Requirements

Each package of Class 7 (radioactive material), unless excepted, must be labeled on two opposite sides, with a distinctive warning label. Excepted packages, and domestic shipments of LSA materials and SCO that are conducted as exclusive use are excepted from the labeling requirements. However, while not a DOT requirement, the ICAO Technical Instructions require excepted packages that are to be shipped by air to have a “Radioactive materials, Excepted Package” label as shown in Figure 19 .

Figure 20 - ICAO Excepted Package Label

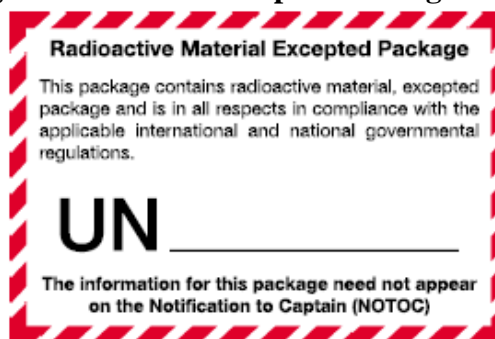

Each of the three label categories, i.e., “RADIOACTIVE WHITE-I”, “RADIOACTIVE YELLOW-II”, or “RADIOACTIVE YELLOW-III”, bears the trefoil symbol. Radioactive material labeling is based on the maximum package surface dose rate and the transport index (TI), as shown in Table 11 (taken from § 172.403).

Table 11 - Label Category Based on TI and Surface Radiation Level

Transport Index (TI)	Maximum radiation level at any point on the external surface	Label Category ¹
0 ²	Less than or equal to 0.005 mSv/h (0.5 mrem/h)	WHITE-I
More than 0 but not more than 1	Greater than 0.005 mSv/h (0.5 mrem/h) but less than or equal to 0.5 mSv/h (50 mrem/h)	YELLOW-II
More than 1 but not more than 10	Greater than 0.5 mSv/h (50 mrem/h) but less than or equal to 2 mSv/h (200 mrem/h)	YELLOW-III
More than 10	Greater than 2 mSv/h (200 mrem/h) but less than or equal to 10 mSv/h (1,000 mrem/h)	YELLOW-III (Must be shipped under exclusive use provisions; see 173.441(b))

¹Any package containing a “highway route controlled quantity” (§173.403) must be labeled as RADIOACTIVE YELLOW-III.

²If the measured TI is not greater than 0.05, the value may be considered to be zero.

The three radioactive labels are prescribed in §§ 172.436 - 440 and are shown in Figure 21.

Figure 21 - Radioactive Material Labels



WHITE-I Label YELLOW-II Label YELLOW-III Label

For each of these labels, the vertical bars following RADIOACTIVE are in red. Each label is diamond-shaped, at least 100 mm (3.9 inches) on each side. The background color of the upper half (within the black line) is white for the “I” label. It is yellow for the “II” and “III” labels. Other label specifications are given in § 172.407.

The following applicable items of information must be entered on the blank spaces of each radioactive label by legible printing (manual or mechanical) using a durable, weather-resistant means of marking:

- Contents – Except for LSA-I material, the names of the radionuclides. For mixtures of radionuclides, the radionuclides that represent 95% of the hazard present as determined in accordance with § 173.433(g) are listed. For LSA-I material, the term “LSA-I” may be used in place of the names of the radionuclides.
- Activity – Activity must be expressed in appropriate SI units (e.g., becquerels (Bq), terabecquerels (TBq), etc.). Except for plutonium-239 and plutonium-241, the weight in grams or kilograms of fissile radionuclides may be inserted instead of activity units. For plutonium-239 and plutonium-241, the weight in grams of fissile radionuclides may be inserted in addition to the activity units.
- Transport Index (TI) on Yellow-II and Yellow-III labels (not on White-I)

For radioactive materials with subsidiary hazards, the required subsidiary labels must also be applied.

For fissile material packages, a FISSILE label with the CSI indicated is required. Two fissile labels must be placed adjacent to the two radioactive material labels on the package. The fissile label is specified in § 172.441 and shown in Figure 22.

Figure 22 - Fissile Label

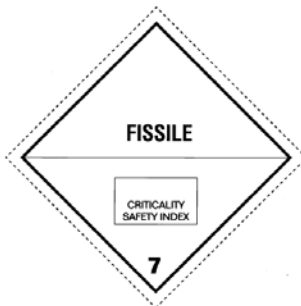

Each such FISSILE label must be completed with the criticality safety index (CSI) assigned in the NRC or DOE package design approval, or in the certificate of approval for special arrangement or the certificate of approval for the package design issued by the Competent Authority for import and export shipments. (For overpacks and freight containers required in § 172.402 to bear a FISSILE label, the CSI on the label must be the sum of the CSIs for all of the packages contained in the overpack or freight container.)

Empty radioactive material packages shipped under § 173.428 must be labeled with the “Empty” label specified in § 172.450 (shown in Figure 23) and have any other affixed labels removed or obliterated.

Figure 23 - Empty Label



The radioactive labels alert persons, particularly cargo handlers, that the package contains radioactive material and that the package may require special handling and stowage distance/separation control. A WHITE-I label indicates that the external radiation level is low and no special stowage controls or handling are required. The YELLOW-II and YELLOW-III labels indicate that the package will have an external radiation level which requires consideration of stowage distance/separation control in transportation. If the package bears the fissile label, the material has properties relating to nuclear criticality safety and may also require stowage controls in transportation. If the package bears a YELLOW-III label, the transport vehicle must be placarded RADIOACTIVE by the carrier when the packages are accepted from a shipper.

F. Placarding Requirements

Section 172.504 requires a placard for a transport vehicle (rail or highway) if any radioactive material package bears the “RADIOACTIVE YELLOW-III” label. Placards are also required for domestic transportation of exclusive use shipments of LSA material (unless the material is unconcentrated U or Th ores) and SCO shipped in excepted packaging under § 173.427(b)(4); liquid LSA-I material; or unpackaged LSA material or SCO. Section 172.506 requires the shipper to provide the required placards to the motor carrier, unless the carrier's motor vehicle is already placarded as required. Section 172.508 requires shippers to affix placards to rail cars.

The RADIOACTIVE placard is specified in § 172.556 and is illustrated in Figure 24.

Figure 24 - Vehicle Radioactive Placard



The background color for the black trefoil symbol in the upper half of this 12” by 12” placard is yellow.

NOTE: In the case of foreign shipments coming into the U.S., the placard may take the format of an enlarged RADIOACTIVE label or may look slightly different with the yellow background extending to the middle of the placard, ending at a black line. Foreign placards may also have the UN identification number in place of the word RADIOACTIVE.

For highway shipments of highway route controlled quantity shipments, the placard must be presented with a white square background and a black border as shown in Figure 25.

Figure 25 - HRCQ Placard



Section 172.505(b) requires that UF₆ shipments containing 454 kg (1,001 lb) or more of UF₆ must display the CORROSIVE placard in addition to any required radioactive placarding.

G. Emergency Response Information Requirements

Section 172.600 requires shippers to provide emergency response information on hazardous materials shipments. The regulation applies to any shipment of a hazardous material which is required to have shipping papers. Shipments of excepted radioactive material packages (packages containing limited quantities, instruments or articles, or “Empty” packagings) are excepted from shipping paper requirements, and, therefore, are not subject to the emergency response information requirements unless they contain a hazardous substance.

1. Required Information

At a minimum, the emergency response information must provide: the basic description and technical name of the hazardous material, immediate hazards to health, immediate precautions to be taken in the event of an accident or incident, immediate methods for handling fires, immediate methods for handling spills or leaks in the absence of fire, and preliminary first aid measures.

This information must be on a shipping paper or an associated document and kept on the vehicle and maintained at all locations where the shipment is handled. This required information is very similar to the information in the guide pages of the Emergency Response Guidebook (ERG) (see Section 3 below). In many cases, shippers satisfy this requirement by attaching to their shipping papers an appropriate guide page from the ERG.

There is a wide range of potential hazards for the many types of radioactive material that can be shipped under a given shipping name and guide number. If the product being shipped has properties that are either less hazardous or more hazardous than the description in the applicable guide in the ERG, then the emergency actions could be more specific than those in the guide. In such cases, the shipper may wish to satisfy the technical information requirements from § 172.602 (a)(1-7) by preparing statements that are appropriate to the product being shipped.

2. Emergency Response Telephone Number

Shippers are required to provide an emergency response telephone number which must be monitored on a 24-hour basis while the shipment is in transportation. The number must be of a person or entity who is knowledgeable of mitigation information or has immediate access to such a person. If the number of the agency hired to provide the information is listed, the person offering the shipment must ensure the agency has received the most current information on the material and that it accepts responsibility for providing this information in an emergency.

3. Emergency Response Guidebook

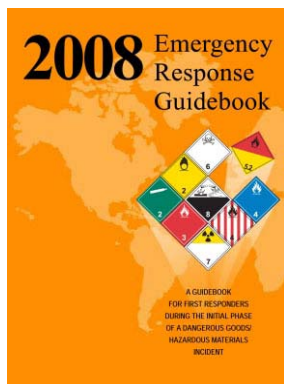

The Emergency Response Guidebook (ERG2008) was developed jointly by the US Department of Transportation, Transport Canada, and the Secretariat of Communications and Transportation of Mexico (SCT) for use by firefighters, police, and other emergency services personnel who may be the first to arrive at the scene of a transportation incident involving a hazardous material. It is primarily a guide to aid first responders in (1) quickly identifying the specific or generic classification of the material(s) involved in the incident, and (2) protecting themselves and the general public during this initial response phase of the incident. DOT's goal is to place one ERG2008 in each emergency service vehicle, nationwide, through distribution to state and local public safety authorities. The ERG may be found online at: <http://hazmat.dot.gov/pubs/erg/guidebook.htm> and at <http://www.tc.gc.ca/canutec/en/guide/guide.htm>.

The Guidebook is divided into color-coded sections: white, yellow, blue, orange and green. Information on how to use the Emergency Response Guidebook and other supporting information can be found in the white pages. The yellow-bordered pages index the list of dangerous goods in numerical order of 4-digit ID number. The blue bordered pages index the list of dangerous goods in alphabetical order by material name. The green-bordered pages suggest initial isolation distances and protective action distances for hazardous material spills that are Toxic by Inhalation (TIH). A list of gases produced when spilled in water is also provided. Both the yellow and blue pages lead you to a guide number located in the orange bordered pages. The orange-bordered pages (orange guides) are most important as this is where all the safety recommendations reside. The orange pages comprise a total of 62 individual guides, each providing safety recommendations and emergency response information to protect first responders and the public. Recommendations include potential hazards, public safety, and emergency response actions.

The orange guides 161- 166 provide information on radioactive material incidents. These guides are titled as follows:

- Guide 161 - Radioactive Materials (Low Level Radiation)
- Guide 162 - Radioactive Materials (Low to Moderate Level Radiation)
- Guide 163 - Radioactive Materials (Low to High Level Radiation)
- Guide 164 - Radioactive Materials (Special Form/Low to High Level External Radiation)
- Guide 165 - Radioactive Materials (Fissile/Low to High Level Radiation)
- Guide 166 - Radioactive Materials – Corrosive (Uranium Hexafluoride/Water-Sensitive).

H. Training Requirements

Training requirements are found in several sections of the HMR as follows:

- General - § 173.1
- Specific - § 172.704
- Modal:
 - Air - § 175.20
 - Vessel - § 176.13
 - Highway - §§ 177.800, 177.816

DOT has information and reference materials for training requirements at: <http://hazmat.dot.gov/training/training.htm>.

Section 172.704 requires that each *hazmat employer* must ensure that each *hazmat employee*, as defined in § 171.8, receives the required training and testing in the following subjects:

- General awareness/familiarization with the 49 CFR hazardous materials transportation requirements
- Function-specific training
- Safety training
- Security awareness training
- In-depth security training, if a security plan is required.

Initial training is required within 90 days of employment on a specific job. The hazmat employee must have **recurrent training** every three years or within 90 days after assignment to a new job for which training has not already been provided.

1. **General Awareness/Familiarization Training**

General awareness/familiarization training is directed toward the hazmat employee being able to recognize and identify hazardous materials in a manner consistent with the hazard communication standards of 49 CFR 172. Training in this area should include a basic orientation on DOT shipping papers, package marking, package labeling, emergency response information and vehicle placarding requirements. Testing should focus on awareness, recognition and identification. DOT has prepared training modules that meet the requirements for general awareness training which may be found at <http://hazmat.dot.gov/training/mods/mod.htm>.

2. **Function-Specific Training**

Function-specific training is intended to focus on those hazardous material activities (functions) which actually involve the hazmat employee. If the employee does not perform certain hazmat activities, then neither training nor testing in those activities is required.

3. **Safety Training**

Safety training must cover the following:

- Required emergency response information
- Measures to protect the employee from hazards
- Methods and procedures for avoiding accidents, such as proper handling procedures

OSHA Safety training may be used to satisfy this requirement.

4. **Security Awareness Training**

Security awareness training is to provide an awareness of security risks associated with hazardous materials transportation and methods designed to enhance transportation security. This training must also include a component covering how to recognize and respond to possible security threats.

5. In-Depth Security Training

Each hazmat employee of a company required to have a security plan in accordance with § 172.800 (see Section I below) must be trained concerning the security plan and its implementation. Security training must include company security objectives, specific security procedures, employee responsibilities, actions to take in the event of a security breach, and the organizational security structure.

6. Testing and Record Keeping

Each hazmat employee must be trained and tested to determine the effectiveness of the training received. The hazmat employer must certify that each hazmat employee has been properly trained, and the employer must maintain the training records for hazmat employees. Training Records must include:

- Hazmat employee's name;
- Completion date of most recent training;
- Training Materials (Copy, description, or location);
- Name and address of hazmat trainer; and
- Certification that the hazmat employee has been trained and tested

I. Security Requirements

Title 49 CFR Part 172, Sections 800-804, establishes the requirements for the development and implementation of security plans for shippers and carriers of specified high-risk hazardous materials. Security plans are required for those who offer for transportation the following types and quantities of hazardous materials:

- A hazardous material in an amount that must be placarded in accordance with Subpart F of Part 172 of the HMR;
- A hazardous material in a bulk packaging having a capacity equal to or greater than 13,248 L (3,500 gallons) for liquids or gases or more than 13.24 cubic meters (468 cubic feet) for solids; or
- A select agent or toxin regulated by the Centers for Disease Control and Prevention under 42 CFR Part 73.
- OSHA safety training may be used to satisfy this requirement.

A security plan must include an assessment of possible transportation security risks for shipments of the hazardous materials covered by the plan and appropriate measures to address the assessed risks. At a minimum, a security plan must include the following elements:

- Personnel security. Measures to confirm information provided by job applicants hired for positions that involve access to and handling of the hazardous materials covered by the security plan.
- Unauthorized access. Measures to address the possibility that unauthorized persons may gain access to the hazardous materials covered by the security plan or to transport conveyances being prepared for transportation of the hazardous materials covered by the security plan.
- En route security. Measures to address the security risks of shipments of hazardous materials covered by the security plan en route from origin to destination, including shipments stored incidental to movement.

Additional information and resources for hazardous materials security can be found at the DOT website:

http://hazmat.dot.gov/riskmgmt/hmt/hmt_security.htm

J. Incident Reporting Requirements

Incident reporting requirements are given in §§ 171.15 and 171.16. Two phases of incident reporting are required in the regulations; § 171.15 covers immediate telephone notification following an incident and § 171.16 outlines written reporting procedures within 30 days.

Section 171.15 requires notification, as soon as practical, but no later than 12 hours after the occurrence, of any reportable incident that occurs during the course of transportation in commerce (including loading, unloading, and temporary storage). Any reporting delay beyond what is necessary to safely secure the incident scene is not permitted. Notification must be made by telephone to the National Response Center on 800-424-8802 (toll free) or 202-267-2675 (toll call). Included in the list of reportable incidents is the following:

- Fire, breakage, spillage, or suspected radioactive contamination occurs involving a radioactive material.

For reportable incidents that require immediate notification, and for some other occurrences, such as the discovery of undeclared hazardous material, § 171.16 requires submittal of a Hazardous Materials Incident Report on DOT Form F 5800.1 (01/2004) within 30 days of discovery of the incident. Reports must be provided to the Information Systems Manager, PHH-63, Pipeline and Hazardous Materials Safety Administration, Department of Transportation, Washington, DC 20590-0001, or an electronic Hazardous Material Incident Report may be filed online at <https://hazmatonline.phmsa.dot.gov/incident/>. For an incident involving transportation by aircraft, a written or electronic copy of the Hazardous Materials Incident Report must be sent to the FAA Security Field Office nearest the location of the incident.

A copy of the Hazardous Materials Incident Report must be retained for a period of two years. In addition, a Hazardous Materials Incident Report must be updated within one year of the date of occurrence of the incident in certain instances.

Further information on incident reporting requirements may be found at <http://hazmat.dot.gov/enforce/spills/spills.htm>.

IX. QUALITY ASSURANCE

DOT requirements for quality control are located in §§ 173.474 and 173.475. These are titled “Quality control for construction of packaging” and “Quality control requirements prior to each shipment of Class 7 (radioactive) materials”, respectively. (The NRC regulations in 10 CFR Part 71 contain similar requirements in paragraphs §§71.85 and 71.87, entitled “Preliminary Determinations” and “Routine Determinations”, respectively).

A. Prior to First Use

Section 173.474 requires that prior to the first use of any packaging for the shipment of Class 7 (radioactive) material, the offeror shall determine that:

- The packaging meets the quality of design and construction requirements as specified in the HMR; and
- The effectiveness of the shielding, containment and, when required, the heat transfer characteristics of the package, are within the limits specified for the package design.

B. Prior to Each Use

Section 173.475 requires that prior to each shipment of Class 7 (radioactive) materials, the offeror must ensure, by examination or appropriate tests, that:

- The packaging is proper for the contents to be shipped;
- The packaging is in unimpaired physical condition, except for superficial marks;
- Each closure device of the packaging, including any required gasket, is properly installed, secured, and free of defects;
- For fissile material, each moderator and neutron absorber, if required, is present and in proper condition;
- Each special instruction for filling, closing, and preparation of the packaging for shipment has been followed;

- Each closure, valve, or other opening of the containment system through which the radioactive content might escape is properly closed and sealed;
- Each packaging containing liquid in excess of an A₂ quantity and intended for air shipment has been tested to show that it will not leak under an ambient atmospheric pressure of not more than 25 kPa, absolute (3.6 psia). The test must be conducted on the entire containment system, or on any receptacle or vessel within the containment system, to determine compliance with this requirement;
- The internal pressure of the containment system will not exceed the design pressure during transportation; and
- External radiation and contamination levels are within the allowable limits specified in this subchapter.

This last requirement to ensure compliance with radiation and contamination limits of §§ 173.441 and 173.443 does **not** require that surveys or direct measurement be made. Both sections give shippers latitude in their methods of ensuring compliance with the radiation and contamination limits; procedures other than measurements, such as quality assurance and quality control, are acceptable means of ensuring compliance. However, if a compliance inspection during transportation determines that radiation or contamination levels exceed the limit, the shipper is subject to a citation.

C. NRC QA Requirements

In addition to the above-mentioned generic quality control requirements of 10 CFR 71.85 and 71.87, 10 CFR 71, Subpart H, contains specific quality assurance (QA) requirements associated with the use of NRC-certified Type B and fissile material packages used under the general licenses of §§ 71.17, 71.20, and 71.21. A major condition applying to the use of such NRC-certified packages is the requirement that each registered user of such a package must have their quality assurance program, associated with use of the package, approved by the NRC as having met applicable requirements of Subpart H, §§ 71.101-71.137. Section 71.37(a) requires that applicants requesting package design approval by the NRC must describe, with respect to Subpart H of 10 CFR Part 71, the QA programs that they will apply in designing, fabricating, assembling, testing, maintaining, repairing, modifying, and using the proposed packaging.

NRC's Regulatory Guide 7.10, "Establishing Quality Assurance Programs for Packaging Used in Transport of Radioactive Material" provides guidance on developing quality assurance programs and guidance for preparing and submitting QA program descriptions for review by the NRC.

X. OVERVIEW OF NRC'S 10 CFR TRANSPORT-RELATED REQUIREMENTS

Transportation requirements of NRC which apply to transport of NRC-licensed radioactive material are located in 10 CFR 71. Since 10 CFR part 71 is a matter of “compatibility” for regulatory programs of the NRC “Agreement States,” effectively it is also applicable to activities of Agreement State licensees. Several other transport-related requirements are in 10 CFR Part 20. A brief overview of these follows.

NOTE: NRC and Agreement States regulate licensed shippers and receivers of radioactive material packages, not carriers. DOT's authority applies to shippers and carriers, not to receivers.

A. 10 CFR PART 71

In accordance with 10 CFR 71.5, each NRC licensee who transports licensed radioactive material outside the site of usage, as specified in the NRC license, or where transport is on a public highway, or who delivers licensed material to a carrier for transport, must comply with the applicable requirements of the DOT hazardous materials transport regulations. NRC inspects the radioactive material shipping practices of its licensees, and enforces licensee compliance with the DOT regulations.

With the exception of packages approved by the U.S. Department of Energy (DOE), all packages used for domestic shipments of fissile material (in excess of fissile exempt quantity) and for quantities of other licensed material in excess of Type A quantities must be certified for use by the NRC. The user must register with the NRC and make all shipments in compliance with the terms of the package approval. The package approval standards and performance requirements are set out in 10 CFR 71.

NRC has published Regulatory Guide 7.9, “Standard Format and Content of Part 71 Applications for Approval of Packages for Radioactive Material” to assist applicants in preparing applications that thoroughly and completely demonstrate the ability of the given packages to meet the regulations. NRC’s “Standard Review Plan for Transportation Packages for Radioactive Material” (NUREG-1609) provides guidance for the review and approval of applications for packages used to transport radioactive material (other than irradiated nuclear fuel) under 10 CFR Part 71. The “Standard Review Plan for Transportation Packages for Spent Nuclear Fuel” (NUREG -1617) provides guidance for the review and approval of applications for packages used to transport spent nuclear fuel under 10 CFR Part 71.

B. 10 CFR PART 20

This Part has transportation-related requirements in 10 CFR §§ 20.1906 and 10 CFR 20.1601(e), and in Appendix G.

1. Procedures for Receiving and Opening Packages

10 CFR § 20.1906 covers procedures for receiving and opening packages. Each licensee who expects to receive a package containing quantities of radioactive material in excess of a Type A quantity shall make arrangements to receive:

- The package when the carrier offers it for delivery; or
- Notification of the arrival of the package at the carrier's terminal and to take possession of the package expeditiously.

This section also requires that an NRC licensee who receives a radioactive package perform certain monitoring of the package, as follows:

- Except for packages containing gaseous or special form radioactive material, any package bearing any of the three categories of RADIOACTIVE labels must be monitored for **external surface contamination**;
- The external surface of any package containing greater than a Type A quantity, (i.e., a Type B quantity) must be monitored upon receipt for **external radiation levels**;
- Monitoring for both surface contamination and external radiation levels must be performed on any package known to contain radioactive material, **if there is evidence of degradation of package integrity** (such as packages that are crushed, wet, or damaged);

The licensee shall perform the required monitoring as soon as practical after receipt of the package, but not later than 3 hours after the package is received at the licensee's facility (if it is received during the licensee's normal working hours, or not later than 3 hours from the beginning of the next working day if it is received after working hours).

Instances of surface contamination and/or external radiation levels exceeding the applicable limits **must be reported immediately to the appropriate NRC regional office.**

Each licensee must:

- Establish, maintain, and retain written procedures for safely opening packages in which radioactive material is received; and
- Ensure that the procedures are followed and that due consideration is given to special instructions for the type of package being opened.

2. Control Of Access To High Radiation Areas Containing Radioactive Material Packages

10 CFR 20.1601 “Control of access to high radiation areas” paragraph (e) reads as follows:

“Control is not required for each entrance or access point to a room or other area that is a high radiation area solely because of the presence of radioactive material prepared for transport and labeled in accordance with the regulations of the Department of Transportation provided that:

- (1) The packages do not remain in the area longer than 3 days; and
- (2) The dose rate at one meter from the external surface of any package does not exceed 0.01 rem (0.1 mSv) per hour.”

In implementing the provisions of Section 20.1601(e), it is apparent that time is of the essence for package storage (not more than 3 days) and no package may have a TI greater than ten.

3. Requirements for Transfers of Low-Level Radioactive Waste

10 CFR 20, Appendix G, covers requirements for transfers of low-level radioactive waste intended for disposal at licensed land disposal facilities and for low-level waste manifests. It requires a waste generator, collector, or processor who transports, or offers for transportation, low-level radioactive waste intended for ultimate disposal at a licensed low-level radioactive waste land disposal facility to prepare a Manifest (OMB Control Numbers 3150-0164, -0165, and -0166) reflecting information requested on applicable NRC forms including Form 540 (Uniform Low-Level Radioactive Waste Manifest (Shipping Paper)). NRC Form 540 contains information needed to satisfy DOT shipping paper requirements in 49 CFR Part 172 and the waste tracking requirements of 10 CFR Part 20. The current revision of Form 540 can be found at <http://www.nrc.gov/reading-rm/doc-collections/forms/>. The instructions for completing Form 540 are contained in NRC document NUREG/BR-0204 available at the NRC web site at: <http://www.nrc.gov/reading-rm/doc-collections/nuregs/brochures/br0204/>

C. Notification Requirements

The NRC regulations in 10 CFR 71.97 and 10 CFR 73.72 require that licensees shipping HRCQ of nuclear waste in Type B packages, spent nuclear fuel, and special nuclear materials provide advance notification to state governors or their designated representative.

D. NRC Requirements for Radioactive Materials in Quantities of Concern

As part of the NRC's efforts to improve radioactive material security after the events of September 11, 2001, the NRC requires additional security measures when an individual and/or company is engaged in certain NRC-licensed activities. These additional security measures include advance notification to the NRC and state governors or their designated representatives about certain radioactive material shipments. The individuals and/or companies engaged in NRC-licensed activities were issued these security measures through a modification of their NRC license and they are cognizant of its specific requirements.

XI. OTHER REQUIREMENTS

A. Carrier Requirements

There are two types of motor carriers, private carriers and for-hire carriers. A private carrier is a company that provides truck transportation of its own cargo, usually as a part of a business that produces, uses, sells and/or buys the cargo being hauled. A for-hire carrier is a company that provides truck transportation of cargo belonging to others and is paid for doing so. For radioactive material, for-hire carriers are exempt from the requirement to obtain a license from NRC or an Agreement State, to the extent that they transport licensed radioactive material for someone else (see 10 CFR §§ 30.13, 40.12 and 70.12). A private carrier generally owns the radioactive material which is being transported and transportation activities are incidental to their regular business activity. A private carrier is always licensed by the NRC or an agreement state to possess and transport the radioactive material.

All carriers are subject to the same safety requirements of the HMR. An exception from the requirement for **certification** of the shipping papers is provided to a private carrier (see §172.204(b)(1)(ii)).

The principal requirements which apply to all carriers are to:

- Assure that the transport vehicle is properly placarded;
- Assure that shipper has properly certified the shipment;
- Maintain radiation control based on package transport index/separation table and the other transport requirements;
- Report to DOT hazmat incidents involving fire, accident, breakage or suspected radioactive contamination (§§ 171.15, 171.16, 174.750, 175.705(e), 176.710(c), and 177.843(c));
- Provide training to “Hazmat Employees”;
- Develop security plans as required by 49 CFR Part 172, §§ 800-804; and
- Register with DOT and submit an annual fee when transporting certain radioactive material.

The sections specifically applicable to radioactive material in the modal parts of the HMR begin at the following sections:

- Rail § 174.700;
- Air § 175.700 (also see §§ 175.33 and 175.75);
- Water § 176.700; and
- Highway §§ 177.842, 177.843, and 177.870(g).

Some of the requirements in these areas have been described above in the sections on Transport Controls and Hazmat Communications and Related Requirements.

B. Registration Requirements

DOT has a national registration program for certain persons engaged in offering for transport and transporting of certain hazardous materials in foreign, interstate or intrastate commerce. The registration requirement (found in §§ 107.601 - 107.620) applies to radioactive material **shippers or carriers** who **offer or transport**:

- Shipments of a “Highway Route Controlled Quantity”;
- Shipments of radioactive material in bulk packaging with a capacity equal to or greater than 13,248 L (3,500 gallons) for liquids or gases, or more than 13.24 cubic meters (468 cubic feet) for solids; or
- Shipments of radioactive material for which vehicle placarding is required, which includes:
 - Domestic transportation of exclusive use shipments of less than an A₂ quantity of LSA material (unless the material is unconcentrated U or Th ores) and SCO shipped in excepted packaging under § 173.427(b)(4); liquid LSA-I material; or unpackaged LSA material or SCO.
 - Shipments of packages bearing RADIOACTIVE-YELLOW III labels, whether in an exclusive or non-exclusive use vehicle.

The registration fee is \$1000 annually (\$275 for small businesses and not-for-profit organizations) (§ 107.612). The fee provides funds for grants distributed to States and Indian tribes for hazardous materials emergency response planning and training. This program began in 1992 and is administered by the Associate Administrator for Hazardous Materials Safety, Pipeline and Hazardous Materials Safety Administration (PHMSA).

Information on the registration program may be found online at <http://hazmat.dot.gov/regs/register/register.htm>.

C. Motor Carrier Safety Requirements

Besides the transportation controls in §§ 177.842, 177.843, and 177.870(g), highway shipments may be subject to the Federal Motor Carrier Safety Regulations (FMCSR) which are located in 49 CFR Parts 350-399. The FMCSR apply if the vehicle has a gross vehicle weight rating of 10,001 pounds or more, or if the radioactive material is being transported in a quantity requiring placarding. For intrastate commerce, a state may impose some requirements different than the FMCSR.

Some of the FMCSR requirements of particular relevance to radioactive materials shipments are those for commercial driver's license with hazardous materials endorsement, Hazardous Materials Safety Permits, and routing requirements.

1. Commercial Driver's License

A "Commercial Driver's License" (CDL) means a license issued to an individual by a state or other jurisdiction, in accordance with the standards in 49 CFR Part 383, which authorizes that individual to operate a "commercial motor vehicle". For radioactive material shipments the driver of a vehicle that requires placarding must have a CDL with a "hazardous materials endorsement" (§ 383.93).

In order to obtain a hazardous materials endorsement, each applicant must pass a test demonstrating knowledge of the following (see § 383.121):

- Hazardous materials regulations,
- Hazardous materials handling,
- Operation of emergency equipment, and
- Emergency response procedures.

A State may not issue, renew, upgrade, or transfer a hazardous materials endorsement for a CDL to any individual authorizing that individual to operate a commercial motor vehicle transporting a hazardous material in commerce unless the Transportation Security Administration (TSA) has determined that the individual does not pose a security risk warranting denial of the endorsement.

2. Hazardous Materials Safety Permits

The Federal Motor Carrier Safety Administration (FMCSA) requires motor carriers to obtain a Hazardous Materials Safety Permit (HMSP) prior to transporting certain highly hazardous materials, including a highway route controlled quantity of a Class 7 (radioactive) material. All motor carriers, including interstate, intrastate and foreign carriers must comply with this regulation. In order to maintain an HMSP, motor carriers are required to:

- Maintain a “satisfactory” safety rating in order to obtain and hold a safety permit.
- Maintain their crash rating, and their driver, vehicle, hazardous materials or out-of service rating so they are not in the worse 30 percent of the national average as indicated in FMCSA's Motor Carrier Management Information System (MCMIS).
- Have a satisfactory security program (and associated training) according to § 172.800 in place.
- Maintain registration (see above) with PHMSA.
- Develop a system of communication that will enable the vehicle operator to contact the motor carrier during the course of transportation and maintain records of these communications.
- Have a written route plan required for radioactive materials set forth in § 397.101 and for explosives in Part 397.19.
- Perform a pre-trip inspection (North American Standard (NAS) Level VI Inspection Program for Radioactive Shipments) for shipments containing highway route controlled Class 7 (radioactive) materials.

The pre-trip inspection required in 49 CFR § 385.415 for HRCQ shipments must be performed by a Federal, State, or local government inspector, or an inspector under contract with a Federal, State, or local government. The inspector must have completed an appropriate training program of at least 104 hours, including at least 24 hours of training in conducting radiological surveys on inspecting vehicles transporting highway route controlled quantity (HRCQ) radioactive materials.

The inspection must cover all applicable requirements in the HMR and the FMCSR--including 49 CFR Parts 383 (commercial driver's license), 391 (driver qualifications), 395 (hours of service), 393 and 396 (vehicle condition)--or compatible State regulations; and provisions in the HMR on the transportation of radioactive materials (49 CFR Parts 171, 172, 173 and 178) and registration (49 CFR Part 107, Subpart G).

The requirements for the HMSP may be found in 49 CFR §§ 385.401- 423 and online at www.fmcsa.dot.gov/safetyprogs/hm.htm.

3. Highway Routing Requirements

The requirements for the routing of radioactive material shipments by highway are in 49 CFR § 397.101 – 397.103.

A carrier or any person operating a motor vehicle that contains a class 7 (radioactive) material as defined in 49 CFR § 173.403 for which placarding is required under 49 CFR Part 172 shall ensure that the motor vehicle is operated on routes that minimize radiological risk and shall tell the driver which route to take and that the motor vehicle contains radioactive materials (49 CFR § 397.101(a)).

If the contents of a package being shipped are a highway route controlled quantity, the package must be transported under specific routing controls as given in 49 CFR § 397.101(b):

- The carrier must operate on “preferred routes”.
(A preferred route is an Interstate System highway for which an alternative route is not designated by a State routing agency, a State-designated route selected by a State routing agency pursuant to §397.103, or both. The “Guidelines for Selecting Preferred Highway Route Controlled Quantity Shipments of Radioactive Materials” describe the guidelines for States to use in designating routes; it may be found online at <http://hazmat.fmcsa.dot.gov/nhmrr/PDFs/ramguide.pdf>. The State-designated routes may be found at: <http://hazmat.fmcsa.dot.gov/nhmrr/index.asp>.)
- The carrier shall select routes to reduce time in transit over the preferred route segment of the trip.
- Interstate System bypass beltway around a city, when available, shall be used in place of a preferred route through a city.
- Deviations from preferred routes are allowed only:
 - As necessary to pick up or deliver HRCQ
 - To make necessary rest, fuel or motor vehicle repair stops, or
 - Under emergency conditions.
- Pickup and delivery segments of the route are to follow:
 - Shortest-distance route from the pickup/delivery location to the nearest preferred route entry/exit location
 - Deviation from the shortest-distance pickup or delivery route is authorized if such deviation:
 - Minimizes the radiological risk;
 - Does not exceed the shortest-distance route by more than 25 miles and
 - Does not exceed five times the length of the shortest-distance route.

- The carrier is required to prepare a written route plan and furnish a copy to the driver and the shipper (before departure for exclusive use shipments and within 15 days following departure for all other shipments).
- Carriers of highway route controlled quantities must also file detailed reports to the Office of Enforcement and Compliance (MC-PSDECH), Federal Motor Carrier Safety Administration, within 90 days of accepting the packages for shipment. The report must include the route plans, shipping papers, names of shippers, carriers and consignees, etc. (Reference 49 CFR § 397.101(g).) *NOTE: Shipments made in compliance with the physical security requirements of 10 CFR Part 73 of the NRC are excepted from this requirement.*
- The driver of a shipment with highway route controlled quantities must be provided with certain training every two years and must have in his possession a certificate of such training.

D. Radioactive Material Shipments By Air

As noted in Section III above, the HMR authorizes air transport of radioactive material in accordance with the ICAO Technical Instructions provided all of the conditions of § 171.22 are met.

Section 175.700 limits Class 7 materials aboard a passenger-carrying aircraft to excepted packages, unless the material is intended for use in, or incident to research, medical diagnosis or treatment. Regardless of its intended use, no person may carry a Type B(M) package aboard a passenger-carrying aircraft, a vented Type B(M) package aboard any aircraft, or a liquid pyrophoric Class 7 material aboard any aircraft.

NRC requirements in 10 CFR § 71.88 limit the air transport of plutonium.

XII. DOT AND NRC ENFORCEMENT POLICIES

Under the DOT/NRC MOU, each agency conducts an inspection and enforcement program within its jurisdiction to assure compliance with its requirements. The NRC will normally carry out enforcement actions for violations of the requirements of 10 CFR Part 71 and 49 CFR (except 49 CFR Parts 390-397) by NRC licensee-shippers and licensee-shipper-private carriers. The DOT will carry out enforcement actions for violations of 49 CFR (including Parts 390-397) by carriers of radioactive materials and shippers of radioactive materials from agreement states, DOE contractors, or any other shippers otherwise not subject to NRC requirements.

Violations of the regulations in 49 CFR and 10 CFR Part 71 may result in civil or criminal penalties, cease/desist orders, suspension orders, etc. DOT's enforcement powers under the HMR are explained in 49 CFR Subpart D. Further information on enforcement of the HMR may be found at <http://hazmat.dot.gov/enforce/hmenforce.htm>. NRC's "Enforcement Policy" may be found on the NRC public web site and the NRC Agency-wide Document Access and Management System (ADAMS) (see <http://www.nrc.gov/about-nrc/regulatory/enforcement.html>).

Import and export shipments must be made in accordance with the international regulations that are cited in §§ 171.12 and 171.22. When import shipments are found to be in violation of the international air and sea transport regulations (which are essentially the same as the IAEA regulations) enforcement action against the foreign shipper or carrier can be taken by DOT by citing the applicable requirements in the ICAO or IMO regulations. If violations are found in radioactive material shipments being exported under the IMO or ICAO, the shipper or carrier may be charged with violating both the domestic and the international regulations.

This page intentionally left blank.

APPENDIX A INTERNATIONAL SYSTEM OF UNITS (SI) FOR RADIOACTIVE MATERIALS IN TRANSPORTATION

The information contained in this appendix is intended to aid persons in understanding the relationships between the International System of Units (SI) and the customary units for radiological measurements. It is designed to help in converting values shown in one system to values in the other system.

To ensure compatibility with international transportation standards, units of measure in the HMR are expressed using SI units. U.S. standard or customary units, which appear in parentheses following the SI units, are for information only and are not intended to be the regulatory standard.

The labels on packages and descriptive information on shipping documents show the measure of the radioactive content or the activity. The SI unit used to measure activity is the becquerel (Bq); the customary unit is the curie (Ci). The maximum radiation level at 1 meter from a package determines the transport index (TI), which is shown on labels and shipping papers. The SI unit of measurement for radiation levels is the sievert (Sv) per hour; traditionally, it has been the rem (or a fraction of the rem) per hour.

It is often necessary to use numerical abbreviations to write the measured values in a practical way. The following pages provide definitions and abbreviations for numerical factors and for the customary and SI units. Additionally, examples of conversions from customary units to SI radiological and SI to customary units are detailed.

DEFINITIONS AND ABBREVIATIONS

NUMERICAL

Multiplication Factors	Prefix	Symbol
1 000 000 000 000 000 000 =	10^{18}	exa
1 000 000 000 000 000 =	10^{15}	peta
1 000 000 000 000 =	10^{12}	tera
1 000 000 000 =	10^9	giga
1 000 000 =	10^6	mega
1 000 =	10^3	kilo
100 =	10^2	hecto
10 =	10^1	deka
0.1 =	10^{-1}	deci
0.01 =	10^{-2}	centi
0.001 =	10^{-3}	milli
0.000 001 =	10^{-6}	micro
0.000 000 001 =	10^{-9}	nano
0.000 000 000 001 =	10^{-12}	pico
0.000 000 000 000 001 =	10^{-15}	femto
0.000 000 000 000 000 001 =	10^{-18}	atto

RADIOLOGICAL

The curie and becquerel are units of measure of the quantity or activity of radioactive material which indicate the rate that atoms in the material are giving off radiation or disintegrating. The curie (Ci) is equal to 37 billion disintegrations per second, while the becquerel (Bq) is equal to only one disintegration per second. Thus, one curie is equal to 37 gigabecquerels or 0.037 terabecquerels; in symbols, $1 \text{ Ci} = 37 \text{ GBq} = 0.037 \text{ TBq}$.

The sievert (Sv) and the rem are units of radiation dose (technically, of dose equivalent) absorbed by the body. A sievert is equal to 100 rem, or $1 \text{ Sv} = 100 \text{ rem}$.

Another unit for activity is disintegrations per minute (dpm), which can be obtained from radiation detection instrumentation readouts in counts per minute (cpm) divided by the detector's system efficiency. Since curies are a measure of disintegrations per second (dps), they are related to dpm as follows:

$$\begin{aligned}
 1 \text{ curie (Ci)} &= 3.7 \times 10^{10} \text{ dps} = 2.22 \times 10^{12} \text{ dpm} \\
 1 \text{ millicurie (mCi)} &= 3.7 \times 10^7 \text{ dps} = 2.22 \times 10^9 \text{ dpm} \\
 1 \text{ microcurie } (\mu\text{Ci}) &= 3.7 \times 10^4 \text{ dps} = 2.22 \times 10^6 \text{ dpm}
 \end{aligned}$$

EQUIVALENTS FOR CONVERSIONS

Quantity (activity)

$$\begin{aligned}
 1 \text{ TBq} &= 27 \text{ Ci} = 27,000 \text{ mCi} \\
 1 \text{ GBq} &= 0.027 \text{ Ci} = 27 \text{ mCi} = 27,000 \mu\text{Ci} \\
 1 \text{ MBq} &= 0.000027 \text{ Ci} = 0.027 \text{ mCi} = 27 \mu\text{Ci} \\
 1 \text{ Ci} &= 0.037 \text{ TBq} = 37 \text{ GBq} = 37,000 \text{ MBq}
 \end{aligned}$$

$$\begin{aligned}
 1 \text{ mCi} &= 0.000037 \text{ TBq} = 37 \text{ MBq} \\
 1 \mu\text{Ci} &= 0.037 \text{ MBq} = 37,000 \text{ Bq} \\
 1 \text{ nCi} &= 0.000037 \text{ MBq} = 37 \text{ Bq} \\
 1 \text{ pCi} &= 0.037 \text{ Bq} = 37 \text{ mB}
 \end{aligned}$$

Radiation Level (dose equivalent rate)

$$\begin{aligned}
 1 \text{ Sv/h} &= 100 \text{ rem/h} = 100,000 \text{ mrem/h} \\
 1 \text{ mSv/h} &= 0.1 \text{ rem/h} = 100 \text{ mrem/h} \\
 1 \mu\text{Sv/h} &= 0.0001 \text{ rem/h} = 0.1 \text{ mrem/h} \\
 1 \text{ rem/h} &= 0.01 \text{ Sv/h} = 10 \text{ mSv/h} = 10,000 \mu\text{Sv/h} \\
 1 \text{ mrem/h} &= 0.00001 \text{ Sv/h} = 0.01 \text{ mSv/h} = 10 \mu\text{Sv/h}
 \end{aligned}$$

USE OF CONVERSION FACTORS

To convert a value from one system of units to the other:

- First, in the left column above, find the unit you wish to convert from.
- Second, find the factor in that line for the unit you wish to convert to.
- Third, multiply the original value by the factor; the result will be the measure in the desired units.

Examples:

1. A radioactive material label shows 14 TBq. How many curies is that?

$$14 \text{ TBq} \times 27 \text{ Ci per TBq} = 378 \text{ Ci}$$

2. There is 50 MBq of a radioactive material in a package. How many millicuries is it?

$$50 \text{ MBq} \times 0.027 \text{ mCi per MBq} = 1.35 \text{ mCi}$$

3. How many TBq are equal to 500 curies?

$$500 \text{ curies} \times 0.037 \text{ TBq per Ci} = 18.5 \text{ TBq}$$

4. The EPA standards require that public drinking water systems limit the natural radium concentration to less than 5 pCi per liter. What is this upper limit in becquerels?

$$5 \text{ pCi per liter} \times 0.037 \text{ Bq per pCi} = 0.185 \text{ Bq/liter}$$

5. The Transport Index (TI) of a package is the number equal to the maximum radiation level in millirem per hour at a distance of 1 meter from the package. A TI of 1.0 corresponds to a radiation level of 1 mrem/h at 1 meter. What is the radiation level in microsieverts per hour which corresponds to a TI of 2.5?

$$2.5 \text{ TI} \times 1.0 \text{ mrem/h per TI} \times 10 \text{ } \mu\text{Sv per mrem} = 25 \text{ } \mu\text{Sv/h}$$

6. The maximum surface radiation level for a package with a Radioactive Yellow-II label is 0.5 mSv per hour. Would a measured radiation level of 38 mrem per hour be acceptable for a Radioactive Yellow II label?

$$38 \text{ mrem/h} \times .01 \text{ mSv/h per mrem/h} = 0.38 \text{ mSv/h}$$

Yes, since 0.38 mSv/h is less than 0.5 mSv per hour.