

September 2006  
Revised July 2008  
06/29/WQPC-WWF  
EPA/600/R-06/136

# **Environmental Technology Verification Report**

## **Stormwater Source Area Treatment Device**

### **The Terre Hill Concrete Products Terre Kleen™ 09**

Prepared by

Penn State Harrisburg  
Middletown, Pennsylvania

Under a Cooperative Agreement with  
 U.S. Environmental Protection Agency

**ET✓ ET✓ ET✓**

# Environmental Technology Verification Report

## Stormwater Source Area Treatment Device

### The Terre Hill Concrete Products Terre Kleen™ 09 Treatment Device

Prepared by:  
Penn State Harrisburg  
Middletown, Pennsylvania 17057

Under a cooperative agreement with the U.S. Environmental Protection Agency

Raymond Frederick, Project Officer  
ETV Water Quality Protection Center  
National Risk Management Research Laboratory  
Water Supply and Water Resources Division  
U.S. Environmental Protection Agency  
Edison, New Jersey

September 2006  
Revised July 2008

Note: Revised in July 2008 to include a change in the method the drainage area, runoff volumes and peak runoff intensities were calculated. The revised drainage area is described in Section 3.2. The revised runoff volume calculation method is described in Section 5.1.1. The revised runoff data is reported in Table 5-2 and is used for the sum of loads calculations in Table 5-4, Table 5-5, and Table 5-6. Section 5.3.3 was also added to provide additional detail on the Hjulstrom Diagram analysis.

**THE ENVIRONMENTAL TECHNOLOGY VERIFICATION  
PROGRAM**



U.S. Environmental Protection Agency



NSF International

**ETV Joint Verification Statement**

|                  |   |  |
|------------------|---|--|
| TECHNOLOGY TYPE: | <b>STORMWATER TREATMENT TECHNOLOGY</b>  |  |
| APPLICATION:     | <b>SUSPENDED SOLIDS TREATMENT</b>   |  |
| TECHNOLOGY NAME: | <b>TERRE KLEEN™ 09</b>  |  |
| TEST LOCATION:   | <b>HARRISBURG, PENNSYLVANIA</b>   |  |
| COMPANY:         | <b>TERRE HILL CONCRETE PRODUCTS</b>   |  |
| ADDRESS:         | <b>485 Weaverland Valley Road<br/>Terre Hill, Pennsylvania 17581</b>              | <b>PHONE: (800) 242-1509<br/>FAX: (717) 445-3108</b> |
| WEB SITE:        | <b><a href="http://www.terrehill.com">http://www.terrehill.com</a></b>            |  |
| EMAIL:           | <b><a href="mailto:precastsales@terrehill.com">precastsales@terrehill.com</a></b> |  |

NSF International (NSF), in cooperation with the U.S. Environmental Protection Agency (EPA), operates the Water Quality Protection Center (WQPC), one of five active centers under the Environmental Technology Verification (ETV) Program. The WQPC recently evaluated the performance of the Terre Kleen™ 09 (Terre Kleen™), manufactured by Terre Hill Silo Company, Inc. T/D/B/A Terre Hill Concrete Products (THCP). The Terre Kleen™ device was installed at the Department of Public Works (DPW) facility in Harrisburg, Pennsylvania. The testing organization (TO) for the evaluation was headed by a faculty member from the Environmental Engineering Department of The Pennsylvania State University – Harrisburg (PSH) in Middletown, Pennsylvania.

EPA created ETV to facilitate the deployment of innovative or improved environmental technologies through performance verification and dissemination of information. The ETV Program's goal is to further environmental protection by accelerating the acceptance and use of improved and more cost-effective technologies. ETV seeks to achieve this goal by providing high quality, peer-reviewed data on technology performance to those involved in the design, distribution, permitting, purchase, and use of environmental technologies.

ETV works in partnership with recognized standards and testing organizations; stakeholder groups, which consist of buyers, vendor organizations, and permittees; and with the full participation of individual technology developers. ETV evaluates the performance of innovative technologies by developing test plans that are responsive to the needs of stakeholders, conducting field or laboratory tests (as appropriate), collecting and analyzing data, and preparing peer-reviewed reports. All evaluations are conducted in accordance with rigorous quality assurance protocols to ensure that data of known and adequate quality are generated and that the results are defensible.

## TECHNOLOGY DESCRIPTION

The following description of the Terre Kleen™ was provided by the vendor and does not represent verified information.

The Terre Kleen™ device combines primary and secondary chambers, baffles, a screen, and inclined sedimentation, as well as oil, litter and debris/sediment storage chambers, into a self-contained concrete structure. The primary benefit of the Terre Kleen™ device is its ability to efficiently settle solids in the inclined cells (lamella plates) located in the secondary chamber using hydrodynamic principles. The design of the unit provides for underground installation as an in-line treatment device, where it may be applied at a critical source area, or a larger unit may be installed in a storm sewer main to provide treatment for larger flows. Installation can be performed using conventional construction techniques. Terre Kleen™ units can be designed to provide specific removal efficiencies based on the size characteristics of the suspended solids and flow rate of storm water to the device.

The Terre Kleen™ device addresses the concern of being space-effective, providing high particle removal efficiency given the device's relatively small footprint. The ability to install the device below grade allows for the use of the above-ground space, and makes it easier for the device to be retrofitted into a pre-existing storm sewer system. The design allows for some treatment of all water that enters the primary settling chamber of the device, even if the flows exceed the capacity of the secondary (lamella inclined plate) chamber. The treated and bypassed water recombine prior to discharge from the device. Re-suspension of captured material below the inclined plates is minimized because the stormwater enters the inclined cells sideways instead of scouring the top of the sediment.

The vendor claims that the Terre Kleen™ device installed for the verification test will remove 100% of particles 200 microns ( $\mu\text{m}$ ) and larger in stormwater when the device is operating at the design storm flow of 3.49 cubic feet per second (cfs), which is based on the 25-year storm for Harrisburg. THCP also claims that at lower flows, removals of particles smaller than 200  $\mu\text{m}$  will also be achieved.

## VERIFICATION TESTING DESCRIPTION

### *Methods and Procedures*

The test methods and procedures used during the evaluation are described in the *Environmental Technology Verification Test Plan for Terre Hill Concrete Products: The Terre Kleen™, City of Harrisburg, Pennsylvania*. (November 2004). The Terre Kleen™ device was installed at the downstream end of the stormwater collection system at the City of Harrisburg Department of Public Works facility. The drainage area is part of the city's maintenance yard occupied by the Bureau of Sanitation, and includes runoff from buildings and paved and unpaved parking areas having a 90 to 95% impervious drainage area initially estimated at approximately 1.27 acres, but was later estimated to be approximately 2.5 to 3 acres after topographic maps with finer contours were made available.

Verification testing consisted of collecting data during a minimum of 15 qualified events that met the following criteria:

- The total rainfall depth for the event, measured at the site, was 0.2 in. (5 mm) or greater;
- Flow through the treatment device was successfully measured and recorded over the duration of the runoff period;
- A flow-proportional composite sample was successfully collected for both the inlet and the outlet over the duration of the runoff event;
- Each composite sample was comprised of a minimum of five aliquots, including at least two aliquots on the rising limb of the runoff hydrograph, at least one aliquot near the peak, and at least two aliquots on the falling limb of the runoff hydrograph; and
- There was a minimum of six hours between qualified sampling events.

Automated samplers and flow monitoring devices were installed and programmed to collect composite samples from the inlet and outlet, and to measure the stormwater flow into and out of the device. In addition to the flow and analytical data, operation and maintenance data were recorded. Samples were analyzed for total suspended solids (TSS) and suspended sediment concentration (SSC). The samples were also analyzed to quantify the mass of particles greater than 250  $\mu\text{m}$  in size and to determine the particle size distribution for particles ranging in size from 0.8 to 240  $\mu\text{m}$ .

## VERIFICATION OF PERFORMANCE

The performance verification of the Terre Kleen™ device consisted of an evaluation of flow, sediment reduction, and operations and maintenance data collected during 15 qualified storm events over a period of approximately 11 months.

### Test Results

The precipitation data for the rain events are summarized in Table 1.

**Table 1. Rainfall Data Summary**

| Event Number | Date     | Start Time | Rainfall Amount (in.) | Rainfall Duration (hr:min) | Peak Flow Rate (cfs) <sup>1</sup> | Runoff Volume (ft <sup>3</sup> ) <sup>1</sup> |
|--------------|----------|------------|-----------------------|----------------------------|-----------------------------------|---|
| 1            | 6/29/05  | 12:00      | 0.31                  | 2:00                       | 0.83                              | 750   |
| 2            | 7/7/05   | 18:40      | 1.68                  | 15:00                      | 0.82                              | 7,900   |
| 3            | 8/16/05  | 09:35      | 0.43                  | 11:10                      | 0.029                             | 210   |
| 4            | 8/27/05  | 19:05      | 0.68                  | 14:00                      | 0.76                              | 1,800   |
| 5            | 9/16/05  | 18:55      | 1.22                  | 5:40                       | 2.0                               | 4,900   |
| 6            | 10/13/05 | 05:20      | 0.63                  | 21:55                      | 0.50                              | 960   |
| 7            | 10/21/05 | 22:45      | 1.17                  | 24:15                      | 0.80                              | 3,800   |
| 8            | 11/16/05 | 10:30      | 0.20                  | 14:40                      | 0.013                             | 110   |
| 9            | 11/22/05 | 23:20      | 0.52                  | 9:45                       | 0.37                              | 1,300   |
| 10           | 11/29/05 | 04:55      | 1.04                  | 19:05                      | 1.2                               | 6,500   |
| 11           | 12/25/05 | 11:50      | 0.45                  | 8:40                       | 0.26                              | 580   |
| 12           | 1/2/06   | 10:45      | 0.99                  | 25:40                      | 0.14                              | 940   |
| 13           | 1/11/06  | 12:50      | 0.42                  | 11:05                      | 0.20                              | 480   |
| 14           | 4/3/06   | 14:40      | 0.75                  | 7:50                       | 0.36                              | 1,500   |
| 15           | 5/13/06  | 16:20      | 0.71                  | 54:10                      | 0.089                             | 660   |

1. Runoff volume and peak discharge rate measured at the outlet monitoring point, with the exception of event 14, which was measured at the inlet monitoring point. See the verification report for further details.

The flow monitoring and analytical results were evaluated using event mean concentration (EMC) and sum of loads (SOL) comparisons. The EMC evaluates treatment efficiency on a percentage basis, with the calculation being made by dividing the outlet concentration by the inlet concentration and multiplying the quotient by 100. The EMC was calculated for each analytical parameter and each individual storm event. The SOL comparison evaluates the treatment efficiency on a percentage basis by comparing the sum of the inlet and outlet loads (the parameter concentration multiplied by the runoff volume) for all storm events. The calculation is made by subtracting the quotient of the total outlet load divided by the total inlet load from one, and multiplying the difference by 100. SOL results can be summarized on an overall basis since the load calculation takes into account both the concentration and volume of runoff from each event. The SOL calculation was also conducted for TSS and SSC samples with sediment particles greater than 250  $\mu\text{m}$ . The analytical data ranges, EMC range, and SOL reduction values are shown in Table 2.

**Table 2. Analytical Data, EMC Range, and SOL Reduction Results**

| <b>Parameter</b> | <b>Inlet Range (mg/L)</b> | <b>Outlet Range (mg/L)</b> | <b>EMC Range (%)</b> | <b>SOL Reduction (%)</b> | <b>SOL Reduction Particle Size &gt;250 µm (%)</b> | <b>SOL Reduction Particle Size &lt;250 µm (%)</b> |
|------------------|---------------------------|----------------------------|----------------------|--------------------------|---|---|
| TSS              | 58 – 6,900                | 35 – 980                   | -88 – 86             | 44                       | 85  | 35  |
| SSC              | 75 – 7,000                | 35 – 1,500                 | -11 – 87             | 63                       | 98  | 32  |

Both the TSS and SSC analytical parameters measure sediment concentrations in water. However, the TSS analysis uses an aliquot drawn by the analyst from the sample container, while the SSC analysis uses the entire contents of the sample container. Heavier solids may not be picked up in the drawn aliquot for the TSS analysis, such that the TSS will tend to be more representative of the lighter solids concentrations.

The particle size distribution data showed that the Terre Kleen™ was approximately 98% effective in removing particles 200 µm or larger. When the particle size distribution data is combined with the hydrologic data, it shows that the performance of the device generally removed all of the particles 200 µm or larger when treating flows of 2.0 cfs or lower. The rated flow capacity (3.49 cfs) of the Terre Kleen™ was not exceeded during any of the 15 storm events. This device is designed to treat the entire entering flow (bypass over the plates was monitored after the primary chamber and at no time during the testing were the plates bypassed).

#### ***System Operation***

The Terre Kleen™ was installed in February 2005, with no major issues noted. The Terre Kleen™ device was cleaned prior to the start of testing in March 2005, and was inspected frequently during verification. A review of the storm event records in January 2006 showed that two late January storms had substantial negative removals. Therefore, the decision was made to clean the device at the end of January 2006. Sediment depths prior to pump-out were between 50% and 75% of the maximum design sediment depth, measured at several points in the device. This maintenance activity consisted of using a sewer vector truck from the City of Harrisburg to dewater and remove sediment from the device. A sample of the sediment was analyzed for Toxicity Characteristic Leachate Procedure (TCLP) metals and the concentrations were lower than the hazardous waste limits of 40 CFR Section 261.42.

#### ***Quality Assurance/Quality Control***

NSF personnel completed a technical systems audit during testing to ensure that the testing was in compliance with the test plan. NSF also completed a data quality audit of at least 10% of the test data to ensure that the reported data represented the data generated during testing. In addition to quality assurance (QA) and quality control audits performed by NSF, EPA personnel conducted an audit of NSF's QA Management Program.

#### ***Note for this Revision***

The original verification statement was signed in September 2006 but revised in July 2008 to reflect a change in the method the drainage area size and the runoff volume and peak runoff intensity were calculated. See Sections 3.2 and 5.1.1 of the verification report for information on the revised drainage area size and runoff calculations, respectively.

*Original signed by*

*Sally Gutierrez*

*October 14, 2007*

Sally Gutierrez

Date

Director

National Risk Management Research Laboratory

Office of Research and Development

United States Environmental Protection Agency

*Original signed by*

*Robert Ferguson*

*October 3, 2007*

Robert Ferguson

Date

Vice President

Water Systems

NSF International

NOTICE: Verifications are based on an evaluation of technology performance under specific, predetermined criteria and the appropriate quality assurance procedures. EPA and NSF make no expressed or implied warranties as to the performance of the technology and do not certify that a technology will always operate as verified. The end user is solely responsible for complying with any and all applicable federal, state, and local requirements. Mention of corporate names, trade names, or commercial products does not constitute endorsement or recommendation for use of specific products. This report is not an NSF Certification of the specific product mentioned herein.

**Availability of Supporting Documents**

Copies of the *ETV Verification Protocol, Stormwater Source Area Treatment Technologies Draft 4.1, March 2002*, the test plan, the verification statement, and the verification report (NSF Report Number 06/29/WQPC-WWF) are available from:

ETV Water Quality Protection Center Program Manager (hard copy)

NSF International

P.O. Box 130140

Ann Arbor, Michigan 48113-0140

NSF website: <http://www.nsf.org/etv> (electronic copy)

EPA website: <http://www.epa.gov/etv> (electronic copy)

Appendices are not included in the verification report, but are available from NSF upon request.

## **Notice**

The U.S. Environmental Protection Agency (EPA) through its Office of Research and Development has financially supported and collaborated with NSF International (NSF) under a Cooperative Agreement. The Water Quality Protection Center, operating under the Environmental Technology Verification Program, supported this verification effort. This document has been peer reviewed and reviewed by NSF and EPA and recommended for public release. Mention of trade names or commercial products does not constitute endorsement or recommendation by the EPA for use.



## Foreword

The following is the final report on an Environmental Technology Verification (ETV) test performed for NSF International (NSF) and the United States Environmental Protection Agency (EPA). The verification test for the Terre Hill Concrete Products' Terre Kleen™ Stormwater Treatment Device was conducted at a site in Harrisburg, Pennsylvania, maintained by the City of Harrisburg Public Works Department.

The EPA is charged by Congress with protecting the Nation's land, air, and water resources. Under a mandate of national environmental laws, the Agency strives to formulate and implement actions leading to a compatible balance between human activities and the ability of natural systems to support and nurture life. To meet this mandate, EPA's research program is providing data and technical support for solving environmental problems today and building a science knowledge base necessary to manage our ecological resources wisely, understand how pollutants affect our health, and prevent or reduce environmental risks in the future.

The National Risk Management Research Laboratory (NRMRL) is the Agency's center for investigation of technological and management approaches for preventing and reducing risks from pollution that threaten human health and the environment. The focus of the Laboratory's research program is on methods and their cost-effectiveness for prevention and control of pollution to air, land, water, and subsurface resources; protection of water quality in public water systems; remediation of contaminated sites, sediments and ground water; prevention and control of indoor air pollution; and restoration of ecosystems. NRMRL collaborates with both public and private sector partners to foster technologies that reduce the cost of compliance and to anticipate emerging problems. NRMRL's research provides solutions to environmental problems by: developing and promoting technologies that protect and improve the environment; advancing scientific and engineering information to support regulatory and policy decisions; and providing the technical support and information transfer to ensure implementation of environmental regulations and strategies at the national, state, and community levels.

This publication has been produced as part of the Laboratory's strategic long-term research plan. It is published and made available by EPA's Office of Research and Development to assist the user community and to link researchers with their clients.

# Contents

|  |      |
|--|------|
| Verification Statement .....                                   | VS-i |
| Notice.....  | i    |
| Foreword.....  | ii   |
| Contents .....   | iii  |
| Figures.....   | iv   |
| Tables.....  | v    |
| Abbreviations and Acronyms .....                               | vi   |
| Chapter 1 Introduction .....                                   | 1    |
| 1.1 ETV Purpose and Program Operation.....                     | 1    |
| 1.2 Testing Participants and Responsibilities.....             | 1    |
| 1.2.1 U.S. Environmental Protection Agency.....                | 2    |
| 1.2.2 Verification Organization .....                          | 2    |
| 1.2.3 Testing Organization.....                                | 3    |
| 1.2.4 Vendor.....  | 4    |
| 1.2.5 Verification Testing Site .....                          | 4    |
| Chapter 2 Technology Description .....                         | 5    |
| 2.1 Technology Overview .....                                  | 5    |
| 2.2 Technology Description .....                               | 5    |
| 2.3 Applications .....   | 9    |
| 2.4 Operation and Maintenance .....                            | 9    |
| 2.5 Performance Claim.....                                     | 10   |
| Chapter 3 Test Site Description .....                          | 11   |
| 3.1 Sizing Methodology .....                                   | 11   |
| 3.2 Site Description .....                                     | 11   |
| 3.3 Peak Flow Calculation .....                                | 16   |
| 3.4 Contaminant Sources and Site Maintenance.....              | 19   |
| 3.5 Stormwater Conveyance System and Receiving Water.....      | 19   |
| 3.6 Terre Kleen™ Installation.....                             | 19   |
| Chapter 4 Sampling Procedures and Analytical Methods .....     | 21   |
| 4.1 Sampling Locations.....                                    | 21   |
| 4.1.1 Upstream Influent .....                                  | 21   |
| 4.1.2 Downstream Effluent.....                                 | 21   |
| 4.1.3 Rain Gauge.....  | 21   |
| 4.2 Monitoring Equipment .....                                 | 21   |
| 4.3 Constituents Analyzed.....                                 | 22   |
| 4.4 Sampling Schedule.....                                     | 22   |
| 4.5 Field Procedures for Sample Handling and Preservation..... | 23   |
| Chapter 5 Monitoring Results and Discussion.....               | 24   |
| 5.1 Storm Event Data .....                                     | 24   |
| 5.1.1 Flow Data Evaluation .....                               | 24   |
| 5.2 Monitoring Results: Performance Parameters.....            | 26   |
| 5.2.1 Concentration Efficiency Ratio.....                      | 26   |
| 5.2.2 Sum of Loads .....                                       | 28   |
| 5.3 Particle Size Distribution .....                           | 29   |
| 5.3.1 Particle Size Distribution with Sieve Data.....          | 29   |

|            |  |    |
|------------|--|----|
| 5.3.2      | Particle Size Distribution with Coulter Counter Data.....        | 31 |
| 5.3.3      | Particle Size Distribution and Hjulstrom Diagram Evaluation..... | 36 |
| 5.4        | Retained Solids Analysis.....                                    | 38 |
| 5.4.1      | Particle Size Distribution of Retained Solids.....               | 38 |
| 5.4.2      | TCLP Analysis of Retained Solids .....                           | 39 |
| Chapter 6  | QA/QC Results and Summary .....                                  | 41 |
| 6.1        | Laboratory/Analytical Data QA/QC .....                           | 41 |
| 6.1.1      | Bias (Field Blanks) .....  | 41 |
| 6.1.2      | Replicates (Precision) .....                                     | 41 |
| 6.1.3      | Accuracy .....   | 44 |
| 6.1.4      | Representativeness.....  | 44 |
| 6.1.5      | Completeness .....   | 45 |
| Chapter 7  | Operation and Maintenance Activities.....                        | 46 |
| 7.1        | System Operation and Maintenance.....                            | 46 |
| Chapter 8  | References .....   | 48 |
| Appendices | .....  | 49 |
| A          | Design and O&M Guidelines .....                                  | 49 |
| B          | Verification Test Plan.....                                      | 49 |
| C          | Event Hydrographs and Rain Distribution .....                    | 49 |
| D          | Analytical Data Reports with QC.....                             | 49 |

## Figures

|             |  |    |
|-------------|--|----|
| Figure 2-1. | Terre Kleen™ schematic and flow diagram. ....  | 6  |
| Figure 2-2. | Adjusted Hjulstrom diagram (provided by vendor). ....  | 8  |
| Figure 3-1. | Site topographic map showing the sampling location and location of the Terre Kleen™.....   | 13 |
| Figure 3-2. | Aerial photograph of Harrisburg Public Works Yard showing outlet and drainage area delineation.....  | 14 |
| Figure 3-3. | Photograph of the drainage area.....   | 14 |
| Figure 3-4. | View from the sampling location across the paved lot to the edge of the watershed (see stop sign in photograph on right). ....                                       | 15 |
| Figure 3-5. | Outlet sampling location for 15-inch reinforced concrete storm drain pipe. ....  | 15 |
| Figure 5-1. | Coulter analysis comparison by count of the Terre Kleen™ influent and effluent total particle count for Event 8. ....  | 32 |
| Figure 5-2. | Coulter analysis comparison by volume of the Terre Kleen™ influent and effluent particle volume for Event 8. ....  | 32 |
| Figure 5-3. | Complete particle size distribution for influent and effluent samples from Event 8. ....   | 33 |
| Figure 5-4. | Particle size distribution for influent and effluent samples from all sampled storm events using mean $d_{10}$ , $d_{25}$ , $d_{50}$ , $d_{75}$ , and $d_{90}$ ..... | 34 |
| Figure 5-5. | Particle size distribution for influent and effluent samples using median $d_{10}$ , $d_{25}$ , $d_{50}$ , $d_{75}$ , and $d_{90}$ . ....                            | 35 |
| Figure 5-6. | Hjulstrom diagram plotting the 95 <sup>th</sup> percentile particle size remaining in solution versus the horizontal water velocity through the plates. ....         | 37 |
| Figure 5-7. | Particle size distribution for material captured in the sediment storages areas of the Terre Kleen™.....   | 39 |

## Tables

|  |    |
|--|----|
| Table 2-1. Terre-Kleen™ Sizing Chart.....  | 7  |
| Table 3-1. Preliminary Suspended Solids Sampling at the Harrisburg Public Works Yard.....  | 11 |
| Table 3-2. Rainfall Depth (in.).....   | 17 |
| Table 3-3. Rainfall Intensities (in./hr).....  | 17 |
| Table 3-4. Peak Flow Calculations (cfs).....   | 17 |
| Table 3-5. Peak Flow Calculations (cfs) Using Time of Concentration.....   | 18 |
| Table 4-1. Constituent List for Water Quality Monitoring.....  | 22 |
| Table 5-1. Summary of Events Monitored for Verification Testing .....  | 25 |
| Table 5-2. Peak Discharge Rate and Runoff Volume Summary .....   | 26 |
| Table 5-3. Monitoring Results and Efficiency Ratios for Sediment Parameters.....   | 27 |
| Table 5-4. Sediment Sum of Loads Results.....  | 29 |
| Table 5-5. Particle Size Distribution Analysis Results (Particle Sizes > 250 µm).....  | 30 |
| Table 5-6. Particle Size Distribution Analysis Results (Particle Sizes Smaller than 250 µm)....  | 31 |
| Table 5-7. Results for Cleanout Solids .....   | 40 |
| Table 6-1. Sampler Calibration for TSS using Sil-Co-Sil Mixture .....  | 42 |
| Table 6-2. Field Duplicate Sample Relative Percent Difference Data Summary .....   | 43 |
| Table 7-1. (a) Initial cleanout of the sedimentation chamber. (b) Bottom of primary chamber<br>after dewatering and during sediment cleanout. .... | 46 |
| Table 7-2. Primary chamber nearing the end of cleanout.....  | 47 |

## Abbreviations and Acronyms

|                 |  |
|-----------------|--|
| BMP             | Best management practice   |
| cfs             | Cubic feet per second  |
| COV             | Coefficient of variation   |
| DTU             | Data transfer unit   |
| d <sub>xx</sub> | Particle size at xx percentile of cumulative volume                              |
| EMC             | Event mean concentration   |
| EPA             | U.S. Environmental Protection Agency   |
| ETV             | Environmental Technology Verification  |
| ft <sup>2</sup> | Square feet  |
| ft <sup>3</sup> | Cubic feet   |
| g               | Gram   |
| gal             | Gallon   |
| gpm             | Gallon per minute  |
| HDPE            | High density polyethylene  |
| hr              | Hour   |
| IDF             | Intensity-Duration-Frequency (curve)   |
| in.             | Inch   |
| kg              | Kilogram   |
| L               | Liter  |
| lb              | Pound  |
| NRMRL           | National Risk Management Research Laboratory                                     |
| mg/L            | Milligram per liter  |
| min             | Minute   |
| mm              | Millimeter   |
| NSF             | NSF International  |
| O&M             | Operations and maintenance   |
| PSH             | Penn State Harrisburg (TO)   |
| QA              | Quality assurance  |
| QC              | Quality control  |
| SOL             | Sum of the loads   |
| SOP             | Standard Operating Procedure   |
| SSC             | Suspended sediment concentration   |
| TCLP            | Toxicity Characteristic Leachate Procedure                                       |
| THCP            | Terre Hill Silo Company, Inc. (T/D/B/A Terre Hill Concrete Products)<br>(vendor) |
| TO              | Testing Organization (Penn State Harrisburg)                                     |
| TSS             | Total suspended solids   |
| µm              | Micron   |
| VO              | Verification Organization (NSF)  |
| WQPC            | Water Quality Protection Center  |
| yd <sup>3</sup> | Cubic yard   |
| yr              | Year   |

# **Chapter 1**

## **Introduction**

### **1.1 ETV Purpose and Program Operation**

The U.S. Environmental Protection Agency (EPA) has created the Environmental Technology Verification (ETV) Program to facilitate the deployment of innovative or improved environmental technologies through performance verification and dissemination of information. The goal of the ETV program is to further environmental protection by accelerating the acceptance and use of improved and more cost-effective technologies. ETV seeks to achieve this goal by providing high quality, peer reviewed data on technology performance to those involved in the design, distribution, permitting, purchase, and use of environmental technologies.

ETV works in partnership with recognized standards and testing organizations; stakeholder groups, which consist of buyers, vendor organizations, and permittees; and with the full participation of individual technology developers. The program evaluates the performance of innovative technologies by developing test plans that are responsive to the needs of stakeholders, conducting field or laboratory testing (as appropriate), collecting and analyzing data, and preparing peer reviewed reports. All evaluations are conducted in accordance with rigorous quality assurance protocols to ensure that data of known and adequate quality are generated and that the results are defensible.

NSF International (NSF), in cooperation with the EPA, operates the Water Quality Protection Center (WQPC). The WQPC evaluated the performance of the Terre Hill Concrete Products' Terre Kleen™ 09 (Terre Kleen™), a stormwater treatment device designed to remove sediments from stormwater runoff. Faculty and students from Penn State Harrisburg's Environmental Engineering Program were the Testing Organization (TO) and conducted the field testing and laboratory analysis.

It is important to note that verification of the equipment does not mean that the equipment is "certified" by NSF or "accepted" by EPA. Rather, it recognizes that the performance of the equipment has been determined and verified by these organizations for those conditions tested by the TO.

### **1.2 Testing Participants and Responsibilities**

The ETV testing of the Terre Kleen™ was a cooperative effort among the following participants:

- U.S. Environmental Protection Agency
- NSF International
- Terre Hill Concrete Products (THCP)
- Penn State Harrisburg (PSH) Environmental Engineering Program
- City of Harrisburg

The following is a brief description of each ETV participant and their roles and responsibilities.

### **1.2.1 U.S. Environmental Protection Agency**

The EPA Office of Research and Development, through the Urban Watershed Management Branch, Water Supply and Water Resources Division, National Risk Management Research Laboratory (NRMRL), provides administrative, technical, and quality assurance guidance and oversight on all ETV Water Quality Protection Center activities. In addition, EPA provides financial support for operation of the WQPC and partial support for the cost of testing for this verification. EPA's responsibilities include:

- Review and approval of the test plan;
- Review and approval of the verification report;
- Review and approval of the verification statement; and
- Post verification report and statement on the EPA website.

The key EPA contact for this program is:

Mr. Ray Frederick  
(732) 321-6627

ETV WQPC Project Officer  
email: [frederick.ray@epa.gov](mailto:frederick.ray@epa.gov)

U.S. EPA, NRMRL  
Urban Watershed Management Branch  
2890 Woodbridge Avenue (MS-104)  
Edison, New Jersey 08837-3679

### **1.2.2 Verification Organization**

NSF is the verification organization (VO) administering the WQPC in partnership with EPA. NSF is a not-for-profit testing and certification organization dedicated to public health, safety, and protection of the environment. Founded in 1946 and located in Ann Arbor, Michigan, NSF has been instrumental in development of consensus standards for the protection of public health and the environment. NSF also provides testing and certification services to ensure that products bearing the NSF name, logo and/or mark meet those standards.

NSF personnel provided technical oversight of the verification process, which include:

- Review and comment on the test plan;
- Review quality systems of all parties involved with the TO, and qualify the TO;
- Oversee TO activities related to the technology evaluation and associated laboratory testing;
- Conduct an on-site audit of test procedures;
- Provide quality assurance/quality control (QA/QC) review and support for the TO;
- Review the verification report and verification statement; and
- Coordinate with EPA to approve the verification report and verification statement.

Key contacts at NSF are:

Mr. Thomas Stevens, P.E.  
(734) 769-5347

Program Manager  
email: [stevens@nsf.org](mailto:stevens@nsf.org)

Mr. Patrick Davison  
(734) 913-5719

Project Coordinator  
email: [davison@nsf.org](mailto:davison@nsf.org)

NSF International  
789 North Dixboro Road  
Ann Arbor, Michigan 48105

### ***1.2.3 Testing Organization***

Penn State Harrisburg's (PSH) Environmental Engineering Program was the TO, and was responsible for ensuring that the test location and conditions allowed the verification testing to meet its stated objectives; preparing the test plan; overseeing the testing; managing the data generated by the testing; and preparing the verification statement and report. TO personnel measured and recorded data during the testing. TO employees also analyzed the samples when they were returned to the laboratory for analysis. The TO's Project Manager provided project oversight.

PSH had primary responsibility for all verification testing, including:

- Coordinate all testing and observations of the Terre Kleen™ in accordance with the test plan;
- Supervise the analytical work performed in support of the test plan;
- Establish a communication network;
- Schedule and coordinate the activities for the verification testing;
- Manage data generated during the verification testing; and
- Prepare the draft verification report and statement for the Terre Kleen™ ETV testing.

The key contact for the TO is:

Dr. Shirley E. Clark, P.E.  
(717) 948-6127

Assistant Professor of Environmental Engineering  
email: [seclark@psu.edu](mailto:seclark@psu.edu)

Penn State Harrisburg  
Environmental Engineering Program  
School of Science, Engineering and Technology  
777 W. Harrisburg Pike  
Middletown, PA 17057



#### ***1.2.4 Vendor***

The vendor is Terre Hill Silo Company, Inc. (T/D/B/A Terre Hill Concrete Products). Vendor responsibilities include:

- Provide, and possibly install, the technology and ancillary equipment required for the verification testing;
- Provide technical support during the installation and operation of the technology, including the designation of a staff person or representative that will conduct at least one on-site inspection during monitoring to ensure the technology is functioning as intended;
- Provide descriptive details about the capabilities and intended function of the technology;
- Review and approve the test plan prior to the start of testing; and
- Review and comment on the draft verification report and verification statement.

The key contact for Terre Hill Concrete Products is:

Dale Groff  
(717) 445-3110

Project Manager  
e-mail: [dgroff@terrehill.com](mailto:dgroff@terrehill.com)

Terre Hill Concrete Products  
485 Weaverland Valley Road  
Terre Hill, Pennsylvania 17581

#### ***1.2.5 Verification Testing Site***

The Terre Kleen™ was installed at the edge of the primary drainage area for the City of Harrisburg Public Works Yard on 19<sup>th</sup> Street in Harrisburg, Pennsylvania. The key contact for City of Harrisburg Public Works Department is:

Mr. James Close, Director  
City of Harrisburg Public Works Department  
1690 S. 19<sup>th</sup> Street  
Harrisburg, PA 17104

## **Chapter 2 Technology Description**

The following technology description was supplied by the vendor and does not represent verified information.

### **2.1 Technology Overview**

The Terre Kleen™ system manufactured by Terre Hill Concrete Products (THCP) that was verified includes baffles, screens, and lamella plates in a self-contained unit. The design of the unit provides for underground installation as an in-line treatment device at locations where substantial stormwater solids loadings may be encountered. Appendix A includes design and operations and maintenance (O&M) guidelines for the Terre Kleen™, and Appendix B includes photographs of the test site.

Product Name: Terre Kleen™ (Patent # US 6,676,832 B2)  
Company Name: Terre Hill Concrete Products  
Authorized Contact Person and Title: Dale Groff, Project Manager

### **2.2 Technology Description**

The Terre Kleen™ device combines primary and secondary chambers, baffles, screen, and inclined sedimentation, as well as oil, litter and debris/sediment storage, into a self-contained concrete structure. A schematic diagram of the Terre Kleen™ is shown in Figure 2-1. The product specifications are included in Appendix B of the test plan, which is found in Appendix B of this report.

The principle of operation is hydrodynamic. The primary benefit of the Terre Kleen™ is its ability to efficiently settle solids in the inclined cells (lamella plates) located in the secondary chamber. The combination of treatment technologies into a single device has been shown to be more effective than the use of a single technology for runoff treatment. The design of the unit provides for underground installation as an in-line treatment device. It may be applied at a critical source area or a larger unit may be installed in a storm sewer main to provide treatment for larger flows. Installation can be performed using conventional construction techniques. Terre Kleen™ units can be designed to provide specific removal efficiencies based on the size characteristics of the suspended solids and flow rate of storm water to the device.

The Terre Kleen™ device addresses the concern of being space-effective, providing high particle removal efficiency given the device's relatively small footprint. The ability to install the device below grade allows for the use of the aboveground space, and makes it easier for the device to be retrofitted into a pre-existing storm sewer system. In addition, if the flows exceed the sizing for the secondary (lamella plate) chamber, all flow is still treated in the primary settling chamber, with the secondary chamber seeing the flows that it can effectively treat. The water is then recombined prior to device discharge. This design allows for some treatment of all water that enters the device.

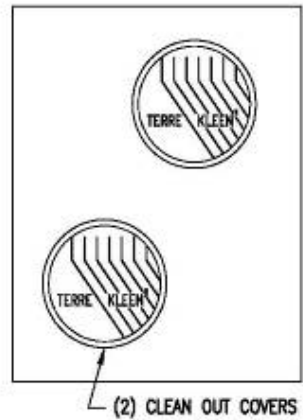

(2) CLEAN OUT COVERS

PLAN

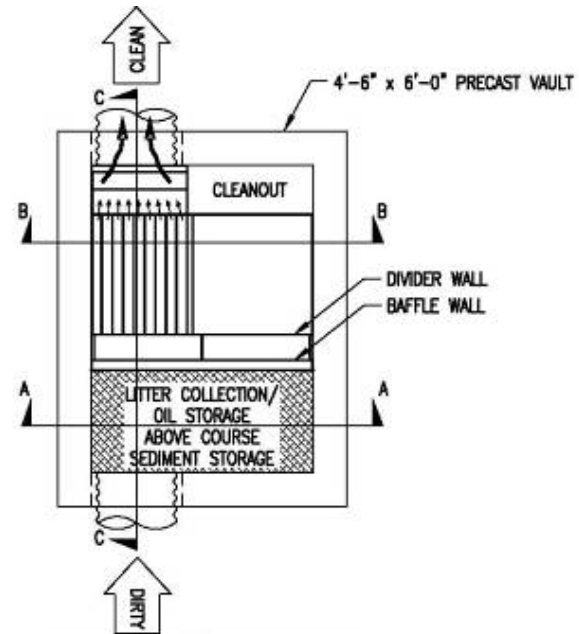

PLAN VIEW WITHOUT LID

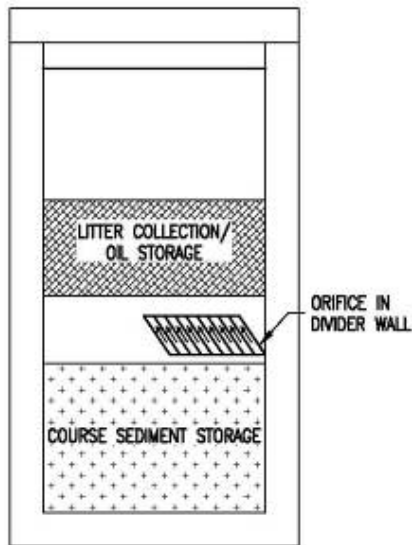

SECTION A-A  
PRIMARY CHAMBER

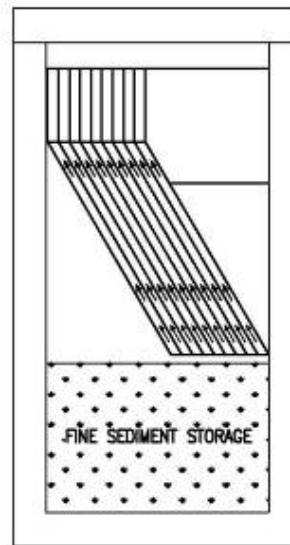

SECTION B-B  
SECONDARY CHAMBER

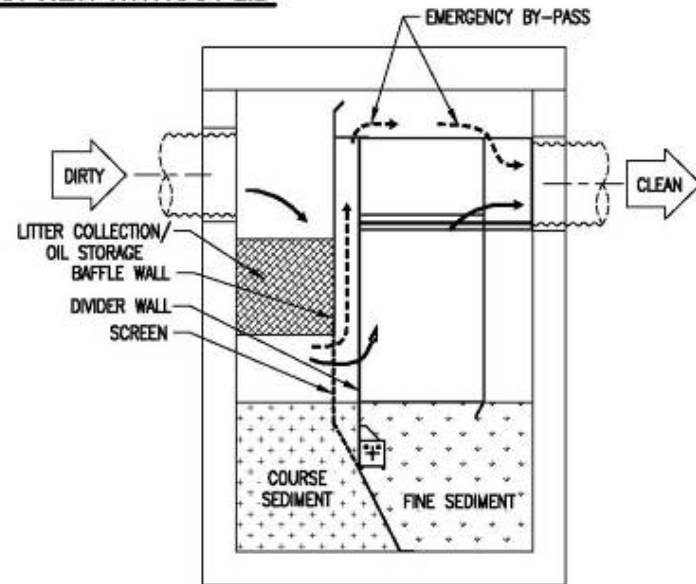

SECTION C-C

US PATENT #6,676,832

Figure 2-1. Terre Kleen™ schematic and flow diagram.

The device is designed to be easily accessible for maintenance purposes and has been designed to provide storage space for sediment below the inclined cells and in the primary chamber. Re-suspension of captured material below the inclined cells is minimized because the stormwater enters the inclined cells sideways instead of scouring the top of the sediment. The storage space was designed to provide sufficient storage so that frequent clean out is not required. The device has been designed with access covers to allow for easy access by vactor truck hose to all chambers when maintenance is required.

The sizing chart for the Terre Kleen™ 09 Unit is shown in Table 2-1. The table values list the anticipated particle size that will be removed based on the flow rate entering the unit. More information on the sizing of the Terre Kleen™ is provided in Section 3.1.

**Table 2-1. Terre-Kleen™ Sizing Chart**

| Terre Kleen 09  |                 |   |  |                        |                  |       | Miscellaneous Data             |  |  |
|-----------------|-----------------|---|--|------------------------|------------------|-------|--------------------------------|--|--|
| Performance     |                 |   |  |                        | Approximate size |       | Oil Storage Capacity (Gallons) | Grit Chamber Loading Rate in GPM per Sq Ft | Primary chamber loading in GPM per Sq Ft |
| Capacity in CFS | Capacity in GPM | Minimum Particle Size Removal in Micron | Grit Chamber Projected Surface Area SqFt | Sediment storage in CF | Length           | Width |                                |  |  |
| 0.3             | 137             | 10                                      | 57                                       | 74                     | 6'-0"            | 4'-6" | 140                            | 2.4  | 15                                       |
| 0.6             | 268             | 30                                      | 57                                       | 74                     | 6'-0"            | 4'-6" | 140                            | 4.7  | 30                                       |
| 1.0             | 428             | 50                                      | 57                                       | 74                     | 6'-0"            | 4'-6" | 140                            | 7.5  | 48                                       |
| 1.3             | 599             | 70                                      | 57                                       | 74                     | 6'-0"            | 4'-6" | 140                            | 10.5                                       | 67                                       |
| 1.9             | 855             | 100                                     | 57                                       | 74                     | 6'-0"            | 4'-6" | 140                            | 15.0                                       | 95                                       |
| 3.4             | 1539            | 150                                     | 57                                       | 74                     | 6'-0"            | 4'-6" | 140                            | 27.0                                       | 171                                      |
| 4.3             | 1930            | 200                                     | 57                                       | 74                     | 6'-0"            | 4'-6" | 140                            | 33.9                                       | 214                                      |
| 5.6             | 2508            | 250                                     | 57                                       | 74                     | 6'-0"            | 4'-6" | 140                            | 44.0                                       | 279                                      |
| 6.4             | 2850            | 300                                     | 57                                       | 74                     | 6'-0"            | 4'-6" | 140                            | 50.0                                       | 317                                      |
| 8.9             | 3990            | 400                                     | 57                                       | 74                     | 6'-0"            | 4'-6" | 140                            | 70.0                                       | 443                                      |
| 11.4            | 5130            | 500                                     | 57                                       | 74                     | 6'-0"            | 4'-6" | 140                            | 90.0                                       | 570                                      |
| 12.7            | 5700            | 600                                     | 57                                       | 74                     | 6'-0"            | 4'-6" | 140                            | 100.0                                      | 633                                      |
| 15.0            | 6726            | 700                                     | 57                                       | 74                     | 6'-0"            | 4'-6" | 140                            | 118.0                                      | 747                                      |
| 17.8            | 7980            | 800                                     | 57                                       | 74                     | 6'-0"            | 4'-6" | 140                            | 140.0                                      | 887                                      |
| 21.0            | 9405            | 900                                     | 57                                       | 74                     | 6'-0"            | 4'-6" | 140                            | 165.0                                      | 1045                                     |

Maximum pipe size Ø 24 inches. For higher flow rates check with our office.

As with all sedimentation devices, the Terre Kleen™ can be sized for future applications to remove the desired particle size based on the Hjulstrom diagram. The Hjulstrom diagram evaluates the ability of particles to be washed away (erosion), travel (transportation), or settle (sedimentation) in fluid as a function of particle size and fluid velocity. The Hjulstrom diagram provided by the vendor is shown in Figure 2-2. This figure provides the empirical loading rate for the inclined plate settlers (gpm/ft<sup>2</sup>), and the particle size for which 100% removal is desired that will settle at that loading rate. The amount of settling area required is the flow rate (gpm) from the inlet pipe divided by the loading rate (gpm/ft<sup>2</sup>). The number of settling cells to provide the required area is then directly proportional to the flow rate to the device. Future sizing can then be based on the flow loading calculations similar to those provided in Appendix E of the Test Plan. This claim is plotted as the line between Sedimentation and Transport on the Hjulstrom diagram

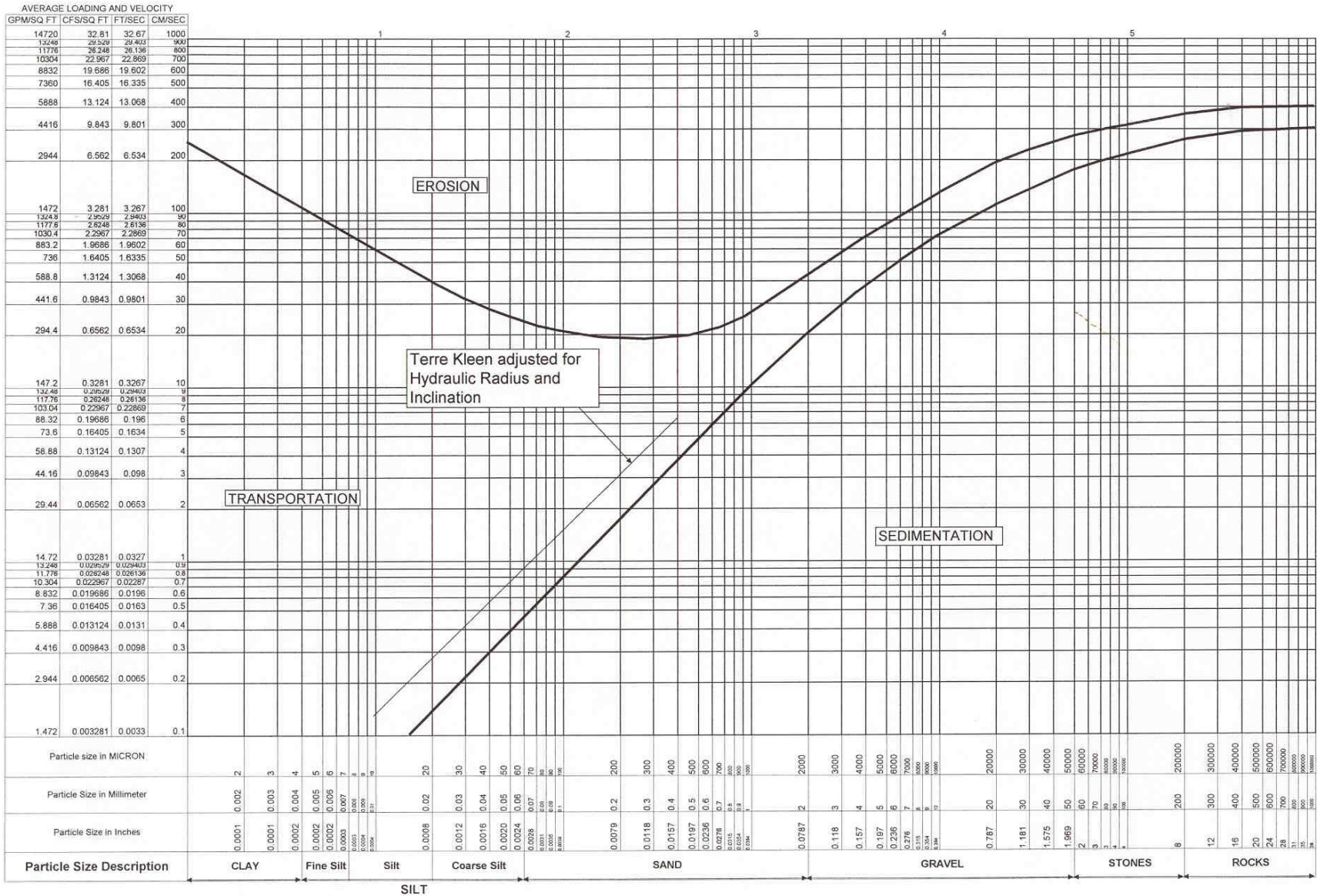

Figure 2-2. Adjusted Hjulstrom diagram (provided by vendor).

Verification of the sizing calculations using the Hjulstrom diagram was performed by the TO through the analysis of periodic sampler bottles that were not included in the composite sampling required as part of the Test Plan. The results of these analyses are shown in Figure 5-7 and are discussed in Section 5.4.1.

Additional equipment specifications, test site descriptions, testing requirements, sampling procedures, and analytical methods were detailed in the *Environmental Technology Verification Test Plan for Terre Hill Concrete Products: The Terre Kleen™, City of Harrisburg, Pennsylvania*, November 2004 (test plan). The test plan is included in Appendix B.

### **2.3 Applications**

This Terre Kleen™ is designed to remove solids from stormwater runoff by improving the sedimentation performance compared with a traditional detention facility, and without requiring chemical addition. The potential markets for this device include municipalities and developers with stormwater runoff not meeting the standards for the receiving water to which it is being discharged. These potential users may be required through retrofit (municipalities) or through installation during construction to treat their stormwater prior to discharge. A more efficient, in-line treatment device for stormwater runoff would allow these owners to meet the upcoming requirements for treating their runoff without incurring the tremendous financial burden that would result from the purchase of a more complex device or multiple devices.

### **2.4 Operation and Maintenance**

The required O&M for this unit will consist of periodic removal of the sediment from the bottom of the Terre Kleen™ device. This sediment removal interval will be based on the solids loading to the device and the sedimentation performance of the device. The storage areas in the device have been designed to retain approximately 74 cubic feet (ft<sup>3</sup>) of sediment. For the test site, it was anticipated that sediment removal would not be required during the testing interval. However, this did not prove true; a description of the O&M activities is contained later in this report.

During normal operation in a post-construction environment, it is anticipated that cleaning would be required once per year. A vactor truck, similar to that used in cleaning a sewer system and stormwater catch basins, would be used for the cleaning. The device has openings built into the top with removable covers for easy access to the sediment storage areas. When the device required cleaning during the testing period, a City of Harrisburg truck was used to remove the sediment.

The Terre Kleen™ O&M guidelines are included in Appendix C of the test plan.

## **2.5 Performance Claim**

The vendor claims that the Terre Kleen™ 09 device will remove 100% of the 200-µm particles and larger in the runoff when the device is operating at the design storm flow (based on the 25-year storm). THCP predicts that at lower flows, removals of particles smaller than 200 µm will also be achieved. The device is sized based on the adjusted Hjulstrom Diagram (Figure 2-2).

## Chapter 3 Test Site Description

The test site for this device was the City of Harrisburg Public Works Yard in Harrisburg, Pennsylvania. The device was installed in the storm collection system adjacent to the swale located in the south corner of the property as shown in Figures 3-1 and 3-2. The drainage area includes roofs, paving and unpaved areas. The watershed delineation is shown in Figure 3-1.

The stormwater runoff from the test site was characterized prior to testing by four samples that were collected at the proposed installation location during the spring of 2004. The results are summarized in Table 3-1. The sample location was roughly the same as the effluent sampling location, as shown on Figure 3-1.

**Table 3-1. Preliminary Suspended Solids Sampling at the Harrisburg Public Works Yard**

| Date      | Time    | Turbidity (NTU) | Total Solids (mg/L) | TDS (mg/L) | TSS (mg/L) |
|-----------|---------|-----------------|---------------------|------------|------------|
| 4/8/2004  | 5:00 PM | 151             | 1,150               | 920        | 230        |
| 4/11/2004 | 8:30 AM | 13              | 150                 | 140        | 13         |
| 4/11/2004 | 2:30 PM | 40.3            | 280                 | 80         | 200        |
| 4/12/2004 | 1:00 PM | 38.2            | 250                 | 110        | 140        |

### 3.1 Sizing Methodology

The calculation of the peak runoff flow rate using a 25-year design storm is included in Appendix E of the Test Plan. In summary, the peak runoff was calculated using the Rational Method and was based on site characteristics and on the Intensity-Duration-Frequency (IDF) curve provided by the Pennsylvania Department of Transportation for the 25-year design storm. The runoff was calculated to be approximately 3.49 cubic feet per second (cfs). The device was then sized based on this flow rate and was determined to be a Terre Kleen™ 09 Unit (Figure B-3 of the Test Plan), based on the removal of 200- $\mu$ m particles for instantaneous peak flows of 3.2 cfs. It is anticipated that the device will provide overall control for the 150- $\mu$ m particles based on the normal flow rates similar to the 5- to 10-year storm, approximately 2.0 – 3.0 cfs.

### 3.2 Site Description

The drainage area is part of the city's maintenance yard occupied by the Bureau of Sanitation, and includes runoff from buildings and paved and unpaved parking areas. The TO obtained topographic maps with 1 ft relief contours from the City of Harrisburg for the area (Figure 3-1). Based on these maps, the watershed was estimated to be approximately 1.27 acres and between 90 and 95% impervious. This delineation could not be confirmed from the aerial photograph in Figure 3-2, since relief contours were not clear. In addition, the topographic map available from the USGS uses 20-ft contours and the entire site has an elevation between 381 and 390 ft. Therefore, no additional delineation information was available.



During field visits to the site, it was noted that at least the upper crushed dirt and stone area where the vehicle wash occurs, plus part of the hillside, was all draining to the site. A review of the site elevations using Google Earth (which was not available when the original plan was developed) showed that the actual drainage area is much larger than originally estimated. Figure 3-2 shows the delineation of the revised watershed. The estimated area of the revised watershed from 20-foot contour maps of the site in conjunction with 1-ft elevations from Google Earth is 3.21 acres. Photographs of the drainage area are given in Figures 3-3, 3-4, and 3-5.

Roof drains are installed at the corners and at points along the outside of the building. Based on the flow pattern from these roof drains, approximately half of the roof drains drained to the device. In addition, Inlets I-10 and I-11 (Figure 3-1) drained to the device. The building is partly office space and the two wings are garage bays, which have floor drains to collect wash water. Part of the area is heavily traveled (to and from the garage bays, but with trucks coming from outside the delineated watershed – past the “front” of the building, which is not in the watershed). In the watershed, there are two gas pumps for refilling city vehicles and a significant number of parked vehicles in the area. Most of these vehicles are either waiting for maintenance or are for sale by the city.

No road salt or soil piles are found in the watershed area. An incinerator, located just off-site, underwent significant renovation and was not in operation during most of the verification. The solids found in the preliminary sampling are assumed to originate from atmospheric deposition or from soils clinging to vehicles passing through or parked in the area. No unusual sources were found in the watershed.

According to a personal conversation with James Close, Public Works Director, no maintenance has been done on the storm sewer system in several years. However, as part of the installation of the Terre Kleen™, the city performed maintenance on the piping system and the drainage swale at the end of the pipe. The walkthrough of the site in June of 2004 indicated stagnant water in the pipe from I-11 to the outlet because of sediment buildup in the swale. While no detailed investigations of inappropriate connections or infiltration and inflow have been performed, no dry-weather flows were observed during the verification, other than occasional water entering storm drains through vehicle washing or maintenance.

The city re-graded the swale prior to verification to ensure that the device and the pipe drained properly. This area is on a hill, so no flooding is anticipated and no flooding was observed on site during Hurricane Ivan (which was the fifth-worst flooding situation recorded on the Susquehanna River in Harrisburg) in September 2004.

Prior to testing, and in order to verify the installation locations and elevations, the vendor surveyed part of the site. It was noted during the survey that the drainage area was slightly smaller than estimated from the topographic information. This was due to the repaving of the site by adding a layer of asphalt over the existing layers. Rutting of the asphalt had resulted in a few areas where runoff from the pavement was actually directed away from the inlets and toward the drainage swale downstream of the Terre Kleen™.

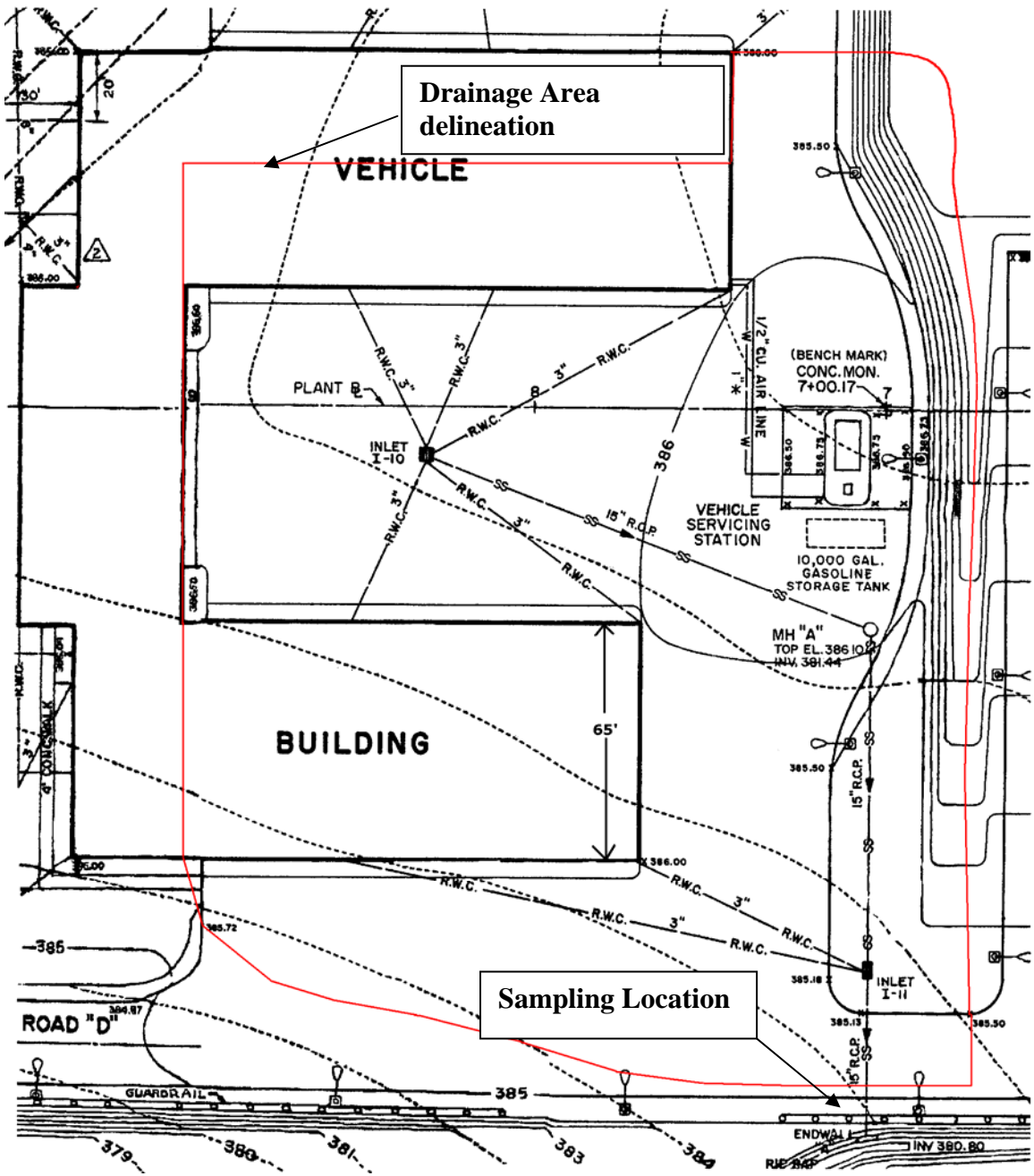

Figure 3-1. Site topographic map showing the sampling location and location of the Terre Kleen™.



**Figure 3-2. Aerial photograph of Harrisburg Public Works Yard showing outlet and drainage area delineation.**



**Figure 3-3. Photograph of the drainage area.**



**Figure 3-4. View from the sampling location across the paved lot to the edge of the watershed (see stop sign in photograph on right).**



**Figure 3-5. Outlet sampling location for 15-inch reinforced concrete storm drain pipe.**

During the winter/spring of 2006, the City of Harrisburg Municipal Waste Incinerator came back on line after a multi-year renovation. While the incinerator itself was not in the drainage area, trucks carrying ash from the incinerator had to pass through the drainage area on their way to the on-site ash landfill. Part of the road that they traversed is not paved. It was reinforced with gravel which quickly sank into the dirt/mud, as illustrated in Figure 3-6. The results in Chapter 5 show that this change in surface activity changed the character of the influent water flowing to the Terre Kleen™ unit.



**Figure 3-6. Dirt and gravel road used by incinerator ash trucks.**

### **3.3 Peak Flow Calculation**

The rainfall amounts for the one-, two-, ten-, and twenty-five year storms for the drainage area are presented in Table 3-2. Table 3-3 presents the intensities in inches per hour calculated for the given rainfall depths, as given in the PA DOT Intensity-Duration-Frequency Curves for Pennsylvania (these were read from the PA DOT charts and were not calculated by the TO. These data were utilized to generate the peak flows shown in Table 3-4. Table 3-5 presents the peak flow calculated using the time of concentration for the drainage basin. The time of concentration was calculated as described in Appendix E of the test plan and is based on the time

of concentration calculation methods described in the United States Department of Agriculture’s Natural Resource Conservation Services’ (NRCS) TR-55 method “Urban Hydrology for Small Watersheds.” (NRCS, June 1986). The method of calculation for the peak flow was the Rational Method (McCuen 2005), where the peak flow rate is equal to the rainfall intensity for the time of concentration multiplied by the drainage area multiplied by a runoff coefficient (which reflects the quantity of rainfall that becomes runoff).

**Table 3-2. Rainfall Depth (in.)**

| <b>Duration</b> | <b>1-yr</b> | <b>2-yr</b> | <b>10-yr</b> | <b>25-yr</b> |
|-----------------|-------------|-------------|--------------|--------------|
| 5 min           | 0.31        | 0.35        | 0.45         | 0.51         |
| 30 min          | 0.79        | 0.93        | 1.27         | 1.42         |
| 1 hr            | 1.0         | 1.3         | 1.7          | 1.9          |
| 2 hr            | 1.3         | 1.5         | 1.9          | 2.3          |
| 12 hr           | 2.0         | 2.5         | 3.7          | 4.5          |

PA DOT. Field Manual of PA DOT Storm Intensity-Duration-Frequency Charts. (1986).

**Table 3-3. Rainfall Intensities (in./hr)**

| <b>Duration</b> | <b>1-yr</b> | <b>2-yr</b> | <b>10-yr</b> | <b>25-yr</b> |
|-----------------|-------------|-------------|--------------|--------------|
| 30 min          | 1.5         | 1.8         | 2.5          | 2.8          |
| 1 hr            | 1.0         | 1.2         | 1.7          | 2.0          |
| 2 hr            | 0.65        | 0.77        | 1.1          | 1.3          |
| 12 hr           | 0.18        | 0.22        | 0.32         | 0.37         |
| 24 hr           | 0.10        | 0.12        | 0.19         | 0.23         |

PA DOT. Field Manual of PA DOT Storm Intensity-Duration-Frequency Charts. (1986).

**Table 3-4. Peak Flow Calculations (cfs)**

| <b>Duration</b> | <b>1-yr</b> | <b>2-yr</b> | <b>10-yr</b> | <b>25-yr</b> |
|-----------------|-------------|-------------|--------------|--------------|
| 30 min          | 4.15        | 4.97        | 6.90         | 7.73         |
| 1 hr            | 2.76        | 3.36        | 4.70         | 5.31         |
| 2 hr            | 1.79        | 2.12        | 3.03         | 3.59         |
| 12 hr           | 0.51        | 0.61        | 0.88         | 1.02         |
| 24 hr           | 0.28        | 0.33        | 0.53         | 0.63         |

**Table 3-5. Peak Flow Calculations (cfs) Using Time of Concentration**

| <b>Duration</b> | <b>1-yr</b> | <b>2-yr</b> | <b>10-yr</b> | <b>25-yr</b> |
|-----------------|-------------|-------------|--------------|--------------|
| 25 min          | 4.42        | 5.13        | 7.72         | 8.98         |

The City of Harrisburg recommends that all storm drain systems for maintenance facilities such as this one be designed to accommodate the 25-year storm, although a 10-year design storm is acceptable. A 25-minute time of concentration was determined for the basin, generating a peak runoff of 7.72 cfs for the 10-year storm event. The Rational Method was used to calculate the peak flows for the device, since the drainage basin is between one and two acres and well within the guidelines for the limits of the Rational Method (drainage area  $\leq$  20 to 200 acres, depending on the reference providing the guidance). The 15-inch reinforced concrete drainage pipe was originally sized to pass the 25-year storm without bypassing the piping system. During installation of the Terre Kleen, the City of Harrisburg replaced the 15-inch reinforced concrete pipe with an 18-inch SDR32 PVC pipe from the Terre-Kleen test unit to the endwall. The replacement of the 15-inch concrete pipe to the smoother 18-inch PVC was part of the installation agreement with the City and was done to ensure that the effluent from the Terre Kleen™ would drain completely. Backwater in the effluent pipe would have invalidated all effluent sampler measurements.

It was also noted during analysis of the sampler data that there was a dry-weather flow component entering the Terre Kleen™ on an uneven schedule. To ensure that this was not a sampler error, this dry weather flow was noticed during most visits to the Terre Kleen for inspection and maintenance. When the dry-weather influent flow rose to more than a trickle, the effluent pipe also had dry-weather flow. Analyzing the sampler data indicates that this dry-weather component also could be seen in the many storm event samples. The TO decided not to remove this dry-weather flow from the calculations and evaluations since this flow passed through the Terre Kleen™.

Because of the nature of the site, trash and debris problems were noted in the influent sampler side of the Terre Kleen™. These problems and their effects are described in Chapters 4 and 5. In summary, the influence of debris on readings at the influent sampler caused a concern about the reliability of the influent sampler for flow readings. Therefore, the effluent sampler was used for all flow measurements, with one exception described later.

A review of the hydrologic behavior of the site indicates that the time of concentration calculated in Table 3-5 actually may be too low for the site. In the more intense storms, a time-to-peak was noted at approximately 5 min, indicating a flashy response of the site to the storm. Therefore, while the numbers in this section were calculated assuming a Rational coefficient that reflects 90% to 95% imperviousness, this site behaved like it was 100% impervious.

### **3.4 Contaminant Sources and Site Maintenance**

The main pollutant sources within the drainage basin are created by vehicular traffic, as well as heavy equipment maintenance and the storage of garbage collection trucks on the site. Only part of the site is paved with asphalt. Much of the rest is gravel embedded in dirt. Trash and debris accumulate on the surface and enter the stormwater system through the two inlets on site. These inlets were sized to accommodate the large storm flows, and the storm sewer catch basins do not have sumps. There are no other stormwater best management practices (BMPs) within the drainage basin.

Minimal site maintenance occurred during the verification test period. The primary maintenance was the deepening of a 3-in. channel to funnel water into the last inlet (I-11) in the drainage system prior to the Terre Kleen™. Additional maintenance consisted of one time delivery of gravel for the prevention of dust and dirt mobilization on the unpaved areas.

### **3.5 Stormwater Conveyance System and Receiving Water**

As previously discussed, the nearest receiving water is the Susquehanna River, which is located approximately one-third of a mile west of the Public Works Yard and the Terre Kleen™ installation. All water, either treated or bypass, flows via a drainage swale off the site in a southwesterly direction before ultimately flowing into the Susquehanna River.

### **3.6 Terre Kleen™ Installation**

Terre Hill Concrete Products supplied the device for testing. The installation was performed by THCP and the City of Harrisburg who provided the construction equipment and operators associated with excavation and placement of the device. Installation consisted of placing the Terre Kleen™ into the existing storm sewer infrastructure. PSH personnel were at the site during installation to ensure that the device was installed correctly and to be sure principal researchers understood the device. Construction activities were completed in February 2005 and samplers were installed in February 2005. A malfunctioning effluent sampler was replaced in March 2005. The installation and final setup are documented in Figure 3-7 and Figure 3-8. Figure 3-7 (a) shows the fifteen-in. reinforced concrete pipe on the upstream side that was connected to the devices primary chamber, and the 18-in. PVC pipe that was connected to the downstream side of the device. Figure 3-7 (b) shows the Terre Kleen device being installed. Figure 3-8 (a) shows the sample tubing and flow meter cables installed into the influent pipe, and Figure 3-8 (b) shows the autosampling equipment.





(a)



(b)

**Figure 3-7. Left: Terre Kleen™ installation site looking from upstream to downstream.**



(a)

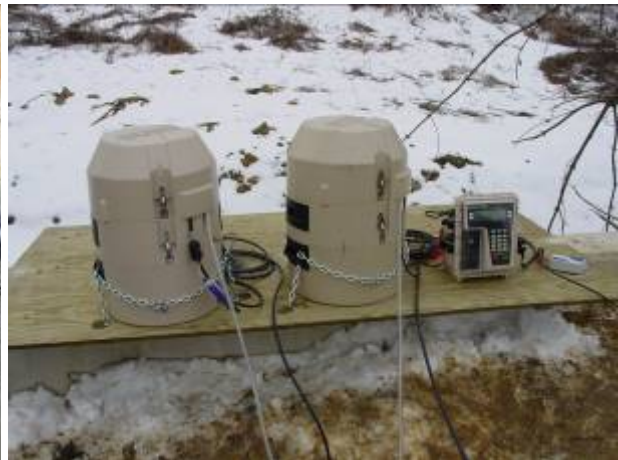

(b)

**Figure 3-8. Sampling equipment installation arrangements.**

## **Chapter 4**

### **Sampling Procedures and Analytical Methods**

Descriptions of the sampling locations and methods used during verification testing are summarized in this section. The test plan presents the details on the approach used to verify the Terre Kleen™. An overview of the key procedures used for this verification is presented below.

#### **4.1 Sampling Locations**

- Two locations in the test site storm sewer system were selected as sampling and monitoring sites to determine the treatment capability of the Terre Kleen™.

##### **4.1.1 Upstream Influent**

- This monitoring site was selected to monitor the stormwater flow rates entering the Terre Kleen™ and collect samples of the influent stormwater. A flow/velocity/stage meter was located in the influent pipe, upstream of the Terre Kleen™ and downstream of Inlet I-11, at a distance where maintenance could be performed and sufficiently downstream that mixing of the inlet water with the in-sewer stormwater would have occurred. Sampler suction tubing to an automatic sampler and the velocity meter were located in the influent pipe as recommended by American Sigma, the sampler manufacturer.

##### **4.1.2 Downstream Effluent**

This sampling and monitoring site was selected to characterize the stormwater discharged from the Terre Kleen™. A velocity/stage meter and sampler suction tubing, connected to the automated sampling equipment, were located in the pipe downstream from the Terre Kleen™.

##### **4.1.3 Rain Gauge**

Two rain gauges were located adjacent to the samplers on top of the endwall for the effluent (downstream) pipe leaving the Terre Kleen™. These gauges were used to monitor the depth of precipitation from storm events. They were also used to trigger the automatic samplers since a small amount of dry flow was found periodically in the influent piping. Triggering by a rain event ensured that the samplers did not trigger until actual runoff had begun. The data were also used to characterize the events to determine if they met the requirements for a qualified storm event. Qualified storms were those whose rainfall depth measured at least 0.2 in.

#### **4.2 Monitoring Equipment**

The specific equipment used for monitoring flow, sampling water quality, and measuring rainfall for the upstream and downstream monitoring points included:

- Samplers: American Sigma 900MAX automatic sampler with a data transfer unit (DTU II) data logger;

- Sample Containers: Twenty-four 500-mL polyethylene bottles designed to fit in the sampler housing;
- Flow Monitors: American Sigma Area/Velocity Flow Monitors; and
- Rain Gauge: American Sigma Tipping Bucket Rain Gauge.

### 4.3 Constituents Analyzed

The list of constituents for which the stormwater samples were analyzed is shown in Table 4-1.

**Table 4-1. Constituent List for Water Quality Monitoring**

| <b>Parameter</b>                       | <b>Reporting Units</b>   | <b>Method Detection Limit</b> | <b>Method</b> |
|--|--------------------------|-------------------------------|---------------|
| Total suspended solids (TSS)           | mg/L                     | 5                             | EPA 160.2     |
| Suspended sediment concentration (SSC) | mg/L                     | 0.5                           | ASTM D3977-97 |
| Particle Size Distribution             | Counts/mL or $\mu^3$ /mL | 1                             | SM 2560       |

The ETV Verification Protocol for Stormwater Source Area Treatment Technologies indicates that SSC ASTM Method D3977-97(C) (wet-sieving filtration) should be used for quantification of particles larger than and smaller than 62  $\mu\text{m}$  in size. For this verification, a more thorough particle size distribution analyses with SM 2560 was utilized to provide a more thorough analysis of particle size counts.

### 4.4 Sampling Schedule

The monitoring equipment was installed in February 2005. From March 2005 through June 2005, several trial events were monitored, and the equipment tested and calibrated. Verification testing began in June 2005, and ended in May 2006. As defined in the test plan, “qualified” storm events met the following requirements:

- The total rainfall depth for the event, measured at the site rain gauge, was 0.2 in. (5 mm) or greater.
- Flow through the treatment device was successfully measured and recorded over the duration of the runoff period.
- A flow-proportional composite sample was successfully collected for both the influent and effluent over the duration of the runoff event.
- Each composite sample collected was comprised of a minimum of five aliquots, including at least two aliquots on the rising limb of the runoff hydrograph, at least one aliquot near the peak, and at least two aliquots on the falling limb.
- There was a minimum of six hours between qualified sampling events.

#### **4.5 Field Procedures for Sample Handling and Preservation**

Water samples were collected with Sigma automatic samplers programmed to collect aliquots during each sample cycle. A peristaltic pump on the sampler pumped water from the sampling location through Teflon™-lined sample tubing to the pump head where water passed through silicone tubing and into the sample collection bottles. After qualified events, samples were removed from the sampler, split and capped by PSH personnel. Samples were analyzed within the holding times allowed by the methods. All samples were analyzed at the PSH Environmental Engineering Research Laboratory. Custody was maintained according to the laboratory's sample handling procedures. To establish the necessary documentation to trace sample possession from the time of collection, field collection was documented for each set of samples and recorded both in the field book and on the computer system.

## **Chapter 5**

### **Monitoring Results and Discussion**

Precipitation and stormwater flow records were evaluated to verify that the storm events met the qualified event requirements. The qualified event data is summarized in this chapter. The monitoring results related to contaminant reduction over the events are reported in two formats, consistent with the protocol:

1. Efficiency ratio comparison, which evaluates the effectiveness of the system on an event mean concentration (EMC) basis.
2. Sum of loads (SOL) comparison, which evaluates the effectiveness of the system on a constituent mass (concentration times volume) basis.

The performance of the device will also be discussed in light of the specific maximum particle size, since the performance of the device is a function of a specific maximum particle size, and not the removal of a specific percentage of the total suspended solids or of the suspended sediment concentration load.

#### **5.1 Storm Event Data**

Table 5-1 summarizes the storm data for the qualified events. Detailed information on each storm's runoff hydrograph and the rain depth distribution over the event period are included in Appendix C.

The sample collection starting times for the influent and effluent samples, as well as the number of sample aliquots collected, varied from event to event. The samplers were activated when the rain gauges sensed a minimum of 0.08 in. of rain (each sampler had its own rain gauge). The value of 0.08 in. of rain was selected based on visual observation of the site during rain events. At rain depths smaller than 0.08 in., the runoff depth in the pipe was too low for adequate sampling. This also prevented the samplers from being turned on when there was a very small rain event or dry-weather flow entering the storm sewer system.

There was intermittent dry-weather flow (typically due to vehicle washing) entering the Terre Kleen™. Occasionally, the dry-weather flow volume was sufficient to activate the effluent sampler. The effluent sampler was operated from flow conditions for the first three storm events, but the trigger for effluent sampling was changed to the rain gauge after the third event to address the concerns of collecting sample aliquots from dry-weather flows.

##### **5.1.1 Flow Data Evaluation**

Table 5-2 summarizes the flow volumes and peak discharge rates for the influent and effluent monitoring locations for each of the qualified events. As described in the next paragraph, litter and sediment build-up was commonly observed on the velocity sensor in the influent pipe. This appeared to impact the flow readings; however, the influent auto sampler appeared to function properly. The effluent sampler flow data were used in all volume calculations except the storm of April 3, 2006, where the effluent flow logger recorded no data. For this event, the influent

pipe had been cleaned approximately a day before the storm, so potential interferences from sediment or litter were minimized, and the influent flow meter provided data to determine the storm volume.

When practical, sensors should be installed at a minimum distance of five times the maximum expected level upstream from an obstruction and ten times the expected level downstream from an obstruction. Obstacles were not an issue in the downstream pipe, but they were a concern for two reasons in the upstream pipe. The first concern was the accumulation of debris in the pipe between inlet I-11 and the Terre Kleen™. It appeared that the pipe joints were not smooth, resulting in a location between pipes where small rock-based dams could form in the pipe. In addition, the site received substantially more litter over the course of the testing than was expected. Some of the litter, such as plastic grocery bags, tended to snag on the influent flow meter. This litter was entrapped by the Terre Kleen™ and did not impact the performance of the effluent sampler.

**Table 5-1. Summary of Events Monitored for Verification Testing**

| <b>Event No.</b> | <b>Start Date</b> | <b>Start Time</b> | <b>End Date</b> | <b>End Time</b> | <b>Rainfall Amount (in.)<sup>1</sup></b> | <b>Rainfall Duration (hr:min)</b> |
|------------------|-------------------|-------------------|-----------------|-----------------|--|-----------------------------------|
| 1                | 6/29/05           | 12:00             | 6/29/05         | 14:00           | 0.31                                     | 2:00                              |
| 2                | 7/7/05            | 18:40             | 7/8/05          | 09:40           | 1.68                                     | 15:00                             |
| 3                | 8/16/05           | 09:35             | 8/17/05         | 0:35            | 0.43                                     | 11:10                             |
| 4                | 8/27/05           | 19:05             | 8/28/05         | 09:05           | 0.68                                     | 14:00                             |
| 5                | 9/16/05           | 18:55             | 9/17/05         | 0:35            | 1.22                                     | 5:40                              |
| 6                | 10/13/05          | 05:20             | 10/14/05        | 03:15           | 0.63                                     | 21:55                             |
| 7                | 10/21/05          | 22:45             | 10/22/05        | 23:00           | 1.17                                     | 24:15                             |
| 8                | 11/16/05          | 10:30             | 11/17/05        | 01:10           | 0.20                                     | 14:40                             |
| 9                | 11/21/05          | 23:20             | 11/22/05        | 08:35           | 0.52                                     | 9:45                              |
| 10               | 11/29/05          | 04:55             | 11/30/05        | 0:00            | 1.04                                     | 19:05                             |
| 11               | 12/25/05          | 11:50             | 12/25/05        | 20:30           | 0.45                                     | 8:40                              |
| 12               | 1/2/06            | 10:45             | 1/3/06          | 12:25           | 0.99                                     | 25:40                             |
| 13               | 1/11/06           | 12:50             | 1/11/06         | 23:55           | 0.42                                     | 11:05                             |
| 14               | 4/3/06            | 14:40             | 4/3/06          | 22:30           | 0.75                                     | 7:50                              |
| 15               | 5/13/06           | 16:20             | 5/15/06         | 22:30           | 0.71                                     | 54:10                             |

1. Rainfall depths recorded by the rain gauge corresponding to the effluent sampler.

**Table 5-2. Peak Discharge Rate and Runoff Volume Summary**

| <b>Event No.</b> | <b>Start Date</b> | <b>Peak Discharge Rate (cfs)<sup>1</sup></b> | <b>Runoff Volume (ft<sup>3</sup>)<sup>1</sup></b> |
|------------------|-------------------|--|---|
| 1                | 6/29/05           | 0.83   | 750   |
| 2                | 7/7/05            | 0.82   | 7,900   |
| 3                | 8/16/05           | 0.029  | 210   |
| 4                | 8/27/05           | 0.76   | 1,800   |
| 5                | 9/16/05           | 2.0  | 4,900   |
| 6                | 10/13/05          | 0.50   | 960   |
| 7                | 10/21/05          | 0.80   | 3,800   |
| 8                | 11/16/05          | 0.013  | 110   |
| 9                | 11/22/05          | 0.37   | 1,300   |
| 10               | 11/29/05          | 1.2  | 6,500   |
| 11               | 12/25/05          | 0.26   | 580   |
| 12               | 1/2/06            | 0.14   | 940   |
| 13               | 1/11/06           | 0.20   | 480   |
| 14               | 4/3/06            | 0.36   | 1,500   |
| 15               | 5/13/06           | 0.089  | 660   |

1. Peak discharge rate and runoff volume reported from effluent data, with the exception of Event 14, where the effluent sampler functioned properly but did not record flow data..

The flow monitors measured the depth and velocity of water in the pipe and calculated the flow rate at five-minute intervals using Manning’s equation with an assumption of normal depth. When the data were reported in the September 2006 version of this report, the flow volumes calculated by the sampler software were substantially higher than what would be expected for any of the rainfall amounts during the testing. A review of the flow records showed that the flow meter was calculating flow with Manning’s equation using the water depth and pipe slope, instead of water depth and velocity, which is generally perceived as being more accurate. The pipe slope method resulted in a velocity data which were substantially higher than the recorded velocity measurements, and resulted in higher calculated flow rates. Subsequently, the flow volumes rates were re-calculated for every qualified event using the recorded depth and velocity data using the flow meter software.

## **5.2 Monitoring Results: Performance Parameters**

### **5.2.1 Concentration Efficiency Ratio**

The concentration efficiency ratio reflects the treatment capability of the device using the event mean concentration (EMC) data obtained for each runoff event. The concentration efficiency ratios are calculated by:

$$\text{Efficiency ratio} = 100 \times (1 - [\text{EMC}_{\text{effluent}} / \text{EMC}_{\text{influent}}]) \quad (5-1)$$

The influent and effluent sample concentrations and calculated efficiency ratios are summarized by the analytical parameter (sediment) categories of TSS and SSC.

The influent and effluent sample concentrations and calculated efficiency ratios for sediments are summarized in Table 5-3. The TSS influent concentrations ranged from 58 to 6,870 mg/L, the effluent concentrations ranged from 35 to 980 mg/L, and the efficiency ratio ranged from -88% to 86%. The SSC influent concentrations ranged 110 to 430 mg/L, the effluent concentrations ranged from 55 to 200 mg/L, and the efficiency ratio ranged from -11% to 87%.

**Table 5-3. Monitoring Results and Efficiency Ratios for Sediment Parameters**

| Event No. | Date     | TSS             |                 |               | SSC             |                 |               |
|-----------|----------|-----------------|-----------------|---------------|-----------------|-----------------|---------------|
|           |          | Influent (mg/L) | Effluent (mg/L) | Reduction (%) | Influent (mg/L) | Effluent (mg/L) | Reduction (%) |
| 1         | 6/29/05  | 540             | 380             | 30            | 500             | 360             | 28            |
| 2         | 7/07/05  | 190             | 190             | 0             | 220             | 200             | 9.1           |
| 3         | 8/16/05  | 69              | 130             | -88           | 140             | 35              | 75            |
| 4         | 8/27/05  | 58              | 35              | 40            | 75              | 38              | 49            |
| 5         | 9/16/05  | 870             | 650             | 25            | 3,800           | 500             | 87            |
| 6         | 10/13/05 | 140             | 140             | 0             | 140             | 140             | 0             |
| 7         | 10/21/05 | 210             | 150             | 29            | 200             | 170             | 15            |
| 8         | 11/16/05 | 250             | 120             | 52            | 220             | 150             | 32            |
| 9         | 11/22/05 | 340             | 220             | 35            | 280             | 300             | -7.1          |
| 10        | 11/29/05 | 1,100           | 590             | 46            | 1,600           | 1,000           | 38            |
| 11        | 12/25/05 | 850             | 240             | 72            | 680             | 110             | 84            |
| 12        | 1/02/06  | 310             | 130             | 58            | 520             | 130             | 75            |
| 13        | 1/11/06  | 890             | 840             | 5.6           | 810             | 900             | -11           |
| 14        | 4/03/06  | 840             | 640             | 24            | 780             | 540             | 31            |
| 15        | 5/13/06  | 6,900           | 980             | 86            | 7,000           | 1,500           | 79            |

As described in Section 3.2, site conditions changed during the fall of 2005. The non-functioning incinerator was restarted for test fire burns and construction began to open up the hillside at the edge of the Terre Kleen's drainage area for ash disposal. The construction had limited, but periodic, effects on the influent solids concentration. The effects of substantially increasing influent solids concentration were most notable when the incinerator began full operation of one burner at the end of November 2005 (from average TSS/SSC less than 350 mg/L influent to greater than 700 mg/L influent TSS/SSC).

In general, the results show a similarity between influent TSS and SSC concentrations. Both the TSS and SSC analytical parameters measure sediment concentrations in water. However, the TSS analytical procedure requires the analyst to draw an aliquot from the sample container, while the SSC procedure requires use of the entire contents of the sample container. If a sample contains a high concentration of settleable (large particle size or high density) solids, acquiring a



representative aliquot from the sample container for the TSS analysis may be very difficult. A disproportionate amount of the settled solids may be left in the container, resulting in a reported TSS concentration lower than the SSC concentration. Since this phenomenon was not observed during this study, it appears that the sediment loading consisted primarily of sediments with small particle size. This observation correlates with the particle size distribution data summarized in Section 5.3.

### 5.2.2 *Sum of Loads*

The sum of loads (SOL) is the sum of the percent load reduction efficiencies for all of the events, and provides a measure of the overall performance efficiency of the Terre Kleen™. The load reduction efficiency is calculated using the following equation:

$$\% \text{ Load Reduction Efficiency} = 100 \times (1 - (A / B)) \quad (5-2)$$

where:

$$A = \text{Sum of Effluent Load} = (\text{Effluent EMC}_1)(\text{Flow Volume}_1) + (\text{Effluent EMC}_2)(\text{Flow Volume}_2) + (\text{Effluent EMC}_n)(\text{Flow Volume}_n)$$

$$B = \text{Sum of Influent Load} = (\text{Influent EMC}_1)(\text{Flow Volume}_1) + (\text{Effluent EMC}_2)(\text{Flow Volume}_2) + (\text{Effluent EMC}_n)(\text{Flow Volume}_n)$$

n = Number of qualified sampling events

As noted in Section 5.1.1, the effluent monitoring location provided the most representative flow data, so the SOL calculation was made using the effluent volumes for both the influent and effluent data.

Table 5-4 summarizes results for the SOL calculations for TSS and SSC. The SOL analyses indicate a 44% reduction for TSS and a 63% reduction for SSC.

**Table 5-4. Sediment Sum of Loads Results**

| Event No.                     | Date     | Runoff<br>Volume<br>(ft <sup>3</sup> ) | TSS              |                  | SSC              |                  |
|-------------------------------|----------|--|------------------|------------------|------------------|------------------|
|                               |          |  | Influent<br>(lb) | Effluent<br>(lb) | Influent<br>(lb) | Effluent<br>(lb) |
| 1                             | 6/29/05  | 750                                    | 25               | 18               | 23               | 17               |
| 2                             | 7/7/05   | 7,900                                  | 93               | 93               | 98               | 98               |
| 3                             | 8/16/05  | 210                                    | 0.9              | 1.7              | 1.9              | 0.5              |
| 4                             | 8/27/05  | 1,800                                  | 6.6              | 4.0              | 8.5              | 4.3              |
| 5                             | 9/16/05  | 4,900                                  | 270              | 200              | 1,200            | 150              |
| 6                             | 10/13/05 | 960                                    | 8.3              | 8.3              | 8.3              | 8.3              |
| 7                             | 10/21/05 | 3,800                                  | 50               | 36               | 47               | 40               |
| 8                             | 11/16/05 | 110                                    | 1.6              | 0.8              | 1.4              | 1.0              |
| 9                             | 11/22/05 | 1,300                                  | 28               | 18               | 23               | 24               |
| 10                            | 11/29/05 | 6,500                                  | 450              | 240              | 650              | 410              |
| 11                            | 12/25/05 | 580                                    | 31               | 8.6              | 24               | 3.9              |
| 12                            | 1/2/06   | 940                                    | 18               | 7.7              | 31               | 7.7              |
| 13                            | 1/11/06  | 480                                    | 27               | 25               | 24               | 27               |
| 14                            | 4/3/06   | 1,500                                  | 79               | 61               | 74               | 51               |
| 15                            | 5/13/06  | 660                                    | 280              | 40               | 290              | 62               |
| <b>Sum of the Loads</b>       |          |  | <b>1,400</b>     | <b>760</b>       | <b>2,500</b>     | <b>910</b>       |
| <b>Removal Efficiency (%)</b> |          |  | <b>44</b>        |                  | <b>63</b>        |                  |

### 5.3 Particle Size Distribution

Particle size distribution analysis was conducted by:

- Sieving the samples to create a second series of TSS and SSC samples that contained particles smaller than 250 µm; and,
- Analyzing the samples using a Coulter Multisizer 3, an instrument (described in the test plan) that measures particle concentration as counts according to particle size.

#### 5.3.1 Particle Size Distribution with Sieve Data

With the apertures available in the PSH laboratory, each sample could be analyzed over a particle size range of 0.8 to 240 µm. In addition, the fraction of the samples above 250 µm could be quantified. The results of the 250-µm sieve split are summarized in Table 5-5, which demonstrate that the SSC analysis was a better measure to quantify the larger particles than TSS. Recalculating the SOL for both TSS and SSC for particles larger than 250 µm shows an 85% reduction for TSS, and a 98% reduction for SSC. The lower removal for TSS has two possible origins: taking a sample aliquot from a bottle instead of analyzing the whole sample; or the potential for scour/resuspension of previously captured solids.

**Table 5-5. Particle Size Distribution Analysis Results (Particle Sizes > 250 µm)**

| Event<br>No                         | <u>TSS</u>      |                 | <u>SSC</u>      |                 | <u>TSS</u>       |                  | <u>SSC</u>       |                  |
|-------------------------------------|-----------------|-----------------|-----------------|-----------------|------------------|------------------|------------------|------------------|
|                                     | Influent<br>(%) | Effluent<br>(%) | Influent<br>(%) | Effluent<br>(%) | Influent<br>(lb) | Effluent<br>(lb) | Influent<br>(lb) | Effluent<br>(lb) |
| 1                                   | NA              | NA              | NA              | NA              | NA               | NA               | NA               | NA               |
| 2                                   | 7               | 1               | NA              | NA              | 6.5              | 0.9              | NA               | NA               |
| 3                                   | 9               | 76              | 54              | 0               | 0.1              | 1.3              | 1.0              | 0                |
| 4                                   | 11              | 17              | 15              | 2               | 0.7              | 0.7              | 1.3              | 0.1              |
| 5                                   | 39              | 16              | 88              | 0               | 110              | 32               | 1,000            | 0                |
| 6                                   | 0               | 0               | 6               | 4               | 0                | 0                | 0.5              | 0.3              |
| 7                                   | 15              | 0               | 11              | 0               | 7.5              | 0                | 5.2              | 0                |
| 8                                   | 12              | 3               | 7               | 12              | 0.2              | 0                | 0.1              | 0.1              |
| 9                                   | 16              | 15              | 32              | 42              | 4.4              | 2.7              | 7.3              | 10               |
| 10                                  | 28              | 4               | 20              | 1               | 130              | 9.6              | 130              | 4.1              |
| 11                                  | 33              | 0               | 40              | 0               | 10               | 0                | 9.8              | 0                |
| 12                                  | 0               | 7               | 29              | 15              | 0                | 0.5              | 8.9              | 1.1              |
| 13                                  | 0               | 1               | 0               | 16              | 0                | 0.3              | 0                | 4.3              |
| 14                                  | 7               | 4               | 11              | 0               | 5.6              | 2.4              | 8.1              | 0                |
| 15                                  | 24              | 0               | 7               | 11              | 68               | 0                | 20               | 6.8              |
| <b>Sum of the Loads</b>             |                 |                 |                 |                 | <b>330</b>       | <b>51</b>        | <b>1,200</b>     | <b>27</b>        |
| <b>Removal Efficiency (percent)</b> |                 |                 |                 |                 | <b>85</b>        |                  | <b>98</b>        |                  |

NA – Not available.

The vendor claimed that the device would remove 100% of the particles greater than 200 µm. Assuming that the influent is well mixed (in the water column), sedimentation theory for flocculating particles indicates that some, but smaller than total, reduction in particles smaller than the cutoff size is expected. Complete sedimentation assumes that the particles do not interact with each other during sedimentation. These results indicate that complete sedimentation of particles greater than 250 µm does not occur, likely due to non-ideal behavior of the particles (such as by the creation of slower-settling flocs with the oils in the runoff) or due to very light particles in the runoff. Based on the samples' behavior in the lab and the amount of oil collected in the primary chamber of the Terre Kleen, it is believed that the creation of flocs and emulsions created non-ideal settling conditions in the treatment device.

Using the data from Tables 5-4 and 5-5, it is also possible to calculate the percentage reduction in loads of particles smaller than 250 µm. Table 5-6 summarizes the results of this calculation. For particles smaller than 250 µm, the TSS evaluation shows a 35% reduction, while the SSC evaluation shows a 32% reduction.

**Table 5-6. Particle Size Distribution Analysis Results (Particle Sizes Smaller than 250 µm)**

| Event No. <sup>1</sup>        | <u>TSS</u>       |                  | <u>SSC</u>       |                  |
|-------------------------------|------------------|------------------|------------------|------------------|
|                               | Influent<br>(lb) | Effluent<br>(lb) | Influent<br>(lb) | Effluent<br>(lb) |
| 3                             | 0.8              | 0.4              | 0.9              | 0.5              |
| 4                             | 5.8              | 3.3              | 7.2              | 4.2              |
| 5                             | 160              | 170              | 140              | 150              |
| 6                             | 8.3              | 8.3              | 7.8              | 8                |
| 7                             | 42               | 36               | 42               | 40               |
| 8                             | 1.4              | 0.8              | 1.3              | 0.9              |
| 9                             | 23               | 15               | 16               | 14               |
| 10                            | 320              | 230              | 520              | 400              |
| 11                            | 20               | 8.6              | 15               | 3.9              |
| 12                            | 18               | 7.1              | 22               | 6.5              |
| 13                            | 27               | 25               | 24               | 23               |
| 14                            | 74               | 58               | 66               | 51               |
| 15                            | 220              | 40               | 270              | 55               |
| <b>Sum of the Loads</b>       | <b>920</b>       | <b>600</b>       | <b>1,100</b>     | <b>770</b>       |
| <b>Removal Efficiency (%)</b> | <b>35</b>        |                  | <b>32</b>        |                  |

1. Data were not available for Events 1 or 2.

### 5.3.2 Particle Size Distribution with Coulter Counter Data

While the analysis discussing the behavior of particles > 250 µm is most relevant to the vendor’s performance claim, samples were also analyzed using the Coulter Counter for particle sized between 0.8 and 240 µm. Particle size distribution analyses were completed on individual storm events.

#### Coulter Counter Analysis – Single Storm Event

For the purposes of this evaluation, the storm of November 16, 2005 was arbitrarily selected for evaluation purposes to demonstrate how the Coulter Counter analyses were completed. A comparison between the influent and effluent samples for the storm is shown in Figure 5-1 for analysis of the number of particles of a particular diameter, and in Figure 5-2 for analyzing the volume of particles of a particular diameter. The volume graph is most comparable to the traditional sieve analysis (because of the relationship to mass through density) and it is the one that will be discussed.

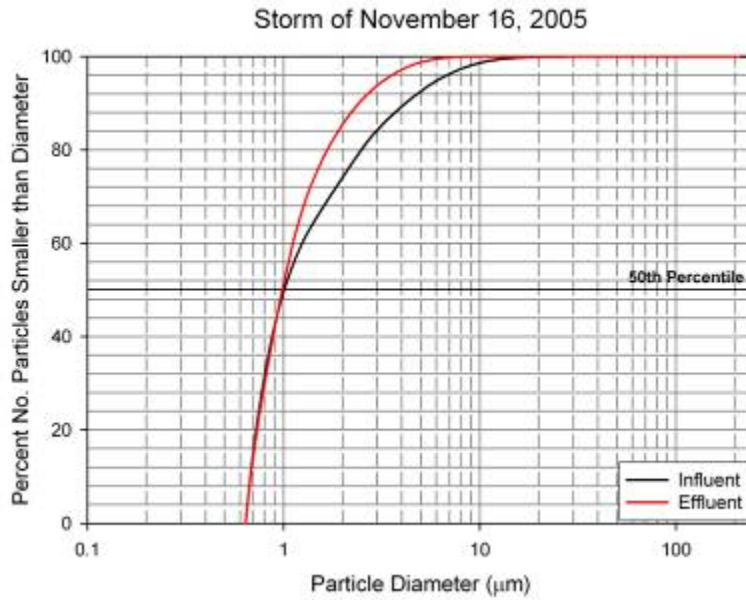

**Figure 5-1. Coulter analysis comparison by count of the Terre Kleen™ influent and effluent total particle count for Event 8.**

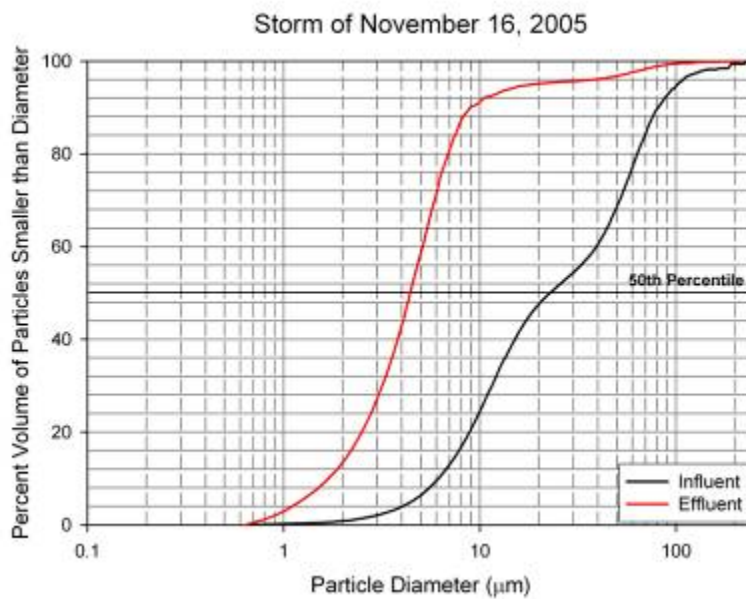

**Figure 5-2. Coulter analysis comparison by volume of the Terre Kleen™ influent and effluent particle volume for Event 8.**

Figure 5-1 shows that when analyzing for a total particle count, the  $d_{50}$  (the particle size corresponding to the 50<sup>th</sup> percentile of the cumulative volume of particles in the sample) of the influent and effluent samples are essentially the same. The  $d_{50}$  by particle count is approximately 1  $\mu\text{m}$ , further emphasizing the small size of the particles in the stormwater runoff at the test site. However, when analyzing the results by volume (Figure 5-2), which is most directly relatable to traditional sieve analysis, the  $d_{50}$  shifts from approximately 20 to 25  $\mu\text{m}$  for the influent to approximately 4.2  $\mu\text{m}$  for the effluent, indicating a substantial removal of the larger particles. This is confirmed on the number count graph (Figure 5-1) by the shift to the “left” of the effluent at the upper end of the particle size range.

Incorporating the two particle size analyses with the data for material  $> 250 \mu\text{m}$  results in the graph shown in Figure 5-3. The graph shows that the  $d_{50}$  of the influent is approximately 30  $\mu\text{m}$  and the effluent approximately 5  $\mu\text{m}$ . This shift in the  $d_{50}$  to the smaller size ranges indicates that removal of both larger and smaller particles is occurring, as would be expected of any sedimentation device as long as complete mixing of the influent occurs. Above a certain particle size, 100% removal is anticipated, and for the smaller particles, partial removal is attained.

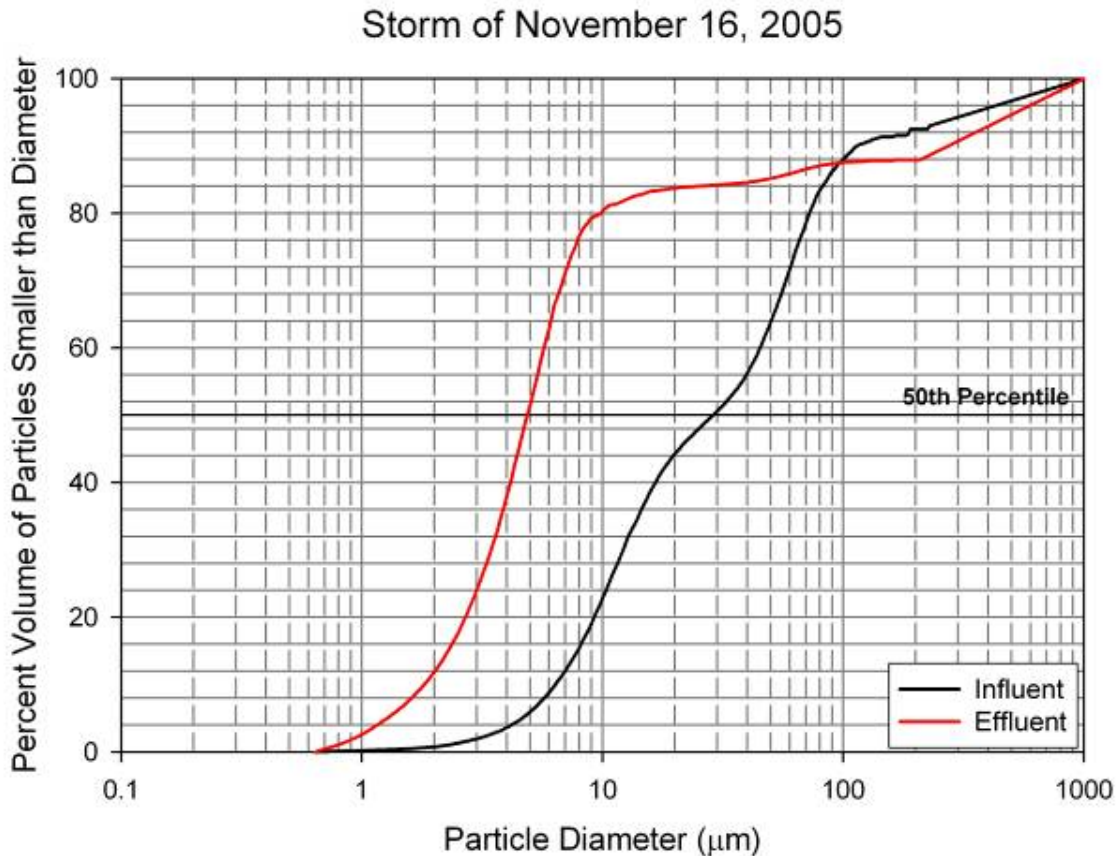

**Figure 5-3. Complete particle size distribution for influent and effluent samples from Event 8.**

## Coulter Counter Analysis – All Qualified Storm Events

The November 16, 2005 storm was arbitrarily selected as a demonstration of analysis for a single storm event. This type of analysis was repeated for the entire sample set for the composite samples. Where duplicate composites were available (for two storms, there was insufficient volume to create replicate samples), each composite was included in the calculations. The particle size distributions for the influent and effluent samples for all sampled storm events were calculated and adjusted for the mass above 250  $\mu\text{m}$  to create a complete mass distribution. The mean particle size for five points on the sieve analysis curve ( $d_{10}$ ,  $d_{25}$ ,  $d_{50}$ ,  $d_{75}$ ,  $d_{90}$ ) were calculated and graphed, and error bars were created assuming that the size of the error bar was one standard deviation (shown only on the positive side when the error bar would exceed the graph width). The results of the analyses are shown in Figure 5-4.

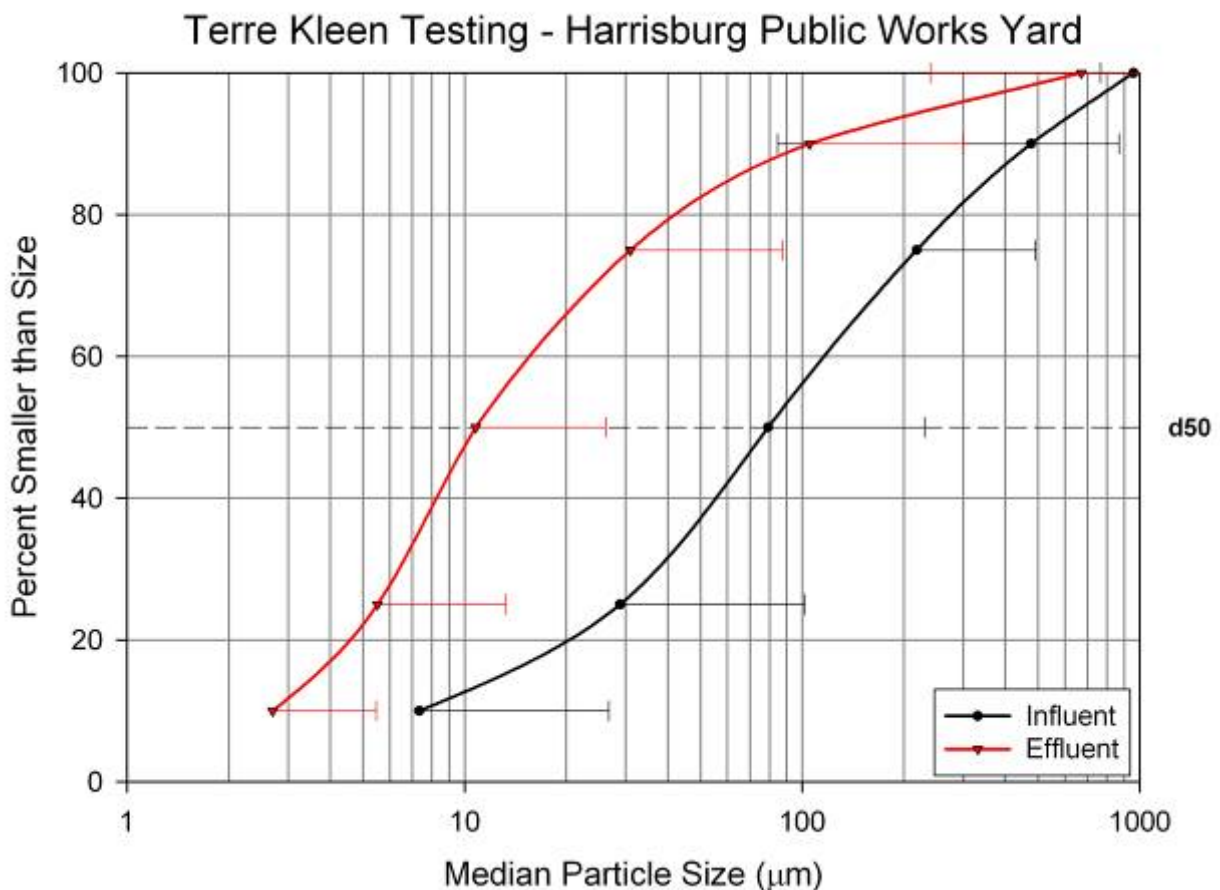

**Figure 5-4. Particle size distribution for influent and effluent samples from all sampled storm events using mean  $d_{10}$ ,  $d_{25}$ ,  $d_{50}$ ,  $d_{75}$ , and  $d_{90}$ .**

Figure 5-4 shows there is a definite shift in the particle size distribution between the influent and effluent, even for composite samples where some of the instantaneous impact of the Terre Kleen™ may be muted due to sample compositing. The error bars highlight the high degree of variability in the composition of the influent and effluent samples from this site. The  $d_{50}$  of the

site, calculated using the mean, shifted from approximately 80  $\mu\text{m}$  in the influent to just over 10  $\mu\text{m}$  in the effluent. Because of this variability in the particle size distributions between samples, the data was reanalyzed using the median particle sizes to reduce the effect of the very large and very small values on the data analysis. The results of the median analyses are summarized in Figure 5-5, and show that the site's median particle diameter shifted from approximately 10.5  $\mu\text{m}$  in the influent to approximately 6.6  $\mu\text{m}$  in the effluent.

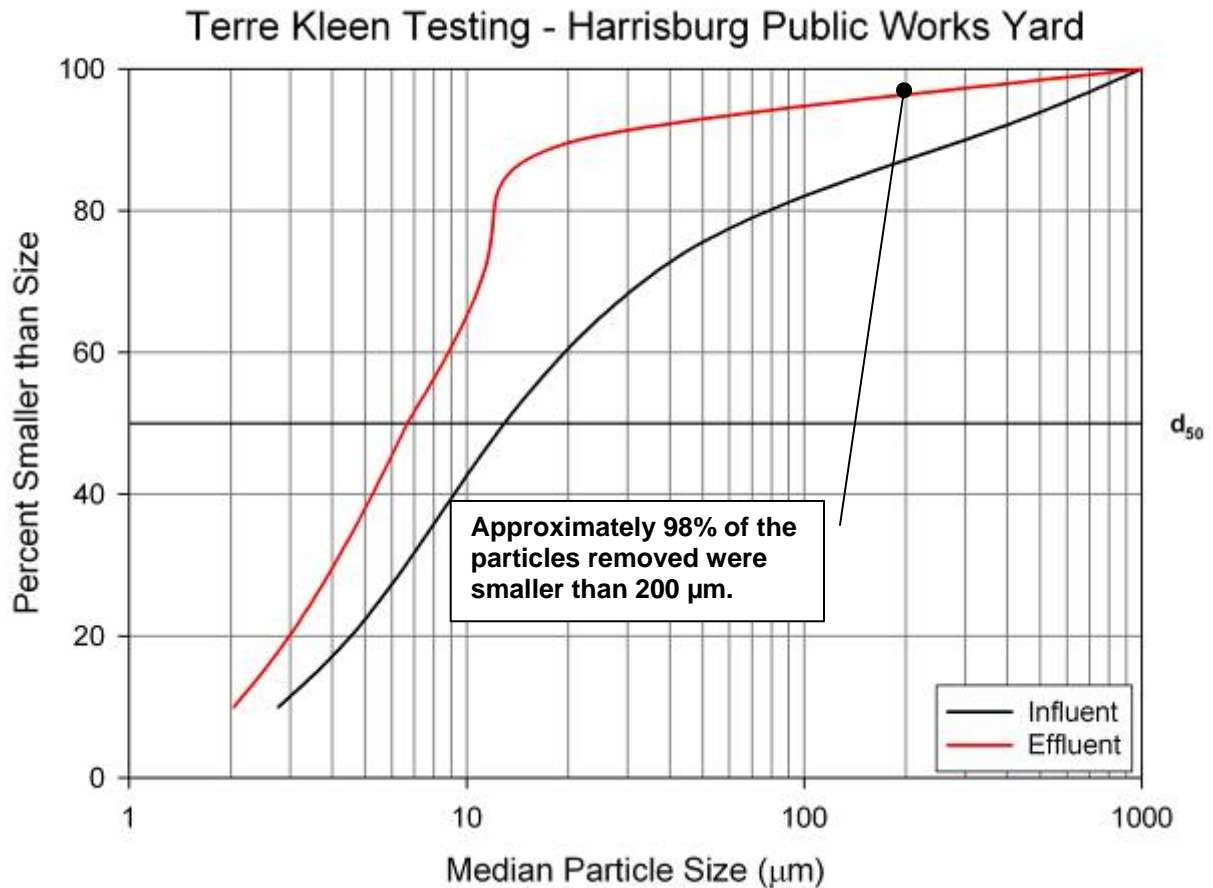

**Figure 5-5. Particle size distribution for influent and effluent samples using median  $d_{10}$ ,  $d_{25}$ ,  $d_{50}$ ,  $d_{75}$ , and  $d_{90}$ .**

The vendor's performance claim stated that the Terre Kleen™ would remove 100% of the particles 200  $\mu\text{m}$  and larger when the device was operated at no greater than the design flow. A review of Figure 5-5 shows that the effluent quality, as measured in these composite samples, did not meet this performance claim. The composite samples showed that the Terre Kleen™ removed approximately 95% to 98% of the particles 200  $\mu\text{m}$  and larger. This data, however, has to be combined with the hydrologic data for the site. The Terre Kleen™ does not contain an inlet flow-control structure where the device only treats the flow up to a certain rate and then bypasses everything else. The entire flow entering the device passes through it (bypass over the plates was monitored after the primary chamber and at no time during the testing were the plates bypassed).



For many of the storms, the device treated instantaneous flow rates greater than the design flow for between ten minutes and two hours. During those times, the higher hydraulic flow rate would create a condition where it would not be expected that the device would remove the 200 µm or larger particles. Therefore, the composite samples likely contain these larger particles.

### 5.3.3 Particle Size Distribution and Hjulstrom Diagram Evaluation

Section 2.2 of the verification report indicated that the vendor uses the Hjulstrom diagram as the basis for their sediment removal performance claims. The Terre Kleen™ performance was evaluated against the Hjulstrom diagram for events where individual grab sample aliquots remained after samples were composited. This evaluation went beyond the test plan requirements, but helped to evaluate the Terre Kleen™ performance and the relevance of the Hjulstrom diagram to stormwater treatment and the vendor's performance claim.

In order to conduct the Hjulstrom diagram evaluation, the particle size and velocity data for the grab samples had to be gathered. Particle size analysis was performed on grab samples for events where sufficient sample was leftover after compositing on a per-bottle basis. The VO determined that the 95<sup>th</sup> percentile particles for the Terre Kleen™ field results should be used for plotting on the Hjulstrom diagram because the 95<sup>th</sup> percentile particle size more accurately represents the upper end of the particle size distribution in the water, and that only 3 to 5 particles represent the remaining mass between the 95<sup>th</sup> and 100<sup>th</sup> percentile.

The instantaneous horizontal water velocity through the laminar plates in the Terre Kleen™ was calculated based on the effluent flow hydrograph using the following equation (AWWA, 1990):

$$v = \frac{Q}{Nwb} \quad (5-3)$$

where:

$v$  = horizontal water velocity (or hydraulic loading rate)

$Q$  = flow rate (calculated from independent level and velocity measurements in the effluent pipe)

$w$  = horizontal width between laminar plates

$b$  = length of one plate in the direction perpendicular to flow

$N$  = number of sedimentation cells

The 95<sup>th</sup> percentile largest sediment particle and horizontal water velocity data were then plotted on the Hjulstrom diagram provided by the vendor. The revised Hjulstrom diagram is shown in Figure 5-6.

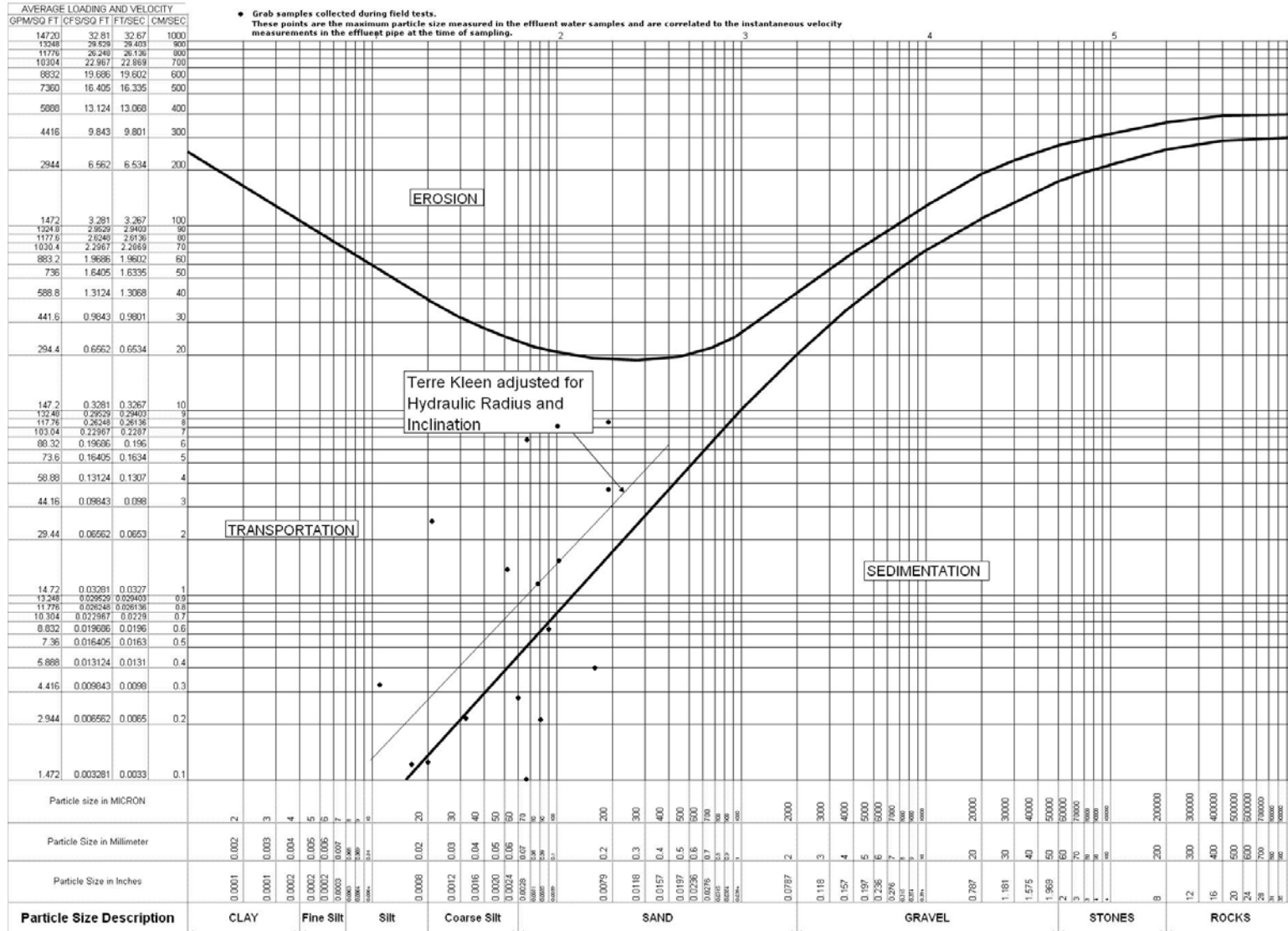

Figure 5-6. Hjulstrom diagram plotting the 95<sup>th</sup> percentile particle size remaining in solution versus the horizontal water velocity through the plates.

Figure 5-6 shows approximately half of the data points in the sedimentation zone, and the other half in the transportation zone. If the Hjulstrom diagram was precisely predicting the site conditions, the data points would lie in the transportation zone, just above the line adjusted for hydraulic radius and inclination. Several reasons could be used to explain the variation, including, but not limited to:

- Water temperature and its impact on water viscosity;
- Non-ideal settling conditions, including turbidity associated with deeper flow conditions and sediment cohesion caused by clay particles and hydrocarbons;
- The presence of irreducibly fine silt particles in the water;
- Variations in particle densities;
- Differences in flow depth between the Terre Kleen™ and the flume on which the Hjulstrom Diagram is based; or
- Sampling inaccuracies.

#### **5.4 Retained Solids Analysis**

During January 2006, after an observation noting substantial negative removals were occurring in the Terre Kleen, the unit was inspected and sediment depths measured. It was determined that the unit needed to be cleaned. The City of Harrisburg agreed to provide the sewer vacuum truck to perform the needed cleaning. Prior to the cleaning, samples were collected in several locations in the device. These samples were composited and shipped to an outside laboratory for a particle size distribution and chemical (Toxicity Characteristic Leachate Procedure [TCLP]) analysis.

##### ***5.4.1 Particle Size Distribution of Retained Solids***

A particle size distribution analysis of the sediment retained in the Terre Kleen™ was performed on a composite sample of the solids. The results of the analysis for particle size distribution are shown in Figure 5-7.

As with all sedimentation devices, for any given flow rate, the device should have a particle size for which 100% removal will occur. This does not mean that particles smaller than that 100%-removal size will not occur, just that they will not be completely removed. Figure 5-7 shows that 80% of the material captured in the sediment storage areas was smaller than the 200- $\mu\text{m}$  particle for which 100% removal was claimed. The analysis also indicates that the Terre Kleen™ is capable of removing and retaining particles smaller than 200  $\mu\text{m}$ .

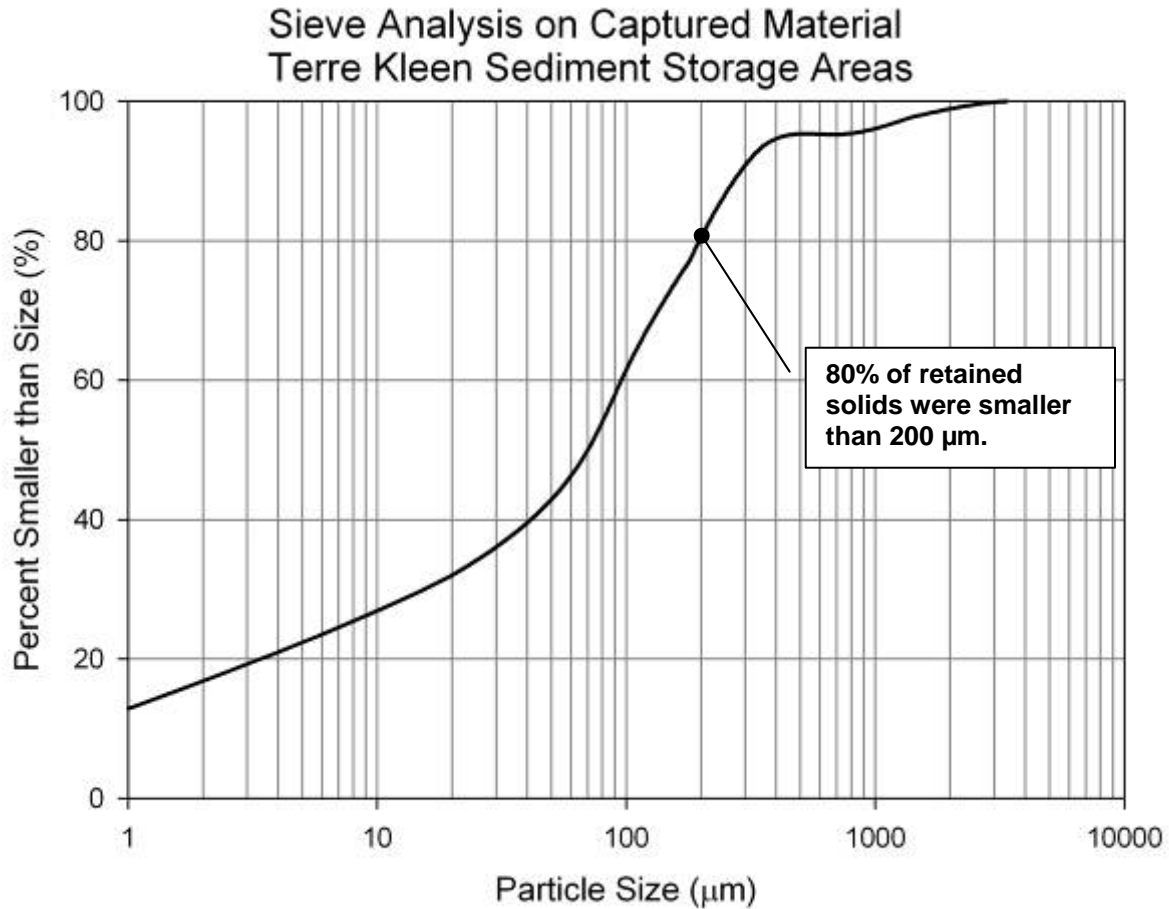

**Figure 5-7. Particle size distribution for material captured in the sediment storages areas of the Terre Kleen™.**

#### **5.4.2 TCLP Analysis of Retained Solids**

A composite sample of the retained solids was also analyzed for metals content in accordance with the guidance for determining if the collected material is a hazardous waste. The test selected for this analysis was the TCLP, a test designed to simulate the behavior of a waste material in contact with acids and acid rain leachate in a landfill. The results are reported in Table 5-7. As expected because of the high organic content of the solids at the site and the resulting high sorption affinity of the metals for the solids, the disposal solids were not hazardous in accordance with the hazardous waste regulations. It is important to note that these results are site-specific and are dependent on the metals found as sources on the site (with the exception of mercury, where most of the mercury in runoff is from airborne deposition). It is anticipated that these results, in general, would be seen at other installation locations for the Terre Kleen™. However, when installed at a site with known specific problems of dissolved or colloidal-sized metals in the runoff or of large metal pieces in the runoff, the captured solids should be tested prior to disposal to confirm the appropriateness of municipal landfill disposal.

**Table 5-7. Results for Cleanout Solids**

| <b>Parameter</b> | <b>TCLP Result (mg/L)</b> | <b>Regulatory Hazardous Waste Limit (mg/L)</b> |
|------------------|---------------------------|--|
| Arsenic          | <0.01                     | 5.0  |
| Barium           | <0.01                     | 100  |
| Cadmium          | <0.01                     | 1.0  |
| Chromium         | 0.10                      | 5.0  |
| Copper           | 1.12                      | NA   |
| Lead             | 0.69                      | 5.0  |
| Mercury          | <0.01                     | 0.2  |
| Nickel           | 0.27                      | NA   |
| Selenium         | <0.01                     | 1.0  |

NA: Not applicable.

## Chapter 6 QA/QC Results and Summary

The Quality Assurance Project Plan (QAPP) in the test plan identified critical measurements and established several QA/QC objectives. The verification test procedures and data collection followed the QAPP. QA/QC summary results are reported in this section, and the full laboratory QA/QC results and supporting documents are presented in Appendix D.

### 6.1 Laboratory/Analytical Data QA/QC

#### 6.1.1 *Bias (Field Blanks)*

Field blanks were collected at both the inlet and outlet samplers to evaluate the potential for sample contamination through the automatic sampler, sample collection bottles, splitters, and filtering devices. The field blanks were analyzed for TSS and SSC only. All samples were below the method detection limit of 5 mg/L, indicating that the samplers were capable of pulling up clean samples. Because of the nature of the influent at the maintenance yard site with the oils and greases, the sampler tubing was replaced and the sampler inlet was cleaned periodically throughout the project.

#### 6.1.2 *Replicates (Precision)*

Precision measurements were performed by the collection and analysis of duplicate samples. The relative percent difference (RPD) recorded from the sample analyses was calculated to evaluate precision. RPD is calculated using the following formula:

$$\% RPD = \left( \frac{|x_1 - x_2|}{\bar{x}} \right) \times 100\% \quad (6-1)$$

where:

$x_1$  = Concentration of compound in sample

$x_2$  = Concentration of compound in duplicate

$\bar{x}$  = Mean value of  $x_1$  and  $x_2$

The RPD data show an acceptable level of field precision, with a few parameters outside generally accepted limits. In most circumstances where the RPD values are high, the concentrations were near or below method detection limits.

*Field precision:* To address the concern of the ability of the sampler to provide repeatable samples, a sampler calibration procedure was performed prior to installing the samplers in the field. A Sil-Co-Sil 106-250 mixture of 200 mg/L was created and 15 replicate samples were collected by the sampler and by hand, grabbing a sample immediately after the sampler collected an aliquot. The results of this sampler calibration are shown in Table 6-1. The results show that the sampler has a higher variability associated with it, but one that is in the acceptable range of error, as measured by the coefficient of variation (COV) (equal to the standard deviation divided by the mean and which provides a measure of the variability relative to the sample average). Part of these differences also may be attributed to the hand mixing of the solution between sampling intervals and to the potentially slightly different sampling heights in the water column.

**Table 6-1. Sampler Calibration for TSS using Sil-Co-Sil Mixture**

| Sample Number    | <u>TSS (mg/L)</u> |             |
|------------------|-------------------|-------------|
|                  | Hand              | Sampler     |
| 1                | 170               | 200         |
| 2                | 200               | 180         |
| 3                | 190               | 150         |
| 4                | 200               | 230         |
| 5                | 160               | 190         |
| 6                | 210               | 210         |
| 7                | 210               | 180         |
| 8                | 210               | 160         |
| 9                | 200               | 220         |
| 10               | 200               | 200         |
| 11               | 180               | 360         |
| 12               | 210               | 150         |
| 13               | 190               | 200         |
| 14               | 230               | 180         |
| 15               | 200               | 170         |
| <b>Average</b>   | <b>197</b>        | <b>199</b>  |
| <b>Std. Dev.</b> | <b>16.9</b>       | <b>48.8</b> |
| <b>COV</b>       | <b>0.09</b>       | <b>0.25</b> |

Field duplicates were collected to monitor the overall precision of the sample collection procedures, including sample splitting. Duplicate inlet samples were collected during two different storm events to evaluate precision in the sampling process and analysis. The duplicate samples were processed, delivered to the laboratory, and analyzed in the same manner as the regular samples. Summaries of the field duplicate data are presented in Table 6-2.

In addition, for periodic storms, not all sample bottles collected were used in the compositing. These individual bottles were periodically analyzed for the same constituents as the composite samples. The results of these analyses are shown in Table 6-3 as a comparison between the field composite sample and the average of the three per-bottle analyses. This is a second method of

verifying that quality control was maintained. This method was performed because many of the qualifying events had most or all of the collected bottles from the sampler used to make the composite. As can be seen, the RPDs are generally in accordance with the desired replication between the field duplicates. Differences are only seen for the storms where the concentration in the individual bottles varied greatly over the storm. This variance across an individual storm was not unexpected since the variable nature of rainfall and intensity on the site will affect the TSS/SSC concentration of the runoff.

**Table 6-2. Field Duplicate Sample Relative Percent Difference Data Summary**

| Analyte | Units | Event 1 |       |      | Event 2 |       |     |
|---------|-------|---------|-------|------|---------|-------|-----|
|         |       | Rep 1   | Rep 2 | RPD  | Rep 1   | Rep 2 | RPD |
| TSS     | mg/L  | 1,322   | 1,316 | 0.45 | 564     | 768   | 31  |

**Table 6-3. Comparison of Composite Concentration with Per-Bottle Average**

| Event Date            | Composite SSC (mg/L) | Average SSC of Per Bottle Samples (mg/L) | RPD |
|-----------------------|----------------------|--|-----|
| 12/25/2005 - Influent | 680                  | 550                                      | 19  |
| 12/25/2005 - Effluent | 110                  | 190                                      | 73  |
| 11/29/2005 - Influent | 1600                 | 1800                                     | 13  |
| 11/29/2005 - Effluent | 990                  | 1200                                     | 21  |
| 11/22/2005 - Influent | 280                  | 280                                      | 0   |
| 11/22/2005 - Effluent | 170                  | 170                                      | 0   |
| 11/16/2005 - Influent | 220                  | 250                                      | 14  |
| 11/16/2005 - Effluent | 150                  | 130                                      | 13  |
| 10/22/2005 - Influent | 200                  | 300                                      | 50  |
| 10/22/2005 - Effluent | 170                  | 120                                      | 29  |
| 10/13/2005 - Influent | 140                  | 160                                      | 14  |
| 10/13/2005 - Effluent | 140                  | 110                                      | 21  |
| 9/17/2005 - Influent  | 3,800                | 3,100                                    | 18  |
| 9/17/2005 - Effluent  | 500                  | 600                                      | 20  |
| 4/3/2006 - Influent   | 780                  | 1400                                     | 79  |
| 4/3/2006 - Effluent   | 540                  | 650                                      | 20  |

*Laboratory precision:* As part of their QA/QC program, PSH analyzed duplicate samples from the cone splitter for every storm for which there was sufficient sample volume. Summaries of the laboratory duplicate data are presented in Table 6-4. Laboratory spikes were discussed as part of the sampler calibration (see Table 6-1). As can be seen from an analysis of that data, the precision of the sampling of the automatic sampler and the analysis combined are an average of



25%. The data show that the quality of sampling and analysis was maintained throughout the course of the project.

### 6.1.3 Accuracy

Method accuracy was determined and monitored using a combination of MS/MSD and laboratory control samples (known concentration in blank water). This information was also pulled from the sampler calibration data. The MS/MSD information showed that the accuracy achieved by the automatic sampler and the full analytical procedures was 2%. The MS/MSD data are evaluated by calculating the deviation from perfect recovery (100%), while laboratory control data are evaluated by calculating the absolute value of deviation from the laboratory control concentration.

The balance used for TSS and SSC analyses was calibrated routinely with weights that were NIST traceable. The laboratory maintained calibration records. The temperature of the drying oven was also monitored using a thermometer that was calibrated with an NIST traceable thermometer.

**Table 6-4. Laboratory Duplicate Sample Relative Percent Difference Data Summary**

| <b>Parameter</b> | <b>Count</b> | <b>Average (%)</b> | <b>Maximum (%)</b> | <b>Minimum (%)</b> | <b>Standard Deviation (%)</b> | <b>Objective (%)</b> |
|------------------|--------------|--------------------|--------------------|--------------------|-------------------------------|----------------------|
| TSS              | 30           | 11                 | 75                 | 0                  | 16                            | 0 – 30               |
| SSC              | 30           | 15                 | 84                 | 0                  | 19                            | 0 – 30               |

### 6.1.4 Representativeness

The field procedures were designed to ensure that representative samples were collected of both influent and effluent stormwater. Field duplicate samples and supervisor oversight provided assurance that procedures were being followed. The challenge in sampling stormwater is obtaining representative samples. The data indicated that while individual sample variability might occur, the long-term trend in the data was representative of the concentrations in the stormwater, and redundant methods of evaluating key constituent loadings in the stormwater were utilized to compensate for the variability of the laboratory data.

The laboratories used standard analytical methods, with written SOPs for each method, to provide a consistent approach to all analyses. Sample handling, storage, and analytical methodology were reviewed to verify that standard procedures were being followed. The use of standard methodology, supported by proper quality control information and audits, ensured that the analytical data were representative of actual stormwater conditions.

### 6.1.5 *Completeness*

Completeness is a measure of the number of valid samples and measurements that are obtained during a test period. Completeness will be measured by tracking the number of valid data results against the specified requirements of the test plan. The goal for this data quality objective was to achieve 80% completeness for flow and analytical data. The data quality objective was exceeded, with discrepancies noted below:

- The flow data (15 events, influent and effluent monitoring per event) is complete for all of the monitored events, except for the effluent flow data on the 14<sup>th</sup> storm. This resulted in the flow data being greater than 95% complete.
- Duplicate samples for TSS and SSC were not analyzed for Events 8 and 9 due to insufficient sample volume collected.
- Sieved TSS and SSC were not analyzed for Events 1 and 2. This analytical parameter was not in the original test plan but was added to account, by mass, for the fraction outside of the range of the Coulter Counter. It had been assumed that few particles larger than 250  $\mu\text{m}$  would be found in the influent to the device because of the piping problems and creation of a miniature detention pond in the influent pipe upstream of the samplers. It was assumed that these larger particles would have settled out/been filtered out prior to the Terre Kleen<sup>TM</sup>.

These issues are appropriately flagged in the analytical reports and the data used in the final evaluation of the Terre Kleen<sup>TM</sup> device.

## Chapter 7 Operation and Maintenance Activities

### 7.1 System Operation and Maintenance

The vendor designed the device to require periodic, but infrequent maintenance. During device installation, Mr. Jim Close of the City of Harrisburg asked what the maintenance interval of the device would be since the device would be maintained by the City. The design maintenance interval was indicated to be a minimum of one year. The device was cleaned prior to the start of testing in March 2005.

PSH personnel periodically inspected the device during the test period. If there was a question about the device maintenance during one of these visits, representatives of THCP were contacted and they made a site visit with the PSH personnel. The device was cleaned prior to the start of testing in March, 2005. A review of the storm event records in January 2006 showed that two late January storms had substantial negative removals. Therefore, the decision was made to clean the device at the end of January 2006. This maintenance activity consisted of using a sewer vector truck from the City of Harrisburg to dewater and remove sediment from the device and to approximate depth of sediment in the device. The TK09 unit was designed to store 74 ft<sup>3</sup> of sediment. Approximate depths of sediment were measured and were in accordance with measurements taken during the start-up part of the project. Sediment depths prior to pump-out were between 50% and 75% of the maximum design sediment depth, measured at several points in the device. A picture of the device before and after maintenance is shown in Figures 7-1 and 7-2, respectively.



(a)

(b)

**Table 7-1. (a) Initial cleanout of the sedimentation chamber. (b) Bottom of primary chamber after dewatering and during sediment cleanout.**



**Table 7-2. Primary chamber nearing the end of cleanout.**

THCP indicates that the sedimentation rate is the primary factor for determining maintenance frequency, and that a maintenance schedule should be based on site-specific sedimentation conditions. Observations by the TO during pumping indicated that the Terre Kleen™ was relatively easy to pump out. The device is constructed so that the plate section can be tilted against the primary chamber headwall to open up the floor of the device below the plates for easy cleaning access. This was relatively easy at the test site because a traditional lid with round manholes (for access) were never installed. Lid design improvements are being considered by THCP to improve access to the sediment removal areas in future installations.

## Chapter 8

### References

1. American Public Health Association. *Standard methods for the examination of water and wastewater, 18th edition*. American Public Health Association, American Water Works Association, Water Pollution Control Federation, Alexandria, VA, 1995.
2. American Water Works Association. *Handbook for Community Water Systems: Water Quality and Treatment, Fourth Edition*. McGraw-Hill, 1990.
3. McCuen, R.H. *Hydrologic Analysis and Design, Third Edition*. Prentice-Hall, Inc., Upper Saddle River, NJ, 2005.
4. National Oceanic and Atmospheric Administration (NOAA). *Technical Paper No. 40 Rainfall Frequency Atlas of the United States*. Washington, DC, 2000.
5. NRCS (Natural Resources Conservation Service). *Urban hydrology for small watersheds (Technical Release 55)*. Natural Resources Conservation Service, 1986.
6. PA DOT (Pennsylvania Department of Transportation). *Field Manual of Pennsylvania Department of Transportation: Storm Intensity-Duration-Frequency Charts*. Pennsylvania Department of Transportation and the Federal Highway Administration, 1986.
7. Penn State Harrisburg. *Environmental Technology Verification Test Plan for Terre Hill Concrete Products: Terre Kleen*. City of Harrisburg Public Works Yard, Harrisburg, Pennsylvania. November 2004.
8. U.S. Environmental Protection Agency. *Handbook of sampling and sample preservation of water and wastewater*. EPA 600/4-82-029 (including later additions under this report number). U.S. Environmental Protection Agency, Washington, D.C., 1982.
9. U.S. Environmental Protection Agency. *Methods for chemical analysis of water and wastes*. EPA 600/4-79-020 (including later additions and revisions under this report number). U.S. Environmental Protection Agency, Washington, D.C. (1979; revised 1983).
10. U.S. Environmental Protection Agency. *Quality criteria for water*. EPA 440/5-86-001. U.S. Environmental Protection Agency, Washington, D.C. , 1986.
11. United States Environmental Protection Agency. *Methods and Guidance for Analysis of Water*, EPA 821-C-99-008, Office of Water, Washington, DC, 1999.