

EPA/600/R-09/015
February 2009

**Arsenic Removal from Drinking Water by Adsorptive Media
U.S. EPA Demonstration Project at Goffstown, NH
Final Performance Evaluation Report**

by

**Sarah E. McCall
Abraham S.C. Chen
Lili Wang**

**Battelle
Columbus, OH 43201-2693**

**Contract No. 68-C-00-185
Task Order No. 0029**

for

**Thomas J. Sorg
Task Order Manager**

**Water Supply and Water Resources Division
National Risk Management Research Laboratory
Cincinnati, OH 45268**

**National Risk Management Research Laboratory
Office of Research and Development
U.S. Environmental Protection Agency
Cincinnati, OH 45268**

DISCLAIMER

The work reported in this document was funded by the United States Environmental Protection Agency (EPA) under Task Order 0029 of Contract 68-C-00-185 to Battelle. It has been subjected to the Agency's peer and administrative reviews and has been approved for publication as an EPA document. Any opinions expressed in this paper are those of the author(s) and do not, necessarily, reflect the official positions and policies of the EPA. Any mention of products or trade names does not constitute recommendation for use by the EPA.

FOREWORD

The U.S. Environmental Protection Agency (EPA) is charged by Congress with protecting the nation's land, air, and water resources. Under a mandate of national environmental laws, the Agency strives to formulate and implement actions leading to a compatible balance between human activities and the ability of natural systems to support and nurture life. To meet this mandate, EPA's research program is providing data and technical support for solving environmental problems today and building a science knowledge base necessary to manage our ecological resources wisely, understand how pollutants affect our health, and prevent or reduce environmental risks in the future.

The National Risk Management Research Laboratory (NRMRL) is the Agency's center for investigation of technological and management approaches for preventing and reducing risks from pollution that threaten human health and the environment. The focus of the Laboratory's research program is on methods and their cost-effectiveness for prevention and control of pollution to air, land, water, and subsurface resources; protection of water quality in public water systems; remediation of contaminated sites, sediments and groundwater; prevention and control of indoor air pollution; and restoration of ecosystems. NRMRL collaborates with both public and private sector partners to foster technologies that reduce the cost of compliance and to anticipate emerging problems. NRMRL's research provides solutions to environmental problems by developing and promoting technologies that protect and improve the environment; advancing scientific and engineering information to support regulatory and policy decisions; and providing the technical support and information transfer to ensure implementation of environmental regulations and strategies at the national, state, and community levels.

This publication has been produced as part of the Laboratory's strategic long-term research plan. It is published and made available by EPA's Office of Research and Development to assist the user community and to link researchers with their clients.

Sally Gutierrez, Director
National Risk Management Research Laboratory

ABSTRACT

This report documents the activities performed and the results obtained from the arsenic removal treatment technology demonstration project at the Orchard Highlands Subdivision site in Goffstown, NH. The main objective of the project was to evaluate the effectiveness of AdEdge Technologies' AD-33 media in removing arsenic to meet the new arsenic maximum contaminant level (MCL) of 10 µg/L. Additionally, this project evaluates: 1) the reliability of the treatment system (Arsenic Package Unit [APU]-GOFF-LL), 2) the required system operation and maintenance (O&M) and operator's skills, and 3) the capital and O&M cost of the technology. The project also characterized the water in the distribution system and process residuals produced by the treatment process.

The treatment system consisted of two 18-in-diameter by 65-in-tall fiberglass reinforced plastic (FRP) vessels in series configuration, each containing approximately 5 ft³ of AD-33 media. The media was an iron-based adsorptive media developed by Bayer AG under the name of Bayoxide 33, which was labeled as AD-33 by AdEdge. The system was designed for a peak flowrate of 10 gal/min (gpm), based on the pump curve provided by the facility, and an empty bed contact time (EBCT) of about 3.7 min per vessel. The actual average flowrate of 13 gpm was 30% higher than the peak flowrate. The higher flowrate decreased the EBCT from 3.7 to 2.9 min, which might have contributed, in part, to earlier than expected breakthrough of arsenic.

The AdEdge treatment system began regular operation on April 15, 2005. Between April 15, 2005, and August 6, 2007, the system operated at an average of 5.3 hr/day for a total of 4,559 hr, treating approximately 3,459,000 gal of water. Two test runs were conducted with Run 1 (from April 15, 2005, through September 6, 2006) treating approximately 2,085,000 gal and Run 2 (from September 6, 2006 through August 6, 2007) treating approximately 1,374,000 gal. Flowrates to the system, calculated based on daily totalizer and hour meter readings on the lead vessel ranged from 9 to 16 gpm and averaged 13 gpm.

Raw water contained 24.0 to 37.3 µg/L of total arsenic, existing almost entirely as soluble As(V). During Run 1, total arsenic levels in the treated water reached 10 µg/L at approximately 19,500 bed volumes (BV) following the lead vessel and at approximately 25,710 BV following the lag vessel. (BV following the lead vessel was calculated based on the amount of media in the lead vessel only; BV following the lag vessel, or the entire system, was calculated based on the combined media volume in both the lead and lag vessels). These results suggested that doubling the EBCT from 2.9 (1 vessel) to 5.8 min (2 vessels) increased the run length, and, therefore, removal capacity, by approximately 32%.

Concentrations of phosphorous and silica, which could interfere with arsenic adsorption by competing with arsenate for adsorption sites, ranged from 16.3 to 99.2 µg/L (as P) and from 23.1 to 31.7 mg/L (as SiO₂), respectively, in raw water. Low concentrations of iron, manganese, and other ions in raw water did not impact the arsenic removal capacity of the media.

On September 6, 2006, the media in Vessel A was changed out and piping was modified to make the vessels switchable. Run 2 was carried out with the partially exhausted Vessel B in the lead position and the newly rebedded Vessel A in the lag position. After approximately 1,374,000 gal of water had been treated by the system, the effluent of the system reached 10 µg/L on August 6, 2007, when sampling was discontinued and the performance evaluation was completed.

The system was backwashed only twice during the demonstration because there had been minimal solids buildup in the vessels and because pressure differential (Δp) across the vessels had remained essentially unchanged at 3 to 6 pounds per square inch (psi). Backwash was initiated manually with each vessel

backwashed with the treated water from the 2,000-gal hydropneumatic tank for 20 min at 16 gpm (or 9 gpm/ft²), producing approximately 320 gal of wastewater. Arsenic concentrations in the backwash wastewater were 30.2 µg/L from the lead vessel and 3.6 µg/L from the lag vessel for the first event, compared to the treated water arsenic level of 0.3 µg/L, suggesting desorption and/or release of media fines. The arsenic desorption might be due to slightly higher pH of the treated water in the hydropneumatic tank following aeration for radon removal. Approximately 0.33 lb of solids were discharged from Vessel A, including 3.6×10^{-4} lb of arsenic, 0.01 lb of iron, and 3.4×10^{-3} lb of manganese. Approximately 0.04 lb of solids were discharged from Vessel B including 3.5×10^{-5} lb of arsenic, 6.5×10^{-4} lb of iron, and 6.9×10^{-5} lb of manganese.

Comparison of the distribution system sampling results before and after operation of the system showed a significant decrease in arsenic concentration (from an average of 30 µg/L to an average of 1.1 µg/L). The arsenic concentrations in the distribution system were similar to those in the system effluent. Neither lead nor copper concentrations appeared to have been affected by the operation of the system.

The capital investment cost of \$34,210 included \$22,431 for equipment, \$4,860 for site engineering, and \$6,910 for installation. Using the system's rated capacity of 10 gpm (14,400 gal/day [gpd]), the capital cost was \$3,421/gpm of design capacity (\$2.38/gpd) and equipment-only cost was \$2,243/gpm of design capacity (\$1.56/gpd).

The O&M cost included only incremental cost associated with the adsorption system, such as media replacement and disposal, electricity consumption, and labor. The media was replaced only once during the demonstration in Vessel A which cost \$4,199. The O&M cost was calculated to \$2.34/1,000 gal based on the media replacement cost and the cost of labor and electricity incurred during the demonstration.

CONTENTS

DISCLAIMER	ii
FOREWORD	iii
ABSTRACT.....	iv
APPENDICES	vii
FIGURES.....	vii
TABLES	vii
ABBREVIATIONS AND ACRONYMS	viii
ACKNOWLEDGMENTS	x
1.0 INTRODUCTION	1
1.1 Background.....	1
1.2 Treatment Technologies for Arsenic Removal	2
1.3 Project Objectives	2
2.0 SUMMARY AND CONCLUSIONS	5
3.0 MATERIALS AND METHODS.....	7
3.1 General Project Approach.....	7
3.2 System O&M and Cost Data Collection	8
3.3 Sample Collection Procedures and Schedules	8
3.3.1 Source Water	10
3.3.2 Treatment Plant Water.....	10
3.3.3 Backwash Wastewater	11
3.3.4 Residual Solids	11
3.3.5 Distribution System Water	11
3.4 Sampling Logistics.....	11
3.4.1 Preparation of Arsenic Speciation Kits.....	11
3.4.2 Preparation of Sampling Coolers.....	11
3.4.3 Sample Shipping and Handling	12
3.5 Analytical Procedures	12
4.0 RESULTS AND DISCUSSION	13
4.1 Facility Description and Preexisting Treatment System Infrastructure	13
4.1.1 Source Water Quality	13
4.1.2 Distribution System	17
4.2 Treatment Process Description	17
4.3 System Installation.....	18
4.3.1 Permitting	18
4.3.2 Building	20
4.3.3 Installation, Shakedown, and Startup	20
4.4 System Operation.....	23
4.4.1 Operational Parameters.....	23
4.4.2 Backwash.....	23
4.4.3 Media Change-out	24
4.4.4 Residual Management	24
4.4.5 System/Operation Reliability and Simplicity	24
4.5 System Performance	25
4.5.1 Treatment Plant Sampling	25
4.5.2 Backwash Wastewater Sampling.....	31

4.5.3	Spent Media.....	32
4.5.4	Distribution System Water Sampling.....	34
4.6	System Cost.....	34
4.6.1	Capital Cost.....	34
4.6.2	Operation and Maintenance Cost.....	36
5.0	REFERENCES.....	38

APPENDICES

Appendix A: OPERATIONAL DATA

Appendix B: ANALYTICAL DATA

FIGURES

Figure 4-1.	Preexisting Treatment Building at Orchard Highlands Subdivision.....	13
Figure 4-2.	Aeration System for Radon Treatment.....	14
Figure 4-3.	10,000-gal Storage Tank.....	14
Figure 4-4.	Booster Pumps.....	15
Figure 4-5.	2,000-gal Hydropneumatic Pressure Tank.....	15
Figure 4-6.	Schematic of APU-GOFF-LL System.....	19
Figure 4-7.	Process Flow Diagram and Sampling Locations.....	21
Figure 4-8.	APU-GOFF-LL Treatment System.....	22
Figure 4-9.	System Control Panel.....	22
Figure 4-10.	System Being Delivered to Site.....	23
Figure 4-11.	Concentrations of Various Arsenic Species at IN, TA, and TB Sampling Locations.....	28
Figure 4-12.	Total Arsenic Breakthrough Curves for Runs 1 and 2.....	29
Figure 4-13.	Total Phosphorous Breakthrough Curves for Runs 1 and 2.....	30
Figure 4-14.	Media Replacement and Operation and Maintenance Cost.....	37

TABLES

Table 1-1.	Summary of Arsenic Removal Demonstration Sites.....	3
Table 3-1.	Predemonstration Study Activities and Completion Dates.....	7
Table 3-2.	Evaluation Objectives and Supporting Data Collection Activities.....	8
Table 3-3.	Sampling Schedule and Analytes.....	9
Table 4-1.	Orchard Highlands Subdivision Water Quality Data.....	16
Table 4-2.	Physical and Chemical Properties of AD-33 Media.....	17
Table 4-3.	Design Features of APU-GOFF-LL System.....	20
Table 4-4.	Summary of Treatment System Operation.....	24
Table 4-5.	Freeboard Measurements after Run 1.....	24
Table 4-6.	Runs 1 and 2 Analytical Results for Arsenic, Orthophosphate, Iron, and Manganese.....	26
Table 4-7.	Runs 1 and 2 Water Quality Parameter Sampling Results.....	27
Table 4-8.	Backwash Wastewater Sampling Results.....	32
Table 4-9.	Average Spent Media Total Metal Analysis.....	33
Table 4-10.	TCLP Results of Spent Media.....	33
Table 4-11.	Distribution System Sampling Results.....	35
Table 4-12.	Capital Investment Cost for APU-GOFF-LL System.....	36
Table 4-13.	Operation and Maintenance Cost for APU-GOFF-LL System.....	37

ABBREVIATIONS AND ACRONYMS

AAL	American Analytical Laboratories
AM	adsorptive media
APU	arsenic package unit
As	arsenic
ATS	aquatic treatment system
BET	Brunauer, Emmett, and Teller
BV	bed volume
Ca	calcium
C/F	coagulation/filtration process
Cl	chlorine
CO ₂	carbon dioxide
CRF	capital recovery factor
Cu	copper
DO	dissolved oxygen
EBCT	empty bed contact time
EPA	U.S. Environmental Protection Agency
F	fluorine
Fe	iron
FRP	fiberglass reinforced plastic
GFH	granular ferric hydroxide
gpd	gallons per day
gpm	gallons per minute
HDPE	high density polyethylene
HIX	hybrid ion exchange
ICP-MS	inductively coupled plasma-mass spectrometry
ID	identification
IX	ion exchange
LCR	Lead and Copper Rule
MCL	maximum contaminant level
MDL	method detection limit
MEI	Magnesium Elektron, Inc.
Mg	magnesium
Mn	manganese
mV	millivolts
Na	sodium
NA	not analyzed

ABBREVIATIONS AND ACRONYMS (Continued)

ND	not detectable
NHDES	New Hampshire Department of Environmental Services
NRMRL	National Risk Management Research Laboratory
O&M	operation and maintenance
OIT	Oregon Institute of Technology
ORD	Office of Research and Development
ORP	oxidation-reduction potential
psi	pounds per square inch
PO ₄	orthophosphate
POU	point of use
PVC	polyvinyl chloride
QAPP	Quality Assurance Project Plan
QA/QC	quality assurance/quality control
RO	reverse osmosis
RPD	relative percent difference
SDWA	Safe Drinking Water Act
SiO ₂	silica
SO ₄ ²⁻	sulfate
STS	Severn Trent Services
TCLP	toxicity characteristic leaching procedure
TDS	total dissolved solids
TOC	total organic carbon
TSS	total suspended solids
U	uranium
V	vanadium

ACKNOWLEDGMENTS

The authors wish to extend their sincere appreciation to Orchard Highlands Subdivision and Mr. John Blumberg, the Chairman of the Board of Directors, who monitored the treatment system and collected samples from the treatment system and distribution system throughout this demonstration. This performance evaluation would not have been possible without his efforts.

1.0 INTRODUCTION

1.1 Background

The Safe Drinking Water Act (SDWA) mandates that the U.S. Environmental Protection Agency (EPA) identify and regulate drinking water contaminants that may have adverse human health effects and that are known or anticipated to occur in public water supply systems. In 1975 under the SDWA, EPA established a maximum contaminant level (MCL) for arsenic at 0.05 mg/L. Amended in 1996, the SDWA required that EPA develop an arsenic research strategy and publish a proposal to revise the arsenic MCL by January 2000. On January 18, 2001, EPA finalized the arsenic MCL at 0.01 mg/L (EPA, 2001). In order to clarify the implementation of the original rule, EPA revised the rule text on March 25, 2003, to express the MCL as 0.010 mg/L (10 µg/L) (EPA, 2003). The final rule required all community and non-transient, non-community water systems to comply with the new standard by January 23, 2006.

In October 2001, EPA announced an initiative for additional research and development of cost-effective technologies to help small community water systems (<10,000 customers) meet the new arsenic standard and to provide technical assistance to operators of small systems in order to reduce compliance costs. As part of this Arsenic Rule Implementation Research Program, EPA's Office of Research and Development (ORD) proposed a project to conduct a series of full-scale, on-site demonstrations of arsenic removal technologies, process modifications, and engineering approaches applicable to small systems. Shortly thereafter, an announcement was published in the *Federal Register* requesting water utilities interested in participating in Round 1 of this EPA-sponsored demonstration program to provide information on their water systems. In June 2002, EPA selected 17 out of 115 sites to host the demonstration studies.

In September 2002, EPA solicited proposals from engineering firms and vendors for cost-effective arsenic removal treatment technologies for the 17 host sites. EPA received 70 technical proposals for the 17 host sites, with each site receiving one to six proposals. In April 2003, an independent technical panel reviewed the proposals and provided its recommendations to EPA on the technologies that it determined were acceptable for the demonstration at each site. Because of funding limitations and other technical reasons, only 12 of the 17 sites were selected for the demonstration project. Using the information provided by the review panel, EPA, in cooperation with the host sites and the drinking water programs of the respective states, selected one technical proposal for each site.

In 2003, EPA initiated Round 2 arsenic technology demonstration projects that were partially funded with Congressional add-on funding to the EPA budget. In June 2003, EPA selected 32 potential demonstration sites, and the Orchard Highlands Community Water System in Goffstown, NH was one of those selected.

In September 2003, EPA again solicited proposals from engineering firms and vendors for arsenic removal technologies. EPA received 148 technical proposals for the 32 host sites, with each site receiving from two to eight proposals. In April 2004, another technical panel was convened by EPA to review the proposals and provide recommendations to EPA with the number of proposals per site ranging from none (for two sites) to a maximum of four. The final selection of the treatment technology at the sites that received at least one proposal was made, again, through a joint effort by EPA, the state regulators, and the host site. Since then, four sites have withdrawn from the demonstration program, reducing the number of sites to 28. AdEdge Technologies (AdEdge), using Bayoxide E33 media developed by Bayer AG, was selected for demonstration at the Orchard Highlands site in September 2004. As of October 2008, 39 of the 40 systems were operational, and the performance evaluation of 31 systems was completed.

1.2 Treatment Technologies for Arsenic Removal

The technologies selected for the Round 1 and Round 2 demonstration host sites include 25 adsorptive media (AM) systems (the Oregon Institute of Technology [OIT] site has three AM systems), 13 coagulation/filtration (C/F) systems, two ion exchange (IX) systems, and 17 point-of-use (POU) units (including nine under-the-sink reverse osmosis [RO] units at the Sunset Ranch Development site and eight AM units at the OIT site), and one process modification. Table 1-1 summarizes the locations, technologies, vendors, system flowrates, and key source water quality parameters (including As, Fe, and pH) at the 40 demonstration sites. An overview of the technology selection and system design for the 12 Round 1 demonstration sites and the associated capital cost is provided in two EPA reports (Wang et al., 2004; Chen et al., 2004), which are posted on the EPA website at <http://www.epa.gov/ORD/NRMRL/wswrd/dw/arsenic/index.html>.

1.3 Project Objectives

The objective of the arsenic demonstration program is to conduct full-scale arsenic treatment technology demonstration studies on the removal of arsenic from drinking water supplies. The specific objectives are to:

- Evaluate the performance of the arsenic removal technologies for use on small systems.
- Determine the required system operation and maintenance (O&M) and operator skill levels.
- Characterize process residuals produced by the technologies.
- Determine the capital and O&M cost of the technologies.

This report summarizes the performance of the AdEdge system at the Orchard Highlands Subdivision in Goffstown, NH from April 15, 2005, through August 6, 2007. The types of data collected include system operation, water quality (both across the treatment train and in the distribution system), residuals, and capital and O&M cost.

Table 1-1. Summary of Arsenic Removal Demonstration Sites

Demonstration Location	Site Name	Technology (Media)	Vendor	Design Flowrate (gpm)	Source Water Quality		
					As (µg/L)	Fe (µg/L)	pH (S.U.)
<i>Northeast/Ohio</i>							
Wales, ME	Springbrook Mobile Home Park	AM (A/I Complex)	ATS	14	38 ^(a)	<25	8.6
Bow, NH	White Rock Water Company	AM (G2)	ADI	70 ^(b)	39	<25	7.7
Goffstown, NH	Orchard Highlands Subdivision	AM (E33)	AdEdge	10	33	<25	6.9
Rollinsford, NH	Rollinsford Water and Sewer District	AM (E33)	AdEdge	100	36 ^(a)	46	8.2
Dummerston, VT	Charette Mobile Home Park	AM (A/I Complex)	ATS	22	30	<25	7.9
Felton, DE	Town of Felton	C/F (Macrolite)	Kinetico	375	30 ^(a)	48	8.2
Stevensville, MD	Queen Anne's County	AM (E33)	STS	300	19 ^(a)	270 ^(c)	7.3
Houghton, NY ^(d)	Town of Canadea	C/F (Macrolite)	Kinetico	550	27 ^(a)	1,806 ^(c)	7.6
Newark, OH	Buckeye Lake Head Start Building	AM (ARM 200)	Kinetico	10	15 ^(a)	1,312 ^(c)	7.6
Springfield, OH	Chateau Estates Mobile Home Park	AM (E33)	AdEdge	250 ^(e)	25 ^(a)	1,615 ^(c)	7.3
<i>Great Lakes/Interior Plains</i>							
Brown City, MI	City of Brown City	AM (E33)	STS	640	14 ^(a)	127 ^(c)	7.3
Pentwater, MI	Village of Pentwater	C/F (Macrolite)	Kinetico	400	13 ^(a)	466 ^(c)	6.9
Sandusky, MI	City of Sandusky	C/F (Aeralater)	Siemens	340 ^(e)	16 ^(a)	1,387 ^(c)	6.9
Delavan, WI	Vintage on the Ponds	C/F (Macrolite)	Kinetico	40	20 ^(a)	1,499 ^(c)	7.5
Greenville, WI	Town of Greenville	C/F (Macrolite)	Kinetico	375	17	7827 ^(c)	7.3
Climax, MN	City of Climax	C/F (Macrolite)	Kinetico	140	39 ^(a)	546 ^(c)	7.4
Sabin, MN	City of Sabin	C/F (Macrolite)	Kinetico	250	34	1,470 ^(c)	7.3
Sauk Centre, MN	Big Sauk Lake Mobile Home Park	C/F (Macrolite)	Kinetico	20	25 ^(a)	3,078 ^(c)	7.1
Stewart, MN	City of Stewart	C/F&AM (E33)	AdEdge	250	42 ^(a)	1,344 ^(c)	7.7
Lidgerwood, ND	City of Lidgerwood	Process Modification	Kinetico	250	146 ^(a)	1,325 ^(c)	7.2
<i>Midwest/Southwest</i>							
Arnaudville, LA	United Water Systems	C/F (Macrolite)	Kinetico	770 ^(e)	35 ^(a)	2,068 ^(c)	7.0
Alvin, TX	Oak Manor Municipal Utility District	AM (E33)	STS	150	19 ^(a)	95	7.8
Bruni, TX	Webb Consolidated Independent School District	AM (E33)	AdEdge	40	56 ^(a)	<25	8.0
Wellman, TX	City of Wellman	AM (E33)	AdEdge	100	45	<25	7.7
Anthony, NM	Desert Sands Mutual Domestic Water Consumers Association	AM (E33)	STS	320	23 ^(a)	39	7.7
Nambe Pueblo, NM	Nambe Pueblo Tribe	AM (E33)	AdEdge	145	33	<25	8.5
Taos, NM	Town of Taos	AM (E33)	STS	450	14	59	9.5
Rimrock, AZ	Arizona Water Company	AM (E33)	AdEdge	90 ^(b)	50	170	7.2
Tohono O'odham Nation, AZ	Tohono O'odham Utility Authority	AM (E33)	AdEdge	50	32	<25	8.2
Valley Vista, AZ	Arizona Water Company	AM (AAFS50/ARM 200)	Kinetico	37	41	<25	7.8

Table 1-1. Summary of Arsenic Removal Demonstration Sites (Continued)

Demonstration Location	Site Name	Technology (Media)	Vendor	Design Flowrate (gpm)	Source Water Quality		
					As (µg/L)	Fe (µg/L)	pH (S.U.)
<i>Far West</i>							
Three Forks, MT	City of Three Forks	C/F (Macrolite)	Kinetico	250	64	<25	7.5
Fruitland, ID	City of Fruitland	IX (A300E)	Kinetico	250	44	<25	7.4
Homedale, ID	Sunset Ranch Development	POU RO ^(f)	Kinetico	75 gpd	52	134	7.5
Okanogan, WA	City of Okanogan	C/F (Electromedia-I)	Filtronics	750	18	69 ^(c)	8.0
Klamath Falls, OR	Oregon Institute of Technology	POE AM (Adsorbisia/ARM 200/ArsenX [®]) and POU AM (ARM 200) ^(g)	Kinetico	60/60/30	33	<25	7.9
Vale, OR	City of Vale	IX (Arsenex II)	Kinetico	525	17	<25	7.5
Reno, NV	South Truckee Meadows General Improvement District	AM (GFH/Kemiron)	Siemens	350	39	<25	7.4
Susanville, CA	Richmond School District	AM (A/I Complex)	ATS	12	37 ^(a)	125	7.5
Lake Isabella, CA	Upper Bodfish Well CH2-A	AM (HIX)	VEETech	50	35	125	7.5
Tehachapi, CA	Golden Hills Community Service District	AM (Isolux)	MEI	150	15	<25	6.9

AM = adsorptive media process; C/F = coagulation/filtration; HIX = hybrid ion exchanger; IX = ion exchange process; RO = reverse osmosis

ATS = Aquatic Treatment Systems; MEI = Magnesium Elektron, Inc.; STS = Severn Trent Services

(a) Arsenic existing mostly as As(III).

(b) Design flowrate reduced by 50% due to system reconfiguration from parallel to series operation.

(c) Iron existing mostly as Fe(II).

(d) Replaced Village of Lyman, NE site which withdrew from program in June 2006.

(e) Facilities upgraded systems in Springfield, OH from 150 to 250 gpm, Sandusky, MI from 210 to 340 gpm, and Arnaudville, LA from 385 to 770 gpm.

(f) Including nine residential units.

(g) Including eight under-the-sink units.

2.0 SUMMARY AND CONCLUSIONS

Based on the information collected during the 30 months of system operation from April 2005 to August 2007, the following conclusions were made relating to the overall objectives of the treatment technology demonstration study.

Performance of the arsenic removal technology for use on small systems

:

- AD-33™ media was effective at removing soluble As(V) in source water. Breakthrough at 10 µg/L from the lead tank occurred at 19,810 bed volumes (BV) (1 BV = 5 ft³), which represented only 32% of the vendor-projected media run length. Breakthrough at 10 µg/L from the lag vessel occurred at 25,710 BV (1BV = 10 ft³). The earlier than expected arsenic breakthrough was attributed, in part, to the relatively short empty bed contact time (EBCT), i.e., 2.9 min versus the design value of 3.7 min in each vessel, and competing anions, such as phosphorous and silica.
- Phosphorous was removed by the media from up to 99.2 µg/L (as P) to less than its detection limit of 10 µg/L during the treatment of first 1,000,000 gal (or 13,700 BV) of raw water. Phosphorus competed with arsenic for available adsorption sites.
- The spent media was non-hazardous and could be disposed of at a lined sanitary landfill permitted by the State for high metal wastes.
- A significant decrease in arsenic concentration (from an average of 30 µg/L to an average of 1.1 µg/L) occurred in the distribution system.
- Neither lead nor copper concentrations appeared to have been affected by the operation of the system.

Required system O&M and operator's skill levels:

- Very little attention was required from the operator. The daily demand was typically 10 min to visually inspect the system and record operational parameters.
- Operation of the system did not require additional skills beyond those necessary to operate the existing water supply equipment.

Process residuals produced by the technology:

- No backwash was required during system operation. The system was backwashed only twice throughout the 30-month evaluation period due to lack of solids buildup in the vessels. Pressure differential (Δp) across the vessels had remained constant throughout the performance evaluation. Each backwash event produced approximately 640 gal of wastewater.
- Some arsenic desorption and/or release of media fines might have occurred during media backwash, as evidenced by elevated total arsenic concentrations in backwash wastewater (i.e., up to 133 µg/L vs. 10.6 µg/L in the treated water). Somewhat higher pH values of the treated water used for backwash likely contributed to the arsenic desorption. The treated water from the hydropneumatic tank had been aerated for radon removal.

Cost-effectiveness of the technology:

- Using the system's rated capacity of 10 gpm (14,400 gpd), the capital cost was \$3,421/gpm of design capacity (\$2.38/gpd) and equipment-only cost was \$2,243/gpm of the design capacity (\$1.56/gpd).
- Media replacement cost represented the majority of the O&M cost. The media in the lead vessel was replaced once at a cost of \$4,199 or \$2.01/1,000 gal, which accounted for 86% of the O&M cost. The rest of the O&M cost was incurred by electricity and labor.

3.0 MATERIALS AND METHODS

3.1 General Project Approach

Following the predemonstration activities summarized in Table 3-1, the performance evaluation study of the AdEdge treatment system began on April 15, 2005, and ended on August 6, 2007. Table 3-2 summarizes the types of data collected and considered as part of the technology evaluation process. The overall system performance was based on its ability to consistently remove arsenic to below the target MCL of 10 µg/L through the collection of water samples across the treatment train, as described in the Study Plan (Battelle, 2005). The reliability of the system was evaluated by tracking the unscheduled system downtime and frequency and extent of repair and replacement. The unscheduled downtime and repair information were recorded by the plant operator on a Repair and Maintenance Log Sheet.

The O&M and operator skill requirements were assessed through quantitative data and qualitative considerations, including the need for pre- and/or post-treatment, level of system automation, extent of preventative maintenance activities, frequency of chemical and/or media handling and inventory, and general knowledge needed for relevant chemical processes and related health and safety practices. The staffing requirements for the system operation were recorded on an Operator Labor Hour Log Sheet.

The quantity of aqueous and solid residuals generated was estimated by tracking the volume of backwash wastewater produced during each backwash cycle and the need to replace media upon arsenic breakthrough. Backwash wastewater and spent media were sampled and analyzed for chemical characteristics.

The cost of the system was evaluated based on the capital cost per gal/min (gpm) (or gal/day [gpd]) of design capacity and the O&M cost per 1,000 gal of water treated. This task required tracking of the capital cost for equipment, engineering, and installation, as well as the O&M cost for media replacement and disposal, electricity usage, and labor.

Table 3-1. Predemonstration Study Activities and Completion Dates

Activity	Date
Introductory Meeting Held	September 13, 2004
Project Planning Meeting Held	November 9, 2004
Draft Letter of Understanding Issued	November 24, 2004
Final Letter of Understanding Issued	December 7, 2004
Request for Quotation Issued to Vendor	January 18, 2005
Vendor Quotation Submitted to Battelle	February 9, 2005
Purchase Order Completed and Signed	March 1, 2005
Engineering Plans Submitted to NHDES	March 3, 2005
Final Study Plan Issued	March 24, 2005
System Permit Issued by NHDES	March 31, 2005
APU Unit Shipped and Arrived	April 12, 2005
System Installation Completed	April 14, 2005
System Shakedown Completed	April 15, 2005
Performance Evaluation Begun	April 15, 2005

NHDES = New Hampshire Department of Environmental Services

Table 3-2. Evaluation Objectives and Supporting Data Collection Activities

Evaluation Objective	Data Collection
Performance	-Ability to consistently meet 10 µg/L of arsenic in treated water
Reliability	-Unscheduled system downtime -Frequency and extent of repairs including a description of problems, materials and supplies needed, and associated labor and cost
System O&M and Operator Skill Requirements	-Pre- and post-treatment requirements -Level of automation for system operation and data collection -Staffing requirements including number of operators and laborers -Task analysis of preventative maintenance including number, frequency, and complexity of tasks -Chemical handling and inventory requirements -General knowledge needed for relevant chemical processes and health and safety practices
Residual Management	-Quantity and characteristics of aqueous and solid residuals generated by system operation
System Cost	-Capital cost for equipment, engineering, and installation -O&M cost for electricity consumption and labor

3.2 System O&M and Cost Data Collection

The plant operator performed weekly and monthly system O&M and data collection according to instructions provided by the vendor and Battelle. Approximately three times a week, the plant operator recorded system operational data, such as pressure, flowrate, totalizer, and hour meter readings on a Daily System Operation Log Sheet, and conducted visual inspections to ensure normal system operations. If any problem occurred, the plant operator contacted the Battelle Study Lead, who determined if the vendor should be contacted for troubleshooting. The plant operator recorded all relevant information, including the problem encountered, course of actions taken, materials and supplies used, and associated cost and labor incurred, on a Repair and Maintenance Log Sheet. Twice a month, the plant operator measured several water quality parameters, including temperature, pH, dissolved oxygen (DO), and oxidation-reduction potential (ORP), and recorded them on a Weekly On-Site Water Quality Parameters Log Sheet. Backwash data were recorded on a Backwash Log Sheet.

The capital cost for the arsenic removal system consisted of the cost for equipment, site engineering, and system installation. The O&M cost consisted of the cost for media replacement and spent media disposal, electricity consumption, and labor. Electricity consumption was determined from utility bills. Labor for various activities, such as routine system O&M, troubleshooting and repairs, and demonstration-related work, was tracked using an Operator Labor Hour Log Sheet. The routine system O&M included activities such as completing field logs, performing system inspections, and others as recommended by the vendor. The labor for demonstration-related work, including activities such as performing field measurements, collecting and shipping samples, and communicating with the Battelle Study Lead and the vendor, was recorded, but not used for the cost analysis.

3.3 Sample Collection Procedures and Schedules

To evaluate system performance, samples were collected at the wellhead, across the treatment plant, during adsorption vessel backwash, and from the distribution system. The sampling schedule and analytes measured during each sampling event are listed in Table 3-3.

Table 3-3. Sampling Schedule and Analytes

Sample Type	Sampling Locations ^(a)	No. of Sampling Locations	Frequency	Analytes	Sampling Date
Source Water	IN	1	Once during initial site visit	On-site: pH, temperature, DO, and ORP Off-site: As (total and soluble), As(III), As(V), Fe (total and soluble), Mn (total and soluble), U (total and soluble), V (total and soluble), Na, Ca, Mg, NH ₄ , NO ₃ , NO ₂ , Cl, F, SO ₄ , SiO ₂ , PO ₄ , TDS, TOC, turbidity, and alkalinity	09/13/04
Treatment Plant Water	IN, TA, TB	3	Once every two to four weeks on a eight-week cycle ^(b,c)	On-site: pH, temperature, DO, and ORP Off-site: As (total), Fe (total), Mn (total), Ca, Mg, F, NO ₃ , SO ₄ , SiO ₂ , PO ₄ , turbidity, and alkalinity	05/02/05, 05/16/05, 05/31/05, 06/27/05, 07/12/05, 07/25/05, 08/22/05, 09/06/05, 09/20/05, 10/04/05, 11/01/05, 11/15/05, 12/12/05, 01/10/06, 02/07/06, 02/21/06, 03/07/06, 04/04/06, 04/18/06, 05/02/06, 05/30/06, 06/27/06, 07/25/06, 08/08/06, 08/23/06, 09/05/06, 09/19/06, 10/02/06, 11/07/06, 12/05/06, 01/03/07, 02/07/07, 03/07/07, 04/02/07, 06/11/07, 08/06/07
			Once every eight-week cycle	On-site: pH, temperature, DO, and ORP Off-site: As (total and soluble), As(III), As(V), Fe (total and soluble), Mn (total and soluble), Ca, Mg, F, NO ₃ , SO ₄ , SiO ₂ , PO ₄ , turbidity, and alkalinity	04/15/05, 06/15/05, 08/08/05, 10/17/05, 11/29/05, 01/24/06, 03/21/06, 05/17/06, 06/12/06, 07/12/06,

Table 3-3. Sampling Schedule and Analytes (Continued)

Sample Type	Sampling Locations ^(a)	No. of Sampling Locations	Frequency	Analytes	Sampling Date
Distribution Water	Three LCR Residences	3	Monthly ^(d)	pH, alkalinity, As (total), Fe (total), Mn (total), Cu (total), and Pb (total)	Baseline sampling: 01/10/05, 01/25/05, 02/07/05, 03/21/05 Monthly sampling: 05/16/05, 06/13/05, 07/11/05, 08/08/05, 09/06/05, 10/05/05, 12/05/05, 12/12/05, 01/09/06, 02/06/06, 03/06/06, 04/03/06, 05/02/06, 06/13/06, 07/10/06
Backwash Wastewater	Backwash Discharge Line from Each Vessel	2	Sampling based on system performance	1 st event: pH, TDS, turbidity, As (soluble), Fe (soluble), and Mn (soluble) 2 nd event: pH, TDS, TSS, turbidity, As (total and soluble), Fe (total and soluble), Mn (total and soluble)	08/22/05, 08/07/06
Spent Media	Top, Middle, and Bottom of Lead Vessel	3	Once during media change-out	Al, As, Ca, Cd, Cu, Fe, Mg, Mn, Ni, P, Pb, Si, and Zn	09/06/06

- (a) Abbreviations corresponding to sample locations shown in Figure 4-7: IN = at wellhead, TA = after Vessel A, TB = after Vessel B
- (b) Ca and Mg analyzed biweekly from November 15, 2005 through August 23, 2006.
- (c) Starting October 2, 2006, analytes reduced to total P, silica, and total arsenic on a monthly basis and on-site measurements of pH, temperature, DO, and ORP discontinued on November 7, 2006.
- (d) Four baseline sampling events performed from January 2005 to March 2005 before system startup. LCR = Lead and Copper Rule, TDS = total dissolved solids, TOC = total organic carbon, TSS = total suspended solids

Specific sampling requirements for analytical methods, sample volumes, containers, preservation, and holding times are presented in Table 4-1 of the EPA-endorsed Quality Assurance Project Plan (QAPP) (Battelle, 2004). The procedure for arsenic speciation is described in Appendix A of the QAPP.

3.3.1 Source Water. During the initial site visit, one set of source water samples was collected and speciated using an arsenic speciation kit (Section 3.4.1). The sample tap was flushed for several minutes before sampling; special care was taken to avoid agitation, which might cause unwanted oxidation. Analytes for the source water samples are listed in Table 3-3.

3.3.2 Treatment Plant Water. Treatment plant water samples were collected by the plant operator once every two to four weeks on an eight-week cycle. Samples were collected at three locations, i.e., at the wellhead (IN), after the lead adsorption vessel (TA), and after the lag adsorption vessel (TB),

and analyzed for the analytes listed in Table 3-3. Arsenic speciation kits were used for on-site speciation at the same three locations on a bimonthly basis.

3.3.3 Backwash Wastewater. Two backwash wastewater samples were collected during the performance evaluation. Samples were collected from the sample tap installed on the backwash wastewater discharge line from each vessel on August 22, 2005, and August 7, 2006. During the first event, a grab sample was collected directly from the outfall of the discharge line. An unfiltered aliquot was analyzed for pH, total dissolved solids (TDS), and turbidity, and a filtered aliquot using 0.45- μm disc filters was analyzed for soluble arsenic, iron, and manganese. During the second event, a composite sample was taken from a 32-gal plastic container that collected a sidestream of backwash wastewater at approximately 1 gpm from a tap on the discharge line over the duration of the backwash for each vessel. An unfiltered aliquot was analyzed for pH, TDS, total suspended solids (TSS), turbidity, and total arsenic, iron, and manganese and a filtered aliquot for soluble arsenic, iron, and manganese.

3.3.4 Residual Solids. Residual solids included backwash solids and spent media samples. Due to low solids in the backwash wastewater, backwash solids were not collected from the two backwash events.

Three spent media samples were collected from the lead vessel during the media change-out on September 6, 2006. Spent media was collected from the top, middle, and bottom of the media bed using a wet/dry shop vacuum that was thoroughly cleaned and disinfected prior to use. The media removed from each layer was well-mixed and stored in a 1-gal wide-mouth high-density polyethylene (HDPE) bottle. Metal analyses were conducted on air dried and acid digested samples (see analytes in Table 3-3), and the toxicity characteristic leaching procedure (TCLP) test was conducted on an unprocessed sample following the protocol described in the QAPP (Battelle, 2004). The plant operator also submitted a sample of the spent media for the TCLP test.

3.3.5 Distribution System Water. Water samples were collected from the distribution system to determine the impact of the arsenic treatment system on the water chemistry in the distribution system, specifically, the arsenic, lead, and copper levels. Prior to system startup from January to March 2005, four baseline distribution water samples were collected from three residences within the distribution system. Following system startup, distribution system sampling continued on a monthly basis at the same three locations.

Homeowners collected samples following an instruction sheet developed according to the *Lead and Copper Monitoring and Reporting Guidance for Public Water Systems* (EPA, 2002). The dates and times of last water usage before sampling and of actual sample collection were recorded for calculation of the stagnation time. All samples were collected from a cold-water faucet that had not been used for at least 6 hours to ensure that stagnant water was sampled. Analytes for the baseline samples coincided with the monthly samples as shown in Table 3-3. Arsenic speciation was not performed for the distribution water samples.

3.4 Sampling Logistics

3.4.1 Preparation of Arsenic Speciation Kits. The arsenic field speciation method uses an anion exchange resin column to separate the soluble arsenic species, As(V) and As(III) (Edwards et al., 1998). Resin columns were prepared in batches at Battelle laboratories according to the procedures detailed in Appendix A of the QAPP (Battelle, 2004).

3.4.2 Preparation of Sample Coolers. For each sampling event, a sample cooler was prepared with the appropriate number and type of sample bottles, disc filters, and/or speciation kits. All sample

bottles were new and contained appropriate preservatives. Each sample bottle was affixed with a pre-printed, colored-coded, waterproof label consisting of the sample identification (ID), date and time of sample collection, collector's name, site location, sample destination, analysis required, and preservative. The sample ID consisted of a two-letter code for the demonstration site, the sampling date, a two-letter code for a specific sampling location, and a one-letter code designating the arsenic speciation bottle (if necessary). The sampling locations at the treatment plant were color-coded for easy identification. The labeled bottles were separated by sampling location, placed in zip-lock bags, and packed into the cooler.

In addition, all sampling- and shipping-related materials, such as disposable gloves, sampling instructions, chain-of-custody forms, prepaid/pre-addressed FedEx air bills, and bubble wrap, were placed in each cooler. The chain-of-custody forms and air bills were completed except for the operator's signature and the sample dates and times. After preparation, the sample cooler was sent to the site via FedEx for the following week's sampling event.

3.4.3 Sample Shipping and Handling. After sample collection, samples for off-site analyses were packed carefully in the original coolers with wet ice and shipped back to Battelle. Upon receipt, the sample custodian checked sample IDs against the chain-of-custody forms and verified that all samples indicated on the forms were included and intact. Discrepancies noted by the sample custodian were addressed with the plant operator by the Battelle Study Lead. The shipment and receipt of all coolers by Battelle were recorded on a cooler tracking log.

Samples for metal analyses were stored at Battelle's Inductively Coupled Plasma-Mass Spectrometry (ICP-MS) Laboratory. Samples for other water quality analyses were packed in separate coolers and picked up by couriers from American Analytical Laboratories (AAL) in Columbus, OH and Belmont Labs in Englewood, OH, which were under contract with Battelle for this demonstration study. The chain-of-custody forms remained with the samples from the time of preparation through analysis and final disposition. All samples were archived by the appropriate laboratories for the respective duration of the required hold time and disposed of properly thereafter.

3.5 Analytical Procedures

The analytical procedures described in Section 4.0 of the EPA-endorsed QAPP (Battelle, 2004) were followed by Battelle ICP-MS, AAL, and Belmont Labs. Laboratory quality assurance/quality control (QA/QC) of all methods followed the prescribed guidelines. Data quality in terms of precision, accuracy, method detection limits (MDLs), and completeness met the criteria established in the QAPP (i.e., relative percent difference [RPD] of 20%, percent recovery of 80 to 120%, and completeness of 80%). The quality assurance (QA) data associated with each analyte will be presented and evaluated in a QA/QC Summary Report to be prepared under separate cover upon completion of the Arsenic Demonstration Project.

Field measurements of pH, temperature, DO, and ORP were conducted by the plant operator using a WTW Multi 340i handheld field meter, which was calibrated for pH and DO prior to use following the procedures provided in the user's manual. The ORP probe also was checked for accuracy by measuring the ORP of a standard solution and comparing it to the expected value. The plant operator collected a water sample in a clean, plastic beaker and placed the probe in the beaker until a stable value was obtained.

4.0 RESULTS AND DISCUSSION

4.1 Facility Description and Preexisting Treatment System Infrastructure

The community water system supplies water to 42 homes in the Orchard Highlands Subdivision in Goffstown, NH. Figure 4-1 shows the water treatment building. The water source was a single, deep bedrock well drilled to a depth of approximately 800 ft. The flowrate from this supply well was estimated to be 7.5 gpm based on the pump curve provided by the facility. The actual average and peak flowrates recorded at the site after the installation of the treatment system were 13 and 15 gpm, respectively. The existing system includes an aeration system for radon treatment (Figure 4-2), a 10,000-gal storage tank (Figure 4-3), two booster pumps (Figure 4-4), and a 2,000-gal hydropneumatic pressure tank (Figure 4-5).



Figure 4-1. Preexisting Treatment Building at Orchard Highlands Subdivision

4.1.1 Source Water Quality. Source water samples were collected inside the treatment building from two sample taps before and after the aeration unit on September 13, 2004. The analytical results are presented in Table 4-1 and compared to historic raw water data taken by the facility for the EPA demonstration site selection and treated water data taken by the New Hampshire Department of Environmental Services (NHDES) for compliance purposes. Except for pH and TDS, the analytical results were comparable for the samples collected before and after the aeration unit.

Total arsenic concentrations in raw water ranged from 30 to 33 $\mu\text{g/L}$. Out of 32.7 $\mu\text{g/L}$ of total arsenic, 32.3 $\mu\text{g/L}$ (98.7%) existed as soluble As(V) and only 0.8 $\mu\text{g/L}$ (1.3%) existed as soluble As(III). Since the majority of arsenic was As(V), a pre-oxidation step prior to adsorption was not necessary.



Figure 4-2. Aeration System for Radon Treatment



Figure 4-3. 10,000-gal Storage Tank



Figure 4-4. Booster Pumps



Figure 4-5. 2,000-gal Hydro-pneumatic Pressure Tank

Table 4-1. Orchard Highlands Subdivision Water Quality Data

Parameter	Unit	Facility Data	Battelle Data		NHDES Treated Water Data
			Raw	Post-Aeration	
<i>Sampling Date</i>		NA	09/13/04	09/13/04	00–04
pH	S.U.	7.2	6.9	7.5	7.2
Temperature	°C	NA	12.0	13.1	8.0
DO	mg/L	NA	5.1	5.9	NA
ORP	mV	NA	226	235	NA
Total Alkalinity (as CaCO ₃)	mg/L	44	85	93	44
Hardness (as CaCO ₃)	mg/L	32	25	31	32
Turbidity	NTU	NA	0.2	0.2	NA
TDS	mg/L	NA	84	248	NA
TOC	mg/L	NA	<0.7	<0.7	NA
Nitrate (as N)	mg/L	NA	<0.04	<0.04	NA
Nitrite (as N)	mg/L	NA	<0.01	<0.01	NA
Ammonia (as N)	mg/L	NA	0.05	<0.05	NA
Chloride	mg/L	<6	1.2	1.1	<6
Fluoride	mg/L	NA	0.3	0.4	0.4
Sulfate	mg/L	6	5.8	5.8	6
Silica (as SiO ₂)	mg/L	NA	25.7	25.8	NA
Orthophosphate (as PO ₄)	mg/L	NA	0.2	0.3	0.03
As(total)	µg/L	30	32.7	30.5	30–33
As (total soluble)	µg/L	NA	33.1	32.2	NA
As (particulate)	µg/L	NA	<0.1	<0.1	NA
As(III)	µg/L	<0.001	0.8	0.5	NA
As(V)	µg/L	30	32.3	31.7	NA
Fe (total)	µg/L	<100	<25	<25	<100
Fe (soluble)	µg/L	NA	<25	<25	NA
Mn (total)	µg/L	NA	13.5	3.5	<30
Mn (soluble)	µg/L	<30	2.8	2.9	NA
U (total)	µg/L	NA	2.4	1.9	NA
V (total)	µg/L	NA	0.4	0.4	NA
Na (total)	mg/L	8	8	9	8
Ca (total)	mg/L	14	7	9	14
Mg (total)	mg/L	3	2	2	3
Radon	PCi/L	13,100	NA	NA	NA

NA = not analyzed, ND = not detectable

The pH values of raw water samples ranged from 6.9 before aeration to 7.5 after aeration. Aeration might have helped remove some carbon dioxide (CO₂), thereby increasing the pH values of the aerated water. Nevertheless, these pH values were well within the acceptable pH range of 6.5 to 8.0 for effective arsenic adsorption by the AD-33 media. Therefore, pH adjustment was not recommended.

The adsorptive capacity of the AD-33 media can be impacted by high levels of competing anions such as orthophosphate, silica, vanadate, and fluoride. Orthophosphate concentrations ranged from 0.2 to 0.3 mg/L (as PO₄), which could compete with arsenate for adsorption sites. Concentrations of other competing anions appeared to be low enough not to affect the media's adsorption of arsenic. Iron was not detected (with a reporting limit of 25 µg/L) in raw water; therefore, pre-treatment for iron removal prior to adsorption was not required.

4.1.2 Distribution System. The distribution system was constructed primarily of polyvinyl chloride (PVC) pipe. Connections to the distribution system and piping within residences were made of copper.

Compliance samples from the distribution system were collected for NHDES for quarterly bacterial analysis, and for periodic analysis of inorganic chemicals, nitrates, radiologicals, synthetic organic compounds, and volatile organic compounds (Table 4-1).

4.2 Treatment Process Description

The AdEdge arsenic package unit (APU) is a fixed-bed down-flow adsorption system, which uses Bayoxide E33 (or AD-33 as branded by AdEdge), an iron-based adsorptive media developed by Bayer AG, for arsenic removal from drinking water supplies. Table 4-2 presents physical and chemical properties of the media. AD-33 media is delivered in a dry crystalline form and listed by NSF International (NSF) under Standard 61 for use in drinking water applications.

Table 4-2. Physical and Chemical Properties of AD-33 Media^(a)

<i>Physical Properties</i>	
Parameter	Value
Matrix	Iron oxide composite
Physical Form	Dry granules
Color	Amber
Bulk Density (lb/ft ³)	28.1
BET Area (m ² /g)	142
Attrition (%)	0.3
Moisture Content (% [by wt.])	~8
Particle Size Distribution (U.S. standard mesh)	10 × 35
Crystal Size (Å)	70
Crystal Phase	α-FeOOH
<i>Chemical Analysis</i>	
Constituents	Weight (%)
FeOOH	90.1
CaO	0.27
MgO	1.00
MnO	0.11
SO ₃	0.13
Na ₂ O	0.12
TiO ₂	0.11
SiO ₂	0.06
Al ₂ O ₃	0.05
P ₂ O ₅	0.02
Cl	0.01

(a) Provided by Bayer AG.
BET = Brunauer, Emmett, and Teller

The arsenic treatment system at the Orchard Highland Subdivision site consisted of two pressure vessels operating in series. For series operation, the media in the lead vessel is removed and replaced when the effluent from the lag vessel reaches 10 µg/L of arsenic. The spent media is disposed of after being

subjected to TCLP testing. After rebedding, the lead vessel is switched to the lag position and the lag vessel is switched to the lead position. The series operation better utilizes the media capacity when compared to the parallel operation because the lead vessel exhausts completely prior to change-out.

The system piping/valving as initially installed did not allow for switching of the lead/lag vessels, but was modified, after the media change-out, to allow for switching of the vessel position. The schematic of the system with switchable lead/lag vessels is shown in Figure 4-6. The adsorption vessels received water directly from the well and the effluent for the adsorption system was further treated by the preexisting aeration unit for radon removal. Table 4-3 presents the key system design parameters. Figure 4-7 shows the generalized process flow for the system including sampling locations and parameters to be analyzed. The key process components are discussed as follows:

- **Intake.** Raw water was pumped from the well and fed into the treatment system at approximately 13 gpm. The well pump was controlled by a float switch within the 10,000-gal storage tank.
- **Adsorption System.** The treatment system consisted of two 18-in-diameter, 65-in-tall pressure vessels in series configuration, each containing 5 ft³ of AD-33 media supported by a gravel underbed. The vessels were fiberglass-reinforced plastic (FRP) construction, rated for 150 pounds per square inch (psi) working pressure, skid-mounted, and piped to a valve rack mounted on a welded frame. The design EBCT for the system was approximately 3.7 min based on a media volume of 5 ft³/vessel (with a bed depth of 37.5 in) and a design flowrate of 10 gpm. Figure 4-8 shows the installed system and Figure 4-9 shows the system control panel.
- **Backwash.** On automatic operation, backwash might be set by time or pressure differential. The system also might be backwashed manually. The adsorption vessels were taken offline for backwash one at a time using the treated water from the 2,000-gal hydropneumatic tank. The purpose of the backwash was to remove particles and media fines accumulating in the beds. The backwash wastewater produced was discharged to an on-site surface drainage field for disposal.
- **Aeration, Storage, and Distribution.** Effluent of the adsorption system was aerated to remove radon before entering the existing 10,000-gal storage tank. Two existing booster pumps were used to pump water from the storage tank to the 2000-gal hydropneumatic tank to ensure adequate supply pressure to the distribution system.

4.3 System Installation

The installation of the APU system was completed by Thursty Water Systems, a subcontractor to AdEdge, on April 14, 2005. The following subsections summarize pre-demonstration activities, including permitting, building preparation, and system offloading, installation, shakedown, and startup.

4.3.1 Permitting. The engineering plan with design drawings for the proposed treatment system was submitted to the NHDES by AdEdge on March 3, 2005. NHDES granted the treatment system permit on March 31, 2005. NHDES commented that the disposal of the periodic backwash wastewater should be consistent with that allowed for the Rollinsford, NH site studied in Round 1 of the EPA's arsenic technology demonstration project and that the completed installation should be disinfected and tested for bacterial presence before being placed into service.

Basic Goffstown Flow Diagram
 Reversible LEAD/LAG Arsenic Treatment System

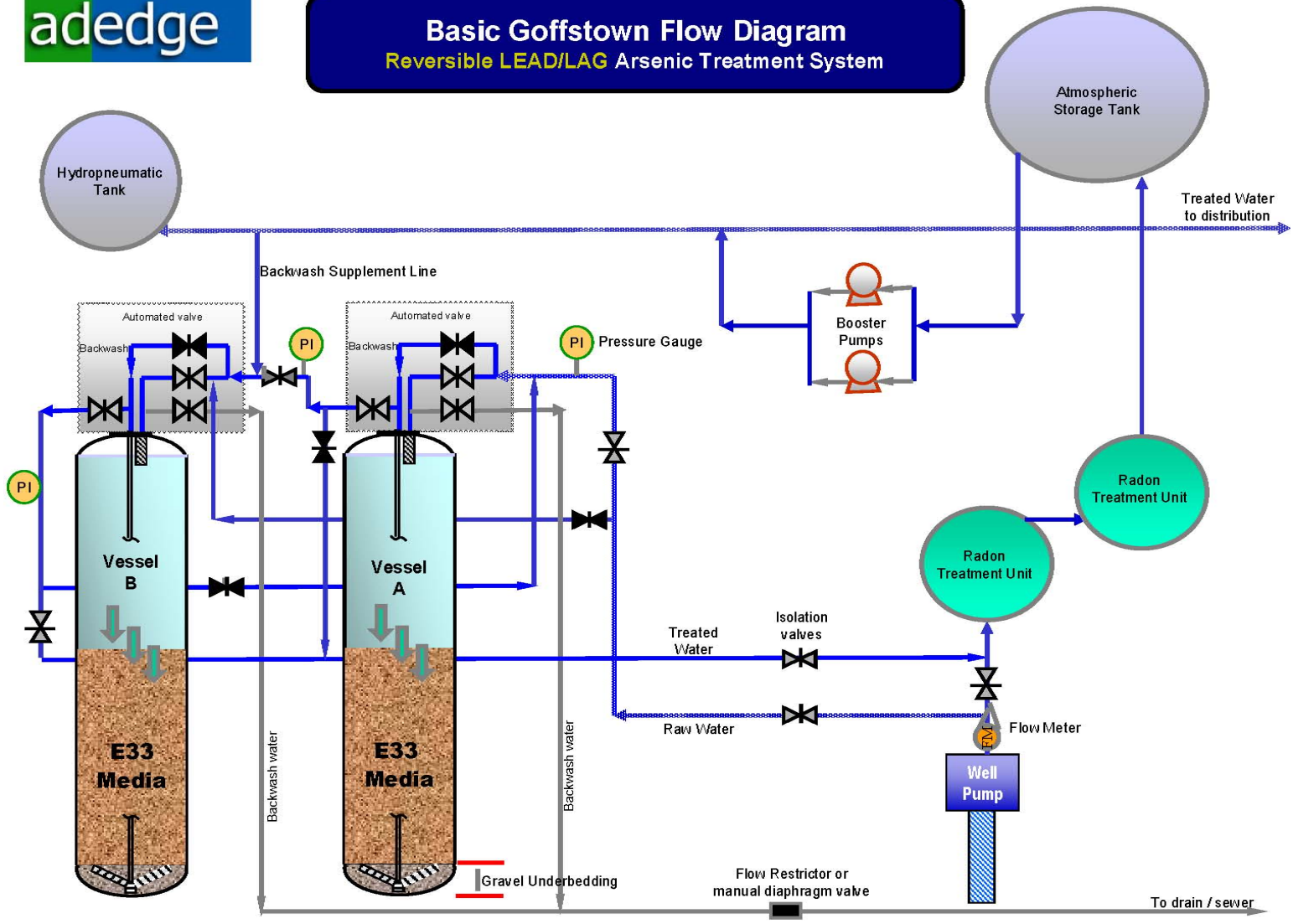

19

Figure 4-6. Schematic of APU-GOFF-LL System

Table 4-3. Design Features of APU-GOFF-LL System

Design Parameter	Value	Remarks
Pretreatment	NA	Not required
<i>Adsorbers</i>		
Number of Adsorbers	2	–
Configuration	Series	–
Vessel Size (in)	18 D × 65 H	–
Vessel Cross Sectional Area (ft ²)	1.77	–
Type of Media	Bayoxide E33	–
Quantity of Media (ft ³)	10 (total)	Two vessels, each vessel with 5 ft ³ of media
Media Bed Depth (in)	34	–
Design Flowrate (gpm)	10	–
Hydraulic Loading Rate (gpm/ft ²)	5.6	–
EBCT (min)	3.7	Based on 10 gpm flowrate
<i>Backwash</i>		
Backwash Flowrate (gpm)	15.9	–
Backwash Hydraulic Loading Rate (gpm/ft ²)	9	–
Backwash Duration (min/vessel)	20	–
Backwash wastewater Generated (gal/vessel)	320	–
Design Backwash Frequency (time/month)	1 to 2	Set to manual so that backwash sample could be collected
<i>Adsorption System</i>		
Average Throughput to System (gpd)	11,550	Vendor estimated
Average Throughput to System (BV/day)	308	
Estimated Working Capacity (BV)	62,690	Bed volumes to breakthrough at 10 µg/L from lead vessel based on vendor estimate
Estimated Volume to Breakthrough (gal)	2,344,600	Based on vendor estimated bed volumes to breakthrough at 10 µg/L from lead vessel
Estimated Media Life (months)	6.7	Estimated frequency of media change-out from lead vessel based on throughput of 11,550 gpd and breakthrough at 10µg/L from lead vessel

4.3.2 Building. The existing building that housed the preexisting treatment system had an adequate building footprint to house the planned arsenic treatment system. Additional preparation was not needed.

4.3.3 Installation, Shakedown, and Startup. The treatment system arrived on-site on April 12, 2005. Figure 4-10 shows a photograph of the system arriving at the site. Several of the PVC connections were damaged during shipping and had to be replaced before system installation. AdEdge and Thursty Water System, an AdEdge subcontractor, installed the treatment system during April 13 through 14, 2005. After media loading, a water sample was collected from the system for bacterial analysis on April 14, 2005. The system was bypassed until April 15, 2005, when the results of the bacterial test indicated that the system could be placed online. Meanwhile, AdEdge and the plant operator performed the system shakedown and startup work, which included media backwash and flow adjustment to approximately 16 gpm for the backwash cycle. Battelle conducted a system inspection and provided operator training on data and sample collection.

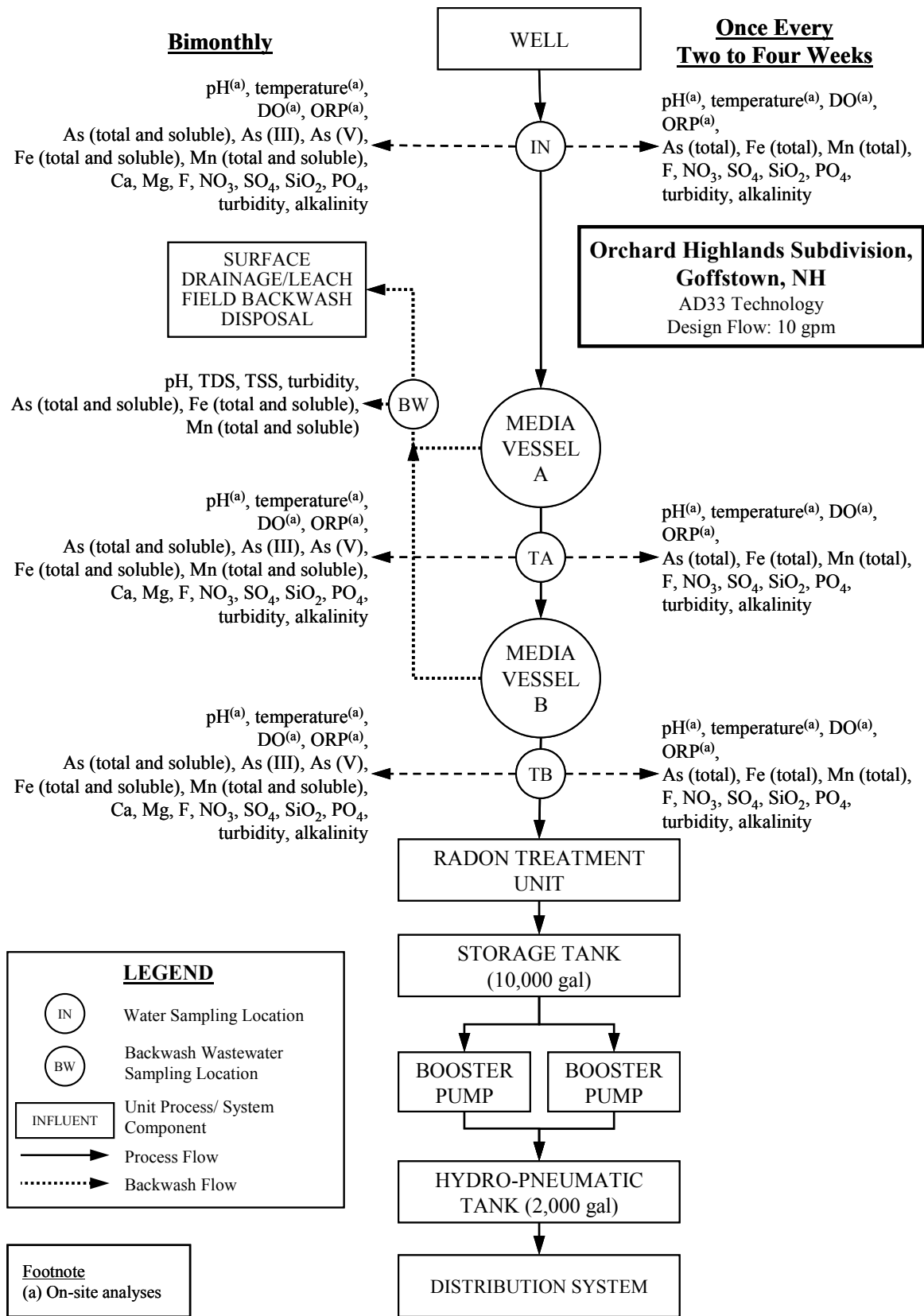

Figure 4-7. Process Flow Diagram and Sampling Locations



Figure 4-8. APU-GOFF-LL Treatment System



Figure 4-9. System Control Panel



Figure 4-10. System Being Delivered to Site

4.4 System Operation

4.4.1 Operational Parameters. System operational data collected during the demonstration were tabulated and are attached as Appendix A. Key parameters are summarized in Table 4-4 and are broken down into Run 1, Run 2, and total. Run 1 covers the operation from system startup on April 15, 2005, to when the media in the lead vessel was replaced on September 6, 2006. Run 2 covers the operation following the media change-out to when the effluent of the treatment system reached approximately 10 µg/L on August 6, 2007. From April 15, 2005, through August 6, 2007, the system operated for a total of 4,559 hr based on well pump hour-meter readings recorded since June 9, 2005 when an hour meter was installed. Before installation of the hour meter, the daily run time was estimated by taking the average. This cumulative operating time represents a use rate of approximately 22.5% during this 30-month demonstration period. The system operated for an average of 5.4 hr/day.

Run 1 treated approximately 2,085,000 gal, or 55,750 BV, of water based on totalizer readings on the lead vessel. (Bed volume was calculated based on 5 ft³ of media in the lead vessel). After media change-out and vessel switching, Run 2 treated approximately 1,374,000 gal, or 36,740 BV, of water. Flowrates to the system, calculated based on daily totalizer and hour meter readings on the lead vessel, ranged from 9 to 16 gpm and averaged 13 gpm. The highest flowrate occurred when the pump was initially turned on and the flowrate decreased gradually as the well pump operated. The average system flowrate was 30% higher than the 10-gpm design value (Table 4-3), which was derived from the 7.5-gpm supply well flowrate according to the facility-provided pump curve. Based on the flowrates to the system, EBCTs for the lead vessel varied from 2.3 to 4.2 min and averaged 2.9 min, compared to the design value of 3.7 min.

4.4.2 Backwash. AdEdge recommended that the treatment system be backwashed approximately once or twice per month either manually or automatically. Automatic backwash could be initiated either

Table 4-4. Summary of Treatment System Operation

Operational Parameter	Run 1	Run 2	Total
Duration	04/15/05–09/06/06	09/07/06–08/06/07	04/15/05–08/06/07
Cumulative Operating Time (hr)	2,716	1,843	4,559
Days of Operation (day)	510	334	844
Average Daily Operating Time (hr)	5.3	5.5	5.4
Throughput (gal)	2,085,000	1,374,000	3,459,000
Bed Volumes (BV) ^(a)	55,749	36,738	92,487
Average (Range of) Flowrate (gpm)	13 (9–16) ^(b)	13 (11–15) ^(c)	13 (9–16) ^(b,c)
Average (Range of) EBCT (min) ^(a)	2.9 (2.3–4.2)	2.9 (2.5–3.4)	2.9 (2.3–4.2)
Average (Range of) Inlet Pressure (psi)	27 (20–36)	24 (18–28)	26 (18–36)
Average (Range of) Outlet Pressure (psi)	9 (5–12)	10 (5–14)	10 (5–14)
Average (Range of) Δp across Vessel A (psi)	5 (1–10)	6 (2–8)	5 (1–10)
Average (Range of) Δp across Vessel B (psi)	4 (3–6)	1 (0–3)	3 (0–6)

- (a) Calculated based on 5 ft³ of media in lead vessel.
- (b) Except for one outlier at 6 gpm on May 9, 2006.
- (c) Except for one outlier at 7 gpm on September 7, 2006.

by a timer or by Δp across the vessels. Due to the steady Δp readings across the vessels (i.e., 1 to 6 psi), the system was backwashed only twice during Run 1, i.e., about four and 16 months after system startup.

4.4.3 Media Change-out. The system was taken offline on September 6, 2006 for media change-out of Vessel A, which was performed by Thursty Water System and AdEdge. Before change-out, depths of freeboard (from the flange at the top of each vessel to the media bed surface) were measured, which showed only 4 to 6% reduction compared to those measured just before system startup. The reduction most likely was due to media compaction. Spent media from Vessel A was then removed as described in Section 3.3.4. After media replacement, the vessels were properly backwashed and the freeboard in Vessel A measured before the system resumed normal operation.

Table 4-5. Freeboard Measurements after Run 1

Parameter	Vessel A	Vessel B
Volume Loaded (ft ³)	5.0	-
Initial Freeboard (in)	19.5	19.5
Final Freeboard (in)	22	21
Bed Reduction (in)	2.5	1.5
Bed Reduction (%)	6	4

Note: Media was change-out in Vessel A only.

4.4.4 Residual Management. Residuals produced by the operation of the system included spent media, as discussed above, and backwash wastewater. Piping for backwash wastewater from both vessels was combined aboveground before exiting the building through the floor. The discharge line traveled underground to behind the treatment building where it exited at the ground surface. Backwash wastewater flowed down the surface drainage field and infiltrated to the ground. Any particulates or media fines carried in the backwash wastewater remained in the drainage field.

4.4.5 System/Operation Reliability and Simplicity. There were no operational problems with the treatment system. The Δp gauge on Vessel B had to be replaced after the gauge was stuck following a

backwash. This gauge was replaced approximately one month later when the media in Vessel A was replaced. The system O&M and operator skill requirements are discussed below in relation to pre- and post-treatment requirements, levels of system automation, operator skill requirements, preventive maintenance activities, and frequency of chemical/media handling and inventory requirements.

Pre- and Post-Treatment Requirements. The majority of arsenic at this site existed as As(V). As such, a pre-oxidation step was not required.

System Automation. The system was fitted with automated controls that would allow for backwash cycles to be controlled automatically; however, because Δp readings across the adsorption vessels did not rise during the performance evaluation, only two manual backwashes were performed. Initially, the system piping did not allow the lead and lag vessels to switch after rebedding of the lead vessel. On September 20, 2006, the piping and valves were reconfigured so that the vessels might be switchable upon media rebedding.

Operator Skill Requirements. Under normal operating conditions, the skill requirements to operate the system were minimal. The operator was onsite typically three times a week and spent approximately 10 min each day performing visual inspection and recording the system operating parameters on the daily log sheets. Normal operation of the system did not require additional skills beyond those necessary to operate the existing water supply equipment.

Based on the size of the population served and the treatment technology, the State of New Hampshire requires Grade IA certification for operation of the treatment system. The State of New Hampshire has five grades of certifications based on the complexity of the treatment and distribution system. The grades range from Grade IA, the least complex, to Grade IV, the most complex.

Preventive Maintenance Activities. Preventive maintenance tasks included such items as periodic checks of flowmeters and pressure gauges and inspection of system piping and valves. Typically, the operator performed these duties only when he was onsite for routine activities.

Chemical/Media Handling and Inventory Requirements. No chemical was used as part of the treatment system at the Orchard Highlands Subdivision site.

4.5 System Performance

The performance of the system was evaluated based on analyses of water samples collected from the treatment plant, the media backwash, and distribution system.

4.5.1 Treatment Plant Sampling. Table 4-6 summarizes the analytical results of arsenic, orthophosphate, total phosphorous, iron, and manganese concentrations measured at the three sampling locations across the treatment train. Table 4-7 summarizes the results of other water quality parameters including those measured onsite. Appendix B contains a complete set of analytical results through the demonstration.

Water samples for Run 1 were collected on 41 occasions, including five duplicates, with field speciation performed during 10 of the 41 occasions at IN, TA, and TB sampling locations. Water samples for Run 2 were collected on 10 occasions at the three sampling locations; speciation was not performed during Run 2. The results of the water samples collected throughout the treatment plant are discussed below.

Arsenic. Figure 4-11 contains three bar charts showing the concentrations of total arsenic, particulate arsenic, soluble As(III), and soluble As(V) at three locations for each of the 10 speciation events. Total

arsenic concentrations in raw water ranged from 24.0 to 37.3 µg/L and averaged 29.7 µg/L. Soluble As(V) was the predominating species, ranging from 25.3 to 33.6 µg/L and averaging 29.0 µg/L. Soluble As(III) and particulate As concentrations were low, each averaging 0.5 µg/L. The arsenic concentrations measured were consistent with those collected previously during source water sampling (Table 4-1).

Table 4-6. Runs 1 and 2 Analytical Results for Arsenic, Orthophosphate, Iron, and Manganese

Parameter	Sampling Location	Unit	Sample Count	Concentration			Standard Deviation
				Minimum	Maximum	Average	
As (total)	IN	µg/L	41 [10]	24.0 [28.2]	37.3 [34.5]	29.7 [31.3]	3.5 [2.2]
	TA	µg/L	41 [10]	(a)			
	TB	µg/L	41 [10]	—			
As (soluble)	IN	µg/L	10	25.4	34.5	29.6	3.2
	TA	µg/L	10	(a)			
	TB	µg/L	10	—			
As (particulate)	IN	µg/L	10	<0.1	1.6	0.5	0.6
	TA	µg/L	10	(a)			
	TB	µg/L	10	—			
As(III)	IN	µg/L	10	<0.1	0.9	0.5	0.2
	TA	µg/L	10	(a)			
	TB	µg/L	10	—			
As(V)	IN	µg/L	10	25.3	33.6	29.0	3.1
	TA	µg/L	10	(a)			
	TB	µg/L	10	—			
Orthophosphate (as P)	IN	mg/L	9	<0.05	0.1	0.1	0.0
	TA	mg/L	9	<0.05	0.1	0.1	0.0
	TB	mg/L	9	<0.05	<0.05	<0.05	-
Total P (as P)	IN	µg/L	27 [9]	28.4 [16.3]	99.2 [80.4]	71.0 [54.0]	18.3 [21.6]
	TA	µg/L	27 [9]	(b)			
	TB	µg/L	27 [9]	—			
Fe (total)	IN	µg/L	41 [1]	<25 [<25]	<25 [<25]	<25 [<25]	- [-]
	TA	µg/L	41 [1]	<25 [<25]	37.7 [<25]	<25 [<25]	3.9 [-]
	TB	µg/L	41 [1]	<25 [<25]	72.5 [<25]	<25 [<25]	9.4 [-]
Fe (soluble)	IN	µg/L	10	<25	<25	<25	-
	TA	µg/L	10	<25	<25	<25	-
	TB	µg/L	10	<25	105	<25	29.1
Mn (total)	IN	µg/L	41 [1]	0.6 [2.4]	16.7 [2.4]	3.3 [2.4]	3.3 [-]
	TA	µg/L	41 [1]	<0.1 [0.4]	3.9 [0.4]	1.2 [0.4]	0.9 [-]
	TB	µg/L	41 [1]	<0.1 [3.0]	2.0 [3.0]	0.6 [3.0]	0.5 [-]
Mn (soluble)	IN	µg/L	10	0.9	3.6	1.5	0.9
	TA	µg/L	10	0.4	1.6	1.1	0.4
	TB	µg/L	10	0.3	1.0	0.7	0.2

Data in brackets collected during Run 2.

One-half of detection limit used for samples with concentrations less than detection limit for calculations.

Duplicate samples included in calculations.

(a) Statistics not meaningful for data related to arsenic breakthrough; see data on Figures 4-11 and 4-12.

(b) Statistics not meaningful for data related to total phosphorous breakthrough; see data on Figure 4-13.

Table 4-7. Runs 1 and 2 Water Quality Parameter Sampling Results

Parameter	Sampling Location	Unit	Sample Count	Concentration			Standard Deviation
				Minimum	Maximum	Average	
Alkalinity (as CaCO ₃)	IN	mg/L	41 [1]	33.0 [62.0]	88.0 [62.0]	46.7 [62.0]	10.5 [-]
	TA	mg/L	41 [1]	34.0 [48.0]	63.0 [48.0]	45.9 [48.0]	6.9 [-]
	TB	mg/L	41 [1]	35.0 [48.0]	60.0 [48.0]	45.4 [48.0]	5.9 [-]
Fluoride	IN	mg/L	41 [1]	<0.1 [0.6]	1.5 [0.6]	0.4 [0.6]	0.2 [-]
	TA	mg/L	41 [1]	0.1 [0.4]	0.7 [0.4]	0.3 [0.4]	0.1 [-]
	TB	mg/L	41 [1]	0.2 [0.4]	0.7 [0.4]	0.3 [0.4]	0.1 [-]
Sulfate	IN	mg/L	41 [1]	4.5 [6.0]	9.0 [6.0]	5.6 [6.0]	1.0 [-]
	TA	mg/L	41 [1]	4.5 [6.0]	10.0 [6.0]	5.6 [6.0]	1.2 [-]
	TB	mg/L	41 [1]	4.6 [6.0]	9.0 [6.0]	5.6 [6.0]	1.0 [-]
Nitrate (as N)	IN	mg/L	41 [1]	<0.05 [<0.05]	4.7 [<0.05]	0.2 [<0.05]	0.7 [-]
	TA	mg/L	41 [1]	<0.05 [<0.05]	1.1 [<0.05]	0.1 [<0.05]	0.2 [-]
	TB	mg/L	41 [1]	<0.05 [0.1]	5.1 [0.1]	0.2 [0.1]	0.8 [-]
Silica (as SiO ₂)	IN	mg/L	41 [9]	23.4 [23.1]	31.7 [25.7]	25.4 [24.7]	1.3 [0.8]
	TA	mg/L	41 [9]	19.1 [22.9]	27.1 [25.1]	25.0 [24.4]	1.3 [0.7]
	TB	mg/L	41 [9]	8.9 [19.7]	27.2 [25.4]	24.6 [24.2]	2.7 [1.8]
Turbidity	IN	NTU	41 [1]	<0.1 [0.2]	3.5 [0.2]	0.6 [0.2]	0.7 [-]
	TA	NTU	41 [1]	<0.1 [0.3]	3.2 [0.3]	0.7 [0.3]	0.8 [-]
	TB	NTU	41 [1]	<0.1 [0.8]	3.6 [0.8]	0.7 [0.8]	0.8 [-]
pH	IN	S.U.	36 [2]	6.8 [7.1]	7.5 [7.1]	7.1 [7.1]	0.2 [0.0]
	TA	S.U.	36 [2]	6.9 [7.3]	7.4 [7.4]	7.2 [7.3]	0.1 [0.1]
	TB	S.U.	36 [2]	6.9 [7.2]	7.5 [7.4]	7.3 [7.3]	0.1 [0.1]
Temperature	IN	°C	36 [2]	10.0 [11.9]	15.9 [12.9]	12.6 [12.4]	1.5 [0.7]
	TA	°C	36 [2]	10.3 [12.1]	16.5 [13.2]	12.8 [12.7]	1.4 [0.8]
	TB	°C	36 [2]	9.6 [12.3]	16.8 [13.5]	12.9 [12.9]	1.8 [0.8]
DO	IN	mg/L	36 [2]	3.7 [5.7]	8.0 [6.2]	6.2 [6.0]	1.0 [0.4]
	TA	mg/L	36 [2]	3.2 [4.2]	7.6 [5.2]	5.8 [4.7]	1.1 [0.7]
	TB	mg/L	36 [2]	3.9 [4.5]	7.4 [5.6]	6.0 [5.0]	0.8 [0.7]
ORP	IN	mV	36 [2]	168 [167]	302 [197]	212 [182]	22.9 [21.2]
	TA	mV	36 [2]	183 [160]	247 [206]	212 [183]	15.7 [32.5]
	TB	mV	36 [2]	194 [160]	307 [196]	218 [178]	20.5 [25.5]
Total Hardness (as CaCO ₃)	IN	mg/L	28	17.8	42.8	28.4	6.4
	TA	mg/L	28	18.5	40.9	29.4	6.2
	TB	mg/L	28	20.1	43.0	28.7	5.2
Ca Hardness (as CaCO ₃)	IN	mg/L	28	12.8	31.7	19.5	5.5
	TA	mg/L	28	13.7	29.9	20.4	4.8
	TB	mg/L	28	13.9	31.8	20.3	4.2
Mg Hardness (as CaCO ₃)	IN	mg/L	28	5.0	12.8	8.9	1.5
	TA	mg/L	28	4.7	13.1	9.0	1.8
	TB	mg/L	28	4.1	12.4	8.5	1.6

Data in brackets collected during Run 2.

One-half of detection limit used for samples with concentrations less than detection limit for calculations.

Duplicate samples included in calculations.

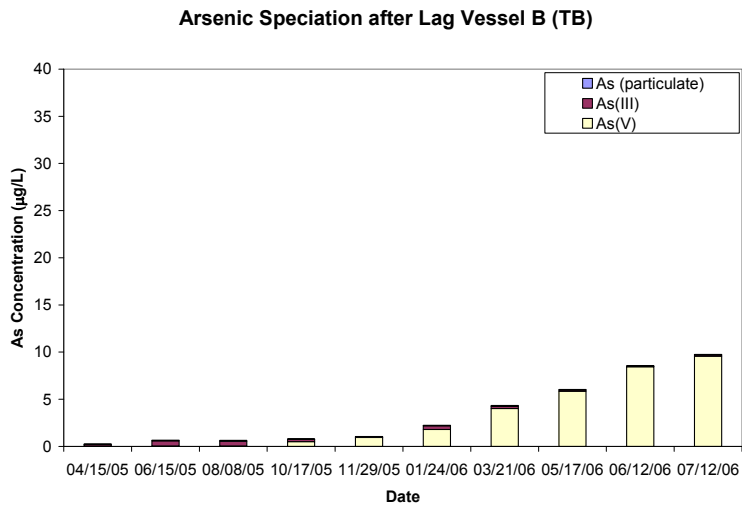
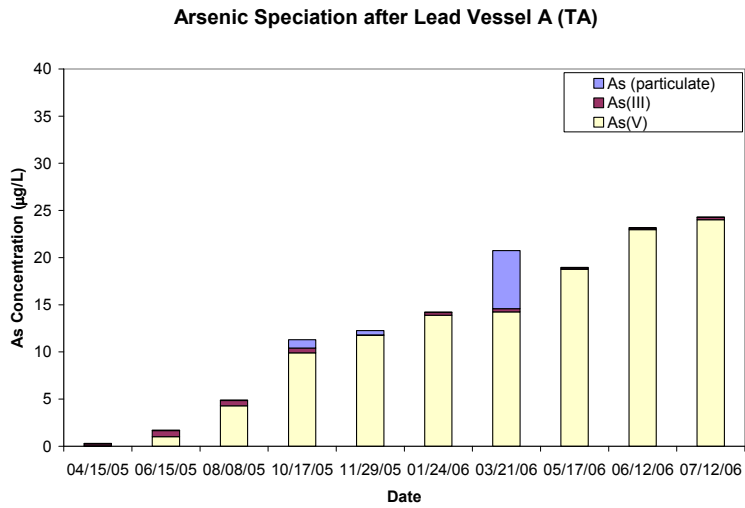
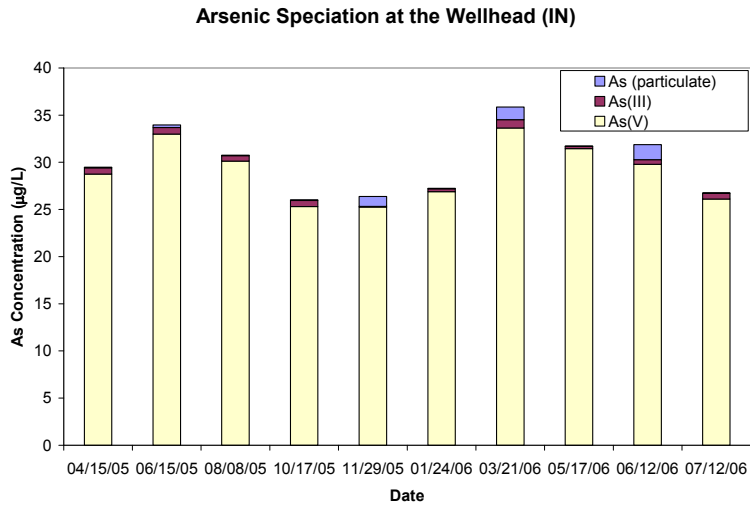

Figure 4-11. Concentrations of Various Arsenic Species at IN, TA, and TB Sampling Locations

The key parameter for evaluating the effectiveness of the system was the arsenic concentration in the treated water. Figure 4-12 shows the arsenic breakthrough curves plotted against the amount of water treated with the number of bed volumes to arsenic breakthrough at 10 µg/L from the lead and lag vessels specified. Bed volumes following the lead vessel were calculated based on the amount of media in the lead vessel only; however, bed volumes following the lag vessel, or the entire system, were calculated based on the combined media volume in both the lead and lag vessels since water exiting the lag had been treated by this entire media volume. Initially, the lead vessel (Vessel A) removed the majority of arsenic from source water until its capacity was gradually diminished. Afterwards, the lag vessel (Vessel B) served as a polishing unit, removing arsenic to less than 10 µg/L throughout most of Run 1. Both breakthrough curves in Figure 4-12 gradually increased over time.

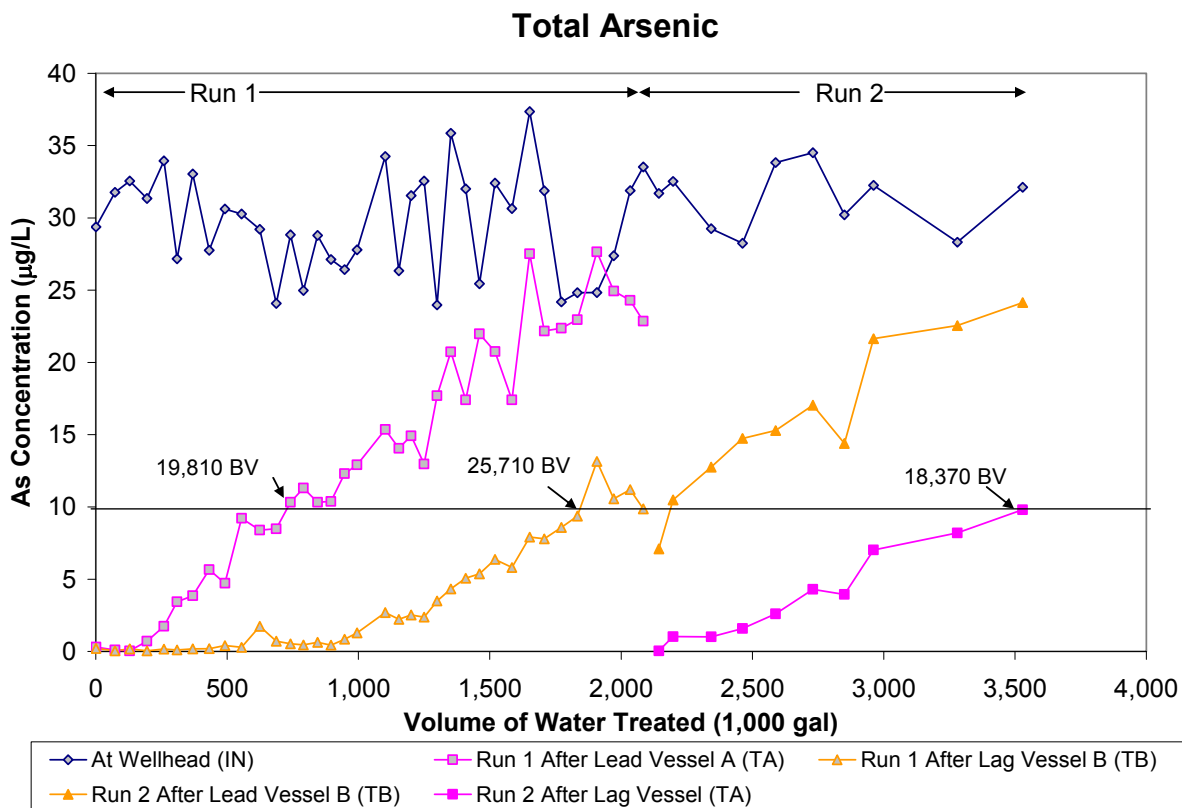

Figure 4-12. Total Arsenic Breakthrough Curves for Runs 1 and 2

Breakthrough of arsenic at 10 µg/L from the lead vessel occurred at approximately 19,810 BV, which was 31.6% of the vendor estimated working capacity, i.e., 62,690 BV, based on 5 ft³ of media in the lead vessel (Table 4-3). One potential contributing factor to the earlier than expected breakthrough was the shorter EBCT (i.e., 2.9 min versus the design value of 3.7 min), which was caused by the higher flowrate of 13 gpm.

Another factor that might have contributed to the shorter media life was the presence of competing anions, such as phosphorous and silica, in raw water with concentrations up to 99.2 µg/L (as P) for phosphorous and 31.7 mg/L (as SiO₂) for silica. As shown in Figure 4-13, phosphorous was effectively removed to below its detection limit of 10 µg/L by both vessels until 13,700 BV (~1,000,000 gal) when detectable concentrations (11.0 µg/L [as P]) of phosphorous were measured in the system effluent.

Breakthrough curves for both lead and lag vessels show a gradual increase of phosphorous in the effluent over time. During the first nine months of operation, water samples were analyzed for orthophosphate (as P) and a similar trend was observed. Orthophosphate was effectively removed to below its detection limit of 0.05 mg/L by the lead vessel up to about 19,500 BV. Coincidentally, as breakthrough of arsenic approached 10 µg/L, orthophosphate also began to break through. After the breakthrough, detectable concentrations of 0.1 mg/L were measured following the lead vessel, but were reduced to below its detection limit following the lag vessel. Sampling of orthophosphate was then discontinued due to laboratory issues. To a lesser extent, silica also might compete with arsenic for available adsorptive sites, as evidenced by the reduced silica concentrations observed during the first sampling event on April 15, 2005, October 4, 2005, and after the media change-out on September 19, 2006.

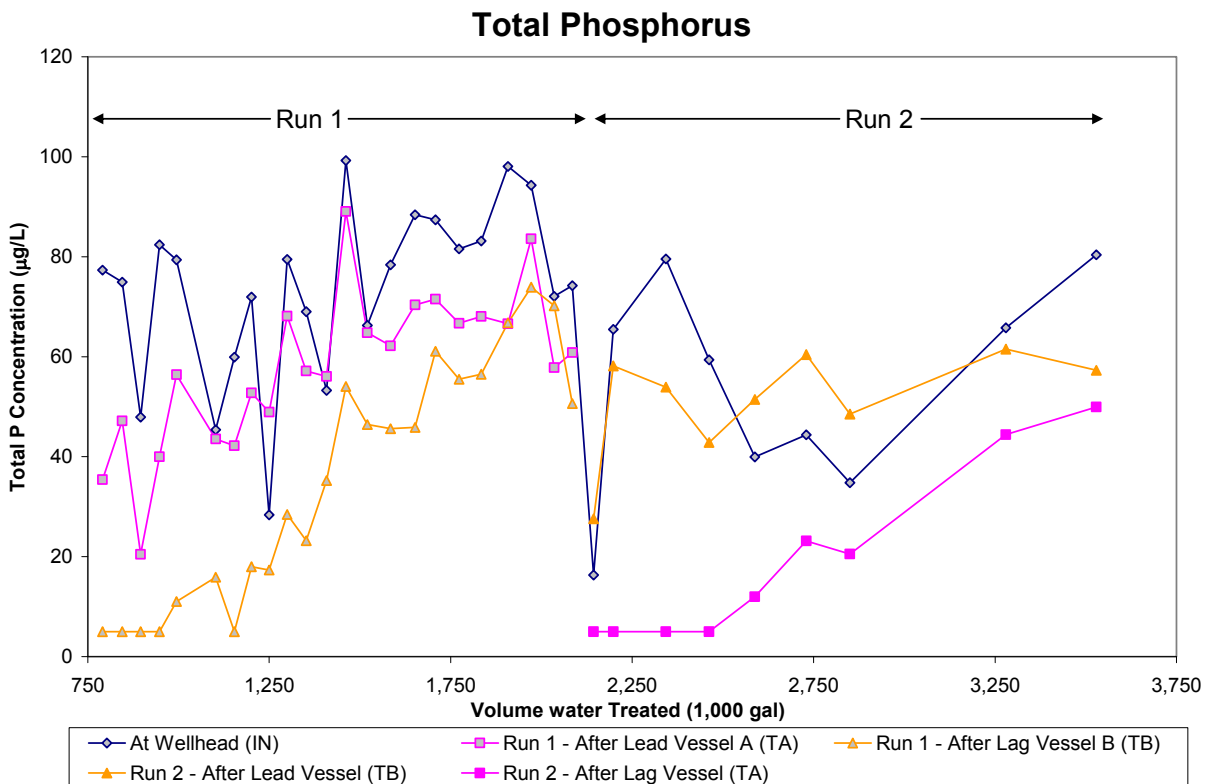

Figure 4-13. Total Phosphorous Breakthrough Curves for Runs 1 and 2

Breakthrough of arsenic at 10 µg/L following Vessel B, or the entire system, occurred at 25,710 BV (1 BV = 10 ft³), which was 30% higher than the 19,810 BV observed following the lead tank. The average EBCT of the system was 5.8 min, which was twice as long as that for the lead tank only. The longer EBCT benefited arsenic adsorption, extending the media run length for 30%. At this time, Vessel A had an approximate arsenic effluent concentration of 22.8 µg/L, which was approaching the influent concentration of 33.5 µg/L on September 5, 2006. Approximately 2,085,000 gal of water was processed through the system before media change-out of the lead vessel was necessary.

The benefit of the lead/lag system is that the media in the lead vessel can be more fully utilized, ideally to or near its full capacity, before it is to be replaced. The lag vessel is used as a polishing unit to bring the concentrations to below the MCL. The first run treated more BV of water due to the use of virgin media

in both vessels. For Run 2, the lead vessel had already been partially exhausted; therefore, fewer BV (i.e., 18,370 vs. 25,710) was treated before arsenic concentrations following the lag vessel reached 10 µg/L. The frequency of lead vessel change-out would be somewhere between 18,370 and 25,710 BV.

On September 6, 2006, the media in Vessel A was changed out and piping modifications were started to make the vessels switchable. The modifications were not completed until September 20, 2006, however, due to unavailability of a valve. Since then, Run 2 was carried out with the partially exhausted Vessel B in the lead position and the newly rebedded Vessel A in the lag position. Results of initial sampling on October 2, 2006, showed 10.5 µg/L of total arsenic following Vessel B (the lead vessel) and 1.0 µg/L following Vessel A (the lag vessel). After approximately 1,374,000 gal of water had been treated by the system, the effluent of the system reached 10 µg/L on August 6, 2007. Sampling was discontinued and the performance evaluation was completed.

Iron and Manganese. Total iron concentrations in raw water were below its detection limit of 25 µg/L (Table 4-6). Total iron concentrations across the treatment train also were below the detection limit, except for two measurements: one at 72.5 µg/L at the TB location on September 6, 2005 and one at 37.7 µg/L at the TA location on June 12, 2006. Total manganese levels ranged from 0.6 to 16.7 µg/L and averaged 3.3 µg/L in raw water. Manganese existed in both soluble and particulate forms. Total manganese concentrations in the effluent from the adsorption vessels showed a decreasing trend, with an average of 1.2 and 0.6 µg/L measured after the lead and lag vessels, respectively, during Run 1 and 3.0 and 0.4 µg/L measured on September 19, 2006 after the lead and lag vessels, respectively, during Run 2.

Other Water Quality Parameters. As shown in Table 4-7, pH values of raw water measured at the IN sample location varied from 6.8 to 7.5 and averaged 7.1. Although not monitored during the demonstration, the pH of the water after aeration was higher than that before aeration as measured during the initial site visit (Table 4-1). The higher pH values might have caused some arsenic to desorb into the backwash wastewater when the aerated water was used to backwash the media.

Alkalinity, reported as CaCO₃, ranged from 33 to 88 mg/L. The results indicate that the adsorptive media had little or no effect on alkalinity in the treated water. Total hardness ranged from 17.8 to 42.8 mg/L (as CaCO₃) and averaged 28.4 mg/L (as CaCO₃). Total hardness as well as calcium and magnesium hardness remained constant throughout the treatment train.

Sulfate concentrations ranged from 4.5 to 9.0 mg/L in raw water, and remained constant throughout the treatment train. Fluoride levels ranged from less than the reporting limit of 0.1 to 1.5 mg/L in all samples. The results indicate that the adsorptive media did not affect the amount of fluoride in the treated water.

DO levels ranged from 3.2 to 8.0 mg/L; ORP readings ranged from 168 to 307 mV across all sampling locations. The water pumped from the 800-ft-deep bedrocks appear to be fairly oxidizing.

4.5.2 Backwash Wastewater Sampling. Backwash was performed using the treated water drawn from the 2,000-gal hydropneumatic tank. As shown in Appendix B, the treated water sampled on August 22, 2005, contained no more than 0.3 µg/L of total arsenic. In contrast, the wastewater samples collected during lead and lag vessel backwashing on the same date contained 30.2 and 3.6 µg/L of soluble arsenic, respectively, indicating desorption. More arsenic was leached from the lead than the lag vessel, likely due to the higher arsenic loading in the lead vessel. Arsenic desorption may be caused by the slightly higher pH of the treated water following aeration for radon removal. The arsenic concentration and pH value of the water from the 2,000-gal hydropneumatic tank were not measured during the study, but the initial site visit samples showed a pH of 7.5 in the aerated water (Table 4-1). Turbidity readings from Vessel A were higher than those from Vessel B, most likely because the lead vessel had removed the

majority of particulates from raw water. The analytical results from the backwash wastewater samples collected are summarized in Table 4-8.

The backwash wastewater sampling procedure was modified during the second backwash event to include the collection of composite samples for total As, Fe, and Mn and TSS. This modified procedure involved diverting a portion of backwash wastewater from the backwash discharge line to a 32-gal plastic container over the duration of backwash for each vessel and collecting a composite sample from the container after the content had been well mixed. The composite samples also were filtered using 0.45- μ m filters and analyzed for soluble As, Fe, and Mn.

For the second backwash on August 7, 2006, the treated water used for backwashing contained 10.6 μ g/L of total arsenic. The backwash wastewater from Vessel A contained a much higher total arsenic level (i.e., 133 μ g/L) with the majority (i.e., 77%) present as particulate. The particulate arsenic likely was associated with media fines, since as much as 5,430 μ g/L of particulate iron also was present in the backwash wastewater. More arsenic and iron were removed from the lead than the lag vessel, apparently caused by the higher arsenic loading in the lead vessel.

Table 4-8. Backwash Wastewater Sampling Results

Sampling Event		Backwash Vessel #1 Date		Backwash Vessel #2 Date	
Analyte	Unit	08/22/05	08/07/06	08/22/05	08/07/06
pH	S.U.	7.1	7.6	7.2	7.5
Turbidity	NTU	58	NA	19	NA
TDS	mg/L	90	84	80	154
TSS	mg/L	NA	123	NA	16
As (total)	μ g/L	NA	133	NA	13.0
As (soluble)	μ g/L	30.2	30.8	3.6	15.8
As (particulate)	μ g/L	NA	102	NA	<0.1
Fe (total)	μ g/L	NA	5,430	NA	242
Fe (soluble)	μ g/L	<25	<25	<25	<25
Mn (total)	μ g/L	NA	1,288	NA	25.8
Mn (soluble)	μ g/L	1.3	9.7	0.3	3.1

TDS = total dissolved solids, TSS = total suspended solids,
NA = not analyzed

As expected, TSS values were higher for Vessel A (i.e., 123 mg/L) than for Vessel B (i.e., 16 mg/L). Assuming that an average of 320 gal backwash was produced from each vessel at an average flowrate of 16 gpm and duration of 20 min, Vessel A would generate about 0.33 lb of solids (including 3.6×10^{-4} lb of arsenic, 0.01 lb of iron, and 3.4×10^{-3} lb of manganese) and Vessel B would generate 0.04 lb of solids (including 3.5×10^{-5} lb of arsenic, 6.5×10^{-4} lb of iron, and 6.9×10^{-5} lb of manganese), for each backwash cycle.

4.5.3 Spent Media. The treatment system was shut down on September 6, 2006, and spent media samples were collected from Vessel A, and analyzed as discussed in Section 3.3.4. Total metals and TCLP results are presented in Tables 4-9 and 4-10, respectively.

The ICP-MS results of the spent media indicated that the media contained mostly iron at 459 mg/g (as Fe), or 730 mg/g (as FeOOH), which is less than the 90.1% (by weight) specified by Bayer AG (Table 4-2). Phosphorus and silicon, both detected in source water, were removed by the media, increasing the

respective loadings from the virgin media levels of 0.009 and 0.03%, as specified by Bayer AG, to 0.34 and 0.06%. This confirms the trends seen in the phosphorous and silica concentrations in the effluent from the system. The spent media also appeared to have removed some amounts of Cu and Pb from source water, as evidenced by the decreasing loadings from the top to the bottom of Vessel A. The spent media also contained trace levels of Ca, Mg, and Mn (Table 4-9).

Table 4-9. Average Spent Media Total Metal Analysis

Analyte	Vessel A (mg/g)		
	Top	Middle	Bottom
Aluminum	0.42	0.44	0.32
Arsenic	3.5	2.4	2.2
Cadmium	<0.0005	<0.0005	<0.0005
Calcium	2.1	2.1	2.1
Copper	0.24	0.05	0.02
Iron	456	466	457
Lead	0.002	0.001	0.0007
Magnesium	1.1	1.1	1.1
Manganese	1.9	1.8	1.7
Nickel	0.11	0.11	0.11
Phosphorous	3.4	3.4	3.4
Silicon	0.20	0.72	0.95
Zinc	16.2	15.7	15.5

Arsenic concentration on the spent media based on the ICP-MS analysis averaged 2.7 mg/g. The calculated adsorptive capacity based on the influent and effluent curves (Figure 4-12) was 2.6 mg/g. This calculation was based upon a media dry weight of 129.3 lb, assuming a bulk density of 28.1 lb/ft³ and a moisture content of 8%. The calculated adsorptive capacity was very close to the loading analyzed by ICP-MS. The calculated adsorptive capacity on the media in Tank B was 1.6 mg/g, which further supported the decision to rebed only Tank A due to the remaining capacity of the media in Vessel B.

The results of the TCLP test indicate that only barium was detected at 0.39 mg/L (Table 4-10) for the sample tested by Belmont Labs. The rest of the analytes were detected below the respective quantitation limits. The TCLP results indicate that the spent media was non-hazardous and might be disposed of at a sanitary landfill.

Table 4-10. TCLP Results of Spent Media

Analyte	Belmont Laboratory (mg/L)	Advanced Chemistry Labs, Inc. (mg/L)
Arsenic	<0.10	<0.10
Barium	0.39	<2.00
Cadmium	<0.010	<0.10
Chromium	<0.010	<0.20
Lead	<0.050	<0.50
Mercury	<0.0020	<0.002
Selenium	<0.10	<0.10
Silver	<0.010	<0.50

4.5.4 Distribution System Water Sampling. Prior to the installation/operation of the treatment system, baseline distribution system water samples were collected four times at three residences on January 10, January 25, February 7, and March 21, 2005. Following the installation of the treatment system, distribution water sampling continued on a monthly basis for 15 months. The results of the distribution system sampling are summarized on Table 4-11.

Baseline arsenic concentrations before treatment ranged from 23.7 to 34.2 µg/L and averaged 30 µg/L for all three locations. One month after the performance evaluation began, arsenic concentrations were reduced to an average of 2.3 µg/L. During the demonstration, arsenic concentrations in the distribution locations mirrored those in the system effluent.

Lead concentrations ranged from <0.1 to 3.0 µg/L, with none of the samples exceeding the action level of 15 µg/L. Copper concentrations ranged from 6.1 to 133 µg/L, with no samples exceeding the 1,300 µg/L action level. The system did not seem to affect the Pb or Cu concentrations in the distribution system.

Measured pH ranged from 6.6 to 8.2 and averaged 7.4. Alkalinity levels ranged from 44 to 67 mg/L (as CaCO₃) with one outlier at 116 measured at DS3 on June 13, 2006. Iron was not detected in any of the samples; manganese concentrations ranged from 0.3 to 3.3 µg/L. The arsenic treatment system did not seem to affect these water quality parameters in the distribution system.

4.6 System Cost

The system cost is evaluated based on the capital cost per gpm (or gpd) of the design capacity and the O&M cost per 1,000 gal of water treated. The capital cost includes the cost for equipment, site engineering, and installation and the O&M cost includes media replacement and disposal, electrical power use, and labor.

4.6.1 Capital Cost. The capital investment for equipment, site engineering, and installation of the Goffstown treatment system was \$34,210 (see Table 4-12). The equipment cost was \$22,431 (or 66% of the total capital investment), which included \$17,171 for the skid-mounted APU-GOFF-LL unit, \$3,000 for the AD-33 media (\$300/ft³ or \$10.68/lb to fill two vessels), \$1,000 for shipping, and \$1,260 for labor.

The engineering cost included the cost for preparation of a process flow diagram of the treatment system, mechanical drawings of the treatment equipment, and a schematic of the building footprint and equipment layout to be used as part of the permit application submittal (see Section 4.3.1). The engineering cost was \$4,860, or 14% of the total capital investment.

The installation cost included the equipment and labor to unload and install the skid-mounted unit, perform piping tie-ins and electrical work, load and backwash the media, perform system shakedown and startup, and conduct operator training. The installation was performed by AdEdge and its local contractor, Thursty Water Systems. The installation cost was \$6,910, or 20% of the total capital investment.

The total capital cost of \$34,210 was normalized to the system's rated capacity of 10 gpm (14,400 gpd), which resulted in \$3,421/gpm of design capacity (\$2.38/gpd). The capital cost also was converted to an annualized cost of \$3,229/year using a capital recovery factor (CRF) of 0.09439 based on a 7% interest rate and a 20-year return period. Assuming that the system operated 24 hours a day, 7 days a week at the system design flowrate of 10 gpm to produce 5,256,000 gal of water per year, the unit capital cost would be \$0.61/1,000 gal. Because the system operated an average of 5.3 hr/day at 13 gpm (see Table 4-4), producing 1,508,900 gal of water during the first year of operation (see Appendix A), the unit capital cost increased to \$2.13/1,000 gal at this reduced rate of use.

Table 4-11. Distribution System Sampling Results

Sampling Event		Treated Water		DS1							DS2							DS3									
No.	Date	As	pH	Stagnation Time	pH	Alkalinity	As	Fe	Mn	Pb	Cu	Stagnation Time	pH	Alkalinity	As	Fe	Mn	Pb	Cu	Stagnation Time	pH	Alkalinity	As	Fe	Mn	Pb	Cu
		µg/L	S.U.	hr	S.U.	mg/L	µg/L	µg/L	µg/L	µg/L	µg/L	hr	S.U.	mg/L	µg/L	µg/L	µg/L	µg/L	µg/L	µg/L	hr	S.U.	mg/L	µg/L	µg/L	µg/L	µg/L
BL1	01/10/05	NA	NA	8.7	8.2	49	23.7	<25	2.1	0.6	67.7	11.0	8.0	45	24.1	<25	1.9	1.1	82.2	7.8	7.9	48	24.7	<25	1.8	0.4	46.6
BL2	01/25/05	NA	NA	8.0	6.9	49	32.4	<25	2.9	0.7	88.1	9.5	7.2	47	33.2	<25	2.3	0.4	47.2	7.3	7.2	48	34.2	<25	2.5	0.3	38.5
BL3	02/07/05	NA	NA	8.6	7.6	51	31.5	<25	2.7	0.7	84.3	9.0	7.5	52	31.3	<25	2.3	0.6	53.1	6.8	7.5	51	31.6	<25	2.3	0.4	37.8
BL4	03/21/05	NA	NA	8.2	7.5	45	31.4	<25	3.3	0.6	89.0	9.0	7.4	45	31.6	<25	3.0	0.4	89.4	8.3	7.4	47	32.0	<25	3.1	0.4	51.4
1	05/16/05	0.2	7.4	8.7	7.8	55	2.5	<25	1.5	1.3	90.9	9.5	7.7	51	2.5	<25	1.3	2.0	132	8.0	7.8	50	1.7	<25	1.3	0.5	68.9
2	06/13/05	0.2	7.3	8.8	6.6	58	2.3	<25	1.3	1.6	92.5	10.0	6.9	57	2.0	<25	1.3	2.0	113	7.0	7.0	52	1.5	<25	1.5	1.0	66.8
3	07/11/05	0.2	7.4	8.6	6.7	50	1.6	<25	1.1	1.4	92.2	10.0	6.8	48	1.1	<25	0.8	0.7	111	8.5	7.1	48	0.7	<25	0.8	0.7	63.9
4	08/08/05	0.4	7.4	8.6	7.4	47	1.2	<25	1.0	1.3	85.1	8.0	7.3	47	0.9	<25	0.7	0.7	103	7.3	7.3	46	0.6	<25	0.7	0.8	80.8
5	09/06/05	1.7	7.5	8.5	7.0	50	1.1	<25	0.8	0.4	30.8	9.5	7.2	50	0.6	<25	0.4	0.2	16.8	7.3	7.3	51	0.5	<25	0.5	0.2	18.4
6	10/05/05	0.5	7.2	8.3	7.4	50	1.2	<25	0.8	1.3	95.6	10.0	7.4	46	0.9	<25	0.3	1.5	82.7	NA	7.4	50	0.8	<25	0.5	1.1	121
7	12/05/05	0.8	7.1	9.0	7.6	47	1.5	<25	1.0	0.2	37.1	10.8	7.6	46	1.4	<25	0.5	0.2	46.8	7.5	7.7	47	1.1	<25	0.7	0.2	19.2
8	12/12/05	1.3	7.2	8.5	7.4	45	1.3	<25	1.0	0.2	33.1	9.0	7.5	46	1.2	<25	0.7	<0.1	33.2	9.0	7.5	46	1.1	<25	0.8	0.1	20.4
9	01/09/06	2.7	7.1	8.3	7.6	47	2.1	<25	1.4	0.9	112	10.5	7.6	46	1.9	<25	0.9	0.5	70.4	7.5	7.6	46	2.0	<25	1.1	0.7	75.0
10	02/06/06	2.5	7.1	8.7	7.6	44	2.7	<25	1.3	0.2	26.9	10.0	7.6	44	2.4	<25	0.7	<0.1	6.1	7.5	7.6	44	2.5	<25	1.0	3.0	17.5
11	03/06/06	3.5	7.2	8.6	7.7	47	3.1	<25	1.7	0.2	30.1	10.0	7.5	45	3.0	<25	1.3	0.2	23.2	7.5	7.6	45	3.1	<25	1.4	0.1	12.9
12	04/03/06	4.3	7.1	8.2	7.6	47	4.2	<25	1.5	1.1	133	10.0	7.6	47	4.2	<25	0.9	0.3	30.0	9.0	7.6	47	4.3	<25	1.0	0.6	70.0
13	05/02/06	6.4	7.3	9.1	7.4	47	5.6	<25	1.2	<0.1	31.0	11.0	7.4	48	5.2	<25	0.9	0.3	45.4	7.5	7.4	48	5.2	<25	1.0	0.4	50.4
14	06/13/06	7.8	7.5	8.6	7.4	50	7.6	<25	1.3	0.6	105	10.0	7.4	67	7.5	<25	0.8	0.3	37.7	7.5	7.4	116	7.5	<25	0.9	0.4	48.2
15	07/10/06	9.4	7.3	8.3	7.3	51	6.1	<25	1.3	1.0	112	10.0	7.4	50	6.1	<25	0.7	0.4	63.3	8.8	7.5	51	6.5	<25	1.0	0.5	58.0

Lead action level = 15 µg/L; copper action level = 1.3 mg/L
 µg/L as unit for analytical parameters except for alkalinity (mg/L as CaCO3).
 BL = Baseline Sampling; NA = Not Available

Table 4-12. Capital Investment Cost for APU-GOFF-LL System

Description	Quantity	Cost	% of Capital Investment
<i>Equipment Cost</i>			
APU Skid-Mounted System (Unit)	1	\$17,171	–
AD-33 Media (ft ³)	10	\$3,000	–
Shipping	–	\$1,000	–
Vendor Labor	–	\$1,260	–
Equipment Total	–	\$22,431	66%
<i>Engineering Cost</i>			
Vendor Labor	–	\$4,860	–
Engineering Total	–	\$4,860	14%
<i>Installation Cost</i>			
Material	–	\$2,520	–
Subcontractor	–	\$1,950	–
Vendor Labor	–	\$1,440	–
Vendor Travel	–	\$1,000	–
Installation Total	–	\$6,910	20%
Total Capital Investment	–	\$34,210	100%

4.6.2 Operation and Maintenance Cost. The O&M cost included the cost for such items as media replacement and disposal, electricity consumption, and labor (Table 4-13). As discussed in Section 4.4, the spent media was replaced on September 6, 2006, after processing approximately 2,085,000 gal. The media replacement cost represented the majority of the O&M cost and was \$4,199 to change out the lead vessel. This media change-out cost included the cost for media, freight, labor, travel, spent media analysis, and media disposal fee. By averaging the media replacement cost of \$4,199 over the media life, the unit cost per 1,000 gal of water treated is plotted as a function of the media life, as shown in Figure 4-14. The media life in BV was calculated by dividing the system throughput (gal) by 5 ft³ (or 37.4 gal) of media. The arsenic concentration in the system effluent exceeded the MCL at 2,085,000 gal or 55,750 BV, so the corresponding media replacement cost was \$2.01/1,000 gal (Table 4-13).

Comparison of electrical bills supplied by the utility prior to system installation and since startup did not indicate a noticeable increase in power consumption. Therefore, electrical cost associated with operation of the system was assumed to be negligible.

Under normal operating conditions, routine labor activities to operate and maintain the system consumed only 30 min per week, as noted in Section 4.4.5. Therefore, the estimated labor cost was \$0.33/1,000 gal of water treated.

Table 4-13. Operation and Maintenance Cost for APU-GOFF-LL System

Cost Category	Value	Assumptions
Volume processed (kgal)	2,085	For Run 1
Media Replacement and Disposal Cost		
Media replacement (\$)	1,500	Vendor invoice; \$300/ft ³ for 5 ft ³ in lead vessel
Underbedding (\$)	154	Vendor invoice; for 4 ft ³
Freight (\$)	250	Vendor invoice
Subcontractor labor (\$)	1,050	Vendor invoice
Vendor Labor (\$)	800	Vendor invoice
Media disposal fee (\$)	200	Vendor invoice
Spent Media Analysis (\$)	245	Vendor invoice for one TCLP test
Subtotal	4,199	Vendor invoice
Media replacement and disposal (\$/1,000 gal)	2.01	Based upon lead vessel media run length at 10-μg/L arsenic breakthrough from lag vessel
Electricity Cost		
Electricity (\$/1,000 gal)	0.001	Electrical costs assumed negligible
Labor Cost		
Average weekly labor (hr)	0.5	30 minutes/per week
Labor (\$/1,000 gal)	0.33	Labor rate = \$21/hr
Total O&M Cost/1,000 gal	\$2.34	Based upon lead vessel media run length at 10-μg/L arsenic breakthrough from lag vessel

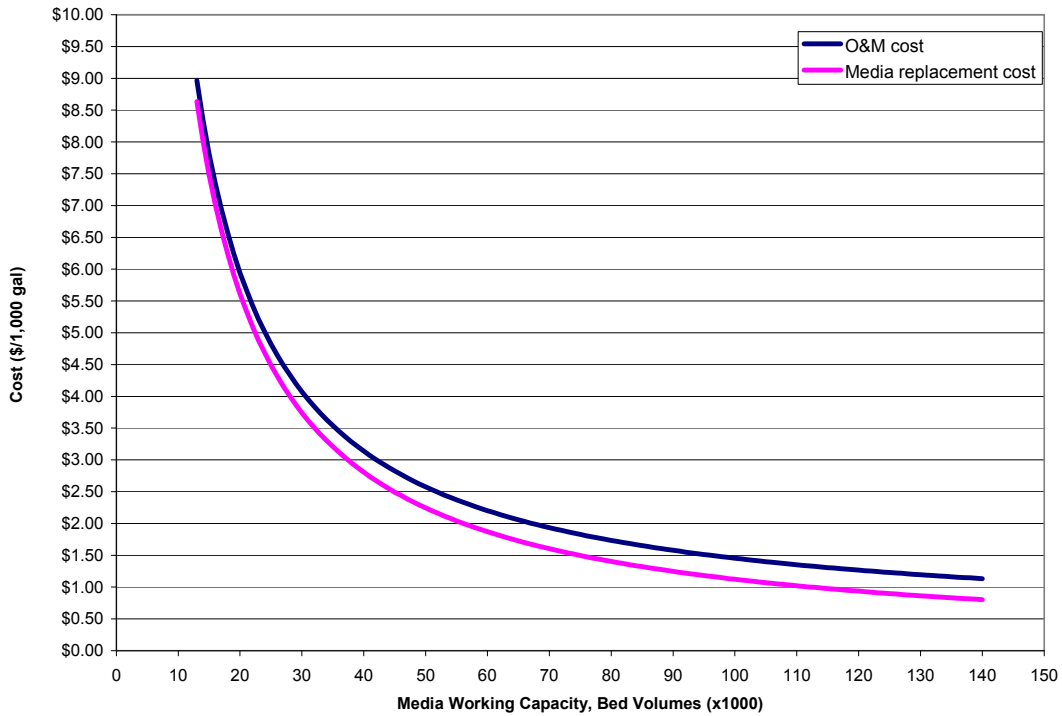

Note: One bed volume equals 5 ft³ (37.4 gal) in lead vessel

Figure 4-14. Media Replacement and Operation and Maintenance Cost

Section 5.0 REFERENCES

- Battelle. 2004. *Quality Assurance Project Plan for Evaluation of Arsenic Removal Technology*. Prepared under Contract No. 68-C-00-185, Task Order No. 0029, for U.S. Environmental Protection Agency, National Risk Management Research Laboratory, Cincinnati, OH.
- Battelle. 2005. *Final System Performance Evaluation Study Plan: U.S. EPA Demonstration of Arsenic Removal Technology at Goffstown, New Hampshire*. Prepared under Contract No. 68-C-00-185, Task Order No. 0029, for U.S. Environmental Protection Agency, National Risk Management Research Laboratory, Cincinnati, OH.
- Chen, A.S.C., L. Wang, J.L. Oxenham, and W.E. Condit. 2004. *Capital Costs of Arsenic Removal Technologies: U.S. EPA Arsenic Removal Technology Demonstration Program Round 1*. EPA/600/R-04/201. U.S. Environmental Protection Agency, National Risk Management Research Laboratory, Cincinnati, OH.
- Edwards, M., S. Patel, L. McNeill, H. Chen, M. Frey, A.D. Eaton, R.C. Antweiler, and H.E. Taylor. 1998. "Considerations in As Analysis and Speciation." *J. AWWA*, 90(3): 103-113.
- EPA. 2003. Minor Clarification of the National Primary Drinking Water Regulation for Arsenic. *Federal Register*, 40 CFR Part 141.
- EPA. 2002. *Lead and Copper Monitoring and Reporting Guidance for Public Water Systems*. EPA/816/R-02/009. U.S. Environmental Protection Agency, Office of Water, Washington, D.C.
- EPA. 2001. National Primary Drinking Water Regulations: Arsenic and Clarifications to Compliance and New Source Contaminants Monitoring. *Federal Register*, 40 CFR Parts 9, 141, and 142.
- Wang, L., W.E. Condit, and A.S.C. Chen. 2004. *Technology Selection and System Design: U.S. EPA Arsenic Removal Technology Demonstration Program Round 1*. EPA/600/R-05/001. U.S. Environmental Protection Agency, National Risk Management Research Laboratory, Cincinnati, OH.

APPENDIX A

OPERATIONAL DATA

Table A-1. EPA Arsenic Demonstration Project at Goffstown, NH - Daily System Operation Log Sheet (Page 1 of 8)

Week No.	Day of Week	Date	Hour Meter	Actual Run Time	Vessel A Flow Meter							Vessel B Flow Meter			Pressure		ΔP	AP	
					Flowrate	Totalizer	Cum. Bed Volume	Usage	Calc. Run Time	Average Flowrate	Cum. Run Time	Flowrate	Totalizer	Cum. Bed Volume	Inlet	Outlet	Inlet - Outlet	Vessel A	Vesse 1B
					gpm	gal	BV	gal	hr	gpm	hr	gpm	gal	BV	psig	psig	psi	psi	psi
0	Fri	04/15/05	NA	NA	14.5	729	19	729	1	15	1	14.5	781	10	29	12	17	3	NA
	Sat	04/16/05	NA	NA	14.7	2,400	64	1,671	2	15	3	14.3	2,443	33	29	12	17	3	NA
	Sun	04/17/05	NA	NA	12.9	8,636	231	6,236	8	13	11	13.1	8,800	118	28.5	10.5	18	3	NA
1	Mon	04/18/05	NA	NA	14.0	14,409	385	5,773	7	14	18	14.3	14,673	196	28	10.5	17.5	4	NA
	Tue	04/19/05	NA	NA	13.4	17,852	477	3,443	4	13	22	13.5	18,160	243	28	10.5	17.5	5	NA
	Wed	04/20/05	NA	NA	12.7	22,950	614	5,098	7	13	29	13.2	23,344	312	27	10	17	5	NA
	Thu	04/21/05	NA	NA	12.2	26,486	708	3,536	5	12	33	12.5	26,948	360	26.5	10.2	16.3	4	NA
	Fri	04/22/05	NA	NA	13.7	30,662	820	4,176	5	14	39	14.1	31,205	417	28	10.5	17.5	5	NA
	Sat	04/23/05	NA	NA	14.4	34,429	921	3,767	4	14	43	14.7	35,053	469	29	12	17	5	NA
	Sun	04/24/05	NA	NA	12.9	41,213	1,102	6,784	9	13	52	13.2	41,996	561	28	10.5	17.5	4	NA
2	Mon	04/25/05	NA	NA	12.1	45,208	1,209	3,995	6	12	57	12.4	46,089	616	26	10	16	4	NA
	Tue	04/26/05	NA	NA	12.9	48,661	1,301	3,453	4	13	62	13.3	49,619	663	28	10.2	17.8	5	NA
	Wed	04/27/05	NA	NA	14.2	53,304	1,425	4,643	5	14	67	14.6	54,372	727	30	10.5	19.5	6	NA
	Thu	04/28/05	NA	NA	12.6	56,709	1,516	3,405	5	13	72	12.9	57,855	773	27.5	10.2	17.3	5	NA
	Fri	04/29/05	NA	NA	13.5	60,806	1,626	4,097	5	14	77	13.8	62,045	829	28	10.2	17.8	5.5	NA
	Sat	04/30/05	NA	NA	14.0	63,839	1,707	3,033	4	14	80	14.4	65,152	871	29	10.5	18.5	5.5	NA
	Sun	05/01/05	NA	NA	13.8	67,553	1,806	3,714	4	14	85	14.3	68,949	922	29	10.1	18.9	6	NA
3	Mon	05/02/05	NA	NA	13.6	73,158	1,956	5,605	7	14	92	13.9	74,701	999	28	10	18	5.5	NA
	Tue	05/03/05	NA	NA	14.2	76,389	2,042	3,231	4	14	95	14.5	78,013	1,043	30	11	19	6	NA
	Wed	05/04/05	NA	NA	13.2	79,933	2,137	3,544	4	13	100	13.6	81,647	1,092	28	10.2	17.8	5.5	NA
	Thu	05/05/05	NA	NA	14.1	83,394	2,230	3,461	4	14	104	14.6	85,185	1,139	29.5	12	17.5	5.8	NA
	Fri	05/06/05	NA	NA	14.2	87,494	2,339	4,100	5	14	109	14.6	89,369	1,195	30	11	19	5.9	NA
	Sat	05/07/05	NA	NA	13.1	90,585	2,422	3,091	4	13	113	13.4	92,546	1,237	28	10.5	17.5	5.8	NA
	Sun	05/08/05	NA	NA	12.0	95,033	2,541	4,448	6	12	119	12.3	97,101	1,298	26	10	16	4.8	NA
4	Mon	05/09/05	NA	NA	13.0	101,056	2,702	6,023	8	13	127	13.3	103,288	1,381	28	10.2	17.8	5	NA
	Tue	05/10/05	NA	NA	13.9	103,347	2,763	2,291	3	14	129	14.1	105,633	1,412	29	11	18	6	NA
	Wed	05/11/05	NA	NA	13.5	108,162	2,892	4,815	6	14	135	13.8	110,580	1,478	28	10.2	17.8	5.9	NA
	Thu	05/12/05	NA	NA	12.5	112,010	2,995	3,848	5	13	140	12.9	114,537	1,531	27	10	17	5.9	NA
	Fri	05/13/05	NA	NA	14.1	116,385	3,112	4,375	5	14	146	14.5	119,024	1,591	29	10.5	18.5	5.5	NA
	Sat	05/14/05	NA	NA	11.8	119,747	3,202	3,362	5	12	150	12.2	122,474	1,637	26	10	16	4	NA
	Sun	05/15/05	NA	NA	12.2	124,653	3,333	4,906	7	12	157	12.5	127,522	1,705	26	10.2	15.8	4.9	NA
5	Mon	05/16/05	NA	NA	11.6	129,439	3,461	4,786	7	12	164	12.1	132,442	1,771	26	10	16	4	NA
	Tue	05/17/05	NA	NA	13.1	134,866	3,606	5,427	7	13	171	13.3	138,019	1,845	28	10	18	5.5	NA
	Wed	05/18/05	NA	NA	14.0	138,653	3,707	3,787	5	14	175	14.6	141,910	1,897	29	10.5	18.5	5.9	NA
	Thu	05/19/05	NA	NA	12.0	142,048	3,798	3,395	5	12	180	12.5	145,393	1,944	27	10.5	16.5	4	NA
	Fri	05/20/05	NA	NA	14.4	147,816	3,952	5,768	7	14	187	14.6	151,816	2,030	29.5	10.5	19	5.5	NA
	Sat	05/21/05	NA	NA	12.7	151,782	4,058	3,966	5	13	192	13.1	155,403	2,078	27	10	17	5.2	NA
6	Tue	05/24/05	NA	NA	14.2	165,420	4,423	13,638	16	14	208	14.6	169,430	2,265	30	11	19	6	NA
	Thu	05/26/05	NA	NA	13.2	174,087	4,655	8,667	11	13	219	13.6	178,334	2,384	28	10.5	17.5	5.5	NA
	Sat	05/28/05	NA	NA	12.8	181,578	4,855	7,491	10	13	229	13.1	186,037	2,487	27.5	10	17.5	5	NA

A-1

Table A-1. EPA Arsenic Demonstration Project at Goffstown, NH - Daily System Operation Log Sheet (Page 2 of 8)

Week No.	Day of Week	Date	Hour Meter	Actual Run Time	Vessel A Flow Meter						Vessel B Flow Meter			Pressure		AP	AP		
					Flowrate	Totalizer	Cum. Bed Volume	Usage	Calc. Run Time	Average Flowrate	Cum. Run Time	Flowrate	Totalizer	Cum. Bed Volume	Inlet	Outlet	Inlet - Outlet	Vessel A	Vessel B
					gpm	gal	BV	gal	hr	gpm	hr	gpm	gal	BV	psig	psig	psi	psi	psi
			hr	gpm	gal	BV	gal	hr	gpm	hr	gpm	gal	BV	psig	psig	psi	psi	psi	
7	Tue	05/31/05	NA	NA	12.7	194,778	5,208	13,200	17	13	246	13.2	199,630	2,669	27	10	17	4	NA
	Thu	06/02/05	NA	NA	13.4	201,319	5,383	6,541	8	13	254	14.2	206,421	2,760	29	10.5	18.5	5.5	NA
	Sat	06/04/05	NA	NA	12.9	208,865	5,585	7,546	10	13	264	13.3	214,270	2,865	27	10	17	3	NA
8	Tue	06/07/05	NA	NA	12.9	222,922	5,960	14,057	18	13	282	13.2	228,822	3,059	27	10	17	4	4
	Thu	06/09/05	17.1	17.1	13.1	232,467	6,216	9,545	12	13	294	13.3	238,609	3,190	27	10	17	5	4.5
	Sat	06/11/05	27.7	10.6	11.3	240,924	6,442	8,457	-	13	305	11.6	247,479	3,309	25	10	15	3	3.5
9	Mon	06/13/05	41.6	13.9	14.2	251,737	6,731	10,813	-	13	319	14.3	258,394	3,454	28	10	18	5.5	5
	Wed	06/15/05	51.1	9.5	12.5	259,252	6,932	7,515	-	13	328	13.2	266,104	3,558	27.5	10	17.5	5	4
	Fri	06/17/05	61.2	10.1	14.0	267,354	7,149	8,102	-	13	338	14.3	274,389	3,668	28	10	18	5	5
	Sun	06/19/05	72.0	10.8	13.0	276,090	7,382	8,736	-	13	349	13.3	283,328	3,788	28	10	18	5	4.5
10	Tue	06/21/05	82.0	10.0	14.1	284,086	7,596	7,996	-	13	359	14.6	291,510	3,897	29	10.5	18.5	5.5	5
	Thu	06/23/05	92.2	10.2	10.6	291,792	7,802	7,706	-	13	369	10.8	299,426	4,003	25	10	15	3	3.2
	Sat	06/25/05	102.8	10.6	11.9	300,045	8,023	8,253	-	13	380	12.2	307,887	4,116	26	10	16	4	3.5
11	Mon	06/27/05	115.7	12.9	11.9	309,679	8,280	9,634	-	12	393	12.4	317,810	4,249	26	10	16	5	4
	Wed	06/29/05	128.5	12.8	13.2	319,412	8,540	9,733	-	13	406	13.5	327,822	4,383	28	10	18	4	4.5
	Sat	07/02/05	145.8	17.3	11.2	333,008	8,904	13,596	-	13	423	11.6	341,786	4,569	25	10	15	3	3.5
12	Tue	07/05/05	162.7	16.9	13.1	346,365	9,261	13,357	-	13	440	13.4	355,498	4,753	28	10	18	5	4.5
	Thu	07/07/05	170.8	8.1	14.2	352,860	9,435	6,495	-	13	448	14.5	362,168	4,842	29	10.5	18.5	5	5
	Sat	07/09/05	180.1	9.3	13.3	360,369	9,636	7,509	-	13	457	13.7	369,876	4,945	28	10	18	5	3.5
13	Mon	07/11/05	191.2	11.1	10.5	369,084	9,869	8,715	-	13	468	10.8	378,857	5,065	24	9	15	3	3.5
	Wed	07/13/05	205.6	14.4	12.8	379,796	10,155	10,712	-	12	483	13.2	389,916	5,213	28	10	18	5	4.5
	Sat	07/16/05	220.7	15.1	12.5	391,514	10,468	11,718	-	13	498	12.9	402,013	5,375	27	10	17	4.5	4
14	Tue	07/19/05	239.2	18.5	13.6	405,781	10,850	14,267	-	13	516	14.3	416,782	5,572	29	10	19	5	5
	Fri	07/22/05	256.5	17.3	12.6	418,948	11,202	13,167	-	13	534	13.0	430,405	5,754	27	10	17	5.5	4.5
	Sat	07/23/05	260.8	4.3	12.5	422,402	11,294	3,454	-	13	538	12.8	433,976	5,802	27	10	17	5	4
15	Mon	07/25/05	273.5	12.7	12.0	431,780	11,545	9,378	-	12	551	12.7	443,686	5,932	26.5	10	16.5	5	3.5
	Wed	07/27/05	287.5	14.0	12.0	442,514	11,832	10,734	-	13	565	12.7	454,794	6,080	27	10	17	5	4.5
	Sat	07/30/05	302.6	15.1	12.0	454,274	12,146	11,760	-	13	580	12.4	466,970	6,243	26	10	16	5	4
16	Tue	08/02/05	321.1	18.5	13.3	468,418	12,525	14,144	-	13	598	13.5	468,418	6,262	28	10	18	5.5	5
	Thu	08/04/05	330.5	9.4	13.8	475,728	12,720	7,310	-	13	608	14.3	475,728	6,360	28	10	18	4.5	5
	Sat	08/06/05	339.0	8.5	13.8	482,427	12,899	6,699	-	13	616	14.4	482,427	6,450	29	10	19	5.5	5
17	Mon	08/08/05	352.3	13.3	13.0	492,367	13,165	9,940	-	12	629	13.4	506,476	6,771	28	10	18	5.5	5
	Wed	08/10/05	365.1	12.8	10.9	502,021	13,423	9,654	-	13	642	11.4	516,496	6,905	25	10	15	5	4
	Sat	08/13/05	381.1	16.0	13.8	514,382	13,754	12,361	-	13	658	14.2	529,330	7,077	28	10	18	5.5	5
18	Tue	08/16/05	398.0	16.9	12.9	527,347	14,100	12,965	-	13	675	13.4	542,800	7,257	28	10	18	5	4.4
	Thu	08/18/05	407.4	9.4	12.7	534,860	14,301	7,513	-	13	684	13.4	550,528	7,360	28	10	18	5	4.5
	Sat	08/20/05	419.3	11.9	12.7	544,045	14,547	9,185	-	13	696	13.3	560,103	7,488	27	10	17	5	4.5
19	Mon	08/22/05	434.4	15.1	11.4	554,938	14,838	10,893	-	12	711	11.8	571,433	7,639	27	10	17	4.5	3.5
	Thu	08/25/05	454.4	20.0	12.2	569,985	15,240	15,047	-	13	731	12.5	569,985	7,620	26	10	16	4	4
	Sat	08/27/05	466.7	12.3	12.5	579,564	15,496	9,579	-	13	744	13.0	579,564	7,748	26	10	16	4	4

A-2

Table A-1. EPA Arsenic Demonstration Project at Goffstown, NH - Daily System Operation Log Sheet (Page 3 of 8)

Week No.	Day of Week	Date	Hour Meter	Actual Run Time	Vessel A Flow Meter						Vessel B Flow Meter			Pressure		AP	AP		
					Flowrate	Totalizer	Cum. Bed Volume	Usage	Calc. Run Time	Average Flowrate	Cum. Run Time	Flowrate	Totalizer	Cum. Bed Volume	Inlet	Outlet	Inlet - Outlet	Vessel A	Vessel B
					gpm	gal	BV	gal	hr	gpm	hr	gpm	gal	BV	psig	psig	psi	psi	psi
20	Tue	08/30/05	484.1	17.4	13.1	592,924	15,854	13,360	-	13	761	13.6	610,682	8,164	28	10	18	5	4.8
	Thu	08/31/05	494.2	10.1	11.5	601,017	16,070	8,093	-	13	771	12.0	619,048	8,276	25	10	15	3	3.5
	Sat	09/03/05	504.6	10.4	13.3	609,281	16,291	8,264	-	13	782	13.6	627,572	8,390	27	10	17	5	4.2
21	Tue	09/06/05	524.4	19.8	13.1	624,840	16,707	15,559	-	13	801	13.7	642,834	8,594	27.5	10	17.5	5	4
	Thu	09/08/05	536.6	12.2	13.7	633,600	16,941	8,760	-	12	814	14.0	652,694	8,726	28	10	18	5	4.5
	Sat	09/10/05	548.2	11.6	13.3	642,626	17,183	9,026	-	13	825	13.5	662,004	8,850	27	10	17	5	4.3
22	Mon	09/12/05	566.4	18.2	11.8	655,624	17,530	12,998	-	12	843	12.2	675,452	9,030	25	10	15	4.2	3.5
	Wed	09/14/05	576.4	10.0	14.1	663,515	17,741	7,891	-	13	853	14.1	683,600	9,139	28	10	18	5	6
	Sat	09/17/05	589.0	12.6	11.8	673,593	18,011	10,078	-	13	866	12.3	694,005	9,278	25	10	15	4.5	4
23	Tue	09/20/05	605.8	16.8	13.5	686,774	18,363	13,181	-	13	883	13.8	707,606	9,460	28	10	18	5	4.5
	Thu	09/22/05	615.6	9.8	13.7	694,629	18,573	7,855	-	13	893	14.0	715,716	9,568	28	10	18	5	4.5
	Sat	09/24/05	623.9	8.3	14.4	701,298	18,751	6,669	-	13	901	14.7	722,600	9,660	29	10	19	5	4.7
24	Tue	09/27/05	639.8	15.9	13.5	713,955	19,090	12,657	-	13	917	14.0	735,641	9,835	28	10	18	5	4.7
	Thu	09/29/05	649.2	9.4	14.0	721,566	19,293	7,611	-	13	926	14.5	743,477	9,940	28	10.1	17.9	5	4.9
	Sat	10/01/05	657.3	8.1	13.1	728,269	19,472	6,703	-	14	934	13.5	750,364	10,032	27	10	17	4.5	4
25	Tue	10/04/05	673.4	16.1	13.2	740,939	19,811	12,670	-	13	950	13.7	763,411	10,206	28	10	18	5	4.2
	Thu	10/06/05	684.0	10.6	13.5	749,348	20,036	8,409	-	13	961	13.9	772,077	10,322	28	10	18	3	3.8
	Sat	10/08/05	692.6	8.6	13.4	756,339	20,223	6,991	-	14	970	13.7	779,286	10,418	27	10	17	5	4.1
26	Tue	10/11/05	707.1	14.5	13.8	767,896	20,532	11,557	-	13	984	14.3	791,183	10,577	28	10.1	17.9	5	5
	Thu	10/13/05	717.1	10.0	13.4	775,977	20,748	8,081	-	13	994	13.8	799,492	10,688	28	10	18	4	4.5
	Sun	10/16/05	729.8	12.7	12.4	786,345	21,025	10,368	-	14	1,007	12.8	810,170	10,831	26	9.5	16.5	3.5	4
27	Mon	10/17/05	734.7	4.9	14.2	790,252	21,130	3,907	-	13	1,012	14.7	814,192	10,885	28	10	18	5.5	4.5
	Thu	10/20/05	748.0	13.3	13.1	801,173	21,422	10,921	-	14	1,025	13.3	825,406	11,035	27	10	17	4.5	4.5
	Sat	10/22/05	755.3	7.3	14.0	807,298	21,586	6,125	-	14	1,032	14.2	831,683	11,119	28	10.5	17.5	4.5	4.7
28	Wed	10/26/05	775.7	20.4	12.8	823,567	22,021	16,269	-	13	1,053	13.2	848,380	11,342	26	10	16	4.5	4.2
	Fri	10/28/06	783.9	8.2	12.9	830,344	22,202	6,777	-	14	1,061	13.6	855,338	11,435	28	10	18	5	4.5
	Sat	10/29/05	788.1	4.2	13.5	833,875	22,296	3,531	-	14	1,065	13.8	858,959	11,483	28	10.1	17.9	4.5	4.2
29	Tue	11/01/05	801.8	13.7	12.3	844,940	22,592	11,065	-	13	1,079	12.7	870,314	11,635	26	10	16	3.5	3.9
	Thu	11/03/05	810.9	9.1	12.8	852,379	22,791	7,439	-	14	1,088	13.2	877,951	11,737	27	10	17	5	4.5
	Sat	11/05/05	818.5	7.6	14.5	858,619	22,958	6,240	-	14	1,096	14.8	884,350	11,823	29	11	18	5	5
30	Tue	11/08/05	833.0	14.5	13.7	870,311	23,270	11,692	-	13	1,110	13.9	896,367	11,984	28	10	18	4.5	4.9
	Thu	11/10/05	841.3	8.3	13.9	877,042	23,450	6,731	-	14	1,118	14.5	903,268	12,076	29	10.5	18.5	5	5
	Sat	11/12/05	849.1	7.8	12.5	883,569	23,625	6,527	-	14	1,126	12.8	909,984	12,166	27	10	17	5	4
31	Tue	11/15/05	863.6	14.5	13.7	895,236	23,937	11,667	-	13	1,141	14.0	921,929	12,325	28	10	18	5	4.5
	Thu	11/17/05	872.3	8.7	13.3	902,353	24,127	7,117	-	14	1,149	13.9	929,240	12,423	28	10.5	17.5	4.5	4.5
	Sat	11/19/05	881.1	8.8	12.5	909,568	24,320	7,215	-	14	1,158	12.7	936,638	12,522	27	10	17	3	3.9
33	Tue	11/29/05	927.8	46.7	13.3	947,229	25,327	37,661	-	13	1,205	13.5	975,234	13,038	28	10	18	5	4
	Thu	12/01/05	936.0	8.2	13.9	953,985	25,508	6,756	-	14	1,213	14.2	982,174	13,131	28	10	18	5	4.8
	Sat	12/03/05	943.8	7.8	14.3	960,426	25,680	6,441	-	14	1,221	14.5	988,779	13,219	29	10.5	18.5	5	4.5
34	Tue	12/06/05	958.9	15.1	13.3	972,598	26,005	12,172	-	13	1,236	13.9	1,001,285	13,386	29	10.5	18.5	5	4.75

A-3

Table A-1. EPA Arsenic Demonstration Project at Goffstown, NH - Daily System Operation Log Sheet (Page 4 of 8)

Week No.	Day of Week	Date	Hour Meter	Actual Run Time	Vessel A Flow Meter						Vessel B Flow Meter			Pressure		AP	AP		
					Flowrate	Totalizer	Cum. Bed Volume	Usage	Calc. Run Time	Average Flowrate	Cum. Run Time	Flowrate	Totalizer	Cum. Bed Volume	Inlet	Outlet	Inlet - Outlet	Vessel A	Vessel B
					gpm	gal	BV	gal	hr	gpm	hr	gpm	gal	BV	psig	psig	psi	psi	psi
34	Thu	12/08/05	967.2	8.3	12.7	979,500	26,190	6,902	-	14	1,244	13.0	1,008,375	13,481	28	10	18	4.5	4.8
	Sat	12/10/05	975.7	8.5	12.6	986,453	26,376	6,953	-	14	1,253	12.9	1,015,431	13,575	27	10	17	4.5	4
35	Mon	12/12/05	985.8	10.1	13.4	994,546	26,592	8,093	-	13	1,263	13.8	1,023,702	13,686	28	10	18	5	4
	Wed	12/14/05	994.3	8.5	14.3	1,001,530	26,779	6,984	-	14	1,271	14.8	1,030,881	13,782	30	11	19	5	5
	Sat	12/17/05	1,006.7	12.4	12.9	1,011,637	27,049	10,107	-	14	1,284	13.4	1,041,261	13,921	27	9.5	17.5	5	4.5
36	Mon	12/19/05	1,018.3	11.6	13.8	1,020,899	27,297	9,262	-	13	1,295	14.2	1,050,753	14,048	29	10	19	5	5
	Thu	12/22/05	1,031.1	12.8	14.7	1,031,450	27,579	10,551	-	14	1,308	14.9	1,061,542	14,192	30	11	19	5	5
	Sat	12/24/05	1,039.3	8.2	12.3	1,038,125	27,757	6,675	-	14	1,316	12.8	1,068,399	14,283	25	9	16	3	3.75
38	Mon	01/02/06	1,081.7	42.4	13.9	1,072,161	28,667	34,036	-	13	1,359	14.2	1,103,339	14,751	29	10	19	5	5
	Wed	01/04/06	1,091.4	9.7	12.1	1,080,027	28,878	7,866	-	14	1,368	13.1	1,111,420	14,859	26	10	16	5	4
	Sat	01/07/06	1,104.0	12.6	13.6	1,090,449	29,156	10,422	-	14	1,381	13.9	1,122,084	15,001	28	10	18	5	4.8
39	Tue	01/10/06	1,119.0	15.0	13.2	1,102,558	29,480	12,109	-	13	1,396	13.5	1,134,476	15,167	28	10	18	5	4.5
	Thu	01/12/06	1,126.7	7.7	13.7	1,108,877	29,649	6,319	-	14	1,404	14.3	1,140,941	15,253	28	10.5	17.5	5	5
	Sat	01/14/06	1,134.9	8.2	14.3	1,115,650	29,830	6,773	-	14	1,412	14.8	1,147,882	15,346	28	10	18	5.5	4.5
40	Tue	01/17/06	1,151.1	16.2	12.9	1,128,542	30,175	12,892	-	13	1,428	13.1	1,161,075	15,522	26	10	16	4.9	4
	Thu	01/19/06	1,159.2	8.1	12.9	1,135,229	30,354	6,687	-	14	1,436	13.5	1,167,928	15,614	26.5	9	17.5	5	4.9
	Sat	01/21/06	1,166.7	7.5	13.3	1,141,500	30,521	6,271	-	14	1,444	13.6	1,174,322	15,699	27	10	17	4.1	3.5
41	Tue	01/24/06	1,181.9	15.2	12.2	1,153,665	30,847	12,165	-	13	1,459	12.6	1,186,793	15,866	26	9	17	4.5	4
	Thu	01/26/06	1,189.7	7.8	13.2	1,160,111	31,019	6,446	-	14	1,467	13.8	1,193,400	15,955	28	10	18	4	4.5
	Sat	01/28/06	1,196.5	6.8	14.2	1,165,778	31,171	5,667	-	14	1,474	14.5	1,199,208	16,032	28.2	10.2	18	5	4.2
42	Tue	01/31/06	1,210.4	13.9	12.9	1,176,000	31,444	10,222	-	12	1,487	13.6	1,210,000	16,176	28	10	18	5	5
	Thu	02/02/06	1,218.5	8.1	14.1	1,183,000	31,631	7,000	-	14	1,496	14.3	1,217,000	16,270	28	10	18	5.1	4.9
	Sat	02/04/06	1,224.9	6.4	14.0	1,189,000	31,791	6,000	-	16	1,502	14.2	1,223,000	16,350	28	10	18	4.5	4.9
43	Tue	02/07/06	1,239.6	14.7	12.7	1,201,000	32,112	12,000	-	14	1,517	13.1	1,235,000	16,511	26	9	17	5	4
	Thu	02/09/06	1,247.4	7.8	13.5	1,207,000	32,273	6,000	-	13	1,524	13.9	1,242,000	16,604	28	10	18	5	5
	Sat	02/11/06	1,255.4	8.0	13.0	1,214,000	32,460	7,000	-	15	1,532	13.3	1,248,000	16,684	26	10	16	4.5	4
44	Wed	02/15/06	1,274.3	18.9	13.3	1,229,000	32,861	15,000	-	13	1,551	13.9	1,264,000	16,898	28	11	17	5	5
	Thu	02/16/06	1,277.8	3.5	14.1	1,232,000	32,941	3,000	-	14	1,555	14.6	1,267,000	16,939	29	10.5	18.5	3.5	5
	Sat	02/18/06	1,285.3	7.5	13.5	1,238,000	33,102	6,000	-	13	1,562	13.8	1,273,000	17,019	28	10	18	5	4
45	Tue	02/21/06	1,300.1	14.8	13.3	1,250,000	33,422	12,000	-	14	1,577	13.6	1,286,000	17,193	26	9	17	4	4
	Thu	02/23/06	1,307.0	6.9	12.9	1,256,000	33,583	6,000	-	14	1,584	13.4	1,292,000	17,273	26	9	17	4	4.5
	Sat	02/25/06	1,314.7	7.7	12.2	1,262,000	33,743	6,000	-	13	1,592	12.5	1,298,000	17,353	25	8	17	3	3.5
46	Tue	02/28/06	1,327.7	13.0	14.5	1,273,000	34,037	11,000	-	14	1,605	14.8	1,309,000	17,500	28	11	17	4	5
	Thu	03/02/06	1,335.6	7.9	12.9	1,280,000	34,225	7,000	-	15	1,613	13.6	1,316,000	17,594	26	9	17	3	4.5
	Sat	03/04/06	1,344.2	8.6	13.3	1,287,000	34,412	7,000	-	14	1,621	13.5	1,323,000	17,687	26	10	16	3.5	4
47	Tue	03/07/06	1,359.0	14.8	13.9	1,299,000	34,733	12,000	-	14	1,636	14.5	1,335,000	17,848	28	10	18	4	5
	Thu	03/09/06	1,367.3	8.3	12.5	1,305,000	34,893	6,000	-	12	1,644	12.9	1,342,000	17,941	25	8	17	4.5	4.5
	Sat	03/11/06	1,377.1	9.8	13.9	1,313,000	35,107	8,000	-	14	1,654	14.2	1,350,000	18,048	28	10	18	5	4.5
48	Tue	03/14/06	1,394.2	17.1	14.4	1,327,000	35,481	14,000	-	14	1,671	14.6	1,364,000	18,235	28	10	18	5	5
	Thu	03/16/06	1,402.5	8.3	13.0	1,334,000	35,668	7,000	-	14	1,680	13.3	1,371,000	18,329	26	9	17	4.5	4.5

A-4

Table A-1. EPA Arsenic Demonstration Project at Goffstown, NH - Daily System Operation Log Sheet (Page 5 of 8)

Week No.	Day of Week	Date	Hour Meter	Actual Run Time	Vessel A Flow Meter						Vessel B Flow Meter			Pressure		AP	AP		
					Flowrate	Totalizer	Cum. Bed Volume	Usage	Calc. Run Time	Average Flowrate	Cum. Run Time	Flowrate	Totalizer	Cum. Bed Volume	Inlet	Outlet	Inlet - Outlet	Vessel A	Vessel B
					gpm	gal	BV	gal	hr	gpm	hr	gpm	gal	BV	psig	psig	psi	psi	psi
			hr	gpm	gal	BV	gal	hr	gpm	hr	gpm	gal	BV	psig	psig	psi	psi	psi	
48	Sat	03/18/06	1,410.5	8.0	12.1	1,340,000	35,829	6,000	-	13	1,688	12.5	1,378,000	18,422	25	8	17	4	4
49	Tue	03/21/06	1,424.7	14.2	13.6	1,352,000	36,150	12,000	-	14	1,702	14.1	1,390,000	18,583	28	10	18	4	5
	Thu	03/23/06	1,435.3	10.6	13.2	1,360,000	36,364	8,000	-	13	1,712	13.5	1,399,000	18,703	27	10	17	4	4
	Sat	03/25/06	1,444.3	9.0	13.4	1,368,000	36,578	8,000	-	15	1,721	13.8	1,406,000	18,797	28	9	19	4	4
50	Tue	03/28/06	1,459.7	15.4	12.7	1,380,000	36,898	12,000	-	13	1,737	13.3	1,419,000	18,971	26	8	18	4	4.5
	Thu	03/30/06	1,469.2	9.5	12.8	1,388,000	37,112	8,000	-	14	1,746	13.6	1,427,000	19,078	27	9	18	3.5	4.5
	Sat	04/01/06	1,479.2	10.0	12.6	1,396,000	37,326	8,000	-	13	1,756	13.0	1,435,000	19,184	25	8	17	4	4
51	Tue	04/04/06	1,494.4	15.2	13.9	1,408,000	37,647	12,000	-	13	1,771	14.1	1,447,000	19,345	28	10	18	5	5
	Thu	04/06/06	1,502.2	7.8	13.4	1,414,000	37,807	6,000	-	13	1,779	13.8	1,454,000	19,439	26	9	17	3.5	4.5
	Sat	04/08/06	1,509.7	7.5	13.2	1,420,000	37,968	6,000	-	13	1,787	13.5	1,460,000	19,519	26	8	18	3	3.5
52	Tue	04/11/06	1,525.3	15.6	12.5	1,433,000	38,316	13,000	-	14	1,802	12.9	1,473,000	19,693	26	8	18	3	4
	Thu	04/13/06	1,533.9	8.6	13.4	1,440,000	38,503	7,000	-	14	1,811	13.7	1,480,000	19,786	26	8	18	5	4.5
	Sat	04/15/06	1,542.7	8.8	13.3	1,447,000	38,690	7,000	-	13	1,820	13.7	1,488,000	19,893	26	8	18	4.5	4
53	Tue	04/18/06	1,561.3	18.6	13.7	1,461,000	39,064	14,000	-	13	1,838	14.1	1,502,000	20,080	28	8	20	5	4
	Thu	04/20/06	1,572.0	10.7	12.9	1,470,000	39,305	9,000	-	14	1,849	13.5	1,511,000	20,201	26	8	18	5	4.5
	Sat	04/22/06	1,583.7	11.7	11.6	1,478,000	39,519	8,000	-	11	1,861	12.1	1,520,000	20,321	26	7	19	5.9	3.5
54	Tue	04/25/06	1,599.7	16.0	13.1	1,491,000	39,866	13,000	-	14	1,877	13.7	1,533,000	20,495	27	8	19	5	4.5
	Thu	04/27/06	1,607.3	7.6	13.4	1,497,000	40,027	6,000	-	13	1,884	13.7	1,540,000	20,588	27	9	18	5	4.9
	Sat	04/29/06	1,618.0	10.7	12.7	1,506,000	40,267	9,000	-	14	1,895	13.1	1,548,000	20,695	26	8	18	5	4
55	Tue	05/02/06	1,636.1	18.1	12.7	1,520,000	40,642	14,000	-	13	1,913	12.9	1,562,000	20,882	26	8	18	4.5	4
	Thu	05/04/06	1,645.8	9.7	13.6	1,527,000	40,829	7,000	-	12	1,923	13.8	1,570,000	20,989	28	9	19	5	5
	Sat	05/06/06	1,654.9	9.1	14.3	1,535,000	41,043	8,000	-	15	1,932	14.5	1,578,000	21,096	29	10	19	5	5
56	Tue	05/09/06	1,708.2	53.3	14.6	1,553,000	41,524	18,000	-	6	1,985	14.7	1,597,000	21,350	29	10	19	4	4.5
	Thu	05/11/06	1,717.7	9.5	13.2	1,560,000	41,711	7,000	-	12	1,995	13.7	1,604,000	21,444	29	9	20	4	4.5
	Sat	05/13/06	1,726.4	8.7	14.1	1,567,000	41,898	7,000	-	13	2,003	14.4	1,612,000	21,551	28	10	18	5	5
57	Wed	05/17/06	1,747.7	21.3	13.4	1,584,000	42,353	17,000	-	13	2,025	13.8	1,629,000	21,778	27	8	19	5	4.5
	Thu	05/18/06	1,752.6	4.9	11.8	1,588,000	42,460	4,000	-	14	2,030	12.1	1,633,000	21,832	24	7	17	4	4.5
	Sat	05/20/06	1,761.7	9.1	13.1	1,595,000	42,647	7,000	-	13	2,039	13.5	1,641,000	21,939	26	8	18	4.5	4
58	Tue	05/23/06	1,778.4	16.7	10.0	1,609,000	43,021	14,000	-	14	2,055	10.4	1,654,000	22,112	21	6	15	1	2.5
	Wed	05/24/06	1,786.7	8.3	12.0	1,615,000	43,182	6,000	-	12	2,064	12.4	1,661,000	22,206	24	8	16	3	4
	Sat	05/27/06	1,812.7	26.0	11.8	1,634,000	43,690	19,000	-	12	2,090	12.1	1,680,000	22,460	24	6	18	3	3.5
59	Tue	05/30/06	1,844.3	31.6	13.5	1,652,000	44,171	18,000	-	9	2,121	13.9	1,699,000	22,714	36	8	28	10	5
	Thu	06/01/06	1,857.7	13.4	13.3	1,661,000	44,412	9,000	-	11	2,135	13.7	1,709,000	22,848	28	9	19	5	4.9
	Sat	06/03/06	1,867.9	10.2	11.9	1,669,000	44,626	8,000	-	13	2,145	12.2	1,717,000	22,955	25	7	18	5.7	3.9
60	Tue	06/06/06	1,885.7	17.8	12.6	1,683,000	45,000	14,000	-	13	2,163	13.0	1,731,000	23,142	26	8	18	5	4.2
	Thu	06/08/06	1,895.0	9.3	12.3	1,690,000	45,187	7,000	-	13	2,172	12.6	1,739,000	23,249	27	8	19	5	4.5
	Sat	06/10/06	1,907.1	12.1	12.7	1,699,000	45,428	9,000	-	12	2,184	13.1	1,748,000	23,369	26	8	18	5	3.5
61	Mon	06/12/06	1,917.7	10.6	12.6	1,708,000	45,668	9,000	-	14	2,195	12.9	1,757,000	23,489	26	8	18	5	4
	Wed	06/14/06	1,929.3	11.6	12.9	1,717,000	45,909	9,000	-	13	2,206	13.1	1,766,000	23,610	27	8	19	5	4.5
	Sat	06/17/06	1,944.3	15.0	13.2	1,728,000	46,203	11,000	-	12	2,221	13.5	1,778,000	23,770	27	8	19	5	4

A-5

Table A-1. EPA Arsenic Demonstration Project at Goffstown, NH - Daily System Operation Log Sheet (Page 6 of 8)

Week No.	Day of Week	Date	Hour Meter	Actual Run Time	Vessel A Flow Meter						Vessel B Flow Meter			Pressure		AP	AP		
					Flowrate	Totalizer	Cum. Bed Volume	Usage	Calc. Run Time	Average Flowrate	Cum. Run Time	Flowrate	Totalizer	Cum. Bed Volume	Inlet	Outlet	Inlet - Outlet	Vessel A	Vessel B
					gpm	gal	BV	gal	hr	gpm	hr	gpm	gal	BV	psig	psig	psi	psi	psi
62	Tue	06/20/06	1,966.0	21.7	11.5	1,745,000	46,658	17,000	-	13	2,243	12.0	1,795,000	23,997	24	6	18	4	4
	Thu	06/22/06	1,975.9	9.9	12.5	1,752,000	46,845	7,000	-	12	2,253	13.0	1,803,000	24,104	26	8	18	4.1	4.5
	Sat	06/24/06	1,985.4	9.5	11.3	1,760,000	47,059	8,000	-	14	2,262	11.7	1,812,000	24,225	23	6	17	3	3
63	Tue	06/27/06	2,003.4	18.0	11.4	1,773,000	47,406	13,000	-	12	2,280	11.9	1,825,000	24,398	23	6	17	3	3
	Thu	06/29/06	2,014.5	11.1	12.1	1,782,000	47,647	9,000	-	14	2,292	12.6	1,834,000	24,519	26	8	18	4.5	4.2
	Sun	07/02/06	2,027.2	12.7	12.0	1,792,000	47,914	10,000	-	13	2,304	12.5	1,844,000	24,652	27	8	19	5	4.9
64	Tue	07/04/06	2,035.6	8.4	13.4	1,799,000	48,102	7,000	-	14	2,313	13.8	1,851,000	24,746	28	9	19	5	5
	Thu	07/06/06	2,046.1	10.5	12.9	1,806,000	48,289	7,000	-	11	2,323	13.2	1,859,000	24,853	28	8.5	19.5	5	5
	Sat	07/08/06	2,057.4	11.3	12.1	1,815,000	48,529	9,000	-	13	2,334	12.6	1,868,000	24,973	25	7.5	17.5	4	4
65	Wed	07/12/06	2,082.2	24.8	13.1	1,834,000	49,037	19,000	-	13	2,359	13.5	1,888,000	25,241	28	8	20	5	4.1
	Fri	07/14/06	2,093.9	11.7	12.1	1,842,000	49,251	8,000	-	11	2,371	12.5	1,896,000	25,348	25	7	18	5	4.2
	Sat	07/15/06	2,099.9	6.0	11.5	1,847,000	49,385	5,000	-	14	2,377	12.0	1,901,000	25,414	24	6	18	4	3.9
66	Tue	07/18/06	2,136.8	36.9	10.7	1,868,000	49,947	21,000	-	9	2,414	11.2	1,923,000	25,709	22	6	16	3	3
	Thu	07/20/06	2,153.5	16.7	12.9	1,879,000	50,241	11,000	-	11	2,431	13.4	1,935,000	25,869	28	8	20	6	4.5
	Sat	07/22/06	2,165.2	11.7	11.4	1,888,000	50,481	9,000	-	13	2,442	12.0	1,944,000	25,989	25	7	18	5	4
67	Tue	07/25/06	2,199.6	34.4	11.9	1,908,000	51,016	20,000	-	10	2,477	12.5	1,965,000	26,270	26	8	18	5	4
	Thu	07/27/06	2,214.8	15.2	12.2	1,918,000	51,283	10,000	-	11	2,492	12.5	1,976,000	26,417	26	8	18	5	4
	Sat	07/29/06	2,226.8	12.0	12.5	1,927,000	51,524	9,000	-	13	2,504	12.9	1,985,000	26,537	27	8	19	5	3.5
68	Wed	08/02/06	2,252.6	25.8	9.9	1,945,000	52,005	18,000	-	12	2,530	10.4	2,004,000	26,791	22	5	17	5	3.5
	Sat	08/05/06	2,269.8	17.2	13.1	1,958,000	52,353	13,000	-	13	2,547	13.5	2,017,000	26,965	28	8	20	5.5	4.5
69	Tue	08/08/06	2,288.0	18.2	11.4	1,972,000	52,727	14,000	-	13	2,565	11.9	2,031,000	27,152	24	6	18	4.5	3
	Thu	08/10/06	2,300.0	12.0	12.2	1,980,000	52,941	8,000	-	11	2,577	12.7	2,041,000	27,286	24	8	16	4	-(1)
	Sat	08/12/06	2,309.7	9.7	11.6	1,988,000	53,155	8,000	-	14	2,587	12.0	2,049,000	27,393	22	7	15	2	-(1)
70	Tue	08/15/06	2,331.2	21.5	12.1	2,003,000	53,556	15,000	-	12	2,608	12.4	2,064,000	27,594	24	7	17	3	-(1)
	Thu	08/17/06	2,342.0	10.8	9.8	2,011,000	53,770	8,000	-	12	2,619	10.3	2,073,000	27,714	20	5	15	2	-(1)
	Sat	08/19/06	2,351.7	9.7	13.4	2,019,000	53,984	8,000	-	14	2,629	14.0	2,080,000	27,807	27	10	17	4.5	-(1)
71	Wed	08/23/06	2,373.8	22.1	11.6	2,035,000	54,412	16,000	-	12	2,651	12.2	2,098,000	28,048	23	7	16	3	-(1)
	Sat	08/26/06	2,387.7	13.9	12.6	2,046,000	54,706	11,000	-	13	2,665	12.9	2,109,000	28,195	25	8	17	3	-(1)
72	Tue	08/29/06	2,405.4	17.7	12.8	2,059,000	55,053	13,000	-	12	2,682	13.7	2,123,000	28,382	26	8	18	4	-(1)
	Thu	08/31/06	2,413.7	8.3	11.6	2,066,000	55,241	7,000	-	14	2,691	12.3	2,130,000	28,476	24	8	16	3	-(1)
	Sat	09/02/06	2,422.1	8.4	13.0	2,072,000	55,401	6,000	-	12	2,699	14.2	2,136,000	28,556	27	9	18	4.5	-(1)
73	Tue	09/05/06	2,438.9	16.8	12.2	2,085,000	55,749	13,000	-	13	2,716	12.6	2,149,000	28,730	24	7	17	3	-(1)
	Thu	09/07/06 ⁽²⁾	2,458.0	19.1	13.3	8,000	107	8,000	-	7	2,735	12.9	9,000	241	22	5	17	3	1
	Sat	09/09/06	2,468.7	10.7	12.5	17,000	227	9,000	-	14	2,746	12.1	17,000	455	25	8	17	3	3
74	Wed	09/13/06	2,491.6	22.9	12.5	34,000	455	17,000	-	12	2,769	12.7	34,000	909	26	10	16	2.5	2
	Sat	09/16/06	2,505.3	13.7	12.5	44,000	588	10,000	-	12	2,782	13.0	45,000	1,203	25	10	15	1.5	1.5
75	Tue	09/19/06 ⁽³⁾	2,523.6	18.3	12.1	58,000	775	14,000	-	13	2,801	12.6	59,000	1,578	25	8	17	2.5	2.5
	Sat	09/23/06	2,541.6	18.0	13.4	71,000	949	13,000	-	12	2,819	13.9	73,000	1,952	25	12	13	5.5	1
76	Wed	09/27/06	2,562.7	21.1	12.7	88,000	1,176	17,000	-	13	2,840	13.6	90,000	2,406	25	12	13	5.5	1
	Sat	09/30/06	2,574.6	11.9	13.7	97,000	1,297	9,000	-	13	2,852	14.5	100,000	2,674	26	13	13	6	1

A-6

Table A-1. EPA Arsenic Demonstration Project at Goffstown, NH - Daily System Operation Log Sheet (Page 7 of 8)

Week No.	Day of Week	Date	Hour Meter	Actual Run Time	Vessel A Flow Meter						Vessel B Flow Meter			Pressure		AP	AP		
					Flowrate	Totalizer	Cum. Bed Volume	Usage	Calc. Run Time	Average Flowrate	Cum. Run Time	Flowrate	Totalizer	Cum. Bed Volume	Inlet	Outlet	Inlet - Outlet	Vessel A	Vessel B
					gpm	gal	BV	gal	hr	gpm	hr	gpm	gal	BV	psig	psig	psi	psi	psi
			hr																
77	Tue	10/03/06	2,590.3	15.7	11.9	109,000	1,457	12,000	-	13	2,867	12.4	113,000	3,021	24	11	13	6	1
	Sat	10/07/06	2,613.4	23.1	13.1	127,000	1,698	18,000	-	13	2,890	13.7	131,000	3,503	26	11	15	6	1
78	Tue	10/10/06	2,630.7	17.3	12.9	140,000	1,872	13,000	-	13	2,908	13.5	145,000	3,877	25	12	13	6	1
	Sat	10/14/06	2,649.4	18.7	13.5	155,000	2,072	15,000	-	13	2,926	13.9	161,000	4,305	26	13	13	6	1
79	Tue	10/17/06	2,666.4	17.0	13.1	168,000	2,246	13,000	-	13	2,943	13.7	175,000	4,679	26	13	13	6	1
	Sat	10/21/06	2,685.0	18.6	13.1	183,000	2,447	15,000	-	13	2,962	13.2	190,000	5,080	25	12	13	6	1
80	Tue	10/24/06	2,700.9	15.9	13.1	195,000	2,607	12,000	-	13	2,978	13.8	203,000	5,428	24	11	13	6	1
	Sun	10/29/06	2,724.7	23.8	11.7	214,000	2,861	19,000	-	13	3,002	12.3	223,000	5,963	24	11	13	5	1
81	Tue	10/31/06	2,735.8	11.1	13.1	222,000	2,968	8,000	-	12	3,013	13.8	232,000	6,203	26	12	14	6	1
	Sat	11/04/06	2,755.4	19.6	13.2	236,000	3,155	14,000	-	12	3,032	13.6	246,000	6,578	27	14	13	6	1
82	Tue	11/07/06	2,770.6	15.2	13.8	249,000	3,329	13,000	-	14	3,048	14.3	258,000	6,898	26	13	13	6	1
	Sat	11/11/06	2,790.8	20.2	12.3	265,000	3,543	16,000	-	13	3,068	12.9	276,000	7,380	25	12	13	6	1
83	Wed	11/15/06	2,812.2	21.4	13.5	281,000	3,757	16,000	-	12	3,089	14.6	294,000	7,861	26	11	15	6	1
	Sat	11/18/06	2,825.8	13.6	11.7	292,000	3,904	11,000	-	13	3,103	12.2	305,000	8,155	24	11	13	6	1
84	Tue	11/21/06	2,842.5	16.7	12.6	304,000	4,064	12,000	-	12	3,120	13.5	318,000	8,503	26	11	15	6	0
	Sat	11/25/06	2,863.8	21.3	12.8	321,000	4,291	17,000	-	13	3,141	13.7	335,000	8,957	26	13	13	6	0
86	Tue	12/05/06	2,915.5	51.7	13.0	361,000	4,826	40,000	-	13	3,193	13.6	377,000	10,080	26	11	15	6	1
	Sat	12/09/06	2,934.6	19.1	13.1	376,000	5,027	15,000	-	13	3,212	13.7	393,000	10,508	25	12	13	6	1
87	Wed	12/13/06	2,958.2	23.6	13.0	393,000	5,254	17,000	-	12	3,235	13.8	412,000	11,016	25	12	13	6	1
	Sat	12/16/06	2,972.5	14.3	12.4	404,000	5,401	11,000	-	13	3,250	13.0	423,000	11,310	20	8	12	7	1
88	Mon	12/18/06	2,984.6	12.1	13.6	414,900	5,547	10,900	-	15	3,262	14.3	433,000	11,578	22	8	14	6	1
	Sat	12/23/06	3,011.0	26.4	10.2	435,000	5,816	20,100	-	13	3,288	10.7	455,000	12,166	18	6	12	4	1
90	Wed	01/03/07	3,071.6	60.6	13.1	481,000	6,430	46,000	-	13	3,349	13.7	503,000	13,449	22	8	14	6	1
	Sat	01/06/07	3,084.3	12.7	12.7	491,000	6,564	10,000	-	13	3,361	13.4	514,000	13,743	20	6	14	7	1
91	Tue	01/09/07	3,104.1	19.8	13.7	506,000	6,765	15,000	-	13	3,381	14.6	530,000	14,171	22	8	14	6.5	1
	Sat	01/13/07	3,121.8	17.7	11.7	520,000	6,952	14,000	-	13	3,399	13.2	544,000	14,545	21	7	14	6	1
93	Tue	01/23/07	3,175.1	53.3	12.3	561,000	7,500	41,000	-	13	3,452	12.7	587,000	15,695	24	11	13	6	1
	Sun	01/28/07	3,199.2	24.1	11.0	579,000	7,741	18,000	-	12	3,476	11.5	607,000	16,230	21	8	13	6	1
95	Tue	02/06/07	3,246.8	47.6	13.4	616,000	8,235	37,000	-	13	3,524	13.7	645,000	17,246	28	13	15	7	1
	Sat	02/10/07	3,265.3	18.5	11.7	630,000	8,422	14,000	-	13	3,542	12.2	660,000	17,647	22	10	12	6	1
96	Tue	02/13/07	3,284.2	18.9	14.2	645,000	8,623	15,000	-	13	3,561	14.6	675,000	18,048	28	11	17	6.5	1
	Sat	02/17/07	3,304.5	20.3	10.6	659,000	8,810	14,000	-	11	3,582	10.9	691,000	18,476	20	8	12	4.5	1
97	Wed	02/21/07	3,329.5	25.0	13.0	677,000	9,051	18,000	-	12	3,607	13.6	709,000	18,957	25	12	13	6	1
	Sat	02/24/07	3,341.4	11.9	12.9	687,000	9,184	10,000	-	14	3,618	13.5	719,000	19,225	25	11	14	5.5	1
99	Wed	03/07/07	3,398.0	56.6	12.5	730,000	9,759	43,000	-	13	3,675	12.9	765,000	20,455	24	11	13	6	1
	Sat	03/10/07	3,411.1	13.1	12.3	741,000	9,906	11,000	-	14	3,688	13.0	776,000	20,749	23	10	13	6	1
101	Wed	03/21/07	3,467.2	56.1	13.2	784,000	10,481	43,000	-	13	3,744	13.8	821,000	21,952	26	12	14	6	1
	Sat	03/24/07	3,480.5	13.3	12.0	795,000	10,628	11,000	-	14	3,758	12.6	832,000	22,246	24	11	13	6	1
102	Tue	03/27/07	3,497.0	16.5	13.4	807,000	10,789	12,000	-	12	3,774	13.8	845,000	22,594	25	12	13	6	1
	Sat	03/31/07	3,514.3	17.3	13.6	821,000	10,976	14,000	-	13	3,791	14.2	859,000	22,968	27	12	15	6	1

A-7

Table A-1. EPA Arsenic Demonstration Project at Goffstown, NH - Daily System Operation Log Sheet (Page 8 of 8)

Week No.	Day of Week	Date	Hour Meter	Actual Run Time	Vessel A Flow Meter						Vessel B Flow Meter			Pressure		ΔP	ΔP		
					Flowrate	Totalizer	Cum. Bed Volume	Usage	Calc. Run Time	Average Flowrate	Cum. Run Time	Flowrate	Totalizer	Cum. Bed Volume	Inlet	Outlet	Inlet - Outlet	Vessel A	Vessel B
					gpm	gal	BV	gal	hr	gpm	hr	gpm	gal	BV	psig	psig	psi	psi	psi
103	Tue	04/03/07	3,535.8	21.5	11.6	837,000	11,190	16,000	-	12	3,813	12.1	876,000	23,422	22	9	13	5	1
104	Tue	04/10/07	3,575.6	39.8	12.7	867,000	11,591	30,000	-	13	3,853	13.5	907,000	24,251	25	11	14	6	1
105	Wed	04/18/07	3,623.9	48.3	13.6	903,000	12,072	36,000	-	12	3,901	14.2	944,000	25,241	27	12	15	7	1
106	Mon	04/23/07	3,654.5	30.6	12.0	926,000	12,380	23,000	-	13	3,932	12.6	968,000	25,882	22	8	14	6	1
107	Sun	04/29/07	3,686.8	32.3	12.0	949,000	12,687	23,000	-	12	3,964	12.3	993,000	26,551	23	10	13	6	1
108	Sat	05/05/07	3,719.8	33.0	12.0	974,000	13,021	25,000	-	13	3,997	12.4	1,020,000	27,273	23	10	13	6	1
109	Tue	05/08/07	3,744.3	24.5	11.0	991,000	13,249	17,000	-	12	4,021	11.7	1,037,000	27,727	22	8	14	6	1
	Sat	05/12/07	3,767.0	22.7	10.7	1,008,000	13,476	17,000	-	12	4,044	11.3	1,055,000	28,209	21	8	13	6	1
110	Wed	05/16/07	3,798.3	31.3	10.4	1,028,000	13,743	20,000	-	11	4,075	10.7	1,077,000	28,797	20	7	13	5	1
111	Tue	05/22/07	3,831.7	33.4	12.7	1,053,000	14,078	25,000	-	12	4,109	13.2	1,102,000	29,465	26	11	15	6.5	1
	Thu	05/24/07	3,842.5	10.8	13.2	1,061,000	14,184	8,000	-	12	4,120	13.7	1,111,000	29,706	27	12	15	7	1
112	Thu	05/31/07	3,892.0	49.5	13.0	1,094,000	14,626	33,000	-	11	4,169	13.7	1,147,000	30,668	28	11	17	8	1
113	Sun	06/03/07	3,909.2	17.2	11.9	1,107,000	14,799	13,000	-	13	4,186	12.3	1,160,000	31,016	23	8	15	6	1
114	Mon	06/11/07	3,955.0	45.8	11.7	1,140,000	15,241	33,000	-	12	4,232	12.4	1,195,000	31,952	23	9	14	7	0
	Wed	06/13/07	3,968.5	13.5	11.5	1,150,000	15,374	10,000	-	12	4,246	12.1	1,206,000	32,246	22	8	14	6.5	0
	Sat	06/16/07	3,983.7	28.7	10.2	1,162,000	15,535	22,000	-	13	4,261	10.9	1,218,000	32,567	20	7	13	5.5	0
115	Sat	06/23/07	4,029.9	61.4	13.7	1,193,000	15,949	43,000	-	12	4,307	14.5	1,252,000	33,476	28	12	16	7.5	0
116	Sat	06/30/07	4,080.2	96.5	12.2	1,228,000	16,417	66,000	-	11	4,357	12.5	1,288,000	34,439	25	10	15	7	0
117	Sat	07/07/07	4,126.4	96.5	12.9	1,260,000	16,845	67,000	-	12	4,403	13.6	1,322,000	35,348	26	11	15	8	0
118	Sat	07/14/07	4,159.5	79.3	12.2	1,285,000	17,179	57,000	-	12	4,437	13.0	1,348,000	36,043	24	10	14	7	0
119	Sat	07/21/07	4,192.2	65.8	11.7	1,309,000	17,500	49,000	-	12	4,469	12.5	1,372,000	36,684	23	9	14	7.5	0
120	Mon	08/06/07	4,282.0	122.5	13.6	1,374,000	18,369	89,000	-	12	4,559	14.0	1,444,000	38,610	28	12	16	7.5	0

A-8

- (1) Differential pressure gauge (ΔP) on Vessel B stuck on 12 psi after backwash; replaced during media change-out.
- (2) Media change-out in Vessel A on 09/06/06; Vessel A is lead vessel.
- (3) Piping modification complete on 09/20/06; Vessel B is lead vessel.

APPENDIX B
ANALYTICAL DATA

Table B-1. Analytical Results from Long-Term Sampling at Goffstown, NH (Page 1 of 9)

Sampling Date		04/15/05			05/02/05			05/16/05			05/31/05			06/15/05		
Sampling Location	Parameter	IN	TA	TB	IN	TA	TB	IN	TA	TB	IN	TA	TB	IN	TA	TB
Bed Volume	x10 ³	-	0.0	0.0	-	2.0	2.0	-	3.5	3.5	-	5.2	5.3	-	6.9	7.1
Alkalinity (as CaCO ₃)	mg/L	52	54	56	60	60	60	48	56	54	67	63	58	63	57	57
Fluoride	mg/L	0.3	0.4	0.4	0.4	0.5	0.4	0.4	0.5	0.6	0.6	0.5	0.5	0.5	0.5	0.5
Sulfate	mg/L	6.4	6.8	7.4	6.3	6.5	6.6	7.0	8.0	8.0	7.0	7.0	7.0	7.0	6.0	6.0
Nitrate (as N)	mg/L	0.1	0.1	<0.05	0.1	0.1	0.4	0.1	0.1	0.1	0.1	0.1	0.4	0.1	<0.05	<0.05
Orthophosphate (as PO ₄)	mg/L	0.3	<0.05	<0.05	<0.05	<0.05	<0.05	0.2	<0.05	<0.05	<0.05	<0.05	<0.05	<0.05	<0.05	<0.05
Silica (as SiO ₂)	mg/L	25.9	19.1	8.9	25.2	25.0	23.7	25.4	25.8	25.4	24.8	25.4	25.3	25.5	26.4	26.6
Turbidity	NTU	0.3	<0.1	0.2	0.1	<0.1	<0.1	<0.1	0.3	0.1	0.2	0.2	0.2	0.1	0.1	0.1
pH ⁽¹⁾	S.U.	7.1	7.4	7.3	7.1	7.3	7.3	7.1	7.3	7.4	6.9	7.1	7.3	6.9	7.2	7.3
Temperature ⁽¹⁾	°C	13.0	13.1	13.1	13.4	13.1	13.2	12.1	12.7	12.7	12.5	12.4	12.4	13.9	14.1	14.5
DO ⁽¹⁾	mg/L	6.3	7.2	5.8	5.0	5.6	5.0	6.5	6.2	5.9	6.1	5.4	6.4	4.8	4.8	5.4
ORP ⁽¹⁾	mV	215	201	202	212	205	204	212	210	214	213	198	228	219	215	210
Total Hardness (as CaCO ₃)	mg/L	26.4	32.2	28.8	-	-	-	-	-	-	-	-	-	35.9	37.7	37.1
Ca Hardness (as CaCO ₃)	mg/L	17.3	23.0	24.7	-	-	-	-	-	-	-	-	-	27.2	28.7	25.7
Mg Hardness (as CaCO ₃)	mg/L	9.1	9.2	4.1	-	-	-	-	-	-	-	-	-	8.7	9.0	11.5
As (total)	µg/L	29.4	0.3	0.2	31.8	0.1	<0.1	32.6	<0.1	0.2	31.3	0.7	<0.1	34.0	1.7	0.2
As (soluble)	µg/L	29.4	0.3	0.2	-	-	-	-	-	-	-	-	-	33.7	1.7	0.2
As (particulate)	µg/L	<0.1	<0.1	<0.1	-	-	-	-	-	-	-	-	-	0.3	<0.1	<0.1
As (III)	µg/L	0.7	0.2	0.2	-	-	-	-	-	-	-	-	-	0.7	0.6	0.6
As (V)	µg/L	28.8	<0.1	<0.1	-	-	-	-	-	-	-	-	-	33.0	1.0	<0.1
Fe (total)	µg/L	<25	<25	<25	<25	<25	<25	<25	<25	<25	<25	<25	<25	<25	<25	<25
Fe (soluble)	µg/L	<25	<25	<25	-	-	-	-	-	-	-	-	-	<25	<25	<25
Mn (total)	µg/L	16.7	1.5	1.0	3.2	0.2	<0.1	0.7	<0.1	<0.1	0.6	0.1	0.1	15.5	0.2	0.2
Mn (soluble)	µg/L	1.4	1.5	1.0	-	-	-	-	-	-	-	-	-	1.1	1.0	0.3

(1) Water quality measurements were collected the Friday after the samples were collected.

Table B-1. Analytical Results from Long-Term Sampling at Goffstown, NH (Page 2 of 9)

Sampling Date		06/27/05			07/12/05			07/25/05			08/08/05			08/22/05		
Sampling Location	Parameter Unit	IN	TA	TB	IN	TA	TB	IN	TA	TB	IN	TA	TB	IN	TA	TB
Bed Volume	x10 ³	-	8.3	8.5	-	9.9	10.1	-	11.5	11.9	-	13.2	13.5	-	14.8	15.3
Alkalinity (as CaCO ₃)	mg/L	33	41	41	55	55	55	39	40	41	58	41	41	44	45	46
Fluoride	mg/L	0.3	0.3	0.3	0.4	0.3	0.3	0.3	0.3	0.3	0.5	0.3	0.2	0.3	0.3	0.3
Sulfate	mg/L	5.0	5.0	6.0	6.0	6.0	6.0	5.0	5.0	6.0	6.0	5.0	5.0	5.3	5.5	5.6
Nitrate (as N)	mg/L	4.7	1.1	5.1	0.2	0.1	0.1	0.3	0.7	0.2	0.1	0.1	0.1	0.7	0.9	0.6
Orthophosphate (as PO ₄)	mg/L	<0.05	<0.05	<0.05	<0.05	<0.05	<0.05	0.2	<0.05	<0.05	0.3	<0.05	<0.05	0.1	<0.05	<0.05
Silica (as SiO ₂)	mg/L	25.1	25.0	24.4	25.2	25.0	25.2	24.4	23.7	23.9	25.5	25.6	24.6	25.3	24.8	24.5
Turbidity	NTU	0.2	0.2	2.7	0.2	0.2	0.3	<0.1	0.1	0.4	0.4	0.2	0.3	0.1	<0.1	0.2
pH ⁽¹⁾	S.U.	7.1	7.3	7.4	7.2	7.3	7.4	7.2	7.4	7.5	7.1	7.3	7.4	7.0	7.3	7.4
Temperature ⁽¹⁾	°C	13.9	13.3	13.5	13.3	12.9	13.2	15.2	16.5	16.8	12.9	13.7	14.8	15.9	15.5	15.9
DO ⁽¹⁾	mg/L	5.2	5.1	5.3	4.8	3.7	4.9	5.1	5.4	5.4	5.3	4.5	6.2	6.1	5.5	5.3
ORP ⁽¹⁾	mV	218	217	215	205	221	222	168	183	194	174	189	213	212	207	203
Total Hardness (as CaCO ₃)	mg/L	-	-	-	-	-	-	-	-	-	23.5	23.6	23.5	-	-	-
Ca Hardness (as CaCO ₃)	mg/L	-	-	-	-	-	-	-	-	-	15.4	15.9	15.7	-	-	-
Mg Hardness (as CaCO ₃)	mg/L	-	-	-	-	-	-	-	-	-	8.1	7.8	7.8	-	-	-
As (total)	µg/L	27.2	3.4	0.1	33.0	3.9	0.2	27.8	5.7	0.2	30.6	4.7	0.4	30.3	9.2	0.3
As (soluble)	µg/L	-	-	-	-	-	-	-	-	-	30.7	4.9	0.3	-	-	-
As (particulate)	µg/L	-	-	-	-	-	-	-	-	-	<0.1	<0.1	0.1	-	-	-
As (III)	µg/L	-	-	-	-	-	-	-	-	-	0.6	0.6	0.5	-	-	-
As (V)	µg/L	-	-	-	-	-	-	-	-	-	30.1	4.3	<0.1	-	-	-
Fe (total)	µg/L	<25	<25	<25	<25	<25	<25	<25	<25	<25	<25	<25	<25	<25	<25	<25
Fe (soluble)	µg/L	-	-	-	-	-	-	-	-	-	<25	<25	<25	-	-	-
Mn (total)	µg/L	2.3	0.3	0.2	1.4	0.2	0.2	3.8	0.3	0.1	1.9	0.4	0.4	2.4	1.1	0.1
Mn (soluble)	µg/L	-	-	-	-	-	-	-	-	-	1.2	0.4	0.4	-	-	-

(1) Water quality measurements were collected the Friday after the samples were collected.

Table B-1. Analytical Results from Long-Term Sampling at Goffstown, NH (Page 3 of 9)

Sampling Date		09/06/05			09/20/05 ⁽³⁾			10/04/05			10/17/05			11/01/05		
Sampling Location	Parameter Unit	IN	TA	TB	IN	TA	TB	IN	TA	TB	IN	TA	TB	IN	TA	TB
Bed Volume	x10 ³	-	16.7	17.2	-	18.4	18.9	-	19.8	20.4	-	21.1	21.8	-	22.6	23.3
Alkalinity (as CaCO ₃)	mg/L	55	53	50	42/ 43	44/ 44	44/ 44	44	43	44	88	44	41	46	47	46
Fluoride	mg/L	0.3	0.3	0.4	0.3/ 0.3	0.3/ 0.3	0.3/ 0.3	0.3	0.3	0.2	0.2	0.2	0.2	0.3	0.4	0.4
Sulfate	mg/L	5.4	6.0	5.7	4.7/ 4.8	5.0/ 4.8	5.0/ 4.8	4.9	4.7	4.6	4.6	4.6	4.8	4.9	5.1	4.9
Nitrate (as N)	mg/L	0.1	0.1	0.1	0.1/ 0.1	0.1/ 0.1	0.1/ 0.2	0.1	0.2	0.1	0.1	0.1	0.1	0.1	0.1	0.1
Orthophosphate (as PO ₄)	mg/L	0.3	0.2	<0.05	0.3/ 0.3	<0.05/ 0.1	<0.05/ <0.05	0.1	0.1	<0.05	0.1	0.1	<0.05	<0.05	<0.05	<0.05
Total Phosphorous (as P)	mg/L	-	-	-	-	-	-	-	-	-	77.3	35.4	<10	74.9	47.2	<10
Silica (as SiO ₂)	mg/L	25.3	24.9	25.0	24.5/ 24.3	24.4/ 24.2	23.8/ 24.2	31.7	25.6	24.3	24.2	23.8	23.4	24.8	25.6	25.8
Turbidity	NTU	0.6	0.5	0.5	0.1/ 0.1	0.8/ 0.9	0.4/ 0.3	0.3	0.2	0.4	0.1	0.3	0.1	0.5	0.1	0.1
pH ⁽¹⁾	S.U.	7.5	7.4	7.5	7.2	7.3	7.4	7.0	7.1	7.2	7.1	7.2	7.2	7.3	7.3	7.3
Temperature ⁽¹⁾	°C	13.9	14.6	14.9	14.6	14.5	15.1	12.0	12.6	13.0	12.1	12.5	12.6	11.4	11.7	11.7
DO ⁽¹⁾	mg/L	6.2	4.9	6.4	6.3	4.7	5.7	6.3	6.2	6.2	6.2	6.3	6.0	4.4	4.3	4.2
ORP ⁽¹⁾	mV	195	196	196	203	212	213	201	215	230	208	198	194	208	214	211
Total Hardness (as CaCO ₃)	mg/L	-	-	-	-	-	-	-	-	-	21.5	23.9	26.3	-	-	-
Ca Hardness (as CaCO ₃)	mg/L	-	-	-	-	-	-	-	-	-	14.1	16.5	18.3	-	-	-
Mg Hardness (as CaCO ₃)	mg/L	-	-	-	-	-	-	-	-	-	7.4	7.5	8.0	-	-	-
As (total)	µg/L	29.2	8.4	1.7	24.1/ 25.9	8.5/ 9.5	0.7/ 0.4	28.8	10.3	0.5	25.0	11.3	0.5	28.8	10.3	0.6
As (soluble)	µg/L	-	-	-	-	-	-	-	-	-	26.0	10.4	0.8	-	-	-
As (particulate)	µg/L	-	-	-	-	-	-	-	-	-	<0.1	0.9	<0.1	-	-	-
As (III)	µg/L	-	-	-	-	-	-	-	-	-	0.6	0.5	0.2	-	-	-
As (V)	µg/L	-	-	-	-	-	-	-	-	-	25.3	9.9	0.5	-	-	-
Fe (total)	µg/L	<25	<25	72.5/ 80.4 ⁽²⁾	<25/ <25	<25/ <25	<25/ <25	<25	<25	<25	<25	<25	<25	<25	<25	<25
Fe (soluble)	µg/L	-	-	-	-	-	-	-	-	-	<25	<25	<25	-	-	-
Mn (total)	µg/L	4.4	1.0	0.6	1.7/ 4.1	0.4/ 0.4	<0.1/ <0.1	1.1	0.4	<0.1	2.7	0.7	0.2	2.4	1.2	0.4
Mn (soluble)	µg/L	-	-	-	-	-	-	-	-	-	1.1	0.8	0.8	-	-	-

(1) Water quality measurements were collected the Friday after the samples were collected;

(2) Rerun Result;

(3) Duplicate collected.

Table B-1. Analytical Results from Long-Term Sampling at Goffstown, NH (Page 4 of 9)

Sampling Date		11/15/05			11/29/05			12/12/05 ⁽²⁾			01/10/06			01/24/06		
Sampling Location	Parameter	IN	TA	TB	IN	TA	TB	IN	TA	TB	IN	TA	TB	IN	TA	TB
Bed Volume	x10 ³	-	23.9	24.7	-	25.3	26.1	-	26.6	27.4	-	29.5	30.3	-	30.8	31.7
Alkalinity (as CaCO ₃)	mg/L	44	44	44	39	37	39	45/ 45	44/ 44	46/ 45	51	48	44	44	45	47
Fluoride	mg/L	0.3	0.3	0.3	0.2	0.2	0.2	0.2/ 0.2	0.2/ 0.2	0.2/ 0.2	0.3	0.3	0.3	0.2	0.2	0.3
Sulfate	mg/L	5.4	5.9	6.1	4.5	4.5	4.6	4.9/ 4.9	4.8/ 4.9	4.8/ 4.8	5.5	5.4	4.9	5.1	5.2	5.3
Nitrate (as N)	mg/L	0.1	0.1	0.2	0.1	0.1	0.1	0.1/ 0.1	0.1/ 0.1	0.1/ 0.1	0.1	0.1	0.1	0.1	0.1	0.1
Orthophosphate (as PO ₄)	mg/L	0.1	0.1	<0.05	0.1	0.1	<0.06	0.1/ 0.1	0.1/ 0.1	<0.05/ <0.05	<0.05	<0.05	<0.05	0.1	0.1	<0.05
Total Phosphorous (as P)	mg/L	47.9	20.5	<10	82.4	40.0	<10	79.4/ 78.2	56.4/ 56.1	11.0/ 11.7	45.4	43.5	15.9	59.9	42.2	<10
Silica (as SiO ₂)	mg/L	24.9	25.2	24.5	24.9	25.6	25.7	27.0/ 25.9	26.1/ 25.7	25.5/ 25.4	25.8	25.9	25.8	25.1	25.3	25.0
Turbidity	NTU	0.2	0.3	0.2	0.1	0.1	<0.1	0.1/ 0.9	0.9/ 1.5	1.5/ 0.7	0.5	1.5	1.0	0.4	1.9	1.1
pH ⁽¹⁾	S.U.	6.8	7.1	7.1	6.9	7.1	7.1	6.9	7.1	7.2	7.0	7.1	7.1	7.0	7.0	7.1
Temperature ⁽¹⁾	°C	11.1	11.0	10.8	10.2	10.9	10.9	10.6	10.4	10.4	11.4	12.0	12.2	10.5	10.9	10.9
DO ⁽¹⁾	mg/L	6.1	5.9	6.1	6.2	5.3	5.1	7.6	7.6	7.1	6.7	6.5	6.8	8.0	7.6	7.2
ORP ⁽¹⁾	mV	204	206	204	212	211	209	197	197	199	213	209	209	244	247	245
Total Hardness (as CaCO ₃)	mg/L	22.1	24.9	24.8	21.3	22.9	23.2	22.7/ 23.1	22.9/ 22.7	22.4/ 22.4	34.6	32.4	25.3	26.8	29.3	30.0
Ca Hardness (as CaCO ₃)	mg/L	14.6	16.8	16.8	14.8	15.4	15.9	14.0/ 14.4	14.5/ 14.4	14.5/ 14.5	25.8	23.2	17.8	17.9	19.6	20.3
Mg Hardness (as CaCO ₃)	mg/L	7.5	8.1	8.0	6.6	7.5	7.4	8.7/ 8.7	8.4/ 8.3	7.9/ 7.9	8.8	9.2	7.5	8.9	9.8	9.7
As (total)	µg/L	27.1	10.4	0.4	26.4	12.3	0.8	27.8/ 27.7	12.9/ 13.1	1.3/ 1.3	34.2	15.4	2.7	26.3	14.1	2.2
As (soluble)	µg/L	-	-	-	25.4	11.9	1.0	-	-	-	-	-	-	27.2	14.2	2.2
As (particulate)	µg/L	-	-	-	1.1	0.5	<0.1	-	-	-	-	-	-	<0.1	<0.1	<0.1
As (III)	µg/L	-	-	-	<0.1	<0.1	<0.1	-	-	-	-	-	-	0.3	0.3	0.4
As (V)	µg/L	-	-	-	25.3	11.8	0.9	-	-	-	-	-	-	26.9	13.9	1.8
Fe (total)	µg/L	<25	<25	<25	<25	<25	<25	<25/ <25	<25/ <25	<25/ <25	<25	<25	<25	<25	<25	<25
Fe (soluble)	µg/L	-	-	-	<25	<25	<25	-	-	-	-	-	-	<25	<25	<25
Mn (total)	µg/L	2.6	1.2	0.5	1.9	0.9	0.4	1.5/ 1.5	1.0/ 1.1	0.6/ 0.6	2.1	1.0	0.4	1.1	1.1	0.7
Mn (soluble)	µg/L	-	-	-	0.9	0.9	0.7	-	-	-	-	-	-	1.0	1.1	0.7

(1) Water quality measurements were collected the Friday after the samples were collected;

(2) Duplicate collected.

Table B-1. Analytical Results from Long-Term Sampling at Goffstown, NH (Page 5 of 9)

Sampling Date		02/07/06			02/21/06 ⁽²⁾			03/07/06			03/21/06			04/04/06		
Sampling Location	Parameter	IN	TA	TB	IN	TA	TB	IN	TA	TB	IN	TA	TB	IN	TA	TB
Bed Volume	x10 ³	-	32.1	33.0	-	33.4	34.4	-	34.7	35.7	-	36.2	37.2	-	37.6	38.7
Alkalinity (as CaCO ₃)	mg/L	42	47	42	58/ 58	56/ 56	46/ 48	37	36	37	34	34	35	48	51	47
Fluoride	mg/L	0.2	0.3	0.3	0.5/ 0.5	0.5/ 0.5	0.4/ 0.4	0.3	0.3	0.3	0.2	0.2	0.2	0.4	0.4	0.4
Sulfate	mg/L	5.1	5.5	5.0	7.0/ 7.0	6.0/ 10.0	6.0/ 6.0	5.0	5.0	5.1	4.9	4.9	5.0	6.1	6.3	6.0
Nitrate (as N)	mg/L	<0.05	<0.05	<0.05	0.1/ <0.05	<0.05/ <0.05	<0.05/ <0.05	0.1	0.1	0.1	0.1	0.1	0.1	<0.05	<0.05	<0.05
Total Phosphorous (as P)	mg/L	71.9	52.8	18.0	28.4/ 33.4	48.9/ 49.0	17.3/ 14.2	79.5	68.1	28.5	69.0	57.2	23.2	53.3	56.1	35.2
Silica (as SiO ₂)	mg/L	25.9	26.4	26.4	25.0/ 25.0	25.6/ 25.9	26.9/ 26.4	23.4	24.0	23.9	24.9	25.1	24.8	23.9	24.4	25.7
Turbidity	NTU	1.8	2.9	2.6	0.8/ 0.8	0.9/ 0.9	0.5/ 0.5	3.5	3.2	3.6	2.6	2	1.9	1.3	1.2	1.1
pH ⁽¹⁾	S.U.	6.9	7.0	7.1	6.8	6.9	6.9	7.1	7.2	7.2	7.0	7.1	7.1	7.0	7.2	7.2
Temperature ⁽¹⁾	°C	10.5	10.3	9.6	10.0	10.8	9.7	10.0	11.3	11.1	11.6	11.1	10.9	11.4	11.4	11.4
DO ⁽¹⁾	mg/L	6.6	5.7	6.8	7.3	6.9	7.1	7.5	6.7	6.9	6.0	6.5	6.0	5.5	5.3	6.5
ORP ⁽¹⁾	mV	228	234	233	211	222	226	230	232	228	205	202	307	191	199	208
Total Hardness (as CaCO ₃)	mg/L	30.6	33.1	29.1	42.8/ 42.8	39.7/ 40.9	30.8/ 30.4	23.4	24.1	24.9	17.8	18.5	20.1	30.0	32.6	30.9
Ca Hardness (as CaCO ₃)	mg/L	21.0	22.8	19.8	31.7/ 31.2	27.1/ 27.8	21.3/ 21.0	14.6	15.7	16.7	12.8	13.7	13.9	21.6	22.9	21.9
Mg Hardness (as CaCO ₃)	mg/L	9.7	10.3	9.3	11.1/ 11.6	12.6/ 13.1	9.5/ 9.4	8.8	8.4	8.2	5.0	4.7	6.1	8.4	9.7	8.9
As (total)	µg/L	31.5	14.9	2.5	32.6/ 32.7	13.0/ 13.2	2.4/ 2.3	24.0	17.7	3.5	35.9	20.7	4.3	32.0	17.4	5.1
As (soluble)	µg/L	-	-	-	-	-	-	-	-	-	34.5	14.6	4.2	-	-	-
As (particulate)	µg/L	-	-	-	-	-	-	-	-	-	1.3	6.1	0.1	-	-	-
As (III)	µg/L	-	-	-	-	-	-	-	-	-	0.9	0.3	0.2	-	-	-
As (V)	µg/L	-	-	-	-	-	-	-	-	-	33.6	14.2	4.0	-	-	-
Fe (total)	µg/L	<25	<25	<25	<25/ <25	<25/ <25	<25/ <25	<25	<25	<25	<25	<25	<25	<25	<25	<25
Fe (soluble)	µg/L	-	-	-	-	-	-	-	-	-	<25	<25	<25	-	-	-
Mn (total)	µg/L	1.1	1.2	0.6	3.1/ 3.6	1.4/ 1.6	0.8/ 0.7	1.4	1.0	0.7	1.7	0.8	0.6	1.1	1.2	0.8
Mn (soluble)	µg/L	-	-	-	-	-	-	-	-	-	1.0	1.2	0.9	-	-	-

(1) Water quality measurements were collected the Friday after the samples were collected;
 (2) Duplicate collected.

Table B-1. Analytical Results from Long-Term Sampling at Goffstown, NH (Page 6 of 9)

Sampling Date		04/18/06			05/02/06 ⁽²⁾			05/17/06			05/30/06			
Sampling Location	Parameter	Unit	IN	TA	TB	IN	TA	TB	IN	TA	TB	IN	TA	TB
Bed Volume	x10 ³		-	39.1	40.2	-	40.6	41.8	-	42.4	43.6	-	44.2	45.4
Alkalinity (as CaCO ₃)	mg/L		37	39	41	45/ 46	45/ 45	42/ 42	41	47	48	35	36	50
Fluoride	mg/L		0.2	0.2	0.2	0.3/ 0.3	0.3/ 0.3	0.2/ 0.3	1.5	0.3	0.3	<0.1	0.1	0.2
Sulfate	mg/L		5.0	5.0	5.0	5.0/ 5.0	5.0/ 5.0	5.0/ 5.0	7.0	5.0	5.0	5.0	6.0	6.0
Nitrate (as N)	mg/L		0.1	0.1	0.1	0.1/ 0.1	0.1/ 0.1	0.1/ 0.1	0.1	0.1	0.1	0.1	0.2	0.1
Total Phosphorous (as P)	mg/L		99.2	89.1	54.1	66.2/ 61.1	64.8/ 64.3	46.4/ 46.8	78.4	62.2	45.6	88.4	70.4	45.9
Silica (as SiO ₂)	mg/L		24.7	24.5	23.6	25.8/ 25.8	26.4/ 25.5	25.4/ 25.0	26.4	26.0	25.9	25.7	23.6	22.3
Turbidity	NTU		0.2	0.2	0.5	0.2/ 0.2	0.2/ 0.2	0.4/ 0.3	0.5	0.6	0.3	2.4	1.7	1.0
pH ⁽¹⁾	S.U.		7.0	7.3	7.3	7.2	7.3	7.3	7.1	7.3	7.4	7.1	7.2	7.4
Temperature ⁽¹⁾	°C		11.9	11.9	11.7	11.6	12.2	12.5	12.9	12.5	12.5	13.4	13.2	13.6
DO ⁽¹⁾	mg/L		6.5	6.3	6.2	7.3	6.7	7.2	7.2	7.1	7.1	6.2	6.5	6.5
ORP ⁽¹⁾	mV		198	206	215	240	247	249	202	210	212	233	237	231
Total Hardness (as CaCO ₃)	mg/L		28.9	31.3	32.0	35.1/ 35.0	35.2/ 34.6	32.3/ 33.0	34.6	40.5	43.0	27.0	32.7	38.0
Ca Hardness (as CaCO ₃)	mg/L		19.5	22.6	23.4	25.4/ 25.2	25.1/ 24.6	23.6/ 24.2	25.2	29.9	31.8	14.2	20.1	25.6
Mg Hardness (as CaCO ₃)	mg/L		9.4	8.7	8.6	9.7/ 9.8	10.0/ 9.9	8.7/ 8.8	9.4	10.6	11.2	12.8	12.5	12.4
As (total)	µg/L		25.4	22.0	5.4	32.4/ 31.0	20.7/ 20.3	6.4/ 6.6	30.7	17.4	5.8	37.3	27.5	7.9
As (soluble)	µg/L		-	-	-	-	-	-	31.7	18.9	6.0	-	-	-
As (particulate)	µg/L		-	-	-	-	-	-	<0.1	<0.1	<0.1	-	-	-
As (III)	µg/L		-	-	-	-	-	-	0.2	0.1	0.1	-	-	-
As (V)	µg/L		-	-	-	-	-	-	31.4	18.8	5.9	-	-	-
Fe (total)	µg/L		<25	<25	<25	<25/ <25	<25/ <25	<25/ <25	<25	<25	<25	<25	<25	<25
Fe (soluble)	µg/L		-	-	-	-	-	-	<25	<25	<25	-	-	-
Mn (total)	µg/L		3.5	0.8	0.6	6.4/ 1.9	1.0/ 1.0	0.7/ 0.7	3.8	1.2	0.8	1.7	3.8	0.4
Mn (soluble)	µg/L		-	-	-	-	-	-	1.3	1.1	0.7	-	-	-

(1) Water quality measurements were collected the Friday after the samples were collected;

(2) Duplicate collected.

Table B-1. Analytical Results from Long-Term Sampling at Goffstown, NH (Page 7 of 9)

Sampling Date		06/12/06			06/27/06			07/12/06			07/25/06			08/08/06		
Sampling Location	Parameter	IN	TA	TB	IN	TA	TB	IN	TA	TB	IN	TA	TB	IN	TA	TB
Bed Volume	x10 ³	-	45.7	47.0	-	47.4	48.8	-	49.0	50.5	-	51.0	52.5	-	52.7	54.3
Alkalinity (as CaCO ₃)	mg/L	41	42	40	34	39	40	38	38	38	40	41	41	41	41	41
Fluoride	mg/L	0.3	0.3	0.3	0.3	0.2	0.2	0.3	0.3	0.3	0.3	0.3	0.3	0.3	0.3	0.3
Sulfate	mg/L	5.0	5.0	5.0	5.0	5.0	5.0	5.0	5.0	5.0	5.0	5.0	5.0	5.0	5.0	5.0
Nitrate (as N)	mg/L	0.2	0.1	0.1	0.4	0.1	0.1	0.1	0.1	0.1	0.1	0.2	0.1	0.1	0.1	0.1
Total Phosphorous (as P)	mg/L	87.4	71.5	61.1	81.6	66.7	55.5	83.2	68.0	56.5	98.1	66.6	66.8	94.3	83.6	73.9
Silica (as SiO ₂)	mg/L	26.2	26.1	26.4	26.7	27.1	27.2	24.6	24.3	23.7	25.1	24.4	24.9	25.4	25.5	24.7
Turbidity	NTU	0.3	0.3	0.7	0.4	0.5	1.3	0.5	0.6	0.4	1.0	0.5	2.5	0.3	0.3	0.8
pH ⁽¹⁾	S.U.	7.2	7.4	7.5	7.2	7.3	7.4	7.1	7.2	7.3	7.1	7.3	7.4	7.4	7.4	7.4
Temperature ⁽¹⁾	°C	13.8	13.3	13.6	14.0	13.6	14.3	13.9	13.6	14.1	14.5	14.0	14.9	14.2	14.0	14.5
DO ⁽¹⁾	mg/L	4.9	4.5	3.9	6.2	6.3	6.1	7.1	7.1	7.4	6.9	5.6	5.4	7.3	7.1	6.9
ORP ⁽¹⁾	mV	302	210	215	200	204	205	215	223	225	248	245	234	204	204	204
Total Hardness (as CaCO ₃)	mg/L	27.1	28.2	29.0	24.7	25.2	26.3	21.9	21.4	25.9	24.1	24.0	24.1	27.7	28.3	28.5
Ca Hardness (as CaCO ₃)	mg/L	18.7	20.4	21.3	15.9	17.1	18.1	13.9	14.2	18.9	16.3	16.5	16.9	17.9	19.0	19.5
Mg Hardness (as CaCO ₃)	mg/L	8.4	7.8	7.7	8.7	8.1	8.1	8.0	7.2	7.1	7.8	7.5	7.2	9.8	9.3	9.0
As (total)	µg/L	31.9	22.2	7.8	24.2	22.4	8.6	24.8	23.0	9.4	24.8	27.7	13.1	27.4	24.9	10.6
As (soluble)	µg/L	30.3	23.1	8.6	-	-	-	26.7	24.3	9.7	-	-	-	-	-	-
As (particulate)	µg/L	1.6	<0.1	<0.1	-	-	-	<0.1	<0.1	<0.1	-	-	-	-	-	-
As (III)	µg/L	0.5	0.2	<0.1	-	-	-	0.6	0.2	0.1	-	-	-	-	-	-
As (V)	µg/L	29.8	23.0	8.5	-	-	-	26.1	24.0	9.6	-	-	-	-	-	-
Fe (total)	µg/L	<25	37.7	<25	<25	<25	<25	<25	<25	<25	<25	<25	<25	<25	<25	<25
Fe (soluble)	µg/L	<25	<25	<25	-	-	-	<25	<25	105	-	-	-	-	-	-
Mn (total)	µg/L	3.2	1.8	0.7	2.0	1.6	0.8	3.4	1.9	1.2	2.1	1.8	0.6	6.7	3.9	1.1
Mn (soluble)	µg/L	2.5	1.6	0.7	-	-	-	3.6	1.4	0.8	-	-	-	-	-	-

(1) Water quality measurements were collected the Friday after the samples were collected.

Table B-1. Analytical Results from Long-Term Sampling at Goffstown, NH (Page 8 of 9)

Sampling Date		08/23/06 ⁽²⁾			09/05/06 ⁽³⁾			09/19/06 ⁽⁴⁾			10/02/06			11/07/06		
Sampling Location	Parameter	IN	TA	TB	IN	TA	TB	IN	TA	TB	IN	TA	TB	IN	TA	TB
Bed Volume	x10 ³	-	54.4	56.1	-	55.7	57.5	-	1.6	1.6	-	2.9	3.0	-	6.7	6.9
Alkalinity (as CaCO ₃)	mg/L	44/ 42	46/ 46	46	48	48	49	62	48	48	-	-	-	-	-	-
Fluoride	mg/L	0.7/ 0.7	0.7/ 0.7	0.7	0.3	0.3	0.3	0.6	0.4	0.4	-	-	-	-	-	-
Sulfate	mg/L	8.0/ 9.0	8.0/ 8.0	8.0	5.0	5.0	5.0	6.0	6.0	6.0	-	-	-	-	-	-
Nitrate (as N)	mg/L	0.1/ 0.1	0.1/ 0.1	0.1	0.1	0.1	0.1	<0.05	<0.05	0.1	-	-	-	-	-	-
Total Phosphorous (as P)	mg/L	72.1/ 52.9	57.8/ 58.0	70.2	74.2	60.8	50.7	16.3	<10	27.6	65.5	<10	58.2	79.6	<10	53.9
Silica (as SiO ₂)	mg/L	25.4/ 24.9	24.6/ 24.8	25.6	24.0	24.0	23.8	25.1	24.4	19.7	25.0	24.1	25.3	25.4	24.5	24.9
Turbidity	NTU	0.2/ 0.2	0.2/ 0.2	0.2	0.4	0.6	0.5	0.2	0.3	0.8	-	-	-	-	-	-
pH ⁽¹⁾	S.U.	7.4	7.3	7.4	7.4	7.4	7.3	7.1	7.3	7.2	7.1	7.4	7.4	-	-	-
Temperature ⁽¹⁾	°C	13.2	13.8	14.2	13.2	13.7	14.3	12.9	13.2	13.5	11.9	12.1	12.3	-	-	-
DO ⁽¹⁾	mg/L	6.3	6.3	6.1	3.7	3.2	5.3	5.7	4.2	4.5	6.2	5.2	5.6	-	-	-
ORP ⁽¹⁾	mV	222	223	220	185	200	205	167	160	160	197	206	196	-	-	-
Total Hardness (as CaCO ₃)	mg/L	30.4/ 32.2	30.8/ 30.4	30.5	-	-	-	-	-	-	-	-	-	-	-	-
Ca Hardness (as CaCO ₃)	mg/L	21.8/ 23.7	22.2/ 21.8	21.8	-	-	-	-	-	-	-	-	-	-	-	-
Mg Hardness (as CaCO ₃)	mg/L	8.6/ 8.5	8.6/ 8.6	8.7	-	-	-	-	-	-	-	-	-	-	-	-
As (total)	µg/L	31.9/ 32.6	24.3/ 24.2	11.2	33.5	22.8	9.9	31.7	<0.1	7.1	32.5	1.0	10.5	29.3	1.0	12.8
Fe (total)	µg/L	<25/ <25	<25/ <25	<25	<25	<25	<25	<25	<25	<25	-	-	-	-	-	-
Mn (total)	µg/L	3.2/ 3.0	3.4/ 3.3	2.0	5.2	1.4	1.5	2.4	0.4	3.0	-	-	-	-	-	-

(1) Water quality measurements were collected the Friday after the samples were collected;

(2) Duplicate collected; (3) Media change-out out from Vessel A on 09/06/06; (

(3) Piping modification complete
Vessel B is now lead vessel on 09/20/06.

Table B-1. Analytical Results from Long-Term Sampling at Goffstown, NH (Page 9 of 9)

Sampling Date		12/05/06			01/03/07			02/07/07			03/07/07			04/02/07		
Sampling Location	Parameter	IN	TA	TB	IN	TA	TB	IN	TA	TB	IN	TA	TB	IN	TA	TB
Bed Volume	x10 ³	-	9.7	10.1	-	12.9	13.4	-	16.5	17.2	-	19.5	20.5	-	22.4	23.4
Total Phosphorous (as P)	mg/L	59.4	<10	42.9	40.0	12.0	51.5	44.4	23.1	60.5	34.8	20.5	48.5	-	-	-
Silica (as SiO ₂)	mg/L	23.9	23.7	24.4	25.0	24.5	25.4	23.1	22.9	23.3	24.1	24.9	24.4	-	-	-
As (total)	µg/L	28.2	1.6	14.7	33.8	2.6	15.3	34.5	4.3	17.0	30.2	4.0	14.4	32.3	7.0	21.6

Table B-1. Analytical Results from Long-Term Sampling at Goffstown, NH (Page 9 of 9 continued)

Sampling Date		06/11/07			08/06/07		
Sampling Location	Parameter	IN	TA	TB	IN	TA	TB
Bed Volume	x10 ³	-	30.5	32.0	-	36.7	38.6
Total Phosphorous (as P)	mg/L	65.8	44.4	61.5	80.4	49.9	57.3
Silica (as SiO ₂)	mg/L	25.0	25.1	25.3	25.7	25.1	24.9
As (total)	µg/L	28.3	8.2	22.6	32.1	9.8	24.1