

Why Mouse?

Roger Reeves, Ph.D./ Tom Sussan, 5-6624
reeves@jhmi.edu/ tsussan@jhmi.edu

Mouse as a Genetic Model System for Mammalian Genetics

- 1. Genetic structures in mice are not found in nature**
 - Mapping in inbred strains
 - Recombinant inbred strains
 - Congenic strains/ speed congenics ("marker-assisted breeding")
 - Haplotype mapping
 - Quantitative trait loci meet genomics
- 2. Make your own Genotype**
 - Transgenesis
 - Gene targeting
 - Chromosome engineering
- 3. Make your own phenotype**
 - Mutagenesis – insertion/ENU
 - Phenome project
- 4. Comparative genetics**
 - Comparative maps/ sequence
 - Biology – comparative phenotypes
 - Functions of a genome
 - Evolution

1. Special Genetic Structures in Mice: Mice can be inbred to homozygosity

“A strain shall be regarded as inbred when it has been mated brother x sister (hereafter called bxs)

for twenty or more consecutive generations (F20), and can be traced to a single ancestral breeding

pair in the 20th or a subsequent generation. Parent offspring matings may be substituted for bxs matings provided that, in the case of consecutive parent x offspring matings, the mating in each case is to the younger of the two parents. Exceptionally, other breeding systems may be used, provided that the inbreeding coefficient achieved is at least equal to that at F20 (0.99).”

2. Hundreds of inbred strains of mice capture many different types of genetic information



Inbred strain categories

- A) Swiss mice
- B) Castle's mice
- C) Strains derived from colonies from China and Japan
- D) Other inbred strains
- E) C57-related strains
- F) Strains derived from wild mice
- G) Mice derived from multiple inbred strains

Note: categories are intended to help the researchers find or define strains of interest and should not be regarded as fixed or mutually exclusive. Species and subspecies are as described in the relevant reference.

^c C57BL	str	Strain names in red denote inbred strains that are referenced, but not in red, for example, ^h CD-1 are not maintained as inbred strains.
^c C57BL	sup	Superscripted number in green denotes reference provided in Table 1 (http://genetics.nature.com/mouse)
bxs	pr	other - sister mating
solid lines	descr	lines from relationship between strains
dash lines	descr	lines possible relationship between strains
U	U	University
ICR	Institut	Institute of Cancer Research
Ctr	entre	Centre
Jax	T	The Jackson Laboratory
Behav	b	Behaviour
ARC	A	Agricultural Research Council
Ani	animal	
Hyg	h	Hygiene
CSH	C	Cold Spring Harbor
NIH	N	National Institutes of Health

Design and layout: Jon Beck (MRC Prion Unit) Final artwork: Ray Young (MRC Prion Unit)

>450 inbred strains

http://www.nature.com/ng/mouse/ng0100_trefinal.pdf

Beck JA, Lloyd S, Hafezparast M, Lennon-Pierce M, Eppig JT, Festing MF, Fisher EM. Nat Genet. 2000 Jan;24(1):23-5.

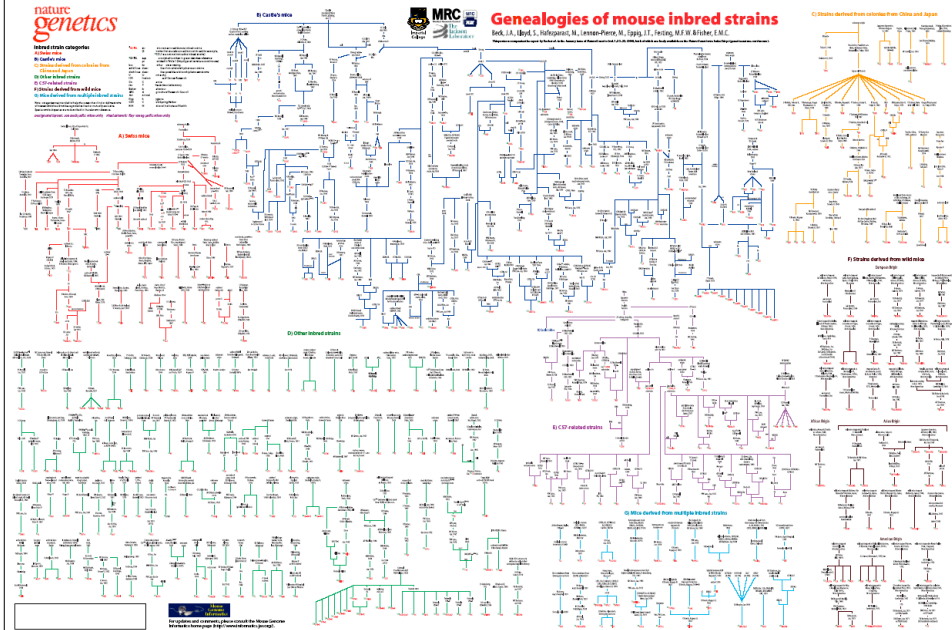

Nomenclature and genetic content

An **intercross** between two parental (P_1) inbred strains produces an F_1 hybrid

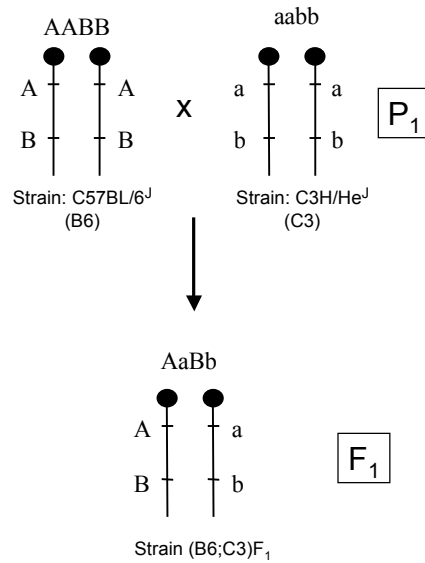

Nomenclature and genetic content

An **advanced intercross** produces F_n hybrids

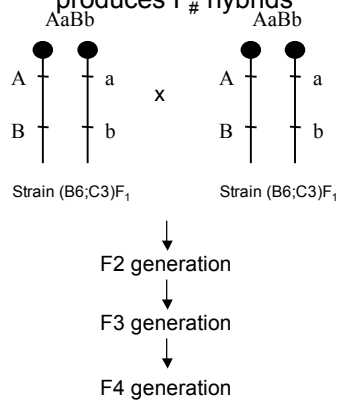

A **backcross** produces N_n generations

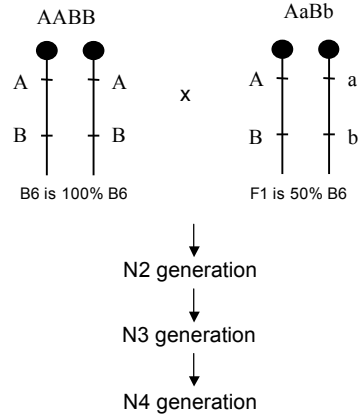

Mapping in inbred mice

For any polymorphic marker, crosses are completely phase-known

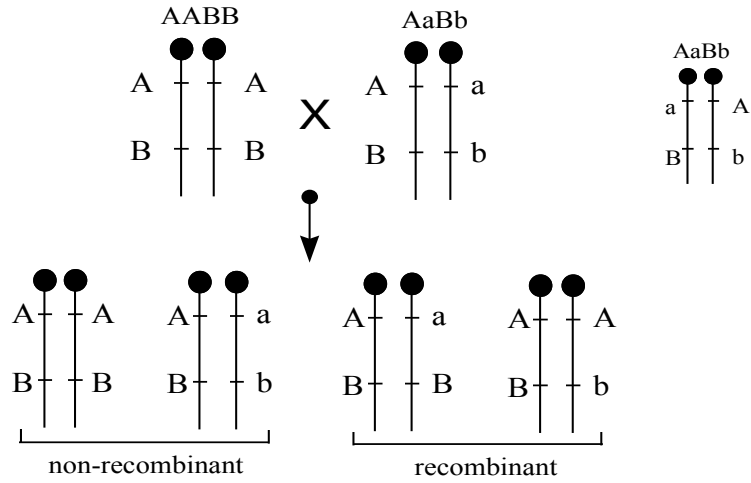

Recombinant inbred mouse strains

resource for genotype and phenotype

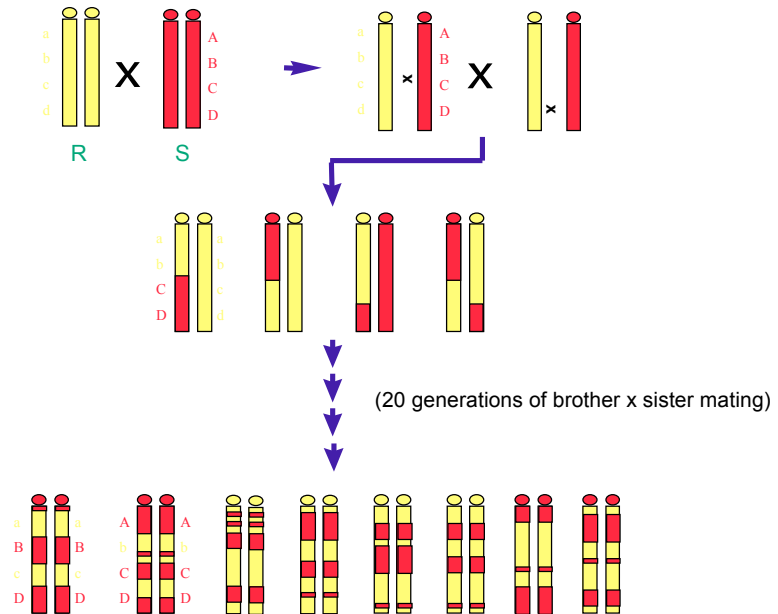

Mapping in Recombinant inbred (RI) strains

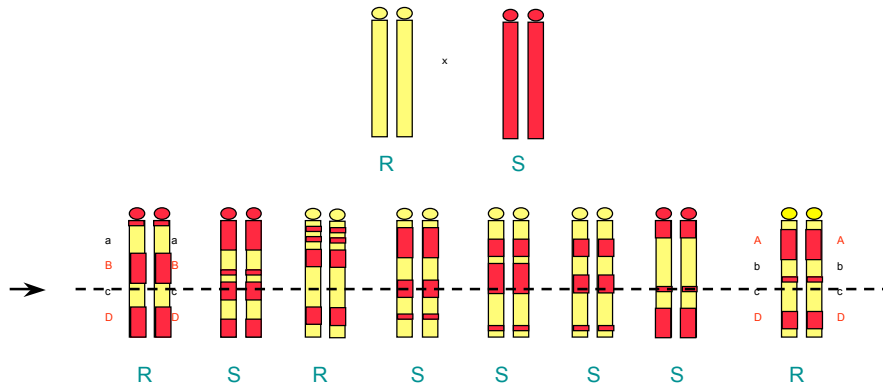

QTX: software for complex trait analysis
 by Jane M. Meer, Robert H. Cudmore, Jr., and Kenneth F. Manly

<http://mapmgr.roswellpark.org/mmQTX.html>

Strain distribution patterns for Chr 6 in the AKXD RI strain set.

Chromosome: 6

	AKXD	1	2	3	6	7	8	9	10	11	12	13	14	15	16	17	18	20	21	22	23	24	25	26	27	28	Experiment (Reference)
Calu	A	D	A	A	D	A	D	A	D	A	D	A	A	A	.	A	D	A	A	A	A	A	D	D	D	D	Yabe D (J:41711)
Mtv23	D	A	A	D	D	A	A	D	D	D	D	D	D	D	D	A	A	D	D	D	A	D	.	A	A	D	Lee BK (J:10675)
D6Mit33	D	A	A	D	D	A	A	D	D	D	D	D	D	A	.	A	A	D	D	D	D	D	D	D	D	D	Taylor BA (J:11923)
Igf1	D	A	D	A	D	A	A	.	.	A	A	D	D	A	.	A	D	A	D	D	A	D	D	D	D	D	Elliott RW (J:10507)
Igf1-J	D	A	D	A	D	A	A	D	D	A	D	D	A	A	A	D	A	A	D	D	A	D	D	D	D	D	Boyd RT (J:8431)
Igf1-V28	D	A	D	A	D	A	A	D	D	A	D	D	A	A	A	D	A	A	D	D	A	D	D	D	D	D	Taylor BA (J:8097)
Odc-rs5	D	A	D	A	D	A	A	D	D	A	D	D	A	A	A	D	A	D	D	D	A	D	D	D	D	D	Richards-Smith BA
Rn7s6	D	A	D	A	D	A	A	D	D	A	D	D	A	A	A	D	A	D	D	A	D	D	D	D	D	D	Taylor BA (J:8097)
D6Nds3	D	A	A	D	A	A	A	D	D	D	D	D	D	.	A	D	D	D	A	D	D	A	D	D	D	D	Cornall RJ (J:3227)
Cd8b	D	A	D	A	D	A	A	D	D	A	D	D	A	A	A	D	A	D	D	D	A	D	D	D	D	D	Taylor BA (J:8097)
Tgfa	D	A	D	A	D	A	A	D	D	A	D	D	A	.	D	D	A	D	D	A	D	D	A	D	A	A	Fowler KJ (J:12769)
D6Nds2	D	A	D	D	A	A	D	D	A	D	D	A	.	D	D	A	D	D	A	D	D	D	D	D	D	D	Cornall RJ (J:3227)
Rho	D	A	A	D	A	D	D	A	D	D	A	D	A	.	D	D	D	D	A	D	D	D	D	D	D	D	Elliott RW (J:10507)
Raf1	D	A	A	.	D	A	D	D	D	A	.	D	A	.	D	D	A	A	D	A	D	D	.	D	.	D	Elliott RW (J:10507)
D6Mit15	D	D	D	A	D	D	D	A	A	A	D	A	A	.	A	D	D	A	D	A	D	A	A	D	A	D	Taylor BA (J:11923)
Xmmv54	D	D	D	D	A	D	D	A	A	D	A	A	A	A	A	D	D	A	D	D	A	D	A	A	D	A	Wejman JC (J:7348)

Mouse Genome Informatics:
http://www.informatics.jax.org/searches/riset_form.shtml

Benefits of RI strains:

- “Pre-genome scan” – cumulative information
- Reassay the “same” individual many times (find true mean and deviation for variable traits)
- Highly beneficial for quantitative traits
- Stock of genetic variation (recombinant congenic mice)

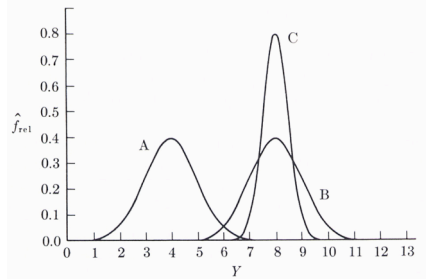

Limitations of RIs:

- Small strain sets have limited statistical power.
- Mapping is relatively low resolution on the first pass.

Congenic mice

are made by repeated backcrossing while selecting for a specific locus of parental type

10-12 generations of backcrossing/selection

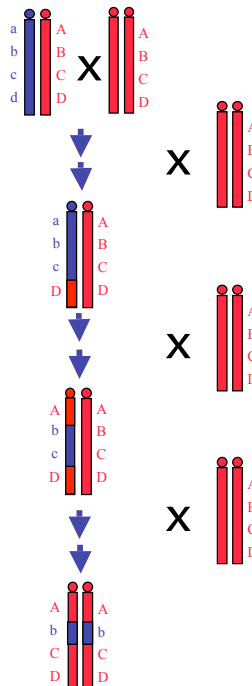

“Speed” congenic mice

are made by repeated backcrossing while selecting for a specific locus of parental type AND screening large sets of progeny with a genome scan to identify those mice which are most inbred

4-5 generations using marker assisted selection to choose the progenitors of the next generation

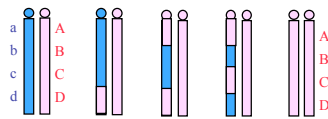

Chromosome pairs from five different F3 individuals assessed by a genome scan – which should be selected for the next generation?

Markel et al., Nat Genet. 1997 Nov;17(3):280-4.

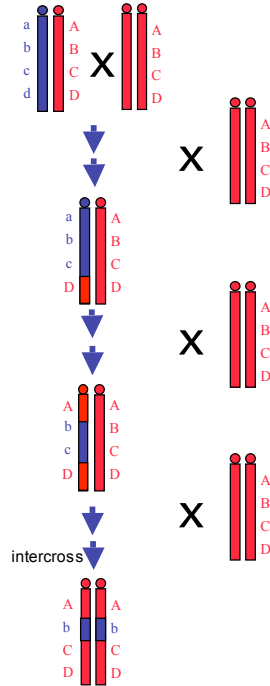

Overcoming limited statistical power of RI strains

38

MATESIC, DE MAIO, AND REEVES

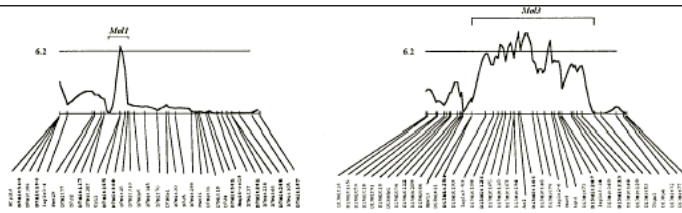
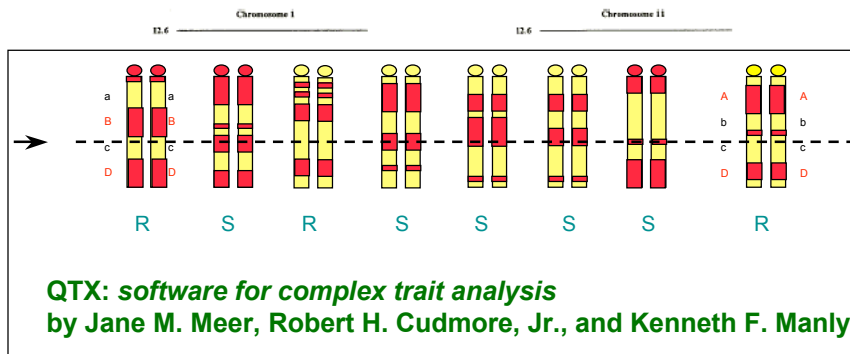

Matesic et al., Genomics 62:34-41.

Congenic mice can be used to confirm and refine localizations made with other approaches.

Further, they demonstrate sufficiency of an individual locus to cause a phenotype (e.g. in QTL studies).

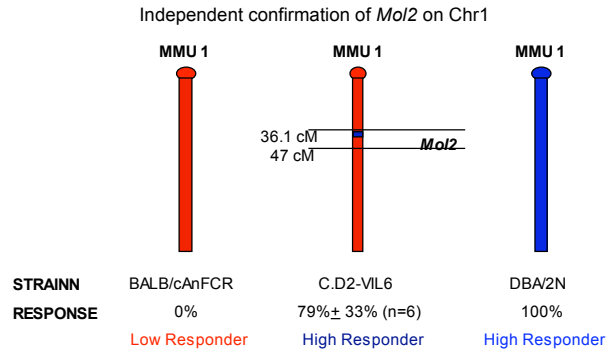

Matesic, L.E., A. De Maio, R.H. Reeves. 1999. Mapping LPS Response Loci in Mice Using Recombinant Inbred and Congenic Strains. *Genomics* 62:34-41.

Increased resolution from RI mapping

1. RIX - Threadgill

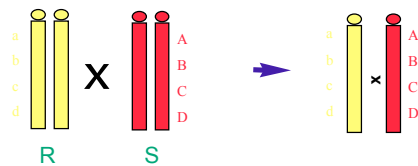

2. Complex Trait Consortium

- 8-way cross
- 2048 RI strains (256 on the shelf)
- www.complextait.org/Workshop1.pdf

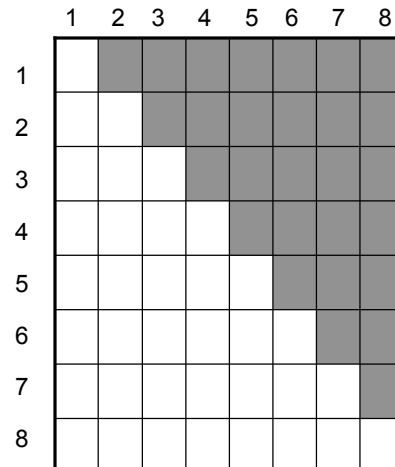

Consomic mice

are made by repeated backcrossing to place one chromosome pair from strain "A" onto the genetic background of strain "B"

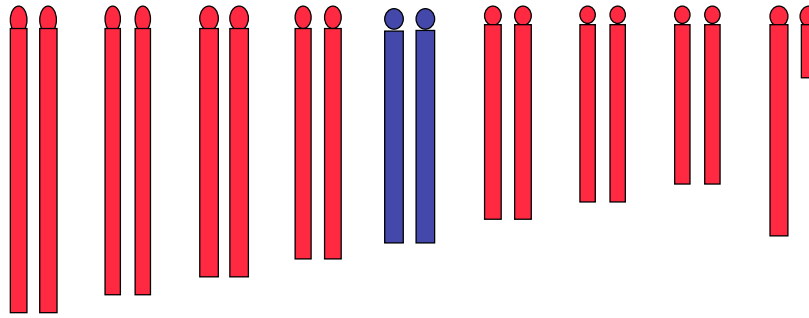

Nadeau et al., Nat Genet. 2000 Mar;24(3):221-5

Haplotype structure in the world of inbred mice

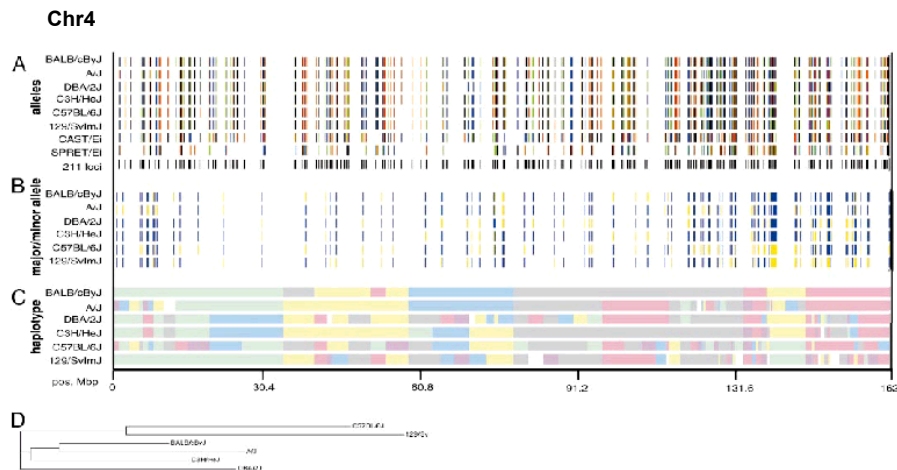

Wiltshire et al., PNAS 100:3380-3385 (2003); www.gnf.org/SNP/

Large haplotype blocks correspond to regions of low SNP density

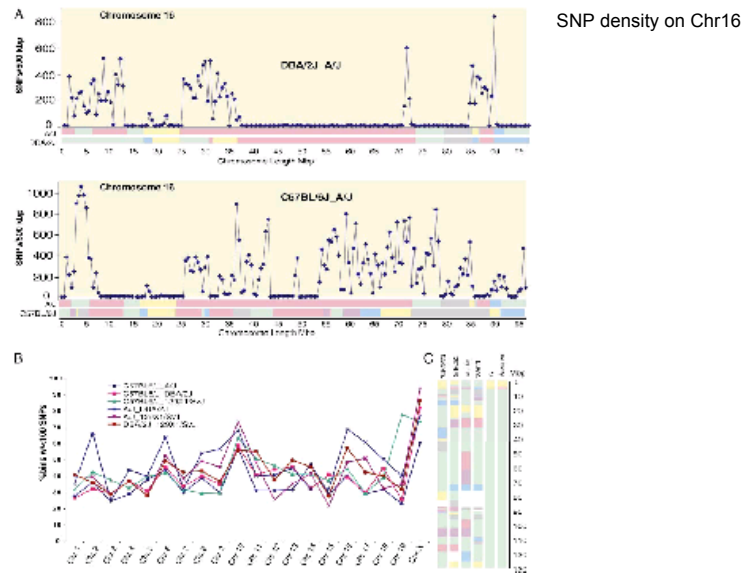

Wiltshire et al., PNAS 100:3380-3385 (2003); www.gnf.org/SNP/

Mapping with haplotypes: Tyr

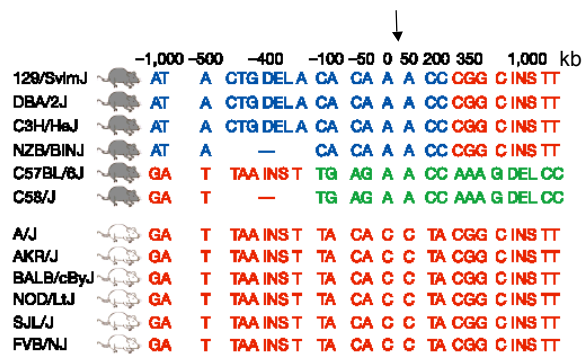
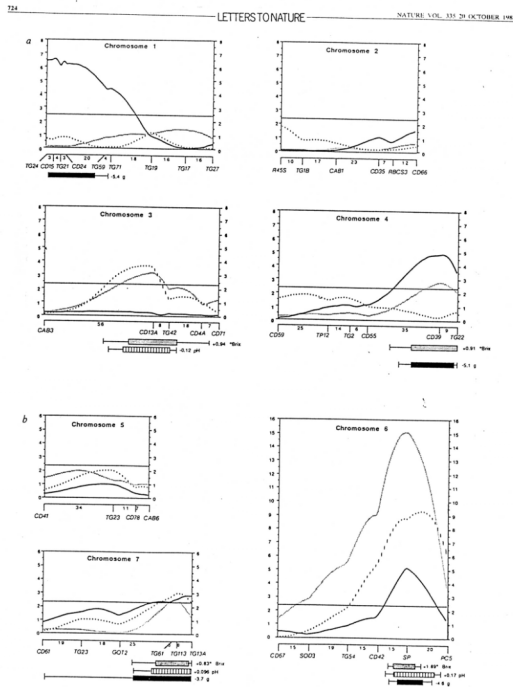

Figure 5 Association between a single haplotype and the albinism phenotype caused by a mutation at the tyrosinase locus²⁰. Columns show SNPs discovered in ten 500-bp assays with positions (kb) relative to the centre of the genomic segment containing the gene (GenBank accession GI:12852585). The causal mutation (Cys103Ser) is located at +32.6 kb. The association between phenotype and ancestral haplotype for 12 strains would be sufficient to identify a haplotype background and 'critical region' of ~500 kb (including the assays from -100 kb before Tyr to 200 kb after Tyr) likely to contain the albinism mutation.

Wade et al., Nature 420:574-578 (2002)

Complex traits

Many traits are influenced by multiple genes. Experiments are used to map such quantitative trait loci (QTLs) in experimental organisms.



QTL modifiers

QTL modifiers are genes that can be identified across the entire genomes of a plant, such as tomato.

mass
pH
brix

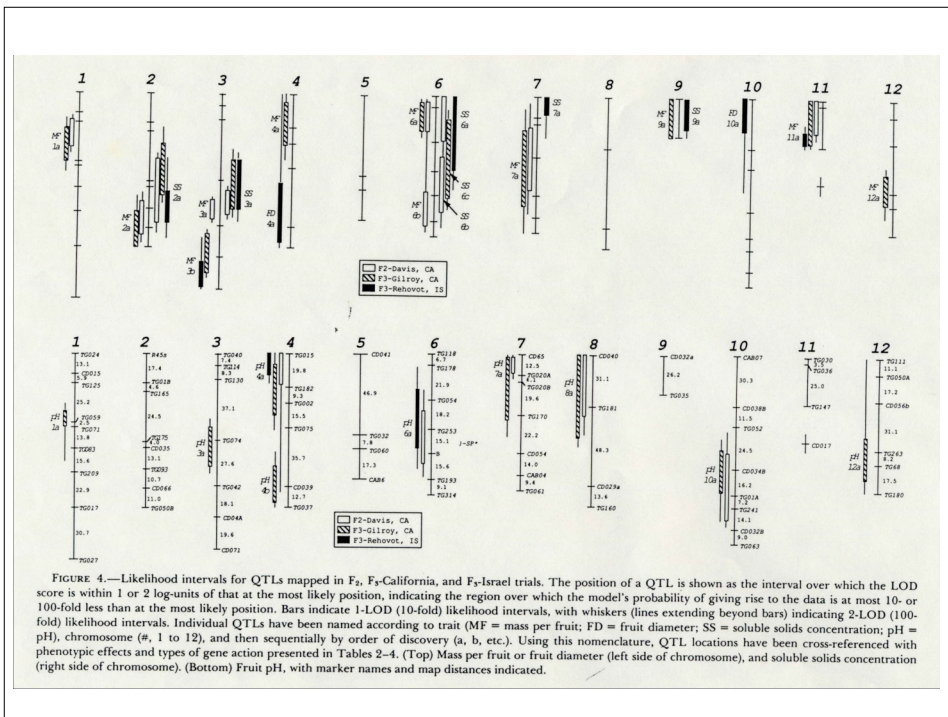

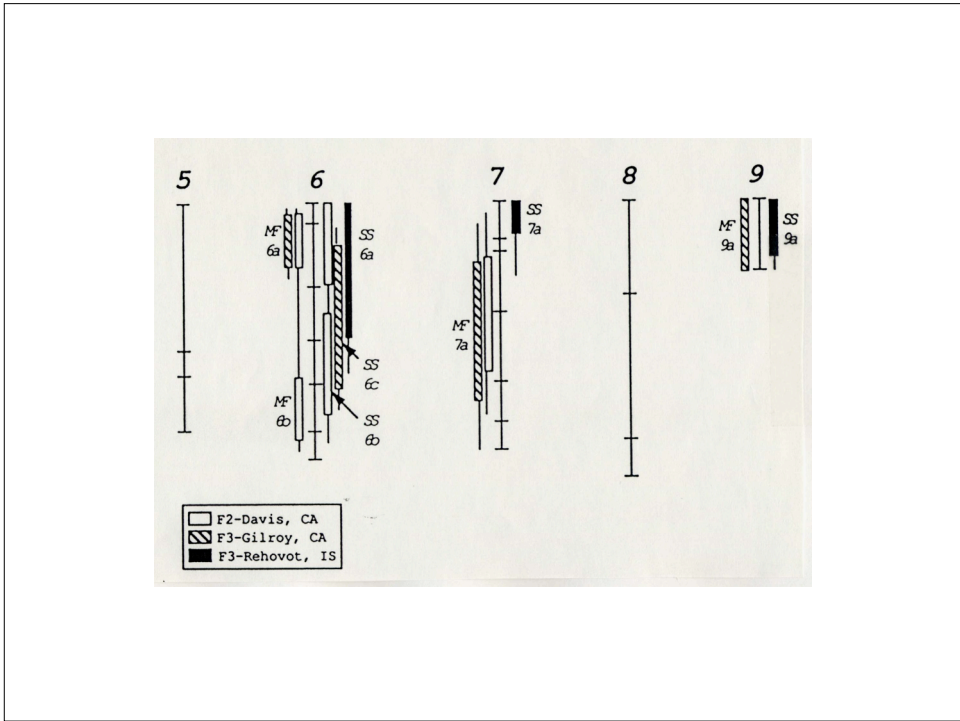

“PURE” positionally cloned QTL in *lyopersicum*

Fig. 2. High-resolution mapping of the fw2.2 QTL. (A) The location of fw2.2 on tomato chromosome 2 in a cross between *L. esculentum* and a NIL containing a small introgression (gray area) from *L. pennellii* [from (8)]. (B) Contig of the fw2.2 candidate region, delimited by recombination events at XO31 and XO33 [from (8)]. Arrows represent the four original candidate cDNAs (70, 27, 38, and 44), and heavy horizontal bars are the four cosmids (cos52, 84, 69, and 50) isolated with these cDNAs as probes. The vertical lines are positions of restriction fragment length polymorphism or cleaved amplified polymorphism (CAPs) markers. (C) Sequence analysis of cos50, including the positions of cDNA44, ORFX, the A-T-rich repeat region, and the “rightmost” recombination event, XO33.

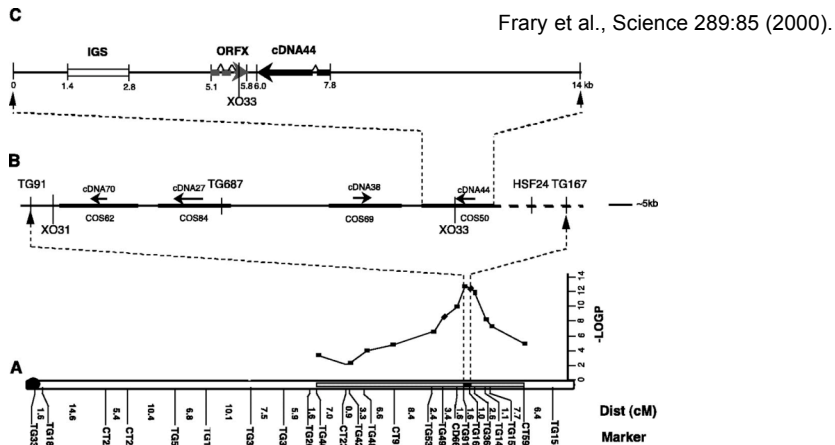

Mouse phenome project

MPD Priority Set of Strains

GROUP A	GROUP B	GROUP C	GROUP D
B17 129S1/SvImJ	B85 AKR/J	D41 BUB/BnJ	none BTBR T ⁺ tf/tf
B68 A/J	E4 C57L/J	E9 C57BL/10J	E5 C57BR/cdJ
B78 BALB/cByJ	E2 C58/J	E23 C57BLKS/J	D110 CE/J
B47 C3H/HeJ	F25 MOLF/Ei	B55 CBA/J	B29 I/LnJ
E12 C57BL/6J	A14 NOD/LtJ	F13 CZECHII/Ei	F34 JF1/Ms
F22 CAST/Ei	B112 NZB/BINJ	C29 KK/HIJ	E10 MA/MyJ
B42 DBA/2J	F48 PERA/Ei	B7 LP/J	A13 NON/LtJ
A25 FVB/NJ	D75 PL/J	F30 MSM/Ms	B114 NZW/LacJ
A29 SJL/J	B37 SM/J	D107 RIIS/J	F10 PWK/Ph
F14 SPRET/Ei	A33 SWR/J	F38 WSB/Ei	B35 SEA/GnJ

- See [explanation](#) of color coding.
- BALB/cJ may be used at investigator's discretion.
- 129S1/SvImJ was renamed in Feb '01. Previous name was 129S3/SvImJ.
- BTBR T⁺ tf/tf was renamed in May '02. Previous name was BTBR+^Ttf/tf.

www.jax.org/pheno

Transgenesis/ gene-targeting/ chromosome engineering

1. Transgenic mice (pronuclear injection) Hogan B, Beddington R, Constantini F, Lacy E. *Manipulating the Mouse embryo: A laboratory manual*. 1994. Cold Spring Harbor Laboratory Press.
2. "Knock out" (null alleles) and "Knock-in" mice (mutations, reporters), tissue-targeted and conditional mutations
Shin MK, Levorse JM, Ingram RS, Tilghman SM. The temporal requirement for endothelin receptor-B signalling during neural crest development. *Nature*. 1999 Dec 2;402(6761):496-501.
3. Chromosome engineering
Ramirez-Solis R, Liu P, Bradley A. Chromosome engineering in mice. *Nature*. 1995 378(6558):720-4.
4. Whole genome gene targeting
Zheng B, Mills AA, Bradley A. A system for rapid generation of coat color-tagged knockouts and defined chromosomal rearrangements in mice. *Nucleic Acids Res*. 1999 27(11):2354-60.
Zambrowicz BP, Friedrich GA, Buxton EC, Lilleberg SL, Person C, Sands AT. Disruption and sequence identification of 2,000 genes in mouse embryonic stem cells. *Nature*. 1998 392(6676):608-11.

Micro-injection of DNA into a male pronucleus to create a transgenic mouse.

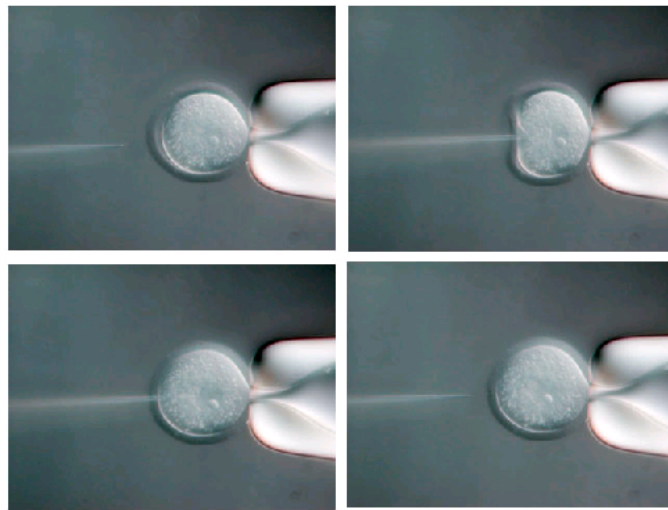

<http://www.med.ic.ac.uk/db/dbbm/figure.htm>

Blastocyst injection

Embryonic stem cells can be manipulated in culture, then injected into mouse blastocysts to form part of the inner cell mass (ICM). The ICM will form the embryo proper while the surrounding trophoblast cells contribute to extra-embryonic structures (placenta).

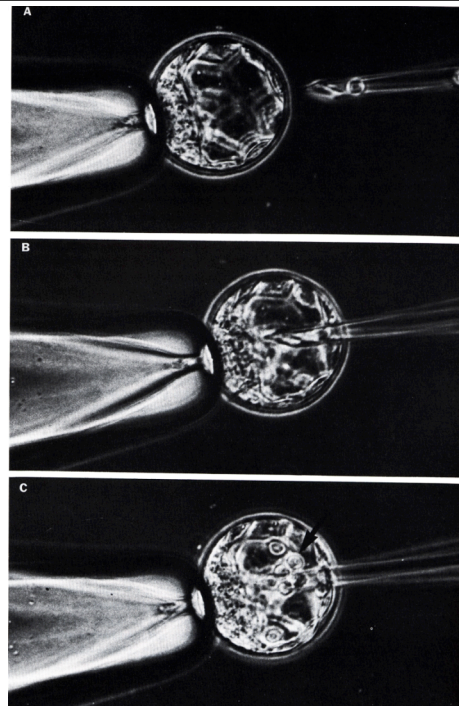

Hogan et al., *Manipulating the Mouse Embryo*, CSHL Press

Chimeras formed from ES cells and host cells.

A chimeras has four parents, but individual cells have genetic information from only one of the two pairs.

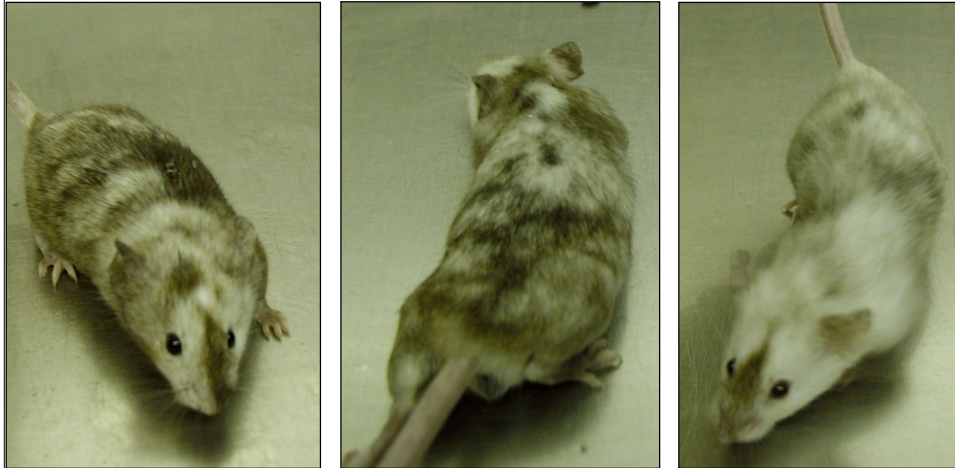

Manipulating the germ-line in embryonic stem cells

“Knock out” mice create null alleles to study loss of function.

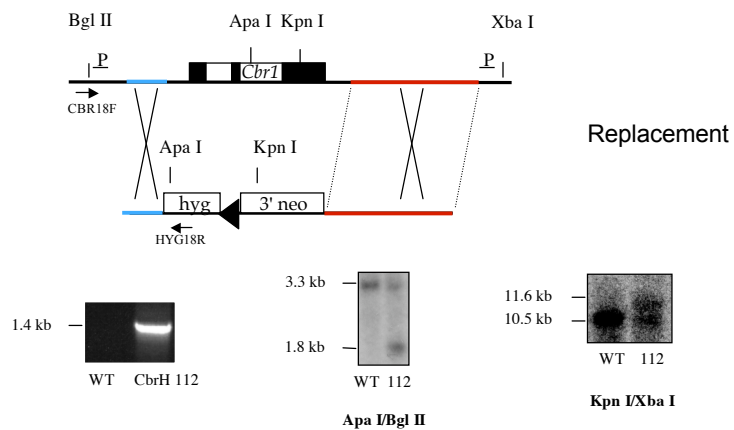

Manipulating the germ-line in embryonic stem cells

Conditional knock-outs allow a much greater range of studies for similar investment of effort.

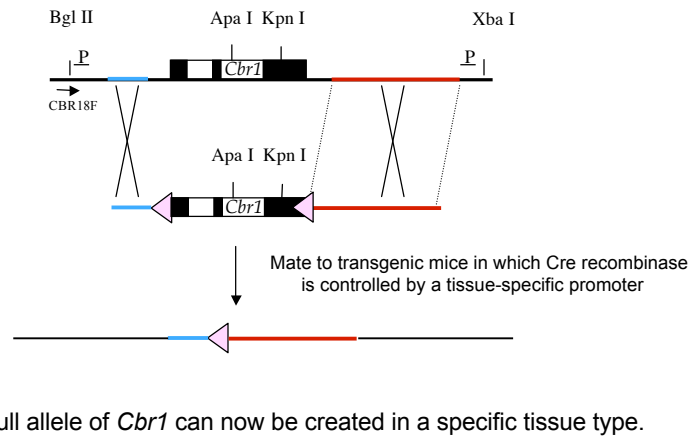

Manipulating the germ-line in embryonic stem cells

“Knock-in” mice (mutations, reporters), allow precise temporal and spatial regulation of gene expression.

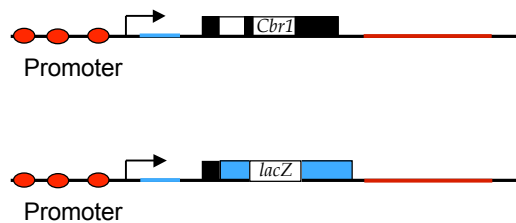

“Two stage” strategies control gene expression in space and time

- Cre-recombinase with a cell type-specific promoter plus marker gene
- Transcriptional activators under pharmaceutical control

articles

The temporal requirement for endothelin receptor-B signalling during neural crest development

Shin et al., Nature 402:496, 1999

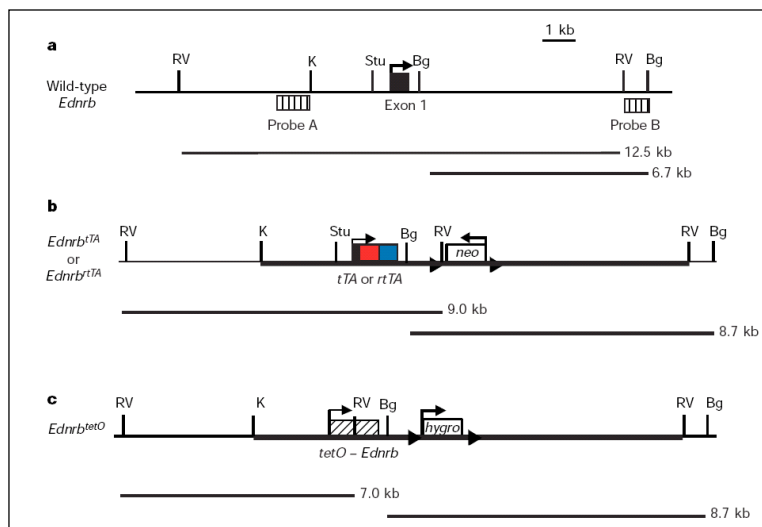

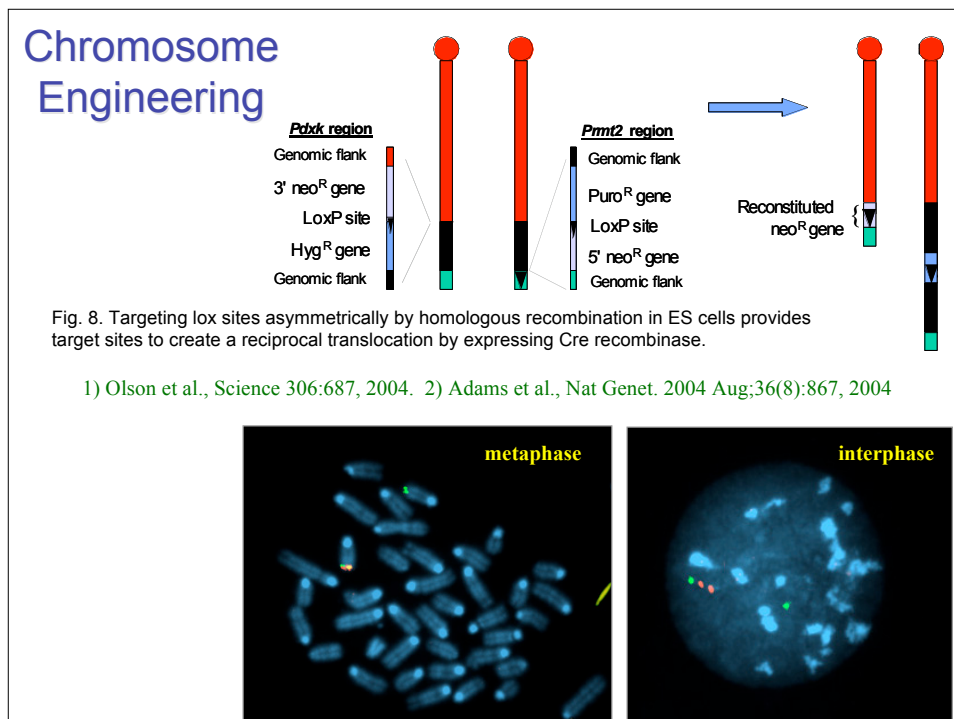
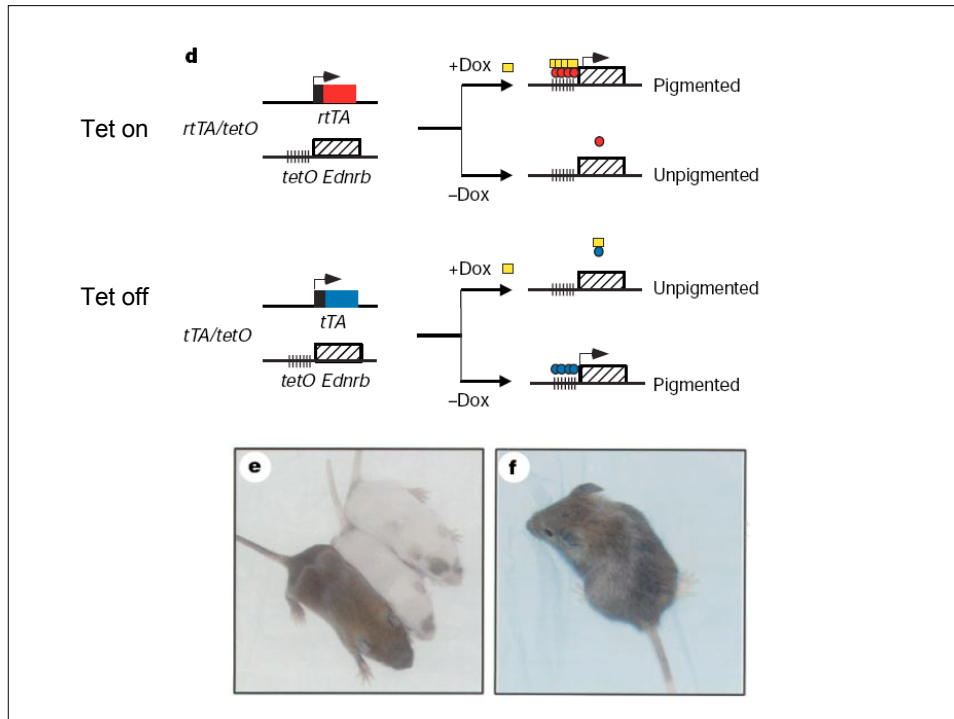

Mapping Genome Function: Creating Phenotypes using Mutagenesis

Mutagenesis provides a means of generating new phenotypes in mouse.

1. Justice, M. J. 2000. Capitalizing on large-scale mouse mutagenesis screens. *Nat Rev Genet* 1: 109-15. Review.
2. MJ Justice in IJ Jackson and CM Abbott, *Mouse Genetics and Transgenics: A Practical Approach*. 2000. Oxford University Press, 299 pp.

Mutagenesis provides a means of generating new phenotypes in mouse.

1. Sources of mutations
 - Spontaneous, frequency is 10^{-5} /locus/generation, all types of mutations;
 - Radiation, frequency is dose dependent, primarily chromosomal rearrangement;
 - Chemical, ENU gives point mutations at 1/600 gametes per locus at some loci
2. Targets/ mutation types
 - Visible single gene dom. or recessive
 - Allelic series
 - Biochemical pathway
 - Sensitization (Shedlovsky A, McDonald JD, Symula D, Dove WF. *Mouse models of human phenylketonuria*. *Genetics*. 1993. 134:1205-10).

Mutagenesis provides a means of generating new phenotypes in mouse.

3. Screens

- Specific locus test
- MutaMouse/ Big Blue
- SHIRPA
- Special targeted screens
- Dominant vs. recessive (1st vs. 3rd generation)
- Mutagenesis in combination with deletion (recessives in first generation)

4. Breeding schemes

- Recessive over deletion;
- Modifier (dominant mutation modifies another mutation)
- Sensitization (recessive mutations in genes that interact in a pathway/ allelic)

Large mutagenesis centers, see Trans-NIH Mouse Initiative

<http://www.nih.gov/science/models/mouse/index.html>

- Mouse Genome Center, ENU
Mutagenesis Programme, Harwell,
<http://www.mgu.har.mrc.ac.uk/mutabase/>
- German ENU Mutagenesis Center,
<http://www.gsf.de/isg/groups/enu-mouse.html>

Enhancer, gene and promoter trapping

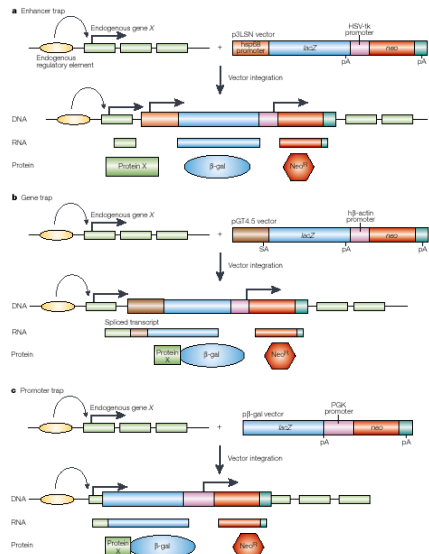

Stanford et al., Nature Reviews Genetics 2, 756-768 (2001)

Figure 1 The basic trap vectors. Enhancer-, gene- and promoter-trap vectors, which all contain a lacZ reporter gene and a neomycin resistance cassette (neo) that is driven by an autonomous promoter, are shown trapping an endogenous gene X.

Uncovering recessive mutations with a deletion/ENU mutagenesis screen

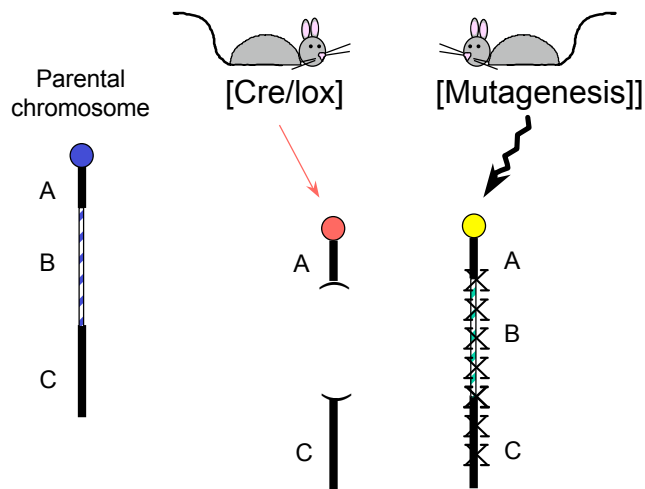

ENU mutagenesis in balancer strains

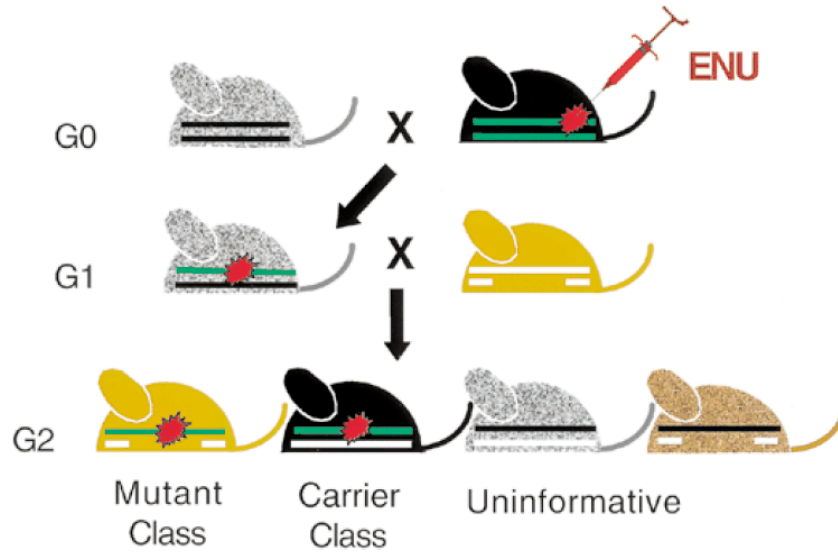

Justice, M. Nature Reviews Genetics 1:109-116 (2000)

ENU mutagenesis in balancer strains

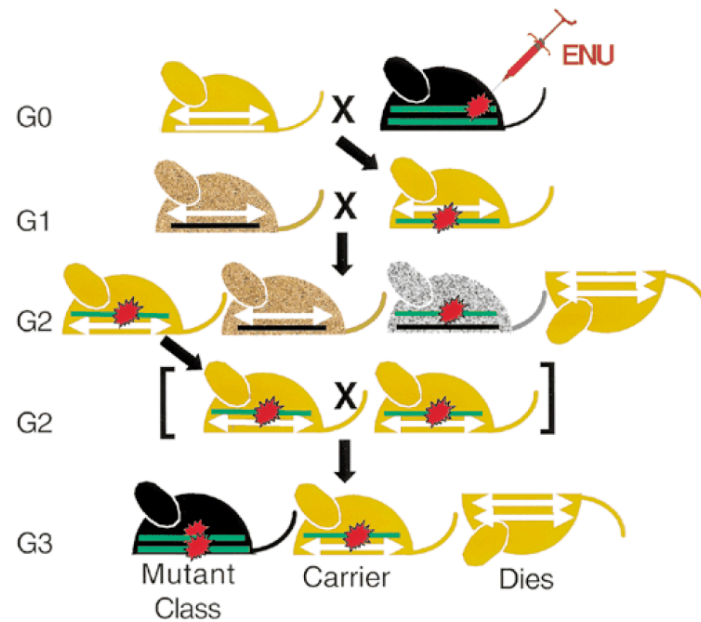

Justice, M. Nature Reviews Genetics 1:109-116 (2000)

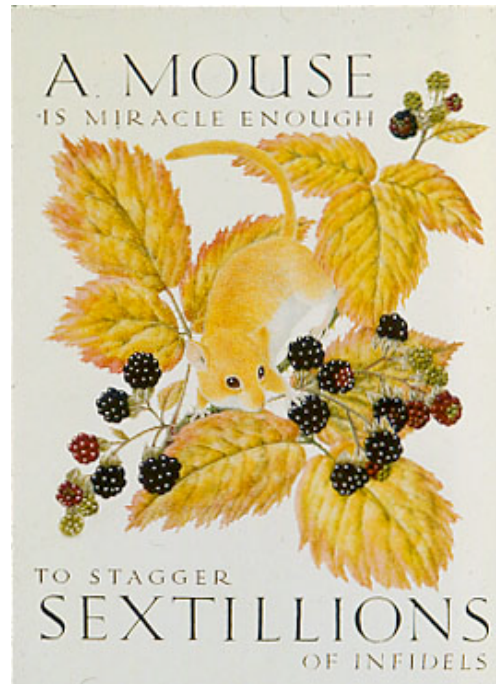

Walt Whitman