

**APPENDIX A**  
**USIO RISERLESS OCEAN DRILLING BACKGROUND INFORMATION**

This appendix provides detailed data on prior USIO riserless drilling activities which are indicative of future operations by the *JOIDES Resolution* (SODV).

- ◇ Table A-1. “ODP (1985 – 2003) and IODP (2004 - 2006) Drill Sites” identifies the sites where riserless drilling operations have taken place since 1985 and includes information pertaining to the duration of each expedition and number of holes drilled and cores recovered.
- ◇ Table A-2. “DSDP, ODP, and IODP Analyses” identifies the number and type of analyses performed during previous U.S. riserless drilling programs.
- ◇ Table A-3. “Status of Existing DSDP/ODP/IODP Legacy Holes” identifies existing boreholes that may be revisited during future SODV expeditions.

**THIS PAGE INTENTIONALLY LEFT BLANK**



**Table A-1. ODP (1985 – 2003) and IODP (2004 - 2006) Drill Sites**

ODP/IODP Leg or Expedition		Drilling Site Area	Number				Length (meters)			% Recovery	Max Water Depth (m)
			Duration (days)	Sites	Holes	Cores	Drilling Penetration	Coring Penetration	Core Recovered		
ODP	100	Gulf of Mexico	12	1	3	37	237	278	264	95.3	889
ODP	101	Bahamas	36	11	19	319	641	2,928	1,439	49.1	3,581
ODP	102	Western Atlantic	19	1	0	0	0	0			5,505
ODP	103	Galicia Bank	47	5	14	157	1,492	1,505	616	40.9	5,321
ODP	104	Norwegian Sea	43	3	8	291	514	2,423	1,707	70.5	2,780
ODP	105	Labrador Sea/Baffin	46	3	11	316	723	2,966	1,885	63.5	3,871
ODP	106	Mid-Atlantic Ridge	41	2	12	17	0	109	14	12.5	3,530
ODP	107	Tyrrhenian Sea	43	7	11	353	343	3,289	1,844	56.1	3,597
ODP	108	Northwest Africa	36	12	27	461	214	4,244	3,843	90.5	4,746
ODP	109	Mid-Atlantic Ridge	48	4	5	25	45	186	22	12	4,490
ODP	110	Lesser Antilles	48	6	10	259	1,269	2,415	1,899	78.7	5,070
ODP	111	Panama Basin	48	3	5	79	143	641	428	66.8	3,474
ODP	112	Peru Margin	45	10	27	514	2,043	4,720	2,664	56.4	5,093
ODP	113	Weddell Sea	44	9	22	386	639	3,405	1,944	57.1	4,667
ODP	114	South Atlantic	39	7	12	392	87	3,585	2,300	64.2	4,647
ODP	115	Mascarene Plateau	30	12	22	426	229	3,954	3,079	77.9	4,440
ODP	116	Bangal Fan	39	3	10	248	1,493	2,290	992	43.3	4,747
ODP	117	Oman Margin	36	12	25	628	1,278	5,848	4,368	74.7	4,045
ODP	118	SW Indian Ridge	46	4	20	117	0	777	447	57.6	5,219
ODP	119	Prydz Bay	37	11	22	427	796	3,650	2,102	57.6	4,093
ODP	120	S Kerguelen	28	5	12	255	1,407	2,149	1,082	50.3	2,041
ODP	121	Broken Ridge	34	7	17	310	1,001	2,731	1,825	66.8	2,937
ODP	122	Exmouth Plateau	43	6	15	445	28	5,205	2,446	47	2,710
ODP	123	Argo Abyssal Plain	47	2	5	189	1,298	1,793	1,080	60.2	5,732
ODP	124	SE Asia Basins	47	5	13	336	2,116	3,112	2,123	68.2	4,916
ODP	124E	Luzon Strait	24	6	15	41	1,444	280	147	52.6	5,817
ODP	125	Bon/Mar	49	9	15	323	623	2,918	1,023	35	4,912
ODP	126	Bon Mar II	53	7	19	500	1,791	4,702	2,122	45.1	3,265
ODP	127	Japan Sea I	49	4	10	317	1,884	2,914	1,658	56.9	3,311
ODP	128	Japan Sea II	43	3	9	226	1,654	2,066	1,574	76.2	2,818
ODP	129	Old Pacific Crust	46	3	5	199	696	1,708	467	27.3	5,980

**Table A-1. ODP (1985 – 2003) and IODP (2004 - 2006) Drill Sites**

ODP/IODP Leg or Expedition		Drilling Site Area	Number				Length (meters)			% Recovery	Max Water Depth (m)
			Duration (days)	Sites	Holes	Cores	Drilling Penetration	Coring Penetration	Core Recovered		
ODP	130	Ontong Java Plateau	51	5	16	639	988	5,889	4,822	81.9	3,862
ODP	131	Nankai Trough	56	1	7	165	2,667	1,463	732	50	4,687
ODP	132	West/Central Pacific	45	3	11	52	80	237	165	69.5	4,696
ODP	133	N/E Australia	51	16	36	885	2,925	7,965	5,508	69.1	1,650
ODP	134	Vanuatu	53	7	16	541	809	4,831	2,045	42.3	3,101
ODP	135	Lau Basin	51	8	18	409	581	4,432	1,254	28.3	4,821
ODP	136	OSN-1	16	2	6	20	846	129	64	49.1	4,441
ODP	137	Hole 504B	22	1	1	8	1,561	60	14	1	3,474
ODP	138	E Equatorial Pacific	38	11	42	599	68	5,543	5,536	99.9	3,861
ODP	139	Sedimented Ridges	57	4	23	331	1,069	2,656	933	35.1	2,457
ODP	140	Hole 504B	40	1	1	57	1,622	379	53	1.7	3,474
ODP	141	Chile Triple Junction	38	5	13	284	810	2,516	1,019	40.5	2,760
ODP	142	East Pacific Rise	37	1	3	5	9	16	10	61.3	2,583
ODP	143	Atolls & Guyots - I	44	6	12	441	140	3,995	1,065	26.7	4,838
ODP	144	Atolls & Guyots - II	46	11	21	358	285	3,201	1,088	27.3	1,537
ODP	145	N Pacific Transect	41	7	25	540	2,710	5,021	4,321	86.1	5,726
ODP	146	Cascadia	52	7	20	272	2,230	2,263	1,197	52.9	2,675
ODP	147	Hess Deep	44	2	13	57	27	518	121	23.3	3,832
ODP	148	Hole 504B	39	2	2	45	1,727	377	84	1.3	3,474
ODP	149	Iberian Abyssal Plain	51	5	10	288	1,211	2,686	1,532	57	5,389
ODP	150	New Jersey Sea Level	39	5	11	515	1,443	4,602	4,032	87.6	2,709
ODP	151	Atl. Arctic Gateways I	38	7	18	475	458	4,216	3,005	71.3	3,330
ODP	152	E Greenland Margin	46	6	13	346	772	2,906	1,255	43.2	2,097
ODP	153	MARK	48	5	15	100	86	728	255	35	3,343
ODP	154	Ceara Rise	43	5	19	653	763	6,161	5,808	94.3	4,369
ODP	155	Amazon Fan	48	17	36	558	116	5,117	4,053	79.2	4,148
ODP	156	N Barbados Ridge	55	3	8	54	2,764	469	267	57	5,013
ODP	157	VICAP/MAP	45	7	12	438	867	4,091	3,090	75.5	5,449
ODP	158	TAG	43	1	17	88	104	531	55	10.4	3,657
ODP	159	Eq. Atlantic Transform	44	4	13	366	919	3,320	2,018	60.8	4,645
ODP	160	Mediterranean I	40	11	48	544	294	4,801	3,363	70.1	3,931

**Table A-1. ODP (1985 – 2003) and IODP (2004 - 2006) Drill Sites**

ODP/IODP Leg or Expedition		Drilling Site Area	Number				Length (meters)			% Recovery	Max Water Depth (m)
			Duration (days)	Sites	Holes	Cores	Drilling Penetration	Coring Penetration	Core Recovered		
ODP	161	Mediterranean II	44	6	16	505	743	4,591	3,875	84.4	3,470
ODP	162	Atl. Arctic Gateways II	44	9	30	828	929	7,708	6,731	87.3	2,879
ODP	163	Gas Hydrates	17	3	4	46	166	314	205	65.1	542
ODP	164	Gas Hydrate Sampling Blake Ridge & Carolina Rise	41	7	17	344	1,115	2,785	1,982	71.2	2,799
ODP	165	Cretaceous/Tertiary Boundary Event	45	5	13	453	1,773	4,178	3,359	80.4	3,260
ODP	166	The Bahamas Transect	41	7	17	572	2,198	5,255	2,939	55.9	658
ODP	167	California Margin	44	13	52	840	2	7,710	7,502	97.3	4,215
ODP	168	Hydrothermal Circulation in the Oceanic Crust: Eastern Flank of the Juan de Fuca Ridge	51	10	19	230	1,409	2,052	1,552	75.6	2,659
ODP	169S	Saanich Inlet	2	2	9	72	0	678	686	101.2	229
ODP	169	Sedimented Ridges II	45	7	25	363	814	3,567	1,205	33.8	3,302
ODP	170	Costa Rica Accretionary Wedge	43	5	17	223	3,405	2,052	1,464	71.3	4,354
ODP	171A	Northern Barbados Accretionary Prism	11	5	5	0	2,973	0	0	0	5,056
ODP	171B	Blake Nose Paleoceanographic Transect	30	5	16	427	561	3,794	3,227	85.1	2,682
ODP	172	Northwest Atlantic Sediment Drifts	37	11	42	623	10	5,689	5,765	101.3	5,568
ODP	173	Return to Iberia	44	6	6	126	2,994	1,188	453	38.1	5,322
ODP	174A	New Jersey Mid-Atlantic Sea-Level Transect	27		12	202	1,498	1,742	1,034	59.3	639
ODP	174B	CORK Hole 395A	5	2	2	8	0	70	66	95.4	4,445
ODP	175	Benguela Current	36	13	40	894	73	8,211	8,003	97.5	2,996
ODP	176	Hole 735B	38	1	1	126	505	994	866	86.3	721

**Table A-1. ODP (1985 – 2003) and IODP (2004 - 2006) Drill Sites**

ODP/IODP Leg or Expedition		Drilling Site Area	Number				Length (meters)			% Recovery	Max Water Depth (m)
			Duration (days)	Sites	Holes	Cores	Drilling Penetration	Coring Penetration	Core Recovered		
ODP	177	Southern Ocean Paleoceanography	33	7	31	549	371	4,989	4,046	81.1	4,624
ODP	178	Antarctic Peninsula	34	9	23	334	375	2,924	1,807	61.8	3,842
ODP	179	Hammer Drilling and NERO	21	4	12	44	528	143	118	82.8	1,659
ODP	180	Woodlark Basin	48	11	23	432	1,021	3,912	1,966	50.3	3,246
ODP	181	SW Pacific Gateways	37	7	21	459	511	4,196	3,625	86.4	4,492
ODP	182	Great Australian Bight	37	9	27	623	1,312	5,754	3,580	62.2	3,876
ODP	183	Kerguelen	33	8	8	353	91	3,154	1,528	48.5	2,394
ODP	184	South China Sea	34	6	17	622	363	5,761	5,462	94.8	3,297
ODP	185	Izu-Mariana Margin	42	2	6	110	1,398	1,060	403	38	5,867
ODP	186	Western Pacific Geophysical Observatories	48	2	8	256	4,865	2,427	1,741	71.8	2,681
ODP	187	Mantle Reservoirs and Migration Associated with Australian-Antarctic Rifting	35	13	23	112	3,790	617	137	22.3	5,736
ODP	188	Prydz Bay-Cooperation Sea, Antarctica: Glacial History and Paleoceanography	31	3	7	201	968	1,852	971	52.4	3,538
ODP	189	The Tasmanian Gateway: Cenozoic climatic and Oceanographic Development	45	5	16	551	1,141	5,117	4,538	88.7	3,568
ODP	190	Deformation and Fluid Flow Processes in the Nankai Grough Accretionary Prism	48	6	8	413	851	3,896	2,625	67.4	4,844
ODP	191	Northwest Pacific Seismic Observatory and Hammer Drill Tests	31	4	18	56	1,394	509	363	71.4	5,566

**Table A-1. ODP (1985 – 2003) and IODP (2004 - 2006) Drill Sites**

ODP/IODP Leg or Expedition		Drilling Site Area	Number				Length (meters)			% Recovery	Max Water Depth (m)
			Duration (days)	Sites	Holes	Cores	Drilling Penetration	Coring Penetration	Core Recovered		
ODP	192	Basement Drilling fo the Ontong Java Plateau	42	5	6	203	2,383	1,764	898	50.9	3,899
ODP	193	Manus Basin	42	4	13	107	564	736	79	10.8	1,703
ODP	194	Marion Plateau	43	8	16	597	1,043	4,965	2,055	41.4	420
ODP	195	Mariana / West Pacific ION	48	3	15	196	923	1,667	1,306	78.4	5,710
ODP	196	Nankai II	47	2	4	3	2,096	20	5	26.6	4,791
ODP	197	Hotspots	37	4	5	188	1,930	1,481	753	50.8	2,594
ODP	198	Shatsky Rise	37	8	16	443	515	3,947	2,914	73.8	3,883
ODP	199	Paleogene Pacific	35	8	21	283	417	2,465	2,197	89.1	5,396
ODP	200	H2O Observatory	28	2	7	39	67	289	100	34.7	4,970
ODP	201	Peru Biosphere	33	7	33	377	211	3,185	2,845	89.3	5,087
ODP	202	Southeast Paleoceanography	38	11	38	762	384	7,080	7,081	100	4,079
ODP	203	Equatorial Pacific Ion	15	1	2	19	314	93	28	30.2	3,871
ODP	204	Gas Hydrates	50	9	45	467	3,476	3,675	3,068	83.5	1,228
ODP	205	Costa Rica	43	3	4	19	998	405	281	69.4	4,387
ODP	206	Fast Spreading Crust	46	1	4	117	496	850	515	60.6	3,645
ODP	207	Demerara Rise	35	5	13	486	1,987	4,167	3,122	74.9	3,203
ODP	208	Walvis Ridge	32	6	17	414	1,357	3,702	3,591	97.01	4,770
ODP	209	MAR Peridotite	40	8	19	218	0	1,187	357	30.1	3,951
ODP	210	Newfoundland Margin	50	2	2	111	807	1,013	824	81.4	4,560
		<b>Subtotal (ODP)</b>	<b>4,549</b>	<b>669</b>	<b>1,797</b>	<b>35,772</b>	<b>117,187</b>	<b>321,482</b>	<b>222,007</b>		
IODP	301	Juan de Fuca	52	2	5	61	841	455	254	55.9	2,669
IODP	303	North Atlantic Climate 1	33	7	26	511	82	4,699	4,656	99.08	3,885
IODP	304	Oceanic Core Complex 1	41	3	12	107	49	536	308	57.5	2,583
IODP	305	Oceanic Core Complex 2	40	1	1	219	0	1,014	800	78.8	1,656
IODP	306	North Atlantic Climate 2	28	5	11	243	181	2,269	2,343	103.2	3,534
IODP	307	Porcupine Carbonate Mounds	12	3	11	181	150	1,529	1,385	90.6	959
IODP	308	Gulf of Mexico Hydrogeology	25	6	13	166	2,573	1,386	1,300	93.8	1,480

**Table A-1. ODP (1985 – 2003) and IODP (2004 - 2006) Drill Sites**

ODP/IODP Leg or Expedition		Drilling Site Area	Number				Length (meters)			% Recovery	Max Water Depth (m)
			Duration (days)	Sites	Holes	Cores	Drilling Penetration	Coring Penetration	Core Recovered		
IODP	309	Superfast Spreading Rate Crust 2	39	1	1	96	0	503	183	36.28	3,645
IODP	311	Cascadia Margin Gas Hydrates	27	5	23	223		1,616	1,218	75.4	2,201
IODP	312	Superfast Spreading Rate Crust 3	39	1	1	62	0	252	47	18.5	3,645
		<b>Subtotal (IODP)</b>	<b>336</b>	<b>34</b>	<b>104</b>	<b>1,869</b>	<b>3,876</b>	<b>14,261</b>	<b>12,494</b>		
		<b>TOTAL (ODP + IODP)</b>	<b>4,886</b>	<b>703</b>	<b>1,901</b>	<b>37,641</b>	<b>121,063</b>	<b>335,743</b>	<b>234,501</b>		

**Table A-2. DSDP, ODP, and IODP Analyses**

ANALYSIS	Total Number		
	IODP	ODP	DSDP
Site/Hole Summary (meters recovered)	12,853	222,430	97,087
Hole/Core Summary (cores)	2,103	36,365	20,094
Core/Section Summary (sections)	10,980	192,668	94,200
Corelog (samples)	142,044	2,277,857	65,445
GRA Bulk Density (sections)	8,557	135,648	0
Magnetic Susceptibility (sections)	8,907	135,819	0
Natural Gamma Radiation (sections)	7,097	72,924	0
P-Wave Vel (Whole Core) (sections)	3,895	58,430	0
P-Wave Vel (Split Core) (samples)	4,208	64,574	0
Moisture Density (samples)	4,429	92,716	0
Thermcon (samples)	1,433	37,019	0
Shear Strength (samples)	1,912	26,451	0
Color Reflectance (sections)	7,569	63,214	0
Point Susceptibility - MS2F (sections)	2,011	2,853	0
Downhole Temp. - Adara (samples)	0	1,219	0
Splicer (tie points)	474	4,372	0
Tensor (cores)	725	2,534	0
Cryomagnetic (sections)	8,721	106,858	0
Paleo Investigation (samples)	287	74,493	0
Range Table (taxa)	1,903	642,290	0
Age Profile (datum list)	0	4,573	0
Depth-Age Model	0	7,257	0
X-Ray Diffraction (samples)	1,036	14,169	0
XRD Images (samples)	0	12,176	0
X-Ray Fluorescence (samples)	0	3,949	0
ICP (samples)	467	1,375	0
Chemistry: Rock Evaluation (samples)	0	7,814	0
Chemistry: Carbonates (samples)	1,456	66,494	0
Chemistry: Gas Elements (samples)	1,446	20,593	0
Chemistry: Interstitial Water (samples)	919	12,825	0
Smear Slides (samples)	698	11,925	0
Sedimentary Thin Sections (samples)	0	118	0
Hard Rock Thin Sections (samples)	1,272	2,123	0
Visual Core Description (sections)	8,082	122,124	0
Hard Rock Visual Core Description (sections)	0	4,472	0
Core Photo Images	1,831	34,037	3,190
Section Photo Images	9,798	21,653	0
Closeup Information	3,130	4,747	0

**Table A-3. Status of Existing DSDP/ODP/IODP Legacy Holes**

Leg	Hole	Location	Latitude	Longitude	Water (m)	T.D. (m)	B.P. (m)	Casing (m)	Remarks
<b>Observatories</b>									
69,70 83,92 111,137 140,148	504B	Costa Rica Rift, S flank	1° 14'N	83° 44'W	3460	2111	1836	90/276	Deepest DSDP/ODP hole; junk below 2000 mbsf; wireline CORK 2001
136	843B	Hawaiian Arch (SW of Oahu )	19° 21'N	159° 6'W	4407	318	79	30/244	OSN Pilot Experiment, 1998; now open
139	858G	Juan deFuca, Middle Valley	48° 27'N	128° 43'W	2415	433	175	25/271	CORK 1991; new CORK 1996
146	889C	Vancouver margin	48° 50'N	126° 52'W	1315	384	0	52/260	CORK and 5-1/2" liner from 270 - 327 mbsf, 1992.
146	892B	Oregon margin	44° 41'N	125° 7'W	674	178	0	22/94	CORK and 5-1/2" liner from 93.4 - 145.6 mbsf, 1992; logger removed 1995; hydrate experiment 1998
148	896A	Costa Rica Rift - S flank	1° 13'N	83° 43'W	3448	469	297	86/191	Wireline CORK 2001
156	948D	Barbados prism	15° 31'N	58° 44'W	4938	538	0	43/476/535	CORK 1994; logger and string removed 1995
156	949C	Barbados prism	15° 32'N	58° 43'W	5005	464	0	46/398/465	CORK and bridge plug, 1994
168	1024C	Juan deFuca, E flank	47° 55'N	128° 45'W	2612	176	24	39/166	CORK 1996; sensor recovered 1999; new logger 2000
168	1025C	Juan deFuca, E flank	47° 53'N	128° 39'W	2606	147	46	40/102	CORK 1996; logger replaced 2000
168	1027C	Juan deFuca, E flank	47° 45'N	127° 44'W	2656	632	57	39/578	CORK 1996; sensors recovered 1999; new logger 1999



**Table A-3. Status of Existing DSDP/ODP/IODP Legacy Holes**

<b>Leg</b>	<b>Hole</b>	<b>Location</b>	<b>Latitude</b>	<b>Longitude</b>	<b>Water (m)</b>	<b>T.D. (m)</b>	<b>B.P. (m)</b>	<b>Casing (m)</b>	<b>Remarks</b>
139 146 169	857D	Juan deFuca, Middle Valley	48° 27'N	128° 43'W	2421	936	465*	48/573	Bent CORK removed; hole reamed and cleaned to 929 mbsf; new CORK installed.
45 78 109 174B	395A	MAR, W flank	22° 45'N	46° 5'W	4490	664	572	62/112	Installation of ODP CORK, instrumented with long-term data logger. 10 thermistors on cable downhole; pressure gauges above and below seal.
179	1107A	90 degree E Ridge	17° 1'S	88° 11'E	1659	494	123	49/413	ION NERO site; seismometer planned 2004/2005
186	1150D	Japan Trench	39° 11'N	143° 20'E	2681	1140	0	55/534/1035	W Pacific ION seismometer/strain observatory 1999; 2nd deepest ODP casing.
186	1151B	Japan Trench	38° 45'N	143° 20'E	2182	1113	0	76/1068	W Pacific ION seismometer/strain observatory 1999; deepest ODP casing.
191	1179E	NW Pacific	41° 5'N	159° 58'E	5566	399	28	64/393	NW Pacific ION seismic observatory 2000
195	1200C	Mariana forearc	13° 47'N	146° 0'E	2932	140	0	24/107/203	CORK 2001
195	1201E	Philippine Sea	19° 18'N	135° 6'E	5710	580	68	39/527	W Pacific ION seismic observatory 2001
196	1173B	Nankai Trough	32° 15'N	135° 1'E	4791	757	26	121/728	Legs 190, 196; ACORK 2001; 5th deepest ODP casing; broken-off pipe above bridge plug

**Table A-3. Status of Existing DSDP/ODP/IODP Legacy Holes**

Leg	Hole	Location	Latitude	Longitude	Water (m)	T.D. (m)	B.P. (m)	Casing (m)	Remarks
196	808I	Nankai Trough	32° 21'N	134° 57'E	4675	1058		157/927	Legs 131, 196; ACORK 2001; top 37 m on seafloor but fully functioning; 3rd deepest ODP casing
200	1224D	E Pacific	27° 53'N	141° 59'W	4967	65	37	26/58	H2O ION site
203	1243A	Eastern Equatorial Pacific	5° 18'N	110° 5'W	3871	212	103	48/212	E Pacific ION
205 301T	1253A	Costa Rica Trench	9° 39'N	86° 11'W	4376	600	87	44/413	CORK II 2002; downhole instrument strings replaced
205	1254B	Costa Rica Trench	9° 40'N	86° 11'W	4176	278	0	20/199	CORK II 4-1/2" casing broke-off and junked hole. Retrieved CORK wellhead.
205 301T	1255A	Costa Rica Trench	9° 39'N	86° 11'W	4312	157	0	20/118	CORK II 2002; downhole instrument strings replaced
168 301	1026B	Juan de Fuca, East Flank	47° 46'N	127° 46'W	2658	295	48	40/249	Replaced 1026B CORK w/CORK II
<b>Reentry Holes</b>									
15	146	Caribbean Sea	15°07'N	69°23'W	3957	762	24	50/-	Lacks second casing string
34	319A	EPR, E flank	13°01'N	101°31'W	4296	157	59	66/-	Bad hole conditions in basement
34	320B	Peru Basin	9°00'S	83°32'W	4497	183	53	65/-	Bad hole conditions in basement
37	333A	MAR, W flank	36°50'N	33°40'W	1680	529	312	70/-	DIANAUT, 1989; junk BHA at 488 mbsf
45	395A	MAR, W flank							First time setting a reentry cone and casing to basement on deep-sea floor. Hole packed with mud
			22°45'N	46°5'W	4494	664	572	62/112	
46	396B	MAR, E flank	22°59'N	43°31'W	4465	406	254	120/163	

**Table A-3. Status of Existing DSDP/ODP/IODP Legacy Holes**

Leg	Hole	Location	Latitude	Longitude	Water (m)	T.D. (m)	B.P. (m)	Casing (m)	Remarks
47	398D	Galicia Bank	40°58'N	10°43'W	3900	1740	0	80/-	Hole plugged by sediments
50	415A	Off Morocco	31°02'N	11°40'W	2817	1079	0	68/311	Bad hole conditions, filled with cavings/mud
50	416A	Off Morocco	32°50'N	10°48'W	4203	1605	0	40/-	Bad hole conditions
51	417D	S. Bermuda Rise	25°07'N	68°03'W	5489	709	366	25/-	Cone plugged with mud; lost BHA in deepest 100m
52	418A	S. Bermuda Rise	25°02'N	68°03'W	5519	868	544	71/0	Cone plugged with mud
55	433C	Suiko Seamount	44°47'N	170°01'E	1874	551	388	40/-	
58	442B	Shikoku Basin	28°59'N	136°03'E	4654	456	165	57/-	Bad hole conditions
61	462A	Nauru Basin	7°15'N	165°02'E	5186	1208	645*	75/-	Needs second casing string; good hole conditions
69	504A	CRR, S flank	1°14'N	83°44'W	3468	278	14	90/-	Lacks second casing; 2 bit cones at bottom
76	534A	East of Blake Escapement	28°21'N	75°23'W	4976	1666	32	86/533	Wireline reentry: LFASE
78									
91	595B	SW Pacific	23°49'S	165°32'W	5630	124	56	34/74	Ngendei expt, 1983; stinger in hole
92	597C	EPR, W flank	18°48'S	129°46'W	4157	143	91	40/-	Good hole in fast-spread crust
103	638C	Galicia Margin	42° 9'N	12°12'W	4673	547	0	40/-	Lacks second casing string
104	642E	Norwegian Sea	67°13'N	2°56'E	1289	1229	917*	51/372	Top of cone at seafloor
105	645E	Baffin Bay & Labrador Sea	70° 7'N	64 °39'W	2008	1147	0	21/-	Lacks second casing string; sediment bridges in open hole
106	648B	Mid-Atlantic Ridge	22°55'N	44°57'W	3333	33	50	9/27	Hard Rock Guide Base.
123	765D	Exmouth Plateau	Argo Abyssal Plain	15°59'S 117°34'E	5714	1195	271	91/933	

**Table A-3. Status of Existing DSDP/ODP/IODP Legacy Holes**

<b>Leg</b>	<b>Hole</b>	<b>Location</b>	<b>Latitude</b>	<b>Longitude</b>	<b>Water (m)</b>	<b>T.D. (m)</b>	<b>B.P. (m)</b>	<b>Casing (m)</b>	<b>Remarks</b>
128	794D	Japan Sea	40°11'N	138°14'E	2818	734	192	58/560	Broadband seismometer expt, 1989, still in hole
129	801C	Old Pacific Crust	18°39'N	156°22'E	5685	594	135	51/481	Jurassic crust; deepened in Leg 185
130	807C	Ontong Java Plateau	3°36'N	156°22'E	2817	1528	148	58/350	Two bit cones in hole
131	808D	Nankai Trough	32°21'N	134°57'E	4673	780	0	21/521	741 m 11-3/4 " casing lost on deployment
131	808E	Nankai Trough	32°21'N	134°56'E	4685	1200	0	31/524	ONDO expt, 1991, still in hole; bad hole conditions
132	809F	Sumisi Rift	31°3'N	139°53'E	1802	79	79	none	Mini HRGB; slim hole cored with DCS
139	856H	Juan de Fuca, Middle Valley	48°26'N	128°41'W	2424	94			Small reentry funnel installed with a 12-m joint of 11-3/4-in. of drill-in casing.
142	864A	Engineering Tests: East Pacific Rise	9°31'N	104°15'W	2571	15	15	none	Hard Rock Guide Base
142	864B	Engineering Tests: East Pacific Rise	9°31'N	104°15'W	2572	3	7	none	Drilling assembly failure; Hard Rock Guide Base picked up and moved to new location - 864C.
142	864C	Engineering Tests: East Pacific Rise	9°31'N	104°15'E	2572	7	7	none	Hard Rock Guide Base
147	894G	Hess Deep Rift Valley	2°18'N	101°32'W	3023	154	154	5.88/35.56	Hard Rock Guide Base and 10-3/4-in casing string successfully retrieved at end of hole.
149 A,B,C	899B	Iberian Abyssal Plain	40°46'N	12°16'W	5302	563	192	50/217	Bit released at 539 mbsf
158	957E	TAG	26°8'N	44°50'W	3646	126	126	28/	13-3/8 " casing; lost BHA below 14 mbsf

**Table A-3. Status of Existing DSDP/ODP/IODP Legacy Holes**

Leg	Hole	Location	Latitude	Longitude	Water (m)	T.D. (m)	B.P. (m)	Casing (m)	Remarks
158	957L	TAG	26°8'N	44°50'W	3645	67	67	20/	16 " casing; collapsed formation in open hole
165	999B	Colombia Basin	12°45'N	78°44'W	2839	1066	0	62/524	16 " casing
118 176	735B	Southwest Indian Ridge	32°43'S	57°16'E	732	1508	1508	none	HRGB; junk below 600 mbsf
186	1150C	Japan Trench	39°1'N	143°20'E	2681	1050	0	58/527/205	Unusable site - 205 m 10-3/4 " casing lost at bottom of hole
192	1185B	Ontong Java	0°21'S	161°40'E	3899	526	125	28/-	Lacks second casing string; only 16 " casing set in full-sized cone
193	1188F	Manus Basin	3°44'S	151°40'E	1642	387	0	0.4/57/190	Freefall deployed cone with HRRS cone; ADCB cored with 7-1/4 " diameter
206	1256D	Fast Spreading Crust	6°44'N	91°56'W	3635	752	502	95/269/?	20 " / 16 " casing
<b>Hard Rock (Open Holes)</b>									
103	637A	Galicia margin	42 5'N	12 52'W	5311	286	66	5311	
103	639E	Galicia margin	42 9'N	12 15'W	4770	238	10	4770	
103	639F	Galicia margin	42 9'N	12 15'W	4771	251	0	4771	
104	642E	Norwegian margin	67 13'N	2 56'E	1278	1229	898	1278	Hardrock material in washcore (2W). Basement Depth listed is top of core 3R.
104	643A	Norwegian margin	67 43'N	1 2'E	2769	565	7		
105	647A	Baffin Bay	53 20'N	45 16'W	3868	736	41		
106	648A	Mid-Atlantic Ridge axis	22 55'N	44 57'W	3299	4	4		Recovery for this hole 0.16 meters.
106	649C	Mid-Atlantic Ridge axis	23 22'N	44 57'W	3518	4	4		Recovery for this hole 0.15 meters.
106	649G	Mid-Atlantic Ridge axis	23 22'N	44 57'W	3518	9	9		Recovery for this hole 0.25 meters.
107	650A	Tyrrhenian Sea	39 21'N	13 54'E	3516	634	32		
107	651A	Tyrrhenian Sea	40 9'N	12 45'E	3578	551	164		

**Table A-3. Status of Existing DSDP/ODP/IODP Legacy Holes**

<b>Leg</b>	<b>Hole</b>	<b>Location</b>	<b>Latitude</b>	<b>Longitude</b>	<b>Water (m)</b>	<b>T.D. (m)</b>	<b>B.P. (m)</b>	<b>Casing (m)</b>	<b>Remarks</b>
107	655A	Tyrrhenian Sea	40 10'N	12 28'E	3290	90	10		
107	655B	Tyrrhenian Sea	40 11'N	12 28'E	3290	196	115		
107	656A	Tyrrhenian Sea	40 11'N	12 11'E	3597	236	48		
109	648B	Mid-Atlantic Ridge axis	22 55'N	44 57'W	3330	50	50		This hole first drilled Leg 106. Leg 109 deepened hole from 33.3 mbsf to 50.5 mbsf
109	669A	Mid-Atlantic Ridge axis	23 31'N	45 3'W	1979	4	4		Recovery only 0.18m.
109	670A	Mid-Atlantic Ridge axis	23 10'N	45 2'W	3625	92	80		
113	690C	Weddell Sea - SW flank of Maud Rise	65 10'S	1 12'E	2914	321	2		1.5 m penetration into basement
114	698A	Subantarctic South Atlantic	51 28'S	33 6'W	2138	237	27		Total recovery of basalts 15.3 m
104	643A	Norwegian margin	67 43'N	1 2'E	2769	565	7		
105	647A	Baffin Bay	53 20'N	45 16'W	3868	736	41		
106	648A	Mid-Atlantic Ridge axis	22 55'N	44 57'W	3299	4	4		Recovery for this hole 0.16 meters.
106	648B	Mid-Atlantic Ridge axis	22 55'N	44 57'W	3333	33	50		This hole re-visited on leg 109. Basement penetration Leg 106 was 33.3 mbsf.
106	649C	Mid-Atlantic Ridge axis	23 22'N	44 57'W	3518	4	4		Recovery for this hole 0.15 meters.
106	649G	Mid-Atlantic Ridge axis	23 22'N	44 57'W	3518	9	9		Recovery for this hole 0.25 meters.
107	650A	Tyrrhenian Sea	39 21'N	13 54'E	3516	634	32		
107	651A	Tyrrhenian Sea	40 9'N	12 45'E	3578	551	164		
107	655A	Tyrrhenian Sea	40 10'N	12 28'E	3290	90	10		
107	655B	Tyrrhenian Sea	40 11'N	12 28'E	3290	196	115		
107	656A	Tyrrhenian Sea	40 11'N	12 11'E	3597	236	48		

**Table A-3. Status of Existing DSDP/ODP/IODP Legacy Holes**

Leg	Hole	Location	Latitude	Longitude	Water (m)	T.D. (m)	B.P. (m)	Casing (m)	Remarks
109	648B	Mid-Atlantic Ridge axis	22 55'N	44 57'W	3330	50	50		This hole first drilled Leg 106. Leg 109 deepened hole from 33.3 mbsf to 50.5 mbsf
109	669A	Mid-Atlantic Ridge axis	23 31'N	45 3'W	1979	4	4		Recovery only 0.18m.
109	670A	Mid-Atlantic Ridge axis	23 10'N	45 2'W	3625	92	80		
113	690C	Weddell Sea - SW flank of Maud Rise	65 10'S	1 12'E	2914	321	2		1.5 m penetration into basement
114	698A	Subantarctic South Atlantic	51 28'S	33 6'W	2138	237	27		Total recovery of basalts 15.3 m
104	643A	Norwegian margin	67 43'N	1 2'E	2769	565	7		
105	647A	Baffin Bay	53 20'N	45 16'W	3868	736	41		
106	648A	Mid-Atlantic Ridge axis	22 55'N	44 57'W	3299	4	4		Recovery for this hole 0.16 meters.
106	648B	Mid-Atlantic Ridge axis	22 55'N	44 57'W	3333	33	50		This hole re-visited on leg 109. Basement penetration Leg 106 was 33.3 mbsf.
106	649C	Mid-Atlantic Ridge axis	23 22'N	44 57'W	3518	4	4		Recovery for this hole 0.15 meters.
106	649G	Mid-Atlantic Ridge axis	23 22'N	44 57'W	3518	9	9		Recovery for this hole 0.25 meters.
107	650A	Tyrrhenian Sea	39 21'N	13 54'E	3516	634	32		
107	651A	Tyrrhenian Sea	40 9'N	12 45'E	3578	551	164		
107	655A	Tyrrhenian Sea	40 10'N	12 28'E	3290	90	10		
107	655B	Tyrrhenian Sea	40 11'N	12 28'E	3290	196	115		
107	656A	Tyrrhenian Sea	40 11'N	12 11'E	3597	236	48		
109	648B	Mid-Atlantic Ridge axis	22 55'N	44 57'W	3330	50	50		This hole first drilled Leg 106. Leg 109 deepened hole from 33.3 mbsf to 50.5 mbsf
109	669A	Mid-Atlantic Ridge axis	23 31'N	45 3'W	1979	4	4		Recovery only 0.18m.

**Table A-3. Status of Existing DSDP/ODP/IODP Legacy Holes**

<b>Leg</b>	<b>Hole</b>	<b>Location</b>	<b>Latitude</b>	<b>Longitude</b>	<b>Water (m)</b>	<b>T.D. (m)</b>	<b>B.P. (m)</b>	<b>Casing (m)</b>	<b>Remarks</b>
109	670A	Mid-Atlantic Ridge axis	23 10'N	45 2'W	3625	92	80		
113	690C	Weddell Sea - SW flank of Maud Rise	65 10'S	1 12'E	2914	321	2		1.5 m penetration into basement
114	698A	Subantarctic South Atlantic	51 28'S	33 6'W	2138	237	27		Total recovery of basalts 15.3 m
115	706A	Mascarene Plateau	13 7'S	61 22'E	2517	48	0		Small piece of basalt in bottom of last APC core.
115	706B	Mascarene Plateau	13 7'S	61 22'E	2518	44	0		
115	706C	Mascarene Plateau	13 7'S	61 22'E	2518	122	54		
115	707C	Mascarene Plateau	7 33'S	59 1'E	1552	443	68		
115	713A	Mascarene Plateau	4 12'S	73 24'E	2920	192	90		
115	715A	Mascarene Plateau	5 5'N	73 50'E	2273	288	76		
118	732B	Atlantis II Fracture Zone	32 33'S	57 3'E	4878	8	8		Recovered 0.34 m of basalt
118	732C	Atlantis II Fracture Zone	32 33'S	57 3'E	4885	24	14		Recovered 0.7 m of basalt
118	732D	Atlantis II Fracture Zone	32 33'S	57 3'E	4810	6	6		Recovered 0.31 m of basalt
118	732E	Atlantis II Fracture Zone	32 33'S	57 3'E	4808	7	7		Recovered 0.18 m of basalt and diabase rubble.
118	732F	Atlantis II Fracture Zone	32 33'S	57 3'E	4807	16	16		Recovered 0.3 m of basalt and diabase rubble.
118	733B	Atlantis II Fracture Zone	33 5'S	56 59'E	4487	4	4		Recovered 0.09 m of metagabbro and amphibolite rubble.
118	733C	Atlantis II Fracture Zone	33 5'S	56 59'E	4487	6	6		Recovered 0.2 m of metabasalt and amphibolite rubble.
118	733D	Atlantis II Fracture Zone	33 5'S	56 59'E	5208	24	24		Recovered 0.47 m of gneiss and rubble.



**Table A-3. Status of Existing DSDP/ODP/IODP Legacy Holes**

<b>Leg</b>	<b>Hole</b>	<b>Location</b>	<b>Latitude</b>	<b>Longitude</b>	<b>Water (m)</b>	<b>T.D. (m)</b>	<b>B.P. (m)</b>	<b>Casing (m)</b>	<b>Remarks</b>
118	734A	Atlantis II Fracture Zone	32 7'S	57 8'E	3660	8	8		Recovered 0.05 m.
118	734B	Atlantis II Fracture Zone	32 7'S	57 8'E	3670	48	48		Recovered 1.10 m.
118	734D	Atlantis II Fracture Zone	32 6'S	57 6'E	3709	20	20		Recovered 0.79 m.
118	734F	Atlantis II Fracture Zone	32 7'S	57 8'E	3425	14	14		Recovered 0.10 m.
118	734G	Atlantis II Fracture Zone	32 7'S	57 8'E	3417	31	31		Recovered 5.95 m.
118	735A	Atlantis II Fracture Zone	32 43'S	57 16'E	727	7	7		Recovered 0.1 m of gabbro rubble.
119	738C	Kerguelen Plateau	62 43'S	82 47'E	2252	534	48		
120	747C	Central Kerguelen Plateau	54 49'S	76 48'E	1695	350	54		Cores 11 - 16 recovered 20.36 m of basaltic basement
120	748C	Central Kerguelen Plateau	58 26'S	78 60'E	1290	935	42		Basalt at core 79R-1.
120	749C	Central Kerguelen Plateau	58 43'S	76 24'E	1070	250	48		Cores 12 - 16 recovered 22.97 m of basaltic basement
120	750B	Central Kerguelen Plateau	57 36'S	81 14'E	2030	710	34		Cores 14 - 17 recovered 23.1 m of basaltic basement
121	756C	Broken Ridge and Ninety-East Ridge	27 21'S	87 36'E	1516	159	9		5.74 m of basalt and basaltic tephra + 0.15 m of basalt pieces from cores 9X - 12N
121	756D	Broken Ridge and Ninety-East Ridge	27 21'S	87 36'E	1513	221	82		26.92 m of basalts recovered from cores 4R-12R
121	757B	Broken Ridge and Ninety-East Ridge	17 1'S	88 11'E	1652	375			1.97 m of basalts recovered from cores 40X - 42N

**Table A-3. Status of Existing DSDP/ODP/IODP Legacy Holes**

<b>Leg</b>	<b>Hole</b>	<b>Location</b>	<b>Latitude</b>	<b>Longitude</b>	<b>Water (m)</b>	<b>T.D. (m)</b>	<b>B.P. (m)</b>	<b>Casing (m)</b>	<b>Remarks</b>
121	757C	Broken Ridge and Ninety-East Ridge	17 1'S	88 11'E	1644	421	48		24.95 m of basalts recovered from cores 8R - 12R
121	758A	Broken Ridge and Ninety-East Ridge	5 23'N	90 22'E	2924	677	159		Basaltic rock first encountered at 498.9 mbsf
123	765C	Argo Abyssal Plain	15 59'S	117 35'E	5718	964	28		9.03 m of basalt recovered from 62R-CC to 65R
123	766A	Argo Abyssal Plain	19 56'S	110 27'E	3998	527	67		
124	767C	Celebes and Sulu Seas	4 48'N	123 30'E	4905	792	5		
124	768C	Celebes and Sulu Seas	8 0'N	121 13'E	4384	1268	222		This hole also contains large deposits of Tuff and Lapillistone.
124	770B	Celebes and Sulu Seas	5 9'N	123 40'E	4505	474	54		
124	771A	Celebes and Sulu Seas	8 41'N	120 41'E	2859	304	0		
126	790C	Bonin Arc - Trench System	30 55'N	139 50'E	2224	387	116		
126	791B		30 55'N	139 52'E	2268	1145	315		
126	792E		32 24'N	140 23'E	1788	886	86		
126	793B		31 6'N	140 53'E	2965	1682	278		Basalt layer also located at 586.5-594.7 mbsf.
127	794B	Japan Sea	40 11'N	138 14'E	2811	549	6		Returned to site on Leg 128. Basement cored to 733.5 mbsf.
127	794C	Japan Sea	40 11'N	138 14'E	2809	654	94		Returned to site on Leg 128. Basement cored to 733.5 mbsf.
127	795B	Japan Sea	43 59'N	138 58'E	3299	762	124		
127	797C	Japan Sea	38 37'N	134 32'E	2865	900	347		
129	800A	Old Pacific Crust	21 55'N	152 19'E	5686	544	46		
129	801B	Old Pacific Crust	18 39'N	156 22'E	5674	511	50		

**Table A-3. Status of Existing DSDP/ODP/IODP Legacy Holes**

<b>Leg</b>	<b>Hole</b>	<b>Location</b>	<b>Latitude</b>	<b>Longitude</b>	<b>Water (m)</b>	<b>T.D. (m)</b>	<b>B.P. (m)</b>	<b>Casing (m)</b>	<b>Remarks</b>
129	802A	Old Pacific Crust	12 6'N	153 13'E	5969	560	51		
130	803D	Ontong Java Plateau	2 26'N	160 32'E	3412	656	30		
131	808C	Nankai Trough	32 21'N	134 57'E	4675	1327	37		
139	855A	Middle Valley Juan de Fuca Ridge	48 27'N	128 38'W	2445	76	11		Total recovery of basalts 0.66 m
139	855B	Middle Valley Juan de Fuca Ridge	48 27'N	128 38'W	2446	63	10		Handfull of rocks recovered in 8R core catcher.
139	855C	Middle Valley Juan de Fuca Ridge	48 27'N	128 38'W	2444	111	10		I piece of basalt recovered.
139	855D	Middle Valley Juan de Fuca Ridge	48 27'N	128 38'W	2444	119	10		Total recovery of basalts 0.74 m
139	856A	Middle Valley Juan de Fuca Ridge	48 26'N	128 41'W	2395	116			Cored 1.2 m into basalt and recovered high quality core. Not determined if basement reached.
139	856B	Middle Valley Juan de Fuca Ridge	48 26'N	128 41'W	2420	122	1		Attempted to drill basement core. Recovered 0.4 m of basalt fragments.
139	856G	Middle Valley Juan de Fuca Ridge	48 26'N	128 41'W	2423	65			Massive sulfide hard rock below 17.6 m
139	858F	Middle Valley Juan de Fuca Ridge	48 27'N	128 43'W	2415	297			Total recovery of basalts 2.7 m
143	865A	Resolution Guyot	18 26'N	179 33'W	1518	871	34		
143	866A	Resolution Guyot	21 20'N	174 19'E	1362	1744			123.6 m penetration into volcanic lavas

**Table A-3. Status of Existing DSDP/ODP/IODP Legacy Holes**

<b>Leg</b>	<b>Hole</b>	<b>Location</b>	<b>Latitude</b>	<b>Longitude</b>	<b>Water (m)</b>	<b>T.D. (m)</b>	<b>B.P. (m)</b>	<b>Casing (m)</b>	<b>Remarks</b>
145	883E	North Pacific Trancsect	51 12'N	167 46'E	2386	856	28		
145	883F	North Pacific Trancsect	51 12'N	167 46'E	2386	849	27		
145	884B	North Pacific Trancsect	51 27'N	168 20'E	3825	854	0		
145	884E	North Pacific Trancsect	51 27'N	168 20'E	3825	930	87		
145	885A	North Pacific Trancsect	44 41'N	168 16'E	5708	59	7		
145	886B	North Pacific Trancsect	44 41'N	168 14'W	5714	69	0		
145	887D	North Pacific Trancsect	54 22'N	148 27'W	3634	373	84		
147	894B	Hess Deep Rift Valley	2 18'N	101 32'W	3020	7			Recovered 0.14 m of metamorphosed gabbros.
147	894C	Hess Deep Rift Valley	2 18'N	101 32'W	3033	31			Recovered 0.17 m of metamorphosed gabbros jammed in broken end of drill collar.
147	894D	Hess Deep Rift Valley	2 18'N	101 32'W	3013	20			Recovered ~0.2 m of basalt rubble.
147	894E	Hess Deep Rift Valley	2 18'N	101 32'W	3014	29			Recovered 0.66 m of basalt and gabbro.
147	894F	Hess Deep Rift Valley	2 18'N	101 32'W	3025	26			Recovered 1.8 m of gabbro and basalt.
147	895A	Hess Deep Rift Valley	2 17'N	101 27'W	3821	17			Recovered 1.27 m of harzburgite
147	895B	Hess Deep Rift Valley	2 17'N	101 27'W	3821	10			Recovered 1.33 m of harzburgite
147	895C	Hess Deep Rift Valley	2 17'N	101 27'W	3820	38			Recovered 6.4 m of harzburgite
147	895D	Hess Deep Rift Valley	2 17'N	101 27'W	3821	94			Recovered 22.5 m of harzburgite

**Table A-3. Status of Existing DSDP/ODP/IODP Legacy Holes**

<b>Leg</b>	<b>Hole</b>	<b>Location</b>	<b>Latitude</b>	<b>Longitude</b>	<b>Water (m)</b>	<b>T.D. (m)</b>	<b>B.P. (m)</b>	<b>Casing (m)</b>	<b>Remarks</b>
147	895E	Hess Deep Rift Valley	2 17'N	101 27'W	3752	88			Recovered 34.14 m of harzburgite
147	895F	Hess Deep Rift Valley	2 17'N	101 27'W	3692	26			Recovered 2.39 m of harzburgite.
149	897C	Iberia Abyssal Plain	40 50'N	12 28'W	5315	745	96		32.47 m of hard rock recovered
149	897D	Iberia Abyssal Plain	40 50'N	12 29'W	5316	837	143		77.69 m of hard rock recovered
149	900A	Iberia Abyssal Plain	40 41'N	11 36'W	5037	805	56		27.71 m of metamorphosed and brecciated mafic rocks.
151	907A	North Atlantic-Arctic Gateway	69 15'N	12 42'E	1801	224	8		
167	1010C	California Margin	29 58'N	118 6'W	3466	214	4		Only one core taken in this hole.
167	1011B	California Margin	31 17'N	117 38'W	2022	282	9		
168	1023A	East Flank Juan de Fuca Ridge	47 55'N	128 48'W	2593	194	2		6 Basalt pieces recovered
168	1024B	East Flank Juan de Fuca Ridge	47 54'N	128 45'W	2614	170	2		16 Basalt pieces recovered
168	1026B	East Flank Juan de Fuca Ridge	47 46'N	127 46'W	2658	295	48	40/249	Coring from 256.0 - 295.2. 1.95 m of Basalt recovered.
168	1026C	East Flank Juan de Fuca Ridge	47 46'N	127 45'W	2658	248	19		0.68 m of Basalt recovered.
168	1028A	East Flank Juan de Fuca Ridge	47 51'N	128 30'W	2659	132	1		~1.2 m of Basalt recovered.
168	1029A	East Flank Juan de Fuca Ridge	47 50'N	128 23'W	2653	223	3		~1.5 m of Basalt recovered.
168	1031A	East Flank Juan de Fuca Ridge	47 53'N	128 34'W	2588	43	2		0.38 m of Basalt recovered.
168	1032A	East Flank Juan de Fuca Ridge	47 47'N	128 7'W	2645	338	48		14.58 m of Basalt recovered.

**Table A-3. Status of Existing DSDP/ODP/IODP Legacy Holes**

<b>Leg</b>	<b>Hole</b>	<b>Location</b>	<b>Latitude</b>	<b>Longitude</b>	<b>Water (m)</b>	<b>T.D. (m)</b>	<b>B.P. (m)</b>	<b>Casing (m)</b>	<b>Remarks</b>
169	856H	Sedimented Ridges	48 26'N	128 41'W	2423	500	34		Sulphides were recovered to 94.47 mbsf. Sediment recovered 94.47 - 465.77 mbsf.
169	1035C	Sedimented Ridges	48 26'N	128 41'W	2448	44	44		The material recovered was Hydrothermal Sulphides rather than Igneous Rocks.
169	1035D	Sedimented Ridges	48 26'N	128 41'W	2448	178	75		The material recovered was Hydrothermal Sulphides rather than Igneous Rocks. There is sediments below the Sulphides.
169	1035F	Sedimented Ridges	48 26'N	128 41'W	2447	225	81		The material recovered was Hydrothermal Sulphides rather than Igneous Rocks. There is sediments below the Sulphides.
169	1035G	Sedimented Ridges	48 26'N	128 41'W	2445	208	29		The material recovered was Hydrothermal Sulphides rather than Igneous Rocks. There is sediments below the Sulphides.
169	1035H	Sedimented Ridges	48 26'N	128 41'W	2443	248	63		The material recovered was Hydrothermal Sulphides rather than Igneous Rocks. There is sediments below the Sulphides.
169	1037B	Sedimented Ridges	40 57'N	127 31'W	3300	546	38		

**Table A-3. Status of Existing DSDP/ODP/IODP Legacy Holes**

Leg	Hole	Location	Latitude	Longitude	Water (m)	T.D. (m)	B.P. (m)	Casing (m)	Remarks
169	1038A	Sedimented Ridges	41 0'N	127 30'W	3222	114	85		The material recovered was Hydrothermal Sulphides rather than Igneous Rocks. There is sediments below the Sulphides.
169	1038I	Sedimented Ridges	40 60'N	127 30'W	3215	404	3		
170	1039C	Costa Rica Accretionary Wedge	9 38'N	86 12'W	4351	449	27		
170	1040C	Costa Rica Accretionary Wedge	9 40'N	86 11'W	4178	665	12		
173	1067A	Iberia	40 41'N	11 36'W	5021	856	92		
173	1068A	Iberia	40 41'N	11 37'W	5044	956	104		
173	1069A	Iberia	40 44'N	11 47'W	5075	959	86		
173	1070A	Iberia	40 48'N	12 43'W	5322	719	60		
179	1105A	Hammer Drill and NERO	32 43'S	57 17'E	714	158	158		Top 15 meters of hole drilled interval
180	1108B	Western Woodlark Basin	9 45'S	151 38'E	3177	485	48		Hardrock in the interval of 14.5 - 62.85 mbsf. Sediment below 62.85 to hole termination.
180	1109D	Western Woodlark Basin	9 30'S	151 34'E	2211	802	47		
180	1110B	Western Woodlark Basin	9 44'S	151 35'E	3246	22	10		Metamorphic Rocks.
180	1111A	Western Woodlark Basin	9 43'S	151 35'E	3201	174	20		Metamorphic Rocks. There was also metamorphic rocks in the intervals 19.7-29.4 mbsf and 87.0-116.1 mbsf.
180	1112A	Western Woodlark Basin	9 45'S	151 37'E	3047	122	87		Metamorphic rocks.

**Table A-3. Status of Existing DSDP/ODP/IODP Legacy Holes**

<b>Leg</b>	<b>Hole</b>	<b>Location</b>	<b>Latitude</b>	<b>Longitude</b>	<b>Water (m)</b>	<b>T.D. (m)</b>	<b>B.P. (m)</b>	<b>Casing (m)</b>	<b>Remarks</b>
180	1112B	Western Woodlark Basin	9 45'S	151 37'E	3047	165	155		Metamorphic Rocks. Top undetermined. Located in washed interval.
180	1113A	Western Woodlark Basin	9 45'S	151 37'E	2916	25	20		Metamorphic Rocks.
180	1114A	Western Woodlark Basin	9 48'S	151 35'E	406	353	86		Metamorphic Rocks.
180	1117A	Western Woodlark Basin	9 47'S	151 33'E	1163	111	111		Metamorphic Rocks.
180	1117B	Western Woodlark Basin	9 47'S	151 33'E	1163	10	10		Metamorphic Rocks.
180	1117C	Western Woodlark Basin	9 47'S	151 33'E	1163	10	10		Metamorphic Rocks.
180	1118A	Western Woodlark Basin	9 35'S	151 34'E	2304	927	57		Metamorphic Rocks.
183	1136A	Kerguelen Plateau - Broken Ridge	59 39'S	84 50'E	1931	161	33		
183	1137A	Kerguelen Plateau - Broken Ridge	56 50'S	68 6'E	1004	371	152		
183	1138A	Kerguelen Plateau - Broken Ridge	53 33'S	75 58'E	1141	843	144		
183	1139A	Kerguelen Plateau - Broken Ridge	50 11'S	63 56'E	1415	694	232		
183	1140A	Kerguelen Plateau - Broken Ridge	46 17'S	68 29'E	2394	322	87		
183	1141A	Kerguelen Plateau - Broken Ridge	32 14'S	97 8'E	1197	186	72		
183	1142A	Kerguelen Plateau - Broken Ridge	32 14'S	97 8'E	1201	142	142		Top of Basement located in Wash core. Top therefore indeterminate.



**Table A-3. Status of Existing DSDP/ODP/IODP Legacy Holes**

Leg	Hole	Location	Latitude	Longitude	Water (m)	T.D. (m)	B.P. (m)	Casing (m)	Remarks
185	801C		18 39'N	156 22'E	5674	936	442		Hole started on Leg 129 and drilled to 493.7m and cored 493.7 - 594.3m. Penetration Leg 185 was 341.4 meters.
185	1149B		31 21'N	143 21'E	5818	445	28		
187	1152A	Southwest Indian Ocean	41 54'S	127 0'E	5055	11	11		
187	1152B		41 54'S	127 0'E	5055	46	24		
187	1153A		41 16'S	129 49'E	5581	275			Basement first contacted in Wash core between 243-267.6 mbsf. Bottom of hole at 274.9 mbsf.
187	1154A		41 29'S	131 19'E	5736	268	34		
187	1155A		41 57'S	127 60'E	4975	204	26		
187	1155B		41 57'S	127 60'E	4975	194			Basement first contacted in Wash core between 0-147.9 mbsf. Bottom of hole at 193.9 mbsf.
187	1156A		42 44'S	127 53'E	4867	130	11		
187	1156B		42 44'S	127 53'E	4867	215			Basement first contacted in Wash core between 0-181.66 mbsf. Bottom of hole at 215.2 mbsf.
187	1157A		43 16'S	128 53'E	5069	216	16		
187	1157B		43 16'S	128 53'E	5069	171	40		
187	1158A		43 57'S	128 50'E	5167	213			Basement first contacted in Wash core between 0-198.9 mbsf. Bottom of hole at 213.39 mbsf.

**Table A-3. Status of Existing DSDP/ODP/IODP Legacy Holes**

<b>Leg</b>	<b>Hole</b>	<b>Location</b>	<b>Latitude</b>	<b>Longitude</b>	<b>Water (m)</b>	<b>T.D. (m)</b>	<b>B.P. (m)</b>	<b>Casing (m)</b>	<b>Remarks</b>
187	1158B		43 57'S	128 50'E	5167	141	15		
187	1158C		43 57'S	128 50'E	5167	117			Basement first contacted in Wash core between 0-108 mbsf. Bottom of hole at 117.4 mbsf.
187	1159A		45 57'S	129 60'E	4504	173			Basement first contacted in Wash core between 0-145.6 mbsf. Bottom of hole at 173.3 mbsf.
187	1160A		44 1'S	134 60'E	4625	171	5		
187	1160B		44 0'S	134 60'E	4625	205			Basement first contacted in Wash core between 0-160.1 mbsf. Bottom of hole at 205.2 mbsf.
187	1161A		44 17'S	129 3'E	5020	145			Basement first contacted in Wash core between 0-116 mbsf. Bottom of hole at 145.3 mbsf.
187	1161B		44 17'S	129 3'E	5020	167			Basement first contacted in Wash core between 0-158.5 mbsf. Bottom of hole at 167 mbsf.
187	1162A		44 38'S	129 11'E	5464	365	31		
187	1162B		44 38'S	129 11'E	5464	407			Basement first contacted in Wash core between 0-348.4 mbsf. Bottom of hole at 407.3 mbsf.

**Table A-3. Status of Existing DSDP/ODP/IODP Legacy Holes**

<b>Leg</b>	<b>Hole</b>	<b>Location</b>	<b>Latitude</b>	<b>Longitude</b>	<b>Water (m)</b>	<b>T.D. (m)</b>	<b>B.P. (m)</b>	<b>Casing (m)</b>	<b>Remarks</b>
187	1163A		44 25'S	126 54'E	4354	208			Basement first contacted in Wash core between 0-161 mbsf. Bottom of hole at 208.19 mbsf.
187	1164A		43 45'S	127 45'E	4798	147	8		
187	1164B		43 45'S	127 45'E	4798	216			Basement first contacted in Wash core between 0-150.4 mbsf. Bottom of hole at 216.19 mbsf.
191	1179D	Northwest Pacific	41 5'N	159 58'E	5566	475	107		
192	1183A	Ontong Java Plateau	1 11'S	157 1'E	1805	1211	81		
192	1185A	Ontong Java Plateau	0 21'S	161 40'E	3899	329	19		
192	1185B	Ontong Java Plateau	0 21'S	161 40'E	3899	526	216		
192	1186A	Ontong Java Plateau	0 41'S	159 51'E	2729	1034	31		
192	1187A	Ontong Java Plateau	0 57'N	161 27'E	3804	508	141		
193	1188A	Eastern Manus Basin	3 44'S	151 40'E	1640	212	202		
193	1189A	Eastern Manus Basin	3 43'S	151 40'E	1690	126	126		
193	1189B	Eastern Manus Basin	3 43'S	151 41'E	1682	206	206		
193	1190A	Eastern Manus Basin	3 43'S	151 41'E	1703	9	9		
193	1190B	Eastern Manus Basin	3 43'S	151 41'E	1701	10	10		
193	1190C	Eastern Manus Basin	3 43'S	151 41'E	1696	17	17		

**Table A-3. Status of Existing DSDP/ODP/IODP Legacy Holes**

<b>Leg</b>	<b>Hole</b>	<b>Location</b>	<b>Latitude</b>	<b>Longitude</b>	<b>Water (m)</b>	<b>T.D. (m)</b>	<b>B.P. (m)</b>	<b>Casing (m)</b>	<b>Remarks</b>
193	1191A	Eastern Manus Basin	3 44'S	151 40'E	1694	20	20		
194	1194B	Marion Plateau	20 15'S	151 59'E	374	427	6		
194	1197B	Marion Plateau	21 5'S	153 4'E	348	675	19		
194	1198B	Marion Plateau	20 58'S	152 44'E	319	523	9		
195	1200A	Kuroshio Current	13 47'N	146 0'E	2910	147	147		
195	1200B	Kuroshio Current	13 47'N	146 0'E	2911	98	98		
195	1200D	Kuroshio Current	13 47'N	146 0'E	2931	44	44		Silty clay Serpentine with Ultra Mafic Clasts
195	1200E	Kuroshio Current	13 47'N	146 0'E	2911	56	52		Silty clay Serpentine with Ultra Mafic Clasts
195	1200F	Kuroshio Current	13 47'N	146 0'E	2911	16	16		Silty clay Serpentine with Ultra Mafic Clasts
195	1201D	Kuroshio Current	19 18'N	135 6'E	5709	600	100		
197	1203A	Hawaiian Hotspot	50 57'N	167 44'E	2594	915	915		
197	1204A	Hawaiian Hotspot	51 12'N	167 46'E	2371	880	65		
197	1204B	Hawaiian Hotspot	51 12'N	167 46'E	2370	954	140		
197	1205A	Hawaiian Hotspot	41 20'N	170 23'E	1310	326	292		
197	1206A	Hawaiian Hotspot	34 56'N	172 9'E	1546	335	278		
198	1213B	Shatsky Rise	31 35'N	157 18'E	3883	494	47		
200	1224A	Hawaii 2 Observatory	27 53'N	141 59'W	4966	32	20		
200	1224E	Hawaii 2 Observatory	27 53'N	141 59'W	4967	37	10		
200	1224F	Hawaii 2 Observatory	27 53'N	141 59'W	4967	174	147		
206	1256B	Guatemala Basin on Cocos Plate	6 44'N	91 56'W	3635	252	1		
206	1256C	Guatemala Basin on Cocos Plate	6 44'N	91 56'W	3635	340	95		
209	1268A	Mid Atlantic Ridge	14 51'N	45 5'W	3007	148	148		
209	1269A	Mid Atlantic Ridge	14 56'N	45 4'W	2809	15	15		
209	1269B	Mid Atlantic Ridge	14 56'N	45 4'W	2800	11	11		
209	1269C	Mid Atlantic Ridge	14 56'N	45 4'W	2668	18	18		

**Table A-3. Status of Existing DSDP/ODP/IODP Legacy Holes**

<b>Leg</b>	<b>Hole</b>	<b>Location</b>	<b>Latitude</b>	<b>Longitude</b>	<b>Water (m)</b>	<b>T.D. (m)</b>	<b>B.P. (m)</b>	<b>Casing (m)</b>	<b>Remarks</b>
209	1270A	Mid Atlantic Ridge	14 43'N	44 53'W	1951	27	27		
209	1270B	Mid Atlantic Ridge	14 43'N	44 53'W	1910	46	46		
209	1270C	Mid Atlantic Ridge	14 43'N	44 53'W	1822	19	19		
209	1270D	Mid Atlantic Ridge	14 43'N	44 53'W	1817	57	57		
209	1271A	Mid Atlantic Ridge	15 2'N	44 57'W	3612	45	45		
209	1271B	Mid Atlantic Ridge	15 2'N	44 57'W	3585	104	104		
209	1272A	Mid Atlantic Ridge	15 6'N	44 58'W	2560	131	131		
209	1273A	Mid Atlantic Ridge	15 30'N	46 41'W	3417	14	14		
209	1273B	Mid Atlantic Ridge	15 30'N	46 41'W	3419	26	26		
209	1273C	Mid Atlantic Ridge	15 30'N	46 41'W	3408	28	28		
209	1274A	Mid Atlantic Ridge	15 39'N	46 41'W	3940	156	156		
209	1275A	Mid Atlantic Ridge	15 44'N	46 54'W	1562	5	5		
209	1275B	Mid Atlantic Ridge	15 44'N	46 54'W	1562	109	109		
209	1275C	Mid Atlantic Ridge	15 44'N	46 54'W	1553	21	8		
209	1275D	Mid Atlantic Ridge	15 44'N	46 54'W	1554	209	209		
210	1276A	Newfoundland end of Newfoundland-Iberia Transect	45 24'N	44 47'W	4549	1737	26		Hardrock was also recovered in this hole in the interval 1601.9 - 1633.3 mbsf.
210	1277A	Newfoundland end of Newfoundland-Iberia Transect	45 12'N	44 23'W	4628	180	180		Top of basement uncertain. First Hardrock recovered in WASH core.

**Notes:**

T.D.= total depth. B.P.= basement penetration. \* = "basement" defined as top of sill/sediment sequence. Casing depths are depths below seafloor of shoes of 16" casing and subsequent casing strings.

**THIS PAGE INTENTIONALLY LEFT BLANK**

**APPENDIX B**  
**INTEGRATED OCEAN DRILLING PROGRAM (IODP)**

- ◇ Description of the IODP
  
- ◇ Tables B-1 through B-9 identifies IODP research themes and the technical drilling and sampling approaches needed to investigate these systems. The research themes include Observatory, Rifting Process, Convergent Margin, Large Igneous Province, Oceanic Crust, Hydrothermal System and Massive Sulfide Deposit, Deep Ocean Sediment, Passive Margin Stratigraphy), and Carbonate Reef, Atoll, or Bank.

**THIS PAGE INTENTIONALLY LEFT BLANK**



## INTEGRATED OCEAN DRILLING PROGRAM (IODP)

IODP is a multiplatform, international operation sponsored by Japan’s Ministry of Education, Culture, Sports, Science and Technology (MEXT) and the U.S. National Science Foundation (NSF) as Lead Agencies, by the European Consortium for Ocean Research Drilling (ECORD), the People’s Republic of China, and the Interim Asian Consortium; IODP is managed by IODP-Management International; and IODP’s drilling platforms are operated by three Implementing Organizations, including the Consortium for Ocean Leadership (COL) formerly known as the JOI Alliance, the ECORD Science Operator, and JAMSTEC’s Center for Deep Earth Exploration.

The following will explain how IODP is funded and managed (Figure 1) illustrating the general overall functioning of this organization.

**Figure 1. IODP Organization**

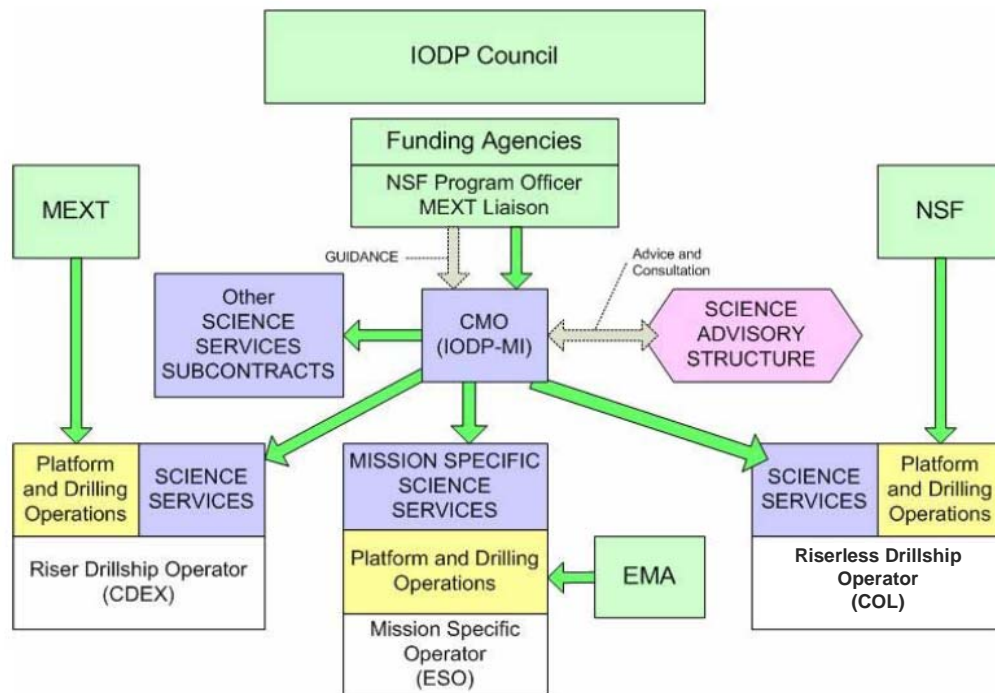

*Green arrows indicate funding flow. Grey arrows denote guidance and advice.*

### 1. Funding

IODP’s initial 10-year life span is supported five funding entities, including the U.S. National Science Foundation and Japan’s Ministry of Education, Culture, Sports, Science, and Technology (the Lead Agencies), the European Consortium for Ocean Research Drilling, the People’s Republic of China and The Interim Asian Consortium. Platform Operation Costs are supplied directly to the Implementing Organizations by the national agencies that support them. Commingled funds from these sources are used for the Science Operation Costs of all IODP program activities.

## **1.1. Lead Agencies**

In April 2003, officials from Japan's Ministry of Education, Culture, Sports, Science and Technology (MEXT) and the U.S. National Science Foundation (NSF) signed a Memorandum of Understanding in which they agreed to form and operate the Integrated Ocean Drilling Program.

IODP is primarily supported by these Lead Agencies. Each Agency has equal membership rights and responsibilities, contribute core capabilities to the IODP, determine total program costs, and contribute equally to the total program costs. The Lead Agencies provide budget guidance to the Central Management Office (IODP Management International) and review and approve the annual IODP Program Plan prior to implementation.

## **1.2. Members**

Membership in the IODP is available to government and/or national agencies that have interest and capability in geoscience research. To become a member, a Memorandum of Understanding (MOU) must be signed by the National Science Foundation of the United States of America, the Ministry of Education, Culture, Sports, Science and Technology of Japan and the appropriate new member agency. The MOU stipulates, among other things, the contribution of the member to the program, the number of scientists that sail on the platforms and number of scientists in SAS Committees and Panels.

IODP members are expected to make appropriate annual payments to the National Science Foundation. The annual payments are then commingled and turned over to the Central Management Office for distribution in support of science-operating costs. Annual payment must be at least equal to one full "participation unit". The amount of a participation unit is adjusted annually to meet the demands of specific program objectives (the US Fiscal Year 2007 amount equals \$5.6 million). To attain membership of IODP, a minimum annual contribution amount equal to one participation unit is required. A member's expected level of participation in the IODP is proportional to the number of participation units represented by that member's contribution to the IODP.

One participation unit entitles an IODP member to the right to (1) have two of its scientists participate in each drilling cruise; (2) be represented on all planning and advisory panels; (3) have access to all data, samples, scientific and technical results, all engineering plans, data or other information produced under contracts supported as program costs; (4) have access to all data from geophysical and other site surveys performed in support of the program which are used for drilling planning; (5) submit proposals to the Science Advisory Structure for drilling or engineering developments in support of IODP science; and (6) be represented on the IODP Council.

The European Consortium for Ocean Research Drilling (ECORD) Managing Agency is currently a member of IODP (in addition to the Lead Agencies). The consortium was initially established with 12 European countries to maximize the impact of European scientists in IODP. The consortium has since grown representing the collaborative ocean-drilling efforts of 14 European

nations, the United Kingdom, and Canada. The European Consortium provides the IODP scientific community with access to mission-specific platforms, in the form of funding and implementation, in addition to the participation unit(s) contributed for science-operating costs.

### **1.2.1. Associate Members**

Associate IODP members are those that contribute an amount less than one participation unit and equivalent to at least 1/6 participation unit. Associate IODP members may elect to have scientific participation and representation on Science Advisory Structure service committees, panels, or working groups in proportion to their contributions. However, associate members do not have representation on the Science Advisory Structure Executive Authority or the Science Planning Committee. Participation in drilling operations is prorated based on the fraction of participation unit contributed by an associate member (one full participation unit corresponds to inclusion of two scientists in all drilling operations).

Currently, IODP Associate Members include: The People's Republic of China Ministry of Science and Technology (MOST) and The Interim Asian Consortium, represented by the Korea Institute of Geoscience and Mineral Resources (KIGAM).

For more information on IODP funding agencies, please visit: [www.iodp.org/funding-agencies/](http://www.iodp.org/funding-agencies/).

### **1.3. IODP Council**

An IODP Council, representing all of the partners, provides a forum for exchange of views among member nations and consortia and serves as a consultative body reviewing financial, managerial, and other matters involving the overall support of IODP. The chairperson of the IODP Council rotates among the Lead Agencies.

### **1.4. Fund Allocation**

Total program costs consist of both Platform Operation Costs and Science Operation Costs. The two Lead Agencies (NSF, MEXT) and one full IODP Member (ECORD) are each responsible for funding their nation's/consortia's implementing organization's drilling platform through Platform Operation Costs, while IODP Science Operations Costs, co-mingled from all the international partners membership fees, are used for the conduct of IODP science.

#### **1.4.1. Platform-Operation costs**

The U.S. National Science Foundation provides Platform Operation Costs directly to the United States Implementing Organization (USIO), which operates the riserless drillship (SODV). The Ministry of Education, Culture, Sports, Science and Technology provides Platform Operation Costs for the riser drillship *CHIKYU*, operated by the JAMSTEC's Center for Deep Earth Exploration. The European Consortium for Ocean Research Drilling Managing Agency provides Platform Operation Costs for the European Implementing Organization's mission specific platforms.

Platform Operation Costs for the SODV, *CHIKYU*, and mission-specific platforms support the basic operation of the vessel as a drillship, and include, for example: (1) costs of the drilling and ship's crew, (2) catering services, (3) fuel, vessel supplies and other related consumables, (4) berthage and port call costs, (5) disposal of wastes, (6) crew travel, (7) inspections and insurance, (8) drilling equipment, supplies, and related consumables, (9) engineering or geophysical surveys, and data acquisition and laboratory analyses required for the safety of platform and drilling operations, and (10) administration and management costs of the platform operators.

#### **1.4.2. Science-operation costs**

The Ocean Drilling Program office at the U.S. National Science Foundation is also responsible for administering co-mingled funds directed towards the science-operating costs of all IODP operations. These co-mingled funds come from the international partners (Lead Agencies, Contributing Members, and Associate Members) as part of their membership fees used for the conduct of IODP science. The contractual distribution of the co-mingled funds is governed by Annual Program Plans that are approved by the Lead Agencies.

Science Operations Costs include: (1) Technical Services, (2) Computer Capability, (3) Data storage and distribution, (4) Description, archiving, and distribution of data and samples, (5) Deployment of a standard suite of logging tools, (6) Development of new drilling tools and techniques required by IODP research, (7) Program publications (8) Costs of consumables (exclusive of those identified under platform operations costs), (9) Costs required for administration and management, including the Central Management Office and (10) Outreach

## **2. IODP Operation**

An IODP Council, representing all of the partners, provides a forum for exchange of views among member nations and consortia, and reviews accomplishments, status, and plans, including financial, managerial and all other matters regarding the overall support of IODP. The chairperson of the IODP Council rotates among the Lead Agencies.

Day to day IODP operations, however, are provided by three main entities:

The Central Management Office (CMO): IODP-Management International, Inc. (IODP-MI) has received a 10-year contract from the Lead Agencies to run the Central Management Office.

The Implementing Organizations (IOs): COL (USIO) is responsible for riserless ship operations, JAMSTEC's Center for Deep Earth Exploration (CDEX) is responsible for the riser-equipped vessel, *CHIKYU*, and the European Consortium of Ocean Research Drilling Science Operator (ESO) is responsible for mission-specific platforms (MSPs).

The Science Advisory Structure (SAS) - The IODP Science Advisory Structure consists of scientists, engineers, and technologists nominated by IODP program member offices.

## **2.1. Central Management Office (IODP-MI)**

IODP is managed by a nonprofit corporation, IODP-Management International, through a 10-year contract with the National Science Foundation. IODP-MI is responsible for program-wide science planning, oversight of engineering development, publication, education and outreach, site survey data management, and core sample repositories. With advisory assistance from an internationally staffed Science Advisory Structure, IODP-MI translates the scientific priorities of the global ocean-drilling community into annual program plans. An executive committee of the Science Advisory Structure approves each annual program plan before it is funded by the Lead Agencies.

For more information on IODP-MI, please visit: <http://www.iodp.org/iodp-mi/>

### **2.1.1. IODP-MI Offices**

IODP-MI has established two offices: the Washington DC office serves as headquarters and corporate office; the Sapporo office, in Japan, is headed by the IODP-MI Vice President for Science Planning.

Senior IODP-MI personnel include the President, the Vice President for Science Operations, the Vice President for Science Planning, the Senior Advisor to the President, the Director of Communications, the Finance and Administrative Officer, and the Contracts Officer.

The President, Manik Talwani, is responsible for all IODP-MI employees and directly oversees the two Vice Presidents (VPs), the Senior Advisor, and the Director of Communications.

The VP for Science Operations, Tom Janecek, is responsible for oversight of IODP field operations as well as of core repositories and of engineering development.

The VP for Science Planning, Hans Christian Larsen is responsible for science planning and managing the production of IODP's key products: data, scientific publications, and education material. The VP will directly oversee the Science Advisory Structure. Japan's Advanced Earth Science and Technology Organization (AESTO) provides support for the Sapporo office through a subcontract to IODP-MI.

The Senior Advisor to the President, Yoichiro Otsuka is IODP's liaison with National Science Foundation, Japan's Ministry of Education, Culture, Sports, Science, and Technology, and The European Consortium for Ocean Research Drilling Management Agency and a contact for external organizations that wish to initiate projects with IODP.

The Director of Communications, Nancy Light, is responsible for IODP Outreach and Public Information.

Stephanie Murphy is the Finance and Administrative Officer.

John Emmitte is the Contracts Officer.

### **2.1.2. Annual Program Plan**

It is the responsibility of IODP-MI to develop an Annual Program Plan for IODP in close coordination with the scientific community represented by the Science Advisory Structure and with the Implementing Organizations.

IODP-MI receives drilling proposals from community scientists and the Science Advisory Structure provides advice and recommendations to IODP-MI on the scientific priority of each proposal. IODP-MI then requests annual operational plans and budgets from the IOs that would be required to implement the highest priority science, and works with IOs and the Science Advisory Structure to produce an integrated IODP Annual Program Plan (APP).

IODP-MI submits the program's Annual Program Plan to the Science Advisory Structure Executive Committee and to the IODP-MI Board of Governors for review prior to its consideration the Lead Agencies. The National Science Foundation has responsibility for contractual approval of the Annual Program Plan, in consultation with Japan's Ministry of Education, Culture, Sports, Science and Technology.

IODP Annual Programs Plans can be located at: <http://www.iodp.org/app/>

### **2.1.3. IODP-MI Board of Governors (BoG)**

A Board of Governors was created to oversee the governance and general management of the affairs, funds, and property of IODP-MI and all its powers. The Board of Governors has the authority to make rules and regulations for IODP-MI's management, create additional offices or special committees, select, employ or remove its agents or employees as necessary, and fill vacancies and change the membership of committees. Additionally, the Board of Governors has the responsibility for the approval and implementation of the annual IODP plan and budget. The Board must approve all grants and contracts; the Board of Governors must receive notification that liability matters are covered beyond the limited liability of IODP-MI in all contractual procedures.

The IODP-MI Board of Governors is made up of appointed persons from IODP member countries and consortia based on financial contribution. Five members from countries or consortia with Lead Agency status are appointed and members of IODP from countries or consortia in IODP without Lead Agency status appoint Governors based on financial contributions (POCs and SOCs) to the IODP according to the following scale, \$5M (US) to \$9.99M (US) = 1 seat, \$10M (US) to \$14.99M (US) = 2 seats, \$15M (US) to \$29.99M (US) = 3 seats, \$30M (US) to \$44.99M (US) = 4 seats, \$45M (US) to \$60M (US) = 5 seats. Additionally, The President of IODP-MI serves as a non-voting Governor to the Board.

Information on the IODP-MI Board of Governors, the officers, contact information and meeting minutes is located at: <http://www.iodp.org/bog/>

#### **2.1.4. IODP-MI Membership**

Currently IODP-MI has 35 members, 15 from the United States, 8 from Japan, and 12 from Europe. Membership in IODP-MI is open to nonprofit educational and/or research organizations formed and operated in an IODP Member entity (i.e., country or consortia) that satisfy criteria, as defined by the IODP-MI By-laws and subsequently approved by the IODP-MI Members, as evidencing “a significant dedication to ocean geoscience research.” All members must pay an initial membership fee of US\$5000 as well as annual dues not to exceed \$5000.

Educational and/or research organizations, government agencies, non-governmental organizations, and for-profit companies ineligible for membership, but having an interest in ocean geoscience research, may become Associate Members. An Associate Member does not have the right to vote upon matters coming before the Membership and cannot serve on the Board of Governors, but can participate in open meetings of the Membership and may serve on other corporate committees, as appropriate. All Associate Members have to pay an initial membership fee of US\$2500 plus an annual fee half that of Members.

Other non-profit and educational and/or research institutions with a major commitment to and involvement in ocean geoscience research may be elected as members by the unanimous consent of the voting members. Associate members shall be elected by a majority of the voting members. An up-to-date list of IODP-MI membership, representative, and representative contact information can be found at: <http://www.iodp.org/members-and-representatives/>.

#### **2.1.5. IODP-MI Task Forces and Project Management Groups**

IODP-MI is responsible for overseeing the implementation of a large number of tasks, including operational planning, engineering development, database management, education and outreach, publications, and repository oversight. IODP-MI utilizes task forces to assist in implementation where necessary. The purpose of task forces is to focus the advice obtained from Science Advisory Structure and provide concrete advice on policy, so that IODP-MI can proceed with implementation. All task forces usually will include Science Advisory Structure members, representatives from the Implementing Organizations, and other experts. The members of the task forces are chosen by IODPMI. Task forces will not be asked to write Request for Proposals. The policy formulations by the task forces, however, will often guide IODP-MI personnel in writing Request for Proposals.

IODP-MI Task Forces are briefly described below. Detailed information, including rosters, meeting minutes, schedules, and agendas are located at: <http://www.iodp.org/iodp-mitask-forces/2/>

#### **Management Forum**

The Management Forum tackles issues that concern IODP as a whole. It reviews and offers advice to the IODP-MI President on policies, procedures, and current and future activities. The Management Forum, while representing the views of the various separate entities that comprise IODP, is able to express a joint perspective on the program.



The Management Forum includes key personnel from IODP-MI, the Heads of the Implementing Organizations, and the Chairs of the Advisory Committees of the National Program Offices, the Science Planning Committee Chair, and the Science Advisory Structure Executive Committee Chair.

Detailed information regarding Management Forum is located at:

<http://www.iodp.org/iodp-mi-task-forces/2/>

### **Operations Task Force (OTF)**

The IODP-MI Operations Task Force's primary function is to formulate the most logistically, fiscally effective operational plans to meet the objectives set forth in IODP's 10-year science plan, as prioritized by the Science Planning Committee. The scheduling strategy involves: (1) examining science plans for each proposal; (2) determining operational and environmental constraints; (3) developing a matrix that combines the Science Planning Committee science plan with operational and environmental constraints and risk, operational days at sea, and transits; and (4) adding fiscal reality to viable options forwarded to the Science Planning Committee.

Operations Task Force members include the IODP-MI Vice President of Science Operations, IODP-MI Vice President of Science Planning, 1-3 representatives from each Implementing Organization, the Chair of the Science Planning Committee plus 2 additional Science Planning Committee members.

Detailed information regarding the Operations Task Force is located at:

<http://www.iodp.org/iodp-mi-task-forces/2/>

### **Operations Review Task Force (ORTF)**

IODP-MI Operations Review Task Force conducts operational reviews of IODP Expeditions. The Task Force review is based upon confidential reports submitted by the Implementing Organization and expedition co-chief scientists. These operational reviews focus on "lessons learned" and "how do we do things better in the future?" Areas of discussion include pre-expedition planning, expedition drilling operations, communications between scientists and operators, roles and responsibilities of scientists and operators, general procedures and policies (e.g., curation, communications), laboratory operations, etc. Each of these operational reviews results in recommendations that are compiled into a short summary report that is posted on the IODP website.

Operations Review Task Force Members include the IODP-MI Vice President of Science Operations (Chair), IODP-MI President, 3-5 representatives from the Implementing Organization under review, 1 representative from each Implementing Organization not under review, the co-chief scientists for the expedition under review, 3 scientists with knowledge about IODP and the expedition under review, and 3 industry representatives.

Detailed information regarding the Operations Review Task Force is located at:

<http://www.iodp.org/iodp-mi-task-forces/2/>



### **Engineering Task Force (ETF)**

The Engineering Task Force assists IODP-MI in its effort to bring appropriate technology to the program that is required to meet the science objectives detailed in the IODP Initial Science Plan. In particular, the Engineering Task Force helps IODP-MI establish a long-term engineering vision for the program, evaluate and use advice provided by the IODP Science Advisory Structure to prioritize and implement engineering initiatives, assist IODP-MI identify potential vendors and additional engineering experts as required, and help IODP-MI review on-going engineering development projects. Major agenda topics and areas of interest include:

- Determining high-level IODP engineering goals
- Review of Science Advisory Structure advice and prioritization
- Implementation of engineering initiatives
- Evaluate engineering development proposals
- Progress reviews of funded developments
- Review IODP technology road map
- Assist IODP-MI determine how best to procure services
- Thematic meetings such as observatory technology, heave compensation, deep drilling and/or coring techniques

The Engineering Task Force is chaired by the IODP-MI Engineering and Operations Manager and includes industry, academic, and government experts on instrument design, drilling techniques, and emerging technologies, as well as one liaison from each Implementing Organization.

Detailed information regarding Engineering Task Force is located at:

<http://www.iodp.org/iodp-mi-task-forces/2/>

### **Curatorial Task Force (CTF)**

The Curatorial Task Force (formerly known as the Curatorial Advisory Board) has several main roles including: (1) Acting as an appeals board vested with the authority to make final decisions regarding sample distribution, if and when conflicts or differences of opinion arise among any combination of the sample requester, an IODP Curator at the repository of interest, or the Sample Allocation Committee Reviewing (2) approving requests to sample the permanent archive and (3) approving requests for loans of core material.

The Curatorial Task Force is chaired by the IODP-MI Vice President of Science Planning. Members also include the IODP-MI Vice President of Science Operations and three members of the scientific community. The latter serve overlapping four-year terms and are nominated by the Scientific Technology Panel.

Detailed information regarding the Curatorial Task Force is located at:

<http://www.iodp.org/iodp-mi-task-forces/2/>

### **Data Management Task Force (DMTF)**

The primary task of the Data Management Task Force is to oversee the development a user-friendly data portal to access and display data generated by the program. The Task Force is also

charged with issuing Request for Proposals related to the data portal, associated search engines or visualization tools, and existing or emerging technologies relevant to the program.

The Data Management Task Force is chaired by the IODP-MI Data Manager and is populated by the IODP-MI Publications Manager, Implementing Organization liaisons, and community specialists within the field of digital library technology, Geographic Information Systems (GIS) and geo-referenced data, Web services, data visualization and cyber-infra structure. The Data Management Task Force is composed of external experts in the following fields:

- Central Web Portal for distributed databases
- Metadata standard for geographic scientific data (ISO 19115)
- Data integration, mining and access in a distributed environment
- GIS, data visualization, mapping and web services
- Scientific data exchange format and standard
- IODP data users

Detailed information regarding Data Management Task Force is located at:

<http://www.iodp.org/iodp-mi-task-forces/2/>

#### **Quality Assurance/Quality Control Task Force (QA/QC)**

The Quality Assurance/Quality Control (QA/QC) Taskforce establishes the framework for QA/QC procedures for measurements made on all IODP platforms and shore-based facilities and monitors the success of the implemented QA/QC framework.

The Task Force also defines the QA/QC guidelines followed by the Implementing Organizations for at least the IODP minimum and standard measurements across the full range of disciplines (e.g., geochemistry, petrophysics, microbiology, core description, logging, etc.) including, but not limited to:

- Establishing general policies for capturing all relevant QA/QC data and metadata;
- Establishing general policies for ensuring quality of data across all IODP platforms and expeditions and including shore-based laboratories (e.g., that all data generated by IODP platforms/labs are traceable);
- Establishing a general policy that, where practical/appropriate, reference materials be used and their data captures;
- Establishing general policies for data transfer and integrity protocols to ensure quality control of the IODP databases; and
- Recommending that the Implementing Organizations develop and implement protocols for calibration, determining uncertainty, and traceability in all IODP measurements, and that the Implementing Organizations report these protocols to the taskforce for review.

Core membership of the QA/QC Task Force includes personnel from IODP-MI and the Implementing Organizations in addition to 1-2 representatives from the Scientific Technology Panel. The nature of the QA/QC Task Force requires that external experts be consulted as needed.

Detailed information regarding the QA/QC Task Force is located at:

<http://www.iodp.org/iodp-mi-task-forces/2>

### **Education and Outreach Task Force**

This Task Force has its roots in planning workshops that took place in February and May of 2004 with a group of advisors convened by the IODP-MI President to construct a fundamental framework of duties and responsibilities to be carried out in an integrated IODP Education and Outreach program. The Task Force has since evolved into a group with two-fold responsibilities: (1) devising and implementing creative education and outreach strategies meant to raise IODP visibility while heightening understanding of scientific ocean drilling; and (2) providing effective counsel to the IODP community in relation to program policies and practices that impact outreach efforts.

The Education and Outreach Task Force is chaired by the IODP-MI Director of Communications. Members include outreach specialists from each of the Implementing Organizations, and scientists representative of each national program office.

Detailed information regarding Education and Outreach Task Force is located at:

<http://www.iodp.org/iodp-mi-task-forces/2>

### **Project Scoping Groups / Project Management Teams**

Project Scoping Groups (PSGs) are used to assess the state of readiness of drilling plans, tool and engineering development, engineering site surveys, etc. The Operations Task Force determines the level of scoping needed for any proposal residing with the Task Force for scheduling and designates a formal Project Scoping Group, if required. Each scoping group will have either the IODP-MI Vice President of Science Operations or the IODP-MI Engineering & Operations Manager as head. This group also will include one or two designated “Chief Project Scientists” and several project proponents to provide the scientific leadership necessary to plan aspects of the project. This Project Scoping Group also has formal liaisons from the Implementing Organizations and Science Advisory Structure and utilizes outside expertise (e.g., engineers) as needed. The Project Scoping Group regularly reports to the Operations Task Force on the state of readiness of the Complex Drilling Project.

If, after initial scoping, the project is placed on the IODP operational schedule by the Operations Task Force, the Project Scoping Group will then become a formal Project Management Team (PMT), which plans and coordinates the project through its multi-year operations. Each Project Management Team will have a “core membership” of either the Vice President of Science Operations or the Engineering and Operations Manager as the chair, one or two designated “Chief Project Scientists”, proposal proponents, Implementing Organization representatives (engineers, staff scientists), Science Advisory Structure representatives, Education and Outreach representation and outside engineers (as required). The Project Management Team reports to the Operations Task Force on planning and implementation issues addressed by the team.

### **Workshops**

Workshops focused on Initial Science Plan initiatives are part of a long-range planning effort instigated by the Board of Governors. The workshops are intended to engage both the IODP and non-IODP community in addressing long term planning issues and programmatic needs of the

Initial Science Plan that are not being adequately addressed at present as well as expanding upon the set-forth IODP mission.

For more information on past workshops, upcoming workshops, applying to attend workshop or submitting a white paper for a particular workshop, please visit <http://www.iodp.org/workshops/>

## 2.2. Implementing Organizations (IOs)

IODP has three Implementing Organizations (IOs), which manage all ships and platform operation for the program.

### 2.2.1. Japanese Agency for Marine-Earth Science and Technology (JAMSTEC)

The Japan Agency for Marine-Earth Science and Technology (JAMSTEC) Center for Deep Earth Exploration (CDEX) manages platform operations for the riser vessel *CHIKYU*. CDEX's mission is to contribute to the accomplishment of IODP scientific goals through safe, effective, and efficient operation of the Deep Sea Drilling Vessel *CHIKYU* (Figures 2 and 3).

Deep Sea Drilling Vessel *CHIKYU* is the first riser-equipped scientific drilling vessel built for science at the planning stage. It is capable of drilling up to 7,000m below sea floor. The ship will initially be able to conduct riser drilling in water depths up to 2500 m. Plans to increase this capability to 4000 m are underway. The riser system includes an outer casing that surrounds the drill pipe to provide return circulation of drilling fluid to maintain pressure balance within the borehole.

**Figure 2. DV CHIKYU**

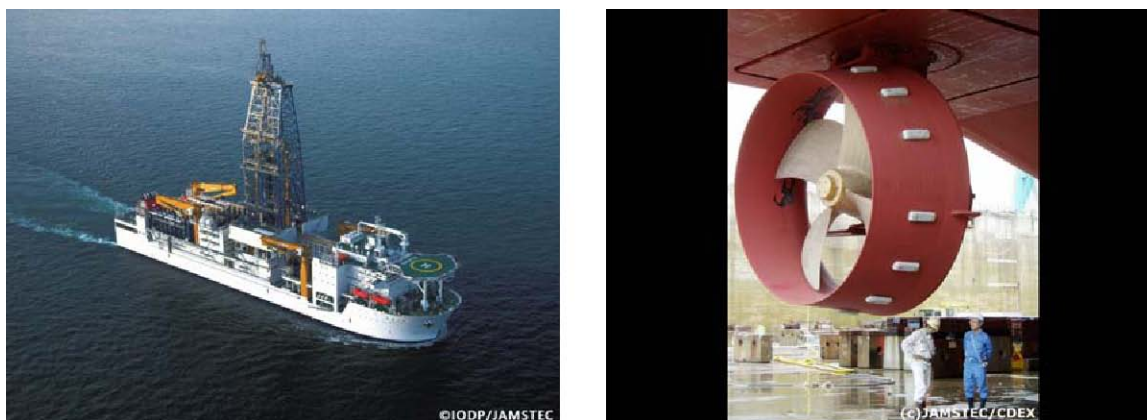

*Left - D/V CHIKYU sailing in Tokyo Bay. Right - The 360 degrees thrusters keep the D/V CHIKYU in position.*

**Figure 3. Riser Drilling Technology**

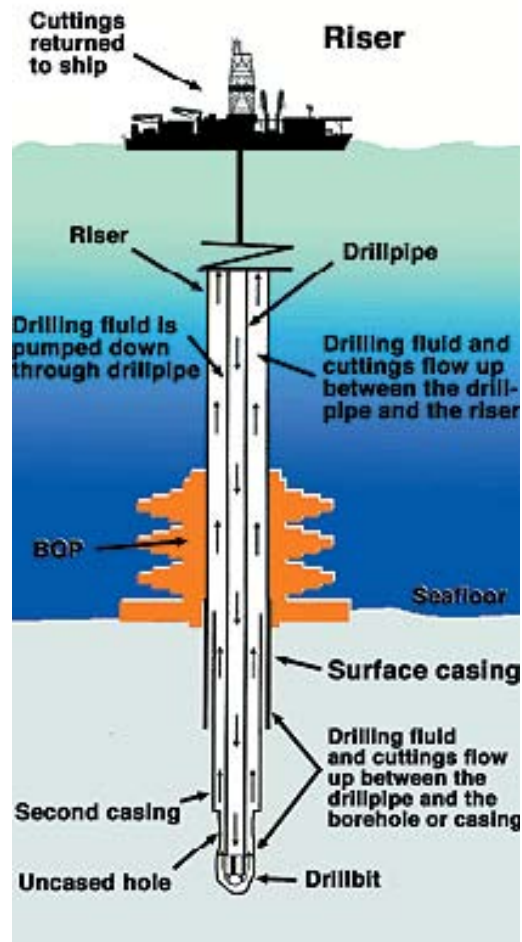

For detailed information on the DV *CHIKYU*, please visit:

<http://www.jamstec.go.jp/CHIKYU/eng/>

### **2.2.2. European Consortium for Ocean Drilling Research (ECORD) Science Operator (ESO)**

Mission Platforms are required to investigate high-priority regions such as the Arctic Ocean, and to drill in shallow water (< 20 m) environments that contain detailed records of climate and sea-level change – these other platforms are labeled mission-specific platforms (MSPs) and are implemented by the European Consortium for Ocean Research Drilling (ECORD) Science Operator, a consortium consisting of the British Geological Survey, the University of Bremen, and the European Petrophysical Consortium.

The British Geological Survey (BGS) acts as the consortium co-coordinator responsible for overall ESO management. BGS provides the Science Manager, who acts as the main contact with the ECORD Management Agency (EMA) and the ECORD Council, the Operations



Manager, Data Manager and Education and Outreach Manager for the consortium, as well as the Staff Scientist and Administrative Support for each MSP.

The University of Bremen provides the ESO Laboratory and the Curation Manager; the latter being responsible for analytical facilities during offshore MSP operations and the onshore science party. The Bremen Core Repository (BCR) is the ESO facility for core curation and management. The University is also involved in data management tasks provided by WDC-MARE/PANGAEA (IODP-MSP data portal), and provides the Public Relations Manager for ESO. GFZ Potsdam additionally supports ESO by contributing the Drilling Information System (DIS) for offshore data acquisition.

The European Petrophysical Consortium carries out all logging and petrophysical activities for ESO. This consortium comprises the University of Leicester (coordinator), U.K, the Université de Montpellier, France and RWTH Aachen, Germany. Figure 4 provides two examples of mission-specific platforms.

**Figure 4. Examples of Mission Specific Platforms**



*(Left) Vidar Viking on Expedition 302: ACEX Arctic Coring Expedition; (Right) DP Hunter on Expedition 310: Tahiti Sea Level.*

For more information on ESO or Mission-Specific Operations, please visit:

<http://www.eso.ecord.org/index.html>

### **2.2.3. U.S. Implementing Organization (USIO/COL)**

The COL, the U.S. Implementing Organization (USIO), manages the SODV with and its partners, the Lamont-Doherty Earth Observatory of Columbia University and Texas A&M University.

The United States Implementing Organization Science Services, Texas A&M University, is responsible for providing a full array of science services, ranging from vessel and drilling operations to ship- and shore-based science laboratories, core repositories, and publication. United States Implementing Organization Science Services, Lamont Doherty Earth Observatory,

is responsible for logging-related shipboard and shore-based science services and for leading an international logging consortium to participate in scientific ocean drilling operations.

Figure 5 provides an illustration of the riserless drilling vessel, *JOIDES Resolution*, which is currently undergoing major modernization and designated the Scientific Ocean Drilling Vessel (SODV). Figure 5 also provides a schematic of riserless drilling. The riserless drilling technology, shown in Figure 5 uses seawater as the primary drilling fluid, which is pumped down through the drillpipe. The seawater cleans and cools the drill bit and lifts cuttings out of the hole, piling them in a cone around the hole.

**Figure 5. *JOIDES Resolution* and Riserless Drilling Technology**

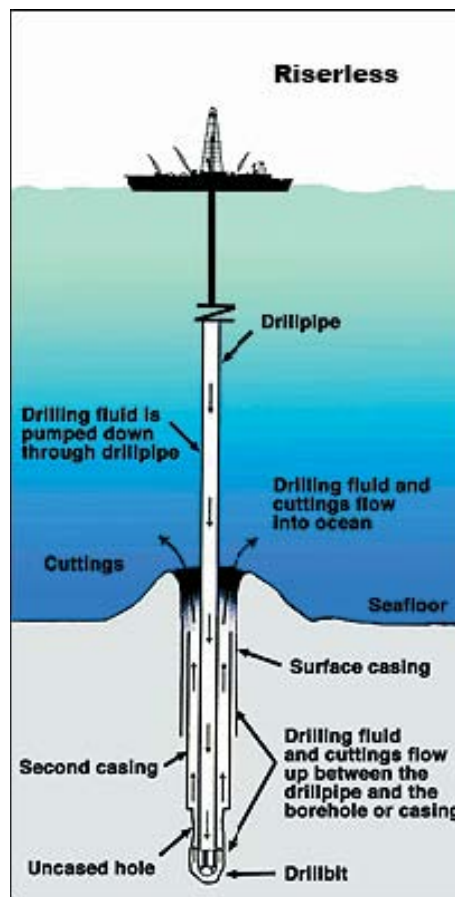

IODP-USIO completed IODP Expeditions 301, 303309, and 311-312 with the riserless drillship *JOIDES Resolution*, the same vessel used during the two decades of ODP. Subsequent to these initial IODP operations, the *JOIDES Resolution* underwent an extensive refit to significantly upgrade its drilling, laboratory, habitability and safety capabilities.

For additional information on the SODV (formerly *JOIDES Resolution*), please visit: [www.joiscience.org/sodv](http://www.joiscience.org/sodv), or go to [www.iodp-usio.org](http://www.iodp-usio.org) for any information regarding the USIO.

### 2.3. Science Advisory Structure

IODP science planning is provided by the Science Advisory Structure (SAS), which involves many scientists and engineers on several standing committees and panels. All IODP science is motivated by community input in the form of unsolicited proposals that are nurtured and prioritized by the IODP Science Advisory Structure (Figure 6). Nine committees and panels currently make up the Science Advisory Structure, with each one serving a very specific purpose in the management and implementation of incoming drilling proposals and overall IODP operations.

**Figure 6: IODP Science Advisory Structure Organization**

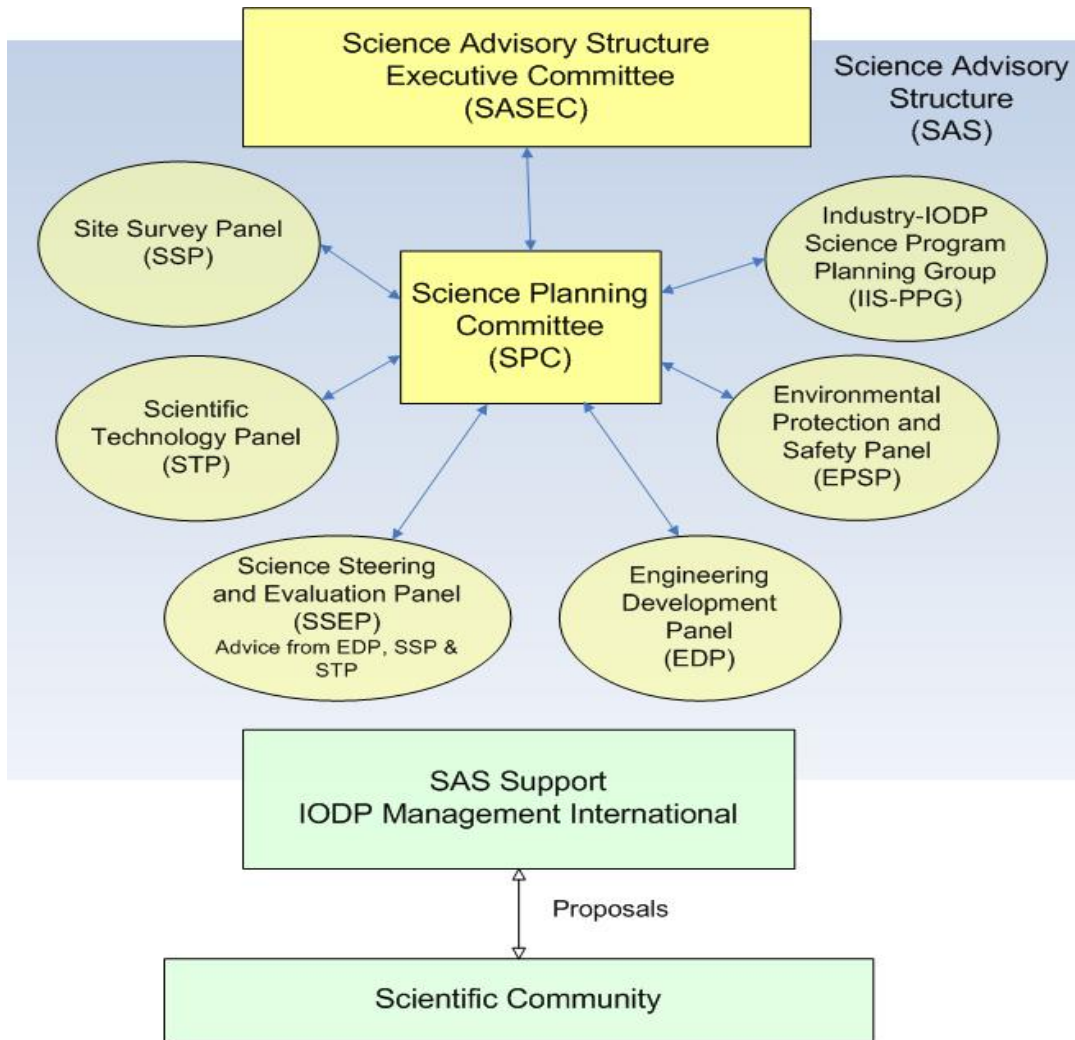

Information on the committees and panels including panel members, contact information, meeting agendas and meeting minutes, is located at:

<http://www.iodp.org/committees-and-panels/>.



### **2.3.1. Scientific Advisory Structure Executive Committee**

The Science Advisory Structure Executive Committee (SASEC), committee of IODP-MI Board of Governors, is considered the Executive Authority of the Science Advisory Structure and is composed of representatives from scientific/academic institutions in IODP member countries. The Science Advisory Structure Executive Committee provides scientific oversight and long term planning.

The prime responsibilities of Science Advisory Structure Executive Committee are to:

- Formulate scientific and policy recommendations for the Council and reports to the Council,
- Work with the Central Management Organization of IODP to develop an annual program plan for scientific ocean drilling based on the recommendations of the Science Advisory Structure,
- Evaluate and assess IODP accomplishments with regard to established ISP goals and objectives, working with the Science Advisory Structure,
- Promote support for IODP where appropriate (including expansion of membership), and ensures liaison with other scientific programs.

Detailed information on SASEC is located at [www.iodp.org/sasec/2](http://www.iodp.org/sasec/2).

### **2.3.2. Science Planning Committee**

The Science Planning Committee (SPC) focuses on the detailed expedition planning activities that are necessary to achieve the aims and objectives of IODP as expressed in the Initial Science Plan. In this capacity, the Science Planning Committee prioritizes, or ranks, scientific and technological objectives to optimize the scientific returns from multi-platform drilling, sampling, and related experiments. These rankings are based in part on input and advice from the other Science Advisory Structure panels.

Detailed information regarding SPC is located at: [www.iodp.org/spc/](http://www.iodp.org/spc/).

### **2.3.3. Science Steering and Evaluation Panel (SSEP)**

The Science Steering and Evaluation Panel (SSEP) reports to the Science Planning Committee. The panel interacts with proposal proponents to nurture submitted drilling proposals to maturity, and send mature proposals for external review before forwarding them to the Science Planning Committee. Within the context of the IODP Initial Science Plan, important thematic (and initiative) areas of investigation addressed by proposals that are considered by these panels include: (1) the deep biosphere and seafloor ocean (deep biosphere; gas hydrates); (2) environmental changes, processes and effects (extreme climates; rapid climate change); (3) solid earth cycles and geodynamics (continental breakup and sedimentary basin formation); (4) large igneous provinces (LIPs); (5) 21st century Mohole; (6) seismogenic zone; and (7) additional themes (and initiatives) that may arise from future scientific planning and assessment.

Detailed information regarding SSEP is located at: [www.iodp.org/ssep/](http://www.iodp.org/ssep/).

#### **2.3.4. Engineering Development Panel**

The Engineering Development Panel (EDP) reports to the Science Planning Committee and also may communicate directly with IODP-Management International (IODP-MI). The panel provides advice on matters related to the technological needs and engineering developments necessary to meet the scientific objectives of active IODP proposals and the IODP Initial Science Plan.

Detailed information regarding the EDP is located at: [www.iodp.org/edp/](http://www.iodp.org/edp/).

#### **2.3.5. Environmental Protection and Safety Panel**

The Environmental Protection and Safety Panel (EPSP) reports to the Science Planning Committee. The panel provides independent advice to the Science Planning Committee, IODP Management International (IODP-MI), and the Implementing Organizations with regard to safety and environmental issues associated with general and specific geologic circumstances of proposed drill sites. The Environmental Protection and Safety Panel also provides advice on appropriate drilling technologies for avoidance of drilling hazards and protecting the environment.

Detailed information regarding EPSP is located at: [www.iodp.org/epsp/](http://www.iodp.org/epsp/).

#### **2.3.6. Site Survey Panel**

The Site Survey Panel (SSP) reports to the Science Planning Committee. The panel advises drilling proponents, the Science Steering and Evaluation Panel, and the Science Planning Committee on the degree of completeness of the drill site characterization data package, and on whether the scientific objectives of each drill site can be effectively achieved on the basis of the proposal and data package.

Detailed information regarding SSP is located at: [www.iodp.org/ssp/](http://www.iodp.org/ssp/).

#### **2.3.7. Scientific Technology Panel**

The Scientific Technology Panel (STP) reports to the Science Planning Committee, and may communicate directly with IODP Management International (IODP-MI). The panel contributes information and advice with regard to handling of IODP data and information, methods and techniques of IODP measurements (including factors that impact measurements, such as sample handling, curation, etc.), laboratory design, portable laboratory needs, downhole measurements and experiments, and observatories.

Detailed information regarding STP is located at [www.iodp.org/stp/](http://www.iodp.org/stp/).

### **2.3.8. Industry-IODP Science Program Planning Group**

The Industry-IODP Science Program Planning Group (IIS PPG) reports to the Science Planning Committee. The Industry-IODP Science Program Planning Group identifies subjects of cooperative scientific research between the IODP and selected industries, and promotes development of IODP drilling proposals to address these objectives within the context of the IODP Initial Science Plan. Industrial sectors of interest may include oil and gas and related services, mining, biotechnology, and research and development organizations in these fields.

Detailed information regarding the IIS-PPG is located at: [www.iodp.org/iis-ppg/](http://www.iodp.org/iis-ppg/).

### **2.4. Program Member Offices**

Each IODP partner has a representative Program Member Office (PMO) that supports the involvement of member country/consortia scientists in IODP. PMOs nominate member country/consortia scientists for expeditions and for service on IODP science panels and committees. Information on IODP Program Member Offices is located at: [www.iodp.org/program-member-offices/](http://www.iodp.org/program-member-offices/).

#### **2.4.1. European Science Support Advisory Committee**

For more information about ESSAC, please visit: [www.essac.ecord.org/](http://www.essac.ecord.org/).

#### **2.4.2. Japan Drilling Earth Science Consortium (J-DESC)**

For more information on J-DESC, please visit: [www.aesto.or.jp/j-desc/english/index\\_e.html](http://www.aesto.or.jp/j-desc/english/index_e.html).

#### **2.4.3. Korea Integrated Ocean Drilling Program (K-IODP)**

For more information on K-IODP, please visit: [www.kodp.re.kr/](http://www.kodp.re.kr/).

#### **2.4.4. Ministry of Science and Technology of the People's Republic of China**

For more information on MOST please visit: [www.most.gov.cn/eng/](http://www.most.gov.cn/eng/).

#### **2.4.5. U.S. Science Support Program (USSSP)**

Additional information about the USSSP is available at: [www.usssp-iodp.org/](http://www.usssp-iodp.org/).

## **3. SCIENCE PLANNING**

Science planning in IODP is an ongoing process, occurring at all levels of the Science Advisory Structure and IODP management. In the short term, the Science Advisory Structure and IODPMI formulate science plans via the IODP Annual Program Plan. In the longer term, the Science Advisory Structure and IODP-M produce planning documents based on deliberations of detailed planning groups and program planning groups, the outcomes of community-wide conferences and workshops, program

evaluations, and other science planning activities. From time to time, IODP will summarize long-term goals and objectives in a published IODP Science Plan, such as the current IODP Science Plan, entitled “Earth, Oceans, and Life.”

### **3.1. SAS Activities**

The Science Advisory Structure evaluates the readiness of scientific drilling proposals in achieving the goals discussed in the Initial Science Plan. The Science Planning Committee, with the aid of the Operations Task Force, selects submitted proposals to be incorporated into annual, multi-platform drilling plans that address the long-term goals of IODP. These plans are formalized by IODP-MI, which then presents them to the Science Advisory Structure Executive Committee and ultimately to the IODP Council for review and approval. Costs and logistical considerations, as well as the list of highly ranked drilling proposals provided by the Science Advisory Structure, figure into the development of the Annual Program Plan.

In tandem with science planning, the Science Advisory Structure also evaluates the needs and plans for technological advancement and engineering innovations that are required to meet the long-term scientific objectives of the Initial Science Plan. All such planning, along with the budgetary impact of executing these plans, must be conducted well in advance; lead time is necessary for engineering and logging developments, and for the establishment and operation of long-term observatories. In these tasks, the Science Advisory Structure works with IODP-MI and the Implementing Organizations to merge scientific priorities with program capabilities.

### **3.2. Proposal Development**

The proposal process provides tremendous opportunities for individuals and groups, including other science programs in liaison with IODP, to explore the frontiers of Earth Science and related disciplines through ocean drilling. The success of IODP rests with the quality of the science proposed and carried out by the community-at-large. Through proposals, individual scientists and groups of scientists have the opportunity to respond to IODP’s scientific priorities, as expressed in the Initial Science Plan, and to recommend appropriate targets for drilling. Scheduling a drilling activity is a major investment of time and funds. Hence, proposals need to be well developed before the Science Planning Committee can consider them. The nurturing, development, and evaluation of proposals are the prime responsibility of the Science Steering and Evaluation Panel. Full development of a drilling proposal can take several years.

Another important aspect of developing a drilling proposal is the collection of the requisite survey information (geophysical, geological, and hydrographic) for both regional and site-specific characterization. The completion of necessary surveys, and the submission of supporting survey data to IODP, is in part the responsibility of the proponents (for regional data), and in part the responsibility of IODP (for site-specific information related to safety). All of this coordination requires long-term planning and careful attention to timing and reviewer and panel recommendations and requests.

In developing and revising a scientific ocean-drilling proposal, proponents may, with the permission of the Science Planning Committee Chair, seek technical and safety-related advice from the Science and Technology Panel and the Environmental, Pollution and Safety Panel. They may also wish to seek help from the Industry Liaison Panel for identifying suitable coproponents in industry or for identifying industry data collected within the proposed study area.

### 3.3. Drilling Proposals

Figure 7 illustrates how a proposals moves through the Science Advisory Structure planning process to reach the stage of actual scheduling.

**Figure. 7: Proposal Submission, Evaluation, and Scheduling Process**

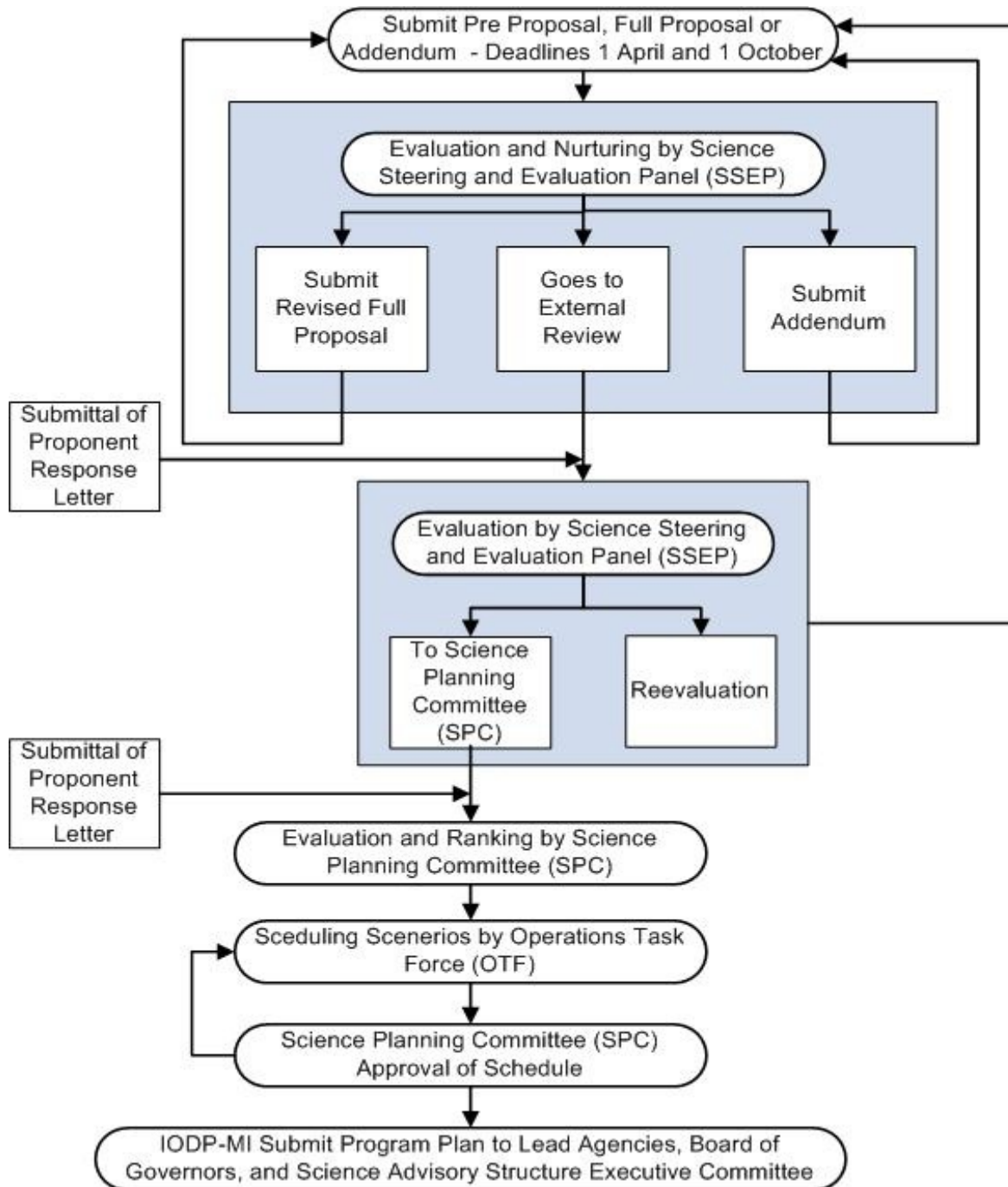

The initiation of the proposal process begins with one of two primary steps:

Submission of a “Preliminary Proposal” that will be evaluated and nurtured (if appropriate) through panels within the Science Advisory Structure; and

Subsequent submission of a “Full Proposal” that is developed while taking into account the advice from the appropriate Panels.

Guidelines for each of these proposal types are outlined. Details regarding the proposal submission process, both guidelines and best practices, are available at <http://www.iodp.org/drilling-proposals/>.

### **3.3.1. Schedule for Submission of IODP Proposals**

Proposals for scientific ocean drilling may be submitted to the Science Coordinators in the IODP-MI Sapporo Office at any time. However, in order to be considered in the annual cycle of Science Advisory Structure panel meetings, there are two deadlines each year for submission of IODP proposals: 1 April (for the Spring Science Steering and Evaluation Panel meeting) and 1 October (for the Fall Steering and Evaluation Panel meeting). Mission proposals have an annual deadline of 1 April. All proposals must be submitted in electronic form through the IODP web site ([www.iodp.org](http://www.iodp.org)) and must follow the length and format limitations described in the proposal guidelines. The IODP-MI will deactivate a proposal or ancillary project letter following the absence of any formal activity for a three-year period or as otherwise recommended by the Science Advisory Structure.

A short outline about the three main types of drilling proposals (i.e., Preliminary, Full, and Mission) and the SAS review process is presented below. Detailed information can be found at: [www.iodp.org/drilling-proposals/](http://www.iodp.org/drilling-proposals/).

### **3.3.2. Preliminary Proposals**

New ideas for scientific ocean drilling are generally submitted initially as Preliminary Proposals. This allows the Science Advisory Structure to evaluate the proposed scientific and technical goals and provide guidance to proponents as to how a competitive full proposal may be prepared. Proponents may be individual scientists or groups of scientists, including national or international scientific groups or programs that are independent of IODP. In each case, the individuals who are submitting the Full Proposal must be named, and a single contact proponent must be clearly identified.

In exceptional cases (such as a narrow window of opportunity to test an exciting, fundamental scientific idea), a new project can bypass the Preliminary Proposal stage and be submitted initially as a Full Proposal. Proponents are encouraged to begin with a Preliminary Proposal so as to evaluate the level of interest from the Science Advisory Structure and target their program accordingly before expending the considerably greater effort necessary to craft a Full Proposal. In addition to the greater overall length and level of detail of Full Proposals compared to Preliminary Proposals, there are considerable data requirements for Full Proposals. Bypassing the Preliminary Proposal stage may not help to move their proposal forward within IODP quickly, and could even result in a net loss of time if the initial submission is not well received by the reviewers and Science Advisory Structure and a new preliminary proposal is required.

Shortly after each proposal deadline, all new and revised preliminary proposals go to the Science Steering and Evaluation Panel for review. The Science Steering and Evaluation Panel assesses each preliminary proposal in terms of its relevance to the IODP Initial Science Plan, the suitability of the study area and study sites for addressing the proposed scientific objectives, and whether the achievement of those objectives would likely result in any fundamental scientific advances. The Science Steering and Evaluation Panel also determines whether a given preliminary proposal provides a satisfactory basis for developing a complex drilling project.

Written reviews from the Science Steering and Evaluation Panel will be returned to the contact proponent with recommendations on how to proceed with proposal development.

### **3.3.3. Full Proposals**

Proponents who have previously submitted a preliminary proposal may submit a full proposal if advised to do so by the Science Steering and Evaluation Panel. In some cases, an individual scientist or group of scientists with a new idea for scientific ocean drilling may submit a full proposal without first submitting a preliminary proposal, provided that it meets all of the relevant requirements.

A well-prepared full proposal should:

- State the scientific objectives and explain how those objectives relate to, or advance beyond, the IODP Initial Science Plan,
- Justify the need for drilling to accomplish the scientific objectives,
- Present a well-defined strategy for addressing the scientific objectives through drilling, logging, or other down-hole measurements,
- Provide detailed estimates of the time required for drilling, logging, or other downhole measurements,
- Describe the available site-survey data and any plans for acquiring additional data, and discuss how the drilling targets relate to those data,
- Describe any special logistical requirements, non-standard measurements technology, or potential natural hazards,
- Discuss the expected scientific outcome of drilling and any subsequent work required to complete the overall project.

Full Proposals are reviewed by the Science Steering and Evaluation Panel with respect to the fundamental scientific advances that the proposed drilling might make; its relevance to the Initial Science Plan; and the appropriateness of both geographic location and proposed operations for addressing the proposed scientific objectives of the proposal. The Science Steering and Evaluation Panel will determine whether the Full Proposal meets criteria necessary for solicitation of external reviews. These criteria are:

1. The proposal addresses one or more scientific problems that are identified as a high priority in the IODP Initial Science Plan (or moves IODP beyond the Initial Science Plan into new, exciting fields of study);
2. There is clear indication that IODP assets and facilities provide the best means to achieve the scientific objectives to be addressed;
3. There is a well-defined operational strategy, the success of which can be assessed on the basis of the data presented in the proposal.

If these criteria are met, the Science Steering and Evaluation Panel will recommend to the IODP-MI Science Coordinators that external comments be acquired. If it is determined that the three criteria are not met adequately, the Panel will advise the proponents (through the Science Coordinators) as to revisions necessary for further consideration.

Proponents will receive the external reviews of their proposal from the Science Coordinators and may



then submit a brief response letter before the next proposal deadline. The steering panels will also receive the external reviews, together with the response letter, and will then write a final panel review assessing the priority of the proposal with respect to the IODP Initial Science Plan. Full proposals that have undergone external review will automatically go forward to the Science Planning Committee for ranking and potential implementation.

### **3.3.4. Mission Proposals**

A new concept in IODP is that of the “Mission Proposal”. A mission is an intellectually integrated and coordinated drilling strategy originating from the scientific community that addresses a significant aspect of the IODP Science Plan theme over an extended period and which merits urgent promotion in order to achieve overall IODP program goals.

A mission proposal outlines and explains the scientific factors that unite a number of individual projects to address an important global scientific theme. It provides an overall identity for the expedition or expeditions that fall within its scope. Although more detailed, full proposals are required for each component of the mission, those proposals will be reviewed in terms of their contributions to the overall mission. Missions and mission proposals are described in greater detail in the document “IODP Missions: Designation and Implementation” (available at [www.iodp.org/missions/](http://www.iodp.org/missions/)).

Mission proposals will be reviewed both within the Science Advisory Structure and by an external review panel. The major criteria in considering mission designation will include: (i) the plan should lead to considerable scientific success and is or should be a high priority for IODP; and (ii) accomplishment of the science goals will require a considerable technological effort and/or complex, multiple drilling strategies, hence requiring planning on a longer term than is typical of “normal” drilling expeditions.

Shortly after each 1 April deadline, all new mission proposals go to the Science Steering and Evaluation Panel for review. The Science Steering and Evaluation Panel forwards its evaluation to the Science Planning Committee. The Science Steering and Evaluation Panel will also provide comments on the compositions of the mission teams. In parallel with the Science Steering and Evaluation Panel review, an external review panel appointed by the Science Advisory Structure Executive Committee will conduct an independent review of the mission proposals as a group, and will forward its evaluations to the Science Planning Committee. The Science Planning Committee will consider the recommendations and the proposals, possibly selecting one or more to be designated as missions. For those selected, the Science Planning Committee will also provide a recommendation on the composition of the Stage 1 core mission team. Other possible outcomes of the Science Planning Committee evaluation are: (i) outright rejection; (ii) recommendation for revision and/or resubmission; or (iii) recommendation that a proposed mission be “unbundled,” with some components being submitted as regular drilling proposals. The Science Planning Committee will also provide comment on the needed expertise for the Stage 1 core mission team.

All mission-component full proposals must fulfill the normal requirements for full proposals and follow the normal review process. The Science Steering and Evaluation Panel will forward mature component proposals to the Science Planning Committee, which will include them in its overall ranking of all proposals forwarded by the Science Steering and Evaluation Panel. As with any proposal, mission-component proposals will need to rank high enough to fall in the group to be sent forward to the Operations Task Force for scheduling.



### **3.3.5. Evaluation and Ranking by Science Planning Committee**

For each Science Steering and Evaluation Panel externally reviewed proposal, a package is assembled and forwarded to the Science Planning Committee members that contains:

- The Science Steering and Evaluation Panel review of the proposal;
- The external comments received from anonymous evaluators;
- The proponents' response to the external comments;
- An assessment by the Science Steering and Evaluation Panel as to the priority of the drilling program in the context of the overall achievement of the IODP Initial Science Plan (or how the proposal addresses an exceptional scientific opportunity).

At its annual spring meeting, the Science Planning Committee takes all this information into consideration and conducts a global ranking of the proposals in terms of their scientific priority. The Science Planning Committee acts under strict conflict-of-interest guidelines, and the ranking procedure is also clearly enunciated. A subset of ranked proposals is selected and forwarded to the Operations Task Force for possible scheduling as drilling legs. Those that do not get selected are advised as to whether (i) the Science Planning Committee wishes to keep the proposal active for consideration at a later time (e.g., perhaps when more data are available, pending results from an already scheduled drilling expedition or scheduled geophysical survey), (ii) the Science Planning Committee wishes to see a revision, in which case the proposal is reconsidered by the Science Steering and Evaluation Panels and sent out again for external comment, or (iii) the Science Planning Committee will not consider it further.

### **3.3.6. Scheduling by the Operations Task Force**

The Operations Task Force meets following the Science Planning Committee, with the main goal devising a multi-platform science schedule for the next operating time window (typically the next unscheduled year of operations, but the planning window may vary in length depending on the nature of programs to be scheduled). Issues that are considered in planning a final schedule include the Science Planning Committee ranking, site-survey readiness, potential safety and pollution considerations, technological requirements and readiness (including, but not limited to: core recovery, enhancements to the standard set of logging tools, use of re-entry cones, and casing), availability of the appropriate platform(s), operational considerations (weather, ice cover, currents, and transit times between potential drilling sites), research clearance issues, heave restrictions in shallow water, and budgetary considerations. Operations Task Force then forwards its proposed schedule to the Science Planning Committee for final approval.

Proponents of proposals scheduled by the Operations Task Force are notified in writing. Proponents of proposals sent forward by the Science Planning Committee to the Operations Task Force, but not scheduled for drilling in the particular fiscal year of interest, receive an explanation of the decision and recommendations for future action. Such proposals generally are not revised and are not sent out for a second external evaluation.

The scheduling of a proposal is not the end of the planning process. Shortly after the schedule is finalized, the Environmental, Pollution and Safety Panel will review the proposal. This requires the compilation of a data package to be submitted to Environmental, Pollution and Safety Panel for a safety review. Depending on the nature of proposed operations, more than one Environmental, Pollution and Safety Panel review may be required.

## 4. TECHNOLOGY PLANNING

IODP is committed to dramatically improving the technological capabilities of the scientific ocean drilling program. Through the use of state-of-the-art drilling vessels, through the vision and aptitude of top scientists and engineers worldwide and through the encouragement of the IODP community, IODP has the ability to continue improving upon the tools necessary to further our understanding of earth and its complex systems.

### 4.1. Current Drilling Technology

IODP's goal is to be able to drill and continuously core at almost any location in the world's oceans. To achieve this goal, the international community has consistently emphasized the use of multiple drilling platforms, including a riser (well-control) vessel, a non-riser vessel, and mission-specific vessels. In response to this requirement, Japan, through its Marine Science and Technology Center (JAMSTEC), has built a riser vessel so that IODP can meet its deep objectives, and also drill targets in potentially overpressured seafloor environments such as seismogenic zones. The US National Science Foundation has supplied funds to significantly upgrade the *JOIDES Resolution* to enable IODP to drill in a wide range of water depths and lithologies where a riser is not needed. Mission-specific drilling platforms will be mobilized in environments not suitable for either of IODP's two primary vessels, such as the polar regions or shallow waters.

An interactive map of the IODP drilling vessels is located at [www.iodp.org/key-technologies](http://www.iodp.org/key-technologies). The map contains links to the drilling technologies being used on each of the three ships.

### 4.2. Technology Road Map

The IODP Engineering Development Panel created a technology roadmap at its June 2006 meeting in Germany. This first version of the roadmap, which is used by IODP-MI and SAS to prioritize funding of IODP engineering proposals, consists of over 80 possible engineering developments broken down into three sub-groups:

- (1) Sampling, Logging and Coring - Near-term engineering focus on improving systems fundamental to IODP (e.g., refinements to core barrels, downhole/formation measurements, etc.)
- (2) Drilling Vessel/Infrastructure - Near-term engineering focus on understanding factors that control core quantity and quality (e.g., rig instrumentation, heave compensation, drilling dynamics, etc.)
- (3) Borehole Infrastructure - Near-term engineering focus on standardizing equipment and procedures

The Technology Roadmap will be continually updated and revised as appropriate by EDP. The technology roadmap can be found at: [www.iodp.org/eng-dev](http://www.iodp.org/eng-dev).

### 4.3. Engineering Development Proposal Process

IODP-MI has created a process to receive, review, and fund proposals for engineering development that will greatly enhance the ability of IODP to achieve the scientific objectives defined in the IODP Initial Science Plan. This process was developed in consultation with the IODP Science Advisory Structure and Implementing Organizations and endorsed by the IODP Lead Agencies. IODP-MI will review and consider all engineering development proposals submitted; however, proposals addressing the technical problems/issues related to the IODP Technology Roadmap will have a greater probability of achieving

funding success then those proposals not aligned with the roadmap.

#### **4.3.1. Funding for Engineering Development Proposals**

IODP Science Operation Costs will fund the successful engineering development proposals submitted to IODP-MI. Projects funded by Science Operation Costs funds will follow the submission, review and implementation procedures described herein and must be part of a Lead Agency approved Annual Program Plan. Engineering development projects not funded by IODP Science Operation Costs funds are not subject to the IODP-MI review process. However, these “third-party” developments or deployments are subject to the IODP Third Party Tool guidelines ([www.iodp.org/program-policies/](http://www.iodp.org/program-policies/)).

#### **4.3.2. Engineering Proposal Types**

Two main types of engineering proposals will be utilized by IODP-MI:

##### **Unsolicited Proposals**

Unsolicited proposals will likely comprise the majority of proposals entering the system. Proponents of unsolicited proposals will most likely have a higher rate of success if they address at least one of the needs identified in the IODP Technology Roadmap. However, these proposals may also identify a development need not envisioned in the IODP Technology Roadmap.

Following the receipt of a proposal, IODP-MI will nurture the proposal by working with the proponent/s to strengthen the submitted material and in some cases suggesting a significant change in scope of work. For example, a feasibility study could be recommended by IODP-MI to explore the viability of a proposed technology.

##### **Solicited Proposals**

Some proposals may be solicited directly by IODP-MI through a Request for Proposal (RFP) process if the pool of unsolicited proposals does not meet the needs of the Program. A solicitation request for a specific technology will be presented by IODPMI to the Science Advisory Structure Panels for their consideration. If the solicitation plan is endorsed, IODP-MI will execute an RFP process ending with the completion of a source selection plan.

#### **4.3.3. Submission and Review Process**

Details of the systematic process of proposal submission, nurturing, review and prioritization by IODP-MI and the Science Advisory can be found at [www.iodp.org/eng/](http://www.iodp.org/eng/).

#### **4.4. Third Party Tools**

A third party tool, which is defined as a tool or instrument developed with funds or resources outside the realm of the IODP, must adhere to the development and deployment guidelines established by the IODP Science Advisory Structure prior to deployment on any IODP expedition. The IODP Science Advisory Structure, in conjunction with IODP-MI and the Implementing Organizations, has created a policy to provide consistent oversight of third party development activity and to provide guidance to all proponents with technology or developments new to the IODP. This document expands upon the Third Party Tool policy by providing additional contextual and timing elements to assist proponents, Implementing Organizations, and the Science Advisory Structure in executing this policy.

The policy, implementation guide and a list of third-party tools used in the past, used currently, and

under development are located at: [www.iodp.org/eng-third-parties/](http://www.iodp.org/eng-third-parties/).

## **5. EXPEDITION INFORMATION**

### **5.1. Expedition Planning**

Once a proposal has been approved by the Science Advisory Structure and scheduled by the Operations Task Force, expedition planning quickly begins.

#### **5.1.1. Staffing**

Approximately 18 months prior to the scheduled expedition, a first call for staffing is announced on the IODP website and also in:

- IODP E-news ([www.iodp.org/community-newsletters/](http://www.iodp.org/community-newsletters/)), a bi-monthly newsletter
- Eos ([www.agu.org/pubs/eos.html](http://www.agu.org/pubs/eos.html)), the weekly American Geophysical Union newsletter that publishes material of interest to Earth and space scientists.
- Newsletters published and distributed by the Program Member Offices ([www.iodp.org/community-newsletters/](http://www.iodp.org/community-newsletters/)).

The announcements provide specific instructions for community scientists on how to apply to their respective Program Member Offices. After Program Member Offices receive and process expedition-staffing applications, they then provide their nominations to the Implementing Organizations. Although each member country/consortia is entitled to their full representation according to the IODP Memorandum of Understanding, there is be no “banking” of unused berths. Berth space can be “traded” between member countries/consortia subject to approval by IODP-MI.

The IOs then work with the PMO, Co-chief scientists to select applicants to fill the various positions on each expedition. Once expedition rosters are agreed upon, the IO sends official invitations directly to each scientist.

Staffing may a two-step process. Initial invitations are sent to key science participants. Key individuals are those considered to provide critical expertise to delivery of the expedition science. Remaining invitations are sent after responses are received from the initial invitations. Sending invitations in two different groupings provides the opportunity to tune the science party based on the results of the initial invitations. This allows for greater flexibility and for maximizing the expedition science.

Special staffing needs may also be identified during pre-cruise meetings and a subsequent call for applicants with specific skill sets might follow.

The IODP policy and procedures on staffing can be downloaded from: [www.iodp.org/program-policies/](http://www.iodp.org/program-policies/).

Interested applicants should apply through their country’s PMO, which has the appropriate application forms and instructions. For more information visit: [www.iodp.org/apply-to-sail/](http://www.iodp.org/apply-to-sail/).

#### **5.1.2. Project Management Team Meetings**

Multi-year, multi-stage expeditions may require a Project Scoping Group and a Project Management Team to plan and coordinate the project through several years of operations. The Project Scoping Group

is assembled as soon as the Science Advisory Structure approves the project. If the Operations Task Force schedules the project, the Project Scoping Group becomes a Project Management Team.

Meetings are held as frequently as needed to plan and coordinate multiple expeditions of the project. After general project scoping is completed, the Project Management Team focuses on the details of expedition planning such as site-by-site operational scoping, drilling strategies, coring and downhole measurement plans, and contingency plans. In addition, they predict possible challenges and hazards, specify critical data sets, determine data requirements, identify site clearance strategies, develop funding scenarios, finalize staffing plans, nominate individuals for specialty science and technology positions, develop plans for long-term observatories, coordinate third-party tool development, and draft a scientific prospectus, etc.

Information about the Project Scoping Groups and Project Management Teams as well as past agendas and reports is located at: [www.iodp.org/project-scoping-groups/](http://www.iodp.org/project-scoping-groups/).

### **5.1.3. Pre-Cruise Meetings**

Pre-Cruise Meetings are held between appropriate implementing organization staff and the co-chief scientists as needed to finalize the operational plans and schedule and to assure cruise logistics are identified and managed. One of the main goals of the pre-cruise meeting is to finalize the Scientific Prospectus, which requires finalizing the schedule, the scientific objectives, drilling strategy, drill site descriptions, logging and downhole measurement plan, sampling strategy, operations schedule, identification of any expedition-specific sampling needs, and any other component of expedition operations that necessitate a formal plan or description. The published Scientific Prospectus and any other important pre-cruise information for each expedition can be found at: [www.iodp.org/expeditions/2/](http://www.iodp.org/expeditions/2/).

## **5.2. Expedition Activity**

### **5.2.1. Expedition operations**

The offshore phase of the expedition follows the operational plan presented in the scientific prospectus as closely as possible with regular daily, weekly and site reports submitted by the operator. Expedition Daily Reports are submitted to appropriate IO and lead agency personnel, and to IODP-MI. The daily reports provide a daily log of location, activity, timeline, transit information, weather, operating parameters, upcoming operational plans and any other pertinent information specific to an expedition.

Expedition Weekly (or Site) Reports provide more details of actual scientific findings. The reports include a summary of operations, preliminary science results, technical support activity and HSE activity.

### **5.2.2. Scientist Job Descriptions**

Participants are invited to serve in particular jobs that need to be completed to ensure scientific success of the cruise. The optimal mix of expertise is determined by the expedition objectives and by the Co-chief Scientists, the Staff Scientist, and the Supervisor of Science Support.

Below are many of the scientific specialties that are required for each expedition:

## **Core Description**

Core describers may have expertise in a wide variety of fields including sedimentology, petrography, petrology, or structural geology. Core description can involve the following tasks:

- Macroscopic visual description of split cores are entered in a core description database that generates standard reports (sediments), or are collected in more detailed core section graphic templates (igneous rocks);
- Microscopic observations from smear slides and/or thin sections, entered in spreadsheet databases and, in some cases, added to the macroscopic description forms;
- Description and measurement of deformational structures;
- Acquisition of data with split-core tracks, including digital images, diffuse color reflectance, and magnetic susceptibility. In some cases, this may also be done by individuals in the physical properties position;
- Preliminary interpretation of depositional, diagenetic, or deformational processes;
- Selection of samples, in consultation with other scientists, for shipboard carbonate, XRD, or chemical (ICP) analysis.
- Analysis of XRD and/or ICP data, if the appropriate expertise exists, this may also be done by one of the inorganic geochemists.

## **Stratigraphic Correlation**

The stratigraphic correlator position is essential on cruises where complete stratigraphic sections are a primary expedition objective. Complete stratigraphic sections are achieved by coring multiple holes at a site. Completion of a meters composite depth (mcd) depth scale in near-real time guides coring operations and ensures complete recovery of the sediment section. A spliced section typically is created and used for sampling. For maximum efficiency, two correlators are needed to cover 24 hours and to guarantee feedback within hours or minutes. Correlation is achieved using workstations and a customized software. The job typically includes operation of the multi-sensor track (MST) because the primary data sets used are magnetic susceptibility, natural gamma radiation, and gamma-ray attenuation density from whole-core logging. Other data may be needed to improve correlation such as color reflectance logs, macroscopic descriptions from split cores, or even biostratigraphic information.

## **Biostratigraphy**

Micropaleontologists provide age data and a biostratigraphic age model for each site. This work mainly is done using core-catcher samples as soon as possible after a core is recovered. Additional samples may be examined to provide as complete a biostratigraphic characterization of the cored section, or of critical intervals, if possible within the time available. Full assemblage analysis is not required on the ship; rather, identification of useful microfossil datums for constructing age-depth plots and sedimentation/accumulation rate curves is the primary emphasis. Paleoenvironmental or bathymetric data, principally from benthic foraminifers, may also be important on certain cruises.

## **Magnetostratigraphy**

Paleomagnetists conduct paleomagnetic measurements and reduction of data to intensities and direction of magnetization. Paleomagnetists also provide absolute orientation data for orientation of deformational structures measured in the core, if appropriate. Some additional rock magnetic properties can be acquired on the ship, which is particularly useful if the magnetic properties are (partly) ephemeral (postrecovery dissolution, reduction, or oxidation of magnetic minerals).

## **Physical Properties**

Scientists assigned to this job usually determine the following properties:

- Moisture content and grain density on core samples
- P-wave velocity on split cores and/or core samples
- Thermal conductivity on full cores or split cores, if appropriate
- Acquisition, analysis, and presentation of downhole temperature measurements;
- Vane shear strength on split cores if warranted by the cruise objectives.

In addition, they oversee and document the overall physical properties measurement program in consultation with other scientists, including the full-core and split-core logging systems. They also ensure that calibrations and control measurements are carried out according to protocol to ensure data quality control.

### **Geochemistry**

The primary responsibility of organic geochemists is to monitor cores for hydrocarbon content. They advise the Operations Manager and scientific party when hydrocarbon levels in cores may constitute a potential safety or pollution hazard. They also provide data concerning organic matter characterization, elemental composition of organic matter, and carbonate carbon content.

Inorganic geochemists conduct chemical analyses on interstitial water, and/or solid sediment, or rock samples.

### **Downhole Logging**

This position includes the following:

- Work closely with the IO logging scientist in designing, implementing, and interpreting the logging program;
- Interact with core physical properties specialists;
- Assist the Schlumberger field engineer with data acquisition if required;
- Participate in integration of core-log-seismic data.

This position sometimes may include the geophysical responsibilities described below. Details about borehole logging can be found at [www.iodp.ldeo.columbia.edu/TOOLS\\_LABS/](http://www.iodp.ldeo.columbia.edu/TOOLS_LABS/).

### **Geophysics**

This position is responsible for the following geophysical tasks:

- Acquisition, analysis, and presentation of downhole temperature measurements and seismic data
- Acquisition and presentation (site surveys);
- Construction of synthetic seismic profiles;
- Vertical or offset seismic profiling
- May participate in acquisition, analysis, and presentation of downhole temperature measurements (see "Physical Properties" above).

### **Microbiology**

Major responsibilities of the shipboard microbiologist include the following:

- Conduct onsite contamination tests by adding highly sensitive tracers (perfluorocarbons and/or fluorescent microspheres) to the drilling fluid or core barrel to evaluate extent of contamination of cores by the drilling process;
- Conduct sampling for shipboard and shorebased microbiological analyses;
- Analyze thin sections of sediments or rocks for preliminary interpretations on contamination and bacterial activity;

- Start cultures and incubation of samples using different media;
- May participate in the chemical analysis of interstitial waters.

### **5.3. Post Expedition Activity**

#### **5.3.1. Post Expedition Sampling**

When feasible, scientists are permitted to collect samples during an expedition. However, in many cases (e.g. MSP operations, high-recovery expeditions, minimal transit time to port) members of the scientific party may need to complete sample requests during a post-expedition sampling party at the appropriate core repository.

#### **Expedition Moratorium**

A moratorium period of one year is granted to members of the expedition science party to conduct drilling project-related research before core samples and data are made available to the general scientific community. During this period, only members of the science party are permitted to receive core samples and/or associated data. The Sample Allocation Committee, comprised of the Expedition Co-Chiefs, Staff Scientist, and Curator, are responsible for approving all moratorium sample requests. The moratorium period may be appropriately adjusted to account for specific issues affecting the scientific objectives of the expedition.

The science party is defined as those scientists selected by IODP to produce initial, openly shared data associated with a particular drilling project within the moratorium period. After the moratorium period ends, samples are given or loaned to persons whose requests have been approved by the IODP Curator in the following three categories:

- Scientists who wish to conduct research on IODP materials and publish the results but who are not necessarily associated with a specific drilling project,
- Curators of museums and collections, and
- Educators.

After the moratorium period expires, project data are also publicly available.

#### **Post Moratorium Sampling**

Samples and data are available to research scientists, educators, museums, and outreach institutions amongst others. IODP has a specific sample, data, and obligations policy to:

- Ensure availability of samples and data to Science Party members so they can fulfill the objectives of the drilling project and their responsibilities to IODP;
- Encourage scientific analyses over a wide range of research disciplines by providing samples to the scientific community;
- Preserve core material as an archive for future description and observations, nondestructive analyses, and sampling;
- Disseminate “Expedition Research Results” papers published in the Proceedings of the Integrated Ocean Drilling Program from drilling project-related research; and
- Support education and outreach related to the drilling program by providing core materials to educators, museums, and outreach institutions.

#### **Sample- and Data-Recipient Responsibilities**

Receipt of samples and data comes with a specific obligation to conduct research and publish their



results. Papers must be published in a peer-reviewed scientific journal or book published in English. In the event that research is discontinued, samples may have to be returned as per instructions from IODP Management International, Inc. Manuscripts for publication must be submitted within 20 months post-mortatorium.

Those scientists not meeting the above obligations may be restricted from obtaining future samples and/or data and may not be allowed to participate in future drilling projects. Obligations incurred during the Ocean Drilling Program (ODP) will be carried forward into IODP.

The Sample, data and obligations policy as well as online sample request forms, online core images, core data, log data and contact information can be found at: [www.iodp.org/access-data/](http://www.iodp.org/access-data/).

#### **5.4. Core Repositories**

IODP oversees repositories around the world. Samples are distributed according to ODP and IODP policies.

IODP maintains three international core repositories: The Gulf Coast Repository (GCR) at Texas A&M University in College Station, TX, USA; The Bremen Core Repository (BCR) at the University of Bremen in Bremen, Germany and; the Kochi Core Center (KCC) in Kochi, Japan. Each repository archives cores based on their geographic location.

For more information on the repositories, please visit: [www.iodp.org/repositories/2/](http://www.iodp.org/repositories/2/).

#### **5.5. Data**

##### **5.5.1. Core and Sample data**

IODP is developing a web-based information service to facilitate access to all data and information related to scientific ocean drilling, regardless of origin or location of data. This service will be designed to integrate distributed scientific drilling data via metadata. The three main data contributors to information service will be the IODP implementing organizations (IOs) from the United States (USIO), Japan (CDEX) and European Consortium (ESO). More information can be found about this service at: <http://sedis.iodp.org/>.

Until this new information service is available, each of the implementing organizations will maintain its own database to archive the data and to make it easily available to the public. Each database includes paleontological, lithostratigraphic, chemical, physical, sedimentological, and geophysical data for ocean sediments and hard rocks.

##### **USIO – SODV (formerly *JOIDES Resolution*)**

The shipboard collected core data for each USIO expedition is stored at Texas A&M University (TAMU), [www.iodp.tamu.edu/database/index.html](http://www.iodp.tamu.edu/database/index.html).

All USIO logging data is processed and stored at Lamont-Doherty Earth Observatory (LDEO), <http://iodp.ldeo.columbia.edu/DATA/IODP/>.

##### **ESO – Mission Specific Platforms**

The ESO MSP data is located at: <http://iodp.wdc-mare.org/>.

## **CDEX – CHIKYU**

All *CHIKYU* data is currently located at:

[http://www.jamstec.go.jp/CHIKYU/eng/Expedition/data\\_sample.html](http://www.jamstec.go.jp/CHIKYU/eng/Expedition/data_sample.html).

### **5.5.2. Site Survey Data Bank (SSDB)**

The Site Survey Data Bank (SSDB) provides an online resource for IODP proposal proponents, reviewers, and panel members worldwide. On average, IODP maintains more than 100 active proposals, involving nearly 1,000 proponents from more than 40 countries. During the process through which IODP proposals evolve into fully mature scheduled expeditions, different sources of data are submitted to augment an original proposal. These data are maintained by the SSDB in a secure and user-friendly environment.

Conceived by IODP-MI in collaboration with Scripps Institute of Oceanography (SIO) at the University of California, San Diego, and the San Diego Supercomputer Center, the SSDB enables users to monitor their proposal status graphically by proposal number, data type, or date. A geographic Java SSDB viewer allows users to view all proposal data objects displayed over a base map of global topography, crustal age, or other custom maps. Data may be viewed or downloaded under password control.

To find out more about the SSDB, and/or to download or contribute data, please visit:

<http://ssdb.iodp.org/>.

## **5.6. Expedition Publications**

IODP publishes numerous documents, mostly in electronic form. Below is a brief summary of these documents and their locations. Please visit <http://www.iodp.org/scientific-publications/> for more details and access to IODP publications.

### **5.6.1. Proposals**

The final version of the expedition proposal is published and made available by IODP. The Science Advisory Structure-approved proposal contains the final information and data describing scientific goals, detailed information on geological setting, drilling justification, drilling and logging/downhole measurement strategies, and site survey data. The site survey data provides general site information such as location, jurisdiction, and water depth, and operation information such as general lithologies, coring plan, logging plan, estimated operational time required, hazards, and expected weather, specific details on available site survey data and data still to be collected, detailed logging plan, and a pollution and safety hazard summary. These data are provided for both planned and contingent sites.

### **5.6.2. Scientific Prospectuses**

The Scientific Prospectus is compiled by the Expedition Co-chief Scientists and finalized during the Pre-Cruise meeting. The document includes all the details describing exactly how the expedition's scientific goals will be met including: a final schedule, the scientific objectives, drilling strategy, drill site descriptions, logging and downhole measurement plan, sampling strategy, operations schedule, identification of any expedition-specific sampling needs, and any other component of expedition operations that necessitate a formal plan or description.

### **5.6.3. Ship Reports**

Daily operational reports are sent from IODP vessels. Relevant portions of these reports can be accessed via the IODP website (<http://www.iodp.org>).

### **5.6.4. Preliminary Report**

A Preliminary Report is released approximately 2 months following the conclusion of offshore operations. The Preliminary Report reiterates the background and scientific objectives of an expedition and also presents the hypotheses tested, summaries of operations and findings at each site, preliminary scientific conclusions and observations, and a preliminary scientific assessment.

### **5.6.5. Proceedings**

The Proceedings present the scientific and engineering results of IODP drilling projects, each an important component of an international program designed to better understand Earth, its environmental changes and processes, the deep biosphere, and climate change. Expedition Proceedings are published by IODP-MI for IODP under the sponsorship of the U.S. National Science Foundation, Japan's Ministry of Culture, Education, Sports, Science and Technology, and other IODP members. Proceedings are published in two stages: (1) Expedition Initial Reports, and (2) Expedition Scientific Results. The Initial Reports volume contains a detailed summary of the scientific and engineering results from each leg, whereas the Scientific Results volume, published approximately 2 years following the Initial Results volume, contains a series of peer-reviewed papers that describe the results of shore-based studies related to the leg.

Results presented in the Proceedings include information such as:

- Expedition summaries: Scientific and operational objectives, operational strategy, site results, conclusions, references, etc.
- Site Summaries: Site objectives, operations, lithostratigraphy, biostratigraphy, paleomagnetism, composite section, geochemistry, physical properties, references, etc.
- Core Descriptions
- Expedition Research Results: data reports and synthesis reports
- Drilling Location Maps
- Supplemental Material

### **5.6.6. Publications during Expedition Moratorium**

A central goal of IODP publications is to disseminate the results to the scientific community via scholarly journals. To assist a scientific party wishing, during the moratorium period, to publish the key scientific findings from an expedition in a journal that requires a temporary embargo on publication of IODP reports, news releases, and/or publications, IODP has developed a series of procedures and protocols. Please see Section 2.1 of the IODP Sample, Data, and Obligations policy for details (<http://www.iodp.org/program-policies/>).

### **5.6.7. Logging Summary**

Description of logging operations and detailed analysis of log data is presented for each logged hole. An example can be found at: [http://iodp.ldeo.columbia.edu/LOG\\_SUM/311/index.html](http://iodp.ldeo.columbia.edu/LOG_SUM/311/index.html).

Access to all IODP, ODP, and (many) DSDP publications can be found at:  
<http://www.iodp.org/scientific-publications/>.

## 6. Expedition Legacy

Archive and preservation of ocean drilling legacy data is a high priority at IODP. Having complete, well-described, logically organized data sets, from drilling and coring logs to post-expedition publications, for each expedition is vital to the worldwide impact of the program. Efforts are still underway to complete the archives from ODP and efforts are continually underway in IODP to ensure that data capture, archive and organization are a part of every-day operation. Figure 8 exhibits just that. The IODP-MI data management team incorporated all borehole data from DSDP, ODP, and IODP into a single database displayed through Google Earth. Every borehole drilled during any of these three programs can be easily located and related information such as: location, water depth, core recovered and specific core data, can be quickly and effortlessly obtained.

**Figure 8. Map Showing Drills Site Locations for DPSP (green), ODP (yellow) and IODP (red) Boreholes**

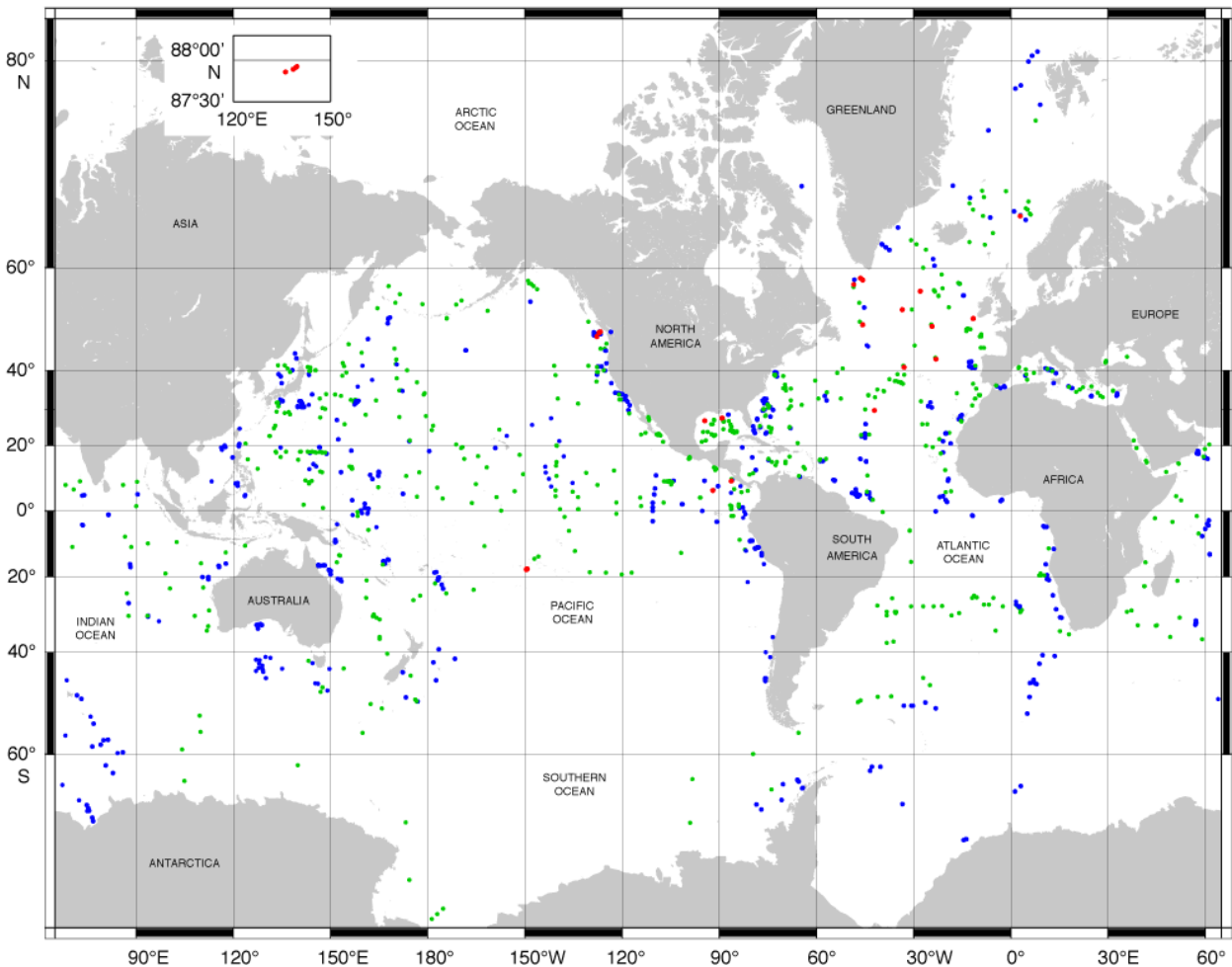

DSDP Legs 1–96 (●), ODP Legs 100–210 (●), IODP Expeditions 301–312 (●)

Program legacy data, currently for DSDP and ODP can be found at: [www.iodp.org/legacy-data/](http://www.iodp.org/legacy-data/)  
<http://www.iodp.org/legacy-data/>.

## **7. Outreach**

### **7.1. Publications**

#### **7.1.1. Website**

Online at [www.iodp.org](http://www.iodp.org), the IODP web portal interlinks numerous IODP program partners and related research programs. Its search engine networks several dozen programs and institutions with content related to scientific ocean drilling.

#### **7.1.2. Scientific Drilling**

*Scientific Drilling* is the IODP program journal. The journal provides reports on deep Earth sampling and monitoring from ocean drilling and continental drilling scientific research projects.

*Scientific Drilling* is a semiannual journal published jointly by Integrated Ocean Drilling Program Management International (IODP-MI) with the International Continental Scientific Drilling Program (ICDP). It is designed to enhance communication between IODP and ICDP, and other scientific drilling communities. IODP and ICDP welcome contributions on any aspect of scientific drilling, including borehole instruments, observatories, and monitoring experiments.

To view past issues or subscribe to the mailing list, please visit: <http://www.iodp.org/scientific-drilling/4/>.

#### **7.1.3. E-News**

E-News is a bi-monthly newsletter sent out electronically to keep interested persons informed on IODP expeditions, ships, platforms, and other breaking news. To view past E-News issues or subscribe to the mailing list, please visit: <http://www.iodp.org/community-newsletters/>.

#### **7.1.4. News / Media**

IODP is committed to keeping the latest happenings in scientific drilling research in the news. The website has a doorway designed specifically for the media with news releases, publications, fact sheets, and other useful tools and information including a direct link for submitting media requests.

To view recent and past news articles, please visit: <http://www.iodp.org/news-releases/2/>.

For media requests such as an interview with IODP representative, high-resolution images, or an onsite visit to a drilling vessel, please fill out a request form at:

[http://www.iodp.org/Portal2?iodp\\_sub\\_template=Portal2sub](http://www.iodp.org/Portal2?iodp_sub_template=Portal2sub).

### **7.2. Public Interface**

### **7.2.1. IODP Distinguished Lecture Series**

The Integrated Ocean Drilling Program (IODP) has launched a new lecture series: **IODP DRILLS**, the Distinguished **R**esearcher & **I**nternational **L**eadership **L**ecture **S**eries.

**IODP DRILLS** is a topical scientific lecture series that features prominent, internationally known scientists describing scientific results derived from samples retrieved from beneath the ocean floor. **DRILLS** will actively engage future generations of scientists in ocean drilling, while highlighting scientific ocean drilling's major accomplishments to the scientific community and beyond.

Academic and educational institutions with lively scientific communities are urged to invite a DRILLS scientist to visit and give a lecture. DRILLS lecturers are fully supported by the Integrated Ocean Drilling Program. It's easy to host a lecturer: visit IODP at [www.iodp.org/DRILLS](http://www.iodp.org/DRILLS) and submit your request using the short form online.

### **7.2.2. IODP Topical Symposia**

IODP-MI, with the assistance of the Science Advisory Structure Executive Committee, supports topical symposia designed to address broader topics of scientific ocean drilling and serve as an outreach outlet to the scientific community.

IODP's first topical symposium, "North Atlantic and Arctic Climate Variability", will be held Aug. 15–16, 2007, at the University of Bremen, in coordination with other events highlighting the International Polar Year. For more information on the climate symposium, go to <http://www.iodp.org/topical-symposium/2/>.

### **7.2.3. Town Hall Meetings**

Cosponsored by the European Consortium of Ocean Research Drilling and IODP-MI since IODP began operating in 2004, Town Hall Meetings are convened around broad themes, feature presentations on emerging topics from scientists working in the program, and are usually held at American Geophysical Union and the European Geophysical Union.

### **7.2.4. Conference Outreach**

IODP aims to meet scientists, engineers, teachers, and academics at large international, regional, and national professional conferences worldwide. Through special technical sessions and exhibitions, IODP seeks to recruit young, interested, and diverse scientists to participate in scientific ocean drilling.

### **7.2.5. Educational Initiatives**

IODP reaches out to teachers and students with unique programs designed to interest young people and adults in scientific investigations of Earth and the ocean floor. Recent successful programs include "School of Rock," rolled out by the USIO for science teachers ([www.joilearning.org/schoolofrock](http://www.joilearning.org/schoolofrock)); "Sand for Students" introduced to high school students in Japan (add link); and teacher workshops presented by ECORD to academics attending EGU (<http://www.sand4students.net/>).

**Table B-1. Observatory**

<b>Model Site Description</b>	Global
<b>Scientific Objectives</b>	Emplace seismographs, CORKS, A-CORKS, and strain gauges To study Earth's structure, hydrology, and deformation
<b>Water Depth Range (m)</b>	2,000-6,500
<b>Maximum penetration (m below seafloor)</b>	100 for seismographs 2,000-4,000 for others
<b>Possible Conditions</b>	
Degree of fractures	Common
Porosity	Variable: high in crust and fault zones; low elsewhere
Pore pressure	Up to lithostatic in fault zones
Existence of volatiles	Probably not
<b>Percent Recovery Required</b>	Low recovery acceptable for seismograph observatories High recovery necessary for fluid and strain observatories
<b>Maximum Core Disturbance Tolerated</b>	Some disturbance acceptable for seismograph observatories Minimum disturbance required for fluid and strain observatories
<b>Sampling, Testing, and Logging Needs</b>	
Core sampling	Some coring necessary for seismograph observatories; Continuous coring desired for fluid and strain observatories
Core sample diameter	–
In situ sampling and testing	– (for seismograph observatories) Geothermal tools, pore pressure, pore waters
Down-hole logging	Long-term straddle packer, pump tests <i>Essential logs:</i> natural gamma, density, sonic ( $V_p$ and $V_s$ ), caliper, porosity, temperature, FMS/FMI, BHTV, resistivity (DLL), check shots (WST) <i>Useful logs:</i> LWD, resistivity images (ARI), geochemical (GLT), fluid sampling/pump tests/pore pressure (MDT), permeability (MDT and NMR), VSP (3-comp./offset)
<b>Endurance</b>	
Maximum days at sea without resupply	14 (for seismograph observatories) Up to 60 for other observatories
<b>Environmental Conditions</b>	
Wind	Highly variable for seismograph observatories Moderate for fluid and strain observatories
Sea state	Highly variable for seismograph observatories Moderate for fluid and strain observatories
Temperature	Highly variable for seismograph observatories Moderate for fluid and strain observatories
Ice conditions	Not for most sites
<b>Other Program Requirements</b>	Proper casing Reentry cone Multi-level A-CORK

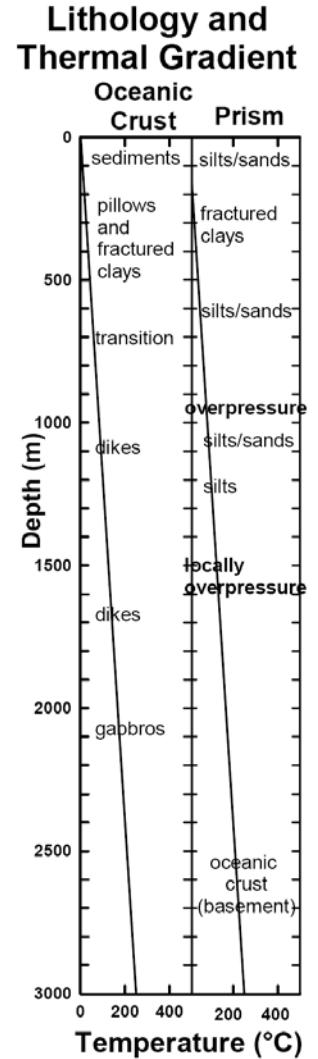

**Table B-2. Rifting Processes**

<b>Model Site Description</b>	Areas of continental extension (e.g., Gulf of Aden, Woodlark Basin)
<b>Scientific Objective</b>	Determine fabric and deformation history, including the role of low-angle normal faults
<b>Water Depth Range (m)</b>	200-2,000
<b>Maximum penetration (m below seafloor)</b>	2,000
<b>Possible Conditions</b>	
Degree of fractures	Generally minor, can be high
Porosity	Generally high (70-80%), can be low (5%)
Pore pressure	Generally minor, can be high
Existence of volatiles	Possible hydrocarbons
<b>Percent Recovery Required</b>	As high as possible (typically 70-80% for sediments; 50-60% for igneous rocks)
<b>Maximum Core Disturbance Tolerated</b>	Minimum disturbance required
<b>Sampling, Testing, and Logging Needs</b>	
Core sampling	XCB and RCB for sediments; RCB for igneous rocks
Core sample diameter	Standard ODP
In-situ sampling and testing	Geothermal gradient; in-situ pore water sampling; pore pressure
Down-hole logging	<i>Essential logs:</i> natural gamma, density, sonic ( $V_p$ and $V_s$ ), caliper, porosity, temperature, FMS/FMI, BHTV, resistivity (DLL), check shots (WST), fluid sampling (MDT), LWD (resistivity images and density/porosity) <i>Useful logs:</i> resistivity images (ARI), geochemical (GLT), VSP (3-comp./offset)
<b>Endurance</b>	
Maximum days at sea without resupply	Up to 60
<b>Environmental Conditions</b>	
Wind	Gentle to moderate for wind, sea state, and temperature; requires picking the right season
Sea state	
Temperature	
Ice-conditions	–
<b>Other Program Requirements</b>	CORKS, A-CORKS, packer experiments

**Lithology and Thermal Gradient**

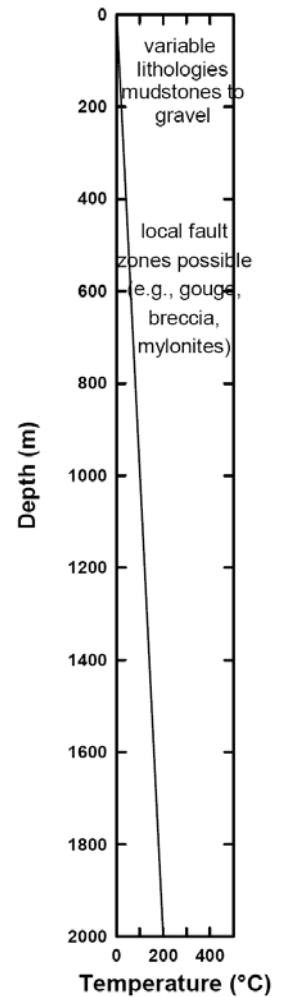
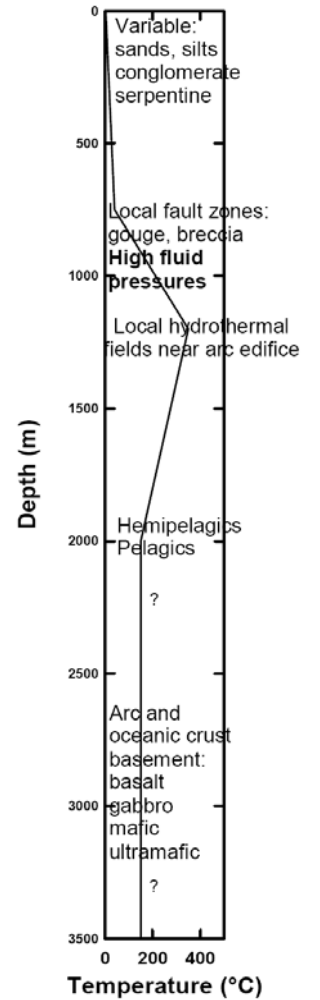



**Table B-3. Convergent Margin**

<b>Model Site Description</b>	Convergent margins (e.g., Nankai, Central America, Izu Bonin-Mariana, Aleutians, Scotia, Taiwan)
<b>Scientific Objectives</b>	Determine relationship between physical and chemical properties of rocks in zones of active seismicity Quantify kinematics and document role of normal faulting in exhumation Quantify/monitor fluxes of sediment, fluids, and basalt Determine early arc history and investigate hydrothermal and ore-forming processes
<b>Water Depth Range (m)</b>	500–7,000
<b>Maximum penetration</b>	2,000–4,500 (m below seafloor)
<b>Possible Conditions</b> Degree of fractures Porosity Pore pressure Existence of volatiles	High probability of fractures, swelling clays Variable: moderate (10-20%) to high (60-70%) Variable: hydrostatic to lithostatic Gas hydrates, biogenic and thermogenic methane, and heavier hydrocarbons
<b>Percent Recovery</b>	As high as possible; if low, then stable holes with logs
<b>Maximum Core Disturbance Tolerated</b>	Minimal to preserve structural fabrics and to minimize contaminating core interiors
<b>Sampling/Testing/Logging</b> Core sampling  Core sample diameter  In situ sampling and testing  Down-hole logging	APC, XCB, and RCB with large sample volumes for physical properties and geochemical and structural studies; possible interbeds of mud and thick unconsolidated sands requiring use of short stroke (~2 m) APC and/or vibracore techniques; directional drilling desirable; oriented cores necessary for structural studies; coring system effective to maintain in-situ P, T  ODP core diameter acceptable; larger diameter better to allow running some downhole logging tools Temperature, pore pressure, gas and fluid compositions, permeability, microbial Sample coils recoverable from outside seal <i>Essential logs:</i> natural gamma, density, sonic ( $V_p$ and $V_s$ ), caliper, porosity, temperature, FMS/FMI, resistivity (DLL), check shots (WST), fluid sampling (MDT), LWD (resistivity images and density/porosity), geochemical (GLT) <i>Useful logs:</i> resistivity images (ARI), BHTV, magnetic susceptibility/reversals (GHMT), VSP (3-comp./offset)
<b>Endurance</b> Maximum days at sea	Fit-to-mission
<b>Environmental Conditions</b> Wind Sea state Temperature Ice conditions	Variable; up to typhoon Flat to large swells; currents to 2-3 knots in some areas Variable -
<b>Other Program Requirements</b>	CORKS, A-CORKS (multi-packers), strain, Packers Casing program as needed Shipboard laboratory facilities for handling microbial and chemical samples at in-situ P,T; improved shipboard chemistry analyses (e.g., ICP-OES)

**Lithology and Thermal Gradient**



**Table B-4. Large Igneous Province**

<b>Model Site Description</b>	Oceanic plateaus and volcanic margins with pelagic, neritic, terrigenous, and terrestrial sediment overlying igneous basement
<b>Scientific Objectives</b>	Investigate magmatic and tectonic development of oceanic plateaus and volcanic passive margins
<b>Water Depth Range (m)</b>	50–6,000
<b>Maximum penetration (m below seafloor)</b>	5,000
<b>Possible Conditions</b>	
Degree of fractures	Low to high
Porosity	Low to high
Pore pressure	Unknown
Existence of volatiles	Possible in sediments
<b>Percent Recovery Required</b>	100% for temporal and geochemical development of volcanics, dikes, and plutonics 100% of sediment section
<b>Maximum Core Disturbance Tolerated</b>	Minor stretching/squeezing in sediment cores; no biscuiting Minimal induced fracturing of rocks
<b>Sampling, Testing, and Logging Needs</b>	
Core sampling	Triple offset APC, XCB in soft semi-consolidated sediments; RCB in lithified material and igneous rock; complete recovery of soft sediment intercalated with lavas
Core sample diameter	>60 mm ODP standard APC; >60 mm ODP standard XCB
In situ sampling and testing	Geothermal gradient
Down-hole logging	<i>Essential logs:</i> Natural gamma, density, sonic ( $V_p$ and $V_s$ ), caliper, porosity, temperature, FMS/FMI, BHTV, resistivity (DLL), check shots (WST) <i>Useful logs:</i> LWD (resistivity images and density/porosity), resistivity images (ARI), geochemical (GLT), magnetic susceptibility, VSP (3-comp./offset)
<b>Endurance</b>	
Maximum days at sea without resupply	60
<b>Environmental Conditions</b>	
Wind	Moderate
Sea state	Maximum ~5 m swell (15-20 m for polar LIPs)
Temperature	~30°C (below freezing for polar LIPs)
Ice-conditions	Not for most sites; 10/10 (100%) ice cover for polar LIPs
<b>Other Requirements</b>	–

**Lithology and Thermal Gradient**

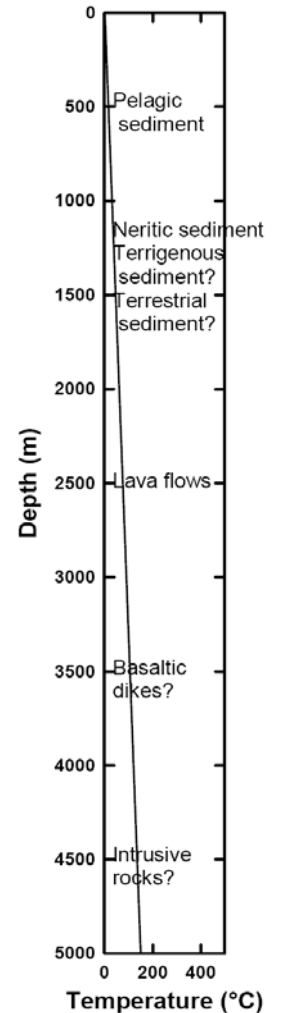

**Table B-5. Oceanic Crust**

<b>Model Site Description</b>	Sections within oceanic crust that might include: bare-rock drilling; drilling through sediment into older crust; drilling in tectonic windows
<b>Scientific Objectives</b>	Delineate crustal architecture Define seismic boundaries and faults Mode of formation and alteration Examine hydrologic properties, fluid and rock chemistry Evaluate subsurface biosphere
<b>Water Depth Range (m)</b>	500–6500
<b>Maximum penetration (m below seafloor)</b>	7,000
<b>Possible Conditions</b>	
Degree of fractures	Extreme in upper 100–300 m volcanics; lower with depth except in short intervals at fault zones where extreme
Porosity	30-80% in sediments; 1-40% in basalts; decreasing with depth
Pore pressure	Up to 1-2 MPa over or under hydrostatic at ridges; lower off-axis
Existence of volatiles	Possible at ridges; unlikely off-axis
<b>Percent Recovery Required</b>	70–90%
<b>Maximum Core Disturbance Tolerated</b>	Minimal disturbance to sediments (if present); minimal induced fracturing preferred
<b>Sampling/Testing/Logging</b>	
Core sampling	APC, XCB, and RCB; other to make hole & collect core Diamond drilling with narrow kerf for high recovery of fractured and brecciated material Core orientation Horizontal (directional) drilling with huge benefits
Core sample diameter	2-3" or greater
In situ sampling and testing	Formation hydrologic properties; fluid and biological sampling; borehole stress; long-term observatories
Down-hole logging	<i>Essential logs:</i> natural gamma, density, sonic ( $V_p$ and $V_s$ ), caliper, porosity, temperature, FMS/FMI, BHTV, resistivity (DLL), VSP (3-comp./offset), fluid sampling and permeability (MDT and NMR), geochemical (GLT) <i>Useful logs:</i> LWD (resistivity images and density/porosity), resistivity images (ARI), magnetic susceptibility
<b>Endurance</b>	
Maximum days at sea without resupply	Up to 60
<b>Environmental Conditions</b>	No unusual conditions expected:
Wind	Up to Force 8, but most likely moderate
Sea state	Moderate
Temperature	Moderate
Ice-conditions	Only for Arctic drilling (lower priority); mostly latitudes <40°
<b>Other Requirements</b>	–

**Lithology and Thermal Gradient**

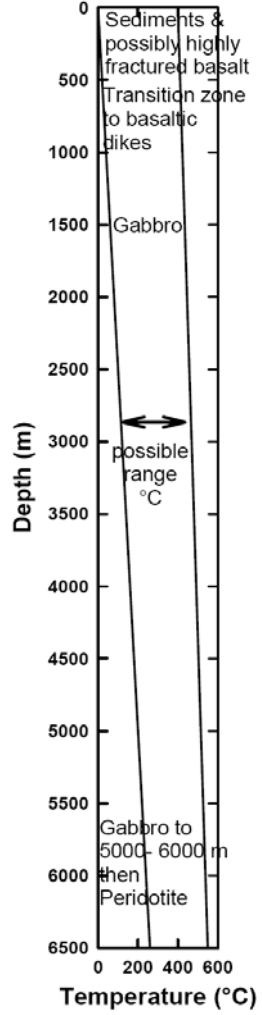

**Table B-6. Hydrothermal System and Massive Sulfide Deposit**

<b>Model Site Description</b>	Sulfide deposits and hydrothermal upflow zones at bare-rock and sedimented ridges, in back arcs and in fracture zones
<b>Scientific Objectives</b>	Delineate sulfide and stockwork architecture down to reaction zone Investigate fluid and rock chemistry, hydrogeologic properties, significance of subsurface biosphere Examine faults
<b>Water Depth Range (m)</b>	500–4,000
<b>Maximum penetration (m below seafloor)</b>	2,000
<b>Possible Conditions</b> Degree of fractures Porosity Pore pressure Existence of volatiles	Moderate to extreme 30-80% in sediments; 10-40% in sulfides; 1-40% in basalts Up to 1-2 MPa over or under hydrostatic pressure possible Likely, particularly hydrogen sulfide
<b>Percent Recovery Required</b>	70–90%
<b>Maximum Core Disturbance Tolerated</b>	Minimal disturbance to sediments (if present) and sulfides; minimal induced fracturing of consolidated sulfides and basalts
<b>Sampling/Testing/Logging</b> Core sampling  Core sample diameter In situ sampling and testing  Down-hole logging	APC, XCB, RCB, or other to make hole and collect core Diamond drilling with narrow kerf for high recovery of fractured and brecciated material Core orientation Horizontal (directional) drilling provide huge benefits 2-3" or more Formation hydrologic properties; fluid and biological sampling; borehole stress; long-term observatories <i>Essential logs:</i> natural gamma, density, sonic (Vp and Vs), caliper, porosity, temperature, FMS/FMI, BHTV, resistivity (DLL), check shots (WST), fluid sampling and permeability (MDT and NMR), geochemical (GLT), LWD (resistivity images and density/porosity), magnetic susceptibility <i>Useful logs:</i> resistivity images (ARI), VSP (3-comp./offset)
<b>Endurance</b> Maximum days at sea without resupply	60
<b>Environmental Conditions</b> Wind Sea state Temperature Ice-conditions	Up to Force 8, but most likely moderate Moderate Moderate –
<b>Other Requirements</b>	–

**Lithology and Thermal Gradient**

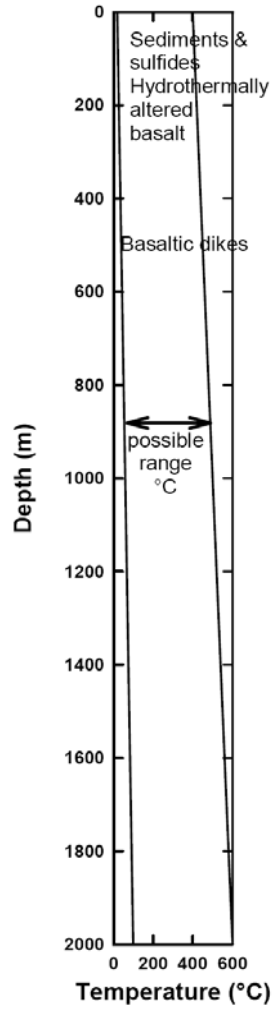

**Table B-7. Deep Ocean Sediment**

<b>Model Site Description</b>	Low to high latitude sedimentary sections
<b>Scientific Objectives</b>	Understand mechanisms of climate variability through analysis of oceanic sediment sections with temporal resolutions ranging from seasonal to tectonic Document depth, geographic extent, trophic strategies, and ecological structure of the recently discovered 'Deep Bacterial Biosphere' and understand its distribution relative to temperature, pH, pressure, redox potential, host lithological substrate, and aqueous media Examine fundamental processes associated with formation, stability, and dissociation of gas hydrates and potential impact of rapid hydrate dissociation on global carbon cycle Document and understand effects of impact events on global climate and mass extinctions
<b>Water Depth Range (m)</b>	200–6,000
<b>Maximum penetration (m below seafloor)</b>	2,000 (to 150°C isotherm for deep biosphere work)
<b>Possible Conditions</b>	
Degree of fractures	Minor in most sections; extreme in meteor impact sites
Porosity	Highly variable according to lithology
Pore pressure	Hydrostatic; overpressure in organic rich sequences
Existence of volatiles	Variable according to location; definitely for gas hydrates
<b>Percent Recovery Required</b>	Generally as high as possible (90–100%) As low as 20% per lithology for impact deposit sites
<b>Maximum Core Disturbance Tolerated</b>	Minor vertical stretching/squeezing generally acceptable (but undesirable) in soft sediments; extensive biscuiting/fracturing not acceptable; microbiological/ chemical contamination not acceptable in core interiors
<b>Sampling/Testing/Logging</b>	
Core sampling	Continuous, multiple offset coring in all cases: APC, XCB, RCB for pelagic sections depending on induration; vibra or hammer coring for sandy intervals Diamond coring or other for alternating hard/soft sections PCS for recovery of sediments containing volatiles <i>Desirable:</i> minimize magnetic overprint due to drilling/coring; APC/XCB to RCB coring without tripping drill string
Core sample diameter	Many requests for larger than current ODP APC/XCB standard for sample volume/availability and minimal contamination of core interior
In situ sampling and testing	Pore waters, microbiology, geothermal gradient, volatiles and hydrates
Down-hole logging	<i>Essential logs:</i> magnetic susceptibility/ reversals (GHMT), natural gamma, sonic ( $V_p$ and $V_s$ ), density, caliper, resistivity, porosity, FMS/FMI, VSP (3-comp./offset), fluid sampling and permeability (MDT and NMR) <i>Useful logs:</i> geochemical (GLT), LWD (resistivity images and density/porosity)
<b>Endurance</b>	60 (maximum days at sea without resupply)
<b>Environmental Conditions</b>	
Wind	To 70 knots
Sea state	To Beaufort 8
Temperature	Below freezing to 30°C
Ice-conditions	Up to 8/10 to 10/10 ice, 2.5 m thick, drifting 0.1-0.5 knots
<b>Other Requirements</b>	Icebreaker, CORKS, VSP's, 3-D seismic surveys

**Lithology and Thermal Gradient**

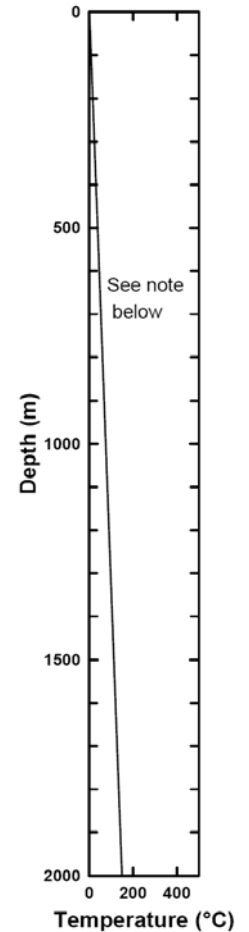

No single lithologic section covers range of expected lithologies. Possible lithologies include:

- Biogenic soft lithologies (siliceous and calcareous oozes)
- Biogenic firm and hard lithologies (chalks, cherts, limestones)
- Interbedded soft and hard lithology possible
- Clastic lithologies (clays/claystones, muds/mudstones, silt/siltstones, with varying sand contents, sandstones, and shales)
- Impact breccia
- Volcanogenic sediments
- Turbidites

**Table B-8. Passive Margin Stratigraphy**

<b>Model Site Description</b>	Low to mid-latitude siliciclastic nearshore and passive margin sediments—stratigraphic drilling
<b>Scientific Objectives</b>	Understand controls on geometry and composition of shallow water stratigraphic record in relation to changes in sea level, climate, and tectonics Evaluate amplitude and mechanisms of global and regional sea level change Understand impact of fluid flow on geochemical and isotopic composition of the global ocean
<b>Water Depth Range (m)</b>	1–1,000
<b>Maximum penetration (m below seafloor)</b>	1,200
<b>Possible Conditions</b> Degree of fractures Porosity Pore pressure Existence of volatiles	Minimal 60–75% in shallower parts of section, less at depth Hydrostatic to pressures requiring BOP Yes
<b>Percent Recovery Required</b>	80–100%
<b>Maximum Core Disturbance Tolerated</b>	Vertical stretching/squeezing acceptable in soft sediments; extensive biscuiting/fracturing not acceptable
<b>Sampling/Testing/Logging</b> Core sampling  Core sample diameter In-situ sampling and testing Down-hole logging	Slim-line might enhance core recovery, but would limit range of logging tools available as well as sample volume Continuous, multiple-hole sites required using short stroke (~2 m) APC and RCB techniques to recover inter-bedded soft mud and unconsolidated sand lithologies 2–3" or more Fluid and biological sampling <i>Essential logs:</i> natural gamma, density, caliper, sonic ( $V_p$ and $V_s$ ), resistivity, porosity, FMS/FMI, magnetic susceptibility/reversals (GHMT), check shots (WST), fluid sampling and permeability (MDT and NMR) <i>Useful logs:</i> geochemical (GLT), LWD, VSP (3-comp./offset)
<b>Endurance</b> Maximum days at sea without resupply	14–60
<b>Environmental Conditions</b> Wind Sea state Temperature Ice-conditions	To 40 knots To Beaufort 5 0 to 30°C –
<b>Other Program Requirements</b>	Casing Anchored platform, jackup rig, or semi-submersible

**Lithology and Thermal Gradient**

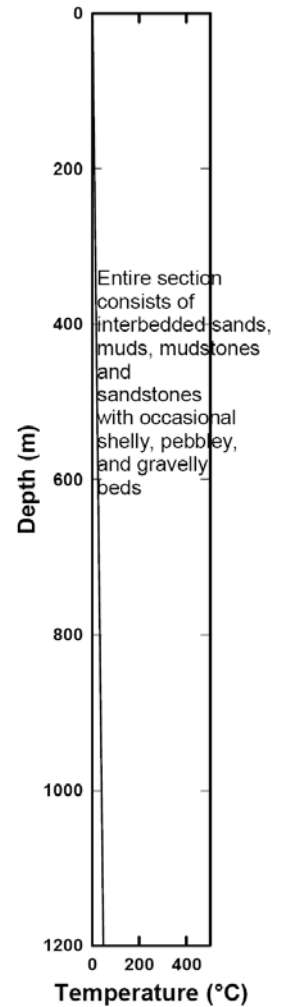

**Table B-9. Carbonate Reef, Atoll, or Bank**

<b>Model Site Description</b>	Barrier reefs, atolls, carbonate banks and platforms
<b>Scientific Objectives</b>	Determine rates, amplitudes and mechanisms of global sea level change Document inter-annual and seasonal variability of sea surface temperature Understand impact of fluid flow on geochemical and isotopic composition of the global ocean Evaluate reef carbonate production and its impact on global carbon budget.
<b>Water Depth Range (m)</b>	5–1,000
<b>Maximum penetration (m below seafloor)</b>	450
<b>Possible Conditions</b>	
Degree of fractures	Low to high
Porosity	Variable: 10–90%
Pore pressure	Near hydrostatic pressure
Existence of volatiles	–
<b>Percent Recovery Required</b>	75–100%
<b>Maximum Core Disturbance Tolerated</b>	Vertical stretching/squeezing acceptable in soft sediments; extensive biscuiting/fracturing not acceptable
<b>Sampling/Testing/Logging</b>	
Core sampling	High recovery RCB cores required to recover intact pieces of reef framework sufficiently large for fine-scale time series sampling
Core sample diameter	Slim-line might enhance core recovery, but would limit range of logging tools available as well as sample volume
In situ sampling and testing	Fluid and biological sampling
Down-hole logging	<i>Essential logs:</i> sonic ( $V_p$ and $V_s$ ), GHMT, natural gamma, density, caliper, resistivity, porosity, FMS/FMI, check shots (WST) <i>Useful logs:</i> geochemical (GLT), fluid sampling (MDT), temperature
<b>Endurance</b>	
Maximum days at sea without resupply	20–60
<b>Environmental Conditions</b>	
Wind	Generally up to $30 \text{ m s}^{-1}$ ; seasonal cyclone potential
Sea state	Beaufort 0 to 5 except seasonal cyclone activity
Temperature	15–30°C
Ice-conditions	–
<b>Other Program Requirements</b>	Anchored or jack-up barge, seabed drilling platform

**Lithology and Thermal Gradient**

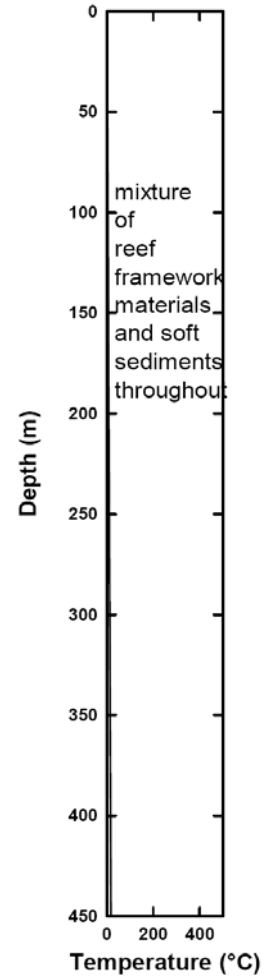

**THIS PAGE INTENTIONALLY LEFT BLANK**



**APPENDIX C**  
**CHARACTERISTICS OF THE MODERNIZED *JOIDES RESOLUTION* (SODV)**

- ◇ Specifications
- ◇ Conversion & Capabilities
- ◇ Typical Annual Hazardous Material Usage

**THIS PAGE INTENTIONALLY LEFT BLANK**

### **JOIDES RESOLUTION Specifications**

<b>Specifications</b>	Official Vessel Number	6151
	Port of Registry	Monrovia, Liberia
	ABS Classification	A1 E Drilling Unit AMS ACCU
	Ice Class	1B
	Place of Construction	Halifax, Nova Scotia, Canada
	Year Built (modernized)	1978 (2007)
	Vessel Call Sign	D5BC
	Size	Length 470.5 ft by breadth 70.0 ft (143.3 m by 21.3 m)
	Draft	Summer Loadline 24 ft 5 1/8 in (7.45 m) Thrusters Down 34 ft 7 1/4 in (10.55 m)
<b>Power</b>	Engines/Generators	7 (16 cyl) Diesel; 5 at 2100 kw (2,875 hp), 2 at 1500 kw (2,100 hp)
<b>Propulsion</b>	Thrusters	9000 hp (10 retractable, 2 fixed; 750 hp each)
	Main Screws	9,000 hp (2 shafts) each powered by (6) 750 hp motors
<b>Transducer-based Instruments</b>	Sub-Bottom Profiler	System: Bathy 2010 CHIRP Operating Frequency: 3.5 kHz
	Fathometer/Single Beam Echo Sounder	System: ELAC LAZ4400 Operating Frequency: 350 kHz
	Acoustic Doppler Current Profiler	Litton Sperry model SRD-500 Dual Axis Operating Frequency: 307 kHz
<b>Liquid Capacities</b>	Diesel Fuel	3,630 tons (3,290 metric tonnes)
	Drill Water	1,810 tons (1,640 metric tonnes)
	Ballast	917 tons (745 metric tonnes)
	Potable Water	Storage Capacity: 320 tons (290 metric tonnes)
		Watermaker 1: Alfa Laval; brinewater blowdown 2,112,000 l/day; continuous operation
		Watermaker 2: Aquachem; brinewater blowdown 57,600 l/day; ~72 hrs/week operation
		Watermaker 3: Aquachem; brinewater blowdown 99,360 l/day; ~72 hrs/week operation
Mud Pit Volume	3,424 bbl (6 pits + slug)	
Drilling Mud Bulk Capacity	13,628 ft <sup>3</sup> (8 pods)	
<b>Wastewater</b>	Sanitary Wastewater	Treatment System: Hamworthy ST10 Super Trident Biological Plant (or equivalent) Conveyance: Vacuum Disinfection: Chlorination Treatment Capacity: 15,810 l/day Holding Tank Capacity: 187,950 L
	Greywater	Holding Tank Capacity: 159,502 L
	Deck Drainage	Oil/Water Separator; 120 m <sup>3</sup> /day

**JOIDES RESOLUTION Specifications**

	Bilge Water	Oil/Water Separator; 120 m <sup>3</sup> /day
<b>Solid Waste</b>	Combustible Waste	Incinerator System: 2 - Therm Tech M-6 (or equivalent) Daily Capacity: 2 m <sup>3</sup>
<b>Miscellaneous</b>	Deck Load	9534 tons
	Moonpool Diameter	22 ft (7 m)
<b>Operating Depths</b>	Reentry Camera and Sonar	<6,000 m
	Max. Drilling/Coring Depth	8,375 m (at 6° roll and 100,000 lb overpull)
	Max. Casing Depth	8,600 m (at 7° roll and 100,000 lb overpull)
	Max. Reentry System Depth	7,960 m (at 7° roll and 55,000 lb dynamic load)

**Notes:** bbl = barrel; bpm = barrels/minute; csg = casing; cyl = cylinders; DP = drill pipe; ea = each; gpm = gallons/minute; jt = joints; max. = maximum; std = stands

## JOIDES RESOLUTION Conversion & Capabilities

### 1. All-New Science Facilities

Space Name *	SODV	JR	% Change	Comments
<b>BRIDGE</b>	<b>1,656 ft<sup>2</sup> (154 m<sup>2</sup>)</b>	<b>1,028 ft<sup>2</sup> (96 m<sup>2</sup>)</b>		
IODP Technical Office	191 ft <sup>2</sup> (18 m <sup>2</sup> )	136 ft <sup>2</sup> (13 m <sup>2</sup> )	40%	
IODP Science Office	241 ft <sup>2</sup> (22 m <sup>2</sup> )	172 ft <sup>2</sup> (16 m <sup>2</sup> )	40%	
IODP Operations Office	221 ft <sup>2</sup> (21 m <sup>2</sup> )	173 ft <sup>2</sup> (16 m <sup>2</sup> )	28%	
Planning Area	273 ft <sup>2</sup> (25 m <sup>2</sup> )	0 ft <sup>2</sup> (0 m <sup>2</sup> )	<i>new</i>	
Hazardous Store.	93 ft <sup>2</sup> (9 m <sup>2</sup> )	85 ft <sup>2</sup> (8 m <sup>2</sup> )	9%	
Flammable Store.	37 ft <sup>2</sup> (3 m <sup>2</sup> )	35 ft <sup>2</sup> (3 m <sup>2</sup> )	6%	
Work Deck	600 ft <sup>2</sup> (56 m <sup>2</sup> )	427 ft <sup>2</sup> (40 m <sup>2</sup> )	41%	
<b>CORE</b>	<b>3,697 ft<sup>2</sup> (343 m<sup>2</sup>)</b>	<b>2,959 ft<sup>2</sup> (275 m<sup>2</sup>)</b>		
Logging Office	140 ft <sup>2</sup> (13 m <sup>2</sup> )	210 ft <sup>2</sup> (20 m <sup>2</sup> )	17%	<i>SODV spaces combined to match equivalent JR space</i>
Telemetry Lab	105 ft <sup>2</sup> (10 m <sup>2</sup> )			
Downhole Lab	359 ft <sup>2</sup> (33 m <sup>2</sup> )	428 ft <sup>2</sup> (40 m <sup>2</sup> )	-16%	<i>Workspace shared to mitigate reduction</i>
ET Shop	90 ft <sup>2</sup> (8 m <sup>2</sup> )	213 ft <sup>2</sup> (20 m <sup>2</sup> )	-58%	
Core Splitting	256 ft <sup>2</sup> (24 m <sup>2</sup> )	145 ft <sup>2</sup> (13 m <sup>2</sup> )	77%	
Microscope Lab	359 ft <sup>2</sup> (33 m <sup>2</sup> )	199 ft <sup>2</sup> (18 m <sup>2</sup> )	80%	
Paleo Prep Lab	206 ft <sup>2</sup> (19 m <sup>2</sup> )	210 ft <sup>2</sup> (20 m <sup>2</sup> )	-2%	
Core Receiving Area	540 ft <sup>2</sup> (50 m <sup>2</sup> )	440 ft <sup>2</sup> (41 m <sup>2</sup> )	23%	
Core Description	535 ft <sup>2</sup> (50 m <sup>2</sup> )	367 ft <sup>2</sup> (34 m <sup>2</sup> )	46%	
Analytical Tracks	279 ft <sup>2</sup> (26 m <sup>2</sup> )	220 ft <sup>2</sup> (20 m <sup>2</sup> )	27%	
Phys. Prop. Lab	167 ft <sup>2</sup> (16 m <sup>2</sup> )	105 ft <sup>2</sup> (10m <sup>2</sup> )	59%	
Strat. Corr.	63 ft <sup>2</sup> (6 m <sup>2</sup> )	20 ft <sup>2</sup> (2 m <sup>2</sup> )	215%	
Sampling	147 ft <sup>2</sup> (14 m <sup>2</sup> )	107 ft <sup>2</sup> (10 m <sup>2</sup> )	37%	
Core Entry	278 ft <sup>2</sup> (26 m <sup>2</sup> )	150 ft <sup>2</sup> (14 m <sup>2</sup> )	85%	
Magnetics	173 ft <sup>2</sup> (16 m <sup>2</sup> )	145 ft <sup>2</sup> (13 m <sup>2</sup> )	19%	
<b>FOC'SLE</b>	<b>3,106 ft<sup>2</sup> (289 m<sup>2</sup>)</b>	<b>2,541 ft<sup>2</sup> (236 m<sup>2</sup>)</b>		
Cold Lab	110 ft <sup>2</sup> (10 m <sup>2</sup> )	0 ft <sup>2</sup> (0 m <sup>2</sup> )	<i>new</i>	
Thin Section	160 ft <sup>2</sup> (15 m <sup>2</sup> )	200 ft <sup>2</sup> (19 m <sup>2</sup> )	-20%	<i>Workspace shared to mitigate reduction</i>
Sample Prep	125 ft <sup>2</sup> (12 m <sup>2</sup> )	120 ft <sup>2</sup> (11 m <sup>2</sup> )	4%	
X-Ray	131 ft <sup>2</sup> (12 m <sup>2</sup> )	40 ft <sup>2</sup> (4 m <sup>2</sup> )	228%	
Open Office	105 ft <sup>2</sup> (10 m <sup>2</sup> )	0 ft <sup>2</sup> (0 m <sup>2</sup> )	<i>new</i>	
Image Office	110 ft <sup>2</sup> (10 m <sup>2</sup> )	140 ft <sup>2</sup> (13 m <sup>2</sup> )	-21%	<i>Dark room eliminated</i>
Chemistry / Microbiology	1,018 ft <sup>2</sup> (95 m <sup>2</sup> )	840 ft <sup>2</sup> (78 m <sup>2</sup> )	21%	
Conference Room	659 ft <sup>2</sup> (61 m <sup>2</sup> )	530 ft <sup>2</sup> (49 m <sup>2</sup> )	24%	
Sample Prep	125 ft <sup>2</sup> (12 m <sup>2</sup> )	120 ft <sup>2</sup> (11 m <sup>2</sup> )	4%	
Publication Office	115 ft <sup>2</sup> (11 m <sup>2</sup> )	103 ft <sup>2</sup> (10 m <sup>2</sup> )	12%	
Science Container Deck	448 ft <sup>2</sup> (42 m <sup>2</sup> )	448 ft <sup>2</sup> (42 m <sup>2</sup> )	0%	

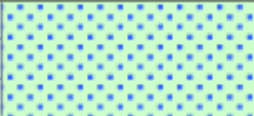
<b>POOP</b>	<b>318 ft<sup>2</sup> (30 m<sup>2</sup>)</b>	<b>318 ft<sup>2</sup> (30 m<sup>2</sup>)</b>		
U/W Geophysics	318 ft <sup>2</sup> (30 m <sup>2</sup> )	318 ft <sup>2</sup> (30 m <sup>2</sup> )	0%	
<b>TWEEN - STORAGE</b>	<b>1,087 ft<sup>2</sup> (101 m<sup>2</sup>)</b>	<b>959 ft<sup>2</sup> (89 m<sup>2</sup>)</b>		
Science Pallet Storage	1,087 ft <sup>2</sup> (101 m <sup>2</sup> )	959 ft <sup>2</sup> (89 m <sup>2</sup> )	13%	
<b>TWEEN - REC</b>	<b>1,452 ft<sup>2</sup> (135 m<sup>2</sup>)</b>	<b>950 ft<sup>2</sup> (88 m<sup>2</sup>)</b>		
Science Movie Room	302 ft <sup>2</sup> (28 m <sup>2</sup> )	350 ft <sup>2</sup> (33 m <sup>2</sup> )	66%	SODV spaces combined to match equivalent JR space
Internet Lounge	281 ft <sup>2</sup> (26 m <sup>2</sup> )			
Data Vault	48 ft <sup>2</sup> (4 m <sup>2</sup> )	0 ft <sup>2</sup> (0 m <sup>2</sup> )	new	
Gym	745 ft <sup>2</sup> (69 m <sup>2</sup> )	600 ft <sup>2</sup> (56 m <sup>2</sup> )	24%	
Shower	77 ft <sup>2</sup> (7 m <sup>2</sup> )	0 ft <sup>2</sup> (0 m <sup>2</sup> )	new	
<b>UPPER TWEEN</b>	<b>1,012 ft<sup>2</sup> (94 m<sup>2</sup>)</b>	<b>1,046 ft<sup>2</sup> (97 m<sup>2</sup>)</b>		
Science Stores	447 ft <sup>2</sup> (42 m <sup>2</sup> )	606 ft <sup>2</sup> (56 m <sup>2</sup> )	-26%	
Staging Area	276 ft <sup>2</sup> (26 m <sup>2</sup> )	440 ft <sup>2</sup> (41 m <sup>2</sup> )	28%	SODV spaces combined to match equivalent JR space
Logistics Shop	289 ft <sup>2</sup> (27 m <sup>2</sup> )			
<b>LOWER TWEEN</b>	<b>947 ft<sup>2</sup> (90 m<sup>2</sup>)</b>	<b>728 ft<sup>2</sup> (68 m<sup>2</sup>)</b>		
IT Office & Storage	208 ft <sup>2</sup> (19 m <sup>2</sup> )	190 ft <sup>2</sup> (18 m <sup>2</sup> )	9%	
Data Center	184 ft <sup>2</sup> (17 m <sup>2</sup> )	150 ft <sup>2</sup> (14 m <sup>2</sup> )	23%	
Science User Room	509 ft <sup>2</sup> (47 m <sup>2</sup> )	346 ft <sup>2</sup> (32 m <sup>2</sup> )	47%	
Office	73 ft <sup>2</sup> (7 m <sup>2</sup> )	42 ft <sup>2</sup> (4 m <sup>2</sup> )	74%	
<b>HOLD</b>	<b>974 ft<sup>2</sup> (90 m<sup>2</sup>)</b>	<b>745 ft<sup>2</sup> (69 m<sup>2</sup>)</b>		
Core Storage	974 ft <sup>2</sup> (90 m <sup>2</sup> )	745 ft <sup>2</sup> (69 m <sup>2</sup> )	31%	
<b>**TOTAL</b>	<b>14,276 ft<sup>2</sup> (1,326 m<sup>2</sup>)</b>	<b>11,274 ft<sup>2</sup> (1,047 m<sup>2</sup>)</b>	<b>27%</b>	
<b>Science</b>	<b>7,421 ft<sup>2</sup> (689 m<sup>2</sup>)</b>	<b>5,551 ft<sup>2</sup> (516 m<sup>2</sup>)</b>	<b>34%</b>	
<b>Storage and Recreational</b>	<b>6,855 ft<sup>2</sup> (637 m<sup>2</sup>)</b>	<b>5,723 ft<sup>2</sup> (532 m<sup>2</sup>)</b>	<b>20%</b>	

\* Chart is based on the SODV floor plan with comparisons made to an equivalent spaces from the JR floor plan, regardless of the deck location. Therefore, the JR Deck subtotals shown are not true JR deck totals.

\*\* When mechanical, passageways, bathrooms, trunks and other support spaces associated with the science facilities are considered, the totals are: SODV = 18,640 and JR = 14,724 sq. foot.

- 27% increase in overall square footage of the science facility spaces
- 34% increase in laboratory spaces (includes offices and conference space)
- Redesigned laboratory layout for better core handling and workflow
- Easier core and freight movement
  - Cores palletized and handling mechanized
  - New larger elevator for off-loading core and more efficient port call work

- New staging area for removing cores from vessel
- New core receiving platform which can be refrigerated for hydrates
- Streamlined accessibility between laboratories and accommodations areas
- Increased bench space and chemical hoods
- Direct and safe access to the Microbiology Isotope Lab (container)
- Enclosed, sound controlled core splitting and sampling room
- Larger science conference facility capable of supporting the entire science party
- Improved core flow and integration of science activities on the Core Deck
- Refrigerated core storage for 8000+ meters

## **2. New Science Capabilities**

- Laboratory Management System - A new data management infrastructure for improvement to data acquisition management, storage, and quality control
- New ergonomic core description stations and software
- New and enhanced science instruments:
  - Two multi-sensor tracks (Magnetic Susceptibility, Gamma Ray Attenuation and Velocity), to improve data acquisition rates and quality
  - Dedicated Natural Gamma track with higher sensitivity and faster acquisition rates
  - High-resolution digital imaging and spectral measurement tracks
  - Upgrade spectroscopy track
  - New Ion Chromatograph, Discrete Analyzer, Rock Eval, systems for the Chemistry lab. Returning equipment refurbished
  - Returning equipment for the Physical Properties, Magnetics, and Microscope labs upgraded and/or refurbished
  - New core splitting saw and thin section equipment
  - New 3.5Khz bathymetric and navigation systems
  - New VSP sound sources logging
- Refurbished sub-sea camera system
- Improved core handling capability
  - Cores palletted
  - New larger elevator for offloading core
  - New staging area for removing cores from vessel
  - Elimination of man handling core boxes - pallet truck
  - New core receiving platform which can be refrigerated for hydrates
- Potential future enhancements to the USIO logging capabilities through infrastructure for use of larger diameter pipe

## **3. Information Technology Network and Infrastructure**

- New and expanded data servers and storage systems with enhanced large file management
- Wireless network access throughout labs and quarters
- New digital media management system (text, images, large binary data files)
- New workstations and video distribution system
- Upgraded vessel data management system

#### **4. Logging**

- New wireline heave compensation system near the rig floor
- Permanent wireline rig-up reducing operational time and adding flexibility of use
- Relocation of the Schlumberger wireline and logging while drilling data acquisition units into the corelab
- Relocation of the logging office and downhole measurements lab into the corelab
- Modification of the dual elevator system for more efficient handling 6-5/8" drill pipe used for drilling and deployment of large diameter tools (newer larger diameter logging tools replace many of the existing slim line tools as well as provide some new exciting capabilities)
- Pipe racker modifications to carry up to 5644 m of 6-5/8" pipe in the riserless vessel for drilling and logging

#### **5. Refined and Expanded Accommodations**

- Streamlined accessibility between laboratories and accommodations areas
- New staterooms providing an additional 10 science berths with shared toilets and showers (60 science, 130 total). There are 16 additional berths total.
- All staterooms will be double occupancy (no more 4 person occupancy)
- New galley located above the waterline with natural lighting
- New air-conditioned gym
- New movie facilities with new entertainment systems
- New lounge outside movie room for social gathering and casual internet access
- Improved noise reduction throughout all accommodations

#### **6. Updated Safety & Environmental Systems**

- New hospital facility with disabled access bathroom and digital X-ray machine
- New Heating Ventilation Air conditioning (HVAC) forward and aft
- All forward spaces and IODP heavy tool store now air conditioned and heated
- Elevated bridge integrated with Dynamic Positioning (DP)
- New 70-man lifeboats and davits
- New water maker (vapor compression) to handle the additional manning and freshwater sanitary system
- New potable water tank
- Renewed Class Certificates - 5 years to next dry dock
- New gas detection system
- Better hazardous materials storage - permanent fire protection
- Infrared camera system for better security
- New galley hood with fixed firefighting system
- New marine sanitation device and vacuum toilet system
- New safety equipment, smoke hoods, SCBAs, survival suits, and lifejackets
- New FRC (Fast Rescue Craft) / Beacon Recovery Boat
- Improved exterior vessel lighting in work areas
- New man rider hoists in the moon pools for safer moon pool operations
- Improved waste management system - new incinerators with redundancy
  - 2 incinerators - set up to burn trash and waste oil
  - New compactors to reduce volume of trash for easy storage and disposal



- Zero discharge modification - grey water and black water can now be routed to Drill Water Tank #1

## **7. Service Life Extension**

- Drill string
- 5000 psi mud system
- Spare iron roughneck
- All DC traction motors for drilling equipment refurbished
- New Epoch instrumentation system with the future possibility for integrated information into user accessible database for correlations to vessel science
- Refurbished drilling equipment
  - Piperackers
  - Drawworks
  - Top drives (2)
  - Swivels (2)
  - Crown block/traveling block
  - Dual elevator system
  - Drill line anchor
  - New EZ Torque
  - Iron roughneck
  - Mud pumps
  - Coring winch
  - Rotary table
  - Derrick
  - Passive Heave Compensator
  - Cement pump
  - LP mud system

## **8. Ship Infrastructure**

- Ship stability will be enhanced with an engineering design that minimizes VCG, reduces downflooding points, utilizes new lighter construction techniques for superstructure and removal of Active Heave Compensator from the derrick, among other improvements
- New superstructure/labs/quarters
- Upgraded Vessel Data Management System
- Removal of derrick A-frame to lower overall height to ease transit through the Panama Canal
- New Panama Canal-rated anchor windlass
- Complete overhaul of 12 thrusters
- All propulsion motors overhauled
- Synchronous condenser overhauled
- New seismic deployment boom
- New expandable Closed Circuit TV system to cover:
  - Drill floor
  - Derrick operations
  - Schlumberger logging operations
  - Moonpool operations
  - Vessel Security

- Improved Harsh Environment Capability with HVAC changes to address warmer/ cold environments; Fuel Oil Heaters added to allow uninterrupted work in Arctic / Antarctic environments; Install fuel oil coalesers (filters) for additional purification while in cold waters; Install new propulsion coolers to lower propulsion temperatures in warm waters (currently we have to slow down if water gets too hot); and Upgraded crane slip rings for additional heaters for cranes

## **9. Communications**

- Ship to shore communication - An enhanced VSAT infrastructure for improved ship to shore communication such as video streaming, data file transfer, and shipboard system management from shore
- GMDSS System with A4 rating
- New general alarm system
- New paging system
- Capability to accommodate 100% up time on VSAT
- New sound powered phone system
- New discrete surveillance and alarm system
- New talkback system

## Typical Annual Hazardous Material Usage

Material	Quantity
<b>Lubricating Oils</b>	
Mobilgard 450NC	15,763 L
Caprinas XR-40	20,707 L
Tellus 32 (No. # 7)	6,007 L
Omala 220 (No. # 1)	3,344 L
Omala 320 (No. # 2)	892 L
Turbo T-78 (No. # 6)	489 L
Turbo T-68 (No. # 5)	282 L
Rotella 30 (No. # 3)	111 L
Rotella T40 (No. # 4)	1,126 L
Anderol 500	869 L
Donax (ATF) (No. # 8)	510 L
Capella 68	370 L
Castrol Icematic	87 L
Laval Pur. Oil	23 L
Turbo T-46 (Shell)	8 L
Vari 608 (Almasol)	11 L
<b>Grease</b>	
Alvania EP2	129 L
Cyprina RA.	11 L
Texaco Threadtex.	4 L
Supergrease.(Topdrive)	4 L
<b>Desalination Chemicals</b>	
AC-2/Inh. Sulf. Acid	431 kg
AC-1000	400 L
AC-1000A	23 L
Ameroyal	340 L
Chlorine.	400 L
Bromine Cartridges	20 each
Saf Acid	272 kg
<b>Cleaners and Other Chemicals</b>	
Nalcool 2000	604 L
Amerstat 10	113 L
CRC Electroclean	83 L
Dessicant	600 L
ACC-9	378 L
SC-200	3,400 L
Drewsperser SWD	132 L
Dispersant (OSD)	873 L
Anti-Freeze	926 L
APEXIOR	19 L
Renewz Cleaner.	19 L
NYlube.	30 L
GAMAZYME DPC	36 kg
BIOTAL	87 L
<b>Refrigerants</b>	
R-22	680 kg
Suva MP-66.	794 kg

Material	Quantity
404A / Suva HP 62	10.9
<b>Laboratory Chemicals</b>	
Acetone	61 L
Acid, Methane Sulfonic	0.4 L
Acid, Glacial, Acetic, 99.7%	0.3 L
Acid, Hydrochloric	38 L
Acid, Hydrofluoric	1 L
Acid, Nitric	10 L
Acid, O-Phosphoric, 85%	0.2 L
Acid, Sulfuric	0.2 L
Amaranth	4 g
Ammonium Acetate	42 g
Ammonium Chloride	34 g
Ammonium Hydroxide	474 g
Ammonium Iron(III) Sulfate, hexahydrate	17 g
Ammonium Molybdate CR	51 g
Ascorbic Acid, L	8 g
Barium Chloride, anhydrous	34 g
Barium hydroxide crystal	465 g
Buffer solution, pH 10	0.4 L
Buffer solution, pH 4.	1 L
Buffer solution, pH 7	1 L
Butanol, 1	1 L
Calcium Chloride, dihydrate	169 g
Coulometer, Anode Solution	1 L
Coulometer, Cathode Solution	3 L
Cupric Chloride	85 g
Cupric Sulfate, anhydrous	77 g
EDTA (Ethylenediamine tetracetic acid)	17 g
EGTA (Ethylene bis Oxyethylene Dinitrilo tetracetic Acid)	0.2 L
Ethyl Acetate	0.2 L
Ethyl Alcohol	8 L
Formaldehyde, 37%	0.1 L
Glyoxal-Bis (2-Hydroxyanila)	4 g
Hexane, n-, Optima Grade	0.3 L
Hydrogen Peroxide, 30%	30 L
Kerosene, Odorless	1 L
Lithium Chloride	169 g
Magnesium Chloride	254 g
Magnesium Sulfate	85 g
Methanol	6 L
Methylene Chloride	1 L
p-Methylaminophenol Sulphate (Metol)	17 g
Potassium Bromide	17 g

<b>Material</b>	<b>Quantity</b>
Potassium Chloride	338 g
Potassium Hydroxide, pellets	338 g
Potassium Iodide	102 g
Potassium Nitrate	17 g
Propanol, (2-, Isopropyl Alcohol)	22 L
Silver Nitrate	4 g
Silver Sulphate	2 g
Sodium Bicarbonate	12 L
Sodium Borate, tetra-, (Borax)	1,354 g
Sodium Carbonate, Anhydrous	423 g
Sodium Chloride	254 g
Sodium Citrate Dihydrate	338 g
Sodium Hydroxide, pellets	288 g
Sodium Metaphosphate	338 g
Sodium Nitrite	85 g
Sodium Nitroprusside	34 g
Sodium Pyrophosphate	169 g
Sodium Silicofluoride	4 g
Sodium Sulfate	34 g
Sodium Sulfite	17 g
Sodium Thiosulfate (pentahydrate)	17 g
Stain, Phenol Red	0.002 L
Strontium Chloride, Hexahydrate	17 g
Tiron Indicator, Dihydroxy-1,3- Benzene disulfonic acid	4 g
Tracer (PFT) [Perfluoromethylcyclohexane]	3,892 g
Trichloroethane, 1,1,1	0.3 L
Xylenes	0.1 L
Zinc Chloride	68 g
Borax	761 g

## **APPENDIX D**

### **DRILLING, CORING, & RELATED RESEARCH DEVICES**

This appendix provides detailed information on tools and resources that may be used in future IODP riserless drilling expeditions.

◇ Drilling and Coring Tools:

- Drillship Tools (Drill String, BHA, VIT, RIS)
- Coring Tools (APC, RCB, XCB, ADCB, MDCB, PCS, Core Bits)
- Reentry Tools (DIC, FFF, HRB, HRRS, RECC, Underreamers)
- Downhole Tools (APCT, APCM, DVTP, IWS, DSS)
- Wireline Tools (LFV, MBR)

◇ Downhole Logging Tools:

- Downhole Logging Tool Selection
- Triple Combo Tools (APS, DIT, HLDS, HNGS, TAP)
- FMS/Sonic Tools (DSI, FMS, SGT)
- Third Party Tools (CB-DSA-XM, CB-RMM, CB-TT, MGT, UHT-MSM)
- Specialty Tools (ARI, ASI, DLL, LWC-RAB8, LWD-adnVISION, LWD-arcVISION, LWD-EcoScope, LWD-sonciVISION, LWD-proVISION, LWD-geoVISION, MWD-TeleScope, QAIT, QSST, UBI, VSI, WST, WST-3 Axis)
- Stuck/lost Tool Procedures

◇ Borehole Research Tools

- Observatories (CORK, ACORK)
- Borehole Instrument Hanger (BIH)
- Borehole Packers

**THIS PAGE INTENTIONALLY LEFT BLANK**

## Scientific Application

The “drill string” is composed of “knobbies,” drill pipe, a bottom-hole assembly (see the BHA tool sheet), and a bit (see the Core Bit tool sheet). It is used to deploy and retrieve (i.e., “run” and “pull”) all of ODP’s coring/drilling BHAs, reentry structures, completion hardware, and associated equipment. A drill string undergoes higher tensile, bending, and torque stresses than standard pipe; thus, the tool joints have shoulders that provide stiffness to prevent bending and breaking. The drill string can be run to a maximum coring/drilling depth of ~8375 m in moderate weather (at 6° roll with 100,000 lb overpull and a typical BHA). All drill string elements have a 4.125 in. (10.47 cm) minimum internal diameter (ID) throughout to allow other tools to pass through; therefore, the drill string is compatible with the ODP coring systems, water samplers, temperature/pressure probes, and logging tools. This compatibility reduces pipe trips and maximizes the time spent drilling a hole or recovering core to achieve the science objectives.

## Tool Operation

The drill string is supported by the top drive (in the derrick), which

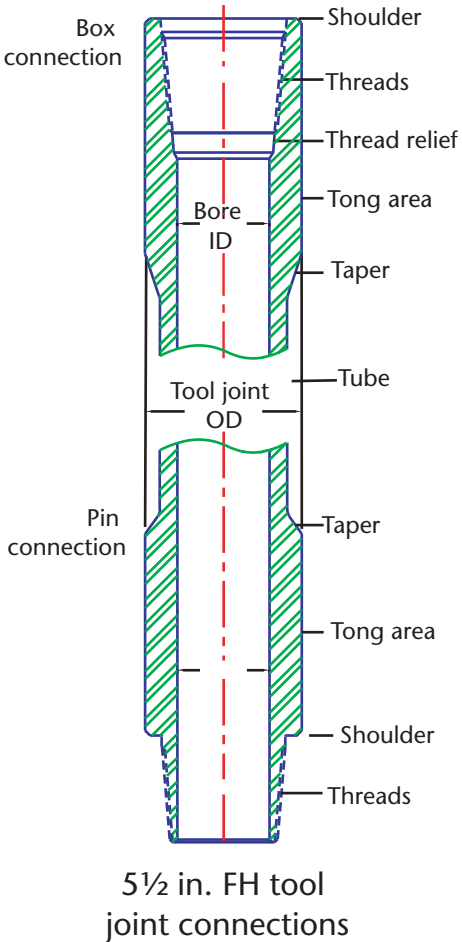

**Figure 1. Schematic of the box and pin ends of a joint of pipe. The tube section is cut away to shorten the drawing. ID = internal diameter, OD = outside diameter, FH = full note.**

rotates the drill string at the surface to drive the bit and allow the drill string to advance downhole. The drill string is tapered to maximize strength and hanging length by using lighter 5 in. outside diameter (OD) drill pipe (Fig. 1)

on bottom to reduce the weight and stronger 5 1/2 in. OD drill pipe on top where bending stresses are higher. The drill string is run using a “dual elevator” system, which uses two heavy lift “elevators” to support the pipe tool joint rather than tooth-type dies in “slips.” The individual drill pipe “joints” are manufactured in nominal 31.6 ft (9.65 m) lengths; however, the pipe is handled on the ship in three-joint “stands” (or “triples”) for speed in running, pulling, and storing the pipe (Fig. 2). Short lengths of drill pipe called “pup joints” are available in 5, 10, and 15 ft lengths to adjust (i.e., “space-out”) the drill string length, where required, for spudding a hole, landing heavy equipment, or running underreamers inside casing.

Two drill strings are maintained on the ship: (a) a ~6900 m working string in the horizontal pipe racker and (b) a ~5000 m backup string in storage in the ship’s riser hold. The drill strings in use on the *JOIDES Resolution* are inspected and refurbished (i.e., thread repairs and recoating) every 1 1/2 to 2 years. In addition, two backup strings are available onshore: (a) a ~6900 m working string and (b) one 3000 m emergency Condition 2 (i.e., the remaining tube thickness is 70% to 80% of the original specification) backup string maintained onshore in storage.

Knobbies are heavy-wall pipe with tool joint-sized “knobs” to reduce the bending stresses as the pipe moves through the curved guide horn and exits the bottom of the ship when tripping pipe. Knobbies are run between the top drive and 5½ in. drill pipe (i.e., at the top of the drill pipe). As the hole is deepened, the knobbies are removed by the rig crew and replaced with 5½ in. pipe as required by depth and weather. In exceptionally rough weather, aluminum “wear knots” can be added to the upper portion of the 5½ in. drill pipe to reduce bending stresses in the guide horn.

## Design Features

### 1) Large Internal Diameter/ Compatibility

All the elements in the drill string have a 4.125 in. (10.47 cm) opening throughout.

*Benefit:* The drill string is compatible with all the ODP coring systems, water samplers, temperature/pressure probes, and logging tools. In addition, pumping pressure losses in long drill strings are reduced, thereby, improving hydraulics for hole cleaning.

### 2) High Strength Pipe

The drill string is made of high tensile strength S-140 steel, which is more brittle than typical drill pipe but stronger, with a tensile strength of 140,000 psi. There are many types of drill pipe, but typical drill pipe has a strength of ~95,000 psi. The strength benefits of the S-140 pipe outweigh the increased brittleness, but the brit-

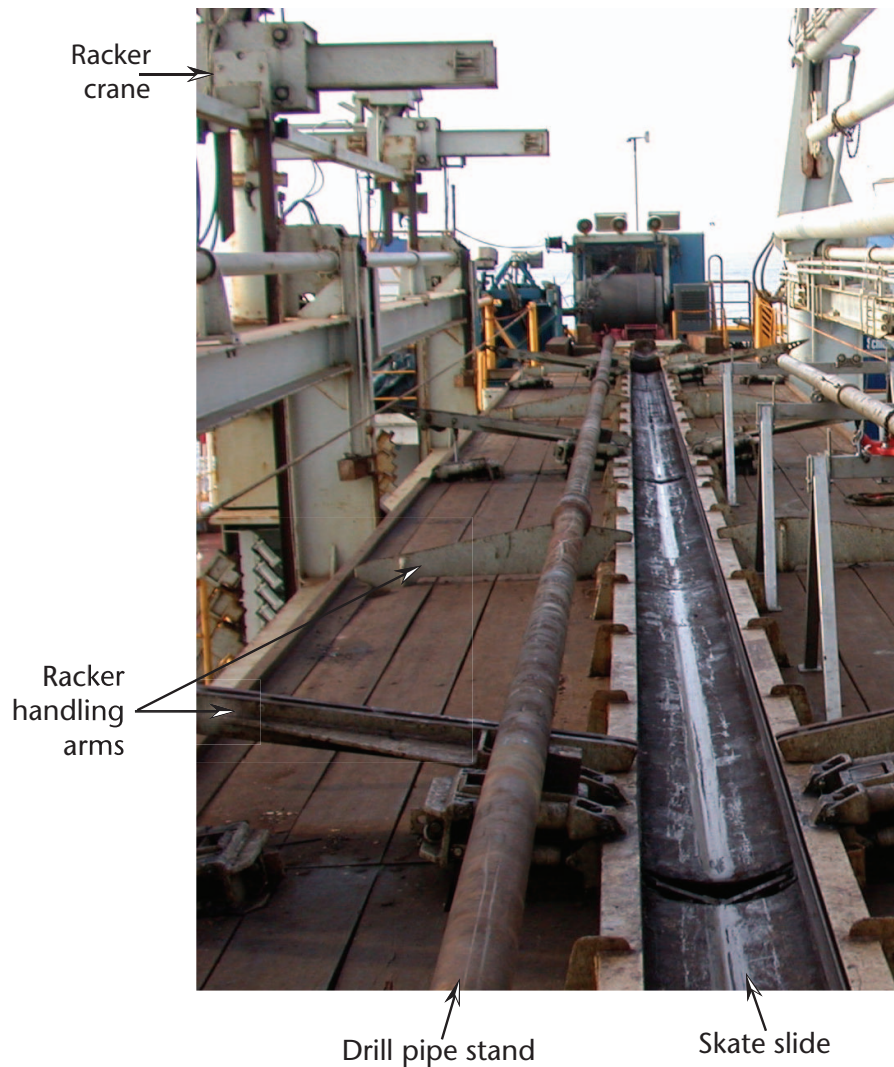

**Figure 2.** Photo shows a stand of drill pipe and the skate slide the stand sits in before it is made up to the drill string. The photo is looking toward the back of the ship and shows a portion of the racker crane (left), which moves pipe to and from the horizontal racker and riser hold storage.

tleness requires special handling. It is essential to avoid notch damage (stress concentration points) (see Design Feature 4). ODP acquired S-135 pipe early in the program, and that is used in the backup drill string (135,000 psi tensile strength).

*Benefit:* The stronger pipe can support heavier hanging loads for longer drill strings, run heavier casing strings and reentry installations and equipment, and

provide more “overpull” force to free struck pipe.

### 3) Triple Lengths

The drill pipe “joints” are made in 31.6 ft (9.6 m) lengths and are run and stored horizontally on the ship in three-joint sections known as “triples” or “stands” (Fig. 3).

*Benefit:* Increases the speed in running, pulling, and handling the pipe and reduces wear to the pipe tool-joint threads. Typical running speeds are ~700 m/





**Figure 3. Drill pipe stands are stored in the horizontal pipe racker, which is located behind the derrick and rig floor.**

hr and typical pulling speeds are ~550 m/hr, depending on weather and string length and weight.

#### 4) Dual Elevator System

The drill string is run using a “dual elevator” system, which uses two “elevators” (or lift collars) to support the pipe tool joint rather than toothed friction-type “slips” that could notch and create stress concentration (weak) points in the tube of the high-strength drill pipe (Fig. 4).

*Benefit:* Elevators provide a positive and stronger support under the tool joint than a slip, and reduce notch damage to the pipe tube; thus, the pipe can be used longer.

#### 5) Coating

The drill pipe is coated inside and outside with an inorganic zinc anti-corrosion compound.

*Benefit:* The internal coating reduces the formation of rust, which can act as a contaminant during coring, and the coating reduces saltwater “corrosion pitting” (i.e., a reduction in tube wall thickness), which can degrade strength during horizontal storage. Rust can hamper thread makeup and handling; thus, an external coating is applied to reduce rust.

#### 6) Threaded Connections

The drill pipe has threaded connections, which are rotary shouldered “tool joints” designed for rotation in the open ocean (i.e., without a constraining riser). The 5 in. drill pipe has 5½ in. full hole (FH) tool joints (7 in. OD), and the 5½ in. drill pipe has 5½ in. internal flush (IF) tool joints (7¾ in. OD). The 5½ in. FH connections in the drill string have been enlarged to a 4.125 in. (10.47 cm) ID.

*Benefit:* The shouldered tool joints prevent bending and breaking. The threaded connections are in heavy tension and are made up with high torque to prevent the pipe from unscrewing during use.

#### 7) Pipe Inspection

Current protocol calls for the pipe to be inspected every 1½ to 2 years using nondestructive electromagnetic induction (EMI) or ultrasound inspection techniques.

*Benefit:* The pipe inspection helps to identify defects in pipe joints to avoid catastrophic failures that could lead to loss of the drill string. Condition 1 pipe has at least 80% remaining wall thickness and is reconditioned if possible. Condition 2 pipe has 80% to 70% remaining wall thickness and is stored for an emergency backup string if it meets tool joint length criteria (i.e., there is enough length in the tool joint to be gripped by power tong jaws).

### Drill String Specifications

For drill pipe tube and pipe strength specifications, see Table 1. For drill pipe tool joint specifications see Table 2.

Drill Pipe Joint Length:  
31.6 ft (9.6 m)

Minimum Internal Diameter:  
4.125 in. (10.47 cm)

Minimum Tensile Strength:  
140,000 psi

**Table 1. Drill pipe tube and pipe strength specifications.**

Drill Pipe Tube OD (in.)	Drill Pipe Tube ID (in.)	Nominal Weight Tube (lb/ft)	Adjusted Overall Joint Weight (lb/ft)	API Steel Grade	100% Tensile Strength (lb)	Cond. 1 Pipe 80% Tensile Strength (lb)
5	4.276	19.50	22.1	S-140	738,443	590,754
5½	4.500	26.67	31.9	S-140	1,099,557	879,645

**Note:** Cond. = condition, API = American Petroleum Institute

**Table 2. Drill pipe tool joint specifications.**

Drill Pipe Tube OD (in.)	API Tool Joint Threads (in.)	Tool Joint OD (in.)	Tool Joint ID (in.)	Tool Joint Makeup Torque (ft/lb)	Burst Strength (psi)	Collapse Strength (psi)
5	5½ Full Hole	7.00	4-1/8 * (*bored to 4-1/8)	28,000	10,000	5,000
5½	5½ Internal Flush	7¾	4-1/8	48,000	10,000	5,000

**Note:** OD = outside diameter, API = American Petroleum Institute, ID = internal diameter.

## Typical Operating Range Limitations

**Depth Range:** 8375 m

**Typical Drill String Configuration:** BHA with crossover to ~3500 m of 5 in. drill pipe, 5 × 5½ in. drill pipe crossovers, and 5½ in. drill pipe as required for total length. Knobby joints are added as required below the top drive and replaced with drill pipe as required.

The depth limit of a tapered 5 in. × 5½ in. S-140 drill string is ~ 8375 m in moderate weather (at 6° roll with 100,000 lb overpull).

The minimum ID through the drill string is 4.125 in. (10.47 cm). The Advanced Piston Corer/Extended Core Barrel (APC/XCB) BHA has a 3.75 in. ID restriction in the seat-



**Figure 4. Making a drill pipe connection on the rig floor. The elevator (red clamp at the bottom of the picture) supports the box [or upper] end of the drill pipe and holds the weight of the entire drill string during a connection.**

ing nipple and the APC/XCB bit ID is 3.80 in. Therefore, the APC/XCB shoes and instruments that pass through the drill string, seating nipple, and bit must have an OD less than 3.75 in.

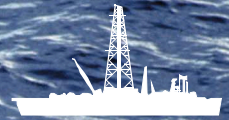

# Bottom-Hole Assembly

## Scientific Application

The bottom-hole assembly (BHA) is the component of the drill string that includes the core bit, outer core barrel, various subs, and the drill collars. It hangs below the drill pipe and provides weight to the drill or core bit to induce the teeth to penetrate the formation, thereby drilling a hole or recovering core to meet the scientific objectives of the cruise. The Ocean Drilling Program (ODP) employs different coring tools to obtain continuous, relatively undisturbed cores in all types of oceanic sediments and igneous basement. ODP uses three primary coring systems, each with a different BHA:

- The Advanced Piston Corer (APC) and Extended Core Barrel (XCB), which use the same BHA; the Pressure Core Sampler (PCS) and Motor-Driven Core Barrel (MDCB) are also compatible with this BHA (note: the MDCB needs an additional sub when it is run);
- The Rotary Core Barrel (RCB), and
- The Advanced Diamond Core Barrel (ADCB).

## I. APC/XCB/RCB BHA

### Tool Operation

The BHA is run on the bottom of the drill string (see the Drill String tool sheet), below the drill pipe. Weight is applied to the bit

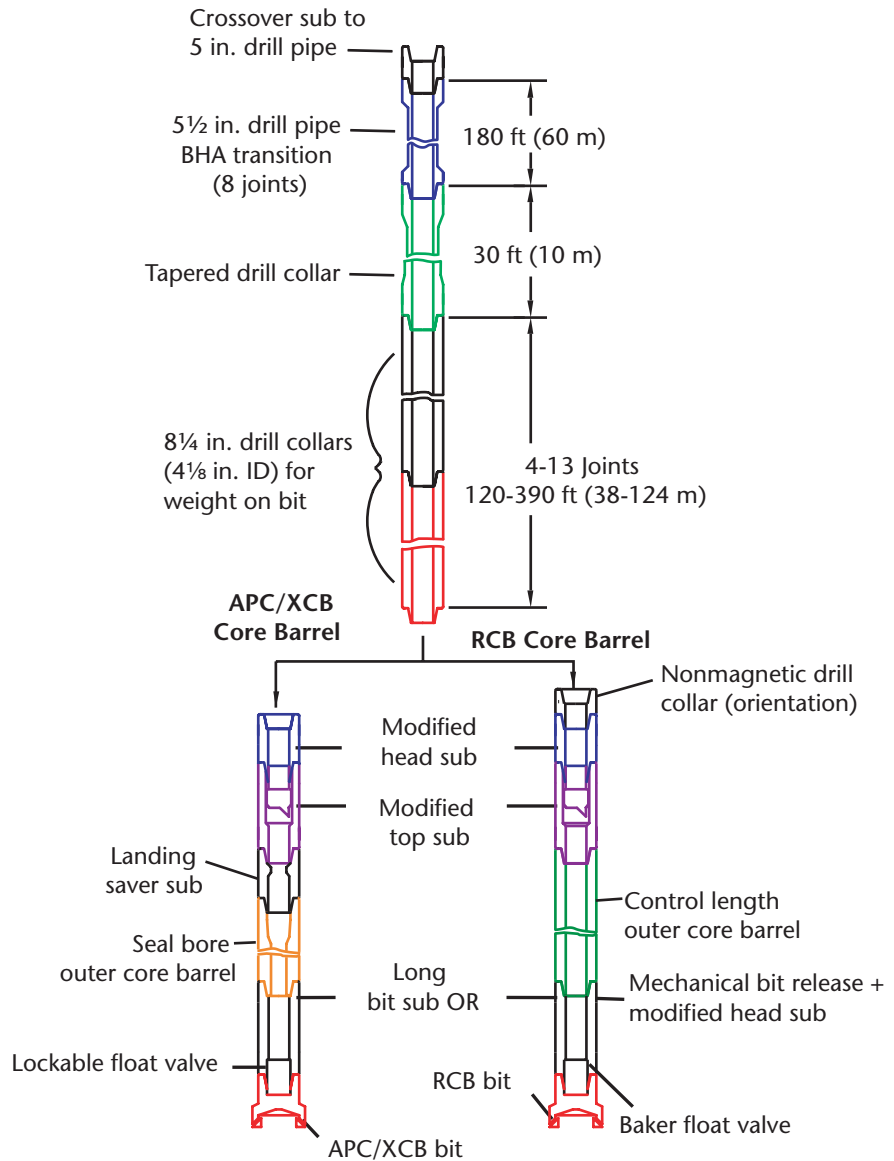

**Schematic of the APC/XCB and RCB BHAs.**

by releasing drill string tension or “slacking-off weight.” The top drive rotates the drill string at the ship’s drill floor to drive the bit and advance the BHA. The BHA consists of a primary core bit, bit sub, outer core barrel (OCB), short sub assemblies, drill collars, transition

section (composed of six joints of 5 1/2 in. drill pipe and tapered drill collar [TDC]), 5 1/2 in. transition drill pipe, and a crossover sub to 5 in. drill pipe. The OCB supports the inner core barrel during coring. Short sub assemblies are added to the OCB as required to



provide landing seats, latch windows, or seal surfaces for the inner core barrel. Drill collars are heavy-weight pipes run above the OCB to apply additional weight to the core or drill bit beneath. A non-magnetic drill collar may be run above the OCB if the core will be oriented or hole directional readings are taken.

## Design Features

### 1) Compatibility

The individual elements of the BHA can be reconfigured to be compatible with a wide range of ODP coring, sampling, and logging tool systems.

*Benefit:* The same basic BHA elements can be used with several coring systems and drilling tools for use in different formations.

### 2) Large Internal Diameter

The drill pipe and drill collars have a 4.25 in. opening throughout (or internal diameter [ID]).

*Benefit:* The drill pipe and BHA are compatible with other coring systems, coring shoes, water samplers, temperature/pressure probes, and logging tools; thus, these tools can pass through the drill pipe and drill collars, eliminating pipe trips to run sampling instruments. In addition, a large ID reduces pumping pressure losses in long drill strings, thereby, significantly improving hydraulics.

### 3) Modified Connections

As the weight of the BHA is applied to the bit, the force on the BHA can change from tension to compression and the drill collars can begin to stand up and start bending. The 6<sup>5</sup>/<sub>8</sub> in. full-hole “modi-

fied” drill collar connections have been strengthened by lengthening the pins 2 in. to stiffen the connection.

*Benefit:* A modified connection reduces bending stresses and connection failures caused by bending and allows bare rock (unsupported) spudding to begin a hole.

### 4) Hole Deviation

The heavy and stiff BHA acts like a pendulum weight as it hangs from the relatively light and flexible drill pipe.

*Benefit:* This keeps the hole relatively vertical without stabilizers.

### 5) Seal Bore Drill Collars (SBDCs)

The APC/XCB outer core barrels are SBDC, with an 8<sup>1</sup>/<sub>4</sub> in. outer diameter (OD) and a 3.820 in. ID smooth honed seal bore section. They are 31 ft, 10<sup>1</sup>/<sub>8</sub> in. long.

*Benefit:* The smaller ID allows the APC inner core barrel piston seals to seal during the piston coring stroke.

### 6) Control Length Drill Collars (CLDCs)

The standard 8<sup>1</sup>/<sub>4</sub> in. OD x 4<sup>1</sup>/<sub>8</sub> in. ID outer core barrels are 30 ft fixed length.

*Benefit:* The fixed length simplifies length space-out requirements for the inner core barrel assemblies.

### 7) Drill Collar Subs

The BHA can be reconfigured by adding short sub assemblies to the OCB as required (e.g., landing sub, top sub, and head sub).

*Benefit:* This provides landing seats, latch windows, or seal surfaces and length space-out for the inner core barrel.

### 8) Nonmagnetic Drill Collar (NMDC)

A drill collar made of nonmagnetic chrome nickel steel may be run above the OCB.

*Benefit:* This allows the core to be oriented and hole directional readings to be taken.

### 9) Tapered Drill Collar (TDC)

A 30 ft long tapered drill collar changes OD from 7<sup>3</sup>/<sub>16</sub> in. to 5<sup>11</sup>/<sub>16</sub> in. to provide a gradual change in cross-sectional area.

*Benefit:* The gradual change in cross-section reduces bending stresses in the transition from BHA to drill string.

### 10) Transition 5<sup>1</sup>/<sub>2</sub> in. Drill Pipe

Two stands (six joints) of 5<sup>1</sup>/<sub>2</sub> in. drill pipe are run at the top of the BHA to reduce bending stresses between the BHA and drill pipe.

*Benefit:* This reduces premature drill string failures.

## Specifications

*Maximum Drill Collar Length:*  
9.5 m

*Internal Diameter:*  
10.79 cm (4.25 in.)

*Connection:*  
6<sup>5</sup>/<sub>8</sub> in. full-hole modified drill collar connections have been modified by lengthening the pins 2 in. to stiffen the connection.

## Typical Operating Range

*Depth Range:*  
No depth limitations

### Typical APC/XCB BHA:

APC/XCB bit, bit sub, seal bore drill collar, landing sub, top sub, head sub, NMDC, five CLDCs, tapered drill collar, six joints of 5½ in. drill pipe, and a crossover to 5 in. drill pipe.

### Typical RCB BHA:

RCB bit, mechanical bit release (MBR), head sub, CLDC, top sub, head sub, seven to ten CLDCs, tapered drill collar, six joints of 5½ in. drill pipe, and a crossover to 5 in. drill pipe.

### Limitation

Bare rock (unsupported) spud-ins to start a hole must restrict weight on bit to the length of the drill collars buried (i.e., supported in the hole) to avoid bending and breaking the BHA. This reduces the available weight on bit and slows the rate of penetration.

## II. Advanced Diamond Core Barrel (ADCB) BHA

### Tool Operation

The ADCB coring system uses a 7¼ in. OD (184 mm) “PQ3” mining-style thin-kerf diamond bit with a 6¾ in. BHA for coring in firm to hard sediments or basement. The bit only requires eight to ten drill collars (each 6¾ in. [171 mm] diameter) for adequate weight on bit. However, the 7¼ in. hole does not have sufficient clearance for the 7 in. OD (178 mm) tool joints on the 5 in. drill pipe to pass through; therefore, additional 6¾ in. drill collars must be used to allow the ADCB BHA to advance.

### Design Features

#### 1) Improved Hole Stability

The 7¼ in. (184 mm) thin-kerf diamond bit produces a smaller hole, and the 6¾ in. (171 mm) smooth

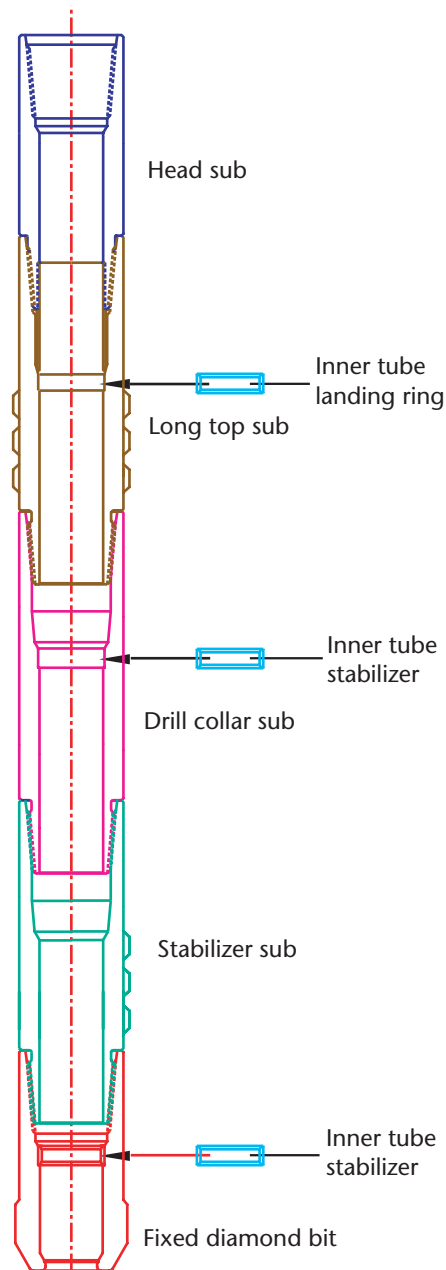

**Schematic of the 6¾ in. 15-ft version of the ADCB BHA.**

BHA provides a “packed hole” with a narrow ¼ in. (6.3 mm) annulus.

*Benefit:* Hole stability has historically been better in smaller diameter holes, and smooth BHAs in packed holes eliminate upsets that can hang up in more rugose holes. Upsets are enlarged sections of pipe connections that provide metal thickness to cut robust rotary threads with shoulders.

#### 2) Smoother Hole Wall

The gentle abrasive action of the thin-kerf diamond bit minimizes hole disturbance and produces a hole with a smoother wall.

*Benefit:* Hole stability and wireline logging quality are improved by reducing the mechanical disturbance to fractured or loosely cemented formations, which minimizes the sloughing and instability problems associated with rugose holes.

### Typical Operating Range

#### Depth Range:

Limited only by the number of 6¾ in. drill collars available (~300 m).

#### Drill Collars:

6¾ in. OD (171.45 mm) with 5½ in. full-hole modified connections.

#### Typical ADCB BHA:

Bit, stabilizer sub, OCB, long top sub with stabilizer and landing ring and latch sleeve, head sub, shock sub, eight to ten drill collars each 6¾ in. in diameter for weight on bit (plus five to six stands for penetration), crossover to 5 in. drill pipe.

### Limitations

BHA must have a ±20 m deep predrilled hole for support (i.e., BHA cannot be used for bare rock spuds).

Penetration is limited by the number of 6¾ in. drill collars available (~300 m).

The OCB is normally run as a 15 ft (4.75 m) core barrel length.

The ADCB BHA is smaller and thinner walled than larger more robust BHAs; therefore, it requires gentler handling and makeup.



## Vibration Isolated Television

### Description

The Vibration Isolated Television (VIT) frame is primarily used to provide visual observation of the sea floor during reentry of an existing borehole. Sonar capability, primarily used to locate objects such as reentry cones which are initially out of camera range, is an integral part of the system. The sonar, in conjunction with a compass attached to the VIT frame, provides primary range and bearing from the VIT frame to the reentry cone. An acoustic beacon can be attached to the VIT frame, which allows the ship's dynamic positioning system computers to fix the position of the VIT frame relative to the ship.

The VIT frame is deployed by latching its guide sleeve around the drill string. The drill string is used as a guide as the VIT is lowered to the sea floor by means of an armored coaxial cable attached to a special winch located in the ship's moonpool area. Power is transmitted down the coaxial cable to operate the underwater lights, camera and sonar. The TV and sonar signals are then transmitted up the coaxial cable for display and recording on board the ship.

The VIT can also be used to precisely locate spudding sites. Once located, the sites can be marked by dropping an identifying marker from the VIT frame itself, via an acoustic release.



## Specifications

- Depth Rating = 22,500 ft (10,000 psi)
- Operating Temperatures = -20° to +60°C (-68° to +140°F)
- Shock Rating = 100 Gs at 11 milliseconds, 3 axes
- Umbilical Cable = double armored coaxial

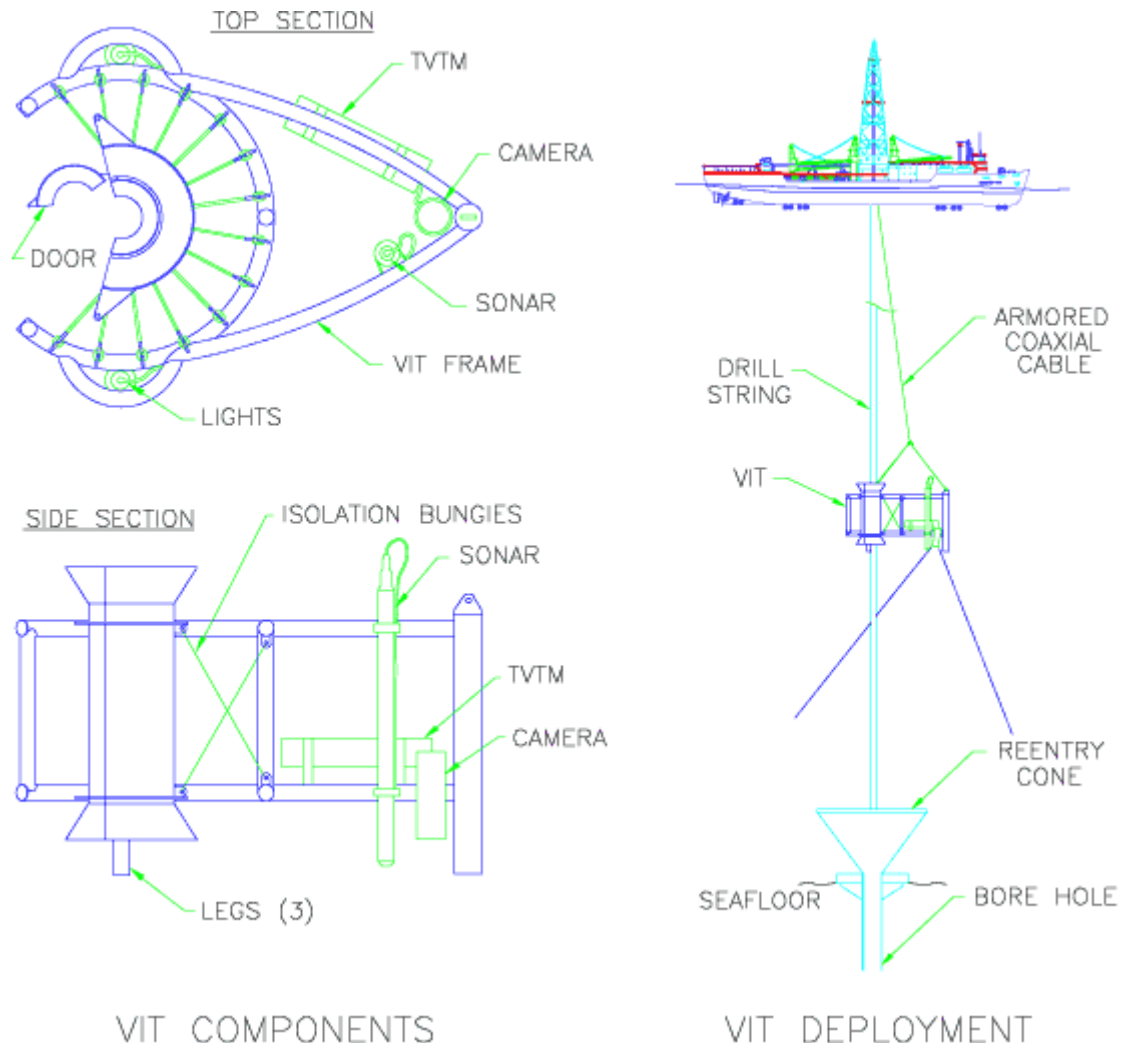

## Design Features

### Underwater Lights

- Lamps = 100 and 250 watt quartz halogen, w/reflectors 2000 hours average rated life, 5000 lumens output
- Beam pattern = 60-70° field of view in water, 20-40 foot range
- Power = 120 volt AC

### Remote Video Camera

- Type = Videospection SIT (high sensitivity)

- Power = -15 VDC
- Video Output = 1VPP negative sync composite video, 75 ohm
- Weight = 28 lbs
- Light Sensitivity = 0.001 candlepower, low level (star light)

### **Telemetry System**

- Type = TVTM-3015 (CSE) Colmek Systems Engineering
- Control = zoom control signals are telemetered to the unit.
- Cable Power = (1) Surface: voltage is stepped up to 480VAC, (2) Subsea: voltage is stepped down to 120 V AC
- Weight = Multiplexer, 212 lbs
- Line voltage = 120 VAC +/- 10%, 60 Hz (at the surface)
- Subsea Power = subsea TVTM 8.4 watts, 590 watts available to operate camera and lights.
- Video resolution = ~300 TV lines horizontal

### **Sonar Head**

- Type = Simrad Mesotech, model 971
- Frequency = 675 kHz
- Beam Width = 1.7° horizontal, 60° vertical
- Mechanical Resolution = 0.225° (step angle)
- Scanning = 360° continuous, or locked
- Connector = DG O'Brien 9 pin
- Cable = DG O'Brien oil filled assembly
- Dimensions = 3.5 in (89 mm) diameter, ~60 in long
- Weight = ~75 lbs (in air), ~50 lbs (in water)



# Rig Instrumentation System and Load Pins

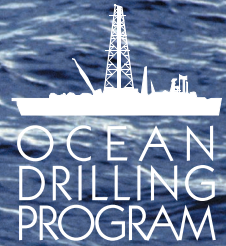

www.oceandrilling.org

## Scientific Application

### Rig Instrumentation System

The Rig Instrumentation System (RIS) on the R/V *JOIDES Resolution* (JR) is a state-of-the-art data acquisition system that can analyze data. The ability of the RIS to present real-time data and drilling parameters in digital and graphical formats provides a powerful tool for the Driller, Core Techs, and ODL/ODP drilling supervisors and enhances interpretation of trends to improve decision making and core recovery. The data export feature allows scientists to merge and correlate drilling data with the physical properties of recovered core. This comparison allows for enhanced assessment of poor core recovery intervals. The data recording and post-processing features of the RIS provide information to analyze bit and downhole tool operation and bottom-hole assembly (BHA) performance; however, the raw data require manipulation and refinement.

### Instrumented Load Pins

The RIS records and displays the hook load. Hook load is measured by a hydraulic “load cell” located in the crown that “weighs” the total load hanging in the derrick, which includes the weight of the drill wireline, heave compensator, traveling block, and drill string weight supported by the hook. The inertial effects of ship’s motion (heave, roll, and pitch) and the stroke of the Active Heave Compensator (AHC) impart a false load into this measurement, which manifests itself as “noise” or erratic needle swings on the driller’s weight indicator. To provide a more stable hook load measurement, two instrumented “load pins” (0-500,000 lb each) were installed at the hook’s upper support point on the AHC’s lower cross-beam, where it is virtually uncoupled from the dynamic reaction forces of the ship’s heave and AHC stroke.

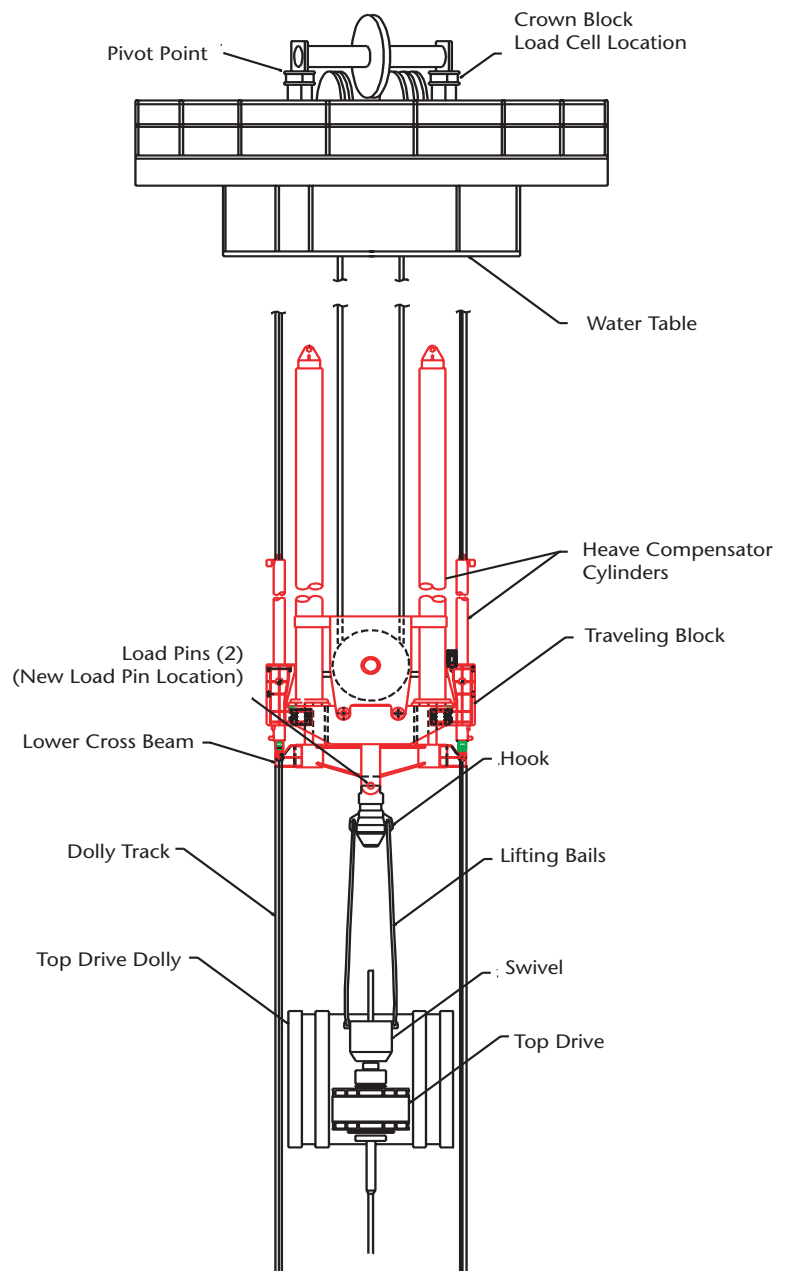

**Schematic of the upper derrick showing location of the load cell and load pins in relation to the crown block, heave compensator cylinders, and traveling block.**

## Tool Operations

All RIS sensor data and analog/digital signals are routed directly to the Databox (data acquisition electronics) located in the subsea shop. The Databox converts the signal and outputs it to the Master Computer, which is located in the computer server room. The Master Computer has six communication ports available for additional devices, of which two are used for receiving data from the AHC controller and the coring wireline depth recorder. Two others are used for two-way communication where the RIS both sends and receives data. When measurement/logging-while-drilling (M/LWD) tools are run, the downhole data from the tools are sent to the RIS and certain sets of RIS data are sent to the M/LWD data acquisition system. When continuous tracer injection is required for microbiology sampling, the RIS controls the tracer pump, which automatically adjusts the injection rate to maintain constant tracer concentration with varying mud pump rates.

A fiber-optic cable runs between the Master Computer and the rig floor display located in the Driller's workstation. The infrared touch screen on the rig floor display allows the Driller's finger to move the mouse cursor to operate the RIS software, which runs in a Microsoft Windows environment. The Master Computer is linked to the ODP ship's network and broadcasts in real time to remote RIS workstations in the ODP and ODL operations offices and Core Tech shop. The remote workstations are available to these personnel for data analyses and report creation. Each user has independent control over how the data are displayed.

## Design Features

### 1) Data Analysis

Drilling data analysis is initially based on a review of drilling parameters and interpretation of the RIS log graphical display, where historical curves are reviewed for trends and to identify abrupt events.

*Benefit:* A data set can be studied in both time and depth domains to help understand the contribution of the individual drilling parameter. Curves can be overlaid and tracks can be rearranged to correlate sets of parameters. A zoom-in and zoom-out feature aids in the analysis. A more detailed analysis can be performed by exporting the data in ASCII format, which can be imported into other graphics and analysis programs (e.g., EXCEL and Lab-View). The science party can acquire exported and corrected ASCII files from the operations office for their data analysis.

### 2) Data Variables

One hundred variables (V1-V100) are available in the TruVu software program. Primary data variables already assigned and used by ODP are listed in the Primary Data Variables section. Variables are assigned (e.g., standpipe pressure) and set up (e.g., units) in the TruVu software. There are three types of data: collected from sen-

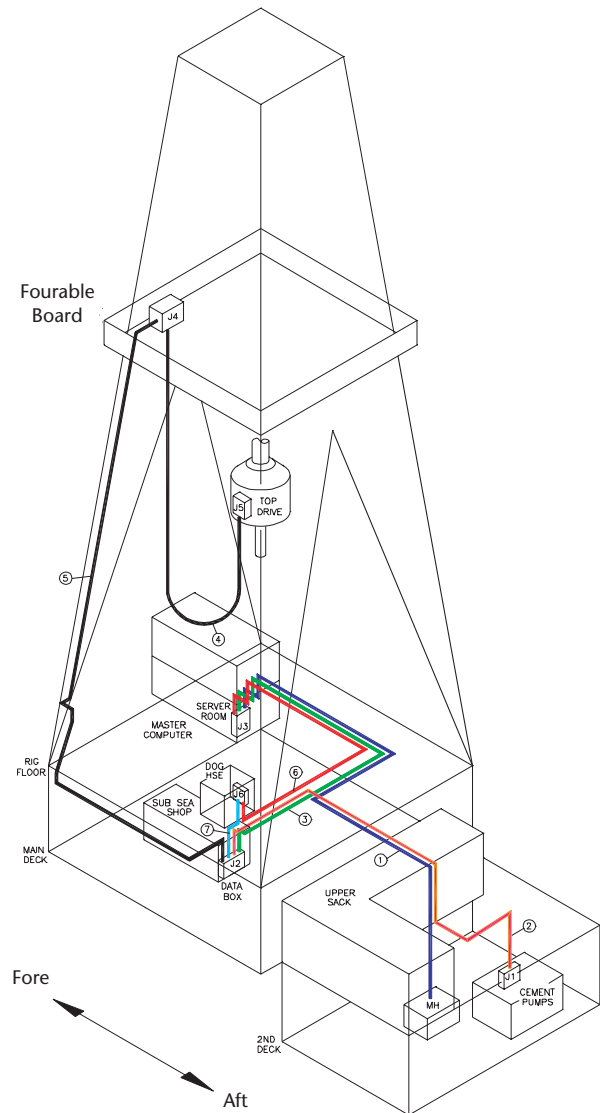

**Schematic of the RIS cable routing. The cable colors indicate gauge and type of cable.**

sors, collected from other devices (e.g., MWD) via communication links, or calculated to one or more variables by math functions in the software. Up to 45 variables can be displayed on the data table screen. Each variable can be set independently with its own filter, refresh rate, and display resolution. Each variable may be saved at its instantaneous, maximum, minimum, or average value over the save period.

*Benefit:* Allows user to save data in a form compatible with future analysis.

### 3) Plotting

Hard copy plots of the data can be used for analyzing drilling performance. There are several available “canned” plot formats, but the user can also create custom formats. Up to six traces can be overlaid on each track; however, the number of tracks is limited to what can be viewed within the available space. The output scales of each variable are user defined as well as the range of depth or time. The graphs may be printed to any printer or plotter.

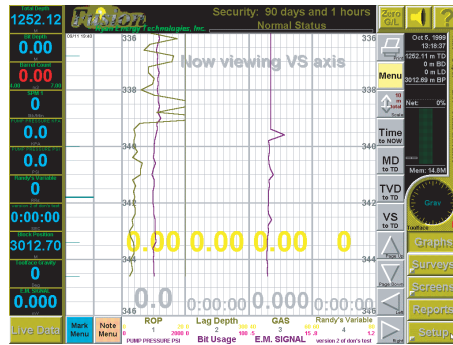

Graphical Data Display

*Benefit:* Allows user to print hard copies (after reviewing electronic file) for additional analysis of trends.

### 4) Data Management

The ODP Marine Electronics Technicians support the operating software and maintain the hardware. The operating software requires a person with significant experience to effectively take advantage of its features.

Data for all ODP holes created during the leg are archived on three sets of CD-ROMs at the end of each leg. One CD set stays on the ship and two are sent to ODP in College Station. Scientists may access RIS data via exported ASCII files, which are requested through the ODP operations office. The RIS database will eventually be moved into the Janus database or moved to a linked database; however, the distribution of raw RIS data presents a data integrity problem. The quality of the raw data must be verified before distribution and manually



Live Data Table Display

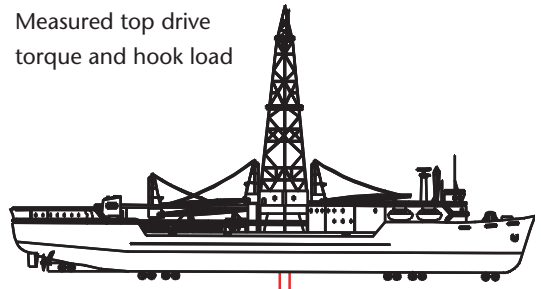

Measured top drive torque and hook load

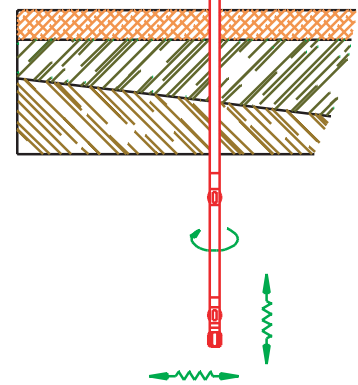

Sensed WOB and TOB

### MWD Real-Time Transmission

**The two diagrams on the left illustrate the two live data displays: graphical (top) or data table (bottom). The data table is the default screen. To move to the graphical display, one clicks on the green “Graphs” button on the right hand side of the screen. The diagram on the right illustrates Real-Time transmission when using a measurement-while-drilling (MWD) tool. Top drive torque and hook load are measured in the derrick during all drilling/coring. The MWD sensor measures WOB and Torque on Bit (TOB) at the bit and transmits the data to the RIS via a sensor sub.**

corrected for sensor calibration changes.

*Benefit:* Allows wide distribution of custom data sets for further analysis.

### Primary Data Variables

- Data collected from sensors: traveling block position, top

drive torque and revolutions per minute (RPM), standpipe pressure, mud pump rate (strokes) and pressure, cement pump rate (strokes) and pressure, coring wireline tension and depth, hook load (crown and two load pins on traveling block), pipe length (joint counts), and pipe makeup torque.



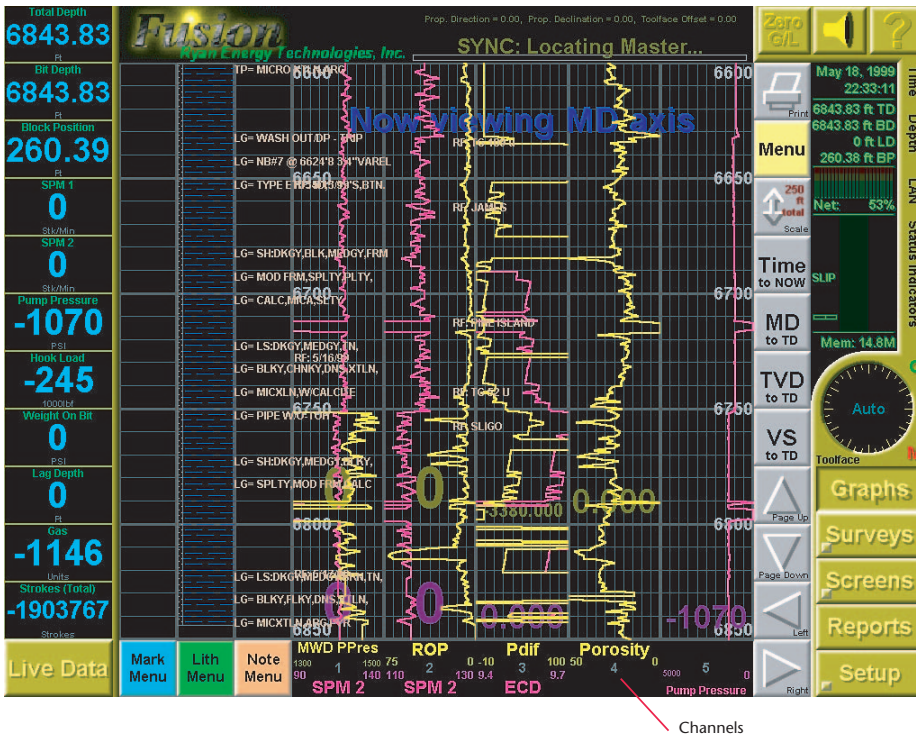

Screen capture of the RIS live data graphical view, showing the five channels. Each channel can display two traces each for 10 traces total. The eight traces (two traces are not being utilized) displayed in this example are MWD pore pressure, ROP, pressure drop across the bit (Pdif), porosity, strokes per minute (SPM2) on two traces, equivalent circulating density (ECD) or mud weight, and pump pressure.

- Data collected from other devices via RS-422 communication links:
  - ship heave and velocity, ship roll and pitch, AHC position/hook load/pressure/ velocity/heave deviation, Schlumberger measurement-while-drilling (MWD) surface measurements and data, and tracer pump status.
- Calculated values: depth, rate of penetration (ROP), and weight on bit (WOB).

### Typical Operating Range

- Operating Range: Records all operations 24/7.
- Sampling Rate: All 100 variables are sampled every 0.5 s, and both time- and depth-based data are saved during a job.

- Data Save Rates: All 100 variables are set for 60 s for the time-based database and for every 1.0 m for the depth-based data. Other rates are available but not used.
- Selected Save Rates: A subset of variables are saved at 1 s using a "capture" device.
- Format: The data is saved in ASCII.
- Live-Data Displays: All 100 variables can be displayed on a strip-chart type log (graphical) or data table display:
- The graphical display can monitor five channels with two traces per channel at one time. A scrolling feature allows viewing of up to 20 channels maximum in five-channel increments.

- Time- or depth-based graphs can be viewed as:
  - Time-based display from 1 to 50 hr of log,
  - Depth-based display from 10 to 250 m of log.
- Up to 45 variables can be monitored at one time in the data table display.
- The user can set the range and scale for each variable.

### Limitations

#### Depth and ROP Measurement

On a riserless vessel, there is no fixed reference to the seafloor (such as a riser) to directly measure drill pipe advancement (i.e., depth and ROP). The RIS constantly collects block position, compensator position, and heave data, however, the current method of obtaining an absolute depth measurement on the JR relies on manually tracking the motion of the traveling blocks, which are referenced from the drill floor. The ability to output a dependable calculated bit depth is limited because the:

- heave compensator stroke effectively disconnects the traveling blocks from the drill pipe advancement,
- heave measurement's null position is continually being recalculated, and
- compensator null position varies depending upon the driller.

#### Raw Data Quality

The quality of the raw data must be verified prior to distribution and manually corrected for sensor calibration changes.

## Scientific Application

The Advanced Piston Corer (APC) is crucial for high-resolution climate and paleoceanographic studies. The APC is a hydraulically actuated piston corer designed to recover relatively undisturbed continuous 9.5 m long oriented core samples from very soft to firm sediments that cannot be recovered well by rotary coring.

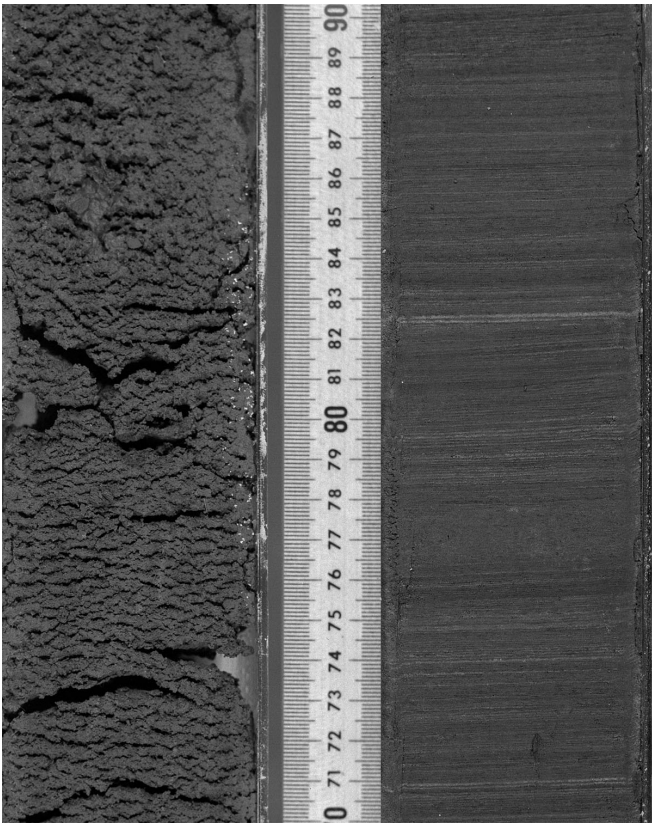

Rotary cored

Piston cored

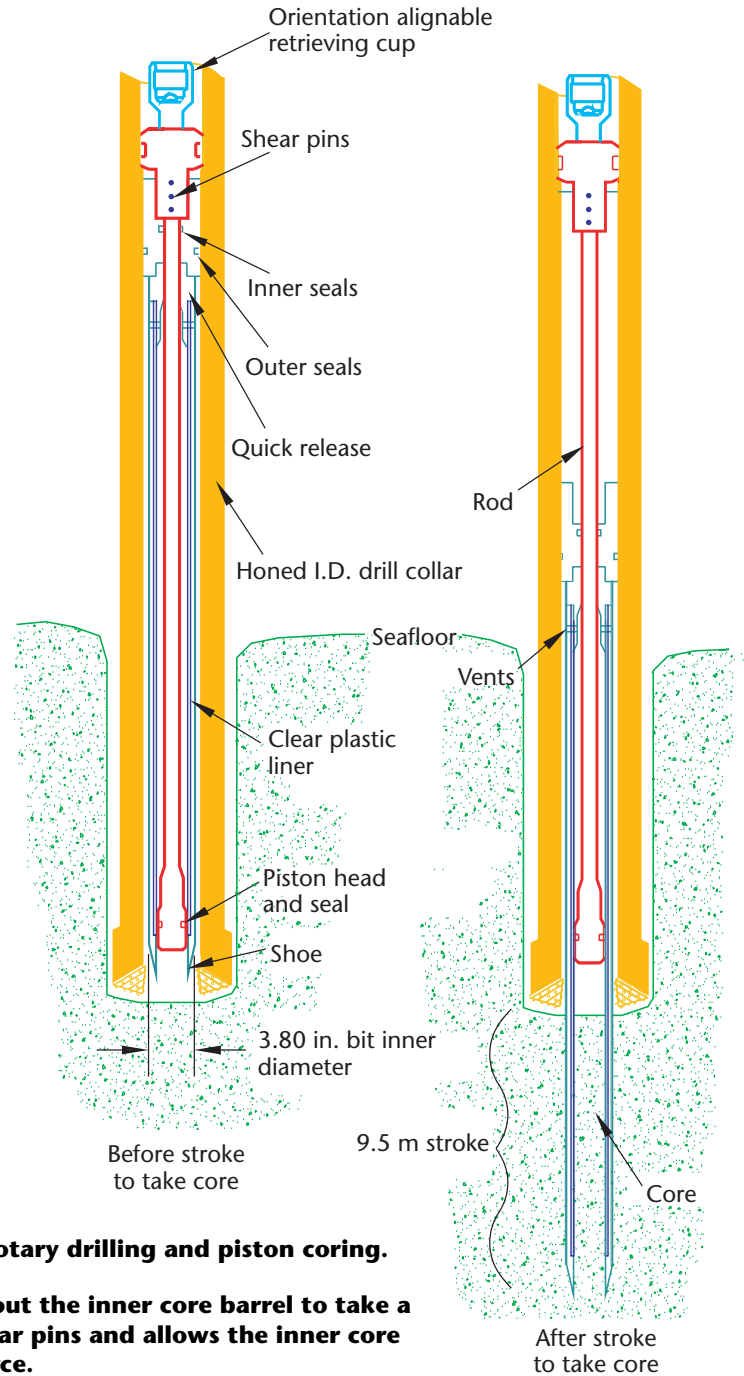

(Above) Comparison of sediment core quality between rotary drilling and piston coring.

(Right) Schematic of the APC before and after stroking out the inner core barrel to take a core. Pump pressure inside the drill string severs the shear pins and allows the inner core barrel to stroke out 9.5 m in 2-3 s with ~27,000 lb of force.



## Tool Operations

The APC inner core barrel is run to bottom on the coring wireline. Pump pressure is then applied to the drill pipe, which severs the shear pins and strokes the inner core barrel 9.5 m into the sediment. The inner core barrel containing the core is then retrieved by wireline. A wireline packoff at the top of the drill string permits rotation of the drill string and continued circulation while the core is retrieved. After core retrieval, the bit and bottom-hole assembly (BHA) are again advanced 9.5 m, repeating the process.

## Design Features

### 1) Compatibility

The APC inner core barrel is deployed in the same BHA as the Extended Core Barrel (XCB); therefore, both tools can be used interchangeably depending on formation lithification. The Motor Driven Core Barrel and Pressure Core Sampler are also compatible with the APC/XCB BHA.

*Benefit:* Tools are interchangeable and no time is spent for bit trips.

### 2) Wireline Deployment

The APC inner core barrel is deployed (and recovered) using the coring wireline to avoid premature release of the shear pins, which determine penetration force of the barrel into the sediment.

*Benefit:* Allows rapid recovery of core with minimal nonproductive time.

### 3) Core Orientation

The APC core can be oriented with respect to the Earth's magnetic field by running a downhole orientation tool above the core barrel.

*Benefit:* Allows recovery of oriented core for paleomagnetic studies.

### 4) In Situ Temperature Measurement

Special APC shoes have a pocket in which a thermistor unit can be run to record the in situ formation temperature after taking a core (see APCT tool sheet).

*Benefit:* Provides in situ heat flow measurements for science and hydrocarbon safety.

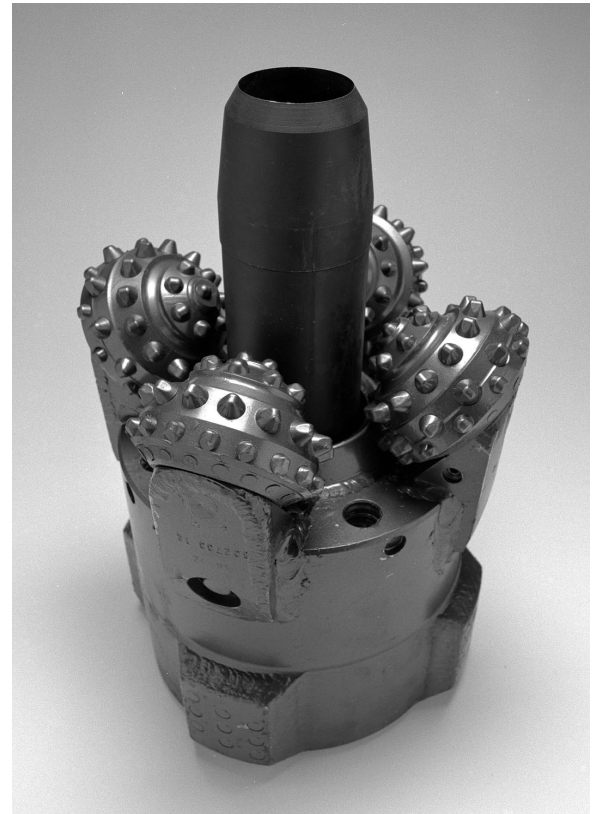

**APC piston shoe extending through 11<sup>7</sup>/<sub>16</sub> in. APC/XCB bit.**

## APC Specifications

### Maximum Piston Stroke (Core) Length

9.5 m (31.16 ft)

### APC Shoe Inside Diameter (Core Outer Diameter)

6.2 cm (2.44 in)

### Piston Force

23,000 to 28,000 lb<sub>f</sub> at 2300 to 2800 psi pump pressure

## Typical Operating Range

### Formation

Very soft to firm sediments

### Depth Range

Seafloor to +300 m below seafloor (mbsf)

### Recovery

~100% in soft sediments

### Rate of Core Recovery

~38.0 to 9.5 m of core/hr (depends on depth/wireline time). Rate of penetration typically decreases with depth.

### Quantity of Cores on Deck

1 to 4 cores/hr depending on water depth and formation cored.

## Limitations

Does not penetrate or recover granular formations (such as sand) or hard ground. Core barrel may stick in firm sediments and require drill-over.

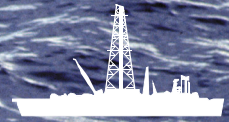

# Rotary Core Barrel

## Scientific Application

The Rotary Core Barrel (RCB) is a rotary coring system designed to recover core samples from firm to hard sediments and igneous basement. The RCB is crucial for oceanic crustal hard rock studies.

## Tool Operation

The RCB inner core barrel free falls (and is pumped) through the drill string and latches into the RCB bottom-hole assembly (BHA). The main RCB bit trims the 2.312 in. core. The BHA, including the bit and outer core barrel, is rotated with the drill string while bearings allow the inner core barrel to remain stationary. The inner core barrel can hold a 9.5 m core and is retrieved by wireline. A wireline packoff at the top of the drill string permits rotation and circulation of the drill string to continue while using the wireline to retrieve the core.

## Design Features

### 1) Rugged Design

The RCB BHA, bit, and inner core barrel assembly have a rugged design for use in abrasive and fractured hard sediments and igneous basement.

*Benefit:* Increases operating time of the bit and improves penetration of hard formations.

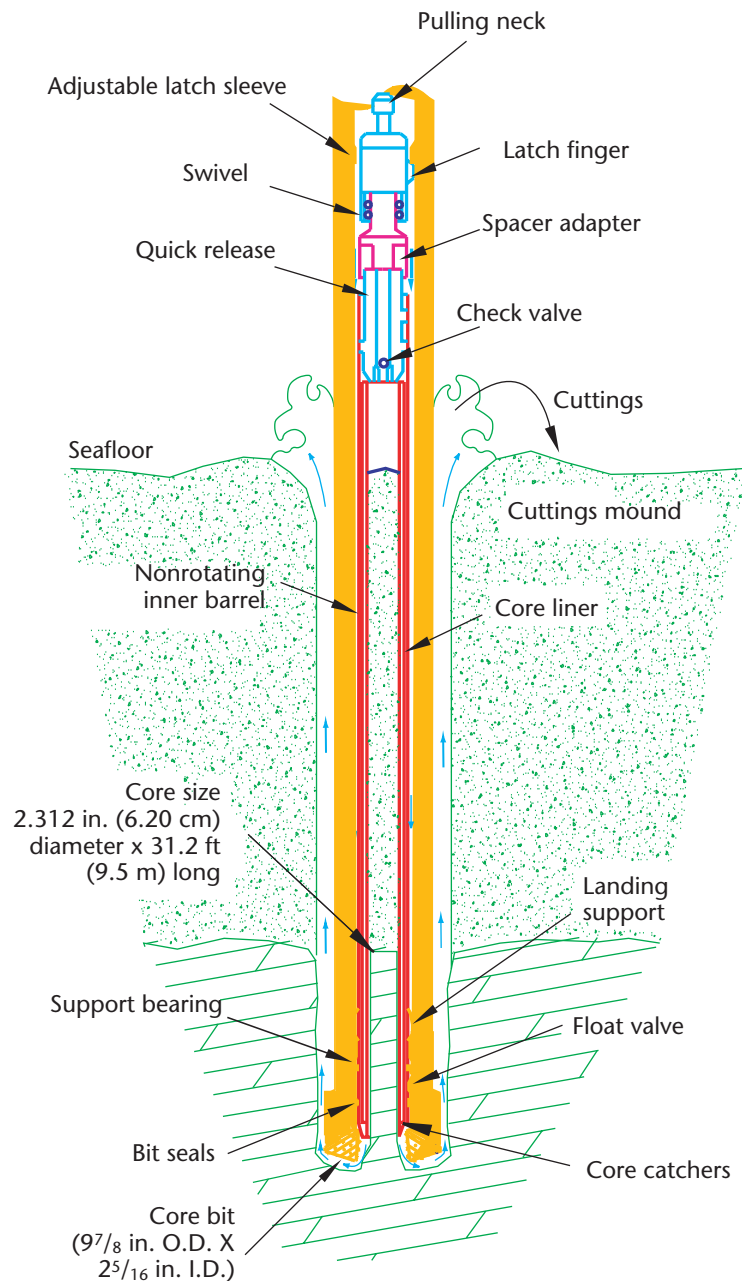

**Schematic of the RCB coring system in coring mode with a bare seafloor spud-in. A center bit can be run on the inner core barrel to drill ahead without core recovery.**

## 2) Drilling with Center Bit

A center bit can be used to drill a hole without attempting to recover core. The center bit is used to drill ahead in hard rock and is run on a special inner barrel sub to lock it into the outer barrel for rotation. The center-bit assembly is configured to allow circulation through the center bit.

*Benefit:* The center bit can be interchanged with a standard RCB core barrel for "spot" coring.

## 3) Wireline Logging with Bit Release

A Mechanical Bit Release (MBR) can be operated by wireline to drop a bit in the hole or on the seafloor to provide a fully open BHA for logging.

*Benefit:* Wireline logs can be run after coring with the RCB system without making a pipe trip to install a logging bit.

## RCB Specifications

**Inner Core Barrel Length**  
9.5 m (31.16 ft)

**RCB Bit Throat (Core Diameter)**  
5.87 cm (2.312 in.)

## Typical Operating Range

### Formation

Firm to very hard sediments and igneous basement

### Depth Range

Seafloor through igneous basement

### Mean Recovery

20% to 55%

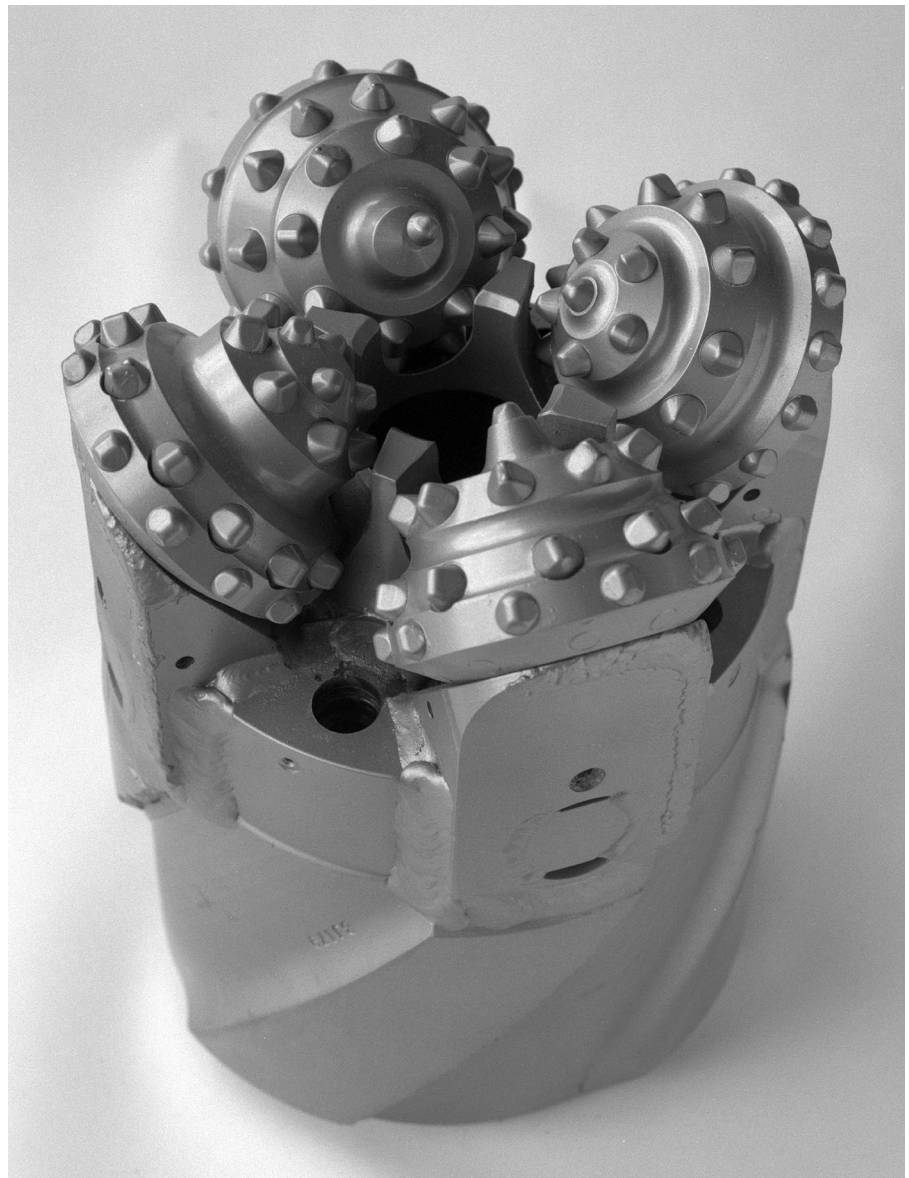

**The RCB roller cone bit utilizes hard tungsten carbide inserts to trim the core.**

### Quantity of Cores on Deck

0.3 to 2 cores/hr depending on water depth and formation hardness

### Rate of Penetration

Depends on rock properties, but averages 4.0 to 9.8 m/hr

### Limitation

Does not recover soft sediments or granular formations (such as sand, fractured rock, or rubble)



## Scientific Application

The Extended Core Barrel (XCB) coring system is used in sedimentological, climate, and paleoceanographic studies.

## XCB Operations

The XCB is used to recover 9.5 m long core samples from soft to moderately hard formations. The XCB is typically deployed when the formation becomes too stiff to piston core (i.e., upon piston coring "refusal") or when it is not hard enough to permit efficient recovery with the Rotary Core Barrel (RCB). The XCB cutting shoe extends ahead of the main bit in soft sediments but retracts into the main bit as the weight on bit increases when firm lithologies are encountered. The XCB uses the same bottom-hole assembly (BHA) as the Advanced Piston Corer (APC). The XCB relies on rotation of the drill string to advance the hole, and an integral cutting shoe trims the core sample at the same time.

## Design Features

### 1) Cutting Shoe Trims Core

The XCB uses an integral cutting shoe to trim the core. The shoe is positioned ahead of the main core bit, which reduces core "washing"

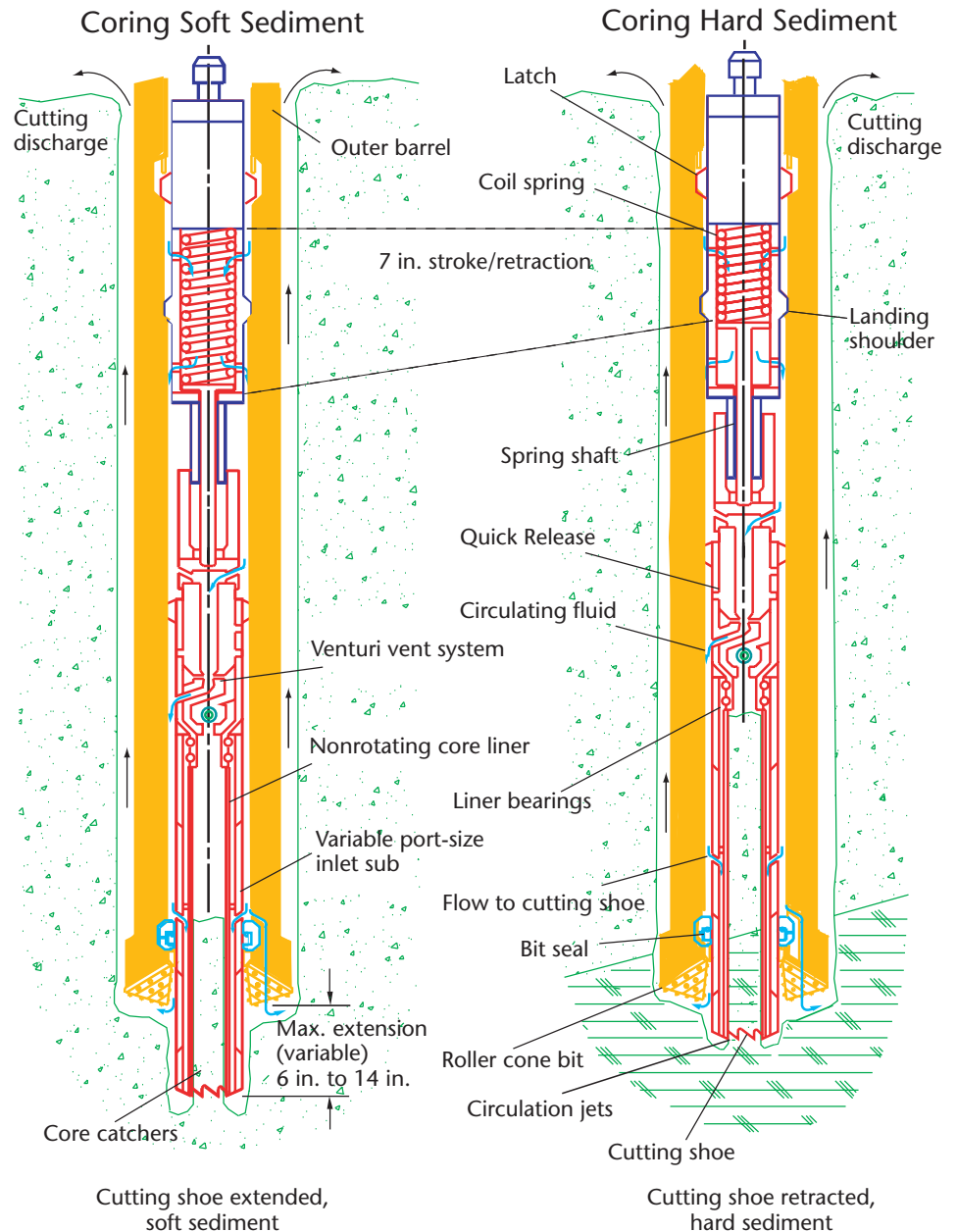

**Schematic of the XCB retractable cutting shoe in standard coring mode. The XCB shoe extends 6 to 14 in. ahead of the bit in very soft formations and retracts ~7 in. (inside the main bit) as weight on bit exceeds about 12,000 lb (collapses a coil spring).**

(i.e., core damage caused by water jets from the main drill bit nozzles).

*Benefit:* Improves core recovery and reduces core disturbance in soft to moderately hard formations.

## 2) Retractable Cutting Shoe

A unique retraction device allows the XCB, which is normally extended ahead of the core bit, to retract inside the BHA until the cutting shoe is flush with the core bit.

*Benefit:* Cutting shoe is retracted to reduce failures when hard formations are encountered.

## 3) Nonrotating Core Liner

An inner core barrel swivel allows the core to remain stationary relative to the formation as the bit rotates, thereby reducing the transfer of rotary torque to weakly laminated formations.

*Benefit:* Reduces “biscuiting” (artificial layering), which is a type of core disturbance caused by transferring rotary torque to the core.

## 4) Compatibility

Utilizes the same BHA as the APC coring system.

*Benefit:* The APC and XCB core assemblies can be run in the same assembly, avoiding non-coring time for pipe trips.

## Cutting Shoe Options

### Soft Formations

Steel “sawtooth” serrated cutting profile hard-faced with tungsten carbide grit.

### Hard Formations

Polycrystalline diamond compact (PDC), diamond impregnated, surface-set diamond, and thermally stable artificial diamond.

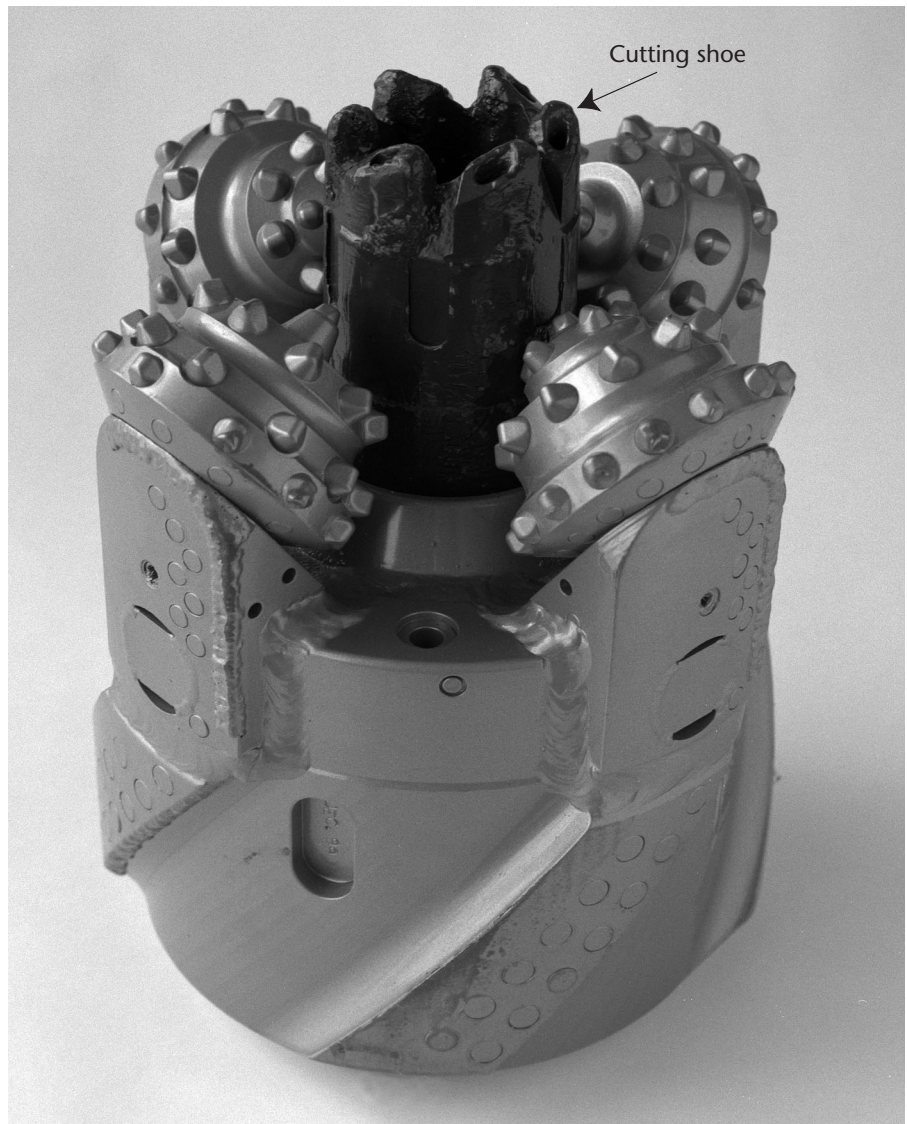

An 11<sup>7</sup>/<sub>16</sub> in. APC/XCB bit and soft formation XCB cutting shoe.

## XCB Specifications

### Core Diameter

2.312 in. (60 mm)

### Maximum Core Length

9.5 m

### Cutting Shoe Extension

7 in. beyond bit (maximum)

## Typical Operating Range

### Formation

Soft to medium firm sediments

### Depth Range

Typically from APC refusal to ~400 to 700 m below seafloor (mbsf) in sediments and can core top of igneous basement (destroys shoe).

### Rate of Penetration

Typically 30 to 12 m/hr.

### Quantity of Core on Deck

1 to 2 cores/hr depending on water depth and formation

## Limitations

Does not recover ooze or very soft sediments, granular formations (such as sand), fractured rock or rubble, or hard igneous formations.



# Advanced Diamond Core Barrel

## Scientific Application

The Advanced Diamond Core Barrel (ADCB) coring system may be used to attempt to recover continuous core samples from firm to well lithified sedimentary or igneous formations when Advanced Piston Corer, Extended Core Barrel, and Rotary Core Barrel (APC/XCB/RCB) coring techniques are ineffective. The ADCB provides a crucial alternative technique using diamond coring technology to attempt to improve recovery of formations that are difficult to core with conventional rotary coring tools.

## Tool Operation

The ADCB uses a 6¾ in. bottom-hole assembly (BHA) and requires some (~20 m) lateral support (i.e., deployment in an existing hole) to commence coring. The ADCB relies on rotation of the drill string to advance the hole while the 7¼ in. drill bit trims the core sample.

## Design Features

### 1) Improved Core Quality

The ADCB uses a diamond mining-style bit to trim the core and incorporates a pressure indicator to monitor core jams.

*Benefit:* May improve core recovery in hard formations, interbedded firm and hard formations, and poorly consolidated formations that are difficult to recover with the RCB and XCB.

### 2) Improved Hole Stability

The ADCB's 7¼ in. mining-style thin-kerf diamond bit produces a smaller and smoother borehole wall than rotary drilling, and the 6¾ in. BHA provides a "packed hole" with a narrow annulus.

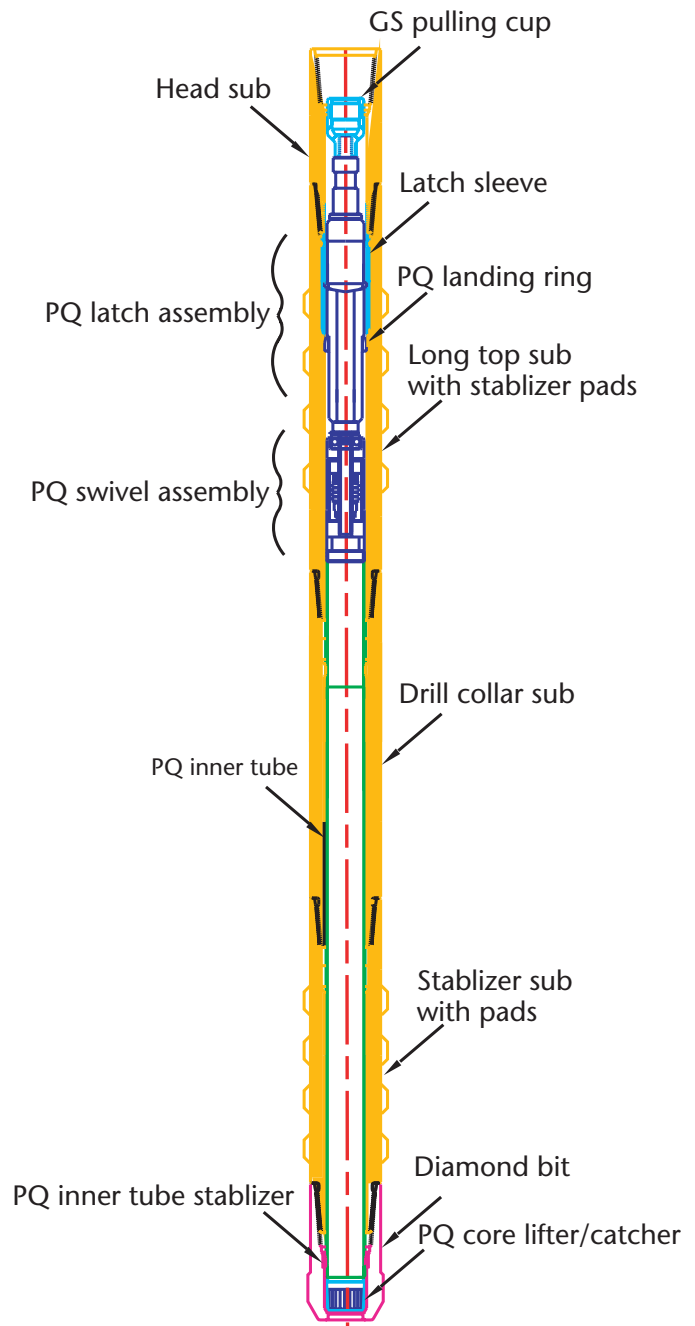

**Schematic of the ADCB showing the bit, outer core barrel, and inner core barrel. The ADCB is an adaptation of a mining style "PQ" coring assembly.**

*Benefit:* Hole stability is improved in hard formations, which requires less time for reaming and hole cleaning and reduces stuck pipe problems.

### 3) Low Fluid Invasion of Core

The ADCB diamond bit creates a fine rock powder (i.e., not rock chips or cuttings); therefore, hole cleaning requires less fluid velocity, circulating rates are lower, and the core is not directly exposed to high-pressure fluid from the bit jets.

*Benefit:* Reduces fluid invasion (i.e., "core flushing") and improves core quality in porous and water sensitive formations.

### 4) Improved Log Quality

The ADCB diamond bit produces a smooth 7¼ in. hole rather than the larger and more rugose borehole walls typical of rotary coring.

*Benefit:* Electric log quality is improved by better pad contact and smaller hole diameter (7¼ vs. 9⅞ in.).

## ADCB Specifications

### Core Size

The PQ3 mining-style bit produces cores with a 3.27 in. (83 mm) diameter when optional split steel or lexan liners are used. The PQ bit, which does not use liners, has a core diameter of 3.345 in. (85 mm).

### Core Length

Typically 15 ft (4.75 m) to reduce core weight and problems with core jamming in the core barrel. A 30 ft (9.5 m) version is also available.

## Equipment

The inner core barrel has a positive indicator latch to confirm inner core barrel latch-in.

Diamond stabilizers on the outer core barrel reduce core barrel vibration.

Bit types include diamond impregnated for hard rock, polycrystalline diamond compact (PDC) for friable rock, and surface-set diamond bits for sedimentary formations.

## Typical Operating Range

### Formation

Designed for hard or well-cemented sediments and igneous formations.

### Recovery

May be higher (relative to XCB and RCB) in formations that are difficult to core, such as fractured hard rock or rubble and interbedded hard and soft formations.

## Limitations

Does not recover soft sediments and granular formations (such as sand, gravel, or coral debris).

Cannot be used for bare rock spud.

The ADCB requires good weight-on-bit control and use of the active heave compensator.



**ADCB bit showing circulation test.**

The inner core barrel and core may be pulled before coring the full 4.75 m length if the core jams.

Depth range is limited by the number of 6¾ in. drill collars (presently ~350 m) available. The 8¼ in. drill collars above the 6¾ in. drill collars will not fit in the hole made by the ADCB. Thus, the pipe must be tripped to change to a rotary bit and BHA to enlarge the hole, then a second pipe trip is made to return to ADCB coring. ADCB cores are of larger diameter than APC or rotary cores. This presents problems in shipboard core processing and curation.



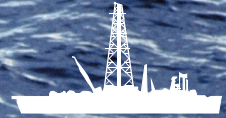

# Motor Driven Core Barrel

## Scientific Application

The Motor Driven Core Barrel (MDCB) is a wireline-retrievable coring system compatible with the Advanced Piston Corer/Extended Core Barrel (APC/XCB) bottom-hole assembly (BHA). It is designed to improve core recovery in formations that are difficult to APC/XCB core (e.g., hard fractured crystalline rock, interbedded hard/soft formations, and friable conglomerate and reef materials). The MDCB is typically used to recover intermittent short intervals (a few 4.5 m cores) because of the handling time (~1 hr) to prepare the tool for consecutive coring runs.

## Tool Operation

The MDCB can be run interchangeably with the APC/XCB coring systems with the addition of a latch sub to the BHA. The MDCB consists of a motor section, thruster section, inner core barrel section, and a narrow-kerf core bit. The motor section is powered by the hydraulic force of fluid pumped down the drill string, which causes the motor to rotate. The thruster section uses hydraulic force to provide weight on bit (WOB) and advance the inner core barrel. The inner core barrel section has a 4.5 m core tube with a thin-kerf core bit on bottom; the core diameter is 2.25 in. (57 mm).

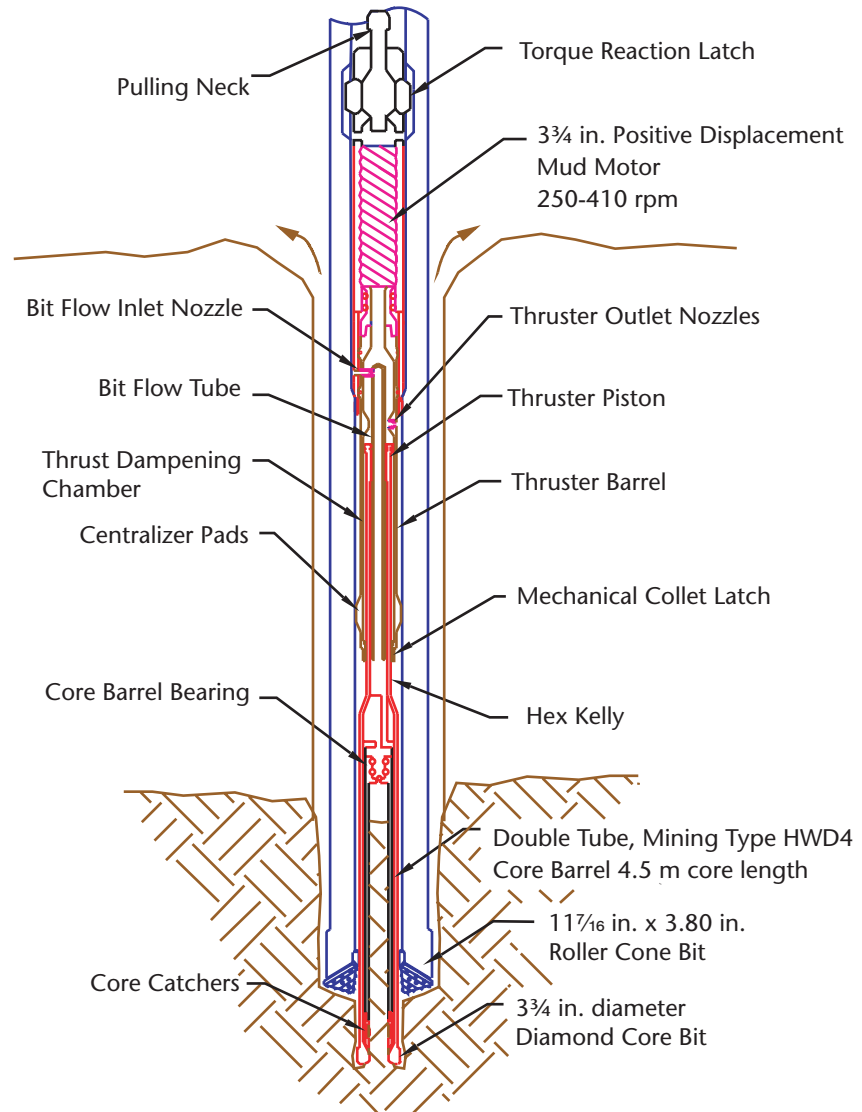

**Schematic of the MDCB tool.**

## Design Features

### 1) Diamond Core Mining Technology

Compared to the APC/XCB coring system, the MDCB operates at higher revolutions per minute

(rpm) with lower WOB and uses narrow-kerf surface-set diamond-impregnated as well as geoset and tungsten carbide core bits to recover cores from friable, laminated hard/soft, and crystalline formations.

*Benefit:* The MDCB applies less drilling stress to the formation, which may improve core quality and recovery in friable, fractured, or crystalline formations.

## 2) Positive Displacement Mud Motor

Downhole rotation and torque are produced by a Baker-Hughes Inteq Mach 1P positive displacement mud motor with a 7:8 lobe rotor/stator power section.

*Benefit:* The motor rotates the bit; therefore, drill string vibration is eliminated.

## 3) Thruster Unit

Hydraulic force is translated into WOB, and interchangeable nozzles optimize WOB at various flow rates.

*Benefit:* The WOB can be controlled to provide a more uniform application of weight to the diamond bit, thereby improving diamond bit life and recovery.

## 4) Core Barrel Assembly

A modified version of a standard Christensen Mining Products HWD4 inner core barrel provides a nonrotating core tube to receive the core sample into a clear plastic liner.

*Benefit:* Reduces rotational torque and stress in cores to improve core quality and recovery.

## 5) Diamond Core Bits

A 3.75 in. (95 mm) outer diameter (OD) core bit is used to trim a 4.5 m long × 2.25 in. (57 mm) diameter core. Optional bit types include: narrow-kerf diamond-impregnated or surface-set diamond bits as well as geoset and tungsten carbide core bits.

*Benefit:* Different bit cutting structures can be selected for each MDCB run, based on the anticipated formation, to optimize core quality and recovery.

## 6) Interchangeability

With the addition of a latch sub, the MDCB can utilize the same BHA as the APC and XCB.

*Benefit:* Eliminates extra pipe trips to change the BHA.

## Specifications

Tool size OD	3¾ in. (95 mm)
Motor pressure	1160 psi
Pump rate	190 gpm
Power	96 hp
Bit speed	410 rpm
WOB	2000–8000 lb
Max. torque	1250 ft-lb
Bit flow rate	15–35 gpm
Efficiency	83%
Core diameter	2.25 in. (57 mm)
Core length	4.5 m



**Rig floor flow test of the MDCB.**

## Limitations

Diamond coring does not work well in soft or unconsolidated granular formations.

The core length is 4.5 m, which requires more wireline and handling time than typical 9.5 m APC/XCB cores.

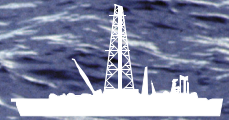

# Pressure Core Sampler

## Scientific Application

The Pressure Core Sampler (PCS) is capable of retrieving core samples from the ocean floor while maintaining in situ pressures up to 689.7 bar (10,000 psi). The primary application of the PCS is to recover in situ hydrates. The PCS is free-fall deployable and wireline retrievable.

## Tool Operations

The PCS is free-fall deployed down the drill string for intermittent “spot” coring while using the Advanced Piston Corer/Extended Core Barrel (APC/XCB) bottom-hole assembly (BHA). The PCS inner core barrel is latched in to the XCB rotary window sub and is rotated with the drill string while weight is applied to the bit. After cutting the core, a ball is released by wireline action to divert flow to a piston that pulls the core tube into the pressured core barrel and closes the ball valve. The core is then retrieved by wireline.

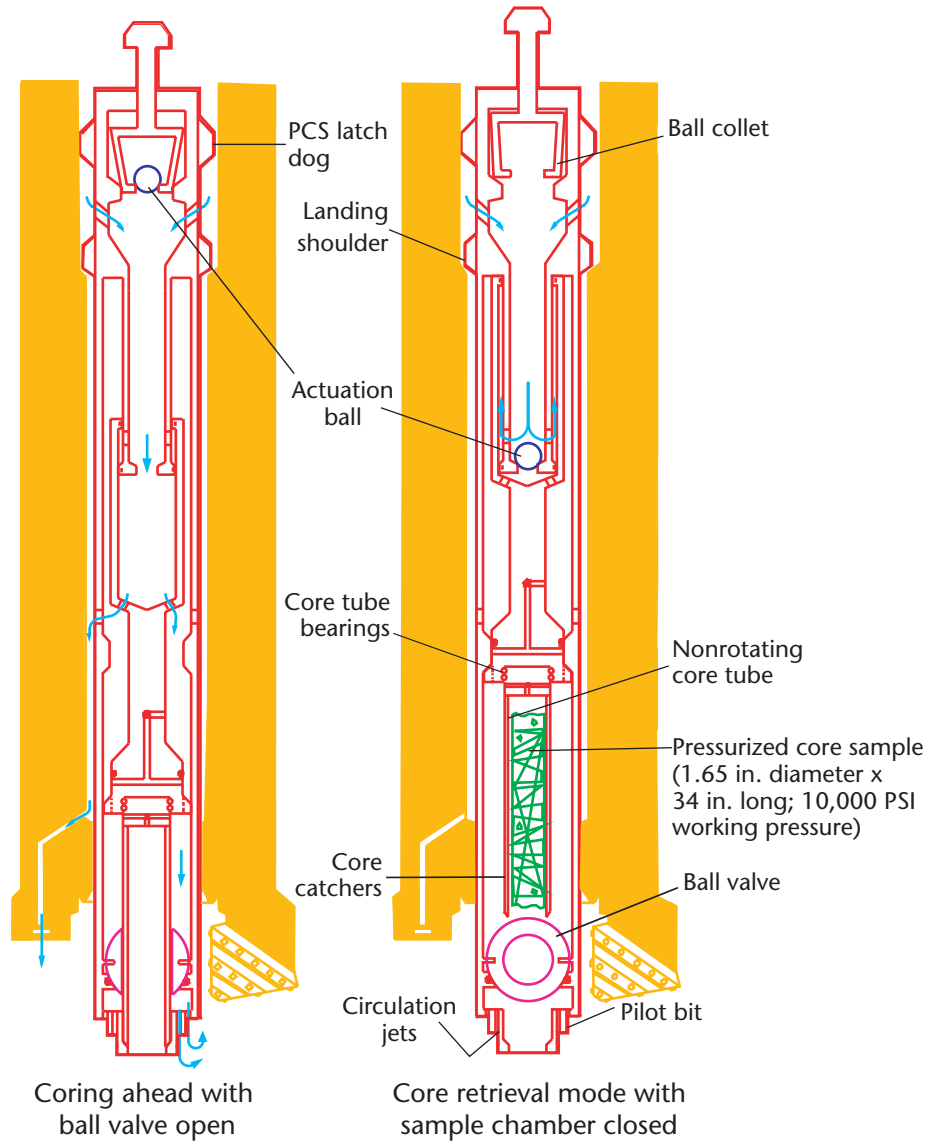

## Design Features

### 1) Compatibility

The PCS is completely compatible with the existing BHA used for the APC and XCB coring systems.

*Benefit:* The PCS can be deployed during routine coring without a pipe trip.

**Schematic of the PCS in the “coring ahead” mode (with the ball valve open to accept core) (left). After cutting the core (right), the wireline is picked up to release the ball, which redirects fluid to lift the core tube for “core retrieval” mode (with the core tube and core retracted inside the tool and the ball valve closed). Arrows indicate fluid flow.**



## 2) Rotary Latch

The PCS latch dog locks into the APC/XCB latch window in the BHA, which transmits BHA rotation to the PCS. A combination of low weight on bit, slow rotation, and low pump rate is required to core.

*Benefit:* Fragile samples and sticky clays can be recovered with minimal hydraulic disturbance or contamination.

## 3) Actuator

After the PCS core sample is cut, the actuator hydraulically pulls the inner core barrel and core sample through a ball valve into the sample chamber and closes the ball valve, thereby sealing the sample chamber at in situ pressure.

*Benefit:* The PCS core sample is trapped at near in situ pressure behind a ball valve that closes by rotation to maintain its seal at both positive and negative pressure differentials.

## 4) Detachable Sample Chamber

A removable pressure chamber maintains the core sample at near in situ pressure, provides for internal pressure monitoring, incorporates safety pressure release mechanisms, and offers two sampling ports for collecting gas and fluids.

*Benefit:* Permits the pressured core sample chamber to be moved to a lab for further examination.

## PCS Specifications

### Core Sample Diameter

1.70 in. (43.2 mm)

### Core Sample Length

39 in. (0.99 m)

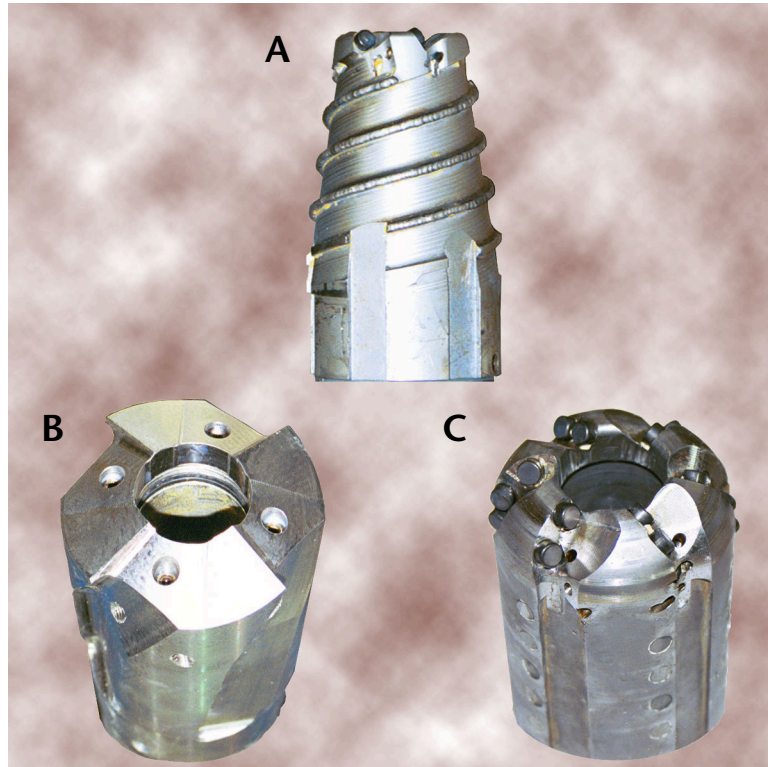

**There are three bits available for rotary coring with the PCS tool: RBI auger bit (A), Christiansen standard bit (B), and RBI PDC bit (C).**

### Sample Chamber Working

#### Pressure

689.7 bar (10,000 psi) maximum

### Sample Chamber Length Overall

67 in. (1.7 m)

### Sample Chamber Outer Diameter

3¾ in. (95.25 mm)

### Sample Port Thread

¼ in. 18 UNF – 2b

## Typical Operating Range

### Formation

From mudline to indurated formations

### Depth Range

Up to ~6500 m combined water depth and formation penetration

## Limitations

Tool is limited to formations composed of soft sediments to firm clay

Sample chamber is short to accommodate lab handling

Core diameter is limited by ball valve size

No method of transferring pressurized cores to an autoclave

Small core diameter could impact scientific sampling

Wireline core recovery time per meter of core increases ≈ 10:1 compared to standard coring system because the core recovered is one-tenth the length of a standard core



## Scientific Application

A core bit (Figs. 1, 2) is a drilling tool with a hole through the center that removes sediment rock and allows the core pedestal to pass through the bit and into the core barrel. The Ocean Drilling Program (ODP) employs different coring systems and bits to obtain continuous cores in all types of oceanic sediments and igneous basement.

Once a coring system is selected based on the expected lithology, the engineer determines which type of core bit to use. As coring conditions change, the coring bit can be changed in an attempt to improve the recovery and rate of penetration with that coring system. The type of bit used depends on the expected lithology and past bit performance in the area or in a similar lithology. Once a bit is removed, it is “graded” (i.e., it is examined to determine wear on the cutting structure, gauge, bearings, etc., based on industry standards) to optimize coring performance.

## Coring System Bits

There are three coring systems. Each uses different bottom-hole assemblies (BHA) and types of core bits:

I. Advanced Piston Corer (APC) (see the APC tool sheet) and

Extended Core Barrel (XCB) (see the XCB tool sheet) (both systems use the same BHA),

II. Rotary Core Barrel (RCB) (see the RCB tool sheet), and

III. Advanced Diamond Core Barrel (ADCB) (see the ADCB tool sheet).

## Bottom-Hole Assembly Operation

The BHA for each coring system is slightly different, but in general consists of a primary core bit, outer core barrel (OCB), short sub assembly, and drill collars. The OCB supports the wireline retrievable inner core barrel, which receives and carries the core. Drill collars are heavyweight pipes that apply weight to the bit on the bottom of the OCB. The BHA is run on the drill pipe string, which is rotated at the surface to drive the bit (except the Motor-Driven Core Barrel [MDCB]) and advance the BHA (see the BHA tool sheet for more information). The MDCB and Pressure Core Sampler (PCS) are compatible with the APC/XCB BHA.

## Core Bit Types

Core bits are classified according to the cutting structure and type of bearings. There are five basic types of bits used by ODP based on their function or structure: drag,

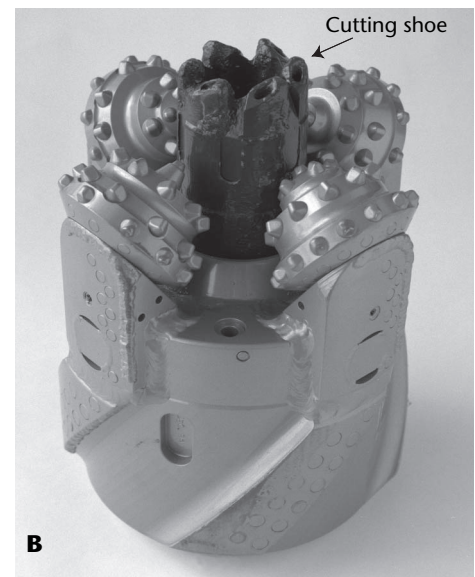
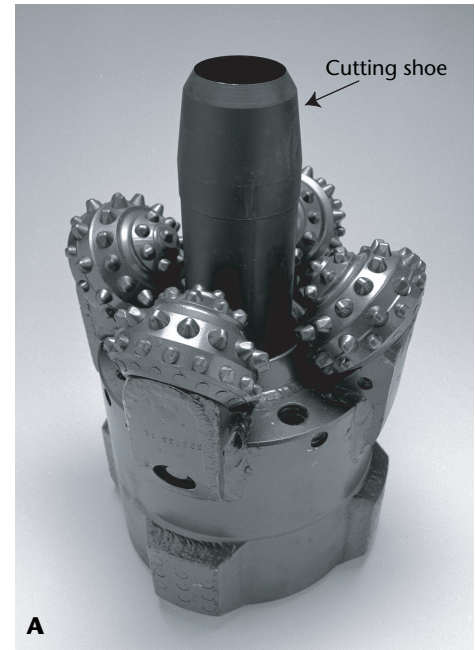

**Figure 1. A. APC/XCB four roller cone bit with an APC cutting shoe. B. APC/XCB four roller cone core bit with the XCB cutting shoe.**

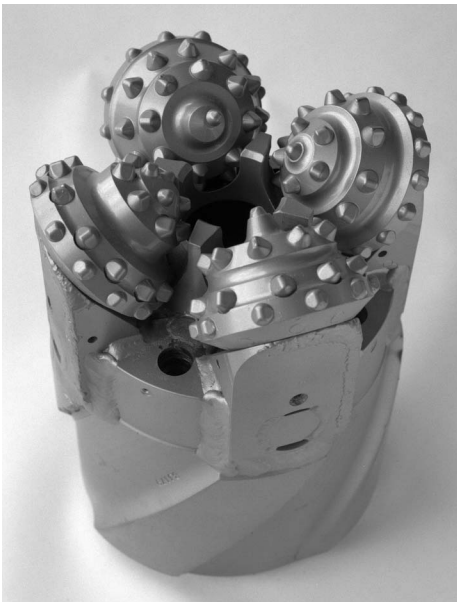

**Figure 2. RCB four roller cone bit.**

scraper, abrasive, roller cone, and hammer.

Drag-type bits have a flat chisel-like surface to plane away soft formations (i.e., clay and chalk).

Polycrystalline diamond compact (PDC) bits use multiple tungsten carbide studs with artificial diamond cutting surfaces in a claw-like scraping action to remove soft formations (e.g., clay and chalk) up to hard claystone and limestone.

Diamond bits use either surface-set or impregnated diamonds to abrade (i.e., sanding-like process) hard formations like shale or basalt.

Roller cone bits rotate cone-shaped rollers encrusted with teeth to remove soft to hard formations through a combination of scraping and crushing processes.

Hammer bits use percussion to crush the hard rock around the core.

Smaller bits called “shoes” are screwed onto the bottom of the

inner core barrel (e.g., APC [Fig. 1A], XCB [Fig. 1B], MDCB, and PCS tools). The shoes on the inner core barrel protrude below the primary roller cone bit and trim the formation to core size. In contrast, the primary core bits in the RCB (Figs. 2, 3) and ADCB systems cut away most of the formation to create the core (i.e., there is no shoe). ODP most commonly uses a four roller cone type bit.

## I. APC/XCB System Core Bits

### Tool Operation

The APC/XCB coring system can use three types of bits for coring soft to firm sediments:

11<sup>7</sup>/<sub>16</sub> in. four roller cone bit with tungsten carbide chisel teeth (Fig. 1),

10<sup>1</sup>/<sub>8</sub> in. PDC “anti-whirl” (Fig. 4) bits, which are rarely used, or

10<sup>1</sup>/<sub>8</sub> in. tungsten carbide blade “drag” bits, which are also rarely used.

### Design Features and Benefits

#### 1) Formation Compatibility

APC/XCB bits are compatible with sediments ranging from soft silts, sands, and sticky clays to moderately firm limestones, claystones, and dolomites.

*Benefit:* One bit can core a wide range of sediments without a trip to change bits.

#### 2) Large Bit Throat

The APC/XCB bit throat has a 3.80-in. opening.

*Benefits:* The APC/XCB bit is compatible with the PCS and MDCB coring shoes; water samplers;

temperature probes; and logging tools, which can pass through the bit throat without requiring a trip to remove the bit or drop it; therefore, coring and logging operations can be resumed without a trip.

### APC/XCB Specifications

Maximum inner core barrel length: 9.5 m

APC/XCB bit throat diameter: 9.652 cm (3.80 in.)

APC shoe throat diameter: 6.197 cm (2.440 in.)

XCB shoe throat diameter: 5.872 cm (2.312 in.)

### APC/XCB Typical Operating Ranges

#### 1) Formation

**APC:** sediments ranging from soft to firm silts/carbonates/chalks/clays.

**XCB:** firm to moderately firm limestones, claystones, dolomites, and with limited penetration in chert or basalt.

#### 2) Depth Range

**APC:** limited by piston core barrel penetration in stiff or laminated firm/soft formations (i.e., to “refusal”) and by wireline overpull to retrieve the core barrel (~100–300 mbsf).

**XCB:** limited by core shoe survival in hard formations (typically used from APC refusal depth to ~500 mbsf).

#### 3) Mean Recovery

**APC:** ~100%.

**XCB:** ~55%–75% in sediments and ~15%–35% in basalt. Not recommended for penetration in basalt other than to sample basement.



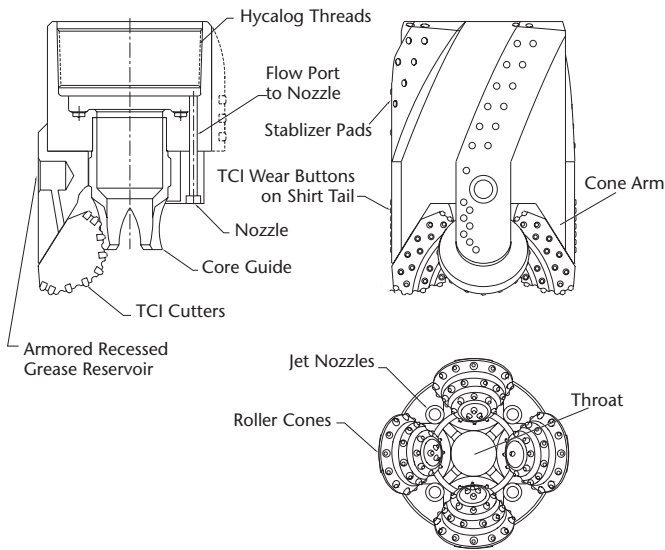

**Figure 3. Schematic of the four roller cone core bit used by the RCB coring system.**

#### 4) Rate of Core Recovery

Depends on water depth (i.e., wireline time) and formation. Penetration rate usually slows with depth.

**APC:** ~28.5–9.5 m/hr.

**XCB:** ~19.0–4.5 m/hr.

#### 5) Rate of Penetration

Depends on rock properties. Penetration rate usually slows with depth.

**APC:** averages ~70–30 m/hr.

**XCB:** averages ~30–12 m/hr.

#### Limitation

Recovery is poor in laminated firm/soft (e.g., chert/clay) or granular sediments (e.g., sand, fractured rock, or rubble).

## II. RCB Core Bits

#### Tool Operation

The RCB coring system typically uses roller cone type bits (Fig. 2) for firm sediments to very hard igneous rocks. PDC RCB bits (Fig. 4) have been used occasionally in firm sediments, as they core faster and can last longer under the right conditions; however, PDC bits

cannot be used in igneous rocks. The diameter of RCB roller cone bits is  $9\frac{7}{8}$  in., and the diameter of PDC bits is  $10\frac{1}{8}$  in.

There are four classes of  $9\frac{7}{8}$  in. RCB four roller cone bits (Fig. 5) with different cutting structures designed for different formation types:

C-3 bits have long extension chisel teeth and are used in soft sediments,

C-4 bits have medium extension chisel teeth and are used in firm to hard sediments (e.g., dolomite and mudstone) and limited upper basement,

C-7 bits have short extension conical teeth for coring/drilling hard sediment and igneous basement, and

C-9 bits have short extension hemispherical teeth for coring/drilling very hard igneous basement.

#### Design Features and Benefits

##### 1) Tool Compatibility

RCB bits have a 2.312-in. opening through the bit throat that enables the Water Sampler Temperature Probe (WSTP) and the Davis-Villinger Temperature Probe (DVTP) to be run through the bit in firm formations without hard layers. The RCB bit must be dropped with the mechani-

cal bit release to permit wireline logging.

*Benefit:* WSTP and DVTP tools can be run through RCB bits so no time is lost for bit trips.

#### 2) Rugged Design

The four cone-arm segments are welded together in the throat area and are armored (faced with hard nickel-chrome) on the leading edge and upper arm areas.

*Benefit:* Reduces the chance of catastrophic cone-arm failure while drilling with heavy weight on bit in hard and abrasive formations.

#### 3) Ductile Teeth

The bit teeth are made with a finer-grained tungsten carbide to increase tooth ductility, and the teeth are pressed into smaller holes using greater force.

*Benefits:* Reduces tooth breakage and loss due to rough drilling in

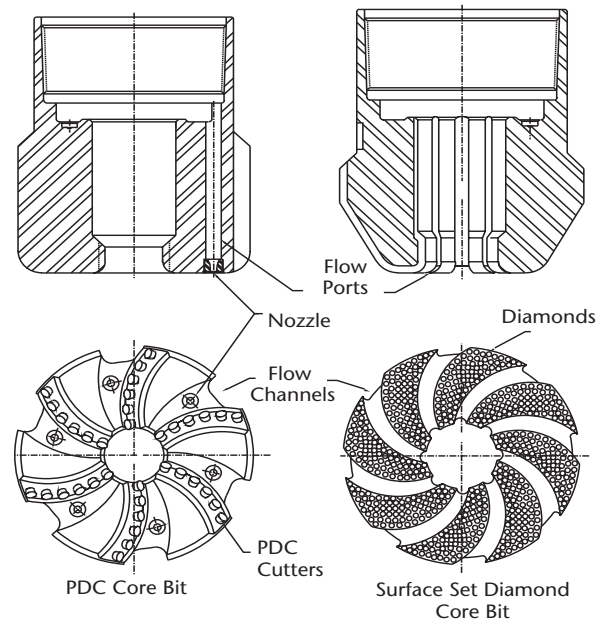

**Figure 4. Side and bottom view schematics of PDC and diamond bits. The PDC bit is used in friable lithologies (e.g., limestone or claystone). The surface set diamond bit is used with sediments.**

fractured rock and reduces tooth losses at high temperatures.

#### 4) Recessed and Armored Lubrication System

The cone bearing has a pressure-compensated grease reservoir that is recessed and covered with a steel plate.

*Benefit:* Increases bit-bearing life for increased penetration per bit by protecting the grease reservoir and bladder from abrasion damage while reaming up (i.e., rotating while pulling pipe out of the hole) to get out of a tight hole that is swelling shut or collapsing.

#### 5) Close Catch (CC)

The core catchers were moved closer to the core trimming point at the bottom of the hole in an effort to catch the core sooner.

*Benefit:* Improved core recovery in fractured formations by capturing the core in the inner core barrel before it can be broken by torsional friction or wedge and jam in the bit throat.

#### 6) Center Bit

Drilling ahead without attempting to recover core can be accomplished with a normal RCB core barrel (i.e., “washing”) or by using a center bit to drill. The 2.25-in. center bit is run on a special barrel sub without a swivel (to lock it into the outer barrel for rotation) and without a check ball in the quick release (to circulate through the inner core barrel and center bit).

*Benefit:* Allows the hole to be alternately cored and drilled ahead (i.e., spot cored) without tripping the pipe.

#### 7) Bit Deplugger

A bit deplugger can be run in an attempt to remove coring debris that can become jammed in the throat of the bit. The 2.25-in. deplugger nose extends through the bit throat and bit cone core trimming area.

*Benefit:* Reduces pipe trips to clear jammed bit throats by removing the jams down-hole.

#### 8) High-Temperature Bearing Seals

The 230°C nitrile elastomers in the standard bit bearing seal can be replaced with 300°C high-temperature elastomers to increase the seal life of bit-cone bearings and prevent premature bit-bearing failure in high-temperature holes. A special high-temperature bit with open bearings is available.

*Benefit:* Increases bit-bearing life for increased penetration per bit in hot holes.

#### RCB Specifications

Maximum inner core barrel length: 9.5 m

RCB bit throat (core diameter): 5.87 cm (2.312 in.)

#### RCB Typical Operating Ranges

##### 1) Formation

RCB will drill all formation types, but it does not recover soft formations, sand, and gravel. The core quality is typically poor in soft formations with the RCB bit, which is why the APC system was adopted.

##### 2) Depth Range

Limited to ~230°C temperature.

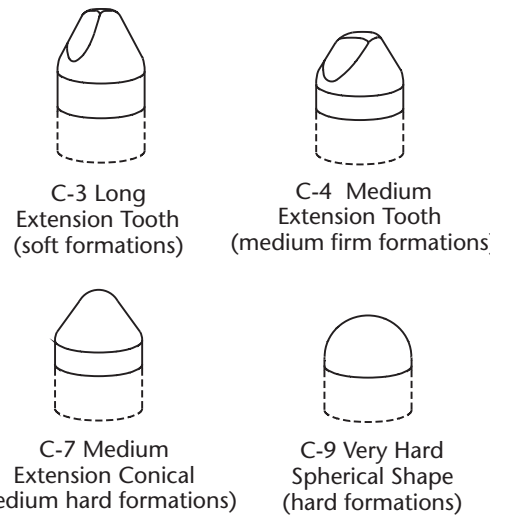

**Figure 5. Tungsten carbide insert cutting options for RCB four roller cone bits. Dashed lines depict depth of insert into bit matrix.**

#### 3) Mean Recovery

Typically ~50%–75% in firm sediments and ~15%–35% in igneous or metamorphic rocks.

#### 4) Rate of Recovery

Depends on water depth and formation, but ~19.0–1.3 m/hr.

#### 5) Rate of Penetration

Depends on rock properties, but ~20.0–6.0 m/hr in sediment and ~4–1.5 m/hr in volcanic basement.

#### Limitation

Does not recover soft or unconsolidated granular sediments (e.g., sand, gravel fractured rock, or rubble).

The RCB bit must be dropped with the mechanical bit release to permit wireline logging, which means drilling/coring cannot resume after logging without a bit trip.

### III. ADCB Core Bits

Refer to the ADCB system for more information on ADCB bits.

# Drill-In-Casing System

## Scientific Application

The Drill-In-Casing (DIC) system drills in a short 10<sup>3/4</sup> in. casing string simultaneously with the bit to support an unstable sediment zone, thus preventing premature loss of the hole or loss of a drill string because of hole collapse, allowing continued coring to meet the scientific objectives at the hole. The DIC is always available as a tool of last resort to achieve penetration in unstable sediments. The purpose of this tool is similar to the **Hard Rock Reentry System (HRRS)**, except the **HRRS** is designed to be used in unstable hard rock formations.

## Tool Operations

The DIC system allows the casing string and a casing ring bit to be drilled in as a unit. The system utilizes a DIC drive head and bushing that enables the drilling torque to be transmitted to both the casing string and bottom-hole assembly (BHA). Once the DIC is drilled into place, the casing string is released from the BHA. The DIC is run in one of two modes: with or without a funnel. When used without a funnel, coring continues directly after the casing is installed. This is not recommended because the drive head restricts circulation in the annulus. When used with a funnel, the drive bushing can be retrieved and a bit tripped back in the hole to continue coring.

## Design Features

### 1) Isolate Unstable Zones

The DIC can support unconsolidated sediments or unstable zones below the seafloor.

*Benefit:* Unstable upper zones and fault zones can be isolated by drill-in casing allowing deeper coring and/or logging.

### 2) Reentry

An optional reentry funnel can be added in the moonpool before running the tool.

*Benefit:* A DIC borehole can be reentered to continue drilling below an unstable or flowing zone.

### 3) Casing Ring Bit

A ring bit is welded to the bottom of the 10<sup>3</sup>/<sub>4</sub> in. casing and left in place with the casing.

*Benefit:* Permits drill-in capability of the casing.

## Considerations

Coring operations cannot occur while the DIC is being drilled into place

Typical DIC depth range is determined by the position of formation instability and casing hole drag, but is generally limited to a depth of 40 to 120 mbsf.

The DIC is designed for drilling-in casing into unstable soft sediment to achieve deeper scientific objectives in a single hole

Deployment of the DIC with the optional reentry funnel does not replace the multiple casing string capability of a standard full-size reentry cone installation on deep holes

The DIC is not robust enough to drill into consolidated formations, hard rock, or basement

Additional casing strings cannot be deployed with the DIC

**Figure 1.** Schematic of the Drill-In-Casing (DIC) system installed in shallow and unstable sediments. The optional reentry funnel is free-fall deployed. The 9<sup>7</sup>/<sub>8</sub> in. rotary core barrel BHA and bit can be released to core ahead without making a trip. Soft formations typically seal the annulus, thereby directing drilling fluid returns through the casing.

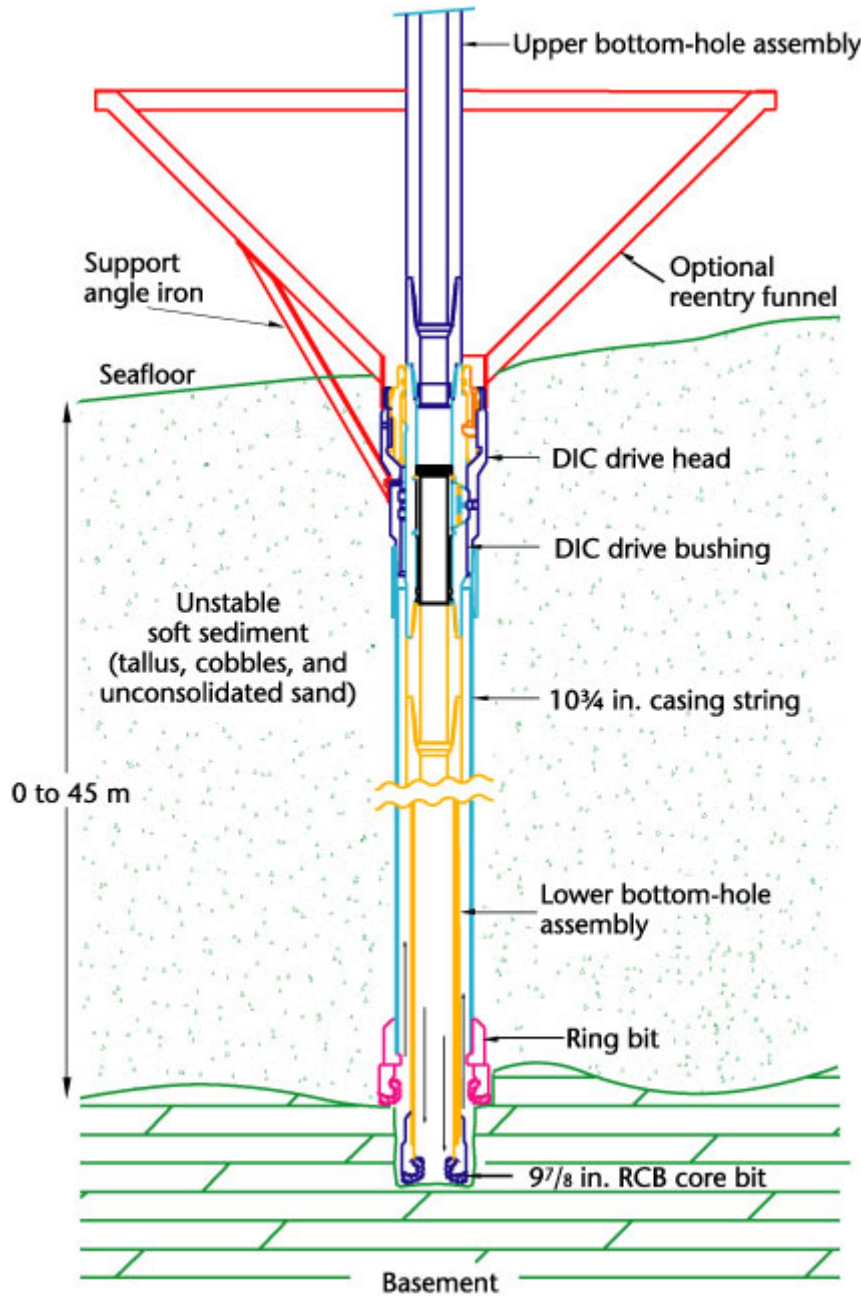

**Figure 2.** Drill-In-Casing system running tool.

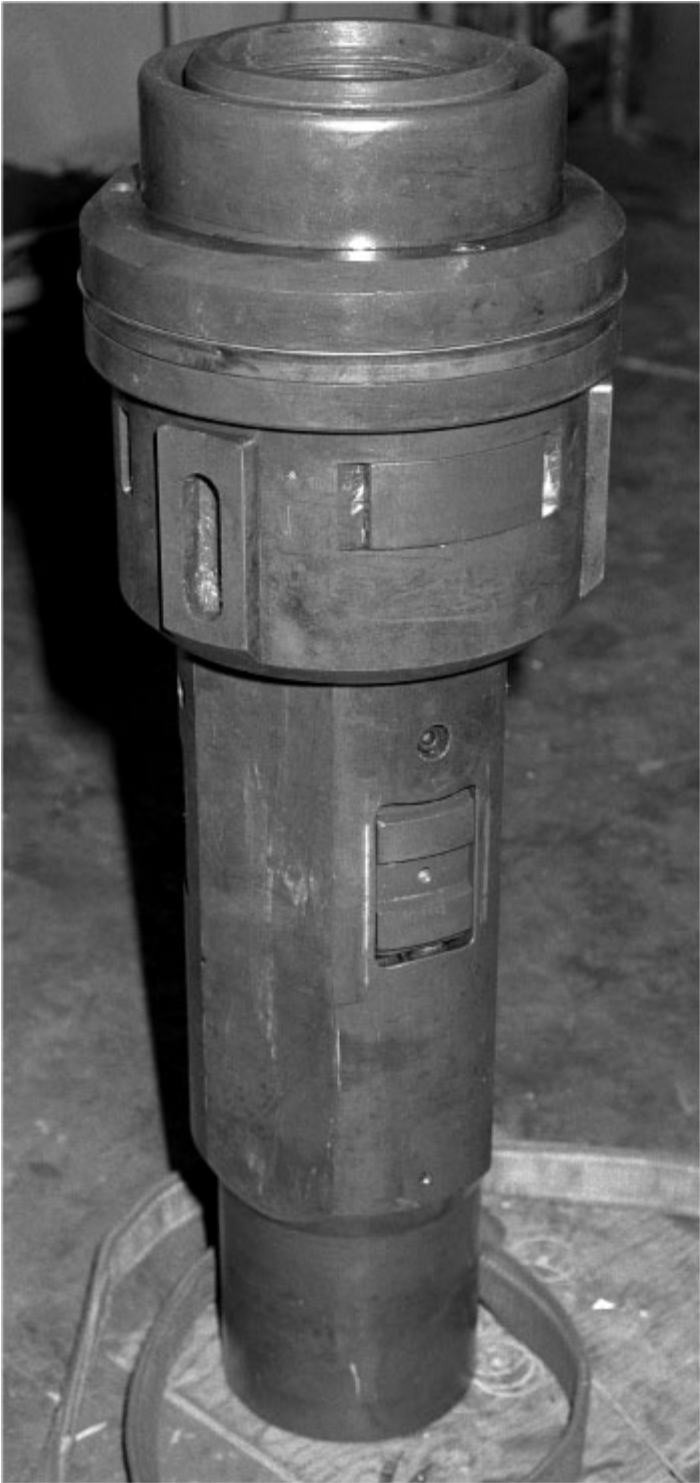



# Free-Fall Funnel

## Scientific Application

The Free-Fall Funnel (FFF) is free-fall deployed to the seafloor before the bit is pulled out of the existing hole. This system provides a quick and low-cost method to reenter the hole to facilitate bit and bottom-hole assembly (BHA) changes.

## Tool Operations

The FFF is split into two halves to permit installation around the drill string at the moonpool while the BHA is still in the hole. The FFF is equipped with a seafloor support plate and a split 9 ft (2.7 m) stub of 13<sup>3/4</sup> in. casing. Glass flotation balls can be attached to the FFF to aid in location and reentry using the underwater TV camera and sonar system.

## Design Features

### 1) Continued Drilling Option

The FFF provides a quickly deployed and low-cost means to reenter an open borehole.

*Benefit:* Permits coring/drilling to continue in a hole where a standard reentry cone was not planned, but a bit or BHA change is necessary.

### 2) Simplified Assembly and Deployment

The split design of the FFF allows for quick and easy assembly and deployment.

*Benefit:* A FFF can be installed around a drill string in ~2 hr while the bit is still in the hole.

### 3) Borehole Alignment and Support

A short ~9 ft long stub of casing keeps the FFF aligned with the hole and a support plate provides a seafloor landing surface.

*Benefit:* The alignment of the FFF casing stub with the hole helps ensure that the bit will follow the existing hole rather than inadvertently start a new hole in soft sediments. The seafloor support plate helps keep the FFF above the seafloor despite soft sediments or upper hole enlargement.

## Specifications

### **Diameter at the Top of the Cone**

7.5 ft (2.28 m)

### **Height above the Seafloor Support**

3.38 ft (1.02 m)

### **Cone Throat Diameter**

12¼ in. (0.32 m)

### **Casing Stub Diameter**

13⅜ in. (0.33 m)

### **Casing Stub Length**

9 ft (2.7 m)

### **Assembled Weight**

~2,000 lb (0.9 metric tons)

## Limitations

The FFF is not capable of supporting a casing string.

The FFF is not intended for use when reentry is considered likely during subsequent legs.

If the top of the borehole is washed out or the sediments are not consolidated enough for adequate support, the FFF can occasionally sink out of sight.

The FFF provides no guarantee that a collapsed borehole can be located and reentered.

**Figure 1.** Schematic of a FFF deployed in sediment. After a hole is drilled in sediment, a FFF can be installed to assist in reentry. Glass floatation balls may be added to enhance hole relocation using sonar.

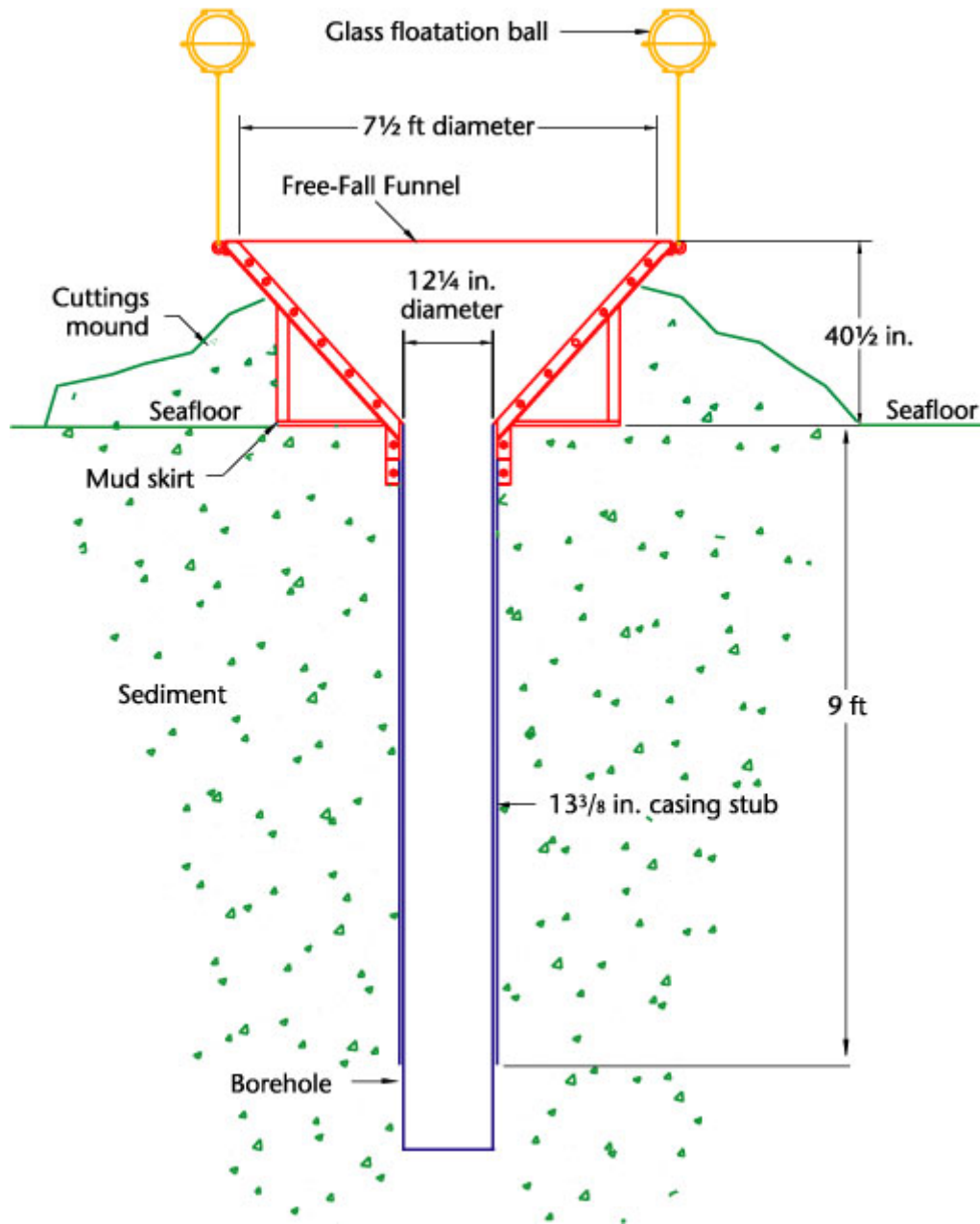

**Figure 2.** FFF with a 9 ft casing stub installed over the drill string and ready to drop in the moonpool.



# Hard Rock Base

## Description

The Hard Rock Base (HRB) is designed to focus the direction of the drill bit into hard irregular seafloor surfaces otherwise undrillable.

## Specifications

- Dry weight (unballasted) = 41,400 lbs
- Submerged weight (unballasted) = 36,000 lbs
- Approximate submerged weight (ballasted) = 125,000 lbs
- Reentry cone diameter = 8 ft
- Reentry cone uprighting moment factor of safety = 2.5
- Factor of safety against leg bolt shear = 19
- Maximum design tilt (into side) = 25°
- Maximum design tilt (into corner) = 30°
- Maximum recommended operational limit = 20°
- Leg extension beneath base = 3 ft

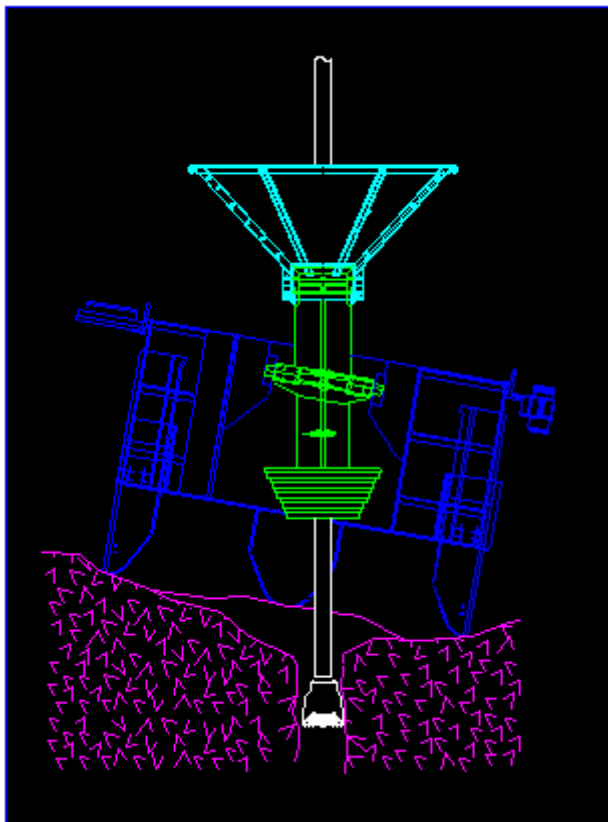

## Problems Associated with Landing an HRB

- Seafloor slope

- Seafloor stability
- Sediment thickness
- Sufficient area suitable to land base
- Weather/sea state/water depth conditions
- BP471 not suitable or efficient as a survey vessel
- Very rugged canyonous topography

## Design/Deployment Capabilities

- Can be set on hard bare rock outcrops with flat or irregular topography on slopes less than or equal to 20°
- Requires sediment cover to be less than 3 ft
- Recoverable/Redeployable
- Can be relocated on the seafloor

## Considerations of Using an HRB

- Permanent/long term reentry site
- 1, 2, or 3 casing strings required
- Time required to under ream or hole open
- Time to locate/position/run HRB
- Adequate survey of seafloor deployment area
- Space availability on BP471 for support hardware of HRB/casing (when considering multiple HRB deployments)

## Input Data for Landing an HRB

- Mechanical tilt indicator (Bullseye)
- maximum range = 23.5°
- Electronic tilt beacon (Note 1) = 40°
- Mesotech (Note 2) = Limited
- Visual form V.I.T. (Note 2) = Limited

## Notes

Electronic Tilt Beacons have experienced some freezing and/or erratic behavior due to rugged reentry cone shielding or topography.

Need experience to interpret results/data.

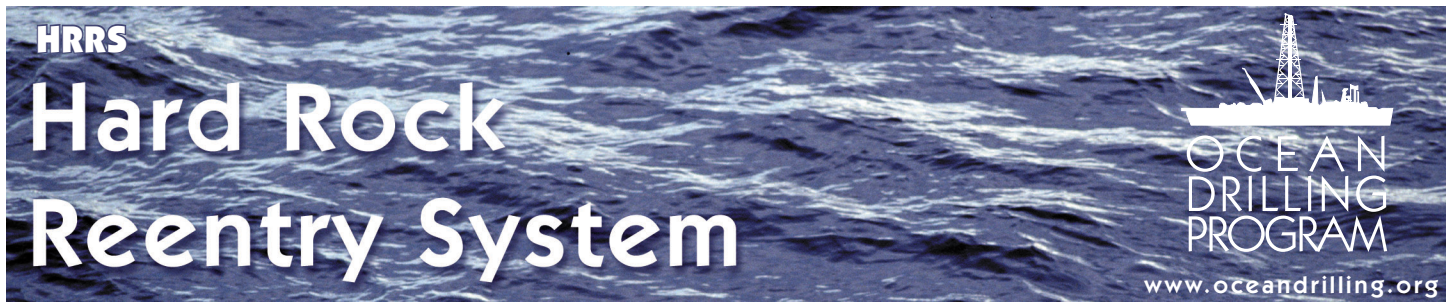

## Scientific Application

Hard rock environments have challenged existing coring technology in two ways: getting a hole started and keeping the hole open in brittle highly fractured formations. The Hard Rock Reentry System (HRRS) was developed to install casing with reentry capability on a sloping or rough hard rock seafloor, where bare rock spud-in or standard reentry cone and casing installations are not practical. The HRRS is crucial for starting holes at hard rock sites with unstable upper hole conditions (e.g., mid-ocean-ridge basalts) because the HRRS simultaneously advances casing while drilling the hole. The HRRS increases the probability of starting a hole and deepening it to recover core for scientists to study the formation and diagenesis of the ocean crust.

## Tool Operation

A few joints of 13<sup>3</sup>/<sub>8</sub> in. casing are advanced with the bit when the HRRS (or hammer-in-casing mode) is used. The HRRS consists of a fluid hammer (FH), underreamer or ring/pilot bit, and a casing running tool to install the 13<sup>3</sup>/<sub>8</sub> in. casing. The rig pumps provide hydraulic pressure through the drill string to power a downhole FH, which drives a percussion bit. Seawater is circulated down the pipe, through the FH, and back through the casing to the seafloor to clean the fine cuttings from the hole. When the casing is set, the FH is released and withdrawn, leaving a cased hole for coring. An HRRS reentry funnel, which is slightly different from the usual free-fall funnel, is installed by free fall from the ship after the casing is set. The FH can also be used with a flat-face bit to drill a hole without installing casing.

## Design Features

### 1) Bare Rock Spud on Slopes

Both the HRRS (to install casing) and the fluid hammer with a flat-face drill bit (to drill ahead) are capable of initiating a bare rock spud on a slope with hard rock or rubble cover.

*Benefit:* Operations can be initiated on unstable or sloping surfaces that previously thwarted efforts to start a hole using conventional drilling and casing techniques.

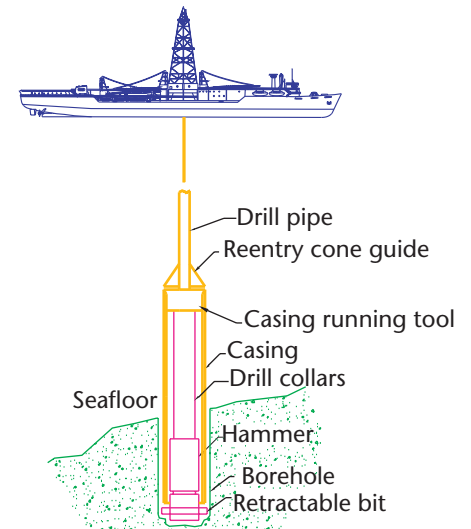

HRRS drilling in

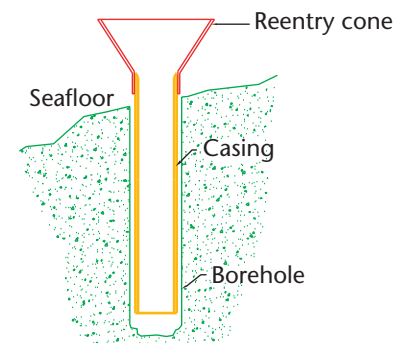

Completed HRRS installation after free-fall deployment of HRRS reentry cone

**Schematic of the HRRS in the Hammer Drill-In-Casing mode. The hammer drill is run inside the casing and simultaneously drills a hole and advances the casing. A reentry cone is free-fall deployed, and the hammer drill is withdrawn from the casing leaving a reentry installation.**



## 2) HRRS Casing

The HRRS simultaneously drills a hole and runs casing.

*Benefit:* Unstable upper formations are isolated by casing as they are drilled, which means less time is spent on reaming and hole cleaning, stuck pipe problems due to hole collapse are reduced, and hole cleaning is improved by preventing enlargement of the seafloor hole.

## 3) Nested Casing

The 13 $\frac{3}{8}$  in. HRRS hammer-in-casing uses a standard 13 $\frac{3}{8}$  in. Drill-Quip (DQ) casing hanger.

*Benefit:* Allows later installation of a conventional 10 $\frac{3}{4}$  in. casing with a standard DQ hanger.

## 4) High Rate of Penetration

The fluid hammer with a flat-face drill bit may have a higher rate of penetration than a rotary bit when drilling in hard rock.

*Benefit:* Useful for drilling noncased holes in hard rock with minimal or no sediment cover for logging and instrumentation. The time spent on the hole is reduced when casing is not set.

## HRRS Specifications

### Fluid Hammer

SDS Digger Tools model 260 FH, 10.23 in. (260 mm) diameter, requires a closing force of 3300 lb and a flow rate of 595 gpm to operate. If the closing force is not 3300 lb or greater, the fluid hammer stops drilling, but circulation can be maintained.



**SDS 260-mm fluid hammer and under reamer bit.**

### Bit Types

HRRS Underreamer Bits: drill a 14 $\frac{3}{4}$  in. (375 mm) hole and close to a 12 $\frac{1}{4}$  in. diameter to retract through the 13 $\frac{3}{8}$  in. casing. These bits are used with the HRRS to set casing.

HRRS Ring Bit: 15 in. (381 mm) diameter ring bit is welded to the 13 $\frac{3}{8}$  in. casing and run with a 12 $\frac{1}{4}$  in. pilot bit. The ring bit is left in the hole because it is welded to the casing, but the pilot bit is recovered. These bits are used with the HRRS to set casing.

Flat-Face Drill Bit: 12 $\frac{1}{4}$  in. (311 mm) diameter bit for drilling with the fluid hammer (i.e., not used to set HRRS casing).

Casing: 13 $\frac{3}{8}$  in. with Atlas Bradford "STL" flush joint connections to minimize hole friction.

## Additional Equipment

### Drill Collars

9 $\frac{1}{2}$  in. outer diameter required for closing force.

### Pulsation Sub

Supplemental tool to reduce fluid pulsations from the fluid hammer.

### Jet Sub

Flushes the annulus above the fluid hammer inside the casing. The primary flow path to remove the fine cuttings is upward through the casing.

### Running Tool

Engages the bearing assembly below the hanger to prevent casing from rotating.

### Reentry Funnel

Deployed by free fall after hammering-in-casing to provide reentry capability.

## Typical Operating Range

Requires use of the Active Heave Compensator to control weight on bit to ~10,000 lb to keep the fluid hammer in drilling mode.

Hammer operates at 25–30 Hz with 595 gpm at 2200 psi.

Casing length is formation dependent, but typically 30–60 m.

## Limitation

HRRS is not suitable for use in soft sediments (see Drill-In-Casing System tool sheet).



# Reentry Cone and Casing

## Scientific Application

The Reentry Cone and Casing (RECC) system is a permanent seafloor installation (or legacy hole) that is able to support up to four nested casing strings that case off unconsolidated sediments to achieve deep target horizons. The RECC allows a borehole to be reentered on multiple legs to deepen the hole or install a borehole observatory for enhanced long-term downhole measurements and sampling. A borehole observatory can be configured as a Circulation Obviation Retrofit Kit (CORK), an Advanced CORK (ACORK), or an instrument hanger for a seismometer package or sensor string. The deeper casing strings need to be cemented to isolate the borehole from open circulation between the formation and ocean bottom water or between formation intervals.

## Tool Operation

The reentry cone assembly consists of a reentry funnel mounted on a support plate that rests on the seafloor and a housing to support the multiple casing strings. The reentry cone is typically run with a short (20–80 m long) casing string (20 or 16 in. diameter). The first string of casing is typically deployed as an integral part of the reentry cone, which is hydraulically washed (or jetted) in pelagic mud

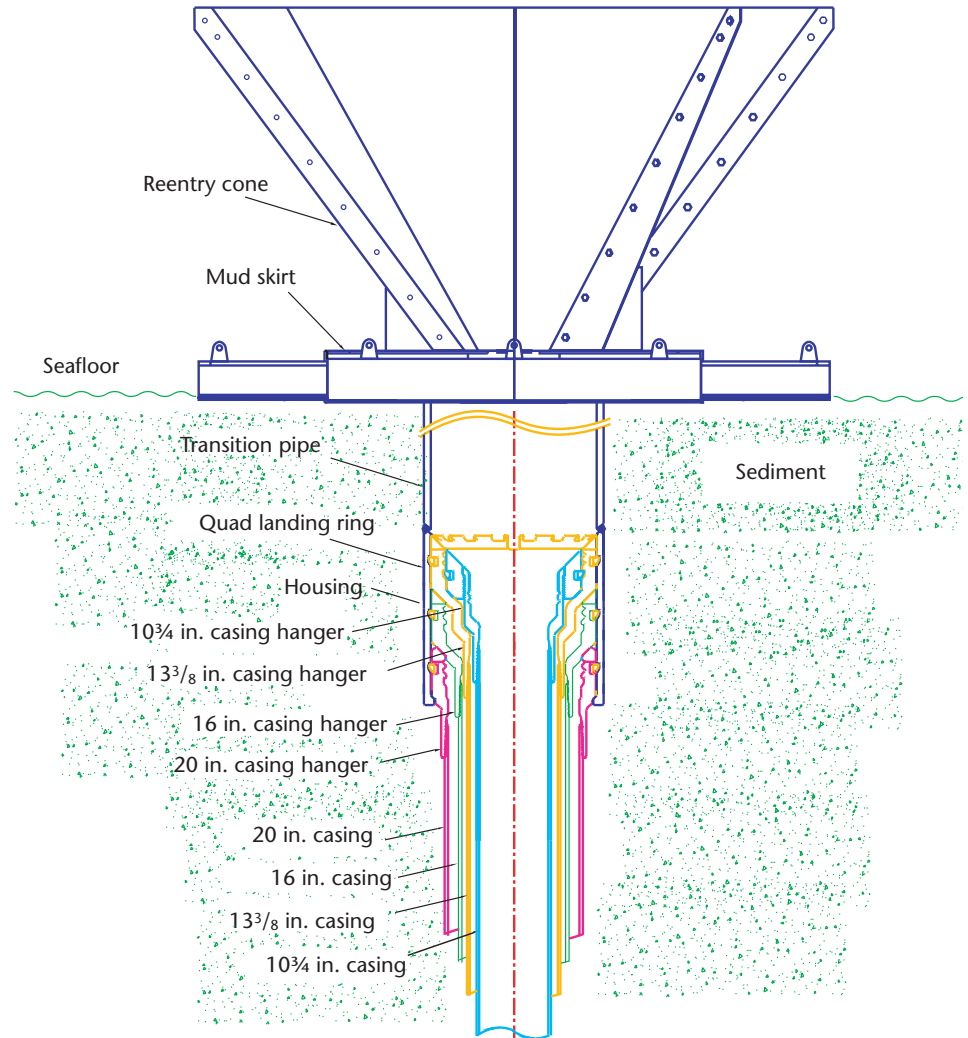

**Schematic of the reentry cone, mud skirt, and housing with four Drill-Quip casing hangers (20 in., 16 in., 13<sup>3</sup>/<sub>8</sub> in. and 10<sup>3</sup>/<sub>4</sub> in.) landed in the housing.**

and supported without cementation. The soft upper formation “heals” around the casing providing support and a weak annular seal. The first string of casing can also be drilled in with an under-reamer and mud motor if the sur-

face sediments are consolidated. Rotation of the casing string is not practical because of the large support plate. Subsequent casing strings are run into a predrilled hole, hung in the housing, and cemented in place.

## Design Features

### 1) Continued Drilling Option

In compliance with ODP guidelines and to determine the casing setting depth, an 'A' hole must be cored to target depth, followed by logging. The casing is then set in the 'B' hole to isolate unconsolidated formations identified in the 'A' hole. A reentry cone provides a means to mark the seafloor entrance to a borehole and to stabilize the sediments. Coring and/or drilling to total depth (TD) is possible with trips for new bits, reentries, and multiple casing strings. Existing cased legacy holes can be reentered and deepened or instruments can be added at a later date.

*Benefit:* Coring and/or drilling in a single borehole can be continued to achieve the deep scientific objectives of the leg.

### 2) Reduction of Borehole Instability

Reentry cones provide a means to hang multiple casing strings to seal off unstable formations. In areas of borehole instability, downhole motors and underreamers can be run inside casing while the casing

is being installed to ensure that the casing reaches TD.

*Benefit:* Coring and/or drilling a borehole can be continued through unstable formations.

### 3) Borehole Instrumentation

Reentry cones provide a stable platform for borehole completions.

*Benefit:* Long-term ancillary scientific investigations can be conducted such as investigating formation permeability, temperature and pressure changes over time, conducting fluid sampling, and seismic event monitoring.

## Casing Running Tools

### 20 in. CADA (Cam Actuated Drill Ahead) Casing Running Tool

The CADA casing running tool is deployed on the drill string to emplace 20 in., 16 in., and 13<sup>3</sup>/<sub>8</sub> in. casing in a borehole where a reentry cone has been installed. As an option, once the casing has been installed, the drill string can be released from the CADA tool. This feature allows casing to be set and the borehole drilled ahead of the casing in a single pipe trip.

*Benefit:* Eliminates a round trip for a bit change to open up the hole for casing.

### 10<sup>3</sup>/<sub>4</sub> in. Casing Running Tool

The 10<sup>3</sup>/<sub>4</sub> in. casing running tool is run on the drill string to install the 10<sup>3</sup>/<sub>4</sub> in. casing in a borehole after a reentry cone has been installed. Unlike the CADA tool, the 10<sup>3</sup>/<sub>4</sub> in. casing running tool does not have a "drill ahead" feature; therefore, before the borehole can be continued, a round trip of the drill string is required to remove the 10<sup>3</sup>/<sub>4</sub> in. casing running tool.

## Reentry Cone Specifications (see Table 1)

### Reentry Cone Diameter

13 ft (4.0 m)

### Height above the Mudline

7 ft (2.1 m)

### Baseplate Support Area

120 ft<sup>2</sup> (11.1 m<sup>2</sup>)

### Transition Pipe below Reentry Cone

26 in. outside diameter (OD); 24 in. inside diameter (ID)

## Limitations

To minimize operational time for setting casing and reduce the risks associated with an underreaming operation, double casing string configurations are recommended.

If triple or quadruple casing programs are required because of formation stability problems, underreaming should be done in the softer formations in the upper hole (<500 to 700 m).

The Ocean Drilling Program does not normally carry underreamers or bits larger than 17<sup>1</sup>/<sub>2</sub> in. as part of its inventory on board the *JOIDES Resolution*.

Table 1. Casing size options.

OD casing (in.)	Open hole (bit size) (in.)	OD casing coupling (in.)	Weight (lb/ft)	ID (nominal) (in.)	Drift (in.)	Cemented?	TD range (m)
20	24	21	94.0	19.124	18.936	No	40–80
16	20	17	75.0	15.124	14.936	Cemented below 20 in. casing	40–80 or 200–500
13 <sup>3</sup> / <sub>8</sub>	17 <sup>1</sup> / <sub>2</sub>	14 <sup>3</sup> / <sub>8</sub>	54.5	12.615	12.456	Yes	300–700
10 <sup>3</sup> / <sub>4</sub>	14 <sup>3</sup> / <sub>4</sub>	10 <sup>3</sup> / <sub>4</sub>	40.5	10.050	9.894	Yes	500–1500

Note: Recommended casing configurations to avoid running an underreamer to create the open hole for the casing are 16:10<sup>3</sup>/<sub>4</sub> in. and 20:13<sup>3</sup>/<sub>8</sub> in.

# Underreamers, Bi-Center Reamers, and Mud Motors

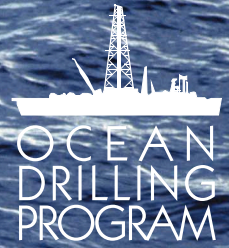

www.oceandrilling.org

## Scientific Application

The Ocean Drilling Program (ODP) installs reentry cones and casing in sediments and basement, typically by coring the hole and then enlarging (i.e., underreaming) it to run casing. Underreamers (Fig. 1) and bi-center reamers (Fig. 2) are used during casing installations to drill an enlarged hole (usually below a casing shoe) to provide clearance to run additional casing strings and provide annular clearance for adequate cement thickness (Table 1). Both tools drill a larger hole than the casing “pass-through diameter” (the maximum diameter of tools that will pass through the casing) by expanding hydraulically (underreamer) or rotating eccentrically (bi-center reamer) once they are through the casing. Underreamers were designed for use in softer sediments. Because of the hydraulically expanding arms, underreamers are not as robust as bi-center reamers. Bi-center reamers are newer than underreamers and are designed to drill in firm sediments and basement rocks. They have fixed eccentric wobble shell cutters (Fig. 2) and, thus, cannot drill as large a hole as an underreamer for any given pass-through diameter.

The engineer determines which tool to use depending on the formation type and the casing

sizes. Both tools can be used (1) to enlarge an existing hole, (2) as a precautionary tool to reopen an enlarged hole if it has closed, and (3) to drill a new hole. More rarely, these tools can be used to “drill-in casing.” The term drill-in casing refers to running a mud motor (see Section III) inside the casing to rotate one of these tools as a precaution to ensure the hole is open ahead of the casing (Fig. 3) or (rarely) to drill and run casing simultaneously (Fig. 4).

## I. Underreamers

### Tool Operation

The underreamer (Fig. 1) is run using 6 to 12 drill collars in the bottom-hole assembly (BHA) below the drill pipe to add weight. A pilot bit drills ahead of the roller cone cutters to center the rotation of the underreamer body to force the roller cones to cut a concentric hole. Fluid pressure inside the drill string is used to hydraulically extend the two underreamer arms, which have roller-cone cutters. The underreamer arms are pre-adjusted to the required hole diameter

**Figure 1. Schematic of the underreamer tool. Mill-tooth roller cone cutters are used with softer sediments. Tungsten carbide roller cone cutters are used with firmer sediments and hard rock.**

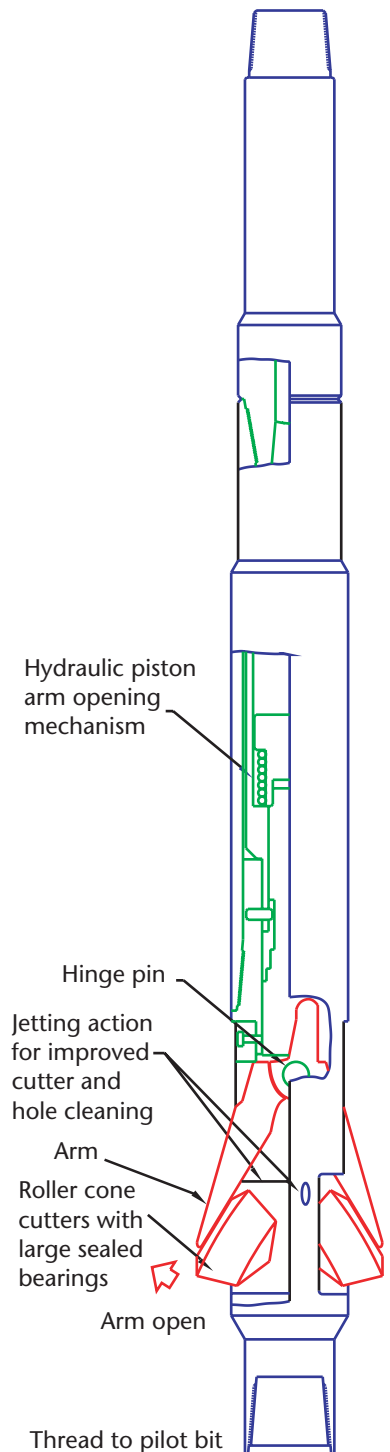



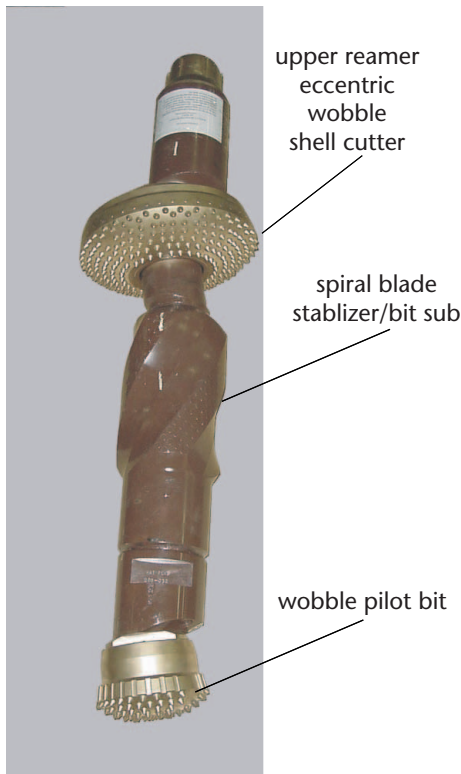

**Figure 2. Photo of bi-center reamer.**

before drilling. The pilot bit and underreamer nozzles must be sized correctly to ensure adequate hole cleaning and provide enough backpressure to open the underreamer arms at the same time.

## Design Features

### 1) Formation Compatibility

Underreamers are compatible with sediments ranging from soft silts/sands and sticky clays to moderately firm sediments. Medium- and

hard-formation bit cones are available. Limited (~20 m) basement (e.g., basalt) penetrations are also possible.

*Benefit:* One underreamer tool can drill a wide range of sediments without a trip to change bits.

### 2) Hole Size/Operating Parameters

Underreamers have adjustable arms that open hydraulically. Table 2 shows the model, underreamer body size, outer diameter (OD) of the casing the underreamer can pass through, the size of the hole that can be drilled when the arms open, and typical operating parameters (weight on bit [WOB] and revolutions per minute [rpm]).

*Benefit:* The underreamer arms can be adjusted to cut different hole diameters, reducing the need for a separate tool for each casing size. Operating parameters can be adjusted to optimize performance in different formations based on rate of penetration, hole conditions, swelling formations, etc.

### Underreamer Specifications

Roller cone cutters include mill tooth cutters for soft sediments and tungsten carbide tooth cut-

ters for firm sediments, chert, and limited (~20 m) basement penetration.

The pressure drop through the underreamer is 250–500 psi (at 1000 gpm maximum). An underreamer will typically require a flow rate of 30–500 gpm/in. hole diameter for proper hole cleaning.

A Drilex D950SSHF (slow speed, high-flow rate) mud motor is used with the underreamer when a mud motor is used to run casing.

### Underreamer Typical Operating Range

*Formation:* Soft to moderately firm sediments

*Depth Range:* No limit

*Rate of Penetration:* Depends on rock properties, but ~30 to 3 m/hr

### Limitations

Should not be used to drill very firm sediments, chert, or deep into volcanic basement rock due to potential damage to the arms.

Holes in granular sediments (such as sand, fractured rock, or rubble) usually will not stay open.

To underream a reasonably straight and concentric hole, the pilot bit should be the same size

**Table 1. Comparison of underreamer and bi-center reamer casing and drill bit specifications.**

Casing OD (in.)	Casing weight (lb/ft)	Casing drift ID (in.)	Buttress coupling OD (in.)	Drill bit option (in.)	DDI bi-center drill-in casing model number	HOC underreamer (in.)	
						DTU 95	DTU 1175
20	94	18.936	21	Jet-in	B#182x215	-----	22
16	75	14.936	17	18.5	B#145x185	-----	20
13.375	54.5	12.459	14.375	14¾	B#122x146	14¾	-----
10.75	40.5	9.894	11.75	12½	-----	14¾	-----

Notes: OD = outer diameter; ID = inner diameter; DDI = Downhole Design, Inc.; HOC = Hole Opener Corporation; DTU is part of the model number.

or larger than the predrilled pilot hole.

## II. Bi-Center Reamers

### Tool Operation

Bi-center reamers (Figs. 2, 5; Table 3) are also run on a BHA composed of 6 to 12 drill collars below the drill pipe. A pilot bit below the bi-center reamer must center the tool body in a hole so the upper reamer shell can rotate eccentrically to enlarge the hole. The pilot bit and bi-center reamer nozzles must be sized correctly to ensure adequate hole cleaning.

### Design Features and Benefits

#### 1) Formation Compatibility

Bi-center reamers are compatible with moderately firm sediments and volcanic basement.

*Benefit:* A bi-center reamer can drill or underream a wide range of firm sediments to basement without a trip to change bits.

#### 2) Durability

The bi-center reamers are a fixed outer diameter (i.e., not hydraulically opened).

*Benefit:* No tool closure is required to pull the tool back through casing, and the design is more robust.

#### 3) Hole Size

Bi-center reamers use IADC Class 5 conical tungsten carbide cutters.

*Benefit:* Bi-center reamers can drill firm sediments and basement rocks that might damage a hydraulic-arm type underreamer.

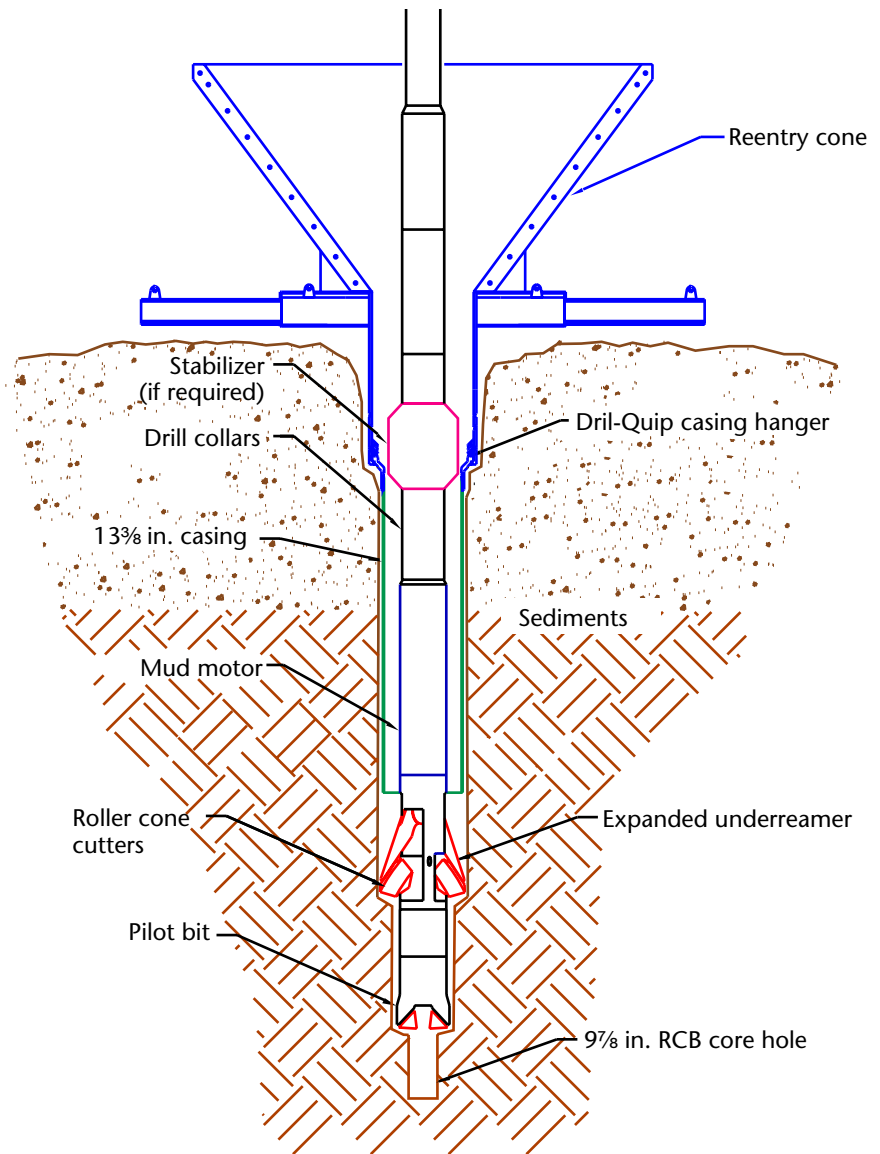

**Figure 3. Underreaming (enlarging) 9<sup>7</sup>/<sub>8</sub> in. core hole with an expanded underreamer below conductor casing before running next casing. If a bi-center reamer was used, it would be in the same position below the mud motor as the underreamer.**

#### 4) Stabilizer and Wobble Bit

A 9<sup>7</sup>/<sub>8</sub> in. OD integral blade stabilizer and a 9<sup>7</sup>/<sub>8</sub> in. OD single-cone wobble bit are available.

*Benefit:* The stabilizer absorbs the side loading forces as a result of eccentric "wobble" of the bi-center reamer shell and reduces damage sustained by the drill or wobble bits. Wobble bits have a

larger bearing than tricone bits and are more robust.

### Bi-Center Reamer Specifications

9<sup>7</sup>/<sub>8</sub> in. OD integral blade stabilizer

9<sup>7</sup>/<sub>8</sub> in. OD single-cone wobble pilot bit

*Weight on Bit:* 3K to 6K lbf/in. of bit diameter

*Circulation Rate:* 30 to 50 gpm/in. of hole diameter

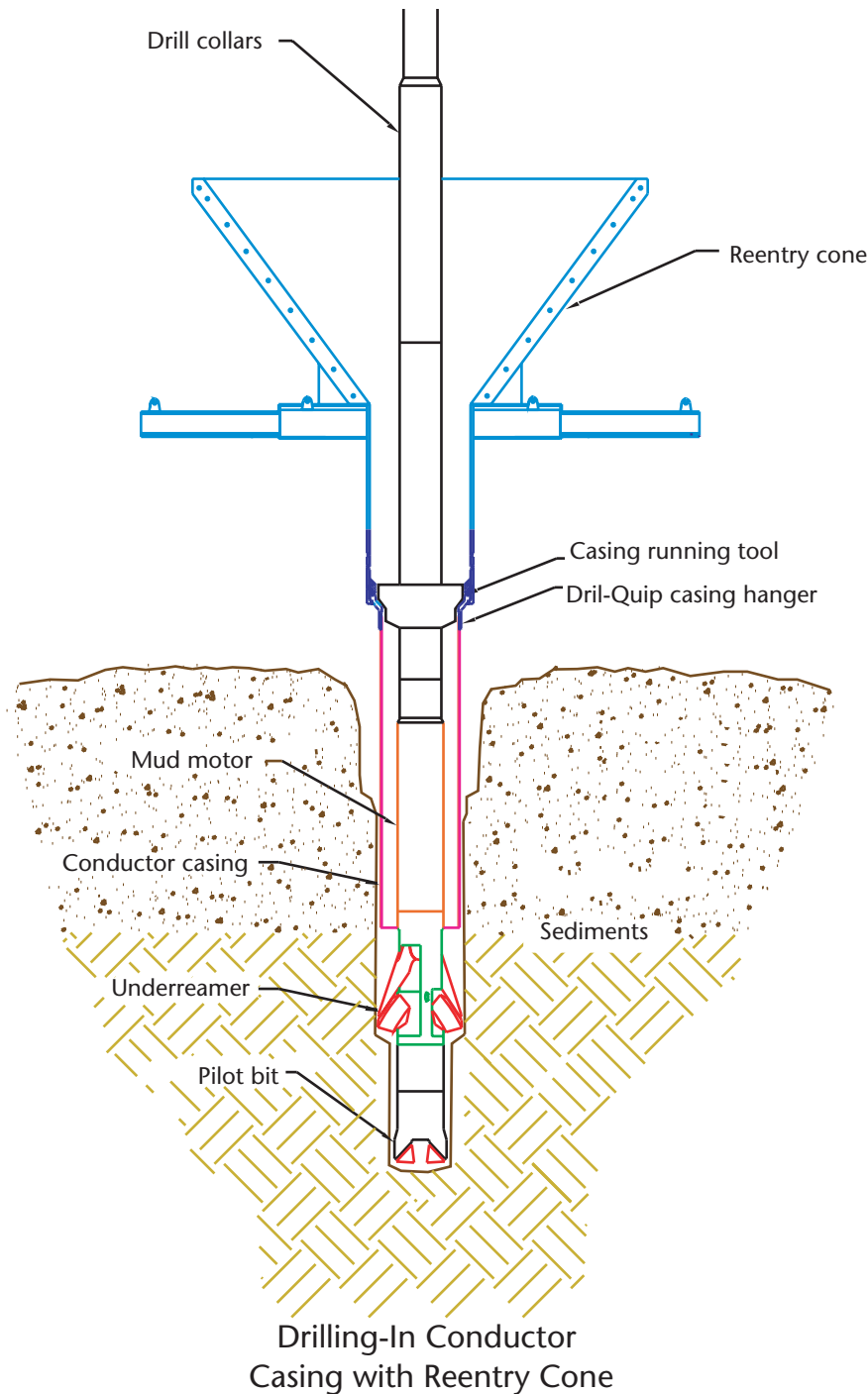

**Figure 4. Underreaming ahead of conductor casing in unstable sediment cover to set reentry cone.**

**Table 2. HOC and underreamer models and specifications.**

HOC model	UR body size (in.)	OD casing (in.)	Hole size drilled (in.)	WOB (klb)	Rev/min (rpm)
DTU 1175	11 3/4	20, 16, 13 3/8	11 3/4 to 22	0-20	70-110
DTU 950	9 1/2	10 3/4	9 1/2 to 14 3/4	0-15	70-110

Note: UR = underreamer.

## Bi-Center Reamer Typical Operating Ranges

*Formation:* Firm to moderately firm sediments to hard volcanic basement rock

*Depth Range:* No limit

*Rate of Penetration:* Depends on rock properties, but ~30 to 10 m/hr in sediments and ~6 to 2 m/hr in basement

## Limitations

Bi-center reamers are not effective for re-reaming an existing large or rugose hole because the pilot bit must be constrained in (i.e., centered in) the hole to center the tool body and force the eccentric upper reamer shell to drill.

No tool is effective in opening a hole in unstable or granular sediments (such as sand, fractured rock, or rubble).

## III. Mud Motors

### Tool Operation

Because casing cannot be rotated from the surface, a mud motor (Fig. 6) is used inside casing to rotate underreamers, bi-center reamers, or bits, using pressure from circulating fluid pumped down the drill pipe. The mud motor nozzles must be sized correctly to ensure adequate hole cleaning for the pilot bit and underreamer or bi-center reamer nozzles. ODP uses a Drilex D950SSHf mud motor (special low rotating speed but with high flow rate and high torque), which runs at ~500 psi pressure drop on bottom when fully loaded. The mud motor assists the casing string past bridges and tight spots in a predrilled hole. A mud motor can also drill-in casing without a predrilled hole over short intervals

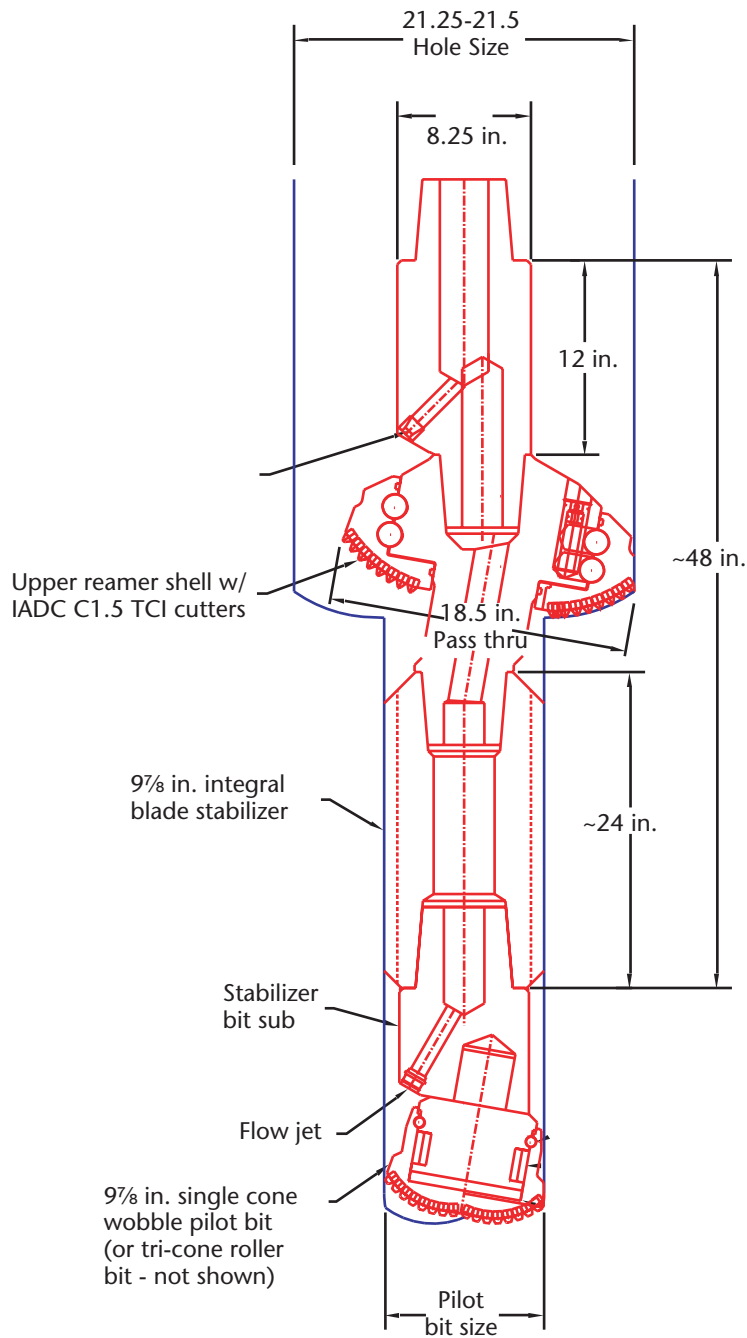
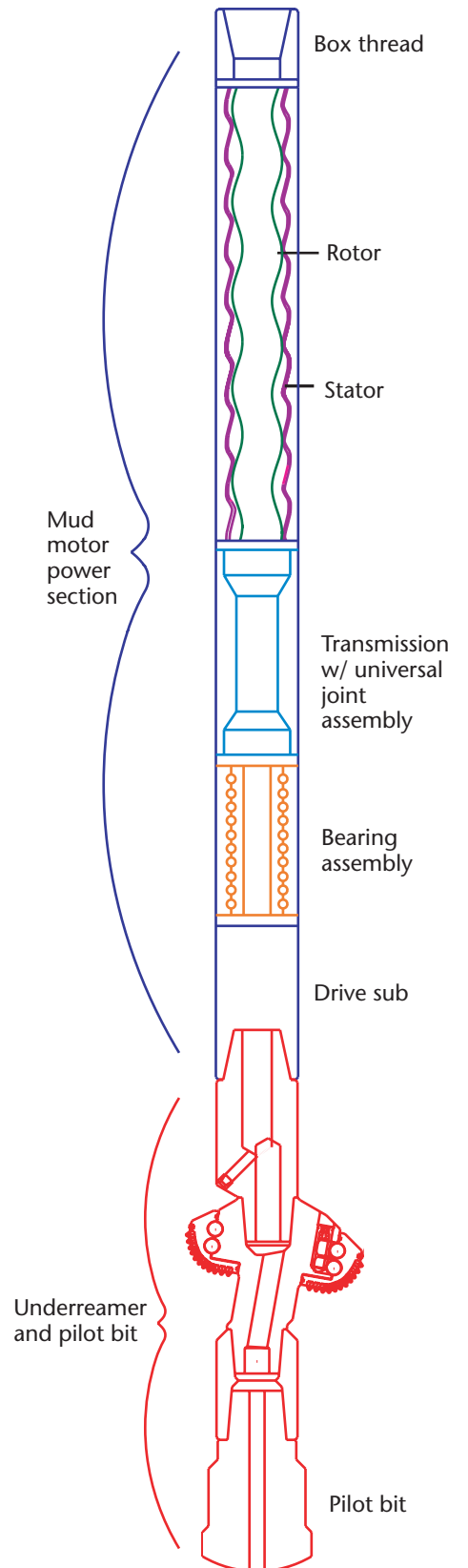

**Figure 5. Schematic of a bi-center reamer by Downhole Design Inc. (DDI).**

**Table 3. DDI bi-center reamer models and specifications.**

DDI bi-center model	Pass-through size (in.)	Hole size (in.)	WOB max. (lb)	Rev/min (rpm)	Est. rot. hours (hr)	Est. ROP (ft/hr)
B#182x215	18.25	21.5	100K	50-60	60-80	20-2
B#145x185	14.5	18.5	70K	60-70	60-80	30-2
B#122x146	12.25	14.625	40K	60-70	60-80	25-2

Notes: Est. = estimated; rot. = rotating; ROP = rate of penetration.



**Figure 6. Schematic diagram of the mud motor with a bi-center reamer and pilot bit. The mud motor could also be used with an underreamer and pilot bit or with only a bit.**



(i.e., less than ~150 m in unstable sediments such as sand or swelling clay).

## Design Features

### 1) Compatibility

The mud motor is compatible with underreamers, bi-center reamers, and tricone drill bits when they are run with the appropriate nozzles and hydraulics.

*Benefit:* One mud motor can be used to drill sediments and base-ment with a wide range of dif-ferent tools.

### 2) Durability

The Drilex D950SSHF mud motor has high stall torque and relatively low rpm.

*Benefit:* Large drilling tools, such as underreamers and bi-center reamers, require low rpm and high torque to drill in hard and fractured rock.

### 3) Pass-Through Hole Size

The Drilex D950SSHF mud motor has a 9.47-in. OD.

*Benefit:* Can be run inside 10<sup>3</sup>/<sub>4</sub> in. casing (9.950-in. nominal/ 9.794-in. drift ID). It is the larg-est motor available that will pass through the 10<sup>3</sup>/<sub>4</sub> in. (smallest) casing size used by ODP.

## Mud Motor Specifications

The mud motor has a 9.47-in. OD.

Pressure drop is 200–300 psi no load and 500 psi on bottom when fully loaded.

Motor displacement is 6.11 gal/ rpm with a rotor speed of 90–164 rpm off-bottom and 72–131 rpm on-bottom at a flow rate of 550–1000 gpm. On-bottom torque is 7600 ft-lb at 500-psi pressure drop and 12,000 ft-lb stall torque.

## Mud Motor Typical Operating Ranges

*Formation:* No limit—depends on drilling tool used

*Depth Range:* No limit

*Rate of Penetration:* Not applicable

## Limitation

Appropriate nozzles and hydraulics must be run in the drilling tools (e.g., underreamers, bi-center reamers, and tricone drill bits) to provide pressure and flow rate to operate the mud motor.

# Advanced Piston Corer Temperature

## Scientific Application

The Advanced Piston Corer Temperature (APCT) tool is an instrumented version of the coring shoe that is run on the Advanced Piston Corer (APC). It is deployed in soft sediments to obtain formation temperatures to determine the heat flow gradient and is essential in determining hydrocarbon maturity for pollution prevention purposes.

## Tool Operation

The APCT is deployed on an APC inner core barrel and provides a precise in situ temperature measurement while adding only 10 min to each core barrel run. Typically, the tool is run starting at 30 m below seafloor (mbsf) and then run after every other core until four good readings are obtained. The shoe is hydraulically stroked 9.5 m into the sediment and remains stationary for ~10 min. The APC inner core barrel is then retrieved, the instrumented shoe is removed, and the data is downloaded into a computer.

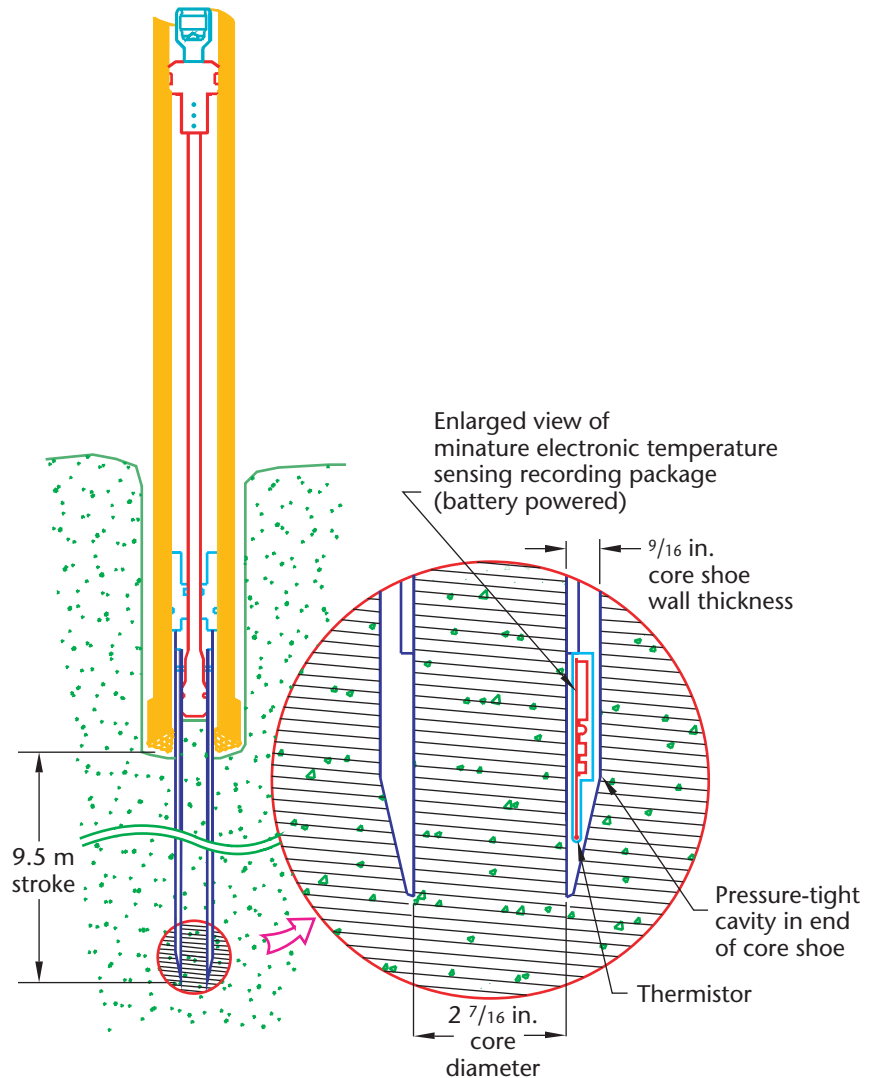

**Continuous temperature measurements are recorded with the APCT core shoe embedded in the sediment.**

## Design Features

### 1) Temperature Measurement Without Wireline Trip

The APCT sensor, electronics, and memory are contained in an annular cavity inside the APC coring shoe.

*Benefit:* Temperature measurements can be obtained without a special wireline trip with a temperature tool.

### 2) Minimal Time Impact

The APCT tool is deployed on an APC inner core barrel and remains stationary for ~10 min in the sediment.

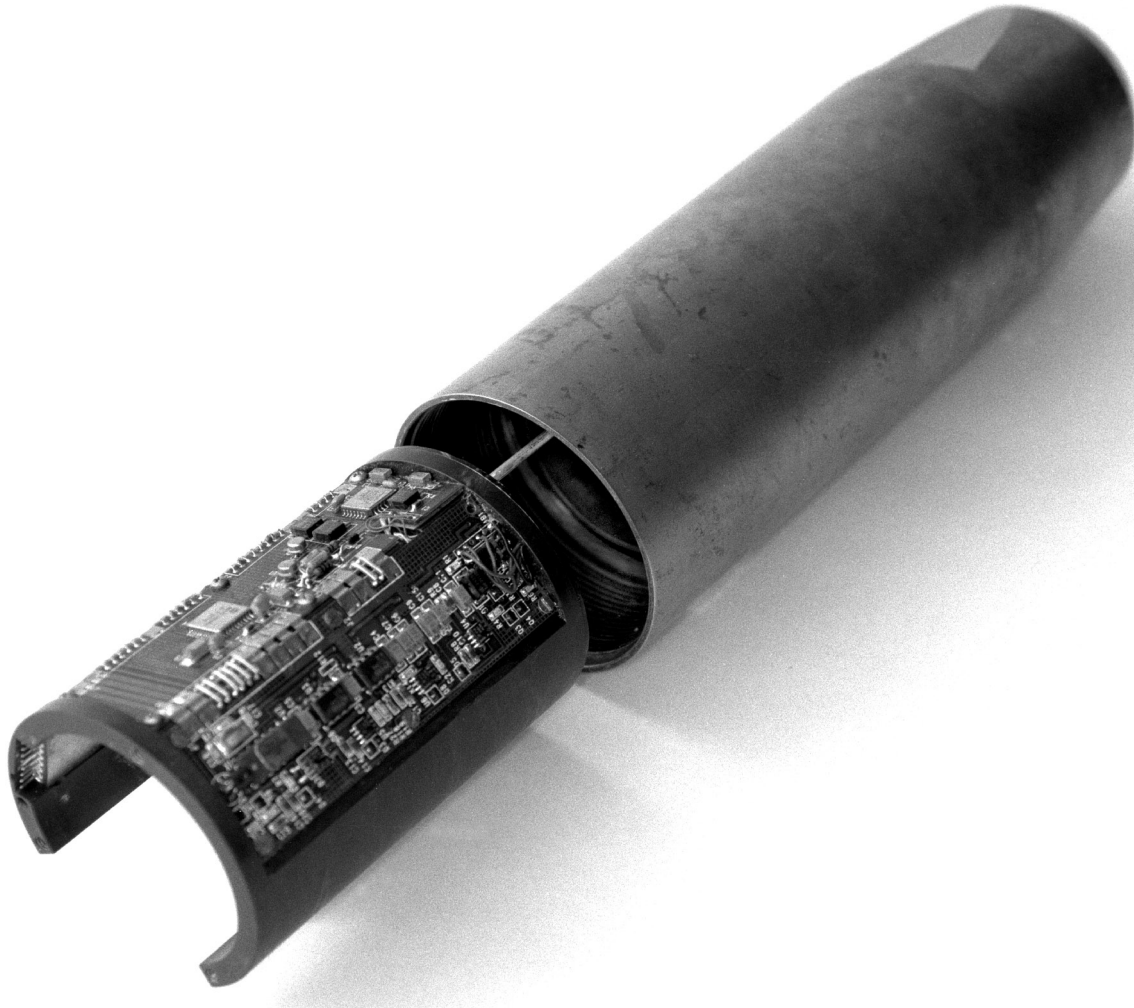

**APCT shoe with pocket to accept electronics, memory board, and battery for temperature measurements while taking an APC core.**

*Benefit:* The APCT provides a precise in situ temperature while adding only 10 min to each core barrel run.

### **3) Rapid Data Download**

The instrumented shoe is removed as soon as the APC inner core barrel is retrieved, and the data are downloaded into a computer program for immediate processing.

*Benefit:* Hydrocarbon maturity evaluations can proceed during coring to avoid delays for data handling.

### **APCT Specifications**

Motorola 68HC811 microprocessor

32K x 8 bit CMOS RAM data storage

Real-time clock

14-bit analog-to-digital converter

Platinum temperature sensor  
±0.02°C accuracy

### **Typical Operating Range**

–20°C to +100°C temperature measurement range

### **Limitations**

Can only be used in soft sediments appropriate for piston coring

Can only be used in relatively stable sediments where danger of hole collapse is minimal

# Advanced Piston Corer Methane



## Scientific Application

The Advance Piston Corer Methane (APCM) tool continuously monitors temperature, pressure, and conductivity changes in the core liner during coring, wireline retrieval, and handling to quantify changes that occur in gas-rich cores. By comparing data plots from successive cores, stratigraphic variations and relative amounts of gas stored in sediments can be determined at individual sites and variations between sites can be assessed. Models indicate that the data also

provide information on the presence of gas hydrate in the sediment that may disassociate before core retrieval.

## Tool Operations

Temperature, pressure, and conductivity sensors are embedded within the piston head on the standard ODP Advanced Piston Corer (APC) (Fig. 1, Fig. 2). During the APC coring stroke, the piston head acts as a plunger to evacuate water from the inner core barrel, which allows the core to enter.

## Design Features

### Wireline Deployment

The APCM is deployed at the beginning of APC coring and removed when coring is suspended. A 100-hr long-life battery allows continuous 1-Hz recording of data for the duration of the APC coring sequence.

*Benefit:* Allows scientists to calculate the amounts of gas stored in sediments.

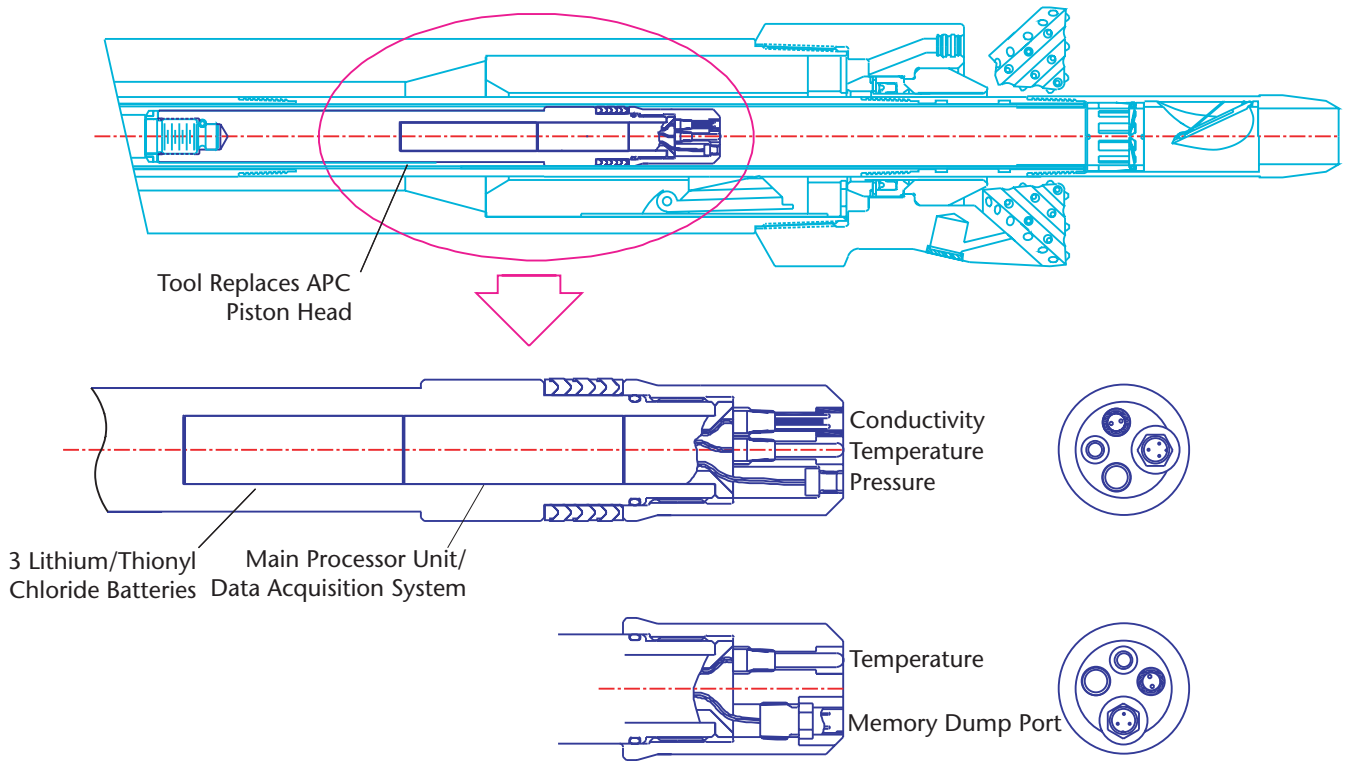

**Figure 1. Top schematic shows the APCM inside the APC bottom-hole assembly. The bottom two drawings show the APCM head in more detail along with a schematic of the top of the sensor head.**



## APCM Specifications

### General

Replaces APC piston and snubber in APC assembly

Three sensors: temperature, pressure, and conductivity

Temperature sensor accuracy:  $\pm 0.05^{\circ}\text{C}$

Pressure transducer operating range: 0-10,000 psi;  $\pm 0.15\%$  full scale

Conductivity sensor: 3-pin Bulk-head Connector (detects gas phase in headspace)

Sample rate: 1 Hz

### Electronics

ODP/MBARI design

Motorola 68338 processor

DOS-like operating system

48 MB of flash memory

Two double-C, lithium/thionyl chloride batteries in series—lasts ~100 hr

### Typical Operating Range

Very soft to firm sediments (any time the APC is deployed).

### Limitations

The APCM can be used any time the APC is deployed.

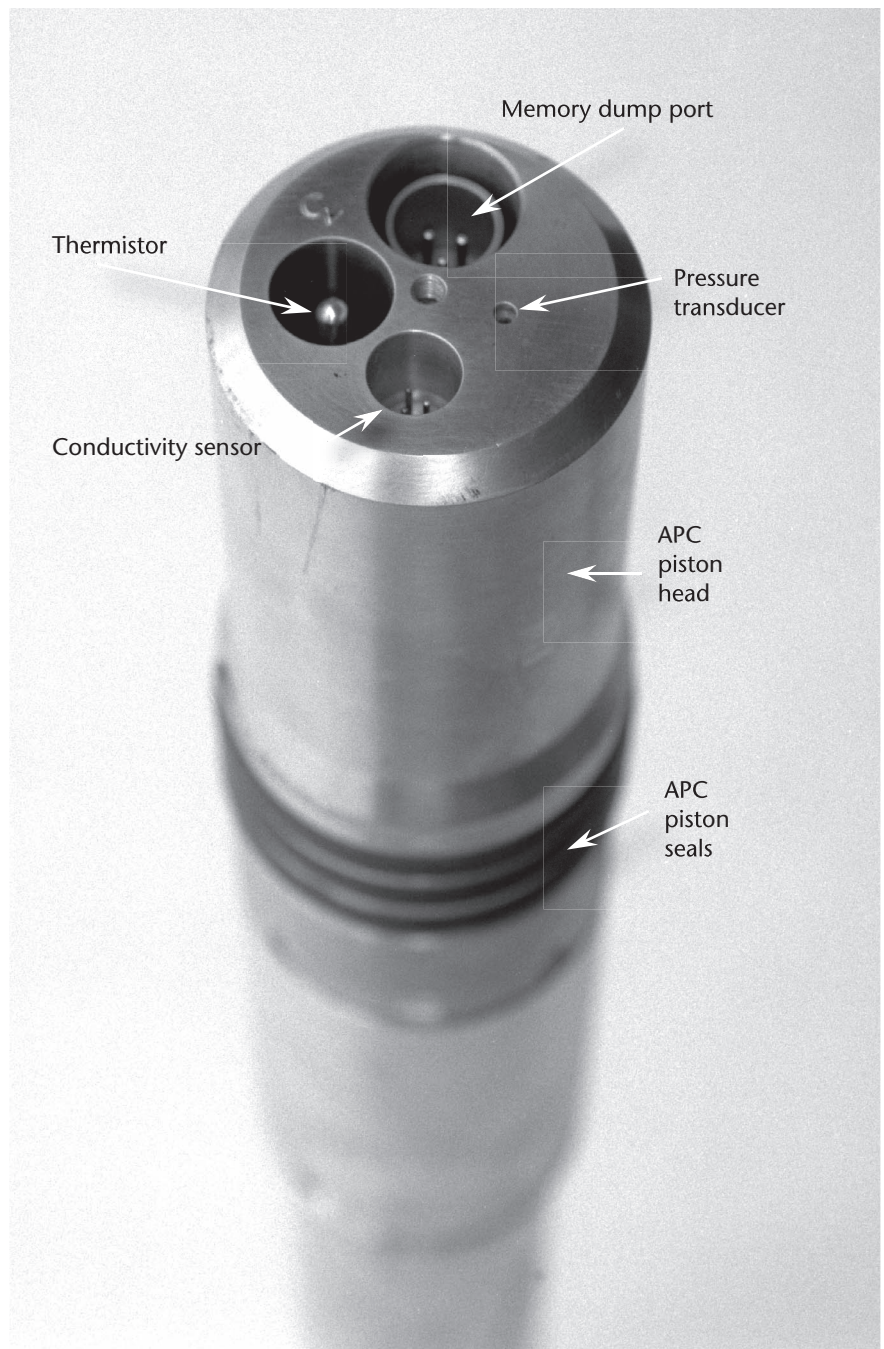

**Figure 2. Sensor head with memory dump port and temperature, pressure, and conductivity sensors.**

DVTP

# Davis-Villinger Temperature Probe

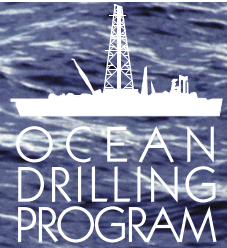

www.oceandrilling.org

## Scientific Application

The Davis-Villinger Temperature Probe (DVTP) is designed to take heat-flow measurements in semi-consolidated sediments that are too stiff for the Advanced Piston Corer Temperature (APCT) tool. Coring must be interrupted to take a temperature measurement. The DVTP can also be run on wireline and hung below the bit (when the bit is off bottom) as a temperature logging tool for borehole fluids.

## Tool Operation

The DVTP is run through the drill string on a dedicated coring wireline round trip. The DVTP is typically run with the colleted delivery system, which latches into the bottom-hole assembly (BHA). The DVTP probe extends 1.4 m below the bit and is pushed into bottom sediment by the driller with 5000–15,000 lbs and held there for 10 min.

## Design Features

### 1) Compatibility

The tool latches into either the Advanced Piston Corer/Extended Core Barrel (APC/XCB) or Rotary Core Barrel (RCB) BHA.

*Benefit:* The tool latches into both major coring BHAs, increasing functionality.

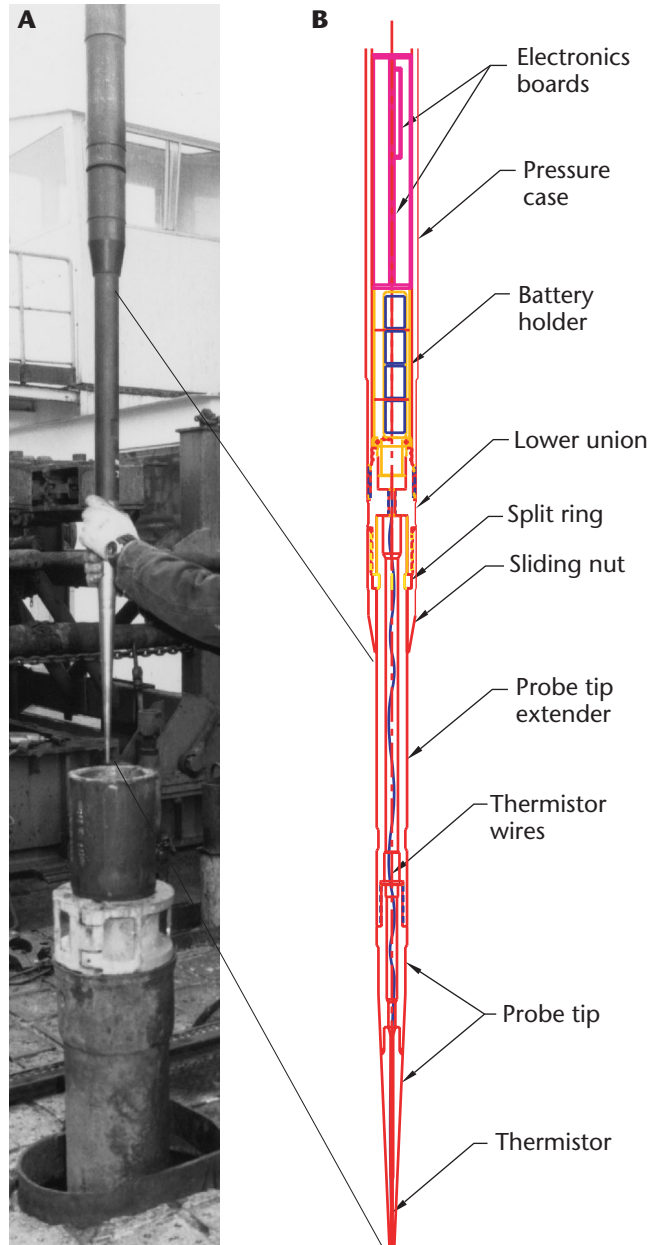

**A. Inserting the DVTP tool in the top of the drill pipe to take a temperature measurement. B. Schematic of the DVTP tool showing the robust probe tip with thermistor and electronics package. The tool is run on wireline using the colleted delivery system, which is above the quick release.**

## 2) Probe Length

The robust probe extends 1.4 m below the bit.

*Benefit:* The probe penetrates into relatively undisturbed sediments ahead of the bit.

## 3) Decoupled from Heave

The DVTP is deployed on the colleted delivery system, which allows the probe to be disengaged from the BHA after it is pushed into the sediments.

*Benefit:* This prevents drill string movement (from ship heave) from disturbing the probe while recording formation temperature.

## 4) Tool Disturbance

An onboard accelerometer monitors tool disturbance while a thermistor records formation temperature.

*Benefit:* Measures potential tool movement during data recording to assist in interpreting temperature data.

## 5) Data Collection

The tool is capable of storing eight channels of data for 24 hr when sampling at 3-s intervals. After the tool is recovered, the data is downloaded and calibrated on a computer running ODP LabView software.

*Benefit:* The DVTP provides sufficient measurement detail and recording time to assure good-quality data.

## DVTP Specifications

16-bit analog-to-digital converter

496 Kb of RAM memory

Programmable sample interval from 3 to 10 s

51,000 ohm thermistor temperature sensor

Temperature accuracy  $\pm 0.02^{\circ}\text{C}$

Acceleration accuracy  $\pm 2$  G

Conical probe tip continuously tapered at  $2.5^{\circ}$  from 55.5 to 8 mm in diameter

## Typical Operating Range

$-5^{\circ}\text{C}$  to  $105^{\circ}\text{C}$  temperature measurement range

Soft to semiconsolidated sediments (e.g., chalks or firm clays)

## Limitation

Not used in hard rocks (e.g., chert, dolomite, limestone, or basalts)



# Instrumented Water Sampler

## Scientific Application

The Instrumented Water Sampler (IWS) is a formation fluid sampling tool with a motorized syringe-type sampling piston. The sampling rate is controlled by software to provide a constant fluid extraction rate. The controlled extraction rate reduces the likelihood of intake screen pack off. In addition, a thermistor and pressure sensor measure in situ formation properties. Internal tool data (e.g., temperature, motor current, and voltage) are recorded to diagnose and debug problems that may occur during sampling.

## Tool Operations

The IWS is the next-generation replacement for the Water Sampler Temperature Probe (WSTP) and Fisseler Water Sampler (FWS). The IWS is 5.17 m (16 ft, 11 ~~1~~ 1/2 in.) long and can be set up to sample formation in situ fluids or bottom water. The software allows the operator to either select a time to initiate sampling or rely on the frictional heat spike of probe insertion to initiate sampling. The operator also selects a maximum sampling period. Once deployed and sampling begins, the software monitors and adjusts the syringe motor current to maintain a controlled extraction rate. The variable-speed syringe motor will run until the sampling period is completed (timed out) or until the sample coils are full. This feature improves the quantity and quality of the collected samples over predecessor water sampling tools.

## Design Features

### 1) Probe Tip Design

The probe tip assembly comprises an intake port, a thermistor, and a pressure transducer to record formation pressure and temperature during water sampling.

*Benefit:* Measures in situ formation properties that correlate with the fluid sample and provides diagnostic information to analyze sampling problems.

### 2) Heat Spike Trigger

The software can use the frictional heat spike caused by insertion of the thermistor probe into the formation as a trigger to start the sampling motor (instead of a preset timer as in the WSTP).

*Benefit:* Reduces unproductive tool down time while waiting for the preset timer to trigger the sampling operation, which in turn reduces exposure to potential hole problems. Using the heat spike also eliminates bad runs due to setup timing errors.

### 3) Sampling Rate

Sampling rate is controlled by feedback from the syringe motor current.

*Benefit:* Reduces the probability of screen pack off, which improves sample quantity and quality.

### Specifications

Diameter: 9.5 cm (3<sup>3</sup>/<sub>4</sub> in.)

Length: 5.17 m (16 ft 11<sup>1</sup>/<sub>2</sub> in.)

Weight: ~400 lb

Pressure: 15,000 psi

Temperature: -5° to 105°C

Electronics: 48 MB memory, 1 Hz sampling rate.

### Typical Operating Range

-5°C to 105°C temperature measurement range.

The IWS can be deployed in soft to semiconsolidated sediments (e.g., chinks or firm clays) where the probe can penetrate without damage or formation fracture.

### Limitations

Not used in hard rocks (e.g., chert, dolomite, limestone, or basalt).

Figure 1. Schematic of the IWS tool.

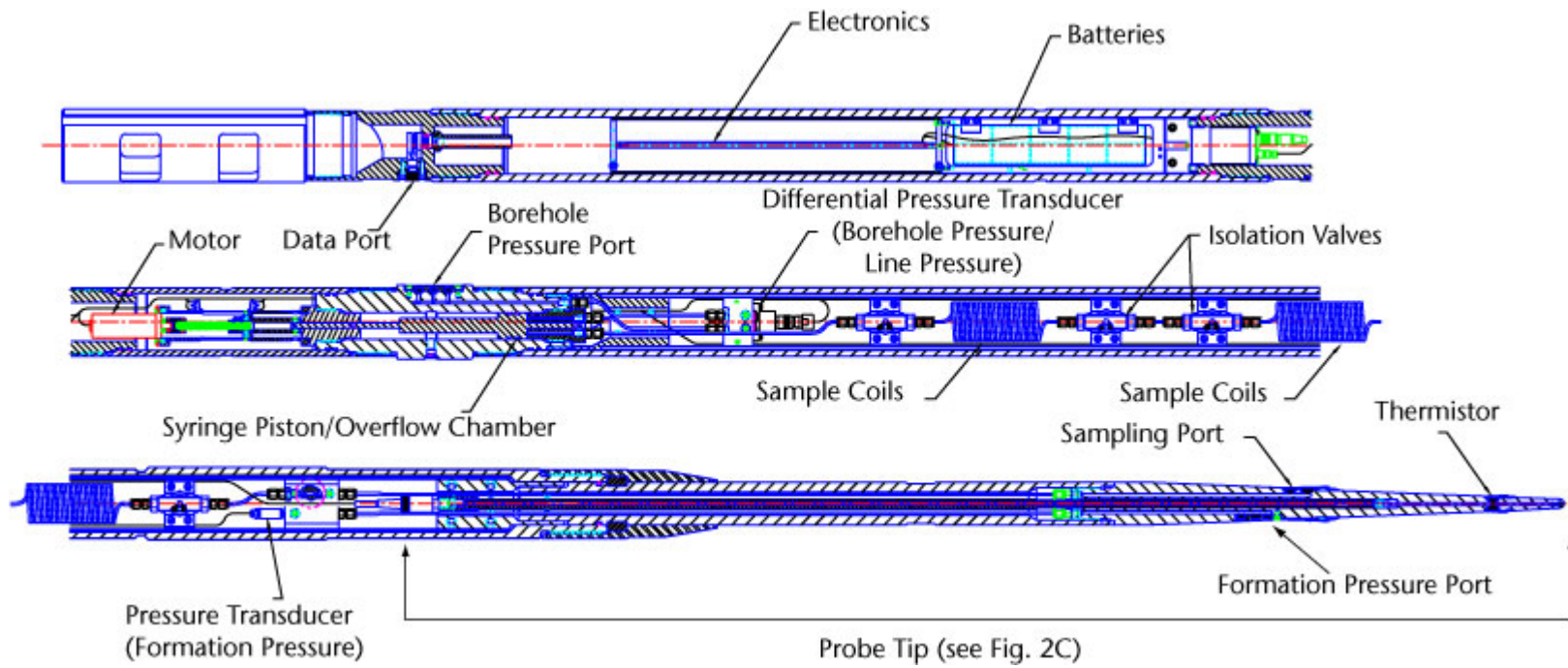

**Figure 2.** Photograph of the IWS probe tip. **A.** Close-up of the sampling and formation pressure ports. **B.** The fluid screen near the tip. The screen allows fluid to surround the thermistor, which eliminates air gaps. **C.** Probe tip (see [Fig. 1](#)).

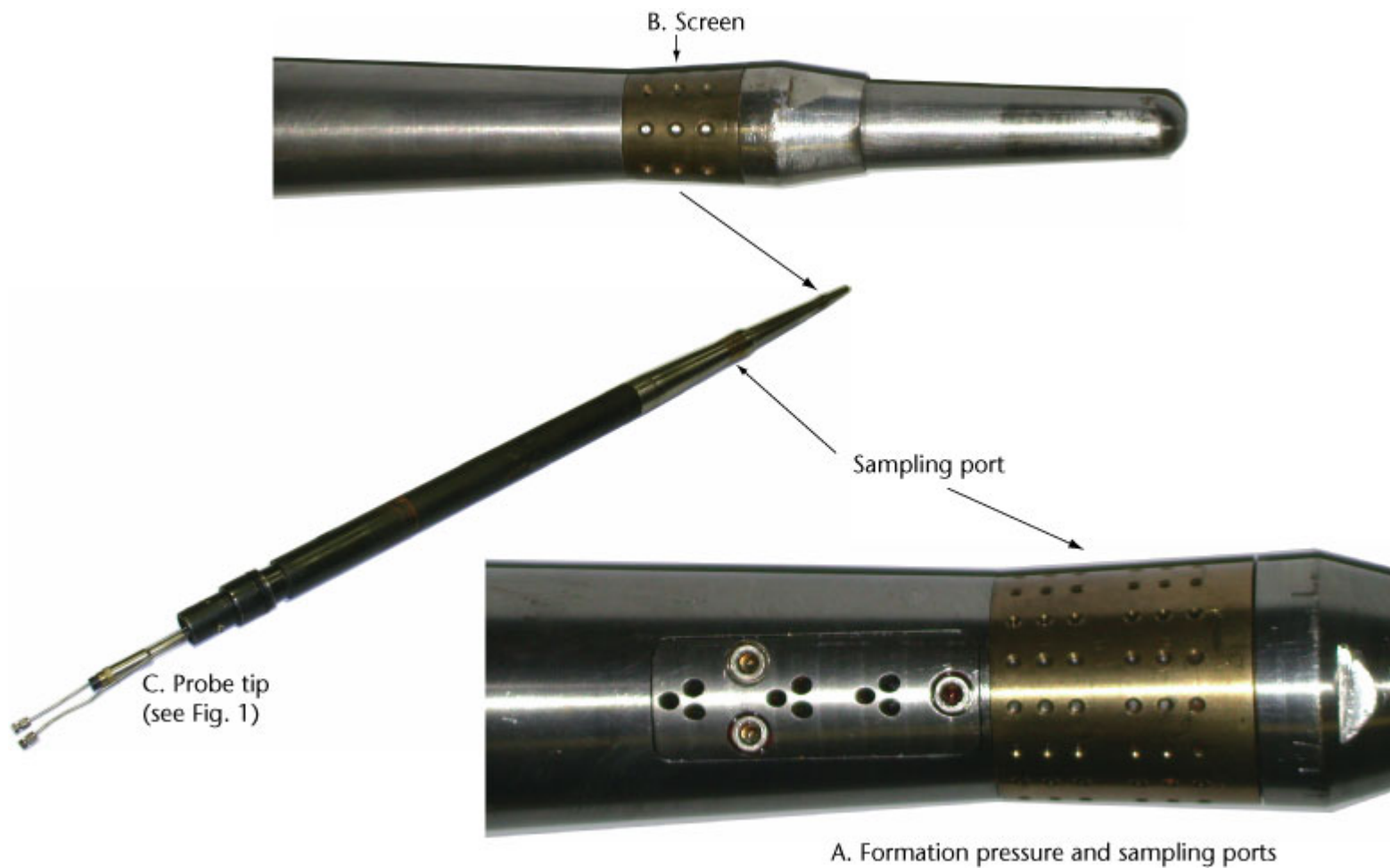

# DSS Drilling Sensor Sub

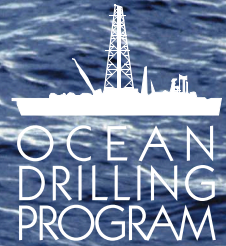

www.oceandrilling.org

## Scientific Application

The Drilling Sensor Sub (DSS) was developed to measure drilling and coring parameters near the bit during operations. The objective of the DSS is to improve downhole tool performance by optimizing control of drilling parameters on the drillship. The DSS sensors measure weight on bit (WOB), torque on bit, annulus and internal pressure, and annulus and instrument temperature. The data are collected by the downhole electronics and stored in memory until the bit and bottom-hole assembly (BHA) are retrieved. The DSS was first deployed during Leg 208. During Leg 210, the DSS was modified

to transmit data in real time via a wireless electromagnetic data link to a Retrievable Memory Module (RMM) on the internal core barrel. The data are saved in the RMM's nonvolatile internal memory and downloaded when each core barrel is recovered on the surface. The data allow drilling/coring parameters to be optimized, thereby improving the chance to recover more and/or better preserved core.

The DSS was under development at the end of the Ocean Drilling Program (ODP), and this overview represents the tool status at that time. The DSS will continue to be developed and improved under the Integrated Ocean Drilling Program (IODP).

## Tool Operations

The 8¼ in. outer diameter (OD) DSS is run in the 8¼ in. OD BHA and is positioned on top of the outer core barrel. The DSS has the same 4½ in. inner diameter (ID) bore as the drill string to accommodate core retrieval by wireline. The sensors, data acquisition electronics, and lithium batteries are packaged in the DSS sub wall. The sensor data are collected by the downhole electronics and stored in memory until the bit and BHA are retrieved. The data for the entire coring run (up to 100 hr) are downloaded on the ship.

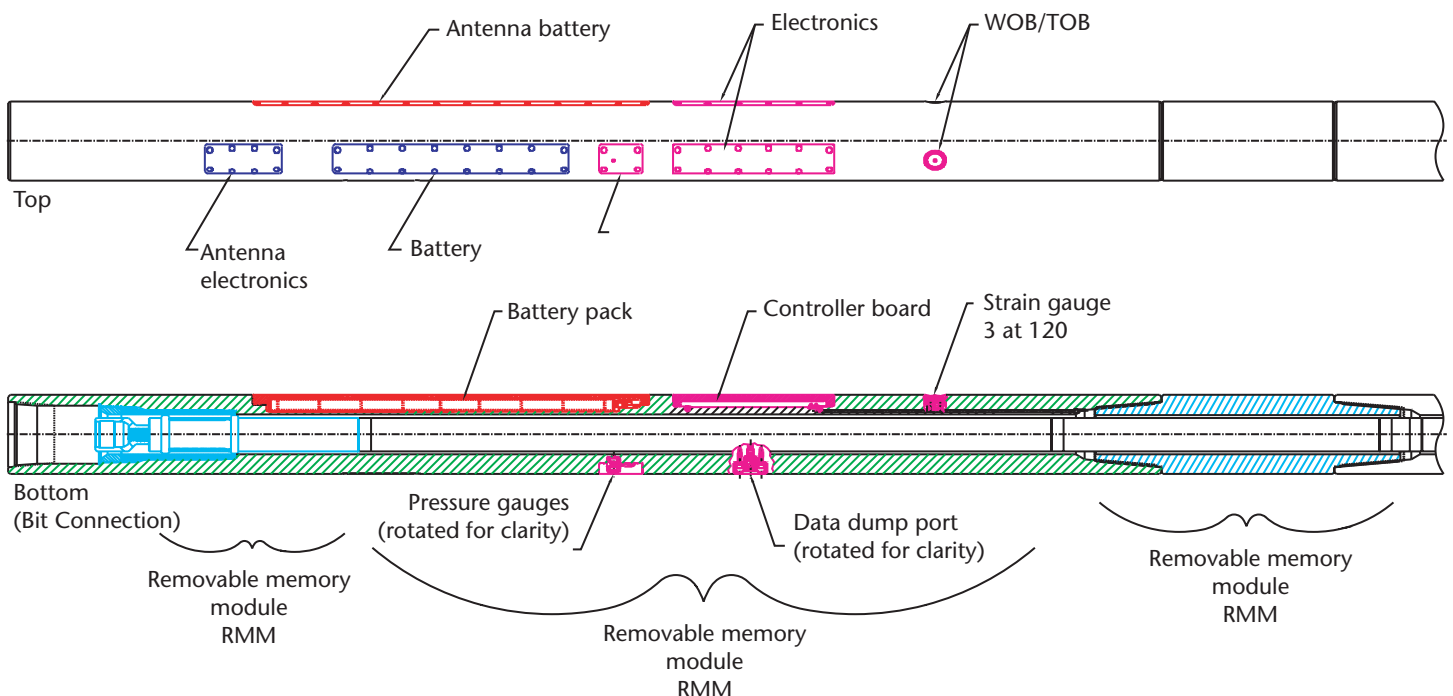

**Schematic of the Drilling Sensor Sub.**

## Design Features

### 1) Compatibility

The DSS is run in the same BHA as the Advanced Piston Corer (APC) and Extended Core Barrel (XCB). The DSS is also compatible with the Rotary Core Barrel (RCB) BHA.

*Benefit:* The standard ODP coring tools can be used with the DSS, and no additional time is required for extra trips.

### 2) Actual Downhole Measurements

The DSS sensors measure downhole WOB, torque on bit, annulus and internal pressure, and annulus and instrument temperature. After the sensor sub is retrieved with the bit and BHA, the internal DSS memory provides data about actual downhole conditions near the bit, which can be used to modify surface-controlled drilling parameters to improve performance and evaluate problems.

*Benefit:* The downhole WOB measurements can be compared to surface controlled drilling parameters and used to determine the effectiveness of heave compensator settings and WOB control. The torque-on-bit measurement can be used to determine optimum WOB, rpm, and hole cleaning techniques to reduce erratic or high torque that could reduce core recovery.

### 3) Retrievable Memory Module

The DSS measures drilling and coring parameters near the bit during coring operations. The initial DSS version saved the data in internal memory and was recovered with the BHA after coring was completed. During Leg 210,

the DSS was modified to transmit data in real time during drilling/coring via a wireless electromagnetic data link to an RMM on the internal core barrel. The data are saved in the RMM's nonvolatile internal memory and the data are downloaded when the core barrel is recovered on the surface. The RMM is redeployed with the next empty core barrel. Data from the DSS are transmitted in real time to the RMM at 80 bits/s (bps), which allows five 16-bit measurements to be transmitted per second. The DSS antenna is switched off when the RMM is removed for tripping to conserve battery power.

*Benefit:* The RMM enables the drillers and supervisors to review the downhole effects on the coring assembly by downloading and analyzing the data after each core and modifying operating parameters (WOB, rpm, circulation rates) to optimize recovery.

## DSS Specifications

### General

Tool OD: 8.25 in. – tolerances per API spec 7, para 6.5

Tool ID: 4.125 in.  $\pm$  .010 in.

Length: 120 in.  $\pm$  1/2 in.

Temperature: -20°C to 150°C

Maximum Hydrostatic Pressure: 15,000 psi

Maximum Pressure differential across sub: 3,500 psi

### Electronics

Battery Life: 100 hr

Sample rate, memory: 1 Hz maximum all sensors

Analog to digital resolution: 16 bit

### Sensors

Weight On Bit:

Operating Range:  $\pm$ 50,000 lb

Accuracy:  $\pm$ 250 lb

Torque-On-Bit:

Operating Range:  $\pm$ 40,000 ft-lb

Accuracy:  $\pm$ 200 ft-lb

Pressure Sensors (2) – Annulus and drill pipe:

Range: 0-15,000 psi

Accuracy:  $\pm$ 75 psi (0.50% Full Scale Output [FSO])

Temperature Sensor – Annulus:

Range: -20°C to 150°C

Accuracy:  $\pm$ 0.50°C (0.3% FSO)

Temperature Sensor – Internal electronics:

Range: -20°C to 150°C

Accuracy:  $\pm$ 0.50°C (0.3% FSO)

### Typical Operating Range

The DSS can be deployed with the APC/XCB/MDCB/PCS and RCB coring systems.

Temperature: -20°C to 150°C

Pressure: 15,000 lb

### Limitations

The DSS must be run in the APC/XCB or RCB BHA.

The DSS internal memory must be retrieved with the BHA to access the data.

The data can be retrieved after each core with the RMM on the internal core barrel.

Maximum Downhole Temperature (electronics) = 150°C

Maximum Weight on Bit on the DSS sub = 75,000 lb

Maximum Hydrostatic Pressure = 15,000 psi

Maximum Pressure Differential across sub = 3,500 psi

Maximum Downhole Battery Life = 100 hr



# Lockable Float Valve

## Scientific Application

The Lockable Float Valve (LFV) is a flapper-type valve used in the Advanced Piston Corer/Extended Core Barrel (APC/XCB) bottom-hole assembly (BHA) when logging is anticipated following or during coring. This tool allows the crew to continue to core in the same hole or move to a new hole after logging without tripping the pipe; thus, more cruise time is available to acquire core.

The LFV is located just above the core bit and seals the throat of the Outer Core Barrel (OCB) when not coring or logging to prevent or reduce backflow (U-tubing) of mud, sand, and drill cutting debris into the bore of the OCB. The backflow debris could prevent the Inner Core Barrel from landing properly, plug the bottom of the drill string, or contaminate the core.

## Tool Operations

During coring, the core barrel pushes the flapper valve open and extends down through it. During logging, the LFV flapper is forced down and latched open by the logging tools to deploy the tools through the APC/XCB BHA and bit without releasing the bit. This leaves an unobstructed bore. The LFV

is held open by a latch until the logging tools are retrieved, at which time the latch releases and the flapper closes. The LFV prevents entrapment of the logging tool and wireline, which can happen when using a standard spring-loaded (non-latching) flapper valve. The LFV can be used with the Rotary Core Barrel (RCB) BHA, but a more economical disposable spring-loaded flapper valve is commonly used instead because the RCB bit and spring-loaded flapper valve are released and dropped to log the hole.

The LFV flapper latch is activated by a 3.70 in. diameter ring or "upset" near the bottom of the logging tool. The latch can also be activated using an expendable aluminum Go-Devil that can be pumped down the drill string (leaves Go-Devil "junk" in the hole), deployed on wireline, or pinned on the end of a logging tool. The operation of the LFV can be described in six steps (see schematic):

1. The spring-actuated flapper remains in the closed position



**Photograph of the LFV showing the flapper in the locked-open position.**

when the core barrel or logging tool is not in place. Pumping fluid down the drill string will force the flapper valve partially open.

2. The flapper is pushed down into the open position when a core barrel or logging tool passes through it and is held open by the tool body extending down through it.
3. A 3.70 in. outer diameter (OD) section on a logging tool or Go-Devil actuates the ball-wedge plunger and latches the flapper valve in the full-open position.
- 4-5. The flapper remains latched open as the logging tool continues downhole.

6. When the logging tool is retrieved through the LFV, a 3.70 in. OD section of the logging tool releases the ball-wedge plunger, which allows the spring-loaded flapper to close and seal the BHA bore.

## Design Features

### 1) Compatibility

The LFV can be used with all tools that are compatible with APC/XCB BHA (i.e., tool OD is less than 3.75 in. minimum inner diameter [ID] of the LFV), when logging through the unreleased bit is possible.

*Benefit:* The LFV allows a float valve to be run in the APC/XCB BHA when logging is planned, and it allows coring operations to continue after logging.

### 2) Flapper Design

The spring-loaded flapper design reduces the back flow (U-tube) of cuttings, mud, sand, sloughing formations, and potential water and gas flows.

*Benefit:* It reduces the inflow (by U-tube) of debris into the BHA, which could result in an inability to land the inner core barrel, a plug in the bottom of the drill string, or contamination of the core.

### 3) Clearances and Flow Paths

The LFV actuation mechanism has additional flow paths and clearances intended to let fluid from the mud pumps flow through the mechanism to clean out the cuttings and debris.

*Benefit:* The additional flow paths and clearances help to wash

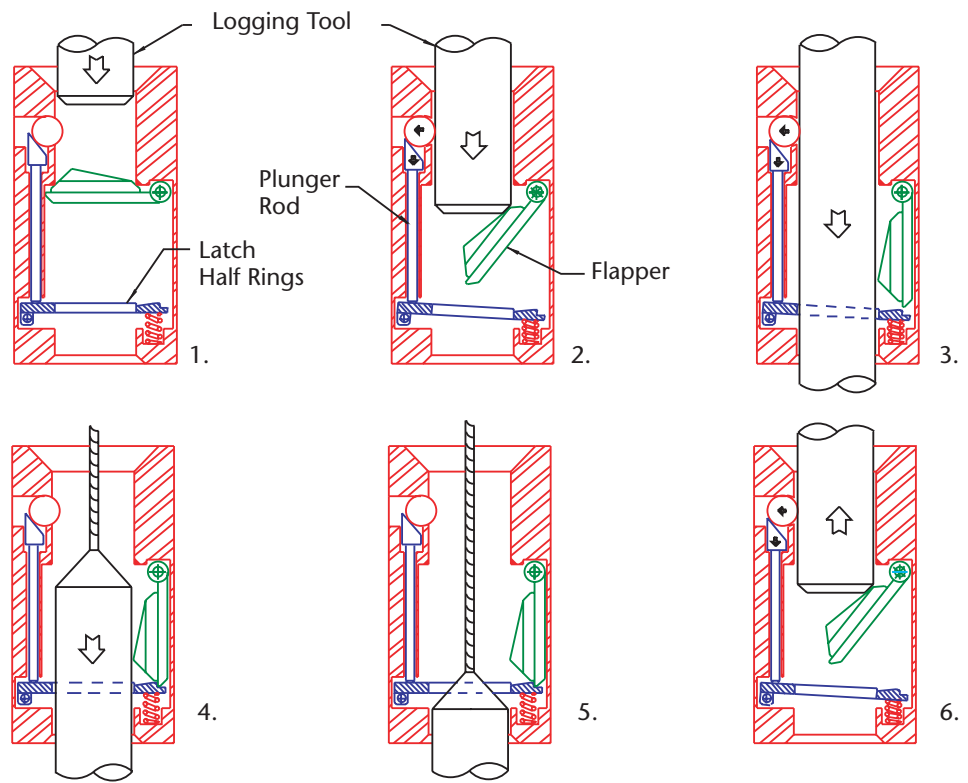

**Schematic illustrating the operational steps of the LFV described in the Tool Operations section.**

away the cuttings and debris and keep the parts clean for uninterrupted operations.

## Specifications

Minimum Bore Diameter: 3.80 in.

Outside Diameter: 6.985 in.

Length: 15<sup>1</sup>/<sub>16</sub> in.

Weight: 78 lb

## Typical Operating Range

Formation:

All formation types

Depth Range:

All depths

## Limitations

The LFV is activated by a 3.70 in. diameter x 24 in. long profile (a short tool will not activate the LFV). Not all logging tools have this activation profile, but when used, the preferred method is to attach an aluminum Go-Devil to actuate the LFV. The Go-Devil can also be dropped; however, this will leave aluminum junk in the hole, which must be drilled if further coring is planned.

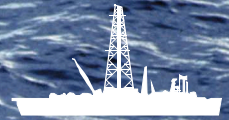

# Mechanical Bit Release

## Scientific Application

The Mechanical Bit Release (MBR) is designed to remotely release the Rotary Core Barrel (RCB) core bit from the Bottom-Hole Assembly (BHA) to allow logging tools to pass through the BHA. The RCB drill bit must be released before logging starts because the internal diameter of the RCB drill bit throat (2.312 in.) is not large enough to pass most logging tools.

## Tool Operations

The MBR is placed in the RCB BHA above the RCB bit. After the hole is cored to logging depth and conditioned for wireline logging, the RCB bit is released with the MBR. To release the MBR, the Rotary Shifting Tool is made up on the bottom of a standard Inner Core Barrel. The Shifting Tool is lowered on the wireline until it engages the latch sleeve on the inside of the MBR. The wireline is slowly pulled up until an overpull of 4000-5000 lb shifts the Latch Sleeve and allows the latch dogs to fall out, thereby releasing the bit. The four metal latch dogs, lower MBR, flapper valve, lower support bearing, and the bit are left in the hole. This metal "junks" the hole and effectively prevents further coring. A second wireline trip is made with the Shifting Tool in the reversed position to close the Latch

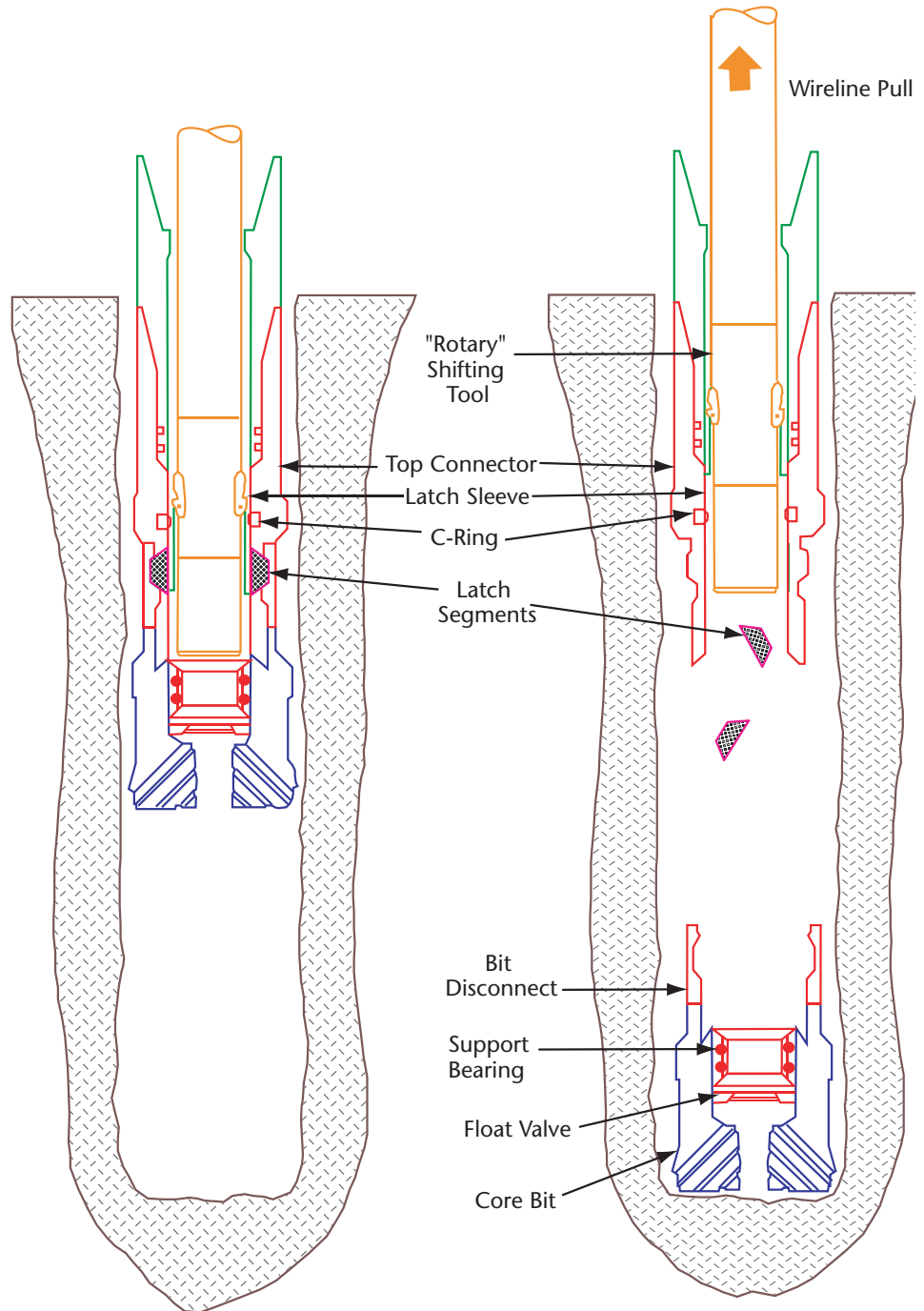

**Schematic illustrating MBR deployment. The MBR tool is outlined in red.**



Sleeve, which covers the empty dog pockets to reduce the possibility of scraping hole wall material into the BHA.

## Design Features

### 1) Compatibility

The MBR is compatible with the RCB BHA.

*Benefit:* The MBR allows wireline logs to be run without the need to “trip the pipe” to remove the RCB bit on the rig floor.

### 2) Latch Sleeve/Dog Mechanism

Shifting the Latch Sleeve with the Rotary Shifting Tool releases the latch dog segments. This releases the bit disconnect, dogs, support bearing, float valve, and the core bit into the hole.

*Benefit:* The core bit can be released in a minimum amount of time, using the Shifting Tool to operate the Latch Sleeve via the wireline.

### 3) Emergency Bit Release

In unstable formations, the MBR can be run for an emergency bit release.

*Benefit:* If the BHA is stuck at the bit, the bit can be released to save the BHA from being severed.

## Specifications

Maximum Outer Diameter: 8¼ in.

Minimum Inner Diameter: 4½ in.

Torque Limit: 12,000 ft-lb

Compression Weight: 45,000 lb



**Photograph of the following MBR components: MBR Bit Disconnect, (left cylinder), Top Connector with hex drive (right cylinder), and Latch Segment (small pyramid-shape in the center).**

## Typical Operating Range

Formation: All formation types

Depth Range: All depths

## Limitations

Dropping the core bit, float valve, four latch dogs, and lower MBR leaves metal junk in the hole, which effectively prevents further drilling or coring.

After removal of the bit, the drill string is open-ended, which makes it susceptible to plugging by “swallowing” some of the hole wall as the pipe moves and/or logging tools drag debris into the pipe. This may plug the drill string, which increases the chance of jamming the logging tool when it is entering and exiting the open end of the pipe.

The MBR must be run with a standard Baker float valve (i.e., the LFV

cannot be run). The LFV cannot be deployed with an RCB BHA because there is only enough room for the Baker float valve and RCB swivel assembly.

Excessive overpull on the MBR (i.e., 150,000 lb to 170,000 lb) can result in the accidental release of the core bit, which would leave junk in the hole.

The Inner Core Barrel can become “packed off” in the OCB (from cuttings flowback) and unintentionally shift the MBR, which would prematurely release the bit.

After the bit is released with the wireline Rotary Shifting Tool, a second wireline run is required with the Shifting Tool to shift the sleeve down and close the dog windows to prevent the open window in the MBR from scooping up cuttings and plugging the drill pipe between loggings runs.

# Downhole logging tools

## Selecting logging tools

The selection of specific downhole logging tools for a particular expedition is an ongoing procedure that starts with the proponents and (usually) ends when the Program Plan is approved. The standard tool strings that measure the basic formation properties are always on the ship, often accompanied by one or more of the specialty tools. Specialty tool use is dictated by the scientific objectives of the expedition, and by the size of the year's budget for specialty tools. The operational plan for logging is determined at the pre-cruise meeting, usually held 6 to 8 months before the cruise, and is included in the expedition prospectus. Confirmation of the logging plan and time estimates are made onboard before each site at the "pre-site" meetings.

The table below displays the various logging measurements associated with specific scientific or technical applications.

Principal Application		Resistivity	Velocity	Density	Porosity	Gamma Ray	Geochemistry	Imaging	Vertical Seismic Profile	Temperature/Pressure	Borehole/Drilling Parameters
		<b>Technical</b>	Core-Log Integration	●	●	●	●	●	●	●	●
	Log-Seismic Integration		●	●					●		
	Drilling Operations									●	●
	High Temperature Environments			●		●				●	●
	Hole Stability Problems				●						●
<b>Scientific</b>	Hydrogeology	●			●			●		●	
	Paleoclimate, High Resolution	●	●	●	●	●					
	Stratigraphy/Sedimentology	●	●	●	●	●	●	●	●		●
	Structural Geology			●		●		●	●		
	Gas Hydrates	●	●	●	●			●	●	●	●

Most of the basic petrophysical and lithological logs (density, porosity, resistivity, velocity) are acquired with the Triple Combo tool string, which is always run first. This string also measures the borehole width, an important indicator of borehole and log quality. The FMS/Sonic is usually run next: the FMS resistivity image reveals the fine details of the formation, and the sonic velocity completes the basic logs. The specialty tools are run, usually in order of scientific importance. Seismic tools are usually run last, because due to the fact that they are clamped against the borehole wall they can destabilize the hole, and their light weight and large caliper arm makes them prone to getting stuck.

When time is short, or when there are adverse logging conditions, the Logging Staff Scientist has the responsibility of preserving the integrity of the logging plan and making appropriate changes to it if necessary. He will keep in regular contact with the Operations Superintendent and the Co-Chief Scientists, so as to be up to date with the latest operational developments. Shipboard scientists should understand that it is the Logging Staff Scientist's job to act as an advocate for the logs, based on their scientific merit - not just because they are part of the logging plan in the scientific prospectus.

The principles to keep in mind when prioritizing tool strings are:

1. To get the logs most relevant to the leg's scientific objectives.
2. To run the tool strings most likely to get good results.
3. To minimize the risk of harming the tools or getting them stuck down the hole.

The scientific, environmental, and technical issues relevant to tool string selection are described briefly below.

---

## **Scientific Issues**

### **Lithology**

The natural gamma and PEF logs yield information on aspects of the chemical and mineralogical composition of the formation, which can be used to infer lithology. This information can then be used to complement the core record, to fill coring gaps, to pinpoint boundaries, etc. The absence of gaps in the logs makes them particularly useful for studies of sediment cyclicity, where a complete record is essential.

### **Petrophysics**

The porosity, density, resistivity, and sonic velocity logs collect petrophysical and geotechnical information about the penetrated formations. In sediments, the general trend in these logs is of consolidation with depth. Deviations from this trend are caused by lithological change, lithification (cementation), under-consolidation (due, for example, to high fluid pressure, or a framework provided by microfossils), or the presence of gas hydrates (hydrate in the pore space increases resistivity and sonic velocity). The principal advantage of these logs over the equivalent core measurements is that the logs record the in-situ property, whereas the cores are expanded and depressurized, and can suffer from end-effects and biscuiting.

### **Relation to the seismic section, synthetic seismograms**

The seismic tools (WST, WST-3, ASI, VSI) are used for checkshot surveys (to obtain a depth-traveltime relation) and zero-offset VSP experiments (to obtain seismograms at the site). The depth-traveltime relation can also be derived from the sonic velocity log, which together with the density log and seismic source wavelet combine to make a synthetic seismogram. Thus, reflectors on the seismic section can be identified with lithological or petrophysical changes in the borehole.

For almost every expedition there is an extensive (and extensively interpreted) set of site survey seismic sections, and so it is of great importance that the borehole information can be associated with seismic reflectors and mapped along the seismic lines.





### **Structure and fabric**

FMS, UBI, LWD-geoVISION, and LWD-EcoScope data provide physical property images of the borehole wall, showing detailed structural (faults, fractures), sedimentological (turbidites, beds, bioturbation, concretions, clasts), and igneous (veins, alteration, and basalt pillows, breccias, and flows) features. In the case of the FMS and UBI, the orientation of these features can be analyzed, since it is

measured by the GPIT on the same tool string. Under favorable circumstances, an azimuthal resistivity imager (ARI) can provide images of the same features.

### **Crustal stress and anisotropy**

The UBI measures the shape of the borehole, which can be interpreted in terms of crustal stress (the borehole is deformed according to the maximum horizontal stress direction). Also, the caliper arms of the FMS tool tend to follow the major and minor axes of the borehole if it is elliptical, and thus can also be used to infer stress orientation.

The Dipole Sonic Imager (DSI) can reveal sonic S-wave anisotropy, which may be due to crustal stress or a preferential rock fabric.

### **Heat and fluid flow**

The Temperature/Acceleration/Pressure (TAP) tool records the temperature of the borehole fluid, which increases downhole. The borehole fluid temperature equilibrates towards the actual formation temperature over the course of the logging run, and thus gives a lower limit to the actual formation temperature. Where formation fluids locally enter the borehole, they will cause an anomaly in the temperature log.

---

## **Environmental Issues**

The state of the hole for logging can be assessed from the conditions experienced during coring. Before logging, the Logging Staff Scientist will confer with the Operations Superintendent and drillers about the general condition of the hole, and whether there are any "tight spots" or likely washouts. The Schlumberger Engineer, the Operations Superintendent, the Drilling Superintendent, the drillers, and the core technicians all have a wealth of experience in dealing with adverse hole conditions, and should be able to advise on specific matters such as how long to spend trying to break through bridges, what the risk to tools might be, how to retrieve stuck tools, and so on.

Logging-while-drilling (LWD) tools may be assigned to expeditions where hole conditions are anticipated to be unsuitable for conventional logging. Currently available LWD tools include the geoVision, EcoScope, proVision, sonicVision, and RAB8 tools. In cases where real time acquisition of downhole data are required, Measurement-while-drilling (MWD-TeleScope) tools may be utilized.

### **Time-limited logging**

Although adequate time for logging is usually allocated in the expedition prospectus, it is not uncommon for unforeseen events (bad weather, difficult

formations slowing the pace of coring, etc.) to reduce the actual time available for the logging program at a given hole. In this case, the Logging Staff Scientist will discuss with the Co-Chiefs the relative merits of allocating extra time to carry out the original program, cutting back on repeat runs or even forgoing a tool string entirely. The Triple Combo will still be run first, but the others should be prioritized according to the leg objectives.

### **Bridged holes**

Some holes may contain constrictions (bridges) that slow the tool string's descent into the hole. The heavier tool strings (Triple Combo and FMS/Sonic) have a better chance of passing through a bridge than the lighter tool strings (WST); therefore, these are run first. One cause of bridges is swelling clays; this phenomenon can be combated by adding KCl to the drilling mud, although this will degrade the natural gamma potassium log. The capillary suction test equipment should be employed when swelling clays are suspected.

### **Blocked holes**

There are various options if the tool string cannot penetrate beyond a certain depth in the hole. If the blockage is near the base of the hole, it is probably best to just log the open interval above the blockage. If the blockage is midway down the hole, several options exist: 1) log only above the blockage; 2) dismantle the logging cable and lower the BHA to tag the blockage, then raise the BHA back to the original position; or 3) tag the blockage and only log below it. If the blockage is near the top of the hole, it is likely that there will be similar blockages further down and the hole is unloggable, but dismantling the wireline cable and re-reaming the hole is always an option.

### **Wide holes**

Wide holes can result in poor contact between the tool sensor and the borehole wall, and hence degraded logs. Affected tools are the HLDS and APS (max caliper extension 18 in), the FMS (max 16 in), and the WST (max ~18 in). The borehole width is measured by caliper during the first (Triple Combo) run.

### **High heave conditions**

The wireline heave compensator (WHC) reduces the effect of ship heave on tool motion, but higher heave conditions lead to increased uncertainty in the downhole tool depth, particularly if the heave is too great (more than 3 m) for the WHC to be used. Increased tool motion (up-down oscillation) poses a risk to those tools with caliper arms (e.g., the HLDS and FMS), as there may be downward tool movement even when logging upwards; higher logging speeds will help. Additionally, high heave makes the process of bringing the tools back into the pipe from the open hole after logging more difficult because of increased differential motion between the pipe and the tool string.

There is an increased risk of the wireline cable slipping on the cable reel when lowering the tools down through the pipe, especially at the start of the descent, because initially there is only a small weight to provide tension in the cable. Tools must be lowered slowly, adding to the logging time particularly in deep waters. The risk of cable slip is worse with the lighter tool strings (for example, WST).

### **High temperature conditions**

When in a high temperature environment (such as a hydrothermal ridge

system), careful attention is paid to the temperature channels on (for example) the Dual Induction Tool (DIT). It is important not to exceed the tool temperature ratings. Circulating water in the hole immediately prior to logging will cool the hole for a period of time. Some measurements, such as resistivity, are temperature dependent.

---

## **Technical Issues**

### **Logging tool limitations**

The logging operation is limited to downhole tools with a diameter of 3.75 in or less. All tools listed in the tool section of this document can be deployed in a standard bottom hole assembly (BHA). The absolute maximum tool diameter which can be run in a standard BHA is 3.81 in, but this is pushing the tolerances to unsafe limits. To run tools up to 4 in in diameter, the BHA can be modified by removing the Kinley crimper landing sub. This is strongly discouraged and formal approval would be necessary since this action would severely limit stuck tool recovery efforts.

### **Stuck/lost tools**

This issue is discussed in more detail on the stuck/lost tools page. Needless to say, every effort should be made to avoid getting any of the tools stuck in the hole. The loggers are required to fish for any tool that is stuck or lost. It is particularly undesirable to lose the HLDT, as that tool contains a radioactive source; losing it would require cementing of the hole, a process that would take days and sour the mood on the ship considerably.

### **Conical side-entry sub (CSES)**

The CSES makes it less risky to log under unstable hole conditions, however, it can increase the logging time by 50% or more, and cannot be used in shallow water depths. A more detailed discussion can be found in the CSES section on the Other Equipment page.

### **Dedicated logging holes**

The more time spent coring a hole, the wider and more unstable it will become. For this reason, a fresh hole should provide better logs. However, the time involved is usually prohibitive, and conversely, it is useful to have cores and logs from the same hole to aid comparison.

### **Logging APC/XCB vs. RCB holes**

The logging tools can pass through the APC/XCB bit, whereas the RCB bit has to be "dropped" at the bottom of the hole before logging tools can pass through. The hole cannot be deepened or bridges tagged after the RCB bit has been dropped. The RCB bit is about 2 in narrower than the APC/XCB bit, so the RCB hole is less likely to be wide, and consequently better for the FMS.

### **The go-devil**

It is important to understand the principles behind the deployment and operation of the go-devil. For details, see the go-devil section on the Other Equipment page.

---

## **Third Party Tool Support**

USIO/LDEO provides support for broad aspects of third-party downhole tool deployment. Third party tools are designed and developed by investigators at

institutions involved with IODP and are reviewed by the relevant JOIDES panels for deployment on the *JOIDES Resolution*. USIO/LDEO Logging Services provides support to third party investigators in the areas of data acquisition systems and software, tool design and manufacturing assistance, and tool testing.

The need for custom-designed surface instrumentation, and acquisition systems has been addressed through the development of a multipurpose data acquisition system installed in the Downhole Measurements Lab (DHML). This system offers numerous benefits, including a standard computer platform from which to launch acquisition software, and a work space in the acquisition area devoted to third party equipment. Data telemetry software currently available includes modules utilizing a Windows XP/LabView 7.1 graphic environment for acquisition of the following data types:

- Temperature
- Depth and Heave
- Acceleration

Third-party tool support also includes the design and production of a cablehead crossover that allows third party tools to connect to the Schlumberger cablehead via an inexpensive, modified off-the-shelf connector. Hardware components currently available for third party tool support at LDEO include:

- PC-based data acquisition system at LDEO and on the *JOIDES Resolution*
- Crossover for connecting third party tools to a Schlumberger-style cablehead
- Telemetry connection to a depth measurement system
- Access to pressure test vessel capable of 10,000 psi
- Access to 740 foot test hole at LDEO
- 22,000 feet of 7-46 wireline with terminations

# Integrated Ocean Drilling Program

## U.S. IMPLEMENTING ORGANIZATION



## Downhole logging tools

### Triple Combo Tools

#### Accelerator Porosity Sonde (APS\*)

##### *Description*

The APS sonde is the key module in the Triple Combo's Integrated Porosity Lithology system components. The powerful electronic neutron source (minitron) allows epithermal neutron measurements and detector shielding, resulting in porosity values that are less influenced by environmental conditions. The near-array ratio epithermal porosity is the primary porosity measurement. Its source-to-detector spacing is optimized to yield a formation hydrogen index measurement that is essentially free of formation matrix density effects. Five detectors provide information for porosity, gas detection, clay evaluation, improved vertical resolution and borehole corrections.



##### *Applications*

###### **Porosity**

In reservoir engineering the importance of porosity measurements is quite evident. In the study of the volcanic rocks that make up the upper oceanic crust, a good in-situ porosity measurement is critical to the correct understanding of the crustal structure, for two reasons: first, because it samples both the small-scale (microcrack, vesicle) porosity seen in the cores and the large-scale fractures not sampled by drilling; and second, because other properties such as density, seismic velocity, and permeability depend strictly on porosity variations and on the geometry of the pore space. In the presence of clays or hydrous alteration minerals a correction is required to account for the presence of bound water.

###### **Lithologic determination**

Because the hydrogen measured by the tool is present not only as free water but also as bound water in clay minerals, the porosity curve, often combined with the density log, can be used to detect shaly intervals, or minerals such as gypsum, which has a high hydrogen

index due to its water of crystallization. Conversely, the neutron curve can be used to identify anhydrite and salt layers (which are both characterized by low neutron readings and by high and low bulk density readings respectively).

---

## ***Environmental Effects***

Eccentralization of the tool by a bow spring is the most important requirement to obtain reliable porosity measurements. The triple combo string utilizes an in-line eccentralizer to maintain consistent contact with the borehole wall. The eccentralizer is vital in preventing poor contact of the tool with the borehole wall, which can lead to attenuation of the formation signal by the borehole fluid and, in turn, the overestimation of the true porosity of the formation.

Hole size also affects the neutron log response; the formation signal, particularly for the epithermal count rates, tends to be masked by the borehole signal with increasing hole size.

In liquid-filled holes the influence of the borehole fluid depends on its salinity -- chlorine is a strong neutron absorber -- and density: the addition of weighting additives such as barite will yield a lower porosity reading. In the Ocean Drilling Program, the neutron tool is sometimes recorded through the drilling pipe and the bottom hole assembly. Because iron is a strong neutron absorber, an increased porosity reading will result, its degree depending on the thickness of the pipe.

---

## ***Tool Specifications***

Temperature rating:	350° F (175° C)
Pressure rating:	20 kpsi (13.8 kPa)
Diameter:	3.625 in (9.2 cm)
Length:	13 ft (3.96 m)
Weight:	222 lbs (100.8 kg)
Sampling interval:	6 in (15.24 cm); 2 in (5.08 cm)
Max. logging speed:	1,800 ft/hr (548 m/hr)

---

## ***Measurement Specifications***

Vertical resolution:	14 in (35.56 cm)
Depth of investigation:	7 in (17.78 cm)
Epithermal porosity:	
0-7 pu:	±0.5 pu
7-30 pu:	±7%
30-60 pu:	±10%



---

## ***Major Outputs***

APLC: Near/array limestone porosity corrected (pu)

STOF: Computed standoff (in)

SIGF: Formation capture cross section (cu)

AFEC: Far detector count rate (cps)

ANEC: Near detector count rate (cps)

---

## ***Deployment Notes***

The APS is typically run with the DIT, HLDS, and HNGS tools.

---

\* ®trademark of Schlumberger

# Integrated Ocean Drilling Program

## U.S. IMPLEMENTING ORGANIZATION

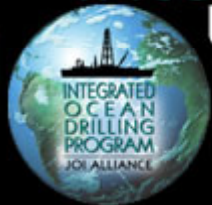

## Downhole logging tools

### Triple Combo Tools

#### Phasor Dual Induction-Spherically Focused Resistivity Tool (DIT\*)

##### *Description*

The Phasor Dual Induction - Spherically Focused Resistivity tool (DIT) provides measurements of spontaneous potential (SP) and three different resistivity values: IDPH (deep induction), IMPH (medium induction) and SFLU (shallow spherically focused resistivity). Since the solid constituents are orders of magnitude more resistive than pore fluids in most rocks, resistivity is controlled mainly by the conductivity of the pore fluids and by the amount and connectivity of the pore space. The spontaneous potential is a measure of the streaming potential generated by differences between borehole and pore fluid electrical properties; these result in both membrane and liquid junction potentials due to differences in the mobility of ions in the pore and drilling fluids. The induction sonde consists of a series of transmitter and receiver coils mounted on the sonde axis. The high frequency, alternating current of constant intensity sent through the transmitter coil produces an alternating magnetic field which in turn induces currents in the formation around the borehole. These currents flow in circular ground loops coaxial with the sonde. Because the alternating current sent by the transmitter coil is of constant frequency and amplitude, they are directly proportional to the formation conductivity. They also produce a magnetic field which induces a voltage in the receiver coil, which is in turn proportional to the ground loop currents and therefore to the resistivity of the formation.

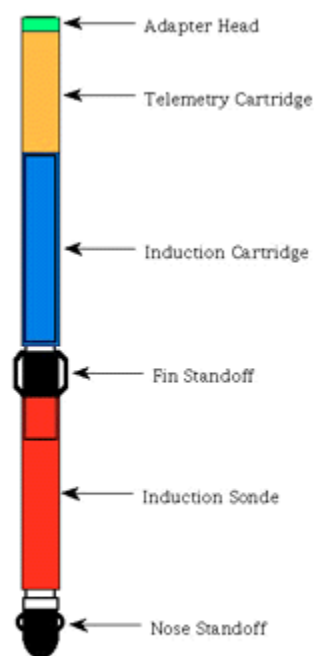

Sensor Geometry

In homogeneous formations with resistivity higher than 100 ohm m the average radial depth of investigation is about 5 ft (1.5 m) and 2.5 ft (76 cm) for the deep and medium induction curves, respectively, and 1.25 ft (38 cm) for the SFL. This drops to 4 ft (122 cm) and 2.2 ft (66 cm) at 0.1 ohm-m resistivities.

The thin bed resolution over a full range of formation conductivities has been greatly improved, due to an enhanced signal processing technique and real time correction for the effect of adjacent formations (shoulder effect).

---

## ***Applications***

### **Porosity estimate**

In sediments that do not contain clay or other conductive minerals, the relationship between resistivity and porosity has been quantified by Archie's Law. Archie's Law relates the resistivity to the inverse power of porosity. This relationship has also been used to estimate apparent porosity in oceanic basalts.

### **Density and velocity reconstruction**

Archie's equation has been used effectively to create "pseudodensity" and/or "pseudovelocity" logs from porosity over intervals where no such logs were recorded or were totally unreliable. In some instances velocities derived from resistivity logs can be used to depth-tie seismic reflectors.

### **Lithologic boundary definition and textural changes**

Resistivity, along with acoustic and velocity logs, is a very valuable tool in defining lithologic boundaries over intervals of poor core recovery. In a particular example, the decrease in resistivity toward the top of a carbonate unit, coupled with a decrease in velocity, allowed one to interpret this unit as a fining-upward sequence in mostly carbonatic sediments. Similar saw-tooth patterns in the resistivity response can also be observed in oceanic basalt units where they are related to porosity changes towards the top of each unit.

---

## ***Environmental Effects***

The Phasor Dual Induction tool provides a set of corrections for different environmental effects, which can be performed in real time during logging. These include corrections for adjacent formations, borehole signal, and invasion. In general, invasion is not a problem in the boreholes logged in the Integrated Ocean Drilling Program, because seawater is used as drilling fluid, but it can occur in land wells. In fact, depending on the type of drilling mud used and on the permeability of the formation, invasion of the mud filtrate into the formation adjacent to the borehole can lead to differences in the response of shallow and deeper resistivity devices. On the other hand, invasion can provide useful information about formation permeability and pore fluid electrical conductivity. Differences in the temperature of drilling fluid compared to undisturbed formation temperatures can also generate this effect, as conductivity in ionic fluids such as seawater is strongly temperature dependent.

---

## ***Log Presentation***

Deep (ILD or IDPH) and medium (ILM or IMPH) induction, and spherically focused resistivity (SFLU), are usually plotted in ohm-m on a logarithmic scale along with gamma ray and caliper logs.

---

### ***Tool Specifications***

Temperature rating:	350° F (175° C)
Pressure rating:	20 kpsi (13.8 kPa)
Diameter:	3.375 in (9.21 cm)
Length:	31 ft (9.5 m)
Weight:	445 lbs (201.9 kg)
Sampling interval:	6 in (15.24 cm)
Max. logging speed:	10,000 ft/hr (3,048 m/hr)

---

### ***Measurement Specifications***

Vertical resolution:	5-6 ft (1.5-1.8 m) and 7-8 ft (2.1-2.4 m) for medium and deep induction logs; 3 ft (92 cm) for spherically focused log.
Depth of investigation:	(See discussion in "Description" section)
Measurement range:	0-150 ohm-m

---

### ***Major Outputs***

ILD:	Deep induction (ohm-m)
ILM:	Medium induction (ohm-m)
IDPH:	Phasor deep induction (ohm-m)
IMPH:	Phasor medium induction (ohm-m)
SFLU:	Spherically focused log (ohm-m)
ITEM:	Internal temperature (°C)

---

### ***Deployment Notes***

Typically run with APS, HLDS, and HNGS, the DIT can be replaced by the DLL or ASI if additional funding is available. The DIT has an internal temperature measurement which may be useful in high temperature environments.

---

\* ®trademark of Schlumberger



## Downhole logging tools

### Triple Combo Tools

#### Hostile Environment Litho-Density Sonde (HLDS\*)

##### *Description*

The Hostile Environment Litho-density sonde (HLDS) consists of a  $Cs_{137}$  radioactive source and two detectors mounted on a shielded skid which is pressed against the formation by a hydraulically activated eccentering arm. The 662 keV gamma rays emitted by the source into the formation experience two types of interaction with the electrons in the formation -- Compton scattering and photoelectric absorption.

Compton scattering is an elastic collision by which energy is transferred from the gamma ray to the electrons in the formation. This interaction forms the basis of the density measurement; in fact, because the number of scattered gamma rays which reach the detectors is directly related to the number of electrons in the formation, the tool responds to the electron density of the rocks, which is in turn related to the bulk density.

Photoelectric absorption occurs when the gamma rays reach a low energy (<150 keV) level after being repeatedly scattered by the electrons in the formation. The photoelectric effect index is determined by comparing the counts from the far detector in the high energy region, where only Compton scattering occurs, with those in the low energy region, where the count rates depend on both reactions. The far detector is used because it has a greater depth of investigation. The response of the short-spacing detector, which is mostly influenced by mudcake (not present in IODP boreholes where a seawater-based drilling fluid is used) and borehole rugosity is used to correct the density measurement for these effects.

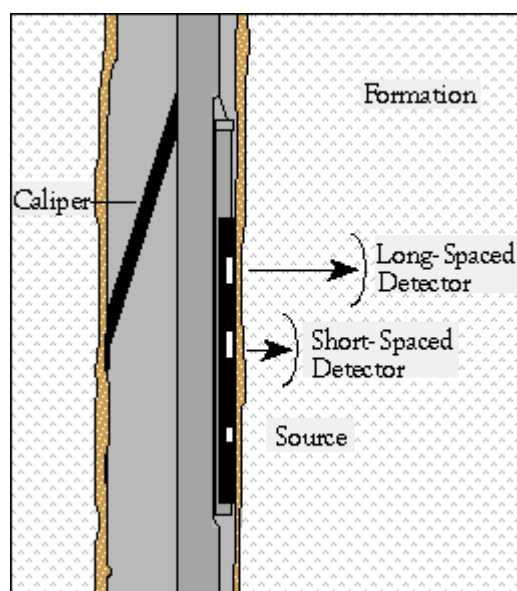

As with the case of the sonic tool, the depth of investigation of the lithodensity tool cannot be easily quantified; it is in the range of tens of centimeters, depending on the density of the rock. The vertical resolution is 16 in (38 cm).

---

## ***Applications***

### **Porosity estimate**

If grain density is known, porosity can be calculated from the density log. Alternatively, porosity and density logs can together be used to calculate grain density.

### **Seismic impedance calculation**

The product of velocity and density can be utilized as input to synthetic seismogram computations.

### **Lithology and rock chemistry definition**

In combination with the neutron log, the density log allows for the definition of the lithology and of lithologic boundaries. Because each element is characterized by a different photoelectric factor, this can be used, alone or in combination with other logs, to determine the lithologic type. Both density and photoelectric effect index are input parameters to some of the geochemical processing algorithms used onshore.

---

## ***Environmental Effects***

A reliable density measurement requires good contact between pad and formation. Because a caliper measurement is made during the recording, it is possible to check the quality of the contact. In the lithodensity tool the presence of mudcake and hole irregularities are automatically accounted for using a "spine and ribs" chart based on a series of laboratory measurements. The "spine" is the locus of the two counting rates (short and long spacing) without mudcake and the "ribs" trace out the counting rates for the presence of mudcake at a fixed formation density. The short and long spacing readings are automatically plotted on this chart and corrected for their departure from true value. These corrected data are typically located in the DRHO data column.

---

## ***Log Presentation***

The primary curves are: bulk density (RHOM, in g/cm<sup>3</sup>), photoelectric effect (PEFL, in barns/electron) density correction (DRH, in g/cm<sup>3</sup>), and caliper (LCAL, in in.). They are usually displayed along with the neutron curve APLC. Also, DPHI (density porosity) can be computed and displayed by assuming a constant grain density of the matrix. DRH is useful for quality control of the data; if the tool is operating correctly it should be less than 0.1 g/cm<sup>3</sup>.

---



## ***Tool Specifications***

Temperature rating:	500° F (260° C )
Pressure rating:	25 kpsi (17.25 kPa)
Diameter:	3.5 in (8.9 cm)
Length:	23.08 ft (7.03 m)
Weight:	292 lbs (132.6 kg)
Sampling interval:	6 in (15.24 cm); 1 in (2.54 cm)
Max. logging speed:	1,800 ft/hr (548 m/hr)

---

## ***Measurement Specifications***

Vertical resolution:	1.25 ft (38 cm)
Depth of investigation:	(see last paragraph of "Description" section)
Density accuracy (2-3 g/cm <sup>3</sup> ):	±0.01 g/cm <sup>3</sup>
Photoelectric effect accuracy (1-6 barns/e-):	±10%

---

## ***Major Outputs***

RHOM:	Bulk density (g/cm <sup>3</sup> )
DRH:	Bulk density correction (g/cm <sup>3</sup> )
PEFL:	Long-spaced photoelectric effect
NRHB:	Enhanced bulk density (g/cm <sup>3</sup> )
LCAL:	Caliper (in)

---

## ***Deployment Notes***

The HLDS is typically run with the HNGS and APS tools. It can be combined with DIT, DLL, and ASI.

---

\* ®trademark of Schlumberger

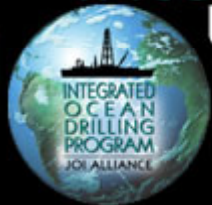

## Downhole logging tools

### Triple Combo Tools

#### Hostile Environment Gamma Ray Sonde (HNGS\*)

##### **Description**

The Hostile Environment Natural Gamma Ray Sonde (HNGS) utilizes two bismuth-germanate (BGO) scintillation detectors to measure the natural gamma ray radiation of the formation. The larger detector volume and higher gamma ray stopping power of BGO makes the HNGS a very effective spectral gamma tool. The HNGS makes similar measurements to the NGT; however, the HNGS is more accurate and capable of making measurements in difficult hole conditions. The HNGS employs a larger and better scintillation detector than the NGT which affords better nuclear decay statistics. The HNGS measures total gamma and 256-window spectroscopy to resolve the detected spectrum into the three most common components of naturally occurring radiation: potassium, thorium, and uranium.

The high-energy part of the spectrum is divided into three energy windows, each covering a characteristic peak of the three radioactivity series. The concentration of each component is determined from the count rates in each window. Because the high-energy region contains only 10% of the total spectrum count rates, the measurements are subject to large statistical variations, even using a low logging speed. The results are considerably improved by including the contribution from the low-energy part of the spectrum. Filtering techniques are used to further reduce the statistical noise by comparing and averaging counts at a certain depth with counts sampled just before and after. The final outputs are the total gamma ray, a uranium-free gamma ray measurement, and the concentrations of potassium, thorium, and

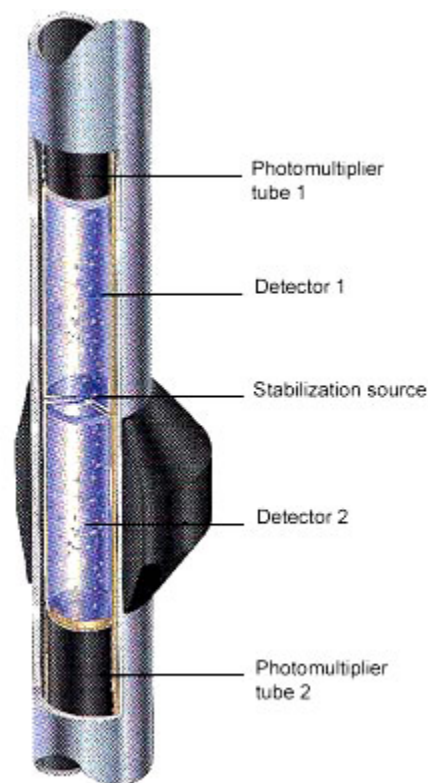

uranium.

The radius of investigation depends on several factors: hole size, mud density, formation bulk density (denser formations display a slightly lower radioactivity) and the energy of the gamma rays (a higher energy gamma ray can reach the detector from deeper in the formation).

Only the high-energy gamma rays are used in the analysis, thereby eliminating sensitivity to mud barite content. The MAXIS system provides real-time corrections for borehole size and the borehole potassium contribution.

---

## ***Applications***

### **Clay typing**

Potassium and thorium are the primary radioactive elements present in clays; because the result is sometimes ambiguous, it can help combining these curves or the ratios of the radioactive elements with the photoelectric effect from the lithodensity tool.

### **Mineralogy**

Carbonates usually display a low gamma ray signature; an increase of potassium can be related to an algal origin or to the presence of glauconite, while the presence of uranium is often associated with organic matter.

### **Ash layer detection**

Thorium is frequently found in ash layers. The ratio of Th/U can also help detect these ash layers.

---

## ***Environmental Effects***

The HNGS response is affected by borehole size, mud weight, and by the presence of bentonite or KCl in the mud. In ODP boreholes KCl is sometimes added to the mud to stabilize freshwater clays which tend to swell and form bridges. This procedure takes place before logging operations start, and even though KCl is probably diluted by the time the tool reaches total depth, it can still affect the tool response. All of these effects are accounted for during the processing of the HNGS data onshore.

---

## ***Log Presentation***

The HNGS log is routinely recorded with each logging string for correlation between logging runs. To this purpose HSGR (total gamma ray in API units) and HCGR (computed gamma ray -- HSGR minus Uranium component, in API units) are usually displayed along with other curves (resistivity, sonic, density, etc.). A full display of the data with HSGR, HCGR, and HTHO (in ppm), HURA (in ppm), and HFK (dec fraction) is usually provided separately.

---

## ***Tool Specifications***

Temperature rating:	260° C (500° F)
Pressure rating:	25 kpsi (17.2 kPa)
Diameter:	3.75 in (9.5 cm)
Length:	8.5 ft (25.88 cm)
Weight:	171.7 lbs (78 kg)
Sampling interval:	6 in (15.24 cm)
Max. logging speed:	3,600 ft/hr (1,097 m/hr)

---

## ***Measurement Specifications***

Vertical resolution:	12 in (30.48 cm)
Depth of investigation:	24 in (61 cm)
Thorium accuracy:	±2%
Uranium accuracy:	±2%
Potassium accuracy:	±5%

---

## ***Major Outputs***

HSGR:	Standard (total) gamma ray (GAPI)
HCGR:	Computed gamma ray (GAPI)
HFK:	Formation potassium (wt. %)
HTHO:	Formation thorium (ppm)
HURA:	Formation uranium (ppm)
HBHK:	Borehole potassium (wt. %)

---

## ***Deployment Notes***

The HNGS is always run at the top of the Triple Combo tool string which also includes APS, HLDS, and DIT tools. At least one pass is made with the HNGS past the mudline for correct location of the mudline itself.

---

\* ®trademark of Schlumberger

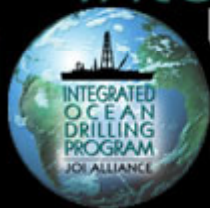

## Downhole logging tools

### Triple Combo Tools

#### Temperature/Acceleration/Pressure Tool (TAP)

##### *Description*

The TAP (High Resolution Temperature / Acceleration / Pressure) tool was designed at LDEO to acquire borehole temperature, tool acceleration and hydrostatic pressure data. It is the successor to the Lamont Temperature Tool (TLT), which was used in the early part of ODP.

The TAP tool is fastened to the bottom of the Triple Combo; because it is a memory tool, the stored data are dumped to the third party DAS (Data Acquisition System) upon the tool's return to the rig floor.

Fast and slow response thermistors are mounted near the bottom of the tool to detect borehole fluid temperatures at two different rates. The thinner, fast-response is able to detect small abrupt changes in temperature, the thicker, slow-response thermistor is used to estimate temperature gradient and thermal regimes more accurately. One pressure transducer is included to turn the tool on and off at specified depths when used in memory mode. Typically data acquisition is programmed to begin 100 m above the sea floor.

A 3-axis accelerometer is also included to measure tool movement downhole. These data are expected to be instrumental in analyzing the effects of heave on a deployed tool string, which will lead to the fine tuning of the WHC (wireline heave compensator).

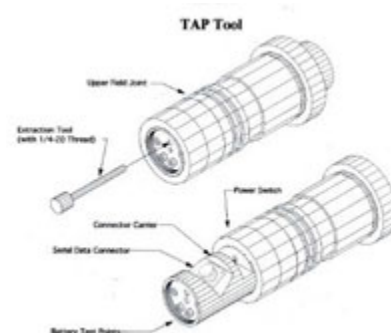

---

### *Applications*

#### **Geothermics**

The recording of temperature provides an insight into the thermal regime of the formation surrounding the borehole. The vertical heat flow is estimated from the vertical temperature gradient combined with the measurements of the thermal conductivity from logs or core samples.

## Hydrogeology

Crust at mid-ocean ridge crests must be permeable to a considerable depth to allow for the efficient removal of heat by hydrothermal systems. Temperature logs in such an environment can clearly differentiate between the advective (hydrothermal) and conductive heat transfer regimes.

---

## Environmental Effects

Drilling and circulation operations considerably disturb the temperature distribution inside the borehole thus preventing equilibrated temperature conditions. The amount of time elapsed between the end of drilling fluid circulation and the beginning of logging operations is not long enough to allow the borehole to recover thermally. Therefore the data recorded is not representative of the thermal equilibrium of that environment. In addition, the thermistors may become fouled with sediment from the drilled formation which reduces the sensitivity and accuracy of the recorded temperature data.

---

## Log Presentation

Temperature data acquired by the fast and slow thermistors may be presented with resistivity, density and porosity log data, or simply alone.

---

## Tool Specifications

Temperature rating:	185° F (85° C)
Pressure rating :	10 kpsi (69 kPa)
Diameter:	3.25 in (8.26 cm)
Length:	8.895 ft (2.71 m)
Temperature sampling rate:	1 Hz
Acceleration sampling rate:	
Low resolution mode (LR):	4 Hz
High resolution mode (HR):	8 Hz
Pressure sampling rate:	1 Hz
Total data recording time:	
HR mode:	5 hrs.
LR mode:	8 hrs.
Power source:	8 alkaline batteries (D type)
Operation time from one set of batteries:	approx. 40 hrs.

---

## Measurement Specifications

Temperature measurement range:	25-185° F (-4 to 85° C)
--------------------------------	-------------------------



Temperature resolution:	0.002° F (0.001° C)
Temperature accuracy:	± 3.6° F (± 2° C)
Acceleration measurement range:	-20 to 20 m/s <sup>2</sup>
Acceleration resolution:	1e-3 m/s <sup>2</sup>
Acceleration accuracy:	± 0.6 m/s <sup>2</sup>
Pressure measurement range:	0-10 kpsi (4.5 kPa)
Pressure resolution:	1 psi (0.45 Pa)
Pressure accuracy:	± 1.4 MPa (± 2% FS)

---

### ***Deployment Notes***

Because it is a memory tool, the TAP needs to be initialized approximately 1/2 hour prior to rig up of the Triple Combo tool string. Once initialized, the TAP tool should be placed on the deck outside of the DHML to be picked up by the roughnecks. The logger then must connect it to the bottom of the Triple Combo using a pin and rotating ring assembly. When the Triple Combo is retrieved to the rig floor, the Logging Staff Scientist must remove the TAP tool, wash it off and download the data on the onboard computer.



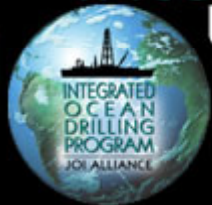

## Downhole logging tools

### FMS/Sonic

#### Dipole Shear Sonic Tool (DSI-2\*)

##### *Description*

The Dipole Shear Sonic (DSI-2) tool combines high-speed telemetry with simultaneous, 12-bit dynamic range digitization of an eight-receiver array. The sonde incorporates both monopole and crossed-dipole transmitters with an eight-station array of electronically configurable hydrophones for monopole and dipole reception. Combining new dipole-based technology with the latest monopole developments into one system provides the best method available today for obtaining borehole compressional, shear and Stoneley slownesses (slowness is the reciprocal of velocity and corresponds to the interval transit time measured by standard sonic tools).

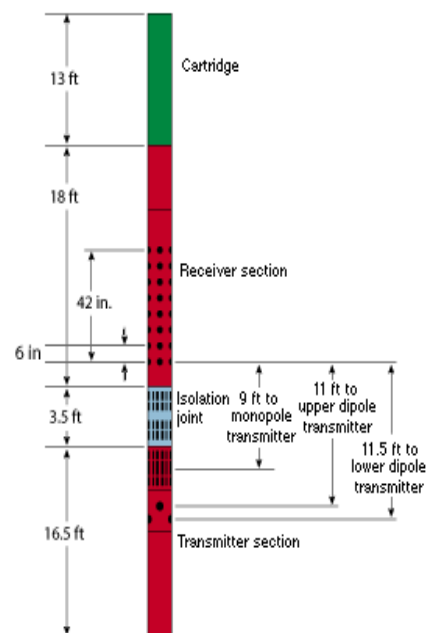

Dipole technology allows borehole shear measurements to be made in "soft" rock as well as "hard" rock formations. Limited by borehole physics, monopole tools can detect only shear velocities that are faster than the borehole fluid velocity -- or in hard rocks only. Dipole tools overcome this fluid velocity barrier.

The receiver array provides more spatial samples of the propagating wavefield for full waveform analysis. The arrangement of the transmitters and receivers allows measurement of wave components propagating deeper into the formation.

The DSI-2 tool differs from the DSI previously used in ODP by an upgraded receiver section. The upgrade improves the shear measurements in slow formations.

## ***Tool Operation Modes***

The DSI-2 tool has several data acquisition operating modes, any of which may be combined to acquire digitized waveforms over each 6-in. logging interval. For waveforms, eight channels are digitized simultaneously with a 12-bit dynamic range.

### **Upper and lower dipole modes**

Eight dipole waveforms from firings of either of the dipole transmitters -- sampling every 40 microsec, 512 samples/waveform.

### **Crossed dipole mode**

Standard acquisition of 32 total waveforms, in-line and cross-line from both transmitters -- sampling every 40 microsec, 256 samples/waveform.

### **Stoneley mode**

Eight monopole waveforms from firings of the monopole transmitter driven with a low-frequency pulse -- sampling every 40 microsec, 512 samples/waveform.

### **P and S monopole mode**

Eight monopole waveforms from firings of the monopole transmitter driven with a high-frequency pulse -- sampling every 10 microsec, 512 samples/waveform.

### **First-motion mode**

Eight sets of monopole threshold-crossing data from firings of the monopole transmitter driven with a high-frequency pulse -- primarily for compressional first-arrival applications.

---

## ***Features***

New fast tool bus and data reduction techniques have allowed double the maximum logging speed in most instances.

A switchable power regulator has enabled a one-third reduction in power needs, resulting in broader combinability with other tools.

Additional human-interface engineering has improved field acquisition quality and efficiency.

A new low-frequency transmitter driver improves signal-to-noise ratio and allows successful logging of extremely slow formations and greatly enlarged holes.

Improved waveform processing techniques have greatly improved vertical resolution.

New answer products utilize Stoneley slowness to evaluate fractures and indicate permeability.

In addition to the new dipole features, acquisition of the Stoneley wave velocity utilizes a low-frequency monopole energy pulse for highest-quality Stoneley measurements. Stoneley-derived

permeability is useful for evaluating fractures as well as investigating deeply into the formation.

A new technique for detecting compressional wave arrival--digital first-motion detection (DFMD)--provides measurements that are compatible with previous sonic logs, in addition to a 6-in (15 cm) vertical resolution compressional sonic.

Processing with the MAXIS wellsite unit displays a full wave and its component characteristics. Its high-speed array processor uses the slowness-time-coherence (STC) method to determine compressional, shear and Stoneley slowness values. A choice of band-pass filters permits utilization of the optimum frequency range within a mode. The process reliably provides unambiguous transit times even in difficult borehole conditions. The resulting values are useful inputs for mechanical properties, formation evaluation and seismic applications.

---

### ***Depth of Investigation/Eccentering Effects***

Depths of investigation for sonic devices depend on the formation type, shear and compressional slowness, the transmitter-to-receiver spacing, wavelength of the wave considered and whether it is a head wave or a guided wave, the source frequency and signal types.

Frequency determines the wavelength that drives the depth of investigation of the measurement.

Typical sonic wavelengths at different frequencies and slownesses are shown in the "Additional Specifications" table. Low frequency penetrates deeper into the formation and helps read beyond altered zones.

Numerical simulations verified by measurements from scale models show that when eccentering is small compared to the borehole radius, there is little change in the character of the dipole waveforms or in the STC-processed slowness values. Large eccentering, on the order of 2 to 4 in (5-10 cm) in a 12-in (31 cm) borehole, increases the flexural wave amplitude relative to the compressional. For the DSI-2 tool, the variation in the shear slowness estimate is  $\pm 2$  percent over the normal slowness range.

---

### ***Log Presentation***

Slowness or velocities can be plotted alongside resistivity, density, or image data.

---

### ***Tool Specifications***

Temperature rating:	350° F (175° C)
Pressure rating:	20 kpsi (13.8 kPa)

Diameter:	3.375 in (8.57 cm)
Length:	51 ft (15.5 m)
Weight:	900 lbs (408.6 Kg)
Sampling interval:	10 and 40 microsec
Maximum logging speed	
One eight-waveform set (singlemode):	3,600 ft/hr (1,097 m/hr)
All six modes simultaneously, without 6-in delta t:	1,000 ft/hr (305 m/hr)
All six modes simultaneously, with 6-in delta t:	900 ft/hr (274 m/hr)
Acoustic bandwidth	
Dipole and Stoneley:	80 Hz to 5 kHz
High-frequency Monopole	8 to 30 kHz

---

### ***Measurement Specifications***

Vertical resolution:	3.5 ft (1 m) for 6-in (15.24 cm) sampling rate
Depth of investigation:	9 in (23 cm)
Accuracy:	2 microsec/ft (6.6 microsec/m)

---

\* ®trademark of Schlumberger

# Integrated Ocean Drilling Program

## U.S. IMPLEMENTING ORGANIZATION

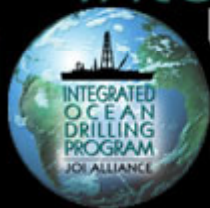

## Downhole logging tools

### FMS/Sonic Tool String

#### Formation MicroScanner (FMS\*)

##### *Description*

The Formation MicroScanner sonde (FMS) consists of four orthogonal imaging pads each containing 16 microelectrodes which are in direct contact with the borehole wall during the recording. The button current intensity is sampled every 0.1 in (2.5 mm). The tool works by emitting a focused current from the four pads into the formation. The current intensity variations are measured by the array of buttons on each of the pads.

Processing transforms the current intensity measurements, which reflect the microresistivity variations of the formation, into high resolution gray or color images of variable intensity. Black and white (darkest or lightest color) indicate low and high microresistivity, respectively. The tool also includes a General Purpose Inclination Cartridge (GPIT) which provides accelerometer and magnetometer data in order to allow one to define the tool position and spatial orientation of the data.

In smooth boreholes with very homogeneous bedding the depth of investigation is about 10 in (25 cm). The vertical resolution is 0.2 in (5 mm).





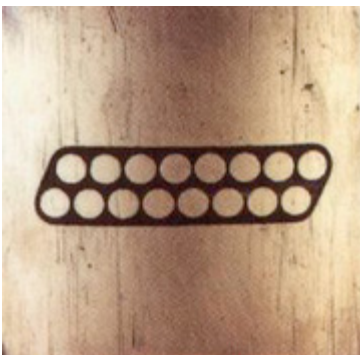

<---- Sixteen-electrode arrangement for the four-pad tool.

---

## ***Applications***

- Mapping of bedding planes, fractures, faults, foliations, and other formation structures and dip determination.
- Detailed correlation of coring and logging depths.
- Precise positioning of core sections where core recovery is less than 100%.
- Analysis of depositional environments.

---

## ***Log Presentation***

FMS images can be plotted with identical vertical and horizontal scales to see features without exaggeration. However, due to physical constraints, different vertical and horizontal scales are commonly used. The images are displayed on an oriented plot, also called an azimuthal plot, because the images are positioned according to their orientation in the borehole with N in the center and S on both edges. Images from two passes of the tool can be merged and plotted together. The calipers or other curves can be plotted alongside the images as well.

With an additional processing step, dipmeter calculations can be made. Standard dipmeter plots consist of borehole drift, calipers, dip angle and direction (tadpoles), azimuth frequency plots, and pad traces.

---

## ***Tool Specifications***

Temperature rating:	350° F (175° C)
Pressure rating:	20 kpsi (13.8 kPa)
Diameter:	3.625 in (9.2 cm)
Length:	25.3 ft (7.72 m)
Weight:	537 lbs (243.8 Kg)
Sampling interval:	0.1 in (2.5 mm)
Maximum logging speed	1,800 ft/hr (549 m/hr)

---

## ***Measurement Specifications***

Vertical resolution:	0.2 in (5 mm)
Depth of investigation:	10 in (25 cm)

---

\* ® trademark of Schlumberger

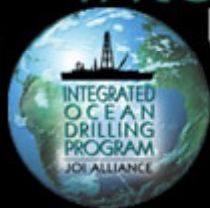

## Downhole logging tools

### FMS/Sonic Tool String

#### Scintillation Gamma Ray Tool (SGT\*)

##### *Description*

All gamma ray tools record naturally occurring gamma rays in the formation adjacent to the borehole. Therefore, they provide a measurement of the radioactive content of the formation. Unlike the HNGS, run on the triple combo, the SGT does not acquire spectral gamma data: it measures only the total number of gamma counts in API units. In the IODP the Scintillation Gamma Tool (SGT) is routinely run with the FMS/DSI combination and is primarily used for depth correlation of the logs from the different runs.

---

##### *Applications*

- Depth correlation between runs
- Lithology identification
- Evaluation of clay content

---

##### *Tool Specifications*

Temperature rating:	350° C (177° F)
Pressure rating:	20 kpsi (13.8 kPa)
Diameter:	3.375 in (8.57 cm)
Length:	5.5 ft (1.68 cm)
Weight:	83 lbs (37.7 kg)
Sampling interval:	6 in (15.24 cm) and 2 in (5.08 cm)
Maximum logging speed:	3,600 ft/hr (1,097 m/hr)

---

##### *Measurement Specifications*

Measurement range :	0-2,000 GAPI
Vertical resolution:	12 in (30.48 cm)
Depth of investigation:	24 in (60.96 cm)
Accuracy:	±5%

---

## ***Major Outputs***

ECGR: Environmentally Corrected Gamma Ray (GAPI)

---

## ***Deployment Notes***

The SGT is routinely run in combination with the FMS and DSI tools.

---

\* ®trademark of Schlumberger

# Integrated Ocean Drilling Program

## U.S. IMPLEMENTING ORGANIZATION



## Downhole logging tools

### Third Party Tools

#### Core Barrel - Extended Memory Drill String Accelerometer (CB-DSA-XM)

##### *Description*

The Core Barrel- Extended Memory Drill String Accelerometer (CB-DSA-XM) was developed during ODP at USIO Science Services/LDEO as a modification of the CB-DSA, which was used on several ODP legs. The CB-DSA-XM operates as a memory tool that measures and records drill string acceleration and ambient pressures during coring. The tool contains a single-axis (vertical) High Sensitivity Accelerometer (HSA) for heave measurements, a three-axial Low Sensitivity Accelerometer (LSA) for drill bit variations, and a high resolution pressure sensor. The tool can operate in acceleration (LSA and HSA signals recorded at high sampling rate) or pressure ((LSA signal and ambient pressure recorded at high sampling rate) mode; in both cases ambient pressure is recorded at low sampling rate (1 sample/sec).



For ease of deployment, the CB-DSA-XM has been designed as a removable extension of the APC/XCB/RCB core barrels. Using standard threaded connections, the CB-DSA-XM is attached to the top of a selected core barrel prior to core barrel deployment. The tool does not need connection to the logging cable and the data are downloaded to a computer after the tool is retrieved from the hole. During initialization and data downloading procedures, communication with the tool is handled by the CB-DSA-XM LabView program.

The modified tool has a longer data recording time, higher reliability and improved operations capabilities. It allows data recording on consecutive coring trips, and the used of hot-swappable non-volatile memory modules virtually eliminates any delay related to data retrieval procedures. The tool continuously monitors battery voltage and temperature inside the electronics module and preserves recorded data in case of battery failure or at temperatures in excess of the maximum specified for tool operation.

---

## ***Applications***

- Drill string vibration analysis
- Heave evaluation
- Reference signal for Seismic-While-Drilling measurements
- Fluid pressure measurement
- Drilling equipment performance evaluation
- Geotechnical applications (i.e. sediment compaction analysis)

---

## ***Tool Specifications***

Temperature rating:	185° F (85° C)
Pressure rating:	10 kpsi (4.5 kPa)
Diameter:	3.375 in (8.57 cm)
Length:	47 in (1.2 m)
Weight:	75 lbs (34.1 kg)
Acceleration sampling rate:	100 Hz
Pressure sampling rate:	1 Hz
Frequency bandwidth (HSA Channel):	0-2 Hz
Frequency bandwidth (LSA Channel):	0-50 Hz (at 100 samples/sec) 0-25 Hz (at 50 samples/sec)
Total data recording time:	2.9 hrs (at 100 samples/sec)
Power source:	6 "AA" alkaline batteries
Battery life:	about 18 hrs

---

## ***Measurement Specifications***

Acceleration measurement range (HSA channel):	-2 to +2 g
Acceleration measurement range (LSA channel):	
Option 1:	±4 g
Option 2 :	±25 g
Temperature measurement range:	32-185° F (0-85° C)
Temperature resolution:	0.9° F (0.5° C)
Pressure measurement range:	0-10 kpsi (6.9 kPa)
Pressure resolution:	4 psi (1.8 Pa)
Pressure measurement precision:	0.1 % FS

---



# Integrated Ocean Drilling Program

## U.S. IMPLEMENTING ORGANIZATION



## Downhole logging tools

### Third Party Tools

#### Core Barrel - Retrievable Memory Module (CB-RMM)

##### *Description*

The Core Barrel – Retrievable Memory Module (CB-RMM) may be deployed routinely with all standard IODP core barrels. It has been designed to capture incoming weight-on-bit, torque-on-bit, and pressure data from the Drilling Sensor Sub via a wireless inductive link. The data are transmitted between two coils, one mounted in the DSS and the other mounted on the CB-RMM antenna. The DSS transmits the data continuously even when the CB-RMM is not present. When the CB-RMM is present, it recognizes the incoming data and stores them in the onboard memory. In addition to storing data from the DSS, the CB-RMM makes its own pressure and acceleration measurements, which are stored with the DSS data.

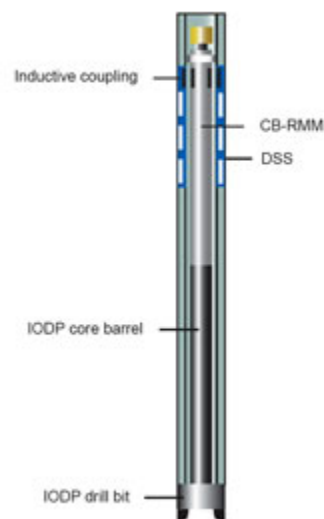

##### *Applications*

- Heave compensated evaluation
- Core barrel performance evaluation
- Sediment compaction
- Fluid pressure

##### *Tool Specifications*

Temperature rating:	185° F (85° C)
Pressure rating:	10 kpsi (4.5 kPa)
Diameter:	3.625 in (9.2 cm)
Length:	155.38-184.25 in (3.94-4.68 m)
Weight:	250 lbs (113.6 kg)

Memory:	8 Mb
Acceleration sampling rate (x and z axis):	50 Hz
Power source:	24 "C" and 6 "AA" alkaline batteries
Battery life:	about 16 hrs
Top connection:	ODP GS fishing cup
Bottom connection:	Interchangeable core barrel-specific adapters

---

### ***Measurement Specifications***

Acceleration measurement range (HSA channel):	
Option 1:	±4 g
Option 2 :	±25 g
Pressure measurement range:	0-10 kpsi (6.9 kPa)
Pressure resolution:	1 psi (0.7 Pa)

---

# Integrated Ocean Drilling Program

## U.S. IMPLEMENTING ORGANIZATION



## Downhole logging tools

### Third Party Tools

#### Core Barrel Temperature Tool (CB-TT)

##### *Description*

The Core Barrel Temperature Tool (CB-TT) has been developed at LDEO-BRG and was first deployed during ODP Leg 193. The CB-TT allows to assess temperature conditions while drilling and determine if they are favorable for subsequent wireline or logging-while-drilling operations in hydrothermal environments. Along with the Core Barrel Drill String Accelerometer (CB-DSA-XM), the CB-TT enables the acquisition of digital measurements while coring. The CB-TT's measurements of borehole temperatures while drilling can then be correlated to pump rates used during coring operations in order to determine the feasibility of performing logging operations in the high temperature conditions associated with superheated water adjacent to hydrothermal vents. The CB-TT contains a thermocouple and a battery operated electronic board, encased in a single dewar inside the pressure case that was designed for the CB-DSA.

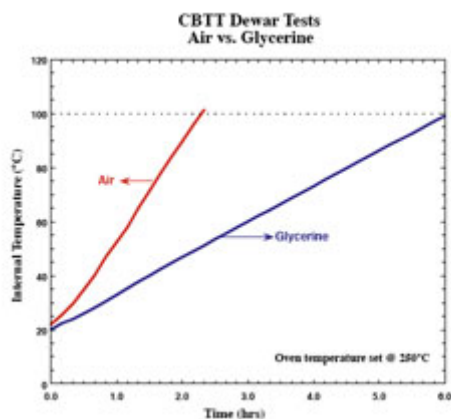

## ***Applications***

- Borehole temperature assessment while drilling
  - Comparison of pumping rates to temperature
  - Estimation of borehole temperature rebound while drilling
- 

## ***Tool Specifications***

Temperature rating:	248° F (120° C)
Pressure rating:	10 kpsi (6.9 kPa)
Diameter:	3.375 in (8.57 cm)
Length:	47 in (1.2 m)
Weight:	60 lbs (27.2 kg)
Memory:	4 Mb
Power source:	lithium batteries
Battery life:	about 12 hrs

---

## ***Measurement Specifications***

Temperature measurement range:	0-599° F (0-315° C)
Temperature resolution:	1.8° F (1° C)
Pressure measurement range:	0-10 kpsi (6.9 kPa)
Pressure resolution:	1 psi (0.7 Pa)

---

# Integrated Ocean Drilling Program

## U.S. IMPLEMENTING ORGANIZATION



## Downhole logging tools

### Third Party Tools

#### Multi-Sensor Spectral Gamma Ray Tool (MGT\*)

##### *Description*

The Multi-Sensor Spectral Gamma Ray Tool (MGT) is a third party tool developed by the Lamont-Doherty Borehole Research Group to improve the vertical resolution of natural gamma-ray logs. This is achieved by using an array of short detector modules with approximately 2 ft (60 cm) spacing. Each module comprises a small 2"x4" (5x100 m) NaI detector, a programmable 256-channel amplitude analyzer, and an Am<sup>241</sup> calibration source. The spectral data are later recalculated to determine the concentration of potassium, thorium, and uranium radioisotopes or their equivalents. The spectral data from individual modules are sampled 4 times per second and stacked in real time based on the logging speed. This approach increases vertical resolution by a factor of 3-4 over conventional Schlumberger tools while preserving comparable counting efficiency and spectral resolution. The radius of investigation depends on several factors: hole size, mud density, formation bulk density (denser formations display a slightly lower radioactivity) and the energy of the gamma rays (a higher energy gamma ray can reach the detector from deeper in the formation).

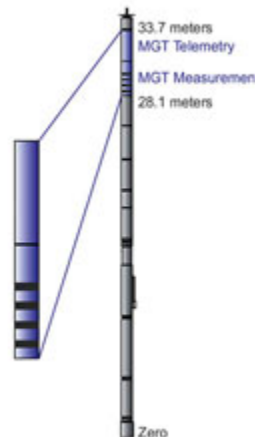

The tool also includes an accelerometer channel to improve data stacking by the precise measurement of logging speed. A specialized telemetry system developed for the MGT allows it to be combined with Schlumberger tool strings in a single logging operation, minimizing the required rig time to acquire the log.

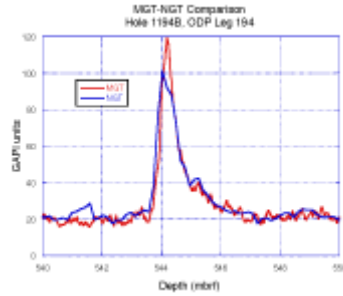

---

## ***Applications***

Spectral gamma ray logs provide one of the best means to investigate the mineralogy of thin-bedded sedimentary sequences, to correlate among different logging runs, and to compare logging data and core measurements. Increasing vertical resolution over currently available tools provides new opportunities for log analysis in reservoirs with rapidly changing lithology and for finer resolution of thin layering and in areas with low sedimentation rates. The added resolution provided by the MGT will be of particular use in paleoclimate studies.

---

## ***Environmental Effects***

The MGT response is affected by borehole size, mud weight, and by the presence of bentonite or KCl in the mud. In IODP boreholes KCl is sometimes added to the mud to stabilize freshwater clays which tend to swell and form bridges. This procedure takes place before logging operations start, and even though KCl is probably diluted by the time the tool reaches total depth, it can still affect the tool response. All of these effects are accounted for during the processing of the MGT data onshore.

---

## ***Tool Specifications***

Temperature rating:	212° F (100° C)
Pressure rating:	10 kpsi (6.9 kPa)
Diameter:	3.375 in (8.6 cm)
Length	
Telemetry module:	9 ft (2.7 m)
Measurement module :	9.5 ft (2.9 m)
Weight:	350 lbs (151.1 kg)
Number of spectrometry modules:	4
Module spacing:	0.64 m
Detectors	
Type:	NaI(Tl)
Dimension:	4x2 in (10x5 cm)
Maximum cable length :	40 ft (131.2 m)
Maximum logging speed :	900 ft/hr (275 m/hr)



Cable head connection:	Schlumberger style
Sample rate:	4 sec

---

### ***Measurement Specifications***

Acceleration measurement range (HSA channel):	
Option 1:	±4 g
Option 2 :	±25 g
Pressure measurement range:	0-10 kpsi (6.9 kPa)
Pressure resolution:	1 psi (0.7 Pa)

---

### ***Major Outputs***

GR:	Gamma ray	GAPI
POTA:	Potassium	wt %
THOR:	Therium	ppm

---

### ***Deployment Notes***

The MGT is run at the top of the Schlumberger Triple Combo. The downhole switch in the MGT telemetry module provides switching of the signal and power lines between the MGT and the Schlumberger logging system.

---

\* ®trademark of Schlumberger

# Integrated Ocean Drilling Program

## U.S. IMPLEMENTING ORGANIZATION



## Downhole logging tools

### Third Party Tools

## Ultra-High Temperature Multi-Sensor Memory Tool (UHT-MSM\*)

### Description

The Ultra-High Temperature Multi-Sensor Memory Tool (UHT-MSM), developed by the Geophysical Research Corporation for the University of Miami under NSF funding, is a slim-hole memory tool capable of measuring pressure and temperature in hot boreholes. It was deployed for the first time during ODP Leg 169. The UHT-MSM contains internal and external temperature measuring devices, a pressure gauge, a multi-sensor memory unit, and a dewar flask that acts as an insulator to maintain a stable temperature and cool-down rate for the tool. The heat shield is aircraft-grade aluminum bound at both ends by brass heat sinks. The dewar flask can maintain an internal temperature suitable for tool operation for 4-5 hours at an external temperature of about 750° F (400° C). Operations are possible for up to 10 hours if the temperature does not exceed 450° F (232° C).

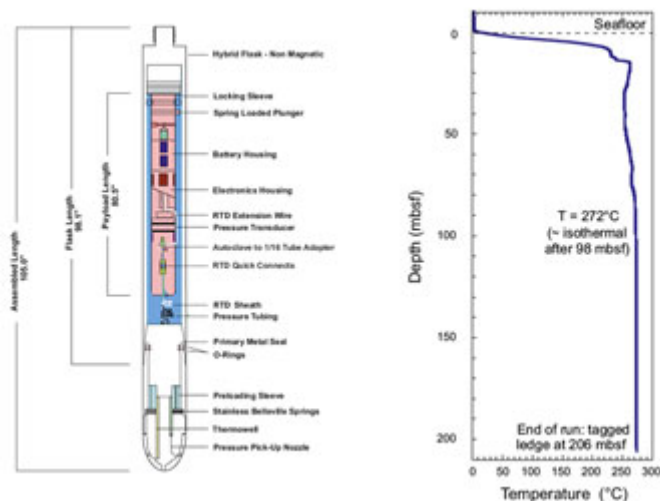

### Applications

- Hydrogeological analysis – identifying regions of fluid in or out flow.
- Geothermics – estimating the vertical fluid flow regime.

- Safety – evaluating fluid temperature prior to deploying heat sensitive tools.

---

### ***Environmental Effects***

The MGT response is affected by borehole size, mud weight, and by the presence of bentonite or KCl in the mud. In IODP boreholes KCl is sometimes added to the mud to stabilize freshwater clays which tend to swell and form bridges. This procedure takes place before logging operations start, and even though KCl is probably diluted by the time the tool reaches total depth, it can still affect the tool response. All of these effects are accounted for during the processing of the MGT data onshore.

---

### ***Tool Specifications***

Temperature rating:	750° F (400° C) for 4-5 hours
Pressure rating:	10 kpsi (4.5 kPa)
Diameter:	2.2 in (5.58 cm)
Length	8.75 ft (2.66m)
Weight:	75 lbs (34.1 kg)
Sampling Rate :	From 20 msec to 65 days
Memory:	1 Mb
Power source:	Lithium batteries
Battery life:	>8 hrs

---

### ***Measurement Specifications***

Temperature measurement range :	32-932° F (500° C)
Temperature resolution:	15.6 Hz/° F (28 Hz/° C)
Temperature measurement accuracy:	3° F (1.67° C)
Pressure measurement range:	0-10 kpsi (0-6.9 kPa)
Pressure resolution:	<0.01 psi
Pressure measurement accuracy:	0.04 % of full scale

---

\* ® trademark of Schlumberger



## ownhole logging tools

### Specialty Tools

#### Azimuthal Resistivity Imager (ARI\*)

##### *Description*

The Azimuthal Resistivity Imager (ARI) is a new generation of laterolog tool that makes deep measurements and azimuthal resistivity images around the borehole. Using these data it is possible to analyze features and details that escape conventional resistivity measurements: thin beds (down to 8 in, 20 cm), borehole formation heterogeneity, formation dip, resistivity in dipping beds, and fracture position and orientation. The ARI produces images similar to the FMS with coarser vertical resolution, but complete azimuthal coverage. Whereas FMS electrodes are pad-mounted and in contact with the borehole surface, the ARI provides a remote image of the formation in a similar way to that of the BHTV.

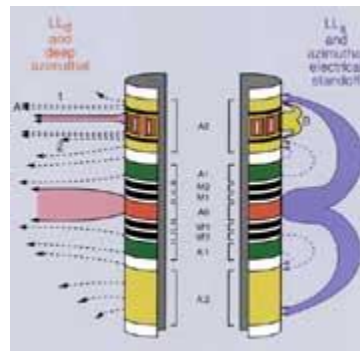

The ARI electrode array operates simultaneously at two frequencies: 35 Hz for the deep readings and 280 Hz for shallow readings. It focuses currents that flow from the 12 electrodes to the grounded logging cable. The sum of these 12 readings produces a high-resolution measurement, equivalent to a single laterolog electrode of the same height. To correct for tool eccentricity and variations in borehole shape, a shallow auxiliary measurement of electrical resistivities is performed at a much higher frequency of 71 kHz. This measurement responds primarily to the volume of borehole fluid affecting each electrode. If the borehole fluid resistivity is independently measured, then borehole size and shape can be deduced from the auxiliary array measurements. While the vertical resolution of the standard laterolog readings is about 0.60 m, the high-resolution array can reduce this by up to a factor of 6, depending on the formation resistivity.

Preliminary processing of ARI images may be accomplished using GeoFrame, a software package developed by Schlumberger and GeoQuest, in a similar manner to FMS image processing. Comparison of image data from different logging tools can also be displayed using this software, which may provide information about fracture and fault orientation and aperture, formation dip and heterogeneity, and borehole shape. As the FMS is less sensitive to features near the

borehole than the FMS, such as drilling-induced fractures, the origin and lateral extent of such features may be determined from the comparison of FMS and ARI images.

---

## ***Environmental Effects***

The electrical standoff measurements can be used to correct the azimuthal resistivities for tool eccentricity and variations in borehole shape and size.

---

## ***Applications***

### **Thin Beds**

The deep, high resolution measurements (vertical resolution of < 1 ft) can be used in the quantitative evaluation of laminated forms.

### **Fractured formations**

The ARI response is affected by the presence of fractures filled with conductive fluids. Though ARI images do not have the same definition and resolution of FMS images, open fractures are clearly visible; some vertical fractures and cracks that may have been induced by drilling, however, may not be clearly visible on the ARI, because they are too shallow to be detected by the deeper reading ARI.

### **Dips**

The formation dip can be derived from the ARI images, though the estimate does not have the accuracy of that derived from an FMS image. ARI images are useful to detect unconformities and faults, and to confirm expected features.

### **Borehole profile**

The 12 auxiliary-mode azimuthal borehole curves show tool eccentricity and borehole irregularities, such as ovality. The ARI electrical calipers are more sensitive to borehole variations than the FMS orthogonal calipers.

---

## ***Log Presentation***

The LLD and LLS measurements are usually displayed on a resistivity logarithmic scale, along with the gamma ray log.

---

## ***Tool Specifications***

Temperature rating:	350° F (175° C)
Pressure rating:	20 kpsi (13.8 kPa)
Diameter:	3.625 in (9.21 cm)
Length:	33.3 in (10.1 cm)
Weight:	578 lbs (262.4 kg)
Sampling interval:	6 in (15.24 cm)

Max. logging speed 1,800 ft/hr (550 m/hr)

---

### ***Measurement Specifications***

Measurement range: 0.2 to 100,000 ohm-m

Vertical resolution: Less than 1 ft (30.24 cm)

---

### ***Major Outputs***

LLD: Deep laterolog (ohm-m)

LLS: Shallow laterolog(ohm-m)

---

### ***Deployment Notes***

The ARI may be deployed as part of the Triple Combo, where it replaces the Dual Induction Tool (DIT), or in combination with a gamma ray tool. To properly orient the images, however, the ARI must be used with the GPIT, as is the case for the FMS tool. Repeat passes of the ARI may be useful to obtain consistent azimuth measurements.

---

\* ®trademark of Schlumberger

# Integrated Ocean Drilling Program

## U.S. IMPLEMENTING ORGANIZATION



## Downhole logging tools

### Specialty Tools

#### Array Seismic Imager (ASI\*)

##### *Description*

The Array Seismic Imager (ASI) consists of an array of five seismic shuttles linked by a bridle to a signal-conditioning cartridge. Each shuttle sensor package contains three mutually orthogonal geophones fixed relative to the sensor package geometry. One geophone lies along the axis of the package (z-axis); the other two geophones (x- and y-axes) form a 45° angle relative to the clamping direction. This design allows the ASI tool to operate in wells with a 90° deviation while not exceeding the 45° limitation of the X and Y geophones. For the study of anisotropy and analysis of split shear, these features make the ASI tool reliable in both vertical and deviated wells, with consistent X and Y component response.

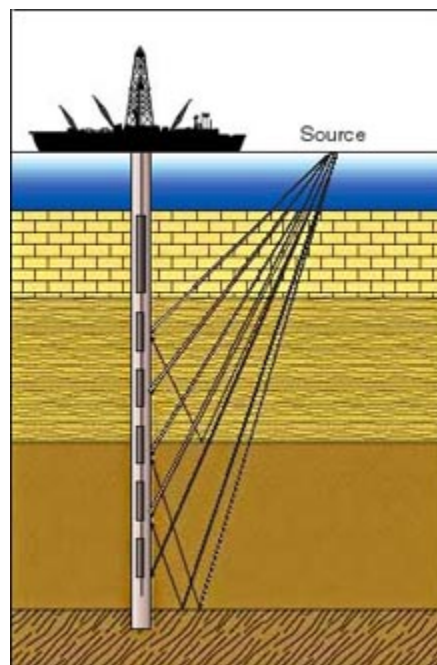

The ASI tool is unique in that it ensures consistent, lengthy coupling periods during downhole seismic acquisition, both in vertical and deviated wells. This feature makes the ASI tool ideal for 2D and 3D time-lapse borehole seismic surveys, reservoir monitoring applications and amplitude variation with offset (AVO) calibration walkaways.

##### *Applications*

The ASI can acquire three-dimension walkaway vertical seismic profile (VSP) surveys in both vertical and deviated wells. One of the primary benefits to IODP is its low deployment time, since multiple geophones are deployed simultaneously.

##### *Tool Specifications*

Temperature rating:	350° F (175° C)
Pressure rating:	20 kpsi (13.8 kPa)



Diameter:	3.375 in (8.57 cm)
Minimum tool length:	280 ft (85 m)
Sampling interval:	1, 2 and 4 msec
Maximum Logging Speed:	Stationary

---

### ***Deployment Notes***

The standard ASI tool can be used in cased holes without special equipment. Adding a bowspring assembly allows surveying of open holes from 8 1/2 to 13 in (21.5 to 33 cm).

---

\* ®trademark of Schlumberger

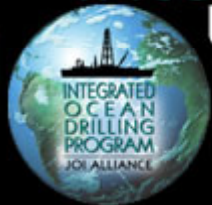

## Downhole logging tools

### Specialty Tools

#### Dual Laterolog (DLL\*)

##### *Description*

The Dual Laterolog (DLL) provides two resistivity measurements with different depths of investigation into the formation: deep (LLd) and shallow (LLs). In both devices, a current beam 2 ft-thick ( $A_0$ ) is forced horizontally into the formation by using focusing (also called bucking) currents ( $A_1$ - $A_2$ ,  $A'_1$ - $A'_2$ ); monitoring electrodes ( $M_1$ ,  $M_2$ ,  $M'_1$ ,  $M'_2$ ) are part of a loop that adjusts the focusing currents so that no current flows in the borehole

between the two electrodes. For the deep measurement both measure and focusing currents return to a remote electrode on the surface; thus the depth of investigation is greatly improved, and the effect of borehole conductivity and of adjacent formations is reduced. In the shallow laterolog, instead, the return electrodes which measure the bucking currents are located on the sonde, and therefore the current sheet retains focus over a shorter distance than the deep laterolog.

The Dual Laterolog has a response range of 0.2 to 40,000 ohm-m, whereas the Phasor Dual Induction Tool (DIT) has a range of 0.2 to 2,000 ohm-m. The DLL is recommended for igneous environments (e.g., oceanic basalts and gabbros) because the resistivities can be higher than the upper limit of what the DIT can measure. However, in upper crustal environments (seismic Layers 2A and 2B), the resistivities are usually low enough that the DIT can be used. This was the case in data from, for example, ODP Legs 104 and 152 as well as Hole 395A.

The DLL is usually run in combination with the Scintillation Gamma Tool (SGT), but may be run with the Triple Combo or alone.

The depth of investigation of the laterolog depends on the resistivity of the rock and on the resistivity contrast between the zone invaded by the drilling fluid and the virgin (uninvaded) zone. The vertical resolution of both LLd and LLs depends on the geometry defined by the focusing electrodes: this is about 2 ft (61 cm).

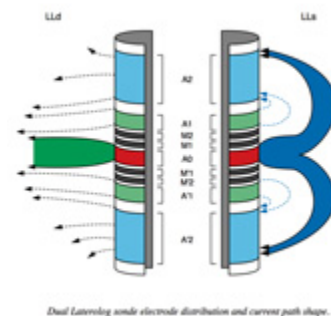

## ***Applications***

### **Porosity estimate**

Because of the inverse relationship between resistivity and porosity, the dual laterolog can be used to compute the porosity of the rock from Archie's equation if the sediments/rocks do not contain any clay or if the contribution of surface conduction to the signal is negligible.

### **Fracture Porosity Estimate**

This can be estimated from the separation between the deep and shallow measurements based on the observation that the former is sensitive to the presence of horizontal conductive features only, while the latter responds to both horizontal and vertical conductive structures.

---

## ***Environmental Effects***

For the LLD the borehole effect is small for hole diameters up to 16 in, while the LLs provides good readings in holes not exceeding 12 in. Corrections are available for holes up to 20 in (25 cm) in diameter.

---

## ***Log Presentation***

The LLD and LLs curves are usually displayed on a resistivity logarithmic scale, along with the gamma ray log.

---

## ***Tool Specifications***

Temperature rating:	350° F (175° C)
Pressure rating:	20 kpsi (13.8 kPa)
Diameter:	3.625 in (9.21 cm)
Length:	30.6 ft (9.35 m)
Weight:	222 lbs (100.8 kg)
Sampling interval:	6 in (15.24 cm)
Max. logging speed:	10,000 ft/hr (3,048 m/hr)

---

## ***Measurement Specifications***

Vertical resolution:	2.5 ft (76 cm)
Depth of investigation:	(see discussion in "Description" section)
Measurement range:	0.2-40,000 ohm-m

---

## ***Major Outputs***

LLD:	Deep laterolog (ohm-m)
LLS:	Shallow laterolog (ohm-m)

---

## ***Deployment Notes***

The DLL is usually run in combination with the Scintillation Gamma tool (SGT), but may be run with the triple combo or alone.

---

\* ®trademark of Schlumberger

# Integrated Ocean Drilling Program

## U.S. IMPLEMENTING ORGANIZATION



## Downhole logging tools

### Specialty Tools

#### Logging-While-Coring

#### Resistivity-at-the-Bit System (LWC-RAB8\*)

##### *Description*

The Logging-While-Coring (LWC) system, developed jointly by USIO/LDEO, Schlumberger Drilling and Measurements, and USIO/TAMU, takes advantage of existing logging, drilling and coring technologies and synthesizes them into a powerful new exploration system. Recent improvements in battery technology have enabled the reformatting of the electronics in an 8-inch Schlumberger Resistivity-at-Bit (RAB) tool. By placing smaller batteries in the drill collar wall, an existing ODP core barrel can pass through the RAB to carry out coring operations while making simultaneous azimuthal geophysical measurements. The coring tool technology consists of the Motor Driven Core Barrel (MDCB) system developed by USIO/TAMU, which needed only minor modifications and the fabrication of crossovers and drilling subs. The assembled system was tested at the Genesis test facility in Sugarland, Texas, and successfully deployed for the first time during ODP Leg 204.

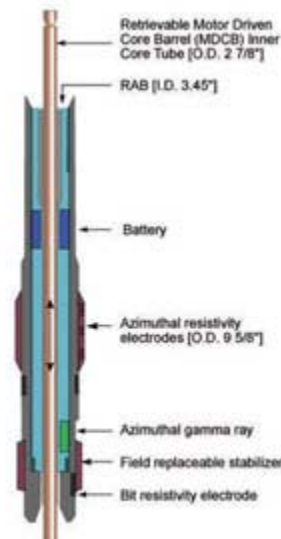

---

##### *Applications*

- Core-log data integration capability
- Assessment of borehole breakout for local and regional stress analyses
- Detection of formation heterogeneity using azimuthal resistivity images
- Lithology characterization

---

##### *Tool Specifications*

Tool make-up length:	13 ft (4 m)
Tool weight:	2,400 lbs (1,090 kg)
API nominal collar outside diameter:	8.25 in (21 cm)
Maximum outside diameter:	9 to 12.25 in (23 to 31 cm)
Minimum bit size:	9.75 in (25 cm)
Maximum bit size:	12.25 in (31 cm)
Maximum Temperature:	300° F (149° C)
Maximum pressure:	18 kpsi (12.4 kPa)
Flow range:	0-1,200 gpm
Pressure drop coefficient (C)*:	n/a
Maximum curvature - sliding:	13 deg/100 ft (13 deg/31 m)
Maximum rotary torque:	23,000 ft-lbf (7,010 m-lbf)
Minimum operating RPM:	30 rpm
Uphole connection:	6-5/8 FH box
Downhole connection:	6-5/8 Reg box

(\* ) pressure drop = [mudweight in ppg] x [flow in gpm]<sup>2</sup>/C

---

## ***Measurement Specifications***

<b>Gamma Ray</b>	
Measurement range:	0-250 GAPI
Accuracy:	7%
Vertical resolution:	6 in (15.24 cm)

### **Azimuthal resistivity**

Measurement range:	0.2-20,000 ohm-m
Accuracy:	5% (0.2-200 ohm-m); 20% (200-2,000 ohm-m) n/a (>2,000 ohm-m)
Vertical resolution:	2-3 in (5.08-7.62 cm)

<b>Ring resistivity</b>	
Measurement range:	0.2-20,000 ohm-m
Accuracy:	5% (0.2-2,000 ohm-m); 20% (>2,000 ohm-m)
Vertical resolution:	2-3 in (5.08-7.62 cm)

### **Bit resistivity**

Measurement range: 0.2-20,000 ohm-m  
 Accuracy: 5% (0.2-2,000 ohm-m); 20% (>2,000 ohm-m)  
 Vertical resolution: 12-24 in (30.5-61 cm)

---

***Additional information***



Assembly of the LWC-RAB8 Tools during an early test in Texas.

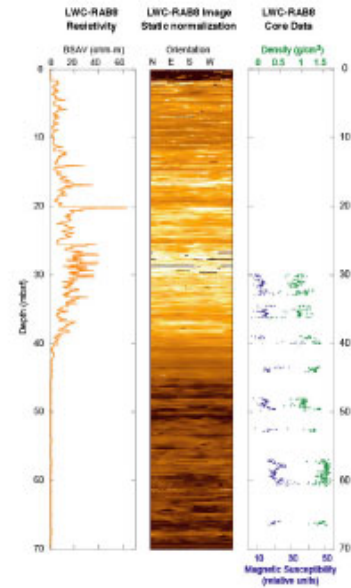

Resistivity image and average resistivity data from the LWC-RAB8 plotted with physical properties data from cores.

---

\* ®trademark of Schlumberger



# Integrated Ocean Drilling Program

## U.S. IMPLEMENTING ORGANIZATION



## Downhole logging tools

### Specialty Tools

#### Logging-While-Drilling

adnVISION Azimuthal Density Neutron Tool (LWD-ADN6\*)

#### *Description*

The adnVISION tool (LWD-ADN6) provides real-time apparent neutron porosity, formation bulk density and photoelectric factor data to characterize formation porosity and lithology while drilling. These nuclear measurements are borehole compensated for improved accuracy. 360-degree images of density and porosity result from the rotation of the tool's sensors. Along with the azimuthal data, average values for each parameter are also available.

The adnVISION radioactive sources are safely contained in the drill collar and are connected to each other by a titanium cable that allows fishing by wireline through the drill pipe.

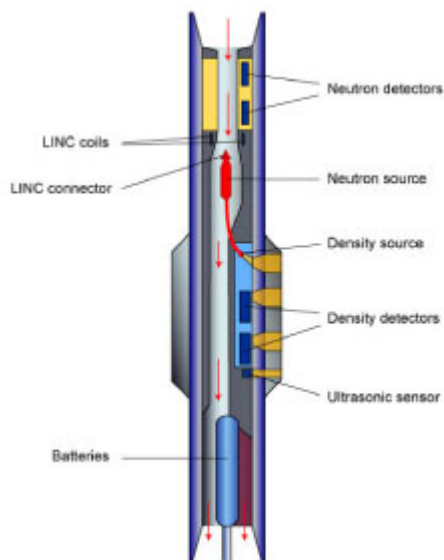

---

#### *Applications*

The ADN6 provides azimuthal borehole compensated formation density, neutron porosity and photoelectric factor measurements. Given present technological capabilities, estimations of bulk porosity and permeability are best made by in situ borehole measurements, preferably at scales large enough to average the effects of irregular

fracture porosity and matrix porosity. ADN6 measurements allow for determining both matrix and fracture porosity and locating overpressure zones.

The ADN6 can be combined with the MWD-TeleScope, which measures parameters such as annulus pressure, torque, and penetration rates. Together, MWD-TeleScope and ADN6 can render reliable measurements of effective pressure through both normal and overpressurized zones. If overpressurized zones exist within a fault zone, the magnitude and effects of fluid pressure on fault displacement and fluid flow can be assessed by estimating the amount of fluid expulsion (porosity reduction) in the immediate vicinity of the borehole.

Fault collapse and strain hardening, active fluid flow, fault-fluid interactions, and the formation of hydrofractures may occur within fault zones. Variations in fault displacement and fluid activity can be related to the in situ measurements to investigate the degree to which these processes are active. The ADN6 measurements of porosity and estimations of fluid pressure can illustrate the nature of the pressure seals as well as the physical processes responsible for fluid migration and redistribution along a fault zone or overpressure zones. The determination of the Vp and bulk modulus using sonicVISION (SWD6) and adnVISION data can also contribute to the understanding of the mechanical strength of the rocks within and near a fault zone. These LWD azimuthal measurements can be used to provide information regarding the spatial variation of physical properties around the borehole.

The ADN6 measurements can also provide porosity information as a function of borehole azimuth. To estimate strain from in situ porosity, lithological effects on these measurements must be first distinguished from the porosity effects. For this purpose, GVR6 resistivity and gamma ray measurements can be used to estimate any significant changes in clay mineralogy within a fault zone. Laboratory porosity measurements and thin sections of core samples allow observations of interstitial pore structures and can serve as a correlation tool for more refined calculations of continuous porosity records from the log data. The porosity and resistivity image data can provide information about fracture density, fracture aperture, and structural orientation in the vicinity of the hole. In addition, these data may be used to distinguish fractures that are transmissive from those that are not.

---

## ***Environmental Effects***

Laboratory measurements and mathematical modeling have been used to define the density and photoelectric response and to quantify environmental effects. These effects include gamma ray streaming, mud weight, tool standoff and photoelectric effects of formation and mud on density.

A reliable density measurement requires good contact between stabilizer and formation. Because a statistical caliper measurement is made during the recording, it is possible to check the quality of the contact. Contact also affects the neutron log response; the formation signal, particularly for the epithermal count rates, tends to be masked by the borehole signal with increasing hole size.

---

## ***Tool Specifications***

Tool make-up length:	20.5 ft (6.3 m)
Tool weight:	1,700 lbs (771.8 kg)
API nominal collar outside diameter:	6.75 in (17.1 cm)
Maximum outside diameter:	6.9 to 9.875 in (17.5 to 25 cm)
Minimum bit size:	6.75 in (17 cm)
Maximum bit size:	8.375 in (21.3 cm)
Maximum temperature:	300° F (150° C)
Maximum pressure:	25 kpsi (17.3 kPa)
Flow range:	0-800 gpm
Pressure drop coefficient (C)*:	135,000
Maximum curvature - sliding:	16 deg/100 ft (16 deg/31 m)
Maximum rotary torque:	16,000 ft-lbf (4.877 m-lbf)
Minimum operating RPM:	30 rpm
Uphole connection:	5-1/2 FH box
Downhole connection:	5-1/2 FH box

(\*) pressure drop = [mudweight in ppg] x [flow in gpm]<sup>2</sup>/C

---

## ***Measurement Specifications***

Porosity	
Measurement range:	0-100 pu
Accuracy:	±0.5 pu (<10 pu); 5% (10-50 pu)
Vertical resolution:	12 in (30.48 cm)
Density	
Measurement range:	1-3.05 g/cm <sup>3</sup>
Accuracy:	±0.015 g/cm <sup>3</sup>
Vertical resolution:	6 in (15.24 cm)
Photoelectric effect	
Measurement range:	0-10 barns/e <sup>-</sup>
Accuracy:	5% (1-10 barns/e <sup>-</sup> )
Vertical resolution:	2 in (5.08 cm)

---

## ***Major Outputs***

RHOB:	Bulk density (g/cm <sup>3</sup> )
DRHO:	Bulk density correction (g/cm <sup>3</sup> )
PEF:	Photoelectric factor (barns/e <sup>-</sup> )
TNPH:	Thermal neutron porosity (%)
DCAV:	Differential caliper (in)
NTCK:	Neutron detector sample depth tick mark
DTCK:	Density detector sample depth tick mark
ROP5:	Rate of penetration, average over last 5 ft (m/hr)

NTAB: Neutron time after bit (s)

DTAB: Density time after bit (s)

RPM: Rotational speed (rpm)

---

## ***Deployment Notes***

Along with the LWD collars, additional equipment such as jars must be included. Responsibility for providing this equipment is discussed at the pre-expedition meeting.



Assembly of the LWD-ADN6 tool  
aboard the *JOIDES Resolution*.

---

\* ®trademark of Schlumberger



## Downhole logging tools

### Specialty Tools

#### Logging-While-Drilling

arcVISION (LWD-ARC6\*)

##### *Description*

The arcVISION (LWD-ARC6) is a compensated array resistivity tool developed by Schlumberger for medium to large

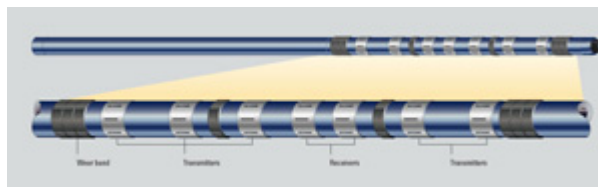

boreholes. The 6.75 in (17 cm) diameter tool makes multiple, borehole-compensated phase shift and attenuation resistivity measurements at two frequencies: 2MHz and 400kHz. The tool's antenna array consists of five transmitters and two receivers to achieve both a range of depths of investigations as well as borehole compensation. Multiple depths of investigation are useful to differentiate between borehole effects, invasion, shoulder beds, and anisotropy. Borehole compensation is important because it significantly reduces the effects of borehole rugosity. In addition to the resistivity measurements, the arcVISION also provide a non-azimuthal gamma ray measurement performed with a plateau sensor (NaI detector) and annular pressure-while-drilling (APWD), including real-time static pressure.

The tool can be operated in memory mode or in real-time mode in combination with the TeleScope MWD tool; also, it is combinable with any other LWD tool.

##### *Applications*

- The separation between the vertically matched resistivities can be used to discriminate between invasion and formation anisotropy
- Identification of impermeable beds - the resistivity curves will match in shales

##### *Tool Specifications*

Tool make-up length:	18 ft (5.49 m)
Tool weight:	1,800 lbs (817.2 kg)
API nominal collar outside diameter:	6.75 in (17 cm)

Maximum outside diameter:	7.5 in (19.05 cm)
Minimum bit size:	8.5 in (21.59 cm)
Maximum bit size:	10.5 in (26.67 cm)
Maximum temperature:	300° F (149° C)
Maximum pressure:	25 kpsi (17.3 kPa)
Flow range:	0-800 gpm
Pressure drop coefficient (C)*:	121,000
Maximum curvature - sliding:	16 deg/100 ft (16 deg/31 m)
Maximum rotary torque:	0 rpm
Minimum operating RPM:	30 rpm
Uphole connection:	5-1/2 FH box
Downhole connection:	NC-50 box

(\*) pressure drop = [mudweight in ppg] x [flow in gpm]<sup>2</sup>/C

---

## ***Measurement Specifications***

<b>Gamma Ray</b>		
Measurement range:	0-250 GAPI	
Accuracy:	3%	
Vertical resolution:	±2 GAPI at 100 ft/hr (31 m/hr)	
Vertical resolution:	6 in (15.24 cm)	
<b>Resistivity</b>		
	<b>Attenuation</b>	<b>Phase Shift</b>
Measurement range:	0.2-500 ohm-m	0.2-3,000 ohm-m
Accuracy (<25 ohm-m):	±3%	±2%
Accuracy (>25 ohm-m):	±1.5 mmho/m	±0.3 mmho/m
Vertical resolution at 0.2 ohm-m:	12 in (30.48 cm)	8.4 in (21.33 cm)
<b>Pressure While Drilling</b>		
Measurement range:	20 kpsi (9 kPa)	
Accuracy:	±20 psi (9 Pa)	
Vertical resolution:	±1 psi (0.45 Pa)	

---

## ***Major Outputs***

GR:	Gamma Ray (API units)
PnB:	Phase Shift Resistivity Blended, n=16, 22, 28, 34, 40 in (ohm-m)
PnH:	Phase Shift Resistivity, 2 MHz, n=16, 22, 28, 34, 40 in (ohm-m)
PnL:	Phase Shift Resistivity, 400 KHz, n=16, 22, 28,

	34, 40 in (ohm-m)
AnB:	Attenuation Resistivity Blended, n=16, 22, 28, 34, 40 in (ohm-m)
AnH :	Attenuation Resistivity, 2 MHz, n=16, 22, 28, 34, 40 in (ohm-m)
AnL:	Attenuation Resistivity, 400 KHz, n=16, 22, 28, 34, 40 in (ohm-m)
APRS:	Annulus Pressure (psi)
ATMP:	Annulus Temperature (degC)
ECD:	Equivalent Circulating Density (lb/gal)
AGTM:	Gamma Ray Time After Bit (s)
ARTM:	Resistivity Time After Bit (s)
ROP5_RM:	Rate of Penetration, average over last 5 ft (m/hr)
RPM:	Tool Rotational Speed (rpm)

---

\* ®trademark of Schlumberger



# Integrated Ocean Drilling Program

## U.S. IMPLEMENTING ORGANIZATION



## Downhole logging tools

### Specialty Tools

#### Logging-While-Drilling

EcoScope Tool (LWD-DVD6\*)

#### *Description*

The EcoScope is the first Schlumberger LWD multifunction tool that provides a complete set of formation evaluation measurements without using the traditional chemical sources. A pulsed neutron generator (PNG) replaces the americium-berillium (AmBe) source commonly used for porosity measurements, while an optional neutron gamma density measurement is performed without the traditional side-mounted Cesium source. This feature considerably reduces the risk previously associated with transportation and operations at the borehole site. Also, the PNG produces more high-energy neutrons than the traditional chemical source, which results in a deeper depth of investigation and therefore more accurate measurements of the properties of the formation. In addition to density and porosity measurements, the EcoScope offers the first LWD measurement of neutron-induced elemental gamma ray spectroscopy and sigma; these data provide mineralogy, lithology and matrix properties. Phase and attenuation resistivity at two frequencies (originally from ARC tool) and gamma ray, as well as some drilling parameters such as annular pressure-while-drilling, caliper, and shock complete the suite of measurements provided by the EcoScope.

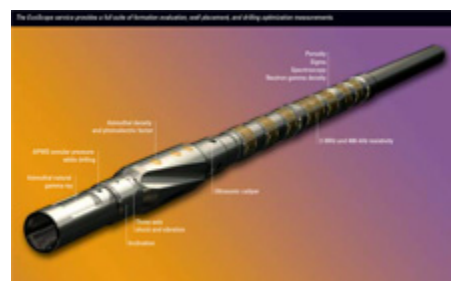

All drilling and measurement sensors are mounted on a single collar mounted close to the bit that can be deployed faster than conventional LWD tools; all EcoScope measurements are delivered in real-time to the surface via TeleScope high speed telemetry. The EcoScope large memory capacity allows for the recording of data at 2 points/ft (30.48 cm) at penetration rates up to 450 ft/hr (137 m/hr).

#### *Applications*

- Formation lithology and physical property evaluation
- Formation mineralogy from elemental gamma spectroscopy
- Drilling performance evaluation

---

## ***Tool Specifications***

Tool make-up length:	28 ft (8.5 m)
Tool weight:	3,200 lbs (1,453 kg)
API nominal collar outside diameter:	6.75 in (17 cm)
Maximum outside diameter:	7.875 to 9.375 in (20 to 23.8 cm)
Minimum bit size:	8.375 in (21.3 cm)
Maximum bit size:	9.875 in (32.5 cm)
Maximum temperature:	300° F (149° C)
Maximum pressure:	20 kpsi (13.8 kPa)
Flow range:	250-800 gpm
Pressure drop coefficient (C)*:	TBD
Maximum curvature - sliding:	16 deg/100 ft (16 deg/31 m)
Maximum rotary torque:	TBD
Minimum operating RPM:	30 rpm
Uphole connection:	5-1/2 FH box
Downhole connection:	5-1/2 FH box

(\*) pressure drop = [mudweight in ppg] x [flow in gpm]<sup>2</sup>/C

---

## ***Measurement Specifications***

<b>Gamma Ray</b>	
Measurement range:	0-250 GAPI
Accuracy:	7%
Vertical resolution:	6 in (15.24 cm)
<b>Resistivity</b>	
Measurement range:	0.2-3,000 ohm-m
Accuracy:	2% (<6 ohm-m); ±0.3 msec/m (>6 ohm-m)
Vertical resolution:	8.4 in (21.33 cm)
<b>Density</b>	
Measurement range:	1.7-3.05 g/cm <sup>3</sup>
Accuracy:	0.015 g/cm <sup>3</sup>
Vertical resolution:	6 in (15.24 cm)
<b>Porosity</b>	
Measurement range:	0-100 pu
Accuracy:	±0.5 pu (<10 pu); ±5% (10-50 pu)
Vertical resolution:	12 in (30.48 cm)
<b>Photoelectric effect</b>	
Measurement range:	1-10 barns/e <sup>-</sup>

Accuracy:	5%
Vertical resolution:	2 in (5.08 cm)

---

## ***Major Outputs***

RHOB:	Bulk Density (g/cm <sup>3</sup> )
DRHO:	Density Correction (g/cm <sup>3</sup> )
DRRT:	Correction for rotational density (g/cm <sup>3</sup> )
IDDR:	Image Derived Density Correction (g/cm <sup>3</sup> )
IDPE:	Image Derived Photoelectric Effect (g/cm <sup>3</sup> )
PEF:	Photoelectric Effect (barns/e <sup>-</sup> )
TNPH:	Thermal Neutron Porosity (%)
BPHI:	Best Thermal Neutron Porosity, Average (%)
DCAL:	Differential Caliper (in)
GRMA:	Gamma Ray, Average (GAPI units)
PnB:	Phase Shift Resistivity Blended, n=16, 22, 28, 34, 40 in (ohm-m)
PnH:	Phase Shift Resistivity, 2 MHz, n=16, 22, 28, 34, 40 in (ohm-m)
PnL:	Phase Shift Resistivity, 400 KHz, n=16, 22, 28, 34, 40 in (ohm-m)
AnB:	Attenuation Resistivity Blended, n=16, 22, 28, 34, 40 in (ohm-m)
AnH :	Attenuation Resistivity, 2 MHz, n=16, 22, 28, 34, 40 in (ohm-m)
AnL:	Attenuation Resistivity, 400 KHz, n=16, 22, 28, 34, 40 in (ohm-m)
APRS:	Annulus Pressure (psi)
ATMP:	Annulus Temperature (degC)
ECD:	Equivalent Circulating Density (lb/gal)
DWAL_WALK2:	Dry Weight % Pseudo Aluminum (Walk2 Mode)
DWCA_WALK2:	Dry Weight % Calcium (Walk2 Mode)
DWFE_WALK2:	Dry Weight % Iron (Walk2 Mode)
DWGD_WALK2:	Dry Weight % Gadolinium (Walk2 Mode)
DWK_WALK2:	Dry Weight Fraction Potassium (Walk2 Mode)
DWSI_WALK2:	Dry Weight Fraction Silicon (Walk2 Mode)
DWSU_WALK2:	Dry Weight Fraction Sulfur (Walk2 Mode)
DWTI_WALK2:	Dry Weight Fraction Titanium (Walk2 Mode)
AGTM:	Gamma Ray Time After Bit (s)
ARTM:	Resistivity Time After Bit (s)
TAB_DEN:	Density Time after Bit (s)
TAB_NEU:	Neutron Time after Bit (s)
ROP5_RM:	Rate of Penetration, average over last 5 ft

(m/hr)

RPM: Tool Rotational Speed (rpm)

---

\* ®trademark of Schlumberger

# Integrated Ocean Drilling Program

## U.S. IMPLEMENTING ORGANIZATION



## Downhole logging tools

### Specialty Tools

#### Logging-While-Drilling

sonicVISION Tool (LWD-SWD6\*)

#### *Description*

Acoustic waveforms are acquired while drilling with the Schlumberger Drilling and Measurement sonicVISION tool (LWD-SWD6). One transmitter and four receivers are positioned within a drill collar just above the bit to collect compressional transit times just seconds after the rock has been cut. As with all Logging-While-Drilling tools, formation data are collected before the borehole alteration or invasion occurs. The data are stored in memory and dumped upon collar retrieval, or they are pulsed in real time if an [MWD](#) tool is in use. Sonic data are then utilized in the traditional manner for sonic velocity, synthetic seismogram and correlation with wireline logs.

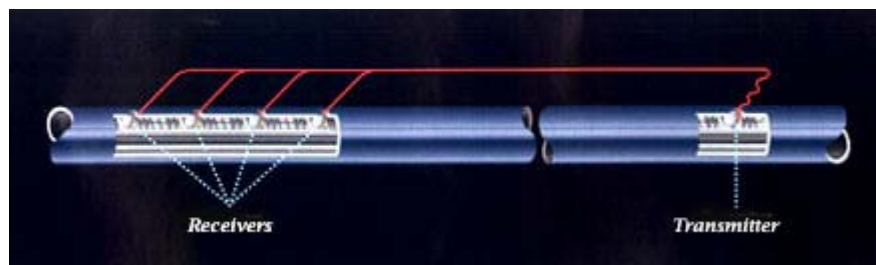

#### *Applications*

##### **Porosity and "pseudodensity" log**

The sonic transit time can be used to compute porosity by using the appropriate transform and to estimate fracture porosity in carbonate rocks. In addition, it can be used to compute a "pseudodensity" log over sections where this log has not been recorded or the response was not satisfactory.

##### **Seismic impedance**

The product of compressional velocity and density is useful in computing synthetic seismograms for time-depth ties of seismic reflectors.

##### **Sonic waveform analysis**

If a refracted shear arrival is present, its velocity can be computed

from the full waveforms, and the frequency content and energy of both compressional and shear arrivals can also be determined.

### Fracture porosity

Variations in energy and frequency content are indicative of changes in fracture density, porosity, and in the material filling the pores. In some cases compressional-wave attenuation can also be computed from the full waveforms.

## Log Presentation

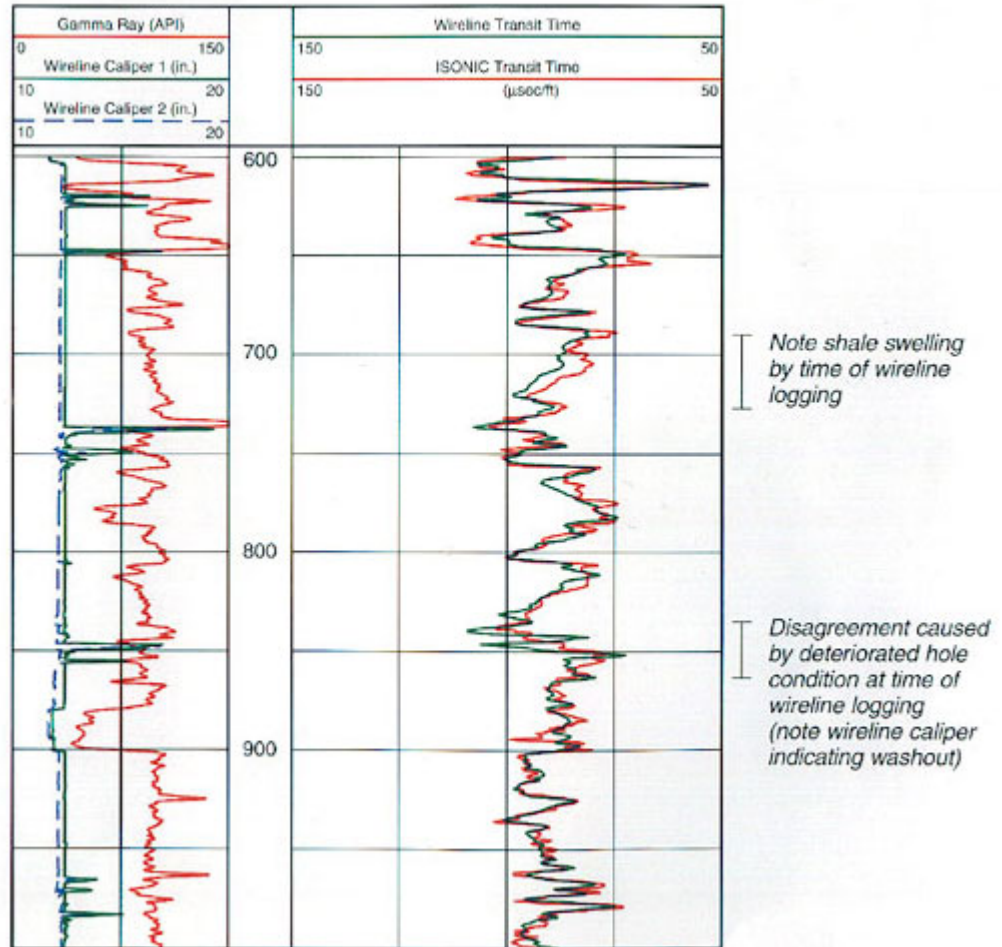

## Tool Specifications

Tool make-up length:	26 ft (7.9 m)
Tool weight:	2,600 lbs (1,180.4 kg)
API nominal collar outside diameter:	6.75 in (17 cm)
Maximum outside diameter:	7.5 to 9.875 in (19 to 25 cm)
Minimum bit size:	8.5 in (21.6 cm)

Maximum bit size:	14 in (35.6 cm)
Maximum Temperature:	300° F (149° C)
Maximum pressure:	25 kpsi (17.3 kPa)
Flow range:	0-800 gpm
Pressure drop coefficient (C)*:	256,000
Maximum curvature - sliding:	16 deg/100 ft (16 deg/31 m)
Maximum rotary torque:	16,000 ft-lbf (4.877 m-lbf)
Minimum operating RPM:	0 rpm
Uphole connection:	5-1/2 FH box
Downhole connection:	5-1/2 FH box

(\* ) pressure drop = [mudweight in ppg] x [flow in gpm]<sup>2</sup>/C

### ***Measurement Specifications***

Measurement range:	40 to $\Delta t_{mud}$ -20 microsec/ft
Accuracy:	$\pm 2$ microsec/ft
Vertical resolution:	24 in (61 cm)

### ***Major Outputs***

CHRA:	Coherence at compression peak, from receiver array
CHTA:	Coherence at compression peak, from transmitter array
DTBC:	Compressional slowness, borehole compensated ( $\mu$ sec/ft)
DTRA:	Compressional slowness, from receiver array ( $\mu$ sec/ft)
DTTA:	Compressional slowness, from transmitter array ( $\mu$ sec/ft)
DTCO:	Compressional slowness, computed downhole ( $\mu$ sec/ft)
CHCO:	Coherence at compression peak, computed downhole
ISTB:	Sonic Time after bit (s)

### ***Deployment Notes***

The LWD-SWD6 is combinable with all other Logging-While-Drilling tools with no reduction in the drilling rate.

\* ®trademark of Schlumberger



# Integrated Ocean Drilling Program

## U.S. IMPLEMENTING ORGANIZATION



## Downhole logging tools

### Specialty Tools

#### Logging-While-Drilling proVISION Tool (LWD-MRT6\*)

The Schlumberger proVISION Logging-While-Drilling (LWD-MRT6) tool performs magnetic resonance measurements in the borehole and transmits them in real-time to the surface. Magnetic resonance provides parameters that are not measured by traditional LWD tools such as permeability, free- and bound fluid-volume, type of fluid, and mineralogy-independent porosity. These allow for an accurate characterization of the formation without use of radioactive sources as well as direct detection of the presence of hydrates.

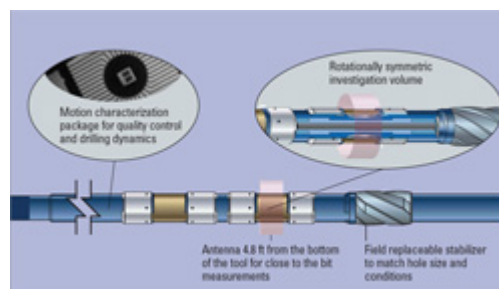

#### **Applications**

- Determination of free vs. bound fluid volume
- Detection of hydrates
- Measurement of mineralogy-independent porosity
- Fluid identification

#### **Tool Specifications**

Tool make-up length:	39 ft (11.9 m)
Tool weight:	3,900 lbs (1,771 kg)
API nominal collar outside diameter:	6.75 in (17 cm)
Maximum outside diameter:	7.75 to 10.375 in (20 to 26.4 cm)
Minimum bit size:	8.5 in (26 cm)
Maximum bit size:	10.625 in (27 cm)
Maximum temperature:	300° F (149° C)
Maximum pressure:	20 kpsi (13.8 kPa)
Flow range:	250-800 gpm

Pressure drop coefficient (C)*:	30,000
Maximum curvature - sliding:	16 deg/100 ft (16 deg/31 m)
Maximum rotary torque:	16,000 ft-lbf (4,877 m-lbf)
Minimum operating RPM:	0 rpm
Uphole connection:	5-1/2 FH box
Downhole connection:	5-1/2 FH box

(\*) pressure drop = [mudweight in ppg] x [flow in gpm]<sup>2</sup>/C

## ***Measurement Specifications***

Measurement range:	0-100 pu
Porosity accuracy :	±5 pu
Vertical resolution:	6 in (15.24 cm)

## ***Major Outputs***

BFV:	Bound Fluid Volume (%)
FFV:	Free Fluid Volume (%)
MRP:	Magnetic Resonance Porosity (%)
T2:	T2 Distribution (%)
T2LM:	T2 Logarithmic Mean (%)

\* ®trademark of Schlumberger

# Integrated Ocean Drilling Program

## U.S. IMPLEMENTING ORGANIZATION

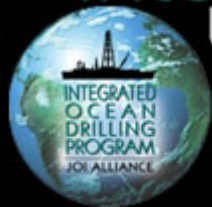

## Downhole logging tools

### Specialty Tools

#### Logging-While-Drilling

#### geoVISION Resistivity-at-the-Bit Tool (LWD-GVR6\*)

##### **Description**

The geoVISION Resistivity Tool (GVR6) makes laterallog resistivity measurements. As a formation evaluation tool, its application is limited to conductive muds. It may be run in several configurations and provides up to five resistivity measurements. The GVR6 contains a scintillation gamma ray detector which supplies a total gamma ray measurement. An azimuthal positioning system allows both gamma ray and various resistivity measurements to be acquired around the borehole. Additional measurements are chassis temperature and radial and longitudinal shocks.

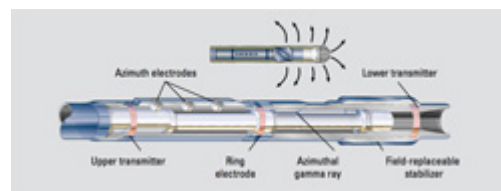

The GVR6 has a nominal 6.75-in (17 cm) diameter; it is meant to be run in 8.5-in (21.6 cm) holes. Designed to be a flexible component of the bottom hole assembly, the GVR6 may be connected directly behind the bit or further back in the bottom hole assembly.

A 1.5-in (3.8 cm) tall cylindrical electrode, located 3 feet from the bottom of the tool, provides a focused lateral resistivity measurement (RING) with a 2-in (5 cm) vertical resolution, independent of the location of the RAB tool in the bottomhole assembly. In addition, the RAB sub has three longitudinally spaced button electrodes that provide staggered depths of investigation. As the tool rotates, azimuthal measurements are acquired from the button electrodes. When connected directly to the bit, the GVR6 uses the lower portion (8-in; 20.3 cm) of the tool and the bit as a measure electrode. In this configuration, it provides a bit resistivity measurement (RBIT) with a vertical resolution just a few inches longer than the length of the bit.



The GVR6 measurements have a high vertical and azimuthal resolution. To make the most of the vertical resolution, the optimal sampling density is greater than one sample every inch. At the maximum sampling interval of 10 sec, the optimal sampling density can be achieved for rates of penetration up to 29.5 ft/hr (9 m/hr). Achieving this vertical sampling is most important when imaging.

---

## ***Applications***

The GVR6 tool provides four depth of investigation measurements to detect early invasion of borehole fluids into the formation, a sensor at the bit to ensure minimum invasion, azimuthal resistivity images of the borehole to detect resistivity heterogeneity, and a gamma-ray sensor for lithology characterization.

The GVR6 tool can also provide a close look at structural information within a fault zone or an active tectonic area with a resolution of 6-12 in (15-30 cm). The GVR6 measures oriented resistivity images of the borehole wall, similar to FMS and FMS images. Fracture orientations and distributions can be observed as resistivity contrasts in the image logs and are critical to recognize the extent of the deformation front along a tectonic front. Conversion of GVR6 images into relative porosity using Archie's equation can be used in combination with density and porosity data to help define the azimuthal distribution of porosity and overpressurized zones which may contribute to fluid flow along planes of structural weakness.

---

## ***Environmental Effects***

The button measurements have a shallow depth of investigation by design, in order to be sensitive to shallow invasion. When the GVR6 tool is centralized in a 8.5-in (21.5 cm) hole, the buttons are 0.1875 in (0.47 cm) from the formation. Controlling this standoff insures correct measurements. Therefore, proper centralization is recommended.

The GVR6 processing automatically corrects the resistivity measurements for frequency effects and the effects of the borehole.

---

## ***Log Presentation***

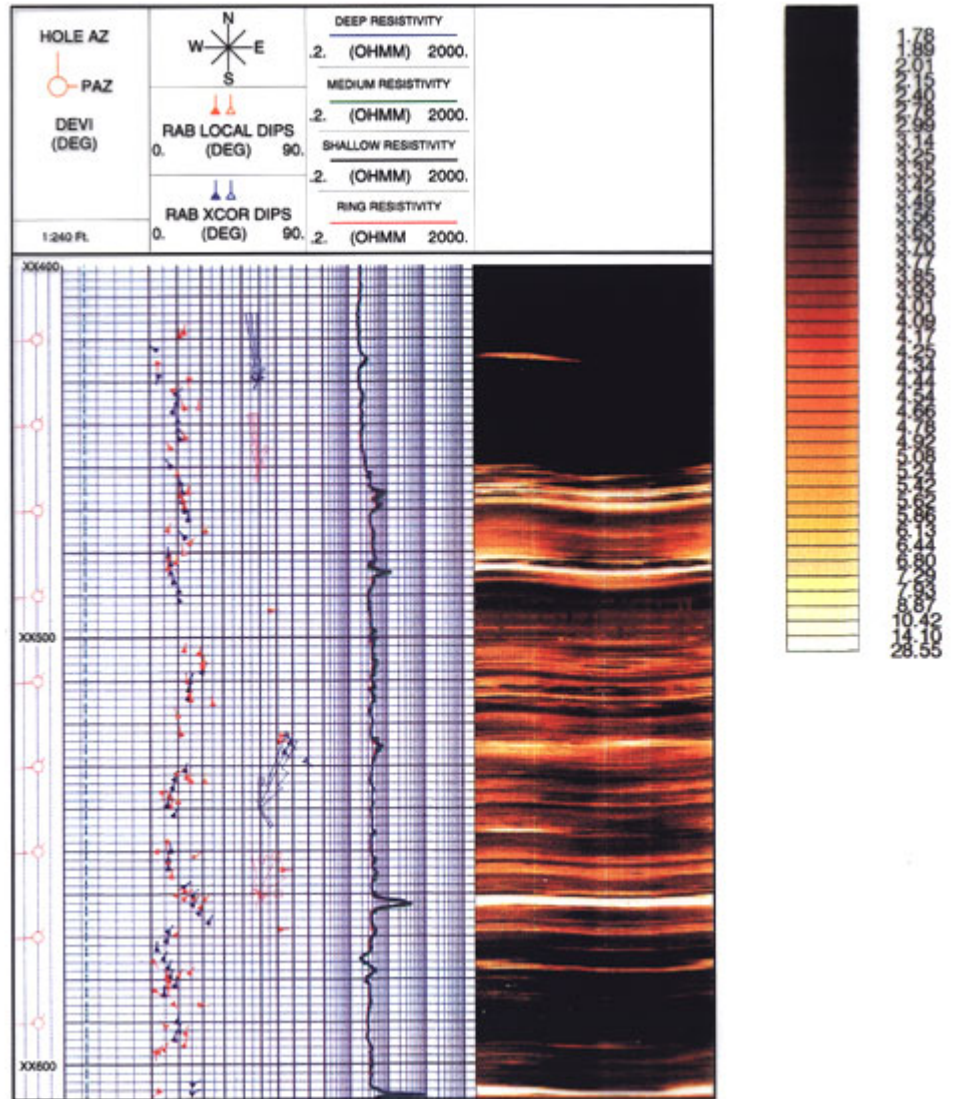

LWD-GVR6 output



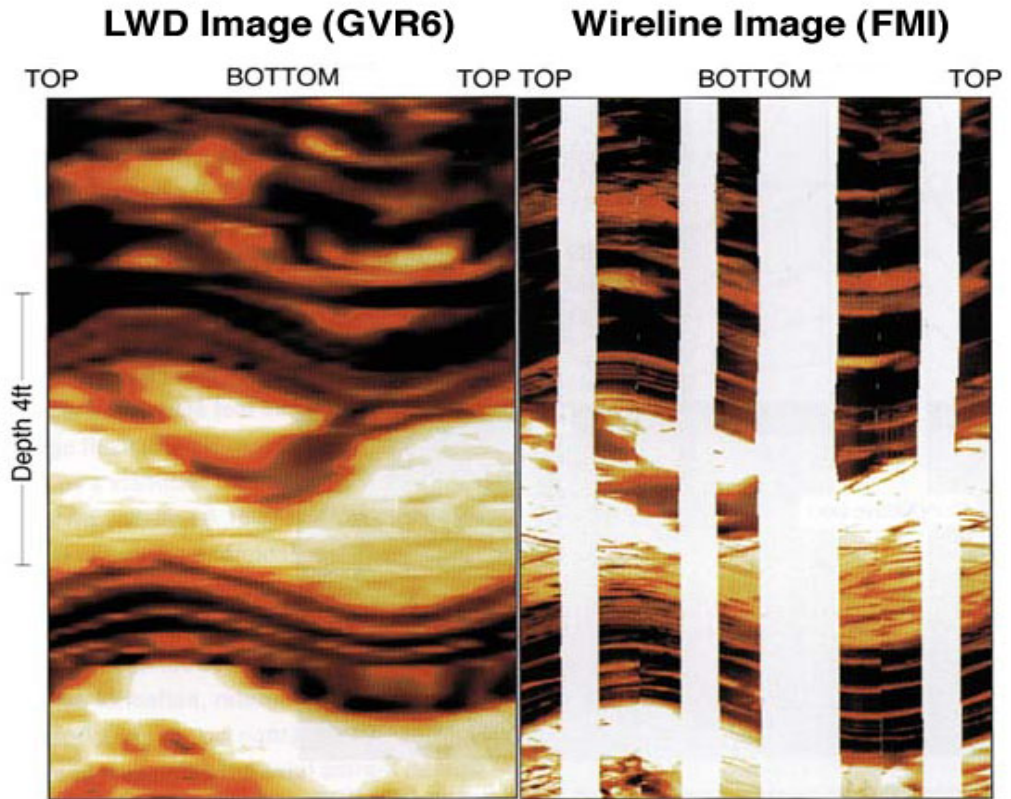

Comparison of LWD-GVR6 tool and wireline FMI tool electrical images in consolidated, highly fractured sediments. Both images of the interior of the borehole wall are oriented to the top of the deviated hole. Although the LWD tool has inferior bed resolution (by a factor of 30), it offers the advantage of data coverage around the entire circumference of the borehole and measurements within minutes after the hole has been drilled.

### ***Tool Specifications***

Tool make-up length:	10 ft (3.3 m)
Tool weight:	1,200 lbs (545 kg)
API nominal collar outside diameter:	6.75 in (17.1 cm)
Maximum outside diameter:	7.5 to 8.5 in (19.6 to 21.6 cm)
Minimum bit size:	8.5 in (21.6 cm)
Maximum bit size:	9.875 in (32.5 cm)
Maximum Temperature:	300° F (149° C)
Maximum pressure:	18 kpsi (12.4 kPa)
Flow range:	0-800 gpm
Pressure drop coefficient (C)*:	135,000

Maximum curvature - sliding:	16 deg/100 ft (16 deg/31 m)
Maximum rotary torque:	16,000 ft-lbf (4.877 m-lbf)
Minimum operating RPM:	30 rpm
Uphole connection:	5-1/2 FH box
Downhole connection:	5-1/2 Reg box

(\*) pressure drop = [mudweight in ppg] x [flow in gpm]<sup>2</sup>/C

---

## ***Measurement Specifications***

Gamma Ray	
Measurement range:	0-250 GAPI
Accuracy:	7%
Vertical resolution:	6 in (15.24 cm)

### Azimuthal resistivity

Measurement range:	0.2-1,000 ohm-m
Accuracy:	5% (0.2-200 ohm-m); 20% (>200 ohm-m)
Vertical resolution:	2-3 in (5.08-7.62 cm)

### Ring resistivity

Measurement range:	0.2-200,000 ohm-m
Accuracy:	5% (0.2-200 ohm-m); 20% (>200 ohm-m)
Vertical resolution:	3-4 in (7.62-10.16 cm)

### Bit resistivity

Measurement range:	0.2-200,000 ohm-m
Accuracy:	5% (0.2-200 ohm-m); 20% (>200 ohm-m)
Vertical resolution:	12-24 in (30.48-60.96 cm)

---

## ***Major Outputs***

GR:	Gamma ray average (API)
BDAV:	Deep resistivity average (ohm-m)
BMAV:	Medium resistivity average (ohm-m)
BSAV:	Shallow resistivity average (ohm-m)
RBIT:	Bit resistivity (ohm-m)
RING:	Ring resistivity (ohm-m)
RTIM:	Ring resistivity time after bit (s)
B1TM:	Shallow resistivity time after bit (s)
B2TM:	Medium resistivity time after bit (s)
B3TM:	Deep resistivity time after bit (s)
GRTK:	Gamma ray time after bit (s)



RBTM:	Bit resistivity time after bit (s)
RPM:	Rotational speed (rpm)
ROP5:	Rate of penetration per 5 ft (m/hr)
RTAB:	Ring time after bit (hr or min)
P1AZ:	P1 azimuth
HAZI:	Azimuth (deg)

Static and dynamic images are output at 3 depths of investigation: medium, shallow, and deep

---

### ***Deployment Notes***

Along with the LWD collars, additional equipment such as jars must be included. Responsibility for providing this equipment is discussed at the pre-expedition meeting.

---

\* ® trademark of Schlumberger

# Integrated Ocean Drilling Program

## U.S. IMPLEMENTING ORGANIZATION



## Downhole logging tools

### Specialty Tools

## Measurement-While-Drilling Telescope Tool (MWD-TeleScope\*)

### Description

The MWD-TeleScope tool is an in-line drill collar that records at-the-bit drilling parameters and telemeters the drilling parameter data as well as data from

other LWD tools to the surface in real-time. MWD measurements include downhole weight-on-bit and torque, shocks, temperature, flowrate, rate of penetration, borehole direction and inclination.



The tool uses a continuous mud wave, or siren-type, telemetry method and incorporates design features and software that enable it to approach data transmission rates of 6 to 12 bits per second.

### Tool Specifications

Tool make-up length:	28 ft (8.5 m)
Tool weight:	2,085 lbs (946.6 kg)
API nominal collar outside diameter:	6.75 in (17 cm)
Maximum outside diameter:	6.9 in (17.5 cm)
Minimum bit size:	8.375 in (21.3 cm)
Maximum bit size:	9.875 in (32.5 cm)
Maximum Temperature:	350° F (177° C)
Maximum pressure:	25 kpsi (17.3 kPa)
Flow range:	250-800 gpm
Pressure drop coefficient (C)*:	16,000
Maximum curvature - sliding:	15 deg/100 ft (15 deg/31 m)
Maximum rotary torque:	12,000 ft-3,658 m-lbf
Minimum operating RPM:	0 rpm
Uphole connection:	5-1/2 FH box
Downhole connection:	5-1/2 FH box

(\*) pressure drop = [mudweight in ppg] x [flow in gpm]<sup>2</sup>/C

---

## ***Measurement Specifications***

### Gamma Ray

Measurement range: 0-300 GAPI

Accuracy: ~ 13 GAPI

### Inclination

Measurement range: 0-180°

Accuracy: ±0.1° (stationary) and ±0.2°  
(continuous)

Resolution: 0.03° (stationary) and 0.1°  
(continuous)

### Azimuth

Measurement range: 0-360°

Accuracy: ±0.1° (above 5° stationary) and ±0.2°  
(continuous)

Vertical resolution: 0.5° (stationary) or 1° (continuous)

---

\* ®trademark of Schlumberger

# Integrated Ocean Drilling Program

## U.S. IMPLEMENTING ORGANIZATION



## Downhole logging tools

### Specialty Tools

#### SlimXtreme Array Induction Imager Tool (QAIT\*)

##### *Description*

Array Induction Imager tools accurately measure the borehole formation conductivity in open holes as a function of both depth and distance from the borehole; the SlimXtreme version (QAIT) used in the IODP was designed to work in slim holes under severe environmental conditions. Wireline array induction tools employ an array induction coil that operates at multiple frequencies. Software focusing of the received signals generates a series of resistivity logs with different depth of investigation. Thanks to the large number of measurements performed, it is possible to obtain quantitative two-dimensional (2D) imaging of the formation resistivity.

Measurement of the conductivity as a function of both depth and distance from the borehole greatly improves induction logging by increasing the depth of investigation of the measured signal as well as bringing the vertical resolution from 4 to 2 ft (1 ft in smooth boreholes).

---

##### *Tool Specifications*

Temperature rating:	500° F (260° C)
Pressure rating:	30 kpsi (206 kPa)
Diameter:	3 in (7.62 cm)
Length:	30.8 ft (9.39 m)
Weight:	499 lbs (226 kg)
Sampling interval:	6 in (15.1 cm)
Max. logging speed:	3,600 ft/hr (1,097 m/hr)

---

##### *Measurement Specifications*

Measurement range:	0.1-2,000 ohm-m
Accuracy:	approximately 2%
Vertical resolution:	1, 2 and 4 ft (30, 60, and 120 cm)

Depth of investigation: 10, 20, 30, 60, 90 in (25.4, 50.8, 76.2, 152.4, 228.6 cm)

---

### ***Deployment Notes***

The QAIT can be deployed with any tool string.

---

\* ® trademark of Schlumberger

# Integrated Ocean Drilling Program

## U.S. IMPLEMENTING ORGANIZATION



## Downhole logging tools

### Specialty Tools

#### Inline Checkshot Tool (QSST)

##### *Description*

The Schlumberger QSST is a single-axis seismic checkshot tool that runs in-line with the Triple Combo tool string. The QSST consists of a single hydrophone and does not utilize a clamping arm like the WST to force it into contact with the borehole wall. Seismic coupling is achieved by setting the tool on the bottom of the hole and allowing it to lean against the borehole wall, coupling passively to the formation.

The QSST then records the vertically incident signals at the bottom of the hole that are generated by a seismic source on the *JOIDES Resolution* (e.g., GI guns) positioned just below the sea surface.

The recorded signals enable a one-way traveltime to be determined from the surface to total depth, providing a check of travel-time vs. depth for calibration of seismic profiles and correction of synthetic seismograms. Off-bottom stations are not possible using the QSST. The rig time required to run this single-point checkshot survey is negligible since the QSST may be part of the Triple Combo logging run.

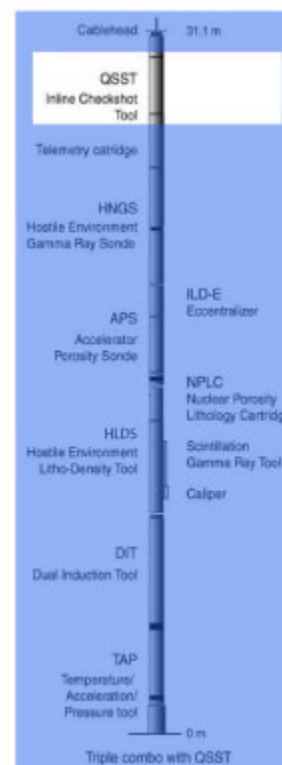

##### *Applications*

Quick seismic time-depth correlations for tying measured borehole seismic horizons with existing seismic survey data.

##### *Tool Specifications*

Temperature rating:	350° F (175° C)
Pressure rating:	20 kpsi (13.8 kPa)
Diameter:	3.375 in (8.573 cm)

Length:	6.9 ft (2.13 m)
Weight:	170 lbs (77.1 kg)
Primary sensor:	Single axis geophone
Geophone frequency:	14 Hz
Geophone damping:	0.27
Sensitivity:	4.1 V / m/s
Sampling rate:	1 ms
ADC resolution:	12 bits

---





About the IODP-USIO

## Downhole logging tools

### Specialty Tools

#### Ultrasonic Borehole Imager (UBI\*)

##### *Description*

The Ultrasonic Borehole Imager features a high-resolution transducer that provides acoustic images of the borehole. Critical borehole stability and breakout information can be derived from the accurate borehole cross section measured by the tool. The high-resolution image from the transducer is also ideal for measuring casing internal geometry. The rotating transducer incorporated in the UBI sonde is both a transmitter and a receiver. The transducer subassembly is available in a variety of sizes for logging the complete range of normal openhole sizes. The subassembly is also selected to optimize the distance traveled by the ultrasonic sound pulse in the borehole fluid by reducing attenuation in heavy fluids and maintaining a good signal-to-noise ratio. For open hole applications, the UBI tool is logged with the transducer operating at either 250 or 500 kHz. The higher frequency has better image resolution, but the lower frequency provides a more robust measurement in highly dispersive muds.

The UBI tool measures amplitude and transit time. An innovative processing technique improves accuracy, avoids cycle skips and reduces echo losses, which makes the UBI transit-time measurement as reliable as that of the amplitude. The tool is relatively insensitive to eccentricization up to 1/4 in (0.6 cm) and yields images that are clean and easy to interpret, even in highly deviated wells. Processing software further enhances UBI images by correcting amplitude and transit-time information for the effects of logging speed variations and tool eccentricity and by applying noise filtering. Transit times are

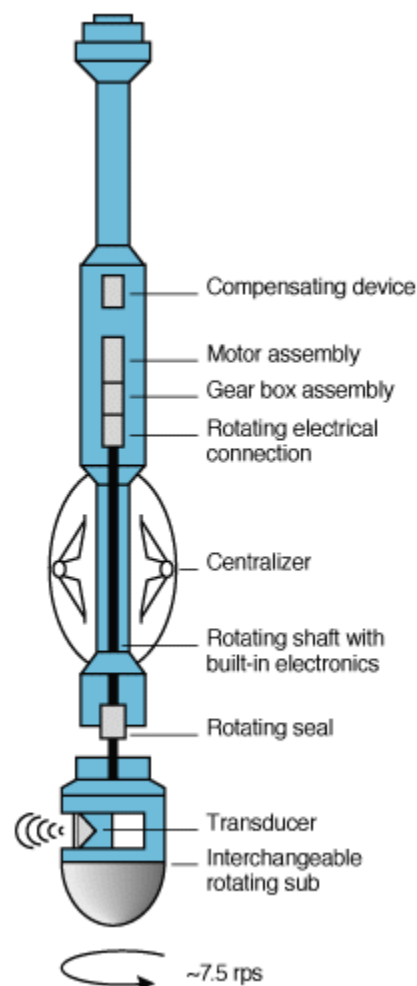

converted to borehole radius information using the velocity of the ultrasonic signal in mud, measured by the tool on the way down. The images are oriented with inclinometry data from the combinable GPIT inclinometry tool and then enhanced by dynamic normalization and displayed as an image for visual interpretation. Amplitude and radius image data can be loaded on a geology workstation for analysis and interpretation. Major events can be automatically extracted from the radius data for wellbore stability evaluation.

---

## ***Applications***

### **High-resolution geological interpretation**

The high resolution of open hole borehole wall images with 360° coverage makes the UBI tool suitable for dip and stratigraphic analysis, as well as fracture evaluation.

### **Borehole stability**

Borehole stability problems can lead to stuck pipe, lost time, and even the loss of equipment or part of the well, resulting in added drilling costs. The UBI radius and the cross-section analysis accurately report the shape of the borehole, enabling a clear and detailed analysis of the problem.

### **Stress analysis**

The UBI tool indications of stress anisotropy and orientation characterize borehole deformations such as breakouts for predicting perforation stability in unconsolidated formations. Shear sliding along a fracture or bedding plane can be detected with UBI radius measurements and cross-section plots, providing strong evidence of potential borehole and drilling problems.

---

## ***Tool Specifications***

Temperature rating:	350° F (177° C)
Pressure rating:	20 kpsi (13.8 kPa)
Diameter:	3.375 in (8.57 cm)
Length:	21 in (6.4 cm)
Weight:	377.6 lbs (171.4 kg)
Sampling interval:	0.1 in (2.54 mm)
Logging speed:	425 ft/hr (130 m/hr)- 2,125 ft/hr (648 m/hr) (depending on desired resolution)

---

## ***Measurement Specifications***

Vertical resolution:	0.2 in (0.51 cm) at 500 kHz 0.4 in (1.02 cm) at 250 kHz
Depth of investigation:	borehole wall
Accuracy:	borehole radius: ± 0.12 in (± 3 mm)

---

## ***Major Outputs***

Static and dynamic images are presented as an unwrapped borehole cylinder. Dark colors represent low amplitude and large radii, indicating borehole rugosity, enlargements and attenuative material. A dipping plane in the borehole appears as a sinusoid on the image: the amplitude of the sinusoid is proportional to the dip of the plane. The images are oriented with respect to the North; hence the strike of dipping features can be determined.

---

## ***Deployment Notes***

The UBI is typically deployed with the SGT and DSI tools.

---

\* ®trademark of Schlumberger

# Integrated Ocean Drilling Program

## U.S. IMPLEMENTING ORGANIZATION

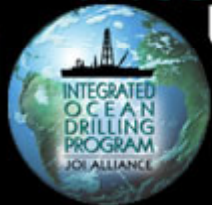

## Downhole logging tools

### Specialty Tools

#### Versatile Seismic Imager (VSI\*)

##### *Description*

The Versatile Seismic Imager (VSI) represents the latest available technology in the acquisition of seismic waves generated by a seismic source. The VSI employs three-axis single sensor seismic hardware and software and advanced telemetry for efficient transmission of the data from the borehole to the surface. Each sensor package delivers high-quality wavefields by using three-axis geophone omnitilt accelerometers, which are acoustically isolated from the main body of the tool and provide a flat response from 3 to 200 Hz. The configuration of the tool (number of sensor packages, sensor spacing, and type of connection (stiff or flexible), varies to provide the maximum versatility of the array. A maximum of 20 shuttles can be used, though only one has been used so far in the ODP and IODP. The anchoring, size, and acoustic isolation of the sensors allow for suppression of the tool harmonic noise and removal of tube waves from the borehole-seismic band. Furthermore, digitization close to the sensor package helps reduce signal distortion.



Among the benefits of using the VSI tool are the increased operating efficiency (rapid mechanic deployment and reduced time between stations), the short shot-cycle time during remote source surveys, and the real-time quality control and data processing.

The VSI tool can be combined with a gamma ray tool for accurate depth control and an inclinometry tool for spatial orientation.

The VSI was successfully deployed during ODP Leg 204 and IODP Expedition 312 on the JOIDES Resolution, with a 120 in<sup>3</sup> GI gun positioned just below the sea surface as the seismic source.

---

#### ***Applications***

- Integrated processing for interpretation of borehole and surface seismic data
- Planning for well placement
- Simultaneous surface and borehole seismic recording for high

definition images

- Shear wave processing and analysis

---

## ***Tool Specifications***

Temperature rating:	350° F (175° C)
Pressure rating:	20 kpsi (13.8 kPa)
Diameter:	3.625 in (9.21 cm)
Cartridge length:	20.9 ft (6.37 m)
Cartridge weight:	190.8 lbs (86.5 kg)
Shuttle length:	6.4 ft (1.96 m)
Shuttle weight:	70.6 lbs (32 kg)
Shuttle spacing:	8-40 ft (2.5-20 m)
Sensor length:	11.4 in (29 cm)
Sensor weight:	6.4 lbs (2.9 kg)
Sensor natural frequency:	25 Hz
Flat bandwidth in acceleration:	2-200 Hz
Length (multiple shuttles):	Up to 1,040 ft (317 m) for 20 shuttles
Weight (multiple shuttles):	Up to 2,200 lbs (998 kg)
Maximum number of shuttles:	20

---

## ***Measurement Specifications***

Logging speed:	Stationary
Sampling rate :	Seismic waveform recording: 1, 2, 4 msec
Combinability:	Bottom only

---

\* ®trademark of Schlumberger

# Integrated Ocean Drilling Program

## U.S. IMPLEMENTING ORGANIZATION



## Downhole logging tools

### Specialty Tools

#### Well Seismic Tool (WST\*)

##### *Description*

The WST is a Schlumberger single axis check shot tool used for zero offset vertical seismic profiles (VSP). The WST consists of a single geophone, pressed against the borehole wall, that is used to record the acoustic waves generated by an air gun located near the sea surface.

A 120 in<sup>3</sup> air gun is suspended by buoys at a depth of 3 mbsl, offset 48.5 m from the hole on the portside.

The WST is clamped against the borehole wall at intervals of approximately 50 m, and the air gun is fired five to seven times. The resulting waveforms are stacked and a traveltime is determined from the median of the first breaks in each trace. These check shot experiments attempt to reproduce the seismic reflection profiling by simulating a similar geometry and source

frequency. In general, the acoustic velocities, and resulting depth-traveltime pairs, determined from the sonic tool differ significantly from the seismic velocities because of frequency dispersion (e.g. the sonic tool works at 10-20 kHz vs. 50-100 Hz in seismic data) and because the sound is forced to travel along the borehole wall, a path this is quite different from the one taken by the air gun signal generated during a seismic reflection survey. In addition, sonic logs are not obtained above the bottom hole assembly, and the traveltime to the uppermost logging point has to be estimated by some other means.

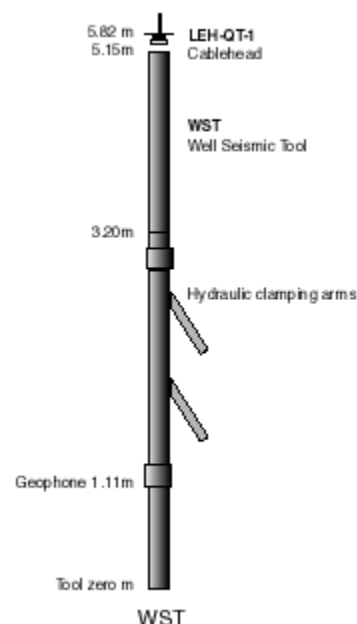

---

#### **Applications**

Depth-traveltime pairs determined from check shots can be used to produce a depth-traveltime plot and to calibrate the sonic logs and determine accurate drilling depths and their relative position with respect to targets on the seismic reflection profiles.

---

## ***Log Presentation***

The first arrival times are plotted against depth (the time vs. depth data derived from core and log sonic velocity measurements can be displayed on the same plot). The interval velocities (gradients of the time vs. depth plot between WST stations) can be plotted in the same track as the sonic velocity log. Velocities are given in km/sec; arrival times are measured in either milliseconds or seconds.

If the WST waveforms have been processed as a zero-offset VSP by the Schlumberger engineer on the Maxis, the resulting seismogram can be plotted vs. two-way-time alongside the seismic section and the synthetic seismogram.

---

## ***Tool Specifications***

Temperature rating:	350° F (175° C)
Pressure rating:	20 kpsi (13.8 kPa)
Diameter:	3.625 in (9.21 cm)
Length:	16.9 ft (5.15 m)
Sampling rate:	1, 2 or 4 msec
Max. logging speed:	Stationary

---

## ***Deployment Notes***

The WST is run alone and placed at stations at regular intervals. At each station a seismic shot is produced at the sea surface using either air or water guns provided by IODP-USIO Science Services, TAMU. Schlumberger provides a blast hydrophone for synchronizing the gun pulse with the system timer.

The WST and other downhole seismic tools are sensitive to pipe noise and ringing of pipe following a shot. Efforts should be made to reduce pipe noise at each station. If time and resources permit, a drill string packer may be deployed to dampen the banging motion of the pipe against the borehole. Also it is always prudent to leave 50 to 75 m distance between the tool and the bottom of pipe.

The WST requires TAMU involvement to provide air or water guns as the energy source. At the beginning of each expedition, it is important that the logging meets with the TAMU technicians to ensure that the guns can/will be ready for use. Typically, one week's notice is required before the guns can be used. If a WST tool deployment is not initially scheduled, a meeting with the co-chiefs must be planned to let them know that running the WST will require at least 7 days' notice prior to deployment.

The CSES should not be used with the WST for three primary reasons:





1. If the bottom of pipe is kept near the tool, it is likely that the tool will measure ringing in the pipe each time the gun is fired.
2. If a significant amount of pipe is downhole, there is a possibility that the pipe could generate noise in the data as the pipe bangs in the hole.
3. The WST is inherently risky to run because the tool is routinely stationary in a deteriorating borehole and must be clamped to the borehole creating additional risks. Use of the CSES may only exacerbate these risks by providing access to a hole that may be unsafe for the WST.

---

\* ®trademark of Schlumberger



## Downhole logging tools

### Specialty Tools

#### WST-3\*

##### *Description*

The WST-3 is a Schlumberger three axis check shot tool used for both zero offset (check shot) and offset vertical seismic profiles (VSP). The WST-3 consists of three geophones which press against the borehole wall and record the acoustic waves generated by an air gun located near the sea surface. The tool was designed specifically for use in an offset VSP experiment, where a remote seismic source would be fired from a second ship. The tool is compatible with Schlumberger's latest data acquisition system, and data output is in SEG-Y format.

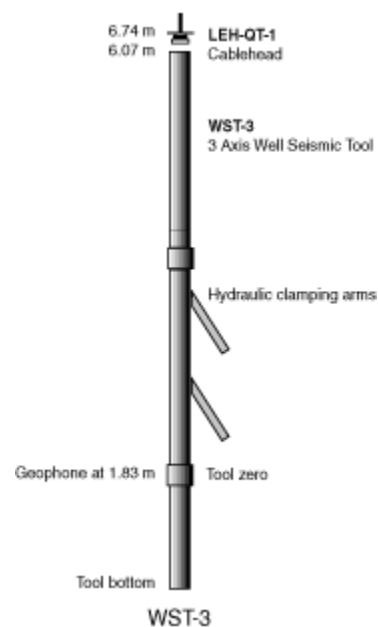

##### *Applications*

Offset VSP data acquired by the WST-3 are useful for:

- Providing seismic interval velocities which can be compared to the rock sequence intersected by the borehole
- Placing the borehole results in their proper setting with respect to the seismically defined structure of the oceanic crust and mantle
- Correlating borehole lithology with the up-going seismic reflected wavefield
- Predicting structure and lithology changes below the drill hole
- Estimating physical properties of rock on seismic scales by studying particle motion and downhole seismic attenuation

In check shot mode, the WST-3 data can be used to produce a depth-traveltime tie and to calibrate the sonic logs and determine accurate drilling depths and their relative position with respect to targets on the seismic reflection profiles.

## ***Tool Specifications***

### **Mechanical:**

Temperature rating:	350° F (175° C)
Pressure rating:	20 kpsi (13.8 kPa)
Diameter:	3.625 in (9.21 cm)
Length:	19.9 ft (6.07 m)
Weight:	310 lbs (141 kg)
Sampling interval:	1, 2 or 4 msec (selectable)
Min. hole diameter:	5 in (12.7 cm) with "short" arms
Max. hole diameter:	19 in (48.3 cm) with "long" arms
Max. logging speed:	Stationary

### **Sensors:**

Axis:	3 axis
Geophone:	One per axis
Geophone type:	SM4 (3ea gimbaled)
Geophone frequency:	10 Hz
Damping:	60 dB
Sensitivity per axis:	83 V/m/sec or 0.8 V/in/sec at 25° C
Low-cut frequency:	0.2 Hz
Low-cut slope:	18 dB per octave
High-cut frequency :	250 Hz for 1 msec or 125 Hz for 2 and 4 msec sampling
High-cut slope:	36 dB per octave
Digitization:	Downhole
Sampling rate:	1, 2 or 4 msec (selectable)
ADC resolution:	11 bit + sign
Autoranger steps:	Five 6 dB steps
Preamplifier gain:	40 - 160 dB by 6 dB steps for each axis
Dynamic range per waveform (shot):	90 dB
Total dynamic range:	156 dB
Input noise level:	2 $\mu$ V
Anti-aliasing filters:	330 Hz / 24 dB per octave

---

## ***Deployment Notes***

The WST-3 can be used in both checkshot and offset vertical seismic profile experiments. A remote seismic source is required for an offset survey, while a traditional check shot survey can be completed with

experiment, the deployment routine for the WST-3 is approximately the same. The main difference is simply the location of the source and the handling of the trigger pulse.

For a check shot, a 120 in<sup>3</sup> air gun is suspended by buoys at a depth of 3 mbsl, offset 48.5 m from the hole on the portside. The WST-3 is clamped against the borehole wall at intervals of approximately 50m, and the air gun fired five to seven times. The resulting waveforms are stacked and a travel-time is determined from the median of the first breaks in each trace. These check shot experiments attempt to reproduce the seismic reflection profiling by simulating a similar geometry and source frequency.

The WST-3 is always the last tool run and it is always run alone. At each selected station, a seismic shot is produced at the sea surface using either air or water guns provided by IODP-USIO Science Services, TAMU. Schlumberger provides a blast hydrophone for synchronizing the gun pulse with the system timer.

The WST-3 and other downhole seismic tools are sensitive to pipe noise and ringing of pipe following a shot. Efforts should be made to reduce pipe noise at each station. If time and resources permit, a drill string packer may be deployed to dampen the banging motion of the pipe against the borehole. In addition, it is always prudent to leave at least 50 to 75 m distance between the tool and the bottom of pipe.

The WST-3 must be powered with a 400 Hz power supply to avoid 60 Hz noise generated when a 60 Hz power supply is used.

The CSES should not be used with the WST-3 for three primary reasons:

1. If the bottom of pipe is kept near the tool, it is likely that the tool will measure ringing in the pipe each time the gun is fired.
2. If a significant amount of pipe is downhole, there is a possibility that the pipe could generate a noise in the data as the pipe bangs in the hole.
3. The WST-3 is an inherently risky tool to deploy because the tool is held in a stationary position in a deteriorating borehole. Use of the CSES may only exacerbate these risks by providing access to a hole that may be unsafe for the WST-3.

---

\* ®trademark of Schlumberger

# Integrated Ocean Drilling Program

## U.S. IMPLEMENTING ORGANIZATION



About the IODP-USIO

## Downhole logging tools

### Stuck/lost tools

Stuck and lost tools are a normal occupational hazard of logging. In spite of our best efforts to avoid tool loss, Schlumberger strings have been lost on ODP Legs 101, 113, 117, 122, and 175. These strings are expensive and therefore are insured against loss in a hole; however, the shipboard loggers try their best to avoid sticking a tool, to recover a stuck tool, and to fish for a lost tool.

If a tool is lost downhole, a reasonable effort must be made to recover it in order to satisfy obligations to Schlumberger and the insurance provider. The recovery effort should follow accepted practices and include multiple recovery attempts if technically feasible. USIO/LDEO must be notified immediately by the Logging Staff Scientist or the drilling superintendent if a tool is stuck or lost.

If all reasonable efforts have been made to recover a stuck or lost tool without success, then the decision to abandon the tool must be made collectively by the Logging Staff Scientist, Operations Superintendent, Rig Superintendent and the Schlumberger engineer. A report must be filed by the Operations Superintendent and delivered to the Logging Staff Scientist. In the event of loss involving a radioactive source, the hole must be cemented to safely entomb the sources, and then abandoned.

---

### *Strategies*

There are four main types of tool "sticking" situations:

1. The tool is either stuck in a bridge or stuck by cavings (possibly beneath a bridge).
2. The tool is not stuck but cannot be pulled up past a bridge.
3. The tool is stuck in the base of pipe.
4. The tool is not stuck but cannot get into pipe

Several strategies are available for dealing with stuck tools:

#### **1. Pulling harder on the cable**

Pulling harder on the cable is recommended as the first course of action when a tool appears to be stuck. Pulling may not exceed the combined cable weight plus weak point strength, or 50% of cable strength, whichever is less. With this method, there is a higher chance of recovery in situations #2 and #4 than #1 and #3.

## 2. Adding pipe (if using the CSES)

If the CSES is used, stands of pipe may be added to break through a bridge or cuttings (situations #1 and #2). Cable tension should be maintained when lowering pipe to prevent: (A) cutting through or kinking a slack cable with the pipe; or (B) sudden dropping of the tool when the tool is freed (a 10'-30' free fall of the tool may be enough to snap the weak point). Once the tool is free, you can pull it well into pipe, raise pipe, and go back down to resume logging.

## 3. Cutting and stripping

Cutting and stripping involves clamping the cable at the drill floor, cutting it, then either adding or removing a stand of pipe. For every 30 m of pipe added or removed, the cable must be threaded in or out of the pipe and re-clamped. In situations #1 or #2, one would add pipe to break through the bridge. In situations #3 and #4, one would remove pipe, eventually pulling the tool on deck with the bottom hole assembly. One disadvantage of cutting and stripping is that all of the cut cable will be discarded (perhaps 1000-3000m) and this may not leave enough cable on the spool for subsequent logging. The Logging Staff Scientist is responsible for making this determination. Cutting and stripping is also not the most favorable alternative because it is time consuming. Cutting and stripping is not needed for situations #1 and #2 if the CSES is in the string, but a modified type of cutting and stripping may be possible with situations #3 and #4 with the CSES.

## 4. Using the Kinley crimper/cutter

The Kinley crimper and cutter system greatly increases the safety of downhole tool recovery operations. The crimper/cutter procedure is **extremely** sequence sensitive. The crimper slides down the wireline and stops about 10m above the base of the bottom hole assembly (BHA), then a hammer is sent down to fire the crimper which crimps the logging cable against the BHA. A successful crimp **must** be observed by the Schlumberger engineer by checking for an electrical short inside the cable. If successful, the cutter is dropped and the cut logging cable is reeled in. The tool is held inside the BHA and recovered by pulling pipe to the rig floor. Crimping and cutting works well for situation #4 but is no guarantee of success. During Leg 175, the Kinley crimper was used to secure the tool in the pipe but it failed to adequately crimp the cable. As the tool and drill pipe were being pulled to the surface, the toolstring dislodged itself and fell to the seafloor where it could not be retrieved.

## 5. Additional strategies

In 1988, Glen Foss (Operations Superintendent at ODP/TAMU), put together a detailed memo on wireline stripping operations. This is **highly recommended reading**.

In addition, USIO/LDEO has compiled a list of very dangerous situations to avoid when logging, along with strategies to avoid and cope with them.

To some degree, each stuck/lost tool situation is unique, and it is impossible for any guidelines we give to always be appropriate. Thus, the recommendations given in the following table should be considered as suggestions only, not requirements:

<b>CSES</b>					
<b>PROBLEM</b>	<b>SOLUTIONS</b>				<b>COMMENTS</b>
	add pipe	cut & strip	crimp & cut	pull cable to failure	
#1. Stuck in bridge and cuttings	YES	--	--	--	--
#2. Cannot pull past bridge	YES	--	--	--	--
#3. Stuck in base of pipe	--	YES <sup>a</sup>	YES <sup>b,f</sup>	YES <sup>e</sup>	d
#4. Cannot get into pipe	--	YES <sup>a</sup>	YES <sup>b</sup>	--	c

<b>NO CSES</b>					
<b>PROBLEM</b>	<b>SOLUTIONS</b>				<b>COMMENTS</b>
	add pipe	cut & strip	crimp & cut	pull cable to failure	
#1. Stuck in bridge and cuttings	--	YES	NO	--	--
#2. Cannot pull past bridge	--	YES	YES	--	--
#3. Stuck in base of pipe	--	YES	YES <sup>f</sup>	YES <sup>e</sup>	d
#4. Cannot get into pipe	--	YES	YES	--	c

a - if a feasible technique can be worked out

b - after pulling the CSES on deck, and detaching it from the drill string



- c - first figure out what is hanging up, circulate while trying (especially with lockable flapper), rotate the drillstring half a turn, and keep trying to pull out (a centralizer or bow spring can sometimes be snapped deliberately by repeated trials)
- d - first try circulating to free the tool, with a slightly slack cable
- e - a last resort if cutting and stripping is rejected; hopefully the tool will break free before failure or, if not, be so well stuck that it will be pulled up with the BHA
- f - if the tool is too far into the pipe, the crimper will not be able to seat

# CORK Borehole Observatory

## Scientific Application

The CORK (Circulation Obviation Retrofit Kit) was designed for thermal and pressure characterization of subseafloor hydrology over an open formation interval in a variety of hydrologic settings. The CORK seals the top of the casing in an Ocean Drilling Program (ODP) reentry cone installation to prevent circulation between the open hole and ocean bottom water. CORKs are designed for long-term in situ monitoring of temperature and pressure as well as collecting borehole fluid samples through added tubing and valves. The CORK also provides a means to hang a third-party sensor or an osmotic sampler (to collect geochemical samples) in the casing and open hole. Remotely operated vehicles (ROVs) or submersibles are routinely used to retrieve the data from the top of a CORK for shore-based study. If the CORK can be attached to an existing subsea cable, data can be downloaded in real time.

## Tool Operations

A reentry cone with a 16 in. and 10<sup>3</sup>/<sub>4</sub> in. casing is initially installed. The CORK is run on the end of the drill string and reenters the cased hole, but does not land in the cone. The instrument string is lowered on a wireline cable through the drill string into the casing and open hole until the electronic data logger lands in the CORK. With the instrument string suspended from the CORK, the data logger package is hydraulically latched into the CORK. The CORK then lands in the reentry cone, seals in the casing hanger, and is hydraulically latched in place, leaving the top of the CORK exposed in the reentry cone above the seafloor. An ROV platform is free-fall deployed to complete the installation (for more information on CORKs see Becker and Davis, 1998).

## Design Features

### 1) Casing Design

Casing is set and cemented through the sediments. If the formations are stable, a 9<sup>7</sup>/<sub>8</sub> in. hole is cored out below the 10<sup>3</sup>/<sub>4</sub> in. casing to access the zone of interest. If the hole is unstable, it is fully cased, and the zone of interest is accessed via a screened or perforated casing.

*Benefit:* Isolates the hydrogeologically active formations from the ocean bottom water. Screened casing prevents hole collapse, which could seal off the bottom of the CORK casing.

## 2) Casing Seal

An elastomer seal package is expanded in the top of the casing.

*Benefit:* Prevents flow into or out of the top of the casing effectively sealing the borehole.

## 3) Sensor String (third-party tool supplied by scientist)

Instruments can be deployed and retrieved from the CORK using the *JOIDES Resolution*, work boats, submersibles, or ROVs. The basic sensor string incorporates a pressure gauge and thermistor at the seafloor as well as pressure gauges and multiple thermistors that are spaced along a cable through the borehole.

*Benefit:* Determines in situ formation temperatures and monitors temperatures and pressures for indications of hydrologic events at the seafloor and within the borehole.

## 4) Data Logger with Memory (third-party tool supplied by scientist)

Temperature and pressure data can be recorded and stored in the data logger unit.

*Benefit:* Long-term borehole data can be downloaded periodically via a submersible or ROV.

## 5) Borehole Fluid Sampling (third-party tool supplied by scientist)

Hydraulic tubing or pipe run from the CORK into the borehole can provide in situ water samples, which are collected via a valve in the CORK at the seafloor.

*Benefit:* The tubing can allow borehole fluid samples to be recovered at the seafloor, and tests can be performed while monitoring pressure (e.g., injecting fluid into the borehole). Two adjacent CORKs would allow hole-to-hole hydrologic tests (pulse, injection, and fluid production).

## 6) Osmotic Sampler (third-party tool supplied by scientist)

Modular downhole osmotic fluid samplers can sample and store in situ fluids over long periods of time.

*Benefit:* Formation fluids can be accessed for long-term geochemical evaluation.

## 7) Submersible/ROV Operations

The CORK extends above the reentry cone, and a landing platform is provided for access by submersibles or ROVs. Borehole fluid sampling and injection is accomplished via a hydraulic line and control valve, which are accessed via a window in the side of the CORK.

*Benefit:* Data and fluid samples can be retrieved by submersible/ROV operations without the ***JOIDES Resolution***.

## CORK Specifications

### **Hydraulic Connector Type**

Aeroquip FD72 "push-on/pull-off" male hydraulic connector

### **Electrical Connector**

Wet-mateable RS-232 connectors to data logger for ROV intervention

### **Minimum Inner Diameter through CORK (without data logger in place)**

3.5 in. (89 mm)

## Limitations

CORK technology only allows monitoring of the average conditions represented by either the full interval of the open hole below casing or a screened or perforated interval in a fully cased hole.

The sensor string and data logger are limited to diameters of less than 3.75 in. because they are deployed through the drill string.

Borehole fluid sampling and the use of an osmotic sampler are limited by the long time period required to displace the seawater from the sampling tube with formation fluids.

Borehole fluid samplers are currently not proven operational instruments.

A reentry cone installation with casing cemented in place is required to install a CORK. Once a CORK is installed, the CORK blocks all borehole reentry operations until it is removed.

Removal of the CORK requires the use of the ***JOIDES Resolution*** or a similar vessel.

The downhole osmotic sampler is a self-contained, modular fluid sampler driven by an osmotic pump. It can only be recovered when the sensor string and data logger are recovered, which exposes the sampling interval to ocean bottom water.

## Reference

Becker, K., and Davis, E.E., 1998. Advanced CORKs for the 21st Century. *JOI/USSSP-sponsored workshop report* [Online]. Available from World Wide Web:

<[http://www.joiscience.org/USSSP/Workshops/AdvancedCORKs/Advanced\\_CORK\\_report.html](http://www.joiscience.org/USSSP/Workshops/AdvancedCORKs/Advanced_CORK_report.html)>. [Cited 2001-05-02]

**Figure 1.** Schematic of a CORK installed in a reentry cone, which has 16 in. and 10<sup>3</sup>/<sub>4</sub> in. casing set. The CORK data logger and fluid sampling ports extend above the top of the reentry funnel, and a platform is free-fall deployed to the top of the funnel to provide access for submersibles/ROVs. The CORK seals the 10<sup>3</sup>/<sub>4</sub> in. casing. An optional third-party instrument string can be installed.

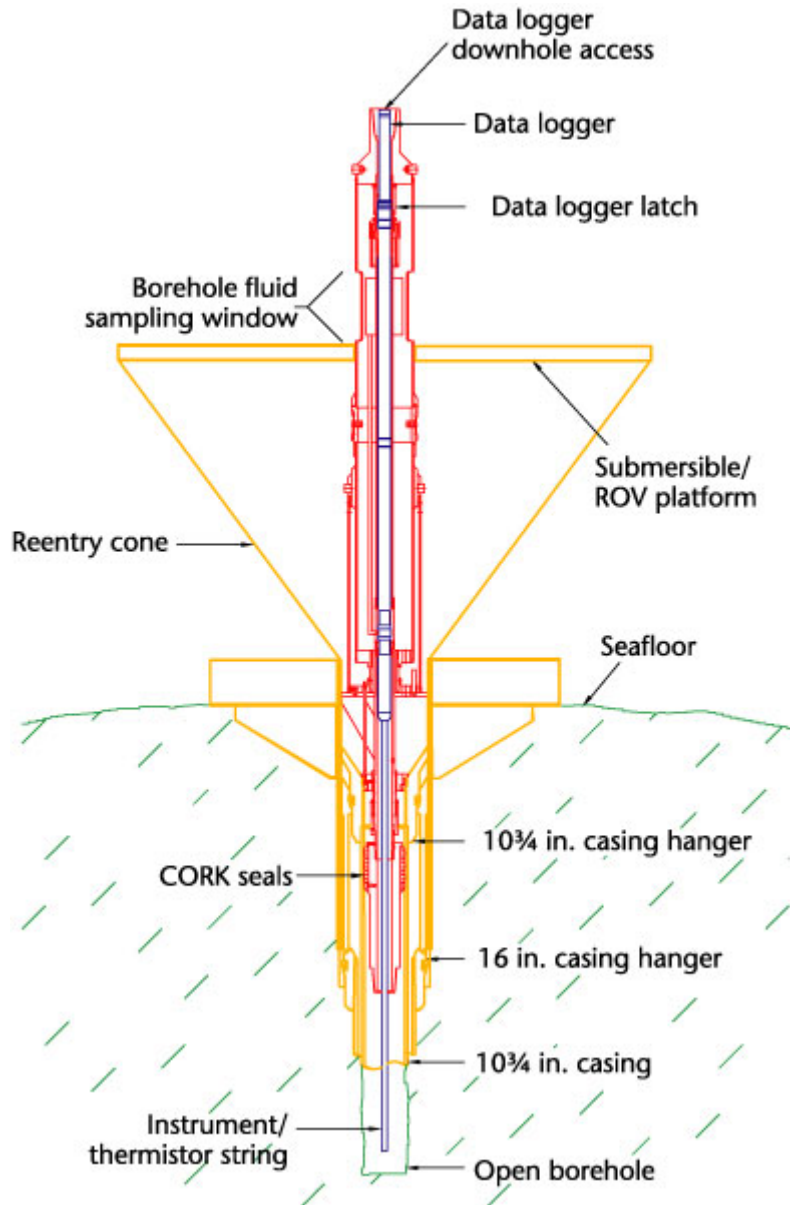

**Figure 2.** Lower portion of CORK with seal elements being prepared for installation in the reentry cone.

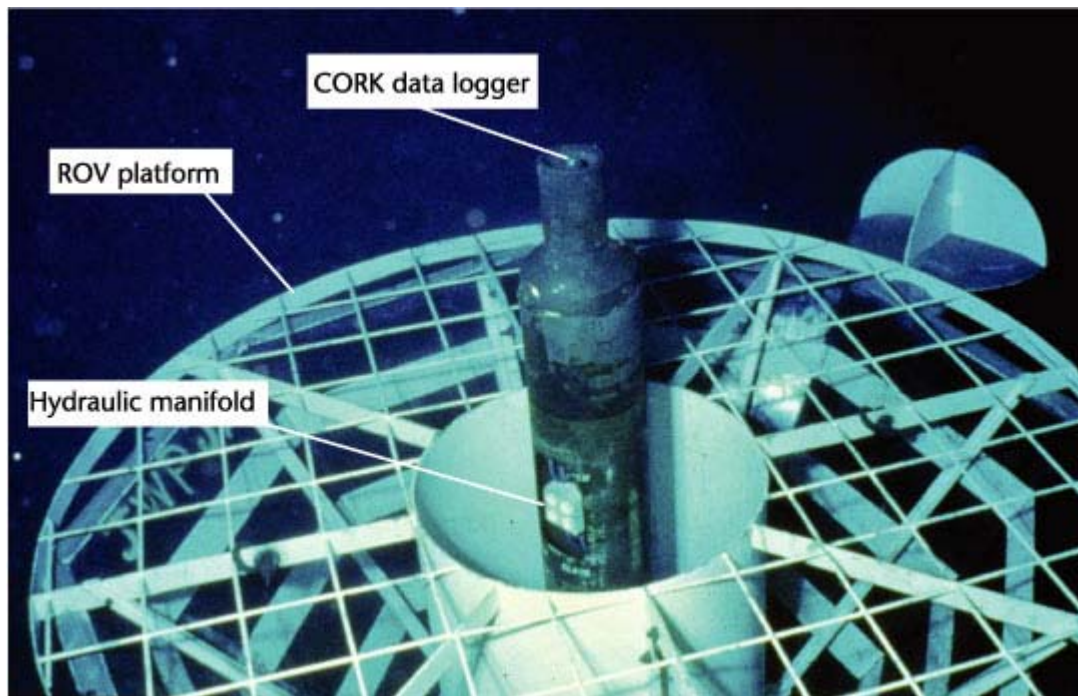



**Figure 3.** ROV platform being assembled in the moonpool for free-fall deployment to finish the CORK installation in the reentry cone.



**Figure 4.** Subsea photograph of one of the first CORKs installed during Leg 139 in 1991. Water depth is 2400 m.



# ACORK Borehole Observatory

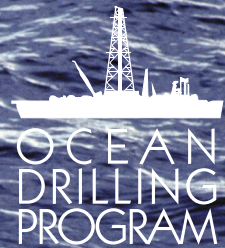

www.oceandrilling.org

## Scientific Application

The ACORK (Advanced Circulation Obviation Retrofit Kit) is designed to isolate multiple zones in a borehole for independent zone investigation. ACORKs allow subseafloor biosphere studies in the context of their hydrological, chemical, microbiological, and thermal regimes, as well as hydrologic responses to seismic ground motion, tides, and barometric loading. Multiple holes could be used to determine lateral gradients and geological property variations. After the ACORK head and casing are installed, the hole may be deepened with coring or drilling operations. The ACORK casing can be sealed with a bridge plug at the bottom to allow installation and servicing of secondary instrument packages and sensor strings. Remotely operated vehicles (ROVs) or submersibles can retrieve ACORK data and samples for shore-based study. Future ACORK installations may be connected to subsea communication cables for real-time data transmission.

## Tool Operations

Core, open-hole logs, or logging-while-drilling (LWD) data are required to identify the individual test zones. A reentry cone and surface casing are drilled or jetted in to stabilize the upper hole and to provide a reentry point. A 17½ in. hole is drilled for the ACORK assembly. The

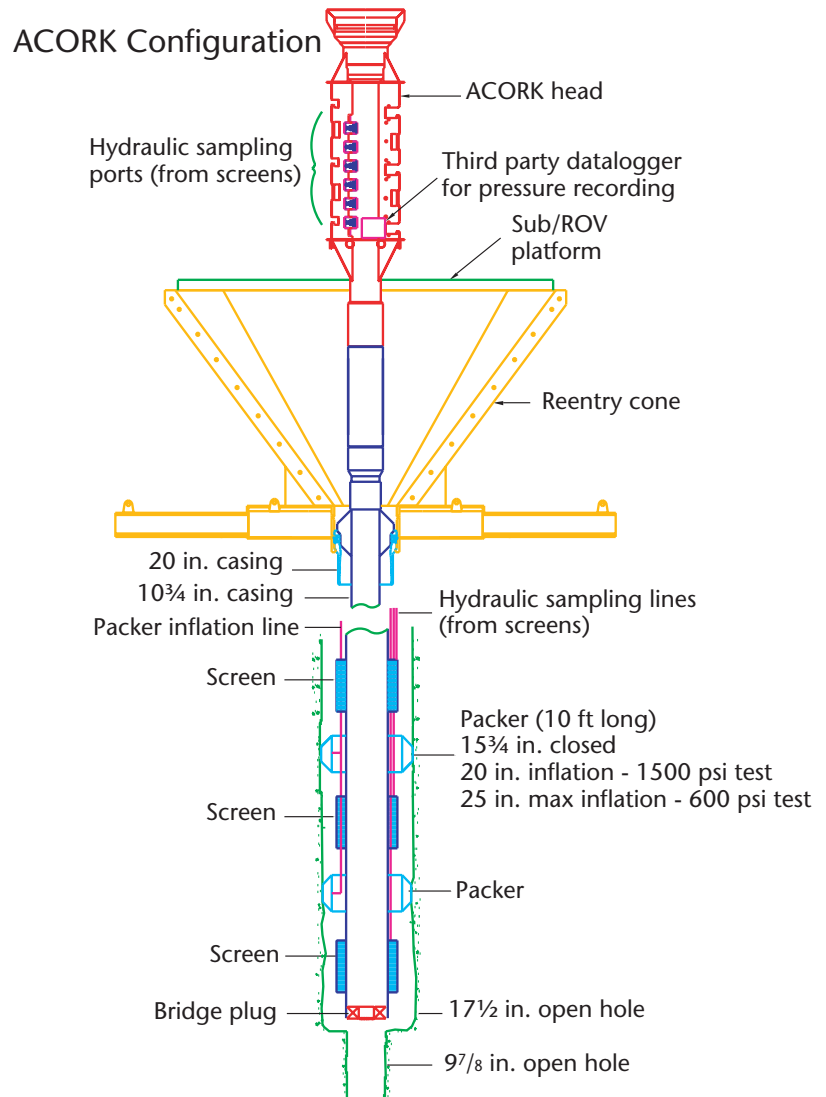

**Schematic of an ACORK installed in a reentry cone. The ACORK features downhole external casing packers to seal off zones and screened sampling sections mounted on the outside of the casing. The screened sections are connected by hydraulic sampling tubing to the T-handle valves and ports (valve manifold) in the ACORK head. The valve manifold allows pressure recording and fluid sampling. The ACORK head sits above the reentry cone to allow the ROVs/submersibles access to sample and download data.**



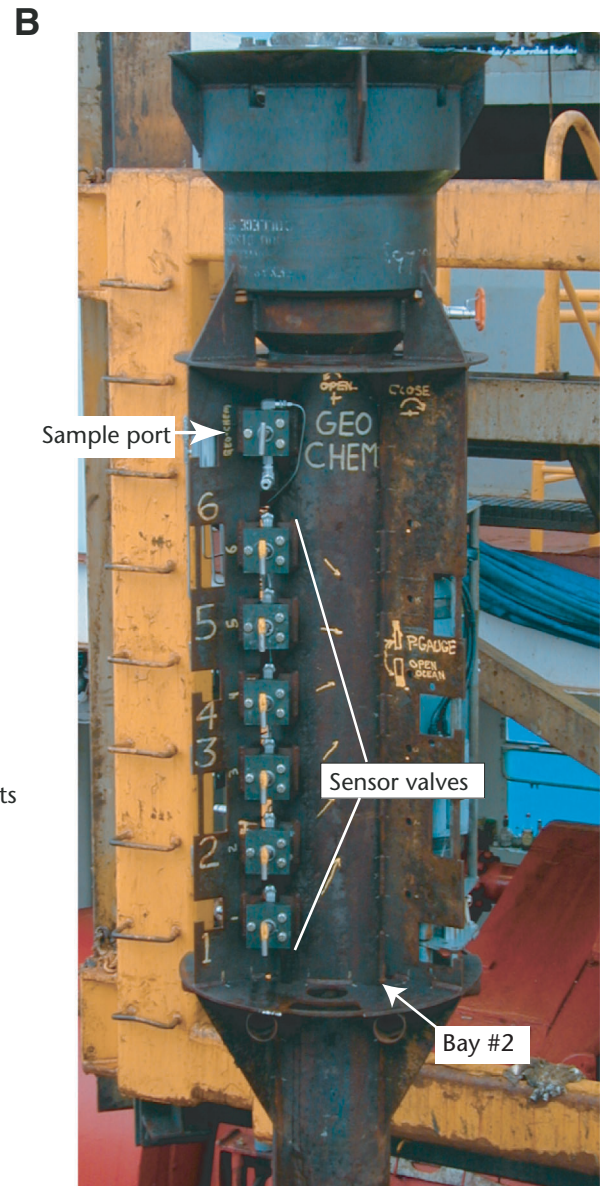
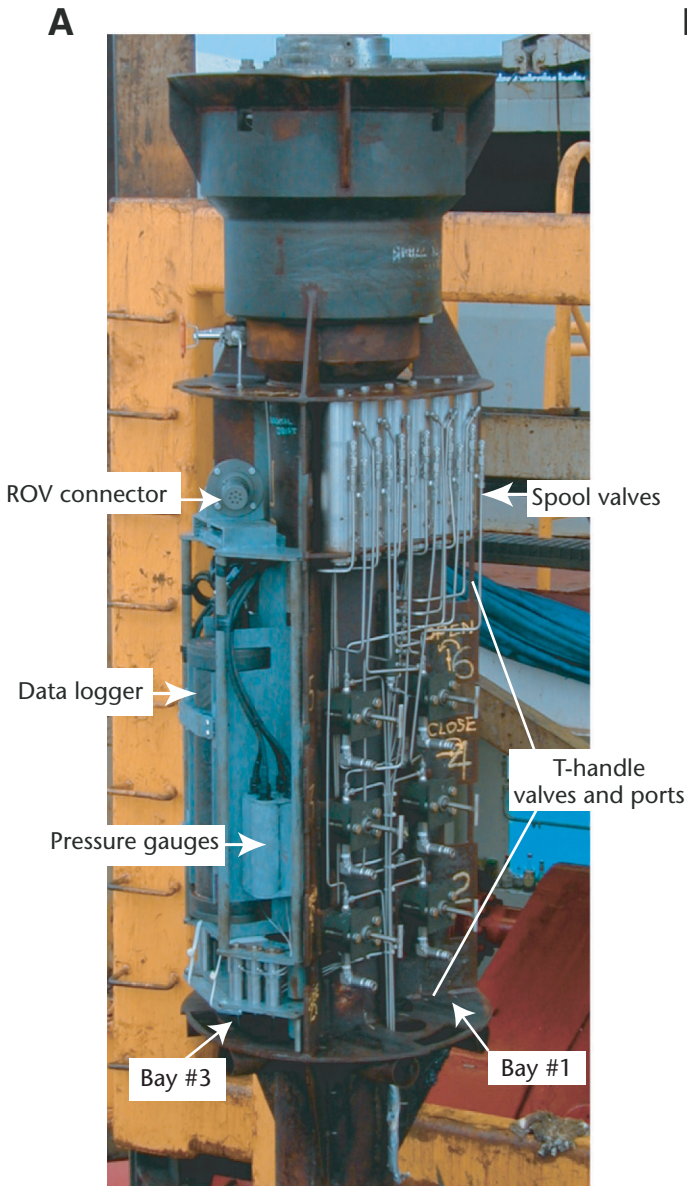

**Photographs of the ACORK head showing the three instrument bays. The ACORK head is a 30 in. diameter cylindrical frame fabricated from 3/8 in. steel around a section of 11-3/4 in. casing. It houses components in each of three 120° wide, 60 in. high bays that are bounded above and below by circular horizontal bulkheads and divided from one another by radial webs. (A) Bay #3 (left) houses the ROV connector, data logger, and pressure gauges. Bay #1 (right) houses the T-handle valves and ports and connecting tubing to downhole screen sections. (B) Bay #2 houses a sample port valve manifold for geochemical sampling and six three-way sensor valves. The sensor valves are tied in to the pumping valves and ports on Bay #1 to protect the pressure gauges from pressure surges when pumping or sampling fluids. Photographs by Adam Klaus.**

ACORK assembly typically consists of 10<sup>3</sup>/<sub>4</sub> in. casing, screened casing joints, tubing to provide a hydraulic connection back to the seafloor, inflatable external casing packers to isolate the test zones, and a multiple valve manifold. A mud motor and underreamer are typically run ahead of the ACORK

casing to work through tight spots in the open hole. A bridge plug is set in the bottom of the ACORK casing to seal off the casing and isolate the borehole from sea level hydrostatic effects. A third-party scientific sensor string may be set inside the ACORK casing to acquire additional scientific data.

## Design Features

### 1) Casing Design

A reentry cone and 20 in. casing are jetted in or underreamed to a preselected depth <120 m.

*Benefit:* This stabilizes the upper hole and provides a reentry point for additional operations

like coring, LWD, and ACORK completion.

## 2) Multiple Zone Isolation

Multiple zones may be isolated in the open hole with the ACORK casing, multiple external casing packers, and multiple screened joints. The elastomers on the external casing packers are expanded in open borehole (or in the surface casing) to provide a hydrologic seal to isolate formation intervals.

*Benefit:* Multiple intervals in the borehole can be isolated for pressure monitoring, fluid sampling, and other scientific experiments.

## 3) Formation Pressure and Fluid Sampling (third-party tool supplied by scientist)

Multiple hydraulic sampling tubes are run from the ACORK head to the individually isolated zones to monitor in situ pressure. These tubes also provide fluid sampling ports for each zone via valves on the ACORK head. Separate fluid sampling and pressure-monitoring lines can be run from each interval.

*Benefit:* The tubes can allow formation fluid samples to be recovered at the ACORK head for seafloor experiments and for surface geochemical and microbiological analysis. Permeability tests can be performed while monitoring pressure (e.g., injecting fluid into the borehole). Two adjacent ACORKs allow for hydrological tests (pulse, injection, and fluid production) across holes.

## 4) External Casing Screens

Screens are mounted on the outside of the casing to protect the sampling point. The screens are

added by welding metal ribs lengthwise on a casing joint and wrapping metal wire continuously around the ribs and casing while controlling the gap between the wraps. The gap size between the wraps creates the primary mesh size. A cap is installed on the bottom of the wrap, and ceramic beads are poured inside the annular space between the casing and the wire wrap, creating a secondary mesh. The size of the mesh depends on the grain size of the sediment.

*Benefit:* Prevents the fluid sampling lines from being plugged by sediment.

## 5) Osmotic Sampler (third-party tool supplied by scientist)

Modular downhole osmotic fluid sampler can sample and store in situ fluids.

*Benefit:* Formation fluids can be accessed for long-term geochemical evaluation.

## 6) Data Logger with Memory (third-party tool supplied by scientist)

Temperature and pressure data can be recorded and stored in the

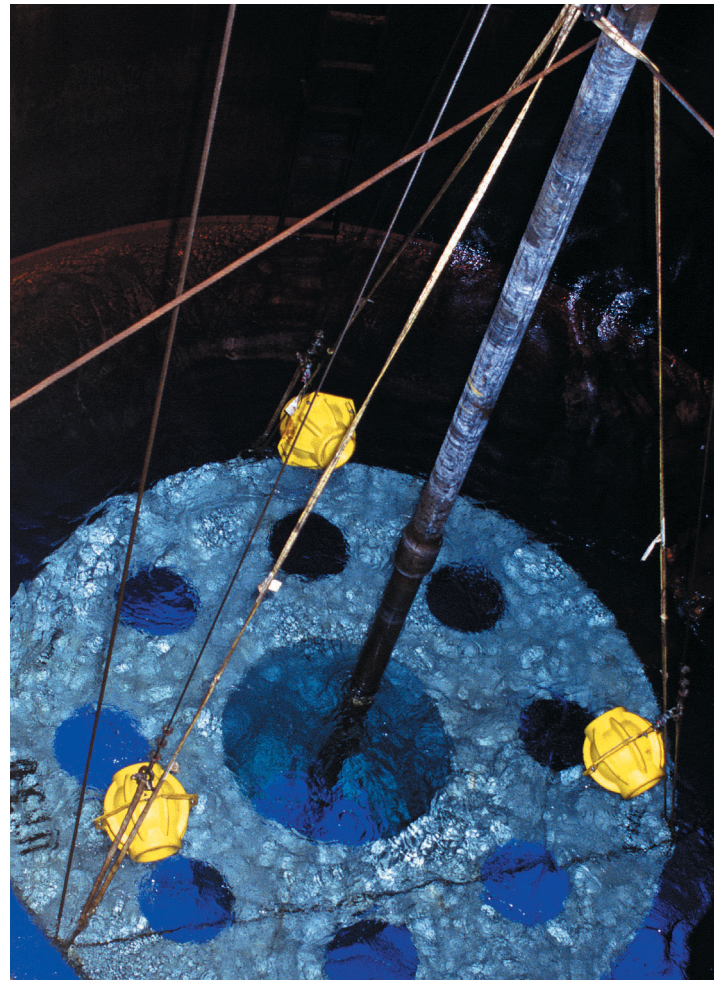

**The ROV platform for the ACORK is deployed by wireline through the moonpool and down the drill string to the ACORK. Yellow spheres are reflectors for sonar location.**

data logger unit mounted on the ACORK head at the seafloor.

*Benefit:* Because the number of submersibles and ROVs is limited, data may not be retrieved for several years. The data are stored and then downloaded when a submersible or ROV is available.

## 7) Sensor String (third-party tool supplied by scientists)

The inside of the ACORK casing string is available for third-party scientific instruments. Instruments may be hung at multiple depths to collect temperature, seismic, and other scientific data.



*Benefit:* Determine in situ formation temperature to calculate heat flow. Monitor temperatures and pressures for indication of chronic or periodic subsea flows and hydrological transients.

## 8) Bridge Plug

A bridge plug may be installed at the bottom (or top) of the ACORK casing (10¾ in.) to isolate the annulus from seawater hydrostatic effects.

*Benefit:* Provides complete isolation of the open hole below the ACORK casing from the open ocean.

## 9) Instrument Hanger

The hanger seals off the top of the ACORK casing and allows sensor strings and seismic packages to be installed inside the casing. Instruments may be set in the open hole if a bridge plug is not required.

*Benefit:* Provides additional simultaneous opportunities for scientific experiments and data collection/correlation.

## 10) Submersible/ROV Operations

The ACORK head assembly extends above the reentry cone and provides a landing platform for access by submersibles or ROVs.

*Benefit:* Data and fluid samples can be retrieved by submersible/ROV operations without a drill ship. In addition the data logger and sensor string can be replaced.

## ACORK Specifications

### Hydraulic Connector

Aeroquip Type FD72 "push-on/pull-off" male hydraulic connector

### Electrical Connector

Wet-mateable single pole RS-232 connector to data logger for ROV intervention

### Minimum Internal Diameter through ACORK

Based on casing size and weight (e.g., 10¾ in. 40.5 lb/ft casing has an internal API drift diameter of 9.894 in.; 6⅝ in. 24.0 lb/ft casing has an internal drift diameter of 5.796 in.).

### External Casing Packer Element

Expands 2–7 in., depending on outer diameter of casing (e.g., a 15¾ in. outer diameter external casing packer expands to 17–22 in.).

### Underreamer Size

Based on casing and packer outer diameter (e.g., a 17½ in. underreamer would be used for 10¾ in. casing).

## Limitations

A reentry cone and surface casing must be set prior to drilling a hole for the ACORK assembly.

Core, LWD logs, or open-hole logs are required to identify the individual test zones and the setting depths for packers and screens.

Third-party instrument strings (thermistors, seismometers, etc.) must be compatible with ACORK casing internal diameter.

The formations must be stable enough to remain open during ACORK completion operations.

Osmotic fluid samplers are slow-acting passive devices that may require ship intervention for recovery.

Current borehole fluid-sampling techniques are limited to pressured intervals with active flow or to slow acting downhole osmotic samplers.

Borehole fluid sampling is limited by the long time period required to displace the seawater from the small ¼ in. sampling tube with formation fluids. Long lengths of small tubing limits fluid flow to very low flow rates. Submersibles and ROVs can apply pump suction to the sample tubes but can only draw a 32 ft (13.8 psi) vacuum unless the formation flows. A powered pump and larger tubing may be required to remove the seawater from the tubing and borehole annulus.

## Proponents Need to Consider

Depth of surface casing to stabilize top hole.

Number and height of zones to be sampled by screened casing joints.

Setting depth of ACORK casing string. The risk of not reaching setting depth with ACORK casing increases with depth.

Size of ACORK casing string (ranges from 6⅝ to 10¾ in.). The risk of not reaching setting depth increases with the larger casing sizes.

Diameter of open hole. The risk of not reaching the setting depth increases with the increase in borehole diameter and formation instability.

**Scientific Application**

The Borehole Instrument Hanger (BIH) evolved along with the CORK and ACORK completion systems. The BIH provides a flexible tool that can be customized to install scientific instruments (e.g., seismometer, tiltmeter, strainmeter) in permanent boreholes for enhanced long-term downhole measurements. A key advantage to this design is that the data loggers are on the outside of the upper BIH (also known as a riser or wellhead) to provide access at the seafloor. Data can be recovered from the borehole by other types of oceanographic vessels using submersibles or a remotely operated vehicle (ROV) (i.e., the ODP drillship is not required).

**Tool Operation**

The instrument hanger completion normally begins with the installation of a standard ODP reentry cone and 16 in. or 10<sup>3</sup>/<sub>4</sub> in. casing. The BIH is composed of an upper section (above the reentry cone) and 4½ in. casing (below the reentry cone). The BIH is deployed and landed inside the reentry cone on top of the casing hangers. An ROV platform, which sits on top of the reentry cone, is installed around the upper BIH. The platform serves as a landing pad for submersibles and/or ROVs to access the data

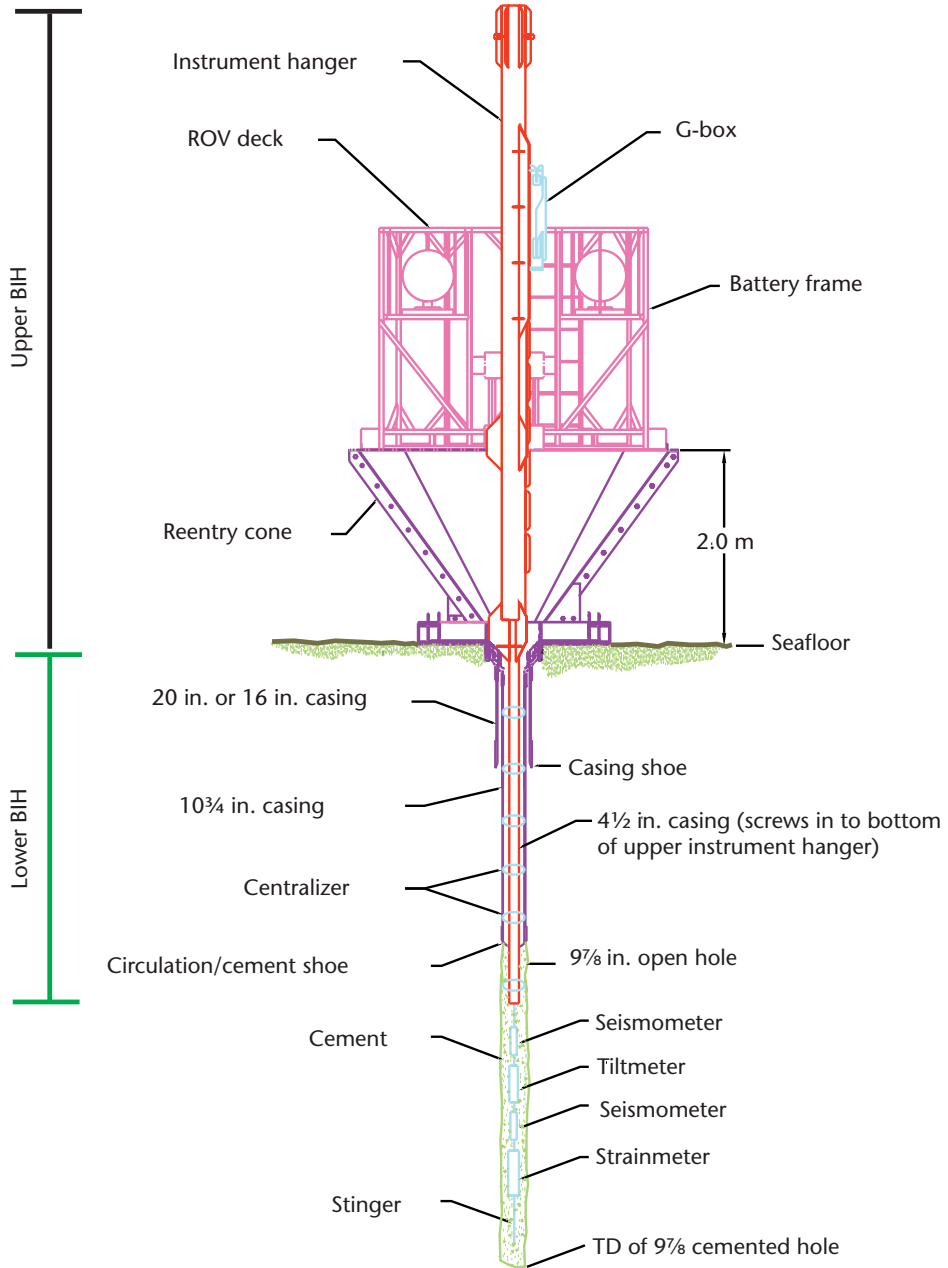

**Schematic of a strain-tilt-seismometer BIH completion.**

loggers and as a support frame for the batteries that power a seismometer.

The ROV platform also provides a frame to mount ancillary instrument packages that may be attached to the instrument hanger. The seismic instrument packages are typically suspended in the hole on 4½ in. (or other) casing. Electrical cables are attached to the side of the casing to connect the instruments in the hole with the data loggers attached to the upper BIH. The various instruments may be cemented in place, if required, to seal the open hole from the ocean tidal effects and to acoustically isolate the seismic instruments to reduce background noise.

## Design Features

### 1) Installation and Support

A standard ODP reentry cone and 10¾ in. casing are typically set before installing the BIH.

*Benefit:* The reentry cone stabilizes the upper borehole and provides a method to reenter the casing.

### 2) Instrument Hanger Design

The upper portion of the BIH houses data loggers and ancillary instruments and provides a means for downloading the data loggers using an ROV or submersible. The BIH may be modified to accept almost any type of downhole instrument.

*Benefit:* Different types of instruments (e.g., seismometer, tiltmeter) can be deployed with the BIH while maintaining access to the data loggers via submersible or ROV.

### 3) Submersible/ROV Operations

The upper BIH provides access to the instrument data loggers via submersible or ROV.

*Benefit:* Data can be collected at any time without relying on the *JOIDES Resolution*. In some instances, complete data loggers may be recovered and replaced via submersible or ROV.

## Instrument Hanger Specifications

The BIH is deployed by the *JOIDES Resolution* on the drill string after setting a reentry cone and casing. The BIH can be configured to land in any size ODP casing hangers.

## Instrument Hanger Limitations

- All instruments attached to the upper BIH must fit within a 30 in. diameter circle (minus the diameter of the upper BIH body) to allow the vibration isolated television (VIT) frame to pass over the BIH during reentry operations. Height above the ROV deck is virtually unlimited.
- Instruments to be inserted through the 4½ in. casing must

fit through the casing's inner diameter. If an instrument will be attached to the outside of the 4½ in. casing before the BIH is installed, then the instrument must fit within an 8½ in. outer diameter by 4½ in. inner diameter annulus to fit through the upper casing strings and open hole.

## Considerations for Usage

- The limitations on instrument size both above and below the seafloor must be considered.
- Physically handling the instrument hanger with instruments attached during deployment must be considered when determining what instruments to install (contact ODP for details regarding specific installations).
- Cables and attached instruments are exposed to some impact from the VIT frame during deployment of a BIH because the vibration isolated television frame must be lowered over the entire instrument hanger for reentry.
- The extra time required to make the water-tight electrical connections in the instrument cables must be considered in the overall deployment time.
- Borehole stability must be considered in determining the probability of achieving a successful installation.



## Scientific Application

### Packers

A “packer” is an inflatable rubber element that inflates to seal the annular space between the drill string and the borehole wall. While there are different types of packers, ODP runs one, or two in tandem assemblies, on drill string into a

pre-existing  $\sim 9\frac{7}{8}$  in. hole (cored, drilled, or cased) and inflates it with seawater to hydraulically isolate a borehole section from the annulus and tidal effects of the open ocean. Isolating the borehole from the open ocean allows measurement of pore pressure and in situ hydrological properties of the

formation. Formation fluids may be sampled if the formation is permeable. It is possible to derive formation permeability and porosity in an isolated open-hole section using a straddle packer (i.e., two packers) by applying pump pressure with pulse, slug, or constant-rate injection tests.

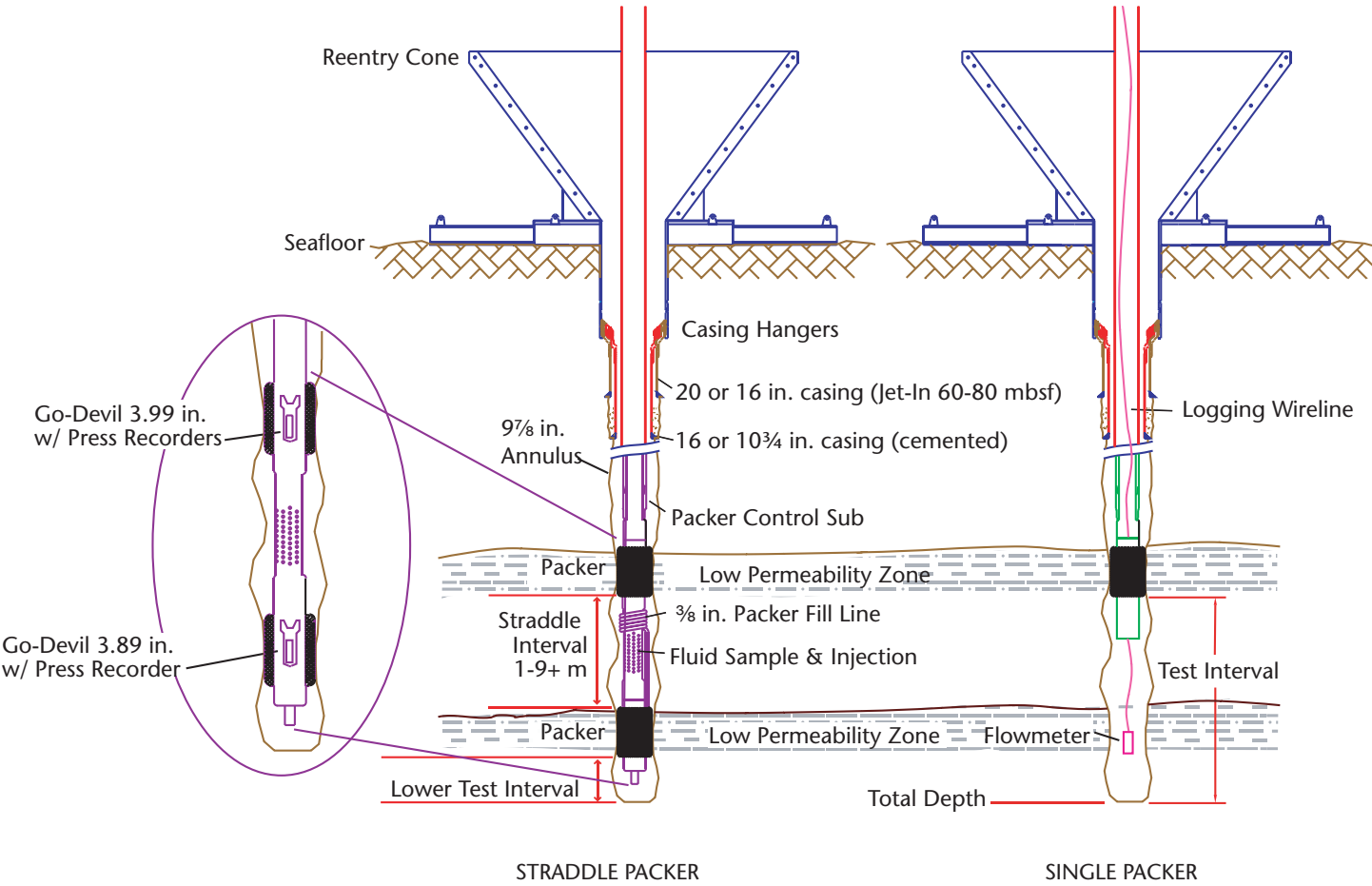

**Schematic compares Straddle and Single Packers in a borehole. The Straddle Packer uses two packers to isolate a test interval between them, and the packers can be moved and reset. A second interval can be tested as well from the bottom packer to total depth. The Straddle Packer is used for hydrological testing as well as pulse and constant rate injection tests. The Single Packer uses one packer and tests the entire borehole below the packer. A flowmeter is shown on the logging wireline in the Single Packer schematic.**

Leg 118 Hole 735B  
Go-Devil #2

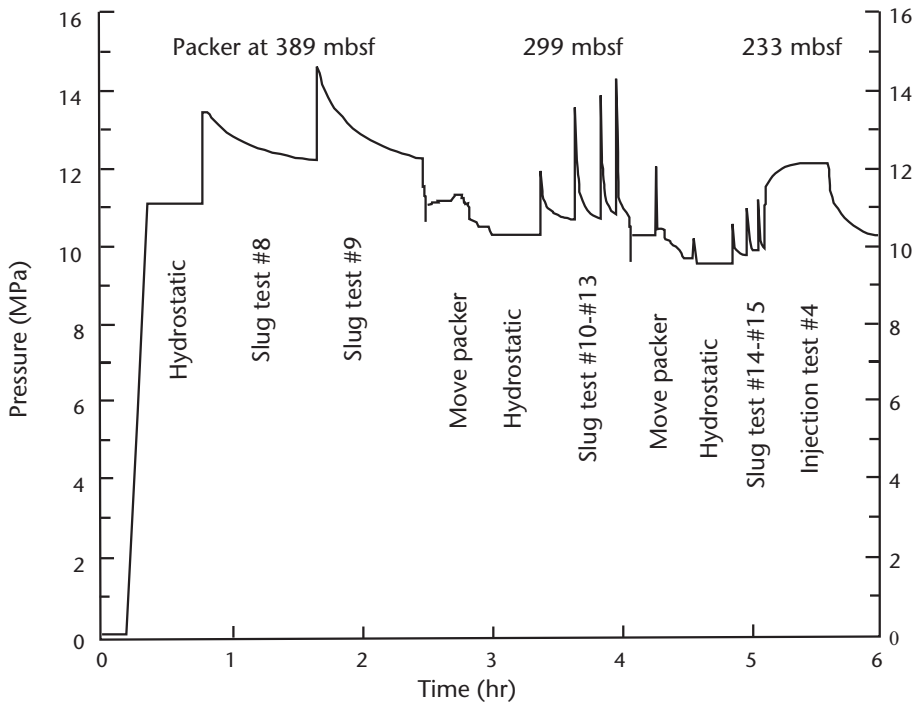

**Graph of a packer injection test taken during Leg 118 showing pressure at the recorder depth vs. time. The chart shows the hydrostatic pressure, the pressure buildup from pumping water into the formation, and the subsequent pressure decay (fall-off) after pumping ceases. The rate of pressure decay indicates the relative permeability of the exposed interval (with adjustments for interval height, viscosity, etc.). The packer was moved to test different intervals in this chart.**

The 8¼ to 8½ in. outer diameter (OD) packer element can be expanded to as much as twice the uninflated diameter (~16 in.); however, full inflation produces a weaker hydraulic seal that withstands less differential test pressure. Effective formation testing in an open hole requires that all packers be positioned in low-permeability borehole sections that are relatively in-gage and have smooth bores. Wireline logs such as caliper, borehole televiwer, resistivity, density, and sonic logs are typically run before packer tests to identify permeable test intervals and good seal sections. The logging information allows the bottom-hole assembly (BHA) and packer(s) to be spaced out accordingly. Logs and experiments

can be run through an *uninflated* packer; however, wireline operations through an *inflated* packer require special safety measures because the packer grips the borehole wall. The packer immobilizes the BHA, but the top of the pipe at the rig floor can still move up and down, requiring drill string heave compensation to avoid tearing the packer loose.

The drill string packer can be run in several combinations:

- A single-element packer is used to isolate the interval below the packer to the bottom of the hole.
- Two packers can be run together, acting as a single packer to increase the seal

length. Pressure gages can be run to confirm the seal.

- A “straddle packer” incorporates two separate packers to span the test interval so it can be sampled or exposed to injection tests. The packers are separated by 1 to 9 m long drill pipe pup joint(s). The interval between the straddle packers and the interval from the bottom packer to the bottom of the hole can be tested separately. The straddle packer elements are connected by ¾ in. stainless steel tubing (strapped on the outside the drill pipe spacer) to ensure that neither element can be inflated if there is a hydraulic failure. A pressure recorder can be hung below the lower Go-Devil to test for leakage from the straddled interval.

### Flowmeters

A flowmeter is run on the wireline to measure the flow rate of the fluid pumped into the hole. The flow rate can be measured throughout the open hole. Within cased hole, the flow rate is 100%. Below the casing, flow rates decrease as a portion of the fluid flows into the formation, providing information about permeability in the borehole (i.e., flow rate decreases below high permeability sections).

## Tool Operation

### Packer Operation

The packers typically used by ODP are made by TAM International, Inc., of Houston, Texas. The 8¼ in. TAM packer assembly consists of an internal steel strength member, an expandable internal rubber bladder, and an 8¼ to 8½ in. OD outer rubber cover. A Go-Devil

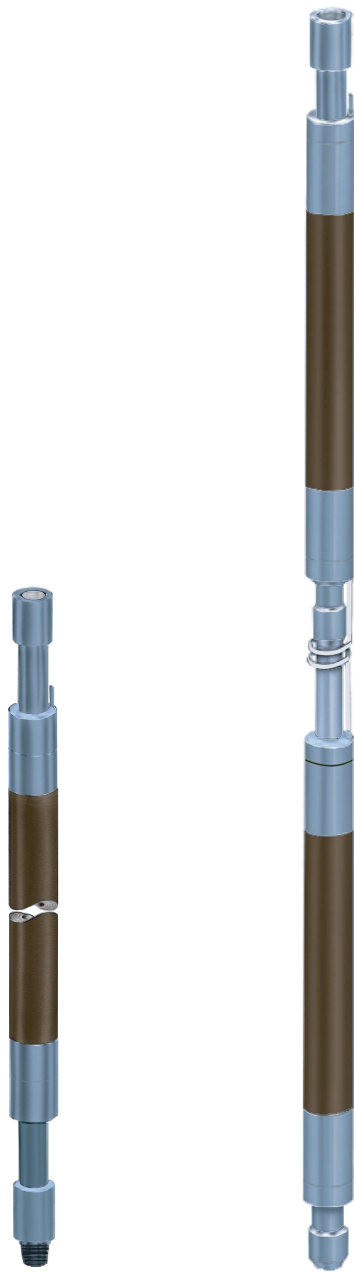

Single Packer      Straddle Packer

**Figure shows examples of a straddle and single TAM packer. A straddle packer assembly consists of two single packers separated by a 1-9 in. perforated spacer.**

plug is dropped down the drill pipe and lands in a seating nipple in the pipe (see Packer Control Sub figure). The Go-Devil seals the drill pipe so pump pressure can inflate the packer bladder with seawater pumped down the drill string.

The seawater presses the rubber bladder outward to grip and seal against the borehole wall. The bladder cover has an embedded expandable (woven stainless steel) strength member.

Drill string packer(s) are run on the drill string as part of the BHA and are positioned over the desired interval based on logging depths. When the drill string is freely suspended without heave compensation (running in and out of the hole), the packer element(s) remain uninflated. When the packer is in position, a wireline retrievable Go-Devil with two GRC (vendor) pressure recorders (covered with a special core barrel and retaining catcher) is free-fall deployed and pumped down the drill string at ~200-250 gpm to increase the speed. The Go-Devil lands in a "seating nipple" at the packer, and a hydrostatic pressure baseline is recorded for 10-15 min.

The rig pumps are typically used to inflate the packer element(s) with seawater to ~1200 to 1500 psi maximum. When the packer elements inflate and start to grip the borehole wall, air is bled off the heave compensator, which lowers the drill string to set down ~15,000 lb weight on the packer (~12,000 lb of weight/1000 psi of test pressure) to prevent packer movement from the piston effect of test pressures.

To inflate and deflate a packer, a Packer Control Sub is used. It also provides a way to run a pressure instrument in the hole. The Packer Control Sub has an internal "control tube" that connects two or more packers hydraulically. Lowering the drill string ~20 cm (8 in.) shifts the packer control sleeve

down, isolates the inflated packer element, and opens the bore to the interval below the upper packer. The heave compensator is positioned at mid-stroke, and ~15-20 min is required for the pressure pulse to decay. A typical set-down weight of 15,000 lb requires a BHA of approximately six 8¼ in. drill collars above the packer. ODP recommends running several drill collars below the packer to help set it. The packer elements are not designed to support much more than ~15,000 lb weight.

Formation fluids may be sampled before pump tests if the formation is permeable enough. Go-Devils can be used to activate multiple packers and open or close valves for formation testing. The Go-Devil and pressure recorders are retrieved with the coring wireline.

After formation testing is completed, the packer(s) are deflated by using the heave compensator to pull the drill string upward and open the deflation ports. The straddle packer element deflates passively in ~30 min, and it can be moved and reset (~2-3 times) if the element is not damaged.

When straddle packers are used, pulse, slug, or constant-rate injection tests may be run to determine the formation transmissivity (from which permeability can be derived) and (less accurately) storage coefficient. Storage coefficient is directly related to formation porosity. The cementing-unit pump is typically used to apply pressure (~500 to 1500 psi) to the isolated open-hole section. Test pressures typically do not exceed 1500 psi (unless formation hydro-fracture is attempted), and pump rates typically do not exceed 3-5 bbl/min. All pumped

(injection) volumes should be measured using a standpipe meter or the volume tanks on the cementing unit. Pressure pulses may require up to 30 min to decay, and multiple tests (2 to 4) may be run.

### Flowmeter Operation

A flowmeter/sinker bar/Go-Devil assembly can be run on the logging wireline. After inflating the packer, the logging line is sheared off the Go-Devil by pressuring up to 2000 psi. The flowmeter is lowered below the packer (~50 m) and calibrated by pumping at several rates. Flowmeter readings typically are taken at 10 m intervals (to total depth [TD]) for ~10-20 min at each interval. The flowmeter/Go-Devil assembly is retrieved by wireline.

## Design Features

### 1) Compatibility

The drill string packer BHA is compatible with wireline logging tools.

*Benefit:* It may be possible to accomplish both logging and packer measurements during a single pipe trip.

### 2) Multiple Tests

A packer can be set, moved, and reset (up to three times) if the element is not damaged.

*Benefit:* Multiple tests can be attempted during one trip in the hole.

## Specifications

### Packer

- TAM International, Inc., model TAMJAY Packer, 8¼ in. OD element, stroked out length 3.12 m (10.2 ft), 3.97 in. internal diam-

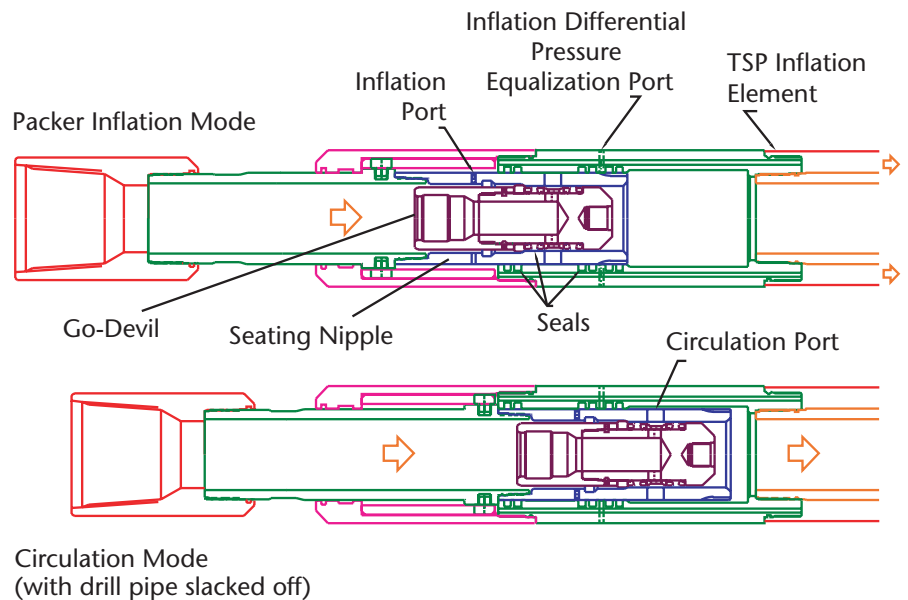

**Schematic of the Packer Control Sub on the TAM Straddle Packer (TSP) showing inflation and circulation flow paths.**

eter (ID), connection 5½ in. IF box up and pin down

- Minimum ID: Single packer 3.94 in., Straddle nonrotating packer 3.84 in., and rotating packer 3.84 in.
- Packer Inflation Pressure: typically ~500 to 1000 psi (~half of planned test pressure), 1500 psi maximum
- Set down weight on packer: ~12,000 lb weight/1000 psi test pressure, 15,000 lb maximum
- Drill string movement to shift control tube: ~20 cm (8 in.)
- Typical Packer BHA: 9 to 9½ in. bit, crossover, 1 joint 5½ in. drill pipe, 8¼ in. packer, crossover, ~5 each 8¼ in. OD drill collars, tapered drill collar, crossover to 5 in. drill pipe. BHA length ~70 m, weight ~18,000 lb

### Pressure Recorders

- GRC Pressure Recorders  
The GRC pressure recorder is typically set for 10,000 measurements per day. It is run below

the Go-Devil in a special core barrel tube with a retaining catcher.

- Kuster Pressure Recorders (for backup)

Kuster model K-3 mechanical self-contained pressure recorders are available in three pressure ranges (0-9925, 0-11900, and 0-15275 psi) and can record for 9, 18, or 36 hours. For a single packer, two K-3 recorders are free-fall deployed inside a 12 ft long inner core barrel tube attached to the Go-Devil. For straddle packers, one K-3 recorder is attached to the lower Go-Devil and one or two to the upper Go-Devil.

- Surface Pressure Recorder

A Gould PG3000 pressure transmitter (0-5000 psi) is installed at the standpipe to provide a real-time pressure record.

## Typical Operating Range

- Temperature

Packer elements and seals are rated to ~100°C. Special high-

temperature elastomers (i.e., packer elements and inner seals) rated to 120°C were used (Leg 111 – Hole 504B) at temperatures of 120°-145°C, but lasted for only one setting.

- Depth Limit: None

## Limitations

### Packer Damage

The rubber elements on packers are made of elastomers that can be damaged by contact with jagged formations. Moving a set packer before it has relaxed back to normal size may damage the element.

### Hole Damage from Packers

The packer expands with hydraulic force to firmly contact the formation; however, over-inflation can fracture the formation or burst the packer element. Packers can also reduce the hydrostatic pressure, causing a formation to flow or cave-in, resulting in stuck pipe.

### Temperature

The packer elements are made of an elastomer that has an operating temperature range of 100°-120°C.

### TAM Nonrotating Packer

The TAM drill string straddle packers are a nonrotating design that is deployed with the drill string. They should be kept in tension and are not compatible with a coring and rotating BHA; therefore, a separate trip is required to run the packer.

### TAM Rotatable Packer

The TAM rotatable packer was designed for use as a single packer for testing and drilling ahead; however, tests (Legs 110, 123, and 130) indicate that it may be more suitable for tests in unstable pre-drilled reentry holes that may require some reaming or cleanout.

**THIS PAGE INTENTIONALLY LEFT BLANK**

## **APPENDIX E**

### **SEISMIC RESEARCH ACTIVITIES**

This appendix provides detailed information characterizing the equipment and activities that may be performed used for single-channel seismic surveys or during Vertical Seismic Profiling (VSP) experiments in future IODP riserless drilling expeditions.

- ◇ A description of the Vertical Seismic Profiling activities that may be performed in future IODP riserless drilling expeditions, including operating parameters of the equipment that will be used.
- ◇ Diagrams of the Sound Exposure Levels (SEL) for various configurations of seismic sources (airguns) that may be used in future SODV seismic surveys or VSP experiments.



**THIS PAGE INTENTIONALLY LEFT BLANK**

## **Vertical Seismic Profiling**

### **Background**

Vertical Seismic Profiling (VSP) is the process of recording seismic data in a wellbore environment. Geophones are vertical in the earth as opposed to horizontal along the surface of the earth or the ocean. The most basic type of VSP is a checkshot survey used to calibrate surface seismic surveys. Surface seismic sections are recorded in time and the checkshot matches known depth to time. The checkshot can also derive formation velocities.

The next simplest type – and the kind most often seen in IODP – is the zero offset VSP. Like the checkshot, the zero offset survey can be used to correlate surface seismic and derive formation velocities, but it also has look-ahead capabilities and can identify things like faults and overpressure zones.

Both checkshot and zero offset VSPs can be performed on the SODV by suspending single or clustered marine seismic sources (airguns) from a crane. Other more complex VSPs (like offset, vertical incident, walkaway, AVO, and 3D) require more than one vessel and more likely greater air pressure, air bottle capacity and gun volume than can be maintained on the SODV.

### **Data Analysis**

VSP provides results intermediate between small-scale measurements such as laboratory analysis of cores and large-scale measurements such as seismic refraction and reflection data which would have preceded drilling operations by the SODV. During a VSP, a seismometer would be secured successively at different depths in the borehole and an airgun would be fired in the water next to the ship each time the seismometer was repositioned. The seismometer would record both the direct, downgoing waves, and up-going waves reflected from changes in acoustic impedance below the receiver. The data would be processed to determine the attenuation properties of rock and prediction of acoustic properties below the bottom of the hole for correlation with borehole lithology, wireline logs, and events on conventional seismic reflection and refraction profiles.

### **Borehole Seismic Surveys on the SODV**

The ODP and IODP Phase 1 used a single airgun (the latest being the Sercel 210 GI gun). That gun will likely remain in use for SODV underway (surface) seismic surveys. For future borehole seismic operations, TAMU has purchased two Sercel 250 G guns to be used in a parallel cluster.



**Sercel 210 GI gun**



**Sercel 250 G gun parallel cluster**

For standard operations, the two-gun cluster will be attached to a buoy to maintain the guns at a constant water depth and suspended from the port aft crane (see Figure). The cluster will be suspended roughly 15 m from the ship. This distance is important, as the minimum safe distance for a 250 G gun cluster is 7.2 m from the hull and 4 m for the single 250 G gun and 210 GI gun.

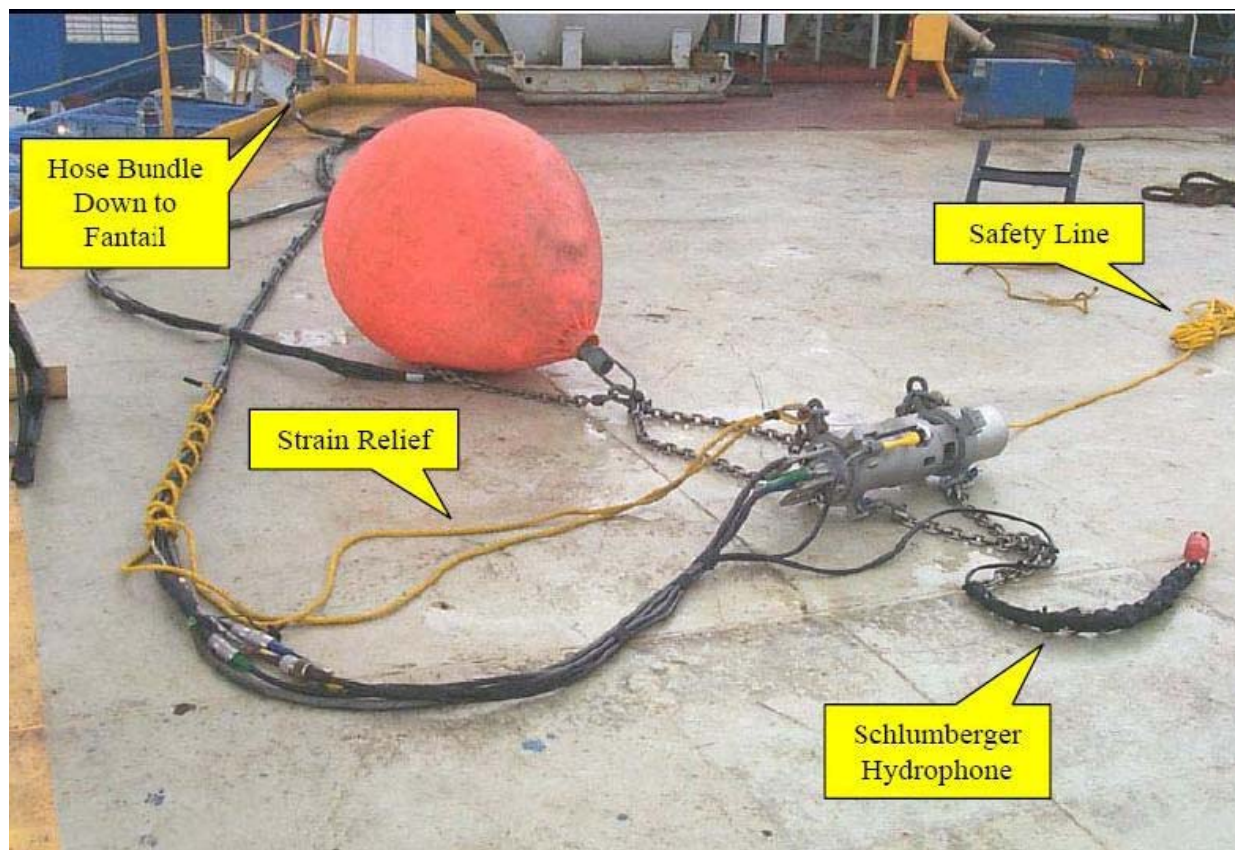

**GI gun and buoy on deck prior to deployment (as used in ODP and IODP Phase 1)**

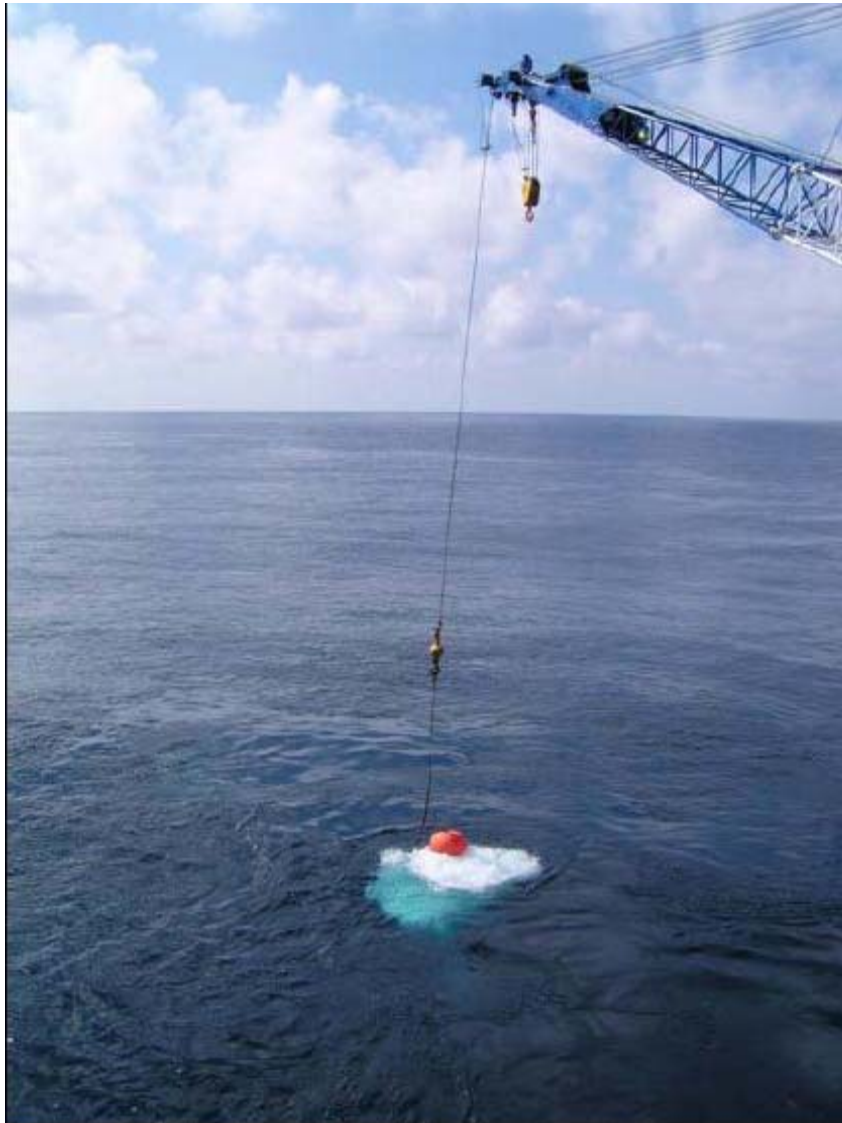

**Gun firing after being suspended in position by the port aft crane**

VSPs on the SODV can be configured many different ways depending on scientific objectives and time constraints. Some of the operations variables include:

- Number of guns
- Gun volume
- Gun pressure
- Gun depth
- Firing interval
- VSP duration

*Number of guns:* VSPs on the SODV now have the option of using i) two 250 G guns; ii) a single 250 G gun; and iii) a single 210 GI gun. Most operations (perhaps 80%) will use the two 250 G gun cluster, with a single gun being used in the event of a failure or if a specific source signature is needed from the 210 GI gun.

*Gun volume:* The double 250 G gun cluster volume is 500 cubic inches (in<sup>3</sup>). A single 250 G gun is 250 in<sup>3</sup>. The 210 GI gun can be configured in nine ways, but will likely be used in “true GI 150” mode with a volume of 150 in<sup>3</sup>.

*Gun pressure:* The SODV supplies air at 2000 psi (even though the guns are able to fire at a range of pressures between 1000 and 3000 psi).

*Gun depth:* Guns are commonly suspended at depths between 2 and 6 m (5 m is typical). The gun depth affects peak source energy by only a few percent but has a large impact on the source signature.

*Firing interval:* Shot interval during the VSP is a function of how rapidly the compressor can recharge the gun(s) to 2000 psi (SODV seismic operations feature no air bottle rack capacity). With the new 3/8 inch hose, minimum firing intervals for the double 250 G gun cluster, a single 250 G gun and the 150 in<sup>3</sup> 210 GI gun are respectively 26 s, 13 s, and 8 s.

*VSP duration:* the time to complete VSP operations can be a function of hole depth, shot depth interval, ease of wireline deployment, weather, etc., and can last anywhere from three to twelve hours. In addition to the shots for actual VSP acquisition, there is a shot protocol for marine mammal protection (please see *Marine Mammal Safety and the Use of Seismic Sources Aboard The R/V JOIDES Resolution* which is more conservative than the U.S. D.O.I. Minerals Management Service directive NTL No. 2003-G08).

# Airgun Sound Exposure Level (dB, SEL)

210 cu in GI Gun @ 3 m depth (1 of 2)

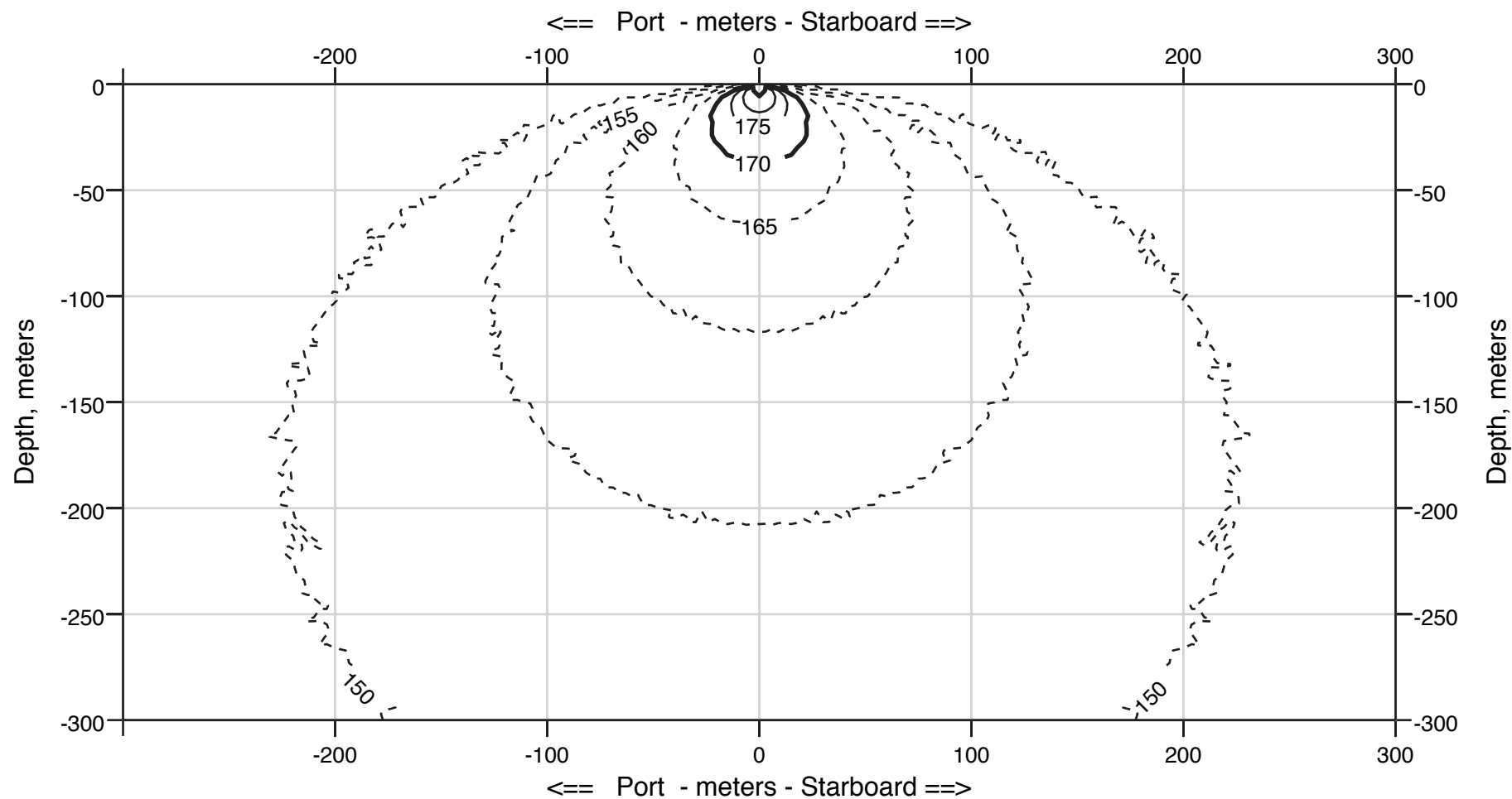

Note: 170 dB re 1 uPa\*s (SEL) ~ 180 dB re 1 uPa (rms)



# Airgun Sound Exposure Level (dB, SEL)

210 cu in GI Gun @ 3 m depth (2 of 2)

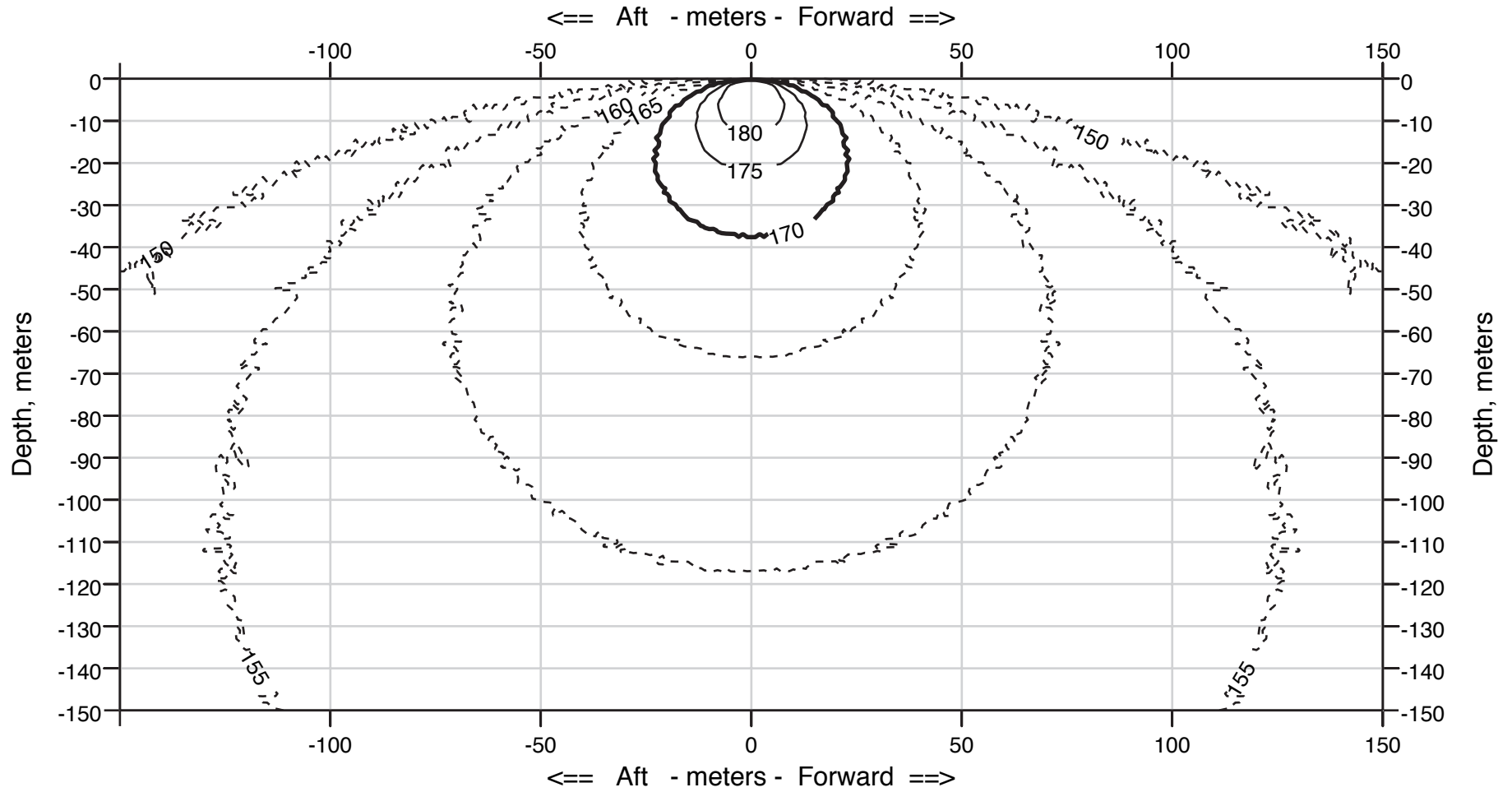

Note: 170 dB re 1 uPa\*s (SEL) ~ 180 dB re 1 uPa (rms)

# Airgun Sound Exposure Level (dB, SEL)

210 cu in GI Gun @ 5 m depth (1 of 2)

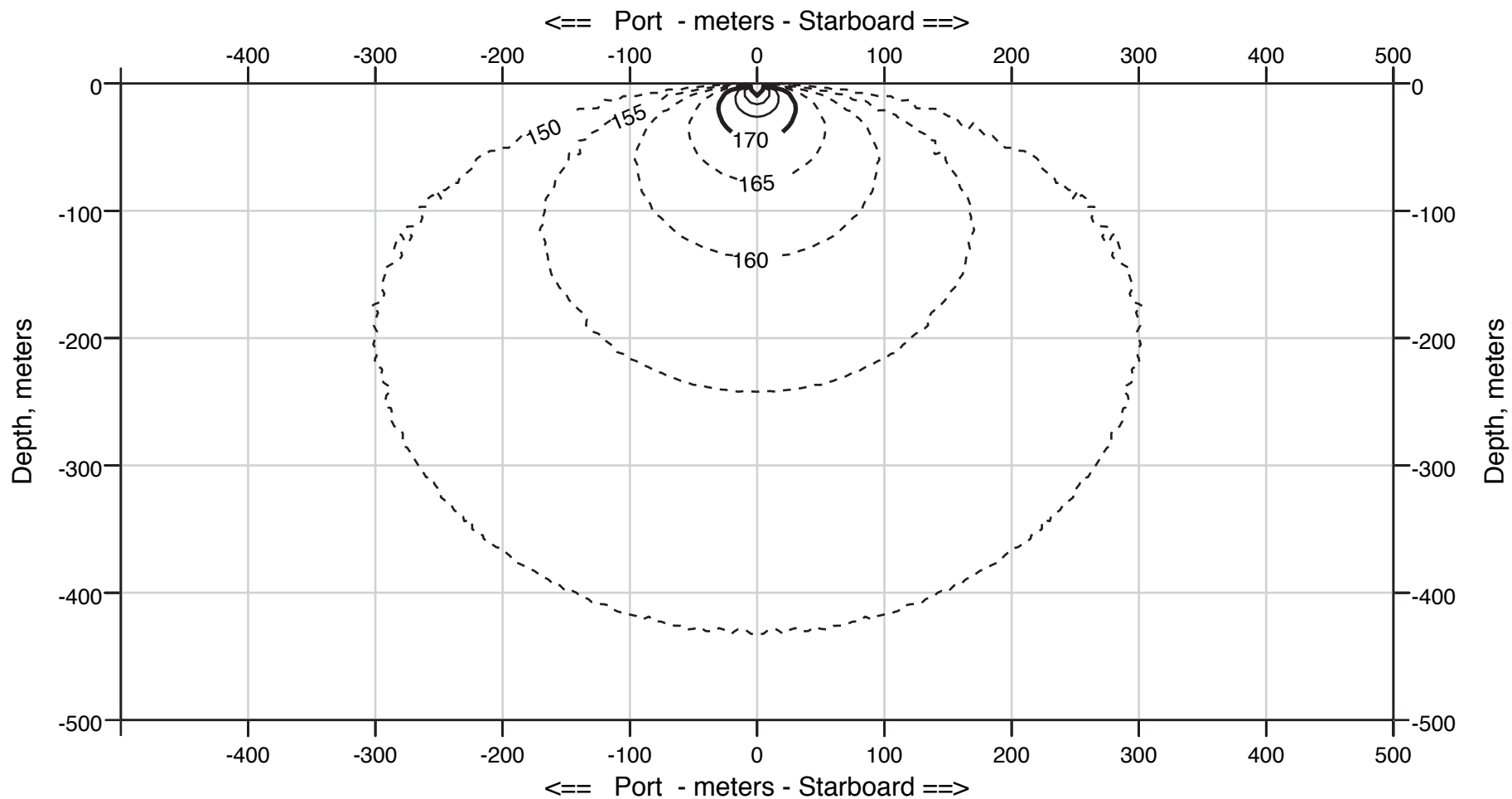

Note: 170 dB re 1 uPa\*s (SEL) ~ 180 dB re 1 uPa (rms)

# Airgun Sound Exposure Level (dB, SEL)

210 cu in GI Gun @ 5 m depth (2 of 2)

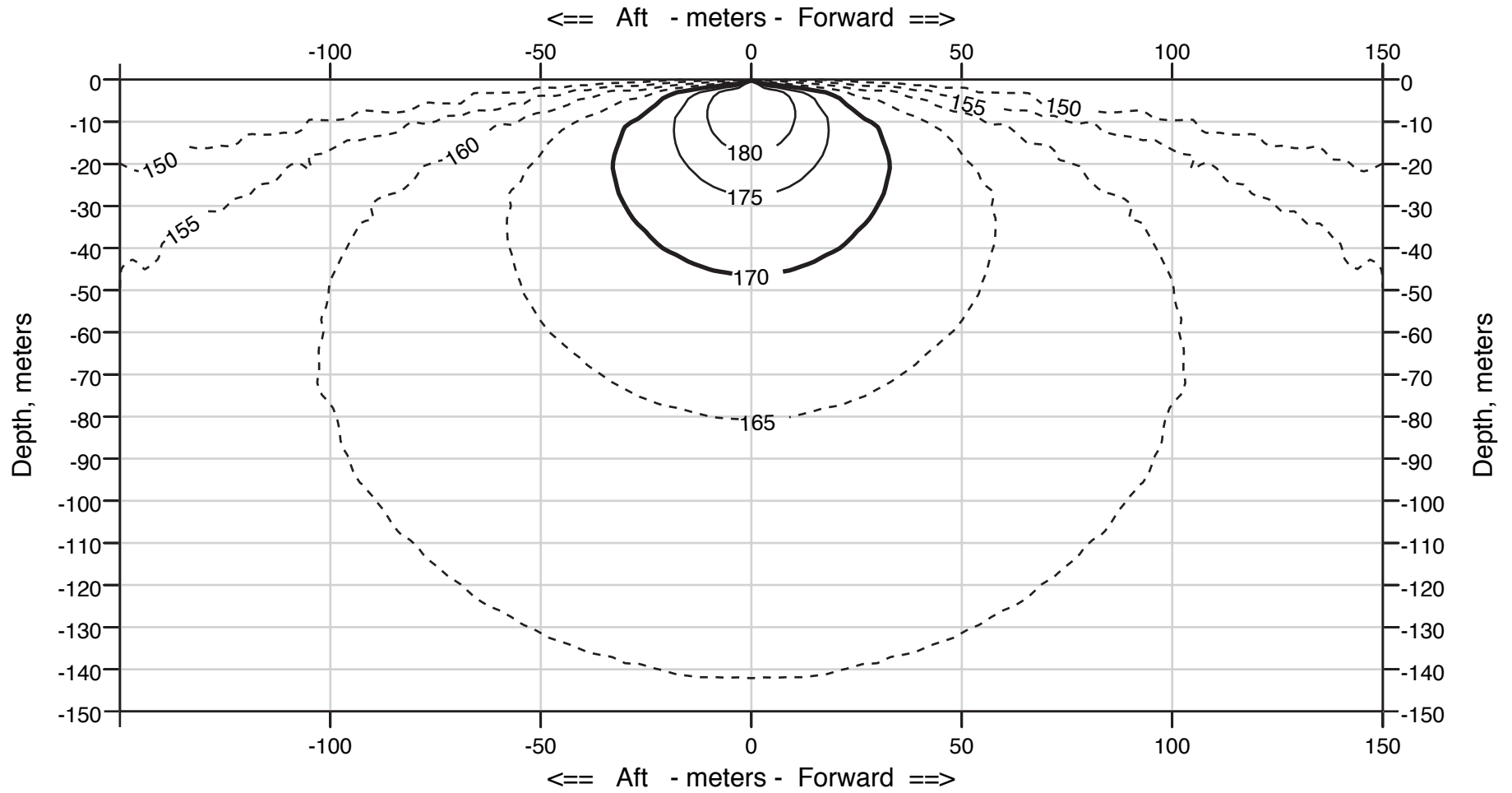

Note: 170 dB re 1 uPa\*s (SEL) ~ 180 dB re 1 uPa (rms)

# Airgun Sound Exposure Level (dB, SEL)

210 cu in GI Gun @ 6 m depth

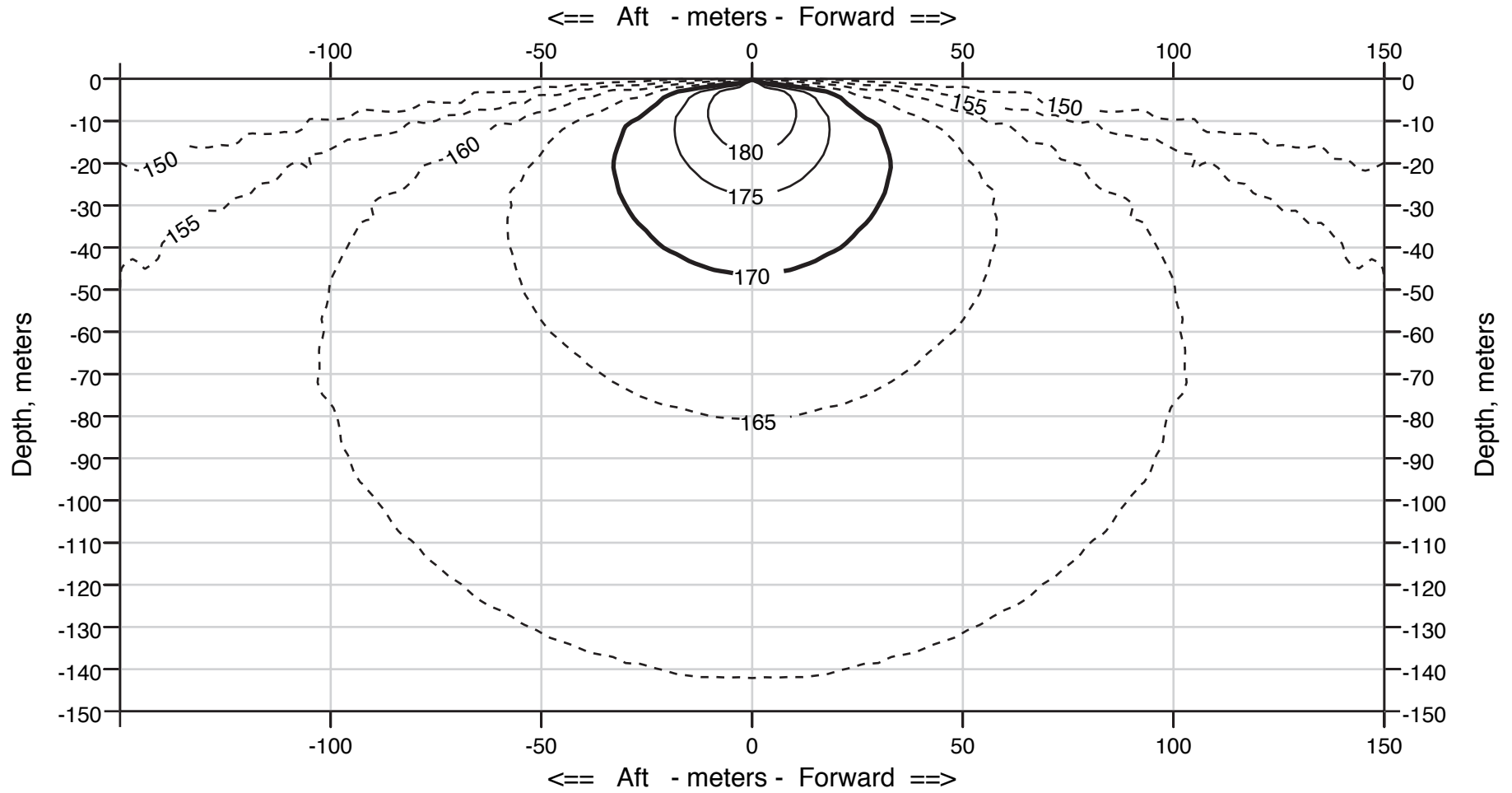

Note: 170 dB re (1 uPa)<sup>2</sup>s (SEL) ~ 180 dB re 1 uPa (rms)

# Airgun Sound Exposure Level (dB, SEL)

210 cu in GI Gun @ 10 m depth

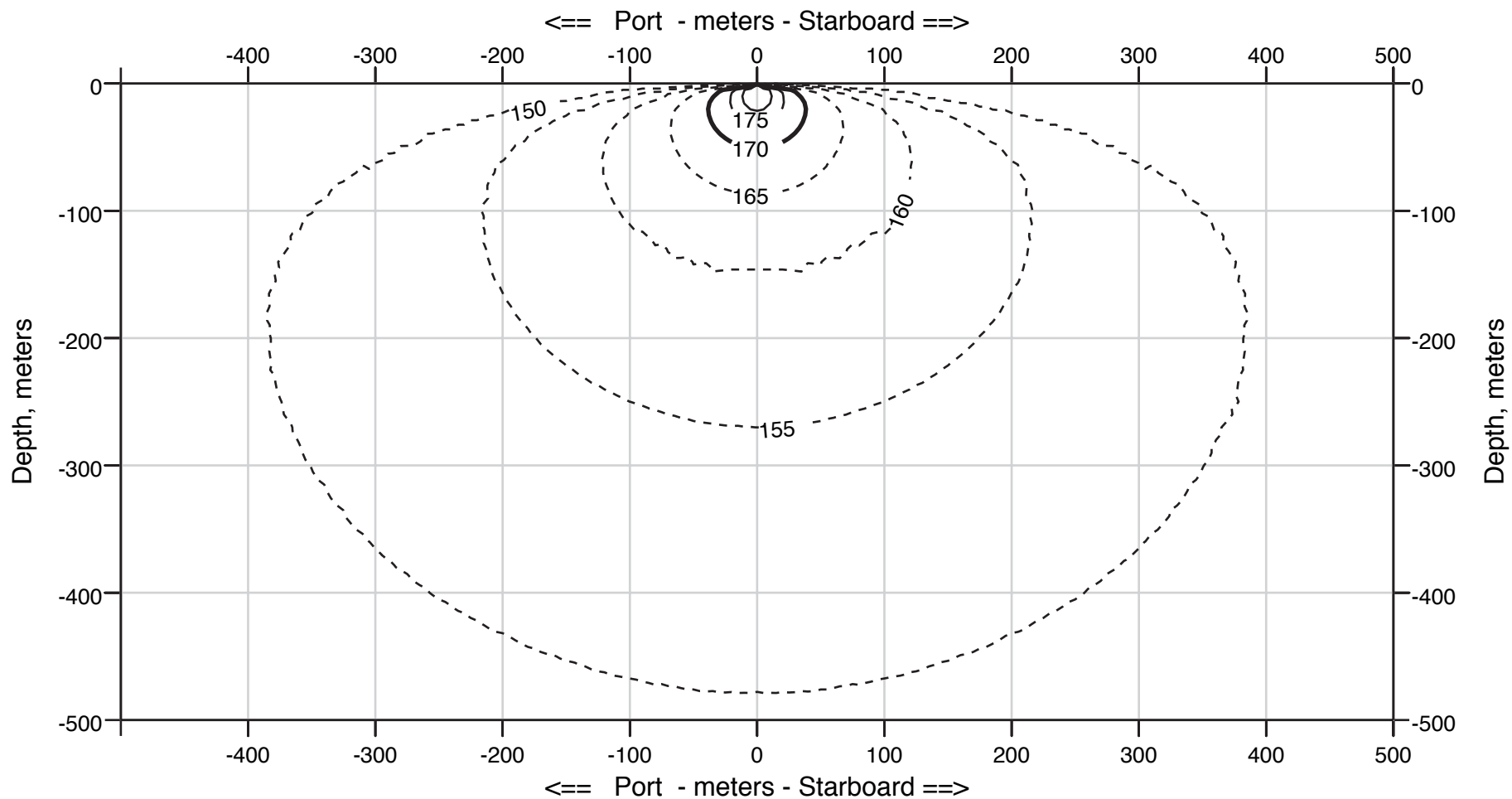

Note: 170 dB re (1 uPa)<sup>2</sup>s (SEL) ~ 180 dB re 1 uPa (rms)

# Airgun Sound Exposure Level (dB, SEL)

250 cu in G Gun @ 3 m depth

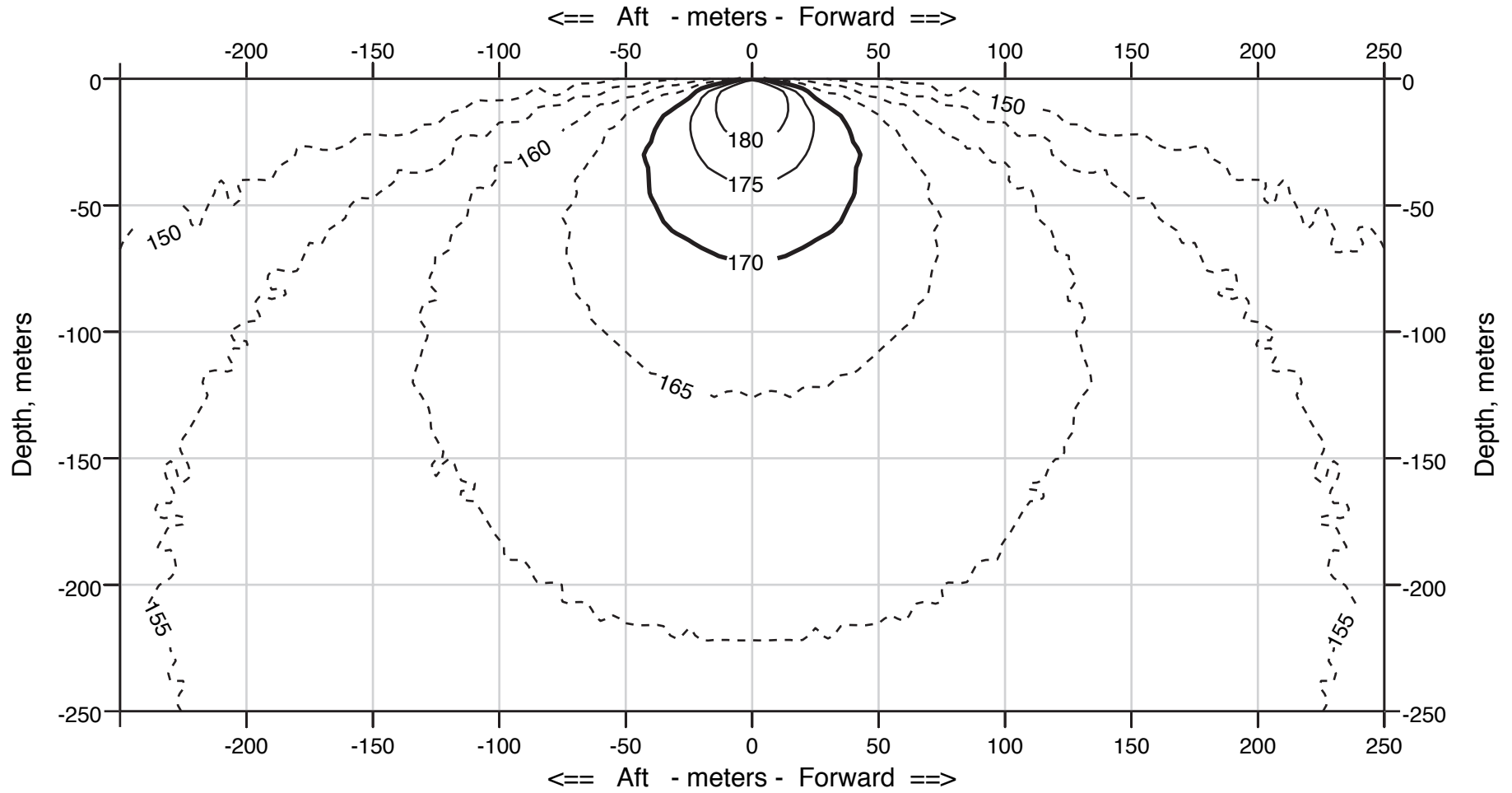

Note: 170 dB re (1 uPa)<sup>2</sup>s (SEL) ~ 180 dB re 1 uPa (rms)

# Airgun Sound Exposure Level (dB, SEL)

250 cu in G Gun @ 5 m depth

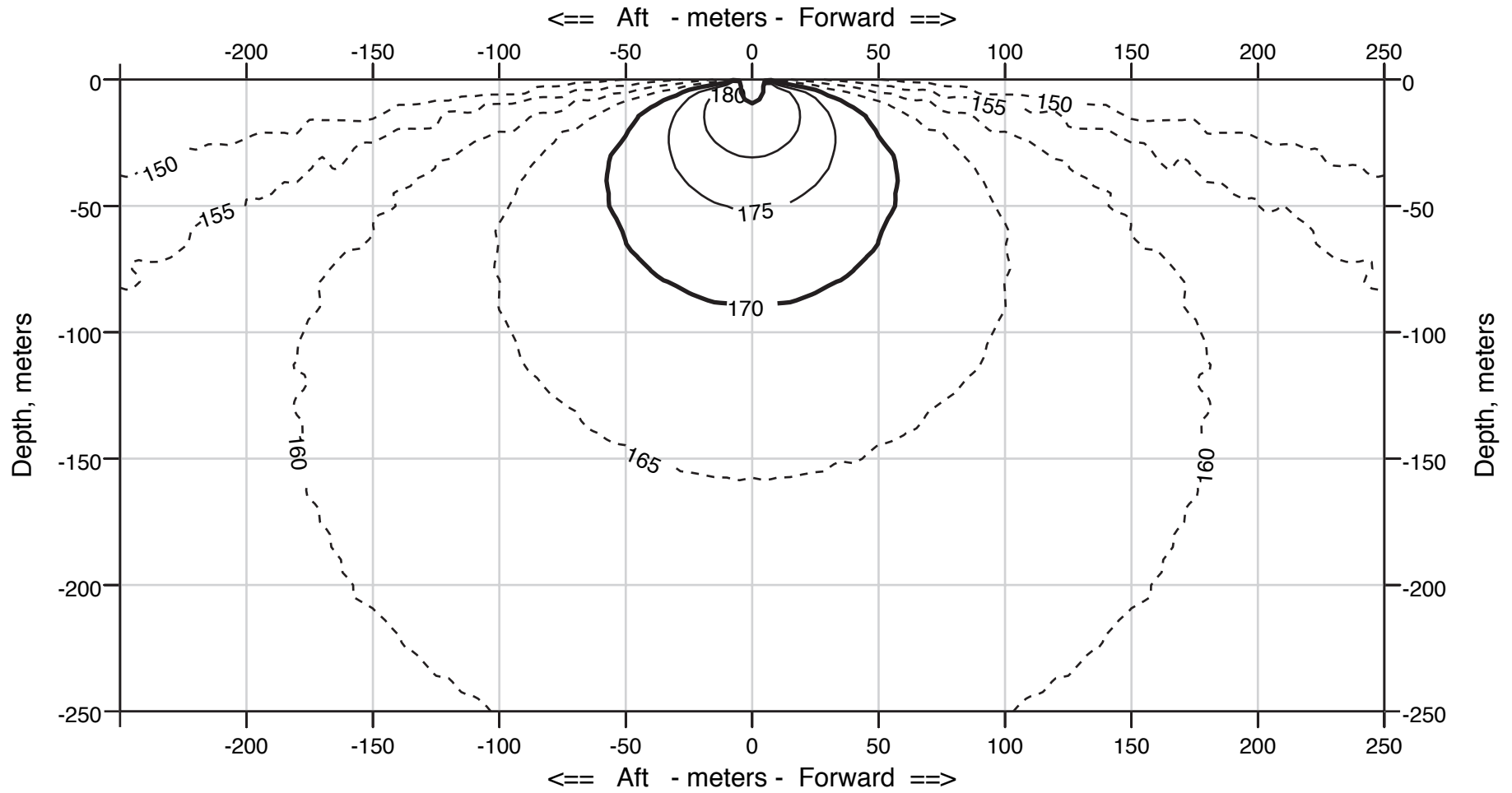

Note: 170 dB re (1 uPa)<sup>2</sup>s (SEL) ~ 180 dB re 1 uPa (rms)



# Airgun Sound Exposure Level (dB, SEL)

250 cu in G Gun @ 6 m depth

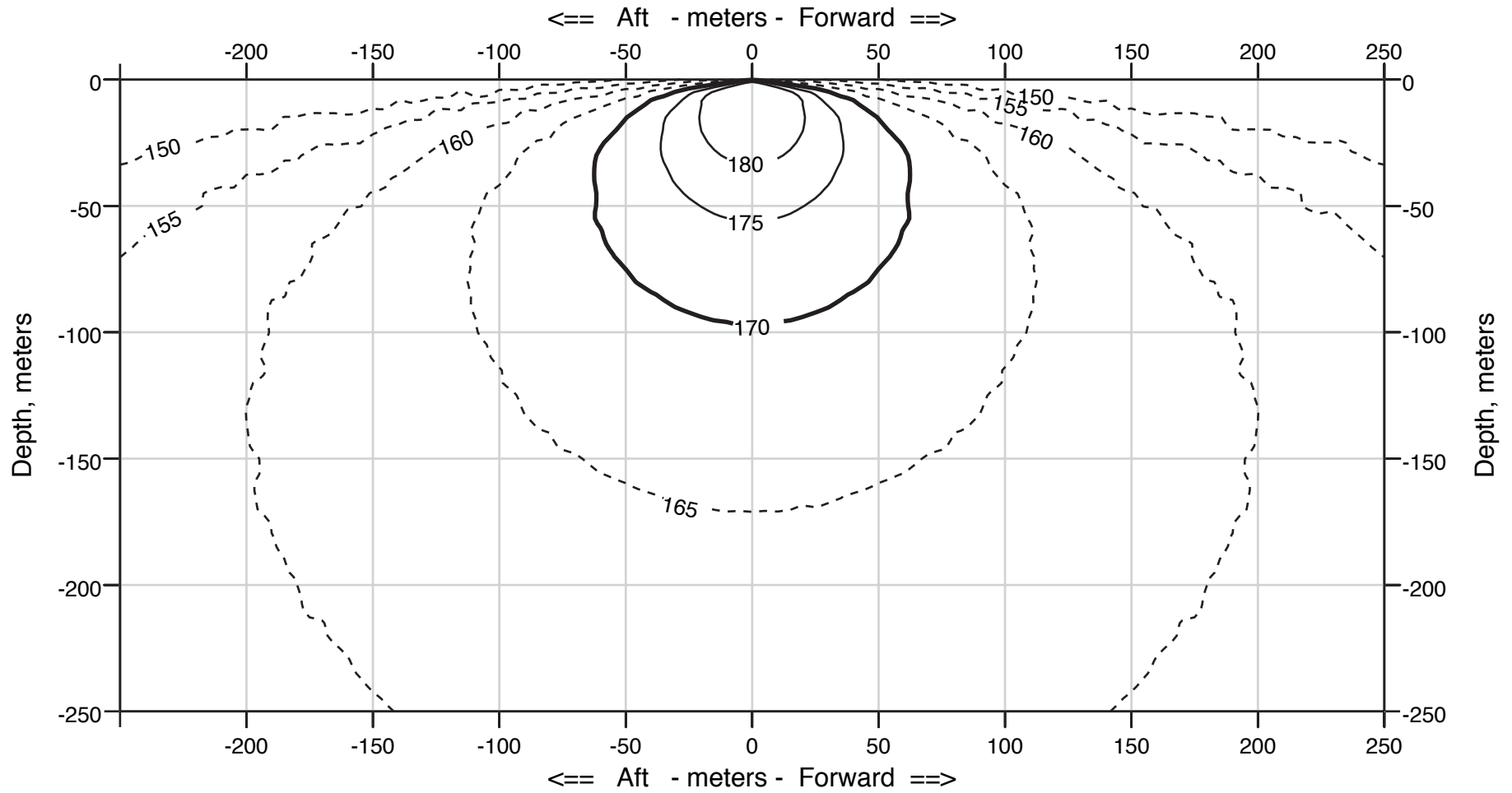

Note: 170 dB re (1 uPa)<sup>2</sup>s (SEL) ~ 180 dB re 1 uPa (rms)

# Airgun Sound Exposure Level (dB, SEL)

Double 250 cu in G Guns @ 3 m depth (1 of 3)

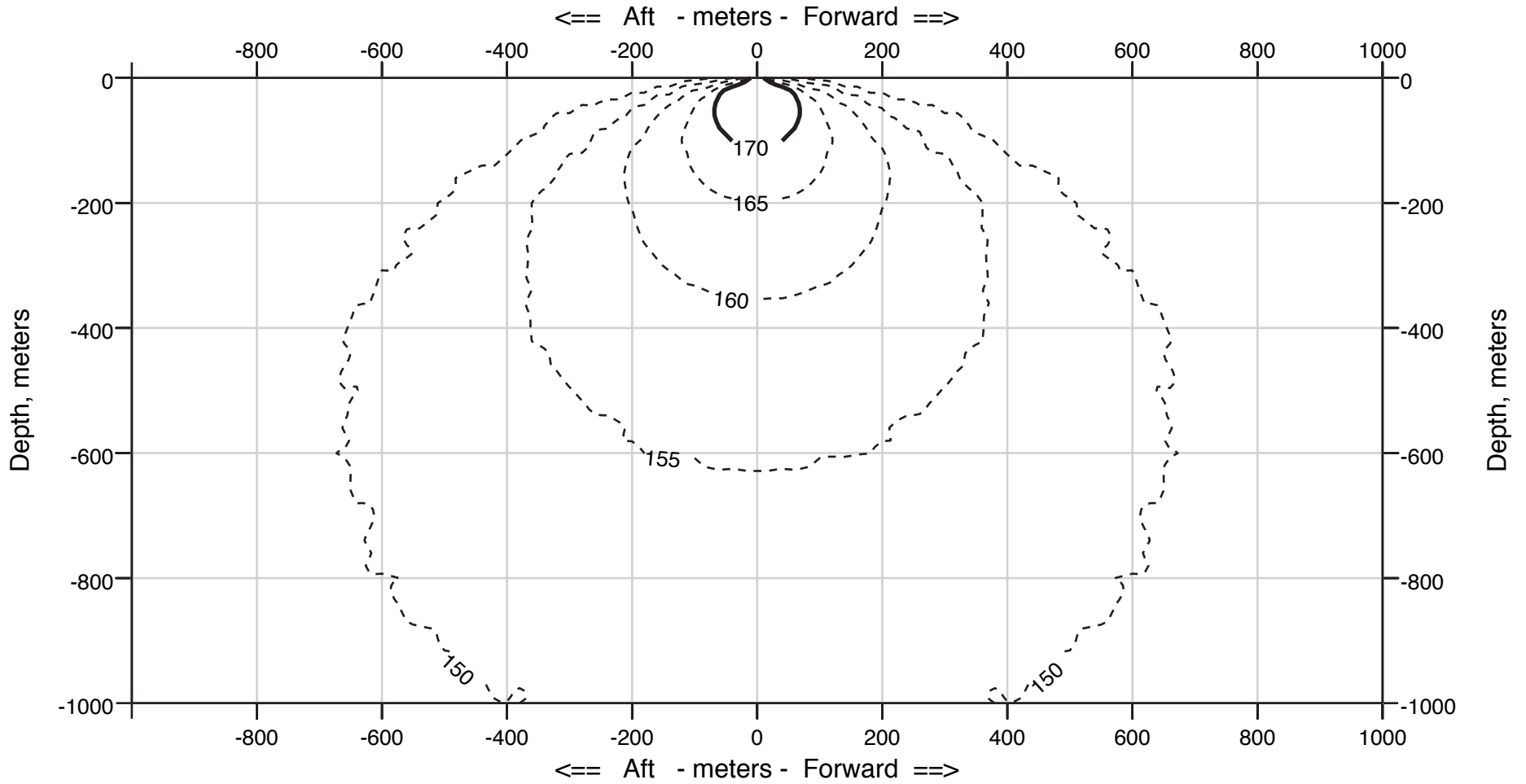

Note: 170 dB re 1 uPa\*s (SEL) ~ 180 dB re 1 uPa (rms)

# Airgun Sound Exposure Level (dB, SEL)

Double 250 cu in G Guns @ 3 m depth (2 of 3)

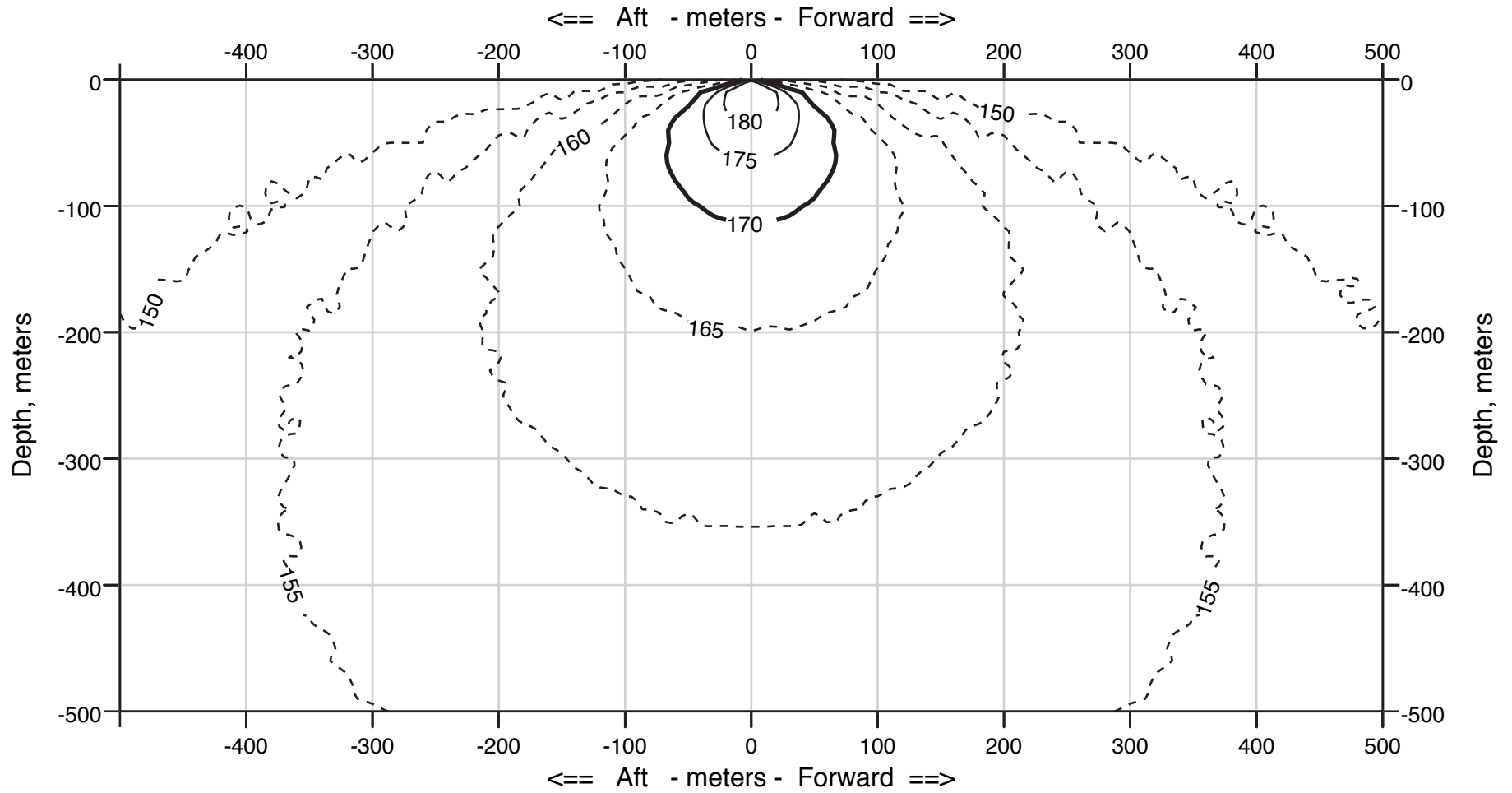

Note: 170 dB re 1 uPa\*s (SEL) ~ 180 dB re 1 uPa (rms)

# Airgun Sound Exposure Level (dB, SEL)

Double 250 cu in G Guns @ 3 m depth (3 of 3)

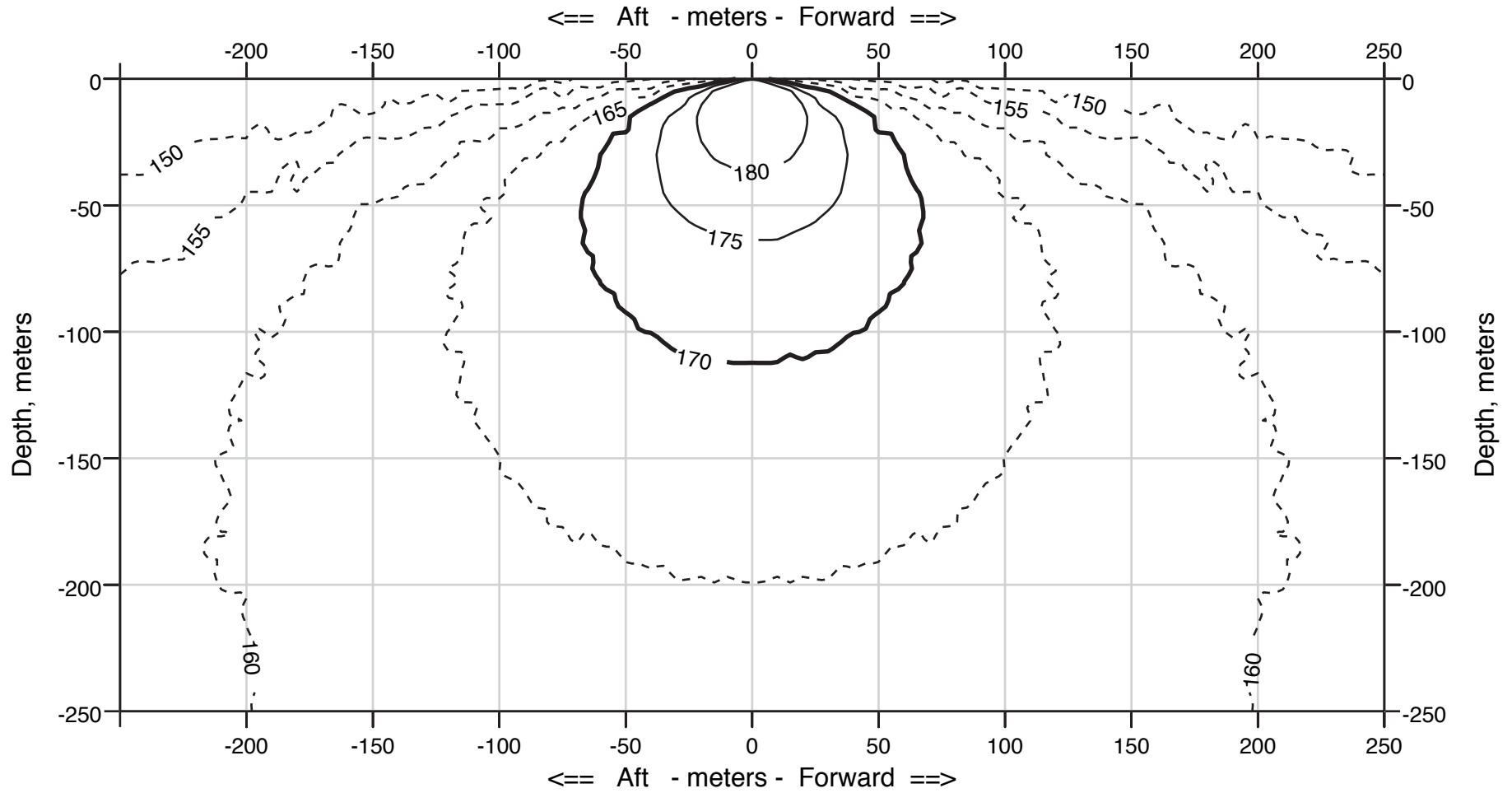

Note: 170 dB re (1 uPa)<sup>2</sup>s (SEL) ~ 180 dB re 1 uPa (rms)

# Airgun Sound Exposure Level (dB, SEL)

Double 250 cu in G Guns @ 5 m depth

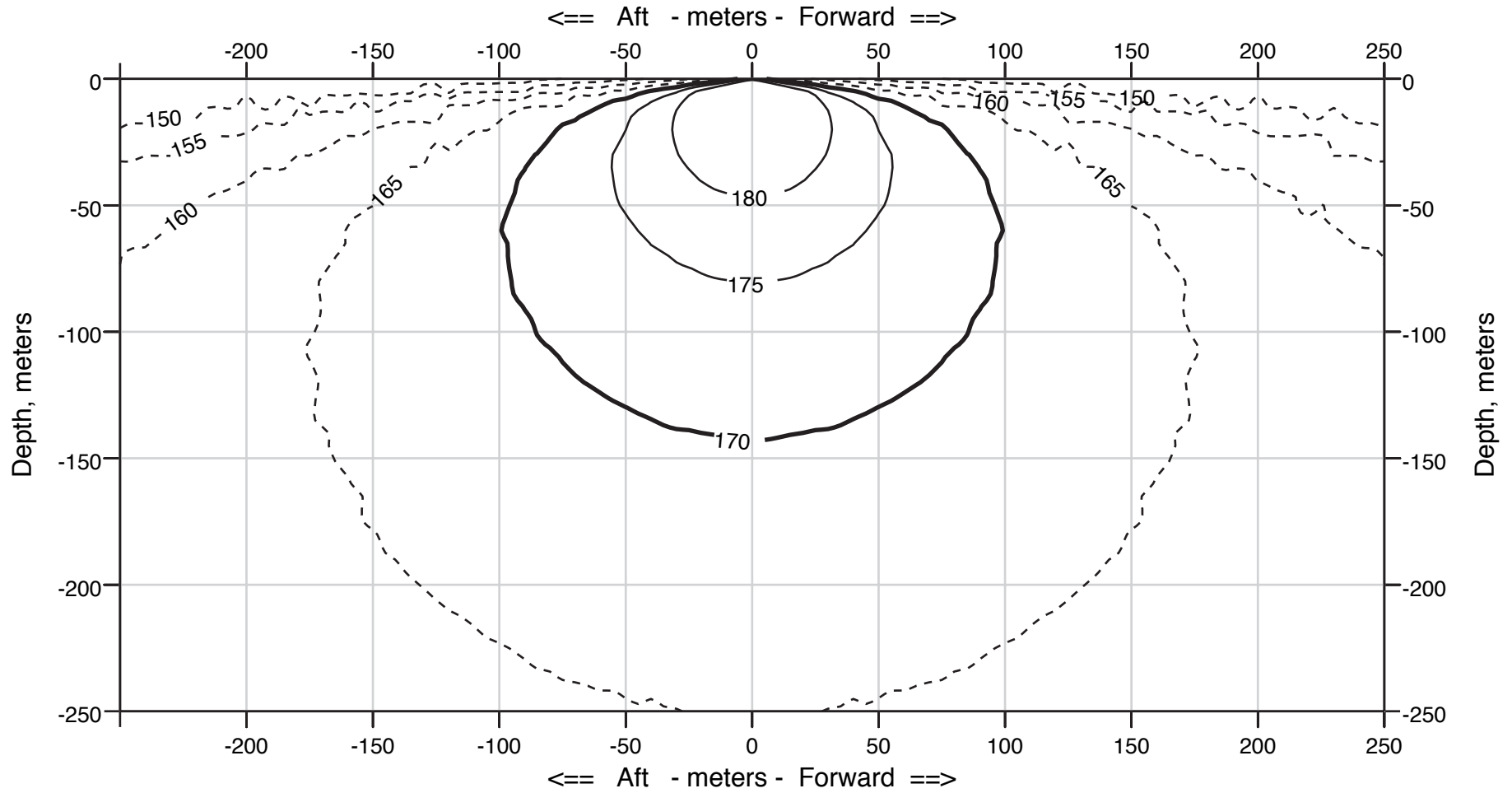

Note: 170 dB re (1 uPa)<sup>2</sup>s (SEL) ~ 180 dB re 1 uPa (rms)

# Airgun Sound Exposure Level (dB, SEL)

Double 250 cu in G Guns @ 6 m depth (1 of 3)

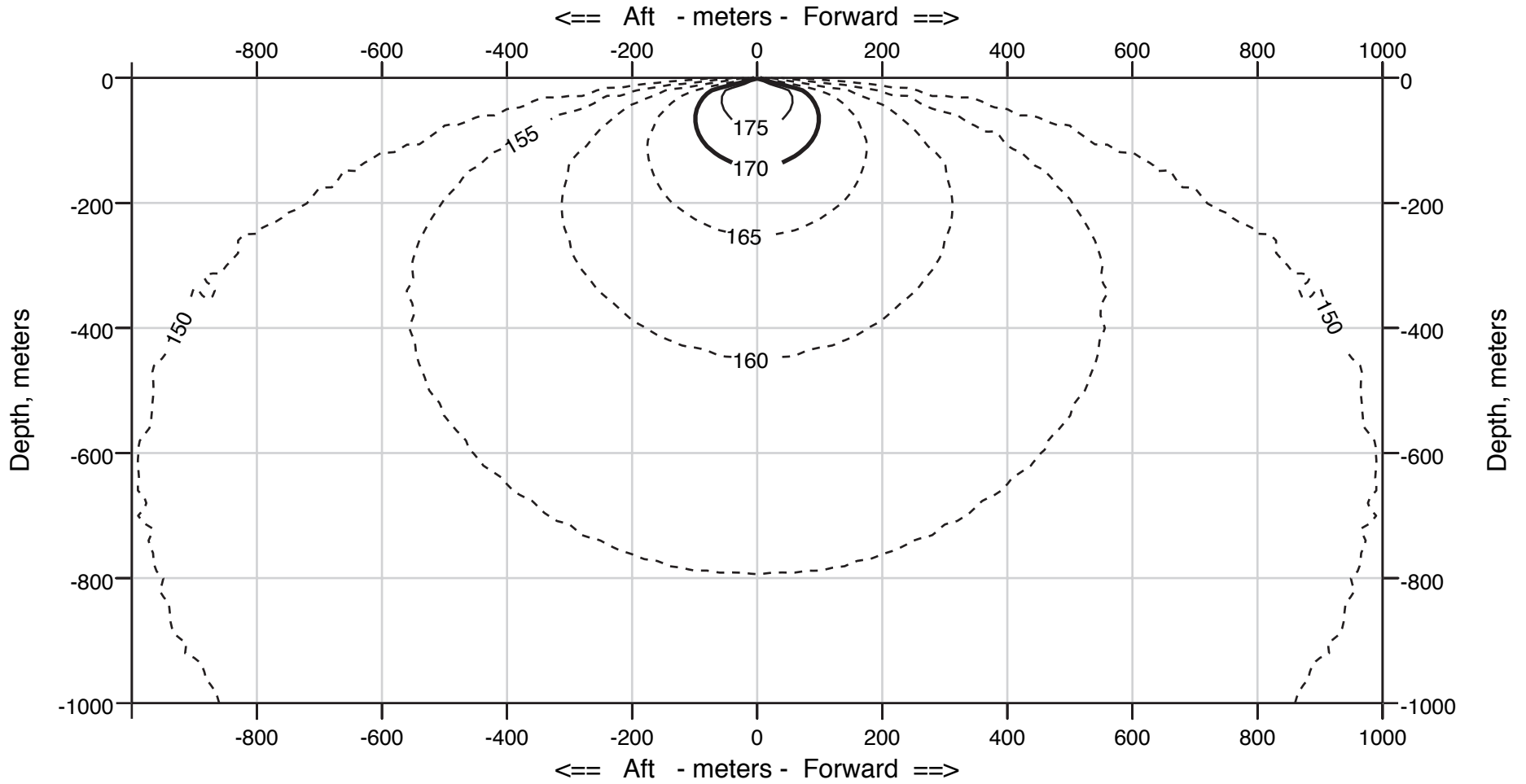

Note: 170 dB re 1 uPa\*s (SEL) ~ 180 dB re 1 uPa (rms)

# Airgun Sound Exposure Level (dB, SEL)

Double 250 cu in G Guns @ 6 m depth (2 of 3)

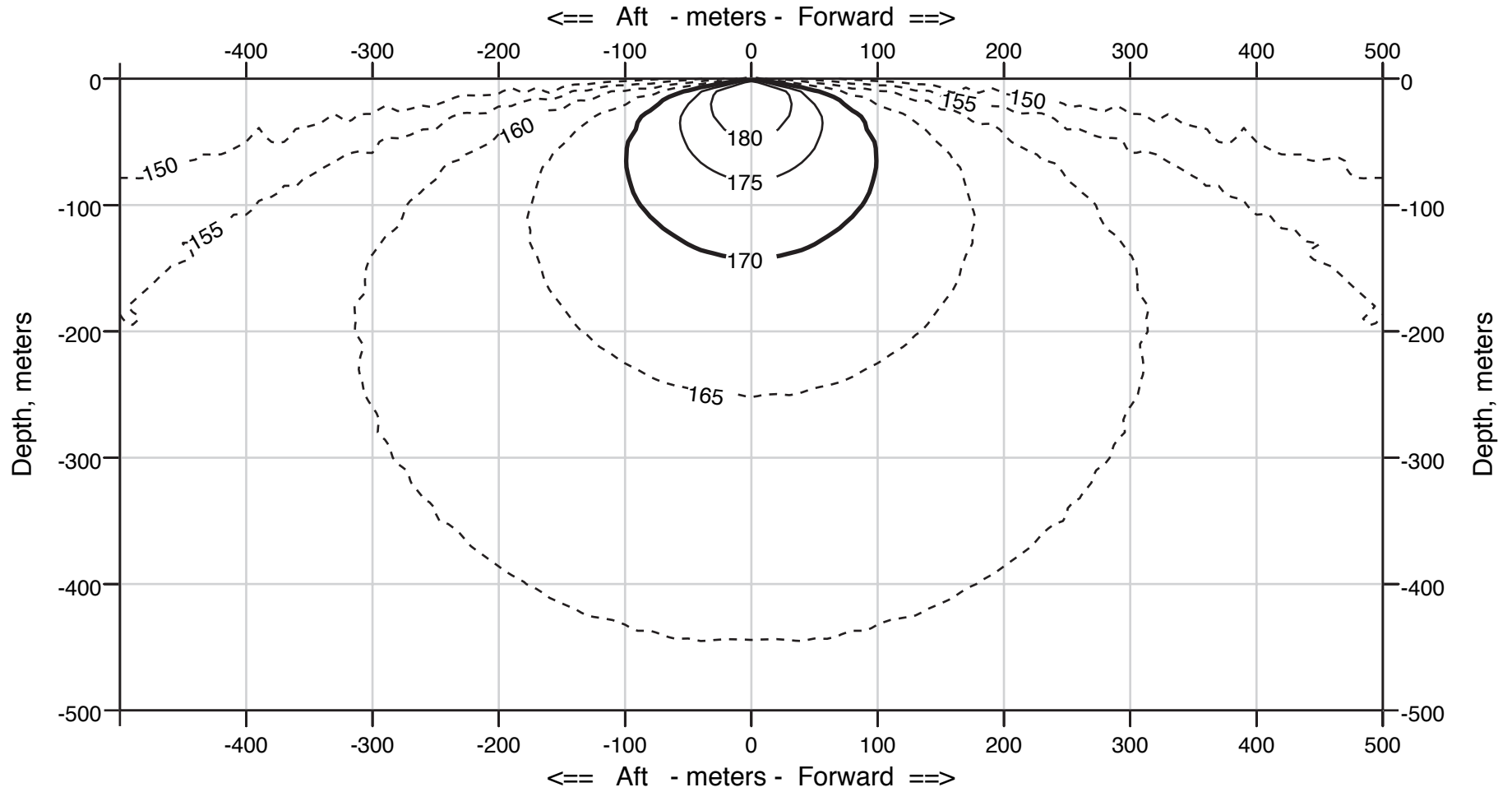

Note: 170 dB re (1 uPa)<sup>2</sup>s (SEL) ~ 180 dB re 1 uPa (rms)



# Airgun Sound Exposure Level (dB, SEL)

Double 250 cu in G Guns @ 6 m depth (3 of 3)

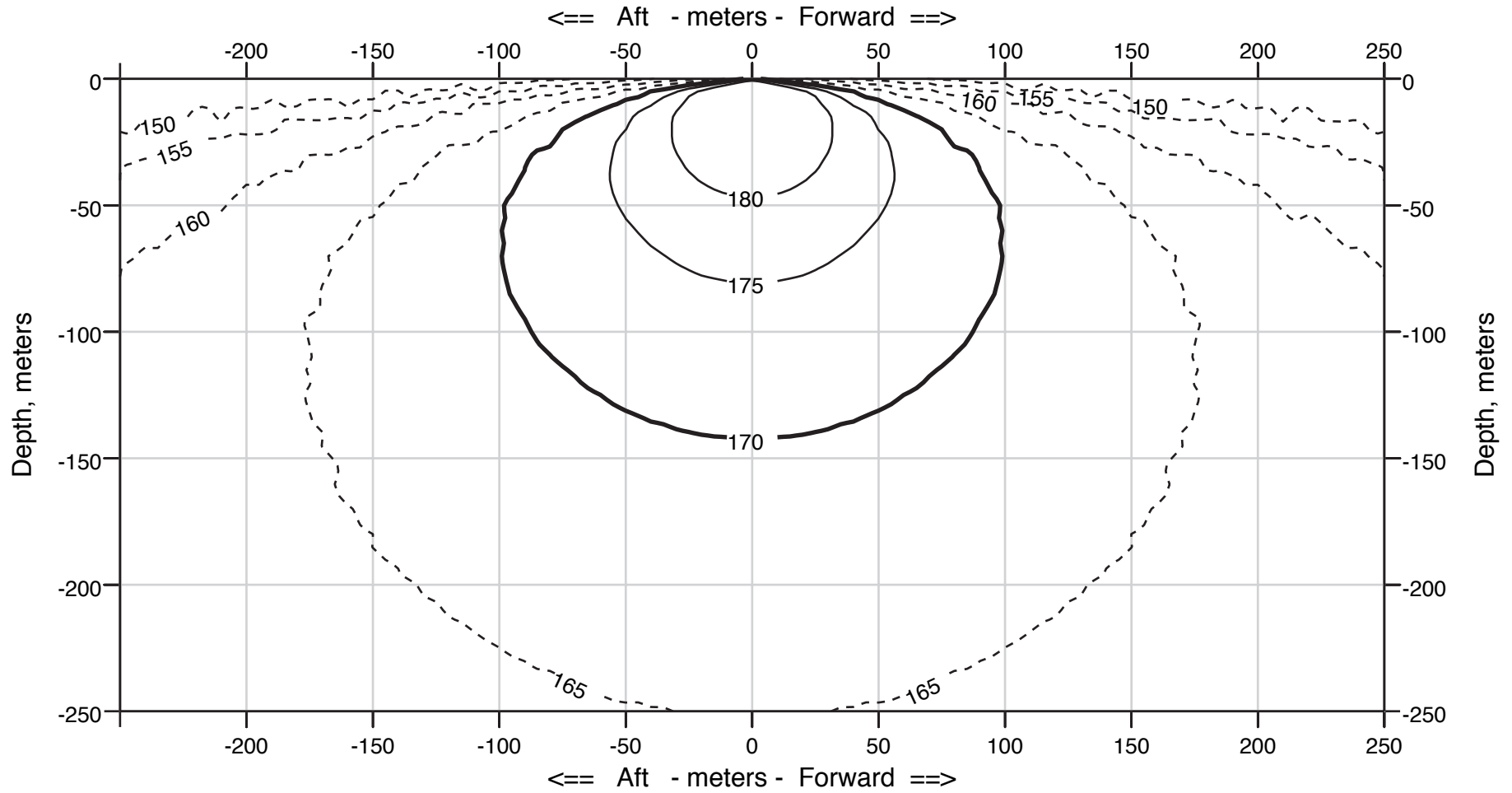

Note: 170 dB re (1 uPa)<sup>2</sup>s (SEL) ~ 180 dB re 1 uPa (rms)

**THIS PAGE INTENTIONALLY LEFT BLANK**

## **APPENDIX F**

### **PRE-CRUISE ACTIVITIES**

Within the IODP Science Advisory Structure and before a drilling and coring expedition is scheduled, site characterization data will be gathered to evaluate (1) whether the regional and site-specific survey data are of sufficient quality and quantity that it will be possible to select the best sites at which to address the scientific questions posed in the proposal, (2) if a site is drilled, whether the regional and site-specific survey data are of sufficient quality and quantity that the results from this borehole could likely be extrapolated over a usefully broad portion of the ocean and/or applied to related questions and analogous sites worldwide, and (3) the known or suspected presence of potential environmental concerns, including sensitive biota, cultural resources, and shallow drilling hazards.

The following document, the Guidelines for the EPSP Safety Review Report and Presentation, and Expedition Safety Package summarizes the information that must be assembled by proponents of drilling proposals including data pertaining to the environmental conditions at each proposed drill site.

**THIS PAGE INTENTIONALLY LEFT BLANK**

# Guidelines for the EPSP Safety Review Report and Presentation, and Expedition Safety Package

## Introduction

This document describes (A) the Environmental Protection and Safety Panel (EPSP) Safety Review Report, and accompanying presentation, and (B) the Expedition Safety Package. Part C defines the parties responsible for creating the various products described in this document, and the distribution lists for these products.

Some terms used in this document:

**EPSP Preview and Review.** The EPSP assesses proposed drill sites in either a preview or review mode. In either case, a representative proponent attends the review meeting and makes a presentation (see below for Safety Presentation Guidelines). The **preview** is an opportunity for the panel to identify key issues that should be addressed before the final review is made. These issues could include data processing requirements, and the need for additional data (including shallow hazard assessments). The **review** is considered the final presentation before the EPSP, where drilling recommendations (see below: Possible EPSP Actions) are made for each of the proposed sites.

The **Safety Review Report** is a PDF document written by the proponent(s), and its contents, in distilled form, are presented by a proponent during an EPSP review (or preview) of proposed sites (see Safety Presentation below).

The **Safety Presentation** is typically a PowerPoint (or PDF) presentation given by a proponent to the EPSP, summarizing the information in the Safety Review Report.

The **Expedition Safety Package** is a collection of documents and site survey data assembled by the Implementing Organization (IO) with the assistance of the expedition Co-chiefs, proponent(s), and IODP-MI, as described in Part B of this document. This package includes the Site Survey Data Package.

The **Site Survey Data Package** is the collection of all site survey data (both raw data, e.g., segy, and data in image format, e.g., PDF) required for an expedition. The authoritative list of required data is defined by the IO, Co-chiefs and/or proponents and is published in the expedition Scientific Prospectus.

The **Site Survey Data Bank (SSDB)** (<http://ssdb.iodp.org>) is the repository for all IODP proposal- and expedition-related site survey data. All site survey data within the site survey data package must be housed in the SSDB.

Note that in addition to safety reviews by the EPSP, the safety panel for the concerned IO performs an independent review of proposed sites. The IO's safety panel has the authority to override decisions made by the EPSP.

The attached figure shows the typical procedural steps and required actions for a proposal as it moves beyond the usual Science Advisory Structure review process

(i.e., reviews by the Science Steering and Evaluation Panel, Site Survey Panel and Science Planning Committee) to the Operations Task Force, through to scheduling and subsequent preparation for the expedition.

## ***Part A. EPSP Safety Review Report & Presentation***

### **1. Safety Review Report & Presentation General Guidance**

Under normal circumstances a representative proponent will be asked by the panel chair to attend an EPSP meeting and make a presentation to the panel. The proponent making the presentation should be aware not only of the scientific justification for the program but the technical details associated with the site survey data presented during the panel meeting and in the Safety Review Report, including acquisition and processing parameters. (If no single proponent is capable of making this presentation the panel chair will invite two presenters to represent the proposal.)

The proponent will be required to submit a Safety Review Report to IODP-MI for distribution to the panel. An EPSP watchdog will be assigned to answer proponent questions and insure that the completed Safety Review Report is satisfactory.

The Safety Presentation typically is broken down into two general sections: (i) an overview; followed by (ii) a site-by-site review.

(i) The general overview is typically 15-30 minutes in duration. The presentation of the overview normally includes:

1. an overview of the proposed scientific program.
2. status of the site survey information.
3. the proposed drilling program (number of sites, types of coring, logging program, necessity of riser capability, etc.).
4. description of key safety and pollution issues as understood by the proponents.

(ii) For the site-by-site review, all relevant information should be presented including:

1. reason(s) for the selection of the site location.
2. planned type(s) of coring, sampling, and logging.

Specifically the panel needs to know:

1. proposed depths of penetration.
2. nature of the section to be penetrated (including the identification of any potential hydrocarbon reservoirs and seals).
3. an expression of your degree of confidence in the velocity control for depthing and your proposed lithologic column.
4. possibilities of thermally mature hydrocarbon source rocks in the vicinity of proposed drilling targets and effective migration pathways.
5. results of any industry and/or previous scientific drilling.
6. likelihood of either abnormal pressure or subsurface fluid flow.
7. environmental and safety issues that may be specific to your leg (including how sites will be located, availability of crossing seismic lines, order of drilling, etc.).

The proponents should consider the following recommendations for site selection when bringing their requests for EPSP approval forward:

- Locate on existing seismic line, if possible (if not, explain rationale for locating offline).
- Locate on cross-line, if available and possible.

Under certain circumstances the EPSP may require from the IO a shallow hazards or other special survey or a drilling protocol document. This may include a request for an interpretation of hazards survey data by an independent entity.

## **2. Safety Review Report Guidelines**

The Safety Review Report is a PDF document created by the proponent(s). Some exemplary previous Safety Review Reports can be obtained by request to the chair of the EPSP. The report should include:

- A summary of the scientific objectives and environmental issues of the proposed expedition.
- Completed site summary forms.
- Always include a contoured seafloor bathymetry map with an appropriate contour interval to illustrate the topography. Especially in areas of complex bathymetry (e.g., reefs), bathymetric maps should be at the highest resolution possible.
- Multibeam maps should be included (contours at 50 or 100m intervals). Shaded relief maps are also helpful in areas of complex bathymetry.
- Track chart of available seismic data. Data included in the report should be highlighted. This chart should be at the same scale as the bathymetry maps. This is usually best done by co-registering and overlaying the seismic acquisition lines on the regional and multibeam bathymetry maps. This map should also identify any known hazards, communication cables, and/or protected areas, as well as any prior commercial wells or scientific drilling sites.
- When appropriate and data are sufficient, map key horizons and intervals when anticlines are present in the near-surface section.
- At a minimum, show an uninterpreted section with the drill-site annotation.

The following type and basic information should be included on all maps:

- Indicate North either with arrow or grid lines
- Include scale bar or other indication of distance
- Label any contours present at a regular interval and ensure that the contour interval is easy to identify
- Indicate the grid resolution in metres for any maps showing gridded (e.g., seafloor bathymetry)
- Label all trackline and shot points at a regular interval
- All charts should use the same projection and the projection should be identified



The following basic information should be included on all seismic data presented:

- Provide as much information as possible about acquisition and processing of the seismic data used.
- Shot points should be labelled.
- Clearly indicate the horizontal and vertical scales.
- All records associated with a single site should be presented at the same vertical and horizontal scales.
- Mark drill sites with “sticks” indicating anticipated depth of penetration based on best time-depth conversion.
- Intersection of cross-line(s), if present should be clearly marked
- Highlight on seismic records any structures or features that are important to both your science case and safety issues. For example, identify potential structural traps (anticlines, etc.), stratigraphic traps (sand bodies and cap formations), bright spots and wash-out zones (e.g. potential free gas).

### **3. Safety Presentation Guidelines**

The Safety Presentation is a PowerPoint or PDF document created, and presented during an EPSP review (or preview), by the proponent(s). Some exemplary previous Safety Presentations can be obtained by request to the chair of the EPSP.

- Keep all text, maps and diagrams simple and clear to read from a distance of 10 m. Do not include lots of pages of text or complex tables of data. This material may be included in the Safety Review Report.
- Maps and seismic data included in the Safety Presentation should include the same basic and labeling information as that included in Safety Review Report.
- The presentation should include high-resolution digital images of the seismic sections. A PDF file with as much detail as possible to allow zooming in to seismic sections is one way this may be accomplished. *It is also recommended that the proponents arrange to have large format paper records and copies of all relative seismic sections and charts.*
- The PowerPoint presentations are attached to the final minutes and will be included as part of the final Expedition Safety Package.

### **4. Possible EPSP Actions**

After each site review the panel will make a recommendation. EPSP site recommendations are forwarded to the Science Planning Committee (SPC), IODP Operations Task Force, and the IO. Possible site recommendations are:

- Approve as requested.
- Approve to a specified depth other than that originally requested.
- Approve at a new site based on discussions between panel members, proponents, and operator.
- Defer any recommendation until additional specified information is provided.
- Not approve

In addition, the panel may recommend a specific drilling order and/or specific monitoring requirements.

### **5. Frequently Asked Questions by EPSP members**

When preparing the Safety Review Report and associated presentation the proponents should prepare themselves to answer the following frequently asked questions:

- How and when were the data collected?
- How were the seismic data processed?
- What was the velocity control used to establish target depths? What is the uncertainty associated with these estimates?
- Are there any velocity anomalies on the profiles near the proposed drilling sites?
- Do additional industry data (seismic, drilling) exist in the relevant area and could these be accessed?
- What was the navigation used (especially important for older data)?
- Are all of the map projections consistent?
- If applicable, have the requested depths accounted for any logging tools?
- Have you considered alternative locations if the EPSP cannot approve the sites as proposed?
- Have alternative sites been prepared if weather, currents, ice, etc. prevent drilling or if additional time is available during the planned expedition?
- What would happen to the science plan if the proposed depth of penetration cannot be approved?
- Do you have a recommended drilling order and why?
- Are there any biological communities within 100 metres of any of the proposed drill sites, what are they (e.g., vents, deep-water reefs, etc.), and what is the evidence for their existence (e.g., sampling, visual, etc.)? When and by whom were these data collected?
- Is the proposed drilling location in the vicinity of a fisheries (species, typical gear, etc.), known breeding/feeding ground or migration route, or “home” of threatened or endangered species?
- Is there a probability of encountering H<sub>2</sub>S or hydrates during coring or core recovery?
- Are there any reasons to suspect that an over-pressured section will be encountered?
- Is there petroleum industry interest in the area? Are the proposed drilling sites located within current or proposed license blocks?
- Have any commercial “dry” wells been examined to determine whether hydrocarbon shows may actually be present?
- Are there any indications of active (or previously active) vent systems or hydrocarbon seeps in the area of proposed drilling?
- Is there an expectation that reservoir facies may be present?
- Are there any other environmental or safety issues that the EPSP should be aware of?

## ***Part B. Expedition Safety Package***

The Expedition Safety Package contains all data and documentation necessary to support a safe operation.

### **Components of the Expedition Safety Package**

- Safety Review Report
- Safety Presentation
- Any required shallow hazard or special survey reports required by the EPSP or the IO.
- The portions of the EPSP and IO safety panel minutes that are relevant to the specific expedition(s), which would include the panel's recommendations
- Scientific Prospectus (SP), which would normally include images of key seismic profiles. The SP also includes the authoritative list of site survey data required for the expedition as defined by the IO, Co-chiefs and/or proponents. This list, which includes the URL link to each item in the Site Survey Data Bank, includes all data necessary to conduct a safe expedition and to address all safety and scientific contingencies, such as the need to relocate or add a new drilling location.
- The Site Survey Data Package (SSDP), which is one (or more as necessary) CD or DVD containing all site survey data (both raw data, e.g., segy, and data in image format, e.g., PDF) required for the expedition as defined in the authoritative list published in the SP.
- Any required governmental approvals for the expedition that may limit site relocation and/or modification to the approved drilling plan.

## ***Part C. Responsible Parties and Distribution of Products***

### **1. Responsible Parties**

**Site Survey Data** – Prior to an EPSP review the proponent is responsible for ensuring that all data (raw digital data and/or image format data) presented in the Safety Review Report are submitted to the Site Survey Data Bank. When an expedition is scheduled, the Co-chiefs and proponent, with the assistance of the IO, are responsible for ensuring that all data (raw data and/or image format data) required for the expedition are submitted to the Site Survey Data Bank (SSDB). The IODP-MI science coordinator responsible for site survey data issues is available to assist users of the SSDB.

**Large format paper plots for EPSP review** – If applicable, proponents are responsible for producing and transporting to the meeting.

**Expedition Safety Package** – The overall responsibility for the assembly and distribution of the Expedition Safety Package rests with the IO. The Expedition Safety Package needs to be distributed prior to the onset of the expedition. Responsibilities for preparing and delivering the components of the package are as follows:

- **Safety Review Report** – Proponents and/or Co-chiefs, if assigned, will prepare. Forwarded directly to IODP-MI by the proponents and/or Co-chiefs via either email or, if necessary because of size, via ftp (IODP-MI will provide an ftp site for uploading the report). The report is due 4 weeks in advance of the EPSP meeting. IODP-MI will distribute (on CD media) to EPSP members for review at least two weeks prior to the semi-annual meeting. IODP-MI will forward to the IO for inclusion in the Expedition Safety Package when the expedition is scheduled.
- **Safety presentation** – Proponents and/or Co-chiefs, if assigned, will prepare and deliver at the time of the EPSP meeting to the chair or co-chair. Forwarded by the EPSP chair to IODP-MI with the final panel minutes. IODP-MI will forward to IO for inclusion in the Expedition Safety Package when the expedition is scheduled.
- **EPSP recommendations** – EPSP chair or co-chair. Forwarded to IODP-MI when the minutes are finalized. IODP-MI will forward to IO for inclusion in the Expedition Safety Package when the expedition is scheduled.
- **IO's safety panel actions** – Forwarded directly by IO's safety panel to IO.
- **Scientific Prospectus** – Created by IO. Forwarded to IODP-MI when completed. To be completed six months prior to the start of the expedition.
- **Site Survey Data Package** – IODP-MI creates CD(s) or DVD(s) containing data specified in the Scientific Prospectus. IODP-MI forwards to the IO for inclusion in the Expedition Safety Package and distribution to expedition participants. The Safety Package should be delivered to the IO three months prior to the start of the expedition, or as soon as possible after all required data have been identified and submitted to the SSDB.
- **Expedition specific approvals** – The IO is responsible for providing as necessary.
- **Shallow hazard or special survey reports and/or drilling protocol documentation** – The IO is responsible for forwarding to IODP-MI for distribution to EPSP members together with the Safety Review Report.
- **Expedition Safety Package** – The IO is responsible for packaging together the components described at the top of Part B. The Expedition Safety Package is forwarded by the IO to all concerned parties as described below.

## **2. Distribution**

The following distribution is intended to ensure a common data/document package onboard the ship and onshore to facilitate any discussions and/or decisions that may be required once an expedition has begun.

*EPSP Safety Review Report* (provided by proponent/Co-chiefs 4 weeks prior to EPSP meeting and distributed by IODP-MI):

- EPSP members, liaisons and IO representatives attending the EPSP meeting

*Expedition Safety Package* (provided and distributed by the IO):

- Co-chief scientists
- Expedition staff scientist
- Chair and co-chair of EPSP
- Chair of SPC

- IODP-MI (Sapporo and Washington, D.C. offices)
- IO

*Site Survey Data Package* (provided by IODP-MI and distributed by the IO)

- Same distribution as the Expedition Safety Package, plus
- All invited scientific expedition participants

APPENDIX F **Proposal / expedition activity surrounding an EPSP review**

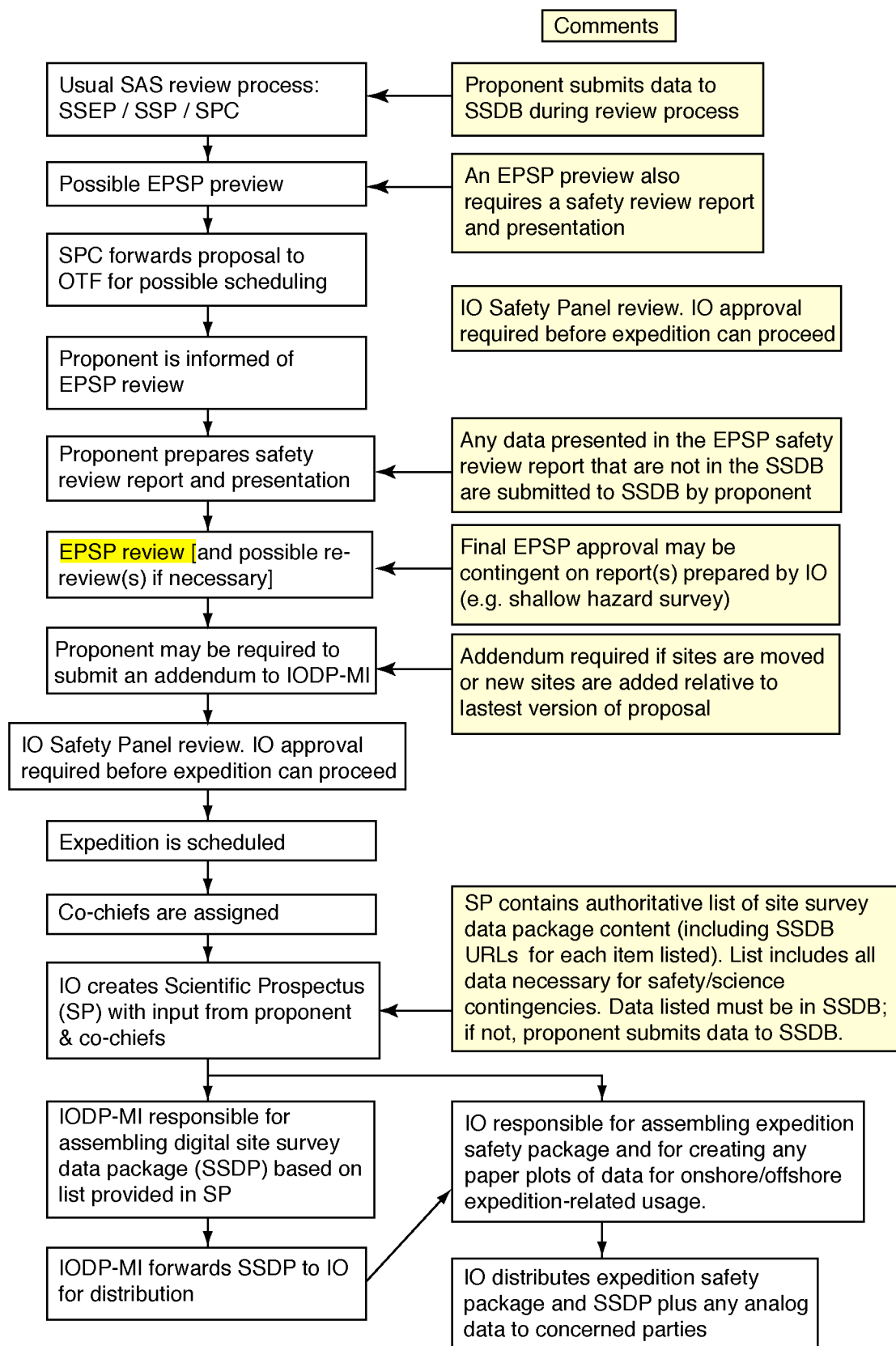

<b>Acronyms:</b>			
EPSP	Environmental Protection & Safety Panel	SAS	Science Advisory Structure
IO	Implementing Organization	SP	Scientific Prospectus
IODP-MI	Integrated Ocean Drilling Program - Management International	SPC	Science Planning Committee
OTF	Operations Task Force	SSDB	Site Survey Data Bank
		SSDP	Site Survey Data Package
		SSEP	Science Steering & Evaluation Panel

**THIS PAGE INTENTIONALLY LEFT BLANK**



## APPENDIX G SENSITIVE ENVIRONMENTS

This appendix provides detailed information on sensitive environments and biota that may be encountered during future IODP riserless drilling expeditions.

### **Chemosynthetic Communities**

In the deep ocean below the photic zone, at depths below 300 m, photosynthesis is not possible and low nutrient concentrations sharply constrain the possibilities for complex community structure. Where venting of hydrothermal fluids, seepage of hydrocarbons, or other geological processes supply abundant reduced compounds, chemosynthesis becomes the dominant process of the ecosystem. Chemosynthesis is a mode of life practiced by numerous groups of bacteria that are able to oxidize simple compounds such as hydrogen sulfide (H<sub>2</sub>S) and methane (CH<sub>4</sub>) (Jannasch, 1989).

Chemosynthetic microbes have evolved by using chemical energy rather than light energy to provide a rich food source in areas otherwise devoid of life. Starting with the basic building blocks of nutrients and water, the bacteria produce carbohydrates, proteins, and other complex organic compounds. Like photosynthetic plants, chemosynthetic bacteria are thus able to form new organic compounds at the base of the food chain. They thrive around areas such as hydrothermal vents, which emit plumes of hot water that can reach 400°C and contain high concentrations of hydrogen sulfide, or at cold seeps, where chemicals seep from the sea floor at the same temperature as the surrounding water. Hydrothermal vent and cold seep communities are considered biologically sensitive areas due to their limited range, large variety of endemic species, and scientific value. It is believed that zooplankton in the vicinity of hydrothermal vents are likely exploiting a food substrate associated with the hydrothermal plume (Cowen *et al.* 2001).

Hydrothermal vents release minerals that form deposits on the surrounding rocks when in contact with cold water. The deposits accumulate and can form chimney-like formations, which have been observed as tall as 49 m and at average depths of 2,100 m. Due to the presence of chemosynthetic bacteria as an abundant food source, the vent areas support high biomass, contrasting with the cold (2°C) and relatively barren areas beyond the vents. The microbes at hydrothermal vents are able to withstand temperatures up to 113°C (WWF, 2006a). Vent ecosystems can be unique, with over three hundred species documented, some of which thrive only at certain vents (endemic species) (WWF, 2006a). Hundreds of hydrothermal vents have been discovered around the world, typically in clusters called fields. A new species of pink sea urchin (*Echinus* sp.) was recently discovered at the Lucky Strike vent field. The field was discovered in 1993 and is located at a depth of 1,700 m on top of a flat-topped volcano in the Azores in the Atlantic Ocean. The largest vent field is the Trans Atlantic Geotraverse on the east margin of the mid-Atlantic ridge.

Cold seeps exude methane and hydrogen sulfide. Species live much longer in the vicinity of cold seeps than hydrothermal vents. The deepest cold seep ecosystem known is 5,000 to 6,000 m deep in the Sea of Japan. Other places where cold seeps have been discovered include the Gulf of Mexico and off the coasts of California and Alaska (WWF, 2006a). Similar to the bacteria at hydrothermal vents, bacteria at cold seeps carry out chemosynthesis using hydrogen sulfide and methane as the energy source. The bacteria form a microbial mat around these seeps on which marine life such as snails, limpets (family Acmaeidae), and scaleworms graze.

Because they require the means for oxidizing their chemical nutrient source, chemosynthetic bacteria typically live at the interface between reduced sediments and oxygenated water. A common genus is *Beggiatoa*, which form long filaments that comprise pale-colored mats on sediment surfaces (Larkin et al., 1994). A symbiotic partnership of chemosynthetic bacteria with invertebrate hosts greatly extends the possible habitat for the chemosynthetic mode of life. Specific adaptations vary, but the basic arrangement consists of bacteria living within specialized cells in the host organism. The host supplies oxygen and a substrate for the bacteria. Major groups that live in hydrothermal vent or cold seep areas are briefly described below, including vestimentiferan tube worms (*Lamellibrachia* sp.), seep mussels (*Bathymodiolus* sp.), and vesicomyid clams (family Vesicomyidae).

Vestimentiferan tube worms are highly adapted marine worms that colonize hydrothermal vent areas. These worms lack a mouth or digestive system (AMNH, 1997) and can thrive in temperatures up to 80°C. They live in a tough polysaccharide tube, typically 1 cm in diameter and up to 2 m long. Gas exchange and oxygen uptake is via a vascularized plume (red in color), which extends 1 to 2 cm from the anterior tube end (Somero, 2006). The tube is often held 1 m or more above the seafloor. Their symbiotic bacteria utilize H<sub>2</sub>S, which the tube worm absorbs from root-like structures that extend below the buried portions of the tubes. The buried length of the tube may be as much as one third the body length.

Seep mussels, of which the most common species is *Bathymodiolus childressi*, possess symbiotic bacteria which live in the linings of greatly enlarged gills (Childress et al., 1986). These bacteria use methane as a carbon source for growth. Seep mussels are restricted to locations where methane concentrations are high, usually near active gas vents. At such sites, mussels may completely cover the seafloor in mats that are bound together by byssal threads and extend for several meters or more. The maximum length of an adult is 12 to 13 cm. The growth rates are slow, with juveniles requiring possibly 20 years to reach maturity and large adults frequently surviving 40 years (Nix et al., 1995).

Vesicomyid clams are surface-dwelling bivalves that inhabit hydrothermal vent areas and plow long, curving furrows across the seafloor (Rosman et al., 1987). The foot is thrust forward and down into the soil while the siphon is extended into the water. Adults are 75 to 90 cm long, with a deep, heavy shell. Nothing is known of the growth rates, but deep-sea bivalves are typically

long lived. Accumulations of dead shells with clusters of live individuals suggest persistent occupation of active seep sites.

## **Coral Reefs**

Coral reefs are among the most biologically diverse and productive ecosystems of the world and can exist for thousands of years. Although coral reefs occupy less than one percent of the marine environment, they are known for their extensive biodiversity, providing feeding grounds, shelter, and breeding habitat for twenty five percent of the world's marine life (WWF, 2006b). Coral reefs are formed by colonies of stony coral polyps which attach to hard surfaces and produce calcium carbonate to form exoskeletons. The polyps feed at night using tentacles capable of stinging prey, which is primarily plankton. These polyps form the base of the food chain, as the polyps provide food for numerous marine species.

There are many types of coral reefs, including fringing reefs, barrier reefs, and atolls. Fringing reefs occur along coastlines, whereas barrier reefs are large and are separated from the coast by lagoons (Encarta, 2006). The Great Barrier Reef off the northeast coast of Australia is an example of a large barrier reef, extending 150 km wide by 2000 km long. Barrier reefs are also found off the coasts of Belize, Honduras, and around islands in the west Atlantic and Pacific Oceans, including Tahiti. Atolls develop on underwater islands, most of which are sinking volcanoes. They are usually circular or irregular shapes and surround a lagoon that is no more than 30 to 50 m deep (WWF, 2006b).

Coral reefs occur in both warm and cold water regions. In tropical areas, where temperatures are above 16°C, symbiotic algae called zooxanthellae live inside coral polyps, giving color to tropical coral reefs (WWF, 2006b). Zooxanthellae require sunlight for photosynthesis, therefore coral reef growth does not occur below 150 m depths. Tropical reefs are the largest and oldest living systems in the world, growing 1 to 100 cm per year.

Coral can also live at temperatures as low as 4°C and at depths as low as 2,000 m (WWF, 2006b). There are no symbiotic algae in cold water coral reefs, which are located in areas with current on the continental shelf or in deep sea areas with elevated topography, such as seamounts (described below) and mounds, including the Darwin mounds off the coast of the United Kingdom. These mounds are located at approximately 1000 m in depth and are likened to sand volcanoes. The field contains hundreds of individual mounds with average dimensions of 5 m in height and 100 m in diameter. The top of the mounds is habitat for the cold water coral, *Lophelia pertusa*.

Deep sea coral reefs grow between 5 and 25 mm per year and some may be over 8,000 years old. The world's largest known cold water coral reef, the Røst Reef, was only recently discovered in May 2002 (Kirby, 2003). The reef is approximately 40 km long and two to three km wide. It covers an area of approximately 100 km<sup>2</sup> and is located west of Røst Island in the Lofoten

Archipelago, Northern Norway. Deepwater coral reefs are generally found near chemosynthetic communities. In fact, coral reefs and other potential hard-bottom communities not associated with chemosynthetic communities appear to be very rare in deep water.

## Seamounts

Seamounts are underwater hills, mountains, or volcanoes that are spatially clustered in the world's ocean basins. Most linear chains of seamounts are formed by plates moving over hotspots. Because the majority of the seafloor volcanism that forms seamounts occurs in the Pacific Ocean, most of the estimated 30,000 to 100,000 seamounts in the world are grouped together in long chains in this region (Figure G-1).

The biological resources found in most seamounts include communities characterized by a wide level of diversity including organisms not present in other deep-sea habitats. Many species are endemic, only thriving in the immediate vicinity of on one seamount or seamount range.

Due to the abundance of plankton, seamounts serve as breeding/spawning and feeding grounds for marine mammals and fish species, as feeding areas for seabirds, and as habitats for sponge communities. Fish species in these areas are slow to reach maturity but have long lifespans. In addition, there are a few "living fossils" known to inhabit seamounts. For example, in 2006 researchers in the Coral Sea discovered a species of "Jurassic" shrimp (*Neoglyphea neocaledonica*), thought to have been extinct over 60 million years ago.

**Figure G-1. Seamount Distribution in the World's Oceans**

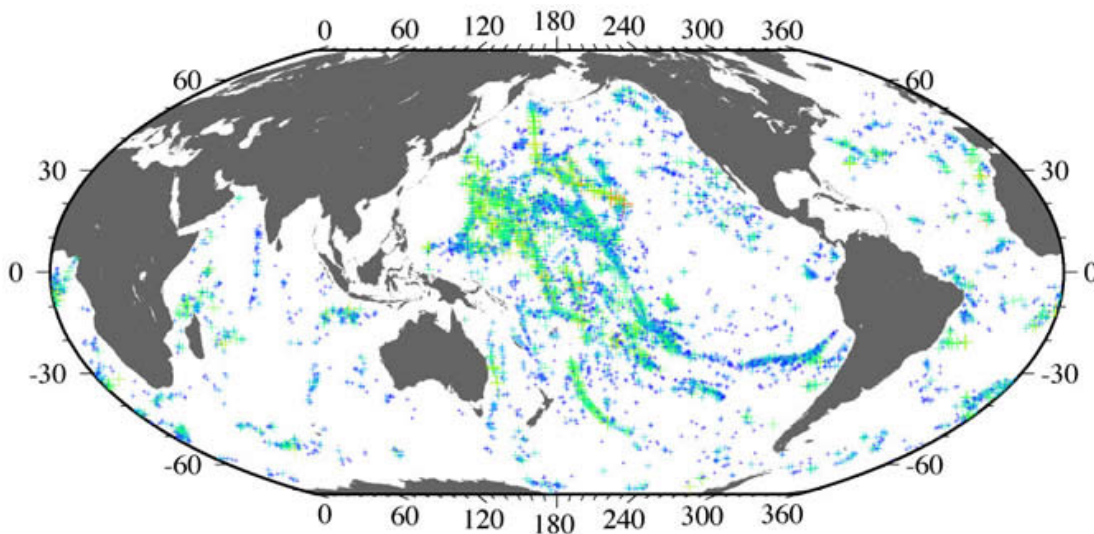

Source: Lamont-Doherty Earth Observatory (LDEO), the Earth Institute at Columbia University (<http://www.ldeo.columbia.edu/~small/GlobalSeamountDistribution.html>)