



---

# TECHNICAL REPORT

---

## PROJECT OFFSHORE STANDARD COMPOSITE COMPONENTS

REPORT No. 2002-0124

REVISION No. 01

DET NORSKE VERITAS



## TECHNICAL REPORT

Date of first issue: 2002-02-08	Project No.: 530 10 352
Approved by:  Elisabeth Heggelund Tørstad Head of Section	Organisational unit: Structural Integrity and Laboratories
Client: Joint Industry Project	Client ref.:

DET NORSKE VERITAS  
REGION NORGE AS

*Structural Integrity and  
Laboratories*

Veritasveien 1,  
N-1322 HØVIK, Norway  
Tel: +47 67 57 99 00  
Fax: +47 67 57 99 11  
http://www.dnv.com  
Org.No: NO 959 627 606 MVA

**Summary:**

This project specific Offshore Standard has been developed in close co-operation with the industry. The following companies have been participants in the Joint Industry Project in addition to DNV:

Advanced Research Partnership, ABB Offshore Technology, Ahlström Glassfibre, AMOCO, Akzo Nobel Faser AG, Baltek, Devold AMT, FiReCo, Hexcel, MMS, Norsk Hydro, Reichold, Saga Petroleum, Tenax Fibers, Umoe Shat Harding. A large number of companies participated through the Advanced Research Partnership.

*Subsequent to the termination of the Joint Industry Project, it has been agreed upon by the project partners that DNV shall transform this project standard into a DNV Offshore Standard, DNV OS-C501.*

Report No.: <b>2002-0124</b>	Subject Group:	
Report title: Project Offshore Standard Composite Components		
Work carried out by: Andreas T. Echtermeyer, Knut O. Ronold, Olivier Breuil, Stefan Palm, Brian Hayman, <u>Philine Noury</u> , Harald Osnes		
Work verified by: Andreas T. Echtermeyer, Knut O. Ronold		
Date of this revision: 8 February 2002	Rev. No.: 01	Number of pages:

**Indexing terms**

Offshore Standard  
Composite  
Components  
Design

- No distribution without permission from the client or responsible organisational unit, i.e. free distribution within DNV after 3 years
- Strictly confidential
- Unrestricted distribution



*Layout of Standard*

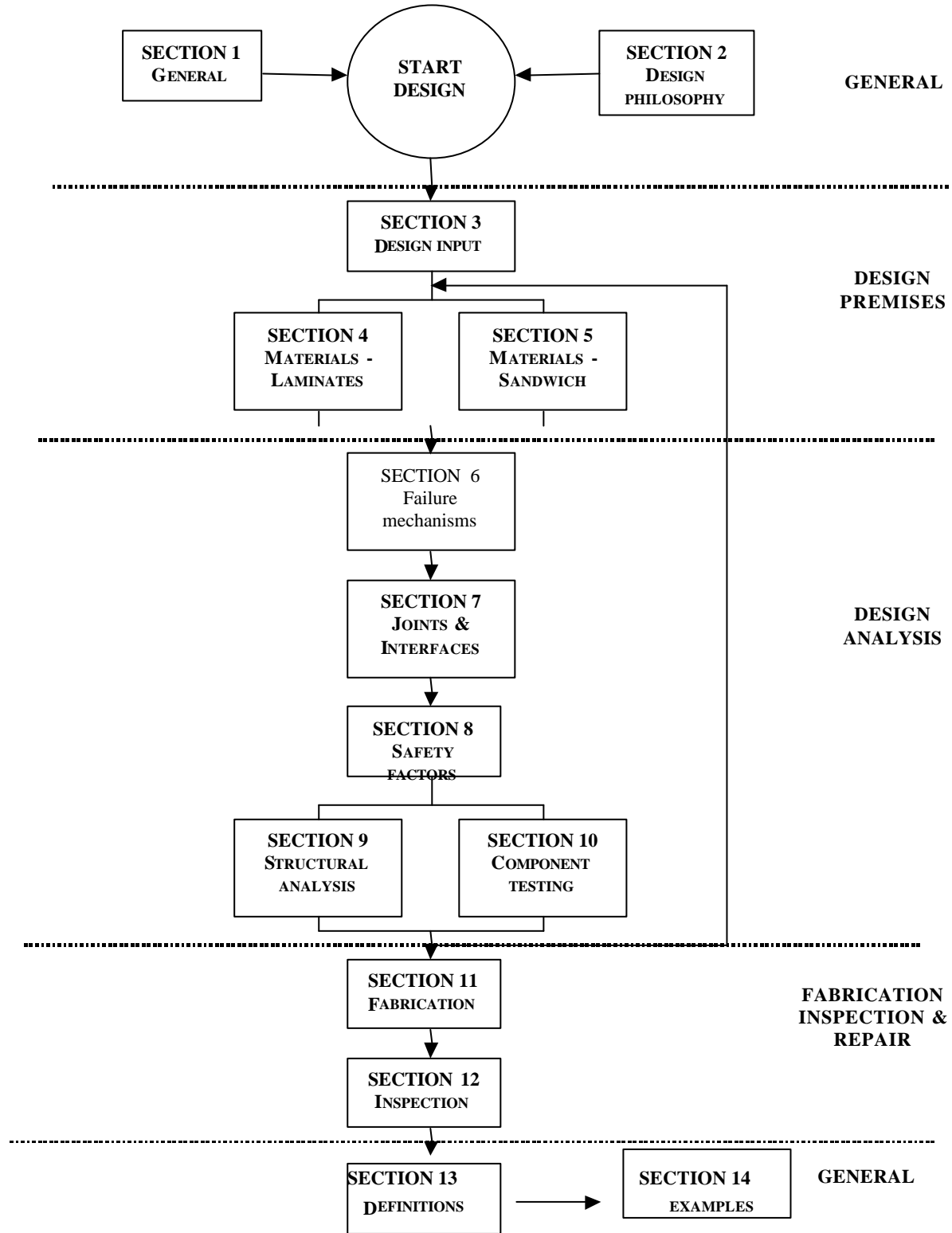



## **TABLE OF CONTENT**

### **1 GENERAL**

---

- A. OBJECTIVES
- B. APPLICATION-SCOPE
- C. HOW TO USE THE STANDARD
- D. NORMATIVE REFERENCES

### **2 DEESIGN PHILOSOPHY AND DESIGN PRINCIPLES**

---

- A. GENERAL
- B. SAFETY PHILOSOPHY
- C. DESIGN FORMAT.
- D. DESIGN APPROACH
- E. REQUIREMENTS TO DOCUMENTATION

### **3 DESIGN INPUT**

---

- A. INTRODUCTION
- B. PRODUCT SPECIFICATIONS
- C. DIVISION OF THE PRODUCT OR STRUCTURE INTO COMPONENTS, PARTS AND DETAILS
- D. PHASES
- E. SAFETY AND SERVICE CLASSES
- F. FUNCTIONAL REQUIREMENTS
- G. FAILURE MODES
- H. EXPOSURE FROM SURROUNDINGS
- I. LOADS
- J. ENVIRONMENT
- K. COMBINATION OF LOADS AND ENVIRONMENT

#### **APPENDIX 3A: CHECK-LISTS FOR DESIGN INPUT**

- A. PHASES
- B. FUNCTIONAL REQUIREMENTS AND FAILURE MODES
- C. LOADS
- D. ENVIRONMENTS
- E. DISTRIBUTION TYPES FOR BASIC VARIABLES

**4 MATERIALS - LAMINATES**

---

- A. GENERAL
- B. STATIC PROPERTIES
- C. PROPERTIES UNDER LONG TERM STATIC AND CYCLIC AND HIGH RATE LOADS
- D. OTHER PROPERTIES
- E. INFLUENCE OF THE ENVIRONMENT ON PROPERTIES
- F. INFLUENCE OF PROCESS PARAMETERS
- G. PROPERTIES UNDER FIRE
- H. QUALIFICATION OF MATERIAL PROPERTIES
- I. PROPERTIES WITH DAMAGED OR NONLINEARLY DEFORMED MATRIX

**SECTION 4: APPENDIX A: LAY-UP AND LAMINATE SPECIFICATION.**

- A. UNIQUE DEFINITION OF A LAMINATE

**SECTION 4: APPENDIX B - TEST METHODS FOR LAMINATES**

- A. GENERAL
- B. STATIC TESTS FOR LAMINATES
- C. TESTS TO OBTAIN PROPERTIES UNDER LONG TERM STATIC AND CYCLIC LOADS
- D. TESTS TO OBTAIN THE FIBRE FRACTION
- E. TESTS ON TUBULAR SPECIMENS
- F. EVALUATION OF STRESS VS. STRAIN CURVES

**SECTION 4: APPENDIX C - EXAMPLE FOR REPRESENTATIVE DATA: STITCH-BONDED UNIDIRECTIONAL PLYS**

- A. GENERAL
- B. DEFINITION OF MATERIAL
- C. QUASI STATIC PROPERTIES IN AIR (QSA)
- D. LONG TERM PROPERTIES IN AIR
- E. LONG TERM PROPERTIES IN WATER
- F.

**SECTION 4: APPENDIX D - EXAMPLE FOR REPRESENTATIVE DATA: UNIDIRECTIONAL CARBON TAPE AS4 12k**

- A. GENERAL
- B. DEFINITION OF MATERIAL
- C. QUASI STATIC PROPERTIES IN AIR (QSA)
- D. LONG TERM PROPERTIES IN AIR
- E. LONG TERM PROPERTIES IN WATER

**SECTION 4: APPENDIX E - EXAMPLE FOR REPRESENTATIVE DATA: UNIDIRECTIONAL CARBON TAPE HTS 5631 Prepreg**

- A. GENERAL
- B. DEFINITION OF MATERIAL
- C. QUASI STATIC PROPERTIES IN AIR (QSA)
- D. LONG TERM PROPERTIES IN AIR
- E. LONG TERM PROPERTIES IN WATER

**SECTION 4: APPENDIX F - EXAMPLE FOR REPRESENTATIVE DATA: UNIDIRECTIONAL CARBON TAPE TPW 0434 Prepreg**



---

**TECHNICAL REPORT**

---

- A. GENERAL
- B. DEFINITION OF MATERIAL
- C. QUASI STATIC PROPERTIES IN AIR (QSA)
- D. LONG TERM PROPERTIES IN AIR
- E. LONG TERM PROPERTIES IN WATER

---

**5 MATERIALS – SANDWICH STRUCTURES**

---

- A. GENERAL
- B. STATIC PROPERTIES
- C. PROPERTIES UNDER LONG TERM STATIC AND CYCLIC LOADS
- D. OTHER PROPERTIES
- E. INFLUENCE OF THE ENVIRONMENT ON PROPERTIES
- F. INFLUENCE OF PROCESS PARAMETERS AND CORE DENSITY
- G. PROPERTIES UNDER FIRE
- H. QUALIFICATION OF MATERIAL PROPERTIES

**SECTION 5: APPENDIX A - TEST METHODS FOR SANDWICH MATERIALS**

- A. GENERAL
- B. CORE MATERIALS - STATIC TESTS
- C. ADHESIVE MATERIALS - STATIC TESTS
- D. CORE SKIN INTERFACE PROPERTIES
- E. TESTS FOR OTHER PROPERTIES

---

**6 FAILURE MECHANISMS & DESIGN CRITERIA**

---

- A. MECHANISMS OF FAILURE
- B. FAILURE CRITERIA: GENERAL APPROACH
- C. FIBRE FAILURE
- D. MATRIX CRACKING
- E. DELAMINATION
- F. YIELDING
- G. ULTIMATE FAILURE OF ORTHOTROPIC HOMOGENOUS MATERIALS
- H. BUCKLING
- I. DISPLACEMENTS
- J. LONG TERM STATIC LOADS
- K. LONG TERM CYCLIC LOADS
- L. IMPACT
- M. WEAR
- N. HIGH/LOW TEMPERATURE / FIRE
- O. RESISTANCE TO EXPLOSIVE DECOMPRESSION
- P. SPECIAL ASPECTS RELATED TO SANDWICH STRUCTURES
- Q. CHEMICAL DECOMPOSITION / GALVANIC CORROSION
- R. REQUIREMENTS FOR OTHER FAILURE CRITERIA



---

**TECHNICAL REPORT**

---

**7 JOINTS AND INTERFACES**

---

- A. GENERAL
- B. JOINTS
- C. SPECIFIC JOINTS
- D. INTERFACES

**8 SAFETY FACTORS, MODEL FACTORS AND SYSTEM FACTORS**

---

- A. OVERVIEW OF THE VARIOUS FACTORS USED IN THE GUIDELINE
- B. PARTIAL LOAD EFFECT AND RESISTANCE FACTORS
- C. MODEL FACTORS
- D. SYSTEM EFFECT FACTOR
- E. FACTORS FOR STATIC AND DYNAMIC FATIGUE ANALYSIS

**SECTION 8: APPENDIX A – TABLES OF SAFETY FACTORS****9 STRUCTURAL ANALYSIS**

---

- A. GENERAL
- B. LINEAR AND NONLINEAR ANALYSIS OF MONOLITHIC STRUCTURES
- C. CONNECTION BETWEEN ANALYSIS METHODS AND FAILURE CRITERIA
- D. ANALYTICAL METHODS
- E. FINITE ELEMENT ANALYSIS
- F. DYNAMIC RESPONSE ANALYSIS
- G. IMPACT RESPONSE
- H. THERMAL STRESSES
- I. SWELLING EFFECTS
- J. ANALYSIS OF SANDWICH STRUCTURES
- K. BUCKLING
- L. PARTIAL LOAD-MODEL FACTOR

**10 COMPONENT TESTING**

---

- A. GENERAL
- B. QUALIFICATION BASED ON TESTS ON FULL SCALE COMPONENTS
- C. VERIFICATION OF ANALYSIS BY TESTING AND UPDATING
- D. TESTING COMPONENTS WITH COMPETING FAILURE MECHANISMS
- E. UPDATING MATERIAL PARAMETERS IN THE ANALYSIS BASED ON COMPONENT TESTING

**11 FABRICATION**

---

- A. INTRODUCTION
- B. LINK OF PROCESS PARAMETERS TO PRODUCTION MACHINE PARAMETERS
- C. PROCESSING STEPS
- D. QUALITY ASSURANCE AND QUALITY CONTROL
- E. COMPONENT TESTING
- F. INSTALLATION
- G. SAFETY HEALTH AND ENVIRONMENT



**12 INSPECTION AND REPAIR**

---

- A. INSPECTION
- B. REPAIR

**13 DEFINITIONS, ABBREVIATIONS & FIGURES**

---

- A. DEFINITIONS
- B. SYMBOLS AND ABBREVIATIONS
- C. FIGURES

**14 CALCULATION EXAMPLE: TWO PRESSURE VESSELS**

---

- A. OBJECTIVE
- B. DESIGN INPUT
- C. FAILURE MECHANISMS
- D. MATERIAL PROPERTIES
- E. ANALYSIS OF GAS VESSEL WITH LINER
- F. NONLINEAR ANALYSIS OF VESSEL FOR WATER WITHOUT LINER
- G. LINEAR ANALYSIS OF VESSEL FOR WATER WITHOUT LINER



## SECTION 1 GENERAL

<b>SECTION 1 GENERAL</b> .....	<b>1</b>
<b>A. OBJECTIVES</b> .....	<b>1</b>
<b>B. APPLICATION-SCOPE</b> .....	<b>1</b>
<b>C. HOW TO USE THE STANDARD</b> .....	<b>2</b>
C 100 USERS OF THE STANDARD .....	2
C 200 FLOW CHART OF THE STANDARD .....	3
C 300 HOW TO USE THE STANDARD .....	4
<b>D. NORMATIVE REFERENCES</b> .....	<b>4</b>
D 100 OFFSHORE SERVICE SPECIFICATIONS .....	4
D 200 OFFSHORE STANDARDS.....	4
D 300 RECOMMENDED PRACTICES .....	4
D 400 RULES.....	4
D 500 CERTIFICATION NOTES AND CLASSIFICATION NOTES .....	5
D 600 GUIDELINES.....	5
D 700 OTHER REFERENCES.....	5

### A. Objectives

**101** The main objectives of this standard is to:

- serve as a basic philosophy and standard
- provide an internationally acceptable standard for safe design with respect to strength and performance by defining minimum requirements for design, materials, fabrication and installation of load-carrying Fibre Reinforced Plastic (FRP) laminates and sandwich structures and components
- serve as a technical reference document in contractual matters between client and contractor and/or supplier
- provide cost-effective solutions based on complete limit state design with reliability based calibration of safety factors
- reflect the state-of-the-art and consensus on accepted industry practice
- to provide guidance and requirements for efficient global analyses and introduce a consistent link between design checks (failure modes), load conditions and load effect assessment in the course of the global analyses

### B. Application-Scope

**101** This standard provides requirements and recommendations for structural design and structural analysis procedures for composite components. Emphasis with respect to loads and environmental conditions is put on applications in the offshore and processing industry. The materials description and calculation methods can be applied to any applications. Aspects related to documentation, verification, inspection, materials, fabrication, testing and quality control are also addressed.

**102** The standard is applicable to all products and parts made of composite material and may

be applied to modifications, operation and upgrading made to existing ones. It is intended to serve as a common reference for designers, manufacturers and end-users, thereby reducing the need for company specifications.

- 103** This standard assumes that material properties such as strength and stiffness are normally distributed. If the properties of a material deviate significantly from the assumption of a normal distribution, a different set of safety factors than specified herein has to be used.
- 104** All properties shall be estimated with 95% confidence.

## C. How to use the standard

### C 100 Users of the standard

- 101** The **client** is understood to be the party ultimately responsible for the system as installed and its intended use in accordance with the prevailing laws, statutory rules and regulations.
- 102** The **authorities** are the national or international regulatory bodies.
- 103** The **contractor** is understood to be the party contracted by the client to perform all or part of the necessary work needed to bring the system to an installed and operable condition.
- 104** The **designer** is understood to be the party contracted by the contractor to fulfil all or part of the activities associated with the design.
- 105** The **manufacturer** is understood to be the party contracted by the contractor to manufacture all or part of the system. Two types of manufacturers can be distinguished: the material manufacturers, which supply the composite material or its constituents (i.e. resin, fibres) and the product manufacturers, which fabricate all or part of the system.
- 106** The **third party verifier** is an independent neutral party that verifies the design of a structure or component.

**C 200 Flow chart of the standard**

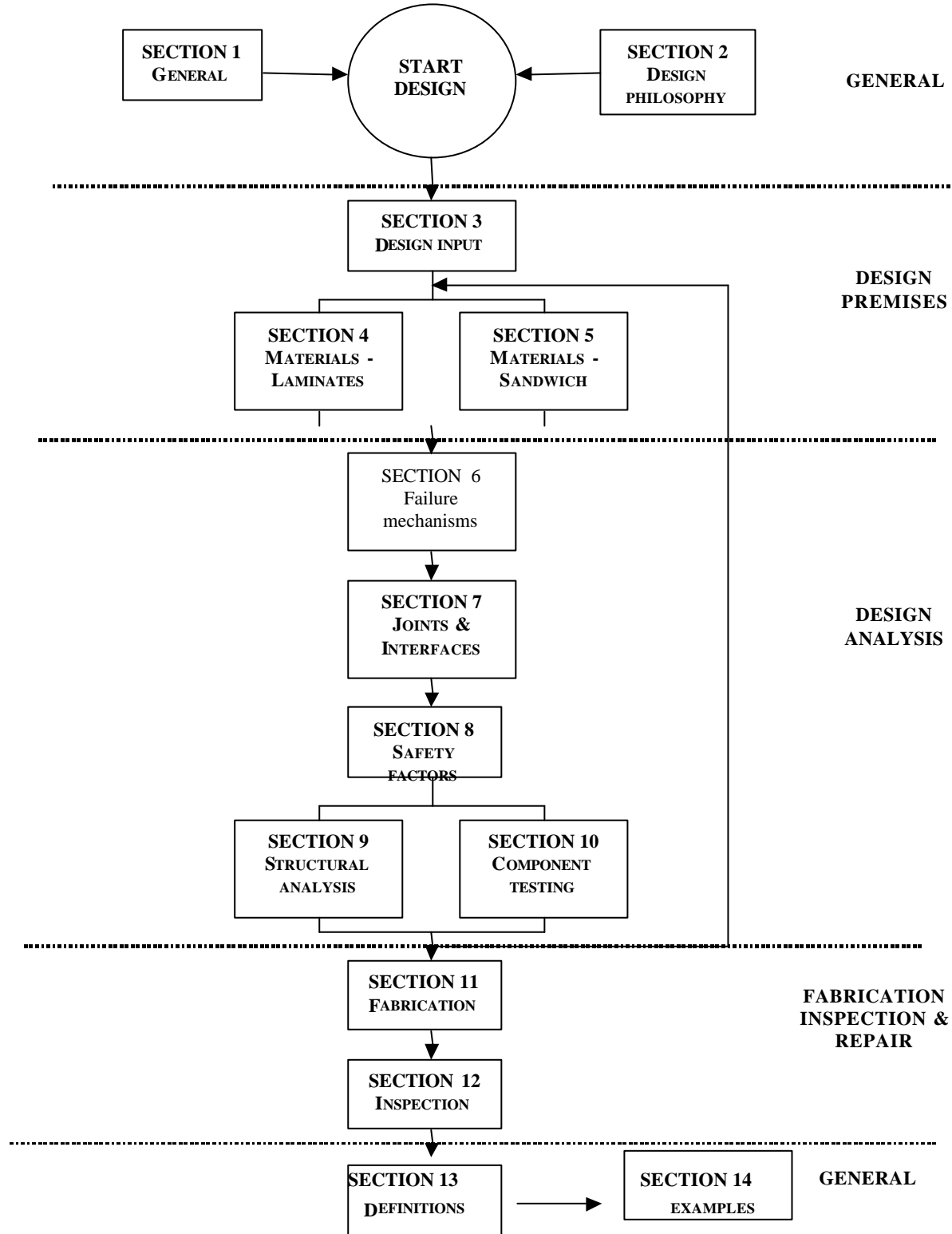

**Figure 1: flow chart of the standard**

## C 300 How to use the standard

- 301** All users should go through *section 1* and *section 2* describing the scope of the standard and the design principles.
- 302** The **client** and **contractor(s)** should specify the Design Premises according to *section 3*.
- 303** The design analysis should be performed by the **designer** according to *section 6*, *section 7*, *section 8*, *section 9* and *section 10*. The main input for the Design Report should come out of these sections.
- 304** The **contractor(s)** and **manufacturer(s)** should specify the fabrication according to *section 11*.
- 305** The **client** and **contractor(s)** should specify the installation and repair procedures according to *section 12*.
- 306** The **third party verifier** should verify that the design documentation is according to the requirements of *section 2E*.

## D. Normative References

The latest revision of the following documents applies:

### D 100 Offshore Service Specifications

DNV-OSS-301 *Certification and Verification of Pipelines*

### D 200 Offshore Standards

DNV-OS-F101 *Submarine Pipeline Systems*  
DNV-OS-F201 *Dynamic Risers*  
DNV-OS-C105 *Structural Design of TLPs by the LRFD Method*  
DNV-OS-C106 *Structural Design of Deep Draught Floating Units*  
DNV-OS-C501 *Composite Components*

### D 300 Recommended Practices

DNV RP B401 *Cathodic Protection Design*  
DNV RP-C203 *Fatigue Strength*  
DNV RP-F101 *Corroded Pipelines*  
DNV RP-F104 *Mechanical Pipeline Couplings*  
DNV RP-F105 *Free Spanning Pipelines*  
DNV RP-F106 *Factory applied Pipeline Coatings for Corrosion Control*  
DNV RP-F108 *Fracture Control for Reeling of Pipelines*  
DNV RP-F201 *Titanium Risers*  
DNV RP-F202 *Composite Risers*  
DNV RP O501 *Erosive Wear in Piping Systems*

### D 400 Rules

DNV Rules for *Certification of Flexible Risers and Pipes*  
DNV Rules for *Planning and Execution of Marine operations*

*DNV Rules for Classification of Fixed Offshore Installations*

**D 500 Certification notes and Classification notes**

DNV CN 1.2 *Conformity Certification Services, Type Approval*

DNV CN 1.5 *Conformity Certification Services, Approval of Manufacturers, Metallic Materials*

DNV CN 7 *Ultrasonic Inspection of Weld Connections*

DNV CN 30.2 *Fatigue Strength Analysis for Mobile Offshore Units*

DNV CN 30.4 *Foundations*

DNV CN 30.5 *Environmental Conditions and Environmental Loads*

DNV CN 30.6 *Structural Reliability Analysis of Marine Structures*

**D 600 Guidelines**

DNV *Design Guideline for Composite Components (DRAFT E-003)*

DNV *Guidelines for Flexible Pipes*

**D 700 Other references**

API RP1111 *Design, Construction, Operation, and Maintenance of Offshore Hydrocarbon Pipelines (Limit State Design)*

API RP2RD *Design of Risers for Floating Production Systems (FPSs) and Tension-Leg Platforms (TLPs)*

ISO/FDIS 2394 *General Principles on Reliability for Structures*

ISO/CD 13628-7 *Petroleum and natural gas industries - Design and operation of subsea production systems - Part 7: Completion/workover riser systems*

**Guidance note:**

The latest revision of the DNV documents may be found in the publication list at the DNV website [www.dnv.com](http://www.dnv.com).

- end - of - Guidance - note -

**SECTION 2 DESIGN PHILOSOPHY AND DESIGN PRINCIPLES**

<b>SECTION 2 DESIGN PHILOSOPHY AND DESIGN PRINCIPLES .....</b>		<b>1</b>
<b>A.</b>	<b>GENERAL.....</b>	<b>2</b>
A 100	OBJECTIVE .....	2
<b>B.</b>	<b>SAFETY PHILOSOPHY .....</b>	<b>2</b>
B 100	GENERAL.....	2
B 200	RISK ASSESSMENT .....	2
B 300	QUALITY ASSURANCE.....	3
<b>C.</b>	<b>DESIGN FORMAT. ....</b>	<b>3</b>
C 100	GENERAL PRINCIPLES .....	3
C 200	LIMIT STATES .....	3
C 300	SAFETY CLASSES AND SERVICE CLASSES .....	4
C 400	FAILURE TYPES .....	5
C 500	SELECTION OF PARTIAL SAFETY FACTORS.....	5
C 600	DESIGN BY LRFD METHOD .....	6
C 700	STRUCTURAL RELIABILITY ANALYSIS.....	9
<b>D.</b>	<b>DESIGN APPROACH .....</b>	<b>10</b>
D 100	APPROACHES.....	10
D 200	ANALYTICAL APPROACH .....	11
D 300	COMPONENT TESTING.....	11
D 400	ANALYSES COMBINED WITH UPDATING .....	11
<b>E.</b>	<b>REQUIREMENTS TO DOCUMENTATION.....</b>	<b>12</b>
E 100	DESIGN DRAWINGS AND TOLERANCES .....	12
E 200	GUIDELINES FOR THE DESIGN REPORT .....	12

## A. General

### A 100 Objective

- 101** The purpose of this section is to identify and address key issues which need to be considered for the design, fabrication, and operation of FRP components and structures. Furthermore, the purpose is to present the safety philosophy and corresponding design format applied throughout this Standard.

## B. Safety philosophy

### B 100 General

- 101** An overall safety objective is to be established, planned and implemented covering all phases from conceptual development until abandonment of the structure.
- 102** This Standard gives the possibility to design structures or structural components with different structural safety requirements, depending on the Safety Class to which the structure or part of the structure belongs. Safety classes are based on the consequence of failures related to the Ultimate Limit State (ULS).
- 103** Structural reliability of the structure is ensured by the use of partial safety factors that are specified in this Standard. Partial safety factors are calibrated to meet given target structural reliability levels. Note that gross errors are not accounted for. Gross errors have to be prevented by a quality system. The quality system shall set requirements to the organisation of the work, and require minimum standards of competence for personnel performing the work. Quality assurance shall be applicable in all phases of the project, like design, design verification, operation, etc.

### B 200 Risk assessment

- 201** To the extent it is practically feasible, all work associated with the design, construction and operation shall ensure that no single failure is to lead to life-threatening situations for any persons, or to unacceptable damage to material or to environment.
- 202** A systematic review or analysis shall be carried out at all phases to identify and evaluate the consequences of single failures and series of failure in the structure such that necessary remedial measures may be taken. The extent of such a review is to reflect the criticality of the structure, the criticality of planned operations, and previous experience with similar structures or operations.

#### Guidance note:

A methodology for such a systematic review is the Quantitative Risk Analysis (QRA) which may provide an estimation of the overall risk to human health and safety, environment and assets and comprises (i) hazard identification, (ii) assessment of probability of failure events, (iii) accident development and (iv) consequence and risk assessment. It should be noted that legislation in some countries requires risk analysis to be performed, at least at an overall level to identify critical scenarios, which may jeopardise the safety and reliability of the structure. Other methodologies for identification of potential hazards are Failure Mode Effect Analysis (FMEA) and Hazardous Operations studies (HAZOP).

---e-n-d--- o-f---G-u-i-d-a-n-c-e---n-o-t-e---

## B 300 Quality Assurance

- 301** The safety format of this Standard requires that gross errors (human errors) shall be controlled by requirements to the organisation of the work, competence of persons performing the work, verification of the design and Quality Assurance during all relevant phases.

## C. Design format.

### C 100 General principles

- 101** The basic approach of the Limit State Design method consists in recognizing the different **failure modes** related to each **functional requirement** and associating to each mode of failure a specific **limit state** beyond which the structure no longer satisfies the functional requirement. Different limit states are defined, each limit state being related to the kind of failure mode and its anticipated consequences.
- 102** The design analysis consists in associating each failure mode to all the possible **failure mechanisms** (i.e. the mechanisms at the material level). A design equation or a failure criterion is defined for each failure mechanism, and failure becomes interpreted as synonymous to the design equation no longer being satisfied.
- 103** The design equations are formulated in the so-called Load and Resistance Factor Design (LRFD) format, where **partial safety factors** (load factors and resistance factors) are applied to the load effects (characteristic load values) and to the resistance variables (characteristic resistance values) that enter the design equations.
- 104** The partial safety factors, which are recommended in this Standard, have been established such that acceptable and consistent reliability levels are achieved over a wide range of structure configurations and applications.
- 105** This section discusses the limit states that have been considered relevant for the design of structures made of FRP materials, presents the underlying safety considerations for the recommended safety factors and finally introduces the adopted LRFD format.
- 106** As an alternative to the LRFD format a recognised Structural Reliability Analysis (SRA) may be applied. The conditions for application of an SRA are discussed at the end of this section.

### C 200 Limit states

- 201** The following two limit state categories shall be considered in the design of the structure:
- Ultimate Limit State (ULS)
  - Serviceability Limit State (SLS)
- 202** The **Ultimate Limit State** shall be related to modes of failure for which safety is an issue. The ULS generally corresponds to the maximum load carrying capacity and is related to structural failure modes. **Safety Classes** are defined in accordance with the consequences



of these failure modes on safety, environment and economy. The ULS is not reversible.

**203** The **Serviceability Limit State** should be related to failure modes for which human risks or environmental risks are not an issue. The SLS is usually related to failure modes leading to service interruptions or restrictions. **Service Classes** are defined in accordance with the frequency of service interruptions due these modes of failure. The SLS is usually reversible, i.e. after repair or after modification of the operating conditions (e.g. interruption of operation, reduction of pressure or speed) the structure will again be able to meet its functional requirements in all specified design conditions.

**Guidance note:**

Ultimate Limit States correspond to, for example:

Loss of static equilibrium of the structure, or part of the structure, considered as a rigid body

Rupture of critical sections of the structure caused by exceeding the ultimate strength or the ultimate deformation of the material

Transformation of the structure into a mechanism (collapse)

Loss of stability (buckling, etc...)

Serviceability Limit States corresponds to, for example:

Deformations which affect the efficient use or appearance of structural or non-structural elements

Excessive vibrations producing discomfort or affecting non-structural elements or equipments

Local damage (including cracking) which reduces the durability of the structure or affects the efficiency or appearance of structural or non-structural elements

---e-n-d--- o-f---G-u-i-d-a-n-c-e---n-o-t-e---

### **C 300 Safety classes and Service classes**

**301 Safety classes** are based on the consequences of failure when the mode of failure is related to the Ultimate Limit State. The operator shall specify the safety class according to which the structure shall be designed. Suggestions are given below.

**302** Safety classes are defined as follows:

- Low Safety Class, where failure of the structure implies small risk of human injury and minor environmental, economic and political consequences.
- Normal Safety Class, where failure of the structure implies risk of human injury, significant environmental pollution or significant economic or political consequences.
- High Safety Class, where failure of the structure implies risk of human injury, significant environmental pollution or very high economic or political consequences.

**303 Service classes** are based on the frequency of service interruptions or restrictions caused by modes of failure related to the Serviceability Limit State. These modes of failure imply no risk of human injury and minor environmental consequences. The operator shall specify the service class according to which the structure shall be designed. Suggestions are given below.

**304** Service classes are defined according to the annual number of service failures. *The Normal and High Service Classes* are defined by the target reliability levels indicated in Table 2-2.

**C 400 Failure types**

**401 Failure types** are based on the degree of pre-warning intrinsic to a given failure mechanism. A distinction shall be made between catastrophic and progressive failures, and between failures with or without reserve capacity during failure. The failure types for each failure mechanism described in this Standard are specified according to the definitions given below.

- Failure type *Ductile*, corresponds to ductile failure mechanisms with reserve strength capacity. In a wider sense, it corresponds to progressive non-linear failure mechanisms with reserve capacity during failure.
- Failure type *Plastic*, corresponds to ductile failure mechanisms without reserve strength capacity. In a wider sense, it corresponds to progressive non-linear failure mechanisms but without reserve capacity during failure.
- Failure type *Brittle*, corresponds to brittle failure mechanisms. In a wider sense, it corresponds to non-stable failure mechanisms.

**402** The different failure types should be used under the following conditions for materials that show a yield point:

The failure type ductile may be used if:  $\sigma_{ult} > 1.3 \sigma_{yield}$  and  $\epsilon_{ult} > 2 \epsilon_{yield}$

The failure type plastic may be used if:  $\sigma_{ult} \geq 1.0 \sigma_{yield}$  and  $\epsilon_{ult} > 2 \epsilon_{yield}$

In all other cases the failure type brittle shall be used.

where  $\sigma_{ult}$  is the ultimate strength at a strain  $\epsilon_{ult}$

and  $\sigma_{yield}$  is the yield strength at a strain  $\epsilon_{yield}$

**C 500 Selection of partial safety factors**

**501** Partial safety factors depend on the safety class and the failure type. The partial factors are available for five different levels and are listed in Section 8.

**102** The selection of the levels is given in the table below for the ultimate limit state.

SAFETY CLASS	FAILURE TYPE	
	Ductile/Plastic	Brittle
Low	A	B
Normal	B	C
High	C	D

**Table 2-1. Safety levels for ULS.**

**503** The recommended selection of the levels for the serviceability limit state is given in the table below.

SERVICE CLASS	SERVICE FAILURES
Normal	A
High	B

**Table 2-2. Safety levels for SLS.**

**C 600 Design by LRFD method**

**601** The Partial Safety Factor format (or Load and Resistance Factor Design, LRFD) separates the influence of uncertainties and variabilities originating from different causes. Partial safety factors are assigned to variables such as load effect and resistance variables. They are applied as factors on specified characteristic values of these load and resistance variables, thereby defining design values of these variables for use in design calculations, and thereby accounting for possible unfavourable deviations of the basic variables from their characteristic values. The characteristic values of the variables are selected representative values of the variables, usually specified as specific quantiles in their respective probability distributions, e.g. an upper-tail quantile for load and a lower-tail quantile for resistance. The values of the partial safety factors are calibrated, e.g. by means of a probabilistic analysis, such that the specified target reliability is achieved whenever the partial safety factors are used for design. Note that characteristic values and their associated partial safety factors are closely linked. If the characteristic values are changed, relative to the ones determined according to procedures described elsewhere in this document, then the requirements to the partial safety factors will also change in order to maintain the intended safety level.

**Guidance note:**

The following uncertainties are usually considered:

- Uncertainties in the loads, caused by natural variability, which is usually a temporal variability
- Uncertainties in the material properties, caused by natural variability, which is usually a spatial variability
- Uncertainties in the geometrical parameters, caused by
  - deviations of the geometrical parameters from their characteristic (normal) value
  - tolerance limits
  - cumulative effects of a simultaneous occurrence of several geometrical variations
- Uncertainties in the applied engineering models
  - uncertainties in the models for representation of the real structure or structural elements
  - uncertainties in the models for prediction of loads, owing to simplifications and idealisations made
  - uncertainties in the models for prediction of resistance, owing to simplifications and idealisations made
  - effect of the sensitivity of the structural system (underproportional or overproportional behaviour)

---e-n-d--- o-f---G-u-i-d-a-n-c-e---n-o-t-e---

**602** Partial safety factors are applied in design inequalities for deterministic design as shown by examples in *Clause 606*. The partial safety factors are usually or preferably calibrated to a specified target reliability by means of a probabilistic analysis. Sometimes the design inequalities include model factors or bias correction factors as well. Such model or bias correction factors appear in the inequalities in the same manner as the partial safety factors, but they are not necessarily to be interpreted as partial safety factors as they are used to correct for systematic errors rather than accounting for any variability or uncertainty. Model factors and bias correction factors are usually calibrated

experimentally.

**103** The following two types of partial safety factors are used in this standard:

- **Partial load effect factors**, designated in this standard by  $\gamma_F$
- **Partial resistance factors**, designated in this standard by  $\gamma_M$

**604** In some cases it is useful to work with only one overall safety factor. The uncertainties in loads and resistance are then accounted for by one common safety factor denoted  $\gamma_{FM}$ . The following simple relationship between this common safety factor on the one hand and the partial load and resistance factors on the other are assumed here corresponding to the general design design inequality quoted in *Clause 606*:

$$\gamma_{FM} = \gamma_F \times \gamma_M \quad (1)$$

**605** The following two types of model factors are used in this Standard:

- **Load model factors**, designated in this Standard by  $\gamma_{Sd}$
- **Resistance model factors**, designated in this Standard by  $\gamma_{Rd}$

**Guidance note:**

- Partial load effect factors  $\gamma_F$  are applicable to the characteristic values of the local response of the structure. They account for uncertainties associated with the variability of the local responses of the structure (local stresses or strains). The uncertainties in the local response are linked to the uncertainties on the loads applied to the structure through the *transfer function*.
- Partial resistance factors  $\gamma_M$  account for uncertainties associated with the variability of the strength.
- Load model factors  $\gamma_{Sd}$  account for inaccuracies, idealizations, and biases in the engineering model used for representation of the real response of the structure, e.g. simplifications in the *transfer function* (see *section 9*). For example, wind characterised by a defined wind speed will induce wind loads on the structure, and those loads will induce local stresses and strains in the structure. The load model factor account for the inaccuracies all the way from wind speed to local response in the material.
- Resistance model factors  $\gamma_{Rd}$  account for differences between true and predicted resistance values, e.g. differences between test and in-situ materials properties (size effects), differences associated with the capability of the manufacturing processes (e.g. deviations of the geometrical parameters from the characteristic value, tolerance limits on the geometrical parameters), and differences owing to temporal degradation processes.
- Uncertainties or biases in a failure criterion are accounted for by the resistance model factor.
- Geometrical uncertainties and tolerances should be included in the load model factor.

---e-n-d--- o-f---G-u-i-d-a-n-c-e---n-o-t-e---

**606** A factored design load effect is obtained by multiplying a characteristic load effect by a load effect factor. A factored design resistance is obtained by dividing the characteristic resistance by a resistance factor.

The structural reliability is considered to be satisfactory if the following design inequalities are satisfied:

- General design inequality for the Load Effect and Resistance Factor Design format:

$$\mathbf{g}_F \cdot \mathbf{g}_{Sd} \cdot S_k \leq \frac{R_k}{\mathbf{g}_M \cdot \mathbf{g}_{Rd}} \quad (2)$$

Where:

- $\gamma_F$  Partial load effect factor
- $\gamma_{Sd}$  Load model factor
- $S_k$  Characteristic load effect
- $R_k$  Characteristic resistance
- $\gamma_M$  Partial resistance factor
- $\gamma_{Rd}$  Resistance model factor

- Design rule expressed in terms of forces and moments:

$$\Phi \left( \mathbf{g}_F \cdot \mathbf{g}_{Sd} \cdot S_k, \frac{R_k}{\mathbf{g}_M \cdot \mathbf{g}_{Rd}} \right) \leq 1 \quad (3)$$

Where:

- $\Phi$  Code check function (e.g. buckling equation)
- $\gamma_F$  Partial load or load effect factor
- $\gamma_{Sd}$  Load model factor
- $S_k$  Characteristic load or load effect
- $R_k$  Characteristic resistance
- $\gamma_M$  Partial resistance factor
- $\gamma_{Rd}$  Resistance model factor

- Design rule expressed in terms of a local response such as local strains:

$$\Phi \left( \mathbf{g}_F \cdot \mathbf{g}_{Sd} \cdot \hat{\mathbf{e}}_k, \frac{R_k}{\mathbf{g}_M \cdot \mathbf{g}_{Rd}} \right) \leq 1 \quad (4)$$

Where:

- $\Phi$  Code check function
- $\gamma_F$  Partial load effect factor
- $\gamma_{Sd}$  Load model factor
- $\epsilon_k$  Characteristic value of the local response of the structure (strain) to the applied load  $S_k$
- $\hat{\mathbf{e}}_k$  Characteristic value of strain to failure
- $R_k$  Characteristic resistance
- $\gamma_M$  Partial resistance factor
- $\gamma_{Rd}$  Resistance model factor

**607** The load model factor shall be applied on the characteristic local stresses or strains. The

resistance model factors apply on the characteristic resistance of the material used at the location on the structure where the design rule is to be applied.

- 608** The characteristic values for load effects and resistance variables are specified as quantiles of their respective probability distributions.
- 609** The characteristic load effect,  $S_k$ , is a value that should rarely be exceeded. For time dependent processes, it is generally given in terms of return values for occurrence, e.g., once in a given reference time period (return period). See *section 3I400* for characteristic loads.
- 610** The characteristic resistance,  $R_k$ , is a value corresponding to a high probability of exceedance, also accounting for its variation with time when relevant. See *section 4 A600* and *section 5 A600* for characteristic resistance.
- 611** The partial safety factors are calibrated against the target reliabilities indicated in *Table 2-1* and *Table 2-2*.
- 612** The partial safety factors defined in this Standard apply to all failure mechanisms and all Safety and Service Classes. They depend on the target reliability, the load distribution type (or the local response distribution type when applicable) and its associated coefficient of variation, and on the coefficient of variation associated with the resistance. When several loads are combined, a combination factor shall be used with the same set of partial factors. The combination of several loads is described in *section 3K*.
- 613** The load model factors depend on the method used for the structural analysis. See *section 8 C* and *section 9 L*.
- 614** The resistance model factors depend on the uncertainties in the material strength properties caused by manufacturing, installation and degradation. See *section 8 B*.

#### **C 700 Structural Reliability Analysis**

- 701** As an alternative to design according to the LRFD format specified and used in this Standard, a recognised Structural Reliability Analysis (SRA) based design method in compliance with Classification Note No. 30.6 "Structural Reliability Analysis of Marine Structures" or ISO 2394 may be applied provided it can be documented that the approach provides adequate safety for familiar cases as indicated in this Standard.
- 702** The Structural Reliability Analysis is to be performed by suitably qualified personnel.
- 703** As far as possible, target reliabilities are to be calibrated against identical or similar designs that are known to have adequate safety. If this is not feasible, the target reliability is to be based on the limit state category, the failure type and the Safety or Service Class as given in *Table 2-3* and *Table 2-4*.

Table 2-3: Target annual failure probabilities $P_{FT}$			
Failure type	Failure consequence		
	LOW SAFETY CLASS	NORMAL SAFETY CLASS	HIGH SAFETY CLASS
Ductile failure type (e.g as for steel)	$P_F=10^{-3}$	$P_F=10^{-4}$	$P_F=10^{-5}$
Brittle failure type (base case for composite)	$P_F=10^{-4}$	$P_F=10^{-5}$	$P_F=10^{-6}$

SERVICE CLASS	SERVICE FAILURES
Normal	$10^{-3}$
High	$10^{-4}$

Table 2-4. Target reliabilities in the SLS expressed in terms of annual probability of failure

## D. Design approach

### D 100 Approaches

**101** The structure can be designed according to three different approaches:

- An analytical approach, i.e. the stress/strain levels at all relevant parts of the structures including the interfaces and joints are determined by means of a stress analyses (e.g. a FEM-analyses, see *section 9*) and compared with the relevant data on the mechanical strength.
- Design by component testing only, i.e. full scale or scaled down samples of the structure or parts of the structure are tested under relevant conditions (see *section 10*) such that the characteristic strength of the complete structure can be determined.
- A combination of an analytical approach and testing, i.e. the same approach specified in *section 10* for updating in combination with full scale component testing.

**102** The structure shall be designed such that none of the failure mechanisms, identified in the design analysis (see *section 3 and 6*), will occur for any of the design cases specified in *section 3*. The design against each individual failure mechanism can be checked with the help of one of the three approaches mentioned in *101*.

#### **D 200 Analytical approach**

**201** The level of all stress (strain) components in all relevant areas of the structure, including stress concentrations, shall be determined according to *section 9*.

**202** Failure criteria and safety factors are applied to the load effects, i.e., the local stresses or strains.

**203** The analysis provides the link between load and load effect. If nonlinear effects change the mean, distribution type and COV of the load effect relative to the load itself, the properties of the load effect shall be used to determine safety factors.

**204** The partial factors in *Section 8* shall be used.

#### **D 300 Component testing**

**301** The purpose of this approach is to define the characteristic strength of the finished and complete structure under relevant load conditions. If deemed relevant, the resistance may be found by testing scaled models or parts of the finished structure.

**302** Details about component testing are given in *Section 10* and *7*.

**303** A sufficiently large number of tests shall be carried out in order to be able to define the characteristic strength of the structure with a confidence level at least as large as required for the data used with the analytical approach.

**304** The failure mode(s), failure mechanism(s) and location(s) of failure shall be verified during/after the tests.

#### **D 400 Analyses combined with updating**

**401** Analyses of the structure may be complicated and a conservative bias may have to be introduced in the analyses. The reasons for such biases may be:

- Scaling effects.
- Uncertainties in the relevance of the design rules, e.g. in areas with large stress gradients.
- The analytical models for analysing the stress level in the structure.
- The effect of the environment on the mechanical properties.
- Etc.



**402** In such cases the analyses that have been carried out may be combined with the procedure for updating given in *Section 10C*. The purpose of this approach is to update the predicted resistance of the structure with the results from a limited number of tests in a manner consistent with the reliability approach of the standard.

**403** It is a basic assumption that that all biases are handled in a conservative way, i.e. that the bias lead to a conservative prediction of the resistance of the structure.

## **E. Requirements to documentation**

### **E 100 Design Drawings and Tolerances**

**101** Design drawings shall be provided according to general standards.

**102** Tolerances shall be indicated.

### **E 200 Guidelines for the design report**

**201** The design Report should contain the following as a minimum:

- Description of the entire structure and of its components
- Design input as described in *Section 3*, including design life, environmental conditions
- Relevant design assumptions and conditions including applicable limitations
- Description of analysis from design phase, evaluation of problem areas, highly utilised and critical areas of the structure and highlighting points that require special attention during subsequent phases
- Reference to accepted calculations and other documents verifying compliance with governing technical requirements for all phases
- Fabrication procedures giving a concentrated description of the manufacturing/fabrication history, reference to specifications, drawings etc., discussion of problem areas, deviations from specifications and drawings, of importance for the operational phase identification of areas deemed to require special attention during normal operation and maintenance
- Reference to documentation needed for repair and modification

**202** All failure modes and failure mechanisms shall be clearly identified and listed in a systematic way, preferably in a table. It shall be shown that each combination of identified failure modes and mechanisms was addressed in the design.

## SECTION 3 DESIGN INPUT

<b>SECTION 3 DESIGN INPUT .....</b>		<b>1</b>
<b>A.</b>	<b>INTRODUCTION .....</b>	<b>2</b>
<b>B.</b>	<b>PRODUCT SPECIFICATIONS .....</b>	<b>2</b>
B 100	GENERAL FUNCTION OR MAIN PURPOSE OF THE PRODUCT .....	2
<b>C.</b>	<b>DIVISION OF THE PRODUCT OR STRUCTURE INTO COMPONENTS , PARTS AND DETAILS .....</b>	<b>2</b>
<b>D.</b>	<b>PHASES .....</b>	<b>4</b>
D 100	PHASES .....	4
<b>E.</b>	<b>SAFETY AND SERVICE CLASSES .....</b>	<b>4</b>
E 100	SAFETY CLASSES .....	4
E 200	SERVICE CLASSES.....	4
<b>F.</b>	<b>FUNCTIONAL REQUIREMENTS .....</b>	<b>5</b>
<b>G.</b>	<b>FAILURE MODES .....</b>	<b>5</b>
G 100	GENERAL .....	5
G 200	FAILURE MODES .....	5
G 300	IDENTIFICATION OF THE TYPE OF LIMIT STATES.....	6
<b>H.</b>	<b>EXPOSURE FROM SURROUNDINGS .....</b>	<b>7</b>
H 100	GENERAL .....	7
H 200	LOADS AND ENVIRONMENT.....	7
H 300	OBTAINING LOADS FROM THE EXPOSURE FROM SURROUNDINGS.....	8
<b>I.</b>	<b>LOADS .....</b>	<b>9</b>
I 100	GENERAL.....	9
I 200	PROBABILISTIC REPRESENTATION OF LOAD EFFECTS.....	10
I 300	SIMPLIFIED REPRESENTATION OF LOAD EFFECTS.....	11
I 400	CHARACTERISTIC LOAD EFFECT .....	11
I 500	THE SUSTAINED LOAD EFFECT .....	12
I 600	THE FATIGUE LOAD EFFECTS.....	15
<b>J.</b>	<b>ENVIRONMENT.....</b>	<b>16</b>
J 100	GENERAL .....	16
J 200	EFFECTS OF THE ENVIRONMENT ON THE MATERIAL PROPERTIES .....	18
<b>K.</b>	<b>COMBINATION OF LOAD EFFECTS AND ENVIRONMENT .....</b>	<b>19</b>
K 100	GENERAL .....	19
K 200	LOAD EFFECT AND ENVIRONMENTAL CONDITIONS FOR ULTIMATE LIMIT STATE.....	20
K 300	LOAD EFFECT AND ENVIRONMENTAL CONDITIONS FOR TIME-DEPENDENT MATERIAL PROPERTIES	22
K 400	LOAD EFFECT AND ENVIRONMENTAL CONDITIONS FOR FATIGUE ANALYSIS.....	22
K 500	DIRECT COMBINATION OF LOADS.....	22

## A. Introduction

- 101** This section identifies the input needed for the analysis of the structure. The material properties are addressed separately in *section 4* for laminates and *section 5* for sandwich structures.
- 102** The Design Input of this section (*Section 3*) and *sections 4* and *5* for Material Properties, form the basis of the **Design Premises**

## B. Product specifications

### B 100 General Function or main purpose of the product

- 101** The general function or the main purpose of the product and its main interactions with other components and the environment shall be specified in the product specifications.
- 102** The design life in service should be specified in the product specifications.

#### Guidance note:

E.g. the product is a gas pressure bottle for diving activities. The filling pressure will be 200 bars, the volume 100 l and the lifetime in service 20 years.

---e-n-d--- o-f---G-u-i-d-a-n-c-e---n-o-t-e---

## C. Division of the product or structure into components, parts and details

- 101** The following levels of division of the product or structure are used in this Guideline:
- Structure / product
  - Sub-structure / sub-product
  - Components
  - Parts
  - Details

- 102** The term product or structure designates in this Guideline the entity being designed.
- 103** The product or structure can be divided into sub-products or sub-structures, each of which may belong to different safety and service classes.
- 104** The structure or product can be divided into components corresponding to the same Safety Class but may be subject to different functional requirements.
- 105** Each component can be divided into parts and each part into details.

**Guidance note:**

For example:

Structure = pipeline

Sub-structure = the pipeline portion close to human activity should be classed under high safety class, whereas the rest of the pipeline can be classed under low or normal safety class. The pipeline can be divided into to sub-structures corresponding to different safety classes

Components = the pipeline could be constituted of an inner liner and an outer shell. The liner's function is to keep the pipeline tight, whereas the shell's function is to hold the pressure loads. The two components have different functional requirements

Parts and details = the pipeline can be divided into pipe body, couplers and fittings. Different design approaches and design solutions may be used for the different parts and details

---e-n-d--- o-f---G-u-i-d-a-n-c-e---n-o-t-e---

- 106** A structure or substructure is an independent part for which a safety class can be defined. Components, parts and details are part of a structure or substructure. Failure of any of these components, parts or details shall be seen in combination with each other. See also *Section 8D*.
- 107** The interfaces between parts, components or structures shall be considered carefully. Interfaces shall be analysed as a part itself if they belong to a continuous structure. If the interfaces are physical interfaces, the requirements of Section 7 D shall be considered.

## D. Phases

### D 100 Phases

- 101** The design life of the product shall be divided into phases, i.e. well defined periods within the life span of the product.
- 102** All phases that could have an influence on the design of the product shall be considered.

**Guidance note:**

E.g. For some products, the transportation phase is critical and is actually driving the design.

---e-n-d--- o-f---G-u-i-d-a-n-c-e---n-o-t-e---

- 103** As a minimum the construction phase and the operation phase shall be considered. However, it may be convenient to split the design life into more detailed phases. A list of phases is presented in *Appendix 3A*.
- 104** A decommissioning phase may be specified in some cases.
- 105** The duration of each phase shall be specified. Especially, the lifetime in service shall be specified.

## E. Safety and Service Classes

### E 100 Safety Classes

- 101** The product can be divided into *sub-products*, each of which may belong to different safety classes.
- 102** For each sub-product the Safety Classes, as described in *section 2C300*, shall be specified and documented.
- 103** Possible deviations in target probabilities of failure from the ones specified for the safety classes in *Table 2-1 and Table 2-2* shall be documented and justified.

**Guidance note:**

This may be needed if clients or authorities want other safety levels than specified here.

---e-n-d--- o-f---G-u-i-d-a-n-c-e---n-o-t-e---

- 104** The safety class of a product or sub-product may change from one phase to the other during the life of the structure.

### E 200 Service classes

- 201** The product can be divided into *sub-products*, each of which may belong to different service classes.

**Guidance note:**

Service classes may be used to discriminate between parts of a product with different maintenance requirements. For example, some parts of a pipeline system, which are less accessible, could be designed for a lower maintenance frequency.

---e-n-d--- o-f---G-u-i-d-a-n-c-e---n-o-t-e---

- 202** For each sub-product the Service Classes as described in *section 2C300* shall be specified when applicable.

## F. Functional requirements

- 101** A functional requirement is defined as a requirement that the product and / or a component has to fulfil. The functional requirements shall be checked for every component of the product.
- 102** The structure or product can be divided into *components* corresponding to the same Safety Class but may be subject to different functional requirements.
- 103** The functional requirements shall be defined for each phase during the design life.
- 104** A list of functional requirements that should be considered as a minimum is given in Appendix 3A.

### Guidance note:

Functional requirements may be related to structural or non-structural performances. This Guideline is orientated towards structural performances. However, it should be noted that non-structural functional requirements might lead to safety issues (e.g. static electricity properties). Moreover, some structural failures may affect non-structural performances, e.g. matrix cracking might influence acoustic performances.

---e-n-d--- o-f---G-u-i-d-a-n-c-e---n-o-t-e---

## G. Failure modes

### G 100 General

- 101** A complete list of all failure modes shall be established for every component of the product.
- 102** Subsequent failure scenarios shall be taken into consideration. For example, rupture of a protective coating may in itself not be a severe event. However, subsequent corrosion of the material behind the coating may cause serious damage.

### G 200 Failure modes

- 201** A failure is defined as a state of inability to perform a normal function, or an event causing an undesirable or adverse condition, e.g. violation of functional requirement, loss of component or system function, or deterioration of functional capability to such an extent that the safety of the unit, personnel or environment is significantly reduced.
- 202** A failure mode is a symptom or condition that leads to failure, in general the fashion in

which the structure fails.

**Guidance note:**

A failure mode is the manner in which one or several functional requirements fail. The importance of all failure modes shall be agreed between the designer and the contractor, i.e. the associated type of limit state shall be identified for each failure mode (see *G300* below and *section 2 C200* for the definition of the type of limit states).

---e-n-d--- o-f---G-u-i-d-a-n-c-e---n-o-t-e---

- 203** Failure shall be considered for all locations of the product taking into account all levels of detail, as defined in *C*.
- 204** The potential failure modes shall be listed for each location of the product. A list of failure modes that should be considered as a minimum is given in Appendix 3A.
- 205** Some products may fail by other failure modes than those listed above. Such failure modes shall be identified and documented.
- 206** For each location a link between possible failure modes and functional requirements shall be established. A table describing links that should be considered as a minimum is given in Appendix 3 A.
- 207** If a number of failure modes can cause a violation of a functional requirement all possible failure modes shall be indicated.
- 208** If any of the indicated failure modes occurs for a single functional requirement the structure shall be considered as failed. Each failure mode shall be evaluated with respect to the type of Limit State it is associated with (see *G300*).
- 209** In some cases several failure modes may interact to violate a certain functional requirement. That interaction shall be specified if relevant
- 210** If a failure mode is not associated with any functional requirement it should be evaluated carefully that this failure mode is not critical in any sense.

**G 300 Identification of the type of limit states**

- 301** For each phase and each part of the product the consequence of a failure (violation of one of the functional requirements) shall be evaluated and it shall be decided whether the mode of failure is related to the Ultimate Limit State or to the Serviceability Limit State.

**Guidance note:**

Note: the client and/or authorities should make this decision. This defines the level of severity of each failure.

---e-n-d--- o-f---G-u-i-d-a-n-c-e---n-o-t-e---

- 302** All possible failures of the product at each location in each phase shall be considered.
- 303** If a failure mode has increasing consequence of failure severity in subsequent phases, it shall be designed for the most severe consequence of failure in all phases, unless the

product can be inspected in between phases and it can be insured that the failure mode has not occurred in the previous phase.

## H. Exposure from surroundings

### H 100 General

**101** Surroundings shall be understood in this Guideline in a general sense. It designates the natural, functional and human phenomena to which the product is exposed to during its lifetime.

**102** It shall be determined to which surroundings the product or parts of the product are exposed to in each phase.

**Guidance note:**

Surroundings can be divided into:

- Natural surroundings, which covers natural phenomena such as wind, wave and currents
- Functional surroundings, which cover phenomena due to the functional surrounding of the structure such as chemicals, fire, temperature or weight of content
- Human surroundings, which cover events due to human activity such as dropped objects or weld spatter

---e-n-d--- o-f---G-u-i-d-a-n-c-e---n-o-t-e---

**103** This document does not specify the surroundings, since they are dependent on the applications. However, a list is provided in *Appendix 3A* to ensure that at least the most frequently encountered surroundings are considered in the design.

### H 200 Loads and environment

**201** A distinction is made in this Guideline between:

- Loads
- Environment

**202** The term loads designates in this Guideline the direct and indirect loads on the product, e.g. wave load on a structure, or thermal expansion loads. Both direct and indirect loads impose load effects, like stresses or strains on the product. Loads can be different in nature: functional loads, environmental loads or accidental loads. The loads on the product shall be specified according to *I*.

**203** Calculations of the load effects on the product to the various environmental phenomena, i.e. environmental loads, are made by a transfer function. Specific transfer functions are not described in this Guideline (e.g. calculation of the load effect on a structure due to wind, with a specified wind speed). The load effects should be determined according to relevant standards or guidelines. As guidance for calculation of characteristic



environmental loads on a structure the principles given in DNV Classification Note No. 30.5 “environmental Conditions and Environmental Loads” may be used.

- 204** The term environment designates in this Guideline the surroundings that impose no direct load on the product, e.g. ambient temperature or moisture. The *environment* shall be specified according to the requirements of *J*.
- 205** The *environment* is generally considered for its effect on the degradation of material strength (see *section 4E* and *section 5E*).
- 206** The *environment* may also impose indirect loads on the structure, e.g. thermal stresses or swelling due to moisture uptake. This effect should be considered as a load, according to I and *section 9H* and *9I* (Structural analysis).
- 207** Material properties may be influenced in the long-term not only by the *environment* but also by the *loads*, or by the combination of *environment* with *loads*, e.g. creep and stress rupture. The combination of loads and environment to be considered when assessing the degradation of material properties is detailed in *section 3K*.

### **H 300 Obtaining loads from the exposure from surroundings**

- 301** The surrounding environment can often not be described as a direct load acting on a structure. In such a case a transfer function shall be established that transforms the surrounding environment into a load. Any uncertainties in the transfer function shall be included in the load model factor described in Sections 8 and 9.
- 302** It is recommended to use a conservative transfer function. In that case it is not necessary to consider the model uncertainties of the transfer function in the load model factor.

**Guidance note:**

The wind load is a typical example where the speed of the wind is transformed to a load on a structure. The load depends not only on the speed but also on the exposed surface and the aerodynamic profile of the structure. The transfer function is the mathematical model that transforms wind speed to a load on the structure.

## I. Loads

### I 100 General

- 101** This Guideline does not specify specific load conditions and characteristic load effects, since these are dependent on the applications.

**Guidance note:**

A non-exhaustive list of the most common loads to be considered in design is given as guidance in Appendix 3A of this section. This list is organised according to a classical classification into functional, environmental and accidental loads. This classical classification is only used in this Guideline as a checklist. The load factors are dependent on the probabilistic representation of the loads.

---e-n-d--- o-f---G-u-i-d-a-n-c-e---n-o-t-e---

- 102** A load is defined as an assembly of one or more concentrated or distributed forces acting on the structure (direct loads), or the cause of imposed or constrained deformations in the structure (indirect loads).

**Guidance note:**

The *environment* may impose indirect loads on the structure, e.g. thermal stresses or swelling due to moisture uptake. This should be considered as a load effect, and calculated according to the relevant parts of *section 9*. However, the *environment* is generally considered for its effect on the degradation of material strength.

---e-n-d--- o-f---G-u-i-d-a-n-c-e---n-o-t-e---

- 103** All the load cases shall be described separately for each phase during the design life of the structure.

- 104** All loads have to be represented as appropriate with due consideration of:

- type of load and load effect: global, regional or local load, or response
- direction of load
- variation with time

- 105** A representative time history of all loads should be documented for the entire life of the structure. This includes a probabilistic representation as specified in *I200*.

- 106** Different load values are defined in this Guideline:

- the *characteristic value* (*I400*) is defined based on the probabilistic representation of the load
- the *sustained value* (*I500*) is defined based on the time representation of the load
- the *fatigue value* (*I600*) is defined based on the time representation of the load

**Guidance note:**

The definition of the different load values is summarised in the table below. The detailed definition presented in the relevant chapters shall be used.

Designation	Definition	To be used for
Characteristic value	Extreme value with return period of 100 years	Check of Ultimate Limit States
Sustained value	Average value over a long period	Long-term degradation of material properties
Fatigue value	Mean and amplitude of variations	Check of Fatigue Limit States
Accidental value	Same as characteristic value	

---e-n-d--- o-f---G-u-i-d-a-n-c-e---n-o-t-e---

- 107** The notion of accidental value is not used in this Guideline. It shall be decided whether the product should be designed for a given accidental event (e.g. fire, impact) or whether it should not be designed for it and instead protected against it by other means (e.g. impact protection structure around the product).
- 108** Different types of loads and environments shall be combined. Depending on which load and environment values are combined, different load and environmental conditions are defined. These different load and environmental conditions define the different design cases to be considered. These design cases are described in *K*.

**I 200 Probabilistic representation of load effects**

- 201** The response of the structure to applied loads shall be calculated on a global or a local level depending on the failure mechanism being checked and its associated design rule. See *section 9 A400*.
- 202** A probabilistic representation should be established for the effect of each load on the structure in every relevant location. The load effect is obtained by from the basic load by structural analysis. The basic load is obtained directly or by a transfer function (e.g. converting wind speed to a basic load on the surface).
- 203** The probability distribution function representative for each load process should be determined. The probability distribution function representative for the response of the structure associated with each load process, the load effect, should also be determined in every relevant location. In particular, the type of distribution should be determined for each distribution function.
- 204** The arbitrary value distribution over the lifetime of the structure and annual extreme value distribution shall be determined for all loads and the corresponding response of the structure.
- 205** A recognised procedure for determination of the distribution type shall be used. The procedure required in the DNV Classification Note N°30.6 "Structural reliability analysis of marine structures" may be used.
- 206** If two types of distributions give equally good fits to data, the distribution with most probability content in the upper tail should be chosen, unless one of the distributions fits possible data observations in the tail better than the other.
- 207** If no satisfactory distribution fit can be obtained or if insufficient data are available, then

the simplified probabilistic representation of load effects presented in *I300* shall be used.

**Guidance note:**

The partial safety factors specified for the simplified probabilistic representation of load effects are conservative. A precise determination of the extreme-value distribution for load would normally lead to lower requirements to the values of the partial safety factors.

---e-n-d--- o-f---G-u-i-d-a-n-c-e---n-o-t-e---

- 208** For some load variables, sufficient knowledge and/or experience is available to provide a basis for recommendation of distribution types. A list of variables with their recommended distribution types is given in *Appendix 3A*.
- 209** The coefficient of variation of each load variable and the corresponding load effect shall be specified. If insufficient data are available the simplified probabilistic representation of load effects presented in *I300* should be used.

**I 300 Simplified representation of load effects**

- 301** A simplified set of partial safety factors is given for use whenever a satisfactory probabilistic representation of the load effects, as required in *I200*, is not available.
- 302** The characteristic load effect shall be defined as specified in *I400*.
- 303** The simplified set of partial safety factors given in *section 8 B300* was determined assuming that the coefficient of variation of load effects were not larger than 20%. These partial safety factors shall not be used for load effects with a COV larger than 20%.
- 304** The simplified set of partial safety factors given in *section 8 B400* was determined assuming that the coefficient of variation of load effects is 0%, i.e. the load effects are exactly known and they do not have any statistical variation. This is usually based on a very conservative description of the load effect.
- 305** The simplified set of partial safety factors shall be used when the characteristic strength is defined as the 2,5 % quantile, as generally required in this Guideline.
- 306** Loads may also be defined as combinations of functional loads and environmental loads according to offshore standards like DNV-OS-F201 "Dynamic Risers" or DNV-OS-F101 "Submarine Pipeline Systems". Partial safety factors for this choice are given in *Section 8 B600*.

**I 400 Characteristic load effect**

- 401** The characteristic load effect value,  $S_k$ , is a value that will only rarely be exceeded. For time-dependent processes, it is generally given in terms of a return value for occurrence, i.e. a load effect which on average is exceeded once in a specified reference time period (denoted return period or recurrence period).
- 402** A unique definition of the characteristic load effect is prescribed and used throughout this Guideline. It shall be used both in case of single and multiple load processes.
- 403** In principle, the characteristic load effect shall be determined as the characteristic value of

the local response of the structure to the applied load. It shall be based on a probabilistic representation of the variability in the local response, as defined in *I200*.

**Guidance note:**

The *partial safety factors* specified in this Guideline and calibrated against specified probabilities of failure apply on the characteristic values of the load effect, i.e., the *local response* of the structure. Simplifications in the *transfer function* (from loads to local response) lead to uncertainties. These uncertainties are accounted for by the *load model factors*. When the *transfer function* from applied loads to local response is linear, the probabilistic representation of the variability in the local response is identical to the probabilistic representation of the variability of the loads. In that case, partial safety factors can be applied directly on the characteristic values of the applied loads.

---e-n-d--- o-f---G-u-i-d-a-n-c-e---n-o-t-e---

- 404** The characteristic load effect can be determined as the characteristic value of the externally applied global load in the following cases:
- when the design rule is expressed in terms of the global response of the structure,
  - when the transfer function from global to local response and the analysis is linear.
- 405** The characteristic load effect is defined as the 99% quantile in the distribution of the annual extreme value of the local response of the structure, or of the applied global load when relevant.
- 406** The 99% quantile in the distribution of the annual maximum load effect is used as the characteristic load value throughout this document. The 99% quantile may be interpreted as the 100-year load, i.e., the load value which has a return period of 100 years. This is the load effect value, which on average will be exceeded once every 100 years.
- 407** Extreme values driving the design can be maximum as well as minimum values. Should minimum values of load effects be driving the design, the characteristic load effect shall be defined as the 1% quantile in the distribution of the annual minimum load. For example, the pressure on the wall of a submerged pressure vessel is function of the differential between internal pressure and external hydrostatic pressure and increases when the external pressure decreases (i.e. when the depth decreases).

**I 500 The sustained load effect**

- 501** The *sustained* load effect value should be used for the determination of time-dependent material properties as described in *section 4C* (for laminates) and *section 5C* (for sandwich structures).

**Guidance note:**

In general, it would be very conservative to determine the time dependent degradation of material properties under long-term loads by using the characteristic load effect value (i.e. extreme load effect value). The sustained value is defined in this Guideline as a kind of average load effect value over the lifetime of the product.

---e-n-d--- o-f---G-u-i-d-a-n-c-e---n-o-t-e---

- 502** Sustained load values are defined over an observation period, which can correspond to the entire design life of the product or to a part of that design life. This observation period shall be divided into several time intervals. Time intervals should not be chosen shorter than 1 hour. The maximum length of a time interval depends on the load variations.

Variations in magnitude of the load within a time interval shall not be larger than half the absolute load amplitude during the total observation period.

- 503** Load effects are divided, according to their variation with time, into:
- permanent load effects; effects which are likely to act or be sustained throughout the design life and for which variations in magnitude with time are negligible relative to their mean values; or load effects which are monotonically in- or decreasing until they attain some limiting values.
  - variable load effects; effects which are unlikely to act throughout the specified design life or whose variations in magnitude with time are random rather than monotonic and not negligible relative to their mean values.

**504** The sustained value of permanent load effects shall correspond to their characteristic value, as defined in *I400*.

**505** The sustained value of variable load effects is defined as the mean value of the effects over the time interval. The sustained value  $S_s$  during the time interval  $t_0$  is determined such that the corresponding total duration above  $S_s$  is a portion  $\mu = 0,5$  of the exposure period  $t_s$ . See *Figure 3-1*:

$$\sum_i t_i \leq \mu t_s$$

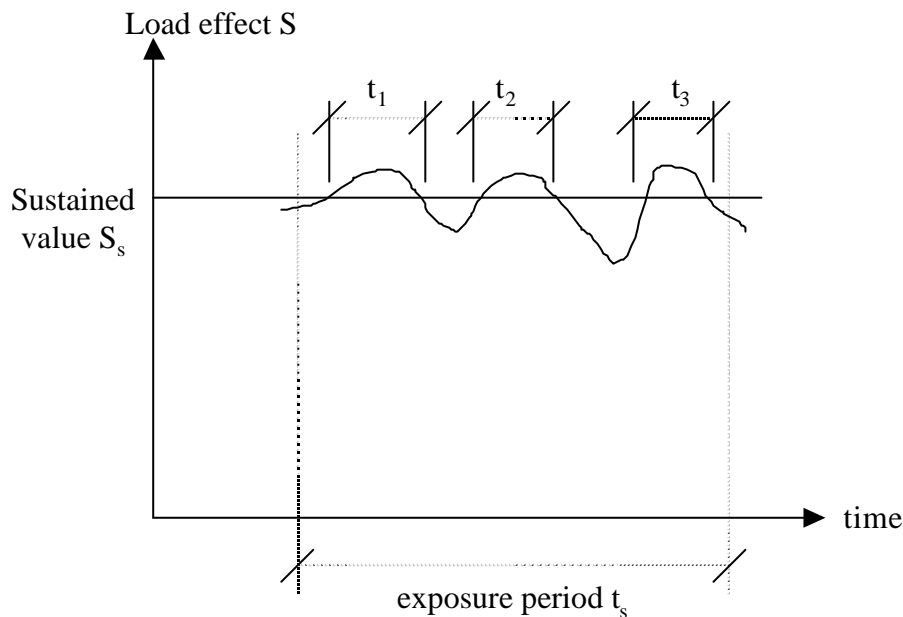

**Figure 1: sustained value of a variable load effect**

**506** The sustained value of the stress or strain fluctuations (Load effect fluctuations) shall be specified within each observation period for each time intervals. Basically a table of the following form should be established.

Exposure time (duration)	Sustained value
$t_s$	$S_s$

**Table 1: sustained values**

- 507 The sustained value of a load effect over an observation period may conservatively be chosen as the maximum value of that load effect during the observation period.
- 508 The sustained conditions shall be considered for failure mechanisms or material property changes governed or influenced by long-term load effects.

**Guidance note:**

For example, the *sustained* load effect value shall be used for the calculation of creep and for stress rupture.

---e-n-d--- o-f---G-u-i-d-a-n-c-e---n-o-t-e---

Examples of division into time intervals and definition of the sustained values  $S_{si}$  for different load effect cases are shown on the figure below:

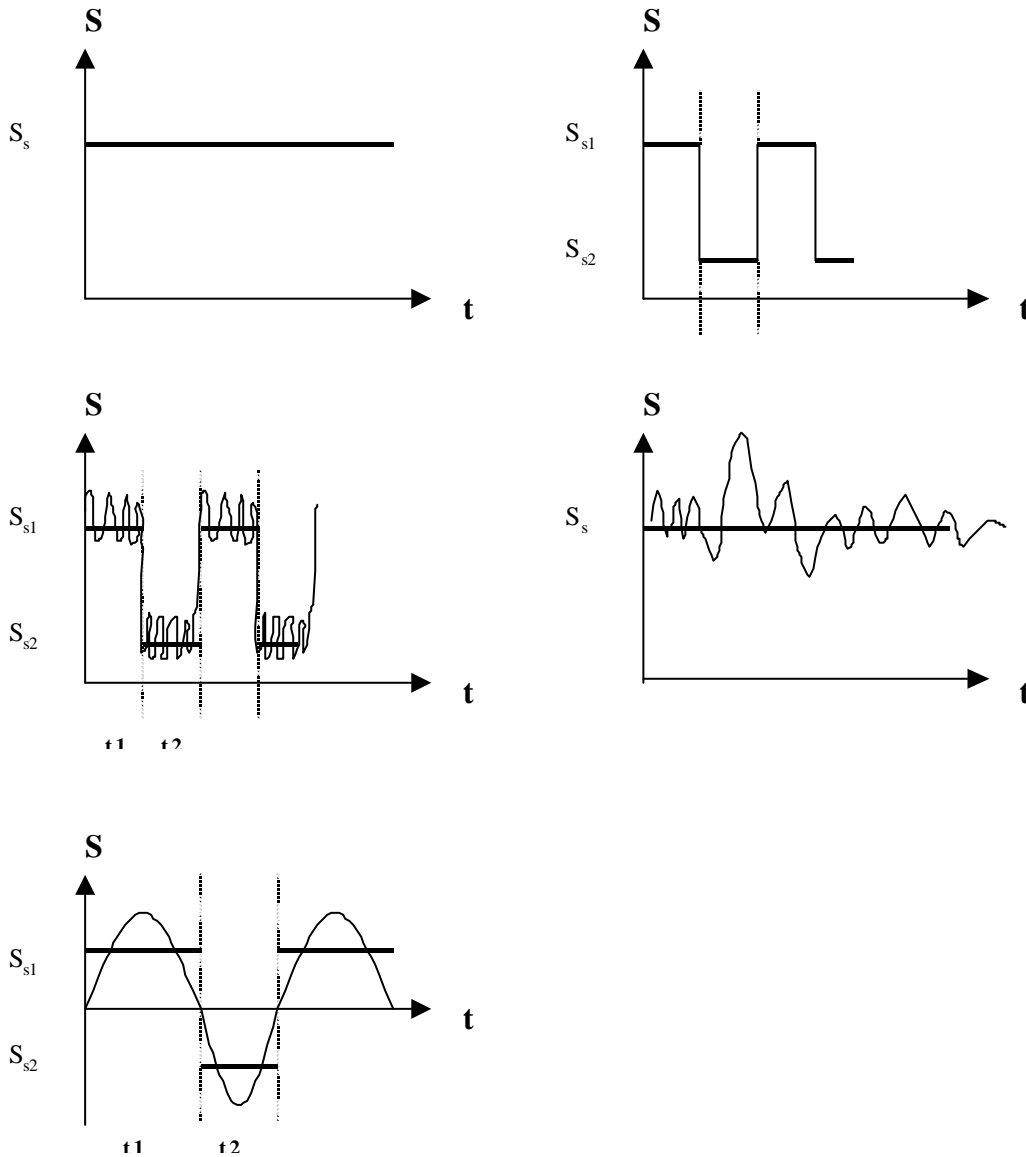

**I 600 The fatigue load effects**

- 601** All load effect fluctuations, e.g. stress or strain fluctuations, imposed during the entire design life, shall be taken into account when determining the long-term distribution of stress or strain ranges. All phases shall be included and both low-cycle fatigue and high-cycle fatigue shall be considered.
- 602** Fatigue may be analysed for load effects in terms of either stress or strain. Strain is preferred for composite laminates.
- 603** The characteristic distribution of load effect amplitudes shall be taken as the expected distribution of amplitudes determined from available data representative for all relevant loads. This is a long-term distribution with a total number of stress/strain cycles equal to the expected number of stress/strain cycles over a reference period such as the design life of the structure.
- 604** For fatigue analysis the mean and amplitude of the stress or strain fluctuations shall be specified. Basically a table of the following form should be established.

Number of cycles	Mean load	Amplitude

**Table 2: definition of fatigue loads**

As an alternative to the representation in Table 2, the fatigue loads can be represented on matrix form with one row for each mean strain, one column for each strain amplitude, and number of cycles as the entry of each matrix element as shown in the Figure below.

		Strain amplitude	
		(col. $j$ )	
Mean strain	(row $i$ )	$n_{ij}$	

Matrix representation of rain-flow counted strain amplitude distribution



**Guidance note:**

- The history of mean and amplitude of stress shall be established on discretised form by a rainflow analysis
- A minimum resolution of the discretisation of stresses has to be defined before the stress history is established
- Note that for the fatigue analysis the history of mean stress/strain and amplitude is needed. In a non-linear analysis, the mean may shift relative to the amplitude during the transfer from applied load to load response.
- If the time duration of some cycles is long or if the mean value is applied over a long time, these loads may have to be considered for sustained load cases (stress rupture) as well.
- Degradation is a non-linear, history-dependent process. If different load and environmental conditions can cause different degradation histories, all relevant load combinations shall be considered.

---e-n-d--- o-f---G-u-i-d-a-n-c-e---n-o-t-e---

**605** Based on the material properties, in particular the *S-N* curve and the magnitude of its slope parameter, it shall be assessed whether the bulk of the fatigue damage will be caused by several thousand or more stress cycles from the characteristic stress distribution, or if it will be caused by only one or a very few extreme stress amplitudes from this distribution. In the former case, the natural variability in the individual stress amplitudes can be disregarded as its effect on the cumulative damage will average out, and the partial load factor can be set equal to 1.0. In the latter case, the natural variability in the few governing extreme stress amplitudes cannot be disregarded and needs to be accounted for by a partial load factor greater than 1.0. If no detailed analysis of the load factor can be made, the same factors as those given in Section 9 for static loads shall be used.

## J. Environment

### J 100 General

- 101** The term environment designates in this Guideline the surroundings that impose no direct load on the product, e.g. ambient temperature or moisture.
- 102** The environment may impose indirect loads on the structure, e.g. thermal stresses or swelling due to moisture uptake. This should be considered as a load effect and should be calculated according to the relevant parts of *section 9*. However, the environment is generally considered for its effect on the degradation of material strength or change of elastic properties.
- 103** The following aspects shall be considered when evaluating the effect of the environment on local volume elements in a structure:
- Direct exposure
  - Possible exposure if protective system fails
  - Exposure after time
  - Exposure after diffusion through a protective layer
  - Exposure after accident
  - Exposure after degradation of a barrier material, or any material

**Guidance note:**

A non-exhaustive list of the most common environments to be considered in the design is given for guidance in the *Appendix 3A*.

---e-n-d--- o-f---G-u-i-d-a-n-c-e---n-o-t-e---

- 104** The time history of all quantities that characterise environmental conditions (e.g. temperature, humidity) shall be documented for each phase during the design life of the structure.
- 105** The time history of all environments has to be documented for the entire life of the product. Time histories and characteristic values shall be established according to the same principles as described for load in Section I.
- 106** Different environmental values are defined in this Guideline:
  - the characteristic value
  - the sustained value

**Guidance note:**

The definition of the different load values is summarised in the table below. The detailed definition presented in the relevant chapters shall be used.

Designation	Definition	To be used for
Characteristic value	Extreme value with return period of 100 years	Check of Ultimate Limit States
Sustained value	Average value over a long period	Long-term degradation of material properties
Fatigue value	Only for loads	
Accidental value	Same as characteristic value	

For example: when considering temperature as an environment, the following values can be defined:

- Sustained environmental value corresponding to the average temperature
- Extreme environmental value corresponding to the maximum temperature
- Accidental environmental value corresponding to a fire situation
- Fatigue environmental values corresponding temperature fluctuations imposing thermal stress fluctuations in the material

---e-n-d--- o-f---G-u-i-d-a-n-c-e---n-o-t-e---

- 107** The notion of fatigue value for the environment is not considered in this chapter. If the environment impose indirect fatigue loads on the structure, e.g. cyclic thermal stresses, these loads should be considered according to *I*.
- 108** The notion of accidental value is not used in this Guideline. It shall be decided whether the product should be designed for a given accidental event (e.g. fire, chemicals leakage) or

whether it should not be designed for it and protected against it by other means (e.g. chemical protection structure around the product).

- 109** Different types of loads and environment shall be combined. Depending on which load and environment values are combined, different load and environmental conditions are defined. These different load and environmental conditions define the different design cases to be considered. These design cases are described in *K*.

## **J 200 Effects of the environment on the material properties**

- 201** All possible changes of material properties due to the effect of the environment shall be considered.

### **Guidance note:**

The following interactions should be considered:

- Temperature: variation of the mechanical properties (stiffness, strength...)
- Exposure to water (salinity / corrosion, marine fouling...)
- Exposure to humidity
- Exposure to chemicals
- Exposure to UV
- Exposure to other radiation
- Erosion

---e-n-d--- o-f---G-u-i-d-a-n-c-e---n-o-t-e---

- 202** The degradation of material properties caused by the environmental conditions is described in *section 4E* (laminates) and *section 5E* (sandwich structures).
- 203** The environmental conditions that shall be used for the determination of time-dependent material properties are described in *K300*.

## K. Combination of load effects and environment

### K 100 General

**101** The combination and severity of load effects and/or environmental conditions should be determined taking into account the probability of their simultaneous occurrence.

**Guidance note:**

For example, a severe wave climate producing a large wave load is usually accompanied by a severe wind climate producing a large wind load.

---e-n-d---o-f---G-u-i-d-a-n-c-e---n-o-t-e---

- 102** If the load effect is related to the actual load in a linear way loads may be combined directly instead of combining load effects. Reference is also made to DNV-OS-F201 Appendix C on how to combine loads for nonlinear systems.
- 103** Load effects and/or environmental conditions, which are mutually exclusive, should not enter together into a combination, e.g. ice load effects and wave load effects in a riser environment.
- 104** All directions of load effects are to be taken as equally probable, unless data clearly show that the probability of occurrence is different in different directions, or unless load effects in a particular direction is particularly critical.
- 105** Permanent load effects and permanent environmental conditions shall be taken into consideration in all combinations of load effects and environmental conditions. When combined with other load effects or environmental conditions, their characteristic values shall be included in the combination.
- 106** The following load effect and environmental conditions are defined in this standard:
- Load effects and environmental conditions for ultimate limit state
  - Load effects and environmental conditions for time-dependent material properties
  - Load effects and environmental conditions for fatigue analysis

**107** The *Table 3-5* summarises the load and environmental conditions that should be considered for the determination of the time-dependent material properties and those that should be used for the design checks at various times during the life of the product.

		Loads		
		Characteristic value	Sustained value	Fatigue value
Environment	Characteristic value	ULS check Fully correlated only <i>See K202</i>	ULS check Not fully correlated <i>See K206</i>	
	Sustained value	ULS check Not fully correlated <i>See K206</i>	Material degradation See K300	Fatigue analysis See K400

**Table 3-5: Combinations of load and environmental conditions to be considered for the determination of material degradation and for design checks.**

**K 200 Load effect and environmental conditions for ultimate limit state**

**201** At any time during the design life of the structure it should be documented that the structure can fulfil its functional requirements for:

- All characteristic load effect values combined with all sustained environmental values
- All sustained load effect values combined with all characteristic environmental values

**202** When environment and load effect are *fully-correlated*, their *characteristic* values shall be combined.

**203** The combination of characteristic load effects and environment should be determined such that the combined characteristic effect has a return-period of 100 years.

**Guidance note:**

A method to determine the 100-years combined effect of several load effects and environments is described in this chapter. It is based on the so-called Turkstra's rule.

---e-n-d---o-f---G-u-i-d-a-n-c-e---n-o-t-e---

**204** When several stochastic load effect and/or environmental conditions occur simultaneously, the extreme combined effects of the associated stochastic processes are required for design against the ultimate limit state. Each process is characterised by a characteristic value. The characteristic values are to be factored and combined to produce a design effect. For this purpose, a (limited) number of possible load effect and/or environmental condition combinations are considered. The most unfavourable combination among these shall be found and will govern the design.

**205** The most unfavourable relevant combinations shall be defined for every point in time during the design life.

**Guidance note:**

In most cases the most unfavourable relevant combinations are the same over the entire design life.

However, in some cases conditions may change with time, which may in turn cause changes in the relevant combinations.

---e-n-d--- o-f---G-u-i-d-a-n-c-e---n-o-t-e---

- 206** The format of this standard for the combination of two or more independent random load effect processes is based on Turkstra's rule. The rule states that the maximum value of the sum of two independent processes occurs when one of the processes has its maximum value.
- 207** The design load effect corresponding to the combination of two independent load effect processes A and B should be determined as

$$S_d = \gamma_{Sd} \cdot \max \left\{ \begin{array}{l} \gamma_{F^A} \cdot S_k^A + \gamma_{F^B} \cdot S_k^B \cdot \Psi^B \\ \gamma_{F^A} \cdot S_k^A \cdot \Psi^A + \gamma_{F^B} \cdot S_k^B \end{array} \right. \quad (1)$$

Where:

- $S_d$  Design load effect
- $\gamma_{Sd}$  Load effect model factor
- $S_k^A$  Characteristic value of load effect A
- $\gamma_{F^A}$  Partial load effect factor for load effect A
- $\Psi^A$  Load effect combination factor for load effect A
- $S_k^B$  Characteristic value of load effect B
- $\gamma_{F^B}$  Partial load effect factor for load effect B
- $\Psi^B$  Load effect combination factor for load effect B

- 208** The design load effect corresponding to the combination of a number of N independent load effect processes should be determined by the maximum of the following N combinations:

$$S_d = \gamma_{Sd} \cdot \max_{j=1}^N \left[ \gamma_{F^j} \cdot S_k^j + \sum_{i \neq j} \gamma_{F^i} \cdot S_k^i \cdot \Psi^i \right] \quad (2)$$

Where:

- $S_d$  Design load effect
- $\gamma_{Sd}$  Load effect model factor
- $S_k^i$  Characteristic value of load effect i
- $\gamma_{F^i}$  Partial load effect factor for load effect i
- $\Psi^i$  Combination factor for load effect i

- 209** The load effect combination factor  $\Psi = 0.7$  should be used for independent load effect processes, unless a detailed probabilistic analysis can justify a different value. For permanent load effects and permanent environmental conditions  $\Psi = 1.0$ .
- 210** Some load effect processes are correlated such that the value of the one load effect process to some degree depends on the simultaneous value of the other load effect process. The combination rule for design load effects quoted in *clause 206* for independent load effect processes can be extended to be used also for correlated load effect processes. When applied to combination of correlated load effect processes, different (usually higher) values of the combination factors  $\Psi$  apply, depending on the degree of correlation.
- 211** The load effect combination factor  $\Psi = 1,0$  shall be used for correlated loads, unless a detailed analysis can show that the load effects are correlated in a different way.

**Guidance note:**

For example:

- Water level (height) and pressure load are fully correlated processes
- Wave height and wind speed are somewhat *correlated* processes: waves are wind driven, so high mean wind speeds are usually accompanied by large significant wave heights, maybe with some delay, whereas the instantaneous wind speed and the simultaneous wave height are *independent* once the mean wind speed and significant wave height are given.
- Self-weight and wind load on a bridge are *un-correlated* processes.
- Snow load and wind load on a roof may be *fully negatively correlated* processes, i.e. the maximum value of the one process and the minimum value of the other process may occur simultaneously.

---e-n-d---o-f---G-u-i-d-a-n-c-e---n-o-t-e---

**K 300 Load effect and environmental conditions for time-dependent material properties**

- 301** The sustained load effect values or the fatigue load effect values (when relevant) and the sustained environmental values should be used for the determination of time-dependent material properties as specified in *I-500*.

**K 400 Load effect and environmental conditions for fatigue analysis**

- 401** The fatigue load effects should be combined with the sustained environmental values for the fatigue analysis as specified in *I-600*.

**K 500 Direct combination of loads**

- 501** The combination of load effects and environments as described above should be used to obtain the load effects, i.e., local stresses and strains.
- 502** If transfer functions and structural analysis are linear, loads or moments can be combined by the procedures given above instead of the load effects.

## SECTION 3 - APPENDIX A: CHECK-LISTS FOR DESIGN INPUT

### SECTION 3 - APPENDIX A: CHECK-LISTS FOR DESIGN INPUT..... 1

<b>A.</b>	<b>PHASES.....</b>	<b>1</b>
<b>B.</b>	<b>FUNCTIONAL REQUIREMENTS AND FAILURE MODES .....</b>	<b>2</b>
B 100	FUNCTIONAL REQUIREMENTS THAT SHALL BE CHECKED AS A MINIMUM .....	2
B 200	FAILURE MODES THAT SHALL BE CHECKED AS A MINIMUM. ....	2
B 300	LINK BETWEEN FUNCTIONAL REQUIREMENTS AND FAILURE MODES. ....	3
<b>C.</b>	<b>LOADS.....</b>	<b>6</b>
C 100	FUNCTIONAL LOADS .....	6
C 200	ENVIRONMENTAL LOADS.....	6
C 300	ACCIDENTAL LOADS .....	6
<b>D.</b>	<b>ENVIRONMENTS .....</b>	<b>7</b>
<b>E.</b>	<b>DISTRIBUTION TYPES OF BASIC VARIABLES .....</b>	<b>8</b>

### A. Phases

Manufacturing	Construction
Fabrication / Assembly	
Transport	
Handling	
Storage	
Installation	
Testing	
Commissioning	
Operation	Operation
Maintenance	
Repair	
Retrieval / recirculation	Post-operation.



## B. Functional requirements and failure modes

### B 100 Functional requirements that shall be checked as a minimum.

<b>Minimum list of Functional Requirements</b>
Load carrying capacity
Pressure containment
Tightness/Fluid containment
Dimensional stability
Environmental, chemical and UV resistance
Maximum vibrations
Fire Resistance
Temperature insulation
Erosion, abreaction, wear
Electrical Resistance or Insulation
Static Electricity / Grounding
Lightning resistance

### B 200 Failure modes that shall be checked as a minimum.

<b>Minimum list of Failure Modes</b>
Fracture (local or global)
Burst
Leakage
Impact
Excessive deformation, Ovalisation, Excessive displacement
Wear

**B 300 Link between functional requirements and failure modes.**

<b>Functional Requirements</b>	<b>Failure Modes</b>	<b>Comments</b>
Load carrying capacity	Fracture	Shall always be checked
	Global, local buckling	Shall always be checked if compressive loads are present. Buckling may lead to fracture.
	Blast	Same as fracture, caused by high rate external loads.
	Impact	Damage from impact may effect load carrying capacity
	Excessive deformation, ovalisation excessive displacement	Only relevant if deformations effect load carrying capacity, e.g. if the structure can jump out of a mechanical joint.
	Wear	Wear may lead to a reduction of strength, causing fracture.

Pressure containment	Fracture, Local fracture	Shall always be checked.
	Global, local buckling	Shall always be checked if compressive loads are present. Buckling may lead to fracture or excessive deformations.
	Blast	Same as fracture, caused by high rate external loads.
	Burst	Same as fracture, but combined with rapid release of fluid from a pressure vessel. Failure consequence is usually related to high safety class.
	Impact	Damage from impact may effect load carrying capacity
	Excessive deformation, ovalization Excessive displacement	Only relevant if deformations effect load carrying capacity, e.g. if the structure can jump out of a mechanical joint or a seal.
	Leakage	Related to fracture, but often just a gradual release of fluid from a pressure vessel. Fracture will cause leakage, but other minor failure mechanisms may also cause leakage. Failure consequence is often less critical and related to normal safety class, but it depends on the fluid.
	Wear	Wear may lead to a reduction of strength, causing fracture.

Tightness/Fluid containment	Same as pressure containment	
Dimensional stability	Excessive deformation, ovalisation Excessive displacement	
	Wear	Wear may lead to a change of acceptable dimensions.
Environmental Resistance Resistance to chemicals UV Resistance	Linked to all other functional requirements	Resistance to the environment or chemicals is treated in this guideline as a possible change to material properties that shall be considered in the evaluation of all other functional requirements.
Maximum vibrations	Part of general structural analysis.	
Fire Resistance	Linked to all other functional requirements.	Resistance to fire is mainly treated in this guideline as a possible change to material properties that shall be considered in the evaluation of all other functional requirements.
Temperature insulation	Not covered in this guideline	Insulation can be tested and analysed the same way as for other materials. Anisotropic thermal coefficients and thermal expansions should be considered.
Erosion, abreaction, wear	Wear	
Electrical Resistance or Insulation	Not covered in this guideline	Electrical aspects are not covered in this guideline. Composites are an insulator, unless filled with conductive particles or fibres. Coating with a fluid or paint may also create some conductivity. Special electrical requirements for the application shall be considered.
Static Electricity / Grounding	Not covered in this guideline	
Lightning resistance	Not covered in this guideline	

## C. LOADS

### C 100 Functional loads

- Weight
- Reactions from components
- Interactions with other components (wear, friction, interference)
- Applied tension
- Pre-stressing (permanent curvature, mooring/anchoring...)
- Permanent deformation of supporting structure
- External hydrostatic pressure
- Vacuum
- Service induced vacuum
- Internal pressure
- Thermal stresses due to temperature of content
- Slugging flow
- Internal fluid flow
- Loads induced by frequent pigging operations
- Loads related to operations and normal use of the installation (cranes, helicopters, drilling, engorgement...)
- Fouling
- Traffic loads
- Live loads
- Installation loads

### C 200 Environmental loads

- 
- Wind
- Waves
- Currents
- Ice
- Possible loads due to ice bulb growth
- Snow
- Earthquake
- Movement of earth
- Cover (soil, rock, and mattresses...)
- Reaction from seafloor
- Permanent deformation due to subsidence of ground
- Soil conditions
- Thermal expansion and contraction due to external temperatures
- Moisture (swelling loads)
- Tides
- Vibrations
- Trawl
- Flooding / ground water buoyancy

### C 300 Accidental loads

- Collisions (vessel impact or other drifting items)
- Dropped objects

- Explosion
- Fire (load redistribution during / after fire)
- Operational malfunction (e.g. leakage or other effects from nearby pipes...)
- Trawl (hooking is normally to be classified as accidental loads)
- Dragging anchor
- Unintended change in ballast condition
- Mud slides
- Failure of an anchor line or dynamic positioning system
- Weld spatter
- Handling by forklift

## D. Environments

The term *environment* designates in this Guideline the surroundings that impose no direct load on the structure.

The *environment* may impose indirect loads on the structure, e.g. thermal stresses or swelling due to moisture uptake. This should be considered as a load effect, and calculated according to the relevant parts of Section 8. However, the *environment* is generally considered for its effect on the degradation of material strength.

NATURAL	Temperature internal and external
	Temperature variations
	Temperature gradients
	UV radiations
	Moisture
	Sea water
	Lightning
	Acid rain
	Atmospheric electrical field
	Animals (e.g. shark bites on tethers, elephants walking on pipes)
FUNCTIONAL	Transported or contained fluids and chemicals
	Temperature internal and external
	Pressure internal and external
	Oil spill
	Cleaning materials
	Paint solvents
	Accidental chemicals
	Fire
	Process gas leaks
	Service induced shocks
Accidental high pressure steam	

### E. Distribution types of basic variables

From DNV Classification Notes – No. 30.6 - Table 2.1

Standard variables and corresponding distribution types		
	Variable name	Distribution type
Wind	Short-term instantaneous gust speed	Normal
	Long-term n-minute average speed	Weibull
	Extreme speed yearly	Gumbel
Waves	Short-term instantaneous surface elevation (deep-water)	Normal
	Short-term heights	Rayleigh
	Wave period	Loguet-Higgins
	Long-term significant wave height	Weibull
	Long-term mean zero upcrossing or peak period	Lognormal
	Joint significant height/mean zero upcrossing or peak period	3-parameter Weibull (height) / Lognormal period conditioned on height
	Extreme height yearly	Gumbel
Current	Long-term speed	Weibull
	Extreme yearly	Gumbel
Forces	Hydro-dynamic coefficients	Lognormal
Fatigue	Scale parameter on SN-curve	Lognormal
	Fatigue threshold	Lognormal
Fracture mechanics	Scale parameter on da/dN-curve	Lognormal
	Initial crack size	Exponential
	P.O.D. - curve	Lognormal
Properties	Yield strength (steel)	Lognormal
	Young's modulus	Normal
	Initial deformation of panel	Normal
Ship data	Still water bending moment	Normal
	Joint still water moment / draught	Joint normal
	Ship speed	Lognormal
	Model uncertainty of linear calculations	Normal

## SECTION 4 MATERIALS - LAMINATES

<b>SECTION 4 MATERIALS - LAMINATES.....</b>	<b>1</b>
<b>A. GENERAL.....</b>	<b>3</b>
A 100 INTRODUCTION.....	3
A 200 LAMINATE SPECIFICATION.....	4
A 300 LAY-UP SPECIFICATION.....	5
A 400 ORTHOTROPIC PLYS.....	5
A 500 MECHANICAL PROPERTIES.....	7
A 600 CHARACTERISTIC VALUES OF MECHANICAL PROPERTIES.....	8
A 700 PROPERTIES OF LAMINATES WITH DAMAGE.....	8
<b>B. STATIC PROPERTIES.....</b>	<b>8</b>
B 100 GENERAL.....	9
B 200 STATIC PROPERTIES.....	9
B 300 RELATIONSHIP BETWEEN STRENGTH AND STRAIN TO FAILURE.....	12
B 400 CHARACTERISTIC VALUES.....	12
B 500 EXPERIMENTAL MEASUREMENT OF MATRIX AND FIBRE DOMINATED STRAIN TO FAILURE.....	13
B 600 EXPERIMENTAL MEASUREMENT OF PLY SHEAR PROPERTIES.....	14
<b>C. PROPERTIES UNDER LONG TERM STATIC AND CYCLIC AND HIGH RATE LOADS.....</b>	<b>15</b>
C 100 INTRODUCTION.....	15
C 200 CREEP.....	17
C 300 STRESS RUPTURE.....	18
C 400 STATIC STRENGTH REDUCTION DUE TO PERMANENT STATIC LOADS.....	19
C 500 STRESS RELAXATION.....	20
C 600 CHANGE OF MODULUS OF ELASTICITY UNDER CYCLIC FATIGUE.....	21
C 700 CYCLES TO FAILURE UNDER CYCLIC FATIGUE LOADS.....	23
C 800 CYCLES TO FAILURE UNDER FATIGUE LOADS FOR MATRIX DOMINATED STRENGTHS.....	27
C 900 STATIC STRENGTH REDUCTION DUE TO CYCLIC LOADS.....	28
C 1000 EFFECT OF HIGH LOADING RATES - SHOCK LOADS - IMPACT.....	29
C 1100 CHARACTERISTIC VALUES.....	29
<b>D. OTHER PROPERTIES.....</b>	<b>32</b>
D 100 THERMAL EXPANSION COEFFICIENT.....	32
D 200 SWELLING COEFFICIENT FOR WATER OR OTHER LIQUIDS.....	32
D 300 DIFFUSION COEFFICIENT.....	32
D 400 THERMAL CONDUCTIVITY.....	32
D 500 FRICTION COEFFICIENT.....	32
D 600 WEAR RESISTANCE.....	32
<b>E. INFLUENCE OF THE ENVIRONMENT ON PROPERTIES.....</b>	<b>37</b>
E 100 INTRODUCTION.....	37
E 200 EFFECT OF TEMPERATURE.....	38
E 300 EFFECT OF WATER.....	40
E 400 EFFECT OF CHEMICALS.....	41
E 500 EFFECT OF UV RADIATION.....	41
E 600 ELECTROLYTIC CORROSION.....	41
E 700 COMBINATION OF ENVIRONMENTAL EFFECTS.....	42
<b>F. INFLUENCE OF PROCESS PARAMETERS.....</b>	<b>42</b>
F 100 INTRODUCTION.....	42
F 200 CHANGE OF PRODUCTION METHOD.....	42



F 300	CHANGE OF PROCESSING TEMPERATURE AND PRESSURE: .....	43
F 400	CHANGE OF POST CURE PROCEDURE .....	43
F 500	CHANGE OF VOID CONTENT:.....	44
F 600	CORRECTION FOR CHANGE IN FIBRE VOLUME FRACTION.....	44
F 700	CONTROL OF FIBRE ORIENTATION:.....	45
F 800	CONTROL OF FIBRE TENSION:.....	45
<b>G.</b>	<b>PROPERTIES UNDER FIRE.....</b>	<b>46</b>
G 100	INTRODUCTION .....	46
G 200	FIRE REACTION.....	46
G 300	FIRE RESISTANCE .....	46
G 400	INSULATION.....	47
G 500	PROPERTIES AFTER THE FIRE.....	47
<b>H.</b>	<b>QUALIFICATION OF MATERIAL PROPERTIES .....</b>	<b>47</b>
H 100	INTRODUCTION.....	47
H 200	GENERAL TEST REQUIREMENTS.....	48
H 300	SELECTION OF MATERIAL QUALIFICATION METHOD .....	48
H 400	DIRECT MEASUREMENT.....	49
H 500	REPRESENTATIVE DATA.....	49
H 600	QUALIFICATION AGAINST REPRESENTATIVE DATA.....	51
H 700	CONFIRMATION TESTING FOR STATIC DATA.....	55
H 800	CONFIRMATION TESTING FOR LONG TERM DATA - HIGH SAFETY CLASS .....	58
H 900	CONFIRMATION TESTING FOR LONG TERM DATA - NORMAL SAFETY CLASS .....	58
H 1000	USE OF MANUFACTURERS DATA OR DATA FROM THE LITERATURE AS REPRESENTATIVE DATA	58
H 1100	CONFIRMING MATERIAL DATA BY COMPONENT TESTING.....	61
H 1200	COMPARING RESULTS FROM DIFFERENT PROCESSES AND LAY-UPS .....	61
<b>I.</b>	<b>PROPERTIES WITH DAMAGED OR NONLINEARLY DEFORMED MATRIX.....</b>	<b>63</b>
I 100	INTRODUCTION .....	63
I 200	DEFAULT VALUES .....	63
I 300	EXPERIMENTAL APPROACH.....	64

## **A. General**

### **A 100 Introduction**

- 101** This section describes the mechanical material properties needed for design. It describes how to obtain all strength properties used in the failure criteria and all elastic properties needed for stress calculations.
- 102** The basic material properties used in these rules are orthotropic ply properties.
- 103** All properties shall be obtained directly by measurements or shall be traced back to measurements. The qualification of material properties is described in this section. Under certain conditions, typical values from databases can be used. Strength and stiffness values should be documented as characteristic values.
- 104** It is only necessary to obtain properties that are used in the design calculations and failure criteria.

**A 200 Laminate Specification**

- 201** A composite laminate is made of many constituent materials arranged and produced in a specific way. Laminates used in a component shall be clearly specified and all materials shall be traceable.
- 202** A minimum set of process parameters and constituent material characterisations is given in Table 1. All these items shall be specified.

<b>Constituent materials:</b>
Generic Fibre type
Type of weave
Generic resin type (e.g. epoxy, polyester)
Specific resin type (trade name)
<b>Process parameters:</b>
Processing method
Processing temperature
Processing pressure
Process atmosphere (e.g. vacuum)
Post curing (temperature and time)
Control of fibre orientation
Fibre volume fraction
Void content
<b>Conditioning parameters:</b>
Temperature
Water content of the laminate (wet, dry)
Chemical environment
Loading rate
Measure values
Guaranteed minimum value
Standard deviation
number of specimens

Table 1: Basic information to identify a laminate.

### **A 300 Lay-up specification**

- 301** A laminate is made of a sequence of layers. All materials and their stacking sequence shall be clearly identified.
- 302** The orientation of non-homogenous or anisotropic materials shall be clearly specified on the materials level and the structural level.
- 303** Laminates shall be specified in a way that they can be described by a sequence of stacked orthotropic plies.
- 304** The procedures of section 4, Appendix A should be followed to describe a lay-up.

### **A 400 Orthotropic Plies**

- 401** An orthotropic ply is defined as a volume element with three axes of symmetry with respect to mechanical properties. For this guideline the fibres should align with the symmetry axis.
- 402** There are three possible ply configurations.
- UD (unidirectional) ply. In this ply all fibres run parallel in the same direction (the 1 direction).
  - cross-ply. In this ply fibres run perpendicular to each other within one plane, they run in the 1 and 2 direction. Typical reinforcement fabrics are woven rovings and twills.
  - Isotropic ply. In this ply fibres are randomly oriented without a preferred direction. A typical reinforcement type of this class is chopped strand mat. It could also be an injection moulded part as long as one can ensure that the fibres are not aligned by the flow of the material into the mould.
- 403** The following is assumed in this guideline:
- The UD ply has linear elastic properties.
  - The cross-ply is bi-linear in tension and in compression. The bi-linearity is caused by substantial matrix cracking.
  - The isotropic ply is bi-linear like the cross-ply.

-----Guidance note:

Bi-linear means that the stress strain curve of a cross plied laminate can be roughly described by two linear lines.

Shear moduli and matrix moduli in compression are often nonlinear. A nonlinear description may be used in the analysis if the nonlinearity is measured experimentally for the material. The assumptions in 403 can be used as a default.

-----End of guidance note-----

- 404** These simplifications are generally valid for thermoset plies. However, their applicability shall always be checked.
- 405** Other modelling methods may be preferred for certain material combinations.
- 406** Thermoplastic composites may show more non-linear characteristics.
- 407** Ply angles shall be specified between the laminate co-ordinate system and the main fibre direction (1 direction). In addition, it may be necessary to define an angle between the component coordinate system and the laminate coordinate system.
- 408** Knitted fabrics shall be described as a sequence of UD plies. This is the best way to describe their bending characteristics properly. If bending is not relevant for a specific application knitted fabrics may also be described as a combination of 0/90 and UD plies.
- 409** Quasi-isotropic laminate configurations, e.g.  $(0/90/\pm 45)_s$  or  $(0/\pm 60)_s$ , shall be described as a sequence of UD plies.
- 410** Filament wound materials shall be described as a sequence of UD plies, even though the filament wound fibres are interwoven. One helical winding sequence shall be described by at least one pair of UD plies. The model should be built of symmetric UD ply sequences to represent helical winding sequences of the same fibre angles in order to prevent unrealistic warping effects. If bending of the laminate has to be described accurately the influence of swapping the surface ply with the ply underneath shall be evaluated. If more plies are needed to model the component probably should be evaluated on an individual basis.

**Guidance note:**

A pipe made of a  $\pm 55$  filament wound material with 6 winding sequences and a total thickness of 6 mm shall be modelled.

If the pipe is just loaded under internal pressure it should be described as a  $(+55/-55)_{3S}$  laminate, i.e. a sequence of 6 alternating UD plies oriented in 55 and -55 direction. Each ply has a thickness of 0.5 mm.

If the same pipe is exposed to bending loads it shall be evaluate whether a  $(-55/+55)_{3S}$  laminate would give different results in the analysis compared to a  $(+55/-55)_{3S}$  laminate.

---e-n-d--- o-f---G-u-i-d-a-n-c-e---n-o-t-e---

**Guidance note:**

A pipe is made of a  $\pm 80$  filament wound material with 8 winding sequences and  $\pm 10$  filament wound material with 4 winding sequences (from inside to outside). The thickness per sequence is 1 mm, giving a total thickness of 12 mm. The pipe may be modelled in the following way:

If the pipe is just loaded under internal pressure it may be described as a  $(+80/-80)_{8S} (+10/-10)_{4S}$  laminate, i.e. a sequence of 16 alternating UD plies oriented in 80 and -80 direction and 8 alternating UD plies oriented in 10 and -10 direction. Each ply has a thickness of 0.5 mm. It may be possible to reduce the number of layers in the analysis. As a minimum a laminate  $(+80/-80)_{2S} (+10/-10)_{2S}$  should be used for modelling where the 80 and -80 plies are each 4mm thick and the 10 and -10 plies are each 2 mm thick.

If the same pipe is exposed to bending loads it shall be evaluate whether a  $(+80/-80)_{8S} (+10/-10)_{4S}$  laminate would give different results in the analysis compared to a  $(-80/+80)_{8S} (-10/+10)_{4S}$  laminate.

---e-n-d--- o-f---G-u-i-d-a-n-c-e---n-o-t-e---

## **A 500 Mechanical properties**

- 501** This guideline uses orthotropic ply properties for the mechanical description of a composite laminate. A complete set of properties for an orthotropic ply is given in the following sections.
- 502** All properties are dependent on the constituent materials and the processing and conditioning conditions. It is convenient to separate the properties into fibre and matrix dominated properties. Which properties are fibre dominated and which are matrix dominated are given in *Section B*.
- 503** It is possible that a structure is loaded in such a way that some material properties are not relevant. In that case the non-relevant properties do not have to be known, but it shall be documented that the properties are not relevant for the application.

### **Guidance note:**

For example, in many cases a composite laminate is a shell that is not loaded in the through thickness direction. In that case all through thickness properties are not relevant. However, the shell may be loaded in the through thickness direction at the load introduction point (joint). In this case the through thickness properties shall be known, unless the load introduction point is qualified by component testing.

If a component is only loaded in tension, all compressive properties are "not relevant".

---e-n-d--- o-f---G-u-i-d-a-n-c-e---n-o-t-e---

- 504** Fibre dominated properties shall be determined for all fibre types in the laminate. Fibres processed by a different method, e.g. woven, knitted, different sizing, different fibre material etc. shall be treated as different types.
- 505** If fibres of the same type are used in different layers in the laminate, one test series is sufficient to determine their properties.
- 506** Matrix dominated properties shall be determined for each ply. Matrix dominated properties determined on the ply level are actually a combination of the pure matrix properties and interaction effects with the fibres and the matrix fibre interface. The properties of each of these combinations shall be documented.
- 507** Matrix dominated properties can be measured just once if the same matrix and same fibre types with the same sizing are used throughout the laminate.

- 508 Properties can be established new or checked against typical values.
- 509 Mechanical properties depend on the load conditions and the environment.
- 510 For test data the condition parameters should be reported.

#### **A 600 Characteristic values of mechanical properties**

- 601 Characteristic values shall be used throughout this guideline.
- 602 The characteristic value is a nominal value to characterise a stochastic variable. The characteristic value of a mechanical property is usually a value, which has a small probability of not being exceeded in a hypothetically unlimited test series.
- 603 The characteristic value of a strength property is defined in this guideline as a low 2.5% quantile in the distribution of the arbitrary strength. This is equivalent to the 97.5% tolerance. For more details see *B400* and *C1100*.
- 604 The characteristic value for stiffness shall be taken as the mean value in the distribution of the arbitrary value of the stiffness property.
- 605 All results shall be based on a 97.5% tolerance with 95% confidence. The confidence requirement is important if only a limited number of test results is available.

#### **A 700 Properties of laminates with damage**

- 701 In some cases a structure is expected to contain some damage, e.g., impact damage, delaminations, cracks etc. If this is the case, the laminate can be modelled with this damage as described in *Sections 9 and 6*. Alternatively, the laminate can be described with properties based on a laminate with damage.
- 702 Strength properties of a laminate with damage shall be measured on laminates that contain the maximum expected damage. It shall be carefully evaluated if the damage can be representative in small test coupons. If there is any doubt about testing of laminates with damage a conservative approach shall be chosen, that gives lower than expected strength values.
- 703 Elastic constants like stiffness and Poisson's ratio shall be measured on damaged and undamaged laminates. It shall be noticed that modelling a structure with elastic properties based on a damaged laminate may give wrong stress distributions (See *Section 9*).

## **B. Static properties**

## B 100 General

- 101** All material properties shall be given with full traceability of materials and conditions. Test results are only valid if the information given in Table A1 is available. Tests shall be reported as mean, standard deviation, and number of tests.
- 102** For many applications the static properties after exposure to long term loads and environments are more important than the static properties of a new material. This fact should be kept in mind when selecting materials and developing a test programme. Long term properties are described in the following sections.

## B 200 Static Properties

- 201** The complete list of orthotropic ply data is shown in following Table. Recommended test methods to obtain the properties are given in Appendix 4B. Fibre and matrix dominated properties are identified in the column "characteristic" as *F* and *M* respectively.
- 202** Static properties are generally assumed to be identical to quasi-static properties, measured at a testing rate of about 1% per minute. If loading rates in the component differ from this rate, tests should be made at the relevant rates or corrections of the data should be considered.

In-plane orthotropic elastic constants	Mechanical parameter	Unit	Characteristic	Reference in Appendix 4B for measurement method
$E_{1 \text{ fibre}}$ UD ply	Modulus of elasticity in main fibre direction	[GPa]	F	<i>Section B100</i>
$E_{2 \text{ matrix}}$ UD ply	Modulus of elasticity transverse to main fibre direction	[GPa]	M	<i>Section B100</i>
$E_{1 \text{ linear}}$ cross-ply	Modulus of elasticity in 0° fibre direction in the liner range	[GPa]	M, F	<i>Section B100</i>
$E_{2 \text{ linear}}$ cross-ply	Modulus of elasticity normal to the 0° fibre direction in the liner range	[GPa]	M, F	<i>Section B100</i>
$E_{1 \text{ non-linear}}$ cross-ply	Secant modulus of elasticity in 0° fibre direction at the failure point	[GPa]	F	<i>Section B100</i>
$E_{2 \text{ non-linear}}$ cross-ply	Secant modulus of elasticity normal to the 0 fibre direction at the failure point	[GPa]	F	<i>Section B100</i>
$G_{12 \text{ linear}}$	In plane shear modulus in the liner range	[GPa]	M	<i>Section B300</i>
$G_{12 \text{ non-linear}}$	In plane secant shear modulus at the failure point	[GPa]	M	<i>Section B300</i>



$v_{12}$	Ply major Poisson's ratio		F, M	<i>Section B100</i>
$v_{21}$	Ply minor Poisson's ratio		F, M	<i>Section B100</i>
<b>In-plane Strain to Fail</b>				
$\hat{e}_{1t}^{\text{fibre}}$	Tensile strain at break for the fibres		F	<i>Section B100</i>
$\hat{e}_{1c}^{\text{fibre}}$	Compressive strain at break for the fibres		F,M	<i>Section B200</i>
$\hat{e}_{2t}^{\text{matrix}}$	Tensile strain at break for the matrix in direction normal to the fibre direction, in the fibre plane.		M	<i>Section B100</i>
$\hat{e}_{2c}^{\text{matrix}}$	Compressive strain at break for the matrix in direction normal to the fibres.		M	<i>Section B200</i>
$\hat{e}_{12}^{\text{matrix}}$	Shear strain at failure in ply plane		M	<i>Section B300</i>
<b>In-plane Strength</b>				
$\hat{S}_{1t}^{\text{fibre}}$	Tensile stress at break in the fibre direction	N/mm <sup>2</sup> (MPa)	F	<i>Section B100</i>
$\hat{S}_{1c}^{\text{fibre}}$	Compressive stress at break in fibre direction	N/mm <sup>2</sup> (MPa)	F,M	<i>Section B200</i>
$\hat{S}_{2t}^{\text{matrix}}$	Tension stress at break normal to the fibre direction.	N/mm <sup>2</sup> (MPa)	M	<i>Section B100</i>
$\hat{S}_{2c}^{\text{matrix}}$	Compressive stress at break normal to the fibre direction	N/mm <sup>2</sup> (MPa)	M	<i>Section B200</i>
$\hat{S}_{12}^{\text{shear}}$	Shear stress in ply plane at failure.	N/mm <sup>2</sup> (MPa)	M	<i>Section B300</i>
<b>Through Thickness</b>				
$E_3$	Modulus of elasticity normal to the fibre plane.	Gpa	M	<i>Section B400</i> or <i>Section B500</i>
$G_{13}$	Shear modulus normal to the fibre plane, including the fibre direction	Gpa	M	<i>Section B600</i>
$G_{23}$	Shear modulus normal to the fibre plane, including the direction normal to the fibres.	Gpa	M	<i>Section B600</i>
$v_{13}$	Poisson's ratio normal to the fibre plane, including the fibre direction, when tensioning in the fibre direction.		M	<i>Section B100</i> or <i>Section B600</i>

$\nu_{23}$	Poisson's ratio normal to the fibre plane, including the direction normal to the fibres,		M	<i>Section B100 or Section B600</i>
$\hat{e}_{3t}$	Tensile strain at break normal to the fibre plane		M	<i>Section B400</i>
$\hat{e}_{3c}$	Compression strain at break normal to the fibre plane		M	<i>Section B500</i>
$\hat{e}_{13}$	Shear strain at failure normal to the fibre plane, including the fibre direction.		M	<i>Section B600</i>
$\hat{e}_{23}$	Shear strain at failure normal to the fibre plane, normal to the fibre direction.		M	<i>Section B600</i>
$\hat{S}_{3t}$	Tension stress at break normal to the fibre plane.	N/mm <sup>2</sup> (MPa)	M	<i>Section B400</i>
$\hat{S}_{3c}$	Compression stress at break normal to the fibre plane.	N/mm <sup>2</sup> (MPa)	M	<i>Section B500</i>
$\hat{S}_{13}$	Shear stress at failure normal to the fibre plane, including the fibre direction.	N/mm <sup>2</sup> (MPa)	M	<i>Section B600</i>
$\hat{S}_{23}$	Shear stress at failure normal to the fibre plane, normal to the fibre direction.	N/mm <sup>2</sup> (MPa)	M	<i>Section B600</i>
<b>Fracture Toughness</b>				
Critical length	Maximum tolerable In-plane length of crack	mm	F/M	<i>Section B700</i>
G1c	Critical strain energy release rate. (Mode I).	N/m	M	<i>Section B800</i>
G2c	Critical strain energy release rate in the fibre plane (Mode II).	N/m	M	<i>Section B800</i>
G3c	Not used			

Table 1: Static properties

**203** If only one sub index is given in the table, it is identical to two indices of the same kind, e.g.,

$$\hat{\mathbf{S}}_{11} = \hat{\mathbf{S}}_1.$$

**204** The index *fibre* indicates ply properties in fibre direction. Failure stresses and strains with the index *fibre* describe ply failure in fibre direction. It does not mean that a single fibre has failed, usually a number of fibres fail before the ply breaks.

**205** The index *matrix* indicates matrix dominated ply properties perpendicular to the fibre direction. Failure stresses and strains with the index *matrix* describe matrix cracking inside the ply. This is usually the initiation of matrix cracks.

### **B 300 Relationship between strength and strain to failure**

**101** For analysis purposes it is important to have a consistent set of data. The relationship below shall always be valid for all linear and bi-linear materials:

$$\sigma = E \varepsilon$$

**302** Strain to failures shall be calculated from strength measurements based on the above equation and using the non-linear secant moduli at failure if relevant.

**303** The coefficient of variation COV of the strain to failure shall be taken as the same as the COV of the measured strength. Without using this procedure the characteristic values will not follow Hook's law as described in 301.

### **B 400 Characteristic values**

**401** Characteristic values shall be used for all strength values in this guideline.

**402** Characteristic values shall be established with 95% confidence

**403** The sample mean of the measurements is  $\bar{x} = \frac{1}{n} \sum_{i=1}^n x_i$  where  $x_i$  is the  $i$ th individual measurement and  $n$  is the number of measurements.

**404** The standard deviation is estimated from the measurements by  $\hat{s}^2 = \frac{1}{n-1} \sum_{i=1}^n (x_i - \bar{x})^2$

**405** The coefficient of variation COV is estimated as:  $COV \hat{V} = \frac{\hat{s}}{\bar{x}}$

**406** The characteristic strength value is  $x_c = \bar{x} - k_m \hat{s}$  with  $k_m$  given in Table 2.

	<b>k<sub>m</sub></b>
	Definition of characteristic value
Number of test	2.5% quantile in distribution of arbitrary

specimens	strength
3	9.0
4	6.0
5	4.9
6	4.3
10	3.4
15	3.0
20	2.8
25	2.7
Infinite	2.0

Table 2: values of  $k_m$

**Guidance note:**

Tabulated values are estimates with 95% confidence. Other values can be found in e.g. DIN 55303

---e-n-d--- o-f---G-u-i-d-a-n-c-e---n-o-t-e---

- 407 The characteristic values of Young's moduli and Poisson's ratios are mean values.
- 408 Characteristic values of strains to failure shall be based on strength measurements (*see B300*)
- 409 Characteristic values shall be used throughout the guideline.

**B 500 Experimental measurement of matrix and fibre dominated strain to failure**

- 501 For unidirectional plies or laminates, the matrix dominated strain to failure  $\hat{\epsilon}_{1t}^{\text{fibre}}$  can simply be measured as the strain to failure in fibre direction.
- 502 For unidirectional plies or laminates, the fibre dominated strain to failure  $\hat{\epsilon}_{2t}^{\text{matrix}}$  can simply be measured as the strain to failure perpendicular to the fibre direction.
- 503 For measurements taken on other laminates the onset of matrix cracking can be defined as the knee point of the stress- strain curve. Some matrix cracking tends to develop before this level, but significant cracking can be defined this way. The knee point is defined as the cross over of the lines defining the initial modulus of the laminate and the tangential modulus of the final part of the stress strain curve. An example for a 0/90 laminate is given in Figure 4-1.

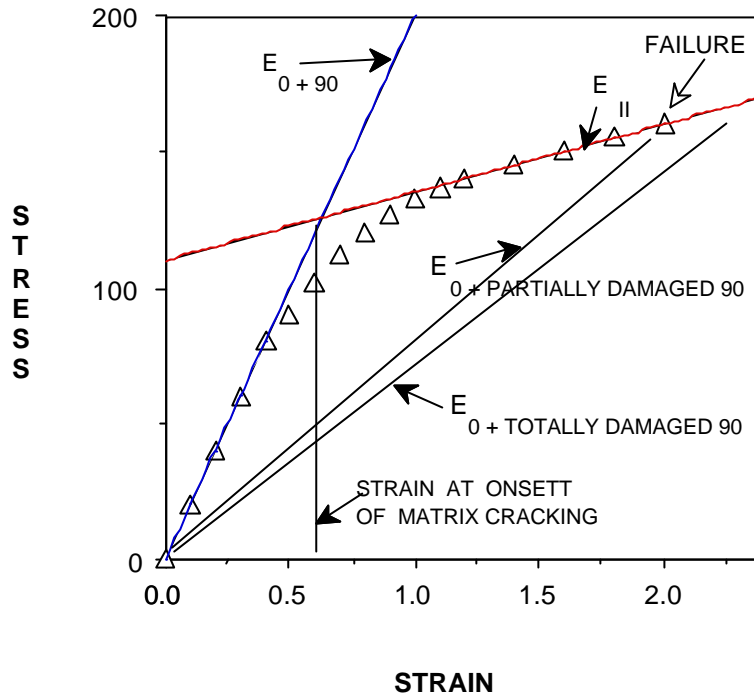
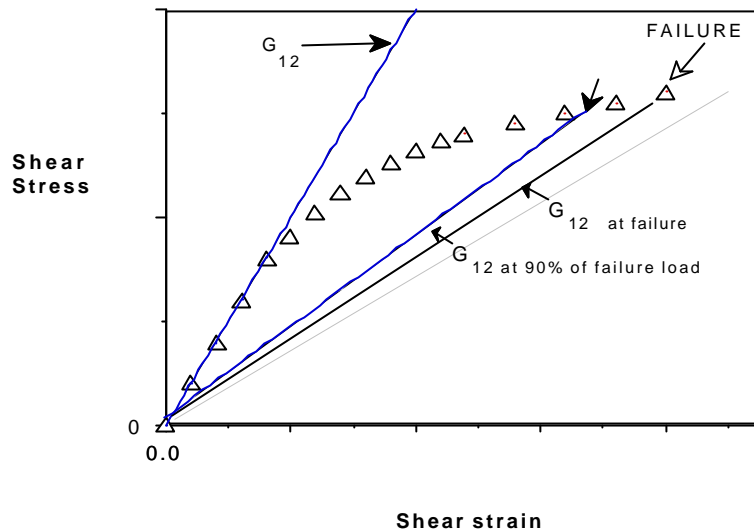

Figure 4-1: Example of a stress strain curve of a 0/90 laminate

- 504 The strain to failure transverse to the fibre direction is identical to the strain at onset of matrix cracking.
- 505 The strain to failure (rupture) of the laminate is the strain to failure of the fibres.
- 506 The remaining ply properties can be calculated with laminate theory and considering *B300*.
- 507 For properties with matrix cracking, see *4I*.

### B 600 Experimental measurement of ply shear properties

- 601 The shear properties of a ply are typically nonlinear. In order to perform a linear analysis an initial un-degraded shear modulus should be defined.
- 602 For a strength analysis initial, undamaged shear modulus may be defined as the secant modulus between 0 and any point on the nonlinear stress strain curve as long as:
  - ❑ Only nonlinear deformation, but no matrix cracking is observed in the experiments.
  - ❑ The point is below 80% of the failure strength.
  - ❑ The point is below 50% of the strain to failure.



- 603** For deflection calculations the modulus should be secant modulus at the maximum design shear stress and all requirements of 602 should be fulfilled.
- 604** The remaining properties can be calculated by laminate theory and considering *B300*.
- 605** For properties with matrix cracking or nonlinear deformations, see *4I*.

## C. Properties under long term static and cyclic and high rate loads

### C 100 Introduction

- 101** For all mechanical data three types of properties are relevant. These are static properties, properties under constant permanent static loads or deformations, and properties under cyclic loads or deformations.
- 102** Long term properties, like all properties are effected by exposure conditions. Long term data should be obtained for the environment and exposure conditions the material is used in. Some aspects related to changes due to exposure conditions are given in *Section E*.
- 103** Permanent static loads may have the following effects:
- Creep: a visco-elastic or plastic deformation with time. This effect is accompanied by a reduction of the elastic modulus.
  - Stress rupture: the material may loose strength leading to failure after some time.
  - Static strength reduction: The static short-term strength (often called residual strength) may become reduced.
- 104** Permanent static deformations may have the following effects:
- Stress relaxation: a visco elastic or plastic process reducing the stresses in the material. This effect is accompanied by a reduction of the elastic modulus.

**105** Cyclic loads may have the following effects:

- Reduction of elastic properties: usually due to the formation of matrix cracks.
- Fatigue failure: the material may lose strength leading to failure after a certain time.
- Static strength reduction: the static short-term strength (often called residual strength) may be reduced.

**106** Fibre and matrix dominated properties show different characteristics with respect to long-term loads or deformations.

**107** The long term properties of all static properties listed in *Section B* should be documented if relevant to the application. Measurements should be made on laminates that represent the actual layup as closely as possible.

**108** Long term properties should be based on effects due to representative loads and environments. The loads described in *Section 3I 500* should be used.

**109** Simplified approaches may be used if it can be documented that the results describe a worst case scenario.

**110** For extrapolation of test data beyond the measured time see Section C1100.

**111** Three aspects shall be considered when evaluating effects of long-term loads (*Section 6*):

- The effect of change of elastic parameters shall be checked by analysing the structure with initial and changed stiffness values.
- A lifetime analysis shall be carried out to establish that the structure will not fail within its design life.
- It shall be shown that the structure still tolerates possible extreme loads at the last day of its design life. This check has to investigate the change of the static properties with time.

## **C 200 Creep**

- 201** The application of a permanent load may lead to increasing deformation of the material denoted as creep. This plastic deformation may permanently change the shape of the component.
- 202** Under the constant load, the increase of deformation results in an apparent reduction of the modulus of elasticity, and the reduction is denoted as the creep modulus. However, creep is plastic deformation process. The response to short term loads is not influenced by the long term loads and is governed by the original elastic constants.
- 203** Creep is a phenomenon mainly observed in the matrix. However, fibres may show some creep behaviour as well.
- 204** The creep of the composite laminate is a combined effect of the creep of the matrix and the fibres.
- 205** Ideally creep shall be measured on the actual laminate for the relevant loading condition.
- 206** For fibre dominated elastic parameters creep data of the same fibre type may be used to estimate creep.
- 207** For short fibre composites all elastic constants shall be considered to be matrix dominated with respect to creep. Creep shall be measured for the combination of matrix and fibres.
- 208** For matrix dominated elastic constants creep data of the matrix alone shall not be used to estimate creep.
- 209** Tensile creep data may be used to estimate creep in compression.
- 210** Compressive creep data shall not be used to estimate creep in tension.



- 211** The change in strain with time can be predicted using the following viscoelastic equation (Findley's theory). The first part describes the time independent elastic response and the second part describes the time dependent viscoelastic response.

$$\mathbf{e} = \mathbf{e}_{elastic} + \mathbf{e}_{plastic}$$

or

$$\mathbf{e} = \frac{\mathbf{s}}{E_{elastic}} + \frac{\mathbf{s}}{E_{plastic}}$$

with

$E_{elastic}$  the elastic modulus obtained from the quasi static data, typically for the duration of about 1 minute.

$E_{plastic}$  the time dependent plastic modulus obtained from creep data.

- 212** The time dependent plastic modulus is given by:

$$\frac{1}{E_{plastic}} = \frac{t^n}{r}$$

where:

t = time after loading

r = constant for the visco-elastic equation (in MPa)

n = constant for the visco-elastic equation (dimensionless)

- 213** The equation in 212 can also be expressed for a time dependent creep modulus  $E_{creep}$  with a time independent and a time dependent part:

$$\frac{1}{E_{creep}} = \frac{1}{E_{elastic}} + \frac{1}{E_{plastic}}$$

### C 300 Stress rupture

- 301** The time to failure under a permanent static stress is described by a stress rupture curve.

- 302** The stress rupture curve shall be represented as:

$$\log \sigma = \log \sigma_{0stress\ rupture} - \beta \log t$$

where  $t$  is the time to failure under a permanent stress  $\sigma$ .

- 303** The material parameters  $\sigma_{\text{stress rupture}}$  and  $\beta$  shall be determined experimentally or be based on typical data as described in *Section H*.
- 304** Ideally stress rupture shall be measured on the actual laminate for the relevant loading condition and environment.
- 305** For fibre dominated strength values stress rupture data of the same fibre type may be used to estimate stress rupture.
- 306** For short fibre composites stress rupture of the matrix due to shear in the matrix shall be considered in addition to stress rupture of the fibres.
- 307** For matrix dominated strengths, stress rupture data of the matrix alone shall not be used to estimate stress rupture. Stress rupture shall be measured for the combination of matrix and fibres.
- 308** Tensile stress rupture data may be used to estimate stress rupture in compression.
- 309** Compressive stress rupture data shall not be used to estimate stress rupture in tension.
- 310** If the component cannot tolerate matrix cracking, effects of long term static loads can only be ignored if both of the conditions below are fulfilled:
- The stresses in the matrix are below the level of initiation of matrix cracking according to Section 6C.
  - The matrix is not the main load carrying material. The component can carry the loads with a fully cracked matrix according to Section 9B200, i.e., all matrix dominated ply properties are set close to 0.

#### **C 400 Static strength reduction due to permanent static loads**

- 401** If a laminate is exposed to a permanent stress of any magnitude for a time  $t$  the static strength influenced by that stress, often called residual strength, shall be estimated from the stress rupture curve:

$$\log \sigma = \log \sigma_{\text{stress rupture}} - \beta \log t$$

The characteristic strength shall be determined according to 4C1100. The coefficient of variation COV of the strength after a certain time should be the same as the COV for short term data, unless a COV of remaining strength has been measured directly.

- 402** Higher static strength values may be used with experimental evidence.

Guidance note

A possible way to document that the residual strength is higher than given by the stress rupture curve is:

- a) Expose the test sample to a permanent load for 90% of the failure time expected according to the

stress rupture curve.

- b) Measure the remaining strength after this exposure time.
- c) Repeat step *a* and *b* for at least one more stress level.
- d) If the remaining strength of the tests is the same, it can be assumed that the remaining strength is also the same up to 90% of the lifetime for lower load levels, provided no changes in failure modes are expected. The possible change of failure modes should be analysed.
- e) Measurements could be made for other test periods than 90% of the lifetime.

End of guidance note

**403** The long term strains to failure may have an elastic and a plastic component. Strains shall be calculated based on *C200*.

**404** Static strength reduction of matrix dominated strength properties can be ignored if the conditions of *C310* are fulfilled.

#### **C 500 Stress relaxation**

**501** Permanent static deformations may have the following effects:

- Stress relaxation: a visco elastic or plastic process reducing the stresses in the material. This effect is accompanied by a reduction of the elastic modulus.
- Residual strength reduction: The static short-term strength may be reduced.

- 502** The application of a permanent deformation may lead to stress relaxation. This is described as a reduction of the Modulus of elasticity. The result of the reduction of the Modulus of elasticity is a reduction of stress in the structure under the constant deformation.
- 503** Stress relaxation is a phenomenon mainly observed in the matrix. However, fibres may show some stress relaxation behaviour as well.
- 504** Ideally stress relaxation should be measured on the actual laminate for the relevant loading condition.
- 505** For fibre dominated elastic constants stress relaxation data of the same fibre type may be used to estimate the change of the modulus. Stress relaxation shall be measured for the combination of matrix and fibres.
- 506** For short fibre composites all elastic constants shall be considered to be matrix dominated with respect to stress relaxation.
- 507** For matrix dominated elastic constants stress relaxation data of the matrix alone shall not be used to estimate the change of the modulus.
- 508** Tensile stress relaxation data may be used to estimate stress relaxation in compression.
- 509** Compressive stress relaxation data shall not be used to estimate stress relaxation in tension.
- 510** Creep modulus measurements may be used to estimate modulus changes under permanent deformation.

#### **C 600 Change of Modulus of elasticity under cyclic fatigue**

- 601** The Modulus of elasticity of a composite laminate tends to reduce under the effect of cyclic fatigue. The main reason for the modulus change is the formation and accumulation of matrix cracks during tensile fatigue loads. The matrix cracks reduce the matrix dominated axial stiffness values.

**602** The in-plane elastic ply constants of plies with thermoset matrix may be estimated to change to the following values after extensive cyclic fatigue exposure (about  $10^6$  cycles):

$E_{1 \text{ fibre}}$	UD ply	Modulus of elasticity in main fibre direction	10% reduction for glass and carbon fibres. Drops significantly for Aramid fibres loaded in compression
$E_{2 \text{ matrix}}$	UD ply	Modulus of elasticity transverse to main fibre direction	drops to 0 in tension no change in compression
$E_{1 \text{ linear}}$	cross-ply	Modulus of elasticity in 0 fibre direction in the liner range	Drops to $0.9 E_{1 \text{ non-linear}}$ from static measurements in tension. No change in compression
$E_{2 \text{ linear}}$	cross-ply	Modulus of elasticity normal to the 0 fibre direction in the liner range	Drops to $0.9 E_{2 \text{ non-linear}}$ from static measurements in tension. No change in compression
$E_{1 \text{ non-linear}}$	cross-ply	Modulus of elasticity in 0 fibre direction at the failure point	Is a combined effect of changes to fibre properties and matrix properties. Roughly a weighted average of the effects to $E_{1 \text{ fibre}}$ and $E_{2 \text{ matrix}}$ .
$E_{2 \text{ non-linear}}$	cross-ply	Modulus of elasticity normal to the 0 fibre direction at the failure point	Is a combined effect of changes to fibre properties and matrix properties. Roughly a weighted average of the effects to $E_{1 \text{ fibre}}$ and $E_{2 \text{ matrix}}$ .
$G_{12 \text{ linear}}$		In plane shear modulus in the linear range	slight drop (unknown)
$G_{12 \text{ non-linear}}$		In plane shear modulus at the failure point	slight drop (unknown)
$\nu_{12}$		Ply major Poisson's ratio	slight drop (unknown)
$\nu_{21}$		Ply minor Poisson's ratio	$\nu_{21} = \nu_{12} E_2 / E_1$

Table 3: change of modulus of elasticity under cyclic fatigue

- 603** Experimental results may be used to demonstrate different changes of the elastic parameters during cyclic fatigue for specific laminates or loading conditions.
- 604** The structure shall be analysed for the values of the elastic parameters before fatigue damage has taken place and for the values of the elastic parameters after fatigue damage has taken place.
- 605** If the structure is exposed to through-thickness cyclic loads a degradation of the through-thickness properties shall be considered. Experimental evidence shall be provided.
- 606** The in-plane matrix dominated modulus does not change if the conditions in C805 are fulfilled.

### **C 700 Cycles to failure under cyclic fatigue loads**

- 701** The number of cycles  $N$  to failure under a cyclic stress is described by an SN curve for a specified R-ratio.
- 702** The R-ratio is defined as the minimum stress divided by the maximum stress.
- 703** For calculation of the R-ratio, note that tensile stresses are defined as positive, while compressive stresses are defined as negative.
- 104** The material curve of fibre dominated properties for the lifetime strength analysis should be described as:

$$\log \sigma = \log \sigma_{0 \text{ fatigue}} - \alpha \log N$$

or

$$\log \varepsilon = \log \varepsilon_{0 \text{ fatigue}} - \alpha \log N$$

- 705** The strain representation is simpler, because it is applicable to a wider group of materials and fatigue data are less effected by volume fraction changes. The strain representation can be obtained from the stress representation by using the relationship  $\sigma = E \epsilon$ .
- 706** The double logarithmic representation of fatigue data shall be chosen.
- 707** All fatigue curves shall be obtained from load controlled tests, unless the structure is clearly only exposed to deformation controlled fatigue.
- 708** SN curves should be preferably obtained for R ratios relevant for the application. Minimum requirements are given in 709-711.
- 709** If the structure is exposed to tensile and compressive fatigue, at least data for  $R=-1$  shall be available.
- 710** If the structure is only exposed to tensile fatigue, data for R with  $1 < R \leq 0$  may be used.
- 711** If the structure is only exposed to compressive fatigue, data between  $R=-1$  or  $R=10$  may be used.
- 712** Care shall be taken to identify whether fatigue data are given as stress amplitude or stress range.
- 713** A constant amplitude lifetime diagram shall be constructed from the fatigue curves if the structure is exposed to fatigue stresses of other R ratios than the measured ones or to various R-ratios. The diagram can be used to extrapolate expected number of cycles to failure for different combinations of mean and amplitude.

#### Guidance note

Constant amplitude lifetime diagrams CAL are commonly used to obtain fatigue lifetimes for a given stress amplitude and mean. Fatigue data are often only available for three R-ratios,  $R=10$ ,  $-1$ , and  $0.1$ . These data represent three lines in the CAL diagram, other values have to be extrapolated. Linear extrapolations may be used, giving the CAL diagram typically triangular shape.

Figure 4-2 gives an example of a CAL diagram.

- The diagram was based on characteristic fatigue curves measured at the R-ratios  $R=10$ ,  $-1$ , and  $0.1$ . In addition the characteristic static tensile and compressive strains at failure were needed.
- The CAL diagram can be divided into four sectors in this case. The sectors are shown in Figure 4-2. Within each sector constant life lines were drawn for lifetimes of 10, 100, 1000, ... cycles. These lines are assumed to be straight.
- For sectors 1 and 4 all lines were connected to the static tensile and compressive strains at failure.
- If fatigue data at other R-ratios exist an equivalent approach with more (or less) sectors can be used.

The expected lifetime  $N^{\text{exp}}$  for a given strain amplitude  $\alpha$  and mean  $\eta$  can be found by the following procedure (see also Figure 4-2):

1. Draw the point P in the constant amplitude life diagram representing the given strain amplitude  $\mathbf{a}$  and mean  $\mathbf{h}$ .
2. Draw a line  $a$  from the origin of the constant amplitude life diagram (0 mean, 0 amplitude) through and beyond the point P.
3. Identify the two closest constant life lines nearest to P,  $n_1$  and  $n_2$ , where  $n_2$  is the line with the higher number of cycles to failure.
4. Measure the length  $a_1$  on line  $a$  between the two constant life lines  $n_1$  and  $n_2$  nearest to P.
5. Measure the length  $a_2$  on line  $a$  between point P and the constant life line  $n_2$  with the higher number of cycles nearest to P.
6. Find the line  $b$  nearest to P representing fatigue life of a measured R-ratio, e.g.  $R=10$ , or  $R=-1$ , or  $R=0.1$ .
7. Measure the length  $b_1$  on  $b$  between  $n_1$  and  $n_2$ .
8. Calculate  $b_2 = b_1 a_2 / a_1$
9. Find the strain amplitude  $\epsilon_{\text{CAL}}$  corresponding to point Q that lies on  $b$  at a distance  $b_2$  away from the intersection of  $b$  and  $n_2$ .
10. Obtain the characteristic value of the expected number of cycles  $N^{\text{exp}}$  for  $\epsilon_{\text{CAL}}$  using the measured characteristic SN curve.

This geometrical description can be fairly easily put into a computer program.



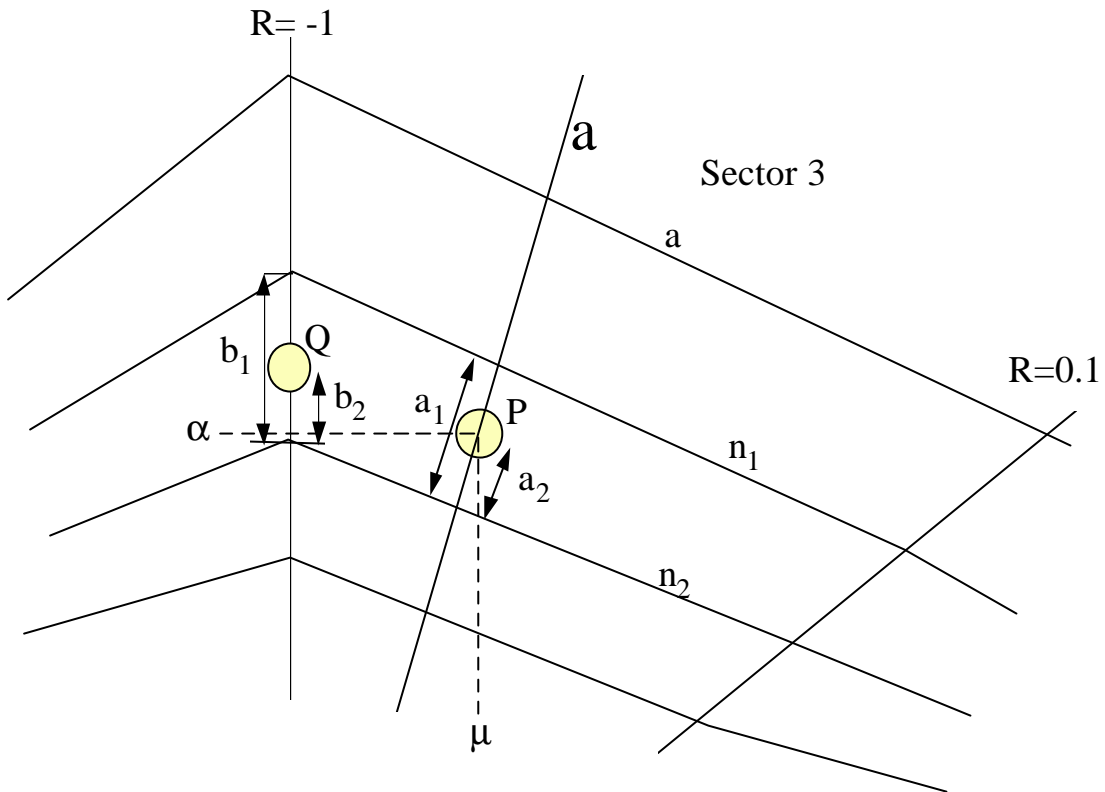

Enlargement of the region with the points P and Q.

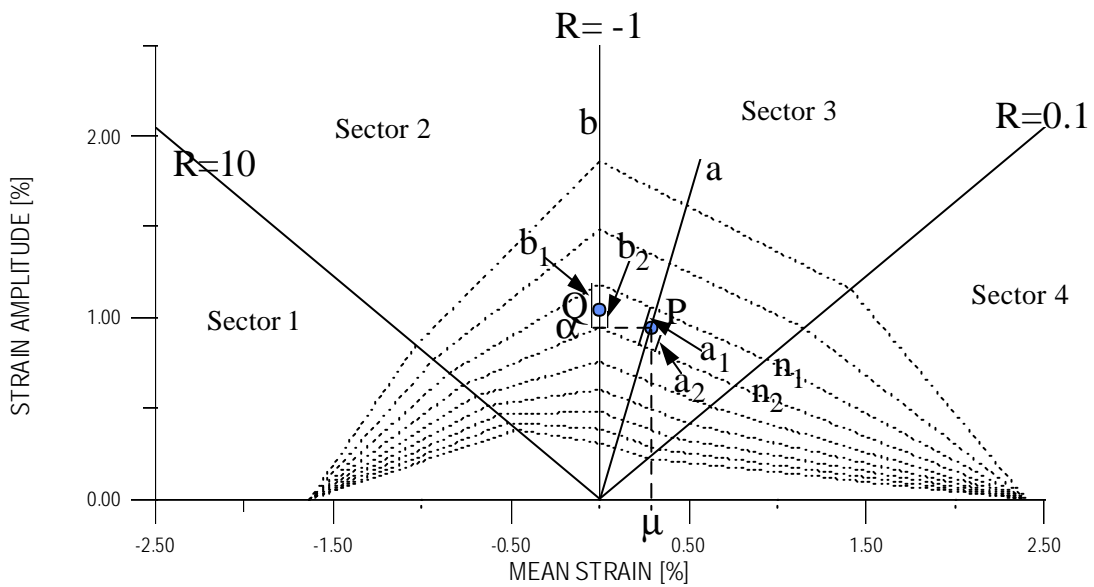

Figure 4-2: Schematic of a constant amplitude life diagram. The drawing illustrates the description above how the fatigue life for a strain amplitude  $\alpha$  at mean  $\mu$  (described by point P as an example) can be found.

End of guidance note

- 714** Ideally fatigue should be measured on the actual laminate for the relevant loading condition and environment.
- 715** For fibre dominated strength values, fatigue data from tests on the same fibre type may be used to estimate fatigue.
- 716** For short fibre composites fatigue of the matrix due to shear in the matrix shall be considered in addition to fatigue of the fibres.
- 717** SN curves may also be measured for specific load sequences if relevant. This may be beneficial, because Miner sum calculations would not be needed for that load sequence. The validity of the data for other load sequences would have to be demonstrated.

### **C 800 Cycles to failure under fatigue loads for matrix dominated strengths**

- 801** There is a considerable lack of data for the performance of composites under matrix dominated fatigue.
- 802** SN curves for materials, whose fatigue behaviour is matrix-dominated, seem to be non-linear in a double logarithmic representation. Fatigue lifetime calculations shall be made in a way to take account of this effect.
- 803** If the component is subjected to in-plane fatigue and matrix cracking can be accepted, and if it can fulfil all static strength requirements with the reduced fatigue moduli given in Section 600, then matrix dominated fatigue does not have to be considered.
- 804** If the component is subjected to in-plane fatigue and matrix cracking cannot be accepted, testing on the actual laminate or component testing shall be carried out. The failure condition shall be a certain level of matrix crack density or a relevant indirect criterion, like weepage of water through a pipe.
- 805** If the component cannot tolerate matrix cracking, effects of long term cyclic loads can be ignored if the following three conditions are fulfilled:
  - The stresses in the matrix are below the level of initiation of matrix cracking according to Section 6C.
  - The matrix is not the main load carrying material. The component can carry the loads with a fully cracked matrix according to Section 9B200, i.e., all matrix dominated ply properties are set close to 0.
  - The total number of cycles does not exceed 1500.
- 806** If the structure is exposed to through thickness cyclic loads the fatigue performance shall be demonstrated by testing on the actual laminate or component.

Guidance note:

Matrix cracks develop very easily during fatigue. A design should be avoided where the structural integrity or any critical performance requirement relies on matrix cracking not occurring under fatigue conditions.

----- end of guidance note -----

## **C 900 Static strength reduction due to cyclic loads**

- 901** Fibre dominated static strength is not changed under cyclic fatigue for most continuous glass and carbon fibres. The same is true for aramid fibres loaded in tension only. The long term static strength according to *C400* may be used as the strength at the end of cyclic loading. The mean fatigue load should be used as the permanent static load under fatigue.
- 102** In all other cases: If a laminate is exposed to a cyclic stress of any magnitude for a number of cycles  $N$ , the static strength (or strain to failure) influenced by that stress shall be estimated from the pertinent SN curve:

$$\log \sigma = \log \sigma_{0\text{fatigue}} - \alpha \log N$$

or

$$\log \varepsilon = \log \varepsilon_{0\text{ fatigue}} - \alpha \log N$$

where  $N$  is the number of cycles expected during the lifetime of the structure.

The characteristic strength shall be determined according to 4C1100. The coefficient of variation COV of the strength after a certain time should be the same as the COV for short term data, unless a COV of remaining strength has been measured directly.

- 903** If the SN curve is not linear in a log log presentation, the static strength cannot be calculated by the above equation, but shall be taken directly from the SN curve.
- 904** Higher static strength values may be used with experimental evidence.

Guidance note

A possible way to document that the residual strength is higher than given by the SN curve is:

- a) Expose the test sample to a fatigue load for 90% of the cycles to failure expected according to the SN curve.
- b) Measure the remaining strength after this exposure time.
- c) Repeat step *a* and *b* for at least one more stress level.
- d) If the remaining strength of the tests is the same, it can be assumed that the remaining strength is also the same up to 90% of the lifetime for lower load levels, provided no changes in failure modes are expected. The possible change of failure modes should be analysed
- e) Measurements could be made for other test periods than 90% of the lifetime.

End of guidance note

**905** The reduction of strength of matrix dominated properties may be ignored if the conditions of C805 are met.

**906** If the cycle dependent strength is known, static strains to failure shall be obtained from the reduced static strength and the cycle dependent stiffness value. If the cycle dependent strain to failure is known, static strengths shall be obtained from the reduced static strains to failure and the cycle dependent stiffness value.

### **C 1000 Effect of high loading rates - shock loads - impact**

**1001** The effect of high loading rates is a slight increase of stiffness, slight increase of strength and possibly a reduction of strain to failure, especially for ductile materials.

**1002** It is conservative to assume the same strength values as for static properties. Higher strength values shall be documented.

### **C 1100 Characteristic values**

**1101** Characteristic values shall be used for all stress rupture and SN curves in this guideline.

**1102** Characteristic values shall be established with a 97.5% tolerance (exceedence probability) and 95% confidence.

**1103** This section is applicable for estimating the characteristic (and subsequently the design) time to failure under a specified load for a laminate exposed to static or cyclic load, provided the plot of log stress vs. log time is linear.

**1104** If the linear relationship cannot be documented, an equivalent approach shall be used, taking the non-linearity into account.

**105** Values shall be based on data that are fairly evenly distributed over the plot of log time to failure vs. log load, or log number of cycles vs. log load. Load is usually expressed as stress or strain. At least 15 data points should be used.

**1106** To obtain the characteristic curve the mean SN curve of the form:

$$\log \sigma = \log \sigma_{0 \text{ fatigue}} - \alpha \log N$$

or the mean stress rupture curve of the form:

$$\log \sigma = \log \sigma_{0 \text{ stress rupture}} - \beta \log t$$

shall be converted to the form:

$$\log(X)_{\text{mean}} = \log(X_0) - k \cdot \log \sigma$$

where  $X$  represents the time (or number of cycles) to failure under a sustained stress  $\sigma$  (or stress range  $\sigma$ ).  $X$  is a function of  $\sigma$  and exhibits a natural variability from point to point within the material.

$$\log X_0 = \frac{\log S_{0stressrupture}}{a} \text{ or } \log X_0 = \frac{\log S_{0fatigue}}{b}$$

$$k = \frac{1}{a} \text{ or } k = \frac{1}{b}$$

Guidance Note:

Usually, estimates of  $k$  and  $\log S_{0stressrupture}$  (or  $\log S_{0fatigue}$ ) can be obtained from linear regression analysis of  $\log X$  on  $\log \sigma$ .

End-of-Guidance-Note

**1107** When the standard deviation  $\sigma_\epsilon$  of the variations in  $\log(X)$  about the mean is constant, i.e. when  $\sigma_\epsilon$  does not depend on the sustained load or stress range  $\sigma$ , then the characteristic value of  $\log(X)_c$  can be taken as

$$\log(X)_c = \log(X_0) - k \cdot \log \sigma - x \cdot \sigma_\epsilon$$

in which  $\sigma_\epsilon$  is estimated from available tests, and  $x$  is taken from

Table 4 depending on the number  $n$  of available data pairs ( $\log S$ ,  $\log X$ ) from tests.

n (# of tests)	x	
	Case 1	Case 2
10	3.9	4.7
15	3.4	4.0
20	3.1	3.7
50	2.6	3.0
100	2.4	2.6
Infinite	2.0	2.0

Table 4: Values of coefficient x

**1108** The coefficient values marked as Case 1 are valid and can be used for sustained loads or cyclic stresses within the range of  $\sigma$ -values covered by available tests, i.e., whenever the available tests cover a wide enough range of  $\sigma$ -values. These coefficient values will be non-conservative if applied for sustained loads or stresses  $\sigma$  outside the range of  $\log \sigma$ -values covered by available tests. When values for  $x$  are needed for  $\sigma$ -values outside this range, coefficient values marked as Case 2 can be used for extrapolation within a concentric range of  $\log \sigma$  twice the length of the range covered by tests.

**1109** The mean curve can be transformed back into the standard formulation of an SN curve or stress rupture or fatigue curve using the same equations as given above.

□ Stress rupture curve:  $\log s_{0\text{stressrupture}} = \frac{\log X_0}{b}$  and  $b = \frac{1}{k}$  with  $X_0$  as time

□ Fatigue curve:  $\log s_{0\text{fatigue}} = \frac{\log X_0}{a}$  and  $a = \frac{1}{k}$  with  $X_0$  as number of cycles.

**1110** The characteristic mean curve can be transformed back into the standard formulation of an SN curve or stress rupture curve using the same equations as given above.

□ Stress rupture curve:  $\log s_{0\text{stressrupture}} = \frac{\log X_0 - c S_e}{b}$  and  $b = \frac{1}{k}$  with  $X_0$  as time

□ Fatigue curve:  $\log s_{0\text{fatigue}} = \frac{\log X_0 - c S_e}{a}$  and  $a = \frac{1}{k}$  with  $X_0$  as number of cycles.

**1111** When a fixed time span  $T$  is considered, the characteristic value of the logarithm of the residual strength  $\sigma$  after the time  $T$  has elapsed can be taken as

$$(\log \sigma)_c = \log \sigma_{\text{stress rupture}} - \beta \cdot \log T - x \cdot \sigma_\epsilon$$

where  $\log \sigma_{0\text{stress rupture}}$  and  $\beta$  can be obtained from a linear regression analysis of  $\log \sigma$  on  $\log t$ , and where  $\sigma_\epsilon$  is the standard deviation of the variations in  $\log \sigma$  about the mean. The factor  $x$  is to be taken from Table 4 depending on the number  $n$  of available data pairs ( $\log t, \log \sigma$ ) from tests.

Guidance Note:

Usually, estimates of  $\beta$  and  $\log \sigma_{0\text{stressrupture}}$  (or  $\log \sigma_{0\text{fatigue}}$ ) can be obtained from linear regression analysis of  $\log \sigma$  on  $\log t$ , and the standard deviation  $\sigma_\epsilon$  of the residuals in  $\log \sigma$  results as a byproduct of the regression analysis. Note that this standard deviation is different from the standard deviation  $\sigma_\epsilon$  of Clause 1107.

End-of-Guidance-Note

## **D. Other Properties**

### **D 100 Thermal expansion coefficient**

- 101** Thermal expansion coefficient of the plies in the relevant temperature range should be measured in the fibre direction and transverse to the fibre direction.
- 102** Stresses due to thermal deformation should be considered. The stresses should be added to stresses from other loads like a combination of load cases as described in *Section 3K*.

### **D 200 Swelling coefficient for water or other liquids**

- 201** Swelling coefficient of the plies in the relevant temperature range should be measured in the fibre direction and transverse to the fibre direction.
- 202** Stresses due to swelling should be considered.

### **D 300 Diffusion coefficient**

- 301** Relevant data shall be obtained as needed for the actual service and exposure of the component. If relevant, the following material data may be required:
- 302** Diffusion rate through the laminate for the relevant fluid (Hydrocarbon gas, oil, gasoline, glycol, methanol, water etc.).

### **D 400 Thermal conductivity**

- 401** Thermal conductivity is anisotropic in composite laminates. The anisotropic effects shall be considered when measurements are done.

### **D 500 Friction coefficient**

- 501** Friction coefficient against support, clamps etc. (Both first movements and after a large number of cycles shall be considered if relevant.
- 502** Friction coefficient range shall be measured in the relevant temperature range.

### **D 600 Wear resistance**

- 601** Wear is the loss of material from a solid surface as a result of pressure sliding exerted by one body on another. Wear properties are not material properties but are very dependent on the system in which the surfaces function.
- The two surfaces in contact (basic part and counterpart)
  - The applied loads
  - The external environment
  - The interlayer environment

- 602** The wear resistance is a property of the entire wear system and shall be measured for the entire system.
- 603** Friction is the force that tends to prevent the relative motion of two surfaces in contact. The term lubrication stands for the interposing of a surface between the two interacting surfaces for the purpose of reducing friction.

**Guidance note:**

In general, the frictional force is associated with the expenditure of energy in the contact region, and it is the process of energy dissipation that may lead to destruction of the surface layers and to the eventual wearing of the material. While both friction and wear are the result of surface interaction, there is often no absolute correlation between the two. Especially the rate of wear may change by several orders of magnitude by varying certain factor of the wear systems and the material properties, yet the friction force remains nearly constant. However, frictional forces are a prerequisite for wear of materials.

---e-n-d--- o-f---G-u-i-d-a-n-c-e---n-o-t-e---

- 604** In most polymer sliding systems, wear takes place by one of the following processes or a combination of them: adhesive wear, abrasive wear, fatigue wear and corrosive wear. In practical situations, the four types of wear interact in a complex and unpredictable way. In addition, the wear process may modify the contact surfaces and thus change the relative importance of the separate mechanisms.
- Adhesive wear arises as a result of a process by which isolated spots on two sliding surfaces adhere together momentarily, weld or stick together, removing a wear particle. It often involves the transfer of material from one surface to the other. It is the only wear mechanism that is always present and, unlike the others, cannot be eliminated. Friction is not involved in adhesive wear.
  - Abrasive wear occurs especially when the surface of a material is loaded by hard and sharp mineral particles. In addition, abrasion can be effective when relatively soft materials slide against rough metallic counterparts. In that case, the abrasive wear is usually highest for the softest material. Abrasive wear is the most destructive wear mechanism and produce the highest material loss in the shortest time. Abrasive wear may be the result of a two body abrasion (e.g. a surface against sandpaper) or a three body abrasion (e.g. sand particles between two moving surfaces).
  - Fatigue wear arises from cyclic loading of surface layers with repetitive compressive and tangential stresses. Material is removed after fatigue crack growth in and below the surface by producing spalled particles. Fatigue wear is extremely small compared with adhesion or abrasion.
- 605** The following wear properties are defined to characterise the properties of a wear system:

- The length related wear rate  $\dot{w}$  designates the ratio between the wear depth  $dy$  (thickness of removed material) and the sliding distance  $dx$ . It is dimensionless.

$$\dot{w} = \frac{dy}{dx} \quad (m/m)$$



- The specific wear rate  $\dot{w}_s$  designates the ratio between the wear rate  $\dot{w}$  and the contact pressure  $p$  between the two surfaces. It has the dimension of a (stress)<sup>-1</sup>.

$$\dot{w}_s = \frac{\dot{w}}{p} \quad (m^3/Nm) \quad (21)$$

- The wear factor  $k^*$  is numerically the same as the specific wear rate  $\dot{w}_s$ . It has the dimension of a (stress)<sup>-1</sup>.
- The time related wear rate  $\dot{w}_t$  designates the ratio between the wear depth  $dy$  (thickness of removed material) and the sliding time  $dt$ . It has the dimension of a speed.

$$\dot{w}_t = \frac{dy}{dt} \quad (m/s) \quad (22)$$

**606** The wear properties are related together according to the following equations:

$$k^* = \dot{w}_s = \frac{\dot{w}}{p} = \frac{\dot{w}_t}{pv} \quad (23)$$

where:  $v = dx / dt$  is the sliding speed

**607** The  $(pv)$  factor is used as a performance criterion for bearings. The  $(pv)$  factors are widely quoted in the literature and may take one of the two forms:

- The “limiting”  $(pv)$  above which wear increases rapidly either as a consequence of thermal effects or stresses approaching the elastic limit
- The  $(pv)$  factor for continuous operation at some arbitrarily specified wear rate

**Guidance note:**

In neither case is the  $(pv)$  factor a unique criterion of performance because the assumptions made in the derivation of *equation (6-20)* are usually valid over only a very restricted range of  $p$  and  $v$  (see Figure 4-3 below). At low speed, the maximum pressure that can be used is limited by the strength of the material, and, as this pressure is approached, the specific wear rate no longer remains independent of load but begins to increase as a result of possible changes in the wear mechanisms. At high speeds, the generation of frictional heat raises the temperature of the surface layers and tends to increase the specific wear rate.

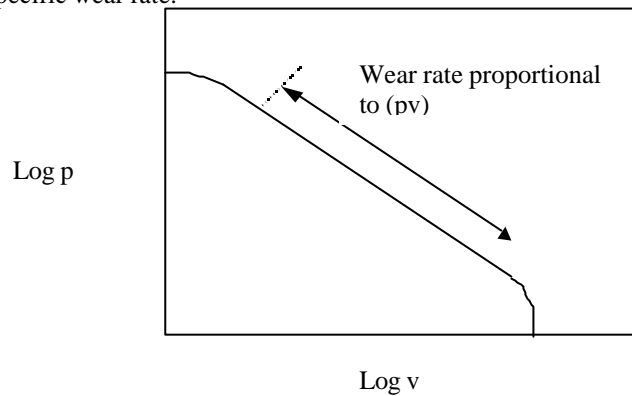

---e-n-d--- o-f---G-u-i-d-a-n-c-e---n-o-t-e---

- 608** Wear properties usually degrade at elevated temperatures. The effects of ambient temperature and of frictional heating should be considered.
- 609** The presence of water between the two surfaces in contact usually has a lubricating effect, i.e. the wear properties of the wear system are better than those of the same system without presence of water.
- 610** Frictional coefficients and wear rates of materials are strongly influenced by the roughness of the counterface against which they are sliding. In the steady state wear condition abrasive wear can become the dominant mechanism if the surface of the wearing material has been modified during previous passages. Typically, the wear mechanism changes from adhesion in the range of very smooth surfaces to abrasion for rough surfaces, leading to an increase of the wear rate.
- 611** The presence of fibres usually improves the wear resistance of a polymer matrix. The fibres are exposed at the sliding surface and support part of the applied loads. Moreover, the fibres smooth the surface of the counterface to reduce the localised stresses at the asperity contacts.

**Guidance note:**

Carbon fibres are usually superior to glass fibres in reducing the wear rate and the frictional coefficient. Especially at high sliding speeds and high loads, they clearly improve the wear properties of the base polymer. For practical application of composites where friction becomes an important problem, the use of a hybrid material (glass and carbon fibres) can be recommended.

---e-n-d--- o-f---G-u-i-d-a-n-c-e---n-o-t-e---

- 612** The orientation of the fibres in a polymer material with a given fibre content has also an influence on its wear properties:
- For unidirectional laminates, the lowest wear rates are often obtained when the fibres are orientated perpendicular (normal) to the sliding surface
  - When the fibres are orientated parallel to the sliding surface, the differences between antiparallel and parallel orientation are less clear.
- 613** The presence of fillers usually helps to reduce wear. However, the wear reducing action of fillers is dependent on factors such as shape and size, as well as the composition of the filler material.
- 614** Internal lubricant such as PTFE or silicone can be used to improve the wear resistance of a material. The two materials combine at the wear surface and form a high lubricity film, which acts in addition as a protecting layer for the fibres.

## **E. Influence of the environment on properties**

### **E 100 Introduction**

- 101** The environment can effect composites. Properties change usually gradually with time and long exposure times (a year and longer) are needed before properties change significantly.
- 102** Fibres and matrix are effected in different ways due to their different chemical nature.
- 103** The fibre matrix interface can have an important influence on the environmental resistance. The interface properties are influenced by the type of fibre, the sizing, the matrix, and the processing conditions.
- 104** Void content and the presence of matrix cracks can also influence the environmental resistance.
- 105** The local environmental conditions shall be taken into account for the documentation of all properties under static and fatigue loads, see also *Section C*.
- 106** Possible degradation of unloaded structures shall also be documented, e.g. liners.
- 107** Cyclic environmental conditions shall be considered.
- 108** It shall be documented that the combined effects of cyclic loads, static load, and the environment are not worse than the separate effects considered in the sections above.
- 109** The following conditions are considered:
- Temperature
  - Water
  - Chemicals
  - UV radiation
- 110** The tables in this section are ONLY valid for thermoset resins, like epoxy, polyester and vinyl ester with glass transition temperature below 150°C. They are also ONLY valid for E-glass, Aramid, and carbon fibres, unless stated otherwise. Behaviour of other materials may be similar but shall be documented by test results.

## E 200 Effect of temperature

The table below lists typical instant (after one hour) property changes.

Property	Qualitative Effect	Quantitative effect or Test requirement
Static elastic constants fibre dominated	none up to Tg - 20 C of matrix Aramid below 60 C	no effect test if outside the range
Static elastic constants matrix dominated	none up to Tg - 20 C	no effect test if outside the range
Static Tensile strengths fibre dominated	None up to Tg - 20 C of matrix Aramid below 60 C	no effect test if outside the range
Static Tensile strengths matrix dominated	None up to Tg - 20 C	no effect test if outside the range
Static Compressive strengths fibre dominated	None up to Tg - 20 C of matrix Aramid below 60 C	no effect test if outside the range
Static Compressive strengths matrix dominated	None up to Tg - 20 C of matrix	no effect test if outside the range
Fracture toughness	Unknown	test
Creep / Stress relaxation fibre dominated	Accelerates with increasing temperature	Measure, may use time temperature superposition
Creep / Stress relaxation matrix dominated	Accelerates with increasing temperature	Measure, may use time temperature superposition
Time to stress rupture fibre dominated	Gets shorter with increasing temperature	Measure, may use time temperature superposition
Time to stress rupture matrix dominated	Gets shorter with increasing temperature	Measure, may use time temperature superposition
Change of static strength under permanent load fibre dominated	Unknown, Probably the same as for static strength	
Change of static strength under permanent load matrix dominated	May drop more quickly with increasing temperature.	Adhesive type behaviour.
Change of modulus under fatigue - fibre dominated	May drop more quickly with increasing temperature.	
Change of modulus under fatigue - matrix dominated	May drop more quickly with increasing temperature.	
Time to fatigue failure fibre dominated	Gets slightly shorter with increasing temperature	
Time to fatigue failure matrix dominated	Gets shorter with increasing temperature	
Change of static strength under fatigue load fibre dominated	Unknown, Probably the same as for static strength	
Change of static strength under fatigue load	Unknown	

matrix dominated		
------------------	--	--

*Table 5: Effect of temperature on properties*

### E 300 Effect of water

The table below lists typical property changes after long exposures of  $10^6$  cycles or 10 years.

Property	Qualitative Effect	Quantitative effect or Test requirement
Static elastic constants fibre dominated	Slight reduction	
Static elastic constants matrix dominated	Slight reduction	
Static Tensile strengths fibre dominated	Glass: small reduction Carbon: slight reduction Aramid: slight reduction?	Glass: reduce strength by 10% Carbon: measure Aramid: measure
Static Tensile strengths matrix dominated	some reduction	measure wet properties
Static Compressive strengths fibre dominated	Glass: small reduction Carbon: slight reduction Aramid: slight reduction?	Glass: reduce strength by 10% Carbon: measure Aramid: measure
Static Compressive strengths matrix dominated	some reduction	measure wet properties can use the same reduction as for tensile strength
Fracture toughness	Unknown, may increase due to plastification effect.	test
Creep / Stress relaxation fibre dominated	Accelerates in the presence of water	measure
Creep / Stress relaxation matrix dominated	Accelerates in the presence of water	measure
Time to stress rupture fibre dominated	gets shorter with the presence of water	measure
Time to stress rupture matrix dominated	gets shorter with the presence of water	measure
Change of static strength under permanent load fibre dominated	Unknown, Probably the same as for static strength	
Change of static strength under permanent load matrix dominated	Unknown, Probably the same as for static strength	
Change of modulus under fatigue - fibre dominated	Unknown, probably small effect	
Change of modulus under fatigue - matrix dominated	Unknown	
Time to fatigue failure fibre dominated	slight reduction	reduce stress level by 10%
Time to fatigue failure matrix dominated	Probably slight reduction	
Change of static strength under fatigue load	Probably the same as for static strength	

fibre dominated		
Change of static strength under fatigue load matrix dominated	Unknown	

Table 6: effect of water on properties

- 301** The effect of seawater is generally less severe than the effect of fresh water.
- 302** The effect of distilled water is more severe than the effect of fresh water.
- 303** The combination of water and high temperature may be worse than the individual effects of temperature and water.
- 304** Aramid fibres shall not be exposed to the combination of water and temperature cycles above and below 0°C.

**E 400 Effect of chemicals**

- 101** The compatibility of a laminate to the exposure to chemicals shall be demonstrated.
- 402** In a qualitative way most chemicals tend to have similar effects as water on a composite. The degradation rates shall be obtained for the actual materials in question. In addition, chemicals may break down the matrix, attack the matrix / fibre interface or destroy the fibres.

**E 500 Effect of UV radiation**

- 501** UV radiation can break down the polymers and reduce their strength. The resistance of surface layers to UV radiation shall be documented and quantified if necessary.
- 502** Glass and carbon fibres are very resistant to UV radiation.
- 503** Aramid fibres are not resistant to UV radiation and shall be protected.
- 504** Polyesters tend to have a good UV resistance.
- 505** Epoxies tend to have a bad UV resistance.
- 506** Vinylester tend to have a variable UV resistance.

**E 600 Electrolytic Corrosion**

- 601** Carbon fibre laminates shall be isolated from direct contact with all metal parts to prevent electrolytic corrosion.
- 602** It is recommended to check the quality of the isolation by resistance measurements.



-----Guidance note-----

Electrical connection between carbon fibres and steel in submerged conditions (with or without anodes) will cause cathodic protection of the carbon fibres where they are exposed to sea water (in cracks, cut surfaces etc.). When polarised the local pH at the fibre surface will be increased to  $\approx 13$  and salts from the sea water will precipitate on the fibres. The associated volume increase will force the crack to open more ("The wedging effect"). As a result, the mechanical properties of the laminate may be reduced, due to the gradually increasing loss of adhesion between the carbon fibres and the matrix.

----- End of guidance note -----

## **E 700 Combination of environmental effects**

- 701** The combination of environmental effects on materials, like combined humidity and heat, may be worse than the individual effects.
- 702** Test data should be obtained of the combined effect of environments on the material properties if relevant. The worst relevant combination of environments should be used for testing.

## **F. Influence of process parameters**

### **F 100 Introduction**

- 101** Composite laminates can be produced in many ways. Changes to the process parameters may influence some or all-material parameters.
- 102** Process parameters are seen here in a wider sense. Change of void content or fibre fraction are part of this section, even though these changes are a results of other changes of more fundamental production parameters.

### **F 200 Change of production method**

- 201** A change in production method, e.g., going from hand lay-up to filament winding, is usually accompanied by many other changes. Different resins are used, different fibres or sizings may be used, and the fibre fraction and void content may change significantly.
- 202** A re-qualification of the materials data shall be done if the production process is not similar to the original process - see *Section H300*.. A production process is similar as long as changes introduced by the new process can be quantified as described in the following parts of *Sections F* and the process group is not changed.

**203** Examples of process groups are:

- Hand-layup
- Spray-layup
- Pre-preg layup
- Autoclave curing (in combination with one of the other processes)
- Resin injection processes
- Resin transfer moulding
- Centrifugal moulding
- Filament winding
- Tape winding

**F 300 Change of processing temperature and pressure:**

**301** For simple processes of thermoset materials with only one cure temperature:

- Curing temperature of the reference data was higher than in reality: Data shall be re-qualified.
- Curing temperature of the reference data was lower than in reality: data are valid, as long as the temperature did not exceed the resin manufacturer's maximum curing temperature.

**302** For simple processes of thermoset materials with only one cure pressure:

- Curing pressure of the reference data was higher than in reality: data shall be re-qualified.
- Curing pressure of the reference data was lower than in reality: data are valid, as long as the pressure did not exceed the resin manufacturer's maximum curing pressure.

**303** For thermoplastic composites where the plies are welded or fused together, a processing window of pressure and temperature should be established in which test data are applicable.

**304** For complex curing cycles with varying temperature and pressure, any change to the process shall require requalification of the data.

**F 400 Change of post cure procedure**

**401** Post-curing has no influence on fibre dominated tensile properties.

**402** Post curing may improve fibre dominated compressive properties and all matrix dominated properties.

**403** For some matrix systems post curing accelerates some slow crosslinking reactions that would also take place at room temperature. This is the case for many types of polyester. For these systems data obtained from post cured specimens are also valid for materials that were not post cured.

**404** For some matrix systems post curing creates a better crosslinked network that will never be achieved if the laminate remains at room temperature. This is the case for many vinyl esters and epoxies. For these systems data obtained from post cured specimens are not valid for materials that were not post cured.

**F 500 Change of void content:**

**501** The void content of the reference data was higher than in reality: data are valid.

**502** The void content of the reference data was more than 10% (relative) lower than in reality: data shall be re-qualified.

**F 600 Correction for change in fibre volume fraction**

**601** For UD plies:

Young's mod in fibre dir.  $E_1 = E_1^0 \cdot \frac{V_f}{V_f^0}$

Young's mod normal to fibre dir.  $E_2 = E_2^0 \cdot \frac{1 - V_f^0}{1 - V_f}$

In-plane shear modulus  $G_{12} = G_{12}^0 \cdot \frac{1 - V_f^0}{1 - V_f}$

Tensile strength in fibre dir.  $X_1 = X_1^0 \cdot \frac{V_f}{V_f^0}$

Compression strength in fibre dir.

$$X_1^* = X_1^{*0} \cdot \frac{V_f}{V_f^0} \quad \text{if } V_f < V_f^0$$

$$X_1^* = X_1^{*0} \quad \text{if } V_f > V_f^0$$

Tensile strength normal to fibre  $Y_1 \approx Y_1^0$

Compr. strength normal to fibre  $Y_1^* \approx Y_1^{*0}$

In plane shear strength  $XY_{12} \approx XY_{12}^0$

The superscript 0 identifies originally measured data.

**602** These formulas are valid if:

- The void content does not change by more than 10% (relative change)
- The change of fibre volume fraction is not more than 10% (absolute change).

- 603** Measured fatigue properties may also be scaled by the formulas given above and within the limits given in 602. In addition, fibre strength data shall only be corrected for fibre volume fractions up to 35%. If the fibre volume fractions are higher than 35%, considerable reductions in fatigue performance have been observed in the past, and fatigue data shall be re-established.
- 604** If the fibre fractions change by more than the validity range of the table, the properties shall be re-established.
- 605** Laminates with dry fibres (due to too high volume fractions or bad processing) have poor properties and shall not be accepted.

**F 700 Control of fibre orientation:**

- 701** If the variation of fibre angles is reduced compared to that of the reference data all data are valid.
- 702** If the variation of fibre angles is increased compared to that of the reference data fibre dominated strength and stiffness values shall be re-qualified.
- 703** If the variation of fibre angle of the reference data and the actual data is known the effect on stiffness and tensile strength may be calculated with laminate theory. Strength and stiffness shall be modified according to these calculations. These calculations shall not be used if the variation in fibre angles has increased by more than 5° (absolute change).
- 704** The stiffness used in design shall be the mean of the effect of the variable fibre orientation while the strength shall be the strength of the least favourable fibre orientation, i.e. the minimum strength.

**F 800 Control of fibre tension:**

- 801** For laminates with constant fibre tension: if the fibre tension is reduced compared to the reference data and fibres do not crimp or change orientation, all data are valid. If the fibre tension increases, fibre dominated values shall be re-qualified.
- 802** Laminates made by filament winding, tape winding and similar processes may show a variation in fibre tension, especially through the thickness. Laminate and ply properties should be established for a representative combination of fibre tensions.
- 803** If fibre tensions vary, but the change in tension is known, the change in fibre tension may be added to the loads acting on the ply in a stress analysis. If such an analysis can be carried out with sufficient accuracy a re-qualification of the material properties is not required.

## **G. Properties under fire**

### **G 100 Introduction**

- 101** The performance of composites in a fire is a complex process, because the various constituent materials respond differently to a fire.
- 102** The requirements under fire conditions can usually be found in the fire codes for a particular application.
- 103** Fire codes may implicitly assume that the structure is built of steel or metal. The relevance of a fire code to composite materials shall be checked carefully.
- 104** Since most composites are flammable and temperature sensitive most applications use protective measures to reduce the impact of fire. In this case the fire performance of the complete system, i.e. a composite structure with fire protection shall be evaluated.
- 105** An advantage of composite laminates is their low thermal conductivity and the usually long times required to reach burn through conditions.
- 106** Some aspects of fire performance can be modelled, but some experimental testing shall always be done to demonstrate fire performance.

### **G 200 Fire reaction**

- 201** Fire reaction describes the response of a composite to fire in terms of flammability, flame spread, smoke development and emission of toxic gases. All these aspects shall be documented if relevant.
- 202** Special additives or fillers are often added to composites to improve fire reaction.
- 203** The influence of such additives or fillers on the basic mechanical properties shall be evaluated.

### **G 300 Fire resistance**

- 301** Fire resistance describes the remaining strength of a composite structure under a fire.
- 302** As a first estimate of fire resistance the temperature dependent properties, as described in *Section E200*, can be used.
- 303** The temperature within a composite laminate can be calculated by means of appropriate models.
- 304** If chemical reactions can occur within the laminate their influence on the temperature distribution shall be considered.
- 305** Through thickness properties and matrix dominated properties shall be carefully evaluated, especially in the region of joints. Matrix dominated properties tend to degrade rapidly in a fire.

#### **Guidance note:**

A panel with stiffeners may lose most of its stiffness if the stiffeners delaminate from the panel due to the fire.

---e-n-d--- o-f---G-u-i-d-a-n-c-e---n-o-t-e---

#### **G 400 Insulation**

- 401** The properties of the insulation with respect to fire reaction and fire resistance shall be evaluated.
- 402** Special consideration shall be given to the joints of the insulation and the method the insulation is attached to the component. Attachment points and joints may create hot spots in the component.
- 403** All large scale testing shall be done with jointed insulation and the same attachments as used in the real application.

#### **G 500 Properties after the fire**

- 501** A fire is usually seen as an accidental load case and properties after the fire shall be evaluated for each individual case.
- 502** If the temperature has locally exceeded the  $T_g$  of the component it is very likely that permanent damage has been made to the component in that area.
- 503** If the temperature remained locally under  $T_g$  damage may be introduced due to overloads from other parts of the structure.

### **H. Qualification of material properties**

#### **H 100 Introduction**

- 101** All material properties needed to describe the performance of a component shall be documented.
- 102** As a general principal, material properties should be obtained from test results of laminates that represent the laminates of the component as closely as possible.

Guidance note

If laminates are used on pipes, it is recommended to obtain material data from tubular specimens.

End of guidance note

- 103** Material properties may be documented by the following methods:
  - Direct measurements
  - Qualification against representative data
  - Qualification against manufacturers data
  - Qualification against data from the open literature
  - Qualification by component testing

**104** Each individual material property may be qualified by any of the different methods.

**105** Which data can be used for qualification depends mainly on two aspects:

- Were the data obtained from laminates that are similar to the laminates used in the component.
- Were the data obtained from reputable sources.

## **H 200 General test requirements**

**201** All relevant information about the material tested, the test method, and the test conditions shall accompany test results. The information requested in *A200* shall be provided.

**202** Static test results shall be reported as mean, standard deviation, coefficient of variation, and number of test specimens. The characteristic values of static tests shall be calculated as described in *Section B400*.

**203** Long-term test results shall be reported as mean regression curve, standard deviation with respect to time or cycles, number of test specimen, range of test time or number of cycles. Test points shall be spread out relatively evenly over the logarithmic test period. The characteristic values of long-term tests shall be calculated as described in *Section C1100*.

## **H 300 Selection of material qualification method**

**301** The test results shall apply to the laminates used in the component to be designed and built. Test results are only applicable if the test laminate and the component laminate are similar enough that the test results are valid or conservative for the actual component.

**302** If the material is the same as an already tested material no further testing is required. The same material means:

- Same fibres, same weave or fabric from the same producer.
- Same matrix system (same resin, curing agent and fillers).
- Similar production process, as defined in *F202*.

**303** If the material is similar to an already tested material qualification against a representative material may be carried out. Requirements for similarity are given in H600, requirements for representative data are given in H500.

**304** Direct measurements as described in H400 shall be carried out if 302 or 303 cannot be applied.

#### **H 400 Direct measurement**

**401** The various properties of a composite may be measured directly for a particular material. Data will be valid for that particular material that was tested. The material shall be characterised as required in *Section A 200*.

**402** The test methods described in Appendix 4B should be preferred.

#### **H 500 Representative data**

**501** If a sufficient number of direct measurements is available, data may be used to establish a set of representative data for a material property. To be considered representative, data should be based on at least 15 measurements per property. Other materials can be compared against the representative data as described in *H600*.

**502** Representative data are most useful if they can be used for a fairly wide range of materials. This will also allow to pool data of different properties that were obtained from slightly different materials. Requirements for the individual materials that can be put into one group of representative data are given below:



<b>Constituent materials:</b>	<b>Requirements to group measurements from different laminates</b>
Generic Fibre type	same for all tests
Bundle type	same trade name*
Fibre trade name	same trade name*
Type of weave	same trade name*
Type of sizing	same trade name*
Fibre Manufacturer	same for all tests
Weaver	same for all tests
Fabric trade name and batch number	same trade name
Generic resin type (e.g. epoxy, polyester)	same for all tests
Specific resin type (trade name, batch number)	same trade name*
Catalyst (trade name and batch number)	same trade name*
Accelerator (trade name and batch number)	same trade name*
Fillers (trade name and batch number)	same trade name*
Additives (trade name and batch number)	same trade name*
<b>Process parameters:</b>	
Laminator (company)	not relevant
Processing method	same for all tests
Processing temperature	maximum from all tests
Processing pressure	maximum from all tests
Process atmosphere (e.g. vacuum)	minimum from all tests
Post curing (temperature and time)	maximum from all tests
Control of fibre orientation	best from all tests
Fibre volume fraction	maximum from all tests
Void content	minimum from all tests
<b>Conditioning parameters to be given with exposure time:</b>	
Temperature	minimum from all tests
Water content of the laminate (wet, dry)	same for all tests
Chemical environment	same for all tests
Loading rate	same for all tests
<i>number of specimens</i>	Reported individually for all properties

*\* a wider range may be chosen if data are the minimum of a wide variety of products.*

Table 7: processing characteristics of the set of representative data

**503** An example of representative data is given in Section 4, Appendix C.

## H 600 Qualification against representative data

**601** It is only necessary to qualify data that are needed in the design analysis and failure criteria.

**602** A property of a laminate may be qualified against representative data if certain requirements are met for fibres, matrix and sizing:

**603** Similarity is described here on the ply level. Fibres, matrix and sizing may be exchanged or modified if the ply properties are not changed.

**604** Similar fibres:

Fibre reinforcements can be considered to be similar under the following conditions:

- The fibre is of the same generic type, e.g. E-glass, high modulus carbon with the same generic precursor, etc.
- The tensile and compressive characteristic fibre dominated ply strength ( $\hat{e}_{1t}$  fibre and  $\hat{e}_{1c}$  fibre) fulfil the similarity requirements given in *H700*. This requirement may be tested with a UD or 0/90 laminate.
- The fibre-dominated modulus is within 5% of the reference ply.

**605** Laminates with different arrangements of the fibres (weave or fabric type or bundle size) type may be considered similar if the test requirements in *604* and *606* are fulfilled.

**606** Laminates with larger fibre bundles relative to the reference laminate have usually lower strength and do not pass the similarity requirement.

**607** Similar matrix:

A matrix can be considered to be similar under the following conditions:

- The matrix is of the same generic type, e.g. iso-polyester, vinylester, phenolic.
- Fillers and curing agents may be different.
- The tensile and compressive characteristic matrix dominated ply strength ( $\hat{e}_{2t}$  matrix and  $\hat{e}_{2c}$  matrix) fulfil the similarity requirements given in *H700*. This requirement may be tested with a UD or 0/90 laminate.
- It can be documented that the matrix-dominated modulus is within 5% of the reference ply.

**608** Similar sizing:

A sizing can be considered to be similar under the following conditions:

- The sizing is of the same generic type, e.g. glass-epoxy compatible
- The tensile and compressive characteristic matrix dominated ply strength ( $\hat{e}_{2t}$  matrix and  $\hat{e}_{2c}$  matrix) fulfil the similarity requirements given in *H700*. This requirement may be tested with a UD or 0/90 laminate.

- 609** Documentation shall show that the properties of the combination of the reference material and the combination of the similar material give the results required above. The materials producers may provide this documentation.
- 610** If the above basic similarity requirements are met, individual static ply properties shall be qualified as described in the table below. Some properties can be based directly on represented data or an equation to modify them is given. Other properties shall be confirmed by experiment (see *Section H700-H900*).
- 611** Instead of confirming all material parameters individually component testing may be used to qualify an analysis, as described in *1100*.

<b>In-plane orthotropic elastic constants</b>	<b>Mechanical parameter</b>	<b>Low Safety class</b>	<b>Normal safety class</b>	<b>High safety class</b>
all elastic constants	all elastic constants	rep * 1	confirm $E_1$ and $E_2$ , other constants rep * 1	confirm
<b>In-plane Strain to Fail and Strength</b>				
all parameters		Rep * 0.8	Confirm $\epsilon_{1t}, \epsilon_{1c}, \sigma_{2t}$ Others: Confirm if critical	confirm
<b>Through Thickness</b>				
E3	Modulus of elasticity normal to the fibre plane	Rep or = E2	confirm	confirm
G13	Shear modulus normal to the fibre plane, including the fibre direction	rep or = G12	rep or = G12	confirm if critical for design
G23	Shear modulus normal to the fibre plane, including the direction normal to the fibre direction.	rep or = G12	rep or = G12	confirm if critical for design
v13	Poisson's ratio normal to the fibre plane, including the fibre direction, when tensioning in the fibre direction.	rep * 1	rep * 1	confirm if critical for design
v23	Poisson's ratio normal to the fibre plane, including the direction normal to the fibres, when tensioning in the plane normal to the	rep * 1	rep * 1	confirm if critical for design

	fibres.			
$\hat{e}_{3t}$	Tensioning strain at break, normal to the fibre plane.	rep * 0.9 or = $\epsilon_{3t} * 0.9$	confirm if critical for design	confirm if critical for design
$\hat{e}_{3c}$	Compression strain at break, normal to the fibre plane.	rep * 0.9 or = $\epsilon_{3c} * 0.9$	confirm if critical for design	confirm if critical for design
$\hat{e}_{13}$	Tensioning strain at break normal to the fibre plane when tensioning in the fibre direction.	rep * 0.9 or = $\epsilon_{12} * 0.9$	confirm if critical for design	confirm if critical for design
$\hat{e}_{23}$	Tensioning strain at break normal to the fibre plane when tensioning in the fibre plane, normal to the fibre direction.	rep * 0.9 or = $\epsilon_{12} * 0.9$	confirm if critical for design	confirm if critical for design
$\hat{S}_{3t}$	Tensioning stress at break normal to the fibre plane.	rep or calculate	calculate	calculate
$\hat{S}_{3c}$	Compression stress at break normal to the fibre plane.	rep or calculate	calculate	calculate
$\hat{S}_{13}$	Stress at break normal to the fibre plane when tensioning in the fibre direction.	rep or calculate	calculate	calculate
$\hat{S}_{23}$	Stress at break normal to the fibre plan, including the direction normal to the fibres, when tensioning normal to the fibre plane.	rep or calculate	calculate	calculate
<b>Fracture Toughness</b>				
Critical length	In-plane	rep * 0.8	confirm	confirm
G1c	Critical strain energy release rate in the fibre direction.	rep * 0.8	confirm	confirm
G2c	Critical strain energy release rate in the fibre plane, normal to the fibre direction.	rep * 0.8	confirm	confirm
<b>Long Term Properties (see 615 and 616)</b>				
Creep/Stress relaxation		rep	confirm if critical for	confirm

			design	
Stress rupture		rep	confirm if critical for design	confirm
Static strength reduction under permanent load		rep	rep	confirm if critical for design
Change of modulus under cyclic fatigue		rep	rep	confirm if critical for design
Cycles to failure fibre dominated		rep	confirm if critical for design	confirm
Cycles to failure matrix dominated		rep	confirm if critical for design	confirm
Fibre dominated static strength reduction under fatigue load		rep	rep	confirm if critical for design
Matrix dominated static strength reduction under fatigue load		rep	confirm if critical for design	confirm if critical for design

Table 8: qualification against representative data

- 612** The entry "rep" in the table means that representative data may be used without testing. In some cases the representative data shall be multiplied by a factor as indicated in the table.
- 613** *Confirm if critical for design* means that the value or procedure of the lower safety class may be used for strength or strain to failure if the material safety factor  $\gamma_m$  can be multiplied by 2 for this property in all relevant failure criteria. Otherwise the property should be confirmed by testing.
- 614** Through thickness elastic properties should only be confirmed by testing if they influence the calculation of a critical strength or strain as defined in 613. Otherwise the representative values may be used.
- 615** Long term test data of fibre dominated properties do not have to be confirmed if the laminate has identical fibres, matrix and sizing compared to a laminate for which long term test data exist and the static similarity tests in 604 are fulfilled. The requirement to the same matrix and sizing can be waived if environmental attack on the fibres can be excluded.
- 616** Long term test data of matrix dominated properties do not have to be confirmed if the laminate has identical fibres, matrix and sizing compared to a laminate for which long term test data exist and the static similarity tests in 604 are fulfilled.
- 617** The procedure of the higher safety class may always be used to obtain better values than can be obtained by using the procedure of the lower safety class.
- 618** If any of the confirmation tests show that the material is not similar to the representative material, all properties shall be re-qualified.
- 619** A full experimental determination of a property may always be used as an alternative to using representative data or confirmation testing.

#### **H 700 Confirmation testing for static data**

- 701** If a material is similar to a material for which representative data exist (as described above) two methods can be used to demonstrate that the similar material is at least as good as the typical material. One is a simplified method, the other is similar data hypothesis testing.
- 702** At least three measurements of the property in question shall be made in all cases. It is recommended to test five or more specimens.
- 703** For the simplified method the following requirements shall be fulfilled:
- The standard deviation estimated from at least three measurements shall not be larger than the standard deviation of the corresponding typical data.
  - At least 50% of the measured values shall be larger than the mean of the typical data.
  - At least 84% of the measured values shall be larger than the mean - 1 standard deviation of the typical data.
  - At least 97.7% of the measured values shall be larger than the mean - 2 standard deviations of the typical data.

**704** If a material is similar to a material for which representative data exist (as described above) the hypothesis testing can be used to determine whether test data can be considered to belong to the same population.

**705** Let  $\mu_0$  denote the mean value of the typical data, and let  $\sigma_0$  denote the standard deviation of the typical data. Calculate:

$$T = \frac{\sqrt{n}(\bar{x} - m_0)}{\hat{s}}$$

where  $x$  is the mean value of the  $n$  measurements of the material to be checked for similarity.

and check that  $T > -t(\alpha)$  is fulfilled, where  $t(\alpha)$  is to be taken from Table xx

	$t(\alpha)$
N	Confidence $1-\alpha=0.75$
2	1.000
5	0.741
10	0.703
15	0.692
20	0.688
25	0.685
100	0.677
Infinity	0.675

Table 9:  $t(\alpha)$

**706** Calculate

$$C^2 = \frac{(n-1)\hat{S}^2}{s_0^2}$$

where  $\hat{S}$  is the standard deviation of the measurements of the material to be checked for similarity.

and check that  $C^2 < \chi^2(\alpha)$ , where  $\chi^2(\alpha)$  is to be taken from Table yy.

	$\chi^2(\alpha)$
N	Confidence 1- $\alpha$ =0.75
2	1.323
5	5.385
10	11.389
15	17.117
20	22.718
25	28.241
50	55.265

Table 10:  $c^2(\mathbf{a})$

**707** If all of the above conditions are fulfilled the typical data may be used to represent the similar material.

**708** If neither the simplified similarity test nor the hypothesis test is passed, the material property has to be measured directly (see *Section H400*).



### **H 800 Confirmation testing for long term data - high safety class**

- 801** At least 9 tests shall be carried out.
- 802** Test data shall be evenly distributed over the logarithmic time or number of cycles scale.
- 803** At least two test results shall fall within 90% of the anticipated lifetime or the anticipated number of cycles.
- 804** If the anticipated lifetime exceeds 10000 hours testing up to 10000 hours is sufficient. The strain levels should be chosen such that failure occurs after about  $10^2$ ,  $10^3$  and  $10^4$  hours, respectively.
- 105** If the anticipated lifetime exceeds  $10^6$  cycles testing up to  $10^6$  cycles is sufficient. The strain levels should be chosen such that failure occurs after about  $10^3$ ,  $10^4$  and  $10^6$  cycles, respectively.
- 806** No more than 2.5% of the measured points should lie below  $\mu - 2\sigma$ , no more than 16% below  $\mu - \sigma$  and no more than 50% below the mean  $\mu$ . If the data points for a material do not fulfil these requirements more testing should be carried out.

### **H 900 Confirmation testing for long term data - normal safety class**

- 901** At least 3 survival tests shall be carried out.
- 902** Tests shall be carried out at strain levels where the anticipated mean lifetime or number of cycles is 1000 hours or  $10^4$  cycles respectively. If the expected lifetime or fatigue cycles of the structure are less, tests shall be carried out up to the expected values.
- 903** Tested specimens shall not fail before the testing time or number of cycles has exceeded the characteristic long test term curve. The characteristic long term test curve shall be based on the representative data's mean curve minus two standard deviations. Details to obtain such a curve are given in *C1100*. (It shall be assumed that the representative data are based on infinite measurements in *C1107*, even if that was not the case in reality.)

### **H 1000 Use of manufacturers data or data from the literature as representative data**

- 1001** There is a vast amount of data available, but unfortunately data are often not well documented and essential information tends to be missing.
- 1002** This section describes under which conditions such data may be used.
- 1003** It shall be documented that the data come from a reputable source. This can be done in the following way:
- All data were taken from calibrated test equipment
  - Data were witnessed by an independent third party or data were published and reviewed by at least two independent research teams.

**1004** If these requirements are not met data can still be used as representative data, but all new materials data have to be confirmed against these data, even if the requirements in *H600* do not require a confirmation.

**1005** If information about processing and conditioning is missing, it shall always be assumed that the best possible laminate has been tested under the most favourable conditions. The following conservative assumptions should be made.

<b>Constituent materials:</b>	
Generic Fibre type	as stated
Type of weave	lay-up of UD plies
Generic resin type (e.g. epoxy, polyester)	as stated
Specific resin type (trade name)	high performance resin for the application
<b>Process parameters:</b>	
Processing method	Autoclave
Processing temperature	high
Processing pressure	high
Process atmosphere (e.g. vacuum)	vacuum
Post curing (temperature and time)	yes
Control of fibre orientation	to less the 1°
Fibre volume fraction	60% volume
Void content	less than 1%
<b>Conditioning parameters:</b>	
Temperature	room temperature
Water content of the laminate (wet, dry)	dry
Chemical environment	none
Loading rate	high
Measure values	mean values
Guaranteed minimum value	mean - 2 standard deviations (must be confirmed)
Standard deviation	15%
number of specimens	3

*Table 11: Use of manufacturers data or data from the literature as representative data*

### **H 1100 Confirming material data by component testing**

- 1101** Instead of confirming all material parameters individually component testing may be used to qualify an analysis, as described in *1100*.
- 1102** The advantage of this approach is its simplicity. The disadvantage is that component test results are based on a combination of many aspects and it is usually not possible to separate individual parameters out of the component test result.
- 1103** When testing the component instead of individual material properties the restrictions given in *Section 10E* will apply and the qualification may not be valid for other geometries or any changes to the component.
- 1104** The relevance of competing failure mechanisms as described in *Section 7B300* shall be evaluated. If competing failure mechanisms are present it may be necessary to measure material properties individually.

### **H 1200 Comparing results from different processes and lay-ups**

- 1201** It is often not possible to measure ply properties from the actual laminate in the component. Special laminates should be produced. In some cases data are available for slightly different reinforcements. In some cases production processes are different.
- 1202** This section shows how data can be converted between these different types of laminates. It is assumed here that the fibre volume fraction and the void content do not change. Further it is assumed that the same fibres matrix and sizing are used. If any of these items are changed in addition, they have to be accounted for by the methods described in the previous sections. If the laminate has a complicated lay-up, but a more simplified lay-up had to be used to obtain ply data, data are valid.
- 1203** Compressive strength of UD laminates should be measured on UD laminates and not cross-ply laminates. Other properties can be treated as equivalent whether measured on UD or cross-ply laminates.

**1204** The following normalised relations may be used to conservatively estimate the influence of reinforcements on ply properties. Properties should only be reduced, but never increased relative to measured values, unless experimental evidence can be provided.

	UD pre-preg	Knitted fabric	Twill	Woven Roving	Filament wound	Short fibre
Fibre dominated tensile strength	1	0.8	0.7	0.6	0.6	0.4
Fibre dominated compress. Strength	1	0.8	0.8	0.8	0.7	0.4
Matrix dominated strength (tensile and compressive)	0.9	1	1	1	1	0.5
Fibre dominated Modulus of elasticity	1	0.9	0.9	0.8	0.8	0.6
Matrix dominated Modulus of elasticity	0.9	1	1	1	1	0.5

*Table 12: Comparing results from different processes and lay-ups*

**1205** The strains to failure can be calculated from the table in 1204 by the simple relationship  $e = s / E$ .

**1206** It is recommended to use direct measurements of the laminates made with the actual production process instead of using the procedures in 1204 and 1205.

**1207** Different production methods may influence the characteristics of the laminate, due to for instance variations in fibre volume fraction, void content, and curing temperature. These aspects shall be considered as described in *Section F*.

## I. Properties with damaged or nonlinearly deformed matrix

### I 100 Introduction

- 101** In most applications the matrix will crack or deform nonlinearly before the laminate fails. Describing this nonlinear behaviour of the laminate properly requires a change of the matrix dominated ply properties to reflect the matrix damage in the laminate.
- 102** For some analysis methods (see Section 9) the nonlinear properties should be known.

### I 200 Default values

- 201** Setting the matrix dominated Young's moduli of a damaged matrix to 0 is usually a conservative estimate. This approach is described here as a default. A better method that requires some testing is described in *I300*.
- 102** If matrix failure occurs in a ply (according to the failure criteria in *Section 6D*), the ply properties should be locally degraded to the values given in the table below.

Default changes of ply properties with matrix damage	
Matrix cracking due to stress (see failure criteria in Section 6D)	Change ply properties to (see also 203)
stress $\sigma_2$ transverse to the fibre direction	$E_2 = \nu_{12} = 0$
shear stress $\sigma_{12}$	$G_{12} = \nu_{12} = 0$
stress $\sigma_3$ transverse to the fibre direction	$E_3 = \nu_{31} = 0$
shear stress $\sigma_{13}$	$G_{13} = \nu_{13} = 0$
shear stress $\sigma_{23}$	$G_{23} = \nu_{23} = 0$

- 203** In numerical calculations certain problems may arise, e.g. lack of invertibility of the structural stiffness matrix, when degraded material properties are set equal to 0. To overcome such problems, one may apply small values, e.g. 1% of the non-degraded values, instead of 0.

#### Guidance note:

Stiffness of a composite in compression will be similar to the linear (initial) value even under the presence of damage, since matrix cracks will close. In tension, the stiffness reduces gradually with the increase of damage.

---e-n-d---o-f---G-u-i-d-a-n-c-e---n-o-t-e---

### I 300 Experimental approach

- 301** Instead of the default values given in *I200*, gradual degradation of the material properties at ply levels can be used, provided experiments document the validity of values larger than 0 for the type of laminate used.
- 302** The change of  $E_2$  due to matrix cracking or nonlinear deformation of the matrix may be determined from tests on 0/90 laminates. The Young's modulus of the laminate can be calculated with laminate theory from the ply properties. The initial modulus of the test  $E_{0+90}$  should be consistent with the calculated modulus based on undamaged ply properties. The secant modulus at failure of the test  $E_{0 + \text{partially damaged } 90}$  should be consistent with the calculated modulus based on an unchanged ply modulus in fibre direction and a modified modulus  $E_2^*$  representing the matrix with cracks. An example of experimental data is given in the Figure 4-4 below.

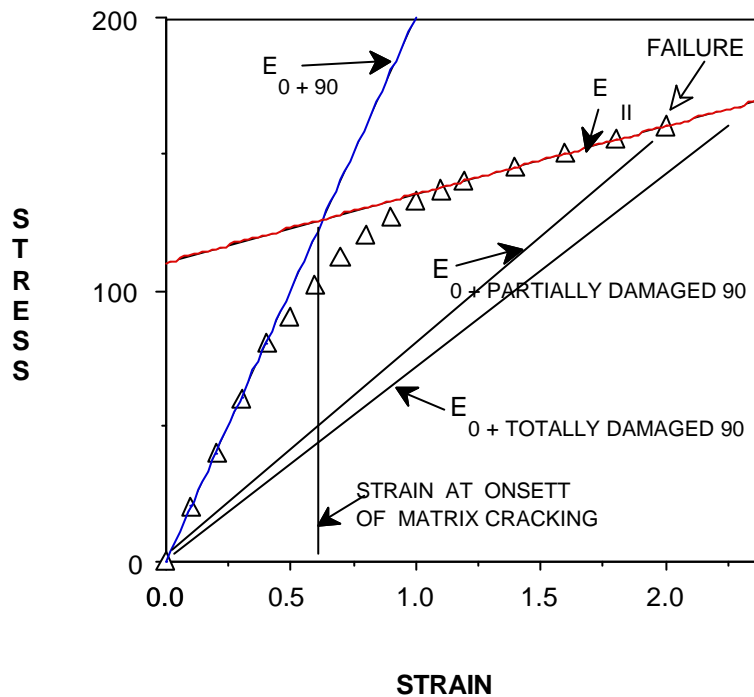

**Figure 4-4: Example of axial stress vs. strain curve of a 0/90 laminate to obtain magnitude of the matrix ply modulus of a laminate with matrix cracks.**

- 303** The change of  $G_{12}$  is usually due to a combination of nonlinear behaviour at low strains and matrix cracking at higher strains. The change may be determined from axial tests on  $\pm 45$  laminates. The shear modulus of the laminate can be calculated with laminate theory from the ply properties. The initial modulus of the test  $G_{12}$  should be consistent with the calculated modulus based on undamaged ply properties (*see B600*). The secant modulus at failure of the test  $G_{12 \text{ at failure}}$  should be consistent with the calculated modulus based on an unchanged ply modulus in fibre direction and a modified modulus  $G_{12}^*$  representing nonlinearities and the matrix with cracks. Instead of determining  $G_{12}^*$  at failure it may be taken at 90% of the failure load. An

example of experimental data is given in the Figure 4-5 below.

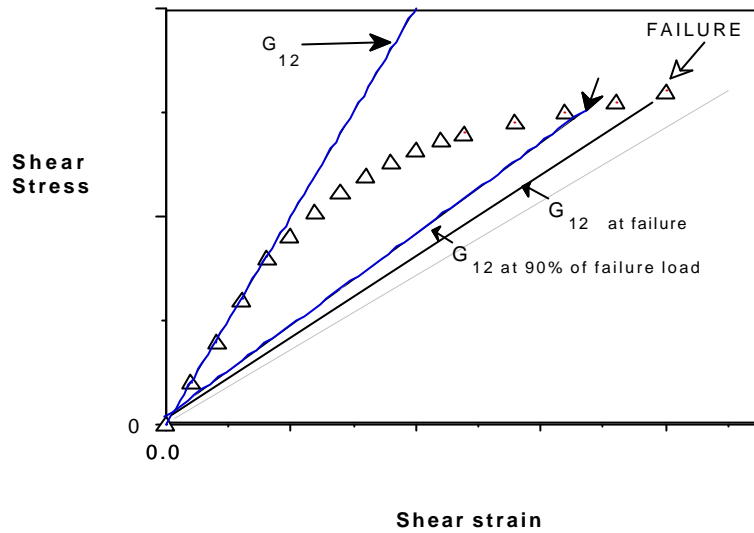

**Figure 4-5: Example of axial stress vs. strain curve of a  $\pm 45$  laminate to obtain magnitude of the matrix shear modulus of a laminate with matrix cracks.**

- 304** Similar procedures may be used on other laminate configurations to obtain ply properties of laminates with matrix cracks or with a nonlinear deformed matrix.



## **SECTION 4: APPENDIX A: Lay-up and laminate specification.**

### **SECTION 4: APPENDIX A: LAY-UP AND LAMINATE SPECIFICATION. 1**

#### **A. UNIQUE DEFINITION OF A LAMINATE 1**

##### **A. Unique definition of a laminate**

- 101** It is important to characterise a laminate in an unambiguous way. All constituent materials have to be identified.
- 102** A composite laminate is generally made of a number of layers stacked on top of each other. These layers can consist of complicated or simple fiber arrangements. The layers are the units that are physically stacked in the production process.
- 103** The basic building block of a laminate is the ply (lamina). The ply is an orthotropic material and its properties are needed for laminate analysis.
- 104** If reinforcement fabrics are not the same (e.g. a multiaxial fabric), both should be identified in a laminate.

**Guidance Note:**

A triaxial fabric is typically specified as one fabric layer in production. The orientation of the fabric in the laminate is given with respect to the long axis of the fabric role. However, for laminate calculations the triaxial fabric shall be described as three orthotropic unidirectional plies.

- 105** The axis of the ply co-ordinate system of each ply shall to be clearly identified.
- 106** The type of the reinforcement and the weight per area in each ply shall be given.
- 107** The stacking sequence of the laminate shall be clearly described. Each ply shall be identified and its orientation in the laminate shall be described. Usually a laminate co-ordinate system  $x,y,z$  is chosen. The  $z$ -axis is the through the thickness direction. The orientation of the main reinforcement direction of the plies (1-direction) is given relative to the  $x$ -direction of the laminate.

A complete description of a laminate is given here as an example:

Fabric Type, Orientation and Number			Ply #	Reinforcement *	Weight	Thick. (mm)	Orientat.	Resin
Gelcoat	-	0	0	none	-	0.2	-	Vinylester
CSM	0	1	1	CSM	400 g/m <sup>2</sup>	0.4	isotropic	Vinylester
WR	90	2	2	WR 50%/50%	800 g/m <sup>2</sup>	0.8	0	Vinylester
CSM	0	3	3	CSM	400 g/m <sup>2</sup>	0.4	isotropic	Vinylester
CSM	0	4	4	CSM	400 g/m <sup>2</sup>	0.4	isotropic	Polyester
800/100	90	5	5	CSM	100 g/m <sup>2</sup>	0.1	isotropic	Polyester
Combimat			6	WR 50%/50%	800 g/m <sup>2</sup>	0.8	0	Polyester
800/100	90	6	7	CSM	100 g/m <sup>2</sup>	0.1	isotropic	Polyester
Combimat			8	WR 50%/50%	800 g/m <sup>2</sup>	0.8	90	Polyester
CSM	0	7	9	CSM	400 g/m <sup>2</sup>	0.4	isotropic	Polyester
90,+45 multiax	90	8	10	SF	400 g/m <sup>2</sup>	0.4	0	Polyester
800 g			11	SF	200 g/m <sup>2</sup>	0.2	+45	Polyester
			12	SF	200 g/m <sup>2</sup>	0.2	-45	Polyester
90,+45 multiax	0	9	13	SF	400 g/m <sup>2</sup>	0.4	90	Polyester
800 g			14	SF	200 g/m <sup>2</sup>	0.2	+45	Polyester
			15	SF	200 g/m <sup>2</sup>	0.2	-45	Polyester
multiax hybrid	90	10	16	CSM	100 g/m <sup>2</sup>	0.1	isotropic	Polyester
combi			17	SF 50% Aramid 50% Glass	300 g/m <sup>2</sup>	0.3	+45	Polyester
			18	SF 50% Aramid 50% Glass	300 g/m <sup>2</sup>	0.3	-45	Polyester
multiax hybrid	90	11	19	CSM	100 g/m <sup>2</sup>	0.1	isotropic	Polyester
combi			20	SF	300 g/m <sup>2</sup>	0.3	+45	Polyester
			21	SF Aramid	400 g/m <sup>2</sup>	0.4	0	Polyester
			22	SF	300 g/m <sup>2</sup>	0.3	-45	Polyester
Twill	90	12	23	WR 70% weft 30% warp	450 g/m <sup>2</sup>	0.45	0	Polyester
Twill	0	13	24	WR 70% weft 30% warp	450 g/m <sup>2</sup>	0.45	90	Polyester
Surface Ply	0	14	25	WR 50/50 Polyester	450 g/m <sup>2</sup>	0.45	0/90	Polyester

\* if no material is mentioned it is glass, % are given in weight fraction of reinforcement.

WR: Woven Roving,

CSM: Chopped Strand Mat, SF: Straight Fibres

Table 1: Descriptions of laminates

**108** The thickness of each ply has to be estimated. This can be done by the following formula (for non-hybrid reinforcements).

$$t = \frac{M}{\rho_f V_f}$$

**109** where  $V_f$  is the fiber volume fraction and  $\rho_f$  is the density of the fiber.  $M$  is the mass per area of the fibers.

## SECTION 4: APPENDIX B

### Test Methods for Laminates

#### **SECTION 4: APPENDIX B..... 1**

#### **TEST METHODS FOR LAMINATES..... 1**

<b>A.</b>	<b>GENERAL.....</b>	<b>2</b>
A 100	INTRODUCTION.....	2
A 200	GENERAL TESTING INFORMATION.....	2
<b>B.</b>	<b>STATIC TESTS FOR LAMINATES .....</b>	<b>3</b>
B 100	INPLANE TENSILE TESTS.....	3
B 200	INPLANE COMPRESSION TESTS.....	4
B 300	INPLANE SHEAR TESTS.....	4
B 400	THROUGH THICKNESS TENSILE TESTS.....	4
B 500	THROUGH THICKNESS COMPRESSIVE TESTS.....	5
B 600	INTERLAMINAR SHEAR TESTS (THROUGH THICKNESS).....	5
B 700	INPLANE FRACTURE TOUGHNESS TESTS.....	5
B 800	INTERLAMINAR FRACTURE TOUGHNESS TESTS.....	5
<b>C.</b>	<b>TESTS TO OBTAIN PROPERTIES UNDER LONG TERM STATIC AND CYCLIC LOADS .....</b>	<b>7</b>
<b>D.</b>	<b>TESTS TO OBTAIN THE FIBRE FRACTION .....</b>	<b>7</b>
<b>E.</b>	<b>TESTS ON TUBULAR SPECIMENS .....</b>	<b>7</b>
<b>F.</b>	<b>EVALUATION OF STRESS VS. STRAIN CURVES .....</b>	<b>8</b>
F 100	BRITTLE CHARACTERISTICS.....	8
F 200	PLASTIC CHARACTERISTICS.....	9
F 300	DUCTILE CHARACTERISTICS.....	10

## A. General

### A 100 Introduction

- 101** This appendix describes recommended and preferred test methods for laminates. Other test methods than the ones described here may be used if they measure the same physical properties under the same conditions.
- 102** If no standard tests exist and no test methods are suggested, tests shall be chosen that measure the desired properties with no or small side effects from specimen size and geometry. It shall be ensured that the test results are correct or conservative with respect to the way they are used in the design.
- 103** The complete list of mechanical static properties of orthotropic plies needed for structural analysis in this guideline is shown in Section 4 - B Static Properties.
- 104** The properties of the guideline are based on ply properties. These can be measured most directly from laminates made of unidirectional plies all oriented in the same direction.
- 105** Ply properties may also be obtained from measurements on laminates, if it is possible to back calculate the orthotropic ply properties from the test results of the laminates. Some examples are given in Section D of this Appendix.
- 106** The evaluation of stress vs. strain curves is described *Section F of this Appendix* for brittle, plastic and ductile materials.
- 107** Guidelines for the testing of sandwich are presented in *Section 5 Appendix A*.
- 108** It is generally recommended to obtain data from laminates that represent the actual product and processing methods as closely as possible.
- 109** Health and safety shall be considered when performing tests. This guideline does not address these aspects and reference to applicable health and safety regulations shall be made.

### A 200 General testing information

- 201** For anisotropic material, mechanical properties should be determined relative to the relevant direction of anisotropy.
- 202** Tests should be carried at a loading rates corresponding to about 1% per minute, unless specified differently in the Guideline.
- 203** For the preparation of test samples, curing conditions, surface treatment and application procedure shall be according to the specifications as described in Section 4 A.
- 204** Measuring the thickness can be difficult for some materials, like laminates made of a coarse woven structure. Micrometers shall be used for thickness measurements and callipers shall not be used. Modulus measurements shall be based on an average thickness. Strength measurements shall be based on the maximum thickness or the thickness at the failure point.

- 205** Strains shall be measured directly on the specimen with an extensometer or strain gauges. Extensionmeters tend to give better results. Strain gauges shall be long enough to be not influenced by the weave characteristics of the reinforcement.

## **B. Static tests for laminates**

### **B 100 Inplane tensile tests**

- 101** Tensile tests can be performed on straight specimens with or without tabs or on specimens with reduced cross-sections in the middle (dogbone or dumbbell tests).
- 102** The recommended test procedure for straight specimens is ISO 527 or ASTM D3039. Some preliminary testing may be needed to find the best tab arrangements and gripping fixtures.
- 103** The recommended test procedure for dogbone shape specimens is ISO 527 or ASTM D638M. The curvature of the shoulder specified by the standards is often too sharp to obtain good results. It is recommended to use specimens with smaller curvatures or straight specimens (see *102*).

\*\*\*\*\* Guidance note \*\*\*\*\*

The Young's modulus can be measured well with all test arrangements. Measuring strength and strain to failure can be more complicated, because stress concentrations at the grips or shoulder may cause premature failure. However, choosing a non-optimized test method gives conservative results for static tests.

\*\*\*\*\*

## **B 200 Inplane compression tests**

- 201** Compressive tests can be performed on straight specimens with or without tabs or on specimens with reduced cross-sections in the middle (dogbone or dumbbell tests). An anti-buckling device should be used in most cases.
- 202** The recommended test procedure is ASTM D3410 using the Celanese test fixture.
- 203** It should be ensured that test specimens do not buckle in the test fixture.

### Guidance note

One way to ensure that a specimen does not buckle is to place at least one strain gauge or extensometer at each side to ensure that the specimen does not buckle. Strain readings should not deviate by more than 10%.

End of guidance note

## **B 300 Inplane shear tests**

- 301** Inplane shear tests tend to show nonlinear stress vs. strain curves and the interpretation of the results is often difficult.
- 302** Recommended test procedures are the 2-rail shear test ASTM D4255 or a tensile or compressive test on a laminate with  $(\pm 45)_s$  reinforcement.
- 103** Test results from axial tests on  $(\pm 45)_s$  laminates must be converted into ply properties using laminate theory. The following formulas shall be used to convert measurements of laminate stress in load direction  $\sigma_x$ , laminate strain in load direction  $\epsilon_x$  and laminate strain perpendicular to the load direction  $\epsilon_y$  into ply shear stress  $\tau_{12}$  and strain  $\gamma_{12}$ :
- $$\tau_{12} = \sigma_x / 2 \quad \text{and} \quad \gamma_{12} = -(\epsilon_x - \epsilon_y)$$
- 304** The nonlinear stress vs. strain curve looks usually like a ductile curve, see C300. The results shall be analysed accordingly.

## **B 400 Through thickness tensile tests**

- 101** Test can be performed on straight, cylindrical or dogbone specimens.
- 402** To increase the length of the specimens, sections of laminates may be glued together. However, care shall be taken that in such case the adhesive properties do not influence the results. If the adhesive fails, the test values may be used as a conservative estimate of the laminate properties.
- 403** A widely used test is ASTM C297.

### **B 500 Through thickness compressive tests**

- 501** Test are usually performed on straight or cylindrical specimens. ASTM D1621 could be used for these tests.
- 502** An anti-buckling device is usually not required, provided the specimen is not too slender.
- 503** Specimens should not be too short. Short specimens may show wrong stress distributions if the cross-sectional surfaces are not totally parallel. In addition, the surfaces touching the test fixture cannot widen due to friction like the rest of the specimen. Due to this effect a too high modulus can be measured if the specimen is too short.
- 504** To increase the length of the specimens, sections of laminates may be glued together.

### **B 600 Interlaminar shear tests (through thickness)**

- 601** The recommended test method is the interlaminar shear test (ILSS) according to ISO 4585 or ASTM D2344.
- 602** The ILSS test is not a pure shear test and the results are, therefore, not ideal for use in design. Other tests may be used if better results can be obtained with them.

### **B 700 Inplane fracture toughness tests**

- 701** Inplane fracture toughness of laminates can be described by the point stress criterion, see Section 6 C600.
- 702** The point stress criterion needs a critical distance that is a material parameter. The critical distance can be measured on specimens with different crack length or hole sizes. At least three different crack or hole sizes should be measured.
- 703** The critical distance for cracked specimens may differ from the critical distance for specimens with holes. The two tests should not be mixed.
- 704** It is recommended to prepare specimens with cracks or holes that resemble closely the real application.
- 705** The specimen width should be wider than the defect size, to avoid measuring edge effects.
- 706** No standard tests are known for measuring fracture toughness.

### **B 800 Interlaminar fracture toughness tests**

- 801** The Double Cantilever Beam (DCB) test is recommended to obtain the Mode I fracture

toughness  $G_{IC}$ .

- 802** The End Notch Flexure (ENF) test is recommended to obtain the Mode I fracture toughness  $G_{IIC}$ .
- 803** No standards are developed for these tests.
- 804** Both specimens use a starter crack to initiate crack growth.
- 805** The starter crack should be introduced by placing a thin film between the two plies that shall delaminate. The film should not adhere to the matrix.
- 806** It is best to grow a natural starter crack from the film by applying a few low amplitude fatigue cycles. Static testing can then be performed based on the crack length of the artificial crack and the naturally grown crack.
- 807** If tests are performed based on the artificial crack only, the film should be very thin, less than 13  $\mu\text{m}$ .



## C. Tests to obtain properties under long term static and cyclic loads

- 101 The same tests as for measuring static properties can be used.
- 102 Loads and test environments shall be carefully controlled over the entire test period.
- 103 The strain rate should be kept constant for cyclic fatigue tests of viscoelastic materials. This means the test frequency can be increased for lower strain (test) amplitudes.
- 104 The temperature of the specimens should be monitored to avoid heating of the specimen due to testing at too high frequencies.

## D. Tests to obtain the fibre fraction

- 101 The fiber volume fraction should be obtained using one of the following standards:
  - ASTM D3171 and ASTM D3553 Fiber volume fraction, digestion method

**Guidance note:**

This method is used to find the fiber volume fraction by digestion of the matrix. The choice of chemical to digest the matrix depends on the matrix and fibers. Suggestions for chemicals are given in the standards. The composite weight is determined before and after the digestion of the matrix. The fiber volume fraction can be calculated from those measurements. Calculations are based on the density of the fibers. However, this density can vary, especially for carbon fibers. In this case only approximate values can be obtained.

---e-n-d--- o-f---G-u-i-d-a-n-c-e---n-o-t-e---

- ASTM D3171 Fiber volume fraction, burnoff method
- ISO 1172

**Guidance note:**

This method is similar to the digestion method, except that the matrix is removed by the burning. This method works well for glass fiber reinforced composites. In calculating the volume fraction it is important to distinguish between fiber volume fraction and fiber weight fraction.

---e-n-d--- o-f---G-u-i-d-a-n-c-e---n-o-t-e---

## E. Tests on Tubular Specimens

- 101 For tubular components it is often preferable to test the laminate properties also on tubular specimens.
- 102 Recommended test methods are ASTM D 5448, ASTM D 5449 and ASTM D 5450.

## F. Evaluation of Stress vs. Strain Curves

### F 100 Brittle characteristics

- 101 A typical schematic of a stress-strain curve for a brittle material is shown in Figure 1. Elastic parameters are represented in the Figure: elastic modulus for the linear range ( $E$  or  $G$  for shear), strength and strain at failure point ( $\sigma_{ult}$  and  $\epsilon_{ult}$ ). Note that the linear limit ( $\sigma_{lin}$  and  $\epsilon_{lin}$ ) is here the same as the point of failure.

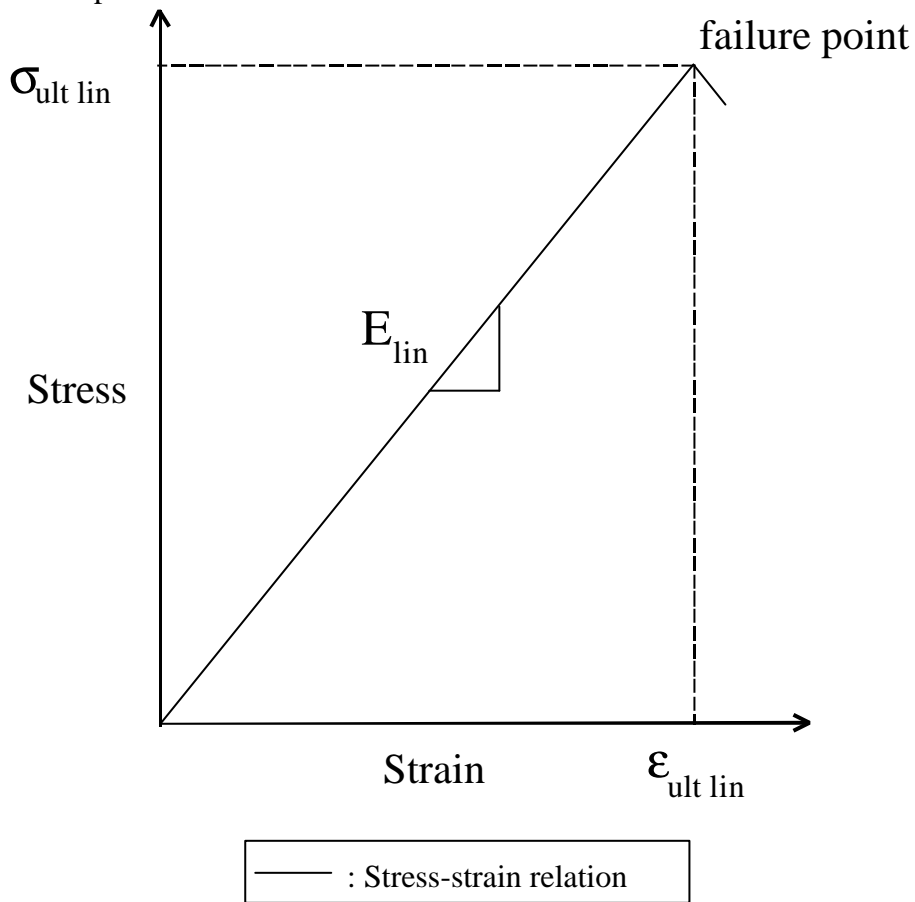

Figure 1: Properties to be measured on a linear stress-strain curve for a brittle core materials.

- 102 Calculation of modulus of elasticity:

$$E_i = \frac{s_i}{e_i}$$

where  $i$  represents the index for the linear limit or ultimate value, etc.

## F 200 Plastic characteristics

201 A typical schematic of a stress-strain curve for a plastic material is shown in Figure 2. Elastic parameters are represented in the Figure: elastic modulus for the linear range and non-linear range ( $E$  or  $G$  for shear), strength and strain at failure point ( $\sigma_{ult}$  and  $\epsilon_{ult}$ ), strength and strain at yield point ( $\sigma_{yield}$  and  $\epsilon_{yield}$ ).

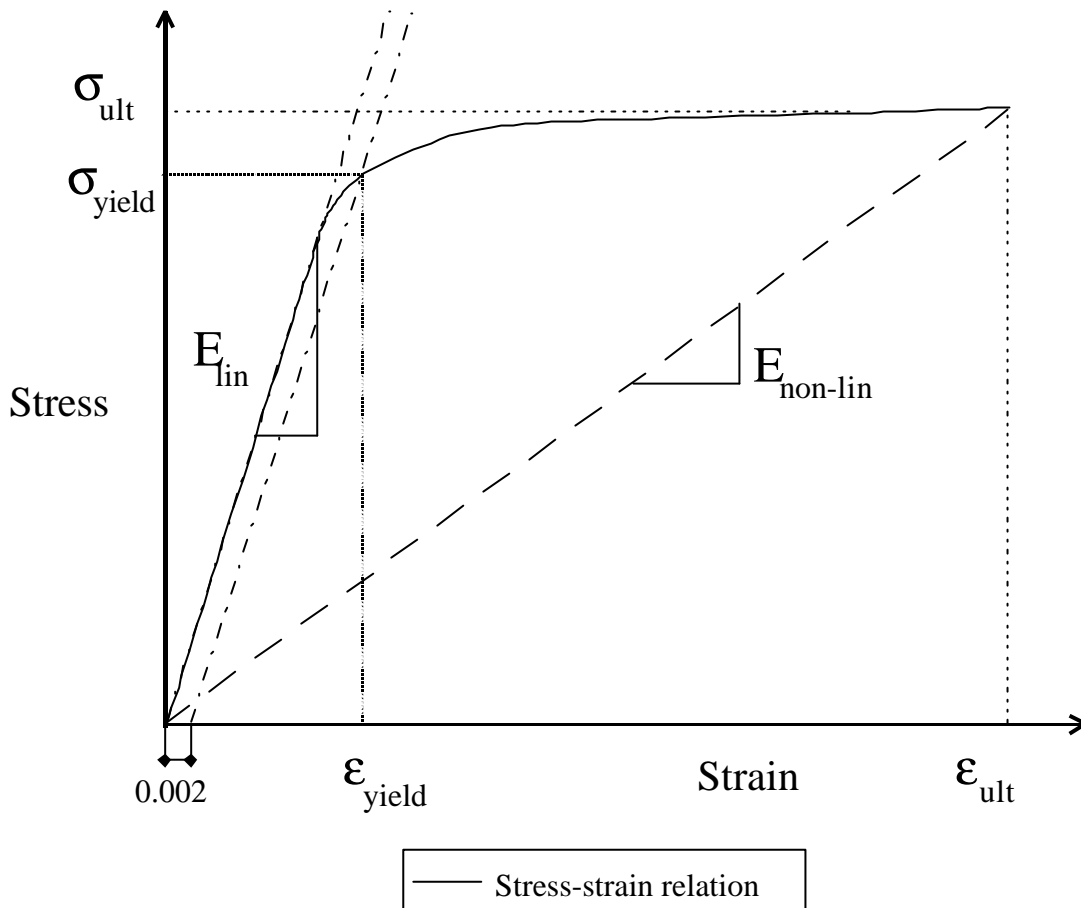

Figure 2: Properties to be measured on a non-linear stress-strain curve for a plastic core materials

202 The offset strain to determine the yield point is defined here as 0.2% strain.

203 Its recommended to calculate the modulus according to ISO 527 as the slope of the curve between 0.05% and 0.25% strain.

**F 300 Ductile Characteristics**

**301** A typical schematic of a stress-strain curve for a ductile material is shown in Figure 3. Elastic parameters are represented in the Figure: elastic modulus for the linear range and non-linear range ( $E$  or  $G$  for shear), strength and strain at failure point ( $\sigma_{ult}$  and  $\epsilon_{ult}$ ), strength and strain at yield point ( $\sigma_{yield}$  and  $\epsilon_{yield}$ ).

-----Guidance note-----

Here the yield point is defined as the intersection between the stress-strain curve and the 0.2% offset of the linear relation.

-----End-----

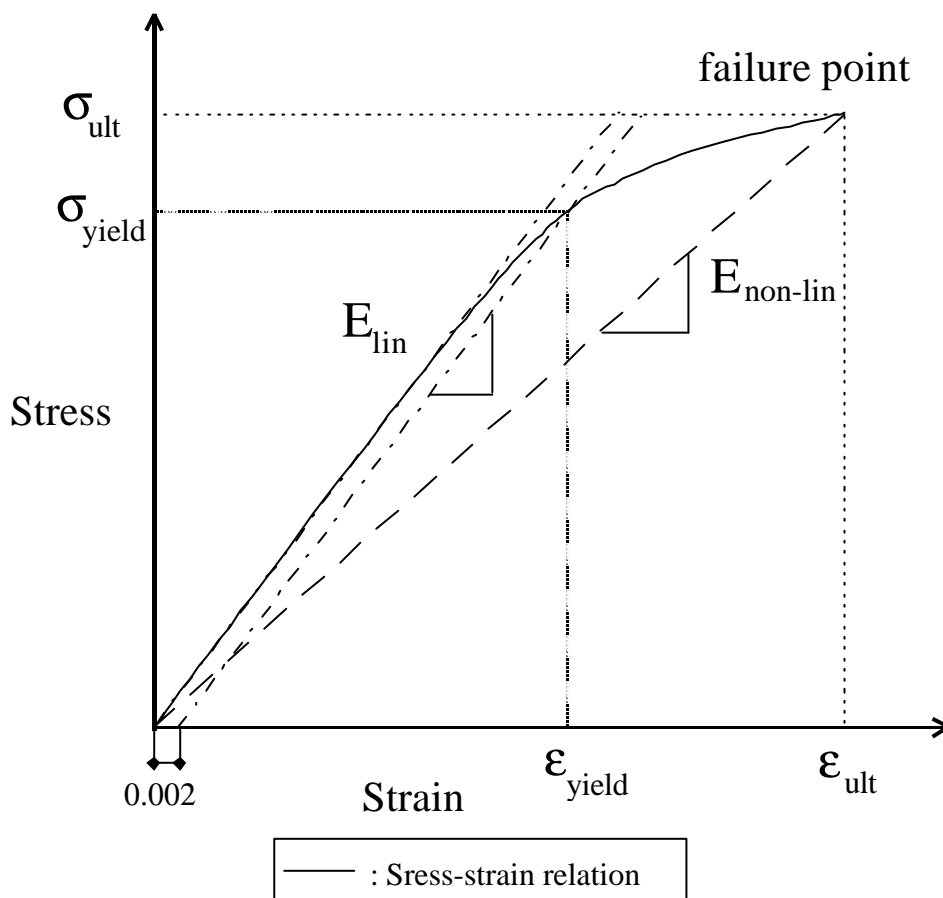

Figure 3: Properties to be measured on a non-linear stress-strain curve for a ductile core materials.

**302** For the calculation of modulus of elasticity, see C102. The linear limit is defined here to be the same as the yield point.

## SECTION 4: APPENDIX C

### Example for Representative Data:

#### Stitch-bonded Unidirectional Plies - E glass polyester

<b>SECTION 4: APPENDIX C</b> .....	<b>1</b>
------------------------------------	----------

<b>EXAMPLE FOR REPRESENTATIVE DATA:</b> .....	<b>1</b>
---	----------

<b>STITCH-BONDED UNIDIRECTIONAL PLIES - E GLASS POLYESTER</b> .....	<b>1</b>
---	----------

<b>A. GENERAL</b> .....	<b>2</b>
<b>B. DEFINITION OF MATERIAL</b> .....	<b>3</b>
<b>C. QUASI STATIC PROPERTIES IN AIR (QSA)</b> .....	<b>4</b>
C 100 TEST ENVIRONMENT .....	4
C 200 FIBRE DOMINATED PLY PROPERTIES .....	4
C 300 MATRIX DOMINATED PLY PROPERTIES .....	5
C 400 THROUGH THICKNESS PLY PROPERTIES .....	6
<b>D. LONG TERM PROPERTIES IN AIR</b> .....	<b>7</b>
D 100 TEST ENVIRONMENT .....	7
D 200 FIBRE DOMINATED TENSILE PROPERTIES .....	7
D 300 FIBRE DOMINATED COMPRESSIVE PROPERTIES .....	10
D 400 MATRIX DOMINATED INPLANE TENSILE PROPERTIES .....	13
D 500 MATRIX DOMINATED INPLANE COMPRESSIVE PROPERTIES.....	13
D 600 MATRIX DOMINATED INPLANE SHEAR PROPERTIES .....	13
D 700 MATRIX DOMINATED THROUGH THICKNESS TENSILE PROPERTIES.....	13
D 800 MATRIX DOMINATED THROUGH THICKNESS COMPRESSIVE PROPERTIES .....	13
D 900 MATRIX DOMINATED THROUGH THICKNESS SHEAR PROPERTIES .....	13
<b>E. LONG TERM PROPERTIES IN WATER</b> .....	<b>14</b>
E 100 TEST ENVIRONMENT .....	14
E 200 FIBRE DOMINATED TENSILE PROPERTIES .....	14
E 300 FIBRE DOMINATED COMPRESSIVE PROPERTIES.....	14
E 400 MATRIX DOMINATED INPLANE TENSILE PROPERTIES .....	14
E 500 MATRIX DOMINATED INPLANE COMPRESSIVE PROPERTIES.....	15
E 600 MATRIX DOMINATED INPLANE SHEAR PROPERTIES.....	15
E 700 MATRIX DOMINATED THROUGH THICKNESS TENSILE PROPERTIES.....	15
E 800 MATRIX DOMINATED THROUGH THICKNESS COMPRESSIVE PROPERTIES .....	15
E 900 MATRIX DOMINATED THROUGH THICKNESS SHEAR PROPERTIES .....	15

## A. General

- 101** This appendix describes an example of a fairly complete set of data for a glass reinforced polyester laminate.
- 102** Many glass reinforced materials will be similar to this example and can be qualified according to *Section 4 H 600* - Qualification against representative data. The fibre dominated properties should be applicable to most E-glass reinforced laminates, matrix dominated properties may change considerably when changing the resin system.
- 103** The fibre dominated fatigue properties in D200 can be used for all E-glass laminates as long as some fibres are oriented in the load direction.
- 104** Representative data for other materials can be measured and used like this example, as long as the requirements given in Section 4 H 500 and 600 are fulfilled.
- 105** There is a lack of data for matrix dominated properties and of properties in water. Properties in other fluids are not listed, since only few and specific data exist. If such properties are needed some qualification testing may be required.

## B. Definition of material

The material is described according to *Section 4 H 502*.

<b>Constituent materials:</b>	<b>Requirements to group measurements from different laminates</b>
Generic Fibre type	E-Glass
Bundle type	-
Fibre trade name	-
Type of weave	Stitch bonded straight parallel fibres
Type of sizing	Polyester compatible
Fibre Manufacturer	all
Weaver	all
Fabric trade name and batch number	all
Generic resin type (e.g. epoxy, polyester)	Polyester
Specific resin type (trade name, batch number)	general
Catalyst (trade name and batch number)	general
Accelerator (trade name and batch number)	general
Fillers (trade name and batch number)	none
Additives (trade name and batch number)	none
<b>Process parameters:</b>	
Laminator (company)	not relevant
Processing method	hand layup
Processing temperature	Room temperature (about 20°C)
Processing pressure	none
Process atmosphere (e.g. vacuum)	Atmospheric pressure
Post curing (temperature and time)	none
Control of fibre orientation	$\pm 2^\circ$
Fibre volume fraction	35%
Void content	Less than 2%
<b>Conditioning parameters:</b>	
See sections for properties:	

## C. Quasi Static Properties in Air (QSA)

### C 100 Test environment

101 The test environment is described according to *Section 4 H 502*.

<b>Conditioning parameters:</b>	
Temperature	18 °C
Water content of the laminate (wet, dry)	dry
Chemical environment	air
Loading rate	about 1% per minute
<i>number of specimens</i>	Reported individually for all properties

102 The following properties are listed according to *Section 4 B 200*. Characteristic values are calculated according to *Section 4 B 400*.

103 Most data are based on 30 measurements, some are based on more.

### C 200 Fibre dominated ply Properties

	Parameter		Value	Unit	Explanation
Fibre dominated properties	$E_{1(UD\ ply)}$	Mean	26.7	[GPa]	Modulus of elasticity in main fibre direction
		COV	5 %		
		Charact.value	as mean		
	$\hat{e}_{1t}$	Mean	0.023	Strain	Tensioning strain at break in the main fibre direction
		COV	5 %		
		Charact.value	0.020		
	$\hat{e}_{1c}$	Mean	0.016	Strain	Compressive strain at break in the main fibre direction
		COV	5 %		
		Charact.value	0.014		
	$\hat{s}_{1t}$	Mean	614	N/mm <sup>2</sup> (MPa)	Tension stress at break in the main fibre direction
		COV	5%		
		Charact.value	534		
	$\hat{s}_{1c}$	Mean	427	N/mm <sup>2</sup> (MPa)	Compressive stress at break in the main fibre direction
		COV	5%		
		Charact.value	373		



**C 300 Matrix dominated ply Properties**

	Parameter		Value	Unit	Explanation
Matrix dominated properties	$E_{2(UD\ ply)}$	Mean	8.4	[GPa]	Modulus of elasticity transverse to main fibre direction
		COV	10 %		
		Charact.value	as mean		
	$\hat{e}_{2t}$	Mean	0.0043	Strain	Tensile strain at break for the matrix in direction normal to the fibre direction, in the fibre plane. (this value is lower for pure UD laminates)
		COV	10 %		
		Charact.value	0.0031		
	$\hat{e}_{2c}$	Mean	0.0065	Strain	Compressive strain at break for the matrix in direction normal to the fibres when tension is applied to the fibres.
		COV	15 %		
		Charact.value	0.0041		
	$\hat{s}_{2t}$	Mean	36.0	N/mm <sup>2</sup> (MPa)	Tension stress at break normal to the fibre direction.
		COV	10 %		
		Charact.value	26.3		
	$\hat{s}_{2c}$	Mean	55.0	N/mm <sup>2</sup> (MPa)	Compressive stress at break normal to the fibre direction.
		COV	15 %		
		Charact.value	34.0		
	$\hat{e}_{12}$	Mean	0.0066 (0.023)	Strain	Shear strain in ply plane at linear limit and at (failure).
COV		10 %			
Charact.value		0.0049 (0.017)			
$\hat{s}_{12}$	Mean	23.0 (40)	N/mm <sup>2</sup> (MPa)	Shear stress in ply plane at linear limit and at (failure).	
	COV	10 %			
	Charact.value	17.0 (29)			
$G_{12\ linear}$	Mean	3.5	[GPa]	Shear modulus in the ply plane in the liner range	
	COV	10 %			
	Charact.value	as mean			
$G_{12\ non-linear}$	Mean	1.7	[GPa]	Shear modulus in the ply plane at the failure point	
	COV	10 %			
	Charact.value	as mean			
$\nu_{12}$	Mean	0.29		Ply major Poisson's ratio	
	COV	10 %			
	Charact.value	as mean			

**C 400 Through thickness ply Properties**

	Parameter		Value	Unit	Explanation
Through thickness Properties	E3	Mean	9.6	GPa	Modulus of elasticity normal to the fibre plane.
		COV	15 %		
		Charact.value	as mean		
	G13	Mean	2.8	GPa	Shear modulus normal to the fibre plane, including the fibre direction
		COV	15 %		
		Charact.value	as mean		
	G23	Mean	2.8	GPa	Shear modulus normal to the fibre plane, including the direction normal to the fibres.
		COV	15 %		
		Charact.value	as mean		
	v13	Mean	0.29		Poisson's ratio normal to the fibre plane, including the fibre direction, when tensioning in the fibre direction.
		COV	10 %		
		Charact.value	as mean		
	v23	Mean	0.29		Poisson's ratio normal to the fibre plane, including the direction normal to the fibres, when tensioning in the fibre plane normal to the fibres.
		COV	10 %		
		Charact.value	as mean		
	$\hat{e}_{3t}$	Mean	0.0014	Strain	Tensioning strain at break normal to the fibre plane
		COV	15 %		
		Charact.value	0.0009		
	$\hat{e}_{3c}$	Mean	0.0063	Strain	Compression strain at break normal to the fibre plane
		COV	15 %		
		Charact.value	0.0039		
$\hat{e}_{13}$	Mean	0.0050	Strain	Shear strain at failure normal to the fibre plane, including the fibre direction.	
	COV	15 %			
	Charact.value	0.0031			
$\hat{e}_{23}$	Mean	0.050	Strain	Shear strain at failure normal to the fibre plane, normal to the fibre direction	
	COV	15 %			
	Charact.value	0.0031			
$\hat{s}_{3t}$	Mean	13.0	N/mm <sup>2</sup> (MPa)	Tension stress at break normal to the fibre plane.	
	COV	15 %			
	Charact.value	8.0			
$\hat{s}_{3c}$	Mean	61.0	N/mm <sup>2</sup> (MPa)	Compression stress at break normal to the fibre plane.	
	COV	15 %			
	Charact.value	38.0			
$\hat{s}_{13}$	Mean	14.0	N/mm <sup>2</sup> (MPa)	Shear stress at failure normal to the fibre plane, including the fibre direction	
	COV	15 %			
	Charact.value	9.0			
$\hat{s}_{23}$	Mean	14.0	N/mm <sup>2</sup> (MPa)	Shear stress at failure normal to the fibre plane, normal to the fibre direction.	
	COV	15 %			
	Charact.value	9.0			

## D. Long Term Properties in Air

### D 100 Test environment

The test environment is described according to *Section 4 H 502*.

<b>Conditioning parameters:</b>	
Temperature	18 °C
Water content of the laminate (wet, dry)	dry
Chemical environment	air
Loading rate	about 1% per minute
<i>number of specimens</i>	Reported individually for all properties

### D 200 Fibre dominated tensile properties

**201** Youngs Modulus of ply in main fibre direction:

	long term Load			Formula
Elt	no load		mean	same as QSA
			COV, n	same as QSA
			charact.	same as QSA
E <sub>1</sub> fibre	perm. load		mean	Elastic modulus same as QSA Plastic strain: $e_p = \frac{s}{1520} t^{0.2}$ Time in hours, strain in %. Plastic modulus $E_p = \frac{s}{e_p}$
			St.Dev.	
			charact.	
	cyclic load R=0		mean	95% of QSA shortly before failure
			St.Dev.	same as QSA
			charact.	95% of QSA shortly before failure
	cyclic load R=0.1		mean	95% of QSA shortly before failure
			St.Dev.	same as QSA
			charact.	95% of QSA shortly before failure
cyclic load R=-1		mean	unknown	
		St.Dev.		
		charact.		

**202** Strain to failure of ply in main fibre direction. All fatigue data are based on amplitudes:

	long term Load			Properties	
$\hat{e}_{1t}$	no load		mean	same as QSA	
			COV,n	same as QSA	
			charact.	same as QSA	
	perm. load	time to fail.	mean	Use stress based equation in 203	
			St.Dev.		
			charact.		
		Stat.strength just before failure	mean	$\hat{e}_{1t}(t) = \frac{\hat{S}_{1t}(t)}{E(t)}$	
			St.Dev., n	"	
			charact.	"	
	cyclic load R=0.1	time to fail.	mean	$\log[e(N)] = e_{0fatigue} - a \log(N)$ $e_{0fatigue} = 0.207, a = 0.101$	
			St.Dev., n	0.716 (of log N), n = 100	
			charact.	$\log[e(N)] = e_{0fatigue} - a \log(N)$ $e_{0fatigue} = 0.063, a = 0.101$	
		Stat.strength just before failure	mean	90% of QSA	
			COV,n	same as QSA	
			charact.	90% of QSA	
	cyclic load R=-1	time to fail.	mean	$\log[e(N)] = e_{0fatigue} - a \log(N)$ $e_{0fatigue} = 0.453, a = 0.1276$	
			St.Dev.	0.438 (of log N), n > 100	
			charact.	$\log[e(N)] = e_{0fatigue} - a \log(N)$ $e_{0fatigue} = 0.342, a = 0.1276$	
		Stat.strength just before failure	mean	90% of QSA	
			COV	same as QSA	
			charact.	90% of QSA	
	cyclic load R=10	time to fail.	mean	No representative data	
			St.Dev.		
			charact.		
Stat.strength just before failure		mean	No representative data		
		COV			
		charact.			

**203** Stress to failure of ply in main fibre direction. All fatigue data are based on amplitudes:

	long term Load			Properties	
$\hat{S}_{1t}$	no load		mean	same as QSA	
			COV,n	same as QSA	
			character.	same as QSA	
	perm. load	time to fail.	mean	$\log[s(t)] = \log[s(1)] - b \log(t)$ $s(1) = 1$ , $b = 0.0423$ relative to QSA time scale in minutes	
			St.Dev.	0.7 (of log N) , n = 50	
			character.	$\log[s(t)] = \log[s(1)] - b \log(t)$ $s(1) = 0.888$ , $b = 0.0423$	
		Stat.strength just before failure	mean	$s(t)$ from time to failure mean curve	
			St.Dev.		
			character.	$s(t)$ from time to failure characteristic curve	
	cyclic load R=0.1	time to fail.	mean	Use strain based equation in 202	
			St.Dev., n	"	
			character.	"	
		Stat.strength just before failure	mean	90% of QSA	
			COV,n	same as QSA	
			character.	90% of QSA	
	cyclic load R=-1	time to fail.	mean	Use strain based equation in 202	
			St.Dev.	"	
			character.	"	
		Stat.strength just before failure	mean	90% of QSA	
			COV	same as QSA	
			character.	90% of QSA	
	cyclic load R=10	time to fail.	mean	No representative data	
			St.Dev.		
			character.		
Stat.strength just before failure		mean	No representative data		
		COV			
		character.			

**D 300 Fibre dominated compressive properties**

**301** Youngs Modulus of ply in main fibre direction:

	long term Load			Formula	
E <sub>lt</sub>	no load		mean	same as QSA	
			COV, n	same as QSA	
			character.	same as QSA	
E <sub>1 fibre</sub>	perm. load		mean	unknown*	
			St.Dev.		
			character.		
	cyclic load R=0			mean	95% of QSA shortly before failure
				St.Dev.	same as QSA
				character.	95% of QSA shortly before failure
	cyclic load R=0.1			mean	95% of QSA shortly before failure
				St.Dev.	same as QSA
				character.	95% of QSA shortly before failure
cyclic load R=-1			mean	unknown	
			St.Dev.		
			character.		

**302** Strain to failure of ply in main fibre direction:

	long term Load			Properties	
$\hat{e}_{1c}$	no load		mean	same as QSA	
			COV,n	same as QSA	
			character.	same as QSA	
	perm. load	time to fail.		mean	Use stress based equation in 203
				St.Dev.	
				character.	
		Stat.strength just before failure		mean	$\hat{e}_{1t}(t) = \frac{\hat{S}_{1t}(t)}{E(t)}$
				St.Dev., n	"
				character.	"
	cyclic load R=0.1	time to fail.		mean	same equation as in 202
				St.Dev., n	"
				character.	"
		Stat.strength just before failure		mean	unknown*
				COV,n	
				character.	
	cyclic load R=-1	time to fail.		mean	same equation as in 202
				St.Dev.	"
				character.	"
		Stat.strength just before failure		mean	unknown*
				COV	
				character.	
cyclic load R=10	time to fail.		mean	No representative data	
			St.Dev.		
			character.		
	Stat.strength just before failure		mean	No representative data	
			COV		
			character.		

\* probably similar to reduction of tensile values

**303** Stress to failure of ply in main fibre direction:

	long term Load			Properties	
$\hat{S}_{1c}$	no load		mean	same as QSA	
			COV,n	same as QSA	
			character.	same as QSA	
	perm. load	time to fail.		mean	Unknown. Can use tensile data as a conservative estimate
				St.Dev.	"
				character.	"
		Stat.strength just before failure		mean	$s(t)$ from time to failure
				St.Dev.	
				character.	
	cyclic load R=0.1	time to fail.		mean	Use strain based equation in 202
				St.Dev., n	"
				character.	"
		Stat.strength just before failure		mean	unknown*
				COV,n	"
				character.	"
	cyclic load R=-1	time to fail.		mean	Use strain based equation in 202
				St.Dev.	"
				character.	"
		Stat.strength just before failure		mean	unknown*
				COV	"
				character.	"
	cyclic load R=10	time to fail.		mean	No representative data
				St.Dev.	
				character.	
Stat.strength just before failure			mean	No representative data	
			COV		
			character.		

\* probably similar to reduction of tensile values



**D 400 Matrix dominated inplane tensile properties**

**401** There are no representative data for inplane tensile properties.

**D 500 Matrix dominated inplane compressive properties**

**501** There are no representative data for inplane compressive properties.

**D 600 Matrix dominated inplane shear properties**

**601** There are no representative data for inplane shear properties.

**D 700 Matrix dominated through thickness tensile properties**

**701** There are no representative data for through thickness tensile properties.

**D 800 Matrix dominated through thickness compressive properties**

**801** There are no representative data for through thickness compressive properties.

**D 900 Matrix dominated through thickness shear properties**

**901** There are no representative data for through thickness shear properties.

## E. Long Term Properties in Water

### E 100 Test environment

The test environment is described according to *Section 4 H 502*.

<b>Conditioning parameters:</b>	
Temperature	18 °C
Water content of the laminate (wet, dry)	Imersed in water
Chemical environment	none
Loading rate	about 1% per minute
<i>number of specimens</i>	Reported individually for all properties

### E 200 Fibre dominated tensile properties

**201** Youngs Modulus of ply in main fibre direction: General experience has shown that a 10% reduction of the modulus relative to the respective values in air can be used. No data are available for the creep modulus.

**202** Strain to failure of ply in main fibre direction: General experience has shown that strain to failure remains the same relative to the respective values in air can be used.

**203** [Stress to failure of ply in main fibre direction](#): General experience has shown that a 10% reduction of the modulus relative to the respective values in air can be used.

### E 300 Fibre dominated compressive properties

**301** Youngs Modulus of ply in main fibre direction: no representative data.

**302** Strain to failure of ply in main fibre direction: no representative data.

**303** [Stress to failure of ply in main fibre direction](#): no representative data.

### E 400 Matrix dominated inplane tensile properties

**401** There are no representative data for inplane tensile properties.

**E 500 Matrix dominated inplane compressive properties**

**501** There are no representative data for inplane compressive properties.

**E 600 Matrix dominated inplane shear properties**

**601** There are no representative data for inplane shear properties.

**E 700 Matrix dominated through thickness tensile properties**

**701** There are no representative data for through thickness tensile properties.

**E 800 Matrix dominated through thickness compressive properties**

**801** There are no representative data for through thickness compressive properties.

**E 900 Matrix dominated through thickness shear properties**

**901** There are no representative data for through thickness shear properties.

## SECTION 4: APPENDIX D

### Example for Representative Data:

### Unidirectional Carbon Tape AS4 12k

**SECTION 4: APPENDIX D..... 1**

**EXAMPLE FOR REPRESENTATIVE DATA:..... 1**

**UNIDIRECTIONAL CARBON TAPE AS4 12K..... 1**

<b>A.</b>	<b>GENERAL.....</b>	<b>1</b>
<b>B.</b>	<b>DEFINITION OF MATERIAL.....</b>	<b>2</b>
<b>C.</b>	<b>QUASI STATIC PROPERTIES IN AIR (QSA).....</b>	<b>4</b>
C 100	TEST ENVIRONMENT .....	4
C 200	FIBRE DOMINATED PLY PROPERTIES .....	4
C 300	MATRIX DOMINATED PLY PROPERTIES .....	5
A 400	THROUGH THICKNESS PLY PROPERTIES.....	6
<b>D.</b>	<b>LONG TERM PROPERTIES .....</b>	<b>6</b>
<b>E.</b>	<b>LONG TERM PROPERTIES IN WATER .....</b>	<b>6</b>

### A. General

- 101** This appendix describes an example of a fairly complete set of data for a carbon fibre reinforced epoxy laminate. The fibre type is AS4 12k
- 102** Data were mainly obtained from Composite Materials Handbook Mil17, Volume 2, Technomics Publishing Company, Pennsylvania, USA, 1997
- 103** Laminates made of similar carbon fibres may be similar to this example and can be qualified according to *Section 4 H 600* - Qualification against representative data.
- 104** Matrix dominated properties may change considerably when changing the resin system.
- 105** Laminates made of carbon fibres with different characteristics than AS4 12k may have very different properties from the ones listed here.
- 106** Representative data for other materials can be measured and used like this example, as long as

the requirements given in Section 4 H 500 and 600 are fulfilled.

- 107** There is a lack of data for matrix dominated properties and of properties in water. Properties in other fluids are not listed, since only few and specific data exist. If such properties are needed some qualification testing may be required.

## B. Definition of material

The material is described according to *Section 4 H 502*.

<b>Constituent materials:</b>	<b>Requirements to group measurements from different laminates</b>
Generic Fibre type	Carbon –PAN Precursor
Bundle type	12k filaments per tow
Fibre trade name	AS4 12k
Type of weave	Unidirectional Tape
Type of sizing	Epoxy compatible
Fibre Manufacturer	Hercules
Weaver	U.S Polymeric
Fabric trade name and batch number	U.S. Polymeric AS4 12k/E7K8 u.d. tape
Generic resin type (e.g. epoxy, polyester)	Epoxy
Specific resin type (trade name, batch number)	U.S. Polymeric E7K8
Catalyst (trade name and batch number)	-
Accelerator (trade name and batch number)	-
Fillers (trade name and batch number)	None
Additives (trade name and batch number)	None
<b>Process parameters:</b>	
Laminator (company)	not relevant
Processing method	Autoclave cured
Processing temperature	149 - 154° C, 120 – 130 min.
Processing pressure	3.79 bar
Process atmosphere (e.g. vacuum)	-
Post curing (temperature and time)	none
Control of fibre orientation	-
Fibre volume fraction	53 –60 %
Void content	0.64 – 2.2 %
<b>Conditioning parameters:</b>	
See sections for properties:	



## C. Quasi Static Properties in Air (QSA)

### C 100 Test environment

101 The test environment is described according to *Section 4 H 502*.

<b>Conditioning parameters:</b>	
Temperature	24 °C
Water content of the laminate (wet, dry)	dry
Chemical environment	air
Loading rate	2.0 mm per minute (ASTM3039)
<i>number of specimens</i>	Reported individually for all properties

102 The following properties are listed according to *Section 4 B 200*. Characteristic values are calculated according to *Section 4 B 400*.

103 Most data are based on 20 measurements, apart from  $\hat{e}_{1t}$  which is based on 5 measurements.

### C 200 Fibre dominated ply Properties

	Parameter		Value	Unit	Explanation
Fibre dominated properties	$E_{1(UD\ ply)}$	Mean	133	[GPa]	Modulus of elasticity in main fibre direction
		COV	3.79 %		
		Charact.value	as mean		
	$\hat{e}_{1t}$	Mean	0.0139	Strain	Tensioning strain at break in the main fibre direction
		COV	11.0 %		
		Charact.value	0.0064		
	$\hat{e}_{1c}$	Mean	0.0177	Strain	Compressive strain at break in the main fibre direction
		COV	4.81 %		
		Charact.value	0.0101		
	$\hat{s}_{1t}$	Mean	2089	N/mm <sup>2</sup> (MPa)	Tension stress at break in the main fibre direction
		COV	8.26 %		
		Charact.value	1606		
	$\hat{s}_{1c}$	Mean	1441	N/mm <sup>2</sup> (MPa)	Compressive stress at break in the main fibre direction
		COV	7.8 %		
		Charact.value	1126		

**C 300 Matrix dominated ply Properties**

	Parameter		Value	Unit	Explanation
Matrix dominated properties	$E_{2(UD\ ply)}$	Mean	8.5	[GPa]	Modulus of elasticity transverse to main fibre direction
		COV	3.76 %		
		Charact. value	as mean		
	$\hat{e}_{2t}$	Mean	n.a.	Strain	Tensile strain at break for the matrix in direction normal to the fibre direction, in the fibre plane.
		COV	n.a.		
		Charact. value	n.a.		
	$\hat{e}_{2c}$	Mean	n.a.	Strain	Compressive strain at break for the matrix in direction normal to the fibres when tension is applied to the fibres.
		COV	n.a.		
		Charact. value	n.a.		
	$\hat{s}_{2t}$	Mean	37.7	N/mm <sup>2</sup> (MPa)	Tension stress at break normal to the fibre direction.
		COV	13.2 %		
		Charact. value	23.8		
	$\hat{s}_{2c}$	Mean	n.a.	N/mm <sup>2</sup> (MPa)	Compressive stress at break normal to the fibre direction.
		COV	n.a.		
		Charact. value	n.a.		
	$\hat{e}_{12}$	Mean	n.a.	Strain	Shear strain in ply plane at failure.
		COV	n.a.		
		Charact. value	n.a.		
	$\hat{s}_{12}$	Mean	113.8	N/mm <sup>2</sup> (MPa)	Shear stress in ply plane at failure.
		COV	6.41 %		
		Charact. value	93.3		
$G_{12\ linear}$	Mean	n.a.	[GPa]	Shear modulus in the ply plane in the liner range	
	COV	n.a.			
	Charact. value	n.a.			
$G_{12\ non-linear}$	Mean	n.a.	[GPa]	Shear modulus in the ply plane at the failure point	
	COV	n.a.			
	Charact. value	as mean			
$\nu_{12}$	Mean	0.32		Ply major Poisson's ratio	
	COV	n.a.			
	Charact. value	as mean			



**C 400 Through thickness ply Properties**

**401** There are no representative data.

**D. Long Term Properties**

**101** There are no representative data.

**E. Long Term Properties in Water**

**101** There are no representative data.

## SECTION 4: APPENDIX E

### Example for Representative Data:

#### Unidirectional Carbon Tape HTS 5631 Prepreg

**SECTION 4: APPENDIX E..... 1**

**EXAMPLE FOR REPRESENTATIVE DATA:..... 1**

**UNIDIRECTIONAL CARBON TAPE HTS 5631 PREPREG..... 1**

<b>A. GENERAL.....</b>	<b>1</b>
<b>B. DEFINITION OF MATERIAL.....</b>	<b>2</b>
<b>C. QUASI STATIC PROPERTIES IN AIR (QSA).....</b>	<b>4</b>
C 100 TEST ENVIRONMENT .....	4
C 200 FIBRE DOMINATED PLY PROPERTIES .....	4
MATRIX DOMINATED PLY PROPERTIES .....	6
C 300 THROUGH THICKNESS PLY PROPERTIES .....	7
<b>D. LONG TERM PROPERTIES .....</b>	<b>7</b>
<b>E. LONG TERM PROPERTIES IN WATER .....</b>	<b>7</b>

### A. General

- 101** This appendix describes an example of a fairly complete set of data for a carbon fibre reinforced epoxy laminate. The laminates were made of Carbon Tape HTS 5631 Prepreg.
- 102** Data were supplied by Tenax Fibers, Germany.
- 103** Laminates made of similar carbon fibres may be similar to this example and can be qualified according to *Section 4 H 600* - Qualification against representative data.
- 104** Matrix dominated properties may change considerably when changing the resin system.
- 105** Laminates made of carbon fibres with different characteristics than HTS 5631 800 tex f12000 t0 may have very different properties from the ones listed here.
- 106** Representative data for other materials can be measured and used like this example, as long as

the requirements given in Section 4 H 500 and 600 are fulfilled.

- 107** There is a lack of data for matrix dominated properties and of properties in water. Properties in other fluids are not listed, since only few and specific data exist. If such properties are needed some qualification testing may be required.

## B. Definition of material

The material is described according to *Section 4 H 502*.

<b>Constituent materials:</b>	<b>Requirements to group measurements from different laminates</b>
Generic Fibre type	Carbon-PAN Precursor
Bundle type	12k filaments per tow
Fibre trade name	HTS 5631 800 tex f12000 t0
Type of weave	Unidirectional Tape
Type of sizing	Epoxy compatible
Fibre Manufacturer	Tenax Fibers Germany
Weaver	Tenax Fibers Germany
Fabric trade name and batch number	UD-Prepreg TPW0567/0572
Generic resin type (e.g. epoxy, polyester)	Epoxy
Specific resin type (trade name, batch number)	CIBA 6376 / F315956A00
Catalyst (trade name and batch number)	---
Accelerator (trade name and batch number)	---
Fillers (trade name and batch number)	---
Additives (trade name and batch number)	---
<b>Process parameters:</b>	
Laminator (company)	Tenax Fibers Germany
Processing method	Autoclave cured
Processing temperature	177°C for 150 minutes
Processing pressure	6.0 bar
Process atmosphere (e.g. vacuum)	0.99 bar
Post curing (temperature and time)	none
Control of fibre orientation	---
Fibre volume fraction	58-60 %
Void content	1.8 - 4.8 %
<b>Conditioning parameters:</b>	
See sections for properties:	



## C. Quasi Static Properties in Air (QSA)

### C 100 Test environment

101 The test environment is described according to *Section 4 H 502*.

<b>Conditioning parameters:</b>	
Temperature	23 °C
Water content of the laminate (wet, dry)	dry
Chemical environment	air
Loading rate	1-2 mm / minute *
<i>number of specimens</i>	Reported individually for all properties

\* Rates varied slightly between test methods. Shear data were obtained from  $\pm 45$  laminates tested at 2 mm/minute and sometimes at faster rates of about 6 mm/min after 2% strain.

102 The following properties are listed according to *Section 4 B 200*. Characteristic values are calculated according to *Section 4 B 400*.

103 Data are based on a set of 6 measurements for each property, backed up by more than 50 measurements from production control.

### C 200 Fibre dominated ply Properties

	Parameter		Value	Unit	Explanation
Fibre dominated properties	$E_{1(\text{UD ply})}$	Mean	134.8 (106.0)	[GPa]	Modulus of elasticity in main fibre direction, in tension and (compression)
		COV	1.26 % (1.73%)		
		Charact.value	as mean		
	$\hat{e}_{1t}$	Mean	0.0151	Strain	Tensioning strain at break in the main fibre direction. Characteristic value calculated from strength data.
		COV	-		
		Charact.value	0.0145		
	$\hat{e}_{1c}$	Mean	1.59	Strain	Compressive strain at break in the main fibre direction. Values calculated from strength data.*
		COV	-		
		Charact.value	1.30		
	$\hat{s}_{1t}$	Mean	2046	N/mm <sup>2</sup> (MPa)	Tension stress at break in the main fibre direction
		COV	2.20%		
		Charact.value	1955		
	$\hat{s}_{1c}$	Mean	1686	N/mm <sup>2</sup> (MPa)	Compressive stress at break in the main fibre direction
		COV	9.1%		
		Charact.value	1379		

\* The measured compressive strain at failure was 1.79% with a COV of 12%. A lower value was put in the table to allow easy linear ply analysis. A higher strain to failure can be used, but nonlinear effects should be taken into account, i.e., drop of Young's modulus.

### Matrix dominated ply Properties

	Parameter		Value	Unit	Explanation
Matrix dominated properties	$E_{2(UD\ ply)}$	Mean	9.43	[GPa]	Modulus of elasticity transverse to main fibre direction
		COV	1.56 %		
		Charact.value	as mean		
	$\hat{e}_{2t}$	Mean	0.010	Strain	Tensile strain at break for the matrix in direction normal to the fibre direction, in the fibre plane. Characteristic value calculated from strength data.
		COV	-		
		Charact.value	0.0093		
	$\hat{e}_{2c}$	Mean	-	Strain	Compressive strain at break for the matrix in direction normal to the fibres.
		COV	-		
		Charact.value	-		
	$\hat{s}_{2t}$	Mean	115.6	N/mm <sup>2</sup> (MPa)	Tension stress at break normal to the fibre direction.
		COV	2.63 %		
		Charact.value	87.5		
	$\hat{s}_{2c}$	Mean	-	N/mm <sup>2</sup> (MPa)	Compressive stress at break normal to the fibre direction.
		COV	-		
		Charact.value	-		
$\hat{e}_{12}$	Mean	-	Strain	Shear strain in ply plane at linear limit and at (failure).	
	COV	-			
	Charact.value	-			
$\hat{s}_{12}$	Mean	115.6	N/mm <sup>2</sup> (MPa)	Shear stress in ply plane at (failure).	
	COV	2.63 %			
	Charact.value	108.3			
$G_{12\ linear}$	Mean	-	[GPa]	Shear modulus in the ply plane in the liner range	
	COV	-			
	Charact.value	-			
$G_{12\ non-linear}$	Mean	5.1	[GPa]	Shear modulus in the ply plane at the failure point	
	COV	2.27 %			
	Charact.value	as mean			
$\nu_{12}$	Mean	-		Ply major Poisson's ratio	
	COV	-			
	Charact.value	-			

### **C 300 Through thickness ply Properties**

**301** There are no representative data.

### **D. Long Term Properties**

**101** There are no representative data.

### **E. Long Term Properties in Water**

**101** There are no representative data.



## SECTION 4: APPENDIX F

### Example for Representative Data:

#### Unidirectional Carbon Tape TPW 0434 Prepreg

**SECTION 4: APPENDIX F ..... 1**

**EXAMPLE FOR REPRESENTATIVE DATA:..... 1**

**UNIDIRECTIONAL CARBON TAPE TPW 0434 PREPREG..... 1**

<b>A.</b>	<b>GENERAL.....</b>	<b>1</b>
<b>B.</b>	<b>DEFINITION OF MATERIAL.....</b>	<b>2</b>
<b>C.</b>	<b>QUASI STATIC PROPERTIES IN AIR (QSA).....</b>	<b>4</b>
C 100	TEST ENVIRONMENT .....	4
C 200	FIBRE DOMINATED PLY PROPERTIES .....	4
	MATRIX DOMINATED PLY PROPERTIES .....	6
C 300	THROUGH THICKNESS PLY PROPERTIES .....	7
<b>D.</b>	<b>LONG TERM PROPERTIES .....</b>	<b>7</b>
<b>E.</b>	<b>LONG TERM PROPERTIES IN WATER .....</b>	<b>7</b>

#### A. General

- 101** This appendix describes an example of a fairly complete set of data for a carbon fibre reinforced epoxy laminate. The laminates were made of Carbon Tape TPW 0343 Prepreg.
- 102** Data were supplied by Tenax Fibers, Germany.
- 103** Laminates made of similar carbon fibres may be similar to this example and can be qualified according to *Section 4 H 600* - Qualification against representative data.
- 104** Matrix dominated properties may change considerably when changing the resin system.
- 105** Laminates made of carbon fibres with different characteristics than IMS 5131 410tex f12000 t0 may have very different properties from the ones listed here.
- 106** Representative data for other materials can be measured and used like this example, as long as

the requirements given in Section 4 H 500 and 600 are fulfilled.

- 107** There is a lack of data for matrix dominated properties and of properties in water. Properties in other fluids are not listed, since only few and specific data exist. If such properties are needed some qualification testing may be required.

## B. Definition of material

The material is described according to *Section 4 H 502*.

<b>Constituent materials:</b>	<b>Requirements to group measurements from different laminates</b>
Generic Fibre type	Carbon-PAN Precursor
Bundle type	12k filaments per tow
Fibre trade name	IMS 5131 410tex f12000 t0
Type of weave	Unidirectional Tape
Type of sizing	Epoxy compatible
Fibre Manufacturer	Tenax Fibers Germany
Weaver	Tenax Fibers Germany
Fabric trade name and batch number	UD-Prepreg TPW0343
Generic resin type (e.g. epoxy, polyester)	Epoxy
Specific resin type (trade name, batch number)	CIBA 6376
Catalyst (trade name and batch number)	---
Accelerator (trade name and batch number)	---
Fillers (trade name and batch number)	---
Additives (trade name and batch number)	---
<b>Process parameters:</b>	
Laminator (company)	Tenax Fibers Germany
Processing method	Autoclave cured
Processing temperature	177°C for 150 minutes
Processing pressure	6.0 bar
Process atmosphere (e.g. vacuum)	0.99 bar
Post curing (temperature and time)	none
Control of fibre orientation	---
Fibre volume fraction	58-60 %
Void content	1.88 - 2.06 %
<b>Conditioning parameters:</b>	
See sections for properties:	



## C. Quasi Static Properties in Air (QSA)

### C 100 Test environment

101 The test environment is described according to *Section 4 H 502*.

<b>Conditioning parameters:</b>	
Temperature	23 °C
Water content of the laminate (wet, dry)	dry
Chemical environment	air
Loading rate	1-2 mm / minute *
<i>number of specimens</i>	Reported individually for all properties

\* Rates varied slightly between test methods. Shear data were obtained from  $\pm 45$  laminates tested at 2 mm/minute and sometimes at faster rates of about 6 mm/min after 2% strain.

102 The following properties are listed according to *Section 4 B 200*. Characteristic values are calculated according to *Section 4 B 400*.

103 Data are based on a set of 6 measurements for each property, backed up by more than 50 measurements from production control.

### C 200 Fibre dominated ply Properties

	Parameter		Value	Unit	Explanation
Fibre dominated properties	$E_{1(\text{UD ply})}$	Mean	170.6 (136.9)	[GPa]	Modulus of elasticity in main fibre direction, in tension and (compression)
		COV	0.82 % (1.69%)		
		Charact.value	as mean		
	$\hat{e}_{1t}$	Mean	0.0162	Strain	Tensioning strain at break in the main fibre direction. Characteristic value calculated from strength data.
		COV	1.49		
		Charact.value	0.0156		
	$\hat{e}_{1c}$	Mean	1.13	Strain	Compressive strain at break in the main fibre direction. Values calculated from strength data.*
		COV			
		Charact.value	1.06		
	$\hat{s}_{1t}$	Mean	2835.6	N/mm <sup>2</sup> (MPa)	Tension stress at break in the main fibre direction
		COV	3.1%		
		Charact.value	2659.8		
	$\hat{s}_{1c}$	Mean	1547.9	N/mm <sup>2</sup> (MPa)	Compressive stress at break in the main fibre direction
		COV	3.18%		

	Charact.value	1449.4	
--	---------------	--------	--

\* The measured compressive strain at failure was 1.195% with a COV of 3.48%. A lower value was put in the table to allow easy linear ply analysis. A higher strain to failure can be used, but nonlinear effects should be taken into account, i.e., drop of Young's modulus.

### Matrix dominated ply Properties

	Parameter		Value	Unit	Explanation
Matrix dominated properties	$E_{2(UD\ ply)}$	Mean	9.5	[GPa]	Modulus of elasticity transverse to main fibre direction
		COV	1.19 %		
		Charact.value	as mean		
	$\hat{e}_{2t}$	Mean	0.0081	Strain	Tensile strain at break for the matrix in direction normal to the fibre direction, in the fibre plane. Characteristic value calculated from strength data.
		COV	-		
		Charact.value	0.0070		
	$\hat{e}_{2c}$	Mean	-	Strain	Compressive strain at break for the matrix in direction normal to the fibres.
		COV	-		
		Charact.value	-		
	$\hat{s}_{2t}$	Mean	77.1	N/mm <sup>2</sup> (MPa)	Tension stress at break normal to the fibre direction.
		COV	6.69 %		
		Charact.value	66.8		
	$\hat{s}_{2c}$	Mean	-	N/mm <sup>2</sup> (MPa)	Compressive stress at break normal to the fibre direction.
		COV	-		
		Charact.value	-		
	$\hat{e}_{12}$	Mean	-	Strain	Shear strain in ply plane at linear limit and at (failure).
		COV	-		
		Charact.value	-		
$\hat{s}_{12}$	Mean	91.9	N/mm <sup>2</sup> (MPa)	Shear stress in ply plane at (failure).	
	COV	4.48 %			
	Charact.value	83.5			
$G_{12\ linear}$	Mean	-	[GPa]	Shear modulus in the ply plane in the liner range	
	COV	-			
	Charact.value	-			
$G_{12\ non-linear}$	Mean	4.5	[GPa]	Shear modulus in the ply plane at the failure point	
	COV	4.24 %			
	Charact.value	as mean			
$\nu_{12}$	Mean	-		Ply major Poisson's ratio	
	COV	-			
	Charact.value	-			

### **C 300 Through thickness ply Properties**

**301** There are no representative data.

### **D. Long Term Properties**

**101** There are no representative data.

### **E. Long Term Properties in Water**

**101** There are no representative data.

## SECTION 5 MATERIALS – SANDWICH STRUCTURES

<b>SECTION 5</b>	<b>MATERIALS – SANDWICH STRUCTURES.....</b>	<b>1</b>
<b>A.</b>	<b>GENERAL.....</b>	<b>2</b>
A 100	INTRODUCTION.....	2
A 200	SANDWICH SPECIFICATION.....	2
A 300	LAY-UP SPECIFICATION.....	3
A 400	ISOTROPIC/ORTHOTROPIC CORE LAYERS.....	4
A 500	MECHANICAL AND PHYSICAL PROPERTIES.....	4
A 600	CHARACTERISTIC VALUES OF MECHANICAL PROPERTIES.....	5
<b>B.</b>	<b>STATIC PROPERTIES.....</b>	<b>6</b>
B 100	GENERAL.....	6
B 200	STATIC PROPERTIES.....	6
B 300	RELATIONSHIP BETWEEN STRENGTH AND STRAIN TO FAILURE.....	12
B 400	CHARACTERISTIC VALUES.....	13
B 500	SHEAR PROPERTIES.....	13
B 600	CORE SKIN INTERFACE PROPERTIES.....	17
<b>C.</b>	<b>PROPERTIES UNDER LONG TERM STATIC AND CYCLIC LOADS.....</b>	<b>17</b>
C 100	GENERAL.....	17
C 200	CREEP.....	18
C 300	STRESS RUPTURE UNDER PERMANENT STATIC LOADS.....	19
C 400	STATIC STRENGTH REDUCTION DUE TO PERMANENT STATIC LOADS.....	19
C 500	STRESS RELAXATION.....	20
C 600	CHANGE OF MODULUS OF ELASTICITY UNDER CYCLIC FATIGUE.....	20
C 700	CYCLES TO FAILURE UNDER FATIGUE LOADS.....	22
C 800	STATIC STRENGTH REDUCTION DUE TO CYCLIC LOADING.....	24
C 900	EFFECT OF HIGH LOADING RATES - SHOCK LOADS - IMPACT.....	24
C 1000	CHARACTERISTIC VALUES.....	25
<b>D.</b>	<b>OTHER PROPERTIES.....</b>	<b>26</b>
D 100	THERMAL EXPANSION COEFFICIENT.....	26
D 200	SWELLING COEFFICIENT FOR WATER OR OTHER LIQUIDS.....	26
D 300	DIFFUSION COEFFICIENT.....	26
D 400	THERMAL CONDUCTIVITY.....	26
D 500	FRICTION COEFFICIENT.....	26
D 600	WEAR RESISTANCE.....	26
<b>E.</b>	<b>INFLUENCE OF THE ENVIRONMENT ON PROPERTIES.....</b>	<b>27</b>
E 100	INTRODUCTION.....	27
E 200	EFFECT OF TEMPERATURE.....	28
E 300	EFFECT OF WATER.....	30
E 400	EFFECT OF CHEMICALS.....	31
E 500	EFFECT OF UV RADIATION.....	31
E 600	ELECTROLYTIC CORROSION.....	31
E 700	COMBINATION OF ENVIRONMENTAL EFFECTS.....	31
<b>F.</b>	<b>INFLUENCE OF PROCESS PARAMETERS AND CORE DENSITY.....</b>	<b>32</b>
F 100	CORE PRODUCTION.....	32
F 200	SANDWICH PRODUCTION.....	32
F 300	INFLUENCE OF CORE DENSITY.....	32
<b>G.</b>	<b>PROPERTIES UNDER FIRE.....</b>	<b>33</b>



G 100	INTRODUCTION.....	33
G 200	FIRE REACTION.....	33
G 300	FIRE RESISTANCE.....	33
G 400	INSULATION.....	34
G 500	PROPERTIES AFTER THE FIRE.....	34
<b>H.</b>	<b>QUALIFICATION OF MATERIAL PROPERTIES .....</b>	<b>34</b>
H 100	INTRODUCTION.....	34
H 200	GENERAL TEST REQUIREMENTS.....	35
H 300	SELECTION OF MATERIAL QUALIFICATION METHOD .....	35
H 400	DIRECT MEASUREMENT.....	36
H 500	REPRESENTATIVE DATA.....	36
H 600	QUALIFICATION AGAINST REPRESENTATIVE DATA.....	38
H 700	CONFIRMATION TESTING FOR STATIC DATA.....	40
H 800	CONFIRMATION TESTING FOR LONG TERM DATA.....	40
H 900	USE OF MANUFACTURERS DATA OR DATA FROM THE LITERATURE AS REPRESENTATIVE DATA	40
H 1000	CONFIRMING MATERIAL DATA BY COMPONENT TESTING.....	40

## A. General

### A 100 Introduction

- 101** This section describes the mechanical material properties needed for design. It describes how to obtain all strength properties used in the failure criteria and all elastic properties needed for stress calculations.
- 102** A sandwich structure is considered here as a light weight core embedded between two faces (or skins). Faces are typically made of FRP laminates. The properties of laminates are described in Section 4. This section concentrates on properties of cores and the core skin interface..
- 103** All properties shall be obtained directly by measurements or shall be traced back to measurements. The qualification of material properties is described in this section. Under certain conditions, typical values from databases can be used. Strength and stiffness values should be documented as characteristic values.
- 104** It is only necessary to obtain properties that are used in the design calculations and failure criteria.
- 105** General aspects that were already described in *Section 4* are not repeated here but only referred to.

### A 200 Sandwich Specification

- 201** A sandwich structure is made of many constituent material arranged and produced in a specific way. Laminate, core materials and adhesives used in a sandwich component shall be clearly specified and all materials shall be traceable. Laminate specification shall be organised as described in Section 4.

**202** For the core material and the adhesive, a minimum set of process parameters and constituent material characterisations is given in Table 1 and Table 2. All these items shall be specified.

<b>Constituent core material(s):</b>
Generic core type (e.g. foam, honeycomb, balsa etc.)
Core trade name (e.g. xyz123)
Type of core (e.g. linear foam)
Type/ characteristics of microstructure
Core manufacturer
Batch number
<b>Process parameters:</b>
Laminator (company)
Processing method
Processing temperature
Processing pressure
Process atmosphere (e.g. vacuum)
Curing temperature
Post curing (temperature and time)
Density of sandwich structures
Glass transition temperature
<b>Conditioning parameters:</b>
Temperature
Water content of the core (wet, dry)
Chemical environment
Loading rate
Number of specimens

*Table 1: core specifications, process parameters and conditioning parameters.*

<b>Constituent adhesive material(s):</b>
Generic adhesive type (e.g. epoxy, polyester)
Specific adhesive type trade name
Specific adhesive type batch number
Catalyst (trade name and batch number)
Accelerator (trade name and batch number)
Fillers (trade name and batch number)
Additives (trade name and batch number)

*Table 2: Adhesive specifications, process parameters and conditioning parameters*

### **A 300 Lay-up specification**

**301** A sandwich structure is made of a sequence of layers. All materials, both core(s) and laminate(s),

and their stacking sequence shall be clearly identified.

- 302** The orientation of non-homogenous or anisotropic materials shall be clearly specified on the materials level and the structural level.
- 303** Laminates and core(s) shall be specified such that they can be described by a sequence of stacked orthotropic plies, see also Section 4.

#### **A 400 Isotropic/orthotropic Core Layers**

- 401** A core layer is defined as a volume element with three axis of symmetry with respect to mechanical properties.
- 402** All layer sequences shall be described by a combination of the three-co-ordinate systems. Ply angles shall be specified between the fibre, laminate co-ordinate system and the main core direction (x-direction).
- 403** Typically, there are two possible microstructure alignments:
- 0/90 cell alignment found in orthotropic cores. Cells run parallel to each other within the same plane. The 3 main directions to which material properties are refereed are; width (W), length (L) and transverse (T) or x-, y- and z-direction. Typical cores are honeycomb, balsa wood and other corrugated core.
  - Random cell alignment in quasi-isotropic core. Cells are randomly oriented without any preferred direction. A typical reinforcement type of this class is cellular foam core.
- 404** The following is assumed in this guideline:
- For cellular cores, i.e. wood and foam, material behaviour and mechanical properties are considered at macroscopic scale, i.e. material properties are taken as an average over a volume of about cm<sup>3</sup>.
  - The measured material properies should be based on a scale that is compatible with the scale of the structural analysis.
- 405** In regions of high local stress concentrations, material properties on a microscopic scale may be needed.
- 406** These simplifications are generally valid. However, their applicability shall always be checked. Other modelling methods may be preferred for certain material combinations.

#### **A 500 Mechanical and physical properties**

- 501** All properties are dependent on the constituent materials, the processing and conditioning environment. It is natural to first separate the properties into laminate(s) and core(s), and interfaces. Interfaces are the core skin connection and possibly other adhesive joints between sections of cores.
- 502** For the sandwich facings, see *Section 4*. If the faces are made of metallic materials, relevant codes for these materials shall be used.
- 503** The mechanical and physical properties of the core are very much dependent upon the nature of

the material used for the core whether it is foam, honeycomb, wood or corrugated. For example, honeycomb cells can be made of paper and polyester resin, or aluminium, or aramid and epoxy.

- 504** It is possible that a structure is loaded in such a way that some material properties are not relevant. In that case the non-relevant properties do not have to be known, but it shall be documented that the properties are not relevant for the application.
- 505** If cores of the same type are used in different layers in the component, one test series is sufficient to determine their properties.
- 506** Properties can be established as new, see Section 5-App.A, or checked against typical values. The procedure is given in Section 4-H600.
- 507** Mechanical properties depend on the load conditions and the environment. Parameters related to the topics should be accounted for, see in this section the C, D and E Headings.
- 508** For test data, the load conditions and the environment parameters should be reported.

**A 600 Characteristic values of mechanical properties**

*See Section 4 A 600.*

## B. Static properties

### B 100 General

- 101** All material properties shall be given with full traceability of materials and conditions. Test results are only valid if the information given in Table A1 and A2 is available. Tests shall be reported as mean, standard deviation, and number of tests.
- 102** For many applications the static properties after exposure to long term loads and environments are more important than the static properties of a new material. This fact should be kept in mind when selecting materials and developing a test programme. Long term properties are described in the following sections.

### B 200 Static Properties

- 201** The complete list of orthotropic data for core and adhesive materials is shown in the following tables. Recommendations for test methods to obtain the properties are given in *Section 5-App.A*.
- 202** Laminate faces elastic constants, strains, strengths and other mechanical properties are described in *Section 4*.
- 203** When different adhesives are used to bond faces and core together, or core layers together, a distinction shall be made between adhesive(s) and matrix properties. In some cases, matrix and adhesive materials properties are significantly dissimilar.
- 204** Static properties are assumed to be identical to quasi-static properties. Accordingly, strain rate should not exceed a value of about 1% per minute.
- 205** The yield point for ductile materials is defined as the 0.02% offset point.

**206** The orthotropic static data for core materials are the following (note that other coordinate systems may be chosen to describe the orthotropic behaviour, e.g. cylindrical coordinates):

	<b>Mechanical parameter</b>	<b>Unit</b>	<b>Reference in Appendix 5a for measurement method</b>
<b>In-plane orthotropic elastic constants</b>			
$E_{xt}$ core linear	Tensile modulus of elasticity of core in x-direction in the linear range	[GPa]	Section B100
$E_{xc}$ core linear	Compressive modulus of elasticity of core in x-direction in the linear range	[GPa]	Section B200
$E_{yt}$ core linear	Tensile modulus of elasticity of core transverse to y-direction in the linear range	[GPa]	Section B100
$E_{yc}$ core linear	Compressive modulus of elasticity of core transverse to y-direction in the linear range	[GPa]	Section B200
$G_{xy}$ core linear	In plane shear modulus of core in the linear range	[GPa]	Section B300
$E_{xt}$ core non-linear	Tensile modulus of elasticity of core in x-direction in the non-linear range	[GPa]	Section B100
$E_{xc}$ core non-linear	Compressive modulus of elasticity of core in x-direction in the non-linear range	[GPa]	Section B200
$E_{yt}$ core non-linear	Tensile modulus of elasticity of core transverse to y-direction in the non-linear range	[GPa]	Section B100
$E_{xc}$ core non-linear	Compressive modulus of elasticity of core in y-direction in the non-linear range	[GPa]	Section B200
$G_{xy}$ core non-linear	In plane shear modulus of core in the non-linear range	[GPa]	Section B300
$\nu_{xy}$ core	Major Poisson's ratio of core	[-]	B100 or B200
$\nu_{yx}$ core	Minor Poisson's ratio of core	[-]	B100 or B200

<b>In-plane strain (to yield point or to the end of the proportional range)</b>			
$\hat{\epsilon}_{xt}$ core linear	Core tensile strain in x-direction		Section B100
$\hat{\epsilon}_{xc}$ core linear	Core compressive strain in x-direction		Section B200
$\hat{\epsilon}_{yt}$ core linear	Core tensile strain in y-direction		Section B100
$\hat{\epsilon}_{yc}$ core linear	Core compressive in y-direction		Section B200
$\hat{\epsilon}_{xy}$ core linear	Core in-plane shear strain		B400 for balsa B300 for other materials
<b>In-plane strain to failure</b>			
all in-plane strain to yield point or to the end of the proportional range, see above			
$\hat{\epsilon}_{xt}$ core non-linear	Core tensile strain in x-direction		Section B100
$\hat{\epsilon}_{xc}$ core non-linear	Core compressive strain in x-direction		Section B200
$\hat{\epsilon}_{yt}$ core non-linear	Core tensile strain in y-direction		Section B100
$\hat{\epsilon}_{yc}$ core non-linear	Core compressive in y-direction		Section B200
$\hat{\epsilon}_{xy}$ core non-linear	Core in-plane shear		B400 for balsa B300 for other materials
<b>In-plane strength (to yield point or to the end of the proportional range)</b>			
$\hat{\sigma}_{xt}$ core linear	Core tensile stress in the x-direction	[N/mm <sup>2</sup> ] (or MPa)	Section B100
$\hat{\sigma}_{xc}$ core linear	Core compressive stress in x-direction	[N/mm <sup>2</sup> ] (or MPa)	Section B200
$\hat{\sigma}_{yt}$ core linear	Core tensile stress at failure in the y-direction	[N/mm <sup>2</sup> ] (or MPa)	Section B100
$\hat{\sigma}_{yc}$ core linear	Core compressive stress in the y-direction	[N/mm <sup>2</sup> ] (or MPa)	Section B200
$\hat{\sigma}_{xy}$ core linear	Core shear stress	[N/mm <sup>2</sup> ] (or MPa)	B400 for balsa B300 for other materials
<b>In-plane strength to failure</b>			

all in-plane strength, see above			
$\hat{\sigma}_{xt}$ core non-linear	Core tensile stress in the x-direction	[N/mm <sup>2</sup> ] (or MPa)	Section B100
$\hat{\sigma}_{xc}$ core non-linear	Core compressive in x-direction	[N/mm <sup>2</sup> ] (or MPa)	Section B200
$\hat{\sigma}_{yt}$ core non-linear	Core tensile stress in the y-direction.	[N/mm <sup>2</sup> ] (or MPa)	Section B100
$\hat{\sigma}_{yc}$ core non-linear	Core compressive in the y-direction.	[N/mm <sup>2</sup> ] (or MPa)	Section B200
$\hat{\sigma}_{xy}$ core non-linear	Core shear stress	[N/mm <sup>2</sup> ] (or MPa)	B400 for balsa B300 for other materials
<b>Through thickness elastic constants</b>			
$E_{zt}$ core linear	Core tensile elasticity modulus normal to the core plane in the linear range	[GPa]	Section B100
$E_{zc}$ core linear	Core compressive elasticity modulus normal to the core plane in the linear range	[GPa]	Section B200
$G_{xz}$ core linear	Core shear modulus normal to the core plane in the linear range	[GPa]	Section B300
$G_{yz}$ core linear	Core shear modulus normal to the core plane in the linear range	[GPa]	Section B300
$E_{zt}$ core non-linear	Core tensile elasticity modulus normal to the core plane in the non-linear range	[GPa]	Section B100
$E_{zc}$ core non-linear	Core compressive elasticity modulus normal to the core plane in the non-linear range	[GPa]	Section B200
$G_{xz}$ core non-linear	Core shear modulus normal to the core plane in the non-linear range	[GPa]	Section B300
$G_{yz}$ core non-linear	Core shear modulus normal to the core plane in the non-linear range	[GPa]	Section B300
$\nu_{xz}$ core	Core Poisson's ratio normal to the core plane	[-]	B100 or B200
$\nu_{yz}$ core	Core Poisson's ratio normal to the core plane	[-]	B100 or B200
<b>Through thickness strain (to yield point or to the end of the proportional range)</b>			
$\hat{\epsilon}_{zt}$ core linear	Core tensile strain normal to the core plane		Section B100



$\hat{\epsilon}_{zC}$ core linear	Core compression strain at failure normal to the core plane		Section B200
$\hat{\epsilon}_{xZ}$ core linear	Core shear strain at failure normal to the core plane		B400 for balsa B300 for other materials
$\hat{\epsilon}_{yZ}$ core linear	Core shear strain normal to the core plane		B400 for balsa B300 for other materials
<b>Through thickness strain to failure</b>			
$\hat{\epsilon}_{zT}$ core non-linear	Core tensile strain normal to the core plane		Section B100
$\hat{\epsilon}_{zC}$ core non-linear	Core compression normal to the core plane		Section B200
$\hat{\epsilon}_{xZ}$ core non-linear	Core shear strain normal to the core plane	[ $\mu$ -strain] (or %)	B400 for balsa B300 for other materials
$\hat{\epsilon}_{yZ}$ core non-linear	Core shear strain normal to the core plane	[ $\mu$ -strain] (or %)	B400 for balsa B300 for other materials
<b>Through thickness strength (to yield point or to the end of the proportional range)</b>			
$\hat{\sigma}_{zT}$ core linear	Core tensile stress normal to the core plane	[N/mm <sup>2</sup> ] (or MPa)	Section B100
$\hat{\sigma}_{zC}$ core linear	Core compressive stress normal to the core plane	[N/mm <sup>2</sup> ] (or MPa)	Section B200
$\hat{\sigma}_{xZ}$ core linear	Core shear stress normal to the core plane	[N/mm <sup>2</sup> ] (or MPa)	B400 for balsa B300 for other materials
$\hat{\sigma}_{yZ}$ core non-linear	Core shear stress normal to the core plane	[N/mm <sup>2</sup> ] (or MPa)	B400 for balsa B300 for other materials

<b>Through thickness strength to failure</b>			
$\hat{\sigma}_{zt}$ core non-linear	Core tensile stress normal to the core plane	[N/mm <sup>2</sup> ] (or MPa)	Section B100
$\hat{\sigma}_{zc}$ core non-linear	Core compressive stress normal to the core plane	[N/mm <sup>2</sup> ] (or MPa)	Section B200
$\hat{\sigma}_{xz}$ core non-linear	Core shear stress normal to the core plane	[N/mm <sup>2</sup> ] (or MPa)	B400 for balsa B300 for other materials
$\hat{\sigma}_{yz}$ core non-linear	Core shear stress normal to the core plane	[N/mm <sup>2</sup> ] (or MPa)	B400 for balsa B300 for other materials
<b>Fracture toughness</b>			
$G_{Ic}$ core	Mode-I (opening) critical strain energy release rate	[N/m]	Section B500
$G_{II}$ core	Mode-II (shearing) critical strain energy release rate	[N/m]	Section B500

Table 3: Mechanical static properties for core materials

207 The static data for adhesive materials are the following:

	Mechanical parameter	Unit	Reference in Appendix 5a for measurement method
<b>In-plane elastic constants</b>			
$E_{\text{adhesive linear}}$	Modulus of elasticity of adhesive in the linear range	[N/mm <sup>2</sup> ] (or MPa)	C200 or C300
$E_{\text{adhesive non-linear}}$	Modulus of elasticity of adhesive at the failure point	[N/mm <sup>2</sup> ] (or MPa)	C200 or C300
$G_{xy \text{ adhesive linear}}$	In plane shear modulus of adhesive in the linear range	[N/mm <sup>2</sup> ] (or MPa)	Section C400
$G_{xy \text{ adhesive non-linear}}$	In plane shear modulus of adhesive at the failure point	[N/mm <sup>2</sup> ] (or MPa)	Section C400
$\nu_{xy \text{ adhesive}}$	Major Poisson's ratio of adhesive	[-]	C200 or C300
<b>In-plane strain to failure</b>			
$\hat{\epsilon}_t^{\text{adhesive}}$	Adhesive tensile strain at failure point		Section C200
<b>In-plane strength</b>			
$\hat{\sigma}_t^{\text{adhesive}}$	Adhesive flatwise tensile strength	[N/mm <sup>2</sup> ] (or MPa)	Section C300
$\hat{\sigma}_t^{\text{adhesive}}$	Adhesive tensile strength	[N/mm <sup>2</sup> ] (or MPa)	Section C200
$\hat{\sigma}_{xy \text{ adhesive}}$	Adhesive shear strength	[N/mm <sup>2</sup> ] (or MPa)	Section C400
<b>Fracture toughness</b>			
$G_{Ic \text{ adhesive}}$	Mode-I (opening) critical strain energy release rate	[N/m]	B500 or D200
$G_{IIc \text{ adhesive}}$	Mode-II (shearing) critical strain energy release rate	[N/m]	B500 or D200

Table 4: Mechanical static properties for adhesive materials

### B 300 Relationship between strength and strain to failure

- 301 For material exhibiting a brittle type (type-I) of failure and a linear elastic behaviour up to ultimate failure then,  $E = \sigma/\epsilon$
- 302 For material exhibiting a ductile or plastic type of failure (respectively type-II and -III), the linear relationship shall be used up to the upper bound of the linear elastic limit. Material properties

listed in Table 3 and Table 4 pertaining to this regime are called linear.

- 303** Beyond the upper bound of the linear elastic limit, a different modulus shall be used; this one shall represent the elastic behaviour related to the range of the stress-strain curve. Material properties, listed in Table 3 and Table 4 and pertaining to this regime, are called non-linear. In most cases, it is convenient to use a linear secant modulus to describe the material.
- 304** When the stress-strain relationship can not be established for non-linear range, a non-linear analysis shall be carried out.

#### **B 400 Characteristic values**

- 401** Characteristic values shall be used for all strength values in this guideline. The procedure to obtain characteristic values is given in *Section 4 B 400*.
- 402** For most core materials the coefficient of variation (COV) of the test specimens is relatively independent of the specimen size. However, for some materials, like balsa, the COV varies with specimen size. This variation should be considered in the analysis.
- 403** Balsa sandwich structures show a reduction of COV with specimen size. If global properties are needed the COV of large specimens may be used. If local properties are needed, e.g., for a joint analysis, COV values of the critical dimensions in the analysis shall be used.

#### **B 500 Shear properties**

- 501** Shear properties of core materials are difficult to measure. Suitable test methods should be used for the determination of shear design properties, see Section 5 B200 and Section 5 Appendix A. When using data from the literature, it should be checked that the proper test methods are used.

-----Guidance note-----

Using the block shear tests data to obtain the shear strength of balsa beams and panels will in many relevant cases overestimates the shear strength by a factor of 2 to 4. Block shear test, such as the one used in ASTM C 273-94 or ISO 1922, should not be used to obtain design shear strength of balsa cored sandwich beams and panels. The flexural test method used in ASTM C 393-62 can be used instead, see Section 5 Appendix A

-----End-----

- 502** Ideally the test method shall measure core yield or ultimate strength that is independent of the specimen geometry and that can be used for all structural geometries. If such a method cannot be found, e.g. for materials like balsa, corrections may have to be applied to the test results. Typical effects that require corrections are change in core thickness, change in skin thickness, in-plane size, effects of bending and shear load superposition.
- 503** For polymeric cellular material the effects due to size and bending/shear load superposition on shear properties are negligible.
- 504** For honeycomb materials thickness correction factor should be applied to strengths and moduli, when using other thicknesses than those available from test data or from the literature. Mechanical properties are usually available from manufacturers according to material, density, cell size, and thickness.
- 505** For balsa wood material there are two important size effects: core thickness size effect and an in-plane size effect. Further, the influence of bending and shear load superposition is significant and reduces the shear strength.
- 506** For balsa wood material the value of the ultimate shear strength obtained from test results should only be used directly for the design of balsa-cored sandwich structures having identical geometrical, physical and loading characteristics as the test specimens. Otherwise the shear strength should be corrected.
- 507** If the core thickness of the component is less than the thickness of the test specimens a core thickness correction is not necessary. This is a conservative simplification.
- 508** The corrected shear strength should be calculated as follows:

For sandwich beams as

$$\tau_{\text{corrected}} = \tau_{\text{ref}} \cdot f_{tc} \cdot f_i \cdot f_b$$

and for sandwich panels as:

$$\tau_{\text{corrected}} = \tau_{\text{ref}} \cdot f_{tc} \cdot f_{ip} \cdot f_b$$

where,

- $\tau_{\text{ref}}$  is the mean value of the shear strengths measured from the reference specimen,
- $f_{tc}$  is a correction factor for the effect of core thickness,
- $f_i$  is a correction factor for the in-plane size of the sandwich beam
- $f_{ip}$  is a correction factor for the in-plane size of the sandwich panel,
- $f_b$  is a correction factor accounting for the effect of bending.

- 509** The correction factors can be obtained experimentally by testing specimens of at least three different dimensions. The corrections factors are based on Weibull theory. A method to obtain the correction factors experimentally is described in [McGeorge, D and Hayman B.: "Shear Strength of balsa-cored-sandwich panels", in proceedings of the 4th international conference on sandwich construction, Olsson, K-A \(Ed\), EMAS Publishing, UK, 1998. The factors are given by:](#)

$f_{tc}$ is a correction factor for the effect of core thickness $t$ of a sandwich beam	$f_{tc} = \frac{t_{corrected}}{t_{ref}} = \left( \frac{t_{ref}}{t_c} \right)^{1/m_{tc}}$
$f_i$ is a correction factor for the in-plane width $w$ of a sandwich beam	$f_i = \frac{\tau_{corrected}}{\tau_{ref}} = \left( \frac{I_{sl,ref} w_{ref}}{I_{sl} w} \right)^{1/m_i}$
$f_{ip}$ is a correction factor for the in-plane size $b$ of square panels	$f_{ip,square} = \frac{\tau_{corrected}}{\tau_{ref}} = \left( \frac{b_{ref}}{b} \right)^{2/m_{ip}}$
$f_{ip}$ is a correction factor for the in-plane size $ab$ of rectangular panels	$f_{ip,rectangular} = \frac{\tau_{corrected}}{\tau_{ref}} = \left( \frac{2b_{ref}^2}{ab} \right)^{1/m_{ip}}$
$f_b$ is a correction factor accounting for the effect of bending	$f_b = \frac{\tau}{\tau_{ref}} = \frac{G_c}{a_1 \frac{\epsilon}{\gamma} + a_2}$

Where  $t_{ref}$  is the mean value of the shear strengths measured from the reference sandwich specimen.

$f_b$  can be derived as follows:

The ratio between shear strain and bending strain for a beam subject to four point bending is given by the following formula (derived from sandwich beam theory):

$$\frac{\epsilon}{\gamma} = \frac{I_b G_c t_c}{t_f E_f d}$$

where  $\frac{\epsilon}{\gamma}$  is the ratio between extensional in-plane strain and shear strain occurring in the core.

A simple failure criterion in terms of shear strain and in-plane normal strain can be chosen as:

$$\frac{\epsilon}{C_\epsilon} + \frac{\gamma}{C_\gamma} = 1$$

where  $C_\epsilon$  and  $C_\gamma$  are empirical constants. These empirical constant  $C_\epsilon$  and  $C_\gamma$  are determined by fitting the previous equation to measured data.

Solving the equations simultaneously for  $\frac{\epsilon}{\gamma}$  and multiplying by  $G_c$ , one obtains the shear stress as

a function of the  $\frac{\epsilon}{\gamma}$  ration:

$$f_b = \frac{\tau}{\tau_{ref}} = \frac{G_c}{a_1 \frac{\epsilon}{\gamma} + a_2}$$

and where  $a_1$  and  $a_2$  are constants.

-----Guidance note-----

The coefficients are based on Weibull theory. The theory states that

$$\frac{\sigma_1}{\sigma_2} = \left( \frac{V_2}{V_1} \right)^{1/m}$$

where  $\sigma_i$  is the uniform stress at failure acting over a volume  $V_i$ .

The equation describes the dependence of the failure stress on the loaded volume, and was originally developed for the failure of brittle materials such as ceramics. In a balsa-cored sandwich beam, one can expect the core failure of a shear-loaded beam to be controlled by randomly distributed defects within the loaded volume. For a 4-point bending specimen, the shear-loaded volume is  $V=2L_bwt_c$ .

-----End of guidance note-----

- 510** Other methods to correct the shear strength may be used if they are backed by experimental evidence.
- 511** For specifically predicting the shear strength at failure of balsa-cored sandwich beams or panels made out of end-grain balsa type of density  $150 \text{ kg/m}^3$ , and provided that the ratio between extensional in-plane strain and shear strain occurring in the core,  $\frac{\epsilon}{\gamma}$ , remains between 0.37 and 1.1, the following correction factors may be used.

$$t_{ref.} = 1.52$$

$$f_{tc} = \left( \frac{50}{t_c} \right)^{1/3.7} \quad f_i = \left( \frac{17600}{l_{sl}w} \right)^{1/7.9}$$

$$f_{ip} = \left( \frac{17600}{l_{sl}w} \right)^{1/7.9} \quad f_b = \frac{104}{22 \frac{e}{g} + 89}$$

and

$$\frac{\epsilon}{\gamma} = \frac{l_{sl}G_c t_c}{t_f E_f d} \quad d = t_c + t_f$$

with:

- $\frac{e}{g}$  : the ratio between extensional in-plane strain and shear strain occurring in the core
- $t_c$  : the core thickness
- $l_{sl}$  : the shear-loaded length
- $w$  : width
- $G_c$  : the core shear modulus
- $t_f$  : the face thickness
- $E_f$  : the face in-plane elastic modulus

In the above equations shear stress values are in MPa and lengths in mm.

-----Guidance note-----

Each correction factor is independent. When no correction is needed, for example when a size effect does not occur because of identical dimensions between reference specimen and structure to design, the corresponding correction factor shall be set to 1 in the above equations.

-----End of guidance note-----

-----Guidance note-----

When using data from the literature, it shall be checked that the geometrical, physical and loading characteristics are proper for the structure under consideration.

-----End-----

**512** Characteristic values of the shear strength,  $\tau_{\text{char}}$ , shall be based on the corrected shear strength values,  $\tau_{\text{corrected}}$ . Calculations shall be done as described in Section 4 B-400.

## **B 600 Core Skin Interface Properties**

**601** Good bonding between skin and cores shall be insured.

**602** The shear strength, transverse tensile strength and peel strength are usually the critical parameters that should be checked for sandwich structures.

**603** If it can be documented that the interface is stronger than the core, core properties can be used to describe the interface. For many sandwich structures made of foam core the interface is stronger than the core and interface failure is actually a failure inside the core close to the interface.

**604** Test methods to obtain interface properties are described in the Appendix 5A.

**605** The general requirements for interfaces described in Section 7 should also be considered.

## **C. Properties under long term static and cyclic loads**

### **C 100 General**

**101** The structure shall be analysed for the elastic constants before time-dependent damage and for the elastic constants with time-dependent damage.

**102** If the structure is exposed to through thickness time-dependent loads or deformations, a degradation of the through thickness properties shall be considered. Experimental evidence shall



be provided since no other guidance can be given today (year 1999).

- 103** The single logarithmic representation of fatigue data shall be preferred; the scale of the x-axis should be logarithmic function of the cycle number.
- 104** For low and normal safety class, the effects of creep and stress relaxation may be ignored if the maximum stress does not exceed 10% of the characteristic strength and the loading time does not exceed  $10^4$  hours.
- 105** For low and normal safety class: the effects of cyclic fatigue may be ignored if the maximum stress does not exceed 10% of the characteristic strength and the number of cycles does not exceed  $10^8$ .
- 106** See also *Section 4*.

## **C 200 Creep**

- 201** The application of a permanent load may lead to creep of the structure and of some of the constituent material. This is described as a reduction of the modulus of elasticity.
- 202** Under the constant load, the increase of deformation results in an apparent reduction of the modulus of elasticity, called creep modulus.
- 203** The creep of the composite sandwich structure is a combined effect of the creep of the matrix, adhesive, core and the fibres. However, creep is a phenomenon observed mainly in the matrix and mainly in the core.
- 204** Depending on the sandwich structure geometry and loading conditions, creep may occur principally in one constituent material. Creep deformation can then be neglected in the constituent materials bearing little stress.
- 205** Ideally, creep shall be measured on the actual sandwich structure for the relevant loading condition.
- 206** Creep is dependant on material, material density, stress level, temperature and loading time.

-----Guidance note-----

For balsa - creep of end-grain balsa is independent on density at both room and elevated temperature.

For polymeric foam - creep of polymeric foam is dependant on density at room temperature and elevated temperature; long-term creep behaviour prediction can be estimated from short-term data using the time-temperature superposition principle or curve fitting functions. For PVC foams, ductile foams exhibits larger creep than brittle foams.

For honeycomb - creep of Nomex honeycomb is dependant of density at room temperature and elevated temperature.

-----End Guidance note-----

Time-temperature superposition principle (TTSP) can be used for the long-term prediction of creep of

some polymeric foam. The principle applied to some type of foams but not all; the fundamental application is indeed dependant on the chemical nature of the polymer. So far, it has been showed that the TTSP is applicable to linear PVC foam but not to cross linked PVC foam. For the latter curve fitting functions may be used to determine long-term properties.

Shift parameters for the determination of tensile or compressive modulus (for the determination of long-term creep behaviour using short-term data) may be different.

-----End-----

- 207** Creep of adhesive can be described in the same fashion as the creep of matrices in matrix-dominated laminate properties, see Section 4.

### **C 300 Stress rupture under permanent static loads**

- 301** The time to failure under a permanent static stress is described by a stress rupture curve.

- 302** The stress rupture curve may be described as:

$$\log \bar{\sigma} = \log \sigma_{\text{stress rupture}} - \beta \log t$$

where  $t$  is the time to failure under a permanent stress  $\sigma$ .

- 303** The material parameters  $\sigma_{\text{stress rupture}}$  and  $\beta$  shall be determined experimentally or be based on typical data as described in *Section H* and *Section 5-App.A*.

- 304** Ideally, stress rupture shall be measured on the actual core for the relevant loading condition and environment.

### **C 400 Static strength reduction due to permanent static loads**

- 401** If a sandwich structure is exposed to a permanent stress of any magnitude for a time  $t$ , the static strength influenced by that stress, often called residual strength, shall be estimated from the stress rupture curve:

$$\log \bar{\sigma} = \log \sigma_{\text{stress rupture}} - \beta \log t$$

- 402** Residual strains shall be obtained from the residual stress and the time dependent stiffness value.

- 403** If static strength reduction curve are not available, stress rupture curve may be used.

-----Guidance note-----

Static strength values estimated from an stress rupture curves are typically conservative.

For low cycle fatigue, when a component is subjected to high load over a short fatigue lifetime, reduced static strength may be comparatively lower than estimated value from stress rupture curves.

-----End of guidance note-----

- 404** If the stress rupture curve is used and is not linear in a log presentation, the static strength cannot be calculated by the above equation, but shall be taken directly from the stress rupture curve.

**405** Higher static mechanical properties values may be used on the ground of experimental evidence. The procedure in *4C400* may be used.

### **C 500 Stress relaxation**

**501** Under the constant deformations, stress relaxation and/or residual strength reduction may occur.

**502** Stress relaxation is a visco-elastic or plastic process reducing the stresses in the material. This effect is accompanied by a reduction of the elastic modulus.

**503** Residual strength reduction is defined as the static short-term strength of the material after creep conditioning.

**504** Stress relaxation is a phenomenon mainly observed in the matrix and core materials. However, fibres may also show some stress relaxation behaviour.

**505** Ideally, stress relaxation should be measured on the actual core for the relevant loading condition.

**506** In some cases, tensile stress relaxation data may be used to estimate stress relaxation in compression and vice-versa, as long as it can be shown to be an equivalent or conservative approach.

**507** For FRP faces, the same paragraphs apply as in Section 4.

### **C 600 Change of modulus of elasticity under cyclic fatigue**

**601** The reduction of stiffness or stability properties of sandwich structures due to cyclic fatigue should be considered. This reduction may be caused by:

- a reduction in modulus of elasticity in the facings materials and/or in the core(s) materials due to various types of damage, e.g. microcracks..
- a local debonding between faces and core at the interface.

- 602** The proportion of the contributions in the modulus reduction of the facings and core varies according to the geometrical, mechanical and loading specifications of the sandwich structure.
- 603** The change of modulus of elasticity of FRP facings and adhesives is described in *Section 4*.
- 604** The decrease of the value of the core elasticity modulus can be due
- 605** The reduction in core elasticity modulus differs according to materials and is dependant on loading conditions, i.e. stress nature, stress level, load ratio, strain rate, exposure time.

-----Guidance note-----

Creep can be induced under cyclic fatigue, especially for R ratio different from -1.

-----End of guidance note-----

- 606** Experimental results may be used to demonstrate different changes of the elastic constants during cyclic for specific cores or adhesives or loading conditions.

-----Guidance note-----

For balsa -

For polymeric foam - Elasticity modulus of polymeric foam cores typically varies less than 10% until short before failure for high cycle fatigue and maximum stress levels pertaining to the linear range. For low cycle fatigue and maximum stress levels close to ultimate values, elasticity modulus varies as much as 100% through the entire life.

For honeycomb -

Input from manufacturers is needed.

-----End of guidance note-----

- 607** The elastic constants can be estimated to change to the following values for crosslinked PVC and balsa cores after extensive cyclic fatigue exposure:

<b>Core Mechanical Properties</b>	<b>Mechanical parameter</b>	<b>Effects of cyclic fatigue exposure</b>
$E_{t \text{ core}}$	Tensile modulus of elasticity of core	10% reduction for high-cycle fatigue.
$E_{c \text{ core}}$	Compressive modulus of elasticity of core	10% reduction for high-cycle fatigue.
$G_{xy \text{ core}}$	In-plane shear modulus of core	10% reduction for high-cycle fatigue.
$E_{zt \text{ core}}$	Out-of-plane core tensile elasticity modulus	10% reduction for high-cycle fatigue
$E_{zc \text{ core}}$	Out-of-plane core compressive elasticity modulus	10% reduction for high-cycle fatigue.
$G_{xz \text{ core}}$	Out-of-plane core shear modulus	10% reduction for high-cycle fatigue.

$G_{yz \text{ core}}$	Out-of-plane core shear modulus	10% reduction for high-cycle fatigue.
$\nu_{xy \text{ core}}$	Major Poisson's ratio of core	(unknown)
$\nu_{yx \text{ core}}$	Minor Poisson's ratio of core	(unknown)
$\nu_{xz \text{ core}}$	Core Poisson's ratio normal to the core plane	(unknown)

Table 5: Effects of cyclic fatigue on elastic constants

### C 700 Cycles to failure under fatigue loads

**701** The number of cycles  $N$  to failure under a cyclic stress is described by an S-N curve for a specified R-ratio.

**702** The R-ratio is defined as the minimum stress divided by the maximum stress.

**703** The core material curve for the lifetime strength analysis should be described as:

$$\log \bar{\sigma} = \log \sigma_{0 \text{ fatigue}} - \alpha \log N$$

**704** The strain representation can be obtained as described earlier in this section.

**705** All fatigue curves shall be obtained from load controlled tests, unless the structure is clearly only exposed to deformation controlled fatigue.

**706** SN curves should be preferably obtained for R ratios relevant for the application. Minimum requirements are given in 707-710.

**707** If the structure is exposed to tensile and compressive fatigue, at least data for  $R=-1$  shall be available.

**708** If the structure is only exposed to tensile fatigue, data between  $R=-1$  or  $R=0.1$  may be used.

**709** If the structure is only exposed to compressive fatigue, data between  $R=-1$  or  $R=10$  may be used.

**710** Care shall be taken to identify whether fatigue data are given as stress amplitude or stress range.

**711** A Hall diagram shall be constructed from the fatigue curves if the structure is exposed to fatigue stresses of other R ratios than the measured ones or to various R-ratios.

**712** Ideally, fatigue should be measured on the actual sandwich structure for the relevant loading condition and environment.

**713** SN curves may also be measured for specific load sequences if relevant. This may be beneficial,

because Miner sum calculations would not be needed for that load sequence. The validity of the data for other load sequences would have to be demonstrated.

### **C 800 Static strength reduction due to cyclic loading**

- 801** If a core is exposed to a cyclic stresses of any magnitude for a number of cycles N, the static strength influenced by that stress shall be determined.
- 802** If static strength reduction values are not available, the S-N curve may be used as a conservative estimate, as long as loads never exceed the static yield strength of the core.

-----Guidance note-----

Static strength values estimated from an S-N curve are typically conservative.

When subjected to very high cyclic load over short period of time, the reduced static strength may be much lower than an estimated value from S-N curve - and here wrongly assumed being a conservative approach.

-----End of guidance note-----

- 803** Static strains to failure shall be obtained from the reduced static strength and the cycle dependent stiffness value.
- 804** If the S-N curve is used and is not linear in a log presentation, the static strength cannot be calculated by the above equation, but shall be taken directly from the S-N curve.
- 805** Higher static mechanical properties values may be used on the ground of experimental evidence. The procedure in *4C400* may be used.

-----Guidance note-----

For balsa -

For polymeric foam - For brittle PVC foam, 90% of the static strength is preserved up to almost the end of the fatigue life. At the end of the cyclic life, static strength decreases very significantly up to 100%.

For honeycomb -

Input from manufacturers is needed.

-----End of guidance note-----

### **C 900 Effect of high loading rates - shock loads - impact**

- 901** The application of a high loading rates may cause the core or the adhesive material to behave differently.
- 902** Strain rate effects are material-dependant but also vary with temperature.

**903** Typical apparent effects of high loading rates are:

- increase in strength
- increase in modulus
- decrease of strain to failure
- change of failure mode from ductile or plastic to brittle.

-----Guidance note-----

The effect of high strain rate is more pronounced for polymeric materials than for wooden or metallic materials.

For polymeric materials, such as polymeric foam, strain rate effects are significant for values superior to 5% per second at room temperature

For balsa wood core materials, strain rate effect is negligible for temperature range belonging to -20 +40°C and for strain due to slamming of waves in marine applications.

Core Material	Typical increase in strength
Aluminium honeycomb	12%
Nomex honeycomb	20%
End-grain balsa	30%
linear PVC foam	80%
cross-linked PVC foam	28%

Table 6: Typical increase in strength due to strain rate increase by 4 decades, i.e. 0.001/s to 10/s.

-----End of guidance note-----

**904** Decrease of strain to failure under high strain rate regime may be render critical stress concentration areas, for example, area of load introduction, joints, inserts.

**905** When strain rates effects are unknown, strength and elasticity modulus for quasi-static conditions should be used together with strain to failure at high strain rate - as a conservative approach.

**C 1000 Characteristic values**

**1001** Characteristic values shall be used for all stress rupture and SN curves in this guideline. The procedure to obtain these values is the same as given in *Section 4 C 1100*.



## **D. Other Properties**

### **D 100 Thermal expansion coefficient**

- 101** Thermal expansion coefficient of the cores in the relevant temperature range shall be measured in the main material directions.
- 102** Stresses due to thermal deformation shall be considered.

### **D 200 Swelling coefficient for water or other liquids**

- 201** Swelling coefficient of the plies in the relevant temperature range shall be measured in the main material directions.
- 202** Stresses due to swelling shall be considered.

### **D 300 Diffusion coefficient**

- 301** Relevant data shall be obtained as needed for the actual service and exposure of the component. If relevant, the following material data may be required:
- Diffusion rate through the thickness of the core.
  - Diffusion rate along the in-plane axis of the core.
  - Diffusion rate along the interfaces between core and skin.
- 302** A special property related to diffusion is vapour transmission. This value is sometime of importance for sandwich structures.

### **D 400 Thermal conductivity**

- 401** Thermal conductivity may be anisotropic for cores. If relevant thermal conductivity shall be obtained.

### **D 500 Friction coefficient**

- 501** Core materials are generally not exposed to friction. If they are the same procedure as given in *Section 4* shall be applied.

### **D 600 Wear resistance**

- 601** Core materials are generally not exposed to wear. If they are the same procedure as given in *Section 4* shall be applied.

## **E. Influence of the environment on properties**

### **E 100 Introduction**

- 101** The environment can affect composites. Both adhesives and cores can be affected in different ways due to their different chemical nature and micro-structure.
- 102** Void content and the presence of matrix cracks in the face laminates can indirectly influence the environmental resistance of the core and adhesive materials. Rapid and excessive water penetration can for example damage quickly the interface bond between faces and core.
- 103** The nature of the core cells, whether closed or opened, influences very significantly the environmental resistance of the core materials.
- 104** The quality of interface bonding between faces and cores, or between cores themselves can also influence the environmental resistance of the adhesive joints, and thereby the entire sandwich structure.
- 105** The local environmental conditions shall be taken into account for the documentation of all properties under static and fatigue loads, as described above.
- 106** Degradation of joining structures shall also be documented, e.g. end enclosures, connections, corners, T-joints and other fasteners.
- 107** Cyclic environmental conditions shall be considered.
- 108** It shall be documented that the combined effects of cyclic loads, static load, and the environment are not worse than the separate effects.
- 109** The following conditions are considered:
- temperature
  - water
  - chemicals
  - UV radiation

**E 200 Effect of temperature**

**201** In general, core materials shall only be used when  $T < T_g - 20^\circ\text{C}$ . Above  $T_g$ , important changes in material properties take place.

Core Material	Glass Transition Temperature
(Paper honeycomb)	(-)
Aluminium honeycomb	210
Glass/Phenolic honeycomb	180/250
Nomex honeycomb	180
(balsa wood)	(-)
Polyurethane foam	100
Polystyrene foam	75
Polyvinyl chloride foam (I)	60
Polyvinyl chloride foam ©	80
Poly-metacryl-imide foam	215

Table 7: Typical glass transition temperature

**202** The effect of temperature on adhesives is similar to the effect of temperature on the matrix material described in *Section 4*.

**203** The effect of temperature on adhesive and core materials can be un-significant when the time of exposure is short.

-----Guidance note-----

Composite materials have very high insulation and low thermal conductivity. Time for heat transfer to the core material is consequently important.

-----End of guidance note-----

**204** Operational temperature effects have to be confirmed for individual material.

<b>Core Mechanical Properties</b>	<b>Qualitative Effect</b>	<b>Quantitative effect or Test requirement</b>
Static elastic constants	Polymeric foam: decrease with increasing temperature; increase with decreasing temperature below room temperature. balsa wood: small variation of properties for the -20, +40°C temperature range	measure
Static tensile strengths	Polymeric foam: decrease with increasing temperature; increase with decreasing temperature below room temperature. balsa wood: small variation of properties for the -20, +40°C temperature range	measure
Static compressive strengths	Polymeric foam: decrease with increasing temperature; increase with decreasing temperature below room temperature. balsa wood: small variation of properties for the -20, +40°C temperature range	measure
Fracture toughness	Polymeric foam: decrease with increasing temperature; increase with decreasing temperature below room temperature. balsa wood: small variation of properties for the -20, +40°C temperature range	measure
Creep / Stress relaxation	<i>(unknown)</i>	test
Time to stress rupture	<i>(unknown)</i>	test
Change of static strength under permanent load	<i>(unknown)</i>	test
Change of modulus under fatigue	<i>(unknown)</i>	test
Time to fatigue failure	<i>(unknown)</i>	test
Change of static strength under fatigue load	<i>(unknown)</i>	test

Table 8: Effects of temperature on foam core materials

**205** In the case of recently-manufactured foam core materials used in sandwich structures, the effect of outgasing under elevated temperature may induce subsequent delamination at the core-facing interface.

**E 300 Effect of water**

**301** The effect of water on adhesive and core materials can be un-significant when the time of exposure is short.

**302** If the laminate of the sandwich protect the entire core and the adhesive from the exposure, the resistance to water may be less critical. However, water diffuses through laminates and may degrade core properties.

**303** Some core materials are specially treated or sealed to reduce any effects of water. The advantageous effect of the treatment shall be documented. If the treated core material is used in a component a quality procedure shall ensure that no untreated core material is used.

**304** The effect of water on cellular core materials is typically severe for open-cell micro-structure and much less severe for closed-cell materials.

**305** Moisture content has an important influence on the mechanical properties of wooden core materials.

**306** Balsa and other wood core materials are very susceptible to water penetration and consequent swelling, debonding and rot.

-----Guidance note-----

Flat-grain balsa (in which the grain lies parallel to the panel surface) has greater susceptibility to water permeation and is generally less satisfactory as a core material than End-grain balsa.

-----End of guidance note-----

**307** Crosslinked PVC cores and specially sealed and treated end grain balsa cores have demonstrated no degradation in a marine environment when embedded in typical laminates. Some documentation with respect to the resistance to a sea water environment shall be provided.

**308** Resistance to water of core materials at high pressures in deep water is unknown and shall be demonstrated if relevant.

**309** The effect of seawater is generally less severe than the effect of fresh water.

**310** The effect of distilled water is more severe than the effect of fresh water.

**311** The combination of water and high temperature may be worse than the individual effects of temperature and water.

**312** In case of a core material permanently exposed to water, long term properties should be documented.

#### **E 400 Effect of chemicals**

**401** The compatibility of cores and adhesives to the exposure to chemicals shall be demonstrated.

**402** In a qualitative way chemicals tend to have the same effects as water on cores and adhesives. The degradation rates shall be obtained for the actual materials in question.

**403** If the laminate of the sandwich protect the core and the adhesive from the exposure, the resistance to chemicals may be less critical. However, most chemicals can diffuse through laminates and may attack the core.

#### **E 500 Effect of UV radiation**

**501** Core materials are typically embedded in a laminate and are not exposed to direct UV radiation.

**502** If core materials are exposed to UV radiation their resistance shall be documented and quantified if necessary.

#### **E 600 Electrolytic Corrosion**

**601** Possible electrolytic corrosion should be considered when metallic components and carbon fibres are used in a sandwich structure.

#### **E 700 Combination of environmental effects**

**701** The combination of environmental effects on materials, like combined humidity and heat, may be worse than the individual effects.

**702** Test data should be obtained of the combined effect of environments on the material properties if relevant. The worst relevant combination of environments should be used for testing.

## **F. Influence of process parameters and core density**

### **F 100 Core production**

- 101** Core materials are generally manufactured in a well-controlled process. This guideline does not address manufacturing methods of core materials. It is assumed that the measured and reported core properties can be reproduced and guaranteed by the core manufacturer.
- 102** In some cases the core properties may be influenced by the joining methods used to join the skins or core sections. This aspect is described in *F200*.

### **F 200 Sandwich production**

- 201** The skins are usually laminated onto the core or glued onto the core. Sections of the core may also be joined with adhesives or some fillers.
- 202** The joints may influence the properties of the core either by modifying the core material itself or by becoming part of the core system. Core properties shall be measured and evaluated with the presence of such joints.
- 203** Changes in process parameters effect joints in a similar way as described for the matrix in a laminate in *Section 4F*.

### **F 300 Influence of core density**

- 301** For core materials that are available in different densities, all mechanical properties shall be assumed to depend on the density unless evidence exists that suggests otherwise.
- 302** All relationships between properties and density shall be confirmed by experimental evidence for the particular core type. Data may be interpolated, but should not be extrapolated to densities outside the measured range.
- 303** If a relationship can be established between core density and certain core properties qualification of material properties may be simplified as described in *Section H600*.

## G. Properties under fire

### G 100 Introduction

- 101** The performance of composites in a fire is a complex process, because the various constituent materials respond differently to a fire.
- 102** The requirements under fire conditions can usually be found in the fire codes for a particular application.
- 103** Fire codes may implicitly assume that the structure is built of steel or metal. The relevance of a fire code to composite materials shall be checked carefully.
- 104** Since most composites are flammable and temperature sensitive most applications use protective measures to reduce the impact of fire. In this case the fire performance of the complete system, composite structure with fire protection shall be evaluated.
- 105** Some aspects of fire performance can be modelled, but some experimental testing shall always be done to demonstrate fire performance.

-----Guidance note-----

*Sanwich panels with no internal cavities, such as wood and foam core materials, will not allow any stack effect or neither help the transportation of combustion products. Conversely, sandwich structures with internal cavities will enhance these phenomenons.*

-----End-----

### G 200 Fire reaction

- 201** Fire reaction describes the response of a composite to fire in terms of flammability, flame spread, smoke development and emission of toxic gases. All these aspects shall be documented if relevant.
- 202** Special additives or fillers are often added to composites to improve fire reaction.
- 203** The influence of such additives or fillers on the basic mechanical properties shall be evaluated.

### G 300 Fire resistance

- 301** Fire resistance describes the remaining strength of a composite structure under a fire.
- 302** As a first estimate of fire resistance, the temperature-dependent properties as described in Section E-200 can be used.
- 303** The temperature within a sandwich component can be calculated by means of appropriate



models.

- 304** If chemical reactions can occur within the sandwich component, their influence on the temperature distribution shall be considered.
- 305** Through thickness properties and core properties shall be carefully evaluated, especially in the region of joints.

-----Guidance note-----

A panel with stiffeners may lose most of its stiffness if the stiffeners delaminate from the panel due to the fire.

-----End of guidance note-----

#### **G 400 Insulation**

- 401** The properties of the insulation with respect to fire reaction and fire resistance shall be evaluated.
- 402** Special consideration shall be given to the joints of the insulation and the method the insulation is attached to the component. Attachment points and joints may create hot spots in the component.
- 403** All large scale testing shall be done with jointed insulation and the same attachments as used in the real application.

#### **G 500 Properties after the fire**

- 501** A fire is usually seen as an accidental load case and properties after the fire shall be evaluated for each individual case.
- 502** If the temperature has locally exceeded the  $T_g$  of the component it is very likely that permanent damage has been made to the component in that area.
- 503** If the temperature remained locally under  $T_g$  damage may be introduced due to overloads from other parts of the structure.

### **H. Qualification of material properties**

#### **H 100 Introduction**

- 101** All material properties needed to describe the performance of a component shall be documented.
- 102** As a general principal, material properties should be obtained from test results of laminates that represent the laminates of the component as closely as possible.
- 103** Material properties may be documented by the following methods:
- Direct measurements
  - Qualification against representative data

- Qualification against manufacturers data
- Qualification against data from the open literature
- Qualification by component testing

**104** Each individual material property may be qualified by any of the different methods.

**105** Which data can be used for qualification depends mainly on two aspects:

- Were the data obtained from laminates that are similar to the laminates used in the component.
- Were the data obtained from reputable sources.

## **H 200 General test requirements**

**201** All relevant information about the material tested, the test method, and the test conditions shall accompany test results. The information requested in *A200* shall be provided.

**202** Static test results shall be reported as mean, standard deviation, coefficient of variation, and number of test specimens. The characteristic values of static tests shall be calculated as described in *Section 4 B400*.

**203** Long-term test results shall be reported as mean regression curve, standard deviation with respect to time or cycles, number of test specimen, range of test time or number of cycles. Test points shall be spread out relatively evenly over the logarithmic test period. The characteristic values of long-term tests shall be calculated as described in *Section 4 C1100*.

## **H 300 Selection of material qualification method**

**301** The test results shall apply to the core and adhesive used in the component to be designed and built. Test results are only applicable if the test core and adhesive and the sandwich structures are similar enough that the test results are valid or conservative for the actual component.

**302** If a core material is the same as an already tested material no further testing is required. The same core material means:

- Same basic material type, e.g. balsa, honeycomb, PVC foam core
- Same core manufacturer, same trade name
- No change with respect to cell structure, processing method, raw materials used.

- 303** If a core material is similar to an already tested material qualification against a representative material may be carried out. Requirements for similarity are given in H600, requirements for representative data are given in H500.
- 304** Direct measurements as described in *H400* shall be carried out if *302* or *303* cannot be applied.
- 305** Any change of adhesive requires re-qualification of the properties related to the adhesive performance as described in *H600*.

#### **H 400 Direct measurement**

- 401** The various properties of a composite may be measured directly for a particular material. Data will be valid for that particular material that was tested. The material shall be characterised as required in *Section A 200*.
- 402** The test methods described in Appendix 5A should be preferred.

#### **H 500 Representative data**

- 501** If a sufficient number of direct measurements is available, data may be used to establish a set of representative data for a material property. To be considered representative, data should be based on at least 15 measurements per property. Other materials can be compared against the representative data as described in *H600*.

**502** Representative data are most useful if they can be used for a fairly wide range of materials. This will also allow to pool data of different properties that were obtained from slightly different materials. Requirements for to the individual materials that can be put into one group of representative data are given below:

<b>Constituent core material(s):</b>	<b>Requirements to group measurements from different sandwich cores</b>
Generic core type (e.g. foam, honeycomb, balsa etc.)	Same for all tests
Core trade name	Same for all tests
Type of core (e.g. linear foam)	Same for all tests
Type/ characteristics of microstructure	Same for all tests
Core manufacturer	Same for all tests
Batch number	Not relevant
Glass transition temperature	Lowest from all tests
<b>Constituent adhesive material(s):</b>	
Generic adhesive type (e.g. epoxy, polyester)	Same for all tests
Specific adhesive type trade name	Same trade name*
Specific adhesive type batch number	Not relevant
Catalyst	Same trade name*
Accelerator	Same trade name*
Fillers (trade name and batch number)	Same trade name*
Additives (trade name and batch number)	Same trade name*
<b>Process parameters to be given with exposure time:</b>	
Laminator (company)	Not relevant
Processing method	Same for all tests*
Processing temperature	Same for all tests*
Processing pressure	Same for all tests*
Process atmosphere (e.g. vacuum)	Same for all tests*
Curing temperature	Same for all tests*
Post curing (temperature and time)	Same for all tests*
Density of sandwich structures	Same for all tests*
<b>Conditioning parameters:</b>	
Temperature	Same for all tests*
Water content of the core (wet, dry)	Same for all tests*
Chemical environment	Same for all tests*
Loading rate	Same for all tests*
<i>number of specimens</i>	Reported individually for all properties

\* a wider range may be chosen if data are the minimum of a wide variety of products.

## H 600 Qualification against representative data

- 601** A product may be qualified against representative data if certain requirements are met for cores and adhesives:
- 602** Similarity is described here for core materials and core adhesives. Skin laminates shall be treated like laminates described in *Section 4H*. For testing of core properties the skin properties are usually not relevant.
- 603** Cores may be considered to be similar, if :
- the core is of the same generic type, e.g. cross-linked PVC, PUR, end-grained balsa, etc.
  - the cell structure is the same.
  - the raw materials to produce the core are the same
  - manufacturer and trade name may be different.
  - The shear strength  $\hat{\sigma}_{XC}^{\text{core linear}}$  and compressive characteristic strength ( $\hat{e}_{1t}$  fibre and  $\hat{e}_{1c}$  fibre) fulfil the similarity requirements given in *H700*.
  - The shear and compressive modulus is within 5% of the reference core.
- 604** Cores may be considered to be similar for a certain property, if :
- the core is of the same generic type, e.g. cross-linked PVC, PUR, end-grained balsa, etc.
  - the cell structure is similar.
  - the raw materials to produce the core are the same
  - manufacturer and trade name may be different.
  - The shear strength  $\hat{\sigma}_{XC}^{\text{core linear}}$  and compressive characteristic strength ( $\hat{e}_{1t}$  fibre and  $\hat{e}_{1c}$  fibre) fulfil the similarity requirements given in *H700* after corrections for the density change have been made according to *F300*.
  - The shear and compressive modulus is within 5% of the reference core after corrections for the density change have been made according to *F300*.
- 605** A core adhesive can be considered to be similar, if the adhesive is of the same generic type, e.g. vinylester, epoxy, and if its strain to failure is not less than the reference adhesive.
- 606** If the above basic similarity requirements are met, individual static sandwich structure properties shall be qualified as described in the table below. Some properties can be based directly on represented data or an equation to modify them is given. Other properties shall be confirmed by experiment (see *Section H700-H900*).
- 607** Instead of confirming all material parameters individually component testing may be used to qualify an analysis, as described in *I100*.

	<b>Mechanical parameter</b>	<b>Low Safety class</b>	<b>Normal safety class</b>	<b>High safety class</b>
Elastic constants	all	rep * 1	confirm E <sub>xt</sub> or E <sub>xc</sub> and G <sub>xc</sub> others: rep * 1	Confirm Moduli , Poisson's ratios confirm if critical
Strength and Strain to failure or yield	all	Rep * 0.9	Confirm if critical	confirm
<b>Fracture Toughness</b>				
Critical length	In-plane	rep * 0.8	confirm	confirm
G1c	Critical strain energy release rate in the fibre direction.	rep * 0.8	confirm	confirm
G2c	Critical strain energy release rate in the fibre plane, normal to the fibre direction.	rep * 0.8	confirm	confirm
<b>Long Term Properties</b>				
Creep/Stress relaxation		rep	confirm if critical for design	confirm
Stress rupture		rep	confirm if critical for design	confirm
Static strength reduction under permanent load		rep	rep	confirm if critical for design
Change of modulus under cyclic fatigue		rep	rep	confirm if critical for design
Cycles to failure		rep	confirm if critical for design	confirm
Static strength reduction under fatigue load		rep	rep	confirm if critical for design

Table 9: qualification against representative data

- 608** The entry "rep" in the table means that representative data may be used without testing. In some cases the representative data shall be multiplied by a factor as indicated in the table.
- 609** Confirm if critical for design means that the value or procedure of the lower safety class may be used if an additional safety factor of 2 can be applied in all relevant failure criteria.
- 610** The procedure of the higher safety class may always be used to obtain better values than can be obtained by using the procedure of the lower safety class.
- 611** If any of the confirmation tests show that the material is not similar to the representative material, all properties shall be re-qualified.
- 612** A full experimental determination of a property may always be used as an alternative to using representative data or confirmation testing.
- 613** For the qualification of adhesive materials data, see Section 4.

#### **H 700 Confirmation testing for static data**

See *Section 4H700*.

#### **H 800 Confirmation testing for long term data**

See *Section 4H800 and 900*.

#### **H 900 Use of manufacturers data or data from the literature as representative data**

- 901** There is a vast amount of data available, but unfortunately data are often not well documented and essential information tends to be missing.
- 902** This section describes under which conditions such data may be used.
- 903** It shall be documented that the data come from a reputable source. This can be done in the following way:
- All data were taken from calibrated test equipment
  - Data were witnessed by an independent third party or data were published and reviewed by at least two independent research teams.
- 904** If these requirements are not met data can still be used as representative data, but all new materials data have to be confirmed against these data, even if the requirements in H600 do not require a confirmation.

#### **H 1000 Confirming material data by component testing**

See *Section 4H1100*.

## SECTION 5: APPENDIX A

### Test Methods for Sandwich Materials

#### **SECTION 5: APPENDIX A..... 1**

#### **TEST METHODS FOR SANDWICH MATERIALS..... 1**

<b>A. GENERAL.....</b>	<b>1</b>
A 100 INTRODUCTION.....	1
A 200 GENERAL TESTING INFORMATION.....	2
<b>B. CORE MATERIALS - STATIC TESTS.....</b>	<b>3</b>
B 100 TENSILE TESTS.....	3
B 200 COMPRESSIVE TESTS.....	3
B 300 SHEAR TESTS.....	5
B 400 SHEAR TEST FOR Balsa.....	5
B 500 FRACTURE TOUGHNESS – STRAIN ENERGY RELEASE RATE.....	5
B 600 TESTS TO OBTAIN PROPERTIES UNDER LONG TERM STATIC AND CYCLIC LOADS.....	7
<b>C. ADHESIVE MATERIALS - STATIC TESTS.....</b>	<b>7</b>
C 100 GENERAL.....	7
C 200 TENSILE TESTS.....	7
C 300 FLATWISE TENSILE TESTS.....	7
C 400 SHEAR TESTS.....	7
C 500 TESTS TO OBTAIN PROPERTIES UNDER LONG TERM STATIC AND CYCLIC LOADS.....	7
<b>D. CORE SKIN INTERFACE PROPERTIES.....</b>	<b>8</b>
D 100 TENSILE TESTS.....	8
D 200 FRACTURE TOUGHNESS OF THE INTERFACE.....	8
D 300 OTHER TESTS.....	9
<b>E. TESTS FOR OTHER PROPERTIES.....</b>	<b>9</b>
E 100 COEFFICIENT OF THERMAL EXPANSION.....	9
E 200 WATER ABSORPTION TESTS.....	9
E 300 DIFFUSION AND VAPOUR TRANSMISSION.....	9
E 400 TESTS FOR THERMAL CONDUCTIVITY MEASUREMENTS.....	10
E 500 OVERALL VOLUME SHRINKAGE FOR GAP FILLING FILLERS.....	10
E 600 DENSITY TESTS.....	10

#### **A. General**

##### **A 100 Introduction**

**101** This appendix describes recommended and preferred test methods for core materials alone and sandwich components (including the face/core adhesive joints and the faces). Other test methods



than the ones described here may be used if they measure the same physical properties under the same conditions.

- 102** If no standard tests exist and no test methods are suggested, tests shall be chosen that measure the desired properties with no or small side effects from specimen size and geometry. It shall be ensured that the test results are correct or conservative with respect to the way they are used in the design.
- 103** The complete list of mechanical static properties (for core and adhesive materials) needed for structural analysis in this guideline is shown in Section 5 - B Static Properties.
- 104** Guidelines for the testing of face materials alone are presented in Section 4 Appendix B.
- 105** Health and safety shall be considered when performing tests. This guideline does not address these aspects and reference to applicable health and safety regulations shall be made.

#### **A 200 General testing information**

- 201** For anisotropic material, mechanical properties should be determined relative to the relevant direction of anisotropy.
- 202** Tests should be carried at a loading rates corresponding to about 1% per minute, unless specified differently in the Guideline.
- 203** For the preparation of test samples, curing conditions, surface treatment and application procedure shall be according to the specifications as described in *Section 5 A*.
- 204** The evaluation of stress vs. strain curves is described in *Appendix 4 B Section C* for brittle, plastic and ductile materials.
- 205** The use of strain gauges for the measurement of deformation in the core is difficult. Suitable adhesive should be used to bond strain gauges to the core in order to avoid stress concentrations.

-----Guidance note-----

If strain gauges are bonded with epoxy resin, for example, stress concentration will arise due to the difference of between the adhesive stiffness and the (typically) low core stiffness. Alternatively, an extensometer could also be used.

-----End-----

## B. CORE MATERIALS - STATIC TESTS

### B 100 Tensile tests

- 101 The specimen dimensions should be sufficiently large to avoid end-effects.
- 102 For anisotropic material, test should be carried on specimen having their long axis parallel and normal to the direction of anisotropy.
- 103 The entire stress-strain curve should be recorded.
- 104 The recommended test methods are ASTM D 1623-78 for in-plane properties and ISO 1926:1979 for through-thickness properties. Other test methods are also available: ASTM D 638-93, ISO/DIS 1798, and ISO 527-2:1993.

### B 200 Compressive tests

- 201 For anisotropic material, test should be carried on specimen having their long axis parallel and normal to the direction of anisotropy.
- 202 The entire stress strain curve should be recorded.
- 203 A typical schematic of a stress-strain curve for a material exhibiting crushing behaviour, like foam cores, is shown in Figure 1. These materials have a compressive strength and a crushing strength ( $\sigma_{\text{crush}}$ ). The elastic parameters are the same as for a brittle material see *Appendix 4B Section C*.

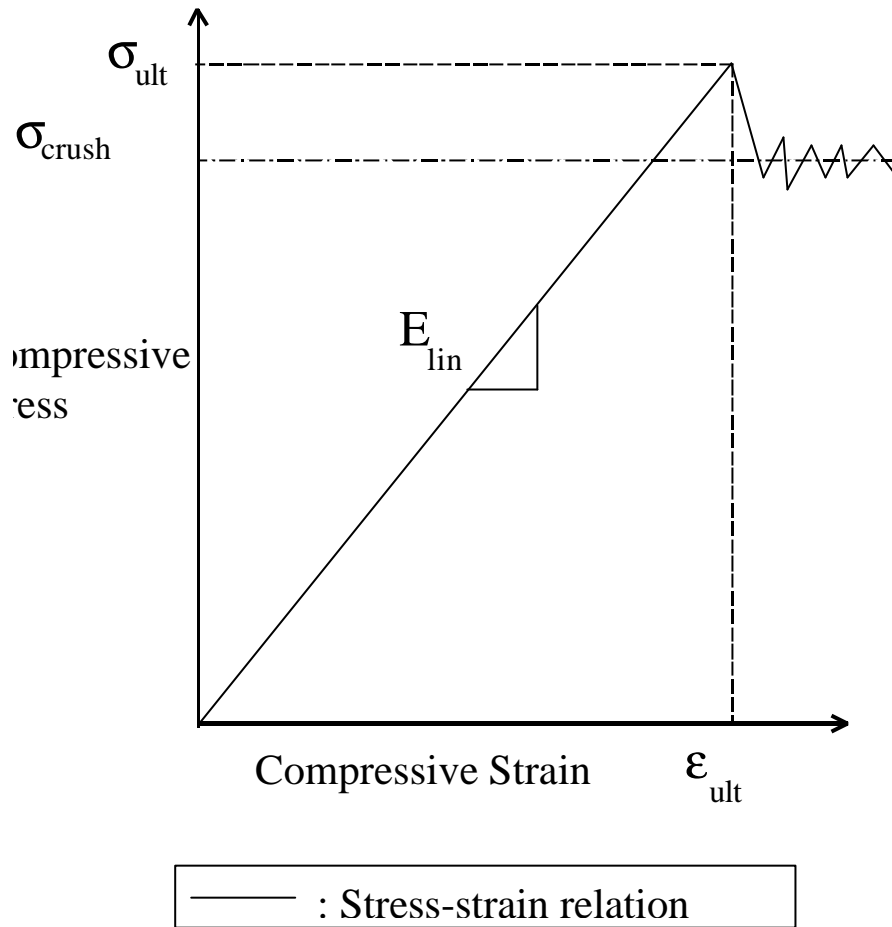

Figure 1: Compressive test and crushing strength

**204** The recommended test methods are ASTM D 1621-73. Other test methods may be used such as ASTM C 365-57, ISO 844:1978, ISO/DIS 844, ISO 1856:1980, ISO 3386-1:1986, ISO 3386-2:1986.

### **B 300 Shear tests**

- 301** Tests cover the determination of the shear properties of the core when loaded in shear parallel to the plane of the faces.
- 302** The entire stress-deformation and stress-strain curves should be recorded.
- 303** The recommended test methods is the block shear test described in the ISO 1922:1981. The test produce pure shear loading. Small deviation from parallelity of the plates can produce undesirable loading and can cause errors in the calculation of the shear properties. Plates thickness should be sufficient to prevent bending of the plates near the attachment points. For balsa cores see *305* and *B 400*.
- 304** An other possible test method is ASTM C 273-94. This test does not produce pure shear, but secondary stresses can be minimised. The test can also be unfavourable because of stress concentration developing at corners causing premature final failure.
- 305** The block shear test from *303* and *304* should not be used to obtain design shear strength of balsa cored sandwich beams and panels. The flexural test method described in ASTM C 393-62 should be used instead, see B400

-----Guidance note-----

Block shear test, such as the one used in ASTM C 273-94 or ISO 1922, should not be used to obtain design shear strength of balsa cored sandwich beams and panels. Using the block shear tests data to obtain the shear strength of balsa beams and panels will in many relevant cases overestimates the shear strength by a factor of 2 to 4.

-----End-----

- 306** The possible corrections of measurements described in *Section 5 B500* shall be considered.

### **B 400 Shear test for balsa**

- 401** The test covers the determination of flexural and shear stiffness of sandwich construction, shear modulus and shear strength of the core, or compressive and tensile strength of the facings.
- 402** The recommended test methods is ASTM C 393-62.
- 403** Typically, the 3-point-bending and the 4-point-bending test methods are used for the determination of properties of flat sandwich constructions subjected to transverse loading.
- 404** One can ensure shear fracture of the core, or (compressive or tensile) failure of the faces laminates by suitable specimen design.
- 405** The entire load-deformation curve should be recorded.
- 406** The possible corrections of measurements described in *Section 5 B500* shall be considered.

### **B 500 Fracture toughness – Strain energy release rate**

- 501** This section covers the determination of fracture toughness  $K_{Ic}$ , or strain energy release rate  $G_c$  of core materials.
- 502** For anisotropic material, tests should be carried in the direction parallel and normal to the direction of anisotropy.
- 503** For mode-I fracture toughness measurement, two test specimen can be used: the single-edge-notch bending specimen (SENB) or the compact-tension specimen (CT).
- 504** For mode-II fracture toughness measurement, the end-notch flexure specimen (ENF) or the compact-tension-shear (CTS) specimen can be used.

-----Guidance note-----

Fracture toughness represents the resistance of a material to fracture. Mode-I refers to tensile stress conditions at the crack tip, whereas mode-II refers to shear stress conditions. Mode-I and mode-II load cases are the principal load cases encountered when designing sandwich constructions.

-----End-----

- 505** No specific standard test exist for core materials.

## **B 600 Tests to obtain properties under long term static and cyclic loads**

- 601** The same tests as for measuring static properties can be used.
- 602** Loads and test environments shall be carefully controlled over the entire test period.
- 603** The strain rate should be kept constant for cyclic fatigue tests of viscoelastic materials. This means the test frequency can be increased for lower strain (test) amplitudes.

## **C. ADHESIVE MATERIALS - STATIC TESTS**

### **C 100 General**

- 101** For testing of shear and flatwise tension, the test samples shall be made of two pieces of high density core material (preferably PVC foam) with the sandwich adhesive located in the midplane parallel to the steel supports. The adhesive should be thicker than 1mm thick and the core material shall be specified.

### **C 200 Tensile tests**

- 201** The recommended test methods is ISO-527-1997 to determine the strength and fracture elongation in tension of the adhesive.

### **C 300 Flatwise tensile tests**

- 301** The recommended test methods is ASTM C 297-61 to determine the strength in tension, flatwise, of the adhesive.

### **C 400 Shear tests**

- 401** The recommended test methods is ISO-1922-1981 to determine the strength of the adhesive.

## **C 500 Tests to obtain properties under long term static and cyclic loads**

- 501** The same tests as for measuring static properties can be used.
- 502** Loads and test environments shall be carefully controlled over the entire test period.
- 503** The strain rate should be kept constant for cyclic fatigue tests of viscoelastic materials. This means the test frequency can be increased for lower strain (test) amplitudes.

## D. Core Skin Interface Properties

### D 100 Tensile tests

- 101** The recommended test methods is ASTM C 297-61 to determine the strength in tension, flatwise, of the core, or of the bond between the core and the faces, of an assembled sandwich beam or panel.

### D 200 Fracture toughness of the interface

- 201** The test method covers the determination of the fracture toughness parameters occurring in an interfacial crack.

-----Guidance note-----

At the cracked interface face/core of a transversally loaded sandwich structure, the crack tip is subjected to both mode-I and mode-II stress fields.

-----End-----

- 202** For mode-I fracture toughness measurement, two test specimen can be used: the double-cantilever test specimen (DCB), or its modified version fitted with hinges.

- 203** The interlaminar fracture toughness for isotropic materials is given by:

$$K_{Ic}^2 = \frac{EG_{Ic}}{1-\nu^2}$$
$$G_{Ic} = \frac{P_c}{2w} \frac{\partial(d/P)}{\partial a}$$

- 204** For mode-I fracture toughness measurement, the Cracked-Sandwich-Beam (CSB) test specimen can be used.
- 205** Delamination strength of honeycomb type core material can be determined by carrying out the test ASTM C 363-57.

### **D 300 Other tests**

- 301** Sandwich peel tests are used to determine the peel resistance of adhesive bonds between facings and cores. Several tests methods exist; the climbing drum tests methods, ASTM D 1781; DCB-type peel test; peel tests using air pressure; the recommended test methods is ASTM D 1781-93.

## **E. Tests for other properties**

### **E 100 Coefficient of thermal expansion**

- 101** The test covers the determination of the coefficient of linear thermal expansion of core materials.
- 102** The recommended test methods are ASTM D 696-91 (whithin the range of +30 and -30°C), ISO 4897:1985.

### **E 200 Water absorption tests**

- 201** The test covers the determination of the relative rate of water absorption when immersed in a highly humid environment.
- 202** The recommended test methods is ASTM D 2842-6. Other test methods are available such as ASTM C 272-91, ISO 2896:1987.

### **E 300 Diffusion and Vapour transmission**

- 301** The test aims to determine the permeability of water vapour through permeable or semi-permeable materials.
- 302** The water vapour permeability (WVP) is calculated as:
- $$WVT = \frac{\Delta W}{tA} \text{ where } \Delta W \text{ is the weight change, } t \text{ is the time and } A \text{ the test area.}$$
- 303** The recommended test methods is SS 02 15 82. Other tests are available: ASTM E 96-94, ISO 1663:1981, ISO/DIS 1663.



**E 400 Tests for thermal conductivity measurements**

**401** The recommended test methods is ASTM C 177-85. Other test methods can be used such as ASTM C 168-90, ASTM C 236-89, ASTM C 1045-90. The test covers the determination of the steady-state heat flux through flat specimens.

**E 500 Overall volume shrinkage for gap filling fillers**

**501** The recommended test methods is ISO-3251-1990 to determine the overall volume shrinkage at room temperature.

**E 600 Density tests**

**601** The recommended test methods is ASTM D 1622-88. Other tests are available such as ASTM C 271-94, , ISO 845:1988.

## SECTION 6 FAILURE MECHANISMS & DESIGN CRITERIA

<b>SECTION 6 FAILURE MECHANISMS &amp; DESIGN CRITERIA .....</b>		<b>1</b>
<b>A. MECHANISMS OF FAILURE .....</b>		<b>2</b>
A 100	GENERAL .....	2
A 200	FRP LAMINATES - FAILURE MECHANISMS AND FAILURE TYPE.....	5
A 300	SANDWICH STRUCTURES - FAILURE MECHANISMS AND FAILURE TYPE.....	6
A 400	DISPLACEMENTS AND LONG TERM FAILURE MECHANISMS AND FAILURE TYPE.....	9
A 500	LINK BETWEEN FAILURE MODES AND FAILURE MECHANISMS.....	10
<b>B. DESIGN CRITERIA: GENERAL APPROACH .....</b>		<b>12</b>
B 100	GENERAL.....	12
B 200	DESIGN CRITERIA FOR SINGLE LOADS.....	13
B 300	DESIGN CRITERIA FOR COMBINED LOADS.....	13
B 400	TIME DEPENDENCY AND INFLUENCE OF THE ENVIRONMENT .....	15
<b>C. FIBRE FAILURE.....</b>		<b>15</b>
C 100	GENERAL.....	15
C 200	FIBRE FAILURE AT THE PLY LEVEL.....	16
C 300	FIBRE FAILURE CHECK USING A MODIFIED TSAI-WU CRITERION.....	17
C 400	SPECIAL CONSIDERATIONS FOR FIBRE FAILURE UNDER INPLANE COMPRESSIVE LOADS.....	20
C 500	FIBRE FAILURE CHECKED BY COMPONENT TESTING .....	20
C 600	FRACTURE MECHANICS APPROACH .....	20
<b>D. MATRIX CRACKING.....</b>		<b>23</b>
D 100	GENERAL .....	23
D 200	MATRIX FAILURE BASED ON SIMPLE STRESS CRITERION .....	24
D 300	MATRIX FAILURE BASED ON PUCK'S CRITERION.....	27
D 400	OBTAINING ORIENTATION OF THE FAILURE SURFACE .....	30
D 500	MATRIX CRACKING CAUSED ONLY BY SHEAR.....	31
D 600	MATRIX FAILURE CHECKED BY COMPONENT TESTING.....	31
<b>E. DELAMINATION.....</b>		<b>32</b>
E 100	GENERAL.....	32
E 200	ONSET OF DELAMINATION.....	32
E 300	DELAMINATION GROWTH .....	32
<b>F. YIELDING.....</b>		<b>32</b>
<b>G. ULTIMATE FAILURE OF ORTHOTROPIC HOMOGENOUS MATERIALS .....</b>		<b>33</b>
<b>H. BUCKLING.....</b>		<b>36</b>
H 100	CONCEPTS AND DEFINITIONS.....	36
H 200	GENERAL REQUIREMENTS.....	37
H 300	REQUIREMENTS WHEN BUCKLING RESISTANCE IS DETERMINED BY TESTING.....	38
H 400	REQUIREMENTS WHEN BUCKLING IS ASSESSED BY ANALYSIS.....	38
<b>I. DISPLACEMENTS .....</b>		<b>40</b>
<b>J. LONG TERM STATIC LOADS .....</b>		<b>42</b>
J 100	GENERAL .....	42
J 200	CREEP .....	42
J 300	STRESS RELAXATION .....	42
J 400	STRESS RUPTURE - STRESS CORROSION .....	43
<b>K. LONG TERM CYCLIC LOADS .....</b>		<b>46</b>
K 100	GENERAL .....	46
K 200	CHANGE OF ELASTIC PROPERTIES.....	47
K 300	INITIATION OF FATIGUE DAMAGE.....	47
K 400	GROWTH OF FATIGUE DAMAGE.....	49
<b>L. IMPACT.....</b>		<b>50</b>

L 100	GENERAL.....	50
L 200	IMPACT TESTING .....	51
L 300	EVALUATION AFTER IMPACT TESTING .....	51
<b>M.</b>	<b>WEAR.....</b>	<b>52</b>
M 100	GENERAL.....	52
M 200	CALCULATION OF THE WEAR DEPTH.....	52
M 300	COMPONENT TESTING .....	52
<b>N.</b>	<b>HIGH/LOW TEMPERATURE / FIRE.....</b>	<b>53</b>
<b>O.</b>	<b>RESISTANCE TO EXPLOSIVE DECOMPRESSION.....</b>	<b>53</b>
O 100	MATERIALS.....	53
O 200	INTERFACES .....	54
<b>P.</b>	<b>SPECIAL ASPECTS RELATED TO SANDWICH STRUCTURES .....</b>	<b>54</b>
P 100	GENERAL.....	54
P 200	FAILURE OF SANDWICH FACES.....	54
P 300	FAILURE OF THE SANDWICH CORE .....	54
P 400	FAILURE OF THE SANDWICH SKIN-CORE INTERFACE .....	55
P 500	BUCKLING OF SANDWICH STRUCTURES.....	55
<b>Q.</b>	<b>CHEMICAL DECOMPOSITION / GALVANIC CORROSION .....</b>	<b>55</b>
<b>R.</b>	<b>REQUIREMENTS FOR OTHER DESIGN CRITERIA.....</b>	<b>56</b>

## A. Mechanisms of failure

### A 100 General

**101** A mechanism of failure is the underlying phenomenon at the material level that determines the mode of failure. Depending on its level of severity a mechanism of failure can lead to various failure modes. For example, matrix cracking can lead to seepage of a fluid through the laminate or lead to fracture depending on the severity of the cracks. Failure mechanism can be regarded as the cause of failure and failure mode as the effect. The failure terminology used in this Guideline is shown on *Figure 6-1*.

**Guidance note:**

Local and global failure shall be distinguished. On a material level, failure tends to be local, i.e. over an area of a few cm<sup>2</sup>, or even less. This local failure may have global consequences immediately, or after some growth with time. In some cases, the local failure does not grow and does not have any global consequences and does not effect any of the design requirements of the structure. In such a case local failure may be acceptable.

---e-n-d---o-f---G-u-i-d-a-n-c-e---n-o-t-e---

**102** Only failure mechanisms that are related to critical failure modes, as identified in *Section 3* should be considered.

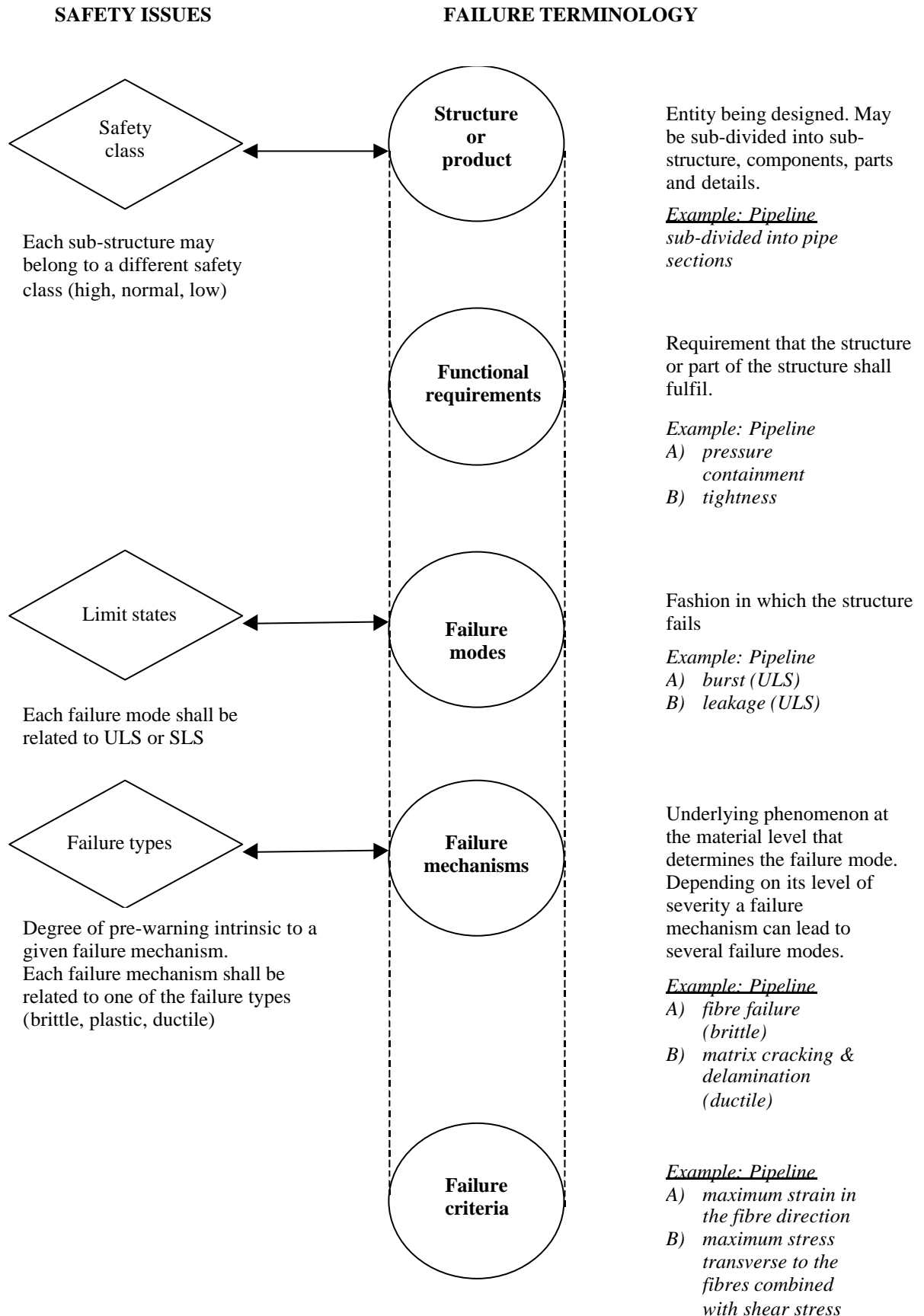

Figure 1: Failure terminology

**103** For the material in consideration, all the relevant mechanisms of failure shall be listed. A minimum list of failure mechanisms is given below. The failure mechanisms are linked to typical material types.

<i>Failure Mechanisms</i>	<i>Material Type</i>
Fibre Failure	Laminates and Sandwich Skins
Matrix Cracking	Laminates
Delamination	Laminates and Sandwich Core/Skin Interface
Yielding	Core materials, liners, resin rich areas
Ultimate failure of isotropic or anisotropic homogenous materials	Core materials
Elastic buckling	All materials
Unacceptably large displacements	All materials
Stress Rupture	All materials, all failure mechanisms.
Fatigue	All materials, all failure mechanisms.
Wear	All materials
Fire*	All materials
Explosive decompression*	All materials
Impact*	All materials
Chemical decomposition	All materials

\* *these items are load conditions, but are treated here as failure mechanisms to simplify the approach in the Guideline.*

**Guidance note:**

The mechanisms of failure of composites can be discussed at different material levels. Failure can be considered to happen in the matrix or in the fibre. On a larger scale, it can happen to the individual ply (or core). Eventually, one can consider the whole thickness of the structure as one quantity, i.e. the laminate or the sandwich structure.

---e-n-d---o-f---G-u-i-d-a-n-c-e---n-o-t-e---

**104** In some cases, a critical sequence of mechanisms of failure may be required for a failure mode to occur. That sequence should be specified (considering the “domino effect”), if relevant.

**Guidance note:**

Different sequences may lead to the same failure mode. In this case, the structure shall only be considered as failed, if the whole sequence of mechanisms of failure modes has happened.

---e-n-d---o-f---G-u-i-d-a-n-c-e---n-o-t-e---

**105** The type of failure corresponding to each failure mechanism shall be determined. See

*Section 2 C400* for the definition of the three types of failure. Failure types for typical failure mechanisms are indicated in the following chapters.

**Guidance note:**

The type of failure determines the partial safety factors (see *Table 2-1* and *Table 2-2*). The determination of the type of failure is a critical step in the design process and can lead to significant differences in the magnitude of the partial safety factors.

---e-n-d---o-f---G-u-i-d-a-n-c-e---n-o-t-e---

- 106** For each location, a link between possible mechanisms of failure and failure modes shall be established. Possible links between failure modes and the failure mechanisms of FRP laminates and sandwich structures are described in *A500*. This is not exhaustive and it should be used for guidance only.
- 107** Special considerations for interfaces between laminates and steel or laminates and laminates are covered in Section 7.

**A 200 FRP laminates - Failure mechanisms and failure type**

- 201** A relationship between failure mechanisms and types according to the principles given in *Section 2 C400* is given below for FRP laminates.

<i>Failure Mechanisms</i>	<i>Failure Type</i>
Fibre Failure	Brittle
Matrix Cracking	Brittle, if cracks are bridged by fibres: Plastic if only used as a criterium for leakage: Ductile
Delamination	Brittle
Elastic buckling	Brittle, plastic or ductile according to type of structure and loading.

- 202** In some cases a failure mechanisms is linked in a conservative way to a failure mode. If the failure mechanisms is only linked to that failure mode in a conservative way, a different failure type than stated in *201* may be used based on the criteria in *Section 2 C400*.

**Guidance note:**

For example: onset of matrix cracking may be linked to leakage, even though it is known that a fairly large number of matrix cracks must be present to cause leakage in most laminates. If matrix cracking is not linked to any other failure modes than leakage, the failure type "ductile" may be chosen.

---e-n-d---o-f---G-u-i-d-a-n-c-e---n-o-t-e---

**Guidance note:**

For elastic buckling the failure type is determined by the post-buckling behaviour. For elastic buckling of most simple, symmetrical columns and struts the failure type may be considered plastic. For plates supported on all edges the behaviour is often ductile. For some shell and optimised stiffened plate structures the behaviour may be brittle.

Note that deformations associated with elastic buckling may trigger other failure mechanisms such as fibre failure, with consequent change of failure type.

---e-n-d---o-f---G-u-i-d-a-n-c-e---n-o-t-e---

**203** Failure mechanisms are often described in more detail for FRP laminates than the mechanisms given in 201. The table below links the detailed failure mechanisms to the ones used in this Guideline.

<b>Fibre</b>	<b>Matrix</b>	<b>Ply</b>	<b>Inter-laminar</b>	<b>Laminate</b>
Fibre failure (tensile or compressive)	Matrix cracking	Fibre/matrix debonding (2)	Delamination	Rupture (1)
Fibre buckling (1)	Matrix yielding		Interlaminar tensile failure (3)	Global buckling
			Interlaminar shear failure (3)	Local buckling
				Laminate creep
				Laminate fatigue

(1) is described in this Guideline by fibre failure.

(2) is described in this Guideline by matrix cracking.

(3) is described in this Guideline by matrix cracking and/or delamination.

**Table 1: Mechanisms of failure for FRP laminates**

**204** Laminates typically show a sequence of failure mechanisms. These sequences should be considered. If one failure mechanism cannot be well described it may be sufficient to design the component in a way that the preceding failure mechanism will not occur. Typical sequences are:

- matrix cracking => delamination => fibre failure
- debonding and matrix cracking => fibre buckling => fibre failure
- delamination => crack propagation due to fatigue => global buckling

An unusual but possible sequence is:

- Wedge shaped matrix cracks => component failure in compression

**A 300 Sandwich Structures - Failure mechanisms and failure type**

**301** Sandwich structures are built of a light weight core embedded between two faces (or skins). Design criteria are given for skins, cores and the core-skin interface.

- 302** Failure mechanisms and types for the faces are the same as for FRP laminates described in *Section A200*.
- 303** A relationship between failure mechanisms and types according to the principles given in *Section 2 C400* is given below for sandwich structures.

<i>Failure Mechanisms</i>	<i>Failure Type</i>
Crack Growth in core-skin interface	Typical plastic
Debonding of core skin interface	Brittle
Yielding of core	Depends on core material, see <i>A304</i>
Ultimate fail of anisotropic homogenous core material	Brittle
Local elastic buckling of skin laminates	Assume brittle unless plastic or ductile type can be documented
Global elastic buckling of panel	See <i>A201</i>

- 304** The following table indicates typical failure types for yielding of common core materials at normal laboratory loading rates (strain rate about 1% per minute). Failure types can change with loading rates. The failure types indicated are typical cases and shall be documented for the specific material, based on the definition given in *Section 2 C400*.

Yielding of Core Material	Typical Failure Type
Paper honeycomb	Ductile
Aluminium honeycomb	Ductile
Glass/Phenolic honeycomb	Does not yield
Nomex honeycomb	Does not yield
Balsa wood	Does not yield
Polyurethane foam	Does not yield
Polystyrene foam	Does not yield
Polyvinyl chloride foam (linear)	Ductile or plastic
Polyvinyl chloride foam (cross-linked)	Ductile or plastic
Poly-methacryl-imide foam	Does not yield
Corrugated core	Material-dependent

**Table 2: Typical failure types for various core types.**

- 305** Failure mechanisms are often described in more detail for sandwich structures than the mechanisms given in 302 and 303. The figure below relates some typically illustrated or discussed failure mechanisms to the ones used in this Guideline.



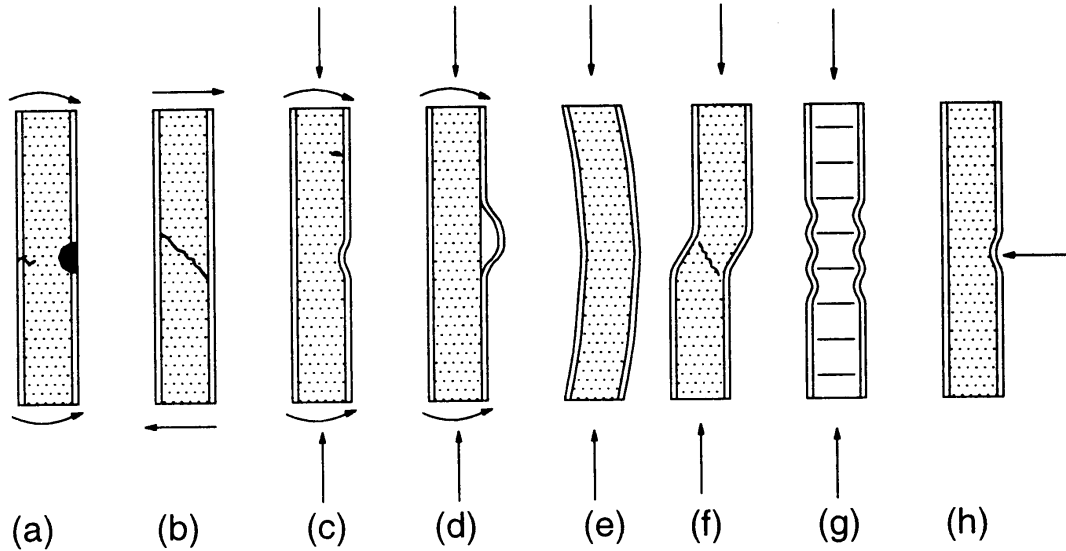

- (a) face/core yielding/fracture;
- (b) core shear;
- (c) buckling - face wrinkling;
- (d) delamination;
- (e) general buckling;
- (f) buckling - shear crimping;
- (g) buckling - face dimpling;
- (h) core indentation - core yield.

Figure 2: The Failure Mechanisms in a Sandwich Beam.

**Guidance note:**

The types and directions of loading shown in the *figure 6-2* are indicative, and are characteristic of loading associated with the elementary failure mechanisms. However, in real structures, a failure mechanism can occur under various loading conditions.

---e-n-d---o-f---G-u-i-d-a-n-c-e---n-o-t-e---

- 306** Sandwich structures typically show a sequence of failure mechanisms. These sequences should be considered. If one failure mechanism cannot be well described it may be sufficient to design the component in a way that the preceding failure mechanism will not occur. A typical sequences is:  
under fatigue loading, crack initiates in the core due to core shearing => crack then propagates in core material => face-core delamination starts when shear crack reaches interface => face-core delamination propagates along the interface until final catastrophic failure.

**A 400 Displacements and long term failure mechanisms and failure type**

**401** A relationship between failure mechanisms and types according to the principles given in *Section 2 C400* is given below for mechanisms applicable to FRP laminates and sandwich structures.

<i>Failure Mechanisms</i>	<i>Failure Type</i>
Unacceptably large displacement	Decide individually, see <i>Section 1103</i>
Stress Rupture	Not required for lifetime calculations
Fatigue	Not required for lifetime calculations

**A 500 Link between failure modes and failure mechanisms**

**501** The most common failure modes and associated failure mechanisms are listed here. For a new design, an exhaustive list of potential failure modes and failure mechanisms shall be established. A more complete list is given in *Section G* and *Section 3 Appendix A*.

<b>Minimum list of Failure Modes</b>	<b>Failure Mechanisms</b>	<b>Comments</b>
Fracture (local/global)	Fibre Failure	Is assumed to cause fracture. Shall always be checked.
	Matrix Cracking	Is assumed to cause fracture in UD laminates. Is assumed to cause fracture in 0/90 laminates loaded in in-plane shear. May reduce compressive fibre strength. May initiate delamination. Otherwise a failure mode that does not influence fracture.
	Delamination	Is assumed to cause fracture if a structure is exposed to through thickness stresses. May be acceptable for in-plane loads.
	Yielding	Shall be checked, unless structure can tolerate large deformations of the material investigated.
	Buckling	May cause fracture. Shall always be checked if compressive and/or significant in-plane shear loads are present. Buckling may be affected by the presence of matrix cracks and delaminations.
	Unacceptably large displacement	It shall be checked that excessive displacements cannot cause fracture.
	Sandwich core failure	Is assumed to cause fracture. Shall always be checked.
	Sandwich core yield	See yielding
	Sandwich buckling	See buckling
	Stress Rupture	Effect shall be checked for all failure mechanisms mentioned above.
	Fatigue	
	Impact	
	Wear	
	Fire	
Explosive Decompression	Special failure mechanisms that can cause fracture or degradation	
Chemical decomposition / Galvanic Corrosion		

<b>Minimum list of Failure Modes</b>	<b>Failure Mechanisms</b>	<b>Comments</b>
Leakage	Fibre Failure	Is assumed to cause leakage. Shall always be checked.
	Matrix Cracking	Is assumed to cause leakage unless a liner or other barrier can keep the fluid out of the laminate.
	Matrix Crack Growth	If data exist that show leakage will only occur after a certain crack density has been reached, this failure mechanism may be used instead of simple matrix cracking. No design criterion is given in this document.
	Delamination	May cause leakage, especially if it causes the violation of a displacement requirement.
	Yielding	May cause leakage.
	Buckling	May cause leakage.
	Unacceptably large displacement	May cause leakage.
	Sandwich core failure	May cause leakage
	Sandwich core yield	May cause leakage
	Sandwich buckling	May cause leakage
	Stress Rupture	Effects shall be checked for all failure mechanisms mentioned above.
	Fatigue	
	Impact	
	Wear	
	Fire	
	Explosive Decompression	Special failure mechanisms that may lead to leakage.
Chemical decomposition / galvanic corrosion		

Minimum list of Failure Modes	Failure Mechanisms	Comments
Buckling (local or global)	Buckling	Buckling is treated as a failure mode and failure mechanism in this guideline. Buckling needs special analysis methods and special design criteria.
	Sandwich buckling	The effect of other failure mechanisms, such as delamination and matrix cracking, on buckling shall be considered carefully.
	Unacceptably large displacement	Buckling may lead to violation of displacement requirements.
Blast/Burst		Consider same failure mechanisms as for fracture.
Impact	Impact	Treated as a failure mode and failure mechanism in this guideline.
Excessive deformation, Ovalisation, Excessive displacement	Unacceptably large displacement	
Wear	Wear	
	Chemical decomposition / galvanic corrosion	

## B. Design criteria: General approach

### B 100 General

- 101** A design criterion shall be assigned to each relevant mechanism of failure.
- 102** Design criteria for typical mechanisms of failure and materials are described in the following chapters.
- 103** If no design criterion is known for a relevant mechanism of failure the following alternative options may be used:
- It may be possible to perform a component test that evaluates the relevant design criteria without the need of a detailed knowledge of the failure mechanisms. This should be documented. See *Section 10*.
  - A design criterion may be proposed. It should be documented by experiments and/or experience that the proposed design criterion is applicable for the component. Details are given in *Section R*.

**104** A modelling uncertainty shall be assigned to each design criterion and/or the strength parameters used in it. A modelling uncertainty factor is included in the design criteria equations proposed in this Guideline.

### **B 200 Design criteria for single loads**

**201** The general design criterion in the case of a single load for the Load and Resistance Factor Design format is:

$$g_F g_{Sd} \cdot S_k < \frac{R_k}{g_M g_{Rd}}$$

where,

$\gamma_F$	Partial load effect factor
$\gamma_{Sd}$	Partial load-model factor
$S_k$	Local stress or strain based on characteristic load effect
$R_k$	Characteristic resistance
$\gamma_M$	Partial resistance factor
$\gamma_{Rd}$	Partial resistance-model factor

**202** The selection of the partial safety factors shall be determined according to *Section 8*.

**203** The characteristic value of the local stress or strain based on the characteristic load shall be determined according to *Section 3 I400*. Nonlinear effects in the analysis should be considered as described in *Section 9* and *8* to obtain the proper value and distribution of the local stress or strain.

#### **Guidance note:**

In the case of a linear analysis load distributions and local stress distributions are the same.

---e-n-d---o-f---g-u-i-d-a-n-c-e---n-o-t-e---

**204** The characteristic value of the resistance shall be determined according to the *Sections 4 A600* and *5 A600*.

**205** The load and environmental conditions for time-dependent design checks shall be selected in accordance with *Section 3K*.

### **B 300 Design criteria for combined loads**

**301** The general design criterion, in the case of a combination of loads, for the Load and Resistance Factor Design format is:

If the design load corresponds to the combination number *j* as follows:

$$S_d = \mathbf{g}_{Sd} \cdot \max_{h=1}^N \left[ \mathbf{g}_F^h \cdot S_k^h + \sum_{i \neq h} \mathbf{g}_F^i \cdot S_k^i \cdot \Psi^i \right] = \mathbf{g}_{Sd} \cdot \left[ \mathbf{g}_F^j \cdot S_k^j + \sum_{i \neq j} \mathbf{g}_F^i \cdot S_k^i \cdot \Psi^i \right]$$

then, the design criterion is written:

$$S_d = \mathbf{g}_{Sd} \cdot \left[ \mathbf{g}_F^j \cdot S_k^j + \sum_{i \neq j} \mathbf{g}_F^i \cdot S_k^i \cdot \Psi^i \right] < \frac{R_k}{\mathbf{g}_M^j \cdot \mathbf{g}_{Rd}}$$

where,

- $S_d$  Design load effect
- $S_k^i$  Local stress or strain based on characteristic load effect  $i$
- $\gamma_F^i$  Partial load effect factor for load  $i$
- $\Psi^i$  Combination factor for load  $i$
- $\gamma_F^j, \gamma_M^j$  Partial load effect and resistance factors for load  $j$
- $\gamma_{Sd}, \gamma_{Rd}$  As defined in *Section B201*

**302** All explanations of *B200* apply also to these criteria for combined loads.

**303** The load combination factors  $\Psi$  shall be determined according to *Section 3 K209*.

**Guidance note:**

In the equation above, it is important to see that the partial resistance factor  $\gamma_M^j$ , corresponding to the load  $j$  alone, is used as the common partial resistance factor.

For example, when combining a wave load and a snow load one should determine first the maximum of the following two load combinations. For clarity, the load model factor is not shown in the equations below. It should however be considered in real problems.

$$S_d = \max \left\{ \begin{array}{l} \mathbf{g}_F^{wave} \cdot S_k^{wave} + \mathbf{g}_F^{snow} \cdot S_k^{snow} \cdot \Psi^{snow} \quad (1) \\ \mathbf{g}_F^{wave} \cdot S_k^{wave} \cdot \Psi^{wave} + \mathbf{g}_F^{snow} \cdot S_k^{snow} \quad (2) \end{array} \right.$$

If combination (1) is the worse, then the design criterion to be checked is given by:

$$\mathbf{g}_F^{wave} \cdot S_k^{wave} + \mathbf{g}_F^{snow} \cdot S_k^{snow} \cdot \Psi^{snow} < \frac{R_k}{\mathbf{g}_M^{wave} \cdot \mathbf{g}_{Rd}}$$

If combination (2) is the worse, then the design criterion to be checked writes:

$$\mathbf{g}_F^{wave} \cdot S_k^{wave} \cdot \Psi^{wave} + \mathbf{g}_F^{snow} \cdot S_k^{snow} < \frac{R_k}{\mathbf{g}_M^{snow} \cdot \mathbf{g}_{Rd}}$$

A conservative value of the load combination factor  $\Psi = 0.7$  can be used for  $\Psi^{snow}$  and  $\Psi^{wind}$

---e-n-d---o-f---G-u-i-d-a-n-c-e---n-o-t-e---

## **B 400 Time dependency and influence of the environment**

- 101** Design criteria are given as static design criteria in this section. It is assumed that time or influence of the environment does not change the design criteria themselves. However, the properties used in the design criteria shall be the appropriate properties for the point of time where the analysis is carried out. The change of properties with time is described in *Sections 4 and 5*.
- 402** Time dependency is seen here in the widest possible sense. Time dependency considers influence on properties due to permanent static and cyclic loads, due to environmental effects, and all possible combinations.

## **C. Fibre failure**

### **C 100 General**

- 101** Fibre failure is defined here as the failure of a ply by fracture of fibres. The fibre strength or strain to failure is based on test results from plies or laminates as described in Section 4. Ply failures are measured as rupture of the ply in fibre direction.
- 102** The maximum strain criterion should be used to check fibre failures.
- 103** Other design criteria may be used if it can be shown that they are equal or conservative compared to the maximum strain criterion given here. See for example *C300*.
- 104** Fibre failure should be checked at the ply level, not at the laminate level.
- 105** If laminates have a layup with fibre orientation seen through the entire thickness that are more than  $45^\circ$  apart, matrix cracking or deformation due to in plane ply shear stresses may cause rupture of the laminate. In this case matrix cracking due to ply shear should also be checked to avoid fracture, burst or leakage (see *also D500 and C300*), unless it can be shown that matrix cracks or deformations can be tolerated by the laminate under the relevant loading conditions.

Guidance note:

A pipe made of  $\pm 55$  laminate with a liner can tolerate matrix cracks and shear deformations, as long as the pipe sees only internal pressure. If the pipe must carry axial loads or bending moments in addition to the pressure, fibres would want to reorient themselves to a different angle, a complicated condition. This is only avoided as long as the shear properties of the pipe are intact.

A pipe made of a 0/90 laminate can tolerate matrix cracks and shear deformations under internal pressure and axial loads. This pipe would have problems with axial torsion, since the stresses due to torsion have to be carried by the matrix.

End of guidance note



**106** Regardless of the analysis method used, these laminates should always be analysed with non-degraded in-plane shear moduli  $G_{12}$ .

**107** If laminates have a layup with fibre orientation seen through the entire thickness that are more than  $70^\circ$  apart, matrix cracking or deformation due to in plane ply shear stresses or stresses transverse to the fibres may cause rupture of the laminate. In this case matrix cracking due to all possible stress components should also be checked to avoid fracture, burst or leakage (see *also D100 to D300*), unless it can be shown that matrix cracks or deformations can be tolerated in by the laminate under the relevant loading conditions.

Guidance note:

This condition is typical for UD laminates where all fibres run parallel in one direction throughout the thickness of the laminate. Great care should be taken when using such laminates due to their low properties in all other directions than the fibre direction.

End of guidance note

**108** Regardless of the analysis method used, these laminates should always be analysed with non-degraded matrix dominated elastic constants, i.e.,  $E_2$ ,  $G_{12}$ ,  $\nu_{12}$ .

## C 200 Fibre failure at the ply level

**201** For single loads, the maximum strain design criterion is given as:

$$\gamma_F \gamma_{Sd} \cdot \epsilon_{nk} < \frac{\hat{\epsilon}_k^{fiber}}{\gamma_M \gamma_{Rd}}$$

where:

- $\epsilon_{nk}$  Characteristic value of the local response of the structure (strain) in the fibre direction n
- $\hat{\epsilon}_k^{fiber}$  Characteristic value of the axial strain to fibre failure
- $\gamma_F$  Partial load effect factor
- $\gamma_{Sd}$  Partial load-model factor
- $\gamma_M$  Partial resistance factor
- $\gamma_{Rd}$  Partial resistance-model factor, given in 202 (below)

**202** The selection of the resistance model factor  $\gamma_{Rd}$  depends on the choice of structural analysis method.

- If a linear analysis with non-degraded properties is chosen according to *Section 9 B400*, then  $\gamma_{Rd} = \gamma_A$ , as described in *Section 9 C203*.
- In all other cases  $\gamma_{Rd} = 1.0$ .

- 203** The maximum strain criterion shall be checked in all  $n$  directions parallel to the fibres, and for tensile and compressive strains.
- 204**  $\hat{\epsilon}_k^{\text{fiber}}$  is the time dependent characteristic strength of the ply in fibre direction. It shall be determined according to *Section 4C*. One value for one fibre and weave type.
- 205** For  $N$  combined loads, with combination  $j$  being the worst combination (see *Section 3 K200*) the maximum strain design criterion is given by:

$$g_{Sd} \cdot \left[ g_F^j \cdot \epsilon_{nk}^j + \sum_{i \neq j} g_F^i \cdot \epsilon_{nk}^i \cdot \Psi^i \right] < \frac{\hat{\epsilon}_k^{\text{fiber}}}{g_M g_{Rd}}$$

where:

- $\epsilon_{nk}^i$  Characteristic value of the local response of the structure (strain) in the fibre direction  $n$  due to load  $i$
- $\hat{\epsilon}_k^{\text{fiber}}$  Characteristic value of the axial strain to fibre failure
- $\gamma_F^i$  Partial load effect factor for load  $i$
- $\Psi^i$  Combination factor for load  $i$
- $\gamma_F^j, \gamma_M$  Partial load effect and resistance factors for load  $j$
- $\gamma_M$  Partial resistance factor
- $\gamma_{Rd}$  Partial resistance-model factor, given in 202

- 206** The partial resistance factor  $\gamma_M$  shall be the largest value for all load strength combinations  $j$ .

**Guidance note:**

In the equation above, it is important to see that the partial resistance factor  $\gamma_M^j$ , corresponding to the load  $j$  alone, is used as the common partial resistance factor.

---e-n-d--- o-f---G-u-i-d-a-n-c-e---n-o-t-e---

**C 300 Fibre failure check using a modified Tsai-Wu criterion**

- 101** In many cases the maximum fibre strain criterion is not available in commercial software packages. As an alternative the Tsai-Wu criterion may be used with modified input parameters as described here. This approach was developed by FiReCo AS.
- 302** If *C105* is relevant, this criterion may be used to check simultaneously for fibre failure and laminate failure due to high shear in the plies.
- 303** The Tsai-Wu criterion is described in 3-D as:

$$R^2 \left( F_{11} \mathbf{s}_1^2 + F_{22} \mathbf{s}_2^2 + F_{33} \mathbf{s}_3^2 + F_{12} \mathbf{s}_1 \mathbf{s}_2 + F_{13} \mathbf{s}_1 \mathbf{s}_3 + F_{23} \mathbf{s}_2 \mathbf{s}_3 \right) + R^2 \left( 2H_{12} \mathbf{s}_1 \mathbf{s}_2 + 2H_{13} \mathbf{s}_1 \mathbf{s}_3 + 2H_{23} \mathbf{s}_2 \mathbf{s}_3 \right) + R \left( F_1 \mathbf{s}_1 + F_2 \mathbf{s}_2 + F_3 \mathbf{s}_3 \right) < 1$$

in 2-D:

$$R^2(F_{11}\mathbf{s}_1^2 + F_{22}\mathbf{s}_2^2 + F_{12}\mathbf{s}_{12}^2 + 2H_{12}\mathbf{s}_1\mathbf{s}_2) + R(F_1\mathbf{s}_1 + F_2\mathbf{s}_2) < 1$$

with

$$R = \gamma_F \gamma_{Sd} \gamma_M \gamma_{Rd}$$

$$F_{11} = \frac{1}{\hat{\mathbf{s}}_{1t} \hat{\mathbf{s}}_{1c}}, F_{22} = \frac{1}{\hat{\mathbf{s}}_{2t} \hat{\mathbf{s}}_{2c}}, F_{33} = \frac{1}{\hat{\mathbf{s}}_{3t} \hat{\mathbf{s}}_{3c}}$$

$$F_{12} = \frac{1}{\hat{\mathbf{s}}_{12}^2}, F_{13} = \frac{1}{\hat{\mathbf{s}}_{13}^2}, F_{23} = \frac{1}{\hat{\mathbf{s}}_{23}^2}$$

$$F_1 = \frac{1}{\hat{\mathbf{s}}_{1t}} - \frac{1}{\hat{\mathbf{s}}_{1c}}, F_2 = \frac{1}{\hat{\mathbf{s}}_{2t}} - \frac{1}{\hat{\mathbf{s}}_{2c}}, F_3 = \frac{1}{\hat{\mathbf{s}}_{3t}} - \frac{1}{\hat{\mathbf{s}}_{3c}}$$

$$H_{12}^* = \frac{H_{12}}{\sqrt{F_{11}F_{22}}}, H_{13}^* = \frac{H_{13}}{\sqrt{F_{11}F_{33}}}, H_{23}^* = \frac{H_{23}}{\sqrt{F_{22}F_{33}}}$$

Where:

$n$  The co-ordinate system is the ply co-ordinate system, where  $n$  refers to the directions 1, 2, 3, 12, 13 and 23

$\sigma_n$  Characteristic value of the local load effect of the structure (stress) in the direction  $n$

$\hat{\mathbf{s}}_{nt}$  Characteristic tensile strength in the direction  $n$

$\hat{\mathbf{s}}_{nc}$  Characteristic compressive strength in the direction  $n$

$\hat{\mathbf{s}}_{nk}$  Characteristic shear strength in the direction  $nk$

$\gamma_F$  Partial load effect factor

$\gamma_{Sd}$  Partial load-model factor

$\gamma_M$  Partial resistance factor

$\gamma_{Rd}$  Partial resistance-model factor, for values see 303.

**304** The interaction parameters  $H_{12}^*$ ,  $H_{13}^*$ ,  $H_{23}^*$  should be determined experimentally for each material. In that case  $\gamma_{Rd} = 1.0$ . Alternatively values between 0 and -0.5 may be chosen as a default, in that case  $\gamma_{Rd} = 1.15$ .

**305** Since Tsai-Wu criterion is here only used to check for fracture of the laminate (*see C105*) and small matrix cracks are acceptable, strength properties should be taken as described below. Characteristic strengths as described in *Section 4 B 400* should always be used.

$\hat{\mathbf{s}}_{1t}$  tensile ply strength in fibre direction, as defined in Section 4.

$\hat{\mathbf{s}}_{1c}$	compressive ply strength in fibre direction, as defined in Section 4.
$\hat{\mathbf{s}}_{2t} = \frac{E_2}{E_1} \hat{\mathbf{s}}_{1t}$	modified inplane tensile ply strength transverse to the fibres.
$\hat{\mathbf{s}}_{2c} = \frac{E_2}{E_1} \hat{\mathbf{s}}_{1c}$	modified inplane compressive ply strength transverse to the fibres.
$\hat{\mathbf{s}}_{3t}$	tensile through thickness ply strength in fibre direction, as defined in Section 4.
$\hat{\mathbf{s}}_{3c}$	compressive through thickness ply strength in fibre direction, as defined in Section 4.
$\hat{\mathbf{s}}_{12}$	inplane shear strength, as defined in Section 4.
$\hat{\mathbf{s}}_{13}$	through thickness shear strength , as defined in Section 4.
$\hat{\mathbf{s}}_{23}$	through thickness shear strength, as defined in Section 4.

**306** If tensile and compressive fibre strength differ by more than 60% it should be checked that the individual design criteria, i.e. fibre failure in *C200* and matrix cracking in *D200* or *D300*, do not give lower allowable stresses than this criterion.

**307** The characteristic strength  $\hat{\sigma}_{nk}$  for each of the stress components  $\sigma_{nk}$  and the corresponding coefficients of variation  $COV_n$  are defined as specified in *Section 4 A600*.

**308** The combined  $COV_{comb}$  of the characteristic strengths  $\hat{\sigma}_{nk}$  is defined according to one of the following alternatives. The second alternative is conservative with respect to the first.

$$COV_{comb} = \left( \sum_n \left| \hat{\sigma}_{nk} \right| \cdot COV_n \right) / \left( \sum_n \left| \hat{\sigma}_{nk} \right| \right)$$

or

$$COV_{comb} = \max_n (COV_n) \quad (10)$$

Where:

- n The coordinate system is the ply coordinate system, where n refers to the directions 11, 22, 33, 12, 13 and 23
- $COV_n$  COV for stress component n
- $COV_{comb}$  COV for the combined stress components

**309** When two or more loads are combined, each stress component  $\sigma_{nk}$  in direction n can be the result of several combined loads. In that case each stress component  $\sigma_{nk}^j$ , which is the local load effect of the structure in direction n due to load j, shall be considered separately as an individual stress component to determine the COV.

$$COV_{comb} = \left( \sum_n |s_{nk}^j| COV_n \right) / \left( \sum_n |s_{nk}^j| \right)$$

or

$$COV_{comb} = \max_n (COV_n)$$

**Guidance note:**

This approach is conservative compared to the approach of Turstra's rule as used for the fibre design criteria. This approach has been chosen for simplification. In the case of fibre failure, only the strains parallel to the fibre directions have to be considered, whereas for matrix cracking all stress directions may interact.

---e-n-d---o-f---G-u-i-d-a-n-c-e---n-o-t-e---

- 310** The choice of the partial safety factors shall be based on the most conservative partial safety factors obtained when treating each stress component  $\sigma_{nk}^j$ , which is the local load effect of the structure in direction n due to load j, as a single load.
- 311** The partial safety factors  $\gamma_F$  and  $\gamma_M$  shall be chosen as described in *Section 8* with COVs equal to  $COV_{comb}$ , as described in *308 and 309*.

**C 400 Special considerations for fibre failure under inplane compressive loads**

- 401** The orientation of matrix cracks shall be checked if the compressive strength of a laminate is important (*Section D400*).
- 402** If matrix cracks with an orientation of  $30^\circ$ - $60^\circ$  relative to the plane of the laminate may be present, the compressive strain to fibre failure used in the design criteria of this section shall be obtained from measurements on laminates with the presence of matrix cracks with an orientation between  $30^\circ$  and  $60^\circ$ . Alternatively, the compressive strain to failure may be reduced by 50%, or a component test shall be carried out (*Section C500*).

**C 500 Fibre failure checked by component testing**

- 501** Refer to section on component testing (*Section 10*)

**C 600 Fracture mechanics approach**

- 601** The fibre design criteria described above can always be used. However, in the presence of stress concentrations that reach infinity a fracture mechanics approach may be applied.
- 602** Stress concentration can be caused by the following factors:
- cut-outs,
  - discontinuous linear and smooth geometry (including rough edges),
  - joints which include bolted joints, bonded joints, and other mechanical joints,
  - mismatch of elastic properties between two adjacent components or materials,
  - voids and damage due to material fabrication.

- 603** Unidirectional laminates should never be used in the presence of infinite stress concentrations, because matrix cracks and delaminations can propagate from that point through the structure with nearly no resistance.
- 604** In the presence of infinite stress concentrations matrix cracking and delamination will occur. If that is not acceptable on a local level, the design shall be changed to remove the stress concentration.
- 605** The suggested design criterion is the point stress criterion: Failure occurs when the stress or strain at a distance  $d_0$  away from the tip of the stress concentration point is equal to or greater than the strength of the un-notched material, see *Figure 6-3*. This means the design criteria described above shall be applied at a distance  $d_0$  away from the stress concentration point.

$$\mathbf{s}_x(0, y) < \hat{\mathbf{S}}$$

$$y = R + d_0$$

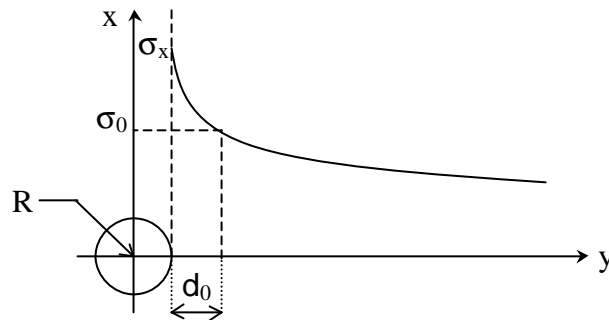

**Figure 3 Point Stress Criterion.**

- 606** The distance  $d_0$  has to be determined experimentally for the laminate in question.
- 607** The stress field ahead of the stress concentration point may be calculated by analytical or FE methods.

**Guidance note:**

For an infinite orthotropic plate, with a circular hole, subjected to a uniform stress,  $\sigma_x^\infty$ , applied parallel to the x-axis at infinity, the normal stress,  $\sigma_x$ , along the y-axis ahead of the hole, see the figure below, can be expressed as:

$$\mathbf{s}_x = \frac{\mathbf{s}_x^\infty}{2} \left\{ 2 + \left( \frac{R}{y} \right)^2 + 3 \left( \frac{R}{y} \right)^4 - (K_T^\infty - 3) \left[ 5 \left( \frac{R}{y} \right)^6 - 7 \left( \frac{R}{y} \right)^8 \right] \right\}$$

$$\text{where } K_T^\infty = 1 + \left\{ 2 \left[ \frac{E_x}{E_y} \right]^{0.5} - \mathbf{n}_{xy} + 0.5 \frac{E_x}{G_{xy}} \right\}^{0.5}$$

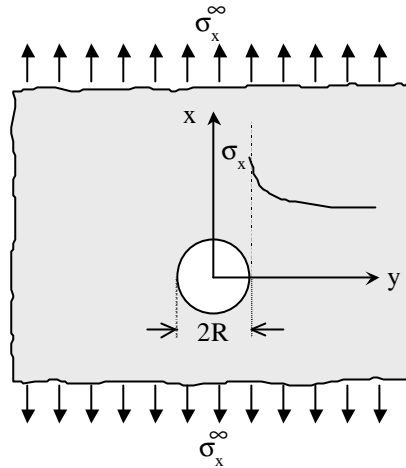

For an infinite orthotropic plate, with a crack, subjected to a uniform stress,  $\sigma_x^\infty$ , applied parallel to the x-axis at infinity, the normal stress,  $\sigma_x$ , along the y-axis ahead of the crack tip, see the figure below, can be expressed as:

$$s_x(0, y) = \frac{s_x^\infty y}{\sqrt{y^2 - c^2}} \text{ for } y > c$$

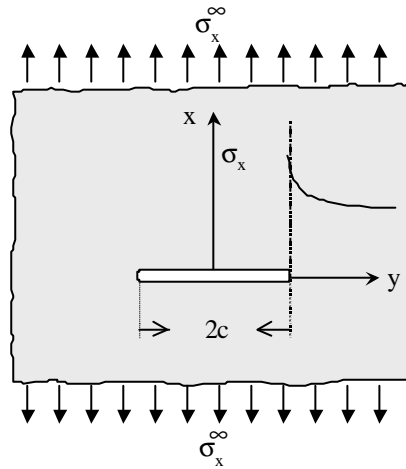

**Figure 4. Infinite Plate with Sharp Crack.**

The equations above are valid for infinite plates. For finite plates, it is necessary to add a Finite Width Correction (FWC) factor. There are several analysis methods, including finite element methods, to determine the FWC factor.

---e-n-d---o-f---G-u-i-d-a-n-c-e---n-o-t-e---

- 608** If certain damage is expected to be present in the structure at various points that can cause stress concentrations, the structure shall be analysed by modelling the presence of this damage. The damage shall be placed into the structure in a representative and conservative way.

- 609** As an alternative to analysing the structure with various points of damage the structure can be analysed with a reduced strength that represents the damage. All strength values used in the design criteria shall be based on measurements from damaged laminates (see *Section 4 A700*)

## D. Matrix cracking

### D 100 General

- 101** Matrix design criteria apply to a matrix in a ply where the deformation of the matrix is restrained by the fibres of the ply or the surrounding laminate.

**Guidance note:**

Matrix cracking is a simple concept at first sight but quite involved in details.

Some laminates have already matrix cracks after manufacturing. These cracks can be introduced by thermal stresses or by shrinkage of the matrix during cure.

Laminates without matrix cracks have an initial ply stress when the first cracks start to form.

Once cracks are formed they start to propagate at higher ply stresses and additional cracks are formed.

Crack formation will eventually lead to a change in stiffness. This point is usually referred to as the matrix crack point or first ply failure etc., because this is what can easily be measured.

Eventually laminates show crack saturation and no further cracks form when loaded more. The change of modulus has been related to matrix crack density in some publications.

See *A102 and A103* for relevance of matrix cracking for a particular application.

---e-n-d---o-f---G-u-i-d-a-n-c-e---n-o-t-e---

- 102** Matrix cracking is defined here as the onset of matrix cracking. The increase of the number of matrix cracks at higher stresses or strains is not covered by the matrix cracking criteria presented in this section.
- 103** Characteristic strength shall be defined according to *Section 4 A600*.
- 104** Matrix cracking shall be checked on the ply level.
- 105** Two alternative design criteria may be used. The simple stress criterion (*D200*) or the Puck criterion (*D300*).
- 106** If the component may fail due to wedge shaped matrix cracks in compression, the Puck criterion must be used to obtain the direction of the failure surface (*D300 and D400*).



## D 200 Matrix failure based on simple stress criterion

**201** The following design criterion should be used when the stress in one direction is dominating compared to the stresses in the other directions. The stress in one direction is said to be dominating when the criterion in 202 is not satisfied.

$$\gamma_F \gamma_{Sd} \sigma_{nk} < \frac{\hat{\sigma}_{nk}^{matrix}}{\gamma_M \gamma_{Rd}}$$

**Where:**

n Direction of the dominating stress

$\sigma_{nk}$  Characteristic value of the local load effect of the structure (stress) in the direction n

$\hat{\sigma}_{nk}^{matrix}$  Characteristic value of the stress components to matrix cracking in the direction n

$\gamma_F$  Partial load effect factor

$\gamma_{Sd}$  Partial load-model factor

$\gamma_M$  Partial resistance factor

$\gamma_{Rd}$  Partial resistance-model factor,  $\gamma_{Rd} = 1.0$

The coordinate system is the ply coordinate system.

**Guidance note:**

The stress to matrix cracking is in general direction-dependent. This is due to the presence of fibres that concentrate the stresses, such that the matrix stress to failure in the direction parallel to the fibres is in generally larger than in the perpendicular direction.

---e-n-d---o-f---G-u-i-d-a-n-c-e---n-o-t-e---

**202** The combination between the stress components in several directions shall be taken into consideration when the criterion below is satisfied. In that case, there is no dominating stress and the combination cannot be disregarded.

$$\max_i \left| \frac{\sigma_{ik}}{\hat{\sigma}_{ik}^{matrix}} \right| / \sum_{n \neq i} \left| \frac{\sigma_{nk}}{\hat{\sigma}_{nk}^{matrix}} \right| \leq 10$$

The coordinate system is the ply coordinate system, where i and n refer to the directions 22, 33, 12, 13 and 23

**203** When the combination between the stress components in several directions shall be taken into consideration, the design criterion for matrix cracking is given by:

$$\gamma_F \gamma_{Sd} \gamma_M \gamma_{Rd} \cdot \sqrt{\sum_n \left( \frac{\sigma_{nk}}{\hat{\sigma}_{nk}^{matrix}} \right)^2} < 1$$

**Where:**

- n The coordinate system is the ply coordinate system, where n refers to the directions 22, 33, 12, 13 and 23
- $\sigma_{nk}$  Characteristic value of the local load effect of the structure (stress) in the direction n
- $\hat{\sigma}_{nk}^{matrix}$  Characteristic value of the stress components to matrix cracking in the direction n
- $\gamma_F$  Partial load effect factor
- $\gamma_{Sd}$  Partial load-model factor
- $\gamma_M$  Partial resistance factor
- $\gamma_{Rd}$  Partial resistance-model factor,  $\gamma_{Rd} = 1.15$

**Guidance note:**

A resistance-model factor  $\gamma_{Rd} = 1.15$  should be used with this design rule. The model factor shall ensure a conservative result with respect to the simplifications made regarding the treatment of combined loads.

---e-n-d---o-f---G-u-i-d-a-n-c-e---n-o-t-e---

**Guidance note:**

This design criterion is often not available in finite element codes or other commercial software. The Tsai-Wu criterion can be used instead to check for matrix cracking, if the following modifications are made to the strength parameters:

- The ply strengths in fibre direction may be chosen to be much (1000 times) higher than the actual values.
- The interaction parameter  $f_{12}=0$  shall be set to 0

It is, however, recommended to use the Puck criterion to predict matrix cracking, see D300).

---e-n-d---o-f---G-u-i-d-a-n-c-e---n-o-t-e---

- 204** The characteristic strength  $\hat{s}_{nk}^{matrix}$  for each of the stress components  $\sigma_{nk}$  and the corresponding coefficients of variation  $COV_n$  are defined as specified in *Section 4 A600*.
- 205** The combined  $COV_{comb}$  of the characteristic strength  $\hat{s}_{nk}$  is defined according to one of the following alternatives. The second alternative is conservative with respect to the first.

$$COV_{comb} = \left( \sum_n \left| \hat{s}_{nk} \right| \cdot COV_n \right) / \left( \sum_n \left| \hat{s}_{nk} \right| \right)$$

or

$$COV_{comb} = \max_n (COV_n) \quad (10)$$

Where:

- n            The coordinate system is the ply coordinate system, where n refers to the directions 22, 33, 12, 13 and 23
- $COV_n$       COV for stress component n
- $COV_{comb}$    COV for the combined stress components

- 206** When two or more loads are combined, each stress component  $\sigma_{nk}$  in direction n can be the result of several combined loads. In that case each stress component  $\sigma_{nk}^j$ , which is the local load effect of the structure in direction n due to load j, shall be considered separately as an individual stress component to determine the COV.

$$COV_{comb} = \left( \sum_n \left| \hat{s}_{nk}^j \right| \cdot COV_n \right) / \left( \sum_n \left| \hat{s}_{nk}^j \right| \right)$$

or

$$COV_{comb.} = \max_n (COV_n)$$

**Guidance note:**

This approach is conservative compared to the approach of Turstra's rule as used for the fibre design criteria. This approach has been chosen for simplification. In the case of fibre failure, only the strains parallel to the fibre directions have to be considered, whereas for matrix cracking all stress directions may interact.

---e-n-d---o-f---G-u-i-d-a-n-c-e---n-o-t-e---

- 207** The choice of the partial safety factors shall be based on the most conservative partial safety factors obtained when treating each stress component  $\sigma_{nk}^j$ , which is the local load effect of the structure in direction n due to load j, as a single load.
- 208** The partial safety factors  $\gamma_F$  and  $\gamma_M$  shall be chosen as described in *Section 8* with COVs equal to  $COV_{comb}$ , as described in *205 and 206*.
- 209** Matrix failure cannot be checked on a laminate level, it shall always be checked on a ply level.

**D 300 Matrix failure based on Puck's criterion**

- 301** Matrix cracking can be predicted using the criterion from Puck. It is probably the design criterion that describes the physics of the process the best.
- 102** The criterion evaluates the stress state over all possible failure surfaces. The orientation of the failure surface is described by the angle  $\theta$ . The stress state  $\sigma_n, \tau_{nt}, \tau_{nl}$  in the co-ordinates of the failure surface described by  $\theta$  is obtained from the ply stresses by:

$$\begin{Bmatrix} \mathbf{s}_n \\ \mathbf{t}_{nt} \\ \mathbf{t}_{nl} \end{Bmatrix} = \mathbf{g}_F \mathbf{g}_{Sd} \mathbf{g}_M \mathbf{g}_{Rd} \begin{bmatrix} c^2 & s^2 & 2sc & 0 & 0 \\ -sc & sc & (c^2 - s^2) & 0 & 0 \\ 0 & 0 & 0 & s & c \end{bmatrix} \begin{Bmatrix} \mathbf{s}_2 \\ \mathbf{s}_3 \\ \mathbf{t}_{23} \\ \mathbf{t}_{31} \\ \mathbf{t}_{21} \end{Bmatrix}$$

$$(c = \cos\theta; s = \sin\theta)$$

In addition, the stress component  $\mathbf{s}_{II}$  in fibre direction is needed.

$$\mathbf{s}_{II} = \mathbf{g}_F \mathbf{g}_{Sd} \mathbf{g}_M \mathbf{g}_{Rd} \mathbf{s}_1$$

Failure is evaluated based on the stress state  $\sigma_n, \tau_{nt}, \tau_{nl}$  for all angles  $\theta$  between -90 and 90 degrees. The design criterion is:

if  $\mathbf{s}_n(\mathbf{q}) \geq 0$

$$\max \left[ F_f \mathbf{s}_{II} + \sqrt{(F_{nt}^+ \mathbf{s}_n(\mathbf{q}))^2 + (F_{nt} \mathbf{t}_{nt}(\mathbf{q}))^2 + (F_{nl} \mathbf{t}_{nl}(\mathbf{q}))^2} + F_n^+ \mathbf{s}_n(\mathbf{q}) \right] < 1 ,$$

for all  $\mathbf{q}$  with  $-90 \leq \mathbf{q} \leq 90$ ,

if  $\mathbf{s}_n(\mathbf{q}) < 0$

$$\max \left[ F_f \mathbf{s}_{II} + \sqrt{(F_{nt}^- \mathbf{s}_n(\mathbf{q}))^2 + (F_{nt} \mathbf{t}_{nt}(\mathbf{q}))^2 + (F_{nl} \mathbf{t}_{nl}(\mathbf{q}))^2} + F_n^- \mathbf{s}_n(\mathbf{q}) \right] < 1 ,$$

or all  $q$  with  $-90 \leq q \leq 90$ ,

Where:

$\sigma_1, \sigma_2, \sigma_3, \sigma_{12}, \sigma_{13}, \sigma_{23}$

Characteristic values of the local load effect of the structure (stress) in the coordinates of the ply.

$\gamma_F$  Partial load effect factor (see 307)

$\gamma_{Sd}$  Partial load-model factor (from structural analysis see Section 9)

$\gamma_M$  Partial resistance factor (see 307)

$\gamma_{Rd}$  Partial resistance-model factor, (see 308)

$F_{ik}$  Strength factors, (see 303)

**303** The strength factors  $F_{ik}$  are functions of the ply strength parameters  $\hat{S}_{2t}^{\text{matrix}}$ ,  $\hat{S}_{2c}^{\text{matrix}}$ ,  $\hat{S}_{12}^{\text{shear}}$ ,  $\hat{S}_{1t}^{\text{fibre}}$ ,  $\hat{S}_{1c}^{\text{fibre}}$  and shape parameters of the failure surface. The factors are defined as:

$$F_f = \frac{1}{A_t \hat{S}_{1t}^{\text{fibre}}} \text{ if } s_{ll} \geq 0 \text{ and } F_f = \frac{1}{A_c \hat{S}_{1c}^{\text{fibre}}} \text{ if } s_{ll} < 0$$

$$F_{nn}^+ = \frac{1}{R_{\perp}^z} - \frac{p_{\perp\Psi}^{(+)}}{R_{\perp\Psi}^A}, F_{nn}^- = \frac{p_{\perp\Psi}^{(-)}}{R_{\perp\Psi}^A}$$

$$F_n^+ = \frac{p_{\perp\Psi}^{(+)}}{R_{\perp\Psi}^A}, F_n^- = \frac{p_{\perp\Psi}^{(-)}}{R_{\perp\Psi}^A}$$

$$F_{nt} = \frac{1}{R_{\perp\perp}^A}, F_{nl} = \frac{1}{R_{\perp\parallel}}$$

with

$$A_t = A_c = 1.6$$

$$\frac{t_{nl}}{t_{nt}} = \tan ?$$

$$\frac{p_{\perp\Psi}^{(+)}}{R_{\perp\Psi}^A} = \frac{p_{\perp\perp}^{(+)}}{R_{\perp\perp}^A} \cos^2 \psi + \frac{p_{\perp\parallel}^{(+)}}{R_{\perp\parallel}} \sin^2 \psi$$

$$\frac{p_{\perp\Psi}^{(-)}}{R_{\perp\Psi}^A} = \frac{p_{\perp\perp}^{(-)}}{R_{\perp\perp}^A} \cos^2 ? + \frac{p_{\perp\parallel}^{(-)}}{R_{\perp\parallel}} \sin^2 ? )$$

$$R_{\perp\perp}^A = \frac{R_{\perp}^d}{2(1 + p_{\perp\perp}^{(-)})}$$

where

the shape parameters  $p_{\perp\parallel}^{(+)}$ ,  $p_{\perp\parallel}^{(-)}$ ,  $p_{\perp\perp}^{(+)}$ ,  $p_{\perp\perp}^{(-)}$  should be determined experimentally. If they are not available the following default values shall be used:

$$p_{\perp\parallel}^{(+)} = 0,30, p_{\perp\parallel}^{(-)} = 0,30, p_{\perp\perp}^{(+)} = 0,15, p_{\perp\perp}^{(-)} = 0,27$$

$$R_{\perp}^z = \mathbf{S}_{2t}^{\wedge \text{matrix}}$$

$$R_{\perp}^d = \mathbf{S}_{2c}^{\wedge \text{matrix}}$$

$$R_{\perp||} = \mathbf{S}_{12}^{\wedge \text{shear}}$$

- 304** The characteristic strength for each of the stress components  $\hat{S}_{2t}^{\text{matrix}}$ ,  $\hat{S}_{2c}^{\text{matrix}}$ ,  $\hat{S}_{12}^{\text{shear}}$  and the corresponding coefficients of variation  $COV_n$  are defined as specified in *Section 4 A600*. The combined  $COV_{\text{comb}}$  is defined as

$$COV_{\text{comb}} = \max_n (COV_n)$$

- 305** When two or more loads are combined, each stress component  $\sigma_{nk}$  in direction  $n$  can be the result of several combined loads. In that case each stress component  $\sigma_{nk}^j$ , which is the local load effect of the structure in direction  $n$  due to load  $j$ , shall be considered separately as an individual stress component to determine the COV.

$$COV_{\text{comb}} = \left( \sum_n |S_{nk}^j| COV_n \right) / \left( \sum_n |S_{nk}^j| \right)$$

or

$$COV_{\text{comb.}} = \max_n (COV_n)$$

**Guidance note:**

This approach is conservative compared to the approach of Turstra's rule as used for the fibre design criteria. This approach has been chosen for simplification. In the case of fibre failure, only the strains parallel to the fibre directions have to be considered, whereas for matrix cracking all stress directions may interact.

---e-n-d---o-f---G-u-i-d-a-n-c-e---n-o-t-e---

- 306** The choice of the partial safety factors shall be based on the most conservative partial safety factors obtained when treating each stress component  $\sigma_{nk}^j$ , which is the local load effect of the structure in direction  $n$  due to load  $j$ , as a single load.
- 307** The partial safety factors  $\gamma_F$  and  $\gamma_M$  shall be chosen as described in *Section 8* with a COV equal to  $COV_{\text{comb}}$ , for both the characteristic strengths and the local load effects (*see 304 to 306*).
- 308** The resistance model factor  $\gamma_{Rd}$  shall be chosen to be 1.1. The model factor shall ensure a conservative result with respect to the simplifications made regarding the treatment of combined loads.
- 309** Matrix failure cannot be checked on a laminate level, it shall always be checked on a ply level.

**D 400 Obtaining orientation of the failure surface**

- 401** The orientation of the fibre failure surface is critical if a structure is loaded in compression. Matrix crack failure surfaces with an orientation of  $30^\circ$  to  $60^\circ$  relative to the

plane of the laminate can reduce compressive fibre strength and reduce the resistance to delamination.

- 102** The orientation of the failure surface should be determined with the Puck design criterion by finding the angle  $\theta$  at which the matrix design criterion in 302 reaches its maximum.
- 403** If the laminate may have matrix cracks with an orientation of  $30^\circ$  to  $60^\circ$  relative to the plane of the laminate the compressive fibre strength shall be measured on laminates with the presence of such cracks and this value shall be used in the fibre design criterion (see *Section C*). In this case the tested laminate should be equal to the one used in the component.

**Guidance note:**

Matrix cracks with an orientation of  $30^\circ$  to  $60^\circ$  occur mainly when the ply is exposed to high inplane shear stresses or compressive stresses normal to the fibre direction.

---e-n-d---o-f---G-u-i-d-a-n-c-e---n-o-t-e---

**D 500 Matrix cracking caused only by shear**

- 501** Some laminates may fail (rupture) due to shear in the plies without fibre failure. This condition was described in *C105*. In this case matrix cracking due to stresses transverse to the fibres is acceptable. To check for this condition the matrix failure design criteria described in *D100-D300* may be used by applying them just for shear stresses.
- 502** For simple 2-D inplane conditions the matrix cracking design criterion in D200 reduces to:

$$\gamma_F \gamma_{Sd} s_{12} < \frac{\hat{s}_{12}^{matrix}}{\gamma_M \gamma_{Rd}}$$

Where:

- $s_{12}$  Characteristic value of the local load effect of the structure (stress) in the inplane shear direction 12.
- $\hat{s}_{12}^{matrix}$  Characteristic value of the stress components to matrix cracking in the inpane shear direction 12.
- $\gamma_F$  Partial load effect factor
- $\gamma_{Sd}$  Partial load-model factor
- $\gamma_M$  Partial resistance factor
- $\gamma_{Rd}$  Partial resistance-model factor,  $\gamma_{Rd} = 1.0$
- The coordinate system is the ply coordinate system.

**D 600 Matrix failure checked by component testing**

- 601** Refer to section on component testing (*Section 10*).



## E. Delamination

### E 100 General

- 101** Delamination is a separation of plies. Delaminations are debonded areas that can grow gradually, once they are initiated.
- 102** Delaminations can also be debonding between core materials and skins.

### E 200 Onset of delamination

- 201** The onset of delamination due to inplane stresses or strains is difficult to predict. It is known that delaminations will not initiate before matrix cracks have formed. It is, therefore, a conservative choice to model the onset of delamination with the matrix cracking criteria from *Section D*.

### E 300 Delamination growth

- 301** Growth of interlaminar cracks can be analysed with a fracture mechanics approach. The crack will propagate when the strain energy release rate  $G$  will reach the critical strain energy release rate  $G_{\text{critical}}$ . The design criterion is then given by:

$$g_F g_{Sd} \cdot G < \frac{G_{\text{critical}}}{g_M \cdot g_{Rd}} \quad (11)$$

$G$  shall be calculated using local interlaminar stresses. For  $\gamma_{Rd}$  see 604.

- 302**  $G_{\text{critical}}$  depends often on the crack length.
- If the dependence on crack length can be considered  $\gamma_{Rd} = 1$
  - If the dependence on crack length is not known  $\gamma_{Rd} = 2$
- 303**  $G_{\text{critical}}$  has to be chosen for the appropriate crack opening mode. For mixed mode conditions  $G_{\text{critical}}$  can be calculated as a weighted average of  $G_{\text{I critical}}$  and  $G_{\text{II critical}}$ .

## F. Yielding

- 101** Yielding design criteria apply to most polymer core materials of sandwich structures.
- 102** Yielding design criteria may apply to a matrix material with plastic characteristics if the matrix is located in a region where it is not restrained between fibres, e.g. in the case of resin rich layers.
- 103** Yielding applies also to typical liner materials, like thermoplastics or resin rich layers.
- 104** The von Mises yield criterion shall be used to describe materials that yield. The stresses used in this criterion are the principal stresses.

$$g_F g_{Sd} g_M g_{Rd} \cdot \sqrt{(s_1 - s_2)^2 + (s_2 - s_3)^2 + (s_3 - s_1)^2} < s_y$$

Where:

$\sigma_n$	Characteristic principal stresses, $n=1,2,3$
$\sigma_y$	Characteristic value of the yield stress of the material
$\gamma_F$	Partial load effect factor
$\gamma_{Sd}$	Load-model factor
$\gamma_M$	Partial resistance factor
$\gamma_{Rd}$	Resistance-model factor, $\gamma_{Rd} = 1.0$

- 105** The characteristic yield strength  $\sigma_y$  and the corresponding coefficients of variation COV are defined as specified in *Sections 4 A600* and *5 A600*.
- 106** When two or several loads are combined, each stress component  $\sigma_n$  in direction  $n$  can be the result of several combined loads. In that case each stress component  $\sigma_n^j$ , local response of the structure in direction  $n$  due to load  $j$ , shall be considered separately as an individual stress component.
- 107** The choice of the partial safety factors shall be based on the most conservative partial safety factors obtained when treating each stress component  $\sigma_n^j$ , local response of the structure in direction  $n$  due to load  $j$ , as a single load. The material's COV shall always be the COV of the yield strength.
- 108** Foam cores under significant hydrostatic pressure or tension shall be checked in addition for ultimate failure of orthotropic homogenous materials (*Section G*). Significant hydrostatic pressure or tension exists if:

$$0.1s_3 \leq \frac{1}{3}(s_1 + s_2 + s_3) \leq 0.1s_1$$

where  $\sigma_1, \sigma_2, \sigma_3$  are the principal stresses with  $\sigma_1 > \sigma_2 > \sigma_3$ .

## G. Ultimate Failure of orthotropic homogenous materials

- 101** The criterion can only be used for orthotropic homogenous materials, i.e. materials with three axes of symmetry. Isotropic materials are included, since they are a sub-group of orthotropic materials. This criterion is typically applied to core materials. Strength values shall be determined relative to the axes of material symmetry (*Section 5 A400*). The criterion is not valid for fibre reinforced laminates, because laminates are not homogeneous.
- 102** The criterion can be applied to brittle core materials or to polymeric materials after yield.
- 103** The following design criterion should be used when the stress in one direction is dominating compared to the stresses in the other directions. The stress in one direction is said to be dominating when the criterion in *104* is not satisfied. The criterion shall be applied for tensile and compressive stresses.

$$g_F g_{Sd} S_{nk} < \frac{\hat{S}_{nk}}{g_M g_{Rd}}$$

Where:

- $n$  Direction of the dominating stress  
 $\sigma_{nk}$  Characteristic value of the local load effect of the structure (stress) in the direction  $n$   
 $\hat{S}_{nk}$  Characteristic value of the strength (stress to failure for component  $n$ )  
 $\gamma_F$  Partial load effect factor  
 $\gamma_{Sd}$  Partial load-model factor  
 $\gamma_M$  Partial resistance factor  
 $\gamma_{Rd}$  Partial resistance-model factor,  $\gamma_{Rd} = 1.0$   
 Local response and strength must be given in the same coordinate system

**Guidance note:**

A typical example for core materials in a sandwich would be to check that the through thickness shear stress does not exceed the shear strength. In many cases the shear stress is the dominating stress component, however, this shall be checked with the criterion in 104.

---e-n-d---o-f---G-u-i-d-a-n-c-e---n-o-t-e---

- 104** The interaction between the stress components in several directions shall be taken into consideration when the following criterion is satisfied. In that case, there is no dominating stress and the interaction can not be disregarded.

$$\max_i \left| \frac{S_{ik}}{\hat{S}_{ik}} \right| / \sum_{n \neq i} \left| \frac{S_{nk}}{\hat{S}_{nk}} \right| \leq 10$$

where  $i$  and  $n$  refer to the directions: 11, 22, 33, 12, 13, 23

For isotropic materials the directions shall be either the principal normal stresses or the principal shear stresses.

For orthotropic materials the directions shall be the material axes.

The same coordinate systems shall be used in 103 and 104.

- 105** When the interaction between the stress components in several directions shall be taken into consideration, the design criterion below shall be applied. The criterion shall be applied for tensile and compressive stresses.

$$g_F g_{Sd} g_M g_{Rd} \cdot \sqrt{\sum_n \left( \frac{S_{nk}}{\hat{S}_{nk}} \right)^2} < 1$$

Where:

n	Refers to the directions 11, 22, 33, 12, 13, 23
$\sigma_{nk}$	Characteristic value of the local load effect of the structure (stress) in the direction n
$\hat{s}_{nk}$	Characteristic value of the strength (stress to failure for component n)
$\gamma_F$	Partial load effect factor
$\gamma_{Sd}$	Partial load-model factor
$\gamma_M$	Partial resistance factor
$\gamma_{Rd}$	Partial resistance-model factor, $\gamma_{Rd} = 1.25$

For orthotropic materials the directions shall be the material axes.  
 For isotropic materials the directions shall be along either the principal normal stresses or the principal shear stresses.

This is a conservative design criterion. It has been chosen due to a lack of data and experience with ultimate failure under multiple stress conditions. Other design criteria may be used if experimental evidence for their validity can be given (see *Section R*).

**Guidance note:**

A resistance-model factor  $\gamma_{Rd} = 1.25$  should be used with this design rule. The modelling factor shall ensure a conservative result with respect to the simplifications made regarding the treatment of combined loads.

---e-n-d---o-f---G-u-i-d-a-n-c-e---n-o-t-e---

- 106** The characteristic strength  $\hat{s}_{nk}$  for each of the stress components  $\sigma_{nk}$  and the corresponding coefficients of variation  $COV_n$  are defined as specified in *Sections 4 A600* and *5 A600*.
- 107** The combined  $COV_{comb}$  is defined according to one of the following alternatives. The second alternative is conservative with respect to the first.

$$COV_{comb} = \left( \sum_n |s_{nk}| \cdot COV_n \right) / \left( \sum_n |s_{nk}| \right)$$

or

$$COV_{comb} = \max_n (COV_n)$$

Where:

- n Refers to the directions 11, 22, 33, 12, 13, 23  
 $COV_n$  COV for stress component n  
 $COV_{comb}$  COV for the combined stress components

- 108** When two or several loads are combined, each characteristic stress component  $\sigma_{nk}$  in direction n can be the result of several combined loads. In that case each stress component  $\sigma_{nk}^j$ , local load effect of the structure in direction n due to load j, shall be considered

separately as an individual stress component to determine the COV.

$$COV_{comb} = \left( \sum_n |s_{nk}^j| COV_n \right) / \left( \sum_n |s_{nk}^j| \right)$$

or

$$COV_{comb} = \max_n (COV_n)$$

The design criterion has then the form:

$$g_F \cdot g_{Sd} \cdot g_M \cdot g_{Rd} \cdot \sqrt{\sum_n \left( \frac{\sum_j s_{nk}^j}{s_{nk}} \right)^2} < 1$$

- 109** The choice of the partial safety factors shall be based on the most conservative partial safety factors obtained when treating each stress component  $\sigma_{nk}^j$ , local response of the structure in direction n due to load j, as a single load.
- 110** The partial safety factors  $\gamma_F$  and  $\gamma_M$  shall be chosen as described in *Section 8* with a resistance COV equal to  $COV_{comb}$ .

## H. Buckling

### H 100 Concepts and definitions

- 101** Elastic buckling phenomena are commonly considered in two main categories:
- Bifurcation buckling: Increasing the applied loading induces at first deformations that are entirely (or predominantly) axial or in-plane deformations. At a critical value of applied load (elastic critical load) a new mode of deformation involving bending is initiated. This may develop in an unstable, uncontrolled fashion without further increase of load (unstable post-buckling behaviour, brittle type of failure), or grow to large values with little or no increase of load (neutral post-buckling behaviour, plastic type of failure) or develop gradually in a stable manner as the load is increased further (stable post-buckling behaviour, ductile type of failure).
  - Limit point buckling: As the applied load is increased the structure becomes less stiff until the relationship between load and deflection reaches a smooth maximum (elastic critical load) at which the deformations increase in an uncontrolled way (brittle type of failure).
- 102** Determination of the elastic critical load of a structure or member that experiences bifurcation buckling corresponds to the solution of an eigenvalue problem in which the elastic buckling load is an eigenvalue and the corresponding mode of buckling

deformation is described by the corresponding eigenvector.

- 103** Elastic buckling may occur at different levels:
- Global level for the structure. This involves deformation of the structure as a whole.
  - Global level for a structural member. This is confined mainly to one structural member or element but involves the whole of that member or element.
  - Local level for a structural member. Only a part of a structural member or element is involved (e.g. local buckling of the flange of an I-beam or of a plate zone between stiffeners in a stiffened plate).
- 104** Resistance of a structural member to elastic buckling is normally expressed as a critical value of load (applied force, or stress resultant induced in a member) or as a critical value of a nominal average stress (e.g. axial or shear force divided by area of cross-section). However, such resistance may also be expressed as a critical value of mean strain induced at a cross-section in a member.
- 105** Initial geometrical imperfections (out-of-straightness, out-of-roundness, or eccentricity of applied loading) that lead to a situation where compressive forces in a structural part are not coincident with the neutral axis of that part may influence significantly the buckling behaviour. An idealised structure without such imperfections is referred to as “geometrically perfect”.
- 106** Bifurcation buckling is essentially a feature of geometrically perfect structures. Geometrical imperfections generally destroy the bifurcation and lead to a situation where bending deformations begin to grow as the load is increased from zero. An elastic critical load may still be associated with the structure, and may provide a good indication of the load level at which the deformations become large. However, some structures with unstable post-buckling behaviour are highly sensitive to geometric imperfections. In the presence of imperfections, such structures may experience limit point buckling at loads that are significantly lower than the elastic critical load of the geometrically perfect structure.
- 107** Elastic buckling deformation of a geometrically perfect or imperfect structure may trigger other failure mechanisms such as fibre failure (compressive or tensile) or matrix cracking.
- 108** The presence of failure mechanisms such as matrix cracking or delamination may influence significantly the buckling behaviour of structures and structural members.

## **H 200 General requirements**

- 201** Resistance of structures or structural members in the presence of buckling may be determined by means of testing or analysis.
- 202** The effects of initial geometrical imperfections shall always be evaluated for structures or structural members being checked for buckling.
- 203** Assumptions regarding geometrical imperfections shall wherever possible be based on
- knowledge of production methods and corresponding production tolerances
  - knowledge of how imperfections of given shape and magnitude influence the structural behaviour, and
  - experience from previous measurements and tests
- If an adequate knowledge base does not exist, a programme of measurement and/or testing

shall be agreed to demonstrate that the design assumptions are justified.

### H 300 Requirements when buckling resistance is determined by testing

- 301** If the resistance of a structure or structural member is determined by testing, the requirements in *Paragraphs 302 to 306* shall be satisfied. Testing shall be done as described in *Section 10 Component Testing*.
- 302** Sufficient tests shall be performed to provide statistical data so that both the mean resistance and the COV may be determined.
- 303** The structures or members tested shall incorporate the least favourable geometrical imperfections that are possible within the specified production tolerances. Alternatively, the structures or structural members tested may incorporate a representative range of geometrical imperfections that may arise in the intended production process; however, in such a case it must be demonstrated that the imperfections considered are representative in terms of their distributions of shape and amplitude.
- 304** The design criterion shall normally be applied at the level of overall load for a structure, or either force (stress resultant) or nominal stress or strain (averaged over the member cross-section) for a structural member.
- 305** The design criterion for buckling when the resistance is determined by testing is as follows:

$$g_F g_{Sd} \cdot F < \frac{\hat{F}_{buckling}}{g_{Mbuckle} g_{Rdbuckle}}$$

where:

$F$	Characteristic value of the load, or induced stress resultant or nominal stress or strain
$\hat{F}_{buckling}$	Characteristic value of the test load when the component buckles
$g_F$	Partial load or load effect factor
$g_{Sd}$	Partial load or load effect model factor
$g_{Mbuckle}$	Partial resistance factor
$g_{Rdbuckle}$	Partial resistance-model factor

- 306** The partial factors shall be determined according to *Section 10 B Component Testing*.

### H 400 Requirements when buckling is assessed by analysis

- 401** If the resistance of a structure or structural member is determined by analysis, the requirements in *Paragraphs 402 to 415* shall be satisfied.

- 402** Buckling analysis may be carried out by analytical or numerical methods as described in *Section 9K*. Such analyses may be applied to either geometrically perfect or imperfect structures. Analytical methods are mainly confined to geometrically perfect structures, except for some simple structural members with imperfections of simple shape.
- 403** When performing a buckling analysis the boundary conditions shall be evaluated carefully.
- 404** If in any buckling analysis the applied load is higher than the load that would introduce partial damage in the structure, e.g. matrix cracking or delaminations, the buckling calculations shall take this partial damage into account.
- 405** For structures or structural elements that are expected to exhibit bifurcation buckling, an analysis to determine the elastic critical load (or critical stress or strain) shall normally be carried out as described in *Section 9K, Paragraph 202* or *302*, before more complex non-linear analysis is performed. The purpose of this is to establish:
- whether it may be acceptable to perform only geometrically linear analysis as described in *Section 9K Paragraph 205* (see also *411* below);
  - whether the structure is clearly under-dimensioned against buckling (if the applied load clearly exceeds, or is close to, the elastic critical load);
  - in the case of finite element analysis, the required fineness of mesh for a more complex buckling analysis
- 406** Analytical formulae for elastic buckling shall be checked carefully if they contain empirical safety factors or not and if they are based on structures with or without imperfections. Without this knowledge analytical formulas should not be used.
- 407** Except in the case of analysis for elastic critical loads (or elastic critical stresses or strains), the analysis model shall incorporate the least favourable geometrical imperfections that are possible within the specified production tolerances. Alternatively, a series of analyses may be performed incorporating a representative range of geometrical imperfections that may arise in the intended production process; these may then be combined with statistical information about the imperfections that arise in practical production, in terms of their distributions of shape and amplitude.
- 408** If imperfections are not directly included in the buckling analysis as described in 407, their effects shall be evaluated by other means such as supplementary analysis or testing. However, if it is demonstrated that the eccentricities or local bending moments induced by the least favourable geometrical imperfections are less than 10% of the corresponding quantities resulting from other features inherent in the structure or its loading, such as out-of-plane loads, the geometrical imperfections may be neglected.
- 409** In assessing buckling-induced failure, the design criteria shall normally be applied at the level of local stress or strain state, considered at all points in the structure. The criteria related to fibre failure, matrix cracking, delamination, yield and ultimate failure given in



*Sections C, D, E, F and G* shall be applied as appropriate. For sandwich structures the special criteria given in *Section P* shall be applied in addition. Additionally the displacement criterion given in *Section I* shall be applied both globally and locally to ensure that there are no excessive buckling displacements.

- 410** To obtain the resistance quantities required for the checks in *409*, geometrically non-linear analysis shall be performed as described in *Section 9K*. Reduction of mechanical properties due to local failure such as matrix cracking or delamination shall be taken into account.
- 411** If the condition described in *Section 9K Paragraph 205* is satisfied, the analysis may be performed without geometric non-linearity provided the load effect modelling factor is increased as specified. In such a case the geometrical imperfections must still be included.
- 412** *Section 9K Paragraph 204* provides an approximate way of estimating the combined influence of imperfections and in-plane or axial loading, based on the use of linear analysis.
- 413** The calculated resistance is to be considered as a mean strength from a probabilistic point of view.
- 414** Variability to the mean strength is introduced by:
- Uncertainties in the stiffness parameters that are used in the buckling calculations
  - Uncertainties in geometric parameters
  - Uncertainties in size of imperfections and how imperfections are considered
- 415** To reflect the uncertainty introduced by geometrical imperfections, the partial load effect model factor for checks on failure mechanisms referred to in *409* shall be based on a COV of 15% unless lower values can be justified.

## I. Displacements

- 101** Maximum displacements shall be defined as extreme values with a small probability of being exceeded and without uncertainties or tolerances associated with them. The following design criterion shall be fulfilled:

$$\gamma_F \gamma_{Sd} \cdot d_n < d_{spec}$$

where:

$d_n$  Characteristic value of the local response of the structure (here displacement)

$d_{spec}$  Specified requirement on maximum displacement

$\gamma_F$  Partial load effect factor

$\gamma_{Sd}$  Load model factor

Displacements may also be defined as maximum strains, curvatures etc.

- 102** Displacements shall be calculated as described in *Section 9* or shall be measured directly. A reduction of stiffness of the structure due to material nonlinearities or due to time dependent effects on the elastic constants shall be considered. Plastic deformations due to permanent static or fatigue loads shall also be considered.

**103** The failure type (*Section 2 C400*) associated with a displacement requirement shall be decided on an individual basis.

**Guidance note:**

If the displacement requirement requires that:

- the structure should never touch the neighbouring structure locally, the failure type would be brittle,
- the structure can touch the neighbouring structure locally at low loads, the failure type would be plastic,
- the structure can touch the neighbouring structure locally at loads that may cause some permanent damage, the failure type would be ductile.

If the structures may touch each other slightly, the corresponding loads and possible damage effects shall be analysed.

---e-n-d---o-f---G-u-i-d-a-n-c-e---n-o-t-e---

**104** If the criterion is used in combination with a linear non-degraded analysis according to 9B400, all strains and stresses in fibre direction above the level to initiate matrix cracking shall be multiplied by the analysis factor  $\gamma_a$  from 9C200.

## J. Long term static loads

### J 100 General

- 101** The *sustained* load conditions, as defined in *Section 3 I500*, shall be used as the applied load when checking for the effects of long term static loads. The observation period is defined as the duration during which stress corrosion is likely to take place. A table similar to *Table 3-1* should be used, indicating the applied stress or strain level(s) during the observation period divided into one or several time intervals. The load conditions shall be based on a conservative estimate.
- 102** The observation period is defined as the period at the end of which effects of long term static loads shall be calculated.
- 103** Analysis with sustained load conditions may be performed on a ply (lamina) level or laminate level. However, long term data shall always be measured on laminates with representative layups to ensure that the data represent the interactions between plies.
- 104** If a component is exposed to static and cyclic long term loads the combined effect shall be taken into account. As a conservative choice the effects may be taken to be additive. Other combinations may be used if experimental evidence can be provided. If fatigue is analysed or tested with a mean load that corresponds to the permanent static load, effects of static and cyclic fatigue may be considered separately.

### J 200 Creep

- 201** The effect of creep is a reduction of the Young's modulus. The reduction of the Young's modulus is denoted as the creep modulus. How the modulus changes with time is described in *Sections 4* and *5*. Usually experimental confirmation of creep behaviour is required.
- 202** The result of creep can be a redistribution of stresses in a larger structure or the exceedence of a maximum displacement requirement. If the redistribution of stresses is of concern a stress analysis with the changed elastic constants shall be performed. If displacement requirements shall be observed the displacement criterion (see *Section 6H*) shall be checked by using the relevant creep moduli in the analysis.

### J 300 Stress Relaxation

- 301** The effect of stress relaxation is a reduction of the Young's modulus that causes a reduction of stresses under constant deformation. How the modulus changes with time is described in *Sections 4* and *5*. Usually experimental confirmation of the behaviour is required.
- 302** The result of stress relaxation can be a redistribution of stresses in a larger structure or the loss of a certain contact pressure. If the redistribution of stresses is of concern a stress analysis with the changed elastic constants shall be performed. If a certain contact pressure is needed the structure shall be checked for the reduced moduli.

**Guidance note:**

A specified contact pressure is often needed for bolted connections, or if a component is kept in place

by friction.

Stress relaxation will be less pronounced when:

- the glass content in the laminate is increased,
- more of the fibres are orientated in the load direction,
- the temperature is lowered.

---e-n-d---o-f---G-u-i-d-a-n-c-e---note---

## J 400 Stress Rupture - Stress Corrosion

**401** Materials may fail due to the permanent application of loads: this process is called stress rupture. If the permanent loads act in combination with an aggressive environment the process is called stress corrosion. The analysis is generally the same for both processes, but the material curve describing the reduction of strength with time depends on the surrounding environment. In the following parts only the notion of stress rupture will be used.

**402** All significant failure mechanisms shall be checked for stress rupture, i.e. all failure mechanisms that are linked to a critical failure mode and limit state. The approach is basically the same for all failure mechanisms, but different stress rupture curves and residual strength values shall be considered. These are described in *Sections 4* and *5*.

**403** A stress rupture analysis shall provide the answers to two questions:

- Can the structure survive the expected load sequence?
- Is the structure strong enough that it can survive all relevant extreme load cases on the last day of its service life?

**404** It is assumed that the reduction of strength with time can be described by one of the following equations:

$$\log[\mathbf{s}(t)] = \log[\mathbf{s}(1)] - \mathbf{b} \log(t)$$

or

$$\log[\mathbf{e}(t)] = \log[\mathbf{e}(1)] - \mathbf{b} \log(t)$$

Where:

$\sigma(t), \varepsilon(t)$	time-dependent stress or strain to failure.
$\sigma(1), \varepsilon(1)$	scalar depending on the material, failure mechanism and on the environmental conditions at time 1. The units of time must be consistent in the equation.
$\beta$	slope depending on the material, failure mechanism and on the environmental conditions
log	denotes the logarithm to the basis 10

- 405** It shall be documented that the material follows the *equation (6-12)*. More details can be found in *Section 4 C300* and *Section 5C300*. If the long term behaviour of the material is different, the following equations to calculate lifetimes may still be used, but the characteristic time to failure (see 407) should be calculated by a statistical analysis appropriate for the specific behaviour of the material.
- 406** The regression line described by the *equation (6-12)* should correspond to the characteristic curve as described in *Section 4 C1100*.
- 407** The characteristic time to failure  $t^{charact}(\mathbf{g}_{Sd} \cdot \mathbf{s}_{applied})$  shall be extracted from the stress rupture curve (see also *Section 4 C300* and *Section 5C300*) for each applied strain condition. The characteristic time to failure shall be found for the applied strains  $\epsilon_{applied}$  multiplied by the partial load model factor  $\gamma_{Sd}$ . Alternatively, the characteristic time to failure can also be found for an applied stress  $t^{charact}(\mathbf{g}_{Sd} \cdot \mathbf{e}_{applied})$ , depending on what type of data is available.

408 One of the following design criterion for stress rupture shall be used, depending what kind of long term data are available:

$$\gamma_{fat} \gamma_{Rd} t_y \sum_{j=1}^N \frac{t^{actual} \left\{ \gamma_{Sd} s^j_{applied} \right\}}{t^{characteristic} \left\{ \gamma_{Sd} s^j_{applied} \right\}} < 1$$

or

$$\gamma_{fat} \gamma_{Rd} t_y \sum_{j=1}^N \frac{t^{actual} \left\{ \gamma_{Sd} e^j_{applied} \right\}}{t^{characteristic} \left\{ \gamma_{Sd} e^j_{applied} \right\}} < 1$$

with  $\gamma_{Rd} = 1$  for a summation over various strain/stress levels, i.e.  $N > 1$ .  
 $\gamma_{Rd} = 0.1$  if the component is exposed to only one strain/stress level, i.e.  $N = 1$ .

Where:

$t \{ \dots \}$   $t$  as a function of...

$\epsilon^j_{applied}$  Local response of the structure to the *permanent static* load conditions (max. strain)

$\sigma^j_{applied}$  Local response of the structure to the *permanent static* load conditions (max. stress)

$t^{actual}$  Actual time at one permanent static load condition per year

$t^{characteristic}$  Characteristic time to failure under the permanent static load condition

$N$  The total number of load conditions

$j$  Index for load conditions

$t_y$  Number of years (typically the design life)

$\gamma_{Sd}$  Partial load-model factor

$\gamma_{Rd}$  Partial resistance-model factor

$\gamma_{fat}$  Partial fatigue safety factor

- 409** A different  $\gamma_{Rd}$  value may be chosen if it can be documented by experimental evidence. Load sequence testing for the actual material on representative load sequences shall be used to document the use of a  $\gamma_{Rd}$  in the range of  $1 > \gamma_{Rd} > 0.1$ . The minimum is  $\gamma_{Rd} = 0.1$ .

Guidance note

The factors  $g_{fat}g_{Rd}$  are designed in such a way that they account for the uncertainty in Miner sum for composites and provide the desired level of safety. When choosing the default value  $g_{Rd} = 1$  an uncertainty of 10 is assumed for the Miner sum.

End of guidance note

- 410** If the design criterion in 408 is fulfilled even if  $g_{Rd}$  can be multiplied by 20 it may be sufficient to use typical fatigue data for the laminate without confirming the data by testing. A minimum requirement for using this clause is that all similarity checks in Section 4H are fulfilled. A cases by case evaluation should be made in addition, in particular evaluating whether environmental effect could change the fatigue properties of the laminate relative to the reference data.
- 411** The selection of the partial safety factors is based on the following assumptions: The long term static load is defined as a conservative mean value, i.e. no uncertainty needs to be considered for that variable. The partial load effect factor  $\gamma_F$  is set equal to 1.0.
- 412** Under permanent loads, composite materials show a reduction of strength with time for various failure mechanisms under permanent loads. All relevant failure mechanisms shall be checked for the reduced strength values under extreme load conditions. More details about strength reduction can be found in *Sections 4* and *5*. Possible reduction of Young's moduli should also be considered, depending on the analysis methods used (see *Section 9*).
- 413** If the criterion is used in combination with a linear non-degraded analysis according to 9B400, all strains and stresses in fibre direction above the level to initiate matrix cracking shall be multiplied by the analysis factor  $\gamma_a$  from 9C200.
- 414** The partial fatigue safety factor  $\gamma_{fat}$  is defined in *Section 8 E* for different safety classes. The same safety class as determined for the static failure mechanism shall be used.

## K. Long term cyclic loads

### K 100 General

- 101** The *fatigue* load conditions, as defined in *Section 3 I600*, shall be used as the applied load when checking fatigue. A table similar to the one given in *Section 3 I605* should be used, indicating the mean and amplitude of applied stress or strain as a function of the number of cycles. The load conditions shall be based on a conservative estimate.
- 102** Fatigue analysis may be performed on a ply (lamina) level or on a laminate level.

However, fatigue data shall always be measured on laminates with representative layups to ensure that the data represent the interactions between plies.

- 103** If a component is exposed to static and cyclic long term loads the combined effect shall be taken into account. As a conservative choice the effects may be taken to be additive. Other combinations may be used if experimental evidence can be provided. If fatigue is analysed or tested with a mean load that corresponds to the permanent static load, effects of static and cyclic fatigue may be considered separately.
- 104** Matrix cracks may develop under cyclic loads even if the maximum stress is below the level to initiate matrix cracking in a static test.

### **K 200 Change of elastic properties**

- 201** Fatigue loads may change the elastic properties of a material. The change is of permanent nature in most cases. How the modulus changes with the number of cycles is described in *Sections 4* and *5*. Usually experimental confirmation of the change of elastic properties is required.
- 202** The result of a change of the elastic properties can be a redistribution of stresses in a larger structure or the exceedence of a maximum displacement requirement. If the redistribution of stresses is of concern a stress analysis with the changed elastic constants shall be performed. If displacement requirements shall be observed the displacement criterion (see *Section 6I*) shall be fulfilled for the relevant elastic properties in the analysis.

**Guidance note:**

The change of elastic constants is usually a result of an accumulation of matrix cracks under cyclic fatigue.

---e-n-d---o-f---g-u-i-d-a-n-c-e---n-o-t-e---

- 203** In some cases a certain contact pressure may be needed for a component. It shall be documented that the change of elastic constants due to cyclic fatigue will not reduce the contact pressure to an unacceptable level.

**Guidance note:**

A specified contact pressure is often needed for bolted connections, or if a component is kept in place by friction.

---e-n-d---o-f---g-u-i-d-a-n-c-e---n-o-t-e---

### **K 300 Initiation of fatigue damage**

- 301** Materials may fail due to the cyclic application of loads: this process is called fatigue. A combination of cyclic loads with an aggressive environment is here also called fatigue. The analysis is generally the same for both processes, but the material curve describing the reduction of strength with time depends on the surrounding environment.
- 302** All failure mechanisms shall be checked for fatigue, unless a particular failure mechanism may be acceptable for the structure. The approach is basically the same for all failure mechanisms, but different SN curves and residual strength values shall be considered. These are described in *Sections 4* and *5*.



- 303** A fatigue analysis shall contain two steps:
- Can the structure survive the expected load sequence.
  - Is the structure strong enough that it can survive all relevant extreme load cases on the last day of its service life.

- 104** A constant amplitude lifetime diagram shall be constructed from the available characteristic SN curves (see *Section 4C700* and *5C700*). The characteristic number of cycles to failure  $n^{charact}(\mathbf{g}_{Sd} \cdot \mathbf{e}_{applied})$  shall be extracted for each applied strain condition (amplitude and mean level) from the constant lifetime diagram. The number of expected cycles to failure shall be found for the applied strains  $\epsilon_{applied}$  multiplied by the partial load model factor  $\gamma_{Sd}$ .

- 305** The following design criterion for fatigue shall be used:

$$\mathbf{g}_{fat} \mathbf{g}_{Rd} t_y \sum_{j=1}^N \frac{n^{actual} \left\{ \mathbf{g}_{Sd} \mathbf{e}^j_{applied} \right\}}{n^{charact} \left\{ \mathbf{g}_{Sd} \mathbf{e}^j_{applied} \right\}} < 1$$

with  $\gamma_{Rd} = 1$  for a summation over various strain conditions, each of which consists of a combination of a specific mean strain and a specific strain amplitude, i.e.  $N > 1$ .  
 $\gamma_{Rd} = 0.1$  if the component is exposed to only one mean strain and one strain amplitude, i.e.  $N = 1$ .

Where:

$n \{ \dots \}$  **n as a function of...**

$\epsilon_{applied}$	Local response of the structure to the strain condition applied
$n^{actual}$	Number of cycles per year at a particular strain condition
$n^{charact}$	Characteristic number of cycles to failure under a given strain condition
$N$	The total number of strain conditions
$j$	Index for strain condition
$t_y$	Number of years for the fatigue evaluation (typically equal to the design life)
$\gamma_{Sd}$	Load-model factor
$\gamma_{Rd}$	Resistance-model factor
$\gamma_{fat}$	Partial fatigue safety factor

- 306** A stress based fatigue analysis may be used as an alternative to 304 and 305, using the same approach, but replacing strains by stresses.
- 307** A different  $\gamma_{Rd}$  value may be chosen if it can be documented by experimental evidence. Load sequence testing for the actual material on representative load sequences shall be used to document the use of a  $\gamma_{Rd}$  in the range of  $1 > \gamma_{Rd} > 0.1$ . The minimum is  $\gamma_{Rd} = 0.1$ .

Guidance note

The factors  $g_{fat}g_{Rd}$  are designed in such a way that they account for the uncertainty in Miner sum for composites and provide the desired level of safety. When choosing the default value  $g_{Rd} = 1$  an uncertainty of 10 is assumed for the Miner sum.

End of guidance note

- 308** If the design criterion in 305 is fulfilled even  $g_{Rd}$  can be multiplied by 20 it may be sufficient to use typical fatigue data for the laminate without confirming the data by testing. A minimum requirement for using this clause is that all similarity checks in Section 4H are fulfilled. A cases by case evaluation should be made in addition, in particular evaluating whether environmental effect could change the fatigue properties of the laminate relative to the reference data.
- 309** If the structure is exposed to a known load sequence and the SN curve has been obtained for that load sequence the Miner sum calculation is not required. If the load sequence changes Miner sum calculations are needed.
- 310** The selection of the partial safety factors is based on the following assumptions: The fatigue load (mean and amplitude) is defined as a conservative mean value, i.e. no uncertainty needs to be considered for that variable. The partial load effect factor  $\gamma_F$  is set equal to 1.0.
- 311** Composite materials may show a reduction of strength with numbers of cycles for various failure mechanisms. All relevant failure mechanisms shall be checked for the reduced strength values under extreme load conditions. More details about strength reduction can be found in *Sections 4* and *5*. Possible reduction of Young's moduli should also be considered, depending on the analysis methods used (see *Section 9*).
- 312** If the criterion is used in combination with a linear non-degraded analysis according to 9B400, all strains and stresses in fibre direction above the level to initiate matrix cracking shall be multiplied by the analysis factor  $\gamma_a$  from 9C200.
- 313** The partial fatigue safety factor  $\gamma_{fat}$  is defined in *Section 8 E* for different safety classes.. The same safety class as determined for the static failure mechanism shall be used.

#### **K 400 Growth of fatigue damage**

- 401** Growth of fatigue damage is defined here as the accumulation of damage due to fatigue loads, e.g. the increase of the number of cracks in the matrix or the growth of a

delamination.

- 402** The initiation of damage due to long term static and cyclic loads is described in *Sections K* and *L*.
- 403** The growth of damage is a complicated process that shall be documented based on experimental evidence. The simplified approach of assuming that the component is always completely saturated with damage may be used.
- 404** If a component may accumulate damage due to fatigue, the component shall be analysed with and without that damage.

## **L. Impact**

### **L 100 General**

- 101** Impact of an object may have two effects on a structure. The impact may be so strong that failure modes are introduced that will immediately lead to a violation of functional requirements. More often impact may cause some minor failures that may lead to further damage and violation of functional requirements in the future.
- 102** When considering the effects of impact, it should be documented that no unintended failure mechanisms will happen due to impact.
- 103** The resistance of a structure to impact should be tested experimentally. This can be done in two ways.
  - The material or a small section is exposed to a relevant impact scenario. The strength of the material with the impact damage is determined as described in *Section 4 or 5*. This strength can be used for further design of the component.
  - The full component is exposed to a relevant impact scenario. The component is tested afterwards to show that it can still tolerate the critical loads.

**104** Impact design criteria may be used if experimental evidence shows that they are applicable for the application.

### **L 200 Impact testing**

**201** The geometry of the impactor and the boundary conditions should represent a worst case for the application. A change of impactor geometry, boundary conditions, material properties or testing rate often changes the structural response completely.

**202** The points of impact should be chosen carefully to represent all worst case scenario. In some cases a single point may be sufficient for testing.

**203** It should further be evaluated whether the component should be able to withstand more than one impact scenario. In that case the component should be exposed to the expected number of impact events.

### **L 300 Evaluation after impact testing**

**301** The impact tests should demonstrate that no unacceptable damage is introduced into the component. Once the component has been exposed to impact it should be carefully inspected to ensure that no unexpected failure mechanisms occurred that may reduce the component's performance, in particular long term performance. If the component will be taken out of service after an impact, long term considerations do not have to be made.

**302** It shall be shown further that the component can carry all relevant loads after impact until it can be taken out of service for repair or replacement. This can be done by analysis taking the observed impact damage into account, by testing, or a combination of analysis and testing. Testing should be done according to *Section 10*.

**303** If the component may be exposed to impact but can or should not be repaired afterwards, it should be shown that the component can withstand all long-term loads with the damage induced by the impact. The same approach as in *302* should be used.

Guidance note

A typical example is impact of dropped objects on a pipe.

The pipe is tested by dropping representative objects, like tools from the maximum possible height onto the pipe.

Damage analysis shows matrix cracking and delamination but no fibre failures. Since the pipe has a liner one could assume that the capability to hold pressure is not reduced in the short term.

One pressure test is used to confirm this prediction according to Section 10C.

End of guidance not

## M. Wear

### M 100 General

**101** Wear is a complicated process that is influenced by the entire system. All material data used for wear calculations shall be relevant for the system investigated.

### M 200 Calculation of the wear depth

**201** The wear depth may be calculated based on the sliding distance, using the length related wear rate  $\dot{w}$  for the corresponding wear system. The wear rate varies with the surfaces in contact, the magnitude of the contact pressure and the environment. The wear depth  $dy$  (thickness of removed material) is given by:

$$\dot{w} = \frac{dy}{dx} \quad (\text{m/m})$$

The total sliding distance  $dx$  shall be calculated assuming one contact point for the entire duration of the wear phase.

**202** Another option is to calculate the wear depth based on the sliding time, using the time related wear rate  $\dot{w}_t$  for the corresponding wear system. The wear rate varies with the surfaces in contact, the magnitude of the contact pressure and the environment. The wear depth  $dy$  (thickness of removed material) is given by:

$$\dot{w}_t = \frac{dy}{dt} \quad (\text{m/s})$$

The total sliding time  $dt$  shall be calculated assuming the same contact point for the entire duration of the wear phase.

**203** The consequences of removing material with respect to all other failure mechanisms shall be evaluated.

### M 300 Component testing

**301** (Refer to section on component testing: *Section 10*)

**Guidance note:**

The performance of a wear system should ideally be assessed by a practical trial in the intended application. However, this trial is often impractical and it is necessary to resort to laboratory testing. Accelerated laboratory tests with simpler geometrical configurations are often used although there is still a considerable amount of controversy about the validity of the results due to the geometry of the test samples.

---e-n-d---o-f---G-u-i-d-a-n-c-e---n-o-t-e---

## **N. High/Low Temperature / Fire**

- 101** The effects of fire and high/low temperature shall be considered by using the appropriate material properties as described in *Section 4* and *5* within the design criteria described in this section.
- 102** High temperatures and fire may introduce changes in the material, even if no other design criteria are violated. The following shall be considered as a minimum:
- Melting
  - Burning
  - Removal of material
  - Phase transitions
- 103** Specific requirements to fire performance are not given in this guideline. These requirements shall be obtained from other codes or regulations covering the application.
- 104** Composite structures usually need special fire protection to fulfil fire performance requirements. Special care shall be taken to ensure that the insulation works properly, including joints and attachments. The joints should remain tight in a fire and insulation should not detach.

## **O. Resistance to explosive decompression**

### **O 100 Materials**

- 101** Materials that are exposed to fluids under high pressure tend to absorb some fluid. If the pressure is removed rapidly (rapid decompression) the fluid inside the material wants to expand and wants to diffuse out of the material. If the material's structure does not allow the fluid to move out rapidly, or if the molecular strength of the material is not strong enough to contain the expanding fluid, severe microscopic damage may happen to the material.
- 102** The resistance of a material to the effects of rapid decompression shall be tested

experimentally, if relevant. Tests shall be carried out at two pressure levels: The maximum expected pressure and the low typical service pressure.

**Guidance note:**

The reason to test at two pressures is based on the two effects interacting during a rapid decompression scenario: Diffusion and Molecular strength.

---e-n-d---o-f---G-u-i-d-a-n-c-e---n-o-t-e---

## **O 200 Interfaces**

- 201** Similar to the effect observed in materials, fluids can accumulate between interfaces of materials with different diffusion constants. A rapid reduction of pressure may destroy the interface, because the fluid wants to expand. In the case of liners or thin materials, the liner may deform substantially, buckle, or even crack.
- 202** The designer should think about venting arrangements in the structure to avoid the build-up of fluids in interfaces.
- 203** The resistance of an interface to the effects of rapid decompression shall be tested at the maximum expected pressure, unless it can be shown that venting arrangements prevent the build-up of fluids.

## **P. Special aspects related to sandwich structures**

### **P 100 General**

- 101** Sandwich structures are built of a light weight core embedded between two faces (or skins). Design criteria are discussed for skins, cores and the core skin interface.

### **P 200 Failure of Sandwich Faces**

- 201** The same general design criteria as discussed above apply.
- 202** Both faces shall be checked for failure, since they may be exposed to different stress states.

### **P 300 Failure of the Sandwich Core**

- 301** Many core materials show plastic behaviour. If yielding cannot be accepted in the sandwich structure the yield criterion in *Section F* shall be applied.
- 302** Ultimate failure of brittle and plastic core materials shall be checked with the design criterion for orthotropic homogenous materials in *Section G*.
- 303** In many cases the dominant stress in a core is shear, causing shear yield or failure or tensile failure in  $45^\circ$  to the through thickness direction. This case is also covered by the criteria given in *Section F and G*.
- 304** Core indentation due to local compressive stress shall be checked. The core will indent if

the compressive strength of the core is exceeded (see 301 and 302).

#### **P 400 Failure of the Sandwich Skin-Core Interface**

- 401** Interface failure between the skin and core of a sandwich can be treated the same way as a delamination (*Section E*).
- 402** Care shall be taken to use proper material properties when applying the design criterion. Interface properties may differ from the core or laminate properties.
- 403** Sandwich structures with PVC core show typically no failure directly in the interface, but they fail inside the PVC core close to the interface. PVC core properties may be used in the design criteria.
- 404** Sandwich structures with Balsa core fail typically in the interface.

#### **P 500 Buckling of sandwich structures**

- 501** The same buckling criteria as for general structures apply, see *Section H*.
- 502** Sandwich structures show some special buckling modes. The following modes shall be considered:
- 503** Face wrinkling will occur when the compressive direct stress in the face will reach the local instability (or wrinkling) stress, i.e.

$$\bar{\sigma}_{face} \geq \hat{\sigma}_{wrinkling} \quad (27)$$

- 504** Global buckling will occur when the axial load will reach the critical buckling load, i.e.

$$\bar{P} \geq P_{cr.} \quad (28)$$

- 505** Shear crimping will occur when the direct stress will reach the crimping stress, i.e.

$$\bar{\sigma}_{face} \geq \hat{\sigma}_{crimping} \quad (29)$$

- 506** Face dimpling or intercellular buckling occurs only in sandwich structures with honeycomb and corrugated cores. Face dimpling will occur when the compressive stress in the cell wall reaches the buckling stress of a honeycomb cell or a corrugated core, i.e.

$$\bar{\sigma}_{core} \geq \hat{\sigma}_{dimpling} \quad (30)$$

### **Q. Chemical decomposition / galvanic corrosion**

- 101** A material may degrade due to chemical decomposition. This effect is covered in principle in this guideline by the time dependence of strength and stiffness values.
- 102** The extrapolation of long term data under environmental exposure describes usually the



gradual effect of environment or load on the properties. Chemical decomposition may act suddenly and rapidly and may not be detected by mechanical long term tests.

- 103** If a material is exposed to chemicals, possible chemical decomposition should be considered.
- 104** Possible galvanic corrosion should be considered when carbon fibre composites are in contact with metal. Usually the metal degrades first, but in some cases also damage to the matrix and the fibres can happen. Carbon composites should be electrically isolated from metal components.

### **R. Requirements for other design criteria**

- 101** If a structure or component shows a failure mechanism not described above it may be necessary to describe a design criterion for this failure mechanism.
- 102** All design criteria shall be verified against experimental evidence. The model factor assigned to the design criterion shall compensate for the discrepancies between prediction and experiment. The model factor is a deterministic factor.
- 103** It shall be confirmed that the design criterion is of general nature and does not just apply to one material or one load case, unless the criterion is only used for that particular condition.
- 104** The partial safety factors in the criterion shall be calibrated by probabilistic methods to ensure a consistent level of safety with respect to the rest of the guideline.

## SECTION 7 JOINTS AND INTERFACES

<b>SECTION 7 JOINTS AND INTERFACES.....</b>	<b>1</b>
<b>A. GENERAL.....</b>	<b>1</b>
A 100 INTRODUCTION .....	1
A 200 JOINTS .....	1
A 300 INTERFACES .....	2
A 400 THERMAL PROPERTIES .....	2
A 500 EXAMPLES .....	2
<b>B. JOINTS.....</b>	<b>2</b>
B 100 ANALYSIS AND TESTING.....	2
B 200 QUALIFICATION OF ANALYSIS METHOD FOR OTHER LOAD CONDITIONS OR JOINTS.....	3
B 300 MULTIPLE FAILURE MODES.....	4
B 400 EVALUATION OF IN-SERVICE EXPERIENCE.....	4
<b>C. SPECIFIC JOINTS.....</b>	<b>4</b>
C 100 LAMINATED JOINTS.....	4
C 200 ADHESIVE JOINTS .....	5
C 300 MECHANICAL JOINTS.....	5
C 400 JOINTS IN SANDWICH STRUCTURES.....	5
<b>D. INTERFACES .....</b>	<b>6</b>

### A. General

#### A 100 Introduction

- 101** Joints and interfaces are special sections or components of a structure. They can in principle be analysed and tested the same way as a structure or component. However, some special considerations are described in the following sections.
- 102** Requirements for joints and interfaces are based on achieving the same level of reliability as the structure of which it is part of.
- 103** If metal components are part of a joint or interface, the metal components shall be designed according to relevant standards for such components. This guideline does not cover metal components.

#### A 200 Joints

- 201** Joints are defined here as load bearing connections between structures, components or parts.
- 202** Three basic types of joints are considered in this guideline.
- Laminated joints, i.e. joints fabricated from the same constituent materials as the laminates that are joined, such as e.g. over-laminations, lap joints, scarf joints etc.
  - Adhesive joints, between laminates, cores or between laminates and other materials, e.g. metals.
  - Mechanical joints, i.e. joints including fasteners, e.g. bolted connections.

### **A 300 Interfaces**

- 301** Interfaces are defined here as the area or region where different structures, components or parts meet each other. All joints have interfaces.
- 302** If the interface shall transfer loads it also has the function of a joint. All requirements for joints apply to such an interface.
- 303** A typical interface is the area where the surface of a load bearing structure and a liner meet.

### **A 400 Thermal properties**

- 401** The effects of thermal stresses and strains and displacements shall be considered for all joints and interfaces.

### **A 500 Examples**

- 501** Examples of good practise shall be evaluated with great care. The examples are usually given for certain load and environmental conditions, without stating those explicitly. The qualification and analysis requirements of this guideline shall also be applied joints based on good practise. See also *Section B400* on how experience can be utilised.

## **B. Joints**

### **B 100 Analysis and testing**

- 101** The same design rules as applied for the rest of the structure shall be applied to joints, as relevant.
- 102** Joints are usually difficult to evaluate, because they have complicated stress fields and the material properties at the interfaces are difficult to determine.
- 103** Joints may be designed according to three different approaches:
- An analytical approach, i.e. the stress/strain levels at all relevant parts of the joint including the interface are determined by means of a stress analyses (e.g. a FEM-analyses) and compared with the relevant data on the mechanical strength.
  - Design by qualification testing only, i.e. full scale or scaled down samples of the joint are tested under relevant conditions such that the characteristic strength of the complete joint can be determined.
  - A combination of an analytical approach and testing, i.e. the same approach specified in *Section 10C* for updating in combination with full scale component testing.

**104** The following options may be used for the different types of joints:

Type of joint	Analytical approach	Qualification testing	Analyses combined with testing (updating)
Laminated joint	x	x	x
Adhesive joint		x	x
Mechanical joint		x	x

*Table 1 Design approaches for different categories of joints*

**105** The level of all stress (strain) components in all relevant areas of the joint, including stress concentrations, shall be determined according to the same procedures as specified for the rest of the structure. Special emphasis shall be put on possible stress concentrations in the joint. It shall be recognised that the stress concentrations in the real structure may be different than determined through the analyses due to e.g. simplifications made, effects of FEM-meshing etc.

**106** An analytical analysis is sufficient, if the stress field can be determined with sufficient accuracy, i.e., all stress concentrations are well characterised and a load model factor  $\gamma_{SD}$  can be clearly defined. In all other cases experimental testing according to *Section 10* shall be carried out to confirm the analysis.

**107** If the material properties, especially of the interface cannot be determined with sufficient accuracy, experimental testing according to *Section 10* shall be carried out.

**108** Long term performance of a joint may be determined based on long term materials data, if a clear link between the material properties and joint performance can be established. The requirements of *102* and *103* also apply for long term performance.

**109** The load cases should be analysed with great care for joints. Relatively small loads in unfavourable directions can do great harm to a jointed connection. Especially loads due to unintended handling, like bending, stepping on a joint etc. should not be forgotten.

**110** Joints may be analysed by testing alone as described in *Section 10B*.

**111** The most practical approach is likely to use a combination of analysis and testing. Since a large conservative bias may be necessary in the analysis to account for the many uncertainties in a joint design it is recommended to use the updating procedures of *Section 10C400* to obtain a better utilisation of the joint. The purpose of this approach is to update the predicted resistance of the joint with the results from a limited number of tests in a manner consistent with the reliability approach of the guideline.

**B 200 Qualification of analysis method for other load conditions or joints**

**201** If an analysis method predicts the tested response and strength of a joint based on basic

independently determined material properties according to *Section 10C*, the analysis works well for the tested load conditions. The same analysis method may be used:

- For the same joint under different load conditions, if the other load conditions do not introduce new stress concentrations in the analysis.
- For a joint that is similar to an already qualified joint, if all local stress concentration points are similar to the already qualified joint and all material properties are known independently.

**202** Local stress concentrations are similar if the local geometries of the two joints and the resulting stress fields at these local points can be scaled by the same factor.

**203** An analysis method that predicts the test results properly but not entirely based on independently obtained materials data can only be used for other load conditions or joint geometries if it can be demonstrated that the material values that were not obtained by independent measurements can also be applied for the new conditions.

### **B 300 Multiple failure modes**

**301** Most joint designs can fail by various failure modes. All possible failure modes shall be carefully identified and analysed. See *Section 10D*.

### **B 400 Evaluation of in-service experience**

**401** In service experience may be used as experimental evidence that a joint functions well.

**402** This evidence shall only be used if the load and environmental conditions of the in-service experience can be clearly defined and if they match or are conservative for the new application.

**403** Material properties of the joints to be compared should be similar. The analysis method should be able to address all differences between the joints according to B100 and 200.

## **C. Specific Joints**

### **C 100 Laminated Joints**

**101** Laminated joints rely on the strength of the interface for load transfer. The interface has resin dominated strength properties. Defects in the interface tend to be more critical than defects in the interface of plies of laminate, because the joint interface is the only and critical load path.

**102** The strength of the joint may be different from the through thickness matrix properties of the laminate, because the joint may be a resin rich layer and the joint may be applied to an already cured surface instead of a wet on wet connection. (see manufacturing). The strength of the joint should be documented.

**103** Laminated joints are very sensitive to peel conditions. Peel stresses should be avoided

**104** For the interface between the joining laminates the matrix design rules given in Section 5

apply. The resistance of the interface shall be determined with the same level of confidence as specified in *section 4 A600*. It shall be recognised that the resistance of the interface between the laminates may not be the same as the corresponding resistance parameter of the joining laminates. Resin rich layers may even have to be analysed by different failure criteria, e.g., the yield criterion in *section 6 F*.

- 105** The laminates themselves, including possible overlaminations, shall be analysed like regular laminates.

### **C 200 Adhesive Joints**

- 201** All issues related to laminated joints also apply to adhesive joints.
- 202** Geometrical details should be clearly specified, especially at points of stress concentrations like the edges of the joints.
- 203** The relationship between all elastic constants of both substrates and the adhesive should be carefully considered. Mismatches may introduce stresses or strains that can cause failure of the joint.
- 204** Thermal stresses should be considered.
- 205** Long term performance of adhesive should be established with great care. The long term performance is not only influenced by properties of the substrate, the adhesive and the interface, but also by the surface preparation and application method.
- 206** Relevant long term data shall be established exactly for the combination of materials, geometries, surface preparation and fabrication procedures used in the joint.
- 207** An adhesive joint may also introduce local through thickness stresses in the composite laminate that can lead to failure inside the laminate in the joint region.

### **C 300 Mechanical Joints**

- 301** Mechanical joints are often very sensitive to geometrical tolerances.
- 302** Creep of the materials shall be considered.
- 303** The pretension of bolted connections shall be chosen by considering possible creep of the material under the bolt.
- 304** It is preferred to design the joint in a way that its performance is independent of the matrix. This way matrix cracking or degradation of matrix properties are not important for the performance of the joint.

### **C 400 Joints in sandwich structures**

- 401** All aspects related to laminated, adhesive and mechanical joint apply also to sandwich structures.
- 402** Sandwich structures have internal joints between core and skin and between cores. These joints are usually evaluated independently, but their properties are treated as an internal

part of the sandwich system. Often the core properties are modified to incorporate the joint properties.

- 403** When two sandwich structures are joined complicated stress fields may result inside the sandwich structure. Stresses inside the core can be very different near a joint compared to the typical shear stresses in a panel.
- 404** A large sandwich plate can be well described by core shear properties obtained from large test specimens. In the neighbourhood of joints local variations in properties of the core may become critical.

## D. Interfaces

- 101** If loads shall be transferred across an interface all aspects related to joints shall be considered.
- 102** If interfaces only touch each other friction and wear should be considered according to *Section 6M*.
- 103** Fluids may accumulate between interfaces. They may accumulate in voids or debonded areas and/or break the bond of the interface. The effect of such fluids should be analysed. Possible rapid decompression of gases should be considered *Section 6 L*.
- 104** Liners that do not carry any structural loads shall have a high enough strain to failure or yield that they can follow all possible movements of the interface. Yielding of liners should be avoided, since yielding can cause local thinning or introduce permanent stresses after yield. If yielding cannot be avoided it shall be analysed carefully.
- 105** If one substrate may crack (e.g. have matrix cracks), but the other shall not crack, it shall be shown that cracks cannot propagate from one substrate across the interface into the other substrate. Possible debonding of the interface due to the high stresses at the crack tip should also be considered.
- 106** It is recommended to demonstrate by experiments that cracks cannot propagate across the interface from one substrate to the other. It should be shown that by stretching or bending both substrates and their interface that no cracks form in the one substrate even if the other substrate has the maximum expected crack density.

Guidance note

This is a typical situation for pressure vessels with liners. The load bearing laminate may have some matrix cracks, but the liner shall not crack to keep the vessel tight. Local debonding of the liner may be acceptable if the liner will not collapse due to its own weight, negative internal pressure or other effects.

End of guidance note

Guidance note

A weak bond between the substrates is beneficial to prevent crack growth across the interface. However, it means that debonding may happen easily.

End of guidance note.

## SECTION 8 SAFETY-, MODEL- AND SYSTEM FACTORS

<b>SECTION 8 SAFETY-, MODEL- AND SYSTEM FACTORS.....</b>		<b>1</b>
<b>A. OVERVIEW OF THE VARIOUS FACTORS USED IN THE GUIDELINE.....</b>		<b>1</b>
<b>B. PARTIAL LOAD EFFECT AND RESISTANCE FACTORS .....</b>		<b>2</b>
B 100	GENERAL.....	2
B 200	HOW TO SELECT THE PARTIAL SAFETY FACTORS .....	2
B 300	SIMPLIFIED SET OF PARTIAL SAFETY FACTORS (GENERAL).....	3
B 400	SIMPLIFIED SET OF PARTIAL SAFETY FACTORS (FOR KNOWN MAXIMUM LOAD EFFECT) .....	3
B 500	FULL SET OF PARTIAL SAFETY FACTORS .....	4
B 600	PARTIAL SAFETY FACTORS FOR FUNCTIONAL AND ENVIRONMENTAL LOADS.....	4
<b>C. MODEL FACTORS .....</b>		<b>5</b>
C 100	GENERAL.....	5
C 200	LOAD MODEL FACTORS .....	5
C 300	RESISTANCE MODEL FACTORS .....	6
<b>D. SYSTEM EFFECT FACTOR .....</b>		<b>7</b>
<b>E. FACTORS FOR STATIC AND DYNAMIC FATIGUE ANALYSIS .....</b>		<b>7</b>

### A. Overview of the various factors used in the guideline

**101** The safety factor methodology used in this Guideline is presented in *Section 2 C600*.

**102** The *Table 8-1* show the various safety factors, model factors and system factors used in this Guideline.

Symbol	Designation	Reference	Type
$\gamma_F$	Partial load effect factor	<i>Section 8B</i>	safety factor
$\gamma_M$	Partial resistance factor	<i>Section 8B</i>	safety factor
$\gamma_{FM}$ (= $\gamma_F \times \gamma_M$ )	Combined load effect and resistance factor	<i>Section 8B</i>	safety factor
$\gamma_{Sd}$	Load model factor	<i>Section 8C</i>	model factor
$\gamma_{Rd}$	Resistance model factor	<i>Section 8C</i>	model factor
$\gamma_S$	System factor	<i>Section 8D</i>	model factor
$\gamma_{fat}$	Partial factor for fatigue analysis	<i>Section 8E</i>	safety factor

**Table 1: overview of the various factors used in the guideline**



## B. Partial load effect and resistance factors

### B 100 General

**101** The following two partial safety factors are defined in this Guideline (see *section 2 C600*):

- **Partial load effect factors**, designated in this Guideline by  $\gamma_F$
- **Partial resistance factors**, designated in this Guideline by  $\gamma_M$

**102** In some cases it is useful to work with only one overall safety factor. The uncertainties in load effects and resistance are then accounted for by one common safety factor, the **combined load effect and resistance factor**, denoted  $\gamma_{FM}$ , which in many cases comes about as the product of  $\gamma_F$  and  $\gamma_M$ :

$$\gamma_{FM} = \gamma_F \times \gamma_M$$

**103** Partial load effect factors  $\gamma_F$  are applicable to the local response of the structure. They account for uncertainties associated with natural variability in the local responses of the structure (local stresses or strains) from its characteristic values. The factors are selected based on the *Distribution type* and *Coefficient of variation (COV)*.

**104** The distribution type and COV of the local response are linked to the uncertainties in the loads applied to the structure, the transfer function and the type of structural analysis that was carried out. If the *transfer function* and structural analysis are linear, the local load effect distribution type and COV will be the same as those of the globally applied loads. If nonlinearities are involved in either the transfer function or the analysis, the distribution type and/or the COV may change. In such a case, the distribution and the COV shall be determined for the local response.

**105** Partial resistance factors  $\gamma_M$  account for uncertainties associated with variability of the strength.

**106** The partial load effect and resistance factor  $\gamma_{FM} = \gamma_F \times \gamma_M$  in this Guideline is calibrated against different target reliabilities. These target reliabilities correspond to annual probabilities of failure. The calibration has been performed under the assumption of a design rule equal to the one given in *Section 2 Clause C-606*, for which the requirement to the partial safety factors in order to meet a specified reliability requirement is a requirement to their product.

### B 200 How to select the partial safety factors

**201** The safety factor  $\gamma_{FM}$  depends on the following:

- Target reliability, expressed in terms of annual probability of failure
- Definition of the characteristic values for load effects and resistance. In this Guideline, there is given only one option for definition of characteristic load effect (see *section 3 I400*) and one for the definition of characteristic resistance (see *section 4 A600*).
- Type of distribution function for load effects and resistance. In this Guideline, a Normal distribution is assumed for resistance, whereas several options are given for the load effect distribution type.
- Coefficient of variation (COV) for load effect and for resistance

**202** The required target reliability in this Guideline depends on the following:

- The limit state (ULS or SLS)
- The Safety or Service Class
- The failure type (brittle, plastic or ductile)

**203** The target reliabilities shall be selected from *Table 1* and *Table 2* in *section 2*.

**204** The full set of partial safety factors is shown in the tables in *B 500*. As an alternative, a simplified set of partial safety factors can be used (see *B 300*).

**B 300 Simplified set of partial safety factors (general)**

**301** A simplified set of partial safety factors is given for use whenever a satisfactory probabilistic representation of the load effects, as required in *section 3 I200*, is not available.

**302** The characteristic load effect shall be defined as the 99% quantile in the distribution of the annual extreme value of the local response of the structure, or of the applied global load when relevant (see *section 9 A400*). It shall correspond to the 100-year return value.

**303** The simplified set of partial safety factors given in this Guideline is determined under the assumption that the coefficients of variation of load effects are not larger than 20%. These partial safety factors shall not be used for load effects with a COV larger than 20%.

**304** The simplified set of partial safety factors shall be used when the characteristic resistance is defined as the 2,5 % quantile in the distribution of the resistance.

**305** Table 8-2 shows the simplified set of partial safety factors  $\gamma_{FM} = \gamma_F \times \gamma_M$ .

Safety Class	Failure Type	COV of the strength		
		COV < 10 %	10 %-12.5 %	12.5 %-15 %
Low	Ductile/Plastic	1.2	1.3	1.4
	Brittle	1.3	1.4	1.6
Normal	Ductile/Plastic	1.3	1.4	1.6
	Brittle	1.5	1.6	2.0
High	Ductile/Plastic	1.5	1.6	2.0
	Brittle	1.7	1.9	2.5

**Table 2: Simplified set of partial safety factors  $g_{FM} = g_F \times g_M$  for general load effects**

**B 400 Simplified set of partial safety factors (for known maximum load effect)**

**101** A simplified set of partial safety factors is given for use whenever a maximum load effect is known that absolutely cannot be exceeded. No extreme value of the specified load effect can under any circumstance be higher than the load effect value used in the design.

**402** The simplified set of partial safety factors given in this Guideline is determined under the assumption that the coefficients of variation of load effects are 0%. The simplified set of partial safety factors shall be used when the characteristic resistance is defined as the 2.5

% quantile in the distribution of the resistance.

**403** The Table 8-3 of simplified set of partial safety factors shows  $\gamma_{FM} = \gamma_F \times \gamma_M$ .

Safety Class	Failure Type	COV of the strength			
		COV < 5 %	10 %	12.5 %	15 %
Low	Ductile/Plastic	1.07	1.16	1.26	1.36
	Brittle	1.11	1.28	1.41	1.60
Normal	Ductile/Plastic	1.11	1.28	1.41	1.60
	Brittle	1.15	1.40	1.62	1.96
High	Ductile/Plastic	1.15	1.40	1.62	1.96
	Brittle	1.18	1.53	1.86	2.46

**Table 8-3: Simplified set of partial safety factors  $g_{FM} = g_F \times g_M$  for known maximum load effects**

**B 500 Full set of partial safety factors**

**501** When a satisfactory probabilistic representation of the load effects, as required in *section 3 I200*, is available, the full set of safety factors may be used instead of the simplified set.

**502** The full set of partial factors is shown in Appendix 8A. It shall be used with a characteristic strength defined as the 2.5 % quantile value. These factors depend on the properties described in *201*.

**B 600 Partial safety factors for functional and environmental loads**

**601** If loads are defined as functional and environmental loads as commonly done in offshore applications as described in Section 3I306, the following partial factors should be used.

Table 8-4 Load effect factors $g_F$		
Limit state	F-load effect	E-load effect
	$\gamma_F$ <sup>1)</sup>	$\gamma_E$ <sup>2)</sup>
ULS	1.1	1.3
FLS	1.0	1.0
<b>NOTES</b> 1) If the functional load effect reduces the combined load effects, $g_F$ shall be taken as 1/1.1. 2) If the environmental load effect reduces the combined load effects, $g_E$ shall be taken as 1/1.3.		

**602** The resistance factors applicable to ultimate limit states (ULS) are specified in the Tables 8-5 and 8-6. The factors are linked to the safety class to account for the consequence of failure.

<b>Table 8-5: Brittle failure type</b>			
<b>Safety Class</b>	<b>COV of the strength</b>		
	<b>COV &lt; 10 %</b>	<b>10 %-12.5 %</b>	<b>12.5 %-15 %</b>
Low	1.22	1.33	1.49
Normal	1.34	1.53	1.83
High	1.47	1.75	2.29

<b>Table 8-6: Ductile/Plastic failure type</b>			
<b>Safety Class</b>	<b>COV of the strength</b>		
	<b>COV &lt; 10 %</b>	<b>10 %-12.5 %</b>	<b>12.5 %-15 %</b>
Low	1.11	1.16	1.23
Normal	1.22	1.33	1.49
High	1.34	1.53	1.83

**603** The resistance factors applicable to serviceability limit states (SLS) are specified in the Table 8-7. The factors are linked to the safety class to account for the consequence of failure.

<b>Table 8-7: SLS</b>			
<b>Safety Class</b>	<b>COV of the strength</b>		
	<b>COV &lt; 10 %</b>	<b>10 %-12.5 %</b>	<b>12.5 %-15 %</b>
Normal	1.11	1.16	1.23
High	1.22	1.33	1.49

## C. Model factors

### C 100 General

**101** The following two types of *model* factors are defined in this Guideline:

- **Load model factors**, designated in this Guideline by  $\gamma_{Sd}$
- **Resistance model factors**, designated in this Guideline by  $\gamma_{Rd}$

### C 200 Load model factors

**101** Load model factors  $\gamma_{Sd}$  account for inaccuracies, idealisations, and biases in the engineering model used for representation of the real response of the structure, e.g. simplifications in the *transfer function* (see *section 9 A800*). Effects of geometric

tolerances shall also be included in the load model factor. The factor is treated here as a deterministic parameter.

- 202** Details about the load model factor are given in *Section 9L*. The factor shall make up for uncertainties and inaccuracies in the transfer function, the analysis methods, and dynamic effects.

**C 300 Resistance model factors**

- 301** Resistance model factors  $\gamma_{Rd}$  account for differences between true and predicted resistance values given by the failure criterion.

- 302** Model factors shall be used for each failure criteria. The factors are given in Section 6 for each failure criterion. A summary is given in Table 8-8.

**Table 8-8: Summary of model factors**

<i>Failure Criterion</i>	<i>Model factors <math>g_{Rd}</math></i>	<i>Reference</i>
Fibre Failure	1.0 or $\gamma_A$	6-C202
Matrix Cracking	1.0-1.15	6-D100-400
Delamination	1.0-2.0	6-E
Yielding	1.0	6-F
Ultimate failure of orthotropic homogenous materials	1.25	6-G
Buckling	Same range as all other criteria.	6-H
Displacements	1.0	6-I
Stress Rupture	0.1-1.0	6-J400
Fatigue	0.1-1.0	6-K300

## D. System effect factor

- 101** The safety factors are given for the entire system. Depending on how the components are connected to form a system, the target probability of failure for individual components may need to be lower than the target probability of failure of the entire system.

**Guidance note:**

E.g. In the case of a pipeline system, the failure of one pipe component (i.e. plain pipe or end connector) is equivalent to the failure of the entire system. This is a chain effect. As a consequence, the target safety of individual components should be higher than the target safety of the entire system, in order to achieve the overall target safety.

---e-n-d--- o-f---G-u-i-d-a-n-c-e---n-o-t-e---

- 102** In order to take this system effect into account, a system effect factor  $\gamma_S$  shall be introduced. If the system effect is not relevant,  $\gamma_S = 1.0$ . Otherwise a system factor shall be documented. A value of  $\gamma_S = 1.10$  can be used as a first approach.
- 103** In some cases a system may consist of parallel components that support each other and provide redundancy, even if one component fails. In that case a system factor smaller than 1 may be used if it can be based on a thorough structural reliability analysis.

## E. Factors for Static and Dynamic Fatigue Analysis

- 101** Table 8-9 shows the factors  $\gamma_{fat}$  shall be used for the prediction of failure due to cyclic fatigue or due to long term static loads. The factors shall be used with the failure criteria in *Section 6 J and K*.

<b>Table 8-9: Factor for fatigue calculations <math>g_{fat}</math></b>		
Safety class		
Low	Normal	High
15	30	50

## SECTION 8: APPENDIX A – TABLES OF SAFETY FACTORS

### SECTION 8: APPENDIX A – TABLES OF SAFETY FACTORS..... 1

#### **A. PARTIAL SAFETY FACTORS ..... 1**

#### **A. Partial safety factors**

- 101** Partial safety factors depend on the safety class and the failure type. The partial factors are available for five different levels.
- 102** The selection of the levels is given in the table below for the ultimate limit state.

SAFETY CLASS	FAILURE TYPE	
	Ductile/Plastic	Brittle
Low	A	B
Normal	B	C
High	C	D

**Safety levels for ULS.**

- 103** The recommended selection of the levels for the serviceability limit state is given in the table below.

SERVICE CLASS	SERVICE FAILURES
Normal	A
High	B

**Safety levels for SLS.**

- 104** Factors for each level A, B, C, D and E are given in the following Tables.

<b>SAFETY LEVEL A</b>					
Distribution types	Local response: <b>Extreme of Gaussian</b>			Characteristic load: <b>99 % quantile</b>	
	Resistance: <b>Normal</b>			Characteristic resistance: <b>2.5% quantile</b>	
Local response COV	Resistance COV				
	0.00	0.05	0.10	0.125	0.15
0.00	$g_{FM}$ $\gamma_{FM} = \gamma_F \times \gamma_M$	<b>1.07</b> 1.00x1.07	<b>1.16</b> 1.00x1.16	<b>1.26</b> 1.00x1.26	<b>1.36</b> 1.00x1.36
0.05	<b>1.07</b> 1.07x1.00	<b>1.01</b> 1.02x0.99	<b>1.04</b> 0.93x1.12	<b>1.09</b> 0.91x1.19	<b>1.16</b> 0.91x1.26
0.10	<b>1.10</b> 1.10x1.00	<b>1.03</b> 1.07x0.96	<b>1.01</b> 0.98x1.04	<b>1.03</b> 0.91x1.13	<b>1.08</b> 0.87x1.23
0.15	<b>1.13</b> 1.13x1.00	<b>1.04</b> 1.10x0.95	<b>1.01</b> 1.01x1.00	<b>1.02</b> 0.96x1.06	<b>1.05</b> 0.90x1.17
0.20	<b>1.14</b> 1.14x1.00	<b>1.06</b> 1.12x0.94	<b>1.01</b> 1.04x0.97	<b>1.01</b> 0.98x1.03	<b>1.03</b> 0.92x1.12

<b>SAFETY LEVEL A</b>					
Distribution types	Local response: <b>Gumbel</b>			Characteristic load: <b>99 % quantile</b>	
	Resistance: <b>Normal</b>			Characteristic resistance: <b>2.5% quantile</b>	
Local response COV	Resistance COV				
	0.00	0.05	0.10	0.125	0.15
0.00	$g_{FM}$ $\gamma_{FM} = \gamma_F \times \gamma_M$	<b>1.07</b> 1.00x1.07	<b>1.16</b> 1.00x1.16	<b>1.26</b> 1.00x1.26	<b>1.36</b> 1.00x1.36
0.05	<b>1.09</b> 1.09x1.00	<b>1.01</b> 1.04x0.97	<b>1.03</b> 0.93x1.11	<b>1.08</b> 0.90x1.20	<b>1.14</b> 0.88x1.29
0.10	<b>1.14</b> 1.14x1.00	<b>1.05</b> 1.11x0.94	<b>1.01</b> 1.02x0.99	<b>1.02</b> 0.95x1.07	<b>1.05</b> 0.88x1.20
0.15	<b>1.18</b> 1.18x1.00	<b>1.09</b> 1.16x0.93	<b>1.03</b> 0.75x1.37	<b>1.01</b> 1.03x0.98	<b>1.02</b> 0.95x1.08
0.20	<b>1.22</b> 1.22x1.00	<b>1.12</b> 1.20x0.93	<b>1.05</b> 1.14x0.92	<b>1.02</b> 1.09x0.94	<b>1.02</b> 1.01x1.00

<b>SAFETY LEVEL A</b>					
Distribution types	Local response: <b>Weibull</b>			Characteristic load: <b>99 % quantile</b>	
	Resistance: <b>Normal</b>			Characteristic resistance: <b>2.5% quantile</b>	
Local response COV	Resistance COV				
	0.00	0.05	0.10	0.125	0.15
0.00	$g_{FM}$ $\gamma_{FM} = \gamma_F \times \gamma_M$	<b>1.07</b> 1.00x1.07	<b>1.16</b> 1.00x1.16	<b>1.26</b> 1.00x1.26	<b>1.36</b> 1.00x1.36
0.05	<b>1.02</b> 1.02x1.00	<b>1.02</b> 0.98x1.05	<b>1.10</b> 0.96x1.15	<b>1.16</b> 0.95x1.22	<b>1.23</b> 0.94x1.30
0.10	<b>1.03</b> 1.03x1.00	<b>1.01</b> 0.99x1.02	<b>1.06</b> 0.94x1.12	<b>1.10</b> 0.93x1.19	<b>1.17</b> 0.91x1.28
0.15	<b>1.05</b> 1.05x1.00	<b>1.00</b> 1.01x1.00	<b>1.03</b> 0.95x1.09	<b>1.07</b> 0.92x1.16	<b>1.12</b> 0.90x1.24
0.20	<b>1.07</b> 1.07x1.00	<b>1.01</b> 1.03x0.98	<b>1.02</b> 0.96x1.05	<b>1.04</b> 0.93x1.12	<b>1.08</b> 0.90x1.21



<b>SAFETY LEVEL B</b>					
Distribution types	Local response: <b>Extreme of Gaussian</b>			Characteristic load: <b>99 % quantile</b>	
	Resistance: <b>Normal</b>			Characteristic resistance: <b>2,5% quantile</b>	
Local response COV	Resistance COV				
	0.00	0.05	0.10	0.125	0.15
0.00	$g_{FM}$ $\gamma_{FM} = \gamma_F \times \gamma_M$	<b>1,11</b> 1,00x1,11	<b>1,28</b> 1,00x1,28	<b>1,41</b> 1,00x1,41	<b>1,60</b> 1,00x1,60
0.05	<b>1,12</b> 1,12x1,00	<b>1,07</b> 1,07x1,00	<b>1,15</b> 0,94x1,22	<b>1,25</b> 0,91x1,37	<b>1,40</b> 0,89x1,57
0.10	<b>1,19</b> 1,19x1,00	<b>1,11</b> 1,15x0,97	<b>1,13</b> 1,02x1,11	<b>1,19</b> 0,94x1,27	<b>1,30</b> 0,87x1,49
0.15	<b>1,24</b> 1,24x1,00	<b>1,15</b> 1,20x0,96	<b>1,14</b> 1,08x1,06	<b>1,18</b> 0,99x1,19	<b>1,27</b> 0,90x1,40
0.20	<b>1,27</b> 1,27x1,00	<b>1,18</b> 1,23x0,96	<b>1,16</b> 1,12x1,03	<b>1,18</b> 1,03x1,14	<b>1,25</b> 0,94x1,34

<b>SAFETY LEVEL B</b>					
Distribution types	Local response: <b>Gumbel</b>			Characteristic load: <b>99 % quantile</b>	
	Resistance: <b>Normal</b>			Characteristic resistance: <b>2,5% quantile</b>	
Local response COV	Resistance COV				
	0.00	0.05	0.10	0.125	0.15
0.00	$g_{FM}$ $\gamma_{FM} = \gamma_F \times \gamma_M$	<b>1,11</b> 1,00x1,11	<b>1,28</b> 1,00x1,28	<b>1,41</b> 1,00x1,41	<b>1,60</b> 1,00x1,60
0.05	<b>1,16</b> 1,16x1,00	<b>1,09</b> 1,11x0,98	<b>1,14</b> 0,95x1,20	<b>1,24</b> 0,90x1,37	<b>1,39</b> 0,88x1,57
0.10	<b>1,27</b> 1,27x1,00	<b>1,18</b> 1,24x0,95	<b>1,15</b> 1,12x1,03	<b>1,18</b> 1,00x1,18	<b>1,28</b> 0,88x1,44
0.15	<b>1,37</b> 1,37x1,00	<b>1,26</b> 1,34x0,94	<b>1,20</b> 1,24x0,97	<b>1,21</b> 1,14x1,06	<b>1,25</b> 1,00x1,25
0.20	<b>1,44</b> 1,44x1,00	<b>1,32</b> 1,42x0,94	<b>1,25</b> 1,32x0,95	<b>1,24</b> 1,24x1,00	<b>1,26</b> 1,11x1,13

<b>SAFETY LEVEL B</b>					
Distribution types	Local response: <b>Weibull</b>			Characteristic load: <b>99 % quantile</b>	
	Resistance: <b>Normal</b>			Characteristic resistance: <b>2,5% quantile</b>	
Local response COV	Resistance COV				
	0.00	0.05	0.10	0.125	0.15
0.00	$g_{FM}$ $\gamma_{FM} = \gamma_F \times \gamma_M$	<b>1,11</b> 1,00x1,11	<b>1,28</b> 1,00x1,28	<b>1,41</b> 1,00x1,41	<b>1,60</b> 1,00x1,60
0.05	<b>1,03</b> 1,03x1,00	<b>1,06</b> 0,98x1,09	<b>1,21</b> 0,96x1,26	<b>1,33</b> 0,95x1,40	<b>1,50</b> 0,94x1,58
0.10	<b>1,06</b> 1,06x1,00	<b>1,06</b> 1,00x1,06	<b>1,17</b> 0,95x1,23	<b>1,27</b> 0,93x1,36	<b>1,42</b> 0,91x1,55
0.15	<b>1,09</b> 1,09x1,00	<b>1,06</b> 1,03x1,03	<b>1,14</b> 0,96x1,19	<b>1,23</b> 0,93x1,32	<b>1,36</b> 0,90x1,51
0.20	<b>1,13</b> 1,13x1,00	<b>1,08</b> 1,07x1,00	<b>1,13</b> 0,99x1,15	<b>1,20</b> 0,94x1,28	<b>1,32</b> 0,90x1,46

<b>SAFETY LEVEL C</b>					
Distribution types	Local response: <b>Extreme of Gaussian</b>			Characteristic load: <b>99 % quantile</b>	
	Resistance: <b>Normal</b>			Characteristic resistance: <b>2.5% quantile</b>	
Local response COV	Resistance COV				
	0.00	0.05	0.10	0.125	0.15
0.00	$g_{FM}$ $\gamma_{FM} = \gamma_F \times \gamma_M$	<b>1.15</b> 1.00x1.15	<b>1.40</b> 1.00x1.40	<b>1.62</b> 1.00x1.62	<b>1.96</b> 1.00x1.96
0.05	<b>1.18</b> 1.18x1.00	<b>1.13</b> 1.12x1.02	<b>1.26</b> 0.95x1.33	<b>1.43</b> 0.91x1.57	<b>1.72</b> 0.91x1.88
0.10	<b>1.28</b> 1.28x1.00	<b>1.21</b> 1.23x0.98	<b>1.26</b> 1.06x1.19	<b>1.37</b> 0.95x1.44	<b>1.60</b> 0.87x1.84
0.15	<b>1.34</b> 1.34x1.00	<b>1.26</b> 1.29x0.97	<b>1.28</b> 1.14x1.13	<b>1.37</b> 1.02x1.34	<b>1.55</b> 0.90x1.73
0.20	<b>1.39</b> 1.39x1.00	<b>1.29</b> 1.34x0.97	<b>1.31</b> 1.19x1.10	<b>1.37</b> 1.07x1.28	<b>1.53</b> 0.94x1.63

<b>SAFETY LEVEL C</b>					
Distribution types	Local response: <b>Gumbel</b>			Characteristic load: <b>99 % quantile</b>	
	Resistance: <b>Normal</b>			Characteristic resistance: <b>2.5% quantile</b>	
Local response COV	Resistance COV				
	0.00	0.05	0.10	0.125	0.15
0.00	$g_{FM}$ $\gamma_{FM} = \gamma_F \times \gamma_M$	<b>1.15</b> 1.00x1.15	<b>1.40</b> 1.00x1.40	<b>1.62</b> 1.00x1.62	<b>1.96</b> 1.00x1.96
0.05	<b>1.23</b> 1.23x1.00	<b>1.17</b> 1.17x0.99	<b>1.25</b> 0.97x1.30	<b>1.42</b> 0.90x1.57	<b>1.70</b> 0.88x1.93
0.10	<b>1.41</b> 1.41x1.00	<b>1.31</b> 1.37x0.96	<b>1.30</b> 1.21x1.08	<b>1.37</b> 1.04x1.31	<b>1.56</b> 0.87x1.78
0.15	<b>1.55</b> 1.55x1.00	<b>1.43</b> 1.51x0.95	<b>1.39</b> 1.37x1.01	<b>1.42</b> 1.24x1.15	<b>1.52</b> 1.01x1.51
0.20	<b>1.66</b> 1.66x1.00	<b>1.53</b> 1.63x0.94	<b>1.47</b> 1.50x0.98	<b>1.48</b> 1.37x1.08	<b>1.54</b> 1.17x1.32

<b>SAFETY LEVEL C</b>					
Distribution types	Local response: <b>Weibull</b>			Characteristic load: <b>99 % quantile</b>	
	Resistance: <b>Normal</b>			Characteristic resistance: <b>2.5% quantile</b>	
Local response COV	Resistance COV				
	0.00	0.05	0.10	0.125	0.15
0.00	$g_{FM}$ $\gamma_{FM} = \gamma_F \times \gamma_M$	<b>1.15</b> 1.00x1.15	<b>1.40</b> 1.00x1.40	<b>1.62</b> 1.00x1.62	<b>1.96</b> 1.00x1.96
0.05	<b>1.04</b> 1.04x1.00	<b>1.10</b> 0.98x1.12	<b>1.32</b> 0.96x1.38	<b>1.52</b> 0.95x1.60	<b>1.83</b> 0.94x1.94
0.10	<b>1.08</b> 1.08x1.00	<b>1.10</b> 1.01x1.09	<b>1.28</b> 0.95x1.34	<b>1.45</b> 0.93x1.56	<b>1.74</b> 0.91x1.91
0.15	<b>1.12</b> 1.12x1.00	<b>1.11</b> 1.05x1.06	<b>1.26</b> 0.97x1.30	<b>1.41</b> 0.93x1.51	<b>1.66</b> 0.90x1.85
0.20	<b>1.17</b> 1.17x1.00	<b>1.14</b> 1.10x1.03	<b>1.25</b> 1.00x1.25	<b>1.38</b> 0.95x1.46	<b>1.61</b> 0.90x1.79

<b>SAFETY LEVEL D</b>					
Distribution types	Local response: <b>Extreme of Gaussian</b>			Characteristic load: <b>99 % quantile</b>	
	Resistance: <b>Normal</b>			Characteristic resistance: <b>2,5% quantile</b>	
Local response COV	Resistance COV				
	0.00	0.05	0.10	0.125	0.15
0.00	$g_{FM}$ $\gamma_{FM} = \gamma_F \times \gamma_M$	<b>1,18</b> 1,00x1,18	<b>1,53</b> 1,00x1,53	<b>1,86</b> 1,00x1,86	<b>2,46</b> 1,00x2,46
0.05	<b>1,24</b> 1,24x1,00	<b>1,19</b> 1,16x1,03	<b>1,38</b> 0,95x1,44	<b>1,64</b> 0,91x1,80	<b>2,15</b> 0,88x2,43
0.10	<b>1,36</b> 1,36x1,00	<b>1,29</b> 1,29x1,00	<b>1,38</b> 1,08x1,27	<b>1,57</b> 0,95x1,66	<b>1,99</b> 0,85x2,33
0.15	<b>1,43</b> 1,43x1,00	<b>1,35</b> 1,37x0,99	<b>1,42</b> 1,17x1,21	<b>1,56</b> 1,02x1,53	<b>1,92</b> 0,87x2,20
0.20	<b>1,49</b> 1,49x1,00	<b>1,40</b> 1,43x0,98	<b>1,45</b> 1,23x1,17	<b>1,57</b> 1,08x1,46	<b>1,88</b> 0,91x2,08

<b>SAFETY LEVEL D</b>					
Distribution types	Local response: <b>Gumbel</b>			Characteristic load: <b>99 % quantile</b>	
	Resistance: <b>Normal</b>			Characteristic resistance: <b>2,5% quantile</b>	
Local response COV	Resistance COV				
	0.00	0.05	0.10	0.125	0.15
0.00	$g_{FM}$ $\gamma_{FM} = \gamma_F \times \gamma_M$	<b>1,18</b> 1,00x1,18	<b>1,53</b> 1,00x1,53	<b>1,86</b> 1,00x1,86	<b>2,46</b> 1,00x2,46
0.05	<b>1,31</b> 1,31x1,00	<b>1,24</b> 1,24x1,00	<b>1,37</b> 0,98x1,41	<b>1,63</b> 0,90x1,81	<b>2,13</b> 0,88x2,43
0.10	<b>1,55</b> 1,55x1,00	<b>1,44</b> 1,50x0,96	<b>1,45</b> 1,29x1,13	<b>1,57</b> 1,06x1,48	<b>1,94</b> 0,85x2,28
0.15	<b>1,73</b> 1,73x1,00	<b>1,61</b> 1,698x0,95	<b>1,58</b> 1,50x1,05	<b>1,64</b> 1,31x1,26	<b>1,87</b> 0,96x1,94
0.20	<b>1,88</b> 1,88x1,00	<b>1,74</b> 1,84x0,95	<b>1,69</b> 1,67x1,01	<b>1,73</b> 1,48x1,17	<b>1,88</b> 1,15x1,63

<b>SAFETY LEVEL D</b>					
Distribution types	Local response: <b>Weibull</b>			Characteristic load: <b>99 % quantile</b>	
	Resistance: <b>Normal</b>			Characteristic resistance: <b>2,5% quantile</b>	
Local response COV	Resistance COV				
	0.00	0.05	0.10	0.125	0.15
0.00	$g_{FM}$ $\gamma_{FM} = \gamma_F \times \gamma_M$	<b>1,18</b> 1,00x1,18	<b>1,53</b> 1,00x1,53	<b>1,86</b> 1,00x1,86	<b>2,46</b> 1,00x2,46
0.05	<b>1,05</b> 1,05x1,00	<b>1,14</b> 0,99x1,16	<b>1,45</b> 0,96x1,51	<b>1,75</b> 0,95x1,84	<b>2,30</b> 0,94x2,44
0.10	<b>1,09</b> 1,09x1,00	<b>1,14</b> 1,02x1,12	<b>1,40</b> 0,96x1,47	<b>1,67</b> 0,93x1,80	<b>2,17</b> 0,91x2,40
0.15	<b>1,15</b> 1,15x1,00	<b>1,16</b> 1,07x1,09	<b>1,38</b> 0,97x1,42	<b>1,62</b> 0,93x1,74	<b>2,08</b> 0,89x2,33
0.20	<b>1,21</b> 1,21x1,00	<b>1,19</b> 1,13x1,06	<b>1,37</b> 1,01x1,37	<b>1,59</b> 0,95x1,68	<b>2,00</b> 0,89x2,26

## SECTION 9 STRUCTURAL ANALYSIS

<b>SECTION 9</b>	<b>STRUCTURAL ANALYSIS</b>	<b>1</b>
<b>A.</b>	<b>GENERAL</b>	<b>2</b>
A 100	OBJECTIVE	2
A 200	INPUT DATA	2
A 300	ANALYSIS TYPES	3
A 400	TRANSFER FUNCTION	3
A 500	GLOBAL AND LOCAL ANALYSIS	4
A 600	MATERIAL LEVELS	4
A 700	NONLINEAR ANALYSIS	5
<b>B.</b>	<b>LINEAR AND NONLINEAR ANALYSIS OF MONOLITHIC STRUCTURES</b>	<b>6</b>
B 100	GENERAL	6
B 200	IN-PLANE 2-D PROGRESSIVE FAILURE ANALYSIS	9
B 300	3-D PROGRESSIVE FAILURE ANALYSIS	10
B 400	LINEAR FAILURE ANALYSIS WITH NON-DEGRADED PROPERTIES	11
B 500	LINEAR FAILURE ANALYSIS WITH DEGRADED PROPERTIES	12
B 600	TWO-STEP NONLINEAR FAILURE ANALYSIS METHOD	14
B 700	THROUGH THICKNESS 2-D ANALYSIS	15
<b>C.</b>	<b>CONNECTION BETWEEN ANALYSIS METHODS AND FAILURE CRITERIA</b>	<b>15</b>
C 100	GENERAL	15
C 200	MODIFICATION OF FAILURE CRITERIA	16
C 300	CREEP, STRESS RELAXATION AND STRESS RUPTURE-STRESS RELAXATION	18
C 400	FATIGUE	18
<b>D.</b>	<b>ANALYTICAL METHODS</b>	<b>18</b>
D 100	GENERAL	18
D 200	ASSUMPTIONS AND LIMITATIONS	18
D 300	LINK TO NUMERICAL METHODS	18
<b>E.</b>	<b>FINITE ELEMENT ANALYSIS</b>	<b>19</b>
E 100	GENERAL	19
E 200	MODELLING OF STRUCTURES – GENERAL	19
E 300	SOFTWARE REQUIREMENTS	21
E 400	EXECUTION OF ANALYSIS	22
E 500	EVALUATION OF RESULTS	22
E 600	VALIDATION AND VERIFICATION	22
<b>F.</b>	<b>DYNAMIC RESPONSE ANALYSIS</b>	<b>23</b>
F 100	GENERAL	23
F 200	DYNAMICS AND FINITE ELEMENT ANALYSIS	24
<b>G.</b>	<b>IMPACT RESPONSE</b>	<b>24</b>
G 100	TESTING	24
<b>H.</b>	<b>THERMAL STRESSES</b>	<b>25</b>
<b>I.</b>	<b>SWELLING EFFECTS</b>	<b>25</b>
<b>J.</b>	<b>ANALYSIS OF SANDWICH STRUCTURES</b>	<b>25</b>
J 100	GENERAL	25
J 200	ELASTIC CONSTANTS	26
J 300	2-D NONLINEAR FAILURE ANALYSIS	27
J 400	3-D PROGRESSIVE FAILURE ANALYSIS	28

J 500	LONG TERM DAMAGE CONSIDERATIONS.....	29
<b>K.</b>	<b>BUCKLING.....</b>	<b>29</b>
K 100	GENERAL.....	29
K 200	BUCKLING ANALYSIS OF ISOLATED COMPONENTS.....	29
K 300	BUCKLING ANALYSIS OF MORE COMPLEX ELEMENTS OR ENTIRE STRUCTURES .....	30
K 400	BUCKLING ANALYSIS OF STIFFENED PLATES AND SHELLS .....	31
K 500	BUCKLING ANALYSIS FOR SANDWICH STRUCTURES.....	32
<b>L.</b>	<b>PARTIAL LOAD-MODEL FACTOR.....</b>	<b>32</b>
L 100	GENERAL.....	32
L 200	CONNECTION BETWEEN PARTIAL LOAD-MODEL FACTOR AND ANALYTICAL ANALYSIS.....	33
L 300	CONNECTION BETWEEN PARTIAL LOAD-MODEL FACTOR AND FINITE ELEMENT ANALYSIS.....	33
L 400	CONNECTION BETWEEN PARTIAL LOAD-MODEL FACTOR AND DYNAMIC RESPONSE ANALYSIS .....	33
L 500	CONNECTION BETWEEN PARTIAL LOAD-MODEL FACTOR AND TRANSFER FUNCTION .....	33

## A. General

### A 100 Objective

**101** The aim of the structural analysis is to obtain the stresses, strains and displacements (denoted load effects in the following) in the structure as a result of loads and environmental conditions. The load effects are subsequently evaluated against failure criteria, see *Section 6*. The following procedures are typically involved in such an analysis:

- procedure to calculate load effects in the structure based on the loads,
- procedure to check for global or local failure.

**102** The objective of the present section is to provide methods to calculate the response, including evaluation of failure, of structures for specified loads, surrounding environments and boundary conditions.

### A 200 Input Data

**201** The input data for the structural analysis should be established as described in the relevant parts of *Section 3*.

**202** Environmental conditions should be converted into loads based on well established physical principles. Guidance may be found in *Section 3* and in relevant standards or guidelines.

**203** The boundary conditions should be selected carefully in order to represent the nature of the problem in the best possible way. It should be demonstrated that the chosen boundary conditions lead to a realistic or conservative analysis of the structure.

**204** Thermal stresses that result from production process or in service loading should be considered in all analysis.

**205** Stresses due to swelling from absorbed fluids should be included if relevant.

**206** The elastic properties of the materials constituting the structure should be taken as described in *Section 4* for laminates and *Section 5* for sandwich structures. In particular, time-dependent stiffness properties based on the expected degradation due to

environmental and loading conditions should be considered. Local variations of these conditions should also be considered.

- 107** Each ply should be described by 4 elastic constants ( $E_1$ ,  $E_2$ ,  $G_{12}$ ,  $\nu_{12}$ ) for in-plane 2-D analysis and by 9 elastic constants ( $E_1$ ,  $E_2$ ,  $G_{12}$ ,  $\nu_{12}$ ,  $E_3$ ,  $G_{13}$ ,  $G_{23}$ ,  $\nu_{13}$ ,  $\nu_{23}$ ) in 3-D analysis. A nomenclature for the various elastic constants is defined in *Section 14*.
- 208** As an alternative to elastic constants, the stiffness matrix for orthotropic plies may be used.
- 209** It should be shown that the estimated stiffness gives conservative results with respect to load effects. The choice of stiffness values may be different in the cases of strength and stiffness limited design. More details are given in the sections below.

### **A 300 Analysis Types**

- 301** Analytical and/or numerical calculations may be used in the structural analysis. The finite element (FE) method is presently the most commonly used numerical method for structural analysis, but other methods, such as finite difference or finite series methods may also be applied.

**Guidance note:**

While the FE method is applicable for a wide range of problems, analytical solutions and the finite series approach often put too many restrictions on laminate lay-up, geometry etc., and are thus insufficient in the design of most real world composite structures.

---e-n-d---o-f---G-u-i-d-a-n-c-e---n-o-t-e---

- 302** Laminate analysis is an additional type of analysis that is applied to layered composites in order to derive the properties of a laminate from the properties of its constituent plies.
- 303** The structural analysis should be performed for all phases over the entire lifetime of the structure. Initial and degraded material properties should be considered if relevant.
- 304** A decision to use 2-D or 3-D analysis methods should generally be made depending on the level of significance of the through thickness stresses. If these stresses can be neglected, in-plane 2-D analysis may be applied. Additionally, the analysis of certain laminate and sandwich structures may be simplified by a through thickness (cross section) 2-D approach, in which plane strain condition is assumed to prevail.

**Guidance note:**

In-plane 2-D analysis is generally preferred when analysing relatively large and complex structures, in which through thickness stresses can be neglected. However, structural details with significant through thickness stresses, such as joints, require a more accurate analysis. In these cases 3-D or through thickness 2-D (for components possessing plane strain conditions) approaches should be applied.

---e-n-d---o-f---G-u-i-d-a-n-c-e---n-o-t-e---

### **A 400 Transfer function**

- 401** The loads and environments described as input to the analysis *in Section 3*, i.e. wind, wave

and currents, are not always directly suitable in a stress analysis. A transfer function shall be defined that converts the specified loads to loads that can be used in the analysis.

- 402** Any nonlinear effect in the transfer function may change the characteristics of the load distribution. These changes shall be taken into account when selecting the load-model factor in *Section L*.

## **A 500 Global and Local Analysis**

- 501** The global response of the structure is defined as the response (displacement and stability) of the structure as a whole.
- 502** The local response of the structure is defined as the stresses and strains (and deformations) in every local part of the structure.
- 503** The response of the structure shall be calculated on a global or local level depending on the failure mechanism being checked and its associated failure criterion.

### **Guidance note:**

The failure of the structure shall generally be checked on the basis of the local response of the structure by the use of failure criteria for each failure mechanism as described in *Section 6*.

Buckling is generally checked on larger parts of the structure and based on average stresses over large areas. Under such conditions a coarser analysis may be sufficient. However, if the FE method is used to calculate buckling stresses, a very local analysis of the structure may be needed.

---e-n-d---o-f---G-u-i-d-a-n-c-e---n-o-t-e---

## **A 600 Material Levels**

- 601** The local response of the structure can in principle be analysed at the following different material levels:
- the “*constituent* level” corresponding to the fibre, matrix and core, separately,
  - the “*ply* level” corresponding to the individual layers in a laminate or the faces of a sandwich structure,
  - the “*laminate* level” corresponding to the whole laminate or sandwich structure.

- 602** Each failure mechanism can in principle be checked at any material level. However, due to the lack of theoretical knowledge or for practical reasons, it is not always possible to check a given failure mechanism at all material levels.
- 603** The local response of the structure shall be analysed at a material level consistent with the failure criteria used in the failure analysis as described in *Section 6*.
- 604** This Guideline does not cover stress analysis on the level of the individual fibre or the matrix between the fibres, i.e. on the constituent level (except for sandwich core materials).
- 605** All failure criteria in this Guideline (except for buckling) require the stresses or strains to be accurately represented on the level of each ply.

#### **A 700 Nonlinear Analysis**

- 701** Nonlinear analysis should be performed when geometrical and/or material nonlinearities are present and when linear and nonlinear analysis results are expected to differ.
- 702** Geometrical nonlinearities are associated with, e.g., large displacements and/or large strains, boundary conditions varying according to deformations, non-symmetric geometry of structure and buckling.
- 703** Nonlinear material behaviour is associated with the stress–strain relation. Following damage in the material, i.e. matrix cracking or yield, stress–strain relationships usually become nonlinear.
- 704** Structures with nonlinear materials should be checked either against early failure mechanisms, e.g. matrix cracking or yield, or against ultimate failure, or both.
- 705** A decision to use a progressive, nonlinear failure analysis or a simplified (linear) failure analysis should be based on the failure modes of the structure/component and the failure mechanisms investigated, see *Sections B* and *C*.



## B. Linear and Nonlinear Analysis of Monolithic Structures

### B 100 General

- 101** Most composite structures possess linear material properties when intact. However, composites can develop various failure mechanisms, e.g. matrix cracking, at very low strains leading to reduced stiffness parameters.
- 102** This nonlinear behaviour of the material shall be taken into account when failure analysis of composite components is performed.
- 103** In the present section several analysis methods will be presented. These methods may be combined with analytically (*Section D*) or numerically (*Section E*) based response calculations. In *Section C* the applicability of the analysis methods will be linked to various failure criteria.
- 104** All response calculations shall be based on time-dependent material properties related to, for example, natural or environmental degradation during service life.
- 105** Regardless of the analysis method being used geometrical nonlinear effects shall be taken into account when significant, see *Section A700*.
- 106** For the choice of 2-D or 3-D analysis methods, see *Section A304*.
- 107** The development of failures is most accurately described by progressive nonlinear analysis methods (presented in *Sections B200* and *B300* for in-plane 2-D and 3-D problems, respectively), in which degradation of material properties in case of, e.g., matrix cracking is included. However, such methods may be extremely time-consuming in problems of practical interest.
- 108** In many cases the simplified analysis methods presented in *Sections B400*, *B500* and *B600* may be applied.
- 109** When using one of the analysis methods based on locally degraded material properties, conservative results are ensured provided the element mesh is sufficiently fine. However, when one of the simple linear failure methods (non-degraded (*B400*) or globally degraded (*B500*)) is applied, the distribution of stresses/strains may be incorrect, in particular, near sharp corners or other kinds of geometrical or material discontinuities. The analyst shall beware of the possibility of introducing serious errors.
- 110** The simplified methods presented in *Sections B400*, *B500* and *B600* are derived under the assumption that matrix failure occurs prior to fibre failure, which is satisfied for most fibre reinforced plastic composites.

**Guidance note:**

For certain metal matrix composites, fibre failure may occur prior to matrix failure. In such cases the simplified failure methods must be modified.

---e-n-d---o-f---G-u-i-d-a-n-c-e---n-o-t-e---

**111** In the sections containing simplified analysis methods the problems to be solved will be divided into three categories:

- statically determinate problems, which mean problems where it is possible to determine all the forces/moments (and laminate stresses) involved by using only the equilibrium requirements without regard to the deformations,
- problems where displacements (and laminate strains) are independent of material properties (and can thus be regarded as known),
- general (or statically indeterminate) problems, which are problems where the forces/moments involved cannot be determined from equilibrium requirements without regard to the deformations.

**112** Some of the main features of the analysis methods to be presented in the following are listed below.

Properties Method	Degradation of material properties	Level of in-plane degradation	Level of through thickness degradation	Load
In-plane 2-D progressive	Step-wise degradation	Local/element level	Ply level	Step-wise increase
3-D progressive	Step-wise degradation	Local/element level	Ply/element level	Step-wise increase
Linear non-degraded	Non-degraded (initial values)	—	—	Extreme value
Linear degraded	All degraded (except $E_1$ and through thickness parameters)	Global (entire domain)	Global (entire domain)	Extreme value
Two-step nonlinear	First step: Initial Second step: All degraded (except $E_1$ , see <i>Section B606</i> )	Local/element level	Ply/element level	Extreme value

**113** If fibres are not oriented in the principle stress directions they want to rotate into these directions. This rotation is usually prevented by the matrix. If the matrix cracks or yields, the fibres may be free to rotate slightly. This rotation is usually not modelled. However one should check that ply stresses transverse to the fibres and ply shear stresses are low in a ply with degraded matrix. Otherwise a reanalysis with rotated fibre directions may be required.

**Guidance note:**

The rotation of fibres may, for example, be important in filament wound pipe designed for carrying just internal pressure. In this case the fibre orientation is typically about  $\pm 55^\circ$ . If the pipe experiences a strong axial load in addition to pressure, the fibres want to orient themselves more into the axial direction.

---e-n-d---o-f---G-u-i-d-a-n-c-e---n-o-t-e---

## **B 200 In-plane 2-D Progressive Failure Analysis**

- 101** If all through thickness stress components can be neglected (see *Section A304*), one may apply a 2-D (laminated based) analysis method. In-plane 2-D progressive nonlinear failure analysis on the ply level provides the highest level of accuracy.
- 202** Initially, non-degraded ply properties ( $E_1$ ,  $E_2$ ,  $G_{12}$  and  $\nu_{12}$ ) shall be used in the progressive nonlinear failure analysis.
- 203** The loads on the laminate structure are imposed in a step-wise manner. In the first step a small portion, e.g. 10 percent, of the expected ultimate load is applied. Based on this load level, laminate and ply stresses and strains are calculated and analysed by the relevant failure criterion (for each ply). If failure is detected somewhere in a ply, certain material properties of that ply shall be locally degraded, which means that the parameters shall be reduced in locations (e.g. finite elements) where the failure is detected. The properties shall be degraded according to the following sections. If no failure is observed, the load is increased to, e.g., 0.2 times the expected maximum load and a similar failure analysis is performed.
- 204** If ply stresses exceed the strength of the matrix according to the failure criteria given in Section 6, the ply properties should be changed according to *Section 4 I*.
- 205** In numerical calculations certain problems may arise, e.g. lack of invertibility of the structural stiffness matrix, when degraded material properties are set equal to 0. To overcome such problems, one may apply small values, e.g. 1% of the non-degraded values, instead of 0.
- 206** After introducing degraded parameters it is assumed that the plies behave linearly (until the next failure occurs). Laminate properties (i.e. ABD matrix) shall be recalculated based on the degraded ply parameters, and the failure analysis will be repeated (for the same load level as above). When a failure mechanism has occurred somewhere in a ply, the ply is not checked for that failure mechanism in the same region (e.g. finite elements) any more.
- 207** The local degradation of ply stiffness properties may induce artificial discontinuities in the stress or strain field. Using gradual change of ply stiffness properties may reduce the effects of discontinuities.
- 208** If fibre failure occurs in a ply and location (e.g. finite element) with matrix damage, or if matrix failure occurs in a ply and location (e.g. element) with fibre damage, all material properties of that ply shall be reduced at the location considered.

**Guidance note:**

If both fibre failure and matrix failure occur at the same location (i.e. a finite element) in a ply, all material properties of that ply are locally degraded. Thus, at that location the ply cannot carry loads any more. However, in a global sense, the ply may still carry loads because stresses can be redistributed around the location of failure. The redistribution of stresses can be of type in-plane (within the same ply) or through thickness (into the neighbouring plies). If considerable through thickness redistribution occurs, a 3-D progressive failure analysis should be applied, see *Section B300*.

---e-n-d---o-f---G-u-i-d-a-n-c-e---n-o-t-e---

**209** The failure analysis is repeated (for the same load level) until no new failure mechanism is detected. Then, the load level is increased, and a similar failure analysis is performed.

**210** Whenever a violation of the ultimate limit state (ULS) condition is detected the analysis is terminated.

**B 300 3-D Progressive Failure Analysis**

**301** If at least one of the through thickness stress components cannot be neglected (see *Section A304*), 3-D effects shall be taken into account. Then the development of failure is most accurately predicted by 3-D progressive failure analysis on the ply level.

**302** Initially, non-degraded 3-D ply properties ( $E_1$ ,  $E_2$ ,  $G_{12}$ ,  $\nu_{12}$ ,  $E_3$ ,  $G_{13}$ ,  $G_{23}$ ,  $\nu_{13}$  and  $\nu_{23}$ ) shall be used in the progressive nonlinear failure analysis.

**303** A crucial effect of the through thickness stresses is the possibility of delamination.

**304** In addition to the failure criteria accounted for in the 2-D failure analysis in *Section B200*, the delamination failure criterion at the ply level should now be considered (see *Section 6E*).

**305** Otherwise, the 3-D progressive failure algorithm follows the same steps as the 2-D method presented in *Section B200*.

**306** 3-D ply properties shall be degraded by the same principles as described for 2-D properties in *Section B200 and Section 4 I*.

## **B 400 Linear Failure Analysis with Non-degraded Properties**

- 401** In this simplest approximate failure method non-degraded or initial material properties are applied.
- 402** The method may be used for both 2-D and 3-D problems, see *Section A304*.
- 403** In the results presented for this method, it is assumed that matrix failure occurs prior to fibre breakage, see *Section B110*. On the other hand, if fibre failure is not the last failure type to occur in the laminate, the overview of the connection between analysis methods and failure criteria in *Section C* is not applicable.
- 404** In certain cases, this simplified method, without local degradation of material properties, may offer considerably incorrect stress/strain distributions, see *B109*. If the error cannot be analysed and included into the model factor (see *Section L300*) a more refined method shall be used.
- 405** Stresses and strains should be calculated on the laminate and ply levels.
- 406** Before matrix cracking (and other kinds of failure mechanisms) the method predicts correct response values provided that the underlying analytical or numerical (FE) analysis method is applied within its assumptions and limitations (see *Section D* and *E*).
- 107** After matrix cracking statically determinate problems result in:
- laminate stiffness – too high,
  - laminate stresses – correct,
  - laminate strains – too small,
  - ply stiffness –  $E_1$  is correct, the other ply properties are generally too large,
  - ply stresses –  $\sigma_1$  is too small, the other stress components are generally too large,
  - ply strains – too small.
- 408** After matrix cracking problems with known displacements result in:
- laminate stiffness – too high,
  - laminate stresses – too large,
  - laminate strains – correct,
  - ply stiffness –  $E_1$  is correct, the other ply properties are generally too large,
  - ply stresses –  $\sigma_1$  is correct, the other stress components are generally too large,
  - ply strains – correct.
- 409** After matrix cracking statically indeterminate problems result in:
- laminate stiffness – too high,
  - laminate stresses – between correct and too large,
  - laminate strains – generally too small,
  - ply stiffness –  $E_1$  is correct, the other ply properties are generally too large,
  - ply stresses –  $\sigma_1$  is too small, the other stress components are generally too large,
  - ply strains – generally too small.

**410** The applicability of this method in conjunction with various failure mechanisms and the need for modifying certain failure criteria are discussed in *Section C*. The fibre failure criterion shall only be used with the factor  $\gamma_a$  defined in C200. It shall also be ensured that the ply strain and stress in fibre direction are multiplied by  $\gamma_a$  in all other failure criteria or analysis where strain or stress values exceed the level of matrix cracking.

### **B 500 Linear Failure Analysis with Degraded Properties**

In this approximate failure method globally degraded material properties are applied. This implies effectively that matrix cracking has occurred in the laminate, and that the laminate is not checked for matrix cracking, see the *table* in *Section C103*.

**501** The method may be applied for both 2-D and 3-D problems, see *Sections A304* and *B505*.

**502** In the results presented for this method it is assumed that fibre breakage is the last failure mechanism to occur, see *Section B403*.

**503** This method should be mainly used for statically determined problems. Otherwise this simplified method, with global degradation of material properties, may offer considerably incorrect stress/strain distributions, see *Section B109*. If the error cannot be analysed and included into the model factor (see *Section L300*) a more refined method shall be used.

**504** The material properties are degraded in the entire domain by changing certain ply elasticity parameters. For in-plane 2-D analysis the stiffness in the fibre direction,  $E_1$ , of each ply is kept unaltered, while the rest of the 2-D ply properties should be changed according to *Section 4I* assuming the matrix has cracked due to high ply stresses  $\tau_{12}$  and  $\sigma_2$ . This is equivalent to using the degraded stiffness ( $E_{\text{nonlin}}$ , see *figure 1*) in the laminate stress-strain relation for loads in the fibre directions. If 3-D analysis is required, the in-plane parameters are dealt with as in the 2-D analysis. Through thickness parameters should only be changed according to *Section 4I* if through thickness stresses cause matrix cracking.

**505** For difficulties arising in numerical calculations when using degraded values equal to 0, and the possibilities to apply larger values for the degraded parameters, refer to *B205* and *Sections 4I*.

**506** Stresses and strains should be calculated at the laminate and ply levels.

**507** For in-plane 2-D analysis statically determined problems result in:

- laminate stiffness – too low,
- laminate stresses – correct,
- laminate strains – too large,
- ply stiffness –  $E_1$  is correct, the other ply properties are generally too small,
- ply stresses –  $\sigma_1$  is too large, the other stress components are generally too small (zero),
- ply strains – too large.

**508** For in-plane 2-D analysis problems with known displacements result in:

- laminate stiffness – too low,
- laminate stresses – too small,
- laminate strains – correct,
- ply stiffness –  $E_1$  is correct, the other ply properties are generally too small,
- ply stresses –  $\sigma_1$  is correct, the other stress components are generally too small (zero),
- ply strains – correct.

**509** For in-plane 2-D analysis statically indeterminate problems result in:

- laminate stiffness – too low,
- laminate stresses – between too small and correct,
- laminate strains – generally too large,
- ply stiffness –  $E_1$  is correct, the other ply properties are generally too small,
- ply stresses –  $\sigma_1$  is too large, the other stress components are generally too small (zero),
- ply strains – generally too large.



**510** The applicability of this method in conjunction with various failure mechanisms is discussed in *Section C*.

## **B 600 Two-step Nonlinear Failure Analysis Method**

**601** The method may be applied for both 2-D and 3-D problems, see *Section A304*.

**602** In the results presented for this method it is assumed that matrix failure occurs prior to fibre breakage, see *Section B403*.

**603** In the first step response calculations are performed with non-degraded material properties.

**604** In regions (e.g. finite elements) where the strains (or stresses) exceed the level for matrix cracking (or other failure mechanisms), the in-plane material properties are degraded according to the method presented in *Section B505*.

**605** The final step consists of response calculations with the locally degraded material properties.

**606** If the final calculations break down, e.g. due to ill-conditioned structural matrices, one should repeat the final step with non-degraded through thickness parameters.

**607** For problems related to the local degradation of material properties, see *Section B207*.

**608** For difficulties arising in numerical calculations when using locally degraded values equal to 0, and the possibilities to apply larger values for the degraded parameters, refer to *Sections B204* and *B205*.

**609** Before matrix cracking (and other kinds of failure mechanisms) the method predicts correct response values provided that the underlying analytical or numerical (FE) analysis method is applied within its assumptions and limitations (see *Section D* and *E*).

**610** After local occurrences of matrix cracking statically determined problems result in:

- laminate stiffness – generally correct, locally too low,
- laminate stresses – correct,
- laminate strains – generally correct, locally too large,
- ply stiffness – generally correct, locally  $E_1$  is correct and the other ply properties are mostly too small,
- ply stresses – generally correct, locally  $\sigma_1$  is too large and the other stress components are mostly too small (zero),
- ply strains – generally correct, locally too large.

**611** After local occurrences of matrix cracking problems with known displacements result in:

- laminate stiffness – generally correct, locally too low,
- laminate stresses – generally correct, locally too small,
- laminate strains – correct,
- ply stiffness – generally correct, locally  $E_1$  is correct and the other ply properties are mostly too small,
- ply stresses – generally correct, locally  $\sigma_1$  is correct and the other stress components are mostly too small (zero),
- ply strains – correct.

**612** After local occurrences of matrix cracking statically indeterminate problems result in:

- laminate stiffness – generally correct, locally too low,
- laminate stresses – generally correct, locally between too small and correct,
- laminate strains – generally correct, locally too large,
- ply stiffness – generally correct, locally  $E_1$  is correct and the other ply properties are mostly too small,
- ply stresses – generally correct, locally  $\sigma_1$  is too large and the other stress components are mostly too small (zero),
- ply strains - generally correct, locally too large.

**613** The applicability of this method in conjunction with various failure mechanisms is discussed in *Section C*.

## **B 700 Through Thickness 2-D analysis**

**701** *Section B200* deals with an in-plane 2-D analysis method that is applicable if through thickness stresses can be neglected, see *Section A304*. The in-plane 2-D approach is frequently used in conjunction with global analysis of relatively large composite structures.

**702** On the other hand, certain structural details, in which plane strain conditions prevail, may be analysed by a through thickness (cross section) 2-D approach.

### **Guidance note:**

Examples on problems that may be analysed by the through thickness 2-D approach include several adhesively bonded joints with a width to thickness ratio that is much larger than unity and certain effects related to bolted joints, including pre-tension, in which axi-symmetric conditions prevail.

---e-n-d---o-f---G-u-i-d-a-n-c-e---n-o-t-e---

**703** All the analysis methods that are applicable for in-plane 2-D problems (presented in *Sections B200, B400, B500 and B600*) may be adopted to through thickness 2-D analysis.

**704** The simplifications introduced in the through thickness analysis shall be carefully investigated to ensure that no crucial effect is lost.

## **C. Connection between Analysis Methods and Failure Criteria**

### **C 100 General**

**101** In this section the connection between the analysis methods from *Section B* and the failure criteria from *Section 6* is presented, see the table below.

**102** Progressive failure analysis is applicable for all kinds of failure criteria.

**103** However, as can be seen from the table, the simplified analysis methods are also applicable in conjunction with several failure criteria.

<b>Analysis Method Failure criteria</b>	Progressive	Linear non-degraded	Linear degraded	Two-step nonlinear
Fibre failure	Yes	Yes (see C201)	Yes	Yes
Matrix cracking and delamination	Yes	First occurrence	No (it is assumed that matrix cracking has already occurred)	First occurrence
Yielding	Yes	Onset of yielding	No (see above)	Onset of yielding
Maximum deformation	Yes	No	Yes	Yes

#### **A 200 Modification of Failure Criteria**

**201** In order to obtain conservative predictions of fibre failure from the linear non-degraded method (see *Sections B407* and *B409*) a partial analysis factor,  $\gamma_A$ , shall be introduced for the fibre failure criterion related to each fibre direction of the laminate.

**202** For each fibre direction of the laminate the partial analysis factor shall be given by

$$\gamma_A = E_{lin}/E_{nonlin},$$

where  $E_{lin}$  and  $E_{nonlin}$  are laminate moduli (stiffnesses) related to loading in the fibre direction of consideration.  $E_{lin}$  is the laminate stiffness based on initial (non-degraded) ply properties, while  $E_{nonlin}$  is the reduced laminate stiffness obtained from degraded ply properties (see *Section B505*). A further explanation is provided by *figure 1* and the *Guidance note* below

**Guidance note:**

The introduction of partial analysis factors,  $\gamma_A$ , above may be thought of as a reduction of the effective strain to failure from  $\hat{\epsilon}$  to  $\hat{\epsilon}_{corr}$  (mean values). *Figure 1* shows a typical laminate stress-strain curve for a laminate containing 0, 45 and 90 layers when loaded in the 0 direction.

A partial analysis factor shall be calculated for each fibre direction of the laminate, which in this example corresponds to obtaining laminate stress-strain relations for loading in the 0, 45 and 90 degrees directions for the laminate in *figure 1*.

---e-n-d---o-f---G-u-i-d-a-n-c-e---n-o-t-e---

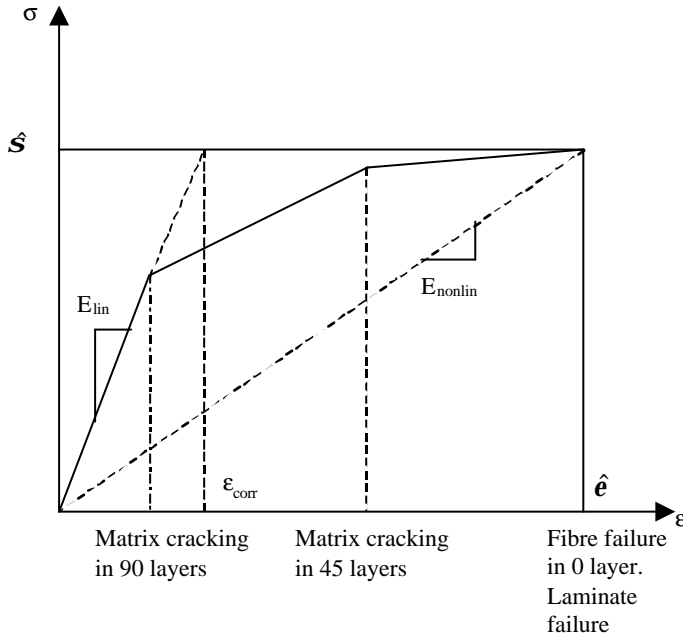

Figure 1. Typical stress-strain relation for a laminate containing 0, 45 and 90 layers

### **C 300 Creep, Stress Relaxation and Stress Rupture-Stress Relaxation**

- 301** The presence of creep, stress relaxation and stress rupture-stress relaxation in composite structures depends on the level of stresses and/or strains and the condition of the constituent materials (intact, presence of cracks or other failures).
- 302** Only analysis methods that provide conservative estimates of stresses/strains and material conditions should be applied in predictions of phenomena like creep.

### **C 400 Fatigue**

- 401** Failure due to fatigue may develop under long term cyclic loading conditions.
- 402** Development of fatigue failure depends on the maximum strains during each cycle, as well as the total number of cycles with strains exceeding prescribed limits.
- 403** Thus, analysis methods providing conservative strain estimates may be applied in conjunction with fatigue.

## **D. Analytical Methods**

### **D 100 General**

- 101** Analytical methods can be divided into two classes: Analytical solutions of (differential) equations or use of handbook formulae.

### **D 200 Assumptions and Limitations**

- 201** Analytical methods shall not be used outside their assumptions and limitations.

**Guidance note:**

The main disadvantage of available analytical solutions is that simplifications often put too many restrictions on geometry, laminate build-up etc. and hence, are insufficient in the design of more complex composite structures.

Handbook formulae are usually too simple to cover all the design issues and are also in general not sufficient.

Simplified isotropic calculation methods should not be used, unless it can be demonstrated that these methods give valid results.

---e-n-d---o-f---G-u-i-d-a-n-c-e---n-o-t-e---

- 202** For analytical analysis of sandwich structures, special care shall be taken with assumptions in approximate solutions that may be found in textbooks.

### **D 300 Link to Numerical Methods**

- 301** Analytical solutions or handbook formulae used within their assumptions and limitations may be used to validate finite element analysis results.

## E. Finite Element Analysis

### E 100 General

- 101** Only recognised FE programs should be used. Other programs shall be verified by comparison with analytical solutions of relevant problems, recognised FE codes and/or experimental testing.

### E 200 Modelling of Structures – General

- 201** Element types shall be chosen on the basis of the physics of the problem
- 202** The choice of the mesh should be based on a systematic iterative process, which includes mesh refinements in areas with large stress/strain gradients.
- 203** Problems of moderate or large complexity shall be analysed in a stepwise way, starting with a simplified model.
- 204** Model behaviour shall be checked against behaviour of the structure. The following modelling aspects shall be treated carefully:
- loads,
  - boundary conditions,
  - important and unimportant actions,
  - static, quasi-static or dynamic problem,
  - damping,
  - possibility of buckling,
  - isotropic or anisotropic material,
  - temperature or strain rate dependent material properties,
  - plastic flow,
  - nonlinearities (due to geometrical and material properties),
  - membrane effects.
- 205** Stresses and strains may be evaluated in nodal points or Gauss points. Gauss point evaluation is generally most accurate, in particular for layered composites, in which the distribution of stresses is discontinuous, and should therefore be applied when possible.

#### Guidance note:

The analyst shall beware that Gauss point results are calculated in local (element or ply based) coordinates and must be transformed (which is automatically performed in most FE codes) in order to represent global results. Thus, Gauss point evaluation is more time-consuming than nodal point calculations.

---e-n-d---o-f---G-u-i-d-a-n-c-e---n-o-t-e---

- 206** Support conditions shall be treated with care. Apparently minor changes in support can substantially affect results. In FE models, supports are typically idealised as completely rigid, or as ideally hinged, whereas actual supports often lie somewhere in between. In-plane restraints shall also be carefully treated.
- 207** Joints shall be modelled carefully. Joints may have less stiffness than inherited in a simple model, which may lead to incorrect predictions of global model stiffness. Individual

modelling of joints is usually not appropriate unless the joint itself is the object of the study. See also requirements for the analysis of joints in *Section 7*.

- 208** Element shapes shall be kept compact and regular to perform optimally. Different element types have different sensitivities to shape distortion. Element compatibility shall be kept satisfactory to avoid locally poor results, such as artificial discontinuities. Mesh should be graded rather than piecewise uniform, thereby avoiding great discrepancy in size between adjacent elements.
- 209** Models shall be checked (ideally independently) before results are computed.
- 210** The following points shall be satisfied in order to avoid ill-conditioning, locking and instability:
- a stiff element shall not be supported by a flexible element, but rigid-body constraints shall be imposed on the stiff element,
  - for plane strain and solid problems, the analyst shall not let the Poisson's ratio approach 0.5, unless a special formulation is used,
  - 3-D elements, Mindlin plate or shell elements shall not be allowed to be extremely thin,
  - the analyst shall not use reduced integration rule without being aware of possible mechanism (e.g. hourglass nodes).

**Guidance note:**

Some of these difficulties can be detected by error tests in the coding, such as a test for the condition number of the structure stiffness matrix or a test for diagonal decay during equation solving. Such tests are usually *a posteriori* rather than *a priori*.

---e-n-d---o-f---G-u-i-d-a-n-c-e---n-o-t-e---

- 211** Need for mesh refinement is usually indicated by visual inspection of stress discontinuities in the stress bands. Analogous numerical indices are also coded.
- 212** For local analysis, a local mesh refinement shall be used. In such an analysis, the original mesh is stiffer than the refined mesh. When the portion of the mesh that contains the refined mesh is analysed separately, a correction shall be made so the boundary displacements to be imposed on the local mesh are consistent with the mesh refinement.
- 213** For nonlinear problems, the following special considerations shall be taken into account:
- the analyst shall make several trial runs in order to discover and remove any mistake,
  - solution strategy shall be guided by what is learned from the previous attempts,
  - the analyst shall start with a simple model, possibly the linear form of the problem, and then add the nonlinearities one by one,
- 214** Computed results shall be checked for self-consistency and compared with, for example, approximate analytical results, experimental data, text-book and handbook cases, preceding numerical analysis of similar problems and results predicted for the same problem by another program. If disagreements appear, then the reason for the discrepancy shall be sought, and the amount of disagreement adequately clarified.

**215** The analyst shall beware the following aspects:

- for vibrations, buckling or nonlinear analysis, symmetric geometry and loads shall be used with care since in such problems symmetric response is not guaranteed. Unless symmetry is known to prevail, it shall not be imposed by choice of boundary conditions,
- for crack analysis, a quarter point element can be too large or too small, thereby possibly making results from mesh refinement worse,
- the wrong choice of elements may display a dependence on Poisson's ratio in problems that shall be independent of Poisson's ratio,
- if plane elements are warped, so that the nodes of the elements are not co-planar, results may be erratic and very sensitive to changes in mesh,
- imperfections of load, geometry, supports and mesh may be far more important in a buckling problem than in problems involving only linear response.

**216** In the context of finite element analysis (FEA) of laminate structures (one of) the following element types should be applied:

- layered shell elements with orthotropic material properties for each layer (for in-plane 2-D analysis, see *Section A304*),
- solid elements with orthotropic material properties (for 3-D and through thickness 2-D analysis, see *Section A304*).

**Guidance note:**

There are two options for the solid elements: The modelling may be performed with (at least) two solid elements through the thickness of each ply. Alternatively, one may apply layered solid elements where the thickness of a single element includes two or more plies.

---e-n-d---o-f---G-u-i-d-a-n-c-e---n-o-t-e---

## **E 300 Software Requirements**

**301** Selection of finite element software package shall be based on the followings:

- software availability,
- availability of qualified personnel having experience with the software and type of analysis to be carried out,
- necessary model size,
- analysis options required,
- validated software for intended analysis.

**302** Useful options for the analysis of composite structures include:

- layered solid elements with orthotropic and anisotropic material behaviour,
- layered shell elements,
- solid elements with suitable core shear deformation models (for analysis of sandwich structures),
- solid elements with correct material models or appropriate interface elements allowing for debond (for analysis of bonded and laminated joints),
- interface elements allowing for large aspect ratio (for analysis of thin layer bonds),
- the possibility to select different co-ordinate systems in a clear and unambiguous way.



**303** Depending on the area of application, additional analysis options should be available, such as:

- appropriate solver with stable and reliable analysis procedures,
- options characterising large displacements and large strains (for geometrically nonlinear analysis),
- material models describing the behaviour of, e.g., laminates beyond first failure as well as ductile sandwich cores (for materially nonlinear analysis),
- robust incremental procedures (for nonlinear analysis in general),
- tools for frequency domain analysis and/or options such as time integration procedures (for dynamic analyses),
- appropriate post-processing functionality,
- database options,
- sub-structuring or sub-modelling.

#### **E 400 Execution of Analysis**

**401** FEA tasks **shall** be carried out by qualified engineers under the supervision of an experienced senior engineer.

**402** Analysis shall be performed according to a plan, which has been defined prior to the analysis.

**403** Extreme care shall be taken when working with different relevant co-ordinate systems, i.e. global, ply based, laminate based, element based and stiffener based systems.

**404** The approach shall be documented.

#### **E 500 Evaluation of Results**

**501** Analysis results shall be presented in a clear and concise way using appropriate post-processing options. The use of graphics is highly recommended, i.e. contour plots, (amplified) displacement plots, time histories, stress and strain distributions etc.

**502** The results shall be documented in a way to help the designer in assessing the adequacy of the structure, identifying weaknesses and ways of correcting them and, where desired, optimising the structure.

#### **E 600 Validation and Verification**

**601** FE programs shall be validated against analytical solutions, test results, or shall be benchmarked against a number of finite element programs.

**602** Analysis designer shall check whether the envisaged combination of options has been validated by suppliers. If this is not the case, he shall perform the necessary validation analysis himself.

- 603 FEA results shall be verified by comparing against relevant analytical results, experimental data and/or results from previous similar analysis.
- 604 Analysis and model assumptions shall be verified.
- 605 Results shall be checked against the objectives of the analysis.
- 606 Verification whether the many different relevant co-ordinate systems have been applied correctly shall be considered.

## F. Dynamic Response Analysis

### F 100 General

- 101 Dynamic analysis should generally be performed when loads are time-dependent and/or when other effects such as inertia (and added mass) and damping forces are significant.
- 102 In a dynamic analysis one may be interested in the transient response of a structure due to prescribed, time-dependent loads or the eigenvalues (eigenfrequencies) of the structure.
- 103 In order to obtain an accurate transient analysis a detailed structural model and small time steps should be used, in particular for rapid varying loads.
- 104 For slowly varying loads a quasi-static analysis may be applied. In such an analysis inertia and damping forces are neglected, and the corresponding static problem is solved for a series of time steps.
- 105 In vibration analysis one may use a coarse structural model if only the first few eigenvalues are of interest, see *Section F202*. Nevertheless, a reasonable representation of structural mass and stiffness is crucial.
- 106 If a large number of eigenfrequencies are required, one shall apply a detailed description of the structure.
- 107 Due account should be taken of fluid-structure interaction effects where these are significant. These may include resonance between structural response and wave excitation frequencies, or more complex, high-frequency vibration phenomena (ringing and springing) caused by non-linear wave loads. In some cases of fluid-structure interaction it may be necessary to perform a dynamic analysis of the coupled fluid-structure system.
- 108 In case of accidental loads, such as explosions, dynamic effects should be considered carefully.
- 109 The dependence of the material properties on strain rate should be taken into account, see *Section 4 C1000*.

**Guidance note:**

Although static material properties may yield conservative predictions of displacements, a strength assessment based on static properties is not necessarily conservative since both the material strength and the material stiffness may be enhanced at high strain rates. The higher stiffness may increase the induced stress so that the benefit of the increase in the material strength may be lost. Furthermore, ductile materials often become brittle at high rates. Thus, the extra margin provided by ductile behaviour may be destroyed.

There is a lack of sophisticated material models taking the rate dependent behaviour into consideration.

---e-n-d--- o-f---G-u-i-d-a-n-c-e---n-o-t-e---

## **F 200 Dynamics and Finite Element Analysis**

- 201** For analysis including dynamic loads with frequencies of interest up to  $\omega_{cr}$ , the mesh shall be able to accurately represent modes associated with frequencies up to  $3\omega_{cr}$ , and a mode superposition analysis shall include frequencies up to about  $3\omega_{cr}$ .
- 202** For eigenvalue analysis, there should be 4 or more times as many degrees of freedom as eigenvalues to be calculated.
- 203** For direct integration methods, the following points should be ensured:
- the time step  $\Delta t$  should be approximately  $0.3/\omega_{cr}$  or less, and should provide numerical stability if the integration method is conditionally stable,
  - there should be a match between the type of algorithm and the mass matrix,
  - abrupt changes in element size should be avoided, thereby avoiding spurious wave reflection and numerical noise.

## **G. Impact Response**

### **G 100 Testing**

- 102** Impact test requirements shall be defined since there are no well-established calculation methods today.
- 103** Component testing (see *Section 10*) should be carried out in order to evaluate the impact characteristics of the structure/component.

## H. Thermal Stresses

- 101** Changes in temperature from the environment resulting in dimensional changes of the body shall be taken in account. The general thermal strains,  $e_i$ , can be expressed as

$$e_i = \mathbf{a}_i \Delta T,$$

where  $\mathbf{a}_i$  is the thermal expansion coefficients. Temperature is denoted by  $T$ .

- 102** Residual strains shall be calculated against the reference temperature for which  $\mathbf{a}_i$  was determined. It is usually the curing temperature

- 103** Accordingly, the stress-strain relations shall be modified to account for the stress free environmentally induced expansional strains as follows:

$$\{\mathbf{e}\} = [S]\{\mathbf{s}\} + \{e\}$$

## I. Swelling Effects

- 101** Changes in gas/fluid absorption from the environment resulting in dimensional changes of the body shall be taken in account. The general swelling strains,  $e_i$ , can be expressed as

$$e_i = \mathbf{b}_i C,$$

where  $\mathbf{b}_i$  is the swelling expansion coefficients and  $C$  is swelling agent concentration inside the laminate.

- 102** Accordingly, the stress-strain relations shall be modified to account for the stress free environmentally induced expansional strains as follows:

$$\{\mathbf{e}\} = [S]\{\mathbf{s}\} + \{e\}$$

## J. Analysis of Sandwich Structures

### J 100 General

- 101** A typical load carrying sandwich structure has the following characteristics; it is build up of three elements: two faces, usually stiff and strong; a core, weaker and lighter; a joint, continuous along each of the two interfaces. Additionally, see the definition in *Section 14*.
- 102** All the sandwich structures that do not fall into the above definition are denoted special sandwich structures. A distinction is made between typical and special sandwich panels. Simple formulas are provided for design of typical sandwich panels whereas special ones shall be designed on the basis of more rigorous analyses and possibly testing.
- 103** A decision to use 2-D or 3-D analysis shall be made depending on the level of significance of the through thickness stresses/through width strains (see *Section A304*). If all through thickness stress components may be neglected, in-plane 2-D analysis may be applied, and

if plane strain conditions prevail, a through thickness 2-D approach may be adopted. Otherwise, 3-D analysis should be performed.

- 104** In the context of FEA of sandwich structures (one of) the following element types/combinations should be applied:
- a single layer of layered shell elements through the thickness of the entire sandwich material (for in-plane 2-D analysis, see *Section A304*),
  - (layered) shell elements for the faces and solid elements for the core (for 3-D and through thickness 2-D analysis, see *Section A304*). In this case a compensation may be desirable for the change in stiffness, or alternatively, in order to avoid overlapping areas, shell elements can be positioned adequately without the need for modifying the material properties by using the eccentricity property of the element. Depending on the commercial package used this option is not always available,
  - solid elements for both faces and core (for detailed 3-D and through thickness 2-D analysis, see *Section A304*).
- 105** For the analysis of sandwich structures, special considerations shall be taken into account, such as:
- elements including core shear deformation shall be selected,
  - for honeycomb cores one shall account for material orthotropy, since honeycomb has different shear moduli in different directions,
  - local load introductions, corners and joints, shall be checked,
  - curved panels with small radii of curvature shall be analysed in 2-D (through thickness direction) or 3-D to account for the transverse normal stresses not included in shell elements.
- 106** The load combinations and associated load factors and the surrounding environmental conditions established in *Section 3* shall be applied to the loads to calculate stresses and strains in the structure.
- 107** Each point in the structure shall be checked for all times against the specified functional requirement and corresponding failure modes.
- 108** Failure criteria for each mechanisms of failure are described in *Section 6*.

## **J 200 Elastic Constants**

- 201** Each laminate shall be described with the suitable set of elastic constants as mentioned in *Section 4* dealing with monolithic structures.
- 202** Core materials are generally orthotropic and are described by more than two elastic constants (*see Section 5*). However, most FE codes can only describe isotropic core materials. If the elements applied in the FEA do not allow values for all three parameters to be specified, one should generally use the measured values for  $G$  and  $\nu$ , and let the  $E$  value be calculated (from the formula above) by the program. In that case the shear response of the core will be described accurately. However, in particular applications, in which core shear effects are negligible and axial stresses/strains are crucial, correct  $E$  values shall be applied.

**Guidance note:**

For many core materials experimentally measured values of E, G and  $\nu$  are not in agreement with the isotropic formula  $G = \frac{E}{2(1+\nu)}$ .

---e-n-d---o-f---G-u-i-d-a-n-c-e---n-o-t-e---

**203** Anisotropic core shall be described with 4 elastic constants in a 2-D analysis, i.e.  $E_x$ ,  $E_z$ ,  $G_{xz}$ ,  $\nu_{xz}$ .

**204** Anisotropic core shall be described with 9 elastic constants in a 3-D analysis, i.e.  $E_x$ ,  $E_y$ ,  $E_z$ ,  $G_{xy}$ ,  $G_{yz}$ ,  $G_{xz}$ ,  $\nu_{xy}$ ,  $\nu_{yz}$ ,  $\nu_{xz}$ .

**J 300 2-D Nonlinear Failure Analysis**

**301** If the through thickness stresses or the through width strains are insignificant, see *J103*, a 2-D progressive analysis may be carried out.

**302** At the beginning of the analysis, the analyst shall use non-degraded material properties.

**303** All displacement calculations shall be based on time-dependent material properties related to, e.g., naturally or environmentally degradation during service life.

**304** For an undamaged sandwich structure, the following stresses and load shall typically be calculated:  $\bar{s}_{face}$ ,  $\bar{s}_{core}$ ,  $\bar{t}_{core}$  and  $P_{cr}$ .

**Guidance note:**

**Example:** Transverse loading case for an open beam.

Stresses shall be calculated as follows:

$$s_{face} = \frac{M_z}{D} E_{face}$$

$$s_{core} = \frac{M_z}{D} E_{core}$$

$$\bar{t}_{core} = \frac{T}{D} \left[ E_{face} \frac{t_{face} d}{2} + \frac{E_{core} t_{core}^2}{4} \right]$$

Identically for a box beam:

$$s_{face} = \frac{M_z}{D} E_{face}$$

$$\bar{t} = \frac{bd}{4I_2} N \text{ in N-direction, and } \bar{t}_{core} = \frac{(2b+d)d}{8I_2} N \text{ in direction perpendicular to N.}$$

---e-n-d---o-f---G-u-i-d-a-n-c-e---n-o-t-e---

- 305** For given loading conditions, stresses and strains shall be calculated and failure criteria shall be checked.
- 306** Any failure of the face material shall be modelled the same way as for monolithic laminates according to *Section 4* and *Section 9B*.
- 307** If core failure of type ductile or plastic occurs due to core yielding (in tension or compression),  $E_{core}^*$  shall be set equal to the secant modulus at the corresponding  $\sigma$  level;  $G_{core}^*$  shall be proportionally reduced by the same amount. If  $\hat{s}_{core}$  is reached,  $E_{core}$  and  $G_{core}$  shall be reduced to 0 (default value) or to positive values as described in *J311*.
- 308** If core failure of type brittle occurs due to core fracture (in tension or compression),  $E_{core}$  shall be reduced to 0 (default value) or to a positive value as described in *J311*.
- 309** If core failure of type ductile or plastic occurs due to core shearing,  $G_{core}^*$  shall be set equal to the secant modulus at the corresponding  $\tau$  level;  $E_{core}^*$  shall be proportionally reduced by the same amount. If  $\hat{t}_{core}$  is reached,  $G_{core}$  and  $E_{core}$  shall be reduced to 0 (default value) or to positive values as described in *J311*.
- 310** If core failure of type brittle occurs due to core shearing,  $G_{core}$  shall be reduced to 0 (default value) or to a positive value as described in *J311*.
- 311** Instead of using the default value 0 for the parameters in *J307-J310*, gradual degradation of the material properties can be used, provided experiments document the validity of values larger than 0 for the material used.
- 312** In numerical calculations certain problems arise, e.g. lack of invertibility of the structure stiffness matrix, when setting degraded material properties equal to 0. Thus, one should apply small values, i.e. 1% of the non-degraded values, instead of 0.
- 313** If the nonlinear behaviour of the core cannot be modelled properly, the core shall not be used beyond its yield point and the yield criterion in Section 6 shall be applied as the ultimate limit state for sandwich failure.

#### **J 400 3-D Progressive Failure Analysis**

- 401** If the through thickness stresses and through width strains are significant, see *J103*, a 3-D progressive analysis shall be carried out.
- 402** A similar progressive failure analysis as presented for monolithic structures in *B300*, shall be carried out. However, failure mechanisms related to the core, see *Sections 6 and J300*, shall be included.

## **J 500 Long Term Damage Considerations**

- 501** The same progressive failure analysis as the one presented in *B200* and *B300* shall be carried out using degraded (long-term) material properties as described in *Section 5C*.
- 502** Degraded material properties shall be used in the calculations of stresses and strains and in the determination of the strength used in the failure criteria.

## **K. Buckling**

### **K 100 General**

- 101** The need for special buckling analysis shall be assessed carefully in every case. In particular the following aspects shall be considered in making this assessment:
- Presence of axial compressive stresses in beam or column-type members or structural elements
  - Presence of in-plane compressive or shear stresses in flat, plate-like elements
  - Presence of in-plane compressive or shear stresses in shell-like elements
- 102** Two alternative approaches may be used in analysing buckling problems:
- Analysis of isolated components of standard type, such as beams, plates and shells of simple shape.
  - Analysis of an entire structure (or of an entire, complex structural component)

### **K 200 Buckling analysis of isolated components**

- 201** When a member or component that is a part of a larger structure is analysed separately a global analysis of the structure shall be first applied to establish
- the effective loading applied to the member/component by the adjoining structural parts;
  - the boundary conditions for the structural member, in terms of translational and rotational stiffness components in all relevant directions.
- 202** For simple members or components standard formulae or tables may be used to estimate elastic critical loads ( $P_e$ ), critical stresses ( $s_e$ ) or critical strains ( $e_e$ ), and the corresponding elastic buckling mode shapes. Alternatively these quantities may be calculated using analytical or numerical methods. It shall always be checked that the buckling mode shape is consistent with the boundary conditions.
- 203** An assessment shall be made of the shape and size of initial, geometrical imperfections that may influence the buckling behaviour of the member. Normally the most critical imperfection shape for a given buckling mode has a similar form to the buckling mode itself. However, any geometrical feature (including eccentricity of loading) that results in compressive forces that are not coincident with the neutral axis of the member may require consideration. The assumed form and amplitude of the imperfection shall be decided on the basis of the production process used with due consideration of the relevant production tolerances. Refer to *Section 6H*.



- 204** In some cases a geometrically non-linear analysis may be avoided as follows. The elastic critical load (without imperfections)  $P_e$  is calculated. In addition an ultimate failure load  $P_f$  is estimated at which the entire cross-section would fail by compressive fibre failure, in the absence of bending stresses at the section in question. If  $P_e > P_f$  the further assessment may be based on geometrically linear analysis provided geometrical imperfections are included and the partial load effect modelling factor is increased by multiplying it by the factor

$$\frac{1}{1 - P_f/4P_e}$$

- 205** In cases where it is possible to establish the bending responses (stresses, strains or displacements) associated with an in-plane loading separately from the in-plane (axial) responses, a first estimate of the influence of geometrical non-linearity combined with the imperfection may be obtained by multiplying the relevant bending response parameter obtained from a geometrically linear analysis by a factor

$$\frac{1}{1 - P/P_e}, \quad \frac{1}{1 - s/s_e} \quad \text{or} \quad \frac{1}{1 - e/e_e}$$

and combining the modified bending responses with the (unmodified) in-plane responses.

- 206** The above procedures (205 and 204) may be non-conservative for some cases where the post-buckling behaviour is unstable. Examples include cylindrical shells and cylindrical panels under axial loading. Such cases shall be subject to special analysis and/or tests.

### **K 300 Buckling analysis of more complex elements or entire structures**

- 301** Buckling analysis of more complex elements or entire structures shall be carried out with the aid of verified finite element software or equivalent.
- 302** Initially an eigenvalue buckling analysis shall be performed assuming initial (non-degraded) elastic properties for the laminates and, for sandwich structures, for the core. This shall be repeated with alternative, finer meshes, until the lowest eigenvalues and corresponding eigenmodes are not significantly affected by further refinement. The main purposes of this analysis are to clarify the relevant buckling mode shapes and to establish the required mesh density for subsequent analysis.
- 303** Careful attention shall be paid to correct modelling of boundary conditions.
- 304** If the applied load exceeds, or is close to, the calculated elastic critical load, the design should be modified to improve the buckling strength before proceeding further.
- 305** A step-by-step non-linear analysis shall be carried out. Geometrical non-linearity shall be included in the model. The failure criteria shall be checked at each step. If failure such as matrix cracking or delamination is predicted, any analysis for higher loads shall be performed with properties reduced as described in *Section 4I*.
- 306** Alternatively to the requirement in 305 a geometrically non-linear analysis may be performed using entirely degraded properties throughout the structure. This will normally provide conservative estimates of stresses and deformations. Provided reinforcing fibres are present in sufficient directions, so that the largest range of unreinforced directions does

not exceed 60°, such an estimate will not normally be excessively conservative.

- 307** The influence of geometric imperfections should be assessed, on the basis of the production method and production tolerances. Refer to *Section 6H*.

**K 400 Buckling analysis of stiffened plates and shells**

- 401** When stiffened plate or shell structures are analysed for buckling, special attention shall be paid to the following failure modes:
- local buckling of laminate (plate) between stiffeners
  - possible local buckling of individual plate-like elements in the stiffeners themselves
  - overall buckling of the stiffened plate or shell, in which case separation (debonding) of the stiffener from the plate or shell laminate must be explicitly considered.
- 402** The finite element model shall be able to reproduce all the relevant failure modes as listed in 401. Stiffener debonding shall be evaluated by the insertion of appropriate elements at the interface to monitor the tensile and shear forces that are transmitted across the bond, together with an appropriate criterion based on tests or relevant published data.

## **K 500 Buckling analysis for sandwich structures**

- 501** Sandwich structures may be exposed to highly localised buckling modes such as wrinkling and dimpling, in addition to more global modes. For simple stress states these local modes may often be checked using standard formulae.
- 102** The wave-lengths for wrinkling are normally very short (often of the order of the sandwich thickness). If a direct FE analysis of wrinkling is carried out it is essential that a sufficiently fine mesh be used in the skin laminates, such that the mode shape is well represented. If each skin laminate is modelled using shell elements, the element size should not normally be greater than  $\lambda/12$ , where  $\lambda$  is the buckling wavelength. The core shall be modelled with solid elements of similar size. The required element size shall be established iteratively.
- 503** In performing FE analysis of wrinkling it is not normally necessary to model a large area of the structure, provided the in-plane stress state in the skin is well represented. A portion of the panel extending over a few wavelengths is normally sufficient. The result is not normally sensitive to the size of the panel selected for modelling.
- 504** In the absence of detailed information about geometrical imperfections and their consequences, these may be allowed for by reducing the critical wrinkling stress by 40%. The face wrinkling stress in some text book formulas may already include such allowance.
- 505** Wrinkling of skin laminates may be accompanied by yielding of the core if the core is made of a ductile material. This may in turn lead to a reduction in the tangent stiffness of the core and a lowering of the critical stress for wrinkling. This is mainly a problem at points of load application and at joints, where the core experiences local loading, and may be avoided by adequate thickening of the skin laminate, insertion of higher strength core material locally or by other local design features. The adequacy shall be proved by testing or analysis unless previous experience shows the solution is adequate.

## **L. Partial Load-Model Factor**

### **L 100 General**

- 101** A deterministic factor shall be assigned to each structural analysis method. It is designated in this Guideline as the partial load-model factor  $\gamma_{SD}$  (see *Section 3* as well as *Section 2 C600* and *Section 8 B200*).
- 102** The load-model factor accounts for uncertainties of the structural analysis method being used to accurately describe and quantify the response of the structure.
- 103** Model factors for the main structural analysis methods are given in the following sub-sections.
- 104** In some cases a structure is only evaluated by testing, and such an approach evaluates only the particular conditions tested. A procedure for this approach is given in *Section 10*.

### **L 200 Connection between Partial Load-Model Factor and Analytical Analysis**

- 201** When analytical methods are used within their assumptions and limitations a model factor of 1.0 should be used.
- 202** If analytical methods are used outside their assumptions and limitations, it shall be documented that the magnitude of the model factor ensures that all predicted stresses and strains are higher than in reality. If the choice of model factor cannot be documented, the analytical method shall not be used.

### **L 300 Connection between Partial Load-Model Factor and Finite Element Analysis**

- 301** The accuracy of FE methods is generally very good when the structure is properly modelled. The use of these methods with unsatisfactory models is much more uncertain.
- 302** When FE methods are used within their assumptions and limitations (and according to *Section E*) a model factor of 1.0 may be used.
- 303** If FE methods are used outside their assumptions and limitations, it shall be documented that the magnitude of the model factor ensures that all predicted stresses and strains are higher than in reality. If the model factor cannot be documented, the analysis method shall not be used.
- 304** If the boundary conditions do not exactly represent the real conditions the effect on the load model factor shall be evaluated. As a minimum a factor of 1.1 shall be used.
- 305** If the load-model factor cannot be determined for calculations in a critical region, e.g. a critical joint or region of stress concentrations, experimental qualification should be done (see *Section 10*).

### **L 400 Connection between Partial Load-Model Factor and Dynamic Response Analysis**

- 401** The accuracy of the dynamic analysis shall be estimated. The load-model factor used, which is described in *Sections L200* and *L300*, shall include all uncertainties due to dynamic effects.

### **L 500 Connection between Partial Load-Model Factor and Transfer Function**

- 501** The accuracy of the transfer function (see *Section A400*) shall be estimated. The load-model factor used, which is described in *Sections L200* and *L300*, shall include all uncertainties due to the transfer function.

## SECTION 10 COMPONENT TESTING

<b>SECTION 10 COMPONENT TESTING.....</b>	<b>1</b>
<b>A. GENERAL.....</b>	<b>1</b>
A 100 INTRODUCTION .....	1
A 200 FAILURE MODE ANALYSIS.....	3
A 300 REPRESENTATIVE SAMPLES .....	3
<b>B. QUALIFICATION BASED ON TESTS ON FULL SCALE COMPONENTS .....</b>	<b>3</b>
B 100 GENERAL.....	3
B 200 SHORT TERM PROPERTIES .....	4
B 300 LONG TERM PROPERTIES.....	4
<b>C. VERIFICATION OF ANALYSIS BY TESTING AND UPDATING.....</b>	<b>6</b>
C 100 VERIFICATION OF DESIGN ASSUMPTIONS .....	6
C 200 SHORT TERM TESTS.....	7
C 300 LONG TERM TESTING.....	8
C 400 PROCEDURE FOR UPDATING THE PREDICTED RESISTANCE OF A COMPONENT .....	10
C 500 SPECIMEN GEOMETRY - SCALED SPECIMEN .....	11
<b>D. TESTING COMPONENTS WITH MULTIPLE FAILURE MECHANISMS .....</b>	<b>13</b>
D 100 GENERAL .....	13
D 200 STATIC TESTS.....	13
D 300 LONG TERM TESTS.....	13
D 400 EXAMPLE OF MULTIPLE FAILURE MECHANISMS.....	15
<b>E. UPDATING MATERIAL PARAMETERS IN THE ANALYSIS BASED ON COMPONENT TESTING.....</b>	<b>16</b>

### A. General

#### A 100 Introduction

**101** Component testing is carried out for either:

- qualification based entirely on tests on full scale or large scale components, or
- updating or verification of analysis by testing

**102** This guideline gives procedures to evaluate test results and shows procedures to determine test programmes.

**103** A structure or part of a structure can in some cases be qualified by testing only, i.e. no structural analysis as presented in *section 9* is performed. This approach is presented in *B*.

**104** Testing can in some cases be carried out to document the design or increase confidence in design calculations. It is an alternative or complement to analysis based on basic material properties. See *C*.

**105** If the component is checked by qualification testing only, design calculations are not relevant. The test results are the only relevant information to evaluate whether the component is fit for purpose. This also means that the qualification is only valid for the conditions tested.

- 106** If testing is carried out to complement the analysis, it is done to reduce or to eliminate the influence of systematic errors introduced in the design methodology or to verify that the assumptions regarding failure mechanisms, failure modes etc. on which the design is based are correct.
- 107** In most practical cases component testing is used in combination with a structural analysis to evaluate the component for a wider range than the actual test conditions.

## **A 200 Failure mode analysis**

- 201** An analysis of all possible failure modes in the structure shall be done as described in *Section 3*.
- 202** It shall be shown by testing or analysis that none of the possible failure modes will be critical for the performance and safety of the structure.

Guidance note:

A special concern with composite materials is that minor loads may cause failures even though the structure can well withstand the main loads for which it was designed or built. Such minor loads can be through thickness loads in laminates or sandwich structures or loads oriented perpendicular to the main fibre direction in the laminate.

End of guidance note

- 203** An evaluation of failure modes is especially critical if long-term performance shall be documented and data must be extrapolated to longer lifetimes than test times. In that case failure may be caused by failure modes that were not critical in a short-term test (see *Section D*).
- 204** Temperature changes may introduce different failure mechanism. If the structure is exposed to different temperatures and resulting thermal stresses, possible changes of failure modes should be evaluated. Analytically these changes are modelled by temperature dependent material properties and by possible changes in the failure criteria that are applied, e.g. ductile brittle transition. Testing should be done for all conditions that cannot be modelled in a satisfactory way.

## **A 300 Representative samples**

- 301** Test specimens shall represent the actual structure.
- 302** Production methods and materials shall be exactly the same, and production tolerances should be known and controlled. The tolerances for producing the test samples should be representative of production conditions of the product.
- 303** If the qualification is based on testing only (Section B), no changes shall be made to materials or production without new tests.
- 304** If testing is combined with analysis changes in materials or geometry may be permitted, if the consequences of the changes can be treated with confidence by the analytical methods.

## **B. Qualification based on tests on full scale components**

### **B 100 General**

- 101** The purpose of tests is to investigate the load effects. Usually displacements and the characteristic strength are determined.
- 102** The load cases in the tests shall be combined in a realistic manner. Test results are only

valid for the load cases tested.

- 103** The environment defined in *section 3J* shall be represented in a realistic manner. The environmental effect can be accounted for either by:
- Carrying out tests on components that have been subjected to a representative ageing (accelerated or not accelerated).
  - Carrying out tests on components combined with ageing (accelerated or not accelerated). An example is the standard techniques used for qualification of pipes.

Test results are only valid for the environments tested.

- 104** The failure mode(s), failure mechanism(s) and location(s) of failure shall be recorded and verified during/after the tests. The partial/safety factor(s) applied shall correspond to the actual failure mechanisms.

## **B 200 Short term properties**

- 201** Short term failure shall be analysed based on the general failure criteria for single or multiple loads as described in *Section 6B200-300*.
- The partial resistance model factor  $\gamma_{Rd}$  can be set equal to 1.0, if the tests represent design and material properties in a satisfactory manner.
  - The partial load model factor  $\gamma_{Sd}$  can be set equal to 1.0, if the tests represent actual applied loads in a satisfactory manner. If loads are representing effects of other phenomena, uncertainties in the conversion from the other phenomena to the loads shall be included in  $\gamma_{Sd}$ , i.e. uncertainties in the transfer function as describe in *Section 9A400* shall be included.
  - The characteristic strength of the tested component shall be determined based on the test results as described in *Section 4B400* for static data.
  - The safety factors shall be chosen based on distribution and COV of the load and COV of the component test results (material's COV) as in Section 8. The distribution and COV of the load shall be based on the loads the structure will experience in the application, not on the loads of the test.
- 202** At least three specimens shall be tested. It is recommended to test more specimens to obtain reasonably high characteristic strengths with the required 95 % confidence. The relationship between number of tests and characteristic strength is given in *Section 4B400*.

## **B 300 Long term properties**

- 301** Long term failure shall be analysed based on the principles for obtaining time dependent properties described in *Section 6J and 6K*.
- The partial resistance model factor  $\gamma_{Rd}$  can be set equal to 1.0, if the tests represent design and material properties in a satisfactory manner.
  - The partial load model factor  $\gamma_{Sd}$  can be set equal to 1.0, if the tests represent actual applied loads in a satisfactory manner. If loads are representing effects of other



phenomena, uncertainties in the conversion from the other phenomena to the loads shall be included in  $\gamma_{Sd}$ , i.e. uncertainties in the transfer function as describe in *Section 9A400* shall be included.

- The characteristic strength shall be determined based on the test results as described in *Section 4C1100* for time dependent data.
- The safety factors shall be chosen based on distribution and COV of the load and COV of the component test results (material's COV) as in *Section 8*. The distribution and COV of the load shall be based on the loads the structure will experience in the application, not on the loads of the test.

**302** At least ten specimens shall be tested. It is recommended to test more specimens to obtain reasonably high characteristic strengths with the required 95 % confidence. The relationship between number of tests and characteristic strength is given in *Section 4 C1100* for data that must be extrapolated to longer lifetimes and for data that can be used within the test period.

**303** If data must be extrapolated to longer lifetimes than the measured time it shall be shown that no other failure modes may develop between the test time and the expected lifetime of the structure or component. It is usually not possible to show this by component testing only. Some analysis and calculations are necessary, *see D305*.

**304** The static strength of the structure after long term exposure shall be the same as the extrapolation of the long term test data of the fatigue or stress rupture tests.

**305** Higher static strength values after long term exposure may be used if experimental evidence can be provided. A procedure to obtain strength data after long term exposure is suggested in *Section 4 C400 and 900*.

## C. Verification of analysis by testing and updating

### C 100 Verification of design assumptions

- 101** Tests under this category are carried out to verify that the assumptions on which the design is based are correct and that no important aspects of the design have been overlooked. Verification tests should be carried out to compensate for:
- Incorrect description of, or an unsatisfactory large uncertainty in the failure mechanisms
  - Incorrect description of load combinations or corresponding large uncertainties
  - Incomplete understanding of the effect of the environment.
  - Lack of experience of similar structures or components.
  - Uncertainty in the accuracy of modelling large stress gradients.
  - Assumptions that can be questioned or are difficult to document.
  - Unknown effect of large scale manufacturing procedures.
- 102** Tests under this category are carried out to verify that the analysis tools predict the response to the most critical load cases and environments in a correct or conservative manner. This type of testing shall be done if the particular analysis method has never been used for a similar structure and load situation before.
- 103** As it is not possible to test all load conditions that the structure will experience, the most critical load conditions should be selected. The selection shall be based not only on the most critical loads the structure is most likely to see. It shall also show that critical failure modes that can be caused by secondary loads are adequately modelled (Section A200).
- 104** It may be necessary to test more than one aspect of an analysis. This may mean that two or more separate test programmes should be carried out, unless both aspects can be evaluated in one test. The remaining parts of this section explain the requirement for one test programme.

#### Guidance note

The end fitting of a pipe has been analysed. There is uncertainty about fatigue performance and long term static strength. In this case both aspects should be tested separately.

There is uncertainty about long term fatigue performance of new specimens and of specimens with impact damage. In this case the specimen can most likely be exposed to impact before the fatigue testing and only one test programme is needed. This test programme would cover both aspects in a conservative way.

End of guidance note

- 105** In general the environment defined in *section 3J* should be represented in a realistic manner. The environmental effect can be accounted for either by:
- Carrying out tests on components that have been subjected to a representative ageing

(accelerated or not accelerated).

- Carrying out tests on components combined with ageing (accelerated or not accelerated). An example is the standard techniques used for qualification of pipes. Since these tests are used to increase the confidence in calculation techniques other environments may be chosen if it can be demonstrated that the effects of the real environment can be predicted in a conservative way by a combination of analytical tools and the test results obtained from a special test environment.

**106** The following steps shall be followed when defining and carrying out test under this category:

1. The load condition(s) and environments are defined as specified in *Section 3*.
2. The failure mode, failure mechanism and location of failure etc. on which the design is based are specified
3. The number of test specimens required per load condition is specified. The number of test specimens may have to be determined based on an engineering judgement.
4. Carry out testing.
5. Verify failure mode, failure mechanism and location of failure. If these are as predicted in 2. the assumptions for the design are considered corroborated. If one or more of these are not as predicted in 2. the reason for the discrepancy shall be investigated and the validity of design assumptions re-evaluated.

**107** Instead of testing the full component it may be more relevant to test parts or details. Which test is the best should be evaluated considering relevant failure modes and all possible interaction effects.

**108** The failure mode(s), failure mechanism(s) and location(s) of failure shall be recorded and verified during/after the tests.

**109** If analysis and test results agree with each other based on the criteria given in *C200* and *C300* the analysis method is suitable for the application. (See also *Section 7 B 200*)

## **C 200 Short term tests**

**201** The requirements here apply to one test aspect as determined in *C100*.

**202** The sequence of the failure modes in the test shall be the same as predicted in the design. If the sequence is different or if other failure modes are observed, the design shall be carefully re-evaluated.

**203** The measured strength of each critical failure mode shall never be less than the predicted characteristic strength. Critical failure modes are failure modes that are linked to a limit state. The characteristic strength of the component shall be updated according to *C300*.

**204** In addition to the requirements above (*201* and *202*), one of the following requirements shall be met:

- The test results fulfil the requirements for "confirmation testing for static data" given

in *Section 4H700*. Application of this criterion requires that at least three tests are carried out.

- The characteristic strength of the structure is updated by the test results as described in *C400*. One test is sufficient to use this method, but more tests are recommended.

### **C 300 Long term testing**

**301** Whether cyclic load testing or long term static load testing or both is required depends on the evaluation of the test programme done in C100. The approach for both testing types is similar and will be treated here in one part.

**302** Fatigue testing for high safety class: at least two survival tests shall be carried out. The specimen should not fail during the survival test and it should not show unexpected damage. The requirements to the testing are:

- Tests should be carried out up to five times the maximum number of design cycles with realistic amplitudes and mean loads that the component will experience.
- If the anticipated lifetime exceeds  $10^5$  cycles testing up to  $10^5$  cycles may be sufficient. The load levels should be chosen such that testing of the two specimens is completed after at least  $10^4$  and  $10^5$  cycles respectively. The two test results shall fall within  $\mu - 2\sigma$  of the anticipated number of cycles to failure, where  $\mu$  is the mean prediction and  $\sigma$  is one standard deviation of the predicted lifetime. If more tests are made the requirements are given in *DNV-OS-C501 Section 4H806*.

**303** Fatigue testing for normal safety class: at least one survival test shall be carried out. The specimen should not fail during the survival test and it should not show unexpected damage. The requirements to the testing are:

- Tests should be carried out up to five times the maximum number of design cycles with realistic amplitudes and mean loads that the component will experience.
- If the anticipated lifetime exceeds  $10^5$  cycles testing up to  $10^5$  cycles may be sufficient. The load levels should be chosen such that testing of the two specimens is completed after at least  $10^4$  and  $10^5$  cycles respectively. The test results shall fall within  $\mu - \sigma$  of the anticipated number of cycles to failure, where  $\mu$  is the mean prediction and  $\sigma$  is one standard deviation of the predicted lifetime. If more tests are made the requirements are given in *DNV-OS-C501 Section 4H806*.

**304** Stress rupture testing for high safety class: at least two survival tests shall be carried out. The specimen should not fail during the survival test and it should not show unexpected damage. The requirements to the test results are:

- Tests should be carried out up to five times the maximum design life with realistic mean loads that the component will experience.
- If the anticipated lifetime exceeds 1000 hours testing up to 1000 hours may be sufficient. The load levels should be chosen such that testing is completed after  $10^3$  hours. The two test results shall fall within  $\mu - 2\sigma$  of the anticipated lifetime, where  $\mu$  is the mean prediction and  $\sigma$  is one standard deviation of the predicted lifetime. If more tests are made the requirements are given in *DNV-OS-C501 Section 4H806*.

- 305** Stress rupture testing for normal safety class: at least one survival test shall be carried out. The specimen should not fail during the survival test and it should not show unexpected damage. The requirements to the test results are:
- ❑ Tests should be carried out up to five times the maximum design life with realistic mean loads that the component will experience.
  - ❑ If the anticipated lifetime exceeds 1000 hours testing up to 1000 hours may be sufficient. The load levels should be chosen such that testing is completed after  $10^3$  hours. The two test results shall fall within  $\mu - \sigma$  of the anticipated lifetime, where  $\mu$  is the mean prediction and  $\sigma$  is one standard deviation of the predicted lifetime. If more tests are made the requirements are given in *DNV-OS-C501 Section 4H806*.
- 306** For low safety class long term testing is not required.
- 307** The sequence of the failure modes in the test shall be the same as predicted in the design. If the sequence is different or if other failure modes are observed, the design shall be carefully re-evaluated.
- 308** The average of the measured number of cycles or time until occurrence of each critical failure shall never be less than the predicted characteristic lifetime or numbers of cycles. Critical failure modes are failure modes that are linked to a limit state.
- 309** Tests should be carried out with a typical load sequence or with constant load amplitude. If a clearly defined load sequence exists, load sequence testing should be preferred.
- 310** Whether reduced test times compared to the component's life are acceptable should be evaluated based on the anticipated failure modes and whether extrapolation of the data to longer lifetimes is possible. This will mainly depend on the confidence and previous knowledge one has about the failure modes that are tested.
- 311** In some cases high amplitude fatigue testing may introduce unrealistic failure modes in the structure. In other cases, the required number of test cycles may lead to unreasonable long test times. In these cases an individual evaluation of the test conditions should be made that fulfils the requirements of 302 or 303 as closely as possible.
- 312** The static strength of the structure after long term exposure shall be taken as the extrapolation of the long term test data of the fatigue or stress rupture tests.
- 313** Higher static strength values after long term exposure may be used if experimental or theoretical evidence can be provided. The same arguments as given in *Section 4C* may be used for matrix and fibre dominated properties. A procedure to obtain strength data after long term exposure is suggested in Section 4 C400 and 900.
- 314** Additional tests may be required if resistance to a failure mode cannot be shown by analysis with sufficient confidence and if this failure mode is not tested by the tests described above.

## C 400 Procedure for updating the predicted resistance of a component

**401** The resistance of the component is  $R$  and is assumed to be normally distributed

$$R \in N(\mu_R, \sigma_R^2)$$

Where:

$\mu_R$  = mean value of the resistance of the component (generally unknown).

$\sigma_R$  = standard deviation of the resistance of the component, representing the natural variability in the material properties and the manufacturing/production process, and here assumed known.

**402** The characteristic value of the resistance is specified as a specific quantile in the distribution of the resistance, here defined as

$$x_C = \mu_R - 2\sigma_R$$

However, because  $\mu_R$  is unknown, the true characteristic value  $x_C$  is also unknown.

**403** Estimates of  $\mu_R$  and  $x_C$  prior to testing are sought. One way of obtaining such prior estimates is to carry out an analysis of the component by means of available analysis models.

The estimate  $\mu_{RA}$  of  $\mu_R$  is obtained from a single analysis using mean values for the material properties. The uncertainty in the estimate  $\mu_{RA}$  should also be assessed, expressed in terms of a standard deviation  $\sigma_{\mu}'$ , and reflecting uncertainties in the underlying material property estimates as well as uncertainties in the applied analysis models.

**404** If the results of an analysis by means of the available analysis models are unbiased, the mean of the estimate of  $\mu_R$  is to be taken as

$$\mu_{\mu}' = \mu_{RA}$$

**405** If the results of an analysis by means of the available analysis models are encumbered with a bias, the mean of the estimate of  $\mu_R$  is to be taken as

$$\mu_{\mu}' = \mu_{RA} + \Delta$$

in which  $\Delta$  represents the effect of the conservatisms implied in the analysis leading to  $\mu_{RA}$ .  $\Delta$  is sometimes referred to as the bias and needs to be estimated.

**406** An estimate of the characteristic value of the resistance, prior to any component testing, can now be obtained with 95% confidence as

$$x_C' = \mu_{\mu}' - 1.64\sigma_{\mu}' - 2\sigma_R$$

**407** After component testing is performed, the characteristic value of the component should be updated based on the test results (and Bayesian updating theory).

**408** When a total of  $n$  tests are performed, leading to  $n$  resistance values  $x_1, \dots, x_n$ , the sample mean is defined as

$$m_{est} = \frac{1}{n} \sum_{i=1}^n x_i$$

**409** Based on the test results, the following updated values of the mean and the standard deviation of the estimate of the mean resistance  $\mu_R$  can be obtained:

$$\mu_{\mu}'' = [n \cdot \mu_{\text{test}} \cdot \sigma_{\mu}'^2 + \mu_{\mu}' \cdot \sigma_R^2] / (n \cdot \sigma_{\mu}'^2 + \sigma_R^2)$$

and

$$\sigma_{\mu}'' = [(\sigma_{\mu}'^2 \cdot \sigma_R^2) / (n \cdot \sigma_{\mu}'^2 + \sigma_R^2)]^{1/2}$$

**110** Based on this, the following updated estimate of the characteristic resistance can be obtained with a confidence of 95%:

$$x_C'' = \mu_{\mu}'' - 1.64 \sigma_{\mu}'' - 2 \sigma_R$$

**411** When the standard deviation  $\sigma_{\mu}'$  of the mean resistance estimate prior to testing is not available, and when a significant, conservative bias  $\Delta$  in the resistance estimate is implied by the available analysis models, then  $\sigma_{\mu}'$  may be approximated by  $\Delta/2$ , unless a better approximation can be estimated. This approximation is not valid when the bias  $\Delta$  is small or zero.

Guidance note:

The present note gives some more details related to the derivations above (see *Sections 401-411*). Assume that an estimate of  $\mu_R$  is sought. The estimate can be based on a prediction by means of available engineering models. Such models are usually encumbered with uncertainty owing to simplifications and idealisations, so the estimate becomes uncertain. The combined effect of simplifications and idealisations are on the conservative side, such that they imply systematic errors in the predictions, i.e., the estimator  $\mu_R'^*$  applied in the estimation of  $\mu_R$  comes out with a bias and is thus not a central estimator. The bias is denoted  $\Delta$  and is defined as

$$\Delta = \mu_R - E[\mu_R'^*]$$

where:

$E[\mu_R'^*]$  = the mean value of the estimator  $\mu_R'^*$  for  $\mu_R$

The bias  $\Delta$  has to be estimated based on all available information and a best possible engineering judgement. This estimation of  $\Delta$  is a very crucial stage.

Once the bias  $\Delta$  has been estimated, an unbiased central estimate of the mean resistance can be established with mean value

$$\mu_{\mu}' = E[\mu_R'] = E[\mu_R'^*] + \Delta$$

The standard deviation of the unbiased central estimate of the mean resistance is taken as

$$\sigma_{\mu}' = D[\mu_R'^*]$$

Where:

$D[\mu_R'^*]$  = standard deviation of the estimator  $\mu_R'^*$  for  $\mu_R$

End of guidance note

## C 500 Specimen geometry - Scaled Specimen

**501** The specimen geometry for testing may be chosen to be different from the actual under

certain conditions.

**502** Scaled specimens may be used if analytical calculations can demonstrate that:

- All critical stress states and local stress concentrations in the critical part of the scaled specimen and the actual component are similar, i.e., all stresses are scaled by the same factor between actual component and test specimen.
- The behaviour and failure of the test specimen and the actual component can be calculated based on independently obtained material parameters. This means no parameters in the analysis should be based on adjustments to make large scale data fit.
- The sequence of predicted failure modes is the same for the scaled specimen and the actual component over the entire lifetime of the component.
- An analysis method that predicts the test results properly but not entirely based on independently obtained materials data can may be used for other joint geometries if it can be demonstrated that the material values that were not obtained by independent measurements can also be applied for the new conditions.

**503** Tests on previous components may be used as testing evidence if the scaling requirement in 502 is fulfilled.



## **D. Testing components with multiple failure mechanisms**

### **D 100 General**

- 101** A component or structure may fail by more than one failure mechanism. In that case it is important that all the critical failure mechanisms will not occur during the lifetime of the structure. Critical failure mechanisms are the ones that are linked to functional requirements in Section 3 and their occurrence will be a violation of a limit state.

Guidance note

A typical case for a component with multiple failure mechanisms is an adhesive joint. If the joint is loaded failure may occur in one of the substrates, in the adhesive, or in one of the two interfaces.

End of guidance note

### **D 200 Static tests**

- 201** Static tests are usually dominated by one failure mode. In that case the testing described in Section B and C is sufficient.
- 202** If the tests show more than one failure mode each failure mode shall be evaluated individually according to the methods given in *B* and *C*.
- 203** If a component shows two failure modes (*X* and *Y*) test results with failure *X* may be interpreted for the statistical analysis in *Section B and C* in a way that failure mode *Y* occurred also at the same load as failure mode *X*. The same approach can be applied for more than two failure modes. More advanced statistical treatments may be used to evaluate two or more failure modes.
- 204** If testing is carried out to verify an analysis of the structure the analysis should predict possible two (or more) failure modes for the given test load.
- 205** Generally, the occurrence of two different failure modes should be avoided.

### **D 300 Long term tests**

- 301** Even if static tests show only one failure mode a change of failure modes may happen over time. Such a change can be caused by different time dependencies of the changes in material properties or by changes in failure mechanisms, e.g., a ductile-brittle transition.
- 302** If test periods to obtain long term data are as long as the design life or design number of cycles, data can be evaluated the same way as described in *D200*.

- 303** If design life or number of cycles exceed testing conditions it is not possible to qualify a component with more than one failure mode just by component testing. Some additional information about the long term characteristics of the individual failure modes is needed. This information must be combined with test results by analytical reasoning.
- 304** The designer shall document that none of the critical failure mode will occur within the lifetime of the structure.
- 305** One possible way to document that none of the critical failure mode will occur within the lifetime of the structure is:
- ❑ If the design life is longer than the testing time the reduction of strength with time shall be established individually for each failure mode by testing or analysis.
  - ❑ If the expected number of cycles is more than the tested number the reduction of strength with number of cycles shall be established individually for each failure mode by testing or analysis.
  - ❑ Based on the individual degradation curves a lifetime analysis can be made.
  - ❑ Tests according to C300 shall be used to verify the predictions as far as possible.
- 306** The lifetime analysis in 305 may be based on a combination of the measured (or predicted) static strength of the component and the worst degradation curve of the individual failure mechanisms. This tends to be a very conservative approach. A better approach is to determine the static failure loads for each failure mechanism and apply the degradation curves for each failure load.
- 307** Obtaining degradation curves and/or failure loads for individual failure mechanisms may require specially designed test pieces that will fail with the required failure mode.
- 308** In some cases it may be possible that one failure mode that usually does not occur within practical testing times can be created by acceleration techniques, e.g. increasing the temperature. In such a case it may be possible to check two failure modes simultaneously under the accelerated conditions. Evidence for the acceleration conditions shall be provided.

## D 400 Example of multiple failure mechanisms

Guidance note

Simplified example of multiple failure mechanisms

The purpose of this example is to explain the concepts used in *Section D*. The example is a simplified end connector of a pipe.

The pipe is shown in the Figure below. It consists of a tube made of a composite laminate and a metal end fitting. The connection between the two is an adhesive joint.

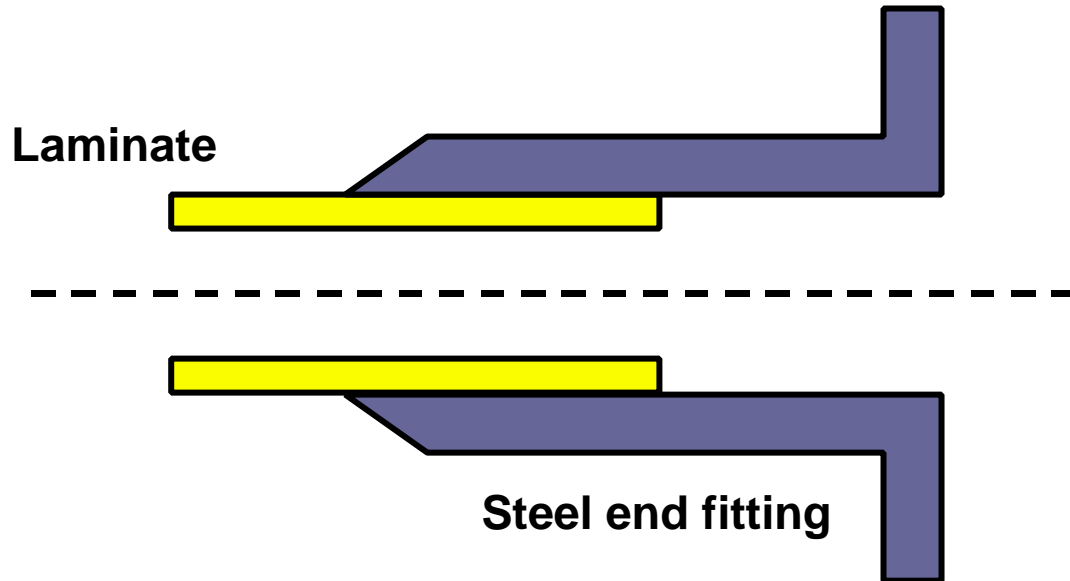

The adhesive joint was designed to be much stronger than the pipe itself. Its predicted failure was at a pressure "A" as shown in the Figure below. Short-term pressure tests confirmed fibre failure in the laminate at level B.

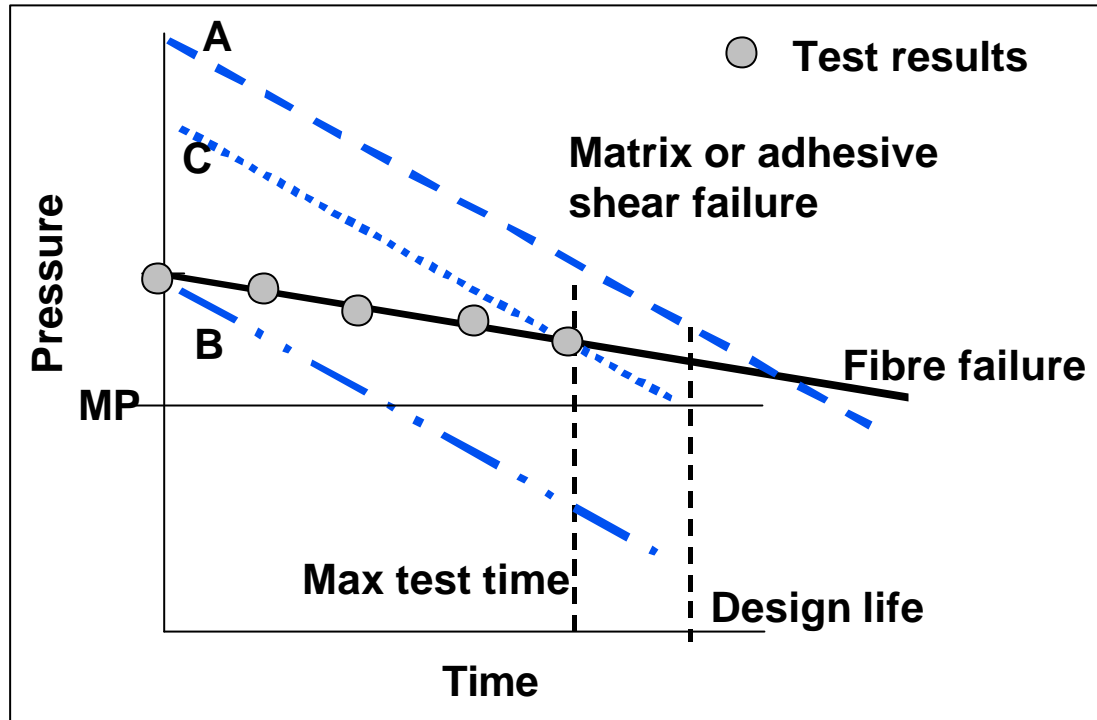

Long term tests also showed fibre failure. The strength reduction with time was fairly small, as expected for fibre dominated properties.

However, it is known from other tests that the strength of the adhesive degrades more rapidly with time than the fibre strength. The predicted reduction of strength is shown in curve A. Even at the end of the design life the pipe should still fail by fibre failure.

The static strength A of the adhesive joint is, however, not well known and cannot be tested experimentally. If the strength is totally unknown it can be assumed that the measured static strength (Fibre failure at level B) is also the strength of the adhesive joint. Applying the degradation curve to this strength gives curve B. This is the approach in 306, giving very conservative long-term pressures.

Testing up to a certain time has always shown that the tube failed by fibre failure. It is now possible to apply the degradation curve of the adhesive joint to the longest test time. This is done in curve C, based on the approach in 305. The resulting maximum pressure MP, is relatively good value.

The simplifications of this example are mainly that more than two failure mechanisms are involved in such a joint. The laminate may show matrix cracking and delamination due to through thickness stresses. The adhesive joint may fail in the adhesive or one of the interfaces. Each of these may have different degradation curves.

End of guidance note.

## E. Updating material parameters in the analysis based on component testing

**101** If test results do not agree with the analysis a change of few material parameters in the

analysis may create agreement between test results and analysis. Such changes should be avoided and shall be made with great caution.

- 102** Material parameters may be changed if the results can be confirmed by independent tests on the material level.
- 103** If such tests cannot be made the analysis is closely linked to the particular test geometry. Such an analysis shall not be used for other geometries or loading conditions unless it can be shown that the adjusted material parameters have a physical meaning.

Guidance note

Changes of material parameters due to damage, like matrix cracking, as described in Section 4 can be made. These values are based on independent material tests and are needed for a nonlinear analysis.

End of guidance note

## SECTION 11 FABRICATION

<b>SECTION 11 FABRICATION.....</b>	<b>1</b>
<b>A. INTRODUCTION .....</b>	<b>2</b>
A 100 OBJECTIVE .....	2
A 200 QUALITY SYSTEM .....	2
<b>B. LINK OF PROCESS PARAMETERS TO PRODUCTION MACHINE PARAMETERS .....</b>	<b>2</b>
B 100 INTRODUCTION.....	2
B 200 PROCESS PARAMETERS.....	2
B 300 PRODUCTION MACHINE PARAMETERS.....	3
<b>C. PROCESSING STEPS .....</b>	<b>4</b>
C 100 GENERAL.....	4
C 200 RAW MATERIALS .....	4
C 300 STORAGE OF MATERIALS .....	4
C 400 MOULD CONSTRUCTION .....	4
C 500 RESIN.....	5
C 600 PRODUCING LAMINATES AND SANDWICH PANELS.....	5
C 700 PRODUCING JOINTS.....	6
C 800 INJECTION OF RESIN AND CURE .....	7
C 900 EVALUATION OF THE FINAL PRODUCT .....	7
<b>D. QUALITY ASSURANCE AND QUALITY CONTROL.....</b>	<b>7</b>
<b>E. COMPONENT TESTING.....</b>	<b>8</b>
E 100 GENERAL.....	8
E 200 FACTORY ACCEPTANCE TEST AND SYSTEM INTEGRITY TEST .....	8
E 300 PRESSURE TESTING OF VESSELS AND PIPES.....	9
E 400 OTHER TESTING.....	9
E 500 DIMENSIONS.....	10
<b>F. INSTALLATION .....</b>	<b>10</b>
<b>G. SAFETY HEALTH AND ENVIRONMENT .....</b>	<b>10</b>

## **A. Introduction**

### **A 100 Objective**

**101** The objective of this section is to provide guidelines to ensure that the structure is built as planned and that the material properties are of consistent quality with the same properties as used in the design analysis. It is not the intention here to give advise on how to operate particular processing equipment.

### **A 200 Quality system**

**201** This guideline does not specify how requirements are controlled, it specifies what should be controlled.

**202** A quality system, like ISO 9001, shall be in place to specify how production activities are controlled. All requirements given in this section shall be addressed in the quality system for components with normal and high safety class.

## **B. Link of Process Parameters to Production Machine parameters**

### **B 100 Introduction**

**101** Composite laminate and sandwich structures are normally produced as the component is built. This is a special situation compared to other materials like metals that are purchased as a finished material and subsequently assembled, joined, and maybe modified.

**102** The material properties depend not only on the raw materials but also on the specific way they are laid up.

**103** The main quality principle when building composite structures is to ensure that the laminates and sandwich structures are built with a consistent quality.

### **B 200 Process parameters**

**201** The following process parameters shall be controlled as a minimum for laminates, as described in *Section 4F*:

- Temperate and pressure over time in production and post-cure
- Void content
- Fibre content (volume fraction) / good local wet-out
- Fibre orientation
- Fibre tension
- Number of layers and thickness

**202** For sandwich structures the requirements for laminates apply (*201*). In addition a good bond between skins and core shall be ensured at all places, see also *Section 5F*. If sections of core materials are joined by adhesives good filling of all joints shall be ensured at all places.

## **B 300 Production machine parameters**

**301** Production machine parameters are defined here in a wide sense as all physical parameters that may have an influence on the process, since no specific production process is addressed in this guideline.

Guidance note

A production machine parameter can be an electrical current that produces a certain temperature in a curing chamber in a pultrusion process; it can be rolling pressure when compacting reinforcements in a hand lay-up process.

End of guidance note

**302** All production machine parameters shall be identified that may influence the process parameters in *B200*.

**303** Ideally a link between the dependence of processing parameters on machine parameters should be established. If such a link cannot be established, the parameters should be kept constant or within well defined tolerances.

**304** Material properties should be established as a function of the process parameters and it shall be shown that the design values (mean and standard deviation) can be achieved under all conditions. Alternatively, material properties shall be measured and used in the design for the worst possible variation of machine parameters.



## **C. Processing steps**

### **C 100 General**

- 101** Bending of composites shall be avoided. A minimum bending radius shall be defined if the process requires bending of materials.
- 102** Materials and components shall not be exposed to point-loads. All possible point loads shall be evaluated and it shall be ensured that they will not damage the material.
- 103** The working conditions are important when producing composite parts. Ambient temperature ranges shall be defined and production areas should be well ventilated. Dust, fumes, chemicals etc. may influence curing conditions or may attack the material later during service. The working conditions shall be defined.
- 104** Humidity shall be controlled at places where chemical reactions occur. If humidity cannot be controlled its effect shall be evaluated.

### **C 200 Raw Materials**

- 201** All raw materials shall be traceable for applications with normal and high safety class.

### **C 300 Storage of materials**

- 301** The manufactures recommended storage conditions should be followed. All materials shall be stored in clean and dry environments.
- 302** Fibres should be stored in a clean environment, preferably wrapped up.
- 303** Resins and other chemicals should be stored in tight containers or tanks.
- 304** All resins and chemicals shall not be used after their shelf life has expired.
- 305** Some foam cores have internal gases from the production process that diffuse out with time. Such cores shall be stored long enough to allow the gases to diffuse out. Core skin delaminations may be the result if the gases remain in the core.
- 306** When taking materials out of storage it is important that they reach the same temperature as in the production facility while inside their sealed storage bag or container. This step prevents the formation of humidity on the materials.

### **C 400 Mould construction**

- 401** The word moulds is interpreted in this section in a wide sense, covering many processes. Laying tables, mandrels and vacuum bags are considered as moulds or parts of moulds.
- 402** Moulds should match all tolerances required by the design.
- 403** Sharp corners and discontinuities at joining points should be avoided.
- 404** The surface finish shall be as specified. It shall be demonstrated that the mould surface finish can produce components with the required surface finish of the component.

- 405** Compatibility of mould release agents with the material and further operations should be considered. Especially adhesive joining or re-lamination may be effected by residues of mould release agents on the surface of the component. This applies for mould release agents that were applied to the mould and for mould release agents that were added to the resin.
- 406** The structural stability of moulds or mandrels should be ensured.
- 407** Possible deformations of the moulds should be considered in the design. The structure should be able to withstand all resulting loads and strains.
- 408** If moulds are heated a controlled distribution of temperature shall be ensured.
- 409** If a vacuum is applied inside the mould (or some bag), it shall be ensured that no leaks exist. The vacuum shall be measured far away from the point where the vacuum is pulled. Large moulds may require more than one measurement point.
- 410** When removing the part from the mould large stresses and deformations may be induced, especially if the component got stuck somewhere. These effects should be avoided or at least carefully controlled. Possible stresses or strains due to these operations should be considered in the design. If such a situation occurs accidentally the loads shall be estimated and the component shall be reanalysed.

#### **C 500 Resin**

- 501** Two or more component resins shall be carefully mixed according to manufacturers instructions, this is essential for a good cure.
- 502** The curing system shall be chosen in a way to prevent exothermic overheating.
- 503** Changing accelerators or other ingredients that control the speed of the cure are only permitted if they have no effect on the mechanical properties. The resin supplier shall confirm this. In addition, tensile tests according to *4H607* shall confirm no change in strength and stiffness for components of normal and high safety class.
- 504** Barcol hardness tests or other means should be used to check the quality of the cure.
- 505** The viscosity of the resin and/or the gel time should be measured for all processes where the flow properties of the resin are important. For details see *Section D200*.
- 506** It is recommended to take a sample from each batch of resin used in components of normal or high safety class. The sample of resin without fibres should be cured separately. A tensile or bending test should be used to confirm that properties are within acceptable tolerances.

#### **C 600 Producing laminates and sandwich panels**

- 601** Procedures to confirm the lay-up of fabrics shall be established. A log shall be kept for components of normal or high safety class. The accuracy of the lay-ups shall be verified independently during production for high safety class components. Whether the verification shall be done by the manufacturer himself, by the customer, or by a third party should be decided by the project.

- 602** The accuracy of fibre orientations shall be specified for high safety class components.
- 603** Fibres shall be well aligned showing no local distortions or kinks.
- 604** Minimum and maximum overlap lengths of adjacent fabrics shall be specified. The effect of overlaps may be similar to damage in the laminate and shall be evaluated as described in *Section 4A700*.
- 605** The tolerances for gaps between cores shall be defined.
- 606** The surfaces of cores shall have smooth transitions across the gaps. This is especially critical if cores are tapered.
- 607** Procedures shall be established to ensure a good bond between skins and cores for all geometrical shapes in the component. The quality of the interfacial bond shall be documented for all relevant geometries, e.g., convex and concave surfaces.
- 608** Any gaps between cores shall be filled with the specified resin or adhesives, unless it was specified that cores shall not be filled and core properties were measured on cores with unfilled gaps, see *Section 5 F200*.
- 609** Absorption of resin by the core shall be considered with respect to weight of the total structure and the amount of resin needed to obtain the desired fibre volume fraction in the laminates.
- 610** The curing temperature and pressure shall not effect the properties of the core.
- 611** The temperature of all materials and the mould should be the same during the lay-up, unless the process specifically requires other conditions.

#### **C 700 Producing joints**

- 701** The same requirements as for laminates and sandwich plates in *C500* apply.
- 702** Overlap lengths shall be clearly specified and tolerances shall be given.
- 703** Surface preparations of adhesive or laminated joints shall be clearly specified and shall be the same as for the specimens that were tested to qualify the joint.
- 704** The application of adhesives shall follow well described procedures. The procedures shall be exactly the same as for the specimens that were tested to qualify the joint.
- 705** Surface preparation of adhesive or laminated joints and the application of adhesives shall be verified independently during production for normal and high safety class components. Whether the verification shall be done by the manufacturer himself, by the customer, or by a third party should be decided by the project.
- 706** The alignment of components and tolerances shall be specified.
- 707** Hole diameters positions and tolerances shall be specified for bolted connections.
- 708** Washer sizes or other supports shall be specified.

**709** Torque of the bolts shall be specified.

**710** Bolted joints shall be verified independently during production for high safety class components. Whether the verification shall be done by the manufacturer himself, by the customer, or by a third party should be decided by the project.

#### **C 800 Injection of resin and cure**

**801** The viscosity of the resin should be specified and controlled for all processes where the flow is important (*see also C505*). As a minimum the gel time should be checked.

**802** The flow patterns of injection processes shall be documented. Every part of the component shall be filled with resin. No paths shall be blocked by resin that is already cured.

**803** The curing schedule shall be specified and documented. A log shall be kept for component of normal or high safety class. The accuracy of the process shall be verified.

#### **C 900 Evaluation of the final product**

**901** A procedure should be given to describe the evaluation of the finished product.

### **D. Quality assurance and quality control**

**101** A programme shall be established to ensure constant quality of the laminates that are produced.

**102** The programme may rely mainly on testing of the product or it may utilise the control of production and machine parameters.

**103** Tests shall be carried out to check whether a consistent quality of the product or products is maintained.

**104** Which tests should be carried out depends on the processing method and the particular structure. The principles given here shall be followed, but details may be changed.

**105** All tests that are performed for quality control shall also be performed on the materials that were used to obtain the design properties. The results of the tests shall be used as reference values for all following QC tests.

**106** Allowable ranges of test results shall be established for all tests.

**107** The easiest way to establish ranges of test results is to produce the materials for obtaining design data with the worst acceptable process parameters. Such values can then be taken as minimum values.

**108** Statistical process control methods may be used.

## E. Component testing

### E 100 General

- 101 Testing on components is done to detect possible manufacturing defects. The testing is not intended to qualify design aspects. These tests are described in Section 10.
- 102 Testing on the system addresses the same aspects as for components. In addition the interaction between the components is tested to detect possible mistakes in the way the components were put together.
- 103 The testing to check for fabrication errors shall be considered in the design analysis. No unintended damage (failure mechanisms, e.g. matrix cracking) shall be introduced into the structure by the tests.

### E 200 Factory acceptance test and system integrity test

- 201 The factory acceptance test (FAT) is performed before the component leaves the factory. The test should identify manufacturing errors before the component leaves the factory.
- 202 The FAT should be performed on all structures with safety class normal and high according to the requirements for pressure testing or other testing.
- 203 It is common practise to perform a FAT test, especially for pressurised components. The test is recommended but not required by this Guideline. If a FAT test is not planned to be performed all parties of the project shall be informed about this decision and the system integrity test shall identify the same aspects as a FAT test.

#### Guidance note

The factory acceptance test has the advantage that gross manufacturing errors are detected before the component leaves the factory. In some cases it is inconvenient or to perform a FAT test. The system integrity test will detect the same manufacturing mistakes as a FAT test, and the defect will be detected before operation starts. However, replacement or repair may be more complicated if a defect is detected as late as in a system integrity test.

\*\*\*\*\* end of guidance note \*\*\*\*\*

- 204 The system integrity test is performed after final installation of all components and before the system goes into service.

**205** The system integrity test shall be performed on all structures according to the requirements for pressure testing or other testing.

### **E 300 Pressure testing of vessels and pipes**

**301** All pressure vessels and pipes of safety class normal or high shall be pressure tested before going into service.

**302** A test pressure of 1.3 times the maximum service pressure shall be used unless such a pressure would introduce damage to the component that may reduce its lifetime. The maximum service pressure shall be the minimum test pressure.

**303** A detailed test programme shall be defined. The following shall be stated as a minimum:

- rates of pressure increase,
- holding times,
- time over which the pressure in the system shall not drop without actively applying pressure, i.e. a leakage test.

**304** The test schedule shall be developed for each application. The testing should allow detecting as many possible defects in the structure as possible. As a general guidance the following schedules are recommended:

- The minimum time over which the maximum test pressure in the system (from E302) shall not drop without actively applying pressure should be at least 10 minutes for systems that do not creep.
- For systems that show creep the maximum test pressure should be kept for 1 hour applying active pressure. The pressure should be monitored for another hour without actively applying pressure. The pressure drop shall be predicted before the test and the test result should be within 10% of the prediction.

**305** Pressure vessels of low safety class shall be tested up to their service pressure. Pressures shall be applied for at least 10 minutes.

**306** Most authorities give general test requirements for pressure vessels. The requirements of the authorities that govern the location of the application shall be followed.

### **E 400 Other testing**

**401** It is recommended to test structures of safety class normal or high up to their main maximum service loads before going into service.

**402** A test programme should be established based on the requirements of the application and the possibilities to test the structure before it goes into service.

**403** An equivalent approach as the one described for pressure testing should be used.

## **E 500 Dimensions**

**501** The dimensions of the component shall be checked to be within the specified tolerances.

## **F. Installation**

- 101** The installation of composite structures shall be carefully planned. It shall be part of the design analysis.
- 102** Handling composite structures like metal structures may introduce severe damage. Any aspects of handling that deviates from typically practice with metal structures should be identified. Procedures should be in place to describe special handling requirements for composites.
- 103** Handling of composite structures requires special care. Handling instructions should follow each component.
- 104** Point loads and should be avoided
- 105** Scraping, wear and tear should be avoided.
- 106** Bending the structure into place should be avoided.
- 107** Lifting shall only be done at specially indicated spots that were designed to take such loads.
- 108** All installation activities shall be verified independently for high safety class components. Whether the verification shall be done by the manufacturer himself, by the customer, or by a third party should be decided by the project.

## **G. Safety Health and Environment**

- 101** The fabrication of laminates may involve certain health risks. This guideline does not address these issues.
- 102** All regulations with respect to safety, health and environment should be followed.
- 103** It is also recommended to perform a careful evaluation of all risks involved in producing composite structures.

## SECTION 12 INSPECTION AND REPAIR

<b>SECTION 12</b>	<b>INSPECTION AND REPAIR</b>	<b>1</b>
<b>A.</b>	<b>INSPECTION</b>	<b>1</b>
A 100	GENERAL	1
A 200	INSPECTION METHODS	2
<b>B.</b>	<b>REPAIR</b>	<b>2</b>
B 100	REPAIR PROCEDURE	2
B 200	REQUIREMENTS FOR A REPAIR	3
B 300	QUALIFICATION OF A REPAIR	3

### A. Inspection

#### A 100 General

- 101** An inspection philosophy for the component should be established. The philosophy shall at least contain:
- The items to be inspected, arranged according to their order of importance.
  - The parameters to look for / measure. (Such as: Cracks, delaminations, impact damages, overheating (or damages from local burning), visible overloading (bending, unintended use), discoloration.
  - Methods of inspection to be applied for each item
  - Inspection frequency
  - Acceptance criteria
  - Reporting routines
- 102** In case of findings at the inspections, a plan should be worked out listing suggested actions to be taken, depending on the type of findings. The plan may be included in the inspection philosophy.
- 103** Inspection procedures shall be defined for:
- Manufacturing control
  - Detection of damage due to accidental loads or overloads in all phases
  - Detection of damage due to unexpected high degradation of long term properties in all phases
- 104** Inspection shall be linked to possible failure modes and mechanisms identified in the design.



## **A 200 Inspection methods**

- 201** Available inspection methods can often not detect all critical failure mechanisms. However, the methods may detect preceding failure mechanisms. A link between detectable failure mechanisms and critical failure mechanisms shall be established.
- 202** In many cases a complete inspection programme cannot be developed due to the limited capabilities of available NDE equipment. In that case the following alternatives may be used:
- 203** Inspection of components during or right after manufacturing may be replaced by well documented production control.
- 204** Inspection to detect damage due to accidental loads or overloads may be compensated for by monitoring the loads and comparing them to the design loads.
- 205** Effect of higher degradation than expected can be compensated for by using the failure type brittle in the long term analysis.
- 206** If the failure mechanisms are not fully understood, or competing failure mechanism are present and one is uncertain about their sequence, inspection is required.
- 207** Inspection frequencies should be determined for each project.

## **B. Repair**

### **B 100 Repair procedure**

- 101** A repair procedure shall be given for each component.
- 102** A repair shall restore the same level of safety and functionality as the original structure, unless changes are accepted by all parties in the project.
- 103** An acceptable repair solution is to replace the entire component if it is damaged. This approach requires that the component can be taken out of the system.
- 104** It may also be acceptable to keep a component in service with a certain amount of damage without repairing it. The size and kind of acceptable damage shall be defined and it must be possible to inspect the damage. The possible damage shall be considered in the design of the structure.
- 105** If local damage may happen to the structure detailed procedures to repair such anticipated damage shall be given.
- 106** If the damage is due to an unknown loading condition or accident, an analysis of the damage situation shall be carried out. The analysis shall identify whether the damage was due to a design mistake or an unexpected load condition. If the

unexpected load may reoccur a design change may be required.

**B 200 Requirements for a repair**

- 201** A repair should restore the stiffness and strength of the original part. If the stiffness and/or strength cannot be restored, the performance of the component and the total system under the new conditions shall be evaluated.
- 202** It shall be documented that local reduction in strength may not be critical for the total performance of the structure.

**B 300 Qualification of a repair**

- 301** A repair is basically a joint introduced into the structure. The repair shall be qualified in the same way as a joint (see *Section 7*).
- 302** The repair procedure used to qualify the joint shall also be applicable for each particular repair situation.
- 303** Suitable conditions for repair work shall be arranged and maintained during the repair. This is mandatory, irrespective of whether the repair is carried out on site or elsewhere. If suitable conditions cannot be arranged and maintained on site, the component should be moved to a more suitable site.

## SECTION 13 DEFINITIONS, ABBREVIATIONS & FIGURES

<b>SECTION 13</b>	<b>DEFINITIONS, ABBREVIATIONS &amp; FIGURES</b>	<b>1</b>
<b>A.</b>	<b>DEFINITIONS</b>	<b>1</b>
A 100	GENERAL	1
A 200	TERMS	1
<b>B.</b>	<b>SYMBOLS AND ABBREVIATIONS</b>	<b>7</b>
<b>C.</b>	<b>FIGURES</b>	<b>10</b>
A 200	PLY AND LAMINATE CO-ORDINATE SYSTEMS	10
A 300	SANDWICH CO-ORDINATE SYSTEM AND SYMBOLS	10

### A. Definitions

#### A 100 General

**101** *May* is used to indicate a preference.

**102** *Shall* is used to indicate a requirement.

**103** *Should* is used to indicate a recommendation.

#### A 200 Terms

**Angle-ply laminate:** symmetric laminate, possessing equal plies with positive and negative angles.

**Anisotropy:** material properties varying with the orientation or direction of the reference co-ordinate.

**Box beam:** a sandwich beam is defined as a box beam if it has face material on 4 sides.

**Buckling:** global buckling refers to an unstable displacement of a structural part, such as a panel, caused by excessive compression and/or shear..

**Characteristic Load:** reference value of a load to be used in the determination of the load effects. The Characteristic Load is normally based upon a defined *fractile* is the upper end of the distribution function load.

**Characteristic Resistance:** the nominal value of the structural strength to be used in the determination of the design strength. The Characteristic Resistance is normally based upon a defined *fractile* in the lower end of the distribution function for resistance.

**Client** is understood to be the party ultimately responsible for the system as installed and its intended use in accordance with the prevailing laws, statutory rules and regulations.

**Component:** a major section of the structure, i.e. tower, that can be tested as a complete unit to qualify the structure.

**Condition:** A particular state of existence

**Construction phase:** all phases during construction, including transportation, installation, testing, commissioning and repair.

**Constituent:** In general, an element of a larger grouping. In advanced composites, the principal constituents are the fibres and the matrix.

**Contractor** is understood to be a party contracted by the Client to perform all or a part of the necessary work needed to bring the System to an installed and operable condition.

**Core:** The central member of a sandwich construction . Metallic or composites facing materials are bonded to the core to form a sandwich panel.

**Cross-ply laminate:** special laminate that contains only 0 and 90 degree plies

**Delamination:** separation or loss of bonds of plies (the 2-D layers) of material in a laminate.

**Design load:** Characteristic load multiplied by the load factor.

**Design resistance:** Characteristic resistance divided by the resistance factor.

**Design rule:** Requirement which is to be fulfilled during design as part of a so-called code check. The design rule is usually an inequality expressed in terms of the design load and the design resistance, e.g., the design load shall be less than or equal to the design resistance. The form of the design rule may resemble the form of the failure criterion, however, it is expressed in terms of fixed design values of the load and resistance variables, whereas the failure criterion is expressed in terms of the physical, stochastic load and resistance variables themselves.

**Design value:** Value to be used in deterministic design procedure, i.e., characteristic value modified by the partial load factor or the partial resistance factor.

**Detail:** or sub-component is a major three-dimensional structure that can provide complete structural representation of a section of the full structure.

**Environmental conditions:** environmental exposure that may harm or degrade the material constituents.

**Environmental loads:** loads due to the environment, such as waves, current, wind, ice, earthquakes.

**Fabric:** planar, woven material constructed by interlacing yarns, fibres or filaments.

**Fabrication:** all operations related to the material assembly into objects with a defined purpose

**Face:** sheet, consisting of metal or layers of composite materials, adhesively bonded to a core material in a sandwich structure.

**Failure criterion:** criterion to define or identify when failure has occurred, usually expressed as an inequality in the governing variables, e.g. load greater than resistance.

**Failure mechanism:** A mechanism of failure is the underlying phenomenon at the material level that determines the mode of failure. Depending on its level of severity a mechanism of failure can lead to various failure. Failure mechanisms are specific to material type.

**Failure mode:** State of inability to perform a normal function, or an event causing an undesirable or adverse condition, e.g. violation of functional requirement, loss of component or system function, or deterioration of functional capability to such an extent that the safety of the unit, personnel or environment is significantly reduced.

**Failure probability:** Probability of failure during a specified time interval such as the design life of a structure.

**Failure type:** failure types are based on safety margin, intrinsic to a given failure mechanism. A distinction is made between catastrophic and progressive failures, and between failures with or without reserve capacity during failure.

**Failure:** A state of inability to perform a normal function, or an event causing an undesirable or adverse condition, e.g. violation of functional requirement, loss of component or system function, or deterioration of functional capability to such an extent that the safety of the unit, personnel or environment is significantly reduced.

**Fatigue:** in materials or structures, the cumulative and irreversible damage incurred by cyclic or static application of mechanical and/or thermal loads in given environments.

**Fibre Reinforced Plastic (FRP):** a general term polymeric composite reinforced by fibres.

**Fibre:** single filament, rolled or formed in one direction, and used as the principal constituent of woven or non-woven composite materials.

**Filament:** The smallest unit of a fibrous material. The basic units formed during drawing and spinning, which are gathered into strands of fibre. It is a continuous discrete fibre with an effective diameter in the range of few micrometers depending on the source.

**Functional requirement:** a functional requirement is defined as a requirement that the global structure has to fulfil.

**Glass Fibre Reinforced Plastic (GRP):** general term polymeric composite reinforced by glass fibres.

**homogeneous:** Descriptive term for a material of uniform composition throughout. A medium that has no internal physical boundaries.

**Inspection:** activities, such as, measuring, examination, testing, gauging one or more characteristic of a product or a service, and comparing the results with specified requirements to determine conformity.

**Installation:** operation related to setting up a system, components or parts.

**Interface:** boundary or transition zone between constituent materials, such as the fibre/matrix interface, or the boundary between plies of a laminate or layers of a sandwich structure. Boundary between different materials in a joint. An interface can also be the area where two components or parts touch each other.

**Lamina:** same as ply.

**Laminae:** Plural of lamina

**Laminate:** Layers of a plies bonded together to form a single structure. Also the process to build a laminate.

**Laminate ply:** One layer of a laminated product.

**Layer:** A single ply of lay up or laminate.

**Limit State:** state beyond which the structure fails to meet a particular functional requirement. A functional requirement can be related to various limit states depending on the modes of failure mode. The following two limit state categories are considered in the Guideline:

**Load effect:** effect of a single load or combination of loads on the system, such as stress, strain, deformation, displacement, acceleration, etc.

**Load factor:** Partial Safety Factor by which the characteristic load is multiplied to obtain the design load.

**Load effect factor:** Partial Safety Factor by which the characteristic load effect is multiplied to obtain the design load effect.

**Load:** assembly of concentrated or distributed forces acting on a structure (direct loads), or cause of imposed or constrained deformations in a structure (indirect loads).

**Local buckling:** unstable displacement of a sub-structural part, such as a lamina, face or cell caused by excessive compression and/or shear.

**Manufacturer** is the party, which manufactures or supplies equipment to perform the duties specified by the Contractor

**Matrix:** the cured resin or polymer material in which the fibre system is imbedded in a ply or laminate.

**Monolithic structure:** laminate consisting uniquely of composites materials except core materials; also called single-skin structure.

**Off-axis:** not coincident with the symmetry axis; also called off-angle.

**On-axis:** coincident with the symmetry axis; also called on-angle.

**Open beam:** a sandwich beam is defined as an open beam if it has face material on 2 sides only.

**Operator** is the party, which assumes ultimate responsibility for the operation and maintenance

of the System. The Operator may or may not be the same as the Principal or Principal's agent.

**Orthotropic:** having three mutually perpendicular planes of material symmetry.

**Owner:** person who is understood to be the operative owner of the System (*same as client?*)

**Part:** A component can be divided into parts

**Partial Factor:** Partial factors are assigned to basic variables in order to take into account their inherent uncertainties or systematic errors.

**Phase:** A well-defined period within the lifespan of a structure.

**Ply:** Basic building block of a laminate with orthotropic properties. Layer of reinforcement surrounded by a matrix.

**Principal:** is the party, which initiates the project and ultimately pays for its design and construction. The Principal will generally specify the technical requirements. The Principal is ultimately responsible for ensuring that safety and all other issues are addressed. The Principal may also include an agent or consultant, authorised to act for the Principal.

**Reinforcement:** a strong material embedded into a matrix to improve its strength, stiffness and impact resistance.

**Reliability:** Ability of a structural component or system to perform its required function without failure during a specified time interval. The reliability is expressed as a probability, sometimes denoted the probability of survival, and can be determined as the probability density integrated over the safe states in the space spanned by the governing stochastic variables. The reliability is the complement of the failure probability.

**Resistance factor:** Partial Safety Factor by which the Characteristic Strength is divided to obtain the design strength, in other literature often termed as Material Factor.

**Resistance:** capability of a structure or part of a structure, to resist load effects.

**Risk:** the quantified probability of a defined failure mode multiplied by its quantified consequence.

**Roving:** a number of strands, tows, or ends collected into a parallel bundle with little or no twist.

**Sandwich Structure:** a structural sandwich is a special form of a laminated composite comprising of a combination of different materials that are bonded to each other so as to utilise the properties of each separate component to the structural advantage of the whole assembly.

**Strand:** Normally a untwisted bundle or assembly of continuous filaments used as a unit, including slivers, twos, ends, yarn and so forth, Sometimes a single filament is called a strand.

**Structure:** general word for system, component, or detail, i.e. when the distinction of size and location is not important.

**Stacking sequence:** A description of the orientation of plies in a laminate

**System:** An assembly consisting of a range of components, connections, attachments, etc.

**Warp:** The direction along which yarn is orientated longitudinally in a fabric and perpendicularly to the fill yarn.

**Weft:** The transversal threads of fibres in a woven fabric running perpendicular to the warp.



## B. Symbols and Abbreviations

<b>Variables</b>	
1,2,3	: ply, laminate, or core local co-ordinate system , 1 being the main direction
a	: half crack length
$a_i$	: scalar
$A_{i,j}$	: matrix A components
[A]	: extensional stiffness matrix
b	: width
b'	: horizontal distance between faces NA for boxed beam
C	: swelling agent concentration coefficient
COV	: coefficient of variation
d	: vertical distance between faces neutral axis (NA)
D	: flexural rigidity
$D_0$	: flexural rigidity of faces about the NA of the entire sandwich structure
e	: core width
{e}	: expansional strain field
E	: modulus of elasticity
$e_i$	: general expansional strain
f	: correction factor - scalar
G	: shear modulus
G	: strain energy release rate
h	: height of boxed beam
H	: anisotropy factor
I	: 2 <sup>nd</sup> moment of area
k	: scalar
K	: stress intensity factor
l	: length
m	: surface mass
M	: moment
N	: in-plane load
$Q_{i,j}$	: matrix Q components
[Q]	: stiffness matrix
R	: resistance
S	: shear stiffness, local or global structure response
SCF	: stress concentration factor
$S_{i,j}$	: matrix S components
[S]	: transformed compliance matrix
t	: thickness
T	: transverse load, temperature
U	: strain energy
u,v,w	: displacement in (x,y,z)
V	: volume fraction
x,y,z	: global co-ordinate system
$\Phi$	: failure criteria function
$\Psi$	: ratio between quantiles in the marginal distributions and extreme-value distributions
$\alpha$	: thermal expansion coefficient
$\alpha$	: loading mode factor

<b>Variables</b>	
$\beta$	: thermal swelling coefficient, or boundary conditions factor
$\epsilon$	: direct strain, i.e. $\epsilon_1$ in the main direction
$\hat{\epsilon}$	: strain to failure
$\{\epsilon\}$	: strain field
$\gamma$	: shear strain
$\gamma_F$	: partial load factors
$\gamma_{FM}$	: partial load and resistance factor
$\gamma_M$	: partial resistance factors
$\gamma_{Rd}$	: partial model factor, resistance component
$\gamma_{Sd}$	: partial model factors, load component
$\mu$	: mean value
$\nu$	: Poisson's ratio, i.e. major $\nu_{12}$ , minor $\nu_{21}$
$\theta$	: ply angle
$\rho$	: density
$\sigma$	: direct stress, i.e. $\sigma_1$ in the main direction, or standard deviation
$\hat{\sigma}$	: strength, or stress to failure
$\{\sigma\}$	: stress field
$\tau$	: shear stress, i.e. $\tau_{12}$ (or $\sigma_{12}$ sometimes)
$\omega$	: angular velocity

Table 1: Definitions of symbols for variables

<b>Subscripts</b>	
b	: bending effects
ben	: bending
c	: compression
core	: core
corrected	: value corrected by using a correction factor
cr	: critical
d	: design
Delam	: delamination
E(n)	: time curve
face	: face
Fiber	: fiber
i	: effects due to in-plane size of sandwich beam
ip	: effects due to in-plane size of sandwich panel
k	: characteristic value
Matrix	: matrix
max	: maximum
meas	: measured value
min	: minimum
nom	: nominal
ply	: ply
ref	: mean of the measured values
Shear	: shear
sl	: shear-loaded
SLS	: serviceability limit state
t	: tension
tc	: core thickness effects
typ	: typical value
ULS	: ultimate limit state

Table 2: Definitions of subscripts

<b>Superscripts</b>	
-	: maximum direct or shear stress in the structure/component
^	: direct or shear stress of material at failure
*	: elastic or shear modulus of damaged face or core
nl	: non-linear
lin	: linear
0	: initial
1	: final
top	: top face
bottom	: bottom face

Table 3: definitions of superscripts

<b>Sub-subscripts</b>	
lin	: proportional limit

Table 4: Definitions of sub-subscripts

### C. Figures

#### A 200 Ply and laminate co-ordinate systems

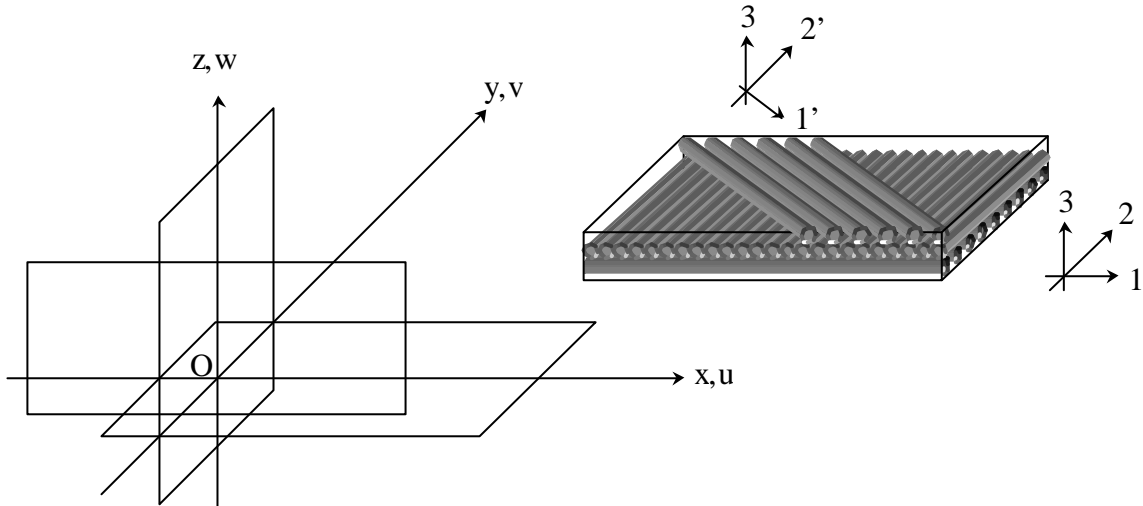

Figure 1: Local Co-ordinate System and Symmetry Planes in an Orthotropic Bi-directional Ply.

#### A 300 Sandwich co-ordinate system and symbols

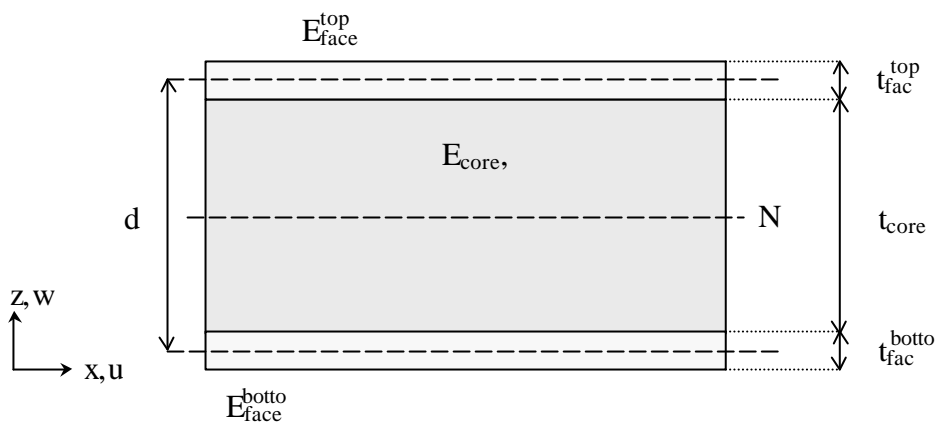

Figure 2: Co-ordinate System, Material and Geometrical Variables for Sandwich Structures

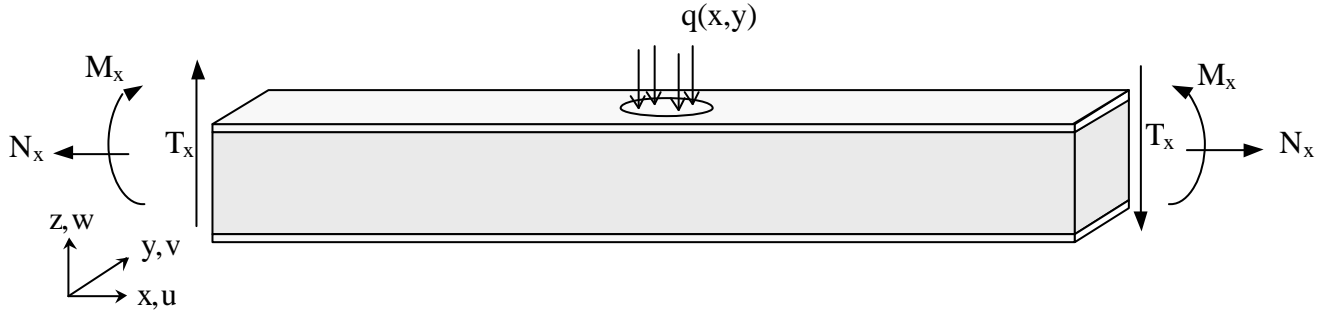

Figure 3: Co-ordinate System, Sign Conventions, Loads and Moments for Sandwich Structures

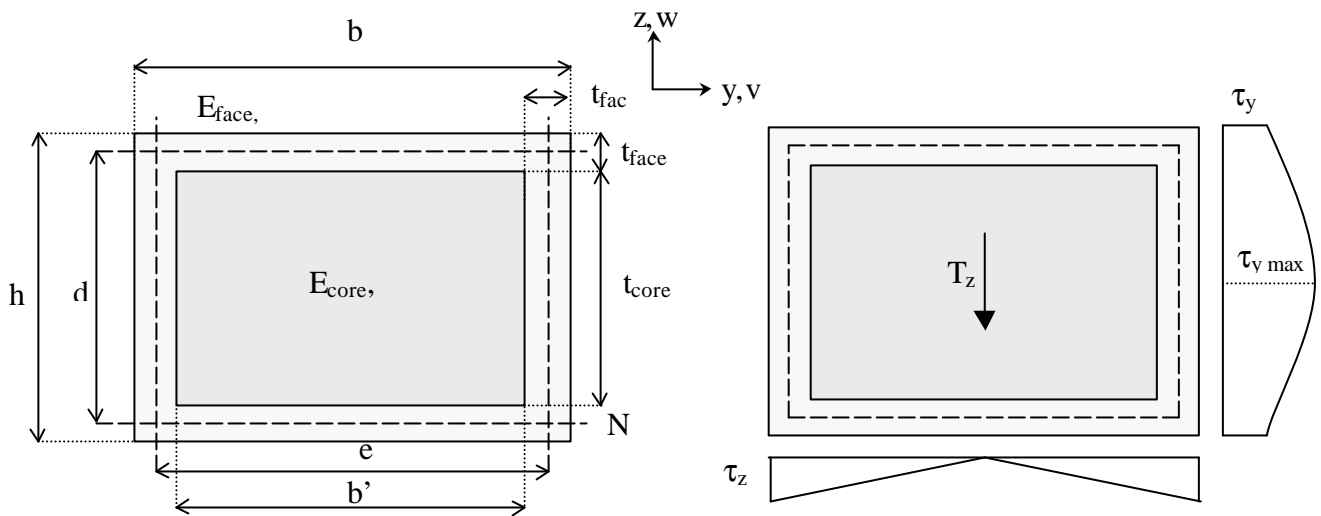

Figure 4: Co-ordinate System, Geometrical Variables and Shear Stress Distribution for Box Beam

## SECTION 14 CALCULATION EXAMPLE: TWO PRESSURE VESSELS

<b>SECTION 14 CALCULATION EXAMPLE: TWO PRESSURE VESSELS</b>		<b>1</b>
<hr/>		
<b>A. OBJECTIVE</b>		<b>2</b>
<b>B. DESIGN INPUT</b>		<b>3</b>
B 100	OVERVIEW	3
B 200	GENERAL FUNCTION (SECTION 3.B.100)	3
B 300	PRODUCT SPECIFICATIONS (SECTION 3.B.200)	3
B 400	DIVISION OF THE PRODUCT INTO COMPONENTS (SECTION 3.C)	4
B 500	PHASES AND SAFETY CLASS DEFINITIONS (SECTION 3.D AND 3.E)	4
B 600	FUNCTIONAL REQUIREMENTS (SECTION 3.F)	6
B 700	FAILURE MODES (SECTION 3.G)	7
B 800	LOADS (SECTION 3.I)	9
B 900	ENVIRONMENT (SECTION 3.J)	10
<b>C. FAILURE MECHANISMS</b>		<b>10</b>
C 100	IDENTIFICATION OF FAILURE MECHANISMS (SECTION 6 A)	10
C 200	CLASSIFICATION OF FAILURE MECHANISMS BY FAILURE TYPES (SECTION 6A)	13
C 300	FAILURE MECHANISMS AND TARGET RELIABILITIES (SECTION 2C500)	14
<b>D. MATERIAL PROPERTIES</b>		<b>15</b>
D 100	GENERAL (SECTION 4)	15
D 200	PLY MODULUS IN FIBRE DIRECTION $E_1$	17
D 300	MATRIX DOMINATED ELASTIC PROPERTIES	18
D 400	FIBRE DOMINATED PLY STRENGTH AND STRAIN TO FAILURE	19
D 500	MATRIX DOMINATED PLY STRENGTH AND STRAIN TO FAILURE	20
D 600	TIME TO FAILURE FOR FIBRE DOMINATED PROPERTIES	20
D 700	TIME TO FAILURE FOR MATRIX DOMINATED PROPERTIES	20
D 800	TEST REQUIREMENTS	21
<b>E. ANALYSIS OF GAS VESSEL WITH LINER</b>		<b>22</b>
E 100	GENERAL	22
E 200	ANALYSIS PROCEDURE (SECTION 9)	23
E 300	FIBRE FAILURE - SHORT-TERM (SECTION 6C)	24
E 400	FIBRE DOMINATED PLY FAILURE DUE TO STATIC LONG-TERM LOADS (SECTION 6J)	25
E 500	FIBRE DOMINATED PLY FAILURE DUE TO CYCLIC FATIGUE LOADS (SECTION 6K)	27
E 600	MATRIX CRACKING (SECTION 6D)	28
E 700	UNACCEPTABLY LARGE DISPLACEMENT (SECTION 6I)	28
E 800	IMPACT RESISTANCE (SECTION 6L)	30
E 900	EXPLOSIVE DECOMPRESSION (SECTION 6O)	30
E 1000	CHEMICAL DECOMPOSITION (SECTION 6Q)	30
E 1100	SUMMARY EVALUATION	30
<b>F. NONLINEAR ANALYSIS OF VESSEL FOR WATER WITHOUT LINER</b>		<b>31</b>
F 100	GENERAL	31
F 200	ANALYSIS PROCEDURE (SECTION 9B)	31
F 300	MATRIX CRACKING (SHORT TERM) AT 1.48 MPa PRESSURE (SECTION 6D)	34
F 400	MATRIX CRACKING UNDER LONG-TERM STATIC LOADS (SECTION 4C400)	35
F 500	MATRIX CRACKING UNDER LONG-TERM CYCLIC FATIGUE LOADS (SECTION 4C900)	35
F 600	FIBRE FAILURE - SHORT-TERM (SECTION 6C)	35
F 700	FIBRE DOMINATED PLY FAILURE DUE TO STATIC LONG TERM LOADS (SECTION 6J)	36
F 800	FIBRE DOMINATED PLY FAILURE DUE TO CYCLIC FATIGUE LOADS (SECTION 6K)	37
F 900	UNACCEPTABLY LARGE DISPLACEMENT (SECTION 6I)	37
F 1000	IMPACT RESISTANCE (SECTION 6L)	37

F 1100	EXPLOSIVE DECOMPRESSION (SECTION 6O)	38
F 1200	CHEMICAL DECOMPOSITION (SECTION 6Q)	38
F 1300	COMPONENT TESTING (SECTION 10)	38
F 1400	SUMMARY EVALUATION	38
<b>G.</b>	<b>LINEAR ANALYSIS OF VESSEL FOR WATER WITHOUT LINER</b>	<b>39</b>
G 100	GENERAL	39
G 200	ANALYSIS PROCEDURE (SECTION 9B)	39
G 300	MATRIX CRACKING (SHORT TERM) (SECTION 6D)	40
G 400	MATRIX CRACKING UNDER LONG-TERM STATIC LOADS (SECTION 4C400)	41
G 500	MATRIX CRACKING UNDER LONG-TERM CYCLIC FATIGUE LOADS (SECTION 4C900)	41
G 600	FIBRE FAILURE – SHORT-TERM (SECTION 6C)	41
G 700	FIBRE DOMINATED PLY FAILURE DUE TO STATIC LONG-TERM LOADS (SECTION 6J)	43
G 800	FIBRE DOMINATED PLY FAILURE DUE TO CYCLIC FATIGUE LOADS (SECTION 6K)	44
G 900	UNACCEPTABLY LARGE DISPLACEMENT	44
G 1000	IMPACT RESISTANCE	44
G 1100	EXPLOSIVE DECOMPRESSION	44
G 1200	CHEMICAL DECOMPOSITION	44
G 1300	SUMMARY EVALUATION	44

## A. Objective

- 101** This example shows the use of the guideline for the body of two simple pressure vessels. The intention of the example is to demonstrate the use of the guideline, its flow and philosophy and to point out important aspects to consider.
- 102** The example looks into many aspects of design, even though some aspects may not be critical for this example. This is done to make the example more useful for a wide range of other applications.
- 103** The two pressure vessels described here are identical except for two aspects. The vessels are:
- A pressure vessel with liner for storage of gas (air)
  - A pressure vessel without liner for storage of water
- 104** The example will concentrate only on the body of the vessels to show the main approach.
- 105** Both vessels are designed for high safety class to demonstrate the difference of using a liner or not without changing other parameters.
- 106** References to parts of the guideline are given in some of the headings, if the respective section is related to one section of the guideline. In addition references are given to specific sections or paragraphs.

## B. Design Input

### B 100 Overview

- 101** This part describes the input needed for the analysis of the structure.
- 102** The guideline is organised in a way to ensure that the input is given in a systematic and complete way. Checklists are provided to ensure that all aspects are considered.
- 103** An experienced designer may quickly show that many of the steps described here do not have to be considered for this example. These steps are shown here as guidance for designing more complicated structures.

### B 200 General function (Section 3.B.100)

- 201** The components shall be two cylindrical pressure vessels, one for the storage of gas (air), the other for the storage of liquid (water).

### B 300 Product specifications (Section 3.B.200)

- 301** A basic simple description is given in the table below. Both pressure vessels are basically identical, except that the gas vessel has a liner while the water vessel does not.

	Gas vessel with liner	Water vessel without liner
Inner diameter:	250 mm	250 mm
Length of tank:	1800 mm	1800 mm
Thickness of laminate:	6 mm	6 mm
Max. Pressure:	46 bar*	14.8 bar*
Service Pressure:	46 bar*	14.8 bar*
Design temperature:	Room temperature	Room temperature
Design life:	25 years	25 years
Type of resin:	Polyester	Polyester
Type of liner:	High density polyethylene	None
Type of laminate:	Filament winding	Filament winding
Type of fibres:	E-glass	E-glass

\* pressures have been chosen to demonstrate the maximum capability of the vessels, when both vessels have the same laminate lay-up and the same thickness.

- 302** The laminate has the following interwoven winding sequence:

±15  
 ±85  
 ±85  
 ±85  
 ±85  
 ±15

Each sequence has the same thickness of 1mm.



**B 400 Division of the product into components (Section 3.C)**

**401** Both pressure vessels can be divided into the following parts:

- Main cylindrical body
- Two end-caps with:
  - Inlet nozzle for water or gas pipe
  - Nozzle for venting
  - Nozzle for pressure gauge
  - Lifting rings
- Support structure to store vessel on the ground
- Liner (gas vessel only)
- Liner - laminate interface (gas vessel only)

**402** Only the design of the laminate shell (cylindrical part) is considered here, to keep the example simple.

**B 500 Phases and safety class definitions (Section 3.D and 3.E)**

**501** The vessels will be built, transported, installed and operated. The minimum phases to consider are construction and operation. A more detailed division into phases is shown in the table below. Further comments are given in Appendix 3A.

Manufacturing	Construction
Fabrication / Assembly	
Transport	
Handling	
Storage	
Installation	
Testing	
Commissioning	
Operation	Operation
Maintenance	
Repair	Post-operation.
Retrieval / recirculation	

**502** Consider the duration of each phase and the corresponding safety class.

Phase	Duration	Safety class	Comments
Manufacturing Fabrication/ Assembly	NR	Low	Not determining design dimensions- structure is not loaded. Thermal stresses may have to be considered (not done in this example)
Transport Handling Storage	NR	Low	Appropriate precautions are assumed to be taken, so that point loads and other loads will not determine design dimensions. Not considered in this example, but transport loads can often be critical.
Testing (tank alone)	Some hours	Low	Pressure test with water. Test set-up must be secured (safety cage). Possible pressure shocks or vibrations may fatigue connected pipes/valves/flanges and fittings, but not considered to be a problem for the vessel body.
Installation	NR	Low	No pressure during installation. Overloading during hook-up because of over-tightening of bolts is assumed to be prevented, and will thus not determine design dimensions.
Commissioning	Some hours / days	Gas: High Water: High	System test. Will not determine design dimensions, since it is not different from operating conditions.
Operation	25 years	Gas: High Water: High	To be de-pressurised every week (1300 load cycles during the design life). Safety class high is chosen here for both vessels to allow a better comparison between the two designs.
Maintenance	NR	NR	Not considered*
Repair	NR	NR	Not considered*
Scrapping / recirculation			Not considered*

NR = Not relevant (no loads are applied or duration is so short that the actual time is irrelevant).

\* We assume maintenance and repair to be carried out without pressure in the vessel.

**503** This evaluation should be repeated for each part of the structure.

**504** Only the two phases Testing and Operation will be considered in this example.

**B 600 Functional requirements (Section 3.F)**

**601** In this example connected pipes, fittings and supports are not included. A checklist of more functional requirements is given in appendix 3.A, part B. Only the relevant ones for the design of the laminate shell with respect to testing and operation are listed here:

Functional Requirements	Phases				Comments
	With liner (gas)		Without liner (water)		
	Testing	Operation	Testing	Operation	
Pressure containment	X	X	X	X	
Tightness (of laminate)			X	X	A tight liner is sufficient for the gas vessel

**602** The other functional requirements given in Appendix 3A Part B were excluded for the following reasons:

Minimum list of Functional Requirements	Relevance for this Example
Load carrying capacity	Pressure containment is the only load
Dimensional stability	No dimensional requirements
Environmental, chemical and UV resistance	Used inside
Maximum vibrations	No vibrations are present
Fire Resistance	No fire requirements
Temperature insulation	Everything is at room temperature
Erosion, abrasion, wear	Not relevant here, but some designs may have sliding supports, strapping devices etc.
Electrical Resistance or Insulation	Not relevant
Static Electricity / Grounding	Not relevant here, but is important if the fluid may be flammable
Lightning resistance	Inside storage

**603** A complete analysis should include all parts of the component and all phases.

**B 700 Failure modes (Section 3.G)**

**701** The minimum list of failure modes is evaluated for the laminate of the main body:

<b>Minimum list of Failure Modes</b>	<b>Evaluation</b>
<b>Fracture</b> (local or global)	Relevant
Buckling (local or global)	Not relevant, since we have no compressive loads.
Burst	Here same as fracture, since no high rate loads are applied
<b>Leakage</b>	Relevant
<b>Impact</b>	Relevant, if tools can be dropped on the vessel etc.
<b>Excessive deformation,</b> Ovalisation, Excessive displacement	Relevant for vessel with liner, because the liner may have a failure strain that should not be exceeded. This strain may put a limit on the strain of the body of the vessel. Otherwise not relevant, since the vessel has no restrictions on deformation. Large deformations may be linked to some other failure modes, but this is covered by analysing the other failure modes.
Wear	Not relevant, since nothing slides over the vessel.

No other failure modes than the ones given in the table have been identified.

**702** The evaluation above should be carried out for all parts of the vessel, but this is not covered in the example.

**703** The relevant failure modes shall be linked to the functional requirements of each part of the component. In the present example this link is only considered for the main body of the vessel.

<b>Functional Requirement</b>	<b>Failure Mode</b>	<b>Comments</b>
Pressure containment	Fracture, Local fracture	Shall always be checked.
	Impact	Damage from impact may effect capacity to contain pressure.
	Excessive deformation	Relevant if deformation is large enough to cause the liner to fail.
	Leakage	Related to fracture, but often just a gradual release of fluid from a pressure vessel. Fracture will cause leakage, but other minor failure mechanisms may also cause leakage. Failure consequence is often less critical and related to normal safety class, but it depends on the fluid.
Tightness/Fluid containment	Same as pressure containment	

**704** Discussions regarding the link between failure mode and limit state should take place between the designer and the client. All failures related to modes that lead to pressure loss or leakage are considered to be Ultimate Limit States (ULS) in this example, i.e., all failure modes are linked to an ULS condition.

**B 800 Loads (Section 3.I)**

**801** For each load a characteristic value shall be established. A checklist of common loads is given in appendix 3A in the Guideline. Only pressure load is considered in this example.

Gas tank with liner:

Load	Char. value	COV	Sustained value	Fatigue value
<b>Pressure loads:</b>				
Maximum peak pressure*, here also identical to assumed operating pressure	46 bar	0	46 bar	0 – 46 bar (1300 times)

Water tank without liner:

Load	Char. value	COV	Sustained value	Fatigue value
<b>Pressure loads:</b>				
Maximum peak pressure*, here also identical to assumed operating pressure	14.8 bar	0	14.8 bar	0 – 14.8 bar (1300 times)

The peak pressure is the maximum pressure the system can reach.

**802** The pressure vessel will be released once a week for less than 1 hour. In 25 years, this will add up to 1300 cycles between 0 bar and 46 bar for the gas tank and between 0 bar and 14.8 bar for the water tank.

**803** The vessel will be pressure tested to peak pressure for certification after installation.

**B 900 Environment (Section 3.J)**

**901** Appendix 3A, part D contains a checklist of common environmental parameters. Only relevant environmental parameters for this example are included below.

<b>Long-term development of environmental parameters</b>				
Environment:	Char. value	COV	Sustained value	Fatigue value
<b>Natural:</b>				
Temperature external (surrounding air):	20 °C	±50 %*	20 °C	Not relevant here
<b>Functional:</b>				
Temperature internal (water /air):	20 °C	±50 %*	20 °C	Not relevant here
Exposure to water (for water vessel only)	-		permanent	

\*Temperature changes of that magnitude do not modify the properties of the materials considerably. Therefore, the COV is not critical in this example.

**C. Failure Mechanisms**

**C 100 Identification of failure mechanisms (Section 6 A)**

**101** All failure mechanisms on the material level shall be identified. A minimum list is given in *Section 6 A 102*. In this example the relevant failure mechanisms for a laminate are identified in the Table below.

<b><i>Failure mechanisms relevant for laminates</i></b>
Fibre Failure
Matrix Cracking
Matrix Crack Growth
Delamination
Elastic buckling
Unacceptably large displacements
Stress Rupture
Fatigue
Wear
Fire*
Explosive decompression*
Impact*
Chemical Decomposition

\* these items are load conditions, but are treated here as failure mechanisms to simplify the approach in the Guideline.

**102** Once the relevant failure mechanisms for the material are identified they shall be evaluated with respect to the critical failure modes of the component. Failure mechanisms that are linked to critical failure modes shall be analysed, other failure mechanisms can be ignored. Linking failure modes and mechanisms is shown in *Section 6 A 500*. The results for this example are:

Failure Modes of this example	Failure Mechanisms	Comments
Fracture (local/global)	Fibre Failure	Is assumed to cause fracture. Shall always be checked.
	Matrix Cracking	Causes leakage if no liner is present, but no fracture.
	Matrix Crack Growth	Not critical since matrix cracking is not critical.
	Delamination	Not critical because no compressive in-plane stresses are present (no danger of buckling) and no through thickness tensile stresses (thin shell) appear.
	Yielding	Not relevant
	Buckling	Not relevant since no compressive and/or significant in-plane shear loads are present.
	Unacceptably large displacement	No requirements to displacements or deformations are formulated.
	Stress Rupture	Effect shall be checked for all critical failure mechanisms mentioned above. In this case it is only fibre failure.
	Fatigue	
	Impact	Shall be checked
	Wear	Not relevant in this application
	Fire	Not relevant in this application
	Explosive Decompression	Shall be checked
	Chemical decomposition	Shall be checked



<b>Failure Modes of this example</b>	<b>Failure Mechanisms</b>	<b>Comments</b>
Leakage	Fibre Failure	Shall be checked.
	Matrix Cracking	Check this for vessel without liner. Acceptable for vessel with liner.
	Matrix Crack Growth	If data exist that show leakage will only occur after a certain crack density has been reached, this failure mechanism may be used instead of simple matrix cracking. In this example we use first matrix cracking as a conservative leak condition.
	Delamination	Not critical if liner is present. For vessel without liner matrix cracking happens prior to delamination. Since we check for matrix cracking we do not need to consider delamination.
	Yielding	Not relevant for the laminate.
	Buckling	Not relevant. See the comments for fracture.
	Unacceptably large displacement	Displacement should be limited to prevent liner failure for gas vessel. No restriction for water vessel without liner.
	Stress Rupture	Fibre failure: Same as for fracture. Matrix cracking – vessel with liner: Not relevant. Matrix cracking – vessel without liner: Check.
	Fatigue	
	Impact	Shall be checked
	Wear	Not relevant in this application
	Fire	Not relevant in this application
	Explosive decompression	Shall be checked
	Chemical decomposition	Shall be checked

<b>Failure Modes of this example</b>	<b>Failure Mechanisms</b>	<b>Comments</b>
Impact	Impact	Shall be checked
Excessive deformation	Unacceptably large displacement	Shall be checked for gas vessel to ensure that liner does not yield.

**103** Based on these tables we shall check the following failure mechanisms:

- Fibre failure:
  - Short-term static
  - Long-term static
  - Long-term fatigue
- Matrix cracking (for vessel without liner):
  - Short term static
  - Long-term static
  - Long-term fatigue
- Unacceptably large displacement (for vessel with liner)
- Impact resistance
- Explosive decompression
- Chemical decomposition

**C 200 Classification of failure mechanisms by failure types (Section 6A)**

**201** The critical failure mechanisms shall be linked to a failure type. This is described for laminates in Section 6 A 200 and also indicated in the Table below. The failure type must be known to find the right safety factors in the failure criteria.

<i>Failure mechanisms relevant for laminates</i>	<i>Failure Type</i>	<i>Comments</i>
Fibre Failure	Brittle	From <i>Table 6 A 201</i>
Stress Rupture	Brittle	From <i>6 A 402</i> . (The component cannot tolerate local fibre failure without burst.)
Fatigue	Brittle	
Matrix Cracking	Ductile	From <i>6 A 202</i>
Stress Rupture	Ductile	From <i>6 A 402</i> . (The component can tolerate initiation of local matrix cracks without instant leakage.)
Fatigue	Ductile	
Unacceptably large displacements	Ductile	From <i>6 I 103</i> . It is assumed here that the liner may be used up to the yield point. Since this is a ductile failure mode the failure type for the related displacement criterion can also be ductile.)
Explosive decompression*	Not applicable	
Impact*	Not applicable	
Chemical decomposition	Not applicable	

\* *these items are load conditions, but are treated here as failure mechanisms to simplify the approach in the Guideline.*

**C 300 Failure mechanisms and target reliabilities (Section 2C500)**

- 301** The safety level shall be determined for each relevant failure mechanism to obtain the right partial safety factors for the failure criteria.
- 302** Safety levels are given in *Section 2 C500* for different safety classes and failure types. Safety classes are related to components and phases. In this example we have only one component (the vessel) and we consider two phases, testing and operation (*see B500*):
- Testing phase: Low safety class
  - Operational phase: High safety class
- 303** All failure modes were identified as Ultimate Limit State conditions. Therefore, all associated failure mechanisms are also related to ULS and can be found in *Section 2 C500*.

<i>Failure mechanisms relevant for laminates</i>	<i>Failure Type</i>	<i>Safety levels Testing Phase</i>	<i>Safety levels Operation Phase</i>
Fibre Failure	Brittle	(C)	D
Stress Rupture	Brittle	(C)	D
Fatigue	Brittle	(C)	D
Matrix Cracking	Ductile	(A)	C
Stress Rupture	Ductile	(A)	C
Fatigue	Ductile	(A)	C
Unacceptably large displacements	Ductile	(A)	C
Explosive decompression*	NA	-	-
Impact*	NA	-	-
Chemical decomposition	NA	-	-

NA: Not applicable

(...): not considered, *see 304*

Note: Matrix cracking is only relevant for the vessel without liner (water)  
 Displacements should only be checked for the vessel with liner (gas)

- 304** All failure mechanisms shall be checked for all loads of the different phases. The failure mechanisms are the same for the testing and operational phase in this example. Short-term loads are the same in both phases and the operational phase has long-term loads in addition. Due to the simple situation of this example it is sufficient to analyse the component for the operational phase only.

## **D. Material properties**

### **D 100 General (Section 4)**

- 101** Properties must be measured or obtained from representative data as described in section 4.H. This example uses the representative data from Section 4 Appendix C and assumes that proper data have been obtained.
- 102** Only a small number of material parameters is needed compared to the extensive list given in Section 4. A simplified 2-D analysis is performed in this example. Only the four 2-D orthotropic elastic constants of the ply are needed. Since the component is loaded in tension (due to internal pressure) only the tensile and shear ply strengths are needed.
- 103** Ply properties are needed for the component at the first day and after 25 years, when it has been exposed to permanent loads and fatigue. How these properties are obtained is explained in the following sections. A summary of the properties is given below in *104*.

**104** The characteristic properties are summarised in the Tables below for a laminate without matrix cracks and with matrix cracks.

<b>Ply properties for laminate without matrix cracks (water vessel)</b>					
Property	New component	after 1300 fatigue cycles	after 1300 fatigue cycles in water	after 25 years of permanent pressure	after 25 years of permanent pressure in water
$E_{1 \text{ fibre}}$	23.7 GPa	23.7 GPa	21.3 GPa	23.7 GPa	21.3 GPa
$E_{2 \text{ matrix}}$	7.6 GPa	7.6 GPa*	6.8 GPa*	7.6 GPa	6.8 GPa
$\nu_{12}$	0.29	0.29*	0.29*	0.29	0.29
$G_{12 \text{ linear}}$	3.2 GPa	3.2 GPa*	2.9 GPa*	3.2 GPa	2.9 GPa
$\hat{e}_{1t}^{\text{ fibre}}$	1.69%	1.69%	1.69%	0.87%	0.87%
$\hat{S}_{1t}^{\text{ fibre}}$	401 MPa	401 MPa	361 MPa	205 MPa	185 MPa
$\hat{e}_{2t}^{\text{ matrix}}$	0.2%	0.2%	0.2%	0.2%	0.2%
$\hat{S}_{2t}^{\text{ matrix}}$	26.3 MPa	26.3 MPa	23.7 MPa	26.3 MPa	23.7 MPa
$\hat{e}_{12}^{\text{ matrix}}$	0.37%	0.37%	0.37%	0.37%	0.37%
$\hat{S}_{12}^{\text{ shear}}$	17.0 MPa	17.0 MPa	15.3 MPa	17.0 MPa	15.3 MPa
Time to fibre failure	Not applicable	<i>see D600</i>			
Time to matrix failure	Not applicable	<i>see D700</i>			

For low cycle fatigue at low stresses

<b>Ply properties for laminate with matrix cracks (gas vessel)</b>					
Property	New component	after 3000 fatigue cycles	after 3000 fatigue cycles in water	after 25 years of permanent pressure	after 25 years of permanent pressure in water
$E_1$ fibre	23.7 GPa	23.7 GPa	21.3 GPa	23.7 GPa	21.3 GPa
$E_2$ matrix	0.08 GPa	0.08 GPa	0.08 GPa	0.08 GPa	0.08 GPa
$\nu_{12}$	0.003	0.003	0.003	0.003	0.003
$G_{12}$ linear	0.03 GPa	0.03 GPa	0.03 GPa	0.03 GPa	0.03 GPa
$\hat{e}_{1t}$ fibre	1.69%	1.69%	1.69%	0.87%	0.87%
$\hat{S}_{1t}$ fibre	401 MPa	401 MPa	361 MPa	205 MPa	185 MPa
$\hat{e}_{2t}$ matrix	NR	NR	NR	NR	NR
$\hat{S}_{2t}$ matrix	NR	NR	NR	NR	NR
$\hat{e}_{12}$ matrix	NR	NR	NR	NR	NR
$\hat{S}_{12}$ shear	NR	NR	NR	NR	NR
Time to fibre failure	NR	<i>see D600</i>			
Time to matrix failure	NR	NR			

NR: Not relevant, since the matrix has already cracked

## D 200 Ply modulus in fibre direction $E_1$

**201** The ply modulus in fibre direction is 26.7 GPa according to the representative data from *Section 4 Appendix C*. Data are for stitchbonded materials, while the vessel is made by filament winding. Data should be corrected according to 4 H 1200:  
 $26.7 \times 0.8 / 0.9 = 23.7$  GPa.

### Guidance note:

It is recommended to use data measured from a laminate made by filament winding to avoid using the corrections made above. Good filament wound laminates can have as good properties as flat panels (*see also 4 H 1206*).

---e-n-d---o-f---g-u-i-d-a-n-c-e---n-o-t-e---

- 202** A reduction of 10% of  $E_{1 \text{ fibre}}$  is suggested after  $10^6$  cycles in *4 C602*. This component is only cycled 1300 times at relatively low strains, where experiments have shown that the modulus does not change. According to *4 C 603* the modulus can be chosen to remain the same, provided the data can be documented.
- 203** Exposure to water typically gives a reduction of 10% according to *Appendix 4C E201*. Therefore, 10% reduction for the exposure to water has been used for long-term fibre dominated properties.
- 204** The material may creep (obtain plastic deformation) to some extent under the permanent load, but the response to short-term loads is still the same as for the original elastic constants (*4 C 202*).
- 205** The fibre dominated ply modulus is not influenced by matrix cracks and the same values are used for the laminate with and without matrix cracks (*9 B 200*).

#### **D 300 Matrix dominated elastic properties**

- 301** The ply modulus transverse to the fibre direction and in in-plane shear are 8.4 GPa and 3.5 GPa, respectively, according to the representative data from *Section 4 Appendix C*. Data are for stitchbonded materials while the vessel is made by filament winding. Data should be corrected according to *4 H 1200*:  
 $8.4 \times 0.9 / 1.0 = 7.6 \text{ GPa}$ .  
 $3.5 \times 0.9 / 1.0 = 3.2 \text{ GPa}$ .
- 302** The Poisson's ratio is 0.29 according to the representative data from *Section 4 Appendix C*. It is not changed for other laminate types.
- 303** The change of the matrix dominated properties under fatigue is uncertain. Matrix cracks can develop even if ply stresses are below the level for initiation of matrix cracks under quasi-static loads. An accumulation of matrix cracks would reduce the matrix dominated stiffness values. The stiffness may drop to 0 (*4C601 and 602*). A value close to 0 (value for a cracked matrix) is used in the analysis of the gas tank. The same value as the original modulus is used for the water tank, since stresses are low and the load could be carried by a vessel full of matrix cracks (*4C606 and 4C805*). The prerequisites for not changing the modulus of the water vessel under fatigue are fulfilled as shown in the analysis in *F600*, where it is shown that matrix cracks will not develop within the lifetime of the vessel.
- 304** Elastic parameters under permanent load do not change. The permanent load may cause plastic deformation (*4 C 202*).
- 305** A 10% reduction for the exposure to water has been used for long-term properties.

**306** When matrix cracks have developed the parameters are set to 1% of the original value according to (9 B 208). Values are not reduced further to account for the influence of water.

**D 400 Fibre dominated ply strength and strain to failure**

**401** The characteristic strength to failure in fibre direction is 534 MPa according to the representative data from *Section 4 Appendix C*. Data are for stitchbonded materials while the vessel is made by filament winding. Data should be corrected according to 4.H1200:  $534 \text{ MPa} \times 0.6 / 0.8 = 401 \text{ MPa}$

**Guidance note:**

It is recommended to use data measured from a laminate made by filament winding to avoid using the corrections made above. Good filament wound laminates can have as good properties as flat panels (see also 4 H 1206).

---e-n-d---o-f---g-u-i-d-a-n-c-e---n-o-t-e---

**402** The characteristic strain to failure is given by:  $\epsilon = \sigma / E = 401 \text{ MPa} / 23.7 \text{ GPa} = 1.69\%$

**403** The long term fibre strength is not effected by fatigue, but by long term static loads (4C900). This is evaluated in 405.

**404** Exposure to water gives typically a reduction of 10% for strength and modulus according to *Appendix 4C E201*.

**405** The strength is reduced by permanent loads as described in the stress rupture equation in 4.C401. The representative values give a 55.6% reduction for the characteristic (long-term) strength in 25 years relative to the (corrected, see D401 and 4.H1200) mean short-term strength ( $\hat{S}_{1r}^{mean}$ ) according to the values given in *Appendix 4C.D203*;

$\log[s(t)] = \log[s(1)] - b \log(t)$ , with  $s(1) = 0.888$  and  $b = 0.0423$ . This formula is expressed in normative strength values (absolute characteristic strength per mean short-term strength) and time in minutes. The stress rupture curve above may be expressed with respect to the absolute strength:  $\log[s_{abs}(t)] = \log\left[0.888 \hat{S}_{1r}^{mean}\right] - 0.0423 \log(t)$ , where  $\hat{S}_{1r}^{mean}$  is the corrected mean

(short-term) strength ( $\hat{S}_{1r}^{mean} = 614 \text{ MPa} \times 0.6 / 0.8 = 461 \text{ MPa}$ ). Inserting this value into the formula above gives  $\log[s_{abs}(t)] = \log[409] - 0.0423 \log(t)$ . This results in a long-term strength after 25 years of  $461 \text{ MPa} \times (1 - 0.556) = 205 \text{ MPa}$ .

**406** The long-term elastic strain to failure is given by:  $\epsilon = \sigma / E = 205 \text{ MPa} / 23.7 \text{ GPa} = 0.87\%$

**407** A 10% reduction of properties has been used to account for the exposure to water under long-term loads.

**408** The fibre dominated strength properties are not influenced by matrix cracks and the same values are used for the laminate with and without matrix cracks (9 B 200).



## D 500 Matrix dominated ply strength and strain to failure

- 101** The characteristic strengths and strains to failure transverse to the fibre direction and in shear are taken from the representative data from *Section 4 Appendix C*. Data were corrected according to 4 H 1200. The strain to failure is given by:  $\epsilon = \sigma / E$
- 502** The change of the matrix dominated properties under fatigue is uncertain. Matrix cracks can develop even if ply stresses are below the level for initiation of matrix cracks under quasi-static loads. However, the same value as the original strength is used for the water tank, since stresses are low and the load could be carried by a vessel full of matrix cracks (*4C805*). The prerequisites for not changing the strength of the matrix of the water vessel under fatigue are fulfilled as shown in the analysis in *F800*. For the gas vessel matrix cracks are acceptable and fracture of the matrix need not be considered.
- 503** The change of the matrix dominated properties under permanent loads is treated similar to the fatigue case. The same value as the original strength is used for the water tank, since stresses are low and the load could be carried by a vessel full of matrix cracks (*4C404*). The prerequisites for not changing the strength of the matrix of the water vessel under permanent load are fulfilled as shown in the analysis in *F700*. For the gas vessel matrix cracks are acceptable and fracture of the matrix need not be considered.
- 504** When matrix cracks have developed the strength parameters are not relevant anymore, since the cracks are assumed to be present already.

## D 600 Time to failure for fibre dominated properties

- 601** For cyclic loads the characteristic SN curve from *Section 4 Appendix C D202* can be used to establish that the fibres have sufficient lifetime. The curve for  $R=0.1$  can be used since the pressure vessel is cycled between 0 and maximum load. The characteristic fatigue curve is given as:  $\log[e(N)] = 0.063 - 0.101 \log(N)$
- 602** The characteristic stress rupture curve from *D405* can be used to establish that the fibres have sufficient lifetime. The characteristic stress curve is given as:  
 $\log[s_{abs}(t)] = \log[348] - 0.0423 \log(t)$ .

## D 700 Time to failure for matrix dominated properties

- 701** The design of the gas vessel is based on the philosophy that matrix cracks are acceptable and the time to initiation of matrix cracks does not have to be checked.
- 702** The design of the water vessel is based on the philosophy that stresses are so low and cycle numbers are low enough, that the time to initiate matrix cracks is less than the lifetime of the component. The method requires that the conditions in *4C310* and *4C805* are fulfilled. These conditions are checked in *F600*.

## **D 800 Test requirements**

- 801** Test requirements should be seen in combination with the analysis results in the following sections. Different properties are critical for the gas vessel with liner and the water vessels without liner. Test requirements are also explained in the following analysis sections, but are summarised here.
- 802** Since representative properties are used for both vessels, it should be verified that these representative properties are applicable for the actual laminates used.
- 803** For the gas vessel with liner only the fibre dominated properties are critical. According to *Section 4 H600* the tensile and compressive strength of the laminates in fibre direction should be confirmed. The Young's modulus should also be measure during theses tests. Since stress rupture is the critical failure mode for this application nine stress rupture tests up to 10000 hours according to Section 4 H800 should be carried out. (Note that the requirements is only three survival tests up to 1000 hours for normal safety class Section 4 H900.)
- 804** For the water vessel without liner the fibre dominated and matrix dominated properties are critical. According to *Section 4 H600* the tensile and compressive strength of the laminates in fibre direction and transverse to the fibres should be confirmed. The Young's modulus should also be measure during theses tests. Long term properties do not need confirmation, since stress levels are very low.

## E. Analysis of gas vessel with liner

### E 100 General

- 101** All relevant failure mechanisms shall be evaluated for all loads of all phases.
- 102** The following failure mechanisms were identified in *C103* for the gas vessel:
- Fibre failure:
    - Short-term static
    - Long-term static
    - Long-term fatigue
  - Unacceptably large displacement (for vessel with liner)
  - Impact resistance
  - Explosive decompression
  - Chemical decomposition
- 103** Matrix cracking does not need to be checked, since the liner keeps the fluid inside the vessel even if cracks are present inside the laminate.
- 104** The filament wound laminate as described in *B302* is modelled as 12 layers of 0.5 mm thickness and the following lay-up is applied, in accordance with *4.A410*:

Ply no:	Fibre angle (°)
1	15
2	-15
3	85
4	-85
5	85
6	-85
7	-85
8	85
9	-85
10	85
11	-15
12	15

- 105** Since the laminate thickness is much smaller than the diameter of the vessel (see the table in *B301*), the vessel is analysed using classical thin-wall theory and laminate theory.

- 106** For the gas vessel with liner matrix cracking in the plies will not lead to leakage. Therefore, we can apply a linear failure analysis with degraded material properties (see *section 9.B500*) for the gas vessel.
- 107** Using degraded properties throughout the laminate may put higher stresses and strains into the fibre direction than in reality. This is a conservative way to model this vessel and fulfils the requirement of *9B109*.
- 108** Based on the above assumptions the simplified analytical analysis may be summarised as shown in *E200*.

**E 200 Analysis procedure (Section 9)**

**101** The (mean/laminate) axial ( $s_x$ ) and hoop ( $s_y$ ) stresses are calculated. From thin-wall theory these stress components are given by:

$$s_x = \frac{P(D+t)}{4t} \text{ and } s_y = \frac{P(D+t)}{2t} \text{ (which means that } s_y = 2s_x)$$

where

$P$  = pressure = 46 bar = 4.6 MPa = 4.6 N/mm<sup>2</sup>.

$D$  = inner diameter of vessel = 250 mm.

$t$  = laminate thickness = 6 mm.

Remark that the laminate shear stress ( $s_{xy}$ ) is zero in the present example.

**202** The mid-plane strains ( $e^0$ ) are calculated from the relation  $N=Ae^0$ ,

where

$N$  = cross section force vector (containing  $N_x$ ,  $N_y$  and  $N_{xy}$ ), which is obtained by integrating the laminate stresses through the thickness of the laminate.

$A$  = extensional stiffness matrix for the laminate (we refer to classical laminate theory), which is obtained by summing the stiffness matrices for all the plies after multiplication by the ply thickness. This means that the material properties for each ply ( $E_1$  fibre,  $E_2$  matrix,  $G_{12}$  and  $v_{12}$ ) contribute to the  $A$  matrix.

**203** When using the degraded failure analysis some of these parameters are assumed to be very small (see *9.B500*). The elastic properties with matrix cracking and no water exposure were calculated in *D104*. The values are the same at the beginning and at the end of the life of the component.

$E_1$ fibre	23.7 GPa
$E_2$ matrix	0.08 GPa
$v_{12}$	0.003
$G_{12}$ linear	0.03 GPa

- 204** Due to the assumption that  $t \ll D$  (thin-wall theory) the in-plane strain components are considered constant through the thickness of the laminate, that is  $e = e^0$ . In fact, this is not completely correct. It may be shown that for the present example the hoop strain at the inner laminate boundary is 4.8% larger than the strain at the outer boundary. This inaccuracy shall be taken into account according to 9.L200.
- 205** The load-model factor of 1.05 is chosen, because of the difference in inner and outer hoop strain (4.8%) which is not taken into account, and the fact that all through thickness stresses are neglected.
- 206** For each of the plies ( $\pm 15^\circ$  and  $\pm 85^\circ$ ) the global strain components ( $e_x$ ,  $e_y$  and  $e_{xy}$ ) are transformed to local ply strain components ( $e_1$ ,  $e_2$  and  $e_{12}$ ) by multiplying a transformation matrix (often referred to by  $T$ ) by the global strain vector
- 207** For each ply the local stress components ( $s_1$ ,  $s_2$  and  $s_{12}$ ) are calculated by multiplying the ply stiffness matrix ( $Q$ ) by the local strain vector.
- 208** The following results are obtained (without using a load factor):

<b>Laminate:</b>		
Pressure	MPa	4.6
Diameter	mm	250
Thickness	mm	6
Average axial stress	MPa	49.1
Average hoop stress	MPa	98.1
$E_{axial}$	GPa	
$E_{hoop}$	GPa	
$\epsilon_{axial}$	%	0.66
$\epsilon_{hoop}$	%	0.60
<b>+15° plies:</b>		
$e_l$	%	0.65
$s_l$	MPa	154
<b>+85° plies:</b>		
$e_l$	%	0.60
$s_l$	MPa	143

- 209** For each ply the local stress and strain components are applied in the failure criteria.

### E 300 Fibre failure - short-term (Section 6C)

- 301** The short-term static design criterion for fibre failure on the ply level is given by:

$$g_F g_{Sd} \cdot e_{nk} < \frac{\hat{e}_k^{fiber}}{g_M g_{Rd}}$$

**302** The following values are selected for the gas vessel with liner:

Partial factor		Value	Explanation
Characteristic value of the local response of the structure (strain) in the fibre direction n	$\epsilon_{nk}$	0.65%	Largest strain in fibre direction, see the table in 208
Characteristic fibre strain to failure	$\hat{\epsilon}_k^{\text{fiber}}$	0.87%	See D104, D405 and D406
Partial load effect factor Partial resistance factor	$\gamma_F \times \gamma_M$	1.18	From section 8.B400: Maximum load is known with 0 COV Strain to failure: $\text{COV} \leq 5\%$ Safety level: E from C303
Load-model factor	$\gamma_{Sd}$	1.05	Due to simplifications in the analytical model used, see E204 and E205.
Partial resistance-model factor	$\gamma_{Rd}$	1.0	Degraded properties are used in the analysis

**Guidance note:**

The characteristic strain to failure of 0.87% is the worst case in this example for short-term loads at the beginning of the life of the component and after exposure to cyclic and permanent loads.

---e-n-d---o-f---g-u-i-d-a-n-c-e---n-o-t-e---

**303** Evaluating the design criterion in E301 we find the maximum allowable strain in fibre direction  $\epsilon_{nk}$  after 25 years of service to be:

$$e_{nk} < \frac{0.87\%}{1.18 \cdot 1.05 \cdot 1.0} = 0.70\%$$

This is more than the largest actual strain (in the fibre directions)  $\epsilon_1=0.65\%$ . (Note that short term loads are not critical for the design, but long term loads as described below.)

**E 400 Fibre dominated ply failure due to static long-term loads (Section 6J)**

**401** The characteristic stress rupture curve is given by:  $\log[s_{abs}(t)] = \log[348] - 0.0423 \log(t)$  (from D602).

**402** The time to stress rupture shall be checked by the criterion given in Section 6J408:

$$g_{fat} g_{Rd} t_y \sum_{j=1}^N \frac{t^{actual} \{ g_{Sd} s^j_{applied} \}}{t^{character} \{ g_{Sd} s^j_{applied} \}} < 1$$

**403** The following values are selected for the gas vessel with liner:

Factors		Value	Explanation
Design life	$t_y$	25 years	Design life of 25 years
The total number of load conditions	N	1	Only one load condition
Actual time at one permanent static load condition per year	$t^{actual}$	1 year	The vessel is basically loaded all year, except for the short unloading times that are ignored here.
Local response of the structure to the <i>permanent static</i> load conditions (max. stress)	$\sigma_{applied}$		Calculated below
Characteristic time to failure under the permanent static load condition	$t^{character}$		Calculated below
Load-model factor	$\gamma_{Sd}$	1.05	Same as before, due to simplifications in the analytical model used, see 204-205
Resistance-model factor	$\gamma_{Rd}$	0.1	Only one load condition
Partial fatigue safety factor	$\gamma_{fat}$	50	See 8.E

**404** The criterion in 402 can be evaluated to show that the characteristic time to failure should be:

$$t^{character} = t_y \mathbf{g}_{Rd} \mathbf{g}_{fat} t^{actual} = 125 \text{ years}$$

**405** From the stress rupture formula in 401 the stress level corresponding to a characteristic life of 125 years is 163 MPa. Dividing this value by the load-model factor  $\gamma_{Sd}$  gives:

$$\mathbf{s}^j_{applied} = 155 \text{ MPa and } \mathbf{e}^j_{applied} = \frac{\mathbf{s}^j_{applied}}{\mathbf{E}_1^{fibre}} = \frac{155 \text{ MPa}}{23.7 \text{ GPa}} = 0.65\%$$

This is the same as the largest actual strain (in the fibre directions)  $\epsilon_1 = 0.65\%$ .

**406** The stress rupture behaviour is critical for the design. For a high safety class application the stress rupture data should be confirmed by testing.

**407** Short-term failure due to maximum loads after 25 years was already considered in E300.

**E 500 Fibre dominated ply failure due to cyclic fatigue loads (Section 6K)**

**501** The characteristic SN curve for R=0.1 is given by:  $\log[e(N)] = 0.063 - 0.101 \log(N)$  (from D602).

**502** The number of cycles to fatigue failure shall be checked by the criterion given in 6 K 305:

$$g_{fat} g_{Rd} t_y \sum_{j=1}^N \frac{n^{actual} \left\{ g_{Sd} e^j_{applied} \right\}}{n^{charact} \left\{ g_{Sd} e^j_{applied} \right\}} < 1$$

**503** The following values are selected for the gas vessel with liner:

factors		Value	Explanation
Number of years for the fatigue evaluation (typically equal to the design life)	$t_y$	25 years	Design life of 25 years
The total number of strain conditions	N	1	Only one load condition
Number of cycles per year at a particular strain condition	$n^{actual}$	52	1 cycle per week
Local response of the structure to the strain condition applied	$\epsilon_{applied}$		Calculated below
Characteristic number of cycles to failure under a given strain condition	$n^{charact}$		Calculated below
Load-model factor	$\gamma_{Sd}$	1.05	Same as before, due to simplifications in analytical model, see 204-205
Partial resistance-model factor	$\gamma_{Rd}$	0.1	Only one load condition
Partial fatigue safety factor	$\gamma_{fat}$	50	See 8 E

**504** The criterion in 502 can be evaluated to show that the characteristic number of cycles to failure should be:

$$n^{charact} = t_y g_{fat} g_{Rd} n^{actual} = 6500$$

**505** The strain amplitude corresponding to a characteristic life of 6500 cycles with an R ratio of 0.1 is 0.476% according to 501. The maximum strain is then 0.952%. Therefore:

$$\left\{ g_{Sd} e^j_{applied} \right\} = 0.952\% \text{ and } e^j_{applied} = 0.907\%$$

This is more than the largest actual strain (in the fibre directions)  $\epsilon_1 = 0.65\%$ .



**506** Fatigue data do not have to be confirmed by testing if the factor  $\gamma_{Rd}$  can be multiplied by 20 (Section 6 K 308). In this case the strain amplitude for a life of  $6500 \times 20 = 130000$  cycles should be found. The strain amplitude with an R ratio of 0.1 is 0.352% according to 501. The maximum strain is then 0.704%. Therefore:

$$\left\{ \mathbf{g}_{Sd} \mathbf{e}^j_{applied} \right\} = 0.704\% \quad \text{and} \quad \mathbf{e}^j_{applied} = 0.67\%$$

This is more than the largest actual strain (in the fibre directions)  $\epsilon_1=0.65\%$ .

Fatigue data do not have to be confirmed by testing, provided the other similarity requirements from (Section 6 K 308) are fulfilled.

**507** Short-term failure due to maximum loads after 25 years was already considered in E300.

### **E 600 Matrix cracking (Section 6D)**

**601** Matrix cracking does not have to be considered for the gas vessel with liner.

### **E 700 Unacceptably large displacement (Section 6I)**

**701** It is assumed for the purpose of this example that the long-term yield strain of the liner is 5%, and this value should not be exceeded to ensure that the liner will not yield.

**702** The liner in this example is thin and does not contribute to the load bearing capabilities of the vessel. The liner will follow the deformations of the laminate body of the vessel.

**703** For simplicity we assume that the liner has the same strain as the laminate. In reality the liner will have slightly larger strain since it is located on the inside of the cylindrical vessel, see 204-205. This is taken into account by introducing a load-model factor,  $\gamma_{Sd} = 1.05$ .

**704** The criterion for unacceptably large displacements from 6I 101 shall be used.

$$\mathbf{g}_F \mathbf{g}_{Sd} \cdot \mathbf{d}_n < \mathbf{d}_{spec}$$

**705** The following values are selected for the gas vessel with liner:

factors		Value	Explanation
Specified requirement on maximum displacement	$d_{spec}$	5%	See 302
Characteristic value of the local response of the structure (here strain)	$d_n$		Calculated below
Partial load effect factor	$\gamma_F$	1.15	From Section 8 B 400: Maximum load is known with 0 COV Strain to failure COV $\leq 5\%$ Safety level C
Load-model factor	$\gamma_{Sd}$	1.05	Same as before, due to simplifications in analytical model, see 204-205

**706** The maximum principle strain in the laminate should be less than  $5/(1.15 \times 1.1) = 4.14\%$ .

**707** The highest elastic strain in fibre direction is only 0.65%. However, in this case we have to look at the elastic strain and the plastic strain due to creep. A method to calculate elastic and plastic strain is given in 4C211.

$$\mathbf{e} = \mathbf{e}_{elastic} + \mathbf{e}_{plastic} \quad \text{or} \quad \mathbf{e} = \frac{\mathbf{s}}{E_{elastic}} + \frac{\mathbf{s}}{E_{plastic}}$$

**708** Creep in the  $\pm 15^\circ$  plies: The elastic strain is 0.65%. The plastic strain can be calculated according to the representative data of Section 4 appendix C for creep:  $\mathbf{e}_{plastic} = \frac{\mathbf{s}}{1520} t^{0.2}$  with time in hours and strain in %. The total strain for the maximum stress of 154 MPa (see 208) and 219000 hours is:  $0.65\% + 1.18\% = 1.83\%$ .

**709** Creep in the  $\pm 85^\circ$  plies can be calculated the same way. Since the ply stresses are slightly lower the creep strain is also slightly less.

**710** The principle strains of the laminate should be calculated from the ply strains and applied to the design criterion. Since the ply strains are so much below the acceptable levels this calculation is not done here.

### **E 800 Impact resistance (Section 6L)**

- 801** Impact may be caused by dropped tools etc. The possible impact scenarios, if any, should be defined.
- 802** There is no good theoretical criterion to evaluate the resistance to impact. According to 6L, the resistance of a structure to impact shall be tested experimentally.
- 803** The critical failure mechanisms in this example is fibre failure. It would have to be shown that the defined impact scenarios do not cause any fibre failure. This could be shown on full scale specimens or on representative laminates.
- 804** Alternatively, the vessel could be protected against impact by covers or other protection devices.

### **E 900 Explosive decompression (Section 6O)**

- 901** If the air diffuses through the liner more rapidly than it can diffuse out of the laminate, a layer of pressurised air may build up in the interface between liner and laminate. In such a case the interface should be vented or experiments should be made to show that the liner will not collapse when the internal pressure is reduced (6O200).
- 902** The rate of air flow through the liner is most likely much less than through the laminate and explosive decompression should be no problem, as long as the vessel is not exposed to external pressures as well, like under water usage.

### **E 1000 Chemical decomposition (Section 6Q)**

- 1001** It is proven by many applications that composite laminates do not chemically decompose in air within 25 years.

### **E 1100 Summary evaluation**

- Impact resistance should be evaluated experimentally if the vessel may be exposed to impact loads. Experiments should show that possible impact loads will not cause fibre damage.
- The gas vessel passed all other requirements for service at 46 bar.
- The reduction of fibre dominated ply strength due to permanent loads is the design limiting factor for this vessel.
- Obtaining material data from tubular specimens instead of flat plates (as used in this example) would allow better utilisation of the cylinder.

## F. Nonlinear analysis of vessel for water without liner

### F 100 General

**101** For the water vessel (without liner) it is assumed that leakage will occur if matrix cracking is present in one of the plies. We apply the 2-D in-plane progressive failure analysis (section 9.B.200) to evaluate fibre failure. An alternative method is given in *Section G*.

**102** All relevant failure mechanisms shall be evaluated for all loads of all phases.

**103** The following failure mechanisms were identified in C103 for the water vessel:

- Fibre failure:
  - Short-term static
  - Long-term static
  - Long-term fatigue
- Matrix cracking (for vessel without liner):
  - Short-term static
  - Long-term static
  - Long-term fatigue
- Impact resistance
- Explosive decompression
- Chemical decomposition

**104** The filament wound laminate is the same as for the gas vessel in *E104*.

### F 200 Analysis procedure (Section 9B)

**201** The thin shell method for calculations of laminate stresses is the same as for the gas vessel. The elastic properties used in the analysis are different.

**202** The elastic properties without and with matrix cracking were calculated in *D104*. The values are different at the beginning and the end of the life of the component.

Property	New component	After 25 years in water	After 25 years in water	After 25 years in water
	No matrix cracks	No matrix cracks	With matrix cracks in $\pm 15$ plies	With matrix cracks in $\pm 15$ plies and $\pm 85$ plies
$\pm 15$ plies				
$E_1$ fibre	23.7 GPa	21.3 GPa	21.3 GPa	21.3 GPa
$E_2$ matrix	7.6 GPa	6.8 GPa	0.08 GPa	0.08 GPa
$\nu_{12}$	0.29	0.29	0.003	0.003
$G_{12}$ linear	3.2 GPa	2.9 GPa	0.03 GPa	0.03 GPa
$\pm 85$ plies				
$E_1$ fibre	23.7 GPa	21.3 GPa	21.3 GPa	21.3 GPa
$E_2$ matrix	7.6 GPa	6.8 GPa	6.8 GPa	0.08 GPa
$\nu_{12}$	0.29	0.29	0.29	0.003
$G_{12}$ linear	3.2 GPa	2.9 GPa	2.9 GPa	0.03 GPa

**203** Using properties of the laminate in water addresses possible diffusion of water into the laminate.

**204** A load-model factor of 1.05 is chosen, for the same reasons as described in *E204-205*.

**205** The following results are obtained from the stress and laminate theory analysis (without using a load factor):

Laminate		After 25 years in water, no matrix cracks	After 25 years in water with matrix cracks
Pressure	MPa	1.48	1.48
Diameter	mm	250	250
Thickness	mm	6	6
Average axial stress	MPa	15.8	15.8
Average hoop stress	MPa	31.6	31.6
$E_{axial}$	GPa	11.02	6.22
$E_{hoop}$	GPa	16.34	14.0
<b>+15° plies:</b>			
$e_1$	%	0.108	0.233
$e_2$	%	0.168	0.217
$e_{12}$	%	0.035	0.009
$s_1$	MPa	27.0	49.5
$s_2$	MPa	13.9	na
$s_{12}$	MPa	1.01	na
<b>+85° plies:</b>			
$e_1$	%	0.17	0.216
$e_2$	%	0.10	0.234
$e_{12}$	%	0.01	0.003
$s_1$	MPa	39.9	45.9
$s_2$	MPa	10.7	na
$s_{12}$	MPa	0.35	na

na: not applicable, since the matrix is cracked.

**206** The component is checked for the pressure of 1.48 MPa.

**207** For each ply the local stress and strain components are applied in the failure criteria.

**F 300 Matrix cracking (short term) at 1.48 MPa pressure (Section 6D)**

**301** The criterion of 6D202 is not fulfilled and stress combinations should be taken into account.

$$\max \left| \frac{\hat{S}_{ik}^{matrix}}{S_{ik}} \right| / \sum_{n \neq i} \left| \frac{\hat{S}_{nk}^{matrix}}{S_{nk}} \right| \leq 10$$

**302** Since there is interaction the design criterion from 6 D203 shall be used:

$$g_F g_{Sd} g_M g_{Rd} \cdot \sqrt{\sum_n \left( \frac{\hat{S}_{nk}^{matrix}}{S_{nk}} \right)^2} < 1$$

**103** The following values are selected for the water vessel without liner:

Partial factor		Value	Explanation
Characteristic value of the local load effect of the structure (stress) in the direction n	$\sigma_{nk}$	13.9 MPa 1.01 MPa 10.7 MPa 0.35 MPa	Ply stresses in +15 and +85 ply. See F205
Characteristic value of the stress components to matrix cracking in the direction 2	$\hat{S}_2^{matrix}$	26.3 MPa 23.7 MPa	For the new vessel For the vessel after 25 years See D104 and D405, D406
Characteristic value of the stress components to matrix cracking in the direction 12	$\hat{S}_{12}^{matrix}$	17.0 MPa 15.3 MPa	For the new vessel For the vessel after 25 years See D104 and D405, D406
Partial load effect factor Partial resistance factor	$\gamma_F \times \gamma_M$	1.4	From Section 8 B 400: Maximum load is known with 0 COV Strain to failure COV $\leq 10\%$ Safety level C
Load-model factor	$\gamma_{Sd}$	1.05	Due to simplifications in analytical model, see E205.
Partial resistance-model factor	$\gamma_{Rd}$	1.15	Given in 6D201

**304** Checking the design criterion in 302 we find that stresses in the  $\pm 15$  plies are just acceptable, while no matrix cracking is predicted for the  $\pm 85$  plies:

$$\text{for } \pm 15 \text{ plies: } 1.05 \cdot 1.4 \cdot 1.15 \sqrt{\left(\frac{13.9 \text{MPa}}{23.7 \text{MPa}}\right)^2 + \left(\frac{1.01 \text{MPa}}{15.3 \text{MPa}}\right)^2} = 1.00$$

$$\text{for } \pm 85 \text{ plies: } 1.05 \cdot 1.4 \cdot 1.15 \sqrt{\left(\frac{10.7 \text{MPa}}{23.7 \text{MPa}}\right)^2 + \left(\frac{0.35 \text{MPa}}{15.3 \text{MPa}}\right)^2} = 0.76$$

**305** First matrix cracking anywhere in the structure is usually used as the criterion for onset of leakage. Matrix cracking determines the design pressure for this component. A maximum pressure of 14.8 bar is acceptable.

**F 400 Matrix cracking under long-term static loads (Section 4C400)**

**401** Matrix cracking under long-term static loads can be ignored if the stresses are below the level to initiate matrix cracking, and if the vessel can carry the loads with a fully cracked matrix according to 4C310 and 4C404. The first point was shown in F300. The second point is shown in F600, where all loads can be carried by a laminate with a fully degraded matrix.

**F 500 Matrix cracking under long-term cyclic fatigue loads (Section 4C900)**

**501** Matrix cracking under long term static loads can be ignored if the stresses are below the level to initiate matrix cracking, and if the vessel can carry the loads with a fully cracked matrix according to 4C905. This is shown in F600. In addition, the total number of fatigue cycles shall be less than 1500. This is the case in this example.

**F 600 Fibre failure - short term(Section 6C)**

**601** Matrix cracking will occur before fibre failure. Fibre failure can be analysed by modelling the laminate as a laminate full of matrix crack. This is basically the same way as for the gas vessel, except that elastic properties shall be degraded for the possible presence of water when analysing the component. The ply strains are given in F206.

**602** The short-term static design criterion for fibre failure on the ply level is given by:

$$\mathbf{g}_F \mathbf{g}_{Sd} \cdot \mathbf{e}_{nk} < \frac{\hat{\mathbf{e}}_k^{fiber}}{\mathbf{g}_M \mathbf{g}_{Rd}}$$



**603** The following values are selected for the water vessel without liner:

Partial factor		Value	Explanation
Characteristic fibre strain to failure	$\hat{\epsilon}_k^{\text{fiber}}$	1.69% 0.87%	For the new vessel For the vessel after 25 years See D104 and D405, D406
Partial load effect factor Partial resistance factor	$\gamma_F \times \gamma_M$	1.18	From Section 8 B 400: Maximum load is known with 0 COV Strain to failure COV $\leq 5\%$ Safety level E
Load-model factor	$\gamma_{Sd}$	1.05	Due to simplifications in analytical model, see E204-205
Partial resistance-model factor	$\gamma_{Rd}$	1	Degraded properties are used in the analysis

**604** Evaluation of the criterion above (see 602) shows that the maximum allowable strain in fibre direction  $\epsilon_{nk}$  after 25 years of service is 0.70%. This is much more than the actual strain  $\epsilon_1=0.23\%$ .

**Guidance note:**

This vessel is designed against cracking of the matrix. Usually the margin against fibre failure is large in such a case. Calculating the margin against failure with a new stress analysis using fully degraded properties may appear as an unnecessary effort in such a situation. It is, however, the proper way of calculating for fibre failure. Using the right method may be more critical in more complicated structures.

---e-n-d---o-f---g-u-i-d-a-n-c-e---n-o-t-e---

**F 700 Fibre dominated ply failure due to static long term loads (Section 6J)**

**701** The analysis method is the same as for the gas vessel in E400.

**102** The stress level corresponding to a characteristic life of 125 years is 155 MPa according to E405. This value should be reduced by 10% due to the possible presence of water, see Appendix 4CE. Therefore:

$$\mathbf{S}^j_{\text{applied}} = 139.5 \text{ MPa and } \epsilon^j_{\text{applied}} = \frac{\mathbf{S}^j_{\text{applied}}}{E_{\text{fibre}}} = \frac{139.5 \text{ MPa}}{23.7 \text{ GPa}} = 0.58\%$$

This is more than the actual strain  $\epsilon_1=0.17\%$  for an internal pressure of 1.48 MPa.

**Guidance note:**

The strain level for a laminate without cracks is used for the applied strain. This value represents the actual condition of the laminate and should be used when applying the design criterion.

---e-n-d---o-f---g-u-i-d-a-n-c-e---n-o-t-e---

**703** Stress rupture data do not have to be confirmed by testing if the factor  $\gamma_{Rd}$  can be multiplied by 20 (see *E400 and Section 6 J 410*). In this case the strain for a life of 125 x 20 = 2500 years should be found. In this case the acceptable characteristic stress level is 143 MPa, after applying the load model factor and the 10% reduction for sea water we get 123 MPa. Therefore:

$$e^j_{applied} = \frac{s^j_{applied}}{E_{fibre}} = \frac{123MPa}{23.7GPa} = 0.518\%$$

This is more than the actual strain  $\epsilon_1=0.17\%$  for an internal pressure of 1.48 MPa. Stress rupture data do not have to be confirmed by testing, provided the other similarity requirements from (Section 6 K 308) are fulfilled.

**704** Short-term failure due to maximum loads after 25 years was already considered in *F600*.

#### **F 800 Fibre dominated ply failure due to cyclic fatigue loads (Section 6K)**

**801** The analysis method is the same as for the gas vessel in *E500*.

**802** The maximum strain corresponding to a characteristic life of 6500 cycles is

$$e^j_{applied} = 0.907\%$$

This is more than the maximum actual strain  $\epsilon_1=0.17\%$ .

**803** The strain in the laminate  $\epsilon_1=0.17\%$  is also less than 0.67%. Therefore, the fatigue properties do not have to be confirmed by testing, provided the similarity requirements from Section 6 K 308 are fulfilled (see also *E506*).

**804** Short-term failure due to maximum loads after 25 years was already considered in *F600*.

#### **F 900 Unacceptably large displacement (Section 6I)**

**901** No requirements to be checked.

#### **F 1000 Impact resistance (Section 6L)**

**1001** Impact may be caused by dropped tools etc. The possible impact scenarios, if any, should be defined.

**1002** There is no good theoretical criterion to evaluate the resistance to impact. According to *6L*, the resistance of a structure to impact shall be tested experimentally.

**1003** The critical failure mode in this example is leakage and burst, linked to the mechanisms fibre failure and matrix cracking. It would have to be shown that the defined impact scenarios do not cause any fibre failure or matrix cracking. This could be shown on full scale specimens or on representative laminates.

**1004** Some matrix cracks after impact may be acceptable as long as they do not cause leakage. This could be shown on tests on pressurised pipes.

**1005** Alternatively, the vessel could be protected against impact by covers or other protection devices.

**F 1100 Explosive decompression (Section 6O)**

**1101** Water can diffuse through the laminate at low rates. It is unlikely that water can accumulate in the laminate and cause effects related to explosive decompression.

**1102** There is no interface in this design where water could accumulate.

**F 1200 Chemical decomposition (Section 6Q)**

**1201** It is proven by many applications that composite laminates do not chemically decompose in water within 25 years.

**F 1300 Component testing (Section 10)**

**1301** The results show that the design limiting factor is matrix cracking. Matrix cracking is assumed here as the beginning of leakage. It is known however, that many more matrix cracks are needed before leakage starts.

**1302** Testing a component with this laminate can show when leakage really starts and would allow to utilise the design much better than it is done here. Short term and long term performance with respect to leakage can be tested according to *section 10B200-300*. Having obtained those data they can be used instead of the checks made here for matrix cracking. This would allow a much better utilisation of the vessel.

**1303** Another alternative to utilise the component better is to use a liner, as shown in the example of the gas vessel.

**F 1400 Summary evaluation**

- ❑ Impact resistance should be evaluated experimentally if the vessel may be exposed to impact loads. Experiments should show that possible impact loads will not cause fibre damage.
- ❑ The water vessel passed all other requirements for service at 14.8 bar.
- ❑ The matrix dominated ply strength is the design limiting factor for this vessel.
- ❑ Component testing is recommended to establish the level of leakage instead of using the matrix cracking criterion. This approach would utilise the vessel much better.

## G. Linear Analysis of vessel for water without liner

### G 100 General

- 101** This method uses a linear analysis with non-degraded properties instead of a nonlinear failure analysis in *Section F*.
- 102** In the present section we assume that leakage will occur if matrix cracking is present in at least one of the plies. Therefore, in the context of the water vessel we can apply the linear failure analysis with non-degraded material properties (*section 9.B.400*). In this case we have to modify the criterion for fibre failure (*see section 9.C.200*)

#### Guidance note:

It is possible to apply a more realistic requirement for leakage, i.e. that leakage will not occur until matrix cracking is present in all the plies of the laminate. In this case, a (nonlinear) progressive failure analysis must be performed as shown in the previous *Section F*.

---e-n-d---o-f---g-u-i-d-a-n-c-e---n-o-t-e---

- 103** Most parts of this analysis are identical to the one in Section F. Only the differences are shown here.

### G 200 Analysis procedure (Section 9B)

- 201** The elastic properties without matrix cracking are needed here and were calculated in *D104*. The values are different at the beginning and the end of the life of the component.

Property	New component	After 25 years in water
$E_1$ fibre	23.7 GPa	21.3 GPa
$E_2$ matrix	7.6 GPa	6.8 GPa
$\nu_{12}$	0.29	0.29
$G_{12}$ linear	3.2 GPa	2.9 GPa

**202** The following results are obtained from the stress and laminate theory analysis (without using a load factor):

<b>General:</b>		After 25 years in water, no matrix cracks
Pressure	MPa	1.48
Diameter	mm	250
Thickness	mm	6
Average axial stress	MPa	15.8
Average hoop stress	MPa	31.6
$E_{axial}$	GPa	11.02
$E_{hoop}$	GPa	16.34
<b>+15° plies:</b>		
$e_1$	%	0.108
$e_2$	%	0.168
$e_{12}$	%	0.035
$s_1$	MPa	27.0
$s_2$	MPa	13.9
$s_{12}$	MPa	1.01
<b>+85° plies:</b>		
$e_1$	%	0.17
$e_2$	%	0.10
$e_{12}$	%	0.01
$s_1$	MPa	39.9
$s_2$	MPa	10.7
$s_{12}$	MPa	0.35

The results are identical with the nonlinear analysis (see F205).

**203** For each ply the local stress and strain components are applied in the design criteria.

**G 300 Matrix cracking (short term) (Section 6D)**

**101** The analysis for matrix cracking is the same as in F300. Matrix cracking determines the design pressure for this component.

**G 400 Matrix cracking under long-term static loads (Section 4C400)**

**401** The analysis for matrix cracking is the same as in F400.

**G 500 Matrix cracking under long-term cyclic fatigue loads (Section 4C900)**

**501** The analysis for matrix cracking is the same as in F400.

**G 600 Fibre failure – short-term (Section 6C)**

**601** Fibre failure can be analysed the same way as in the progressive failure analysis in F700. This method requires a stress analysis with degraded matrix properties. Since checking for matrix cracks in G300 requires an analysis with non-degraded properties the structure is analysed two times. This is easily done in this example, but may be time-consuming for more complicated structures. An alternative method is given here, where fibre failure is checked by the same analysis with non-degraded properties as is used for checking matrix cracking.

**102** The short-term static design criterion for fibre failure on the ply level is given by:

$$\mathbf{g}_F \mathbf{g}_{Sd} \cdot \mathbf{e}_{nk} < \frac{\hat{\mathbf{e}}_k^{fiber}}{\mathbf{g}_M \mathbf{g}_{Rd}}$$

where:

- $\epsilon_{nk}$  Characteristic value of the local response of the structure (strain) in the fibre direction n
- $\hat{\mathbf{e}}_k^{fiber}$  Characteristic value of the axial strain to fibre failure

**603** The following values are selected for the water vessel without liner:

Partial factor		Value	Explanation
Characteristic fibre strain to failure	$\hat{\mathbf{e}}_k^{fiber}$	1.69% 0.87%	For the new vessel For the vessel after 25 years See D104 and D405, D406
Partial load effect factor Partial resistance factor	$\gamma_F \times \gamma_M$	1.18	From Section 8 B 400: Maximum load is known with 0 COV Strain to failure COV $\leq 5\%$ Safety level E
Load-model factor	$\gamma_{Sd}$	1.05	Due to simplifications in analytical model, see E205
Partial resistance-model factor	$\gamma_{Rd}$	$\gamma_a$	Non-degraded properties are used in the analysis

**604** To find the model factor  $\gamma_a$  the procedure in 9C200 shall be used. The laminate's Young's modulus in each fibre direction shall be determined for non-degraded properties and for properties with matrix cracking. We use the ply properties for the laminate after 25 years in water as a basis for the laminate calculations (*from D104*):

Property	after 25 years in water	after 25 years in water with matrix cracking
$E_{1 \text{ fibre}}$	21.3 GPa	21.3 GPa
$E_{2 \text{ matrix}}$	6.8 GPa	0.08 GPa
$\nu_{12}$	0.29	0.003
$G_{12 \text{ linear}}$	2.9 GPa	0.03 GPa

**605** The laminate modulus in the 15 degree direction is obtained by calculation the Youngs modulus in the main x-direction for the original laminate rotated by -15 degrees, i.e.:

Ply no:	Fibre angle (°)
1	0
2	-30
3	70
4	-100
5	70
6	-100
7	-100
8	70
9	-100
10	70
11	-30
12	0

The laminate modulus is obtained from laminate theory calculations. Even though the laminate is not symmetric and the laminate modulus is not a meaningful value, it is sufficient for the calculation  $\gamma_a$ . The results are 10.31 GPa for non-degraded properties and 4.04 GPa for the laminate with matrix cracks. Therefore:  $\gamma_A = E_{lin}/E_{nonlin}$ , = 2.55 for the 15 degree ply.

**606** The laminate modulus in the -15 degree direction is obtained in a similar way by rotating the original laminate by +15 degrees. The result is the same as in 605.

**607** The laminate modulus in the 85 degree direction is obtained by calculation the Youngs modulus in the main x-direction for the original laminate rotated by -85 degrees, i.e.:

Ply no:	Fibre angle (°)
1	-70
2	-100
3	0
4	-170
5	0
6	-170
7	-170
8	0
9	-170
10	0
11	-100
12	-70

The laminate modulus is obtained from laminate theory calculations. Even though the laminate is not symmetric and the laminate modulus is not a meaningful value, it is sufficient for the calculation  $\gamma_a$ . The results are 16.02 GPa for undegraded properties and 12.01 GPa for the laminate with matrix cracks. Therefore:  $\gamma_A = E_{lin}/E_{nonlin} = 1.33$  for the 85 degree ply.

**608** The laminate modulus in the -85 degree direction is obtained in a similar way by rotating the original laminate by +85 degrees. The result is the same as in 607.

**609** Analysing the design criterion above (see 602) we find the maximum allowable strain in fibre direction  $\epsilon_{nk}$  after 25 years of service to be:

$$\square \quad \text{maximum strain in } 15^\circ \text{ plies: } e_{nk} = \frac{\hat{e}_k^{fiber}}{g_{Sd} g_{FM} g_{Rd}} = \frac{0.87}{1.05 \times 1.18 \times 2.55} = 0.275\%$$

$$\square \quad \text{maximum strain in } 85^\circ \text{ plies: } e_{nk} = \frac{\hat{e}_k^{fiber}}{g_{Sd} g_{FM} g_{Rd}} = \frac{0.87}{1.05 \times 1.18 \times 1.33} = 0.528\%$$

The maximum ply strains in fibre direction calculated by this method are 0.17%. This shows that fibres are not predicted to fail.

**Guidance note:**

Note that these strains are artificially low to compensate for the simplified calculation method used.

---e-n-d---o-f---g-u-i-d-a-n-c-e---n-o-t-e---

**G 700 Fibre dominated ply failure due to static long-term loads (Section 6J)**

**701** The analysis method is the same as for the water vessel in F800.



**G 800 Fibre dominated ply failure due to cyclic fatigue loads (Section 6K)**

**801** The analysis method is the same as for the water vessel in *F900*.

**G 900 Unacceptably large displacement**

**901** Same as in *Section F1000*, no requirements to be checked.

**G 1000 Impact resistance**

**1001** Same as in *Section F1100*.

**G 1100 Explosive decompression**

**1101** Same as in *Section F1200*.

**G 1200 Chemical decomposition**

**1201** Same as in *Section F1300*.

**G 1300 Summary evaluation**

- The analysis and results are identical to the nonlinear analysis.
- This method is more complicated in this example, but may be simpler in larger structures, because the analysis has to be done only once.
- The conclusions are also identical to the nonlinear analysis in *F1400*.