



CAREFUL RELEASE PROTOCOLS FOR SEA TURTLE RELEASE WITH MINIMAL INJURY



U.S. DEPARTMENT OF COMMERCE
National Oceanic and Atmospheric Administration
NOAA Fisheries
Southeast Fisheries Science Center
75 Virginia Beach Drive
Miami, Florida 33149

December 2008



NOAA Technical Memorandum NMFS-SEFSC-580

CAREFUL RELEASE PROTOCOLS FOR SEA TURTLE RELEASE WITH MINIMAL INJURY

U.S. DEPARTMENT OF COMMERCE
Carlos M. Gutierrez, Secretary

National Oceanic and Atmospheric Administration
William J. Brennan
Acting Undersecretary of Commerce for Oceans and Atmosphere

National Marine Fisheries Service
James W. Balsiger, Acting Assistant Administrator for Fisheries

December 2008

This Technical Memorandum series is used for documentation and timely communication of preliminary results, interim reports, or special-purpose information. Although the memoranda are not subject to complete formal review, editorial control, or detailed editing, they are expected to reflect sound professional work.

NOTICE

The NOAA Fisheries (NMFS) does not approve, recommend or endorse any proprietary product or material mentioned in this publication. No reference shall be made to NOAA Fisheries, or to this publication furnished by NOAA Fisheries, in any advertising or sales promotion which would indicate or imply that NOAA Fisheries approves, recommends or endorses any proprietary product or material herein or which has as its purpose any intent to cause or indirectly cause the advertised product to be used or purchased because of NOAA Fisheries publication.

This report should be cited as follows:

National Marine Fisheries Service Southeast Fisheries Science Center. 2008. Careful release protocols for sea turtle release with minimal injury. NOAA Technical Memorandum NMFS-SEFSC-580, 130 pp.

Copies of this report can be obtained from:

Librarian
Southeast Fisheries Science Center
NOAA Fisheries
75 Virginia Beach Drive
Miami, FL 33149
(305) 361-4229

or

National Technical Information Center
Southeast Fisheries Science Center
5825 Port Royal Road
Springfield, VA 22161
(703) 605-6000, (800) 553-6847

or

PDF version available at <http://www.sefsc.noaa.gov/seaturtletechmemos.jsp>
Updates will be provided periodically at this location.

ACKNOWLEDGEMENTS

The development of these protocols involved a large number of very cooperative people from government, industry, and academia. We are especially grateful to all the NMFS fisheries observers who have provided their feedback on the use of careful release equipment and protocols. Invaluable was the cooperation and assistance of the captains, crew, managers, and owners of the vessels participating in the NED experimental fishery for their input and willingness to try the gear removal devices and develop many of the procedures outlined in this document.

We appreciate also the efforts of many past and current NOAA Fisheries staff and contractors: Debra Abercrombie, Myrto Argyropoulou, Larisa Avens, Lawrence Beerkircher, Lisa Belskis, Charles Bergmann, Cheryl Brown, Marina Burgos, Kimberly Damon-Randall, Sheryan Epperly, Lance Garrison, Dominy Hataway, Ben Higgins, Nick Hopkins, Dennis Lee, Joanne Braun-McNeill, Sara McNulty, David Morin, Chris Sasso, Lesley Stokes, Wendy Teas, and John Watson.

Many thanks go to the Blue Water Fishermen's Association, Fisheries Research Institute, and Aquatic Release Conservation (ARC). Special thanks go to Shawn Dick, Jess Dick, Kristin Raabe, and the entire staff from ARC for their contributions. We also would like to thank our academic colleagues for their input: Dr. Craig Harms and Dr. Jeanette Wyneken. The NOAA/Laforce Line Cutter was designed by Lionel Laforce, the NOAA/Arceneaux Line Clipper by Stuart (Joe) Arceneaux, and the NOAA/Bergmann Dehooker by Charles Bergmann. Some of the devices were conceptualized by members from the industry: the turtle tether by Jay McCormack (current version was designed by ARC), the T&G Ninja Sticks by Tony Geismann and Georg Hinteregger, the Roby Dehooker by Doug Roby, the Scotty's Dehooker by Scott Drabinowitz, the large turtle hoist by Jim Budi and Malcolm MacLean, and the ARC Dehookers by Shawn Dick. Earlier versions of this document benefited from reviews by a number of people, including Colleen Bass, the late Nelson Beideman, Russell Dunn, Greg Fairclough, Rick Pearson, and Shawn Dick.

TABLE OF CONTENTS

Chapter 1: Introduction	1-1
Handling Recommendations for Other Species	1-1
Marine Mammal Careful Handling and Release Guidelines	1-2
Vessel/Crew’s Responsibilities upon Sighting a Sea Turtle	1-4
Gear Removal Protocols	1-4
Trawl Fisheries	1-5
Gillnet Fisheries	1-5
Fixed Gear Fisheries	1-5
Hook-and-line Fisheries	1-5
Assessing Whether to Remove Hooks	1-6
Releasing the Turtle	1-7
 Chapter 2: Equipment and Techniques for Sea Turtles Not Boated	 2-1
Turtle Control Devices	2-2
Turtle Tether	2-2
T&G Ninja Sticks	2-3
Equipment to Remove Line	2-3
Long-handled Line Clipper/Cutter	2-3
Monofilament Cutters	2-4
Equipment to Remove Hooks	2-4
Long-handled Dehooker for Internal Hooks	2-4
ARC Pole Big Game Dehookers	2-4
Notch Modification for ARC Dehookers	2-6
Plate 2-1: Instructions for ARC Dehookers	2-8
Long-handled Dehooker for External Hooks	2-10
ARC Pole Big Game Dehookers	2-10
Long-handled J-Style Dehooker	2-10
Long-handled Roby Dehooker	2-11
Plate 2-3: Instructions for the Roby Dehooker	2-12
Long-handled Device to Pull an “Inverted V”	2-13
“Inverted V” Technique	2-13
Possible Scenarios Encountered for Sea Turtles Not Boated	2-14
Entangled but Not Hooked	2-14
Hooked but Not Entangled	2-14
Hooked and Entangled	2-15
 Chapter 3: Boating and Holding Sea Turtles	 3-1
Boating the Turtle	3-1
Dip Net	3-1
Turtle Hoist	3-2
Large Turtle Hoist	3-2

Small Turtle Hoist.....	3-3
Holding the Turtle.....	3-4
Cushion/Support Device.....	3-4
Comatose Turtles.....	3-5
Plate 3-1: Sea Turtle Resuscitation Guidelines.....	3-6
Chapter 4: Equipment and Techniques for Opening the Mouth of Boated Turtles	4-1
Opening the Mouth.....	4-1
Mouth Openers and/or Gags.....	4-2
Set of Two Rope Loops with Protective Tubing.....	4-2
Large Avian Oral Speculum.....	4-3
Block of Hard Wood.....	4-3
Set of Three Canine Mouth Gags.....	4-4
Set of Two Sturdy Dog Chew Bones.....	4-5
Hank of Rope.....	4-5
Set of Four PVC Couplings.....	4-6
Chapter 5: Equipment/Techniques for Removing Hooks from Boated Turtles....	5-1
Needle-nose or Long-nose Pliers.....	5-2
Bolt Cutters.....	5-2
Short-handled Dehooker for Internal Hooks.....	5-2
17” Bite Block Deep-Hooked (Sea Turtle) ARC Dehooker.....	5-2
Plate 5-1: Instructions for the ARC Dehooker with	
Bite Block.....	5-3
NOAA/Bergmann Dehooker.....	5-5
Plate 5-2: Instructions for the NOAA/Bergmann Dehooker	5-6
Short-handled Dehooker for External Hooks.....	5-7
17” Bite Block Deep-Hooked (Sea Turtle) ARC Dehooker.....	5-7
NOAA/Bergmann Dehooker.....	5-7
Short-handled J-Style Dehooker	5-7
Plate 5-3: Instructions for the J-Style Dehooker.....	5-8
Scotty’s Dehooker.....	5-9
Plate 5-4: Instructions for Scotty’s Dehooker.....	5-10
Short-handled Roby Dehooker.....	5-11

Appendix A: Design Standards and Equipment for the Careful Release of Sea Turtles Caught in Hook and Line Fisheries

Chapter A1: Introduction	A1-1
Chapter A2: Equipment for Sea Turtles Not Boated	A2-1
Turtle Control Devices.....	A2-1
Turtle Tether.....	A2-1
Design Standards.....	A2-1
Example Models Meeting Current Design Standards.....	A2-1
T&G Ninja Sticks.....	A2-2
Design Standards.....	A2-2
Example Models Meeting Current Design Standards.....	A2-2
Equipment to Remove Line.....	A2-2
Long-handled Line Clipper/Cutter.....	A2-2
Design Standards.....	A2-2
Example Models Meeting Current Design Standards.....	A2-3
Monofilament Cutters.....	A2-3
Design Standards.....	A2-3
Example Models Meeting Current Design Standards.....	A2-3
Equipment to Remove Hooks.....	A2-4
Long-handled Dehooker for Internal Hooks.....	A2-4
Design Standards.....	A2-4
Example Models Meeting Current Design Standards.....	A2-4
ARC Pole Big Game Dehookers (multiple models)	A2-4
Notch Modification for ARC Dehookers...	A2-5
Long-handled Dehooker for External Hooks.....	A2-5
Design Standards.....	A2-5
Example Models Meeting Current Design Standards.....	A2-6
ARC Pole Big Game Dehookers (multiple models)	A2-6
Long-handled “J-Style” Dehooker.....	A2-6
Long-handled Roby Dehooker.....	A2-6
Long-handled Device to Pull an “Inverted V”.....	A2-6
Design Standards.....	A2-7
Example Models Meeting Current Design Standards.....	A2-7
Long-handled “J-Style” Dehooker.....	A2-7
Standard Boat Hook.....	A2-7
Standard Fishing Gaff.....	A2-7
Chapter A3: Boating and Holding Sea Turtles	A3-1
Boating the Turtle.....	A3-1
Dip Net.....	A3-1
Design Standards.....	A3-1
Example Models Meeting Current Design Standards.....	A3-1
Turtle Hoist.....	A3-2
Large Turtle Hoist.....	A3-2

	Design Standards.....	A3-2
	Example Models Meeting Current Standards.....	A3-2
	Large Turtle Hoist.....	A3-2
	Small Turtle Hoist.....	A3-3
	Design Standards.....	A3-3
	Example Models Meeting Current Standards.....	A3-3
	Small Turtle Hoist.....	A3-3
Holding the Turtle.....		A3-3
	Cushion/Support Device.....	A3-3
	Design Standards.....	A3-3
	Example Models Meeting Current Design Standards.....	A3-4
	Standard Automobile Tire.....	A3-4
	Boat Cushion.....	A3-4
	Large Turtle Hoist.....	A3-4
Chapter A4: Equipment for Opening the Mouth of Boated Turtles.....		A4-1
Opening the Mouth.....		A4-1
Mouth Openers and/or Gags.....		A4-1
Set of Two Rope Loops with Protective Tubing.....		A4-1
Large Avian Oral Speculum.....		A4-1
Block of Hard Wood.....		A4-1
Set of Three Canine Mouth Gags.....		A4-2
Set of Two Sturdy Dog Chew Bones.....		A4-2
Hank of Rope.....		A4-2
Set of Four PVC Couplings.....		A4-2
Chapter A5: Equipment for Removing Gear from Boated Turtles.....		A5-1
Needle-nose or Long-nose Pliers.....		A5-1
Design Standards.....		A5-1
Example Models Meeting Current Design Standards.....		A5-1
Bolt Cutters.....		A5-1
Design Standards.....		A5-1
Example Models Meeting Current Design Standards.....		A5-2
Equipment to Remove Line.....		A5-2
Design Standards.....		A5-2
Example Models Meeting Current Design Standards.....		A5-2
Short-handled Dehooker for Internal Hooks.....		A5-2
Design Standards.....		A5-2
Example Models Meeting Current Design Standards.....		A5-3
17” Bite Block Deep-Hooked (Sea Turtle) ARC Dehooker		A5-3
NOAA/Bergmann Dehooker.....		A5-3
Short-handled Dehooker for External Hooks.....		A5-3
Design Standards.....		A5-3
Example Models Meeting Current Design Standards.....		A5-3
17” Bite Block Deep-Hooked (Sea Turtle) ARC Dehooker		A5-3
NOAA/Bergmann Dehooker.....		A5-3

Short-handled “J-style” Dehooker.....	A5-4
Scotty’s Dehooker.....	A5-4
Short-handled Roby Dehooker.....	A5-4

Appendix B: Design Schematics for Careful Release Equipment

Plate B-1 Turtle Tether.....	B1-1
Plate B-2 T&G Ninja Sticks.....	B2-1
Plate B-3 NOAA/Arceneaux Line Clipper.....	B3-1
Plate B-4 NOAA/Laforce Line Cutter.....	B4-1
Plate B-5 ARC Pole Big Game Dehooker.....	B5-1
Plate B-6 J-Style Dehooker.....	B6-1
Plate B-7 Long-handled Roby Dehooker.....	B7-1
Plate B-8 Dip Net.....	B8-1
Plate B-9 Large Turtle Hoist.....	B9-1
Plate B-10 Small Turtle Hoist.....	B10-1
Plate B-11 ARC Bite Block Dehooker.....	B11-1
Plate B-12 NOAA/Bergmann Dehooker.....	B12-1
Plate B-13 Scotty’s Dehooker.....	B13-1
Plate B-14 Short-handled Roby Dehooker.....	B14-1

Appendix C: Tool Selection Chart

Plate C-1 Sea Turtles Not Boated.....	C-1
Plate C-2 Sea Turtles Boated.....	C-2

Appendix D: Sea Turtle and Marine Mammal Handling and Careful Release Placards

References	Ref-1
-------------------------	-------

List of Figures

1-1. Dehooking a shark (A) and recovering a billfish before release (B).....	1-2
2-1. Long-handled tools for sea turtles not boated.....	2-1
2-2. Controlling a leatherback using a turtle tether.....	2-2
2-3. Controlling a leatherback using a pair of T&G Ninja Sticks.....	2-3
2-4. Using line cutter (A) and monofilament cutter (B) on entangled leatherbacks.....	2-4
2-5. Removing hook with an ARC Pole Big Game Dehooker.....	2-5
2-6. Point of the hook is shielded to prevent re-engagement.....	2-6
2-7. Notch the pigtail curl where the shank of the hook contacts the bottom of the curl...	2-7
Plate 2-1. Instructions for ARC Dehookers.....	2-8
2-8. Using J-Style dehooker on externally hooked leatherback.....	2-10
2-9. Roby dehooker.....	2-11
Plate 2-2. Instructions for the Roby Dehooker.....	2-12
2-10. Pulling an “Inverted V”.....	2-13
2-11. Using a dehooker on a leatherback hooked but not entangled.....	2-14
2-12. A hooked and entangled leatherback.....	2-15
3-1. Bringing a turtle onboard using a dip net.....	3-1
3-2. Dip net.....	3-2
3-3. Bringing leatherback onboard using a large turtle hoist.....	3-3
3-4. Leatherback supported onboard in large turtle hoist.....	3-3
3-5. Small turtle hoist.....	3-4
3-6. Loggerhead supported using an automobile tire.....	3-5
Plate 3-1. Sea Turtle Resuscitation Guidelines.....	3-6
3-6. Oral cavity anatomy.....	3-7
4-1. Opening the mouth.....	4-1
4-2. Mouth openers and gags.....	4-2
4-3. Opening the mouth using rope loops.....	4-3
4-4. Using an avian speculum as a (A) mouth opener and (B) gag.....	4-3
4-5. Wooden brush handle used as a (A) mouth opener and (B) gag.....	4-4
4-6. (A) Canine mouth gag fully compressed, (B) partially compressed (C) and fully open.....	4-4
4-7. Canine mouth gag.....	4-5
4-8. Large (A) and small (B) dog chew bones.....	4-5
4-9. Hank of rope mouth gag.....	4-6
4-10. PVC coupling mouth gag.....	4-6
5-1. Bolt cutters, needle-nose pliers, and monofilament cutters.....	5-1
5-2. Short handled dehookers.....	5-1
5-3. Bite Block Deep-hooked (Sea Turtle) ARC Dehooker.....	5-2
Plate 5-1. Instructions for the 17” Bite Block Deep-Hooked (Sea Turtle) ARC Dehooker.....	5-3
5-4. NOAA/Bergmann dehooker.....	5-5
Plate 5-2. Instructions for NOAA/Bergmann Dehooker.....	5-6
5-5. J-Style dehooker.....	5-7
Plate 5-3. Instructions for the J-Style Dehooker.....	5-8
5-6. Scotty’s dehooker.....	5-9
Plate 5-4. Instructions for Scotty’s Dehooker.....	5-10

Handling Recommendations for Other Species

Although these release protocols and equipment design standards have been developed primarily with sea turtles in mind, many of the devices and techniques also are effective on some species of fish, marine mammals and seabirds. Although bringing sea turtles onboard for gear removal is recommended whenever feasible, it is not advisable to bring most other large species (e.g., marine mammals, medium and large sharks, sawfish, billfish, some finfish) onboard for gear removal. Deeply ingested (where the insertion point of the barb is not visible) hooks should not be removed from any species, including sea turtles; however, all species would benefit from having as much line removed from the hook as possible. For further information on reef fish release, including discussions on hook removal and weighted release devices (“release sinkers”), see Bartholomew and Bohnsack (2005). Information on using venting tools may be found at: http://www.flseagrant.org/program_areas/fisheries/venting/ and <http://isurus.mote.org/research/cfe/fish-bio/how-to-vent-a-fish.htm>.

Caution must be exercised when handling sharks (Figure 1-1a), and the use of long-handled dehookers is advised. Billfish (Figure 1-1b) and tuna often benefit from dehooking and resuscitation or recovery before release; see details on billfish handling and recovery in Prince et al. (2002). Specific guidelines for releasing smalltooth sawfish have been established (71 FR 45428, August 9, 2006), and additional information on sawfish and billfish/tuna handling can be found at: <http://www.flmnh.ufl.edu/fish/education/sawfishbrochure.pdf>, <http://www.nmfs.noaa.gov/pr/species/fish/smalltoothsawfish.htm>, and <http://www.sefsc.noaa.gov/fisheriesbiology.jsp>.



Figures 1-1a and b. Dehooking a shark (a) and recovering a billfish (b) before release [Photos courtesy of Aquatic Release Conservation (ARC)].

Sturgeon bycatch, including several Endangered Species Act (ESA) listed species, has been documented in several coastal and estuarine fisheries that use gill nets, trawls, pots, traps, weirs, pound nets and hook-and-line. In some instances, particularly when captured in gill nets, the fish

may benefit from resuscitation if their opercular flaps were obstructed or in areas of low dissolved oxygen. If a sturgeon is removed from fishing gear and appears non-responsive, attempt to resuscitate the fish by flushing water over the gills for several minutes (~ five to ten minutes) or “swim” the fish by gently moving it through the water to flush water over the gills.

More information on sturgeon conservation can be found at:

<http://www.nmfs.noaa.gov/pr/species/fish/> and at http://www.nero.noaa.gov/prot_res/.

Marine Mammal Careful Handling and Release Guidelines

Summarized from: Marine Mammal Handling/Release Guidelines: A quick reference for Atlantic pelagic longline gear (Appendix D).

Available from: http://www.nmfs.noaa.gov/pr/pdfs/interactions/handling_release.pdf

Marine mammal interactions are a relatively rare event in most fisheries; however, due to the protected status and small population sizes of most marine mammal species, each event is significant. Therefore, it is important that fishermen provide as much documentation as possible about these interactions and work to carefully remove gear from marine mammals where conditions and safety considerations allow. When an interaction with a marine mammal occurs, the fishermen should document the appearance and size of the animal, the types of injuries that occurred, efforts to release the animal, and the characteristics of any gear remaining on the animal after release. These data on each marine mammal interaction must be reported to the NMFS Office of Protected Resources on the Marine Mammal Injury/Mortality Reporting Form (see reporting address and form availability information below) if there is an incidental mortality or injury to a marine mammal during commercial fishing activities. The incident must be reported within 48 hours after the end of the fishing trip, or for non-vessel fisheries, within 48 hours of the occurrence. Detailed documentation is critical because if this whale is seen again with the gear remaining or with serious injuries, it could be counted twice against the allowed incidental take for the fishery if the initial interaction was not properly documented and reported.

In the case of small cetaceans (e.g, dolphins and pilot whales) entangled in fishing gear or hooked, the crew should work carefully to disentangle the animal and/or remove gear as conditions and human safety allows. The vessel crew should avoid abrupt actions or vessel movements that may panic the animal. The vessel should stop alongside the animal, attempt to recover gear, and gently work to bring the animal alongside the vessel. Work to minimize the amount of tension on the animal from gear remaining in the water, and ensure that the animal has access to the surface to breathe. Cut wraps or other entangling gear from the animal’s body using a gaff or long-line cutter, being careful to avoid direct contact between the animal and sharp objects. If the animal is hooked, cut the barb off the hook using long-handled bolt cutters and/or use a NMFS approved de-hooking device to remove the hook. If a hook remains attached to the animal, cut any attached line as close to the hook as possible.

In the case of large whales (for example humpback whales, right whales, or sperm whales), fishers should not attempt to directly disentangle the animal without assistance. Instead, the vessel should be maneuvered in such a way as to minimize tension on the line, and the fishers

should immediately contact the U.S. Coast Guard at VHF Ch. 16 or contact the Provincetown Center for Coastal Studies Disentanglement Hotline at (800) 900-3622 for instructions if fishing within the U.S. EEZ. It is strongly recommended that disentanglement is only attempted with the assistance or advice of these experts. However, if contact is not possible (e.g., due to the vessel's location), the decision to attempt disentanglement should be made based on the experience and comfort level of the crew due to the significant risk of the procedure. If the crew decides to proceed with disentanglement, proper documentation of the interaction (video, multiple photographs and drawings) is essential. The primary goal if attempting disentanglement should be to remove all complete loops wrapped around the animal if possible. If the line is embedded in the flesh and healed over, cut the lines on either side as short as possible, and do not attempt to remove that section of line. Never enter the water to attempt disentanglement under any circumstances.

If a marine mammal interaction occurs, it is likely that another will occur if fishing is continued in the same area. Following an interaction, fishermen should notify other vessels working in the area that the interaction occurred and move to another area or wait 48 hours before continuing fishing operations.

Contact Information: NMFS Office of Protected Resources Attn: MMAP, 1315 East-West Highway, Silver Spring, MD 20910. Fax Number: 301-427-2522.

MMAP Form Available at:

http://www.nmfs.noaa.gov/pr/pdfs/interactions/mmap_reporting_form.pdf.

Vessel/Crew's Responsibilities upon Sighting a Sea Turtle

Generally, it is expected that all turtles less than three feet straight carapace length can be boated safely if sea conditions permit; larger turtles should also be boated when conditions and equipment permit. If it is determined that the turtle cannot be brought aboard without causing further injury to the turtle, or if conditions are such that the turtle cannot be safely brought aboard, then protocols for turtles not boated should be followed (refer to Chapter 2). Whenever possible, turtles should be brought onboard to make gear removal easier and safer, following the handling guidelines for turtles boated (refer to Chapters 3 - 5). The vessel's crew must attempt to remove all of the gear from the turtle. The captain and crew are responsible for the turtle's safety from first sighting until release, and all efforts should be made to release the turtle with minimal injury and minimal remaining gear.

Gear Removal Protocols

General guidelines for removing gear from sea turtles not boated and boated follow in Chapters 2 – 5. These removal tools and techniques are applicable to a variety of fisheries, but a few gear-specific protocols are introduced here.

Trawl Fisheries

In trawl fisheries, care should be taken not to drop the turtle from the net onto the deck below or allow the bag to slam into the side of the vessel, as this can result in serious injury. Turtles incidentally captured in trawl fisheries may have sustained an extended period of forced submergence and may require resuscitation (Chapter 3).

Gillnet Fisheries

If a sea turtle is entangled in gillnet gear, slow the vessel and adjust the vessel direction to move towards the turtle. Once the turtle is brought alongside the vessel, stop and put the vessel in neutral. Slowly retrieve the net, avoiding tugging or yanking motions. Considering the size of the turtle, sea conditions, and crew safety, determine whether the turtle can be boated. Avoid pulling up the turtle by the gear that it is entangled in, as this could injure the turtle. Bring the turtle onboard using a dip net or turtle hoist. If the turtle cannot be disentangled easily from the net, carefully cut the net off the turtle using a blunt-sided line cutter and attempt to remove any gear attached to the turtle. If conditions do not permit the turtle to be boated, control the turtle with a pair of turtle control devices if possible, and bring the turtle close to the vessel. Try to work the turtle free from the net, and use long-handled line cutters to cut the net and lines off of the turtle if necessary.

Fixed Gear Fisheries

Sea turtles can become entangled in the vertical lines of fixed gear (e.g., crab pots, whelk pots). If a turtle is encountered entangled in fixed gear, contact the NMFS Northeast Region Stranding Hotline at 1-978-281-9351 (when the interaction occurred in the coastal waters of Maine, New Hampshire, Massachusetts, Rhode Island, Connecticut, New York, New Jersey, Pennsylvania, Delaware, Maryland, and Virginia) or the U.S. Coast Guard on VHF Ch. 16 (all other U.S. coastal waters) for further instructions. It is recommended that disentanglement is only attempted with the assistance or advice of experts.

Specific guidelines for disentangling sea turtles captured in fixed gear, gear collection protocols and required documentation procedures can be found at:

http://www.nero.noaa.gov/prot_res/stranding/stdn.html and

http://www.nero.noaa.gov/prot_res/stranding/SeaTurtleDisentanglementNetwork.pdf.

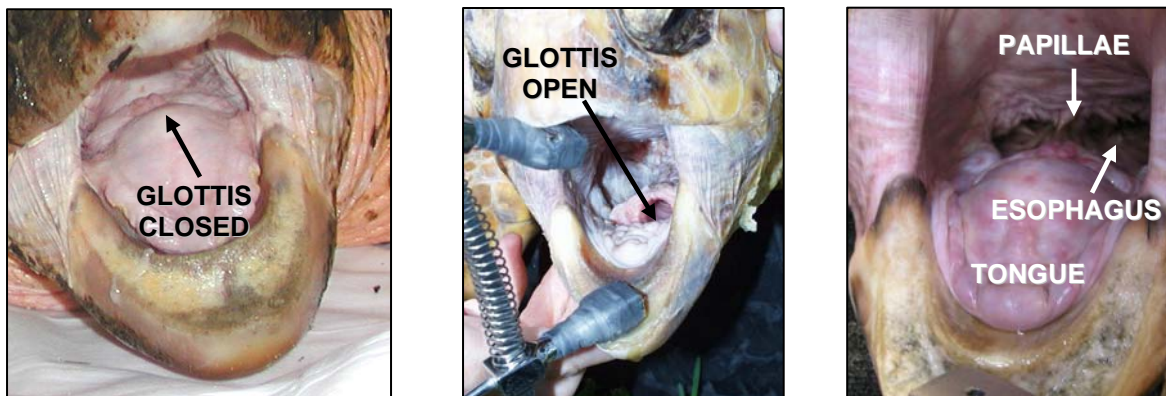
Hook-and-line Fisheries

Captains and crews in hook-and-line fisheries should scan the line as far ahead as possible during gear retrieval to sight turtles in advance and to avoid getting ahead of the line while retrieving gear. Upon sighting a turtle, the vessel and line reel speed should be slowed and the vessel direction adjusted to move toward the turtle, minimizing tension on the line. Gentle, consistent tension should be kept with enough slack to keep the turtle near the vessel but in the water. Once the turtle is brought alongside the vessel, stop and put the vessel in neutral. Do not use gaffs or other sharp objects in direct contact with the turtle to retrieve or control it, although a gaff may be used to control the line. Assess the turtle's condition and size, nature of the interaction,

location of the hook, and available crew. The vessel must be stopped in order to respond to these interactions, and a decision must be made whether the turtle can be brought onboard safely. There are three possible sea turtle interactions with hook-and-line fishing gear: (1) entangled but not hooked, (2) hooked but not entangled, and (3) hooked and entangled. The protocols here are written to optimize the success of gear removal, utilizing at least three crew members in some scenarios. If there are not at least three crew members available, modifications to the protocols have been suggested where appropriate (e.g., the turtle control devices can be tied off, some mouth gags offer hands-free operation).

Assessing Whether to Remove Hooks

The decision whether to remove a hook is very important, and may directly affect the turtle's chances for survival. If you are unsure whether hook removal will cause further serious injury to the turtle, do not remove the hook. All externally embedded hooks should be removed. Chapter 4 contains details on opening the mouth of boated turtles to conduct an assessment of ingested hook location. Hooks in the mouth should be removed when they are visible in part or whole, but judgment should be used in each case. If the hook is in the braincase, glottis, or otherwise deeply embedded where you believe removal will cause more damage, do not remove the hook.



Figures 1-1 a, b and c. Oral cavity anatomy [(a) Photo courtesy of Don Lewis, (b) & (c) NMFS/SEFSC photos]

The glottis (Figures 1-1a and b) is located in the middle of the tongue (Figure 1-1c, large muscular organ fixed to the floor of the mouth), and consists of the opening to the trachea and the valve to open and close the airway. The esophagus begins at the back of the mouth and is lined with papillae (Figure 1-1c). Only remove hooks from the esophagus (Figure 1-1c) when the insertion point of the barb is clearly visible, and exercise extreme caution during hook removal. Never attempt to remove a hook that has been swallowed when the insertion point is not visible, as removal may cause more damage to the turtle than leaving the hook in place. When a hook cannot safely be removed, monofilament cutters should be used to cut the line as close as possible to the eye of the hook. If part of the hook is visible and accessible, but cannot be removed (e.g., hook in glottis), bolt cutters should be used to cut off and remove the visible part of the hook. See Chapter 2 for details about removing hooks from turtles not boated and Chapter 5 for turtles that are boated.

Releasing the Turtle

Once gear is removed and the turtle recovered, boated turtles should be released in waters of similar temperature as at capture, when fishing or scientific collection gear is not in use, the engine is in neutral, and in an area where they are unlikely to be recaptured or injured by vessels. Make sure that the turtle is safely away from the vessel before starting the engines. Release the turtle by lowering it over the aft portion of the vessel, close to the water's surface, when gear is not in use and the engines are in neutral. The turtle's behavior and swimming and diving abilities should be monitored after release and recorded. A turtle that has shown no sign of life after 24 hours on deck may be considered dead and returned to the water in the same manner.

Chapter 2 Equipment and Techniques for Sea Turtles Not Boated

When a turtle is too large to be boated, or if sea conditions prevent the safe boating of turtles, the gear must be removed while the turtle remains in the water. The turtle should be brought as close as possible and allowed a short time to calm down if necessary before being brought fully alongside, where gear removal must be conducted as quickly as possible. Do not ever enter the water to remove gear from an animal under any circumstances. The first section in this chapter details the tools and methods to control the turtle for both the crew's and the turtle's safety. The second section details the tools and techniques to be used for gear removal. Next, different possible scenarios involving three types of potential hook-and-line gear interactions are described, outlining the combination of tools (Figure 2-1) best adapted for each scenario.

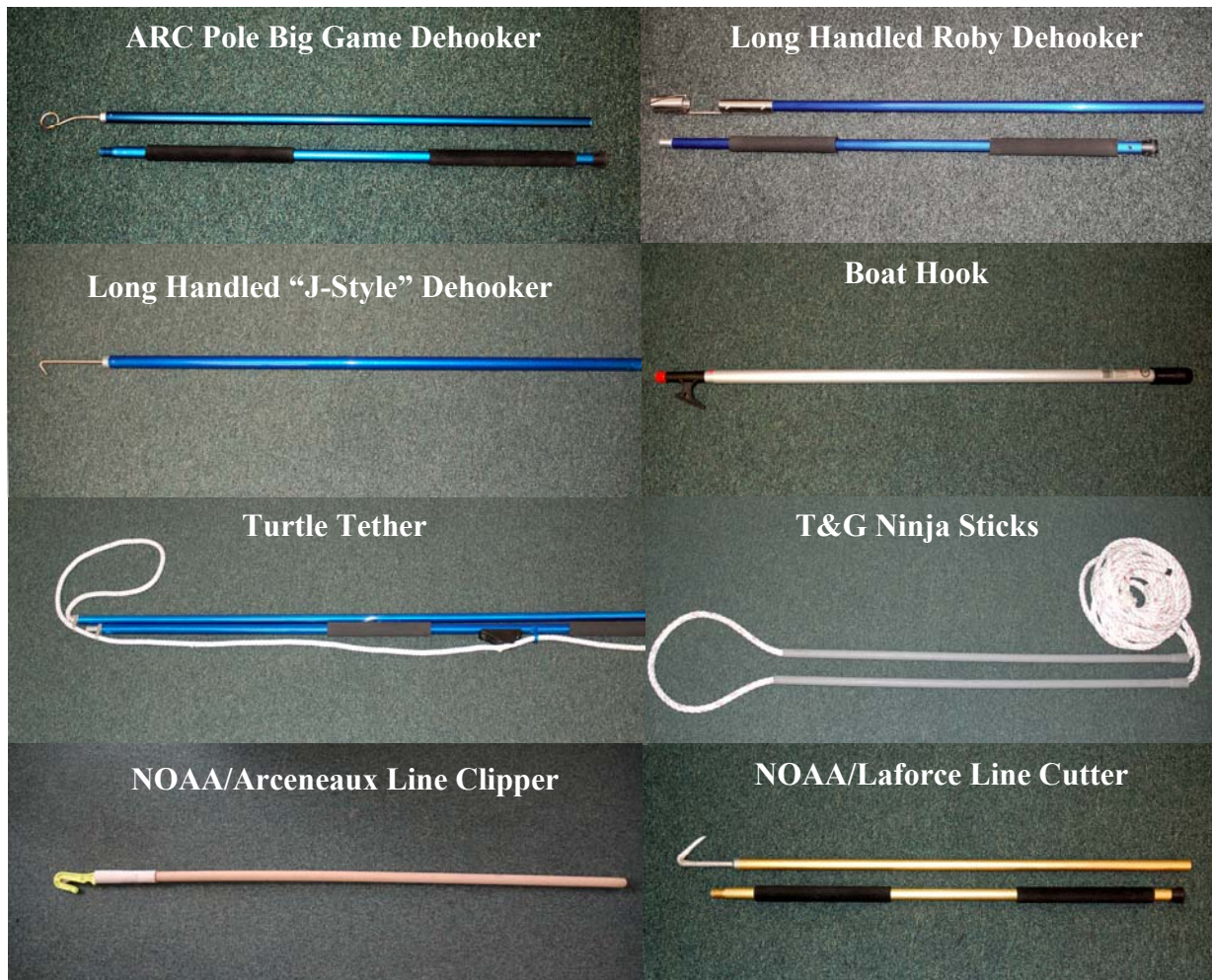


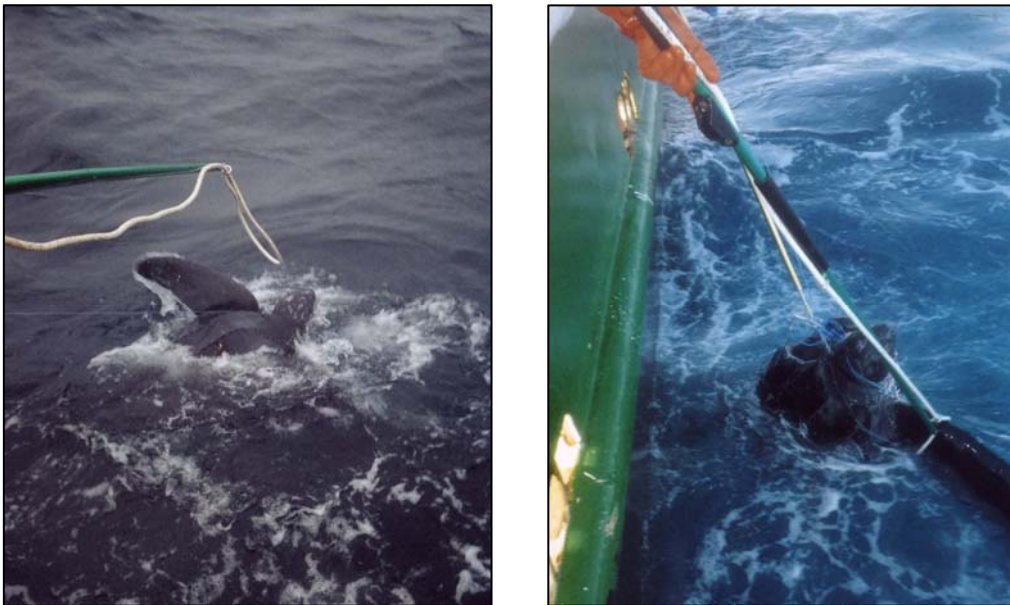
Figure 2-1. Long-handled tools for sea turtles not boated (NMFS/SEFSC photos).

Turtle Control Devices

Turtle control devices were designed in response to safety concerns for fishing vessel crew members and for incidentally captured sea turtles, as well as to facilitate the likelihood of maximum gear removal potential. These devices, which should be used in pairs, take pressure off the involved gear and help stabilize the animal. They secure the front flippers of the sea turtle so that the animal can be controlled at the side of the vessel, facilitating rapid gear removal while reducing the chances that taut line could snap under the strain of the active sea turtle and recoil towards the crew members on deck. These devices should never be used around the turtle's neck or head. After securing the animal's flippers at the side of the vessel, use dehookers and line cutters as needed, depending on the type of gear interaction, as described on Pages 2-13 – 2-14. Currently, there are two turtle control device styles that reduce safety risks associated with removing gear from active sea turtles not boated, particularly leatherbacks.

(1) Turtle Tether

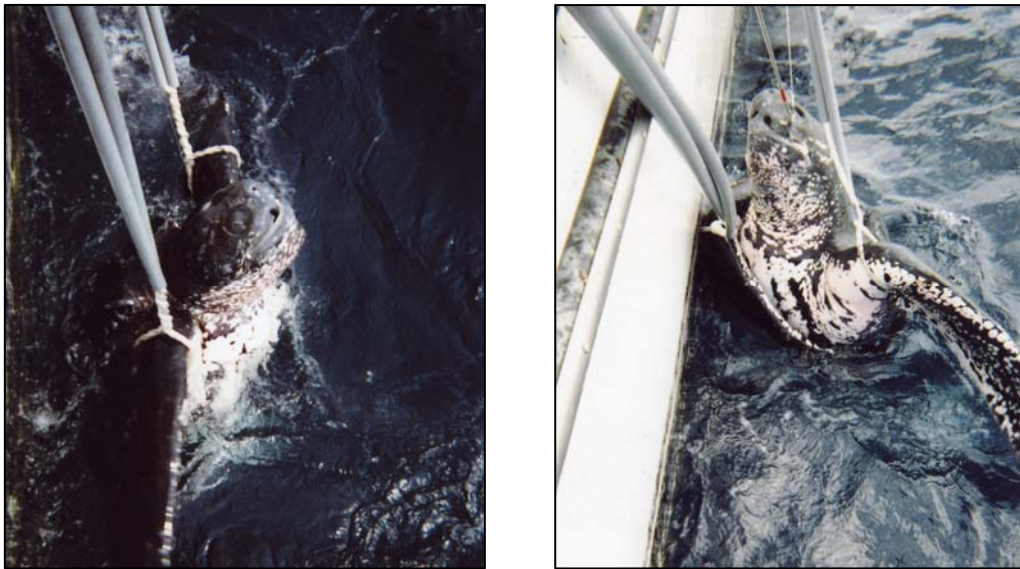
The first type of turtle control device, referred to as the “Turtle Tether,” is designed to “noose” the flipper using one pole and a line threaded through eyebolts. The end of the negatively buoyant tether line should be threaded through an eyebolt at the end of the tether, then through two eyebolts farther down the pole. A tag line threaded through the end of the tether must be attached to the vessel to ensure that the turtle cannot escape with the tether attached. Loop the stiff rope around the front flipper up to the “shoulder” region, tighten, and cinch the rope in the cleat. Keep a firm hold of the tether pole to keep the animal near the vessel, allowing for dehooking and disentanglement (Figures 2-2a and b). To optimize safe handling of the turtle, two people should each operate a set of the Turtle Tethers to capture both flippers and restrain the turtle alongside the vessel.



Figures 2-2a and b. Controlling a leatherback using a turtle tether (NMFS/SEFSC photos)

(2) T&G Ninja Sticks

The second type of turtle control device, referred to as the “T&G Ninja Sticks,” consists of two long poles (electrical conduit PVC, fiberglass, aluminum, or similar) with line threaded through or securely affixed to both lengths. The free end of the line should be tethered to the vessel unless an additional tag line is used, leaving enough slack to create a ~24” working section of line between the two poles to secure the flipper. Holding one pole in each hand, capture the flipper, bring the poles together, and twist the line until the flipper is secured. To optimize safe handling of the turtle, two people should each operate a set of the T&G Ninja Sticks to capture both flippers and restrain the turtle alongside the vessel (Figures 2-3a and b).



Figures 2-3a and b. Controlling a leatherback using a pair of T&G Ninja Sticks (NMFS/SEFSC photos).

Equipment to Remove Line and Netting

(1) Long-handled Line Clipper/Cutter

Line cutters are designed to cut high-test monofilament line, netting material, and line (e.g., braided/twisted rope) from entangled sea turtles. Carefully slide the blunt end of the line cutter under the line or netting that you wish to remove and pull the line cutter to capture it within the recessed blade(s) of the device (Figure 2-4a). In hook and line fisheries, a line cutter may also be used to cut the monofilament line as close as possible to the hook, minimizing remaining gear when hook removal is not possible.



Figures 2-4a and b. Using line cutter (a) and monofilament cutter (b) on entangled leatherbacks (NMFS/SEFSC photos).

(2) Monofilament Cutters

If the turtle is close to the vessel, hand-held monofilament cutters may be used to remove line or netting material from hooked and/or entangled turtles (Figure 2-4b). Turtles should be released with as little gear as possible remaining.

Equipment to Remove Hooks

(1) Long-handled Dehooker for Internal Hooks

(a) ARC (Aquatic Release Conservation) Pole Big Game Dehookers

The ARC Pole Big Game Dehooker models, which are manufactured in several sizes, are examples of NOAA Fisheries certified equipment. These dehookers are designed for removing hooks that are external or that are lodged in the mouth, throat, or esophagus without touching or removing the animal from the water. The device engages and secures the leader, allowing the hook to be secured within an offset loop without re-engaging the barb during the removal process (Figure 2-5). Specific instructions for the long-handled pole models are given here, and more general guidelines for using all types of ARC dehookers can be found in Plate 2-1.



Figure 2-5. Removing hook with an ARC Pole Big Game Dehooker (NMFS/SEFSC photo).

Instructions for using ARC Pole Big Game Dehookers:

- 1) The person controlling the leader must carefully bring the animal alongside the vessel, using a turtle control device to help control the turtle if possible. They should stay to the left of the dehooking person and maintain a taut leader.
- 2) The person with the dehooker should be to the right of the person with the leader to capture the leader, and no one should get in between the leader and the dehooking device in case the line breaks or the hook dislodges.
- 3) There is only one correct way to place the pigtail over the leader. The person controlling the leader must maintain leader tension. The person with the dehooker places the dehooker on the leader at a 90° angle with the open end of the curl facing them, and the tail end of the curl facing up. Pull until the curl of the dehooking device captures the line (like a bow and arrow), and rotate the device 1/4 turn clockwise. When placed correctly, the leader will be in the center of the pigtail curl.
- 4) Slide the dehooker down the leader until it engages the shank of the hook and bottoms out. Slightly rotate the device back and forth to ensure proper engagement on the hook. If the dehooker has been notched (see instructions below) to help facilitate circle hook removal, the hook will seat into the notch.
- 5) When the hook is engaged, the dehooking device must be brought together with the leader, parallel to the line. If the line is not parallel with the dehooking device, the point of the hook will have a tendency to turn out and allow for possible re-engagement after release.
- 6) Working together, the person with the leader and the person with the dehooker must communicate and keep the line taut until the exact moment that the person using the dehooker disengages the hook with a short, sharp jab downward. If removing a circle hook, a rocking or twisting motion of approximately 180° during the downward jab motion may be necessary to facilitate circle hook removal. After engaging shank of the

hook, keep the line parallel with tension and start a rocking (back and forth) and pushing motion to remove the circle hook. The rocking motion in addition to the traditional pushing motion allows the circle hook to be twisted and pushed out.

- 7) The leader person must give a little slack when the person with the dehooker is jabbing downward, so timing and communication are important. After the hook is removed, the point of the hook will rotate and stop on the offset bend of the dehooker (Figure 2-6), protecting the point and preventing re-engagement of the hook.



Figure 2-6. Point of the hook is shielded to prevent re-engagement (NMFS/SEFSC photo).

Notch Modification for the ARC Dehookers:

In collaboration with the Australian Fisheries Management Authority and industry experts, ARC tested a notch modification to their dehookers. They determined that notching the pigtail curl allows the fisher to use a rocking and pushing (instead of just pushing) motion that increases the effectiveness of circle hook removal. The notch is created where the hook lies in the bottom portion of the curl (Figure 2-7a), securing the shank enough to rock the hook from side to side while pushing the circle hook out. The notch modification can be easily and quickly accomplished with a simple metal file (Figure 2-7b) in approximately 15 minutes. During laboratory trials, the notch modification (Figure 2-7c) was found to be an effective modification to these tools to assist in hook removal, particularly circle hook removal, while maintaining the integrity of the device's tensile strength. However, it was determined that by maintaining proper line tension and using a rocking or twisting motion while pushing downward, circle hooks still could be removed effectively without the notch modification. Detailed instructions for notching the ARC dehookers can be found in Appendix A, Chapter A2.

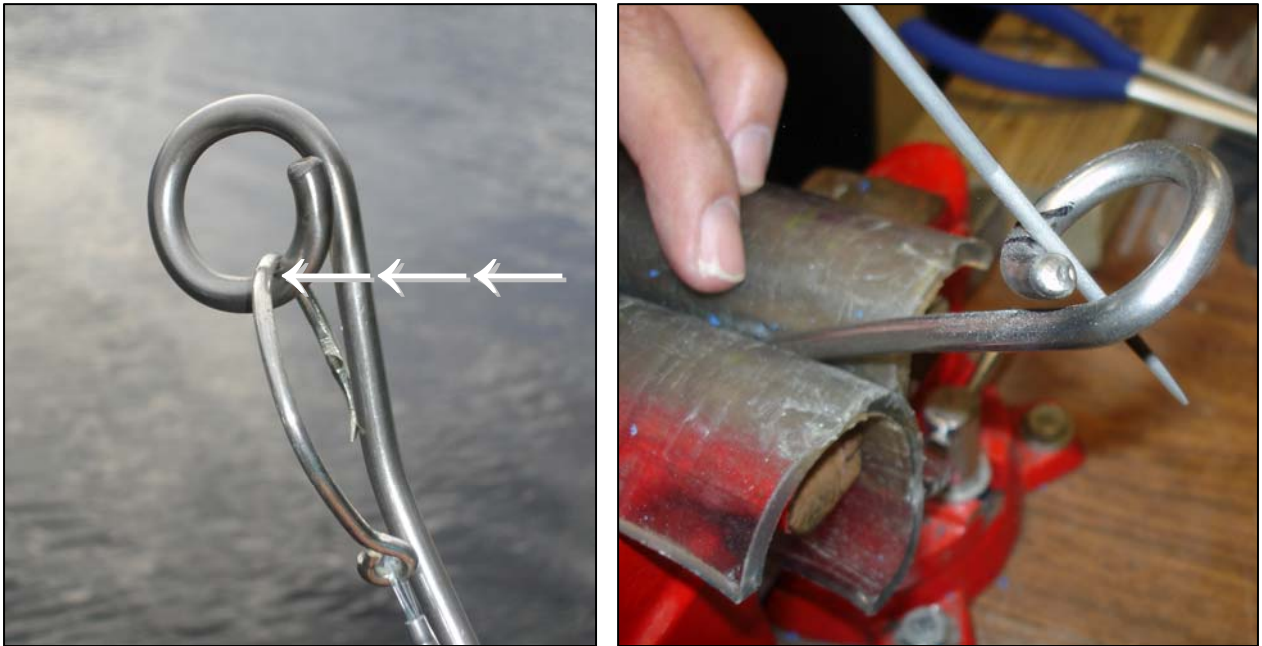
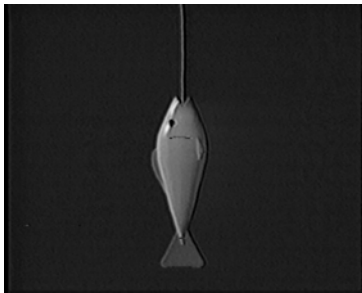


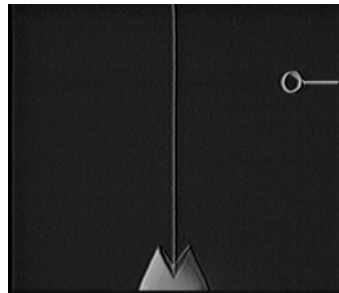
Figure 2-7 a, b and c. Notch the pigtail curl where the shank of the hook contacts the vertical bottom of the pigtail curl, ~1/16" - 1/8" deep and ~1/8" wide using a metal file [(a) Photo courtesy of ARC; (b) and (c) NMFS/SEFSC photos].

Plate 2-1 Instructions for ARC Dehookers

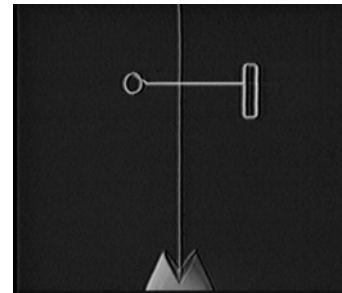
The illustrations here depict fish, but the technique can be used for sea turtles, marine mammals, and sea birds as well.



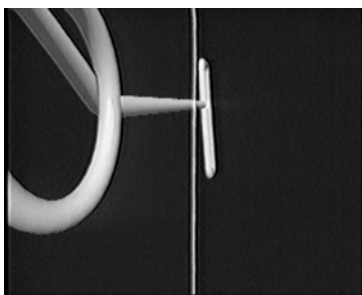
Step 1



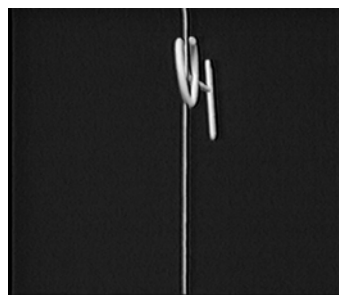
Step 2



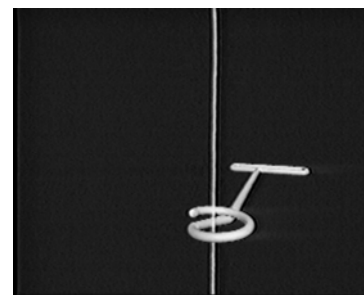
Step 3



Step 4



Step 5

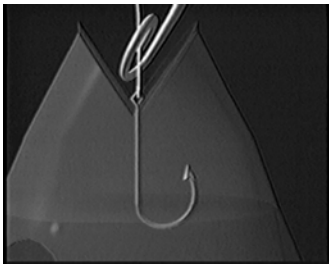


Step 6

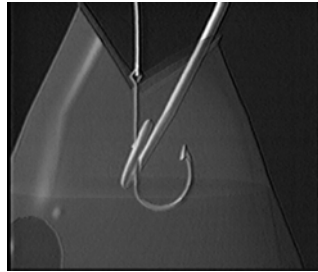
Figures provided by Aquatic Release Conservation

- (1 – 2) Grab the leader with one hand and hold the dehooker in your other hand, making sure the open end of the pigtail is facing up.
- (3) Place the rod of the dehooker on the leader perpendicular to the leader as you would a bow and arrow.
- (4 – 5) Draw the dehooker back towards you until you engage the line.
- (6) Turn the dehooker 1/4 turn clockwise. This puts the leader in the center of the curl.

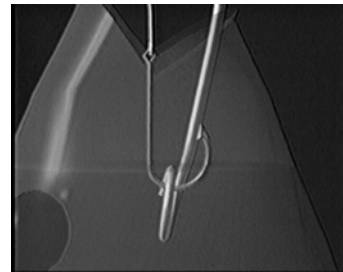
Plate 2-1 Continued



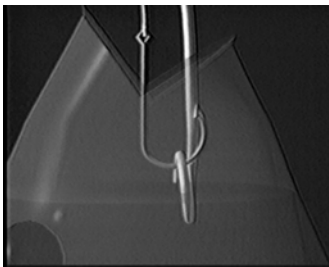
Step 7



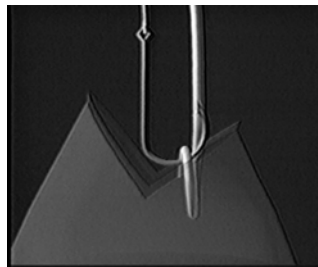
Step 8



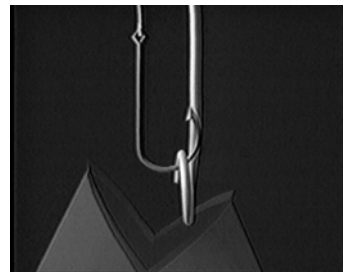
Step 9



Step 10



Step 11



Step 12

- (7 - 9) Keeping your hands apart, follow the leader down until the dehooker bottoms out on the hook.
- (10) Bring your hands together making sure the leader is tight and parallel with the dehooking device.
- (11-12) Give a slight thrust downward (or rocking/twisting downward thrust) with the dehooking device until the hook disengages, then pull out the dehooker with the hook. The point of the hook will be hidden by the offset bend so that the hook does not re-engage.

(2) Long-handled Dehooker for External Hooks

(a) Aquatic Release Conservation (ARC) Pole Big Game Dehookers

Refer to the description of this device beginning on Page 2-4.

(b) Long-handled J-Style Dehooker

This long-handled dehooking device may be used for dehooking in circumstances where the animal is hooked externally. Hold the leader in one hand with tension and hold the dehooker in your other hand. Place the dehooker on the leader and follow the leader down until it bottoms out on the shank of hook (Figure 2-8). With tension on the leader, the ideal position for dehooking is to lower the hand with the leader to the 8 o'clock position and raise the hand with the dehooker to the two o'clock position (Illustrated in Plate 5-3); depending on the positioning, a smaller angle may be appropriate. Twist the dehooker slightly and pull until the hook is dislodged. Be cautious not to allow the hook to re-engage once removed.



Figure 2-8. Using J-Style dehooker on externally hooked leatherback (NMFS/SEFSC photo).

(c) Long-handled Roby Dehooker

This dehooker is suitable for removing external hooks and can be mounted to a long handle for use on turtles not boated. The design, which incorporates four notches at 90° angles at the base of a cylinder, grasps the hook very securely (Figure 2-9), facilitating the twisting motion necessary to remove circle hooks. Engage the line by feeding it through the diagonal slit in the side of the cylinder, and then secure the hook in the notches. Once the hook is secured, use a pushing motion to release the hook. If you are removing a circle hook, a twisting motion of approximately 180° while thrusting the dehooker downward may be required to remove the circle hook.



Figure 2-9. Roby dehooker (NMFS/SEFSC photo).

Plate 2-2

Instructions for the Roby Dehooker



Step 1



Step 2



Step 3



Step 4

- (1) Hold leader in one hand with tension and hold the Roby dehooker in the other hand. Feed the leader through the diagonal slit in the cylinder.
- (2) Position the dehooker so that it is firmly seated against the shank of the hook, secured in the notches.
- (3) Bring both hands together (leader and dehooker parallel with each other) while maintaining tension on the leader.
- (4) With the leader and dehooker together, give a short, sharp jab to dislodge the hook and remove it from the animal. Rotate or twist up to 180° during the jabbing motion if necessary to remove the hook, particularly when removing circle hooks. Maintain line tension and take care to prevent the hook from re-engaging after removal.

Long-handled Device to Pull an “Inverted V” during Disentanglement

A standard boat hook, long-handled J-Style dehooker, or standard fishing gaff may be used to assist in disentanglements and to pull a “V” for dehooking entangled sea turtles, as described in the “Inverted V” dehooking technique below.

“Inverted V” Dehooking Technique

- 1) Once at the surface, the animal may have a tendency to entangle itself more. After the first inspection, let the turtle calm down for a short period of time (in some cases up to 10 minutes) then gently draw it to the boat, using turtle control devices when practical to control the animal.
- 2) An additional crew member should carefully engage the monofilament leader closest to the embedded hook with a gaff, boat hook or long-handled J-Style dehooker, depending on the distance to the hook. If using a gaff, care should be taken to ensure that the point of the gaff does not ever contact the turtle. The gaff person should pull the line upward into an “Inverted V” to enable engagement of the dehooking device on the line closest to the hook (Figure 2-10).
- 3) Follow the instructions on Pages 2-4 – 2-12 to remove the hook from the turtle using a long-handled dehooking device. The gaff person would serve the same function as the leader person.
- 4) After the hook is removed and secured by the dehooker, carefully remove all line with the line cutter to disentangle the animal (Pages 2-3 – 2-4).



Figure 2-10. Pulling an “Inverted V” (Photo courtesy of ARC).

Possible Scenarios Encountered for Sea Turtles Not Boated in Hook-and-line Fisheries

(1) Entangled but not hooked (*recommended personnel and equipment: at least three crew / two turtle control devices / long-handled dehooker for internal hooks / line cutter / long-handled device to pull an “Inverted V”*)

Control the turtle at the side of the boat using the involved line, or preferably with a turtle control device (Pages 2-2 – 2-3). If there are not at least three crew members available, the turtle control devices should be tied off. Secure the loose hook with the long-handled dehooker for internal hooks and carefully slide the blunt end of the line cutter under the line that you wish to remove. The dehooker for internal hooks is preferable because it can hold the loose hook to control it and protect the barb from reengaging. Pull the line cutter and the line will be captured within the recessed blade(s) of the device (Figure 2-4a). A long-handled J-Style dehooker, boat hook, or gaff may be carefully used to manage the line while cutting with the line cutters. Monofilament cutters may also be useful if the turtle is close to the side of the vessel (Figure 2-4b).

(2) Hooked but not entangled (Figure 2-11) (*recommended personnel and equipment: at least three crew / two turtle control devices / long-handled dehooker*).

Control the turtle at the side of the boat using the involved line, or preferably with turtle control devices (Pages 2-2 – 2-3). If there are not at least three crew members available, the turtle control devices should be tied off. The choice of dehooker will depend on the location and depth of the hook. Do not attempt to remove hooks that have been swallowed beyond where the insertion point of the barb is visible, or when it appears that hook removal will cause further serious injury to the turtle. If the hook cannot be removed, ensure that as much line as possible is removed and, if possible, remove some of the hook with bolt cutters.

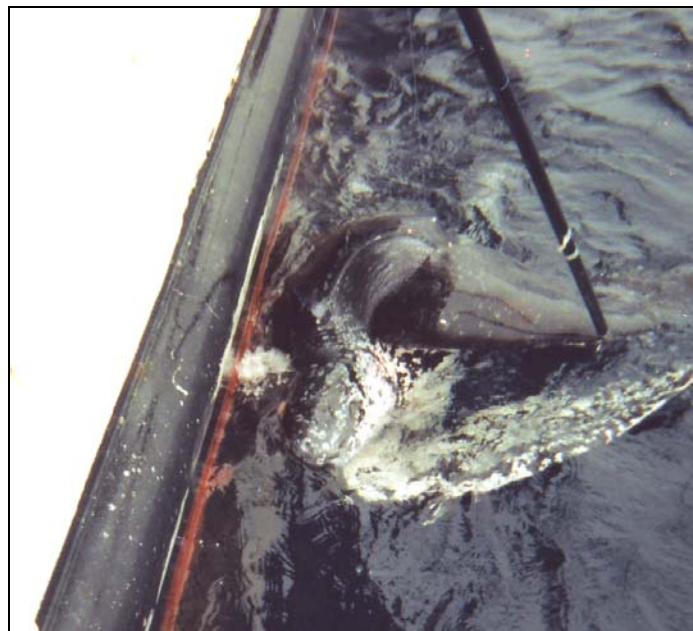


Figure 2-11. Using a dehooker on a leatherback hooked but not entangled (NMFS/SEFSC photo).

(3) Hooked and entangled (Figure 2-12) (*recommended personnel and equipment: multiple crew / two turtle control devices / dehooker / line cutter / long-handled device to pull an “Inverted V”*)

Control the turtle at the side of the boat using the line (if applicable), or preferably with turtle control devices (Pages 2-2 – 2-3). For turtles wrapped in line or hooked in the armpit or shoulder with the line running underneath the turtle, not over the turtle, the “Inverted V” technique is necessary for release (Page 2-10). Remove the hook first prior to line removal. Follow the instructions on Pages 2-3 – 2-12 for removing hooks and line.



Figure 2-12. A hooked and entangled leatherback (NMFS/SEFSC photo)

Chapter 3 Boating and Holding Sea Turtles

Boating the Turtle

It is very important that the turtle is never pulled out the water, even partially or for a short distance, using the gear with which the turtle is hooked or entangled. This could cause serious injury to the turtle, especially when the turtle has swallowed a hook. Once boated, the turtle will be handled according to the procedures for boated turtles.



Figure 3-1. Bringing a turtle onboard using a dip net (NMFS/SEFSC photo).

(1) Dip Net

If the turtle is small enough and conditions are such that it can be brought aboard the vessel safely (Figure 3-1), use a dip net (Figure 3-2) meeting standards specified in NMFS regulations to carefully bring the turtle aboard. Place the net under the turtle, and safely lift the turtle out of the water and onto the deck. If the vessel is equipped with “cut out doors,” use this door to minimize the distance from the water for the turtle to be retrieved.



Figure 3-2. Dip net (NMFS/SEFSC photo).

(2) Turtle Hoist

(a) Large Turtle Hoist

A large turtle hoist is recommended to bring turtles onboard that cannot be boated using a smaller dip net or on vessels equipped with a hydraulic lift. This is particularly useful when removing gear from leatherback sea turtles. The hoist is lowered into the water using a hydraulic lift and brought near the turtle. Once the hoist is in the water, the turtle can be guided into the device using the attached gear and/or turtle control device. Once the turtle is positioned within the hoist, release tension on the gear, and the turtle will descend deeper into the lift. The hoist and turtle are then raised slowly back onto the deck (Figure 3-3). The device is designed so that when onboard, the turtle is suspended above the deck on a platform of mesh netting supported by a rigid ring and contained within a webbing fence (Figure 3-4). The turtle is immobilized in this lift, facilitating

safe and rapid gear removal. Once all gear has been removed, the hoist and turtle are lowered back into the water deep enough for the turtle to swim out of the frame. Orient the hoist so that the turtle is facing away from the boat upon release. The use of this device is demonstrated in the video “Leatherbacks Aboard” (Epperly and Hataway 2004).



Figure 3-3. Bringing leatherback onboard using a large turtle hoist (NMFS/SEFSC photo).



Figure 3-4. Leatherback supported onboard in large turtle hoist (NMFS/SEFSC photo).

(b) Small Turtle Hoist

A small turtle hoist (Figure 3-5) is recommended to bring turtles onboard that cannot be boated using a traditional dip net with an extended reach handle. This is particularly useful when removing gear from sea turtles while on a vessel with a high freeboard or when storage space is extremely limited. Once the hoist is in the water, the turtle can be guided into the device using the attached gear and/or turtle control device. Use the attached lines to guide the frame under the turtle, and haul the lines evenly to capture the

turtle and bring it onboard, using care to maintain the net parallel to the water's surface so that the turtle cannot slip out. A pulley system or hydraulic lift can be used to hoist the frame out of the water if available. Once all gear has been removed, the hoist and turtle are lowered back into the water deep enough for the turtle to swim out of the frame, releasing tension on the outer lines if necessary to tip the frame. Orient the hoist so that the turtle is facing away from the boat upon release.



Figure 3-5. Small turtle hoist (Photo courtesy Alvaro Segura, World Wildlife Fund).

Holding the Turtle

While onboard, the turtle must be kept moist and in the shade, maintaining its body temperature above 60° F, similar to water temperatures at capture. It must be safely isolated and immobilized on a cushioned surface. The large turtle hoist serves this purpose; smaller turtles will need to be placed on a cushioned surface, such as an automobile tire. If you encounter a turtle with a tag, note the tag number and species and report the find to the address on the tag. All gear should be removed immediately. If possible, and especially if the turtle appears lethargic, leave the turtle on deck at least four hours up to twenty-four hours and monitor its condition, allowing stress toxins to dissipate.

(1) Cushion/Support Device

A suitably-sized cushion/support device, such as a standard automobile tire (Figure 3-6) without a rim or boat cushion, should be used to safely isolate and immobilize the animal once it is onboard. Place the turtle in its normal orientation whenever possible while immobilized, unless there is a reason to have it temporarily resting on its carapace.



Figure 3-6. Loggerhead supported using an automobile tire (NMFS/SEFSC photo)

(2) Comatose Turtles

If a turtle appears to be comatose (unresponsive, unconscious), attempt to revive it before release per 66 FR 67495, December 31, 2001. Place the turtle on its plastron (lower shell) and elevate the hindquarters approximately 15 - 30° (Refer to Plate 3-1) to permit the lungs to drain off water for a period of four up to twenty-four hours. A board, tire or boat cushion, etc. can be used. Keep the skin, and especially the eyes, moist while the turtle is on deck by covering the animal's body with a wet towel, periodically spraying it with water, or by applying petroleum jelly to its skin and carapace. Periodically, gently touch the corner of the eye or eyelid and pinch the tail near the vent (reflex tests) to monitor responsiveness. Do not put the turtle in a container of water for resuscitation, as even shallow water may cause it to drown.

Turtles can withstand lengthy periods without breathing; a comatose sea turtle may not move, breathe voluntarily, or show reflex responses or other signs of life. In other cases, a lightly comatose turtle may show shallow breathing or reflexes such as eyelid or tail movement when touched. Sea turtles may take some time to revive; do not give up too quickly. Regulations (66 FR 67495, December 31, 2001; 50 CFR 223.206) allow a fisherman to keep a turtle on deck up to 24 hours for resuscitation purposes without a permit. Even turtles that are successfully resuscitated benefit from being held on deck as long as possible (up to 24 hours) to fully recover from the stress of accidental forced submergence.

In the past, an alternative method of resuscitation, known as plastral pumping, was sometimes recommended (see FR 43 32801, July 28, 1978; 57 FR 57354, December 4, 1992). This practice involved placing the turtle on its carapace and pumping the plastron with hand or foot. However, we strongly discourage this technique, as further study determined that it may actually do more harm than good and should not be attempted during resuscitation (per 66 FR 67495, December 31, 2001). Plastral pumping may cause the airway to block and cause the viscera to compress the lungs which are located dorsally, thereby hindering lung ventilation.

Plate 3-1

Sea Turtle Resuscitation Guidelines

If a turtle appears to be unresponsive or comatose, attempt to revive it before release. Turtles can withstand lengthy periods without breathing; a comatose sea turtle will not move, breathe voluntarily, or show reflex responses or other signs of life. In other cases, an unresponsive turtle may show shallow breathing or reflexes such as eyelid or tail movement when touched. Use the following method of resuscitation in the field if veterinary attention is not immediately available:

- Place the turtle on its plastron (lower shell) and elevate the hindquarters approximately 15 - 30 degrees to permit the lungs to drain off water for a period of 4 up to 24 hours. A board, tire or boat cushion, etc. can be used for elevation.
- Keep the turtle in the shade, at a temperature similar to water temperature at capture. Keep the skin (especially the eyes) moist while the turtle is on deck by covering the animal's body with a wet towel, periodically spraying it with water, or by applying petroleum jelly to its skin and carapace. Do not put the turtle into a container with water.
- Do not put the turtle on its carapace (top shell) and pump the plastron (breastplate) or try to compress the turtle to force water out, as this is dangerous to the turtle and may do more harm than good.
- Periodically, gently touch the corner of the eye or eyelid and pinch the tail near the vent (reflex tests) to monitor consciousness.
- Sea turtles may take some time to revive; do not give up too quickly. Turtles that are successfully resuscitated benefit from being held on deck as long as possible (up to 24 hours) to fully recover from the stress of accidental forced submergence.
- Release successfully resuscitated turtles over the stern of the boat, when fishing or scientific collection gear is not in use, the engine is in neutral, and in areas where they are unlikely to be recaptured or injured by vessels. A turtle that has shown no sign of life after 24 hours on deck may be considered dead and returned to the water in the same manner.



NMFS/SEFSC Photos



References:

Federal Register, December 31, 2001. Government Printing Office, Washington DC 66 (250), pp. 67495-67496.

October 2008

Chapter 4 Equipment and Techniques for Opening the Mouth of Boated Turtles

Opening the Mouth

When a turtle with an internal hook injury is brought on board, it will likely have its mouth open. If the animal is not voluntarily opening its mouth, there are a few mouth-opening techniques you can apply:

- 1) Block the turtle's nostrils to encourage the turtle to open its mouth (Figure 4-1).
- 2) Tickle the throat or pull outward on the throat skin.
- 3) Cover the nostrils and carefully apply light pressure to the anterior corner of the eye socket (not the eye itself) with one hand and apply firm pressure in the throat area with your other hand.



Figure 4-1. Opening the mouth (NMFS/SEFSC photo).

If you still cannot open the mouth, use a mouth opener, such as rope loops covered with protective tubing or an avian speculum. The mouth openers will enable you to access the turtle's mouth, while the mouth gags will keep the turtle's mouth open so you can remove any hooks and/or line. Keep in mind that various mouth gags will block your view inside the mouth in different ways. Therefore, select which mouth gag will best suit the dehooking or disentanglement procedure that you need to perform. You can improve your visibility at the back of the turtle's mouth and upper esophagus by using the needle-nose pliers. After securing the mouth open, gently slide the pliers in the closed position forward into the upper esophagus and separate the pliers' jaws to open the esophagus.



Figure 4-2. Mouth openers and gags (NMFS/SEFSC photo).

Mouth Openers and/or Gags

The following devices (Figure 4-2) can be used to open the mouth and/or maintain the mouth open: Use caution with these methods, as injury can result if these tools slip.

(1) Set of Two Rope Loops with Protective Tubing (both a mouth opener and mouth gag)

Slide the ropes with protective tubing in between the jaws and move them away from the front of the mouth to gain the greatest leverage (Figure 4-3). Care should be taken to avoid contact with the eyes. With the free ends of the rope knotted together to form a loop, you can hold the lower rope loop with your foot and the other with one hand, leaving one free hand.



Figure 4-3. Opening the mouth using rope loops (Photo courtesy of ARC).

(2) Large Avian Oral Speculum (both a mouth opener and mouth gag)

Slide the avian speculum flat inside the turtle's mouth (Figure 4-4a) and rotate it (Figure 4-4b). Notice that the speculum is stepped and can be used for different sized turtles by selecting for its different widths. This mouth opener can be used only on the smallest of animals, as larger turtles can easily crush the avian speculum.



Figures 4-4a and b. Using an avian speculum as an (a) mouth opener and (b) gag (NMFS/SEFSC photos).

(3) Block of Hard Wood (mouth opener and mouth gag)

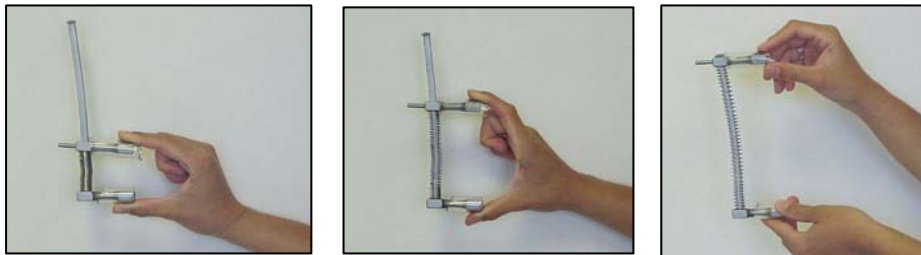
Soak the wood block/handle first to soften it and decrease damage to the beak. Position it in the posterior corner of the mouth to keep the mouth open (Figures 4-5a and b).



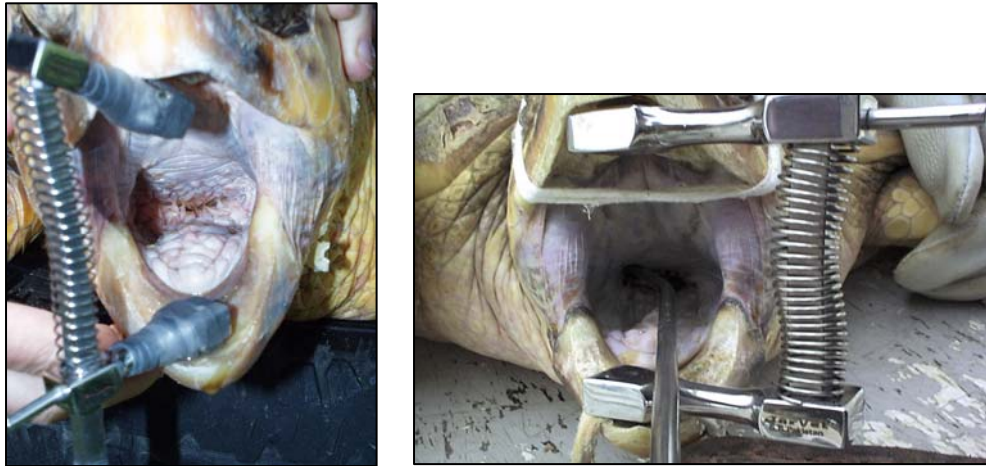
Figures 4-5 a and b. Wooden brush handle used as (a) mouth opener and (b) gag [(a) Photo courtesy of ARC, (b) NMFS/SEFSC photo]

(4) Set of Three Canine Mouth Gags (mouth gag)

This type of gag locks into the open position and allows for hands free operation once it is in place. The canine mouth gag's arms are compressible when they are perpendicular to the main axis. The rubber feet on the gag lock nicely into the groove on the upper and lower beak. When the turtle bites down on the extremity of the arms, they will shift from being perpendicular and therefore will lock. Use the smallest one possible that will not crush. Compress the gag and insert it in the turtle's mouth. As the turtle opens its mouth, the gag will expand (Figures 4-6a – c). Maintain your hold on the gag until it has locked in place. Do not force the turtle's mouth open all the way; let the spring tension on the gag and turtle's own mouth movement set the maximum open position. Position the mouth gag at the front center of the jaw with the axis off to one side to provide the maximum open working area in the mouth and the surest footing for the gag (Figures 4-7a and b).



Figures 4-6a, b, and c. (a) Canine mouth gag fully compressed, (b) partially compressed, and (c) fully open (NMFS/SEFSC photos).



Figures 4-7a and b. Canine mouth gag (NMFS/SEFSC photos).

(5) Set of Two Sturdy Dog Chew Bones (mouth gag)

Position the proper size dog chew bone in the posterior corner of the mouth to keep the mouth open. The larger bones (Figure 4-8a) are easy to hold, but block access to much of the mouth. Smaller bones (Figure 4-8b) do not reduce your view inside the turtle's mouth and work equally well.



Figures 4-8a and b. Large (a) and small (b) dog chew bones (NMFS/SEFSC photo).

(6) Hank of Rope (mouth gag)

Position the lanyard in the posterior corner of the jaw to keep the mouth open (Figure 4-9). Alternatively, you can place the rope across the entire width of the mouth and block both sides of the jaw, but this blocks your view of the back of the mouth.



Figure 4-9. Hank of rope mouth gag (NMFS/SEFSC photo)

(7) Set of Four PVC couplings (mouth gag)

Insert the appropriate size PVC coupling (chosen by considering both the size of the turtle and the tools to be used) inside the turtle's mouth (Figure 4-10). Hold it with a pair of pliers to stabilize it inside the mouth. In order to prevent the coupling from interfering with the dehooking devices, thread the line through the coupling before inserting it.



Figure 4-10. PVC coupling mouth gag (NMFS/SEFSC photo).

Chapter 5 **Equipment and Techniques for Removing Gear from Boated Turtles**

When dehooking is possible, several devices (Figure 5-1 and Figure 5-2) may be used to remove hooks, depending on the depth and location. Some hooks that are lightly hooked externally may be easily removed using your hand. If the hook has been deeply ingested, a short-handled dehooker for internal hooks must be used. If the hook is external or in the front of the mouth or beak with the barb of the hook clearly visible, a short-handled dehooker for internal hooks or a short-handled dehooker for external hooks may be used.

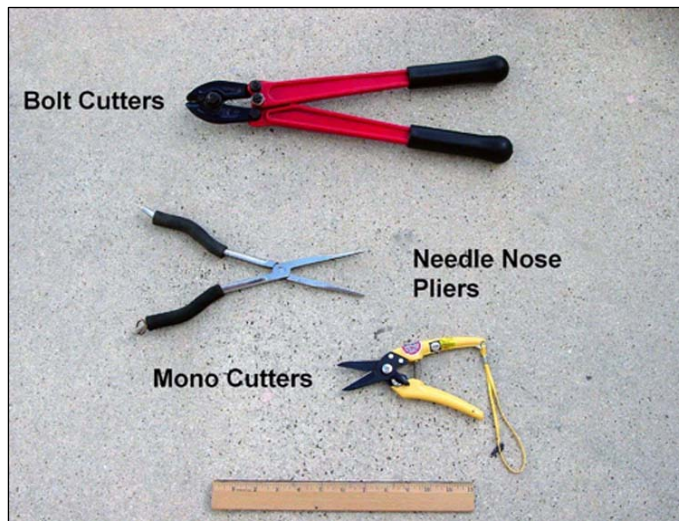


Figure 5-1. Bolt cutters, needle-nose pliers, and monofilament cutters (NMFS/SEFSC photo).

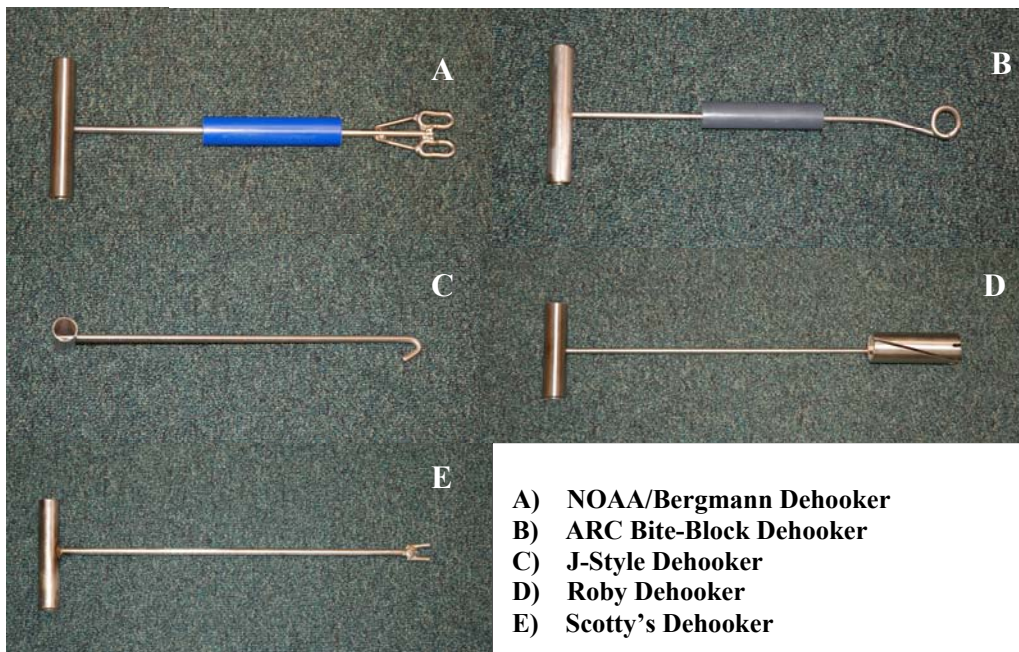


Figure 5-2. Short handled dehookers (NMFS/SEFSC photos).

Needle-nose or Long-nose Pliers

The needle-nose pliers can be used to remove hooks that are deep in the animal's flesh and must be twisted during removal. They are also useful in holding PVC splice couplings in place when used as mouth openers, and they can be used to remove hooks in the mouth in some situations.

Bolt Cutters

Bolt cutters are essential for removing hooks, as the easiest way to remove a hook may be to cut off the eye or barb so that the hook can be pushed through or backed out without causing further injury to the sea turtle. If the hook cannot be removed, bolt cutters should be used to cut off as much of the hook as possible.

Equipment to Remove Line and Netting

Refer to description in Chapter 2.

Short-handled Dehooker for Internal Hooks

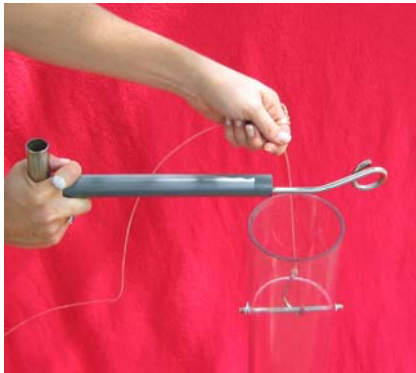
(1) 17" Bite Block Deep-Hooked (Sea Turtle) ARC Dehooker

This dehooking device has been designed to prevent sea turtles from biting down on the dehooking device during internal hook removal (Figure 5-3). The PVC bite block also reduces the damage on the sea turtle's beak if the turtle bites down. This dehooker can be modified to facilitate removal of circle hooks, as described in the notch modification text in Chapter 2. Refer to Plate 5-1 for detailed instructions on using this device.

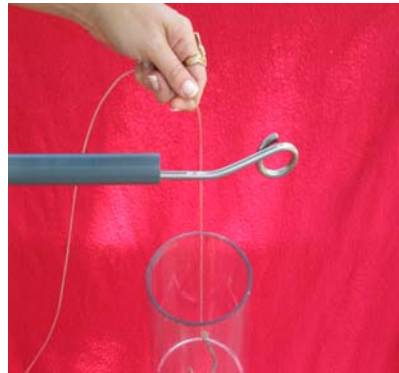


Figure 5-3. Bite Block Deep-hooked (Sea Turtle) ARC Dehooker (NMFS/SEFSC photo).

**Plate 5-1 Instructions for the 17” Bite Block Deep-Hooked (Sea Turtle)
ARC Dehooker**



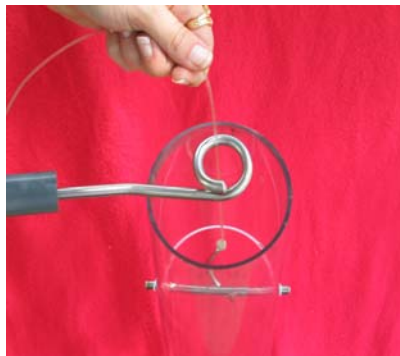
Step 1



Step 2



Step 3



Step 4



Step 5



Step 6

Figures provided by Aquatic Release Conservation

- (1) To correctly use this dehooking device, you must keep the PVC bite block pulled up along the handle when engaging the leader to allow for proper leader and hook engagement.
- (2) Maintain leader tension and place the dehooker on the leader at a 90° angle with the open end of the curl up.
- (3) Pull the dehooker towards you (like a bow & arrow) until the open end of the curl engages/captures the leader.
- (4) Turn the dehooker 1/4 turn clockwise. The leader is now in the center of the pigtail.
- (5) Release the bite block, allowing it to slide to the bottom of the dehooker. Following the leader, insert the curl and PVC end into the mouth as far as the animal will allow.
- (6) Should the sea turtle bite down, the dehooker will slide up to 5” in and out.

Plate 5-1 Continued



Step 7



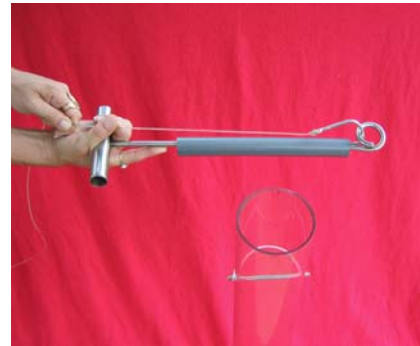
Step 8



Step 9



Step 10



Step 11

Figures provided by Aquatic Release Conservation

- (7) With the sliding motion allowed by the bite block, continue to follow the leader down the shank of the hook. If the dehooker has been notched to help facilitate circle hook removal, the hook will seat into the notch.
- (8) After the dehooker is seated on the shank of the hook, (leader tight) give a sharp, short jab downward with the dehooker. As the hook is removed, the point of the hook will rotate and stop on the offset angle of the dehooker, protecting the point and preventing re-engagement of the hook
- (9) After the hook is dislodged, keep the leader tight and pull the dehooker out until it stops at the PVC bite block.
- (10) The bite block will cover the hook and further prevent re-engagement.
- (11) Wait for the turtle to open its mouth and remove the entire dehooking device and hook.

(2) NOAA/Bergmann Dehooker

This dehooker has been found to be effective in removing both external and internal hooks during field and laboratory trials. The design, similar to that of the Scotty's dehooker (Pages 5-10 – 5-11), employs a pushing method to remove hooks (Figure 5-4). Because it grasps the hook securely, it also facilitates the twisting motion necessary to remove circle hooks. Unlike the Scotty's dehooker, it has rounded terminal ends, enabling its use for internal hooks in addition to external hooks. However, because the barb of a J-hook may not be protected, this device should not be used to remove internal J-hooks.

This dehooker works by pushing or pushing/twisting the hook out of the turtle; consider hook location and placement prior to use. Hold the leader in one hand with tension and hold the NOAA/Bergmann dehooker in the other hand. Position the dehooker so that it is firmly seated against the shank of the hook. Bring both hands together (leader and dehooker parallel with each other) while maintaining tension on the leader. With the leader and dehooker together, give a short, sharp jab to dislodge the hook and remove it from the animal. If you are removing a circle hook, a twisting motion of approximately 180° while thrusting the dehooker may be required to remove the circle hook. Be cautious not to allow the hook to re-engage once removed. The barb of the circle hook should rest against the center of the dehooker with proper line tension to prevent reengagement. Refer to Plate 5-2 for detailed instructions on using this device.

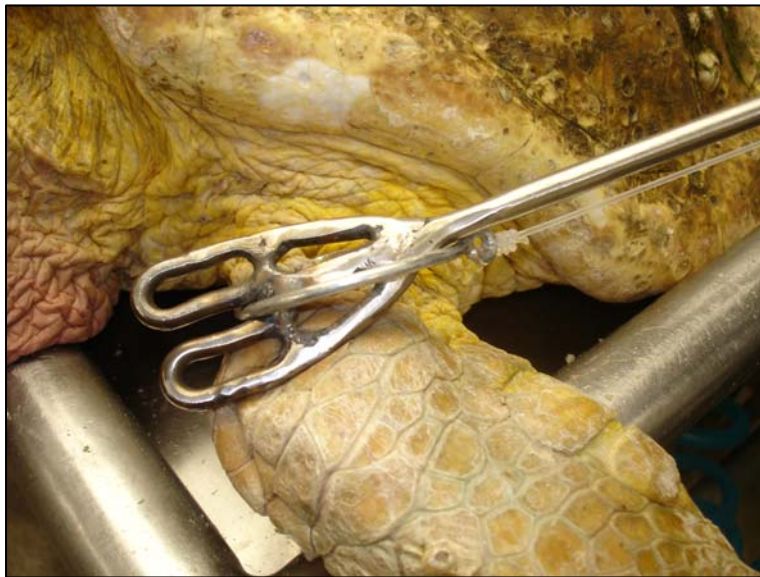


Figure 5-4. NOAA/Bergmann dehooker (NMFS/SEFSC photo).

Plate 5-2 Instructions for NOAA/Bergmann Dehooker



Step 1



Step 2



Step 3



Step 4

- (1) Hold leader in one hand with tension and hold the dehooker in the other hand.
- (2) Position the dehooker so that it is firmly seated against the shank of the hook.
- (3) Bring both hands together (leader and dehooker parallel with each other) while maintaining tension on the leader.
- (4) With the leader and dehooker together, give a short, sharp jab to dislodge the hook and remove it from the animal. Rotate or twist up to 180° if necessary to remove the hook, particularly when removing circle hooks. Maintain line tension at an angle if necessary to prevent the hook from re-engaging after removal.

Short-handled Dehooker for External Hooks

(1) 17” Bite Block Deep-Hooked (Sea Turtle) ARC Dehooker

Refer to description beginning on Page 5-2.

(2) NOAA/Bergmann Dehooker

Refer to description beginning on Page 5-5.

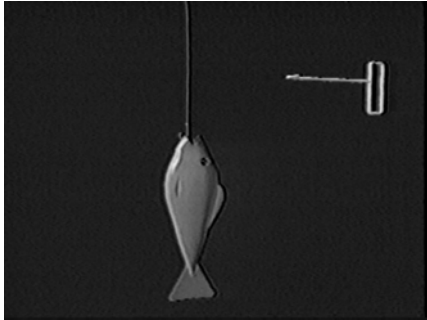
(3) Short-handled J-Style Dehooker

The J-Style dehooker is designed for use only when the hook is visible in the front of the mouth or beak, or if it is external (Figure 5-5). This dehooker works by rotating and pulling the hook out of the turtle; consider hook location and placement prior to use. Hold the leader in one hand with tension and hold the J-Style dehooker in your other hand. Place the dehooker on the leader and follow the leader down until it bottoms out on the shank of hook. With tension on the leader, lower the hand with the leader to the eight o’clock position, and raise the hand with the dehooker to the two o’clock position. Twist the dehooker slightly and pull until the hook is dislodged, and be cautious not to allow the hook to re-engage once removed. Refer to Plate 5-3 for detailed instructions on using this device.

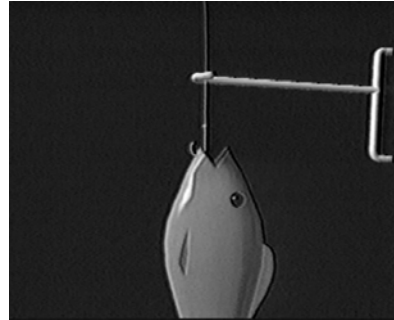


Figure 5-5. J-Style dehooker (NMFS/SEFSC photo).

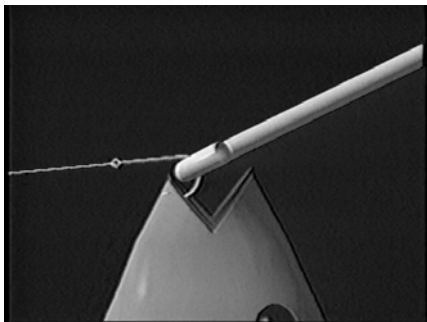
Plate 5-3 Instructions for the J-Style Dehooker



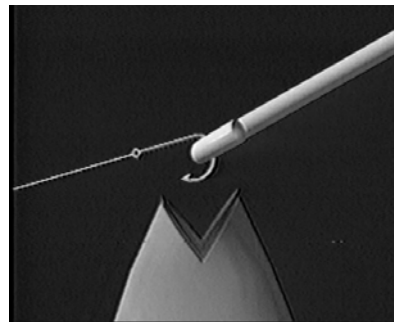
Step 1



Step 2



Step 3



Step 4

Figures provided by Aquatic Release Conservation

- (1)** Grab the leader with one hand and hold the dehooking device with your other hand (with the end facing toward you).
- (2)** Place the dehooking device on the leader.
- (3)** Follow the leader down until you engage the hook.
- (4)** Pull the dehooking device and leader apart with constant pressure and raise the hand with the dehooking device to the two o'clock position and lower the hand with the leader to the eight o'clock position. With a slight twist and shake the hook will be disengaged.

(4) Scotty's Dehooker

The Scotty's dehooker is designed for use only when the hook is visible in the front of the mouth or beak (Figure 5-6), or if it is external. This dehooker works by pushing or pushing/twisting the hook out of the turtle; consider hook location and placement prior to use. Hold the leader in one hand with tension and hold the Scotty's dehooker in your other hand. Position the dehooker so that it is firmly seated against the shank of the hook. Bring both hands together (leader and dehooker parallel with each other) while maintaining tension on the leader. With the leader and dehooker together, give a short, sharp jab to dislodge the hook and remove it from the animal. Be cautious not to allow the hook to re-engage once removed.



Figure 5-6. Scotty's dehooker (NMFS/SEFSC photo).

Plate 5-4

Instructions for Scotty's Dehooker



Step 1



Step 2



Step 3



Step 4



Step 5

- (1) Hold leader with tension in one hand and hold the Scotty's dehooker in the other hand.
- (2) Position the dehooker so that it is firmly seated against the shank of the hook.
- (3) Bring both hands together (leader and dehooker parallel with each other) while maintaining tension on the leader. With the leader and dehooker together, give a short, sharp jab to dislodge the hook and remove it from the animal.
- (4) Rotate or twist slightly if necessary to remove the hook.
- (5) Be careful not to allow the hook to re-engage once removed.

(5) Short-handled Roby Dehooker (Refer to Plate 2-3)

The short-handled Roby dehooker is suitable for removing external hooks and works by pushing and twisting the hook out of the turtle; consider hook location and placement prior to use. The design, which incorporates four notches at 90° angles at the base of a cylinder, grasps the hook very securely, facilitating the twisting motion necessary to remove circle hooks. Engage the line by feeding it through the diagonal slit in the side of the cylinder, and then position the dehooker so that it is firmly seated against the shank of the hook, which is secured in the notches. Once the hook is secured, give a short, sharp jab to dislodge the hook and remove it from the animal. If you are removing a circle hook, a twisting motion of approximately 180° during the downward jab may be required to remove the circle hook.

Appendix A

DESIGN STANDARDS AND EQUIPMENT FOR THE CAREFUL RELEASE OF SEA TURTLES CAUGHT IN HOOK AND LINE FISHERIES

Chapter A1 Introduction

The purpose of the careful release equipment is to increase post-release survival of incidentally-captured sea turtles by releasing them with minimal injury. These specifications have been revised and expanded, based upon field-testing of equipment, user feedback, and product design updates resulting in part from experiments in the Northeast Distant (NED) statistical reporting area and subsequent experiments and observations.

Several fisheries have mandatory release gear requirements; requirements and appropriate release tools may vary by fishery. This document contains the general approved design standards for currently certified release gears. Individual fisheries may have more specific design standards. Check with the applicable regulations as the final authority for required tools and specifications in each fishery. Note: approved release gear previously constructed according to original Atlantic Highly Migratory Species (HMS) Pelagic Longline Fishery design standards (FSEIS June 22, 2004; 69 FR 40736 July 6, 2004) would still qualify for this fishery under these current standards.

New release tools may be certified by submitting them to the NOAA Fisheries Southeast Fisheries Science Center for testing. Gear specialists and researchers will assess each item's usefulness and safety in removing gear from animals during laboratory and/or field trials. When new items are certified by NOAA Fisheries, a notice will be published in the Federal Register.

The National Marine Fisheries Service does not recommend or endorse any proprietary product or material mentioned in this document. However, example models of certified commercially available products are listed for convenience; other products meeting minimum design standards may be available or may be constructed. The use of registered or trademarked products is by reference only; no endorsement or affiliation is implied for any of these products.

The “pigtail style” dehookers described in this document are manufactured by Aquatic Release Conservation, Inc. (ARC). ARC has stated that their dehookers are covered by their U.S. and international patents, specifically identifying U.S. Patent # 4,914,853, #6,840,002 and U.S. Design Patent # 382,628, as well as modifications to these patents. In essence, ARC has given permission, by means of a license, to all individual fisheries participants to make, have made, construct, and use, any of its patented dehookers provided that these dehookers are for individual use. No authority is granted by ARC to make dehookers for resale or for gifts. The precise rights granted by ARC are defined in a License Agreement to be found at the ARC website located at: <http://dehooker4arc.com/disclaimer.cfm>. If an individual fisheries participant desires to enter into and take advantage of this License Agreement, they must register with ARC and execute a License Agreement. The government has not studied any of the ARC patents, and therefore has no opinion whatsoever as to the validity of these patents or whether making or using the ARC dehookers would infringe patents of others.

Chapter A2 **Equipment for Sea Turtles Not Boated**

In circumstances where a sea turtle is too large to be boated, or conditions preclude the safe boarding of the animal, vessels should possess, maintain, and utilize the following equipment and release the turtle with minimal injury.

Turtle Control Devices

In response to safety concerns for fishing vessel crew members and for incidentally captured sea turtles, as well as to facilitate the likelihood of maximum gear removal, turtle control devices were devised. Their function is to control the front flippers of the sea turtle so that the animal can be controlled at the side of the vessel during gear removal. Restraint is most effective when a pair of turtle control devices is used. Currently, there are two approved turtle control device styles, the “Turtle Tether” and the “T&G Ninja Sticks;” both reduce safety risks associated with removing gear from active sea turtles not boated, particularly leatherbacks. Minimum design standards are as follows:

(1) Turtle Tether

(a) *Design Standards:*

(i) *Line.* 15 – 20’ of 1/2” hard lay negative buoyancy line (e.g., Samson crab rope #SSR-100-MHL) or similar is used to make a ~ 30” loop to slip over the flipper. The line is fed through a ~ 3/4” inside diameter fair lead, eyelet or eyebolt at the working end of a pole and through a ~ 3/4” eyelet or eyebolt in the midsection. A 1/2” quick release cleat (e.g., Clamcleat[®] or similar) holds the line in place near the end of the pole. A final ~ 3/4” eyelet or eyebolt should be positioned ~ 7” behind the cleat to secure the line, while allowing a safe working distance to avoid injury when releasing the line from the cleat.

(ii) *Extended reach handle.* The line must be securely fastened to an extended reach handle or pole. Check applicable regulations for required minimum handle length (e.g., the U.S. Highly Migratory Species Pelagic Longline Fisheries require a minimum length equal to or greater than 150% of the freeboard or a minimum of 6’, whichever is greater. Freeboard is defined for these purposes (other definitions exist) as the working distance between the top rail of the gunwale to the water’s surface, and will vary based on the vessel design). There is no restriction on the type of material used to construct this handle as long as it is sturdy. The handle must include a tag line to attach the tether to the vessel to prevent the turtle from breaking away with the tether still attached.

(b) *Example Model(s) Meeting Current Design Standards:*

(i) *Turtle Tether* (e.g., ARC Model TT08, Model TT12) (Plate B-1)

(2) T&G Ninja Sticks

(a) *Design Standards:*

(i) *Line.* Approximately 30 – 35' of 1/2" to 5/8" soft lay polypropylene line, nylon line, or similar is fed through 2 PVC conduit, fiberglass, or similar sturdy poles and knotted using an overhead (recommended) knot at the end of both poles or otherwise secured. There should be ~ 18 - 24" of exposed rope between the poles to be used as a working surface to capture and secure the flipper. Knot the line at the ends of both poles to prevent line slippage if they are not otherwise secured. The remaining line is used to tether the apparatus to the boat unless an additional tag line is used.

(ii) *Extended reach handles.* Two lengths (cut to freeboard height) of rigid electrical conduit sunlight resistant 3/4" Schedule 40 PVC, fiberglass, aluminum or similar should be used. Check applicable regulations for required minimum handle length (e.g., the U.S. Highly Migratory Species Pelagic Longline Fisheries require a minimum length equal to or greater than 150% of the freeboard or a minimum of 6', whichever is greater. Freeboard is defined for these purposes (other definitions exist) as the working distance between the top rail of the gunwale to the water's surface, and will vary based on the vessel design).

(b) *Example Model(s) Meeting Current Design Standards:*

(i) "*T&G Ninja Sticks*" (Plate B-2)

Equipment to Remove Line and Netting

(1) Long-handled Line Clipper/Cutter

Line clippers or cutters are designed to cut high test monofilament line as close as possible to the hook and to assist in removing other line and netting from entangled sea turtles, in an effort to minimize remaining gear upon release. NOAA Fisheries has established minimum design standards for the line clippers (65 FR 16347, March 28, 2000, and 66 FR 17370, March 30, 2001) that can be purchased or fabricated using available and low cost materials. One long-handled line clipper or cutter and a set of replacement blades should be onboard. The minimum design standards for line clippers or cutters are as follows:

(a) *Design Standards:*

(i) *A protected and secured cutting blade.* The cutting blade(s) must be capable of cutting 2.0 – 2.1 mm monofilament line (400# test) or polypropylene multi-strand material, known as braided or tarred mainline, and it should be maintained in working order. The blade must be curved, recessed, contained in a holder, or otherwise designed to facilitate its safe use so that direct contact between the cutting surface and the sea turtle or the user is prevented. The cutting instrument must be securely attached to an extended reach handle and easily replaced. One extra set of replacement blades meeting these

standards must also be carried on board to replace all cutting surfaces on the line cutter or clipper;

(ii) *Extended reach handle.* The line cutter blade must be securely fastened to an extended reach handle or pole. Check applicable regulations for required minimum handle length (e.g., the U.S. Highly Migratory Species Pelagic Longline Fisheries require a minimum length equal to or greater than 150% of the freeboard or a minimum of 6', whichever is greater. Freeboard is defined for these purposes (other definitions exist) as the working distance between the top rail of the gunwale to the water's surface and will vary based on the vessel design). For flexibility of configuration during use and for storage purposes, it is recommended that the handle break down into sections, although this is not a requirement. There is no restriction on the type of material used to construct this handle as long as it is sturdy and facilitates the secure attachment of the cutting blade.

(b) Example Model(s) Meeting Current Design Standards:

(i) *NOAA/Arceneaux Line Clipper (Plate B-3).* The NOAA/Arceneaux line clipper can be fabricated by securely attaching a flat hardened stainless steel seat belt cutter with recessed cutting blades (such as the Lifesaver II Seat Belt Cutter™, Lifesaver Seat Belt Cutter™, Emergency Seat Belt Cutter, Innovative Scuba Razor Line Cutter or similar) to an extended reach handle using bolts and/or cable ties. A replacement blade set would require one additional seat belt cutter for the NOAA/Arceneaux Line Clipper;

(ii) *NOAA/Laforce Line Cutter (Plate B-4).* The Laforce Line Cutter has a cutting end manufactured from a 6" long 1/2" aluminum rod with a 4 1/8" end at a 45° angle with two 420 C stainless steel serrated cutting blades secured inside the angle. It must be attached to an extended reach handle. A set of replacement blades would require two stainless steel serrated cutting blades for the NOAA/Laforce Line Cutter.

(2) Monofilament Cutters

Monofilament cutters should be used to remove netting, entangling line, or line as close as possible to the eye of the hook in the event that the hook was swallowed, or when the hook cannot be removed. This reduces the amount of gear retained by the animal in the event that all gear cannot be removed safely. Minimum design standards are as follows:

(a) Design Standards:

(i) *General.* These should be ~ 7 1/2" in length with ~1 3/4" long, 5/8" wide (closed) blades.

(b) Example Model(s) Meeting Current Design Standards:

(i) *Any monofilament cutters meeting design standards [e.g., Jinkai Model MC-T].*

Equipment to Remove Hooks

Dehooking devices may be designed to remove internal hooks, external hooks, or both. All long-handled tools should be able to capture and control the line, and the dehooking end must be securely fastened to the extended reach handle. They also should be designed to allow a twisting motion, which is necessary for circle hook removal.

(1) Long-handled Dehooker for Internal Hooks.

Some long-handled dehooking devices are designed to remove internal hooks from sea turtles that cannot be boated, and it may also be used to remove external hooks. Because this design should shield the barb of the hook and prevent it from re-engaging, this device also may be used to engage a loose hook during line removal when the turtle is entangled but not hooked.

Minimum design standards are as follows:

(a) Design Standards:

(i) *Hook removal device.* The hook removal device should be constructed of ~ 3/16" - 5/16" marine grade stainless steel (316L) or similar and have a dehooking end no larger than 1 7/8" outside diameter. This device must securely control the leader while shielding the barb to prevent the hook from re-engaging during removal. It cannot have any unprotected sharp terminal points, as these could cause injury to the mouth and esophagus during hook removal. The device must be of a size appropriate to secure the range of hook sizes and styles in the applicable fishery (e.g., 16/0 - 20/0 circle hooks in the Atlantic pelagic longline swordfish and tuna fisheries would require use of 5/16" wire and an outside diameter of 1 7/8");

(ii) *Extended reach handle.* Check applicable regulations for required minimum handle length (e.g., the U.S. Highly Migratory Species Pelagic Longline Fisheries require a minimum length equal to or greater than 150% of the freeboard or a minimum of 6', whichever is greater. Freeboard is defined for these purposes (other definitions exist) as the working distance between the top rail of the gunwale to the water's surface and will vary based on the vessel design). For flexibility of configuration during use and for storage purposes, it is recommended that the handle break down into sections, although this is not a requirement. There is no restriction on the type of material used to construct this handle as long as it is sturdy and facilitates the secure attachment of the hook removal device.

(b) Example Model(s) Meeting Current Design Standards:

(i) *ARC Pole Big Game Dehooker Models BP04, BP08, BP11, P610 and BPIN (Plate B-5).* These devices are constructed of a 5/16" 316 L stainless steel rod curled into a pigtail spiral loop end with no exposed terminal point, and they are recommended for hook sizes 6/0 to 20/0. The rod is 7" from point of attachment to the end of the loop, and includes a 5.3° angle offset to shield the barb of the hook. The loop is designed at a 12.2° angle

bend from the rod and has an inside diameter of 1 1/4" and an outside diameter of 1 7/8" with an 1/8" gap between rod and loop to facilitate line engagement. Some models are manufactured with a three-part anodized aluminum pole that breaks down into 4' sections for storage. The 9" insert model (*BPIN*) must be attached to an extended reach handle.

Notch Modification for the ARC Dehookers

Any of the ARC models listed above can be notched to facilitate circle hook removal (refer to Chapter 2 for photographs and more discussion on the notch modification). The notch is created where the hook lies in the bottom portion of the curl, securing the shank enough to rock the hook from side to side while pushing the circle hook out. The notch modification can be accomplished with a metal file in approximately 15 minutes. The depth and width of each notch should be customized for the hooks used, although no notch should be deeper than 1/3 of the wire diameter to maintain the integrity of the device's tensile strength.

Instructions for notching the dehooker:

1. Place the type and size circle hook that you are using in the pigtail curl with the line parallel and tight.
2. Mark with a felt-tip pen/marker the exact location that the shank of the circle hook comes into contact with the vertical bottom of the pigtail curl.
3. Remove the hook, take a metal file (rectangle recommended, e.g., General 6 Piece Needle File Set from Ultratech Tool System, model # 707476), and notch (file) the marked area of the pigtail curl, where the shank of the hook was, approximately 1/16" to 1/8" deep and approximately 1/8" wide, depending on the hooks used. Use eye protection while filing the notch.
4. The width and depth of the notch should be determined by the size and type of the circle hook used in that particular fishery in order to facilitate the best fit. Do not exceed a depth of ~ 1/3 the wire diameter to avoid compromising the tensile strength of the wire.

(2) Long-handled Dehooker for External Hooks. Some long-handled dehookers are designed for use on externally hooked sea turtles that cannot be boated. The long-handled dehooker for internal hooks will also satisfy this purpose.

Minimum design standards are as follows:

(a) Design Standards:

(i) *Hook removal device.* The dehooker should be constructed of ~ 3/16" – 5/16" marine grade stainless steel (316L) rod if constructing a wire style dehooker (e.g., the ARC and J-style dehookers). When constructing other styles (e.g., NOAA/Bergmann and Roby

dehookers), marine grade stainless steel (316L) should be used for all components. The design should be such that the hook can be rotated out without pulling it out at an angle. The dehooking end should be blunt with all edges rounded (it is critical that there are no sharp edges) and the outside diameter should be no greater than 1 7/8"; a smaller diameter end may be more appropriate in fisheries which often encounter small turtles or use small hooks. The device must be of a size appropriate to secure the range of hook sizes and styles observed to date in the applicable fishery (e.g., 16/0 – 20/0 circle hooks in the Atlantic pelagic longline swordfish and tuna fisheries would require use of 5/16" wire and an outside diameter of 1 7/8");

(ii) *Extended reach handle.* The hook removal device must be securely fastened to an extended reach handle or pole. Check applicable regulations for required minimum handle length (e.g., the U.S. Highly Migratory Species Pelagic Longline Fisheries require a minimum length equal to or greater than 150% of the freeboard or a minimum of 6', whichever is greater. Freeboard is defined for these purposes (other definitions exist) as the working distance between the top rail of the gunwale to the water's surface and will vary based on the vessel design).

(b) Example Model(s) Meeting Current Design Standards:

(i) *ARC Pole Big Game Dehooker Models BP04, BP08, BP11, P610 and BPIN (Plate B-5).* These devices are constructed of a 5/16" 316 L stainless steel rod curled into a pigtail spiral loop end with no exposed terminal point, and they are recommended for hook sizes 6/0 to 20/0. The rod is 7" from point of attachment to the end of the loop, and includes a 5.3° angle offset to create a 1/8" gap between rod and loop to facilitate line engagement. The loop is designed at a 12.2° angle bend from the rod and has an inside diameter of 1 1/4" and an outside diameter of 1 7/8". Some models are manufactured with a three-part anodized aluminum pole that breaks down into 4' sections for storage. The 9" insert model (*BPIN*) must be attached to an extended reach handle;

(ii) *Long-handled J-Style Dehooker or "Flip Stick" [e.g., ARC Model LJ6P (Plate B-6)].* The dehooker should be constructed of ~ 3/16" – 5/16" diameter marine grade stainless steel (316L) rod ≥ 48" in length with a 1" dehooking end at a 45° angle to the rod forming a "J" shape;

(iii) *Long-handled Roby Dehooker (Plate B-7).* This device has a 3 3/4" long cylinder (1 5/8" outside diameter) with four ~ 1/8" notches at 90° angles on the edge and a ~ 1/8" diagonal slit to capture the line across the length of the cylinder. To attach the working end to a long handle, two pieces of 1/4" x 1" x 3" flat bar one at upper end and one at the midrange of the central rod can be welded and formed around long handled pole and securely fastened using a through bolt.

Long-handled Device to Pull an “Inverted V” during Disentanglement

The primary use for this tool is to pull a “V” when implementing the “Inverted V” dehooking technique for disentangling and dehooking entangled sea turtles. Minimum design standards are as follows:

(1) *Design Standards:*

(i) *Hook end.* The device, such as a boat hook, gaff, or long-handled J-Style dehooker should be constructed of stainless steel or aluminum. The semicircular or “J” shaped end must be securely attached to a handle. A sharp point, such as a gaff hook, is only to be used in holding the monofilament line and should never contact the sea turtle;

(ii) *Extended reach handle.* The device must be securely fastened to an extended reach handle or pole. Check applicable regulations for required minimum handle length (e.g., the U.S. Highly Migratory Species Pelagic Longline Fisheries require a minimum length equal to or greater than 150% of the freeboard or a minimum of 6’, whichever is greater. Freeboard is defined for these purposes (other definitions exist) as the working distance between the top rail of the gunwale to the water’s surface and will vary based on the vessel design).

(2) *Example Model(s) Meeting Current Design Standards:*

(i) *Any long-handled J-Style Dehooker or “Flip Stick” [e.g., ARC Model LJ6P (Plate B-6)] See Page A2-6 above for a description;*

(ii) *Any standard boat hook (e.g., Davis Telescoping Boat Hook to 96” Model 85002A;*

(iii) *Any standard fishing gaff [e.g., West Marine # F6H5 Hook and # F6-006 Handle].*

Chapter A3 Boating and Holding Sea Turtles

Whenever possible, sea turtles must be brought on board immediately and handled in accordance with the procedures outlines in the standards for the handling of incidentally caught sea turtles [50 CFR 223.206 (d)(1)], unless extreme sea conditions prevent the crew from safely boating the turtle. Generally, all turtles < 3' straight carapace length should be boated. Vessels should maintain and utilize the following equipment and release the turtle with minimal injury:

Boating the Turtle

(1) Dip Net. A dip net facilitates the safe handling of sea turtles by allowing them to be brought onboard for gear removal without causing further injury to the animal. The turtle should never be brought onboard without a net or hoist. Using the involved gear to raise the turtle may result in serious injury and impact post-release survivorship, especially in cases where the turtle has ingested the hook. NMFS has established minimum design standards for the dip nets (65 FR 16347, March 28, 2000 and 66 FR 17370, March 30, 2001). These minimum design standards for dip nets are as follows:

(a) Design Standards:

(i) *Size of dip net.* The dip net must have a sturdy net hoop of at least 31" inside diameter and a bag depth of at least 38" to accommodate turtles less than 3' carapace length. The bag mesh openings may not exceed 3" x 3" (bar measure). There should be no sharp edges or burrs on the hoop or where it is attached to the handle. There is no requirement for the hoop to be circular as long as it meets the minimum specifications;

(ii) *Extended reach handle.* The dip net hoop must be securely fastened to an extended reach handle or pole. Check applicable regulations for required minimum handle length (e.g., the U.S. Highly Migratory Species Pelagic Longline Fisheries require a minimum length equal to or greater than 150% of the freeboard or a minimum of 6', whichever is greater. Freeboard is defined for these purposes (other definitions exist) as the working distance between the top rail of the gunwale to the water's surface and will vary based on the vessel design). For flexibility of configuration during use and for storage purposes, it is recommended that the handle break down into sections, although this is not a requirement. There is no restriction on the type of material used to construct this handle, as long as it is sturdy enough to support a minimum of 100 lbs without bending or breaking, and facilitates the sturdy attachment of the net hoop.

(b) Example Model(s) Meeting Current Design Standards:

(i) *ARC 12' Breakdown Lightweight Dip Net Model DN6P (6'), DN08 (8') or DN14 (12') or ARC Net Assembly (hoop, net, coupling-DNIN) and handle (Plate B-8).* This dip net is constructed of a hollow heavy duty aluminum tubing to form a 97" circumference hexagonal frame, and the 38" bag is 2 1/2" square nylon mesh;

(ii) *Lindgren-Pitman, Inc. Model NMFS-Turtle Net*. This dip net is constructed of heavy duty stainless steel tubing to form a 31" diameter circular frame with a 45" bag of 2" square nylon mesh;

(iii) *Bluewater Tackle*. This lightweight dip net is constructed of a composite material frame and handle with a bag of 3" stretch mesh;

(iv) *Howell Tackle*. This lightweight dip net is constructed of a composite material frame and handle with a bag of 3" stretch mesh.

(2) Turtle Hoist. A hoist is recommended to bring turtles onboard that cannot be boated using a smaller dip net, or where storage constraints do not allow for an extended reach handle. Minimum design standards are as follows:

(a) Large Turtle Hoist. This style is recommended for boating large turtles, such as leatherbacks, which need a supportive platform while onboard.

(1) Design Standards:

(i) *General*. The hoist should be designed so that when onboard, the turtle is suspended above the deck on a platform of mesh netting supported by a rigid ring, and contained within a webbing fence a minimum of 18" high. The top two rings (1 3/4" 50 series aluminum round bar) should be ~ 7'6" in diameter, and the bottom ring (1 1/2" 50 series aluminum round bar) should be ~ 4' in diameter. The middle and bottom rings are connected using 12 angled (~ 25") spoke braces of ~ 23" (1" 50 series aluminum round bar or 6061 T6 1" Schedule 40 pipe) welded in place with an appropriate welding wire (5052, 6061 or 3003 wire). Knotless polypropylene 8 mm 600 ply netting, 6.5" stretch is stretched across the middle ring. The fence is supported by the top and middle rings, which are connected by a 3 mm, 4.7" stretch mesh braided polyethylene webbing to create a fence a minimum of 18" high, wrapped along the top ring with 1/2" polypropylene rope. 8" x 2 1/2" rubber cookies (4 per each of 12 sections) can be used on the middle ring to facilitate rolling the hoist up the side of the vessel and to cushion impact of hoist against the side of the vessel. In rough seas, a vang is necessary to hold the hoist close to side of vessel. A three or four point bridle is attached to the top ring using pairlinks and 3/4" nylon 3-strand line, and a hydraulic lift is used to bring hoist aboard. The hoist should be capable of lifting a minimum of 1/2 ton.

(2) Example Model(s) Meeting Current Design Standards:

(i) *Large Turtle Hoist (Plate B-9)*. This hoist (designed, in part, and constructed by Blue Water Fishing Tackle Co., Inc., D.N. Kelley Shipyard, Diversified Marine LLC, Eagle Eye II Corporation, Polar Packaging, Inc., Reidar's Manufacturing, Inc., *F/V Sea Hawk*, and Scandia, Inc.) was designed to bring leatherbacks onboard following the above specifications. Modifications to the

vessel will likely be necessary to install the hoist, including: a platform to house the lift, alterations to the boom including strongback, pivoting gooseneck, hydraulic ram attachment and reinforcement, hydraulic ram, hydraulic runs, or a dual winch arrangement, and for safe lifting, a 2200 PSI planetary hydraulic winch with hydraulic runs, control and rigging (SS wire and blocks).

(b) *Small Turtle Hoist.* In some cases, such as on a vessel with a high freeboard distance or if there is not enough room for storing a dip net, an extended reach handle may be impractical, even with small turtles. A supportive frame with mesh netting, but without an extended reach handle, may be best in these circumstances.

(1) *Design Standards:*

(i) *General.* The frame should be rigid and capable of supporting at least 100 pounds, with a minimum diameter of 31” to accommodate turtles less than 3’ carapace length. This frame can be hinged or otherwise designed so that it can be folded for ease of storage as long as it can be quickly reassembled. If the frame is designed to fold or break down for storage, the hardware must be self contained (e.g., barrel bolts on both sides to lock down frame with no loose pieces like through bolts and nuts), and there must be no sharp edges. The shape of the frame does not matter (e.g., round, square, rectangular, or a “U-shaped” or “J-shaped” basket) as long as it meets the required specifications and securely contains the turtle. The frame may be constructed of heavy duty stainless steel tubing welded into shape or ~ 2” PVC pipe connected at the corners using 90° elbow fittings. PVC pipes should be drilled to facilitate water drainage for ease of hauling. A shallow bag net with mesh openings not to exceed 3” x 3” (bar measure) should be securely affixed to the frame, and lines (e.g., polypropylene, nylon, polyester) should be securely attached to each corner to control and retrieve the frame and net. The lines can be operated using a pulley system if available on the vessel. No extended reach handle is needed on this type of net.

(2) *Example Model(s) Meeting Current Design Standards:*

(i) *Small Turtle Hoist (Plate B-10).* This is a frame net without a handle, with a square, rectangular or round stainless steel or PVC frame with a mesh bag securely affixed and lines attached to the corners or at least three points around a circle to bring turtles onboard.

Holding the Turtle

(1) *Cushion/support Device.*

(a) *Design Standards:*

(i) The device should effectively cushion and support the animal while it is onboard. It should be appropriately sized to fully support a range of turtle sizes.

(b) Example Model(s) Meeting Current Design Standards:

(i) *A standard automobile tire.* A standard (not from a truck or heavy equipment) passenger vehicle tire not mounted on a rim, free of exposed steel belts, is effective for supporting the turtle while it is onboard. If the turtle is too large for the tire, it must be contained and supported on an alternative cushioned surface. An assortment of sizes is recommended to accommodate a range of turtle sizes.

(ii) *Boat cushion.* A standard boat cushion will effectively support smaller turtles.

(iii) *Large turtle hoist.* This style is recommended for supporting large turtles, such as leatherbacks, which need a supportive platform while onboard.

Chapter A4 Equipment for Opening the Mouth of Boated Turtles

Opening the Mouth

In many cases, a mouth opener or gag must be used in order to remove internal hooks from boated turtles. It must be designed to allow access to the hook or line without causing further injury to the turtle. It is recommended that at least one type allow for hands-free operation of the gear removal devices once the gag is in place (only the canine mouth gag satisfies this recommendation, see item (2) below). Design standards are included in the item description. A minimum of two of the seven different types/categories of mouth openers/gags from the following list will offer the necessary flexibility:

Mouth Openers and/or Mouth Gags

(1) Set of Two Rope Loops Covered with Protective Tubing. A set consists of two pieces of poly braid rope covered with light duty garden hose or similar flexible tubing each tied or spliced into a loop to provide a one-handed method for keeping the mouth open. The upper loop gives the user control using one hand, and the second rope/hose length is secured on lower beak using the user's foot for extra control. This keeps the mouth open to allow access to the hook and/or line. Two 36" lengths of poly-braid rope (3/8" diameter suggested) should be covered with an 8" section of 1/2" or 3/4" tubing and each tied or spliced into two loops. Any set of rope loops covered with tubing meeting these specifications is acceptable;

(2) Large Avian Oral Speculum. An avian oral speculum gives you the ability to hold the mouth open and control the head with one hand while removing the hook with the other hand. This tool is for use only on small turtles, as larger turtles may be able to crush the speculum. The avian oral speculum should be 9" long, and constructed of 3/16" wire diameter surgical stainless steel (Type 304). It should be covered with 8" of clear vinyl tubing (5/16" outside diameter, 3/16" inside diameter), friction tape (e.g., 3M™ Temflex™ 1755 Cotton Friction Tape) or similar to pad the surface. Example models meeting these specifications include: Model # 85408 from Webster Vet Supply; VSP # 216-08 from Veterinary Specialty Products; Jorvet Model J-51z; and Krusse Model 273117. These can be purchased through veterinary supply businesses;

(3) Block of Hard Wood. A smooth block of hard wood is an inexpensive, effective and practical mouth-gagging device that meets these requirements and is readily available on most vessels. Placed in the corner of the jaw, it is used to gag open the mouth. The wood should be of a type that does not splinter (e.g., maple) with rounded edges, and it should be sanded smooth, if necessary, and soaked in water to soften the wood. The dimensions should be approximately 11" x 1" x 1" or appropriately sized for the size of turtles that might be caught. Any block of hard wood meeting these specifications is acceptable. A long-handled, wire brush with a maple wooden handle and the wires removed is an inexpensive, effective and practical device that meets these requirements (e.g., *Olympia Tools Long-Handled Wire Brush and Scraper #974174*).

A wooden hammer handle may be suitable, providing it is made from wood which does not splinter under pressure (e.g. ash, maple);

(4) Set of Three Canine Mouth Gags. The use of canine mouth gags is highly recommended to hold the mouth open, as the gag locks into the open position and allows for hands free operation once it is in place. These tools are for use only on small and medium sized turtles, as larger turtles may be able to crush the mouth gag. A set of canine mouth gags should include one of each of the following sizes: small (~ 5"), medium (~ 6"), and large (~ 7"). They must be constructed of stainless steel. The ends should be covered with clear vinyl tubing, friction tape (e.g., 3M™ Temflex™ 1755 Cotton Friction Tape) or similar to pad the surface. A set includes one of each size and can be purchased through veterinary supply businesses. An example set meeting these specifications is *Jorvet Model #4160, 4162, and 4164*;

(5) Set of Two Sturdy Dog Chew Bones. These “chew toys” are inexpensive, easy to handle, and sold in several sizes in pet stores. Placed in the corner of the jaw, it is used to gag open the mouth. They should be designed of durable nylon or thermoplastic polymer, strong enough to withstand biting without splintering. One large (e.g., “Giant” 8” or “Wolf” 5 1/2”) and one small (e.g., “Regular” 4 1/2” or “Petite” 3 1/2”) will accommodate a variety of beak sizes. Example models meeting current specifications include: Nylabone® (a trademark owned by T.F.H. Publications, Inc.); Gumabone® (a trademark owned by T.F.H. Publications, Inc.); and Galileo® dog chew (a trademark owned by T.F.H. Publications, Inc.);

(6) Hank of Rope. A lanyard of braided rope (e.g., nylon, polypropylene, polyester) can be folded to create a hank of rope. Placed in the corner of the jaw, it is used to gag open the mouth. A 6’ lanyard of approximately 3/16” braided nylon rope can be folded to create a hank of rope. Any size soft braided nylon rope is acceptable, provided it creates a hank of approximately 2 - 4” thickness;

(7) Set of Four PVC Couplings. Inexpensive PVC couplings can be positioned inside the mouth to allow access to the back of the mouth. They should be held in place with the needle-nose pliers. Standard Schedule 40 PVC couplings in a variety of sizes (1”, 1 1/4”, 1 1/2”, and 2”) will ensure proper fit and access. A set includes all four sizes.

Chapter A5 Equipment for Removing Gear from Boated Turtles

Assess what the best hook removal technique is in each circumstance. Depending on the position and depth of the hook, needle-nose pliers and/or bolt cutters may be the most efficient way to remove hooks. If required, dehooking devices may be used to remove external or internal hooks (if the insertion point of the hook can be seen). All short-handled dehooking tools for removing internal hooks should have a bite block to protect the turtle's beak. They should also be designed to allow a twisting motion, which is necessary for circle hook removal. The NOAA/Bergmann dehooker is approved for removing external circle or J-hooks, and internal circle hooks from turtles boated. It should not be used to remove internal J-hooks from turtles boated.

Needle-nose or Long-nose Pliers

Long-nose or needle-nose pliers can be used to assist in removal of hooks that are embedded in the animal's flesh and must be twisted during removal, or for removing hooks from the front of the mouth. They are also useful in holding PVC splice couplings in place when used as mouth openers. Minimum design standards are as follows:

(1) *Design Standards:*

(i) *General.* They should be ~ 12" in length. It is recommended that these be of stainless steel material.

(2) *Example Model(s) Meeting Current Design Standards:*

(i) *Any 12" long-nose or needle-nose pliers [e.g., 12" S.S. NuMark Model #030 281 109 871, Offshore Angler[®] Stainless Longreach Pliers Model #38-481-759-00, Pittsburgh[®] 15" Long Nose Locking Pliers].*

Bolt Cutters

Bolt cutters are essential for removing hooks, and must be of a size practical to be used inside the turtle's mouth. They are used to cut off the eye or barb so that the hook can be pushed through easily without causing further injury to the sea turtle. They also are used to cut off as much of the hook as possible when the remainder cannot be removed. Minimum design standards are as follows:

(1) *Design Standards:*

(i) *General.* They should be ~ 14 – 17" in total length, ~ 4" long blades that are ~ 2 1/4" wide (closed) with ~ 10 – 13" long handles. They must be able to cut hard metals such as stainless or carbon steel hooks up to 1/4" diameter.

(2) Example Model(s) Meeting Current Design Standards:

- (i) Any bolt cutters meeting design standards [e.g., H.K. Porter Model 1490 AC].

Equipment to Remove Line

(1) Monofilament Cutter. Monofilament cutters should be used to remove line as close as possible to the eye of the hook in the event that the hook was swallowed, or when the hook cannot be removed. This reduces the amount of gear retained by the animal in the event that the hook cannot safely be removed. Minimum design standards are as follows:

(a) Design Standards:

- (i) *General.* These should be ~ 7 1/2" in length with ~1 3/4" long, 5/8" wide (closed) blades.

(b) Example Model(s) Meeting Current Design Standards:

- (i) Any monofilament cutters meeting design standards [e.g., Jinkai Model MC-T]

Short-handled Dehooker for Internal Hooks

This dehooker is designed to remove internal hooks from boated sea turtles, including hooks in the front of the mouth, as well as external hooks. Minimum design standards are as follows:

(1) Design Standards:

(i) *Hook removal device.* The dehooker should be constructed of ~ 3/16" – 5/16" marine grade stainless steel (316L) rod if constructing a wire style dehooker (e.g., ARC dehooker). When constructing other styles (e.g., NOAA/Bergmann dehooker), marine grade stainless steel (316L) should be used for all components. The end must allow the hook to be secured and the barb to be shielded without re-engaging during the removal process. It must be no larger than 1 7/8" total width; a smaller diameter end may be more appropriate in fisheries which often encounter small turtles or use small hooks. It cannot have any unprotected terminal points as this could cause injury to the esophagus during hook removal (it is critical that there are no sharp edges). A sliding PVC bite block should be used to protect the beak and facilitate hook removal if the turtle bites down on the dehooking device. The bite block should be constructed of a 3/4" or smaller inside diameter high impact plastic cylinder (e.g., Schedule 80 PVC) that is 4 - 6" long to allow for at least 5" of slide along the shaft. The device must be of a size appropriate to secure the range of hook sizes and styles observed to date in the applicable fishery (e.g., 16/0 - 20/0 circle hooks in the Atlantic pelagic longline swordfish and tuna fisheries would require use of 5/16" wire and an outside diameter no greater than 1 7/8");

(ii) *Handle length.* The handle should be ≤ 47" (recommended length of 16" – 24") with a ~ 4 – 6" long tube T-handle of ~ 1" diameter, wire loop handle or similar.

(2) Example Model(s) Meeting Current Design Standards:

(i) *17" Bite Block Deep-Hooked (Sea Turtle) ARC Dehooker Model ST08 (Plate B-11)*. This device is constructed of a 1/4" 316 L stainless steel rod curled into a pigtail spiral loop end. The loop is placed at a 5.3° angle offset to create a 1/8" gap between rod and loop to facilitate line engagement. The loop is designed at a 12.2° angle bend from the rod, and an inside diameter of 13/16" and an outside diameter of 1 5/16". It has a 3/4" I.D. high impact plastic cylinder bite block 5" in length. This model may be notched according to the instructions in Chapter A2.

(ii) *The NOAA/Bergmann Dehooker (Plate B-12)*. This device has two ~2 3/4" rounded prongs at the end to form a uniform gap of at least 7/32". It has a 3/4" inside diameter high impact plastic cylinder bite block 5" in length. *Note:* This dehooker is approved for removing external circle or J-hooks, and internal circle hooks from turtles boated. It **should not be used to remove internal J-hooks** from turtles boated.

Short-handled Dehooker for External Hooks. These dehookers are designed for use when the hook is external, or when hooks are located in the front of the mouth. Minimum design standards are as follows:

(1) Design Standards:

(i) Hook removal device. The dehooker should be constructed of ~ 3/16" – 5/16" marine grade stainless steel (316L) rod if constructing a wire style dehooker (e.g., the ARC, Scotty's and J-Style dehookers). When constructing other styles (e.g., NOAA/Bergmann and Roby dehookers), marine grade stainless steel (316L) should be used for all components. The design should be such that the hook can be rotated out without pulling it out at an angle, and the dehooking end should be blunt and all edges rounded (it is critical that there are no sharp edges). The device must be of a size appropriate to secure the range of hook sizes and styles observed to date in the applicable fishery (e.g., 16/0 - 20/0 circle hooks in the Atlantic pelagic longline swordfish and tuna fisheries would require use of 5/16" wire and an outside diameter of 1 7/8");

(ii) *Handle length.* The handle length should be ≤ 47" (recommended length of 16"-24"), with a ~ 5" long tube T-handle of ~ 1" diameter, wire loop handle or similar is recommended.

(2) Example Model(s) Meeting Current Design Standards:

(i) *17" Bite Block Deep-Hooked (Sea Turtle) ARC Dehooker Model ST08 (Plate B-11)*. This model may be notched according to the instructions in Chapter A2. See description on Page A5-2 above;

(ii) *NOAA/Bergmann Dehooker (Plate B-12)*. See description on Page A5-2;

(iii) *Short-handled J-Style Dehooker (Plate B-6)* [e.g., ARC Hand Held Large J-Style Dehooker Model LJ07 or LJ24]. See description on Page A5-2 above;

(iv) *Scotty's Dehooker (Plate B-13)*. This device has two 1 1/4" long prongs at the end to form a 3/4" wide fork. This device is approved for removing external circle or J-hooks from turtles boated. It should **not** be used to remove any internal hooks;

(v) *Short-handled Roby Dehooker (Plate B-14)*. This device has a ~ 3 3/4" long cylinder (1 5/8" outside diameter) with four ~1/8" notches at 90° angles on the edge and a ~1/8" diagonal slit to capture the line across the length of the cylinder.

Appendix B

DESIGN SCHEMATICS FOR CAREFUL RELEASE EQUIPMENT

TURTLE TETHER

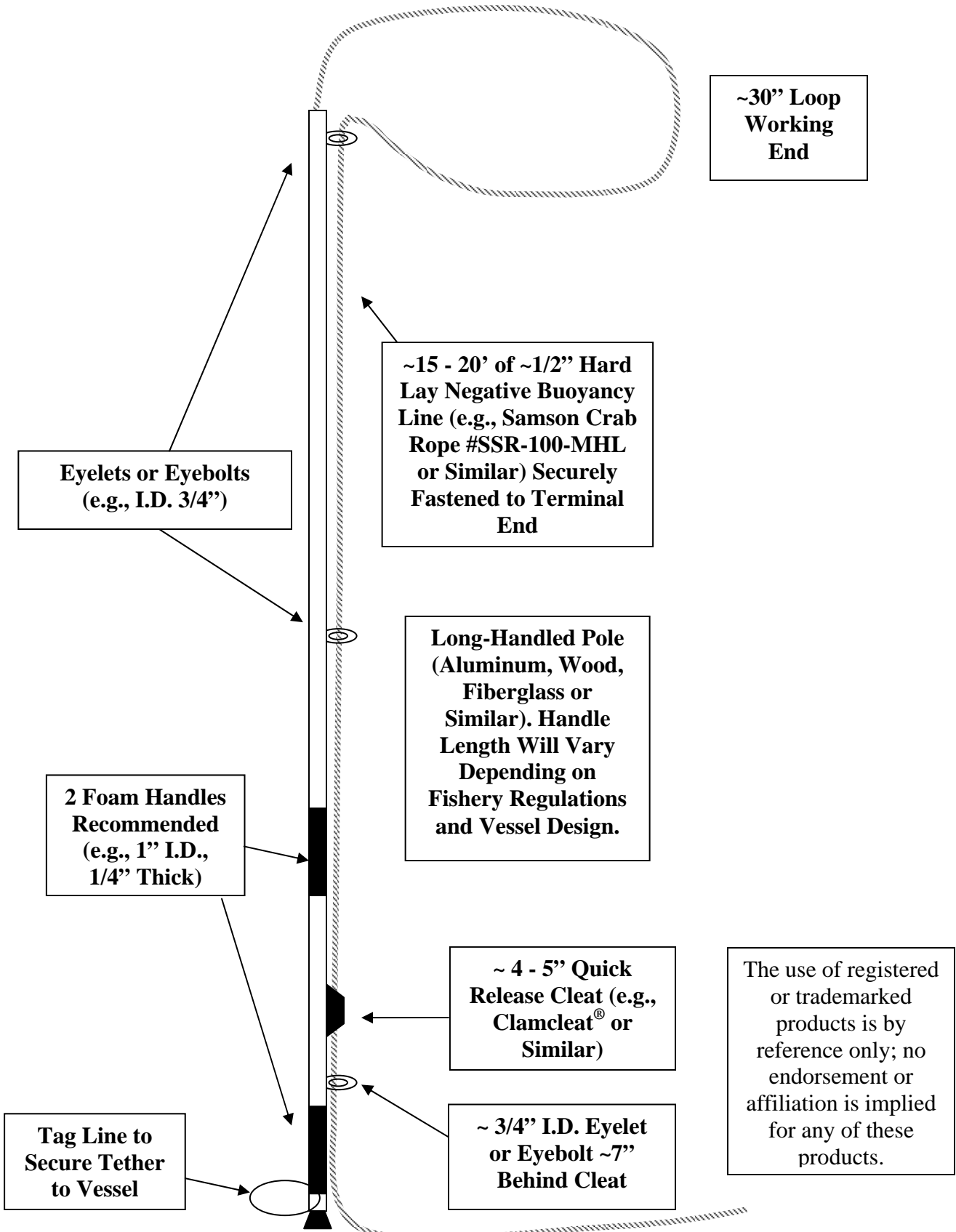
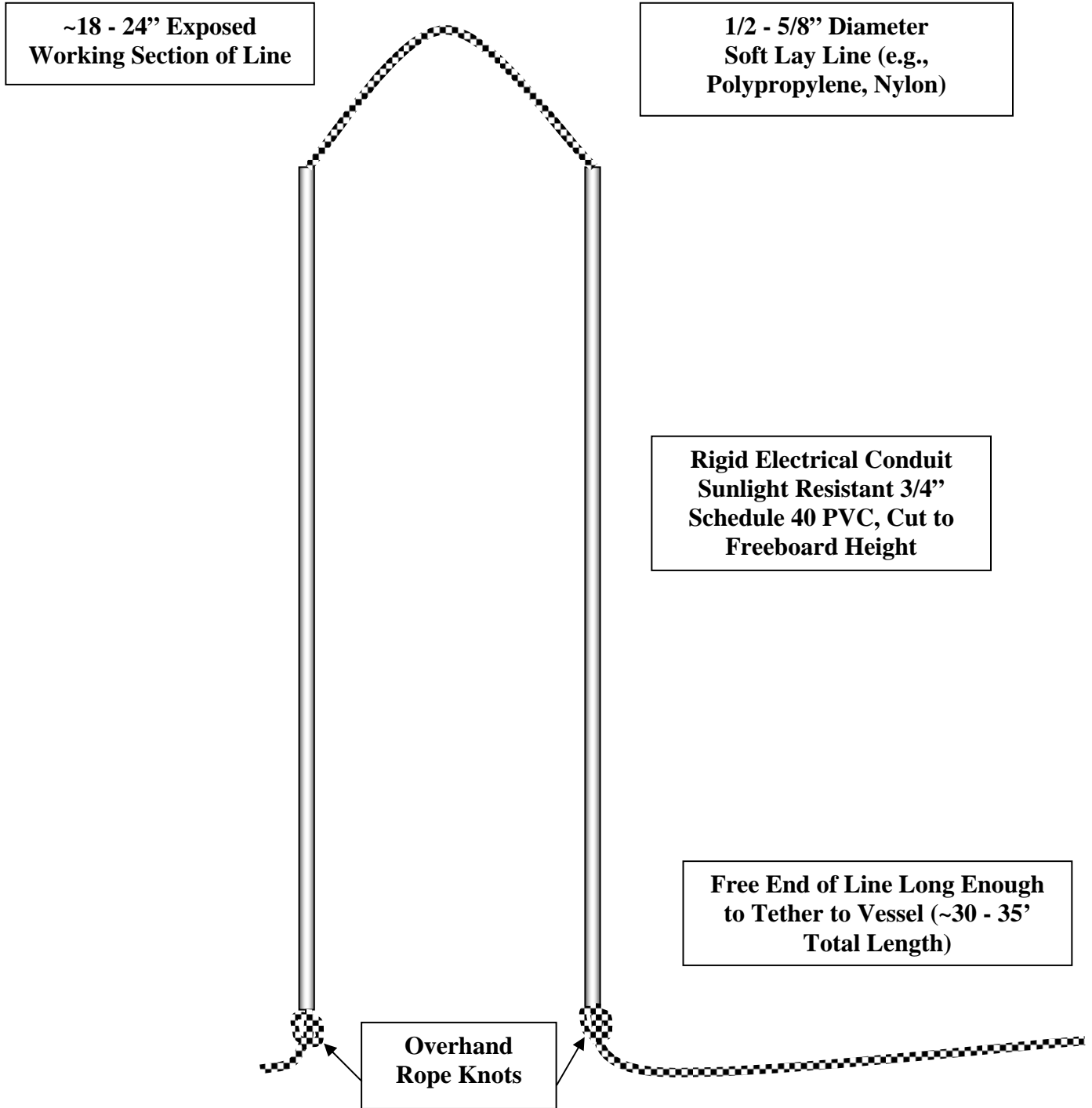


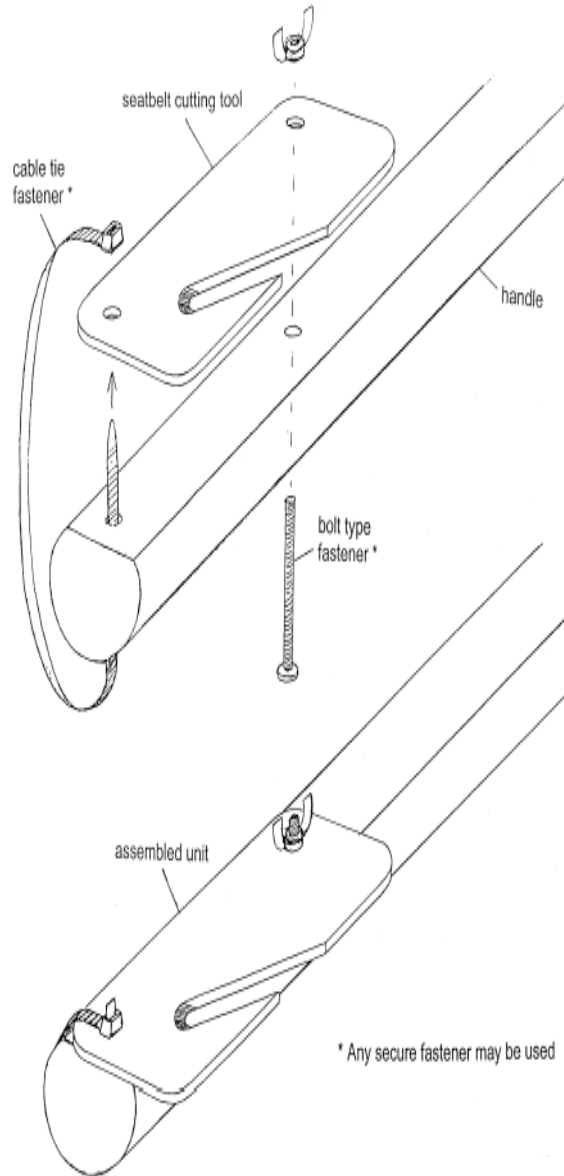
Plate B-2

T&G NINJA STICKS



§ 660.33

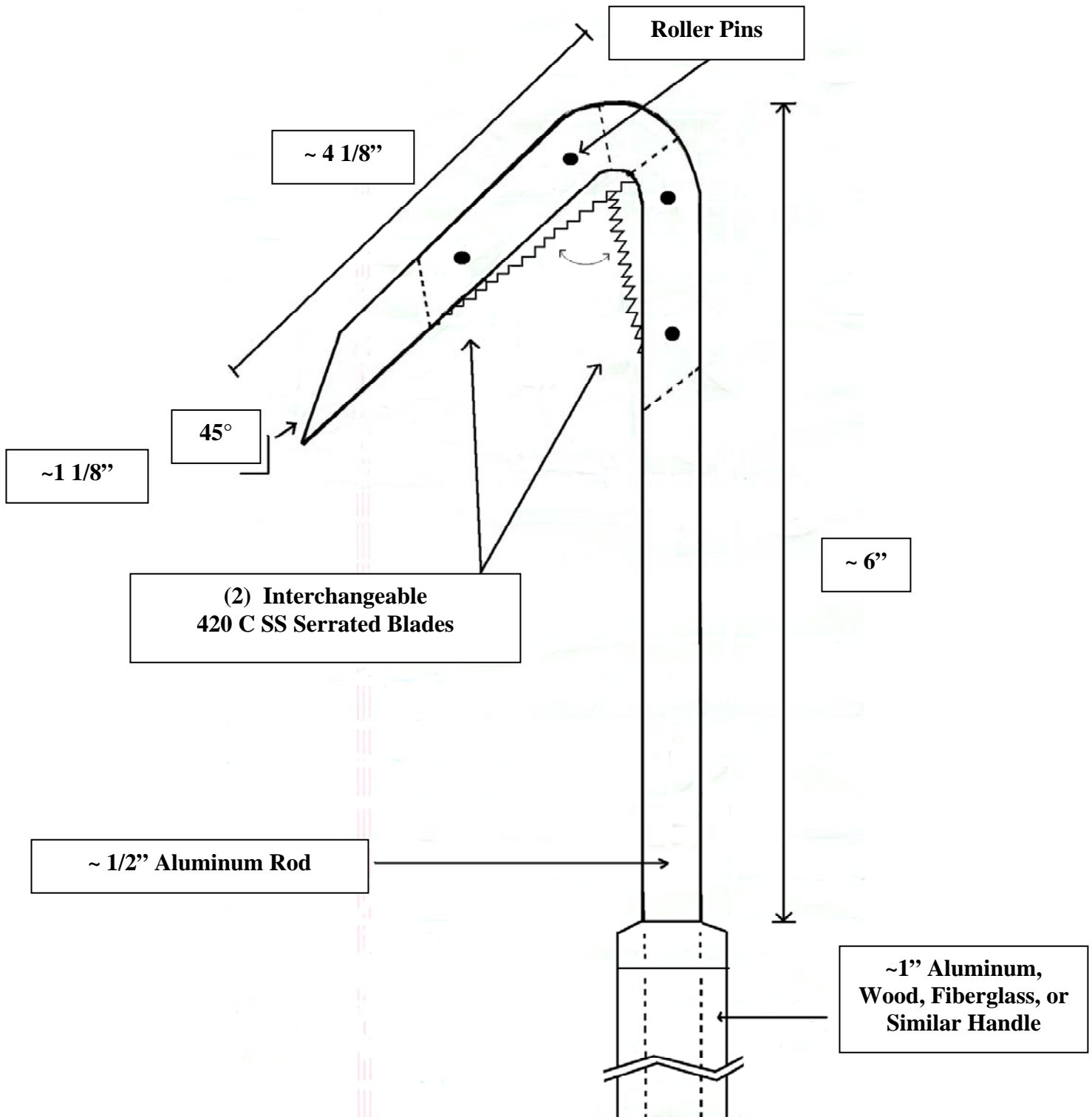
50 CFR Ch. VI (10-1-02 Edition)



50 CFR 660.33 Ch. VI (10-1-02 Edition)

[65 FR 16347, Mar. 28, 2000, as amended at 67 FR 40236, June 12, 2002; 67 FR 48576, July 25, 2002]

NOAA/LAFORCE LINE CUTTER



Modified Version of Diagram Provided by ARC

Plate B-5

ARC POLE BIG GAME DEHOOKER

~ 3/16" - 5/16" 316L SS Rod

Total Length 4 - 12' Depending on Freeboard Height. Working End Must Be Securely Attached to Sturdy Handle (e.g., Wood, Aluminum, Fiberglass) (2 Breakdown Pole Sections Depicted Here).

2 Foam Handles (Optional) (e.g., 1" I.D., 1/4" Thick)

Detail of Working End

~ 5 - 7" From Point of Insertion to End of Curl

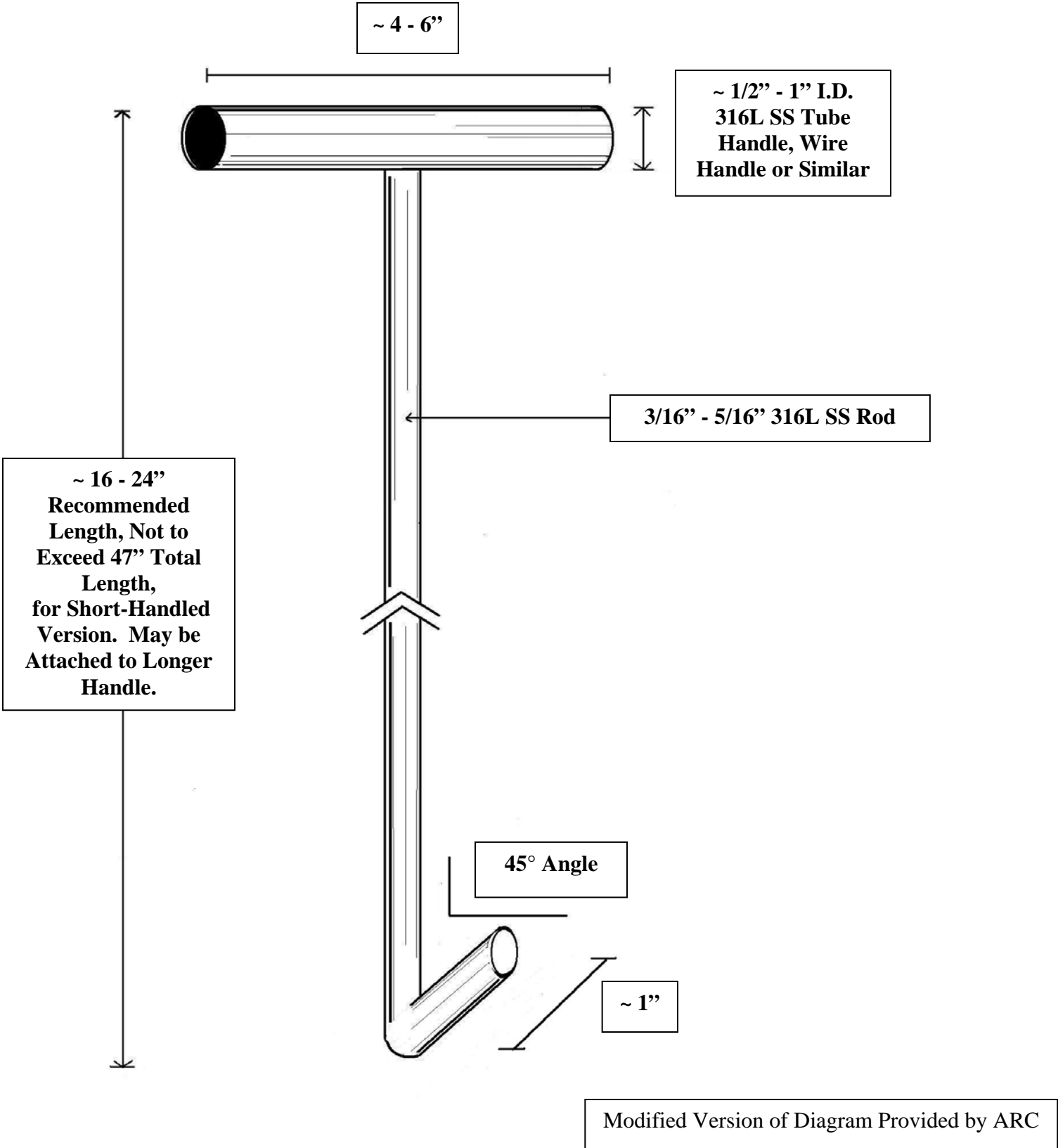
5.3° to 13° (Range) Offset Angle to Shield the Point of the Hook

Loop I.D. 1 1/4" and O.D. No Greater than 1 7/8" with ~1/8" Gap Between Rod and Loop to Facilitate Line Engagement

12.2° to 24° (Range) Angle Bend from the Rod to Accept a Range of Hook Sizes

Modified Version of Diagram Provided by ARC
U.S. Patent # 4,914,853; U.S. Design Patent # 382,628

J- STYLE DEHOOKER



LONG-HANDLED ROBY DEHOOKER

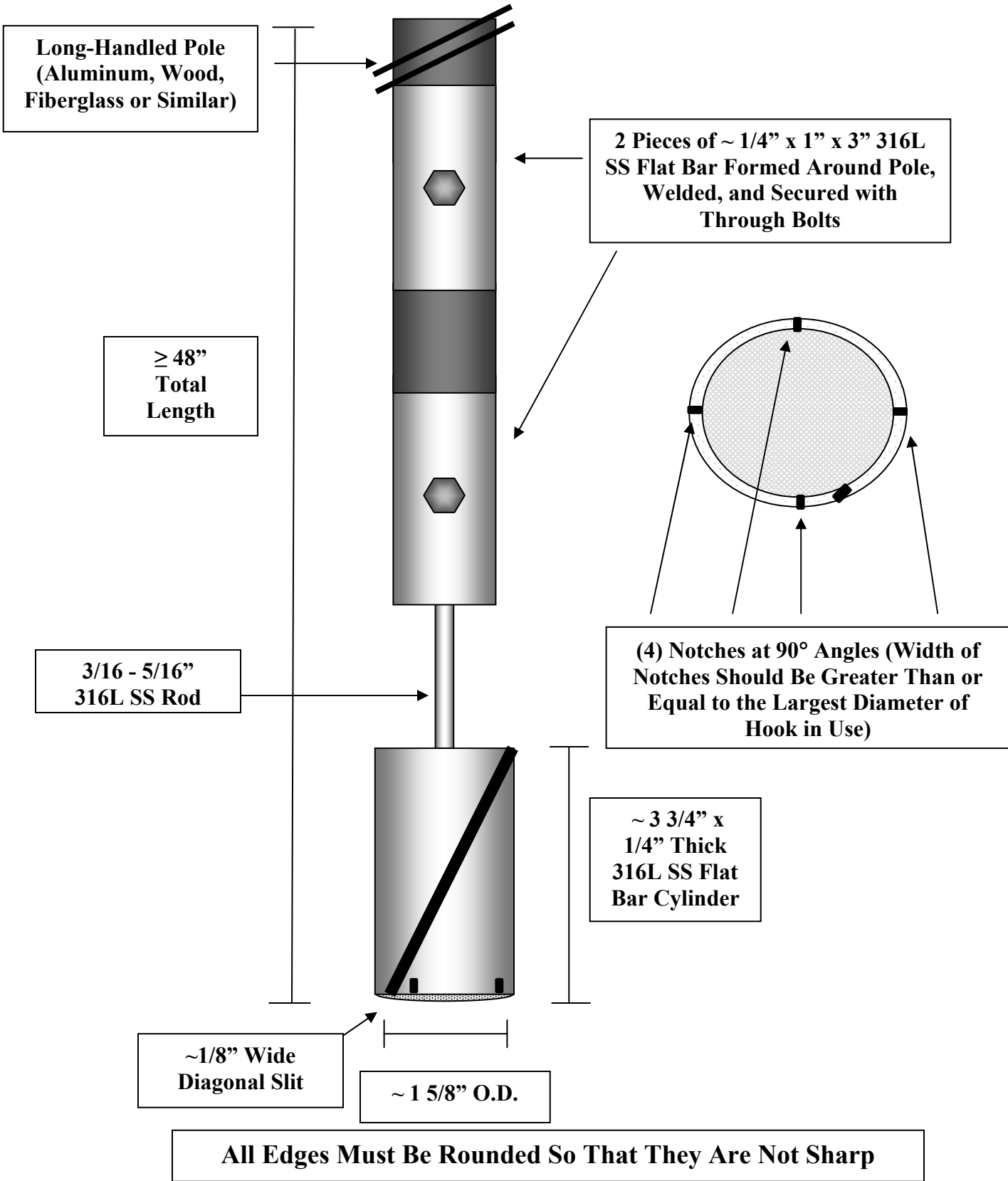
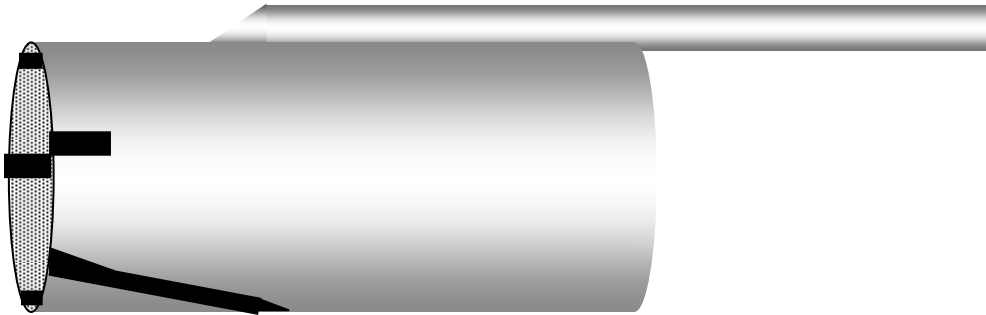
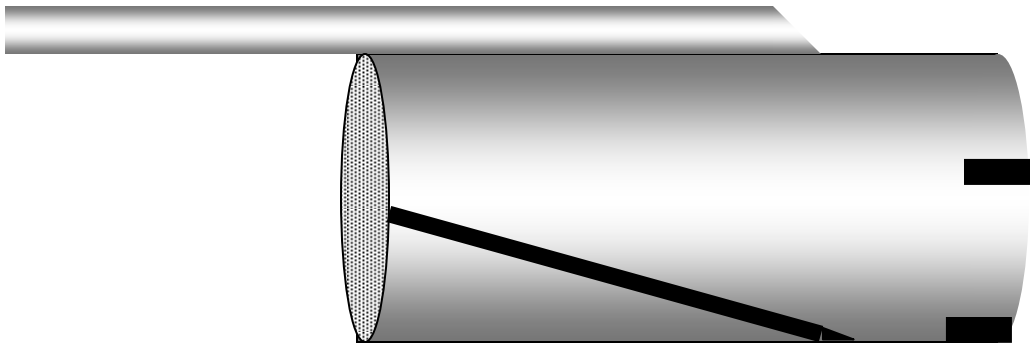


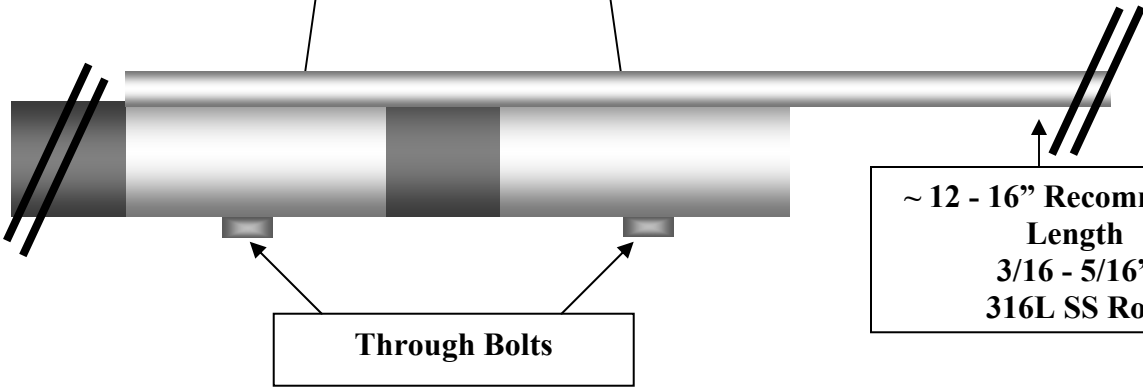
Plate B-7 Continued

Side Views



All Edges Must Be Rounded So That They Are Not Sharp

2 Pieces of ~ 1/4" x 1" x 3" 316L SS Flat Bar Formed Around Pole and Welded to Central Rod



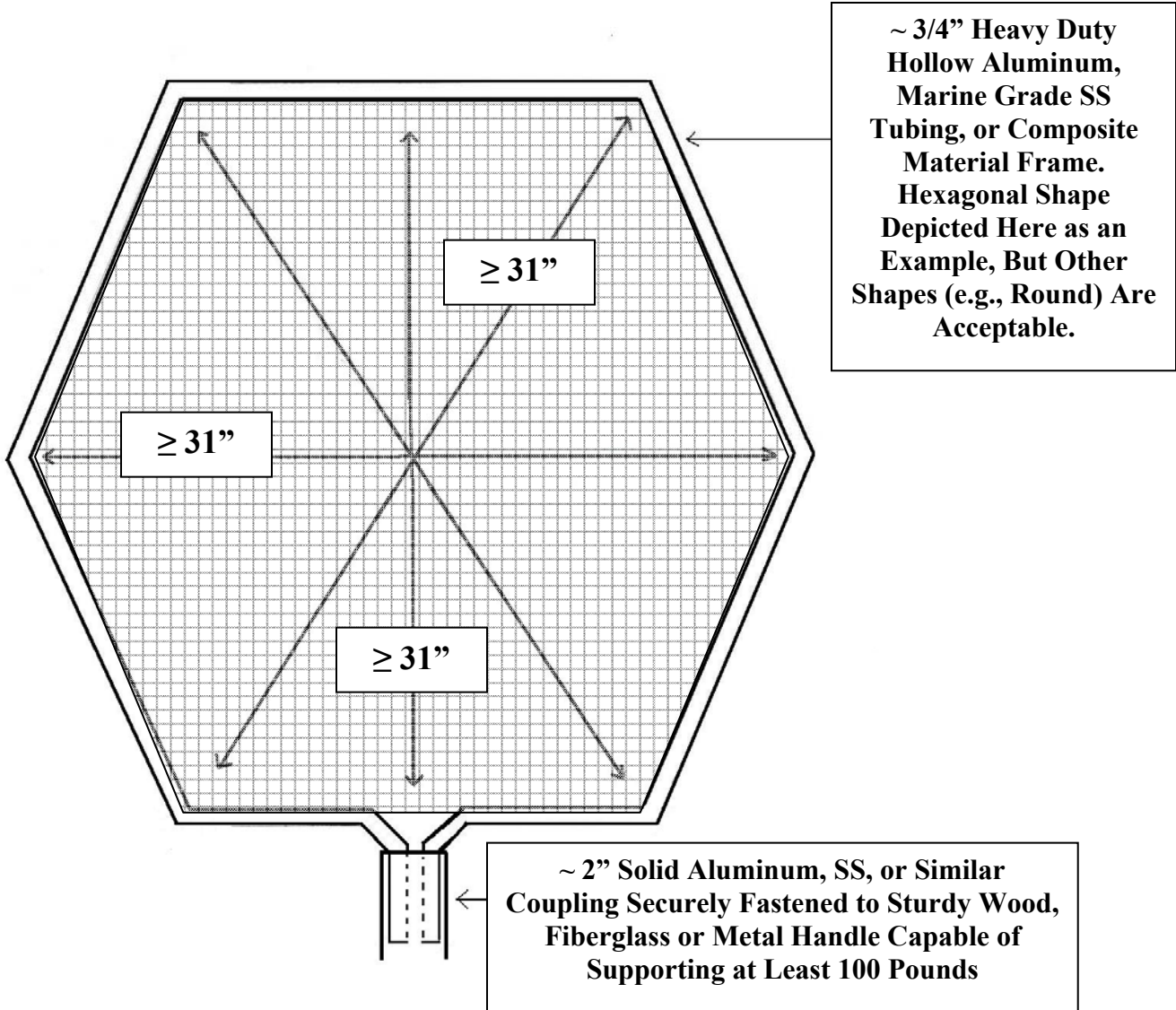
**~ 12 - 16" Recommended Length
3/16 - 5/16"
316L SS Rod**

Through Bolts

Attachment Method May Vary as Long as Working End Is Securely Attached

Plate B-8

DIP NET

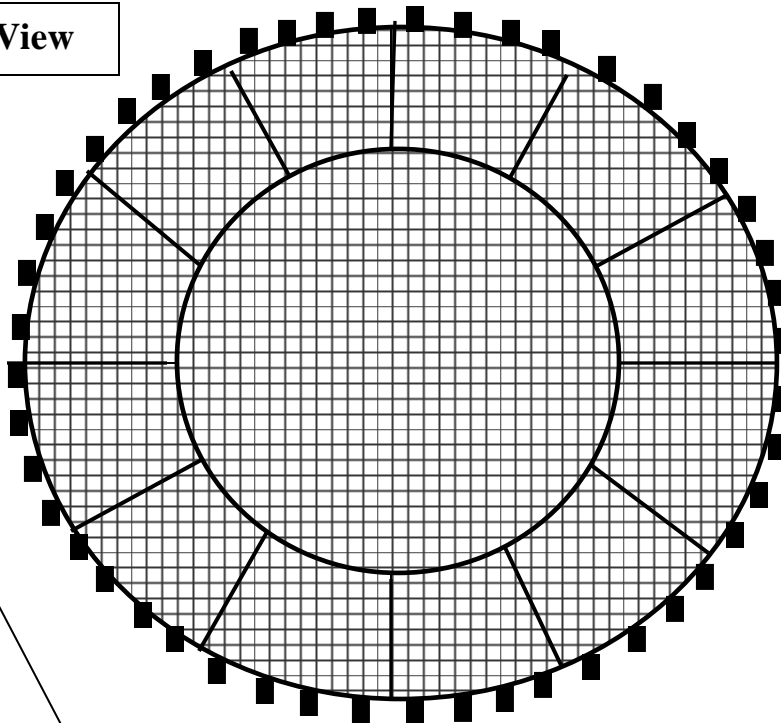


**Mesh Openings Must Not Exceed 3" x 3" (Bar Measure).
Bag Depth Must Be ≥ 38".**

Modified Version of Diagram Provided by ARC

LARGE TURTLE HOIST

Top View



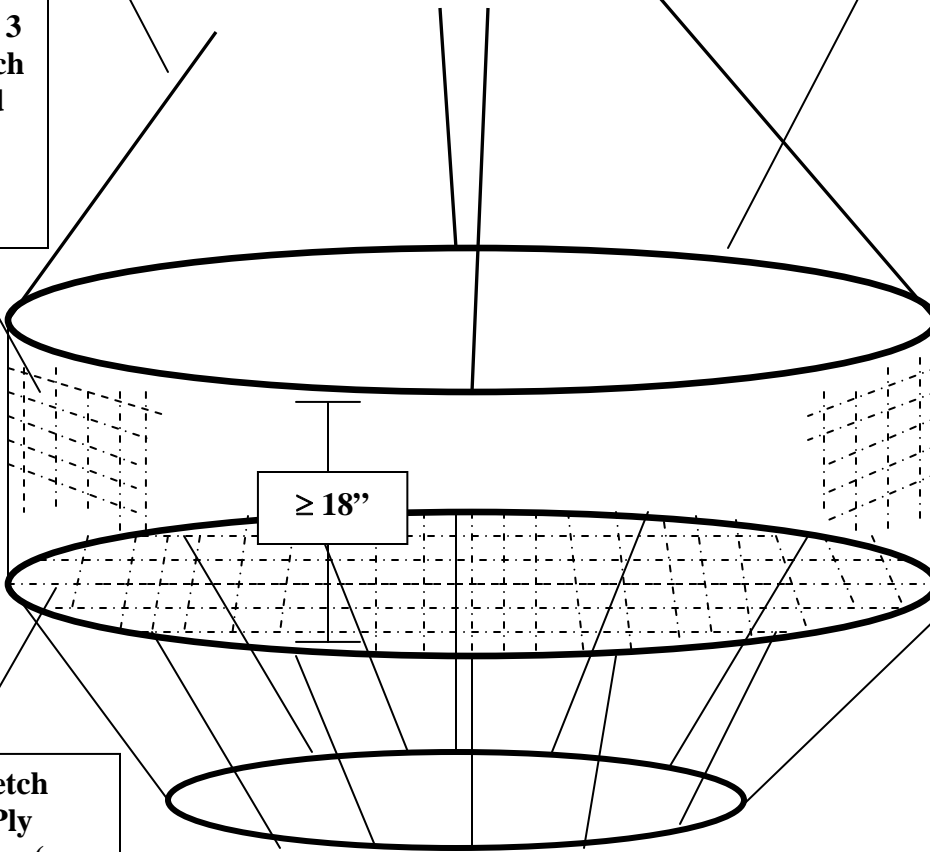
4 Round Rubber Cookies (8" x 2 1/2") per section (48 Total) on Top

3 or 4 Point Bridle Attached with Pairlinks and 3/4" Nylon 3-Strand Line

Top/Fence Ring 7' 6" Diameter (1 3/4" Round 50 Series Aluminum Bar Wrapped in 1/2" Polypropylene Wrap Rope)

Fence Constructed of 3 mm, 4.7" Stretch Mesh Braided Polyethylene Webbing

Middle Ring 7' 6" Diameter (1 3/4" Round 50 Series Aluminum Bar) Wrapped in 1/2" Polysteel Rope Around Circumference



(12) Beveled Spokes ~23" (1" Round 50 Series Aluminum Bar or 6061 T6 Schedule 40 Pipe) Set at ~25°. Welded Using Appropriate Welding Wire (5052, 6061 or 3003).

8 mm, 6.5" Stretch Knotless 600 Ply Polyethylene Netting (e.g., Ultra Cross Netting by NET Systems, Inc.)

Bottom Ring 4' Diameter (1 1/2" Round 50 Series Aluminum Bar)

Plate B-10

SMALL TURTLE HOIST

$\geq 31''$

$\geq 31''$

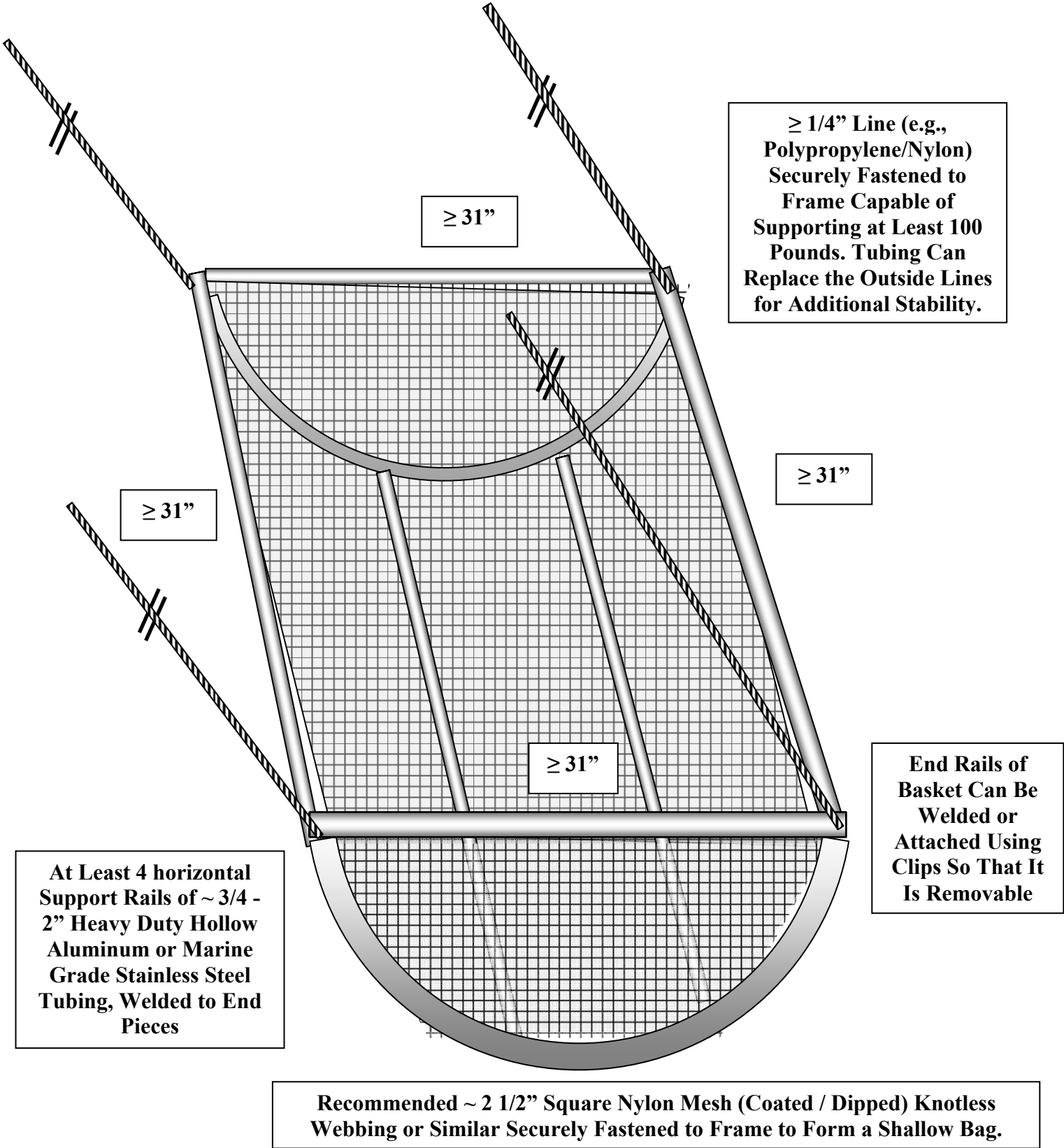
$\geq 1/4''$ Line (e.g., Polypropylene, Nylon) Securely Fastened to Frame Capable of Supporting At Least 100 Pounds

$\sim \geq 3/4''$ Heavy Duty Hollow Aluminum or Marine Grade SS Tubing, or $\sim 2''$ Schedule 40/80 PVC. Welded or Joined Using Elbow Joints. Square Shape Depicted Here As an Example, but Other Shapes (e.g., Round) Are Acceptable.

**Mesh Openings Must Not Exceed 3" x 3" (Bar Measure)
~ 2 1/2" Square Nylon Mesh, (Coated /Dipped) Knotless Webbing or Similar Securely Fastened to Frame to Form a Shallow Bag.**

**Plate B-10
Continued**

**BASKET STYLE
SMALL TURTLE HOIST**



≥ 1/4" Line (e.g., Polypropylene/Nylon) Securely Fastened to Frame Capable of Supporting at Least 100 Pounds. Tubing Can Replace the Outside Lines for Additional Stability.

≥ 31"

≥ 31"

≥ 31"

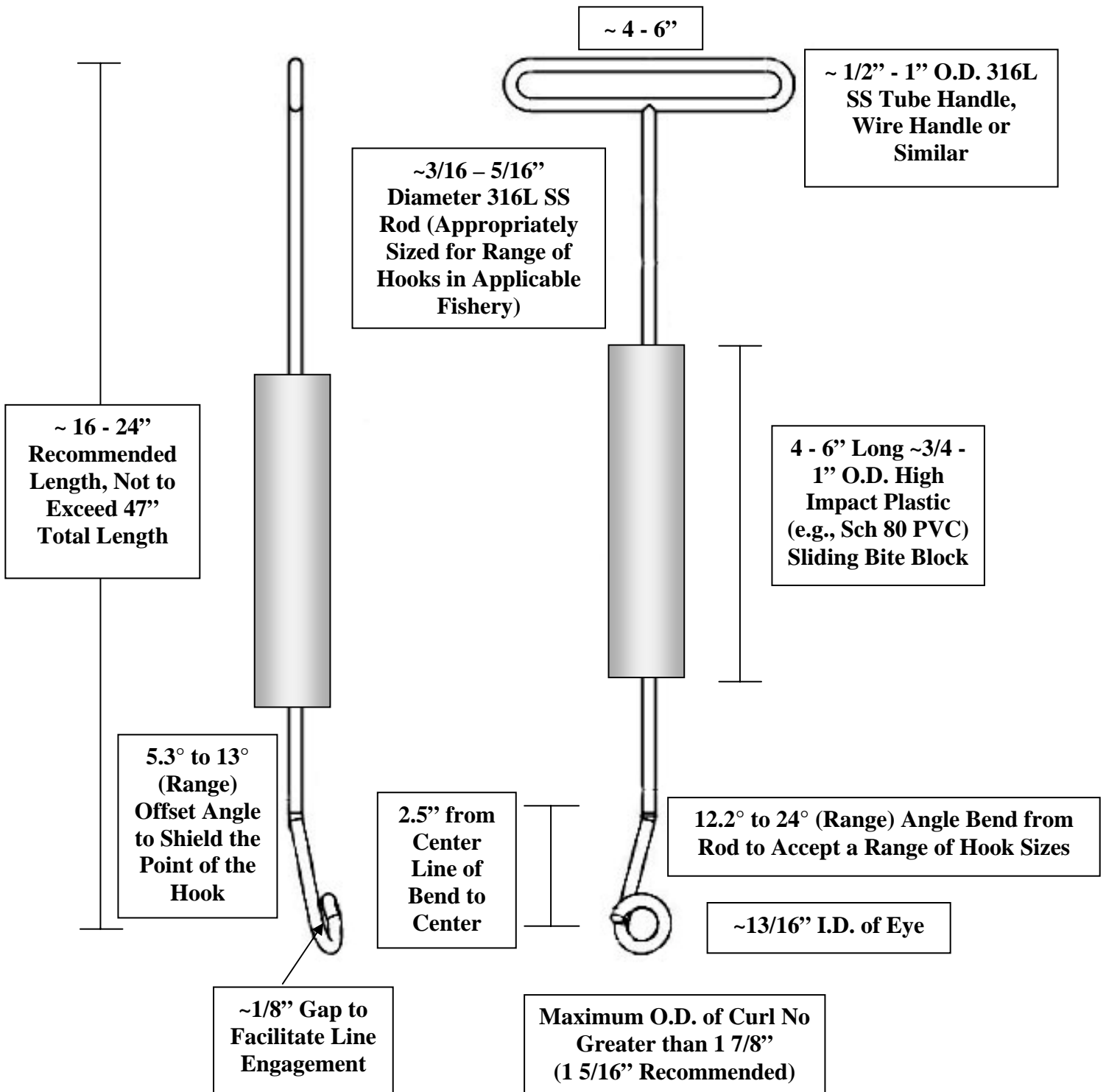
≥ 31"

End Rails of Basket Can Be Welded or Attached Using Clips So That It Is Removable

At Least 4 horizontal Support Rails of ~ 3/4 - 2" Heavy Duty Hollow Aluminum or Marine Grade Stainless Steel Tubing, Welded to End Pieces

Recommended ~ 2 1/2" Square Nylon Mesh (Coated / Dipped) Knotless Webbing or Similar Securely Fastened to Frame to Form a Shallow Bag.

ARC BITE BLOCK DEHOOKER



Modified Version of Diagram Provided by ARC
U.S. Patent # 4,914,853 and 6,840,002; U.S. Design Patent # 382,628; International Patent # WO/2005/055712

NOAA/BERGMANN DEHOOKER

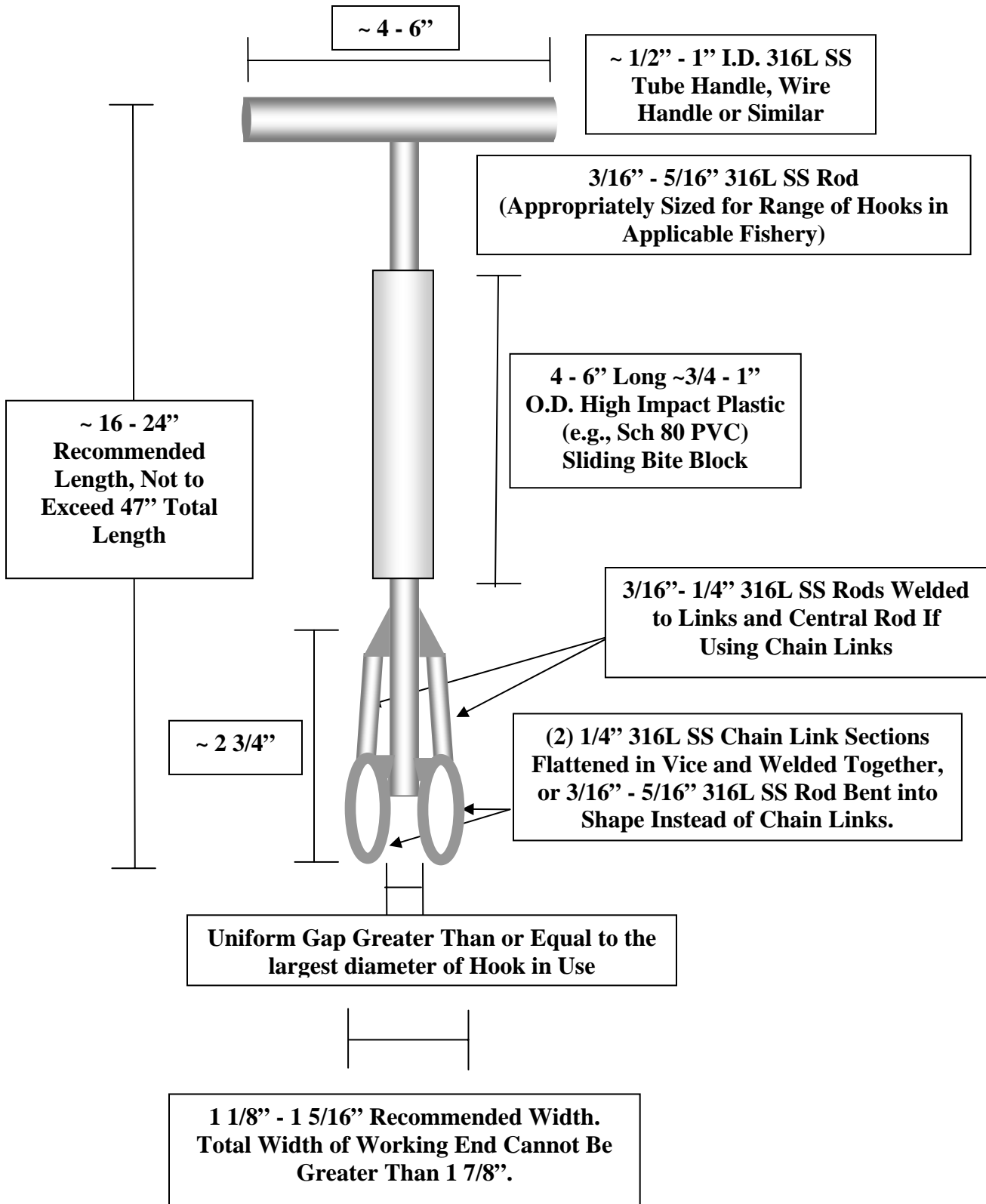
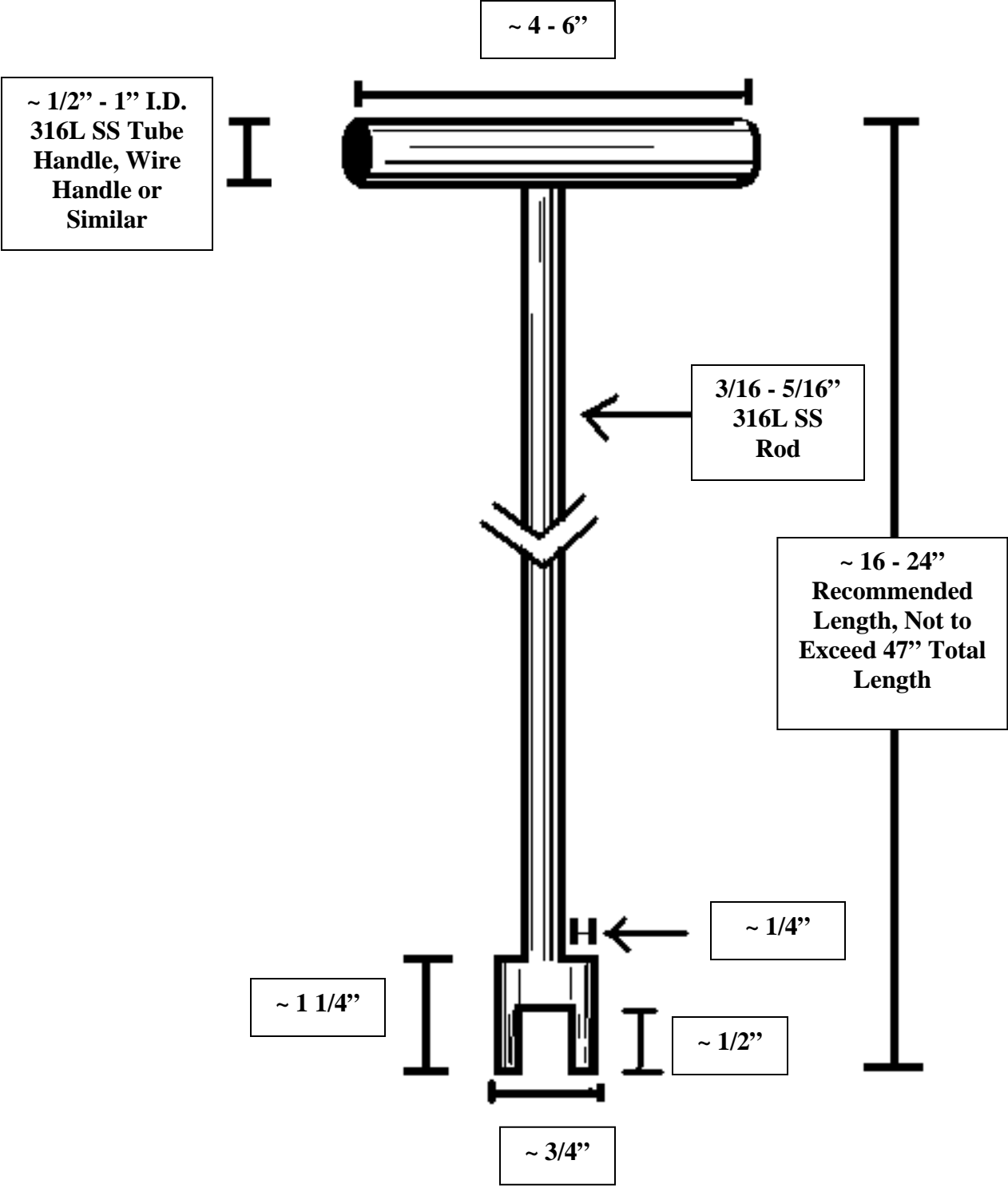


Plate B-13

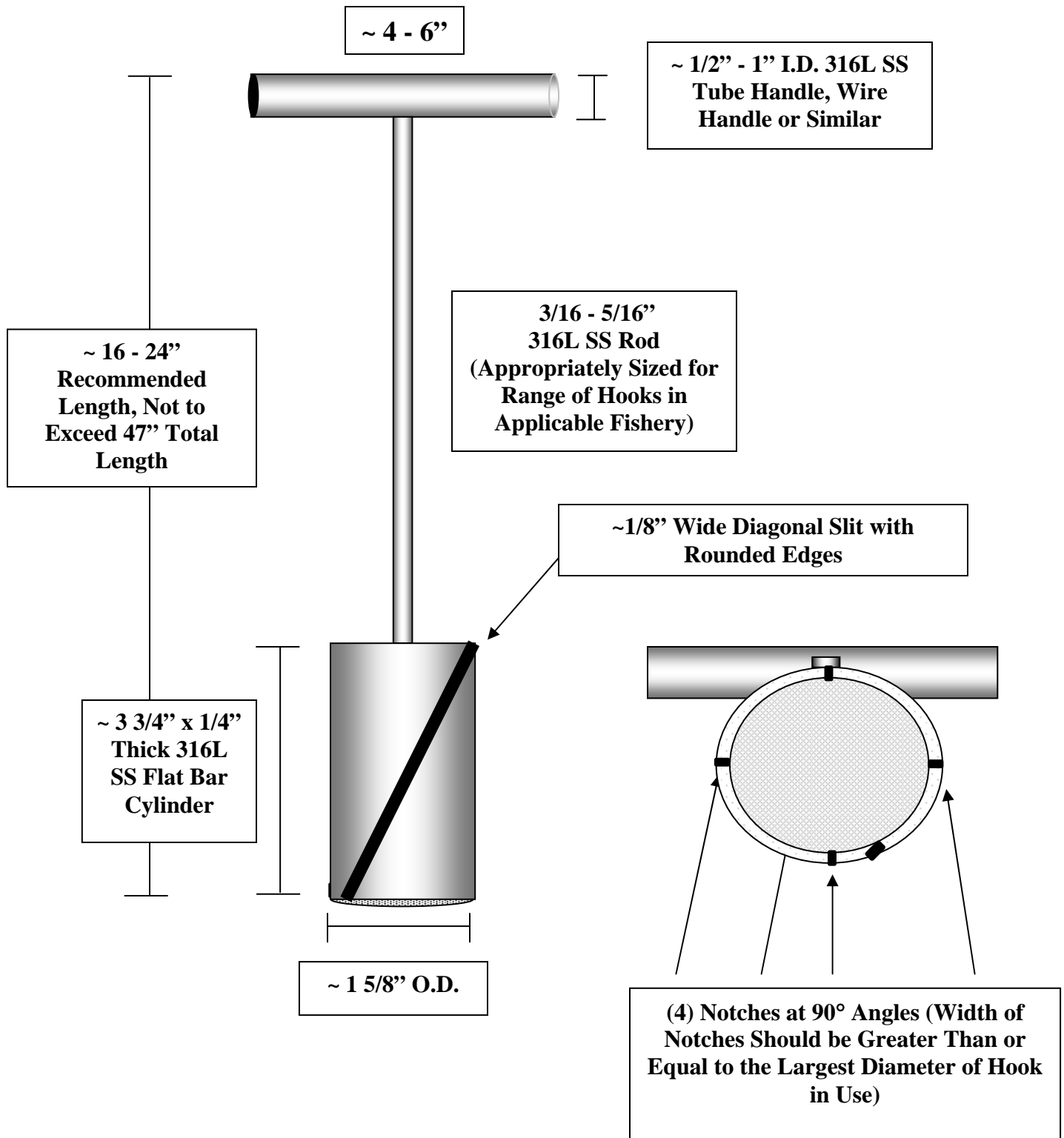
SCOTTY'S DEHOOKER



Modified Version of Diagram Provided by ARC

Plate B-14

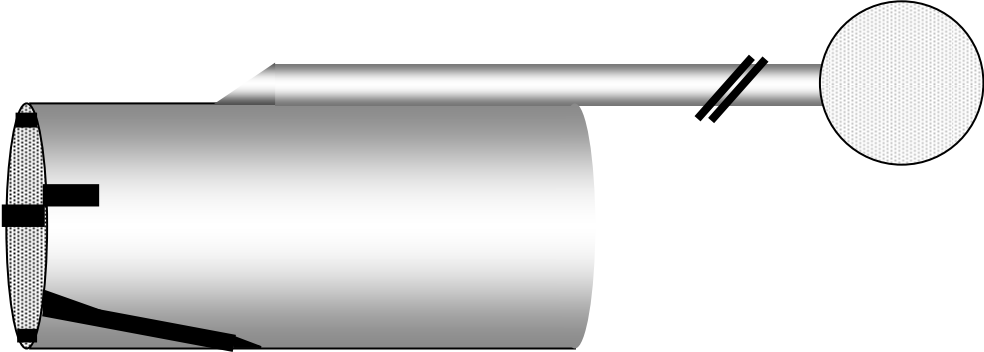
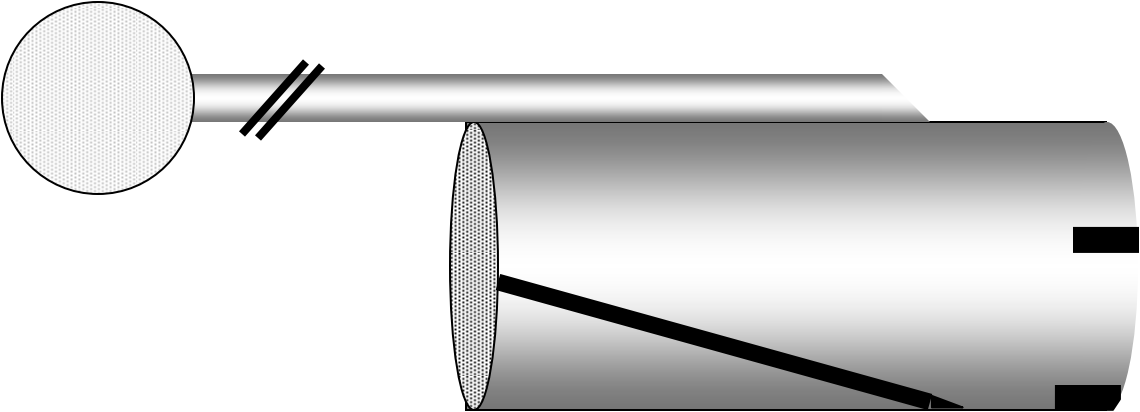
SHORT-HANDLED ROBY DEHOOKER



All Edges Must be Rounded So That They Are Not Sharp

Plate B-14 Continued

Side Views



All Edges Must Be Rounded So That They Are Not Sharp

Appendix C

EQUIPMENT SELECTION FLOWCHART FOR THE CAREFUL RELEASE OF INCIDENTALLY CAPTURED SEA TURTLES

Sea Turtles Not Boated

Entangled and/or Hooked

Entangled

Long-handled Line Cutter

AND

Long-handled Device to Pull "Inverted V"

AND

Long-handled Dehooker for Internal Hooks to Secure Loose Hook

Hooked

Long-handled Dehooker

External

Long-handled Dehooker for Internal Hooks or Long-handled Dehooker for External Hooks

Internal

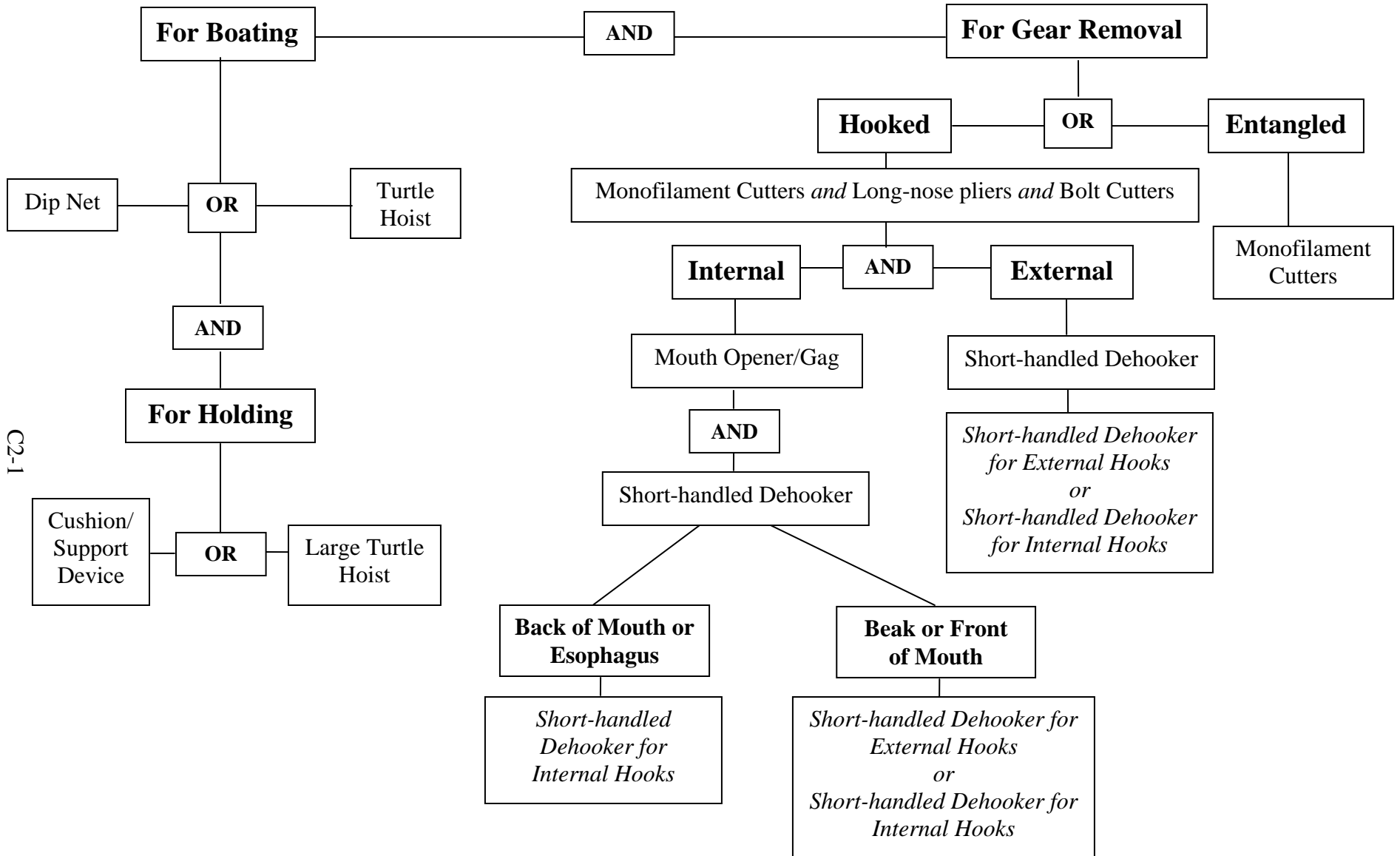
Long-handled Dehooker for Internal Hooks

To control turtle at side of boat

Turtle Control Device

Plate C-2

Sea Turtles Boated



C2-1

Appendix D

SEA TURTLE AND MARINE MAMMAL HANDLING AND CAREFUL RELEASE PLACARDS

Sea Turtle Handling/Release Guidelines:

Quick Reference for Atlantic Longline Gear

Guidelines for all turtles

- Scan mainline as far ahead as possible to sight turtles in advance and reduce likelihood of jerking turtles out of the water.
- Do not get ahead of the mainline while picking up gear. This reduces the chance of fouling or running over gear and turtle.
- Upon sighting a turtle:
 - ◆ Slow vessel and mainline reel speed
 - ◆ Adjust direction of the vessel to move toward turtle
 - ◆ Minimize tension on the mainline and branchline with the turtle
- Holding the snap-clip of the branchline with the turtle on it, continue to move toward the turtle at a slow speed. **STOP VESSEL** and **PUT IN NEUTRAL** once turtle is brought alongside.
- Slowly retrieve branchline with turtle, keeping a gentle, consistent tension on the line. Avoid tugging or yanking line quickly. **DO NOT USE GAFFS OR SHARP OBJECTS** in direct contact with the turtle to retrieve it; a gaff may be used only to control the line during line removal.
- Ensure that enough slack is left in the line to keep turtle near the vessel, yet in water, until it can be determined whether or not it is possible to release turtle in the water, or safely bring it aboard.
- If turtle can be safely brought aboard and vessel is equipped with “cut-out doors,” use this cut-out area to bring turtles aboard to minimize the distance from the water.
- Resuscitate comatose boated turtles as needed, holding them for up to 24 hours (keep moist and in the shade) if necessary.
- More information on releasing sea turtles is available in the *Careful Release Protocols for Sea Turtle Release with Minimal Injury* and on the web at: <http://www.nmfs.noaa.gov/sfa/hms>.

Guidelines for turtles not boated

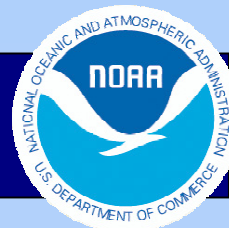
- Control turtle by maintaining pressure on branchline, or preferably, with turtle tether, and bring the turtle as close to the vessel as possible.
- If entangled and not hooked, use dehooking tools to secure unattached hooks. Use clippers to cut the line. **DO NOT** leave line attached.
- If hooked and entangled, remove the hook first. Then, after the hook is removed, proceed to remove all line.
- All externally embedded hooks should be removed without lifting the turtle clear of the water. If hook removal is not possible, cut the line at the eye of the hook (or as close as possible).
- If hooked internally: do not attempt to remove hook if the hook has been swallowed beyond where the insertion point of the barb is visible, or when it appears that the hook removal will cause further injury. Remove as much of the line and/or hook as possible.

Guidelines for boated turtles

- If possible, bring turtle on board using a suitable dip net or other approved lifting device. Support turtle on a cushioned surface, such as a tire, while onboard.
DO NOT LIFT THE TURTLE OUT OF THE WATER USING THE BRANCHLINE, GAFF, OR OTHER SHARP OBJECTS
- Remove all externally embedded hooks. Internal hooks should be removed when the insertion point of the barb is clearly visible. Do not remove the hooks that have been swallowed when the insertion point is not visible, or when it appears hook removal will cause further damage (e.g., in the brain case or glottis). Remove as much of the line and/or hook as possible.

Stop!

- To release turtle (1) **STOP VESSEL** and place in neutral; (2) Ease turtle gently into the water, head first, through cut-out door if so equipped; and (3) Observe that turtle is safely away from the vessel before engaging the propeller and continuing operations.



Sea Turtle Handling/Release Guidelines:

Quick Reference for

Atlantic Shark GILLNET Gear

October 2006

Guidelines for Handling Gear

- Gillnet gear should be set and/or fished to achieve maximum net **tautness**. This will prevent turtles from becoming entangled in the net in the case of an encounter.
- Scan net as far ahead as possible to sight turtles in advance and reduce the risk of jerking turtles out of the water.
- Vessel operators are required to check nets every 0.5 to 2 hours (50 CFR§ 635.21 (e) (3) (vi)).

Upon Sighting a Turtle

- **Slow vessel** and adjust direction to move towards the turtle. Once turtle is alongside, place the vessel in **neutral**.
- Slowly retrieve the net, avoiding tugging or yanking motions.
- Considering the size of the turtle, sea conditions, and safety of crew, determine whether the turtle can be boated. (All turtles should be **boated if possible**.)

Guidelines for Turtles Boated

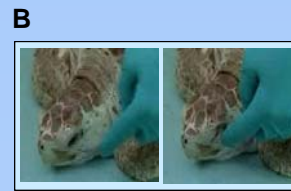
- **Boat the turtle** using a dipnet or large turtle hoist. Avoid pulling up the turtle by the gear it is entangled in, as this could injure the animal. Gaffs may only be used to control the fishing gear, **DO NOT USE GAFFS OR SHARP OBJECTS** to retrieve the turtle.
- **Support the turtle** on a cushioned surface, such as a tire, while it is onboard.
- If the turtle cannot easily be disentangled from the net, **carefully cut the net** off the turtle. **Blunt-sided** line cutters such as first-aid clippers are preferred. If one-sided cutters/clippers are used, carefully slide the blunt end under the line or net you want to cut. Attempt to remove any lines or net attached to the turtle.
- **Identify** the species of turtle and record when and where the interaction occurred.

Guidelines for Turtles NOT Boated

- If the turtle is too large to be boated, control the turtle with a turtle tether if possible and bring the turtle close to the vessel.
- **Identify** the species of turtle and record when and where the interaction occurred.
- Try to work the turtle free from the net while the turtle is next to the boat. Use line cutters/clippers with a handle extension or first-aid clippers to cut the net off the turtle if necessary. Carefully slide the **BLUNT END** of the line cutter under the line or net you want to remove. Attempt to remove any lines or net attached to the turtle.

Guidelines for UNCONSCIOUS Turtles

- Place the turtle on its lower shell and **elevate** its hindquarters approximately 6 inches to permit the lungs to drain off water (Figure A).
- Keep the **skin and eyes moist** by covering the turtle with a moist towel or periodically spraying it with water while it is onboard. Place the turtle in the shade if necessary, while maintaining its body temperature above 60°F.
- Check for muscle **reflexes** approximately every 3 hours by touching the eyelid or tail (Figure B). An unconscious, but live turtle may or may not respond to touch.
- Be patient. Sea turtles caught and held underwater are stressed and may take some time to revive. If the turtle has shown no sign of life before returning to port, or after 24 hours on deck, it may safely be considered dead. Release the turtle in the water in a non-fishing area.



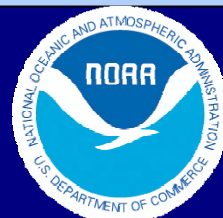
Contact Information

More information on releasing sea turtles is available on the on the web at: <http://www.nmfs.noaa.gov/sfa/hms> and in the publication, *Careful Release Protocols for Sea Turtle Release with Minimal Injury*, which is available on this website. Call (301) 713-2347 to obtain a copy of the report or for additional copies of this placard.

Stop!

GUIDELINES FOR RELEASING A TURTLE

- (1) **STOP VESSEL** and place in **NEUTRAL**;
- (2) **Ease turtle** gently into the water, head first, through cut-out door if so equipped;
- (3) Observe that turtle is safely **away from the vessel** before engaging the propeller and move 1 nmi before continuing fishing operations.



Sea Turtle Handling/Release Guidelines:

Quick Reference for the Reef Fish Fishery

Guidelines for all turtles

- Scan as far as possible to sight turtles in advance and reduce likelihood of jerking turtles out of the water.
- Longline Vessels: Do not get ahead of the line while picking up gear. This reduces the chance of fouling or running over gear and turtle.

Upon sighting a turtle:

- ◆ Slow vessel and line reel speed
- ◆ Adjust direction of the vessel to move toward turtle
- ◆ Minimize tension on the line with the turtle

Holding the line with the turtle on it, continue to move toward the turtle at a slow speed. **STOP VESSEL** and **PUT IN NEUTRAL** once turtle is brought alongside.

- Slowly retrieve line with turtle, keeping a gentle, consistent tension on the line. Avoid tugging or yanking line quickly. **DO NOT USE GAFFS OR SHARP OBJECTS** in direct contact with the turtle to retrieve it; a gaff may be used only to control the line during line removal.
- Ensure that enough slack is left in the line to keep turtle near the vessel, yet in water, until it can be determined whether or not it is possible to release turtle in the water, or safely bring it aboard.
- If turtle can be safely brought aboard and vessel is equipped with "cut-out doors," use this cut-out area to bring turtles aboard to minimize the distance from the water.
- Resuscitate comatose boated turtles as needed, holding them for up to 24 hours (keep moist and in the shade) if necessary.
- More information on releasing sea turtles is available in the *Careful Release Protocols for Sea Turtle Release with Minimal Injury* and on the web at: sero.nmfs.noaa.gov.

Guidelines for turtles not boated

- Control turtle by maintaining pressure on line, or preferably, with a type of turtle tether, and bring the turtle as close to the vessel as possible. **DO NOT** lift turtles clear of the water.
- If entangled and not hooked, use dehooking tools to secure unattached hooks. Use clippers to cut the line. **DO NOT** leave line attached.
- If hooked and entangled, remove the hook first. Then, after the hook is removed, proceed to remove all line.
- All externally embedded hooks should be removed. If hook removal is not possible, cut the line at the eye of the hook (or as close as possible).
- Internal hooks should be removed only if an internal dehooker is being used. Do not attempt to remove hook if the hook has been swallowed beyond where the insertion point of the barb is visible, or when it appears that the hook removal will cause further injury. Remove as much of the line and/or hook as possible.

Guidelines for boated turtles

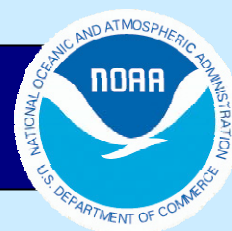
- If possible, bring turtle on board using a suitable dip net or other approved lifting device. Support turtle on a cushioned surface, such as a tire, while onboard.

DO NOT LIFT THE TURTLE OUT OF THE WATER USING THE LINE, GAFF, OR OTHER SHARP OBJECTS

- Remove all externally embedded hooks.
- Internal hooks should be removed when the insertion point of the barb is clearly visible and only if an approved internal dehooker is being used. Do not remove the hooks that have been swallowed when the insertion point is not visible, or when it appears hook removal will cause further damage (e.g., in the brain case or glottis). Remove as much of the line and/or hook as possible.

Stop!

To release turtle (1) **STOP VESSEL** and place in neutral;
(2) Ease turtle gently into the water, head first, through cut-out door if so equipped;
and (3) Observe that turtle is safely away from the vessel before engaging the propeller and continuing operations.



		Required Item	Examples of NMFS Approved Models	
These Items Required for Any Vessel with a Freeboard Height Greater than 4ft	Choose At Least One	Long-handled line cutter (6ft. or 150 percent of freeboard height, which ever is greater)	LaForce Line Cutter; Arceneaux Line Clipper	
		Long-handled ¹ (6ft. (1.83 m) or 150 percent of freeboard height, which ever is greater) dehooker for ingested hooks ²	ARC Pole Model, BP11 Deep Hooked Dehooker	
	These Items Required for Any Vessel with a Freeboard Height of 4ft or Less	Choose At Least One	Long-handled ¹ (6 ft. (1.83 m) or 150 percent of freeboard height) dehooker for external hooks	ARC 6 ft. Pole Big Game Dehooker Model 6P10; ARC Model LJ6P (6 ft. or 1.83 m)
			Dipnet (must have at least 31 in diameter and handle may be of variable length)	ARC Breakdown Lightweight Dipnet Model (DN6P (6 ft.), DNO8 (8 ft.), or DN14 (12 ft.)); Lindgren Pittman, Inc. Model NMFS-Turtle Net; ARC net assembly and Handle (Model DNIN)
		Choose At Least One	Short Handled Dehooker for Ingested Hooks ²	ARC 17-in. Hand Held Bite Block Deep Hooked Turtle Dehooking Device (Model ST08)
			Short Handled Dehooker for External Hooks	ARC 16-in Hand Held Large J-style Dehooker (Model LJ07); ARC 24-in Hand Held Large J-style Dehooker (Model LJ24); or ARC 17-in. (43.18 cm) Hand Held Bite Block Deep Hooked Turtle Dehooking Device (Model STO8); or Scotty's Dehooker
			Long-nose or Needle-nose Pliers	12 in. S.S. NuMark Model #030281109871; any 12-in. stainless steel long or needle-nose pliers
			Bolt Cutter	H.K. Porter Model 1490 AC
			Monofilament Line Cutter	Jinkai Model MC-T
			Two (2) of the following Mouth Openers and Mouth Gags	
		Choose At Least Two Different Types	Block of Hard Wood	Any block of hard wood or long-handled wire brush (e.g., Olympia Tools Model 974174)
			Set of (3) Canine Mouth Gags	Jorvet Model 4160, 4162, and 4164
Set of (2) Sturdy Dog Chew Bones	Nylabone®, Gumabone®, or Galileo® (trademarks owned by T. F. H. Publications, Inc)			
Set of (2) Rope Loops Covered with Hose	Any set of (2) rope loops covered with hose meeting design standards			
Hank of Rope	Any size soft braided nylon rope is acceptable, provided it creates a hank of rope approximately 2–4 in. thickness			
Set of (4) PVC Splice Couplings	A set of (4) Standard Schedule 40 PVC splice couplings (1-in., 1.25-in., 1.5-in., and 2-in.)			
	Large Avian Oral Speculum	Webster Vet Supply Model (Model 85408); Veterinary Specialty Products (Model VSP 216–08); Jorvet (Model J–51z); and Krusse (Model 273117)		
Gear Recommended ³		Standard Automobile Tire ³ Recommended for all vessels	Any standard automobile tire or other comparable, cushioned, elevated surface that allows boated turtles to be immobilized	
		Long-handled device to pull an “inverted V” (6 ft. (1.83 m) or 150 percent of freeboard height, which ever is greater) ³ Recommended for vessels with a freeboard height greater than 4ft.	ARC Model LJ6P (6 ft.); ARC Pole Model Deep Hooked Dehooker (Model BP11); ARC 6 ft. Pole Big Game Dehooker (Model P610); Davis Telescoping Boat Hook (Model 85002A); West Marine Fishing Gaff (Model F6H5 with F6–006 handle)	

¹ A short-handled dehooker with an appropriate length handle extender will also fulfill this requirement.

² A dehooker that is approved for the removal of both internal and external hooks is recommended. Do not attempt to remove ingested hooks until you have received training on the proper use of internal dehookers and internal dehooking techniques.

³ This gear was inadvertently omitted in the final rule due to an error. Therefore, these items are currently not required but are recommended. Measures to require these items will be proposed and if approved, they will be required.

Disclaimer: This placard is meant to help fishermen comply with sea turtle release measures contained in regulations published in the *Federal Register* on August 9, 2006 (71 FR 45428), and select the appropriate required sea turtle release gear for their vessel. All sea turtle release gear must meet the specific requirements in 50 CFR 635.21(c)(5)(A-L). Any discrepancies between the contents of this guide and the regulations will be resolved in favor of the regulations published in the *Federal Register* or Code of Federal Regulations.

SEA TURTLE DISENTANGLEMENT NETWORK



EMERGENCY CONTACT NUMBERS – Please Call Immediately
NOAA Fisheries Service Stranding HOTLINE: 978-281-9351
PCCS (Mass. Only): 800-900-3622 or USCG VHF CH. 16



Sea turtles can become accidentally entangled in active or discarded fixed fishing gear and other man-made material. These entanglements may prevent the recovery of endangered and threatened sea turtle populations. NOAA Fisheries has established the Sea Turtle Disentanglement Network to promote reporting and increase successful disentanglement of sea turtles. Please report all sea turtle entanglements and disentanglements, including documentation, to the contact numbers listed above.

How to Approach an Entangled Sea Turtle:

- Look for moving or unusually clumped buoys and lines near the turtle.
- Approach turtle slowly and carefully until vessel is alongside, then stop the vessel.
- If possible, record lat/lon and time at turtle's initial location.

How to Assess and Document the Entanglement:

- Is the turtle moving, attempting to swim away from the vessel or diving?
- How is the turtle entangled: flippers (front right, front left, etc.), head, shell?
- Are there single or multiple wraps of line on the turtle?
- Are the wraps restricting the turtle's movement or cutting into the skin?
- Is the turtle bleeding?
- Are there any other new or old injuries (such as propeller wounds)?



Leatherback Photos: Don Lewis



Loggerhead Photo: Thomas Dellinger / University of Madeira, Portugal

How to Disentangle:

- Do not get into the water with the turtle or bring it aboard. Work from the vessel with the turtle in the water.
- Determine which line is under strain from anchoring or drifting gear.
- Grapple the anchoring line and maintain a firm hold to keep turtle close to the vessel without lifting the turtle above the water. To avoid losing the turtle before completely disentangled, **do not release or cut this line before trying to remove all other gear.**
- Try to unravel the gear from the turtle without cutting. Be careful around powerful flippers, jaws, and claws.
- If the gear cannot be removed by unraveling and the turtle is at risk of strangulation, drowning or further injury, try to cut the line.
- Avoid cutting turtle by pulling line away from the turtle with a boat hook before cutting.
- If gear must be cut, tie it off to the boat or existing gear to avoid losing the gear. Save all cut off/removed gear for analysis ashore (see *Documentation*).
- If you cannot free the turtle of **ALL** gear, report the last known location, area landmarks, wind and current speed and direction, and any identifying characteristics about the turtle or gear. Report this information to the red contact numbers above or VHF Ch. 16.

How to Release:

- Leave engines in neutral and release the turtle from the last line (the anchoring line).
- Record the lat/lon and time of release.
- Ensure that the turtle is safely away from the vessel before starting the engines.
- Observe turtle behavior after release. Did it dive and/or swim away or did it remain relatively immobile at the surface?

Documentation:

- Log critical information (time, location, sea turtle description, signs of injury, behavior) when you encounter an entangled sea turtle.
- Log information about gear (line type, color and diameter, buoy/float type and color, buoy/pot ID#s), and final location of gear (brought ashore, left at site, etc.). Photograph/video the gear and sea turtle if possible.
- Reports and documentation (time, location, description, photos, video) of dead or injured sea turtles are also important.
- Report logged information to the red contact numbers at top of this card. Send photos, video and any removed gear to:

NOAA Fisheries Protected Resources Division
One Blackburn Drive, Gloucester, MA 01930

MARINE MAMMAL HANDLING/RELEASE GUIDELINES

A Quick Reference for Atlantic Pelagic Longline Gear



GUIDELINES FOR ALL MARINE MAMMALS

- Have an identification guide, paper, and camera ready at all times in case of an interaction.
- Document as much information as possible to describe the marine mammal, particularly physical appearance and potential injuries:
 - Animal's length
 - Animal's features to be used for species identification (color pattern, dorsal fin shape, head shape)
 - Any gear remaining on the animal (type, placement, color, size, etc.)
 - Any existing tags on the animal (description, tag number)
- Take photographs from different angles. Pictures of the head, dorsal fin, and tail are most helpful in species ID. Fishermen should submit these photos to NMFS Office of Protected Resources, along with the Injury/Mortality Reporting Form.
- Attempt to release the animal with minimal injury (see below).
- After an interaction with a marine mammal:
 - Remove remainder of the gear from the water
 - Record all injuries and mortalities of marine mammals within 24 hrs of returning to shore on the NMFS Marine Mammal Injury/Mortality Reporting Form (see below)
 - Move at least one nautical mile away to avoid further interactions
 - Alert other fishermen in the area of the presence of marine mammals
- **Reporting Requirement:** Submit the Marine Mammal Injury/Mortality Reporting Form by fax to (301) 427-2522, or by mail: NMFS Office of Protected Resources Attn: MMAP, 1315 East West Highway, Silver Spring, MD 20910. Additional copies of the reporting form may be requested from the same address, or found online at: http://www.nmfs.noaa.gov/pr/pdfs/interactions/mmap_reporting_form.pdf.

GUIDELINES FOR SMALL MARINE MAMMALS

- Ensure the crew is ready to assist.
- Avoid abrupt actions or vessel movements that may panic the animal.
- As soon as the opposite side of the mainline is available, use two long gaffs to recover it. **DO NOT USE GAFFS OR SHARP OBJECTS** in direct contact with the animal. A gaff should be used only to control the line.
- Move the vessel cautiously, **STOP THE VESSEL** within range of the marine mammal.
- Gently bring the marine mammal alongside the vessel.
- If a tangle exists:
 - Gaff the other side of the mainline and attach it to the vessel or float ball to isolate the vessel and marine mammal from any tension on the remaining gear in the water
 - Work the tangle off the marine mammal as smoothly and quickly as possible
- If the animal is hooked:
 - Use a NMFS-approved dehooking device
 - Cut the barb off the hook with long-handled bolt cutters
 - Cut the line with line cutters as close to the hook as possible
- Remove as much line as possible from the animal.
- **DO NOT** use a tether, ninja sticks, or other devices more appropriate for dehooking or disentangling sea turtles to control the animal.

GUIDELINES FOR LARGE WHALES

- If a large whale is alive and entangled in fishing gear, contact the Provincetown Center for Coastal Studies Disentanglement Hotline at (800) 900-3622 or immediately contact the U.S. Coast Guard at VHF Ch. 16 for instructions.
 - Maneuver the vessel in such a way as to minimize tension on the line
- If a large whale is dead and on the line, immediately contact the U.S. Coast Guard at VHF Ch. 16 for instructions.

SAFETY FIRST!

Hooked or entangled marine mammals can be unpredictable. There are inherent human safety concerns associated with handling/disentangling marine mammals. Be prudent and safe on the water. Human safety is paramount.

GET A MOVE ON!

If you have one marine mammal interaction, there is a high likelihood that you will have additional encounters if you continue fishing in the same area. Alert other fishermen via radio communication and MOVE, or wait 48 hours to reset gear rather than risk further interactions.

MARINE MAMMAL SPECIES FACT SHEET



LONG-FINNED PILOT WHALE

Globicephala melas



SIZE: 16-18 ft, 4,000-5,000 lbs

BODY: Long robust body, bulbous head with prominent melon and slight beak. Sickle-shaped flippers are sharply pointed and long. Black with white cape behind dorsal fins, prominent white anchor patch on abdomen between flippers, very long peduncle.

DIET: Squid and fish.

HABITAT: Pelagic continental shelf edge and slope, submerged banks; associated with Gulf Stream features.

HUMPBACK WHALE

Megaptera novaeangliae



SIZE: 36-52 ft, 25-30 tons

BODY: Flippers long, usually white, flukes broad with irregular trailing edge. Black with white on throat and belly. Small dorsal fin with a broad base, raised bump in front, and "knuckles" behind. Shows flukes when diving.

DIET: Small schooling fish (herring, sand lance, capelin) and krill.

HABITAT: Pelagic and coastal.

SHORT-FINNED PILOT WHALE

Globicephala macrorhynchus



SIZE: 15-18 ft, 3,000-4,000 lbs

BODY: Long robust body, flippers gently curved, pointed and less than one-sixth of body length, all black, diffuse white anchor patch between fins, very long dorsal fin.

DIET: Squid and fish.

HABITAT: Tropical, pelagic to coastal; in the Gulf Stream.

MINKE WHALE

Balaenoptera acutorostrata



SIZE: 29-33 ft, 5-10 tons

BODY: Small, sleek body, head is sharply pointed with a flat rostrum. Flippers pointed, flukes broad. Black or dark grey, white band on both flippers. Prominent dorsal fin, two thirds back on body.

DIET: Variety of schooling fish, squid, and zooplankton.

HABITAT: Pelagic, but common in bays and shallow coastal waters.

RISSO'S DOLPHIN

Grampus griseus



SIZE: 10-12.5 ft, 500-600 lbs

BODY: Blunt head with squared melon but no beak. Vertical crease in forehead.

Light gray back and sides with darker dorsal fin, flippers, and flukes. White color from scarring, large prominent dorsal fin, and darker than body. Large black eyes.

DIET: Squid specialist.

HABITAT: Pelagic; continental shelf edge and steep upper sections of slope; tropical waters.

ATLANTIC SPOTTED DOLPHIN

Stenella frontalis



SIZE: 7-7.5 ft, 220-310 lbs

BODY: Long, thick, white-tipped beak. Tri-color background, variable spotting. Dorsal fin is

tall, dark, located on middle back.

DIET: Squid and variety of fish.

HABITAT: Coastal to pelagic. Tropical to warm-temperate waters over the continental shelf.

BOTTLENOSE DOLPHIN

Tursiops truncatus



SIZE: 6-12 ft, 330-1,435 lbs

BODY: Short, thick well-defined beak. Coastal form is shorter and slimmer, offshore form is larger. Gray with no distinctive color pattern. Dorsal fin is tall with broad base, located on the middle back.

DIET: Fish, invertebrates, and squid.

HABITAT: Coastal form: shallow, warm inshore waters. Offshore form: offshore waters of shelf edge and slope.

PANTROPICAL SPOTTED DOLPHIN

Stenella attenuata



SIZE: 5.2-8.5 ft, 220-255 lbs

BODY: Slender body with long narrow, white-tipped beak. Bi-color background, distinct cape is narrow at face, dips deeply forward of dorsal fin. Small spots develop with age. Dorsal fin is tall and slender.

DIET: Squid and schooling fish.

HABITAT: Pelagic; deep waters seaward of shelf edge, tropical to warm-temperate waters.

PYGMY SPERM WHALE

Kogia breviceps



SIZE: 10-12 ft, 695-880 lbs

BODY: Robust body with squared or conical shark-like head with tiny underslung lower jaw. Dark gray, lighter down sides to white belly. Pale crescent-shaped false gill on each side between eye and flipper. Tiny dorsal fin, located aft of mid-back.

DIET: Squid, fish, and crustaceans.

HABITAT: Pelagic; continental shelf edge, and slope.

COMMON DOLPHIN

Delphinus delphis



SIZE: 7.5-8.5 ft, 155-245 lbs

BODY: Slender body, with long pointed beak. Black back and cape form V-shaped saddle, hourglass pattern on sides: tan patch forward and gray patch aft. Black beak and eye ring, line from jaw to flipper.

DIET: Variety of fish and squid.

HABITAT: Pelagic; subtropical to temperate waters >100 fathoms.

HARBOR PORPOISE

Phocoena phocoena



SIZE: 4.5-6 ft, 125-145 lbs

BODY: Smallest cetacean in the U.S. Atlantic. Stocky with small pointed flippers, no beak. Dark gray or black on back with lighter sides and white belly. No distinctive markings. Dorsal fin is small, triangular; located slightly aft of mid-body.

DIET: Schooling fish and invertebrates.

HABITAT: Coastal, cold waters usually less than 650 ft.

STRIPED DOLPHIN

Stenella coeruleoalba



SIZE: 7-8 ft, 200-330 lbs

BODY: Slender body with narrow pale tail stock, moderately long dark beak. Bold light blaze from shoulder to dorsal fin, black stripe from eye to anus. Dorsal fin is tall and dark.

DIET: Deepwater squid, fish, and shrimp.

HABITAT: Pelagic; deep waters of continental shelf edge and slope. Associated with Gulf Stream north wall.

References

- Bartholomew, A. and Bohnsack, J.A. 2005. A review of catch-and-release angling mortality with implications for no-take reserves. *Reviews in Fish Biology and Fisheries* 15: 129-154.
- Code of Federal Regulations, 50 CFR 635, October 1, 2007. Government Printing Office, Washington DC, pp. 264-326.
- Code of Federal Regulations, 50 CFR 622, October 1, 2007. Government Printing Office, Washington DC, pp. 175-264.
- Code of Federal Regulations, 50 CFR 223.206, October 1, 2003. Government Printing Office, Washington DC, pp. 164-170.
- Epperly, S. and Hataway, D. 2004. *Leatherbacks Aboard*. Video. <http://www.sefsc.noaa.gov/seaturtlefisheriesobservers.jsp>. National Marine Fisheries Service, Southeast Fisheries Science Center, Miami, FL.
- Epperly, S., Stokes, L., and Dick, S. 2004. *Careful Release Protocols for Sea Turtle Release with Minimal Injury*. National Oceanic and Atmospheric Administration, National Marine Fisheries Service, Southeast Fisheries Science Center Technical Memorandum-524, 42p.
- Federal Register, July 28, 1978. Government Printing Office, Washington DC 43 (146), p. 32800-32811.
- Federal Register, December 4, 1992. Government Printing Office, Washington DC 57 (234), pp. 57354-57358.
- Federal Register, September 24, 2001. Government Printing Office, Washington DC 66 (185), pp. 44812-44813.
- Federal Register, December 31, 2001. Government Printing Office, Washington DC 66 (250), pp. 67495- 67496.
- Federal Register, July 6, 2004. Government Printing Office, Washington DC 69 (128), pp. 40734- 40758.
- Federal Register, August 9, 2006. Government Printing Office, Washington DC 71 (153), pp. 45428-45436.

- Federal Register, February 7, 2007. Government Printing Office, Washington DC 72 (25), pp. 5633.
- Hataway, D. and Epperly, S. 2004. Removing Fishing Gear from Longline Caught Sea Turtles. Video. <http://www.sefsc.noaa.gov/seaturtlefisheriesobservers.jsp>. National Marine Fisheries Service, Southeast Fisheries Science Center, Miami, FL.
- NOAA Fisheries. 2004. Final Supplemental Environmental Impact Statement for the Reduction of Sea Turtle Bycatch and Bycatch Mortality in the Atlantic Pelagic Longline Fishery. U.S. Department of Commerce, National Marine Fisheries Service, Office of Sustainable Fisheries, Highly Migratory Species Management Division, Silver Spring, MD. Public Document.
- Prince, E. D., Ortiz, M., Venizelos, A., and Rosenthal, D. S. 2002. In-Water Conventional Tagging Techniques Developed by the Cooperative Tagging Center for Large Highly Migratory Species, p. 155-171. *In*: Jon A. Lucy and Anne L. Studholme, Eds., Catch and Release in Marine Recreational Fisheries: Proceedings of the Symposium, National Symposium on Catch and Release in Marine Recreational Fisheries. American Fisheries Society, Bethesda, MD. American Fisheries Society Symposium No. 30.
- Watson, J.W., Foster, D.G., Epperly, S., and Shah, A. 2004. Experiments in the Western Atlantic Northeast Distant Waters to Evaluate Sea Turtle Mitigation Measures in the Pelagic Longline Fishery. Report on Experiments Conducted in 2001-2003. <http://www.mslabs.noaa.gov/mslabs/docs/pubs.html>. National Marine Fisheries Service, Southeast Fisheries Science Center, Mississippi Laboratory.
- Watson, J.W., Epperly, S.P., Shah, A.K., and Foster, D.G. 2005. Fishing methods to reduce sea turtle mortality associated with pelagic longlines. *Canadian Journal of Fisheries and Aquatic Sciences* 62:965-981.