

## Reagents for HIV/SIV Vaccine Studies

Sonia Vasil, Rama Thakallapally, Satish Pillai, Carla Kuiken

T10, MS K710, Los Alamos National Laboratory, Los Alamos, NM 87545

Since last year's edition of this section, a large number of new attenuated SIVs and SHIVs have been added to the collection. We have attempted to include all strains we could find in this reagent overview. If there are any that are not included, we would very much appreciate hearing about them; we will make sure they will be added in the next edition of the Compendium. A few changes to the format have been necessary because of the increased number of isolates. All isolates have a separate color code, so that identifying the rough structure and composition of the genome of the strains can be done at a glance. Suggestions to make this section more useful are welcome.

Progress in developing a vaccine against HIV has been much slower than expected. There are many reasons why development of a vaccine against HIV is extremely difficult:

- There is no clear protective immunity even after natural infection
- The virus is highly variable
- The virus is able to escape aspects of the immune pressure
- It can infect different cell types over the course of infection
- Not all infected cells are recognizable by the immune system
- The virus affects cells of the immune system itself
- There is a risk of inducing infection-enhancing antibodies
- There is no perfect animal model for the infection

In spite of years of research into HIV, much is still unknown about the virus. What exactly makes it so pathogenic, what are the mechanisms that appear to protect some people against infection, and what determines the dramatically different rates of progression to AIDS after infection? An important part of the research into these questions is done using animal, mostly primate, models. Unfortunately, no single primate model is perfectly suited for the job.

Chimpanzees are the primates genetically most closely related to humans. They can be infected with HIV, but progress to AIDS very slowly after HIV infection. Thus far, only one chimpanzee has died from an AIDS-like illness, ten years after infection with HIV-1 (Villinger *et al.* 1997). This is a drawback in the light of recent discussions about the lack of necessity for sterilizing immunity (the total prevention of infection, as opposed to partial immunity, where infection after vaccination can occur but is less severe). Even a vaccine that does not prevent infection may still boost the immune system enough to prevent or delay disease in the event of infection. In fact, vaccines that protect against other viral diseases generally do not induce sterilizing immunity (polio, measles, varicella, smallpox). Since chimpanzees develop disease only very slowly, this effect cannot easily be studied using chimpanzee models. In addition, chimpanzees are a threatened species, they are very expensive, they cannot be put down unless they are extremely ill, and since HIV usually does not make them sick they must be kept in isolation for their lifetime, up to 40 years. Being HIV-infected, they pose a risk for their caretakers. Finally, the use of chimpanzees in potentially lethal experiments gives rise to complicated ethical considerations. After the initial, disappointing results involving HIV-1 vaccines (usually subunit vaccines) based on lab strains, the chimpanzee trials have largely been abandoned in favor of the cheaper and less demanding macaque monkey.

Macaques in the wild are not natural hosts for SIV, and most SIV strains are highly pathogenic to them, so they provide a very good model system to study pathogenesis. HIV-2, which is much more similar to SIV than HIV-1, quickly produces an AIDS-like disease in the pig-tailed macaque, *M. nemestrina*. This is also the only macaque species that can be productively infected with HIV-1, although thus far without developing AIDS (Heeney 1996). Challenge strains used in macaques are most

frequently derived from SIV<sub>sm</sub>, usually after several passages in macaques. A recent development is the use of chimeric SIV/HIV (SHIV) viruses that can infect macaques, cause an AIDS-like disease just like other SIVs, but share a varying number of genes with HIV-1. Only in the last few years have SHIV strains become available that are sufficiently pathogenic to be used as challenge strains in vaccine trials (see Fig. 1c).

In many cases the results of vaccine trials are different in different animal models. It is not always known if this is a virus effect (SIV vs. HIV), or if the host immune system responds differently to different immunizations and challenges. This problem obviously makes the interpretation of vaccine studies in animal models difficult. Furthermore, subtle differences in the design of the vaccine (adjuvants, quantity and variability of antigens) and the trials (frequency and timing of inoculations, timing and severity of challenge, virus type, cell-free or cell associated) can all influence the outcome.

By far the best protection against both cell-free and cell-bound infection with HIV and SIV so far has been obtained using live attenuated virus vaccines. The protection is not type-specific, and SIV-vaccinated monkeys can even be protected against superinfection with virulent SHIV strains (Heeney 1996). Live attenuated virus vaccines basically establish an infection, which appears to be the best way to prime the immune system to react to the presence of an alien invader; both humoral and cellular immune responses are optimized in this situation. However, there are many risks associated with the use of attenuated virus vaccines. First of all, it is uncertain that the attenuated virus is really non-pathogenic. It has been reported some time ago that virus that was apathogenic in adult monkeys could cause disease in neonates (Ruprecht *et al.* 1996). According to a recent report (Cohen 1997), several adult monkeys that were vaccinated with an attenuated virus several years ago have now also fallen ill. Apparently, this is not a matter of repair of the crippling mutations, but rather an inability of the immune system to control even very weak immunodeficiency viruses in the long run. However, even if this approach is ultimately deemed to be too dangerous, vaccine trials using attenuated SIV variants provide very important insights into the nature of protective immunity against immunodeficiency viruses.

In recent years, many successes have been reported using attenuated and SHIV based vaccines. Without striving for completeness, we cite some examples of successful vaccination attempts here. Successful protection from vaginal challenge in rhesus macaques has been reported by Miller *et al.* (1997). Dunn *et al.* (1997) reported that macaques infected with the SIV<sub>mac251</sub> clone BK28 were protected against subsequent challenge with a chimeric strain, SHIV<sub>sbg</sub>. No virus could be recovered from three of the five challenged monkeys, although SHIV-infected cells were found. Two monkeys did develop viremia, but the viral load was 100-fold reduced compared to unvaccinated control animals. Comparable results were reported by Stevens *et al.* (1997) using attenuated SIV<sub>mac</sub> or SHIV as a vaccine and a pathogenic SHIV-KU1 for challenge. Interestingly, animals in this study that were productively infected with a pathogenic virus were later unable to fend off superinfection with a second virulent strain. Quesada-Rolander (1996) reported protection of monkeys vaccinated with SHIV-4 against rectal challenge with a virulent SIV<sub>sm</sub>. From two out of four monkeys, no virus could be recovered a year after challenge; two others showed initial viremia, which was later suppressed. Linhart *et al.* (1997) reported on an attempt to use attenuated viruses in a post-exposure vaccination, using simultaneous inoculation. The study showed no effect of co-injection of a non-virulent variant along with a virulent one. An attempt was made to prevent infection of newborn macaques by vaccinating pregnant monkeys with the attenuated strain SIV<sub>mac1A11</sub>. Two out of three newborns were protected against mucosal challenge after birth (Van Rompay *et al.* 1996). Stahl-Hennig *et al.* (1996) reported sterilizing immunity in 4 out of 8 macaques vaccinated with the attenuated strain 32H-C8. Putkonen *et al.* (1995) report protection of cynomolgous monkeys against SIV challenge using an attenuated HIV-2 strain as a vaccine. Other successful vaccinations have been reported using SIV<sub>mac1A11</sub> (Otsyula *et al.* 1996), SIV<sub>mac316-Δnef</sub> and 239-Δ3 (Wyand *et al.* 1996) and several other attenuated SIV strains. A recent review of encouraging results with live attenuated vaccines can be found in Johnson and Desrosiers, 1998. The journal *AIDS Research and Human Retroviruses* devoted a special issue to developments in the vaccine field (Vol. 14, Supplement 3, October 1998).

The number of different viral strains used in vaccine research is rapidly growing. In Figures 1–3 we present an overview of the virus strains that are frequently used in these studies and their derivation. A distinction must be made between strains used for vaccination, which obviously must be non-pathogenic, and strains used for challenge, which tend to be pathogenic. However, it should be mentioned that some strains have been used both as vaccine and as challenge strains. Pathogenicity is a relative concept, and depends on the virus, the host species, and the individual host (most probably on characteristics of the MHC). For example, SIVsm is not pathogenic in its natural host, the sooty mangabey, but can be highly pathogenic to macaques.

SIVmac viruses are used most extensively in these studies. The SIVmac isolates 251 and 32H both have a reduced pathogenic counterpart, clones 1A11 and C8, respectively. These clones are genetically very similar to the quasispecies they were derived from, but they have one or more attenuating genetic deletions. Another important SIVmac isolate, 239, is a clonal isolate from rhesus monkey #239. SIVmac239 is pathogenic, but a long series of reduced- or non-pathogenic strains with varying number of deletions in the genome has been derived from it. These strains cover a spectrum of pathogenicity, ranging from highly pathogenic to apparently non-infectious (unable to replicate in the host) (Desrosiers *et al.* 1998). It has recently become apparent that monkeys infected with SIVmac239-Δ3, in the lower mid range of the pathogenicity spectrum, do develop AIDS after several years (Cohen 1997). Two macrophage-tropic variants have also been derived from SIVmac-239: SIVmac316 and 17E (see Figure 1a).

SIVsm isolates can be highly pathogenic to macaques. Pathogenic challenge stocks in this group are usually bulk (rather than clonal) isolates, passaged in one of several macaques. Genetic clones of this group (such as SIVsmH4) tend to be much less pathogenic. An important and highly pathogenic strain is SIVsmPBj14, which kills a majority of infected macaques at primary infection, within a few weeks; monkeys that survive primary infection usually die of an AIDS-like illness within two years. Other isolates that have been used as challenge stocks are B670 and E660. Derivation of commonly used isolates from this group is shown in Figure 1b.

SHIV strains have traditionally been used for both protection and challenge. SHIV strains have recently been developed that are highly pathogenic, especially those that have been composed from a CXCR4-using HIV strain. The viruses usually are pathogenic only in their derivative form, after passage in several monkeys. Derivation of some frequently used SHIV strains is shown in Figure 1c.

In recent years the repertoire of non-pathogenic vaccine strains has been extended by the creation of artificially attenuated virus variants. This is usually done either by creating stop codons in non-vital sections, or deleting sections from the genome of a virulent strain. Since these attenuated virus strains often are not included in Genbank, we have produced an alignment for them. The alignment itself is not reproduced here, but it will be made available on the web page (<http://hiv-web.lanl.gov>). Instead, Figure 2 shows a schematic representation of attenuated SIV strains. The diagram shows where changes have been made or documented with respect to the wild type.

The number of SHIV chimeras is also growing rapidly; a fairly large number of pathogenic SHIV strains is now available. The diagram in Figure 3 gives an overview of SHIV strains that are presently in use in the vaccine field, and indicates which section of the genomes are derived from HIV-1 (and which strain of HIV-1), and which from a SIV strain.

### Acknowledgements

We gratefully acknowledge the help of Drs. Jim Bradac and Alan Schultz from NIAID for invaluable background information and helpful suggestions, and Dr. Marta Marthas from the California Regional Primate Research Center of the University of California at Davis for critical reading of the manuscript.

Fig. 1a

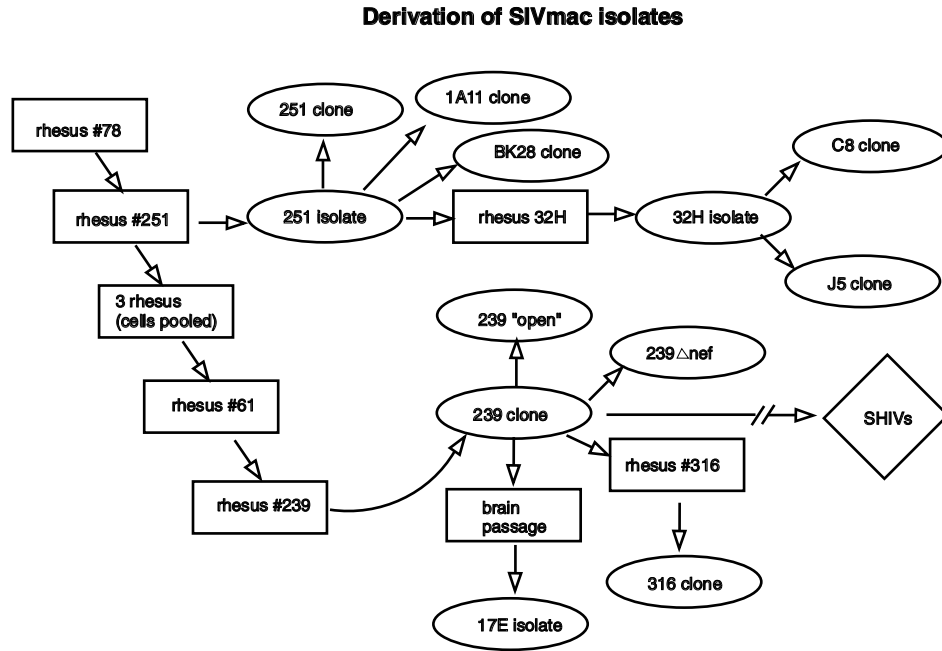

Fig. 1b

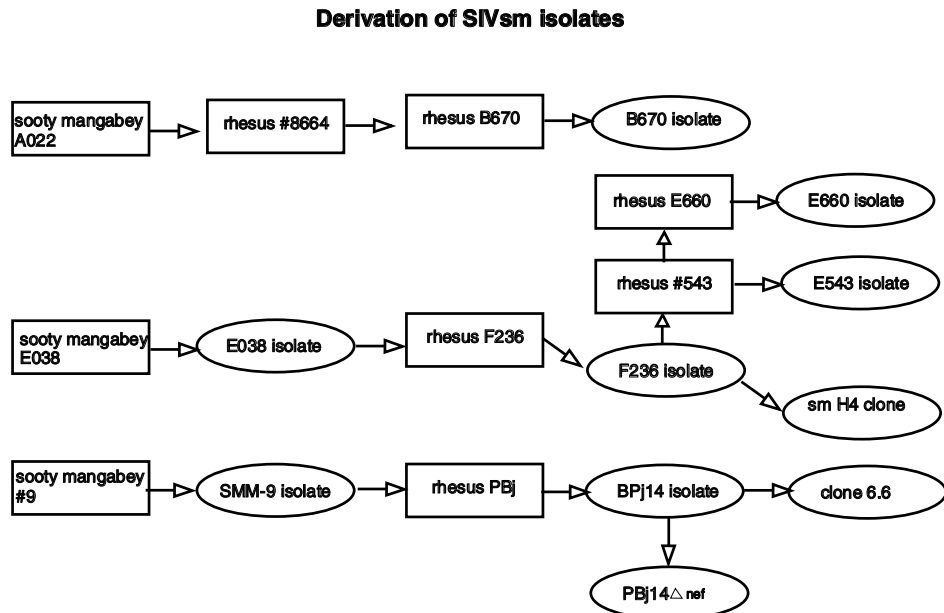

Figure 1a, b. An overview of derivation of SIVmac (a) and SIVsm (b) strains. Rectangles indicate passages in a rhesus macaque, ovals indicate isolates or clones derived from these. Figures 1a and 1b were updated from (Schultz & Hu, 1993).

References:

SIVmac (figure 1a): 251/BK8 (Kornfeld et al., 1987); 1A11 (Marthas et al., 1990); 32H-C8 (Rud et al., 1992); 32H-J5 (Rud et al., 1992); 239 (Kestler et al., 1990); 239 derivatives (Desrosiers et al., 1998); 17E (Anderson et al., 1993); 316 (Mori et al., 1992).

SIVsm (Figure 1b): B670 (Conway et al., 1991); H4 (Novembre et al., 1993); BPJ14 (Dewhurst et al., 1990); BPJ14-Δnef (Novembre et al., 1996); E543 (Hirsch et al., 1997).

Fig. 1c

Derivation of SHIV isolates

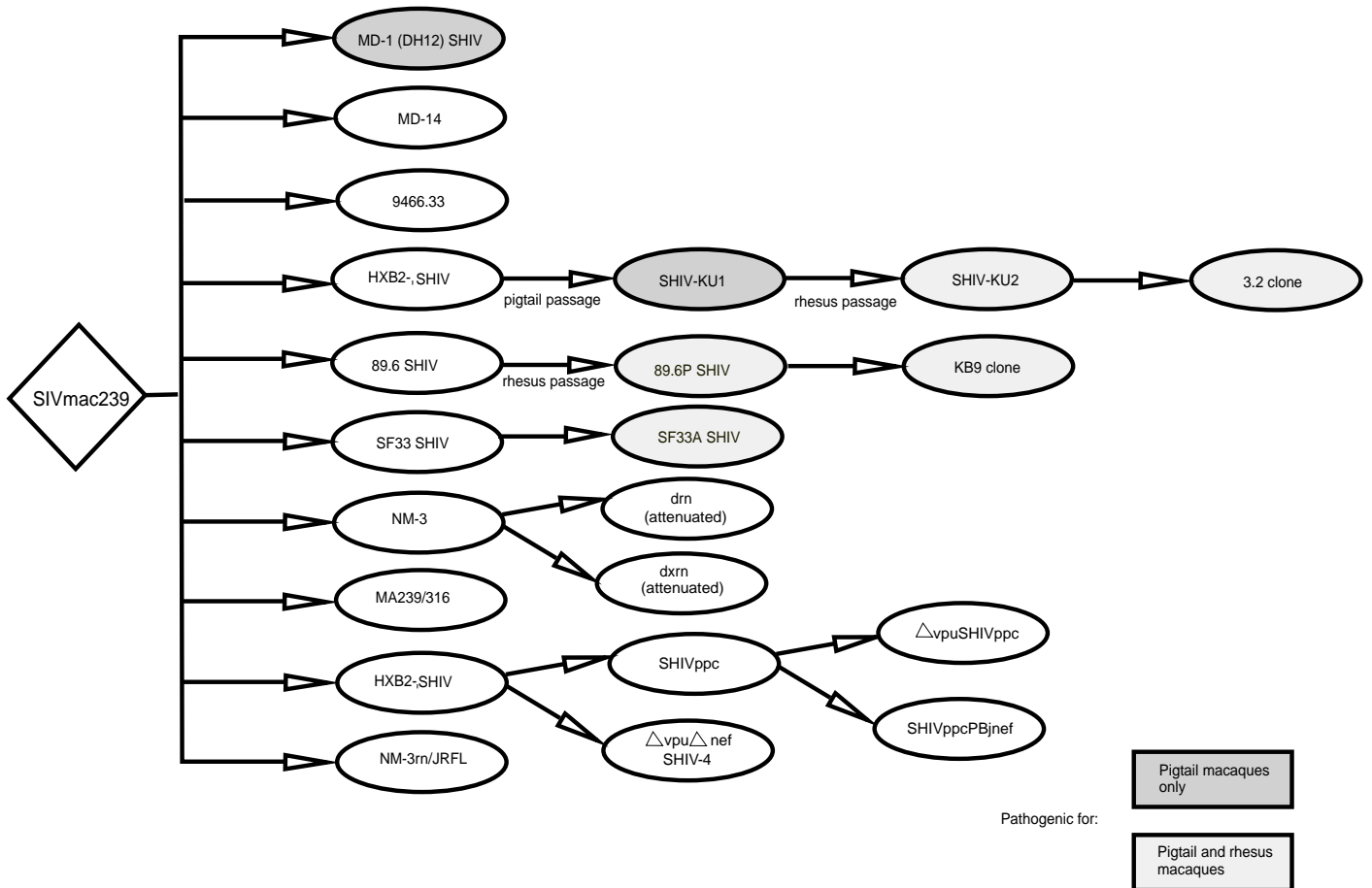
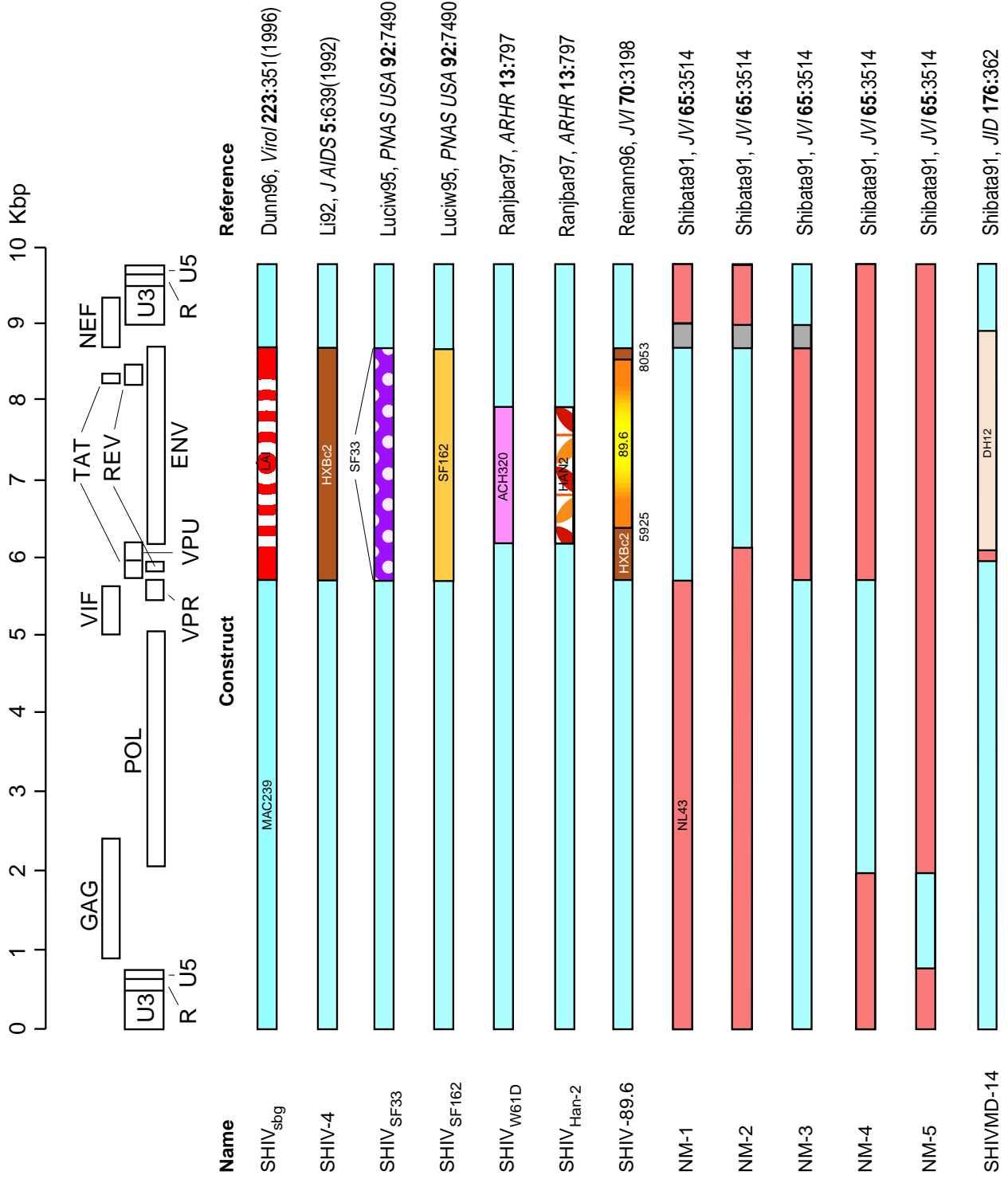

Figure 1c. An overview of derivation of SHIV strains. Rectangles indicate passages in a rhesus macaque, ovals indicate isolates or clones derived from these. Figure 1c was produced by Dr. Alan Schultz (NIAID) based on information from the original references, and was updated this year based on the new strains.

References:

SHIV(Figure 1c): MD1 & MD14 (Shibata et al., 1997); ppc and PBjnef (Stephens et al., 1998); NM-3rn/JRFL and MA239/316 (Chen et al., 1998); 9466.33 (Klinger et al., 1998); 239Δ5, 239Δvif, 239Δ3x, ΔvprΔvpx, and 239Δvpx (Desrosiers et al., 1998); ΔvpuSHIVppc and Δvpu Δnef SHIV-4 (Joag et al., 1998); drn & dxrn (Igarashi et al., 1998).

### Chimeric SIV/HIV Strains



**Figure 2**  
Schematic representation of chimeric HIV/SIV strains used in vaccine research. The information was obtained from the references shown in figure. Although every attempt was made to contact the authors to clarify ambiguities, in some cases the exact location of the borders between HIV and SIV could not be established. The uncertain regions are shown in gray.

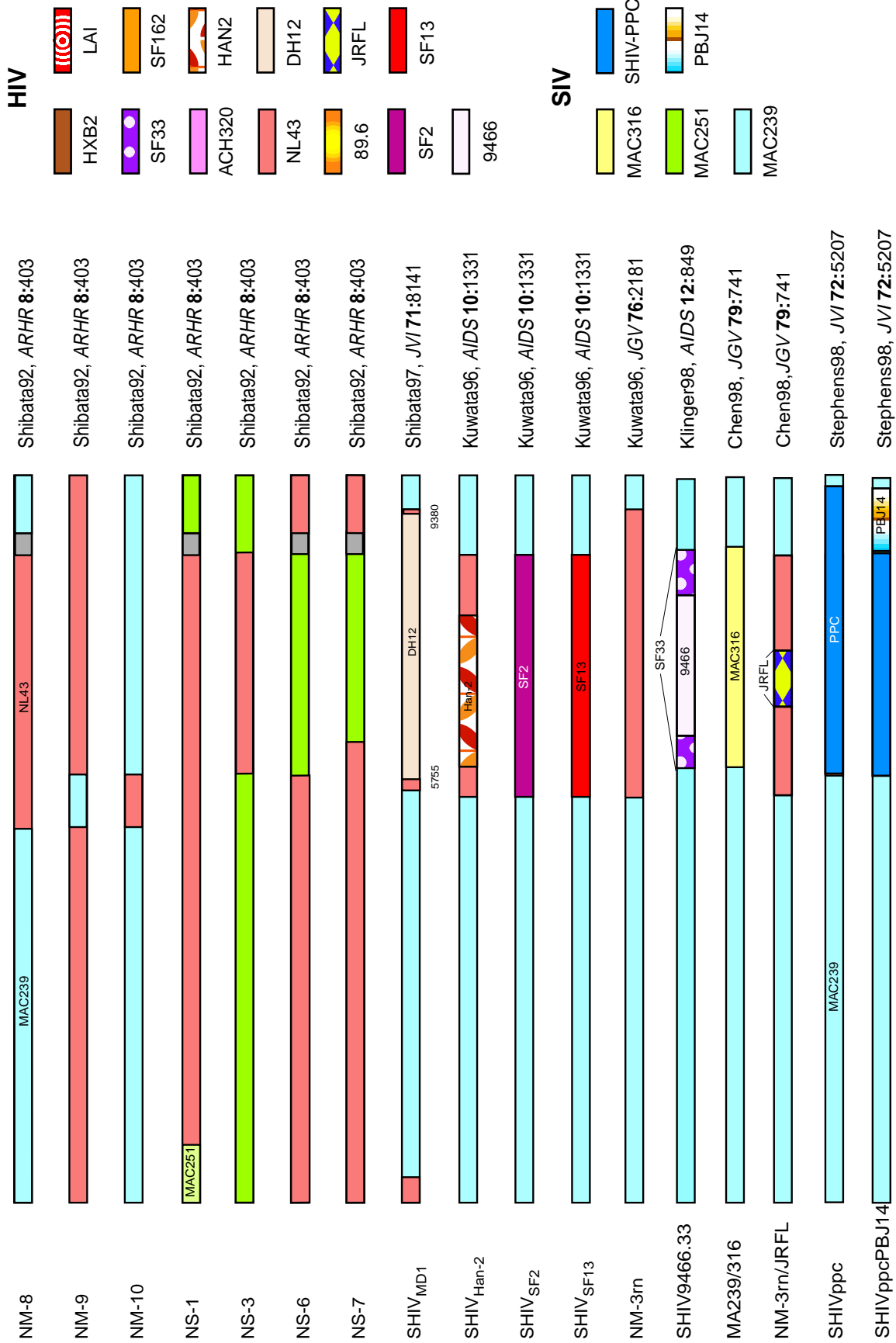

Attenuated SIV Strains

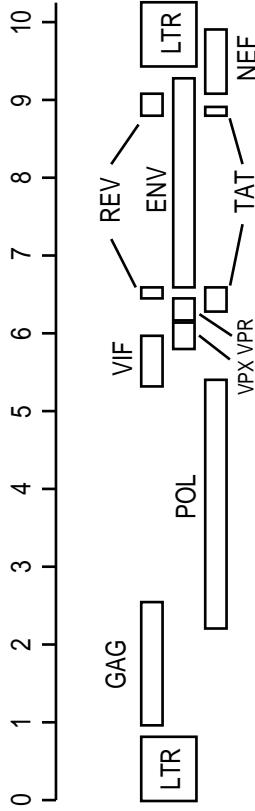

Name	Construct	Reference
SIV-Δvpr	MAC239	Hoch95, <i>JVI</i> <b>69</b> :4807
SIVmac239-Δnef		Destrosiers92, <i>ARHR</i> <b>8</b> :411
SIVmac251-Δnef	MAC251	Chakrabarti95, <i>Virology</i> <b>213</b> :535
SIV/17E-C1		Anderson93, <i>Virology</i> <b>195</b> :616
SIVmac-BK28		Kornfeld87, <i>Nature</i> <b>326</b> :610
SIVmac-C8	32H	Rud92, <i>Vaccines</i> 92
SIVagm3-Δnef	AGM	Beer97, <i>PNAS USA</i> <b>94</b> :4062
SIVmac1-Δ11		Luciw92, <i>ARHR</i> <b>8</b> :395
SIVmac316-Δnef		Mori92, <i>JVI</i> <b>66</b> :2067
SIVmac239-Δ2		Destrosiers92, <i>ARHR</i> <b>8</b> :411
SIVmac239-Δ3		Destrosiers92, <i>ARHR</i> <b>8</b> :411
SIVmac239-Δ4		Destrosiers92, <i>ARHR</i> <b>8</b> :411

**Figure 3**

Schematic representation of common attenuated SIV strains used in vaccine research. Deletions are indicated in white, mutations are shown as black lines. Mutations may include insertion or deletion of a stop codon.

Notes:

- SIVmac239, a frequently used pathogenic strain, contains a stop codon (TAA) in nef.
- BK28 is a clone from the SIVmac251 bulk isolate; it is the only sequence available from SIVmac251.
- SHIV KU1 and KU2 are passages of SHIV-4.
- SHIV 98.6P and KB9 are passages of SHIV89.6.
- SF33A is a passage of SF33.



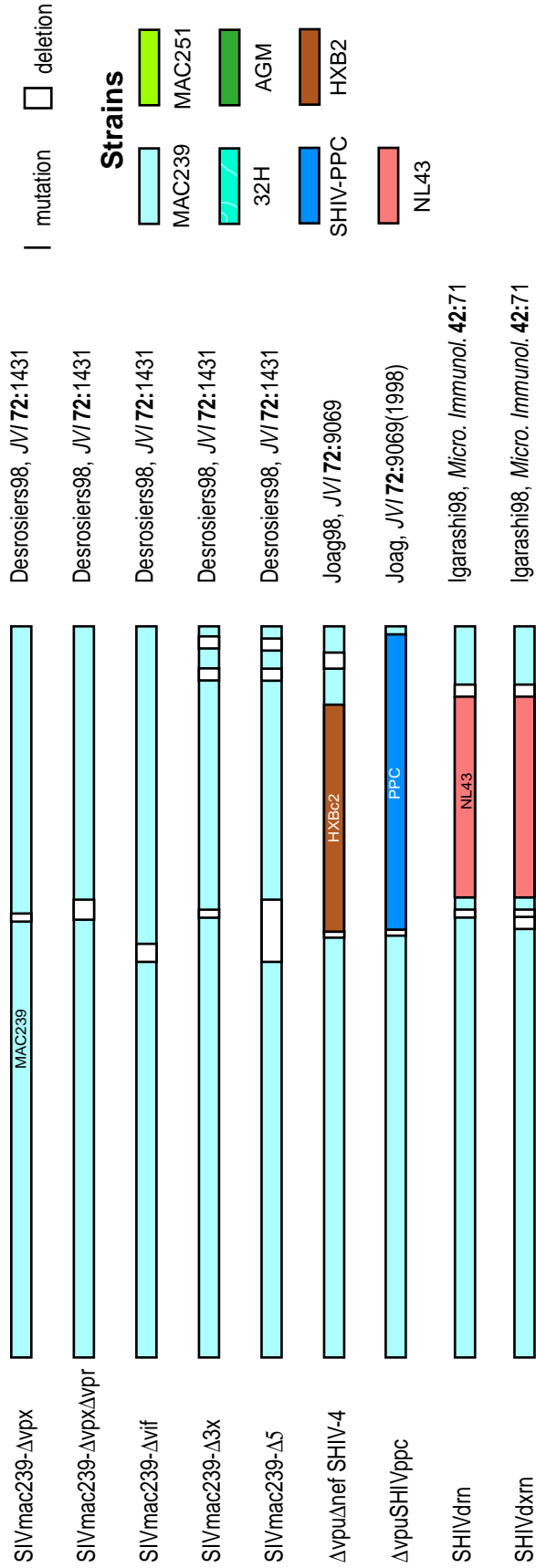

## References

- Anderson, M. G., D. Hauer, D. P. Sharma, S. V. Joag, O. Narayan, M. C. Zink, and J. E. Clements, 1993. Analysis of envelope changes acquired by SIVmac239 during neuroadaptation in rhesus macaques. *Virology* **195**,616–26.
- Cohen, J., 1997. Weakened SIV vaccine still kills [news]. *Science* **278**,24–5.
- Conway, M. D., B. Davison-Fairburn, L. N. Martin, M. S. Insler, and M. Murphey-Corb, 1991. Infection of rhesus monkeys with topical instillation of simian immunodeficiency virus (SIV)B670 into the conjunctival sac. *J Med Primatol* **20**,152–5.
- Desrosiers, R. C., J. D. Lifson, J. S. Gibbs, S. C. Czajak, A. Y. Howe, L. O. Arthur, and R. P. Johnson, 1998. Identification of highly attenuated mutants of simian immunodeficiency virus. *J Virol* **72**,1431–7.
- Dewhurst, S., J. E. Embretson, D. C. Anderson, J. I. Mullins, and P. N. Fultz, 1990. Sequence analysis and acute pathogenicity of molecularly cloned SIVSMM- PBj14. *Nature* **345**,636–40.
- Dunn, C. S., B. Hurtrel, C. Beyer, L. Gloeckler, T. N. Ledger, C. Moog, M. P. Kieny, M. Mehtali, D. Schmitt, J. P. Gut, A. Kirn, and A. M. Aubertin, 1997. Protection of SIVmac-infected macaque monkeys against superinfection by a simian immunodeficiency virus expressing envelope glycoproteins of HIV type 1. *AIDS Res Hum Retroviruses* **13**,913–22.
- Heeney, J. L., 1996. Primate models for AIDS vaccine development. *AIDS* **10** Suppl A,S115–22.
- Hirsch, V., D. Adger-Johnson, B. Campbell, S. Goldstein, C. Brown, W. R. Elkins, and D. C. Montefiori, 1997. A molecularly cloned, pathogenic, neutralization-resistant simian immunodeficiency virus, SIVsmE543-3. *J Virol* **71**,1608–20.
- Joag, S. V., Z. Li, L. Foresman, E. B. Stephens, L. J. Zhao, I. Adany, D. M. Pinson, H. M. McClure, and O. Narayan, 1996. Chimeric simian/human immunodeficiency virus that causes progressive loss of CD4+ T cells and AIDS in pig-tailed macaques. *J Virol* **70**,3189–97.
- Johnson, R. P., and R. C. Desrosiers, 1998. Protective immunity induced by live attenuated simian immunodeficiency virus. *Curr Opin Immunol* **10**,436–43.
- Karlsson, G. B., M. Halloran, J. Li, I. W. Park, R. Gomila, K. A. Reimann, M. K. Axthelm, S. A. Iliff, N. L. Letvin, and J. Sodroski, 1997. Characterization of molecularly cloned simian-human immunodeficiency viruses causing rapid CD4+ lymphocyte depletion in rhesus monkeys. *J Virol* **71**,4218–25.
- Kestler, H., T. Kodama, D. Ringler, M. Marthas, N. Pedersen, A. Lackner, D. Regier, P. Sehgal, M. Daniel, N. King, and *et al.*, 1990. Induction of AIDS in rhesus monkeys by molecularly cloned simian immunodeficiency virus. *Science* **248**,1109–12.
- Kornfeld, H., N. Riedel, G. A. Vigiante, V. Hirsch, and J. I. Mullins, 1987. Cloning of HTLV-4 and its relation to simian and human immunodeficiency viruses. *Nature* **326**,610–3.
- Linhart, H., B. R. Gundlach, S. Sopper, U. Dittmer, K. Matz-Rensing, E. M. Kuhn, J. Muller, G. Hunsmann, C. Stahl-Hennig, and K. Uberla, 1997. Live attenuated SIV vaccines are not effective in a postexposure vaccination model. *AIDS Res Hum Retroviruses* **13**,593–9.
- Luciw, P. A., E. Pratt-Lowe, K. E. Shaw, J. A. Levy, and C. Cheng-Mayer, 1995. Persistent infection of rhesus macaques with T-cell-line-tropic and macrophage-tropic clones of simian/human immunodeficiency viruses (SHIV). *Proc Natl Acad Sci U S A* **92**,7490–4.
- Marthas, M. L., S. Sutjipto, J. Higgins, B. Lohman, J. Torten, P. A. Luciw, P. A. Marx, and N. C. Pedersen, 1990. Immunization with a live, attenuated simian immunodeficiency virus (SIV) prevents early disease but not infection in rhesus macaques challenged with pathogenic SIV. *J Virol* **64**,3694–700.
- Miller, C. J., M. B. McChesney, X. Lu, P. J. Dailey, C. Chutkowski, D. Lu, P. Brosio, B. Roberts, and Y. Lu, 1997. Rhesus macaques previously infected with simian/human immunodeficiency virus are protected from vaginal challenge with pathogenic SIVmac239. *J Virol* **71**,1911–21.
- Mori, K., D. J. Ringler, T. Kodama, and R. C. Desrosiers, 1992. Complex determinants of macrophage tropism in env of simian immunodeficiency virus. *J Virol* **66**,2067–75.
- Novembre, F. J., P. R. Johnson, M. G. Lewis, D. C. Anderson, S. Klumpp, H. M. McClure, and V. M. Hirsch, 1993. Multiple viral determinants contribute to pathogenicity of the acutely lethal simian immunodeficiency virus SIVsmmPBj variant. *J Virol* **67**,2466–74.
- Novembre, F. J., M. G. Lewis, M. M. Saucier, J. Yalley-Ogunro, T. Brennan, K. McKinnon, S.

- Bellah, and H. M. McClure, 1996. Deletion of the nef gene abrogates the ability of SIV smmPBj to induce acutely lethal disease in pigtail macaques. *AIDS Res Hum Retroviruses* **12**,727–36.
- Otsyula, M. G., C. J. Miller, A. F. Tarantal, M. L. Marthas, T. P. Greene, J. R. Collins, K. K. van Rompay, and M. B. McChesney, 1996. Fetal or neonatal infection with attenuated simian immunodeficiency virus results in protective immunity against oral challenge with pathogenic SIVmac251. *Virology* **222**,27–58.
- Putkonen, P., L. Walther, Y. J. Zhang, S. L. Li, C. Nilsson, J. Albert, P. Biberfeld, R. Thorstensson, and G. Biberfeld, 1995. Long-term protection against SIV-induced disease in macaques vaccinated with a live attenuated HIV-2 vaccine. *Nat Med* **1**,914–8.
- Quesada-Rolander, M., B. Makitalo, R. Thorstensson, Y. J. Zhang, E. Castanos-Velez, G. Biberfeld, and P. Putkonen, 1996. Protection against mucosal SIVsm challenge in macaques infected with a chimeric SIV that expresses HIV type 1 envelope. *AIDS Res Hum Retroviruses* **12**,993–9.
- Raghavan, R., E. B. Stephens, S. V. Joag, I. Adany, D. M. Pinson, Z. Li, F. Jia, M. Sahni, C. Wang, K. Leung, L. Foresman, and O. Narayan, 1997. Neuropathogenesis of chimeric simian/human immunodeficiency virus infection in pig-tailed and rhesus macaques. *Brain Pathol* **7**,851–61.
- Reimann, K. A., J. T. Li, R. Veazey, M. Halloran, I. W. Park, G. B. Karlsson, J. Sodroski, and N. L. Letvin, 1996. A chimeric simian/human immunodeficiency virus expressing a primary patient human immunodeficiency virus type 1 isolate env causes an AIDS-like disease after in vivo passage in rhesus monkeys. *J Virol* **70**,6922–8.
- Reimann, K. A., J. T. Li, G. Voss, C. Lekutis, K. Tenner-Racz, P. Racz, W. Lin, D. C. Montefiori, D. E. Lee-Parritz, Y. Lu, R. G. Collman, J. Sodroski, and N. L. Letvin, 1996. An env gene derived from a primary human immunodeficiency virus type 1 isolate confers high in vivo replicative capacity to a chimeric simian/human immunodeficiency virus in rhesus monkeys. *J Virol* **70**,3198–206.
- Rud, E. W., J. R. Yon, B. A. Larder, B. E. Clarke, N. Cook, and M. Cranage. 1992. Infectious molecular clones of SIVmac32: Nef deletion controls ability to reisolate virus from rhesus macaques, p. 229–235. In F. Brown and R. M. Chanock and H. S. Ginsberg and R. A. Lerner (ed.), *Vaccines*. Cold Spring Harbor Laboratory Press, New York.
- Ruprecht, R. M., T. W. Baba, V. Liska, R. Bronson, D. Penninck, and M. F. Greene, 1996. “Attenuated” simian immunodeficiency virus in macaque neonates. *AIDS Res Hum Retroviruses* **12**,459–60.
- Schultz, A. M., and S. L. Hu, 1993. Primate models for HIV vaccines. *AIDS* **7** Suppl 1,S161–70.
- Shibata, R., F. Maldarelli, C. Siemon, T. Matano, M. Parta, G. Miller, T. Fredrickson, and M. A. Martin, 1997. Infection and pathogenicity of chimeric simian-human immunodeficiency viruses in macaques: determinants of high virus loads and CD4 cell killing. *J Infect Dis* **176**,362–73.
- Stahl-Hennig, C., U. Dittmer, T. Nisslein, H. Petry, E. Jurkiewicz, D. Fuchs, H. Wachter, K. Matz-Rensing, E. M. Kuhn, F. J. Kaup, E. W. Rud, and G. Hunsmann, 1996. Rapid development of vaccine protection in macaques by live-attenuated simian immunodeficiency virus. *J Gen Virol* **77**,2969–81.
- Stephens, E. B., S. V. Joag, B. Atkinson, M. Sahni, Z. Li, L. Foresman, I. Adany, and O. Narayan, 1997. Infected macaques that controlled replication of SIVmac or nonpathogenic SHIV developed sterilizing resistance against pathogenic SHIV(KU-1). *Virology* **234**,328–39.
- Van Rompay, K. K., M. G. Otsyula, R. P. Tarara, D. R. Canfield, C. J. Berardi, M. B. McChesney, and M. L. Marthas, 1996. Vaccination of pregnant macaques protects newborns against mucosal simian immunodeficiency virus infection. *J Infect Dis* **173**,1327–35.
- Villinger, F., S. S. Brar, G. T. Brice, N. F. Chikkala, F. J. Novembre, A. E. Mayne, S. Bucur, C. D. Hillyer, and A. A. Ansari, 1997. Immune and hematopoietic parameters in HIV-1-infected chimpanzees during clinical progression toward AIDS. *J Med Primatol* **26**,11–8.
- Wyand, M. S., K. H. Manson, M. Garcia-Moll, D. Montefiori, and R. C. Desrosiers, 1996. Vaccine protection by a triple deletion mutant of simian immunodeficiency virus. *J Virol* **70**,3724–33.