

BP Exploration (Alaska) Inc.

LIBERTY DEVELOPMENT PROJECT
Development and Production Plan

April 2007

SUBMITTED TO:

U.S. Minerals Management Service
Alaska OCS Region
3801 Centerpoint Drive, Suite 500
Anchorage, Alaska 99503-5823

SUBMITTED BY:

BP Exploration (Alaska) Inc.
P.O. Box 196612
Anchorage, Alaska 99519-6612

LIST OF ACRONYMS

ADEC	Alaska Department of Environmental Conservation
ADF&G	Alaska Department of Fish and Game
ADNR	Alaska Department of Natural Resources
AOGCC	Alaska Oil and Gas Conservation Commission
API	American Petroleum Institute
BACT	Best available control technology
BAT	Best available technology
BOP	Blowout preventer
Bpd	Barrels per day
BPXA	BP Exploration (Alaska) Inc.
BS&W	Basic sediments and water
CFR	Code of Federal Regulations
CO₂	Carbon dioxide
CRA	Corrosion resistant alloy
DHFC	Down hole flow control
DOT	U.S. Department of Transportation
DPP	Development and Production Plan
DR&R	Dismantlement, removal, and restoration
DTS	Distributed temperature sensing
ECD	Equivalent circulating density
EIS	Environmental impact statement
EOR	Enhanced oil recovery
EPA	U.S. Environmental Protection Agency
ERD	Extended reach drilling
ESD	Emergency shutdown
ESP	Electrical submersible pump
FEIS	Final environmental impact statement
FG	Fracture gradient
gpd	Gallons per day
H₂S	Hydrogen sulfide
HSE	Health, safety, and environment
HVAC	Heating, ventilation, and air conditioning
IHA	Incidental Harassment Authorization
LACT	Lease allocation and custody transfer

LCU	Lower Cretaceous Unconformity
LoSal™	LoSal™ is a trademark of BP p.l.c., associated with a BP process to produce low-salinity water for enhanced oil recovery
LWD	Logging while drilling
mD	Millidarcy
MF	Microfiltration
mg/l	Milligram per liter
MLLW	Mean lower low water
MMS	Minerals Management Service
MOU	Memorandum of understanding
MPI	Main Production Island
MPFM	Multi-phase flow meter
MSDS	Material safety data sheet
MWD	Measurement while drilling
NACE	National Association of Corrosion Engineers
NEPA	National Environmental Policy Act
NMFS	National Marine Fisheries Service
NOx	Nitrogen oxides
NPDES	National Pollutant Discharge Elimination System
NSB	North Slope Borough
NSPS	New Source Performance Standards
OBM	Oil-based mud
OCS	Outer continental shelf
PLC	Programmable logic controller
ppm	Parts per million
PSDM	Pre-stack depth migration
psi	Pounds per square inch
psia	Pounds per square inch absolute
psig	Pounds per square inch gauge
PVT	Pressure, volume, temperature
RO	Reverse osmosis
RP	Recommended Practice
RSS	Rotary steerable system
SBM	Synthetic-based mud
SCADA	Supervisory control and data acquisition
scf/stb	Standard cubic feet per stock tank barrel
scfd	Standard cubic feet per day
SDI	Satellite Drilling Island
SSV	Surface safety valve
SSSV	Subsurface safety valve
STP	Seawater treatment plant
TAPS	Trans Alaska Pipeline System
TBD	To be determined
TDS	Total dissolved solids
TSS	Total suspended solids
TVD	True vertical depth

TVDSS	True vertical depth sub sea
TVP	True vapor pressure
uERD	Ultra extended reach drilling
USCG	U.S. Coast Guard
USCOE	U.S. Army Corps of Engineers
USFWS	U.S. Fish and Wildlife Service
VFD	Variable frequency drive
WBM	Water-based mud
WP	Working pressure

TABLE OF CONTENTS

1.	INTRODUCTION.....	1-1
	1.1 Liberty Project History.....	1-1
	1.2 Project Overview	1-3
	1.3 Permits and Approvals	1-3
2.	SCHEDULE.....	2-1
	2.1 Construction.....	2-1
	2.1.1 Ice Road Construction	2-1
	2.1.2 Mine Site Development.....	2-2
	2.1.3 Satellite Drilling Island Expansion	2-2
	2.1.4 West Sagavanirktok River Bridge	2-2
	2.1.5 Fabrication.....	2-2
	2.1.6 Pipeline Construction	2-2
	2.1.7 Facilities Installation	2-3
	2.2 Drilling.....	2-3
	2.3 Operations	2-3
3.	GEOLOGY AND RESERVOIR DEVELOPMENT	3-1
	3.1 General Reservoir Description.....	3-1
	3.2 Depletion Plan.....	3-1
	3.3 Shallow Hazards	3-2
	3.4 Future Geological and Geophysical Activities.....	3-2
	3.5 Hydrogen Sulfide.....	3-2
4.	PROJECT ACCESS	4-1
	4.1 Air Access	4-3
	4.2 Ice Roads	4-3
	4.3 Marine Access	4-3
	4.4 Road Access.....	4-3
5.	DRILLING PAD	5-1
	5.1 Drilling Pad Structure.....	5-1
	5.2 SDI Surface Layout	5-2
	5.3 Civil Construction	5-2
6.	FACILITIES	6-1
	6.1 Design Basis.....	6-1
	6.2 Oil and Gas Process System	6-2
	6.2.1 Oil Separation.....	6-2
	6.2.2 Produced Water Treatment.....	6-2

6.2.3	Liberty Water Injection	6-3
6.2.4	High-Pressure Gas Lift	6-3
6.2.5	Fuel Gas	6-3
6.3	Liberty Well Testing and Production Allocation Metering	6-4
6.3.1	Well Testing	6-4
6.3.2	Crude Oil Allocation Metering	6-4
6.3.3	Gas Allocation Metering	6-4
6.3.4	Multi Phase Flow Meter Technology	6-4
6.3.5	Sampling and Calibration for a MPFM	6-5
6.4	LoSal™ Enhanced Oil Recovery Process Facilities	6-5
6.5	Host Facility Selection and Modifications.....	6-6
6.6	Process Safety Systems.....	6-6
6.7	Chemicals	6-6
7.	DRILLING AND WELL COMPLETIONS.....	7-1
7.1	Introduction	7-1
7.2	Liberty Drilling Rig Layout, Footprint, and Well Spacing	7-2
7.2.1	Drilling Pad Layout and Well Spacing.....	7-2
7.2.2	Drilling Footprint	7-2
7.3	Drilling Unit	7-3
7.4	Well Design	7-5
7.4.1	Casing Design.....	7-5
7.4.2	Directional Drilling and Surveying	7-6
7.4.3	Drilling Fluids and Cementing	7-6
7.4.4	Data Acquisition.....	7-8
7.5	Completion Design	7-8
7.6	Logistics.....	7-8
7.7	Mud Plant.....	7-9
7.8	Well Control.....	7-9
8.	PIPELINE SYSTEM	8-1
8.1	Pipeline Route.....	8-1
8.2	Design Basis.....	8-1
8.3	Construction.....	8-1
8.4	Safety and Leak Prevention Measures	8-2
8.5	Monitoring and Surveillance.....	8-3
9.	INFRASTRUCTURE AND SUPPORT FACILITIES	9-1
9.1	Utilities and Infrastructure	9-1
9.1.1	Seawater Inlet Facilities	9-1
9.1.2	Electrical Power	9-1
9.2	Support Facilities.....	9-2
9.2.1	Ice Roads	9-2
9.2.2	Gravel Source	9-2
9.2.3	West Sagavanirktok River Bridge	9-3
9.2.4	Construction Camp/Support	9-4
9.2.5	Water Sources.....	9-4
10.	ENVIRONMENTAL SAFEGUARDS	10-1
10.1	Habitat and Wildlife Protection.....	10-1

10.1.1	Overview of Mitigation	10-1
10.1.2	Oil Spill Response Plan.....	10-2
10.1.3	Marine Mammal Authorizations	10-3
10.1.4	Environmental Training Program.....	10-3
10.2	Discharges and Emissions.....	10-3
10.3	Waste Management.....	10-4
10.3.1	Strategies by Project Phase	10-4
10.3.2	Management Options by Waste Stream	10-4
11.	OPERATIONS AND MAINTENANCE.....	11-1
11.1	Safety Equipment	11-1
11.1.1	Firefighting Philosophy and Equipment.....	11-1
11.1.2	Fire and Gas Detection, Alarm Action, and HVAC Philosophy.....	11-1
11.2	Criteria	11-2
11.2.1	Safety and Loss Control Regulations	11-2
11.2.2	Control and Monitoring.....	11-2
11.2.3	Shutdown Systems.....	11-2
11.2.4	Flares and Vents	11-3
11.2.5	Telecommunications	11-3
11.2.6	Safety System Testing.....	11-3
11.2.7	Equipment Identification.....	11-3
11.2.8	Documentation and Information Management.....	11-3
12.	TRAINING	12-1
13.	PROJECT TERMINATION	13-1
14.	BONDS, OIL SPILL FINANCIAL RESPONSIBILITY, AND WELL CONTROL STATEMENTS	14-1
15.	BIBLIOGRAPHY OF PREVIOUSLY SUBMITTED MATERIAL	15-1
 ATTACHMENTS:		
A.	Environmental Impact Analysis	A-1
B.	Geochemical Reports (CONFIDENTIAL)	B-1
C.	Oil Discharge Prevention and Contingency Plan.....	C-1
D.	Gravel Site Mining and Rehabilitation Plan	D-1
E.	Endicott Amended NPDES Permit Application.....	E-1
F.	Coastal Zone Project Questionnaire and Certification Statement Along with Coastal Consistency Analysis.....	F-1

LIST OF TABLES

1-1	Summary Chronology of Liberty Project	1-2
1-2	Development and Production Plan Cross-Reference to 30 CFR 250.241-262.....	1-4
1-3	Permits and Approvals Required for Liberty Development	1-8
4-1	Liberty Project Transportation Needs	4-1
4-2	Estimated Liberty Transportation Requirements.....	4-2
5-1	Design Summary for Liberty Expansion of Endicott SDI.....	5-1
6-1	Liberty Design Capacities and Specifications	6-1
6-2	Multi Phase Flow Metering Conditions	6-5
6-3	Chemical Storage at the <i>LoSal</i> TM EOR Process Plant.....	6-7
6-4	Liberty Chemical Usage	6-8
7-1	Liberty Development Drilling Program (Maximum Number of Wells).....	7-1
7-2	Preliminary Design Requirements for Liberty uERD Drilling Rig	7-4
7-3	Casing Design for Reference Case of 36,000-Foot Departure	7-5
7-4	Summary of Drilling Fluids for a Single Well	7-7
8-1	Design Features of Liberty Pipeline System	8-2

LIST OF FIGURES

NOTE: Figures for each section are at the end of that section.

- 1-1 Vicinity Map
- 2-1 Overall Project Schedule
- 3-1 Liberty Field Location Map
- 3-2 Structural Cross-Section A-A'
- 3-3 Structural Cross-Section B-B'
- 3-4 Top Reservoir Structure Map
- 3-5 Liberty Stratigraphic Column
- 3-6 Seismic Line Through Well #1
- 3-7 Seismic Line Through Well #2
- 3-8 Seismic Line Through Well #3
- 3-9 Seismic Line Through Well #4
- 3-10 Seismic Line Through Well #5
- 3-11 Projected Annual Average Gross Production Rates
- 5-1 Satellite Drilling Island Proposed Expansion General Plan
- 5-2 Satellite Drilling Island Proposed Expansion Cross-Section, Side View A-A'
- 5-3 Satellite Drilling Island Proposed Expansion Cross-Section, Side View B-B'
- 5-4 Satellite Drilling Island Proposed Expansion Cross-Section, Side View C-C'
- 5-5 Satellite Drilling Island Proposed Erosion Control Sections
- 6-1 Simplified Process Flow Diagram
- 6-2 *LoSal*TM Enhanced Oil Recovery Flow Diagram
- 6-3 Liberty to Endicott Production Flow
- 6-4 Main Production Island Proposed New Modules and Boat Launch
- 7-1 uERD Envelope
- 7-2 Trajectory of Liberty Wells Showing Endicott SDI Wells
- 7-3 uERD Drilling Technologies
- 7-4 uERD Well Completion Intervention Technologies
- 7-5 Artist's Conception of Proposed Liberty uERD Drilling Rig
- 7-6 Well Design for Reference Case of 36,000-Foot Departure
- 7-7 Typical Directional Plan for Liberty Wells
- 7-8 Well Completion Design

- 8-1 Proposed Pipelines Location Map
- 8-2 Proposed Pipelines MPI to SDI Cross-Section A-A'
- 8-3 Proposed Pipelines MPI to SDI Cross-Section B-B'

- 9-1 Proposed Ice Roads for Construction
- 9-2 Potential Sagavanirktok River New Bridge Option Location Map
- 9-3 Potential Sagavanirktok River New Bridge Option Elevation
- 9-4 Potential Sagavanirktok River New Bridge Option Pier Plan and Elevation

- 10-1 Satellite Drilling Island Proposed Expansion Drainage Plan

1. INTRODUCTION

This Development Production Plan (DPP) is being submitted by BP Exploration (Alaska) Inc. (BPXA) to the U.S. Minerals Management Service (MMS) to initiate the permitting process and National Environmental Policy Act (NEPA) review for the Liberty Development Project. This DPP has been prepared in accordance with the MMS requirements contained in 30 CFR 250.241-262 to describe the full scope of activity associated with Liberty construction, drilling, and production operations.

The Liberty Development Project design and scope have evolved from an offshore stand-alone development in the Outer Continental Shelf (production/drilling island and subsea pipeline) — as described in the 2002 *Liberty Development and Production Plan Final Environmental Impact Statement* — to use of existing infrastructure involving an expansion of the Endicott Satellite Drilling Island (SDI). This project evolution reflects a number of factors including environmental mitigation, advances in ultra-extended-reach drilling (uERD) technology, use of depth-migrated three-dimensional (3D) seismic data, and advances in reservoir modeling among others. As result, BPXA believes Liberty can be developed with relatively few wells (up to six) and less environmental footprint and impacts of the originally proposed offshore development.

BPXA proposes to develop the Liberty Oil Field, located on the outer continental shelf (OCS) about 6 miles offshore in Foggy Island Bay (Figure 1-1). Liberty is located on two leases, OCS-Y1650, acquired in Beaufort Sea OCS Lease Sale 144, and OCS-Y1585 (Lease Sale 124 — acquired from another company). BPXA holds a 100 percent interest in these leases and would be owner and operator of the Liberty Field.

Table 1-2 at the end of this section provides a cross-index of the contents of this DPP to the MMS requirements for a DPP in 30 CFR 250.241-262.

1.1 LIBERTY PROJECT HISTORY

BPXA has been moving forward on the Liberty Development Project since the fall of 1996, when BPXA first acquired Tract OCS-Y1650 in OCS Lease Sale 144 and initiated permitting activity for the Liberty #1 exploration well. The well was drilled and tested in the first part of 1997, and based on interpretation of geologic data, seismic data, and well tests, BPXA confirmed the discovery of the Liberty field on May 1, 1997. On February 17, 1998, BPXA submitted a DPP to MMS for review and approval of a Liberty Development Project based on a manmade gravel island with full production facilities and a buried subsea pipeline to shore. MMS issued a final environmental impact statement (FEIS) on the offshore project in 2002. However, BPXA put the project on hold to further review design and economics after completion of its Northstar project.

In August 2005, BPXA decided to pursue use of ultra-extended-reach drilling (uERD) from an onshore location. Such a project eliminates the offshore impacts of island and pipeline construction. Recent advancements in drilling technology have made such a project feasible. This change in project scope significantly mitigated the potential offshore environmental impacts related to the Boulder Patch, marine mammals, and concerns of the North Slope Inupiat communities related to the bowhead whale and subsistence whaling. It also made issues related to offshore pipeline design moot. This decision encouraged BPXA in August 2006 to pursue development of Liberty from an expansion of the existing Endicott SDI — the project described in this document. This decision to evaluate development using the existing infrastructure at Endicott further mitigates impacts by avoiding construction of a pad on the shoreline of Foggy Island Bay and an access road and pipelines crossing the Sagavanirktok River delta.

Table 1-1 presents a brief history of the Liberty Project.

Table 1-1
Summary Chronology of Liberty Project

TIME	EVENT
Summer 1982	Shell builds Tern Island and drills first exploration well.
Winter 1983	Shell drills second exploration well on Tern Island.
Winter 1987	Shell drills third exploration well from Tern Island and subsequently relinquishes leases in area.
Winter 1995	3-D Seismic survey (118 square miles).
September 1996	Federal Beaufort Sea Lease Sale #144. BPXA acquires leases in Tern Island area.
Winter 1997	BPXA drills Liberty #1 exploration well.
May 1997	BPXA confirms discovery of Liberty field.
February-April 1998	BPXA submits federal Development and Production Plan (DPP) and pipeline right-of-way application for Liberty Project. EIS process begins. Project includes an artificial gravel island with production facilities and a buried subsea pipeline to shore.
January 2001	MMS publishes Draft EIS for Liberty Project.
March 2002	BPXA withdraws application for Liberty Project pending further analysis of BPXA's recently completed Northstar project, which is similar in scope.
May 2002	MMS publishes Final EIS for Liberty Project.
2003-2004	BPXA continues evaluation of feasibility of Liberty.
August 2005	BPXA redefines the project as onshore satellite using uERD from shore on a new gravel well pad with an overland pipeline.
August 2006	Based on continued engineering work, BPXA decides to move the drilling pad to the existing Endicott SDI and use Endicott production facilities, thus eliminating the need for a new gravel pad and overland pipeline.

1.2 PROJECT OVERVIEW

The Liberty prospect is located about 5.5 miles offshore in about 20 feet of water and approximately 5 to 8 miles east of the existing Endicott SDI. To take advantage of the infrastructure at Endicott, BPXA has elected to drill the uERD wells from the SDI by expanding the island to support Liberty drilling (see Section 5). Liberty is one of the largest undeveloped light-oil reservoirs near North Slope infrastructure. BPXA estimates the Liberty Development could recover approximately 105 million barrels of hydrocarbons by waterflooding and using the *LoSal*TM enhanced oil recovery (EOR) process (*LoSal*TM is a trademark of BP p.l.c.).

The development drilling program will include one to four producing wells and one or two water injection wells. No well test flaring is planned for this drilling program. Production from the Liberty uERD project will be sent by the existing Endicott production flowline system from the SDI to the Endicott Main Production Island (MPI) for processing. The oil would then be transported to the Trans Alaska Pipeline System via the existing Endicott sales oil pipeline. Produced gas will be used for fuel gas and artificial lift for Liberty, with the balance being re-injected into the Endicott reservoir for enhanced oil recovery. Water for waterflooding will be provided via the existing produced-water injection system available at the SDI. This supply will be augmented by treated seawater if needed from the Endicott Seawater Treatment Plant. The *LoSal*TM EOR process will be employed during a portion of the flood and will be supplied by a *LoSal*TM facility constructed on the MPI.

Associated onshore facilities to support this project will include upgrade of the existing West Sagavanirktok River Bridge or construction of a new bridge, ice road construction, and development of a new permitted mine site adjacent to the Endicott Road to provide gravel for expanding the SDI. Existing North Slope infrastructure will also be used to support the project.

All wells for this project will be outside current industry performance for this depth. As a result, the state-of-the-art of uERD must be advanced (Section 7 provides a discussion of uERD technology). BPXA first plans to drill a single well in order to assure that such drilling is feasible. If that well is successful and the technology is proven, then BPXA will proceed with drilling additional wells and installing new facilities to complete the project as described in this document.

The project will need to secure access to Duck Island Unit lands and Endicott area equipment for construction, drilling, and production operations. (Note that the term “Duck Island Unit” refers to the lease area, while “Endicott” refers to the facilities.) Terms for access must be agreed upon with the Endicott owners in a comprehensive facility sharing agreement. Negotiations on this agreement are ongoing at the time of submittal of this DPP (April 2007).

1.3 PERMITS AND APPROVALS

The Liberty Project is subject to the federal, state, and local approvals listed in Table 1-3. This Project Description provides a comprehensive description of the proposed project, including all the information required under 30 CFR 250.241-262. Submitted under separate cover are the environmental impact analysis required by 30 CFR 250.227 and the oil spill response plan required by 30 CFR 250.250.

**Table 1-2
Development and Production Plan Cross-Reference to 30 CFR 250.241-262**

30 CFR PART 250 REQUIREMENT	SECTION OF DPP
250.241 What must the DPP or DOCD include?	
250.241 (a) Description, objectives, schedule	Section 1.1, 1.2, and 2
250.241 (b) Location	Section 1.1, 1.2
250.241 (c) Drilling unit	Section 7.3
250.241 (d) Production facilities	Section 6
250.242 (a)-(t) What information must accompany DPP	See references to specific sections below
250.243 What general information must accompany the DPP or DOCD?	See references to specific sections below
250.243 (a) Applications and permits	Section 1.3, Table 1-1
250.243 (b) Drilling fluids	Section 7.4 (no drilling waste discharges proposed for this project)
250.243 (c) Production	Section 3.1, 6.1
250.243 (d) Chemical products	Sections 6, 7, and 9
250.243 (e) New or unusual technology	Section 7.1
250.243 (f) Bonds, oil spill financial responsibility, and well control statements	Section 14
250.243 (g) Suspensions of production or operations	None are planned.
250.243 (h) Blowout scenario	Section 7.7 discusses well control issues, while the <i>Oil Discharge Prevention and Contingency Plan</i> will discuss response to a blowout scenario.
250.243 (i) Contact	Identified in cover letter submitting DPP
250.244 What geological and geophysical information must accompany the DPP or DOCD?	
250.244 (a) Geological description	Section 3.1
250.244 (b) Structure contour maps	Section 3
250.244 (c) Two dimensional (2-D) or three-dimensional (3-D) seismic lines	Section 3
250.244 (d) Geological cross-sections	Section 3
250.244 (e) Shallow hazards report	Section 3.3
250.244 (f) Shallow hazards assessment	Section 3.3
250.244 (g) High resolution seismic lines	Section 3
250.244 (h) Stratigraphic column	Section 3
250.244 (i) Time-versus-depth chart	Section 3
250.244 (j) Geochemical information	Attachment B (separate confidential submittal)
250.244 (k) Future G&G activities	Section 3.2
250.245 What hydrogen sulfide (H₂S) information must accompany the DPP or DOCD?	
250.245 (a) Concentration	Section 3.3

**Table 1-2
Development and Production Plan Cross-Reference to 30 CFR 250.241-262**

30 CFR PART 250 REQUIREMENT	SECTION OF DPP
250.245 (b) Classification	Section 3.3
250.245 (c) H ₂ S Contingency Plan	Section 3.3
250.245 (d) Modeling report	Section 3.3
250.246 What mineral resource conservation information must accompany the DPP or DOCD?	
250.246 (a) Technology and reservoir engineering practices and procedures	Section 3.2
250.247 (b) Technology and recovery practices and procedures	Section 3.2
250.247 (c) Reservoir development	Section 3.2
250.247 What biological, physical, and socioeconomic information must accompany the DPP or DOCD?	
250.247 (a) Biological environment reports	<i>Environmental Impact Analysis (Attachment A)</i>
250.247 (b) Physical environment reports	<i>Environmental Impact Analysis (Attachment A)</i>
250.247 (c) Socioeconomic study reports	<i>Environmental Impact Analysis (Attachment A)</i>
250.248 What solid and liquid wastes and discharges information and cooling water intake information must accompany the DPP or DOCD?	
250.248 (a) Projected wastes	Section 10.3
250.248 (b) Projected ocean discharges	None proposed; will use existing permitted facilities
250.248 (c) – National Pollutant Discharge Elimination System Permit	
(1) compliance with existing permit, or	Section 10.4
(2) copy of NPDES permit application	Attachment E
250.248 (d) Modeling report	Will be submitted after EPA issues a draft permit based on the NPDES application for Endicott
250.248 (e) Projected cooling water intake	None proposed
250.249 What air emissions information must accompany the DPP or DOCD?	
250.249 (a) Projected emissions	No emissions in OCS. Refer to ADEC air permit application(s) and to qualitative discussion of air emissions in Section 10.3
250.249 (b) Emission reduction measures	No emissions in OCS. Refer to ADEC air permit application(s) and to qualitative discussion of air emissions in Section 10.3
250.249 (c) Processes, equipment, fuels, and combustibles	Sections 6, 7
250.249 (d) Distance to shore	Not applicable because facilities are located on state lands
250.249 (e) Non-exempt facilities	Not applicable because facilities are located on state lands. ADEC requirements apply.
250.249 (f) Modeling report	Not applicable because facilities are located on state lands. ADEC requirements apply. Refer to ADEC permit application modeling results.

**Table 1-2
Development and Production Plan Cross-Reference to 30 CFR 250.241-262**

30 CFR PART 250 REQUIREMENT	SECTION OF DPP
250.250 What oil and hazardous substance spills information must accompany the DPP?	
250.250 (a) Oil Spill Response Plan	Refer to ADEC <i>Oil Discharge Prevention and Contingency Plan</i> .
250.250 (b) Modeling Report	Refer to ADEC <i>Oil Discharge Prevention and Contingency Plan</i> .
250.251 If I propose activities in the Alaska OCS region, what planning information must accompany the DPP?	
250.251 (a) Emergency plans	See Section 7.8 and ADEC <i>Oil Discharge Prevention and Contingency Plan</i> .
250.251 (b) Critical operations and curtailment procedures	Not applicable because facilities are not located in OCS
250.252 What environmental monitoring information must accompany the DPP or DOCD?	
250.252 (a) Monitoring systems	<i>Environmental Impact Analysis</i> (Attachment A)
250.252. (b) Flower Garden Banks National Marine Sanctuary	Not applicable
250.253 What lease stipulations information must accompany DPP or DOCD?	<i>Environmental Impact Analysis</i> (Attachment A)
250.254 What mitigation measures information must accompany DPP or DOCD?	<i>Environmental Impact Analysis</i> (Attachment A)
250.255 What decommissioning information must accompany the DPP or DOCD?	Section 13
250.256 What related facilities and operations information must accompany the DPP or DOCD?	
250.256 (a) OCS facilities and operations	No facilities (except well bottomholes) in OCS. However, entire document provides information on project including drilling unit, drilling pad, pipelines and other facilities.
250.256 (b) Transportation system	No facilities (except well bottomholes) in OCS. However, entire document provides information on project including drilling unit, drilling pad, pipelines and other facilities. See specifically Sections 4, 7.6, and 8.
250.257 What information on support vessels, offshore vehicles, and aircraft you will use must accompany the DPP or DOCD?	
250.257 (a) General	Section 4
250.257 (b) Air emissions	Not applicable. No support vessels, offshore vehicles, or aircraft. Project may involve sealift of facilities.
250.257 (c) Drilling fluids and chemical products transportation	Sections 4, 7
250.257 (d) Solid and liquid wastes transportation	Section 10.3

**Table 1-2
Development and Production Plan Cross-Reference to 30 CFR 250.241-262**

30 CFR PART 250 REQUIREMENT	SECTION OF DPP
250.258 What information on the onshore support facilities you will use must accompany the DPP or DOCD?	
250.258 (a) General	Entire document
250.258 (b) Air emissions	No emissions in OCS. Refer ADEC air permit application(s) and to qualitative discussion of air emissions in Section 10.2.
250.258 (c) Unusual solid and liquid wastes	Section 10.3
250.258 (d) Waste disposal	Section 10.3
250.259 What sulphur operations information must accompany the DPP or DOCD?	Not applicable
250.260 What Coastal Zone Management Act (CZMA) information must accompany the DPP or DOCD?	
250.260 (a) Consistency Certification	Attachment F
250.260 (b) Other information	Attachment F
250.261 What environmental impact analysis (EIA) information must accompany the DPP or DOCD?	
250.261 (a) General	<i>Environmental Impact Analysis (Attachment A)</i>
250.261 (b) Resources, conditions, and activities	<i>Environmental Impact Analysis (Attachment A)</i>
250.261 (c) Environmental impacts	<i>Environmental Impact Analysis (Attachment A)</i>
250.261 (d) Consultation	<i>Environmental Impact Analysis (Attachment A)</i>
250.261 (e) References cited	<i>Environmental Impact Analysis (Attachment A)</i>
250.262 What administrative information must accompany the DPP or DOCD?	
250.262 (a) Exempted (proprietary) information description (public information copies only)	Not applicable
250.262 (b) Bibliography (previously submitted material)	Section 15

**Table 1-3
Permits and Approvals Required for Liberty Development**

AGENCY	PERMIT / APPROVAL	SCOPE AND JURISDICTION
Federal Agencies:		
All Federal Agencies	NEPA Review	All project construction and operation activities authorized by federal permits
U.S. Army Corps of Engineers	Clean Water Act, Section 404 (33 CFR 320-330)	Civil works in wetlands and navigable waters (gravel construction, pipelines, river crossings etc.)
U.S. Army Corps of Engineers	Rivers and Harbors Act, Section 10	Construction and activities in navigable waters (river crossings and marine waters)
U.S. Environmental Protection Agency	National Pollutant Discharge Elimination System (NPDES) Individual Permit (40 CFR 122)	Discharges of wastewater and stormwater to "waters of the U.S." (e.g., domestic wastewater and hydrotest water)
U.S. Minerals Management Service	Development and Production Plan (DPP) (30 CFR Part 250 Subpart B)	All development and production activities and facilities of the project in the OCS
U.S. Minerals Management Service	Oil Spill Response Plan (30 CFR 254); applies to OCS and state waters	Oil handling, storage and transportation facilities
U.S. Minerals Management Service	Application for Permit to Drill (30 CFR 250 Subpart D)	All wells into federal subsurface
National Marine Fisheries Service	Section 7 Finding (Endangered Species Act; required by NEPA process)	Any marine construction or support operations activities that may affect bowhead whales (e.g., island/drilling noise, oil spills, marine support/sealifts, SDI construction)
National Marine Fisheries Service	Letter of Authorization for Incidental Take of Marine Mammals (whales and seals)	Any marine construction and operation activities that may affect bowhead whales and seals (e.g., SDI construction)
National Marine Fisheries Service	Incidental Harassment Authorization (IHA)	Marine construction and operation activities that may affect bowhead whales and seals (e.g., island/drilling noise, marine support)
National Marine Fisheries Service	Essential Fish Habitat Consultation	All construction and operation activities that may effect Essential Fish Habitat
U.S. Fish and Wildlife Service	Letter of Authorization for Incidental Take of Marine Mammals (polar bear and Pacific walrus)	All construction and operation activities that may affect polar bears and Pacific walrus
U.S. Fish and Wildlife Service	Section 7 Finding (Endangered Species Act; required by NEPA process)	Project activities that may affect Steller's and Spectacled eiders
U.S. Coast Guard	Oil Discharge Prevention and Contingency Plan	See ADEC <i>Oil Discharge Prevention and Contingency Plan</i>

**Table 1-3
Permits and Approvals Required for Liberty Development**

AGENCY	PERMIT / APPROVAL	SCOPE AND JURISDICTION
U.S. Coast Guard	Section 9 Bridge Permit	Construction of bridge (pipeline or road) across navigable streams
State Agencies:		
Department of Natural Resources, Office of Project Management and Permitting	Coastal Zone Consistency Review (11 AAC 110)	All project construction and operation activities (both within North Slope Borough Coastal Zone and OCS) — Certification of Consistency
Department of Natural Resources, Division of Mining, Land, and Water	Material Sales Contract (including Mining and Rehabilitation Plan)	Construction gravel
Department of Natural Resources, Division of Oil and Gas	Right-of-Way Easements	All new and modified facilities at Endicott Liberty wells drilled through state lands (subsurface) to access the OCS
Department of Natural Resources, Division of Mining, Land and Water	Land Use Permit	Ice road construction on state lands, tundra travel, geotechnical boring program, and other survey work — all project phases
Department of Natural Resources, Division of Mining, Land and Water	Water Use Permits	Freshwater removal from lakes, ponds, rivers
Department of Natural Resources, Office of Habitat Management and Permitting	Title 41 Fish Habitat	Construction activities in fish-bearing streams
Department of Environmental Conservation	Air Quality Construction Permit (NSR)	Major stationary emission source or major modification of existing source (e.g., turbines, generators, heaters)
Department of Environmental Conservation	Title V Operating Permit	Major stationary emission source or major modification of existing source (e.g., turbines, generators, heaters)
Department of Environmental Conservation	Oil Discharge Prevention and Contingency Plan (18 AAC 75)	Onshore and offshore (within 3 miles) production facilities and oil transmission lines; pipeline and modifications to host facilities
Department of Environmental Conservation	Section 401 Water Quality Certification Short-Term Water Quality Variance	Discharges associated with NPDES and Section 404 permits
Department of Environmental Conservation	Certificate of Financial Responsibility (18 AAC 75, Article 2)	Oil spill contingency planning
Local Government:		
North Slope Borough	Development Permit	Construction and operation activities located within the North Slope Borough (territorial waters and onshore)

**Table 1-3
Permits and Approvals Required for Liberty Development**

AGENCY	PERMIT / APPROVAL	SCOPE AND JURISDICTION
Miscellaneous:		
Minerals Management Service	Lease Terms and Conditions	
	Gravel Mine Site Mining and Rehabilitation Plan	
	Waste Management Plan	
	Waste Analysis Plan	
	Wildlife Interaction Plan	

Liberty Development and Production Plan

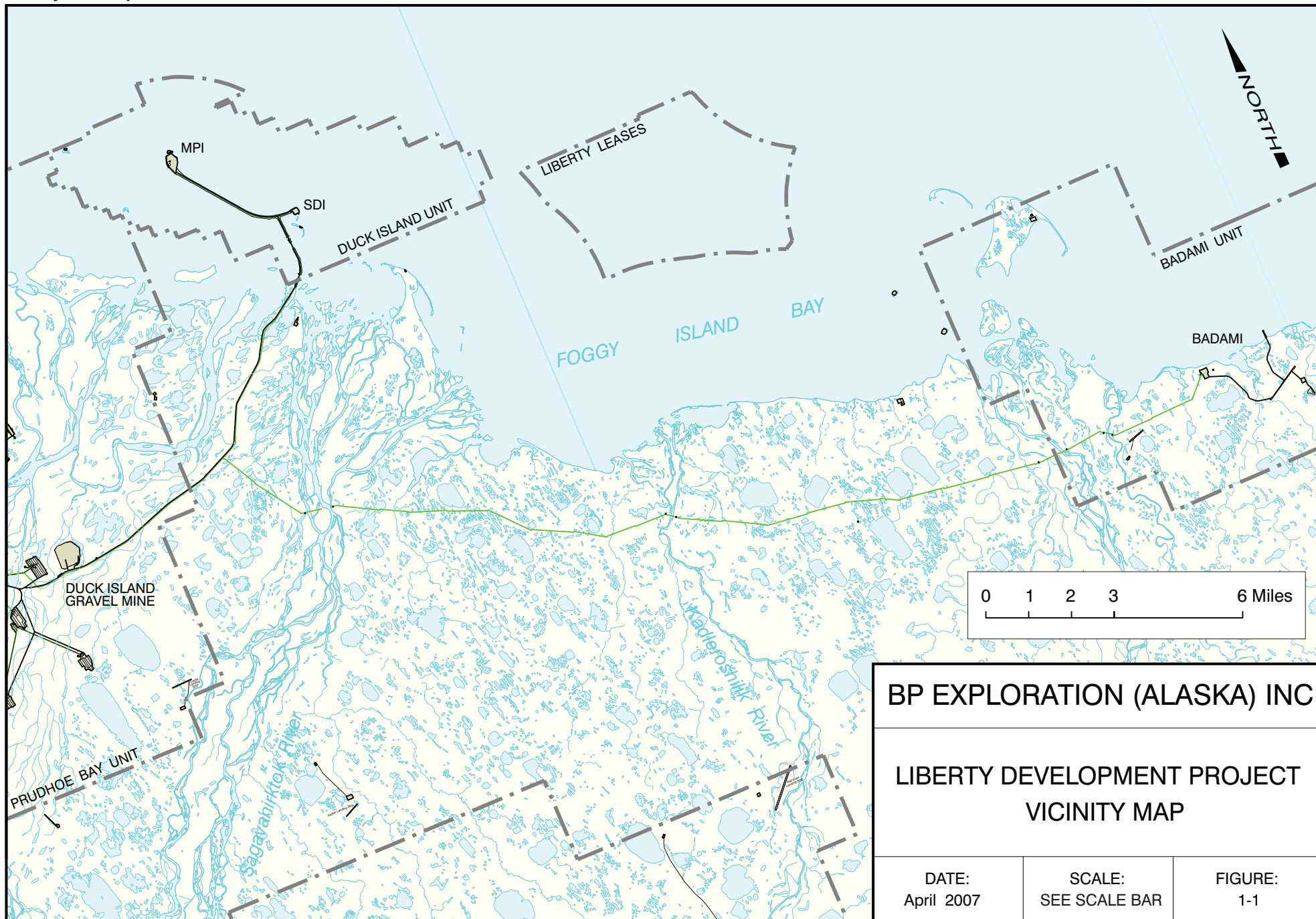

BP EXPLORATION (ALASKA) INC.

**LIBERTY DEVELOPMENT PROJECT
VICINITY MAP**

DATE:
April 2007

SCALE:
SEE SCALE BAR

FIGURE:
1-1

2. SCHEDULE

Figure 2-1 shows the overall project schedule for the proposed Liberty Development. The project currently includes the following milestones contingent on permits and facility access agreements:

- Construction of a purpose-built drill rig commencing in early 2008;
- Satellite Drilling Island (SDI) pad expansion in 2009;
- Upgrade of the West Sagavanirktok River bridge or construction of a new bridge in 2009;
- Fabrication and installation of well pad facilities in 2009;
- Rig assembly, commissioning, and crew training in early 2010; and
- Drilling the initial Liberty development well starting in the early 2010, with completion and first oil production in the first quarter of 2011.

Once the initial well has proven uERD technology, then BPXA will proceed with the remaining wells and facilities:

- Drilling of additional production and injection wells starting in 2011 through mid-2013;
- Installation of the Liberty inter-island pipelines in 2012; and
- Fabrication and installation of the *LoSal*TM EOR process modules from mid-2011 through the end of 2012.

Drilling operations may be required in subsequent years to accommodate infill development wells and/or existing well workovers. Final project abandonment would begin when project facilities are no longer needed, consistent with plans for abandonment of the Endicott facilities.

2.1 CONSTRUCTION

Liberty will use conventional North Slope construction methods, and the schedule will be governed by the usual seasonal constraints on North Slope activities.

2.1.1 Ice Road Construction

In order to expand the Endicott SDI, an ice road will be built starting in January 2009, or when seasonal conditions allow. The ice road will start from a new gravel mine site near the Duck Island mine site on the west side of the Endicott Road. The ice road will cross under one of the Endicott Causeway bridges (depending on water depth) in the Sagavanirktok (Sag) River delta and run across the sea ice to the south side of the SDI. This ice road will allow the gravel-haul trucks direct, unobstructed access to the SDI without affecting normal traffic on the causeway, which has a single-lane bridge.

2.1.2 Mine Site Development

The source of gravel for the SDI expansion is currently planned to be a new site east of the existing Duck Island mine site in the Sag River delta. Snow clearance and removal of unusable overburden will take place in January 2009 while the ice road is being built, followed by gravel excavation and hauling. The gravel haul will take place during a single winter season (early 2009). A mining and rehabilitation plan will be submitted under separate cover to the State of Alaska, Department of Natural Resources, Division of Mining, Land and Water, and the U.S. Army Corps of Engineers for review and approval. Disposition of the overburden, plus any other stipulated reclamation measures, will be done according to the approved mining plan.

2.1.3 Satellite Drilling Island Expansion

The Endicott SDI will be expanded to accommodate the new drilling rig, the Liberty wells, and the various production facilities and piping required to support the Liberty Development. The existing slope protection may be removed while the ice road is being built. The gravel haul will begin as soon as the ice road is ready, and the haul will be complete before breakup in mid-April 2009. In June and July following breakup, the fresh gravel on the SDI will be compacted to provide a suitable working surface, and new slope protection will be placed around the island.

2.1.4 West Sagavanirktok River Bridge

BPXA is evaluating whether to upgrade the West Sag River Bridge or construct a new bridge upstream of the existing one in order to accommodate increased traffic and vehicular loads for the project. Construction will take place during the winter of 2009.

2.1.5 Fabrication

Process facilities to support the initial drilling stage of the Liberty Development will be fabricated as truckable modules and shipped to the North Slope by road. These facilities include:

- A fuel gas conditioning skid to provide fuel to the rig engines, and
- Interconnect piping, including production and test, gas lift, and water injection lines, for the initial wells.

This work will commence in 2009 in order to be in place when drilling commences in the first quarter of 2010.

A *LoSal*TM enhanced oil recovery (EOR) process plant and supporting facilities will be fabricated during the second half of 2011 and first half of 2012 and sealifted to the site. This fabrication will be done at a site to be chosen later.

2.1.6 Pipeline Construction

Two new pipelines will be run approximately 3 miles between the Endicott MPI and SDI parallel to the existing inter-island pipelines: a *LoSal*TM EOR process water injection pipeline and a high-pressure gas pipeline. Since these lines will be run on the Endicott Causeway, there are no seasonal constraints on their construction. They will be installed in 2012 in order to be operational by the time the *LoSal*TM EOR process modules arrive. The current plan is for traditional North Slope elevated pipes.

2.1.7 Facilities Installation

Facilities installation will take place in two stages. The relatively minor facilities required to support drilling and production of the first few wells will be installed in second half of 2009, while the *LoSal*[™] EOR process plant and associated modules will be installed in 2012. Revamps to the Endicott Seawater Treatment Plant will occur during 2012 to support the *LoSal*[™] EOR process.

2.2 DRILLING

Construction of the new, purpose-built drilling rig for the project is expected to begin by the first quarter of 2008. The first well should be spudded in 2010, with drilling of the remaining wells likely to extend through 2013.

2.3 OPERATIONS

Production operations will commence following hook-up of the first well in early 2011.

Liberty Development and Production Plan

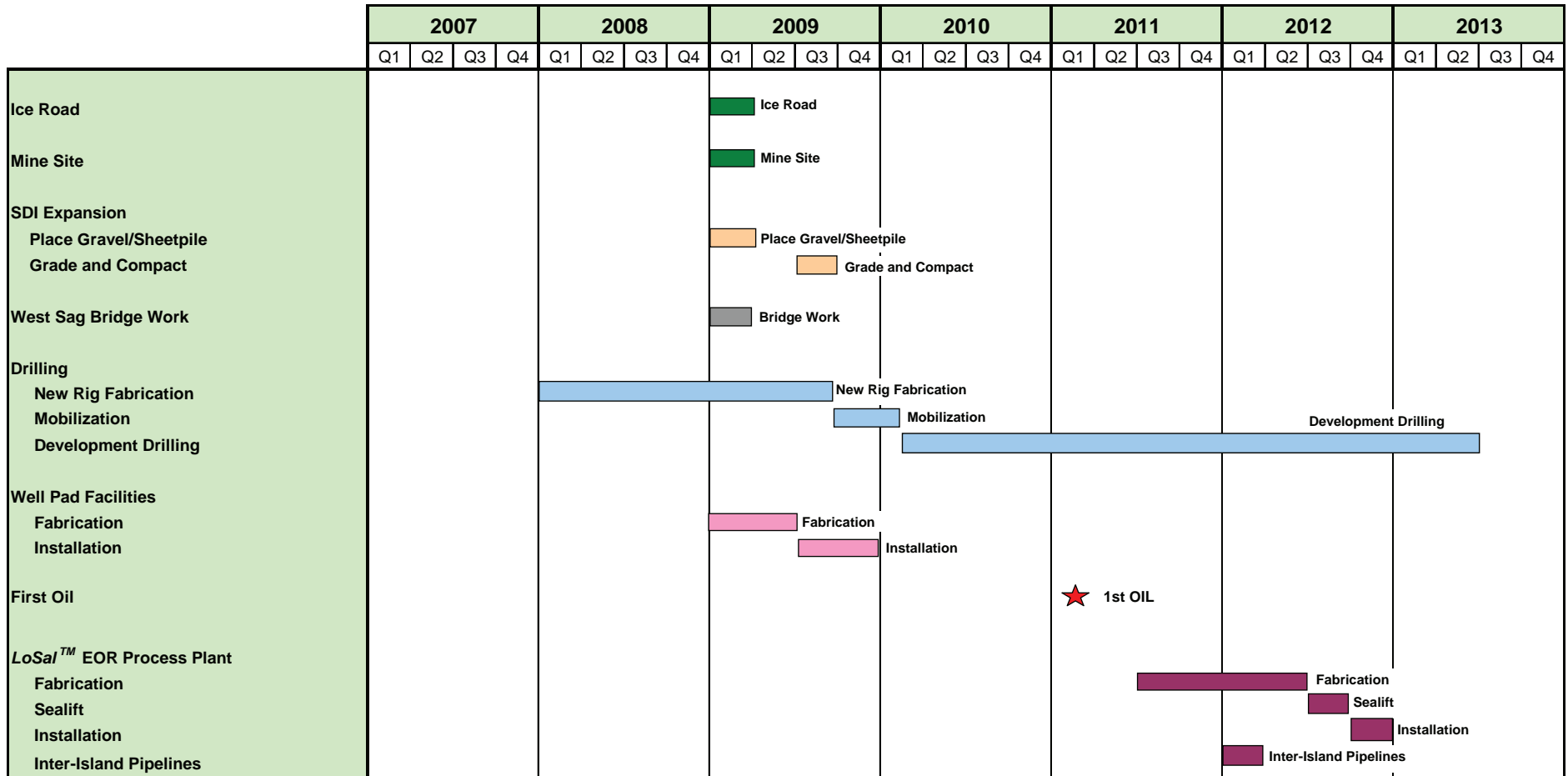

BP EXPLORATION (ALASKA) INC.		
LIBERTY DEVELOPMENT PROJECT OVERALL PROJECT SCHEDULE		
DATE: April 2007	SCALE: None	FIGURE: 2-1

LoSal™ is a trademark of BP p.l.c.

3. GEOLOGY AND RESERVOIR DEVELOPMENT

3.1 GENERAL RESERVOIR DESCRIPTION

The Liberty Field is located about 5 miles offshore in Foggy Island Bay, southeast of Endicott (Figure 3-1). The Tern #3 and Liberty #1 wells establish the presence of producible hydrocarbons within the Kekiktuk Zone 2 reservoir. Two additional wells exist in the Liberty area (Tern Island #1A and #2A) and provide additional data on the field. A depth-migrated three-dimensional (3D) seismic survey covers the accumulation and is used to map the reservoir and define the field limits. The well and seismic data support an estimate of 105 million barrels of recoverable oil.

The Liberty accumulation is similar to the nearby Endicott Field, which is operated by BPXA. Both fields are structural-stratigraphic traps involving north-west trending faults and reservoir truncation by the Lower Cretaceous Unconformity (LCU). The Liberty Field is bounded to the southwest by the Tigvariak Fault and erosional pinchout by the LCU to the northeast (Figures 3-2 and 3-3). The reservoir is truncated by the LCU across the entire field; therefore, the LCU depth map is the top reservoir structure map for the accumulation (Figure 3-4). The Kekiktuk Zone 2 sandstone of the Liberty Field is a high-quality reservoir, similar to that of the Endicott Field (Figure 3-5).

The Tern Island #3 and Liberty #1 wells encountered a “tar mat” in the Zone 2 reservoir at the base of the movable oil column. In the Liberty #1 well, the tar mat lies near the base of Zone 2 at 10,932 feet true vertical depth sub sea (TVDSS), with an overlying oil column to the top of the reservoir at 10,707 feet TVDSS. No gas cap was encountered in this well. In Tern Island #3, a tar mat exists in the Zone 2 reservoir from 10,922 to 11,045 feet TVDSS, below which there is a water leg in the lower portion of the reservoir. The first 8 feet of Zone 2 reservoir (10,914 to 10,922 feet TVDSS) is interpreted to have movable hydrocarbons. Top tar represents the base of producible hydrocarbons in the Liberty Field. This type of basal tar mat is common in North Slope oil fields such as the Endicott and Prudhoe Bay Fields.

3.2 DEPLETION PLAN

Experience with developing the Endicott Field allows BPXA to determine the most efficient method to maximize oil recovery in the Liberty Field. Waterflood will be employed as the primary recovery mechanism for Liberty. This flood will be enhanced by the use of the *LoSal*[™] enhanced oil recovery (EOR) process. A late-life carbon dioxide (CO₂) flood may also be employed in conjunction with major gas sales. BPXA estimates the Liberty Development could recover approximately 105 million barrels of oil by waterflooding and using the *LoSal*[™] EOR process.

The exceptional rock properties and the simple structural geometry make it possible to develop the reservoir with relatively few wells. Reservoir studies indicate a five- to six-well development to a horizontal departure of 44,000 feet would develop 105 million barrels of oil. A two-well development to a horizontal departure of 39,000 feet would develop 60 million barrels of oil. Drilling studies support departures of 39,000 to 44,000 feet. Departures beyond 44,000 feet have not been studied. Achievements in drilling departure and well performance will influence the final well count and resources developed. The intent is to maximize resource capture as drilling performance is proven.

The depletion plan calls for two to six wells, with one to four producers and one or two water injectors (Figure 3-4). The need, type, and target for a sixth well will be dependent on reservoir and drilling performance. One or two producers will be placed as far up dip as possible to encounter both Zone K2A and Zone K2B (Figures 3-6 and 3-7). One or two injectors will be placed in a mid-field location near the Liberty #1 well (Figures 3-8 and 3-9). Based on drilling success, one or two producers could be placed down-dip to recover reserves between Liberty #1 and Tern #3 (Figure 3-10). The producer-injector drilling sequence will be phased to ensure adequate reservoir pressure support. A production profile is provided in Figure 3-11.

3.3 SHALLOW HAZARDS

Development drilling will be from the existing Endicott Satellite Drilling Island. No shallow hazards have been encountered in this location.

3.4 FUTURE GEOLOGICAL AND GEOPHYSICAL ACTIVITIES

The existing 3D seismic survey over the Liberty Field is currently undergoing reprocessing to yield a new pre-stack depth migration (PSDM) that will be available for detailed well planning in 2007. In addition, work is underway to potentially acquire new seismic data during the summer of 2008 that will have closer bin spacing and greater coverage of the well paths from the SDI.

3.5 HYDROGEN SULFIDE

Minor amounts (8 ppm) of hydrogen sulfide (H₂S) were reported during testing of the Liberty #1 well. BPXA will follow standard safety procedures and design considerations typically used on the North Slope of Alaska for this level of hazard. These procedures will be described in an H₂S contingency plan to be submitted to MMS for review and approval before drilling operations begin.

Liberty Development and Production Plan

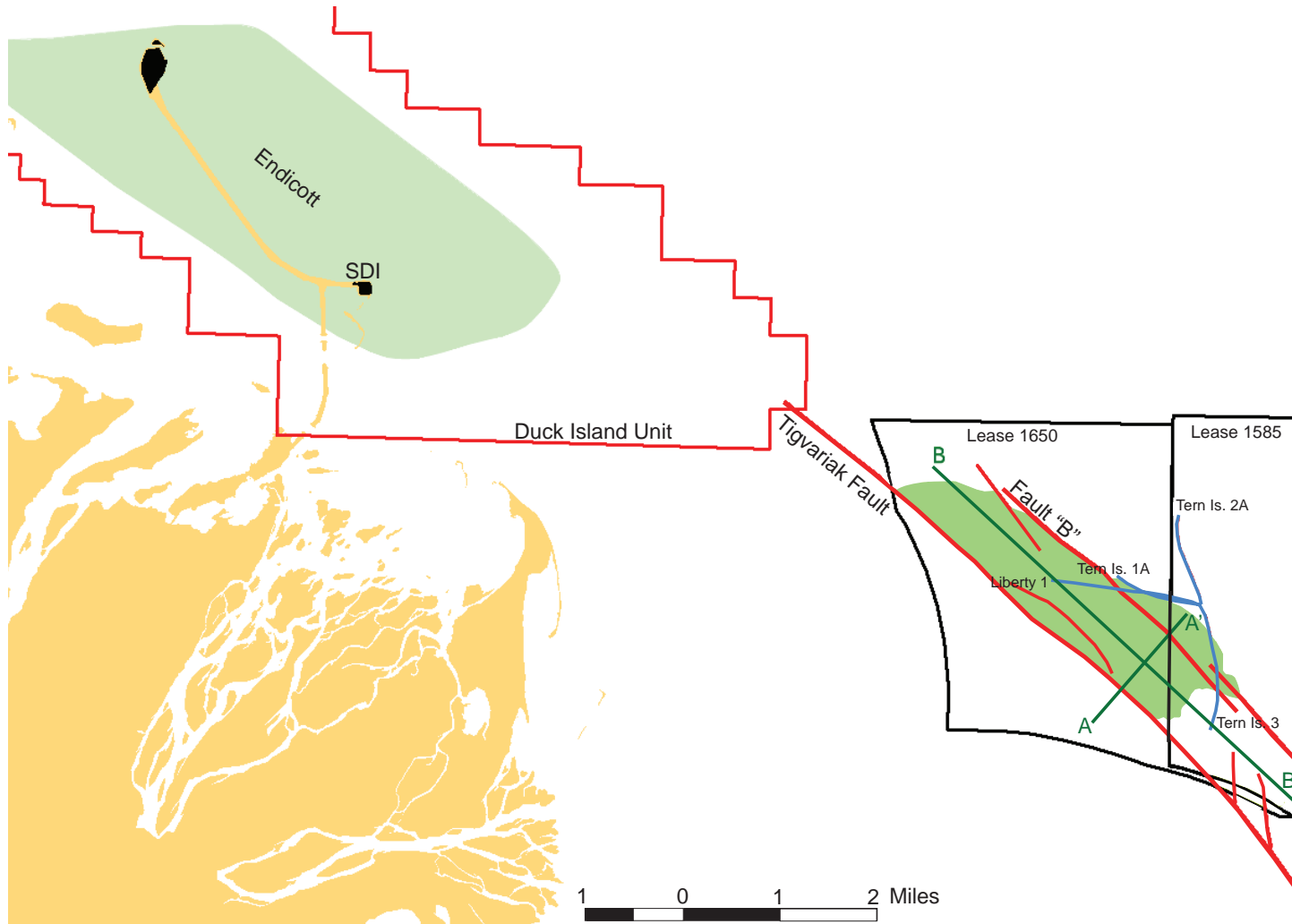

BP EXPLORATION (ALASKA) INC.

LIBERTY DEVELOPMENT PROJECT
LIBERTY FIELD LOCATION MAP

DATE:
April 2007

SCALE:
SEE SCALE BAR

FIGURE:
3-1

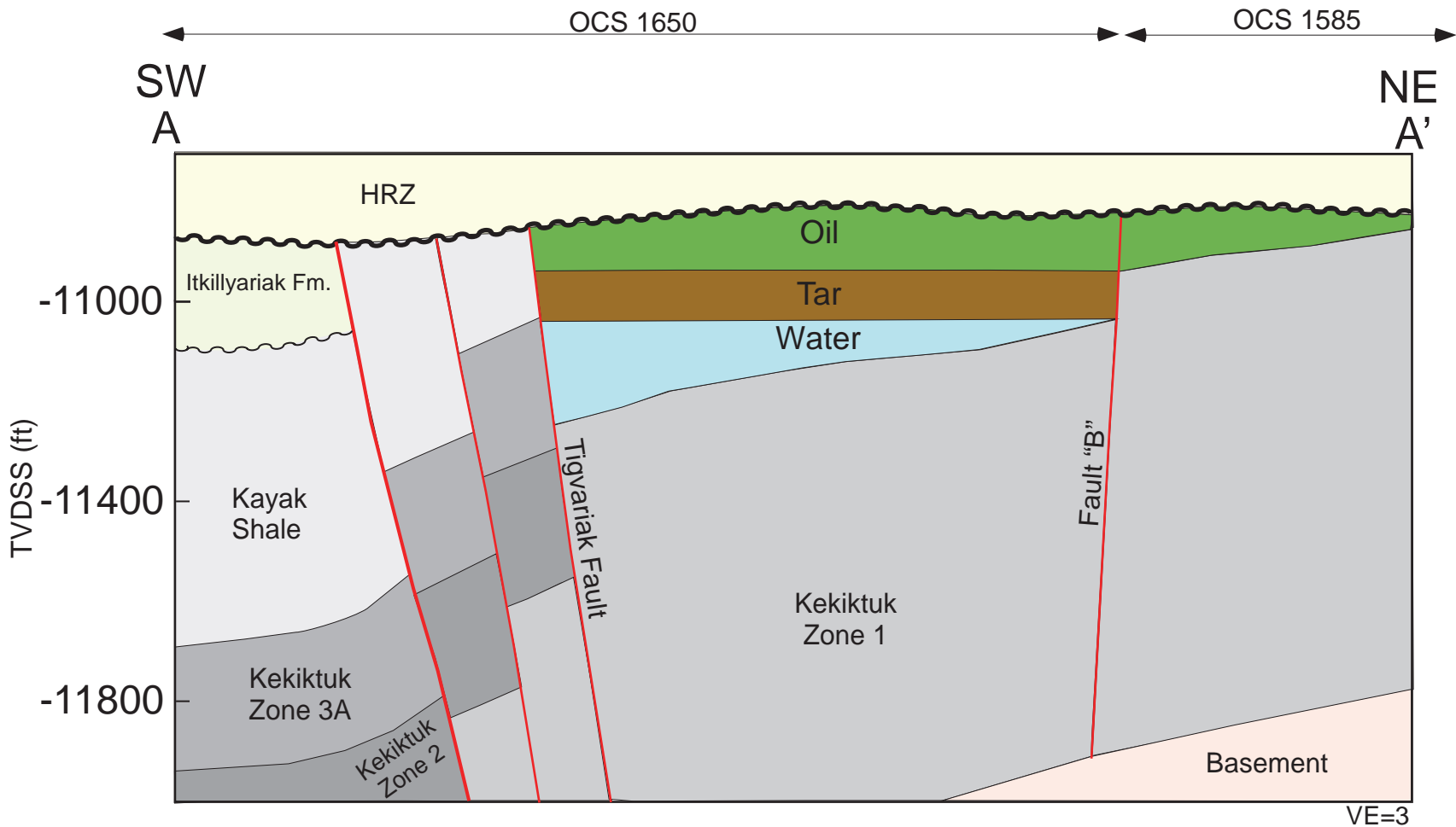

BP EXPLORATION (ALASKA) INC.

LIBERTY DEVELOPMENT PROJECT
STRUCTURAL CROSS-SECTION A-A'

DATE:
April 2007

HORIZ. SCALE:
SEE SCALE BAR

FIGURE:
3-2

Liberty Development and Production Plan

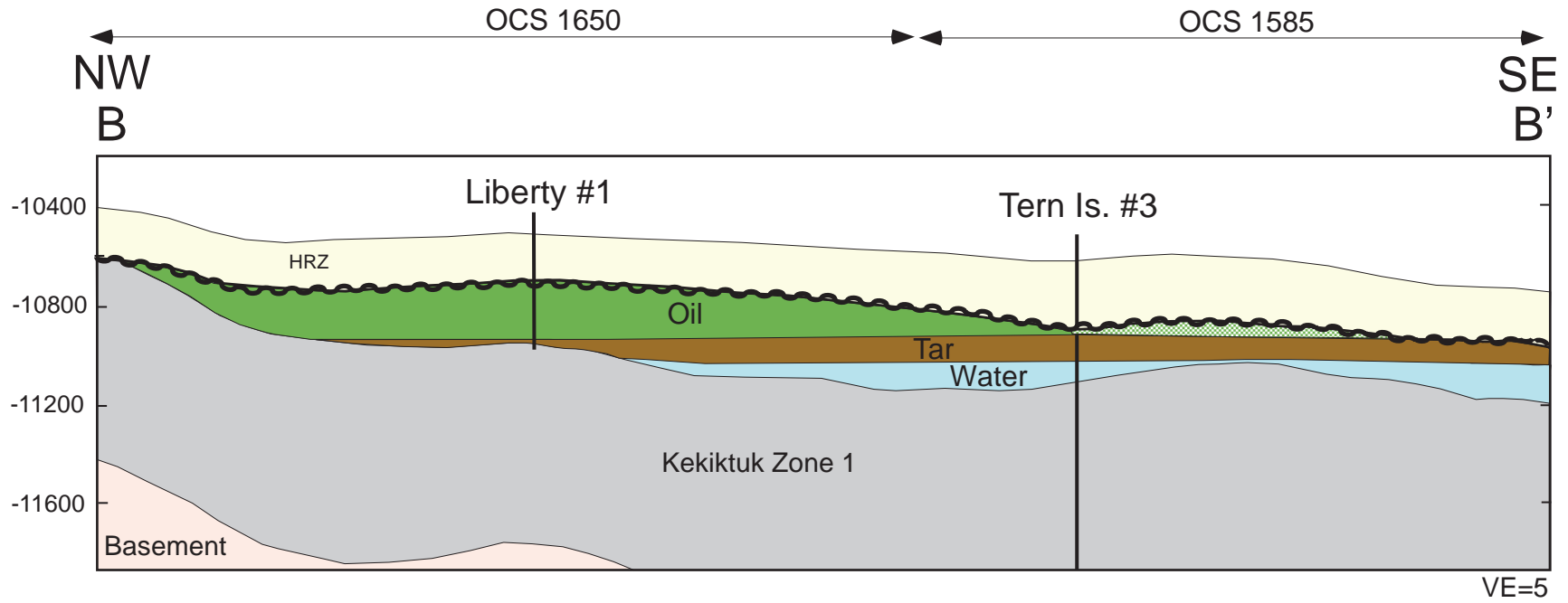

0 3,500 ft
HORIZ. SCALE

BP EXPLORATION (ALASKA) INC.

LIBERTY DEVELOPMENT PROJECT
STRUCTURAL CROSS-SECTION B-B'

DATE:
April 2007

HORIZ. SCALE:
SEE SCALE BAR

FIGURE:
3-3

Liberty Development and Production Plan

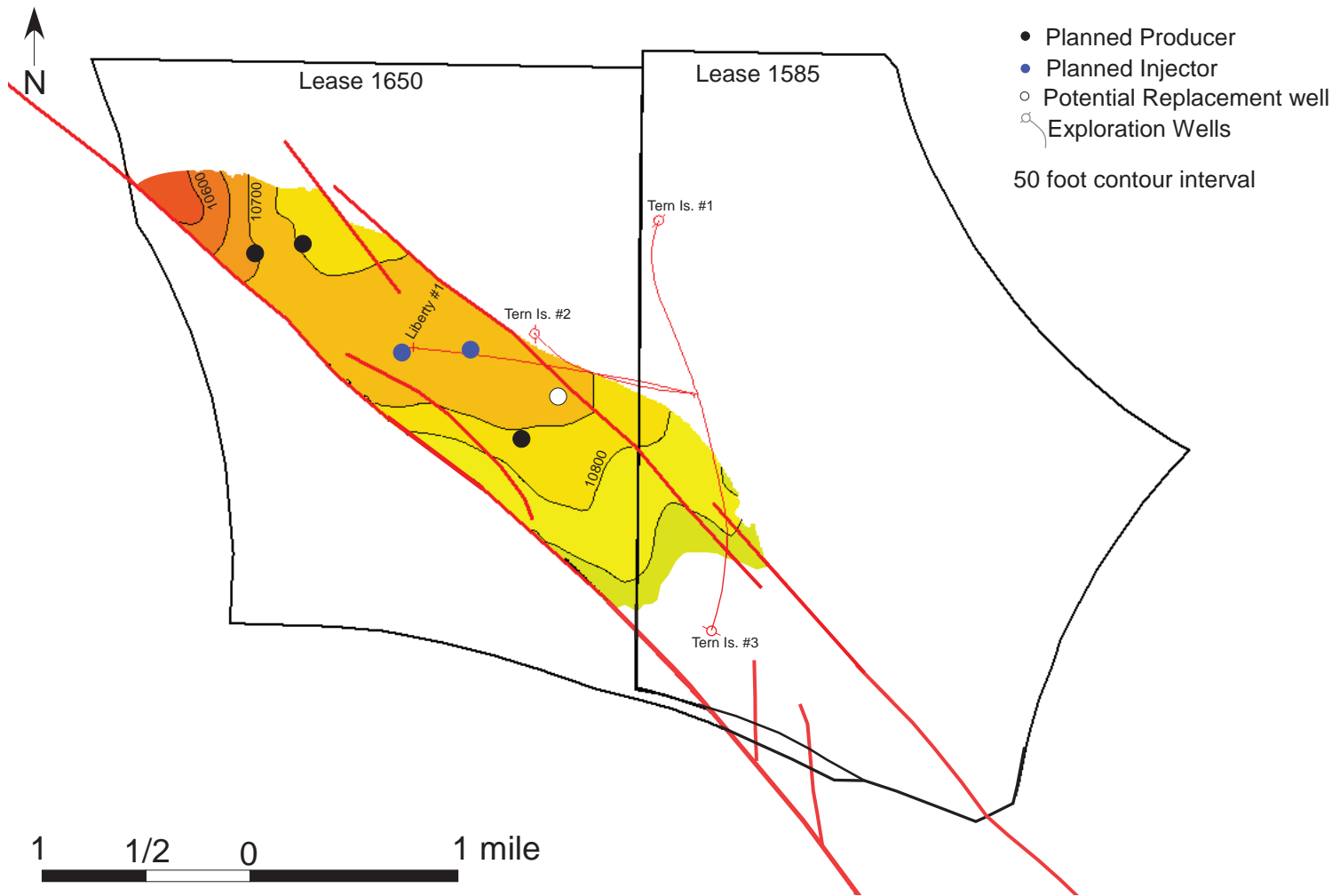

BP EXPLORATION (ALASKA) INC.		
LIBERTY DEVELOPMENT PROJECT TOP RESERVOIR STRUCTURE MAP		
DATE: April 2007	SCALE: SEE SCALE BAR	FIGURE: 3-4

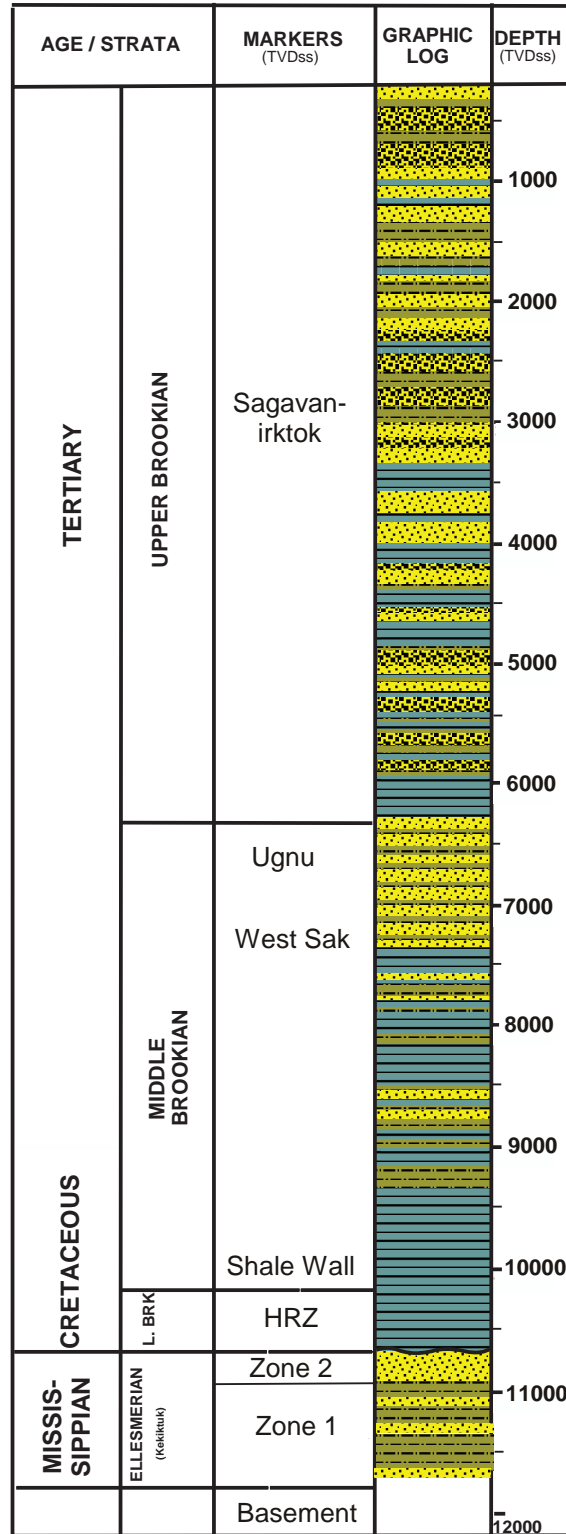

BP EXPLORATION (ALASKA) INC.

LIBERTY DEVELOPMENT PROJECT
LIBERTY STRATIGRAPHIC COLUMN

DATE:
April 2007

SCALE:
SEE SCALE BAR

FIGURE:
3-5

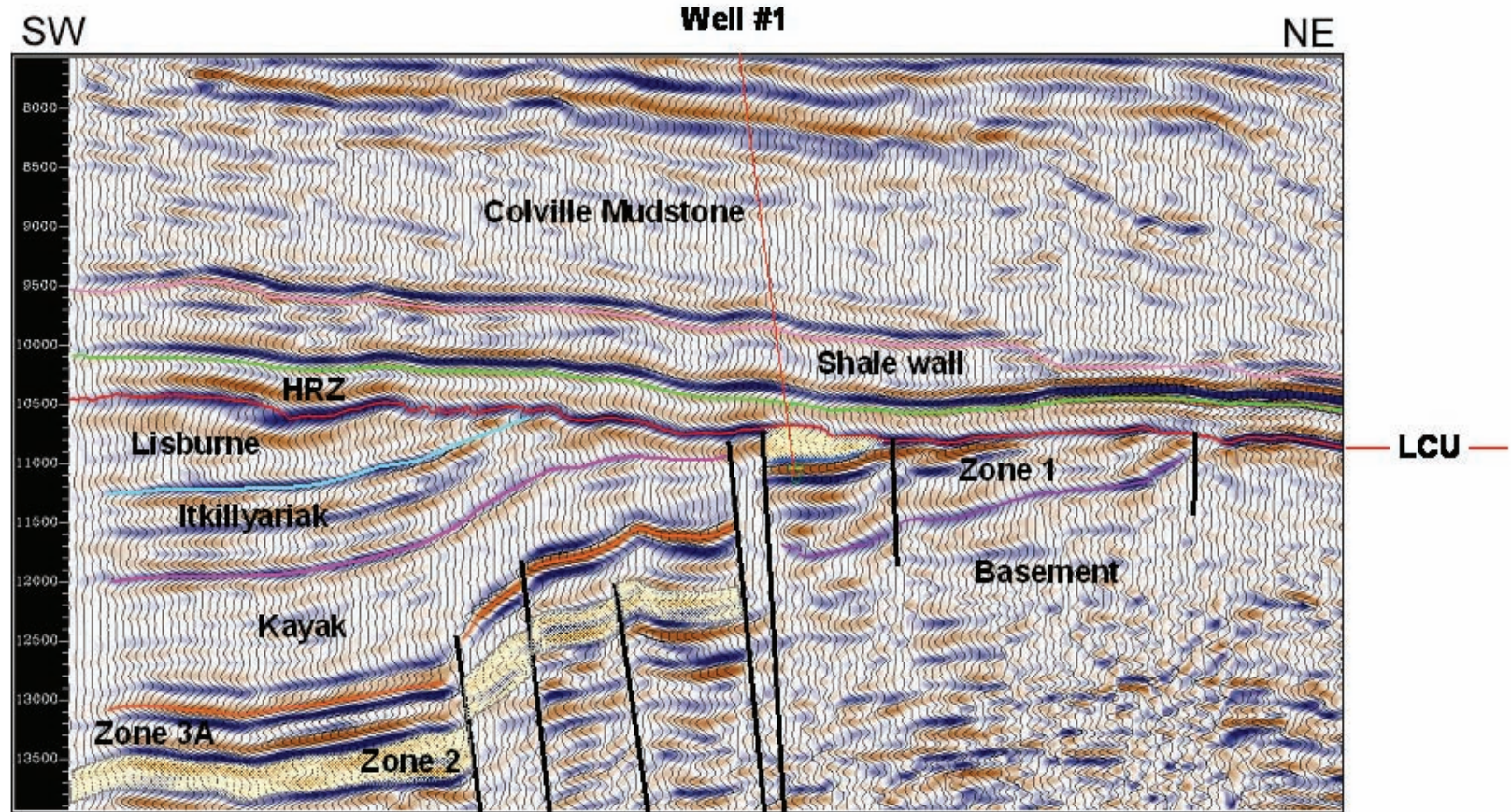

BP EXPLORATION (ALASKA) INC.

LIBERTY DEVELOPMENT PROJECT
SEISMIC LINE THROUGH WELL #1

DATE:
April 2007

SCALE:
SEE SCALE BAR

FIGURE:
3-6

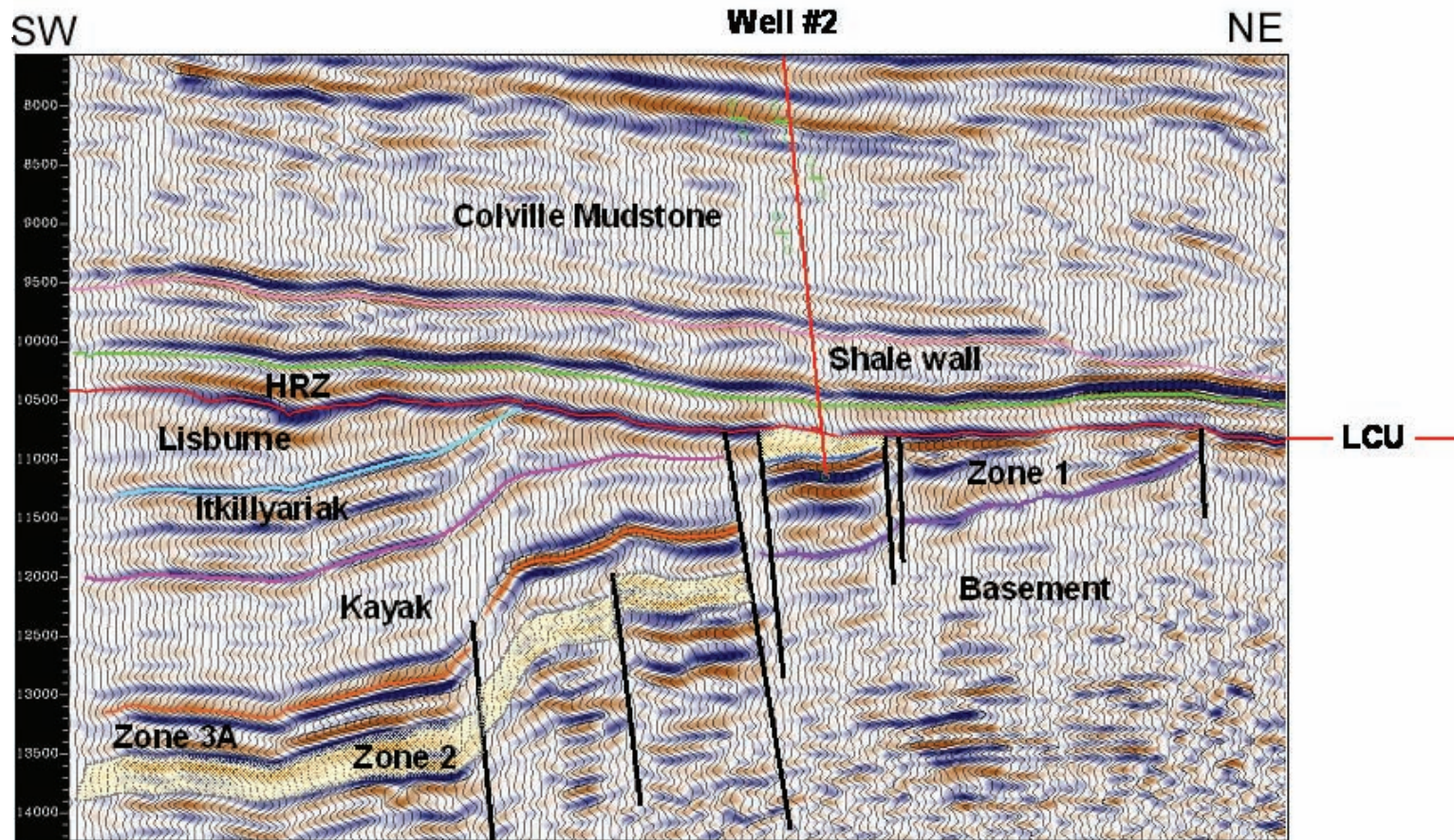

BP EXPLORATION (ALASKA) INC.		
LIBERTY DEVELOPMENT PROJECT SEISMIC LINE THROUGH WELL #2		
DATE: April 2007	SCALE: SEE SCALE BAR	FIGURE: 3-7

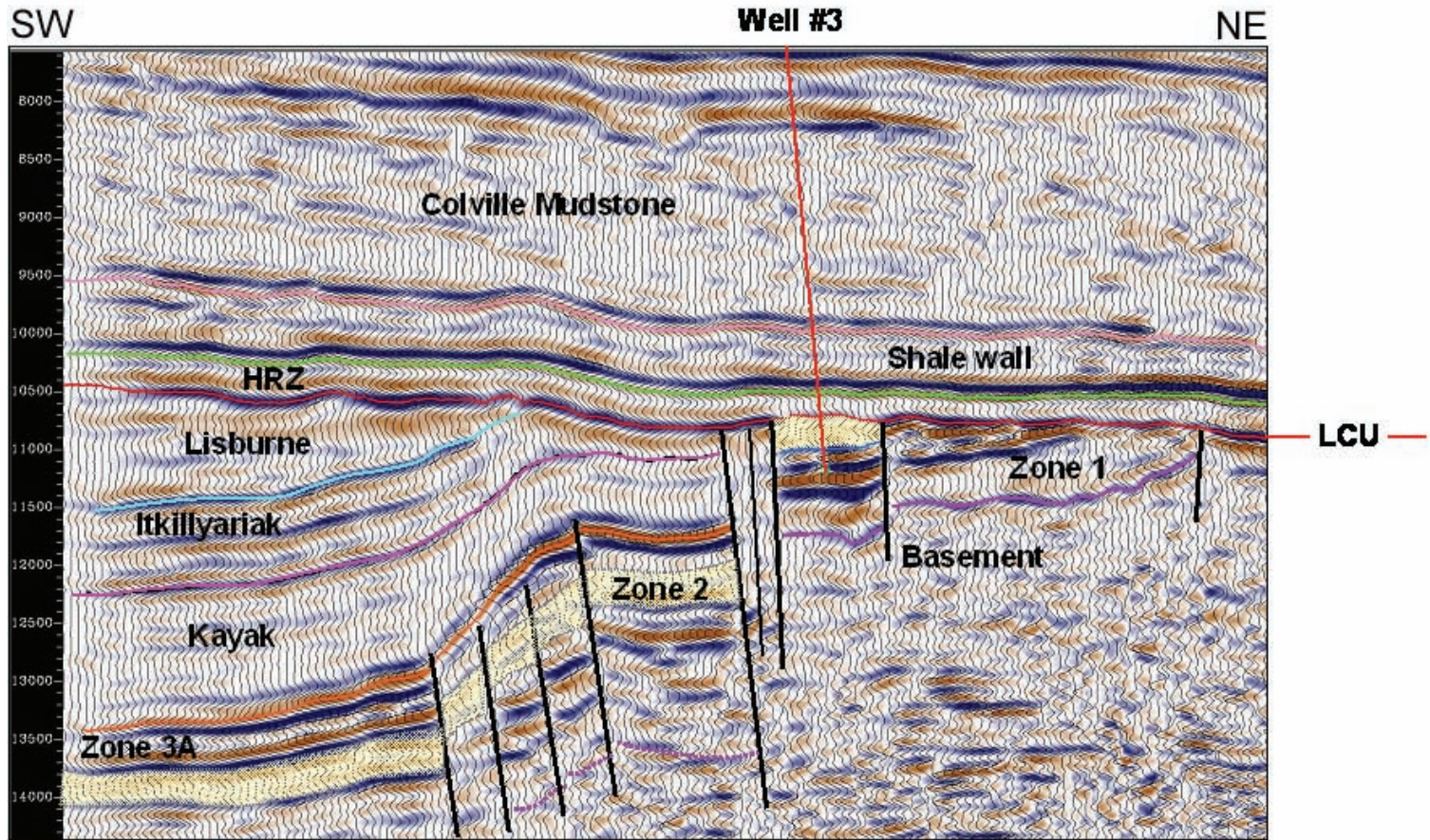

BP EXPLORATION (ALASKA) INC.		
LIBERTY DEVELOPMENT PROJECT SEISMIC LINE THROUGH WELL #3		
DATE: April 2007	SCALE: SEE SCALE BAR	FIGURE: 3-8

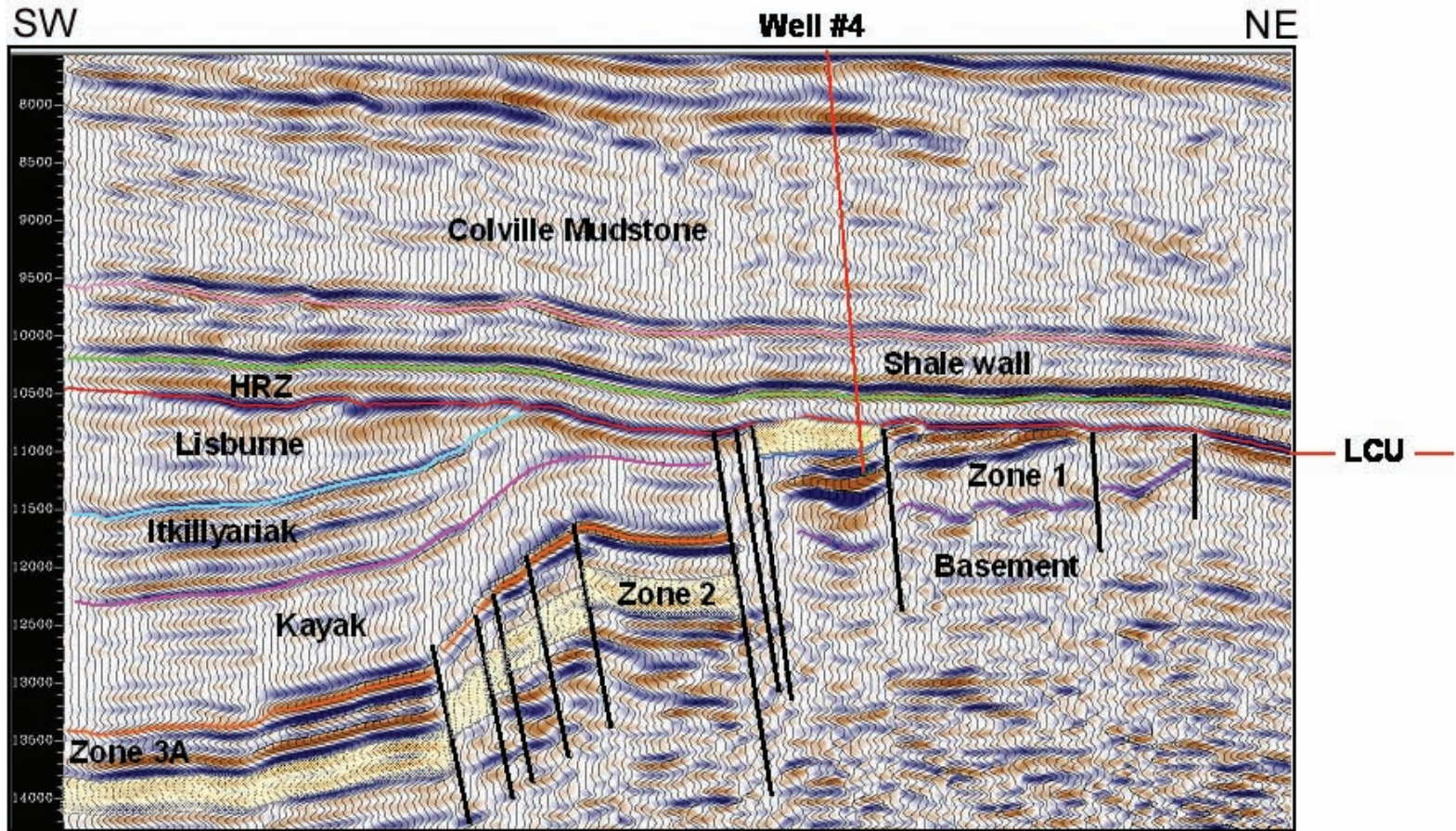

BP EXPLORATION (ALASKA) INC.		
LIBERTY DEVELOPMENT PROJECT SEISMIC LINE THROUGH WELL #4		
DATE: April 2007	SCALE: SEE SCALE BAR	FIGURE: 3-9

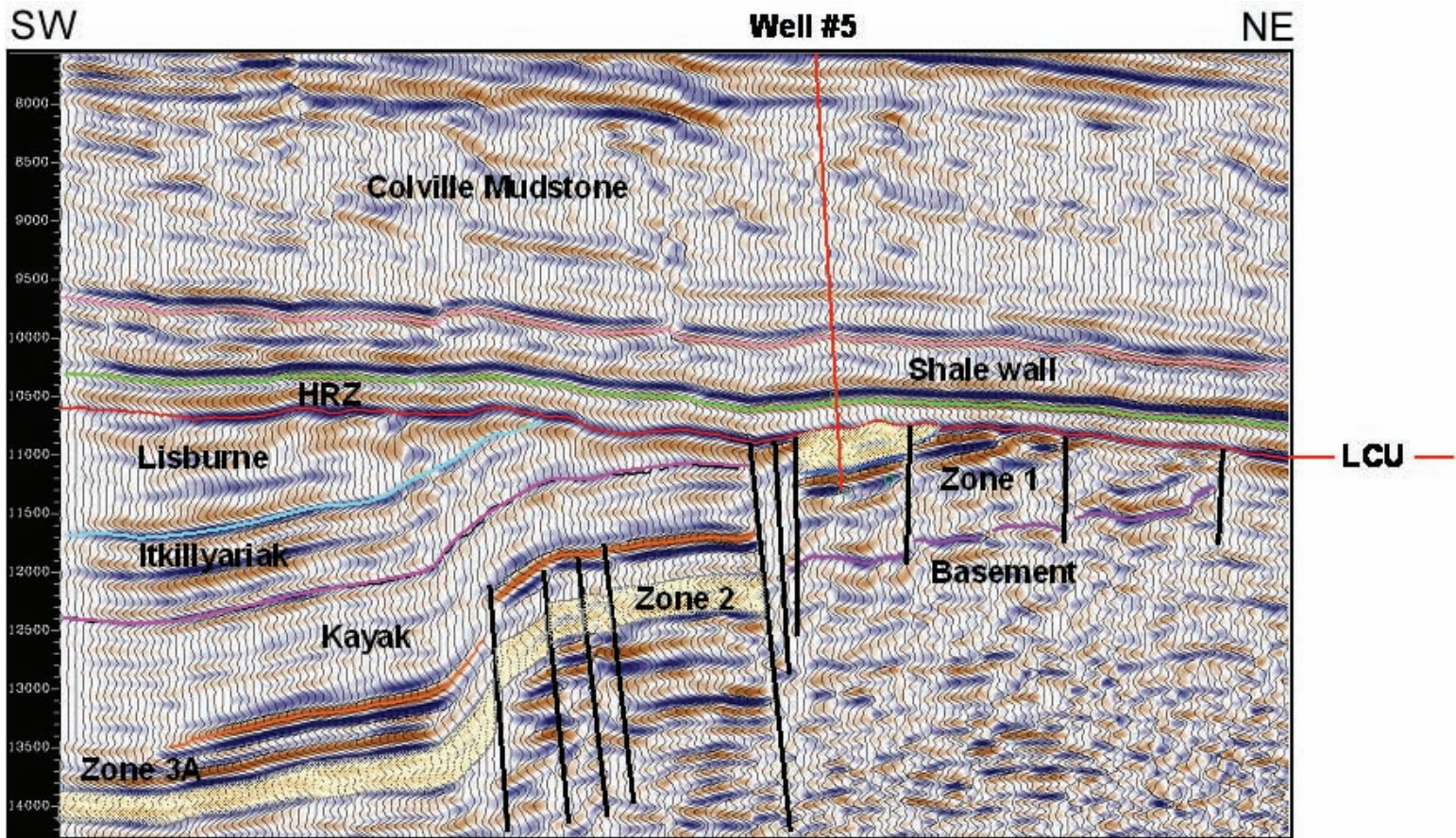

BP EXPLORATION (ALASKA) INC.		
LIBERTY DEVELOPMENT PROJECT SEISMIC LINE THROUGH WELL #5		
DATE: April 2007	SCALE: SEE SCALE BAR	FIGURE: 3-10

Liberty Development and Production Plan

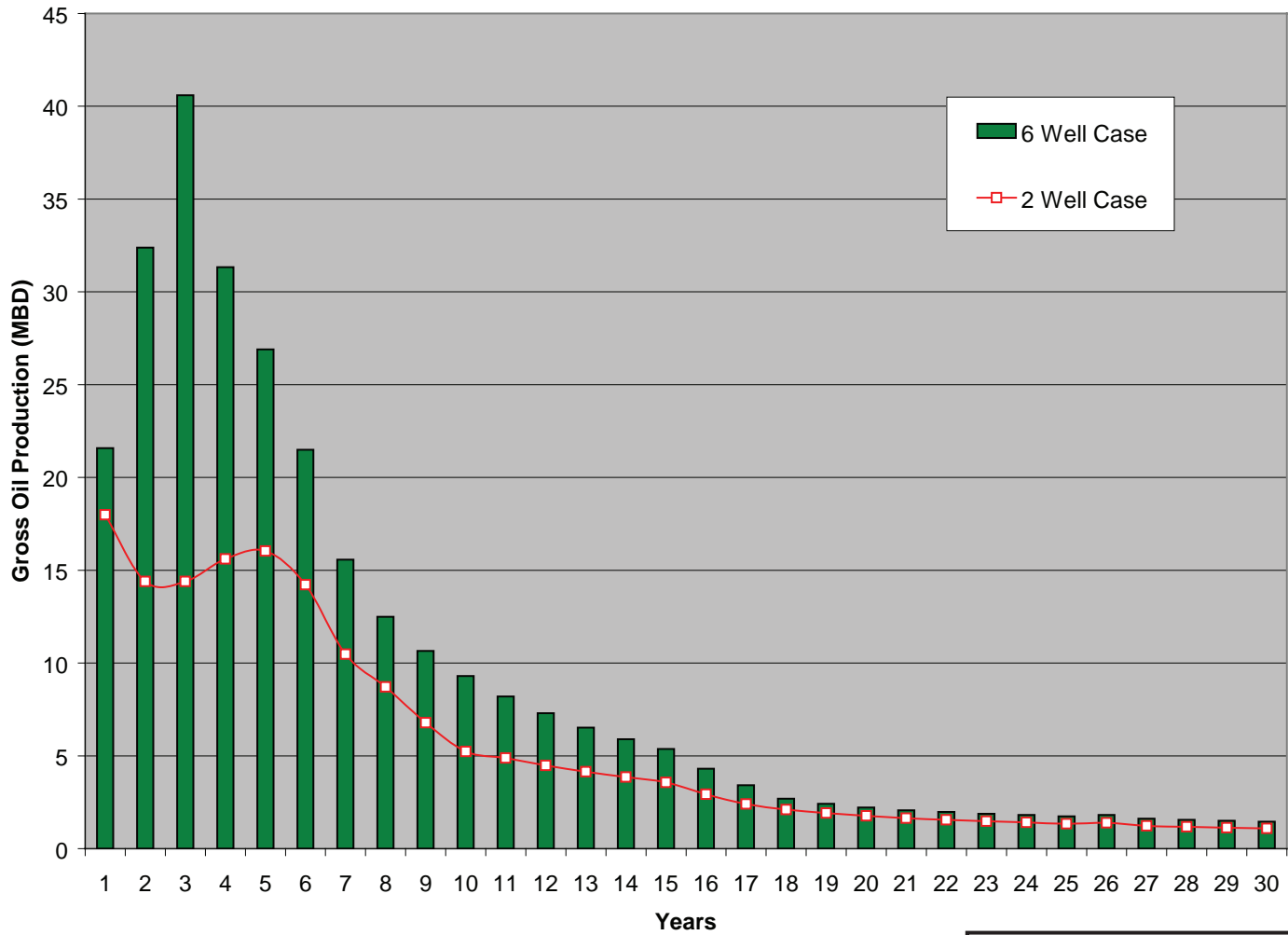

BP EXPLORATION (ALASKA) INC.		
LIBERTY DEVELOPMENT PROJECT PROJECTED ANNUAL AVERAGE GROSS PRODUCTION RATES		
DATE: April 2007	SCALE: None	FIGURE: 3-11

4. PROJECT ACCESS

Liberty Project transportation needs include safely transporting personnel, supplies, and equipment on a daily basis to and from the Satellite Drilling Island (SDI) during construction, drilling, and operations. During construction, quantities of pipe and gravel will be moved to the site. Drilling operations will require movement of a large quantity of pipe materials, heavy modules, chemicals, water, drilling mud, drill cuttings, and other supplies to and from the island. During ongoing field operations, limited equipment and supplies will be transported to the site. Table 4-1 summarizes basic project transportation needs and their frequency, while Table 4-2 provides the detailed requirements.

Equipment, supplies, and personnel will have access to and from the site via the existing Endicott road system, which connects with roads at Prudhoe Bay and with the Dalton Highway. Several different modes of transportation are currently available, and the following sections describe the basic features and limitations of each mode.

Before construction begins, a detailed emergency evacuation plan will be completed addressing all phases of the project.

Table 4-1
Liberty Project Transportation Needs

PROJECT ACCESS NEEDS	FREQUENCY	
	ONGOING	DISCRETE
Haul gravel from mine site to construction-site		X
Haul pipeline construction materials		X
Sealift for construction material and modules		X
Transport truckable production modules		X
Spill response. Includes mobilizing equipment and personnel to onshore and offshore locations as needed for containment and cleanup	X	
Transport supplies and equipment to the site	X	
Drill rig transport		X
Personnel transport	X	
Waste handling, including backhauling drilling waste, domestic waste, waste stored in barrels, and scrap to Prudhoe	X	

**Table 4-2
Estimated Liberty Transportation Requirements**

YEAR	<u>CONSTRUCTION</u>			<u>DRILLING AND PRODUCTION OPERATIONS</u>		
	Summer	Breakup/Freeze-up	Winter	Summer	Breakup/Freeze-up	Winter
2009	Transport construction materials to the SDI from Prudhoe using existing road system.	Transport construction materials to the SDI from Prudhoe using existing road system.	B70-class gravel haul trucks over ice road to SDI. Other construction materials over existing road system.	Transport truckable rig modules and drilling consumable materials, and backhaul drilling wastes to DS-4 using existing road system. Possible sealift of rig modules to SDI.	Transport truckable rig modules and drilling consumable materials, and backhaul drilling wastes to DS-4 using existing road system.	Transport truckable rig modules and drilling consumable materials, and backhaul drilling wastes to DS-4 using existing road system.
2010	Transport construction materials and truckable modules using existing road system.			Transport drilling consumable materials to the SDI and backhaul drilling wastes from the SDI to Prudhoe using existing road system.		
2011	Transport construction materials and truckable modules using existing road system.					
2012	Sealift of LoSa TM process and power generation modules to the MPI dock in August. Transport construction materials and truckable modules using existing road system.	Transport construction materials and truckable modules to the SDI from Prudhoe using existing road system.	Transport construction materials and truckable modules to the SDI from Prudhoe using existing road system.			
2013	N/A	N/A	N/A			
2014	N/A	N/A	N/A			
2015	N/A	N/A	N/A			

N/A = Not applicable

4.1 AIR ACCESS

No regularly scheduled helicopter access to the Liberty area is needed because the Liberty Development is proposed as an extension to the SDI and is accessible from the existing Endicott road system. There will be sufficient area for helicopter landing for emergency evacuation of personnel on the SDI.

4.2 ICE ROADS

Ice roads are commonly used on the North Slope for winter travel, typically from late December through mid-April. As described in more detail in Section 9, onshore and offshore ice roads will be built to support project construction, and in subsequent years, possibly to support drilling operations.

4.3 MARINE ACCESS

Significant marine traffic is not needed to support Liberty construction and operation. A sealift by barge is planned to transport the *LoSal*TM EOR process and power generation modules to the existing MPI dock. In addition, a dock may be provided in the SDI design as a contingency for providing marine access to the SDI for rig mobilization and demobilization. Extensive dredging is not expected to occur; however, some localized removal (e.g., screeding) of high spots on the seafloor may be required and will be determined by field survey.

4.4 ROAD ACCESS

The existing road system will provide access to Liberty facilities throughout the project. The West Sag River Bridge connecting the Endicott Road to the Prudhoe Bay road system provides access to the MPI and SDI from Deadhorse and other oilfield infrastructure, as well as the Dalton Highway, and is therefore a major transportation link for the project. However, due to the age of the bridge and the recent discovery of fatigue cracking, it cannot support the load and traffic requirements for Liberty. BPXA is evaluating whether to upgrade the existing bridge or build a new bridge upstream of the existing one (see Section 9.2.3).

The Liberty drilling rig is being designed in truckable modules for virtual year-round delivery. Following barging to Valdez from a fabrication site in the lower 48 states, approximately 460 tractor-trailerloads will be required via highway from Valdez to the SDI to transport the rig to the SDI drilling site for reassembly. The final rig mobilization plan will be developed as the rig construction schedule evolves and the fabrication site is chosen.

The existing road system will support the needs of Liberty uERD wells. Transportation of all drilling consumables, services, and support for Liberty will be similar to that for any other land-based project on the Prudhoe Bay road system. Because of the scale of each Liberty well, more of each product will be used per well, but the requirement will be spread over a much longer time. Thus, the daily traffic for moving drilling consumables will be about the same as for a typical North Slope well.

5. DRILLING PAD

The Liberty Project will extend the eastern and southern sides of the Satellite Drilling Island (SDI) by conventional gravel placement to support project drilling, production operations, and infrastructure support functions (Figure 5-1). The size of the SDI expansion is dictated primarily by the size of the drilling rig, storage requirements for drilling supplies, and a safe area for emergency evacuation and protection of workers.

The current working area of the existing SDI is approximately 11 acres, and the Liberty pad expansion will add approximately 20 acres of working area for facilities and drilling. Thus, the total combined working area will be 31 acres. Based on the slopes of the existing SDI and the expansion, the total footprint on the seabed of the expanded SDI will be approximately 40 acres versus the current 20 acres.

Island coordinates (NAD83) are 70°19'17.51"N, 147°51'34.8"W. The island extension will be located in approximately 4 to 11 feet of water. Table 5-1 summarizes the SDI island design features.

Table 5-1
Design Summary for Liberty Expansion of Endicott SDI

ITEM	DESCRIPTION
Surface Dimensions (approximate)	704 by 1,394 feet
Height (working surface)	13 feet above MLLW
Gravel Volume	860,000 cubic yards
Dock Size	150 by 160 feet
Rock Riprap for Slope Protection	Approx. 6,000 cubic yards

5.1 DRILLING PAD STRUCTURE

The extension of the SDI to accommodate the Liberty Project will be constructed of gravel from a new permitted gravel mine to the west of the Endicott Road; approximately 860,000 cubic yards of gravel will be required (see Section 9.2.2). The currently proposed island extension will have approximate surface dimensions of 704 feet by 1,394 feet, and the gravel will be placed within a sheet-piled perimeter wall as protection from summer wave action and winter ice loads (see Section 5.3 below). Consequently, the design bottom dimensions will be roughly the same as the surface dimensions for the north and east sides. Where the sheet piling merges with the existing island slope protection, large pieces of rock will be used as riprap to stabilize the transition from the sheet piling to the existing concrete mat slope protection.

The island will have a working surface elevation of 13 feet above mean lower low water (MLLW). The proposed sheet pile wall will protect the island from the erosive forces of waves, ice ride-up, and currents.

In the winter of 2006-2007, BPXA will conduct surveys and geotechnical investigations at potential mine sites and the SDI location. Bore holes will be drilled at the SDI to confirm the soils types, which are generally expected to be sands and gravels overlain by silts.

5.2 SDI SURFACE LAYOUT

The SDI surface layout is shown in Figure 5-1. Key to this layout is a single row of wells oriented north-south and offset from the existing SDI well rows by approximately 200 feet. The well row will start approximately 250 feet north of the southern end of the gravel expansion and will include 10 well slots (including spare slots), with the slots on 30-foot centers. The drilling rig will be capable of moving up and down the well row to access the desired well. The new Liberty wells will be tied into production, test, and water injection headers, which will in turn be tied into the existing SDI production test and injection headers.

The east side of the SDI expansion is dedicated to drilling. Much of the work surface area on the island is for storage of drilling consumables. The SDI has road access to the Prudhoe Bay drilling infrastructure for re-supply of drilling consumables.

Surface facilities that will be located on the SDI will include the following:

- Pipe rack and well tie-in piping
- Fuel-gas conditioning skid
- Booster pumps for high-salinity water injection
- Electrical transformer and switchgear
- Control room
- Transformer module for the electrical submersible pump variable frequency drive (ESP VFD)
- *LoSal*TM pipeline pig-launcher module
- *LoSal*TM EOR process injection pumps

The fuel-gas conditioning skid and the booster pumps for high-salinity water injection will be located to the north of the Liberty header tie-in to the existing Endicott pipe rack, while the *LoSal*TM EOR process injection pumps will be located south of the existing Endicott SDI Module 405 on the south side of the existing pipe rack. The electrical transformer and switchgear and ESP VFD transformer module and the pig launcher module will be located south of Module 405 on the west side of the existing pipe rack.

5.3 CIVIL CONSTRUCTION

Construction will commence during the winter of 2009. An ice road will be constructed along the west side of the Endicott Road in order to establish a traffic loop between the gravel mine site and the SDI for gravel hauling. The ice road will pass under one of the Endicott Causeway bridges depending on water depth.

The SDI island slope protection will be removed from the east side of the existing island. This will occur progressively as gravel is dumped and pushed outward by front end loaders just beyond the intended expanded island perimeter. Gravel dumping and placement will continue until the whole footprint is complete. The island surface will be overbuilt to allow for settlement during the first summer.

A new gravel mine will be blasted and excavated just to the north of the existing Duck Island mine site (see Section 9.2.2). Vegetation and overburden will be stripped separately and stockpiled for restoration purposes. The gravel layer will be mined and hauled to the SDI using B70 haul units or similar.

Gravel will be hauled and dumped to build up the initial surface to approximately 1 to 2 feet above sea level. A vibratory roller will be used to provide initial compaction and provide a working surface for traffic. A mound of gravel will be stockpiled at the southwest corner of the island for eventual use for grading after the island has seasoned for the first summer. The existing slope protection on the east side of the SDI would be removed immediately prior to placing gravel.

Sheet piling would commence on the north side of the SDI, progress east and then south, and terminate at the southeast corner of the island expansion. The south end of the new island extension would not be sheet piled as it is not affected by ice or erosion forces. The sheet pile wall would be driven by a vibratory hammer to create an interlocking open-cell sea wall. Construction equipment would be supported on wooden mats. Additional gravel would be filled in behind the sea wall, which would be terminated at 13 feet above the MLLW sea level. A vibra-compaction roller would be used to consolidate the fresh gravel lift as placement progresses.

The gravel island will be over-built and allowed to settle during the summer after the placement of gravel. The gravel will be machine-graded during the summer to encourage settlement before the drilling equipment arrives on-site. If required, additional gravel will be hauled to the pad to make up for any localized settlement that may occur. The new island will be graded to integrate the surface drainage with the existing SDI drainage system, and a perimeter road will confine surface water drainage inside the island (see Figure 10-1).

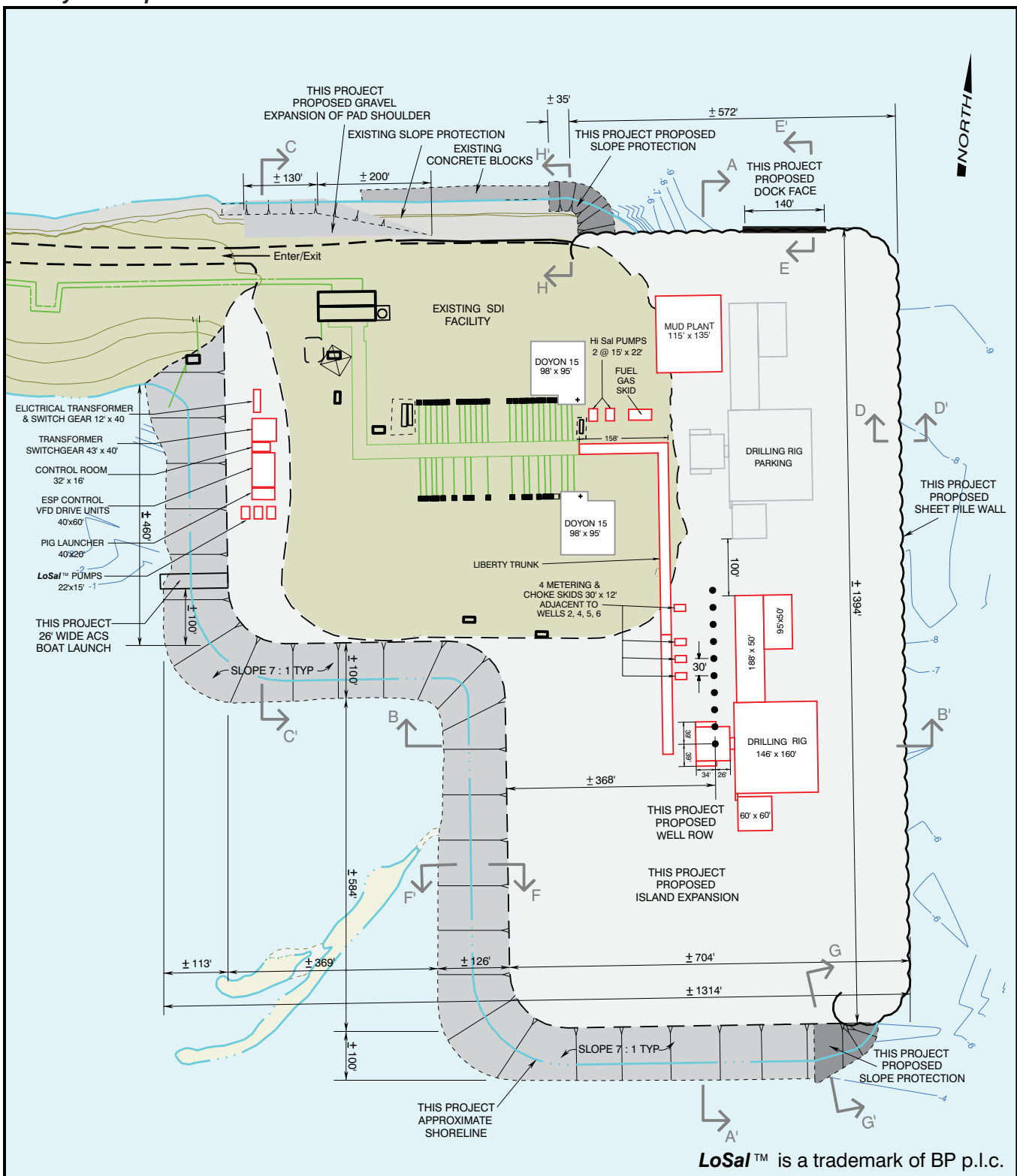

LoSal™ is a trademark of BP p.l.c.

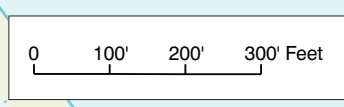

APPROXIMATE TIDE RANGE 9 INCHES
 APPROXIMATE ISLAND EXPANSION FOOT PRINT 20 ACRES
 APPROXIMATE ISLAND EXPANSION FILL QUANTITY 860,000 CY
 APPROXIMATE SLOPE PROTECTION ARMOR ROCK 6,000 CY

BP EXPLORATION (ALASKA) INC.
LIBERTY DEVELOPMENT PROJECT
SATELLITE DRILLING ISLAND
PROPOSED EXPANSION
GENERAL PLAN

DATE: April 2007	SCALE: SEE SCALE BAR	FIGURE: 5 - 1
---------------------	-------------------------	------------------

NORTH

SOUTH

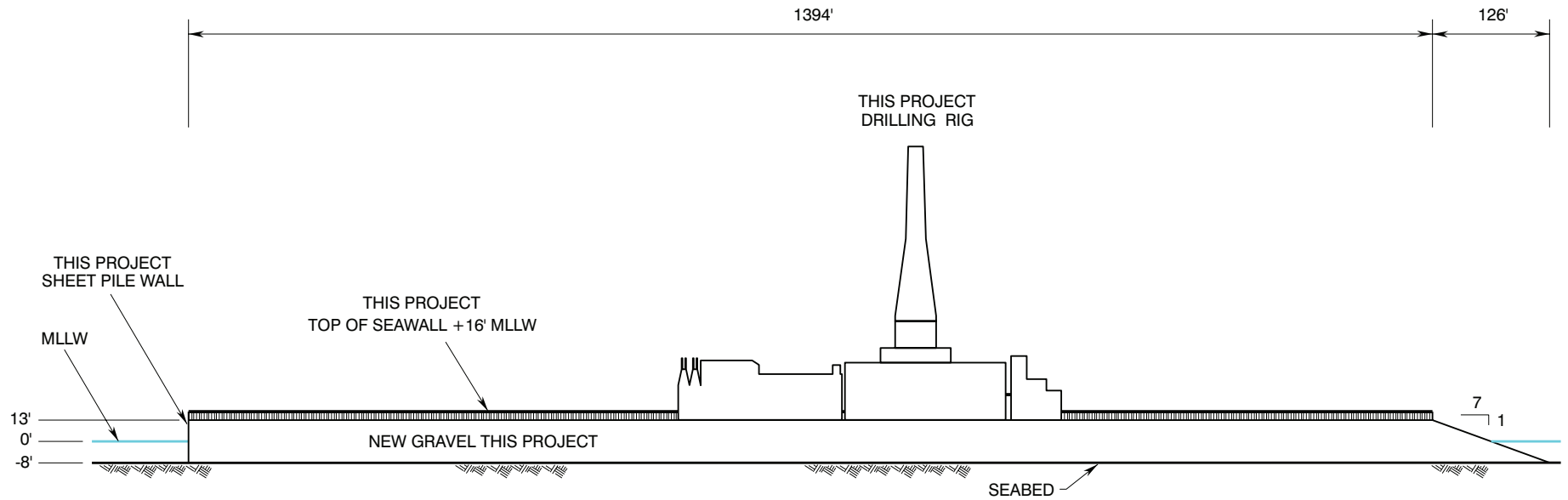

SIDE VIEW A-A'

PAD SURFACE +13 MLLW
 APPROXIMATE TIDE RANGE IS 9 INCHES
 DIMENSIONS AND LOCATIONS OF FACILITIES
 AND ISLAND EXPANSION ARE APPROXIMATE

BP EXPLORATION (ALASKA) INC.

LIBERTY DEVELOPMENT PROJECT
 SATELLITE DRILLING ISLAND
 PROPOSED EXPANSION
 CROSS-SECTION

DATE:
 April 2007

SCALE:
 NOT TO SCALE

FIGURE:
 5 - 2

Liberty Development and Production Plan

WEST

EAST

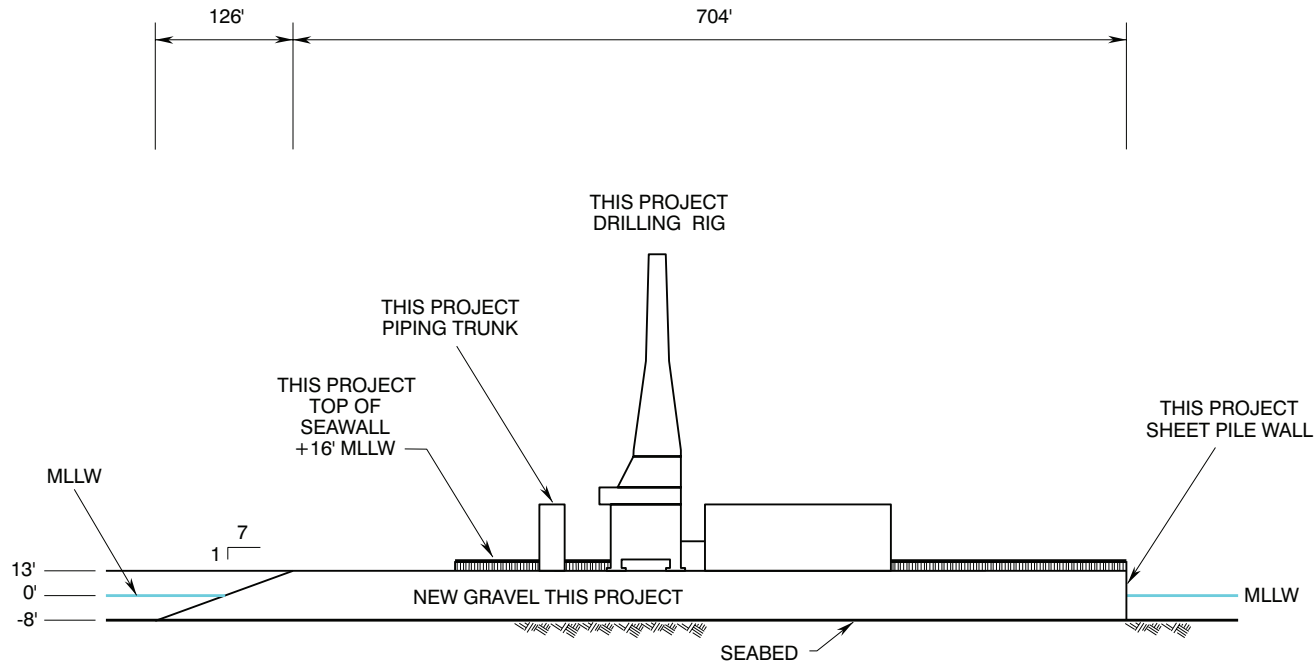

SIDE VIEW B-B'

PAD SURFACE +13 MLLW
 APPROXIMATE TIDE RANGE IS 9 INCHES
 DIMENSIONS AND LOCATIONS OF FACILITIES
 AND ISLAND EXPANSION ARE APPROXIMATE

BP EXPLORATION (ALASKA) INC.		
LIBERTY DEVELOPMENT PROJECT SATELLITE DRILLING ISLAND PROPOSED EXPANSION CROSS-SECTION		
DATE: April 2007	SCALE: NOT TO SCALE	FIGURE: 5 - 3

NORTH

SOUTH

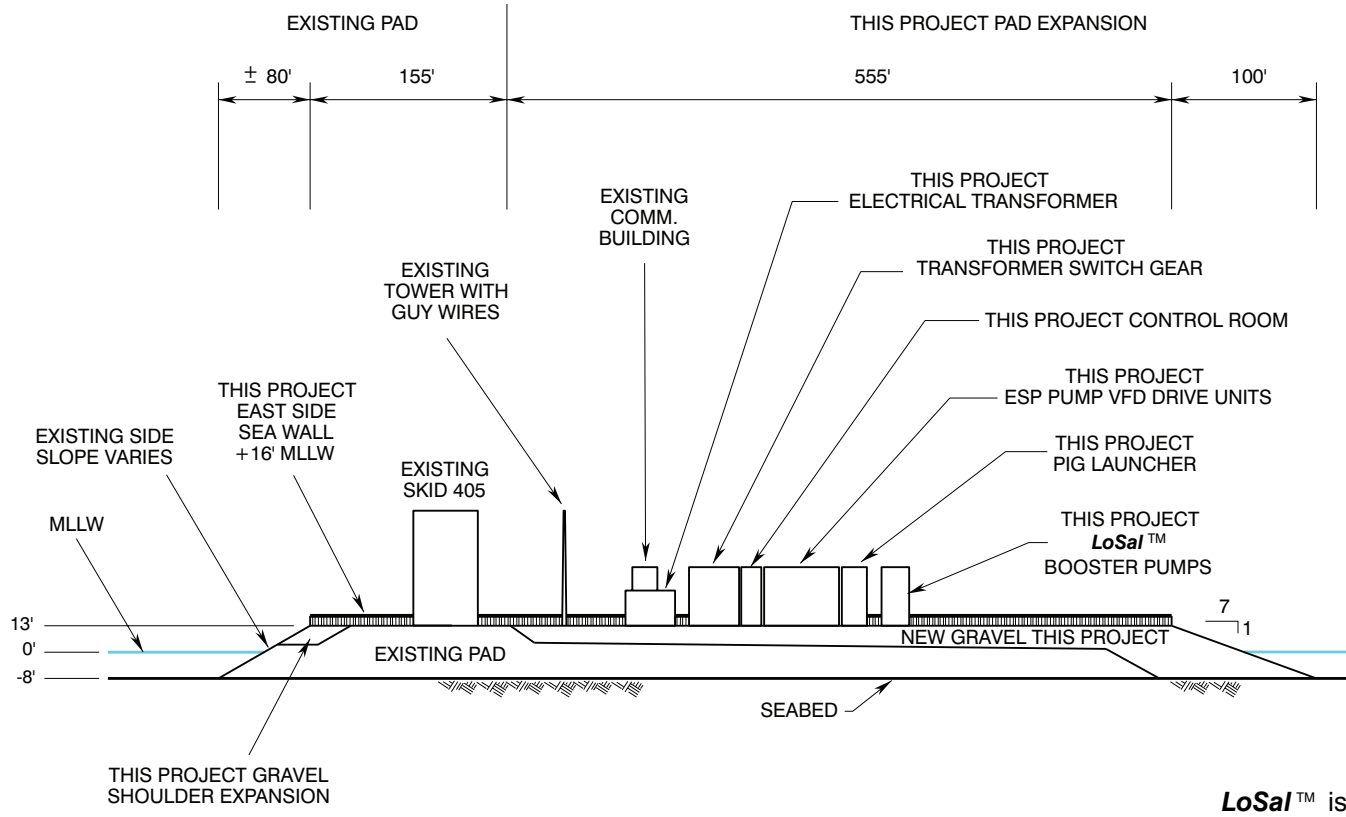

SIDE VIEW C-C'

PAD SURFACE +13 MLLW
 APPROXIMATE TIDE RANGE IS 9 INCHES
 DIMENSIONS AND LOCATIONS OF FACILITIES
 AND ISLAND EXPANSION ARE APPROXIMATE

BP EXPLORATION (ALASKA) INC.

**LIBERTY DEVELOPMENT PROJECT
 SATELLITE DRILLING ISLAND
 PROPOSED EXPANSION
 CROSS-SECTION**

DATE: April 2007	SCALE: NOT TO SCALE	FIGURE: 5 - 4
---------------------	------------------------	------------------

Liberty Development and Production Plan

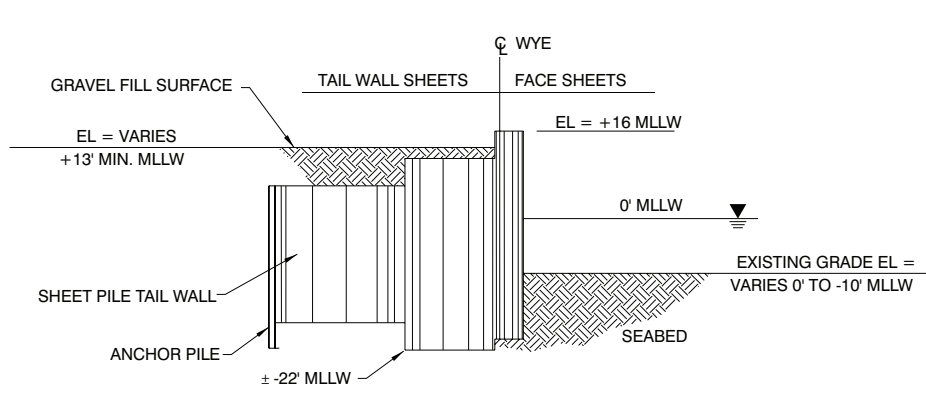

TYPICAL SHEET PILE CROSS SECTION D - D'
(NEW CONSTRUCTION THIS PROJECT)

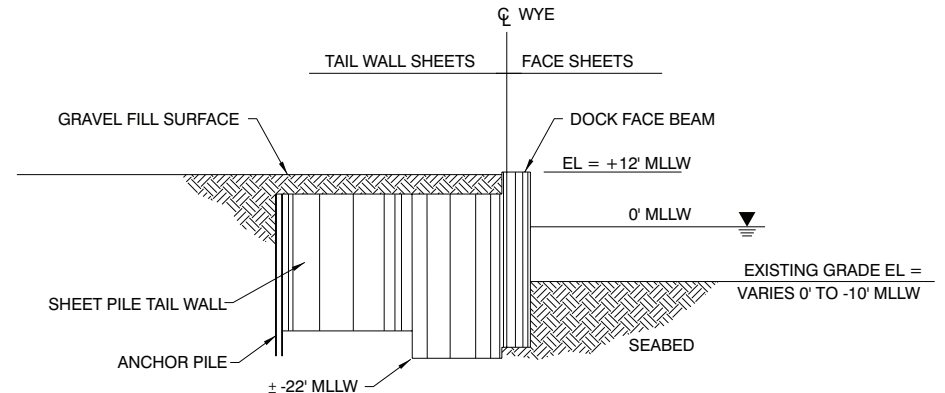

TYPICAL SHEET PILE CROSS SECTION E - E'
(NEW CONSTRUCTION THIS PROJECT)

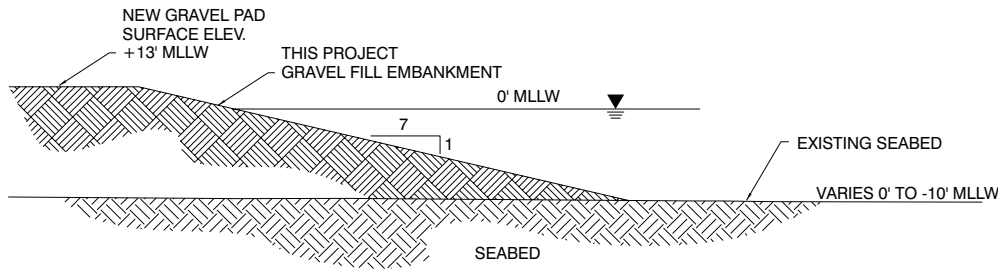

TYPICAL GRAVEL SLOPE CROSS SECTION F - F'

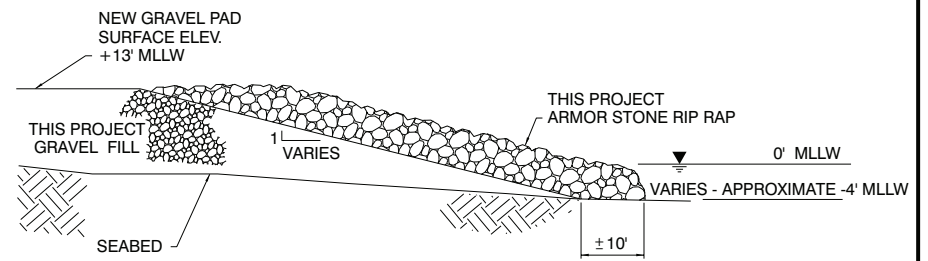

TYPICAL SLOPE PROTECTION CROSS SECTION G - G'

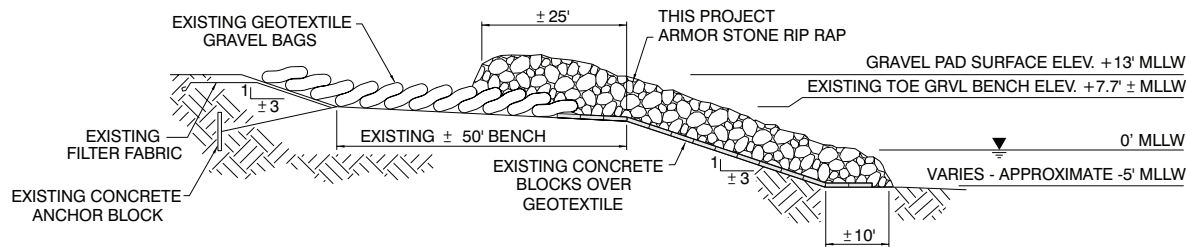

TYPICAL SLOPE PROTECTION CROSS SECTION H - H'

BP EXPLORATION (ALASKA) INC.

**LIBERTY DEVELOPMENT PROJECT
SATELLITE DRILLING ISLAND PROPOSED
EROSION CONTROL SECTIONS**

DATE:
April 2007

SCALE:
NOT TO SCALE

FIGURE:
5 - 5

6. FACILITIES

6.1 DESIGN BASIS

Table 6-1 lists the design capacities and specifications for the proposed Liberty facilities. Liberty oil is a medium-gravity crude with an API gravity of 27°, a solution-gas-to-oil ratio of approximately 800 to 900 standard cubic feet per stock tank barrel (scf/stb), and a carbon dioxide content of approximately 7 to 8 percent in the reservoir fluid (12 percent in the separated gas phase). Liberty facilities will be designed using the National Association of Corrosion Engineers (NACE) standards for hydrogen sulfide content, and the wet gas piping will be constructed of duplex stainless steel for carbon dioxide content.

Additional Liberty facilities will be designed to handle peak rates up to 55,000 barrels of oil per day along with associated gas and water to the existing Endicott host facilities for processing to sales-quality crude oil. To support production, waterflood will be used, initially with produced water and later with low-salinity water [*LoSal*[™] enhanced oil recovery (EOR) process water]. Liberty produced gas will be dehydrated and compressed in the existing Endicott facilities, and used for Liberty fuel gas and Liberty lift gas. The net Liberty gas will be re-injected into the Endicott reservoir. Produced water and seawater from Endicott will be used for waterflood injection.

Table 6-1
Liberty Design Capacities and Specifications

DESIGN	ITEM	DESIGN CAPACITY/SPECIFICATIONS
Production	Oil	55,000 barrels per day (bpd)
	Produced Gas	50 million standard cubic ft per day (scfd) maximum
	Produced Water	55,000 bpd
Injection	High-Salinity Water	70,000 bpd at 4,400 psig
	<i>LoSal</i> [™] EOR Water	50,000 bpd at 4,400 psig
	Gas-Lift Requirement (future)	20 million scfd at 2,800 psig
Single Well	Maximum Oil Flow	20,000 bpd
	Associated Gas At Maximum Oil Flow	18 million scfd
	Maximum Produced Gas	25 million scfd
Product Specifications	Sales Oil (delivered as a commingled oil stream from Endicott production facility)	TVP 14.2 psia maximum, 0.35 percent BS&W delivered to TAPS at 105°F to 142°F, 85 psig minimum

BS&W = basic sediments and water; psia = pounds per square inch absolute; psig = pounds per square inch gauge; TVP = true vapor pressure

The design reservoir temperature is 223°F and the pressure is 5,200 pounds per square inch absolute (psia). The surface flowing temperature will vary over time depending on gas-to-oil ratio, water cut, and oil rate, but is expected to be between 140°F and 180°F. Flowing wellhead pressure will vary from well to well over the life of the project, with an expected range of 350 to 500 psig depending on water cut and gas-to-oil ratio. Wellhead shut-in pressure will be less than 5,000 psig.

Three-phase production (crude oil, gas, and water) from the Liberty production facility will be commingled with Endicott three-phase production and processed in the Endicott facilities. The processed commingled crude stream will be metered, sampled, and then transported to the Trans Alaska Pipeline System (TAPS) via Endicott pipelines (see Section 6.3).

6.2 OIL AND GAS PROCESS SYSTEM

Oil and gas from Liberty production will be processed using the existing Endicott production facilities based on a facility sharing agreement with the Endicott owners. Only minimal modifications are planned for Endicott facilities to optimize both Liberty and Endicott production. Figure 6-1 describes the Liberty process and Liberty tie-ins to the existing Satellite Drilling Island (SDI) facilities.

Because of the carbon dioxide content of Liberty crude oil, duplex corrosion-resistant-alloy (CRA) piping will be used for well production lines and production headers. Endicott oil also has a high carbon dioxide content, and well lines, headers, and the main production flowline are constructed of duplex stainless steel. Endicott also uses stainless steel piping for all wet gas services, and all Endicott production separators are either internally coated or clad with stainless steel for corrosion protection.

6.2.1 Oil Separation

The wellhead crude oil mixture (oil, water, and gas) will flow from the Liberty producing wells into a Liberty production header which will be tied into the existing production header on the SDI. Liberty production fluids will be commingled with Endicott production fluids and routed to the existing Endicott production facility on the Main Production Island (MPI) through an existing 28-inch-diameter duplex-stainless-steel production flowline. The commingled fluid will then be treated in the existing Endicott separation and crude and gas conditioning system to produce a metered stock tank oil stream, a metered compressed gas stream, and a produced water stream. All three streams will consist of commingled Liberty and Endicott ownership. See Figure 6-1.

6.2.2 Produced Water Treatment

Produced water separated from Liberty crude will be commingled with the Endicott produced water in the Endicott flowline and the processing facility. Following treatment to remove oil, the water will be pumped and reused in the waterflood injection program for both Liberty and Endicott. Supplemental water needed for injection will come from the existing seawater treatment plant (STP).

6.2.3 Liberty Water Injection

Liberty production will be supported by waterflood using two types of water: high-salinity water — which is a mixture of recycled produced water and additional seawater as required to achieve the desired injection rate — and low-salinity water which has been processed through a reverse osmosis plant to reduce the salinity of the water to enhance oil recovery. The *LoSal*[™] EOR process is described in Section 6.4 below.

High-salinity injection water (produced water) will be supplied from the existing water injection header on the SDI, and the maximum injection rate will be 70,000 bbl/day. The high-salinity water will be boosted in pressure from the existing header pressure of approximately 2,400 psig to 4,400 psig for injection into Liberty wells via new electric-driven booster pumps installed on the SDI.

The *LoSal*[™] EOR water supply will come from the *LoSal*[™] EOR water process plant to be located at the MPI. The water will be pumped from the MPI to the SDI through a new 10-inch-diameter carbon-steel pipeline. The water will be routed to the suction of the *LoSal*[™] EOR booster pumps where the pressure will be boosted from approximately 300 to 4,400 psig for injection into Liberty wells. The discharge of the booster pumps will be routed to a new *LoSal*[™] EOR header in the Liberty pipe rack and then to the injection wells.

6.2.4 High-Pressure Gas Lift

High-pressure gas lift at an expected maximum rate of 20 million standard cubic feet per day (scfd) will be supplied from a tie-in to the existing 4,500-psig gas injection header on the MPI. The pressure of the gas lift will be reduced to approximately 2,800 psig at the MPI and routed via a new 6-inch-diameter pipeline to the SDI, where the pipeline will tie into a new high-pressure gas-lift header in the Liberty pipe rack.

6.2.5 Fuel Gas

The Liberty Development will consume two fuel-gas streams:

- Fuel gas used by drilling operations,
- Fuel gas used by the Endicott process facility to process Liberty fluids and to meet the Liberty utility requirements, and
- Fuel gas used by the new turbine generator described in Section 9.1.

The fuel gas used by the drilling rig will be supplied from the existing SDI gas-lift header. This stream will be metered and routed to a fuel-gas skid where the pressure will be reduced from approximately 2,100 psig to approximately 100 psig to fire the rig electrical generators and rig boilers. The total fuel gas consumed at the MPI process facility is also metered and reported daily. To determine the Liberty fuel-gas allocation at the MPI, a methodology will be established and agreed to by the Minerals Management Service (MMS), Alaska Oil and Gas Conservation Commission (AOGCC), Duck Island Unit owners, and BPXA (as the sole Liberty owner) which will apportion the total fuel gas to the Liberty and non-Liberty owners based on the process fluid rates for each. The total Liberty fuel gas will be the sum of these two streams and will be reported daily.

6.3 LIBERTY WELL TESTING AND PRODUCTION ALLOCATION METERING

The Liberty well production stream will be commingled on the surface with the Endicott well production stream prior to separation and final sales-oil metering. The Liberty Project will submit a written application to the MMS Regional Supervisor to commingle the production from the Liberty leases with the production from the existing Duck Island Unit (State of Alaska leases), which is currently produced through the Endicott facility. Similar application for commingling production will be made to the AOGCC, Alaska Department of Revenue, and Alaska Department of Natural Resources.

6.3.1 Well Testing

For well testing, each individual Liberty well will be continually metered by multi phase flow meter (MPFM) and will meet the requirement of 30 CFR 250.1204 for surface commingling and will be approved by MMS.

6.3.2 Crude Oil Allocation Metering

The Liberty project proposes continuous MPFM on each Liberty well for daily Liberty crude oil production allocation. The MPFM will be installed downstream of the well control choke. These meters will be installed, operated, and maintained in accordance with vendor recommendations and API Recommended Practice (RP) 85 and API RP 86. Crude oil allocation will be as follows: the multi phase flow meters on the Liberty well will have an allocation factor of “one,” and the sum of these meters determines the Liberty oil rate on a daily basis. The non-Liberty oil rate will be determined by subtracting the Liberty oil rate from the Endicott pipeline crude oil meter. The current allocation method between TAPS Pump Station 1 (PS 1) and Endicott will continue to be used. The Liberty MPFM systems will be periodically checked via operation in series with the existing SDI well test separator (see Figure 6-3).

A final oil allocation methodology for Liberty will require agreement with the MMS, the AOGCC, Alaska Department of Revenue, Alaska Department of Natural Resources (as Duck Island royalty holder), the Duck Island Unit owners, and BPXA (as the sole Liberty owner).

6.3.3 Gas Allocation Metering

Allocation of Liberty produced gas will be provided by the MPFM system methodology described above. Lift gas and fuel gas used in the Liberty operation at the SDI will be metered by conventional gas meters located at SDI and totalized daily. Gas consumed at the MPI for processing Liberty fluids is described above in Section 6.2.5. The daily Net Liberty gas allocation is described below:

$$\text{Net Liberty Gas} = \text{MPFM gas rate} - \text{gas lift rate} - \text{SDI fuel gas} - \text{MPI fuel gas consumed}$$

6.3.4 Multi Phase Flow Meter Technology

Selection of a MPFM for the Liberty application requires understanding the range of gas-to-oil ratio, gas volume fraction, and the API gravity of the Liberty crude and the expected temperature and pressure at the metering point. The expected conditions for Liberty are shown in Table 6-2 below. The Liberty Project studied MPFM technology and selected a meter which has proven reliable over the expected range of Liberty conditions when the system is installed,

operated, and maintained in accordance with vendor and API recommendation. The exact configuration of the meter(s) installation is the subject of continued engineering. The final configuration of the Liberty metering system will be approved by MMS, AOGCC, the Alaska Department of Revenue, and the Alaska Department of Natural Resources.

Table 6-2
Multi Phase Flow Metering Conditions

PARAMETER	VALUE
API Gravity	27°
Oil Viscosity Range	2.5 to 4.5 centipoise
Solution Gas- to-Oil Ratio	800 to 900 scf/bbl
Gas Volume Fraction Range	0.8 to 0.89
Water Cut	0 to 98%
Metering Pressure	350 to 500 psig
Metering Temperature	140°F to 180°F

6.3.5 Sampling and Calibration for a MPFM

Accuracy of a MPFM depends significantly on the input fluid properties and determination of the meter attenuation based on the individual fluids. Liberty well samples will be collected on a periodic basis to determine the physical properties of the Liberty oil and the pressure-volume-temperature (PVT) relationship of the oil. Samples will be taken periodically to determine the oil's quality.

The measured properties are then used to tune an equation-of-state model in the MPFM software and generate fluid properties at various pressures and temperatures in a data table. The data table is then used in the MPFM software to determine the flow rates of oil, gas and water at standard conditions.

6.4 *LoSal*TM ENHANCED OIL RECOVERY PROCESS FACILITIES

The Liberty *LoSal*TM EOR process plant will be located on the Endicott MPI and will have the capacity to produce 50,000 bpd of *LoSal*TM EOR water. Figure 6-2 shows the process flow for the *LoSal*TM process plant, and Figure 6-4 identifies the location of the new *LoSal*TM process modules as well as the existing Endicott seawater treatment plant (STP). The plant will use up to approximately 120,000 bpd of filtered seawater from the Endicott STP. The feed water from the STP seawater heater will be pumped to approximately 200 psi and pass through the micro-filtration (MF) membranes to remove fine solids which could plug the reverse-osmosis (RO) membranes. The water from the MF membranes will then flow to the existing Endicott deaerator for removal of dissolved oxygen and from there to the RO feed pumps, which will increase the pressure of the water stream approximately 1,200 psi to pass through the RO membranes.

The feed water to the RO membranes will have a total dissolved solids (TDS) concentration of approximately 36,000 mg/l (which will vary during spring breakup). This will then pass through the first and second stage of the RO membranes. The product (*LoSal*TM EOR water) from the RO membranes will have a TDS of approximately 200 to 500, and the concentrated reject stream will have a TDS of approximately 60,000 to 70,000. The *LoSal*TM EOR water will

then be pumped to approximately 300 psi and routed by a new 10-inch-diameter pipeline to the SDI *LoSal*TM EOR booster/injection pumps.

The *LoSal*TM process will generate three additional streams during normal operations:

- A high total suspended solids (TSS) stream from the MF unit,
- The brine reject from the RO units, and
- Chemical cleaning solution required periodically of cleaning the MF and the RO units.

The RO membrane reject stream is the largest of these streams at approximately 50,000 bpd. Reuse of this stream is being considered in the expansion of the Endicott waterflood program.

6.5 HOST FACILITY SELECTION AND MODIFICATIONS

Endicott will be the host facility for processing all Liberty fluids in conjunction with Endicott produced fluids. The expected oil production rate from the Liberty Development is within the existing capacity of the Endicott facilities, and only minor facility modifications are required. The compositions of the Endicott and Liberty production fluids are very similar, both having high carbon dioxide content. Liberty/Endicott crude compatibility tests are currently being completed.

The Endicott production flowlines and plant internals are constructed of duplex stainless steel for production and 316L stainless steel for all wet-gas service. In addition, all main process vessels are internally clad with stainless steel, and other tanks are internally coated for corrosion protection. These corrosion-resistant materials are considered the correct materials for the Liberty production fluids, and no further materials upgrades are necessary for Endicott.

6.6 PROCESS SAFETY SYSTEMS

The key concept for the basic process control systems and safety instrumented systems is segregation including the field devices, data highway, and the programmable logic controller (PLC) or other field control devices. All of the Liberty process controls will be tied into the existing Endicott control systems.

The primary shutdown device will be the remote-actuated wellhead surface safety system (the surface safety valve and the well wing valve). These valves will be automated and will stop the flow from a Liberty production well when actuated by the Endicott shutdown system or by the operator. In addition, an automated shutdown valve actuated by the Endicott shutdown system will be installed in the main Liberty production header to isolate the header. All production wells will be equipped with subsurface safety valves.

All well shutdown and safety systems associated with wells penetrating MMS leases will comply with 30 CFR 250 Subpart H and API RP 14C, "Design, Installation and Testing of Surface Safety Systems for Offshore Production Platforms." To help assure safe operation of the facilities, complete piping and instrument diagrams and safe charts will be developed.

6.7 CHEMICALS

Tables 6-3 and 6-4 below describe the chemicals that may be used by the Liberty development. Table 6-3 describes the chemical and the estimate dosage which may be used in the *LoSal*TM EOR process; the volumes to be stored have not yet been determined. Table 6-4 describes chemicals and approximate dosage rates currently used for production at the SDI. These chemical will be available for Liberty use. The Liberty Development will not install

separate storage volumes on the SDI for these chemicals but will rely on the existing Endicott storage and injection systems to meet any Liberty requirement.

Table 6-3
Chemical Storage at the LoSa™ EOR Process Plant
 (TBD = to be determined)

PRODUCT	DESCRIPTION	TYPICAL USE CONCENTRATION	VOLUME	STORAGE VOLUME
PC-191	Broad-spectrum antiscalant for moderate to high scaling	1 to 2 ppm (0.75 ppm recommended)	126 to 252 gal/month (94.5 gal/month recommended)	TBD
PC-306	Clarification aid for sea and surface water for use in the clarifier	0.5 ppm (RO suggested max. use limit)	63 gal/month	TBD
PC-11	Non-oxidizing biocide (DBNPA); primary biocide for preventing biological growth in the reverse-osmosis (RO) and micro-filtration (MF) membranes	100 ppm for 30 minutes	8.75 gal/treatment (~528 gal/month)	TBD
Sodium Hypochlorite	Back up oxidizing biocide; primary biocide for preventing biological growth in the RO and MF membranes	0 to 2 ppm free	388 gal/day (17,516 gal/month)	TBD
Potassium Hypochlorite	Back up oxidizing biocide; primary biocide for preventing biological growth in the RO and MF membranes	0 to 2 ppm free	~142 lb/month	TBD
NaOH	Sodium hydroxide to adjust the pH of the membrane cleaning solution	3%	1,585 gal/month for MF	TBD
Citric Acid	Citric acid to adjust the pH of the membrane chemical cleaning solution	3%	1,585 gal/month for MF	TBD
PC-87	Strong acid cleaner - phosphoric acid blend for removal of CaCO ₃ scale and iron oxide	Process specific 5.0% typical	93 gal/cleaning (~837gal/month)	TBD
PC-98	Strong alkaline cleaner (tetrasodium EDTA and laurel sulfate surfactant) for removal of organic debris and biofouling of RO membranes.	2% to 4 %	37 to 74 gal/cleaning (~333 gal/month)	TBD
PC-33: Alternate	Sequestrant injection for treatment and removal of acid-insoluble scale in RO and MF membranes	2% to 2.5%		TBD
PC-67: Alkaline Alternate	Mild anionic surfactant alkaline cleaner; alternate for P-98 above	1% for UF 1 to 2% for RO / NF		TBD

Table 6-3 (Cont'd)
Chemical Storage at the LoSa™ EOR Process Plant
 (TBD = to be determined)

PRODUCT	DESCRIPTION	TYPICAL USE CONCENTRATION	VOLUME	STORAGE VOLUME
PC-77 - Acid Alternate	Mild acidic cleaner; alternate for P-87 above	4% for 2 hours		TBD
Sodium Bisulfite	Oxygen scavenger injected downstream of the deaerator to assure the LoSa™ EOR water meets the dissolved oxygen specification	16.4 ppm sodium bisulfite for 1 ppm dissolved oxygen	~ 1,470 gal/month	TBD
Sodium Bisulfite	Chlorine scavenger injected to remove residual chlorine from the RO feed water. Chlorine will damage the membrane material	3.66 ppm sodium bisulfite for 1 ppm free chlorine		TBD
Citric Acid	Adjustment of pH and neutralization of cleaning solution prior to discharge	1 ppm / 0.95 ppm alkalinity destroyed	Depends on cleaning solution strength for neutralization	TBD
NaOH	Adjustment of pH and neutralization of cleaning solution prior to discharge	1 ppm / 1.23 ppm alkalinity desired	Depends on cleaning solution strength for neutralization	TBD

Table 6-4
Liberty Chemical Usage

PRODUCT	DESCRIPTION	TYPICAL USE CONCENTRATION	VOLUME	STORAGE VOLUME
Methanol	60/40 mixture of methanol and water stored in existing tankage at the SDI; used for freeze protection	Used only as required for well work and well and flow line freeze protection	As required	Currently at SDI
Emulsion breaker	Oil-based oil/water emulsion breaker; injected into the 28" three-phase flowline to aid in oil/water separation at the process facility	10 ppm based on oil rate	Approx. 23 gal/day based on 55,000 bbl/day capacity for Liberty	Currently at the SDI
Corrosion inhibitor	Water-based corrosion inhibitor injected into the produced (high-salinity) water header at the MPI.	30 ppm	Approx. 7 bbl/day based on current maximum produced water rate of 230,000 bbl/day	Currently at the MPI
Sodium Hypochlorite	Backup oxidizing biocide; primary biocide for preventing biological growth in the RO and MF membranes	0 to 2 ppm free	388 gal/day (17,516 gal/month)	TBD

TBD = To be determined

Liberty Development and Production Plan

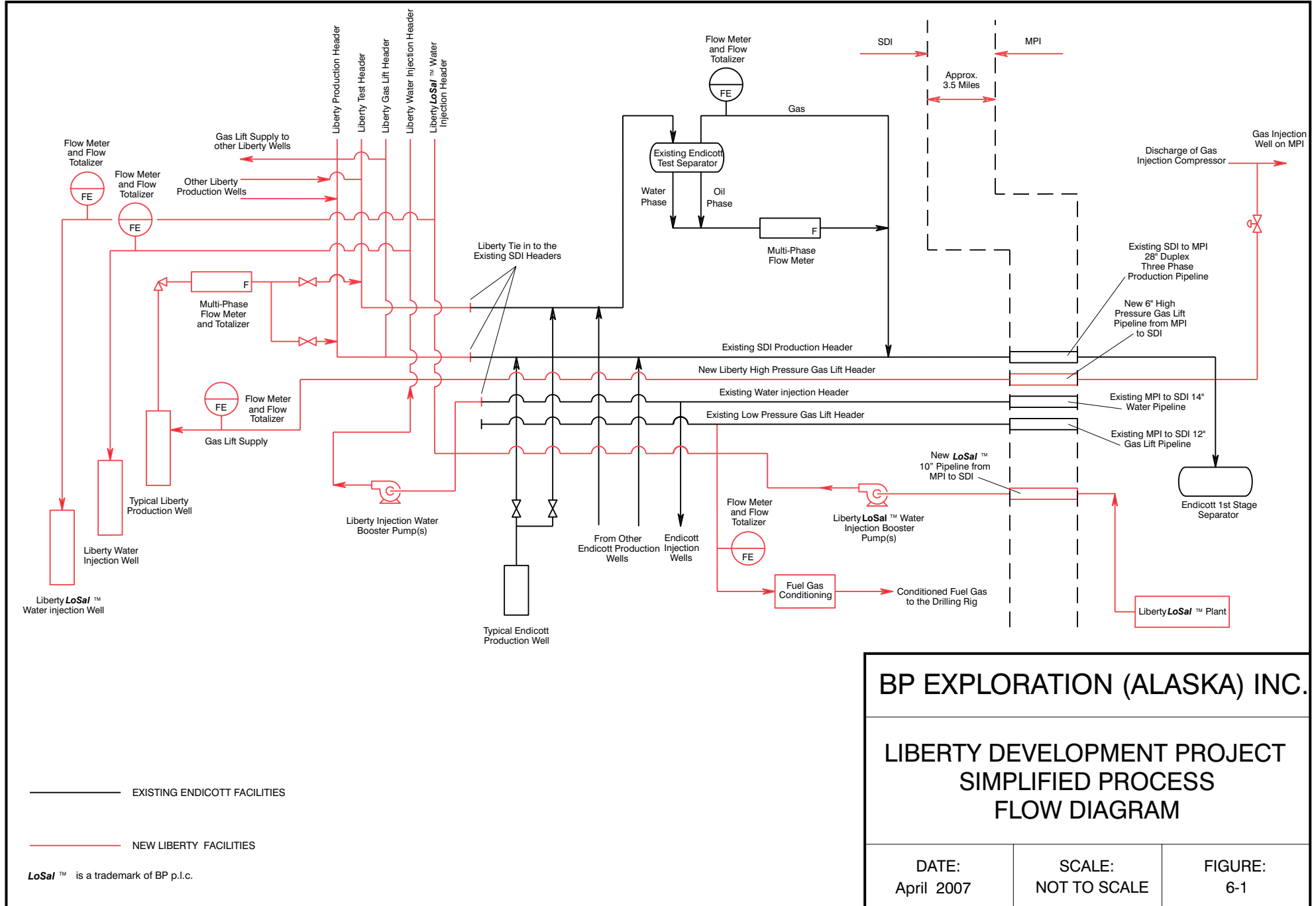

BP EXPLORATION (ALASKA) INC.		
LIBERTY DEVELOPMENT PROJECT SIMPLIFIED PROCESS FLOW DIAGRAM		
DATE: April 2007	SCALE: NOT TO SCALE	FIGURE: 6-1

Liberty Development and Production Plan

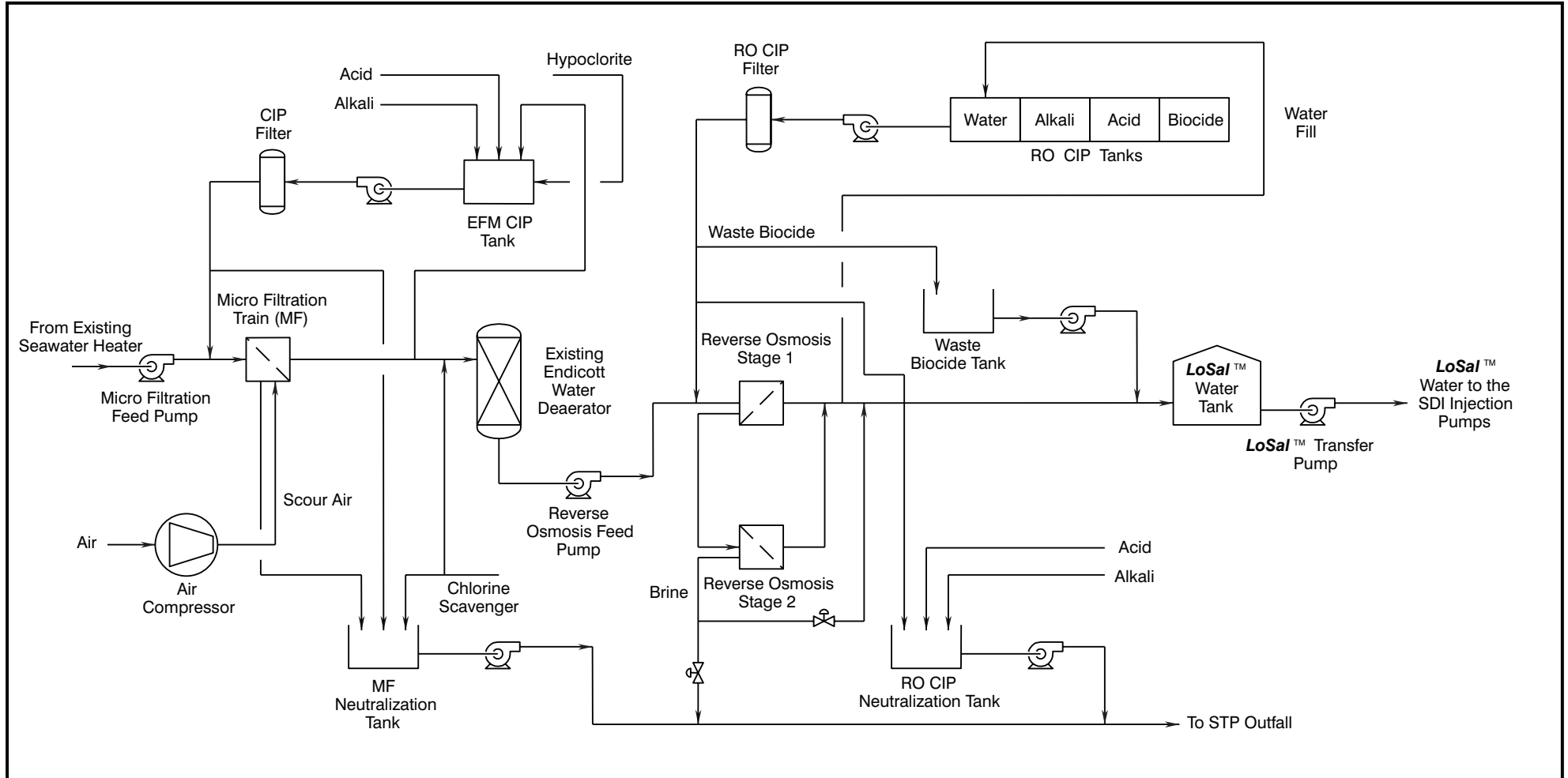

BP EXPLORATION (ALASKA) INC.		
LIBERTY DEVELOPMENT PROJECT LoSal™ ENHANCED OIL RECOVERY FLOW DIAGRAM		
DATE: April 2007	SCALE: NOT TO SCALE	FIGURE: 6-2

LoSal™ is a trademark of BP p.l.c.

Liberty Development and Production Plan

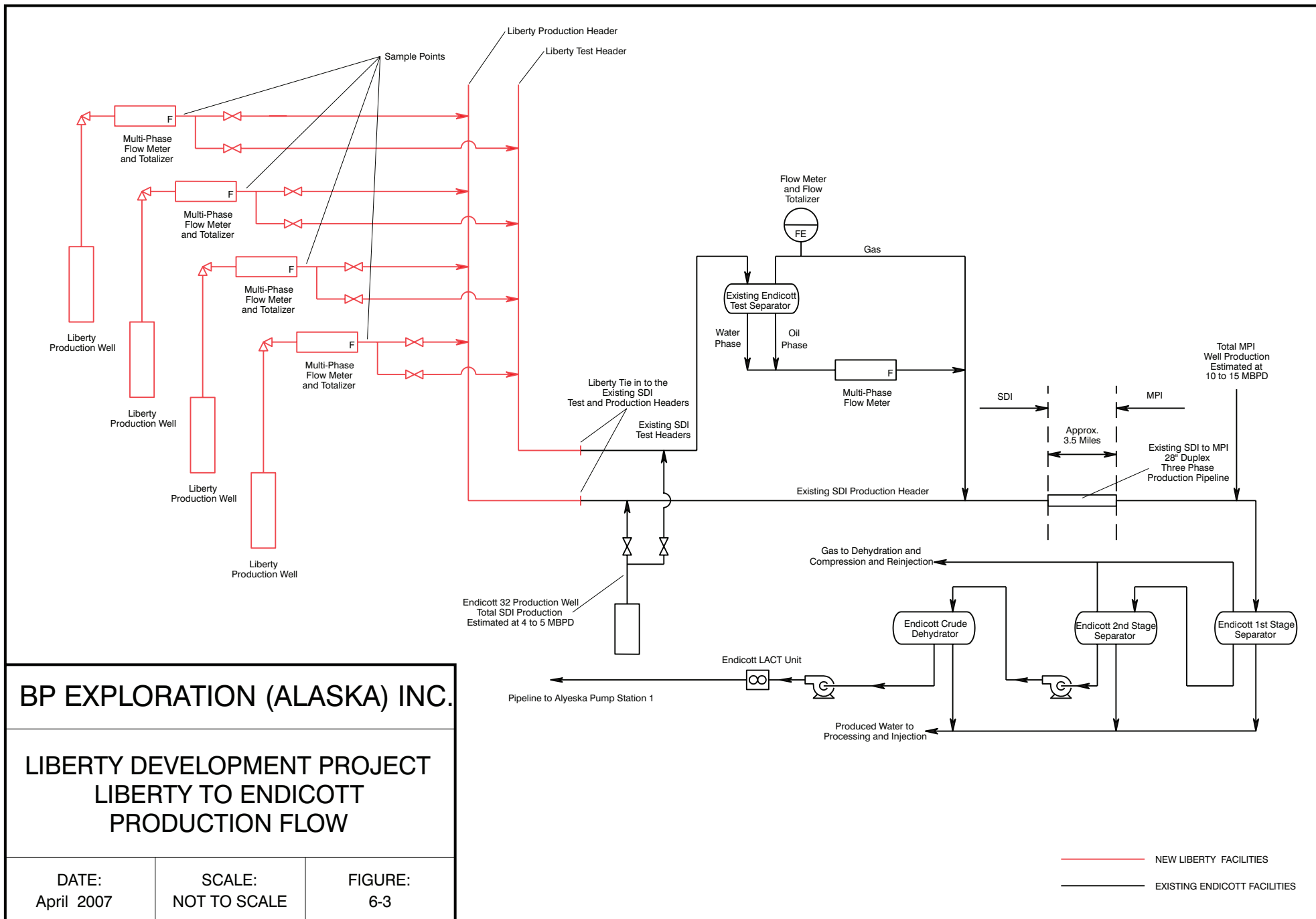

Liberty Development and Production Plan

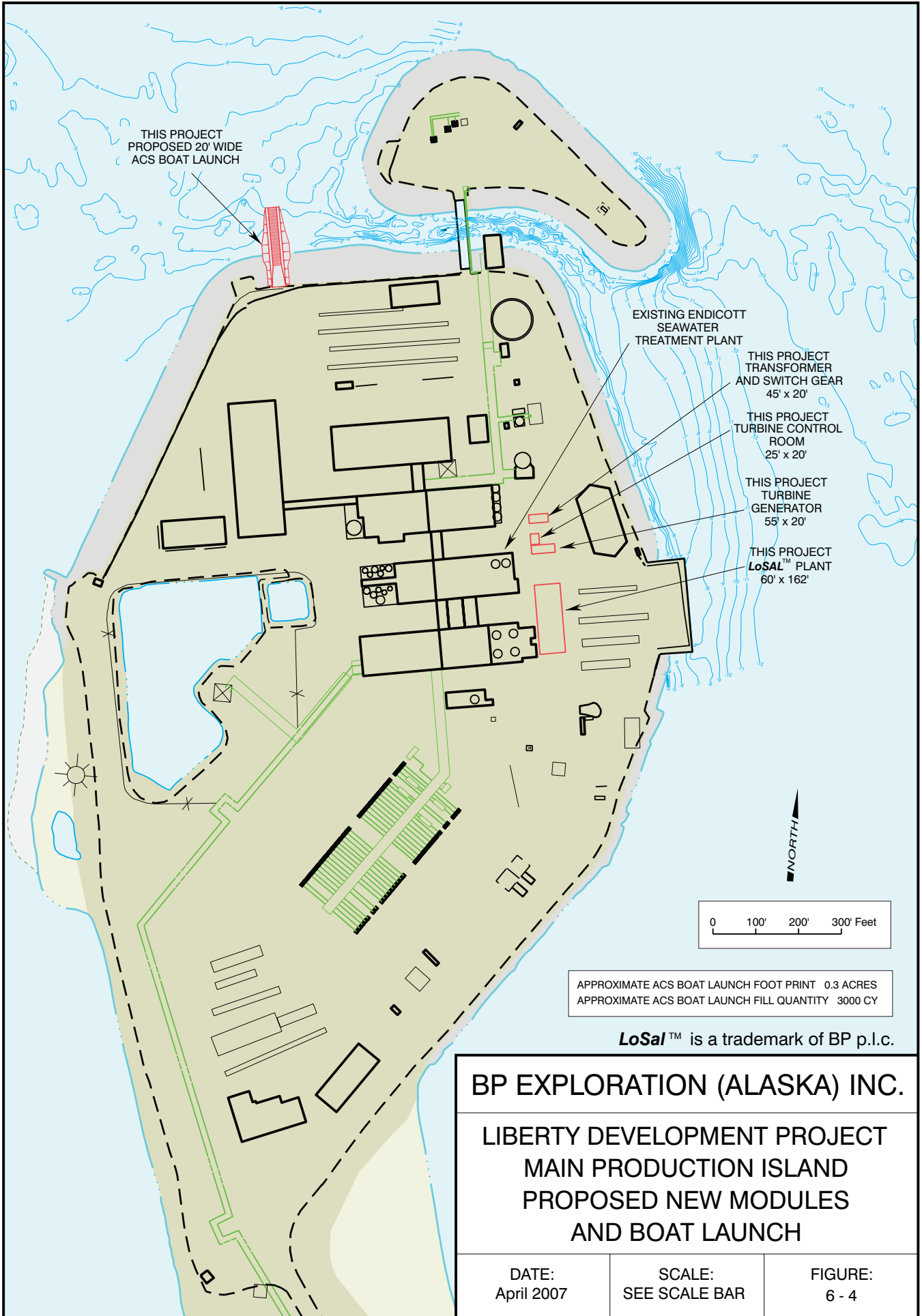

BP EXPLORATION (ALASKA) INC.

**LIBERTY DEVELOPMENT PROJECT
 MAIN PRODUCTION ISLAND
 PROPOSED NEW MODULES
 AND BOAT LAUNCH**

DATE:
 April 2007

SCALE:
 SEE SCALE BAR

FIGURE:
 6 - 4

7. DRILLING AND WELL COMPLETIONS

7.1 INTRODUCTION

Liberty reserves will be recovered using a waterflood depletion plan requiring one to four producers and one or two water injectors (Table 7-1 identifies these six potential wells). The wells will be drilled from the Endicott Satellite Drilling Island (SDI) and will have horizontal departures in the range of 34,000 to 44,000 feet, based on current engineering studies. These types of high-departure wells have not been drilled before and will extend both the Alaska and global ultra-extended-reach drilling (uERD) envelopes. BP has successfully applied this technology at the Wytch Farm field in England, which holds the world record for horizontal departure. Figure 7-1 shows that all of the proposed Liberty wells will fall outside the current uERD envelope, and all but one of those wells will have record-breaking departures. Figure 7-2 shows the trajectories of the Liberty wells.

Engineering analysis has determined that specialized well designs are required to deliver these uERD wells. These well designs, combined with the high well departures and measured depths, require that a very large purpose-built rig be designed, fabricated, and mobilized to the SDI. Rig requirements for these wells exceed the capabilities of the existing North Slope rig fleet, and no upgrades to an existing rig are thought feasible. The Liberty rig may be the largest land rig operating in the world. Major rig design considerations are in the areas of providing for high torque and managing large volumes of drilling fluids and pipe.

Table 7-1
Liberty Development Drilling Program (Maximum Number of Wells)
 (Assumes a maximum horizontal departure of 44,000 feet)

SDI WELL	WELL TYPE	ESTIMATED DEPARTURE (ft)	ESTIMATED MEASURED DEPTH (ft)	ESTIMATED TANGENT	TOTAL VERTICAL DEPTH (ft)	ESTIMATED DAYS TO DRILL
1	Producer	34,000	38,000	80°	11,350	193
2	Injector	39,000	43,000	82°	11,350	209
3	Producer	35,000	39,000	81°	11,350	177
4	Producer	43,000	47,000	83°	11,350	214
5	Injector	41,000	44,000	82°	11,350	195
6	Producer	TBD	TBD	TBD	TBD	TBD

TBD = To be determined

The proposed Liberty uERD wells will be up to four or five time longer than a conventional North Slope well. The ratio of the horizontal distance to vertical drill length can be viewed as a measure of the degree of difficulty associated with drilling the well. It is easier to drill a short vertical well compared to a long horizontal well as the friction between the drill pipe and drill hole increases with the distance drilled. The extra length requires bigger and more sophisticated equipment and drilling mud to keep the hole open throughout the drilling and completion operations. A greater length of casing, extra casing strings, and significantly larger volumes of fluid products are required for each well.

Technical challenges associated with long well-hole sections include managing the surface torque required to turn the drill pipe, the hydraulic power to circulate fluid, and potentially high downhole circulating pressures. Drilling technology beyond that normally used in development wells will include high-capacity top-drive system, rotary steerable drilling assemblies, low-rheology drilling fluids, friction-reduction devices, and casing flotation devices (Figure 7-3). Such drilling also requires a much larger drilling rig than has been used on the North Slope — one with more powerful rotating, pumping, hoisting, and power generation equipment to manage significantly more drill pipe and casing. The enhanced level of technology required to operate the rig systems is also a challenge. In addition, completing these very long wells reliably and cost-effectively, and being able to manage and access them, will require unique technologies such as well bore tractors, swell packers, and dedicated intervention conveyance equipment (Figure 7-4).

7.2 LIBERTY DRILLING RIG LAYOUT, FOOTPRINT, AND WELL SPACING

7.2.1 Drilling Pad Layout and Well Spacing

The drilling pad layout and design are described in Sections 5.1 and 5.2. Access to the existing Endicott wells on the island (in two east-west oriented well rows) would be provided to allow for both rig and non-rig intervention well work while the Liberty rig is on the island.

7.2.2 Drilling Footprint

The total drilling footprint includes:

- The area of the rig moving from one end of the row of slots to the other;
- Pipe loading/access space at each end;
- Area for the mud plant, service units, and plant support;
- Area for equipment maintenance/warm storage shop;
- Area for storage of well consumables; and
- Rig storage site.

Rig/Slots

The Liberty drilling rig will be a newly designed and constructed rig that will be mobilized to the SDI location. The conceptual rig design shows the rig being made up of four large main modules capable of moving from well to well along a straight well row by means of a rig skidding system. The conceptual moving system is a Columbia walking beam system, which will allow the rig to be self-propelled but will use skidding systems versus the wheel systems used on other North Slope rigs. Future rig workovers may be done with either the purpose-built Liberty drilling rig or one of the large North Slope drilling rigs. The 30-foot well spacing will allow use of most of the North Slope rigs. A maximum of 10 new well slots are currently planned.

Service Units

The SDI Liberty wells will use large volumes of drilling fluids, and an on-site mud plant will be required to manage these fluids. This mud plant will consist of mud mixing and treating equipment, along with tankage for storage of new and recycled drilling fluids, and mud materials.

The Liberty drilling mud and cuttings waste stream will be managed by hauling the material to the Central Grind and Inject Facility at Prudhoe Bay Drill Site 4. Cementing equipment will be called out from Deadhorse when required for specific jobs and will not be stored on location. The other service units are mobile and will be located where possible.

Well Consumables/Pipe Storage

Consumables, tools, and drillpipe will be stored on the open gravel areas on the SDI. Detailed planning of logistics will be vital for minimizing double-handling of materials for rig moves. Since the SDI has full-time road access, drilling materials will not be stockpiled for multiple wells, but a minimum inventory of drilling tools and consumables will be maintained on-site.

Drilling/Facilities Interface

The drilling rig will generate all the electrical power needed to run the rig. The rig generators, heaters, and boilers will use natural gas fuel that will be provided by SDI infrastructure. Mud transfer lines will be used to move drilling fluids between the drilling rig and the mud plant. Fuel gas, mud transfer, and processed-waste transfer lines may be included in a utility piperack which will run the length of the well row.

7.3 DRILLING UNIT

The well design work already completed has confirmed that there are no rigs currently operating anywhere in the world that are capable of successfully drilling and completing Liberty uERD wells. The demands placed on the rig for drilling the Liberty wells are mainly in the areas of rotating torque capacity, hydraulic horsepower, pipe management, and fluids management. These demands require a new, purpose-built rig which will be fabricated outside of Alaska and shipped by a combination of barging and trucking to the SDI. The rig will be reassembled and commissioned on-site at SDI. Unlike the smaller modularized rigs currently on the North Slope, the rig will be designed for truck mobilization to allow for ease of assembly and commissioning. Table 7-2 provides the current design specifications for the Liberty drilling rig, while Figure 7-5 shows an artist's conception of the rig.

Safety features of the new rig will include:

- Surface hole diverter system;
- Main blowout preventer (BOP) stack consisting of 5,000 psi preventers, choke and kill lines, choke manifold, BOP control system and remote panels;
- Degasser;
- Drillstring BOP devices; and
- Fire/first aid items including fire extinguishers, fire hoses, first aid kits, stretchers, breathing packs, etc.

**Table 7-2
Preliminary Design Requirements for Liberty uERD Drilling Rig**

PARAMETER	REQUIREMENTS
Rig Handling Requirements	<ul style="list-style-type: none"> • Ability to horizontally rack and buck-up in Range 3 doubles (80 ft) an entire string of 10-3/4 inch by 9-5/8 inch production casing for the longest well expected (~45,000 ft). • Ability to efficiently transfer casing doubles from horizontal to vertical in sizes 15-inch, 10-3/4 inch, 9-5/8 inch, 7-inch and smaller. • Ability to access the pipe barn for tubular loading or unloading from either side. • Advanced control systems driving an appropriate balance of automated and mechanized pipe handling equipment.
Derrick	Accommodate a projected differential stretch of up to 60 ft plus 90 ft stands. In addition, parallel tubular handling structures/devices and other processes for handling tubulars off the critical path will be required. The derrick structure will be fully winterized. The required derrick rating is 1.5 million lb based on hook-load modeling of both casing and drill pipe and capable of racking 25,000 ft of drill pipe.
Pumps	Preliminary design calculations indicate that a minimum of three 2,200 hp triplex mud pumps will be required. The pressure rating of the discharge system should be at least 7,500 psi.
Top Drive	Extensive use of rotary speeds of 120 rpm and greater in most hole sections results in a minimum continuous torque output specification of 95,000 ft-lb.
Rig Power	The rig will use natural gas fuel and be able to generate sufficient power to sustain maximum loading expected to occur during back-reaming of the 12-1/4" hole section at TD, with top drive, drawworks and mud pumps at full capacity. Total horsepower available is estimated at 21,000 hp. The required design will use natural gas at an agreed specification as fuel. Diesel-fired backup emergency generator will be provided.
Blowout Preventer	The blowout preventer stack specification is a single stack, 21-1/4 inch or 18-3/4" 5000 psi WP with a single 5,000 psi WP rated annular BOP and at least three ram-type BOP elements, with sealing elements to be confirmed but consistent with the specified drill string but including blind shear rams. The wellhead system will be 21-1/4" or 18-3/4" 5k psi rated (with possible uprating for CO ₂ injection duties on selected wells).
Mud System	<p>A 7,500 psi system is required. The required surface volume of the active, reserve and storage pits is approximately 25,000 bbl or more, which is intended to accommodate major fluid system change-outs in the deepest wells planned. However, the required surface volume remains a goal of detailed engineering. The solids control package required includes a minimum of:</p> <ul style="list-style-type: none"> • 6 high-speed shakers • 2 de-silters • 2 high-speed centrifuges • Mud cleaner • 2 degassers • Cuttings dryer
HVAC	Although winterization of drilling rigs for North Slope operations has been optimized over several generations of designs, the derrick and any associated structures with large vertical components may need specialized design.
Mobilization System	The rig will be designed for truck mobilization, unlike the smaller modularized rigs currently on the Slope. The design will allow for ease of assembly and commissioning.
Skidding System	<p>The skidding mechanism must have the following key features built into the substructure, pipe barn and utilities modules:</p> <ul style="list-style-type: none"> • Be safe and efficient • Able to skid along the axis of the well row • Able to skid laterally for minor adjustments to ensure the rig is dead center on the well slot • Avoid interference with flowlines

Power will be generated at the rig site through internal combustion engines in the rig package using natural gas as a fuel source. It is expected that the rig power generation will supply enough power for the drilling rig, the mobile drilling office and all contractor engineering units, such as mud logging, measurement while drilling/logging while drilling (MWD/LWD), the mud lab, and the mud plant (storage facility). In addition, emergency power will be provided by a diesel generator on the rig to power critical functions.

7.4 WELL DESIGN

Both production and water injection wells will use the same basic well design: a fit-for-purpose conceptual five-string design that has not been used on the North Slope but shares some similarity with the bigger-bore designs that have been used elsewhere on the North Slope. Unique aspects of this design are that both the 15-inch and the tapered 10-3/4-inch x 9-5/8-inch casing strings require mud over air flotation to reach total depth. The major drivers governing the well design are equivalent circulating density (ECD) management in narrow ECD-fracture gradient (FG) windows, and successfully running the long casing strings to their respective casing points. Table 7-3 and Figure 7-6 show the well design for a 36,000-foot-departure reference case.

The present conceptual well design is based on the preliminary engineering and subsurface work. Future engineering work to identify optimizations and contingencies may change the conceptual design by changing casing sizes, adding a casing string to provide a contingency casing string, or combining the smaller hole intervals.

Table 7-3
Casing Design for Reference Case of 36,000-Foot Departure

CASING STRING	HOLE SIZE (in.)	CASING SIZE (in.)	LENGTH (ft)	TVD (ft)	COMMENT
Conductor		30	100	100	Driven or augered
Surface	26	20	6,200	4,570	Set at end of build
Intermediate #1	18-3/4	15	15,000	5,720	Casing flotation required
Intermediate #2	12-1/4	10-3/4 x 9-5/8	38,810	9,900	Casing flotation required
Drilling Liner	8-1/2	7	1,500	10,900	Problem shale interval
Production liner	6	4-1/2	750	11,350	Slotted liner
Tubing		7 x 5-1/2 x 4-1/2	40,000		Corrosion resistant alloy

7.4.1 Casing Design

The Liberty casing and tubing designs are the same for both production wells and water injection wells. The design is focused on minimizing well-bore stability risks in the Shale Wall and HRZ shale formations overlying the Kekiktuk Reservoir. These unstable shale intervals will be isolated by setting production casing in the top of the shale after reducing hole angle. The shales would then be drilled at a low angle and cased off with 7-inch drilling liner, before drilling the reservoir in a 6-inch hole.

- **Conductor:** All wells will have 30-inch conductor driven to 100 feet true vertical depth sub sea (TVDSS) or 150 feet TVD below rig floor. The conductors will likely be driven with impact hammers consecutively over a period of one to two weeks.
- **20" Surface Casing:** Will be set in the SV shales at approximately 4,700 feet TVD, which gives adequate fracture gradient strength to drill the intermediate hole. The tangent inclination will be established in the surface hole interval.
- **15" Intermediate Casing:** Will be set near the top of the Ugnu. This intermediate casing is set in the tangent interval, cases off a section of the extremely long tangent section, and enhances running of the 9-5/8" casing string. Partial mud over air flotation is required to run the casing.
- **10-3/4" x 9-5/8" Production Casing:** Will be set above the Shale Wall to provide the fracture gradient needed for the higher mud weights that will be used in the next shale interval. Partial mud over air flotation and casing rollers are required to run the casing.
- **7" Drilling Liner:** Will be set at the base of the HRZ shale interval, prior to drilling the Kekiktuk Reservoir.
- **4-1/2" Production Liner:** Will be set just into the Kekiktuk Zone #1 allowing sufficient sump to log the Zone #2 reservoir.
- **Production tubing:** Will be a tapered 7-inch by 5-1/2-inch by 4-1/2-inch tubing string.

7.4.2 Directional Drilling and Surveying

Directional planning for all of the Liberty uERD wells is based on an S-shaped profile (Figure 7-7). The directional plans include shallow kick-off depths, slow build rates to minimize side contact forces between the casing and drill pipe, and long high-inclination well-tangent intervals, followed by an angle drop to lower inclination through the problematic shale interval and the reservoir. Well separation requirements are met by having the wells planned in vertical corridors. The wells all require +80° tangent inclinations. Figure 7-2 presents the spider plot of Liberty locations and well trajectories, while Table 7-1 above lists the vertical and measured depths for all the wells.

7.4.3 Drilling Fluids and Cementing

Drilling Fluids

Standard North Slope freshwater-based mud (WBM) systems will be used in the 26-inch surface and 18-5/8-inch intermediate hole intervals. The fresh water will be trucked to the SDI from permitted sites. The 26-inch surface hole will be drilled with a freshwater spud mud with the required viscosity for effective hole cleaning. The 18-3/4-inch intermediate hole will be drilled with a freshwater, low-solids, non-dispersed mud. Either an oil-based mud (OBM) or synthetic-based (SBM) mud system is planned in the long 12-1/4-inch interval and shorter 8-1/2-inch and 6-inch intervals. Actual fluid to drill the reservoir interval will be determined after fluid compatibility studies and well completion requirements are finalized. Mud weights and rheological properties for all drilling fluids will be adjusted as required through the use of drilling mud products and mud processing equipment.

Table 7-4 provides a summary of the drilling fluids currently planned for use at Liberty.

**Table 7-4
Summary of Drilling Fluids for a Single Well**

TYPE	CHEMICAL CONSTITUENTS (Major Components)	DESCRIPTION	DISCHARGE RATE* (bbl/day)	AMOUNT (bbl/well)
Water-Based Mud (26" Hole)	Spud Mud		1,700	35,000
	Bentonite	Bentonite Clay		
	Barite	Barium Sulfate		
	Polypac	Cellulose Polymer		
	Duovis	Xanthan Gum Polymer		
	Caustic	NaOH / KOH		
Water-Based Mud (18-3/4" Hole)	Low-Solids Non- Dispersed		850	20,000
	Bentonite	Bentonite Clay		
	Barite	Barium Sulfate		
	Polypac	Cellulose Polymer		
	Duovis	Xanthan Gum Polymer		
	Caustic	NaOH / KOH		
	Resinex	Lignite Fluid Loss Agent		
	Tannathin	Lignite Fluid Loss Agent		
	Ashasol	Sulfonated Asphalt Lubricant		
Oil-Based Mud (12-1/4" and 8- 1/2" Hole)	OBM/SBM		250	15,000
	LVT-200 or Rheliant	Base Oil		
	V-Mul	Emulsifier		
	V-Wet	Wetting Agent		
	V-Mod	Thinner		
	Barite	Barium Sulfate		
Oil- or Water- Based Mud (6" Production Hole)	OBM/SBM or WBM		250	6,000
	LVT-200 or Rheliant	Base Oil		
	V-Mul	Emulsifier		
	V-Wet	Wetting Agent		
	V-Mod	Thinner		
	Barite	Barium Sulfate		
	Calcium Chloride	CaCl ₂		
	Safe Carb	Calcium Carbonate		

*This discharge from solids control equipment will be disposed of by backhauling to Prudhoe Bay Drill Site 4 for processing and underground injection. No surface discharge of waste mud or drill cuttings will occur.

Cementing

The cementing program will be based on MMS requirements and current North Slope practices. The surface-casing cement job will be designed to ensure that the casing is cemented to surface. It is anticipated that the surface casing job will use excess slurry with either an inner-string single-stage design or two-stage design. The intermediate casing strings will be cemented to provide the required zonal isolation at the casing shoes. No hydrocarbons are expected to be encountered in the 15-inch and 9-5/8-inch casing hole intervals. The 7-inch liners will be completely cemented. The 4-1/2-inch completion liner set across the Kekiktuk Reservoir is planned as a slotted liner and will not be cemented. Zonal isolation across the reservoir will be provided with the use of swell packers.

7.4.4 Data Acquisition

All required subsurface well data will be obtained with logging while drilling (LWD) tools. Reservoir evaluation will include gamma ray, resistivity, neutron, density, and nuclear magnetic resonance. No open-hole wireline logs are planned.

7.5 COMPLETION DESIGN

The completion philosophy is to keep the design simple due to the extreme depth and inclination of the wells. The lower completion is a 4-1/2-inch slotted liner that will be run across the Kekiktuk Reservoir. Zonal isolation requirements within the Kekiktuk Reservoir will be achieved with the use of swell-packer technology by placing the swell packers in the K2M Shale between the K2B and K2A Sands, and across any encountered fluid contacts. This completion design eliminates the need for small-diameter liner cementing and perforating at extreme depth. The upper completion consists of a tapered tubing string with downhole pressure and temperature gauges, gas lift mandrels, and subsurface safety valve (SSSV). The completion design does not require deep well intervention work for the initial completion. Figure 7-7 shows the completion design.

All completion and wellhead/Xmas tree equipment will be 6,500 psi rated. All well surfaces that will be in contact with wellbore fluids will be made of corrosion resistant alloy (CRA).

7.6 LOGISTICS

The SDI is connected by road to the existing North Slope infrastructure, and year-round truck access is available for drilling equipment and consumables. Liberty SDI drilling operations will have logistical support requirements similar to those for other North Slope rig operations which are totally truck-supported. The Liberty uERD wells are much longer and use greater volumes of materials, but they will also take longer to drill. Average monthly or weekly logistical support is expected to be similar to other drilling operations.

The drilling rig and ancillary equipment will be constructed in the Lower 48 and mobilized to the SDI by truck after barging to a road-accessible Alaskan port. The drilling rig is designed to be moved in either small truckable units or in larger modules on barges. While the base case is to mobilize the rig to SDI in small truckable units, the option for a sealift barge mobilization directly to the North Slope will also be evaluated. Drilling tools and materials will be transported by trucks using the existing road system.

The drilling footprint on the island will be used for storage of the following items in addition to the rig and its movements:

- **Mud Plant:** Will include mud mixing and conditioning equipment, tankage for liquid mud storage, sack and drum mud material storage, and bulk barite and bentonite storage. Both oil-based mud and water-based mud systems and material will be used (see Section 7.7 below).
- **Cement Materials and Service Equipment:** Will be brought from Deadhorse as needed for specific well operations but will not be permanently stored on-site.
- **Tubulars:** Most drill pipe and casing will be stored in the rig pipe barn.
- **Diesel Storage:** A diesel-fueled emergency generator and diesel tank will be built into the drill rig. The main rig power will be provided by natural-gas-fueled electrical generator sets. Large volumes of diesel will not be stored on the location. The diesel day tank will service the rig and will have a capacity of less than 10,000 gallons. This tank will be filled as needed by tank truck.
- **Drilling Services Units:** Mudlogging, logging while drilling/measurement while drilling (LWD/MWD), and mud lab services will be located on or near the drilling rig.
- **Rig Support Services Building:** A small repair and fabrication shop to support the drilling rig operation will be provided.
- **Office Facilities:** Office and communication facilities will be provided for the drilling supervisory staff.
- **Rig Crew Camp:** A new crew camp will be installed at a to-be-determined location.

7.7 MUD PLANT

Drilling Liberty wells will require much larger volumes of both water-based and non-aqueous drilling fluids than what is typical on the North Slope. Current analysis indicates the need for a dedicated mud plant at the SDI to minimize risk from road transportation and to increase operational efficiency.

The conceptual mud-plant design consists of 18 to 20 1,000-barrel vertical tanks to hold the various liquids and some dry bulk products. A process building for batch mixing and preparing the specialized drilling fluids would be sited next to the tanks. The building would also include an area for temporary dry storage of palletized and/or containerized mud products. The tank farm will be contained within a lined and bermed area that will meet state and federal requirements. Fluid transfer lines will be installed between the mud plant and the drilling rig to facilitate fluid movements. The conceptual design is expected to cover an area of approximately 115 feet by 135 feet (see Figure 5-1).

The final mud plant design will be contingent upon the approved well plans, which are currently being developed. The plant will be a temporary facility used in support of the Liberty drilling program and will likely be removed at the end of the drilling program.

7.8 WELL CONTROL

The primary well control for Liberty development drilling program will be the drilling fluid weight used, which will be based on appraisal well data from the Liberty #1 well and from other exploratory wells drilled from Tern Island, plus the nearby Endicott Field analogue. The secondary well control equipment is described in the Section 7.3 above. In addition to this, the experienced BPXA and North Slope drilling contractor personnel will be certified in accordance

with 30 CFR 250 Subpart O. The drilling crews will be using established formal procedures and guidelines to ensure all well control instances are addressed immediately and adequate resources of both personnel and equipment are promptly employed to mitigate the occurrence of a loss of well control (blowout).

Well control procedures that will be used on the Liberty uERD wells are similar to methods used on other North Slope directional wells. Well kill operations in the event of a kick are the same for uERD wells, although higher fluid volumes and longer circulating times are required. The higher-inclination wellbores and the longer measured depths can add more complexity to both the drilling and well control operations, and close attention to detail in the drilling practices is required for these wells to be successfully drilled. The Kekiktuk Reservoir is normally pressured, and the reservoir formation pressures and temperatures are well understood from the previously drilled exploration wells. Also, there are no known hydrocarbon intervals that will be drilled above the Kekiktuk. With the current well design, 95 percent of the wellbore will be cased off before the hydrocarbon interval is drilled.

In accordance with well control procedures outlined in current North Slope oil discharge prevention and contingency plans, surface intervention or well capping is recognized as the preferred method (best available technology, or BAT) of response to a well blowout. Likewise, well-capping is also the preferred response method (BAT) for the Liberty Development.

A relief well scenario for a Liberty blowout is based on establishing communication between the relief well and the blowout well in the Kekiktuk Reservoir. The Kekiktuk is the only hydrocarbon interval in the well and is the only source of a well control problem. The relief well scenario would require construction of a gravel island in the general vicinity of the blowout well's penetration of the Kekiktuk Reservoir. From this location, the relief well would be drilled with a conventional North Slope rig. Provisions for well capping and well control response will be discussed in detail in the *Oil Discharge Prevention and Contingency Plan*.

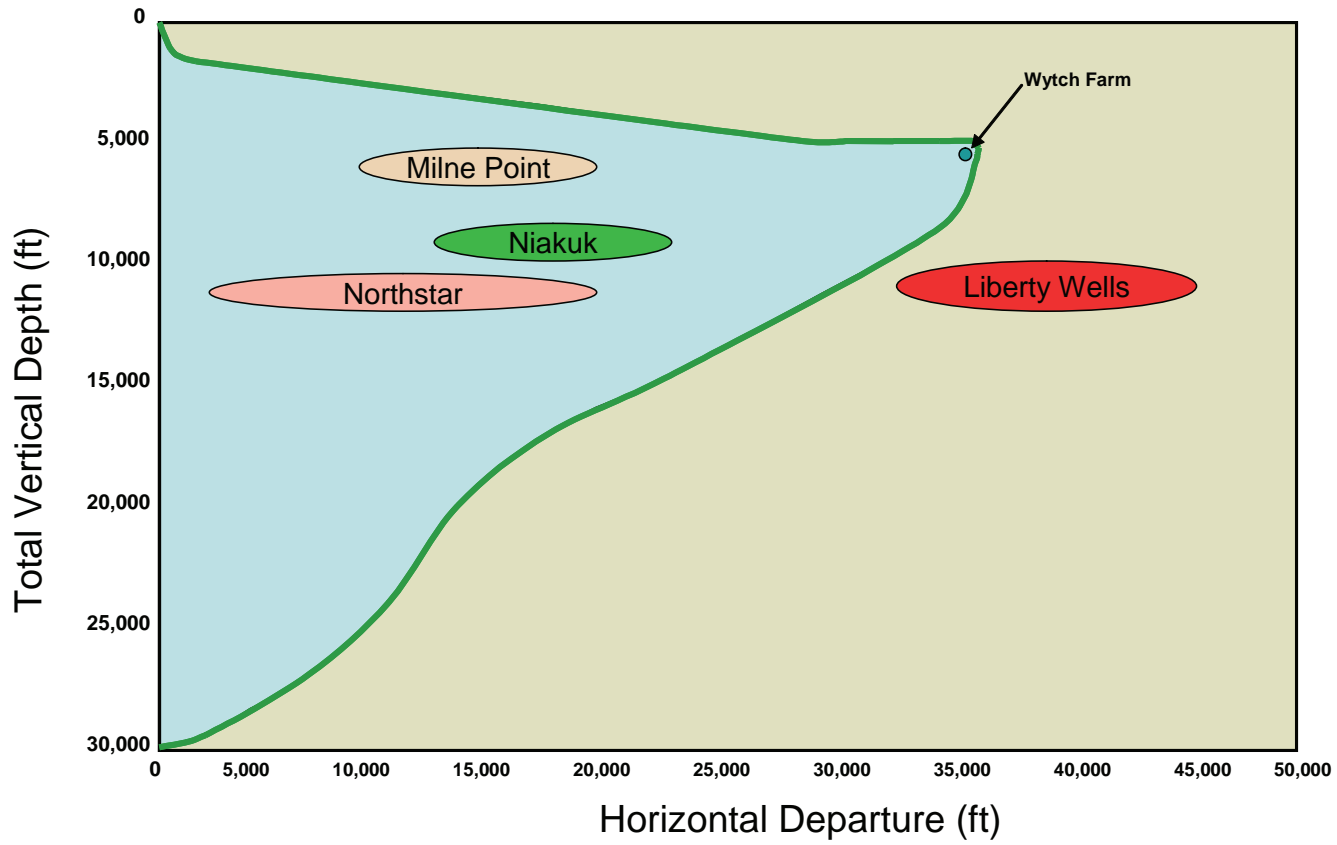

BP EXPLORATION (ALASKA) INC.

uERD ENVELOPE

DATE:
April 2007

SCALE:
SEE SCALE BAR

FIGURE:
7-1

Liberty Development and Production Plan

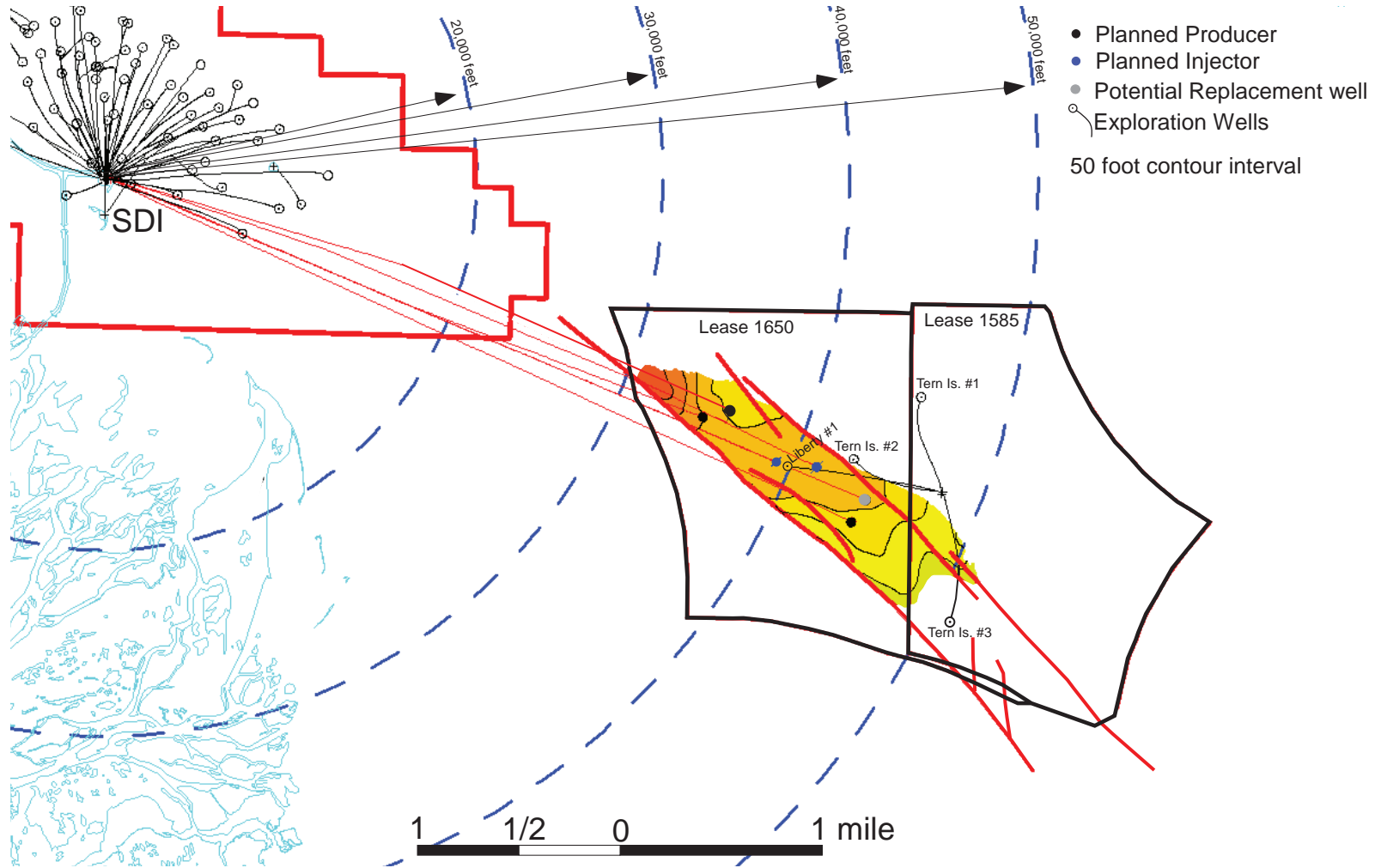

BP EXPLORATION (ALASKA) INC.		
LIBERTY DEVELOPMENT PROJECT TRAJECTORY OF LIBERTY WELLS SHOWING ENDICOTT SDI WELLS		
DATE: April 2007	SCALE: SEE SCALE BAR	FIGURE: 7-2

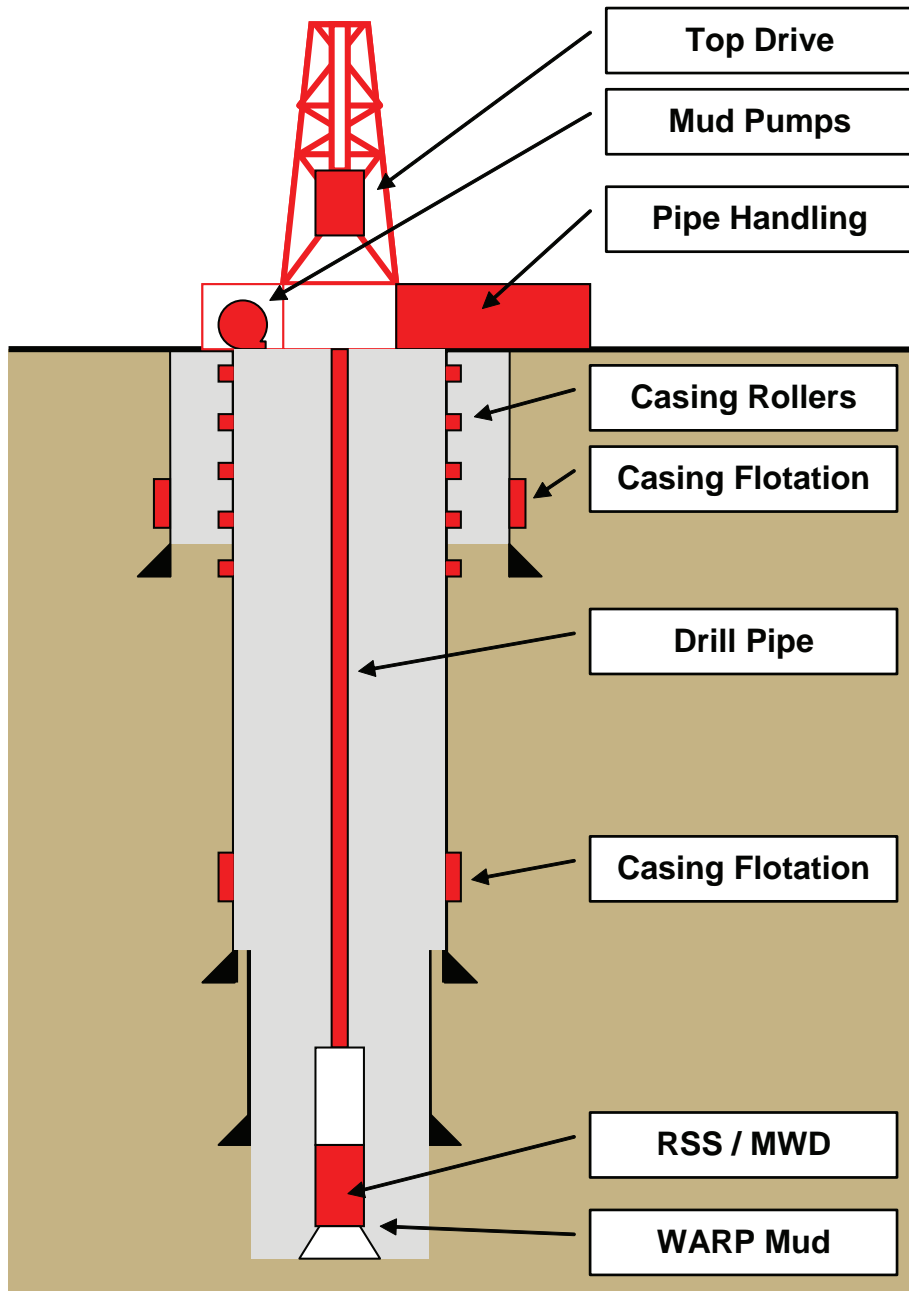

BP EXPLORATION (ALASKA) INC.

uERD DRILLING TECHNOLOGIES

DATE:
April 2007

SCALE:
None

FIGURE:
7-3

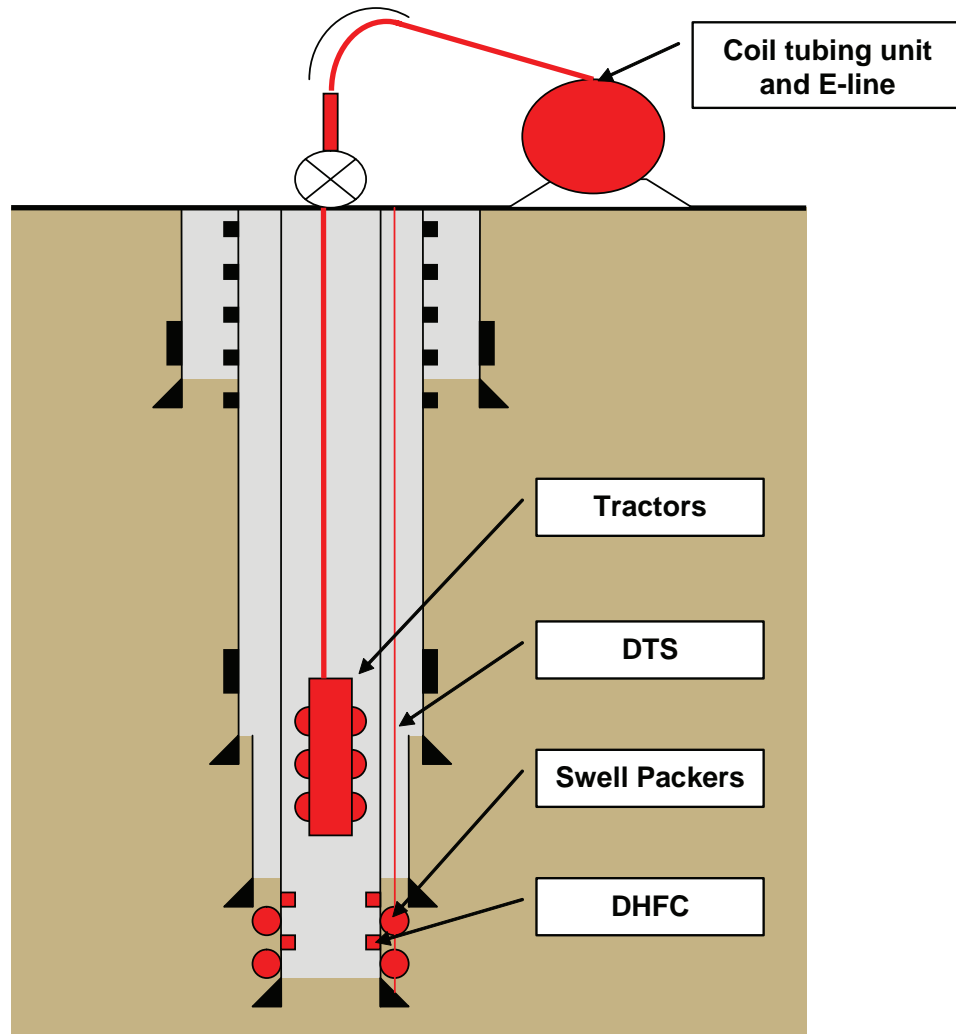

 New Technology

BP EXPLORATION (ALASKA) INC.

uERD WELL COMPLETION
INTERVENTION TECHNOLOGIES

DATE:
April 2007

SCALE:
None

FIGURE:
7-4

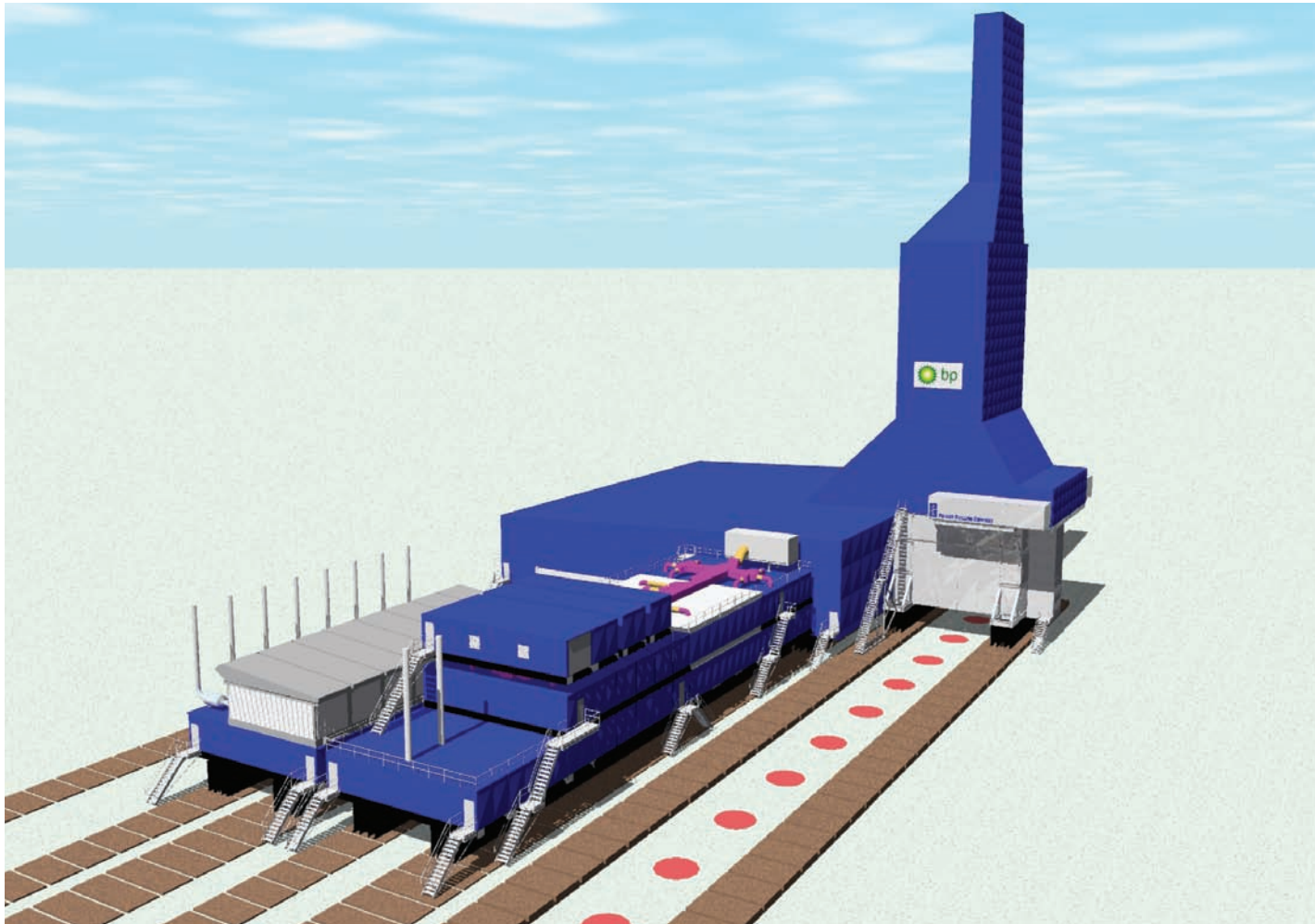

BP EXPLORATION (ALASKA) INC.

LIBERTY DEVELOPMENT PROJECT
ARTIST'S CONCEPTION OF PROPOSED
LIBERTY uERD DRILLING RIG

DATE:
April 2007

SCALE:
None

FIGURE:
7-5

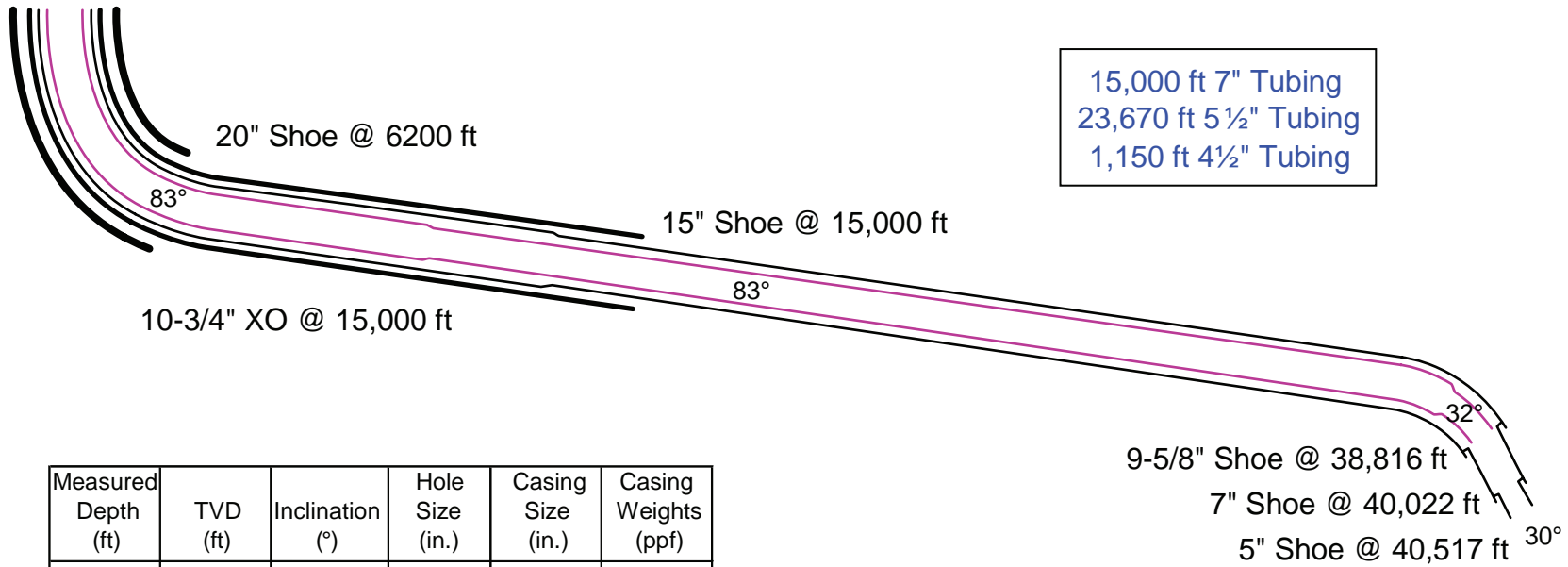

Measured Depth (ft)	TVD (ft)	Inclination (°)	Hole Size (in.)	Casing Size (in.)	Casing Weights (ppf)	
6,200	4,570	83	26	20	106.5	
15,000	5,720	83	18.75	15	109	
15,000	5,720	83	-	10-3/4	60.7	
38,810	9,900	32	12.25	9-5/8	47 x 53.5	
40,022	10,900	30	8.5	7	29	1,500 ft Liner
40,517	11,330	30	6	4-1/2	18	700 ft Liner

BP EXPLORATION (ALASKA) INC.

LIBERTY DEVELOPMENT PROJECT
WELL DESIGN FOR REFERENCE CASE
OF 36,000-FOOT DEPARTURE

DATE:
April 2007

SCALE:
None

FIGURE:
7-6

Liberty Development and Production Plan

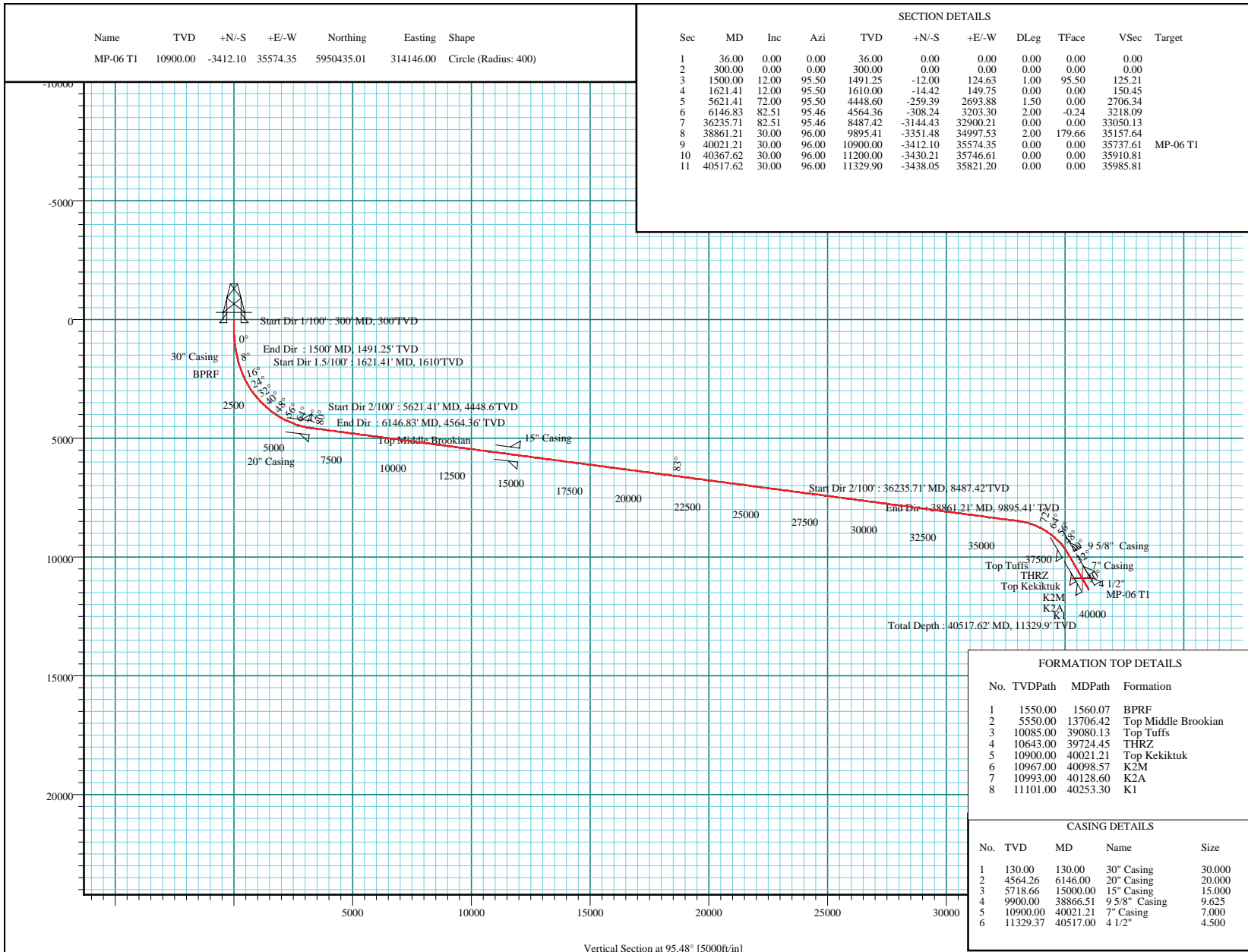

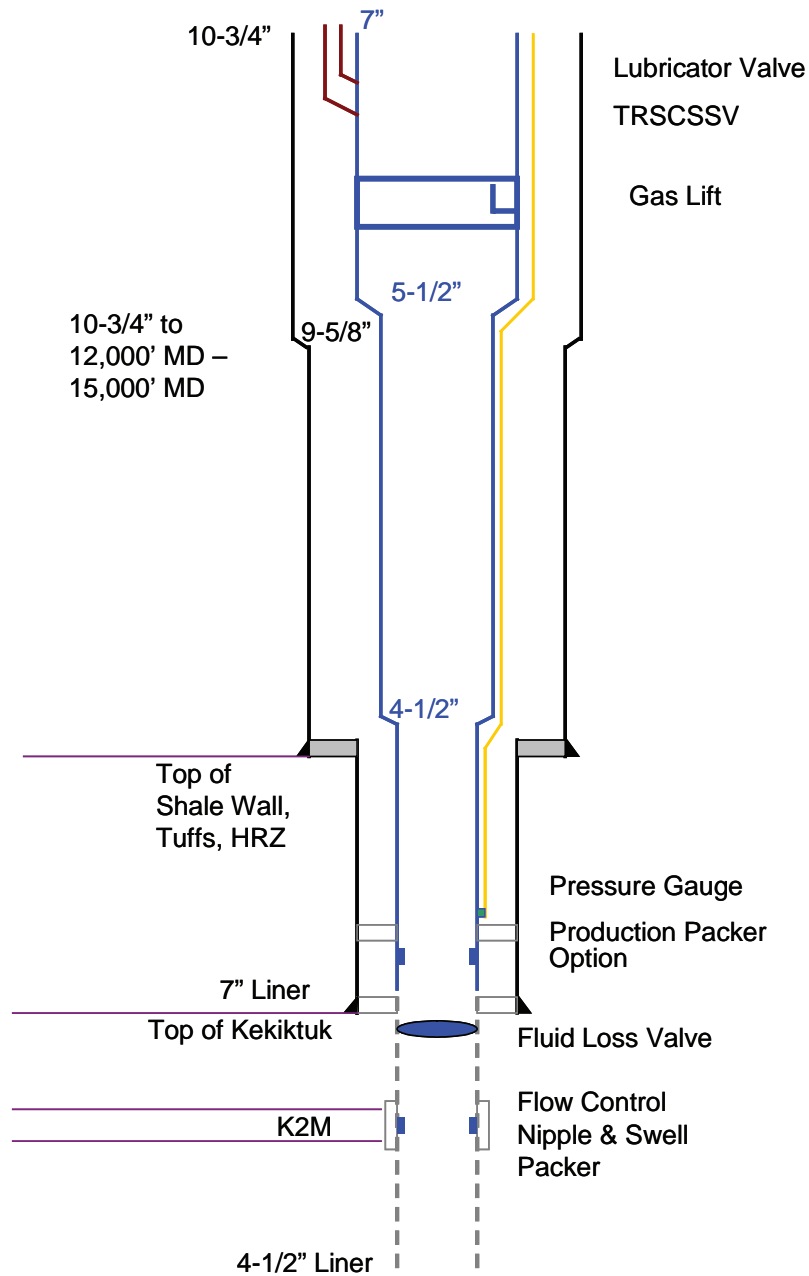

BP EXPLORATION (ALASKA) INC.

LIBERTY DEVELOPMENT PROJECT
WELL COMPLETION DESIGN

DATE:
April 2007

SCALE:
None

FIGURE:
7-8

8. PIPELINE SYSTEM

This section provides a summary of the proposed Liberty pipeline system. Liberty production will be routed through facility piping from the wellheads into a new production header that will be tied into the existing SDI 24-inch-diameter production header. The commingled production from the SDI and Liberty will flow to the MPI for processing through Endicott's existing 28-inch-diameter flowline.

A *LoSal*TM EOR process water injection line independent from the existing MPI-SDI water injection line will be routed between the MPI to the SDI. Additionally, a high-pressure gas line will be installed alongside the new water injection line.

8.1 PIPELINE ROUTE

Figure 8-1 shows the routing of the proposed 10-inch-diameter *LoSal*TM water injection pipeline and 6-inch-diameter gas-lift pipeline. The pipeline route will be along the existing Endicott gravel causeway between the SDI and MPI, a distance of approximately 3 miles. The pipeline will be on a new vertical support member (VSM) system and on the lagoon side (west) of the existing Endicott SDI VSM system.

8.2 DESIGN BASIS

The design features for the pipelines are listed in Table 8-1. The *LoSal*TM and gas-lift pipelines will be elevated on standard VSMs. The *LoSal*TM line will have a polyurethane foam insulation jacket. Expansion loops will be in an "L" loop configuration, spaced approximately 3,300 feet apart. The pipeline will have a minimum elevation of 7 feet above the ground surface.

8.3 CONSTRUCTION

The pipelines will be constructed in 2012. An ice road may be installed on the lagoon side of the Endicott Causeway to allow equipment access in winter. The water injection and gas pipelines will be supported on new VSMs between the MPI and SDI facilities. The above-ground pipeline will include expansion loops or offsets to account for thermal movement of the pipeline. Design and installation of the VSMs will be completed following typical procedures used for other elevated pipelines on the North Slope.

**Table 8-1
Design Features of Liberty Pipeline System**

PARAMETER	FEATURE
Existing Endicott Sales Oil Line	
Design flowrate	100,000 bpd
Maximum operating pressure	1,200 psig
Nominal diameter	16 inches
Wall thickness	0.372 inch
Pipeline material	API-5L X-65
Existing Endicott 3-Phase Inter-Island Flowline	
Design flowrate	60,000 bpd
Maximum operating pressure	720 psig
Nominal diameter	28 inches
Wall thickness	0.281 inch
Pipeline material	Duplex stainless steel
LoSa™ EOR Process Water Injection Line	
Design LoSa™ EOR process flowrate	50,000 bpd
Maximum operating pressure	3,705 psig
Nominal diameter	10 inches
Wall thickness	0.17 inch
Pipeline material grade	API-5L X-65
Gas Line	
Design flowrate	25 million scfd
Maximum operating pressure	3,600 psig
Nominal diameter	6 inches
Wall thickness	0.42 inch
Pipeline material grade	API-5L X-65

8.4 SAFETY AND LEAK PREVENTION MEASURES

The proposed Liberty pipelines include the following measures to assure safety and leak prevention:

- The pipelines will be externally coated to prevent corrosion.
- Cleaning and inspection pigs will be run during operations as described in Section 8.5 below.
- The elevated overland pipeline section will be conventional, proven North Slope design.

The existing 16-inch-diameter Endicott sales oil line will be used to export Liberty oil to Pump Station 1 of the Trans Alaska Pipeline System (TAPS). This line has isolation valves installed at both sides of the causeway bridges. The pipeline is monitored for leaks using the industry-standard mass-balance line-pack compensation system. The leak detection system meets

all current Department of Transportation Office of Pipeline Safety (DOT) and Alaska Department of Environmental Conservation (ADEC) leak detection requirements.

8.5 MONITORING AND SURVEILLANCE

Following is a summary of monitoring and surveillance for existing Endicott pipelines and planned new Liberty lines based on existing Endicott procedures. The *Oil Discharge Prevention and Contingency Plan* will provide detailed information on the proposed pipeline surveillance and monitoring program. The Liberty and Endicott pipelines will comply with ADEC regulations for surveillance, monitoring and record keeping for pipelines and flowlines (18 AAC 75).

- **Three-phase pipeline:** This existing 28-inch-diameter line is inspected annually to verify its condition. The pipeline material is duplex stainless, which is highly resistant to corrosion. It is not possible to smart-pig the line due to the non-magnetic properties of the steel. BPXA will conduct annual visual inspections combined with spot-item ultrasonic wall-thickness gauging, as well as digital radiography, to assess continuing pipeline integrity. Additionally, the line will be pigged annually with a cleaning pig to ensure that there is no deposition of sediment in the line.
- **Gas-lift pipeline:** This existing 14-inch-diameter line will be used initially to provide fuel gas for the Liberty Project. This line is visually inspected for external corrosion every year, with particular emphasis at the pipeline vault under the Endicott Causeway “T” junction.
- **Water injection pipeline:** This existing 14-inch-diameter water line is routinely pigged approximately once a month. The line was also smart-pigged in 2006 and its integrity was confirmed.
- **Gas and LoSal™ EOR water injection pipelines:** When Liberty production warrants, a new 6-inch-diameter gas line and 10-inch-diameter water line will be installed, and they will be smart-pigged at start-up to provide baseline wall-thickness data against which future pigging runs can be compared. The lines will then be pigged and inspected at a similar frequency to the existing Endicott gas and water injection lines.
- **Sales oil line:** The existing 16-inch-diameter Endicott sales line will be used to export Liberty production to Pump Station 1. This line was smart-pigged in 2006 to confirm its integrity. The line was verified to be in good condition, and it will continue to be smart-pigged every 5 years. The line is subject to routine cleaning pig runs every 3 months.

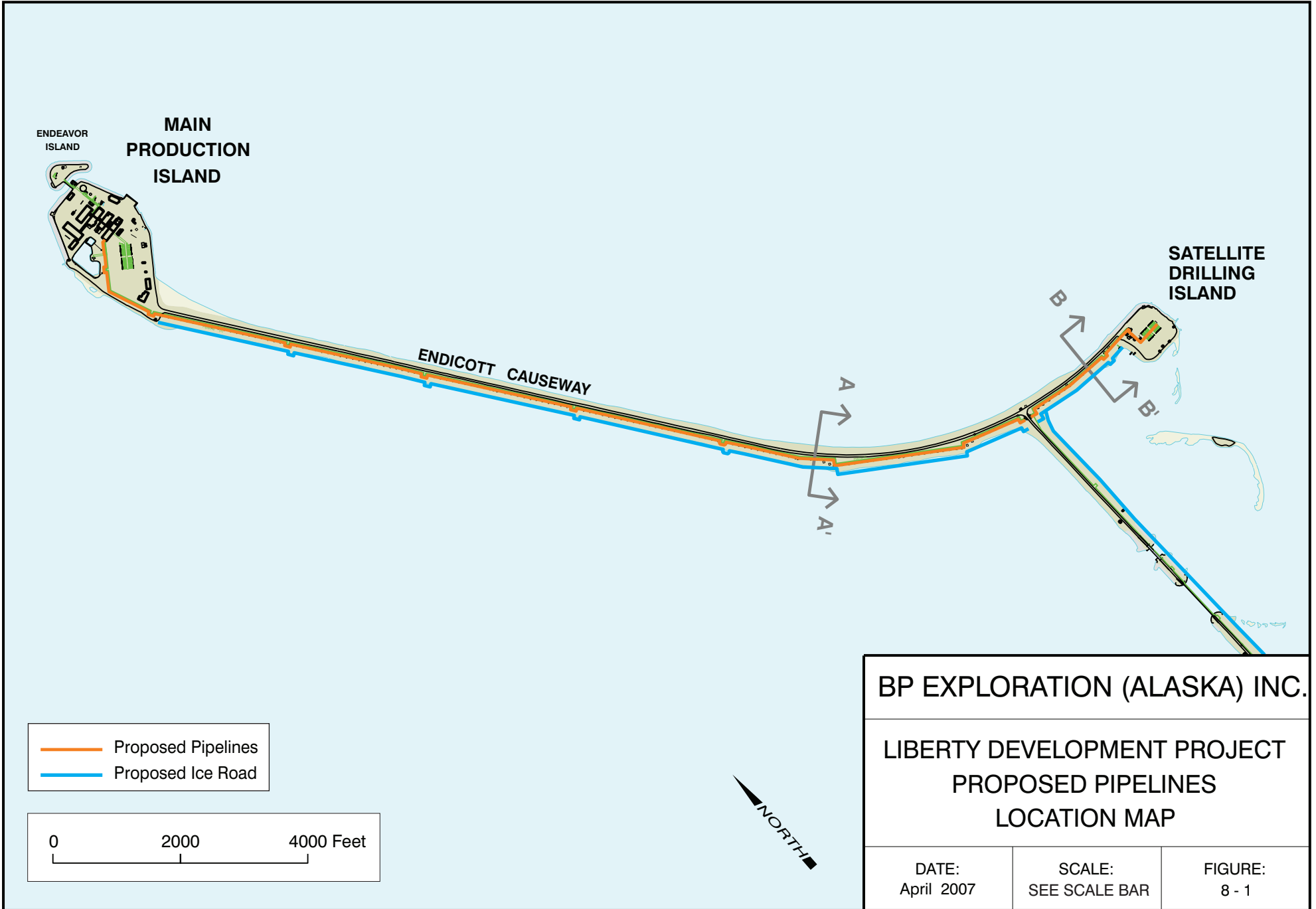

NORTH

VSM CONFIGURATION
FROM MPI TO "Y" INTERSECTION

SOUTH

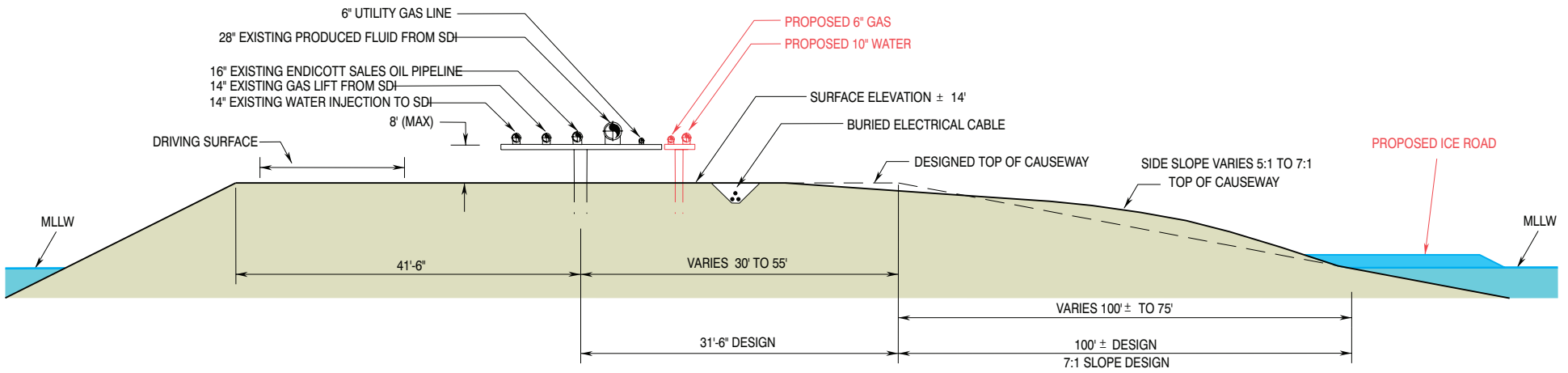

SECTION A-A'

BP EXPLORATION (ALASKA) INC.

LIBERTY DEVELOPMENT PROJECT
ENDICOTT PROPOSED PIPELINES
MPI TO SDI CROSS SECTIONS

DATE:
April 2007

SCALE:
NOT TO SCALE

FIGURE:
8 - 2

VSM CONFIGURATION
FROM "Y" INTERSECTION TO SDI

NORTH

SOUTH

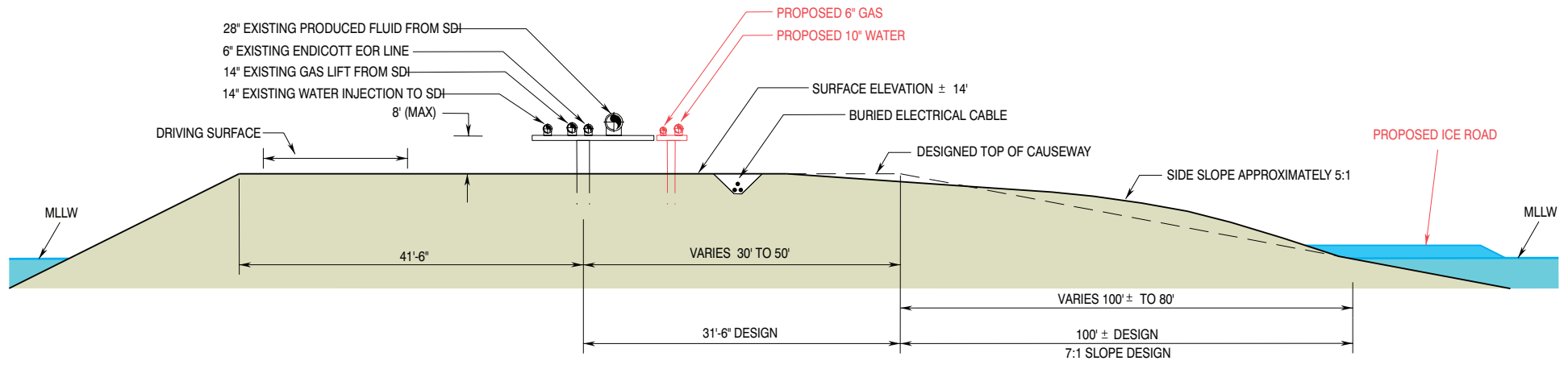

SECTION B-B'

BP EXPLORATION (ALASKA) INC.

LIBERTY DEVELOPMENT PROJECT
ENDICOTT PROPOSED PIPELINES
MPI TO SDI CROSS SECTIONS

DATE:
April 2007

SCALE:
NOT TO SCALE

FIGURE:
8 - 3

9. INFRASTRUCTURE AND SUPPORT FACILITIES

This section describes support utilities and infrastructure associated with production and pipeline operations, as well as onshore and offshore facilities to be developed or used directly in support of this project.

9.1 UTILITIES AND INFRASTRUCTURE

9.1.1 Seawater Inlet Facilities

The Liberty *LoSal*TM EOR process will use approximately 120,000 barrels per day (bpd) of filtered and deaerated seawater from the existing Endicott seawater treatment plant in order to produce up to 50,000 bpd of *LoSal*TM EOR process water for injection. See Section 6.4 for a description of the *LoSal*TM EOR process facilities.

9.1.2 Electrical Power

Power Generation and Transmission

All Liberty process equipment to be installed will be electrically driven. The power forecast for the added Liberty equipment is approximately 6 to 8 megawatts, and the Liberty Project will install a 6- to 7-megawatt turbine-driven generator supplemented by existing Endicott generation capacity to meet this load requirement. This new generator will be located at the MPI and will be tied into the Endicott power generation system, which currently consists of four 6-megawatt turbine-driven generators. This will allow the Liberty generator and the Endicott power generation system to work together to supply both the Liberty and Endicott power requirements and will maintain Endicott's generator spinning-reserve/spare philosophy. The Liberty high-salinity-water booster pumps and the *LoSal*TM EOR process injection pumps to be located at the SDI will draw approximately 4 megawatts.

The present power distribution system for the SDI is not sized to meet this added power Liberty requirement. To distribute the additional power from the generation facilities at the MPI, the Liberty Project will install an additional buried power cable from the MPI to the SDI for the added load. In addition, the project will install a step-up transformer at the MPI and a step-down transformer at the SDI, and switchgear and motor control centers will be installed at the SDI to operate the new Liberty facilities.

The Liberty Project will not install any permanent diesel-fired back-up emergency power.

Electrical Design Basis

The enclosed areas of Liberty-installed process modules and buildings containing production equipment and oil, gas or produced water will be designed as Class I Division II. All control and control module/switchgear buildings will be designed as non-hazardous. Normal air changes will be provided by the heating, ventilation, and air conditioning (HVAC) system. Under emergency

gas-leak conditions, additional exhaust fans will ensure that 25 percent of the LEL will not be reached during normal operation. The HVAC system will maintain a minimum temperature of 40°F in all process buildings.

9.2 SUPPORT FACILITIES

In addition to the major project components (gravel island, production facilities and infrastructure, and pipeline system), a system of project support facilities will also be required for construction and operation of this project. These include:

- Winter ice roads,
- A gravel mine site,
- Construction camp/support, and
- Freshwater sources

9.2.1 Ice Roads

Ice roads will be built to support project construction, as shown on Figure 9-1. In order to expand the Endicott SDI, an ice road will be built starting in January 2009. The ice road will start from the gravel mine site near the Duck Island mine site on the west side of the Endicott Road. The ice road will cross under one of the Endicott Causeway bridges (depending on water depth) and run across the sea ice to the south side of the SDI. This ice road will allow the gravel-haul trucks direct, unobstructed access to the SDI without impacting normal traffic on the causeway, which has a single-lane bridge.

The ice road between the mine site and the shore will be up to 7 miles long and approximately 6 inches thick and will be constructed by using snow cover and water to form an initial trail. Snow fences may be required to gather snow. Ice thickness will be increased by spraying additional water until the road is the desired thickness. Additional water will be used as necessary for road maintenance. Construction will begin as soon as conditions are appropriate in late December or January, and the ice roads and pads will thaw in summer. The offshore section of the ice road will be approximately 3 miles long on grounded sea ice. Both segments will have a traveled surface approximately 50 feet wide.

A second 3-mile-long ice road may be built on the lagoon side of the Endicott Causeway between the MPI and the SDI to be used as access and as a construction platform during pipeline construction. Ice roads may also be required at the West Sag Bridge construction site to support construction.

In subsequent years during drilling operations, an ice road system may be built to access the island and relieve traffic on the existing Endicott Causeway. The location of the coastal ice road will remain essentially the same from year to year.

9.2.2 Gravel Source

Approximately 860,000 cubic yards of gravel will be required for construction of the SDI expansion. The source of gravel will be a new mine site just east of the Duck Island mine site adjacent to the West Channel of the Sagavanirktok River (Figure 9-1).

The mine sites lie approximately 9 miles southwest of the SDI on a partially vegetated gravel bench adjacent to the Sagavanirktok River (Figure 9-1). Gravel will be removed from an area of approximately 18 acres, with the primary excavation area developed as a single cell, and the

entire development mine site, including a stockpile area for overburden, would be approximately 35 acres in size.

The mining and rehabilitation plan was developed with the objective of minimizing environmental impacts through mitigation features incorporated into the design. The mine cell will be developed, gravel extracted, and site rehabilitation initiated in the winters of 2009 and 2010. Unusable material will be stripped from the site and stockpiled in a designated reserve area. Gravel will be removed in two 20-foot lifts, and after usable gravel has been removed from the mine, materials unsuitable for construction (e.g., unusable materials stockpiled during mining) will be placed in the mine excavation. Final rehabilitation will be in accordance with the gravel mining and rehabilitation plan (see Attachment D to this DPP).

9.2.3 West Sagavanirktok River Bridge

The West Sag Bridge connecting the Endicott Road to the Prudhoe Bay road system provides access to the MPI and SDI from Deadhorse and Prudhoe Bay infrastructure, as well as the Dalton Highway. It is therefore a major transportation link for the project. The logistics planning for construction and drilling indicates a substantial increase in traffic volume and heavier transportation loads during these project phases. Although heavy traffic is routed across an ice road during winter months, traffic interruptions could occur in summer, especially during Liberty drilling. In view of the increased traffic and a project design load requirement of 175 tons (for a fully laden vacuum truck), the bridge must be either upgraded or a new bridge constructed to avoid unscheduled bridge closures and delays due to bridge repairs.

BPXA is presently evaluating the condition of the existing bridge to determine whether it will remain serviceable throughout the Liberty project drilling program for transportation of drilling mud and disposal of drilling byproducts without interruption. The steel deck of the bridge was recently replaced due to cracking. Despite this repair and other weld-crack repairs on the secondary members, the bridge is still at risk of periodic closure or load restriction due to fatigue cracking of welds. The volume and load characteristics of the Liberty construction and drilling operations traffic will increase the likelihood of a prolonged bridge closure. BPXA is thus considering whether to replace the existing bridge superstructure or build a new bridge to mitigate the risk of a prolonged bridge closure or capacity derating that could adversely affect construction and/or drilling operations. Upgrade of the existing bridge for the Liberty Project would require an agreement with the Prudhoe Bay Unit owners.

If BPXA elects to construct a new bridge, it would be installed approximately 22 feet upstream of the existing bridge location (see Figures 9-2 and 9-3). The overall bridge span would be approximately 800 feet compared to existing 750-foot bridge and would extend over the existing bridge abutment shoring. The bridge would have a 175-ton capacity with up to two traffic lanes. A replacement superstructure to the existing road bridge would also have a 175-ton capacity (up from the present bridge capacity of 110 tons). The bridge girder bottom elevation would be +23 feet (MLLW) versus +22 feet for the existing bridge. For the purposes of this application, Figures 9-2 and 9-3 show a bridge with two traffic lanes. However, a single-lane bridge may be adequate for project needs.

New ice-breaking piers would be installed immediately upstream of a new road bridge (Figure 9-4). New piers would be in line with piers on the pipeline bridge located approximately 200 feet downstream of the road bridge. This arrangement is intended to reduce ice loads to both the road bridge and pipeline bridge piers.

Bridge construction would be completed in a single winter season (2009). The river ice would be thickened to facilitate construction from an ice pad across the river channel. Piers would be augured and/or driven into the river bed using specialized piling equipment supported by tracked cranes. Bridge span sections would be welded and assembled on the ice pad.

The existing river banks have been stabilized using a combination of steel H piles and wooden retaining slats. These will not be disturbed during construction. Abutment piles for a new bridge would be augured into the river bank behind the existing bridge abutment shoring.

Once the bridge support spans (girders) are erected and set atop the intermediate pier supports, pre-cast concrete deck panels would be set on the steel-box-girder span sections and grouted in place. Once the bridge structure is completed, the gravel approach ramps on both sides would be realigned with the new bridge.

Materials needed for bridge construction would be transported to the site via existing roads. An ice road across the West Sag may be needed before the new bridge is complete, and ice work pads may be required at the West Sag Bridge construction site to support construction.

9.2.4 Construction Camp/Support

Construction will be staged from existing facilities at Deadhorse and Endicott. Capacity and availability of these camp facilities including the camp at the Endicott MPI will be evaluated by BPXA. A temporary drilling camp housing up to 75 workers may be installed at another site (but not on the SDI).

9.2.5 Water Sources

As shown on Figure 9-1, existing and/or newly permitted water sources will be used for ice road construction, operation of the drilling rig and drilling camp, and operation and maintenance of the *LoSal*TM EOR process facilities. Additional sources may be identified prior to submittal of permit applications. The following estimates of freshwater requirements will be refined in early 2007 and submitted in the final permit applications:

- **Ice Roads:** 22 million gal/yr during peak construction season
- **Drilling Rig Use:** 15 million gal/yr during drilling
- **Temporary Camp:** 2.7 million gal/yr during drilling
- ***LoSal*TM EOR Process Facilities:** 18 million gal/yr during operations

Liberty Development and Production Plan

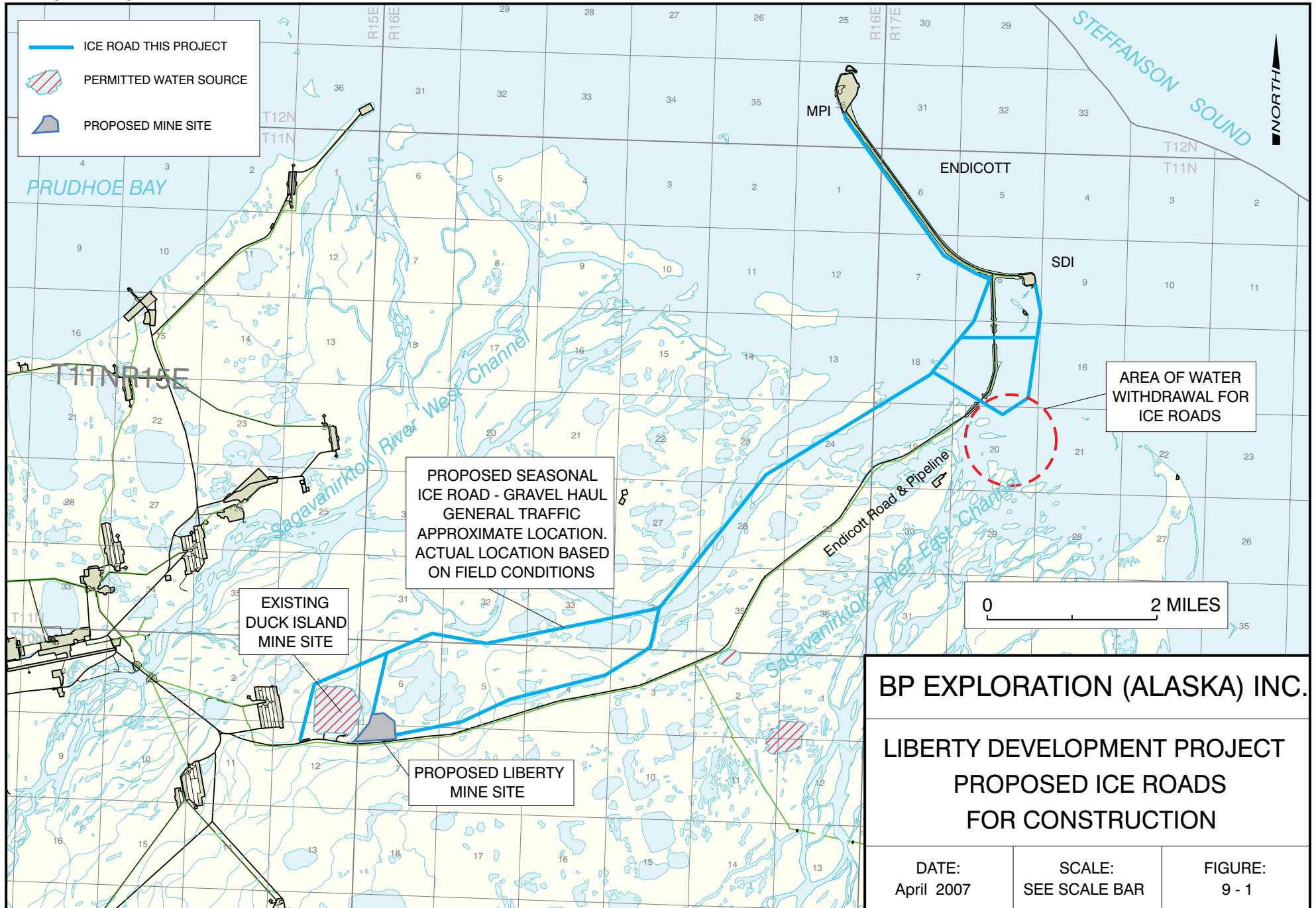

PROPOSED SEASONAL ICE ROAD - GRAVEL HAUL GENERAL TRAFFIC APPROXIMATE LOCATION. ACTUAL LOCATION BASED ON FIELD CONDITIONS

EXISTING DUCK ISLAND MINE SITE

PROPOSED LIBERTY MINE SITE

AREA OF WATER WITHDRAWAL FOR ICE ROADS

0 2 MILES

BP EXPLORATION (ALASKA) INC.

**LIBERTY DEVELOPMENT PROJECT
PROPOSED ICE ROADS
FOR CONSTRUCTION**

DATE:
April 2007

SCALE:
SEE SCALE BAR

FIGURE:
9 - 1

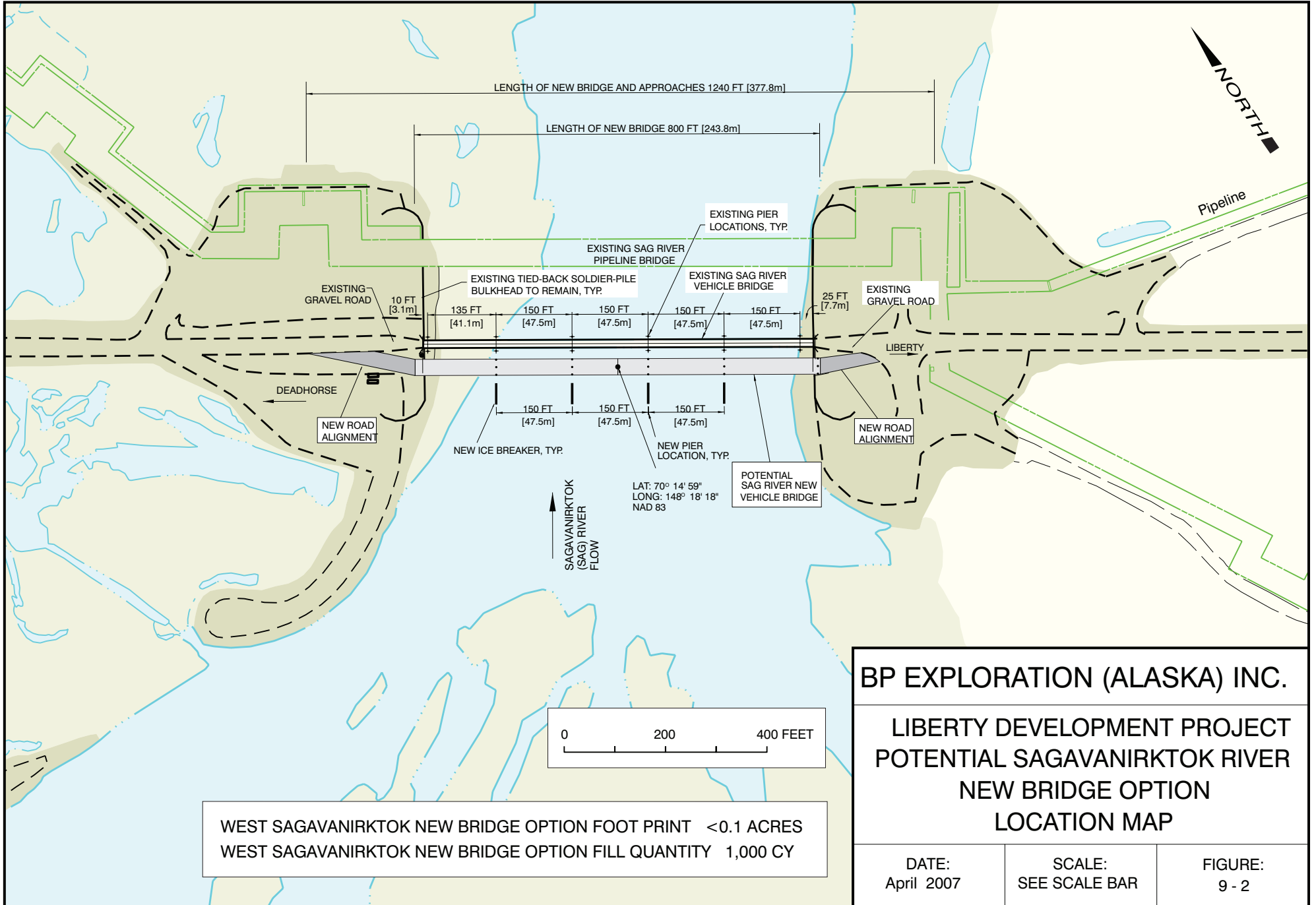

WEST SAGAVANIRK TOK NEW BRIDGE OPTION FOOT PRINT <0.1 ACRES
 WEST SAGAVANIRK TOK NEW BRIDGE OPTION FILL QUANTITY 1,000 CY

BP EXPLORATION (ALASKA) INC.

**LIBERTY DEVELOPMENT PROJECT
 POTENTIAL SAGAVANIRK TOK RIVER
 NEW BRIDGE OPTION
 LOCATION MAP**

DATE: April 2007	SCALE: SEE SCALE BAR	FIGURE: 9 - 2
---------------------	-------------------------	------------------

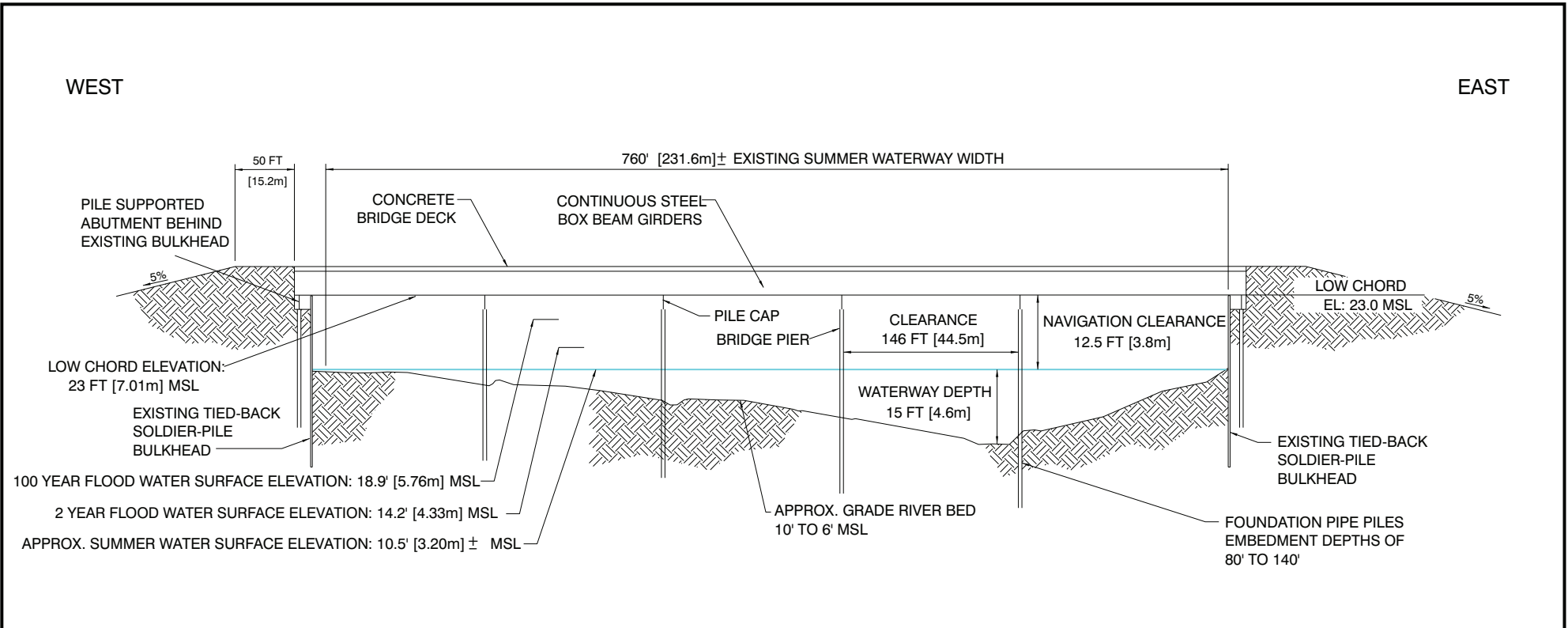

VEHICLE BRIDGE ELEVATION AT CENTER LINE

BP EXPLORATION (ALASKA) INC.

LIBERTY DEVELOPMENT PROJECT
 POTENTIAL SAGAVANIRKTOK RIVER
 NEW BRIDGE OPTION
 ELEVATION

DATE:
 April 2007

SCALE:
 NOT TO SCALE

FIGURE:
 9 - 3

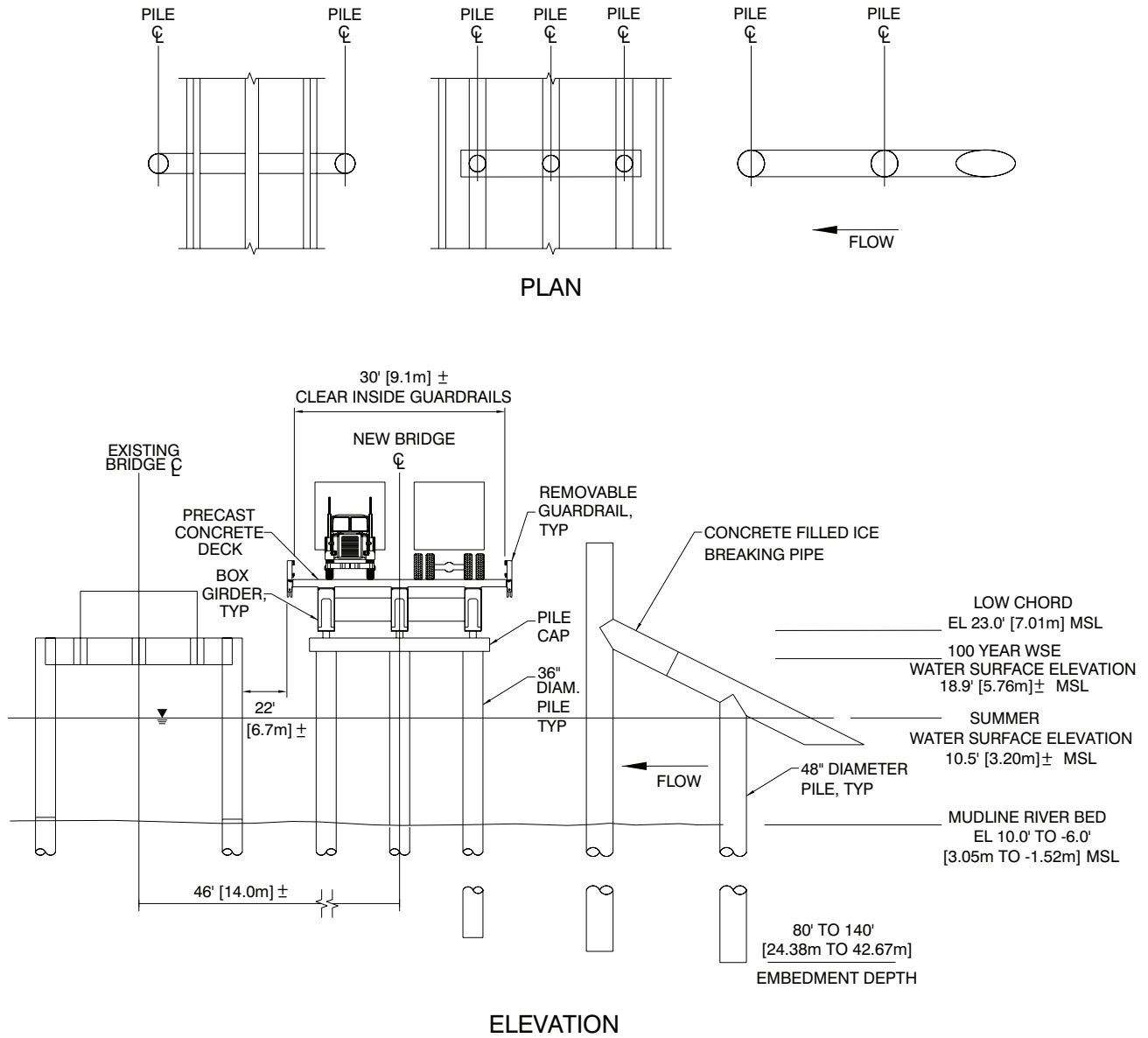

BP EXPLORATION (ALASKA) INC.

LIBERTY DEVELOPMENT PROJECT
 POTENTIAL
 SAGAVANIRKTOK RIVER BRIDGE
 PIER PLAN AND ELEVATION

DATE:
April 2007

SCALE:
NOT TO SCALE

FIGURE:
9 - 4

10. ENVIRONMENTAL SAFEGUARDS

This section outlines measures taken to assure environmental protection, including protection of biological resources, pollution prevention, minimization of discharges and emissions, and management of wastes. An environmental impact analysis (EIA) that accompanies this DPP (Attachment A) contains a detailed analysis of the affected environment, environmental impacts, and project mitigation. As discussed below, the evolution in scope from an offshore stand-alone project to utilization of existing infrastructure at Endicott reflects the project's commitment to minimize environmental impacts. This is enabled by a number of factors, including advances in uERD technology, use of depth-migrated 3D seismic data, and advances in reservoir modeling — among others. As a result, Liberty can be developed with relatively few wells (up to six) and less potential environmental impact than the originally proposed offshore development.

10.1 HABITAT AND WILDLIFE PROTECTION

10.1.1 Overview of Mitigation

A description of habitats, wildlife, project environmental impacts and mitigation is contained in the EIA. The overall Liberty Project has been planned and designed to minimize adverse effects to biological resources. In addition, the project incorporates mitigation measures to offset impacts from construction and operations.

The Liberty Project design and scope have evolved from an offshore stand-alone development in the outer continental shelf (production/drilling island and subsea pipeline) — as described in the 2002 *Liberty Development and Production Plan Final Environmental Impact Statement* — to use of existing infrastructure involving an expansion of the Endicott Satellite Drilling Island (SDI).

In 2005, BPXA made the decision to move the Liberty Project onshore to be developed using ultra-extended-reach drilling (uERD). Several onshore well pad locations were considered along with access road and pipelines as described in the EIA. This significantly mitigated the potential offshore environmental impacts related to the Boulder Patch, marine mammals, and concerns of the North Slope Inupiat communities related to the bowhead whale and subsistence whaling. It also made issues related to offshore pipeline design moot. These onshore options, which are described in the EIA, included host facilities at either Badami or Endicott (to process Liberty oil), well pad locations at either Pt. Brower and East Kadleroshilik, pipelines to either of the host facilities, and an access road to the well pad from the Endicott Road requiring bridges across the East Channel of the Sagavanirktok River. Development from the Endicott SDI will further mitigate impacts by avoiding construction of a pad on the shoreline of Foggy Island Bay and an access road and pipelines crossing the delta of the Sagavanirktok River. Impacts to wetlands have been significantly reduced including shoreline and tundra habitat for birds and caribou along the coast of the delta and Foggy Island Bay.

The main impact of the Liberty Development will be from expansion of the SDI which involves gravel placement covering about approximately 20 acres of the seabed and the opening of a new mine site that will affect approximately 35 acres just north of the existing Duck Island mine adjacent to the West Channel of the Sagavanirktok River. However, this civil construction involving gravel mining, hauling, and placement will take place in the winter. Slope protection will be installed concurrently with gravel placement. All other construction activity is located at Endicott, including installation of the *LoSal*TM EOR process plant on the MPI, installation of water and natural gas pipelines from the MPI to SDI, connections of the Liberty wells to the Endicott facilities, and modest upgrades to the power generation capacity at the MPI plant. Some dredging may be required at the seawater intake at the MPI, and screeding (i.e., leveling) to remove high spots on the seafloor may take place at the dock face being considered for the SDI.

10.1.2 Oil Spill Response Plan

Implementation of an approved oil spill response plan will mitigate the potential for adverse impacts to wildlife and habitats as a result of an oil spill. Liberty Project planning includes oil spill prevention measures, as well as spill response preparedness. The project must meet the requirements of:

- Minerals Management Service, 30 CFR Part 254, Oil Spill Response Requirements for Facilities Located Seaward of the Coastline, and
- State of Alaska, 18 AAC 75, Article 4, Oil Discharge Prevention and Contingency Plans.

BPXA will submit an application to the Alaska Department of Environmental Conservation to amend the *Endicott and Badami Oil Discharge Prevention and Contingency Plan* to cover the operations of the Liberty Project at the Endicott facility. Following state approval, the amended plan will be submitted to MMS for its approval. MMS spill response planning regulations (30 CFR 254.53) provide for submitting a response plan developed under state requirements for facilities within 3 miles of the natural shoreline.

The approved oil spill plan will meet the state and MMS spill response planning requirements concurrently. The plan describes BPXA's extensive emergency oil spill response organization, the capabilities of Alaska Clean Seas as BPXA's federally certified Oil Spill Removal Organization, oil spill prevention measures, and best available technology (BAT) analyses.

The proposed project has incorporated design measures to assure that the potential for spills and leaks has been minimized to the extent practicable. These features include:

- Storage tanks located in lined, bermed areas,
- Discharge detection technology,
- Tank overfill protection technology,
- Well control design, and
- Pad design and grading.

The plan will identify spill prevention measures, including use of BAT for well capping in the event of well blowout at the surface. The plan will describe the ability to respond and clean up spills with the appropriate equipment in conditions expected at the site. The spill plan for this project will be developed in coordination with a North Slope-wide effort. This planning effort will involve all relevant local, state, and federal agencies responsible for oil spill plan approvals and for natural resource management, with the goal of developing a set of scenarios and

associated response tactics to assure that North Slope operators can respond to spills. Liberty spill planning will consider this Slope-wide information, adjusting as necessary to reflect site-specific conditions.

10.1.3 Marine Mammal Authorizations

In accordance with the requirements of the Marine Mammal Protection Act, BPXA will seek Incidental Harassment Authorizations (IHA) and/or Letters of Authorization addressing incidental or small take of marine mammals, including preparation and implementation of a project polar bear interaction plan, for those activities of the project that may affect marine mammals. BPXA will evaluate in consultation with the National Marine Fisheries Service (NMFS) whether expansion of the SDI will affect ringed seals and will apply for an IHA, if necessary, and take any necessary measures to protect seals (Note: most of the SDI expansion area lies in water less than 6 feet deep — areas not typically used by seals).

10.1.4 Environmental Training Program

BPXA has a comprehensive environmental and safety training program which will be implemented for the Liberty Project. This program includes components to assure that all personnel (BPXA and contractors) are appropriately trained in wildlife avoidance and interactions, and fully understand the need for protection of subsistence wildlife resources and endangered species. A list of potential applicable environmental, safety, and technical training is provided in Section 12.

10.2 DISCHARGES AND EMISSIONS

A major goal of Liberty Project planning has been to minimize waste generation, minimize air emissions (both regulated pollutants and greenhouse gasses), and have zero surface discharges of drilling wastes. As described in Section 10.3, most waste streams will be disposed of through backhaul to existing North Slope facilities.

Project operation will result in several discharges. BPXA currently has an application on file with the EPA for renewal of the Endicott NPDES permit (see Attachment E). That application includes a request that the reject water from the *LoSal*TM EOR process plant be added to the existing Endicott discharges. Discharges under the reissued permit will include reverse-osmosis reject water, seawater treatment filter backwash, and sanitary/domestic wastewater. The existing NPDES General Permit for Facilities Related to Oil and Gas Extraction (AKG-33-0000) will be used to permit gravel mine site dewatering (if required) at the new mine site and will continue to permit stormwater and firewater test discharges from the Endicott MPI and SDI. This permit may also be used for rig camp sanitary/domestic wastewater, although the preferred option would be to haul sanitary/domestic wastes to the existing treatment facility at Endicott.

The project will generate air emissions principally from the drilling rig, which will be fueled by natural gas supplied by pipeline from the Endicott MPI, operation of construction equipment, drilling activities, and some power upgrades at the MPI plant. BPXA is operating a monitoring station on the SDI to obtain ambient air quality data to support its permit application to ADEC. That application contains the information required by 30 CFR 250.249 to the extent consistent with ADEC requirements.

10.3 WASTE MANAGEMENT

The waste management strategy developed for the Liberty Project consists of waste minimization to the greatest extent possible and integration into the existing Endicott procedures and facilities. The principal waste management strategy will be to dispose of drilling wastes in an existing permitted disposal well at the Prudhoe Bay Drill Site 4 facility. The design considerations associated with implementing this strategy include physical access to the site, on-site storage capability, and regulatory compliance.

Details of waste disposal facilities and procedures can be found in the *Alaska Waste Disposal and Reuse Guide (Revision 7, October 2005)*, also known as the “Red Book.” This guide is periodically updated as needed to conform with new regulatory requirements, internal procedures, or changes in facilities or operations. The Liberty Project will follow these guidelines to ensure regulatory compliance and conformance with BPXA environmental policies.

The following sections discuss disposal strategies for each project phase (construction, drilling, and production) and identify management options for the wastes expected to be generated during the project.

10.3.1 Strategies by Project Phase

Construction

Solid wastes generated during construction will be backhauled to existing approved facilities for recycling, storage, treatment, and disposal. Portable restroom facilities will be located at construction sites, and wastewater will be hauled away or the units exchanged regularly. Wastewater will be handled at the existing Endicott wastewater treatment plant.

Drilling

Drilling wastes will be trucked over the existing roads to the central grind-and-inject (G&I) facility at Prudhoe Bay Drill Site 4 for processing and disposal. Waste material that must be transported off-site for disposal will be transported by vehicles in accordance with any road restrictions. Solid wastes will be hauled off-site for ultimate disposal or recycling at existing facilities. The preferred option for sanitary and domestic wastewater from the drilling camp is to haul it to the existing permitted Endicott wastewater treatment plant for treatment and disposal. An option being considered is to provide for on-site grinding and injection of drilling waste on the SDI, but this option has not been fully evaluated.

Production Operations

Any wastes generated by Liberty production operations will be handled in accordance with existing Endicott facility practices, which conform to the *Red Book*. Details by waste stream are described below.

10.3.2 Management Options by Waste Stream

Non-Hazardous Solid Waste

Non-hazardous solid waste consisting of trash, food wastes, wood debris, metal debris and construction debris will be segregated into burnables, non-burnables, and recyclable scrap, and stored in designated containers. Burnables will be transported to existing North Slope processing facilities, while non-burnables will be transported to the existing North Slope Borough landfill.

Recyclable scrap will be transported to existing North Slope facilities for consolidation and transport off-site.

Oily Trash

Non-hazardous oily trash such as oily pit liners, empty oil and grease containers, and oily debris will be collected and stored on-site in designated lined and labeled dumpsters. The waste will be transported to existing North Slope facilities for processing or disposal.

Drilling Mud and Cuttings

As noted above, drilling mud and cuttings will be hauled off-site to the Drill Site 4 facility. Temporary on-site storage for mud and cuttings will be provided at the SDI.

Non-Hazardous Fluid Wastes

Waste fluids determined to be non-hazardous, including certain chemicals, tank rinse, sump fluids, and contaminated snowmelt, will be properly transported to existing North Slope facilities for disposal. Temporary on-site storage in portable tanks or tank trucks may be necessary.

BPXA plans installation and operation of a *LoSal*TM EOR process plant on the MPI which will be integrated into the existing Endicott seawater treatment plant (STP). The filter backwash and reverse-osmosis reject water from the *LoSal*TM plant will be returned to the STP seawater outfall and discharged under the Endicott NPDES permit.

Produced Water

Produced water from Liberty will be used for waterflood by injection in Class II wells (Liberty produced water will be commingled with Endicott produced water in the MPI plant and transmitted via pipeline to the Liberty water injection wells on the SDI).

Recyclable/Reusable Fluids

All fluids determined to be recyclable or reusable materials in accordance with state and federal regulations will be managed as such and not as waste products.

Used oil will be segregated from other materials and stored in containers marked with the words "Used Oil". All used oil will be tested to verify acceptability for recycling and inserted into the crude oil stream at Liberty or other North Slope facilities. Testing may consist of a halogens screen and flashpoint test. Used oil generated from a known source with known inputs (such as from a turbine within the facility) will be evaluated for recycling based on material safety data sheet (MSDS) information.

All other fluids determined to be potentially reusable will, at a minimum, be visually inspected to verify contents. Suitable materials will be labeled with the container contents and stored until reused. Testing will be conducted on fluids which are found to be questionable. All materials determined to be unsuitable for reuse or recycling will be managed as a waste material and characterized for proper disposal.

Hazardous Waste

All wastes determined to be hazardous in accordance with Resource Conservation and Recovery Act (RCRA) definitions will be managed in accordance with all federal and state requirements. Hazardous waste will be placed in drums or other approved containers for storage. All containers will be marked with the contents, the date generated, and the words "Hazardous Waste". All containers will be temporarily stored in areas with secondary containment and fluid collection capabilities. All hazardous waste will be transported to existing approved treatment,

storage, and disposal facilities, most likely located in the lower 48 states, for recycling and/or disposal.

RCRA compliance files will be maintained on-site, including information on waste identification, transportation manifests, and all correspondence with state and federal agencies regarding hazardous waste shipments.

Sanitary and Domestic Wastewater

Any incremental sanitary and domestic wastewater generated by this project will likely be handled by the Endicott wastewater treatment plant where it will be treated and discharged under the existing NPDES permit.

Sewage Sludge

Sewage sludge generated from camp operations will be backhauled to existing North Slope facilities for treatment and disposal.

Contaminated Snow

Any contaminated snow would be treated in a snowmelter located on-site, or possibly hauled off-site to an alternate location. Some contaminated snow might be temporarily stored at the point of generation or at a central location in impermeable containers.

Melted non-hazardous contaminated snow may be reused as a fluid in the drilling process or injected into a disposal well. Any snow suspected to have the potential for being designated as hazardous will be segregated and melted in a designated bin to recover material for further handling as appropriate to its characteristics.

Snow contaminated with gravel, soil, trash, wood, and other debris will be stored on the island and melted by natural or mechanical means. Resulting debris will be recovered and properly disposed of according to its characteristics.

Stormwater

Uncontaminated stormwater will be managed under the Endicott Stormwater Discharge permit and Endicott Storm Water Pollution Prevention Plan, which applies to roads and pads within the Endicott Unit.

Contaminated Gravel

Any contaminated gravel and soil will be managed on-site or at other North Slope facilities. Gravel will be remediated and reused for pad maintenance or other uses where possible. Any needed storage areas will have impermeable containment. Remediation may consist of washing, grind and inject, or other approved technology.

Naturally Occurring Radioactive Material

Naturally occurring radioactive materials (NORM) may be present in some production facilities, and BPXA will implement measures to identify and properly handle NORM materials. Well tubulars and piping will be scanned for NORMs when they are pulled from a well or removed from the process. Piping and tubulars that show indications of NORMs (above established background levels) will be properly stored on-site until transported to a North Slope area facility for batch treatment using equipment designed for NORM removal with high-pressure water. The resultant water-based slurry will be injected in an approved Class II disposal well.

Special Cases

If the following are generated, they will be managed as follows:

- **Empty Drums:** Due to waste minimization and limited storage space, drum stock will be kept to a minimum. Empty drums will be stored on-site and backhauled to existing BPXA North Slope facilities for flushing, crushing, and processing. Empty drum storage will be in secondary containment if any threat residual fluids will be released from the drums or if the physical condition of the drums will result in contamination of snow or gravel.
- **Aerosol Cans:** Aerosol cans that are completely empty (nothing is heard or felt when shaken) will be placed in the non-burnable dumpster. Non-empty cans will be punctured and the contents collected. Punctured cans will be placed in the non-burnable dumpster and the contents will be characterized for proper disposal. Aerosols will not be emptied into facility sumps.
- **Lead Acid Batteries:** Lead acid batteries will be segregated from waste streams and stored inside until transported to existing North Slope facilities to exchange for new batteries with the supplier. Lead acid batteries that are not standard size (e.g., from heavy equipment) may not be accepted by suppliers for exchange and may have to be transported to recycling facilities in the lower 48 states.
- **Medical Waste:** Medical waste will be stored in containers marked "Medical Waste" and will be sent off site to a regulated medical waste incinerator for disposal.
- **Fluorescent Light Tubes:** Fluorescent light tubes will be collected and sent to recycling facilities in the lower 48 states.
- **Used Oil Filters:** Used oil filters will be punctured and hot-drained on-site as generated. The collected oil will be screened for halogens and flashpoint prior to insertion into the crude stream, and the drained filter will be placed in the oily trash dumpster.
- **Radioactive Waste:** All radioactive waste will be characterized for disposal as generated. Common sources of radioactive waste are exit signs and smoke detectors. These materials will be stored in containers with the contents clearly identified until being transported off-site for proper treatment and disposal.

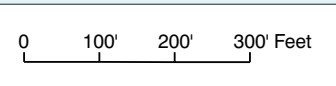
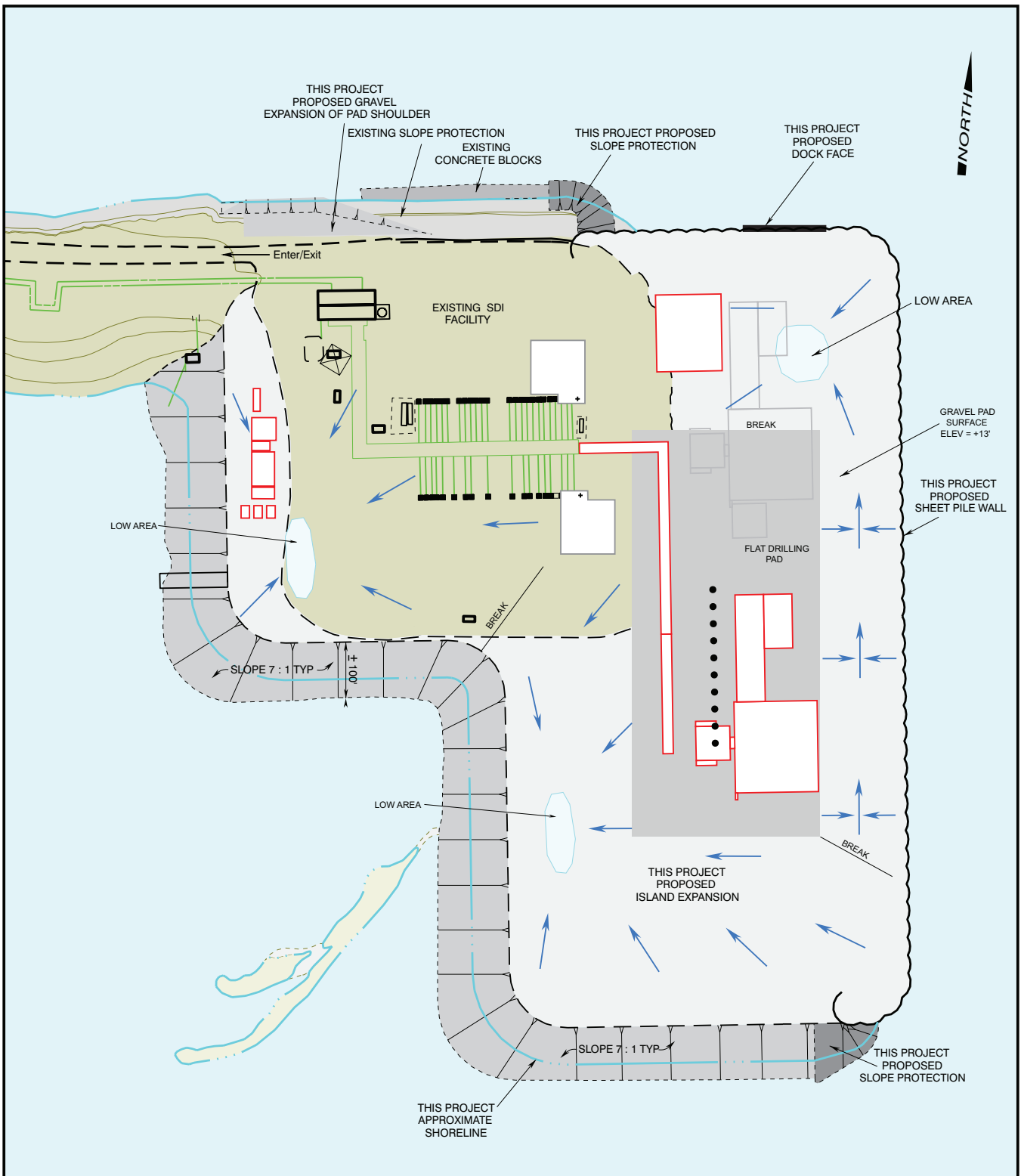

APPROXIMATE TIDE RANGE 9 INCHES
 APPROXIMATE ISLAND EXPANSION FOOT PRINT 20 ACRES
 APPROXIMATE ISLAND EXPANSION FILL QUANTITY 860,000 CY
 APPROXIMATE SLOPE PROTECTION ARMOR ROCK 6,000 CY

BP EXPLORATION (ALASKA) INC.
LIBERTY DEVELOPMENT PROJECT
SATELLITE DRILLING ISLAND
PROPOSED EXPANSION
DRAINAGE PLAN

DATE: April 2007	SCALE: SEE SCALE BAR	FIGURE: 10 - 1
---------------------	-------------------------	-------------------

11. OPERATIONS AND MAINTENANCE

New facilities added to the MPI and SDI for Liberty are limited to several small modules which will be operated and maintained in accordance with the procedures already in place at Endicott. Liberty facilities will be staffed consistent with safe, efficient, and environmentally sound operation. This requires a design for simple, reliable and unattended operation wherever possible. Specialized maintenance activities such as major equipment overhauls will be performed by external maintenance contractors or by vendor.

11.1 SAFETY EQUIPMENT

11.1.1 Firefighting Philosophy and Equipment

The basic philosophy for Liberty is to attempt a response to a fire in the incipient stage. Upon detection of a fire, the Liberty facilities and the associated Endicott host facilities will shut down and depressure. All personnel will evacuate the site. Fire protection and suppression systems will be provided as required by the State of Alaska Fire Marshal or applicable BP design standards. The system will be designed in accordance with API 14G where MMS regulations require this design standard be used. Portable fire fighting facilities of dry powder will be provided as necessary. Manual actuation of fire suppression systems will be possible either through the central control system and/or at strategic remote locations. Full-time fire/gas and process alarm monitoring will be performed from a monitoring station located in the Endicott Control Room.

11.1.2 Fire and Gas Detection, Alarm Action, and HVAC Philosophy

A fire and gas system will be provided which monitors the Liberty facilities and provides status information to the Endicott Control Room monitoring console. Unlike the Endicott facilities, Liberty facilities will not use Halon as an inerting agent. Liberty will rely on automatic and manual fire and gas detection, isolation, depressurization, high-rate ventilation, and alternatives to Halon such as fine water mist. The Liberty system will be integrated into the overall Endicott system.

Instruments for continuously monitoring for the presence of flammable gas and fire will be installed in areas as required by the State of Alaska Fire Marshal or applicable BP design standards. Smoke detection will be installed in buildings as necessary. Detection systems will provide alarm only at key locations. Protective action will be by remote and local manual initiation.

Manual alarm indications will be located at strategic points, and a fire protection panel will be programmed in the Endicott central computer system, provided with zone indication of detector points. The fire and gas system will be provided with a secure electrical power supply.

When activated, the fire alarm detection system will signal an alarm and will shut down and depressure or otherwise isolate the affected hydrocarbon processes. A suppression system, where installed, will be automatically activated. Because there are instances, such as a gas jet fire, where extinguishing should only be done after the fuel supply has been cut off, manual initiation of suppression systems may be part of the suppression philosophy. For the Liberty facilities, the emergency ventilation fans will start at 25 percent LEL gas detection, increasing air changes to a minimum of one cubic foot per minute of outside fresh air per square foot of floor space but not less than six air changes per hour. If the gas concentration continues to rise to 60 percent LEL, an emergency shutdown (ESD) will be activated causing the facility to shut down and isolate itself.

11.2 CRITERIA

11.2.1 Safety and Loss Control Regulations

Where applicable or as required by the MMS, the facilities will be designed in accordance with 30 CFR 250 Chapter II, Oil and Gas Operations in the Outer Continental Shelf and 33 CFR 140 Subchapter N, Outer Continental Shelf Activities. Other applicable regulations and standards will which will be adhered to include:

- 33 CFR 67, Aids to Navigation on Artificial Islands and Fixed Structures
- 18 AAC 75, State of Alaska Spill Prevention and Response Regulations
- API Recommended Practices
- International Building, Fire, Mechanical and Plumbing Codes, 2005 edition
- National Electrical Code, 2005 edition
- BP Recommended Practices
- BP Alaska specifications, and
- Other federal and state regulations and other international standards, as appropriate.

The design will be suited to the safe execution of operational requirements as written in the *Alaska Safety Handbook*. The following measures will be taken to reduce emissions and/or leaks:

- A regular, systematic walk-through of the plant will enable the operators to identify leaking components and plan their repair or replacement, and
- Gas detectors will be located around the plant to detect and warn of gas leakage.

11.2.2 Control and Monitoring

Liberty facility field control devices will report to the Endicott Control Room on the MPI, thereby facilitating unattended operation. The technology being employed will allow remote access to process control functions that will enable off-site control and supervision. Remote control supervision will allow a person at the Endicott Control Room to monitor control system operations for the Liberty facilities. An additional option for this type of system allows remote instrument calibration and troubleshooting. The facilities will have supervisory control and data acquisition (SCADA) systems capable of all production control functions, including well testing and volume accounting. The control system will have a human/machine interface allowing operator control of the Liberty operation.

11.2.3 Shutdown Systems

Stand-alone shutdown systems will be provided to generate safe and logical shutdowns from field shutdown inputs, manual shutdown stations, and the fire and gas system. These systems will

have the capability to generate first-out alarm and shutdown sequence, and be able to record the sequence of events. The shutdown system programmable logic controller (PLC) will be separate from the main PLC, which controls the normal process control functions. Fire and gas PLCs will be provided with inputs from the fire and gas detectors and manual stations, and with appropriate outputs to the ESD/plant shutdown systems. The design of any depressuring or process isolation systems will take full account of temperature effects on equipment metallurgy.

After activation of a shutdown system, the facility must be restarted following a standard reset philosophy. The resets will be activated from the human/machine interface but will not allow equipment startup without human intervention. The resets will not activate until specific permissives, as required for the equipment and plant, are met.

11.2.4 Flares and Vents

Flare and vent systems are not currently envisioned as part of the Liberty design. For well pad operations such as the SDI, process isolation is a preferable method of securing the operation. Depressurization of the Liberty facilities also requires depressurization of the Endicott SDI facilities. Depressurization would be accomplished by isolating incoming production from both the Liberty and Endicott SDI wells and relieving pressure through the normal process flow to the host processing facility. In this scenario, the flare at the host facility would be used to fully depressurize the system.

11.2.5 Telecommunications

Operational telecommunications requirements include:

- Communication system providing access to the national telephone network,
- Communication links (tie line) with local BPXA network,
- Data transmission capability,
- Mobile radio system with effective coverage over the facility area, and
- Mobile radio system linked to Alaska Clean Seas or other spill response contractor.

11.2.6 Safety System Testing

All well shutdown and safety systems associated with wells penetrating MMS leases will comply with 30 CFR 250 Subpart H and API RP 14C, "Design, Installation and Testing of Surface Safety Systems for Offshore Production Platforms."

11.2.7 Equipment Identification

The plant, equipment, and main/critical instruments will be identified by a tag numbering system. Equipment that can be changed out on a like-for-like basis (e.g., relief valves) should use the manufacturer's serial numbers as the identifier in addition to the above. The tagging identification convention will be consistent with MMS tagging conventions and BPXA's information management system.

11.2.8 Documentation and Information Management

A documentation and information management philosophy will be prepared. The following are examples of documents that may be prepared for the facility:

- Emergency Procedures

- Engineering Manuals
- Maintenance Manuals
- Operating Procedures
- Operations Manual
- Safety Manual
- Training Manual

12. TRAINING

BPXA has developed health, safety, and environmental (HSE) and technical training programs that should address the requirements of 30 CFR Subpart B, Stipulation No. 3 (Orientation Program of Lease Sale 144), and Stipulation No. 2 (Protection of Biological Resources) of Lease Sale 124. Those stipulations are focused on projects located in the OCS. BPXA will evaluate its existing training programs with respect to these MMS requirements and the specific circumstances of an Endicott-based development prior to initiating construction and drilling operations, and consult with the MMS to assure the programs comply with MMS requirements.

General topical areas in BPXA's HSE and technical training programs that Liberty personnel will have to take as applicable to their job include the following:

- uERD drilling
- Well control
- Permit and regulatory compliance
- Pollution prevention and spill reporting
- Biological resource protection and wildlife interaction (e.g., polar bears)
- Safety and health

13. PROJECT TERMINATION

All Liberty surface facilities will be located on State of Alaska lands. The only project components subject to MMS decommissioning regulations at 30 CFR Part 250 Subpart Q will be Liberty wells. Abandonment of Liberty facilities will be closely related to the life of the Endicott Field because the project is essentially an extension of this existing development. Accordingly, State of Alaska oil and gas lease and Alaska Department of Natural Resources permit conditions related to field abandonment for Endicott are assumed to apply to Liberty facilities located at Endicott.

Abandonment and rehabilitation of the gravel mine site for Liberty is described in the Liberty Gravel Site Mining and Rehabilitation Plan submitted for approval to the Alaska Department of Natural Resources and U.S. Army Corps of Engineers (See Attachment D).

At the time the Endicott facilities used by Liberty and Liberty-specific facilities are no longer required, BPXA will make a decision on abandoning those facilities or leaving them in place until Endicott abandonment. Considerations will include:

- Permit and lease stipulations both for the Liberty Project and Endicott;
- Regulations in place at the time;
- Impact on Endicott, including operational, safety, and environmental issues related to decommissioning; and
- Efficiencies in decommissioning all Endicott facilities at the same time.

This same rationale would also apply in implementing Special Condition No. 9 included in the U.S. Army Corps of Engineers Section 404/10 permit for the Endicott Development which states that “the gravel causeway, islands and onshore roads shall be removed within two years of abandonment of the facilities, unless it is determined by the Corps of Engineers that removal of any or all of these structures will result in unacceptable environmental impact.” Although not yet permitted, it can be expected that the gravel planned to be placed for Liberty will have similar provisions.

The Liberty wells are under the jurisdiction of both the MMS and the Alaska Oil and Gas Conservation Commission (AOGCC). The wells would be plugged and abandoned in accordance with the requirements of the applicable MMS and AOGCC regulations in place at the time of abandonment. Current requirements are specified in 30 CFR Part 250.1710-1717 and 20 AAC 25.105-172, respectively.

Actual detailed abandonment procedures will not be determined at this time, but will be developed as a project modification at the time BPXA or any future owner or operator decides to terminate the project. Abandonment as indicated above is subject to numerous overlapping federal, state, and local authorities and will involve multiple agency reviews and approvals, as well as opportunity for public comment. The agency discretion allowed in identification of termination and abandonment procedures allows for full consideration of environmental impacts

of removal options, and allows for any benefits from leaving certain facilities or structures in place at the time of abandonment.

14. BONDS, OIL SPILL FINANCIAL RESPONSIBILITY, AND WELL CONTROL STATEMENTS

BPXA attests that:

- The activities and facilities proposed in this DPP will be or are covered by an appropriate bond under 30 CFR 256, Subpart I.
- BPXA has or will demonstrate oil spill financial responsibility for facilities proposed in the final DPP, according to 30 CFR 253.
- BPXA has the financial capability to drill a relief well and to conduct other emergency well control operations.

15. BIBLIOGRAPHY OF PREVIOUSLY SUBMITTED MATERIAL

- BP Exploration (Alaska) Inc. 1998 and 2000. *Liberty Development Project Development and Production Plan*. Submitted to U.S. Minerals Management Service. Anchorage, Alaska.
- BP Exploration (Alaska) Inc. 1998. Geophysical data and interpretive results submitted to the MMS under separate cover in February 1998, prepared in accordance with Specification NTL 89-2, Section G. Anchorage, Alaska.
- BP Exploration (Alaska) Inc. 2000. *Liberty Development Project Oil Discharge Prevention and Contingency Plan*. Submitted to U.S. Minerals Management Service and Alaska Department of Environmental Conservation. Anchorage, Alaska.
- BP Exploration (Alaska) Inc. 2006. *Liberty Development Project: Project Description (First Draft, Development and Production Plan)*. Submitted to U.S. Minerals Management Service. Anchorage, Alaska.
- Intec Engineering, Inc. 2000. *Pipeline System Alternatives Report Addendum: Liberty Development Project Conceptual Engineering*. Prepared for BP Exploration (Alaska) Inc. Anchorage, AK. Intec Project No. H-0851.02, Project Study PS 19.
- LGL Alaska Research Associates, Woodward-Clyde Consultants, and Applied Sociocultural Research. 1998. *Liberty Development Project Environmental Report*. Prepared for BP Exploration (Alaska) Inc. Anchorage, Alaska.