

**NTP TECHNICAL REPORT**  
**ON THE**  
**TOXICOLOGY AND CARCINOGENESIS**  
**STUDIES OF**  
**MOLYBDENUM TRIOXIDE**  
**(CAS NO. 1313-27-5)**  
**IN F344/N RATS AND B6C3F<sub>1</sub> MICE**  
**(INHALATION STUDIES)**

**NATIONAL TOXICOLOGY PROGRAM**  
**P.O. Box 12233**  
**Research Triangle Park, NC 27709**

**April 1997**

**NTP TR 462**

**NIH Publication No. 97-3378**

**U.S. DEPARTMENT OF HEALTH AND HUMAN SERVICES**  
**Public Health Service**  
**National Institutes of Health**

## FOREWORD

The National Toxicology Program (NTP) is made up of four charter agencies of the U.S. Department of Health and Human Services (DHHS): the National Cancer Institute (NCI), National Institutes of Health; the National Institute of Environmental Health Sciences (NIEHS), National Institutes of Health; the National Center for Toxicological Research (NCTR), Food and Drug Administration; and the National Institute for Occupational Safety and Health (NIOSH), Centers for Disease Control. In July 1981, the Carcinogenesis Bioassay Testing Program, NCI, was transferred to the NIEHS. The NTP coordinates the relevant programs, staff, and resources from these Public Health Service agencies relating to basic and applied research and to biological assay development and validation.

The NTP develops, evaluates, and disseminates scientific information about potentially toxic and hazardous chemicals. This knowledge is used for protecting the health of the American people and for the primary prevention of disease.

The studies described in this Technical Report were performed under the direction of the NIEHS and were conducted in compliance with NTP laboratory health and safety requirements and must meet or exceed all applicable federal, state, and local health and safety regulations. Animal care and use were in accordance with the Public Health Service Policy on Humane Care and Use of Animals. The prechronic and chronic studies were conducted in compliance with Food and Drug Administration (FDA) Good Laboratory Practice Regulations, and all aspects of the chronic studies were subjected to retrospective quality assurance audits before being presented for public review.

These studies are designed and conducted to characterize and evaluate the toxicologic potential, including carcinogenic activity, of selected chemicals in laboratory animals (usually two species, rats and mice). Chemicals selected for NTP toxicology and carcinogenesis studies are chosen primarily on the bases of human exposure, level of production, and chemical structure. The interpretive conclusions presented in this report are based only on the results of these NTP studies. Extrapolation of these results to other species and quantitative risk analyses for humans require wider analyses beyond the purview of these studies. Selection *per se* is not an indicator of a chemical's carcinogenic potential.

These NTP Technical Reports are available for sale from the National Technical Information Service, U.S. Department of Commerce, 5285 Port Royal Road, Springfield, VA 22161 (703-487-4650). Single copies of this Technical Report are available without charge while supplies last from NTP Central Data Management, NIEHS, P.O. Box 12233, MD E1-02, Research Triangle Park, NC 27709 (919-541-3419). Listings of all published NTP reports and ongoing studies are also available from NTP Central Data Management. The Abstracts and other study information for 2-year studies are also available at the NTP's World Wide Web site: <http://ntp-server.niehs.nih.gov>.

**NTP TECHNICAL REPORT**  
**ON THE**  
**TOXICOLOGY AND CARCINOGENESIS**  
**STUDIES OF**  
**MOLYBDENUM TRIOXIDE**  
**(CAS NO. 1313-27-5)**  
**IN F344/N RATS AND B6C3F<sub>1</sub> MICE**  
**(INHALATION STUDIES)**

**NATIONAL TOXICOLOGY PROGRAM**  
**P.O. Box 12233**  
**Research Triangle Park, NC 27709**

**April 1997**

**NTP TR 462**

**NIH Publication No. 97-3378**

**U.S. DEPARTMENT OF HEALTH AND HUMAN SERVICES**  
**Public Health Service**  
**National Institutes of Health**

## CONTRIBUTORS

### National Toxicology Program

*Evaluated and interpreted results and reported findings*

P.C. Chan, Ph.D., Study Scientist  
 G.A. Boorman, D.V.M., Ph.D.  
 D.A. Bridge, B.S.  
 J.R. Bucher, Ph.D.  
 L.T. Burka, Ph.D.  
 J.R. Hailey, D.V.M.  
 J.K. Haseman, Ph.D.  
 R.A. Herbert, D.V.M., Ph.D.  
 G.N. Rao, D.V.M., Ph.D.  
 J.H. Roycroft, Ph.D.  
 G.S. Travlos, D.V.M.  
 D.B. Walters, Ph.D.  
 K.L. Witt, M.S., Oak Ridge Associated Universities

### Hazleton Laboratories America, Inc.

*Conducted 14-day and 13-week studies, evaluated pathology findings*

W.B. Coate, Ph.D., Principal Investigator  
 R.D. Alsaker, D.V.M., M.S.  
 R.L. Tacey, B.S.  
 B.M. Ulland, D.V.M.

### Battelle Pacific Northwest Laboratories

*Conducted 2-year studies, evaluated pathology findings*

B.J. Chou, D.V.M., Ph.D., Principal Investigator  
 B.J. Greenspan, Ph.D.  
 T.J. Mast, Ph.D.  
 R.A. Miller, D.V.M., Ph.D.

### Experimental Pathology Laboratories, Inc.

*Provided pathology quality assurance*

J.F. Hardisty, D.V.M., Principal Investigator  
 M. Wells, D.V.M.

### Dynamac Corporation

*Prepared quality assurance audits*

S. Brecher, Ph.D., Principal Investigator

### NTP Pathology Working Group

*Evaluated slides, prepared pathology report on rats (1 August 1995)*

P.K. Hildebrandt, D.V.M., Chairperson  
 PATHCO  
 M.R. Elwell, D.V.M., Ph.D.  
 National Toxicology Program  
 R.A. Herbert, D.V.M., Ph.D.  
 National Toxicology Program  
 A. Radovsky, D.V.M., Ph.D.  
 National Toxicology Program  
 R.C. Sills, D.V.M., Ph.D.  
 National Toxicology Program  
 M. Wells, D.V.M.  
 Experimental Pathology Laboratories, Inc.  
 J.R. Leininger, D.V.M., Ph.D.  
 Integrated Laboratory Systems  
 M. Torii, D.V.M., Ph.D., Observer  
 National Toxicology Program  
 J.D. Trujillo, Observer  
 North Carolina State University

*Evaluated slides, prepared pathology report on mice (31 July 1995)*

P.K. Hildebrandt, D.V.M., Chairperson  
 PATHCO  
 J.R. Hailey, D.V.M.  
 National Toxicology Program  
 R.A. Herbert, D.V.M., Ph.D.  
 National Toxicology Program  
 A. Radovsky, D.V.M., Ph.D.  
 National Toxicology Program  
 M. Wells, D.V.M.  
 Experimental Pathology Laboratories, Inc.  
 J.R. Leininger, D.V.M., Ph.D.  
 Integrated Laboratory Systems  
 L. Healy, D.V.M.  
 North Carolina State University  
 R.C. Sills, D.V.M., Ph.D.  
 National Toxicology Program

**Analytical Sciences, Inc.**

*Provided statistical analyses*

R.W. Morris, M.S., Principal Investigator

N.G. Mintz, B.S.

S. Rosenblum, M.S.

**Biotechnical Services, Inc.**

*Prepared Technical Report*

S.R. Gunnels, M.A., Principal Investigator

J.R. Carlton, B.A.

L.M. Harper, B.S.

D.C. Serbus, Ph.D.

# CONTENTS

<b>ABSTRACT</b>		<b>5</b>
<b>EXPLANATION OF LEVELS OF EVIDENCE OF CARCINOGENIC ACTIVITY</b>		<b>9</b>
<b>TECHNICAL REPORTS REVIEW SUBCOMMITTEE</b>		<b>10</b>
<b>SUMMARY OF TECHNICAL REPORTS REVIEW SUBCOMMITTEE COMMENTS</b>		<b>11</b>
<b>INTRODUCTION</b>		<b>13</b>
<b>MATERIALS AND METHODS</b>		<b>21</b>
<b>RESULTS</b>		<b>33</b>
<b>DISCUSSION AND CONCLUSIONS</b>		<b>55</b>
<b>REFERENCES</b>		<b>59</b>
<b>APPENDIX A</b>	<b>Summary of Lesions in Male Rats in the 2-Year Inhalation Study of Molybdenum Trioxide</b>	<b>65</b>
<b>APPENDIX B</b>	<b>Summary of Lesions in Female Rats in the 2-Year Inhalation Study of Molybdenum Trioxide</b>	<b>107</b>
<b>APPENDIX C</b>	<b>Summary of Lesions in Male Mice in the 2-Year Inhalation Study of Molybdenum Trioxide</b>	<b>139</b>
<b>APPENDIX D</b>	<b>Summary of Lesions in Female Mice in the 2-Year Inhalation Study of Molybdenum Trioxide</b>	<b>173</b>
<b>APPENDIX E</b>	<b>Genetic Toxicology</b>	<b>213</b>
<b>APPENDIX F</b>	<b>Organ Weights and Organ-Weight-to-Body-Weight Ratios</b>	<b>221</b>
<b>APPENDIX G</b>	<b>Hematology, Clinical Chemistry, and Blood Molybdenum Concentration Results</b>	<b>225</b>
<b>APPENDIX H</b>	<b>Reproductive Tissue Evaluations</b>	<b>229</b>
<b>APPENDIX I</b>	<b>Liver Copper Analysis</b>	<b>231</b>
<b>APPENDIX J</b>	<b>Bone Density and Curvature Results</b>	<b>233</b>
<b>APPENDIX K</b>	<b>Chemical Characterization and Generation of Chamber Concentrations</b>	<b>237</b>
<b>APPENDIX L</b>	<b>Ingredients, Nutrient Composition, and Contaminant Levels in NIH-07 Rat and Mouse Ration</b>	<b>257</b>
<b>APPENDIX M</b>	<b>Sentinel Animal Program</b>	<b>261</b>

## ABSTRACT



### MOLYBDENUM TRIOXIDE

CAS No. 1313-27-5

Chemical Formula: MoO<sub>3</sub>      Molecular Weight: 143.95

**Synonyms:** Molybdena; molybdenum anhydride; molybdenum (VI) oxide; molybdenum peroxide; molybdic acid anhydride; molybdic anhydride; molybdic oxide; molybdic trioxide; natural molybdite

Molybdenum is an essential element for the function of nitrogenase in plants and as a cofactor for enzymes including xanthine oxidoreductase, aldehyde oxidase, and sulfide oxidase in animals. Molybdenum trioxide is used primarily as an additive to steel and corrosion-resistant alloys. It is also used as a chemical intermediate for molybdenum products; an industrial catalyst; a pigment; a crop nutrient; components of glass, ceramics, and enamels; a flame retardant for polyester and polyvinyl chloride resins; and a reagent in chemical analyses. Molybdenum trioxide was nominated by the NCI for toxicity and carcinogenicity studies as a representative inorganic molybdenum compound. The production of molybdenum trioxide is the largest of all the molybdenum compounds examined.

Male and female F344/N rats and B6C3F<sub>1</sub> mice were exposed to molybdenum trioxide (approximately 99% pure) by inhalation for 14 days, 13 weeks, or 2 years. Genetic toxicology studies were conducted in *Salmonella typhimurium* and cultured Chinese hamster ovary cells.

#### 14-DAY STUDY IN RATS

Groups of five male and five female F344/N rats were exposed to 0, 3, 10, 30, 100, or 300 mg molybdenum trioxide/m<sup>3</sup>. Rats were exposed for 6 hours per day, 5 days per week, for a total of 10 exposure days during a 14-day period. All rats survived to the end of the study. The final mean body weights of male rats exposed to 100 mg/m<sup>3</sup> and male and female rats exposed to 300 mg/m<sup>3</sup> were significantly lower than those of the control groups. Male rats exposed to 300 mg/m<sup>3</sup> lost weight during the study. There were no clinical findings related to exposure to molybdenum trioxide. No chemical-related lesions were observed.

#### 14-DAY STUDY IN MICE

Groups of five male and five female B6C3F<sub>1</sub> mice were exposed to 0, 3, 10, 30, 100, or 300 mg molybdenum trioxide/m<sup>3</sup>. Mice were exposed 6 hours per day, 5 days per week, for a total of 10 exposure days during a 14-day period. All mice survived to the end of the study. Final mean body weights of male and female mice exposed to 300 mg/m<sup>3</sup> were significantly lower than those of the control groups. Male mice exposed to 300 mg/m<sup>3</sup> lost weight during the study. There were no clinical findings related to exposure to molybdenum trioxide. No chemical-related lesions were observed.

### 13-WEEK STUDY IN RATS

Groups of 10 male and 10 female F344/N rats were exposed to molybdenum trioxide by inhalation at concentrations of 0, 1, 3, 10, 30, or 100 mg/m<sup>3</sup> for 6.5 hours per day, 5 days per week, for 13 weeks. All rats survived to the end of the study. The final mean body weights of exposed rats were similar to those of the control groups. No clinical findings related to molybdenum trioxide exposure were observed. There were no significant chemical-related differences in absolute or relative organ weights, hematology or clinical chemistry parameters, sperm counts or motility, or liver copper concentrations between control and exposed rats. No chemical-related lesions were observed.

### 13-WEEK STUDY IN MICE

Groups of 10 male and 10 female B6C3F<sub>1</sub> mice were exposed to molybdenum trioxide by inhalation at concentrations of 0, 1, 3, 10, 30, or 100 mg/m<sup>3</sup> for 6.5 hours per day, 5 days per week, for 13 weeks. All mice survived to the end of the study. The final mean body weights of exposed mice were similar to those of the control groups. There were no chemical-related clinical findings. There were no significant differences in absolute or relative organ weights or sperm counts or motility between control and exposed mice. There were significant increases in liver copper concentrations in female mice exposed to 30 mg/m<sup>3</sup> and in male and female mice exposed to 100 mg/m<sup>3</sup> compared to those of the control groups. No chemical-related lesions were observed.

### 2-YEAR STUDY IN RATS

Groups of 50 male and 50 female F344/N rats were exposed to molybdenum trioxide by inhalation at concentrations of 0, 10, 30, or 100 mg/m<sup>3</sup>. Rats were exposed for 6 hours per day, 5 days per week, for 106 weeks.

#### *Survival, Body Weights, and Special Studies*

Survival rates of exposed male and female rats were similar to those of the control groups. Mean body weights of exposed groups of male and female

rats were similar to those of the control groups throughout the study. There was a significant exposure-dependent increase in blood molybdenum concentration in exposed rats. Blood concentrations of molybdenum in exposed male rats were greater than those in exposed female rats. There were no toxicologically significant differences in bone density or curvature between control and exposed rats.

#### *Pathology Findings*

The incidences of alveolar/bronchiolar adenoma or carcinoma (combined) were increased in male rats with a marginally significant positive trend. No increase in the incidences of lung neoplasms occurred in female rats. Incidences of chronic alveolar inflammation in male and female rats exposed to 30 or 100 mg/m<sup>3</sup> were significantly greater than those in the control groups. No nasal or laryngeal neoplasms were attributed to exposure to molybdenum trioxide. Incidences of hyaline degeneration in the nasal respiratory epithelium in 30 and 100 mg/m<sup>3</sup> males and in all exposed groups of females were significantly greater than those in the control groups. The incidences of hyaline degeneration in the nasal olfactory epithelium of all exposed groups of females were significantly greater than that in the control group. In the larynx, incidences of squamous metaplasia of the epithelium lining the base of the epiglottis in all exposed groups of male and female rats were significantly greater than those in the control groups and increased with increasing exposure concentration.

### 2-YEAR STUDY IN MICE

Groups of 50 male and 50 female B6C3F<sub>1</sub> mice were exposed to molybdenum trioxide by inhalation at concentrations of 0, 10, 30, or 100 mg/m<sup>3</sup>. Mice were exposed for 6 hours per day, 5 days per week, for 105 weeks.

#### *Survival, Body Weights, and Special Studies*

The survival rate of male mice exposed to 30 mg/m<sup>3</sup> was marginally lower than that of the control group; survival rates of 10 and 100 mg/m<sup>3</sup> males and of all exposed groups of females were similar to those of the control groups. Mean body weights of exposed male



mice were generally similar to those of the control group throughout the study. Mean body weights of exposed female mice were generally greater than those of the control group from week 11 until the end of the study. There was a significant exposure-dependent increase in blood molybdenum concentration in exposed mice. There were no toxicologically significant differences in bone density or curvature between control and exposed mice.

### ***Pathology Findings***

The incidences of alveolar/bronchiolar carcinoma in all exposed groups of males were significantly greater than that in the control group. Incidences of alveolar/bronchiolar adenoma in females in the 30 and 100 mg/m<sup>3</sup> groups were significantly greater than that in the control group. Incidences of alveolar/bronchiolar adenoma or carcinoma (combined) in 10 and 30 mg/m<sup>3</sup> males and in 100 mg/m<sup>3</sup> females were significantly greater than those in the control groups and exceeded the historical control ranges for 2-year NTP inhalation studies.

Incidences of metaplasia of the alveolar epithelium of minimal severity in the centriacinar region of the lung were significantly increased in all exposed groups of mice. The incidences of histiocyte cellular infiltration in all exposed groups of males were significantly greater than that in the control group. Incidences of hyaline degeneration of the respiratory epithelium of the nasal cavity in 100 mg/m<sup>3</sup> males and females and hyaline degeneration of the olfactory epithelium of the nasal cavity in 100 mg/m<sup>3</sup> females were significantly greater than those in the control groups. The incidences of squamous metaplasia of the epithelium lining the base of the epiglottis were significantly increased in all exposed groups of males and females. In both male and female mice, the incidences of hyperplasia of the laryngeal epithelium in level II of the larynx increased with increasing exposure concentration. The increase was statistically significant only in mice exposed to 100 mg/m<sup>3</sup> with 82% of male and 70% of female mice affected.

### **GENETIC TOXICOLOGY**

Molybdenum trioxide was not mutagenic in any of five strains of *Salmonella typhimurium*, and it did not induce sister chromatid exchanges or chromosomal aberrations in cultured Chinese hamster ovary cells *in vitro*. All tests were conducted with and without S9 metabolic activation enzymes.

### **CONCLUSIONS**

Under the conditions of these 2-year inhalation studies, there was *equivocal evidence of carcinogenic activity\** of molybdenum trioxide in male F344/N rats based on a marginally significant positive trend of alveolar/bronchiolar adenoma or carcinoma (combined). There was *no evidence of carcinogenic activity* of molybdenum trioxide in female F344/N rats exposed to 10, 30, or 100 mg/m<sup>3</sup>. There was *some evidence of carcinogenic activity* of molybdenum trioxide in male B6C3F<sub>1</sub> mice based on increased incidences of alveolar/bronchiolar carcinoma and adenoma or carcinoma (combined). There was *some evidence of carcinogenic activity* of molybdenum trioxide in female B6C3F<sub>1</sub> mice based on increased incidences of alveolar/bronchiolar adenoma and adenoma or carcinoma (combined).

Exposure of male and female rats to molybdenum trioxide by inhalation resulted in increased incidences of chronic alveolar inflammation, hyaline degeneration of the respiratory epithelium, hyaline degeneration of the olfactory epithelium (females), and squamous metaplasia of the epiglottis.

Exposure of male and female mice to molybdenum trioxide by inhalation resulted in increased incidences of metaplasia of the alveolar epithelium, histiocyte cellular infiltration (males), hyaline degeneration of the respiratory epithelium, hyaline degeneration of the olfactory epithelium (females), squamous metaplasia of the epiglottis, and hyperplasia of the larynx.

---

\* Explanation of Levels of Evidence of Carcinogenic Activity is on page 9. A summary of the Technical Reports Review Subcommittee comments and the public discussion on this Technical Report appears on page 11.

---

**Summary of the 2-Year Carcinogenesis and Genetic Toxicology Studies of Molybdenum Trioxide**


---

	Male F344/N Rats	Female F344/N Rats	Male B6C3F <sub>1</sub> Mice	Female B6C3F <sub>1</sub> Mice
<b>Doses</b>	0, 10, 30, or 100 mg/m <sup>3</sup>	0, 10, 30, or 100 mg/m <sup>3</sup>	0, 10, 30, or 100 mg/m <sup>3</sup>	0, 10, 30, or 100 mg/m <sup>3</sup>
<b>Body weights</b>	Exposed groups similar to control group	Exposed groups similar to control group	Exposed groups similar to control group	Exposed groups greater than control group
<b>2-Year survival rates</b>	17/50, 10/50, 16/50, 17/50	28/50, 24/50, 24/50, 23/50	36/50, 33/50, 25/50, 37/50	25/50, 31/50, 33/50, 35/50
<b>Nonneoplastic effects</b>	<u>Lung</u> : chronic inflammation, alveolus (2/50, 3/50, 25/50, 47/50) <u>Nose</u> : hyaline degeneration, respiratory epithelium (2/50, 7/49, 48/49, 49/50) <u>Larynx</u> : squamous metaplasia, epiglottis (0/49, 11/48, 16/49, 39/49)	<u>Lung</u> : chronic inflammation, alveolus (14/50, 13/50, 43/50, 49/50) <u>Nose</u> : hyaline degeneration, respiratory epithelium (1/48, 13/49, 50/50, 50/50); hyaline degeneration, olfactory epithelium (39/48, 47/49, 50/50, 50/50) <u>Larynx</u> : squamous metaplasia, epiglottis (0/49, 18/49, 29/49, 49/50)	<u>Lung</u> : metaplasia, alveolar epithelium (0/50, 32/50, 36/49, 49/50); histiocyte infiltration, cellular (2/50, 16/50, 9/49, 9/50) <u>Nose</u> : hyaline degeneration, respiratory epithelium (11/50, 13/50, 11/49, 41/50) <u>Larynx</u> : squamous metaplasia, epiglottis (0/50, 26/49, 37/48, 49/50); hyperplasia (1/50, 3/49, 6/48, 41/50)	<u>Lung</u> : metaplasia, alveolar epithelium (2/50, 26/50, 39/49, 46/49) <u>Nose</u> : hyaline degeneration, respiratory epithelium (26/49, 23/50, 28/49, 48/49); hyaline degeneration, olfactory epithelium (22/49, 14/50, 14/49, 36/49) <u>Larynx</u> : squamous metaplasia, epiglottis (1/49, 36/50, 43/49, 49/50); hyperplasia (1/49, 1/50, 7/49, 35/50)
<b>Neoplastic effects</b>	None	None	<u>Lung</u> : alveolar/ bronchiolar carcinoma (2/50, 16/50, 14/49, 10/50); alveolar/ bronchiolar adenoma or carcinoma (11/50, 27/50, 21/49, 18/50)	<u>Lung</u> : alveolar/ bronchiolar adenoma (1/50, 4/50, 8/49, 9/49); alveolar/bronchiolar adenoma or carcinoma (3/50, 6/50, 8/49, 15/49)
<b>Uncertain findings</b>	<u>Lung</u> : alveolar/ bronchiolar adenoma (0/50, 0/50, 0/50, 3/50); alveolar/bronchiolar carcinoma (0/50, 1/50, 1/50, 1/50); alveolar/ bronchiolar adenoma or carcinoma (0/50, 1/50, 1/50, 4/50)	None	None	None
<b>Level of evidence of carcinogenic activity</b>	Equivocal evidence	No evidence	Some evidence	Some evidence
<b>Genetic toxicology</b>	<ul style="list-style-type: none"> <li><i>Salmonella typhimurium</i> gene mutations: Negative with and without S9 in strains TA97, TA98, TA100, TA1535, and TA1537</li> <li>Sister chromatid exchanges: Negative with and without S9</li> <li>    Cultured Chinese hamster ovary cells <i>in vitro</i>:</li> <li>Chromosomal aberrations: Negative with and without S9</li> <li>    Cultured Chinese hamster ovary cells <i>in vitro</i>:</li> </ul>			

---

## EXPLANATION OF LEVELS OF EVIDENCE OF CARCINOGENIC ACTIVITY

The National Toxicology Program describes the results of individual experiments on a chemical agent and notes the strength of the evidence for conclusions regarding each study. Negative results, in which the study animals do not have a greater incidence of neoplasia than control animals, do not necessarily mean that a chemical is not a carcinogen, inasmuch as the experiments are conducted under a limited set of conditions. Positive results demonstrate that a chemical is carcinogenic for laboratory animals under the conditions of the study and indicate that exposure to the chemical has the potential for hazard to humans. Other organizations, such as the International Agency for Research on Cancer, assign a strength of evidence for conclusions based on an examination of all available evidence, including animal studies such as those conducted by the NTP, epidemiologic studies, and estimates of exposure. Thus, the actual determination of risk to humans from chemicals found to be carcinogenic in laboratory animals requires a wider analysis that extends beyond the purview of these studies.

Five categories of evidence of carcinogenic activity are used in the Technical Report series to summarize the strength of the evidence observed in each experiment: two categories for positive results (**clear evidence** and **some evidence**); one category for uncertain findings (**equivocal evidence**); one category for no observable effects (**no evidence**); and one category for experiments that cannot be evaluated because of major flaws (**inadequate study**). These categories of interpretative conclusions were first adopted in June 1983 and then revised in March 1986 for use in the Technical Report series to incorporate more specifically the concept of actual weight of evidence of carcinogenic activity. For each separate experiment (male rats, female rats, male mice, female mice), one of the following five categories is selected to describe the findings. These categories refer to the strength of the experimental evidence and not to potency or mechanism.

- **Clear evidence** of carcinogenic activity is demonstrated by studies that are interpreted as showing a dose-related (i) increase of malignant neoplasms, (ii) increase of a combination of malignant and benign neoplasms, or (iii) marked increase of benign neoplasms if there is an indication from this or other studies of the ability of such tumors to progress to malignancy.
- **Some evidence** of carcinogenic activity is demonstrated by studies that are interpreted as showing a chemical-related increased incidence of neoplasms (malignant, benign, or combined) in which the strength of the response is less than that required for clear evidence.
- **Equivocal evidence** of carcinogenic activity is demonstrated by studies that are interpreted as showing a marginal increase of neoplasms that may be chemical related.
- **No evidence** of carcinogenic activity is demonstrated by studies that are interpreted as showing no chemical-related increases in malignant or benign neoplasms.
- **Inadequate study** of carcinogenic activity is demonstrated by studies that, because of major qualitative or quantitative limitations, cannot be interpreted as valid for showing either the presence or absence of carcinogenic activity.

When a conclusion statement for a particular experiment is selected, consideration must be given to key factors that would extend the actual boundary of an individual category of evidence. Such consideration should allow for incorporation of scientific experience and current understanding of long-term carcinogenesis studies in laboratory animals, especially for those evaluations that may be on the borderline between two adjacent levels. These considerations should include:

- adequacy of the experimental design and conduct;
- occurrence of common versus uncommon neoplasia;
- progression (or lack thereof) from benign to malignant neoplasia as well as from preneoplastic to neoplastic lesions;
- some benign neoplasms have the capacity to regress but others (of the same morphologic type) progress. At present, it is impossible to identify the difference. Therefore, where progression is known to be a possibility, the most prudent course is to assume that benign neoplasms of those types have the potential to become malignant;
- combining benign and malignant tumor incidence known or thought to represent stages of progression in the same organ or tissue;
- latency in tumor induction;
- multiplicity in site-specific neoplasia;
- metastases;
- supporting information from proliferative lesions (hyperplasia) in the same site of neoplasia or in other experiments (same lesion in another sex or species);
- presence or absence of dose relationships;
- statistical significance of the observed tumor increase;
- concurrent control tumor incidence as well as the historical control rate and variability for a specific neoplasm;
- survival-adjusted analyses and false positive or false negative concerns;
- structure-activity correlations; and
- in some cases, genetic toxicology.

**NATIONAL TOXICOLOGY PROGRAM BOARD OF SCIENTIFIC COUNSELORS  
TECHNICAL REPORTS REVIEW SUBCOMMITTEE**

The members of the Technical Reports Review Subcommittee who evaluated the draft NTP Technical Report on molybdenum trioxide on 5 December 1995, are listed below. Subcommittee members serve as independent scientists, not as representatives of any institution, company, or governmental agency. In this capacity, subcommittee members have five major responsibilities in reviewing NTP studies:

- to ascertain that all relevant literature data have been adequately cited and interpreted,
- to determine if the design and conditions of the NTP studies were appropriate,
- to ensure that the Technical Report presents the experimental results and conclusions fully and clearly,
- to judge the significance of the experimental results by scientific criteria, and
- to assess the evaluation of the evidence of carcinogenic activity and other observed toxic responses.

Arnold L. Brown, M.D., Chairperson  
University of Wisconsin Medical School  
Madison, WI

Irma Russo, M.D.  
Fox Chase Cancer Center  
Philadelphia, PA

Gary P. Carlson, Ph.D.  
School of Health Sciences  
Purdue University  
West Lafayette, IN

Louise Ryan, Ph.D.  
Division of Biostatistics  
Dana-Farber Cancer Institute  
Boston, MA

Thomas L. Goldsworthy, Ph.D.  
Department of Experimental Pathology and Toxicology  
Chemical Industry Institute of Toxicology  
Research Triangle Park, NC

Robert E. Taylor, M.D., Ph.D.  
Department of Pharmacology  
Howard University College of Medicine  
Washington, DC

Robert LeBoeuf, Ph.D.  
Corporate Professional and Regulatory Services  
Human Safety Department  
The Procter & Gamble Company  
Cincinnati, OH

Frederick L. Tyson, Ph.D.  
St. Mary's Hospital and Medical Center  
Cancer Research Institute  
Grand Junction, CO

Janardan K. Reddy, M.D.\*  
Department of Pathology  
Northwestern University Medical School  
Chicago, IL

Jerrold M. Ward, D.V.M., Ph.D.\*  
National Cancer Institute  
Frederick, MD

---

\* Did not attend

## SUMMARY OF TECHNICAL REPORTS REVIEW SUBCOMMITTEE COMMENTS

On 5 December 1995, the draft Technical Report on the toxicology and carcinogenesis studies of molybdenum trioxide received public review by the National Toxicology Program's Board of Scientific Counselors' Technical Review Subcommittee. The review meeting was held at the National Institute of Environmental Health Sciences, Research Triangle Park, NC.

Dr. P.C. Chan, NIEHS, introduced the toxicology and carcinogenesis studies of molybdenum trioxide by discussing the uses and rationale for study, describing the experimental design, reporting on survival and body weight effects, and commenting on compound-related nonneoplastic lesions in rats and mice. The proposed conclusions for the 2-year studies in rats and mice were *equivocal evidence of carcinogenic activity* in male F344/N rats, *no evidence of carcinogenic activity* in female F344/N rats, and *some evidence of carcinogenic activity* in male and female B6C3F<sub>1</sub> mice.

Dr. Taylor, a principal reviewer, agreed with the proposed conclusions. His major criticism concerned the failure to select higher doses for the 2-year study. While some of the outcomes, e.g., neoplasm promoter activity, were detected at doses used, toxicities and neoplasms at other sites might have been induced by doses as high as 200 mg/m<sup>3</sup>. Dr. Chan said the dose selection was based on body weight effects in the 14-day and 13-week studies but agreed that the top dose could have been higher. Dr. Taylor noted a statement in the report that male rats exhibited higher blood molybdenum concentrations and greater variability than females. He wondered if this was related to body weight or if pharmacokinetic data were not available and there was no explanation for the blood concentration differences.

Dr. Russo, the second principal reviewer, agreed with the proposed conclusions. She inquired as to the criteria used to designate the lung neoplasm findings in male rats as "uncertain neoplastic effects." Dr. J.R. Bucher, NIEHS, said that in the summary table in the Abstract, equivocal responses were generally listed under "uncertain findings." These were neoplastic responses that may or may not be chemical-related, and they should not be discounted.

Dr. Brown initiated a discussion about the severity grades assigned to the nonneoplastic lesions of the respiratory system in rats and mice. The severity grades range from 1 (minimal) to 4 (marked). Dr. Brown noted that many of the lesions were listed as 2 (mild) or below and wondered about the significance of such apparently slight changes from normal. Dr. Carlson said he would find the inclusion of ranges of severity within a group to be helpful. Dr. J.R. Hailey, NIEHS, said lesions probably would be characterized as minor. Dr. J.K. Haseman, NIEHS, said reporting the average severity grade primarily was a space-saving device, and for selected lesions the complete distribution could be included. Dr. LeBoeuf asked why the level of evidence for male mice was not *clear evidence*, since malignant lung neoplasms at all three exposure concentrations were significantly increased over controls. Dr. Haseman said there were two reasons: (1) the lack of a dose response, and (2) for lung neoplasms, combined neoplasm incidence was given primary emphasis, so that when adenomas and carcinomas were combined, the high dose group lost significance.

Dr. G. Van Riper, Vice President, Environmental Services, Behre Dolbear & Company, Inc., said he was representing Climax Molybdenum Company, which is the largest producer of molybdenum compounds in the United States, having produced such compounds since the early 1900s. He stated that during that time there has never been correlation of cancer with employees exposed to the compounds and because of the process used, worker exposure is quite low. Dr. Van Riper said he believed the pure oxide was used in NTP studies and detailed the synthetic processes to its production. With regard to toxicity, he commented that the pure trioxide is quite acidic (pH of 3.5) and speculated that bronchial effects might be an artifact of the low pH. Dr. Van Riper concluded by referring to reports of the anticarcinogenic effects of molybdenum and the need for more discussion of such effects. Dr. Brown asked if there was any comment on effects of inhalation of other materials with such a low pH. Dr. Bucher said there have been epidemiology studies of certain refinery populations where there had been fairly high sulfuric acid levels in the air, and there was an association with increased lung cancer incidence.

among the workers. Dr. Brown asked for any comment on the purported anticarcinogenic effects. Dr. Bucher said selenium was another example whereby low levels appeared to be anticarcinogenic and high levels carcinogenic. Dr. LeBoeuf agreed and said that where such data might be used in the risk assessment process, considerations of discontinuity in terms of dose and biological activity needed to be discussed.

Dr. Taylor moved the Technical Report on molybdenum trioxide be accepted with revisions discussed and with the conclusions as written for male rats, *equivocal evidence of carcinogenic activity*, for female rats, *no evidence of carcinogenic activity*, and for male and female mice, *some evidence of carcinogenic activity*. Dr. Russo seconded the motion, which was accepted unanimously with seven votes.

# INTRODUCTION



## MOLYBDENUM TRIOXIDE

CAS No. 1313-27-5

Chemical Formula: MoO<sub>3</sub>      Molecular Weight: 143.95

**Synonyms:** Molybdena; molybdenum anhydride; molybdenum (VI) oxide; molybdenum peroxide; molybdic acid anhydride; molybdic anhydride; molybdic oxide; molybdic trioxide; natural molybdite

### CHEMICAL AND PHYSICAL PROPERTIES

Molybdenum trioxide is a white or slightly yellow to slightly bluish powder with a boiling point of 1155 °C, a melting point of 795 °C, and a specific gravity of 4.50 at 19.5 °C. It is soluble in water (0.49 g/L at 28 °C), concentrated mineral acids, and solutions of alkali hydroxides, ammonia, and potassium bitartrate. Its vapor pressure is less than 10<sup>-3</sup> mm Hg at 600 °C (*Merck Index*, 1989).

### BIOLOGICAL FUNCTION

Molybdenum is an essential element in plants and animals. The metal is required for the function of the nitrogen-fixing enzyme, nitrogenase, in nitrogen-fixing bacteria and plants. It is a cofactor for the enzymes xanthine oxidoreductase, sulfite oxidase, and aldehyde oxidase in mammals (USEPA, 1975). Xanthine oxidoreductase is the product of a single gene and is present in two interconvertible forms, xanthine dehydrogenase and xanthine oxidase. Xanthine oxidase oxidizes hypoxanthine to xanthine and xanthine to uric acid in purine catabolism and is inhibited by the drug allopurinol. The enzyme transfers electrons from the substrate to molecular

oxygen and, in the process, generates superoxide anion radicals which may cause tissue damage in many pathological conditions (Fried *et al.*, 1973; McCord, 1985). Cofactor deficiency leads to abnormal sulfur and xanthine metabolism, i.e., high xanthine and low cystine and uric acid concentrations in plasma and urine (Van Gennip *et al.*, 1994).

Sulfite oxidase catalyzes the oxidation of sulfite to sulfate, and aldehyde oxidase catalyzes the oxidation of aldehydes and various nitrogen-containing aromatic heterocyclic compounds. There is evidence that high molybdenum intake reduces dental caries in humans and animals by increasing the availability of fluoride ions (USEPA, 1975).

### PRODUCTION, USE, AND HUMAN EXPOSURE

Molybdenum is widely distributed in nature. It is found in the minerals molybdenite, wulfenite, ferrimolybdate, jordisite, and powellite. It is present at an average concentration of 12 to 16 ppm in sea water and 1 ppm in the earth's crust. Molybdenum concentrations vary from 0.28 to 15 µg/g in coal from different parts of the United States (USEPA, 1975). Molybdenum concentrations are below 0.1 µg/g in

light oils and up to 0.52  $\mu\text{g/g}$  in heavier oils. Due to its high boiling point, a large amount of molybdenum remains in ash after combustion (USEPA, 1975). The average concentration of molybdenum is 0.35  $\mu\text{g/L}$  in large United States rivers, 1.4  $\mu\text{g/L}$  (highest concentration 68  $\mu\text{g/L}$ ) in the drinking water of the 100 largest United States cities, and 0.005  $\mu\text{g/m}^3$  (highest concentration 0.78  $\mu\text{g/m}^3$ ) in urban air (Hammond and Beliles, 1980). In the Climax area of Colorado where mining is extensive, molybdenum concentrations are as high as several  $\text{mg/L}$  in water, 530  $\text{mg/kg}$  dry weight in the river sediments, and 200 to 400  $\mu\text{g/L}$  in the Dillon reservoir (USEPA, 1975).

Molybdenum occurs in five valence states: +2, +3, +4, +5, and +6. Molybdenum forms two series of stable and water-soluble salts in tri- and hexavalent states. The biological differences with respect to valence are not clear. Molybdenum trioxide is a hexavalent compound (Kirk-Othmer, 1981; Goyer, 1991).

Molybdenum trioxide is produced by roasting an ore containing molybdenum at 1200° F. Of all the molybdenum compounds examined, molybdenum trioxide has the largest production volume ( $4.4 \times 10^{10}$  g in 1977). Total United States production in 1979 was 110 million pounds. Current import and export figures are not available. Molybdenum trioxide is used primarily (90% or more) as an additive to steel and corrosion-resistant alloys. It is also used as a chemical intermediate for molybdenum products; an industrial catalyst; a pigment; a crop nutrient; a component of glass, ceramics, and enamels; a flame retardant for polyester and polyvinyl chloride resins; and a reagent in chemical analyses (Kirk-Othmer, 1981; NIOSH/OSHA, 1981; Patty's, 1981).

Occupational standards of exposure established by the Occupational Safety and Health Administration (OSHA) are 5  $\text{mg/m}^3$  for soluble molybdenum compounds and 15  $\text{mg/m}^3$  for insoluble molybdenum compounds (Hammond and Beliles, 1980). In the United Kingdom the short-term exposure limit values are 10  $\text{mg/m}^3$  for soluble molybdenum compounds and 20  $\text{mg/m}^3$  for insoluble molybdenum compounds (Sittig, 1994). According to the National Occupa-

al Exposure Survey, approximately 17,072 workers in the United States were potentially exposed to molybdenum trioxide during the years 1981 to 1983 (NIOSH, 1990). The American Conference of Governmental Industrial Hygienists (ACGIH, 1995) recommends a threshold limit value-time-weighted average of 5  $\text{mg/m}^3$  for soluble molybdenum compounds and 10  $\text{mg/m}^3$  for insoluble molybdenum.

Environmental release of molybdenum trioxide from industrial activities can occur in air (stack emissions), water (liquid effluents), or solid wastes (sludge). However, exposure of the general public to molybdenum trioxide is generally minimal because of government regulations, and the price of molybdenum trioxide (about \$10 per pound) encourages efficient capture of the chemical during its production and use (Hazard Information Review, 1981). Nevertheless, release of molybdenum trioxide dust during control equipment failure has been reported. The use of molybdenum in fertilizers may also be a problem in some areas. Thus, molybdenum is a potential pollutant. It is harmful to aquatic life in very low concentrations. Human exposure to molybdenum trioxide occurs primarily through inhalation of dust and ingestion in food and drinking water. A fumehazard may result from the sublimation characteristic of molybdenum trioxide at temperatures above 800° C (Patty's, 1981).

Molybdenum is ubiquitous in foodstuffs and in plant and animal tissues. Shellfish have high concentrations of molybdenum because the plankton they eat concentrate the element from sea water. Humans ingest an average of 350  $\mu\text{g}$  molybdenum per day in food (Hammond and Beliles, 1980). The chemical form in which molybdenum exists in plant and animal tissues is unknown (De Renzo, 1962). The daily requirement of molybdenum for humans is estimated to be 0.1 to 0.5 mg, but exact requirements are not known (Venugopal and Luckey, 1978; National Research Council, 1980). The average 70-kg man has a body content of about 9 mg molybdenum, most of it concentrated in bone, liver, kidneys, adrenal glands, and omentum. Molybdenum concentrations in newborn humans are relatively low, but the concentrations gradually increase up to age 20 and decline thereafter (Hammond and Beliles, 1980).



## ABSORPTION, DISTRIBUTION, METABOLISM, AND EXCRETION

### *Experimental Animals*

Molybdenum trioxide is water soluble and is absorbed rapidly in most species after oral administration, intramuscular injection, or inhalation exposure. After temporary retention in the tissues, molybdenum is excreted completely in the form of molybdate, with no accumulation in mammals. The biologic half-life is on the order of hours in experimental animals and weeks in humans (Friberg, 1979).

Low concentrations of molybdenum (20-270  $\mu\text{g}/10\text{ g}$  fresh tissue) were found in the lungs, liver, kidneys, spleen, and bone of guinea pigs exposed by inhalation to the dust or fumes of molybdenum trioxide (150-300  $\text{mg}/\text{m}^3$ ) for 1 hour per day, 5 times per week, for 5 weeks (Fairhall *et al.*, 1945). The molybdenum concentrations in these tissues gradually decrease after molybdenum trioxide exposure was stopped; the concentration declined to about 20% of the original levels after 2 weeks.

After an oral gavage dose of 50 mg molybdenum trioxide was administered to guinea pigs, molybdenum was distributed to the kidneys, spleen, blood, bile, liver, and lungs within 4 hours. The concentrations of molybdenum in the organs decreased, whereas in the blood and bile molybdenum titers were higher at 48 hours. Bone retained molybdenum longer than any other tissue (Fairhall *et al.*, 1945). Based on the amount recovered in feces for up to 48 hours, Fairhall *et al.* (1945) calculated that 85% of the oral dose was absorbed.

Fischer rats fed dietary sodium molybdate (2 ppm) and subcutaneously injected with *N*-methyl-*N*-benzyl-nitrosamine had increased molybdenum concentrations in the esophagus, forestomach, blood serum, and liver. Xanthine oxidase activities were also increased in the esophagus and forestomach, but not in the liver (Komada *et al.*, 1990). Radioactivity was detected in the liver, bone, heart, lungs, blood, and kidney 2.5 hours after rats were fed a single dose (13.34 mg) of  $^{99}\text{Mo}$ . The concentrations of radioactivity were higher in the intestine, kidney, and bone than in other tissues 51 hours after dosing. It was estimated that 35% of the administered dose was absorbed (Neilands

*et al.*, 1948). In dogs receiving  $^{99}\text{Mo}$  by injection, molybdenum was selectively concentrated in the liver, kidneys, and endocrine glands (pancreas, pituitary, adrenal, and thyroid). The brain, white marrow, and fat contained negligible amounts of the injected molybdenum (Patty's, 1981). In lactating goats,  $^{99}\text{MoO}_3$  administered orally was found in skeleton, liver, skin, muscles, blood, kidney, ovary, and hair 4 days later (Anke *et al.*, 1971).

In normal blood, molybdenum is firmly bound to red blood cells and plasma protein, with somewhat greater amounts associated with red blood cells (Bela and Lifshits, 1966; Mills and Davis, 1987).

Excessive hexavalent forms of molybdenum are excreted rapidly through the kidneys and the bile. Twice as much molybdenum is eliminated in urine as in feces. The urinary and fecal concentrations of molybdenum returned to normal 96 hours after an oral dose of molybdenum trioxide was administered to guinea pigs (Fairhall *et al.*, 1945). The predominant urinary metabolite of molybdenum was in the form of conjugated molybdate complexes (Venugopal and Luckey, 1978). Molybdenum was also detected in the milk of goats fed molybdenum trioxide (Anke *et al.*, 1971), and the concentration of molybdenum in cows' milk was increased after daily feeding of 500 mg ammonium molybdate (Mills and Davis, 1987). The absorption, tissue distribution, and excretion patterns of molybdenum in rabbits are similar to those in other species described above.

Increased molybdenum intake by experimental animals has been shown to increase tissue levels of xanthine oxidase (liver, intestine, and kidney; Luo *et al.*, 1983). Exposure to molybdenum trioxide dust (30  $\text{mg}/\text{m}^3$ ) for 5.5 months increased serum and urinary ascorbic acid levels in rabbits, but no similar effects occurred in rats (Lukashev and Shishkova, 1971a).

In mammals, there are metabolic interactions between molybdenum and copper, sulfate, and tungsten. High dietary levels of molybdenum produce a conditioned copper deficiency by depleting copper storage in the liver. Dairy cows given feed containing sodium molybdate (53-300 ppm) had decreased liver copper and increased milk copper concentrations (Huber *et al.*, 1971). Molybdenum causes an impairment of

copper uptake by liver cells, and thus disturbs the synthesis of copper-containing proteins, including ceruloplasmin (Marcilese *et al.*, 1969). The antagonism of copper depends on sulfate concentration in the diet.

Molybdenum depresses liver sulfide oxidase activity (Halverson *et al.*, 1960). The resulting sulfide accumulation leads to the formation of highly insoluble cupric sulfide and the subsequent appearance of symptoms of copper deficiency. However, copper prevents the accumulation of molybdenum in the liver by antagonizing the absorption of molybdenum. Sulfate limits molybdenum retention both by reducing its gastrointestinal absorption and by increasing its urinary and fecal excretion. The transport of molybdenum across tissue membrane is prevented by excessive  $\text{SO}_4$  ions (Venugopal and Luckey, 1978). Sulfate may also displace molybdate in the body. Thus copper, sulfate, and copper sulfate have been used to treat diseases caused by excessive molybdenum (Arrington and Davis, 1953).

Tungsten is antagonistic to molybdenum. It interferes with absorption and increases urinary excretion of molybdenum. The activities of molybdenum-dependent enzymes are inhibited in neonates when pregnant animals are fed tungsten. Tungsten is believed to replace molybdate in the molybdate-dependent enzymes (De Renzo, 1962). As a result, sulfite oxidase and xanthine oxidase activities are reduced (Cohen *et al.*, 1973).

### **Humans**

The absorption, tissue distribution, and excretion patterns of molybdenum in humans are similar to those in other species described above. As in experimental animals, high dietary levels of molybdenum produces a conditioned copper deficiency in humans. Increased urinary copper excretion and elevated levels of plasma copper were found in human volunteers ingesting 1.54 mg of molybdenum daily (Deosthale and Gopalan, 1974).

## **TOXICITY**

### **Experimental Animals**

Species differences exist with respect to the toxicity of molybdenum and its compounds. Cattle are the most

susceptible to molybdenum toxicity, followed by sheep, guinea pigs, poultry, rats, rabbits, pigs, and horses (Davis, 1950; Miller and Engel, 1960). Molybdenum is more toxic to ruminants than to monogastric animals, probably due to the formation of thiomolybdate in the sulfide-rich environment of the rumen (Suttle, 1974; Dick *et al.*, 1975). The inhalation  $\text{LC}_{75}$  for rats is  $431 \text{ mg/m}^3$  per hour, whereas the oral  $\text{LD}_{50}$  is  $125 \text{ mg/kg}$  (Sax, 1984). The subcutaneous  $\text{LD}_{50}$  for mice is  $94 \text{ mg/kg}$  (Sax, 1984). Acute symptoms of molybdenum toxicity include diarrhea, coma, and death from cardiac failure.

Typical symptoms of toxicity include weight loss or growth retardation, anorexia, anemia, diarrhea, achromotrichia, testicular degeneration, poor conception and deficient lactation, dyspnea, incoordination, and irritation of mucous membranes. Molybdenum also disturbs bone metabolism, giving rise to lameness, bone joint abnormalities, osteoporosis, and high serum phosphatase levels. Elevated molybdenum intake depresses copper availability and produces copper deficiency; the symptoms of molybdenosis described above are similar to those of hypocuprosis (Miller and Engel, 1960).

Cattle exposed for short periods (as little as several days) to pastures having concentrations of molybdenum in the soil and herbage that are higher (20-100 ppm) than the normal 3 to 5 ppm develop the disease known as "teart" (Lewis, 1943; Mills and Davis, 1987). The symptoms of teart include weight loss, diarrhea, loss of coat color (greying of black hair areas), anemia, poor conception and deficient lactation, lack of libido, testicular abnormalities (aspermato-genesis, interstitial cell and germinal epithelial damage), bone and joint abnormalities (brittleness and osteoporosis), and death (Thomas and Moss, 1951). Supplementing the diet with ammonium molybdate reduced serum and pituitary luteinizing hormone concentrations in dairy steers (Xin *et al.*, 1993). The poor reproductive function may be due to an effect on the hypothalamo-pituitary-gonad axis as a result of copper depletion following high molybdenum intake.

Sheep also develop the teart syndrome but are less susceptible than cattle (Mills and Davis, 1987).

Exostoses, hemorrhages about the long bones, and loosening of the great trochanters of the femurs have been described (Pitt *et al.*, 1980). The lesions were due to defects in the connective tissue at points where muscle is inserted into bone and to defects in the epiphysal plates of the trochanters.

Guinea pigs have been studied by Fairhall *et al.* (1945) by the inhalation and oral routes of administration. Inhalation exposure of 24 animals to molybdenum trioxide dust ( $205 \text{ mg/m}^3$ ) for 1 hour per day, 5 days per week, for 5 weeks was reported to produce eye and nasal irritation, anorexia and weight loss, diarrhea, muscular incoordination, and hair loss. Gross autopsy examination revealed changes in the liver (vacuolization and necrosis), spleen (cell damage), and lungs (alveolar and bronchiolar exudate). A 51% mortality rate was observed. Exposure to the fumes of molybdenum trioxide ( $191 \text{ mg/m}^3$ ) for the same duration was less toxic, with a mortality rate of only 8.3%. Oral administration by intubation of 25 to 200 mg molybdenum trioxide per guinea pig daily for 1 month produced dose-related changes in the liver (fatty changes) and kidney (focal necrosis and granulomatosis).

Numerous studies have been performed in rats. Inhalation exposure to 3 to  $10 \text{ mg/m}^3$  molybdenum trioxide dust for 2 hours on alternate days for 2 months caused changes in the liver (dystrophic changes manifested by protoplasmic swelling and granulation, focal fatty degeneration, and binucleate cells with hyperchromic nuclei), kidney (dystrophic), and lungs (alveolar wall thickening, interstitial pneumonia, and areas of emphysema) (Russian study cited in Hazard Information Review, 1981; details unavailable). Molybdenum trioxide dust also irritates the eyes and mucous membranes. In other studies, inhalation exposure to  $30 \text{ mg/m}^3$  molybdenum trioxide dust for 4 hours per day for 4 to 6 months (usually 5.5 months) resulted in reductions in alkaline and acid phosphatase activities in serum and decreased inorganic phosphorus levels in the tibia, but no changes were detected in ascorbic acid levels in serum or urine or in liver or spleen weights (Lukashev and Shishkova, 1971a,b,c).

Sodium molybdate administered in feed to Long-Evans rats for 4 to 7 weeks induced achromotrichia (loss of hair pigment) at 80 to 140 ppm (Jeter and Davis, 1954), femorotibial joint enlargement (epiphyseal thickening of femur characterized as chondrodystrophy of epiphyseal cartilages and mast cell accumulation in the diaphysis of long bones) at 75 to 300 ppm (Miller *et al.*, 1956), mandibular and maxillary exostoses at 400 ppm (Van Reen, 1959; Ostrom *et al.*, 1961), and diarrhea at 800 to 1,400 ppm (Ostrom *et al.*, 1961). Reduced erythrocyte counts and hemoglobin concentrations were observed at 75 to 400 ppm (Miller *et al.*, 1956; Ostrom *et al.*, 1961). Feed consumption and body weight gain were reduced at 400 to 1,200 ppm. Doses of 400 to 1,200 ppm also increased liver xanthine oxidase (Luo *et al.*, 1983) and alkaline phosphatase activities (Mills *et al.*, 1958; Van Reen, 1959); decreased liver sulfide oxidase, alkaline phosphatase, and cytochrome oxidase activities (Mills and Davis, 1987); and caused fatty degeneration of the liver and kidney (Van Reen, 1959). Deaths occurred at 4,000 to 5,000 ppm (Neilands *et al.*, 1948).

Oral intubation with a molybdenum salt,  $(\text{NH}_4)_6\text{Mo}_7\text{O}_{24}\cdot 4\text{H}_2\text{O}$ , in water at 80 mg/kg daily for 8 weeks caused a reduction in body weight and absolute kidney weight but an increase in relative kidney weight in male Sprague-Dawley rats. The molybdenum salt induced a significant increase in diuresis and creatinuria. Glomerular function, as measured by creatinine clearance, was significantly decreased. Urinary excretion of kallikrein was increased. The renal changes were considered to indicate a mild chronic renal failure (Bompart *et al.*, 1990).

Weanling male rats fed a diet containing 6 mg molybdenum in the form of ammonium tetrathiomolybdate and 3 mg copper per kg body weight for 2 to 21 days showed severe changes at long bone growth plates, at muscle insertions, and beneath the periosteum (Spence *et al.*, 1980). Thickening and widening of the epiphyseal growth plates of the femur, tibia, humerus, radius, and ulna were observed. Microscopically, the lesions included growth plate cartilaginous dysplasia with subsequent interference with endochondral ossification, subperiosteal multiplication of osteogenic cells and production of

large amounts of disorganized bone, resorption of trabecular bone, and interference with fibrogenesis at ligamentous attachments to bone. No toxic effects of molybdenum in mice have been reported in the literature.

Rabbits have been studied using both inhalation and oral routes of administration. In three inhalation studies, rabbits were exposed to an average chamber concentration of 30 mg/m<sup>3</sup> molybdenum trioxide dust for 4 hours per day for 5.5 months. Reductions in serum alkaline and acid phosphatase activities, decreased inorganic phosphorus levels in tibia, and increased ascorbic acid levels in serum and urine were reported. There were no changes in liver or spleen weights (Lukashev and Shishkova, 1971a,b,c). In an oral study in which sodium molybdate was administered in feed to weanling and adult rabbits for 5 weeks, concentrations of 0.1% to 0.4% produced anorexia, weight loss, decreased erythrocyte counts and hemoglobin concentrations, alopecia, dermatosis, and death. In addition, weanlings developed an abnormality of the front legs, i.e., an inability to support their weight, and bending of the humerus (Arrington and Davis, 1953). Administration of 5 mg/kg ammonium molybdate per day for 4 to 6 months produced an increase in spleen weight and a reduction in liver weight (Lukashev and Shishkova, 1971c).

No signs of toxicity were observed in pigs fed high levels of molybdenum (100 ppm) for 3 months (Davis, 1950) or in horses exposed to teart pasture s (Lewis, 1943).

### **Humans**

No specific symptoms of molybdenum trioxide exposure were reported in the literature except for arthralgia (pain in joints). Serum uric acid levels were increased in 34 of 37 copper-molybdenum plant workers who complained of arthralgia (USEPA, 1975).

In a plant producing molybdenum trioxide, the 8-hour exposure to respirable dusts of molybdenum trioxide and other soluble oxides of molybdenum was 9.47 mg/m<sup>3</sup>, about twice that of the OSHA permissible exposure limit of 5 mg/m<sup>3</sup>. Mean serum uric acid levels of 25 male workers were 1.18-fold higher (P<0.025) and mean serum ceruloplasmin (copper transport protein) levels were 1.65-fold higher

(P<0.005) than those of unexposed workers. No evidence of a gout-like syndrome was observed (Walravens *et al.*, 1979). However, development of gout and multiple sclerosis has been reported in humans exposed to high molybdenum concentrations in food and air (Bruin, 1976; Pitt, 1976).

## **REPRODUCTIVE AND DEVELOPMENTAL TOXICITY**

### **Experimental Animals**

No information on reproductive or developmental toxicity of molybdenum trioxide in experimental animals was found in the literature. However, studies of other forms of molybdenum have been performed.

In a study in which male and female rats (strain not specified) were mated after receiving 80 or 140 ppm sodium molybdate in feed from the time of weaning (approximately 3 weeks of age) to 11 weeks of age, significant findings included fewer litters, degeneration of the seminiferous tubules, and impaired growth of pups (weaning weights of the litters were reduced). The latter effect was not due to a decrease in feed consumption by any of the dams (Jeter and Davis, 1954). Significant findings in a three-generation reproduction study during which Charles River CD mice were exposed to 10 ppm molybdenum in drinking water included early deaths of the F<sub>1</sub> mice (15/238 exposed F<sub>1</sub> mice vs. 0/209 controls), the F<sub>2</sub> mice (7/242 exposed F<sub>2</sub> mice vs. 6/248 controls), and the F<sub>3</sub> mice (34/123 exposed F<sub>3</sub> mice vs. 1/230 controls). Additional findings were confined to the F<sub>2</sub> and F<sub>3</sub> mice and included failure to breed, increased maternal deaths, litters with no live pups, and the appearance of runts (11/123 exposed F<sub>3</sub> mice vs. 0/230 controls) (Schroeder and Mitchener, 1971).

Sodium molybdate (0.8 mg) injected into the yolk sacs of 4- and 8-day-old chick embryos failed to induce embryonic toxicity (Ridgway and Karnofsky, 1952).

When pregnant ewes were fed a diet high in molybdate, severe demyelination of the cerebral nervous system was observed in the newborn lambs (Mills and Fell, 1960). Little or no radioactivity was found in fetuses of pregnant sows sacrificed 30 hours following

an oral dose of  $^{99}\text{Mo}$  with  $\text{Na}_2\text{MoO}_4$  as a carrier 6 days before farrowing (Shirley *et al.*, 1954).

### **Humans**

No information on reproductive and developmental toxicity of molybdenum trioxide or other forms of molybdenum in humans was found in a search of the available literature.

## **CARCINOGENICITY**

### **Experimental Animals**

Evidence of carcinogenicity of molybdenum (VI) trioxide has not been reported. However, molybdenum (III) trioxide has been reported to be weakly carcinogenic in a short-term lung adenoma assay (the Shimkin test) in strain A mice. Three groups of 20 mice were intraperitoneally injected with 50, 144, or 250 mg molybdenum (III) trioxide per kg body weight in normal saline three times per week for a total of 19 injections. The total doses received by each group were 950, 2,735, and 4,750 mg/kg. At the end of 30 weeks, the frequency of lung tumors in the 4,750 mg/kg group was significantly higher ( $1.13 \pm 0.20$  tumors per mouse in 10/15 survivors) than that in the controls ( $0.42 \pm 0.10$  tumors in 7/19 survivors). Tumor incidences of mice in the two lower dose groups were similar to the incidence in the controls (Stoner *et al.*, 1976).

Molybdenum orange (a mixture of lead chromate and lead molybdate) administered as a single 30 mg subcutaneous injection to rats produced sarcoma (rhabdomyosarcomas and fibrosarcomas) at the injection site in 36 of 40 animals after an average latency period of 32 weeks (Maltoni, 1976a,b). This study, however, is inadequate for evaluating the potential carcinogenicity of molybdenum due to the presence of lead and chromium in the test substance. These chemicals have been implicated as potential carcinogens, and lead chromate (as chromium yellow and chromium orange) also produced sarcomas in this study.

Sodium molybdate ( $\text{Na}_2\text{MoO}_4$ ) administered in drinking water at a concentration of 2 mg/L reduced the incidence of *N*-nitrososarcosine ethyl ester-induced esophageal and forestomach cancer in male Sprague-

Dawley rats (Luo *et al.*, 1983). Dietary molybdenum at 2 ppm significantly inhibited *N*-methyl-*N*-benzyl nitrosamine-induced esophagus squamous cell carcinomas in F344 rats (Komada *et al.*, 1990). High levels of molybdenum were found in the esophagus and forestomach tissues. The incidence of mammary gland tumors induced by *N*-nitroso-*N*-methylurea (NMU) was lower in female Sprague-Dawley rats receiving 10 mg/L sodium molybdate in drinking water compared with controls (Wei *et al.*, 1985; Seaborn and Yang, 1993). Molybdenum dichloride inhibits growth of Ehrlich ascites tumors in mice (strain not specified) (Köpf-Maier *et al.*, 1979). *N*-Nitrosodiethylamine (NDEA) is a potent rodent carcinogen, inducing liver, esophageal, forestomach, and lung tumors in mice and liver and esophageal tumors in rats (strains not specified). NDEA forms DNA adducts in rats at the O<sup>6</sup>-guanine and O<sup>4</sup>-thymidine positions and induces DNA strand breaks in rat liver. Sodium molybdate inhibits O<sup>6</sup>-ethylguanine formation and prevents DNA damage in rat liver (Koizumi *et al.*, 1995). The protective action of molybdenum is considered to be enhanced detoxification by denitrosation of nitroso compounds rather than the activation reaction of dealkylation (Koizumi *et al.*, 1995). Inhibition of the NMU mammary gland carcinogenesis by sodium molybdate indicates that molybdenum acts at the promotional phase (Seaborn and Yang, 1993). Because molybdenum lowers serum copper levels and increases urinary copper excretion, molybdenum is considered to be the biological antagonist of the cancer-promoting copper (Nederbragt, 1982).

### **Humans**

No data on the possible relationship between molybdenum trioxide exposure and human carcinogenesis were found in the literature. However, low intake of molybdenum has been attributed to the high incidences of esophageal cancer in South Africa among the Bantu of Transkei (Burrell *et al.*, 1966), in China (Luo *et al.*, 1983), and in Russia (Nemenko *et al.*, 1976).

In contrast, Robinson and Clifford (1968) found no correlation between an above-normal incidence of nasopharyngeal carcinoma and the concentrations of food crops and soil in the high-altitude areas of Kenya.

## GENETIC TOXICITY

Little mutagenicity data are available for molybdenum trioxide. It was reported to be negative in the *Bacillus subtilis* rec assay with cold incubation (Kada *et al.*, 1980), and it was not mutagenic in any of five strains of *Salmonella typhimurium*, with or without S9 metabolic activation enzymes (Zeiger *et al.*, 1992). Additional negative results were obtained in a *Salmonella* test with molybdate orange, mixed with lead molybdate and lead chromate (Milvy and Kay, 1978). Venitt and Levy (1974) reported that various soluble salts of molybdenum (unspecified) failed to induce reversions to tryptophan prototrophy in *Escherichia coli* strains WP2, WP2*uvrA*, and WP2*exrA*.

Increased frequencies of chromosomal aberrations were reported in peripheral blood lymphocytes of workers exposed to molybdenum, molybdenite, and

molybdenum trioxide (Babaian *et al.*, 1980). Additional cytogenetic data for molybdenum trioxide are presented in Appendix E of this report.

## STUDY RATIONALE

The NCI nominated molybdenum trioxide for toxicity and carcinogenicity studies as a representative of a group of 13 inorganic molybdenum compounds in a class study of toxicity of selected metals. Molybdenum trioxide was chosen for study because the production of molybdenum trioxide is the largest of all the molybdenum compounds examined; molybdenum trioxide has widespread industrial use, so the potential for human exposure is significant; and there is a lack of adequate test data on molybdenum compounds in general. The NTP conducted 14-day, 13-week, and 2-year inhalation studies of molybdenum trioxide in rats and mice.

## MATERIALS AND METHODS

### PROCUREMENT AND CHARACTERIZATION OF MOLYBDENUM TRIOXIDE

Molybdenum trioxide was obtained from S.W. Shattuck Chemical Company, Inc. (Houston, TX) in one lot (G1220) and from Climax Molybdenum Company (Greenwich, CT) in one lot (1104CL). Lot G1220 was used during the 14-day and 13-week studies and lot 1104CL was used during the 2-year studies. Identity and purity analyses were conducted by the analytical chemistry laboratory, Midwest Research Institute (Kansas City, MO). Reports on analyses performed in support of the molybdenum trioxide studies are on file at the National Institute of Environmental Health Sciences. The methods and results of these studies are detailed in Appendix K.

Each lot of the chemical, a grayish green or greenish white powdered solid, was identified as molybdenum trioxide by infrared and ultraviolet/visible spectroscopy. In addition, the identity of lot 1104CL was determined by energy dispersive X-ray analysis and X-ray diffraction. The purity of each lot was determined by elemental analyses (atomic absorption spectroscopy for lots G1220 and 1104CL and gravimetric analysis for lot G1220), Karl Fischer water analysis, and spark source mass spectrometry. In addition, the purity of lot 1104CL was determined by inductively coupled plasma atomic emission spectrometry (ICP-AES). Elemental analysis by atomic absorption for molybdenum was in agreement with the theoretical value for molybdenum trioxide. Gravimetric analysis indicated a purity of  $100.6\% \pm 0.2\%$  for lot G1220. Karl Fischer water analysis indicated  $0.03\% \pm 0.02\%$  water for lot G1220 and  $0.15\% \pm 0.03\%$  water for lot 1104CL. Total inorganic impurities, determined by spark source mass spectrometry, were less than 3,000 ppm for lot G1220 (cadmium,  $\leq 100$  ppm; potassium, 2,400 ppm; and silicon, 180 ppm) and less than 201 ppm for lot 1104CL (sodium, 50 ppm). ICP-AES indicated a

purity of  $105\% \pm 5\%$  for lot 1104CL relative to lot G1220, analyzed concomitantly. The overall purity for each lot was determined to be approximately 99%.

No accelerated chemical stability studies were performed for molybdenum trioxide based on literature information about physical and chemical properties of the compound (Gould, 1962; Weast, 1989). To ensure stability, the bulk chemical was stored under refrigeration when not in use and allowed to warm to room temperature overnight prior to use (14-day and 13-week studies) or stored at room temperature in 10-gallon metal drums (2-year studies). The stability of the bulk chemical was monitored periodically by the study laboratories using atomic absorption spectroscopy, gravimetric analysis (13-week studies), and ICP-AES (2-year studies). No degradation of the bulk chemical was observed.

### AEROSOL GENERATION AND EXPOSURE SYSTEM

For the 14-day and 13-week studies, molybdenum trioxide was generated by Wright dust-feed mechanisms at gear ratios appropriate for each target concentration on top of approximately 1-L elutriators which opened into the top of each chamber. The airborne dust was swept into the chamber by compressor air at 30 psi and 200 L/minute. Chamber air pressure was negative with respect to that of the room.

For the 2-year studies, the molybdenum trioxide aerosol generation and delivery system was composed of four basic components: a flexible-brush dust-feed mechanism developed at the study laboratory, a Trost air impact mill, an aerosol charge neutralizer, and an aerosol distribution system (Figure K2). The Trost air impact pulverizer used the fluid energy from opposing air jets to cause particle-to-particle, head-on impaction to deagglomerate and reduce the size distribution of the feed material. Aerosol passed through the charge neutralizer and through the distribution line. At each

chamber location, an Air-Vac pump withdrew material from the distribution line into the chamber inlet. Each distribution line branch was terminated with a high-efficiency particulate air filter to remove any excess material.

## AEROSOL CONCENTRATION MONITORING

During the 14-day and 13-week studies, gravimetric samples were obtained during exposure periods from closed-face Gelman DM-450 Metrical filters in each exposure chamber two to six times per day. Samples were analyzed for molybdenum content by atomic absorption. In the 13-week studies, a real-time aerosol monitor (RAM) (Model RAM-1; GCA Corp., Bedford, MA) was used to monitor chambers in real time during the exposure periods. Readings were recorded approximately hourly for each chamber and were used to make adjustments to the dust generating systems. In the 2-year studies, molybdenum trioxide aerosol was monitored using a RAM-1 (MIE, Inc., Bedford, MA). RAMs were calibrated twice monthly. Filter samples were taken daily for gravimetric analysis of chamber concentration to verify RAM calibration.

## CHAMBER ATMOSPHERE CHARACTERIZATION

Particle size distributions in each chamber were determined twice during the 14-day studies and weekly for 6 or 7 weeks then again in week 11 or 12 during the 13-week studies using an Anderson 8-stage cascade impactor with an 11-micron preseparator. Impactor samples (Mercer-style 7-stage impactor; In-Tox Products, Albuquerque, NM) were taken from each exposure chamber at monthly intervals during the 2-year studies. An estimation was made of the mass median aerodynamic particle diameter and the geometric standard deviation of each set of samples (Tables K1, K2, and K3).

For the 13-week studies, the time required to achieve 90% of target concentration at the start of exposure ( $T_{90}$ ) was 23 minutes. The time required for concentration to decay to 10% of target at the end of

exposure ( $T_{10}$ ) was 23 minutes. For the 2-year studies,  $T_{90}$  was 7 to 13 minutes without animals present and 7 to 12 minutes with animals present. The  $T_{10}$  was 7 to 9 minutes without animals present and 9 to 10 minutes with animals present in the chambers. A  $T_{90}$  of 12 minutes was used for the 2-year studies. Uniformity of aerosol concentration in the 2-year inhalation exposure chambers was evaluated approximately every 3 months from 12 chamber positions (one in front and one in back for each of the six possible animal cage unit positions per chamber). The means of concentration in all chambers during the 14-day studies except the 10 mg/m<sup>3</sup> mouse chamber were within 10% of the target concentration; the 10 mg/m<sup>3</sup> mouse chamber averaged 12% over target (Table K4). The means of concentration in all chambers during the 13-week studies were within 10% of the target concentration (Table K5). The means of concentration in all chambers for the 2-year studies were at least 95% of the target (Table K6). At least 82% of all concentration readings were within the specified limits.

## 14-DAY STUDIES

Male and female F344/N rats and B6C3F<sub>1</sub> mice were obtained from Simonsen Laboratories, Inc. (Gilroy, CA). On receipt, the rats and mice were 6 weeks old. Animals were quarantined for 2 weeks and were 8 weeks old on the first day of the studies. Groups of five male and five female rats and mice were exposed to molybdenum trioxide by inhalation at concentrations of 0, 3, 10, 30, 100, or 300 mg/m<sup>3</sup> for 6 hours per day, 5 days per week, for a total of 10 days during a 14-day period. Water was available *ad libitum*; feed was available *ad libitum* except during exposure periods. Rats and mice were housed individually. Clinical findings were recorded and animals were weighed initially, at one week, and at the end of the studies. A necropsy was performed on all animals. A histopathologic examination of the nose was performed on all animals. Details of the study design and animal maintenance are summarized in Table 1.

## 13-WEEK STUDIES

The 13-week studies were conducted to evaluate the cumulative toxic effects of repeated exposure to



molybdenum trioxide and to determine the appropriate exposure concentrations to be used in the 2-year studies.

Male and female F344/N rats and B6C3F<sub>1</sub> mice were obtained from Frederick Cancer Research Center (Frederick, MD). On receipt, the rats and mice were 4 weeks old. Animals were quarantined for 2 weeks and were 6 weeks old on the first day of the studies. Before initiation of the studies, two male and two female rats and mice were randomly selected for parasite evaluation and gross observation for evidence of disease.

Groups of 10 male and 10 female rats and mice were exposed to molybdenum trioxide by inhalation at concentrations of 0, 1, 3, 10, 30, or 100 mg/m<sup>3</sup> for 6.5 hours per day including T<sub>90</sub> (23 minutes), 5 days per week, for 13 weeks. Water was available *ad libitum*; feed was available *ad libitum* except during exposure periods. Rats and mice were housed individually. Clinical findings were recorded weekly for rats and mice. The animals were weighed initially, weekly, and at the end of the studies. Details of the study design and animal maintenance are summarized in Table 1.

Clinical pathology studies were performed for all exposed and control rats at the end of the 13-week study. Rats were anesthetized and blood was drawn from the abdominal aorta. Blood for hematology determinations was placed in tubes containing potassium EDTA as the anticoagulant. Blood for serum analyses was collected in containers without anticoagulant, allowed to clot at room temperature, centrifuged, and the serum separated. Erythrocyte and leukocyte counts, hemoglobin concentration, and hematocrit values were determined using a Coulter S+ hematology analyzer (Coulter Electronics, Hialeah, FL). Differential leukocyte counts and morphological evaluation of blood cells were determined by light microscopic examination of blood films stained with Wright-Giemsa. Clinical chemistry determinations were performed on a CentrifChem® chemistry analyzer (Baker Instruments, Allentown, PA). The hematology and clinical chemistry parameters evaluated are listed in Table 1. All rats and mice were evaluated for liver copper burden. Liver tissue was prepared by wet digestion with nitric and perchloric

acids for copper analysis by atomic absorption spectroscopy.

At the end of the 13-week study, sperm samples were collected from 0, 10, 30, and 100 mg/m<sup>3</sup> rats and mice by the standard methods (NTP, 1983). The parameters evaluated are listed in Table 1. For sperm analyses, the left epididymis and testis were isolated and weighed. The tail of the epididymis (cauda epididymis) was then removed from the epididymal body (corpus epididymis) and weighed. Test yolk (rats) or modified Tyrode's buffer (mice) was applied to slides, and a small incision was made at the distal border of the cauda epididymis. The sperm effluxing from the incision were dispersed in the buffer on the slides, and the numbers of motile and nonmotile spermatozoa were counted for five fields per slide by two observers. Following completion of sperm motility estimates, each left cauda epididymis was placed in buffered saline solution. Caudae were finely minced, and the tissue was incubated in the saline solution and then heat fixed at 65 °C. Sperm density was then determined microscopically with the aid of a hemacytometer. To quantify spermatogenesis, the testicular spermatid head count was determined by removing the tunica albuginea and homogenizing the left testis in phosphate-buffered saline containing 10% dimethyl sulfoxide. Homogenization-resistant spermatid nuclei were counted with a hemacytometer.

A necropsy was performed on all animals. The brain, heart, right kidney, liver, lung, right testis, and thymus were weighed. Tissues for microscopic examination were fixed and preserved in 10% neutral buffered formalin (except testis with epididymis which was fixed in Bouin's solution), processed and trimmed, embedded in paraffin, sectioned to a thickness of 5 to 6 μm, and stained with hematoxylin and eosin. A complete histopathologic examination was performed on 0 and 100 mg/m<sup>3</sup> rats and mice. Table 1 lists the tissues and organs routinely examined.

## 2-YEAR STUDIES

### Study Design

Groups of 50 male and 50 female rats and mice were exposed to molybdenum trioxide by inhalation at concentrations of 0, 10, 30, or 100 mg/m<sup>3</sup> for 6 hours

per day plus  $T_{90}$  (12 minutes), 5 days per week, for 105 (mice) or 106 (rats) weeks.

### Source and Specification of Animals

Male and female F344/N rats and B6C3F<sub>1</sub> mice were obtained from Simonsen Laboratories (Gilroy, CA) for use in the 2-year studies. Rats and mice were quarantined for 15 days before the beginning of the studies. Five male and five female rats and mice were selected for parasite evaluation and gross observation of disease. Serology samples were collected for viral screening. Animals were approximately 6 weeks old at the beginning of the studies. The health of the animals was monitored during the studies according to the protocols of the NTP Sentinel Animal Program (Appendix M).

### Animal Maintenance

Rats and mice were housed individually. Water was available *ad libitum*; feed was available *ad libitum* except during exposure periods. Cages and racks were rotated weekly. Further details of animal maintenance are given in Table 1. Information on feed composition and contaminants is provided in Appendix L.

### Clinical Examinations and Pathology

All animals were observed twice daily. Body weights were recorded initially, weekly for 12 weeks, at week 15, monthly thereafter, and at the end of the studies. Clinical observations were recorded initially, at 4, 8, 12, and 15 weeks, monthly thereafter, and at the end of the studies. Blood was collected from 10 randomly selected animals per group at the end of the studies (Appendix G). Blood molybdenum concentrations were determined with inductively coupled plasma-atomic emission spectrometry. Samples were prepared and analyzed in batches of about 40 samples each, with each batch including five quality control standards prepared by spiking blank blood or serum with approximately 0.5 µg/g molybdenum. These standards were digested and analyzed with the samples. One quality control standard was analyzed after calibration and one was analyzed after every 10 samples. The measured concentration was required to be within 20% of the known value, or the instrument was recalibrated before proceeding with further sample assays.

Right femurs were collected from 10 randomly selected animals per group at the end of the studies (Appendix J). Bone density was calculated by weighing freshly collected right femurs both in air and suspended in water. Femoral curvature was assessed by measuring two lengths defined between points on the femur tangential to a straight line placed along the medial aspect. The curvature was defined as the ratio of the length following the outline of the bone and the straight-line distance between the landmarks. Measurements were made using Bioscan Optimas image analysis software (Bioscan, Inc., Edmonds, WA).

A complete necropsy was performed on all rats and mice. At necropsy, all organs and tissues were examined for grossly visible lesions, and all major tissues were fixed and preserved in 10% neutral buffered formalin, processed and trimmed, embedded in paraffin, sectioned to a thickness of 5 to 6 µm, and stained with hematoxylin and eosin for microscopic examination. For all paired organs (i.e., adrenal gland, kidney, ovary), samples from each organ were examined. Tissues examined microscopically are listed in Table 1.

Microscopic evaluations were completed by the study laboratory pathologist, and the pathology data were entered into the Toxicology Data Management System. The slides, paraffin blocks, and residual wet tissues were sent to the NTP Archives for inventory, slide/block match, and wet tissue audit. The slides, individual animal data records, and pathology tables were evaluated by an independent quality assessment laboratory. The individual animal records and tables were compared for accuracy, the slide and tissue counts were verified, and the histotechnique was evaluated. For the 2-year studies, a quality assessment pathologist reviewed the nose, larynx, lung, and thyroid gland of rats and mice; adrenal gland, heart, kidney, and skin of male and female rats; brain, liver, pancreas, pancreatic islets, prostate gland, spleen, and unspecified tissue of male rats; clitoral gland, mammary gland, ovary, pituitary gland, and urinary bladder of female rats; epididymis and small intestine of male mice; and ovary and uterus of female mice.

The quality assessment report and the reviewed slides were submitted to the NTP Pathology Working Group (PWG) chairperson, who reviewed the selected tissues

and addressed any inconsistencies in the diagnosis made by the laboratory and quality assessment pathologists. Representative histopathology slides containing examples of lesions related to chemical administration, examples of disagreements in diagnoses between the laboratory and quality assessment pathologists, or lesions of general interest were presented by the chairperson to the PWG for review. The PWG consisted of the quality assessment pathologist and other pathologists experienced in rodent toxicologic pathology. This group examined the tissues without any knowledge of dose groups or previously rendered diagnoses. When the PWG consensus differed from the opinion of the laboratory pathologist, the diagnosis was changed. Thus, the final diagnoses represent a consensus of quality assessment pathologists, the PWG chairperson, and the PWG. Details of these review procedures have been described, in part, by Maronpot and Boorman (1982) and Boorman *et al.* (1985). For subsequent analyses of the pathology data, the diagnosed lesions for each tissue type were evaluated separately or combined according to the guidelines of McConnell *et al.* (1986).

## STATISTICAL METHODS

### Survival Analyses

The probability of survival was estimated by the product-limit procedure of Kaplan and Meier (1958) and is presented in the form of graphs. Animals found dead of other than natural causes were censored from the survival analyses; animals dying from natural causes were not censored. Statistical analyses for possible dose-related effects on survival used Cox's (1972) method for testing two groups for equality and Tarone's (1975) life table test to identify dose-related trends. All reported P values for the survival analyses are two sided.

### Calculation of Incidence

The incidences of neoplasms or nonneoplastic lesions as presented in Tables A1, A5, B1, B4, C1, C5, D1, and D5 are given as the number of animals bearing such lesions at a specific anatomic site and the number of animals with that site examined microscopically. For calculation of statistical significance, the incidences of most neoplasms (Tables A3, B3, C3, and D3) and all nonneoplastic lesions are given as the

numbers of animals affected at each site examined microscopically. However, when macroscopic examination was required to detect neoplasms in certain tissues (e.g., skin, intestine, Harderian gland, and mammary gland) before microscopic evaluation, or when neoplasms had multiple potential sites of occurrence (e.g., leukemia or lymphoma), the denominators consist of the number of animals on which a necropsy was performed. Tables A3, B3, C3, and D3 also give the survival-adjusted neoplasm rate for each group and each site-specific neoplasm, i.e., the Kaplan-Meier estimate of the neoplasm incidence that would have been observed at the end of the study in the absence of mortality from all other competing risks (Kaplan and Meier, 1958).

### Analysis of Neoplasm Incidences

The majority of neoplasms in these studies were considered to be incidental to the cause of death or not rapidly lethal. Thus, the primary statistical method used was logistic regression analysis, which assumed that the diagnosed neoplasms were discovered as the result of death from an unrelated cause and thus did not affect the risk of death. In this approach, neoplasm prevalence was modeled as a logistic function of chemical exposure and time. Both linear and quadratic terms in time were incorporated initially, and the quadratic term was eliminated if the fit of the model was not significantly enhanced. The neoplasm incidences of exposed and control groups were compared on the basis of the likelihood score test for the regression coefficient of dose. This method of adjusting for intercurrent mortality is the prevalence analysis of Dinse and Lagakos (1983), further described and illustrated by Dinse and Haseman (1986). When neoplasms are incidental, this comparison of the time-specific neoplasm prevalences also provides a comparison of the time-specific neoplasm incidences (McKnight and Crowley, 1984).

In addition to logistic regression, other methods of statistical analysis were used, and the results of these tests are summarized in the appendixes. These methods include the life table test (Cox, 1972; Tarone, 1975), appropriate for rapidly lethal neoplasms, and the Fisher exact test and the Cochran-Armitage trend test (Armitage, 1971; Gart *et al.*, 1979), procedures based on the overall proportion of neoplasm-bearing animals.

Tests of significance included pairwise comparisons of each exposed group with controls and a test for an overall dose-related trend. Continuity-corrected tests were used in the analysis of neoplasm incidence, and reported P values are one sided. The procedures described in the preceding paragraphs were also used to evaluate selected nonneoplastic lesions. For further discussion of these statistical methods, refer to Haseman (1984).

### **Analysis of Nonneoplastic Lesion Incidences**

Because all nonneoplastic lesions in this study were considered to be incidental to the cause of death or not rapidly lethal, the primary statistical analysis used was a logistic regression analysis in which nonneoplastic lesion prevalence was modeled as a logistic function of chemical exposure and time.

### **Analysis of Continuous Variables**

Two approaches were employed to assess the significance of pairwise comparisons between exposed and control groups in the analysis of continuous variables. Organ and body weight data, which have approximately normal distributions, were analyzed using the parametric multiple comparison procedures of Dunnett (1955) and Williams (1971, 1972). Data for clinical chemistry, hematology, blood molybdenum levels, spermatid evaluations, liver copper levels, and bone density and curvature, which have typically skewed distributions, were analyzed using the nonparametric multiple comparison methods of Shirley (1977) and Dunn (1964). Jonckheere's test (Jonckheere, 1954) was used to assess the significance of the dose-related trends and to determine whether a trend-sensitive test (Williams' or Shirley's test) was more appropriate for pairwise comparisons than a test that does not assume a monotonic dose-related trend (Dunnett's or Dunn's test). Prior to analysis, extreme values identified by the outlier test of Dixon and Massey (1951) were examined by NTP personnel, and implausible values were eliminated from the analysis. Average severity values were analyzed for significance using the Mann-Whitney U test (Hollander and Wolfe, 1973).

### **Historical Control Data**

Although the concurrent control group is always the first and most appropriate control group used for evaluation, historical control data can be helpful in the overall assessment of neoplasm incidence in certain instances. Consequently, neoplasm incidences from the NTP historical control database, which is updated yearly, are included in the NTP reports for neoplasms appearing to show compound-related effects.

### **QUALITY ASSURANCE METHODS**

The 13-week and 2-year studies were conducted in compliance with Food and Drug Administration Good Laboratory Practice Regulations (21 CFR, Part 58). In addition, as records from the 2-year studies were submitted to the NTP Archives, these studies were audited retrospectively by an independent quality assurance contractor. Separate audits covering completeness and accuracy of the pathology data, pathology specimens, final pathology tables, and a draft of this NTP Technical Report were conducted. Audit procedures and findings are presented in the reports and are on file at NIEHS. The audit findings were reviewed and assessed by NTP staff, so all comments had been resolved or were otherwise addressed during the preparation of this Technical Report.

### **GENETIC TOXICOLOGY**

The genetic toxicity of molybdenum trioxide was assessed by testing the ability of the chemical to induce mutations in various strains of *Salmonella typhimurium* and sister chromatid exchanges and chromosomal aberrations in cultured Chinese hamster ovary cells. The protocols for these studies and the results are given in Appendix E.

The genetic toxicity studies of molybdenum trioxide are part of a larger effort by the NTP to develop a database that would permit the evaluation of carcinogenicity in experimental animals from the structure and responses of the chemical in short-term *in vitro* and *in vivo* genetic toxicity tests. These genetic toxicity tests were originally developed to study mechanisms of chemically induced DNA damage and to predict carcinogenicity in animals, based on the electrophilic theory of chemical carcinogenesis.

and the somatic mutation theory (Miller and Miller, 1977; Straus, 1981; Crawford, 1985).

There is a strong correlation between a chemical's potential electrophilicity (structural alert to DNA reactivity), mutagenicity in *Salmonella*, and carcinogenicity in rodents. The combination of electrophilicity and *Salmonella* mutagenicity is highly correlated with the induction of carcinogenicity in rats and mice and/or at multiple tissue sites (Ashby and Tennant, 1991). Other *in vitro* genetic toxicity tests do not correlate well with rodent carcinogenicity (Tennant *et al.*, 1987; Zeiger *et al.*, 1990), although these other tests can

provide information on the types of DNA and chromosome effects that can be induced by the chemical being investigated. Data from NTP studies show that a positive response in *Salmonella* is currently the most predictive *in vitro* test for rodent carcinogenicity (89% of the *Salmonella* mutagens were rodent carcinogens), and that there is no complementarity among the *in vitro* genetic toxicity tests. That is, no battery of tests that included the *Salmonella* test improved the predictivity of the *Salmonella* test alone. The predictivity for carcinogenicity of a positive response in bone marrow chromosome aberration or micronucleus tests is not yet defined.

**TABLE 1**  
**Experimental Design and Materials and Methods in the Inhalation Studies of Molybdenum Trioxide**

14-Day Studies	13-Week Studies	2-Year Studies
<b>Study Laboratory</b> Hazleton Laboratories America, Inc. (Vienna, VA)	Hazleton Laboratories America, Inc. (Vienna, VA)	Battelle Pacific Northwest Laboratories (Richland, WA)
<b>Strain and Species</b> Rats: F344/N Mice: B6C3F <sub>1</sub>	Rats: F344/N Mice: B6C3F <sub>1</sub>	Rats: F344/N Mice: B6C3F <sub>1</sub>
<b>Animal Source</b> Simonsen Laboratories (Gilroy, CA)	Frederick Cancer Research Center (Frederick, MD)	Simonsen Laboratories (Gilroy, CA)
<b>Time Held Before Studies</b> 2 weeks	2 weeks	15 days
<b>Average Age When Studies Began</b> 8 weeks	6 weeks	6 weeks
<b>Date of First Dose</b> Rats: 8 December 1982 Mice: 9 December 1982	Rats: 8-9 June 1983 Mice: 15-16 June 1983	Rats: 15 March 1990 Mice: 22 March 1990
<b>Duration of Dosing</b> 6 hours per day, 5 days per week, for 2 weeks	6.5 hours per day including T <sub>0</sub> (23 minutes), 5 days per week, for 13 weeks	6 hours per day plus T <sub>0</sub> (12 minutes), 5 days per week, for 105 (mice) or 106 (rats) weeks
<b>Date of Last Dose</b> Rats: 21 December 1982 Mice: 22 December 1982	Rats: 6-7 September 1983 Mice: 14-15 September 1983	Rats: 19 March 1992 Mice: 25 March 1992
<b>Necropsy Dates</b> Rats: 22 December 1982 Mice: 23 December 1982	Rats: 7-9 September 1983 Mice: 14-16 September 1983	Rats: 18-20 March 1992 Mice: 23-27 March 1992
<b>Average Age at Necropsy</b> 10 weeks	19 weeks	110 (mice) or 111 (rats) weeks
<b>Size of Study Groups</b> five males and five females	10 males and 10 females	50 males and 50 females
<b>Method of Distribution</b> Animals were distributed randomly into groups of approximately equal initial mean body weight.	Same as 14-day studies	Same as 14-day studies
<b>Animals per Cage</b> 1	1	1
<b>Method of Animal Identification</b> Ear punch	Ear punch	Tail tattoo

**TABLE 1**  
**Experimental Design and Materials and Methods in the Inhalation Studies of Molybdenum Trioxide** (continued)

14-Day Studies	13-Week Studies	2-Year Studies
<b>Diet</b> NIH-07 open formula, pellets (Zeigler Brothers, Inc., Gardners, PA), available <i>ad libitum</i> , except during exposure periods	Same as 14-day studies	Same as 14-day studies, except changed weekly
<b>Water Distribution</b> Tap water (City of Vienna water supply) available <i>ad libitum</i> via automatic watering system	Same as 14-day studies	Tap water (City of Richland water supply) available <i>ad libitum</i> via an automatic watering system (Edstrom Industries, Waterford, WI), changed weekly
<b>Cages</b> Stainless steel mesh cages, changed twice weekly	Same as 14-day studies	Stainless-steel wire-bottom (Hazleton Systems, Inc., Aberdeen, MD), changed weekly
<b>Bedding/Cageboard</b> None	None	Untreated Techsorb (Shepherd Specialty Papers, Inc., Kalamazoo, MI) or untreated (Bonzl Cincinnati Paper Co., Cincinnati, OH) removed during exposure periods and changed daily
<b>Chamber Filters</b> HEPA (intake and exhaust)	HEPA (intake) and charcoal and HEPA (exhaust)	Single HEPA (Flanders Filters, Inc., San Rafael, CA); charcoal (RSE, Inc., New Baltimore, MI)
<b>Racks</b> Stainless steel	Stainless steel	Stainless steel (Lab Products, Inc., Rochelle Park, NJ), changed weekly
<b>Animal Room Environment</b> Temperature: 21°-26° C Relative humidity: 30%-71% Fluorescent light: 12 hours/day Chamber air: 200 L/minute	Temperature: 20°-31° C Relative humidity: 55%-95% Fluorescent light: 12 hours/day Chamber air: 200 L/minute	Temperature: 21°-27° C Relative humidity: 31%-84% (rats) or 28%-87% (mice) Fluorescent light: 12 hours/day Chamber air: 15 ± 3 changes/hour
<b>Exposure Concentrations</b> 0, 3, 10, 30, 100, or 300 mg/m <sup>3</sup>	0, 1, 3, 10, 30, or 100 mg/m <sup>3</sup>	0, 10, 30, or 100 mg/m <sup>3</sup>
<b>Type and Frequency of Observation</b> Observed daily; animals were weighed and clinical findings were recorded initially, at 1 week, and at the end of the studies.	Observed twice daily; animals were weighed initially, weekly, and at the end of the studies; clinical findings were recorded weekly.	Observed twice daily; animals were weighed initially, weekly for 12 weeks, at week 15, monthly thereafter, and at the end of the studies. Clinical findings were recorded initially, at 4, 8, 12, and 15 weeks, monthly thereafter, and at the end of the studies.

**TABLE 1**  
**Experimental Design and Materials and Methods in the Inhalation Studies of Molybdenum Trioxide** (continued)

14-Day Studies	13-Week Studies	2-Year Studies
<p><b>Method of Sacrifice</b>            Intraperitoneal injection of pentobarbital, followed by exsanguination</p>	<p>Intraperitoneal injection of pentobarbital, followed by exsanguination</p>	<p>Asphyxiation with 70% CO<sub>2</sub></p>
<p><b>Necropsy</b>            Necropsy performed on all animals.</p>	<p>Necropsy performed on all animals. Organs weighed were brain, heart, right kidney, liver, lung, right testis, and thymus.</p>	<p>Necropsy performed on all animals.</p>
<p><b>Clinical Pathology</b>            None</p>	<p>Blood was collected from the abdominal aorta of rats at necropsy for hematology and clinical chemistry analyses.  <b>Hematology:</b> hematocrit, hemoglobin, erythrocyte count, and leukocyte count and differential  <b>Clinical Chemistry:</b> calcium and inorganic phosphorus concentrations; alanine aminotransferase, alkaline phosphatase, aspartate aminotransferase, lactate dehydrogenase, and sorbitol dehydrogenase activities</p>	<p>Ten male and 10 female rats and mice were randomly selected for blood molybdenum concentration determinations.</p>
<p><b>Histopathology</b>            Histopathology was performed on the nose of all rats and mice.</p>	<p>Complete histopathology was performed on 0 and 100 mg/m<sup>3</sup> rats and mice. In addition to gross lesions and tissue masses, the tissues examined included: adrenal gland, brain, clitoral gland (rats), esophagus, eye, femorotibial joint, gallbladder (mice), heart, large intestine (cecum, colon, rectum), small intestine, kidney, larynx, liver, lung, lymph nodes (mandibular, mediastinal, peribronchial), mammary gland, nose (all animals in all exposure groups), ovary, pancreas, parathyroid gland, pituitary gland, preputial gland (rats), prostate gland, salivary gland, seminal vesicle (mice), spinal cord, spleen, sternum, stomach, testis and epididymis, thymus, thyroid gland, trachea, urinary bladder, uterus, and vagina.</p>	<p>Complete histopathology was performed on all rats and mice. In addition to gross lesions and tissue masses, the tissues examined included: adrenal gland, brain, clitoral gland, esophagus, femur, gallbladder (mice), heart and aorta, large intestine (cecum, colon, rectum), small intestine (duodenum, jejunum, ileum), kidney, larynx, liver, lung and bronchi, lymph nodes (mandibular, mesenteric, bronchial, mediastinal), mammary gland, nose, ovary, pancreas, parathyroid gland, pituitary gland, preputial gland, prostate gland, salivary gland, skin, spleen, stomach, testes and epididymis, seminal vesicle, thymus, thyroid, trachea, urinary bladder, and uterus.</p>



**TABLE 1**  
**Experimental Design and Materials and Methods in the Inhalation Studies of Molybdenum Trioxide** (continued)

14-Day Studies	13-Week Studies	2-Year Studies
<b>Sperm Motility</b> None	At terminal sacrifice, sperm samples were collected from 0, 10, 30, and 100 mg/m <sup>3</sup> rats and mice. The parameters evaluated included: sperm count and motility.	None
<b>Liver Copper Analysis</b> None	Liver copper concentrations were determined from a portion of the liver taken from rats and mice at necropsy.	None
<b>Bone Density and Curvature Determinations</b> None	None	Ten male and 10 female rats and mice were randomly selected from each exposure group for bone density and curvature studies.



## RESULTS

### RATS

#### 14-DAY STUDY

All rats survived to the end of the study (Table 2). The final mean body weights of male rats exposed to 100 mg/m<sup>3</sup> and male and female rats exposed to 300 mg/m<sup>3</sup> were significantly lower than those of the

control groups. Male rats exposed to 300 mg/m<sup>3</sup> lost weight during the study. There were no clinical findings related to exposure to molybdenum trioxide. No chemical-related lesions were observed.

**TABLE 2**  
**Survival and Body Weights of Rats in the 14-Day Inhalation Study of Molybdenum Trioxide**

Dose (mg/m <sup>3</sup> )	Survival <sup>a</sup>	Mean Body Weight <sup>b</sup> (g)		Final Weight Relative to Controls (%)
		Initial	Final	
<b>Male</b>				
0	5/5	158 ± 10	215 ± 8	
3	5/5	156 ± 9	208 ± 9	97
10	5/5	155 ± 11	213 ± 11	99
30	5/5	156 ± 11	215 ± 9	100
100	5/5	155 ± 12	193 ± 16*	90
300	5/5	156 ± 13	149 ± 31**	69
<b>Female</b>				
0	5/5	119 ± 4	143 ± 5	
3	5/5	116 ± 5	144 ± 11	101
10	5/5	115 ± 4	138 ± 13	97
30	5/5	116 ± 4	142 ± 7	99
100	5/5	117 ± 4	135 ± 4	94
300	5/5	116 ± 5	124 ± 5**	87

\* Significantly different ( $P \leq 0.05$ ) from the control group by Williams' or Dunnett's test

\*\*  $P \leq 0.01$

<sup>a</sup> Number of animals surviving at 14 days/number initially in group

<sup>b</sup> Weights and weight changes are given as mean ± standard deviation.

### 13-WEEK STUDY

All rats survived to the end of the study (Table 3). The final mean body weights of exposed rats were similar to those of the control groups. No clinical findings related to molybdenum trioxide exposure were observed.

There were no significant differences between control and exposed rats in absolute or relative organ weights (Table F1), hematology or clinical chemistry parameters (Table G1), sperm counts or motility

(Table H1), or liver copper concentrations (Table I1). No chemical-related lesions were observed.

*Exposure Concentration Selection Rationale:* The 13-week study did not provide adequate information on which to select the exposure concentrations for the 2-year study. However, based on lower final mean body weights of rats exposed to 300 mg/m<sup>3</sup> in the 14-day study, exposure concentrations selected for the 2-year study were 10, 30, and 100 mg/m<sup>3</sup>.

**TABLE 3**  
**Survival and Body Weights of Rats in the 13-Week Inhalation Study of Molybdenum Trioxide**

Dose (mg/m <sup>3</sup> )	Survival <sup>a</sup>	Mean Body Weight <sup>b</sup> (g)		Final Weight Relative to Controls (%)
		Initial	Final	
<b>Male</b>				
0	10/10	137 ± 5	327 ± 24	
1	10/10	137 ± 6	327 ± 20	100
3	10/10	137 ± 4	330 ± 18	101
10	10/10	135 ± 9	335 ± 30	102
30	10/10	137 ± 5	335 ± 16	102
100	10/10	137 ± 4	328 ± 24	100
<b>Female</b>				
0	10/10	108 ± 3	191 ± 6	
1	10/10	108 ± 4	190 ± 9	99
3	10/10	109 ± 3	193 ± 7	101
10	10/10	108 ± 3	182 ± 8	95
30	10/10	107 ± 3	189 ± 11	99
100	10/10	107 ± 3	191 ± 10	100

<sup>a</sup> Number of animals surviving at 13 weeks/number initially in group

<sup>b</sup> Weights and weight changes are given as mean ± standard deviation. Differences from the control group were not significant by Williams' or Dunnett's test.

## 2-YEAR STUDY

### Survival

Estimates of 2-year survival probabilities for male and female rats are shown in Table 4 and in the Kaplan - Meier survival curves (Figure 1). Survival rates of exposed male and female rats were similar to those of the control groups.

### Body Weights and Clinical Findings

Mean body weights of exposed groups of male and female rats were similar to those of the control groups throughout the study (Figure 2 and Tables 5 and 6).

No clinical findings related to molybdenum trioxide exposure were observed.

### Special Studies

There was a significant exposure-dependent increase in blood molybdenum concentration in exposed rats (Table G2). Blood concentrations of molybdenum in exposed male rats were greater than those in exposed female rats. There were no toxicologically significant differences in bone density or curvature between control and exposed rats (Table J1).

**TABLE 4**  
**Survival of Rats in the 2-Year Inhalation Study of Molybdenum Trioxide**

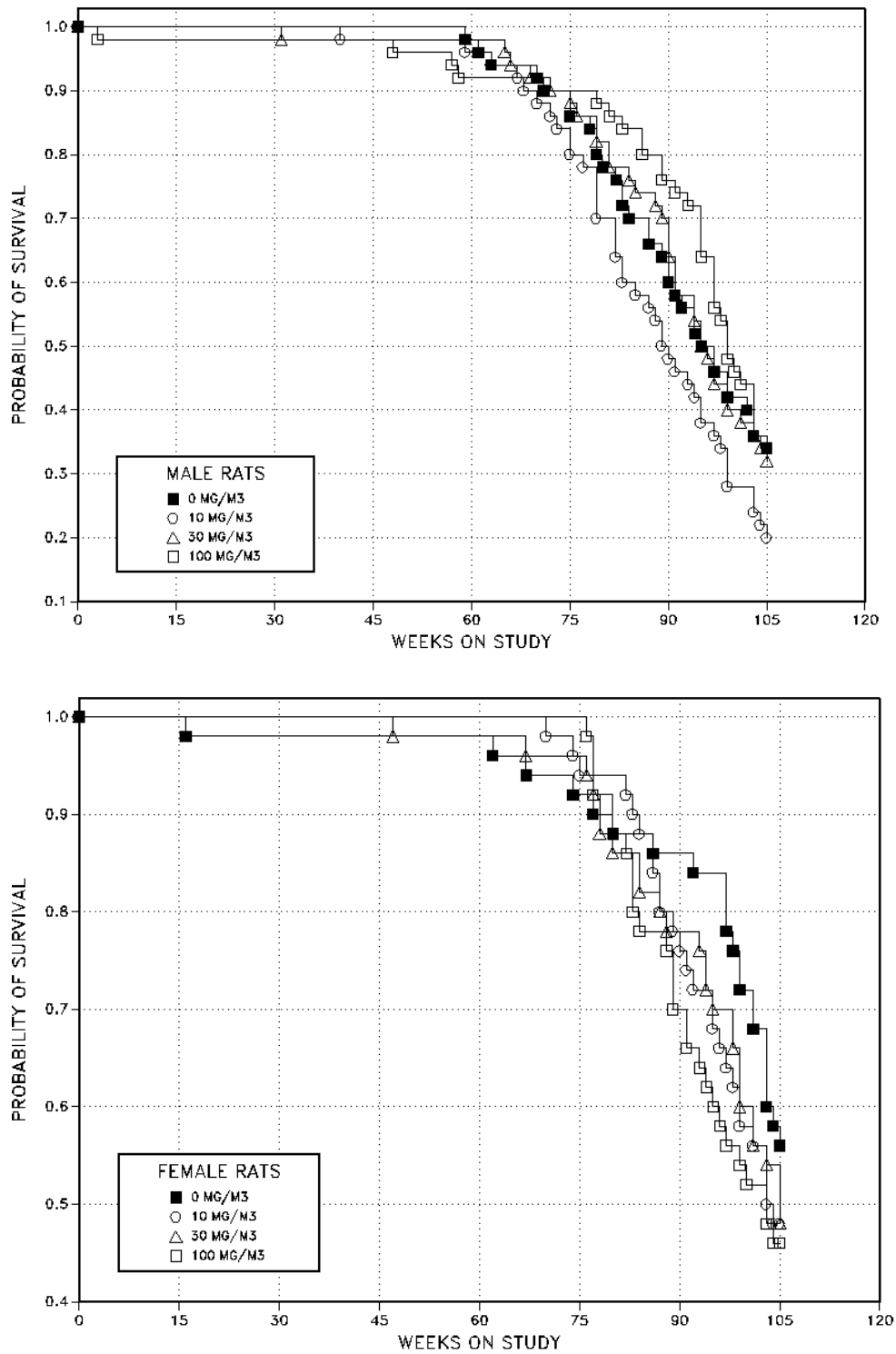
	0 mg/m <sup>3</sup>	10 mg/m <sup>3</sup>	30 mg/m <sup>3</sup>	100 mg/m <sup>3</sup>
<b>Male</b>				
Animals initially in study	50	50	50	50
Moribund	29	35	31	28
Natural deaths	4	5	3	5
Animals surviving to study termination	17 <sup>d</sup>	10	16	17
Percent probability of survival at end of study <sup>g</sup>	34	20	32	34
Mean survival (days) <sup>b</sup>	645	617	646	654
Survival analyses <sup>c</sup>	P=0.198N	P=0.142	P=1.000	P=0.681N
<b>Female</b>				
Animals initially in study	50	50	50	50
Moribund	18	25	23	23
Natural deaths	4	1	3	4
Animals surviving to study termination	28	24	24	23 <sup>d</sup>
Percent probability of survival at end of study	56	48	48	46
Mean survival (days)	685	684	678	673
Survival analyses	P=0.328	P=0.426	P=0.459	P=0.253

<sup>a</sup> Kaplan-Meier determinations based on the number of animals alive on the first day of terminal sacrifice

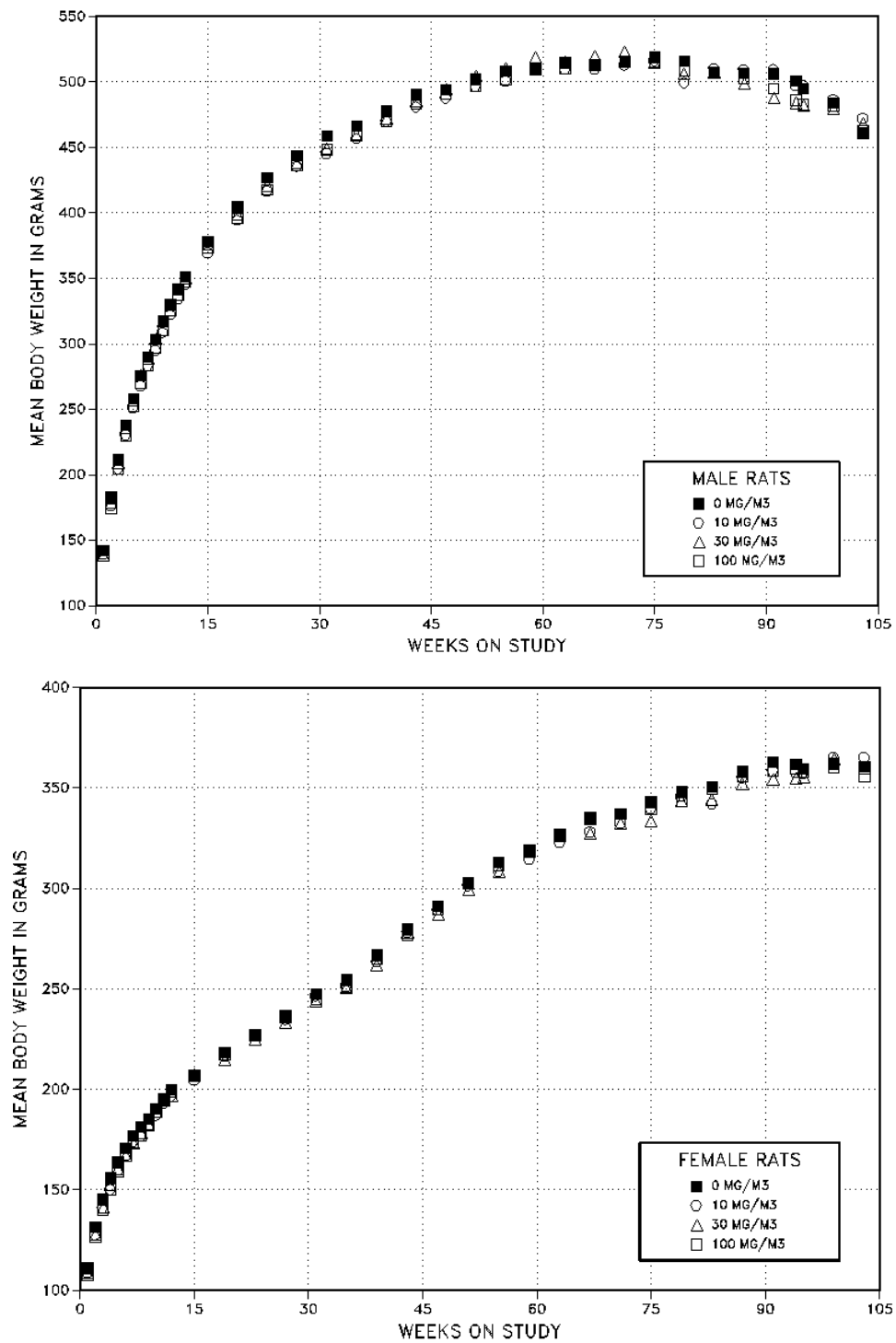
<sup>b</sup> Mean of all deaths (censored, uncensored, and terminal sacrifice)

<sup>c</sup> The result of the life table trend test (Tarone, 1975) is in the control column, and the results of the life table pairwise comparisons (Cox, 1972) with the controls are in the exposed columns. A negative trend or lower mortality in an exposure group is indicated by N.

<sup>d</sup> Includes one animal that died during the last week of the study



**FIGURE 1**  
**Kaplan-Meier Survival Curves for Male and Female Rats**  
**Administered Molybdenum Trioxide by Inhalation for 2 Years**



**FIGURE 2**  
**Growth Curves for Male and Female Rats**  
**Administered Molybdenum Trioxide by Inhalation for 2 Years**

**TABLE 5**  
**Mean Body Weights and Survival of Male Rats in the 2-Year Inhalation Study of Molybdenum Trioxide**

Weeks on Study	0 mg/m <sup>3</sup>		10 mg/m <sup>3</sup>			30 mg/m <sup>3</sup>			100 mg/m <sup>3</sup>		
	Av. Wt. (g)	No. of Survivors	Av. Wt. (g)	Wt. (% of controls)	No. of Survivors	Av. Wt. (g)	Wt. (% of controls)	No. of Survivors	Av. Wt. (g)	Wt. (% of controls)	No. of Survivors
1	142	50	140	98	50	139	98	50	138	97	50
2	183	50	177	97	50	179	98	50	174	95	50
3	211	50	205	97	50	209	99	50	205	97	49
4	238	50	230	97	50	236	99	50	230	97	49
5	258	50	251	97	50	257	100	50	252	98	49
6	276	50	268	97	50	276	100	50	270	98	49
7	290	50	283	98	50	289	100	50	284	98	49
8	303	50	295	97	50	304	100	50	297	98	49
9	318	50	309	97	50	317	100	50	310	98	49
10	330	50	322	98	50	330	100	50	325	99	49
11	342	50	335	98	50	341	100	50	337	99	49
12	351	50	346	98	50	350	100	50	348	99	49
15	378	50	370	98	50	376	100	50	373	99	49
19	405	50	395	98	50	399	99	50	396	98	49
23	427	50	417	98	50	421	99	50	418	98	49
27	444	50	436	98	50	438	99	50	436	98	49
31	459	50	446	97	50	449	98	49	448	98	49
35	467	50	457	98	50	460	99	49	460	99	49
39	478	50	470	98	50	472	99	49	470	98	49
43	490	50	481	98	49	485	99	49	484	99	49
47	494	50	488	99	49	494	100	49	491	99	49
51	502	50	497	99	49	504	101	49	497	99	48
55	508	50	501	99	49	510	100	49	502	99	48
59	510	50	510	100	48	519	102	49	511	100	46
63	515	47	510	99	47	516	100	49	510	99	46
67	512	47	510	100	47	520	101	47	513	100	46
71	515	45	513	100	44	523	102	46	515	100	46
75	519	43	516	100	40	515	99	45	515	99	45
79	516	41	500	97	39	507	98	43	508	99	44
83	507	38	510	101	32	507	100	39	507	100	43
87	507	34	510	101	28	499	98	37	503	99	40
91	506	29	510	101	23	488	96	31	495	98	37
94	501	28	497	99	22	484	97	29	486	97	36
95	495	26	498	101	20	482	97	27	483	98	33
99	484	22	487	101	15	480	99	22	482	100	26
103	461	19	472	103	12	468	102	19	463	101	20
<b>Mean for weeks</b>											
1-13	270		263	97		269	100		264	98	
14-52	454		446	98		450	99		447	98	
53-103	504		503	100		501	99		500	99	



**TABLE 6**  
**Mean Body Weights and Survival of Female Rats in the 2-Year Inhalation Study of Molybdenum Trioxide**

Weeks on Study	0 mg/m <sup>3</sup>		10 mg/m <sup>3</sup>			30 mg/m <sup>3</sup>			100 mg/m <sup>3</sup>		
	Av. Wt. (g)	No. of Survivors	Av. Wt. (g)	Wt. (% of controls)	No. of Survivors	Av. Wt. (g)	Wt. (% of controls)	No. of Survivors	Av. Wt. (g)	Wt. (% of controls)	No. of Survivors
1	111	50	109	98	50	109	98	50	107	97	50
2	132	50	128	97	50	128	97	50	127	96	50
3	145	50	141	97	50	142	98	50	140	97	50
4	156	50	150	96	50	153	98	50	150	96	50
5	164	50	160	98	50	160	98	50	159	97	50
6	171	50	167	98	50	167	98	50	167	98	50
7	177	50	174	99	50	173	98	50	173	98	50
8	181	50	177	98	50	178	98	50	177	98	50
9	185	50	182	98	50	183	99	50	182	98	50
10	190	50	187	98	50	189	99	50	189	99	50
11	195	50	193	99	50	195	100	50	195	100	50
12	200	50	197	98	50	197	98	50	199	99	50
15	207	50	205	99	50	207	100	50	207	100	50
19	218	49	217	99	50	215	98	50	217	100	50
23	227	49	227	100	50	225	99	50	227	100	50
27	236	49	235	100	50	233	99	50	237	100	50
31	247	49	247	100	50	244	99	50	245	99	50
35	255	49	251	99	50	251	99	50	251	99	50
39	267	49	264	99	50	262	98	50	265	99	50
43	280	49	278	100	50	278	99	50	277	99	50
47	291	49	289	99	50	287	99	49	290	100	50
51	303	49	302	100	50	299	99	49	303	100	50
55	313	49	309	99	50	308	99	49	312	100	50
59	319	49	315	99	50	319	100	49	319	100	50
63	327	48	323	99	50	326	100	49	327	100	50
67	334	47	328	98	50	327	98	48	335	100	50
71	337	47	332	99	49	332	99	48	337	100	50
75	343	46	340	99	48	333	97	48	340	99	50
79	348	45	346	99	47	343	99	44	343	99	46
83	351	44	342	98	45	344	98	43	350	100	41
87	358	43	355	99	41	352	98	40	356	99	39
91	363	43	359	99	38	354	98	39	358	99	34
94	362	42	358	99	36	355	98	38	360	99	31
95	359	42	357	99	34	355	99	36	358	100	30
99	362	37	365	101	30	364	101	31	360	100	27
103	361	30	365	101	28	360	100	28	356	99	25
<b>Mean for weeks</b>											
1-13	167		164	98		165	99		164	98	
14-52	253		252	100		250	99		252	100	
53-103	346		342	99		341	99		344	99	

### ***Pathology and Statistical Analyses***

This section describes the statistically significant or biologically noteworthy changes in the incidences of neoplasms and/or nonneoplastic lesions of the respiratory system (lung, nose, and larynx), clitoral gland, and mammary gland. Summaries of the incidences of neoplasms and nonneoplastic lesions, individual animal tumor diagnoses, statistical analyses of primary neoplasms that occurred with an incidence of at least 5% in at least one animal group, and historical incidences for the neoplasms mentioned in this section are presented in Appendix A for male rats and Appendix B for female rats.

*Respiratory System:* The incidences of alveolar/bronchiolar adenoma or carcinoma (combined) were increased in male rats with a marginally significant positive trend (Tables 7 and A3). However, the incidences were within the range of historical controls for 2-year NTP inhalation studies (Tables 7 and A4). No increase in the incidences of lung neoplasm occurred in female rats (Tables 7 and B3). Incidences of chronic alveolar inflammation in male and female rats exposed to 30 or 100 mg/m<sup>3</sup> were significantly greater than those in the control groups (Tables 7, A5, and B4). The severity of chronic inflammation was greater in rats exposed to 100 mg/m<sup>3</sup> compared to control rats or rats exposed to 10 or 30 mg/m<sup>3</sup>.

Chronic inflammation in the alveoli in control rats consisted of focal intra-alveolar aggregates of a few foamy macrophages. Such aggregates are commonly observed in the alveoli of rats of various ages but are more prevalent in aged rats. Chronic inflammation in the alveoli of exposed rats was a multifocal lesion localized to subpleural and peribronchiolar sites (Plates 1 and 2). Lesions were variably sized, sharply delineated, and densely cellular consisting of aggregates of predominantly large foamy macrophages, with lesser numbers of epithelioid cells, multinucleated giant cells, and neutrophils mixed with cellular debris (Plate 3). Cholesterol crystals (clefts) were present within macrophages and multinucleated giant cells and free among the inflammatory cells in many lesions (Plate 4). Within lesions, alveolar septae were thickened by mild interstitial fibrosis, infiltrates of mononuclear inflammatory cells, and hyperplastic type II epithelial cells, many of which were vacuolated (Plates 3 and 4). Alveoli in some advanced lesions were lined

by ciliated cuboidal or columnar cells (metaplasia) and frequently contained mucus (Plate 5). In the most severe lesions, fibrous tissue obliterated the alveolar architecture. Mast cells were often prominent in lesions with significant amounts of fibrous tissue.

No nasal neoplasms were attributed to exposure to molybdenum trioxide (Tables A3 and B3). Incidences of hyaline degeneration in the nasal respiratory epithelium in 30 and 100 mg/m<sup>3</sup> males and in all exposed groups of females were significantly greater than those in the control groups (Tables 7, A5, and B4). Most male and all female rats exposed to 30 or 100 mg/m<sup>3</sup> and several male and female rats exposed to 10 mg/m<sup>3</sup> were affected. However, the severity of the lesion was generally mild in the 100 mg/m<sup>3</sup> groups and minimal in the control groups and 10 and 30 mg/m<sup>3</sup> groups. The incidences of hyaline degeneration in the nasal olfactory epithelium of all exposed groups of females were significantly greater than in the control group.

Hyaline degeneration is a common age-related lesion in the nasal epithelium of rats. The incidence and severity of this change has been observed to increase proportionally with exposure concentration in inhalation studies and is considered a nonspecific defensive response to prolonged inhalation of a variety of irritants. Hyaline degeneration generally affected the respiratory epithelium of the nasal septum in level II of the nasal cavity and the olfactory epithelium in levels II and III of the nasal cavity. The epithelial cells in these regions contained variably sized brightly eosinophilic cytoplasmic globules which often filled and distorted the cells (Plate 6). Affected segments of the olfactory epithelium often had fewer cell layers and disorganization of the typically layered rows of cell nuclei.

No laryngeal neoplasms were attributed to exposure to molybdenum trioxide (Tables A3 and B3). Incidences of squamous metaplasia of the epithelium lining the base of the epiglottis in all exposed groups of male and female rats were significantly greater than those in the control groups and increased with increasing exposure concentration (Tables 7, A5, and B4). The severity of squamous metaplasia was generally mild at 100 mg/m<sup>3</sup> and minimal at 10 and 30 mg/m<sup>3</sup>, and this lesion most likely represents a mild toxic and/or adaptive response to chronic inhalation exposure to molybdenum.

**TABLE 7**  
**Incidences of Respiratory System Neoplasms and Nonneoplastic Lesions in Rats**  
**in the 2-Year Inhalation Study of Molybdenum Trioxide**

	0 mg/m <sup>3</sup>	10 mg/m <sup>3</sup>	30 mg/m <sup>3</sup>	100 mg/m <sup>3</sup>
<b>Male</b>				
Nose <sup>a</sup>	50	49	49	50
Respiratory Epithelium, Degeneration, Hyaline <sup>b</sup>	2 (1.0) <sup>c</sup>	7 (1.0)	48** (1.6)	49** (2.0)
Larynx	49	48	49	49
Epiglottis, Metaplasia, Squamous	0	11** (1.6)	16** (1.7)	39** (2.3)
Lung	50	50	50	50
Alveolus, Inflammation, Chronic	2 (1.0)	3 (1.0)	25** (1.5)	47** (2.5)
Alveolar/bronchiolar Adenoma	0	0	0	3
Alveolar/bronchiolar Carcinoma	0	1	1	1
Alveolar/bronchiolar Adenoma or Carcinoma <sup>d</sup>	0	1	1	4
<b>Female</b>				
Nose	48	49	50	50
Olfactory Epithelium, Degeneration, Hyaline	39 (1.2)	47* (1.5)	50** (3.0)	50** (3.2)
Respiratory Epithelium, Degeneration, Hyaline	1 (1.0)	13** (1.2)	50** (1.9)	50** (2.0)
Larynx	49	49	49	50
Epiglottis, Metaplasia, Squamous	0	18** (1.3)	29** (1.7)	49** (2.2)
Lung	50	50	50	50
Alveolus, Inflammation, Chronic	14 (1.1)	13 (1.2)	43** (1.7)	49** (3.0)
Alveolar/bronchiolar Adenoma	0	1	0	2
Alveolar/bronchiolar Carcinoma	0	1	0	0
Squamous Cell Carcinoma	1	0	0	0
Alveolar/bronchiolar Adenoma, Alveolar/bronchiolar Carcinoma, or Squamous Cell Carcinoma	1	2	0	2

\* Significantly different (P<0.05) from the control group by the logistic regression test

\*\* P<0.01

<sup>a</sup> Number of animals with organ examined microscopically

<sup>b</sup> Number of animals with lesion

<sup>c</sup> Average severity grade of lesions in affected animals: 1=minimal, 2=mild, 3=moderate, 4=marked

<sup>d</sup> Historical incidence for 2-year NTP inhalation studies with untreated controls (mean ± standard deviation): 23/654 (3.5% ± 3.7%); range 0-10%

In affected rats, the single layer of ciliated cuboidal to columnar epithelium that normally lines the base of the epiglottis (Plate 7) was replaced by an epithelium that consisted of a basal layer of cuboidal cells with one or more superficial layers of flattened epithelial (squamous) cells that lacked cilia (Plate 8). Keratinization of the epithelial surface was common.

*Clitoral Gland:* The incidence of clitoral gland adenoma or carcinoma (combined) in the 30 mg/m<sup>3</sup> female rats was greater than that in the controls (0 mg/m<sup>3</sup>, 3/44; 10 mg/m<sup>3</sup>, 7/48; 30 mg/m<sup>3</sup>, 10/47; 100 mg/m<sup>3</sup>, 3/47; Table B3). The increase was marginally significant but not exposure concentration-

related and was considered to be a spurious event unrelated to chemical exposure.

*Mammary Gland:* The incidence of mammary gland fibroadenoma, adenoma, or carcinoma (combined) was significantly increased in female rats exposed to 10 mg/m<sup>3</sup> (23/50, 33/50, 30/50, 20/50; Table B3). However, the incidences in the controls and the two lowest exposure groups exceeded the historical control range for 2-year NTP inhalation studies (202/653; mean  $\pm$  standard deviation: 31%  $\pm$  9%; range: 16%-46%; includes data for fibroma, fibroadenoma, adenoma, and carcinoma) and were not exposure concentration-related and therefore not considered to be related to chemical exposure.

**MICE****14-DAY STUDY**

All mice survived to the end of the study (Table 8).

Final mean body weights of male and female mice exposed to 300 mg/m<sup>3</sup> were significantly lower than

those of the control groups. Male mice exposed to 300 mg/m<sup>3</sup> lost weight during the study. There were no clinical findings related to exposure to molybdenum trioxide. No chemical-related lesions were observed.

**TABLE 8**  
**Survival and Body Weights of Mice in the 14-Day Inhalation Study of Molybdenum Trioxide**

Dose (mg/m <sup>3</sup> )	Survival <sup>a</sup>	Mean Body Weight <sup>b</sup> (g)		Final Weight Relative to Controls (%)
		Initial	Final	
<b>Male</b>				
0	5/5	24.4 ± 0.7	26.0 ± 1.0	
3	5/5	24.1 ± 0.2	25.4 ± 0.9	98
10	5/5	23.9 ± 0.7	25.6 ± 0.6	98
30	5/5	24.4 ± 0.8	25.8 ± 0.8	99
100	5/5	24.2 ± 0.8	25.1 ± 0.9	97
300	5/5	24.4 ± 1.1	23.4 ± 2.0**	90
<b>Female</b>				
0	5/5	20.8 ± 1.5	22.8 ± 1.1	
3	5/5	20.7 ± 1.3	22.8 ± 0.8	100
10	5/5	20.6 ± 1.2	21.1 ± 0.7	93
30	5/5	20.7 ± 1.1	21.7 ± 1.0	95
100	5/5	21.2 ± 0.8	22.2 ± 0.9	97
300	5/5	20.0 ± 0.9	20.4 ± 1.7**	89

\*\* Significantly different (P<0.01) from the control group by Williams' or Dunnett's test

<sup>a</sup> Number of animals surviving at 14 days/number initially in group

<sup>b</sup> Weights and weight changes are given as mean ± standard deviation.

### 13-WEEK STUDY

All mice survived to the end of the study (Table 9). The final mean body weights of exposed mice were similar to those of the control groups. There were no chemical-related clinical findings.

There were no significant differences between control and exposed mice in absolute or relative organ weights (Table F2) or in epididymal weights, sperm counts, or motility (Table H2). There were significant increases in liver copper concentrations in female mice exposed to 30 mg/m<sup>3</sup> and in male and female

mice exposed to 100 mg/m<sup>3</sup> compared to those of the control groups (Table I2). No chemical-related lesions were observed.

*Exposure Concentration Selection Rationale:* The 13-week study did not provide adequate information on which to select the exposure concentrations for the 2-year study. However, based on lower final mean body weights of mice exposed to 300 mg/m<sup>3</sup> in the 14-day study, the exposure concentrations selected for the 2-year study were 10, 30, and 100 mg/m<sup>3</sup>.

**TABLE 9**  
**Survival and Body Weights of Mice in the 13-Week Inhalation Study of Molybdenum Trioxide**

Dose (mg/m <sup>3</sup> )	Survival <sup>a</sup>	Mean Body Weight <sup>b</sup> (g)		Final Weight Relative to Controls (%)
		Initial	Final	
<b>Male</b>				
0	10/10	23.0 ± 0.9	29.8 ± 1.2	
1	10/10	22.9 ± 0.7	30.0 ± 1.3	101
3	10/10	23.0 ± 0.7	30.2 ± 0.9	101
10	10/10	23.1 ± 0.9	29.6 ± 1.1	99
30	10/10	23.3 ± 0.9	28.9 ± 1.6	97
100	10/10	23.1 ± 0.8	29.4 ± 1.4	99
<b>Female</b>				
0	10/10	18.6 ± 0.3	26.3 ± 1.0	
1	10/10	18.9 ± 0.7	27.3 ± 1.7	104
3	10/10	18.4 ± 0.7	26.3 ± 1.4	100
10	10/10	18.9 ± 0.7	25.7 ± 0.9	98
30	10/10	18.8 ± 0.7	25.7 ± 0.9	98
100	10/10	18.6 ± 0.8	26.3 ± 1.4	100

<sup>a</sup> Number of animals surviving at 13 weeks/number initially in group

<sup>b</sup> Weights and weight changes are given as mean ± standard deviation. Differences from the control group were not significant by Williams' or Dunnett's test.

## 2-YEAR STUDY

### Survival

Estimates of 2-year survival probabilities for male and female mice are shown in Table 10 and in the Kaplan-Meier survival curves (Figure 3). The survival rate of male mice exposed to 30 mg/m<sup>3</sup> was marginally lower than that of the control group; survival rates of 10 and 100 mg/m<sup>3</sup> males and of all exposed groups of females were similar to those of the control groups.

### Body Weights and Clinical Findings

Mean body weights of exposed male mice were generally similar to those of the control group through-

out the study (Table 11 and Figure 4). Mean body weights of exposed female mice were generally greater than those of the control group from week 11 until the end of the study (Table 12 and Figure 4). No clinical findings related to molybdenum trioxide exposure were observed.

### Special Studies

There was a significant exposure-dependent increase in blood molybdenum concentration in exposed mice (Table G3). There were no toxicologically significant differences in bone density or curvature between control and exposed mice (Table J2).

**TABLE 10**  
**Survival of Mice in the 2-Year Inhalation Study of Molybdenum Trioxide**

	0 mg/m <sup>3</sup>	10 mg/m <sup>3</sup>	30 mg/m <sup>3</sup>	100 mg/m <sup>3</sup>
<b>Male</b>				
Animals initially in study	50	50	50	50
Moribund	8	13	14	9
Natural deaths	6	4	11	4
Animals surviving to study termination	36	33	25	37
Percent probability of survival at end of study <sup>a</sup>	72	66	50	74
Mean survival (days) <sup>b</sup>	689	706	663	701
Survival analysis <sup>c</sup>	P=0.536N	P=0.843	P=0.052	P=0.908N
<b>Female</b>				
Animals initially in study	50	50	50	50
Accidental deaths <sup>d</sup>	0	1	1	0
Moribund	17	12	14	10
Natural deaths	8	6	2	5
Animals surviving to study termination	25 <sup>e</sup>	31	33 <sup>f</sup>	35
Percent probability of survival at end of study	50	64	67	70
Mean survival (days)	683	689	704	681
Survival analysis	P=0.174N	P=0.230N	P=0.074N	P=0.096N

<sup>a</sup> Kaplan-Meier determinations based on the number of animals alive on the first day of terminal sacrifice

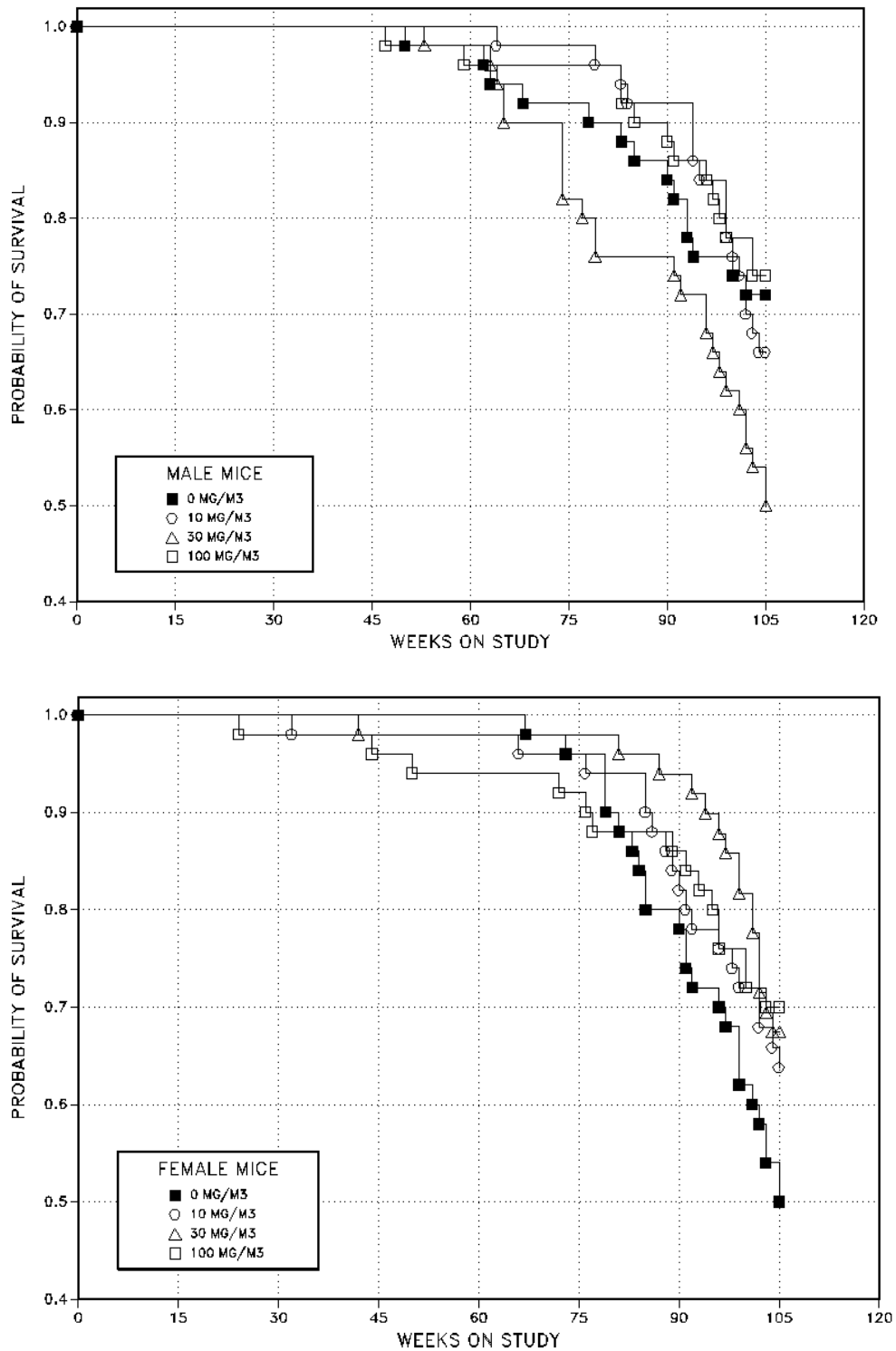
<sup>b</sup> Mean of all deaths (uncensored, censored, and terminal sacrifice)

<sup>c</sup> The result of the life table trend test (Tarone, 1975) is in the control column, and the results of the life table pairwise comparisons (Cox, 1972) with the controls are in the exposed columns. A negative trend or lower mortality in an exposure group is indicated by N.

<sup>d</sup> Censored from survival analyses

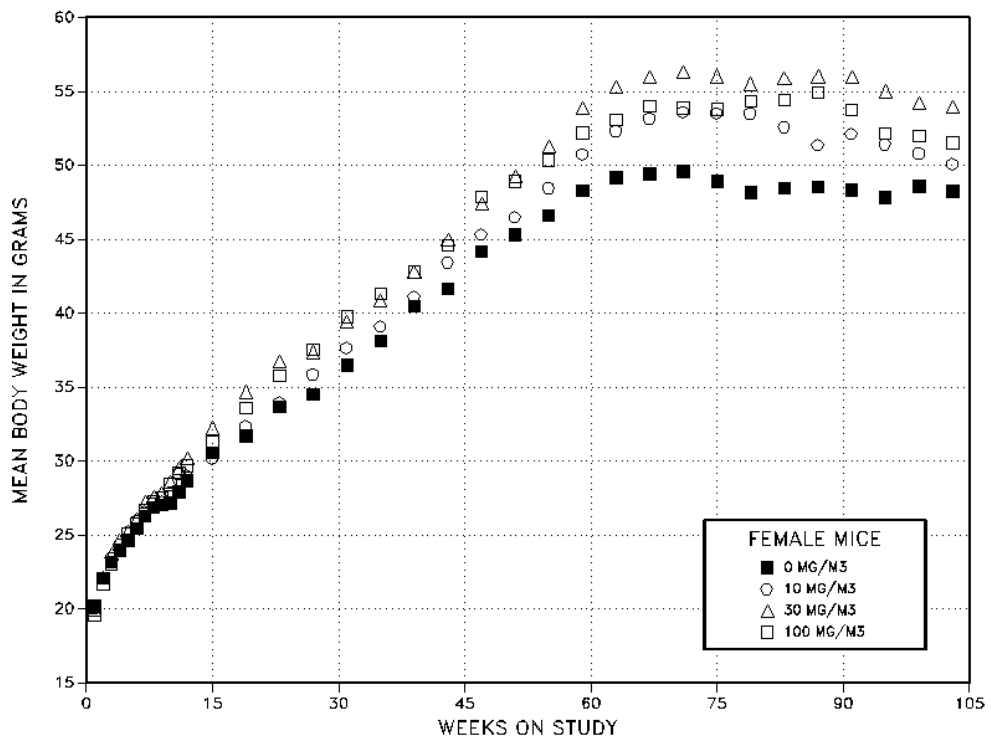
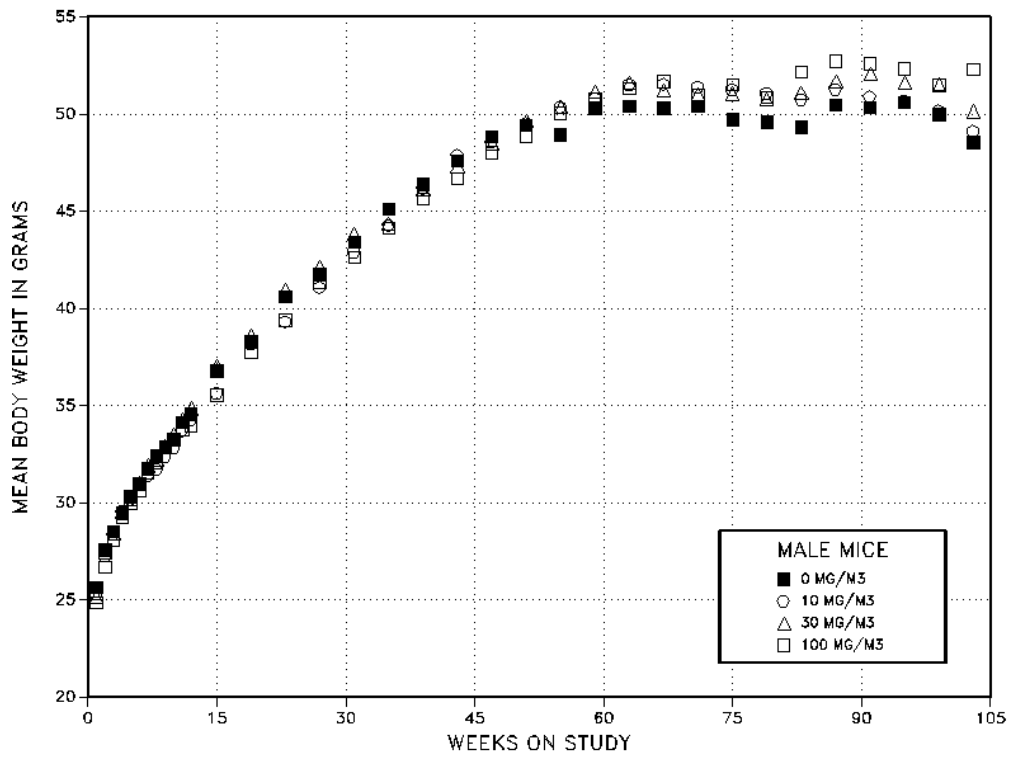
<sup>e</sup> Includes one animal that died during the last week of the study

<sup>f</sup> Includes two animals that died during the last week of the study



**FIGURE 3**  
**Kaplan-Meier Survival Curves for Male and Female Mice**  
**Administered Molybdenum Trioxide by Inhalation for 2 Years**





**FIGURE 4**  
**Growth Curves for Male and Female Mice**  
**Administered Molybdenum Trioxide by Inhalation for 2 Years**

**TABLE 11**  
**Mean Body Weights and Survival of Male Mice in the 2-Year Inhalation Study of Molybdenum Trioxide**

Weeks on Study	0 mg/m <sup>3</sup>		10 mg/m <sup>3</sup>			30 mg/m <sup>3</sup>			100 mg/m <sup>3</sup>		
	Av. Wt. (g)	No. of Survivors	Av. Wt. (g)	Wt. (% of controls)	No. of Survivors	Av. Wt. (g)	Wt. (% of controls)	No. of Survivors	Av. Wt. (g)	Wt. (% of controls)	No. of Survivors
1	25.6	50	25.3	99	50	25.1	98	50	24.8	97	50
2	27.6	50	27.3	99	50	27.5	100	50	26.7	97	50
3	28.5	50	28.4	100	50	28.4	100	50	28.0	98	50
4	29.5	50	29.5	100	50	29.5	100	50	29.2	99	50
5	30.3	50	30.2	100	50	30.2	100	50	29.9	99	50
6	31.0	50	31.0	100	50	31.0	100	50	30.6	99	50
7	31.7	50	31.4	99	50	31.9	101	50	31.5	99	50
8	32.4	50	31.7	98	50	32.2	99	50	32.0	99	50
9	32.9	50	32.3	98	50	32.9	100	50	32.9	100	50
10	33.3	50	32.8	99	50	33.5	101	50	33.3	100	50
11	34.1	50	33.7	99	50	34.3	101	50	33.7	99	50
12	34.5	50	34.2	99	50	34.8	101	50	33.9	98	50
15	36.8	50	35.6	97	50	37.0	101	50	35.5	97	50
19	38.3	50	38.2	100	50	38.6	101	50	37.8	99	50
23	40.6	50	39.3	97	50	41.0	101	50	39.4	97	50
27	41.7	50	41.1	99	50	42.1	101	50	41.3	99	50
31	43.4	50	42.9	99	50	43.8	101	50	42.6	98	50
35	45.1	50	44.3	98	50	44.4	98	50	44.1	98	50
39	46.4	50	46.2	100	50	46.1	99	50	45.6	98	50
43	47.6	50	47.9	101	50	47.3	99	50	46.7	98	50
47	48.8	50	48.5	99	50	48.5	99	50	48.0	98	50
51	49.4	49	49.5	100	50	49.6	100	50	48.9	99	49
55	48.9	49	50.4	103	50	50.4	103	49	50.1	103	49
59	50.3	49	50.8	101	50	51.2	102	49	50.8	101	48
63	50.4	47	51.5	102	50	51.6	102	48	51.3	102	48
67	50.3	47	51.5	102	49	51.2	102	45	51.7	103	48
71	50.4	46	51.4	102	49	51.0	101	45	51.0	101	48
75	49.7	46	51.3	103	49	51.0	103	41	51.5	104	48
79	49.6	45	51.1	103	48	50.8	102	39	50.9	103	48
83	49.3	45	50.7	103	48	51.1	104	38	52.1	106	46
87	50.4	43	51.3	102	46	51.7	103	38	52.7	105	45
91	50.3	42	50.9	101	46	52.1	104	37	52.6	105	44
95	50.6	38	50.7	100	42	51.6	102	36	52.3	103	43
99	50.0	38	50.2	100	41	51.5	103	32	51.5	103	39
103	48.5	36	49.1	101	35	50.1	103	27	52.3	108	38
<b>Mean for weeks</b>											
1-13	31.0		30.7	99		30.9	100		30.5	98	
14-52	43.8		43.4	99		43.8	100		43.0	98	
53-103	49.9		50.8	102		51.2	103		51.6	103	

**TABLE 12**  
**Mean Body Weights and Survival of Female Mice in the 2-Year Inhalation Study of Molybdenum Trioxide**

Weeks on Study	0 mg/m <sup>3</sup>		10 mg/m <sup>3</sup>			30 mg/m <sup>3</sup>			100 mg/m <sup>3</sup>		
	Av. Wt. (g)	No. of Survivors	Av. Wt. (g)	Wt. (% of controls)	No. of Survivors	Av. Wt. (g)	Wt. (% of controls)	No. of Survivors	Av. Wt. (g)	Wt. (% of controls)	No. of Survivors
1	20.2	50	20.0	99	50	19.9	99	50	19.5	97	50
2	22.1	50	22.1	100	50	22.1	100	50	21.7	98	50
3	23.1	50	23.4	101	50	23.7	103	50	23.0	100	50
4	23.9	50	24.3	102	50	24.6	103	50	24.0	100	50
5	24.6	50	25.2	102	50	25.3	103	50	25.1	102	50
6	25.4	50	26.0	102	50	26.0	102	50	25.8	102	50
7	26.3	50	26.6	101	50	27.3	104	50	26.7	102	50
8	26.8	50	27.1	101	50	27.5	103	50	27.3	102	50
9	27.0	50	27.2	101	50	27.8	103	50	27.5	102	50
10	27.2	50	27.9	103	50	28.6	105	50	28.4	104	50
11	27.9	50	29.1	104	50	29.5	106	50	29.2	105	50
12	28.7	50	29.0	101	50	30.2	105	50	29.7	104	50
15	30.5	50	30.2	99	50	32.2	106	50	31.3	103	50
19	31.7	50	32.4	102	50	34.7	110	50	33.6	106	50
23	33.7	50	34.0	101	50	36.7	109	50	35.8	106	50
27	34.5	50	35.8	104	50	37.4	108	50	37.5	109	49
31	36.5	50	37.7	103	50	39.5	108	50	39.7	109	49
35	38.1	50	39.1	103	49	40.9	107	50	41.3	108	49
39	40.5	50	41.1	102	49	42.8	106	50	42.8	106	49
43	41.6	50	43.4	104	49	44.9	108	49	44.6	107	49
47	44.2	50	45.3	103	49	47.4	107	49	47.9	108	48
51	45.3	50	46.5	103	49	49.2	109	49	48.9	108	47
55	46.6	50	48.4	104	49	51.3	110	49	50.3	108	47
59	48.3	50	50.7	105	49	53.9	112	49	52.2	108	47
63	49.2	50	52.3	106	49	55.3	112	49	53.1	108	47
67	49.4	50	53.2	108	48	56.0	113	49	54.0	109	47
71	49.6	49	53.6	108	48	56.3	114	49	53.9	109	47
75	48.9	48	53.5	109	48	56.0	115	49	53.8	110	46
79	48.2	46	53.5	111	47	55.5	115	49	54.3	113	44
83	48.5	44	52.6	109	47	55.9	115	47	54.4	112	44
87	48.5	40	51.4	106	44	56.0	116	46	54.9	113	44
91	48.3	38	52.1	108	40	55.9	116	46	53.8	111	42
95	47.8	36	51.4	108	39	55.0	115	44	52.1	109	41
99	48.6	34	50.8	105	37	54.2	112	41	52.0	107	38
103	48.2	29	50.1	104	33	54.0	112	35	51.5	107	35
<b>Mean for weeks</b>											
1-13	25.3		25.7	102		26.0	103		25.7	102	
14-52	37.7		38.6	102		40.6	108		40.3	107	
53-103	48.5		51.8	107		55.0	113		53.1	109	

### ***Pathology and Statistical Analyses***

This section describes the statistically significant or biologically noteworthy changes in the incidences of neoplasms and/or nonneoplastic lesions of the respiratory system (lung, nose, and larynx). Summaries of the incidences of neoplasms and nonneoplastic lesions, individual animal tumor diagnoses, statistical analyses of primary neoplasms that occurred with an incidence of at least 5% in at least one animal group, and historical incidences for the neoplasms mentioned in this section are presented in Appendix C for male mice and Appendix D for female mice.

*Respiratory System:* The incidences of alveolar/bronchiolar carcinoma were significantly greater in all exposed groups of males than in the control group and exceeded the historical control range for 2-year NTP inhalation studies (Tables 13 and C4). The incidences of alveolar/bronchiolar adenoma or carcinoma (combined) in male mice exposed to 10 or 30 mg/m<sup>3</sup> were also significantly greater than that in the control group (Tables 13 and C3) and exceeded the range of historical controls (Tables 13 and C4). Female mice exposed to 30 or 100 mg/m<sup>3</sup> had significantly greater incidences of alveolar/bronchiolar adenoma than did the control group and the incidences exceeded the range of historical controls (Tables 13 and D4). The incidence of carcinoma was greater in female mice exposed to 100 mg/m<sup>3</sup> than in the control group, although the increase was not significant (Tables 13 and D3). However, the incidence of alveolar/bronchiolar adenoma or carcinoma (combined) in female mice exposed to 100 mg/m<sup>3</sup> was significantly greater than that in the control group and exceeded the range of historical controls (Tables 13 and D4). The combined incidence increased with a significant positive trend.

Alveolar adenomas were discrete nodular masses composed of well-differentiated epithelial cells that formed papillary or solid patterns distorting the underlying architecture and sometimes compressing the adjacent alveolar parenchyma (Plates 9 and 10). Papillary neoplasms were composed of irregular papillary structures lined by uniform cuboidal cells with abundant cytoplasm and round to oval nuclei. Solid neoplasms were composed of sheets of uniform polygonal cells with abundant eosinophilic cytoplasm and round, oval, or polygonal nuclei. Carcinomas were expansive, and at times invasive, masses composed of a pleomorphic population of anaplastic cells in

papillary or pleomorphic growth patterns (Plate 11). Mitotic figures varied in number but were often numerous.

Incidences of metaplasia of the alveolar epithelium of minimal severity in the centriacinar region of the lung were significantly increased in all exposed groups of males and females (Tables 13, C5, and D5). The average severity of metaplasia was graded as minimal. Metaplasia was characterized by a change from the flattened epithelial cell type normally lining the alveolar ducts and adjacent alveolar septa to low cuboidal cells considered to be either Clara and/or Type II pneumocytes (Plate 12). The incidences of histiocyte cellular infiltration in all exposed groups of males were significantly greater than that in the control group. The incidence correlated to the incidence of alveolar/bronchiolar carcinoma and might be related to the presence of carcinomas in the lung.

In the nose, incidences of hyaline degeneration of the respiratory epithelium in 100 mg/m<sup>3</sup> males and females and hyaline degeneration of the olfactory epithelium in 100 mg/m<sup>3</sup> females were significantly greater than those in the control groups (Tables 13, C5, and D5). The degree of severity was generally minimal in all exposed and control groups, and, as in rats, this was considered a nonspecific degenerative response to chronic inhalation of molybdenum trioxide. Hyaline degeneration generally affected the respiratory epithelium lining the nasal septum in levels I and II of the nasal cavity, the medial surfaces of the nasoturbinates in level II, and was confined to the olfactory epithelium lining the dorsal meatus of level II. Microscopically, the lesions at both sites were morphologically similar to those observed in rats. The incidences of minimal focal suppurative inflammation in the nasal cavity of 30 and 100 mg/m<sup>3</sup> males and of minimal to mild focal atrophy of the olfactory epithelium of 100 mg/m<sup>3</sup> males were slightly greater than those of the control group. However, the degree of severity was similar to that of the control group, and it was not clear whether these lesions were related to chemical exposure. In the larynx, the incidences of squamous metaplasia of the epithelium lining the base of the epiglottis were significantly increased in all exposed groups of males and females (Tables 13, C5, and D5). However, the degree of

**TABLE 13**  
**Incidences of Selected Respiratory System Neoplasms and Nonneoplastic Lesions in Mice**  
**in the 2-Year Inhalation Study of Molybdenum Trioxide**

	0 mg/m <sup>3</sup>	10 mg/m <sup>3</sup>	30 mg/m <sup>3</sup>	100 mg/m <sup>3</sup>
<b>Male</b>				
Nose <sup>a</sup>	50	50	49	50
Inflammation, Suppurative <sup>b</sup>	2 (1.0) <sup>c</sup>	6 (1.0)	10* (1.2)	8* (1.1)
Olfactory Epithelium, Atrophy	3 (1.0)	5 (1.8)	3 (2.0)	10* (1.8)
Respiratory Epithelium, Degeneration, Hyaline	11 (1.2)	13 (1.0)	11 (1.0)	41** (1.1)
Larynx	50	49	48	50
Hyperplasia	1 (1.0)	3 (1.0)	6 (1.0)	41** (1.5)
Epiglottis, Metaplasia, Squamous	0	26** (1.0)	37** (1.3)	49** (2.2)
Lung	50	50	49	50
Infiltration Cellular, Histiocyte	2 (2.5)	16** (2.8)	9* (2.4)	9* (2.3)
Alveolar Epithelium, Metaplasia	0	32** (1.0)	36** (1.0)	49** (1.1)
Alveolar/bronchiolar Adenoma				
Overall rate <sup>d</sup>	9/50 (18%)	14/50 (28%)	10/49 (20%)	9/50 (18%)
Adjusted rate <sup>e</sup>	23.5%	37.8%	29.8%	22.5%
Terminal rate <sup>f</sup>	7/36 (19%)	11/33 (33%)	5/25 (20%)	7/37 (19%)
First incidence (days)	651	653	440	576
Logistic regression test <sup>g</sup>	P=0.322N	P=0.205	P=0.464	P=0.571N
Alveolar/bronchiolar Carcinoma <sup>h</sup>				
Overall rate	2/50 (4%)	16/50 (32%)	14/49 (29%)	10/50 (20%)
Adjusted rate	4.9%	40.7%	43.3%	25.3%
Terminal rate	1/36 (3%)	11/33 (33%)	8/25 (32%)	8/37 (22%)
First incidence (days)	544	580	513	629
Logistic regression test	P=0.385	P<0.001	P<0.001	P=0.017
Alveolar/bronchiolar Adenoma or Carcinoma <sup>i</sup>				
Overall rate	11/50 (22%)	27/50 (54%)	21/49 (43%)	18/50 (36%)
Adjusted rate	27.7%	64.8%	56.1%	43.4%
Terminal rate	8/36 (22%)	19/33 (58%)	10/25 (40%)	14/37 (38%)
First incidence (days)	544	580	440	576
Logistic regression test	P=0.541N	P=0.001	P=0.020	P=0.106
<b>Female</b>				
Nose	49	50	49	49
Olfactory Epithelium, Degeneration, Hyaline	22 (1.4)	14 (1.1)	14 (1.2)	36** (1.5)
Respiratory Epithelium, Degeneration, Hyaline	26 (1.2)	23 (1.0)	28 (1.2)	48** (1.8)
Larynx	49	50	49	50
Hyperplasia	1 (2.0)	1 (1.0)	7 (1.3)	35** (1.9)
Epiglottis, Metaplasia, Squamous	1 (1.0)	36** (1.1)	43** (1.5)	49** (2.2)

(continued)

**TABLE 13**  
**Incidences of Selected Respiratory System Neoplasms and Nonneoplastic Lesions in Mice**  
**in the 2-Year Inhalation Study of Molybdenum Trioxide** (continued)

	0 mg/m <sup>3</sup>	10 mg/m <sup>3</sup>	30 mg/m <sup>3</sup>	100 mg/m <sup>3</sup>
<b>Female</b> (continued)				
Lung	50	50	49	49
Alveolar Epithelium, Metaplasia	2 (1.0)	26** (1.1)	39** (1.1)	46** (1.1)
Alveolar/bronchiolar Adenoma <sup>d</sup>				
Overall rate	1/50 (2%)	4/50 (8%)	8/49 (16%)	9/49 (18%)
Adjusted rate	3.7%	11.0%	23.5%	24.8%
Terminal rate	0/25 (0%)	2/31 (6%)	7/33 (21%)	8/35 (23%)
First incidence (days)	729	610	720	667
Logistic regression test	P=0.018	P=0.184	P=0.036	P=0.016
Alveolar/bronchiolar Carcinoma				
Overall rate	2/50 (4%)	2/50 (4%)	0/49 (0%)	6/49 (12%)
Adjusted rate	5.8%	5.2%	0.0%	16.3%
Terminal rate	0/25 (0%)	0/31 (0%)	0/33 (0%)	5/35 (14%)
First incidence (days)	642	629	— <sup>k</sup>	632
Logistic regression test	P=0.024	P=0.694	P=0.256N	P=0.140
Alveolar/bronchiolar Adenoma or Carcinoma <sup>d</sup>				
Overall rate	3/50 (6%)	6/50 (12%)	8/49 (16%)	15/49 (31%)
Adjusted rate	9.3%	15.6%	23.5%	40.1%
Terminal rate	0/25 (0%)	2/31 (6%)	7/33 (21%)	13/35 (37%)
First incidence (days)	642	610	720	632
Logistic regression test	P<0.001	P=0.223	P=0.152	P=0.003

\* Significantly different ( $P \leq 0.05$ ) from the control group by the logistic regression test

\*\*  $P \leq 0.01$

<sup>a</sup> Number of animals with organ examined microscopically

<sup>b</sup> Number of animals with lesion

<sup>c</sup> Average severity grade of lesions in affected animals: 1=minimal, 2=mild, 3=moderate, 4=marked

<sup>d</sup> Number of animals with neoplasm per number of animals with organ examined microscopically

<sup>e</sup> Kaplan-Meier estimated neoplasm incidence at the end of the study after adjustment for intercurrent mortality

<sup>f</sup> Observed incidence in animals surviving until the end of the study

<sup>g</sup> In the control column are the P values associated with the trend test. In the exposed group columns are the P values corresponding to the pairwise comparisons between the controls and that exposed group. The logistic regression test regards lesions in animals dying prior to terminal kill as nonfatal. For all tests, a negative trend or a lower incidence in an exposure group is indicated by N.

<sup>h</sup> Historical incidence for 2-year NTP inhalation studies with untreated controls (mean  $\pm$  standard deviation): 75/947 (7.9%  $\pm$  5.7%); range 0%-16%

<sup>i</sup> Historical incidence: 205/947 (21.7%  $\pm$  8.0%); range 10%-42%

<sup>j</sup> Historical incidence: 61/939 (6.5%  $\pm$  3.2%); range 0%-14%

<sup>k</sup> Not applicable; no neoplasms in animal group

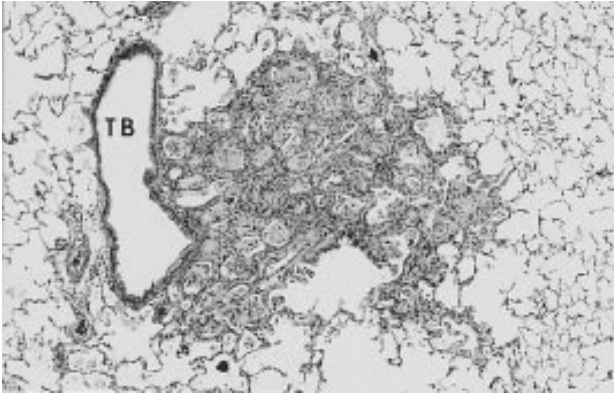
<sup>l</sup> Historical incidence: 97/939 (10.3%  $\pm$  3.7%); range 0%-16%

severity was generally minimal in the 10 and 30 mg/m<sup>3</sup> groups and mild in the 100 mg/m<sup>3</sup> groups. Squamous metaplasia was similar to that observed in rats. The normally single layer of pseudostratified ciliated cuboidal to low columnar epithelium lining the base of the epiglottis was replaced by an epithelium that consisted of a hypercellular layer of basal cells with one or more superficial layers of flattened (squamous) epithelial cells that lacked cilia. In advanced cases, there was slight keratinization of the epithelial surface. In both male and female mice, the incidences of hyperplasia in level II of the laryngeal epithelium increased with increasing exposure concentration. The increase was statistically significant only in mice exposed to 100 mg/m<sup>3</sup> with 82% of male and 70% of female mice affected. This lesion was characterized by increased thickness of the stratified squamous epithelium that normally covers the medial and ventral aspects of the corniculate processes of the

arytenoid cartilage of the vocal cords. Because the severity of both squamous metaplasia of the epiglottis and hyperplasia of the laryngeal epithelium did not vary significantly between exposed and control groups, these lesions were not considered to represent adaptive responses to chronic inhalation of molybdenum trioxide.

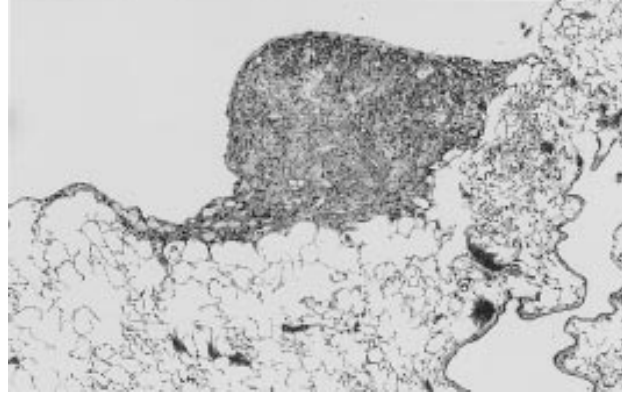
## GENETIC TOXICOLOGY

Molybdenum trioxide (10-10,000 µg/plate) did not induce mutations in *Salmonella typhimurium* strain TA97, TA98, TA100, TA1535, or TA1537, with or without induced hamster or rat liver S9 (Table E1). No induction of sister chromatid exchanges (Table E2) or chromosomal aberrations (Table E3) was observed, with or without S9, in cytogenetic tests with cultured Chinese hamster ovary cells.



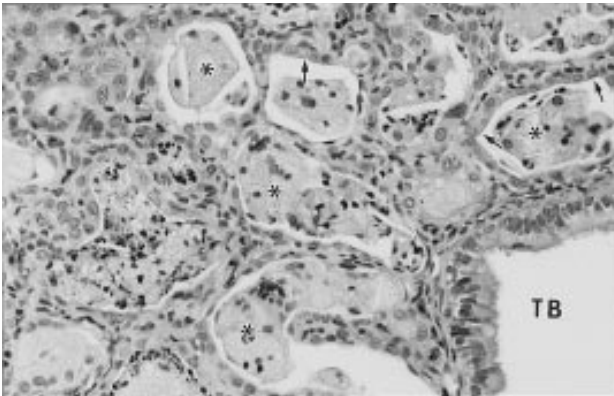
**PLATE 1**

Peribronchiolar chronic inflammation in the lung of a female rat exposed to 100 mg/m<sup>3</sup> molybdenum trioxide by inhalation for 2 years. TB=terminal bronchiole. H&E; 45×



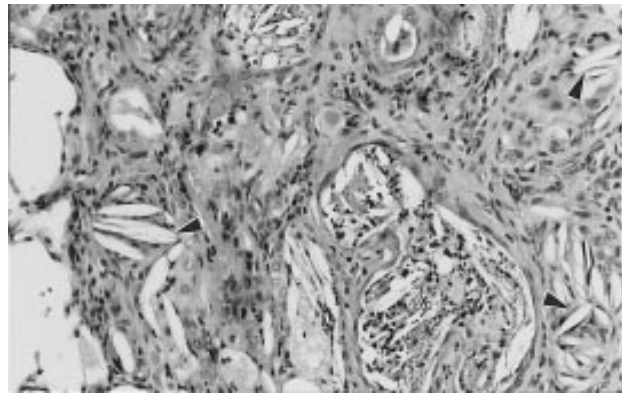
**PLATE 2**

Subpleural chronic inflammation in the lung of a male rat exposed to 30 mg/m<sup>3</sup> molybdenum trioxide by inhalation for 2 years. H&E; 36×



**PLATE 3**

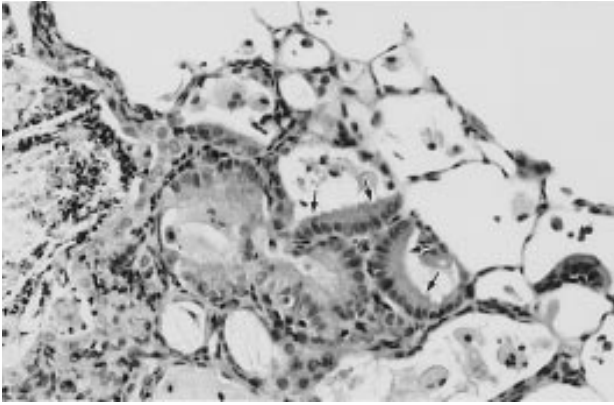
Peribronchiolar chronic inflammation in the lung of a male rat exposed to 100 mg/m<sup>3</sup> molybdenum trioxide by inhalation for 2 years. Alveoli contain aggregates of large foamy macrophages (asterisks). Alveolar septae are lined by cuboidal hyperplastic type II cells (arrows). TB=terminal bronchiole. H&E; 180×



**PLATE 4**

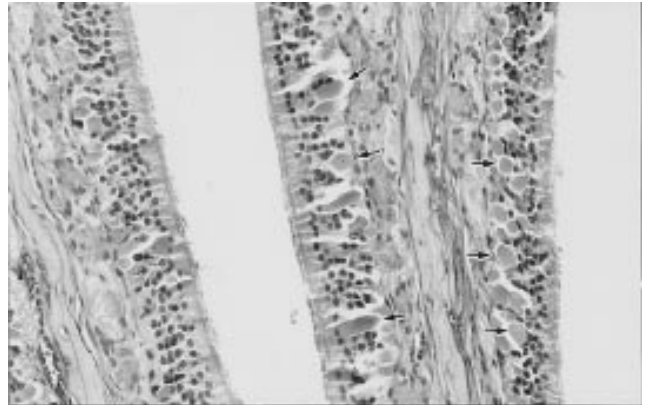
Chronic inflammation in the lung of a female rat exposed to 100 mg/m<sup>3</sup> molybdenum trioxide by inhalation for 2 years. Note macrophages within alveoli and alveolar septae, type II cell hyperplasia, and cholesterol clefts (arrowheads). An alveolus contains aggregates of neutrophils mixed with cellular debris (asterisk). H&E; 150×





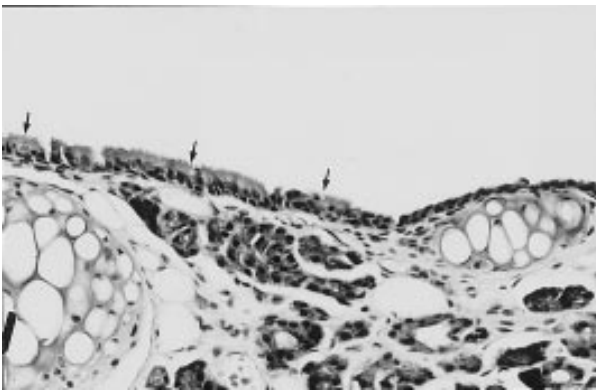
**PLATE 5**

Alveolar epithelial metaplasia in a focus of chronic inflammation in the lung of a female rat exposed to 100 mg/m<sup>3</sup> molybdenum trioxide by inhalation for 2 years. Alveolar septae are lined by ciliated columnar epithelial cells (arrows). Note macrophages within alveoli. H&E; 180×



**PLATE 6**

Hyaline degeneration of the olfactory epithelium in level III of the nasal cavity of a male rat exposed to 100 mg/m<sup>3</sup> molybdenum trioxide by inhalation for 2 years. Large eosinophilic globules (arrows) fill the cytoplasm of epithelial cells of the ethmoid turbinates. The epithelium has fewer cell layers and there is disorganization of the normally layered rows of sensory cell nuclei. H&E; 180×



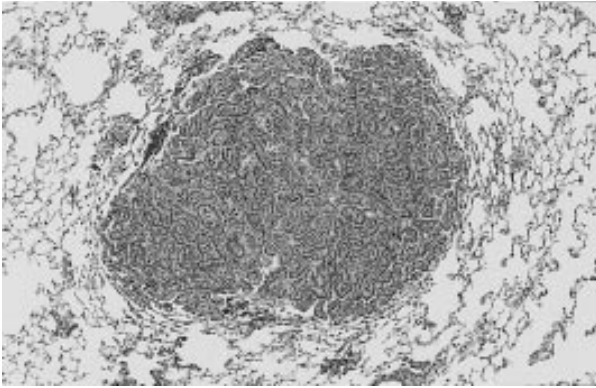
**PLATE 7**

Normal ciliated columnar epithelium lining the base of the epiglottis (arrows) of a male rat exposed to 100 mg/m<sup>3</sup> molybdenum trioxide by inhalation for 2 years. H&E; 180×



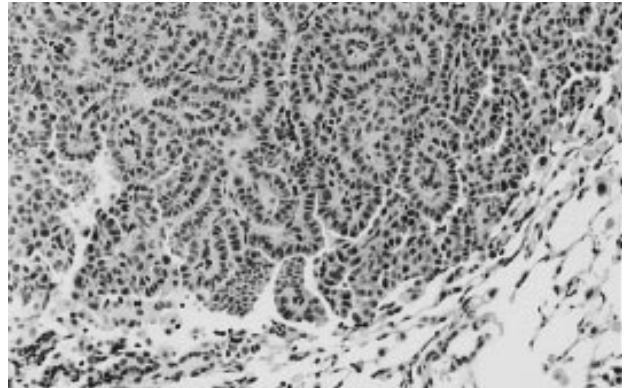
**PLATE 8**

Squamous metaplasia of the epithelium at the base of the epiglottis of a male rat exposed to 100 mg/m<sup>3</sup> molybdenum trioxide by inhalation for 2 years. Flattened (squamous), non-ciliated epithelium (arrows) replaces the ciliated columnar epithelium normally present at this location. H&E; 56×



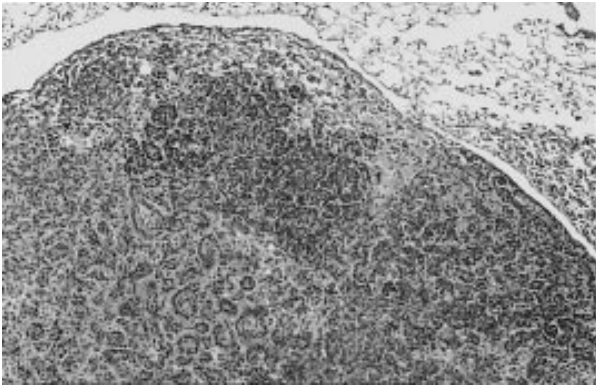
**PLATE 9**

Alveolar/bronchiolar adenoma in the lung of a male mouse exposed to  $100 \text{ mg/m}^3$  molybdenum trioxide by inhalation for 2 years. H&E;  $45\times$



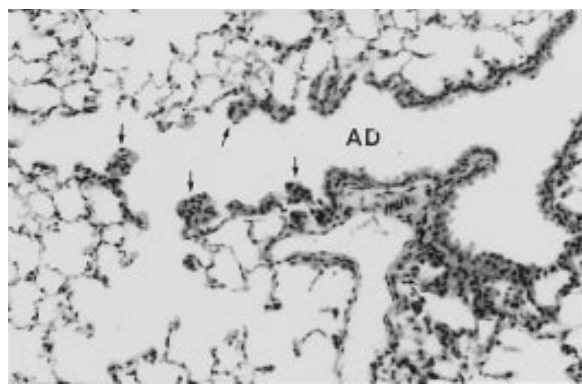
**PLATE 10**

Higher magnification of Plate 9. The alveolar architecture is effaced by uniform, well-differentiated cuboidal neoplastic epithelial cells arranged in a papillary pattern. H&E;  $150\times$



**PLATE 11**

Alveolar/bronchiolar carcinoma in the lung of a male mouse exposed to  $100 \text{ mg/m}^3$  molybdenum trioxide by inhalation for 2 years. Anaplastic epithelial cells in pleomorphic growth patterns efface the alveolar architecture. H&E;  $60\times$



**PLATE 12**

Epithelial metaplasia in the centriacinar region of the lung of a female mouse exposed to  $100 \text{ mg/m}^3$  molybdenum trioxide by inhalation for 2 years. Cuboidal (metaplastic) epithelial cells (arrows) replace the normally flattened epithelial cells lining the alveolar duct (AD) and the adjacent alveolar septae. H&E;  $125\times$



## DISCUSSION AND CONCLUSIONS

Molybdenum trioxide is water soluble and is well absorbed after inhalation or oral exposure. Fairhal *et al.* (1945) reported that in guinea pigs exposed to molybdenum trioxide at  $204.7 \text{ mg/m}^3$  for 1 hour per day, 5 days per week, for 5 weeks, molybdenum concentrations in liver, kidney, lung, spleen, and bone were higher than those of the controls. In the present studies, blood molybdenum concentrations in rats and mice increased proportionally with increasing exposure concentration; male rats exhibited higher blood molybdenum concentrations and greater variability than female rats. Blood molybdenum concentrations of male rats were higher than those of mice exposed to the same concentration. This was probably due to the larger lung capacity of rats and, therefore, more molybdenum trioxide was inhaled. The blood levels of molybdenum in rats and mice in these studies demonstrated that molybdenum trioxide administered via inhalation was well absorbed.

Exposure of rats and mice to molybdenum trioxide for 14 days at concentrations of 0, 3, 10, 30, 100, or  $300 \text{ mg/m}^3$  had no effect on survival or clinical findings. However, final mean body weights of male and female rats and mice exposed to  $300 \text{ mg/m}^3$  were significantly lower than those of the control groups. No chemical-related lesions were observed in rats or mice. Because of the body weight effects in the 14-day studies, rats and mice were exposed to 0, 1, 3, 10, 30, or  $100 \text{ mg/m}^3$  molybdenum trioxide during the 13-week studies. There were no effects on survival, final mean body weights, clinical findings, organ weights, clinical pathology parameters, sperm counts, or sperm motility. The concentrations of copper in the liver of male and female mice exposed to  $100 \text{ mg/m}^3$  were significantly greater than those of the control groups. The significance of the increased liver copper concentrations in mice is not known. The concentrations of copper in the liver of exposed male and female rats were similar to those of the control groups. No chemical-related lesions were observed in rats or mice.

Exposure of rats to molybdenum trioxide for 2 years at concentrations of 0, 10, 30, or  $100 \text{ mg/m}^3$  had no

effect on survival, body weight gain, clinical findings, or bone density or curvature. Exposure to molybdenum is known to cause deformities in the joints (USEPA, 1975). In the present studies, no bone or joint abnormalities were observed.

The rats did not show any typical symptoms of molybdenum toxicity such as diarrhea, alopecia, achromotrichia, dermatosis, or anemia. The amount of molybdenum absorbed in the present studies was probably below the threshold level needed to initiate such symptoms of toxicity. The bone and joint effect of molybdenum may be more difficult to manifest in young adult rats (7-8 weeks old) when the skeletal system is almost fully developed. The bone and joint effects were demonstrated by Miller *et al.* (1956), Van Reen (1959), and Lalich *et al.* (1965) when weanling rats were exposed to high molybdenum and low copper concentrations. The concentration of copper in the diet ( $4 \text{ mg/kg}$ ) might have protected the rats from molybdenum toxicity to a certain extent.

Exposure of male and female rats to molybdenum trioxide resulted in the development of respiratory system lesions. In the lung, the incidence and severity of chronic alveolar inflammation increased with increasing exposure concentration in male and female rats. In addition, four alveolar/bronchiolar adenomas or carcinomas were present in male rats exposed to  $100 \text{ mg/m}^3$ ; none were present in controls. However, the combined incidence of these neoplasms was within the range of historical controls for 2-year NTP inhalation studies. No carcinogenic response was observed in female rats exposed to molybdenum trioxide. The lesions in the nose (hyaline degeneration) and larynx (squamous metaplasia) were considered to be nonspecific defensive or adaptive responses to the chronic inhalation exposure to molybdenum trioxide.

Bompart *et al.* (1990) reported that molybdenum salt administered at  $80 \text{ mg/kg}$  orally for 8 weeks induced mild renal failure in male Sprague-Dawley rats. USEPA (1975) reported fatty degeneration in liver and kidney. In the present studies, F344/N rats exposed to

molybdenum trioxide at concentrations of 0, 1, 3, 10, 30, or 100 mg/m<sup>3</sup> for 13 weeks or at concentrations of 0, 10, 30, or 100 mg/m<sup>3</sup> for 2 years did not show any signs or symptoms of renal effects. Kidney weights and creatinine concentrations of exposed rats in the 13-week study were similar to those of the controls. No liver lesions were observed.

High intake of molybdenum significantly increased serum and tissue molybdenum concentrations in sheep (Pitt *et al.*, 1980) and in rats (Seaborn and Yang, 1993). In female Sprague-Dawley rats, higher intake of molybdenum resulted in proportionally higher excretion in urine and feces (Seaborn and Yang, 1993). Renal and urinary copper concentrations were increased in sheep following molybdenum ingestion (Marcilese *et al.*, 1969). However, Seaborn and Yang (1993) did not notice any increase in copper excretion in female Sprague-Dawley rats exposed to molybdenum in drinking water. There were no significant differences in the concentration of copper in the liver of exposed and control rats in the current 13-week study.

Exposure of mice to molybdenum trioxide for 2 years at concentrations of 0, 10, 30, or 100 mg/m<sup>3</sup> had no effect on survival, clinical findings, or bone density or curvature. Final mean body weights of 30 mg/m<sup>3</sup> and 100 mg/m<sup>3</sup> females were greater than that of the control group.

In contrast to rats, exposure of mice to molybdenum trioxide was associated with the development of lung neoplasms. The incidences of alveolar/bronchiolar carcinoma and alveolar/bronchiolar adenoma or carcinoma (combined) in male mice exceeded the historical control range for 2-year NTP inhalation studies. In female mice, the incidences of alveolar/bronchiolar adenoma in the 30 and 100 mg/m<sup>3</sup> groups and of alveolar/bronchiolar adenoma or carcinoma (combined) in the 100 mg/m<sup>3</sup> group were significantly greater than those in the control group. Unlike in rats, chronic inflammatory lesions were not present in the lungs of mice. The nose and larynx lesions present in mice were similar to those observed in rats and were considered to be nonspecific, defensive, or adaptive responses to chronic inhalation exposure to molybdenum trioxide.

Inherent species differences may explain the pulmonary responses associated with molybdenum

trioxide exposure in rats and mice. Fischer 344/N rats are known to have a low incidence of spontaneous lung neoplasms, whereas the spontaneous incidence of lung neoplasms in B6C3F<sub>1</sub> mice is relatively high. In NTP studies, chemical-associated increased incidences of lung neoplasms occur twice as often in mice as in rats. Rats are known to develop chronic inflammatory lesions in the lung following inhalation exposure to particulates, and in many of these studies increased incidences of lung neoplasms also occur. The distribution of chronic inflammatory lesions observed in the lungs of rats in this study is similar to that observed in other inhalation studies of particulate compounds, with lesions developing adjacent to terminal bronchioles and alveolar ducts (centriacinar region of the lung) and in subpleural sites (Lee, 1989). Qualitatively, these lesions are similar to those observed in other inhalation studies of particulates. However, the severity of chronic inflammation in rats in the present study is rather mild compared to that observed in other particulate studies with talc, nickel oxide, and nickel subsulfide (NTP, 1993; NTP, 1996a,b).

Molybdenum trioxide is not mutagenic. The mechanism of action of molybdenum trioxide in lung carcinogenesis is not known. The nonneoplastic lesions observed in the nose and larynx of rats and in the nose, larynx, and lung of mice were apparently attempts by the rats and mice to develop a more durable epithelium in response to the chronic effects of molybdenum trioxide exposure. Pneumoconiosis has been described by Friberg (1979) in experimental animals exposed to molybdenum trioxide subchronically.

## CONCLUSIONS

Under the conditions of these 2-year inhalation studies, there was *equivocal evidence of carcinogenic activity*\* of molybdenum trioxide in male F344/N rats based on a marginally significant positive trend of alveolar/bronchiolar adenoma or carcinoma (combined). There was *no evidence of carcinogenic activity* of molybdenum trioxide in female F344/N rats exposed to 10, 30, or 100 mg/m<sup>3</sup>. There was *some evidence of carcinogenic activity* of molybdenum trioxide in male B6C3F<sub>1</sub> mice based on increased

incidences of alveolar/bronchiolar carcinoma and adenoma or carcinoma (combined). There was *some*

*evidence of carcinogenic activity* of molybdenum trioxide in female B6C3F<sub>1</sub> mice based on increased incidences of alveolar/bronchiolar adenoma and adenoma or carcinoma (combined).

Exposure of male and female rats to molybdenum trioxide by inhalation resulted in increased incidences of chronic alveolar inflammation, hyaline degeneration of the respiratory epithelium, hyaline degenera-

tion of the olfactory epithelium (females), and squamous metaplasia of the epiglottis.

Exposure of male and female mice to molybdenum trioxide by inhalation resulted in increased incidences of metaplasia of the alveolar epithelium, histiocytic cellular infiltration (males), hyaline degeneration of the respiratory epithelium, hyaline degeneration of the olfactory epithelium (females), squamous metaplasia of the epiglottis, and hyperplasia of the larynx.

---

\* Explanation of Levels of Evidence of Carcinogenic Activity is on page 9. A summary of the Technical Reports Review Subcommittee comments and the public discussion on this Technical Report appears on page 11.



## REFERENCES

- American Conference of Governmental Industrial Hygienists (ACGIH) (1995). 1995-1996 Threshold Limit Values (TLVs™) for Chemical Substances and Physical Agents and Biological Exposure Indices (BEIs™). ACGIH, Cincinnati, OH.
- Anke, M., Hennig, A., Dietrich, M., Hoffmann, G., Wicke, G., and Pflug, D. (1971). Absorption, excretion and distribution pattern of <sup>99</sup>molybdenum after oral administration to lactating ruminants [in German, English summary]. *Arch. Tierernahr.* **21**, 505-513.
- Armitage, P. (1971). *Statistical Methods in Medical Research*, pp. 362-365. John Wiley and Sons, Inc., New York.
- Arrington, L.R., and Davis, G.K. (1953). Molybdenum toxicity in the rabbit. *J. Nutr.* **51**, 295-304.
- Ashby, J., and Tennant, R.W. (1991). Definitive relationships among chemical structure, carcinogenicity and mutagenicity for 301 chemicals tested by the U.S. NTP. *Mutat. Res.* **257**, 229-306.
- Babaian, E.A., Bagramian, S.B., and Pogolian, A.S. (1980). Effect of some chemical hazards involved in molybdenum production on the chromosome apparatus of experimental animals and of man [in Russian]. *Gig. Tr. Prof. Zabol.* **9**, 33-36.
- Bela, Y.M., and Lifshits, V.M. (1966). Contents of trace elements in the blood of leukemia and anemia. *Fed. Proc. Transl. Suppl.* **25**, 370-372.
- Bompart, G., Pécher, C., Prévot, D., and Girolami, J.-P. (1990). Mild renal failure induced by subchronic exposure to molybdenum: urinary kallikrein excretion as a marker of distal tubular effect. *Toxicol. Lett.* **52**, 293-300.
- Boorman, G.A., Montgomery, C.A., Jr., Eustis, S.L., Wolfe, M.J., McConnell, E.E., and Hardisty, J.F. (1985). Quality assurance in pathology for rodent carcinogenicity studies. In *Handbook of Carcinogen Testing* (H.A. Milman and E.K. Weisburger, Eds.), pp. 345-357. Noyes Publications, Park Ridge, NJ.
- Bruin, A. De. (1976). In *Biochemical Toxicology of Environmental Agents*, pp. 460-461. Elsevier/North-Holland Biochemical Press, Amsterdam.
- Burrell, R.J.W., Roach, W.A., and Shadwell, A. (1966). Esophageal cancer in the Bantu of the Transkei associated with mineral deficiency in garden plants. *J. Natl. Cancer Inst.* **36**, 201-214.
- Code of Federal Regulations (CFR) **21**, Part 58.
- Cohen, H.J., Drew, R.T., Johnson, J.L., and Rajagopalan, K.V. (1973). Molecular basis of the biological function of molybdenum: The relationship between sulfite oxidase and the acute toxicity of bisulfite and SO<sub>2</sub>. *Proc. Acad. Sci.* **70**, 3655-3659.
- Cox, D.R. (1972). Regression models and life-tables. *J. R. Stat. Soc.* **B34**, 187-220.
- Crawford, B.D. (1985). Perspectives on the somatic mutation model of carcinogenesis. In *Advances in Modern Environmental Toxicology: Mechanisms and Toxicity of Chemical Carcinogens and Mutagens* (M.A. Mehlman, W.G. Flamm, and R.J. Lorentzen, Eds.), pp. 13-59. Princeton Scientific Publishing Co. Inc., Princeton, NJ.
- Davis, G.K. (1950). The influence of copper on the metabolism of phosphorus and molybdenum. In *Copper Metabolism: A Symposium on Animal, Plant and Soil Relationships* (W.D. McElroy and B. Glass, Eds.), pp. 216-229. The Johns Hopkins Press, Baltimore.



- Deosthale, Y.G., and Gopalan, C. (1974). The effect of molybdenum levels in sorghum (*Sorghum vulgare* Pers.) on uric acid and copper excretion in man. *Br. J. Nutr.* **31**, 351-355.
- De Renzo, E.C. (1962). Molybdenum. In *Mineral Metabolism: An Advanced Treatise* (C.L. Comar and F. Bronner, Eds.), Vol. II, Part B, pp. 483-498. Academic Press, New York.
- Dick, A.T., Dewey, D.W., and Gawthorne, J.M. (1975). Thiomolybdates and the copper-molybdenum-sulphur interaction in ruminant nutrition. *J. Agric. Sci.* **85**, 567-568.
- Dinse, G.E., and Haseman, J.K. (1986). Logistic regression analysis of incidental tumor data from animal carcinogenicity experiments. *Fundam. Appl. Toxicol.* **6**, 44-52.
- Dinse, G.E., and Lagakos, S.W. (1983). Regression analysis of tumour prevalence data. *Appl. Statist.* **32**, 236-248.
- Dixon, W.J., and Massey, F.J., Jr. (1951). *Introduction to Statistical Analysis*, 1st ed., pp. 145-147. McGraw-Hill Book Company, New York.
- Dunn, O.J. (1964). Multiple comparisons using rank sums. *Technometrics* **6**, 241-252.
- Dunnnett, C.W. (1955). A multiple comparison procedure for comparing several treatments with a control. *J. Am. Stat. Assoc.* **50**, 1096-1121.
- Fairhall, L.T., Dunn, R.C., Sharpless, N.E., and Pritchard, E.A. (1945). The toxicity of molybdenum. *U.S. Public Health Bull.* **293**, 1-36.
- Friberg, L. (1979). Molybdenum. In *Handbook on the Toxicology of Metals* (L. Friberg, G.F. Nordberg, and V.B. Vouk, Eds.), pp. 531-539. Elsevier/North-Holland Biomedical Press, Amsterdam.
- Fried, R., Fried, L.W., and Babin, D.R. (1973). Biological role of xanthine oxidase and tetrazolium-reductase inhibitor. *Eur. J. Biochem.* **33**, 439-445.
- Galloway, S.M., Armstrong, M.J., Reuben, C., Colman, S., Brown, B., Cannon, C., Bloom, A.D., Nakamura, F., Ahmed, M., Duk, S., Rimpo, J., Margolin, B.H., Resnick, M.A., Anderson, B., and Zeiger, E. (1987). Chromosome aberrations and sister chromatid exchanges in Chinese hamster ovary cells: Evaluations of 108 chemicals. *Environ. Mol. Mutagen.* **10** (Suppl. 10), 1-175.
- Gart, J.J., Chu, K.C., and Tarone, R.E. (1979). Statistical issues in interpretation of chronic bioassay tests for carcinogenicity. *JNCI* **62**, 957-974.
- Gould, E.S. (1962). *Inorganic Reactions and Structure*, pp. 331-332. Holt, Rinehart and Winston, Inc., New York.
- Goyer, R.A. (1991). Toxic effects of metals. In *Casarett and Doull's Toxicology: The Basic Science of Poisons* (M.O. Amdur, J. Doull, and C.D. Klaassen, Eds.), 4th ed., pp. 623-680. Pergamon Press, New York.
- Halverson, A.W., Phifer, J.H., and Monty, K.J. (1960). A mechanism for the copper-molybdenum interrelationship. *J. Nutr.* **71**, 95-100.
- Hammond, P.B., and Beliles, R.P. (1980). Metals. In *Casarett and Doull's Toxicology: The Basic Science of Poisons* (J. Doull, C.D. Klaassen, and M.O. Amdur, Eds.), 2nd ed., pp. 409-467. Macmillan Publishing Co., Inc., New York.
- Hanafi, Z.M., Khilla, M.A., and Abu-El Saud, A. (1975). Infrared measurements on molybdenum trioxide and its suboxides. *Rev. Chimie Minerale* **12**, 546-552.
- Haseman, J.K. (1984). Statistical issues in the design, analysis and interpretation of animal carcinogenicity studies. *Environ. Health Perspect.* **58**, 385-392.
- Hazard Information Review (1981). Molybdenum (VI) Oxide, EPA TSCA Interagency Testing Committee. Prepared by Enviro Control, Rockville, MD, May 31, 1981.

- Hollander, M., and Wolfe, D.A. (1973). *Nonparametric Statistical Methods*, pp. 120-123. John Wiley and Sons, New York.
- Huber, J.T., Price, N.O., and Engel, R.W. (1971). Response of lactating dairy cows to high levels of dietary molybdenum. *J. Anim. Sci.* **32**, 364-367.
- Jeter, M.A., and Davis, G.K. (1954). The effect of dietary molybdenum upon growth, hemoglobin, reproduction and lactation of rats. *J. Nutr.* **54**, 215-220.
- Jonckheere, A.R. (1954). A distribution-free *k*-sample test against ordered alternatives. *Biometrika* **41**, 133-145.
- Kada, T., Hirano, K., and Shirasu, Y. (1980). Screening of environmental chemical mutagens by the rec-assay system with *Bacillus subtilis*. In *Chemical Mutagens: Principles and Methods for Their Detection* (F.J. de Serres and A. Hollaender, Eds.), Vol. 6, pp. 149-173. Plenum Press, New York.
- Kaplan, E.L., and Meier, P. (1958). Nonparametric estimation from incomplete observations. *J. Am. Stat. Assoc.* **53**, 457-481.
- Kirk-Othmer Encyclopedia of Chemical Technology* (1981). Molybdenum and molybdenum alloys. 3rd ed., Vol. 15, pp. 670-685. John Wiley and Sons, New York.
- Koizumi, T., Tajima, K., Emi, N., Hara, A., and Suzuki, K.T. (1995). Suppressive effect of molybdenum on hepatotoxicity of *N*-nitrosodiethylamine in rats. *Biol. Pharm. Bull.* **18**, 460-462.
- Komada, H., Kise, Y., Nakagawa, M., Yamamura, M., Hioki, K., and Yamamoto, M. (1990). Effect of dietary molybdenum on esophageal carcinogenesis in rats induced by *N*-methyl-*N*-benzyl nitrosamine. *Cancer Res.* **50**, 2418-2422.
- Köpf-Maier, P., Leitner, M., Voigtländer, R., and Köpf, H. (1979). Molybdocene dichloride as an anti-tumor agent [in German, English summary]. *Z. Naturforsch.* **34c**, 1174-1176.
- Lalich, J.J., Groupner, K., and Jolin, J. (1965). The influence of copper and molybdate salts on the production of bony deformities in rats. *Lab. Invest.* **14**, 1482-1493.
- Lee, K.P. (1989). Lung response to particulates. In *Encyclopedia of Environmental Control Technology: Air Pollution Control*, Vol. 2, pp. 835-882. Gulf Publishing Co., Houston.
- Lewis, A.H. (1943). The teart pastures of Somerset. II. Relation between soil and teartness. *J. Agric. Sci.* **33**, 52-59.
- Lukashev, A.A., and Shishkova, H.K. (1971a). Vitamins C and B<sub>1</sub> in the tissues and urine of chronic poisoning experiment with inhalation administration of molybdenum [in Russian]. *Tr. Inst. Kraev. Patol.* **22**, 152-154.
- Lukashev, A.A., and Shishkova, H.K. (1971b). State of phosphatase activity and phosphorus content in animal tissues in a chronic experiment with inhalation molybdenum poisoning [in Russian]. *Tr. Inst. Kraev. Patol.* **22**, 175-180.
- Lukashev, A.A., and Shishkova, H.K. (1971c). Non-specific indexes for rabbits and rats in a chronic poisoning experiment with molybdenum [in Russian]. *Tr. Inst. Kraev. Patol.* **22**, 191-196.
- Luo, X.-M., Wei, H.-J., and Yang, S.P. (1983). Inhibitory effects of molybdenum on esophageal and forestomach carcinogenesis in rats. *JNCI* **71**, 75-80.
- McConnell, E.E., Solleveld, H.A., Swenberg, J.A., and Boorman, G.A. (1986). Guidelines for combining neoplasms for evaluation of rodent carcinogenesis studies. *JNCI* **76**, 283-289.
- McCord, J.M. (1985). Oxygen-derived free radicals in postschismic tissue injury. *N. Engl. J. Med.* **312**, 159-163.
- McKnight, B., and Crowley, J. (1984). Tests for differences in tumor incidence based on animal carcinogenesis experiments. *J. Am. Stat. Assoc.* **79**, 639-648.

- Maltoni, C. (1976a). Predictive value of carcinogenesis bioassays. *Ann. N.Y. Acad. Sci.* **271**, 431-443.
- Maltoni, C. (1976b). Precursor lesions in exposed populations as indicators of occupational cancer risk. *Ann. N.Y. Acad. Sci.* **271**, 444-447.
- Marcilese, N.A., Ammerman, C.B., Valsecchi, R.M., Dunavant, B.G., and Davis, G.K. (1969). Effect of dietary molybdenum and sulfate upon copper metabolism in sheep. *J. Nutr.* **99**, 177-183.
- Maronpot, R.R., and Boorman, G.A. (1982). Interpretation of rodent hepatocellular proliferative alterations and hepatocellular tumors in chemical safety assessment. *Toxicol. Pathol.* **10**, 71-80.
- The Merck Index* (1989). 11th ed. (S. Budavari, Ed.). Merck and Company, Rahway, NJ.
- Miller, J.A., and Miller, E.C. (1977). Ultimate chemical carcinogens as reactive mutagenic electrophiles. In *Origins of Human Cancer* (H.H. Hiatt, J.D. Watson, and J.A. Winsten, Eds.), pp. 605-627. Cold Spring Harbor Laboratory, Cold Spring Harbor, NY.
- Miller, R.F., and Engel, R.W. (1960). Interrelations of copper, molybdenum and sulfate sulfur in nutrition. *Fed. Proc.* **19**, 666-677.
- Miller, R.F., Price, N.O., and Engel, R.W. (1956). Added dietary inorganic sulfate and its effect upon rats fed molybdenum. *J. Nutr.* **60**, 539-547.
- Mills, C.F., and Davis, G.K. (1987). Molybdenum. In *Trace Elements in Human and Animal Nutrition* (W. Mertz, Ed.), 5th ed., Vol. 1, pp. 429-463. Academic Press, Inc., San Diego.
- Mills, C.F., and Fell, B.F. (1960). Demyelination in lambs born of ewes maintained on high intakes of sulphate and molybdate. *Nature* **185**, 20-22.
- Mills, C.F., Monty, K.J., Ichihara, A., and Pearson, P.B. (1958). Metabolic effects of molybdenum toxicity in the rat. *J. Nutr.* **65**, 129-142.
- Milvy, P., and Kay, K. (1978). Mutagenicity of 19 major graphic arts and printing dyes. *J. Toxicol. Environ. Health* **4**, 31-36.
- National Cancer Institute (NCI) (1976). Guidelines for Carcinogen Bioassay in Small Rodents. Technical Report Series No. 1. NIH Publication No. 76-801. U.S. Department of Health, Education, and Welfare, Public Health Service, National Institutes of Health, Bethesda, MD.
- National Institute for Occupational Safety and Health (NIOSH) (1990). National Occupational Exposure Survey (1981-1983), unpublished provisional data as of July 1, 1990. NIOSH, Cincinnati, OH.
- National Institute for Occupational Safety and Health/Occupational Safety and Health Administration (NIOSH/OSHA) (1981). Occupational Health Guidelines for Chemical Hazards. DHHS (NIOSH) Publication No. 81-123. U.S. Department of Health and Human Services. U.S. Department of Labor.
- National Institutes of Health (NIH) (1978). Open Formula Rat and Mouse Ration (NIH-07). Specification NIH-11-1335. U.S. Department of Health, Education, and Welfare, Public Health Service, National Institutes of Health, Bethesda, MD.
- National Research Council (1980). Recommended Dietary Allowances. 9th ed. National Academy of Sciences, Washington, DC.
- National Toxicology Program (NTP) (1983). National Toxicology Program General Statement of Work. Technical Proposal for Sperm Morphology and Vaginal Cytology Evaluation in Toxicity Testing for Rats and mice, 10/31/82 version (updated October 1983). Research Triangle Park, NC.
- National Toxicology Program (NTP) (1993). Toxicology and Carcinogenesis Studies of Talc (CAS No. 14807-96-6) in F344/N Rats and B6C3F<sub>1</sub> Mice (Inhalation Studies). Technical Report Series No. 421. NIH Publication No. 93-3152. U.S. Department of Health and Human Services, Public Health Service, National Institutes of Health, Research Triangle Park, NC.

- National Toxicology Program (NTP) (1996a). Toxicology and Carcinogenesis Studies of Nickel Oxide (CAS No. 1313-99-1) in F344/N Rats and B6C3F<sub>1</sub> Mice (Inhalation Studies). Technical Report Series No. 451. NIH Publication No. 96-3363. U.S. Department of Health and Human Services, Public Health Service, National Institutes of Health, Research Triangle Park, NC.
- National Toxicology Program (NTP) (1996b). Toxicology and Carcinogenesis Studies of Nickel Subulfide (CAS No. 12035-72-2) in F344/N Rats and B6C3F<sub>1</sub> Mice (Inhalation Studies). Technical Report Series No. 453. NIH Publication No. 96-3369. U.S. Department of Health and Human Services, Public Health Service, National Institutes of Health, Research Triangle Park, NC.
- Nederbragt, H. (1982). Changes in the distribution of copper and molybdenum after Mo administration and subsequent additional oral or intraperitoneal Cu administration to rats. *Br. J. Nutr.* **48**, 353-364.
- Neilands, J.B., Strong, F.M., and Elvehjem, C.A. (1948). Molybdenum in the nutrition of the rat. *J. Biol. Chem.* **172**, 431-439.
- Nemenko, B.A., Moldakulova, M.M., and Zorina, S.N. (1976). Rasprostranenie rak a pishchevoda V Gur'evskoi blasti v zavisimosti ot mineral'nogo sostava pit'evovody [in Russian]. *Vopr. Onkol.* **22**, 75-76.
- Nyquist, R.A. (1971). Spectrum No. 352. In *Infrared Spectra of Inorganic Compounds*, pp. 224-225, Academic Press, Inc., New York.
- Ostrom, C.A., Van Reen, R., and Miller, C.W. (1961). Changes in the connective tissue of rats fed toxic diets containing molybdenum salts. *J. Dent. Res.* **40**, 520-528.
- Patty's Industrial Hygiene and Toxicology* (1981). (G.D. Clayton and F.E. Clayton, Eds.), 3rd rev. ed., Vol. 2A, pp. 1493-2060. John Wiley and Sons, New York.
- Pitt, M.A. (1976). Molybdenum toxicity: Interactions between copper, molybdenum and sulphate. *Agents Actions* **6**, 758-769.
- Pitt, M., Fraser, J., and Thurley, D.C. (1980). Molybdenum toxicity in sheep: Epiphysiolysis, exotoses and biochemical changes. *J. Comp. Pathol.* **90**, 567-576.
- Ridgway, L.P., and Karnofsky, D.A. (1952). The effects of metals on the chick embryo: Toxicity and production of abnormalities in development. *Ann. N.Y. Acad. Sci.* **55**, 203-215.
- Robinson, J.B.D., and Clifford, P. (1968). Trace element levels and carcinoma of the nasopharynx in Kenya. *East Afr. Med. J.* **45**, 694-700.
- Sax, N.I. (1984). *Dangerous Properties of Industrial Materials*, 6th ed. Van Nostrand Reinhold, New York.
- Schroeder, H.A., and Mitchener, M. (1971). Toxic effects of trace elements on the reproduction of mice and rats. *Arch. Environ. Health* **23**, 102-106.
- Seaborn, C.D., and Yang, S.P. (1993). Effect of molybdenum supplementation on *N*-nitroso-*N*-methylurea-induced mammary carcinogenesis and molybdenum excretion in rats. *Biol. Trace Elem. Res.* **39**, 245-256.
- Shirley, E. (1977). A non-parametric equivalent of Williams' test for contrasting increasing dose levels of a treatment. *Biometrics* **33**, 386-389.
- Shirley, R.L., Jeter, M.A., Feaster, J.P., McCall, J.T., Outler, J.C., and Davis, G.K. (1954). Placental transfer of Mo<sup>99</sup> and Ca<sup>45</sup> in swine. *J. Nutr.* **54**, 59-64.
- Sittig, M. (1994). *World-Wide Limits for Toxic and Hazardous Chemicals in Air, Water and Soil*, pp. 527-528. Noyes Publications, Park Ridge, NJ.
- Spence, J.A., Suttle, N.F., Wenham, G., El-Gallad, T., and Bremner, I. (1980). A sequential study of the skeletal abnormalities which develop in rats given a small dietary supplement of ammonium tetrathiomolybdate. *J. Comp. Pathol.* **90**, 139-153.

- Stoner, G.D., Shimkin, M.B., Troxell, M.C., Thompson, T.L., and Terry, L.S. (1976). Test for carcinogenicity of metallic compounds by the pulmonary tumor response in strain A mice. *Cancer Res.* **36**, 1744-1747.
- Straus, D.S. (1981). Somatic mutation, cellular differentiation, and cancer causation. *JNCI* **67**, 233.
- Suttle, N.F. (1974). Recent studies of the copper-molybdenum antagonism. *Proc. Nutr. Soc.* **33**, 299-305.
- Tarone, R.E. (1975). Tests for trend in life table analysis. *Biometrika* **62**, 679-682.
- Tennant, R.W., Margolin, B.H., Shelby, M.D., Zeiger, E., Haseman, J.K., Spalding, J., Caspary, W., Resnick, M., Stasiewicz, S., Anderson, B., and Minor, R. (1987). Prediction of chemical carcinogenicity in rodents from in vitro genetic toxicity assays. *Science* **236**, 933-941.
- Thomas, J.W., and Moss, S. (1951). The effect of orally administered molybdenum on growth, spermatogenesis and testes histology of young dairy bulls. *J. Dairy Sci.* **34**, 929-934.
- U.S. Environmental Protection Agency (USEPA) (1975). Molybdenum — A toxicological appraisal: EPA-600/1-75-004. Health Effects Research Laboratory, Office of Research and Development, Research Triangle Park, NC.
- Van Gennip, A.H., Abeling, N.G.G.M., Stroomer, A.E.M., Overmars, H., and Bakker, H.D. (1994). The detection of molybdenum cofactor deficiency: Clinical symptomatology and urinary metabolite profile. *J. Inherit. Metab. Dis.* **17**, 142-145.
- Van Reen, R. (1959). The specificity of the molybdate-sulfate interrelationship in rats. *J. Nutr.* **68**, 243-250.
- Venitt, S., and Levy, L.S. (1974). Mutagenicity of chromates in bacteria and its relevance to chromate carcinogenesis. *Nature* **250**, 493-495.
- Venugopal, B., and Luckey, T.D. (1978). *Metal Toxicity in Mammals • 2. Chemical Toxicity of Metals and Metalloids*. Plenum Press, New York.
- Walravens, P.A., Moure-Eraso, R., Solomons, C.C., Chappell, W.R., and Bentley, G. (1979). Biochemical abnormalities in workers exposed to molybdenum dust. *Arch. Environ. Health* **34**, 302-307.
- Weast, R.C., Ed. (1989). *CRC Handbook of Chemistry and Physics*, 70th ed., p. B-108. CRC Press, Inc., Boca Raton, FL.
- Wei, H.-J., Luo, X.-M., and Yang, S.P. (1985). Effects of molybdenum and tungsten on mammary carcinogenesis in SD rats. *JNCI* **74**, 469-473.
- Williams, D.A. (1971). A test for differences between treatment means when several dose levels are compared with a zero dose control. *Biometrics* **27**, 103-117.
- Williams, D.A. (1972). The comparison of several dose levels with a zero dose control. *Biometrics* **28**, 519-531.
- Xin, Z., Silvia, W.J., Waterman, D.F., Hemken, R.W., and Tucker, W.B. (1993). Effect of copper status on luteinizing hormone secretion in dairy steers. *J. Dairy Sci.* **76**, 437-444.
- Zeiger, E., Haseman, J.K., Shelby, M.D., Margolin, B.H., and Tennant, R.W. (1990). Evaluation of four in vitro genetic toxicity tests for predicting rodent carcinogenicity: Confirmation of earlier results with 41 additional chemicals. *Environ. Mol. Mutagen.* **16** (Suppl. 18), 1-14.
- Zeiger, E., Anderson, B., Haworth, S., Lawlor, T., and Mortelmans, K. (1992). Salmonella mutagenicity tests: V. Results from the testing of 311 chemicals. *Environ. Mol. Mutagen.* **19** (Suppl. 21), 2-141.

**APPENDIX A**  
**SUMMARY OF LESIONS IN MALE RATS**  
**IN THE 2-YEAR INHALATION STUDY**  
**OF MOLYBDENUM TRIOXIDE**

<b>TABLE A1</b>	<b>Summary of the Incidence of Neoplasms in Male Rats in the 2-Year Inhalation Study of Molybdenum Trioxide .....</b>	<b>66</b>
<b>TABLE A2</b>	<b>Individual Animal Tumor Pathology of Male Rats in the 2-Year Inhalation Study of Molybdenum Trioxide .....</b>	<b>70</b>
<b>TABLE A3</b>	<b>Statistical Analysis of Primary Neoplasms in Male Rats in the 2-Year Inhalation Study of Molybdenum Trioxide .....</b>	<b>94</b>
<b>TABLE A4</b>	<b>Historical Incidence of Alveolar/bronchiolar Neoplasms in Untreated Male F344/N Rats .....</b>	<b>100</b>
<b>TABLE A5</b>	<b>Summary of the Incidence of Nonneoplastic Lesions in Male Rats in the 2-Year Inhalation Study of Molybdenum Trioxide .....</b>	<b>101</b>

**TABLE A1**  
**Summary of the Incidence of Neoplasms in Male Rats in the 2-Year Inhalation Study of Molybdenum Trioxide<sup>a</sup>**

	0 mg/m <sup>3</sup>	10 mg/m <sup>3</sup>	30 mg/m <sup>3</sup>	100 mg/m <sup>3</sup>
<b>Disposition Summary</b>				
Animals initially in study	50	50	50	50
Early deaths				
Moribund	29	35	31	28
Natural deaths	4	5	3	5
Survivors				
Died last week of study	1			
Terminal sacrifice	16	10	16	17
Animals examined microscopically	50	50	50	50
<b>Alimentary System</b>				
Intestine large, colon	(49)	(46)	(50)	(50)
Intestine large, rectum	(49)	(49)	(50)	(49)
Intestine large, cecum	(48)	(47)	(48)	(49)
Leiomyoma				1 (2%)
Intestine small, duodenum	(49)	(48)	(49)	(49)
Carcinoma		1 (2%)	1 (2%)	
Intestine small, jejunum	(48)	(48)	(48)	(48)
Intestine small, ileum	(48)	(47)	(46)	(49)
Liver	(50)	(50)	(50)	(50)
Hepatocellular carcinoma	2 (4%)	1 (2%)	1 (2%)	2 (4%)
Hepatocellular adenoma		1 (2%)		1 (2%)
Mesentery	(10)	(9)	(9)	(11)
Oral mucosa	(1)		(1)	(1)
Pharyngeal, squamous cell carcinoma	1 (100%)			
Pharyngeal, squamous cell papilloma			1 (100%)	1 (100%)
Pancreas	(50)	(50)	(50)	(50)
Adenoma	1 (2%)	1 (2%)	2 (4%)	1 (2%)
Mixed tumor benign	1 (2%)			1 (2%)
Salivary glands	(50)	(50)	(50)	(50)
Stomach, forestomach	(50)	(50)	(50)	(50)
Stomach, glandular	(50)	(50)	(50)	(50)
<b>Cardiovascular System</b>				
Heart	(50)	(50)	(50)	(50)
Alveolar/bronchiolar carcinoma, metastatic, lung				1 (2%)
Hemangioma			1 (2%)	
Schwannoma malignant			1 (2%)	
<b>Endocrine System</b>				
Adrenal cortex	(50)	(50)	(50)	(50)
Adenoma			2 (4%)	
Adrenal medulla	(50)	(50)	(50)	(50)
Pheochromocytoma malignant	2 (4%)	1 (2%)	1 (2%)	2 (4%)
Pheochromocytoma complex		1 (2%)		
Pheochromocytoma benign	15 (30%)	4 (8%)	15 (30%)	14 (28%)
Bilateral, pheochromocytoma benign		7 (14%)	2 (4%)	3 (6%)

**TABLE A1**  
**Summary of the Incidence of Neoplasms in Male Rats in the 2-Year Inhalation Study of Molybdenum Trioxide** (continued)

	0 mg/m <sup>3</sup>	10 mg/m <sup>3</sup>	30 mg/m <sup>3</sup>	100 mg/m <sup>3</sup>
<b>Endocrine System</b> (continued)				
Islets, pancreatic	(50)	(50)	(49)	(49)
Adenoma	3 (6%)	6 (12%)	1 (2%)	4 (8%)
Carcinoma	1 (2%)	2 (4%)	2 (4%)	4 (8%)
Parathyroid gland	(47)	(49)	(46)	(49)
Adenoma			1 (2%)	
Pituitary gland	(49)	(50)	(50)	(48)
Pars distalis, adenoma	37 (76%)	39 (78%)	40 (80%)	36 (75%)
Thyroid gland	(50)	(50)	(50)	(50)
Bilateral, C-cell, adenoma		2 (4%)	2 (4%)	
C-cell, adenoma	3 (6%)	3 (6%)	6 (12%)	3 (6%)
C-cell, carcinoma	4 (8%)		1 (2%)	3 (6%)
Follicular cell, adenoma	1 (2%)	1 (2%)		1 (2%)
Follicular cell, carcinoma			2 (4%)	2 (4%)
<b>General Body System</b>				
Tissue NOS	(1)			
Chemodectoma malignant	1 (100%)			
<b>Genital System</b>				
Epididymis	(50)	(50)	(50)	(50)
Preputial gland	(50)	(50)	(50)	(50)
Adenoma	2 (4%)	3 (6%)	3 (6%)	3 (6%)
Carcinoma	3 (6%)	3 (6%)	1 (2%)	1 (2%)
Prostate	(50)	(50)	(50)	(50)
Adenoma, multiple	1 (2%)			
Seminal vesicle	(50)	(50)	(50)	(50)
Testes	(50)	(50)	(50)	(50)
Bilateral, interstitial cell, adenoma	30 (60%)	21 (42%)	23 (46%)	30 (60%)
Interstitial cell, adenoma	9 (18%)	11 (22%)	13 (26%)	8 (16%)
<b>Hematopoietic System</b>				
Bone marrow	(50)	(50)	(50)	(50)
Hemangiosarcoma		1 (2%)		
Squamous cell carcinoma, metastatic, skin				1 (2%)
Lymph node	(16)	(17)	(8)	(15)
Iliac, squamous cell carcinoma, metastatic, skin	1 (6%)			
Lymph node, bronchial	(45)	(45)	(42)	(43)
Lymph node, mandibular	(48)	(48)	(49)	(48)
Lymph node, mesenteric	(50)	(50)	(50)	(49)
Lymph node, mediastinal	(48)	(49)	(46)	(48)
Spleen	(50)	(50)	(50)	(50)
Fibroma				2 (4%)
Hemangiosarcoma	1 (2%)			
Sarcoma				1 (2%)
Thymus	(45)	(45)	(44)	(44)
Thymoma malignant			1 (2%)	



**TABLE A1**  
**Summary of the Incidence of Neoplasms in Male Rats in the 2-Year Inhalation Study of Molybdenum Trioxide** (continued)

	0 mg/m <sup>3</sup>	10 mg/m <sup>3</sup>	30 mg/m <sup>3</sup>	100 mg/m <sup>3</sup>
<b>Integumentary System</b>				
Mammary gland	(30)	(25)	(25)	(27)
Fibroadenoma			2 (8%)	1 (4%)
Skin	(49)	(50)	(49)	(49)
Basal cell adenoma			1 (2%)	
Basal cell carcinoma		2 (4%)		
Keratoacanthoma	1 (2%)	4 (8%)	1 (2%)	2 (4%)
Squamous cell carcinoma	1 (2%)			2 (4%)
Squamous cell papilloma		1 (2%)		1 (2%)
Sebaceous gland, squamous cell papilloma	1 (2%)			
Subcutaneous tissue, fibroma	3 (6%)	3 (6%)	3 (6%)	4 (8%)
Subcutaneous tissue, fibrosarcoma				1 (2%)
Subcutaneous tissue, fibrous histiocytoma		1 (2%)		
Subcutaneous tissue, lipoma		1 (2%)		
Subcutaneous tissue, sarcoma				1 (2%)
<b>Musculoskeletal System</b>				
Bone	(50)	(50)	(50)	(50)
Osteosarcoma		1 (2%)	1 (2%)	
<b>Nervous System</b>				
Brain	(50)	(50)	(50)	(50)
Meningioma malignant		1 (2%)		
Oligodendroglioma benign			1 (2%)	
<b>Respiratory System</b>				
Lung	(50)	(50)	(50)	(50)
Alveolar/bronchiolar adenoma				3 (6%)
Alveolar/bronchiolar carcinoma		1 (2%)	1 (2%)	1 (2%)
Carcinoma, metastatic, thyroid gland			1 (2%)	
Neoplasm NOS		1 (2%)		
Osteosarcoma, metastatic, bone		1 (2%)		
Squamous cell carcinoma, metastatic, skin	1 (2%)			1 (2%)
Mediastinum, alveolar/bronchiolar carcinoma, metastatic, lung				1 (2%)
Nose	(50)	(49)	(49)	(50)
Carcinoma			1 (2%)	
Chondroma				1 (2%)
Squamous cell carcinoma, metastatic, skin				1 (2%)
<b>Special Senses System</b>				
Zymbal's gland	(2)		(1)	
Carcinoma	2 (100%)		1 (100%)	

**TABLE A1**  
**Summary of the Incidence of Neoplasms in Male Rats in the 2-Year Inhalation Study of Molybdenum Trioxide** (continued)

	0 mg/m <sup>3</sup>	10 mg/m <sup>3</sup>	30 mg/m <sup>3</sup>	100 mg/m <sup>3</sup>
<b>Urinary System</b>				
Kidney	(50)	(50)	(50)	(50)
Adenoma		1 (2%)		
Histiocytic sarcoma			1 (2%)	
Sarcoma		1 (2%)		
Renal tubule, adenoma	1 (2%)		2 (4%)	2 (4%)
Urinary bladder	(50)	(50)	(50)	(50)
<b>Systemic Lesions</b>				
Multiple organs <sup>b</sup>	(50)	(50)	(50)	(50)
Histiocytic sarcoma			1 (2%)	
Leukemia mononuclear	35 (70%)	31 (62%)	28 (56%)	32 (64%)
Mesothelioma benign	3 (6%)	3 (6%)		1 (2%)
Mesothelioma malignant		1 (2%)		
<b>Neoplasm Summary</b>				
Total animals with primary neoplasms <sup>c</sup>	50	50	50	49
Total primary neoplasms	165	162	166	176
Total animals with benign neoplasms	50	48	49	46
Total benign neoplasms	112	112	122	124
Total animals with malignant neoplasms	40	38	34	40
Total malignant neoplasms	53	49	44	52
Total animals with metastatic neoplasms	1	1	1	2
Total metastatic neoplasms	2	1	1	5
Total animals with uncertain neoplasms — benign or malignant		1		
Total uncertain neoplasms		1		

<sup>a</sup> Number of animals examined microscopically at the site and the number of animals with neoplasm

<sup>b</sup> Number of animals with any tissue examined microscopically

<sup>c</sup> Primary neoplasms: all neoplasms except metastatic neoplasms

**TABLE A2  
Individual Animal Tumor Pathology of Male Rats in the 2-Year Inhalation Study of Molybdenum Trioxide: 0 mg/m<sup>3</sup>**

Number of Days on Study	4 4 4 4 4 5 5 5 5 5 5 5 5 5 5 6 6 6 6 6 6 6 6 6
	1 2 3 8 9 2 2 4 4 5 5 6 8 8 8 0 0 1 2 2 3 4 5 5 6
	3 5 6 7 5 0 0 6 9 3 9 8 1 1 6 6 9 7 6 9 1 3 3 5 5
Carcass ID Number	0 0
	3 4 4 1 3 1 2 0 0 0 3 1 3 4 1 4 1 1 2 3 2 4 2 3 1
	1 5 1 8 3 6 4 2 6 3 9 3 0 3 0 4 2 9 2 4 6 9 3 8 5
<b>Alimentary System</b>	
Esophagus	+ +
Intestine large, colon	+ + + A +
Intestine large, rectum	+ + + A +
Intestine large, cecum	+ + + A + + + + + + + + A + + + + + + + + + + + + +
Intestine small, duodenum	+ + + A +
Intestine small, jejunum	+ + + A + + + + + + + + A + + + + + + + + + + + + +
Intestine small, ileum	+ + + A + + + + + + + + A + + + + + + + + + + + + +
Liver	+ +
Hepatocellular carcinoma	
Mesentery	
+	
Oral mucosa	
Pharyngeal, squamous cell carcinoma	
Pancreas	+ +
Adenoma	
Mixed tumor benign	
X	
Salivary glands	+ +
Stomach, forestomach	+ +
Stomach, glandular	+ +
<b>Cardiovascular System</b>	
Blood vessel	
Heart	+ +
<b>Endocrine System</b>	
Adrenal cortex	+ +
Adrenal medulla	+ +
Pheochromocytoma malignant	
Pheochromocytoma benign	
X	
X	
X	
Islets, pancreatic	+ +
Adenoma	
Carcinoma	
X	
X	
Parathyroid gland	+ + + + + + + M + M + + + + + + + + + + + + + + +
Pituitary gland	+ + + + + + + + + + + + + + + + + + + M + + + + +
Pars distalis, adenoma	
X	
X	
X	
X	
X	
X	
Thyroid gland	+ +
C-cell, adenoma	
C-cell, carcinoma	
Follicular cell, adenoma	
X	
X	
<b>General Body System</b>	
Tissue NOS	
Chemodectoma malignant	

+ : Tissue examined microscopically  
A : Autolysis precludes examination

M: Missing tissue  
I: Insufficient tissue

X: Lesion present  
Blank: Not examined





TABLE A2

Individual Animal Tumor Pathology of Male Rats in the 2-Year Inhalation Study of Molybdenum Trioxide: 0 mg/m<sup>3</sup>

(continued)

Number of Days on Study	6	6	6	6	7	7	7	7	7	7	7	7	7	7	7	7	7	7	7	7	7	7	7	7	7	Total	
Carcass ID Number	0	0	0	0	2	5	4	2	3	0	0	0	1	1	1	2	2	3	3	4	2	3	4	4	2	4	Tissues/ Tumors
	4	8	8	3	2	5	1	9	5	5	5	5	5	5	5	5	5	5	5	5	6	6	6	6	7	7	
<b>Genital System</b>																											
Epididymis	+																										50
Preputial gland	+																										50
Adenoma																											2
Carcinoma																											3
Prostate	+																										50
Adenoma, multiple																											1
Seminal vesicle	+																										50
Testes	+																										50
Bilateral, interstitial cell, adenoma	X																										30
Interstitial cell, adenoma																											9
<b>Hematopoietic System</b>																											
Bone marrow	+																										50
Lymph node	+																										16
Iliac, squamous cell carcinoma, metastatic, skin																											1
Lymph node, bronchial	+																										45
Lymph node, mandibular	+																										48
Lymph node, mesenteric	+																										50
Lymph node, mediastinal	+																										48
Spleen	+																										50
Hemangiosarcoma																											1
Thymus	+																										45
<b>Integumentary System</b>																											
Mammary gland	M																										30
Skin	+																										49
Keratoacanthoma																											1
Squamous cell carcinoma																											1
Sebaceous gland, squamous cell papilloma																											1
Subcutaneous tissue, fibroma																											3
<b>Musculoskeletal System</b>																											
Bone	+																										50
<b>Nervous System</b>																											
Brain	+																										50
<b>Respiratory System</b>																											
Larynx	+																										49
Lung	+																										50
Squamous cell carcinoma, metastatic, skin																											1
Nose	+																										50
Trachea	+																										50
<b>Special Senses System</b>																											
Eye																											2
Zymbal's gland																											2
Carcinoma																											2

**TABLE A2**  
**Individual Animal Tumor Pathology of Male Rats in the 2-Year Inhalation Study of Molybdenum Trioxide: 0 mg/m<sup>3</sup>**  
 (continued)

<b>Number of Days on Study</b>	4	4	4	4	4	5	5	5	5	5	5	5	5	5	5	6	6	6	6	6	6	6	6	6	6	6
	1	2	3	8	9	2	2	4	4	5	5	6	8	8	8	0	0	1	2	2	3	4	5	5	6	6
	3	5	6	7	5	0	0	6	9	3	9	8	1	1	6	6	9	7	6	9	1	3	3	5	5	5
<b>Carcass ID Number</b>	0	0	0	0	0	0	0	0	0	0	0	0	0	0	0	0	0	0	0	0	0	0	0	0	0	0
	3	4	4	1	3	1	2	0	0	0	3	1	3	4	1	4	1	1	2	3	2	4	2	3	1	1
	1	5	1	8	3	6	4	2	6	3	9	3	0	3	0	4	2	9	2	4	6	9	3	8	5	5
<b>Urinary System</b>																										
Kidney	+	+	+	+	+	+	+	+	+	+	+	+	+	+	+	+	+	+	+	+	+	+	+	+	+	+
Renal tubule, adenoma																										
Ureter											+															
Urinary bladder	+	+	+	+	+	+	+	+	+	+	+	+	+	+	+	+	+	+	+	+	+	+	+	+	+	+
<b>Systemic Lesions</b>																										
Multiple organs	+	+	+	+	+	+	+	+	+	+	+	+	+	+	+	+	+	+	+	+	+	+	+	+	+	+
Leukemia mononuclear	X		X			X		X	X	X	X	X	X		X	X	X	X	X	X	X			X	X	
Mesothelioma benign				X																	X					



























**TABLE A2****Individual Animal Tumor Pathology of Male Rats in the 2-Year Inhalation Study of Molybdenum Trioxide: 30 mg/m<sup>3</sup>**

(continued)

<b>Number of Days on Study</b>	2	4	4	4	5	5	5	5	5	5	5	5	5	5	6	6	6	6	6	6	6	6	6	6	6	6	6	6	6	6	6
	1	5	5	7	0	2	2	5	5	6	6	8	9	1	2	2	2	3	3	3	3	5	5	6	6						
	3	4	9	7	3	5	6	3	3	6	6	5	4	1	3	7	9	0	2	7	7	3	3	5	5						
<b>Carcass ID Number</b>	4	4	4	4	4	4	4	4	4	4	4	4	4	4	4	4	4	4	4	4	4	4	4	4	4	4	4	4	4	4	4
	3	2	1	4	4	0	2	2	4	1	3	2	1	3	1	4	1	4	2	3	3	4	4	1	3						
	8	0	6	0	4	9	7	8	7	9	0	2	5	1	3	2	4	3	6	4	6	5	8	0	2						
<b>Urinary System</b>																															
Kidney	+	+	+	+	+	+	+	+	+	+	+	+	+	+	+	+	+	+	+	+	+	+	+	+	+	+	+	+	+	+	+
Histiocytic sarcoma																															
Renal tubule, adenoma																															
Urinary bladder	+	+	+	+	+	+	+	+	+	+	+	+	+	+	+	+	+	+	+	+	+	+	+	+	+	+	+	+	+	+	+
<b>Systemic Lesions</b>																															
Multiple organs	+	+	+	+	+	+	+	+	+	+	+	+	+	+	+	+	+	+	+	+	+	+	+	+	+	+	+	+	+	+	+
Histiocytic sarcoma																															
Leukemia mononuclear						X		X	X	X	X		X	X		X	X	X		X		X		X	X						















**TABLE A2**  
**Individual Animal Tumor Pathology of Male Rats in the 2-Year Inhalation Study of Molybdenum Trioxide: 100 mg/m<sup>3</sup>**  
 (continued)

<b>Number of Days on Study</b>	6 6 7	
	9 9 0 1 1 2 2 3 3 3 3 3 3 3 3 3 3 3 3 3 3 3 3 3 3 3	
	3 6 6 5 7 1 1 2 5 5 5 5 5 5 5 5 5 5 5 5 6 6 6 6 6 7 7	
<b>Carcass ID Number</b>	6 6	Total
	3 0 4 2 2 2 3 3 0 0 1 1 2 3 3 4 4 4 4 1 1 1 2 4 1 2	Tissues/
	0 2 2 2 1 4 7 6 3 7 0 3 6 1 9 3 4 5 4 6 7 8 1 5 7	Tumors
<b>Special Senses System</b>		
Eye		1
<b>Urinary System</b>		
Kidney	+ +	50
Renal tubule, adenoma		2
	X X	
Urinary bladder	+ +	50
<b>Systemic Lesions</b>		
Multiple organs	+ +	50
Leukemia mononuclear	X X	32
Mesothelioma benign		1

**TABLE A3**  
**Statistical Analysis of Primary Neoplasms in Male Rats in the 2-Year Inhalation Study of Molybdenum Trioxide**

	0 mg/m <sup>3</sup>	10 mg/m <sup>3</sup>	30 mg/m <sup>3</sup>	100 mg/m <sup>3</sup>
<b>Adrenal Medulla: Benign Pheochromocytoma</b>				
Overall rate <sup>a</sup>	15/50 (30%)	11/50 (22%)	17/50 (34%)	17/50 (34%)
Adjusted rate <sup>b</sup>	60.4%	66.3%	58.1%	56.7%
Terminal rate <sup>c</sup>	8/17 (47%)	5/10 (50%)	6/16 (38%)	6/17 (35%)
First incidence (days)	559	622	525	598
Life table test <sup>d</sup>	P=0.532N	P=0.473	P=0.398	P=0.539
Logistic regression test <sup>d</sup>	P=0.476	P=0.503N	P=0.430	P=0.566
Cochran-Armitage test <sup>d</sup>	P=0.232			
Fisher exact test <sup>d</sup>		P=0.247N	P=0.415	P=0.415
<b>Adrenal Medulla: Benign, Complex, or Malignant Pheochromocytoma</b>				
Overall rate	15/50 (30%)	13/50 (26%)	18/50 (36%)	18/50 (36%)
Adjusted rate	60.4%	70.6%	59.2%	60.6%
Terminal rate	8/17 (47%)	5/10 (50%)	6/16 (38%)	7/17 (41%)
First incidence (days)	559	622	525	598
Life table test	P=0.524N	P=0.288	P=0.331	P=0.461
Logistic regression test	P=0.474	P=0.476	P=0.345	P=0.487
Cochran-Armitage test	P=0.225			
Fisher exact test		P=0.412N	P=0.335	P=0.335
<b>Liver: Hepatocellular Adenoma or Carcinoma</b>				
Overall rate	2/50 (4%)	2/50 (4%)	1/50 (2%)	3/50 (6%)
Adjusted rate	11.8%	13.8%	6.3%	14.0%
Terminal rate	2/17 (12%)	1/10 (10%)	1/16 (6%)	2/17 (12%)
First incidence (days)	735 (T)	634	735 (T)	621
Life table test	P=0.475	P=0.527	P=0.522N	P=0.518
Logistic regression test	P=0.481	P=0.598	P=0.522N	P=0.562
Cochran-Armitage test	P=0.373			
Fisher exact test		P=0.691N	P=0.500N	P=0.500
<b>Lung: Alveolar/bronchiolar Adenoma</b>				
Overall rate	0/50 (0%)	0/50 (0%)	0/50 (0%)	3/50 (6%)
Adjusted rate	0.0%	0.0%	0.0%	14.8%
Terminal rate	0/17 (0%)	0/10 (0%)	0/16 (0%)	1/17 (6%)
First incidence (days)	— <sup>e</sup>	—	—	717
Life table test	P=0.017	—	—	P=0.133
Logistic regression test	P=0.017	—	—	P=0.140
Cochran-Armitage test	P=0.009			
Fisher exact test		—	—	P=0.121
<b>Lung: Alveolar/bronchiolar Adenoma or Carcinoma</b>				
Overall rate	0/50 (0%)	1/50 (2%)	1/50 (2%)	4/50 (8%)
Adjusted rate	0.0%	5.3%	4.3%	17.4%
Terminal rate	0/17 (0%)	0/10 (0%)	0/16 (0%)	1/17 (6%)
First incidence (days)	—	675	677	665
Life table test	P=0.048	P=0.453	P=0.492	P=0.080
Logistic regression test	P=0.034	P=0.473	P=0.502	P=0.078
Cochran-Armitage test	P=0.019			
Fisher exact test		P=0.500	P=0.500	P=0.059

**TABLE A3**  
**Statistical Analysis of Primary Neoplasms in Male Rats in the 2-Year Inhalation Study of Molybdenum Trioxide** (continued)

	0 mg/m <sup>3</sup>	10 mg/m <sup>3</sup>	30 mg/m <sup>3</sup>	100 mg/m <sup>3</sup>
<b>Pancreatic Islets: Adenoma</b>				
Overall rate	3/50 (6%)	6/50 (12%)	1/49 (2%)	4/49 (8%)
Adjusted rate	11.2%	32.4%	6.3%	13.4%
Terminal rate	1/17 (6%)	2/10 (20%)	1/16 (6%)	1/17 (6%)
First incidence (days)	581	581	735 (T)	567
Life table test	P=0.450N	P=0.124	P=0.308N	P=0.569
Logistic regression test	P=0.572N	P=0.202	P=0.309N	P=0.489
Cochran-Armitage test	P=0.587			
Fisher exact test		P=0.243	P=0.316N	P=0.489
<b>Pancreatic Islets: Carcinoma</b>				
Overall rate	1/50 (2%)	2/50 (4%)	2/49 (4%)	4/49 (8%)
Adjusted rate	4.2%	20.0%	12.5%	20.0%
Terminal rate	0/17 (0%)	2/10 (20%)	2/16 (13%)	2/17 (12%)
First incidence (days)	678	735 (T)	735 (T)	715
Life table test	P=0.202	P=0.346	P=0.476	P=0.207
Logistic regression test	P=0.214	P=0.395	P=0.497	P=0.219
Cochran-Armitage test	P=0.123			
Fisher exact test		P=0.500	P=0.492	P=0.175
<b>Pancreatic Islets: Adenoma or Carcinoma</b>				
Overall rate	4/50 (8%)	7/50 (14%)	3/49 (6%)	8/49 (16%)
Adjusted rate	14.9%	40.8%	18.8%	31.3%
Terminal rate	1/17 (6%)	3/10 (30%)	3/16 (19%)	3/17 (18%)
First incidence (days)	581	581	735 (T)	567
Life table test	P=0.346	P=0.119	P=0.517N	P=0.244
Logistic regression test	P=0.267	P=0.201	P=0.503N	P=0.192
Cochran-Armitage test	P=0.174			
Fisher exact test		P=0.262	P=0.511N	P=0.168
<b>Pituitary Gland (Pars Distalis): Adenoma</b>				
Overall rate	37/49 (76%)	39/50 (78%)	40/50 (80%)	36/48 (75%)
Adjusted rate	89.6%	100.0%	97.4%	97.0%
Terminal rate	13/17 (76%)	10/10 (100%)	15/16 (94%)	16/17 (94%)
First incidence (days)	425	274	454	497
Life table test	P=0.071N	P=0.054	P=0.373	P=0.331N
Logistic regression test	P=0.319N	P=0.366	P=0.381	P=0.505N
Cochran-Armitage test	P=0.462N			
Fisher exact test		P=0.478	P=0.384	P=0.570N
<b>Preputial Gland: Adenoma</b>				
Overall rate	2/50 (4%)	3/50 (6%)	3/50 (6%)	3/50 (6%)
Adjusted rate	11.8%	23.8%	18.8%	13.7%
Terminal rate	2/17 (12%)	2/10 (20%)	3/16 (19%)	1/17 (6%)
First incidence (days)	735 (T)	660	735 (T)	696
Life table test	P=0.593N	P=0.290	P=0.471	P=0.520
Logistic regression test	P=0.574N	P=0.353	P=0.471	P=0.562
Cochran-Armitage test	P=0.500			
Fisher exact test		P=0.500	P=0.500	P=0.500

**TABLE A3**  
**Statistical Analysis of Primary Neoplasms in Male Rats in the 2-Year Inhalation Study of Molybdenum Trioxide** (continued)

	0 mg/m <sup>3</sup>	10 mg/m <sup>3</sup>	30 mg/m <sup>3</sup>	100 mg/m <sup>3</sup>
<b>Preputial Gland: Carcinoma</b>				
Overall rate	3/50 (6%)	3/50 (6%)	1/50 (2%)	1/50 (2%)
Adjusted rate	12.2%	21.3%	6.3%	5.9%
Terminal rate	1/17 (6%)	1/10 (10%)	1/16 (6%)	1/17 (6%)
First incidence (days)	553	622	735 (T)	735 (T)
Life table test	P=0.164N	P=0.498	P=0.318N	P=0.287N
Logistic regression test	P=0.167N	P=0.598	P=0.302N	P=0.288N
Cochran-Armitage test	P=0.216N			
Fisher exact test		P=0.661N	P=0.309N	P=0.309N
<b>Preputial Gland: Adenoma or Carcinoma</b>				
Overall rate	5/50 (10%)	6/50 (12%)	4/50 (8%)	4/50 (8%)
Adjusted rate	23.1%	41.7%	25.0%	19.1%
Terminal rate	3/17 (18%)	3/10 (30%)	4/16 (25%)	2/17 (12%)
First incidence (days)	553	622	735 (T)	696
Life table test	P=0.245N	P=0.241	P=0.530N	P=0.469N
Logistic regression test	P=0.227N	P=0.352	P=0.496N	P=0.428N
Cochran-Armitage test	P=0.379N			
Fisher exact test		P=0.500	P=0.500N	P=0.500N
<b>Skin: Keratoacanthoma</b>				
Overall rate	1/50 (2%)	4/50 (8%)	1/50 (2%)	2/50 (4%)
Adjusted rate	5.9%	21.1%	5.6%	11.8%
Terminal rate	1/17 (6%)	0/10 (0%)	0/16 (0%)	2/17 (12%)
First incidence (days)	735 (T)	553	727	735 (T)
Life table test	P=0.504N	P=0.108	P=0.754	P=0.500
Logistic regression test	P=0.497N	P=0.133	P=0.759	P=0.500
Cochran-Armitage test	P=0.591N			
Fisher exact test		P=0.181	P=0.753N	P=0.500
<b>Skin: Squamous Cell Papilloma or Keratoacanthoma</b>				
Overall rate	1/50 (2%)	5/50 (10%)	1/50 (2%)	3/50 (6%)
Adjusted rate	5.9%	29.0%	5.6%	17.6%
Terminal rate	1/17 (6%)	1/10 (10%)	0/16 (0%)	3/17 (18%)
First incidence (days)	735 (T)	553	727	735 (T)
Life table test	P=0.610	P=0.048	P=0.754	P=0.300
Logistic regression test	P=0.591N	P=0.063	P=0.759	P=0.300
Cochran-Armitage test	P=0.517			
Fisher exact test		P=0.102	P=0.753N	P=0.309
<b>Skin: Squamous Cell Papilloma, Keratoacanthoma, or Squamous Cell Carcinoma</b>				
Overall rate	2/50 (4%)	5/50 (10%)	1/50 (2%)	5/50 (10%)
Adjusted rate	8.9%	29.0%	5.6%	22.7%
Terminal rate	1/17 (6%)	1/10 (10%)	0/16 (0%)	3/17 (18%)
First incidence (days)	629	553	727	618
Life table test	P=0.377	P=0.117	P=0.496N	P=0.256
Logistic regression test	P=0.348	P=0.155	P=0.496N	P=0.255
Cochran-Armitage test	P=0.254			
Fisher exact test		P=0.218	P=0.500N	P=0.218

**TABLE A3**  
**Statistical Analysis of Primary Neoplasms in Male Rats in the 2-Year Inhalation Study of Molybdenum Trioxide** (continued)

	0 mg/m <sup>3</sup>	10 mg/m <sup>3</sup>	30 mg/m <sup>3</sup>	100 mg/m <sup>3</sup>
<b>Skin: Squamous Cell Papilloma, Basal Cell Adenoma, Basal Cell Carcinoma, or Squamous Cell Carcinoma</b>				
Overall rate	2/50 (4%)	6/50 (12%)	2/50 (4%)	5/50 (10%)
Adjusted rate	8.9%	35.5%	8.0%	22.7%
Terminal rate	1/17 (6%)	1/10 (10%)	0/16 (0%)	3/17 (18%)
First incidence (days)	629	553	585	618
Life table test	P=0.480	P=0.060	P=0.682N	P=0.256
Logistic regression test	P=0.437	P=0.081	P=0.693N	P=0.255
Cochran-Armitage test	P=0.340			
Fisher exact test		P=0.134	P=0.691N	P=0.218
<b>Skin (Subcutaneous Tissue): Fibroma</b>				
Overall rate	3/50 (6%)	3/50 (6%)	3/50 (6%)	4/50 (8%)
Adjusted rate	13.2%	14.7%	15.5%	20.1%
Terminal rate	0/17 (0%)	0/10 (0%)	2/16 (13%)	2/17 (12%)
First incidence (days)	665	629	653	696
Life table test	P=0.561	P=0.511	P=0.648	P=0.540
Logistic regression test	P=0.538	P=0.664N	P=0.661N	P=0.576
Cochran-Armitage test	P=0.413			
Fisher exact test		P=0.661N	P=0.661N	P=0.500
<b>Skin (Subcutaneous Tissue): Fibrous Histiocytoma, Fibroma, Fibrosarcoma, or Sarcoma</b>				
Overall rate	3/50 (6%)	3/50 (6%)	3/50 (6%)	6/50 (12%)
Adjusted rate	13.2%	14.7%	15.5%	23.7%
Terminal rate	0/17 (0%)	0/10 (0%)	2/16 (13%)	2/17 (12%)
First incidence (days)	665	629	653	406
Life table test	P=0.253	P=0.511	P=0.648	P=0.287
Logistic regression test	P=0.175	P=0.664N	P=0.661N	P=0.252
Cochran-Armitage test	P=0.136			
Fisher exact test		P=0.661N	P=0.661N	P=0.243
<b>Testes: Adenoma</b>				
Overall rate	39/50 (78%)	32/50 (64%)	36/50 (72%)	38/50 (76%)
Adjusted rate	97.3%	96.5%	97.1%	100.0%
Terminal rate	16/17 (94%)	9/10 (90%)	15/16 (94%)	17/17 (100%)
First incidence (days)	413	469	525	567
Life table test	P=0.178N	P=0.325	P=0.404N	P=0.296N
Logistic regression test	P=0.462N	P=0.191N	P=0.273N	P=0.336N
Cochran-Armitage test	P=0.358			
Fisher exact test		P=0.093N	P=0.322N	P=0.500N
<b>Thyroid Gland (C-cell): Adenoma</b>				
Overall rate	3/50 (6%)	5/50 (10%)	8/50 (16%)	3/50 (6%)
Adjusted rate	11.5%	33.4%	26.8%	13.3%
Terminal rate	1/17 (6%)	2/10 (20%)	2/16 (13%)	1/17 (6%)
First incidence (days)	586	629	454	602
Life table test	P=0.263N	P=0.188	P=0.121	P=0.613N
Logistic regression test	P=0.367N	P=0.275	P=0.101	P=0.651N
Cochran-Armitage test	P=0.402N			
Fisher exact test		P=0.357	P=0.100	P=0.661N

**TABLE A3**  
**Statistical Analysis of Primary Neoplasms in Male Rats in the 2-Year Inhalation Study of Molybdenum Trioxide** (continued)

	0 mg/m <sup>3</sup>	10 mg/m <sup>3</sup>	30 mg/m <sup>3</sup>	100 mg/m <sup>3</sup>
<b>Thyroid Gland (C-cell): Carcinoma</b>				
Overall rate	4/50 (8%)	0/50 (0%)	1/50 (2%)	3/50 (6%)
Adjusted rate	22.2%	0.0%	4.5%	15.2%
Terminal rate	3/17 (18%)	0/10 (0%)	0/16 (0%)	2/17 (12%)
First incidence (days)	729	—	693	693
Life table test	P=0.546	P=0.146N	P=0.196N	P=0.487N
Logistic regression test	P=0.566	P=0.122N	P=0.178N	P=0.439N
Cochran-Armitage test	P=0.445			
Fisher exact test		P=0.059N	P=0.181N	P=0.500N
<b>Thyroid Gland (C-cell): Adenoma or Carcinoma</b>				
Overall rate	7/50 (14%)	5/50 (10%)	9/50 (18%)	6/50 (12%)
Adjusted rate	32.1%	33.4%	30.1%	27.0%
Terminal rate	4/17 (24%)	2/10 (20%)	2/16 (13%)	3/17 (18%)
First incidence (days)	586	629	454	602
Life table test	P=0.332N	P=0.569	P=0.401	P=0.455N
Logistic regression test	P=0.415N	P=0.533N	P=0.395	P=0.412N
Cochran-Armitage test	P=0.521N			
Fisher exact test		P=0.380N	P=0.393	P=0.500N
<b>Thyroid Gland (Follicular Cell): Adenoma or Carcinoma</b>				
Overall rate	1/50 (2%)	1/50 (2%)	2/50 (4%)	3/50 (6%)
Adjusted rate	5.9%	5.3%	12.5%	15.8%
Terminal rate	1/17 (6%)	0/10 (0%)	2/16 (13%)	2/17 (12%)
First incidence (days)	735 (T)	675	735 (T)	715
Life table test	P=0.265	P=0.674	P=0.478	P=0.313
Logistic regression test	P=0.280	P=0.709	P=0.478	P=0.334
Cochran-Armitage test	P=0.188			
Fisher exact test		P=0.753N	P=0.500	P=0.309
<b>All Organs: Mononuclear Cell Leukemia</b>				
Overall rate	35/50 (70%)	31/50 (62%)	28/50 (56%)	32/50 (64%)
Adjusted rate	86.0%	85.5%	77.2%	82.1%
Terminal rate	12/17 (71%)	6/10 (60%)	9/16 (56%)	11/17 (65%)
First incidence (days)	413	408	525	334
Life table test	P=0.126N	P=0.289	P=0.198N	P=0.231N
Logistic regression test	P=0.412N	P=0.303N	P=0.105N	P=0.324N
Cochran-Armitage test	P=0.463N			
Fisher exact test		P=0.263N	P=0.107N	P=0.335N
<b>All Organs: Benign or Malignant Mesothelioma</b>				
Overall rate	3/50 (6%)	4/50 (8%)	0/50 (0%)	1/50 (2%)
Adjusted rate	10.6%	11.0%	0.0%	3.8%
Terminal rate	1/17 (6%)	0/10 (0%)	0/16 (0%)	0/17 (0%)
First incidence (days)	436	469	—	693
Life table test	P=0.137N	P=0.422	P=0.121N	P=0.281N
Logistic regression test	P=0.161N	P=0.600	P=0.115N	P=0.304N
Cochran-Armitage test	P=0.166N			
Fisher exact test		P=0.500	P=0.121N	P=0.309N

**TABLE A3**  
**Statistical Analysis of Primary Neoplasms in Male Rats in the 2-Year Inhalation Study of Molybdenum Trioxide** (continued)

	0 mg/m <sup>3</sup>	10 mg/m <sup>3</sup>	30 mg/m <sup>3</sup>	100 mg/m <sup>3</sup>
<b>All Organs: Benign Neoplasms</b>				
Overall rate	50/50 (100%)	48/50 (96%)	49/50 (98%)	46/50 (92%)
Adjusted rate	100.0%	100.0%	100.0%	100.0%
Terminal rate	17/17 (100%)	10/10 (100%)	16/16 (100%)	17/17 (100%)
First incidence (days)	413	274	454	497
Life table test	P=0.039N	P=0.107	P=0.509N	P=0.172N
Logistic regression test	P=0.066N	P=0.339N	— <sup>f</sup>	P=0.055N
Cochran-Armitage test	P=0.047N			
Fisher exact test		P=0.247N	P=0.500N	P=0.059N
<b>All Organs: Malignant Neoplasms</b>				
Overall rate	40/50 (80%)	38/50 (76%)	34/50 (68%)	40/50 (80%)
Adjusted rate	92.4%	94.2%	88.1%	97.3%
Terminal rate	14/17 (82%)	8/10 (80%)	12/16 (75%)	16/17 (94%)
First incidence (days)	413	408	213	334
Life table test	P=0.172N	P=0.155	P=0.254N	P=0.360N
Logistic regression test	P=0.476	P=0.488N	P=0.126N	P=0.591N
Cochran-Armitage test	P=0.424			
Fisher exact test		P=0.405N	P=0.127N	P=0.598N
<b>All Organs: Benign or Malignant Neoplasms</b>				
Overall rate	50/50 (100%)	50/50 (100%)	50/50 (100%)	49/50 (98%)
Adjusted rate	100.0%	100.0%	100.0%	100.0%
Terminal rate	17/17 (100%)	10/10 (100%)	16/16 (100%)	17/17 (100%)
First incidence (days)	413	274	213	334
Life table test	P=0.077N	P=0.071	P=0.540	P=0.295N
Logistic regression test	P=0.451N	—	—	—
Cochran-Armitage test	P=0.221N			
Fisher exact test		P=1.000N	P=1.000N	P=0.500N

(T)Terminal sacrifice

<sup>a</sup> Number of neoplasm-bearing animals/number of animals examined. Denominator is number of animals examined microscopically for adrenal gland, liver, lung, pancreatic islets, pituitary gland, preputial gland, testes, and thyroid gland; for other tissues, denominator is number of animals necropsied.

<sup>b</sup> Kaplan-Meier estimated neoplasm incidence at the end of the study after adjustment for intercurrent mortality

<sup>c</sup> Observed incidence at terminal kill

<sup>d</sup> Beneath the control incidence are the P values associated with the trend test. Beneath the exposed group incidence are the P values corresponding to pairwise comparisons between the controls and that exposed group. The life table test regards neoplasms in animals dying prior to terminal kill as being (directly or indirectly) the cause of death. The logistic regression test regards these lesions as nonfatal. The Cochran-Armitage and Fisher exact tests compare directly the overall incidence rates. For all tests, a negative trend or a lower incidence in an exposure group is indicated by **N**.

<sup>e</sup> Not applicable; no neoplasms in animal group

<sup>f</sup> Value of statistic cannot be computed.



**TABLE A4**  
**Historical Incidence of Alveolar/bronchiolar Neoplasms in Untreated Male F344/N Rats <sup>a</sup>**

Study	Incidence in Controls		
	Adenoma	Carcinoma	Adenoma or Carcinoma
<b>Historical Incidence at Battelle Pacific Northwest Laboratories</b>			
<i>o</i> -Chlorobenzalmalononitrile (CS2)	4/50	0/50	4/50
Acetonitrile	1/48	1/48	2/48
2-Chloroacetophenone	1/49	1/49	2/49
<i>l</i> -Epinephrine Hydrochloride	4/50	1/50	5/50
Chloroethane	0/50	0/50	0/50
Hexachlorocyclopentadiene	5/50	0/50	5/50
Ozone	1/50	1/50	2/50
Total	16/347 (4.6%)	4/347 (1.2%)	20/347 (5.8%)
Standard deviation	4.0%	1.1%	3.7%
Range	0%-10%	0%-2%	0%-10%
<b>Overall Historical Incidence</b>			
Total	17/654 (2.6%)	6/654 (0.9%)	23/654 (3.5%)
Standard deviation	3.6%	1.0%	3.7%
Range	0%-10%	0%-2%	0%-10%

<sup>a</sup> Data as of 12 May 1995

**TABLE A5**  
**Summary of the Incidence of Nonneoplastic Lesions in Male Rats in the 2-Year Inhalation Study of Molybdenum Trioxide<sup>a</sup>**

	0 mg/m <sup>3</sup>	10 mg/m <sup>3</sup>	30 mg/m <sup>3</sup>	100 mg/m <sup>3</sup>
<b>Disposition Summary</b>				
Animals initially in study	50	50	50	50
Early deaths				
Moribund	29	35	31	28
Natural deaths	4	5	3	5
Survivors				
Died last week of study	1			
Terminal sacrifice	16	10	16	17
Animals examined microscopically	50	50	50	50
<b>Alimentary System</b>				
Intestine large, colon	(49)	(46)	(50)	(50)
Mineralization		1 (2%)		
Intestine large, cecum	(48)	(47)	(48)	(49)
Hemorrhage				1 (2%)
Infiltration cellular, mixed cell			1 (2%)	
Mineralization	1 (2%)		1 (2%)	1 (2%)
Necrosis			1 (2%)	
Intestine small, duodenum	(49)	(48)	(49)	(49)
Mineralization		1 (2%)		
Necrosis				2 (4%)
Intestine small, ileum	(48)	(47)	(46)	(49)
Inflammation, chronic active		1 (2%)		
Mineralization		1 (2%)		
Liver	(50)	(50)	(50)	(50)
Angiectasis	3 (6%)	6 (12%)	1 (2%)	2 (4%)
Basophilic focus	21 (42%)	21 (42%)	23 (46%)	21 (42%)
Clear cell focus	5 (10%)	4 (8%)	7 (14%)	3 (6%)
Cyst		1 (2%)		
Degeneration, cystic	17 (34%)	16 (32%)	16 (32%)	24 (48%)
Degeneration, fatty	15 (30%)	15 (30%)	17 (34%)	14 (28%)
Eosinophilic focus	4 (8%)	8 (16%)	7 (14%)	10 (20%)
Hematopoietic cell proliferation		1 (2%)		
Hepatodiaphragmatic nodule	1 (2%)		5 (10%)	4 (8%)
Mixed cell focus	5 (10%)	3 (6%)	3 (6%)	5 (10%)
Necrosis				1 (2%)
Vacuolization cytoplasmic, focal	2 (4%)	1 (2%)		
Bile duct, hyperplasia	46 (92%)	35 (70%)	40 (80%)	39 (78%)
Centrilobular, necrosis	14 (28%)	11 (22%)	12 (24%)	10 (20%)
Mesentery	(10)	(9)	(9)	(11)
Inflammation, acute		1 (11%)		
Artery, mineralization		1 (11%)		
Fat, hemorrhage		1 (11%)		
Fat, necrosis	9 (90%)	6 (67%)	9 (100%)	10 (91%)
Pancreas	(50)	(50)	(50)	(50)
Atrophy	32 (64%)	28 (56%)	24 (48%)	34 (68%)
Basophilic focus	1 (2%)			2 (4%)
Hyperplasia	6 (12%)	2 (4%)	2 (4%)	5 (10%)
Thrombosis				1 (2%)
Artery, inflammation				1 (2%)

<sup>a</sup> Number of animals examined microscopically at the site and the number of animals with lesion

**TABLE A5**  
**Summary of the Incidence of Nonneoplastic Lesions in Male Rats in the 2-Year Inhalation Study**  
**of Molybdenum Trioxide** (continued)

	0 mg/m <sup>3</sup>	10 mg/m <sup>3</sup>	30 mg/m <sup>3</sup>	100 mg/m <sup>3</sup>
<b>Alimentary System</b> (continued)				
Salivary glands	(50)	(50)	(50)	(50)
Atrophy	2 (4%)			3 (6%)
Artery, mineralization		1 (2%)		
Stomach, forestomach	(50)	(50)	(50)	(50)
Hyperplasia, squamous			2 (4%)	2 (4%)
Inflammation, acute		1 (2%)		
Mineralization	3 (6%)	4 (8%)	4 (8%)	1 (2%)
Necrosis	11 (22%)	4 (8%)	7 (14%)	4 (8%)
Stomach, glandular	(50)	(50)	(50)	(50)
Mineralization	5 (10%)	7 (14%)	5 (10%)	10 (20%)
Necrosis	7 (14%)	6 (12%)	4 (8%)	2 (4%)
Tooth		(2)	(1)	
Developmental malformation		1 (50%)		
Inflammation, chronic active		1 (50%)	1 (100%)	
<b>Cardiovascular System</b>				
Blood vessel	(1)	(2)	(1)	(2)
Aorta, mineralization	1 (100%)	2 (100%)	1 (100%)	2 (100%)
Heart	(50)	(50)	(50)	(50)
Cardiomyopathy	44 (88%)	38 (76%)	40 (80%)	45 (90%)
Artery, mineralization	1 (2%)	2 (4%)	1 (2%)	3 (6%)
Atrium, thrombosis	5 (10%)	7 (14%)	6 (12%)	4 (8%)
Endocardium, hyperplasia			1 (2%)	
<b>Endocrine System</b>				
Adrenal cortex	(50)	(50)	(50)	(50)
Atrophy			1 (2%)	1 (2%)
Hyperplasia	35 (70%)	19 (38%)	26 (52%)	26 (52%)
Hypertrophy	5 (10%)	6 (12%)	8 (16%)	8 (16%)
Necrosis	1 (2%)	1 (2%)		1 (2%)
Thrombosis			1 (2%)	
Vacuolization cytoplasmic	4 (8%)	2 (4%)	2 (4%)	2 (4%)
Adrenal medulla	(50)	(50)	(50)	(50)
Hyperplasia	31 (62%)	25 (50%)	27 (54%)	25 (50%)
Bilateral, hyperplasia	1 (2%)	2 (4%)	1 (2%)	4 (8%)
Islets, pancreatic	(50)	(50)	(49)	(49)
Hyperplasia		3 (6%)		1 (2%)
Parathyroid gland	(47)	(49)	(46)	(49)
Hyperplasia	11 (23%)	9 (18%)	10 (22%)	14 (29%)
Pituitary gland	(49)	(50)	(50)	(48)
Pars distalis, hyperplasia	7 (14%)	7 (14%)	6 (12%)	6 (13%)
Thyroid gland	(50)	(50)	(50)	(50)
C-cell, hyperplasia	35 (70%)	29 (58%)	31 (62%)	30 (60%)
Follicular cell, hyperplasia	2 (4%)			4 (8%)
<b>General Body System</b>				
None				

**TABLE A5**  
**Summary of the Incidence of Nonneoplastic Lesions in Male Rats in the 2-Year Inhalation Study**  
**of Molybdenum Trioxide** (continued)

	0 mg/m <sup>3</sup>	10 mg/m <sup>3</sup>	30 mg/m <sup>3</sup>	100 mg/m <sup>3</sup>
<b>Genital System</b>				
Epididymis	(50)	(50)	(50)	(50)
Granuloma sperm	1 (2%)	1 (2%)		1 (2%)
Penis			(2)	
Inflammation, acute			1 (50%)	
Preputial gland	(50)	(50)	(50)	(50)
Cyst				1 (2%)
Hyperplasia				1 (2%)
Inflammation, chronic active	1 (2%)	4 (8%)	3 (6%)	3 (6%)
Prostate	(50)	(50)	(50)	(50)
Hyperplasia	6 (12%)	6 (12%)	12 (24%)	7 (14%)
Inflammation, chronic active	4 (8%)	5 (10%)	2 (4%)	5 (10%)
Seminal vesicle	(50)	(50)	(50)	(50)
Inflammation, chronic active	1 (2%)			
Mineralization		1 (2%)		
Testes	(50)	(50)	(50)	(50)
Atrophy	6 (12%)	4 (8%)	3 (6%)	2 (4%)
Artery, inflammation, chronic active	2 (4%)	4 (8%)	2 (4%)	2 (4%)
Interstitial cell, hyperplasia	7 (14%)	7 (14%)	7 (14%)	5 (10%)
<b>Hematopoietic System</b>				
Bone marrow	(50)	(50)	(50)	(50)
Atrophy				1 (2%)
Myelofibrosis		1 (2%)		
Necrosis		1 (2%)		
Lymph node	(16)	(17)	(8)	(15)
Iliac, ectasia		1 (6%)		
Iliac, infiltration cellular, plasma cell				1 (7%)
Renal, hemorrhage	3 (19%)	1 (6%)	1 (13%)	
Renal, infiltration cellular, plasma cell				1 (7%)
Lymph node, mandibular	(48)	(48)	(49)	(48)
Infiltration cellular, plasma cell	1 (2%)	3 (6%)	1 (2%)	2 (4%)
Lymph node, mesenteric	(50)	(50)	(50)	(49)
Ectasia		2 (4%)		
Lymph node, mediastinal	(48)	(49)	(46)	(48)
Hemorrhage	1 (2%)	1 (2%)		1 (2%)
Spleen	(50)	(50)	(50)	(50)
Accessory spleen		1 (2%)		1 (2%)
Atrophy				2 (4%)
Fibrosis	15 (30%)	13 (26%)	15 (30%)	17 (34%)
Hematopoietic cell proliferation		1 (2%)	1 (2%)	
Hemorrhage		2 (4%)		1 (2%)
Necrosis	1 (2%)	2 (4%)	2 (4%)	1 (2%)
Thrombosis				1 (2%)
Thymus	(45)	(45)	(44)	(44)
Atrophy				1 (2%)
Cyst	1 (2%)			
Hemorrhage		1 (2%)		

**TABLE A5**  
**Summary of the Incidence of Nonneoplastic Lesions in Male Rats in the 2-Year Inhalation Study**  
**of Molybdenum Trioxide** (continued)

	0 mg/m <sup>3</sup>	10 mg/m <sup>3</sup>	30 mg/m <sup>3</sup>	100 mg/m <sup>3</sup>
<b>Integumentary System</b>				
Mammary gland	(30)	(25)	(25)	(27)
Galactocele	3 (10%)	3 (12%)	1 (4%)	2 (7%)
Skin	(49)	(50)	(49)	(49)
Fibrosis			1 (2%)	
Hyperkeratosis		3 (6%)	1 (2%)	1 (2%)
Inflammation, acute	1 (2%)	2 (4%)	1 (2%)	
Inflammation, chronic active	3 (6%)	8 (16%)	3 (6%)	2 (4%)
Inflammation, granulomatous		1 (2%)		
<b>Musculoskeletal System</b>				
Bone	(50)	(50)	(50)	(50)
Fibrous osteodystrophy	2 (4%)	1 (2%)	2 (4%)	5 (10%)
Hyperostosis	1 (2%)	1 (2%)	2 (4%)	
Skeletal muscle		(2)		
Mineralization		2 (100%)		
<b>Nervous System</b>				
Brain	(50)	(50)	(50)	(50)
Hemorrhage		1 (2%)		1 (2%)
Necrosis			1 (2%)	2 (4%)
<b>Respiratory System</b>				
Larynx	(49)	(48)	(49)	(49)
Hyperplasia	2 (4%)	1 (2%)		
Inflammation, chronic	1 (2%)			
Metaplasia, squamous	1 (2%)			
Mineralization		1 (2%)		
Epiglottis, hyperplasia	8 (16%)	5 (10%)	13 (27%)	5 (10%)
Epiglottis, inflammation, chronic				1 (2%)
Epiglottis, metaplasia, squamous		11 (23%)	16 (33%)	39 (80%)
Lung	(50)	(50)	(50)	(50)
Foreign body	1 (2%)			
Hemorrhage		3 (6%)	3 (6%)	1 (2%)
Inflammation, granulomatous	1 (2%)			
Metaplasia, osseous	1 (2%)		1 (2%)	
Mineralization	1 (2%)	2 (4%)		2 (4%)
Thrombosis	2 (4%)	4 (8%)	1 (2%)	1 (2%)
Alveolar epithelium, hyperplasia	7 (14%)	9 (18%)	12 (24%)	7 (14%)
Alveolar epithelium, inflammation, chronic		1 (2%)		
Alveolus, infiltration cellular, histiocyte		1 (2%)		
Alveolus, inflammation, chronic	2 (4%)	3 (6%)	25 (50%)	47 (94%)
Artery, mediastinum, inflammation		1 (2%)		
Artery, mediastinum, mineralization	1 (2%)	2 (4%)		2 (4%)
Interstitialium, fibrosis			1 (2%)	

**TABLE A5**  
**Summary of the Incidence of Nonneoplastic Lesions in Male Rats in the 2-Year Inhalation Study**  
**of Molybdenum Trioxide** (continued)

	0 mg/m <sup>3</sup>	10 mg/m <sup>3</sup>	30 mg/m <sup>3</sup>	100 mg/m <sup>3</sup>
<b>Respiratory System</b> (continued)				
Nose	(50)	(49)	(49)	(50)
Inflammation, suppurative	7 (14%)	5 (10%)	5 (10%)	3 (6%)
Thrombosis	14 (28%)	11 (22%)	15 (31%)	9 (18%)
Olfactory epithelium, degeneration, hyaline	46 (92%)	43 (88%)	48 (98%)	49 (98%)
Olfactory epithelium, metaplasia, focal	1 (2%)			
Respiratory epithelium, degeneration, hyaline	2 (4%)	7 (14%)	48 (98%)	49 (98%)
Respiratory epithelium, metaplasia, squamous	1 (2%)			
Trachea	(50)	(50)	(50)	(50)
Mineralization		1 (2%)		
<b>Special Senses System</b>				
Eye	(2)	(1)		(1)
Cataract	1 (50%)			
Degeneration	1 (50%)	1 (100%)		1 (100%)
<b>Urinary System</b>				
Kidney	(50)	(50)	(50)	(50)
Accumulation, hyaline droplet				1 (2%)
Cyst			3 (6%)	1 (2%)
Fibrosis, focal	1 (2%)			
Hyperplasia, oncocytic				3 (6%)
Infarct	1 (2%)	1 (2%)	2 (4%)	1 (2%)
Metaplasia				1 (2%)
Mineralization		2 (4%)	1 (2%)	3 (6%)
Nephropathy	50 (100%)	49 (98%)	49 (98%)	48 (96%)
Pelvis, inflammation, acute	1 (2%)			1 (2%)
Renal tubule, hyperplasia	6 (12%)	3 (6%)	7 (14%)	4 (8%)
Renal tubule, necrosis		2 (4%)		
Transitional epithelium, hyperplasia	3 (6%)	3 (6%)	2 (4%)	4 (8%)
Urinary bladder	(50)	(50)	(50)	(50)
Hemorrhage	1 (2%)		1 (2%)	
Inflammation, acute		1 (2%)		
Inflammation, chronic active			1 (2%)	2 (4%)
Mineralization		1 (2%)		
Capillary, hyperplasia			1 (2%)	
Transitional epithelium, hyperplasia	1 (2%)			1 (2%)



**APPENDIX B**  
**SUMMARY OF LESIONS IN FEMALE RATS**  
**IN THE 2-YEAR INHALATION STUDY**  
**OF MOLYBDENUM TRIOXIDE**

<b>TABLE B1</b>	<b>Summary of the Incidence of Neoplasms in Female Rats in the 2-Year Inhalation Study of Molybdenum Trioxide .....</b>	<b>109</b>
<b>TABLE B2</b>	<b>Individual Animal Tumor Pathology of Female Rats in the 2-Year Inhalation Study of Molybdenum Trioxide .....</b>	<b>112</b>
<b>TABLE B3</b>	<b>Statistical Analysis of Primary Neoplasms in Female Rats in the 2-Year Inhalation Study of Molybdenum Trioxide .....</b>	<b>130</b>
<b>TABLE B4</b>	<b>Summary of the Incidence of Nonneoplastic Lesions in Female Rats in the 2-Year Inhalation Study of Molybdenum Trioxide .....</b>	<b>135</b>





**TABLE B1**  
**Summary of the Incidence of Neoplasms in Female Rats in the 2-Year Inhalation Study of Molybdenum Trioxide <sup>a</sup>**

	0 mg/m <sup>3</sup>	10 mg/m <sup>3</sup>	30 mg/m <sup>3</sup>	100 mg/m <sup>3</sup>
<b>Disposition Summary</b>				
Animals initially in study	50	50	50	50
Early deaths				
Moribund	18	25	23	23
Natural deaths	4	1	3	4
Survivors				
Died last week of study				1
Terminal sacrifice	28	24	24	22
Animals examined microscopically	50	50	50	50
<b>Alimentary System</b>				
Intestine large, colon	(49)	(49)	(48)	(48)
Sarcoma	1 (2%)			
Intestine large, cecum	(49)	(49)	(47)	(48)
Intestine small, duodenum	(49)	(49)	(48)	(49)
Intestine small, jejunum	(47)	(49)	(47)	(47)
Intestine small, ileum	(48)	(49)	(47)	(48)
Liver	(50)	(49)	(50)	(50)
Hepatocellular adenoma	1 (2%)			
Mesentery	(3)	(11)	(5)	(8)
Oral mucosa	(1)			
Gingival, squamous cell carcinoma	1 (100%)			
Pancreas	(49)	(49)	(50)	(50)
Salivary glands	(50)	(50)	(50)	(50)
Stomach, forestomach	(50)	(49)	(50)	(50)
Stomach, glandular	(49)	(49)	(50)	(50)
Tongue	(1)		(1)	
Squamous cell papilloma	1 (100%)		1 (100%)	
<b>Cardiovascular System</b>				
Heart	(50)	(50)	(50)	(50)
Schwannoma benign			1 (2%)	
<b>Endocrine System</b>				
Adrenal cortex	(49)	(49)	(50)	(50)
Adenoma	1 (2%)			
Adrenal medulla	(49)	(49)	(50)	(50)
Pheochromocytoma complex	1 (2%)			
Pheochromocytoma benign	3 (6%)		4 (8%)	6 (12%)
Bilateral, pheochromocytoma benign	2 (4%)			
Islets, pancreatic	(49)	(49)	(50)	(50)
Adenoma	1 (2%)		1 (2%)	1 (2%)
Carcinoma				1 (2%)
Pituitary gland	(49)	(50)	(50)	(50)
Pars distalis, adenoma	43 (88%)	39 (78%)	40 (80%)	38 (76%)
Thyroid gland	(49)	(49)	(50)	(50)
C-cell, adenoma	3 (6%)	8 (16%)	6 (12%)	3 (6%)
C-cell, carcinoma	3 (6%)	1 (2%)	1 (2%)	2 (4%)
Follicular cell, adenoma	1 (2%)	1 (2%)		
Follicular cell, carcinoma		1 (2%)		1 (2%)

**TABLE B1**  
**Summary of the Incidence of Neoplasms in Female Rats in the 2-Year Inhalation Study of Molybdenum Trioxide** (continued)

	0 mg/m <sup>3</sup>	10 mg/m <sup>3</sup>	30 mg/m <sup>3</sup>	100 mg/m <sup>3</sup>
<b>General Body System</b>				
None				
<b>Genital System</b>				
Clitoral gland	(44)	(48)	(47)	(47)
Adenoma	2 (5%)	6 (13%)	5 (11%)	1 (2%)
Carcinoma	1 (2%)	1 (2%)	5 (11%)	2 (4%)
Ovary	(50)	(50)	(50)	(50)
Granulosa cell tumor malignant	1 (2%)	1 (2%)		
Granulosa-theca tumor malignant	1 (2%)			
Uterus	(50)	(49)	(50)	(50)
Deciduoma benign			1 (2%)	
Leiomyoma				1 (2%)
Polyp stromal	6 (12%)	8 (16%)	6 (12%)	8 (16%)
Polyp stromal, multiple			2 (4%)	
Sarcoma stromal			1 (2%)	2 (4%)
Vagina				(1)
Schwannoma malignant				1 (100%)
<b>Hematopoietic System</b>				
Bone marrow	(50)	(49)	(50)	(50)
Lymph node	(3)	(8)	(2)	(2)
Lymph node, bronchial	(44)	(36)	(37)	(40)
Lymph node, mandibular	(46)	(41)	(47)	(43)
Carcinoma, metastatic, Zymbal's gland			1 (2%)	
Lymph node, mesenteric	(49)	(49)	(50)	(50)
Lymph node, mediastinal	(41)	(41)	(43)	(48)
Spleen	(49)	(49)	(50)	(50)
Thymus	(48)	(45)	(47)	(46)
<b>Integumentary System</b>				
Mammary gland	(50)	(50)	(49)	(50)
Adenoma		3 (6%)	3 (6%)	1 (2%)
Carcinoma	1 (2%)	2 (4%)	2 (4%)	3 (6%)
Fibroadenoma	16 (32%)	24 (48%)	22 (45%)	13 (26%)
Fibroadenoma, multiple	6 (12%)	8 (16%)	6 (12%)	5 (10%)
Skin	(50)	(49)	(50)	(50)
Basal cell carcinoma	1 (2%)			
Squamous cell papilloma	1 (2%)			
Subcutaneous tissue, lipoma			1 (2%)	
Subcutaneous tissue, melanoma malignant				1 (2%)
Subcutaneous tissue, schwannoma malignant	1 (2%)			
<b>Musculoskeletal System</b>				
Skeletal muscle				(1)

**TABLE B1**  
**Summary of the Incidence of Neoplasms in Female Rats in the 2-Year Inhalation Study of Molybdenum Trioxide** (continued)

	0 mg/m <sup>3</sup>	10 mg/m <sup>3</sup>	30 mg/m <sup>3</sup>	100 mg/m <sup>3</sup>
<b>Nervous System</b>				
Brain	(50)	(50)	(50)	(50)
Astrocytoma benign		1 (2%)		
Carcinoma, metastatic, Zymbal's gland			1 (2%)	
Oligodendroglioma benign			1 (2%)	
Meninges, granular cell tumor benign			1 (2%)	
<b>Respiratory System</b>				
Larynx	(49)	(49)	(49)	(50)
Lung	(50)	(50)	(50)	(50)
Alveolar/bronchiolar adenoma		1 (2%)		2 (4%)
Alveolar/bronchiolar carcinoma		1 (2%)		
Carcinoma, metastatic, Zymbal's gland		1 (2%)	1 (2%)	
Melanoma malignant, metastatic, skin				1 (2%)
Sarcoma				1 (2%)
Squamous cell carcinoma	1 (2%)			
Nose	(48)	(49)	(50)	(50)
<b>Special Senses System</b>				
Zymbal's gland	(1)	(1)	(2)	
Carcinoma	1 (100%)	1 (100%)	2 (100%)	
<b>Urinary System</b>				
Kidney	(50)	(49)	(50)	(50)
Lipoma		1 (2%)	1 (2%)	
Renal tubule, adenoma				1 (2%)
Renal tubule, carcinoma		1 (2%)	1 (2%)	
Urinary bladder	(49)	(50)	(50)	(50)
Transitional epithelium, papilloma				1 (2%)
<b>Systemic Lesions</b>				
Multiple organs <sup>b</sup>	(50)	(50)	(50)	(50)
Leukemia mononuclear	18 (36%)	19 (38%)	13 (26%)	20 (40%)
Lymphoma malignant		1 (2%)		
<b>Neoplasm Summary</b>				
Total animals with primary neoplasms <sup>c</sup>	48	50	49	49
Total primary neoplasms	119	129	127	115
Total animals with benign neoplasms	45	49	49	47
Total benign neoplasms	87	100	102	81
Total animals with malignant neoplasms	28	23	23	30
Total malignant neoplasms	32	29	25	34
Total animals with metastatic neoplasms		1	1	1
Total metastatic neoplasms		1	3	1

<sup>a</sup> Number of animals examined microscopically at the site and the number of animals with neoplasm

<sup>b</sup> Number of animals with any tissue examined microscopically

<sup>c</sup> Primary neoplasms: all neoplasms except metastatic neoplasms

**TABLE B2**  
**Individual Animal Tumor Pathology of Female Rats in the 2-Year Inhalation Study of Molybdenum Trioxide: 0 mg/m<sup>3</sup>**

Number of Days on Study	1	4	4	5	5	5	5	6	6	6	6	6	6	6	7	7	7	7	7	7	7	7	7	7	7		
	0	3	6	1	3	5	9	3	7	7	7	8	8	9	0	0	1	1	1	1	1	2	3	3	3		
	6	3	4	6	4	9	8	8	4	9	9	0	8	3	6	7	5	6	6	6	6	7	0	5	5		
Carcass ID Number	1	1	1	1	1	1	1	1	1	1	1	1	1	1	1	1	1	1	1	1	1	1	1	1	1		
	4	4	4	0	1	2	2	3	1	0	3	3	3	0	3	0	2	0	2	4	0	0	1	2	3		
	0	8	3	7	6	1	4	5	0	8	4	1	2	4	9	2	8	6	6	1	1	5	8	0	0		
<b>Alimentary System</b>																											
Esophagus	+	+	+	+	+	+	+	+	+	+	+	+	+	+	+	+	+	+	+	+	+	+	+	+	+	+	
Intestine large, colon	+	+	+	A	+	+	+	+	+	+	+	+	+	+	+	+	+	+	+	+	+	+	+	+	+	+	
Sarcoma																											
Intestine large, rectum	+	+	+	A	+	+	+	+	+	+	+	+	+	+	+	+	+	+	+	+	+	+	+	+	+	+	
Intestine large, cecum	+	+	+	A	+	+	+	+	+	+	+	+	+	+	+	+	+	+	+	+	+	+	+	+	+	+	
Intestine small, duodenum	+	+	+	A	+	+	+	+	+	+	+	+	+	+	+	+	+	+	+	+	+	+	+	+	+	+	
Intestine small, jejunum	+	+	A	A	+	+	+	A	+	+	+	+	+	+	+	+	+	+	+	+	+	+	+	+	+	+	
Intestine small, ileum	+	+	+	A	+	+	+	+	+	A	+	+	+	+	+	+	+	+	+	+	+	+	+	+	+	+	
Liver	+	+	+	+	+	+	+	+	+	+	+	+	+	+	+	+	+	+	+	+	+	+	+	+	+	+	
Hepatocellular adenoma																									X		
Mesentery					+	+																+					
Oral mucosa																											
Gingival, squamous cell carcinoma																											
Pancreas	+	+	+	A	+	+	+	+	+	+	+	+	+	+	+	+	+	+	+	+	+	+	+	+	+	+	
Salivary glands	+	+	+	+	+	+	+	+	+	+	+	+	+	+	+	+	+	+	+	+	+	+	+	+	+	+	
Stomach, forestomach	+	+	+	+	+	+	+	+	+	+	+	+	+	+	+	+	+	+	+	+	+	+	+	+	+	+	
Stomach, glandular	+	+	+	A	+	+	+	+	+	+	+	+	+	+	+	+	+	+	+	+	+	+	+	+	+	+	
Tongue																											
Squamous cell papilloma																											
Tooth	+																										
<b>Cardiovascular System</b>																											
Heart	+	+	+	+	+	+	+	+	+	+	+	+	+	+	+	+	+	+	+	+	+	+	+	+	+	+	
<b>Endocrine System</b>																											
Adrenal cortex	+	+	+	A	+	+	+	+	+	+	+	+	+	+	+	+	+	+	+	+	+	+	+	+	+	+	
Adenoma																											
Adrenal medulla	+	+	+	A	+	+	+	+	+	+	+	+	+	+	+	+	+	+	+	+	+	+	+	+	+	+	
Pheochromocytoma complex																											
Pheochromocytoma benign												X															
Bilateral, pheochromocytoma benign													X	X													
Islets, pancreatic	+	+	+	A	+	+	+	+	+	+	+	+	+	+	+	+	+	+	+	+	+	+	+	+	+	+	
Adenoma																									X		
Parathyroid gland	+	+	+	+	+	+	+	+	+	+	+	+	+	+	+	+	+	+	+	+	+	+	+	+	+	+	
Pituitary gland	+	+	+	A	+	+	+	+	+	+	+	+	+	+	+	+	+	+	+	+	+	+	+	+	+	+	
Pars distalis, adenoma					X	X	X	X	X	X	X	X	X	X	X	X	X	X	X	X	X	X	X	X	X	X	
Thyroid gland	+	+	+	A	+	+	+	+	+	+	+	+	+	+	+	+	+	+	+	+	+	+	+	+	+	+	
C-cell, adenoma																							X	X		X	
C-cell, carcinoma																											
Follicular cell, adenoma																											
<b>General Body System</b>																											
None																											

+ : Tissue examined microscopically  
A : Autolysis precludes examination

M : Missing tissue  
I : Insufficient tissue

X : Lesion present  
Blank : Not examined



**TABLE B2**

**Individual Animal Tumor Pathology of Female Rats in the 2-Year Inhalation Study of Molybdenum Trioxide: 0 mg/m<sup>3</sup>**

(continued)

<b>Number of Days on Study</b>	1	4	4	5	5	5	6	6	6	6	6	6	7	7	7	7	7	7	7	7	7	7	7	7	7		
	0	3	6	1	3	5	9	3	7	7	7	8	8	9	0	0	1	1	1	1	1	2	3	3	3		
	6	3	4	6	4	9	8	8	4	9	9	0	8	3	6	7	5	6	6	6	6	7	0	5	5		
<b>Carcass ID Number</b>	1	1	1	1	1	1	1	1	1	1	1	1	1	1	1	1	1	1	1	1	1	1	1	1	1		
	4	4	4	0	1	2	2	3	1	0	3	3	3	0	3	0	2	0	2	4	0	0	1	2	3		
	0	8	3	7	6	1	4	5	0	8	4	1	2	4	9	2	8	6	6	1	1	5	8	0	0		
<b>Genital System</b>																											
Clitoral gland	+	+	+	M	+	+	+	+	+	+	+	+	M	M	+	+	+	+	M	+	+	+	+	+	+		
Adenoma																						X					
Carcinoma																											
Ovary	+	+	+	+	+	+	+	+	+	+	+	+	+	+	+	+	+	+	+	+	+	+	+	+	+		
Granulosa cell tumor malignant																											
Granulosa-theca tumor malignant													X														
Uterus	+	+	+	+	+	+	+	+	+	+	+	+	+	+	+	+	+	+	+	+	+	+	+	+	+		
Polyp stromal									X						X		X					X					
<b>Hematopoietic System</b>																											
Bone marrow	+	+	+	+	+	+	+	+	+	+	+	+	+	+	+	+	+	+	+	+	+	+	+	+	+		
Lymph node																											
Lymph node, bronchial																											
Lymph node, mandibular																											
Lymph node, mesenteric	M	+	+	+	+	+	+	+	+	+	+	+	+	+	+	+	+	+	+	+	+	+	+	+	+		
Lymph node, mediastinal		+	M	+	+	+	+	M	+	+	+	+	+	+	+	+	+	+	+	+	+	+	M	+	M		
Spleen	+	+	+	+	A	+	+	+	+	+	+	+	+	+	+	+	+	+	+	+	+	+	+	+	+		
Thymus	+	M	+	+	+	+	M	+	+	+	+	+	+	+	+	+	+	+	+	+	+	+	+	+	+		
<b>Integumentary System</b>																											
Mammary gland	+	+	+	+	+	+	+	+	+	+	+	+	+	+	+	+	+	+	+	+	+	+	+	+	+		
Carcinoma				X																							
Fibroadenoma						X		X				X	X						X								
Fibroadenoma, multiple																				X		X					
Skin	+	+	+	+	+	+	+	+	+	+	+	+	+	+	+	+	+	+	+	+	+	+	+	+	+		
Basal cell carcinoma																											
Squamous cell papilloma																											
Subcutaneous tissue, schwannoma malignant													X														
<b>Musculoskeletal System</b>																											
Bone	+	+	+	+	+	+	+	+	+	+	+	+	+	+	+	+	+	+	+	+	+	+	+	+	+		
<b>Nervous System</b>																											
Brain	+	+	+	+	+	+	+	+	+	+	+	+	+	+	+	+	+	+	+	+	+	+	+	+	+		
<b>Respiratory System</b>																											
Larynx	+	+	+	A	+	+	+	+	+	+	+	+	+	+	+	+	+	+	+	+	+	+	+	+	+		
Lung	+	+	+	+	+	+	+	+	+	+	+	+	+	+	+	+	+	+	+	+	+	+	+	+	+		
Squamous cell carcinoma																						X					
Nose	+	+	+	A	+	+	+	A	+	+	+	+	+	+	+	+	+	+	+	+	+	+	+	+	+		
Trachea	+	+	+	+	+	+	+	+	+	+	+	+	+	+	+	+	+	+	+	+	+	+	+	+	+		
<b>Special Senses System</b>																											
Eye																											
Harderian gland																											
Zymbal's gland																											
Carcinoma																							X				





**TABLE B2**  
**Individual Animal Tumor Pathology of Female Rats in the 2-Year Inhalation Study of Molybdenum Trioxide: 0 mg/m<sup>3</sup>**  
 (continued)

<b>Number of Days on Study</b>	1 4 4 5 5 5 5 6 6 6 6 6 6 6 7 7 7 7 7 7 7 7 7
	0 3 6 1 3 5 9 3 7 7 7 8 8 9 0 0 1 1 1 1 2 3 3 3 3
	6 3 4 6 4 9 8 8 4 9 9 0 8 3 6 7 5 6 6 6 7 0 5 5 5
<b>Carcass ID Number</b>	1 1
	4 4 4 0 1 2 2 3 1 0 3 3 3 0 3 0 2 0 2 4 0 0 1 2 3
	0 8 3 7 6 1 4 5 0 8 4 1 2 4 9 2 8 6 6 1 1 5 8 0 0
<b>Urinary System</b>	
Kidney	+ +
Urinary bladder	+ + + <b>A</b> +
<b>Systemic Lesions</b>	
Multiple organs	+ +
Leukemia mononuclear	
	X X X X X X X X X X X X

**TABLE B2**  
**Individual Animal Tumor Pathology of Female Rats in the 2-Year Inhalation Study of Molybdenum Trioxide: 0 mg/m<sup>3</sup>**  
 (continued)

<b>Number of Days on Study</b>	7	7	7	7	7	7	7	7	7	7	7	7	7	7	7	7	7	7	7	7	7	7	7	7	7	7	
	3	3	3	3	3	3	3	3	3	3	3	3	3	3	3	3	3	3	3	3	3	3	3	3	3	3	
	5	5	6	6	6	6	6	6	6	6	6	6	6	7	7	7	7	7	7	7	7	7	7	7	7	7	
<b>Carcass ID Number</b>	1	1	1	1	1	1	1	1	1	1	1	1	1	1	1	1	1	1	1	1	1	1	1	1	1	1	Total Tissues/ Tumors
	3	4	1	1	1	1	1	1	2	3	4	4	0	0	1	2	2	2	2	2	3	3	4	4	4	5	
	6	4	1	2	4	5	7	9	9	8	5	7	3	9	3	2	3	5	7	3	7	2	6	9	0		
<b>Urinary System</b>																											
Kidney	+	+	+	+	+	+	+	+	+	+	+	+	+	+	+	+	+	+	+	+	+	+	+	+	+	+	50
Urinary bladder	+	+	+	+	+	+	+	+	+	+	+	+	+	+	+	+	+	+	+	+	+	+	+	+	+	+	49
<b>Systemic Lesions</b>																											
Multiple organs	+	+	+	+	+	+	+	+	+	+	+	+	+	+	+	+	+	+	+	+	+	+	+	+	+	+	50
Leukemia mononuclear	X	X												X	X									X	X		18







**TABLE B2**  
**Individual Animal Tumor Pathology of Female Rats in the 2-Year Inhalation Study of Molybdenum Trioxide: 10 mg/m<sup>3</sup>**  
 (continued)

<b>Number of Days on Study</b>	7 7	
	2 3	
	7 5 5 5 5 5 6 6 6 6 6 6 6 6 6 6 7 7 7 7 7 7 7 7	
<b>Carcass ID Number</b>	3 3	Total Tissues/ Tumors
	1 0 1 2 3 4 0 0 1 1 2 2 3 3 3 5 0 1 1 1 2 4 4 4 4	0 4 9 6 4 2 7 9 1 6 4 5 0 1 6 0 3 2 5 8 2 3 7 8 9
<b>Integumentary System</b>		
Mammary gland	+ +	50
Adenoma		
Carcinoma		
Fibroadenoma		
Fibroadenoma, multiple		
Skin	+ +	49
<b>Musculoskeletal System</b>		
Bone	+ +	50
<b>Nervous System</b>		
Brain	+ +	50
Astrocytoma benign		1
<b>Respiratory System</b>		
Larynx	+ +	49
Lung	+ +	50
Alveolar/bronchiolar adenoma		
Alveolar/bronchiolar carcinoma		
Carcinoma, metastatic, Zymbal's gland		
Nose	+ +	49
Trachea	+ +	50
<b>Special Senses System</b>		
Eye		
Zymbal's gland		
Carcinoma		1
<b>Urinary System</b>		
Kidney	+ +	49
Lipoma		1
Renal tubule, carcinoma		1
Urinary bladder	+ +	50
<b>Systemic Lesions</b>		
Multiple organs	+ +	50
Leukemia mononuclear		19
Lymphoma malignant		1







**TABLE B2**  
**Individual Animal Tumor Pathology of Female Rats in the 2-Year Inhalation Study of Molybdenum Trioxide: 30 mg/m<sup>3</sup>**  
 (continued)

	3	4	5	5	5	5	5	5	5	6	6	6	6	6	6	6	6	6	6	7	7	7	7	7		
<b>Number of Days on Study</b>	2	6	3	3	4	4	6	8	8	0	1	5	5	5	6	8	8	8	8	9	9	0	0	2	2	2
	6	4	1	4	1	1	0	3	3	4	5	0	3	3	5	6	6	8	2	3	6	6	1	9	9	
<b>Carcass ID Number</b>	5	5	5	5	5	5	5	5	5	5	5	5	5	5	5	5	5	5	5	5	5	5	5	5	5	5
	1	0	4	0	3	4	1	2	3	2	3	2	1	4	3	4	4	3	4	1	2	2	1	0	3	
	2	7	5	2	7	0	0	5	6	9	5	7	4	7	8	3	9	9	6	9	3	6	8	3	0	
<b>Hematopoietic System</b>																										
Bone marrow	+	+	+	+	+	+	+	+	+	+	+	+	+	+	+	+	+	+	+	+	+	+	+	+	+	+
Lymph node																										+
Lymph node, bronchial	+	M	+	M	+	+	+	M	+	+	+	+	+	+	+	+	+	M	+	M	+	+	M	M	M	
Lymph node, mandibular	+	+	+	+	+	+	+	M	+	+	M	+	+	+	+	+	+	+	+	+	+	+	M	+	+	+
Carcinoma, metastatic, Zymbal's gland																									X	
Lymph node, mesenteric	+	+	+	+	+	+	+	+	+	+	+	+	+	+	+	+	+	+	+	+	+	+	+	+	+	+
Lymph node, mediastinal	+	+	+	+	+	+	+	M	+	+	+	+	+	+	+	+	+	M	+	+	+	+	M	+	+	+
Spleen	+	+	+	+	+	+	+	+	+	+	+	+	+	+	+	+	+	+	+	+	+	+	+	+	+	+
Thymus	+	+	+	+	+	+	+	+	+	+	+	+	+	+	+	+	+	+	+	+	+	+	+	+	+	+
<b>Integumentary System</b>																										
Mammary gland	+	+	+	+	+	+	+	+	+	+	+	+	+	+	+	+	+	+	+	+	+	+	+	+	+	+
Adenoma																										
Carcinoma												X														
Fibroadenoma				X			X	X		X			X	X						X			X		X	
Fibroadenoma, multiple			X																X							
Skin	+	+	+	+	+	+	+	+	+	+	+	+	+	+	+	+	+	+	+	+	+	+	+	+	+	+
Subcutaneous tissue, lipoma																									X	
<b>Musculoskeletal System</b>																										
Bone	+	+	+	+	+	+	+	+	+	+	+	+	+	+	+	+	+	+	+	+	+	+	+	+	+	+
<b>Nervous System</b>																										
Brain	+	+	+	+	+	+	+	+	+	+	+	+	+	+	+	+	+	+	+	+	+	+	+	+	+	+
Carcinoma, metastatic, Zymbal's gland																									X	
Oligodendroglioma benign																										
Meninges, granular cell tumor benign													X													
Spinal cord							+																			
<b>Respiratory System</b>																										
Larynx	+	+	+	+	+	+	+	+	+	A	+	+	+	+	+	+	+	+	+	+	+	+	+	+	+	+
Lung	+	+	+	+	+	+	+	+	+	+	+	+	+	+	+	+	+	+	+	+	+	+	+	+	+	+
Carcinoma, metastatic, Zymbal's gland																									X	
Nose	+	+	+	+	+	+	+	+	+	+	+	+	+	+	+	+	+	+	+	+	+	+	+	+	+	+
Trachea	+	+	+	+	+	+	+	+	+	+	+	+	+	+	+	+	+	+	+	+	+	+	+	+	+	+
<b>Special Senses System</b>																										
Eye																										+
Harderian gland																										
Zymbal's gland										+																+
Carcinoma										X															X	
<b>Urinary System</b>																										
Kidney	+	+	+	+	+	+	+	+	+	+	+	+	+	+	+	+	+	+	+	+	+	+	+	+	+	+
Lipoma																										
Renal tubule, carcinoma																									X	
Urinary bladder	+	+	+	+	+	+	+	+	+	+	+	+	+	+	+	+	+	+	+	+	+	+	+	+	+	+
<b>Systemic Lesions</b>																										
Multiple organs	+	+	+	+	+	+	+	+	+	+	+	+	+	+	+	+	+	+	+	+	+	+	+	+	+	+
Leukemia mononuclear													X	X	X	X				X					X	



**TABLE B2**  
**Individual Animal Tumor Pathology of Female Rats in the 2-Year Inhalation Study of Molybdenum Trioxide: 100 mg/m<sup>3</sup>**

<b>Number of Days on Study</b>	5 5 5 5 5 5 5 5 5 5 5 6 6 6 6 6 6 6 6 6 6 6 6 7
	2 3 3 3 5 6 6 8 8 8 8 1 1 1 2 3 3 4 5 6 6 7 8 9 2
	7 4 8 8 5 0 9 0 0 1 3 5 8 9 2 6 7 6 2 0 7 3 8 8 0
<b>Carcass ID Number</b>	7 7
	2 0 0 4 1 1 0 1 3 3 0 2 4 2 3 3 4 5 3 0 4 4 1 4 1
	0 8 9 7 3 7 6 2 0 8 3 4 4 8 7 5 3 0 6 4 6 8 1 0 8
<b>Alimentary System</b>	
Esophagus	+ +
Intestine large, colon	A + A + + +
Intestine large, rectum	+ +
Intestine large, cecum	A + A + + +
Intestine small, duodenum	+ +
Intestine small, jejunum	A + A + + A
Intestine small, ileum	A + A + + +
Liver	+ +
Mesentery	+ +
Pancreas	+ +
Salivary glands	+ +
Stomach, forestomach	+ +
Stomach, glandular	+ +
<b>Cardiovascular System</b>	
Heart	+ +
<b>Endocrine System</b>	
Adrenal cortex	+ +
Adrenal medulla	+ +
Pheochromocytoma benign	X  X
Islets, pancreatic	+ +
Adenoma	
Carcinoma	
Parathyroid gland	M + M + + + +
Pituitary gland	+ +
Pars distalis, adenoma	X X
Thyroid gland	+ +
C-cell, adenoma	X  X
C-cell, carcinoma	
Follicular cell, carcinoma	
<b>General Body System</b>	
None	
<b>Genital System</b>	
Clitoral gland	+ M + +
Adenoma	
Carcinoma	
Ovary	+ +
Uterus	+ +
Leiomyoma	
Polyp stromal	X  X  X
Sarcoma stromal	
Vagina	
Schwannoma malignant	







**TABLE B3**  
**Statistical Analysis of Primary Neoplasms in Female Rats in the 2-Year Inhalation Study of Molybdenum Trioxide**

	0 mg/m <sup>3</sup>	10 mg/m <sup>3</sup>	30 mg/m <sup>3</sup>	100 mg/m <sup>3</sup>
<b>Adrenal Medulla: Benign Pheochromocytoma</b>				
Overall rate <sup>a</sup>	5/49 (10%)	0/49 (0%)	4/50 (8%)	6/50 (12%)
Adjusted rate <sup>b</sup>	14.3%	0.0%	10.7%	20.7%
Terminal rate <sup>c</sup>	2/28 (7%)	0/24 (0%)	0/24 (0%)	3/23 (13%)
First incidence (days)	680	— <sup>e</sup>	583	555
Life table test <sup>d</sup>	P=0.093	P=0.055N	P=0.563N	P=0.363
Logistic regression test <sup>d</sup>	P=0.142	P=0.035N	P=0.371N	P=0.486
Cochran-Armitage test <sup>d</sup>	P=0.143			
Fisher exact test <sup>f</sup>		P=0.028N	P=0.487N	P=0.514
<b>Adrenal Medulla: Benign or Complex Pheochromocytoma</b>				
Overall rate	6/49 (12%)	0/49 (0%)	4/50 (8%)	6/50 (12%)
Adjusted rate	17.6%	0.0%	10.7%	20.7%
Terminal rate	3/28 (11%)	0/24 (0%)	0/24 (0%)	3/23 (13%)
First incidence (days)	680	—	583	555
Life table test	P=0.143	P=0.032N	P=0.444N	P=0.472
Logistic regression test	P=0.207	P=0.020N	P=0.268N	P=0.598
Cochran-Armitage test	P=0.212			
Fisher exact test		P=0.013N	P=0.357N	P=0.606N
<b>Clitoral Gland: Adenoma</b>				
Overall rate	2/44 (5%)	6/48 (13%)	5/47 (11%)	1/47 (2%)
Adjusted rate	6.9%	21.2%	17.6%	2.9%
Terminal rate	1/26 (4%)	4/23 (17%)	3/23 (13%)	0/21 (0%)
First incidence (days)	716	573	653	637
Life table test	P=0.217N	P=0.109	P=0.176	P=0.575N
Logistic regression test	P=0.156N	P=0.152	P=0.215	P=0.498N
Cochran-Armitage test	P=0.141N			
Fisher exact test		P=0.164	P=0.245	P=0.475N
<b>Clitoral Gland: Carcinoma</b>				
Overall rate	1/44 (2%)	1/48 (2%)	5/47 (11%)	2/47 (4%)
Adjusted rate	3.8%	3.7%	19.3%	9.5%
Terminal rate	1/26 (4%)	0/23 (0%)	3/23 (13%)	2/21 (10%)
First incidence (days)	735 (T)	721	721	735 (T)
Life table test	P=0.388	P=0.735	P=0.083	P=0.425
Logistic regression test	P=0.367	P=0.738	P=0.077	P=0.425
Cochran-Armitage test	P=0.479			
Fisher exact test		P=0.731N	P=0.117	P=0.525
<b>Clitoral Gland: Adenoma or Carcinoma</b>				
Overall rate	3/44 (7%)	7/48 (15%)	10/47 (21%)	3/47 (6%)
Adjusted rate	10.6%	24.1%	35.0%	12.2%
Terminal rate	2/26 (8%)	4/23 (17%)	6/23 (26%)	2/21 (10%)
First incidence (days)	716	573	653	637
Life table test	P=0.405N	P=0.126	P=0.025	P=0.559
Logistic regression test	P=0.343N	P=0.172	P=0.027	P=0.606
Cochran-Armitage test	P=0.265N			
Fisher exact test		P=0.196	P=0.046	P=0.629N

**TABLE B3**  
**Statistical Analysis of Primary Neoplasms in Female Rats in the 2-Year Inhalation Study of Molybdenum Trioxide** (continued)

	0 mg/m <sup>3</sup>	10 mg/m <sup>3</sup>	30 mg/m <sup>3</sup>	100 mg/m <sup>3</sup>
<b>Mammary Gland: Fibroadenoma</b>				
Overall rate	22/50 (44%)	32/50 (64%)	28/50 (56%)	18/50 (36%)
Adjusted rate	61.8%	83.5%	76.4%	63.6%
Terminal rate	15/28 (54%)	18/24 (75%)	16/24 (67%)	13/23 (57%)
First incidence (days)	534	485	464	618
Life table test	P=0.165N	P=0.014	P=0.073	P=0.580
Logistic regression test	P=0.062N	P=0.023	P=0.126	P=0.529N
Cochran-Armitage test	P=0.034N			
Fisher exact test		P=0.035	P=0.159	P=0.270N
<b>Mammary Gland: Adenoma</b>				
Overall rate	0/50 (0%)	3/50 (6%)	3/50 (6%)	1/50 (2%)
Adjusted rate	0.0%	10.6%	12.5%	2.9%
Terminal rate	0/28 (0%)	2/24 (8%)	3/24 (13%)	0/23 (0%)
First incidence (days)	—	618	735 (T)	636
Life table test	P=0.595N	P=0.101	P=0.094	P=0.459
Logistic regression test	P=0.571N	P=0.118	P=0.094	P=0.496
Cochran-Armitage test	P=0.539N			
Fisher exact test		P=0.121	P=0.121	P=0.500
<b>Mammary Gland: Fibroadenoma or Adenoma</b>				
Overall rate	22/50 (44%)	33/50 (66%)	29/50 (58%)	19/50 (38%)
Adjusted rate	61.8%	84.0%	79.4%	64.7%
Terminal rate	15/28 (54%)	18/24 (75%)	17/24 (71%)	13/23 (57%)
First incidence (days)	534	485	464	618
Life table test	P=0.205N	P=0.010	P=0.049	P=0.492
Logistic regression test	P=0.077N	P=0.015	P=0.086	P=0.580
Cochran-Armitage test	P=0.044N			
Fisher exact test		P=0.022	P=0.115	P=0.342N
<b>Mammary Gland: Carcinoma</b>				
Overall rate	1/50 (2%)	2/50 (4%)	2/50 (4%)	3/50 (6%)
Adjusted rate	2.1%	8.3%	6.6%	11.3%
Terminal rate	0/28 (0%)	2/24 (8%)	1/24 (4%)	2/23 (9%)
First incidence (days)	464	735 (T)	615	636
Life table test	P=0.233	P=0.469	P=0.476	P=0.260
Logistic regression test	P=0.277	P=0.484	P=0.482	P=0.301
Cochran-Armitage test	P=0.274			
Fisher exact test		P=0.500	P=0.500	P=0.309
<b>Mammary Gland: Adenoma or Carcinoma</b>				
Overall rate	1/50 (2%)	5/50 (10%)	5/50 (10%)	3/50 (6%)
Adjusted rate	2.1%	18.8%	18.8%	11.3%
Terminal rate	0/28 (0%)	4/24 (17%)	4/24 (17%)	2/23 (9%)
First incidence (days)	464	618	615	636
Life table test	P=0.499	P=0.083	P=0.082	P=0.260
Logistic regression test	P=0.555	P=0.102	P=0.104	P=0.301
Cochran-Armitage test	P=0.570			
Fisher exact test		P=0.102	P=0.102	P=0.309



**TABLE B3**  
**Statistical Analysis of Primary Neoplasms in Female Rats in the 2-Year Inhalation Study of Molybdenum Trioxide** (continued)

	0 mg/m <sup>3</sup>	10 mg/m <sup>3</sup>	30 mg/m <sup>3</sup>	100 mg/m <sup>3</sup>
<b>Mammary Gland: Fibroadenoma, Adenoma, or Carcinoma</b>				
Overall rate	23/50 (46%)	33/50 (66%)	30/50 (60%)	20/50 (40%)
Adjusted rate	62.6%	84.0%	79.9%	68.2%
Terminal rate	15/28 (54%)	18/24 (75%)	17/24 (71%)	14/23 (61%)
First incidence (days)	464	485	464	618
Life table test	P=0.235N	P=0.016	P=0.054	P=0.486
Logistic regression test	P=0.084N	P=0.029	P=0.099	P=0.533N
Cochran-Armitage test	P=0.053N			
Fisher exact test		P=0.035	P=0.115	P=0.343N
<b>Pituitary Gland (Pars Distalis): Adenoma</b>				
Overall rate	43/49 (88%)	39/50 (78%)	40/50 (80%)	38/50 (76%)
Adjusted rate	97.7%	86.1%	88.6%	84.2%
Terminal rate	27/28 (96%)	18/24 (75%)	19/24 (79%)	16/23 (70%)
First incidence (days)	534	485	464	527
Life table test	P=0.397	P=0.467	P=0.414	P=0.390
Logistic regression test	P=0.203N	P=0.143N	P=0.246N	P=0.032N
Cochran-Armitage test	P=0.177N			
Fisher exact test		P=0.154N	P=0.220N	P=0.104N
<b>Thyroid Gland (C-cell): Adenoma</b>				
Overall rate	3/49 (6%)	8/49 (16%)	6/50 (12%)	3/50 (6%)
Adjusted rate	9.6%	31.3%	22.4%	9.4%
Terminal rate	1/28 (4%)	7/24 (29%)	4/24 (17%)	1/23 (4%)
First incidence (days)	716	674	706	555
Life table test	P=0.361N	P=0.059	P=0.183	P=0.571
Logistic regression test	P=0.339N	P=0.056	P=0.179	P=0.663N
Cochran-Armitage test	P=0.252N			
Fisher exact test		P=0.100	P=0.254	P=0.651N
<b>Thyroid Gland (C-cell): Carcinoma</b>				
Overall rate	3/49 (6%)	1/49 (2%)	1/50 (2%)	2/50 (4%)
Adjusted rate	10.7%	4.2%	4.2%	8.7%
Terminal rate	3/28 (11%)	1/24 (4%)	1/24 (4%)	2/23 (9%)
First incidence (days)	735 (T)	735 (T)	735 (T)	735 (T)
Life table test	P=0.602	P=0.360N	P=0.360N	P=0.591N
Logistic regression test	P=0.602	P=0.360N	P=0.360N	P=0.591N
Cochran-Armitage test	P=0.608N			
Fisher exact test		P=0.309N	P=0.301N	P=0.490N
<b>Thyroid Gland (C-cell): Adenoma or Carcinoma</b>				
Overall rate	6/49 (12%)	9/49 (18%)	7/50 (14%)	5/50 (10%)
Adjusted rate	19.7%	35.4%	26.3%	17.7%
Terminal rate	4/28 (14%)	8/24 (33%)	5/24 (21%)	3/23 (13%)
First incidence (days)	716	674	706	555
Life table test	P=0.395N	P=0.180	P=0.389	P=0.617
Logistic regression test	P=0.399N	P=0.171	P=0.392	P=0.576N
Cochran-Armitage test	P=0.266N			
Fisher exact test		P=0.288	P=0.516	P=0.486N

**TABLE B3**  
**Statistical Analysis of Primary Neoplasms in Female Rats in the 2-Year Inhalation Study of Molybdenum Trioxide** (continued)

	0 mg/m <sup>3</sup>	10 mg/m <sup>3</sup>	30 mg/m <sup>3</sup>	100 mg/m <sup>3</sup>
<b>Uterus: Stromal Polyp</b>				
Overall rate	6/50 (12%)	8/50 (16%)	8/50 (16%)	8/50 (16%)
Adjusted rate	16.9%	27.9%	27.6%	28.1%
Terminal rate	2/28 (7%)	5/24 (21%)	5/24 (21%)	5/23 (22%)
First incidence (days)	638	663	326	560
Life table test	P=0.299	P=0.274	P=0.294	P=0.250
Logistic regression test	P=0.395	P=0.345	P=0.381	P=0.354
Cochran-Armitage test	P=0.430			
Fisher exact test		P=0.387	P=0.387	P=0.387
<b>Uterus: Stromal Polyp or Stromal Sarcoma</b>				
Overall rate	6/50 (12%)	8/50 (16%)	8/50 (16%)	10/50 (20%)
Adjusted rate	16.9%	27.9%	27.6%	32.1%
Terminal rate	2/28 (7%)	5/24 (21%)	5/24 (21%)	5/23 (22%)
First incidence (days)	638	663	326	560
Life table test	P=0.123	P=0.274	P=0.294	P=0.116
Logistic regression test	P=0.189	P=0.345	P=0.381	P=0.197
Cochran-Armitage test	P=0.208			
Fisher exact test		P=0.387	P=0.387	P=0.207
<b>All Organs: Mononuclear Cell Leukemia</b>				
Overall rate	18/50 (36%)	19/50 (38%)	13/50 (26%)	20/50 (40%)
Adjusted rate	45.8%	48.8%	39.5%	50.7%
Terminal rate	7/28 (25%)	6/24 (25%)	6/24 (25%)	6/23 (26%)
First incidence (days)	674	525	650	534
Life table test	P=0.193	P=0.311	P=0.377N	P=0.208
Logistic regression test	P=0.465	P=0.489N	P=0.237N	P=0.539N
Cochran-Armitage test	P=0.359			
Fisher exact test		P=0.500	P=0.194N	P=0.418
<b>All Organs: Benign Neoplasms</b>				
Overall rate	45/50 (90%)	49/50 (98%)	49/50 (98%)	47/50 (94%)
Adjusted rate	97.8%	100.0%	98.0%	95.9%
Terminal rate	27/28 (96%)	24/24 (100%)	23/24 (96%)	21/23 (91%)
First incidence (days)	534	485	326	527
Life table test	P=0.159	P=0.076	P=0.092	P=0.076
Logistic regression test	P=0.603N	P=0.159	P=0.086	P=0.392
Cochran-Armitage test	P=0.582			
Fisher exact test		P=0.102	P=0.102	P=0.357
<b>All Organs: Malignant Neoplasms</b>				
Overall rate	28/50 (56%)	23/50 (46%)	23/50 (46%)	30/50 (60%)
Adjusted rate	64.9%	58.9%	62.8%	73.5%
Terminal rate	13/28 (46%)	9/24 (38%)	11/24 (46%)	13/23 (57%)
First incidence (days)	433	525	583	534
Life table test	P=0.082	P=0.484N	P=0.468N	P=0.160
Logistic regression test	P=0.158	P=0.216N	P=0.246N	P=0.398
Cochran-Armitage test	P=0.187			
Fisher exact test		P=0.212N	P=0.212N	P=0.420

**TABLE B3**  
**Statistical Analysis of Primary Neoplasms in Female Rats in the 2-Year Inhalation Study of Molybdenum Trioxide** (continued)

	0 mg/m <sup>3</sup>	10 mg/m <sup>3</sup>	30 mg/m <sup>3</sup>	100 mg/m <sup>3</sup>
<b>All Organs: Benign or Malignant Neoplasms</b>				
Overall rate	48/50 (96%)	50/50 (100%)	49/50 (98%)	49/50 (98%)
Adjusted rate	100.0%	100.0%	98.0%	98.0%
Terminal rate	28/28 (100%)	24/24 (100%)	23/24 (96%)	22/23 (96%)
First incidence (days)	433	485	326	527
Life table test	P=0.160	P=0.133	P=0.188	P=0.098
Logistic regression test	P=0.650N	P=0.600	P=0.614	P=0.709
Cochran-Armitage test	P=0.627			
Fisher exact test		P=0.247	P=0.500	P=0.500

(T)Terminal sacrifice

<sup>a</sup> Number of neoplasm-bearing animals/number of animals examined. Denominator is number of animals examined microscopically for adrenal gland, clitoral gland, pituitary gland, and thyroid gland; for other tissues, denominator is number of animals necropsied.

<sup>b</sup> Kaplan-Meier estimated neoplasm incidence at the end of the study after adjustment for intercurrent mortality

<sup>c</sup> Observed incidence at terminal kill

<sup>d</sup> Beneath the control incidence are the P values associated with the trend test. Beneath the exposed group incidence are the P values corresponding to pairwise comparisons between the controls and that exposed group. The life table test regards neoplasms in animals dying prior to terminal kill as being (directly or indirectly) the cause of death. The logistic regression test regards these lesions as nonfatal. The Cochran-Armitage and Fisher exact tests compare directly the overall incidence rates. For all tests, a negative trend or a lower incidence in an exposure group is indicated by N.

<sup>e</sup> Not applicable; no neoplasms in animal group

**TABLE B4**  
**Summary of the Incidence of Nonneoplastic Lesions in Female Rats in the 2-Year Inhalation Study of Molybdenum Trioxide<sup>a</sup>**

	0 mg/m <sup>3</sup>	10 mg/m <sup>3</sup>	30 mg/m <sup>3</sup>	100 mg/m <sup>3</sup>
<b>Disposition Summary</b>				
Animals initially in study	50	50	50	50
Early deaths				
Moribund	18	25	23	23
Natural deaths	4	1	3	4
Survivors				
Died last week of study				1
Terminal sacrifice	28	24	24	22
Animals examined microscopically	50	50	50	50
<b>Alimentary System</b>				
Intestine large, colon	(49)	(49)	(48)	(48)
Necrosis		1 (2%)		
Intestine large, rectum	(49)	(50)	(46)	(50)
Mineralization				1 (2%)
Intestine large, cecum	(49)	(49)	(47)	(48)
Mineralization	1 (2%)			3 (6%)
Intestine small, duodenum	(49)	(49)	(48)	(49)
Inflammation, acute				1 (2%)
Intestine small, ileum	(48)	(49)	(47)	(48)
Inflammation, chronic active			1 (2%)	
Liver	(50)	(49)	(50)	(50)
Angiectasis	3 (6%)	1 (2%)	4 (8%)	3 (6%)
Basophilic focus	43 (86%)	44 (90%)	43 (86%)	39 (78%)
Clear cell focus	7 (14%)	5 (10%)	11 (22%)	7 (14%)
Degeneration, cystic				1 (2%)
Degeneration, fatty	18 (36%)	18 (37%)	13 (26%)	18 (36%)
Eosinophilic focus	5 (10%)	1 (2%)	2 (4%)	4 (8%)
Hematopoietic cell proliferation	2 (4%)		1 (2%)	
Hepatodiaphragmatic nodule	5 (10%)	10 (20%)	9 (18%)	9 (18%)
Mixed cell focus	9 (18%)	9 (18%)	6 (12%)	12 (24%)
Necrosis	2 (4%)	1 (2%)	1 (2%)	1 (2%)
Thrombosis		1 (2%)		
Vacuolization cytoplasmic, focal	3 (6%)	2 (4%)		4 (8%)
Bile duct, hyperplasia	15 (30%)	11 (22%)	12 (24%)	10 (20%)
Centrilobular, necrosis	5 (10%)	7 (14%)	2 (4%)	4 (8%)
Mesentery	(3)	(11)	(5)	(8)
Artery, inflammation, chronic active			1 (20%)	
Fat, necrosis	2 (67%)	11 (100%)	4 (80%)	8 (100%)
Pancreas	(49)	(49)	(50)	(50)
Atrophy	21 (43%)	11 (22%)	15 (30%)	18 (36%)
Basophilic focus	2 (4%)	1 (2%)	2 (4%)	1 (2%)
Hyperplasia		1 (2%)	1 (2%)	3 (6%)
Artery, inflammation			1 (2%)	1 (2%)
Salivary glands	(50)	(50)	(50)	(50)
Atrophy	1 (2%)	1 (2%)	2 (4%)	

<sup>a</sup> Number of animals examined microscopically at the site and the number of animals with lesion

**TABLE B4**  
**Summary of the Incidence of Nonneoplastic Lesions in Female Rats in the 2-Year Inhalation Study**  
**of Molybdenum Trioxide** (continued)

	0 mg/m <sup>3</sup>	10 mg/m <sup>3</sup>	30 mg/m <sup>3</sup>	100 mg/m <sup>3</sup>
<b>Alimentary System</b> (continued)				
Stomach, forestomach	(50)	(49)	(50)	(50)
Hyperplasia, squamous		2 (4%)	1 (2%)	2 (4%)
Mineralization	1 (2%)	1 (2%)	1 (2%)	5 (10%)
Necrosis	3 (6%)	5 (10%)	2 (4%)	8 (16%)
Stomach, glandular	(49)	(49)	(50)	(50)
Inflammation, chronic active			1 (2%)	
Mineralization	7 (14%)	11 (22%)	8 (16%)	6 (12%)
Necrosis		2 (4%)	3 (6%)	1 (2%)
Tooth	(1)			
Developmental malformation	1 (100%)			
<b>Cardiovascular System</b>				
Heart	(50)	(50)	(50)	(50)
Cardiomyopathy	41 (82%)	41 (82%)	43 (86%)	46 (92%)
Artery, thrombosis				1 (2%)
Atrium, thrombosis				2 (4%)
<b>Endocrine System</b>				
Adrenal cortex	(49)	(49)	(50)	(50)
Degeneration, cystic		2 (4%)	2 (4%)	1 (2%)
Hyperplasia	21 (43%)	23 (47%)	26 (52%)	25 (50%)
Hypertrophy	9 (18%)	10 (20%)	8 (16%)	8 (16%)
Necrosis	1 (2%)	3 (6%)		1 (2%)
Vacuolization cytoplasmic	6 (12%)	6 (12%)	4 (8%)	4 (8%)
Adrenal medulla	(49)	(49)	(50)	(50)
Hyperplasia	9 (18%)	12 (24%)	12 (24%)	7 (14%)
Islets, pancreatic	(49)	(49)	(50)	(50)
Hyperplasia		2 (4%)		
Parathyroid gland	(50)	(49)	(48)	(48)
Hyperplasia	1 (2%)	2 (4%)	1 (2%)	2 (4%)
Pituitary gland	(49)	(50)	(50)	(50)
Pars distalis, cyst		1 (2%)	1 (2%)	1 (2%)
Pars distalis, hyperplasia	3 (6%)	9 (18%)	9 (18%)	8 (16%)
Thyroid gland	(49)	(49)	(50)	(50)
Bilateral, C-cell, hyperplasia	1 (2%)			
C-cell, hyperplasia	41 (84%)	37 (76%)	42 (84%)	41 (82%)
Follicular cell, hyperplasia				1 (2%)
<b>General Body System</b>				
None				

**TABLE B4**  
**Summary of the Incidence of Nonneoplastic Lesions in Female Rats in the 2-Year Inhalation Study**  
**of Molybdenum Trioxide** (continued)

	0 mg/m <sup>3</sup>	10 mg/m <sup>3</sup>	30 mg/m <sup>3</sup>	100 mg/m <sup>3</sup>
<b>Genital System</b>				
Clitoral gland	(44)	(48)	(47)	(47)
Cyst				1 (2%)
Hyperplasia		2 (4%)	1 (2%)	
Inflammation, chronic active	2 (5%)	6 (13%)	4 (9%)	3 (6%)
Duct, hyperplasia, squamous		2 (4%)		
Ovary	(50)	(50)	(50)	(50)
Cyst	3 (6%)	6 (12%)	7 (14%)	7 (14%)
Hyperplasia, tubular			1 (2%)	
Uterus	(50)	(49)	(50)	(50)
Hydrometra	2 (4%)			
Endometrium, hyperplasia		1 (2%)		
<b>Hematopoietic System</b>				
Lymph node	(3)	(8)	(2)	(2)
Pancreatic, hemorrhage			1 (50%)	
Pancreatic, pigmentation		1 (13%)		
Renal, ectasia			1 (50%)	
Renal, hemorrhage		1 (13%)		
Lymph node, mandibular	(46)	(41)	(47)	(43)
Infiltration cellular, plasma cell	1 (2%)	1 (2%)		
Lymph node, mediastinal	(41)	(41)	(43)	(48)
Hemorrhage		1 (2%)		
Spleen	(49)	(49)	(50)	(50)
Accessory spleen	1 (2%)			
Fibrosis		3 (6%)	5 (10%)	2 (4%)
Hematopoietic cell proliferation	4 (8%)	2 (4%)	6 (12%)	2 (4%)
Hemorrhage	1 (2%)	2 (4%)	1 (2%)	1 (2%)
<b>Integumentary System</b>				
Mammary gland	(50)	(50)	(49)	(50)
Galactocele		1 (2%)		
Hyperplasia, atypical	1 (2%)	1 (2%)	1 (2%)	
Inflammation, chronic active		1 (2%)		
Skin	(50)	(49)	(50)	(50)
Hyperkeratosis	1 (2%)	1 (2%)		
Inflammation, chronic active	2 (4%)	2 (4%)	2 (4%)	
Subcutaneous tissue, angiectasis				1 (2%)
<b>Musculoskeletal System</b>				
Bone	(50)	(50)	(50)	(50)
Fibrous osteodystrophy		1 (2%)	1 (2%)	
Hyperostosis	4 (8%)	4 (8%)	1 (2%)	9 (18%)
<b>Nervous System</b>				
Brain	(50)	(50)	(50)	(50)
Thrombosis		1 (2%)		
Meninges, hyperplasia		1 (2%)		

**TABLE B4**  
**Summary of the Incidence of Nonneoplastic Lesions in Female Rats in the 2-Year Inhalation Study**  
**of Molybdenum Trioxide** (continued)

	0 mg/m <sup>3</sup>	10 mg/m <sup>3</sup>	30 mg/m <sup>3</sup>	100 mg/m <sup>3</sup>
<b>Respiratory System</b>				
Larynx	(49)	(49)	(49)	(50)
Epiglottis, hyperplasia	3 (6%)	10 (20%)	5 (10%)	1 (2%)
Epiglottis, metaplasia, squamous		18 (37%)	29 (59%)	49 (98%)
Lung	(50)	(50)	(50)	(50)
Metaplasia, focal		1 (2%)		
Metaplasia, squamous		1 (2%)		
Alveolar epithelium, hyperplasia	7 (14%)	10 (20%)	12 (24%)	7 (14%)
Alveolus, infiltration cellular, histiocyte		1 (2%)		
Alveolus, inflammation, chronic	14 (28%)	13 (26%)	43 (86%)	49 (98%)
Bronchiole, hyperplasia	1 (2%)			
Mediastinum, thrombosis				1 (2%)
Nose	(48)	(49)	(50)	(50)
Inflammation, suppurative	7 (15%)	2 (4%)	6 (12%)	2 (4%)
Thrombosis	4 (8%)	5 (10%)	1 (2%)	4 (8%)
Olfactory epithelium, degeneration, hyaline	39 (81%)	47 (96%)	50 (100%)	50 (100%)
Olfactory epithelium, metaplasia, focal		1 (2%)		
Respiratory epithelium, degeneration, hyaline	1 (2%)	13 (27%)	50 (100%)	50 (100%)
<b>Special Senses System</b>				
Eye	(1)	(6)	(1)	(2)
Cataract		1 (17%)	1 (100%)	
Degeneration	1 (100%)	4 (67%)		2 (100%)
<b>Urinary System</b>				
Kidney	(50)	(49)	(50)	(50)
Cyst		1 (2%)	1 (2%)	
Infarct	1 (2%)			
Nephropathy	48 (96%)	47 (96%)	47 (94%)	50 (100%)
Renal tubule, hyperplasia	1 (2%)	3 (6%)	2 (4%)	1 (2%)
Transitional epithelium, mineralization		1 (2%)		
Urinary bladder	(49)	(50)	(50)	(50)
Transitional epithelium, hyperplasia		1 (2%)		1 (2%)

**APPENDIX C**  
**SUMMARY OF LESIONS IN MALE MICE**  
**IN THE 2-YEAR INHALATION STUDY**  
**OF MOLYBDENUM TRIOXIDE**

<b>TABLE C1</b>	<b>Summary of the Incidence of Neoplasms in Male Mice in the 2-Year Inhalation Study of Molybdenum Trioxide .....</b>	<b>141</b>
<b>TABLE C2</b>	<b>Individual Animal Tumor Pathology of Male Mice in the 2-Year Inhalation Study of Molybdenum Trioxide .....</b>	<b>144</b>
<b>TABLE C3</b>	<b>Statistical Analysis of Primary Neoplasms in Male Mice in the 2-Year Inhalation Study of Molybdenum Trioxide .....</b>	<b>162</b>
<b>TABLE C4</b>	<b>Historical Incidence of Alveolar/bronchiolar Neoplasms in Untreated Male B6C3F<sub>1</sub> Mice .....</b>	<b>166</b>
<b>TABLE C5</b>	<b>Summary of the Incidence of Nonneoplastic Lesions in Male Mice in the 2-Year Inhalation Study of Molybdenum Trioxide .....</b>	<b>167</b>





**TABLE C1**  
**Summary of the Incidence of Neoplasms in Male Mice in the 2-Year Inhalation Study of Molybdenum Trioxide<sup>a</sup>**

	0 mg/m <sup>3</sup>	10 mg/m <sup>3</sup>	30 mg/m <sup>3</sup>	100 mg/m <sup>3</sup>
<b>Disposition Summary</b>				
Animals initially in study	50	50	50	50
Early deaths				
Moribund	8	13	14	9
Natural deaths	6	4	11	4
Survivors				
Terminal sacrifice	36	33	25	37
Animals examined microscopically	50	50	50	50
<b>Alimentary System</b>				
Gallbladder	(43)	(40)	(38)	(43)
Intestine small, duodenum	(44)	(47)	(41)	(48)
Sarcoma			1 (2%)	
Intestine small, jejunum	(44)	(46)	(41)	(48)
Hemangiosarcoma			1 (2%)	
Intestine small, ileum	(44)	(46)	(41)	(48)
Histiocytic sarcoma		1 (2%)		
Liver	(50)	(50)	(50)	(50)
Hemangiosarcoma			1 (2%)	
Hepatocellular carcinoma	9 (18%)	7 (14%)	13 (26%)	10 (20%)
Hepatocellular carcinoma, multiple	3 (6%)	11 (22%)	8 (16%)	3 (6%)
Hepatocellular adenoma	13 (26%)	12 (24%)	15 (30%)	14 (28%)
Hepatocellular adenoma, multiple	7 (14%)	3 (6%)	4 (8%)	5 (10%)
Hepatocholangiocarcinoma			1 (2%)	
Histiocytic sarcoma		1 (2%)		
Sarcoma				1 (2%)
Mesentery	(3)	(4)	(2)	(2)
Pancreas	(50)	(48)	(48)	(50)
Salivary glands	(50)	(50)	(49)	(50)
Stomach, forestomach	(50)	(49)	(48)	(50)
Squamous cell papilloma				1 (2%)
Stomach, glandular	(50)	(48)	(46)	(49)
Carcinoma	1 (2%)			
Tooth		(1)	(1)	(1)
Odontoma		1 (100%)	1 (100%)	
<b>Cardiovascular System</b>				
None				
<b>Endocrine System</b>				
Adrenal cortex	(50)	(49)	(48)	(50)
Adenoma	1 (2%)	1 (2%)	2 (4%)	
Alveolar/bronchiolar carcinoma, metastatic, lung	1 (2%)			
Adrenal medulla	(50)	(49)	(48)	(50)
Pheochromocytoma benign			1 (2%)	

**TABLE C1**  
**Summary of the Incidence of Neoplasms in Male Mice in the 2-Year Inhalation Study of Molybdenum Trioxide** (continued)

	0 mg/m <sup>3</sup>	10 mg/m <sup>3</sup>	30 mg/m <sup>3</sup>	100 mg/m <sup>3</sup>
<b>Endocrine System</b> (continued)				
Islets, pancreatic	(50)	(48)	(48)	(50)
Adenoma		2 (4%)		1 (2%)
Carcinoma		1 (2%)		
Pituitary gland	(47)	(47)	(46)	(47)
Pars intermedia, adenoma		1 (2%)		2 (4%)
Thyroid gland	(50)	(50)	(49)	(50)
Follicular cell, adenoma	1 (2%)	3 (6%)	2 (4%)	1 (2%)
Follicular cell, carcinoma	1 (2%)			
<b>General Body System</b>				
None				
<b>Genital System</b>				
Epididymis	(50)	(50)	(49)	(50)
Histiocytic sarcoma	1 (2%)	1 (2%)		
Preputial gland	(49)	(50)	(48)	(50)
Histiocytic sarcoma				1 (2%)
Prostate	(48)	(47)	(47)	(47)
Seminal vesicle	(50)	(48)	(47)	(49)
Testes	(50)	(50)	(49)	(50)
Hemangioma			1 (2%)	
Bilateral, interstitial cell, adenoma			1 (2%)	
<b>Hematopoietic System</b>				
Bone marrow	(50)	(50)	(49)	(50)
Histiocytic sarcoma		1 (2%)		
Mast cell tumor malignant				1 (2%)
Lymph node	(2)	(3)	(2)	(2)
Renal, histiocytic sarcoma	1 (50%)	1 (33%)		
Lymph node, bronchial	(31)	(37)	(32)	(36)
Histiocytic sarcoma		1 (3%)		
Lymph node, mandibular	(32)	(33)	(32)	(34)
Lymph node, mesenteric	(46)	(47)	(45)	(48)
Histiocytic sarcoma	1 (2%)	2 (4%)		
Lymph node, mediastinal	(34)	(37)	(39)	(34)
Histiocytic sarcoma		1 (3%)		
Spleen	(50)	(48)	(49)	(50)
Hemangiosarcoma	1 (2%)			
Histiocytic sarcoma	1 (2%)	1 (2%)		
Sarcoma				1 (2%)
Thymus	(30)	(35)	(32)	(36)
<b>Integumentary System</b>				
Skin	(50)	(50)	(49)	(50)
Squamous cell carcinoma		1 (2%)		
Subcutaneous tissue, sarcoma			1 (2%)	
<b>Musculoskeletal System</b>				
None				

**TABLE C1**  
**Summary of the Incidence of Neoplasms in Male Mice in the 2-Year Inhalation Study of Molybdenum Trioxide** (continued)

	0 mg/m <sup>3</sup>	10 mg/m <sup>3</sup>	30 mg/m <sup>3</sup>	100 mg/m <sup>3</sup>
<b>Nervous System</b>				
Brain	(50)	(50)	(49)	(50)
<b>Respiratory System</b>				
Lung	(50)	(50)	(49)	(50)
Alveolar/bronchiolar adenoma	8 (16%)	13 (26%)	10 (20%)	8 (16%)
Alveolar/bronchiolar adenoma, multiple	1 (2%)	1 (2%)		1 (2%)
Alveolar/bronchiolar carcinoma	1 (2%)	9 (18%)	13 (27%)	7 (14%)
Alveolar/bronchiolar carcinoma, multiple	1 (2%)	7 (14%)	1 (2%)	3 (6%)
Alveolar/bronchiolar carcinoma, metastatic, lung			1 (2%)	
Carcinoma, metastatic, harderian gland				1 (2%)
Hepatocellular carcinoma, metastatic, liver	5 (10%)	2 (4%)	6 (12%)	3 (6%)
Histiocytic sarcoma		1 (2%)		
Nose	(50)	(50)	(49)	(50)
Carcinoma, metastatic, harderian gland				1 (2%)
<b>Special Senses System</b>				
Ear		(1)		
Histiocytic sarcoma		1 (100%)		
Harderian gland	(3)	(4)	(4)	(3)
Adenoma	1 (33%)	4 (100%)	4 (100%)	2 (67%)
Carcinoma	2 (67%)			1 (33%)
<b>Urinary System</b>				
Kidney	(49)	(50)	(49)	(50)
Histiocytic sarcoma		1 (2%)		
Urinary bladder	(50)	(49)	(46)	(49)
Hemangioma				1 (2%)
<b>Systemic Lesions</b>				
Multiple organs <sup>b</sup>	(50)	(50)	(50)	(50)
Histiocytic sarcoma	2 (4%)	4 (8%)		1 (2%)
Lymphoma malignant	2 (4%)	2 (4%)	2 (4%)	2 (4%)
<b>Neoplasm Summary</b>				
Total animals with primary neoplasms <sup>c</sup>	40	44	45	42
Total primary neoplasms	55	83	83	66
Total animals with benign neoplasms	28	26	28	28
Total benign neoplasms	32	41	41	36
Total animals with malignant neoplasms	20	36	35	24
Total malignant neoplasms	23	42	42	30
Total animals with metastatic neoplasms	6	2	7	4
Total metastatic neoplasms	6	2	7	5

<sup>a</sup> Number of animals examined microscopically at the site and the number of animals with neoplasm

<sup>b</sup> Number of animals with any tissue examined microscopically

<sup>c</sup> Primary neoplasms: all neoplasms except metastatic neoplasms

**TABLE C2**  
**Individual Animal Tumor Pathology of Male Mice in the 2-Year Inhalation Study of Molybdenum Trioxide: 0 mg/m<sup>3</sup>**

Number of Days on Study	3	4	4	4	5	5	5	6	6	6	6	6	6	7	7	7	7	7	7	7	7	7	7	7	7	7	7	7
	5	3	3	7	4	8	9	2	3	5	5	5	9	1	3	3	3	3	3	3	3	3	3	3	3	3	3	3
	0	3	5	3	4	0	2	9	6	1	1	6	8	2	3	3	3	3	3	3	3	3	3	3	4	4	4	4
Carcass ID Number	0	0	0	0	0	0	0	0	0	0	0	0	0	0	0	0	0	0	0	0	0	0	0	0	0	0	0	0
	0	3	1	2	0	3	1	0	3	0	0	2	3	4	0	1	2	2	4	4	5	0	0	1	1			
	2	0	9	1	4	5	5	8	7	3	9	3	1	4	7	7	2	4	0	6	0	5	6	2	3			
<b>Alimentary System</b>																												
Esophagus	+	+	+	I	+	+	+	+	+	+	+	+	+	+	+	+	+	+	+	+	+	+	+	+	+	+	+	+
Gallbladder	A	+	+	A	+	+	M	A	+	+	+	+	A	+	M	+	+	+	+	+	+	+	+	+	+	+	+	+
Intestine large, colon	A	+	+	+	+	+	+	A	+	+	+	+	A	+	+	+	+	+	+	+	+	+	+	+	+	+	+	+
Intestine large, rectum	A	+	+	+	+	+	+	+	+	+	+	+	+	+	+	+	+	+	+	+	+	+	+	+	+	+	+	+
Intestine large, cecum	A	+	+	A	+	+	+	A	+	+	+	+	A	M	+	+	+	+	+	+	+	+	+	+	+	+	+	+
Intestine small, duodenum	A	A	+	A	+	+	+	A	+	+	+	+	A	A	+	+	+	+	+	+	+	+	+	+	+	+	+	+
Intestine small, jejunum	A	A	+	A	+	+	+	A	+	+	+	+	A	A	+	+	+	+	+	+	+	+	+	+	+	+	+	+
Intestine small, ileum	A	A	+	A	+	+	+	A	+	+	+	+	A	A	+	+	+	+	+	+	+	+	+	+	+	+	+	+
Liver	+	+	+	+	+	+	+	+	+	+	+	+	+	+	+	+	+	+	+	+	+	+	+	+	+	+	+	+
Hepatocellular carcinoma	X							X	X	X			X	X					X									X
Hepatocellular carcinoma, multiple				X																								
Hepatocellular adenoma		X	X	X											X	X	X				X	X			X			X
Hepatocellular adenoma, multiple															X				X				X				X	
Mesentery												+																+
Pancreas	+	+	+	+	+	+	+	+	+	+	+	+	+	+	+	+	+	+	+	+	+	+	+	+	+	+	+	+
Salivary glands	+	+	+	+	+	+	+	+	+	+	+	+	+	+	+	+	+	+	+	+	+	+	+	+	+	+	+	+
Stomach, forestomach	+	+	+	+	+	+	+	+	+	+	+	+	+	+	+	+	+	+	+	+	+	+	+	+	+	+	+	+
Stomach, glandular	+	+	+	+	+	+	+	+	+	+	+	+	+	+	+	+	+	+	+	+	+	+	+	+	+	+	+	+
Carcinoma																												
<b>Cardiovascular System</b>																												
Heart	+	+	+	+	+	+	+	+	+	+	+	+	+	+	+	+	+	+	+	+	+	+	+	+	+	+	+	+
<b>Endocrine System</b>																												
Adrenal cortex	+	+	+	+	+	+	+	+	+	+	+	+	+	+	+	+	+	+	+	+	+	+	+	+	+	+	+	+
Adenoma																												
Alveolar/bronchiolar carcinoma, metastatic, lung					X																							
Adrenal medulla	+	+	+	+	+	+	+	+	+	+	+	+	+	+	+	+	+	+	+	+	+	+	+	+	+	+	+	+
Islets, pancreatic	+	+	+	+	+	+	+	+	+	+	+	+	+	+	+	+	+	+	+	+	+	+	+	+	+	+	+	+
Parathyroid gland	+	+	+	+	+	M	M	+	+	+	+	+	M	+	M	+	+	M	+	M	+	M	+	M	+	+	+	+
Pituitary gland	+	+	+	+	+	+	+	M	+	+	+	+	+	+	+	+	+	I	+	+	+	+	+	+	+	+	+	+
Thyroid gland	+	+	+	+	+	+	+	+	+	+	+	+	+	+	+	+	+	+	+	+	+	+	+	+	+	+	+	+
Follicular cell, adenoma																												
Follicular cell, carcinoma																												X
<b>General Body System</b>																												
Peritoneum												+																
<b>Genital System</b>																												
Epididymis	+	+	+	+	+	+	+	+	+	+	+	+	+	+	+	+	+	+	+	+	+	+	+	+	+	+	+	+
Histiocytic sarcoma																												X
Preputial gland	+	+	+	+	+	+	+	+	+	+	+	+	+	+	+	+	+	+	+	+	+	+	+	+	+	+	+	+
Prostate	+	+	+	+	+	+	+	M	+	+	+	+	+	+	+	+	+	+	+	+	+	+	+	+	+	+	+	+
Seminal vesicle	+	+	+	+	+	+	+	+	+	+	+	+	+	+	+	+	+	+	+	+	+	+	+	+	+	+	+	+
Testes	+	+	+	+	+	+	+	+	+	+	+	+	+	+	+	+	+	+	+	+	+	+	+	+	+	+	+	+

+: Tissue examined microscopically  
A: Autolysis precludes examination

M: Missing tissue  
I: Insufficient tissue

X: Lesion present  
Blank: Not examined





**TABLE C2**  
**Individual Animal Tumor Pathology of Male Mice in the 2-Year Inhalation Study of Molybdenum Trioxide: 0 mg/m<sup>3</sup>**  
 (continued)

Number of Days on Study	7	7	7	7	7	7	7	7	7	7	7	7	7	7	7	7	7	7	7	7	7	7	7	7	7	Carcass ID Number	Total Tissues/ Tumors
	3	3	3	3	3	3	3	3	3	3	3	3	3	3	3	3	3	3	3	3	3	3	3	3	3	0 1 4	0 1 4
	4	4	4	4	4	4	4	4	4	5	5	5	5	5	5	5	5	5	5	5	7	7	7	7	7	0 1 4	0 1 4
<b>Hematopoietic System</b>																											
Bone marrow	+	+	+	+	+	+	+	+	+	+	+	+	+	+	+	+	+	+	+	+	+	+	+	+	+		50
Lymph node																											2
Renal, histiocytic sarcoma																											1
Lymph node, bronchial	+	+	+	+	M	M	+	+	M	+	M	+	+	+	+	+	+	+	+	M	+	+	+	+	+		31
Lymph node, mandibular	M	+	+	+	+	+	M	+	+	M	+	+	M	+	+	+	+	+	+	M	+	+	+	+	M		32
Lymph node, mesenteric	+	+	+	+	+	+	+	+	+	+	+	+	+	+	+	+	+	+	+	+	+	+	+	+	+		46
Histiocytic sarcoma																											1
Lymph node, mediastinal	M	+	+	+	+	+	+	+	M	+	+	+	M	+	M	M	+	+	M	+	M	+	+	+	M		34
Spleen	+	+	+	+	+	+	+	+	+	+	+	+	+	+	+	+	+	+	+	+	+	+	+	+	+		50
Hemangiosarcoma																											1
Histiocytic sarcoma																											1
Thymus	M	+	M	M	I	+	+	+	M	M	+	+	M	M	M	+	M	+	+	M	+	+	+	+	+		30
<b>Integumentary System</b>																											
Mammary gland	M	M	M	M	M	M	M	M	M	M	M	M	M	M	M	M	M	M	M	M	M	M	M	M	M		50
Skin	+	+	+	+	+	+	+	+	+	+	+	+	+	+	+	+	+	+	+	+	+	+	+	+	+		50
<b>Musculoskeletal System</b>																											
Bone	+	+	+	+	+	+	+	+	+	+	+	+	+	+	+	+	+	+	+	+	+	+	+	+	+		50
Skeletal muscle																											1
<b>Nervous System</b>																											
Brain	+	+	+	+	+	+	+	+	+	+	+	+	+	+	+	+	+	+	+	+	+	+	+	+	+		50
<b>Respiratory System</b>																											
Larynx	+	+	+	+	+	+	+	+	+	+	+	+	+	+	+	+	+	+	+	+	+	+	+	+	+		50
Lung	+	+	+	+	+	+	+	+	+	+	+	+	+	+	+	+	+	+	+	+	+	+	+	+	+		50
Alveolar/bronchiolar adenoma							X					X						X						X		8	
Alveolar/bronchiolar adenoma, multiple																										1	
Alveolar/bronchiolar carcinoma																										1	
Alveolar/bronchiolar carcinoma, multiple																										1	
Hepatocellular carcinoma, metastatic, liver											X											X				5	
Nose	+	+	+	+	+	+	+	+	+	+	+	+	+	+	+	+	+	+	+	+	+	+	+	+		50	
Trachea	+	+	+	+	+	+	+	+	+	+	+	+	+	+	+	+	+	+	+	+	+	+	+	+		50	
<b>Special Senses System</b>																											
Harderian gland																											3
Adenoma																										1	
Carcinoma												X														2	
<b>Urinary System</b>																											
Kidney	+	+	+	+	+	+	+	+	+	+	+	+	+	+	+	+	+	+	+	+	+	+	+	+	+		49
Urinary bladder	+	+	+	+	+	+	+	+	+	+	+	+	+	+	+	+	+	+	+	+	+	+	+	+	+		50
<b>Systemic Lesions</b>																											
Multiple organs	+	+	+	+	+	+	+	+	+	+	+	+	+	+	+	+	+	+	+	+	+	+	+	+	+		50
Histiocytic sarcoma																										2	
Lymphoma malignant																										2	









**TABLE C2**  
**Individual Animal Tumor Pathology of Male Mice in the 2-Year Inhalation Study of Molybdenum Trioxide: 10 mg/m<sup>3</sup>**  
 (continued)

Number of Days on Study	7 7																														Total Tissues/ Tumors
	3 3																														
	3 4 4 4 4 4 4 4 4 5 5 5 5 5 5 5 5 5 5 7 7 7 7 7 7 7 7 7 7 7																														
Carcass ID Number	2 2																														
	4 0 1 2 3 3 4 5 1 1 1 2 2 3 3 4 4 4 0 2 3 3 3 4 4																														
	1 1 0 5 1 7 6 0 3 4 7 2 7 3 5 0 5 7 5 8 0 4 8 4 8																														
<b>Hematopoietic System</b>																															
Bone marrow	+ +																														50
Histiocytic sarcoma	X																														1
Lymph node	+ +																														3
Renal, histiocytic sarcoma	X																														1
Lymph node, bronchial	+ + + M + + + + M + + + + M + + + M M + + + + + + +																														37
Histiocytic sarcoma	X																														1
Lymph node, mandibular	+ + + M + + + M + M + + M + + M + + + M M + + + + +																														33
Lymph node, mesenteric	+ + + + + + + + + + I + + + + + + + + + + + + + +																														47
Histiocytic sarcoma	X																														2
Lymph node, mediastinal	+ + + + + + + + M M + M + + + + M + + + + + + + +																														37
Histiocytic sarcoma	X																														1
Spleen	+ +																														48
Histiocytic sarcoma	X																														1
Thymus	+ + + M M + + + + + M + + M + + + + + + + M M + +																														35
<b>Integumentary System</b>																															
Mammary gland	M M																														1
Skin	+ +																														50
Squamous cell carcinoma	X																														1
<b>Musculoskeletal System</b>																															
Bone	+ +																														50
<b>Nervous System</b>																															
Brain	+ +																														50
<b>Respiratory System</b>																															
Larynx	+ +																														49
Lung	+ +																														50
Alveolar/bronchiolar adenoma	X X X X X X X X																														13
Alveolar/bronchiolar adenoma, multiple	X																														1
Alveolar/bronchiolar carcinoma	X X X X X X X X																														9
Alveolar/bronchiolar carcinoma, multiple	X X X X X X X X																														7
Hepatocellular carcinoma, metastatic, liver	X																														2
Histiocytic sarcoma	X																														1
Nose	+ +																														50
Trachea	+ +																														49
<b>Special Senses System</b>																															
Ear	+																														1
Histiocytic sarcoma	X																														1
Harderian gland	+																														4
Adenoma	X																														4

TABLE C2

Individual Animal Tumor Pathology of Male Mice in the 2-Year Inhalation Study of Molybdenum Trioxide: 10 mg/m<sup>3</sup>

(continued)

	4	5	5	5	6	6	6	6	6	6	6	6	6	7	7	7	7	7	7	7	7	7	7	7	7	7
<b>Number of Days on Study</b>	4	4	8	8	5	5	5	6	8	9	9	9	0	0	0	2	2	3	3	3	3	3	3	3	3	3
	8	9	0	7	3	3	5	4	9	2	2	9	5	8	9	0	3	3	3	3	3	3	3	3	3	3
<b>Carcass ID Number</b>	2	2	2	2	2	2	2	2	2	2	2	2	2	2	2	2	2	2	2	2	2	2	2	2	2	2
	4	1	0	0	1	2	1	0	4	0	1	2	2	2	3	1	4	0	0	0	1	2	2	3	3	3
	2	1	7	2	5	9	8	8	9	4	9	0	1	4	9	6	3	3	6	9	2	3	6	2	6	6
<b>Urinary System</b>																										
Kidney	+	+	+	+	+	+	+	+	+	+	+	+	+	+	+	+	+	+	+	+	+	+	+	+	+	+
Histiocytic sarcoma																										
Urinary bladder	+	+	+	+	+	+	+	+	+	+	+	+	A	+	+	+	+	+	+	+	+	+	+	+	+	+
<b>Systemic Lesions</b>																										
Multiple organs	+	+	+	+	+	+	+	+	+	+	+	+	+	+	+	+	+	+	+	+	+	+	+	+	+	+
Histiocytic sarcoma																										
Lymphoma malignant																								X		

**TABLE C2**  
**Individual Animal Tumor Pathology of Male Mice in the 2-Year Inhalation Study of Molybdenum Trioxide: 10 mg/m<sup>3</sup>**  
(continued)

	7	7	7	7	7	7	7	7	7	7	7	7	7	7	7	7	7	7	7	7	7	7	7	
<b>Number of Days on Study</b>	3	3	3	3	3	3	3	3	3	3	3	3	3	3	3	3	3	3	3	3	3	3	3	
	3	4	4	4	4	4	4	4	5	5	5	5	5	5	5	5	5	5	7	7	7	7	7	
<b>Carcass ID Number</b>	2	2	2	2	2	2	2	2	2	2	2	2	2	2	2	2	2	2	2	2	2	2	2	Total
	4	0	1	2	3	3	4	5	1	1	1	2	2	3	3	4	4	4	0	2	3	3	3	Tissues/
	1	1	0	5	1	7	6	0	3	4	7	2	7	3	5	0	5	7	5	8	0	4	8	Tumors
<b>Urinary System</b>																								
Kidney	+	+	+	+	+	+	+	+	+	+	+	+	+	+	+	+	+	+	+	+	+	+	50	
Histiocytic sarcoma															X								1	
Urinary bladder	+	+	+	+	+	+	+	+	+	+	+	+	+	+	+	+	+	+	+	+	+	+	49	
<b>Systemic Lesions</b>																								
Multiple organs	+	+	+	+	+	+	+	+	+	+	+	+	+	+	+	+	+	+	+	+	+	+	50	
Histiocytic sarcoma						X					X		X						X				4	
Lymphoma malignant															X								2	

















**TABLE C2**  
**Individual Animal Tumor Pathology of Male Mice in the 2-Year Inhalation Study of Molybdenum Trioxide: 100 mg/m<sup>3</sup>**  
 (continued)

	7	7	7	7	7	7	7	7	7	7	7	7	7	7	7	7	7	7	7	7	7	7	
<b>Number of Days on Study</b>	3	3	3	3	3	3	3	3	3	3	3	3	3	3	3	3	3	3	3	3	3	3	
	4	4	5	5	5	5	5	5	5	5	5	7	7	7	7	7	7	7	7	7	7	7	
<b>Carcass ID Number</b>	6	6	6	6	6	6	6	6	6	6	6	6	6	6	6	6	6	6	6	6	6	6	
	3	4	0	0	1	1	1	2	3	3	4	4	0	0	0	0	1	1	1	2	3	4	
	1	1	1	9	6	7	9	7	4	9	2	3	3	4	5	7	0	5	8	5	7	0	
<b>Hematopoietic System</b>																						Total	
Bone marrow	+	+	+	+	+	+	+	+	+	+	+	+	+	+	+	+	+	+	+	+	+	+	
Mast cell tumor malignant																							
Lymph node																							
Lymph node, bronchial					M	M	M	M	+	+	+	+	+	+	M	+	+	+	M	+	+	+	
Lymph node, mandibular	+	+	M	+	M	M	M	+	M	M	+	+	+	+	+	+	+	+	M	+	+	+	
Lymph node, mesenteric	+	+	+	+	+	+	+	+	+	+	+	+	+	+	+	+	+	+	M	+	+	+	
Lymph node, mediastinal	+	+	+	M	+	+	M	M	+	+	M	M	+	M	+	M	M	+	M	+	+	+	
Spleen	+	+	+	+	+	+	+	+	+	+	+	+	+	+	+	+	+	+	+	+	+	+	
Sarcoma																							
Thymus	+	+	+	+	+	M	+	+	+	+	+	+	M	+	+	+	+	M	+	+	+	M	
																							50
																							1
																							2
																							36
																							34
																							48
																							34
																							50
																							1
																							36
<b>Integumentary System</b>																							
Mammary gland	M	M	M	M	M	M	M	M	M	M	M	M	M	M	M	A	M	M	M	M	M	M	
Skin	+	+	+	+	+	+	+	+	+	+	+	+	+	+	+	+	+	+	+	+	+	+	
																							50
<b>Musculoskeletal System</b>																							
Bone	+	+	+	+	+	+	+	+	+	+	+	+	+	+	+	+	+	+	+	+	+	+	
Skeletal muscle																							
																							50
																							1
<b>Nervous System</b>																							
Brain	+	+	+	+	+	+	+	+	+	+	+	+	+	+	+	+	+	+	+	+	+	+	
																							50
<b>Respiratory System</b>																							
Larynx	+	+	+	+	+	+	+	+	+	+	+	+	+	+	+	+	+	+	+	+	+	+	
Lung	+	+	+	+	+	+	+	+	+	+	+	+	+	+	+	+	+	+	+	+	+	+	
Alveolar/bronchiolar adenoma																		X	X				
Alveolar/bronchiolar adenoma, multiple																				X			
Alveolar/bronchiolar carcinoma												X								X			
Alveolar/bronchiolar carcinoma, multiple											X	X									X		
Carcinoma, metastatic, harderian gland																							
Hepatocellular carcinoma, metastatic, liver																							
Nose	+	+	+	+	+	+	+	+	+	+	+	+	+	+	+	+	+	+	+	+	+	+	
Carcinoma, metastatic, harderian gland																							
Trachea	+	+	+	+	+	+	+	+	+	+	+	+	+	+	+	+	+	+	+	+	+	+	
																							50
																							1
																							50
<b>Special Senses System</b>																							
Harderian gland				+																			
Adenoma				X																X			
Carcinoma																							
																							3
																							2
																							1
<b>Urinary System</b>																							
Kidney	+	+	+	+	+	+	+	+	+	+	+	+	+	+	+	+	+	+	+	+	+	+	
Urinary bladder	+	+	+	+	+	+	+	+	+	+	+	+	+	+	+	+	+	+	+	+	+	+	
Hemangioma												X											
																							50
																							49
																							1
<b>Systemic Lesions</b>																							
Multiple organs	+	+	+	+	+	+	+	+	+	+	+	+	+	+	+	+	+	+	+	+	+	+	
Histiocytic sarcoma										X													
Lymphoma malignant																				X			
																							50
																							1
																							2

**TABLE C3**  
**Statistical Analysis of Primary Neoplasms in Male Mice in the 2-Year Inhalation Study of Molybdenum Trioxide**

	0 mg/m <sup>3</sup>	10 mg/m <sup>3</sup>	30 mg/m <sup>3</sup>	100 mg/m <sup>3</sup>
<b>Harderian Gland: Adenoma</b>				
Overall rate <sup>a</sup>	1/50 (2%)	4/50 (8%)	4/50 (8%)	2/50 (4%)
Adjusted rate <sup>b</sup>	2.8%	9.8%	15.1%	5.4%
Terminal rate <sup>c</sup>	1/36 (3%)	1/33 (3%)	3/25 (12%)	2/37 (5%)
First incidence (days)	733 (T)	580	715	733 (T)
Life table test <sup>d</sup>	P=0.488N	P=0.184	P=0.094	P=0.510
Logistic regression test <sup>d</sup>	P=0.517N	P=0.168	P=0.121	P=0.510
Cochran-Armitage test <sup>d</sup>	P=0.532N			
Fisher exact test <sup>d</sup>		P=0.181	P=0.181	P=0.500
<b>Harderian Gland: Adenoma or Carcinoma</b>				
Overall rate	3/50 (6%)	4/50 (8%)	4/50 (8%)	3/50 (6%)
Adjusted rate	8.3%	9.8%	15.1%	7.7%
Terminal rate	3/36 (8%)	1/33 (3%)	3/25 (12%)	2/37 (5%)
First incidence (days)	733 (T)	580	715	677
Life table test	P=0.465N	P=0.486	P=0.315	P=0.644N
Logistic regression test	P=0.497N	P=0.506	P=0.380	P=0.640N
Cochran-Armitage test	P=0.514N			
Fisher exact test		P=0.500	P=0.500	P=0.661N
<b>Liver: Hepatocellular Adenoma</b>				
Overall rate	20/50 (40%)	15/50 (30%)	19/50 (38%)	19/50 (38%)
Adjusted rate	50.5%	37.9%	64.1%	48.4%
Terminal rate	17/36 (47%)	9/33 (27%)	15/25 (60%)	17/37 (46%)
First incidence (days)	433	689	513	580
Life table test	P=0.510N	P=0.273N	P=0.201	P=0.458N
Logistic regression test	P=0.497	P=0.183N	P=0.557	P=0.469N
Cochran-Armitage test	P=0.455			
Fisher exact test		P=0.201N	P=0.500N	P=0.500N
<b>Liver: Hepatocellular Carcinoma</b>				
Overall rate	12/50 (24%)	18/50 (36%)	21/50 (42%)	13/50 (26%)
Adjusted rate	27.0%	42.0%	46.6%	28.3%
Terminal rate	5/36 (14%)	10/33 (30%)	5/25 (20%)	5/37 (14%)
First incidence (days)	350	448	365	408
Life table test	P=0.310N	P=0.162	P=0.028	P=0.541
Logistic regression test	P=0.492N	P=0.072	P=0.133	P=0.372
Cochran-Armitage test	P=0.356N			
Fisher exact test		P=0.138	P=0.044	P=0.500
<b>Liver: Hepatocellular Adenoma or Carcinoma</b>				
Overall rate	30/50 (60%)	27/50 (54%)	34/50 (68%)	28/50 (56%)
Adjusted rate	66.1%	60.4%	79.3%	60.6%
Terminal rate	21/36 (58%)	16/33 (48%)	17/25 (68%)	19/37 (51%)
First incidence (days)	350	448	365	408
Life table test	P=0.314N	P=0.435N	P=0.044	P=0.375N
Logistic regression test	P=0.479N	P=0.410N	P=0.361	P=0.451N
Cochran-Armitage test	P=0.441N			
Fisher exact test		P=0.343N	P=0.266	P=0.420N

**TABLE C3**  
**Statistical Analysis of Primary Neoplasms in Male Mice in the 2-Year Inhalation Study of Molybdenum Trioxide** (continued)

	0 mg/m <sup>3</sup>	10 mg/m <sup>3</sup>	30 mg/m <sup>3</sup>	100 mg/m <sup>3</sup>
<b>Lung: Alveolar/bronchiolar Adenoma</b>				
Overall rate	9/50 (18%)	14/50 (28%)	10/49 (20%)	9/50 (18%)
Adjusted rate	23.5%	37.8%	29.8%	22.5%
Terminal rate	7/36 (19%)	11/33 (33%)	5/25 (20%)	7/37 (19%)
First incidence (days)	651	653	440	576
Life table test	P=0.272N	P=0.146	P=0.270	P=0.570N
Logistic regression test	P=0.322N	P=0.205	P=0.464	P=0.571N
Cochran-Armitage test	P=0.335N			
Fisher exact test		P=0.171	P=0.480	P=0.602N
<b>Lung: Alveolar/bronchiolar Carcinoma</b>				
Overall rate	2/50 (4%)	16/50 (32%)	14/49 (29%)	10/50 (20%)
Adjusted rate	4.9%	40.7%	43.3%	25.3%
Terminal rate	1/36 (3%)	11/33 (33%)	8/25 (32%)	8/37 (22%)
First incidence (days)	544	580	513	629
Life table test	P=0.462	P<0.001	P<0.001	P=0.020
Logistic regression test	P=0.385	P<0.001	P<0.001	P=0.017
Cochran-Armitage test	P=0.371			
Fisher exact test		P<0.001	P<0.001	P=0.014
<b>Lung: Alveolar/bronchiolar Adenoma or Carcinoma</b>				
Overall rate	11/50 (22%)	27/50 (54%)	21/49 (43%)	18/50 (36%)
Adjusted rate	27.7%	64.8%	56.1%	43.4%
Terminal rate	8/36 (22%)	19/33 (58%)	10/25 (40%)	14/37 (38%)
First incidence (days)	544	580	440	576
Life table test	P=0.432N	P=0.001	P=0.005	P=0.123
Logistic regression test	P=0.541N	P=0.001	P=0.020	P=0.106
Cochran-Armitage test	P=0.547			
Fisher exact test		P<0.001	P=0.022	P=0.093
<b>Pancreatic Islets: Adenoma or Carcinoma</b>				
Overall rate	0/50 (0%)	3/48 (6%)	0/48 (0%)	1/50 (2%)
Adjusted rate	0.0%	9.1%	0.0%	2.7%
Terminal rate	0/36 (0%)	3/33 (9%)	0/25 (0%)	1/37 (3%)
First incidence (days)	— <sup>e</sup>	733 (T)	—	733 (T)
Life table test	P=0.593N	P=0.106	—	P=0.505
Logistic regression test	P=0.593N	P=0.106	—	P=0.505
Cochran-Armitage test	P=0.620N			
Fisher exact test		P=0.114	—	P=0.500
<b>Thyroid Gland (Follicular Cell): Adenoma</b>				
Overall rate	1/50 (2%)	3/50 (6%)	2/49 (4%)	1/50 (2%)
Adjusted rate	2.8%	8.2%	8.0%	2.7%
Terminal rate	1/36 (3%)	2/33 (6%)	2/25 (8%)	1/37 (3%)
First incidence (days)	733 (T)	664	733 (T)	733 (T)
Life table test	P=0.388N	P=0.294	P=0.373	P=0.756N
Logistic regression test	P=0.403N	P=0.321	P=0.373	P=0.756N
Cochran-Armitage test	P=0.421N			
Fisher exact test		P=0.309	P=0.492	P=0.753N



**TABLE C3**  
**Statistical Analysis of Primary Neoplasms in Male Mice in the 2-Year Inhalation Study of Molybdenum Trioxide** (continued)

	0 mg/m <sup>3</sup>	10 mg/m <sup>3</sup>	30 mg/m <sup>3</sup>	100 mg/m <sup>3</sup>
<b>Thyroid Gland (Follicular Cell): Adenoma or Carcinoma</b>				
Overall rate	2/50 (4%)	3/50 (6%)	2/49 (4%)	1/50 (2%)
Adjusted rate	5.6%	8.2%	8.0%	2.7%
Terminal rate	2/36 (6%)	2/33 (6%)	2/25 (8%)	1/37 (3%)
First incidence (days)	733 (T)	664	733 (T)	733 (T)
Life table test	P=0.278N	P=0.480	P=0.558	P=0.490N
Logistic regression test	P=0.289N	P=0.522	P=0.558	P=0.490N
Cochran-Armitage test	P=0.305N			
Fisher exact test		P=0.500	P=0.684	P=0.500N
<b>All Organs: Hemangioma or Hemangiosarcoma</b>				
Overall rate	1/50 (2%)	0/50 (0%)	3/50 (6%)	1/50 (2%)
Adjusted rate	2.8%	0.0%	11.3%	2.7%
Terminal rate	1/36 (3%)	0/33 (0%)	2/25 (8%)	1/37 (3%)
First incidence (days)	733 (T)	—	715	733 (T)
Life table test	P=0.620	P=0.517N	P=0.196	P=0.756N
Logistic regression test	P=0.612	P=0.517N	P=0.236	P=0.756N
Cochran-Armitage test	P=0.592			
Fisher exact test		P=0.500N	P=0.309	P=0.753N
<b>All Organs: Histiocytic Sarcoma</b>				
Overall rate	2/50 (4%)	4/50 (8%)	0/50 (0%)	1/50 (2%)
Adjusted rate	5.6%	12.1%	0.0%	2.7%
Terminal rate	2/36 (6%)	4/33 (12%)	0/25 (0%)	1/37 (3%)
First incidence (days)	733 (T)	733 (T)	—	733 (T)
Life table test	P=0.224N	P=0.296	P=0.322N	P=0.490N
Logistic regression test	P=0.225N	P=0.296	P=0.322N	P=0.490N
Cochran-Armitage test	P=0.245N			
Fisher exact test		P=0.339	P=0.247N	P=0.500N
<b>All Organs: Malignant Lymphoma</b>				
Overall rate	2/50 (4%)	2/50 (4%)	2/50 (4%)	2/50 (4%)
Adjusted rate	5.6%	5.3%	5.1%	4.6%
Terminal rate	2/36 (6%)	1/33 (3%)	0/25 (0%)	1/37 (3%)
First incidence (days)	733 (T)	664	442	328
Life table test	P=0.594N	P=0.681	P=0.615	P=0.686N
Logistic regression test	P=0.617	P=0.679N	P=0.673N	P=0.668
Cochran-Armitage test	P=0.627			
Fisher exact test		P=0.691N	P=0.691N	P=0.691N
<b>All Organs: Benign Neoplasms</b>				
Overall rate	28/50 (56%)	26/50 (52%)	28/50 (56%)	28/50 (56%)
Adjusted rate	67.8%	58.8%	83.9%	66.3%
Terminal rate	23/36 (64%)	15/33 (45%)	20/25 (80%)	23/37 (62%)
First incidence (days)	433	580	440	576
Life table test	P=0.432N	P=0.516N	P=0.075	P=0.513N
Logistic regression test	P=0.522	P=0.371N	P=0.452	P=0.532N
Cochran-Armitage test	P=0.478			
Fisher exact test		P=0.421N	P=0.580N	P=0.580N

**TABLE C3**  
**Statistical Analysis of Primary Neoplasms in Male Mice in the 2-Year Inhalation Study of Molybdenum Trioxide** (continued)

	0 mg/m <sup>3</sup>	10 mg/m <sup>3</sup>	30 mg/m <sup>3</sup>	100 mg/m <sup>3</sup>
<b>All Organs: Malignant Neoplasms</b>				
Overall rate	20/50 (40%)	36/50 (72%)	35/50 (70%)	24/50 (48%)
Adjusted rate	44.7%	77.6%	73.3%	49.7%
Terminal rate	12/36 (33%)	23/33 (70%)	13/25 (52%)	13/37 (35%)
First incidence (days)	350	448	365	328
Life table test	P=0.209N	P=0.006	P=0.001	P=0.356
Logistic regression test	P=0.337N	P<0.001	P=0.006	P=0.209
Cochran-Armitage test	P=0.255N			
Fisher exact test		P=0.001	P=0.002	P=0.273
<b>All Organs: Benign or Malignant Neoplasms</b>				
Overall rate	40/50 (80%)	44/50 (88%)	45/50 (90%)	42/50 (84%)
Adjusted rate	84.9%	89.7%	93.5%	84.0%
Terminal rate	29/36 (81%)	28/33 (85%)	22/25 (88%)	29/37 (78%)
First incidence (days)	350	448	365	328
Life table test	P=0.331N	P=0.223	P=0.012	P=0.522
Logistic regression test	P=0.516	P=0.178	P=0.189	P=0.357
Cochran-Armitage test	P=0.561			
Fisher exact test		P=0.207	P=0.131	P=0.398

(T)Terminal sacrifice

- <sup>a</sup> Number of neoplasm-bearing animals/number of animals examined. Denominator is number of animals examined microscopically for liver, lung, pancreatic islets, and thyroid gland; for other tissues, denominator is number of animals necropsied.
- <sup>b</sup> Kaplan-Meier estimated neoplasm incidence at the end of the study after adjustment for intercurrent mortality
- <sup>c</sup> Observed incidence at terminal kill
- <sup>d</sup> Beneath the control incidence are the P values associated with the trend test. Beneath the exposed group incidence are the P values corresponding to pairwise comparisons between the controls and that exposed group. The life table test regards neoplasms in animals dying prior to terminal kill as being (directly or indirectly) the cause of death. The logistic regression test regards these lesions as nonfatal. The Cochran-Armitage and Fisher exact tests compare directly the overall incidence rates. For all tests, a negative trend or a lower incidence in an exposure group is indicated by N.
- <sup>e</sup> Not applicable; no neoplasms in animal group

**TABLE C4**  
**Historical Incidence of Alveolar/bronchiolar Neoplasms in Untreated Male B6C3F<sub>1</sub> Mice<sup>a</sup>**

Study	Incidence in Controls		
	Adenoma	Carcinoma	Adenoma or Carcinoma
<b>Historical Incidence at Battelle Pacific Northwest Laboratories</b>			
1,3-Butadiene	18/50	5/50	21/50
Acetonitrile	6/50	4/50	10/50
Allyl Glycidyl Ether	7/50	0/50	7/50
2-Chloroacetophenone	7/50	6/50	11/50
<i>l</i> -Epinephrine Hydrochloride	11/50	5/50	15/50
Chloroethane	3/50	2/50	5/50
Hexachlorocyclopentadiene	11/49	0/49	11/49
<i>o</i> -Chlorobenzalmalononitrile (CS2)	7/49	7/49	14/49
Ozone	6/50	8/50	14/50
Total	76/448 (17.0%)	37/448 (8.3%)	108/448 (24.1%)
Standard deviation	8.7%	5.8%	9.5%
Range	6%-36%	0%-16%	10%-42%
<b>Overall Historical Incidence</b>			
Total	141/947 (14.9%)	75/947 (7.9%)	205/947 (21.7%)
Standard deviation	7.0%	5.7%	8.0%
Range	6%-36%	0%-16%	10%-42%

<sup>a</sup> Data as of 12 May 1995

**TABLE C5**  
**Summary of the Incidence of Nonneoplastic Lesions in Male Mice in the 2-Year Inhalation Study of Molybdenum Trioxide<sup>a</sup>**

	0 mg/m <sup>3</sup>	10 mg/m <sup>3</sup>	30 mg/m <sup>3</sup>	100 mg/m <sup>3</sup>
<b>Disposition Summary</b>				
Animals initially in study	50	50	50	50
Early deaths				
Moribund	8	13	14	9
Natural deaths	6	4	11	4
Survivors				
Terminal sacrifice	36	33	25	37
Animals examined microscopically	50	50	50	50
<b>Alimentary System</b>				
Gallbladder	(43)	(40)	(38)	(43)
Degeneration, hyaline			1 (3%)	
Inflammation, suppurative	1 (2%)	2 (5%)		
Epithelium, hyperplasia			1 (3%)	
Intestine large, cecum	(45)	(47)	(44)	(47)
Inflammation, chronic		1 (2%)		
Intestine small, duodenum	(44)	(47)	(41)	(48)
Epithelium, hyperplasia			1 (2%)	
Intestine small, ileum	(44)	(46)	(41)	(48)
Peyer's patch, hyperplasia			1 (2%)	
Liver	(50)	(50)	(50)	(50)
Amyloid deposition			1 (2%)	
Angiectasis	1 (2%)			1 (2%)
Basophilic focus	3 (6%)	4 (8%)	1 (2%)	1 (2%)
Congestion, focal			1 (2%)	
Degeneration, fatty		1 (2%)	2 (4%)	1 (2%)
Eosinophilic focus	11 (22%)	10 (20%)	7 (14%)	6 (12%)
Hematopoietic cell proliferation	1 (2%)		3 (6%)	2 (4%)
Hepatodiaphragmatic nodule			1 (2%)	
Infiltration cellular, mast cell				1 (2%)
Inflammation, chronic	1 (2%)	1 (2%)	3 (6%)	
Necrosis	5 (10%)	5 (10%)	5 (10%)	5 (10%)
Vacuolization cytoplasmic	1 (2%)	1 (2%)		1 (2%)
Bile duct, cyst	1 (2%)		1 (2%)	1 (2%)
Centrilobular, degeneration		1 (2%)		
Centrilobular, necrosis	1 (2%)			
Serosa, fibrosis		1 (2%)		1 (2%)
Mesentery	(3)	(4)	(2)	(2)
Congestion		1 (25%)		
Hemorrhage		1 (25%)		
Fat, necrosis	3 (100%)	3 (75%)	2 (100%)	1 (50%)
Pancreas	(50)	(48)	(48)	(50)
Atrophy	8 (16%)	3 (6%)	4 (8%)	8 (16%)
Basophilic focus		1 (2%)	1 (2%)	
Hyperplasia				1 (2%)
Hypertrophy			2 (4%)	
Salivary glands	(50)	(50)	(49)	(50)
Inflammation, suppurative		2 (4%)		

<sup>a</sup> Number of animals examined microscopically at the site and the number of animals with lesion

**TABLE C5**  
**Summary of the Incidence of Nonneoplastic Lesions in Male Mice in the 2-Year Inhalation Study**  
**of Molybdenum Trioxide** (continued)

	0 mg/m <sup>3</sup>	10 mg/m <sup>3</sup>	30 mg/m <sup>3</sup>	100 mg/m <sup>3</sup>
<b>Alimentary System</b> (continued)				
Stomach, forestomach	(50)	(49)	(48)	(50)
Inflammation		1 (2%)		
Ulcer	1 (2%)			
Epithelium, hyperplasia	2 (4%)	2 (4%)	1 (2%)	1 (2%)
Stomach, glandular	(50)	(48)	(46)	(49)
Inflammation, suppurative			2 (4%)	
Necrosis		1 (2%)	1 (2%)	
Epithelium, hyperplasia				1 (2%)
Tooth		(1)	(1)	(1)
Developmental malformation				1 (100%)
<b>Cardiovascular System</b>				
Heart	(50)	(50)	(49)	(50)
Cardiomyopathy	44 (88%)	48 (96%)	46 (94%)	47 (94%)
Mineralization				1 (2%)
Atrium, thrombosis		1 (2%)		
<b>Endocrine System</b>				
Adrenal cortex	(50)	(49)	(48)	(50)
Hemorrhage		1 (2%)		
Hyperplasia	8 (16%)	11 (22%)	10 (21%)	5 (10%)
Hypertrophy	24 (48%)	29 (59%)	27 (56%)	30 (60%)
Capsule, hyperplasia	1 (2%)			1 (2%)
Adrenal medulla	(50)	(49)	(48)	(50)
Hyperplasia	1 (2%)	2 (4%)	2 (4%)	
Islets, pancreatic	(50)	(48)	(48)	(50)
Hyperplasia	1 (2%)	6 (13%)	3 (6%)	4 (8%)
Parathyroid gland	(36)	(39)	(31)	(35)
Hyperplasia			1 (3%)	
Pituitary gland	(47)	(47)	(46)	(47)
Pars distalis, cyst		1 (2%)		
Pars distalis, hyperplasia		3 (6%)	2 (4%)	
Thyroid gland	(50)	(50)	(49)	(50)
Follicular cell, hyperplasia	20 (40%)	19 (38%)	12 (24%)	15 (30%)
<b>General Body System</b>				
Peritoneum	(1)			
Inflammation	1 (100%)			
<b>Genital System</b>				
Epididymis	(50)	(50)	(49)	(50)
Angiectasis			1 (2%)	
Granuloma sperm	2 (4%)		2 (4%)	
Hyperplasia, atypical		1 (2%)		
Inflammation, chronic	3 (6%)	2 (4%)	1 (2%)	2 (4%)
Penis		(1)	(1)	
Capillary, inflammation, suppurative		1 (100%)		

**TABLE C5**  
**Summary of the Incidence of Nonneoplastic Lesions in Male Mice in the 2-Year Inhalation Study**  
**of Molybdenum Trioxide** (continued)

	0 mg/m <sup>3</sup>	10 mg/m <sup>3</sup>	30 mg/m <sup>3</sup>	100 mg/m <sup>3</sup>
<b>Genital System</b> (continued)				
Preputial gland	(49)	(50)	(48)	(50)
Cyst	6 (12%)	7 (14%)	8 (17%)	6 (12%)
Hyperplasia			1 (2%)	
Inflammation	6 (12%)	6 (12%)	7 (15%)	11 (22%)
Prostate	(48)	(47)	(47)	(47)
Hyperplasia	2 (4%)	1 (2%)		1 (2%)
Inflammation, chronic				1 (2%)
Inflammation, suppurative	2 (4%)	1 (2%)	1 (2%)	3 (6%)
Seminal vesicle	(50)	(48)	(47)	(49)
Congestion		1 (2%)		
Inflammation, chronic		1 (2%)		2 (4%)
Inflammation, suppurative	1 (2%)			
Testes	(50)	(50)	(49)	(50)
Atrophy	2 (4%)	4 (8%)	9 (18%)	4 (8%)
<b>Hematopoietic System</b>				
Bone marrow	(50)	(50)	(49)	(50)
Angiectasis	1 (2%)			
Hyperplasia	2 (4%)	2 (4%)	2 (4%)	2 (4%)
Hyperplasia, histiocytic	1 (2%)			
Infiltration cellular, mast cell				1 (2%)
Infiltration cellular, megakaryocyte				2 (4%)
Lymph node	(2)	(3)	(2)	(2)
Iliac, hyperplasia	1 (50%)		1 (50%)	
Iliac, pigmentation			1 (50%)	
Lymph node, bronchial	(31)	(37)	(32)	(36)
Hyperplasia	1 (3%)	5 (14%)	3 (9%)	2 (6%)
Lymph node, mandibular	(32)	(33)	(32)	(34)
Hyperplasia		1 (3%)		
Infiltration cellular, mast cell				1 (3%)
Lymph node, mesenteric	(46)	(47)	(45)	(48)
Angiectasis		2 (4%)	1 (2%)	1 (2%)
Congestion	1 (2%)		1 (2%)	
Hematopoietic cell proliferation	1 (2%)	1 (2%)		
Hyperplasia	4 (9%)	4 (9%)	3 (7%)	2 (4%)
Inflammation, chronic			1 (2%)	
Lymph node, mediastinal	(34)	(37)	(39)	(34)
Hyperplasia	3 (9%)	2 (5%)	1 (3%)	2 (6%)
Spleen	(50)	(48)	(49)	(50)
Amyloid deposition			1 (2%)	
Hematopoietic cell proliferation	11 (22%)	13 (27%)	11 (22%)	8 (16%)
Hyperplasia, lymphoid	3 (6%)	3 (6%)	1 (2%)	1 (2%)
Infiltration cellular, mast cell				1 (2%)
Infiltration cellular, mononuclear cell	1 (2%)			
Infiltration cellular, histiocyte	1 (2%)			
Pigmentation, melanin		1 (2%)		
Thymus	(30)	(35)	(32)	(36)
Atrophy	1 (3%)	1 (3%)		2 (6%)
Epithelial cell, hyperplasia			1 (3%)	

**TABLE C5**  
**Summary of the Incidence of Nonneoplastic Lesions in Male Mice in the 2-Year Inhalation Study**  
**of Molybdenum Trioxide** (continued)

	0 mg/m <sup>3</sup>	10 mg/m <sup>3</sup>	30 mg/m <sup>3</sup>	100 mg/m <sup>3</sup>
<b>Integumentary System</b>				
Skin	(50)	(50)	(49)	(50)
Inflammation, chronic active	1 (2%)			1 (2%)
Prepuce, inflammation, chronic active	4 (8%)	3 (6%)	4 (8%)	6 (12%)
Prepuce, inflammation, suppurative	1 (2%)			
Subcutaneous tissue, inflammation, focal, granulomatous	2 (4%)			
<b>Musculoskeletal System</b>				
Bone	(50)	(50)	(50)	(50)
Degeneration			1 (2%)	
Fibrous osteodystrophy		2 (4%)	1 (2%)	
Inflammation, chronic			1 (2%)	
Skeletal muscle	(1)			(1)
Hemorrhage	1 (100%)			
<b>Nervous System</b>				
Brain	(50)	(50)	(49)	(50)
Gliosis				1 (2%)
Meninges, infiltration cellular, mast cell				1 (2%)
Meninges, inflammation, chronic		1 (2%)		
<b>Respiratory System</b>				
Larynx	(50)	(49)	(48)	(50)
Hyperplasia	1 (2%)	3 (6%)	6 (13%)	41 (82%)
Inflammation, suppurative			1 (2%)	1 (2%)
Epiglottis, hyperplasia		8 (16%)	2 (4%)	
Epiglottis, metaplasia, squamous		26 (53%)	37 (77%)	49 (98%)
Lung	(50)	(50)	(49)	(50)
Hematopoietic cell proliferation	1 (2%)			
Hemorrhage			4 (8%)	
Infiltration cellular, histiocyte	2 (4%)	16 (32%)	9 (18%)	9 (18%)
Inflammation, chronic	1 (2%)			
Alveolar epithelium, hyperplasia	2 (4%)	1 (2%)	6 (12%)	2 (4%)
Alveolar epithelium, metaplasia		32 (64%)	36 (73%)	49 (98%)
Artery, inflammation		2 (4%)		
Perivascular, infiltration cellular				1 (2%)
Nose	(50)	(50)	(49)	(50)
Atrophy			1 (2%)	
Infiltration cellular, mast cell				1 (2%)
Inflammation, suppurative	2 (4%)	6 (12%)	10 (20%)	8 (16%)
Metaplasia, squamous	1 (2%)	2 (4%)	3 (6%)	1 (2%)
Nasolacrimal duct, inflammation, suppurative	1 (2%)	2 (4%)	1 (2%)	
Olfactory epithelium, atrophy	3 (6%)	5 (10%)	3 (6%)	10 (20%)
Olfactory epithelium, degeneration, hyaline	1 (2%)	1 (2%)	1 (2%)	2 (4%)
Olfactory epithelium, metaplasia	1 (2%)			2 (4%)
Respiratory epithelium, degeneration, hyaline	11 (22%)	13 (26%)	11 (22%)	41 (82%)
<b>Special Senses System</b>				
None				

**TABLE C5**  
**Summary of the Incidence of Nonneoplastic Lesions in Male Mice in the 2-Year Inhalation Study**  
**of Molybdenum Trioxide** (continued)

	0 mg/m <sup>3</sup>	10 mg/m <sup>3</sup>	30 mg/m <sup>3</sup>	100 mg/m <sup>3</sup>
<b>Urinary System</b>				
Kidney	(49)	(50)	(49)	(50)
Hydronephrosis	1 (2%)	1 (2%)	2 (4%)	3 (6%)
Inflammation, chronic				1 (2%)
Inflammation, suppurative	1 (2%)		2 (4%)	2 (4%)
Metaplasia, osseous		2 (4%)	1 (2%)	
Nephropathy	44 (90%)	48 (96%)	44 (90%)	46 (92%)
Cortex, cyst				1 (2%)
Papilla, necrosis	1 (2%)			1 (2%)
Renal tubule, hyperplasia	1 (2%)	3 (6%)	3 (6%)	3 (6%)
Renal tubule, necrosis			1 (2%)	
Urinary bladder	(50)	(49)	(46)	(49)
Calculus, gross observation				1 (2%)
Inflammation, chronic active	2 (4%)			2 (4%)
Inflammation, suppurative			2 (4%)	1 (2%)
Transitional epithelium, hyperplasia	1 (2%)			2 (4%)





**APPENDIX D**  
**SUMMARY OF LESIONS IN FEMALE MICE**  
**IN THE 2-YEAR INHALATION STUDY**  
**OF MOLYBDENUM TRIOXIDE**

<b>TABLE D1</b>	<b>Summary of the Incidence of Neoplasms in Female Mice in the 2-Year Inhalation Study of Molybdenum Trioxide .....</b>	<b>174</b>
<b>TABLE D2</b>	<b>Individual Animal Tumor Pathology of Female Mice in the 2-Year Inhalation Study of Molybdenum Trioxide .....</b>	<b>178</b>
<b>TABLE D3</b>	<b>Statistical Analysis of Primary Neoplasms in Female Mice in the 2-Year Inhalation Study of Molybdenum Trioxide .....</b>	<b>202</b>
<b>TABLE D4</b>	<b>Historical Incidence of Alveolar/bronchiolar Neoplasms in Untreated Female B6C3F<sub>1</sub> Mice .....</b>	<b>206</b>
<b>TABLE D5</b>	<b>Summary of the Incidence of Nonneoplastic Lesions in Female Mice in the 2-Year Inhalation Study of Molybdenum Trioxide .....</b>	<b>207</b>

**TABLE D1**  
**Summary of the Incidence of Neoplasms in Female Mice in the 2-Year Inhalation Study of Molybdenum Trioxide<sup>a</sup>**

	0 mg/m <sup>3</sup>	10 mg/m <sup>3</sup>	30 mg/m <sup>3</sup>	100 mg/m <sup>3</sup>
<b>Disposition Summary</b>				
Animals initially in study	50	50	50	50
Early deaths				
Accidental deaths		1	1	
Moribund	17	12	14	10
Natural deaths	8	6	2	5
Survivors				
Died last week of study	1		2	
Terminal sacrifice	24	31	31	35
Animals examined microscopically	50	50	50	50
<b>Alimentary System</b>				
Gallbladder	(40)	(44)	(46)	(41)
Carcinoma, metastatic, pancreas			1 (2%)	
Intestine small, duodenum	(43)	(46)	(47)	(46)
Polyp adenomatous	1 (2%)			
Intestine small, jejunum	(44)	(45)	(47)	(46)
Liver	(50)	(50)	(50)	(49)
Carcinoma, metastatic, islets, pancreatic				1 (2%)
Hemangiosarcoma				2 (4%)
Hepatocellular carcinoma	17 (34%)	8 (16%)	13 (26%)	5 (10%)
Hepatocellular carcinoma, multiple	2 (4%)	4 (8%)	3 (6%)	6 (12%)
Hepatocellular adenoma	7 (14%)	8 (16%)	7 (14%)	10 (20%)
Hepatocellular adenoma, multiple	2 (4%)	3 (6%)	6 (12%)	6 (12%)
Hepatocholangiocarcinoma	1 (2%)			
Histiocytic sarcoma	1 (2%)	1 (2%)		1 (2%)
Teratoma malignant, metastatic, ovary		1 (2%)		
Mesentery	(4)	(9)	(9)	(7)
Carcinoma, metastatic, pancreas			1 (11%)	
Hepatocholangiocarcinoma, metastatic, liver	1 (25%)			
Teratoma malignant, metastatic, ovary		1 (11%)		
Oral mucosa	(1)	(1)		
Squamous cell carcinoma		1 (100%)		
Pancreas	(50)	(49)	(48)	(46)
Carcinoma			1 (2%)	
Hepatocholangiocarcinoma, metastatic, liver	1 (2%)			
Histiocytic sarcoma		1 (2%)		
Salivary glands	(50)	(49)	(49)	(49)
Stomach, forestomach	(50)	(50)	(49)	(47)
Squamous cell papilloma			2 (4%)	
Stomach, glandular	(49)	(49)	(47)	(46)
Tooth	(2)			
Odontoma	1 (50%)			
<b>Cardiovascular System</b>				
Heart	(50)	(50)	(49)	(49)
Hepatocholangiocarcinoma, metastatic, liver	1 (2%)			
Histiocytic sarcoma	1 (2%)			
Pheochromocytoma malignant, metastatic, adrenal medulla			1 (2%)	

**TABLE D1**  
**Summary of the Incidence of Neoplasms in Female Mice in the 2-Year Inhalation Study of Molybdenum Trioxide** (continued)

	0 mg/m <sup>3</sup>	10 mg/m <sup>3</sup>	30 mg/m <sup>3</sup>	100 mg/m <sup>3</sup>
<b>Endocrine System</b>				
Adrenal cortex	(50)	(50)	(49)	(49)
Adenoma	1 (2%)	1 (2%)		
Carcinoma, metastatic, pancreas			1 (2%)	
Histiocytic sarcoma		1 (2%)		
Capsule, adenoma			1 (2%)	
Adrenal medulla	(50)	(49)	(49)	(49)
Pheochromocytoma malignant			1 (2%)	
Pheochromocytoma benign	1 (2%)			
Islets, pancreatic	(50)	(49)	(48)	(46)
Adenoma	1 (2%)			1 (2%)
Carcinoma			1 (2%)	1 (2%)
Pituitary gland	(49)	(48)	(48)	(49)
Pars distalis, adenoma	9 (18%)	8 (17%)	9 (19%)	9 (18%)
Pars distalis, carcinoma			1 (2%)	
Pars intermedia, adenoma				2 (4%)
Thyroid gland	(50)	(50)	(49)	(49)
Follicular cell, adenoma	2 (4%)	1 (2%)	1 (2%)	1 (2%)
Follicular cell, adenoma, multiple		1 (2%)		1 (2%)
<b>General Body System</b>				
None				
<b>Genital System</b>				
Ovary	(50)	(49)	(48)	(46)
Cystadenoma	1 (2%)	2 (4%)	3 (6%)	
Granulosa cell tumor benign		1 (2%)	1 (2%)	
Histiocytic sarcoma	1 (2%)			
Luteoma	1 (2%)	1 (2%)	1 (2%)	
Teratoma malignant		1 (2%)		
Uterus	(50)	(50)	(49)	(49)
Carcinoma			1 (2%)	
Hemangioma			1 (2%)	
Histiocytic sarcoma	1 (2%)			
Polyp stromal	4 (8%)	3 (6%)		3 (6%)
Sarcoma			1 (2%)	
Endometrium, adenoma				1 (2%)

**TABLE D1**  
**Summary of the Incidence of Neoplasms in Female Mice in the 2-Year Inhalation Study of Molybdenum Trioxide** (continued)

	0 mg/m <sup>3</sup>	10 mg/m <sup>3</sup>	30 mg/m <sup>3</sup>	100 mg/m <sup>3</sup>
<b>Hematopoietic System</b>				
Bone marrow	(50)	(50)	(49)	(49)
Histiocytic sarcoma		1 (2%)		
Lymph node	(4)	(6)	(7)	(4)
Iliac, teratoma malignant, metastatic, ovary		1 (17%)		
Pancreatic, teratoma malignant, metastatic, ovary		1 (17%)		
Lymph node, bronchial	(41)	(32)	(36)	(31)
Hepatocarcinoma, metastatic, liver	1 (2%)			
Lymph node, mandibular	(39)	(40)	(43)	(40)
Histiocytic sarcoma	1 (3%)			
Lymph node, mesenteric	(49)	(49)	(46)	(44)
Carcinoma, metastatic, pancreas			1 (2%)	
Histiocytic sarcoma	1 (2%)			1 (2%)
Teratoma malignant, metastatic, ovary		1 (2%)		
Lymph node, mediastinal	(41)	(41)	(40)	(41)
Hepatocarcinoma, metastatic, liver	1 (2%)			
Histiocytic sarcoma	1 (2%)			1 (2%)
Spleen	(50)	(50)	(49)	(47)
Hemangiosarcoma		1 (2%)		
Histiocytic sarcoma	1 (2%)	1 (2%)		1 (2%)
Thymus	(40)	(35)	(40)	(37)
Histiocytic sarcoma		1 (3%)		1 (3%)
Thymoma malignant		1 (3%)		
<b>Integumentary System</b>				
Mammary gland	(49)	(49)	(49)	(50)
Carcinoma		2 (4%)	1 (2%)	
Skin	(50)	(50)	(49)	(50)
Melanoma malignant		1 (2%)		
Trichoepithelioma		1 (2%)		
Pinna, squamous cell papilloma	1 (2%)			
Subcutaneous tissue, hemangiosarcoma				1 (2%)
Subcutaneous tissue, osteosarcoma	1 (2%)			
Subcutaneous tissue, sarcoma		1 (2%)	2 (4%)	4 (8%)
Subcutaneous tissue, sarcoma, multiple			1 (2%)	
<b>Musculoskeletal System</b>				
Bone	(50)	(50)	(50)	(50)
Osteosarcoma	1 (2%)			
Skeletal muscle	(1)	(1)		
Hepatocarcinoma, metastatic, liver	1 (100%)			
Teratoma malignant, metastatic, ovary		1 (100%)		
<b>Nervous System</b>				
Brain	(50)	(50)	(49)	(49)
Carcinoma, metastatic, pituitary gland			1 (2%)	
Histiocytic sarcoma	1 (2%)			1 (2%)
Choroid plexus, adenoma				1 (2%)

**TABLE D1**  
**Summary of the Incidence of Neoplasms in Female Mice in the 2-Year Inhalation Study of Molybdenum Trioxide** (continued)

	0 mg/m <sup>3</sup>	10 mg/m <sup>3</sup>	30 mg/m <sup>3</sup>	100 mg/m <sup>3</sup>
<b>Respiratory System</b>				
Lung	(50)	(50)	(49)	(49)
Alveolar/bronchiolar adenoma	1 (2%)	4 (8%)	8 (16%)	8 (16%)
Alveolar/bronchiolar adenoma, multiple				1 (2%)
Alveolar/bronchiolar carcinoma	2 (4%)	2 (4%)		6 (12%)
Carcinoma, metastatic, harderian gland	1 (2%)			1 (2%)
Hepatocellular carcinoma, metastatic, liver	2 (4%)	3 (6%)	2 (4%)	1 (2%)
Hepatocholangiocarcinoma, metastatic, liver	1 (2%)			
Histiocytic sarcoma	1 (2%)	1 (2%)		1 (2%)
Pheochromocytoma malignant, metastatic, adrenal medulla			1 (2%)	
Teratoma malignant, metastatic, ovary		1 (2%)		
Nose	(49)	(50)	(49)	(49)
Carcinoma, metastatic, harderian gland				1 (2%)
<b>Special Senses System</b>				
Harderian gland	(3)	(2)	(1)	(1)
Adenoma	2 (67%)	2 (100%)		
Carcinoma	1 (33%)		1 (100%)	1 (100%)
<b>Urinary System</b>				
Kidney	(50)	(50)	(49)	(47)
Histiocytic sarcoma	1 (2%)	1 (2%)		1 (2%)
Teratoma malignant, metastatic, ovary		1 (2%)		
Renal tubule, carcinoma	1 (2%)			
Urinary bladder	(48)	(50)	(49)	(46)
<b>Systemic Lesions</b>				
Multiple organs <sup>b</sup>	(50)	(50)	(50)	(50)
Histiocytic sarcoma	1 (2%)	1 (2%)		1 (2%)
Lymphoma malignant	3 (6%)	5 (10%)	8 (16%)	6 (12%)
<b>Neoplasm Summary</b>				
Total animals with primary neoplasms <sup>c</sup>	40	39	43	40
Total primary neoplasms	65	64	75	77
Total animals with benign neoplasms	25	24	30	26
Total benign neoplasms	35	36	40	44
Total animals with malignant neoplasms	28	25	29	25
Total malignant neoplasms	30	28	35	33
Total animals with metastatic neoplasms	4	4	5	3
Total metastatic neoplasms	10	11	9	4

<sup>a</sup> Number of animals examined microscopically at the site and the number of animals with neoplasm

<sup>b</sup> Number of animals with any tissue examined microscopically

<sup>c</sup> Primary neoplasms: all neoplasms except metastatic neoplasms

**TABLE D2**  
**Individual Animal Tumor Pathology of Female Mice in the 2-Year Inhalation Study of Molybdenum Trioxide:**  
**0 mg/m<sup>3</sup>**

	4	5	5	5	5	5	5	5	5	5	6	6	6	6	6	6	6	6	6	7	7	7	7	7	7		
<b>Number of Days on Study</b>	6	1	4	5	5	6	8	8	9	9	2	3	3	4	7	7	9	9	9	0	0	2	2	2	3		
	9	1	8	2	2	2	1	7	0	4	6	4	6	2	0	4	2	2	2	2	5	9	0	0	9	0	
<b>Carcass ID Number</b>	1	1	1	1	1	1	1	1	1	1	1	1	1	1	1	1	1	1	1	1	1	1	1	1	1		
	2	2	0	0	1	0	1	3	2	2	0	3	0	4	1	3	1	3	4	4	4	3	4	3	4		
	5	8	7	9	0	4	1	0	9	4	6	7	8	5	5	3	3	2	9	4	8	9	3	1	0		
<b>Alimentary System</b>																											
Esophagus	+	+	+	+	+	+	+	+	+	+	+	+	+	+	+	+	+	+	+	+	+	+	+	+	+	+	
Gallbladder	A	A	+	+	+	+	+	A	+	A	+	A	+	I	+	+	+	+	+	+	A	+	+	A	I		
Intestine large, colon	A	+	+	+	+	+	+	+	A	+	+	+	+	+	+	+	+	+	+	+	+	+	+	+	+	+	
Intestine large, rectum	+	+	+	+	+	+	+	A	+	A	+	+	+	+	+	+	+	+	+	+	+	+	+	+	+	+	
Intestine large, cecum	A	A	+	+	A	+	+	A	+	A	+	A	+	+	+	+	+	+	+	+	+	+	+	+	+	+	
Intestine small, duodenum	A	A	+	+	A	+	+	A	+	A	+	A	+	+	+	+	+	+	+	+	+	+	+	+	A	+	
Polyp adenomatous																											
Intestine small, jejunum	A	+	+	+	A	+	+	A	+	A	+	A	+	+	+	+	+	+	+	+	+	+	+	+	A	+	
Intestine small, ileum	A	+	+	+	+	+	+	A	+	A	+	A	+	+	+	+	+	+	+	+	+	+	+	+	A	+	
Liver	+	+	+	+	+	+	+	+	+	+	+	+	+	+	+	+	+	+	+	+	+	+	+	+	+	+	
Hepatocellular carcinoma	X					X	X		X	X	X				X	X								X	X		
Hepatocellular carcinoma, multiple																								X			
Hepatocellular adenoma							X																		X		
Hepatocellular adenoma, multiple																											
Hepatocholangiocarcinoma																									X		
Histiocytic sarcoma																							X				
Mesentery						+																			+		
Hepatocholangiocarcinoma, metastatic, liver																									X		
Oral mucosa																											
Pancreas	+	+	+	+	+	+	+	+	+	+	+	+	+	+	+	+	+	+	+	+	+	+	+	+	+		
Hepatocholangiocarcinoma, metastatic, liver																									X		
Salivary glands	+	+	+	+	+	+	+	+	+	+	+	+	+	+	+	+	+	+	+	+	+	+	+	+	+		
Stomach, forestomach	+	+	+	+	+	+	+	+	+	+	+	+	+	+	+	+	+	+	+	+	+	+	+	+	+		
Stomach, glandular	+	+	+	+	+	+	+	+	+	A	+	+	+	+	+	+	+	+	+	+	+	+	+	+	+		
Tooth																									+		
Odontoma																											
<b>Cardiovascular System</b>																											
Blood vessel												+														+	
Heart	+	+	+	+	+	+	+	+	+	+	+	+	+	+	+	+	+	+	+	+	+	+	+	+	+	+	
Hepatocholangiocarcinoma, metastatic, liver																									X		
Histiocytic sarcoma																									X		
<b>Endocrine System</b>																											
Adrenal cortex	+	+	+	+	+	+	+	+	+	+	+	+	+	+	+	+	+	+	+	+	+	+	+	+	+	+	
Adenoma																									X		
Adrenal medulla	+	+	+	+	+	+	+	+	+	+	+	+	+	+	+	+	+	+	+	+	+	+	+	+	+		
Pheochromocytoma benign																											
Islets, pancreatic	+	+	+	+	+	+	+	+	+	+	+	+	+	+	+	+	+	+	+	+	+	+	+	+	+		
Adenoma																											
Parathyroid gland	I	+	+	M	+	+	+	M	M	+	+	+	M	+	M	+	+	+	M	M	+	+	+	I	+		
Pituitary gland	+	+	+	+	+	+	+	+	+	+	+	+	+	+	M	+	+	+	+	+	+	+	+	+	+		
Pars distalis, adenoma			X					X												X	X						
Thyroid gland	+	+	+	+	+	+	+	+	+	+	+	+	+	+	+	+	+	+	+	+	+	+	+	+	+		
Follicular cell, adenoma																											
<b>General Body System</b>																											
None																											

+ : Tissue examined microscopically  
A : Autolysis precludes examination

M : Missing tissue  
I : Insufficient tissue

X : Lesion present  
Blank : Not examined

**TABLE D2**  
**Individual Animal Tumor Pathology of Female Mice in the 2-Year Inhalation Study of Molybdenum Trioxide:**  
**0 mg/m<sup>3</sup> (continued)**

Number of Days on Study	7 7																				Total Tissues/ Tumors	
	3 4 4 4 4 4 4 4 4 4 4 6 6 6 6 6 6 6 6 7 7 7 7																					
Carcass ID Number	1 1																				Total Tissues/ Tumors	
	1 2 3 0 1 2 3 4 4 4 5 0 0 1 1 1 1 2 2 3 4 0 2 2 3 8 0 4 2 9 3 5 2 6 7 0 1 3 2 4 6 7 1 2 6 1 5 6 7 8																					
<b>Alimentary System</b>																						
Esophagus	+																				50	
Gallbladder	+																				40	
Intestine large, colon	+																				48	
Intestine large, rectum	+																				48	
Intestine large, cecum	+																				44	
Intestine small, duodenum	+																				43	
Polyp adenomatous																					1	
Intestine small, jejunum	+																				44	
Intestine small, ileum	+																				45	
Liver	+																				50	
Hepatocellular carcinoma																					17	
Hepatocellular carcinoma, multiple																					2	
Hepatocellular adenoma																					7	
Hepatocellular adenoma, multiple																					2	
Hepatocholangiocarcinoma																					1	
Histiocytic sarcoma																					1	
Mesentery																					4	
Hepatocholangiocarcinoma, metastatic, liver																					1	
Oral mucosa																					1	
Pancreas	+																				50	
Hepatocholangiocarcinoma, metastatic, liver																					1	
Salivary glands	+																				50	
Stomach, forestomach	+																				50	
Stomach, glandular	+																				49	
Tooth																					2	
Odontoma																					1	
<b>Cardiovascular System</b>																						
Blood vessel																					2	
Heart	+																				50	
Hepatocholangiocarcinoma, metastatic, liver																					1	
Histiocytic sarcoma																					1	
<b>Endocrine System</b>																						
Adrenal cortex	+																				50	
Adenoma																					1	
Adrenal medulla	+																				50	
Pheochromocytoma benign																					1	
Islets, pancreatic	+																				50	
Adenoma																					1	
Parathyroid gland	+																				31	
Pituitary gland	+																				49	
Pars distalis, adenoma																					9	
Thyroid gland	+																				50	
Follicular cell, adenoma																					2	
<b>General Body System</b>																						
None																						







**TABLE D2**  
**Individual Animal Tumor Pathology of Female Mice in the 2-Year Inhalation Study of Molybdenum Trioxide:**  
**0 mg/m<sup>3</sup> (continued)**

<b>Number of Days on Study</b>	4	5	5	5	5	5	5	5	5	5	6	6	6	6	6	6	6	6	7	7	7	7	7	7																		
	6	1	4	5	5	6	8	8	9	9	2	3	3	4	7	7	9	9	9	0	0	2	2	2	3																	
	9	1	8	2	2	2	1	7	0	4	6	4	6	2	0	4	2	2	2	5	9	0	0	9	0																	
<b>Carcass ID Number</b>	1	1	1	1	1	1	1	1	1	1	1	1	1	1	1	1	1	1	1	1	1	1	1	1																		
	2	2	0	0	1	0	1	3	2	2	0	3	0	4	1	3	1	3	4	4	4	3	4	3	4																	
	5	8	7	9	0	4	1	0	9	4	6	7	8	5	5	3	3	2	9	4	8	9	3	1	0																	
<b>Special Senses System</b>																																										
Harderian gland																			+	+																						
Adenoma																				X																						
Carcinoma																			X																							
<b>Urinary System</b>																																										
Kidney	+	+	+	+	+	+	+	+	+	+	+	+	+	+	+	+	+	+	+	+	+	+	+	+	+																	
Histiocytic sarcoma																																								X		
Renal tubule, carcinoma																	X																									
Urethra																																										
Urinary bladder	A	+	+	+	I	+	+	+	+	+	+	+	+	+	+	+	+	+	+	+	+	+	+	+	+																	
<b>Systemic Lesions</b>																																										
Multiple organs	+	+	+	+	+	+	+	+	+	+	+	+	+	+	+	+	+	+	+	+	+	+	+	+	+																	
Histiocytic sarcoma																																								X		
Lymphoma malignant													X																													

**TABLE D2**  
**Individual Animal Tumor Pathology of Female Mice in the 2-Year Inhalation Study of Molybdenum Trioxide:**  
**0 mg/m<sup>3</sup>** (continued)

<b>Number of Days on Study</b>	7 7	
	3 3	
	3 3 3 4 4 4 4 4 4 4 4 6 6 6 6 6 6 6 6 6 6 7 7 7 7	
<b>Carcass ID Number</b>	1 1	Total
	1 2 3 0 1 2 3 4 4 4 5 0 0 1 1 1 1 2 2 3 4 0 2 2 3	Tissues/
	8 0 4 2 9 3 5 2 6 7 0 1 3 2 4 6 7 1 2 6 1 5 6 7 8	Tumors
<b>Special Senses System</b>		
Harderian gland		3
Adenoma	+	2
Carcinoma	X	1
<b>Urinary System</b>		
Kidney		50
Histiocytic sarcoma	+	1
Renal tubule, carcinoma	+	1
Urethra		1
Urinary bladder	+	48
<b>Systemic Lesions</b>		
Multiple organs	+	50
Histiocytic sarcoma		1
Lymphoma malignant	X	3



















**TABLE D2**

**Individual Animal Tumor Pathology of Female Mice in the 2-Year Inhalation Study of Molybdenum Trioxide: 30 mg/m<sup>3</sup>**

(continued)

<b>Number of Days on Study</b>	2	5	5	6	6	6	6	6	6	7	7	7	7	7	7	7	7	7	7	7	7	7	7	7	7	7		
	8	6	6	0	3	5	7	7	8	9	0	0	0	1	1	2	2	3	3	3	3	3	3	3	3	3		
	8	2	6	3	8	3	0	8	9	2	5	5	9	2	2	0	3	3	3	3	3	3	3	3	3	3		
<b>Carcass ID Number</b>	5	5	5	5	5	5	5	5	5	5	5	5	5	5	5	5	5	5	5	5	5	5	5	5	5	5		
	2	3	1	0	4	3	1	3	1	3	3	3	3	0	4	4	4	0	0	1	1	1	1	2	2			
	5	8	7	8	4	1	4	0	9	5	4	6	7	7	8	7	1	1	2	0	1	3	6	3	4			
<b>Genital System</b>																												
Clitoral gland	M	A	+	+	+	+	M	M	+	+	+	+	+	M	+	M	+	+	+	M	+	+	M	+	+	+		
Ovary	+	A	+	+	+	+	+	+	+	+	+	+	+	A	+	+	+	+	+	+	+	+	+	+	+	+		
Cystadenoma																			X									
Granulosa cell tumor benign																							X					
Luteoma																								X				
Uterus	+	A	+	+	+	+	+	+	+	+	+	+	+	+	+	+	+	+	+	+	+	+	+	+	+	+		
Carcinoma																X												
Hemangioma																					X							
Sarcoma																												
<b>Hematopoietic System</b>																												
Bone marrow	+	A	+	+	+	+	+	+	+	+	+	+	+	+	+	+	+	+	+	+	+	+	+	+	+	+		
Lymph node				+									+															
Lymph node, bronchial	+	A	+	+	+	M	+	+	M	+	+	M	M	+	+	+	+	+	+	+	+	+	+	+	+	M		
Lymph node, mandibular	+	+	+	+	+	+	+	+	+	M	+	+	M	+	+	+	+	+	+	+	+	+	+	+	+	+		
Lymph node, mesenteric	+	A	M	+	+	+	+	+	+	+	+	+	+	+	+	+	+	+	+	+	+	+	+	+	+	+		
Carcinoma, metastatic, pancreas																			X									
Lymph node, mediastinal	+	A	+	+	+	+	+	+	+	+	+	M	+	+	+	+	+	+	+	+	+	+	+	+	+	+		
Spleen	+	A	+	+	+	+	+	+	+	+	+	+	+	+	+	+	+	+	+	+	+	+	+	+	+	+		
Thymus	+	A	M	+	M	M	+	+	+	+	+	+	+	+	+	+	+	+	+	+	+	+	+	+	+	+		
<b>Integumentary System</b>																												
Mammary gland	+	A	+	+	+	+	+	+	+	+	+	+	+	+	+	+	+	+	+	+	+	+	+	+	+	+		
Carcinoma																											X	
Skin	+	A	+	+	+	+	+	+	+	+	+	+	+	+	+	+	+	+	+	+	+	+	+	+	+	+		
Subcutaneous tissue, sarcoma													X				X											
Subcutaneous tissue, sarcoma, multiple																			X									
<b>Musculoskeletal System</b>																												
Bone	+	+	+	+	+	+	+	+	+	+	+	+	+	+	+	+	+	+	+	+	+	+	+	+	+	+		
<b>Nervous System</b>																												
Brain	+	A	+	+	+	+	+	+	+	+	+	+	+	+	+	+	+	+	+	+	+	+	+	+	+	+		
Carcinoma, metastatic, pituitary gland																					X							
<b>Respiratory System</b>																												
Larynx	+	A	+	+	+	+	+	+	+	+	+	+	+	+	+	+	+	+	+	+	+	+	+	+	+	+		
Lung	+	A	+	+	+	+	+	+	+	+	+	+	+	+	+	+	+	+	+	+	+	+	+	+	+	+		
Alveolar/bronchiolar adenoma																X				X	X							
Hepatocellular carcinoma, metastatic, liver																			X									
Pheochromocytoma malignant, metastatic, adrenal medulla																			X									
Nose	+	A	+	+	+	+	+	+	+	+	+	+	+	+	+	+	+	+	+	+	+	+	+	+	+	+		
Trachea	+	A	+	+	+	+	+	+	+	+	+	+	+	+	+	+	+	+	+	+	+	+	+	+	+	+		
<b>Special Senses System</b>																												
Eye																					+							
Harderian gland																			+									
Carcinoma																			X									









TABLE D2 Individual Animal Tumor Pathology of Female Mice in the 2-Year Inhalation Study of Molybdenum Trioxide: 100 mg/m<sup>3</sup>

Table with 21 columns representing individual mice and rows for various anatomical systems (Alimentary, Cardiovascular, Endocrine, General Body, Genital) and their respective findings (e.g., Esophagus, Liver, Heart, Adrenal cortex, etc.).

TABLE D2

Individual Animal Tumor Pathology of Female Mice in the 2-Year Inhalation Study of Molybdenum Trioxide: 100 mg/m<sup>3</sup>

(continued)

Number of Days on Study	7 7
3 3	
4 4 4 4 4 4 6 6 6 6 6 6 6 6 6 6 7 7 7 7 7 7 7	
Carcass ID Number	7 7
2 2 3 3 4 4 0 0 1 1 1 2 2 2 3 4 0 0 1 1 1 2 2 3 3	
1 5 3 4 3 8 2 9 5 7 9 6 8 9 5 7 3 4 4 6 8 2 7 1 6	
Total Tissues/ Tumors	
Alimentary System	
Esophagus	+ +
Gallbladder	+ + + + + + + + + + I + + + M + + + + + + I + +
Intestine large, colon	+ +
Intestine large, rectum	+ +
Intestine large, cecum	+ +
Intestine small, duodenum	+ +
Intestine small, jejunum	+ +
Intestine small, ileum	+ +
Liver	+ +
Carcinoma, metastatic, islets, pancreatic	
Hemangiosarcoma	X
Hepatocellular carcinoma	X X
Hepatocellular carcinoma, multiple	X
Hepatocellular adenoma	X X X X
Hepatocellular adenoma, multiple	X X X X
Histiocytic sarcoma	
Mesentery	+ +
Pancreas	+ +
Salivary glands	+ +
Stomach, forestomach	+ +
Stomach, glandular	+ +
Cardiovascular System	
Heart	+ +
Endocrine System	
Adrenal cortex	+ +
Adrenal medulla	+ +
Islets, pancreatic	+ +
Adenoma	X
Carcinoma	
Parathyroid gland	+ + I M + + + + + + M M + M + + + + + + M M + M
Pituitary gland	+ +
Pars distalis, adenoma	X
Pars intermedia, adenoma	X
Thyroid gland	+ +
Follicular cell, adenoma	
Follicular cell, adenoma, multiple	X
General Body System	
None	
Genital System	
Clitoral gland	+ M + + + + + M M + M + + + + + M + + + + M M M
Ovary	+ +
Uterus	+ +
Polyp stromal	X
Endometrium, adenoma	X



TABLE D2

Individual Animal Tumor Pathology of Female Mice in the 2-Year Inhalation Study of Molybdenum Trioxide: 100 mg/m<sup>3</sup>

(continued)

Number of Days on Study	7 7
	3 3
	4 4 4 4 4 4 6 6 6 6 6 6 6 6 6 6 7 7 7 7 7 7 7 7
Carcass ID Number	7 7
	2 2 3 3 4 4 0 0 1 1 1 2 2 2 3 4 0 0 1 1 1 2 2 3 3
	1 5 3 4 3 8 2 9 5 7 9 6 8 9 5 7 3 4 4 6 8 2 7 1 6
Total Tissues/Tumors	
<b>Hematopoietic System</b>	
Bone marrow	+ 49
Lymph node	+ 4
Lymph node, bronchial	M + + + M + + M M + M + M M + M + + M + M + + + M 31
Lymph node, mandibular	+ M + + + M M M + + M + + + + I + + + + + + + M + 40
Lymph node, mesenteric	+ 44
Histiocytic sarcoma	1
Lymph node, mediastinal	+ + + + + + + + + + + + + + + + M + M + + + + + + + 41
Histiocytic sarcoma	1
Spleen	+ 47
Histiocytic sarcoma	1
Thymus	+ + + + M + + M + + M + + + + + + + M M + + M + + + 37
Histiocytic sarcoma	1
<b>Integumentary System</b>	
Mammary gland	+ 50
Skin	+ 50
Subcutaneous tissue, hemangiosarcoma	1
Subcutaneous tissue, sarcoma	X 4
<b>Musculoskeletal System</b>	
Bone	+ 50
<b>Nervous System</b>	
Brain	+ 49
Histiocytic sarcoma	1
Choroid plexus, adenoma	X 1
<b>Respiratory System</b>	
Larynx	+ 50
Lung	+ 49
Alveolar/bronchiolar adenoma	X 8
Alveolar/bronchiolar adenoma, multiple	X X X X 1
Alveolar/bronchiolar carcinoma	X X X 6
Carcinoma, metastatic, harderian gland	1
Hepatocellular carcinoma, metastatic, liver	X 1
Histiocytic sarcoma	1
Nose	+ 49
Carcinoma, metastatic, harderian gland	1
Trachea	+ 48
<b>Special Senses System</b>	
Harderian gland	1
Carcinoma	1



**TABLE D2**  
**Individual Animal Tumor Pathology of Female Mice in the 2-Year Inhalation Study of Molybdenum Trioxide: 100 mg/m<sup>3</sup>**  
 (continued)

<b>Number of Days on Study</b>	7 7	
	3 3	
	4 4 4 4 4 4 6 6 6 6 6 6 6 6 6 6 7 7 7 7 7 7 7 7	
<b>Carcass ID Number</b>	7 7	Total
	2 2 3 3 4 4 0 0 1 1 1 2 2 2 3 4 0 0 1 1 1 2 2 3 3	Tissues/
	1 5 3 4 3 8 2 9 5 7 9 6 8 9 5 7 3 4 4 6 8 2 7 1 6	Tumors
<b>Urinary System</b>		
Kidney	+ +	47
Histiocytic sarcoma		1
Urinary bladder	+ +	46
<b>Systemic Lesions</b>		
Multiple organs	+ +	50
Histiocytic sarcoma		1
Lymphoma malignant	X	X 6

**TABLE D3**  
**Statistical Analysis of Primary Neoplasms in Female Mice in the 2-Year Inhalation Study of Molybdenum Trioxide**

	0 mg/m <sup>3</sup>	10 mg/m <sup>3</sup>	30 mg/m <sup>3</sup>	100 mg/m <sup>3</sup>
<b>Harderian Gland: Adenoma or Carcinoma</b>				
Overall rate <sup>a</sup>	3/50 (6%)	2/50 (4%)	1/50 (2%)	1/50 (2%)
Adjusted rate <sup>b</sup>	9.6%	6.5%	2.4%	2.7%
Terminal rate <sup>c</sup>	1/25 (4%)	2/31 (6%)	0/33 (0%)	0/35 (0%)
First incidence (days)	692	733 (T)	689	699
Life table test <sup>d</sup>	P=0.232N	P=0.427N	P=0.235N	P=0.245N
Logistic regression test <sup>d</sup>	P=0.271N	P=0.466N	P=0.289N	P=0.503N
Cochran-Armitage test <sup>d</sup>	P=0.277N			
Fisher exact test <sup>e</sup>		P=0.500N	P=0.309N	P=0.309N
<b>Liver: Hepatocellular Adenoma</b>				
Overall rate	9/50 (18%)	11/50 (22%)	13/50 (26%)	16/49 (33%)
Adjusted rate	32.2%	31.5%	35.2%	45.7%
Terminal rate	7/25 (28%)	8/31 (26%)	10/33 (30%)	16/35 (46%)
First incidence (days)	562	629	638	733 (T)
Life table test	P=0.213	P=0.586	P=0.482	P=0.304
Logistic regression test	P=0.093	P=0.471	P=0.352	P=0.151
Cochran-Armitage test	P=0.061			
Fisher exact test		P=0.402	P=0.235	P=0.074
<b>Liver: Hepatocellular Carcinoma</b>				
Overall rate	19/50 (38%)	12/50 (24%)	16/50 (32%)	11/49 (22%)
Adjusted rate	49.9%	31.9%	38.3%	26.3%
Terminal rate	8/25 (32%)	7/31 (23%)	9/33 (27%)	6/35 (17%)
First incidence (days)	469	600	562	350
Life table test	P=0.065N	P=0.053N	P=0.147N	P=0.028N
Logistic regression test	P=0.138N	P=0.099N	P=0.395N	P=0.080N
Cochran-Armitage test	P=0.134N			
Fisher exact test		P=0.097N	P=0.338N	P=0.071N
<b>Liver: Hepatocellular Adenoma or Carcinoma</b>				
Overall rate	23/50 (46%)	22/50 (44%)	25/50 (50%)	27/49 (55%)
Adjusted rate	61.7%	57.1%	59.7%	67.0%
Terminal rate	12/25 (48%)	15/31 (48%)	17/33 (52%)	22/35 (63%)
First incidence (days)	469	600	562	350
Life table test	P=0.535	P=0.251N	P=0.333N	P=0.415N
Logistic regression test	P=0.168	P=0.477N	P=0.426	P=0.248
Cochran-Armitage test	P=0.161			
Fisher exact test		P=0.500N	P=0.421	P=0.241
<b>Lung: Alveolar/bronchiolar Adenoma</b>				
Overall rate	1/50 (2%)	4/50 (8%)	8/49 (16%)	9/49 (18%)
Adjusted rate	3.7%	11.0%	23.5%	24.8%
Terminal rate	0/25 (0%)	2/31 (6%)	7/33 (21%)	8/35 (23%)
First incidence (days)	729	610	720	667
Life table test	P=0.042	P=0.236	P=0.045	P=0.032
Logistic regression test	P=0.018	P=0.184	P=0.036	P=0.016
Cochran-Armitage test	P=0.013			
Fisher exact test		P=0.181	P=0.014	P=0.007

**TABLE D3**  
**Statistical Analysis of Primary Neoplasms in Female Mice in the 2-Year Inhalation Study of Molybdenum Trioxide** (continued)

	0 mg/m <sup>3</sup>	10 mg/m <sup>3</sup>	30 mg/m <sup>3</sup>	100 mg/m <sup>3</sup>
<b>Lung: Alveolar/bronchiolar Carcinoma</b>				
Overall rate	2/50 (4%)	2/50 (4%)	0/49 (0%)	6/49 (12%)
Adjusted rate	5.8%	5.2%	0.0%	16.3%
Terminal rate	0/25 (0%)	0/31 (0%)	0/33 (0%)	5/35 (14%)
First incidence (days)	642	629	— <sup>e</sup>	632
Life table test	P=0.044	P=0.655N	P=0.192N	P=0.235
Logistic regression test	P=0.024	P=0.694	P=0.256N	P=0.140
Cochran-Armitage test	P=0.024			
Fisher exact test		P=0.691N	P=0.253N	P=0.128
<b>Lung: Alveolar/bronchiolar Adenoma or Carcinoma</b>				
Overall rate	3/50 (6%)	6/50 (12%)	8/49 (16%)	15/49 (31%)
Adjusted rate	9.3%	15.6%	23.5%	40.1%
Terminal rate	0/25 (0%)	2/31 (6%)	7/33 (21%)	13/35 (37%)
First incidence (days)	642	610	720	632
Life table test	P=0.004	P=0.320	P=0.205	P=0.015
Logistic regression test	P<0.001	P=0.223	P=0.152	P=0.003
Cochran-Armitage test	P<0.001			
Fisher exact test		P=0.243	P=0.094	P=0.001
<b>Ovary: Cystadenoma</b>				
Overall rate	1/50 (2%)	2/49 (4%)	3/48 (6%)	0/46 (0%)
Adjusted rate	3.4%	6.5%	8.4%	0.0%
Terminal rate	0/25 (0%)	2/31 (6%)	2/33 (6%)	0/35 (0%)
First incidence (days)	720	733 (T)	692	—
Life table test	P=0.195N	P=0.565	P=0.393	P=0.462N
Logistic regression test	P=0.225N	P=0.543	P=0.349	P=0.486N
Cochran-Armitage test	P=0.266N			
Fisher exact test		P=0.492	P=0.293	P=0.521N
<b>Pituitary Gland (Pars Distalis): Adenoma</b>				
Overall rate	9/49 (18%)	8/48 (17%)	9/48 (19%)	9/49 (18%)
Adjusted rate	28.1%	25.4%	22.4%	24.9%
Terminal rate	5/25 (20%)	6/29 (21%)	3/32 (9%)	8/35 (23%)
First incidence (days)	511	709	670	698
Life table test	P=0.410N	P=0.384N	P=0.414N	P=0.361N
Logistic regression test	P=0.564N	P=0.491N	P=0.596	P=0.563N
Cochran-Armitage test	P=0.529			
Fisher exact test		P=0.519N	P=0.584	P=0.603N
<b>Pituitary Gland (Pars Distalis): Adenoma or Carcinoma</b>				
Overall rate	9/49 (18%)	8/48 (17%)	10/48 (21%)	9/49 (18%)
Adjusted rate	28.1%	25.4%	25.1%	24.9%
Terminal rate	5/25 (20%)	6/29 (21%)	4/32 (13%)	8/35 (23%)
First incidence (days)	511	709	670	698
Life table test	P=0.395N	P=0.384N	P=0.499N	P=0.361N
Logistic regression test	P=0.551N	P=0.491N	P=0.500	P=0.563N
Cochran-Armitage test	P=0.539			
Fisher exact test		P=0.519N	P=0.480	P=0.603N



**TABLE D3**  
**Statistical Analysis of Primary Neoplasms in Female Mice in the 2-Year Inhalation Study of Molybdenum Trioxide** (continued)

	0 mg/m <sup>3</sup>	10 mg/m <sup>3</sup>	30 mg/m <sup>3</sup>	100 mg/m <sup>3</sup>
<b>Skin: Sarcoma</b>				
Overall rate	0/50 (0%)	1/50 (2%)	3/50 (6%)	4/50 (8%)
Adjusted rate	0.0%	3.2%	7.5%	10.2%
Terminal rate	0/25 (0%)	1/31 (3%)	0/33 (0%)	1/35 (3%)
First incidence (days)	—	733 (T)	653	664
Life table test	P=0.065	P=0.543	P=0.165	P=0.095
Logistic regression test	P=0.027	P=0.543	P=0.118	P=0.064
Cochran-Armitage test	P=0.044			
Fisher exact test		P=0.500	P=0.121	P=0.059
<b>Uterus: Stromal Polyp</b>				
Overall rate	4/50 (8%)	3/50 (6%)	0/50 (0%)	3/50 (6%)
Adjusted rate	16.0%	9.1%	0.0%	8.6%
Terminal rate	4/25 (16%)	2/31 (6%)	0/33 (0%)	3/35 (9%)
First incidence (days)	733 (T)	709	—	733 (T)
Life table test	P=0.435N	P=0.388N	P=0.033N	P=0.319N
Logistic regression test	P=0.481N	P=0.427N	P=0.033N	P=0.319N
Cochran-Armitage test	P=0.550N			
Fisher exact test		P=0.500N	P=0.059N	P=0.500N
<b>All Organs: Hemangiosarcoma</b>				
Overall rate	0/50 (0%)	1/50 (2%)	0/50 (0%)	3/50 (6%)
Adjusted rate	0.0%	2.2%	0.0%	8.0%
Terminal rate	0/25 (0%)	0/31 (0%)	0/33 (0%)	2/35 (6%)
First incidence (days)	—	594	—	664
Life table test	P=0.054	P=0.523	—	P=0.174
Logistic regression test	P=0.041	P=0.530	—	P=0.127
Cochran-Armitage test	P=0.040			
Fisher exact test		P=0.500	—	P=0.121
<b>All Organs: Hemangioma or Hemangiosarcoma</b>				
Overall rate	0/50 (0%)	1/50 (2%)	1/50 (2%)	3/50 (6%)
Adjusted rate	0.0%	2.2%	3.0%	8.0%
Terminal rate	0/25 (0%)	0/31 (0%)	1/33 (3%)	2/35 (6%)
First incidence (days)	—	594	733 (T)	664
Life table test	P=0.091	P=0.523	P=0.555	P=0.174
Logistic regression test	P=0.066	P=0.530	P=0.555	P=0.127
Cochran-Armitage test	P=0.066			
Fisher exact test		P=0.500	P=0.500	P=0.121
<b>All Organs: Malignant Lymphoma</b>				
Overall rate	3/50 (6%)	5/50 (10%)	8/50 (16%)	6/50 (12%)
Adjusted rate	10.4%	12.9%	19.9%	16.3%
Terminal rate	2/25 (8%)	2/31 (6%)	3/33 (9%)	5/35 (14%)
First incidence (days)	636	592	603	632
Life table test	P=0.436	P=0.444	P=0.203	P=0.398
Logistic regression test	P=0.309	P=0.354	P=0.108	P=0.264
Cochran-Armitage test	P=0.311			
Fisher exact test		P=0.357	P=0.100	P=0.243

**TABLE D3**  
**Statistical Analysis of Primary Neoplasms in Female Mice in the 2-Year Inhalation Study of Molybdenum Trioxide** (continued)

	0 mg/m <sup>3</sup>	10 mg/m <sup>3</sup>	30 mg/m <sup>3</sup>	100 mg/m <sup>3</sup>
<b>All Organs: Benign Neoplasms</b>				
Overall rate	25/50 (50%)	24/50 (48%)	30/50 (60%)	26/50 (52%)
Adjusted rate	72.2%	62.7%	69.6%	70.2%
Terminal rate	16/25 (64%)	17/31 (55%)	20/33 (61%)	24/35 (69%)
First incidence (days)	511	610	638	667
Life table test	P=0.230N	P=0.212N	P=0.453N	P=0.145N
Logistic regression test	P=0.532	P=0.409N	P=0.382	P=0.542N
Cochran-Armitage test	P=0.457			
Fisher exact test		P=0.500N	P=0.211	P=0.500
<b>All Organs: Malignant Neoplasms</b>				
Overall rate	28/50 (56%)	25/50 (50%)	29/50 (58%)	25/50 (50%)
Adjusted rate	62.8%	55.6%	59.1%	54.0%
Terminal rate	9/25 (36%)	12/31 (39%)	13/33 (39%)	14/35 (40%)
First incidence (days)	469	220	288	350
Life table test	P=0.194N	P=0.196N	P=0.281N	P=0.140N
Logistic regression test	P=0.549N	P=0.408N	P=0.319	P=0.513
Cochran-Armitage test	P=0.372N			
Fisher exact test		P=0.344N	P=0.500	P=0.344N
<b>All Organs: Benign or Malignant Neoplasms</b>				
Overall rate	40/50 (80%)	39/50 (78%)	43/50 (86%)	40/50 (80%)
Adjusted rate	84.8%	84.5%	86.0%	85.1%
Terminal rate	18/25 (72%)	24/31 (77%)	26/33 (79%)	28/35 (80%)
First incidence (days)	469	220	288	350
Life table test	P=0.159N	P=0.186N	P=0.225N	P=0.113N
Logistic regression test	P=0.542	P=0.520N	P=0.212	P=0.586
Cochran-Armitage test	P=0.546			
Fisher exact test		P=0.500N	P=0.298	P=0.598N

(T)Terminal sacrifice

<sup>a</sup> Number of neoplasm-bearing animals/number of animals examined. Denominator is number of animals examined microscopically for liver, lung, ovary, and pituitary gland; for other tissues, denominator is number of animals necropsied.

<sup>b</sup> Kaplan-Meier estimated neoplasm incidence at the end of the study after adjustment for intercurrent mortality

<sup>c</sup> Observed incidence at terminal kill

<sup>d</sup> Beneath the control incidence are the P values associated with the trend test. Beneath the exposed group incidence are the P values corresponding to pairwise comparisons between the controls and that exposed group. The life table test regards neoplasms in animals dying prior to terminal kill as being (directly or indirectly) the cause of death. The logistic regression test regards these lesions as nonfatal. The Cochran-Armitage and Fisher exact tests compare directly the overall incidence rates. For all tests, a negative trend or a lower incidence in an exposure group is indicated by N.

<sup>e</sup> Not applicable; no neoplasms in animal group

**TABLE D4**  
**Historical Incidence of Alveolar/bronchiolar Neoplasms in Untreated Female B6C3F<sub>1</sub> Mice<sup>a</sup>**

Study	Incidence in Controls		
	Adenoma	Carcinoma	Adenoma or Carcinoma
<b>Historical Incidence at Battelle Pacific Northwest Laboratories</b>			
1,3-Butadiene	4/50	0/50	4/50
Acetonitrile	7/49	1/49	8/49
Allyl Glycidyl Ether	0/50	0/50	0/50
2-Chloroacetophenone	4/50	3/50	6/50
<i>l</i> -Epinephrine Hydrochloride	3/50	2/50	5/50
Chloroethane	2/49	3/49	5/49
Hexachlorocyclopentadiene	4/48	3/48	7/48
<i>o</i> -Chlorobenzalmalononitrile (CS2)	4/50	1/50	5/50
Ozone	4/50	2/50	6/50
Total	32/446 (7.2%)	15/446 (3.4%)	46/446 (10.3%)
Standard deviation	3.8%	2.4%	4.6%
Range	0%-14%	0%-6%	0%-16%
<b>Overall Historical Incidence</b>			
Total	61/939 (6.5%)	38/939 (4.1%)	97/939 (10.3%)
Standard deviation	3.2%	3.2%	3.7%
Range	0%-14%	0%-12%	0%-16%

<sup>a</sup> Data as of 12 May 1995

**TABLE D5**  
**Summary of the Incidence of Nonneoplastic Lesions in Female Mice in the 2-Year Inhalation Study of Molybdenum Trioxide<sup>a</sup>**

	0 mg/m <sup>3</sup>	10 mg/m <sup>3</sup>	30 mg/m <sup>3</sup>	100 mg/m <sup>3</sup>
<b>Disposition Summary</b>				
Animals initially in study	50	50	50	50
Early deaths				
Accidental deaths		1	1	
Moribund	17	12	14	10
Natural deaths	8	6	2	5
Survivors				
Died last week of study	1		2	
Terminal sacrifice	24	31	31	35
Animals examined microscopically	50	50	50	50
<b>Alimentary System</b>				
Esophagus	(50)	(50)	(49)	(50)
Inflammation		2 (4%)	1 (2%)	
Epithelium, hyperplasia			1 (2%)	
Gallbladder	(40)	(44)	(46)	(41)
Cyst				1 (2%)
Inflammation, suppurative	1 (3%)			1 (2%)
Intestine small, duodenum	(43)	(46)	(47)	(46)
Epithelium, hyperplasia				1 (2%)
Peyer's patch, hyperplasia			1 (2%)	
Intestine small, jejunum	(44)	(45)	(47)	(46)
Epithelium, hyperplasia				1 (2%)
Peyer's patch, hyperplasia				2 (4%)
Intestine small, ileum	(45)	(45)	(47)	(46)
Peyer's patch, hyperplasia	1 (2%)			
Liver	(50)	(50)	(50)	(49)
Angiectasis	1 (2%)			1 (2%)
Basophilic focus		1 (2%)		1 (2%)
Degeneration, fatty		1 (2%)		1 (2%)
Eosinophilic focus	5 (10%)	15 (30%)	12 (24%)	4 (8%)
Hematopoietic cell proliferation	2 (4%)		3 (6%)	2 (4%)
Hepatodiaphragmatic nodule	1 (2%)			
Inflammation, chronic		1 (2%)	1 (2%)	1 (2%)
Mixed cell focus		1 (2%)		
Necrosis	5 (10%)	3 (6%)	2 (4%)	3 (6%)
Vacuolization cytoplasmic	1 (2%)		1 (2%)	
Bile duct, cyst	2 (4%)		1 (2%)	1 (2%)
Centrilobular, degeneration		1 (2%)	2 (4%)	1 (2%)
Centrilobular, hypertrophy			2 (4%)	
Mesentery	(4)	(9)	(9)	(7)
Artery, inflammation, chronic			1 (11%)	
Fat, necrosis	3 (75%)	8 (89%)	5 (56%)	7 (100%)
Pancreas	(50)	(49)	(48)	(46)
Atrophy	3 (6%)	2 (4%)	4 (8%)	6 (13%)
Basophilic focus		1 (2%)		1 (2%)
Hyperplasia	1 (2%)	2 (4%)		
Hypertrophy		1 (2%)	1 (2%)	1 (2%)
Inflammation, chronic	1 (2%)			
Duct, cyst		1 (2%)		2 (4%)

<sup>a</sup> Number of animals examined microscopically at the site and the number of animals with lesion

**TABLE D5**  
**Summary of the Incidence of Nonneoplastic Lesions in Female Mice in the 2-Year Inhalation Study**  
**of Molybdenum Trioxide** (continued)

	0 mg/m <sup>3</sup>	10 mg/m <sup>3</sup>	30 mg/m <sup>3</sup>	100 mg/m <sup>3</sup>
<b>Alimentary System</b> (continued)				
Stomach, forestomach	(50)	(50)	(49)	(47)
Diverticulum				1 (2%)
Inflammation		1 (2%)	1 (2%)	1 (2%)
Inflammation, suppurative				1 (2%)
Ulcer	2 (4%)			
Epithelium, hyperplasia	1 (2%)	3 (6%)	1 (2%)	3 (6%)
Stomach, glandular	(49)	(49)	(47)	(46)
Inflammation, chronic		1 (2%)		
Necrosis	1 (2%)			
Epithelium, hyperplasia	1 (2%)	1 (2%)		
Tooth	(2)			
Developmental malformation	1 (50%)			
<b>Cardiovascular System</b>				
Blood vessel	(2)			
Inflammation, chronic	1 (50%)			
Mineralization	1 (50%)			
Heart	(50)	(50)	(49)	(49)
Cardiomyopathy	39 (78%)	42 (84%)	43 (88%)	43 (88%)
Mineralization	2 (4%)		1 (2%)	
Artery, inflammation				1 (2%)
<b>Endocrine System</b>				
Adrenal cortex	(50)	(50)	(49)	(49)
Hematopoietic cell proliferation			2 (4%)	
Hyperplasia	1 (2%)	3 (6%)	1 (2%)	2 (4%)
Hypertrophy	5 (10%)	3 (6%)	4 (8%)	6 (12%)
Adrenal medulla	(50)	(49)	(49)	(49)
Hyperplasia	4 (8%)	5 (10%)	6 (12%)	3 (6%)
Islets, pancreatic	(50)	(49)	(48)	(46)
Hyperplasia	4 (8%)	2 (4%)	1 (2%)	
Parathyroid gland	(31)	(39)	(37)	(33)
Hyperplasia		1 (3%)		
Pituitary gland	(49)	(48)	(48)	(49)
Pars distalis, hyperplasia	13 (27%)	23 (48%)	15 (31%)	17 (35%)
Pars intermedia, hyperplasia	1 (2%)	3 (6%)	1 (2%)	
Thyroid gland	(50)	(50)	(49)	(49)
Inflammation, chronic				1 (2%)
Follicular cell, hyperplasia	15 (30%)	16 (32%)	14 (29%)	18 (37%)
<b>General Body System</b>				
None				

**TABLE D5**  
**Summary of the Incidence of Nonneoplastic Lesions in Female Mice in the 2-Year Inhalation Study**  
**of Molybdenum Trioxide** (continued)

	0 mg/m <sup>3</sup>	10 mg/m <sup>3</sup>	30 mg/m <sup>3</sup>	100 mg/m <sup>3</sup>
<b>Genital System</b>				
Ovary	(50)	(49)	(48)	(46)
Angiectasis	1 (2%)	3 (6%)	2 (4%)	1 (2%)
Atrophy	5 (10%)	5 (10%)	6 (13%)	4 (9%)
Cyst	22 (44%)	15 (31%)	16 (33%)	11 (24%)
Degeneration, fatty			1 (2%)	
Hemorrhage	1 (2%)			
Hyperplasia	1 (2%)	1 (2%)	1 (2%)	
Inflammation, chronic		1 (2%)		
Metaplasia, osseous		1 (2%)		
Thrombosis	1 (2%)			
Corpus luteum, hyperplasia		2 (4%)	1 (2%)	
Interstitial cell, hyperplasia		2 (4%)		
Uterus	(50)	(50)	(49)	(49)
Angiectasis	2 (4%)	2 (4%)	1 (2%)	3 (6%)
Hydrometra		1 (2%)	3 (6%)	4 (8%)
Hyperplasia, cystic	2 (4%)	2 (4%)	3 (6%)	1 (2%)
Inflammation, suppurative	1 (2%)		3 (6%)	3 (6%)
Thrombosis	1 (2%)			
Endometrium, hemorrhage			1 (2%)	
Endometrium, hyperplasia	1 (2%)	1 (2%)		
<b>Hematopoietic System</b>				
Bone marrow	(50)	(50)	(49)	(49)
Angiectasis	1 (2%)			
Hyperplasia	1 (2%)		4 (8%)	
Infiltration cellular, mast cell				1 (2%)
Necrosis			1 (2%)	
Lymph node	(4)	(6)	(7)	(4)
Angiectasis		1 (17%)		2 (50%)
Iliac, congestion	1 (25%)			
Iliac, hyperplasia	2 (50%)	2 (33%)	1 (14%)	1 (25%)
Lumbar, hyperplasia			1 (14%)	
Renal, congestion	1 (25%)			
Renal, hyperplasia	1 (25%)	1 (17%)		1 (25%)
Lymph node, bronchial	(41)	(32)	(36)	(31)
Hyperplasia	2 (5%)	3 (9%)	1 (3%)	4 (13%)
Lymph node, mandibular	(39)	(40)	(43)	(40)
Angiectasis	1 (3%)			
Hyperplasia	2 (5%)	7 (18%)	6 (14%)	5 (13%)
Lymph node, mesenteric	(49)	(49)	(46)	(44)
Angiectasis		1 (2%)		
Congestion	1 (2%)		1 (2%)	
Hyperplasia	4 (8%)	8 (16%)	5 (11%)	5 (11%)
Lymph node, mediastinal	(41)	(41)	(40)	(41)
Hyperplasia	3 (7%)	5 (12%)	2 (5%)	4 (10%)
Spleen	(50)	(50)	(49)	(47)
Hematopoietic cell proliferation	16 (32%)	9 (18%)	18 (37%)	10 (21%)
Hyperplasia, lymphoid	5 (10%)	11 (22%)	9 (18%)	9 (19%)
Infiltration cellular, mononuclear cell				1 (2%)
Thymus	(40)	(35)	(40)	(37)
Atrophy	1 (3%)		1 (3%)	
Hyperplasia, lymphoid		2 (6%)	1 (3%)	1 (3%)

**TABLE D5**  
**Summary of the Incidence of Nonneoplastic Lesions in Female Mice in the 2-Year Inhalation Study**  
**of Molybdenum Trioxide** (continued)

	0 mg/m <sup>3</sup>	10 mg/m <sup>3</sup>	30 mg/m <sup>3</sup>	100 mg/m <sup>3</sup>
<b>Integumentary System</b>				
Mammary gland	(49)	(49)	(49)	(50)
Hyperplasia		2 (4%)	1 (2%)	
Skin	(50)	(50)	(49)	(50)
Inflammation, chronic active				1 (2%)
Inflammation, focal, granulomatous				1 (2%)
<b>Musculoskeletal System</b>				
Bone	(50)	(50)	(50)	(50)
Fibrous osteodystrophy	25 (50%)	17 (34%)	19 (38%)	26 (52%)
Fracture	1 (2%)		1 (2%)	
<b>Nervous System</b>				
Brain	(50)	(50)	(49)	(49)
Gliosis	1 (2%)			
Necrosis	1 (2%)			1 (2%)
Meninges, inflammation, chronic	3 (6%)	3 (6%)	2 (4%)	3 (6%)
<b>Respiratory System</b>				
Larynx	(49)	(50)	(49)	(50)
Hyperplasia	1 (2%)	1 (2%)	7 (14%)	35 (70%)
Necrosis			1 (2%)	1 (2%)
Epiglottis, hyperplasia		6 (12%)	1 (2%)	
Epiglottis, metaplasia	1 (2%)			
Epiglottis, metaplasia, squamous	1 (2%)	36 (72%)	43 (88%)	49 (98%)
Epiglottis, necrosis			2 (4%)	1 (2%)
Lung	(50)	(50)	(49)	(49)
Hemorrhage		1 (2%)		
Infiltration cellular, histiocyte	5 (10%)	3 (6%)	2 (4%)	6 (12%)
Alveolar epithelium, hyperplasia	1 (2%)	3 (6%)	3 (6%)	6 (12%)
Alveolar epithelium, metaplasia	2 (4%)	26 (52%)	39 (80%)	46 (94%)
Perivascular, infiltration cellular				2 (4%)
Nose	(49)	(50)	(49)	(49)
Hemorrhage		1 (2%)	1 (2%)	
Inflammation, suppurative	8 (16%)	6 (12%)	6 (12%)	16 (33%)
Metaplasia, squamous			1 (2%)	2 (4%)
Nasolacrimal duct, inflammation, suppurative				1 (2%)
Olfactory epithelium, atrophy	5 (10%)	1 (2%)	4 (8%)	4 (8%)
Olfactory epithelium, degeneration, hyaline	22 (45%)	14 (28%)	14 (29%)	36 (73%)
Respiratory epithelium, degeneration, hyaline	26 (53%)	23 (46%)	28 (57%)	48 (98%)
Respiratory epithelium, necrosis	1 (2%)			
<b>Special Senses System</b>				
Eye			(1)	
Retrolbulbar, inflammation, suppurative			1 (100%)	

**TABLE D5**  
**Summary of the Incidence of Nonneoplastic Lesions in Female Mice in the 2-Year Inhalation Study**  
**of Molybdenum Trioxide** (continued)

	0 mg/m <sup>3</sup>	10 mg/m <sup>3</sup>	30 mg/m <sup>3</sup>	100 mg/m <sup>3</sup>
<b>Urinary System</b>				
Kidney	(50)	(50)	(49)	(47)
Atrophy		1 (2%)		
Hydronephrosis		1 (2%)	1 (2%)	
Metaplasia, osseous	1 (2%)	2 (4%)	2 (4%)	2 (4%)
Nephropathy	31 (62%)	30 (60%)	32 (65%)	29 (62%)
Renal tubule, degeneration			2 (4%)	
Renal tubule, hyperplasia			1 (2%)	
Renal tubule, necrosis	1 (2%)			1 (2%)
Transitional epithelium, hyperplasia	1 (2%)			
Urinary bladder	(48)	(50)	(49)	(46)
Inflammation, chronic			1 (2%)	





## APPENDIX E

# GENETIC TOXICOLOGY

<i>SALMONELLA</i> MUTAGENICITY TEST PROTOCOL .....	214
CHINESE HAMSTER OVARY CELL CYTOGENETICS PROTOCOLS .....	214
RESULTS .....	215
TABLE E1 Mutagenicity of Molybdenum Trioxide in <i>Salmonella typhimurium</i> .....	216
TABLE E2 Induction of Sister Chromatid Exchanges in Chinese Hamster Ovary Cells by Molybdenum Trioxide .....	218
TABLE E3 Induction of Chromosomal Aberrations in Chinese Hamster Ovary Cells by Molybdenum Trioxide .....	220

## GENETIC TOXICOLOGY

### **SALMONELLA MUTAGENICITY TEST PROTOCOL**

Testing was performed as reported by Zeiger *et al.* (1992). Molybdenum trioxide was sent to the laboratory as a coded aliquot from Radian Corporation (Austin, TX). It was incubated with the *Salmonella typhimurium* tester strains TA97, TA98, TA100, TA1535, and TA1537, either in buffer or S9 mix (metabolic activation enzymes and cofactors from Aroclor 1254-induced male Sprague-Dawley rat or Syrian hamster liver) for 20 minutes at 37° C. Top agar supplemented with *l*-histidine and *d*-biotin was added, and the contents of the tubes were mixed and poured onto the surfaces of minimal glucose agar plates. Histidine-independent mutant colonies arising on these plates were counted following incubation for 2 days at 37° C.

Each trial consisted of triplicate plates of concurrent positive and negative controls and five doses of molybdenum trioxide. The high dose was limited by experimental design to 10,000 µg/plate.

In this assay, a positive response is defined as a reproducible, dose-related increase in histidine-independent (revertant) colonies in any one strain/activation combination. An equivocal response is defined as an increase in revertants which is not dose related, not reproducible, or not of sufficient magnitude to support a determination of mutagenicity. A negative response is obtained when no increase in revertant colonies is observed following chemical treatment. There is no minimum percentage or fold increase required for a chemical to be judged positive or weakly positive.

### **CHINESE HAMSTER OVARY CELL CYTOGENETICS PROTOCOLS**

Testing was performed as reported by Galloway *et al.* (1987). Molybdenum trioxide was sent to the laboratory as a coded aliquot by Radian Corporation. It was tested in cultured Chinese hamster ovary (CHO) cells for induction of sister chromatid exchanges (SCEs) and chromosomal aberrations (Abs), both in the presence and absence of Aroclor 1254-induced male Sprague-Dawley rat liver S9 and cofactor mix. Cultures were handled under gold lights to prevent photolysis of bromodeoxyuridine-substituted DNA. Each test consisted of concurrent solvent and positive controls and of at least three doses of molybdenum trioxide; the high dose was limited by toxicity. A single flask per dose was used, and all trials were repeated.

**Sister Chromatid Exchange Test:** In the SCE test without S9, CHO cells were incubated for 26 hours with molybdenum trioxide in supplemented McCoy's 5A medium. Bromodeoxyuridine (BrdU) was added 2 hours after culture initiation. After 26 hours, the medium containing molybdenum trioxide was removed and replaced with fresh medium plus BrdU and Colcemid, and incubation was continued for 2 hours. Cells were then harvested by mitotic shake-off, fixed, and stained with Hoechst 33258 and Giemsa. In the SCE test with S9, cells were incubated with molybdenum trioxide, serum-free medium, and S9 for 2 hours. The medium was then removed and replaced with medium containing serum and BrdU and no molybdenum trioxide, and incubation proceeded for an additional 26 hours, with Colcemid present for the final 2 hours. Harvesting and staining were the same as for cells treated without S9. All slides were scored blind, and those from a single test were read by the same person. Fifty second-division metaphase cells were scored for frequency of SCEs per cell from each dose level.

Statistical analyses were conducted on the slopes of the dose-response curves and the individual dose points (Galloway *et al.*, 1987). An SCE frequency 20% above the concurrent solvent control value was chosen as a statistically conservative positive response. The probability of this level of difference occurring by chance at one dose point is less than 0.01; the probability for such a chance occurrence at two dose points is less than 0.001. An increase of 20% or greater at any single dose was considered weak evidence of activity; increases at two or more doses resulted in a determination that the trial was positive. A highly significant trend ( $P \leq 0.005$ ) in the absence of any responses reaching 20% above background led to a call of equivocal.

**Chromosomal Aberrations Test:** In the Abs test without S9, cells were incubated in McCoy's 5A medium with molybdenum trioxide for 8.5 hours; Colcemid was added and incubation continued for 2 hours. The cells were then harvested by mitotic shake-off, fixed, and stained with Giemsa. For the Abs test with S9, cells were treated with molybdenum trioxide and S9 for 2 hours, after which the treatment medium was removed and the cells were incubated for 8 to 11 hours in fresh medium, with Colcemid present for the final 2 hours. Cells were harvested in the same manner as for the treatment without S9.

Cells were selected for scoring on the basis of good morphology and completeness of karyotype ( $21 \pm 2$  chromosomes). All slides were scored blind, and those from a single test were read by the same person. One hundred first-division metaphase cells were scored at each dose level. Classes of aberrations included simple (breaks and terminal deletions), complex (rearrangements and translocations), and other (pulverized cells, despiralized chromosomes, and cells containing 10 or more aberrations).

Chromosomal aberration data are presented as percentage of cells with aberrations. To arrive at a statistical call for a trial, analyses were conducted on both the dose response curve and individual dose points. For a single trial, a statistically significant ( $P \leq 0.05$ ) difference for one dose point and a significant trend ( $P \leq 0.015$ ) were considered weak evidence for a positive response; significant differences for two or more doses indicated the trial was positive. A positive trend in the absence of a statistically significant increase at any one dose resulted in an equivocal call (Galloway *et al.*, 1987). Ultimately, the trial calls were based on a consideration of the statistical analyses as well as the biological information available to the reviewers.

## RESULTS

Molybdenum trioxide (10-10,000  $\mu\text{g}/\text{plate}$ ) did not induce mutations in any of the *Salmonella typhimurium* strains tested (TA97, TA98, TA100, TA1535, and TA1537), with or without induced hamster or rat liver S9 (Zeiger *et al.*, 1992; Table E1). Negative results were also obtained with molybdenum trioxide in cytogenetic tests with cultured CHO cells. No induction of SCEs (Table E2) or Abs (Table E3) was observed, with or without S9.

**TABLE E1**  
**Mutagenicity of Molybdenum Trioxide in *Salmonella typhimurium*<sup>a</sup>**

Strain	Dose ( $\mu\text{g}/\text{plate}$ )	Revertants/plate <sup>b</sup>					
		-S9		+ hamster S9		+ rat S9	
		Trial 1	Trial 2	10%	30%	10%	30%
TA100	0	122 $\pm$ 21.0	125 $\pm$ 8.4	153 $\pm$ 6.4	152 $\pm$ 13.7	148 $\pm$ 14.7	117 $\pm$ 12.7
	100	119 $\pm$ 15.2	143 $\pm$ 2.6	158 $\pm$ 7.1	154 $\pm$ 14.1	127 $\pm$ 7.5	168 $\pm$ 13.6
	333	133 $\pm$ 5.0	133 $\pm$ 10.3	135 $\pm$ 10.2	147 $\pm$ 12.0	139 $\pm$ 11.9	161 $\pm$ 17.4
	1,000	120 $\pm$ 8.0	131 $\pm$ 3.5	126 $\pm$ 1.5	156 $\pm$ 1.7	139 $\pm$ 2.3	161 $\pm$ 20.7
	3,333	115 $\pm$ 15.4	116 $\pm$ 11.3	135 $\pm$ 24.0	142 $\pm$ 6.7	120 $\pm$ 3.7	125 $\pm$ 10.4
	10,000	114 $\pm$ 13.6	73 $\pm$ 4.3	112 $\pm$ 8.1	146 $\pm$ 13.3	96 $\pm$ 3.5	116 $\pm$ 4.4
	Trial summary	Negative	Negative	Negative	Negative	Negative	Negative
Positive control <sup>c</sup>	409 $\pm$ 4.5	465 $\pm$ 18.0	658 $\pm$ 30.9	958 $\pm$ 21.0	486 $\pm$ 16.3	774 $\pm$ 31.2	
TA1535	0	18 $\pm$ 2.5	20 $\pm$ 2.6	8 $\pm$ 1.2	11 $\pm$ 3.8	8 $\pm$ 0.7	8 $\pm$ 2.2
	33		16 $\pm$ 0.3	9 $\pm$ 1.5		10 $\pm$ 1.2	
	100	12 $\pm$ 2.5	18 $\pm$ 2.6	10 $\pm$ 1.5	14 $\pm$ 0.6	10 $\pm$ 2.0	8 $\pm$ 1.2
	333	16 $\pm$ 0.9	16 $\pm$ 2.0	7 $\pm$ 0.6	7 $\pm$ 1.5	8 $\pm$ 3.2	12 $\pm$ 2.3
	1,000	15 $\pm$ 1.8	15 $\pm$ 1.8	10 $\pm$ 3.5	7 $\pm$ 0.9	9 $\pm$ 1.2	12 $\pm$ 1.2
	3,333	13 $\pm$ 2.2	11 $\pm$ 2.2	4 $\pm$ 0.6	4 $\pm$ 1.2	6 $\pm$ 0.9	9 $\pm$ 1.8
	10,000	4 $\pm$ 1.2			4 $\pm$ 0.9		3 $\pm$ 0.0
Trial summary	Negative	Negative	Negative	Negative	Negative	Negative	
Positive control	427 $\pm$ 11.8	439 $\pm$ 8.6	174 $\pm$ 7.7	505 $\pm$ 19.3	102 $\pm$ 2.2	194 $\pm$ 10.4	
		Revertants/plate					
		-S9		+ 30% hamster S9		+ 30% rat S9	
				Trial 1	Trial 2		
TA1537	0	7 $\pm$ 1.0		11 $\pm$ 1.3	9 $\pm$ 0.9	11 $\pm$ 1.7	
	10				13 $\pm$ 2.3		
	33				11 $\pm$ 1.0		
	100	5 $\pm$ 2.0		10 $\pm$ 1.5	9 $\pm$ 3.4	12 $\pm$ 1.8	
	333	7 $\pm$ 1.7		9 $\pm$ 0.7	8 $\pm$ 1.8	7 $\pm$ 0.6	
	1,000	8 $\pm$ 1.9		4 $\pm$ 1.2	8 $\pm$ 0.9	6 $\pm$ 1.0	
	3,333	5 $\pm$ 0.7		1 $\pm$ 0.9		5 $\pm$ 0.7	
10,000	1 $\pm$ 0.3		1 $\pm$ 0.6		1 $\pm$ 0.7		
Trial summary	Negative		Negative	Negative	Negative		
Positive control	214 $\pm$ 51.6		53 $\pm$ 2.1	46 $\pm$ 1.5	44 $\pm$ 6.4		

**TABLE E1**  
**Mutagenicity of Molybdenum Trioxide in *Salmonella typhimurium*** (continued)

Strain	Dose ( $\mu\text{g}/\text{plate}$ )	Revertants/plate						
		-S9		+ hamster S9		+ rat S9		
		Trial 1	Trial 2	10%	30%	10%	30%	30%
TA97	0	146 $\pm$ 4.3	138 $\pm$ 12.6	138 $\pm$ 7.4	152 $\pm$ 21.7	121 $\pm$ 12.7	124 $\pm$ 14.7	207 $\pm$ 4.7
	33		111 $\pm$ 1.0	111 $\pm$ 8.7		144 $\pm$ 5.4		210 $\pm$ 5.9
	100	137 $\pm$ 1.5	126 $\pm$ 6.4	155 $\pm$ 2.5	165 $\pm$ 9.0	156 $\pm$ 4.4	135 $\pm$ 15.5	208 $\pm$ 22.0
	333	147 $\pm$ 9.2	123 $\pm$ 10.5	158 $\pm$ 4.9	168 $\pm$ 7.9	149 $\pm$ 10.8	164 $\pm$ 12.9	211 $\pm$ 2.3
	1,000	123 $\pm$ 7.1	93 $\pm$ 6.3	141 $\pm$ 9.7	174 $\pm$ 16.0	130 $\pm$ 17.1	113 $\pm$ 15.0	170 $\pm$ 14.0
	3,333	113 $\pm$ 8.1	5 $\pm$ 1.0	55 $\pm$ 8.7	105 $\pm$ 33.7	69 $\pm$ 7.1	29 $\pm$ 4.4	41 $\pm$ 22.8
	10,000	3 $\pm$ 0.9			6 $\pm$ 4.3		7 $\pm$ 1.7	
Trial summary		Negative	Negative	Negative	Negative	Negative	Negative	Negative
Positive control		569 $\pm$ 20.9	358 $\pm$ 11.5	343 $\pm$ 12.8	394 $\pm$ 12.2	316 $\pm$ 2.6	405 $\pm$ 10.8	404 $\pm$ 1.7

	Dose ( $\mu\text{g}/\text{plate}$ )	Revertants/plate					
		-S9		+ hamster S9		+ rat S9	
		Trial 1	Trial 2	10%	30%	10%	30%
TA98	0	20 $\pm$ 1.2	20 $\pm$ 1.5	24 $\pm$ 2.7	27 $\pm$ 3.0	28 $\pm$ 4.0	35 $\pm$ 1.5
	100	21 $\pm$ 2.2	19 $\pm$ 1.5	35 $\pm$ 7.3	30 $\pm$ 1.5	30 $\pm$ 5.8	34 $\pm$ 1.5
	333	16 $\pm$ 2.4	14 $\pm$ 3.7	33 $\pm$ 3.5	30 $\pm$ 1.7	32 $\pm$ 3.5	30 $\pm$ 4.7
	1,000	18 $\pm$ 1.3	19 $\pm$ 1.2	29 $\pm$ 4.5	28 $\pm$ 0.7	25 $\pm$ 2.6	25 $\pm$ 2.7
	3,333	16 $\pm$ 1.3	15 $\pm$ 1.5	28 $\pm$ 2.1	18 $\pm$ 1.5	29 $\pm$ 4.0	26 $\pm$ 5.0
	10,000	20 $\pm$ 2.4	10 $\pm$ 2.2	29 $\pm$ 3.5	14 $\pm$ 2.9	25 $\pm$ 3.5	21 $\pm$ 3.8
Trial summary		Negative	Negative	Negative	Negative	Negative	Negative
Positive control		644 $\pm$ 14.7	442 $\pm$ 7.2	434 $\pm$ 11.9	509 $\pm$ 17.6	280 $\pm$ 23.7	172 $\pm$ 3.8

<sup>a</sup> Study performed at SRI International. The detailed protocol and these data are presented in Zeiger *et al.* (1992); 0  $\mu\text{g}/\text{plate}$  is the solvent control.

<sup>b</sup> Revertants are presented as mean  $\pm$  standard error from three plates.

<sup>c</sup> The positive controls in the absence of metabolic activation were sodium azide (TA1535 and TA100), 9-aminoacridine (TA97 and TA1537), and 4-nitro-*o*-phenylenediamine (TA98). The positive control for metabolic activation with all strains was 2-aminoanthracene.

**TABLE E2**  
**Induction of Sister Chromatid Exchanges in Chinese Hamster Ovary Cells by Molybdenum Trioxide<sup>a</sup>**

Compound	Dose (µg/mL)	Total Cells	No. of Chromosomes	No. of SCEs	SCEs/Chromosome	SCEs/Cell	Hrs in BrdU	Relative Change of SCEs/Chromosome <sup>b</sup> (%)
<b>-S9</b>								
<b>Trial 1</b>								
Summary: Negative								
Dimethylsulfoxide		50	1,044	451	0.43	9.0	26.0	
Mitomycin-C	0.01	50	1,044	3,190	3.05	63.8	26.0	607.32
Molybdenum trioxide	0.5	50	1,031	407	0.39	8.1	26.0	-8.62
	1.6	50	1,036	435	0.41	8.7	26.0	-2.80
	5.0	50	1,042	437	0.41	8.7	26.0	-2.92
	10.0	50	1,023	413	0.40	8.3	26.0	-6.55
					P=0.674 <sup>c</sup>			
<b>Trial 2</b>								
Summary: Negative								
Dimethylsulfoxide		50	1,029	465	0.45	9.3	26.0	
Mitomycin-C	0.01	50	1,040	3,029	2.91	60.6	26.0	544.52
Molybdenum trioxide	5.0	50	1,036	476	0.45	9.5	26.0	1.67
	7.5	50	1,029	436	0.42	8.7	26.0	-6.24
	10.0	50	1,026	465	0.45	9.3	26.0	0.29
					P=0.663			

**TABLE E2**  
**Induction of Sister Chromatid Exchanges in Chinese Hamster Ovary Cells by Molybdenum Trioxide** (continued)

Compound	Dose ( $\mu\text{g/mL}$ )	Total Cells	No. of Chromo- somes	No. of SCEs	SCEs/ Chromo- some	SCEs/ Cell	Hrs in BrdU	Relative Change of SCEs/ Chromosome (%)
<b>+S9</b>								
<b>Trial 1</b>								
Summary: Negative								
Dimethylsulfoxide		50	1,036	360	0.34	7.2	26.0	
Cyclophosphamide	2.0	50	1,043	1,161	1.11	23.2	26.0	220.33
Molybdenum trioxide	0.5	50	1,040	397	0.38	7.9	26.0	9.85
	1.6	50	1,042	349	0.33	7.0	26.0	-3.62
	5.0	50	1,037	341	0.32	6.8	26.0	-5.37
	10.0	50	1,037	359	0.34	7.2	26.0	-0.38
					P=0.856			
<b>Trial 2</b>								
Summary: Negative								
Dimethylsulfoxide		50	1,023	419	0.40	8.4	26.0	
Cyclophosphamide	2.0	50	1,037	1,190	1.14	23.8	26.0	180.18
Molybdenum trioxide	5.0	50	1,021	358	0.35	7.2	26.0	-14.39
	7.5	50	1,019	395	0.38	7.9	26.0	-5.36
	15.0	50	1,042	377	0.36	7.5	26.0	-11.66
					P=0.909			

<sup>a</sup> Study performed at Environmental Health Research & Testing, Inc. A detailed description of the protocol is presented by Galloway *et al.* (1987).  
 SCE=sister chromatid exchange; BrdU=bromodeoxyuridine.

<sup>b</sup> SCEs/chromosome in treated cells versus SCEs/chromosome in solvent control cells

<sup>c</sup> Significance of SCEs/chromosome tested by the linear regression trend test versus log of the dose



**TABLE E3**  
**Induction of Chromosomal Aberrations in Chinese Hamster Ovary Cells by Molybdenum Trioxide<sup>a</sup>**

-S9					+S9						
Dose (µg/mL)	Total Cells	No. of Abs	Abs/ Cell	Cells with Abs (%)	Dose (µg/mL)	Total Cells	No. of Abs	Abs/ Cell	Cells with Abs (%)		
<b>Trial 1</b> - Harvest time: 10.5 hours Summary: Negative					<b>Trial 1</b> - Harvest time: 10.0 hours Summary: Negative						
Dimethylsulfoxide	100	1	0.01	1.0	Dimethylsulfoxide	100	1	0.01	1.0		
Mitomycin-C	0.5	100	37	0.37	26.0	Cyclophosphamide	50.0	100	47	0.47	36.0
Molybdenum trioxide	0.5	100	2	0.02	2.0	Molybdenum trioxide	0.5	100	1	0.01	1.0
	1.6	100	3	0.03	2.0		1.6	100	1	0.01	1.0
	5.0	100	3	0.03	3.0		5.0	100	0	0.00	0.0
	7.0	100	1	0.01	1.0		10.0	100	1	0.01	1.0
	10.0	100	6	0.06	6.0						
P=0.061 <sup>b</sup>					P=0.661						
<b>Trial 2</b> - Harvest time: 10.5 hours Summary: Negative					<b>Trial 2</b> - Harvest time: 10.0 hours Summary: Negative						
Dimethylsulfoxide	100	3	0.03	3.0	Dimethylsulfoxide	100	4	0.04	4.0		
Mitomycin-C	0.5	100	33	0.33	25.0	Cyclophosphamide	50.0	100	56	0.56	39.0
Molybdenum trioxide	5.0	100	3	0.03	3.0	Molybdenum trioxide	5.0	100	1	0.01	1.0
	7.5	100	4	0.04	4.0		7.5	100	2	0.02	2.0
	10.0	100	4	0.04	4.0		10.0	100	2	0.02	2.0
P=0.309					P=0.774						
<b>Trial 3</b> - Harvest time: 13.0 hours Summary: Negative					<b>Trial 3</b> - Harvest time: 13.0 hours Summary: Negative						
Dimethylsulfoxide	100	1	0.01	1.0	Dimethylsulfoxide	100	1	0.01	1.0		
Cyclophosphamide	15.0	100	32	0.32	28.0	Cyclophosphamide	15.0	100	32	0.32	28.0
	50.0	50	42	0.84	46.0		50.0	50	42	0.84	46.0
Molybdenum trioxide	1.6	100	3	0.03	3.0	Molybdenum trioxide	1.6	100	3	0.03	3.0
	5.0	100	1	0.01	1.0		5.0	100	1	0.01	1.0
	7.5	100	3	0.03	3.0		7.5	100	3	0.03	3.0
	10.0	100	1	0.01	1.0		10.0	100	1	0.01	1.0
P=0.505					P=0.505						

<sup>a</sup> Study performed at Environmental Health Research & Testing, Inc. The detailed protocol is presented in Galloway *et al.* (1987).  
 Abs=aberrations.

<sup>b</sup> Significance of percent cells with aberrations tested by the linear regression trend test versus log of the dose

## **APPENDIX F**

### **ORGAN WEIGHTS AND ORGAN-WEIGHT-TO-BODY-WEIGHT RATIOS**

<b>TABLE F1</b>	<b>Organ Weights and Organ-Weight-to-Body-Weight Ratios for Rats in the 13-Week Inhalation Study of Molybdenum Trioxide .....</b>	<b>222</b>
<b>TABLE F2</b>	<b>Organ Weights and Organ-Weight-to-Body-Weight Ratios for Mice in the 13-Week Inhalation Study of Molybdenum Trioxide .....</b>	<b>223</b>

**TABLE F1**  
**Organ Weights and Organ-Weight-to-Body-Weight Ratios for Rats in the 13-Week Inhalation Study of Molybdenum Trioxide<sup>a</sup>**

	0 mg/m <sup>3</sup>	1 mg/m <sup>3</sup>	3 mg/m <sup>3</sup>	10 mg/m <sup>3</sup>	30 mg/m <sup>3</sup>	100 mg/m <sup>3</sup>
n	10	10	10	10	10	10
<b>Male</b>						
Necropsy body wt	312 ± 7	314 ± 6	315 ± 6	300 ± 13	320 ± 5	313 ± 7
Brain						
Absolute	1.885 ± 0.012	1.906 ± 0.016 <sup>b</sup>	1.882 ± 0.028	1.917 ± 0.015	1.915 ± 0.015	1.895 ± 0.019
Relative	6.06 ± 0.12	6.17 ± 0.13 <sup>b</sup>	5.99 ± 0.11	6.50 ± 0.29	5.99 ± 0.09	6.07 ± 0.09
Heart						
Absolute	0.963 ± 0.018	0.956 ± 0.038	0.980 ± 0.052	0.955 ± 0.023	0.992 ± 0.027	0.956 ± 0.021
Relative	3.09 ± 0.03	3.05 ± 0.10	3.10 ± 0.12	3.24 ± 0.17	3.10 ± 0.07	3.06 ± 0.07
R. Kidney						
Absolute	1.015 ± 0.020	1.033 ± 0.027	1.017 ± 0.025	1.027 ± 0.033	1.045 ± 0.021	1.037 ± 0.021
Relative	3.26 ± 0.03	3.29 ± 0.07	3.23 ± 0.04	3.47 ± 0.16	3.26 ± 0.04	3.32 ± 0.06
Liver						
Absolute	8.238 ± 0.210	8.201 ± 0.202	8.332 ± 0.176	8.572 ± 0.308	8.340 ± 0.182	8.479 ± 0.287
Relative	26.41 ± 0.39	26.13 ± 0.28	26.48 ± 0.24	29.04 ± 1.66	26.02 ± 0.29	27.02 ± 0.45
Lung						
Absolute	1.191 ± 0.022	1.315 ± 0.049*	1.259 ± 0.045 <sup>b</sup>	1.218 ± 0.034	1.227 ± 0.026	1.255 ± 0.015
Relative	3.82 ± 0.05	4.19 ± 0.13	4.02 ± 0.08 <sup>b</sup>	4.11 ± 0.17	3.83 ± 0.04	4.02 ± 0.07
R. Testis						
Absolute	1.519 ± 0.021	1.507 ± 0.013	1.544 ± 0.022	1.548 ± 0.014	1.568 ± 0.033	1.466 ± 0.073
Relative	4.88 ± 0.06	4.82 ± 0.06	4.92 ± 0.08	5.26 ± 0.25	4.92 ± 0.17	4.72 ± 0.28
Thymus						
Absolute	0.302 ± 0.011	0.282 ± 0.011	0.270 ± 0.014	0.297 ± 0.014	0.321 ± 0.011	0.304 ± 0.014
Relative	0.97 ± 0.03	0.90 ± 0.03	0.86 ± 0.05	1.02 ± 0.08	1.00 ± 0.04	0.97 ± 0.05
<b>Female</b>						
Necropsy body wt	182 ± 2	180 ± 3	184 ± 2	173 ± 2	179 ± 3	181 ± 3
Brain						
Absolute	1.793 ± 0.014	1.764 ± 0.017	1.792 ± 0.013	1.767 ± 0.011	1.803 ± 0.024	1.779 ± 0.014
Relative	9.87 ± 0.15	9.80 ± 0.18	9.77 ± 0.13	10.23 ± 0.14	10.07 ± 0.16	9.85 ± 0.13
Heart						
Absolute	0.615 ± 0.014	0.613 ± 0.020	0.631 ± 0.030	0.583 ± 0.014	0.580 ± 0.016	0.608 ± 0.012
Relative	3.38 ± 0.06	3.39 ± 0.08	3.43 ± 0.15	3.37 ± 0.07	3.23 ± 0.06	3.37 ± 0.08
R. Kidney						
Absolute	0.601 ± 0.008	0.597 ± 0.011	0.576 ± 0.013	0.566 ± 0.012	0.591 ± 0.013	0.592 ± 0.014
Relative	3.31 ± 0.04	3.31 ± 0.06	3.14 ± 0.08	3.27 ± 0.07	3.29 ± 0.05	3.27 ± 0.06
Liver						
Absolute	4.472 ± 0.072	4.448 ± 0.081	4.651 ± 0.081	4.259 ± 0.078	4.415 ± 0.046	4.575 ± 0.068
Relative	24.58 ± 0.20	24.66 ± 0.26	25.32 ± 0.33	24.62 ± 0.35	24.65 ± 0.33	25.31 ± 0.35
Lung						
Absolute	0.923 ± 0.029	0.902 ± 0.025	0.971 ± 0.061 <sup>b</sup>	0.889 ± 0.034	0.912 ± 0.025	0.943 ± 0.026
Relative	5.07 ± 0.14	5.00 ± 0.12	5.26 ± 0.30 <sup>b</sup>	5.14 ± 0.19	5.09 ± 0.15	5.21 ± 0.12
Thymus						
Absolute	0.230 ± 0.009	0.215 ± 0.011	0.236 ± 0.008	0.220 ± 0.008	0.237 ± 0.006	0.230 ± 0.013
Relative	1.26 ± 0.04	1.20 ± 0.07	1.29 ± 0.05	1.28 ± 0.06	1.32 ± 0.04	1.27 ± 0.07

\* Significantly different (P<0.05) from the control group by Dunnett's test

<sup>a</sup> Organ weights (absolute weights) and body weights are given in grams; organ-weight-to-body-weight ratios (relative weights) are given as mg organ weight/g body weight (mean ± standard error).

<sup>b</sup> n=9

**TABLE F2**  
**Organ Weights and Organ-Weight-to-Body-Weight Ratios for Mice in the 13-Week Inhalation Study of Molybdenum Trioxide<sup>a</sup>**

	0 mg/m <sup>3</sup>	1 mg/m <sup>3</sup>	3 mg/m <sup>3</sup>	10 mg/m <sup>3</sup>	30 mg/m <sup>3</sup>	100 mg/m <sup>3</sup>
n	10	10	10	10	10	10
<b>Male</b>						
Necropsy body wt	30.1 ± 0.6	30.0 ± 0.5	30.7 ± 0.4	30.6 ± 0.4	29.6 ± 0.6	29.8 ± 0.4
Brain						
Absolute	0.467 ± 0.005	0.461 ± 0.007	0.461 ± 0.008	0.456 ± 0.006	0.465 ± 0.008	0.466 ± 0.006
Relative	15.59 ± 0.35	15.40 ± 0.21	15.04 ± 0.16	14.95 ± 0.25	15.76 ± 0.40	15.66 ± 0.26
Heart						
Absolute	0.189 ± 0.007	0.171 ± 0.006	0.172 ± 0.007	0.184 ± 0.010	0.185 ± 0.006	0.189 ± 0.008
Relative	6.29 ± 0.19	5.70 ± 0.17	5.60 ± 0.21	6.01 ± 0.26	6.25 ± 0.17	6.35 ± 0.28
R. Kidney						
Absolute	0.311 ± 0.006	0.294 ± 0.014	0.294 ± 0.022	0.299 ± 0.012	0.319 ± 0.014	0.309 ± 0.007
Relative	10.35 ± 0.14	9.80 ± 0.38	9.57 ± 0.69	9.80 ± 0.40	10.74 ± 0.32	10.39 ± 0.26
Liver						
Absolute	1.587 ± 0.056	1.537 ± 0.057	1.551 ± 0.035	1.616 ± 0.082	1.599 ± 0.060	1.646 ± 0.037
Relative	52.72 ± 1.19	51.26 ± 1.50	50.66 ± 1.24	52.84 ± 2.47	53.89 ± 1.26	55.37 ± 1.61
Lung						
Absolute	0.171 ± 0.004	0.181 ± 0.009	0.195 ± 0.003*	0.179 ± 0.005	0.186 ± 0.006	0.178 ± 0.006
Relative	5.70 ± 0.14	6.03 ± 0.27	6.37 ± 0.13	5.86 ± 0.13	6.31 ± 0.24	5.97 ± 0.19
R. Testis						
Absolute	0.117 ± 0.005	0.116 ± 0.005	0.120 ± 0.004	0.117 ± 0.004	0.113 ± 0.007	0.102 ± 0.006
Relative	3.91 ± 0.20	3.87 ± 0.17	3.91 ± 0.13	3.85 ± 0.15	3.84 ± 0.23	3.41 ± 0.19
Thymus						
Absolute	0.034 ± 0.002	0.031 ± 0.003	0.031 ± 0.003	0.033 ± 0.003	0.031 ± 0.003	0.033 ± 0.007
Relative	1.13 ± 0.06	1.02 ± 0.09	1.03 ± 0.12	1.07 ± 0.10	1.07 ± 0.14	1.10 ± 0.22
<b>Female</b>						
Necropsy body wt	26.7 ± 0.4	27.9 ± 0.6	27.1 ± 0.4	26.5 ± 0.3	25.9 ± 0.2	26.7 ± 0.4
Brain						
Absolute	0.474 ± 0.006	0.488 ± 0.011	0.475 ± 0.005	0.468 ± 0.005	0.471 ± 0.008	0.470 ± 0.005
Relative	17.77 ± 0.27	17.57 ± 0.45	17.60 ± 0.35	17.67 ± 0.20	18.18 ± 0.21	17.67 ± 0.29
Heart						
Absolute	0.144 ± 0.007	0.139 ± 0.005	0.141 ± 0.004	0.151 ± 0.005	0.142 ± 0.007	0.149 ± 0.004
Relative	5.40 ± 0.27	5.00 ± 0.20	5.22 ± 0.15	5.70 ± 0.17	5.49 ± 0.30	5.59 ± 0.11
R. Kidney						
Absolute	0.206 ± 0.012	0.205 ± 0.008	0.203 ± 0.006	0.199 ± 0.004	0.214 ± 0.009	0.209 ± 0.006
Relative	7.72 ± 0.44	7.40 ± 0.36	7.52 ± 0.24	7.51 ± 0.16	8.25 ± 0.30	7.84 ± 0.20
Liver						
Absolute	1.338 ± 0.043	1.352 ± 0.066	1.398 ± 0.045	1.355 ± 0.044	1.305 ± 0.037	1.387 ± 0.041
Relative	50.15 ± 1.59	48.55 ± 2.16	51.69 ± 1.45	51.07 ± 1.29	50.32 ± 1.08	51.99 ± 1.01
Lung						
Absolute	0.195 ± 0.007	0.191 ± 0.005	0.186 ± 0.006	0.184 ± 0.006	0.193 ± 0.006	0.207 ± 0.008
Relative	7.34 ± 0.35	6.88 ± 0.21	6.88 ± 0.18	6.94 ± 0.20	7.44 ± 0.18	7.77 ± 0.29
Thymus						
Absolute	0.047 ± 0.004	0.045 ± 0.002	0.046 ± 0.003	0.045 ± 0.004	0.043 ± 0.004	0.041 ± 0.004
Relative	1.76 ± 0.15	1.60 ± 0.08	1.72 ± 0.10	1.68 ± 0.14	1.64 ± 0.13	1.51 ± 0.12

\* Significantly different ( $P \leq 0.05$ ) from the control group by Dunnett's test

<sup>a</sup> Organ weights (absolute weights) and body weights are given in grams; organ-weight-to-body-weight ratios (relative weights) are given as mg organ weight/g body weight (mean ± standard error).



**APPENDIX G**  
**HEMATOLOGY, CLINICAL CHEMISTRY,**  
**AND BLOOD MOLYBDENUM**  
**CONCENTRATION RESULTS**

<b>TABLE G1</b>	<b>Hematology and Clinical Chemistry Data for Rats in the 13-Week Inhalation Study of Molybdenum Trioxide .....</b>	<b>226</b>
<b>TABLE G2</b>	<b>Blood Molybdenum Concentration Data for Rats in the 2-Year Inhalation Study of Molybdenum Trioxide .....</b>	<b>227</b>
<b>TABLE G3</b>	<b>Blood Molybdenum Concentration Data for Mice in the 2-Year Inhalation Study of Molybdenum Trioxide .....</b>	<b>227</b>

**TABLE G1**  
**Hematology and Clinical Chemistry Data for Rats in the 13-Week Inhalation Study of Molybdenum Trioxide<sup>a</sup>**

	0 mg/m <sup>3</sup>	1 mg/m <sup>3</sup>	3 mg/m <sup>3</sup>	10 mg/m <sup>3</sup>	30 mg/m <sup>3</sup>	100 mg/m <sup>3</sup>
<b>Male</b>						
n	10	10	10	10	10	10
<b>Hematology</b>						
Hematocrit (%)	47.7 ± 0.5	47.9 ± 0.9	48.3 ± 0.7	46.9 ± 0.9	47.3 ± 1.1	48.4 ± 0.9
Hemoglobin (g/dL)	16.8 ± 0.2	16.9 ± 0.1	17.0 ± 0.1	16.6 ± 0.3	16.9 ± 0.2	16.6 ± 0.1
Erythrocytes (10 <sup>6</sup> /μL)	9.21 ± 0.10	9.19 ± 0.17	9.26 ± 0.12	9.00 ± 0.15	9.06 ± 0.20	9.15 ± 0.14
Leukocytes (10 <sup>3</sup> /μL)	4.09 ± 0.29	4.29 ± 0.22	4.92 ± 0.29	4.48 ± 0.53	4.46 ± 0.18	3.99 ± 0.38
Segmented neutrophils (10 <sup>3</sup> /μL)	0.98 ± 0.12	1.04 ± 0.06	1.05 ± 0.09	0.97 ± 0.12	0.98 ± 0.11	0.99 ± 0.12
Lymphocytes (10 <sup>3</sup> /μL)	3.03 ± 0.26	3.17 ± 0.23	3.74 ± 0.27	3.44 ± 0.43	3.35 ± 0.18	2.92 ± 0.31
Monocytes (10 <sup>3</sup> /μL)	0.04 ± 0.02	0.04 ± 0.01	0.07 ± 0.02	0.04 ± 0.02	0.06 ± 0.01	0.02 ± 0.01
Eosinophils (10 <sup>3</sup> /μL)	0.04 ± 0.01	0.05 ± 0.02	0.07 ± 0.02	0.03 ± 0.01	0.06 ± 0.01	0.05 ± 0.02
<b>Clinical Chemistry</b>						
Calcium (mg/dL)	10.19 ± 0.10	10.05 ± 0.08	10.23 ± 0.07	10.10 ± 0.11	9.98 ± 0.05	10.18 ± 0.13
Inorganic phosphorus (mg/dL)	6.3 ± 0.2	6.3 ± 0.2	6.2 ± 0.2	6.6 ± 0.2	6.2 ± 0.2	6.4 ± 0.2
Alanine aminotransferase (IU/L)	37 ± 2	40 ± 4	34 ± 1	40 ± 2	39 ± 3	37 ± 4
Alkaline phosphatase (IU/L)	86 ± 2	89 ± 2	85 ± 2	82 ± 3	81 ± 1	80 ± 2
Aspartate aminotransferase (IU/L)	79 ± 4	85 ± 7	75 ± 3	82 ± 4	77 ± 4	74 ± 4
Lactate dehydrogenase (IU/L)	593 ± 52	630 ± 81	625 ± 70	625 ± 42	582 ± 43	468 ± 43
Sorbitol dehydrogenase (IU/L)	9 ± 1	10 ± 1	8 ± 0	11 ± 1	11 ± 1	10 ± 1
<b>Female</b>						
n	10	9	10	10	10	10
<b>Hematology</b>						
Hematocrit (%)	49.5 ± 0.8	48.2 ± 1.2	50.0 ± 0.7	48.8 ± 0.8	48.5 ± 1.0	47.5 ± 0.8
Hemoglobin (g/dL)	17.0 ± 0.2	16.9 ± 0.2	16.9 ± 0.2	17.1 ± 0.2	16.8 ± 0.2	16.6 ± 0.2
Erythrocytes (10 <sup>6</sup> /μL)	9.10 ± 0.14	8.92 ± 0.22	9.15 ± 0.11	8.98 ± 0.11	8.93 ± 0.17	8.66 ± 0.13
Leukocytes (10 <sup>3</sup> /μL)	3.03 ± 0.25	3.59 ± 0.28	3.00 ± 0.20	2.97 ± 0.19	3.01 ± 0.18	3.52 ± 0.44
Segmented neutrophils (10 <sup>3</sup> /μL)	0.78 ± 0.08	0.92 ± 0.10	0.80 ± 0.06	0.63 ± 0.06	0.72 ± 0.08	0.93 ± 0.13
Lymphocytes (10 <sup>3</sup> /μL)	2.18 ± 0.27	2.63 ± 0.22	2.16 ± 0.15	2.29 ± 0.16	2.21 ± 0.13	2.52 ± 0.33
Monocytes (10 <sup>3</sup> /μL)	0.04 ± 0.01	0.02 ± 0.01	0.03 ± 0.02	0.02 ± 0.01	0.03 ± 0.01	0.03 ± 0.01
Eosinophils (10 <sup>3</sup> /μL)	0.03 ± 0.01	0.02 ± 0.01	0.02 ± 0.01	0.03 ± 0.01	0.05 ± 0.01	0.04 ± 0.01
<b>Clinical Chemistry</b>						
Calcium (mg/dL)	10.03 ± 0.12	9.91 ± 0.07	10.23 ± 0.07	9.84 ± 0.10	9.83 ± 0.08	9.82 ± 0.12
Inorganic phosphorus (mg/dL)	5.5 ± 0.4	5.3 ± 0.2	5.6 ± 0.3	5.4 ± 0.3	5.3 ± 0.5	5.7 ± 0.4
Alanine aminotransferase (IU/L)	26 ± 2	25 ± 1	26 ± 1	28 ± 2	23 ± 1	25 ± 1
Alkaline phosphatase (IU/L)	67 ± 3	68 ± 2	65 ± 2	68 ± 3	69 ± 4	65 ± 4
Aspartate aminotransferase (IU/L)	68 ± 3	67 ± 1	64 ± 2	67 ± 3	60 ± 2	65 ± 2
Lactate dehydrogenase (IU/L)	447 ± 36	463 ± 31	442 ± 25	448 ± 34	439 ± 54	469 ± 43
Sorbitol dehydrogenase (IU/L)	7 ± 1	7 ± 0	6 ± 0	7 ± 1	5 ± 0*	6 ± 1

\* Significantly different (P≤0.05) from the control group by Dunn's test

<sup>a</sup> Mean ± standard error. Statistical tests were performed on unrounded data.

**TABLE G2**  
**Blood Molybdenum Concentration Data for Rats in the 2-Year Inhalation Study of Molybdenum Trioxide**<sup>a</sup>

	0 mg/m <sup>3</sup>	10 mg/m <sup>3</sup>	30 mg/m <sup>3</sup>	100 mg/m <sup>3</sup>
<b>Male</b>				
n	8 <sup>b</sup>	10	10	10
Molybdenum (µg/g)	0.221 ± 0.052	0.800 ± 0.115	1.774 ± 0.297	6.036 ± 1.102
<b>Female</b>				
n	6 <sup>b</sup>	10	10	10
Molybdenum (µg/g)	0.059 ± 0.007	0.355 ± 0.073	0.655 ± 0.103	2.411 ± 0.478

<sup>a</sup> Data are presented as mean ± standard error. No statistical analyses were performed.

<sup>b</sup> Some of the measurements from the 10 control animals were below the limit of detection (0.03 µg/g) and therefore were omitted from the mean.

**TABLE G3**  
**Blood Molybdenum Concentration Data for Mice in the 2-Year Inhalation Study of Molybdenum Trioxide**<sup>a</sup>

	0 mg/m <sup>3</sup>	10 mg/m <sup>3</sup>	30 mg/m <sup>3</sup>	100 mg/m <sup>3</sup>
<b>Male</b>				
n	0 <sup>b</sup>	6 <sup>b</sup>	10	10
Molybdenum (µg/g)	—	0.102 ± 0.010	0.208 ± 0.028	0.770 ± 0.109
<b>Female</b>				
n	1 <sup>b</sup>	6 <sup>b</sup>	10	10
Molybdenum (µg/g)	0.043	0.066 ± 0.007	0.198 ± 0.018	0.523 ± 0.025

<sup>a</sup> Data are presented as mean ± standard error. No statistical analyses were performed.

<sup>b</sup> Some or all of the measurements from the 10 animals per group were below the limit of detection (0.04 µg/g) and therefore were omitted from the mean.





## **APPENDIX H**

### **REPRODUCTIVE TISSUE EVALUATIONS**

<b>TABLE H1</b>	<b>Summary of Reproductive Tissue Evaluations for Male Rats in the 13-Week Inhalation Study of Molybdenum Trioxide .....</b>	<b>230</b>
<b>TABLE H2</b>	<b>Summary of Reproductive Tissue Evaluations for Male Mice in the 13-Week Inhalation Study of Molybdenum Trioxide .....</b>	<b>230</b>

**TABLE H1**  
**Summary of Reproductive Tissue Evaluations for Male Rats in the 13-Week Inhalation Study**  
**of Molybdenum Trioxide<sup>a</sup>**

	0 mg/m <sup>3</sup>	10 mg/m <sup>3</sup>	30 mg/m <sup>3</sup>	100 mg/m <sup>3</sup>
n	10	10	10	10
Weights (g)				
Necropsy body weight	312 ± 7	300 ± 13	320 ± 5	313 ± 7
R. cauda	0.1580 ± 0.0047	0.1724 ± 0.0112	0.1642 ± 0.0067	0.1794 ± 0.0233
R. epididymis	0.5026 ± 0.0065	0.4795 ± 0.0059	0.4917 ± 0.0077	0.4690 ± 0.0163
R. testis	1.519 ± 0.021	1.548 ± 0.014	1.568 ± 0.033	1.466 ± 0.073
Spermatid measurements				
Sperm count (mean/10 <sup>-4</sup> mL suspension)	41.50 ± 2.14	39.80 ± 1.82	41.40 ± 1.12	44.89 ± 2.31 <sup>b</sup>
Epididymal spermatozoal measurements				
Motility (%)	67.89 ± 4.73 <sup>b</sup>	62.00 ± 7.25	66.70 ± 6.24	57.22 ± 10.36 <sup>b</sup>
Concentration (10 <sup>6</sup> /g cauda epididymal tissue)	657.10 ± 28.13	592.80 ± 36.67	640.90 ± 33.85	646.89 ± 59.67 <sup>b</sup>

<sup>a</sup> Data are presented as mean ± standard error. Differences from the control group are not significant by Dunnett's (body and organ weights) or Dunn's (spermatid and epididymal spermatozoal measurements) test.

<sup>b</sup> n=9

**TABLE H2**  
**Summary of Reproductive Tissue Evaluations for Male Mice in the 13-Week Inhalation Study**  
**of Molybdenum Trioxide<sup>a</sup>**

	0 mg/m <sup>3</sup>	10 mg/m <sup>3</sup>	30 mg/m <sup>3</sup>	100 mg/m <sup>3</sup>
n	10	10	10	10
Weights (g)				
Necropsy body weight	30.1 ± 0.6	30.6 ± 0.4	29.6 ± 0.6	29.8 ± 0.4
R. cauda	0.0175 ± 0.0013	0.0246 ± 0.0030	0.0167 ± 0.0012	0.0196 ± 0.0026
R. epididymis	0.0569 ± 0.0071	0.0586 ± 0.0045	0.0486 ± 0.0026	0.0473 ± 0.0041
R. testis	0.117 ± 0.005	0.117 ± 0.004	0.113 ± 0.007	0.102 ± 0.006
Spermatid measurements				
Sperm count (mean/10 <sup>-4</sup> mL suspension)	49.20 ± 2.88	51.10 ± 2.80	41.60 ± 3.44	41.70 ± 3.59
Epididymal spermatozoal measurements				
Motility (%)	74.90 ± 6.15	81.20 ± 2.39	77.00 ± 4.68	60.00 ± 9.85
Concentration (10 <sup>6</sup> /g caudal tissue)	1,446.5 ± 95.0	1,135.8 ± 117.4	1,284.5 ± 124.3	1,196.5 ± 152.3

<sup>a</sup> Data are presented as mean ± standard error. Differences from the control group are not significant by Dunnett's (body and organ weights) or Dunn's (spermatid and epididymal spermatozoal measurements) test.

## APPENDIX I

### LIVER COPPER ANALYSIS

<b>TABLE I1</b>	<b>Liver Copper Analysis for Rats in the 13-Week Inhalation Study of Molybdenum Trioxide .....</b>	<b>232</b>
<b>TABLE I2</b>	<b>Liver Copper Analysis for Mice in the 13-Week Inhalation Study of Molybdenum Trioxide .....</b>	<b>232</b>

**TABLE I1**  
**Liver Copper Analysis for Rats in the 13-Week Inhalation Study of Molybdenum Trioxide<sup>a</sup>**

	0 mg/m <sup>3</sup>	1 mg/m <sup>3</sup>	3 mg/m <sup>3</sup>	10 mg/m <sup>3</sup>	30 mg/m <sup>3</sup>	100 mg/m <sup>3</sup>
n	10	10	10	10	10	10
<b>Male</b>						
Liver copper (µg/g)	4.93 ± 0.08	5.47 ± 0.21	5.30 ± 0.22	4.04 ± 0.40	4.17 ± 0.42	4.35 ± 0.21
<b>Female</b>						
Liver copper (µg/g)	6.32 ± 0.18	5.80 ± 0.67	6.94 ± 0.43	8.52 ± 0.92	8.50 ± 1.11	6.35 ± 0.73

<sup>a</sup> Data are presented as mean ± standard error. Differences from the control group are not significant by Dunn's or Shirley's test.

**TABLE I2**  
**Liver Copper Analysis for Mice in the 13-Week Inhalation Study of Molybdenum Trioxide<sup>a</sup>**

	0 mg/m <sup>3</sup>	1 mg/m <sup>3</sup>	3 mg/m <sup>3</sup>	10 mg/m <sup>3</sup>	30 mg/m <sup>3</sup>	100 mg/m <sup>3</sup>
n	10	10	10	10	10	10
<b>Male</b>						
Liver copper (µg/g)	8.19 ± 0.27	7.81 ± 0.41	6.85 ± 0.74	8.09 ± 0.61	9.50 ± 0.61	11.51 ± 0.58**
<b>Female</b>						
Liver copper (µg/g)	5.68 ± 0.23	5.53 ± 0.16	5.52 ± 0.17	5.51 ± 0.16	6.51 ± 0.25*	6.98 ± 0.39**

\* Significantly different (P≤0.05) from the control group by Shirley's test

\*\* P≤0.01

<sup>a</sup> Data are presented as mean ± standard error.

## APPENDIX J

# BONE DENSITY AND CURVATURE RESULTS

<b>TABLE J1</b>	<b>Bone Density and Curvature Data for Rats in the 2-Year Inhalation Study of Molybdenum Trioxide .....</b>	<b>234</b>
<b>TABLE J2</b>	<b>Bone Density and Curvature Data for Mice in the 2-Year Inhalation Study of Molybdenum Trioxide .....</b>	<b>235</b>

**TABLE J1**  
**Bone Density and Curvature Data for Rats in the 2-Year Inhalation Study of Molybdenum Trioxide <sup>a</sup>**

	0 mg/m <sup>3</sup>	10 mg/m <sup>3</sup>	30 mg/m <sup>3</sup>	100 mg/m <sup>3</sup>
n	10	10	10	10
<b>Male</b>				
Weight of bone in air (g)	1.36 ± 0.02	1.30 ± 0.03	1.42 ± 0.03	1.40 ± 0.03
Weight of bone in water (g)	0.432 ± 0.007	0.403 ± 0.010	0.450 ± 0.009	0.440 ± 0.010
Bone density of right femur (g/mL)	1.47 ± 0.01	1.45 ± 0.01	1.46 ± 0.01	1.46 ± 0.02
Straight length of bone (cm)	3.12 ± 0.06	3.18 ± 0.02	3.17 ± 0.04	3.07 ± 0.04
Curved length of bone (cm)	3.37 ± 0.07	3.44 ± 0.04	3.45 ± 0.05	3.29 ± 0.04
Bone curvature (curved/straight)	1.09 ± 0.01	1.09 ± 0.01	1.09 ± 0.01	1.08 ± 0.01
<b>Female</b>				
Weight of bone in air (g)	0.926 ± 0.022	0.932 ± 0.020	0.920 ± 0.012	0.918 ± 0.039
Weight of bone in water (g)	0.309 ± 0.009	0.308 ± 0.006	0.305 ± 0.005	0.303 ± 0.019
Bone density of right femur (g/mL)	1.50 ± 0.01	1.49 ± 0.01	1.50 ± 0.01	1.49 ± 0.02
Straight length of bone (cm)	2.73 ± 0.04	2.71 ± 0.02	2.68 ± 0.02	2.68 ± 0.02
Curved length of bone (cm)	2.89 ± 0.04	2.88 ± 0.03	2.85 ± 0.04	2.81 ± 0.03
Bone curvature (curved/straight)	1.06 ± 0.02	1.06 ± 0.02	1.06 ± 0.02	1.03 ± 0.02

<sup>a</sup> Data are presented as mean ± standard error. Differences from the control group are not significant by Dunn's (bone length, curvature, or density) or Dunnett's (bone weights) test.

**TABLE J2**  
**Bone Density and Curvature Data for Mice in the 2-Year Inhalation Study of Molybdenum Trioxide<sup>a</sup>**

	0 mg/m <sup>3</sup>	10 mg/m <sup>3</sup>	30 mg/m <sup>3</sup>	100 mg/m <sup>3</sup>
n	10	10	10	10
<b>Male</b>				
Weight of bone in air (g)	0.110 ± 0.004	0.106 ± 0.003	0.105 ± 0.002	0.108 ± 0.004
Weight of bone in water (g)	0.038 ± 0.002	0.035 ± 0.001	0.036 ± 0.001	0.037 ± 0.001
Bone density of right femur (g/mL)	1.54 ± 0.03	1.51 ± 0.03	1.52 ± 0.02	1.52 ± 0.03
Straight length of bone (cm)	1.46 ± 0.01 <sup>b</sup>	1.46 ± 0.01	1.45 ± 0.02	1.47 ± 0.01
Curved length of bone (cm)	1.52 ± 0.01 <sup>b</sup>	1.52 ± 0.01	1.50 ± 0.02	1.52 ± 0.01
Bone curvature (curved/straight)	1.04 ± 0.00 <sup>b</sup>	1.04 ± 0.01	1.04 ± 0.01	1.04 ± 0.00
<b>Female</b>				
Weight of bone in air (g)	0.107 ± 0.004	0.108 ± 0.002	0.107 ± 0.005	0.107 ± 0.003
Weight of bone in water (g)	0.032 ± 0.001	0.031 ± 0.001	0.029 ± 0.002	0.031 ± 0.001
Bone density of right femur (g/mL)	1.42 ± 0.01	1.40 ± 0.01	1.37 ± 0.02*	1.41 ± 0.01
Straight length of bone (cm)	1.45 ± 0.03	1.46 ± 0.01	1.46 ± 0.02 <sup>b</sup>	1.47 ± 0.02
Curved length of bone (cm)	1.52 ± 0.03	1.55 ± 0.02	1.54 ± 0.02 <sup>b</sup>	1.54 ± 0.02
Bone curvature (curved/straight)	1.05 ± 0.01	1.06 ± 0.01	1.05 ± 0.01 <sup>b</sup>	1.05 ± 0.01

\* Significantly different ( $P \leq 0.01$ ) from the control group by Dunn's or Dunnett's test

<sup>a</sup> Data are presented as mean ± standard error.

<sup>b</sup> n=9





## APPENDIX K

# CHEMICAL CHARACTERIZATION AND GENERATION OF CHAMBER CONCENTRATIONS

PROCUREMENT AND CHARACTERIZATION OF MOLYBDENUM TRIOXIDE .....	238
AEROSOL GENERATION AND EXPOSURE SYSTEM .....	239
AEROSOL CONCENTRATION MONITORING .....	239
CHAMBER ATMOSPHERE CHARACTERIZATION .....	240
FIGURE K1 Infrared Absorption Spectrum of Molybdenum Trioxide .....	242
FIGURE K2 Schematic of the Molybdenum Trioxide Aerosol Generation and Delivery System for the 2-Year Studies .....	243
FIGURE K3 Schematic of the Molybdenum Trioxide Inhalation Exposure Chamber for the 2-Year Studies .....	244
TABLE K1 Summary of Aerosol Size Measurements for the Rat and Mouse Exposure Chambers in the 14-Day Inhalation Studies of Molybdenum Trioxide .....	245
TABLE K2 Summary of Aerosol Size Measurements for the Rat and Mouse Exposure Chambers in the 13-Week Inhalation Studies of Molybdenum Trioxide .....	245
TABLE K3 Summary of Aerosol Size Measurements for the Rat and Mouse Exposure Chambers in the 2-Year Inhalation Studies of Molybdenum Trioxide .....	246
TABLE K4 Summary of Chamber Concentrations in the 14-Day Inhalation Studies of Molybdenum Trioxide .....	248
TABLE K5 Summary of Chamber Concentrations in the 13-Week Inhalation Studies of Molybdenum Trioxide .....	248
TABLE K6 Summary of Chamber Concentrations in the 2-Year Inhalation Studies of Molybdenum Trioxide .....	249
FIGURE K4 Monthly Mean Concentration and Standard Deviation in the 10 mg/m <sup>3</sup> Rat Exposure Chamber in the 2-Year Inhalation Study of Molybdenum Trioxide .....	250
FIGURE K5 Monthly Mean Concentration and Standard Deviation in the 30 mg/m <sup>3</sup> Rat Exposure Chamber in the 2-Year Inhalation Study of Molybdenum Trioxide .....	251
FIGURE K6 Monthly Mean Concentration and Standard Deviation in the 100 mg/m <sup>3</sup> Rat Exposure Chamber in the 2-Year Inhalation Study of Molybdenum Trioxide .....	252
FIGURE K7 Monthly Mean Concentration and Standard Deviation in the 10 mg/m <sup>3</sup> Mouse Exposure Chamber in the 2-Year Inhalation Study of Molybdenum Trioxide .....	253
FIGURE K8 Monthly Mean Concentration and Standard Deviation in the 30 mg/m <sup>3</sup> Mouse Exposure Chamber in the 2-Year Inhalation Study of Molybdenum Trioxide .....	254
FIGURE K9 Monthly Mean Concentration and Standard Deviation in the 100 mg/m <sup>3</sup> Mouse Exposure Chamber in the 2-Year Inhalation Study of Molybdenum Trioxide .....	255

# CHEMICAL CHARACTERIZATION AND GENERATION OF CHAMBER CONCENTRATIONS

## PROCUREMENT AND CHARACTERIZATION OF MOLYBDENUM TRIOXIDE

Molybdenum trioxide was obtained from S.W. Shattuck Chemical Company, Inc. (Houston, TX) in one lot (G1220) and from Climax Molybdenum Company (Greenwich, CT) in one lot (1104CL). Lot G1220 was used during the 14-day and 13-week studies and lot 1104CL was used during the 2-year studies. Identity and purity analyses were conducted by the analytical chemistry laboratory, Midwest Research Institute (Kansas City, MO). Reports on analyses performed in support of the molybdenum trioxide studies are on file at the National Institute of Environmental Health Sciences.

Each lot was subjected to particle size reduction with an 8-inch micronizer (Sturtevant Mill Company, Boston, MA) prior to use. Lots G1220 and 1104CL were individually homogenized by mixing the material for approximately 15 minutes in a Day® blender.

Each lot of the chemical, a grayish green or greenish white powdered solid, was identified as molybdenum trioxide by infrared and ultraviolet/visible spectroscopy. All spectra were consistent with that expected for the structure. The infrared spectra were consistent with the literature spectra (Nyquist, 1971; Hanafi *et al.*, 1975) of molybdenum trioxide (Figure K1), and the spectra for lot 1104CL were consistent with those for lot G1220. In addition, the identity of lot 1104CL was determined by energy-dispersive X-ray analysis (EDX) and X-ray diffraction. The EDX spectrum indicated the sample was molybdenum, with minor amounts of silicon, chlorine, tin, and zinc present. Quantitative analysis determined that the sample was  $98.1\% \pm 0.7\%$  molybdenum trioxide. X-ray diffraction of three samples of the chemical indicated the samples contained no crystalline material other than molybdenum trioxide.

The purity of each lot was determined by elemental analyses (atomic absorption spectroscopy for lots G1220 and 1104CL and gravimetric analysis for lot G1220), Karl Fischer water analysis, and spark source mass spectrometry. In addition, the purity of lot 1104CL was determined by inductively coupled plasma atomic emission spectrometry (ICP-AES). For ICP-AES, the sample was dissolved in a mixture of ammonium hydroxide and hydrochloric acid and the molybdenum concentration was determined using a Perkin-Elmer II ICP-AES.

Elemental analysis by atomic absorption for molybdenum was in agreement with the theoretical value for molybdenum trioxide. Gravimetric analysis indicated a purity of  $100.6\% \pm 0.2\%$  for lot G1220. Karl Fischer water analysis indicated  $0.03\% \pm 0.02\%$  water for lot G1220 and  $0.15\% \pm 0.03\%$  water for lot 1104CL. Total inorganic impurities, determined by spark source mass spectrometry, were less than 3,000 ppm for lot G1220 (cadmium,  $\leq 100$  ppm; potassium, 2,400 ppm; and silicon, 180 ppm) and less than 201 ppm for lot 1104CL (sodium, 50 ppm). ICP-AES indicated a purity of  $105\% \pm 5\%$  for lot 1104CL relative to lot G1220, analyzed concomitantly. The overall purity for each lot was determined to be approximately 99%.

No accelerated chemical stability studies were performed for molybdenum trioxide based on literature information about physical and chemical properties of the compound (Gould, 1962; Weast, 1989). The analytical chemistry laboratory recommended that the bulk chemical be stored at room temperature in sealed plastic bags within sealed fiberboard or metal drums. To ensure stability, the bulk chemical was stored under refrigeration when not in use and allowed to warm to room temperature overnight prior to use (14-day and 13-week studies) or stored at room temperature in 10-gallon metal drums (2-year studies). The stability of the bulk chemical was monitored periodically by the study laboratories using atomic absorption spectroscopy,

gravimetric analysis (13-week studies), and ICP-AES (2-year studies). No degradation of the bulk chemical was observed.

## AEROSOL GENERATION AND EXPOSURE SYSTEM

For the 14-day and 13-week studies, molybdenum trioxide was generated by Wright dust-feed mechanisms at gear ratios appropriate for each target concentration on top of approximately one-liter elutriators that opened into the top of each chamber. The airborne dust was swept into the chamber by compressor air at 30 psi and 200 L/minute. Chamber air pressure was less than that of the room.

For the 2-year studies, the molybdenum trioxide aerosol generation and delivery system was composed of four basic components: a flexible-brush dust-feed mechanism developed at the study laboratory, a Trost air-impact mill, an aerosol charge neutralizer, and an aerosol distribution system (Figure K2). The flexible-brush dust-feed mechanism employed a hopper into which the dry powder was poured. This hopper enclosed a large, random-wound bristle brush that continually rotated, stirring the powder and delivering it into a feed tube through a small hole in the bottom of the hopper. The feed tube contained a spiral-wound feed brush rotated at a controlled rate by a stepping motor. The dust fell from the end of the feed tube and was aspirated into the Trost air impact mill. The hopper was reloaded with additional chemical at regular intervals throughout each day's exposure period to maintain the performance of the generation system and the stability of the chamber concentrations. Chemical for each day was stored overnight in a nitrogen-purged desiccator to achieve more uniform behavior and promote the free-flow properties of the chemical in the generator.

The Trost air-impact mill used the fluid energy from opposing air jets to cause particle-to-particle, head-on impaction to deagglomerate and reduce the size distribution of the feed material. Following impaction, the particles were swept into a classification chamber; smaller particles passed through and larger ones were thrown to the perimeter by centrifugal force. Larger particles were re-entrained into impacting air jets until they were sufficiently reduced in size. To control static charge, the aerosol was passed through a length of plastic duct in the center of which two  $^{63}\text{Ni}$ -plated foils (10 mCi) were suspended until the aerosol approached Boltzmann equilibrium at the system flow rate.

Aerosol passed through the charge neutralizer and through the distribution line, which crossed the hall from the Suite Control Center into the exposure room and branched to supply chambers on both sides of the room. At each chamber location, an air-vac pump withdrew material from the distribution line into the chamber inlet. Each distribution line branch was terminated with a high-efficiency particulate air (HEPA) filter to remove any excess material. Flow through the distribution line was controlled by air-vac pumps and monitored by photohelic differential pressure gauges coupled to a venturi.

## AEROSOL CONCENTRATION MONITORING

Prior to study initiation, filter samples were obtained from each chamber to confirm the validity of gravimetric sampling. During the 14-day and 13-week studies, gravimetric samples were obtained during exposure periods from closed-face Gelman DM-450 Metrical filters in each exposure chamber two to six times per day. Samples were analyzed for molybdenum content by atomic absorption.

In the 13-week studies, a real-time aerosol monitor (RAM) (Model RAM-1; GCA Corp., Bedford, MA) was used to monitor chambers in real time during the exposure periods. Readings were recorded approximately hourly for each chamber and were used to make adjustments to the dust generating systems.

In the 2-year studies, molybdenum trioxide aerosol was monitored with a RAM-1 (MIE, Inc., Bedford, MA). These devices use a pulsed-light-emitting diode in combination with a silicon detector to sense the light scattered over a forward angular range of  $45^\circ$  to  $95^\circ$  by particles traversing the sensing volume. The instrument responds to particles 0.1 to 20  $\mu\text{m}$  in diameter. The sampling system consisted of a valve which multiplexed each RAM to two or three exposure chambers and either the control chamber, the room, or a HEPA filter. Each RAM was calibrated by correlating the measured RAM voltage with molybdenum trioxide concentrations determined by analyzing exposure chamber filter samples. Chemical-specific analyses of filter samples were performed using flame atomic absorption spectroscopy. A calibration curve for each RAM was constructed by plotting molybdenum trioxide concentration obtained by analyzing filter samples against the average RAM voltage measured while filter samples were being collected. The RAM output was recorded by the Automated Data Acquisition and Control System. Selecting the correct sampling stream and data acquisition from each RAM was remotely controlled by computer (Hewlett-Packard Model HP-85B, Palo Alto, CA). Equations for calibration curves were stored in the computer and were used to convert the measured RAM voltages to exposure concentrations. RAMs were calibrated twice monthly. Filter samples were taken daily for gravimetric analysis of chamber concentration to verify RAM calibration. If a discrepancy in RAM calibration was observed, additional samples were collected and, if necessary, the RAM was recalibrated using chemical-specific analysis of filter samples.

### CHAMBER ATMOSPHERE CHARACTERIZATION

Particle size distributions in each chamber were determined twice during the 14-day studies and weekly for 6 or 7 weeks then again in week 11 or 12 during the 13-week studies using an Anderson 8-stage cascade impactor with an 11-micron preseparator. Impactor samples (Mercer-style 7-stage impactor; In-Tox Products, Albuquerque, NM) were taken from each exposure chamber at monthly intervals during the 2-year studies. An estimation was made of the mass median aerodynamic particle diameter and the geometric standard deviation of each set of samples (Tables K1, K2, and K3).

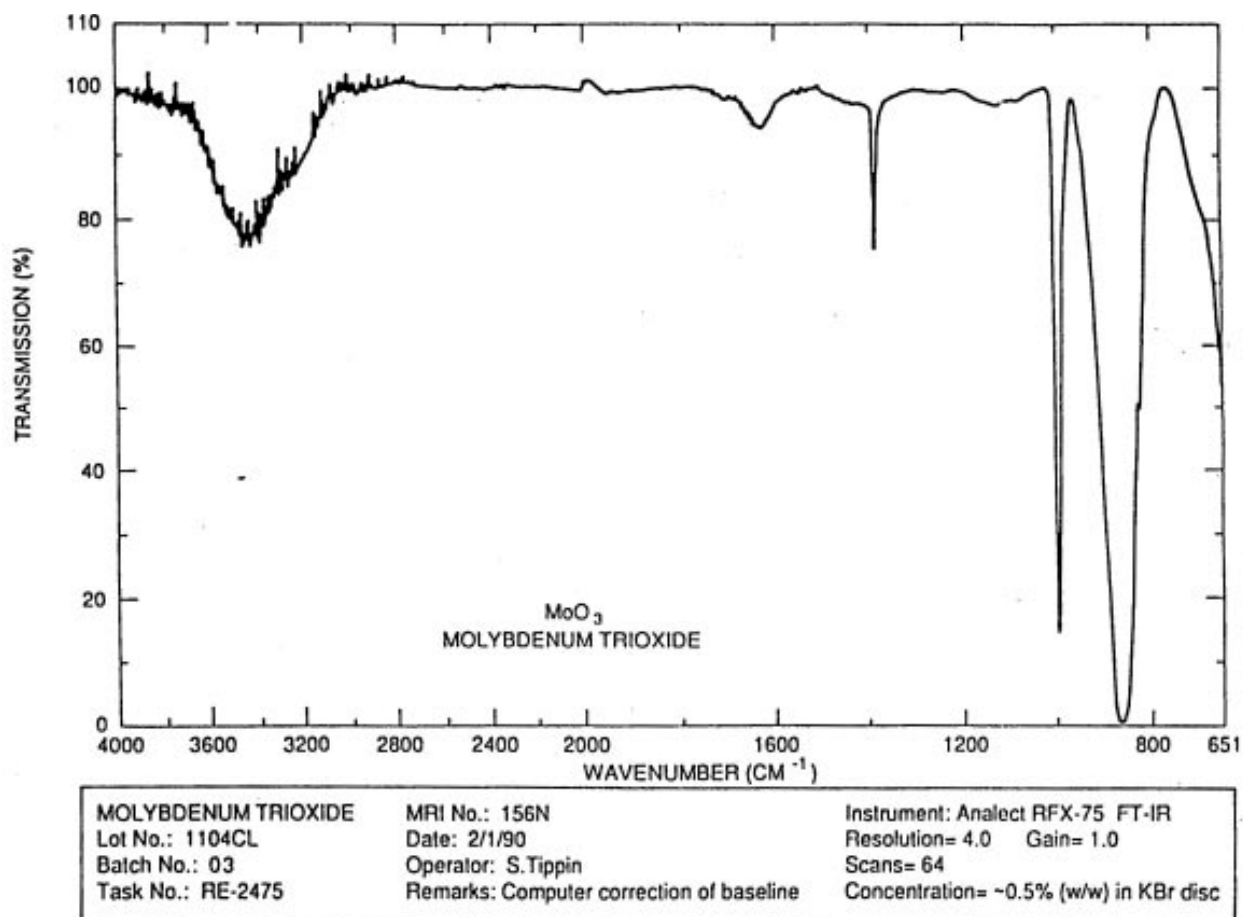
Buildup and decay rates for chamber aerosol concentrations during the 13-week and 2-year studies were determined with and without animals present in the chambers. For the 13-week studies, the time required to achieve 90% of target concentration at the start of exposure ( $T_{90}$ ) was 23 minutes. The time required for the concentration to decay to 10% of target at the end of exposure ( $T_{10}$ ) was 23 minutes. For the 2-year studies,  $T_{90}$  was 7 to 13 minutes without animals present and 7 to 12 minutes with animals present. The  $T_{10}$  was 7 to 9 minutes without animals present and 9 to 10 minutes with animals present in the chambers. Variations were due to differences in discrete sampling times, flow-rate differences among chambers, fluctuations in generator output, and differences in transit time of aerosol through the delivery system. Apparent irregularities in some of the curves were attributed to the rate at which the driving air was applied to the Air-Vac pumps on individual chambers. A  $T_{90}$  of 12 minutes was used for the 2-year studies.

To determine the persistence of the molybdenum trioxide aerosol in the chambers following exposure, concentration was monitored overnight following shutoff of aerosol delivery to the 100  $\text{mg}/\text{m}^3$  chamber. The RAMs normally used to monitor the lowest concentration chambers were connected simultaneously to the chamber. As measured by both RAMs, average molybdenum trioxide concentration decayed to 1% of target concentration within 20 minutes.

Uniformity of aerosol concentration in the 2-year inhalation exposure chambers was evaluated approximately every 3 months from 12 chamber positions (one in front and one in back for each of the six possible animal cage unit positions per chamber). An extension tube fitted to the sampling lines of each RAM allowed sampling from the ports. For this purpose, RAM readings are expressed in volts, rather than  $\text{mg}/\text{m}^3$ , because

the presence of the extension tube may have slightly altered the normal calibration of the monitors. The exposure chambers were, however, operating at their target concentrations at the time measurements were taken.

The means of concentration in all chambers during the 14-day studies except the 10 mg/m<sup>3</sup> mouse chamber were within 10% of the target concentration; the 10 mg/m<sup>3</sup> mouse chamber averaged 12% over target (Table K4). The means of concentration in all chambers during the 13-week studies were within 10% of the target concentration (Table K5). The means of concentration in all chambers for the 2-year studies were at least 95% of the target. At least 82% of all concentration readings were within the specified limits.



**FIGURE K1**  
**Infrared Absorption Spectrum of Molybdenum Trioxide**

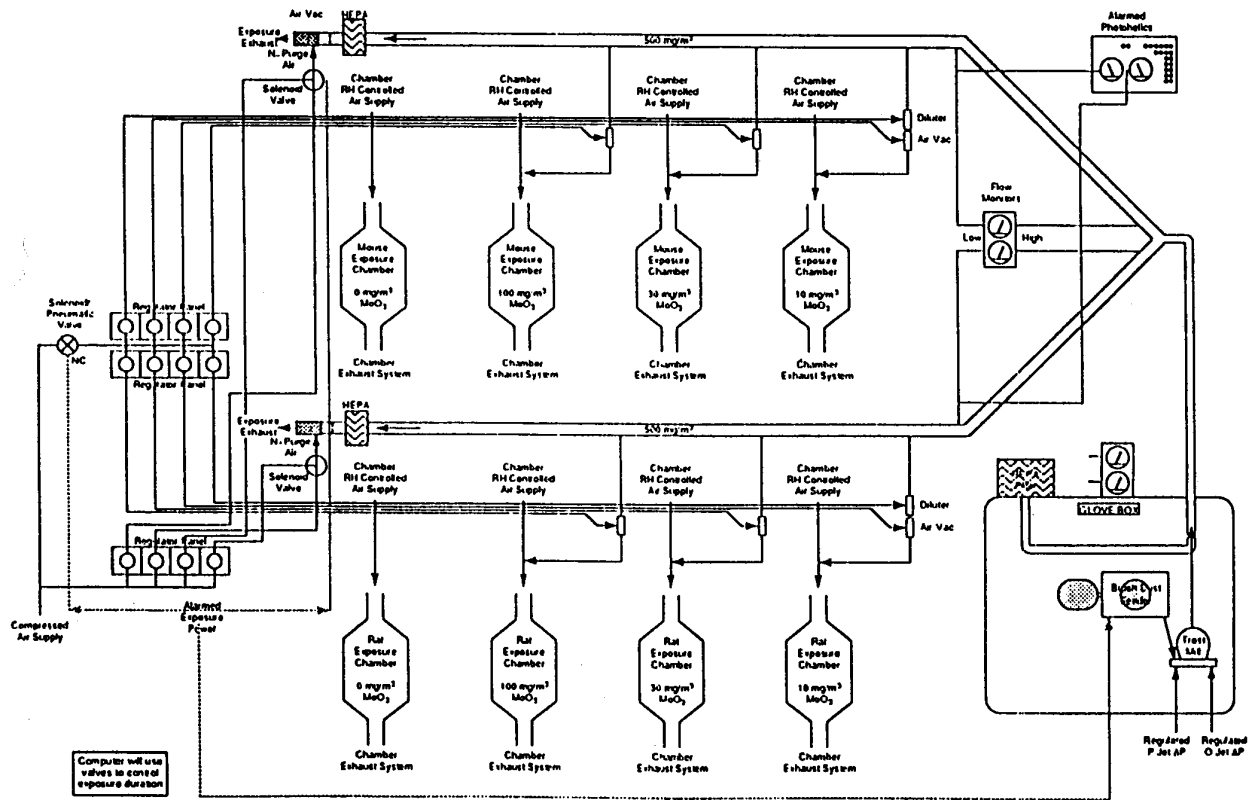
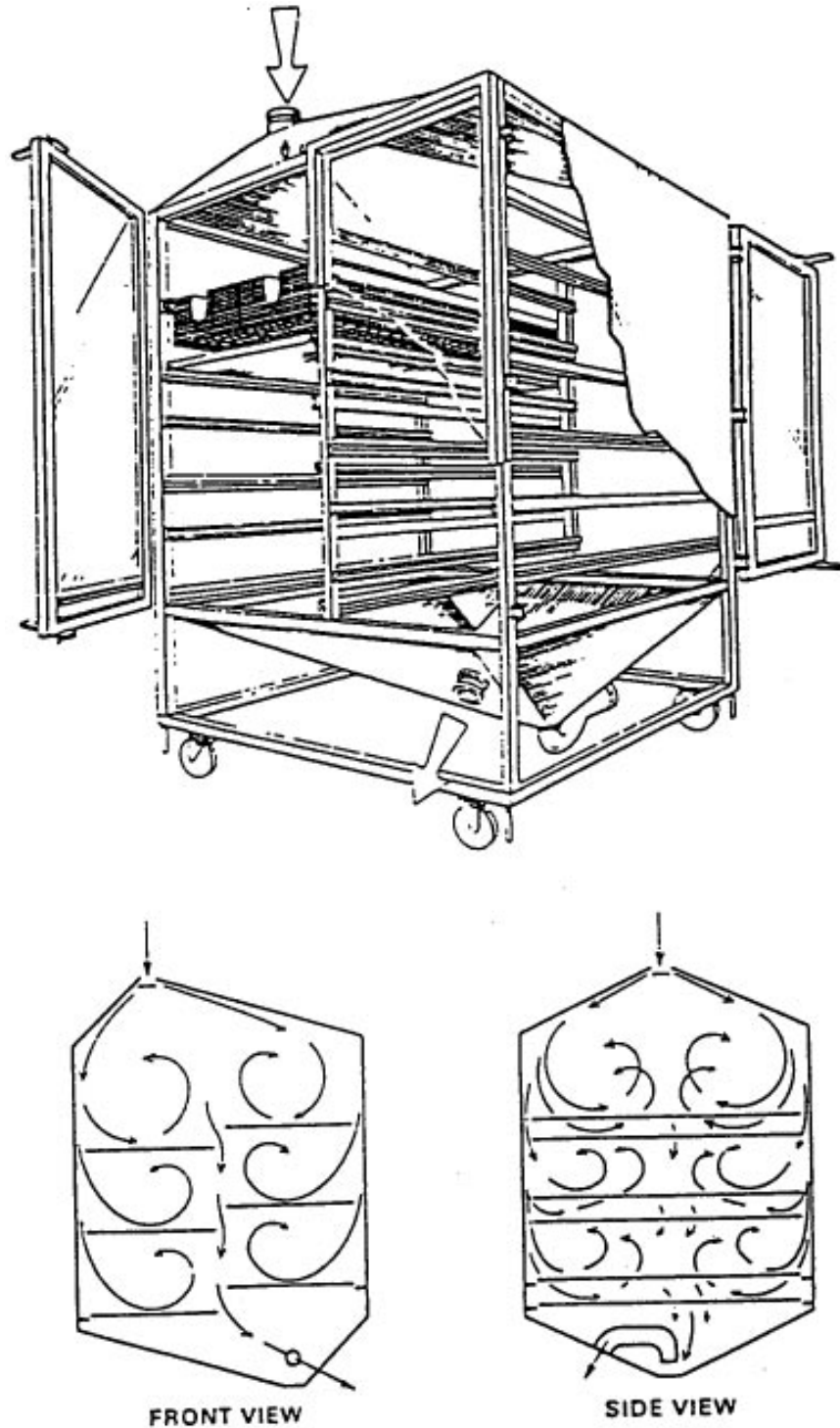


FIGURE K2  
Schematic of the Molybdenum Trioxide Aerosol Generation and Delivery System  
for the 2-Year Studies





**FIGURE K3**  
**Schematic of the Molybdenum Trioxide Inhalation Exposure Chamber**  
**for the 2-Year Studies**

**TABLE K1**  
**Summary of Aerosol Size Measurements for the Rat and Mouse Exposure Chambers**  
**in the 14-Day Inhalation Studies of Molybdenum Trioxide<sup>a</sup>**

	3 mg/m <sup>3</sup>		10 mg/m <sup>3</sup>		30 mg/m <sup>3</sup>		100 mg/m <sup>3</sup>		300 mg/m <sup>3</sup>	
	MMAD (µm)	GSD	MMAD (µm)	GSD	MMAD (µm)	GSD	MMAD (µm)	GSD	MMAD (µm)	GSD
<b>Rats</b>										
Week 1	2.25	1.91	1.65	1.92	2.12	1.60	2.00	1.74	2.05	1.71
Week 2	2.17	2.02	2.25	1.73	2.20	1.69	2.05	1.64	2.05	1.95
<b>Mice</b>										
Week 1	2.25	1.91	1.65	1.92	2.12	1.60	2.00	1.74	2.05	1.71
Week 2	2.17	2.02	2.25	1.73	2.20	1.69	2.05	1.64	2.05	1.95

<sup>a</sup> MMAD=mass median aerodynamic particle diameter; GSD=geometric standard deviation

**TABLE K2**  
**Summary of Aerosol Size Measurements for the Rat and Mouse Exposure Chambers**  
**in the 13-Week Inhalation Studies of Molybdenum Trioxide<sup>a</sup>**

	1 mg/m <sup>3</sup>		3 mg/m <sup>3</sup>		10 mg/m <sup>3</sup>		30 mg/m <sup>3</sup>		100 mg/m <sup>3</sup>	
	MMAD (µm)	GSD	MMAD (µm)	GSD	MMAD (µm)	GSD	MMAD (µm)	GSD	MMAD (µm)	GSD
<b>Rats</b>										
Week 1	1.76	1.97	1.75	1.75	1.68	1.69	2.15	1.80	1.14	2.21
Week 2	1.74	2.37	1.86	1.87	2.04	1.79	2.31	1.73	1.76	1.83
Week 3	— <sup>b</sup>	—	1.94	1.51	1.74	1.65	2.43	1.75	1.70	1.85
Week 4	2.07	1.82	2.00	1.78	1.91	1.79	2.23	1.82	—	—
Week 5	1.69	1.78	1.74	1.76	2.03	1.64	2.06	1.82	2.18	1.64
									1.62	1.95
Week 6	—	—	1.92	1.76	1.82	1.65	2.21	1.89	1.89	1.92
Week 7	1.71	2.42	1.72	1.78	1.93	1.63	2.15	1.76	2.32	1.73
Week 12	1.33	1.93	1.45	1.80	1.37	1.97	1.60	1.83	1.36	1.94
<b>Mice</b>										
Week 1	1.74	2.37	1.86	1.87	2.04	1.79	2.31	1.73	1.76	1.83
Week 2	—	—	1.94	1.51	1.74	1.65	2.43	1.75	1.70	1.85
Week 3	2.07	1.82	2.00	1.78	1.91	1.79	2.23	1.82	—	—
Week 4	1.69	1.78	1.74	1.76	2.03	1.64	2.06	1.82	2.19	1.64
									1.62	1.95
Week 5	—	—	1.92	1.75	1.82	1.65	2.21	1.89	1.89	1.92
Week 6	1.71	2.42	1.72	1.78	1.93	1.63	2.15	1.76	2.32	1.73
Week 11	1.33	1.93	1.45	1.80	1.37	1.97	1.60	1.83	1.32	1.84

<sup>a</sup> MMAD=mass median aerodynamic particle diameter; GSD=geometric standard deviation

<sup>b</sup> No impactor samples were taken at this exposure concentration.

**TABLE K3**  
**Summary of Aerosol Size Measurements for the Rat and Mouse Exposure Chambers**  
**in the 2-Year Inhalation Studies of Molybdenum Trioxide<sup>a</sup>**

Date	10 mg/m <sup>3</sup>		30 mg/m <sup>3</sup>		100 mg/m <sup>3</sup>	
	MMAD (µm)	GSD	MMAD (µm)	GSD	MMAD (µm)	GSD
<b>Rats</b>						
March 1990	1.6	1.9	1.8	1.9	1.9	1.9
April 1990	1.3	1.9	1.6	1.8	1.6	1.8
May 1990	1.5	2.0	1.9	1.9	1.7	2.0
June 1990	1.5	1.9	1.4	1.8	1.8	1.9
July 1990	1.8	1.8	1.7	1.8	2.1	1.9
August 1990	1.8	2.0	1.9	1.9	1.9	1.8
September 1990	— <sup>b</sup>	—	1.7	1.9	1.8	1.7
October 1990	1.4	1.8	1.6	1.7	1.8	1.8
November 1990	1.4	1.7	1.8	1.7	1.6	1.8
December 1990	1.4	1.8	1.5	1.9	1.5	2.0
January 1991	1.3	1.8	1.5	1.8	1.5	1.8
February 1991	1.3	1.8	1.4	1.8	1.5	1.8
March 1991	1.5	1.8	1.7	1.8	1.6	1.8
April 1991	1.3	1.8	1.4	1.8	1.6	1.9
May 1991	1.5	1.9	1.6	1.8	1.8	1.9
June 1991	1.7	1.8	1.4	1.7	1.6	1.8
July 1991	1.3	1.8	1.6	1.8	1.6	1.8
August 1991	1.5	1.8	1.4	1.7	1.7	1.8
September 1991	1.3	1.7	1.5	1.9	1.5	1.8
October 1991	1.5	1.7	1.6	1.7	1.8	1.7
November 1991	1.5	1.8	1.6	1.8	1.8	1.8
December 1991	1.7	1.8	1.4	1.7	1.3	1.8
January 1992	1.4	1.7	1.4	1.7	1.8	1.8
February 1992	1.5	1.8	1.5	2.0	1.5	1.8
March 1992	1.4	1.9	1.4	1.9	1.6	1.9
Mean ± standard deviation	1.5 ± 0.15	1.8 ± 0.08	1.6 ± 0.16	1.8 ± 0.08	1.7 ± 0.17	1.8 ± 0.07

**TABLE K3**  
**Summary of Aerosol Size Measurements for the Rat and Mouse Exposure Chambers**  
**in the 2-Year Inhalation Studies of Molybdenum Trioxide** (continued)

Date	10 mg/m <sup>3</sup>		30 mg/m <sup>3</sup>		100 mg/m <sup>3</sup>	
	MMAD (µm)	GSD	MMAD (µm)	GSD	MMAD (µm)	GSD
<b>Mice</b>						
March 1990	1.4	1.8	1.5	1.9	1.3	1.7
April 1990	1.3	1.9	1.6	2.0	1.5	1.8
May 1990	1.1	1.9	1.6	2.0	1.5	2.0
June 1990	1.3	1.7	1.3	1.7	1.5	1.7
July 1990	1.5	1.9	1.5	1.8	1.5	1.8
August 1990	1.5	1.9	1.7	1.9	1.5	1.8
September 1990	—	—	—	—	1.7	1.9
October 1990	1.5	1.8	1.5	1.8	1.6	1.8
November 1990	1.3	1.8	1.3	1.8	1.3	1.7
December 1990	1.3	1.8	1.3	1.8	1.6	1.8
January 1991	1.3	1.7	1.4	1.7	1.5	1.7
February 1991	1.3	1.7	1.4	1.8	1.4	1.8
March 1991	1.5	1.9	1.4	1.8	1.5	1.8
April 1991	1.2	1.7	1.3	1.8	1.3	1.8
May 1991	1.3	1.8	1.3	1.7	1.6	1.9
June 1991	1.2	1.8	1.3	1.8	1.5	1.8
July 1991	1.5	1.7	1.3	1.8	1.5	1.8
August 1991	1.4	1.8	1.3	1.6	1.4	1.7
September 1991	1.3	1.8	1.4	1.7	1.9	1.8
October 1991	1.4	1.7	1.4	1.6	1.4	1.6
November 1991	1.5	1.6	1.5	1.8	1.5	1.8
December 1991	1.3	1.7	1.4	1.8	1.5	1.8
January 1992	1.3	1.6	1.3	1.6	1.5	1.7
February 1992	1.1	1.8	1.2	1.8	1.4	1.8
March 1992	1.1	1.9	1.3	1.8	1.5	1.9
Mean ± standard deviation	1.3 ± 0.13	1.8 ± 0.09	1.4 ± 0.12	1.8 ± 0.10	1.5 ± 0.12	1.8 ± 0.08

<sup>a</sup> MMAD=mass median aerodynamic particle diameter; GSD=geometric standard deviation

<sup>b</sup> No impactor samples were taken at this exposure concentration.

**TABLE K4**  
**Summary of Chamber Concentrations in the 14-Day Inhalation Studies of Molybdenum Trioxide**

Target Concentration (mg/m <sup>3</sup> )	Total Number of Readings	Average Concentration <sup>a</sup> (mg/m <sup>3</sup> )
<b>Rats</b>		
3	40	2.93 ± 0.43
10	41	11.02 ± 2.13
30	40	32.44 ± 2.47
100	40	99.27 ± 17.65
300	44	300.31 ± 29.04
<b>Mice</b>		
3	40	3.06 ± 0.23
10	41	11.27 ± 1.94
30	40	31.83 ± 1.83
100	40	102.50 ± 12.73
300	44	304.34 ± 24.13

<sup>a</sup> Mean ± standard deviation

**TABLE K5**  
**Summary of Chamber Concentrations in the 13-Week Inhalation Studies of Molybdenum Trioxide<sup>a</sup>**

Target Concentration (mg/m <sup>3</sup> )	Total Number of Readings	Average Concentration <sup>b</sup> (mg/m <sup>3</sup> )
<b>Rats</b>		
1	138	1.03 ± 0.15
3	261	3.10 ± 0.29
10	261	9.84 ± 0.63
30	261	29.90 ± 1.93
100	261	105.51 ± 8.12
<b>Mice</b>		
1	132	1.02 ± 0.12
3	261	3.09 ± 0.28
10	261	9.78 ± 0.46
30	261	29.76 ± 4.16
100	261	105.14 ± 8.23

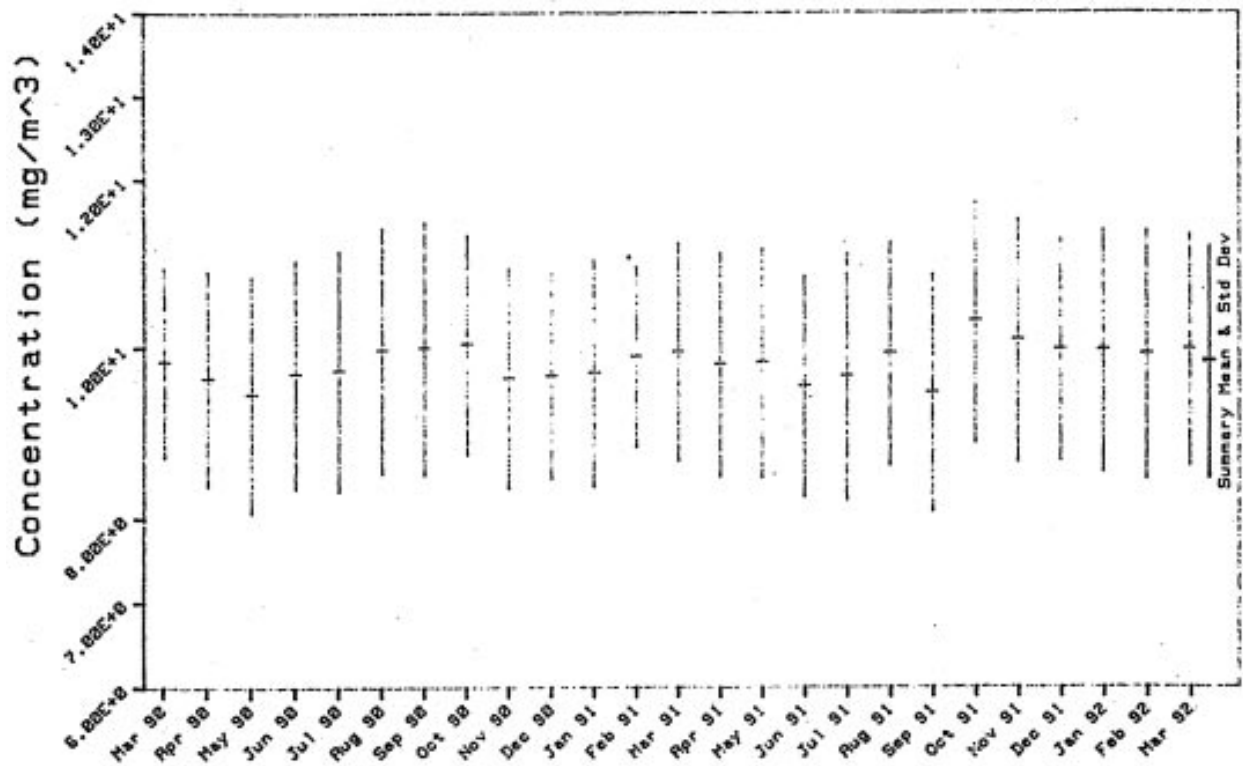
<sup>a</sup> Gravimetric analysis

<sup>b</sup> Mean ± standard deviation

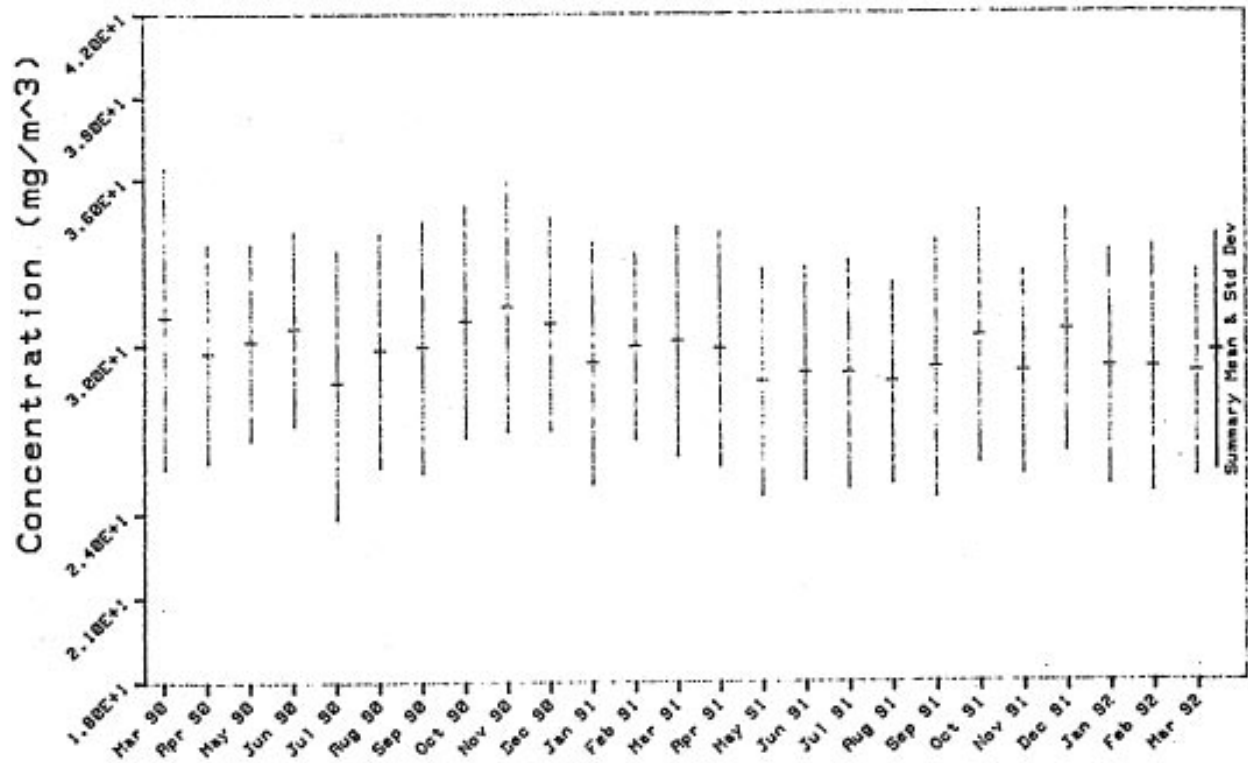
**TABLE K6**  
**Summary of Chamber Concentrations in the 2-Year Inhalation Studies of Molybdenum Trioxide**

Target Concentration (mg/m <sup>3</sup> )	Total Number of Readings	Average Concentration <sup>a</sup> (mg/m <sup>3</sup> )	% of Samples Within Range
<b>Rats</b>			
10	4,634	9.83 ± 1.36	85
30	4,603	29.7 ± 4.20	87
100	4,613	99.4 ± 12.5	90
<b>Mice</b>			
10	4,606	9.51 ± 1.40	82
30	4,662	30.5 ± 3.56	91
100	4,663	98.2 ± 12.0	91

<sup>a</sup> Mean ± standard deviation

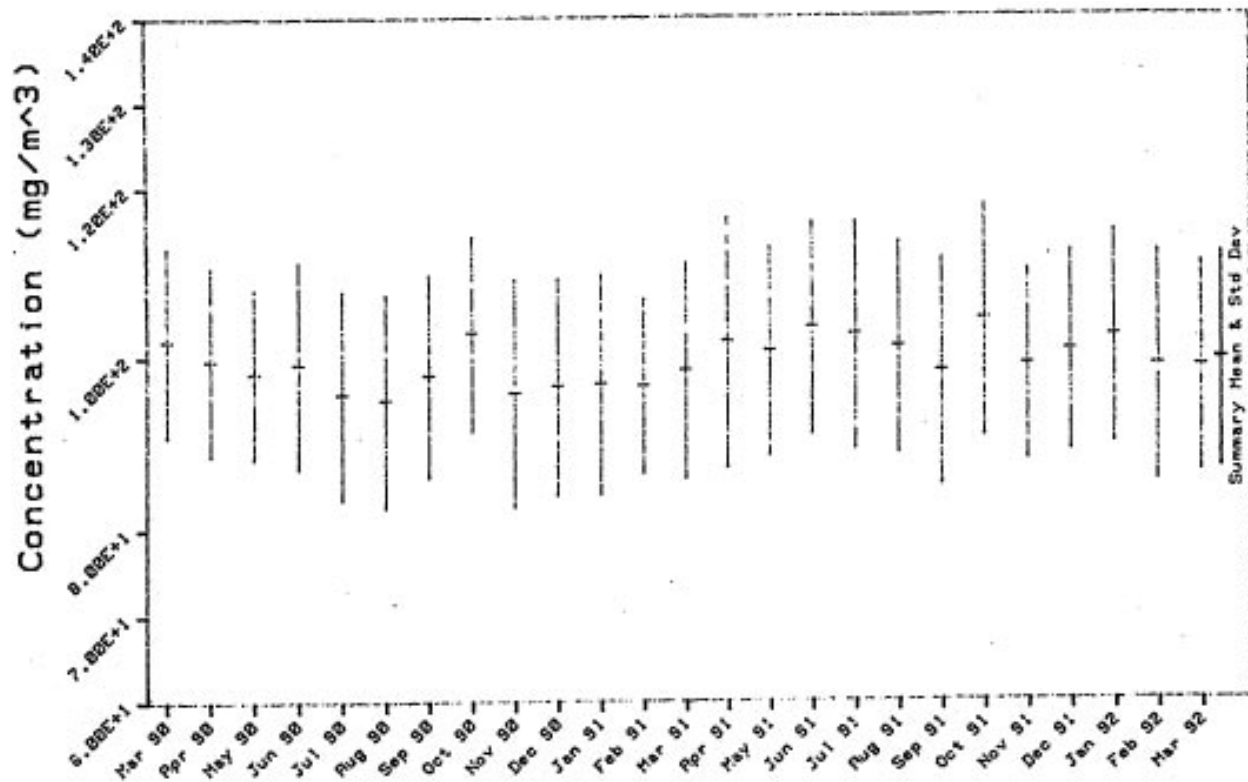


**FIGURE K4**  
Monthly Mean Concentration and Standard Deviation in the 10 mg/m<sup>3</sup>  
Rat Exposure Chamber in the 2-Year Inhalation Study of Molybdenum Trioxide

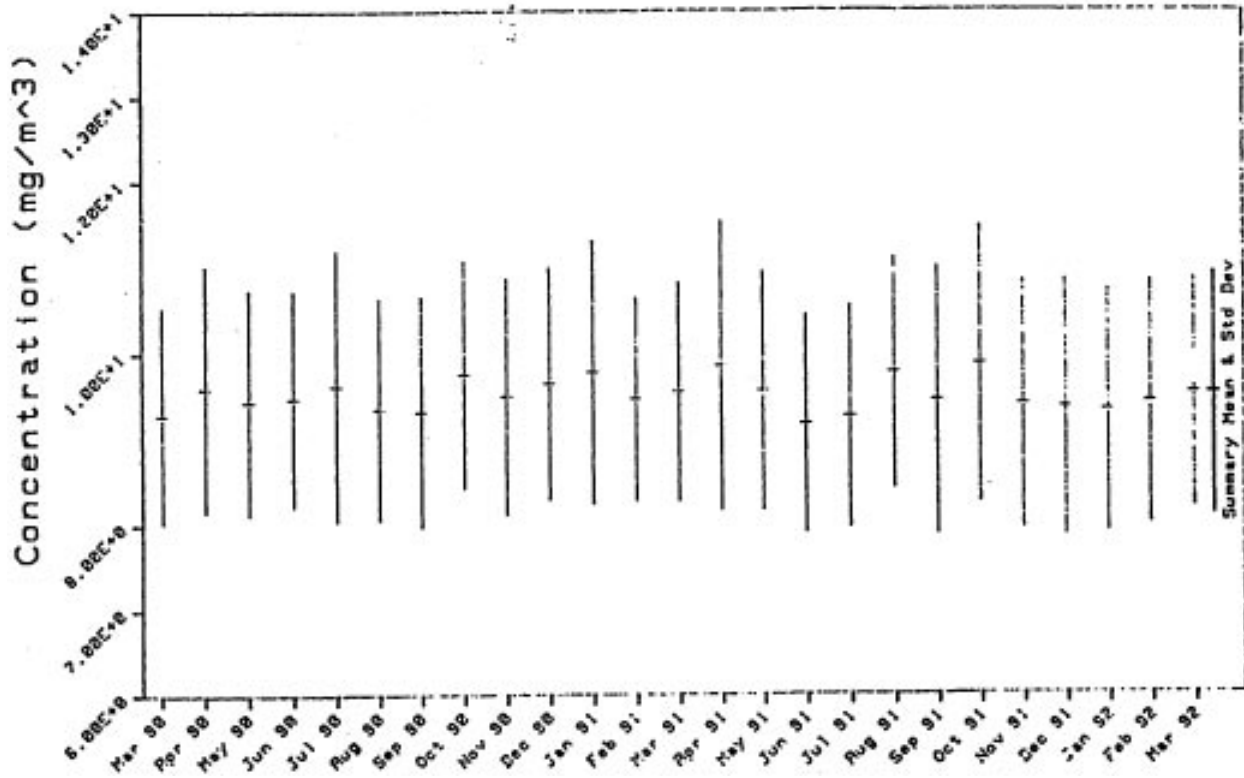


**FIGURE K5**  
Monthly Mean Concentration and Standard Deviation in the 30 mg/m<sup>3</sup>  
Rat Exposure Chamber in the 2-Year Inhalation Study of Molybdenum Trioxide

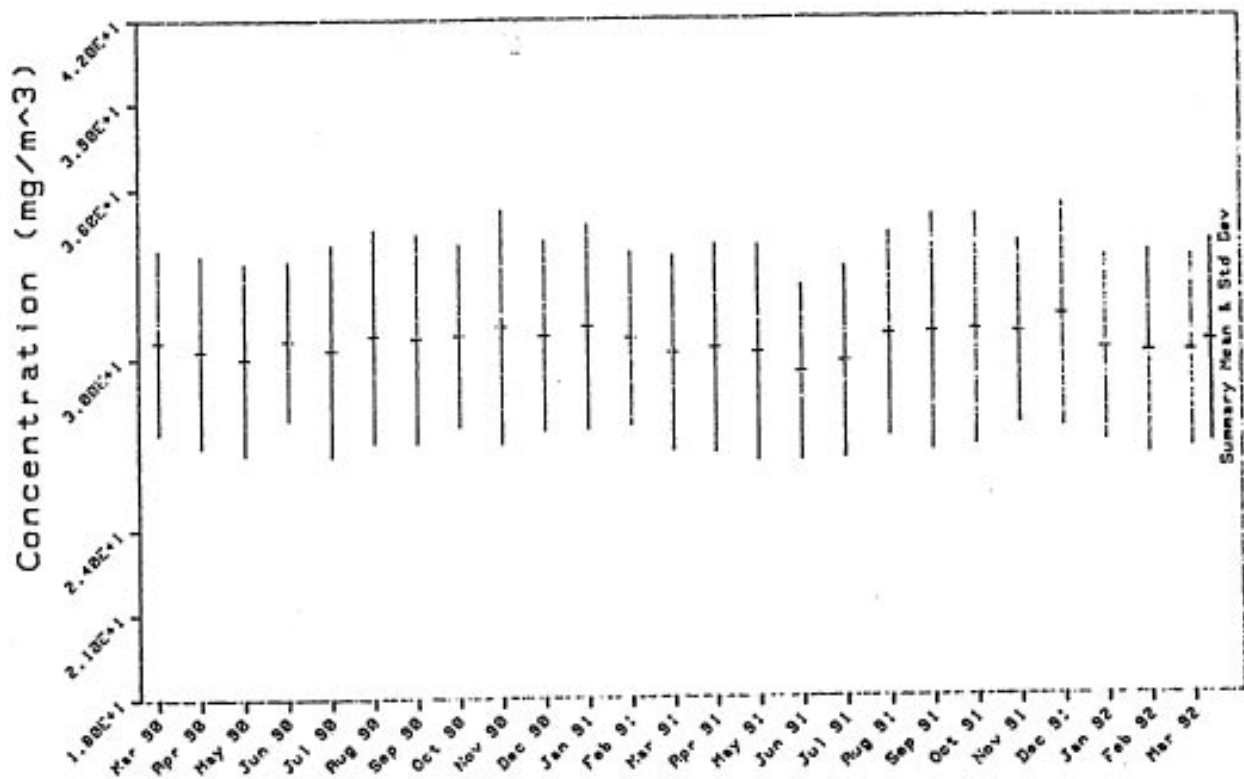




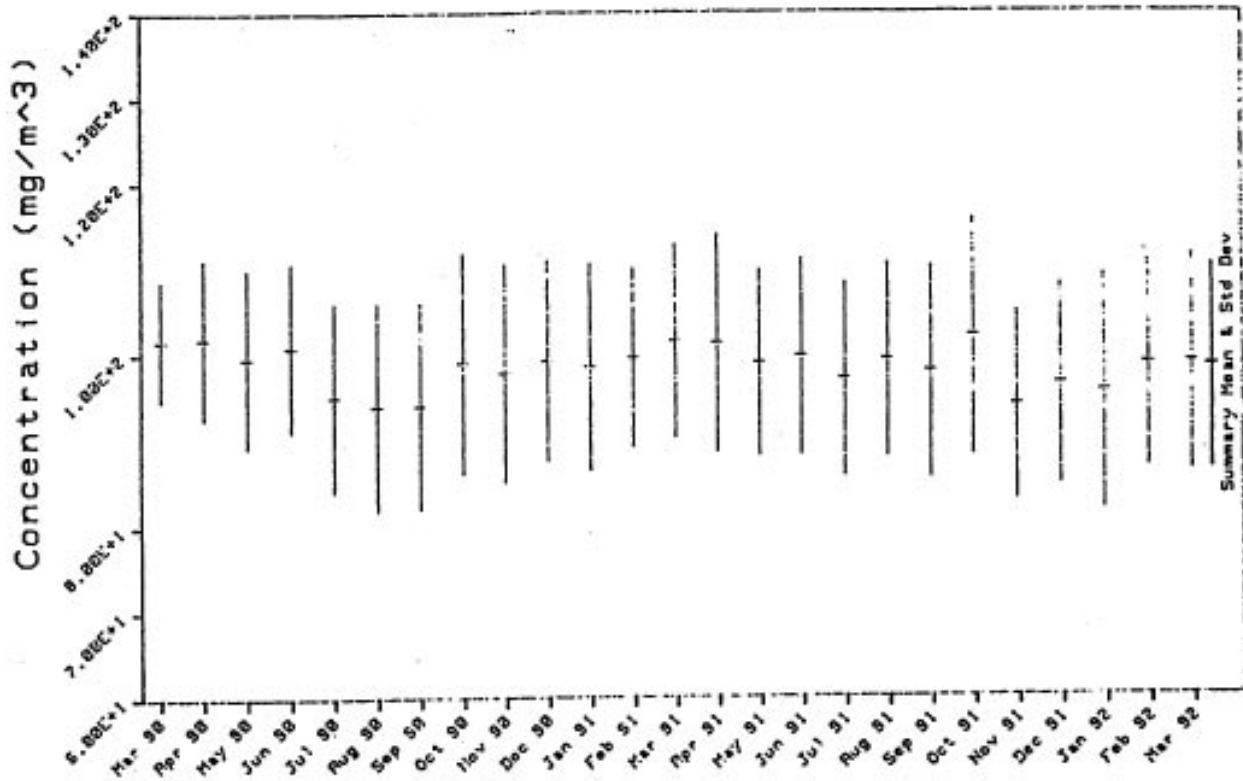
**FIGURE K6**  
 Monthly Mean Concentration and Standard Deviation in the 100 mg/m<sup>3</sup>  
 Rat Exposure Chamber in the 2-Year Inhalation Study of Molybdenum Trioxide



**FIGURE K7**  
Monthly Mean Concentration and Standard Deviation in the 10 mg/m<sup>3</sup>  
Mouse Exposure Chamber in the 2-Year Inhalation Study of Molybdenum Trioxide



**FIGURE K8**  
Monthly Mean Concentration and Standard Deviation in the 30 mg/m<sup>3</sup>  
Mouse Exposure Chamber in the 2-Year Inhalation Study of Molybdenum Trioxide



**FIGURE K9**  
Monthly Mean Concentration and Standard Deviation in the 100 mg/m<sup>3</sup>  
Mouse Exposure Chamber in the 2-Year Inhalation Study of Molybdenum Trioxide



**APPENDIX L**  
**INGREDIENTS, NUTRIENT COMPOSITION,**  
**AND CONTAMINANT LEVELS**  
**IN NIH-07 RAT AND MOUSE RATION**

<b>TABLE L1</b>	<b>Ingredients of NIH-07 Rat and Mouse Ration .....</b>	<b>258</b>
<b>TABLE L2</b>	<b>Vitamins and Minerals in NIH-07 Rat and Mouse Ration .....</b>	<b>258</b>
<b>TABLE L3</b>	<b>Nutrient Composition of NIH-07 Rat and Mouse Ration .....</b>	<b>259</b>
<b>TABLE L4</b>	<b>Contaminant Levels in NIH-07 Rat and Mouse Ration .....</b>	<b>260</b>

**TABLE L1**  
**Ingredients of NIH-07 Rat and Mouse Ration<sup>a</sup>**

Ingredients <sup>b</sup>	Percent by Weight
Ground #2 yellow shelled corn	24.50
Ground hard winter wheat	23.00
Soybean meal (49% protein)	12.00
Fish meal (60% protein)	10.00
Wheat middlings	10.00
Dried skim milk	5.00
Alfalfa meal (dehydrated, 17% protein)	4.00
Corn gluten meal (60% protein)	3.00
Soy oil	2.50
Dried brewer's yeast	2.00
Dry molasses	1.50
Dicalcium phosphate	1.25
Ground limestone	0.50
Salt	0.50
Premixes (vitamin and mineral)	0.25

<sup>a</sup> NCI, 1976; NIH, 1978

<sup>b</sup> Ingredients were ground to pass through a U.S. Standard Screen No. 16 before being mixed.

**TABLE L2**  
**Vitamins and Minerals in NIH-07 Rat and Mouse Ration<sup>a</sup>**

	Amount	Source
<b>Vitamins</b>		
A	5,500,000 IU	Stabilized vitamin A palmitate or acetate
D <sub>3</sub>	4,600,000 IU	D-activated animal sterol
K <sub>3</sub>	2.8 g	Menadione
<i>d</i> - $\alpha$ -Tocopheryl acetate	20,000 IU	
Choline	560.0 g	Choline chloride
Folic acid	2.2 g	
Niacin	30.0 g	
<i>d</i> -Pantothenic acid	18.0 g	<i>d</i> -Calcium pantothenate
Riboflavin	3.4 g	
Thiamine	10.0 g	Thiamine mononitrate
B <sub>12</sub>	4,000 $\mu$ g	
Pyridoxine	1.7 g	Pyridoxine hydrochloride
Biotin	140.0 mg	<i>d</i> -Biotin
<b>Minerals</b>		
Iron	120.0 g	Iron sulfate
Manganese	60.0 g	Manganous oxide
Zinc	16.0 g	Zinc oxide
Copper	4.0 g	Copper sulfate
Iodine	1.4 g	Calcium iodate
Cobalt	0.4 g	Cobalt carbonate

<sup>a</sup> Per ton (2,000 lb) of finished product

**TABLE L3**  
**Nutrient Composition of NIH-07 Rat and Mouse Ration**

<b>Nutrient</b>	<b>Mean ± Standard Deviation</b>	<b>Range</b>	<b>Number of Samples</b>
Protein (% by weight)	23.42 ± 0.56	22.2 — 24.3	25
Crude fat (% by weight)	5.30 ± 0.16	5.00 — 5.60	25
Crude fiber (% by weight)	3.49 ± 0.41	2.60 — 4.30	25
Ash (% by weight)	6.37 ± 0.18	6.11 — 6.81	25
<b>Amino Acids (% of total diet)</b>			
Arginine	1.280 ± 0.083	1.110 — 1.390	11
Cystine	0.308 ± 0.071	0.181 — 0.400	11
Glycine	1.158 ± 0.048	1.060 — 1.220	11
Histidine	0.584 ± 0.027	0.531 — 0.630	11
Isoleucine	0.917 ± 0.033	0.867 — 0.965	11
Leucine	1.975 ± 0.051	1.850 — 2.040	11
Lysine	1.274 ± 0.049	1.200 — 1.370	11
Methionine	0.437 ± 0.109	0.306 — 0.699	11
Phenylalanine	0.999 ± 0.120	0.665 — 1.110	11
Threonine	0.904 ± 0.058	0.824 — 0.985	11
Tryptophan	0.218 ± 0.153	0.107 — 0.671	11
Tyrosine	0.685 ± 0.094	0.564 — 0.794	11
Valine	1.086 ± 0.055	0.962 — 1.170	11
<b>Essential Fatty Acids (% of total diet)</b>			
Linoleic	2.407 ± 0.227	1.830 — 2.570	10
Linolenic	0.259 ± 0.065	0.100 — 0.320	10
<b>Vitamins</b>			
Vitamin A (IU/kg)	6,595 ± 1,548	4,180 — 11,450	25
Vitamin D (IU/kg)	4,450 ± 1,382	3,000 — 6,300	4
α-Tocopherol (ppm)	36.12 ± 9.15	22.5 — 48.9	10
Thiamine (ppm)	18.16 ± 1.54	15.0 — 21.0	25
Riboflavin (ppm)	7.83 ± 0.923	6.10 — 9.00	11
Niacin (ppm)	98.64 ± 25.51	65.0 — 150.0	10
Pantothenic acid (ppm)	30.55 ± 3.52	23.0 — 34.6	11
Pyridoxine (ppm)	9.11 ± 2.53	5.60 — 14.0	11
Folic acid (ppm)	2.46 ± 0.63	1.80 — 3.70	11
Biotin (ppm)	0.268 ± 0.047	0.190 — 0.354	11
Vitamin B <sub>12</sub> (ppb)	40.5 ± 19.1	10.6 — 65.0	11
Choline (ppm)	2,991 ± 382	2,300 — 3,430	10
<b>Minerals</b>			
Calcium (%)	1.17 ± 0.10	1.00 — 1.49	25
Phosphorus (%)	0.93 ± 0.03	0.850 — 1.00	25
Potassium (%)	0.886 ± 0.063	0.772 — 0.971	9
Chloride (%)	0.529 ± 0.087	0.380 — 0.635	9
Sodium (%)	0.316 ± 0.033	0.258 — 0.371	11
Magnesium (%)	0.166 ± 0.010	0.148 — 0.181	11
Sulfur (%)	0.272 ± 0.059	0.208 — 0.420	10
Iron (ppm)	350.5 ± 87.3	255.0 — 523.0	11
Manganese (ppm)	92.48 ± 5.14	81.7 — 99.4	11
Zinc (ppm)	59.33 ± 10.2	46.1 — 81.6	11
Copper (ppm)	11.81 ± 2.50	8.09 — 15.4	11
Iodine (ppm)	3.54 ± 1.19	1.52 — 5.83	10
Chromium (ppm)	1.66 ± 0.46	0.85 — 2.09	11
Cobalt (ppm)	0.76 ± 0.23	0.49 — 1.15	7



**TABLE L4**  
**Contaminant Levels in NIH-07 Rat and Mouse Ration<sup>a</sup>**

	Mean ± Standard Deviation <sup>b</sup>	Range	Number of Samples
<b>Contaminants</b>			
Arsenic (ppm)	0.37 ± 0.18	0.10 — 0.70	25
Cadmium (ppm)	0.10 ± 0.06	0.05 — 0.20	25
Lead (ppm)	0.30 ± 0.24	0.10 — 1.00	25
Mercury (ppm)	0.02 ± 0.00	0.02 — 0.03	25
Selenium (ppm)	0.33 ± 0.12	0.05 — 0.60	25
Aflatoxins (ppb)	<5.0		25
Nitrate nitrogen (ppm) <sup>c</sup>	11.72 ± 5.20	2.90 — 21.0	25
Nitrite nitrogen (ppm) <sup>c</sup>	0.23 ± 0.18	0.10 — 0.70	25
BHA (ppm) <sup>d</sup>	1.88 ± 1.94	1.00 — 10.0	25
BHT (ppm) <sup>d</sup>	1.56 ± 1.58	1.0 — 8.00	25
Aerobic plate count (CFU/g)	78,748 ± 143,028	4,100 — 710,000	25
Coliform (MPN/g)	3 ± 0.2	3 — 4	25
<i>Escherichia coli</i> (MPN/g)	<3		25
<i>Salmonella</i> (MPN/g)	Negative		25
Total nitrosoamines (ppb) <sup>e</sup>	7.25 ± 1.71	4.80 — 11.40	25
<i>N</i> -Nitrosodimethylamine (ppb) <sup>e</sup>	5.50 ± 1.30	3.80 — 9.10	25
<i>N</i> -Nitrosopyrrolidine (ppb) <sup>e</sup>	1.75 ± 1.00	1.00 — 4.30	25
<b>Pesticides (ppm)</b>			
α-BHC	<0.01		25
β-BHC	<0.02		25
γ-BHC	<0.01		25
δ-BHC	<0.01		25
Heptachlor	<0.01		25
Aldrin	<0.01		25
Heptachlor epoxide	<0.01		25
DDE	<0.01		25
DDD	<0.01		25
DDT	<0.01		25
HCB	<0.01		25
Mirex	<0.01		25
Methoxychlor	<0.05		25
Dieldrin	<0.01		25
Endrin	<0.01		25
Telodrin	<0.01		25
Chlordane	<0.05		25
Toxaphene	<0.10		25
Estimated PCBs	<0.20		25
Ronnel	<0.01		25
Ethion	<0.02		25
Trithion	<0.05		25
Diazinon	<0.10		25
Methyl parathion	<0.02		25
Ethyl parathion	<0.02		25
Malathion	0.24 ± 0.21	0.05 — 0.97	25
Endosulfan I	<0.01		25
Endosulfan II	<0.01		25
Endosulfan sulfate	<0.03		25

<sup>a</sup> CFU=colony forming units, MPN=most probable number, BHC=hexachlorocyclohexane or benzene hexachloride

<sup>b</sup> For values less than the limit of detection, the detection limit is given as the mean.

<sup>c</sup> Sources of contamination: alfalfa, grains, and fish meal

<sup>d</sup> Sources of contamination: soy oil and fish meal

<sup>e</sup> All values corrected for percent recovery.

## **APPENDIX M**

# **SENTINEL ANIMAL PROGRAM**

<b>METHODS</b> .....	<b>262</b>
<b>RESULTS</b> .....	<b>263</b>

## SENTINEL ANIMAL PROGRAM

### METHODS

Rodents used in the Carcinogenesis Program of the National Toxicology Program are produced in optimally clean facilities to eliminate potential pathogens that may affect study results. The Sentinel Animal Program is part of the periodic monitoring of animal health that occurs during the toxicologic evaluation of chemical compounds. Under this program, the disease state of the rodents is monitored via serology on sera from extra (sentinel) animals in the study rooms. These animals and the study animals are subject to identical environmental conditions. The sentinel animals come from the same production source and weanling groups as the animals used for the studies of chemical compounds.

Serum samples were collected from sentinel rats and mice at 6, 12, and 18 months and from 30 mg/m<sup>3</sup> rats and mice at the end of the 2-year studies. Blood from each animal was collected and allowed to clot, and the serum was separated. The samples were processed appropriately and sent to Microbiological Associates, Inc. (Bethesda, MD), for determination of antibody titers. The laboratory serology methods and viral agents for which testing was performed are tabulated below; the times at which blood was collected during the studies are also listed.

#### Method and Test

#### Time of Analysis

### RATS

#### ELISA

*Mycoplasma arthritidis*

Study termination

*Mycoplasma pulmonis*

Study termination

PVM (pneumonia virus of mice)

6, 12, and 18 months, study termination

RCV/SDA

(rat coronavirus/sialodacryoadenitis virus)

6, 12, and 18 months, study termination

Sendai

6, 12, and 18 months, study termination

#### Immunofluorescence Assay

RCV/SDA

12 months

Sendai

6 months

#### Hemagglutination Assay

H-1 (Toolan's H-1 virus)

6, 12, and 18 months, study termination

KRV (Kilham rat virus)

6, 12, and 18 months, study termination

**MICE**

## ELISA

Ectromelia virus	6, 12, and 18 months, study termination
EDIM (epizootic diarrhea of infant mice)	6 and 18 months, study termination
GDVII (mouse encephalomyelitis virus)	6, 12, and 18 months, study termination
LCM (lymphocytic choriomeningitis virus)	6, 12, and 18 months, study termination
Mouse adenoma virus	6, 12, and 18 months, study termination
MHV (mouse hepatitis virus)	6, 12, and 18 months, study termination
<i>M. arthritidis</i>	Study termination
<i>M. pulmonis</i>	Study termination
PVM	6, 12, and 18 months, study termination
Reovirus 3	6, 12, and 18 months, study termination
Sendai	6, 12, and 18 months, study termination

## Immunofluorescence Assay

EDIM	12 months
GDVII	12 months, study termination
Mouse adenoma virus	12 months
MHV	12 months
LCM	6 and 12 months, study termination

## Hemagglutination Assay

K (papovavirus)	6, 12, and 18 months, study termination
MVM (minute virus of mice)	6, 12, and 18 months, study termination
Polyoma virus	6, 12, and 18 months, study termination

**RESULTS**

One rat had a positive titer to *M. arthritidis* at study termination. Further evaluation of the serum positive for *M. arthritidis* by immunoblot and Western blot procedures indicated that the positive titer may have been due to cross reaction with antibodies of nonpathogenic *Mycoplasma* or other agents. Only one sample was positive, and there were no clinical findings or histopathologic changes of *M. arthritidis* infection in the animal with the positive titer. Accordingly, the *M. arthritidis*-positive titer was considered to be a false positive.

