

Technical Basis for Regulatory Guidance on Lightning Protection in Nuclear Power Plants

Oak Ridge National Laboratory

**U.S. Nuclear Regulatory Commission
Office of Nuclear Regulatory Research
Washington, DC 20555-0001**



AVAILABILITY OF REFERENCE MATERIALS IN NRC PUBLICATIONS

NRC Reference Material

As of November 1999, you may electronically access NUREG-series publications and other NRC records at NRC's Public Electronic Reading Room at <http://www.nrc.gov/reading-rm.html>.

Publicly released records include, to name a few, NUREG-series publications; *Federal Register* notices; applicant, licensee, and vendor documents and correspondence; NRC correspondence and internal memoranda; bulletins and information notices; inspection and investigative reports; licensee event reports; and Commission papers and their attachments.

NRC publications in the NUREG series, NRC regulations, and *Title 10, Energy*, in the Code of *Federal Regulations* may also be purchased from one of these two sources.

1. The Superintendent of Documents
U.S. Government Printing Office
Mail Stop SSOP
Washington, DC 20402-0001
Internet: bookstore.gpo.gov
Telephone: 202-512-1800
Fax: 202-512-2250
2. The National Technical Information Service
Springfield, VA 22161-0002
www.ntis.gov
1-800-553-6847 or, locally, 703-605-6000

A single copy of each NRC draft report for comment is available free, to the extent of supply, upon written request as follows:

Address: Office of the Chief Information Officer,
Reproduction and Distribution
Services Section
U.S. Nuclear Regulatory Commission
Washington, DC 20555-0001

E-mail: DISTRIBUTION@nrc.gov

Facsimile: 301-415-2289

Some publications in the NUREG series that are posted at NRC's Web site address <http://www.nrc.gov/reading-rm/doc-collections/nuregs> are updated periodically and may differ from the last printed version. Although references to material found on a Web site bear the date the material was accessed, the material available on the date cited may subsequently be removed from the site.

Non-NRC Reference Material

Documents available from public and special technical libraries include all open literature items, such as books, journal articles, and transactions, *Federal Register* notices, Federal and State legislation, and congressional reports. Such documents as theses, dissertations, foreign reports and translations, and non-NRC conference proceedings may be purchased from their sponsoring organization.

Copies of industry codes and standards used in a substantive manner in the NRC regulatory process are maintained at—

The NRC Technical Library
Two White Flint North
11545 Rockville Pike
Rockville, MD 20852-2738

These standards are available in the library for reference use by the public. Codes and standards are usually copyrighted and may be purchased from the originating organization or, if they are American National Standards, from—

American National Standards Institute
11 West 42nd Street
New York, NY 10036-8002
www.ansi.org
212-642-4900

Legally binding regulatory requirements are stated only in laws; NRC regulations; licenses, including technical specifications; or orders, not in NUREG-series publications. The views expressed in contractor-prepared publications in this series are not necessarily those of the NRC.

The NUREG series comprises (1) technical and administrative reports and books prepared by the staff (NUREG-XXXX) or agency contractors (NUREG/CR-XXXX), (2) proceedings of conferences (NUREG/CP-XXXX), (3) reports resulting from international agreements (NUREG/IA-XXXX), (4) brochures (NUREG/BR-XXXX), and (5) compilations of legal decisions and orders of the Commission and Atomic and Safety Licensing Boards and of Directors' decisions under Section 2.206 of NRC's regulations (NUREG-0750).

NUREG/CR-6866
ORNL/TM-2001/140

Technical Basis for Regulatory Guidance on Lightning Protection in Nuclear Power Plants

Manuscript Completed: May 2005
Date Published: January 2006

Prepared by
P.D. Ewing, R.A. Kisner, K. Korsah,
M.R. Moore, J.B. Wilgen, R.T. Wood

Oak Ridge National Laboratory
Managed by UT-Battelle, LLC
Oak Ridge, TN 37831-6472

C.E. Antonescu, NRC Project Manager

Prepared for
Division of Engineering Technology
Office of Nuclear Regulatory Research
U.S. Nuclear Regulatory Commission
Washington, DC 20555-0001
NRC Job Code W6851



ABSTRACT

Oak Ridge National Laboratory (ORNL) has been engaged by the U.S. Nuclear Regulatory Commission (NRC) Office of Nuclear Regulatory Research (RES) to develop the technical basis for regulatory guidance to address design and implementation practices for lightning protection systems in nuclear power plants (NPPs). With the advent of digital and low-voltage analog systems in NPPs, lightning protection is becoming increasingly important. These systems have the potential to be more vulnerable than older, analog systems to the resulting power surges and electromagnetic interference (EMI) when lightning hits facilities or power lines. This report documents the technical basis for guidance on the protection of nuclear power structures and systems from direct lightning strikes and the resulting secondary effects. Four Institute of Electrical and Electronics Engineers (IEEE) standards are recommended for endorsement to address issues associated with the lightning protection of nuclear power plants and their equipment and personnel: IEEE Std 665-1995 (R2001), *IEEE Guide for Generating Station Grounding*; IEEE Std 666-1991 (R1996), *IEEE Design Guide for Electric Power Service Systems for Generating Stations*, IEEE Std 1050-1996, *IEEE Guide for Instrumentation and Control Equipment Grounding in Generating Stations*; and IEEE Std C62.23-1995 (R2001), *IEEE Application Guide for Surge Protection of Electric Generating Plants*.

FOREWORD

A nuclear power plant has numerous structures, systems, and components that are susceptible to lightning strikes. The detrimental effects of such strikes can include reactor trips, actuation of safety systems, and loss of fire protection. Licensing reviews for lightning protection are based on established industry design standards and practices, and the resulting level of protection has generally been satisfactory. However, with the advent of digital and low-voltage analog electronics in safety systems, lightning protection is becoming increasingly more important to the operations of a plant. Guidance specific to nuclear power plants will improve consistency in the design and implementation of lightning protection systems and ensure that the frequency of lightning-induced events remains low.

The purpose of the research discussed in this NUREG/CR report was to document the technical basis for guidance on lightning protection in nuclear power plants. Oak Ridge National Laboratory was engaged to conduct the research. The research approach taken was to first establish the relevance of lightning protection guidance by assessing plant operating experiences associated with lightning strikes and then, if needed, select appropriate industry standards to provide lightning protection guidance specific to nuclear power plants.

The need was established with the examination of 240 licensee event reports dating back to 1980 related to lightning-induced damage, along with the review of both NRC and nuclear industry reports discussing the ramifications of lightning strikes. Recommendations for guidance were then established that included the endorsement of four IEEE standards related to lightning protection: IEEE Std 665, IEEE Std 666, IEEE Std 1050, and IEEE Std C62.23.

This NUREG/CR report describes current industry design criteria and practices and standards appropriate for implementing lightning protection systems in nuclear power plants. While the report contains recommendations for use in a regulatory guide on lightning protection, such a regulatory guide would apply only to new nuclear power plants.



Carl J. Paperiello, Director
Office of Nuclear Regulatory Research

CONTENTS

ABSTRACT.....	iii
LIST OF FIGURES AND TABLES.....	xi
EXECUTIVE SUMMARY	xiii
ACKNOWLEDGMENTS	xv
ABBREVIATIONS AND ACRONYMS	xvii
GLOSSARY	xix
1. INTRODUCTION	1
1.1 Purpose.....	1
1.2 Research Approach and Scope of Guidance	1
1.3 Facts About Lightning	2
1.4 History of NRC Lightning Protection Guidance.....	3
2. LIGHTNING-RELATED OPERATING EVENTS	5
2.1 Licensee Event Reports.....	5
2.1.1 Summary of Lightning-Related Events from the Rourk Study (1980 – 1991).....	5
2.1.2 ORNL Study of Lightning-Related Events (1992 – 2003).....	6
2.2 U.S. NRC Reports.....	10
2.2.1 Special Inspection 50-29/91-09 (Yankee Rowe – Loss of Offsite Power Event).....	10
2.2.2 Engineering Evaluation Report AEOD/E605	13
2.2.3 NRC Information Notice 85-86.....	15
2.3 Industry Reports	15
2.3.1 Nuclear Safety Analysis Center Report 41	15
2.3.2 Reports on World Wide Web	18
3. KEY ISSUES OF LIGHTNING PROTECTION	21
3.1 Review of ANSI/NFPA 780-2004	21
3.1.1 Zones of Protection.....	22
3.1.2 Strike Termination Devices	22
3.1.3 Down Conductors	22
3.1.4 Ground Terminals.....	22
3.1.5 Special Structures	23
3.2 Review of UL 96A.....	23
3.3 Guiding Principles of Lightning Protection	23
4. REVIEW OF APPLICABLE STANDARDS.....	25
4.1 Applicable Standards for Lightning Protection.....	25
4.2 IEEE Std 665-1995 (R2001), IEEE Guide for Generating Station Grounding.....	27
4.2.1 IEEE Std 665 Overview	27
4.2.2 Grounding Principles (Section 5.1)	27
4.2.3 Ground Grid Design (Section 5.2).....	27
4.2.4 Grounding of Main Generator Neutral (Section 5.3).....	28
4.2.5 Grounding of Buildings, Fences, and Structures (Section 5.4)	28
4.2.6 Grounding of Generating Station Auxiliaries (Section 5.5)	28
4.2.7 Lightning Protection for Generating Station Structures (Section 5.6).....	28
4.2.8 Grounding of Buried Structures (Section 5.7).....	29
4.2.9 Sizing of Grounding Conductors (Section 5.8)	29
4.3 IEEE Std 666-1991 (R1996), IEEE Design Guide for Electrical Power Service Systems for Generating Stations	29
4.4 IEEE Std 1050-1996, IEEE Guide for Instrumentation and Control Equipment Grounding in Generating Stations.....	29
4.5 IEEE Std C62.23-1995 (R2001), IEEE Application Guide for Surge Protection of Electric Generating Plants.....	30

4.6	IEEE Std 80-2000, IEEE Guide for Safety in AC Substation Grounding	30
4.7	IEEE Std 81-1983, IEEE Guide for Measuring Earth Resistivity, Ground Impedance, and Earth Surface Potentials of a Ground System	31
4.8	IEEE Std 81.2-1991, IEEE Guide for Measurement of Impedance and Safety Characteristics of Large, Extended or Interconnected Grounding Systems.....	31
4.9	IEEE Std 142-1991, IEEE Recommended Practice for Grounding of Industrial and Commercial Power Systems	31
4.10	IEEE Std 367-1996, IEEE Recommended Practice for Determining the Electric Power Station Ground Potential Rise and Induced Voltage from a Power Fault.....	31
4.11	IEEE Std 487-2000, IEEE Recommended Practice for the Protection of Wire-Line Communication Facilities Serving Electric Supply Locations	32
4.12	IEEE Std 1100-1999, IEEE Recommended Practice for Powering and Grounding Electronic Equipment.....	32
4.13	IEEE Std C37.101-1993, IEEE Guide for Generator Ground Protection	32
4.14	IEEE Std C57.13.3-1983 (R1990), IEEE Guide for the Grounding of Instrument Transformer Secondary Circuits and Cases	32
4.15	IEEE Std C62.92.1-2000, IEEE Guide for the Application of Neutral Grounding in Electrical Utility Systems, Part I-Introduction.....	32
4.16	IEEE Std C62.92.2-1989 (R2001), IEEE Guide for the Application of Neutral Grounding in Electrical Utility Systems, Part II-Grounding of Synchronous Generator Systems	33
4.17	IEEE Std C62.92.3-1993 (R2000), IEEE Guide for the Application of Neutral Grounding in Electrical Utility Systems, Part III-Generator Auxiliary Systems	33
4.18	IEEE Std C62.41.1-2002, IEEE Guide on the Surge Environment in Low-Voltage (1000 V and Less) AC Power Circuits.....	33
4.19	IEEE Std C62.41.2-2002, IEEE Recommended Practice on Characterization of Surges in Low-Voltage (1000 V and Less) AC Power Circuits	33
4.20	IEEE Std C62.45-2002, IEEE Recommended Practice on Surge Testing for Equipment Connected to Low-Voltage (1000 V and Less) AC Power Circuits	33
4.21	IEEE Std 998-1996, IEEE Guide for Direct Lightning Stroke Shielding of Substations	34
5.	ASSESSMENT OF LIGHTNING PROTECTION REQUIREMENTS	35
5.1	Overall Grounding Plan	35
5.1.1	Grounding Overview	35
5.1.2	Grid Design	35
5.1.3	Grounding Systems	37
5.2	Lightning Protection System.....	38
5.2.1	LPS Overview	38
5.2.2	Striking Distance	38
5.2.3	Strike Termination Devices (Air Terminals).....	39
5.2.4	Down Conductors	39
5.2.5	Lightning Earthing System	39
5.3	Conductors Egressing the LPS.....	40
5.3.1	Service Entrance (Power Lines)	40
5.3.2	Wire-Line Communications	40
5.3.3	External Systems and Piping	40
5.4	Cable Routing inside the Lightning Protection System	41
5.5	Protection of Medium-Voltage Equipment.....	41
5.6	Surge Protection Devices	41
5.7	Surge Testing of Equipment.....	42
5.8	Maintenance and Testing of LPSs.....	42
5.9	Alternative Lightning Protection Systems	42

6. RECOMMENDATIONS.....	45
7. REFERENCES	47

LIST OF FIGURES AND TABLES

Figures

1	Components of research approach.....	1
2	Elements of the power plant system.....	2
3	Facts about lightning.....	2
4	Lightning-related events for two 12-year periods (1980-1991, 1992-2003).....	8
5	Lightning-related events by year.....	9
6	Yankee Nuclear Power Station June 15, 1991 lightning event sequence.....	10
7	Issues for lightning protection in generating stations.....	24
8	Diagram showing the interdependencies of the standards applicable to lightning protection at nuclear power plants.....	26
9	Overview of lightning protection standards for generating stations.....	37
10	Three types of grounding covered by IEEE Std 665.....	38

Tables

1	Comparison of lightning-related events.....	8
2	Lightning-related events by year.....	9
3	Units in AEOD/E605 review.....	14
4	Key lightning protection issues.....	24
5	The 20 standards judged most applicable to lightning protection for nuclear power plants.....	25
6	Lightning protection checklist and the standards that address checklist issues.....	36



EXECUTIVE SUMMARY

Oak Ridge National Laboratory (ORNL) has been engaged by the U.S. Nuclear Regulatory Commission (NRC) Office of Nuclear Regulatory Research (RES) to develop the technical basis for regulatory guidance to address design and implementation practices for lightning protection systems in nuclear power plants (NPPs). With the advent of digital and low-voltage analog systems in NPPs, lightning protection is becoming increasingly important. These systems have the potential to be more vulnerable than older, analog systems to the resulting power surges and electromagnetic interference (EMI) when lightning hits facilities or power lines. This report documents the technical basis for guidance on the protection of nuclear power structures and systems from direct lightning strikes and the resulting secondary effects.

The scope of the technical basis for guidance includes protection of (1) the power plant and relevant ancillary facilities, with the boundary beginning at the service entrance of buildings; (2) the plant switchyard, (3) the electrical distribution system, safety-related instrumentation and control (I&C) systems, communications, and personnel within the power plant; and (4) other important equipment in remote ancillary facilities that could impact safety. The scope includes signal lines, communication lines, and power lines. The scope also includes the testing and maintenance of the lightning protection systems. The scope does not cover the testing and design practices specifically intended to protect safety-related I&C systems against the secondary effects of lightning discharges, i.e., low-level power surges and EMI. These practices are covered in Regulatory Guide (RG) 1.180, *Guidelines for Evaluating Electromagnetic and Radio-Frequency Interference in Safety-Related Instrumentation and Control Systems*.

This report recommends that four primary standards be endorsed in their entirety for the lightning protection of NPPs and their equipment and personnel:

- IEEE Std 665-1995 (R2001): This report recommends that IEEE Std 665 be endorsed for guidance on lightning protection for NPPs. This standard draws heavily from NFPA 780, which is widely accepted for lightning protection of most types of structures but which specifically excludes power generation plants. One exception is taken to this standard due to a misquote.
- IEEE Std 666-1991 (R1996): This report recommends that IEEE Std 666 be endorsed for its coverage of grounding and surge protection for medium-voltage equipment in NPPs.
- IEEE Std 1050-1996: In addition to IEEE Std 665 and IEEE Std 666, which focuses on the direct effects of lightning strokes, this report recommends the endorsement of IEEE Std 1050, which covers the specific components necessary to prevent damage to I&C equipment from the secondary effects of lightning.
- IEEE Std C62.23-1995 (R2001): This report recommends the endorsement of IEEE Std C62.23 as general guidance on surge protection. This standard consolidates many electric utility power industry practices, accepted theories, existing standards/guides, definitions, and technical references as they specifically pertain to surge protection of electric power generating plants.

This report further recommends that the applicable portions of IEEE Std 80, IEEE Std 81, IEEE Std 81.2, IEEE Std 142, IEEE Std 367, IEEE 487, IEEE Std 1100, IEEE Std C37.101, IEEE Std C57.13.3, IEEE Std C62.92.1, IEEE Std C62.92.2, IEEE Std C62.92.3, IEEE Std C62.41.1, IEEE Std C62.41.2, and IEEE Std C62.45 be endorsed (with qualifications) by the endorsement of the four primary standards. These standards are referenced and provide necessary details not recorded in the primary standards.

ACKNOWLEDGMENTS

The authors wish to thank Christina Antonescu, JCN W6851 Project Manager, and Bill Kemper, Section Chief, of the U.S. NRC Office of Nuclear Regulatory Research (RES) for her help in initiating, planning, and implementing this research effort.

ABBREVIATIONS AND ACRONYMS

ACB	Air circuit breaker
ANSI	American National Standards Institute
BIL	basic impulse level
CB	circuit breaker
DOE	Department of Energy
EDG	emergency diesel generator
EMI	electromagnetic interference
EMP	electromagnetic pulse
ENS	emergency notification system
EOF	emergency offsite facility
ESF	engineering safety feature
GPR	ground potential rise
HPCI	high pressure coolant injection
I&C	instrumentation and controls
IEC	International Electrotechnical Commission
IEEE	Institute of Electrical and Electronics Engineers
IT	information technology
LEMP	lightning electromagnetic pulse
LER	licensee event report
LOPT	loss of power telephones
LPS	lightning protection system
LPZ	lightning protection zone
LWS	lightning warning system
MCP	main coolant pump
MDS	multipoint discharge system
NAS	nuclear alert system
NEUPS	non-essential uninterruptible power supply
NFPA	National Fire Protection Association
NPP	nuclear power plant
NRC	U.S. Nuclear Regulatory Commission
NSAC	Nuclear Safety Analysis Center
OCB	oil circuit breaker
ORNL	Oak Ridge National Laboratory
RCIC	reactor core isolation cooling
RES	Office of Nuclear Regulatory Research
RTD	resistance temperature detector
SPD	surge protection device
SPDS	safety parameter display system
SST	service station transformer
UL	United Laboratories
UPS	uninterruptible power supply
U.S.	United States

GLOSSARY

A	ampere, unit of current
AC	alternating current
DC	direct current
ft	feet, unit of length
in ²	square inch, unit of area
km ²	kilo square meter— 10^3 m ² , unit of area
kV	kilovolt— 10^3 V, unit of voltage
m	meter, unit of length
m ²	square meter, unit of area
MVA	megavolt-ampere— 10^6 VA, unit of apparent power
μs	microsecond— 10^{-3} sec, unit of time
min	minute, unit of time
Ω	ohm, unit of resistance
Ω-cm	ohm-centimeter, unit of area resistivity
sec	second, unit of time
V	volt, unit of voltage

1. INTRODUCTION

1.1 Purpose

Oak Ridge National Laboratory (ORNL) has been engaged by the U.S. Nuclear Regulatory Commission (NRC) Office of Nuclear Regulatory Research (RES) to develop the technical basis for regulatory guidance to address design and implementation practices for lightning protection systems (LPSs) in nuclear power plants (NPPs). With the advent of digital and low-voltage analog systems in NPPs, lightning protection is becoming increasingly important. These systems have the potential to be more vulnerable than older, analog systems to the resulting power surges and electromagnetic interference (EMI) when lightning hits facilities or power lines. The purpose of this report is to document the technical basis for guidance on the protection of nuclear power structures and systems from direct lightning strikes and the resulting secondary effects.

1.2 Research Approach and Scope of Guidance

The three components thought to be needed to establish a detailed technical basis for regulatory guidance on lightning protection are shown in Fig. 1. Because of time constraints, the approach taken during this research includes only two of the components. The first step of the approach is to ascertain the relevance of lightning protection guidance by assessing operating experiences associated with lightning strikes. The sources of these experiences include licensee event reports (LERs), other NRC reports, and industry reports. The second step is to review and select industry standards suitable to provide adequate lightning protection. The third logical step would be to do a detailed system analysis that includes failure mechanisms within plants and their subsequent effects. These failure mechanisms might include the effects of excessive voltage and current, coupling mechanisms (e.g., inductive, capacitive, and conductive coupling), and the breakdown mechanisms for plant equipment, surge protection devices, and wire insulation. The first two steps are adequate for establishing the technical basis at present and the third step is recommended if additional rationale is needed.

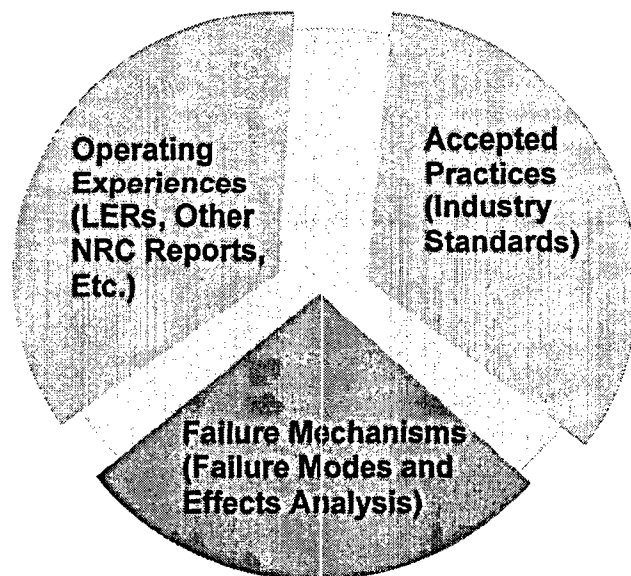

Figure 1. Components of research approach.

The scope of the technical basis for guidance includes protection of (1) the power plant and relevant ancillary facilities, with the boundary beginning at the service entrance of buildings; (2) the plant switchyard, (3) the electrical distribution system, safety-related instrumentation and control (I&C) systems, communications, and personnel within the power plant; and (4) other important equipment in remote ancillary facilities that could impact safety. Fig. 2 illustrates how the elements of the power plant system tie together. The scope includes signal lines, communication lines, and power lines. The scope also includes the testing and maintenance of LPSs. The scope does not cover the testing and design practices specifically intended to protect safety-related I&C systems against the secondary effects of lightning discharges, i.e., low-level power surges and EMI. These practices are covered in Regulatory Guide (RG) 1.180, *Guidelines for Evaluating Electromagnetic and Radio-Frequency Interference in Safety-Related Instrumentation and Control Systems* [1]. Any future guidance on lightning protection founded on the technical basis developed in this report is expected to complement RG 1.180 by helping to ensure that the electromagnetic phenomena induced within NPPs as a result of lightning activity do not exceed the expected RG 1.180 levels.

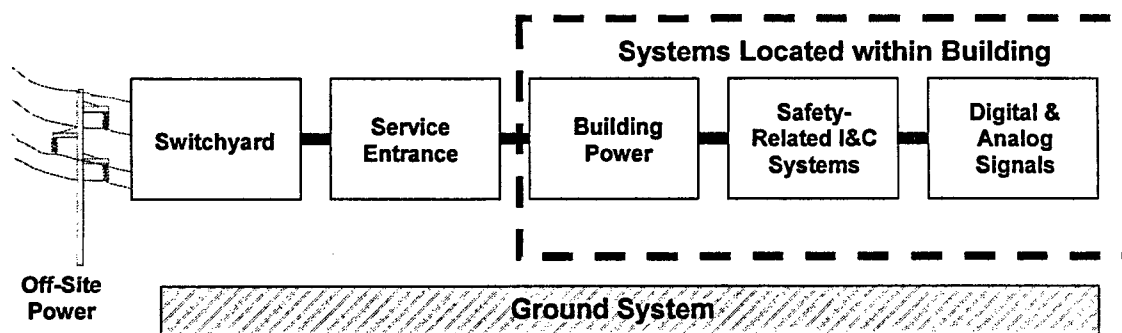

Figure 2. Elements of the power plant system.

1.3 Facts About Lightning

Weather experts report that lightning strikes the earth 100 times each second around the world and that 16 million thunderstorms occur worldwide each year [2]. The regions most prone to this violent weather are those where very moist and unstable air masses move through year-round (e.g., regions in close proximity to the Gulf of Mexico and the Atlantic Ocean) [3]. Some additional facts about lightning are shown in Fig. 3.

Lightning ...

- packs between 35,000 to 40,000 A of current,
- can generate temperatures as high as 50,000°C,
- travels as far as 40 miles,
- can, and does, strike the same place twice,
- kills nearly 100 people each year in the United States and injures hundreds of others, and
- causes billions of dollars in property damage each year, many times resulting in fire and total property loss.

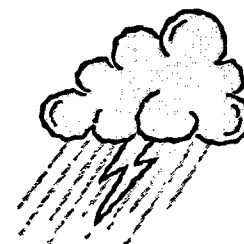

Source: Lightning Protection Institute, "Lightning and Lightning Protection Systems," at <http://www.lightning.org/protect.htm>, 1999.

Figure 3. Facts about lightning.

1.4 History of NRC Lightning Protection Guidance

During the research for this report, it was found that a draft regulatory guide had been written in 1979 entitled *Lightning Protection for Nuclear Power Plants*. The draft guide described criteria acceptable to the NRC staff for the design, application, and testing of LPSs to ensure that electrical transients resulting from lightning phenomena did not render systems important to safety inoperable or cause spurious operation of such systems. Specific practices on the use of lightning rods (air terminals) from National Fire Protection Association (NFPA) 78-1968, *Lightning Protection Code*, were endorsed. Note that this standard has been updated a number of times since 1968 and the latest version is NFPA 780-2004, *Standard for the Installation of Lightning Protection Systems* [4]. The draft guide also endorsed practices on the use of surge arresters found in two American National Standards Institute (ANSI) standards. Issues such as common mode failures, surge protection of redundant systems, and surge protection of solid-state logic systems were mentioned but not discussed in great detail. The draft regulatory guide was never finalized and was subsequently terminated in 1981.

Petition for Rulemaking (PRM) 50-56 [5] was originated in 1991 by Richard Grill, a former NRC staffer, petitioning the NRC to again address concerns related to lightning, as well as other sources such as electromagnetic pulses (EMP), EMI, geomagnetic currents, and ferromagnetic effects. The PRM 50-56 petition specifically requested that lightning (and the other electrical transients) be added to the list of phenomena that NPPs must be designed to safely withstand, and that licensees be required to “*consider the effect of electrical transients on the operability and reliability of nuclear safety related systems and potential accident scenarios ... to assure that such transients can not compromise the safety of the facility or the health and safety of the public.*” The petition also requested that NRC regulations be amended to require that this “*unreviewed safety question be scoped, reviewed, and resolved for all nuclear power plants on a generic basis ...*” The main motivation, and reason for concern, for Mr. Grill was that potential effects of electrical transients on the integrity of safety related systems had not been rigorously analyzed, nor had implications for safety been factored into conservative preventative designs, as had been done previously when considering other natural (and man-made) phenomena, such as earthquakes, floods, tornados, tsunamis, and aircraft crashes.

The NRC staff issued a report authored by Chris Rourk, *Report on the Sources and Effects of Electrical Transients on the Electrical Systems of Commercial Nuclear Power Plants* [6], in 1992 in response to PRM 50-56. The Rourk report was structured accordingly, with EMP, geomagnetic currents, ferromagnetic effects, switching surges, and lightning being addressed in individual chapters. EMI was not addressed in this report because it was being studied under a separate program that eventually led to the issuance of RG 1.180. Lightning related LERs were reviewed to address concerns that could not be addressed by a review of information in the technical literature. The purpose was to examine whether, on the basis of operating experience, NPPs are adequately protected from the transients associated with lightning strikes. Based on the review of the lightning related LERs, the report concluded that “*it does not appear that the effects from electrical transients which have occurred could compromise the safe shutdown of licensed nuclear power plants.*” It further stated that “*regulation of lightning protection does not appear to be justified on the basis of safety significance. However, in light of ... the increasing reliance on digital controls, it seems prudent to consider changes to regulatory requirements for future plants.*” It also stated that “*the structural and power line protection practices currently used by licensees appear to adequately protect licensed facilities from the effects of direct strikes based upon the operating experiences reviewed in this report. Therefore, existing standards could be used as the technical basis for consideration of any new regulation for structural and power line protection.*”

This is where the status of regulatory guidance on lightning protection stood until the initiation of the ORNL research effort. As stated earlier, ORNL’s approach is to ascertain the relevance of lightning

protection guidance by assessing the operating experiences in NPPs associated with lightning strikes. The sources include LERs, other NRC reports, and industry reports. A review of lightning-related operating events is discussed in Section 2.

2. LIGHTNING-RELATED OPERATING EVENTS

2.1 Licensee Event Reports

Lightning-related events from LERs were reviewed for the period 1980 to 2003. LERs for the period 1980 to 1991 had been reviewed by Rourk [5] to identify events involving equipment misoperation and damage caused by lightning strikes. The results of this review are reported in Ref. [6]. ORNL staff built upon this earlier work by reviewing lightning-related events from 1992 to 2003 and comparing the results with the Rourk study. In order for the ORNL review and analysis to be a logical extension of the study by Rourk, similar analysis methods to those used in the Rourk study were applied. For example, the ORNL study uses the same categorization of lightning-related events used by Rourk.

2.1.1 Summary of Lightning-Related Events from the Rourk Study (1980 – 1991)

The objective of the Rourk review was to determine *“whether any trends were developing that indicated potential problems due to lightning.”* Significant results of the review are identified below:

- A total of 174 events were reported.
- Six events involved a total loss of offsite power.
- 42 events involved the loss of one or more offsite power sources.
- Only 1 of the 42 events cited involved any equipment damage.
- The other 41 events included some adverse equipment effects that appeared to result from low voltage at the plant (e.g., the tripping of equipment protective relays), but did not involve any equipment damage or failure.
- Six events involved loss of fire protection equipment from lightning, but no fire actually occurred.
- Four events involved a fire at the plant caused by lightning. (Note: It is likely that additional fires have occurred at plants that were not reported on LERs, because to be reportable an event must involve actuation or unavailability of safety-related equipment or systems.)
- Of the 174 events, only 58 involved reactor trips.
- 20 events involved actuation of the control rod drive DC power supply over-voltage protection. When this happens, the control rod gripper units are de-energized, causing the control rods to fall into the reactor core. The reactor then trips because of a high negative flux rate.
- 18 events involved damage to meteorological equipment mounted on towers. Such events do not threaten the ability of a plant to safely shut down. However, they do establish that one indication of a local lightning strike is failure of equipment on a meteorological tower.

Conclusions from the Rourk study included the following:

- Most events that resulted in component damage appeared to have been caused by a local strike, rather than a transmission line strike.
- Although it is possible that a lightning strike may result in a fire simultaneously with the loss of fire protection, such a scenario did not occur in the 12-year period reviewed. Taken into account the number of operating reactors within the period, this constituted 967 years of plant operation.
- The most significant impact on plant operations that may be caused by lightning is from the effects of local strikes.
- High-frequency voltage transients created on the transmission system by lightning do not cause significant equipment misoperation or damage.

2.1.2 ORNL Study of Lightning-Related Events (1992 – 2003)

Lightning-related events from 1992 – 2003 were analyzed and grouped into categories. Note that this period covers the next 12 years after the 12-year period reviewed by Rourk (1980 – 1991). In order to compare the two reviews, methods of analysis similar to those used by Rourk were applied and the categorization of events follows the same methods used by Rourk. To have reasonable assurance that similar search methods were used, the keywords used to search for lightning-related events for the 1992 – 2003 period were also used to retrieve lightning-related events from 1980 – 1991. A total of 172 events were retrieved. The Rourk study reported a total of 174 lightning-related events for the same period. The percentage difference (< 2%) is small, and provides additional assurance of the validity of any comparisons made with regard to the two review periods. The search for lightning-related occurrences from 1992-2003 uncovered a total of 66 events. This is a significant reduction from the 174 events reported in the Rourk study.

The following is a category-by-category comparison of lightning-related LER events within the two periods of study:

Loss of Offsite Power, Without Equipment Damage:

A loss of offsite power occurs when any transmission line connecting the plant to the power system is disconnected by circuit breakers. A plant typically has more than one offsite power source. Plants are also required to have on-site backup sources, such as diesel generators, to provide sufficient power to safely shut down the plant in case of a total loss of offsite power.

The ORNL review found a total of 21 events that involved a loss of one or more offsite power sources, but which did not result in equipment damage. This is in contrast with 41 events reported for the same category for the period 1980-1991 in the Rourk study.

Loss of Offsite Power, Accompanied by Equipment Damage:

A lightning strike on a transmission line creates a surge on the line with a current magnitude that is determined by the charge characteristics of the lightning and the location of the strike. By contrast, the effect of a local strike will be largely dependent on the magnitude and distribution of ground potential rise and capacitive and inductive coupling of plant equipment to the lightning channel.

Examination of the LER events in the 1992 – 2003 period did not uncover any loss of offsite power events that subsequently resulted in plant equipment damage. The Rourk study found one event in this category. Thus, there is consistently little or no occurrence of events over the 24-year period covered by both reviews relating to equipment damage as a result of loss of offsite power. It is reasonable to assert therefore, that the most likely cause of plant equipment damage is from a local strike rather than a transmission line strike.

Reactor Trip:

This category involves events that resulted in a reactor trip, but did not involve any equipment damage. Reactor trips that also resulted in equipment and emergency safety function (ESF) actuation, i.e., pump or valve actuation, also fall under this category.

Of the 66 events examined, 48 events (or about 73%) involved no reactor trip. This is a slightly higher percentage than (and therefore an improvement over) the previous 12-year period.

Low Voltage Transient:

Eleven lightning-related events out of the 66 examined were attributed to under-voltage transient effects. The Rourk study did not specifically identify the number of low voltage transient effects. Instead, the study reported 41 events that included both high frequency transmission line surges/spikes, as well as low voltage transients.

Control Rod Drive Power Supply Overvoltage Protection Actuation:

For the period 1992 – 2003, two events involved actuation of the control rod drive over-voltage protection, causing the control rod gripper units to de-energize and the rods to drop into the reactor core. This is in contrast to 20 similar events reported in the Rourk study for the 198 – 1991 period.

Fire-Related Events and Loss of Fire Protection:

A lightning strike could simultaneously cause loss of fire suppression/protection equipment and cause a fire. This review found only three lightning incidents that resulted in loss of fire protection equipment. However, none of these involved an actual fire. The Rourk study reported 6 incidents which involved loss of fire protection equipment. In addition to these events, there were 4 events that involved a fire at the plant caused by lightning. Thus, while the incidence of loss of fire protection equipment or an outright outbreak of fire at plants caused by lightning was not high during the 12-year period of the Rourk study, the ORNL study reveals a further significant reduction in these occurrences over the last 12-year period.

Meteorological and Other Equipment Damage:

Out of the 66 events examined, one involved damage to meteorological equipment mounted outside the plant, and 10 were attributed to damage to instrumentation equipment (e.g., transmitters, RTDs, etc.) in the plant. This again is a significant reduction over the previous 12-year period (18 and 26 respectively) covered by the Rourk study.

Table 1 shows a tabular comparison of the lightning-related events from the two periods of study. Fig. 4 shows a graphical representation of events. Note that while the Rourk study includes a good discussion on the lightning events within the period studied, it does not include an actual tabulation/graphical representation of these LER events. The LER event tabulation of the 1980 – 1991 events included in Table 1 is for the purpose of comparison to the ORNL study and has been inferred from the analyses and discussions in the Rourk study. Thus, no entry could be made for events due to under-voltage transients for the Rourk study because these events were included with other high-frequency transmission line effects.

As already noted, the ORNL study retrieved all lightning-related events from 1980 through 2003. However, only events from 1992 through 2004 were reviewed in detail to form a basis for comparison to the Rourk study which covered 1980 – 1991.

Table 1. Comparison of lightning-related events

Event Category	Event Designation	Number of Occurrences 1980 – 1991	Number of Occurrences 1992 – 2003
Loss of offsite power, without any equipment damage	LOOP_NED	41/174	21/66
Loss of offsite power, accompanied by equipment damage	LOOP_DMG	1/174	0/66
Reactor trip – no equipment damage, but there could be spurious ESF actuation (valve or pump actuation, etc.)	TRIP	58/174	18/66
Low voltage transient	LV_TRANST	(see text)	11/66
Control rod drive power supply overvoltage protection actuation	CTRD_DRP	20/174	2/66
Loss of fire protection	LOFP	6	3/66
Fire	FIRE	4	0
Meteorological equipment damage	METEQ_DMG	18/174	1/66
Other equipment damage	OTHER_DMG	26/174	10/66

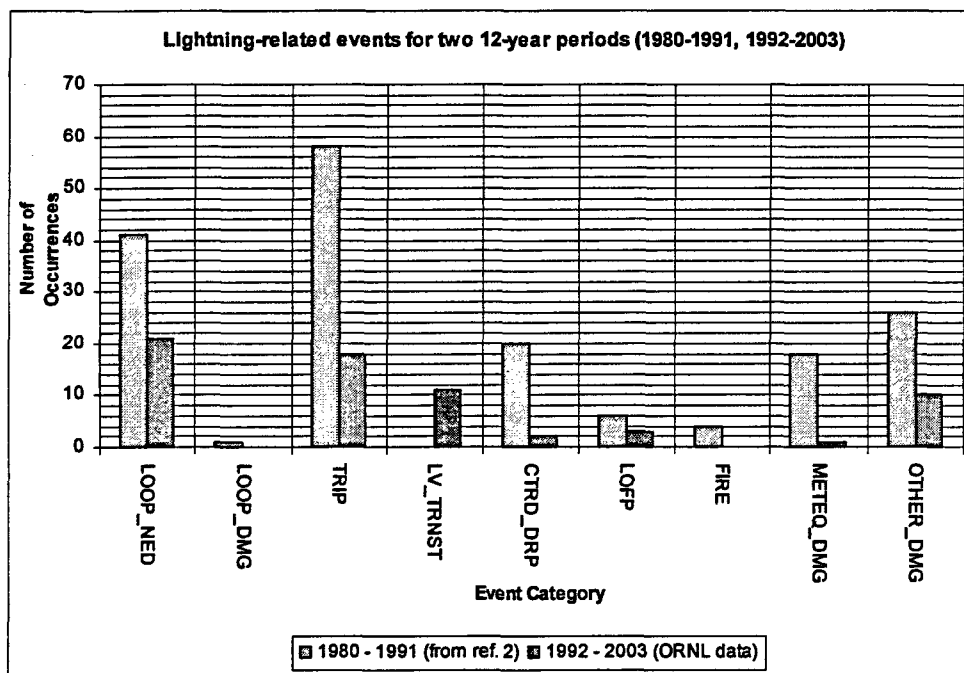

Figure 4. Lightning-related events for 2, 12-year periods (1980-1991, 1992-2003)

A tabulation of the lightning-related events as a function of year for the entire 24-year period (from 1980 – 2003) is shown in Table 2. A graphical representation of the tabulation is shown in Fig. 5. As can be seen, the average number of occurrences per year during the period of the Rourk study (14.3 incidents per year) is significantly higher than in the following 12-year period reviewed by ORNL (5.5 incidents per

year). This constitutes about a 62% reduction in the number of lightning-related incidents. This appears to suggest that plants that had high incidences of lightning-related events may have put in place more robust protective equipment to mitigate the effect of the occurrences. However, there appears to be an irregularity in the relative number of incidents recorded in 2003. ORNL re-examined the LERs to see if there was some unusual occurrences that could explain this anomaly (such as one plant experiencing peculiar problems or incidents involving a vulnerable component). The review did not uncover any peculiarities.

Table 2. Lightning-related events by year

	1980 - 1991											1992 - 2003												
Year	1980	1981	1982	1983	1984	1985	1986	1987	1988	1989	1990	1991	1992	1993	1994	1995	1996	1997	1998	1999	2000	2001	2002	2003
No. of occurrences	12	6	14	14	10	18	18	19	14	11	13	23	7	6	9	5	8	3	5	7	1	3	2	10

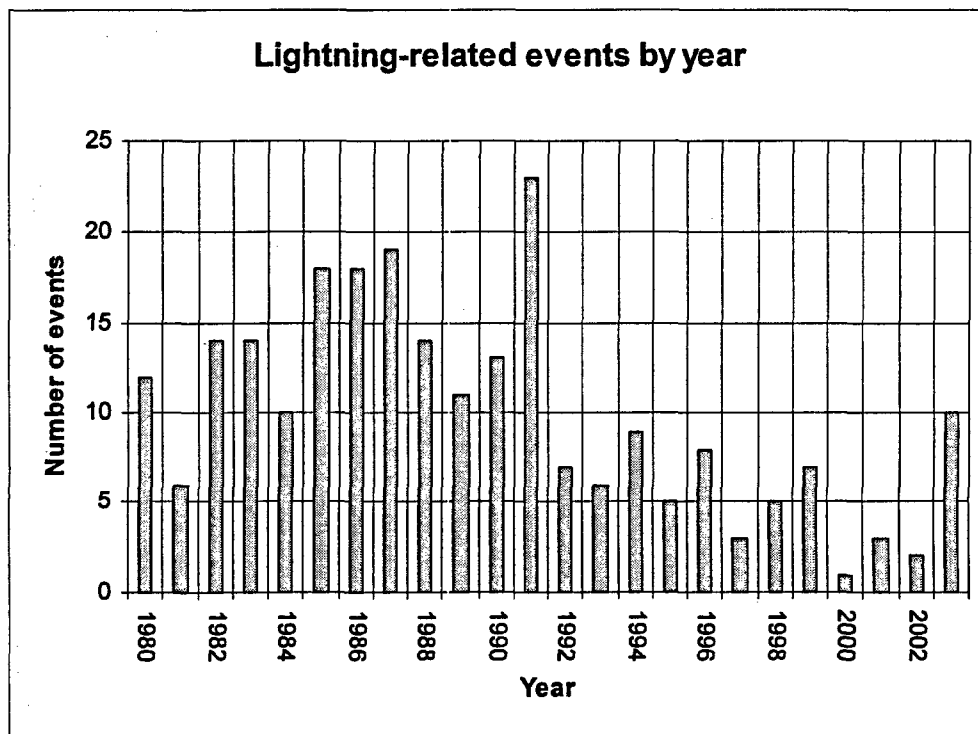

Figure 5. Lightning-related events by year.

2.2 U.S. NRC Reports

2.2.1 Special Inspection 50-29/91-09 (Yankee Rowe – Loss of Offsite Power Event)

Special Inspection 50-29/91-09, *Loss of Offsite Power Event* [8], is a report issued by an inspection team in NRC Region 1 detailing the sequence of events initiated by a lightning strike at 11:50 p.m. on June 15, 1991, to the switchyard at Yankee Nuclear Power Station, Rowe, Massachusetts. Operating power level prior to the event was 89 percent of full power. The event was initiated by a lightning strike that disabled both offsite AC power sources, started a transformer fire, and disabled communications systems. At the onset of the event, the turbine tripped and reactor automatically scrammed. The trigger for the episode was one or more lightning strikes to the plant substation, which injected voltage transients into the plant power distribution system causing disruption to many systems and starting a fire. The event sequence worsened after another lightning strike disabled a nearby communications tower. The event sequence is depicted in Figure 6, in which events related to the fire and the communication systems are separated. The account below includes a description of the plant's offsite and onsite power systems, the response to lightning strike, the plant's lightning protection and surge suppression systems, and a list of equipment damage. The applicability of lightning protection guidance is also discussed.

Yankee Nuclear Power Station
June 15, 1991 Lightning Event Sequences

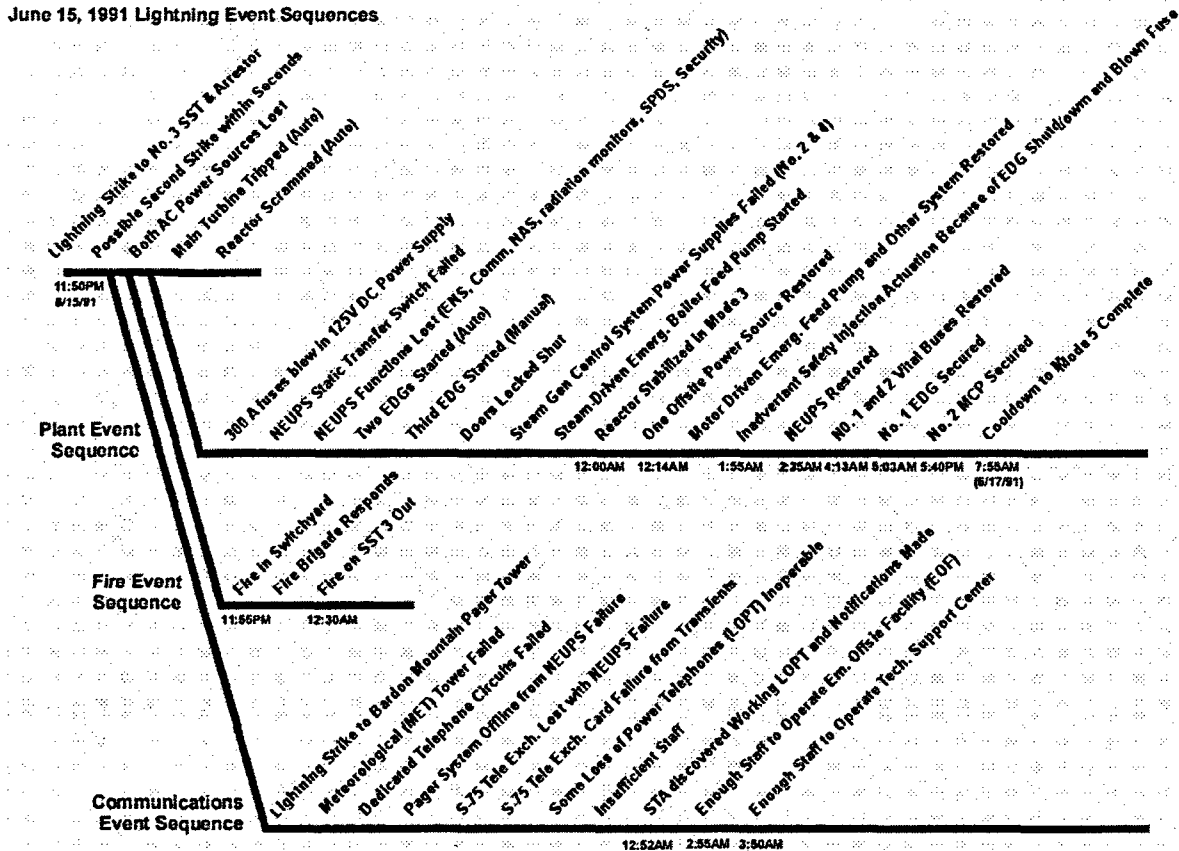

Figure 6. Yankee Nuclear Power Station June 15, 1991 Lightning Event Sequence

2.2.1.1 Offsite and Onsite Power Systems

The Station Service System contains three station service transformers (SSTs): No.1 rated at 5.0/6.25 MVA, 18kV-2400V is connected to the main generator to backfeed station loads; Nos. 2 and 3, rated at 5.0/6.25 MVA, 115kV-2400V, are each connected to one of the two 115kV transmission lines respectively. Station auxiliaries are divided among three 2400V busses, which are normally independent but can be cross-connected. Bus section No. 1, which is backfed from the main generator, supplies power to two main coolant pumps. Generator coastdown inertia supplies power to the two pumps for about 2 minutes through bus No. 1. Bus sections Nos. 2 and 3 are powered from two separate SSTs: each supplies one main coolant pump and one motor-driven emergency feedwater pump. Each SST has a voltage regulator on the secondary side to maintain 2400V to the load. Station service also includes three 480V non-safety buses.

Three 480V emergency buses are normally energized from the 480V non-safety buses. The emergency buses power the low- and high-pressure safety injection pumps and emergency motor control circuits. Loss of voltage to the emergency buses results in auto start of the associated emergency diesel generator (EDG), the breakers re-energize the affected bus. The EDGs can be aligned to backfeed a non-safety 480V bus and a 2400V bus.

Instrumentation is powered by two separate 120VAC vital buses, which are energized through static inverters powered from the 120VDC system. Failure of static inverters transfers power supply from 125VDC to 480V through a 480-120 transformer. Vital buses Nos. 1 and 2 are aligned to be powered from EDGs Nos. 1 and 3, respectively.

2.2.1.2 Response to Lightning Strike

Based on damage evidence, the initial lightning strike was to the A-Phase manual disconnect switch that isolates the 115kV Harriman line from the 115kV switch through and oil circuit breaker. The energy of the strike caused failure of the A-Phase surge arrester connected to the No. 3 SST. Operators noted to interviewers that some instrumentation (rod position indication and nuclear instruments) remained energized for a few seconds after reactor scram. Therefore not all off-site power was lost initially which suggests that two lightning strikes may have sequentially (within seconds) hit the switchyard.

A strike initiated the trip of the one-directional 21-2 impedance relay, which measured the impedance of the 115kV Harriman line in the direction of the Harriman Station. The trip signal from the impedance relay resulted in an air circuit breaker (ACB) trip, which caused a loss of the Harriman line. The supply breakers tripped to 2400V bus No. 2 and 480V bus No.5-2, which supplies emergency bus No. 3. Undervoltage relays sensed the loss of voltage condition and automatically started EDG No. 3. The EDG re-energized emergency bus No. 3.

Oil circuit breaker Y-177 tripped and disconnected 115kV switchyard from the Cabot line. The cause of the oil circuit breaker trip was not clear since it could have been from the initial lightning strike, reactor scram, or turbine trip. Although supply ACBs to the 2400V No. 3 and 480V bus No. 6-3 remained closed, a loss of voltage condition existed at 2400V bus No. 3 and 480V bus No. 6-3, which supplies emergency bus No. 1. Undervoltage relays sensed this condition and started EDG No. 1, re-energizing emergency bus No. 1.

Emergency bus No. 2 remained energized for one to two minutes by the main generator after reactor scram and turbine trip. The reactor scram may have been due to the loss of 2 of 4 main coolant pumps. Exact cause of reactor trip was not recorded. Anticipating that the generator would spin down, operators manually started EDG No. 2. Once the voltage on emergency bus No. 2 dropped below the undervoltage relay threshold, the bus was isolated and EDG No. 2 closed onto the bus.

The lightning transient also caused a failure of the safety-related static inverters. The failure resulted in automatic transfer of the 120VAC vital bus power supply from the inverters to the backup supply of emergency buses through a 480-120V transformer. Each inverter was realigned to their respective emergency buses Nos. 1 and 3. Therefore, until EDGs Nos. 1 and 3 re-energized their respective buses, the Nos. 1 and 2 120VAC vital buses remained de-energized. With no vital buses energized, most of the primary and reactor plant instrumentation would be off line. This would include such instruments as all nuclear instruments, pressurizer level and pressure, vapor container pressure and level, steam generator pressures and levels, and loop temperatures and flows. The loss of vital buses was only momentary.

The lightning transient also resulted in the loss of power to the Non-Essential Uninterruptible Power Supply (NEUPS) distribution panel. The NEUPS distribution panel provides 120V power to communications equipment, area and process radiation monitors, and the Safety Parameter Display System (SPDS). Damage to the NEUPS inverter and static switch, which allows the diesel to bypass the inverter, prevented operators from closing motor operated circuit breaker CB-4 and therefore energizing NEUPS distribution panel. Post accident analysis determined that there may have been alternative means to energize the NEUPS distribution panel.

A Safety Injection System was automatically actuated when the operator was transferring the emergency buses to offsite power. A blown fuse in the inverters (directly attributable to the lightning transient) was a contributing factor to the inadvertent injection although operator error in following procedure was a direct cause.

Loss of off-site power caused certain doors to fail in the locked state. Security personnel provided operators access to equipment and facilities through the security key system.

2.2.1.3 Lightning Protection and Surge Suppression Systems

The two incoming 115kV transmission lines into the Yankee switchyard were not protected with overhead shield wires. The susceptibility of direct lightning strikes to transmission lines can be reduced by providing overhead shield wires, which limit the magnitude and rate of rise of voltage surges. The switchyard had a single lightning mast.

The station service transformers were equipped with one metal-oxide surge arrester per phase. Arrestors were rated at 96kV with a maximum continuous operating voltage of about 75kV. (70kV minimum needed for grounded Y at 121kV maximum allowable). It is not known whether surge protection was present further down the internal distribution lines.

2.2.1.4 Equipment Damage

Lightning strike and resulting overvoltage caused multiple equipment failures.

- SST No. 3 A-phase surge arrester shattered and burned.
- Z-126/C-126-5 disconnect bushing was damaged.
- NEUPS inverter and static switch failed.
- No. 1 Vital bus inverter fuse was blown.
- No. 1 Vital bus inverter output frequency meter was decalibrated.
- No. 2 Vital bus inverted fuse was blown.
- Y-177 Oil Circuit Breaker (OCB) relay coil opened.
- Loss of compensated level indications to No. 2 and No. 4 steam generators.
- No. 2 and No. 4 feedwater control system power supply had blown fuses.
- Several panel indicators were damaged.

2.2.1.5 Application of LPS Guidance

The effects of the lightning strike could have been reduced by better protection in the switchyard. Because the switchyard had no overhead static shield conductor, it is concluded that the lightning strike attained maximum rate of rise in current and hence transient voltages. The lightning arrestors (including the one that shattered and burned) may have had less energy to bypass with overhead protection. As far as the ORNL analysis could determine, there was no service entrance protection nor were internal power distribution buses protected by surge arrestors. Internal protection could have prevented overvoltage effects such as blown fuses, tripped breakers, and disrupted circuits such as the safety-related static inverters. Such protection is the subject of several IEEE standards.

In the special inspection of the plant, analysts did not examine the grounding system. We can only speculate that some of the power transients were propagated through the grounding system. Design of effective grounding systems is the subject of several IEEE standards. By limiting the propagation of lightning induced transients, key systems may have remained operation and greatly reduced the effort, time, and risk involved in subduing the situation.

2.2.2 Engineering Evaluation Report AEOD/E605

NRC Engineering Evaluation Report AEOD/E605, *Lightning Events at Nuclear Power Plants* [9], discusses lightning-related events obtained from LERs from the period of 1981 – 1985 and their evaluation by the Office for Analysis and Evaluation of Operational Data (AEOD). The search identified 62 events that occurred at 32 reactor units. The evaluation shows that the following systems were affected:

1. Offsite power system;
2. Safety-related instrumentation and control systems;
3. Meteorological and weather systems;
4. Radiation, gas, and effluent flow monitoring systems; and
5. Air intake tunnel halon system.

The report concludes that although lightning strikes have adversely affected the operation of some nuclear power plants, in most cases, there has been no significant degradation of safety and minimal equipment damage. Where damage has been extensive, licensees have taken corrective actions to reduce the consequences of future strikes. The report suggests that no further actions be taken. The report's appendix contains a listing of LER data from which the evaluation was prepared.

2.2.2.1 1981 – 1985 LER Review

As a result of lightning-related events of the summer of 1985, in which several nuclear plants were affected, a search for and review of lightning events at nuclear plants was initiated to determine effects of lightning on safety-related systems. The 62 events occurred at 30 plant sites and involved 32 reactor units. Units affected and numbers of events involved are shown in Table 3.

Table 3. Units in AEOD/E605 review

Plant Name	Number of Events Per Plant
Big Rock Point, Brunswick 1, Byron 1, Catawba 1, Connecticut Yankee, Cooper, Davis-Besse, D. C. Cook 1, Duane Arnold, Fitzpatrick, Hatch 1, McGuire 2, Shoreham, Summer 1, Turkey Point 3, Vermont Yankee, Waterford 3	1
Arkansas Nuclear One 2, Farley 2, Grand Gulf 1, Maine Yankee, Peach Bottom 3, Pilgrim, Susquehanna 1, Susquehanna 2, St. Lucie 2, Wolf Creek	2
Yankee Rowe	3
Browns Ferry 1, Crystal River 3	5
McGuire 1, TMI 2	6

All plants affected were in the mid-western and eastern regions with the majority east of the Mississippi river. In general, plants with high number of lightning events are located in areas of high mean annual ground flash density (greater than 10 flashes/km²). There are exceptions such as Yankee Rowe, Pilgrim, and Vermont Yankee which, though located in a low flash density zone (2 flashes/km²), have experienced multiple lightning induced events. The report attributes that situation to less than adequate design or installation of lightning protection equipment of those plants. The LER data indicate that the peak lightning-related events occur in June and July, which is of course when thunderstorms prevail. Winter months are a minimum with only one occurrence in December.

Offsite power systems are the most affected by lightning-induced events (47 percent). Seven (24 percent) of the offsite power events led to a reactor trip. Six events led to inadvertent emergency diesel start up. With one or two exceptions, most of the loss of offsite power was localized to the plant switchyard (i.e., lightning strike in the switchyard led to failure).

Events related to safety-related instrumentation accounted for about 15 percent of the total events. Typical were blown fuses and inadvertent activation of systems such as tripping of control rod drive systems. The reactor tripped in 67 percent of the safety-related instrumentation events. Note that the lightning transients crossed multiple channels of safety-related systems; however, the failures were fail safe. A case of lightning striking containment resulted in voltage transients that failed four power supplies plus actual damage to numerous instruments.

Events affecting meteorological, weather, and environmental systems account for 19 percent of the total events. Events affecting radiation, gas, and effluent flow monitors account for 11 percent of the total events. Events affecting air intake tunnel halon system account for 8 percent.

2.2.2.2 ORNL Conclusions

Mid-western and eastern plants experience most of the lightning events. There is a direct correlation between regional lightning strike density and number of events experienced by a nuclear plant. Data from the short period of this analysis suggest that the number of lightning-related events is relatively constant. Several plants in low lightning density zones experienced an unusually high number of events suggesting that they have an inadequate level of lightning protection. No safety-related systems were damaged during the period of this study. The sensitivity of signal level measurement systems makes them susceptible to spurious actuation during lightning strikes. Licensees moved to improve these susceptible systems when significant damage occurs or other compelling factors are present. The author of the report concludes that no further action regarding lightning events is recommended based on the five-year study.

2.2.3 NRC Information Notice 85-86

Information Notice 85-86, *Lightning Strikes at Nuclear Power Generating Stations* [10], was issued in 1986 for all nuclear power reactor facilities holding a license or construction permit. The purpose is to alert recipients of potentially significant problems of reactor trips and instrumentation damage cause by lightning strikes. No actions are required regarding the notice. The notice concentrates on the effects of lightning-induced surges on solid-state circuitry and summarizes lightning events at five operating plants: Zion units I and 2, Salem unit 1, Kewaunee, Byron unit 1, and Arkansas unit 2.

Zion

Lightning transients damaged safety-related systems and induced transients in the low-voltage power supplies that resulted in control rod drops. Corrections actions were made to the affected, yet reactor trips have still occurred for other as yet uncorrected systems.

Salem

Lightning strike entered containment penetration and damaged pressure transmitters. Reactor trip occurred.

Kewaunee

Electrical storm resulted in loss of two of four instrument busses causing spurious safety injection and blown fuses.

Byron

Lightning strike to containment caused reactor trip due to transient voltages in instrument and control cabling. Failure of four containment power supplies including a redundant pair resulted in partial control rod drop. Thirty plant instruments were damaged. Deficiencies in containment penetration were a common denominator to the incident.

Arkansas

Lightning strike induced spurious signal in core protection system channels resulting in a trip from departure-from-nucleate-boiling ratio. No equipment damage was reported.

2.3 Industry Reports

2.3.1 Nuclear Safety Analysis Center Report 41

Nuclear Safety Analysis Center Report (NSAC) 41, *Lightning Problems and Protection at Nuclear Power Plants* [11] reviews lightning protection features at four sample nuclear power plants. Note that plant identities were not revealed. The goal of the NSAC project was to assess the effectiveness of existing lightning protection (up to 1981). NFPA 78-1975 (now superseded by NFPA 780) was used as the evaluation basis. Adherence to the NFPA code is not a licensing requirement of nuclear plants; however, it is a widely accepted standard for lightning protection. That is why the investigators constructed a check sheet based on the NFPA document.

The review showed that two plants have higher levels of lightning protection. Neither of these plants reported lightning-caused events. The two plants with less lightning protection experienced significant lightning-caused upsets and damage. This comparison strongly suggests that high-quality lightning protection systems lower the risk to lightning-caused problems.

The two plants that had no lightning-related damage were also newer plants with relatively high levels of lightning protection. They are located in high thunderstorm-day zones. The two plants that experienced damage had less lightning protection and are located in lower thunderstorm-day zones. In all four cases, there were visible improvements that could be made to the lightning protection systems. It should be noted that the evaluation period was short (only a few years); over the last 20 years, it is conceivable that all four of the plants have reported lightning-related events. The anonymity of the plants prevents us from such a comparison.

The report concedes that nuclear power plants pose special problems in protection from lightning because of the existence of sensitive instrumentation. Unfortunately these special problems were outside the scope of the study and not covered in the report. The report's scope specifically covers lightning protection required to prevent lightning currents from entering the plant.

Two lightning-related events at about the period that the project was underway were highlighted:

- At one nuclear power plant in June 1980, lightning hit in the vicinity of the south penetration area of the containment building and caused a severe transient on seven main steam pressure transmitters. Two of the transmitters failed which ultimately resulted in a reactor trip and safety injection.
- In August 1980, an instrument bus and two inverters were lost during an electrical storm at a nuclear plant. The reactor tripped and automatic safety injection and containment isolation were initiated.

According to the investigators, NSAC's files on LERs dating from 1978 to 1980 and from Nuclear Power Experience files dating back to 1973 revealed numerous examples of lightning-caused events:

- Numerous generator trips.
- Loss of off-site power and 120VAC vital buses, reactor trips.
- Spurious main steam line isolation and a safety injection.
- Incapacitated annunciators and transformers.
- Initiation of HPCI and RCIC and trip of startup and emergency feedwater pumps.
- Loss of a diesel generator transformer.

From the results of this study it is apparent that protection of switchyard structures is the first layer of defense against propagation of lightning surges into buildings and eventually into electronic systems and safety-related systems. It seems clear from the four examples that well designed protection systems (designed according to standards), which are also well maintained, provide better defense than the converse. Other plant structures, besides the switchyard, must be grounded according to the standards to prevent lightning penetration since lightning can strike pipes, vents, and antennas. Regardless, a designer must assume that surges get past bushings and service entrance connections. Therefore, distribution-level power buses and signal-level lines internal to the plant must be further protected against voltage transients.

2.3.1.1 Plant A

Survey

Plant A generally conforms to NFPA standard with some exceptions. Ground conductors have multiple bends that are below minimum recommended diameter and with greater than 90 degree angles. Ground conductors are close to other conductive components to which they could flash over. In some places, the ground conductors were left unconnected (dead-end).

Several essential structures are not protected from lightning including the control building and the diesel generator building.

Events

None

2.3.1.2 Plant B

Survey

Plant B compares favorably with NFPA code with some exceptions such as improper location of ground cable runs, insufficient number of down conductors, and lack of ground bonding on some vents and structures. Diesel generator building is not protected and is outside the cone of protection of the turbine building lightning protection system. Cable trays for outdoor runs of 24kV three phase power are not grounded. These trays provide an opportunity for damaging lightning current to arc over and propagate through the medium voltage system of the plant.

Events

None

2.3.1.3 Plant C

Survey

Plant was determined to have a high level of lightning protection; however the plant was designed prior to the publication of NFPA 78-1975. The ground grid was measured using a three probe method and found to be 0.2 ohms. Here is a summary of the deficiencies:

- Less than recommended number of containment down conductors and those are not properly bonded to the lightning protection system.
- Protruding piping not bonded to lightning protection system.
- Insufficient number of air terminals.
- Several unprotected buildings: auxiliary building, diesel generator building, fire protection pump house.
- Communications system cabling and equipment are unprotected.

Events

1977

Lightning struck the containment mast. Ground potential rise (GPR) caused failure of steam line pressure transmitters. The lightning mast was connected to the ground grid in such a way that other parts of the ground loop could momentarily rise subjecting other solid-state transducers to GPR.

1980

A lightning stroke penetrated the zone of direct strike protection of the containment structure lightning protection system. The stroke hit main steam line vent pipes, which project above the roof, and the surge was carried into the building via piping connections. Safety injections were spuriously initiated. Numerous pressure transmitters and other analog electronics components failed or received spurious signals causing incorrect action to be taken. Both arc over and GPR are believed to be mechanisms for propagation of the transient currents. No local, component-level surge protection was installed.

2.3.1.4 Plant D

Survey

Lightning protection systems were present at the plant but improvements could be made. Several air terminals were broken or in poor condition. Many pipes, vents, and conductors are not well bonded to down conductors and down conductors have tight radii and acute bend angles. Some of the conductors pass through areas that provide arc over and current induction paths. Some buildings are not protected such as auxiliary building and the diesel generator area in administration building. The plant grounding system appears design to focus lightning currents so as to exacerbate GPR rather than dissipating the lightning current away from plant structures.

Events

1979

During refueling, a nearby lightning storm produced a transient that failed three inverters by opening circuit breakers and blowing 120V fuses. No direct strike was reported.

No Date Given

During an electrical storm, the plant lost an instrument bus and two inverters. The reactor tripped, safety injection and containment isolation was initiated. Off-site power was never lost to the plant. It was believed that a high-voltage spike propagated through the instrument bus inverter to reactor safety instrumentation and resulted in the 2 out of 4 coincidences required for reactor trip.

2.3.2 Reports on World Wide Web

Rivne, Ukraine, August 2000

“Nuclear reactor shuts down after lightning strike”

from http://www.ananova.com/news/story/sm_39104.html

A reactor at Ukraine's Rivne nuclear power plant automatically shut down after it was struck by lightning. Safety systems at the plant took reactor No 3 off-line after the lightning strike damaged electricity transformers, said the state Energoatom company.

There were no reports of radiation leaks. Currently, nine out of 14 nuclear reactors at Ukraine's five atomic power plants are working and produce about 40% of country's electricity output.

Leningrad, Russia, June 19, 2000

“Leningrad NPP: a power unit gone down as a result of a lightning stroke”

from http://www.nuclear.ru/news_e/240700.htm

On June 19th of 2000, at 01.17 p.m. as a result of a lightning stroke in a phase A 330 kV bus arrangement of the NPP power line, the insulation was damaged.

In consequence of the strike the power unit transformer TG-2 shut off and the power unit capacity level reduced 50 %, automatically. There are no irregularities detected as to the transient conditions. The radiation background stays normal.

After checking the insulation the technological systems the 2nd turbogenerator was put back into operation. On July 20th at 9.50 a.m. the 1st power unit has reached the rated power level.

Ginna Unit #1, June 30, 1995

from <http://scss.ornl.gov/ScssScripts/Results/resLERDetl.cfm?lernmbr=24495006>

POWER LEVEL - 097%. On June 30, 1995, at approximately 1528 EDST, with the reactor at approximately 97% steady state power, power from Circuit 751 (34.5 KV offsite power source) was lost, due to a lightning strike on an offsite utility pole for Circuit 751. This resulted in deenergization of 4160 Volt bus 12A and 'A' train 480 Volt safeguards buses 14 and 18. The 'A' Emergency Diesel Generator (D/G) automatically started and reenergized buses 14 and 18 as per design. There was no change in reactor power or turbine load. Immediate corrective action was to perform the appropriate actions of Abnormal Procedure AP-ELEC.1 (Loss of 12A And/Or 12B Busses) to stabilize the plant and to verify that the 'A' Emergency D/G had started and reenergized buses 14 and 18. This event is NUREG-1022 Cause Code (C). Corrective action to prevent recurrence is outlined in Section V.B.

Nine Mile Point Unit #1, August 31, 1993

from <http://scss.ornl.gov/ScssScripts/Results/resLERDetl.cfm?lernmbr=22093007>

POWER LEVEL - 100%. On August 31, 1993 at 14:33 hours (during a severe thunderstorm), with the mode switch in 'RUN,' reactor power at 97.8 percent thermal and station service power being supplied from the main turbine generator, Nine Mile Point Unit 1 (NMP1) experienced a momentary Loss of Offsite Power (LOOP) that resulted in the automatic start of Emergency Diesel Generators (EDG) 102 and 103. The LOOP resulted in the de-energization of Power Board (PB) 101, which caused the subsequent loss of Reactor Recirculation Pump (RRP) #13. The loss of RRP #13 reduced reactor power to approximately 87 percent thermal. An Unusual Event was declared per Emergency Plan Procedure EPP-01. The cause of the event was two concurrent lightning strikes on both 115kv lines, line #1 at NMP1 and line #3 at Lighthouse Hill. The immediate corrective action was to enter Special Operating Procedure N1-SOP-5, 'Loss of 115kv,' verify auto start of EDGs, stabilize plant electrical loads according to procedure, and contact Relay and Control Personnel to analyze the event and record relay flags received. The Loss of Offsite Power was corrected approximately 12 seconds into the event when breaker R30 auto re-closed re-energizing line #3.

Salem Unit #1, June 16, 1991

from <http://scss.ornl.gov/ScssScripts/Results/resLERDetl.cfm?lernmbr=27291024>

POWER LEVEL - 100%. On 6/16/91, at 1940 hrs, during normal full power operation, Salem Unit 1 experienced a reactor trip/turbine trip. The first out overhead annunciation was '4kV group bus undervoltage'. At the time of the event a severe thunderstorm was in progress. Investigation revealed that lightning had struck in the vicinity of the Phase B generator step-up (GSU) transformer (EL). Evidence of the lightning strike included carbonization of the high voltage bushing, damage to the corona rings and lightning arrestor and eyewitness accounts. The root cause of the reactor trip event is attributed to an act of nature; i.e., a lightning strike in the vicinity of the Phase B GSU transformer, resulted in a 4kV group bus undervoltage and subsequent reactor trip. Lightning protection was assessed by engineering and found to be appropriate. The damage to the Phase B GSU transformer was repaired. Subsequently, on 6/24/91, Unit 1 was returned to service. Also as a result of the lightning strike, 500 kV breaker flashover protection was initiated due to sufficient current through the transformer neutral. This resulted in the loss of the No. 2 station power transformer and subsequent de-energization of the 1F and 1G group busses. An engineering review has been initiated to prevent flashover protection actuation from a coasting generator.

3. KEY ISSUES OF LIGHTNING PROTECTION

Operating experiences in NPPs show that all critical facilities should have a well-designed, properly-installed, and well-maintained LPS. Traditionally, LPSs are construed as referring to an external system consisting of air termination (lightning rods), down-conductors, and an earth grounding system. Additionally, facilities containing electronic equipment require an internal grounding system that addresses cable routing and bonding to the earth grid at key locations.

The best known source of information about LPS design guidelines in use today is NFPA 780-2004, *Standard for the Installation of Lightning Protection Systems* [4]. It is the foundation document for lightning protection of facilities from direct strikes. Almost all lightning protection guidance standards reference NFPA 780. However, while NFPA 780 gives good guidance and philosophies on lightning protection, it has a disclaimer concerning electric power generation facilities:

Electric generating facilities whose primary purpose is to generate electric power are excluded from this standard with regard to generation, transmission, and distribution of power. Most electrical utilities have standards covering the protection of their facilities and equipment. Installations not directly related to those areas and structures housing such installations can be protected against lightning by the provisions of this standard.

A good source of information about LPS installation practices is Underwriters Laboratories (UL) 96A-2001, *Installation Requirements for Lightning Protection Systems* [12]. UL 96A contains the requirements that cover the installation of LPSs on all types of structures other than structures used for the production, handling, or storage of ammunition, explosives, flammable liquids or gases, and explosive ingredients. This standard only applies to lightning protection systems that are complete and cover all parts of the structure. Partial systems are not covered. UL96A provides good guidance, but like NFPA 780 it too has a disclaimer for electrical generating systems:

These requirements do not cover the installation of lightning protection systems for electrical generating, distribution, or transmission systems.

Thus, while the concepts of these two standards can be adopted, NFPA 780 and UL96A itself cannot be endorsed as primary guidance for NPPs. They can, however, be used as guides to ensure all of the key elements of lightning protection are covered when endorsing other standards.

3.1 Review of ANSI/NFPA 780-2004

NFPA 780-2004 is a revision of NFPA 780-2001 and reflects extensive editorial changes that alter the chapter numbering within the standard. The standard specifies LPS installation requirements for (a) ordinary structures, (b) miscellaneous structures and special occupancy structures, (c) heavy-duty stacks, (d) watercraft, and (e) structures containing flammable vapors, flammable gases, or liquids that can give off flammable vapors. The purpose of NFPA 780 is to safeguard persons and property from lightning.

The basic lightning protection guidance from NFPA 780 is given in Chapter 4, entitled "Protection for Ordinary Structures." Chapters 5 through 7 cover special structures that may also be part of some power plants. Chapter 8 covers the lightning protection of watercraft. The following subsections cover the details of Chapters 4 through 7 in NFPA 780.

3.1.1 Zones of Protection

Based on the physics of a lightning stroke, a zone of protection is established surrounding any termination device that is equipped to handle a lightning stroke. A rolling-sphere model or a straight-line approximation thereof can be used to determine whether or not shorter structures in the vicinity of taller structures are inherently protected. For ordinary structures, NFPA 780 recommends that a rolling sphere with a diameter of 150 ft be used in conjunction with a model of the profile of the buildings to determine strike termination device placement.

3.1.2 Strike Termination Devices

Buildings that are not metal clad require arrays of strike termination devices (often called air terminals or lightning rods). NFPA 780 gives specific guidelines on the material requirements and air terminal placements for "ordinary" structures. The locations and quantities of the air terminals are dependent on the roof geometry, as well as the relative height of nearby structures. There are specific guidelines that take into account the slope of the roof and the complexities of chimneys, dormers, and other roofline considerations.

3.1.3 Down Conductors

Once the locations of strike termination devices have been determined, the system of down conductors must be planned. Down conductors (consisting of main conductors, roof conductors, cross-run conductors, and down conductors) connect the base of the air terminal to the ground terminals. These conductors typically extend from the top of the roof to the base of the structure as one continuous wire. However, the outer shell of metal buildings and tanks can be utilized as strike termination devices and/or down conductors if certain bonding requirements are maintained.

The guiding principles behind the geometry of down conductors include satisfying the following conditions:

- two paths to ground for every strike termination device;
- paths always traveling downward or horizontally toward the ground terminal; and
- avoidance of sharp bends.

Section 4.9 gives details and qualifications for implementing these principles.

3.1.4 Ground Terminals

The down conductors of the LPS must terminate at a dedicated grounding rod. Although the LPS grounding electrode (ground rod) is required to be bonded to the other grounding systems of the facility's earthing grid, a dedicated ground rod is still required. The spacing of the ground rods is dependent on both accommodating the geometry of the air terminals and achieving sufficiently low grid impedance. The latter issue is affected greatly by the soil type. Various soil types require significantly different ground rod geometries. Section 4.13 discusses general guidelines for ground rod geometries based on generalized assumptions about soil type. A refined application of the principles can be achieved by following the guidance and referenced materials in IEEE Std 665-1995, *IEEE Guide for Generating Station Grounding* [13].

3.1.5 Special Structures

Chapters 5 through 7 of NFPA 780 include guidance on the lightning protection of various “special” structures. Several of these are especially pertinent to NPPs. Tall, slender structures such as masts and flagpoles need only a single strike termination device, down conductor, and ground terminal. Metal towers and tanks designed to be able to absorb lightning strokes without damage require only bonding to ground terminals. Chapter 6 is dedicated to the protection of heavy-duty stacks, which are defined as smoke or vent stacks having a flue cross-section greater than 500 in² (0.3 m²) and a height greater than 75 ft (23 m). Special material and conductor interconnections are established for these stacks. Chapter 7 covers the protection of structures containing flammable vapors, flammable gases, and liquids that can give off flammable vapors. Some of the key concerns in this case are the elimination of potential spark gaps and the prevention of the accumulation of flammable mixtures. Chapter 7 further stipulates a more stringent 100-ft rolling sphere model, to achieve a closer spacing of strike termination devices and conductors.

3.2 Review of UL 96A

UL96A covers the installation of complete lightning protection systems, including air terminals, down conductors, and grounding systems. Guidance for the proper placement and spacing of air terminal on all types of structures is given in Section 8, consistent with the 150 ft. rolling sphere definition of the zone of protection. Down conductors installation is covered in Section 9, and the installation of grounding systems for a variety of conditions is covered in Section 10. Choice of fitting and use of incompatible materials is given in Sections 12 & 7, respectively. Grounding and surge protection for antennas and service entrances are addressed very briefly in Section 13.

Several additional topics might also be of interest to NPP installations. For steel buildings, it is stated that *“the structural steel framework of a building is not prohibited from being utilized as the main conductor of a lightning protection system if it is electrically continuous or is made so.”* Guidance is provided in Section 15 for ground connections to the steel columns, and for the connections to air terminals. In addition, the protection of heavy-duty stacks is covers in Section 16. Testing and maintenance of lightning protection systems is not addressed.

3.3 Guiding Principles of Lightning Protection

The key guiding principles to lightning protection are the following:

1. If it is metal and is not intended to carry current, ground it.
2. If it is metal and is intended to carry current, and
 - a. it is outside a building, protect it with taller grounded structures.
 - b. it is inside a building, surge-protect it.
3. If it is a sensitive electronic circuit, build it to withstand whatever gets past the above-mentioned barriers.

To determine whether or not NPPs have sufficient protection against lightning, the seven issues listed in Table 4 should be addressed. An illustration of the key issues is shown in Fig. 7. These issues are a practical approach to meeting the principles stated above. In Section 5, this list of issues is expanded into a checklist, and the issues are discussed at length.

Table 4. Key lightning protection issues

Issue	Focus
1	Overall grounding plan
2	Quality of lightning protection system (LPS)
3	Quality of filtering and grounding of conductors that egress LPS
4	Cable routing within the facility
5	Correct selection and placement of surge protection devices (SPDs) throughout the facility
6	Grounding of the instrumentation and control (I&C) components
7	Protection of equipment from electromagnetic surges

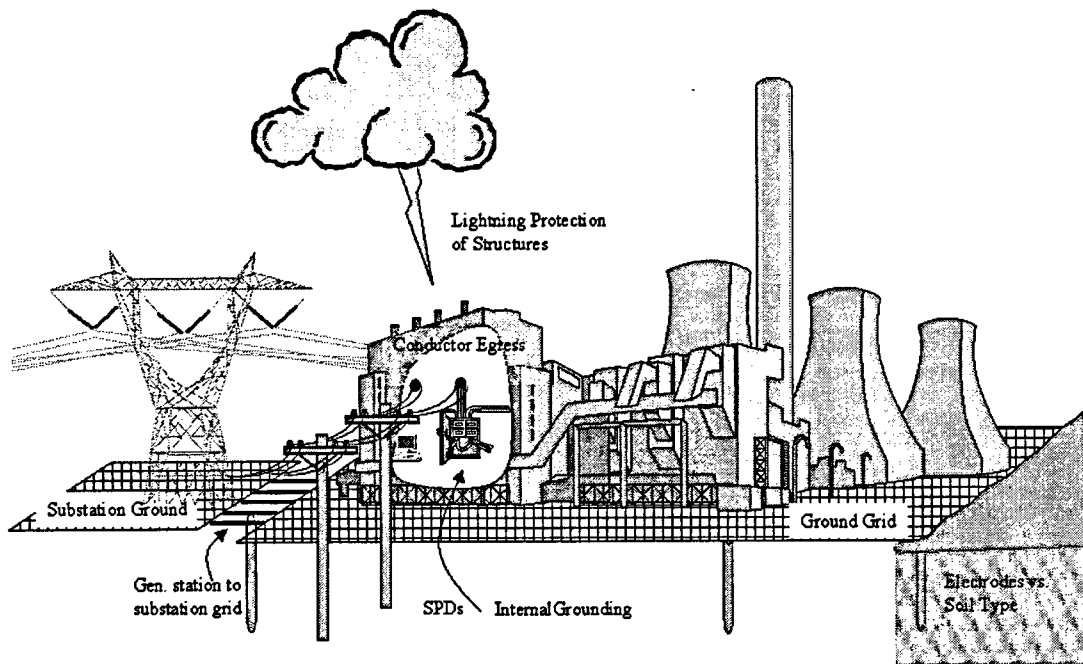

Figure 7. Issues for lightning protection in generating stations.

4. REVIEW OF APPLICABLE STANDARDS

4.1 Applicable Standards for Lightning Protection

A list of 20 standards found to be most applicable to lightning protection for NPPs is given in Table 5. Four of the standards are considered key and taken together cover the basics of lightning protection in power generation stations. These standards cover external grounding grids and lightning protection (IEEE Std 665), grounding for both low-voltage and medium-voltage power systems (IEEE Std 666), internal equipment grounds (IEEE Std 1050), and the proper selection and use of surge protection devices (SPDs) (IEEE Std C62.23). In addition to these standards, most of the other 16 standards are frequently referenced by them and help to clarify key concerns. Only one of the standards, IEEE Std 998, is not referenced by the four primary standards.

Table 5. The 20 standards judged most applicable to lightning protection for nuclear power plants.

Standard number	Standard title
IEEE Std 80-2000	IEEE Guide for Safety in AC Substation Grounding (ANSI)
IEEE Std 81-1983	IEEE Guide for Measuring Earth Resistivity, Ground Impedance, and Earth Surface Potentials of a Ground System (ANSI)
IEEE Std 81.2-1991	IEEE Guide for Measurement of Impedance and Safety Characteristics of Large, Extended or Interconnected Grounding Systems
IEEE Std 142-1991	IEEE Recommended Practice for Grounding of Industrial and Commercial Power Systems (<i>IEEE Green Book</i>)
IEEE Std 367-1996	IEEE Recommended Practice for Determining the Electric Power Station Ground Potential Rise and Induced Voltage from a Power Fault (ANSI)
IEEE Std 487-2000	IEEE Recommended Practice for the Protection of Wire-Line Communication Facilities Serving Electric Supply Locations (ANSI)
IEEE Std 665-1995 (R2001)	IEEE Guide for Generating Station Grounding
IEEE Std 666-1991 (R1996)	IEEE Design Guide for Electrical Power Service Systems for Generating Stations
IEEE Std 998-1996	IEEE Guide for Direct Lightning Stroke Shielding of Substations
IEEE Std 1050-1996	IEEE Guide for Instrumentation and Control Equipment Grounding in Generating Stations (ANSI)
IEEE Std 1100-1999	IEEE Recommended Practice for Powering and Grounding Electronic Equipment (<i>IEEE Emerald Book</i>) [ANSI]
IEEE Std C37.101-1993	IEEE Guide for Generator Ground Protection (ANSI)
IEEE Std C57.13.3-1983 (R1990)	IEEE Guide for the Grounding of Instrument Transformer Secondary Circuits and Cases (ANSI)
IEEE Std C62.23-1995 (R2001)	IEEE Application Guide for Surge Protection of Electric Generating Plants (ANSI)
IEEE Std C62.92.1-2000	IEEE Guide for the Application of Neutral Grounding in Electrical Utility Systems, Part I-Introduction (ANSI)
IEEE Std C62.92.2-1989 (R2001)	IEEE Guide for the Application of Neutral Grounding in Electrical Utility Systems, Part II-Grounding of Synchronous Generator Systems (ANSI)
IEEE Std C62.92.3-1993 (R2000)	IEEE Guide for the Application of Neutral Grounding in Electrical Utility Systems, Part III-Generator Auxiliary Systems (ANSI)
IEEE Std C62.41.1-2002	IEEE Guide on the Surge Environment in Low-Voltage (1000 V and Less) AC Power Circuits (ANSI)
IEEE Std C62.41.2-2002	IEEE Recommended Practice on Characterization of Surges in Low-Voltage (1000 V and Less) AC Power Circuits (ANSI)
IEEE Std C62.45-2002	IEEE Recommended Practice on Surge Testing for Equipment Connected to Low-Voltage (1000 V and Less) AC Power Circuits (ANSI)

IEEE Std 62.23 was specifically developed to address the need for surge protection in nuclear power plants, so the applicability of the standard is fully assured. It is noteworthy that the working group that developed this particular guide decided that *“this guide should not only cover nuclear power plants but that the method of surge protection is applicable to nuclear as well as all electric generating plants, and that no special differentiation should be made.”* Similarly, IEEE Std 665 was developed to address the grounding requirements of electric generating stations, and IEEE Std 1050 was developed to provide grounding methods for I&C grounding in generating stations. IEEE Std 666 was developed to address neutral grounding and the grounding of generating station auxiliaries. The only question that need be asked is whether nuclear plants were included in the definition of “generating station” during the development of these standards, and if not, whether any special differentiation should be made between the grounding requirements in nuclear plants and all other electric generating plants. Given the precedent set in this regard by the working group for Std 62.23, this might not be cause for concern. Unless otherwise noted, it will be assumed that industry standards developed to meet the needs and requirements of generating plants are equally applicable to nuclear plants, and that no special differentiation should be made. Note that generally speaking, terms such as “electric generating station” can properly be interpreted as including the nuclear variety, unless specifically noted to the contrary.

The diagram in Fig. 8 shows the interdependencies of the various standards related to lightning protection and supports the selection of the four primary standards recommended for endorsement. In the diagram each standard is connected to the standards that it references as regards grounding or lightning protection. The standards listed in Table 5 are all discussed in detail in the following subsections, with the primary standards being discussed first and then the secondary standards.

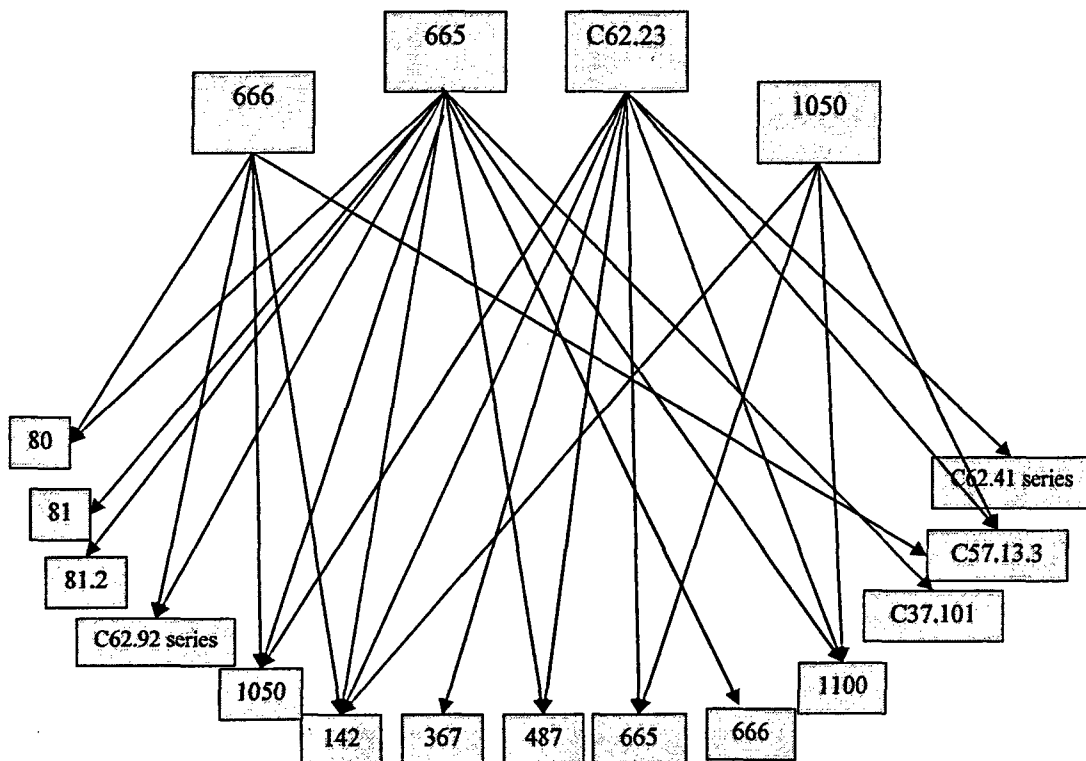

Figure 8. Diagram showing the interdependencies of the standards applicable to lightning protection at nuclear power plants.

4.2 IEEE Std 665-1995 (R2001), IEEE Guide for Generating Station Grounding

4.2.1 IEEE Std 665 Overview

IEEE Std 665-1995 (R2001) [13] identifies grounding practices that have generally been accepted by the electric utility industry as contributing to effective grounding systems for personnel safety and equipment protection in generating stations. The standard also provides a guide for the design of generating station grounding systems and for grounding practices applied to generating station indoor and outdoor structures and equipment, including the interconnection of the station and substation grounding systems. Section 5.6 specifically addresses lightning protection for generating station structures.

IEEE Std 665 draws from other IEEE standards and NFPA 780 for implementation details. It provides a good overview of the steps that need to be taken to protect personnel and equipment from harmful levels of electrical energy, whether from lightning or other abnormal conditions. While the standard specifically states that it covers direct effects of lightning, it does not cover indirect effects such as the electromagnetic emanations from lightning strokes; these are covered by IEEE Std 1050-1996.

IEEE Std 665 comprises six sections plus appendices. Sections 4 and 5 cover the key issues relative to protecting personnel and equipment from harmful electrical potentials. Section 4 provides fundamental definitions and states the key design objectives of a proper grounding system. Section 5 gives the key technical guidance for grounding, including detailed design requirements. Each of these sections is discussed below, with emphasis given to the sections pertinent to lightning protection.

4.2.2 Grounding Principles (Section 5.1)

Section 5.1 of IEEE Std 665 lists the key principles of grounding. In general, they stipulate that all non-current-carrying conductive materials should be grounded. These principles further stipulate that all ground systems should be sized to handle the expected ground fault currents, not include switching devices, and be mechanically sound.

4.2.3 Ground Grid Design (Section 5.2)

The guidance for the proper design of a ground grid given in Section 5.2 is based on the concepts of Std 80-2000. As noted in IEEE Std 80, generating stations generally cover a larger area and have more buried structures than do substations and are located near a large reservoir of water. All of these features mean that generating stations typically have a lower overall grid resistance than do substations. IEEE Std 665 assumes that concrete floor systems within buildings will have a mesh of rebar that is tied to building steel. This mesh of metal bars will fortuitously act as a ground grid within buildings; therefore, IEEE Std 665 concentrates on the ground grid structures outside of buildings.

The first step in proper design of a ground grid is to determine the soil resistivity. If the maximum and minimum resistivity measurements fall within 30% of each other, the uniform resistivity assumptions of IEEE Std 80 are adequate. If there are more variations, then more refined calculations may be necessary.

The next step is to determine the total area covered by the grid. This area should be maximized. In order to utilize the calculations in IEEE Std 80, the largest rectangular area that fits within the actual boundaries of the facility should be chosen.

Finally, the expected ground fault currents are estimated. Using the soil resistivity, the grid size, and ground fault current estimates, the mesh size and conductor size of the grid conductors and ground rods are determined.

4.2.4 Grounding of Main Generator Neutral (Section 5.3)

Section 5.3 covers the various methods of grounding the neutral conductor of the main generator. The type and size of grounding conductors utilized for neutral grounding are based on the possibility of large fault currents rather than on the possibility of direct lightning strokes.

4.2.5 Grounding of Buildings, Fences, and Structures (Section 5.4)

Section 5.4 covers the grounding of metallic structures that are not intended to conduct current but are exposed to possible lightning strikes, buildup of static electricity, or accidental contact with voltage service conductors. It stipulates that all buildings, fences, and ancillary structures within the station grounding area be grounded to the main grid. The guidelines described in this section should be followed for all metal structures within the overall station grounding area.

In Section 5.5.6 the issue of conflicting grounding requirements is mentioned briefly as concerns single-point grounding designs for control systems. This section notes that a situation may arise in which a person simultaneously touching a "control ground" and a panel enclosure could be exposed to a significant touch voltage. With this qualification, IEEE Std 1050 is deemed as the proper source for grounding protection and control equipment.

4.2.6 Grounding of Generating Station Auxiliaries (Section 5.5)

Section 5.5 is similar to Section 5.3 in that it covers grounding of conductors primarily on the basis of their proximity to and possible contact with high-voltage conductors rather than on the possibility of exposure to lightning strikes.

4.2.7 Lightning Protection for Generating Station Structures (Section 5.6)

Subsection 5.6 covers lightning protection for generating station structures. The bulk of the details are also contained in ANSI/NFPA 780. However, ANSI/NFPA 780 states in three separate locations that it shall not be used to cover requirements for generating stations. Therefore, IEEE Std 665 should be used as the basis document for NPPs, with ANSI/NFPA 780 used as a source of additional details.

This section states that IEEE Std 665 covers the direct effects of lightning and not the indirect effects. It refers the reader to IEEE Std 1050 for guidance on the protection against indirect effects.

This section gives an overview of the various building types, risk assessment, and the planning of an air terminal lightning protection system. It also covers other methods of protection such as masts and overhead ground wires. In the case that there is a substation proximate to the power station, the reader is referred to IEEE Std 80 for proper grounding practices.

This section gives some details necessary for lightning protection, but leaves the bulk of the guidance to the referenced portions of NFPA-780.

4.2.8 Grounding of Buried Structures (Section 5.7)

Buried metallic conductors within the grid area of the power plant connecting with areas outside the grid should be grounded to the grid so that they do not transfer the grid voltage to remote points. Section 5.7 of the standard covers buried tanks, pipes, gas lines, and other structures. It discusses the effects that concrete has on the resistivity between grounding conductors and the earth.

Note that the section on reinforcing steel (Sect. 5.7.4 of IEEE Std 665) misquotes IEEE Std 142-1991. Section 5.7.4 quotes subclause 4.2.4 of IEEE Std 142 as saying that “concrete below ground level is a semiconducting medium of about 30 Ω -cm resistivity.” However, the proper section number is 4.2.3, and the resistivity of concrete under the stated conditions should be listed as about 3000 Ω -cm.

4.2.9 Sizing of Grounding Conductors (Section 5.8)

Section 5.8 mandates using the worst-case (largest) expected ground-fault current to size conductors. Additionally, the conductor materials are to be selected to minimize corrosion and to handle the mechanical and thermal stresses.

4.3 IEEE Std 666-1991 (R1996), IEEE Design Guide for Electrical Power Service Systems for Generating Stations

IEEE Std 666-1991 (R1996) [14] is a design guide that applies to generating station service systems that supply electric power to auxiliary equipment. This design guide applies to all types of generating stations that produce electric power, and is particularly applicable to stations in which the electric power service system is required to perform continuously. Such a service system consists of a main auxiliary power distribution network that might supply many subsystems (including dc systems and Class 1E power systems), much of which is “medium-voltage” equipment. In this standard, “medium-voltage” is defined to be equipment with nominal 2.14, 4.16, 6.9 or 13.8 kV ratings.

Regarding lightning protection issues, this standard addresses recommendations for neutral grounding, and the grounding of generating station auxiliaries. Grounding methods for both low-voltage (120-480 V) and medium voltage (2.4-13.8 kV) power service systems are covered. All of Chapter 8 of IEEE Std 666 is dedicated to grounding issues, including standby generator grounding (Section 8.9), but specific grounding issues are addressed where relevant throughout the guide. Other lightning-related issues are covered as well. For the specification of transformer electrical insulation, basic lightning impulse level (BIL) insulation ratings are covered (in Section 9.6.6). Surge protection of transformers, switchgear, & motors is also covered, mostly in Chapters 9 & 11, much of which largely parallels similar guidance on this same issue in IEEE Std C62.23.

4.4 IEEE Std 1050-1996, IEEE Guide for Instrumentation and Control Equipment Grounding in Generating Stations

IEEE Std 1050-1996 [15], a revision of the 1989 version of the standard, provides information about grounding methods for generating station I&C equipment. This standard identifies grounding methods for I&C equipment to achieve both a suitable level of protection for personnel and equipment, as well as suitable noise immunity for signal ground references in generating stations. Both ideal theoretical methods and accepted practices in the electric utility industry are presented. Since the standard covers grounding issues specific to the protection of I&C equipment, it has been endorsed by Regulatory Guide 1.180.

4.5 IEEE Std C62.23-1995 (R2001), IEEE Application Guide for Surge Protection of Electric Generating Plants

IEEE Std C62.23-1995 (R2001) [16] consolidates most electric utility standards and practices as they specifically pertain to the surge protection of electric power generating plants. The development of this guide was motivated in part by the need for an application guide for the surge protection of nuclear electric generating plants. Surge protection is addressed from a generalized viewpoint, including all aspects of the plant. It is considered that the over-voltage surges in power generating plants may be generated by lightning, or by system events such as switching, faults, load rejections, or combinations of these. In this guide, the power generating plant has been divided into four areas: the transmission lines, the switchyard, the power plant (including equipment, controls, and communication), and remote ancillary facilities. Within each of these areas, protection methods are considered for addressing five different types of sources: 1) direct lightning strokes, 2) incoming surges, 3) internally generated surges, 4) ground potential rise, and 5) electromagnetic interference. Of these five categories, only the third is not specifically lightning-related.

The scope of this standard is very broad. For example, Chapter 4 on the protection of transmission lines includes: protection from direct lightning strikes using overhead ground wires, tower footing resistance, counterpoise wires, surge arresters on transmission lines, protection of distribution lines from direct lightning strikes, switching surges, ferroresonance, and the selection of arrestors for distribution lines. Chapter 5 on the switchyard includes: protection of switchyard equipment from direct lightning strikes using overhead wires or masts, protection from incoming surges on the transmission line, protection of directly connected switchyard equipment with surge arrestors, protection from internally generated switching surges, protection of control and communication circuits in the switchyard (from lightning, incoming surges, internally generated surges, GPR, and EMI), and the different methods used to address each of these latter issues including cable shielding, routing, and grounding. The discussion of direct lightning stroke protection of the switchyard and transmission lines using overhead wires and masts is similar to the guidance provided by IEEE Std 665.

Surge protection of the power plant (Chapter 6) includes protection of equipment (both indoor and outdoor, including transformers, motors, switchgear, etc.) from direct lightning strikes, incoming surges, internally generated surges, and GPR. It also covers the protection of control and communication circuits from direct lightning strokes, incoming surges, internally generated surges, GPR, and EMI. The beneficial effects of shielding, grounding, routing of cables and surge protective devices is addressed, as well as the protection of communication circuits, and the shielding and grounding of power plant buildings. By comparison with these earlier chapters, Chapter 7 on remote ancillary facilities is relatively brief, dealing mostly with protection from direct lightning strikes and surges induced on underground cables. In order to efficiently and effectively cover all of these varied aspects of surge, transient, and lightning protection in nuclear power plants, IEEE Std C62.23 relies heavily on referencing other industry standards.

4.6 IEEE Std 80-2000, IEEE Guide for Safety in AC Substation Grounding

While the scope of IEEE Std 80-2000 [17] is limited to the grounding of AC substations, it provides thorough guidance on the design of grounding grids and electrodes appropriate for power generation facilities.

In particular, Section 9 defines the terms and concepts that are key to a good grounding system. Section 10 details the conductor material and connector types that are necessary for reducing impedances, as well as retarding corrosion. Sections 12–14 detail the methods of modeling and measuring the soil characteristics. Sections 16 and 18 deal with design geometries and construction methods necessary to properly implement the grounding system. Finally, Section 19 gives guidance on conducting

measurements and field surveys to verify that the grounding system has been adequately implemented. Endorsement of this standard is implied by endorsement of IEEE Std 665.

4.7 IEEE Std 81-1983, IEEE Guide for Measuring Earth Resistivity, Ground Impedance, and Earth Surface Potentials of a Ground System

IEEE Std 81-1993 [18] provides procedures for measuring the earth resistivity, the resistance of the installed grounding system, the surface gradients, and the continuity of the grounding grid conductors (from IEEE Std 80). Part II of this standard (IEEE Std 81.2) is intended to address methods of measurements applicable when unusual difficulties make normal measurements either impractical or inaccurate, such as the measurements for very large power station ground grids.

4.8 IEEE Std 81.2-1991, IEEE Guide for Measurement of Impedance and Safety Characteristics of Large, Extended or Interconnected Grounding Systems

IEEE Std 81.2-1991 [19] covers the measurement of very low values of ground impedance ($< 1 \Omega$) and the extensive use of specialized instrumentation, measuring techniques, and safety aspects. Practical instrumentation methods are presented for measuring the ac characteristics of large, extended or interconnected grounding systems. Measurements of impedance to remote earth, touch and step potentials, and current distributions are covered for grounding systems ranging from small grounding grids with few connections, to large grids ($> 20,000 \text{ m}^2$) with many connected neutrals, overhead ground wires, counterpoises, grid tie conductors, cable shields, and metallic pipes.

4.9 IEEE Std 142-1991, IEEE Recommended Practice for Grounding of Industrial and Commercial Power Systems

IEEE Std 142-1991 [20] covers general grounding practices for all aspects of industrial and commercial power systems. Section 3.3 focuses on grounding relative to lightning protection. It covers the grounding issues relative to lightning protection in a general fashion but relies on ANSI/NFPA-780 for most details.

One key component of lightning protection described in Section 3.3.4.6, "Power Stations and Substations," is the installation of overhead grounded conductors or diverters (static wires) to protect the overhead attached high-voltage lines. These overhead grounded conductors would prevent direct strikes on those sections of the high-voltage lines and would therefore reduce the amount of energy propagating to the station surge arresters. This section recommends that overhead ground wires accompany high-voltage lines to a distance of 2000 ft, or 610 m, away from the station.

4.10 IEEE Std 367-1996, IEEE Recommended Practice for Determining the Electric Power Station Ground Potential Rise and Induced Voltage from a Power Fault

For wire-line telecommunication facilities that either enter electric power stations or that are otherwise exposed to the influence of high-voltage electric power circuits, suitably rated protection devices are required for personnel safety and for the protection and continuity of service. IEEE Std 367-1996 [21] provides guidance for the calculation of power station GPR, and longitudinally induced voltages, for use in metallic telecommunications protection design. The difficulties experienced by telecommunications, protection, and relay engineers in determining "appropriate" values of power station GPR and longitudinally induced voltage to be used in developing specifications for systems and component protection are addressed.

4.11 IEEE Std 487-2000, IEEE Recommended Practice for the Protection of Wire-Line Communication Facilities Serving Electric Supply Locations

IEEE Std 487-2000 [22] is dedicated to wire-line communications entering electric power stations. This subject necessitates a dedicated standard because of the jurisdictional overlap between the telecommunications company and the user (power plant operator). IEEE Std 487 discusses how the boundaries between the hardware covered by the telecommunications company and those covered by the user affect implementation of surge protection. It covers surge arresters, fuses, isolation transformers, and other protective devices. It further advises that the operation of a protective device must preclude unsafe levels of residual voltage between the telecommunication conductors and earth so that personnel and plant safety are not jeopardized.

4.12 IEEE Std 1100-1999, IEEE Recommended Practice for Powering and Grounding Electronic Equipment

IEEE Std 1100-1999 [23] focuses on the protection of electronic equipment from electrical disturbances including lightning. Section 8.6, "Lightning/Surge Protection Considerations," gives guidance on the use of SPDs to protect equipment from the indirect effects of lightning.

This standard stipulates that facilities should be master labeled for structural lightning protection. Master labeling certifies that the LPS conforms to UL 96A. The standard references IEEE Std C62.41 for determining the proper SPDs to be used in each portion of the building. It also covers some specific surge protective needs of communication lines, buried structures, and service power.

4.13 IEEE Std C37.101-1993, IEEE Guide for Generator Ground Protection

IEEE Std C37.101-1993 [24] provides specific guidance on the application of relays and relaying schemes for protection against stator ground faults on high-impedance grounded generators.

4.14 IEEE Std C57.13.3-1983 (R1990), IEEE Guide for the Grounding of Instrument Transformer Secondary Circuits and Cases

IEEE Std C57.13.3-1983 (R1990) [25] contains general and specific recommendations for grounding current and voltage transformer secondary circuits and cases of connected equipment. The recommended practices apply to all types of transformers, irrespective of primary voltage, or whether the primary windings are connected to power circuits or are connected in the secondary circuits of other transformers.

4.15 IEEE Std C62.92.1-2000, IEEE Guide for the Application of Neutral Grounding in Electrical Utility Systems, Part I-Introduction

IEEE Std C62.92.1-2000 [26] serves as the introduction to five IEEE standards on neutral grounding in three-phase electrical utility systems. In this series of guides, consideration and practices are given for the grounding of synchronous generator systems, generator-station auxiliary systems, distribution systems, and transmission and sub-transmission systems. This introductory guide provides definitions and considerations that are general to all types of electrical utility systems, and presents the basic considerations for the selection of neutral grounding parameters that will provide for control of over-voltage and ground-fault current on all parts of three-phase electric utility systems. The principal performance characteristics for the various classes of system neutral grounding, as well as the major considerations in selecting an appropriate grounding class are presented.

4.16 IEEE Std C62.92.2-1989 (R2001), IEEE Guide for the Application of Neutral Grounding in Electrical Utility Systems, Part II-Grounding of Synchronous Generator Systems

The considerations and practices relating to the grounding of synchronous generator systems in electrical utility systems are covered by IEEE Std C62.92.2-1989 (R2001) [27]. Factors to be considered in the selection of grounding class and the application of grounding methods are discussed. Application techniques for high resistance grounding are discussed, and examples given.

4.17 IEEE Std C62.92.3-1993 (R2000), IEEE Guide for the Application of Neutral Grounding in Electrical Utility Systems, Part III-Generator Auxiliary Systems

IEEE Std C62.92.3-1993 (R2000) [28] summarizes the general considerations in the grounding of generating station auxiliary power systems. Basic factors and general considerations in selecting the appropriate grounding class and means of neutral grounding are given. Apparatus to be used to achieve the desired grounding are suggested, and methods for specifying the grounding devices are given. This guide applies to both medium-voltage and low-voltage auxiliary power systems, and was specifically written for electrical utility systems.

4.18 IEEE Std C62.41.1-2002, IEEE Guide on the Surge Environment in Low-Voltage (1000 V and Less) AC Power Circuits

IEEE Std C62.41.1-2002 [29] is a result of the recent revision of IEEE Std C62.41-1991 (R1996). To make the use of the standard more reader-friendly (after the inclusion of additional data), the information has been separated into two documents, IEEE Std C62.41.1 & IEEE Std C62.41.2, both of which are intended to be used in conjunction with revised standard IEEE Std C62.45-2002. IEEE Std C62.41.1-2002 provides guidance on the surge environment in low-voltage ac power circuits, whereas IEEE Std C62.41.2-2002 is a recommended practice for characterizing surges in low-voltage ac power circuits. IEEE Std C62.41-2002 defines location categories within a building based on their relative position from the entry point-of-service lines. These categories are assigned test waveforms that are necessary in specifying the correct SPDs. By following the criteria in IEEE Std C62.41.1, a facility planner can add the necessary layer of protection between the building's exterior LPS and the I&C or other equipment within the building. This standard references other SPD standards for specific details about measurements, test methods, and certification of devices. The standard also gives guidance pertinent to the protection of I&C equipment; thus, it also has been endorsed by Regulatory Guide 1.180.

4.19 IEEE Std C62.41.2-2002, IEEE Recommended Practice on Characterization of Surges in Low-Voltage (1000 V and Less) AC Power Circuits

IEEE Std C62.41.2-2002 [30] is a recommended practice for characterizing surges in low-voltage ac power circuits. This standard is intended to be used in conjunction with IEEE Std C62.41.1-2002 to achieve the goals outlined in the previous section, as well as with IEEE Std C62.45-2002, which provides a recommended practice on surge testing for equipment connected to low-voltage ac power circuits.

4.20 IEEE Std C62.45-2002, IEEE Recommended Practice on Surge Testing for Equipment Connected to Low-Voltage (1000 V and Less) AC Power Circuits

IEEE Std C62.45-2002 [31] describes test methods for surge-voltage testing of the AC power interfaces of equipment connected to low voltage ac power circuits, for equipment that are subject to transient overvoltages. A description of the surge environment that can be expected in low voltage ac power circuits is presented in IEEE Std C62.41.1, which also provides guidance on transient waveforms that can be selected for use with the testing methods described by this guide.

4.21 IEEE Std 998-1996, IEEE Guide for Direct Lightning Stroke Shielding of Substations

IEEE Std 998-1996 [32] provides additional design information for the methods historically and typically applied by the substation designers to minimize direct lightning strokes to equipment and buswork within substations. General information is provided on the lightning stroke phenomena, and the problems associated with providing protection from direct strikes. It is noted that all known methods of providing direct stroke shielding of outdoor distribution, transmission, and generating plant substations were investigated during the preparation of this guide. Detailed information is provided on two methods found to be widely used: a) the classical empirical method, and b) the electrogeometric model, both of which utilize passive terminals to intercept the lightning stroke. Of these, the electrogeometric model utilizes the rolling sphere model to determine the protection zones provided by overhead masts and shield wires. In addition, a third category of alternative lightning protections systems that make use of *active* lightning terminals is reviewed briefly.

5. ASSESSMENT OF LIGHTNING PROTECTION REQUIREMENTS

Based on the discussions in Section 4, the seven issues shown in Table 4 can be expanded into a checklist, as shown in Table 6, to clarify the major steps in evaluating the lightning protection of NPPs. The relationships between the major grounding components and the key standards that address them are highlighted in Fig. 9. Table 6 gives a more detailed listing of topics and applicable standards. Their application to lightning protection is discussed at length within this section.

IEEE Std 665 can be used as the starting point for guidance on protection of the whole facility. IEEE Std 1050-1996 covers grounding and filtering I&C equipment inside a facility. IEEE Std 666 covers grounding for both low-voltage and medium-voltage power systems. IEEE C62.23 covers the implementation of SPDs for the protection of transmission lines, the switchyard, the power plant (including equipment, controls, and communications), and remote ancillary facilities. While these standards address the major issues, further guidance on secondary issues can be found in the other standards called out in Table 6.

5.1 Overall Grounding Plan

5.1.1 Grounding Overview

A well-planned earth grounding system is the most foundational portion of any electrical or electronic protection scheme. The purpose is to equalize grid potentials to the greatest extent possible over the widest possible area for the greatest number of possible conditions (lower the overall grid resistance). Lightning transients typically are the most extreme condition for which the grounding system must compensate.

The grounding system typically consists of a horizontal grid of conductors buried in the earth called a ground grid, several ground rods reaching deeper into the earth, and grounding conductors that connect equipment or circuits to the ground grid.

5.1.2 Grid Design

The most important concepts relative to the ground grid are the effects of soil resistivity and ground grid area, as highlighted in Section 5.2 of IEEE Std 665. Careful soil measurements must be performed in order to determine adequate ground electrode and grid configurations. Not only must the ground grid be well connected to the earth with proper ground electrodes (typically vertical elements), but it should also cover as much area as possible. The larger the area covered by the grid, the lower the overall grid resistance.

The most foundational standard for grid design is IEEE Std 80. It gives design equations and guidance necessary to implement grounding systems in which potential differences are kept within safe limits. It provides extensive guidance and design basis for implementing the proper ground grid and ground electrodes for various soil types and facility geometries. However, the focus of IEEE Std 80 is substation grounding systems. Therefore, the design procedures in IEEE Std 665 are based on the concepts of IEEE Std 80, but with qualifications as discussed in Section 5.2 of IEEE 665.

Table 5. Lightning protection checklist and the standards that address checklist issues

	Issue	Primary standard
1.0	Is there a well-planned grounding system in place?	IEEE Std 665/IEEE Std 142
1.1	Has the grounding grid been properly designed and installed?	IEEE Std 665/IEEE Std 80
1.2	Have the grounding electrodes been properly matched to the soil type?	IEEE Std 665/IEEE Std 80
1.3	Is the LPS grounding system tied into the ground grid?	IEEE Std 665
1.4	Is the station service power grounding properly tied to the ground grid?	IEEE Std 142
1.5	Are the non-electrical metallic equipment grounds all tied to the ground grid?	IEEE Std 665
1.6	Are the I&C grounds designed properly and connected to the ground grid?	IEEE Std 1050
1.7	Have the grounds of nearby substations been tied in?	IEEE Std 665
2.0	Is there an adequate LPS in place?	IEEE Std 665
3.0	Are all conductors egressing the LPS grounded and protected?	IEEE Std C62.23/IEEE Std 1100
3.1	Do the service power cables have proper SPD and ground connections at the service entrance?	IEEE Std C62.23/IEEE Std 1100
3.2	Do the telecommunication lines have proper grounding and SPD connections?	IEEE Std C62.23/IEEE Std 487
3.3	Do all external metal structures and piping that enter the facility have proper grounding connections?	IEEE Std C62.23/IEEE Std 1100
4.0	Has the routing of power and communication cables within the facility been properly addressed?	IEEE Std C62.23/IEEE Std 1100
4.1	Do any power and communication cables passing near the LPS have adequate grounding to the LPS?	IEEE Std C62.23/IEEE Std 1100
4.2	Do high-voltage lines have overhead grounded conductors out to 2000 ft from the facility?	IEEE Std C62.23/IEEE Std 142
4.3	Do all communication cables have minimal inductance (loop area?)	IEEE Std C62.23/IEEE Std 1100
4.4	Do all communication cables have adequate shielding?	IEEE Std 1050
4.5	Have the surge protection methods of the communication lines been coordinated between the plant operator and the telecommunication company?	IEEE Std C62.23/IEEE Std 487
4.6	Do all power lines within the facility have sufficient secondary SPDs?	IEEE Std C62.23
5.0	Have SPDs been properly selected and placed to match their intended functions?	IEEE Std C62.23
6.0	Is the proper I&C grounding in place?	IEEE Std 1050
7.0	Has the I&C equipment been adequately protected for the intended environment and surge-tested to standard lightning waveforms?	IEEE Std C62.23/IEEE Std C62.41

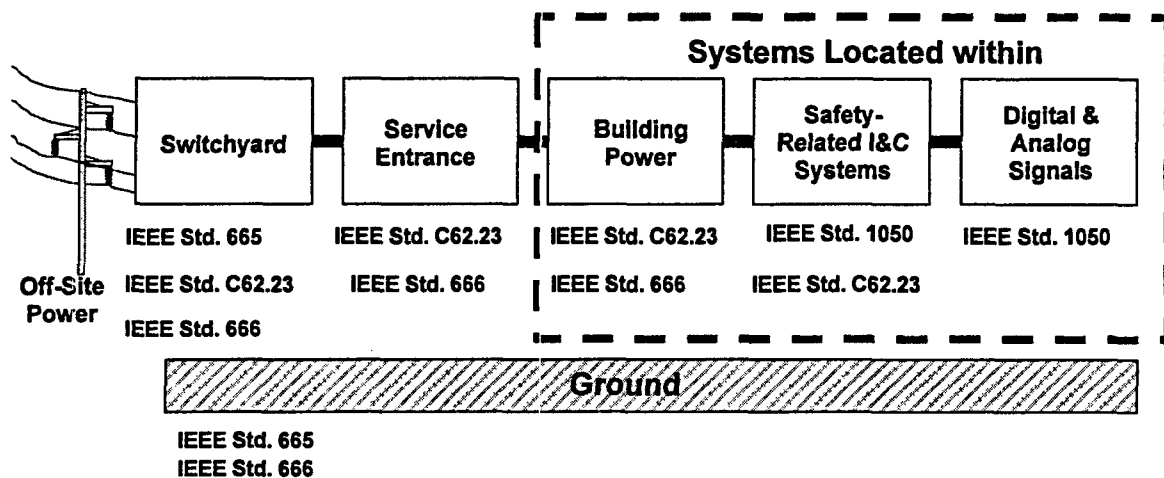

Figure 9. Overview of lightning protection standards for generating stations.

5.1.3 Grounding Systems

Once sufficient ground grid and ground electrodes have been established, individual grounding systems must be addressed. All metal structures should have conductors connecting them to the ground grid.

IEEE Stds 665, 666, and 1050 identify five types of grounding systems: (1) lightning (safety), (2) station service power, (3) balance-of-plant equipment, (4) neutral lines, and (5) I&C equipment. The first three of these are addressed in IEEE Std 665. The fourth is addressed in IEEE Std 666. The last one is covered by IEEE Std 1050. In addition to these five grounding systems, some power plants have a proximate substation with its own grounding system. Section 5.2.4.1 of IEEE Std 665 gives guidance on interconnecting the grounding grid of the power station to that of the substation. All of these grounding systems consist of dedicated grounding conductors (as shown in Fig. 9) connected to the same ground grid.

The three types of grounding conductors covered by IEEE Std 665 are shown in Fig. 10. The neutral ground establishes the reference of the station service power. The equipment ground provides a low-impedance path from the equipment housing back to the neutral ground in case there is a current fault.

The safety ground connects the equipment housing directly to the grounding system. Both the safety ground and the equipment ground are important in minimizing the effects of lightning strikes on personnel and equipment.

The specific grounding issues relative to I&C equipment are covered in great detail by IEEE Std 1050. The grounding of equipment that carries control signals, data, and communications is the most dynamic topic of the four types of systems. Because of the rapid advance of electronics and information technologies in the past few decades, the utilization of higher frequencies, and the increased reliance on digital equipment, the grounding issues relative to I&C equipment have experienced the greatest change. Systems that previously required single-point (tree-type) grounding systems now often require a multipoint connection scheme, sometimes requiring a dedicated conductor grid in the subfloor of the room housing the equipment.

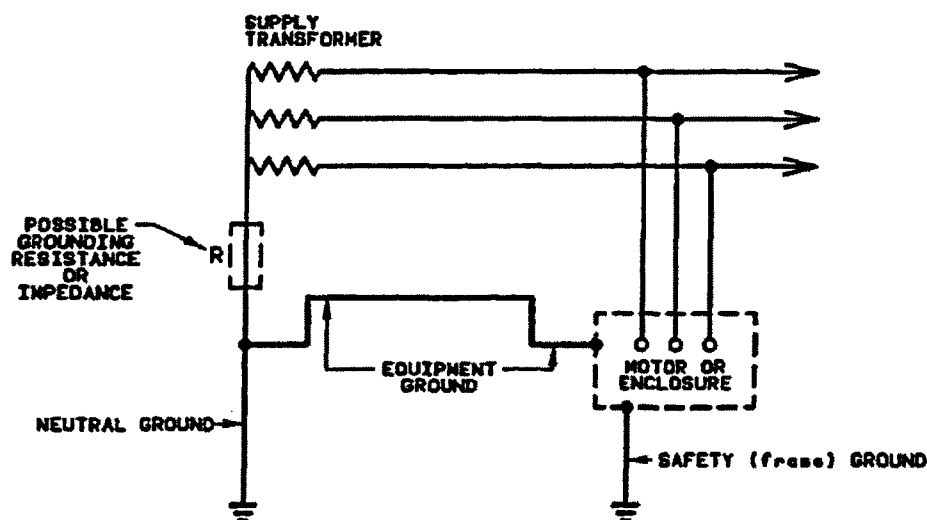

Figure 10. Three types of grounding covered by IEEE Std 665.

IEEE Std 665 has specific subsections that cover isolated phase bus grounding; grounding of buildings, fences and structures; and grounding of buried structures and others. In addition, it gives an overview of lightning protection for generating stations, which is covered in the next section of this document.

5.2 Lightning Protection System

5.2.1 LPS Overview

An LPS consists of strike termination devices (lightning rods), down-conductors, and earth grounding systems. This system is intended to protect against the effects of direct strikes of lightning. While this section discusses the LPS as a conductive grounding system, lightning also produces indirect effects, such as potentially disruptive radiated electromagnetic fields. IEEE Std 665 does not address these indirect effects. Therefore, other standards such as IEEE Std 1050 must be consulted. This approach is discussed in the later sections of this report.

Section 5.6 of IEEE Std 665 gives general guidance on lightning protection for generating station structures. This portion of the standard is based primarily on NFPA 780. Therefore, following the guidance in IEEE Std 665 Section 5.6 and the referenced sections of NFPA 780 should result in a well-designed external LPS. NFPA 780 gives extensive guidance on LPS systems; however, it has an exception clause for generating stations. Therefore, IEEE Std 665 describes how to apply NFPA 780 to generating stations.

5.2.2 Striking Distance

The important guiding philosophy behind the geometry of an LPS is the striking distance of lightning strokes. The striking distance is the distance over which the final arc (or breakdown) occurs when the initial stroke is forming. As the downward leaders approach objects near the earth, they are attracted to specific parts of structures that have a higher than usual charge density. This occurs naturally at geometric points. Lightning strikes carrying large currents complete their downward path from a greater striking distance. The greater the distance of this last arc, the wider the necessary spacing of the air terminals. Most strokes complete their downward path from a distance of no less than 100 ft. Therefore,

geometric models using a strike distance of 100 ft and a profile of the building can be used to determine the correct spacing of air terminals.

5.2.3 Strike Termination Devices (Air Terminals)

“Strike termination devices” is the generic term for the components of the lightning protection system that intercept the lightning strike and connect it with a grounded conductor. Air terminals, often called lightning rods, are the most commonly used device. Other strike termination devices include metal masts and, in some cases, the metal parts of buildings that can be adapted to function as an air terminal. NFPA 780 gives specific guidelines on the material requirements and air terminal placements for “ordinary” structures. The locations and numbers of air terminals are dependent on the roof geometry as well as on the relative height of nearby structures. NFPA 780 utilizes a striking distance of 150 ft for ordinary structures and 100 ft for some special structures. IEEE Std 665 refers to NFPA 780 in general but does not mention which striking distance should be used in the calculations of the placement of air terminals for ordinary structures. Although the implication would be that IEEE Std 665 endorses 150 ft for ordinary structures, it is recommended that the more conservative 100-ft distance be maintained for all NPP structures to provide a closer spacing of the air terminals for these critical facilities.

NFPA 780 also describes specific types of materials that are acceptable for air terminals and for grounding conductors. In particular, there is a distinction between the material thickness required for structures that are taller than 75 ft and those that are shorter. These guidelines should be followed. The use of aluminum rather than copper is acceptable as long as certain constraints are followed. These constraints are also given in NFPA 780.

5.2.4 Down Conductors

Down conductors (i.e., main conductors, roof conductors, cross-run conductors, and down conductors) connect the base of the air terminal to the ground terminals. These conductors typically extend from the top of the roof to the base of the structure as one continuous wire. However, the outer shell of metal buildings and tanks can be utilized as both strike termination devices and/or down conductors if certain bonding requirements are maintained.

The guiding principles for the geometry of down conductors include satisfying the following conditions:

1. two paths to ground for every strike termination device;
2. travel always downward or horizontally toward the ground terminal; and
3. avoidance of sharp bends.

NFPA 780 gives details and qualifications for implementing these principles.

5.2.5 Lightning Earthing System

The down conductors of the LPS must terminate at a dedicated grounding rod. Although the LPS grounding electrode (ground rod) is required to be bonded to the other grounding systems of the facility’s earthing grid, a dedicated ground rod is still required. The spacing of the ground rods is dependent on both accommodating the geometry of the air terminals and achieving a sufficiently low grid impedance. The latter issue is affected greatly by the soil type. Various soil types require significantly different ground rod geometries. IEEE Std 665, Section 5.2.3, gives general guidance on the determination of soil resistivity and discusses the application of the design equations in IEEE Std 80. NFPA 780 discusses general guidelines for ground rod geometries based on generalized assumptions about facilities’ soil types. A refined application of the principles can be achieved by following the guidance and referenced materials in IEEE Std 665.

5.3 Conductors Egressing the LPS

Several types of conductors connect equipment outside the LPS boundary to equipment inside the LPS boundary. These include telecommunication lines, metal piping, cable trays, service power lines, and conduits. All of these metallic structures that are exposed to direct lightning strikes at one end and that enter the LPS protected facility on the other have the potential to conduct harmful energy to the I&C equipment. There are two main mechanisms for preventing this problem: (1) bonding the metallic conductor to the LPS grounding system at the point of egress, and (2) attaching SPDs at key locations.

IEEE Std C62.23 discusses the importance of having this additional line of defense for all conductors entering a facility. This standard recommends the installation of a listed secondary surge arrester at the service entrance of all major electronic equipment facilities. It also calls for the application of SPDs on each set of electrical conductors (e.g., power, voice, and data) penetrating any of the six sides forming a structure.

IEEE Std 1100 individually addresses service entrance lines, site electrical systems, uninterruptible power supplies (UPSs), data cabling, and telecommunication lines. In addition, IEEE Std 487 specifically addresses wire-line communications (i.e., telecommunication lines).

5.3.1 Service Entrance (Power Lines)

IEEE Std C62.23 addresses the use of SPDs at the service entrance. In addition to the use of SPDs, IEEE Std 142 recommends an additional layer of protection for high-voltage power lines. It recommends that overhead grounded conductors (diverters) be installed over the attached overhead power lines from the power station out to a distance of 2000 ft beyond the facility. For practicality, it recommends this protection only for lines carrying 66 kV or higher.

5.3.2 Wire-Line Communications

IEEE Stds C62.23 and 1100 give guidance on all conductors entering a facility, including data and voice communications. IEEE Std 487 specifically addresses wire-line communications (telecommunication lines) that enter a power station. Specific recommendations are important because there are overlapping business and technical issues that must be addressed cooperatively between the telecommunications company and the NPP operator. IEEE Std 487 addresses the protection of telecommunication lines from harmful energy caused by sources such as lightning. The same mechanisms that protect the telecommunication system also help to reduce the chances that the telecommunication lines will conduct harmful energy into the interior of a facility and thus harm the I&C equipment. In addition to the guidance given in IEEE Std 487, Chapter 9 (pp. 349–76) of IEEE Std 1100 has an extended discussion on the proper way to ground and interconnect telecommunication systems, distributed computing systems, and other types of networks. Chapter 9 covers several network topologies and references information technology (IT) industry standards.

5.3.3 External Systems and Piping

Since the energy from a lightning strike can be conducted into a building via any metallic structure, each of these is a potential source of harmful energy for I&C equipment inside a NPP. The following passage from IEEE Std 1100 covers these types of systems:

All exterior mechanical system items (e.g., cooling towers, fans, blowers, compressors, pumps, and motors) that are in an area not effectively protected by a lightning protection system per NFPA 780 should be considered as targets for a lightning strike. Therefore, it is recommended practice to individually provide SPD protection on both the power input and data circuits connected to all such equipment. For ac power circuits, the SPD should be Category "B" or "C" devices (as specified in IEEE C62.41), depending on building location and system reliability requirements. Any metal pipe or conduit (exposed conductor) that runs externally to the building and then also extends back into the building (especially if the extension is into an electronic load equipment area, such as the piping for heating, ventilation, and air conditioning) has a possibility of the external portion of the item being directly struck by lightning. It is capable of carrying a lightning voltage and current back into the building and arc, i.e., side-flash, from the energized item to other grounded items. This concern is real from both an equipment damage and shock and fire hazard standpoint.

Therefore, all such metallic items should be grounded to the building steel as they pass in/out of the building. Bonding of all such pipes, electrical conduits, and similar items into a single electrically conductive mass is very important. If nearby building steel is not available, all items should be bonded to the local electrical equipment grounding system and, if available, to the lightning ring ground via a down-conductor system generally installed as a lightning conductor per NFPA 780. (IEEE Std 1100-1999, Sect. 8.6.8, p. 342)

5.4 Cable Routing inside the Lightning Protection System

The same cabling techniques used in reducing noise coupling (small loop areas, shielding, and grounding) also lessen the coupling of lightning strike energy. Within IEEE Std 1100, portions of Chapter 8 (especially Sect. 8.5.4, p. 326) and Chapter 9 (especially Sect. 9.11.3, pp. 359–61) provide good guidance on cabling techniques to reduce the coupling of potentially harmful energy onto electronic equipment. Chapter 4 (pp. 61–75) of this standard gives extensive information on the basic physics related to good cabling practices.

5.5 Protection of Medium-Voltage Equipment

Medium-voltage equipment should be protected from the effects of lightning-induced power surges. IEEE Std 666 should be applied to electric power service systems that consist of a main auxiliary power distribution network that supply subsystems (including DC systems and Class 1E power systems), much of which is medium-voltage equipment. In IEEE Std 666, "medium-voltage" is defined on p. 8 to be equipment with nominal 2.14, 4.16, 6.9, or 13.8 kV ratings. In addition, IEEE Std C62.92.3 can provide guidance on the grounding of medium-voltage power systems.

5.6 Surge Protection Devices

As mentioned above, SPDs should be applied at the entry point of all conductors. IEEE C62.23 covers the implementation of SPDs for the protection of transmission lines, the switchyard, the power plant (including equipment, controls, and communications), and remote ancillary facilities. The selection of SPDs typically depends on the location of the device. The SPDs are recommended to be sized per IEEE Std C62.41.1 and IEEE Std C62.45 requirements to achieve proper coordination.

IEEE Std 1100 recommends that in addition to applying SPDs at the service entrance points, the category A or B SPDs specified in IEEE Std C62.41.1 *"be applied to downstream electrical switchboards and panelboards, and [to] panelboards on the secondary of separately derived systems if they support communications, information technology equipment, signaling, television, or other form of electronic load equipment."*

5.7 Surge Testing of Equipment

NRC guidance on the electromagnetic compatibility of I&C systems is provided in Regulatory Guide 1.180. For surge testing relative to lightning strikes, it calls for the combination wave, which is discussed in detail in IEEE Std C62.41.1:

The Combination Wave involves two waveforms, an open-circuit voltage and a short-circuit current. The Combination Wave is delivered by a generator that applies a 1.2/50 μ s voltage wave across an open circuit and an 8/20 μ s current wave into a short circuit. The exact waveform that is delivered is determined by the generator and the impedance to which the surge is applied.

The value of either the peak open-circuit voltage or the peak short-circuit current is to be selected by the parties involved according to the severity desired. The nominal ratio of peak open-circuit voltage to peak short-circuit current is 2 Ω for all severity levels.

IEEE Std C62.41.1 describes the limits and IEEE Std C62.45 gives the necessary procedures for conducting the test. Application of these standards is discussed in NUREG/CR-6431, *Recommended Electromagnetic Operating Envelopes for Safety-Related I&C Systems* [33].

5.8 Maintenance and Testing of LPSs

Lightning-protection equipment should be a low-maintenance item and care should be taken in selecting the equipment to fit the expected conditions. In addition, guidance by the vendor for the maintenance of the LPS should be provided at the completion of the installation.

All of the ground systems should be maintained and periodic inspections made of bolted connections for tightness and corrosion. Ground grid integrity tests should be performed to detect any open circuit in the grounding systems or to identify isolated structures. Measurements of resistance to earth should be repeated periodically to determine whether the resistance is remaining constant, or increasing. Chapter 8 of IEEE Std 81 describes methods for measuring ground impedance and earth resistivity.

Section 4.1 of IEEE 81.2 recommends that field measurements not be scheduled during periods of forecast lightning activity, and to terminate such testing in the event that lightning commences while testing is underway. The high-current testing of grounding systems by staged power system faults is described in Chapter 9 of the standard (pp. 23-24). These tests can be performed during power-systems operations. In Section 6.10, it is stated that prior to grounding impedance measurements, grounding connection should be inspected, or measured, especially in older grounding systems in which low-resistance connections to the grid may have been destroyed by corrosion, or fault currents. The measurement of grounding systems by test current injection is described in Chapter 8.

NFPA 780, Annex D, *Inspection and Maintenance of Lightning Protection Systems*, provides excellent guidance on the inspection and maintenance of LPSs. Topics covered include frequency of inspection, visual inspection, complete inspection and testing, inspection guides and records, test data, maintenance procedures and maintenance records. Further advice is given in Section B.4 of Annex B, *Principles of Lightning Protection*.

5.9 Alternative Lightning Protection Systems

Alternative lightning protection methods have been considered during the periodic review and revision process for some of the industry standards, but to date such alternative systems have been specifically addressed by only one of these standards, IEEE Std 998-1996. In recent years, it has been suggested that

lightning protection can be improved by using what may be referred to as *active* lightning terminals. IEEE Std 998-1996 provides a discussion of the three types of alternative lightning protection systems that make use of *active* lightning terminals, including: 1) lightning rods with radioactive tips, 2) early streamer emission lightning rods, and 3) lightning prevention devices. Regarding the use of such alternative lightning protection systems, IEEE Std 998-1996 advises that "*There has not been sufficient scientific investigation to demonstrate that the above devices are effective, and since these systems are proprietary, detailed design information is not available. It is left to the design engineer to determine the validity of the claimed performance for such systems.*" If and when such alternative systems are addressed by subsequent revisions of the industry standards recommended for endorsement, then they should be reviewed and a technical basis established for accepting the alternative systems.



6. RECOMMENDATIONS

This report recommends that four primary standards be endorsed in their entirety for the lightning protection of NPPs and their equipment and personnel. As shown below, one exception was taken to IEEE Std 665-1995.

- IEEE Std 665-1995 (R2001): This report recommends that IEEE Std 665 be endorsed for guidance on lightning protection for NPPs. This standard draws heavily from NFPA 780, which is widely accepted for lightning protection of most types of structures but which specifically excludes power generation plants.

Exception: The section on reinforcing steel (Sect. 5.7.4 of IEEE Std 665) misquotes IEEE Std 142-1991. Section 5.7.4 quotes subclause 4.2.4 of IEEE Std 142 as saying that "concrete below ground level is a semiconducting medium of about 30 Ω -cm resistivity." However, the proper section number is 4.2.3, and the resistivity of concrete under the stated conditions should be listed as about 3000 Ω -cm.

- IEEE Std 666-1991 (R1996): This report recommends that IEEE Std 666 be endorsed for its coverage of grounding and surge protection for medium-voltage equipment in NPPs.
- IEEE Std 1050-1996: In addition to IEEE Std 665 and IEEE Std 666, which focuses on the direct effects of lightning strokes, this report recommends the endorsement of IEEE Std 1050, which covers the specific components necessary to prevent damage to I&C equipment from the secondary effects of lightning.
- IEEE Std C62.23-1995 (R2001): This report recommends the endorsement of IEEE Std C62.23 as general guidance on surge protection. This standard consolidates many electric utility power industry practices, accepted theories, existing standards/guides, definitions, and technical references as they specifically pertain to surge protection of electric power generating plants.

This report further recommends that the applicable portions of IEEE Std 80, IEEE Std 81, IEEE Std 81.2, IEEE Std 142, IEEE Std 367, IEEE 487, IEEE Std 1100, IEEE Std C37.101, IEEE Std C57.13.3, IEEE Std C62.92.1, IEEE Std C62.92.2, IEEE Std C62.92.3, IEEE Std C62.41.1, IEEE Std C62.41.2, and IEEE Std C62.45 be endorsed (with qualifications) by the endorsement of the four primary standards. These standards are referenced and provide the necessary details not recorded in the primary standards.

Non-safety equipment does not fall under the purview of NRC, but it is expected that the implementation of a lightning protection system to protect safety-related equipment will also provide some degree of protection for this equipment, as well. Hence, lightning protection practices are recommended for all electrical equipment in the power plant.

7. REFERENCES

- [1] Regulatory Guide 1.180, Revision 1, *Guidelines for Evaluating Electromagnetic and Radio-Frequency Interference in Safety-Related Instrumentation and Control Systems*, U.S. Nuclear Regulatory Commission, Aug. 2003.
- [2] "When Lightning Strikes," *Emergency Essentials*, <http://www.beprepared.com/Articles/Lightn.html>, June 15, 2000.
- [3] Karin Schill, "SRS Frequent Lightning Target," *Augusta Chronicle Online*, http://www.augustachronicle.com/headlines/091796/srs_lightning.html, Sept. 16, 1996.
- [4] NFPA 780-2004, *Standard for the Installation of Lightning Protection Systems*, National Fire Protection Association.
- [5] Richard Grill, *Petition for Rulemaking (PRM) 50-56*, Nuclear Regulatory Commission, Aug. 1991.
- [6] Chris Rourk, *Report on the Sources of Effects of Electrical Transients on the Electrical Systems of Commercial Nuclear Power Plants*, Engineering Issues Branch (EIB), Office of Nuclear Regulatory Research, Nuclear Regulatory Commission, Sept. 1992 (Memorandum for Robert Baer, Chief, EIB, from Chris Rourk).
- [7] Chris Rourk, *A Review of Lightning-Related Operating Events at Nuclear Power Plants*, IEEE Transactions on Energy Conversion, Vol 9, No. 3, Sept. 1994.
- [8] Special Inspection 50-29/91-09, *Loss of Offsite Power*, NRC Region 1, Nuclear Regulatory Commission. Jul. 1991.
- [9] Matthew Chiramal, *Lightning Events at Nuclear Power Plants*, AEOD/E605, Office for Analysis and Evaluation of Operational Data, Nuclear Regulatory Commission, Apr. 1986.
- [10] IN 85-86, *Lightning Strikes at Nuclear Power Generating Stations*, Office of Inspection and Enforcement, Nuclear Regulatory Commission, SSINS No. 6835, Nov. 1985.
- [11] H. W. Pielage, *Lightning Problems and Protection at Nuclear Power Plants*, NSAC 41, Nuclear Safety Analysis Center operated by Electric Power Research Institute, Dec. 1981.
- [12] UL 96A-2001, *Installation Requirements for Lightning Protection Systems*, Underwriters Laboratories.
- [13] IEEE Std 665-1995 (R2001), *IEEE Guide for Generating Station Grounding*, Institute of Electrical and Electronics Engineers.
- [14] IEEE Std 666-1991 (R1996), *IEEE Design Guide for Electrical Power Service Systems for Generating Stations*, Institute of Electrical and Electronics Engineers.
- [15] IEEE Std 1050-1996, *IEEE Guide for Instrumentation and Control Equipment Grounding in Generating Stations*, Institute of Electrical and Electronics Engineers.
- [16] IEEE Std C62.23-1995 (R2001), *IEEE Application Guide for Surge Protection of Electric Generating Plants*, Institute of Electrical and Electronics Engineers.
- [17] IEEE Std 80-2000, *IEEE Guide for Safety in AC Substation Grounding*, Institute of Electrical and Electronics Engineers.
- [18] IEEE Std 81-1983, *IEEE Guide for Measuring Earth Resistivity, Ground Impedance, and Earth Surface Potentials of a Ground System*, Institute of Electrical and Electronics Engineers.
- [19] IEEE Std 81.2-1991, *IEEE Guide for Measurement of Impedance and Safety Characteristics of Large, Extended or Interconnected Grounding Systems*, Institute of Electrical and Electronics Engineers.
- [20] IEEE Std 142-1991, *IEEE Recommended Practice for Grounding of Industrial and Commercial Power Systems*, Institute of Electrical and Electronics Engineers.
- [21] IEEE Std 367-1996, *IEEE Recommended Practice for Determining the Electric Power Station Ground Potential Rise and Induced Voltage from a Power Fault*, Institute of Electrical and Electronics Engineers.

- [22] IEEE Std 487-2000, *IEEE Recommended Practice for the Protection of Wire-Line Communication Facilities Serving Electric Supply Locations*, Institute of Electrical and Electronics Engineers.
- [23] IEEE Std 1100-1999, *IEEE Recommended Practice for Powering and Grounding Electronic Equipment*, Institute of Electrical and Electronics Engineers.
- [24] IEEE Std C37.101-1993, *IEEE Guide for Generator Ground Protection*, Institute of Electrical and Electronics Engineers.
- [25] IEEE Std C57.13.3-1983 (R1990), *IEEE Guide for the Grounding of Instrument Transformer Secondary Circuits and Cases*, Institute of Electrical and Electronics Engineers.
- [26] IEEE Std C62.92.1-2000, *IEEE Guide for the Application of Neutral Grounding in Electrical Utility Systems, Part I-Introduction*, Institute of Electrical and Electronics Engineers.
- [27] IEEE Std C62.92.2-1989 (R2001), *IEEE Guide for the Application of Neutral Grounding in Electrical Utility Systems, Part II-Grounding of Synchronous Generator Systems*, Institute of Electrical and Electronics Engineers.
- [28] IEEE Std C62.92.3-1993 (R2000), *IEEE Guide for the Application of Neutral Grounding in Electrical Utility Systems, Part III-Generator Auxiliary Systems*, Institute of Electrical and Electronics Engineers.
- [29] IEEE Std C62.41.1-2002, *IEEE Guide on the Surge Environment in Low-Voltage (1000 V and Less) AC Power Circuits*, Institute of Electrical and Electronics Engineers.
- [30] IEEE Std C62.41.2-2002, *IEEE Recommended Practice on Characterization of Surges in Low-Voltage (1000 V and Less) AC Power Circuits*, Institute of Electrical and Electronics Engineers.
- [31] IEEE Std C62.45-2002, *IEEE Recommended Practice on Surge Testing for Equipment Connected to Low-Voltage (1000 V and Less) AC Power Circuits*, Institute of Electrical and Electronics Engineers.
- [32] IEEE Std 998-1996, *IEEE Guide for Direct Lightning Stroke Shielding of Substations*, Institute of Electrical and Electronics Engineers.
- [33] P. D. Ewing and R. T. Wood, *Recommended Electromagnetic Operating Envelopes for Safety-Related I&C Systems in Nuclear Power Plants*, NUREG/CR-6431, Oak Ridge National Laboratory, Jan. 2000.

BIBLIOGRAPHIC DATA SHEET

(See instructions on the reverse)

NUREG/CR-6866

2. TITLE AND SUBTITLE

Technical Basis for Regulatory Guidance on
Lighting Protection in Nuclear Power Plants

3. DATE REPORT PUBLISHED

MONTH

YEAR

January

2006

4. FIN OR GRANT NUMBER

W6851

5. AUTHOR(S)

P. D. Ewing R. A. Kisner K. Korsah M. R. Moore J. B. Wilgen R. T. Wood

6. TYPE OF REPORT

NUREG/CR

7. PERIOD COVERED (Inclusive Dates)

8. PERFORMING ORGANIZATION - NAME AND ADDRESS (If NRC, provide Division, Office or Region, U.S. Nuclear Regulatory Commission, and mailing address; if contractor, provide name and mailing address.)

Oak Ridge National Laboratory
Managed by UT-Battelle, LLC

9. SPONSORING ORGANIZATION - NAME AND ADDRESS (If NRC, type "Same as above"; if contractor, provide NRC Division, Office or Region, U.S. Nuclear Regulatory Commission, and mailing address.)

Division of Engineering Technology
Office of Nuclear Regulatory Research
U. S. Nuclear Regulatory Commission
Washington, DC 20555-0001

10. SUPPLEMENTARY NOTES

C. E. Antonescu, NRC Project Manager

11. ABSTRACT (200 words or less)

Oak Ridge National Laboratory (ORNL) has been engaged by the U.S. Nuclear Regulatory Commission (NRC) Office of Nuclear Regulatory Research (RES) to develop the technical basis for regulatory guidance to address design and implementation practices for lightning protection systems in nuclear power plants (NPPs). With the advent of digital and low-voltage analog systems in NPPs, lightning protection is becoming increasingly important. These systems have the potential to be more vulnerable than older, analog systems to the resulting power surges and electromagnetic interference (EMI) when lightning hits facilities or power lines. This report documents the technical basis for guidance on the protection of nuclear power structures and systems from direct lightning strikes and the resulting secondary effects. Four Institute of Electrical and Electronics Engineers (IEEE) standards are recommended for endorsement to address issues associated with the lightning protection of nuclear power plants and their equipment and personnel: IEEE Std 665-1995 (R2001), IEEE Guide for Generating Station Grounding; IEEE Std 666-1991 (R1996), IEEE Design Guide for Electric Power Service Systems for Generating Stations, IEEE Std 1050-1996, IEEE Guide for Instrumentation and Control Equipment Grounding in Generating Stations; and IEEE Std C62.23-1995 (R2001), IEEE Application Guide for Surge Protection of Electric Generating Plants.

12. KEY WORDS/DESCRIPTORS (List words or phrases that will assist researchers in locating the report.)

I&C, Instrumentation and Control, Lightning, Surge Protection, EMI, Electromagnetic Interference, Grounding, Lightning Protection

13. AVAILABILITY STATEMENT

unlimited

14. SECURITY CLASSIFICATION

(This Page)

unclassified

(This Report)

unclassified

15. NUMBER OF PAGES

16. PRICE

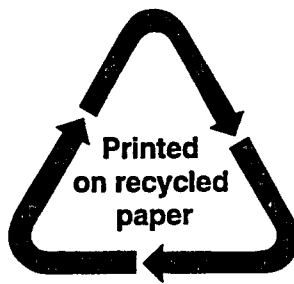

Federal Recycling Program