

Dr. Curt M. White

Separation and Capture of CO₂ from Large Stationary Sources and Sequestration in Geological Formations—Coalbeds and Deep Saline Aquifers

Curt M. White, Brian R. Strazisar, Evan J. Granite, James S. Hoffman, and Henry W. Pennline

National Energy Technology Laboratory, Pittsburgh, Pennsylvania

ABSTRACT

The topic of global warming as a result of increased atmospheric CO₂ concentration is arguably the most important environmental issue that the world faces today. It is a global problem that will need to be solved on a global level. The link between anthropogenic emissions of CO₂ with increased atmospheric CO₂ levels and, in turn, with increased global temperatures has been well established and accepted by the world. International organizations such as the United Nations Framework Convention on Climate Change (UNFCCC) and the Intergovernmental Panel on Climate Change (IPCC) have been formed to address this issue. Three options are being explored to stabilize atmospheric levels of greenhouse gases (GHGs) and global temperatures without severely and negatively impacting standard of living: (1) increasing energy efficiency, (2) switching to less carbon-intensive sources of energy, and (3) carbon sequestration. To be successful, all three options must be used in concert. The third option is the subject of this review. Specifically, this review will cover the capture and geologic sequestration of CO₂ generated from large point sources, namely fossil-fuel-fired power gasification plants. Sequestration of CO₂ in geological formations is necessary to meet the President's Global Climate Change Initiative target of an 18% reduction in GHG intensity by 2012. Further, the best strategy to stabilize the atmospheric concentration of CO₂ results from a multifaceted approach where sequestration of CO₂ into geological formations is combined with increased efficiency in electric power generation and utilization, increased conservation, increased use of lower carbon-intensity fuels, and increased use of nuclear energy and renewables.

This review covers the separation and capture of CO₂ from both flue gas and fuel gas using wet scrubbing technologies, dry regenerable sorbents, membranes, cryogenics, pressure and temperature swing adsorption, and other advanced concepts. Existing commercial CO₂ capture facilities at electric power-generating stations based on the

use of monoethanolamine are described, as is the Rectisol process used by Dakota Gasification to separate and capture CO₂ from a coal gasifier.

Two technologies for storage of the captured CO₂ are reviewed—sequestration in deep unmineable coalbeds with concomitant recovery of CH₄ and sequestration in deep saline aquifers. Key issues for both of these techniques include estimating the potential storage capacity, the storage integrity, and the physical and chemical processes that are initiated by injecting CO₂ underground. Recent studies using computer modeling as well as laboratory and field experimentation are presented here. In addition, several projects have been initiated in which CO₂ is injected into a deep coal seam or saline aquifer. The current status of several such projects is discussed. Included is a commercial-scale project in which a million tons of CO₂ are injected annually into an aquifer under the North Sea in Norway. The review makes the case that this can all be accomplished safely with off-the-shelf technologies. However, substantial research and development must be performed to reduce the cost, decrease the risks, and increase the safety of sequestration technologies.

This review also includes discussion of possible problems related to deep injection of CO₂. There are safety concerns that need to be addressed because of the possibilities of leakage to the surface and induced seismic activity. These issues are presented along with a case study of a similar incident in the past. It is clear that monitoring and verification of storage will be a crucial part of all geological sequestration practices so that such problems may be avoided. Available techniques include direct measurement of CO₂ and CH₄ surface soil fluxes, the use of chemical tracers, and underground 4-D seismic monitoring.

Ten new hypotheses were formulated to describe what happens when CO₂ is pumped into a coal seam. These hypotheses provide significant insight into the fundamental chemical, physical, and thermodynamic phenomena that occur during coal seam sequestration of CO₂.

INTRODUCTION

Carbon sequestration refers to the removal and long-term storage of CO₂ from the atmosphere or emission sources. It is a necessary part of the U.S. Global Climate Change Initiative (GCCCI) to reduce greenhouse gas (GHG) emissions by 18% by 2012. This review finds that geological sequestration represents a technologically feasible, safe, and verifiable option to meet the President's GHG emission targets and stabilize the atmospheric CO₂ concentration.

The geological formations that typically receive the most consideration as potential hosts for CO₂ storage are depleted petroleum reservoirs, deep unmineable coal seams, and deep saline aquifers. Formations such as depleted and depleting gas reservoirs, salt domes, salt formations, depleted CO₂ domes, carbonaceous shales, and others are also potential host formations. The review focuses on sequestration in deep unmineable coal seams as a host formation because the authors have a background in coal research to draw upon and because sequestration in coalbeds has the potential to yield a value-added product, CH₄. We also selected deep saline aquifers as a topic because they underlie approximately two-thirds of the United States and are thus a convenient sink for most large stationary sources of CO₂.

The Greenhouse Effect and Climate Change

The Earth's atmosphere naturally absorbs and reflects radiation from the sun and acts as a blanket, trapping heat coming to Earth from the sun. The Earth is warmed by the incoming solar radiation, and the Earth emits longer-wavelength thermal radiation back into space. Some of this terrestrial infrared radiation is absorbed by gaseous constituents in the atmosphere, such as CO₂ and water vapor, and is re-emitted in all directions, warming the atmosphere. Atmospheric gases trap some of the energy radiated from the Earth, retaining heat in a manner similar to a greenhouse that warms the Earth's surface and lower atmosphere. The physical phenomena associated with this process were first established by John Tyndall. However, Joseph Fourier was the first to express the notion that the atmosphere acts like the glass in a greenhouse, by allowing solar radiation to pass through it while trapping thermal radiation from the ground.¹ This notion was further studied by Pouillet² and quantified by Svante Arrhenius.³ Arrhenius observed that the greenhouse effect is primarily associated with water vapor and CO₂, which are minor constituents of air. The theory that the Earth's atmosphere acts like a blanket by trapping heat is substantiated by the observation that the average temperature of the Earth is 15 °C, while the average temperature of the moon is -19 °C.⁴ Both receive the same amount of solar radiation. The difference is that the Earth possesses an

atmosphere that traps heat. This warming is known as the greenhouse effect.

Greenhouse Gases

Gases that trap heat as a consequence of their ability to absorb infrared radiation are known as GHG. Naturally occurring GHG include H₂O, CO₂, N₂O, CH₄, O₃, and halocarbons (such as chloroform and methyl bromide). Alteration of the atmospheric concentration of these gases can shift the equilibrium of heat transfer between the surface of the Earth, the atmosphere, space, and the oceans. A measure of these changes is called "radiative forcing." With all other factors remaining constant, an increase in the atmospheric concentration of GHG will result in an increase in the amount of energy absorbed by the Earth. The abilities of individual GHG to absorb heat differ. For example, CH₄ traps approximately 21 times more thermal energy per molecule than does CO₂, and a molecule of N₂O traps 310 times more energy than a molecule of CO₂. Global Warming Potential (GWP) is the ratio of the time-integrated radiative forcing from the instantaneous release of 1 kg of a trace substance relative to that of CO₂,⁵ see Table 1.⁶ There is some controversy concerning the use of this simple metric to compare the thermal impact of different gases. Nevertheless, the Intergovernmental Panel on Climate Change (IPCC) has proposed this approach and it is adopted here.

Table 1. GWPs and atmospheric lifetimes.⁶

Gas	Atmospheric Lifetime (yr)	GWP
CO ₂	50–200	1
CH ₄ ^a	12 ± 3	21
N ₂ O	120	310
HFC-23	264	11,700
HFC-32	5.6	650
HFC-125	32.6	2800
HFC-134 ^b	14.6	1300
HFC-143 ^b	48.3	3800
HFC-152 ^b	1.5	140
HFC-227 ^b	36.5	2900
HFC-236 ^b	209	6300
HFC-4310	17.1	1300
CF ₄	50,000	6500
C ₂ F ₆	10,000	9200
C ₄ F ₁₀	2600	7000
C ₆ F ₁₄	3200	7400
SF ₆	3200	23,900

Note: The concept of GWP allows comparison of the thermal impacts of emissions or reductions of various gases; ^aIncludes the direct effects and those indirect effects caused by the production of tropospheric ozone and stratospheric water vapor—the indirect effect caused by the production of CO₂ is not included; ^b100-yr time horizon.

Climate Change

Long-term global fluctuations in temperature, precipitation, and wind result from natural processes including variations in solar radiation, changes in the Earth's orbit, volcanic activity, and El Niño effects. Fluctuations also result from changes in GHG concentration. According to the United Nations Framework Convention on Climate Change (UNFCCC), climate change can be defined as "a change of climate which is attributed directly or indirectly to human activity that alters the composition of the global atmosphere and which is in addition to natural climate variability observed over comparable time periods."⁷ The IPCC reported that the Earth's average global surface temperature increased 0.6 ± 0.2 K over the twentieth century.⁸ The 10 warmest years in the twentieth century occurred after 1984, with 1998 being the warmest year ever recorded and 2001 being the second. Rising temperatures have resulted in decreased snow cover over the northern hemisphere, decreased amounts of floating ice in the Arctic ocean, and a global rise in sea level of 0.1–0.2 m in the last century.⁹ In March of 2002, the northern section of the Larsen ice shelf shattered, separated from Antarctica, and went adrift in the Weddell Sea. A total of approximately 3250 km² of shelf area was lost.¹⁰ Alaskan glaciers lose a total of approximately 6.25×10^{10} – 1.38×10^{11} m³ of ice/yr, causing a rise in sea level of approximately 0.025 cm. Since the 1960s, Alaska has warmed approximately 2.8 K.¹¹ Fitter and Fitter recently reported that 385 plant species "in south-central England bloomed an average of 4.5 days earlier in the 1990s than they did in the previous four decades."¹² The IPCC estimates that temperatures will increase by 3.7 K by 2100, with the greatest rise occurring at mid-latitudes in the winter, accompanied by a sea level increase of an average of 10–30 cm.¹³

The ambient CO₂ concentration has been measured on a regular basis from 1957 to the present on Mauna Loa, Hawaii. The concentration of CO₂ in air dating back thousands of years can be estimated by extracting air from polar ice and measuring the CO₂ concentration, as shown in Figure 1, along with information on emissions of CO₂ from fossil-fuel utilization.⁴ Both the Mauna Loa and ice core measurements were made great distances from major industrial sources of CO₂ and are derived from well-mixed atmospheres. The general trends show a correlation with the increase in global mean surface temperature changes. The data on CO₂ concentration taken from ice cores and from Mauna Loa show an approximate constant CO₂ concentration of 280 ppmv until approximately 1800, when a steady increase began, and the level reached ~367 ppmv in 1999,⁸ coinciding with increased use of fossil fuels. CO₂ levels are lower in the Southern Hemisphere because approximately 90% of the CO₂ emissions are in the Northern Hemisphere.

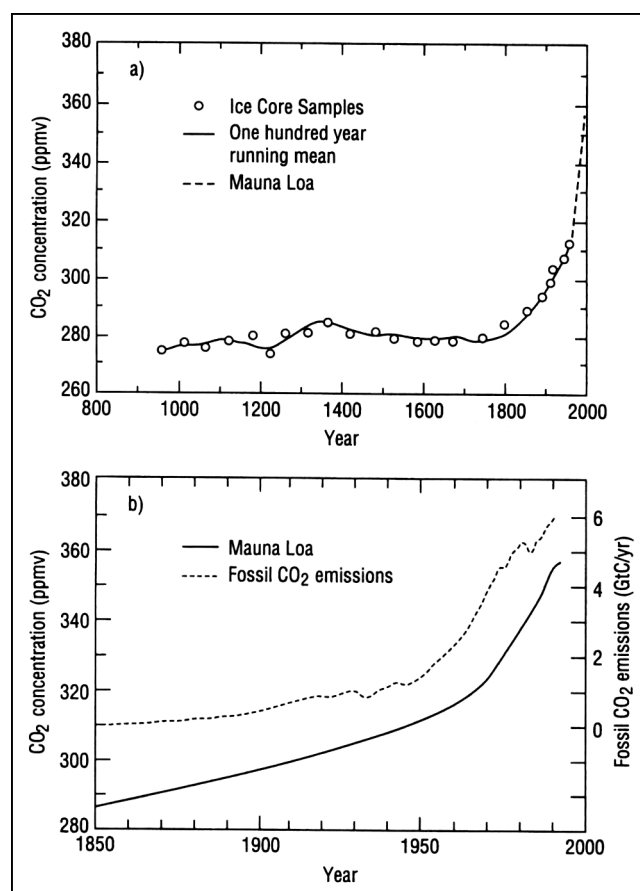

Figure 1. Atmospheric concentration of CO₂ over the previous millennium as determined from ice core records and from Mauna Loa and CO₂ emissions from combustion of fossil fuels. Taken from Halmann and Steinberg.⁴

Emissions and Sinks

Many nations have developed detailed "emissions inventories" for individual pollutants, including CO₂. This inventory shows that CO₂ emissions result from many sources, including industrial, agricultural, and transportation activities. Figure 2 shows the global CO₂ emissions from fossil-fuel combustion, cement manufacture, and gas flaring from 1751 to 1998.¹⁴ Table 2 delineates the various sources of this CO₂ within the United States.⁶ The largest source of CO₂ within the United States is fossil-fuel combustion, distantly followed by emissions from iron and steel production and cement manufacture (not shown in table).

The major sinks for CO₂ are the biosphere, the geosphere, and utilization of CO₂ to make other useful products. Table 2 indicates that the major CO₂ sink within the United States is the terrestrial biosphere, through changes in land-use practices (especially forestry). Since 1990, the amount of CO₂ sequestered in that sink has varied from 1.23 to 0.98 Gt of CO₂/yr. Forestry and similar forms of terrestrial sequestration are attractive because they have the potential to store large amounts of CO₂ at relatively

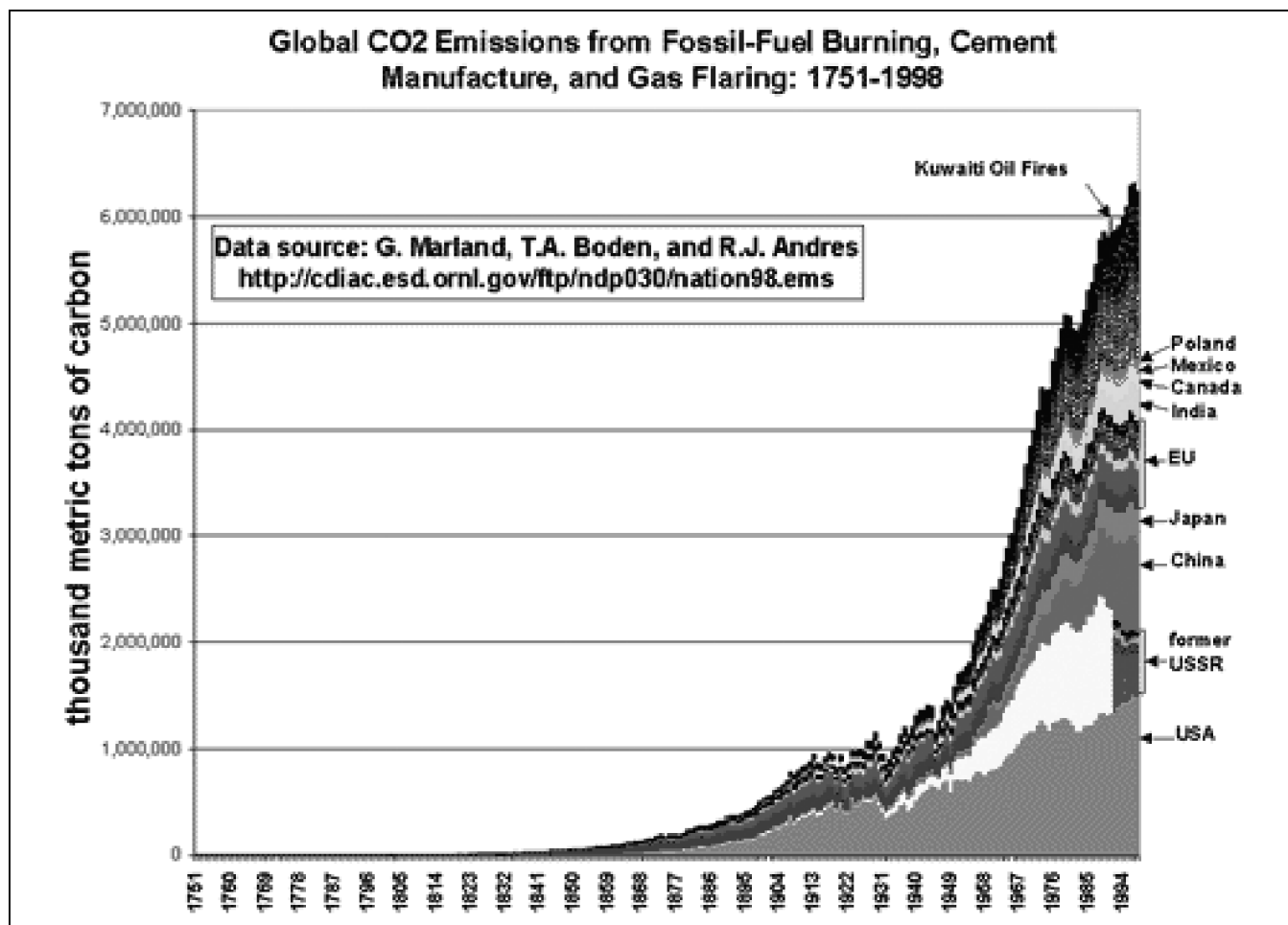

Figure 2. Global CO₂ emissions from fossil-fuel burning, cement manufacture, and gas flaring from 1751 to 1998. Taken from <http://yosemite.epa.gov/oar/globalwarming.nsf/content/EmissionsInternational.html>.

low cost. For example, the Forests Absorbing Carbon Dioxide Emissions (FACE) Foundation operates a project to absorb 3 Mt(CO₂)/yr by planting 1250 km² of forest in the tropics, and an additional 200 km² in central Europe and 50 km² in the Netherlands. These forests are expected to absorb 3 Mt CO₂/yr, which is approximately the amount of CO₂ emitted by a 600-MW coal-fired electric power-generating station.¹⁵ Similarly, Costa Rica has reserved 5300 km² (1.25 million acres) of forest as a CO₂ sink in the “Protected Areas Project.” Costa Rica is selling “credits” for GHG removed from the atmosphere that are certified by the Societe Generale de Surveillance.¹⁶ Compensating for emissions of CO₂ to the atmosphere by removal using forests is often mentioned as being the cheapest mitigation option, with estimated costs as low as approximately \$0.54/t of CO₂ removed,¹⁷ but they also may be as high as \$22/t of CO₂.¹⁸ Biota such as forests are a temporary form of CO₂ storage. Eventually the trees die and decompose back to CO₂. Temperate forests that are CO₂ sinks today may become future sources when global warming increases soil respiration.¹⁹ This has recently been disputed by data produced during a decade-long

soil-warming experiment that shows that in a mid-latitude hardwood forest, warming has the potential to stimulate plant carbon storage sufficiently to compensate for accelerated organic matter decay in soil.²⁰

Kaya Identity

International policy for GHG emission reductions requires estimates of current and future emissions. A commonly used empirical estimate has been developed by Kaya et al.^{21–25} The original equation was modified for net carbon emissions and is as follows:

$$\begin{aligned} &\text{net atmospheric C emissions from a country} \\ &= P \times GDP/P \times E/GDP \times C/E - S \end{aligned} \quad (1)$$

where *P* is the population; *GDP/P* is the per capita gross domestic product (a measure of the standard of living); *E/GDP* is the energy generated per gross domestic product (energy efficiency); *C/E* is the carbon emissions per unit of energy generated (carbon intensity), which reflects the fuel mix used in a country; and *S* is the natural and

Table 2. Comparison of GHG emissions by sector in the U.S. using IPCC SAR and TAR GWP values (Tg CO₂ Eq).⁶

Sector	1990	1991	1992	1993	1994	1995	1996	1997	1998	1999	2000
Energy											
SAR GWP (used in inventory)	5141.9	5097.3	5202.5	5312.4	5409.5	5452.4	5629.9	5697.9	5709.5	5793.9	5962.6
TAR GWP	5162.6	5117.8	5222.6	5331.7	5428.5	5471.6	5648.6	5716.2	5727.6	5811.2	5979.4
Difference (%)	0.4	0.4	0.4	0.4	0.4	0.4	0.3	0.3	0.3	0.3	0.3
Industrial Processes											
SAR GWP (used in inventory)	295.7	279.9	279.7	281	289.2	301.9	312.3	322.4	322.1	310.8	312.8
TAR GWP	291.8	276	276.3	277.5	285.8	299.6	310.8	321.7	323.1	312.6	315.5
Difference (%)	-1.3	-1.4	-1.2	-1.2	-1.2	-0.8	-0.5	-0.2	0.3	0.6	0.8
Agriculture											
SAR GWP (used in inventory)	448.4	453	464.3	457.8	485.2	476.4	481.3	485.9	487.6	485	485.1
TAR GWP	451.3	455.8	467.1	460.7	487.6	479.6	483.6	487.9	489.7	487.1	487.1
Difference (%)	0.6	0.6	0.6	0.6	0.5	0.7	0.5	0.4	0.4	0.4	0.4
Land-Use Change and Forestry											
SAR GWP (used in inventory)	(1097.7)	(1085.6)	(1091.1)	(1113.8)	(1117.8)	(1110)	(1108.1)	(887.5)	(885.9)	(896.4)	(902.5)
TAR GWP	(1097.7)	(1085.6)	(1091.1)	(1113.8)	(1117.8)	(1110)	(1108.1)	(887.5)	(885.9)	(896.4)	(902.5)
Difference (%)	NC ^a	NC	NC	NC	NC	NC	NC	NC	NC	NC	NC
Waste											
SAR GWP (used in inventory)	244.7	245	248.4	250.9	251.7	251.1	246.3	241.9	236.9	239.8	240.6
TAR GWP	267	267.3	271	273.7	274.6	273.9	268.7	263.8	258.3	261.5	262.4
Difference (%)	9.1	9.1	9.1	9.1	9.1	9.1	9.1	9.1	9	9	9
Net Emission (sources and sinks)											
SAR GWP (used in inventory)	5033.0	4989.6	5103.6	5188.4	5317.9	5371.8	5561.7	5860.5	5870.3	5933.1	6098.7
TAR GWP	5074.9	5031.2	5145.9	5229.9	5358.7	5414.7	5603.6	5902.1	5912.9	5975.9	6141.8
Difference (%)	0.8	0.8	0.8	0.8	0.8	0.8	0.7	0.7	0.7	0.7	0.7

Note: In the IPCC's third assessment report (TAR), the GWPs of several gases were changed relative to the values given in the second assessment report (SAR). Totals may not add up because of independent rounding; ^aNC = no change.

induced removal of carbon as CO₂ from the atmosphere. Carbon sequestration lowers net emissions by lowering the *C/E* term. The equation represents a specific use of the impacts, population, affluence, and technology (IPAT) identity employed to relate the drivers of emissions to those four factors.²⁶ The equation predicts that development of technologies that separate and capture CO₂ from large point sources and subsequent long-term storage of that carbon in the geosphere will have direct effects on the CO₂ content of the atmosphere. Because *P* and *GDP/P* are expected to increase in most countries, *E/GDP* and *C/E* must decrease and *S* must increase to achieve stabilization, let alone a reduction in GHG levels.

The Carbon Cycle

Carbon is a nonmetallic element that exists in its elemental form in nature as graphite and diamond. Carbon is the fourth most abundant element in the universe following H, He, and O. Carbon is commonly found combined with O to form of carbonate minerals with Ca and Mg, such as marble, limestone, calcite, magnesite, chalk, dolomite, and shells. Carbon is stored on Earth in various sinks listed in Table 3.²⁷ Carbon is stored in the geosphere

primarily as sedimentary rocks that contain either kerogen or carbonates, with smaller amounts of coal and oil. In the form of CO₂, it constitutes approximately 0.03 vol % of the atmosphere. Terrestrial carbon is found as minerals (99.7%), atmospheric CO₂ (0.2%), and living organisms (0.1%). The cycle of carbon is dominated by reactions in which CO₂ is the key component, shown in simplified form in Figure 3.²⁸ Table 4 shows the global annual average anthropogenic carbon budget for the 1980s and 1990s.⁴

The global terrestrial biosphere removes CO₂ from the atmosphere via photosynthetic processes and adds it via respiration and decay of dead tissue. These withdrawals and

Table 3. Estimated major stores of carbon on the Earth.⁴⁴⁴

Sink	Amount Gt CO ₂
Atmosphere	2120 (as of 1700)–2810 (as of 1999)
Soil organic matter	5500–5870
Ocean	139,000–147,000
Marine sediments and sedimentary rocks	242,000,000–367,000,000
Terrestrial plants	1980–2240
Fossil fuel deposits	14,700

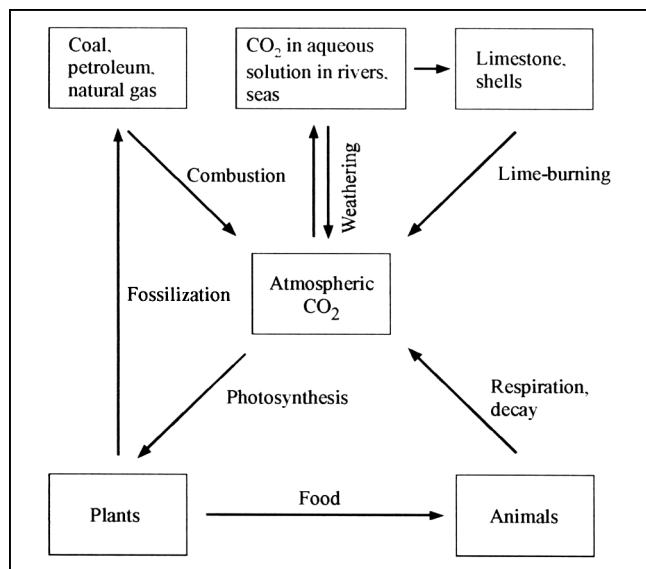

Figure 3. The geochemical CO₂ cycle. Combustion of fossil fuels is the main source of anthropogenic CO₂ input into the atmosphere. CO₂ plays a central role in all the previously mentioned processes, including photosynthesis, decay, respiration, weathering, combustion, and fossilization. Taken from Hitchon.²⁸

additions to the atmosphere from the biosphere are clearly observed in the seasonal variations of the atmospheric CO₂ concentrations observed by Keeling at Mauna Loa.⁴

Land-use change has resulted in approximately 405 Gt of CO₂ being released to the atmosphere worldwide from 1850 to 1990.²⁹ This conclusion is based on the annual rates of deforestation and changes in carbon that accompany changes in land use. The amount of carbon released annually increased from 1850 to 1990. During the 1980s, the release averaged 7.7 Gt of CO₂/yr.

The global carbon cycle can be divided into geological and biological components. The geological carbon

Table 4. Global CO₂ budgets (in Gt CO₂/yr) based on intradecadal trends in atmospheric CO₂ and O₂.⁸

	1980s	1990s
Atmosphere increase	13.3 ± 0.4	12.9 ± 0.4
Emissions (fossil fuel, cement)	21.8 ± 1.2	25.4 ± 1.6
Ocean-atmosphere flux	-7.7 ± 2.4	-6.9 ± 2
Land atmosphere flux ^a	-0.8 ± 2.8	-5.6 ± 2.8
Land-use change	6.9 (2.4 to 10.1)	NA ^b
Residual terrestrial sink	-7.7 (-15.8 to 1.2)	NA

Note: Positive values are fluxes to the atmosphere, while negative values represent uptake from the atmosphere. The fossil-fuel emissions figure for the 1980s has been revised downward slightly since the SAR. Error bars denote uncertainty (± 1 s), not interannual variability, which is substantially greater; ^athe land atmosphere flux represents the balance of a positive term caused by land-use change and a residual terrestrial sink—the two terms cannot be separated on the basis of current atmospheric measurements; ^bNA = not applicable.

cycle operates over millions of years, while the biological cycle operates over days to thousands of years. In the geological cycle (Figure 4),³⁰ carbonic acid reacts with Ca, Mg, Fe, and other metals to form relatively insoluble metal carbonates via chemical weathering. These rocks are then eroded or dissolved by rainwater and washed into the oceans. Later, they may precipitate out, settling to the ocean floor to form sedimentary layers. Subduction occurs through plate tectonics and draws sediments into the Earth's interior, where they are subjected to high temperatures and pressures.³⁰ Metal carbonates are thermally unstable and decompose back to CO₂ within the deep Earth's hot interior. CO₂ is eventually returned to the atmosphere through volcanism and carbonated springs.³¹ Applying a geochemical carbon cycle model, Berner and Lasaga³⁰ concluded that the primary factor affecting the atmospheric concentration of CO₂ is the rate of degassing, not anthropogenic CO₂. Our limited understanding of the global carbon cycle has only been developed over the last 20 years, during which time it has been placed into the context of plate tectonics.

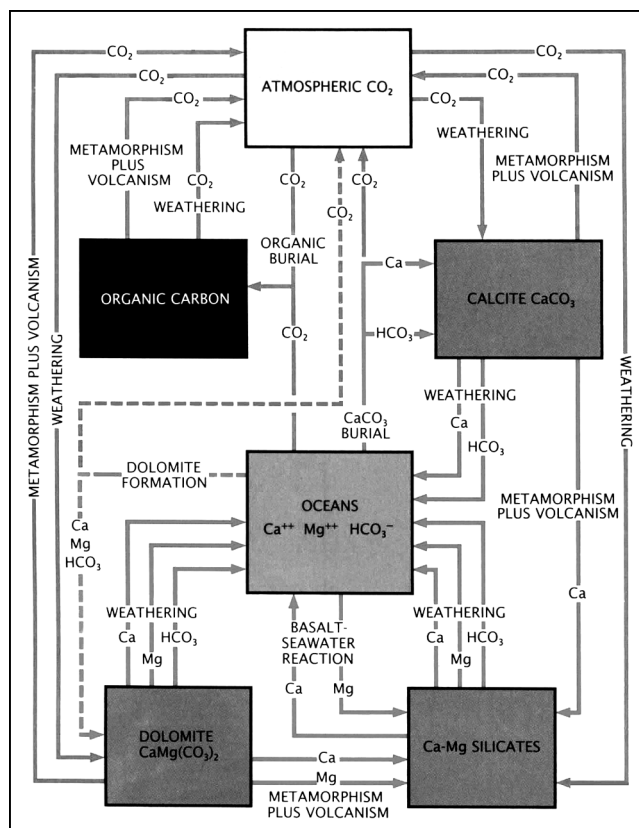

Figure 4. Computer model of the geochemical carbon cycle. The model includes chemical reactions involving Mg and Ca. The products of weathering are carried to the ocean, where metal carbonates are deposited, buried, and eventually subducted. CO₂ fluxes are given. Lines associated with dolomite formation are dashed; the processes were once important but are no longer relevant. Taken from Berner and Lasaga.³⁰

An Approach to Solving the Problem—The Pathway to Stabilization

There are a number of approaches that can be implemented in concert to have an effect on net CO₂ emissions. Energy consumption must be decreased by conservation and by improving the efficiency of energy utilization and conversion systems. With respect to electric power generation from fossil fuels, efficiency is the ratio of usable energy output to energy input.³² Audus³³ noted that, "At 40% operating efficiency a 1% point increase in efficiency to 41% results in a 2.5% reduction in the CO₂ released per unit of electricity generated. At present, the average efficiency of coal-fired plants in the Organization for Economic Cooperation and Development (OECD) is around 36% and the global average is around 31%. State-of-the-art coal-fired plants operating on supercritical steam cycles have efficiencies of around 47%. Power generation with the natural gas combined cycle (NGCC) is attractive in many countries and has the bonus of reducing emissions by increased efficiency and use of a fuel with low carbon intensity. State-of-the-art efficiencies are in the 56% region";³³ see Table 5.

A second approach, directed at stabilizing the atmospheric concentration of CO₂, is to switch to fuels that are less carbon-intensive. For example, more electricity is produced per mol of CO₂ produced when one burns CH₄ as compared with combusting coal. Per joule of heat produced, CH₄ yields less CO₂ than oil, which emits less than coal.³⁴ Shifting some generators from coal to natural gas can reduce emissions while still producing the same amount of electricity or more. Power generation with nuclear and renewable energy, such as wind, solar, geothermal, tidal, and hydroelectric, must be expanded as much as possible. A caveat to using fuels that are less carbon-intensive is to use fuels that are essentially carbon-neutral, such as biomass.

Another fuel that, on the surface, appears to have zero carbon intensity is H₂. At the point of combustion, H₂ does not release CO₂. However, H₂ is made by steam reforming of CH₄ or from gasification of a fossil fuel, and CO₂ is produced during that process. The cost of

manufacturing H₂ by steam reforming of CH₄ even with CO₂ capture and sequestration is considerably less than the cost of producing it from electrolysis of H₂O employing electricity from hydroelectric-generating facilities.³⁵ "Per unit of heat generated, more CO₂ is produced by making H₂ from fossil fuel than by burning the fossil fuel directly."³² Production of H₂ by electrolysis is more practical when nuclear electric power from nonpeak demand periods is available. Such H₂ can be used for transportation or generation of electricity during peak demand times.

The third approach is carbon sequestration. Bachu defines geological sequestration as "The capture of CO₂ directly from anthropogenic sources and disposing of it deep into the ground for geologically significant periods of time."³⁶ Sequestration of CO₂ in geological formations is a storage process. The ability to capture CO₂ from large point sources such as fossil fuel electric power-generating stations, large cement kilns, NH₃ production, and natural gas purification must be developed to the point where the technology is economical and reliable. Then, the techniques to sequester CO₂ in geological formations must be improved and refined. The cost of capture and sequestration must be significantly reduced. Reliable and proven tools to monitor the integrity of geologically sequestered CO₂ must be developed. Then, these tools must be employed at sequestration sites to protect public health and safety.

Neither conservation, increased energy efficiency, nor sequestration used individually can significantly reduce and or stabilize the atmospheric levels of CO₂ to the levels that will be required. However, each will have a role to play. Carbon management is required to stabilize the atmospheric concentration of CO₂. Research has been carried out to quantify the benefits that could be realized through reductions in CO₂ emissions caused by improved energy utilization and conversion systems, by employing low carbon fuels, and by various forms of sequestration. These data are shown in Figure 5, which depicts GHG emission scenarios for the United States as a function of time.³⁷

This is congruent with substantially reducing the GHG intensity by 2012 as well as placing the United States on a path toward slowing and then stopping the

Table 5. Costs and efficiencies of postcombustion CO₂ capture.⁴⁴⁵

Process	Efficiency (% LHV)	Specific Investment (\$/kWe)	Cost of Electricity (c/KWh)	CO ₂ Emission (g/kWh)	Cost of CO ₂ Avoided (\$/t CO ₂)
Base-case plant					
Pulverized coal	46	1020	3.7	720	Reference case
Natural gas combined cycle	56	410	2.2	370	Reference case
With CO ₂ capture					
Pulverized coal	33	1860	6.4	150	47
Natural gas combined cycle	47	790	3.2	60	32

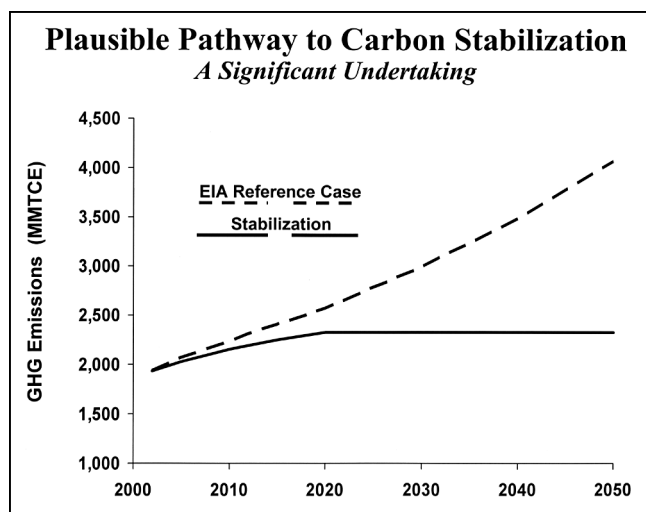

Figure 5. Various GHG emission scenarios for the United States as a function of time. The emissions are in millions of metric tons of carbon equivalents (MMTCE). The top line is the projected emissions if we conduct “business as anticipated” and includes reductions accrued by using natural gas instead of coal, assumes that significantly advanced electric power-generating technologies begin to be used that include significant advances in energy efficiency, and contributions from renewable energy sources and non-CO₂ GHG mitigation. The bottom line represents emissions associated with a “reduced emissions scenario” where “the rate of growth in U.S. GHG emissions is slowed and then stopped according to the following schedule:⁴¹ 2002–2012: GHG intensity reduced to 0.56 Gt CO₂/\$GDP; 2013–2020: Emissions growth reduced 50% below the Energy Information Agency’s Annual Energy Outlook 2002 reference case; 2021–2040: GHG emissions stabilized at the 2020 emissions level.³⁷

growth of GHG emissions as described by the GCCI. By 2012, the gap between the two lines shown in Figure 5 is 0.39 Gt CO₂, and it balloons to 4 Gt CO₂ in 2040. To close this gap, Klara et al. propose a multifaceted approach including increased “efficiency and renewables,” “non-CO₂ GHG mitigation,” “forestry and agriculture,” “early value-added geologic sequestration,” and “advanced geologic sequestration technologies.” The contributions that each make to closing the gap are shown collectively in Figure 6.³⁷ The information in Figures 5 and 6 was generated using a modeling framework based upon the mixed application of multiple models including the Carbon Sequestration Benefits (CarBen) model and the National Energy Modeling System (NEMS), a general equilibrium model of the U.S. economy and energy sector. The overall modeling framework also draws upon the “Value-Added Geologic Sequestration” minimodel.³⁷

Early value-added geologic sequestration includes enhanced oil recovery (EOR) and enhanced coalbed methane recovery (ECBM), which produce value-added oil or gas to offset the overall costs of capture and sequestration. Under this scenario, to meet the President’s GCCI target, EOR will be required to sequester 0.037 Gt CO₂/yr and ECBM will be required to sequester 0.007 Gt CO₂/yr by

2012. This is achievable using high-purity CO₂ exhaust streams from a diverse set of industrial off-gases that are currently vented to the atmosphere, such as cement kilns and fermentation processes. Overall, Klara et al. estimate that approximately 0.16 Gt CO₂/yr of easily captured CO₂ is available in the United States.³⁷ Advanced sequestration uses unconventional geologic formations such as deep saline aquifers, salt domes, salt formations, depleted CO₂ domes, hydrocarbon-containing shales, and depleting natural gas formations that have the potential to produce value-added byproducts. Figure 6 shows that sequestration in geologic media is essential to stabilize the atmospheric concentration of CO₂ and to meet the U.S. CO₂ net emission targets set forth in the GCCI. This is consistent with the overall theme of this review.

CO₂ CAPTURE AND SEPARATION

The capture and separation of CO₂ from an anthropogenic mobile or stationary source is the first step in the sequestration process. Examples of stationary sources include fossil-fuel-based power generation, natural gas production and upgrading, H₂ production, oil refineries, iron and steel plants, and cement and lime production.³⁸ CO₂ is often generated as a byproduct of natural gas production. Gas fields can contain 20 vol % CO₂ or more, most of which must be removed to produce pipeline-quality gas. Sequestration from natural gas operations is a logical first step in applying a CO₂ capture technology. A good example of this is the Sleipner project^{39,40} being conducted in Norway, where the CO₂ removed from natural gas (9 vol% CO₂) by an amine solvent process is stored in a geologic aquifer. Production of NH₃ and ethylene generate nearly pure CO₂ streams and therefore allow relatively inexpensive recovery. Refineries, especially those that use heavier crudes, also provide some opportunities for CO₂ capture, as do major CO₂-emitting industries, including iron and steel production and the broader petrochemical industries.⁴¹

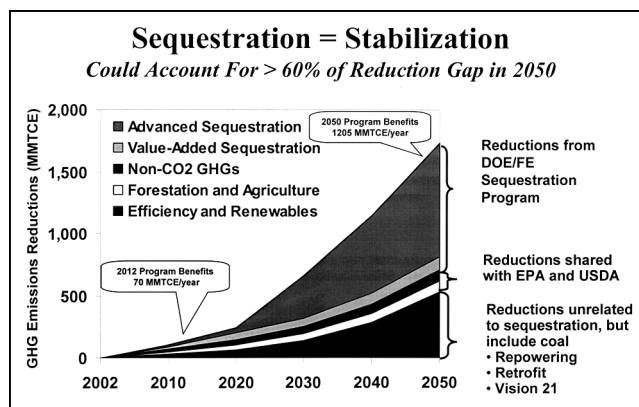

Figure 6. Contribution of technologies to the GHG emissions reductions needed to reach 4.07 Gt CO₂/yr in 2040.³⁷

Table 5 presents the costs and efficiencies of pulverized coal (PC) and NGCC power plants with and without postcombustion CO₂ capture. The efficiency of the base case is greater for NGCC than for a PC plant. CO₂ capture causes the efficiency to decrease and the cost of electricity to increase in both cases.

Power Generation

Fossil-fuel-fired electric power-generation plants contribute approximately one-third of the world's CO₂ emissions from fossil-fuel sources.^{42,43} Generally, power plants have the highest density of CO₂ emissions in terms of mass per area per time. The capture and separation of CO₂ from large point sources is the critical step with respect to the cost and technical feasibility of the overall sequestration process. Power generation sources that lend themselves best to capture technologies include conventional PC combustion steam power plants, NGCC plants, and advanced power systems, such as the integrated gasification combined cycle (IGCC) or oxygen-blown combustion with CO₂ recycle.

PC-fired steam cycles have been the main power-generation technology for many years. Coal is burned in a boiler to create high-pressure steam; the steam is then passed through a steam turbine, generating electricity. A generic scheme of a PC power generation plant is depicted in Figure 7a. Coal is combusted with air that is preheated

by the flue gases, and an excess of air ensures total burn-out of the coal. The type of combustor (e.g., wall-fired, tangential, or cyclone) will impact some of the minor components typically found in flue gas, but the concentration of CO₂ will not be impacted significantly for the most part. For a low-sulfur eastern U.S. bituminous coal burned in a PC combustor with 20% excess air, the typical flue gas composition is 15–16 vol % CO₂, 6–7% H₂O, 3–4% O₂, 500–1000 ppm SO₂, 500 ppm NO_x, 100 ppm HCl, 1 ppb Hg, and the remainder N₂. After the furnace, the flue gas is cooled in an economizer and its sensible heat is transferred to the combustion air in the preheater. For a PC system, approximately 80% of the ash in the coal exits the combustor as fly ash, whereas the remaining 20% exits as bottom ash from the furnace.

CO₂ capture can occur at different points along the path of the flue gas. A prime process variable will be temperature, because in a conventional plant, the pressure is near atmospheric. Another consideration will be the quantity of gas to be removed from the flue gas stream. In the United States, the quantity of CO₂ removed may parallel the restrictions placed on SO₂ emissions, in that allowances for CO₂ may be adopted. Ideally, a high percentage, 80% and above, of CO₂ reduction could economically be feasible with a particular capture technology, but the quantity that would need to be controlled

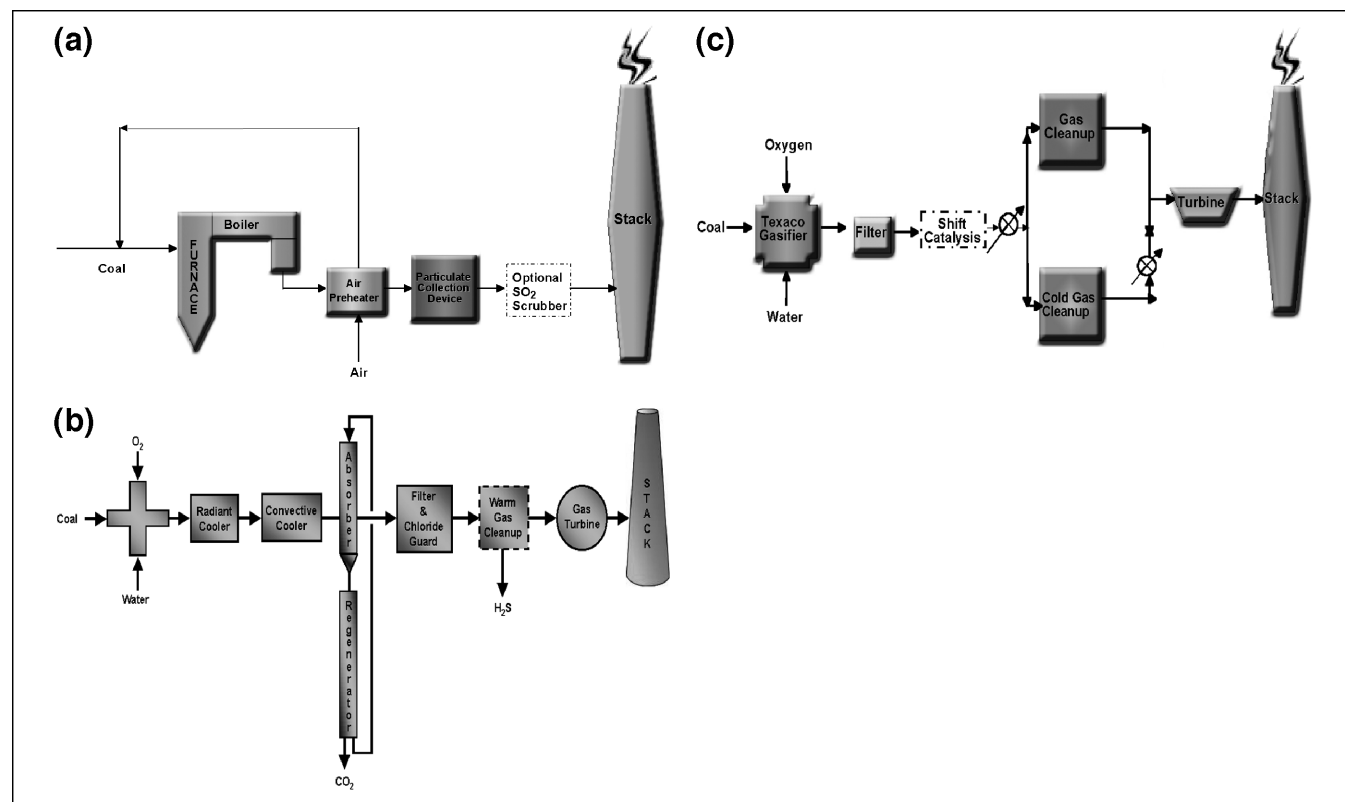

Figure 7. (a) A generic PC-fired power generation plant. (b) Process diagram of an IGCC power plant using O₂ and coal. (c) A solid, regenerable absorbent plumbed into the gas path of an IGCC system.

from each plant would be impacted by the regulation that would be enacted. A typical 500-MWe PC-fired power plant emits approximately 10,000–12,000 t of CO₂ per day.

In NGCCs, natural gas is burned in a gas turbine that generates electricity. The hot exhaust gas from the gas turbine is fed to a boiler that generates steam, which is then passed through a steam turbine, generating more electricity. Worldwide, gas turbine-based systems now constitute more than half of the market for fossil-fueled power plants.⁴³ Large commercial gas turbine combined cycle plants have typical thermal efficiencies of 56–58%. The CO₂ concentration in the flue gas from such a power system is near 4% by volume.

In IGCC power plants, a fossil fuel reacts with O₂ and steam in a gasifier to produce a fuel gas (also frequently referred to as synthesis gas or syngas) consisting mainly of CO and H₂. This mixture is then cleaned and burned to generate power in a gas turbine combined cycle. The high efficiency of this process makes residual oil and coal attractive fuels for this process.⁴³ The plants consist basically of three main building blocks: coal gasification, gas cleaning, and power generation.⁴⁴ As shown in Figure 7b, the main processing units within the plant include coal receiving, coal grinding, and slurry preparation; O₂ plant, gasification, sour shift, and low-temperature gas cooling; Selexol-selective H₂S removal and bulk CO₂ removal; sulfur recovery and tail-gas treating; syngas saturation; syngas expansion for power generation; combined cycle power generation; CO₂ compression and drying; and the pipeline for CO₂ injection.⁴⁵ Assuming O₂-blown gasification with coal, the main products of the gasification process are CO, H₂, CO₂, H₂O, H₂S, some gaseous hydrocarbons, and trace amounts of certain pollutants, including Hg.

The gas cleanup system of the plant involves particulate removal and acid gas scrubbing. In a typical IGCC plant, the crude synthesis gas (syngas) is first fed to a scrubbing facility to remove the particulates from the gas stream. The gas leaving the particulates scrubber is then cooled and dewatered and at this point consists mainly of CO, H₂, and CO₂. It also contains the acid gas H₂S, which will be removed in the desulfurization system. The acid gas scrubbing process (cold gas cleanup in Figure 7b) is generally designed for the removal of S-bearing compounds, and very little CO₂ is removed in the process. However, removal of CO₂ at this location is possible. Some designs employ S-tolerant shift catalysts followed by acid gas removal at low temperatures. This approach appears to be preferable when CO₂ recovery is desired. The power generation consists of a gas turbine system followed by a steam turbine bottoming cycle. The desulfurized gas is first injected with steam and partially expanded in gas expanders to recover some energy. The partially expanded gas, which is rich in CO and H₂, is

then burned with air and expanded in a gas turbine to recover more work. The residual thermal energy in the gas turbine exhaust produces steam for the steam turbine bottoming cycle.

The upper flow path in Figure 7b shows the option where the acid gas cleaning occurs within a hot/warm gas cleanup system rather than at the previously described cold or lower temperatures. The main advantage in cleaning the gas at higher temperatures is that the thermal plant efficiency will be greater as compared with the lower temperature acid gas-cleaning scenario. The areas of efficiency improvements are (1) the transfer of heat and latent heat to the more efficient gas turbine cycle are maximized, (2) capital and operating costs are lowered by reducing the duty on the heat exchangers, and (3) the need for wastewater treatment facilities are eliminated.⁴⁶

CO₂ can be captured in an IGCC system, both before and after combustion. With coal utilization and after the gas turbine, the concentration (partial pressure) of the CO₂ is low in the flue gas, at approximately 9%. However, the IGCC offers the opportunity to remove CO₂ from the fuel gas before it is combusted in the turbine. The high pressure of the system and the possible shifting of the CO to CO₂ produce a high concentration of CO₂ that could be removed by certain technologies. It is expected to be possible to burn H₂ in an existing gas turbine with little modification; however, this has not been demonstrated.⁴³

Fossil fuels may be burned in pure O₂ while recycling some of the CO₂ product back to the combustor, thereby facilitating the separation of CO₂ from the flue gas. The primary objective of burning fuels with O₂ is to increase the concentration of CO₂ in the flue gas as a result of avoiding the N₂ in that stream. CO₂, H₂O, and excess O₂ are the key constituents of the flue gas, along with trace quantities of SO₂, NO_x, and particulates. O₂ concentrations are low and water vapor is readily separable by condensation at moderate temperatures. O₂ combustion cannot be simply substituted for air combustion in existing fossil-fueled power plants because of differences in the combustion characteristics. A thermal diluent is required to replace the N₂ in air.⁴⁴ O₂ produced from air separation would be mixed with recycled flue gas to approximate the combustion characteristics of air. In air, the N₂/O₂ ratio is approximately 3.65. A CO₂/O₂ ratio of 2.42 gives similar flame temperatures as well as similar ratios of radiant heat transfer to convective heat transfer.

CO₂ Capture Issues

Pertaining to the power-generation systems discussed previously, CO₂ can be captured either postcombustion or precombustion. However, much is related to the optimum location of the capture technology as well as the optimum operating conditions. In postcombustion

capture, CO₂ is a product of combustion within the flue gas and would exit the power station into the surrounding atmosphere if uncontrolled. The flue gas in these systems approaches ambient pressure and, thus, the CO₂ partial pressure of the gas is low, indicating that a very large volume of gas needs to be treated. However, as in the case of O₂-blown combustion, the CO₂ concentration in the resulting flue gas is >90%, and possibly only a simple treatment of this stream will suffice before the CO₂ is sequestered.

Precombustion capture occurs in the gasification system. The carbon in the coal is transformed into CO₂ or CO at high pressures. If desired, the CO can be shifted to CO₂ to increase the H₂ content of the fuel gas and also to concentrate the CO₂. The advantage of this type of system is the higher CO₂ concentration (partial pressure), thus the lower volume of gas to be handled, resulting in smaller equipment sizes and lower capital costs. In a case study, Booras and Smelser⁴⁵ indicate that energy penalties and costs for CO₂ sequestration in a precombustion setting are significantly less than those from a PC combustion plant.

Location of the capture technique along the gas path is important in postcombustion applications as well as in precombustion systems. In Figure 7c, a solid absorption, regenerable sorbent for CO₂ removal is placed in the gasification scheme before the desulfurization process. With hot or warm gas desulfurization, the efficiency of an IGCC plant is greater than if cold gas cleanup were used as the desulfurization technique.⁴⁶ This approach, coupled with a CO₂ capture technique that could withstand high temperatures, is feasible at this location and takes advantage of the energy savings. A disadvantage of removing both H₂S and CO₂ while the fuel gas is hot is that the fuel gas cannot be shifted. Thus, a lower partial pressure of CO₂ would exist at the location, and only a fraction of the total carbon would be removed at this location. However, the regulations for CO₂ are not known at this time, and the amount of CO₂ removed may be appropriate.

The presence of pollutants in postcombustion (e.g., SO₂, NO_x, air toxics including Hg) or precombustion (e.g., H₂S, NH₃, air toxics including Hg) gases will have an impact on the CO₂ capture technology. The corrosive nature of some of these species complicates separation processes. Sulfur-bearing compounds and O₂ present in small quantities in flue gas result in irreversible chemical reactions if an amine-scrubbing system is used. If natural gas is burned, SO₂ and NO_x are minimal, but for coal-fired combustion, the resulting SO₂/NO_x concentrations are high, and their scrubbing from the flue gas upstream of the amine removal process is necessary.⁴⁴

Because of air quality standards and regional haze regulations, SO₂ and NO_x emissions may need to be controlled regardless of their impact on a CO₂ capture

technology. The CO₂ capture technology may require even larger SO₂ and NO_x reductions because of their deleterious effects on the capture technology. Pending regulations pertaining to Hg emissions in the United States from coal-utilization facilities will also make utility companies rethink strategies with respect to all pollutants, including CO₂. For example, in Figure 7b, although high-temperature CO₂ removal is possible, if Hg must be removed at room temperature via activated carbon, then a more conventional solvent process for the acid gases H₂S and CO₂ would be suggested. However, the thermal efficiency advantage of the hot CO₂ removal process coupled with the hot/warm gas desulfurization would be lost.

The interfacing between the capture/separation technology and the storage technology can raise important issues. The first deals with the purity of the captured CO₂. The impurities in the product must be of sufficiently low concentrations that transportation and sequestration operations are not compromised. The purity requirements imposed by sequestration operations are not known because sequestration technology is being developed concurrently. Some initial investigation to develop provisional purity requirements will be necessary and will be reviewed and modified as the requirements of various sequestration options become clear.³⁸ End-state specifications may be for the final product of separation and capture and could have a dramatic impact on proposed multicomponent capture technologies.

Another interfacing issue involves the quantity of CO₂ removed from the point source. This will depend on the regulations governing CO₂ and the related purity of the cleaned gas stream finally emitted to the atmosphere from the power-generation facility. If a large quantity needs to be sequestered on a daily basis, the captured CO₂ must be promptly delivered and dispersed immediately. From an energy and cost basis, a carbon sequestration scenario could ill afford to include temporary storage of CO₂ before permanent storage.

Capture techniques can be retrofitted on existing conventional air-based fossil-fuel-fired power plants or integrated into new power-generation facilities. The capture technologies include solvent wet scrubbing with chemical or physical absorbents, solid dry scrubbing with physical adsorbents or chemical absorbents, cryogenic methods, and gas membrane separation. The selection of a technology for a given capture application will depend on many factors, as outlined by Herzog et al.⁴⁴ These include partial pressure of the CO₂ in the gas stream; extent of CO₂ recovery required; sensitivity to impurities, such as acid gases and particles; purity of the desired CO₂ product; capital and operating costs of the process, including cost of additives necessary to overcome fouling and corrosion when applicable; and environmental impacts.

Solvent Wet Scrubbing

For wet scrubbing, the technology is divided into processes where a chemical reaction between the solvent and CO₂ occurs or where the CO₂ is physically dissolved into the solvent. The quantity of absorbent required is a function of the quantity of CO₂ to be removed, as are the regeneration costs. Chemical solvents are preferred for cases with low concentrations or amounts of CO₂ in the combusted gases and those that do not gain significant advantage by operating at elevated pressure. Physical solvents are favored by high pressures and low concentrations of inert gases. The solvent regeneration step is relatively simple for physical absorption because it is carried out by reducing the pressure. For chemical absorption, regeneration is accomplished by applying heat to dissociate the chemical complex formed by reaction with the CO₂.⁴⁷

Chemical absorption involves one or more reversible chemical reactions between CO₂ and an aqueous solution of an absorbent, such as an alkanolamine or K₂CO₃. Upon heating the product, the bond between the absorbent and CO₂ will be broken, yielding a stream enriched in CO₂. Monoethanolamine (MEA) is a widely used solvent in this type of capture scheme, although significant amounts of energy are required in the regeneration step.

Physical absorption is a bulk phenomenon where inorganic or organic liquids may be used to preferentially absorb a gaseous species from the mixture. The absorption process depends on the operating temperature and pressure, as well as on the nature of the gases and the absorption liquid. The absorption liquid is regenerated by increasing its temperature or reducing its pressure. High-boiling-point solvents are preferred to minimize solvent losses and to prevent contamination of the released gas with solvent vapors. This type of process could be a very efficient approach for processing such high-pressure CO₂-rich streams as those encountered in advanced power-generation systems, such as IGCC.⁴⁸

A further explanation distinguishing between the two processes can be found in Park et al.⁴⁹ In physical absorption, the solubilities of gases in absorbent solutions are proportional to the partial pressures of the solubilized gases in the feed. The magnitude of the heat of absorption is lower than that in chemical absorption. The physical absorption process can be more advantageous in the high partial-pressure region where the treated gas removal at low partial pressure is not required. Chemical absorption is the coupling reaction between chemical absorbent and treated gas, and the resulting solubilities are governed mainly by the stoichiometric relations. Because the capacity is not highly sensitive to the gas partial pressure, it is preferable for cases where the removal to high purity is required.

Selection of a suitable process for an acid gas removal duty is not usually affected by the sweet gas purity specification alone but rather by a large number of interacting parameters, such as partial pressure of the acid gas impurities, total pressure of the feed gas, inlet temperature of the feed gas, degree of removal, utilities available, economic considerations (energy and capital costs), required plant life, size and weight, location, and environmental constraints. The possibility of integrating the acid gas removal unit within the overall plant, utilizing, for example, low-grade heat for regeneration, can also influence the choice of CO₂ capture technology.⁵⁷

Meisen and Shuai⁵⁰ indicated that the disadvantages of chemical absorption processes are their limited CO₂ loadings and significant energy requirements resulting from the reaction stoichiometry and the heats of reaction, respectively. Furthermore, they require extensive equipment for circulating large volumes of liquid absorbents and for heat exchange. Nevertheless, absorption is generally competitive for large-scale applications, especially when CO₂ occurs in high-pressure mixtures having constituents which react reversibly with the absorbents. However, most power station flue gases are near atmospheric pressure and contain O₂, SO_x, and NO_x, which can be detrimental to the solvent.

IGCC systems operate at high pressure, making CO₂ capture by physical absorption feasible. Booras and Smelser⁴⁵ incorporated a two-stage Selexol process into the IGCC design for selective H₂S removal and bulk CO₂ removal. A similar exercise was conducted by Herzog.⁵¹ In both cases, the use of a physical solvent (Selexol) resulted in the capture step being much less energy-intensive than an amine-based chemical absorption process because capture takes place from the high-pressure syngas as opposed to the atmospheric pressure flue gas.

Chemical Absorption

Amines of principal commercial interest for gas purification include MEA, diethanolamine (DEA), and methyldiethanolamine (MDEA). In addition to simple aqueous solutions of alkanolamines, proprietary formulations comprising mixtures of the amines with various additives are widely used.⁵² To date, all commercial plants that capture CO₂ from power plant flue gas use processes based on chemical absorption with MEA solvent. Examples of plants where CO₂ is removed from flue gas produced from coal burning and where the CO₂ product is ultimately used commercially can be found in Trona, CA; Poteau, OK; and Cumberland, MD.^{42,53,54}

A prime requirement for absorptive solutions to be used in regenerative CO₂ and H₂S removal processes is that any compounds formed by reactions between the acid gas and the solution must be readily dissociated. The

salts of strong alkalis with weak acids offer many possibilities, and a number of processes have been developed that are based on such salts. Typically, the processes employ an aqueous solution of a salt containing Na or K as the cation with an anion so selected that the resulting solution is buffered at a pH of approximately 9–11. Such an alkaline solution absorbs H₂S and CO₂. Because of the buffering action of the weak acid present in the original solution, the pH will not change rapidly as the acid gases are absorbed. The major commercial processes that have been developed for H₂S and CO₂ absorption use aqueous solutions of Na or K compounds. The principal technologies employed are processes based on hot K₂CO₃ solutions that are used for the removal of CO₂ from high pressure gas streams; processes based on absorption in ambient temperature Na₂CO₃ or K₂CO₃ solutions with vacuum regeneration and used primarily for the removal of H₂S from coke-oven gas; and processes based on ambient temperature absorption into solutions containing free caustic and used to remove small traces of CO₂ and H₂S from gases.⁵²

The hot K₂CO₃ process is an example of an alkaline salt solution technology and is used in many NH₃, H₂, ethylene oxide, and natural gas plants. To improve CO₂ absorption mass transfer and to limit corrosion, inhibitors and proprietary activators, such as an amine,⁵⁵ are added and, thus, these systems are known as activated hot K₂CO₃ systems. The most widely licensed of these are the Benfield process and the Catacarb process. The processes are designed for bulk CO₂ removal from high-pressure streams but also produce high-purity CO₂. The vapor liquid equilibrium curves for the partial pressure of CO₂ versus solution loading of CO₂ for various activators show that the full capacity of the hot K₂CO₃ process requires a feed CO₂ partial pressure of approximately 0.69 MPa.⁵⁶ This high optimum pressure is not favorable for power-generation point sources that typically produce a low-pressure (near ambient) flue gas. Leci and Goldthorpe⁵⁷ performed an assessment of CO₂ removal from a gas containing a low concentration of CO₂ produced by a 500-MWe conventional pulverized fuel power station. Amine (MEA) scrubbing was compared with the hot K₂CO₃ process. Besides the optimum pressure disadvantage, hot K₂CO₃ requires an extremely low concentration of SO_x and NO_x (1 ppm) entering the system. Leci and Goldthorpe⁵⁷ concluded that amine scrubbing is substantially cheaper than the hot K₂CO₃ system.

Amine Scrubbing

Figure 8 shows the basic flow arrangement for all alkanolamine acid-gas absorption/regenerable stripping processes.⁴² In relation to the power-generation point sources, the amine chemical absorption technology

would be used in the cleanup of CO₂ from low-pressure flue gases, although cleanup from the turbine exhaust flue gas is not thought to be a feasible option.⁴⁷ Herzog et al.⁴⁴ evaluated the removal of CO₂ from flue gas by using MEA and concluded that a plant energy penalty would approach 35%. Using the results of Mimura et al.,⁵⁸ Herzog et al.⁴¹ indicated that the energy penalty can be driven down to 15% for a conventional coal-burning power plant by developing new solvent technology and integrating energy requirements of regeneration within the plant. Others^{59–61} have detailed where improvements in amine scrubbing can impact the energy requirements and costs of the process. Areas of interest pertain to new solvents with high absorption capacity, regeneration energy requirements, process integration into the plant, and amine degradation. Process parameters that impact the energy requirements are concentration of the amine in the aqueous solution, contacting of the gas phase with the liquid phase, and dilution of the aqueous content.

There are several disadvantages to using MEA for scrubbing CO₂ from flue gas. First, it has a high heat of absorption with CO₂, which means that this energy will need to be supplied in the regeneration step so that the bonded CO₂ complex can be broken. Second, the absorptivity of MEA with CO₂ is not great. The limitation comes from the aqueous reaction of CO₂ with MEA:



In this reaction, 2 mol of MEA must be used to capture 1 mol of CO₂. Third, the concentration of MEA in the aqueous phase in the presence of O₂ is limited to approximately 20 wt% because of corrosion effects. Although certain gas scrubbing processes that use MEA, such as the Econamine FG process,⁵⁶ claim that up to a 30 wt % solution can be used, there still is a limitation on the concentration of MEA in the aqueous fraction. This limitation has a significant impact on the regeneration step because the fraction of water in the mixture needs to be heated, and this is an energy sink. Fourth, with conventional contact or packing material, the mass transfer may not be that great for MEA and, especially, for new solvents.

Properties of Solvents

Sterically hindered amines and formulated or mixed solvents are also used as wet scrubbing solvents. Molecular structures of sterically hindered amines are generally similar to those of amines, except sterically hindered amines have an amino group attached to a bulky alkyl group.^{62,63} By nature of molecular configuration, the bulky alkyl group plays an important role in process performance, by affecting the capacity of absorption and the desorption

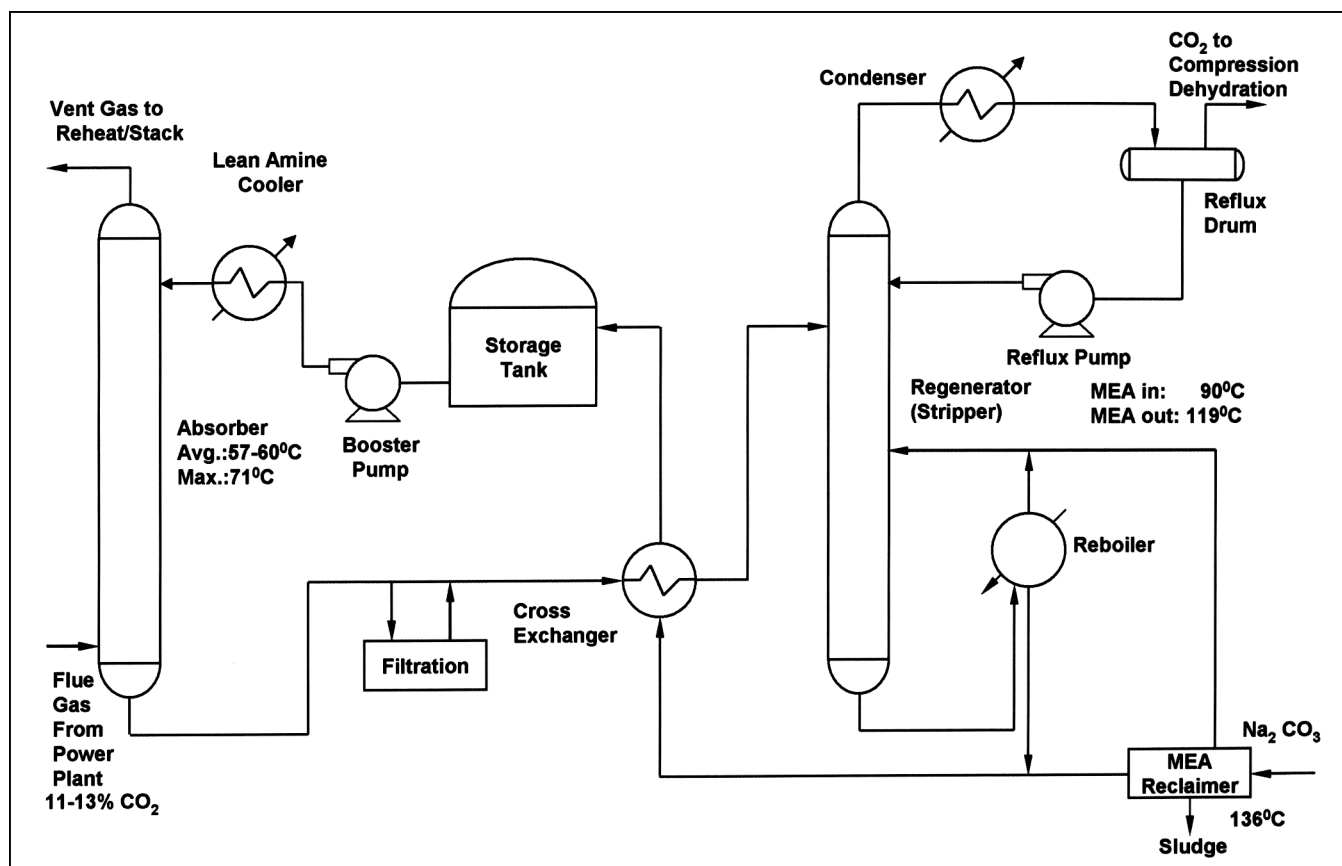
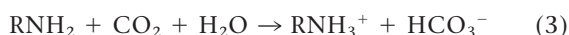

Figure 8. Process flow diagram for an MEA absorption/regeneration process for CO₂ capture and separation from flue gas. The flue gas entering the absorption column flows up through the vessel, countercurrent to the aqueous solution. The CO₂ in the flue gas reacts chemically with the solvent, while the purified gas is vented to the atmosphere, and the solvent enriched by CO₂ (referred to as rich solvent) is pumped from the contact tower to a heat exchanger. The rich solvent solution enters the top of the regenerator, where it flows down through the vessel countercurrent to the stripping steam generated in the solution reboiler. Steam and solvent vapors move up the regenerator column, condensing as CO₂ is liberated and the solvent solution is heated. Uncondensed steam and CO₂ leave the top of the regenerator and then enter the reflux condenser. The condensate is recycled through the system while the CO₂ is removed for further processing. From Herzog et al.⁴²

temperature. In the case of primary and secondary alkanolamines, the formation of carbamate (RNHCOO⁻) is the main reaction, as indicated by the previous chemical reaction equation. A carbamate ion hydrolysis hardly takes place because of stability of the carbamate compound, which is caused by unrestricted rotation of the aliphatic carbon atom around the aminocarbamate group. In contrast to the alkanolamines, the rotation of the bulky alkyl group around the aminocarbamate group is restricted in sterically hindered amines, resulting in considerably lower stability of the carbamate compound. Therefore, CO₂ reacts with the amine to form bicarbonate ions. This becomes the dominant reaction:



The advantage of sterically hindered amines over alkanolamines is that only 1 mol of the sterically hindered amine, instead of 2 mol of alkanolamine, is required to react with 1 mol of CO₂. The theoretical capacity of

absorption and desorption is therefore stoichiometrically superior in sterically hindered amine systems.⁶³ The previous finding, combined with the fact that sterically hindered amine systems can have lower heats of absorption/regeneration as compared with MEA,^{58,64} makes these types of amines potential candidates for CO₂ removal in power-generation systems.

2-Amino-2-methyl-1-propanol (AMP) is an example of a sterically hindered amine that has some excellent characteristics compared with the primary amine MEA.⁶⁵ Not only does its stoichiometry with CO₂ enhance its absorption capacity, it also induces less corrosion. One limitation in using AMP is that its absorption rate is lower than that of MEA. Aroonwilas and Tontiwachwuthikul⁶⁵ investigated the role of high-efficiency structured packing in improving the absorption efficiency of the CO₂ absorption process. Results indicate that the structured packing shows at least a 6-fold superior performance in the CO₂-AMP system as compared with random (berl saddles) packing. Yeh et al.⁶⁶ showed that the absorption rate at

the same parametric conditions was greater for the MEA and lower for the AMP aqueous system. However, in using either MEA or AMP, the structured packing significantly improved the overall rate of absorption. Additionally, the rate of regeneration of the rich AMP sample was faster than that of the MEA solution. Pertaining to corrosiveness, process parameters play an essential role in the AMP-CO₂ system.⁶³ Increases in liquid temperature and CO₂ loading increase corrosion rate. However, in comparison with the MEA system, the AMP system induces less corrosiveness at elevated temperature.

Mimura et al.^{58,67} investigated different sterically hindered amine-based solvents, KS-1, KS-2, and KS-3. Compared with MEA, KS-1 has a lower circulation rate (because of its higher lean to rich CO₂ loading differential), lower regenerative temperature (383 K), and lower heat of reaction with CO₂.⁵⁶ A newer solvent, KS-2, has a regeneration energy ~20% less than MEA and almost the same as that of KS-1. KS-1 has been used in a commercial gas scrubbing operation in Malaysia to produce a pure CO₂ stream for urea production. Excellent performance of the scrubbing system was reported⁶⁷ after 5700 hr on stream with low steam consumption, very low solvent degradation, and low solvent loss.

A formulated amine is defined as an amine that has been specifically formulated to perform basic tasks, such as the bulk separation of CO₂. It can consist of a single solvent such as MDEA or a solvent mixture such as a mixture of MDEA and DEA in aqueous solution. By judicious choice of a formulated amine or amine mixture, capture process efficiency can be enhanced significantly compared with the use of traditional amines. Furthermore, some of the gas processing problems that cannot be dealt with using the conventional technology in an economical manner can be easily handled with formulated amines.⁶⁸ According to Kohl and Nielsen,⁵² MDEA is rapidly increasing in importance as a nonselective solvent for the removal of high concentrations of acid gas, particularly CO₂, because of its low energy requirements, high capacity, excellent stability, and other favorable attributes. Its principal disadvantage is a low rate of reaction with CO₂. The addition of primary or secondary amines has been found to increase the rate of CO₂ absorption significantly without diminishing the many advantages of MDEA. Niswander et al.⁶⁹ reported that a next-generation MDEA-based amine mixture was even more energy-efficient and showed improved separation and overall capacity while maintaining long-term performance.

Tontiwachwuthikul and Chakma⁷⁰ have investigated formulated amines and have developed the amine-based PSR process for scrubbing CO₂ from flue gas. The solvents were developed by blending a variety of reactive amines and high-capacity physical solvents in such a way that the

full advantage of the desirable properties of each solvent was obtained, including fast physical absorption of CO₂ into the liquid phase, fast reaction in the liquid phase, and high absorption capacity.⁷⁰ The process utilizes various process operation improvements, but the PSR solvent is the heart of the process.⁷¹ Because it is composed of a number of ingredients, its formulation can be optimized to meet the needs of specific tasks. The key features of the PSR solvents are (1) lower solvent circulation rate, (2) lower regeneration temperature, (3) lower solvent degradation rate, and (4) lower corrosion rate. As compared with MEA, the PSR solvents are purported to have 20–80% more moles CO₂ removed per mol of solvent circulated, a 15–45% energy savings, and solvent degradation and corrosion rates lower than that of MEA.⁷²

Process Parameters

As much as 80% of the total energy consumption in an alkanolamine absorption process occurs during solvent regeneration.⁵⁹ The reboiler duty usually represents the major energy cost and is a combination of sensible heat, heat of reaction, and heat of vaporization.⁶⁹ The total energy required to regenerate a CO₂-loaded solvent is equivalent to the sum of (1) the heat of reaction, (2) the sensible heat of solution, (3) the latent heat of vaporization of water, and (4) the latent heat of vaporization of the solvent. First, the rich solvent temperature must be raised to the stripper temperature by sensible heat transfer. The amount of heat required for this process is dictated by the specific heat capacity of the solvent, which does not vary much among the various solvents. In addition, the water component of the solvent must also be vaporized to generate the stripping vapor. While the specific heat capacity and the latent heat of vaporization of water remains the same for all solvents, the energy required for this step depends on the proportion of water present in a given solvent. The higher the water content, the greater the energy requirement for this step. Part of the solvent itself would also be vaporized. The amount of energy required by various solvents for this part can be compared with the latent heats of vaporization. Finally, sufficient heat must be provided to break up the CO₂-solvent complex formed during the absorption process and is accounted for by the heat of reaction.⁵⁹

The increased concentration or loading of the amine in the solvent solution is an area where energy savings could occur. Leci⁷³ indicated that increasing the concentration of MEA in a conventional MEA aqueous solution will significantly reduce solvent circulation rate, although corrosion issues will be a factor at concentrations above the conventional 30%. Total CO₂ capture plant operating costs decrease substantially with increasing MEA aqueous concentration. In terms of relative variation in operating

costs with increasing solvent concentration, it is clear that substantial savings are brought about in steam, cooling water, and pump power. Similarly, Suda et al.⁶¹ discovered in bench-scale tests at high concentrations of MEA that to obtain the same level of CO₂ absorptivity, the liquid-to-gas ratio can be reduced in inverse proportion to the MEA concentration. This means that if high-purity MEA is used, the absorbing liquid circulating amount can be lowered, thus reducing the pump power and absorbing liquid regenerated energy. Additionally, mixing of solvents to increase the amine loading essentially behaves the same way as the single amine increased concentration. Regeneration energy for a mixed solvent is as much as 30% lower than that of MEA.⁵⁹

With respect to regeneration energy requirements, the higher the amine loading, the less sensible heat will be required for the aqueous fraction. As discussed by Chakma,⁵⁹ by mixing certain amines, the regeneration energy requirements will be decreased. Veawab et al.⁷⁴ used a laboratory-scale regeneration unit to experimentally determine energy requirements for MEA, DEA, and MDEA. As expected, MEA required the highest energy for regeneration, followed by DEA and MDEA. The reason for the high energy requirement for MEA is that MEA has a higher reactivity with CO₂ and, thus, a higher heat of reaction. It was found that MEA is more difficult to regenerate and tends to have higher lean or residual CO₂ loading than the less reactive solvents. The MEA gave the residual CO₂ loading of 0.2 mol/mol of solvent while the lean loading of DEA and MDEA can reach as low as 0.06 and 0.03 mol/mol, respectively.

Diluting of the water fraction in an aqueous amine solution with an organic diluent may offer certain advantages. The diluent must be soluble in water and amine. With respect to the regeneration requirement, the heat capacity of the diluent should be less than that of water so that the sensible heating of the aqueous plus organic fraction is now decreased. Reduction of the aqueous fraction with an organic compound could also reduce the corrosiveness of the original MEA solution.⁷⁵ Leites⁷⁶ has investigated alcohols, glycols, esters of glycols, and others mixed with an aqueous MEA solution. Actual information from a commercial gas purification unit to remove CO₂ using a proprietary mixture that contained 25–40% of organic diluent and 20% MEA revealed that heat consumption had been reduced by a factor of 1.4–1.7 as compared with aqueous MEA solutions. Yeh et al.⁶⁶ noted the possible energy saving with organic diluents but observed the impact of the diluent on the absorption step. CO₂ removal was observed in a packed column bench-scale reactor using methanol or ethylene glycol as diluent in a 20-wt % MEA solution. Absorption in the ethylene glycol diluent solution decreased with increasing diluent

concentration. Song et al.⁷⁵ showed that the solubility of CO₂ decreased at higher ethylene glycol mass fractions. The CO₂ removals were approximately the same for methanol concentrations ranging from 20 to 60%, although the low boiling point of methanol resulted in methanol losses from the amine solution during operation.

If gas-liquid contact is increased in a scrubbing system, the overall mass transfer coefficient will most likely increase. Contacting can be done within the scrubbing vessels using packing. Improvements can be made through the use of structured packing or gas absorption membranes. Aroonwilas and Tontiwachwuthikul⁶⁵ investigated the role of a high-efficiency structured packing in improving the efficiency of the CO₂ absorption process. AMP or NaOH solutions were tested in a laboratory-scale absorption column that was packed with either random packing or structured packing. The testing results with the CO₂-NaOH system indicated that the structured packing provided an excellent overall mass transfer coefficient that was higher than the random packing coefficient by a factor of 10–33. Yeh et al.⁶⁶ compared structured packing to random saddle packing using an MEA or AMP solvent and found the CO₂ absorption rates for each solvent were greater with the structured packing. Mimura et al.⁷⁷ showed that a structured packing that they have developed has a very low pressure loss under atmospheric flue gas conditions and has a high gas and liquid contact efficiency.

Membrane gas absorption has been identified as a promising new hybrid technology that employs both liquid absorption and a membrane for the recovery of CO₂ from flue gas streams.⁷⁸ An optimal membrane gas absorption system makes use of the benefit of equipment compactness and the benefit of process selectivity resulting from the chemical absorption process. Feron and Jansen⁷⁸ describe a membrane gas absorption application where CO₂ is brought into contact with a suitable absorption liquid via a porous, hydrophobic membrane. The essential element is compatibility between the membrane and the absorption liquid. A 3- to 10-fold size reduction in scrubbing hardware is achievable through the use of hollow fiber porous membranes. A conventional amine solvent cannot be used with these polypropylene membranes, so novel liquids were developed.^{79,80} Kvaerner Ltd. of Norway has fabricated contact membranes from polytetrafluoroethylene (PTFE, or Teflon) that have high hydrophobicity characteristics and thus are compatible with conventional aqueous amine solvents, such as MEA and MDEA. It is claimed that the membrane-based absorption/regeneration system weighs less and occupies significantly less footprint area compared with the conventional technology.⁷⁹

A novel contactor developed by Raterman et al.⁸¹ eliminates the need for physically large scrubbers that require high liquid absorbent throughputs, incur high operating costs to regenerate absorbent, and have limited turndown capabilities. A vortex tube technology is the basis for the contactor design. In an absorption process, the diffusion of the gas into the liquid can be rate limiting, and a vortex contactor can increase the turbulent mixing between gas and liquid and thus decrease the resistance to mass transfer. Likewise, the absorption rate can be enhanced if the interfacial area to mass transfer per unit volume is also increased. The combination of turbulent expansion and mixing and high centrifugal forces affords the vortex tube the necessary attributes to become a high-efficiency gas-liquid contactor. Although testing has not concluded, the new absorber seeks to achieve high mass transfer efficiencies while minimizing energy requirements.

One of the reasons that alkanolamine processes have become the predominant choice for certain gas purification treatments is their comparative freedom from operating difficulties. Yet several factors, such as amine loss and corrosion, can result in undue expense and cause operational difficulties.⁵² For the removal of CO₂ from flue gas produced in a power-generation facility burning coal, aqueous MEA scrubbing is the present choice. However, MEA degrades in the presence of O₂ and CO₂, resulting in extensive amine loss and equipment corrosion.⁸² Additionally, the presence of SO₂ and NO_x impacts the stability of the solution by the formation of heat-stable salts. Amine losses are reported to fall in the range of 0.5–2 kg MEA/t of CO₂ recovered.^{56,61,77}

Flue gases can contain significant concentrations of SO₂ depending on the fuel combusted. If low- to high-sulfur coals are the fuels, then some form of desulfurization must be conducted to reduce the SO₂ concentration into the amine absorber to 10 ppm. SO₂ reacts with MEA to form heat-stable salts. For MEA-based processes, it is less expensive to install an SO₂ scrubber than to accept the solvent losses when the flue gas contains more than 10 ppmv SO₂.⁵⁶ Although the concentration of NO_x in flue gas is generally less than SO₂, the NO₂ component (typically 5–10% of the NO_x) can react and also form a heat-stable salt.⁵⁷ Fly ash should also be removed because if it collects in the solvent, it may cause foaming in the absorber and stripper, scaling and plugging, and increased solvent loss through chemical degradation and physical association with removed sludge.⁵⁶

Chi and Rochelle⁸² defined three MEA degradation routes. First, carbamate polymerization requires high temperatures and CO₂, produces high molecular weight degradation products, and is expected to occur at the higher temperature of the stripper. Second, oxidative degradation

requires O₂ and is catalyzed by Fe, produces oxidized fragments of the solvent such as organic acids and NH₃, and is expected to occur in the presence of dissolved O₂ in the liquid holdup at the bottom of the absorber. Third, thermal degradation occurs at temperatures higher than 478 K. With respect to the impact of O₂, inhibitors can be added to the solvent to prevent the solvent degradation and corrosion problems. An example of this is the Econamine FG process, in which chemical inhibitors counter the effects of corrosion caused by O₂ in the flue gas. The additives in the MEA solution inhibit amine degradation and passivate the metal, and a minimum O₂ concentration in the incoming flue gas is desired.^{56,83,84}

MEA degradation products present in the reclaimers at the IMC Chemicals CO₂ capture plant in Trona, CA, have been identified. This plant captures CO₂ from a coal-fired electric power-generating station for commercial production of carbonates. This project represents the first study of MEA degradation products in an industrial-scale CO₂ separation plant and has led to the identification of a major pathway for MEA degradation that had not been previously known.^{85,86} A chromatogram with identified MEA degradation products is presented in Figure 9.

Finally, optimized process design and systems integration are beneficial to maximizing the total CO₂ avoided and minimizing capture costs. An example is the integration of reboiler heat duty with the power plant thermal cycle. Chakma⁵⁹ proposed that external steam injection at two locations in the stripping tower will enhance the stripping process by providing additional heat and stripping vapor to that generated in the reboiler. The net effect is that the cyclic capacity of the solvent increases, reducing the solvent circulation rate by as much as 50%. It is purported that the incorporation of a pre-contactor before the absorption tower can also provide some benefit by decreasing the height requirements of the main absorber. Modeling with sensitivity studies has also been conducted to further optimize the amine scrubbing process.^{56,87}

New Absorption Techniques

Aqueous NH₃ has been investigated as a solvent for removal of CO₂ from flue gas. As reported in Kohl and Nielsen,⁵² NH₃ has been recovered from coke oven gas and used to scrub H₂S. Bai and Yeh⁸⁸ proposed that the NH₃ system could be used for scrubbing CO₂ from flue gas. They obtained crystalline solids of NH₄HCO₃ by sparging CO₂ with air into NH₄OH solution. The preliminary experimental results led to a conceptual solvent regenerable process where the crystalline NH₄HCO₃ product is heated to regenerate the NH₃. Yeh and Bai⁸⁹ concluded that the maximum CO₂ removal efficiency by NH₃ absorbent can reach 99% and the CO₂ loading capacity

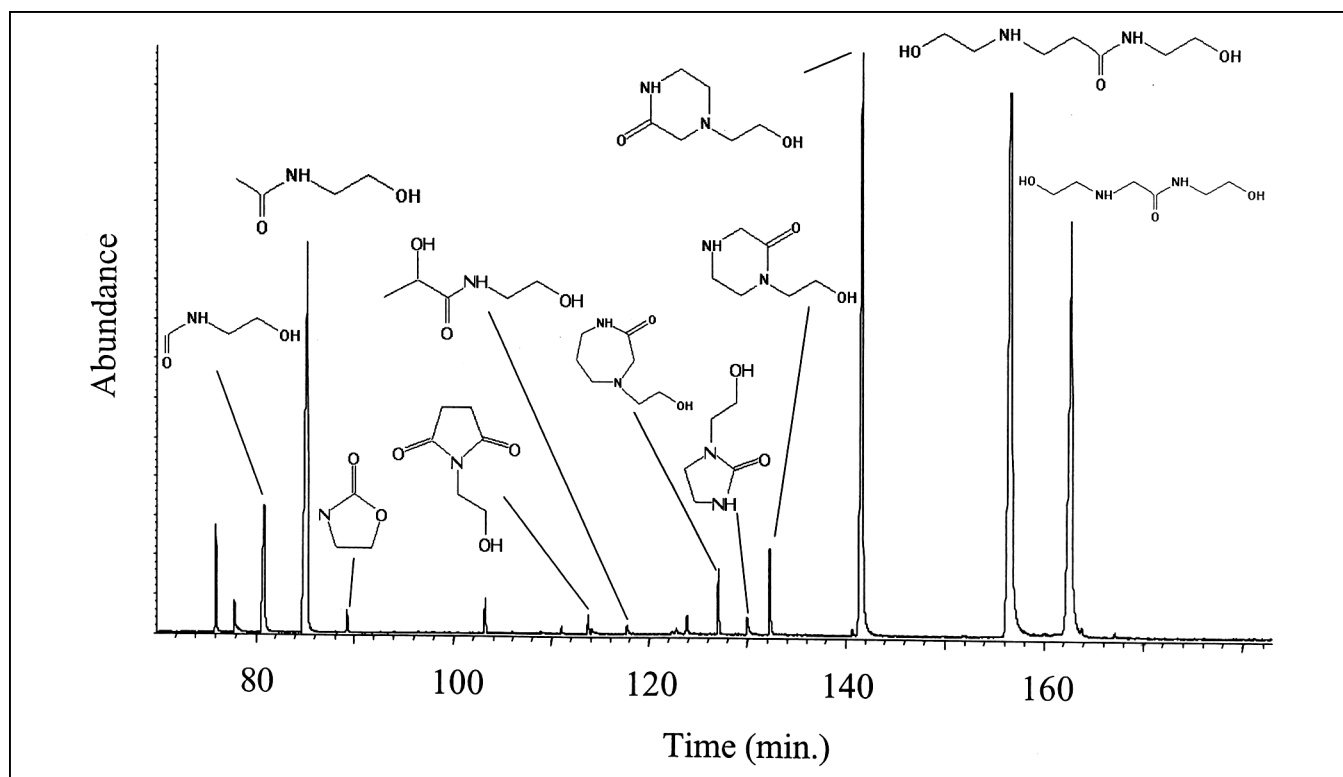

Figure 9. Total ion gas chromatographic profile of MEA degradation products found in the reclaimers bottoms from the IMC Chemicals CO₂ capture facility.

can approach 1.20 kg CO₂/kg NH₃. On the other hand, the maximum CO₂ removal efficiency and loading capacity by MEA absorbent were 94% and 0.40 kg CO₂/kg MEA, respectively.

Other researchers are pursuing the NH₃ scrubbing technique to remove CO₂ from flue gas. Yeh et al.⁹⁰ propose a scrubbing system where CO₂ in flue gas, along with the acid gas pollutants, SO₂, NO_x, HCl, and HF, could be removed in a regenerable scheme. They predict that a key advantage to the process is that the thermal energy consumption for the CO₂ regeneration is expected to be significantly less than the MEA process. Absorption was investigated using a semicontinuous reactor system with a simulated flue gas, and the impact of absorber sparger design, temperature, and NH₃ concentration on gas loadings and rates were discussed. Huang et al.⁹¹ are developing an ion-exchange resin technique to regenerate the spent NH₃ solution. The sustainability of the resin for the regeneration step was demonstrated.

Still others are looking at the scrubbing not as a regenerable process but as a technique to produce NH₄HCO₃ fertilizer. Zheng et al.⁹² have used the CO₂-NH₃ reaction to produce NH₄HCO₃ in a column with plates using simulated flue gas. The effect of reaction temperature, CO₂ concentration, and NH₃ concentration on removal efficiency was determined. Li et al.⁹³ explored the possibility of using NH₄HCO₃ formation by NH₃

carbonation in the gas phase to achieve reduction of CO₂ emissions from flue gas. The thought is to reduce the volume required in wet scrubbers by performing the reaction in the gas phase. Gas residence times and NH₃ concentrations were varied in an unobstructed tubular reactor. Solids were identified using nuclear magnetic resonance analysis and consisted of NH₄HCO₃ and ammonium carbamate.

Ionic liquids and low-temperature molten salts have been proposed as reagents for gas separations.⁹⁴ A liquid that could facilitate the sequestration of gases without solvent loss into the gas stream could prove to be a superior material. Because of the properties of these liquids, they exhibit no measurable vapor pressure up to their thermal decomposition point, generally >573 K—a certain advantage compared with other wet scrubbing solvents. Bates et al.⁹⁴ indicated that ionic salts could be an effective candidate for CO₂ scrubbing.

Physical Absorption

CO₂ can be physically absorbed in a nonreactive solvent according to Henry's law and then regenerated using pressure reduction or heat. The absorption capacity of organic and inorganic solvents for CO₂ increases with increasing pressures and with decreasing temperatures. Because the partial pressure of CO₂ in flue gas is low and the flue gas temperature is relatively high, the physical absorption

method does not appear likely to compete. At lower pressures, chemical absorption processes are more economical. Additionally, in CO₂ removal from flue gas, moisture and fly ash could cause operational problems.^{47,48} However, for advanced power-generation schemes such as pressurized precombustion (e.g., IGCC) or combustion processes, this technique would be most applicable.^{44,48}

Physical absorption processes are used in various industries for gas purification. The processes are used primarily for acid-gas removal from high-pressure natural gas streams, and for CO₂ removal from crude H₂ and NH₃ synthesis gases produced by partial oxidation or steam-hydrocarbon reforming and synthesis gas produced from coal gasification. According to Kohl and Nielsen,⁵² the absorbents are either a simple physical solvent or a mixed solvent, the latter containing both a physical and chemical solvent, typically an amine. In the mixed solvent, the bulk removal capabilities of the physical solvent are combined with the amine's ability to achieve very low residual acid gas specifications in a single treatment step. To be practical, physical solvents must have an equilibrium capacity for acid gases several times that of water and a low capacity for the primary constituents of the gas stream. They must have low viscosity, low or moderate hygroscopicity, and low vapor pressure at ambient temperature. They must be noncorrosive to common metals as well as nonreactive with all components in the gas stream. Finally, they must be available commercially at a reasonable cost. Heat requirements are usually far less for physical solvents than for chemical solvents because the heat of desorption of the acid gas for the physical solvent is lower. The circulation rate of the physical solvent may also be less, particularly when the CO₂ partial pressure is high.

In a simplistic scheme, physical solvent processes require little more than an absorber, a flash vessel, and a recycle pump. In the absorption step, the gas enters the bottom of the absorber, which contains either packing or trays, and is washed by a descending stream of regenerated solvent. The rich solvent leaves the bottom of the absorber and flows to the regeneration system. There are several regeneration configurations that differ in the method by which the solvent is stripped. Regeneration can be done by simple flashing or depressurization of the liquid, possibly in multiple stages; by stripping with inert gas to lower the acid gas content of the lean solvent; or by thermal regeneration of the solvent.⁵²

Physical solvent commercial technologies such as Selexol, Rectisol, and Morphosorb will be discussed as related to CO₂ sequestration. The Selexol process has been the subject of many sequestration feasibility and assessment studies.^{45,47,51,87} This commercial process has been used to remove CO₂ from NH₃ synthesis gas and uses a homologue

of dimethyl ether of polyethylene glycol as a solvent. Advantages of the process are its (1) selective absorption of H₂S and CO₂ to ppm levels, (2) low heat requirements for H₂S removal and no heat requirement for CO₂ removal, (3) noncorrosiveness so that carbon steel construction can be used, (4) extremely low vapor pressure, and (5) nonreactivity with other gas components and thus no degradation or reclaiming. The philosophy of selective CO₂ removal from synthesis gas streams is outlined by Shah and Hurdeman,⁹⁵ where relative solubilities of the gases are listed. CO₂ is ~76 times more soluble than H₂ and approximately 50 times more soluble than N₂, indicating that the solubility differences allow selective removal of CO₂ while leaving most of the H₂ and N₂ unabsorbed. To keep the solvent circulation rates low in NH₃ synthesis gas scrubbing, the absorption is operated from 261 K to ambient temperature. Another improved Selexol solvent, also glycol-based, has a much higher solubility for CO₂ and, thus, some key process and economic advantages.⁹⁶

The Rectisol process, which uses methanol as a physical organic solvent, has been used in many coal gasification applications. It separates troublesome impurities produced during coal gasification. It also facilitates dehydration and the prevention of ice and hydrate formation at the low temperatures used in the process. It operates at much lower temperatures (approximately 211–272 K) than other physical processes. Methanol has a low viscosity at these temperatures so that mass and heat transfer are not significantly impaired, yet the solvent carrying capacity for both CO₂ and H₂S is high. Drawbacks to the system are the relatively complex flow schemes and the need for low-level refrigeration, leading to high plant costs.⁵² A recent study⁹⁷ of an IGCC plant where all pollutants, including CO₂, were removed from the coal gasification process stream was conducted, and the Rectisol process was identified as the optimum choice for the fuel gas purification task. Rectisol was used to remove H₂S and CO₂ along with other trace contaminants from the gas stream.

Rectisol is currently being used to clean fuel gas produced from gasification in the United States. In Eastman's coal-to-chemicals plant, the methanol scrubbing eliminates the H₂S and some CO₂ before the syngas stream is used to produce chemicals.⁹⁸ The Dakota Gasification Company is removing CO₂ from its gasification process using the Rectisol process and transporting it to the Weyburn Field in Saskatchewan, where it is being used in EOR.^{99,100} Synthesis gas is produced by gasifying lignite coal. The CO₂ and H₂S must be removed from the raw gas before it enters the methanation units for conversion to substitute natural gas. The Rectisol process removes the acid gases, and the methanol is regenerated for reuse by

flashing it from 2.86 MPa to subatmospheric pressure. As the pressure is reduced, the CO₂, H₂S, and a small amount of hydrocarbons are released and sent to a compression unit, where a total of 6.8 million standard m³/day of CO₂ are available for sale. The compressors pressurize the gas to 18.6 MPa for pipeline transportation 330 km to the Weyburn oil field. The gas contains approximately 96% CO₂ and 1% H₂S, with the remainder being mostly hydrocarbons.¹⁰⁰

The Morphysorb process^{101,102} is based on the use of mixed morpholine derivatives (N-formyl-morpholine and N-acetyl-morpholine) as a physical solvent to remove highly concentrated acid gas compounds, up to 70% CO₂ or H₂S, from pressurized gas streams. The purported economic advantage of the technology mimics the physical solvent criteria listed previously. The Morphysorb process has low solubility of C1-C6 hydrocarbons; high capacity for acid gas compounds resulting in lower solvent circulation; low vapor pressure; potential for simultaneous dehydration; chemical and thermal stability; environmental compatibility; and low capital costs because mainly carbon steel construction can be used. The key advantage is the low solubility of hydrocarbons within the solvent. Because of a eutectic formation with a mixture of both morpholines, the process can be run at a minimum temperature of 263 K, providing the advantage of high gas loadings.

All of the solvent advantages lead to significant process improvements. The increased capacity for CO₂, H₂S, and organic S compounds at low temperatures reduces the required solvent circulation rate, resulting in considerably reduced equipment dimensions. Because of low coabsorption of hydrocarbons, the losses of CH₄ and higher hydrocarbons are reduced. Additionally, the recycle flash stream to the feed gas is smaller, which reduces not only the inlet gas flow to the absorber but also the energy demand for recycle gas compression. Utility and investment costs are clearly reduced.

The Morphysorb process was applied to upgrade a sour natural gas stream at the Kwoen Gas Plant in British Columbia, Canada,¹⁰³ owing to the (1) prediction of lower hydrocarbon losses to acid gas, (2) larger capacity for acid gas removal, and (3) lower pumping and recycle horsepower requirements. These benefits are partially offset by higher solvent losses. A total of 8.5 million standard m³/day of sour gas will be directed to the Kwoen Plant, which operates at 7.6 MPa. Two 4.25 million standard m³/day packed column absorbers will scrub with Morphysorb solvent. Approximately 0.94 million standard m³/day of acid gas, consisting primarily of H₂S and CO₂, will be removed, compressed to 7.6 MPa and liquefied, transported via a pipeline, and injected into depleted sour gas production reservoirs.

Dry (Gas/Solid) Scrubbing

Dry scrubbing uses a solid instead of a liquid scrubbing medium. The system involves gas/solid interactions and may also be regenerable. Depending on the nature of the gas/solid interactions, the CO₂ may be physically adsorbed or chemically absorbed. In the case of chemical absorption, CO₂ undergoes a chemical reaction with an active compound present on the solid to form a new product, such as a carbonate or bicarbonate. Hence, chemical absorption involves heterogeneous gas/solid chemical reactions. However, in the case of physical adsorption, the CO₂ is sorbed onto the surface of the solid and does not undergo chemical reaction on the surface to form a new species. Adsorption capacities and kinetics are influenced by pore size, pore volume, surface area, and the affinity of the solid for weakly bonding the CO₂.

Halmann and Steinberg⁴ provide an overview of the research and actual applied techniques for reducing CO₂ and utilizing waste CO₂ as a feedstock, including newer, more effective ways to separate CO₂ from waste-stream gases and improved fossil-fuel utilization with reduced CO₂ emissions. Hendriks¹⁰⁴ examines the removal of CO₂ from coal-fired power plants and considers both conventional PC-fired and IGCC plants. Table 6 compares plant and cost characteristics for various CO₂ recovery techniques. The results highlight the significant penalties associated with CO₂ capture on the power cycles and demonstrates that further research for improved CO₂ capture processes is warranted.

Solid Chemical Absorption

For chemical absorption of CO₂ onto a solid, a heterogeneous reaction occurs on the surface of the solid to form a new chemical species. Because CO₂ is an acid gas, reaction often involves neutralization of the CO₂ with a base compound on or within the solid. Such acid/base neutralization reactions are commonly employed in commercial wet scrubbing of CO₂ using basic solvents, including alkanolamines, NH₃, hot K₂CO₃, and so on.³⁸ Hence, analogous reactions can be extended to a gas/solid system in place of the liquid scrubbing medium.

Compounds of alkali and alkaline earth metals can be employed in chemical reactions with CO₂. As an example, an alkali metal carbonate can react with CO₂ and H₂O to form an alkali metal bicarbonate:

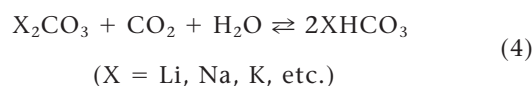

Another class of reactions involves alkaline earth metals, whereby an alkaline earth metal oxide can react with CO₂ to form an alkaline earth metal carbonate:

Table 6. Comparison of plant and cost characteristics of a PC-fired power plant and an IGCC plant when various CO₂ recovery methods are used.¹⁰⁴

Plant	Recovery Technology	CO ₂ Recovery Degree ^a (%)	Power Output (MW _e)	Energy Conversion Efficiency ^b (%)	Specific CO ₂ Emission (kg/kWh)	Electricity Production Costs (¢/kWh)	Specific Mitigation Costs (U.S.\$/t of CO ₂ avoided)	Specific Mitigation Costs (U.S.\$/t of carbon avoided)
PC	Reference plant		600	41.0	0.80	3.7		
IGCC	Reference plant		600	43.6	0.76	3.8		
Decarbonization of Flue Gases								
PC	Chemical absorption/MEA	90	462	31.5	0.10	6.1	34	125
PC	Chemical absorption/DEA	90	480	32.8	0.10	—	—	—
PC	Polymer membrane separation (two-stage cascade)	90 ^c	436	29.8	0.11	8.2	65	239
PC	Polymer membrane separation	75	490	33.5	0.25	6.6	51	188
PC	Polymer membrane separation	90	452	30.9	0.11	8.5	68	250
PC	Low-temperature distillation	90	435	29.7	0.11	6	32	117
PC	Low-temperature distillation	95	426	29.1	0.06	6.1	32	117
Modification of the Energy Conversion Process								
IGCC	Shift + physical absorption	96	500	36.3	0.04	5.1	17	62
IGCC	Polymer-membrane + O ₂ /CO ₂ combustion	94	515	37.4	0.06	5	17	62
IGCC	Pd/Ag-membrane + O ₂ /CO ₂ combustion	100	521	37.8	0	4.9	14	51
IGCC	O ₂ /CO ₂ combustion	100	504	36.6	0	5.1	17	62

^aPurity of CO₂ is 99% or more, unless indicated otherwise; ^bEfficiency based on lower heating value of coal; ^c95% purity of recovered CO₂.

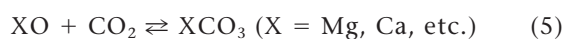

A different type of reaction involves substitution of metals to form a metal carbonate, for example, in the case of Li and Zr:



Thermodynamic analyses can be used to identify ranges of temperature for absorption and regeneration for a particular reaction. Enthalpy and free energy changes are calculated for both absorption (forward) and regeneration (reverse) reactions, and equilibrium constants are determined over a range of temperatures. However, equilibrium calculations do not yield information regarding the rate of reaction (kinetics), but rather the final equilibrium chemical state. A reaction may be thermodynamically favorable but may require a very long time to achieve its final chemical state. Reactions should have sufficiently fast kinetics to have practical application in a CO₂ chemical absorption process employing solids as the scrubbing medium. The effect of other gaseous components in the mixture on the absorbent reactivity with CO₂ must also be considered.

Carbonate/bicarbonate reactions using alkali metals (eq 4) occur at temperatures less than 373–473 K and can be applicable to flue gas temperatures. The alkaline earth

metal reactions (eq 5), depending on the specific metal, can occur over a wide and elevated range of temperature (approximately 773–1173 K). The high-temperature materials may have application suitable for CO₂ capture in process streams at elevated temperature, such as in IGCC or other advanced power systems. Regarding temperatures for suitable operation, it is difficult to generalize any one group of reactions, but rather, a specific reaction should be considered in its entirety.

These examples of gas/solid chemical absorption reactions are descriptive for the capture of CO₂, but consideration should be given to the physical form of the solid as well. If the material is to be used over multiple cycles and thus be regenerable, then the structural integrity (strength) of the material is important. Attrition describes the process of wearing down a particle into finer material, and attrition can be both physical (i.e., friction by movement) as well as chemical (volume change caused by reaction) in nature. To minimize attrition, the active metal compound may be deposited onto a solid support (substrate) having higher strength. The composite sorbent may be highly porous; pore characteristics and surface area can influence the overall reaction kinetics. There are competing trade-offs for the sorbent system. It is desirable to have the maximum loading or amount of active compound to undergo reaction with CO₂, while at the same time minimizing loss of the material through attrition.

The use of a substrate support strengthens the sorbent but acts as a diluent with respect to the metal loading (weight fraction) of the sorbent.

The desirable characteristics of a solid CO₂ chemical absorbent are^{105,106} (1) high equilibrium capacity, (2) ability to achieve separation under flue gas conditions (low pressure and hot temperature), (3) low equilibrium concentration, and (4) pure CO₂ product stream. High equilibrium capacity refers to the maximum mass ratio of captured CO₂ per mass of sorbent. Higher equilibrium capacity facilitates lower sorbent requirements and handling and lower regeneration costs, thereby reducing capital and operating costs. For criterion (2), CO₂ is present in dilute concentration in flue gas. Some conventional CO₂ separation processes would require compression and cooling of the entire process stream, which is energy-intensive. Therefore, capture of CO₂ under existing flue gas conditions is preferable. For criterion (3), a low equilibrium concentration would allow CO₂ to be removed from flue gas to very low levels. For criterion (4), the separation process is more effective if the only gas coming off from the sorbent during regeneration is CO₂.

Flue Gas Application

CO₂ capture as metal bicarbonates proceeds at temperatures compatible with flue gas conditions. K₂CO₃ has been studied in a thermogravimetric analyzer (TGA) reactor, and suitable ranges of temperature for absorption and regeneration have been reported.¹⁰⁷ Origin of the sorbent lies with the hot K₂CO₃ wet scrubbing process described previously. The sorbent consisted of K₂CO₃ deposited on a high surface area alumina support (0.16-cm diameter spherical material). The optimal temperature for absorption ranged between 333 and 373 K, and the sorbent could be thermally regenerated at 423 K. The kinetics of the absorption reaction were found to be relatively slow.

Green et al.¹⁰⁸ examined fine powdered or granular unsupported Na₂CO₃ and K₂CO₃ in a TGA reactor and bench-scale fluidized-bed reactor. Based on thermodynamic calculations, the Na₂CO₃ reactions should take place at a slightly lower temperature than the K₂CO₃ reaction, and this was experimentally verified. The absorption reaction was most favorable at 333 K for Na₂CO₃, and negligible absorption was observed at 353 K. The product material (Na₂CO₃) was regenerable at temperatures less than 393 K. The K absorption was studied between 333 and 373 K, indicating a slightly higher temperature window versus Na. Multicycle tests of pure Na₂CO₃ showed minimal loss of activity.

Work by Hayashi et al.¹⁰⁹ encompassed the potential use of K, Na, and Li compounds as CO₂ sorbents. K₂CO₃ was emphasized as a good candidate while utilizing an activated carbon as the substrate material. Earlier studies

by the same researchers^{110,111} examined the use of other substrate materials, including silica gel and alumina.

The use of K₂CO₃, in addition to other alkali metal materials, was studied by the National Aeronautics and Space Administration (NASA) as a regenerative means by which to absorb CO₂ and H₂O.¹¹² The intent was to develop portable life-support systems to scrub breathing air during human space travel. Japan, in conjunction with development of the space station with NASA, also pursued regenerable solid sorbents for space travel using a solid amine.¹¹³ Some of the even earlier space work considered molecular sieves, clathrates, and zeolites for regenerable solid sorbents for CO₂ capture.^{114–116}

In other work, a silver salt was used to capture CO₂.¹¹⁷ The unsupported solid sorbent was composed of silver carbonate in a combination of alkali metal silicate (Na or K), alkali metal carbonate (Ce, K, or Na), and an alkaline earth metal salt (nitrates and chlorides of Ca, Mg, or Ba). An example was cited for a sorbent comprised of calcium nitrate, sodium silicate, K₂CO₃, and silver carbonate. Amine compounds on solid supports for CO₂ sorbents were also investigated.¹¹⁸

Aqueous solutions of amine compounds are used in industrial wet scrubbing for CO₂ removal, and the use of amine compounds as a dry, regenerable sorbent has recently been pursued.¹¹⁹ Amine compounds were deposited onto a fly ash enriched in carbon. Adsorption studies followed by a temperature-programmed desorption (TPD) technique were conducted under ambient pressure and at temperatures between 303 and 393 K. It was concluded that the amine-enriched samples chemically absorb CO₂ and H₂O upon contact with a gaseous stream, thereby forming the amine complexes. However, it is possible that a combination of both adsorption and absorption processes was occurring.

In another study, alkanolamines and polyamines were impregnated onto high-surface-area, high-pore-volume solid supports, including silica, silica-zirconia, alumina, and clay.¹²⁰ TGA and laboratory-scale experiments were performed on the materials. The absorption step was conducted at room temperature, and the desorption (regeneration) step involved heating to 333–373 K with moderate flow of N₂ or under reduced pressure. The results indicated that the support should be structured with large pore dimensions. The best sorbent was found to be a mix of two amines on an alumina support, while silica support yielded low absorptivity.

Adsorption studies were conducted at 348 K in a packed-bed column using a “molecular basket” adsorbent, consisting of a mesoporous molecular sieve impregnated with polyethyleneimine (PEI).¹²¹ Desorption studies were conducted at the same temperature (348 K) by switching the gas flow to inert (He) flow. The PEI reacted

with CO₂ with and without moisture, effectively adsorbing CO₂ from the simulated flue gas.

Fuel Gas Application

The capture of CO₂ from fuel or synthesis gas represents different process conditions than with a typical flue gas. For example, IGCC produces a highly reducing gas mixture containing H₂, CO, and CO₂, whereas flue gas is an oxidizing gas mixture. The system pressure is much higher in gasification streams versus near-atmospheric exhaust pressure from conventional PC-fired combustion. A wide range of temperatures is encountered in fuel gas streams, similar to those found during fossil-fuel combustion.

Calcium has been used for CO₂ capture in a dry, regenerable sorbent. The carbonation reaction is employed in the CO₂ acceptor process developed several decades ago for coal gasification.¹²² A summary of the process¹²³ describes the gasification of coal by steam. The energy required for gasification is partially supplied by the exothermic carbonation reaction of dolomitic lime. Two main fluidized-bed reactors, a gasifier and a regenerator, are employed. Coal is gasified with steam in the gasifier, while limestone is calcined (decomposed to lime) in the regenerator to form lime. Heat for the gasification reactions is provided by circulating calcined limestone (the acceptor) from the regenerator. The CO₂ reacts exothermically with the lime in the gasifier to form CaCO₃, thus "accepting" the CO₂ in the gasifier. The limestone is circulated from the gasifier to the regenerator. The endothermic heat required to reverse the reaction in the regenerator is supplied by combustion of residual char from the gasifier with air. Thus, the process allows the capture of CO₂ in coal gasification by using a regenerable solid scrubbing system.

Recent studies^{124–126} were conducted using fine, unsupported, powdered materials. The effects of temperature, pressure, and reactive gas composition on the gas-solid reaction were examined in an electrobalance reactor. Multicycle tests were conducted to demonstrate the durability of the material. Some degradation of the material was observed during multicycle tests. Calcined dolomite, a mixture of CaCO₃ and MgCO₃, performed better than calcined CaCO₃.

Researchers have also been studying the use of CaO as a dry, regenerable sorbent for CO₂ capture.^{127,128} Bench-scale studies using a TGA reactor have been performed using supported and unsupported Ca reagents. Supported materials were on 0.16- and 0.32-cm-diameter spherical or cylindrical pellets, including silica, alumina, and zirconia. A series of tests were performed to identify temperature and gas composition conditions under which suitable absorption and reaction kinetics could be observed. For

the unsupported Ca reagent tests, the CO₂ absorption reaction was observed to be initially very quick, followed by a much slower reaction. Most likely caused by diffusional limitations from formation of a product layer of CaCO₃, CO₂ absorption is favorable between 1023 and 1123 K, while regeneration (decomposition or the reverse reaction) occurs at 1273 K. The preceding temperature ranges were identified for unsupported CaO exposed to a pure CO₂ gas atmosphere and is strongly dependent on the background gas composition. In pure N₂, temperatures suitable for regeneration are significantly lower than in pure CO₂. CaCO₃ begins to decompose at 923 K in pure N₂ but is stable in pure CO₂ at temperatures up to 1173–1223 K.

With respect to substrate supports, mixed results were obtained. Initial sorbent studies with Ca deposited on silica¹²⁸ were unsuccessful because of side reaction of the Ca with silica at elevated temperature to form calcium silicate. TGA tests were conducted using sorbent composed of CaO impregnated onto lanthanum-doped alumina substrate.¹²⁷ As with the pure reagent tests, the initial rate of reaction was fast between 823 and 1023 K, achieving ~15–20% sorbent conversion. The reaction then slowed significantly because of increased gas diffusional resistance through a product layer of CaCO₃. The regeneration of the Ca/alumina sorbent was examined over the same temperature range. The sorbent lost most of its absorption weight gain, indicating that decomposition of CaCO₃ was occurring. The Ca/alumina sorbent was unsatisfactory with respect to CO₂ capture. The sorbent conversion is much lower in the case of the sorbent versus the pure reagent, and the captured CO₂ is not permanently adsorbed, as indicated by significant wt loss after gas switching. High conversion, in the case of the sorbent, does not appear attainable even with a significantly longer time on stream. Pore pluggage caused by CaCO₃ layer formation is a possible cause.

TGA experiments were conducted using Ca deposited on two types of zirconium oxide substrate. The zirconia support was mesoporous, with larger pore diameter but lower surface area compared with the lanthanum alumina substrate. Consistent with the reagent tests and the alumina sorbent tests, the absorption reaction at 773 K is initially fast and then enters a slower kinetics regime. The zirconia sorbents exhibited much higher conversion (50–75%) than the alumina sorbent (15–20%), possibly because of the pore size differential between mesoporous zirconia and microporous lanthanum-alumina. Even though the alumina has much higher surface area, pore pluggage or increased diffusional resistance through the CaCO₃ product layer appears to be a plausible cause for the Ca/alumina sorbent. When gas switching from pure CO₂ to pure N₂ at the end of the absorption stage at 773

K, the zirconia lost significantly less weight and retained a larger fraction of the absorbed CO₂. Regeneration of the zirconia sorbents was quickly achieved by raising the temperature from 773 to 1023 K. At the temperatures that may be expected by incorporating the sorbent scheme in a gasification process, the pure Ca and Ca/alumina system had good initial reactivity, but the capacity and overall reactivity were poor. Better results were obtained with a Ca/zirconia sorbent.

Separation of CO₂ from flue gas has been explored using Ca-based sorbents.^{105,129,130} Although the research is intended for flue gas separation, their sorbent process may have application to fuel gas streams, given the high absorption process temperatures of the sorbent. A novel precipitation technique was developed to produce predominantly mesoporous CaCO₃ and CaO sorbents, similar to Ca-based sorbents for SO₂ removal,^{131,132} capable of high conversion. TGA experiments were conducted for absorption temperatures ranging between 823 and 973 K. CaO from natural sources did not achieve complete conversion because of the microporous pore structure. The mesoporous CaO sorbent achieved high (>90%) conversion, which was attributed to less pore filling and plug-gage. Cyclical absorption/regeneration tests were performed at 973 K, with carbonation occurring in pure CO₂ and calcination occurring in pure N₂. Multicycle tests indicated complete regeneration at 973 K with no adverse sintering effects on sorbent reactivity. The high range of temperatures for absorption may make the process more suitable for fuel gas than flue gas applications.

The use of macroporous lime or limestone has also been investigated.^{133–135} Although this research was aimed at SO₂ removal rather than at CO₂ removal, the preparation methods may have application for development of macroporous materials for CO₂ removal. Mesoporous CaO was prepared from limestone and lime particles using swelling methods involving acetic acid vapor, water-acetic acid mixture, and water. The effect of the pore-size distribution was investigated at 1073 K using a natural limestone, natural lime, modified macroporous lime, and limestone. Larger pore size enhanced the reactivity by providing a diffusion route for SO₂ in the sorbent during sulfation.

The zero-emission coal alliance (ZECA)^{136–138} combines a coal-based electric power plant with a process for capturing and sequestering CO₂, an update of the CO₂ acceptor process. The process involves hydrogasification of coal or other feedstocks, creating synthesis gas that is reformed in the presence of steam and lime, to produce H₂ and CaCO₃. The H₂ powers a high-temperature solid oxide fuel cell to generate electricity and heat, part of which is used in a calciner to thermally regenerate the limestone back into lime. Regeneration releases a concentrated

stream of CO₂ amenable for sequestration. In the ZECA process, CO₂ reacts with readily available mineral rock to form inert mineral carbonates. The process does not involve any combustion and has no smokestack or other air emissions.

In addition to Ca, some Li-based materials are potential candidates as high temperature CO₂ absorbents. Researchers at Toshiba^{139–141} have been studying Li compounds for CO₂ capture. Initial work focused on Li₂ZrO₃ powder and demonstrated absorption of CO₂ at temperatures near 773 K. Subsequent research investigated the effect of K₂CO₃ added to Li₂ZrO₃.¹⁴² Results indicated that the absorption reaction kinetics were accelerated because of the formation of a eutectic carbonate composed of Li₂CO₃ and K₂CO₃. Essaki et al.¹⁴³ extended the binary system to a ternary system by the addition of Na₂CO₃. A ternary eutectic carbonate is formed that has a lower melting point than the binary eutectic carbonate.

Lin¹⁴⁴ seeks to develop an inorganic membrane material for high-temperature CO₂ separation from either flue or fuel gas. A K-doping agent is added to the Li₂ZrO₃ reagent to enhance the reaction kinetics and improve CO₂ sorption rate of Li₂ZrO₃. Potassium doping causes formation of a eutectic compound, creating a liquid interface within the solid matrix. This interface lessens the diffusional resistance of CO₂ and enhances the reaction kinetics. Lin¹⁴⁴ indicated the eutectic complex absorbs CO₂ 40 times faster than pure Li₂ZrO₃.

Lithium silicates have been investigated as a high-temperature CO₂ absorbent.^{145,146} The reaction involves lithium orthosilicate (Li₄SiO₄) reacting with CO₂ to form Li₂CO₃, and more than one reaction pathway is considered:



At complete conversion, eq 7 results in a solid product having approximately 37 wt % gain. Preliminary TGA tests¹⁴⁷ have confirmed this weight gain. However, the possibility of additional CO₂ absorption with the intermediate, lithium metasilicate (Li₂SiO₃) to form silicon dioxide (quartz) can be written as



At complete conversion, eq 8 results in a ~49 wt % gain. The overall reaction (eq 9), yields a weight gain of ~73 wt % at complete conversion.



Based on thermodynamic calculations by Kato et al.,^{145,146} the equilibrium temperature, at which reaction

of CO₂ absorption stops, was 983 K for eq 7, 523 K for eq 8, and 718 K for eq 9. Absorption of CO₂ was studied in the 773–973 K temperature range and, therefore, eq 8 did not proceed in the forward direction. Regeneration was studied at temperatures up to 1123 K, and complete regeneration was achieved during multicycle tests. The Li₄SiO₄ system appears to have much faster kinetics (factor of 30) than the Li₂ZrO₃ system at equivalent temperature (773 K) and, therefore, has considerable potential as a CO₂ absorbent.

Knight et al.¹⁴⁸ considered pressurized coal gasification using CO₂ as the gasifying medium to generate a medium BTU gas (principally CO), followed by a solid sorbent system for high-temperature CO₂ removal with CO₂ recycled back to the gasifier. The chemical reaction for the solid sorbent is described by eq 5, whereby MgO reacts with CO₂ to form magnesium carbonate. Various MgO-containing materials were examined in a high-pressure thermobalance, but naturally occurring MgO materials were found to be unreactive. Potassium was doped into commercial magnesium carbonate and formulated into 0.32-cm extruded pellets. The final calcined material consisted of MgO and K₂CO₃ · 1.5 H₂O. CO₂ absorption/desorption experiments were conducted at temperatures ranging between 723 and 903 K and pressures ranging between 0.79 and 2.2 MPa. The CO₂ absorption/desorption cycle was achieved by simple pressure swing operation between 0 and 2.2 MPa CO₂ partial pressure. Thermal regeneration was attempted, but experiments simulating a thermal-swing technique did not result in significant desorption, and so pressure swing was employed for sorbent regeneration.

Physical Adsorption

Once the gas is adsorbed onto the solid, several modes of operation are used to release or regenerate the adsorbed gas from the solid. Pressure or temperature is manipulated during regeneration to repeat the adsorption cycle. Pressure swing adsorption (PSA) entails adsorbing the gas at higher pressure, isolating the solid, and then desorbing the sorbed gas by lowering the system pressure. Vacuum PSA utilizes a vacuum pressure during the regeneration step. In temperature swing adsorption (TSA), gases are adsorbed at a lower temperature, the solid is isolated, and then temperature is raised during the regeneration step to release the trapped gas. Cycle time for regeneration is typically much shorter for PSA (order of seconds) versus TSA (hours).⁴⁷

In addition to PSA and TSA, other modes of regeneration can be utilized. One regeneration method employs a stream of fluid that does not contain any of the trapped gas, which is flowed through the bed to “wash” the bed. Another method is a chromatographic technique that

uses a desorption gas stream that contains a material that can displace or “bump” the trapped gas from its place in the bed. Most commercial units use either PSA regeneration or a combined thermal swing/wash method with regeneration at lower pressure. Chromatographic “bumping” is used for small applications.

PSA processes can produce high-purity H₂ from steam CH₄ reforming off-gas and refinery off-gas. PSA processes can also be used for direct production of NH₃ synthesis gas from steam CH₄ reforming off-gas. In a review of commercially available PSA processes for H₂ production, Sincar and Golden¹⁴⁹ showed that high-purity CO₂ can be a byproduct of the gas separation. Commercial PSA processes are complex, involving numerous adsorption vessels and process cycle steps of adsorption, cocurrent or countercurrent depressurization, purge, and pressurization. Examples include the Polybed, Lofin, and Gemini processes. The Gemini process is named because of its ability to produce two products (H₂ and CO₂) of high purity (>99%) from a multicomponent feed gas. The H₂ product was produced at the feed gas pressure and the CO₂ product was produced at ambient pressure. An example of dual H₂ and CO₂ gas separation using PSA has been demonstrated by Reddy.¹⁵⁰

The International Energy Agency⁴⁷ examined various methods of capturing CO₂ from power-generation schemes, including PC-fired combustion and coal gasification plants. Typical gas separation (adsorption) systems employ beds of alumina, zeolite, or activated carbon, but can also include alumina gel and silica gel, although gel processes can be considered a hybrid of adsorption and absorption. The study concludes that although PSA and TSA are commercially available processes (in H₂ production and upgrading subquality natural gas), they are energy-intensive and expensive in the power cycles considered. However, breakthroughs in this area could improve the energy efficiency and economics.

Molecular sieves (13X and 4A) and activated carbon were examined^{151,152} in volumetric adsorption and TGA studies with CO₂, N₂, and O₂. Experiments were conducted at 298 K and pressures up to 2.1 MPa. CO₂ was preferentially adsorbed on all three sorbents, but the activated carbon performed best at the elevated pressure, while molecular sieve 13X performed best at low pressure (less than 0.17 MPa). Molecular sieve 13X yielded better adsorption capacity than did molecular sieve 4A for all pressures examined. Competitive adsorption of CO₂ from gas mixtures also indicated that both molecular sieve 13X and activated carbon can be used for CO₂ separation from gas mixtures. Adsorption of CO₂ was reversible on both molecular sieve 13X and on activated carbon. Their experimental results for molecular sieve 13X have been modeled.¹⁵³ The optimal conditions at cyclic steady state

are obtained and indicate that the optimal feed pressure should not be high.

Siriwardane et al.¹⁵⁴ examined three natural zeolites (aluminosilicates) containing Na or K/Ca in the same adsorption apparatus at 298 K and 2.1 MPa. All three materials showed preferential adsorption of CO₂, but the cation effect displayed an important role. Zeolite with high Na content performed best, yielding the highest CO₂ adsorption capacity and highest CO₂ adsorption rate. Studies with gas mixtures of CO₂, N₂, and O₂ revealed that good separation was achieved using high-Na zeolite. Using TPD studies, two types of adsorption sites on zeolites were discovered. The majority of adsorbed CO₂ is physically adsorbed and can be desorbed at room temperature. The remainder of adsorbed CO₂ can be desorbed at 388 K and was attributed to either bicarbonate or bidentate carbonate type species.

Activated carbon can remove CO₂ from a gas stream by adsorption in the micropores. Typical activated carbons have surface areas ranging from 600 to 1200 m²/g, with pores characterized as either micropores (<5 nm), mesopores (5–100 nm), or macropores (>100 nm). Fibers of activated carbon having a higher surface area are being developed.^{155,156} Carbon fiber composite molecular sieve (CFCMS) has a monolithic structure with high micropore surface area (>1900 m²/g) with a narrow micropore size distribution. The monoliths have a macroporous, open structure that allows the free flow of fluids through the material. Because of the continuous monolithic structure, the material is electrically conductive and is therefore capable of being regenerated by direct electrical current. Electrical swing adsorption applies an electrical current, rather than pressure or temperature, to the adsorbent bed. It is possible to regenerate the material without heating, potentially reducing swing cycle times and improving separation efficiency. Microporous CFCMS has a strong affinity for CO₂, and separations of CO₂ from CH₄, from air, and from other gas mixtures have been demonstrated at 303 K.

Activated carbon pellets were developed from coconut shell, and their physical adsorption of CO₂ was investigated in a gas adsorption system based on PSA.¹⁵⁷ Adsorption experiments conducted at 288 K and atmospheric pressure found a relatively high CO₂ adsorption capacity of the pellets. In future work, they intend to develop an adsorption system for gas separation/purification, namely to separate CO₂ from air/CH₄ mixtures.

The recovery of CO₂ from flue gas using PSA is being pursued.^{158,159} Initial work examined activated carbon and zeolite 13X in a single-stage PSA process. In comparing the performance of PSA with the two materials, zeolite 13X yielded more favorable results and was concluded to be a better adsorbent for bulk separation of CO₂ from flue

gas. However, it is difficult to attain high recovery (99%) from a low-CO₂ feed gas, such as flue gas, in a single-stage PSA process. More recent work using zeolite 13X has focused on the use of a two-stage PSA process.¹⁶⁰ At the first stage, CO₂ is concentrated to 40–60% and then to 99% at the second stage.

Activated carbon was studied as an adsorbent because it was speculated that it was much cheaper than zeolite and negligibly affected by the moisture contents in the feed.¹⁶¹ A PSA unit with a 3-bed, 8-step process, including pressure equalization and product purge step, was designed, and the effect of step time was observed. Maximum product purity of CO₂ was 99.8% and recovery was 34%. Zeolite 13X was also found to be suitable for CO₂ sequestration.¹⁶² Simplified gas mixtures of CO₂/N₂/He were investigated, rather than multicomponent flue gas. Recovery of CO₂ from furnace gas using three adsorption towers was described by Yamano et al.¹⁶³ CO₂ is recovered in the middle stage, while the process gas from the initial and final stage is used as washing gas. The adsorbents investigated include zeolite, activated carbon, and molecular-sieved activated carbon. Pressure is varied between vacuum and atmospheric. Their PSA process has potential application in treating blast furnace gas, converter gas, or hot-air furnace exhaust gas generated at a steel mill.

An interesting hybrid concept of PSA combined with cryogenic separation is described as an improved means to recover CO₂ from flue gas.¹⁶⁴ PSA can be combined with a super-cold separator to recover CO₂ from exhaust combustion gases using a Na-X zeolite at the same pressure as the super-cold separator and for desorption at atmospheric pressure. By using the PSA process downstream of the super-cold separator, CO₂ concentration was raised from 50% exiting the super-cold separator to 70% in the PSA recovery gas, and the CO₂ recovery efficiency of the plant was ~90%.

The use of PSA to capture CO₂ from different types of coal-derived power plants, including PC, pressurized fluidized-bed combustion (PFBC), and IGCC, was investigated.¹⁶⁵ Five kinds of molecular sieve zeolites and a molecular sieve carbon were tested in the study, and the best performing zeolite was selected for the adsorbent of PSA to separate CO₂ from simulated coal gas at 423 K. The coal gas composition simulated that of a fuel gas downstream of a shift converter and dehumidifier. The molecular sieve zeolite showed a high effective capacity for CO₂ capture in a pressurized condition at 423 K, and other coal gas constituent effects were small regarding CO₂ adsorption. At higher temperatures, the adsorbent acted as a catalyst for the shift reaction and carbon deposition occurred on the adsorbent.

Cryogenic Separation

One means to separate a gas component from other gas components is to produce a phase change (liquefaction or solidification) of the component, thereby condensing it and removing it as a liquid/solid from the gas mixture. The phase diagram for CO₂, shown in Figure 10, dictates the pressure and temperature conditions under which solid or liquid CO₂ can be formed in a single-component system. In a multicomponent system, a multicomponent phase diagram is required to determine the freezing zone. For a binary mixture of CO₂ and other gas, a binary diagram of CO₂ with the other constituent of gas separation is used, and the freezing zone is determined not only by temperature and pressure but also by composition. Cryogenic systems are a low-temperature physical approach to separation, in which the CO₂ is separated directly by phase change, not to be confused by using a low-temperature solvent (liquid scrubbing). Gazzi and Rescalli showed an example of a low-temperature solvent process used for CO₂ separation from natural gas or synthesis gas.¹⁶⁶

In low-temperature distillation, a liquid having a low boiling point is purified by evaporation, followed by condensation.³⁸ For streams having a high CO₂ (>90%) level, low-temperature distillation is used in commercial practice to liquify and purify CO₂. For lower CO₂ levels (such as in exhaust gas of power plants for electric generation), low-temperature distillation is more difficult. Lean CO₂ streams require refrigeration at low temperature (<273 K), as well as solids handling of CO₂ for refrigeration temperatures below the triple point of CO₂ (216 K).

Cryogenic separation is more applicable to high-pressure gases, such as in precombustion capture processes or O₂-fired combustion. Cryogenic separation is advantageous with respect to direct production of liquid CO₂, which is favorable for certain transport and storage

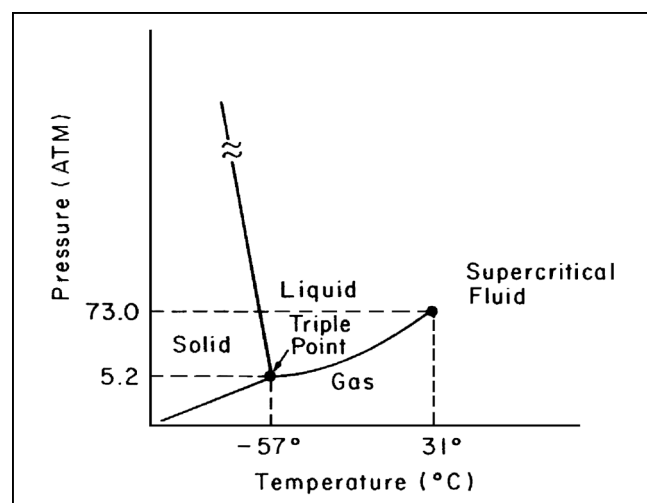

Figure 10. Phase diagram of CO₂.⁴⁴²

options. A disadvantage of cryogenic CO₂ separation, particularly for dilute CO₂ streams, is the refrigeration energy. Some components, such as water, may have to be removed before the cryogenic cooling step to avoid blockage from freezing. Low-temperature distillation is only practical for gas streams at high pressure and high CO₂ content, as found in gas wells.⁴³

An earlier study⁴⁷ examined various methods, including cryogenic separation, of capturing CO₂ from power-generation schemes, including PC-fired combustion and coal gasification plants. The study concludes that cryogenic is not attractive. Hendriks¹⁰⁴ examined low-temperature distillation for flue gas decarbonization of PC-fired plants (see Table 6) and determined that it was the poorest capture technology with respect to reduced plant power output and energy conversion efficiency.

The SIMTECHE Process¹⁶⁷⁻¹⁷⁰ separates CO₂ from shifted syngas with water at low temperature near its freezing point (273 K). Separation is achieved by the formation of CO₂ hydrates, in which a number of water molecules (theoretically 5.75) surround the "guest" (CO₂) molecule to form a cagelike solid structure. The reactor for hydrate formation accepts shifted syngas at high pressure (4.8–6.9 MPa) and nucleated water (saturated with CO₂) at ~273 K. A slurry of CO₂ hydrate plus H₂ syngas exits the hydrate reactor and is subsequently separated in a gas separator. The remaining gas is passed as a product gas cleansed of CO₂, and the CO₂ hydrate slurry is sent to a flash reactor. CO₂ gas is liberated from the hydrate slurry in the flash reactor by heating to 283–285 K at 3.4–4.1 MPa. The slurry liquor is converted to water, cooled (274 K), and recycled to the nucleation reactor. Most of the CO₂ is then compressed and stored. A portion of the CO₂ offgas is recycled to a nucleation reactor, mixed with recycled water to saturation, and returned as the nucleated water feed to the hydrate formation reactor to repeat the capture cycle. The process may show promise for lower cost and improved energy conservation for separating CO₂ from a high-pressure, shifted synthesis gas stream.

Membranes for Separation of CO₂

The development of a membrane separator for the selective removal of CO₂ in the presence of CO, H₂, H₂O, and H₂S (fuel gas) or N₂, O₂, H₂O, SO₂, NO_x, and HCl (flue gas) would be of tremendous economic value. A membrane separation process requires less maintenance and energy than a comparable absorption system (alkanolamine or alkaline salt solution).⁵² A membrane material that allows either the selective transport (diffusion) or selective exclusion of CO₂ is desired. The use of membranes for CO₂ separation has increased in the natural gas processing industry.

Membranes separate CO₂ from a gas stream by size exclusion or by chemical affinity.^{155,171,172} Chemical affinity membranes are often impregnated with a scrubbing solution or chemical functional group (e.g., amine) selective for CO₂.

A large body of research has been conducted on the properties of CO₂-selective membranes based on inorganic materials such as zeolites, alumina, carbon, and silica. Noble and Falconer¹⁷³ examined CO₂ separations from simple two-component mixtures using zeolite membranes. Shih¹⁷⁴ suggested that the gas permeabilities of zeolites are limited by the tortuous pore structures, and the selectivity between CO₂ and N₂ is low because of the similar molecular diameters. Andrews¹⁷⁵ proposed the use of carbon-multiwall nanotube membranes to separate CO₂-N₂ mixtures. The carbon selectively adsorbed CO₂ from the simple two-component mixture at temperatures ranging from 303 to 423 K, and the potential of carbon nanotube materials for membrane separation of CO₂ was further examined.¹⁷⁵ In a review of inorganic membranes, Shekhawat et al.¹⁷⁶ concluded that substantial advances in selectivity, permeability, and chemical stability are needed for successful application to flue or fuel gas mixtures.

Polymer membranes have been applied for the separation of CO₂ from natural gas streams.^{177–188} The harsh chemically reactive and high-temperature matrix that is flue and fuel gas makes the use of polymer membranes unlikely for these applications. Hendriks¹⁰⁴ examined the use of polymer membranes for the separation of CO₂ from flue gas. He treated flue gas as a two-component mixture fast permeating (CO₂) and slow permeating (N₂) compounds. He concluded that a polymer membrane would require a CO₂-N₂ selectivity greater than 200 and a permeability of more than 5×10^{-9} m³/m² Pa sec. The available polymer membranes are not economically competitive with other separation methods for flue gas. Shekhawat et al.¹⁷⁶ conducted a review on polymer membranes for CO₂ separation.

Palladium-Based Membranes for Concentrating CO₂ from Fuel Gas. Palladium membranes have been extensively studied and used for the separation of H₂ from various gas streams.^{189,190} The metal can absorb enormous quantities of H₂; at 1260 K, it absorbs enough to correspond to the formula PdH_{0.6}.¹⁹⁰ The properties of Pd relevant in the separation of H₂ are provided by Buxbaum and Kinney.¹⁸⁹ Palladium is readily fabricated into a variety of shapes and sizes and has excellent chemical resistance to CO, steam, and hydrocarbons.¹⁸⁹ Palladium membranes have been studied for potential application of H₂ separation from fuel gas mixtures, leaving a gas residue enriched in CO₂. Palladium is an active oxidation catalyst and therefore

not an appropriate membrane for H₂ separation from streams that contain O₂.

Palladium is not inert; it chemisorbs and reacts with S and Cl species present in fuel gas. A rich variety of compounds can form from Pd and Cl. Hydrogen embrittlement can occur in Pd. Undesirable phase changes also occur in Pd at elevated temperatures. Therefore, alternative metal membranes are necessary for H₂ separation from fuel gas mixtures.

Govind and Atnoor¹⁹¹ prepared composite Pd membranes for selective H₂ separation at high temperature. A thin Pd film was formed on an Ag substrate, and the resulting membrane had promising mechanical strength and selectivity for H₂ from argon streams at 643–680 K.

Buxbaum and Kinney¹⁸⁹ proposed tubular membranes of Pd-coated tantalum and niobium for the separation of H₂ from hot gas streams, demonstrating continuous separation of H₂ from Ar at 693 K over a 31-day period. Buxbaum and Kinney suggested that the economics of H₂ separation using the Pd-coated refractory metals are promising.¹⁸⁹

Morreale et al.¹⁹² obtained an Arrhenius-type expression for the H₂ permeability of Pd and examined the mechanism of H₂ transport within Pd at elevated temperatures and pressures. Ciocco et al.¹⁹³ examined the permeability of H₂ through thin-film Pd membranes. Palladium films, Pd-coated tantalum, and Pd-coated stainless-steel membranes were examined for their H₂ transport characteristics.¹⁹³ Thin films of Pd were utilized to minimize the material cost of the precious metal. The tantalum and stainless-steel substrates were employed to improve the material properties of the membrane. Damle¹⁹⁴ studied the use of thin Pd-Ag alloy films deposited on a ceramic substrate for H₂ separation from CO₂. Alloying Pd with Ag increases the permeability for H₂ and reduces H₂ embrittlement. Commercially available alumina ceramics were used as the substrate.

Way et al.¹⁹⁵ examined Pd-Cu alloy composite membranes for high-temperature H₂ separation from fuel gas streams. The Pd-Cu alloy improved resistance to poisoning by H₂S, enhanced H₂ permeability, and reduced H₂ embrittlement. Further improvements in the material properties of metal membranes are needed for their use in fuel gas mixtures.

Mixed Ionic-Electronic Conducting Membranes for Concentrating CO₂ from Fuel Gas. Proton-conducting membranes with application of an external electromagnetic field (EMF) in a closed circuit are discussed in the section on electrochemical separations. A disadvantage of proton pumps for H₂ separation (and CO₂ concentration) is the need for an externally applied voltage. The rate of proton transport across an H₂ solid electrolyte ceramic membrane is

determined by the diffusivity and is small in the absence of an external EMF. Mixed ionic-electronic conducting membranes may eliminate the need for external EMF.¹⁹⁶⁻¹⁹⁸

Gade et al.¹⁹⁸ used a proprietary proton-conducting ceramic sandwiched between outer nickel films. The initial work has focused on the fabrication of the novel membranes. This design is envisioned to be incorporated within a monolithic, multimembrane H₂ separation module for Vision 21 plants. Eltron employed cerates doped with transition metals to impart electronic conductivity for H₂ separation. Roark et al.¹⁹⁷ found that a large flux of H₂ passed through this membrane without the application of an external EMF. Data are provided for H₂ separation from He at temperatures between 923 and 1223 K by the proprietary Eltron membranes. Rothenberger¹⁹⁶ examined dense cermet membranes for H₂ separation from simulated syngas at temperatures between 873 and 1173 K. Barium cerium yttrium oxide ceramic was doped with proprietary metals to obtain high permeabilities for H₂. H₂ fluxes through the membranes of varying thickness were measured. The H₂ flux through the most promising membrane exhibited no reduction over a 190-hr test at 1173 K in a simulated syngas consisting of 66% H₂, 33% CO, and 1% CO₂. Further research is needed to develop highly selective and permeable mixed ionic-electronic membranes that are also chemically stable in hot fuel gas streams.

Capture/Separation Techniques on the Horizon

Electrochemical Pumps for Separation of CO₂ from Flue Gas: Carbonate Ion Pumps. Operation of a molten carbonate fuel cell in a closed circuit mode (with application of an external EMF) transports carbonate ions across a membrane.¹⁹⁹⁻²⁰⁶ The molten carbonate electrochemical separator requires oxidizing conditions for the formation of carbonate from CO₂ and is less applicable for direct separation of CO₂ from fuel gases. Winnick et al.²⁰⁴⁻²⁰⁶ proposed molten carbonate fuel cell membranes for separation of CO₂ from air for space flight (Sky Lab) and examined molten carbonate membranes for separation of CO₂ from power plant flue gas. Others²⁰⁰⁻²⁰³ have also experimented with molten carbonate electrochemical systems for CO₂ capture from flue gas.

There are several advantages of molten carbonate electrochemical cells for CO₂ separation. A large knowledge base exists for the use and application of molten carbonate from its use in fuel cells. Molten carbonate is nearly 100% selective for the transport of carbonate anions at elevated temperatures. It exhibits high conductivity of approximately 1 S/cm at 1100 °F, or equivalently a diffusivity of 10⁻⁵ cm²/sec for the carbonate anion.²⁰⁴⁻²⁰⁶ The parasitic power requirements for the separation of CO₂ from power plant flue gases are low and estimated to

be less than 5%.²⁰⁴ The cost for CO₂ capture from flue gas was estimated at \$20/t in 1990 by Winnick.²⁰⁴

Unfortunately, molten carbonate electrochemical cells have disadvantages for separation of CO₂ from power plant flue gas. High temperatures and the corrosive nature of molten carbonate hinder fabrication and handling. The small applied voltages that avoid decomposition of the molten carbonate result in low currents. The current represents the flux of carbonate anions across the membrane. This necessitates the use of huge stacks to obtain a significant flux of carbonate ions across the device.²⁰⁰⁻²⁰⁴ SO₂ in flue gas poisons the cell, resulting in SO₄²⁻ formation.²⁰⁰⁻²⁰⁴ Electrolyte segregation and electrode degradation may also occur at flue gas temperatures.²⁰⁰⁻²⁰⁴

A solid electrolyte membrane would solve many of the problems associated with molten carbonate.^{199,207,208} Solid electrolytes are solid ionic conductors and are used in sensors, catalyst studies, and fuel cells.²⁰⁹ Millions are used in automobiles as oxide air-fuel ratio sensors. Most solid electrolytes are ceramics. Solid electrolytes often operate at lower temperatures than molten carbonate cells. A solid electrolyte would be easier to handle, have reduced corrosion problems, and would possess a longer operating life than its molten carbonate counterpart. Development of a highly conductive carbonate ion solid electrolyte is an area of active research.^{199,207,208} The possibility of using alkali carbonate or alkaline earth carbonate solid electrolytes for the separation of CO₂ from flue gas is discussed by Granite et al.,^{207,208} and Pennline et al.¹⁹⁹ propose doping alkaline earth carbonates to increase the ionic conductivity by orders of magnitude.

Electrochemical Pumps for Concentrating CO₂ from Fuel Gas: Proton Pumps. H₂ gas can be produced by IGCC plants, steam gasification reactions, the pyrolysis of coal, the electrolysis of water, and biochemistry. Each generates H₂ with impurities, such as CO, CO₂, CH₄, N₂, H₂O, and O₂. O₂ must be removed from H₂ streams to avoid explosion hazards.

Previous H₂ purification processes involved the stepwise removal of the impurities through absorption processes such as MEA washing to remove the CO₂, TEG (glycol) dehydration of the gas, as well as the catalytic (Pt) removal of trace O₂. A far simpler and potentially more cost-effective means of H₂ separation and CO₂ concentration can be accomplished in one step by an electrochemical pump.²⁰⁹⁻²¹⁴ Electrochemical pumps are efficient, silent, and nonpolluting. They can be based upon the readily available β" alumina, nafion, and barium cerium oxide solid electrolytes.²⁰⁹⁻²¹⁴ An analysis of the electrochemical H₂ pump, similar to the previous analysis of the CO₂ pump, follows.

The application of an external EMF (voltage) to a proton-conducting solid electrolyte through a closed circuit will cause H₂ to be selectively transported (pumped) to or from a metal electrode. The rate of H₂ transport is given by the current (flux of protons) across the membrane as

$$\text{flux of H}_2 = I/2F \quad (10)$$

where F is Faraday's constant, 96,487 coulombs/mol. Transport of H₂ (current) across the membrane is limited by conductivity of the electrolyte, thermodynamic stability of the electrolyte, and electrode kinetics.

For an ohmic membrane ($V = IR$), current is inversely proportional to the resistance or proportional to the conductivity. Doped barium cerium oxide, BaCe_{0.9}Y_{0.1}O_{2.95}, has a conductivity of 10⁻¹ ohm⁻¹cm⁻¹ at 1273 K.^{209,212-214} The conductivity of β" alumina is 10⁻⁶ ohm⁻¹cm⁻¹ at 373 K. Nafion (polymer electrolyte) is typically employed at temperatures of approximately 373 K.²⁰⁹⁻²¹¹ The higher conductivity of the doped barium cerium oxide allows a higher flux of protons to be pumped to a metal electrode.

The maximum value for the applied external voltage is determined by the decomposition potential of the solid electrolyte. This is found from the thermodynamic stability, the free energy of formation, G_f , of the material. More stable electrolytes can be subjected to higher applied voltages. Typically, a 1–2 V potential can be applied to a ceramic membrane. Therefore, the rate of transport of protons across the membrane is limited by both the conductivity (resistance) and stability of the electrolyte.

Electrode kinetics play a key role in the rate of separation of H₂. Consider for example a closed β" alumina electrochemical cell having Pd electrodes. H₂ must be first adsorbed from the impure gas stream onto the Pd electrode. H₂ then dissociates to H atoms. Charge transfer occurs, with protons forming. The protons migrate across the electrolyte under the influence of the externally applied field (voltage). Finally, the protons reverse the earlier steps and form H₂ gas at the opposite Pd electrode. At the interface between the gas, metal electrode, and solid electrolyte (the three-phase boundary), the overall reaction can be written as

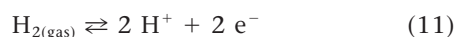

Therefore, an electrode must efficiently adsorb and dissociate H₂ so as to not limit the rate of H₂ transport across the electrolyte. The electrode must be porous, to allow gas to diffuse in and out, yet continuous, to avoid short circuits. Electrodes can be formed by thermal decomposition of organometallic precursor compounds on the electrolyte surface or with metal pastes.

For the laboratory-scale separator, with an applied voltage of approximately 1 V and a resulting current in the milliamp range, the power requirement is on the order of milliwatts. Granite and Jorne²¹⁰ applied external voltages to β" alumina and barium cerium oxide membranes to obtain the selective transport of deuterium from D₂-N₂ mixtures. Balachandran et al.²¹²⁻²¹⁴ applied an external voltage to a yttria-doped barium cerium oxide membrane to obtain the selective transport of protons. The mechanism of proton conduction by SrCe_{0.95}Y_{0.05}O_{3-δ} is discussed by Soong et al.²¹²

Biomimetic-Enzymatic Pathways for CO₂ Removal. The formation of CaCO₃ with the enzyme carbonic anhydrase (CA) is an intriguing method for CO₂ capture.^{215,216} CO₂ sequestration as CaCO₃ has many advantages. It is a non-toxic end product. CaCO₃ is stable, has few adverse environmental impacts, and represents a more permanent removal of CO₂. CA was discovered in blood by Roughton in 1933.²¹⁷ It is among the most active enzymes known and exhibits the highest turnover number of 36,000,000 min⁻¹ of any enzyme.²¹⁷ CA contains Zn, Cd, or Co,²¹⁷ facilitates the hydration of CO₂,^{217,218} and alters the distribution of CO₂, HCO₃⁻, and CO₃²⁻. CA is a large enzyme, possessing 260 amino acids surrounding a Zn core.²¹⁷ It may act as a seed or potential nucleation site for the formation of CaCO₃. The enzyme is present in algae, higher plants, and animals and is vital for both photosynthesis and respiration.²¹⁷ CA can catalyze the calcification (CaCO₃) reaction at near ambient temperatures.

CA has recently been successfully employed by a Japanese steel company to produce CaCO₃ from seawater.²¹⁵ Enhanced mass transfer of CO₂ from air into seawater using CA was recently demonstrated by Matthews.²¹⁸ Bond et al.²¹⁹⁻²²² suggested potential application of CA for power plant flue gases and that acid gases present in flue gas, such as NO_x and SO_x, will not adversely impact the action of the CA enzyme. CO₂ removal via biomimetic-enzymatic pathways is in a very early stage of technology development.²¹⁹⁻²²⁴

Photosynthesis. Photosynthesis is represented by the chemical reaction²¹⁷

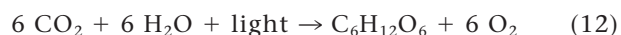

Pigments that absorb energy from visible light for photosynthesis include chlorophylls and accessory pigments, which are carotenoids and phycobilins.²¹⁷ Absorption maxima have been determined for many of the pigments involved in the capture and transfer of energy from visible light.²¹⁷ The synthesis, characterization, and mechanism

of CO₂ fixation by enzymes involved in photosynthesis, such as D-ribulose-1,5-bisphosphate (RuBP) carboxylase-oxygenase (Rubisco), and phosphoenolpyruvate carboxylase (PEPC), are being investigated.²²⁵⁻²³² The genes responsible for the formation of cellulose are also being determined.²³³

Many organisms capable of photosynthesis have been proposed for use in the capture of CO₂ from flue gas.²³⁴⁻²⁶³ A wide array of photoreactor configurations have been examined for CO₂ fixation.²⁵⁴⁻²⁶³ Biomass from CO₂ fixation can be used as fuels, animal feeds, pharmaceutical compounds, chemicals, paper, plastics, and concrete fillers.²⁴³⁻²⁵³

Several species of algae that can thrive under high concentrations of CO₂ (up to 15%) have been identified. Photosynthetic bacteria have also been investigated for capture of CO₂ from flue gas. No known species of algae or bacteria can successfully thrive in a gas composition similar to flue gas shown in Table 7.²⁶⁴ Most studies of photosynthesis for CO₂ fixation use CO₂ in air mixtures (300 ppm—15% CO₂ in air) in lieu of flue gas compositions. The maximum temperature that an algae colony was demonstrated to grow in a high CO₂ atmosphere was approximately 318 K. The sources of light for the studies of photosynthesis as a method of CO₂ capture include both natural (sun) and artificial (fluorescent lamps) illumination. Hardier organisms, which can incorporate CO₂ into biomass at greater rates than currently possible, are needed for flue gas applications.

The CO₂ capture technologies named previously have advantages and disadvantages when installed in a power-generation system. Initial evaluations of energy and costs by Herzog et al.⁴⁴ indicate that certain technologies for CO₂ control from flue gas from conventional PC-fired power plants create a substantial thermal efficiency power loss. A study by Kosugi et al.²⁶⁵ scoped the various technologies by using a graphical evaluation and

review technique. The target CO₂ capture technologies were compared for different levels of development. Although some of the technologies presently have larger penalties than others, future research and development will improve the projected energy efficiencies.

GEOLOGICAL SEQUESTRATION OF CO₂

For decades, petroleum companies have injected CO₂ into active oil fields to improve production rates and total productive lifetime of the field. Although this practice has previously been motivated by EOR, there is a potential added benefit from the fact that CO₂ is trapped underground in the process. In fact, because of the economic benefits to offset the cost, it is expected that EOR will be the earliest method of CO₂ storage to be widely practiced. In the long term, however, the large capacity and advantageous locations of deep saline aquifers will likely make them the preferred storage site as the amount of CO₂ to be sequestered increases. The technological experience gained through EOR will undoubtedly prove to be valuable in designing effective techniques for injection into saline aquifers.

Some Chemical and Physical Properties of CO₂

To begin to predict the behavior of CO₂ that is injected into the geosphere, it is useful to first understand some of the fundamental properties of CO₂ and its behavior under the conditions that will be typical for underground storage. CO₂ is a relatively nonreactive compound that is a gas under ambient conditions. The CO₂ phase diagram showing the triple point and critical point is in Figure 10. The critical point is that temperature and pressure above which a gas cannot be liquefied irrespective of the pressure applied. For CO₂, that is 304 K and 7.4 MPa. Matter above the critical point exists as a dense gas. As shown in Figure 10, CO₂ may be readily compressed into a liquid when below the critical point. This is how CO₂ is generally stored and transported for industrial applications. However, the critical temperature of 304.3 K will be exceeded under typical conditions of the deep geosphere. Therefore, for the purposes of geological sequestration, CO₂ will be gaseous or supercritical.

Liquid and dense gaseous CO₂ are excellent solvents for small hydrocarbons and aromatics. Thus, when supercritical CO₂ is injected into a coal seam or other geological formation, it can extract small molecules trapped in the macromolecular network of coal or within the pore space of coal or other geological media. The solvating power of supercritical CO₂ is a function of its density and, thus, its temperature and pressure. The relationship between density and temperature at multiple pressures is shown in Figure 11. The relationship between density and pressure and dielectric constant for CO₂ at 313 K is shown in Figure 12.²⁶⁶

Table 7. Typical untreated flue gas composition.²⁶⁴

Species	Concentration (by volume)
H ₂ O	5-7%
O ₂	3-4%
CO ₂	15-16%
Total Hg	1 ppb
CO	20 ppm
Hydrocarbons	10 ppm
HCl	100 ppm
SO ₂	800 ppm
SO ₃	10 ppm
NO _x	500 ppm
N ₂	Balance

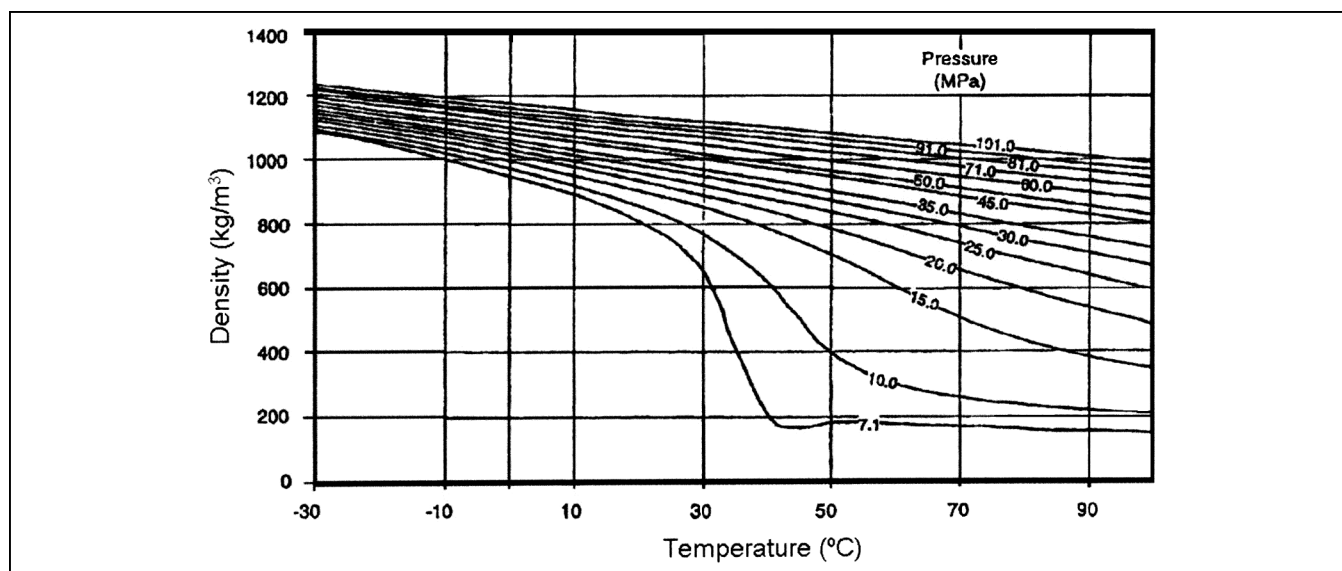

Figure 11. Variation of CO₂ density as a function of temperature at various pressures.⁴⁴³

Natural brines are characterized by high salinity, which can significantly impact the solubility of CO₂. Figure 13a shows the solubility of CO₂ in water as a function of pressure at several different salinity levels for the simplified case of CaCl₂ at 348 K. These experimental measurements²⁶⁷ show the same trend as the results of simulations performed with the Geochemist's Workbench (GWB)²⁶⁸ for the same conditions as shown in Figure 13b. CO₂ solubility decreases by a factor of 3–4 when concentration of CaCl₂ is increased from 0 to 30%, meaning that higher salinity aquifers will have a significantly smaller capacity for solubility trapping than those with moderate to low salinity.

The dissolution of CO₂ in water is an important issue because it will be the first step in any chemical reactions with the brine constituents or the mineral matrix of the formation. It is also important to mineral trapping, because dissolution of CO₂ in the formation water is typically the first step in chemical reactions. The issue has been tackled through theoretical modeling as well as experimental techniques covering a great range of temperatures and pressures. Temperature and pressure ranges relevant to brine sequestration were covered by Wiebe and Gaddy and are summarized in Figure 13c for the case of solubility in pure water.^{269,270} Solubility increases with increasing pressure. The deviation of this relation from linearity represents a significant deviation from Henry's Law, particularly at high pressures and low temperatures. Figure 13d shows the results of modeling the same relation using the GWB.²⁶⁸ The trends seen here are the same with a slight shift in the magnitude toward higher solubility. An evaluation of the solubility of CO₂ in water and brine can be found in the publications of Enick and Klara.^{271,272}

Another property of CO₂ that will significantly affect its fate when stored in the geosphere is its acidity. When

CO₂ is dissolved in water, it readily forms carbonic acid (H₂CO₃), which lowers the pH of the solution:

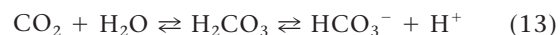

The GWB simulation shown in Figure 14 shows the pH of carbonated water (a) and brine (20% NaCl) (b) as a function of CO₂ pressure at 298, 318, 333, and 348 K. Increased acidity, in general, leads to greater solubility of minerals, which may lead to increased porosity and permeability of the formation. As will be discussed later, this may also lead to secondary precipitation of carbonate minerals.²⁷³ As pressure increases, pH decreases. As temperature increases, pH increases.

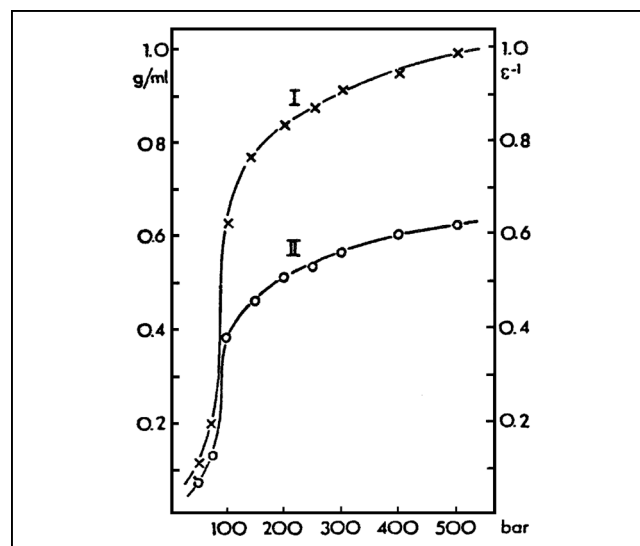

Figure 12. Relationship between density (I) and dielectric constant of CO₂ at 313 K as a function of pressure.²⁶⁶

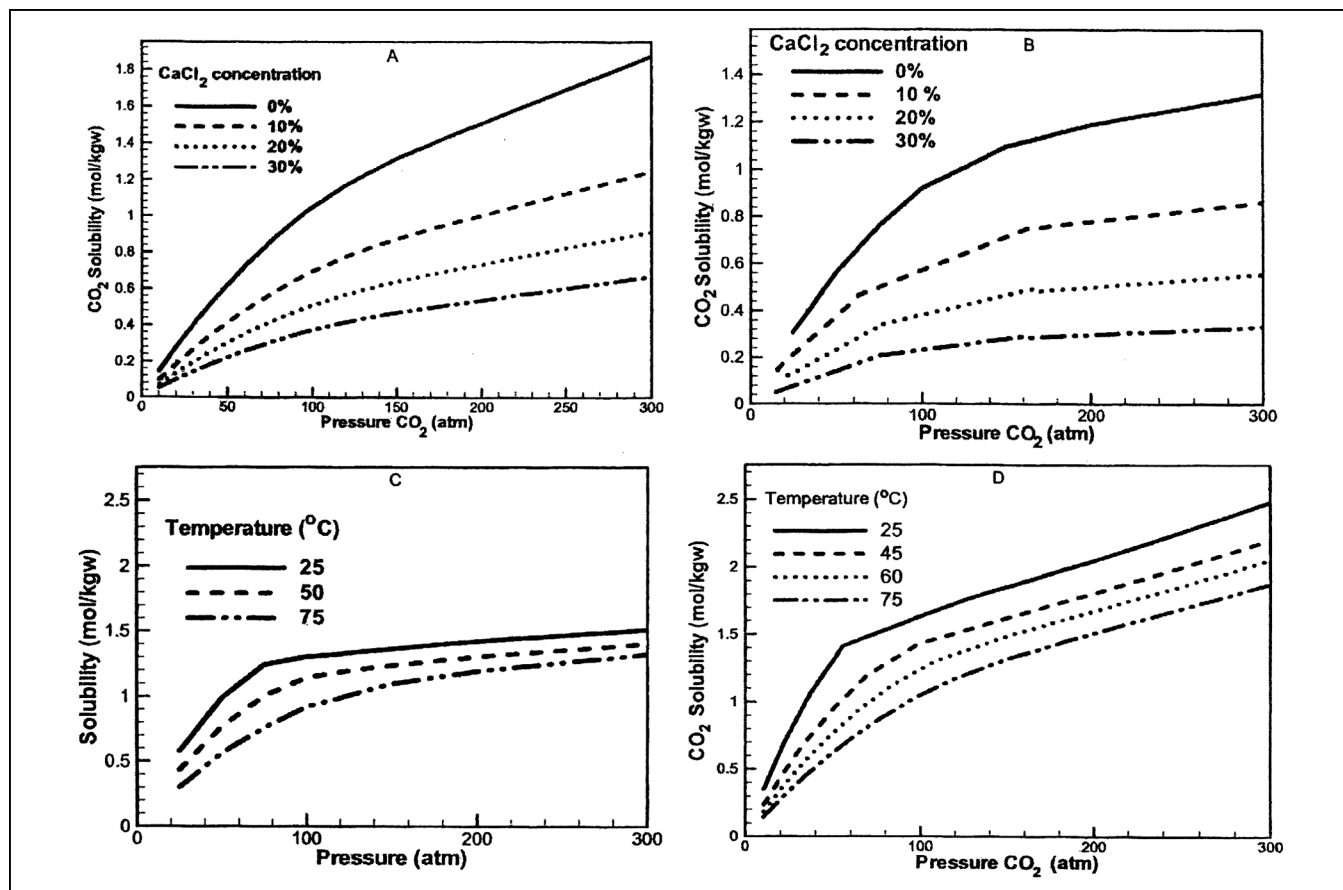

Figure 13. Solubility of CO₂ in pure water and brine as a function of pressure (a) at various concentrations (wt %) of CaCl₂ and 75 °C— experimental results from Prutton and Savage;²⁶⁷ (b) at various concentrations (wt %) of CaCl₂ and 75 °C— calculated using GWB; (c) in pure water at various temperatures— experimental results from Wiebe and Gaddy;^{269,270} and (d) in pure water at various temperatures— calculated using PHREEQC.

SEQUESTRATION OF CO₂ IN DEEP UNMINEABLE COAL SEAMS WITH SIMULTANEOUS PRODUCTION OF METHANE

White et al. define coal seam sequestration as “the storage of CO₂ from anthropogenic sources in deep unmineable coal seams for geologically significant times with or without the concomitant recovery of natural gas.”²⁷⁴ The

concept was first proposed by Don MacDonald of Alberta Energy in 1991 during conversations with researchers from the Alberta Research Council.²⁷⁵ However, the concept of ECBM with CO₂ was well developed in 1991. Using laboratory experiments, Fulton et al.²⁷⁶ and Reznik et al.²⁷⁷ showed that CH₄ was rapidly displaced from coal when CO₂ was injected. These results were later confirmed

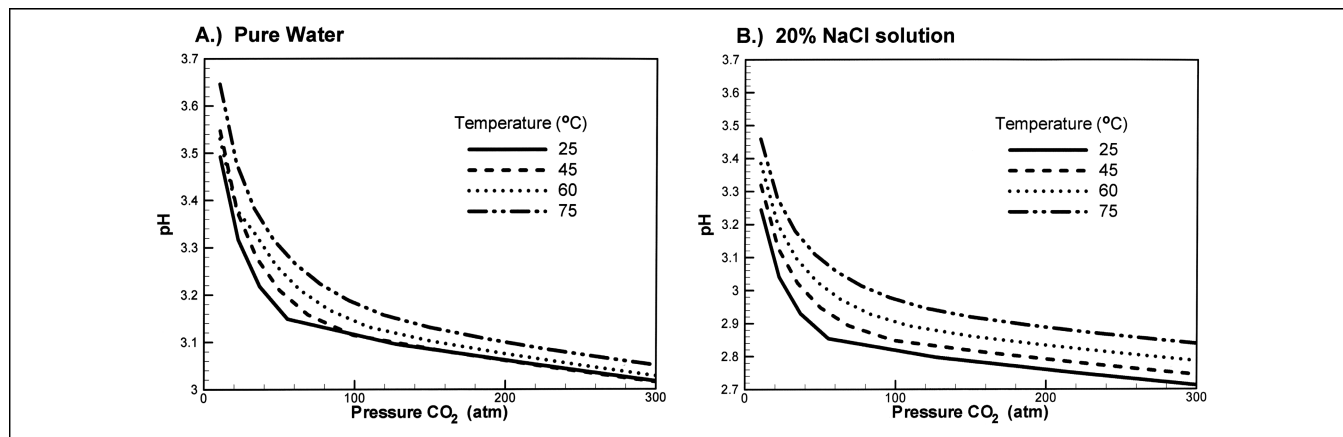

Figure 14. pH of carbonated water (a) and carbonated brine (water containing 20% NaCl) (b) as a function of pressure at 298, 318, 333, and 348 K. The results in pure water were estimated using PHREEQC, while the brine results were estimated using GWB.

by Arri et al.²⁷⁸ In a series of patents, Amoco demonstrated that CH₄ could be removed from deep unmineable coal using many gases including CO₂.^{279–281} Chaback et al.²⁸¹ simulated the effects of injection of pure CO₂, pure N₂, and flue gas on coal and showed that CH₄ was removed by displacement chromatography. When CH₄ recovery from coalbeds is enhanced by injecting another gas, the process is called ECBM.

“When ECBM is performed using CO₂, the term becomes CO₂-ECBM, and when an objective is to also sequester CO₂ in addition to producing CH₄, the term becomes CO₂-ECBM/sequestration.”²⁷⁴ A more detailed review of CO₂-ECBM/sequestration with concomitant CH₄ recovery can be found in White et al.²⁷⁴ Sequestration of CO₂ in coal seams with concomitant recovery of natural gas is an attractive approach to stabilizing the atmospheric concentration of CO₂. It partially offsets the costs associated with capture of CO₂ from large point sources, transporting it to a sequestration site, and pumping it underground. Those sequestration methods that allow production of a value-added product such as natural gas or oil during EOR will most probably be the sequestration technologies first practiced commercially.

The technology required to pump CO₂ into geological media is well developed and has been used commercially during EOR and enhanced gas recovery (EGR) for many decades. In December 1993, a small CO₂ pilot injection to recover CH₄ was performed in the Fruitland Coal Formation in southern Colorado.²⁷⁵ Similarly, raw combustion gas from a diesel that contained 83% N₂ and 12% CO₂, and a small amount of O₂ was injected into a San Juan Basin coal and produced CH₄.²⁸² Burlington Resources²⁸³ performed a large scale CO₂-ECBM/sequestration field test in the Allison Unit in northern New Mexico in the San Juan Basin near Colorado to evaluate CO₂-ECBM and to develop sequestration.²⁸⁴ The San Juan Basin is very well developed with respect to coalbed methane recovery (CBM), having thousands of gas wells that are responsible for production of approximately 75% of total worldwide CBM production. The wells in the Allison Unit produced approximately 42,000 m³/day/well by standard CBM recovery practices of pressure depletion. This is approximately half the production rate of wells in the San Juan Basin Fairway. Most importantly, the Allison Unit is near a CO₂ pipeline that crosses the Basin. The Burlington pilot test was performed on a 1.3 × 10⁶-m² spacing and consisted of four CO₂ injection wells and nine CH₄ recovery wells. The wells were initially employed as CBM recovery wells using standard pressure depletion methods for more than 5 yr. Burlington Resources drilled the four CO₂ injection wells in 1995. Injection of CO₂ started at a 142,000 m³/day rate and was later reduced to approximately 85,000 m³/day because of

loss of injectivity.²⁸⁵ To facilitate CO₂/CH₄ transfer within the reservoir, five of the production wells were shut in for 6 months during the initial 6 months of operation. There was unexpectedly severe water encroachment during this time, slowing the CH₄ desorption process, changing the relative permeability, and lowering gas flow.²⁸⁶

Field performance was evaluated after 6 months by suspending CO₂ injection and the five shut-in wells were reopened and injection resumed approximately 8 months later. Water production increased substantially when CO₂ injection was restarted, indicating that sweep was improved. Surprisingly, CH₄ production was most dramatically improved at the only recovery well that was not shut in. There has been no significant breakthrough of CO₂ at the CH₄ production wells after injecting 57 million m³ of CO₂. After nearly 5 yr of injecting CO₂, the concentration of CO₂ at the production well was still only approximately 6%, while the original CO₂ content of the produced CH₄ was approximately 4%, strongly suggesting that the processes of CH₄ displacement and CO₂ sequestration are occurring underground. This experiment clearly shows that CH₄ production was increased by CO₂ injection and CO₂ was sequestered. However, the physical, chemical, and thermodynamic phenomena occurring during the process remain poorly understood.

An N₂-ECBM project at the Tiffany Unit was operated in the San Juan Basin in southern Colorado using four N₂ injection wells surrounding a central production well in 1996,²⁸⁷ and 10 new directional N₂ injection wells and two additional converted production wells in 1999.²⁸⁸ The information collected to date from this active N₂-ECBM flood is being used for planning and design of a future CO₂ injection in this field. A CO₂-ECBM/sequestration micropilot test is being performed in Alberta, Canada, at Fenn Big Valley.²⁸⁹ The highly volatile B bituminous coal is distributed between two seams that are both in the Upper Manville group and have a combined thickness of approximately 9 m and a depth of between 1250 and 1300 m. The micropilot test uses the top seam with a permeability ranging from approximately 1 to 5 mD. The micropilot test has two main objectives. They are to reduce GHG emissions by developing technologies to inject CO₂ into deep coalbeds and to enhance production of CH₄ from the coal as a result of CO₂ injection.²⁸⁹ The first phase was a proof of concept that evaluated the feasibility of injecting CO₂, N₂, and flue gas into a deep coal seam with the concomitant production of twice as much CH₄ as CO₂ sequestered.²⁹⁰ The second phase designed and implemented a micropilot (huff and puff) test employing CO₂ and N₂. The third phase will simulate, design, and perform a full-scale pilot project. The first two phases were successfully completed. Both pure CO₂ and flue gas were

injected during phase 2. Initial results showed that flue gas injection enhances CH₄ production more than does CO₂ alone. Core samples allowed measurement of the gas-in-place, the composition of the gas, and gas storage capacity. Two tests were performed using the new well in 2000. The first test injected pure N₂, while the second injected the exhaust (13% CO₂ and 87% N₂) from a compressor engine used for drilling.

Several other CO₂-ECBM/sequestration projects are planned. Scientists in Australia are considering a demonstration pilot at the Dawson River Site in the Southern Bowen Basin. Several major coalbeds and CO₂ sources are located in the Basin.²⁹¹ Wong et al. state that a successful pilot test could eventually lead to a commercial-scale CO₂-ECBM/sequestration project in the Basin.²⁹²

An international consortium is performing a CO₂-ECBM/sequestration project in Poland known as the Reduction of CO₂ Emissions by Means of CO₂ Storage in the Silesian Coal Basin of Poland (RECOPOL) Project, which started in November 2001.²⁹³ The objective was to perform the first European field demonstration of the technology. The project will contribute to the understanding of the process and assist in defining its potential to reduce European CO₂ emissions. A site in the Polish Silesian Basin was selected for the project.²⁹⁴ The selected site has favorable reservoir properties, including depth, permeability, and gas content, as well as an existing surface infrastructure with wells and surface facilities. The field already has two production wells. Thus, only the injection well must be drilled. Plans are to begin drilling in 2003. Once completed, CO₂ injection will be performed for 18 months. CO₂ will be delivered by a local supplier using trucks.

The Netherlands Agency for Energy and the Environment (NOVEM) performed a technical and economic study to assess the potential of the technology in the Netherlands.²⁹⁵ They considered Dutch carboniferous coal seams within 2000 m of the surface. The investigators concluded that CO₂-ECBM/sequestration can be economically feasible in the Netherlands in the short term.^{296,297}

The estimated capacity of Japanese coal to sequester CO₂ is approximately 500 billion m³ of CO₂. The unmineable coals are located in the Kushiro, Ishikari, Joban, Miike, and Sakito Matsushima Basins. Large power plants are also located in these basins that could be used as a source of CO₂.²⁹⁸ The Japan Forum on CO₂ Sequestration in Coal Seams (JCOSC) was founded in May 2001 to organize a field test program of CO₂-ECBM/sequestration.²⁹⁹ Similarly, the Japanese Ministry of Economy and Trade (METI) is planning a CO₂-ECBM/sequestration project over a 5-yr period with a total budget of approximately (U.S.) \$ 27 million. The purpose of the project is to develop cost-effective CO₂ sequestration technologies

using unmineable coal seams in Japan that includes both research and a micropilot test.

The potential for CO₂-ECBM/sequestration was confirmed in two carboniferous coal deposits in China. A northeastern coal basin is heavily industrialized and is home to numerous coal-fired power plants that could provide CO₂. Unfortunately, there are no existing gas pipelines to move the produced CH₄ to market and no CO₂ pipelines to transport the CO₂ from the power plants to the coal seams. Further, the coal seams have low permeability, less than 1 mD. On the other hand, the Ordos coal Basin in north central China has permeabilities that are 1 order of magnitude higher, with little fracturing. Stevens et al. estimate that the potential for CO₂ sequestration in the Ordos Basin is approximately 0.66Gt of CO₂.²⁸⁴ The Canadian International Development Agency and the Chinese Ministry of Foreign Trade and Economic Cooperation (MOFTEC) recently agreed to jointly develop China's CO₂-ECBM/sequestration capabilities. Over the next 3 yr, three micropilot tests are planned at an estimated cost of (U.S.) \$ 6.1 million. The results of these tests will be used to select a location for a full-scale pilot test.³⁰⁰

Estimated Capacity of Gassy Coals Worldwide to Adsorb CO₂

Reeves estimated the CO₂ adsorption capacity of coal basins that contained significant amounts of CH₄. He considered gassy coals in North America, Australia, and India to have a combined CO₂ adsorption capacity of ~37.8 Gt of CO₂.³⁰¹ Table 8 ranks each basin according to its potential reserves, the resource concentration, producibility, CO₂ availability, and approximate development costs. NOVEM estimates that 8 Gt CO₂ could be stored in their coals^{302,303} while ~0.208 Gt of CO₂ could be stored in the Westphalian Campine coal basin.³⁰⁴ Kuuskraa et al.³⁰⁵ and Gunter et al.³⁰⁶ estimate that the worldwide CO₂ sequestration capacity in coalbeds is between 82 and 263 Gt of C or approximately 300–964 Gt of CO₂. Lastly, Stevens et al. have estimated the global coalbed CO₂ sequestration capacity to be approximately 225 Gt of CO₂.²⁸⁴ Increased production may be possible using lateral drilling techniques.³⁰⁷

Estimates of the CH₄ Content of Coal

CH₄ in U.S. coalbeds is estimated at 1.13×10^{13} m³ (11.3 Tm³) and is illustrated in Table 9.³⁰⁸ There are substantial CH₄ reserves in coalbeds in different areas of the United States. Many of these areas are near fossil fuel-fired electric power-generating stations that could serve as sources of CO₂ for ECBM recovery. Approximately 2.5 Tm³ are thought to be recoverable. These estimates include the CH₄ content of mineable coals that may not be suitable

Table 8. Ranking of the world's most prospective coal deposits for CO₂ ECBM/sequestration for 13 coal basins.³⁰¹

Coal Basin/ Region	Country	Potential Reserves	Resources Concentration	ECBM Producibility	Development Costs	Gas		Overall Score	Overall Ranking	CO ₂ Enhanced Reserves ^a (Tcf)	CO ₂ Sequestration Potential (10 ⁶ t)
						Sales Market	CO ₂ Availability				
San Juan	U.S.A.	5	5	5	5	4	5	29	1	13	1400
Kuznetsk	Russia	5	4	4	3	4	4	24	3	10	1000
Bowen	Australia	5	4	4	4	4	3	24	4	8.3	870
Ordos	China	4	3	4	3	2	2	18	13	6.4	660
Sumatra	Indonesia	4	3	3	3	4	4	21	8	3.5	370
Uinta	U.S.A.	2	3	5	5	4	5	24	2	2.2	230
Western Canada	Canada	4	2	3	4	3	3	19	9	1.6	170
Sydney	Australia	4	4	3	3	4	4	22	7	1.4	150
Raton	U.S.A.	2	3	4	5	4	5	23	5	0.8	90
Cambay	India	3	5	3	4	5	3	23	6	0.7	70
Donetsk	Ukraine/ Russia	1	5	2	3	4	4	19	11	0.3	30
Northeastern China	China	2	4	2	3	4	4	19	12	0.2	20
Damodar Valley	India	2	3	2	4	4	4	19	10	0.1	10
Total of high-potential basins										48.5	5070

Note: Ranking scale is from 1 (lowest) to 5 (highest); ^aEstimated reserves additional to pressure-depleted recovery.

for sequestration purposes. Others estimate U.S. coalbed CH₄ resources to range between 7.77 and 18.3 Tm³.²⁷⁵ Kuuskraa et al. estimate the global coalbed CH₄ resources to range from 84.1 to 262 Tm³.³⁰⁵

Stored gases are either physically sorbed on the internal surfaces or absorbed within the molecular structure, within the pores and cleats of the coal.³⁰⁹ Gases are held by van der Waals forces of attraction or as physically trapped molecules within the molecular sieve-like macromolecular network. Until recently, it was thought that CH₄ adsorption capacity was a function of rank, with higher rank coals having greater capacity.^{310–312} After studying the CH₄ storage capacity of coals from Canada, Australia, and the United States, Bustin and Clarkson concluded that there was “no or little correlation between coal rank and CH₄ adsorption capacity (as commonly assumed), although in particular basins there are general trends with rank and composition.”³¹³ Gas sorption capacity is a function of temperature and pressure of the coal. Higher pressures result in greater storage capacity, while higher temperatures lead to decreased capacity.^{314–316}

Storage capacity is related to water content in a coal, as shown in Figure 15. The same coal has a greater CH₄ storage capacity when dry.³¹⁶ Water content also determines the amount of CO₂ a coal imbibes.³¹⁷ The ability of coals to sorb gases is also a function of the amount of trapped compounds present as occluded material. Trapped compounds in the coal matrix reduce the

capacity of the coal to store gases by “plugging” the micropore structure in the coal.³¹⁸ The two most important factors controlling the amount of CH₄ stored in coal are the confining pressure and the surface area of the internal micropore system.

An Initial Set of Working Hypotheses Concerning Some Chemical, Physical, and Thermodynamic Events That Occur When CO₂ Is Injected into a Coalbed

There is a very incomplete understanding of what happens when CO₂ is injected into a coal seam. Therefore, we formulated a number of hypotheses concerning the chemical, physical, and thermodynamic phenomena that occur. These hypotheses can be used to develop models that simulate the CO₂-ECBM/sequestration process. A more complete understanding of what occurs when CO₂ is injected into a coal seam is needed to understand the causes of operational problems when they occur and to take the most appropriate steps to resolve operational problems. White has described these hypotheses in preliminary form in a recent publication.³¹⁹

Hypotheses. (1) The glass-to-rubber transition temperature (T_g) of the coal will be dramatically reduced by imbibition of CO₂. The coal will become plasticized.³²⁰

(2) The cleat system within the coalbed will begin to close and become restricted, slowing Darcy flow within that area of the seam because of swelling.

Table 9. U.S. coalbed methane resources.³⁰⁸

Coal Basin/Region	States	Gas in Place (Tm ³)
Arkoma Basin	Oklahoma, Arkansas	0.06–0.11
Black Warrior Basin	Alabama, Mississippi	0.57
Cahaba coal field	Alabama	0.06
Central Appalachian Basin	Tennessee, Kentucky, West Virginia, Virginia	0.14
Coosa coal field	Alabama	0.03
Greater Green River coal region	Wyoming, Colorado	0.03–0.85
Illinois Basin	Illinois, Indiana, Kentucky	0.14–0.59
Northern Appalachian Basin	Pennsylvania, Maryland, West Virginia, Ohio, Kentucky	1.73
Pennsylvania anthracite fields	Pennsylvania	NQ ^a
Piceance Basin	Colorado	2.38
Powder River Basin	Montana, Wyoming	0.85
Ratan Basin	Colorado, New Mexico	0.23–0.51
Richmond and Deep River Basins	Virginia, North Carolina	0.06–0.08
San Juan Basin	Colorado, New Mexico	
Fruitland Formation		1.42
Menefee Formation		0.62–0.96
Uinta Basin	Utah, Colorado	0.03–0.14
Valley coal fields	Virginia	NQ
Western Washington coal region	Washington	0.03–0.68
Wind River Basin	Wyoming	0.03–0.06
Total		8.4–11.2

^aNQ = not quantified.

(3) There will be a substantial increase in the self-diffusivity of CO₂ in coal once it has become plasticized and is above its T_g .^{320,321}

(4) The diffusivity of CO₂ in coal swollen by high-pressure CO₂ can be described by free-volume theory.

(5) The degree to which plasticization, swelling, increased diffusivity, lowering of T_g , relaxation of the macromolecular network, and depression of the softening temperature occur will be limited by the degree that the coal is free to swell.

(6) Both liquid and supercritical CO₂ moving through a coalbed will extract small molecules trapped within the macromolecular network. As the network relaxes, these molecules will be released and move with the flowing CO₂ as long as the pressure is above their threshold pressure.

(7) Some of the minerals commonly found in coal will dissolve in the acidic, carbonated formation water during those times when both water and high-pressure CO₂ are present together in the coal.

(8) The Ca and Mg content of the coal will decrease because of dissolution of carbonate minerals by carbonic

acid and because of Ca and Mg being displaced from carboxylic acids in low-rank coal.

(9) Injection of dry CO₂ will dry the coal, particularly in those areas where the flow rate of CO₂ is highest.

(10) There will be a CO₂ pressure, temperature, and pH gradient across the coalbed from the injection well to the recovery well. The temperature gradient is caused by Joule-Thompson cooling. When dissolved minerals and organics reach areas of the seam with lower pressure, they will precipitate, clogging the coal's pores.

Possible Effects of CO₂ Adsorption on the Glass-to-Rubber Transition Temperature and Softening Temperature. Coals exist as either a glass or a flexible rubber depending on the temperature and other factors. The glassy state is characterized by brittleness and little or no large segmental molecular motion throughout the macromolecular network. Diffusion throughout the system is slow, and diffusivity of guest molecules is highly dependent upon their molecular size and thus their molecular weight. Individual components of the macromolecular network are held together by noncovalent interactions, such as van der Waals

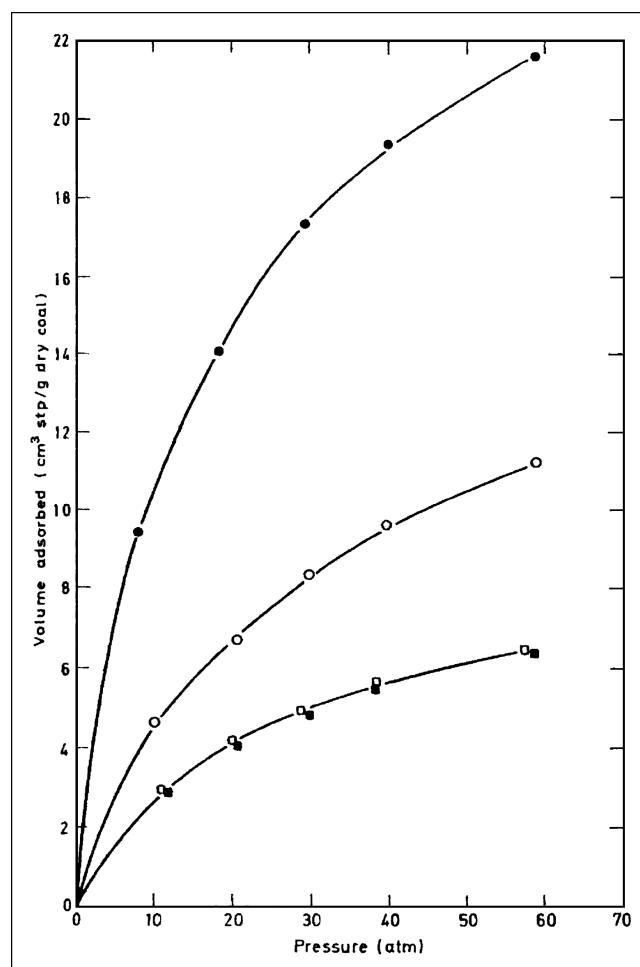

Figure 15. Methane adsorption isotherms for Illinois No. 6 coal at 303 K. Moisture content ● Zero, ○ 5–44%, ■ 10–70%, □ 14–28%.³¹⁶

forces, that are of sufficient strength to prevent movement with the exception of local vibrations and rotations.^{320,321} Conversely, when in the rubbery state, sufficient thermal energy is available to surmount the noncovalent interactions. Then the macromolecular system is free to move, allowing the coals to become flexible, internal molecular motion becomes liquidlike, diffusion is much more rapid, and the dependence of guest molecule diffusivities on molecular size is much reduced.^{320,321}

The temperature at which a coal is transformed from a glass to a rubber is known as the glass-to-rubber transition temperature (T_g). When coals and other macromolecular systems such as polymers imbibe small molecules like CO_2 , their T_g can be decreased (hypothesis 1).^{320,321} The physical and chemical properties of coal change depending upon the state it is in, glass or rubber. The molecular transport dynamics of guest molecules are greatly affected. CO_2 -induced depression of the T_g and other plasticization effects have been investigated in a variety of systems.^{322,323} When coal imbibes CO_2 , it swells (hypothesis 2). The CO_2 acts as a plasticizer depressing T_g , causing a structural rearrangement of the macromolecular system. Plasticizers add free volume and molecular mobility, converting a glass into a rubber. Once coal is plasticized by CO_2 , it rearranges and moves to a lower energy, where it displays different adsorption properties toward CO_2 . Upon imbibing CO_2 and swelling, the softening temperature of the coal is depressed, as shown graphically in Figure 16.³²⁴ CO_2 lowers the T_g by acting as a plasticizer, dissolves in the coal, the structure rearranges and relaxes, and the softening temperature decreases. As shown in Figure 16, at low CO_2 pressures, there is little or no effect on softening temperature. However, at higher pressures, approximately 3 MPa, the effect is dramatic. The softening

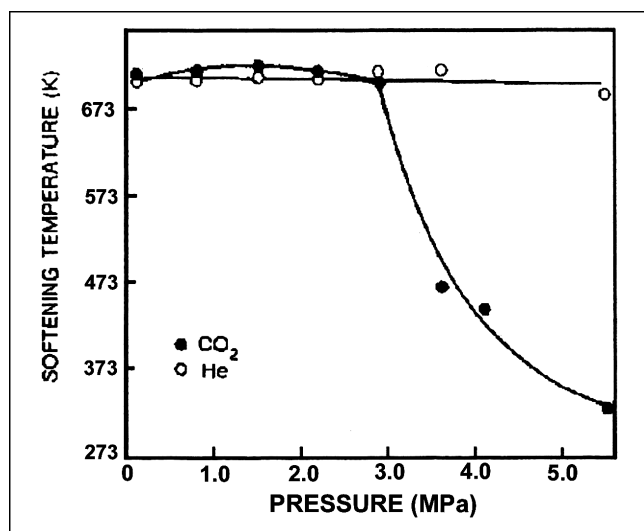

Figure 16. Depression of the softening point temperature of a coal in the presence of increasing pressures of both CO_2 (●) and He (○).³²⁴

temperature is decreased more than 300 K from something greater than 673 K to less than 373 K. John Larsen originally brought this to our attention.^{320,321}

Hsieh and Duda³²⁵ showed that fluids are imbibed by coal in three stages. There is a rapid surface adsorption, presumably at least in part into the pores; followed by a slow diffusion of fluid into the coal; followed by relaxation of the macromolecular network and additional diffusion of the fluid.³²⁵ Reucroft and Sethuraman³²⁶ showed that CO_2 dissolves in coal and is not simply adsorbed on the surface. Table 10 shows that swelling increases as the carbon content of the coal decreases, and as rank decreases, that swelling continues to increase with time for approximately 200 hr as more CO_2 is imbibed into the macromolecular structure, as pressure increases swelling increases, and as pressure increases the time required to reach equilibrium swelling decreases.³²⁶

Effect of CO_2 Adsorption on Organic Matter. When CO_2 interacts with coal, multiple processes occur. CH_4 desorption occurs simultaneously with CO_2 adsorption. CH_4 is displaced into the cleat system of the coal, where it begins to move toward an area of lower pressure, the production well. CH_4 desorption causes coal to shrink, whereas CO_2 adsorption causes the coal to swell and the macromolecular structure to relax.³²⁰ Although this is not in the literature, we hypothesize that general, coal swelling caused by CO_2 sorption is greater than shrinkage caused by CH_4 desorption (hypothesis 2). The net effect is coal swelling. Weak intermolecular interactions such as van der Waals interactions, hydrogen bonds, and charge transfer interactions between one part of the macromolecule and another or between two macromolecules are broken and replaced by interactions between the macromolecule and CO_2 . This allows the small molecules trapped within the interwoven macromolecular network to be released so that they are free to move. Liquid and dense gaseous CO_2 are excellent solvents. As the trapped molecules are released, they become solvated and extracted by the CO_2 and migrate with CO_2 throughout the coalbed (hypothesis 6). The extraction process and movement of formerly trapped molecules begins with the lower molecular weight compounds first. Movement of compounds is a function of each compound's threshold pressure. The threshold pressure of a substance was originally defined by Giddings et al. as the lowest supercritical pressure that will cause a substance to just begin migrating in a flowing stream of supercritical fluid.³²⁷ Among hydrocarbons, the threshold pressure is an approximate function of their molecular weight. Generally, the amount extracted from coal is quite small, approximately 2.5 wt % or less.

Table 10. The behavior of a bituminous coal, a subbituminous coal, and a lignite in CO₂ at 298 K and CO₂ pressures of 0.5, 1, and 1.5 MPa.³²⁶

Carbon Percentage	CO ₂ Pressure (MPa)	Coal Swelling Volume (%)	CO ₂ Dissolved in Coal (%)
83.8	0.5	0.75	13.8
	1	0.85	16
	1.5	1.33	24
78.3	0.5	1.24	23
	1	2.23	41
	1.5	3.11	58
65.8	0.5	2.16	24
	1	3.00	32
	1.5	4.18	47

Effect on Diffusivity. The plasticization effects of CO₂ on coal (hypotheses 1 and 3) are discussed elsewhere.³²⁰ Hypothesis 3 is an extension of one proposed by Larsen to include the self-diffusion of CO₂ in plasticized coal. Mass transport through coal is a controlling function during the sequestration of CO₂. If the cleat fracture system becomes restricted because of swelling, then Darcy flow will be restricted and transport through the coal in that part of the seam will be primarily Fickian (hypothesis 2).

A substantial increase in molecular diffusivity of guest molecules in macromolecular systems in contact with supercritical CO₂ has been documented recently. The diffusivity of ethylbenzene in CO₂ swollen polystyrene shows a 10⁶-fold increase when supercritical CO₂ is present.³²⁸ Experimental information that defines factors that impact and control transport properties in CO₂ swollen macromolecular systems is limited for polymeric systems and, to our knowledge, unknown for coals. Transport properties of Co(II) complexes in polymeric systems in contact with supercritical CO₂ are dependent upon the degree of CO₂ swelling and the degree of plasticization.³²³ These are plasticization-induced changes in the transport properties of guest molecules in the swollen macromolecular network. We hypothesize that the substantial increases in diffusivity of guest molecules in polymeric systems applies to the self-diffusion of CO₂ in CO₂ swollen macromolecular systems such as coal. As such, we expect diffusion of CO₂ in coal swollen by high-pressure supercritical CO₂ will be much more rapid than in the same coal before plasticization (hypothesis 3).

The CO₂ swollen polymeric systems described previously were unconfined and free to swell. Similarly, the coal in the softening point depression experiment performed by Khan and Jenkins was free to swell.³²⁴ A coal seam is a relatively fixed-volume system, in which coal is confined and not free to swell. Therefore, plasticization, swelling, increased diffusivity, lowering of T_g , relaxation

of the macromolecular network, and depression of the softening temperature will be confined and limited to the degree that the coal is free to swell. The only volume available to swell into is the cleat volume in the seam. Cleat volume is generally 0.2–2 vol %.^{329–333} The pore volume is also available but usually amounts to less than 10% of the coal volume. Thus, we expect that the confined space will limit the degree the coal can swell and will thus limit the increase in CO₂ diffusivity and possibly limit the other plasticization-induced changes a coal may undergo (hypothesis 5).

Lee et al.³²³ showed that in a polymeric system swollen by CO₂, the effect of CO₂ swelling on mass transport can be understood using free-volume theory. They estimated the fractional free volume (FFV) of the swollen polymeric system from the following relationship:

$$\text{FFV} = \frac{Vm - Vw}{Vm} \quad (14)$$

where $Vm = M/d$ is the molar volume of the swollen polymer, M and d are the molecular weight and density of the swollen polymer, and Vw is the estimated van der Waals volume. CO₂ diffusivity should decrease exponentially with the reciprocal free volume, $1/\text{FFV}$. As swelling increases, free volume increases and diffusivity increases.³²³ The same theoretical approach may explain CO₂ diffusion in supercritical CO₂ swollen coals and allow estimation of the CO₂ diffusivity under a variety of conditions in swollen coal matrices (hypothesis 4).

Effect of CO₂ Adsorption on Mineral Matter. High-pressure CO₂ and water can have a profound effect on the mineral matter present in coal. Many minerals present in coal are soluble in acidic aqueous solutions (hypothesis 7). The solubility of CO₂ in water and brine is substantial at high pressures (see Figure 13). According to simulations performed, the pH of CO₂ solutions at 10.1 MPa and 318 K is approximately 3.1 in pure water and approximately 2.9 in brine (see Figure 14). Alkaline earth metals are removed from coal by treatment with acidic aqueous solutions. Calcite, dolomite, and other carbonate minerals are removed from coal at room temperature by extraction under acidic conditions with aqueous CO₂ solutions. The solubilities of some minerals common to coal in carbonated water and brine solutions at various pressures of CO₂ at 323 K are shown in Figure 17. The solubility of carbonate minerals in carbonated brine was estimated using GWB²⁶⁸ while the solubility of other coal-associated minerals and clays was estimated using the pH-Redox Equilibrium Equation Program in C Language (PHREEQC).³³⁴

Hayashi et al.³³⁵ studied the removal of Ca and Mg from several low-rank coals by batch extraction with CO₂

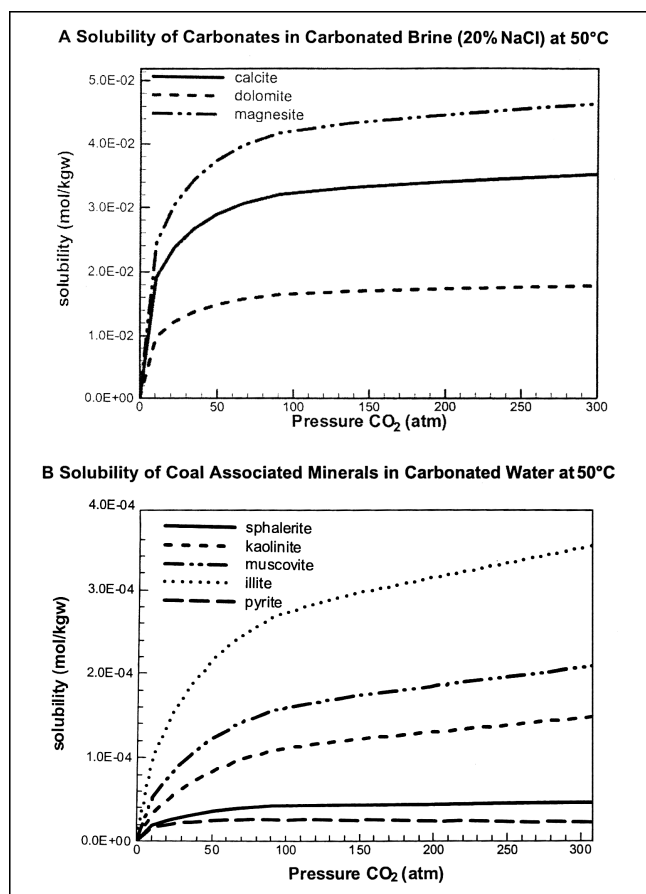

Figure 17. Solubility of calcite, dolomite, and magnesite in carbonated water (a) and carbonated brine (water containing 20% NaCl) (b) as a function of pressure at 323 K. The results in pure water were estimated using PHREEQC, while the brine results were estimated using GWB.

dissolved in water at 600 kPa and 298 K at various extraction times; see Figure 18. They showed that the Ca removal yield is affected by the total Ca content of the coal and the total carboxyl content. Ca removal is also affected by the coal-water ratio in that Ca removal decreases as the

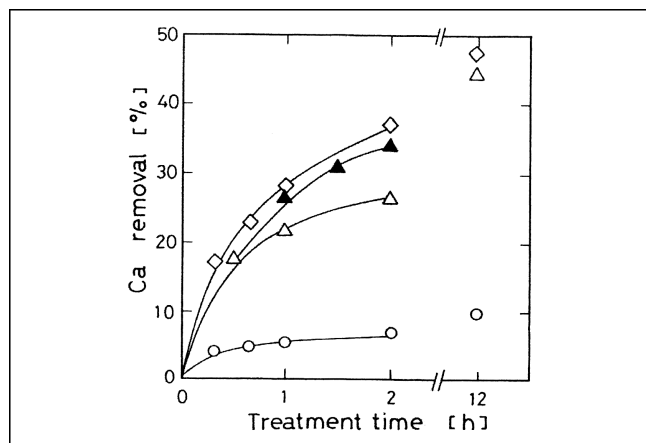

Figure 18. The removal of Ca from several low-rank coals by batch extraction with CO₂ dissolved in water at 0.6 MPa and 298 K at various extraction times.³³⁵

amount of water decreases. During CO₂ sequestration in coal, it is expected that the water content of the coal will initially decrease with time. The coal will most probably be dewatered before CO₂ injection. This process will remove some of the bulk water in the cleat system. After CO₂ injection begins, the remaining water in the cleat system and the water present in the pores should be reduced. The rate and extent of these processes are unknown. The Ca and Mg content of the coal will be reduced when both water and CO₂ are present (hypothesis 8). The dissolved minerals will be transported through the coal seam and eventually recovered in the produced water when the process is taken to completion. As the water content decreases, the amount of Ca and Mg removed will decrease. If water migrates back into the seam, then Ca and Mg removal could increase. The solubility of carbonate minerals in acidic aqueous solutions requires both H₂O and CO₂.

Drying of Coal by Flowing CO₂. Iwai et al. reported the use of supercritical CO₂ to dry coal.³³⁶ Water is removed either by dissolving in the CO₂ or by being displaced by CO₂. Water is only sparingly soluble in supercritical CO₂ at sequestration temperatures and pressures. Under some conditions, water is almost quantitatively removed from low-rank coals. Iwai et al. showed that drying of ground and sieved coal (8 g, 1000–595 μm) with CO₂ (1.5 mol/hr for 20 hr) at either 9.8 or 14.7 MPa and 313 K removed water and increased the surface area and the pore volume of the coal, as shown in Table 11. The degree of coal drying that will occur during CO₂-ECBM/sequestration is unknown but will probably not be quantitative, except near the injection well (hypothesis 9). Water removed during the dewatering process and that removed by CO₂ can be eventually replaced by recharge of water from aquifers. In areas of the seam that are at pressures higher than the surrounding hydrostatic pressure, re-invasion of water is expected to be slow.

Precipitation Caused by the Pressure Drop. There will be both a pressure drop and a CO₂ partial pressure drop from the point of injection to the production well (hypothesis 10). The injected CO₂ follows the path of least resistance,

Table 11. Drying of ground coal using supercritical CO₂ and thermal drying.³³⁶

Sample	Berau Coal (g water/g dried coal)	Taiheiyu Coal (g water/g dried coal)
Supercritical drying (14.7 MPa)	0.0188	0.01
Thermal drying (383 K)	0.0153	0.0091
Raw coal	0.2271	0.0622

moving from areas of high pressure near the injection well to those of lower pressure (toward the production well) through the areas of the coalbed that have the highest permeability. As injection continues, the areas of highest permeability become less permeable with time because the swelling process begins to close the cleat system (hypothesis 2), which initially controls gas transport within the coalbed. Extracted compounds that are moving with the flowing CO_2 will precipitate as they reach areas of lower pressure and begin to clog or plug the coal's pores (hypothesis 10).³¹⁸ Dissolved hydrocarbons will precipitate when the pressure drops below their threshold pressure. The effect of this pore clogging on permeability is unknown. The back pressure increases because of closing of the cleat system caused by swelling. Then, CO_2 begins to flow into other areas of the coalbed that now represent areas of higher permeability. Eventually, many areas of the cleat system become restricted. When this happens, the pressure across the coalbed rises, increasing the density and solvating power of the CO_2 , which is directly related to its pressure, density, and dielectric constant (see Figure 12). The precipitated components then begin to redissolve according to their threshold pressure. As the redissolution process occurs, flow begins again from areas of high pressure toward the production well. CO_2 moves through the coal as a front, probably with fingering, similar to frontal chromatography. The partial pressure of CO_2 will be high in areas behind the front and at the front but low ahead of the moving CO_2 front. When dissolved carbonate minerals migrate to areas of lower CO_2 partial pressure or decreased amounts of water, they will precipitate out of solution and initiate the clogging process.

Eventually, the flowing CO_2 finds its way to the area of lowest pressure at the production well, causing the CO_2 density and solvent strength to decrease. This causes the dissolved organic molecules and minerals to precipitate again when the pressure becomes less than their threshold pressure, clogging the coal matrix adjacent to the production well. Eventually, these molecules will be re-extracted as the CO_2 pressure builds up behind them, redissolving them and moving them into the production well. The Ca and Mg content of the produced water may not increase until the CO_2 front has migrated into close proximity of the production well. Ca- and Mg-containing minerals will precipitate out of solution rapidly as the pH increases because of loss of CO_2 pressure at the production well, forming carbonate scale in the production well. It is important to note that these are only initial hypotheses that await additional experimental confirmation from the laboratory and field.

Recovery of CH_4 from Coalbeds

CH_4 can be recovered from coal by drilling into the coalbed vertically and possibly horizontally. CH_4 in the coalbed diffuses from an area of high pressure within the coalbed into and up the borehole, where the pressure is lower. The holes drilled into the coal seam act as the CH_4 transport and recovery system. The cleat system also serves as an internal gas transport system. With time, the seam naturally depressurizes. The rate of diffusion of CH_4 from the coal is a function of the amount of water in the cleat system. CH_4 diffusion is enhanced by dewatering the coal by pumping the water out. As the water is removed and the CH_4 diffuses from the seam, the seam pressure decreases. This "natural depressurization" recovers approximately half the CH_4 in the coalbed and produces huge amounts of water requiring disposal.³³⁷ Dewatering results in the coal structure shrinking and collapsing, with the physical and chemical properties of the coal changing.³³⁸ Changes caused by dewatering are reversible for high-rank coals but irreversible for low rank coals.^{339,340}

CO_2 -ECBM/sequestration is conducted by first identifying a deep unmineable coal seam that is "well characterized in terms of depth, thickness, gas content, and permeability"³⁴¹ In this case, at least two wells are drilled: one for injection of CO_2 and one for recovery of CH_4 . Often, multiple recovery wells are used in concert with one injection well. The wells are laid out in a pattern called a five-spot pattern, with the injection well at the center and four producing wells surrounding the injector at equal distance. Other patterns such as a three-spot or a seven-spot can also be used.³⁰² CO_2 injection is not usually initiated until after primary production of CH_4 decreases. Figure 19 illustrates both the surface and subsurface facilities associated with CO_2 -ECBM/sequestration. CO_2 is injected into the coal seam, and CH_4 , water, and coal fines are produced at the recovery wells. Substantially more CH_4 is recovered using CO_2 -ECBM recovery techniques than is typically recovered through primary production. The injected gas does not need to be pure CO_2 . Mixtures of CO_2 and inert gas such as N_2 can also be used. In this case, N_2 acts as an inert sweep gas. Little CO_2 was detected at the production well after 18 months when a mixture of CO_2 and N_2 was injected at the Tiffany Unit, while N_2 appeared at the production well within weeks.³⁴² Combustion gases can also be directly injected, as verified with diesel engine exhaust.²⁸²

BRINE FIELD SEQUESTRATION

Deep saline aquifers are a particularly promising option for sequestration of large quantities of CO_2 ,³⁴³⁻³⁴⁵ because they have a large potential and are widespread over a large portion of the United States, as well as throughout the world. Therefore, in most cases, injection of CO_2 captured

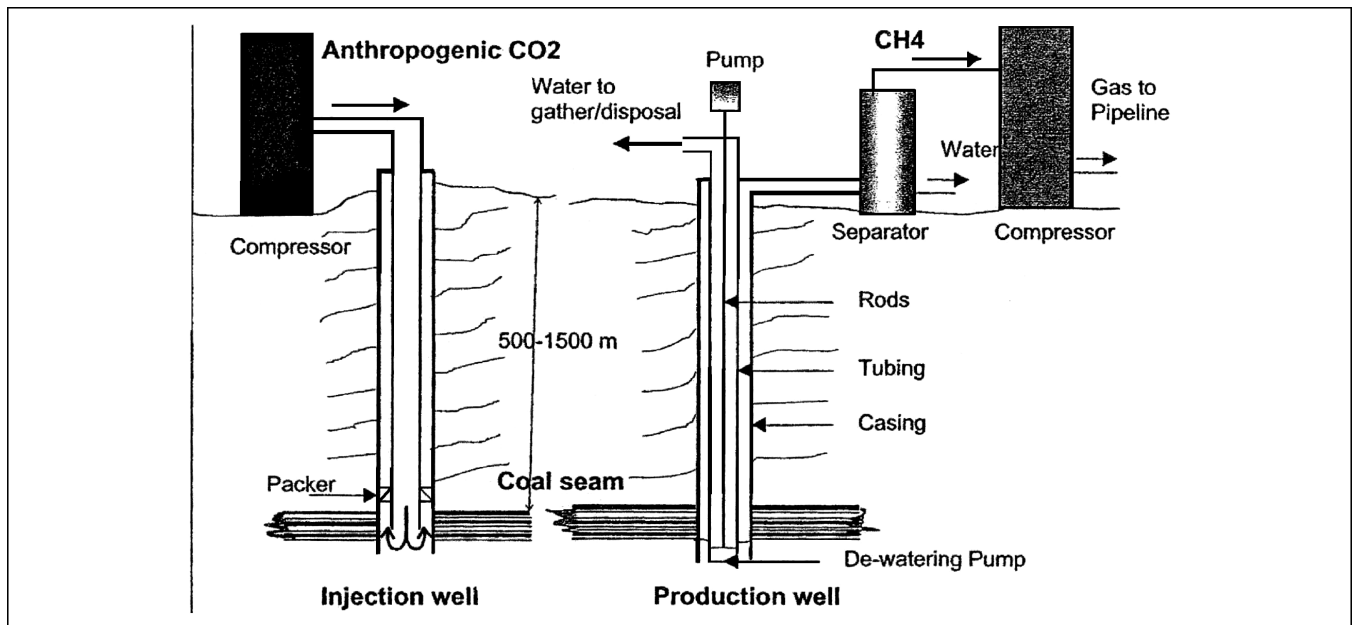

Figure 19. Surface and subsurface equipment for CO₂ injection and CH₄/H₂O production and well configuration.³⁰²

from a power plant would not require transportation over a significant distance. Figure 20 shows the major deep saline aquifers that have been characterized in the United States.³⁸ Because much of the country is underlain by saline aquifers, this option would be geographically favorable for the great majority of power plants and, thus, has

the potential to be the most widely used option for CO₂ storage.

Although the total capacity for CO₂ storage in deep saline aquifers is not well known, a 1995 estimate puts the total capacity in the United States at between 5.5 and 550 Gt of CO₂.³⁴⁶ More recent estimates on individual

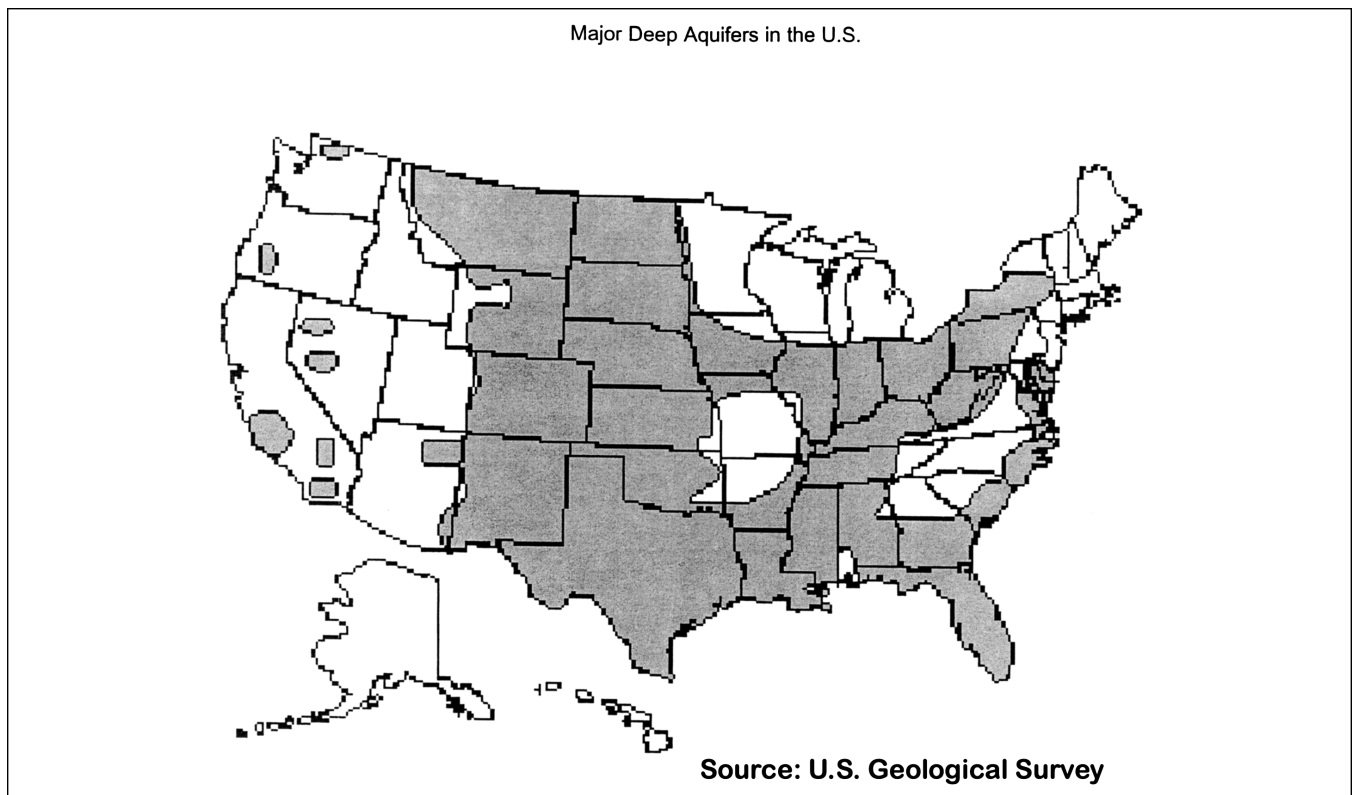

Figure 20. The geographical location of all major deep saline aquifers that have been characterized in the United States.

aquifers show that this early approximation may be too low.^{347,348} These numbers compare favorably with the annual emissions of U.S. power plants which are approximately 1.9 Gt CO₂. It is estimated that 65% of CO₂ from U.S. power plants may be directly injected without long pipeline transport. Estimates put the worldwide potential storage capacity at between 350 and 11,000 Gt,^{343,344} compared with total emissions from power production of 24 Gt. For this reason, deep saline aquifers have been considered the most promising long-term option for CO₂ sequestration.

Storage of CO₂ in Deep Saline Aquifers—Present and Near Future

The most compelling argument for the feasibility of CO₂ storage in deep saline aquifers would be a successful application on an industrial scale. Such a demonstration of success has been in operation since September 1996 in the Sleipner natural gas field in the North Sea off the coast of Norway.^{39,349,350} The natural gas harvested from this field contains up to 9% CO₂. To lower the CO₂ content to under the customer-dictated 2.5% limit, the CO₂ is captured using an amine system. To avoid a steep CO₂ emission tax imposed by the Norwegian government, the operators of the plant inject 1.1 Mt (or 0.0011 Gt) of CO₂/yr into a saline aquifer that lies 1000 m below the seabed. This project represents the first time that CO₂ has been stored underground for reasons of GHG mitigation. In this case, CO₂ separation and sequestration make economic sense because of Norway's emission tax and because the separation step is necessary to produce an acceptable natural gas product. As the world begins to implement GHG mitigation policies, projects such as this will become economically feasible on a much broader scale. Much scientific work^{39,349,350} is being done to determine the long-term behavior of the gas and the formation as CO₂ is injected. This will establish a knowledge base that will be needed as similar practices are adopted on a worldwide scale.

In addition to this large-scale project, there are several other field projects in the planning stages that aim to demonstrate and study CO₂ injection in deep saline aquifers. The Texas Bureau of Economic Geology is planning a pilot-scale CO₂ injection study on the Gulf coast of Texas.^{348,351,352} CO₂ will be injected into the Frio formation, which has ideal geological characteristics for CO₂ sequestration and is close to numerous power plants and other CO₂ emitters. This project involves extensive pre-injection modeling as well as monitoring before, during, and after injection.

Plans are also under way for the evaluation of American Electric Power's (AEP) Mountaineer Plant in New Haven, WV, as a possible site for injection of CO₂.^{353,354} The plant is a 1300 MW coal-fired power plant that is located near the Ohio–West Virginia border. Underlying

this location is the Mt. Simon sandstone saline formation, one of the largest saline aquifer formations in the United States,^{347,355} stretching from western Pennsylvania as far west as Illinois and Wisconsin. The potential storage capacity of this formation has been recently estimated at 270 Gt of CO₂, with a range between 160 and 800 Gt. Comparison with the total annual CO₂ output from U.S. power plants of 1.7 Gt illustrates the enormous potential for this aquifer formation. Mt. Simon also has a particularly advantageous location with respect to proximity to major CO₂ emission sources. Studies will determine the suitability for sequestration.

The Alberta Sedimentary Basin in Western Canada has been studied over the past decade to evaluate the geochemistry, the storage capacity, and ultimate fate of injected CO₂ in this deep aquifer formation.^{28,36,306,345,356,357} These studies present the most thorough evaluation of any aquifer for the purpose of CO₂ sequestration. The capacity of the Alberta Basin has been estimated to be approximately 18.3 Gt of CO₂.

Fate of CO₂ in a Deep Saline Aquifer

The most critical issues for sequestration in saline aquifers relate to what occurs after the CO₂ is injected. Of particular interest is an understanding of what factors affect the length of time the CO₂ will remain underground. It is important to avoid a sudden and rapid release of CO₂ to the surface. Slow releases could lead to groundwater contamination and CO₂ infiltration into homes. Therefore, it is essential that the safety and integrity of underground storage be verified before any large-scale injection takes place. A great deal of preliminary research is necessary to predict what will happen to CO₂ once it is injected. Three processes describe the ultimate fate of CO₂ sequestered in a deep saline aquifer.^{38,343} Hydrodynamic trapping keeps CO₂ an undissolved gas phase that is trapped by an overlying low-permeability caprock. The storage capacity for this mechanism is much greater at depths of ≥800 m, where CO₂ exists as a supercritical fluid with much greater density than that of the subcritical gas phase. Even above the critical point, the density of CO₂ is less than that of the formation water, so buoyancy will cause the CO₂ to rise to the top of the aquifer. The second method is solubility trapping, where the CO₂ is dissolved in the formation water. Dissolved CO₂ is not subject to buoyancy and is therefore less dependent on the integrity of a caprock. CO₂ movement through the aquifer is limited by the slow groundwater flow. The third mechanism is mineral trapping, which occurs when dissolved CO₂ reacts with either aqueous species or the mineral matrix to precipitate as a solid, most likely a calcium, iron, or magnesium carbonate. Mineral trapping results in permanent CO₂ storage that is not subject to leakage. However, premature mineral formation may clog pore throats,

decreasing the permeability and the effective storage capacity of a formation.

Hydrodynamic Trapping. In hydrodynamic trapping, the CO₂ remains in a separate gas phase from the brine and is prevented from migrating vertically to the surface by an overlying, nearly impermeable layer typically referred to as a caprock or aquitard. The pressure induced by injection causes CO₂ and brine to move away from the well. However, once the CO₂ migrates outside the radius of influence of the well, the flow will follow the natural hydrodynamic gradient. Typically, this flow is on the order of 1–10 cm/yr. Therefore, as long as the caprock integrity is not compromised over distances of a few kilometers downstream of the injection site, CO₂ should not escape for hundreds of thousands to millions of years.²⁸ Intuitively, one may imagine that a domelike structure in the formation would be required to store CO₂ for long periods of time to confine the buoyant supercritical CO₂ phase to a specific location. Because of the typically very slow regional flow, such a structure is not necessary to trap the CO₂ hydrodynamically. Some authors²⁸ have concluded that even if there is a long but unimpeded path for the CO₂ to migrate to the surface, it is possible to contain the CO₂ for geologically significant periods of time. The most important factor in determining the storage integrity is the ability of the caprock to halt vertical flow of the buoyant CO₂ phase in the vicinity of the injection point.

Solubility Trapping. Solubility trapping increases storage capacity by reducing the overburden pressure of the formation for a given amount of injected CO₂. Because dissolution leads to lowering of the aquifer pH, it also may initiate chemical reactions. The factors affecting CO₂ solubility and pH in a general sense were included in the discussion of Figure 14. In the case of a deep saline aquifer, the mineral matrix may change the situation. Most minerals are more soluble in acidic solutions. Therefore, lowering pH by CO₂ injection can cause dissolution of mineral matter. Dissolution has a buffering effect that counteracts the lower pH by consuming the H⁺ ions formed in eq 13. For example, the following reaction shows the dissolution of K-feldspar (KAlSi₃O₈), an aluminosilicate mineral commonly found in sandstone formations:

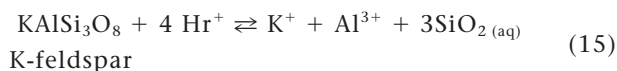

Consumption of H⁺ in eq 15 enhances the forward direction of the reaction in eq 13, leading to increased solubility of CO₂. Figure 21 shows the solubility of CO₂ in water in the presence of K-feldspar. The buffering provided by the mineral increases the capacity for dissolved CO₂.

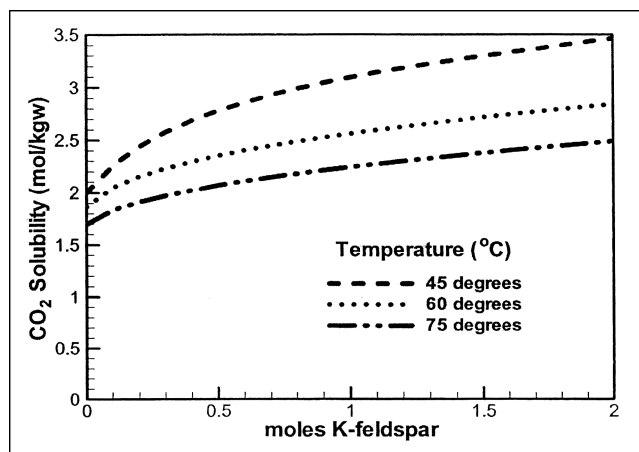
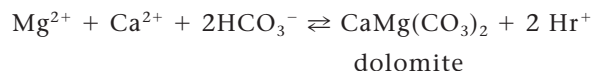
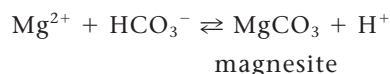
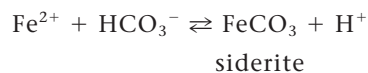
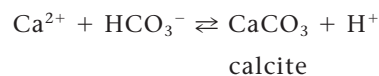

Figure 21. CO₂ solubility in water in the presence of K-feldspar as a function of K-feldspar amount at various temperatures and 25 MPa of CO₂. Modeling results were obtained using GWB.

In the case of a carbonate-minerals dominated formation (e.g., calcite, dolomite, siderite), dissolution of the mineral matrix does not increase the capacity for solubility trapping. In addition to consuming H⁺, the dissolution of carbonate minerals increases the HCO₃⁻ ion concentration. The net result is no effect on the equilibrium in eq 13.

Mineral Trapping. In addition to stabilizing the pH, dissolution of the mineral matrix may increase the aqueous concentration of cations, which can lead to secondary precipitation of carbonate minerals. This process results in mineral trapping, the most stable, long-term form of underground carbon sequestration. A few mineral trapping reactions are as follows:



All of these reactions consume doubly charged cations and release protons, thus lowering the pH. The ideal conditions for this process include a large source of doubly charged cations (Ca²⁺, Mg²⁺, Fe²⁺) and a buffer that consumes the excess H⁺ ions to keep the pH relatively high. It is not favorable for aquifers with a high initial carbonate mineral content, because they would contribute to the reverse reactions. There are several common

silicate minerals that can serve as both the cation source and pH buffer to facilitate mineral trapping, including glauconite ((K, Na)(Fe³⁺, Al, Mg)₂(Si, Al)₄O₁₀(OH)₂), illite (K_{0.6}Mg_{0.25}Al_{1.8}Al_{0.5}Si_{3.5}O₁₀(OH)₂), anorthite (CaAl₂Si₂O₈), chlorite ((Fe, Mg, Al)₆(Si, Al)₄O₁₀(OH)₈), smectite ((1/2Ca, Na)_{0.7}(Al, Mg, Fe)₄(Si, Al)₈O₂₀(OH)₄ · 7nH₂O), and several others. Both theoretical models and laboratory experiments confirm that sandstone aquifers high in Ca-, Mg-, and Fe-containing silicates and low in carbonates are the most favorable for mineral trapping of CO₂.^{358,359}

Effects of CO₂ Injection on a Saline Aquifer

One of the most important issues for injection of CO₂ into a saline aquifer is the change in permeability of the formation induced by CO₂. This may have a great impact on the rate of injection that is feasible in a given well. Because of the complexity of the chemical equilibrium in these systems as well as the great variance among individual aquifer formations, it is difficult to predict what change in permeability will be induced by CO₂ in a given aquifer. Past experiments observed both increased³⁶⁰ and decreased permeability^{361,362} as well as no change in permeability³⁶³ as a result of CO₂ flooding. CO₂ dissolution in brine leads to decreased pH, which, in turn, leads to dissolution of material that makes up the mineral matrix. This can result in the release of fine particles, which may build up in pore throats of the matrix leading to decreased permeability. Alternatively, if these released fine particles are small enough, they may be carried away in the brine flow, leading to an increase in permeability. In either of these cases, the porosity of the formation is increased by the removal of solids from the matrix.

The secondary precipitation of carbonates previously discussed in the mineral trapping section can lead to decreases in both porosity and permeability of the formation. Although this form of trapping is desirable because of its permanence, it is not desirable to have large amounts of carbonates precipitate too quickly in the vicinity of the injection well. The effective capacity of a formation can be severely limited by clogging of pore throats with newly formed precipitates. In the case of the silicate-dominated formation discussed previously, carbonate minerals cannot be formed until Ca, Mg, or Fe is liberated by the dissolution of silicates. Because silicate dissolution is generally much slower than carbonate precipitation, it is unlikely that rapid precipitation of carbonates will cause many problems in this type of formation.

Another possible impact that CO₂ sequestration could have on a formation is caused by the increased pressure of the formation induced by injection. If the pressure at the well bottom becomes too high, the reservoir rock as well as the confining caprock could be fractured. This could possibly lead to failure of the reservoir

and result in leakage of CO₂ back to the surface. For this reason, it has been suggested that the well bottom pressure must not exceed the formation pressure by more than 9–19%.³⁶⁴

Applied and Theoretical Modeling of Brine Sequestration

To predict the behavior of injected CO₂ as well as to determine such properties as the ideal conditions for CO₂ injection and the CO₂ storage capacity, several computer simulations of CO₂ sequestration in saline aquifers have been performed. These models may be divided into two categories, reservoir and geochemical models. Reservoir models focus on the physical characteristics of the aquifer and injected CO₂ to determine possible injection rates and total capacity. Several reservoir model simulations have been performed over the past decade. Although each was aimed at understanding a specific candidate location for injection, they all came to some of the same general conclusions. The most important properties that affect the rate that CO₂ may be injected are the permeability of the aquifer and the injection pressure.^{365–367} A higher rate of injection may be achieved at higher absolute injection pressures and in higher permeability formations. The requirement for high absolute pressure favors deeper formations. Because deeper formations have a higher initial pressure, a higher injection pressure is possible without risking fracture of the caprock. Deeper injection is also more practical because it reduces the risk of contamination of fresh water sources. Even though high permeability is important for rapid injection of CO₂, simulations have shown that it is possible to achieve an enhanced injection rate in a regionally low-permeability aquifer if the injection point itself is in a zone of local high permeability (referred to as a “sweet” zone).³⁶⁵ Porosity and aquifer thickness are much less important factors in determining maximum injection rates, although these factors are important to the total storage capacity of an aquifer.

Geochemical models have been more recently applied to issues of carbon sequestration in deep saline aquifers to focus on chemical reactions induced by injection of CO₂. These models use thermodynamic and kinetic information to determine how the chemical makeup of the brine and mineral matrix affect the relative importance of mineral trapping, solubility trapping, and hydrodynamic trapping in the long term. The majority of work done in this field has been specifically applied to the Alberta sedimentary basin.³⁵⁸ Although there is some disagreement as to the extent of mineral trapping that will take place, it is fairly clear what conditions will favor mineral trapping as well as solubility trapping, namely, the presence of basic minerals and an abundance of Mg,

Ca, and Fe. The main limitation to geochemical models for sequestration is the scarcity of reliable kinetic data. Reaction rates determined through laboratory experimentation often differ from underground rates by several orders of magnitude because of varying conditions that are not easily quantified (such as particle size distribution, localized ion concentrations, and the presence of other minerals). Efforts are under way to compile the kinetic data that are available in the literature into a database that may be used in a geochemical model.³⁶⁸ This will represent the most complete database of its kind, providing the most accurate results possible with the current body of knowledge.

Recent efforts have been made to combine reservoir models with geochemical models to create a more complete picture of the sequestration process. Such tools will prove to be essential in predicting both short- and long-term behavior to aid in site selection as well as engineering and design for injection operations.^{358,359}

Natural Analogs

It is difficult to accurately predict the long-term behavior of CO₂ that has been injected into a deep saline aquifer. Field and laboratory experiments that approach the time scales that are important for carbon sequestration (tens, hundreds, or even thousands of years) are not practical. Computer modeling is a very useful tool but will always be limited in accuracy by simplifying assumptions that are made about the system. To overcome these limitations, natural occurrences of deep underground storage of CO₂ have been studied. There are several such CO₂ reservoirs throughout the world that are believed to have held CO₂ trapped underground for up to millions of years. These reservoirs can provide excellent insight into the effects of long-term underground CO₂ storage. They may be viewed as deep saline aquifers that had been injected with CO₂ long ago. Natural CO₂ deposits will also prove to be important in gaining public acceptance of underground CO₂ storage because they prove that such storage can be successful over a long time period.

The most extensively studied natural CO₂ reservoirs are the McElmo Dome in southwestern Colorado^{369–371} and the Bravo Dome in northeastern New Mexico.^{372–376} These deposits had initial CO₂ contents estimated at 0.85 Tm³ and 0.28 Tm³, respectively. They were found (accidentally) during petroleum exploration. Both reserves have been used extensively over the past two decades for the production of CO₂ for EOR. Information has been recorded and recently revisited to study as natural analogs for carbon sequestration. In addition to demonstrating a suitable setting for CO₂ underground storage that has remained stable for a long period of time, these two reservoirs provide an illustration of what may happen to the

reservoir rock as well as the overlying caprock of a formation after long-term exposure to CO₂. Current studies include detailed geochemical analysis of core samples. These samples are compared with cores with similar lithology that do not contain CO₂, to determine the chemical reactions that have resulted from long-term exposure to CO₂. In the Bravo Dome, chemical reactions include the dissolution of early anhydrite (CaSO₄), dolomite (CaMg(CO₃)₂) and detrital plagioclases (sodium or calcium aluminosilicates) and the precipitation of kaolinite (Al₂Si₂O₅(OH)₄), zeolites, and gibbsite (Al(OH)₃), leading to an overall decrease in the permeability of the formation.³⁷⁴ The precipitation of these minerals was not able to be reproduced in a laboratory experiment, indicating that it is taking place over a very long time scale.³⁷⁴ In addition, monitoring experiments are performed to detect evidence of leakage from these reservoirs.

White et al.³⁷⁷ have applied a numerical model on the Farnham Dome in Utah using the CHEMTOUGH2 simulator. This model was used to “predict” the behavior of the reservoir in response to storage of CO₂ that has already occurred. The modeling results can then be compared with measurable properties to demonstrate the model’s effectiveness. This will add credibility to the model so that it may be more confidently relied on for predictions of future behavior.

The Natural Analogues for the Storage of CO₂ in the Geological Environment (NASCENT) project is currently under way to perform studies throughout Europe.^{378–380} In addition to looking into the long-term effects of CO₂ storage underground, this project examines natural CO₂ leakage to the surface to determine the associated environmental and safety impacts. The village of Mátraderecske in Hungary³⁷⁹ and France’s peri-Alpine province³⁸⁰ experience significant natural leakage of CO₂ at the surface. In both cases, local residents have developed ways to deal with potential health risks. Both regions have exploited these occurrences by creating an industry producing naturally carbonated water. In Mátraderecske, natural CO₂ leakage is used in health facilities for medical treatment of blood circulation problems. These two cases of active leakage of CO₂ to the surface are being studied to better understand the mechanisms of underground gas migration.³⁷⁸ They also serve as examples of CO₂ leakage that do not cause any serious safety concerns.

ENVIRONMENT, HEALTH, AND SAFETY ASPECTS OF CO₂ SEQUESTRATION IN COALBEDS AND DEEP SALINE AQUIFERS

Seismic Activity Caused by Injection of Fluids Underground

The possibility exists that earthquakes could be caused by injection of CO₂ into geologic formations. In fact,

anthropogenically induced seismic activity is well documented. The first known instance of anthropogenic seismicity occurred in Johannesburg, South Africa, in 1894 as a result of gold mining activities at the Witwatersrand mine.³⁸¹ Seismicity as a result of mining activities was recognized in Europe in 1908 in Bochum, Germany. Other seismic triggering phenomena have since been recognized, including seismic activity resulting from injection or extraction of gases or liquids into geological strata.³⁸² Induced seismic activity happens when an external factor is introduced to a local tectonic system that causes a mechanical failure of the rock. Failure can be the result of either increased stress that reactivates the fault or a reduction in strength via fault zone lubrication. A bibliography of articles addresses injection-induced earthquakes.³⁸³

The relationship between induced seismic activity and injection of liquids into geological strata is best illustrated by the earthquakes associated with the Rocky Mountain Arsenal, northeast of Denver. Starting in April 1962, Denver had more than 700 earthquakes.³⁸⁴ The magnitude of most of the earthquakes was small, but in April 1967, an earthquake estimated to be 5 on the Richter scale shook the Denver area.^{385,386} Evans³⁸⁴ suggested a direct relationship between seismic activity and wastewater

from chemical manufacturing operations being injected into a 3.7-km wastewater disposal well. These earthquakes started in an area with no previous seismic activity, one month after the injection program began. The clear and direct correlation between earthquake frequency and the volume of contaminated waste injected is shown in Figure 22.³⁸⁴ Wong²⁹² calculated both the epicenters and hypocenters of the Denver earthquakes that occurred between 1963 and 1965. The epicenters of most of the earthquakes are 8 km or less from the injection well. All epicenters located on the basis of data from four or more recording stations were within 11 km of the injection well. Healy et al.³⁸⁵ estimated the joint probability that a naturally occurring earthquake swarm could be so closely related to the injection well in both time and space to be 1 in 2,500,000.

Well head pressure and seismic activity were also correlated, as shown in Figure 23. The increase in seismic activity in 1967 while average pressure was decreasing indicates that it is not a simple relationship. Healy et al.³⁸⁵ showed that the cross correlation between the peak fluid pressure and the peak seismic activity is not symmetrical. The peak in seismic activity trails the peak pressure by approximately 10 days. Cessation of fluid injection causes

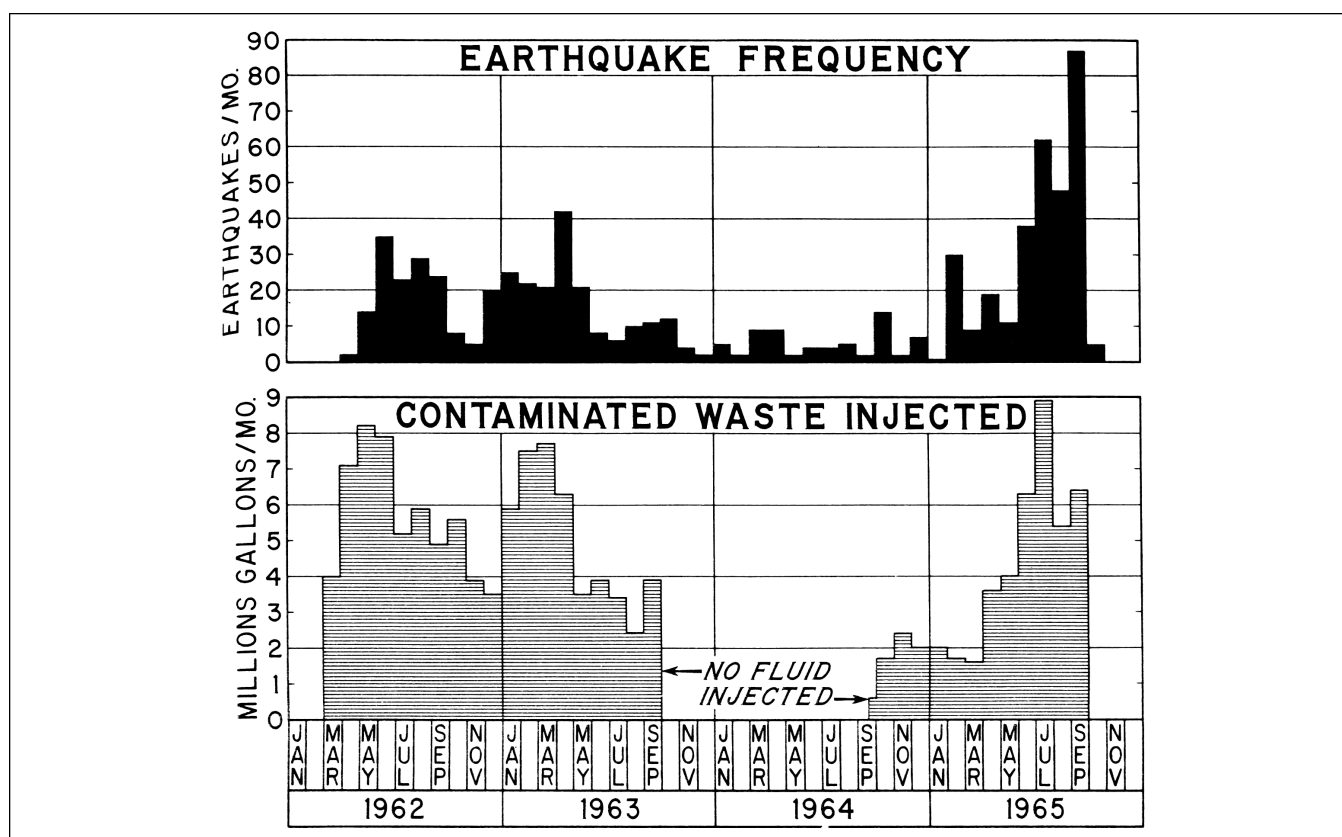

Figure 22. The relationship between earthquake frequency and the volume of contaminated waste injected at the Rocky Mountain Arsenal waste injection well. The total number of earthquakes is graphed in the top half, while the monthly volume of waste injected into the well is graphed in the bottom half. There is a clear and direct correlation between the two.³⁸⁴

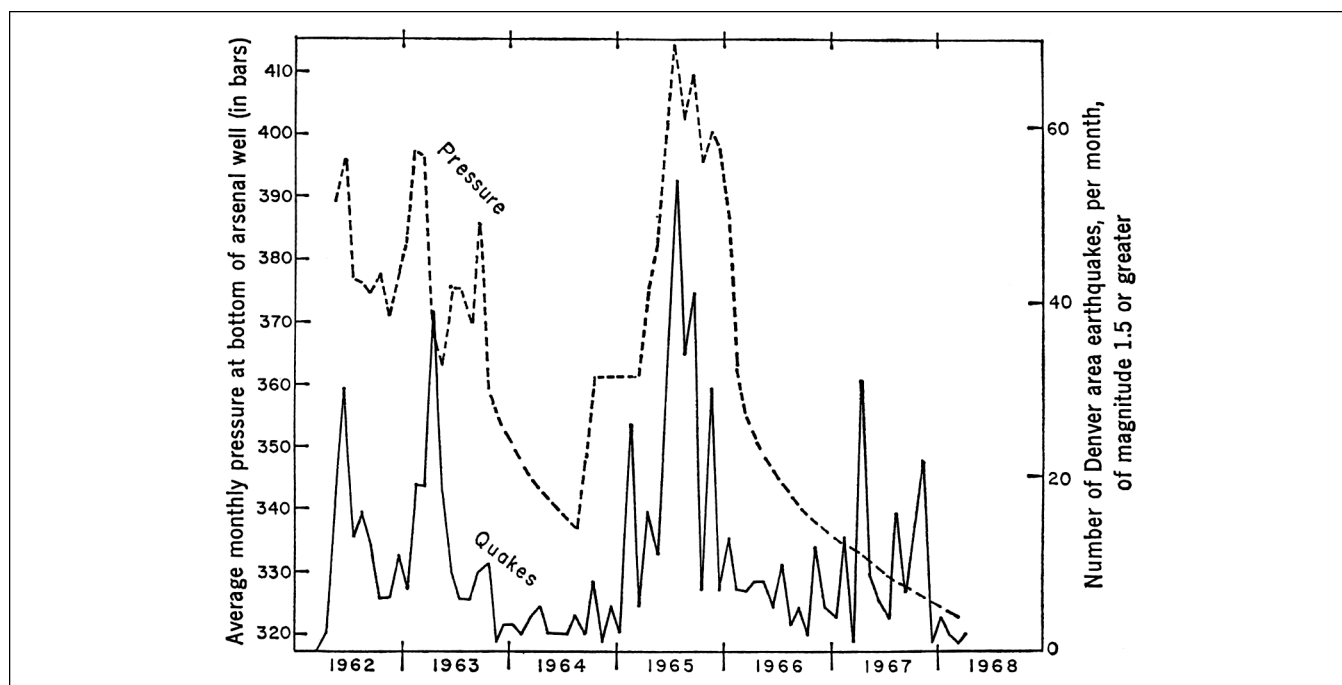

Figure 23. Correlation between fluid pressure and degree of seismic activity at the Rocky Mountain Arsenal waste injection well. The level of seismic activity from 1962 to 1967 is plotted against average monthly pressure. However, the increase in seismic activity in 1967 while average pressure was decreasing indicates that it is not a simple relationship.³⁸⁵

a swift pressure decrease adjacent to the well; however, the pressure front continues to advance away from the well for some time, resulting in continued earthquakes in those areas.³⁸⁵

Hsieh and Bredehoeft³⁸⁷ calculated the pressure buildup along the length of the reservoir and compared that with the spatial distribution of earthquake epicenters. Wellhead pressure ranged from 0 Pa (gravity flow) to approximately 7.2 MPa. Healy et al. theorized that earthquakes were the result of an increase in fluid pressure in fractures that were already present in the Precambrian bedrock reservoir.³⁸⁵ Figure 24 compares computed pressure buildup within the Precambrian reservoir with the earthquake epicenters for nine characteristic periods between 1962 and 1972.³⁸⁷ This is consistent with the Hubert-Rubey mechanism, which states that “the increase in fluid pressure serves to reduce the frictional resistance against the shear stress along a fracture plane. If the fluid pressure is increased to a point where the frictional resistance becomes less than the shear stress on the fracture plane, slippage will occur, and the result is an earthquake.”³⁸⁷

Paradox Valley earthquakes³⁸⁸ and the Rangely Oil Field earthquakes are associated with water flooding used for secondary oil recovery.³⁸⁹ Seismicity is often induced where faults intersect formations that have a hydraulic connection with injection points. Seismic activity is often focused on the component of the fault having the least hydraulic resistance. Initially, seismicity occurs adjacent to the point of injection and responds to changes in

injection pressure and injection rate. As injection continues, the “zone of influence” becomes greater and the magnitude of seismic events increases. The response to changes in wellhead pressure slows and becomes more subtle. Seismic activity adjacent to the injection point often ceases immediately when injection stops; however, seismicity more distant from the injection point continues for some time after.³⁸² Deep injection wells have triggered seismic events in strata several kilometers below the injection point.³⁹⁰ Conjecture that an injection well is safe at a depth of 1000 m because previous seismic events at a potential sequestration site have occurred at a much deeper location should be very carefully analyzed before proceeding.

A Conceptual Model of Induced Seismic Activity

Figure 25 depicts a conceptual model of phenomena associated with inducing seismicity through underground injection wells.³⁹⁰ The fluid within a fault becomes pressurized and assumes the stresses associated with the overlying strata and water. The frictional resistance along the fault decreases (the fluid lubricates the fault) and the fault blocks slip, resulting in an earthquake. Sminchak et al. outline additional phenomena that can be associated with triggering seismic events such as “transfer of stress to a weaker fault, hydraulic fracture, contraction of rocks due to the extraction of fluids, subsidence due to the saturation of a rock formation, mineral precipitation along a fault, and density-driven stress loading.”³⁹⁰

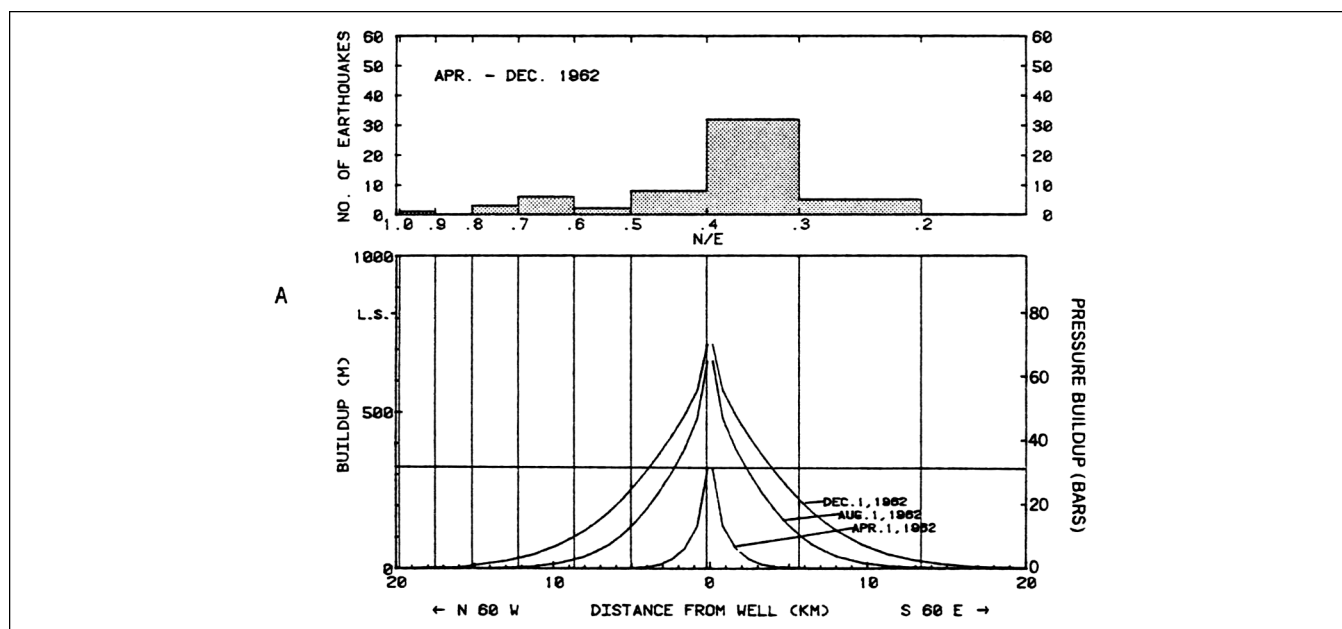

Figure 24. The comparison between computed pressure buildup within the Precambrian reservoir at the Rocky Mountain arsenal waste injection well with the earthquake epicenters for nine characteristic periods between 1962 and 1972. The top graph gives the distribution of earthquakes for a period, while the bottom graph shows the calculated reservoir pressure increase along the reservoir axis. Earthquake activity stopped by the end of 1972. Therefore, the pressure above which earthquakes will occur, known as the triggering pressure, must have dropped below this value across the reservoir. The maximum pressure buildup during January 1973 was estimated to be 3.2 MPa. The horizontal line drawn at 3.2 MPa shows that earthquakes are confined to those portions of the reservoir that are above the triggering value.³⁸⁷

Both the principal and confining pressures are reduced as a result of deep well injection, while the differential pressure remains constant, causing the system to fail.³⁹⁰ The injection pressure decreases the effective confining pressure as well as the axial strength of a geological formation by counteracting them, resulting in a fracture or faulting of the system. The confining pressure and principle pressure of a geological formation can be both measured and estimated, allowing one to predict if a seismic event will be triggered based on various injection pressures. The injection pressure required to force CO₂ into a formation is a function of the rocks' permeability and porosity. Both of these parameters can also be measured. Thus, it is possible to estimate the seismic potential of a given deep saline aquifer injection well.

The liability associated with induced seismic activity can be huge.³⁹¹ The potential for litigation will result in private concerns performing geological sequestration to be reluctant to release data associated with the injection well, such as volume of CO₂ injected and well head pressure. Thus, these and related data must be required by law. Each sequestration site will need to be completely instrumented to detect seismic activity and to locate epicenters and hypocenters.

Existing Regulations Governing Deep Well Injection

Industry has experience in the injection of wastes into deep saline aquifers dating back to the 1930s, when

depleted oil reservoirs were first used for the disposal of brines and other liquid wastes.³⁹² By the mid-1970s, waste disposal wells were subject to U.S. Environmental Protection Agency (EPA) regulations as part of the Safe Drinking Water Act (SDWA) to protect potential underground sources of drinking water (USDWs). EPA established the Underground Injection Control (UIC) program, which regulates all underground fluid disposal and defines five classes of injection wells. Injection into a deep saline aquifer falls under Class I, which is defined as injection beneath the lowermost formation with potential to be a USDW. Table 12 summarizes monitoring requirements for a Class I underground injection well.³⁹⁰ This class represents the deepest and most strictly regulated injection wells and is the only class for which injection of hazardous materials are permitted. Regulations require initial detailed characterization of the formation. There must be a thick, impermeable caprock between the formation and the nearest USDW, and the region must not be seismically active. There are also strict standards on the construction of Class I wells and injection pressures. Injection pressure must be monitored 24 hr/day during injection to detect any problems with the well casing. In addition, there are numerous other tests required to ensure that contamination of a USDW does not occur.

Each state may choose to enforce more strict requirements than that required by EPA on underground waste disposal. Currently, 35 states have been granted primary

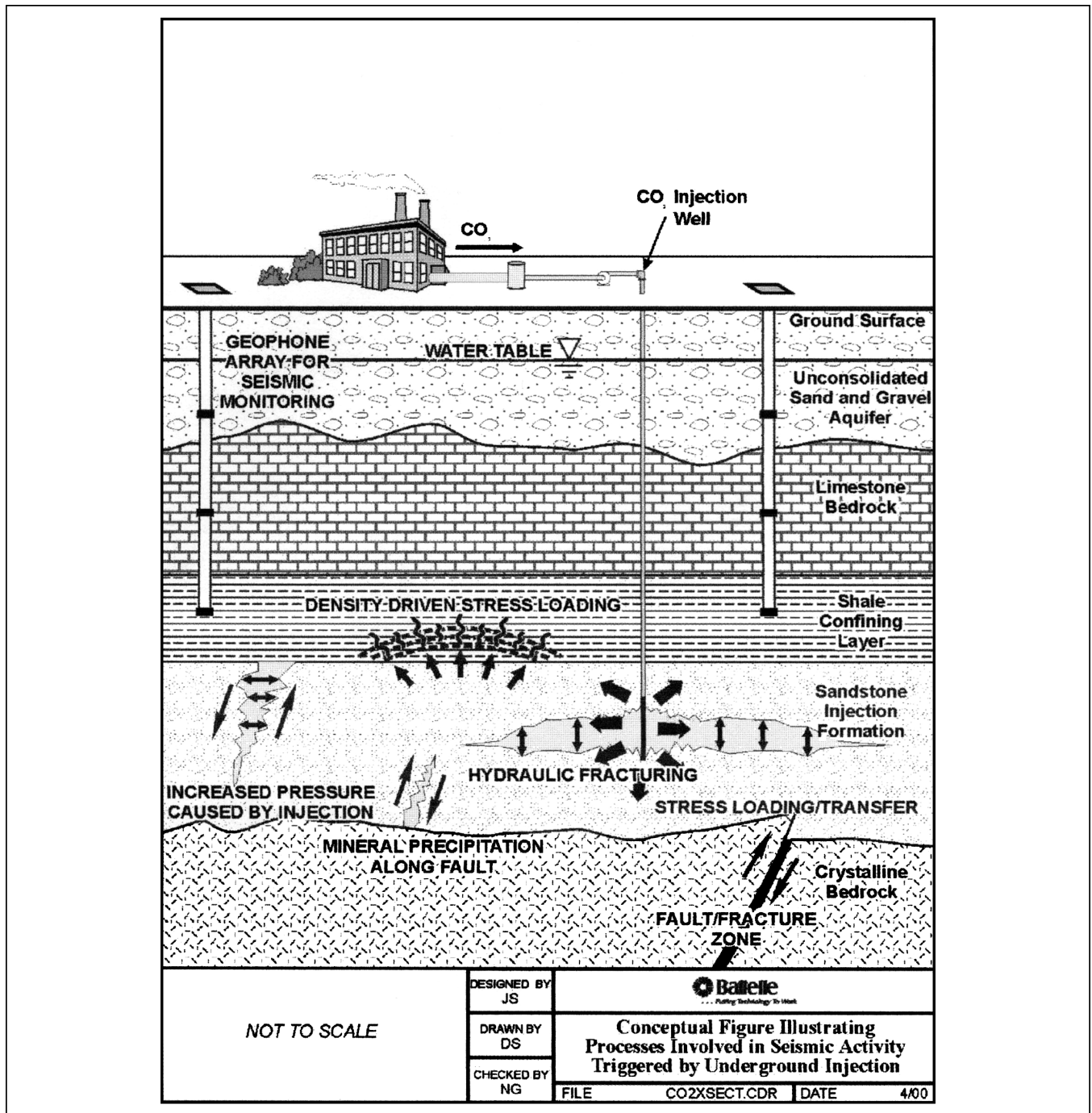

Figure 25. A conceptual model of phenomena associated with inducing seismicity through underground injection wells.³⁹⁰

responsibility for the UIC program with regards to Class I injection wells. There are 272 active Class I injection facilities in the United States consisting of 529 individual wells scattered throughout 19 states. Of these, 163 are approved for the disposal of hazardous waste. CO₂ is not considered a hazardous waste and, therefore, poses a lower risk to public health than other chemicals injected into deep aquifers. Because of the unusually large volume of CO₂ and the unique physical and chemical properties of CO₂, "significant modifications of the UIC framework would be necessary."³⁴³ Tsang et al. have recently compared

and contrasted the issues associated with deep well injection of both hazardous waste and CO₂. Specific components of new regulations for CO₂ sequestration should include site selection based upon integrity of the confining layers, the possibility of degradation of the confining layers by reaction with CO₂, and the presence of a comprehensive monitoring plan for CO₂ leak detection.³⁹³

The current U.S. Code of Federal Regulations (CFR) contains two sections that are pertinent to seismic activity: 40CFR146.13: "Except during stimulation, injection pressure at the wellhead shall not exceed a maximum

Table 12. Typical monitoring requirements for a Class I underground injection facility.³⁹⁰

Parameter	Monitoring Requirements	Reporting Requirements
Injection pressure	Continuous	Monthly
Bottomhole pressure		Monthly
Annulus pressure	Continuous	Monthly
Interannulus pressure	Continuous	Monthly
Temperature	Continuous	Monthly
Flow rate	Continuous	Monthly
Specific gravity	Weekly	Monthly
pH	Weekly	Monthly
Composition of injectate	Every 6 months	Monthly
Cumulative volume	Daily	Monthly
Annulus sight glass level	Daily	Monthly
Groundwater monitoring	Quarterly	Quarterly
Seismic monitoring (if required)	Continuous	Monthly

which shall be calculated so as to assure that the pressure in the injection zone does not initiate new fractures or propagate existing fractures in the injection zone. In no case shall injection pressure initiate new fractures or propagate existing fractures in the injection zone. In no case shall injection pressure initiate fractures in the confining zone or cause the movement of injection or formation fluids into an underground source of drinking water.”

40CFR146.68: “The Director may require seismicity monitoring when he has reason to believe that the injection activity may have the capacity to cause seismic disturbances.”

The presence of pre-existing faults is determined by a variety of geophysical tools: “(1) 2-D or 3-D seismic surveys; (2) Core sample collection from major units during drilling; (3) Down-hole caliper logging to detect fractures and lithographic changes; (4) Down-hole resistivity logging to detect fractures and lithographic changes; (5) Down-hole spontaneous potential logs; (6) Down-hole γ ray logging to detect formation changes; (7) Down-hole density testing; (8) Fracture finder logs to detect fractures; (9) Compression tests on formation samples to determine rock strength; (10) Geochemical tests on formation samples (porosity, density, permeability); (11) Compatibility test of injection fluids with formation unit and confining unit; (12) Pressure fall-off/shut-in tests; (13) Radioactive tracer survey.”³⁹⁰

The regulations require seismic monitoring at the EPA Director’s discretion. The seismic activity at a site should be monitored well before any injection starts to obtain a baseline snapshot of prevailing conditions. A network of underground sensors should be used at the site, including tools to monitor changes in elevation caused by expansion, movement of fault blocks or subsidence,

and tiltmeters to detect varying fracture orientation. Information from this wide array of geophysical tools and from the testing described previously should be combined with reservoir models to estimate the potential of deep well injection to induce seismic activity. Simulation can be employed to estimate when and where the triggering pressure is reached in a formation and provide estimates of the rock strength, formation pressure, and other properties.³⁹⁰

The density of CO₂ varies from approximately 0.6 g/cc at the critical point to approximately 1 g/cc at very high pressures; see Figure 11. The density of saline formations ranges from approximately 1 to 1.2 g/cc. The solubility of CO₂ in saline solutions at high temperatures is approximately 50 g of CO₂ per kg of formation water.³⁹⁴ The solubility of CO₂ in pure water and brine at various temperatures and pressures is given in Figure 13. Thus, we expect that most of the CO₂ injected into a deep saline aquifer will remain as a dense gas resulting in a two-phase system of CO₂ gas and liquid carbonated saline solution. Because of the large difference in density between supercritical CO₂ and brines, it is expected that the lighter CO₂ will migrate to the top of the formation where it encounters a confining cap rock. The upward forces exerted on the cap rock could weaken it or “transfer stress to overlying faults.”³⁹⁰ Davis and Pennington identified stress transfer as a potential cause of induced seismicity at a deep injection well in Cogdell, TX.³⁹⁵

Aqueous solutions containing dissolved CO₂ under high pressure can be quite acidic, reaching pH values around 3. The pH of aqueous solutions of CO₂ at various temperatures and pressures for pure water and brine is given in Figure 14. At these acidities, many common minerals can dissolve or precipitate from solution, altering the mineralogical properties of formation rocks, weakening the formation, and increasing the potential for hydraulic fracturing. Minerals precipitated along a fault can be dissolved in the newly acidified carbonated brine weakening the fault. Other minerals can precipitate under the acidic conditions, decreasing formation porosity and permeability, causing an unexpected rise in injection pressure and increased seismic potential.^{390,396}

Sminchak et al. estimated the size of the “zone of influence” associated with a deep injection well, where 0.2 Gt of CO₂ are injected into a formation 20 m thick, with a porosity of 15% and a storage efficiency of 6%, to be approximately 22 km. No faults or fractures are allowed within this zone.³⁹⁰

Despite these potential problems, as the results from Sleipner show in the next section, storage of CO₂ in deep saline aquifers is “technically feasible with very little environmental downside.” “Underground storage offers a safe, verifiable, technologically feasible, and ultimately

affordable option" to the stabilization of the atmospheric CO₂ concentration.³⁹⁷ Millions of tons of CO₂ have been injected into the Utsira Formation at Sleipner with no reported seismic activity. Further, according to Dr. Andrew Chadwick, Principal Geophysicist at the British Geological Survey, "The Utsira Sand is by no means an unusual geological formation in terms of its storage potential."³⁹⁷

Environmental Aspects of Geological Sequestration

The primary environment, health, and safety (EH&S) concern associated with geological sequestration of CO₂ is the possibility of release of CO₂ to the surface through either a fast catastrophic leak or a slow intermittent leak. In high concentrations, CO₂ is an asphyxiant; however, it is nonflammable, nonexplosive, noncarcinogenic, and relatively nontoxic in low concentrations.

Breathing atmospheres containing 10% CO₂ and higher can cause unconsciousness and death from O₂ deficiency. Atmospheric concentrations of 5% can cause shortness of breath and headache. Continuous exposure to atmospheres containing 1.5% CO₂ can result in physiological changes.³⁹⁸ Outdoor atmospheric concentrations of CO₂ generally range from 300 to 700 ppm. Breathing higher concentrations can cause increased respiratory rate, headache, sleepiness, dizziness, lassitude, narcosis, and dyspnea. Fortunately, the symptoms caused by exposure to increased concentrations of CO₂ are reversible. The current U.S. Occupational Safety and Health Administration (OSHA) standard for maximum exposure to CO₂ is 5000 ppm as an 8-hr time-weighted average (TWA) concentration.

The Need for Supercritical Injection into Geological Formations. Bachu³⁴⁷ cautions that injection of CO₂ as a liquid near the CO₂ phase boundary can result in a change to the gas phase if the CO₂ migrates to shallower units. The CO₂ phase diagram is illustrated in Figure 10. "In the absence of stratigraphic or structural traps, gas buoyancy will lead to rapid CO₂ rise or flow through the sedimentary column and escape to the surface."³⁴¹ Thus, the depth and temperature of the host geological formation should be sufficient to provide a temperature and pressure well above the critical point, 304.3 K and 7.4 MPa. In general, these temperature and pressure conditions are met at approximately 800 m depth.

Brine Displacement into Overlying Aquifers. It is possible that during sequestration of CO₂ in a deep saline aquifer, brine could be displaced into overlying fresh water aquifers, resulting in contamination of fresh water. Constant monitoring of the salinity of overlying fresh water aquifers should be performed with emphasis on analysis of

ions that are present in the brine in high concentrations but absent or of relatively low concentration in the fresh water aquifer.

Hydrodynamic Flow. Water flow through a coal seam can result in reaction with and dissolution of CO₂ into the water. The dissolved CO₂ and the reaction products, CO₃²⁻, HCO₃⁻, and H₂CO₃, can be transported from the coal seam in the flowing water and move into lower pressure areas where the CO₂ is exsolved from the water and released as a gas, which can then migrate to the surface. Injection of CO₂ into a coalbed is expected to "affect the pressure, flow regime and salinity of the formation waters."³⁴¹

Mobilization of Trace Metals, Metalloids, and Radionuclides. Jaffe and Wang have shown that if leaking CO₂ reaches shallow drinking water aquifers, it could result in harmful effects on water quality by dissolution of trace metals, metalloids, and some radionuclides.^{399,400} Using a series of numerical simulations and a series of CO₂ release scenarios and different aquifer geochemical properties, they evaluated the effects of CO₂-induced pH changes on trace metal solubilization. The results indicate that elevated CO₂ levels in groundwater can amplify the solubilization of trace metals to the point that undesirable concentrations are reached. The authors focus on the concentration of Pb in drinking water, with galena as its source. These deleterious effects of CO₂ on groundwater decrease in aquifers with a large buffering capacity or high alkalinity.

Environmental Aspects of ECBM

CH₄ leaks naturally from coalbeds along faults and fractures, resulting in a significant source of atmospheric CH₄.^{401,402} CH₄ fluxes along a fault in the Black Warrior Basin coal field have been measured at 1000 kg/yr⁴⁰¹ and 13 × 10⁶ kg/yr along a San Juan Basin creek bed.⁴⁰² Soil CH₄ concentrations of 6000 ppm at 2 m depth have been reported in Polish coal mining areas. If CH₄ can reach the surface from a coalbed, then CO₂ can also reach the surface. CH₄ is a colorless, odorless, flammable, and explosive gas. When injecting CO₂ during CO₂-ECBM/sequestration, it is very important not to exceed the fracture pressure of the cap rock. Fracturing the cap rock could provide an escape route for the CO₂ and the CH₄.

Thousands of CBM recovery wells are operating in the San Juan Basin in both New Mexico and Colorado, the Black Warrior Basin in Alabama, and the Powder River Basin in Wyoming. The EH&S problems associated with CBM recovery could be heightened during CO₂-ECBM/sequestration. EH&S problems occur in large part because recovery of CH₄ from coalbeds often requires dewatering the seam. The water in the seam is pumped out. The

process is called dewatering, and it lowers the water pressure in the seam by removing water from the cleat system in the coalbed. This allows CH₄ in the coal matrix to migrate into the cleat system and then flow from areas of high pressure to those of lower pressure at the recovery well. Dewatering of a coal seam requires pumping out millions of liters of water. This results in changes in underground water pressure across large areas, permitting the previously sorbed gases to migrate through faults, fissures, and microfissures and into water wells, homes, and through the Earth's surface. Old abandoned wells of various types can become conduits for gas migration to the surface.

Produced Water. Huge amounts of water are produced during CBM and ECBM production. Produced water is a brine containing substantial amounts of Na⁺, Cl⁻, HCO₃⁻, and other dissolved solids and organics. The amount of water produced and the contaminants in it vary from seam to seam and from well to well. "On average, for wells in the USA, coalbed CH₄ produces approximately 1.74 cm³ of water per m³ of gas."⁴⁰³ The age of the seam and its depth impact the amount of water produced during CBM recovery. The lower the permeability, the less water produced. In general, water production is greatest during the initial stages of CH₄ production and subsequently decreases at a constant rate. Coalbed gas wells often have a distinctive CH₄ and water production history, as given in Figure 26.⁴⁰⁴

The total dissolved solids associated with produced water from CBM wells range from 200 to 90,000 mg/L, with values typically less than 30,000 mg/L.^{405,406} Their pH generally ranges between 7 and 8. Typical anions include CO₃²⁻, HCO₃⁻, Cl⁻, and SO₄²⁻, and cations include Na⁺, K⁺, Ca²⁺, and Mg²⁺ in amounts that vary considerably. Representative concentration values of common constituents in produced water from both CBM and conventional natural gas wells are printed in Table 13.⁴⁰³

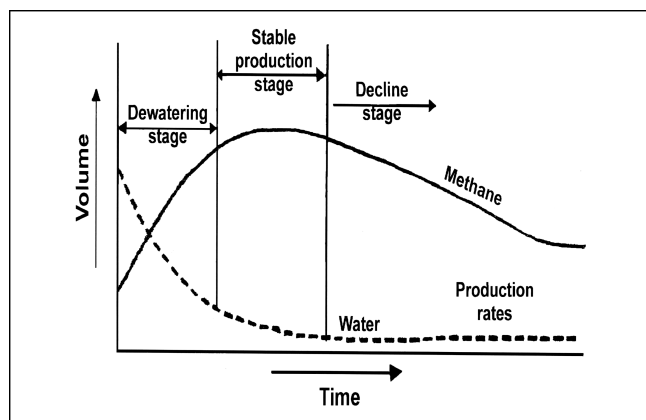

Figure 26. Generalized production history showing the volume of both water and CH₄ as a function of time for a typical coalbed gas well.⁴⁰⁴

Table 13. Some water compositions for produced water from coalbed methane and conventional natural gas extraction in the U.S.⁴⁰³

Parameter	Coalbed Methane	Natural Gas
pH	7.8	7
Major components (mg/L)		
Total dissolved solids (TDS)	4000	20,000–100,000
Total suspended solids (TSS)		1
Cl ⁻	2000	11,000
SO ₄ ²⁻	12.9	0–400
HCO ₃ ⁻	597	
CO ₃ ²⁻	0.008	
F ⁻	2.6	
NO ₃ ⁻	3	
Fe	10	
Ca	89	
Na	1906	
K	7.5	
Trace elements and hydrocarbons (µg/L)		
Ag	1.1	10–70
Al	40	
As		30
Ba	2780	10–100
Cd	5	30
Cr	3	20–230
Cu	5.6	0–100
Hg	0.13	1
Li	92	
Mn	250	
Ni	29	100
Pb	55	100–170
Sb	30	70
Se	25	60
Sr	4000	
Tl		90
V	5	
Zn	109	40–200
Oil/grease		3000–25,000
Phenol		0–2000
Benzene		1000–4000
Methylbenzene (toluene)		0.2–12.3
Dimethylbenzene (xylene)		500
Ethylbenzene		0–300
Naphthalene		30–900

MONITORING AND VERIFICATION OF GEOLOGICALLY SEQUESTERED CO₂ LEAKAGE

There is considerable industry experience in monitoring underground gases associated with EOR as well as underground gas storage reservoirs. However, monitoring for carbon sequestration will be required on a much longer time scale than required previously. It is expected that

monitoring systems will need to be in place for more than 1000 yr after CO₂ injection takes place.³⁴²

Monitoring of geologically sequestered CO₂, quantification of the amount of CO₂ sequestered, and validating that it remains in the formation will require the simultaneous application of a wide variety of techniques, including geophysical methods and the use of chemical tracers combined with reservoir simulation. Knowledge gained from monitoring underground CH₄ gas storage and EOR provides a model for monitoring the integrity of geologically sequestered CO₂. Irrespective of the care taken in selecting the most appropriate geological formation for sequestration, the third law of thermodynamics demands that all of the CO₂ will not reside permanently in the sequestration formation. Entropy is working against CO₂ remaining in the host geologic formation. Techniques that determine when and how much CO₂ migrates from one place to another must be developed and their veracity proven. Tools that measure the rate of migration of CO₂ and CH₄ from one formation to another and the rate of CO₂ leakage to the surface are needed. One must be able to differentiate between CO₂ leaking to the surface from an underground storage formation and CO₂ reaching the surface as a result of the decay of subsurface plant debris. One must be able to distinguish between CH₄ from coal reaching the surface and CH₄ produced from methanogenic bacteria in the soil. It is possible to use ¹³C isotope ratio mass spectrometry to distinguish between these sources.

Monitoring has the potential to prevent catastrophes, protect public health and safety, and significantly reduce risks associated with geologic sequestration of CO₂. Monitoring can provide an early warning for CO₂ invasion into homes or into valleys where CO₂ may collect at ground level, giving rise to O₂-depleted breathing zones. If leaks are detected, depending upon the leak rate and location, the sequestration site can be abandoned and the CO₂ safely vented, eliminating risks associated with the leak.

Figure 27 depicts some possible escape paths for CO₂ sequestered in a geological formation.³⁴³ The buoyancy of CO₂ gas relative to brine, the variable characteristics of the cap rock that acts as a barrier to upward migration, and the pressure gradients from injection are factors that combine to increase the likelihood of leakage. Leaks that reach the surface could be localized or dispersed. Bruant et al. have stated that "catastrophic releases are unlikely for CO₂ injected into deep saline aquifers and probably would occur only as a result of a 'blowout' of an injection well or existing well in the vicinity, or a seismic disturbance. Risks can be minimized through proper design, operation and monitoring of the injection process, detailed cataloging of locations and use history of existing

Potential pathways for CO₂ leakage from deep saline aquifers

Localized vertical migration may be driven by large pressure gradients near the injection well. Lateral migration occurs as CO₂ moves around the edges of the confining layers. Significant seepage may occur through natural and induced fractures and faults in the confining layers and through existing wells.

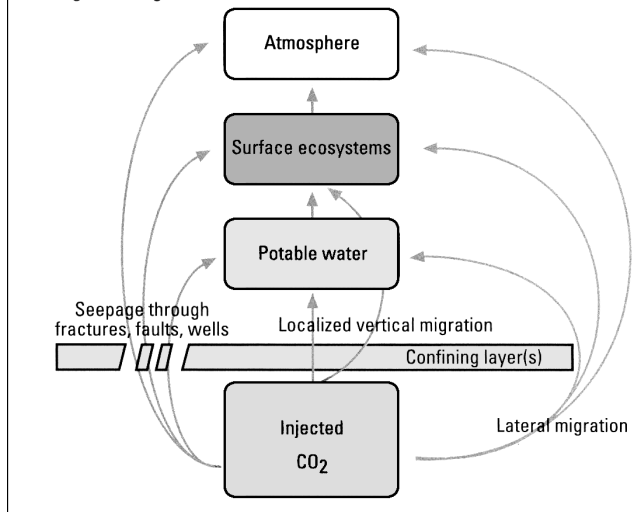

Figure 27. Some possible escape paths for CO₂ sequestered in a geological formation. The buoyancy of CO₂ gas relative to brine, the variable characteristics of the cap rock that acts as a barrier to upward migration, and the pressure gradients resulting from injection are factors that combine to increase the likelihood of leakage.³⁴³

wells in the injection vicinity, and avoiding of seismically active areas."³⁴³

Monitoring of geologically sequestered CO₂ will be required to protect the environment as well as the public health and safety before the technology is widely applied. Sequestration of CO₂ in coalbeds and other geological formations must first be proven to be safe and secure for long time periods. The amount of injected gas must be known and well documented. Underground movement of injected gas from the injection point must be monitored. Monitoring will be required to satisfy expected regulations and to minimize uncertainties associated with the long-term safety and security of the process.³⁴² Careful design of the monitoring program can produce information concerning the leak rate to the surface and identify points at the surface where the flux of CO₂ is highest. It can also produce information concerning storage capacity of a reservoir over time, residence time of CO₂ within the reservoir, and subsurface migration of CO₂; further, it can identify CO₂ leakage pathways and potential pathways as well as monitor movement of the CO₂ front. Monitoring results can also provide information to validate numerical reservoir models. A monitoring program includes the simultaneous application and integration of results from a variety of technologies, including geochemical methods such as tracers, measurement of the

CO₂ flux in soil gas, geophysical methods such as 4-D seismic, and electrical methods combined with the use of advanced geologic models, flow simulators, and forward seismic models. Each technique yields different and unique but complementary information that when integrated provides a more complete picture than is possible from any single technique.

How Much Leakage Is Acceptable?

CO₂ leakage has been included in mitigation models to determine whether underground sequestration of CO₂ can still be beneficial under imperfect storage conditions.^{407–412} Several studies of the implications and impacts of leakage of CO₂ from geological formations have recently been reported.^{408,409,411} Pacala performed calculations that assume a fossil fuel consumption rate that would result in an atmospheric concentration of 750 ppm. He then calculated the sequestration and leak rates that would reduce the atmospheric concentrations to 450 and 550 ppm. “In some cases, the reduction from 750 to 450 ppm would be possible even with a mean (leak) rate of 1%/yr or more. The results imply that economic considerations or local risks are likely to constrain allowable leakage rates more tightly than impacts of leakage on global atmospheric CO₂.”^{407–412}

Hepple and Benson⁴⁰⁹ attempted to answer two questions: How much CO₂ might be stored underground and for how long? What would be an acceptable surface leakage rate? They estimated the annual amounts of CO₂ that must be sequestered to meet CO₂ atmospheric stabilization targets of 350, 450, 550, 650, and 750 ppmv as described by Wigley et al.⁴¹³ using six different emission scenarios described in the IPCC’s Special Report on Emission

Scenarios.⁴¹⁴ “With few exceptions, seepage rates of 1%/yr were unacceptably high. For stabilization at 350, 450 and 550 ppmv, seepage rates must be less than 0.01%/yr to be acceptable for all scenarios.” The authors propose that a leak rate of 0.01%/yr be established as a performance requirement for geologically sequestered CO₂.

Dooley and Wise⁴¹¹ evaluated the consequences of leakage rates of 1% and 0.1% over a century and concluded that even a leakage rate of 1%/yr makes atmospheric stabilization of CO₂ much more expensive and more difficult to reach. They use the IPCC’s Special Report on Emission Scenarios Case B2 as the reference case. In this case, modest economic growth is included with continued increases in fossil fuel utilization as well as significant use of renewable energy sources. This scenario is used against atmospheric CO₂ stabilization control regimes described by Wigley et al. of 450, 550, and 650 ppmv (denoted as WRE 450, WRE 550, and WRE 650).^{413,415} The results of the calculations are shown in Figure 28.⁴¹¹ A leak rate of 1%/yr was arbitrarily used in the calculations. These results were then compared with a scenario where the leakage rate is reduced to 0.1%/yr after 2035 as a result of future technological advancements. “With a hypothetical leakage rate of 0.1%/yr after 2035, the incremental impact on required net annual carbon emissions reductions does not appear substantial. However, a 1%/yr leakage rate would have an enormous impact on emission targets. With a 1% leakage rate, net annual carbon emissions would have to be *negative* by the last half of the century,” as shown in Figure 28, to meet the WRE 450 target.⁴¹¹

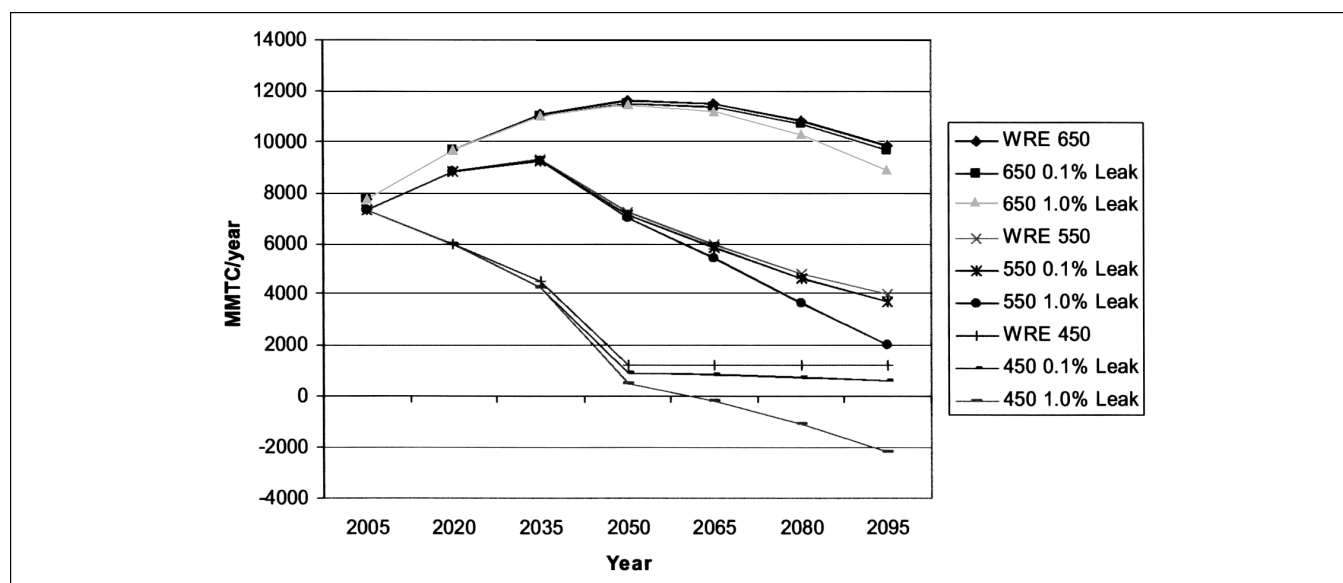

Figure 28. Net allowable annual CO₂ emissions with leakage from geological sequestration sites. With a 1% leakage rate, net annual carbon emissions would have to be negative by the last half of the century to meet the WRE 450 target.⁴¹¹

These studies are not in total agreement. Nevertheless, all agree that the acceptable leak rate will be low. Until the discrepancies in the previously estimated acceptable leak rates are reconciled, we propose using an acceptable leak rate of 0.1% as the performance standard required for geologically sequestered CO₂. The 0.1% leak rate could be very difficult to meet in all cases. Nevertheless, results from modeling as well as natural analog studies indicate that leakage rates of less than 0.01% are attainable.⁴⁰⁹ The U.S. Department of Energy (DOE) has set a goal for global seepage of less than 0.01%/yr by 2012.

Having a 0.1% or lower performance standard assumes that one can measure an annual leak rate of <0.1%. To our knowledge, the monitoring techniques required to do this are not well documented or proven. Substantial research and development will be needed to be able to reliably, accurately, and precisely measure annual CO₂ leakage rates of 0.1% and less.

Herzog et al.⁴¹⁶ takes a completely different approach to assessing what may be an acceptable leak rate from geologically sequestered CO₂ reservoirs. In their analysis, two things are of major importance and affect what may be an acceptable leak rate, the discount rate (a monetary interest rate) and the future cost of emitting CO₂ to the atmosphere (referred to as the future carbon price). They present a technique that quantifies the effectiveness of carbon mitigation options that takes “into account the ‘permanence’ of the emissions reductions.” They value temporary storage as an economic problem having explicitly related assumptions, such as the future carbon price and the discount rate. To explain the approach, they calculate the “sequestration effectiveness” of deep ocean sequestration of CO₂. Sequestration effectiveness is defined as “the ratio of the benefit gained from temporary storage to the benefit gained if the storage was permanent.” The authors claim the approach is valid for assessing the benefits of sequestration in any nonpermanent reservoir, not just the ocean. They conclude “that the value of relatively deep ocean sequestration is nearly equivalent to permanent sequestration if marginal damages (i.e., carbon prices) remain constant or there is a backstop technology that caps the abatement cost in the not to distant future. There is little value to temporary storage if carbon prices rise at or are near the discount rate.”⁴¹⁶

Ha-Duong⁴¹⁷ also assessed what may be an acceptable leak rate using an economic assessment that employs a cost-efficiency microeconomic model followed by a “global cost-benefit integrated assessment model” to evaluate acceptable leak rates. According to the author, economic analysis provides a numeric anchor that can be employed to evaluate acceptable CO₂ leak rates on a case-by-case basis. His approach links the acceptable leak rate

to a monetary interest rate, the discount rate. “The simplest interpretation of our results is that leakage rates one order of magnitude below the discount rate are negligible. In line with previous findings from the literature reviewed, sequestration with residence times greater than a thousand years is good enough.” The author goes on to say that with a discount rate of between 1 and 4%, a 1% annual leak rate is “not overwhelming.” It should be noted that this last statement is not in concert with the first, namely, a 1–4% discount rate would mean that an acceptable leak rate is no more than 0.4%.

Lessons from Storage of Natural Gas

Valuable insight into leakage from CO₂ storage reservoirs can be gained by studying leakage from underground storage of natural gas. Anderson and Vogh⁴¹⁸ described the underground storage of CH₄ by 87 companies in 229 active reservoirs in the United States. Most were in depleted gas fields, some were in aquifers and depleted oil fields, and the fewest group of nine were in salt caverns. Thirty-seven of the companies reported some loss of CH₄. In most cases, the loss was minor, while in four cases, the loss was massive and uncontrollable. Some operators reported loss caused by earthquake damage. The minor losses occurred through faulty well casing or cementing, loss to the surface, and migration to other reservoirs. Interestingly, “Aquifers experienced a significantly higher incidence of serious gas loss than the other reservoir types.”^{418–420} Based upon these observations, CO₂ leaks out of the host geological formation can be expected.

Pressure Monitoring and Other Methods

The simplest monitoring technique consists of measuring the pressure. When no additional CO₂ is injected, the pressure should remain constant unless CO₂ is leaking out. The pressure measurements can be made at the surface or downhole in situ. Surface pressure gauges can suffer from uncertainties caused by wellbore storage effects. In situ pressure gauges are favored. Other methods for detection of movement of stored CO₂ will include the use of chemical tracers, isotopic ratios of CO₂, and geophysical methods. Visual inspection of the surface for dead vegetation and bubbles in water-covered areas, as well as the production response of nearby wells, can be effective. For example, “When our pressure is increased, does their pressure or oil and gas production go up?”⁴¹⁸ Observation wells within the geologic formation and in nearby formations can also be employed. Monitoring wells act passively to the flow of CO₂, water, and oil. They can be used to acquire samples of gas, tracers, water, or oil. Observation wells are critically important for monitoring fluid flow in a sequestration reservoir.

Leak Detection Using Direct CO₂ and CH₄ Flux Measurements in Soil Gas

One way to monitor leakage from a coalbed or any other geological medium is to determine the flux of CO₂ and CH₄ emanating from the soil above a sequestration site on a seasonal basis at several depths before and after CO₂ is sequestered.⁴²¹ Similarly, the isotopic composition of the CO₂ and CH₄ emanating from the soil should be measured on a seasonal basis before and after sequestration is started. Consequently, one can distinguish between natural CO₂ and CH₄ emissions from those resulting from leakage of sequestered CO₂ and thermogenic CH₄ leaking from the coalbed. These pre-sequestration baseline values are compared with other measurements made during and after sequestration. Quantitative information on the CO₂ and CH₄ flux is needed on a seasonal basis. Analytical techniques that determine CO₂ and CH₄ content of the soil gas at various depths and in the atmosphere immediately above the soil are needed. Measurement of the concentration of chemical tracers that were added to the CO₂ will also be important. These chemical methods will be the most important tools in the arsenal. They quantify leakage rates to the surface, which directly impact the environment and human health and safety. In our opinion, from the standpoint of protection of public health and safety, the geophysical techniques that detect movement of CO₂ and CH₄ underground will be of less value. The geophysical tools are important because they will show where the CO₂ front is located within the host geologic formation. This information defines the bounds of the area at the surface that is most important to monitor for upward gas migration. From a public health and safety perspective, the subsurface movement of CO₂ and CH₄ from one location within a formation to another, or from the host formation into an adjacent formation, is not necessarily important unless the gas migrates to the surface. Underground movement of gases from one subsurface location to another does not necessarily impact public health and safety. Migration to the surface is most important from an environmental and public health and safety viewpoint.

Chemical Tracers

Sampling and analyses of CO₂ at the surface to determine leakage is difficult because of the high background concentration of CO₂ in the atmosphere, an average of approximately 360 ppm that changes seasonally. If an atmospheric CO₂ concentration of 1000 ± 50 ppm is measured at a geological sequestration site, then most would agree that CO₂ may be leaking from the host formation. However, in the case of a slow or intermittent leak where the surface CO₂ concentration is measured at 380 ± 19 ppm, the situation is not so clear-cut. A

monitoring technique that permits detection of a slow or intermittent CO₂ leak to the surface is needed. This can be done using a tracer. A tracer is an extraneous substance that is added to the CO₂. Tracers can be either radioactive or chemical. Radioactive tracers have a poor public perception and are therefore not considered further. Chemical tracers are nonradioactive materials that are easily detected at ultratrace levels. Even though tracers are detected at ultratrace levels, because very large amounts of CO₂ must be sequestered, on the order of Gt of CO₂/yr, very large amounts of some tracer compounds could be needed.

Knowledge of the migration rate of the tracer is important to its successful application. Ideally, the tracer and the CO₂ will migrate in concert through the geologic media. If the tracer is strongly sorbed by the geologic media or dissolves in formation water and does not migrate with the CO₂, then it becomes less useful. Only very limited migration information on tracers is available in the literature. In the case of sequestration of CO₂ in a deep saline aquifer, modeling results indicate that most of the CO₂ remains as a gas for decades. Thus, nonpolar tracer compounds are expected to remain preferentially with the CO₂ gas. Partition of a tracer from the moving CO₂ phase into the coalbed is directly analogous to a frontal chromatographic system. The migration of tracers in a moving CO₂ stream on coal has not, to our knowledge, been studied. Anderson and Vogh studied the migration rates of a few tracers on Berea sandstone enriched in clay with a high-pressure gas chromatographic system. The column was eluted with CH₄. Pressure was maintained using a restrictor. Capacity factors were measured at 273, 293, 313, and 333 K and pressures of 0.34, 3.4, and 10 MPa, respectively.⁴¹⁸ The results are shown in Table 14. Clearly, "in a high pressure environment, most of the tracers would migrate nearly as fast as methane." No compound has been reported to be successfully used as a tracer during CO₂-ECBM/sequestration or sequestered with CO₂ in a deep saline aquifer with the express purpose of acting as a means to detect leakage of CO₂ to the surface. SF₆ has been used as a tracer to study the ventilation patterns and systems within coal, uranium, and limestone mines.⁴²²⁻⁴²⁵

Many chemical tracers have been used in geologic media to monitor migration of gases. SF₆ has been used to monitor leakage from underground CH₄ storage reservoirs and has been detected at the surface.⁴²⁶ Craig used halogenated compounds such as SF₆, halocarbon-11, and dichlorodifluoromethane to identify the source of produced CO₂ in a field-wide miscible flood EOR project in the Alvord South Field located on the northern flank of the Fort Worth Basin in Wise County, TX. Results indicated "that adsorption of these tracers was insignificant

Table 14. Capacity factors for tracer compounds and natural gas components.⁴²¹

	Capacity Factor Values ^a											
	0 °C			20 °C			40 °C			60 °C		
	0.34 MPa	3.4 MPa	10.3 MPa	0.34 MPa	3.4 MPa	10.3 MPa	0.34 MPa	3.4 MPa	10.3 MPa	0.34 MPa	3.4 MPa	10.3 MPa
Ethane		0.07		0.11			0.03	0.01		0.02		
Propane	0.49	0.13	0.03	0.28	0.14	0.04	0.17	0.1	0.04	0.09	0.05	0.03
i-Butane	2.13		0.06	1.04	0.40	0.09	0.64	0.3	0.1	0.26	0.18	0.06
n-Butane	2.95	0.52	0.06	1.39	0.51	0.10	0.82	0.34	0.12	0.32	0.21	0.07
Ethylene	0.19	0.06	0.01	0.25	0.08	0.02	0.09	0.06	0.03	0.04	0.04	0.02
Propylene	1.79	0.39	0.08	0.88	0.43	0.11	0.38	0.28	0.09	0.19	0.18	0.06
Isobutene	5.33	1.57	0.22	4.52	1.85	0.36	2.64	1.13	0.27	0.76	0.66	0.18
Butene-1	4.06	1.38	0.18	3.07	1.55	0.30	2.13	0.91	0.24	0.66	0.51	0.14
CO	0	0.01	0	0	0	0	0	0	0	0	0	0
Sulfur hexafluoride	0.1	0.04	0	0.08	0.04	0.02	0.05	0.02	0.03	0.03	0.02	0.01
Freon-13 (CClF ₃)	0.13	0.05	0	0.10	0.04	0.02	0.07	0.05	0.02	0.04	0.03	0.02
Freon-12 (CCl ₂ F ₂)	0.81	0.39	0.06	0.77	0.32	0.09	0.44	0.22	0.07	0.20	0.14	0.05
Freon-23 (CHF ₃)	1.08	0.44	0.08	0.72	0.35	0.12	0.37	0.25	0.08	0.17	0.14	0.07
Freon-14 (CF ₄)	0.01	0.01	0	0	0	0	0.01	0.01	0	0.01	0	0

^aDetermined on Berea clay with methane carrier gas.

and the tracer remains with the CO₂ throughout the flood process."⁴²⁷ When co-injected into the formation with CO₂, breakthrough of dichlorodifluoromethane occurred simultaneously with CO₂ breakthrough at two production wells, occurred after CO₂ breakthrough at another well, and led CO₂ breakthrough in still another well by 9 days. Migration and adsorption of some tracers is not a problem during some subsurface applications. The physical properties of common tracers are in Table 15.⁴²⁸

Blencoe et al.⁴²⁹ are developing a unique approach to the monitoring problem using the stable isotopic composition of CO₂ as the tracer. By first defining how the various isotopes of C and O partition as a result of mineral and water interactions, it may be possible to use the CO₂ as a tracer. "As the injected CO₂ interacts with the subsurface geologic materials, its isotopic signature changes, making it a useful tracer."⁴²⁹

Table 15. Physical properties of the tracer compounds.⁴²⁹

Tracer	Formula	Molecular Weight	Boiling Point (K)	Density Sat'd Liquid @ 25 °C (kg/m ³)	Solubility Water @ 25 °C (wt %)
Freon 11	CCl ₃ F	137.4	297.0	1476	0.11
Freon 12	CCl ₂ F ₂	120.9	243.4	1311	0.028
Freon 13B1	CBF ₃	148.9	215.4	1538	0.03
Freon 114	CClF ₂ -CClF ₂	170.9	277.0	783	0.013
Sulfur hexafluoride	SF ₆	146.1	209.7	1910 @ 223 K	0.033

Geophysical Monitoring

Geophysical monitoring tools represent another major category of techniques that will be employed to evaluate the fate and integrity of geologically sequestered CO₂. Surveillance of the sequestered CO₂ using geophysical techniques allows the observation of moving reservoir fluids at locations distant from the injection point. Injection of CO₂ into a geologic formation such as a coalbed or brine aquifer can alter the bulk density, the Poisson's ratio, and the seismic velocity of the p-wave and the s-wave. These phenomena combine to alter the reflected seismic wave's amplitude and travel times. By performing careful 3-D seismic surveys before, during, and after injection of CO₂, one can obtain a time-lapsed picture of the movement of fluids in the subsurface, called 4-D seismic, with the added dimension being time. This technique is used to map the movement of CO₂ in the formation and to locate the leading edge of the moving CO₂

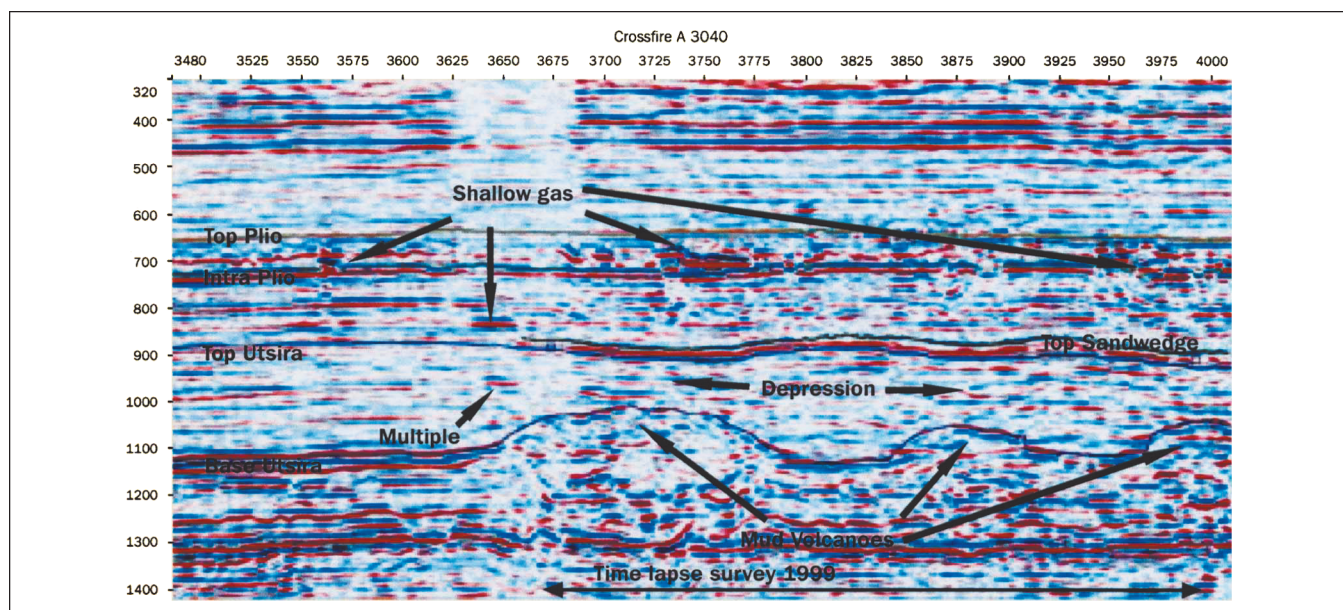

Figure 29. The preinjection seismic survey was obtained in 1994. Three-dimensional seismic results from the baseline survey performed in 1994 are shown. Study of the 1994 results revealed the presence of mounds at the base of the Utsira Formation that were thought to be the result of mud diapirism. Up to 14 thin shale layers were observed in the Utsira Formation having a thickness of less than 1 m. The thick Pliocene cap rock is divided into two units.⁴³⁵

front. Wang and Nur showed that “it is possible that seismic methods can be used in mapping and locating CO₂ zones, tracking CO₂ flood front movement, and monitoring CO₂ flooding processes in reservoirs undergoing CO₂ flooding.”⁴³⁰ Four-dimensional seismic surveys have been successfully employed to monitor injection of

CO₂ during EOR projects, while 3-D seismic techniques have been successfully applied in the investigation of the CBM recovery process. Davis et al. have used geophysical methods to define the characteristics of the Cedar Hill coalbed gas reservoir using 3-D multicomponent seismic surveys.^{431,432} The previous studies indicate that the

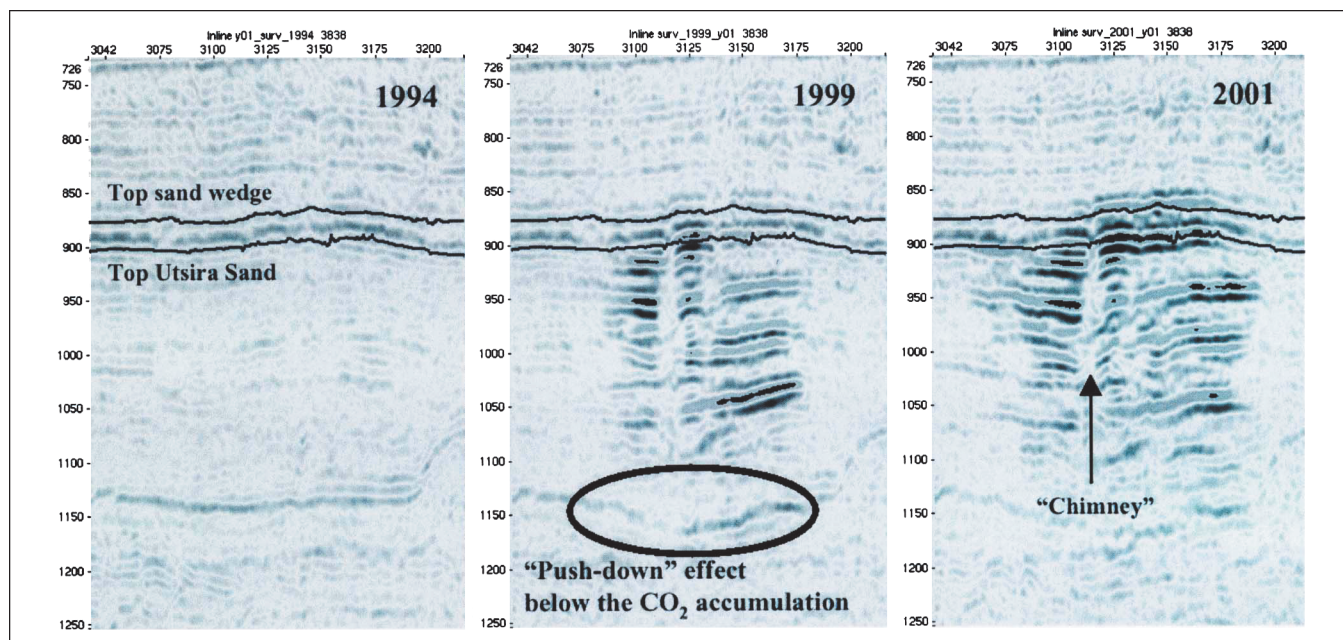

Figure 31. The seismic results from 1994, 1999, and 2001 are displayed, again showing the dramatic increase in reflectivity seen previously through the injection point. As many as nine depth levels having strong negative reflections, seen as black peaks, can be clearly seen in the 1999 and 2001 time-lapsed results. There is very good consistency among the CO₂ levels observed in the 1999 and 2001 results, with the 2001 results showing a larger lateral distribution of CO₂ and having been “pushed down” more than the 1999 results. The two reflections near the top of the 2001 survey represent CO₂ accumulations at the top of a sand wedge of the Utsira Formation. The 1999 results indicate that the CO₂ had reached the sand wedge at the thick shale cap rock, and the 2001 results clearly show the CO₂ spreading laterally along the cap rock.⁴³⁴

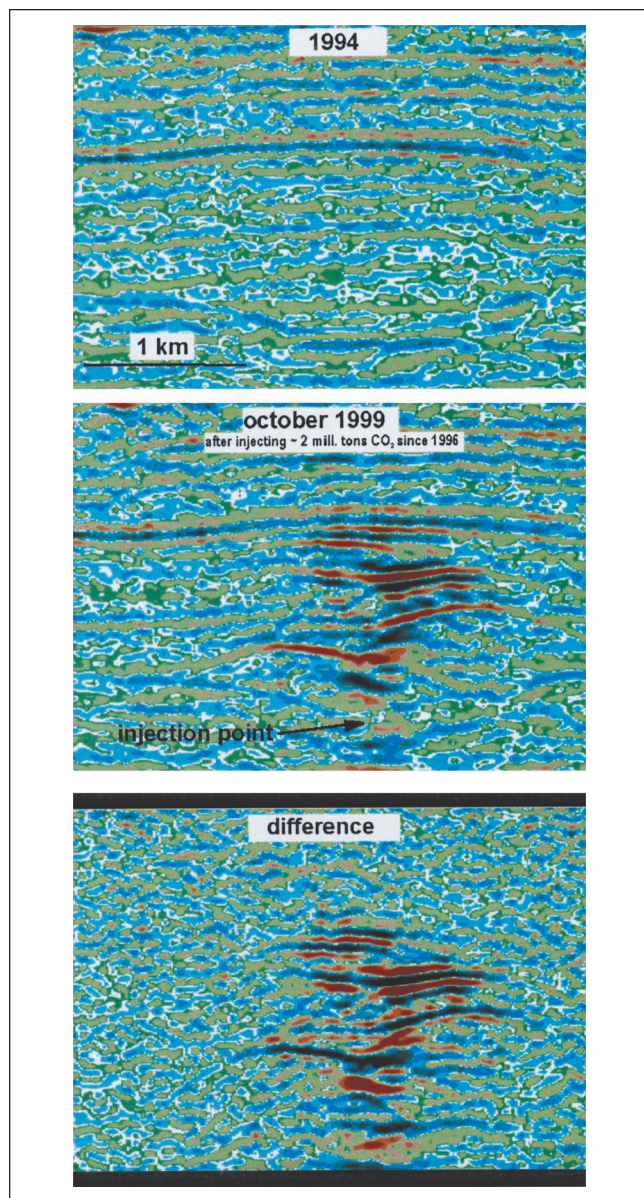

Figure 30. The time-lapsed comparison of seismic results from both the 1994 and 1999 surveys are shown. The data from 1999 exhibit increased reflectivity within the Utsira Formation compared with the 1994 vintage. This is in accordance with the modeling results. The reflectivity increases are more prominent at the lower levels, indicating that the bulk of the CO₂ has not yet migrated to the top of the formation. The presence of lateral lines indicates ponding of CO₂ under intrareservoir shale layers. These thin shales behave as barriers to flow.⁴³³

application of 3-D and 4-D seismic and other geophysical techniques will be very useful in monitoring the integrity and subsurface movement of CO₂ sequestered in coalbeds, oil formations, brine formations and other geological media.

Geophysical Monitoring at Sleipner

Members of the Saline Aquifer CO₂ Storage (SACS) project have obtained information on the nature and behavior of the CO₂ injected at Sleipner. The impetus for forming the

SACS project was to monitor and predict the migration and fate of the CO₂ injected at Sleipner. As described previously, Statoil has been injecting approximately 1 Mt of CO₂/yr into the Utsira Sandstone since 1996.^{40,397,433–436} Monitoring the behavior and migration of the CO₂ and the sealing characteristics of the cap rock are important issues associated with the injection process. A preinjection seismic survey was obtained in 1994, and new surveys were performed in October 1999, after approximately 2.5 Mt of CO₂ had been injected, and again in October of 2001, after injection of 4.8 Mt of CO₂.

Before the 1999 seismic survey, the expected changes in seismic response caused by the presence of large amounts of CO₂ were modeled.⁴³³ According to the modeling results, a volumetric mix of 25% CO₂ gas and 75% brine will result in doubling the reflected amplitude. Fully substituting formation water with CO₂ gas is predicted to result in a 3-fold brightening of the amplitude. A travel time delay of up to 25 msec is estimated to occur in a 100-m-thick section of the Utsira sandstone that is fully occupied with CO₂ gas. A smaller amount of CO₂ gas in the formation is predicted to result in a smaller time delay. The travel time delay is referred to as a “push-down” effect.

After the 1999 seismic survey, the time-lapsed information indicated that there was an increase in reflectivity caused by CO₂, and a large push-down effect was evident, again caused by the CO₂. Gas at various levels within the formation appeared to be trapped between thin shale layers. The 1999 seismic survey indicated that only a small amount of CO₂ had migrated to the surface of the Utsira formation, where it was being confined by the thick shale cap rock.

Three-dimensional seismic results from the baseline survey performed in 1994 are shown in Figure 29.⁴³⁵ Study of the 1994 results revealed the presence of mounds at the base of the Utsira Formation that were thought to be the result of mud diapirism. Up to 14 thin shale layers were observed in the Utsira Formation having a thickness of less than 1 m. The thick Pliocene cap rock is divided into two units. The time-lapsed comparison of seismic results from both the 1994 and 1999 surveys are shown in Figure 30.⁴³³ The data from 1999 exhibit increased reflectivity within the Utsira Formation compared with the 1994 data. This is in accordance with the modeling results. This increased reflectivity is further enhanced in the difference data, where strong reflections from four vertical levels are observed, with the top of the Utsira Formation being the shallowest. The reflectivity increases are more prominent at the lower levels, indicating that the bulk of the CO₂ has not yet migrated to the top of the formation. The presence of lateral lines on Figure 30 indicated “ponding” of CO₂ under intrareservoir shale layers. These thin

shales behave as barriers to flow. When CO₂ becomes trapped beneath the shales, the shales become illuminated during the seismic surveys and are easily identified as amplitude anomalies, despite their thickness being less than the limit of seismic resolution. The changes in reflectivity are limited to a semicircular area near the injection point that has a radius of approximately 1 km.

The seismic results from 1994, 1999, and 2001 are shown in Figure 31, which again displays the dramatic increase in reflectivity seen previously through the injection point.⁴³⁴ As many as nine depth levels having strong negative reflections, seen as black peaks, can be clearly seen in the 1999 and 2001 time-lapsed results. There is very good consistency among the CO₂ levels observed in the 1999 and 2001 results, with the 2001 results showing a larger lateral distribution of CO₂ and more push-down than the 1999 results. The two reflections near the top of the 2001 survey represent CO₂ accumulations at the top of a sand wedge of the Utsira Formation. The 1999 results indicate that the CO₂ had reached the sand wedge at the thick shale cap rock, and the 2001 results clearly show the CO₂ spreading laterally along the cap rock. Again, the other levels represent ponding of the CO₂ beneath the intra-reservoir shale layers. The pronounced vertical feature is a "chimney" of CO₂ located above the injection point that forms a primary vertical migration path leading to the cap rock. CO₂ is lighter than water and migrates upward. Clearly, 4-D seismic technology is useful for monitoring CO₂ injection into a saline aquifer and can be used for both monitoring and independent verification of the amount of CO₂ injected and for observing the integrity of the cap rock. According to Chadwick, "In 2001 we found that it had spread horizontally under the impermeable cap-rock, but had not penetrated it. And this demonstrates to us that it's not leaking at all. The gas is trapped as we expected."³⁹⁷

Other Geophysical Monitoring Tools

Burrowes and Gilboy⁴³⁷ have described numerous state-of-the-art geophysical monitoring techniques being used at the Weyburn CO₂ Monitoring and Storage Project. The monitoring includes multicomponent 3-D seismic surveys performed over a 3-yr period employing acquisition techniques to obtain both p- and s-wave information. This allows monitoring of the CO₂ flood front. These techniques are being applied to an EOR project but could be applied to situations where CO₂ is being injected into almost any geologic formation.

Newmark et al.⁴³⁸ described another geophysical tool used to monitor CO₂ sequestration in geologic formations known as electrical resistance tomography. When CO₂ is present in a geological formation, it alters the electrical resistivity. The electrical properties of a geological formation

are sensitive to and affected by the presence of CO₂. Researchers hope to employ metallic well casings as long electrodes, providing a noninvasive technique to monitor CO₂ sequestration.

Westrich et al.⁴³⁹ described a suite of geophysical monitoring tools they are applying to a sequestration project at a depleted oil well in the West Pearl Queen Field in southeastern New Mexico. Remote geophysical sensing tools are being applied before, during, and after injection of CO₂. They are using surface-to-borehole surveys and surface reflection surveys to identify and possibly characterize formation changes as a consequence of CO₂ injection. The surface-to-borehole seismic approach they are using includes a Vertical Seismic Profile. They are using dipole sonic logs, microseismic surveys during injection, and multilevel 3C crosswell seismic surveys.

Application of some of these geochemical and geophysical techniques or simulations described previously have not been widely reported in the literature on sequestration projects. Many of the techniques have been applied to EOR projects, such as Weyburn. Four-dimensional seismic techniques have been used at Sleipner. Some of these techniques are in their infancy and have not been extensively applied during coalseam or brine field sequestration. These techniques have been successfully applied to monitoring EOR using CO₂ injection and to monitoring and verifying underground CH₄ storage. Three-dimensional seismic techniques have been applied to CBM recovery, but 4-D seismic has not. Thus, application of some of these techniques to monitoring and verification of CO₂ sequestration in coalbeds with concomitant recovery of CH₄ or at brine fields has not been demonstrated.

Combination of Reservoir Simulations with Information from Geochemical and Geophysical Monitoring

Fanchi is developing the possibility of simultaneously applying 4-D seismic and an integrated flow simulator (IFLO) to monitor CO₂ sequestered in a mature oil field. "IFLO is a pseudomiscible, multicomponent, multidimensional fluid flow simulator" that has been previously employed to monitor the depletion of oil and gas reservoirs, water flooding of reservoirs, influx of an aquifer into a gas reservoir, injection of CO₂ into reservoirs, and other applications.⁴⁴⁰ Fanchi concluded that IFLO can produce data that are useful in predicting reservoir geophysical characteristics. Additionally, Fanchi concluded that IFLO can combine 4-D seismic methods to successfully monitor subsurface storage of CO₂. Lastly, the IFLO model can be used to optimize the timing of expensive 4-D seismic surveys.^{440,441} Simulators that combine geophysical and geochemical monitoring information with geomechanical data and heat transfer models with models that describe

multiphase flow over an entire reservoir are needed. These combined models must accurately represent chemical, physical, and thermodynamic phenomena over a wide spatial range and over extended time periods, centuries, while applying long-term transport and reaction chemistry.

CONCLUSIONS

Figure 5 shows that by 2012 the gap between two GHG emission scenarios, the Reference Case (“business as anticipated”) and the target GHG emissions set forth in the President’s GCCI differ by 0.39 Gt CO₂ (107 MMTCE) and the difference balloons to 4 Gt CO₂ (1100 MMTCE) in 2040. Figure 6 shows a plausible scenario to meet the GCCI goal of an 18% reduction in GHG intensity by 2012 that includes a portfolio of technologies, including sequestration of CO₂ in geological formations. According to the modeling platform developed by Klara et al.,³⁷ the 18% reduction can not be plausibly met without including contributions from geological sequestration of CO₂. The review proceeds to show how sequestering this amount of CO₂ is possible.

The review clearly documents that capture of CO₂ from large electric power-generating stations can be performed using MEA and related alkanolamine-based technologies for flue gas applications and physical absorption techniques for capture of CO₂ from gasification process streams. However, the overall cost of capturing CO₂ using current technologies must be substantially reduced before it can be considered viable for wide-scale sequestration related applications.

Similarly, the review documents that commercial-scale sequestration of CO₂ in deep unmineable coal seams with simultaneous recovery of CH₄ has been successfully practiced by Burlington Resources in New Mexico. In addition, Statoil is storing a million tons of CO₂/yr in the Utsira deep saline aquifer under the North Sea as part of a commercial natural gas operation. The success of these two projects along with more than 30 yr of commercial applications of CO₂ injection into depleted petroleum reservoirs for EOR purposes combine to make a compelling argument that sequestration of CO₂ in geological formations represents a safe, practical, and viable approach to meeting the President’s GCCI target and eventually stabilizing the atmospheric concentration of CO₂ while still using fossil fuels for electric power generation and allowing the economy to continue to grow. Further research and development is needed to substantially improve the economics of the processes.

There are potential EH&S problems associated with geological sequestration as described in the review. Despite these potential problems, the results from both Sleipner and the Burlington Resources project show that

storage of CO₂ in deep saline aquifers and in deep unmineable coal seams is technically feasible and can have little or no negative environmental aspects. “Underground storage offers a safe, verifiable, technologically feasible, and ultimately affordable option to the stabilization of the atmospheric CO₂ concentration.”³⁹⁷

ACKNOWLEDGMENTS

Thanks are given to the A&WMA Critical Review Committee for extending the invitation to prepare the review, particularly Dr. Judith Chow (Desert Research Institute) and Prof. Delbert Eatough (Brigham Young University). Dr. Chow and Dr. John Watson (Desert Research Institute) provided valuable editorial comments. Our coworkers, Bernie Kenny (NETL), Emily Brown (NETL), Karen Pietosi (NETL), and Pauletta Beehler (NETL) performed literature searches and acquired the articles for review. Dr. Bob LaCount (NETL), Rod Diehl (NETL), and Norman Mankim (Desert Research Institute) provided valuable assistance adding information to Reference Manager. The authors thank Prof. Howard Herzog (MIT), Dr. Tom Baker (LANL), Dr. Earl Whitney (LANL), Dr. Peter Mueller (independent consultant), Sarah Forbes (NETL), Mike Knaggs (NETL), Scott Klara (NETL), Dr. James Polandri (USGS), Prof. Tom Wilson (WVU), Bob Kane (DOE), and Dr. Dave Thomas (Advanced Resources International) for reviewing the manuscript and providing thoughtful suggestions for improvement. Fred White (NETL) performed work on all of the graphics in the article.

DISCLAIMER

Reference in this report to any specific commercial product or service is to facilitate understanding and does not imply endorsement by the United States Department of Energy.

REFERENCES

1. Fourier, J. *Mem. de l'Ac. R. d. Sci. de l'Inst. de France* **1827**, + (vii).
2. Pouillet. *Comptes Rendus*; vii ed.; 1838.
3. Arrhenius, S. On the Influence of Carbonic Acid in the Air Upon the Temperature of the Ground; *Philosophical Magazine* **1896**, *41*, 237-276.
4. Halmann, M.M.; Steinberg, M. *Greenhouse Gas Carbon Dioxide Mitigation: Science and Technology*; Lewis Publishers, CRC Press: Boca Raton, FL, 1999.
5. *Global Warming: Emissions: National: Global Warming Potentials*; U.S. Environmental Protection Agency: Washington, DC, 2002. Available at: <http://yosemite.epa.gov/oar/globalwarming.nsf/550d4b46b29f68a6852568660081f938/85256bd400517e4885256bfe0057a223?OpenDocument>.
6. U.S. Environmental Protection Agency. *Inventory of U.S. Greenhouse Gas Emissions and Sinks: 1990–2000*; EPA 430-R-02–003; Office of Atmospheric Programs: Washington, DC, 2002.
7. *Revised Guidelines for the Preparation of National Communications by Parties Included in Annex I to the Convention*; Report of the Conference of the Parties at Its Second Session; FCCC 1996 Framework Convention on Climate Change: Geneva, 1996.
8. *IPCC 2001, Climate Change 2001: A Scientific Basis, Intergovernmental Panel on Climate Change*; Cambridge University Press: Cambridge, UK, 2003.
9. *Global Warming: Climate*; U.S. Environmental Protection Agency: Washington, DC, 2002. Available at: <http://yosemite.epa.gov/oar/globalwarming.nsf/content/climate.html>.

10. *Antarctic Ice Shelf Collapses*; National Snow and Ice Data Center: Boulder, CO, 2002. Available at: <http://nsidc.org/iceshelves/larsenb2002/>.
11. Meier, M.F.; Dyurgerov, M.B. How Alaska Affects the World; *Science* **2002**, *297*, 350-351.
12. Fitter, A.H.; Fitter, R.S.R. Rapid Changes in Flowering Time in British Plants; *Science* **2002**, *296*, 1689-1691.
13. *Greenhouse Issues* **1992**, Issue 3.
14. Global Warming: Emissions: International; U.S. Environmental Protection Agency: Washington, DC, 2002. Available at: <http://yosemite.epa.gov/oar/globalwarming.nsf/content/EmissionsInternational.html>.
15. Adams, D. Technologies for Activities Implemented Jointly; *Greenhouse Issues* **1997**, Issue 31. Available at: <http://www.ieagreen.org.uk/july31.htm>.
16. Costa Rica's Carbon Is Certified for Trading; *Greenhouse Issues* **1998**, Issue 36. Available at: <http://www.ieagreen.org.uk/may36.htm>.
17. *Greenhouse Issues* **1995**, Issue 19. Available at: <http://www.ieagreen.org.uk/may36.htm>.
18. Davison, J.E.; Freund, P. A Comparison of Sequestration of CO₂ by Forestry and Capture from Power Stations. In *Proceedings of the 4th International Conference on Greenhouse Gas Control Technologies, Interlaken, Switzerland, 1998*; Elsevier: Oxford, UK, 1999.
19. Cox, P.M.; Betts, R.A.; Jones, C.D.; Spall, S.A.; Totterdell, I.J. Acceleration of Global Warming Due to Carbon-Cycle Feedbacks in a Coupled Climate Model; *Nature* **2000**, *408*, 184-187.
20. Melillo, J.M.; Steudler, P.A.; Aber, J.D.; Newkirk, K.; Lux, H.; Bowls, F.P.; Catricala, C.; Magill, A.; Ahrens, T.; Morrisseau, S. Soil Warming and Carbon-Cycle Feedbacks to the Climate System; *Science* **2002**, *298*, 2173-2176.
21. Kaya, Y.; et al. A Grand Strategy for Global Warming. In *Tokyo Conference on Global Environment*; 1989.
22. Kaya, Y. *Impact of Carbon Dioxide Emission Control on GNP Growth: Interpretation of Proposed Scenarios*; IPCC Energy and Industry Subgroup, Response Strategies Working Group: Paris, 1990.
23. Yamaji, K.R.; Matsuhashi, R.; Nagata, Y.; Kaya, Y. An Integrated System for CO₂/Energy/GNP Analysis: Case Studies on Economic Measures for CO₂ Reduction in Japan. Presented at Workshop on CO₂ Reduction and Removal: Measures for the Next Century; Laxenburg, Austria, 1991.
24. Kaya, Y. The Role of CO₂ Removal and Disposal; *Energy Convers. Mgmt.* **1995**, *36*, 375-380.
25. Hoffert, M.I.; Caldeira, K.; Jain, A.K.; Haites, E.F.; Harvey, L.D.D., Potter, S.E.; Schlesinger, M.E.; Schneider, S.H.; Watts, R.G.; Wigley, T.M.L.; Wuebbles, D.J. Energy Implications of Future Stabilization of Atmospheric CO₂ Content; *Nature* **1998**, *395*, 881-884.
26. Intergovernmental Panel on Climate Change. *IPCC Special Report on Emissions Scenarios—2.4. Analysis of Literature*; Cambridge University Press: Cambridge, NY, 2000. Available at: <http://www.grida.no/climate/ipcc/emission/038.htm>.
27. *Okanagan University College Fundamentals of Physical Geography—9. Introduction to Biogeography and Ecology—(r) The Carbon Cycle*; OUC Department of Geography: Kelowna, British Columbia, Canada, 2000. Available at: <http://www.geog.ouc.bc.ca/physgeog/contents/9r.html>.
28. Hitchon, B. *Aquifer Disposal of Carbon Dioxide: Hydrodynamic and Mineral Trapping—Proof of Concept*; Geoscience Publishing Ltd.: Sherwood Park, Alberta, Canada, 1996.
29. *Understanding the Global Carbon Cycle*; The Woods Hole Research Center: Woods Hole, MA, 2003. Available at: <http://www.whrc.org/science/carbon/carbon.htm>.
30. Berner, R.A.; Lasaga, A.C. Modeling the Geochemical Carbon Cycle; *Sci. Am.* **1989**, *260*, 74-81.
31. Kerrick, D. Present and Past Non-Anthropogenic CO₂ Degassing From Solid Earth; *Review of Geophysics* **2001**, *39*, 565-585.
32. Hoffert, M.I.; Caldeira, K.; Benford, G.; Criswell, D.R.; Green, C.; Herzog, H.; Jain, A.K.; Khesghi, H.S.; Lackner, K.S.; Lewis, J.S.; et al. Advanced Technology Paths to Global Climate Stability: Energy for a Greenhouse Planet; *Science* **2002**, *298*, 981-987.
33. Audus, H. Technologies for CO₂ Emission Reduction. Presented at International Conference on Sustainable Future of the Global System, Tokyo, Japan, 1999. Available at: <http://www.ieagreen.org.uk/audus99.htm>.
34. Marchetti, C. Nuclear Plants and Nuclear Riches; *Nucl. Sci. Eng.* **1985**, *90*, 521-526.
35. Audus, H.; Kaarstad, O.; Kowal, M. Decarbonization of Fossil Fuels: Hydrogen as an Energy Carrier. In *Proceedings of the Eleventh World Hydrogen Energy Conference: Hydrogen Energy Progress XI*; International Association for Hydrogen Energy, Ed.; 1996; pp 525-534.
36. Bachu, S. Sequestration of CO₂ in Geological Media in Response to Climate Change: Road Map for Site Selection Using the Transform of the Geological Space into the CO₂ Phase Space; *Energy Convers. Mgmt.* **2002**, *43*, 87-102.
37. Klara, S.; Beecy, D.; Kuuskraa, V.; DiPietro, P. Economic Benefits of a Technology Strategy and R&D Program in Carbon Sequestration. In *Proceedings of GHGT-6*, Kyoto, 2002.
38. *Carbon Sequestration Research and Development*; DOE/SC/FE-1; U.S. Department of Energy: Washington, DC, 1999. Available at: http://www.ornl.gov/carbon_sequestration/.
39. Korboel, R.; Kaddour, A. Sleipner Vest CO₂ Disposal—Injection of Removed CO₂ into the Utsira Formation; *Energy Convers. Mgmt.* **1995**, *36* (6-9), 509-512.
40. Baklid, A.; Korbol, R.; Owren, G. Sleipner Vest CO₂ Disposal, CO₂ Injection into a Shallow Underground Aquifer. Presented at SPE Annual Technical Conference and Exhibition; Society of Petroleum Engineers: Denver, CO, 1996.
41. Herzog, H.; Drake, E.; Adams, E. *CO₂ Capture, Reuse, and Storage Technologies for Mitigating Global Climate Change: A White Paper*; Final Report, DOE Contract No. DE-AF22-96PC01257; Massachusetts Institute of Technology, Energy Laboratory: Cambridge, MA, 1997. Available at: <http://sequestration.mit.edu/pdf/WhitePaper.pdf>.
42. Herzog, H.; Golomb, D.; Zemba, S. Feasibility, Modeling and Economics of Sequestering Power Plant CO₂ Emissions in the Deep Ocean; *Envir. Prog.* **1991**, *10* (1), 64-74.
43. United Kingdom Department of Trade and Industry. *Carbon Dioxide Capture and Storage*; IEA Report DTI/Pub URN 00/1081; UKDTI Cleaner Coal Technology Programme: London, UK, 2001. Available at: <http://www.dti.gov.uk/energy/coal/cfft/cct/pub/tsr016.pdf>.
44. Herzog, H.; Drake, E.; Tester, J.; Rosenthal, R. *A Research Needs Assessment for the Capture, Utilization, and Disposal of Carbon Dioxide from Fossil Fuel-Fired Power Plants*; Final Report DOE Contract No. DE-FG02-92ER30194; Massachusetts Institute of Technology, Energy Laboratory: Cambridge, MA, 1993.
45. Booras, G.S.; Smelser, S.C. An Engineering and Economic Evaluation of CO₂ Removal from Fossil-Fuel-Fired Power Plants; *Energy* **1991**, *16* (11/12), 1295.
46. Mitchel, S.C. *Hot Gas Cleanup of Sulphur, Nitrogen, and Minor and Trace Elements*; IEA Report ISBN 92-9029-317-9; International Energy Agency, Coal Research: London, UK, 1998.
47. Riemer, P.; Audus, H.; Smith, A. *Carbon Dioxide Capture from Power Stations*; IEA Report ISBN 1-898373-15-9; International Energy Agency, Greenhouse Gas R&D Programme: Cheltenham, UK, 1994. Available at: <http://www.ieagreen.org.uk/sr2p.htm>.
48. Wolsky, A.M.; Daniels, E.J.; Jody, B.J. CO₂ Capture from the Flue Gas of Conventional Fossil-Fuel-Fired Power Plants; *Envir. Progress* **1994**, *13* (3), 214-219.
49. Park, S.B.; Lee, H.; Lee, K.H. Solubilities of Carbon Dioxide in Aqueous Potassium Carbonate Solutions Mixed with Physical Solvents; *Int. J. Thermophys.* **1998**, *19* (5), 1421-1428.
50. Meisen, A.; Shuai, X. Research and Development Issues in CO₂ Capture; *Energy Convers. Mgmt.* **1997**, *38*, S37-S42.
51. Herzog, H. An Introduction to CO₂ Separation and Capture Technologies. Presented at U.S. Department of Energy Workshop, Houston, TX, 1999.
52. Kohl, A.L.; Nielsen, R.B. *Gas Purification*, 5th ed.; Gulf Publishing: Houston, TX, 1997.
53. Smith, I. *CO₂ Reduction—Prospects for Coal*; IEA Report ISBN 92-9029-336-5; International Energy Agency, Coal Research: London, UK, 1999.
54. Kane, R.L.; Klein, D.E. Carbon Sequestration: An Option for Mitigating Global Climate Change; *CEP* **2001**, *97* (6), 44-52.
55. Trotter, C. Experience with British Gas Hot Potash Promoter LRS 10; *Ammonia Plant Saf. Relat. Facil.* **1994**, *34*.
56. Chapel, D.G.; Mariz, C.L.; Ernest, J. Recovery of CO₂ from Flue Gases: Commercial Trends. Presented at the Canadian Society of Chemical Engineers Annual Meeting, Saskatoon, Saskatchewan, Canada, 1999.
57. Leci, C.L.; Goldthorpe, S.H. Assessment of CO₂ Removal from Power Station Flue Gas; *Energy Convers. Mgmt.* **1992**, *33* (5-8), 477.
58. Mimura, T.; Simayoshi, H.; Suda, T.; Iijima, M.; Mitsuoka, S. Development of Energy-Saving Technology for Flue Gas Carbon Dioxide Recovery in Power Plants; *Energy Convers. Mgmt.* **1997**, *38*, S57-S62.
59. Chakma, A. CO₂ Capture Processes—Opportunities for Improved Energy Efficiencies; *Energy Convers. Mgmt.* **1997**, *38*, S51-S56.
60. Palysynski, S.I.; Chen, Z.Y. Review of CO₂ Capture Technologies and Some Improvement Opportunities; *Preprint Paper Am. Chem. Soc. Div. Fuel Chem.* **2000**, *45* (4), 650-655.
61. Suda, T.; Fujii, M.; Yoshida, K.; Iijima, M.; Seto, T.; Mitsuoka, S. Development of Flue Gas Carbon Dioxide Recovery Technology; *Energy Convers. Mgmt.* **1992**, *33* (5-8), 317-324.
62. Sartori, G.; Ho, W.S.; Savage, D.W.; Chludzinski, G.R.; Wiechert, S. Sterically Hindered Amines for Acid-Gas Absorption. Presented at the 1988 AIChE Spring National Meeting, New Orleans, 1988; Paper 69D.
63. Veawab, A.; Tontiwachwuthikul, P.; Chakma, A. Influence of Process Parameters on Corrosion Behavior in a Sterically Hindered Amine-CO₂ System; *Ind. Eng. Chem. Res.* **1999**, *38*, 310-315.
64. Rochelle, G.T.; Bishnoi, S.; Dang, H.; Santos, J. *Research Needs for CO₂ Capture from Flue Gas by Aqueous Absorption/Stripping*; DE-AF26-99FT01029; University of Texas: Austin, TX, 2001.
65. Aroonwilas, A.; Tontiwachwuthikul, P. Mass Transfer Studies of High Performance Structured Packing for CO₂ Separation Processes; *Energy Convers. Mgmt.* **1997**, *38*, S75-S80.

66. Yeh, J.T.; Pennline, H.W.; Resnik, K.P. Study of CO₂ Absorption and Desorption in a Packed Column. *Energy Fuels* **2001**, *15* (2), 274-278.
67. Mimura, T.; Matsumoto, K.; Iijima, M.; Mitsuoka, S. Development and Application of Flue Gas Carbon Dioxide Recovery Technology. In *Proceedings of GHGT-5*, Cairns, Australia, 2000.
68. Chakma, A. Formulated Solvents: New Opportunities for Energy Efficient Separation of Acid Gases; *Energy Sources* **1999**, *21* (1-2), 51-62.
69. Niswander, R.H.; Edwards, D.J.; Dupaart, M.S.; Tse, J.P. A More Energy Efficient Product for Carbon Dioxide Separation; *Separation Science Technol.* **1993**, *28* (1-3), 565-578.
70. Tontiwachwuthikul, P.; Chakma, A. R&D on High Efficiency CO₂ Separation Processes for Enhanced Oil Recovery at University of Regina; *J. Canadian Petroleum Technol.* **1997**, *36* (2), 9.
71. Chakma, A. An Energy Efficient Mixed Solvent for the Separation of CO₂; *Energy Convers. Mgmt.* **1995**, *36* (6-9), 427-430.
72. Chakma, A.; Tontiwachwuthikul, P. Designer Solvents for Energy Efficient CO₂ Separation from Flue Gas Streams. In *Proceedings of the 4th International Conference on Greenhouse Gas Control Technologies, Interlaken, Switzerland, 1998*; Elsevier: Oxford, UK, 1999; pp 35-42.
73. Leci, C.L. Development Requirements for Absorption Processes for Effective CO₂ Capture from Power Plants; *Energy Convers. Mgmt.* **1997**, *38*, S45-S50.
74. Veawab, A.; Tontiwachwuthikul, P.; Aroonwilas, A.; Chakma, A. Performance and Cost Analysis for CO₂ Capture from Flue Gas Streams: Absorption and Regeneration Aspects. Presented at GHGT-6, Kyoto, 2002; Paper C4-5.
75. Song, J.H.; Yoon, J.H.; Lee, H. Solubility of Carbon Dioxide in Monoethanolamine + Ethylene Glycol + Water and Monoethanolamine + Poly(Ethylene Glycol) + Water; *J. Chem. Eng. Data* **1996**, *41* (3), 497-499.
76. Leites, I.L. Thermodynamics of CO₂ Solubility in Mixtures of Monoethanolamine with Organic Solvents and Water and Commercial Experience of Energy Saving Gas Purification Technology; *Energy Convers. Mgmt.* **1998**, *39* (16-18), 1665-1674.
77. Mimura, T.; Nojo, T.; Iijima, M.; Yoshiyama, R.; Tanaka, H. Recent Developments in Flue Gas CO₂ Recovery Technology. Presented at GHGT-6, Kyoto, 2002; Paper J2-3.
78. Feron, P.H.M.; Jansen, A.E. The Production of Carbon Dioxide from Flue Gas by Membrane Gas Absorption; *Energy Convers. Mgmt.* **1997**, *38*, S93-S98.
79. Dave, N.; Fookes, C.; Walters, C. Assessment of Novel Technologies for CO₂ Capture and Separation. In *Proceedings of the 18th Annual International Pittsburgh Coal Conference, Newcastle, Australia, 2001*; Pittsburgh Coal Conference: Pittsburgh, PA, 2001.
80. Hanisch, C. Exploring Options for CO₂ Capture and Management; *Environ. Sci. Technol.* **1999**, *33* (3), 66-70.
81. Raterman, K.T.; McKellar, M.; Podgorney, A.; Stacey, D.; Turner, T.; Stokes, B.; Vranicar, J. A Vortex Contactor for Carbon Dioxide Separations. Presented at the 1st National Conference on Carbon Sequestration, Washington, DC, 2001; Paper 7b.3.
82. Chi, S.; Rochelle, G.T. Oxidative Degradation of Monoethanolamine; *Ind. Eng. Chem. Res.* **2002**, *41* (17), 4178-4186.
83. Singh, D.J.; Croiset, E.; Douglas, P.L.; Douglas, M.A. A Techno-Economic Comparison of Amine Scrubbing vs. O₂/CO₂ Recycle Combustion for CO₂ Capture from Coal Fired Power Plants. Presented at the 18th Annual International Pittsburgh Coal Conference, Newcastle, Australia, 2001; Paper 5-3.
84. Simmonds, M.; Hurst, P.; Wilkinson, M.B.; Watt, C.; Roberts, C.A. A Study of Very Large Scale Post Combustion CO₂ Capture at a Refining & Petrochemical Complex. Presented at GHGT-6, Kyoto, 2002; Paper B4-1.
85. Strazisar, B.R.; Anderson, R.R.; White, C.M. Degradation of Monoethanolamine Used in CO₂ Capture from Flue Gas of a Coal-Fired Electric Power Generating Station; *Abstracts Papers American Chemical Soc.* **2002**, *223* (054-FUEL).
86. Strazisar, B.R.; Anderson, R.R.; White, C.M. Degradation Pathways for Monoethanolamine in a CO₂ Capture Facility; *Energy Fuels* **2003**, in press.
87. Leci, C.L. Financial Implication on Power Generation Costs Resulting from the Parasitic Effect of CO₂ Capture Using Liquid Scrubbing Technology from Power Station Flue Gases; *Energy Convers. Mgmt.* **1996**, *37* (6-8), 915-921.
88. Bai, H.; Yeh, A.C. Removal of CO₂ Greenhouse Gas by Ammonia Scrubbing; *Ind. Eng. Chem. Res.* **1997**, *36* (6), 2490-2493.
89. Yeh, A.C.; Bai, H. Comparison of Ammonia and Monoethanolamine Solvents to Reduce CO₂ Greenhouse Gas Emissions; *Sci. Total Environ.* **1999**, *228*, 121-133.
90. Yeh, J.T.; Pennline, H.W.; Resnik, K.P. Aqua Ammonia Process for Simultaneous Reduction of CO₂, SO₂, and NO_x. Presented at the 19th Annual International Pittsburgh Coal Conference, Pittsburgh, PA, 2002; Paper 45-1.
91. Huang, H.; Chang, S.G.; Dorchak, T. Method to Regenerate Ammonia for the Capture of Carbon Dioxide; *Energy Fuels* **2002**, *16* (4), 904-910.
92. Zheng, X.Y.; Diao, Y.F.; He, B.S.; Chen, C.H.; Xu, X.C.; Feng, W. Carbon Dioxide Recovery from Flue Gases by Ammonia Scrubbing. Presented at GHGT-6, Kyoto, 2002; Paper 14-5.
93. Li, X.; Hagaman, E.; Tsouris, C.; Lee, J.W. Removal of Carbon Dioxide from Flue Gas by Ammonia Carbonation in the Gas Phase; *Energy Fuels* **2003**, *17* (1), 69-74.
94. Bates, E.D.; Mayton, R.D.; Ntai, I.; Davis, J.H. CO₂ Capture by a Task-Specific Ionic Liquid; *J. Am. Chem. Soc.* **2002**, *124* (6).
95. Shah, V.A. CO₂ Removal from Ammonia Synthesis Gas with Selexol Solvent Process; *Energy Progress* **1988**, *8* (2), 67-70.
96. Shah, V.A.; Huurdeman, T.L. Synthesis Gas Treating with Physical Solvent Process Using Selexol Process Technology; *Ammonia Plant Safety* **1990**, *30*, 216-224.
97. Koss, U.; Meyer, M. "Zero Emission IGCC" with Rectisol Technology. Presented at the 2002 Gasification Technologies Conference, San Francisco, CA.
98. *Project Data on Eastman Chemical Company's Chemical-from-Coal Complex in Kingsport, TN*; U.S. DOE Contract No. DE-FC22-92PC90543, Draft Final Report; Eastman Chemical Co.: Kingsport, TN, 2002.
99. Dittus, M.; Johnson, D. The Hidden Value of Lignite Coal. Presented at the 2001 Gasification Technologies Conference, San Francisco, CA.
100. Hattenbach, R.P.; Wilson, M.; Brown, K.R. Capture of Carbon Dioxide from Coal Combustion and Its Utilization for Enhanced Oil Recovery. In *Proceedings of the 4th International Conference on Greenhouse Gas Control Technologies, Interlaken, Switzerland, 1998*; Elsevier: Oxford, UK, 1999; pp 217-221.
101. Kolbe, B.; Menzel, J.; Grob, M. Acid Gas Removal; *Hydrocarbon Engr.* **2000**, 71-74.
102. Grob, M.; Menzel, J.; Tondorf, O. Acid Gas Removal from Natural and Synthesis Gas; *Hydrocarbon Engr.* **1998**, 30-34.
103. Kowalsky, G. Kwoen Gas Plant: The Sour Gas Upgrader. Presented at the GTI Natural Gas Technologies Conference, Orlando, FL, 2002.
104. Hendriks, C. *Carbon Dioxide Removal from Coal-Fired Power Plants*; Kluwer Academic Publishers: Norwell, MA, 1994.
105. Gupta, H.; Fan, L.S. Carbonation-Calcination Cycle Using High-Reactivity Calcium Oxide for Carbon Dioxide Separation from Flue Gas; *Ind. Eng. Chem. Res.* **2002**, *41*, 4035-4042.
106. Gupta, H.; Iyer, M.; Sakadjian, B.; Fan, L.S. Separation of CO₂ from Flue Gas by High Reactivity Calcium Based Sorbents. Presented at the 19th Annual International Pittsburgh Coal Conference, Pittsburgh, PA, 2002; Paper 39-3.
107. Hoffman, J.S.; Pennline, H.W. Investigation of CO₂ Capture Using Regenerable Sorbents. Presented at the 17th Annual International Pittsburgh Coal Conference, Pittsburgh, PA, 2000; Paper 12-1.
108. Green, D.A.; Turk, B.S.; Gupta, R.P.; Portzer, J.W.; McMichael, W.J.; Harrison, D.P. Capture of Carbon Dioxide from Flue Gas Using Solid Regenerable Sorbents. Presented at the 19th Annual International Pittsburgh Coal Conference, Pittsburgh, PA, 2002; Paper 39-4.
109. Hayashi, H.; Taniuchi, J.; Furuyashiki, N.; Sugiyama, S.; Hirano, S.; Shigemoto, N.; Nonaka, T. Efficient Recovery of Carbon Dioxide from Flue Gases of Coal-Fired Power Plants by Cyclic Fixed-Bed Operations over K₂CO₃-on-Carbon; *Ind. Eng. Chem. Res.* **1998**, *37*, 185-191.
110. Hayashi, H.; Hirano, S.; Shigemoto, N.; Yamada, S. Characterization of Potassium Carbonate Supported on Porous Materials and Application for the Recovery of Carbon Dioxide from Flue Gases Under Moist Conditions; *Nippon Kagaku Kaishi* **1995**, 1006-1012.
111. Hirano, S.; Shigemoto, N.; Yamada, S.; Hayashi, H. Cyclic Fixed-Bed Operations over K₂CO₃-on-Carbon for the Recovery of Carbon Dioxide under Moist Conditions; *Bull. Chem. Soc. Jpn.* **1995**, *68*, 1030-1035.
112. Onischak, J.; Baker, B. Development of a Prototype Regenerable Carbon Dioxide Absorber for Portable Life Support Systems; *J. Eng. Ind.* **1978**, *100* (3), 383-385.
113. Otsuji, K.; Hirao, M.; Satoh, S. A Regenerable Carbon Dioxide Removal and Oxygen Recovery System for the Japanese Experiment Module; *Acta Astronaut.* **1987**, *15* (1), 45-54.
114. Martin, R. Regenerable Sorbents and Portable Life Support; *NASA Spec. Publ.* **1969**, *NASA SP-234*, 379-389.
115. Remus, G.; Nuccio, P.; Honegger, R. Carbon Dioxide Removal System of the Regenerable Solid Adsorbent Type; *U.S. Govt. Res. Develop. Rep.* **1969**, *69* (18), 39.
116. Trusch, R. Carbon Dioxide Control in Spacecraft by Regenerable Solid Adsorbents; *Space Congr., 4th* **1967**, 1-31-1-56.
117. Nalette, T.; Bibara, P.; Aylward, J. Preparation of High Capacity Unsupported Regenerable CO₂ Sorbent; U.S. Patent No. 5,079,209, 1992.
118. Bibara, P.; Filburn, T.; Nalette, T. Regenerable Solid Amine Sorbent; U.S. Patent No. 5,876,488, 1999.
119. Soong, Y.; Gray, M.L.; Siriwardane, R.V.; Champagne, K.J.; Chuang, S.S.C. Novel Amine Enriched Solid Sorbents for Carbon Dioxide Capture. Presented at the 1st National Conference on Carbon Sequestration, Washington, DC, 2001; Paper 7b.2.
120. Contarini, S.; Barbini, M.; Del Piero, G.; Gambarotta, E.; Mazzamuro, G.; Riocci, M.; Zappelli, P. Solid Sorbents for the Reversible

- Capture of Carbon Dioxide. Presented at GHGT-6, Kyoto, 2002; Poster Paper 14-1.
121. Xu, X.; Song, C.; Andresen, J.M.; Miller, B.G.; Scaroni, A.W. Adsorption Separation of CO₂ from Simulated Flue Gas by Novel Mesoporous "Molecular Basket" Adsorbent. Presented at the 19th Annual International Coal Conference, Pittsburgh, PA, September 2002; Paper 39-2.
 122. Curran, G.P.; Fink, C.E.; Gorin, E. CO₂ Acceptor Gasification Process: Studies of Acceptor Properties, Advances in Chemistry. In *Fuel Gasification*, 69th ed.; Schorda, F.C., Ed.; American Chemical Society: Washington, DC, 1967; pp 141-165.
 123. Elliott, M.A. *Chemistry of Coal Utilization*, Second Supplementary Volume; Elliot, M.A., Ed.; Wiley & Sons: New York, 1981; pp 1642-1648.
 124. Han, C.; Harrison, D.P. Multicycle Performance of a Single-Step Process for H₂ Production; *Sep. Sci. Technol.* **1997**, *32*, 681-697.
 125. Siliban, A.; Narcida, M.; Harrison, D.P. Characteristics of the Reversible Reaction between CO_{2(g)} and Calcined Dolomite; *Chem. Eng. Comm.* **1996**, *4*, 149-162.
 126. Siliban, A.; Harrison, D.P. High-Temperature Capture of CO₂: Characteristics of the Reversible Reaction Between CaO(s) and CO_{2(g)}; *Chem. Eng. Comm.* **1995**, *137*, 177-190.
 127. Hoffman, J.S.; Fauth, D.J.; Pennline, H.W. Development of Novel Dry Regenerable Sorbents for CO₂ Capture. Presented at the 19th Annual International Pittsburgh Coal Conference, Pittsburgh, PA, 2002, Paper 39-1.
 128. Hoffman, J.S.; Pennline, H.W. Study of Regenerable Sorbents for CO₂ Capture. Presented at the 1st National Conference on Carbon Sequestration, Washington, DC, 2001; Paper 3b.2.
 129. Gupta, H.; Iyer, M.; Sakadjian, B.; Fan, L.S. *CO₂ Separation from Flue Gas by the Carbonation and Calcination of Metal Oxides*; Report Number C2.11; Ohio Department of Development, Ohio Coal Development Office, Coal Research Consortium: Columbus, OH, 2001. Available at: <http://www.ohiocoal.org/projects/Year2/C2.11.pdf>.
 130. Gupta, H.; Fan, L.S. Separation of CO₂ from Flue Gas by High Reactivity Calcium Based Sorbents. Presented at the AIChE Annual Meeting, Reno, NV, Nov. 4-9, 2001; Poster 28w.
 131. Fan, L.S.; Agnihotri, R.; Mahuli, S.K. Suspension Carbonation Process for Reactivation of Partially Utilized Sorbent; U.S. Patent No. 6,309,996, 2001.
 132. Fan, L.S.; Ghosh-Dastidar, A.; Mahuli, S. Calcium Carbonate Sorbent and Methods of Making and Using Same; U.S. Patent No. 5,779,464, 1998.
 133. Sasaoka, E.; Uddin, A.; Nojima, S. Novel Preparation Method of Macroporous Lime from Limestone for High-Temperature Desulfurization; *Ind. Eng. Chem. Res.* **1997**, *36*, 3639-3646.
 134. Wu, S.; Sumie, N.; Su, C.; Sasaoka, E.; Uddin, A. Preparation of Macroporous Lime from Natural Lime by Swelling Method with Water and Acetic Acid Mixture for Removal of Sulfur Dioxide at High-Temperature; *Ind. Eng. Chem. Res.* **2002**, *41*, 1352-1356.
 135. Wu, S.; Uddin, A.; Su, C.; Nagamine, S.; Sasaoka, E. Effect of the Pore-Size Distribution of Lime on the Reactivity for the Removal of SO₂ in the Presence of High-Concentration CO₂ at High Temperature; *Ind. Eng. Chem. Res.* **2002**, *41*, 5455-5458.
 136. Johnson, A.A. Zero Emission Coal: Competitive, Highly Efficient Electricity Production from Even High Sulfur Coals. *Energeia* **2002**, *13* (5), 1-3.
 137. Ziock, H.J.; Brosha, E.L.; Garzon, F.H.; Guthrie, G.D.; Mukundan, R.; Robison, T.W.; Roop, B.; Smith, B.F.; Johnson, A.A.; Lackner, K.S.; et al. Presented at the 19th Annual International Pittsburgh Coal Conference, Pittsburgh, PA, 2002; Paper 25-2.
 138. Ziock, H.J.; Lackner, K.S.; Harrison, D.P. Zero Emission Coal Power, a New Concept. Presented at the 1st National Conference on Carbon Sequestration, Washington, DC, 2001; Paper 2b.2.
 139. Nakagawa, K.; Ohashi, T. A Novel Method of CO₂ Capture from High-Temperature Gases. *J. Electrochem. Soc.* **1998**, *145* (4), 1344-1345.
 140. Nakagawa, K.; Ohashi, T. High Temperature CO₂ Absorption Using Lithium Zirconate Powder. Presented at the 193rd Meeting of The Electrochemical Society, San Diego, 1998; Abstract No. 1073.
 141. Ohashi, T.; Nakagawa, K.; Kato, M.; Yoshikawa, S.; Essaki, K. High-Temperature CO₂ Removal Technique Using Novel Solid Chemical Adsorbent. Presented at the 5th International Conference on Greenhouse Gas Control Technologies, Cairns, Australia, 2000.
 142. Ohashi, T.; Nakagawa, K. Effect of Potassium Carbonate Additive on CO₂ Absorption in Lithium Zirconate Powder; *Mat. Res. Soc. Symp. Proc* **1999**, *547*, 249-254.
 143. Essaki, K.; Nakagawa, K.; Kato, M. Acceleration Effect of Ternary Carbonate on CO₂ Absorption Rate in Lithium Zirconate Powder; *J. Ceramic Soc. Japan* **2001**, *109* (10), 829-833.
 144. Lin, J.Y.S. *Novel Inorganic Materials for High Temperature Carbon Dioxide Separation. Year II. Membrane Synthesis and Sorbent Improvement*; Subcontract No. OCRC3-00-1. C1.8, Project Report C2.8; Ohio Department of Development, Ohio Coal Development Office, Coal Research Consortium: Columbus, OH, 2002. Available at: <http://www.ohiocoal.org/projects/Year2/C2.8.pdf>.
 145. Kato, M.; Yoshikawa, S.; Nakagawa, K. Carbon Dioxide Absorption by Lithium Orthosilicate in a Wide Range of Temperature and Carbon Dioxide Concentrations; *J. Materials Sci. Lett.* **2002**, *21*, 485-487.
 146. Kato, M.; Nakagawa, K. New Series of Lithium Containing Complex Oxides, Lithium Silicates, for Application as a High-Temperature CO₂ Adsorbent; *J. Ceramic Soc. Japan* **2001**, *109* (11), 911-914.
 147. Hoffman, J.S.; Pennline, H.W. Letter to Toshiba, Inc., October 2002.
 148. Knight, R.A.; Feldkirchner, H.L.; Carty, R.H.; Babu, S.P. *A Process to Produce Medium-Btu Gas from Coal*; Conference Paper CONF-900391-4, Ref No. DE90007584; Presented at the AIChE Spring Meeting, Orlando, FL, March, 1990, American Institute of Chemical Engineers: New York, 1990.
 149. Sincar, S.; Golden, T.C. Purification of Hydrogen by Pressure Swing Adsorption; *Sep. Sci. Technol.* **2000**, *35*, 667-687.
 150. Reddy, S. Hydrogen and Carbon Dioxide Coproduction; U.S. Patent Application No. 20020073845, 2002.
 151. Siriwardane, R.V.; Shen, M.S.; Fisher, E.P.; Poston, J.A. Adsorption of CO₂ on Molecular Sieves and Activated Carbon; *Energy Fuels* **2001**, *15* (2), 279-284.
 152. Siriwardane, R.V.; Shen, M.S.; Fisher, E.P.; Poston, J.A.; Shamsi, A. Adsorption and Desorption of CO₂ on Solid Sorbents. Presented at the 1st National Conference on Carbon Sequestration, Washington, DC, 2001; Paper 3b.3.
 153. Ko, D.; Siriwardane, R.; Biegler, L.T. Optimization of a Pressure-Swing Adsorption Process Using Zeolite 13X for CO₂ Sequestration. Presented at the American Institute of Chemical Engineers Annual Meeting, New York, November 2002; Paper 121d. Available at: <http://www.netl.doe.gov/products/t&d/techpaper/2002-682.pdf>.
 154. Siriwardane, R.V.; Shen, M.S.; Fisher, E.P. Adsorption of CO₂, N₂, and O₂ on Natural Zeolites; *Energy Fuels* **2003**, in press.
 155. Judkins, R.R.; Armstrong, T.R. An Overview of Technologies for Separating and Concentrating CO₂ from Mixed Gas Streams. Presented at the 19th Annual International Pittsburgh Coal Conference, Pittsburgh, PA, 2002; Paper 43-1. Available at: http://www.netl.doe.gov/publications/proceedings/01/carbon_seq/3b1.pdf.
 156. Judkins, R.R.; Burchell, T.D. CO₂ Removal from Gas Streams Using a Carbon Fiber Composite Molecular Sieve. Presented at the 1st National Conference on Carbon Sequestration, Washington, DC, 2001; Paper 3b.1.
 157. Sarkar, S.C.; Bose, A. Role of Activated Carbon Pellets in Carbon Dioxide Removal; *Energy Convers. Mgmt.* **1997**, *38* (18), S105-S110.
 158. Chue, K.T.; Kim, J.N.; Yoo, Y.J.; Cho, S.H.; Yang, R.T. Comparison of Activated Carbon and Zeolite 13X for CO₂ Recovery from Flue Gas by Pressure Swing Adsorption; *Ind. Eng. Chem. Res.* **1995**, *34*, 591-598.
 159. Kikkiniades, E.S.; Yang, R.T.; Cho, S.H. Concentration and Recovery of CO₂ from Flue Gas by Pressure Swing Adsorption; *Ind. Eng. Chem. Res.* **1993**, *32*, 2714-2720.
 160. Park, J.H.; Beum, H.T.; Kim, J.N.; Cho, S.H. Numerical Analysis of the Power Consumption of the PSA Process for Recovering CO₂ from Flue Gas; *Ind. Eng. Chem. Res.* **2002**, *41*, 4122-4131.
 161. Na, B.K.; Koo, K.K.; Eum, H.M.; Lee, H.; Song, H.K. CO₂ Recovery from Flue Gas by PSA Process Using Activated Carbon; *Korean J. Chem. Eng.* **2001**, *18*, 220-227.
 162. Gomes, V.G.; Yee, K.W.K. Pressure Swing Adsorption for Carbon Dioxide Sequestration from Exhaust Gases; *Separation Purification Technol.* **2002**, *28*, 161-171.
 163. Yamano, M.; Aono, T.; Kurimoto, M.; Uno, M. Process for Separation of High-Purity Gas from Mixed Gas; International Patent No. WO87/01611, 1987.
 164. Takamura, Y.; Narita, S.; Aoki, J.; Uchida, S. Application of High-Pressure Swing Adsorption Process for Improvement of CO₂ Recovery System from Flue Gas; *Can. J. Chem. Eng.* **2001**, *79*, 812-816.
 165. Ito, S.; Makino, H.; Eliasson, B.; Riemer, P.; Wokaun, A. Carbon Dioxide Separation from Coal Gas by Physical Adsorption at Warm Temperature. In *Proceedings of the 4th International Conference on Greenhouse Gas Control Technologies, Interlaken, Switzerland, 1998*; Elsevier: Oxford, UK, 1999; pp 131-136.
 166. Gazzì, L.; Rescalli, C. Cryogenic Process for the Removal of Acidic Gases from Mixtures of Gases by Using Solvents; European Patent Application No. 86200865.3, 1986.
 167. Spencer, D.F.; Tam, S.S.; Deppe, G.; Currier, R.F.; Young, J.S.; Anderson, G.K. Carbon Dioxide Separation from a High Pressure Shifted Synthesis Gas. Presented at the 19th Annual International Pittsburgh Coal Conference, Pittsburgh, PA, 2002; Paper 37-3.
 168. Spencer, D.F.; Tam, S.S. An Engineering and Economic Evaluation of a CO₂ Hydrate Separation System for Shifted Synthesis Gas. Presented at the 16th Annual International Pittsburgh Coal Conference, Pittsburgh, PA, 1999; Paper 7-3.
 169. Spencer, D.F.; Eliasson, B.; Riemer, P.; Wokaun, A. Integration of an Advanced CO₂ Separation Process with Methods for Disposing of CO₂ in Oceans and Terrestrial Deep Aquifers. In *Proceedings of the 4th International Conference on Greenhouse Gas Control Technologies, Interlaken, Switzerland, 1998*; Elsevier: Oxford, UK, 1999; pp 89-94.

170. Tam, S.S.; Stanton, M.E.; Ghose, S.; Deepe, G.; Spencer, D.F.; Currier, R.P.; Young, J.S.; Anderson, G.K.; Le, L.A.; Devlin, D.J. A High Pressure Carbon Dioxide Separation Process for IGCC Plants. Presented at the 1st National Conference on Carbon Sequestration, Washington, DC, 2001; Paper 1b.4.
171. Pennline, H.W.; Hoffman, J.S. Carbon Dioxide Capture Process with Regenerable Sorbents. U.S. Patent 6,387,337, 2002.
172. Ciora, R.J., Jr.; Liu, R.K. Development of CO₂ Affinity Inorganic Membrane Suitable for CO₂ Sequestration Applications. Presented at the 19th Annual International Pittsburgh Coal Conference, Pittsburgh, PA, 2002; Paper 45-2.
173. Noble, R.D.; Falconer, J.L. CO₂ Separations Using Zeolite Membranes. Presented at the University Coal Research Contractors Review Meeting, Pittsburgh, PA, June 6–7, 2001.
174. Shih, W.-H.M.R. Development of (Barium-Doped Alumina) Mesoporous Membrane for CO₂ Separation. Presented at the University Coal Research Contractors Review Meeting, Pittsburgh, PA, June 6–7, 2001.
175. Andrews, R. Separation of CO₂ from Flue Gases by Carbon-Multiwall Carbon Nanotube Membranes. Presented at the University Coal Research Contractors Review Meeting, Pittsburgh, PA, June 6–7, 2001.
176. Shekhawat, D.; Luebke, D.R.; Pennline, H.W. *A Review of Carbon Dioxide Selective Membranes*; Draft U.S. Dept of Energy, Topical Report; 2003.
177. Schell, W.J.; Houston, C.D. Separation of CO₂ from Mixtures by Membrane Permeation. Presented at the 61st Gas Conditioning Conference, 1983.
178. Goddin, C.S. Comparison of Processes for Treating Gases with High CO₂ Content. Presented at the 61st Gas Conditioning Conference, 1983.
179. Perry, E.S. *Progress in Separation and Purification*; Wiley Interscience: New York, 1968; Vol. 1.
180. Huckins, H.E.; Kammermeyer, K. Correction to the Separation of Gases by Means of Porous Membranes; *Chem. Eng. Prog.* **1953**, *49* (10), 517.
181. Huckins, H.E.; Kammermeyer, K. The Separation of Gases by Means of Porous Membranes Part II; *Chem. Eng. Prog.* **1953**, *49* (6), 294-298.
182. Huckins, H.E.; Kammermeyer, K. The Separation of Gases by Means of Porous Membranes Part I; *Chem. Eng. Prog.* **1953**, *49* (4), 180-184.
183. Weller, S.; Steiner, W.A. *J. Appl. Physics* **1950**, *21* (4), 279.
184. Russell, F.G.; Coady, A.B. Gas-Permeation Process Economically Recovers CO₂ from Heavily Concentrated Streams; *Oil Gas J.* **1982**, June 28, 128-134.
185. Schell, W.J.; Houston, C.D. Process Gas with Selective Membranes; *Hydrocarbon Process.* **1982**, *61* (9), 249-252.
186. Hogsett, J.E.; Mazur, W.H. Estimate Membrane Surface Area; *Hydrocarbon Process.* **1983**, *62* (8), 52-54.
187. Cheng, S.I. U.S. Patent No. 4,353,713, 1982.
188. Granite, E.J. A Pilot Plant Design for the Integrated Gasification Process; MS Thesis Chemical Engineering, The Cooper Union: New York, 1989.
189. Buxbaum, R.E.; Kinney, A.B. Hydrogen Transport through Tubular Membranes; *Ind. Eng. Chem. Res.* **1996**, *35*, 530-537.
190. Pauling, L. *General Chemistry*; Dover Publications: New York, 1970.
191. Govind, R.; Atnoor, D. Development of a Composite Palladium Membrane for Selective Hydrogen Separation at High Temperature; *Ind. Eng. Chem. Res.* **1991**, *35*, 591-594.
192. Morreale, B.D.; Ciocco, M.V.; Enick, R.M.; Morsi, B.I.; Howard, B.H.; Cugini, A.V.; Rothenberger, K.S. The Permeability of Hydrogen in Bulk Palladium at Elevated Temperatures and Pressures; *J. Membrane Sci.* **2003**, *212*, 87-97.
193. Ciocco, M.V.; Morreale, B.D.; Rothenberger, K.S.; Howard, B.H.; Cugini, A.V.; Killmeyer, R.P.; Enick, R.M. High-Pressure, High-Temperature Hydrogen Permeability Measurements of Supported Thin-Film Palladium Membranes. Presented at the 19th Annual International Pittsburgh Coal Conference, Pittsburgh, PA, 2002; Paper 49-3.
194. Damle, A.S. Separation of Hydrogen and Carbon Dioxide in Advanced Fossil Energy Conversion Processes Using a Membrane Reactor. Presented at the 19th Annual International Pittsburgh Coal Conference, Pittsburgh, PA, 2002; Paper 49-2.
195. Way, J.D.; McCormic, R.L.; Roa, F. Palladium/Copper Alloy Composite Membranes for High-Temperature Hydrogen Separation from Coal-Derived Gas Streams. Presented at the University Coal Research Contractors Review Meeting, Pittsburgh, PA, June 6–7, 2001.
196. Dorris, S.E.; Lee, T.H.; Wang, S.; Picciolo, J.J.; Dusek, J.T.; Balachandran, U.; Rothenberger, K.S. Dense Cermet Membranes for Hydrogen Separation. Presented at the 19th Annual International Pittsburgh Coal Conference, Pittsburgh, PA, 2002; Paper 49-1.
197. Roark, S.E.; Mackay, R.; Sammells, A.F. Catalytic Membrane Reactors for Hydrogen Separation in Hydrocarbon Feedstreams. Presented at the 19th Annual International Pittsburgh Coal Conference, Pittsburgh, PA, 2002; Paper 43-2.
198. Gade, S.; Schaller, R.; Berland, B.; Schwartz, M. Novel Composite Membranes for Hydrogen Separation in Gasification in Vision 21 Plants. Presented at the 19th Annual International Pittsburgh Coal Conference, Pittsburgh, PA, 2002; Paper 43-3.
199. Pennline, H.; Hoffman, J.; Gray, M.; Siriwandane, R.; Granite, E. Recent Advances in Carbon Dioxide Capture and Separation Techniques at the National Energy Technology Laboratory. Presented at AIChE National Meeting, Reno, NV, November 2001; Paper 28g.
200. Sugiura, K.; Yanagida, M.; Tanimoto, K.; Kojima, T. The Removal Characteristics of Carbon Dioxide in Molten Carbonate for the Thermal Power Plant. In *Proceedings of GHGT-5*, Cairns, Australia, 2000.
201. Sugiura, K.; Takei, K.; Tanimoto, K.; Kojima, T. The Carbon Dioxide Concentrator by Using MCFC. Presented at the 8th Grove Fuel Cell Symposium, London, UK, 2003.
202. Amorelli, A.; Wilkinson, M.B.; Bedont, P.; Capobianco, P.; Marcenaro, B.; Parodi, F.; Torazza, A. An Experimental Investigation into the Use of Molten Carbonate Fuel Cells to Capture CO₂ from Gas Turbine Exhaust Gases. Presented at GHGT-6, Kyoto, 2002; Paper F3-4.
203. Itou, K.; Tani, H.; Ono, Y.; Kasai, H.; Ota, K.-I. High Efficiency CO₂ Separation and Concentration System by Using Molten Carbonate. Presented at GHGT-6, Kyoto, 2002; Paper F3-5.
204. Winnick, J. Electrochemical Membrane Gas Separation; *Chem. Eng. Prog.* **1990**, *1990*, 41-46.
205. Weaver, J.L.; Winnick, J. The Molten Carbonate Carbon Dioxide Concentrator: Cathode Performance at High CO₂ Utilization. *J. Electrochem. Soc.* **1983**, *130* (1), 20-28.
206. Winnick, J.; Toghiani, H.; Quattrone, P. Carbon Dioxide Concentration for Manned Spacecraft Using a Molten Carbonate Electrochemical Cell; *AIChE J.* **1982**, *28* (1), 103-111.
207. Granite, E.; Kazonich, G.; Pennline, H. Electrochemical Devices for Separating and Detecting Carbon Dioxide. Presented at the 19th Annual International Pittsburgh Coal Conference, Pittsburgh, PA, 2002; Paper 45-3.
208. Granite, E.; Kazonich, G.; Pennline, H. Electrochemical Devices for Separating and Detecting Carbon Dioxide. Presented at the DOE Carbon Sequestration Program Review Meeting, Pittsburgh, PA, February 2002.
209. Granite, E.J. Solid Electrolyte Aided Studies of Oxide Catalyzed Oxidation of Hydrocarbons; Ph.D. Thesis Chemical Engineering, University of Rochester, Rochester, NY, 1994.
210. Granite, E.J.; Jorne, J.A. Novel Method for Studying Electrochemically Induced "Cold Fusion" Using a Deuteron-Conducting Solid Electrolyte; *J. Electroanal. Chem.* **1991**, *317*, 285-290.
211. Granite, E.J. *Electrochemical Pumps for the Separation of Hydrogen*; NETL Project Proposal; U.S. Department of Energy: Pittsburgh, PA, 1999.
212. Soong, S.-J.; Wachsmann, E.D.; Dorris, S.E.; Balachandran, U. Defect Chemistry Modeling of High-Temperature Proton-Conducting Cerates; *Solid State Ionics* **2002**, *149*, 1-10.
213. Guan, J.; Dorris, S.E.; Balachandran, U.; Liu, M. Transport Properties of SrCe_{0.95}Y_{0.05}O_{3-y} and Its Application for Hydrogen Separation; *Solid State Ionics* **1998**, *110*, 303-310.
214. Balachandran, U.; Ma, B.; Maiya, P.S.; Mieville, R.L.; Dusek, J.T.; Picciolo, J.; Guan, J.; Dorris, S.E.; Liu, M. Development of Mixed-Conducting Oxides for Gas Separation; *Solid State Ionics* **1998**, *108*, 363-370.
215. Crenshaw, M. Letter to Evan J. Granite, 2000.
216. Crenshaw, M.; Chapman, T.; Granite, E.; Kazonich, G. Sequestration of CO₂ Via a Molluscan Bio-Mimetic Pathway. Presented at the Carbon Sequestration Merit Review Meeting, National Energy Technology Center, Pittsburgh, PA, 2000.
217. Lehninger, A.L. *Biochemistry*; Worth Publishers: New York, 1975.
218. Matthews, B.J.H. The Rate of Air-Sea CO₂ Exchange: Chemical Enhancement and Catalysis by Marine Microalgae; Ph.D. Thesis, University of East Anglia, Norwich, UK, 1999.
219. Bond, G.M.; Stringer, J.; Brandvold, D.K.; Simsek, F.A.; Medina, M.-G.; Egeland, G. Development of Integrated System for Biomimetic CO₂ Sequestration Using the Enzyme Carbon Anhydrase; *Energy Fuels* **2001**, *15*, 309-316.
220. Bond, G. M.; Medina, M.-G.; Stringer, J.; Simsek-Ege, F.A. CO₂ Capture from Coal-Fired Utility Generation Plant Exhausts, and Sequestration by Biomimetic Route Based on Enzymatic Catalysis—Current Status. Presented at the 1st National Conference on Carbon Sequestration, Washington, DC, 2001; Paper 5a.5.
221. Bond, G.M.; Stringer, J.; Brandvold, D.K.; Medina, M.-G.; Simsek, F.A.; Egeland, G. Development of Integrated Systems for Biomimetic CO₂ Sequestration Using the Enzyme Carbonic Anhydrase; *Prepr. ACS Div. Fuel Chem.* **2000**, *45* (4), 713.
222. Bond, G.M.; Egeland, G.; Grandvold, D.K.; Medina, M.-G.; Stringer, J.J. *Enzymatic Catalysis And CO₂ Sequestration*, World Resource Review ed.; 1999; Chapter 11(4), pp 603-619.
223. Ichikawa, K.; Nakata, K.; Ibrahim, M.M.; Kawabata, S. Biochemical CO₂ Fixation by Mimicking Zinc (II) Complex for Active Site of Carbonic Anhydrase. In *Advances in Chemical Conversions for Mitigating Carbon Dioxide*; Inui T., Anpo, M., Izui, K., Yanagida, S., Yamaguchi, T., Eds.; Elsevier: New York, 1998.
224. Hirano, S.; Yamamoto, K.; Inue, H.; Draget, K.I.; Varum, K.M.; Smidsrod, O. Chitosan-Calcium Carbonate Composite: Biomimetic

- Mineralization of Aqueous Carbonate Ions into Chitosan-Calcium Alginate Hydrogels. In *Advances in Chemical Conversions for Mitigating Carbon Dioxide*; Inui, T., Anpo, M., Yanagida, S., Yamaguchi, T., Eds.; Elsevier: New York, 1998.
225. Yokota, A. Super-RuBisCO: Improvement of Photosynthetic Performances of Plants. In *Advances in Chemical Conversions for Mitigating Carbon Dioxide*; Inui, T.; Anpo, M.; Izui, K.; Yanagida, S.; Yamaguchi, T., Eds.; Elsevier: New York, 1998.
226. Fujii, T.; Sadaie, M.; Saijou, M.; Nagano, T.; Suzuki, T.; Ohtani, M.; Shinoyama, H. Physiological Properties of Phosphoenolpyruvate Carboxylase and Phosphoenolpyruvate Carboxykinase from *Rhodospseudomonas* sp. No. 7. In *Advances in Chemical Conversions for Mitigating Carbon Dioxide*; Inui, T., Anpo, M., Izui, K., Yanagida, S., Yamaguchi, T., Eds.; Elsevier: New York, 1998.
227. Murakami, M.; Yamaguchi, N.; Nashide, T.; Muranaka, T.; Takimoto, Y. Overexpressed Effect of Carbonic Anhydrase on CO₂ Fixation in Cyanobacterium, *Synechococcus* sp. PCC7942. In *Advances in Chemical Conversions for Mitigating Carbon Dioxide*; Inui, T., Anpo, M., Izui, K., Yanagida, S., Yamaguchi, T., Eds.; Elsevier: New York, 1998.
228. Ishii, M.; Yoon, K.-S.; Ueda, Y.; Ochiai, T.; Yun, N.; Takishita, S.; Kodama, T.; Igarashi, Y. Reductive TCA Cycle in an Aerobic Bacterium, *Hydrogenobacterthermophilus* Strain TK-6. In *Advances in Chemical Conversions for Mitigating Carbon Dioxide*; Inui, T., Anpo, M., Izui, K., Yanagida, S., Yamaguchi, T., Eds.; Elsevier: New York, 1998.
229. Tomizawa, K.-I.; Shikanai, T.; Shimoide, A.; Foyer, C. H.; Yokata, A. Revertant of No-Active RuBisCo Tobacco Mutant, Sp25, Obtained by Chloroplast Transformation Method Using Microprojectile Bombardment. In *Advances in Chemical Conversions for Mitigating Carbon Dioxide*; Inui, T., Anpo, M., Izui, K., Yanagida, S., Yamaguchi, T., Eds.; Elsevier: New York, 1998.
230. Nakamura, T.; Izui, K. Molecular Characterization of Recombinant Phosphoenolpyruvate Carboxylase from an Extreme Thermophile. In *Advances in Chemical Conversions for Mitigating Carbon Dioxide*; Inui, T., Anpo, M., Izui, K., Yanagida, S., Yamaguchi, T., Eds.; Elsevier: New York, 1998.
231. Matsumura, H.; Nagata, T.; Inoue, T.; Nagara, Y.; Yoshinaga, T.; Izui, K.; Kai, Y. Crystallization and Preliminary X-Ray Studies of Phosphoenolpyruvate Carboxylase from *Escherichia Coli*. In *Advances in Chemical Conversions for Mitigating Carbon Dioxide*; Inui, T., Anpo, M., Izui, K., Yanagida, S., Yamaguchi, T., Eds.; Elsevier: New York, 1998.
232. Mauser, H.; King, W.A.; Gready, J.E.; Andrews, T.J. CO₂ Fixation by Rubisco: Computational Dissection of the Key Steps of Carboxylation, Hydration and C-C Bond Cleavage; *J. Am. Chem. Soc.* **2001**, *123*, 10821-10829.
233. Umeda, Y.; Hirano, A.; Hon-Nami, K.; Kunito, S.; Akiyama, H.; Onizuka, T.; Ikeuchi, M.; Inoue, Y. Conversion of CO₂ into Cellulose by Gene Manipulation of Microalgae: Cloning of Cellulose Synthase Genes from *Acetobacter xylinum*. In *Advances in Chemical Conversions for Mitigating Carbon Dioxide*; Inui, T., Anpo, M., Izui, K., Yanagida, S., Yamaguchi, T., Eds.; Elsevier: New York, 1998.
234. Kurano, N.; Sasaki, T.; Miyachi, S. Carbon Dioxide and Microalgae. In *Advances in Chemical Conversions for Mitigating Carbon Dioxide*; Inui, T., Anpo, M., Izui, K., Yanagida, S., Yamaguchi, T., Eds.; Elsevier: New York, 1998.
235. Kawata, M.; Nanba, M.; Matsukawa, R.; Chihara, M.; Karube, I. Isolation and Characterization of a Green Alga *Neochloris* sp. for CO₂ Fixation. In *Advances in Chemical Conversions for Mitigating Carbon Dioxide*; Inui, T., Anpo, M., Izui, K., Yanagida, S., Yamaguchi, T., Eds.; Elsevier: New York, 1998.
236. Hanagata, N.; Matsukawa, R.; Chihara, M.; Karube, I. Tolerance of a Green Alga, *Scenedesmus komarekii*, to Environmental Extremes. In *Advances in Chemical Conversions for Mitigating Carbon Dioxide*; Inui, T., Anpo, M., Izui, K., Yanagida, S., Yamaguchi, T., Eds.; Elsevier: New York, 1998.
237. Pedroni, P.; Davison, J.; Beckert, H.; Bergman, P.; Benemann, J.A. Proposal to Establish an International Network on Biofixation of CO₂ and Greenhouse Gas Abatement with Microalgae; *NETL J. Energy Env. Res.* **2001**, *1*, 136-150.
238. Pedroni, P.; Davison, J.; Beckert, H.; Bergman, P.; Benemann, J. A Proposal to Establish an International Network on Biofixation of CO₂ and Greenhouse Gas Abatement with Microalgae. Presented at the 1st National Conference on Carbon Sequestration, Washington, DC, 2001; Poster Paper 17.
239. Nakamura, T.; Senior, C.; Olaizola, M.; Cushman, M.; Masutani, S. Capture and Sequestration of CO₂ from Stationary Combustion Systems by Photosynthesis of Microalgae. Presented at the 1st National Conference on Carbon Sequestration, Washington, DC, 2001; Poster Paper 15.
240. Yamada, K.; Suzuki, Y.; Casareto, B.E.; Komiyama, H. Possibility of High CO₂ Fixation Rate by Coral Reef Ecosystems. Presented at GHGT-6, Kyoto, 2002; Paper D2-5.
241. Benemann, J.R. CO₂ Mitigation with Microalgae Systems; *Energy Convers. Mgmt.* **1997**, *38*, S475-S479.
242. Usui, N.; Ikenouchi, M. The Biological CO₂ Fixation and Utilization Project by RTE (1)-Highly Effective Photobioreactor System; *Energy Convers. Mgmt.* **1997**, *38*, S487-S492.
243. Hirata, S.; Hayashitani, M. Carbon Dioxide Fixation and Biomass Production with Blue-Green Algae *Spirulina Platensis*. In *Advances in Chemical Conversions for Mitigating Carbon Dioxide*; Inui, T., Anpo, M., Izui, K., Yanagida, S., Yamaguchi, T., Eds.; Elsevier: New York, 1998.
244. Pal, N. Microbial Sequestration of Carbon Dioxide and Subsequent Conversion to Methane. Presented at the 1st National Conference on Carbon Sequestration, Washington, DC, 2001; Poster Paper 13.
245. Sinha, V.R.P.; Fraley, L.; Chowdhry, B.S. Carbon Dioxide Utilization and Seaweed Production. Presented at the 1st National Conference on Carbon Sequestration, Washington, DC, 2001; Poster Paper 14.
246. Hon-Nami, K.; Hirano, A.; Kumito, S.; Tsuyuki, Y.; Kinoshita, T.; Ogushi, Y.A. New Marine Microalga Cultivation in a Tubular Bioreactor and Its Utilization as an Additive for Paper Surface Improvements; *Energy Convers. Mgmt.* **1997**, *38*, S481-S486.
247. Shishido, Y.; Kawata, M.; Matsukawa, R.; Chihara, M.; Karube, I. Screening of Polysaccharide-Producing Microalgae. In *Advances in Chemical Conversions for Mitigating Carbon Dioxide*; Inui, T., Anpo, M., Izui, K., Yanagida, S., Yamaguchi, T., Eds.; Elsevier: New York, 1998.
248. Matsukawa, R.; Wada, Y.; Tan, N.; Saiai, N.; Chihara, M.; Karube, I. Antioxidant Activity of CO₂ Fixing Microalgae. In *Advances in Chemical Conversions for Mitigating Carbon Dioxide*; Inui, T., Anpo, M., Izui, K., Yanagida, S., Yamaguchi, T., Eds.; Elsevier: New York, 1998.
249. Samejima, Y.; Hirano, A.; Hon-Nami, K.; Kunito, S.; Masuda, K.; Haseiue, M.; Tsuyuki, Y.; Ogushi, Y. A Marine Microalga Utilization for a Paper: Semi-Batch Cultivation of *Tetraselmis* sp. Tt-1 by a Tubular Bioreactor and the Partial Substitution of Whole Kenaf Pulp for a Paper. In *Advances in Chemical Conversions for Mitigating Carbon Dioxide*; Inui, T., Anpo, M., Izui, K., Yanagida, S., Yamaguchi, T., Eds.; Elsevier: New York, 1998.
250. Yamagat, H.; Matoba, R.; Fujii, T.; Yukawa, H. Application of Photosynthetic Bacteria for Porphyrin Production. In *Advances in Chemical Conversions for Mitigating Carbon Dioxide*; Inui, T., Anpo, M., Izui, K., Yanagida, S., Yamaguchi, T., Eds.; Elsevier: New York, 1998.
251. Otsuki, T.; Yamashita, M.; Hirotsu, T.; Kabeya, H.; Kitagawa, R. Utilization of Micro-Algae for Building Materials after CO₂ Fixation. In *Advances in Chemical Conversions for Mitigating Carbon Dioxide*; Inui, T., Anpo, M., Izui, K., Yanagida, S., Yamaguchi, T., Eds.; Elsevier: New York, 1998.
252. Miyasaka, H.; Nakano, H.; Akiyama, H.; Kanai, S.; Hirano, M. Production of PHA (Polyhydroxyalkanoate) by Genetically Engineered Marine Cyanobacterium. In *Advances in Chemical Conversions for Mitigating Carbon Dioxide*; Inui, T., Anpo, M., Izui, K., Yanagida, S., Yamaguchi, T., Eds.; Elsevier: New York, 1998.
253. Hayashi, T.; Ihara, Y.; Nakai, T.; Tominaga, R. Cellulose as a Biological Sink of CO₂. In *Advances in Chemical Conversions for Mitigating Carbon Dioxide*; Inui, T., Anpo, M., Izui, K., Yanagida, S., Yamaguchi, T., Eds.; Elsevier: New York, 1998.
254. Suh, I.S.; Park, C.B.; Han, J.-K.; Lee, S.B. Cultivation of Cyanobacterium in Various Types of Photobioreactors for Biological CO₂ Fixation. In *Advances in Chemical Conversions for Mitigating Carbon Dioxide*; Inui, T., Anpo, M., Izui, K., Yanagida, S., Yamaguchi, T., Eds.; Elsevier: New York, 1998.
255. Watanabe, Y.; Morita, M.; Saiki, H. Photosynthetic CO₂ Fixation Performance by a Helical Tubular Photobioreactor Incorporating *Chlorella* sp. under Outdoor Culture Conditions. In *Advances in Chemical Conversions for Mitigating Carbon Dioxide*; Inui, T., Anpo, M., Izui, K., Yanagida, S., Yamaguchi, T., Eds.; Elsevier: New York, 1998.
256. Bayless, D.J.; Kremer, G.G.; Prudich, M.E.; Stuart, B.J.; Vis-Chiasson, M.L.; Cooksey, K.; Muhs, J. Enhanced Practical Photosynthetic CO₂ Mitigation. Presented at the 1st National Conference on Carbon Sequestration, Washington, DC, 2001; Paper 5a.4.
257. Ono, E.; Cuello, J.L. Design Parameters of Solar Concentrating Systems for CO₂-Mitigating Algal Photobioreactors. Presented at GHGT-6, Kyoto, 2002; Paper F2-5.
258. Watanabe, Y.; Saiki, H. Development of a Photobioreactor Incorporating *Chlorella* Sp. for Removal of CO₂ in Stack Gas; *Energy Convers. Mgmt.* **1997**, *38* (19), S499-S503.
259. Kadam, K.L. Power Plant Flue Gas as a Source for CO₂ for Microalgae Cultivation: Economic Impact of Different Process Options; *Energy Convers. Mgmt.* **1997**, *38* (19), S505-S510.
260. Kajiwara, S.; Yamada, H.; Ohkuni, N.; Ohtaguchi, K. Design of the Bioreactor for Carbon Dioxide Fixation by *Synechococcus* PCC7942; *Energy Convers. Mgmt.* **1997**, *38* (19), S529-S532.
261. Borodyanski, G.; Konstantinov, I. Microalga Separator Apparatus and Method; U.S. Patent Application No. 20020079270, 2002.
262. Nakamura, T.; Olaizola, M.; Masutani, S.M. Recovery and Sequestration of CO₂ from Stationary Combustion Systems by Photosynthesis of Microalgae; Quarterly Report #4; National Energy Technology Laboratory: Pittsburgh, PA, 2002.
263. Bayless, D.J.; Vis-Chiasson, M.L.; Kremer, G.G. Enhanced Practical Photosynthetic CO₂ Mitigation; U.S. Patent Application 20020072109, 2002.

264. Granite, E.J.; Pennline, H.W. Photochemical Removal of Mercury from Flue Gas; *Ind. Eng. Chem. Res.* **2002**, *41*, 5470-5476.
265. Kosugi, T.; Hayashi, A.; Matsumoto, T.; Akimoto, K.; Tokimatsu, K.; Yoshida, H.; Tomoda, T.; Kaya, Y. Evaluation of CO₂ Capture Technologies Development by Use of Graphical Evaluation and Review Technique. Presented at GHGT-6, Kyoto, 2002; Paper B4-3.
266. Stahl, E.; Schilz, W.; Schutz, E.; Willing, E. A Quick Method for the Microanalytical Evaluation of the Dissolving Power of Supercritical Gases; *Angew. Chem. Int. Ed. Engl.* **1978**; *17*, 731-738.
267. Prutton, C.F.; Savage, R.L. The Solubility of Carbon Dioxide in Calcium Chloride-Water Solutions at 75, 100, 120° and High Pressures; *J. Am. Chem. Soc.* **1945**, *67*, 1550-1554.
268. Bethke, C.M. *The Geochemist's Workbench—A User's Guide to Rxn, Act2, Tact, React, and Gtplot*; 4.0 ed.; University of Illinois: Urbana, IL, 2002.
269. Wiebe, R.; Gaddy, V.L. The Solubility in Water of Carbon Dioxide at 50, 75 and 100°, at Pressures to 700 Atmospheres; *J. American Chemical Soc.* **1939**, *61*, 315-318.
270. Wiebe, R.; Gaddy, V.L. The Solubility of Carbon Dioxide in Water at Various Temperatures from 12 to 40° and at Pressures to 500 Atmospheres. Critical Phenomena; *J. Am. Chem. Soc.* **1940**, *62*, 815-817.
271. Enick, R.M.; Klara, S.M. CO₂ Solubility in Water and Brine under Reservoir Conditions; *Chem. Eng. Comm.* **1990**, *90*, 23-33.
272. Enick, R.M.; Klara, S.M. Effects of CO₂ Solubility in Brine on the Compositional Simulation of CO₂ Floods; *Reservoir Eng.* **1992**, 253-258.
273. Duan, Z.; Moller, N.; Weare, J.H. An Equation of State for the CH₄-CO₂-H₂O System: I. Pure Systems from 0 to 1000 °C and 0 to 8000 Bar; *Geochimica Cosmochim. Acta* **1992**, *56*, 2605-2617.
274. White, C.M.; Smith, D.; Jones, K.; Goodman, A.; Jikich, S.; LaCount, R.; DuBose, S.; Ozdemir, E.; Morsi, B.; Schroeder, K.T. Storage of Carbon Dioxide in Coal with Concomitant Enhanced Coalbed Methane Recovery—A Review; to be submitted.
275. Gunter, W.D.; Gentz, T.; Rottenfusser, B.A.; Richardson, R.J.H. Deep Coalbed Methane in Alberta, Canada: A Fuel Resource with the Potential of Zero Greenhouse Gas Emissions; *Energy Convers. Mgmt.* **1997**, *38* (18), S217-S222.
276. Fulton, P.F.; Parente, C.A.; Rogers, B.A.; Shah, N.; Reznik, A.A. A Laboratory Investigation of Methane from Coal by Carbon Dioxide Injection; *Soc. Petroleum Eng. J.* **1980**, 65.
277. Reznik, A.A.; Singh, P.K.; Foley, W.L. An Analysis of the Effect of CO₂ Injection on the Recovery of In-Situ Methane from Bituminous Coal: An Experimental Simulation; *Soc. Petroleum Eng. J.* **1984**, October, 521-528.
278. Arri, L.E.; Yee, D.; Morgan, W.D.; Jeansonne, M.W. *Modeling Coalbed Methane Production with Binary Gas Sorption*; SPE Paper 24363; SPE Rocky Mountain Regional Meeting, Casper, WY, 1992; pp 459-472.
279. Chaback, J.J.; Yee, D.; Volz, R.F., Jr.; Seidle, J.P.; Puri, R. Method for Treating a Mixture of Gaseous Fluids within a Solid Carbonaceous Subterranean Formation; Chicago, Ill. U.S. Patent 5,439,054, 1994; 1995.
280. Seidle, J.P.; Yee, D.; Puri, R. Method for Recovering Methane from Solid Carbonaceous Subterranean Formations; U.S. Patent 5,566,755, February 13, 1995; 1996.
281. Chaback, J.; Yee, D.; Volz, R.F.; Seidle, J.P.; Puri, R. Method for Recovering Methane from Solid Carbonaceous Subterranean Formations; U.S. Patent 5,566,756, August 7, 1995; 1996.
282. Lyle, D. Coalbed Methane Production Techniques Progress in Rocky Mountain Basins; *Hart's Oil Gas World* **1994**, July, 55-56.
283. Stevens, S.H.; Spector, D.; Riemer, P. Enhanced Coalbed Methane Recovery Using CO₂ Injection: Worldwide Resource and CO₂ Sequestration Potential. In *Proceedings of the International Oil & Gas Conference and Exhibition*, Beijing, China, November 2-6, 1998; SPE paper 48881; p 489.
284. Stevens, S.H.; Kuuskraa, V.A.; Spector, D.; Riemer, P. CO₂ Sequestration in Deep Coal Seams: Pilot Results and Worldwide Potential. In *Proceedings of the 4th International Conference on Greenhouse Gas Control Technologies*, Interlaken, Switzerland, 1998; Elsevier: Oxford, UK, 1999; pp 175-180.
285. Reeves, S.R. Geological Sequestration of CO₂ in Deep, Unmineable Coalbeds: An Integrated Research and Commercial-Scale Field Demonstration Project. Presented at the Annual Technical Conference and Exhibition, New Orleans, LA, Sept 30-Oct 3, 2001; SPE paper 71749.
286. Gale, J.; Freund, P. Coal Bed Methane Enhancement with CO₂ Sequestration Worldwide Potential. In *Proceedings of the 21st World Gas Conference*, Nice, France, June 6-9, 2000.
287. Seidle, J.P.; Sigdestad, C.A.; Raterman, K.T.; Negahban, S. Characterization of Enhanced Coalbed Methane Recovery Injection Wells. In *Proceedings of the Annual Technical Conference and Exhibition*, San Antonio, TX, Oct 5-8, 1997; SPE paper 38861; pp 171-176.
288. Puri, R.; Yee, D. Enhanced Coalbed Methane Recovery. In *Conference Proceeding: 65th SPE Annual Technical Conference and Exhibition*, New Orleans, LA, Sept 23-26, 1990; pp 193-202.
289. Gunter, W. CO₂ Sequestration in Deep "Unmineable" Coal Seams. In *Conference Proceedings; CAPP/CERI Industry Best Practices Conference*, 2000; pp 1-19.
290. Wong, S.; Gunter, B. Testing CO₂—Enhanced Coalbed Methane Recovery; *Greenhouse Gas R&D* **1995**, 1-4.
291. Bradshaw, B.E.; Simon, G.; Bradshaw, J.; Mackie, V. GEODISC Research: Carbon Dioxide Sequestration Potential of Australia's Coal Basins. In *Proceedings of the 18th Annual International Pittsburgh Coal Conference*, Newcastle, Australia, 2001; Pittsburgh Coal Conference: Pittsburgh, PA, 2001.
292. Wong, S.; MacLeod, K.; Wold, M.; Gunter, W.D.; Mavor, M.J.; Gale, J. CO₂ Enhanced Coalbed Methane Recovery Demonstration Pilot—A Case for Australia. In *Proceedings of the International Coalbed Methane Symposium*, Tuscaloosa, AL, 2001; pp 75-86.
293. Pagnier, H.; Van Bergen, F. CO₂ Storage in Coa: the RECOPOL Project. Presented at the First International Forum on Geologic Sequestration of CO₂ in Deep, Unmineable Coalseams, "Coal-Seq I," Houston, TX, March 14-15, 2002. Available at: <http://www.coal-seq.com/Proceedings/FrankVanBergen-CO2-Presentation.pdf>.
294. Pagnier, H.; Van Bergen, F. *Demonstrating CO₂-ECMB: The RECOPOL Project*; International Energy Agency, Greenhouse Gas R&D Programme: 2002. Available at: <http://www.ieagreen.org.uk/jan58.htm>.
295. Pagnier, H.J.M.; Bergen, F.V.; Vate, L.V.D.; Hills, L.; Bamber, W. *Inventory of the Potential of Combined Coalbed Methane Production Carbon Dioxide Disposal in the Dutch Subsurface XIV International Congress on the Carboniferous and Permian (ICCP): Programme with Abstracts*; 14. International Congress on the Carboniferous and Permian, 1999; p 109.
296. Schreurs, H.C.E. Potential for CO₂—Sequestration and Enhanced Coalbed Methane Production in the Netherlands. In *Proceedings of the 18th Annual International Pittsburgh Coal Conference*, Newcastle, Australia, 2001; Pittsburgh Coal Conference: Pittsburgh, PA, 2001.
297. World Energy Outlook; International Energy Agency: Paris, 2000. Available at: <http://www.worldenergyoutlook.org>.
298. Deguchi, G. Japanese Current R&D Effort on Coal Seam Sequestration of CO₂. Presented at the First International Forum on Geologic Sequestration of CO₂ in Deep, Unmineable Coalseams, "Coal-Seq I," Houston, TX, March 14-15, 2002. Available at: http://www.coal-seq.com/Coal-Seq_I_Forum.htm.
299. Japan Coal Energy Center. JCOAL Topics #93: JCOAL Organized Japan Forum on CO₂ Sequestration in Coal Seams; Japan Coal Energy Center: June 4, 2001. Available at: http://www.jcoal.or.jp/jcoal/en/e_topics.nsf/7f28de9c5d8dbd3649256986002d2f7f/575cabf276ef140749256a610032c140?OpenDocument.
300. Japan Coal Energy Center. Chinese Coal Project Gets Canadian Aide (April 9, 2002); Japan Coal Energy Center: April 9, 2002. Available at: http://www.jcoal.or.jp/jcoal/en/e_topics.nsf/7f28de9c5d8dbd3649256986002d2f7f/7c3ac2f9e652ff2a49256b96003da761?OpenDocument.
301. Reeves, S. Seminar at National Energy Technology Laboratory, 2001.
302. Hamelinck, C.N.; Faaij, A.P.; Ruijg, G.J.; Jansen, D.; Pagnier, H.J.M.; van Bergen, F.; Wolf, K.-H.A.A.; Barzandji, O.H.; Bruining, H.; Schreurs, H. Potential for CO₂ Sequestration and Enhanced Coalbed Methane Production in the Netherlands; The Netherlands Agency for Energy and the Environment (NOVEM): Utrecht, The Netherlands, 2001. Available at: <http://www.chem.uu.nl/nws/www/publica/e2001-07.pdf>.
303. NOVEM Report Abstract *Sequestration and Enhanced Coalbed Methane Potential for CO₂*; The Netherlands Agency for Energy and the Environment (NOVEM): Utrecht, The Netherlands, 2001.
304. Dressen, R.; van Tongeren, P.; Laenen, B.; Dumar, M.; Wolf, K.H.A. CO₂ Storage/ECBM Production Scenarios for the Campine Basin (Belgium). Presented at the 5th International Conference on Greenhouse Gas Control Technologies, Cairns, Australia, 2000.
305. Kuuskraa, V.A.; Boyer, C.M., Jr.; Kelafant, J.A. Hunt for Quality Basins Goes Abroad; *OGJ Special, Oil Gas J.* **1992**, Oct. 5, 49-54.
306. Gunter, W.D.; Wong, S.; Cheel, D.B.; Sjostrom, G. Large CO₂ Sinks: Their Role in the Mitigation of Greenhouse Gases from an International, National (Canadian) and Provincial (Alberta) Perspective; *Appl. Energy* **1988**, *61*, 209-227.
307. Nye, B.; Reid, D.; Childers, R.D.; Miller, G.C.; Sanchez, E. Cost-Effective Re-completions of Fruitland Formation Coalbed Methane Gas Wells Are Achieved with PDC Technology-Based One-Trip Sidetracking and Lateral-Drilling Technique. Presented at the Rocky Mountain Petroleum Technology Conference, Keystone, CO, May 21-23, 2001; SPE paper 71052.
308. ICF Resources, Inc. The United States Coalbed Methane Resource; *Quarterly Review of Methane from Coal Seams Technology* **1990**, *7* (March), 10-28.
309. Jungten, H.; Karweil, J. Gasbildung Und Gasspeicherung in Steinkohleflözen; *Erdöl und Erdgas Petrochemie* **1966**, *19* (5), 339-344.
310. Yee, D.; Seidle, J.P.; Hanson, W.P. Gas Sorption on Coal and Measurement of Gas Content. In *Hydrocarbons from Coal*; Law, B.E., Rice, D.D., Eds.; AAPG Studies in Geology 38; American Association of Petroleum Geologists: Tulsa, OK, 1993; pp 203-218.

311. Moffat, D.H.; Weale, K.E. Sorption by Coal of Methane at High Pressures; *Fuel* **1955**, *54*, 449-462.
312. Levine, J.R. Coalification: The Evolution of Coal as Source Rock and Reservoir Rock for Oil and Gas. In *Hydrocarbons from Coal*; Law, B.E., Rice, D.D., Eds.; AAPG Studies in Geology 38; American Association of Petroleum Geologists: Tulsa, OK, 1993; pp 39-77.
313. Bustin, R.M.; Clarkson, C.R. Geological Controls on Coalbed Methane Reservoir Capacity and Gas Content; *Int. J. Coal Geol.* **1998**, *38* (1-2), 3-26.
314. Meissner, F.F. Cretaceous and Lower Tertiary Coals as Sources for Gas Accumulations in the Rocky Mountain Area. In *Hydrocarbon Source Rocks of the Greater Rocky Mountain Region*; Woodward, J., Meissner, F.F., Clayton, J.L., Eds.; Rocky Mountain Association of Geologists: Denver, CO, 1984; pp 401[hyphen]431.
315. Wyman, R.E. Gas Resources in Elmworth Coal Seams; *AAPG Memoir* **1984**, *38*, 173-187.
316. Joubert, J.I.; Grein, C.T.; Bienstock, D. Effect of Moisture on the Methane Capacity of American Coals; *Fuel* **1974**, *53* (July), 186-190.
317. Clarkson, C.R.; Bustin, R.M. Binary Gas Adsorption/Desorption Isotherms: Effect of Moisture and Coal Composition upon Component Selectivity. In *Proceedings of the International Coalbed Methane Symposium*, Tuscaloosa, AL, 1999; pp 91-115.
318. Levine, J.R. The Impact of Oil Formed during Coalification on Generation and Storage of Natural Gas. In *Proceedings of the Coalbed Methane Symposium*, 1991; pp 307-315.
319. White, C.M. An Initial Set of Working Hypotheses Concerning Some Chemical and Physical Events When CO₂ Is Injected into a Coalbed; *Fuel Chem. Division Preprints* **2003**, *48* (1), 114-116.
320. Larsen, J.W. Polymeric Nature of Coals: Some Consequences and Some Unknowns. In *Proceedings: International Conference on Coal Science*, San Francisco, CA, 2001; pp 1-18.
321. Larsen, J.W. Sorption of Carbon Dioxide by Coals; *Fuel Chem. Division Preprints* **2003**, *48* (1), 112-113.
322. Wissinger, R.G.; Paulaitis, M.E. Swelling and Sorption in Polymer-CO₂ Mixtures at Elevated Pressures; *J. Polymer Science: Part B: Polymer Phys.* **1987**, *25*, 2497-2510.
323. Lee, D.; Hutchison, J.C.; Leone, A.M.; DeSimone, J.M.; Murray, R.W. Electron and Mass Transport in Hybrid Redox Polyether Melts Contacted with Carbon Dioxide; *J. Am. Chem. Soc.* **2002**, *124*, 9310-9317.
324. Khan, M.R.; Jenkins, R.G. Thermoplastic Properties of Coal at Elevated Pressures: Effects of Gas Atmospheres. In *Proceedings of Conference on Coal Science*, Sydney, Australia, October 28, 1985; p 5.
325. Hsieh, S.T.; Duda, J.L. Probing Coal Structure with Organic Vapour Sorption; *Fuel* **1987**, *66* (2), 170-178.
326. Reucroft, P.J.; Sethuraman, A.R. Effect of Pressure on Carbon Dioxide Induced Coal Swelling; *Energy Fuels* **1987**, *1* (1), 72-75.
327. Giddings, J.C.; Myers, M.N.; King, J.W. Dense Gas Chromatography at Pressures to 2000 Atmospheres; *J. Chromatogr. Sci.* **1969**, *7* (5), 276-283.
328. Dooley, K.M.; Launey, D.; Becnel, J.M.; Caines, T.L. Measurement and Modeling of Supercritical Fluid Extraction from Polymeric Matrices. In *ACS Symp. Series 608*, American Chemical Society: Washington, DC, 1995; Chapter 18, pp 269-281.
329. Gash, B.W. Measurement of "Rock Properties" in Coal for Coalbed Methane Production. Presented at the 66th Annual Technical Conference and Exhibition of the Society of Petroleum Engineers, Dallas, TX, October 6-9, 1991; SPE paper 22909, pp 221-230.
330. Gash, B.W.; et al. The Effects of Cleat Orientation and Confining Pressure and Cleat Porosity, Permeability, and Relative Permeability in Coal. In *Proceedings of the SPWLA/SCA Symposium*, Oklahoma City, OK, June 15-16, 1992.
331. Harpalani, S.; Chen, G. Influence of Gas Production Induced Volumetric Strain on Permeability of Coal; *Geotech. Geolog. Eng.* **1997**, *15*, 303-325.
332. Rice, D.D.; Young, G.B.C.; Paul, G.W. Methodology for Assessment of Technically Recoverable Resources of Coalbed Gas. In *1995 National Assessment of United States Oil and Gas Resources—Results, Methodology, and Supporting Data*; Gautier, D.L., Dolton, G.L., Takahashi, K.I., Varnes, K.L., Eds.; U.S. Geological Survey: Denver, CO, 1995.
333. Somerton, W.H.; Soylemezoglu, I.M.; Dudley, R.C. *Effect of Stress on Permeability of Coal*. Final Report; Aug 24, 1971–June 30, 1974.
334. Parkhurst, D.L.; Appelo, C.A.J. *User's Guide to PHREEQC (Version 2)—A Computer Program for Speciation, Batch-Reaction, One Dimensional Transport, and Inverse Geochemical Modeling*; 99–4259; U.S. Geological Survey: Reston, VA, 1999.
335. Hayashi, J.; Hayashi, K.; Takeuchi, K.; Kusakabe, L. Removal of Calcium from Low Rank Coals by CO₂/Water Treatment; *Fuel* **1991**, *70*, 1181.
336. Iwai, Y.; Murozono, T.; Koujina, Y.; Arai, Y.; Sakaniahi, K. Physical Properties of Low Rank Coal Dried with Supercritical Carbon Dioxide; *J. Supercritical Fluids* **2000**, *18*, 73-79.
337. Gentzis, T. Subsurface Sequestration of Carbon Dioxide: An Overview from an Alberta (Canada) Perspective. *Int. J. Coal Geol.* **2000**, *43* (1-4), 287-305.
338. Levine, J.R. Influences of Coal Composition on Coal Seam Reservoir Quality: A Review. In *Symposium on Coalbed Methane Research and Development in Australia*; Beamish, B.B., Gamson, P.D., Eds.; James Cook University: Townsville, Australia, Nov 1992; pp 1-17.
339. Stansfield, E.; Gilbert, K.C. *Moisture Determination for Coal Classification*; 1932; pp 125-143.
340. Rees, O.W.; Reed, F.H.; Land, G.W. *A Study of the Equilibration Method of Determining Moisture in Coal for Classification by Rank*; Report of Investigation #58; Illinois State Geological Survey: Champaign, IL, 1939.
341. Bachu, S. Sequestration of CO₂ in Geological Media: Criteria and Approach for Site Selection in Response to Climate Change; *Energy Convers. Mgmt.* **2000**, *41* (9), 953-970.
342. Gunter, W.D.; Chalaturnyk, R.J.; Scott, J.D.; Eliasson, B.; Riemer, P.; Wokaun, A. Monitoring of Aquifer Disposal of CO₂: Experience from Underground Gas Storage and Enhanced Oil Recovery; *Greenhouse Gas Control Technol.* **1999**, 151-156.
343. Bruant, R.G.; Guswa, A.J.; Celia, M.A.; Peters, C.A. Safe Storage of CO₂ in Deep Saline Aquifers; *Environ. Sci. Technol.* **2002**, *36* (11), 240A-245A.
344. Holloway, S. An Overview of the Underground Disposal of Carbon Dioxide; *Energy Convers. Mgmt.* **1997**, *38* (18), S193-S198.
345. Hitchon, B.; Gunter, W.D.; Gentzis, T.; Bailey, R.T. Sedimentary Basins and Greenhouse Gases: A Serendipitous Association; *Energy Convers. Mgmt.* **1999**, *40*, 825-843.
346. Bergman, P.D.; Winter, E.M. Disposal of Carbon Dioxide in Aquifers in the U.S.; *Energy Convers. Mgmt.* **1995**, *36* (6-9), S23-S26.
347. Gupta, N.; Sass, B.; Sminchak, J.; Naymik, T.; Bergman, P. *Hydrodynamics of CO₂ Disposal in a Deep Saline Formation in the Midwestern United States*; Eliasson, B., Riemer, P., Wokaun, A., Eds.; Greenhouse Gas Control Technologies; Elsevier Science: New York, 1999; pp 157-162.
348. Hovorka, S.D.; Doughty, C.; Knox, P.R.; Green, C.T.; Pruess, K.; Benson, S.M. *Evaluation of Brine-Bearing Sands of the Frio Formation, Upper Texas Gulf Coast for Geological Sequestration of CO₂*; National Energy Technology Laboratory: Pittsburgh, PA, 2001; pp 1-13. Available at: http://www.netl.doe.gov/publications/proceedings/01/carbon_seq/4a2%20.pdf.
349. Ondrey, G. Carbon Dioxide Gets Grounded; *Chem. Eng. (N.Y.)* **2000**, *107* (3), 41-45.
350. Kongsjorden, H.; Karstad, O.; Torp, T.A. Saline Aquifer Storage of Carbon Dioxide in the Sleipner Project; *Waste Management* **1997**, *17* (5/6), 303-308.
351. Doughty, C.; Pruess, K.; Benson, S.M.; Hovorka, S.D.; Knox, P.R.; Green, C.T. *Capacity Investigation of Brine-Bearing Sands of the Frio Formation for Geologic Sequestration of CO₂*; National Energy Technology Laboratory: Pittsburgh, PA, 2001; pp 1-16. Available at: http://www.netl.doe.gov/publications/proceedings/01/carbon_seq/p32.pdf.
352. Hovorka, S.D.; Knox, P.R.; Holtz, M.H.; Fouad, K.; Sakurai, S.; Yeh, J.S. *Field Experiment for CO₂ Sequestration*; Texas Bureau of Economic Geology: Austin, TX, 2002. Available at: <http://www.beg.utexas.edu/environmental/co2seq/fieldexperiment.htm>.
353. Battelle Memorial Institute. *AEP's Mountaineer Plant to Be Site for Research Project on Climate Change Technology*; Battelle News Release: Columbus, OH, 2002. Available at: <http://www.battelle.org/news/02/11-21-02AEP.stm>.
354. U.S. Department of Energy. *A Climate Change Solution beneath Our Feet?*; National Energy Technology Laboratory: Pittsburgh, PA, 2002. Available at: http://www.netl.doe.gov/publications/press/2002/tl_sequestration_aep.html.
355. Sass, B.; Gupta, N.; Sminchak, J.; Bergman, P. *Geochemical Modeling to Assess the Capacity of a Midwestern United States Geologic Formation for CO₂ Sequestration*; Eliasson, B., Riemer, P., Wokaun, A., Eds.; Greenhouse Gas Control Technologies; Elsevier Science: New York, 1999; pp 1079-1085.
356. Gunter, W.D.; Bachu, S.; Law, D.H.; Marwaha, V.; Drysdale, D.L.; Macdonald, D.E.; Mccann, T.J. Technical and Economic Feasibility of CO₂ Disposal in Aquifers within the Alberta Sedimentary Basin, Canada; *Energy Convers. Mgmt.* **1996**, *37* (6-8), 1135-1142.
357. Frimpong, S.; Hachiya, A. Quantitative Risk Simulation of Aquifer CO₂ Disposal Economics for Alberta; *Int. J. Soc. Mater. Eng. Resour.* **1999**, *7* (1), 55-72.
358. Gunter, W.D.; Perkins, E.H.; Hutcheon, I. Aquifer Disposal of Acid Gases: Modelling of Water-Rock Reactions for Trapping of Acid Wastes; *Appl. Geochem.* **2000**, *15* (8), 1085-1095.
359. Gunter, W.D.; Wiwchar, B.; Perkins, E.H. Aquifer Disposal of CO₂-Rich Greenhouse Gases. Extension of the Time Scale of Experiment for CO₂-Sequestering Reactions by Geochemical Modeling; *Mineral. Petrol.* **1997**, *59* (1-2), 121-140.
360. Ross, G.D.; Todd, A.C.; Tweedie, J.A. The Effect of Simulated CO₂ Flooding on the Permeability of Reservoir Rocks. In *Enhanced Oil Recovery*; Fayers, F.J., Ed.; Elsevier: Amsterdam, 2003; pp 351-366.
361. Shiraki, R.; Dunn, T.L. Experimental Study on Water-Rock Interactions during CO₂ Flooding in the Tensleep Formation, Wyoming, USA; *Applied Geochem.* **2000**, *15*, 265-279.

362. Sayegh, S.G.; Krause, F.F.; Girard, M.; DeBree, C. Rock/Fluid Interactions of Carbonated Brines in a Sandstone Reservoir: Pembina Cardium, Alberta, Canada. *SPE Formation Eval.* **1990**, December, 399-405.
363. Bowker, K.A.; Shuler, P.J. Carbon Dioxide Injection and Resultant Alteration of the Weber Sandstone, Rangely Field, Colorado; *AAPG Bull.* **1991**, 75 (9), 1489-1499.
364. Hendriks, C.A.; Blok, K. Underground Storage of Carbon Dioxide. *Energy Convers. Mgmt.* **1993**, 34 (9-11), 949-957.
365. Law, D.H.; Bachu, S. Hydrogeological and Numerical Analysis of CO₂ Disposal in Deep Aquifers in the Alberta Sedimentary Basin; *Energy Convers. Mgmt.* **1996**, 37 (6-8), 1167-1174.
366. van der Meer, L.G.H. The Conditions Limiting CO₂ Storage in Aquifers; *Energy Convers. Mgmt.* **1993**, 34 (9-11), 959-966.
367. Saripalli, P.; McGrail, P. Semi-Analytical Approaches to Modeling Deep Well Injection of CO₂ for Geological Sequestration; *Energy Convers. Mgmt.* **2002**, 43, 185-198.
368. Palandri, J.L.; Kharaka, Y.K. Adding Kinetics to Equilibrium-Based Geochemical Modeling of CO₂ Sequestration. Presented at the Annual Meeting of the Geological Society of America, 2002.
369. Stevens, S.H.; Fox, C.E.; Melzer, L.S. McElmo Dome and St. Johns Natural CO₂ Deposits: Analogs for Geologic Sequestration. Presented at the 5th International Conference on Greenhouse Gas Control Technologies, Cairns, Australia, 2000.
370. Stevens, S.H.; Pearce, J.M.; Rigg, A.A.J. *Natural Analogs for Geologic Storage of CO₂: An Integrated Global Research Program*; National Energy Technology Laboratory: Pittsburgh, PA, 2001; pp 1-12. Available at: http://www.netl.doe.gov/publications/proceedings/01/carbon_seq/6a1.pdf.
371. Stevens, S.H.; White, T.; Melzer, S.; Byrer, C. Production Operations at Natural CO₂ Fields: Technologies for Geologic Sequestration. In *Proceedings of GHGT-6*, Kyoto, 2002; pp E1-4.
372. Broadhead, R.F. Carbon Dioxide in Northeast New Mexico; *West Texas Geological Soc. Bull.* **1993**, 32 (7), 5-8.
373. Broadhead, R.F. Carbon Dioxide in Union and Harding Counties; *New Mexico Geological Soc. Guidebook* **1987**, 38, 339-349.
374. Pearce, J.M.; Holloway, S.; Wacker, H.; Nelis, M.K.; Rochelle, C.; Bateman, K. Natural Occurrences as Analogues for the Geological Disposal of Carbon Dioxide; *Energy Convers. Mgmt.* **1996**, 37 (6-8), 1123-1128.
375. Rochelle, C.A.; Bateman, K.; Pearce, J.M. Fluid-Rock Interactions Resulting from the Underground Disposal of Carbon Dioxide. In *Proceedings of the International Symposium on the Geochemistry of the Earth's Surface*, 1996; pp 448-452.
376. Baines, S.J.; Worden, R.H. Geological CO₂ Disposal: Understanding the Long-Term Fate of CO₂ in Naturally Occurring Accumulations. Presented at the 5th International Conference on Greenhouse Gas Control Technologies, Cairns, Australia, 2000.
377. White, S.P.; Allis, R.G.; Moore, J.; Chidsey, T.; Morgan, C.; Gwynn, W.; Adams, M. Natural CO₂ Reservoirs on the Colorado Plateau and Southern Rocky Mountains, USA: A Numerical Model. In *Proceedings of GHGT-6*, Kyoto, 2002; pp E1-3.
378. Pearce, J.M.; Baker, J.; Beaubien, S.; Brune, S.; Czernichowski-Lauriol, I.; Faber, E.; Hatzilyannis, G.; Hildenbrand, A.; Kroos, B.M.; Lombardi, S.; et al. Natural CO₂ Accumulations in Europe: Understanding Long-Term Geological Processes in CO₂ Sequestration. In *Proceedings of GHGT-6*, Kyoto, 2002; pp E1-1.
379. Pearce, J.M.; Nador, A.; Toth, E. Living with CO₂: Experiences from Hungary; *Greenhouse Issues* **2002**, Issue 58. Available at: <http://www.ieagreen.org.uk/jan58.htm>.
380. Czernichowski-Lauriol, I.; Pauwels, H.; Vigouroux, P.; Le Nindre, Y.-M. The French Carbogaseous Province: An Illustration of Natural Processes of CO₂ Generation, Migration, Accumulation and Leakage. In *Proceedings of GHGT-6*, Kyoto, 2002; pp E1-2.
381. McDonald, A.J. Seismicity of the Witwatersrand Basin; M.Sc. Thesis, University of Witwatersrand, Johannesburg, South Africa, 1982.
382. McGarr, A.; Simpson, D.; Seeber, L. Case Histories of Induced and Triggered Seismicity. In *International Handbook of Earthquake and Engineering Seismology*; Lee, W.H.K., Kanamori, H., Jennings, P.C., Kisslinger, C., Eds.; Academic Press: San Diego, CA, 2002.
383. Cypser, D.A. Induced Earthquake Bibliography. Available at: <http://www.nyx.net/~dcypser/induceq/iis.html>.
384. Evans, D.M. Man-Made Earthquakes in Denver; *Geotimes* **1966**, 10 (9), 11-17.
385. Healy, J.H.; Rubey, W.W.; Griggs, D.T.; Raleigh, C.B. The Denver Earthquakes; *Science* **1968**, 161, 1301-1310.
386. Major, M.; Simon, R. *Colorado School of Mines Quarterly* **1968**, 63 (9).
387. Hsieh, P.A.; Bredehoeft, J.D.A. Reservoir Analysis of the Denver Earthquakes: A Case of Induced Seismicity; *J. Geophys. Res.* **1981**, 86, 903-920.
388. Ake, J.; Maher, K.; Block, L. *Status Report—Paradox Valley Project, Southwestern Colorado*; Technical Memo D8330-2000-012; 1999.
389. Raleigh, C.B.; Healy, J.H.; Bredehoeft, J.D. An Experiment in Earthquake Control at Rangely, Colorado; *Science* **1976**, 191, 1230-1237.
390. Sminchak, J.; Gupta, N.; Byrer, C.; Bergman, P. *Issues Related to Seismic Activity Induced by the Injection of CO₂ in Deep Saline Aquifers*; National Energy Technology Laboratory: Pittsburgh, PA, 2001; pp 1-15. Available at: http://www.netl.doe.gov/publications/proceedings/01/carbon_seq/p37.pdf.
391. Cypser, D.A.; Davis, S.D. Liability for Induced Earthquakes; *J. Environ. Law Litigation* **1994**, 9, 551-589.
392. Harlow, I.F. Waste Problems of a Chemical Company; *Indust. Eng. Chem.* **1939**, 31 (11), 1346-1349.
393. Tsang, C.-F.; Benson, S.M.; Kobelski, B.; Smith, R.E. Scientific Considerations Related to Regulation Development for CO₂ Sequestration in Brine Formations; *Environmental Geology* **2002**, 42, 275-281.
394. Czernichowski-Lauriol, B.S.; Rochelle, C.; Bateman, K.; Pearce, P.; Blackwell, P. Area 5—Inorganic Chemistry. In *The Underground Disposal of Carbon Dioxide*; Holloway, S., Ed.; British Geological Survey: Keyworth, UK, 1996.
395. Davis, S.D.; Pennington, W.D. Induced Seismic Deformation in the Cogdell Oil Field of West Texas; *Bull. Seismological Society America* **1989**, 79, 1477-1494.
396. Melcer, A.; Gerrish, H.W. Effects of Formation Damage on Injection Operations and on Pressure Transient Tests. In *Deep Injection Disposal of Hazardous and Industrial Waste*; Apps, J.A., Tsang, C., Eds.; Academic Press: San Diego, CA, 2000; pp 277-286.
397. *Geology News: Geoscience at the BA: Putting Something Back*; Geological Society of London: London, UK, Sept 11, 2002. Available at: <http://www.geolsoc.org.uk/template.cfm?name=BA2002H>.
398. Key, M. *Occupational Diseases, A Guide to Their Recognition*; U.S. Department of Health, Education, and Welfare: Washington, DC, 1977.
399. Jaffe, P.R.; Wang, S. Potential Effect of CO₂ Releases from Deep Reservoirs on the Quality of Fresh-Water Aquifers. Presented at GHGT-6, Kyoto, 2002. Available at: <http://www.ieagreen.org.uk/ghgt6.htm>.
400. Wang, S.; Jaffe, P. Dissolution of Trace Metals in Potable Aquifers Due to CO₂ Releases from Deep Formations; *Groundwater* **2003**, in press.
401. Clayton, J.L.; Leventhal, J.S.; Rice, D.D.; Pashin, J.C.; Mosher, B.; Czepl, P. Atmospheric Methane Reflux from Coals—Preliminary Investigation of Coal Mines and Geologic Structures in the Black Warrior Basin, Alabama. In *The Future of Energy Gases*; Howell, D.G., Ed.; U.S. Geological Survey Professional Paper 1570; U.S. Geological Survey: Denver, CO, 1993; pp 471-492.
402. Clayton, J.L.; Leventhal, J.S.; Rice, D.D.; Kotarba, M.; Korus, A. Atmospheric Methane Flux from U.S. and Polish Coals. In *Organic Geochemistry: Developments and Applications to Energy, Climate, Environmental and Human History*; Grimalt, J.O., Dorron, C., Eds.; AIGOA: San Sebastian, Spain, 1995.
403. Sloss, L.L.; Davidson, R.M.; Clarke, L.B. *Coalbed Methane Extraction*; IEA: London, 1995.
404. Kuuskraa, V.; Brandenburg, C.F. Coalbed Methane Sparks a New Energy Industry; *Oil Gas Journal* **1989**, 87 (41), 49-56.
405. Rice, D.D.; Law, B.E.; Clayton, J.L. Coalbed Gas—An Undeveloped Resource. In *The Future of Energy Gases*; Howell, D.G., Ed.; U.S. Geological Survey Professional Paper 1570; U.S. Geological Survey: Denver, CO, 1993; pp 389-404.
406. Kaiser, W.R.; et al. *Hydrology of the Fruitland Formation*; Topical Report No. GRI-91/0072; Gas Research Institute: 1991.
407. Hawkins, D.G. Passing Gas: Policy Implications of Leakage from Geologic Carbon Storage Sites. In *Proceedings of GHGT-6*, Kyoto, 2002; pp B2-1.
408. Pacala, S.W. Global Constraints on Reservoir Leakage. In *Proceedings of GHGT-6*, Kyoto, 2002; pp B2-4.
409. Hepple, R.P.; Benson, S.M. Implications of Surface Seepage on the Effectiveness of Geologic Storage of Carbon Dioxide as a Climate Change Mitigation Strategy. In *Proceedings of GHGT-6*, Kyoto, 2002; pp A2-3.
410. Celia, M.A.; Bachu, S. Geological Sequestration of CO₂: Is Leakage Unavoidable and Acceptable? In *Proceedings of GHGT-6*, Kyoto, 2002; pp G1-2.
411. Dooley, J.J.; Wise, M.A. Why Injecting CO₂ into Various Geologic Formations Is Not the Same as Climate Change Mitigation: The Issue of Leakage. In *Proceedings of GHGT-6*, Kyoto, 2002; pp B2-5.
412. Lindeberg, E. The Quality of a CO₂ Repository: What Is the Sufficient Retention Time of CO₂ Stored Underground? In *Proceedings of GHGT-6*, Kyoto, 2002; pp B2-2.
413. Wigley, T.M.L.; Richels, R.; Edmonds, J. Economic and Environmental Choices in Stabilization of Atmospheric CO₂ Concentrations; *Nature* **1996**, 379, 240-243.
414. Nakicenovic, N.; et al. *Special Report on Emissions Scenarios (SRES)*; Cambridge University Press: New York, 2000.
415. Edmonds, J.; Clarke, J.; Dooley, J.; Kim, S.H.; Smith, S.J. *Stabilization of CO₂ in a B2 World: Insights on the Roles of Carbon Capture and Disposal, Hydrogen, and Transportation Technologies*; Joint Global Change Research Institute: College Park, MD, 2000.
416. Herzog, H.; Caldeira, K.; Reilly, J. An Issue of Permanence: Assessing the Effectiveness of Temporary Carbon Storage; *Climatic Change* **2003**, in press. Available at: http://sequestration.mit.edu/pdf/climate_change.pdf.

417. Ha-Duong, M. CO₂ Sequestration: Normative Economics of Leakage; *Clean Technology and Environmental Policy* 2002, in press. Available at: <http://www.andrew.cmu.edu/user/nduong/HaDuong-2002-CO2-SequestrationNormativeEconomicsLeakage.pdf>.
418. Anderson, R.P.; Vogh, J.W. Identification of Injected Storage Gas; *Oper Sect. Proc. -Am. Gas Assoc* **1988**, 526-535.
419. Anderson, R.P.; Vogh, J.W. Various Tracers Identify Injected Storage Gas; *Oil & Gas Journal* **1989**, 87, 52-56.
420. Anderson, R.P.; Vogh, J.W. Gas Identification—Major Tracer Gas Migration and Stability; *Oil Gas J.* **1989**, 87 (15), 44-51.
421. Klusman, R.W. A Protocol for Detection of Surface Leakage from a CO₂ Injection Project; *Fuel Chem. Division Preprints* **2002**, 47 (1), 3-4.
422. Thimons, E.D.; Bielicki, R.J.; Kissel, F.N. *Using Sulfur Hexafluoride as a Gaseous Tracer to Study Ventilation Systems in Mines*; 7916; U.S. Dept of Int. Library: Washington, DC, 1974.
423. Thimons, E.D.; Kissel, F.N. *Tracer Gas as an Aid in Mine Ventilation Analysis*; 7917; U.S. Dept. of the Int. Library: Washington, DC, 1974.
424. Matta, J.E.; Maksimovic, S.D.; Kissell, F.N. *Tracer Gas Method for Measuring Leakage through Mine Stoppings*; 8324; U.S. Dept. of the Int. Library: Washington, DC, 1978.
425. Vinson, R.P.; Kissell, F.N. *Three Coal Mine Ventilation Studies Using Sulfur Hexafluoride Tracer Gas*; 8142; U.S. Dept of the Int. Library: Washington, DC, 1976.
426. Araktingi, R.E.; Benefield, M.E.; Bessenyei, Z.; Coats, K.H.; Tek, M.R. Leroy Storage Facility, Uinta County, Wyoming: A Case History of Attempted Gas-Migration Control; *J. Petroleum Technology* **1984**, January, 132-140.
427. Craig, F.F., III. *Field Use of Halogen Compounds to Trace Injected CO₂*; Presented at the 60th Annual Technical Conference and Exhibition of the Society of Petroleum Engineers, Las Vegas, NV September 22-25, 1985; SPE paper 14309.
428. Carr, L.; Wong, F.; Nagel, R.; McIntyre, F.; Rosenegger, A. Application of Chemical Tracers in Monitoring Injection in Vertical Hydrocarbon Miscible Floods; *J. Canadian Petroleum Technol.* **1997**, 36 (8), 43-55.
429. Blencoe, J.G.; Cole, D.R.; Horita, J.; Moline, G.R. *Experimental Geochemical Studies Relevant to Carbon Sequestration*; National Energy Technology Laboratory: Pittsburgh, PA, 2001; pp 1-14. Available at: http://www.netl.doe.gov/publications/proceedings/01/carbon_seq/p31.pdf.
430. Wang, Z.; Nur, A.M. Effects of CO₂ Flooding on Wave Velocities in Rocks with Hydrocarbons; *SPE Reservoir Eng.* **1989**, November, 429-436.
431. Shuck, E.L.; Davis, T.L.; Benson, R.D. Multicomponent 3-D Characterization of a Coalbed Methane Reservoir; *Geophysics* **1996**, 61 (2), 315-330.
432. Ramos, A.C.B.; Davis, T.L. 3-D AVO Analysis and Modeling Applied to Fracture Detection in Coalbed Methane Reservoirs. In *Fractured Reservoirs: Characterization and Modeling Guidebook*; Hoak, T.E., Klawitter, A.L., Blomquist, P.K., Eds.; The Rocky Mountain Association of Geologists: Denver, CO, 1997; pp 165-176.
433. Eiken, O.; Brevik, I.; Arts, R.; Lindeberg, E. Seismic Monitoring of CO₂ Injected into a Marine Aquifer. Presented at the 5th International Conference on Greenhouse Gas Control Technologies, Cairns, Australia, 2000.
434. Arts, R.; Eiken, O.; Chadwick, A.; Zweigel, P.M.L.; Zinsner, B. Monitoring of CO₂ Injected at Sleipner Using Time Lapsed Seismic Data. In *Proceedings of GHGT-6*, Kyoto, 2002. Available at: <http://www.ieagreen.org.uk/ghgt6.htm>.
435. Arts, R.; Brevik, I.; Eiken, O.; Solle, R.; Causse, E.; van der Meer, B. Geophysical Methods for Monitoring Marine Aquifer CO₂ Storage—Sleipner Experiences. Presented at the 5th International Conference on Greenhouse Gas Control Technologies, Cairns, Australia, 2000.
436. Durnford, L. *Seismic Hubble Bubble*; Radio Nederland Wereldomroep: Hilversum, The Netherlands, 2002. Available at: <http://www.rnw.nl/science/html/bubble021119.html>.
437. Burrowes, G.; Gilboy, C. *Investigating Sequestration Potential of Carbonate Rocks during Tertiary Recovery from a Billion Barrel Oil Field, Weyburn, Saskatchewan: the Geoscience Framework (IEA Weyburn CO₂ Monitoring and Storage Project)*; National Energy Technology Laboratory: Pittsburgh, PA, 2001; pp 1-20. Available at: http://www.netl.doe.gov/publications/proceedings/01/carbon_seq/p20.pdf.
438. Newmark, R.L.; Ramirez, A.L.; Daily, W.D. *Monitoring Carbon Dioxide Sequestration Using Electrical Resistance Tomography (ERT): Sensitivity Studies*; National Energy Technology Laboratory: Pittsburgh, PA, 2001; pp 1-18. Available at: http://www.netl.doe.gov/publications/proceedings/01/carbon_seq/7a1.pdf.
439. Westrich, H.; Lorenz, J.; Cooper, S.; Colon, C.J.; Warpinski, N.; Zhang, D.; Bradley, C.; Lichtner, P.; Pawar, R.; Stubbs, B.; et al. *Sequestration of CO₂ in a Depleted Oil Reservoir: An Overview*; National Energy Technology Laboratory: Pittsburgh, PA, 2001; pp 1-11. Available at: http://www.netl.doe.gov/publications/proceedings/01/carbon_seq/2a3.pdf.
440. Fanchi, J.R. Feasibility of Monitoring CO₂ Sequestration in a Mature Oil Field Using Time-Lapse Seismic Analysis. Presented at the SPE/EPA/DOE Exploration and Production Environmental Conference, San Antonio, TX, February 26-28, 2001.
441. Fanchi, J.R. Predicting 4D Seismic Performance Using an Integrated Flow Model. In *Proceedings of Annual Technical Conference and Exhibition*, Houston, TX, October 3-6, 1999; pp 335-345.
442. White, C.M.; Houck, R.K.; *J. High Resolution Chromatog. Chromatog. Comm.* **1986**, 9, 4-17.
443. Bachu, S. *Energy Convers. Mgmt.* **2000**, 41, 953-970.
444. Pidwirny, M. J. Fundamentals of Physical Geography 9(r): The Carbon Cycle; Department of Geography, Okanagan University College: Kelowna, British Columbia, Canada, 2000. Available at: <http://www.geog.ouc.bc.ca/physgeog/contents/9r.html>.
445. *Greenhouse Issues* **2000**, Issue 51; p 3.

About the Authors

Dr. Curt M. White is the Carbon Sequestration Science Focus Area Leader at DOE's National Energy Technology Laboratory (NETL) in Pittsburgh, PA. The focus area studies the capture and separation of CO₂ from large point sources, such as fossil-fuel-fired electric power generating stations and gasification facilities; oceanic sequestration of CO₂; geological sequestration of CO₂ in deep unmineable coal seams, deep saline aquifers, and depleted petroleum reservoirs; geological sequestration modeling; and the development of tools to monitor and verify the integrity of geologically sequestered CO₂. Dr. White received his B.A. in chemistry from California State College, his M.S. in chemistry from the University of North Dakota, and his Ph.D. in chemistry from Duquesne University. He has been at NETL for 29 years and has authored or coauthored more than 80 publications, addressing such diverse topics as the degradation of MEA used for CO₂ capture at coal-fired generating stations, the nature of organosulfur constituents in fossil fuels, the chemistry of carcinogens, monitoring the air for hazardous substances, sampling and examination of combustion products, analysis of fuels, coal science, and coal technology. He is currently on the editorial board of *Energy & Fuels* and has served on other editorial boards and edited several books.

Dr. White prepared this review in collaboration with his NETL focus area group. Dr. Brian R. Strazisar investigates solvent degradation at CO₂ capture facilities, models geochemical processes resulting from CO₂ sequestration in deep saline aquifers, determines the effects of contaminants on oceanic sequestration, and develops methods to monitor leakage from underground CO₂ sequestration. Dr. Evan J. Granite developed a pilot plant design for an integrated gasification process. The design included CO₂ recovery by calcium sorbents as well as by hot carbonate and MEA scrubber systems. Dr. James S. Hoffman develops dry, regenerable sorbent processes for CO₂ capture from gaseous streams. Henry W. Pennline develops and tests economically and environmentally acceptable flue-gas control systems that remove pollutants such as sulfur dioxide, nitric oxide, fine particulate matter, mercury, and CO₂ on pilot-scale combustion devices. Address correspondence to: Dr. Curt M. White, National Energy Technology Laboratory, 626 Cochran Mill Road, P.O. Box 10940, Pittsburgh, PA 15236; fax: (412) 386-5920; e-mail: curt.white@netl.doe.gov.